

A New Soil Conservation Methodology and Application to Cropping Systems in Tropical Steeplands

A comparative synthesis of results obtained in ACIAR Project PN 9201

Editors: K.J. Coughlan and C.W. Rose

Australian Centre for International Agricultural Research
Canberra, 1997

The Australian Centre for International Agricultural Research (ACIAR) was established in June 1982 by an Act of the Australian Parliament. Its mandate is to help identify agricultural problems in developing countries and to commission collaborative research between Australian and developing country researchers in fields where Australia has special research competence.

Where trade names are used this does not constitute endorsement of nor discrimination against any product by the Centre.

ACIAR TECHNICAL REPORT SERIES

This series of publications contains technical information resulting from ACIAR-supported programs, projects and workshops (for which proceedings are not published), reports on Centre-supported fact-finding studies, or reports on other useful topics resulting from ACIAR activities. Publications in the series are distributed internationally to selected individuals and scientific institutions.

© Australian Centre for International Agricultural Research,
GPO Box 1571, Canberra, ACT 2601

Coughlan, K.J. and Rose, C.W. 1997. A new soil conservation methodology and application to cropping systems in tropical steplands. ACIAR Technical Reports No. 40, 147 p.

ISBN 1 86320 211 0

Editorial management: PK Editorial Services, Brisbane
Typesetting and layout: Sun Photoset Pty Ltd, Brisbane
Printed by: Watson Ferguson & Co., Brisbane

Contents

Chapter 1

A New Conservation Methodology and Application to Cropping Systems in Tropical Steeplands

K.J. Coughlan and C.W. Rose 1

Chapter 2

Description of Sites, Experimental Treatments and Methodology

K.J. Coughlan 3

Chapter 3

Field Experimental Results — Runoff, Soil Loss and Crop Yield

K.J. Coughlan and C.W. Rose 9

Chapter 4

Plot-scale Runoff Modelling for Soil Loss Predictions

B. Yu, C.W. Rose, K.J. Coughlan and B. Fentie 24

Chapter 5

Program GUEST (Griffith University Erosion System Template)

C.W. Rose, K.J. Coughlan, C.A.A. Ciesiolka and B. Fentie 34

Chapter 6

The Role of Cover in Soil Conservation

C.W. Rose, K.J. Coughlan, C.A.A. Ciesiolka and B. Fentie 59

Chapter 7

Loss of Chemical Nutrients by Soil Erosion

G.H. Hashim, C.A.A. Ciesiolka, C.W. Rose, K.J. Coughlan and B. Fentie 79

Chapter 8

Runoff and Soil Loss Prediction

B. Yu, C.W. Rose, K.J. Coughlan and B. Fentie 101

Chapter 9

Long-term Effects of Land Management on Soil Erosion, Crop Yield and On-farm Economics in The Philippines

R.A. Nelson, J.D. Dimes, D.M. Silburn, E.P. Paningbatan, Jr., R.A. Cramb and M.A. Mamicpic 111

Chapter 10

Conclusion

C.W. Rose and K.J. Coughlan 141

References 144

Contributors

Dr Chaiyasit Anecksamphant
Regional Director
Department of Land Development
Amphur Muang, Nan, 55000
THAILAND

Cyril A. Ciesiolka
QDPI
PO Box 102
TOOWOOMBA QLD 4350
AUSTRALIA

Dr Keppel J. Coughlan
ACIAR
GPO Box 1571
CANBERRA ACT 2601
AUSTRALIA

Dr Robert Cramb
Faculty of Agriculture
University of Queensland
ST LUCIA QLD 4072
AUSTRALIA

Dr John Dimes
Agricultural Production Systems
Research Unit
QDPI
PO Box 102
TOOWOOMBA QLD 4350
AUSTRALIA

Bantigegne Fentie
Faculty of Environmental Sciences
Griffith University
NATHAN QLD 4111
AUSTRALIA

Dr Ghulam Hashim
Soil Science Unit
Central Research Laboratories Division
MARDI
GPO Box 12301
KUALA LUMPUR
MALAYSIA

Dr May Mamicpic
Faculty of Agriculture
University of Queensland
ST LUCIA QLD 4072
AUSTRALIA

Rohan Nelson
Department of Agriculture
University of Queensland
ST LUCIA QLD 4072
AUSTRALIA

A. Presbitero
Department of Agricultural
Engineering and Applied
Mathematics
ViSCA
LEYTE 6521-A
PHILIPPINES

Dr E. Paningbatan Jr
Department of Soil Science
University of the Philippines
Los Baños, College, Laguna
PHILIPPINES

Emeritus Professor Calvin Rose
Faculty of Environmental Sciences
Griffith University
NATHAN QLD 4111
AUSTRALIA
— also Project Director

Dr Mark Silburn
Agricultural Production Systems
Research Unit
QDPI
PO Box 102
TOOWOOMBA QLD 4350
AUSTRALIA

Dr Bofu Yu
Faculty of Environmental Sciences
Griffith University
NATHAN QLD 4111
AUSTRALIA

PROJECT CO-ORDINATOR

Dr Ian Willett
ACIAR
GPO BOX 1571
CANBERRA ACT 2601
AUSTRALIA

Chapter 1

A New Conservation Methodology and Application to Cropping Systems in Tropical Steeplands

K.J. Coughlan and C.W. Rose

RECOGNISING the seriousness of on-site and off-site problems associated with water erosion in tropical steplands, the Australian Centre for International Agricultural Research (ACIAR) has funded two collaborative projects, PN 8551 and PN 9201, with institutions in Southeast Asia. The projects have three general aims:

- to test a range of locally-applicable technologies to reduce soil loss rates to some acceptable level, such as less than 10 t/ha/yr;
- to quantify hydrologic and sediment transport processes with a view to matching soil conservation technologies to dominant processes at different sites;
- to develop methodologies to predict runoff, soil and nutrient losses, and the consequences of these losses in terms of soil productivity.

The two projects had ambitious objectives, and aimed to integrate research in a number of topic areas relevant to soil conservation. Field experiments were carried out at sites in Malaysia, Thailand, the Philippines and Australia, using a diverse range of cropping systems but a common methodology that was developed during the projects (Ciesiolka et al. 1995a).

The research program brought together a number of research institutions including the Malaysian Agricultural Research and Development Institute (MARDI), the Department of Land Development (DLD) in Thailand, the University of the Philippines, Los Baños (UPLB) and Visayas State College of Agriculture (ViSCA) in the Philippines, and Griffith University (GU) and Department of Primary Industries, Queensland (DPI) in Australia. This collaboration has had a number of advantages, including:

- rigorous testing of research methodology and electronic and mechanical monitoring equipment

at a range of sites in difficult, sometimes remote, tropical environments. Methodology developed during these projects has been adopted by a number of other organisations including the International Board for Soil Research and Management (IBSRAM) in Southeast Asia and the Pacific;

- development of a strong training capability within the team in soil erosion processes and research methods;
- testing of soil erosion theory in a range of conditions with respect to slope, soil infiltration characteristics and soil erodibility. This testing has led to useful modification of the theory and understanding of processes during the life of the project.

The project has prepared a number of outputs including conference papers (for example Coughlan, 1995; Rose et al. 1997; Ciesiolka et al. 1997; Coughlan et al. 1997) and a range of journal publications describing preliminary results at the different sites. These papers have been combined in a special issue of *Soil Technology* on 'Soil Erosion and Conservation', Vol. 8(3) (1995). A handbook describing the research and interpretation methodology of the projects is also in preparation, as are user manuals for the computer programs developed to manipulate hydrology data and to calculate erodibility parameters.

Final review of the project was carried out in April 1995, and the reviewers considered that there was a need to present the more recent project results in a form which:

- compared and contrasted data across sites; and
- integrated results in different research areas to provide data for decision-making on the sustainability of cropping systems. This publication aims to achieve these objectives. The integration across research areas is reflected in Figure 1.

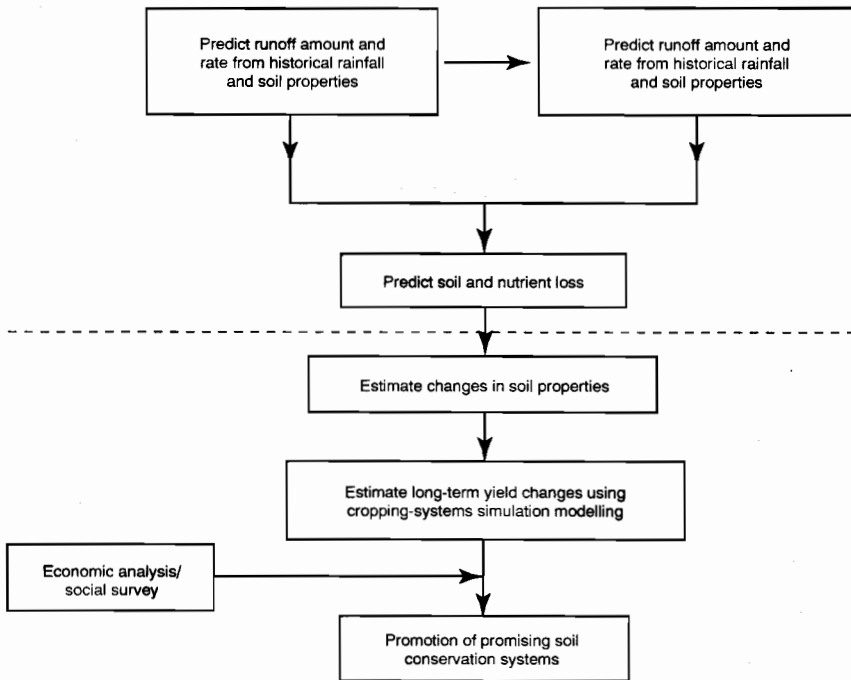

Figure 1. A flowchart showing data inputs required to make decisions on the sustainability of soil conservation systems.

This report will concentrate on the early steps in the flowchart, above the dotted line in Figure 1. However, data on yield and some simple economic analyses are given, along with preliminary data on application of a cropping system simulation model at the UPLB site.

This book is divided into two fairly distinct sections. The first describes climate, soils and treatments applied at the sites, along with information on runoff, soil loss and crop yields. This section also

provides data comparing and contrasting the importance of different hydrologic, sediment generation and sediment transport processes across the sites.

The second section follows the framework given in Figure 1, and uses theory to develop model parameters for prediction of runoff rate and amount and sediment concentration. It also reports methodology for assessing the effect of treatment, particularly vegetative cover, on soil and nutrient losses.

Chapter 2

Description of Sites, Experimental Treatments and Methodology

K.J. Coughlan

Location of Sites

ALL seven sites studied are in Southeast Asia and Australia. Table 1 provides general information on the location and geography of the sites which places the research in a general eco-regional context. Further information on location of some of the sites, and on other descriptive material given in this chapter, is contained in the consolidated set of papers in *Soil Technology*, Vol. 8(3) (1995). Figure 1 shows the six sites involved in ACIAR Project 9201.

All sites are in tropical or sub-tropical humid zones, with no frost occurrence at any of the sites except the Imbil, Gympie site in Australia, where average frost occurrence is two per year.

Rainfall

Monthly rainfalls for 1990 for the Khon Kaen site, and average monthly rainfalls over periods greater than 10 years for all other sites, are shown in Table 2.

A number of geographic features determine the nature of the distribution of monthly rainfall, including closeness to the ocean, the nature of rainfall influences and orographic effects.

The Khon Kaen and Nan sites are the most distant from the ocean, and have lower annual rainfall and fairly distinct wet and dry seasons. The wet season in central and northern Thailand is generally May–October associated with the

Table 1. Location and geography of soil erosion research sites.

Site	Latitude	Longitude	Elevation (m)	Position	Parent material
Kemaman, Malaysia	4°N	103°E	<100	Maritime environment in east coastal Peninsular Malaysia; less than 10 km from South China Sea; folded metamorphic sediments	Shale
Khon Kaen, Thailand	17°N	103°E	195	Broad, lowslope alluvial/colluvial plain; about 450 km inland from Gulf of Thailand	Sandstone
Nan, Thailand	19°N	101°E	700	Hilly terrain, consisting of folded shale and limestone; nearest ocean (Gulf of Tonkin) about 450 km	Shale
Los Baños, The Philippines	14°N	121°E	~30	Maritime climate, 10 km from Laguna de Bay in W. Luzon; situated in volcanic foothills	Volcanic Tuff
ViSCA, The Philippines	11°N	125°E	~50	Maritime, W. coastal Leyte, 1 km from Visayan sea in volcanic foothills	Basalt
Gympie, Australia (2 sites)	26°S	153°E	<200	Sites are 30–50 km from the Pacific Ocean in east Queensland with rolling (Goomboorian site) to hilly (Imbil site) local relief	Sandstone (Goomboorian) shale/rhyolite (Imbil)

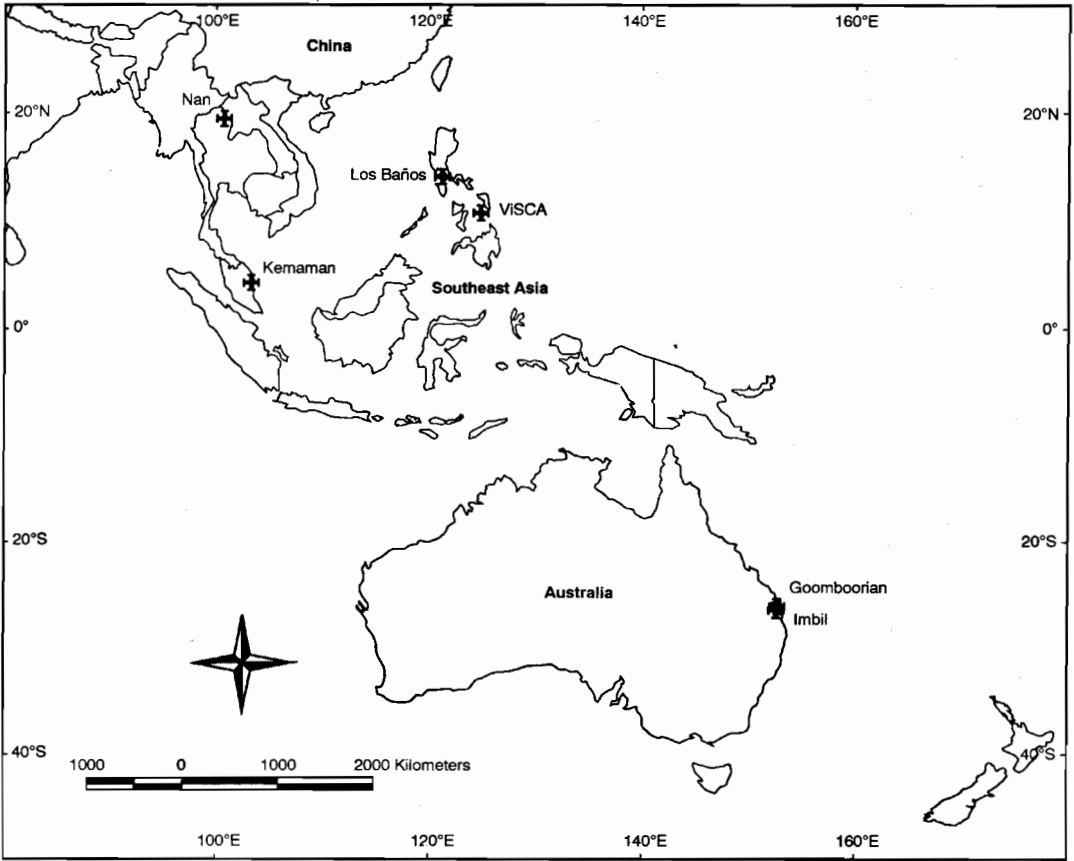

Figure 1. The six sites active in ACIAR Project 9201.

Table 2. Monthly rainfall data (mm) and annual rainfall for research sites.

Site	Month												Annual
	J	F	M	A	M	J	J	A	S	O	N	D	
Kemaman (1982–1995)	231	116	266	107	200	234	110	213	209	291	904	657	3538
Khon Kaen (1990)	0	97	103	33	280	106	202	158	206	146	8	0	1341
Nan Province (1973–1987)	11	12	27	96	165	148	211	237	218	87	18	6	1236
Los Baños (1949–1989)	49	18	30	37	164	237	261	238	243	280	237	152	1946
ViSCA (1976–1991)	222	207	209	81	83	177	280	273	206	224	99	177	2238
Gympie (average 2 sites) (1913–1992)	174	186	168	107	79	68	63	39	43	76	96	144	1246

southwest monsoon and the influence of decaying typhoons. Rainfall at Los Baños is also strongly influenced by the southwest monsoon, although the wet season is extended through to December. Active typhoons with high winds are a feature of this area.

ViSCA and Kemaman have the highest rainfall, and rainfall distribution is seasonably even. Orographic effects at ViSCA are very important since the college is situated on a western coastal plain with significant volcanic mountains immediately to the east. Typhoons are common, particularly in October and November. Kemaman is influenced by both the southwest and northeast monsoons, with heaviest rainfall being in November–December associated with the northeast monsoon. Typhoons are very rare in eastern peninsular Malaysia.

Rainfall at Gympie is greatest in December–March, during the hottest months in the southern hemisphere. Decaying tropical depressions generated in the monsoon trough to the north of Queensland make an important contribution to this rainfall. Since Gympie is in a sub-tropical environment, it is also influenced in the cooler months by cold fronts generated in higher latitudes.

During the experimental period, all sites except Khon Kaen experienced at least one extreme rainfall event or period; for example 250 mm in one day at Los Baños, 625 mm in two days at Gympie, and 1673 mm in the month of November, 1994 at Kemaman.

Electronic loggers installed at the sites measured rainfall rate at 1 minute intervals. Illustrative rate distributions for the different sites are shown in Table 3.

Concerning the data in Table 3, it should be realised that rainfall rates of less than

1 tip/measurement period, using a tipping bucket pluviometer, are only approximate, e.g., 1 tip in 3 minutes is counted as 1/3 tip in each of the minutes. Rainfall rates <5.5 mm/hr for Gympie and <12–15 mm/hr for other sites are subjected to this averaging.

Although there is considerable variation between site data sets (which may arise from the relatively short periods chosen for analyses), the surprising feature is that the average distribution for the sites reveals much lower rainfall rates than those reported by Hudson (1973) for semi-arid tropical regions in southern Africa. Hudson regards rainfall at >25 mm/hr as erosive, and points out that 95% of rates in temperate areas are less than this value compared with only 60% in the tropical area. The data for humid tropical areas shown in Table 3 are much more similar to temperate rainfall, with 90% of rates <25 mm/hr. Maximum 1 minute rainfall rates at these sites varied from 100 to 200 mm/hr.

Soils

The properties of soils at the seven sites are given in Table 4. Soil texture varies from loamy sand for the Goomboorian site to clay for Nan, Los Baños and ViSCA. The soil at Imbil is very stony, with 44% of particles being larger than 5 mm. Silt percentages in the three clay soils are high, particularly in the ViSCA soil which has 65% in the silt size range, but only 26% measured in the clay range by particle size analysis. These high measured percentages may reflect the strong aggregation of clay particles, and explain the high infiltration rate of these soils. The lower clay soils tend to have poorer infiltration characteristics, associated with higher bulk density and consequently lower total porosity.

Table 3. Frequency distributions of rainfall during wet seasons for a number of sites.

Site	Period	Rainfall (mm)	Percentage of 1 minute rainfall rates <X* (mm/hr)									
			0.4	2.0	3.5	5.0	10.0	20.0	30.0	40.0	50.0	75.4
Kemaman	25/8/92 to 31/12/92	2069	6	37	54	60	71	81	88	92	94	98
Nan	1/5/89 to 31/10/93	1332	7	53	62	71	86	92	95	97	98	99
Los Baños	1/7/90 to 31/10/90	1144	1	39	59	68	78	91	93	95	97	99
ViSCA	1/10/90 to 30/11/90	392	1	32	51	55	67	81	87	92	96	98
Gympie	1/1/95 to 30/4/95	321	10	38	50	57	76	95	98	99	99	99
Average distribution			5	40	55	62	76	88	92	95	97	99
Tropical rainfall**			—	—	13	18	31	56	69	84	91	98

*Only rainfall events >2 mm analysed.

**Hudson (1973) p.75; interpreted from interpolation of data in his Figure 4.7.

The effect of soil movement within the plot on bulk density is illustrated for the ViSCA site. Erosion from the top of the plot and deposition towards the bottom resulted in bulk density differences ($P < 0.01$). The transported and deposited aggregates are presumably less consolidated, resulting in the lower bulk density.

Variation in soil pH is relatively small from 4.9 to 6.2. In contrast, organic matter (OM) percentage varies from 0.5 to 5.1, with this variation being reflected in general soil fertility. The Khon Kaen site appears to be very degraded, while the low OM% at Goomboorian is typical of these under virgin conditions on these very sandy soils. The C:N ratio of OM in the surface of the Goomboorian soil is 78, compared with a more realistic value of 10 for Kemaman. This is due to accumulated charcoal in the surface of the Goomboorian soil.

Another feature of the Goomboorian soil is that OM% is higher in the 0.5–0.6 m layer (2.3%) than in the surface. This is due to leaching and deposition of OM in the profile of this sandy soil. C:N ratio at 0.5–0.6 m is 26.

Very low levels of extractable P and K are defined as <10 and <40 mg/kg respectively (Bruce and Rayment 1982). On this basis, five of the soils are limiting in P, while only Los Baños and Imbil have adequate levels of both P and K in the initial soil.

The low values of P, K and OM% are a serious limitation at Khon Kaen, where Rozelle is grown and fertiliser application is not economic due to low cash returns from this crop. They are not an issue for the pineapple soils at Goomboorian, where soil drainage is a major limitation to production and chemical nutrients are supplied by high applications of mineral fertiliser.

Description of Methodology and Treatments

As mentioned in Chapter 1, this research aimed to test soil conservation strategies under a wide range of locally important cropping systems, using a common methodology for both plot monitoring and interpretation of results.

Variations in crops, slope and plot sizes at the different sites are shown in Table 5, which is modified from a table given in Coughlan (1995).

Field experiments are carried out on hydrologically bounded plots with areas varying from 18 to 3500 m², the size depending on the size of the production system unit being studied. The sides of the runoff plots run up and down slope, and these, together with a division ditch at the the upper end of the plot, prevent surface flow entering or leaving the plot except through the collection and measuring device located at the lower end of plots.

Table 4. Soil properties at the research sites (0–0.1 m layer).

Site	Soil type	Percentages (%) in four particle size ranges (mm)				Bulk density Mg/m ³	pH	Organic matter %	Total nitrogen %	Extractable	
		>0.2	0.2–0.02	0.02–0.002	<0.002					P mg/kg	K mg/kg
Kemaman	Orthoxic Tropudult	22	43	16	19	1.55	4.9	1.7	0.1	6	27
Khon Kaen	Oxic* Paleustult	← 79 →		16	5	—	5.1	0.5	—	4	92
Nan	Oxic Paleustult	5	14	38	43	—	5.7	3.7	—	4	137
Los Baños	Typic Tropudalf	← 9 →		35	56	1.06	6.2	5.1	—	21	1170
ViSCA	Oxic Dystropept	← 9 →		65	26	1.17+ (plot top) 0.88 (bottom)	5.6	4.7	—	5	154
Gympie (Imbil)	Lithic Eutropept	72	7	13	8	1.60	5.5	1.7	0.2	23	78
Gympie (Goomboorian)	Typic Eutropept	40	53	5	2	1.45	6.0	1.3	0.02	8	8

*Soil Taxonomy; +Measured after one year's experimentation.

Table 5. Field program structure of ACIAR projects.

Country	Site	Main crop(s)	Slope (%)	Standard plot area (m ²)
Malaysia	Kemaman	Cocoa, Banana	17	20 (bare plot) 1000 (treatment plots)
Thailand*	Nan	Maize	12–50	288
Thailand*	Khon Kaen	Rozelle	4	150
Philippines	Los Baños	Maize, Mungbean	14–21	72
Philippines	ViSCA	Maize, Peanuts	10, 50, 60 and 70	72
Australia	Gympie	Pineapples	14 (Goomboorian) 38 (Imbil)	18–3500

* Detailed soil erosion studies ceased at Khon Kaen in 1992. Only limited data are available from Nan at this stage.

To allow measurement of both total soil loss and runoff rate, sediment-laden water leaving the plot is collected in a modified Gerlach trough consisting of a concrete or galvanised iron collecting channel of low slope (= 1%). This low slope leads to the net deposition of the coarser or more rapidly settling fraction of the eroded sediment, described as 'bedload'.

After dropping its bedload, the remaining water and sediment (the 'suspended load') is passed through a device for measuring flow rate. This device is a flume in the case of large plots (over 400 m²), or, in the case of smaller plots, a 'tipping bucket' device. Water falls into the calibrated tipping bucket (of PVC construction) via a slotted manifold in the floor of the collecting trough at its exit. The tipping bucket is an over-centre device which tips after accepting a certain volume of runoff. Tipping is sensed using a proximity switch, and the number of tips per minute recorded and stored in an electronic Robinson Logger (an 8-channel logger developed by DPI). Data management programs (ROBDATA, DATALOG, DATAMAN) have been developed to convert data on flume flow height or bucket tiprate into meaningful hydrologic data such as total runoff (mm) and runoff rate (mm/hr).

As water passes out of the tipping bucket, a small proportion (~0.1%) of the suspended load is sampled by slotted pipe and stored in a plastic container. The sediment concentration in this container is assumed to represent the average suspended sediment concentration during the runoff event.

Total loss of suspended sediment is calculated by multiplying the average concentration of suspended load by the total volume of runoff. This suspended load is then added to the bedload to give the total soil loss in the event. Separate measurement of suspended load allows assessment of the potential for off-site pollution by soil erosion, and aids in interpreting nutrient enrichment in sediment.

Rainfall rate is measured using inexpensive pluviometers constructed from standard 2000 mm daily rainfall gauges by incorporating a 0.22 mm PVC tipping bucket (Dr Peter Ross, pers. comm.).

A standard set of measurements is taken on the plot to help interpret runoff and soil-erosion processes. This includes estimates of aerial (crop) cover, surface contact cover (both living cover and crop residues), surface roughness, and the extent of rill (or ephemeral gully) formation after a runoff event. Soil shear strength (which influences detachment or entrainment of particles from the soil surface) and the particle settling velocity distribution after rainfall (which determines rate of deposition of sediment) are also monitored at regular intervals. Details of experimental methodology are also given by Ciesiolka et al. (1995a).

Treatments at 5 out of the 7 sites are described in detail in *Soil Technology* 8(3). Treatments to be discussed in this report are summarised below, and references to more complete descriptions are given.

Kemaman

A small (20 m²) bare plot was used, and was not cultivated; both treatments studied had cocoa with glyricidia as a shade tree, and intercropped with banana. Treatment plots were 1000 m². Treatment T1 had no living ground cover, and was clean weeded with herbicide. Treatment T2 had ground cover of *Indogofera spicata* and natural grasses. Ground cover was slashed in a 1 m radius around trees to reduce competition (see also Hashim et al. 1995).

Khon Kaen

Treatment plots were 150 m², with a smaller bare plot receiving the same cultivation treatment as T1.

Treatments were T1 (cultivation up and downslope), T2 (cultivation on contour), T3 (subsoiling to 0.5 m, contour cultivation), T4 (no tillage). T3 and T4 are not regarded as economically viable strategies for Rozelle (see also Sombatpanit et al. 1995).

Los Baños

Four treatments were applied in addition to the bare plot. T1 and T3 are considered as 'conventional' and 'improved' practices in this report. T1 involves tillage and preparation of planting beds up-and-down the slope and weed-free culture. T3 incorporates alley cropping with tillage and planting along the contour, and hedgerow clippings, crop and weed residues used as a mulch in the alleyway. The bare plot is kept clean-weeded with weeding and cultivation occurring at the same time as for T1 and T3. However, cultivation of the bare plot produces a randomly rough surface with no hills and furrows (see also Paningbatan et al. 1995).

Visca

Treatments are essentially similar to those at Los Baños, except that hedgerow spacing is 12 m, compared with 6 m at Los Baños. In this case, T1 is a bare plot, T2 is farmer's practice and T4 (hedgerow plus mulching with legume *Arachis hypogaea* intercrop) is the 'improved' practice (see also Presbitero et al. 1995).

Imbil, Gympie

The aim in this case was to determine optimum slope length for pineapples planted on raised beds oriented up-and-downslope. All treatments were conventional in that no mulching of the furrows was carried out. Furrow slope lengths of 7, 12 and 22 m were tested, and soil loss from the small plots was compared with that from the paddock at a whole (see also Ciesiolka et al. 1995b).

Since the reports incorporated into *Soil Technology* 8(3) were prepared, two new sites have been established and measurements at Khon Kaen have ceased. Descriptions of the sites at Nan and Goomboorian, Gympie are given below.

Nan, Thailand

For Nan, 21 plots each 288 m² in size were constructed. Three replicates of each of six main treatments were randomly allocated. The treatments are:

- T1 = Local farmer's practice, no conservation measure, crop planted on the contour.
- T2 = Vetiver grass strip as conservation measure with mango trees planted at 1 metre upslope from the grass strip.
- T3 = Tephosia hedgerow as conservation measure with mango trees planted at 1 metre upslope from the hedgerow.
- T4 = Hillside ditch on the contour as conservation measure with mango trees planted at 1 metre upslope from the ditch.
- T5 = Small hillside ditch plus tephosia hedgerow with mango trees planted at 1 metre upslope from the hedgerow.
- T6 = Bare soil.

Another three demonstration plots designated T7 are natural vegetation (T7R1), trash row of crop residue as conservation measure (T7R2) and pigeon pea hedgerow as conservation measure (T7R3).

Goomboorian, Gympie

At the Goomboorian site, research plots are laid out on a 14% slope. Pineapples are planted on raised beds to improve drainage. However, because the soil is highly erodible, beds must be constructed across the slope to reduce furrow gradient to less than 6%. In addition to this primary soil conservation strategy (the existing farmer's practice), other practices were incorporated such as compaction of furrows, construction of tied-ridges in furrows to trap both runoff and sediment, and mulching of furrows with residues from previous pineapple crops. For comparison in this report, the main treatments analysed will be bare plot, farmer's practice and furrow mulching.

Erosion in mature pineapple crops is normally not serious because of raindrop interception by leaves, consolidation of the soil after planting, and the relatively low streampower of overland flow. However, every 3.5–4 years the crop must be ploughed out and replanted. The time involved in this operation is 5–6 months, and rotary hoe cultivation to control regrowth of the original pineapples may require up to 16 operations. This leaves the soil in a highly erodible condition, often over periods of very erosive rainfall. At the Gympie sites, some observation-demonstration experiments have been carried out in relation to this topic.

Chapter 3

Field Experimental Results — Runoff, Soil Loss and Crop Yield

K.J. Coughlan and C.W. Rose

THIS chapter provides information on the broad results obtained from monitoring experimental field plots, and comments on the processes involved in sediment generation and transport. The implications of these processes to the determination of appropriate land management practices are also analysed. Yields from 'conventional' and 'improved' soil and crop management practices are also reported to provide an integrated indicator of the effectiveness of the practices over the experimental period. Longer-term effects of soil management and soil erosion on crop yields are analysed in a separate chapter.

Annual Runoff and Soil Loss

Data for 5 of the 7 sites are reported for part of the total experimental period in *Soil Technology* 8(3). Data for the whole experimental period and for all sites are shown in Table 1. For all sites except Imbil, Gympie, results are given for 'bare' plots, 'conventional practice' plots and 'improved practice' plots. The Imbil experiment, reported in detail by Ciesiolka et al. (1995b), examined the effect of row length on soil loss, with all plots receiving the same management. Results for the 12 m long plots (the optimum row length) are reported here for this site. To allow ready comparison between field sites with different experimental periods, results are reported on an 'average annual' basis.

Soil loss

For all sites except Imbil (where there is no bare plot) and Nan (where runoff and soil loss in the single year of measurement was small), soil loss from unprotected soil was very high ranging from 48 to 216 t/ha/yr. These unsustainable soil loss rates illustrate the importance of maintaining either projected (crop canopy) cover or surface contact

cover (mulches or low-growing ground cover) at all times during the rainy season in humid tropical environments.

At Kemaman, Los Baños, ViSCA and Goomboorian, the conventional farmer's practice also results in unacceptable soil losses of 38–119 t/ha/yr. Annual cropping systems are practised at Los Baños and ViSCA. However, perennial plantation crops are grown at Kemaman (cocoa) and Goomboorian (pineapples) where the major soil disturbance is associated with crop establishment. This resulted in higher sediment concentration in runoff (Hashim et al. 1995). However, over the five years of the experiment at Kemaman there was no evidence of a consistent reduction in sediment concentrations as the plantation became more established. Average sediment concentrations for the five years are 8.3, 6.2, 3.0, 8.1 and 5.7 kg/m³ respectively. This soil exhibits spontaneous dispersion in water (Hashim, unpublished data), which may explain the continued production of sediment from the undisturbed soil.

In contrast, the Goomboorian site shows a very marked reduction in soil loss and sediment concentration with time after planting. This is shown in Table 2.

A similar result was reported for the conventional practice at the other pineapple site in Australia (Imbil) by Ciesiolka et al. (1995b). See also in Table 1 that soil loss in year 1 was 76 t/ha at the Imbil site compared with an average value of 7.5 t/ha/yr in years 2 and 3.

Both these pineapple soils consolidate with time after planting, with surface soil strength measured using a Tor Vane increasing from 5–12 kPa during the growth period at the Goomboorian site. Preferential removal of fine material by soil loss also results in an 'armouring' of the soil surface with

Table 1. Average annual runoff, runoff co-efficient, soil loss and sediment concentration from plots at seven experimental sites.

Site*	Treatments	Average annual			
		Runoff (mm)	Runoff** co-efficient	Soil loss (t/ha)	Sediment concentration (kg/m ³)
Kemaman, Malaysia 4.5 years Sandy clay loam 17% slope Average annual rainfall = 3638 mm	Bare plot	2245	0.62	127	5.7
	T1 — no living ground cover	1287	0.35	90	7.0
	T2 — grass and legume ground cover	413	0.11	17	4.1
Khon Kaen, Thailand 3 years Loamy sand 4% slope Average annual rainfall = 913 mm	Bare plot	372	0.41	48	12.9
	T1 — cultivation up-and-down slope	151	0.17	2.8	1.8
	T2 — cultivation across slope	116	0.13	1.0	0.9
Nan, Thailand 1 year Clay Average slope = 30% Annual rainfall 1993 = 1886 mm	T6 — bare plot	42	0.02	7.2	17.1
	T1 — clean cultivation farmer's practice	10	<0.01	0.6	6.0
	T3 — Tephrosia hedgerows	10	<0.01	0.4	4.0
	T7R1 — natural vegetation	8	<0.01	Trace	—
Los Baños, the Philippines 6 years Clay Average slope = 18% Average annual rainfall = 2037 mm	Bare plot	393	0.19	184	47
	T1 — clean cultivated farmer's practice	387	0.19	119	31
	T3 — alley cropping and mulching	114	0.06	6	5.3
ViSCA, the Philippines 2 years Clay 50% slope plots Average annual rainfall = 2800 mm	T1 — bare plot	55	0.02	69	125
	T2 — clean cultivated furrows up-and-down slope	84	0.03	38	45
	T4 — alley cropping and mulching	16	<0.01	3	19
	T3 — alley cropping and mulching	16	<0.01	3	19
Imbil, Gympie, Australia 3 years Sandy loam Slope = 38% Average annual rainfall = 1232 mm	12 m row length. Pineapples planted on beds oriented up-and-down slope	436	0.35	30	6.9
	Note: Soil loss in year 1 of crop was 76 t/ha. Average soil loss in years 2 and 3 was 7.5 t/ha/yr.				
Goomboorian, Gympie, Australia 3 years Loamy sand Slope: Landslope = 14% Furrow slope = <6% Average annual rainfall = 1045 mm	Bare plot	286	0.27	216	76
	Conventional plot, no surface contact cover	213	0.20	51	24
	Improved practice — furrow mulching	150	0.14	3	2

*Information on length of experimental period, soil type, slope, and average annual rainfall over the experimental period is given.

** R_c = average annual runoff/average annual rainfall.

Table 2. Soil loss and sediment concentration from conventional and improved practices at Goomboorian over a three year period after planting.

Year	Conventional practice		Improved practice	
	Soil loss (t/ha)	Sediment conc. (kg/m ³)	Soil loss (t/ha)	Sediment conc. (kg/m ³)
1	127	91	4.4	4.5
2	21	10.8	1.3	1.2
3	4.0	1.3	3.6	1.5

coarse particles, particularly at Imbil where percentage stone in the soil is high.

Management of pineapple soils to reduce soil loss is therefore critical in the inter-crop period (see later) and in the first year after planting. The effectiveness of mulching practices in reducing soil loss in the first year is illustrated for the Goomboorian site in Table 2. Similar results have since been obtained at the much steeper Imbil site (Ciesiolka, pers. comm.).

Table 1 shows that, at all sites, locally-developed improved management practices can reduce soil loss to apparently acceptable levels of <10–20 t/ha/yr. A

common feature of these practices is the use of living ground cover or mulches, often associated with the use of hedgerows. Agronomic soil conservation methods which manipulate cover are a favoured option in humid, tropical environments where biomass production is high provided that plant nutrition is adequate.

Surface contact cover (which is close enough to the ground surface to interfere with the process of sediment entrainment by runoff) is much more effective than canopy cover (which only limits soil detachment by rainfall) in reducing soil loss. As seen in a later section of this chapter, rainfall detachment makes only a minor contribution to sediment generation at slopes greater than 10–15%.

This effect is illustrated clearly for the Kemaman site (Table 1) where canopy cover is similar for both treatments T1 and T2. However, T2 has a living grass–legume ground cover in addition to the surface contact cover provided in both treatments by leaf litter resulting from cocoa and glyricidia leaf senescence. The living ground cover has reduced runoff markedly, presumably due to increased infiltration associated with biopores formed by roots and soil macro-fauna.

The effectiveness of hedgerows in reducing soil loss is well illustrated in Table 1 for the Philippine sites. Unless obvious hedgerow failure occurs (see later) soil loss for any runoff event is almost negligible. Hedgerows have a significant effect on soil loss both by reducing runoff and by reducing sediment concentration. The physical barrier of the hedgerow reduces runoff velocity and enhances deposition of sediment (particularly larger particles or 'bedload' which have a higher settling velocity). At the Los Baños site, Comia et al. (1994) measured saturated hydraulic conductivity on cores taken from T1 and between hedgerows in a mulched, zero-till plot. K_{sat} values were 82 and 187 mm/hr respectively. In another experiment, Tapa (unpublished data) measured K_{sat} values within the hedgerow 3–5 times greater than those in the alley. These results explain the reduced runoff from the improved, hedgerow treatments.

Experimental plots at Nan were on well-drained Oxic Paleustults with slopes from 12% to 35%. Soil organic matter measured in May 1993 was high, being 3–4% in the top 0.15 m. The soil was very well aggregated with 93% of aggregates >0.25 mm after immersion wetting. As a consequence, runoff and soil loss from all five cropping treatments was low at this relatively early stage in cropping history. For the 1994 cropping treatment the average runoff for the five cropping treatments was 11 mm compared with 42 mm from the bare treatment. Soil loss from the cropping treatments was also low, being 0.5 t/ha

compared with 21.9 t/ha lost from the bare soil treatment. Soil loss for the treatment with no conservation measure other than contour planting was only 0.6 t/ha. In the two years of measurement, all cropping treatments commenced the growing season with reasonable levels of surface contact cover. The period of time for which these low soil and water losses will be sustained for the range of cropping treatments remains for the future.

Runoff and sediment concentration from bare plots

The runoff co-efficient, R_c (runoff/rainfall) may be used to compare runoff generation in different soils and environments. R_c values shown for bare plots for 6 sites in Table 1 are highly variable, ranging from 0.02 to 0.62. Although Kemaman has both the highest R_c and the highest rainfall, rainfall amount is not a strong determinant of R_c . Rather, R_c values for the clay soils (range 0.02–0.19) are lower than those of the three lighter textured soils (range 0.27–0.62). Presumably this is due to the better water stable aggregation of the clay soils, which results in less surface sealing and maintains higher infiltration rates.

Average sediment concentration from bare plots (Table 1) is very variable, ranging from 5.7 kg/m³ for Kemaman to 125 kg/m³ for ViSCA. Average sediment concentration is dependent on a wide range of factors including runoff rate (mm/hr), slope (which determines streampower of runoff), formation of rills or existence of preferred flow pathways, settling velocity of sediment, and erodibility of the surface soil. Table 1 shows that slope alone is not a strong determinant of sediment concentration. Highest sediment concentrations are measured in the ViSCA soil (slope = 50%) and in the Goomboorian soil (slope <6%). The GUEST program is designed to analyse the effect of the above factors on sediment concentration. This analysis is presented in a later chapter.

Effect of treatments on runoff and sediment concentration

The relative effects of reductions of runoff (ΣQ) and sediment concentration (\bar{c}) on reductions in soil loss is analysed in Table 3. Soil loss is calculated from the equation:

$$\text{Soil loss (t/ha)} = [\Sigma Q \text{ (mm)} \cdot \bar{c} \text{ (kg/m}^3\text{)}] / 100$$

where the factor 100 allows for unit conversions.

Table 3. Effect of treatments on runoff and sediment concentration for six sites.

Site	Conventional treatment		Improved treatment	
	Q_{rat}^*	\bar{c}_{rat}^{**}	Q_{rat}	\bar{c}_{rat}
Kemaman	0.57	1.20	0.18	0.72
Khon Kaen	0.41	0.14	0.31	0.07
Nan	0.24	0.35	0.24	0.23
Los Baños	0.98	0.65	0.29	0.11
ViSCA	1.53	0.36	0.29	0.15
Goomboorian	0.74	0.32	0.52	0.03

* Q_{rat} is the ratio of ΣQ for the nominated treatment to ΣQ from the bare plot.

** is the ratio of \bar{c} for the nominated treatment to \bar{c} from the bare plot.

Data in Table 3 show that, in most cases, cropping treatments reduce both ΣQ and \bar{c} below that measured in the bare plot. Exceptions are Kemaman, where \bar{c} is higher in the conventional treatment, and the two Philippine sites where ΣQ in the conventional treatment is equal to or greater than that measured from the bare plot. At Kemaman, the explanation of this exception is simple in that treatment plots are much larger (1000 m²) than the bare plot (20 m²). Although ΣQ is reduced in the T1 plot, the much larger size of the plot presumably results in increased streampower of runoff. These data are further analysed in the GUEST chapter (Chapter 5).

The higher ΣQ in the conventional treatment plots at Los Baños and ViSCA can be explained in terms of plot surface geometry. Bare plots are rough cultivated by hand, while in the conventional treatment, hills for corn planting are aligned up-and-down the slope. Furrows between the hills act as a conduit for runoff, reducing infiltration opportunity time and increasing runoff amount. At Nan, however, ΣQ is dramatically reduced in the conventional treatment despite the fact that the cropping system is similar to that practised in the Philippines. This may be associated with the low annual runoff at this site. However, a more likely explanation is the fact that, at Nan, planting hills are constructed along the contour. So long as the contour hills are not breached by excess rainfall accumulating in furrows, infiltration opportunity time is increased by this practice.

Considering the improved treatments, the T2 treatment at Kemaman has the largest effect on ΣQ . As pointed out previously, this is probably due to biopores associated with the living ground cover. The three hedgerow treatments (Nan, Los Baños, ViSCA) have the next largest effect on ΣQ , reducing ΣQ by >70% compared with the bare soil.

The two very light textured soils (Khon Kaen and Goomboorian) show a very large reduction in \bar{c} in the improved treatment, combined with less dramatic decreases in ΣQ (Q_{rat} of 0.31 and 0.52, Table 3). Table 2 shows the corresponding reduction in sediment concentration for Goomboorian. This is explained by the effectiveness of the furrow mulch in reducing flow velocity in the improved practice, thus enhancing deposition of sediment and reducing erosion.

The relatively small effect of treatment on ΣQ on the loamy sand soils may be due to loss of surface porosity on these soils which have a low sorbtivity. This would be particularly the case at Goomboorian where the soil is not cultivated over the three year pineapple growth cycle. In this soil, the runoff coefficient, R_c , increased over time for all treatments, although rainfall amount over the period was approximately constant. In the conventional treatment, R_c increased from 0.15 to 0.22 while in the mulched treatment the increase over the 3-year period was from 0.10 to 0.21. This is probably due to soil consolidation over time. In contrast, no trend in R_c with time was observed at the other non-cultivated site (Kemaman) where soil texture is heavier.

Trends in R_c with time were examined for all soils. In only two was there an apparent trend — Imbil and Los Baños. At Los Baños, R_c over the first three years of experimentation was 0.16 (conventional) and 0.04 (improved) compared with 0.23 and 0.07, respectively, in the last three years. This could not be due to soil consolidation as the soil is frequently cultivated under annual cropping. Possibly the change in R_c is due to soil structured degradation over time.

Any changes in infiltration characteristics and runoff generation over time are examined in the next chapter, where a model predicting runoff rates from rainfall rates is developed.

The above chapter examines the effect of treatments on both ΣQ and \bar{c} . Since soil loss is given by the product of ΣQ and \bar{c} it is not a properly posed question to ask: What is more important — to reduce ΣQ or to reduce \bar{c} ? However, this is not to say that attempts to reduce ΣQ or \bar{c} may be equally effective.

In general, it may be argued that treatments which reduce ΣQ will be effective because:

- they also reduce runoff rate, and the streampower of runoff, from the field plot, to which sediment concentration is well related;
- they have important implications for soil erosion at a larger scale. Clearing of native or permanent-cover vegetation in a catchment results in a marked increase in runoff generation. This is illustrated, albeit for a low runoff situation, in Table 1 for the Nan site. At a larger scale the resultant

change in natural hydrology often results in gully formation and streambank erosion. These forms of erosion may be more significant in terms of off-site (water quality) effects than soil loss at a field scale. Firstly, gully and streambank erosion rates may be very high; and secondly, soil lost at the field scale will often be redeposited on the hillslope unless it is composed of a high proportion of fine material or 'suspended load' (see later).

Soil conservation practices should certainly aim at reducing the velocity of surface runoff in catchments, since the techniques which reduce the velocity of overland flow also reduce ΣQ and \bar{c} and thus sediment generation at a field plot scale (see Table 1).

Event soil loss

It is common knowledge that soil loss from most runoff events is small, with only a small number of catastrophic large soil losses occurring. However, it is these unusual events which cause a significant percentage of runoff and total soil loss. These observations are illustrated for the ViSCA site below:

- during the two-year period of experimentation at ViSCA, 384 observations of runoff and soil loss were made for 32 events on three slopes (50, 70 and 70%), and for four treatments (bare, farmer's practice and two hedgerow treatments). Of these observations, the vast majority (310) measured soil losses of <4 t/ha in an event;
- a period during the months of October and November, 1990 accounted for well over 50% of runoff and soil loss measured in the two year period, despite the fact that rainfall was <10% of that measured in the total period. For the T2 (farmer's practice) treatment, ΣQ was 110 mm (c.f. a total of 167 mm) while soil loss was 52.4 t/ha (c.f. a total of 76.2 t/ha). This highly episodic behaviour for both runoff and soil loss demonstrates the danger of using short-term monitoring to predict long-term behaviour if the range of climate and soil property conditions is not appropriately sampled.

The remainder of this chapter gives some examples of soil loss behaviour exhibited in individual, sometimes extreme, events.

Hedgerow failure

Hedgerow failure, where breaching of the physical barrier occurs, resulting in concentrated flow and rilling, was observed at both the Philippine sites during large rainfall/runoff events. Hedgerow failure results in a marked increase in sediment concentration in runoff.

For example, at Los Baños, hedgerow failure occurred during a typhoon in October 1994. Sediment concentrations from different treatments are shown for this event, and for an event earlier in the cropping season, in Table 4.

Table 4 demonstrates the large increase in \bar{c} associated with hedgerow failure in T3 in October 1994.

Table 4. Sediment concentrations in runoff for three treatments and two events at the Los Baños site in 1994.

Treatment	Sediment concentration (kg/m ³)	
	Event June 1994	Event October 1994
Bare	596	101
T1	89	40
T3	0.1	27

The phenomenon of hedgerow failure is illustrated even more dramatically at ViSCA. Over the period 4-8 October 1990 a series of storms resulted in significant soil loss. Sediment was collected on each day and this allowed examination of soil loss over time from the different treatments. Runoff, sediment concentration and rill formation are shown for T2 (conventional treatment) and T4 (improved hedgerow treatment) for three days in Table 5.

Table 5. Runoff, sediment concentration and rilling for treatments T2 and T4 at ViSCA in October 1990.

Date	Treatment					
	T2			T4		
	ΣQ (mm)	\bar{c} (kg/m ³)	N*	ΣQ (mm)	\bar{c} (kg/m ³)	N
5/10/90	11.4	126	0.8	1.1	<1	0
6/10/90	4.2	90	0.7	0.3	<1	0
7/10/90	10.1	165	1.0	1.6	151	0.5

*N = number of rills per metre of plot width, measured after the runoff event.

Despite the fact that ΣQ is markedly reduced in T4 throughout the period, hedgerow failure occurred on 7/10/90, with an associated large increase in \bar{c} and the formation of rills (3 in the 6 m wide plot) above the hedgerow. The soil loss in treatment T4 associated with the event of 7/10/90 (2.7 t/ha) was the only soil loss in excess of 1 t/ha for that treatment for the two-year experimental period.

These data illustrate the importance of maintenance of hedgerows to ensure a strong physical barrier, particularly if multiple hedgerows are constructed on a hillslope. Failure of a hedgerow near the top of the slope may result in significant concentration of runoff, and a 'domino effect' of failure further down slope. Strategies such as strengthening at-risk portions of the hedgerow with hedgerow clippings should reduce the danger of failure.

Soil management in critical periods

Demonstration studies at the Imbil site following the cropping period reported by Ciesiolka et al. (1995b) have shown the importance of sound management of the soil between harvest and re-establishment of a new pineapple crop. This transition often occurs during a period of high soil erosion hazard (October–March) in sub-tropical Australia. A major problem during the transition is managing the residue of the previous pineapple crop, and in particular preventing regrowth of pineapple residue as a weed.

Observations of soil erosion during the period between crops emphasise the importance of land management in minimising soil loss. The cropping cycle finished in October 1991, and two areas of the Imbil farm were managed in different ways. Area 1 was subjected to 16 rotary hoe operations in the period October 1991 to March 1992, and deep ripping was to be carried out just prior to planting. On Area 2, an 'improved' technology was used. The area was rotary-hoed soon after harvest to 'mulch' the prior crop residue. The pineapple plants were then deep-ripped. Over most of the inter-crop period the pineapple mulch was maintained on the soil surface and high rates of weedicide (Gramoxone) were used to control growth of volunteer pineapples. Final 'mulching' (three rotary hoe operations) was delayed until just before bed and furrow preparation for planting.

An extreme rainfall event in late February 1992 (600 mm in 3 days) resulted in soil loss of 1000 t/ha in Area 1. This represented the complete removal of 6–8 cm of top soil. In contrast, loss from Area 2 was estimated at <20 t/ha, mainly as suspended load. This graphically illustrates the effectiveness of deep ripping and maintenance of surface cover in reducing surface runoff and soil loss.

Similar critical periods may be identified at other sites. For example, at Kemaman in east peninsular Malaysia, plantation establishment during the peak rainfall months of the north-east monsoon (November–December) should be avoided. Fortunately, for annual maize crops in Southeast Asia planting is usually carried out early in the wet season (in May) before the soil water profile is full and this

limits runoff generation. A greater risk may arise from planting a 'dry season' legume crop if typhoon conditions occur during the crop establishment period (normally in October).

Cultivation and soil loss

The effect of cultivation on subsequent soil erosion is not well defined. Over a long time period cultivation may reduce soil organic matter and structural stability, increasing runoff and sediment transport. Over a short period, it reduces soil strength, particularly in soils which consolidate on wetting and drying. This reduced strength may result in increased soil erodibility.

Alternatively, cultivation may produce larger stable aggregates and enhance infiltration rate. This is particularly so if cultivation is carried out in wet conditions using methods, e.g., hand tillage, which do not compact the soil. There is some evidence from the ViSCA site that these effects of cultivation may be important.

At the ViSCA site, individual bare plots were set up at three slopes (50, 60 and 70%). For most runoff events, when the three plots had been subjected to similar cultivation treatments, soil losses from the different slopes were of a similar order. However, in the first two events (October 1989 and January 1990) no standardised cultivation strategy had been developed, and plots were cultivated only if significant rilling had developed. (Note: subsequently all plots were cultivated at the same time.)

Runoff and soil loss from the three bare plots for Events 1 and 2 are shown in Table 6.

For Event 1, although ΣQ from the three plots was similar, soil loss from the 50% and 70% plots was much higher, and rilling much more severe. There is no explanation of the soil loss differences for

Table 6. Runoff and soil loss from bare plots at ViSCA for Events 1 (October 1989) and 2 (January 1990).

Plot	Event 1		Event 2	
	ΣQ (mm)	Soil loss (t/ha)	ΣQ (mm)	Soil loss (t/ha)
50% Bare	1.6	4.2	4.1	0.4
60% Bare	2.2	0.3	9.6	25.9
70% Bare	1.9	7.3	3.9	0.5

Event 1 as soil conditions before the runoff event are unknown. Immediately after Event 1, when the soil was still wet, the 50% and 70% plots were hand-cultivated to remove the rills, while the 60% plot was not disturbed.

For Event 2, a contrasting behaviour was observed, with runoff and particularly soil loss markedly higher in the 60% plot. A likely explanation of this result is the formation of stable aggregates in the 50% and 70% plots by wet cultivation, increasing infiltration rate and reducing soil erodibility. Presbitero (pers. comm.) reports that this soil weathers with wetting and drying to produce a mulch of fine, dry aggregates in the surface. This material may be fine enough to enhance surface sealing on rainfall wetting (increasing runoff generation), and would be readily transportable.

The importance of cultivation on soil erosion for later events is difficult to judge as, subsequent to Event 2, all plots experienced similar cultivation history. Examination of soil erodibility using program GUEST may provide more information on these effects.

Size/Settling Velocity of Sediment

The physical properties of sediment were not measured in this study. However, as part of the measurement methodology, sediment with a high settling velocity was collected in troughs at the bottom of the plot. This material is termed 'bedload'. A representative sample of material with lower settling velocity (termed 'suspended load') is obtained from the runoff after removal of the bedload. Suspended load is an important component of eroded sediment because it is enriched in plant nutrients (see later, Loss of Chemical Nutrients by Soil Erosion). Also, because it has a lower settling velocity it is capable of moving greater distances in the landscape, and contributes to off-site effects of soil erosion such as deterioration in water quality.

This chapter examines the factors influencing the contribution of suspended load to total soil loss, and analyses the likely off-site impact of runoff and soil loss at the different sites.

For the two clay soil sites in the Philippines for which full data are available, suspended load is less than 5% of total soil loss. This result is expected considering the strong natural aggregation of these soils. A similar result would be expected for the Nan site. At these sites, soil loss from farming practices would not be expected to contribute significantly to stream turbidity, although increased runoff, particularly at Los Baños (Table 1) could be expected to cause increases in gully erosion and instability of stream banks.

For the other four sites on lighter textured soils, the percentage of suspended load in total soil loss is higher, and is dependent on plot treatment. The average percentage suspended load in total soil loss

over the total experimental period is shown for the four sites and nominated treatments in Table 7.

Table 7. Average percentage of suspended load for bare plots, conventional treatments and cover treatments of Kemaman, Khon Kaen, Imbil and Goomboorian.

Site	% Suspended load		
	Bare plot	Conventional treatment	Cover treatment
Kemaman	46	76	84
Khon Kaen	9	59	—
Imbil	—	16	—
Goomboorian	18	17	31

From Table 7, highest percentage suspended load was measured at Kemaman for a soil which, as previously mentioned, tends to disperse spontaneously in water. Suspended load percentage is much higher in the treatment plots (as was also noted at Khon Kaen). However, for Kemaman this was probably due to the much larger size of the treatment plots (1000 m² compared with 20 m² for the bare plot). At the larger scale, opportunity for deposition of bedload would be enhanced, while generated suspended load would tend to remain in suspension. This would increase the percentage of suspended load in runoff at the plot exit.

At Khon Kaen (as compared with Kemaman, Table 1), soil loss from the bare plot was very much higher than that from the conventional treatment and active rilling was observed in the bare plot. Loch and Thomas (1987) observed that high bedload sediment concentration is a reliable indicator of rill formation. Active rilling would therefore explain the much lower percentage suspended load in the bare plot at Khon Kaen.

Data from ViSCA also confirm the observation in which the ratio of suspended load to bedload tended to decrease with increasing event soil loss. The ViSCA soil exhibits strong rilling in events where soil loss is high.

At Goomboorian, suspended load percentage is similar for the bare and conventional treatment plots. These plots are the same size, and surface configuration (and hence flow geometry) is fixed by the construction of pineapple planting beds and furrows.

At Kemaman, and particularly at Goomboorian, percentage suspended load was higher in the cover treatment plots. Cover increases hydraulic roughness (Manning's Roughness Coefficient, see Chapter 5) and hence reduces flow velocity for a given runoff rate. Deposition of bedload is enhanced by reduced

flow velocity, increasing the percentage of suspended load in runoff.

For most sites, there was no trend in percentage suspended load with time. However, for the two non-cultivated pineapple soils, which contain a very high percentage of particles >0.2 mm (coarse sand and gravel, Table 4, Chapter 2), suspended percentage in all treatments tends to increase with time.

This is illustrated for the Imbil 12 m plot which shows the greatest change with time, in Table 8.

Table 8. Changes in percentage suspended load, total mass of suspended load, and total mass of bed load over time at the Imbil site.

Year	Percentage suspended load	Suspended load (t/ha)	Bed load (t/ha)
1	10	7.7	67.1
2	26	3.9	11.1
3	42	1.8	2.5
4*	74	2.2	0.8
5*	100	0.6	<0.1

* These data cover two more years than those reported by Ciesiolka et al. (1995b).

The increase in suspended load is associated with armouring of the surface by coarse particles in the

absence of active rilling. The exact mechanism of generation of fine sediment from armoured surfaces is unknown, but selective removal by raindrop detachment is possible.

Table 8 shows that, even though percentage suspended load increases markedly with time, its magnitude and hence contribution to off-site sediment load decreases steadily with time. The contribution of suspended load sediment to off-site water quality problems is a function of sediment concentration in runoff, percentage suspended load in sediment and runoff amount. Potential for off-site pollution from bare soils and from soils under the conventional farmer's practice is shown for all sites in Table 9.

A number of indicators of effect of runoff and soil loss on water quality may be obtained from Table 9. These include:

- Turbidity:** The highest suspended load sediment concentrations were obtained from Goomboorian and Kemaman. Turbidity is a significant issue in water treatment for human consumption.
- Total sediment load to streams:** Average annual soil loss as suspended load is a good indicator of this, although it is recognised that some of this material would be deposited before it reaches major waterways. Once again, sediment loss to streams is likely to be highest at Goomboorian and particularly at Kemaman. Loss from the conventional practice plot at Kemaman was higher.

Table 9. Sediment concentration, percentage suspended load, concentration of suspended load, total runoff and average annual soil loss as suspended load for six experimental sites.

Site	Average sediment concentration (kg/m ³)	Percentage suspended load	Average sediment concentration of suspended load (kg/m ³)	Average annual runoff (mm)	Average annual soil loss as suspended load (t/ha)
Kemaman					
• Bare	5.7	46	2.6	2245	58.4
• Conventional	7.0	76	5.3	1287	68.4
Khon Kaen					
• Bare	12.9	9	1.2	372	4.3
• Conventional	1.8	59	1.1	151	1.7
Los Baños					
• Bare	47	1	0.5	393	1.8
• Conventional	31	1	0.3	387	1.2
ViSCA					
• Bare	125	2	2.5	55	1.4
• Conventional	45	2	0.9	84	0.8
Imbil					
• Conventional	6.9	16	1.1	436	4.8
Goomboorian					
• Bare	76	18	13.7	286	38.9
• Conventional	24	17	4.1	213	8.7

However, it must be remembered that the bare plot at this site was much smaller, and much larger suspended load losses would be expected from a bare plot equal in size to the treatment plots.

- (c) Runoff from bare and conventional plots, and in particular the increase in runoff compared with an undeveloped hillslope. Data from undeveloped areas were not available for the sites reported in Table 9. However, the very high average annual runoff from bare soil at Kemaman, along with the substantial increase in runoff compared with the best treatment tested (413 mm/yr in T2 compared with 2245 mm/yr in the bare plot — Table 1), suggest an enormous change in the surface hydrology of the landscape with clearing and even after establishment of conventional plantation practices. Runoff from an undeveloped hillslope segment would be expected to be even less than the 413 mm/yr measured in T2.

A significant amount of water movement to streams in undeveloped catchments occurs as slow, sub-surface throughflow. This maintains baseflow in streams but strongly dampens streamflow during periods of heavy rainfall. If throughflow is converted to quick surface runoff, gully formation and stream-bank erosion will result. These phenomena would be expected to be particularly pronounced in east peninsular Malaysia.

All the above indicators support the Malaysian Government's concern at deterioration in water quality due to sediment generated by plantation, forestry and mining operations on the sandstone and shale-derived soils common in this area.

The off-site effects in Queensland, Australia are mainly associated with export of chemicals, both fertilisers and pesticides, used in pineapple production. Losses of plant nutrients, both sorbed onto sediment and in solution in runoff are discussed in Chapter 7.

Mechanisms of Sediment Generation

Two major mechanisms of sediment generation are recognised by Rose (1993), rainfall detachment and runoff entrainment. In rainfall detachment, sediment is generated from the surface by raindrop impact, and is mobilised into a thin layer of water moving downslope. After deposition of the sediment, it may be re-detached by raindrops from the unconsolidated surface. Rainfall detachment/re-detachment is expected to be a major process where flow velocities of runoff are low (i.e., at low slopes) and where water depth is less than about 5 mm (i.e., for lower runoff

rates and where flow depth is not increased by concentration of flow in rills). Processes related to rainfall detachment are often referred to as 'inter-rill erosion', e.g., Loch (1996).

Runoff entrainment is removal of soil particles arising from shear stresses applied to the soil surface by runoff water. As with rainfall detachment, sediment may then be re-entrained from an unconsolidated layer of soil formed by deposition. In general, the sediment concentration produced by re-entrainment is proportional to runoff velocity. Runoff velocity increases with runoff rate, slope angle and slope length. Runoff entrainment/re-entrainment is dominant where rilling is active.

Sediment concentration attributed to rainfall detachment is compared with total sediment concentration from bare plots for five sites in Table 10. Detachment was measured from small plots <1 m² in size with slope <2%. The size and slope of these plots was such that runoff velocity was insufficient to initiate runoff entrainment (Ciesiolka et al. 1995a).

Table 10. The ratio of sediment concentration from detachment trays (\bar{c}_d) to sediment concentration from the bare plot (\bar{c}) for five sites.

Site	Slope %	\bar{c}_d/\bar{c}
Kemaman	17	0.22*
Khon Kaen	3.6	>1.0*
Los Baños	18	0.15
ViSCA	50	0.18
Goomboorian	5.5	0.55

*Also reported in *Soil Technology* 8(3).

For slopes >15%, \bar{c}_d/\bar{c} is less than about 0.25, confirming that at these slopes runoff entrainment is dominant. In contrast, at the Khon Kaen site with 3.6% slope, rainfall detachment is clearly dominant. The Goomboorian site is intermediate with entrainment dominant, but not strongly so. The slope percentage reported for Goomboorian is that of the furrow bottom. Eroded sediment is also generated in the hills, and particular from the steep sides which have a slope length of about 0.3 m at 100% slope. Rilling is observed in these steep sides and possibly contributed to the relatively low value of \bar{c}_d/\bar{c} at this relatively low slope site.

These data are consistent with those obtained by Moss (1979) in a laboratory flume experiment. He found that, at slopes >8–10% on a sand, sediment concentration was dependent only on slope, irrespective of whether the (constant) runoff discharge was supplied by rainfall or overland flow. This dependency on slope alone confirms that runoff entrainment is dominant at slopes >8–10%.

Knowledge of the dominant process in sediment generation is important since judgment on soil management practices to reduce soil erosion can be made on this basis. At low slopes of say <5–10%, low aerial crop cover is effective in reducing soil erosion since it reduces rainfall detachment. The effect of crop cover alone in reducing soil loss is well demonstrated in the low slope sites at Khon Kaen and Goomborian (Table 1), but particularly at Khon Kaen where cover from the Rozelle crop reduces average annual soil loss from 48 t/ha to 2.8 t/ha. It should be noted that these two sites have the highest value of \bar{c}_d/\bar{c} (Table 10).

In contrast, at the higher slope sites (Kemaman, Los Baños and VISCA) crop cover alone was not sufficient to cause a dramatic reduction in soil loss. For these three sites, average soil loss from the conventional treatment was 71%, 65% and 55%, respectively, of that from the bare plot. In these cases, flow-driven erosion processes are dominant (see Table 10), and strategies to reduce soil loss must either reduce the streampower of runoff or increase the resistance of the surface soil to shear stresses produced by runoff.

Options include:

- terracing to reduce slope angle to below 5%, or to reduce slope length;
- hedgerow planting and alley cropping;
- minimum tillage or furrow compaction (in pine-apples) to increase soil strength;
- use of contour banks or hillside ditches to reduce effective slope length and allow for safe disposal of runoff water away from cultivated areas;
- use of surface contact cover which both retards runoff and minimises rainfall detachment. The effect of cover on soil loss and runoff will be further analysed in Chapter 6.

In particular, all strategies must aim to reduce flow concentration and rill formation, since flow concentration results in a large increase in stream-power and runoff entrainment/re-entrainment.

Loch (1996) describes a methodology, based on varying plot length and discharge under simulated rainfall and overland flow, of analysing the contribution of rainfall detachment and runoff entrainment to sediment generation. It allows decisions similar to those described above to be made about management options. In addition, it allows the effect of slope length on erosion processes to be assessed.

Crop Yield

Los Baños

Crop yield is a useful agronomic indicator of the effectiveness of land management practices.

However, since improved practices often involve increased capital and labour inputs, yield is only one of the parameters used to calculate short-term and long term viability of these practices. Long-term economic viability of different practices used at the Los Baños site is examined in Chapter 9, using cropping systems simulation modelling.

As a first approximation, it is important that improved soil conservation practices do not result in a decrease in yield per unit of limiting resource, in this case assumed to be the area available for cropping. Because of this, yield from alley cropping systems is calculated per unit of total area, including the non-cropped area occupied by hedgerows. This chapter provides some yield data for all sites, but concentrates on the Los Baños site where data are available for seven years of annual cropping, allowing yield data to be used as an input for the long-term prediction of effects of land management practices on soil erosion and productivity.

Kemaman

At this site, data on cocoa pod yield were limited, because the plots had just started to produce marketable pods in December 1995 after planting in February 1991. In December 1995, cumulative yield of fresh pods from treatment T1 (no living surface contact cover) was 1.86 t/ha compared with 0.44 t/ha in treatment T2 (grass-legume ground cover). This initial yield difference probably arises from large initial growth rate differences in the two plots.

Measurements of tree girth (mean of 45 trees, taken 7.5 cm above ground level) were made monthly following planting. These data, shown in Figure 1, illustrate the slow initial growth rate in T2 compared with T1. This slow growth was probably associated with competition for water and nutrients provided by the grass-legume ground cover. At later stages, particularly after 30 months, growth rate for T2 was greater than that for T1, resulting in only small differences in girth between T1 and T2 at the end of the measurement period. During later stages of the growth period, there was considerable entrapment of leaf litter by the living ground cover in T2, compared with T1 where a significant amount of litter was mobilised in runoff. This entrapment resulted in increases in organic C and N in the surface soil in T2 (see Chapter 7), increasing soil fertility and observed root exploitation of the surface soil.

A similar result was observed for bananas which were planted in both T1 and T2 to provide cash income in the period before cocoa came into production. Banana plants in T1 yielded earlier, once again illustrating the competition between young

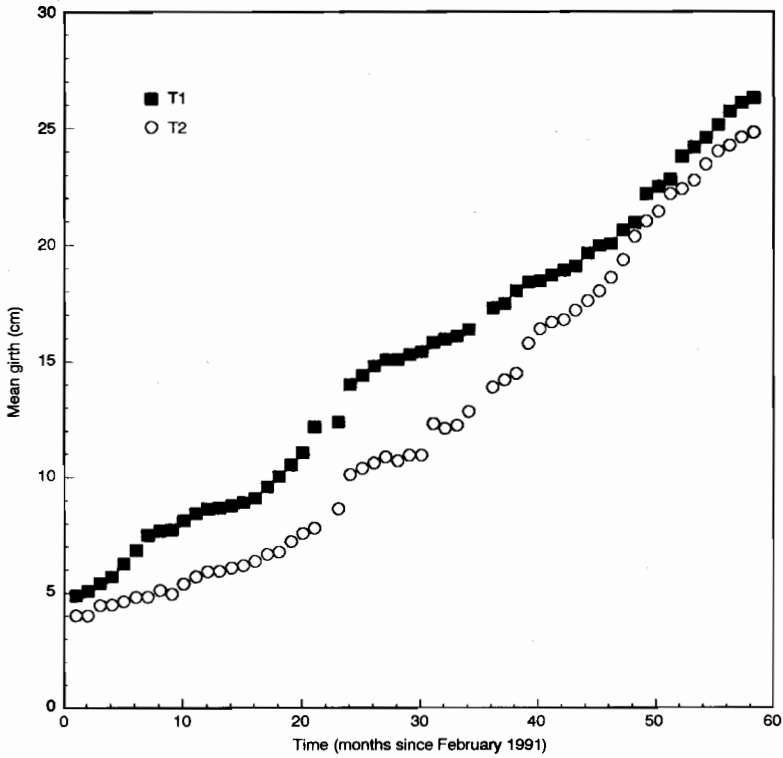

Figure 1. Increase in girth of cocoa trees as a function of time for two plot treatments at Kemaman.

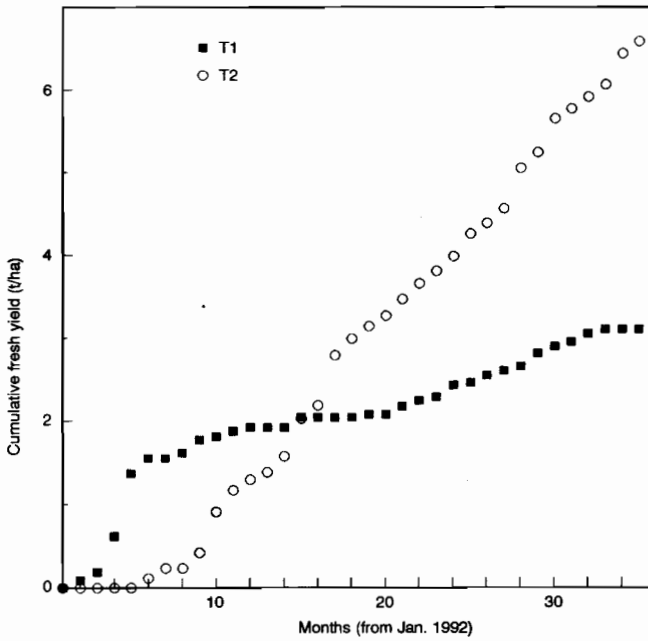

Figure 2. Cumulative banana yield from two treatment plots at Kemaman.

crop plants and the living ground cover in T2 (Figure 2). However, during the later period of production, T2 vastly outyielded T1, producing 6.6 t/ha of fresh yield compared with 3.1 t/ha in T1 over the three-year period.

The limited yield data at Kemaman were insufficient to make definite conclusions on the productivity of conventional versus improved cocoa production practices. However, both the cocoa growth data (Figure 1) and the results for the more rapidly producing bananas (Figure 2) suggest that longer-term productivity of T2 could well be at least equivalent to that of T1. On the other hand, it emphasises the importance of improving agronomic practices to minimise competition early in the growth of commercial perennial crops, while still maintaining the soil conservation benefits of living ground cover.

Khon Kaen

Yields of Rozelle were reported for a three-year period from 1989–1991 by Sombatpanit et al. (1995). Similar yields were obtained for all treatments except for T4, which involved minimum tillage practices. Average yields for the three years for T1, T2, T3 and T4 were 13.5, 13.6, 13.7 and 11.6 t/ha respectively. Treatment T4 is not regarded as a practical management system for Rozelle.

Nan

The growing season for maize is from May to September. Total nitrogen was about 0.2% in topsoil and available phosphorus (Bray II extraction) very low at about 2 ppm. Crop yields given in Table 11

Table 11. Average yield of traditional maize (kg/ha) in the experiments at Nan in 1994 and 1995 (three replicates).

Treatment	Maize yield (kg/ha)	
	1994	1995
T1 No conservation measure, contour planted	2430	3550
T2 Vetiver grass strip	2330	2850
T3 Tephrosia hedgerow	2525	2600
T4 Hillside ditch	2450	2760
T5 Small hillside ditch plus tephrosia hedgerow	2710	2838

Note: Treatments T2–T5 had mango trees planted 1 m upslope from the hedgerow.

An unreplicated contour trash line conservation treatment gave higher maize yields than the treatments given in Table 11 in both 1994 and 1995.

for 1994 and 1995 are low in part due to the use of traditional (non-hybrid) varieties of maize. Yields in 1994 may have suffered from the late application of P fertiliser.

Los Baños

An extensive data set is available for this site over a 7-year cropping period. All treatments are considered here, compared with the two (T1 and T3) discussed in earlier sections of this chapter. This allows full illustration of the treatment factors influencing yield at this site.

The experimental period is divided into two parts:

- 1989–1992: During this 4-year period, seven crops were grown — four of a local corn variety, Lagkitan, two of mungbean and one of peanut. Nitrogen fertiliser as urea (30 kg elemental N/ha) was applied at sowing of the corn.

Treatments T1 (farmer's practice) and T3 (hedgerows plus mulching) are described in Chapter 2, while a fuller description of all treatments including the two other hedgerow treatments (T2 and T4) is given in Paningbatan et al. (1995).

- 1993–1995: During this three-year period a hybrid corn variety (IPB193) was grown in the rainy season, with peanuts as the dry season crop; 60 kg of N/ha as urea was applied to the corn.

Treatments T1, T2 and T3 are as for the first period, but the hedgerows were removed from T4 before the 1993 corn crop. T4 after that time was a treatment involving contour cultivation and retention of crop residues.

Yields of maize and legume crops for the four treatments over the 7-year period are shown in Table 12.

For the period 1989–1992, although corn yields were quite variable, there is only one year (1991) in which yields were significantly lower in the hedgerow treatments (T2, T3 and T4). In this year, floral initiation was reduced by ash falls during the eruption of Mt Pinatubo. It was also a relatively dry year, as indicated by crop failure in the peanut crop. In this year, it was likely that yield in the hedgerow treatments was affected by competition for water with the hedgerow shrubs. Overall average yields of the four treatments over the 4-year period were 2312, 2257, 2219 and 2234 kg/ha for T1, T2, T3 and T4 respectively.

Reductions in yield in the mungbean crops in the first period were statistically significant in both years. Low-growing legume crops can experience competition for both water and radiation from the hedgerow shrub.

Table 12. Yields in kg/ha of wet season maize and dry season legume crops at Los Baños.

Treatment	1989	1990	1991	1992	1993	1994	1995#
	Green corn, var. Lagkitan			Hybrid corn			
T1	1473a	4833a	1510a	1430a	5236b	3435b	3509b
T2	1473a	4633a	1161b	1759a	4408b	2576b	3436b
T3	1465a	4549a	1255ab	1608a	5288b	2446b	3951b
T4	1489a	4943a	1193b	1310a	7112a	5116a	5681a
	Mungbean		Peanut				
T1	772a	1447a	*	1844a	1449a	603a	
T2	605b	1025c	*	1451a	809b	544a	
T3	415c	1058bc	*	1947a	832b	638a	
T4	350c	1151b	*	1856a	1329a	616a	

Notes: Means within a column followed by the same letter are not significantly different at the 5% probability level. 1989 to 1992 yields are in terms of fresh marketable green corn. 1993 to 1995 maize yield is at 14% moisture content harvested at maturity. Mungbean and peanut yield are 14% moisture content.

*No yield data because of crop failure due to drought.

#Yield for corn in 1995 is the average of 'upslope' and 'downslope' halves of each plot. The two halves received different fertiliser applications (see Table 12).

In the period 1993–1995, no statistically significant reductions in corn yield were noted in the hedgerow treatments (T2 and T3) compared with the farmer's practice (T1). However, in the 1993 peanut crop, yields in T2 and T3 were significantly lower than those from T1 and T4 (from which hedgerows had been recently removed).

Although it has been shown above that hedgerows can reduce the yield of corn, and particularly legumes at Los Baños, **per unit field area (including hedgerows)**, Table 12 dramatically shows the medium term gains in productivity associated with alley cropping systems. Until 1993, T4 was a hedgerow treatment in which minimum tillage was practised and crop residues and hedgerow clippings were added to the soil surface in the alley. Because of this treatment, soil erosion in the 4-year period up to 1993 was very low in T4. Soil losses in T1, T2, T3 and T4 for this period were 518, 73, 6.9 and 5.5 t/ha respectively. This low soil loss plus the addition of organic residues to the alley resulted in significantly high organic C%, available P and extractable K in T3 and T4 compared with T1. These soil chemical data will be given in detail in Chapter 7, but for illustration organic carbon percentages for T1, T2, T3 and T4 were 2.0, 2.2, 2.5 and 2.9% respectively.

The effect of this increased soil fertility on yield once hedgerows were removed in T4 is shown for 1993, 1994 and 1995 in Table 12. Average corn yield for this period in T4 was 5970 kg/ha compared with 4060 kg/ha in T1. It should be noted that, after 1992, both T1 and T4 were open-field situations with

no hedgerows, the only management differences being that T4 was cultivated on the contour and crop residues were retained. It is likely that the significant increase in yield in T4 was due to the fact that soil fertility had been maintained in this plot, compared with the reduction in fertility in T1. A nutrient balance for this site is reported in Chapter 7, and it shows a highly negative balance in T1, mainly due to soil loss, compared with a significant positive balance in T3, largely due to addition of residues and hedgerow clippings.

The differences in soil fertility with respect to nitrogen are well illustrated in Table 13 which shows results of a split plot experiment carried out in 1995 where the normal urea application was used on the 'downslope' half of the plot, while no fertiliser was applied to the 'upslope' half.

The following conclusions may be made from Table 13:

- If fertiliser is withheld, there is a very significant yield difference between plots, with yield being in the order $T4 > T3 \geq T2 \geq T1$. This is the same order as that reported earlier for organic C%. It is apparent from these data that N status in T4 and T3 at least is better than T1.
- The above conclusion is confirmed by comparing yields with and without fertiliser application for the different treatments. There was no statistically significant response to N in yield in T2, T3 and T4. However, the yield response in T1 was highly significant, with a yield increase for N application of nearly 100%. It should be noted that the 'upslope' half of the plot would have experienced

Table 13. Yield of maize (dry weight ear, kg/ha) in 1995 for split plots with and without urea application.

Slope	Treatment	Replicate			Mean
		R1	R2	R3	
Upslope (0 kg of N/ha)	T1	2764	2516	1782	2354e
	T2	2651	3060	3795	3169de
	T3	4005	4374	3707	4029cd
	T4	5287	4636	5872	5250ab
Downslope (60 kg of N/ha)	T1	5507	4241	4242	4663bc
	T2	3807	3465	3839	3704cd
	T3	4282	3812	3524	3873cd
	T4	6914	5623	5798	6112a

the greatest loss of topsoil depth due to soil erosion.

- The yields for 'downslope' halves of the plot may be approximately compared with whole-plot yields in 1993 and 1994 (Table 12). Despite the apparently adequate N status in all plots due to fertiliser application, yield in T4 was significantly higher than that for T1 (the other treatment without hedgerows). This is attributed to other differences in soil chemical fertility, for example available P (range 4–8 mg/kg) or micronutrients.

The yield data from Los Baños graphically illustrate the two competing issues involved in adoption of alley cropping, i.e., the short-term yield losses, particularly in legumes, arising from competition between crop and hedgerow and the longer-term gains in yield due to differences in soil fertility. A major issue in the viability of hedgerow systems is how long cropping must occur before yield gains due to fertility are greater than yield losses due to competition.

ViSCA

Considerable variability in soil fertility occurred over this site. Therefore, corn yields were averaged over the three slopes for the first three corn crops to examine any effects of treatment on yield. Fertiliser applied at this site was 80 kg/ha of 14:14:14 analyses.

Average yields (t/ha) for the three treatments were:

- T2 farmer's practice = 3100
- T3 hedgerows + mulching = 2214
- T4 hedgerows + mulching + peanut intercrop = 2614.

This soil is deficient in P and K (Table 4, Chapter 2) compared with the Los Baños site, and

the apparently lower yields in T3 and T4 over a short period of cropping (20 months) may well reflect a more serious competition for nutrients between crop and hedgerow in this less fertile soil. Competition for water at ViSCA is expected to be less serious than at Los Baños since average annual rainfall at ViSCA is about 10% higher (Table 2, Chapter 2).

Pineapple Sites, Australia

The Imbil site is not considered here, as there is no reason to expect plot length to have any effect on pineapple yield in the short term.

At Goomboorian, most studies were carried out on a site which had grown pineapples for the previous 12 years. There was concern that some of the improved treatments applied, such as mulching or construction of tied-ridges in the furrow, may increase waterlogging and favour infestation of plants by root pathogens. However, no effect of treatment was evident in the first harvest, 21 months after planting, which took place in August 1992. Average fresh yield of pineapples was 106 t/ha.

The situation with pineapple cropping differs from that of most farming enterprises. Chemically infertile soils with good drainage characteristics are chosen, and large amounts of plant nutrients are supplied as fertiliser. Despite the high fertiliser rates, farmers have found that yields on newly cleared land are significantly less than those in established areas. For example, some virgin land was planted in August 1993, and yield from the plant crop was only 55 t/ha of fresh fruit compared to 106 t/ha for land that had been under cropping for 12 years.

Fruit yield responds to a mix of artificial fertilisers, especially the micronutrients copper, boron, zinc and molybdenum. Micronutrient levels are very low in the sandy virgin soil. Cropping and the return

of organic crop residues to the soil has increased the buffering capacity of the soil and hence the reliability of supply of nutrients to the crop. Increased organic matter also reduces the loss of nutrients by leaching.

The above processes explain the increased yield of pineapple crops in the period after land development. They also suggest that degradation of soil fertility with cropping is not a threat to sustainability of this farming enterprise, as it is in so many subsistence farms in developing countries. In pineapple cropping, the major threat to sustainability is off-site pollution by sediment, fertiliser and agricultural chemicals, and the low acceptability of this pollution by off-site communities.

Conclusion

The yield data support the conclusion that, in most situations, improved practices which reduce soil loss to acceptable levels may be introduced without incurring a significant short-term yield penalty. Improved practices are, of course, introduced to maintain stability of yield in the long term.

One exception to this conclusion is for alley cropping systems, particularly for legumes and on infertile soils, where the short-term yield penalty resulting from crop/hedgerow competition for scarce resources (light, water, nutrients) may be significant. This penalty needs to be balanced against potential long-term gains.

Chapter 4

Plot-scale Runoff Modelling For Soil Loss Predictions

B. Yu, C.W. Rose, K.J. Coughlan and B. Fentie

SURFACE runoff plays a critical role in determining the rate of soil loss from agricultural lands. This is especially the case during large events with high stream power (Proffitt and Rose 1991). In the Universal Soil Loss Equation (USLE) (Wischmeier and Smith 1978), the effect of rainfall and runoff is encapsulated in a rainfall and runoff factor, known as the *R*-factor, to represent the climatic influence on soil erosion. As such, the *R*-factor cannot and should not be used to determine the soil loss on an event basis. In WEPP (Water Erosion Prediction Project, United States Department of Agriculture (USDA), 1995), which represents a new generation of process-based erosion model, the User Requirement (Foster and Lane 1987) suggests that the maximum information required to represent a design storm consists of:

- (i) storm amount;
- (ii) storm duration;
- (iii) ratio of peak intensity to average intensity; and
- (iv) time to peak.

With these standard inputs of storm characteristics, WEPP uses the Green-Ampt infiltration model to determine runoff amount and kinematic wave model to determine the peak runoff rate. The peak runoff rate is then assumed to be the steady-state runoff rate for erosion computations. In contrast, GUEST uses an effective runoff rate as the steady-state runoff rate for erosion calculations. The effective runoff rate, Q_{eff} , is defined as:

$$Q_{eff} = \left(\frac{\sum Q^{1.4}}{\sum Q} \right)^{2.5} \quad (1)$$

where Q is the instantaneous runoff rate.

The theoretical basis for this effective runoff rate is presented later in Chapter 8. Although the present version of GUEST requires input of either runoff rates at 1 minute intervals or an effective runoff rate calculated from 1 minute data, the effective runoff rate is likely to be the only hydrological variable that is available in a predictive mode.

This chapter is focused on modelling the runoff processes in the context of soil erosion using the GUEST technology. The nature of rainfall and runoff data collected for the project and the implications of the sampling error for runoff modelling are discussed; then a model (SSRFM) for 1 minute runoff rates is discussed, taking into account the spatial variation in the infiltration capacity and the lag between rainfall excess and observed runoff rate. A further section compares the model efficiency of SSRFM with that of another established hydrological model based on a time series approach. The discussion and conclusion sections summarise the results obtained and the lessons learned.

Rainfall and Runoff Data

Apart from the Kemaman site in Malaysia, both rainfall intensity and runoff rate were measured using tipping bucket technology. Details of recording equipment and measurements made were given in Ciesiolka et al. (1995a). Data on rainfall and runoff rates at 1 minute intervals were prepared for the 30 largest events in terms of total rainfall from the six sites for bare plots, and for two additional treatments representing the conventional and improved practices for Goomboorian and Los Baños sites. Rainfall intensity and runoff rate are continuous processes while the tipping bucket technology is discrete in nature. As a result, there is a fixed absolute sampling error depending on such factors as the bucket size, catchment area, and sampling interval. For given plot size and sampling equipment, the shorter the sampling interval the higher the sampling error. Table 1 shows the magnitude of the relative error for average peak rainfall intensity and runoff rate for the five sites where tipping bucket technology is employed. The relative error was calculated from a formula for the absolute error in terms of bucket size, catchment area and the sampling frequency. Such a

Table 1. Bucket size (V), catchment area (A), standard error (σ_e), number of events recorded (n), mean peak rainfall intensity (Pm) and runoff rate (Qm), and the corresponding relative error (RE) for each of the five sites. The sampling interval was 1 minute for both rainfall intensity and runoff rate at all sites.

	V (L)	A (m ²)	σ_e (mm/hr)	n	Pm (mm/hr)	RE %	Qm (mm/hr)	RE (%)
Rainfall	0.007	0.07	2.4					
Goomboorian, Australia	5	108	1.1	95	45.4	5	23.4	5
Los Baños, Philippines	5	96	1.3	302	46.1	5	10.7	12
Nan, Thailand	5	216	0.6	66	43.3	6	7.6	7
ViSCA, Philippines	5	71.4	1.7	85	68.8	4	4.4	39
Imbil, Australia	5	32	3.8	341	40.3	6	9.0	43

formula can be derived from a theoretical consideration of the error distribution brought about by the discrete sampling procedure (Yu et al., in preparation). It can be seen that the relative error can be high for small events with low rainfall intensity and runoff rate. The large relative sampling error makes it particularly difficult to model events of low runoff rate (see Figure 2e as an example).

Modelling Runoff Rates at Small Time Intervals

At sufficiently small spatial scales or for sufficiently large time intervals, the difference between rainfall intensity and infiltration rate, commonly known as rainfall excess rate, can be regarded as the runoff rate. For this project, plot length ranges from 5 m at Kemaman to 36 m at Nan and Goomboorian. Limited field observations suggested that the overland flow speed was about 0.1–0.2 m/s. Time of travel to the collecting device is, therefore, of the order 10^2 seconds, a time scale comparable with the time interval for which runoff rate was recorded. As a result, the lag between rainfall excess and the measured runoff rate needs to be taken into account. For this reason, the model has two separate but connected components. The first component addresses infiltration, therefore the rainfall excess, and the second one deals with runoff routing down the slope length. Since the model was developed especially for small-scale runoff plots, the model is henceforth called SSRRM to stand for a Small-Scale Runoff Routing Model.

Infiltration component

All classic theories of infiltration, such as the Green-Ampt infiltration equation, suggest two distinct infiltration phases. Initially the infiltration capacity is high due to the capillary effect. The maximum rate

of infiltration decreases rapidly to approach the saturated hydraulic conductivity. For operational hydrologists, it has been a common practice to model the two phases of infiltration separately. An initial infiltration amount is followed by either a constant infiltration rate or an infiltration rate in proportion to the rainfall intensity. Pilgram and Cordery (1992) reviewed these and other operational infiltration models in connection with flood estimation.

Most infiltration models describe a decrease over time of the maximum infiltration rate at a point in the landscape. Field measurements of hydraulic properties, including saturation hydraulic conductivity and steady-state infiltration rate, have all shown enormous spatial variability (Nielsen et al. 1973; Sharma et al. 1980; Loague and Gander 1990) even at the plot scale. As rainfall intensity increases, the proportion of the surface with rainfall intensity being greater than the infiltration rate would increase, hence the rainfall excess and surface runoff rate would increase. As a result, the apparent infiltration rate (the difference between rainfall and runoff) would increase as rainfall intensity increases. Dependence of the observed infiltration rate on rainfall intensity is strongly supported by the ACIAR hydrological data.

If run-on from less permeable areas to more permeable areas within the plot is negligible, the rate of rainfall excess can be written as (Hawkins 1982):

$$R = \int_0^P (P - I) f(I) dI \quad (2)$$

where P , I and R are rainfall intensity, maximum infiltration rate and rate of rainfall excess, respectively; $f(I)$ is the frequency distribution of the maximum infiltration rate over space which weights the rainfall excess in the integral. Integrating equation (2) by parts yields

$$R = \int_0^P F(I) dI \quad (3)$$

where $F(I)$ is the distribution function. Log-normal distribution was used to describe the spatial distribution of the saturation hydraulic conductivity (Nielsen et al. 1973) and the steady-state infiltration capacity (Sharma et al. 1980; Loague and Gander 1990), while Hawkins and Cundy (1987) used an exponential distribution to describe the spatial variation of the infiltration rate. For parameter efficiency, one-parameter exponential distribution was used to characterise the spatial variation of the infiltration, i.e.:

$$F(I) = 1 - e^{-I/I_m} \quad (4)$$

The rainfall excess as a function of the rainfall intensity is therefore given by:

$$R = P - I_m (1 - e^{-P/I_m}) \quad (5)$$

The parameter I_m is the mean maximum infiltration rate across the field when saturation occurs everywhere and the entire plot generates runoff. It is

the spatially-averaged infiltration rate, or the maximum possible infiltration rate, and it is distinct from the average actual infiltration rate during a storm event. Figure 1 shows the relationship between the apparent infiltration rate as a function of rainfall intensity assuming an exponential distribution.

Runoff routing component

The rainfall excess, R , is routed to the plot outlet using the kinematic wave approximation, i.e., the storage equation, which can be written as:

$$\frac{dS}{dt} = R - Q \quad (6)$$

where S is the depth of water stored on the soil surface. If one assumes a linear relationship between flow rate and storage, with the storage written as $S = KQ$, then a constant lag between rainfall excess and runoff rate is implied. The storage equation (6) combined with the linearity assumption were shown to be an approximate analytical solution of the basic partial differential equation governing the overland flow (Rose et al. 1983). A variant of this linear approximation of the storage/discharge relationship,

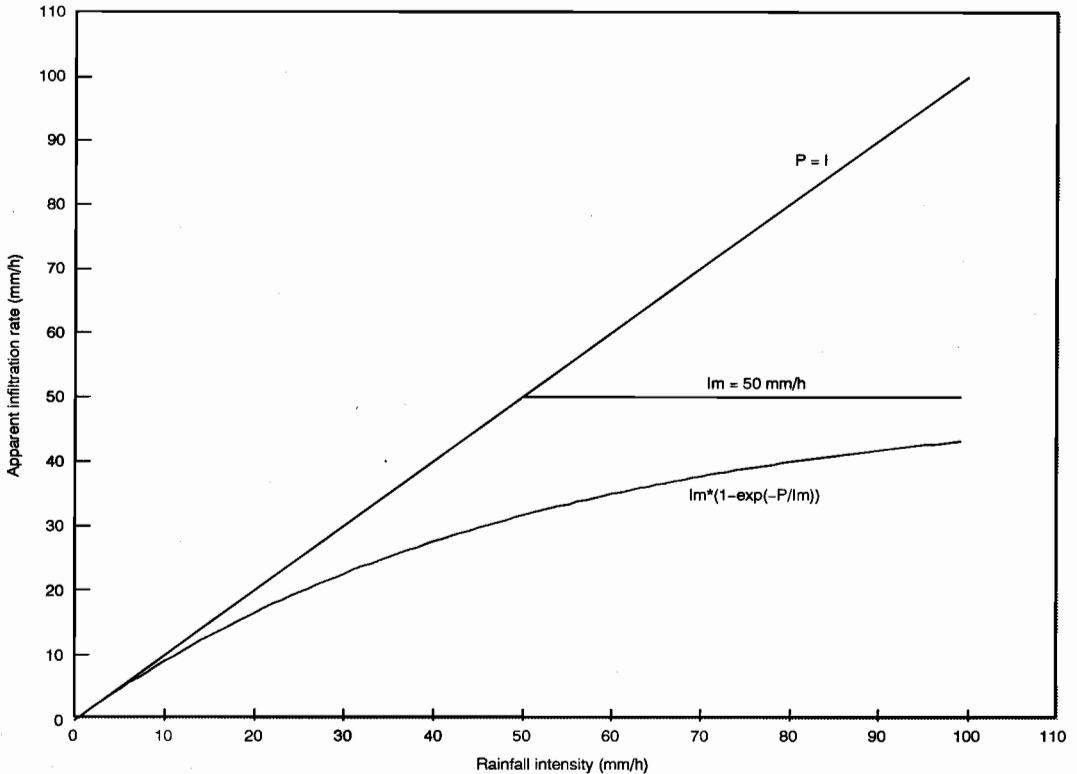

Figure 1. The relationship between apparent infiltration rate and rainfall intensity assuming an exponential distribution for the maximum infiltration rate (the parameter I_m is set to be 50 mm/hr).

known as the Muskingum method, has been widely used for flood routing purposes (Chow et al. 1988). Let Q_i and R_i be the average runoff rate and rainfall excess rate for the time interval i , then the storage equation can be written in a discrete form:

$$K(Q_i - Q_{i-1}) = (R_i - Q_i)\Delta t \quad (7)$$

or

$$Q_i = \alpha Q_{i-1} + (1 - \alpha)R_i \quad (8)$$

where the parameter α is related to the lag, K , and time interval, Δt by:

$$\alpha = \frac{K}{K + \Delta t} \quad (9)$$

Since velocity, and therefore the time of travel, varies as a function of the flow rate, one would expect that the lag relating storage to flow rate actually varies as a function of the flow rate as well. If one assumes the overland flow to be fully turbulent and the Manning's formula is applicable, the lag K is relative to the roughness, n , length, L , slope, S , and flow rate, Q , in the following manner:

$$K = \frac{1}{2} \left(\frac{nL}{\sqrt{S}} \right)^{3/5} Q^{-2/5} \quad (10)$$

For this report, parameter α is assumed to be a constant within an event. A variable lag, thus variable α , may be used in the future to determine whether use of a variable lag would improve model performance.

In summary, there are three model parameters to describe the variation in the plot-scale runoff rate at small time intervals:

- F_o — the initial infiltration amount in mm before runoff occurs;
- I_m — a spatially averaged maximum infiltration rate in mm/h when the entire plot produces runoff;
- α — a dimensionless routing parameter between 0 and 1 depending on the lag and the time interval.

Sub-surface flow at plot-scale is not considered in SSRFM because contribution of sub-surface flow to soil erosion from bare plots is in most cases insignificant and could be ignored.

Parameter estimation and model evaluation

The three parameters, namely F_o , I_m and α , were estimated by minimising the sum of squared errors, SSE, between the observed and modelled runoff rates, i.e.

$$SSE = \sum_{i=1}^N (Q_i - \hat{Q}_i)^2 \quad (11)$$

The Levenberg-Marquardt method (Press et al. 1989) was used for optimisation purposes.

Model performance is measured by the coefficient of efficiency, E (Nash and Sutcliffe 1970), and it is defined as:

$$E = 1 - \frac{\sum_{i=1}^N (Q_i - \hat{Q}_i)^2}{\sum_{i=1}^N (Q_i - \bar{Q})^2} \quad (12)$$

$$= 1 - \frac{SSE}{\sum_{i=1}^N (Q_i - \bar{Q})^2}$$

The coefficient of efficiency, E , is commonly used as a measure of model performance in hydrology (e.g., Loague and Freeze 1985) and soil sciences (e.g., Risse et al. 1993). The standard error of modelled runoff rate in mm/h was also computed to characterise the model performance.

For some of the events, only a segment of the original rainfall/runoff time series containing peak runoff rate was modelled because it would appear that for these events, baseflow continued long after the rainfall had ceased.

Of the 30 events for each site, and for each of three treatments for two of the six sites, the modelled hydrograph was fitted to the observed hydrograph for 10 randomly selected events. Averages of the estimated parameter values, model efficiency as a measure of the goodness of fit, and the standard error of the estimated hydrograph are summarised in Table 2. The observed and modelled hydrographs are presented in Figures 2(a-e). They include hydrographs in relation to the three treatments at Goomboorian and one hydrograph each at Nan and ViSCA. The last two sites have the lowest model efficiency of the six sites (Table 2). From the table and Figure 2, a number of observations can be made.

1. The model efficiency is high (at least 0.72), implying a good fit between the observed and modelled hydrograph. The standard error is small and of the same order of magnitude as the sampling error in peak runoff rates at 1 minute interval (c.f. Table 1). This suggests that the infiltration component of the model is plausible and the spatial variation of the maximum infiltration rate at the plot scale is a significant feature and should not be ignored. The lag between rainfall excess and runoff rate is not negligible at 1 minute intervals, although a constant lag for each event seems to be a reasonable assumption. Given that the model is simple with only three parameters, there is a great potential for predicting runoff rates at 1 minute intervals if compatible rainfall data are available.

Table 2. Summary of parameter values and model efficiency.

Site	Treatment	N	P _{tot} (mm)	P _{max} (mm/h)	R _c (%)	F _o (mm)	I _m (mm/h)	α	E	SE (mm/h)
Goomboorian	Bare plot	10	39.9	89.2	53	3.0 ± 1.1	13.9 ± 7.3	0.48 ± 0.19	0.94	3.1
	Mulch in furrow (BB1)	10	—	—	42	13.0 ± 5.2	14.6 ± 11.8	0.90 ± 0.05	0.74	1.7
	Conventional (BB2)	10	—	—	45	4.1 ± 1.6	40.6 ± 21.5	0.62 ± 0.15	0.91	2.1
Kemaman	Bare plot	10	76.3	275.0	83	2.3 ± 1.6	4.1 ± 3.6	0.56 ± 0.13	0.92	4.8
	Bare plot	10	54.6	100.1	34	7.5 ± 5.3	44.1 ± 46.5	0.78 ± 0.05	0.83	4.0
Los Baños	Conventional (CT1)	10	—	—	45	7.0 ± 5.6	68.4 ± 162.2	0.79 ± 0.06	0.87	3.6
	Mulch in alleyway (BT3)	10	—	—	13	12.9 ± 6.9	173.3 ± 262.1	0.81 ± 0.08	0.72	2.2
	Bare plot	10	29.2	81.1	20	5.6 ± 3.3	97.9 ± 113.1	0.69 ± 0.13	0.79	2.0
Nan	Bare plot	10	90.8	119.0	6	18.4 ± 4.9	443.8 ± 309.1	0.67 ± 0.13	0.72	0.9
ViSCA	Bare plot	10	116.6	103.9	61	6.0 ± 6.6	20.0 ± 10.5	0.86 ± 0.10	0.80	3.8

N — number of events.

P_{tot} — average rainfall amount.

P_{max} — average peak rainfall intensity.

R_c — average gross runoff coefficient.

SE — standard error of estimates.

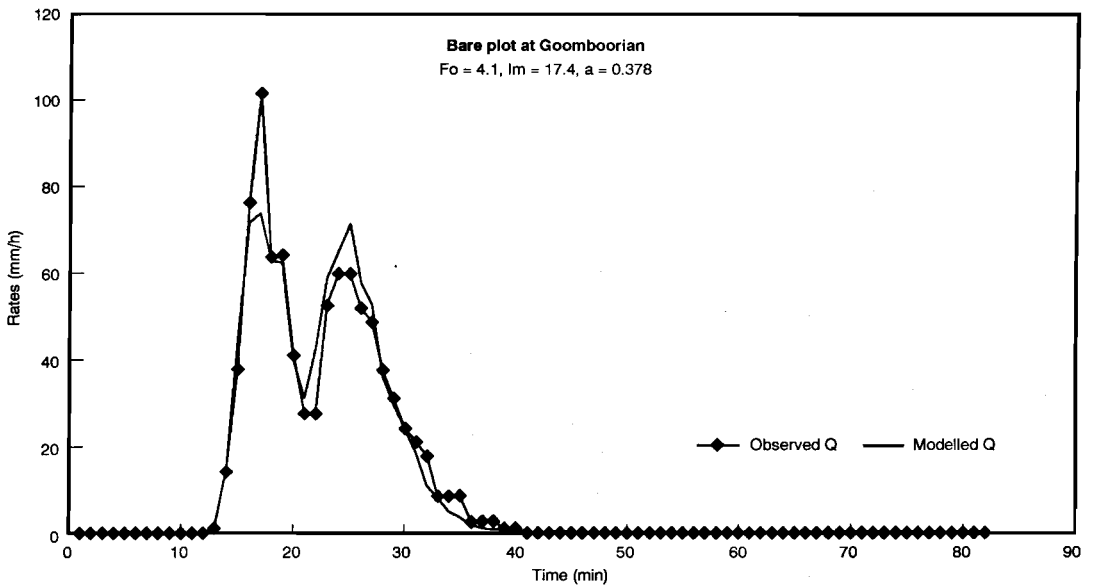

Figure 2a. Observed and modelled hydrographs at 1 minute intervals: event 22/02/93, bare plot at Goomboorian (E = 0.96).

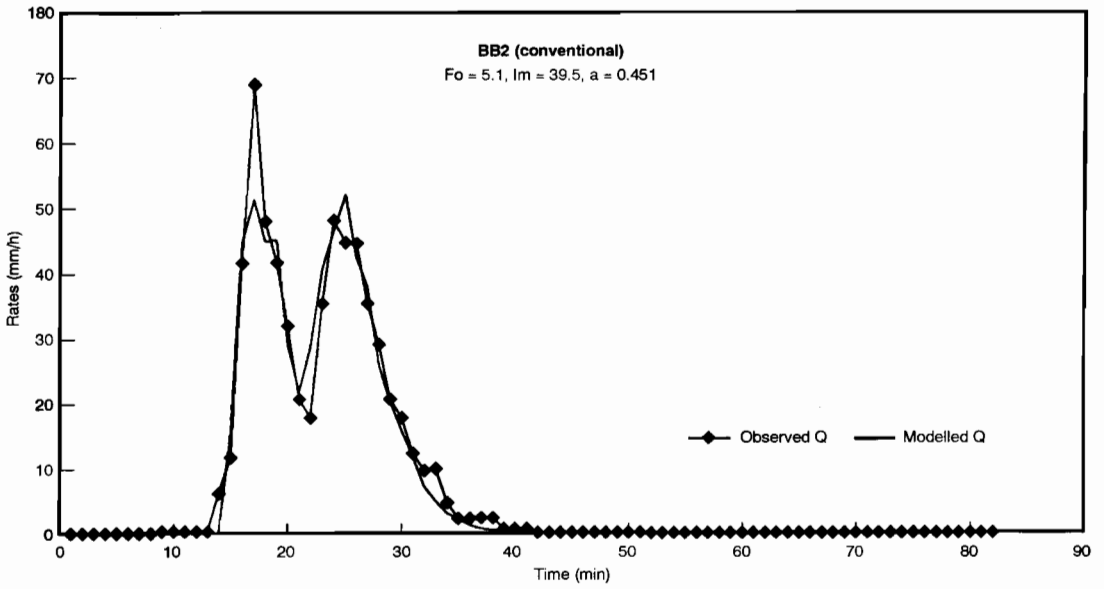

Figure 2b. Observed and modelled hydrographs at 1 minute intervals: event 22/03/93, BB1 (mulch) at Goomboorian (E = 0.96).

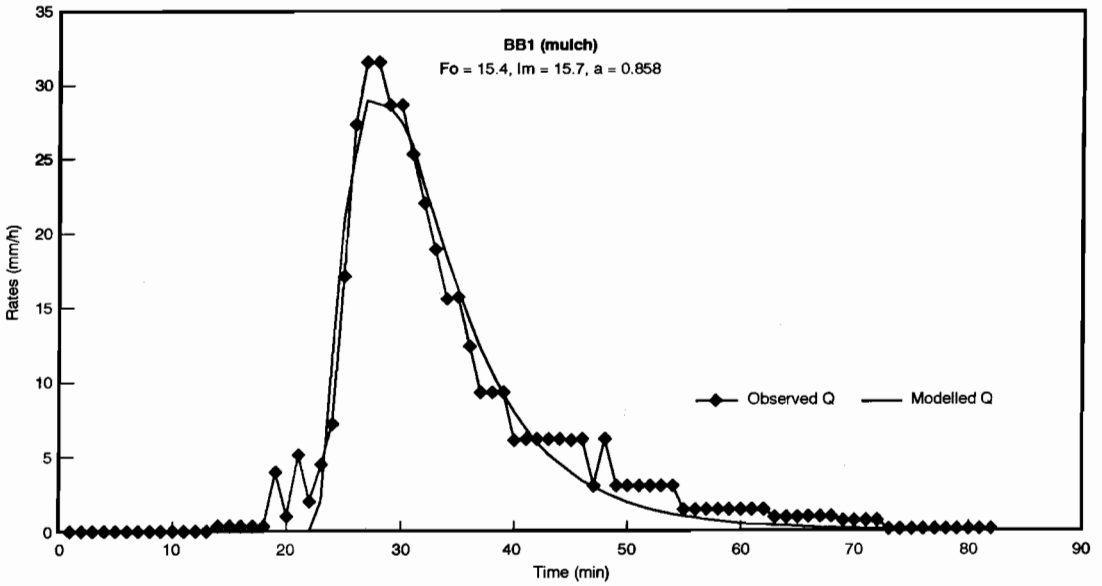

Figure 2c. Observed and modelled hydrographs at 1 minute intervals: event 22/02/93, BB2 conventional at Goomboorian.

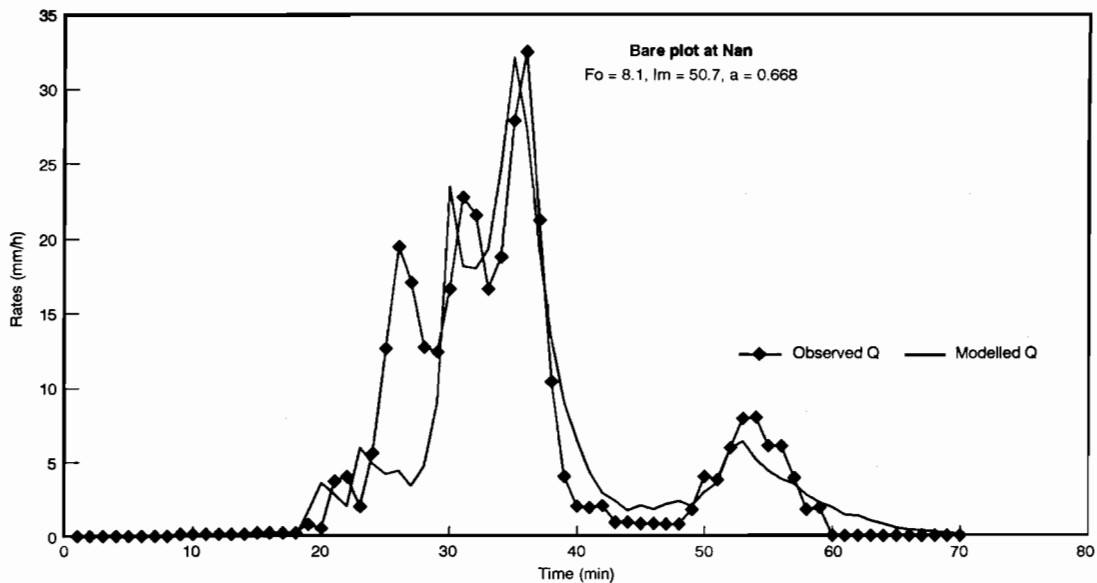

Figure 2d. Observed and modelled hydrographs at 1 minute intervals: event 01/05/95, bare plot at Nan ($E = 0.79$).

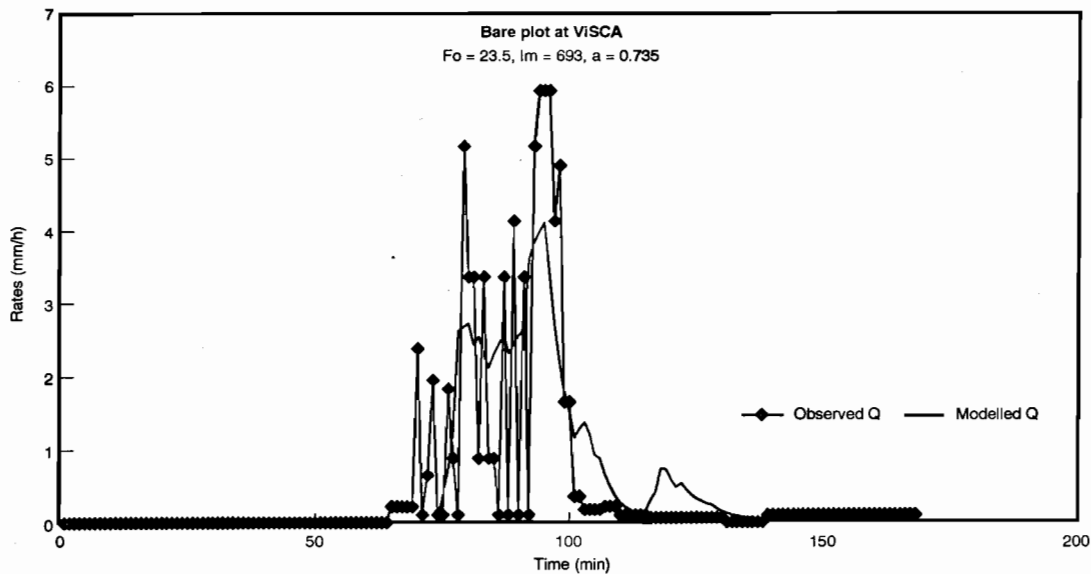

Figure 2e. Observed and modelled hydrographs at 1 minute intervals: event 21/06/92, bare plot at ViSCA ($E = 0.62$).

2. There is a considerable event-to-event variability in parameter values at all sites. For bare plots, the average coefficient of variation (C_v) for the initial infiltration is 0.7, ranging from 0.4 to 1.1. The average maximum infiltration rate has an even greater variability ($C_v = 0.8$, range 0.5–2.4). Of the three parameters, the routing parameter α has least amount of variation between events with C_v in the range from 0.1 to 0.4 only. Investigations of the variability of the effective hydraulic conductivity for the Green-Ampt equation have shown that parameter variability over time is strongly influenced by factors such as soil crusting, event size and antecedent moisture conditions for plots under fallow conditions (Risse et al. 1995), and the effective surface cover is an additional factor for crop lands (Zhang et al. 1995a, b). One therefore would expect that similar factors would influence the initial infiltration amount as well as the spatially-averaged maximum infiltration rate in the current context. Unless the 1 minute rainfall and runoff modelling is undertaken in a continuous mode, rather than on an event basis as reported here, it is not possible to isolate the effects of antecedent moisture conditions and soil crusting development to explain the event-to-event variation in estimated parameter values.

3. There are systematic and significant changes in the parameter values between different treatments. In terms of the initial infiltration amount, F_o , improved practice using mulch to cover the primary flow pathways resulted in an increase of F_o by factors of 3 and 2 for Goomboorian and Los Baños, respectively (Table 2). The difference between bare plots and conventional practice is minimal in terms of the initial infiltration amounts. The average maximum infiltration rate, I_m , is significantly higher for conventional practices in comparison with the bare plots (Table 2). There is also a noticeable increase in values of α when the flow pathways are covered with mulch, implying an increased lag, probably as a result of an increase in the surface roughness.

4. Modelling runoff rates at small time intervals is important because it helps understand the infiltration characteristics at each site, and the processes that need to be considered. Predicting runoff rates at 1 minute intervals, however, is not feasible given the present level of understanding of the precipitation processes and general lack of 1 minute rainfall measurement. Future rainfall intensity at 1 minute intervals simply cannot be predicted.

Table 3. Plot characteristics of the six sites.

Name of site	Country	Length (m)	Area (m ²)	Slope (%)
Goomboorian	Australia	36.0	108.0	5.0
Kemaman	Malaysia	5.0	20.0	15.0
Los Baños	Philippines	12.0	96.0	26.4
Nan	Thailand	36.0	216.0	—
ViSCA	Philippines	11.9	71.4	50.0
Imbil	Australia	12.2	32.0	32.9

In summary, plot-scale runoff models need to take into account the spatial variation of the maximum infiltration rate and the lag between rainfall and runoff can be important at small time intervals. A simple exponential distribution of the maximum infiltration rate and a constant lag can satisfactorily describe the temporal variation of the runoff rate within an event. Modelling at small time intervals is useful in identifying predominant infiltration and runoff processes. Table 3 gives site characteristics.

Comparison of SSRFM with an Alternative Hydrological Model Using a Time Series Approach

To gauge the performance of SSRFM, another hydrological model based on a time series approach, which is quite distinct from the infiltration-routing approach adopted for SSRFM, was used for the same six sites and for the same runoff events. Performance of the two models was compared in terms of the coefficient of efficiency. Following is a brief description of the alternative model and associated parameter estimation procedures, and a comparison of modelling results.

Time series approach to hydrological modelling

The alternative model used is a modified version of the model proposed by Jakeman and Hornberger (1993) which allows prediction of runoff rate from a 1 minute rainfall rate. The original model of Jakeman and Hornberger (1993) is given as:

$$R_i = P_i S_i \quad (13)$$

where R_i is effective excess rainfall rate, P_i is rainfall rate and S_i is a catchment wetness index given by:

$$S_i = C P_i + (1 - \lambda) S_{i-1} \quad (14)$$

in which i as a subscript is a time step, λ is the rate at which the catchment wetness declines in the absence

of rainfall, and C is a parameter chosen so that the volume of excess rainfall is equal to the total runoff or streamflow volume over the calibration period. The model has been successfully applied to a number of small to medium-sized catchments (up to 89.6 km²) mainly in the temperate regions of Australia, China and the USA.

A lag parameter, l , was introduced which took into account the discrepancy in time between rainfall rate and the corresponding runoff rate due to factors such as depression storage in the rainfall/runoff model. Equation (13) can then be written as:

$$\hat{Q}_i = C S_i P_{i-l} \text{ (mm/hr)} \quad (15)$$

where \hat{Q}_i is estimated runoff rate, l is the statistically estimated lag between variation in rainfall and runoff rates and S_i is modified to:

$$S_i = P_i + (1 - \lambda)S_{i-1} \text{ (mm/hr)} \quad (16)$$

It can be shown that equations (13) and (15) are the same with the assumption that $Q = R$ and by expanding the series in both equations. Then from the definition of C and from equations (15) and (16) it follows that:

$$C = \frac{\sum_{i=1}^N (Q_i)}{\sum_{i=1}^N (S_i P_{i-l})} \text{ (hr/mm)} \quad (17)$$

where Q_i is the measured runoff rate, and the summation is done for the whole calibration period. Let the runoff coefficient be R_c , and substituting C in equation (15) with equation (17) one obtains:

$$\hat{Q}_i = \frac{R_c \sum_{i=1}^N (P_i)}{\sum_{i=1}^N (S_i P_{i-l})} S_i P_{i-l}, \text{ Cum}P > F_0 \quad (18)$$

$$\hat{Q}_i = 0, \text{ Cum}P \leq F_0$$

where $\text{Cum}P$ is the cumulative rainfall up to the commencement of runoff (mm) and F_0 is initial loss (amount of rainfall before runoff commences (mm)).

This time series model, henceforth called TSA, described in equations (15)–(18) has four unknowns, namely, l , R_c , F_0 , and λ . These parameters can be directly calculated or their values optimised given rainfall and runoff rate data.

Parameter estimation

The lag l was estimated as a first approximation by correlating runoff rate at time step l , Q_i , to rainfall rate

at previous time steps (P_{i-l}). The estimated lag is the lag time l with the highest correlation coefficient. The final value of l is then selected from the optimisation process described later. Original estimates of l from correlation varied from 0 to 7 minutes among all events analysed at the six sites.

By definition R_c is the ratio of the total runoff, Q_{tot} (mm), to the total rainfall, P_{tot} (mm), or

$$R_c = \frac{Q_{tot}}{P_{tot}} \quad (19)$$

Since initial loss, F_0 , does not produce runoff, a corrected form of R_c designated R_{cc} can be calculated as:

$$R_{cc} = \frac{Q_{tot}}{(P_{tot} - F_0)} \quad (20)$$

From (19) and (20) it follows that:

$$R_c = R_{cc} \left(1 - \frac{F_0}{P_{tot}}\right) \quad (21)$$

If a rainfall–runoff model is to be fully predictive it should be applicable in situations where total runoff is unknown. In the development of this model, empirical relationships between Q_{tot} and R_c as well as R_{cc} were investigated with the relationship between Q_{tot} and R_{cc} having the highest correlation coefficient.

Another significance of equation (21) is the possibility of using this relationship in equation (18) where F_0 can be optimised along with λ which may result in a higher model efficiency than those calculated using F_0 values from SSRFM reported in Table 4.

Table 4. Comparison of results of the two models referred to above.

Site	Model efficiency E			
	SSRFM		TSA	
	Best	Worst	Best	Worst
Goomboorian	0.97	0.85	0.90	0.79
Kemaman	0.96	0.80	0.74	0.45
Los Baños	0.92	0.60	0.84	0.72
Nan	0.94	0.52	0.81	0.49
ViSCA	0.87	0.54	0.80	0.52
Imbil	0.95	0.68	0.85	0.52

Estimation of the initial loss or the amount of rainfall before runoff commences is subject to measurement errors and can be subjective. The time when the first runoff tip occurred may not necessarily be the time runoff commences as it may take some time for the tipping bucket to fill, depending, of course, on

the bucket size and the rate of runoff. On the other hand, a runoff tip may occur following a prolonged period of no runoff in which case it may not be appropriate to determine initial loss based on this first tip. Examining hydrographs and estimating the time when runoff commences can also be subjective. Another probably better method of estimating F_o would be to optimise it in this model itself (see equations (18) and (21)). However, this has not been attempted yet. F_o values estimated for SSRFM were used instead.

Parameter λ was estimated using an optimisation tool available in the spreadsheet program Excel (version 5) to give a maximum value of the coefficient of efficiency, E . To determine whether the lag selected from the correlation analysis was the optimal lag, the coefficient of efficiency, E , was maximised for two additional lags, namely, $t - 1$, and $t + 1$. The lag giving the highest E was used as the final lag.

Comparison of modelling results

Data for two rainfall-runoff events in each of the six ACIAR sites with plot characteristics described as in Table 3 were analysed and model performance compared with that of SSRFM. The two events from each site were selected as best and worst (in terms of E) out of the 10 events for bare plot at each site analysed (Table 2). This comparison is given in Table 4.

From Table 4, it can be seen that SSRFM outperformed on all occasions apart from the worst-case event at Los Baños. The fact that SSRFM has three parameters (unknowns) compared to four in this time series model which also involves a tedious procedure of estimating the best lag as described above, suggests that SSRFM is a better model for these sites. SSRFM was therefore recommended for further use.

Discussion and Conclusion

This chapter has reported attempts to model the highly variable runoff processes at plot scale. The objective was to develop a method whereby 1 minute rainfall rate data can be used to predict 1 minute runoff rates because the latter is the required hydrological input for the GUEST technology used in the analysis presented in Chapter 5. Through the

modelling exercise, it became apparent that the spatial variation of the infiltration characteristics at plot scale cannot be ignored and the spatial variability of the maximum infiltration rate can be approximated by an exponential distribution function. At plot scale, the time it takes for water to run off the plot length is comparable with the time interval at which both rainfall and runoff data were logged. As a result, the lag between rainfall excess and observed runoff cannot be ignored. With SSRFM, three important aspects of the runoff processes were modelled at small temporal and spatial scales. Firstly, infiltration was separated into two distinct phases. No runoff occurs in the first phase because the maximum infiltration rate is usually quite high in the beginning of a rainfall event. Secondly, an exponential distribution was used to model the spatial variation in the maximum infiltration rate over the plot once runoff commenced. The net result was that once runoff begins, the runoff rate is closely related to the rainfall rate. Thirdly, a linear storage formulation was used to model the lag between rainfall excess of the plot and the observed runoff rate at the plot outlet. A total of three parameters, one for each of the three aspects of the runoff processes, was used to achieve parameter parsimony. Observed hydrographs were fitted at 1 minute intervals for a total of 100 site-events and SSRFM performed satisfactorily, using a model efficiency measure, and by comparison with the performance of another established hydrological model.

To predict 1 minute runoff rates, not only the required parameter values for each runoff event are needed but also 1 minute rainfall rates as input to SSRFM. While runoff rates at the scale of interest for the purposes of erosion prediction have been successfully modelled, the authors cannot state with any degree of confidence that they are at this stage able to predict 1 minute runoff rates. This is because the parameter values have considerable site-to-site, treatment-to-treatment and event-to-event variations, as Table 2 amply shows. Another obstacle to runoff rate prediction, which is fundamentally more difficult to overcome, is that the authors cannot truly predict, with any degree of accuracy, the rainfall rates at small time scales. The implications of this chapter and the issue of runoff and soil erosion prediction in general will be examined in greater detail in Chapter 8.

Chapter 5

Program GUEST (Griffith University Erosion System Template)

C.W. Rose, K.J. Coughlan, C.A.A. Ciesiolka and B. Fentie

Introduction To GUEST Theory

THIS chapter outlines the theory behind program GUEST (Griffith University Erosion System Template), whose primary purpose is to analyse data on runoff rate and soil loss from bare plots to yield a soil erodibility parameter given by the symbol β . The chapter also outlines the historical development of program GUEST, describes the inputs required in order to use GUEST, and illustrates results obtained from ACIAR Project 9201.

Before it is feasible to predict soil erosion adequately under a variety of conditions, a measure of the soil's resistance to erosion processes is required. While there is a great variety of management methods which can be utilised to reduce soil loss, a benchmark is the erosion which will occur on bare soil, though even here soil loss can be significantly affected by management, particularly tillage.

Program GUEST, originally documented by Misra and Rose (1990), mobilises theory describing soil erosion. This theory has undergone some development during ACIAR Projects 8551 and 9201, and this is reflected in program GUEST, the version used in the latter half of ACIAR program PN 9201 being called GUEST+.

Program GUEST assumes the runoff area can be approximated by a plane surface, which may be rilled. However, GUEST assumes that runoff rate is a measured quantity. With erodibility determined using GUEST, erosion prediction is a separate and subsequent step, though utilising exactly the same type of erosion theory.

Computing methodology

The theoretical basis on which GUEST depends makes a fundamental distinction between the two

types of sediment characteristics that control soil erosion in a bare soil situation. These are:

- soil erodibility, described by β ; and
- soil depositability (Rose et al. 1990) denoted here by ϕ , where ϕ is the mean settling velocity of

sediment given by $\sum_{i=1}^I v_i/I$, where v_i is the

settling velocity of any arbitrary size class i with the total number of equal mass size classes being denoted by I .

The magnitude of the depositability depends on the settling-velocity characteristic of the sediment. However, with the shallow flows quite common in the context of soil erosion from plots of modest size, soil aggregates of size up to some 4 mm which contribute to ϕ may not be fully immersed, and so cannot be considered as contributing to deposition. Hence there is a reduction in value of depositability, ϕ , for shallow water depths to the 'effective depositability', denoted ϕ_e , calculated using the Griffith University Depositability Program (called GUDPRO; Lisle et al. 1995).

Another consequence of non-immersion of larger aggregates is that flow occurs only around such aggregates (assuming they remain in place and do not shift by rolling).

Thus some of the shear stress exerted by flowing water is dissipated on these larger stationary sedimentary units, and only the remainder of shear stress is available to erode other immersed sediment. This reduction in effective shear stress has consequences for soil erosion theory. Program GUDPRO also provides an estimate, for any depth of water flow, of the fraction of the soil surface which is occupied by these larger aggregates.

Data on sediment depositability can be obtained using a variety of experimental methods. The

program GUDPRO accepts data from a variety of experimental techniques and provides, as output to program GUEST, the effective depositability, ϕ_e , and the fraction $(1 - C)$ of the surface exposed to erosion, where C is the fraction covered by larger unimersed aggregates. Both ϕ_e and $(1 - C)$ are provided as functions of the depth of water, D , as is illustrated in Lisle et al. (1995).

A lap-top computer is used to extract data from loggers, and to provide on site a graphical display of the recorded data in cumulative form. This allows some check on equipment operation. Total number of bucket tips per event, measured mechanically, is also compared with the electronic record as a further check.

Program DATALOG converts runoff measurements into average flow rate per minute, Q , and it does the same for rainfall rate. GUEST accepts the input from DATALOG, together with information from GUDPRO, and information on soil loss, plot geometry, instrument and rill configuration (from what is called a configuration file). GUEST then computes the erodibility parameter β for the recorded erosion event. The interactions or relationships between the various programs are illustrated in Figure 1.

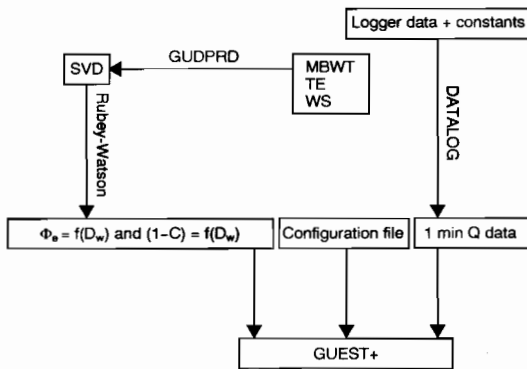

Figure 1. Illustrating the flow relationship between the data preparation program, DATALOG, the program GUDPRO which processes experimental data of soil from the experimental site to give the relationship illustrated in Figure 2, and GUEST+, which uses output from both these programs to yield the erodibility parameter β . MBWT indicates modified bottom withdrawal tube, TE the top entry tube, and WS wet sieving, alternative methods for obtaining the settling velocity distribution (SVD).

In Figure 1, the program GUEST is shown as GUEST+ to indicate recent additions to the original program, these modifications partly being due to the current common availability of greater computing

power. The output of GUEST+ is the erodibility parameter β . The theoretical basis on which the derivation of β depends will now be outlined. A more complete description of this theoretical basis is given by Rose (1993) and Ciesiolka et al. (1995a).

Indication of theoretical bases for β

Foster (1982), among others, recognised experimentally that in the absence of mass movement, there is an upper limit to the observed concentration of sediment in any given soil and flow context. This has been called the 'transport limit' or the 'transport capacity', and is denoted by c_t . Use is made of this limit in many soil erosion models, for example WEPP (Nearing et al. 1989), and EUROSEM (Morgan et al. 1992). These erosion models use experimentally based relationships to estimate c_t in any particular flow circumstance.

Program GUEST, however, uses a theoretically derived expression to estimate c_t (Rose and Hairsine 1988; Rose 1993). The theoretically derived equation for c_t is in good agreement with the experimental database used for c_t where available data make it possible to make that comparison in quantitative terms (e.g., the data of Yang 1972).

This theoretically derived expression for c_t uses the concept of stream power, Ω , introduced by Bagnold (1977) and defined as the rate of working of the mutual shear stresses which exist between water and the soil surface over which it is flowing. Thus:

$$\Omega = \tau V \text{ (Wm}^{-2}\text{)} \quad (1)$$

where τ is the mutual shear stress between flowing water and the soil surface, and V is the bulk velocity of the flow.

The theoretical expression used in GUEST to estimate c_t is based on the following set of assumptions:

- At the transport limit, the eroding surface is completely covered by sediment previously eroded in the same erosion event. Such sediment is termed a 'deposited layer'.
- The mechanical strength of sediment in this deposited layer is negligible. (This assumption is plausible since the typically short dwell time for eroded particles is unlikely to allow bonds of significant strength to develop between neighbouring sedimentary units in the deposited layer.)
- A fraction, F , of streampower, Ω , is used in the process of erosion by flowing water. The magnitude of the fraction F has been found to be commonly in the range 0.1–0.2 (Proffitt et al. 1993), though in some circumstances F may be a little higher (Misra and Rose 1995). (The fraction $(1 - F)\Omega$ is dissipated as heat and noise.)

- Denoting the threshold streampower by Ω_0 (where sediment flux is zero if $\Omega < \Omega_0$), then the term $F(\Omega - \Omega_0)$ can be called the 'effective excess streampower'. This component of streampower is assumed to be consumed in lifting sediment from the deposited layer into the flow against its (downward) immersed weight in water.
- In a steady state (or steady rate) situation, the rate of re-entrainment of sediment from the deposited layer is equal to the rate of deposition. This leads to an equation for c_t which is assumed to hold generally for the sediment concentration at the transport limit, even if conditions are not steady.

It follows from these physical assumptions that the maximum sediment concentration due to flow (the concentration of the transport limit, c_t) is given for sheet flow by:

$$c_t = \frac{F}{\Sigma v_i/I} \left[\frac{\sigma}{\sigma - \rho} \right] \rho S V \quad (2)$$

where F = fraction of streampower used in erosion of sediment,

$\Sigma v_i/I$ = mean settling velocity or depositability of the sediment,

σ = wet density of sediment,

ρ = fluid density,

S = sine of the angle of land inclination (the land slope),

and V = flow velocity, determined from flow information using an appropriate value of Manning's n (discussed later in this chapter).

Should the flow occur in rills, as is quite common, Equation (2) is modified to recognise this altered geometry, but the physical assumptions behind the equation for c_t in rill flow are basically the same as those outlined earlier.

The implication of Equation (2) for c_t in a plane or sheet-flow situation is illustrated in Figure 2. This figure shows c_t increases with Ω , but the rate of increase with Ω declines as Ω itself becomes larger.

While it is possible for the sediment concentration to equal c_t , commonly the actual observed sediment concentration, c , is less than c_t . Theory of how c is expected to vary with Ω when $c < c_t$ is given by Hairsine and Rose (1992a, b) and by Rose (1993). This theory is based on the assumption that for flow to entrain unit mass of a cohesive soil, a certain energy per unit mass, J (joules/kg), must be expended. This energy per unit mass must be related to the strength of the soil matrix. The theory referred to predicts that c will vary with Ω in the form of a unique curve for any given value of J (shown as solid lines in Figure 3). As is discussed more fully in Rose (1993), these curved relationships for different

values of J are very well fitted by the other geometrical forms shown as dashed curves in Figure 3. These dashed curves are for the erodibility parameter β , where β is defined by the simple equation:

$$c = c_t^\beta \quad (3)$$

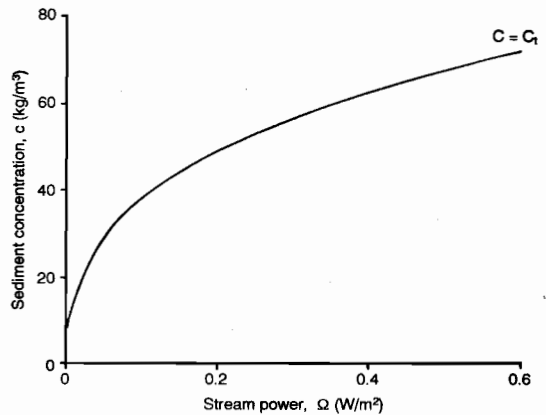

Figure 2. Illustrating the form of variation with streampower in sediment concentration at the transport limit, c_t , for sheet flow.

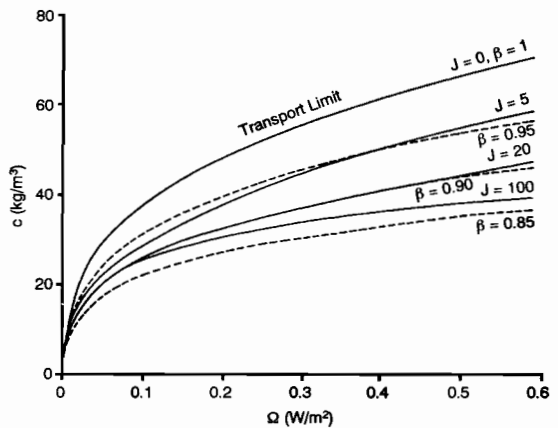

Figure 3. Sediment concentration (c) calculated as a function of streampower (Ω) for various values of a parameter J , related to soil strength, and to the soil erodibility parameter β defined in the text. The uppermost curve describes the transport limit situation for which $c = c_t$, $J = 0$ and $\beta = 1$. Other solid curves apply to increasing values of J (indicating stronger soils), and dashed curves to values of β indicated. Comparison of solid and dashed curves show that the form of variation of c with Ω calculated using the simple Equation (3) using β are similar in form to the results of a more complex equation involving J . (From Rose 1993).

Thus β is the power to which the calculated value of c_t must be raised to equal the measured value of c .

Program GUEST+ calculates an average value of c_t for the entire duration of the event, denoted by \bar{c}_t , calculating β for each minute. This is then related to the average sediment concentration, \bar{c} , measured for the entire event, and then β is evaluated from:

$$\bar{c} = \bar{c}_t^\beta, \text{ or } \beta = \frac{1n \bar{c}}{1n \bar{c}_t} \quad (4)$$

It follows from its definition that the lower the value of β , the lower the erodibility of the soil. There is a dependence of β on soil strength, a soil characteristic which can be measured in the field.

With low streampowers (e.g., low slopes) and for compacted soils, erosion rate commonly depends more on the detachability of soil to rainfall, which is also affected by soil strength and by rainfall characteristics. With low slopes and streampowers and tilled soils, β is commonly close to 1. Whatever the relative contribution of processes to erosion may be, they are effectively incorporated into the value of β determined as described earlier.

Some examples of the values of β and their variation through time for bare soil plots will be given for the project in the section headed 'Inputs to GUEST' later in this chapter.

Historical Developments in the GUEST Program

Like any computer program, GUEST has undergone some change over time. One reason for change has been the development over time in process understanding reflected in the theory on which GUEST is based, this development largely resulting from the application of GUEST to data from a very wide range of conditions and soils in different countries and sites within countries in this ACIAR program. Another reason for change has been the substantial increase in power of portable computers used by collaborators in the successive ACIAR projects, 8551 and 9201.

This section outlines these changes, the reasons for them, and the consequences of these changes for results obtained. There was an original version of GUEST based on the publications of Hairsine and Rose (1991; 1992a, b), and two subsequent versions. Changes are chiefly in the detail of the theory used to calculate the sediment concentration of the transport limit, c_t .

Hairsine and Rose version of GUEST

The expression used in this early version of GUEST is:

$$c_t = \frac{F}{g} \left(\frac{\sigma}{\sigma - \rho} \right) \frac{1}{\phi} \frac{\Omega - \Omega_0}{D} (\text{s.f.}) \quad (5)$$

Differences between Equations (5) and (2) are chiefly that Equation (2) assumes sheet flow in which case $\Omega = \rho g SD$. Also Ω_0 was assumed zero in Equation (2) and in later versions of GUEST. Furthermore

$\phi = \sum_{i=1}^I v_i / I$ is called the depositability, derived

from the full settling velocity characteristics of the soil. The inclusion of a shape factor, (s.f), recognises the role of rill shape on c_t , and (s.f) = 1 for sheet flow.

For rills, (s.f) is given in Hairsine and Rose (1992b) as:

$$\text{s.f} = \left(\frac{W_b}{W_p} \cdot \frac{1}{f} \right) \quad (6)$$

where W_b is the bottom width of the rill, W_p the wetted parameter, and f is a factor (unity for a rectangular rill but assumed >1 for a trapezoidal rill) which expresses the degree to which deposition rate to the base of a trapezoidal rill is enhanced if sediment deposited to the side walls quickly slides down to the rill base before re-entrainment occurs. The ratio (W_b/W_p) in Equation (6) is based on the assumption that re-entrainment takes place only from the bottom of the rill, and (W_b/W_p) represents the fraction of the stream-power effective in re-entrainment.

In the original Hairsine and Rose version of GUEST, Manning's n was assumed constant at $0.025 \text{ m}^{-1/3} \text{ s}$, with no option to vary it.

Misra and Rose (1992) version of GUEST

As shown in Misra and Rose (1992), this version of GUEST (version 2.8), together with its companion program GUDPRO (version 2.1) was provided with an interfacing program EMA (Erosion Modelling Applications, version 1.1). Each program could also be run separately.

As with the Hairsine and Rose version of GUEST, two types of analyses were incorporated. Type A analysis assumed that sediment concentration could be measured as a function of time during an erosion event, a type of measurement found very difficult to achieve practically in the field. Type A analysis, described fully in Misra and Rose (1992), could yield the specific energy entrainment (J , defined in Hairsine and Rose 1992 a, b). Since the necessary automatic sediment sampling equipment necessary in order to determine sediment concentration as a function of time was not used, Type A analysis was therefore not employed in any routine way in field projects, but it was used to assist in the interpretation

of controlled environment data obtained manually in the GUTSR, as reported in Misra and Rose (1995).

Type B analysis yielded the erosion parameter β introduced earlier, and it was this type of analysis which was routinely used in interpreting ACIAR field experiments.

As the result of experience in using GUEST with field data in ACIAR Project 8551, two conceptual changes were introduced which distinguished the Misra and Rose (1992) version of GUEST from its earlier version. These were:

- (a) It was recognised that especially at some field sites, the sediment concentration was sufficiently high (>50–100 kg/m³) that the contribution of sediment to fluid density should not be ignored. The value of density ρ involved in calculating streampower should include the effect of sediment, so that ρ was replaced by an effective fluid density, ρ_e , where to a good approximation:

$$\rho_e = \rho + 0.62c \quad (7)$$

where c is sediment concentration (kg/m³).

- (b) Estimations of depths of flow during erosion events indicated that especially at the ViSCA site, but occasionally elsewhere, the depth of overland flow was so low that larger aggregates which would be used in measuring the settling velocity characteristic would not be immersed. Since unimmersed sediment could not be involved in deposition, it was theoretically inappropriate to include their settling velocity in the calculation of depositability ϕ . Thus the concept of an 'effective depositability', ϕ_e , was introduced, in which the contribution to ϕ of aggregates of size larger than the estimated mean depth of water during the erosion event was ignored.

The magnitude of ϕ_e was calculated in program GUDPRO after calculation of mean water depth in GUEST. Interaction between these two programs was allowed during analysis, so that the appropriate value of ϕ_e was used in calculating c_t via Equation (8), which incorporated changes from Equation (5) to read:

$$c_t = \frac{F}{\phi_e} \left(\frac{\sigma}{\sigma - \rho} \right) \frac{\rho_e SRV}{D_w} \text{ (s.f.)} \quad (8)$$

where R is the hydraulic radius of flow in a rill (= D_w for sheet flow), and for rill flow, $\Omega = \rho_e gSRV$. Note that $\Omega_0 = 0$ is assumed in Equation (8).

Furthermore, during the use of this version of GUEST, experience was gained, especially at the Imbil site, of erosion in trapezoidal rills with narrow base widths which led to reappraisal and modification of the expression given in Equation (6) for the

shape factor (s.f). Use of Equation (6) in the context of narrow-based rills, where $W_b \ll W_p$, and where the slope of the rill side walls were not too steep, led to quite unrealistically low values of c_t (and thus unrealistically high values of β). Thus it would appear that in these circumstances sediment depositing on the rill sidewalls is re-entrained before it has time to slide down to the base of the rill. On the other hand, if trapezoidal rills have steeper sidewall slopes, with sidewall angle greater than say 45°, the situation may be more similar to that of a rectangular rill.

Appropriate theory for the shape factor with trapezoidal rills having sideslope angles $\geq 45^\circ$ (somewhat arbitrarily selected) was developed from the following considerations:

- (a) The rate of deposition of sediment in size class i in a trapezoidal rill is $v_i c_i$ (the rate per unit area) multiplied by the width of the water surface in the rill, which is fW_b , where f is the ratio of the water surface width to the rill base width W_b , defined by rill geometry.
- (b) If re-entrainment takes place along the entire wetted perimeter of the rill, then the area over which the streampower is effective is proportional to W_p .

Equating the rate of deposition ($fW_b v_i c_i$ from (a)), to the rate of re-entrainment which is proportional to W_p leads to the following form for the shape factor in Equation (8):

$$\text{s.f} = \frac{W_p}{f W_b} \text{ (trapezoidal rill } \alpha \leq 45^\circ) \quad (9)$$

where α is the rill sideslope angle.

For a trapezoidal rill with sideslope angle $\alpha > 45^\circ$, then, as described in detail in the GUEST+ Manual, the trapezoidal rill is considered to be replaced by an 'equivalent' rectangular rill of width W given by Equation (17) in the Manual, and then:

$$\text{s.f} = \frac{W}{W_p} \quad (10)$$

where Equation (10) is assumed appropriate either for a trapezoidal rill with sideslope angle $\alpha > 45^\circ$, or a rectangular rill of width W . The reduction in calculated values of erodibility β from use of Equation (9) rather than (6) for trapezoidal rills with $\alpha > 45^\circ$ may be only a few per cent in broader-based rills (e.g., in pineapple cultivation at the Goomborian site), but for steeper-walled narrow-based trapezoidal rills this difference can be much larger, and use of Equation (9) is recommended in this situation. These Equations (9) and (10) are included in the current version of GUEST (i.e., GUEST+).

In the Misra and Rose (1992) version of GUEST, the restriction of Manning's n to a constant value of $0.025 \text{ m}^{-1/3} \text{ s}$ was relieved, because of increased availability of data on Manning's n (see later section headed 'The Role of Manning's n '), and recognition of the important effect it can have on the estimated value of c_e , and thus β . Thus the program was modified so that the value of Manning's n could be read from a GUEST input file along with other variables in the 'batch processing' option of type B analysis. Another change found to improve convenience and readability was to have the input data printed along with the analysis results for the 'batch processing' option of Type B analysis.

Experience with use of the Misra and Rose version of GUEST has led to recognition of a number of limitations in it when water depths become very small, as was the case on some occasions at the ViSCA site. The reason for these limitations can be more readily understood if the expression for ρ_e in Equation (7) is substituted (with $c = c_t$) into Equation (8), which leads to the following expression for c_t :

$$c_t = \frac{F \rho S V (R/D_w) [\sigma / (\sigma - \rho)] (\text{s.f})}{\phi_e \left[1 - \frac{0.62 F S V R}{\phi_e D_w} \left(\frac{\sigma}{\sigma - \rho} \right) (\text{s.f}) \right]} \quad (11)$$

with $R = D_w$ in sheet flow.

As D_w decreases, ϕ_e decreases non-linearly and more rapidly than D_w , thus increasing the second component of the bracketed term in the denominator of the right hand side of Equation (11). The consequent decrease in this bracketed term, amplified by its product with ϕ_e leads to an escalation in the calculated value of c_t that can reach impossible values where calculated c_t exceeds σ . This escalation in c_t continues to infinity as the bracketed term in the denominator of Equation (11) tends to zero.

For even lower estimated values of D_w , the bracketed term in the denominator of Equation (11) can become negative, with c_t therefore negative and meaningless. From Equation (11) this outcome will occur if:

$$\phi_e < 0.62 F S V \frac{R}{D_w} \left(\frac{\sigma}{\sigma - \rho} \right) (\text{s.f})$$

or, using Manning's equation for V , if:

$$\phi_e < 0.62 F \frac{S^{3/2} R^{(5/3)}}{n D_w} \left(\frac{\sigma}{\sigma - \rho} \right) (\text{s.f}) \quad (12)$$

which, for sheet flow, when $R = D$ and (s.f) = 1 becomes:

$$\phi_e < 0.62 F \frac{S^{3/2}}{n} D_w^{2/3} \left(\frac{\sigma}{\sigma - \rho} \right) \quad (13)$$

For this reason, negative values of c_t were calculated by Equation (11) for a few events at the high slope bare plots of the ViSCA site.

These limitations appear because of neglect of other features of shallow flow, as will be discussed in the next section. Thus introduction of the valid concepts of ϕ_e and ρ_e in the Misra and Rose version of GUEST has drawn attention to other limitations in the theory of Hairsine and Rose (1992a, b) which were not so apparent from the first version of GUEST built upon this theory.

GUEST+ (Also denoted GUEST 3.0)

A recognised limitation in the Misra and Rose (1992) version of GUEST was that as the depth of water decreased, ϕ_e decreased, so that as shown by Equations (8) or (11), c_t will increase. Moreover ϕ_e becomes less than ϕ when depth of overland flow falls below the size of the larger aggregates of soil used in determining the settling velocity characteristic of the soil. When this is so, these larger components are not fully immersed and, although they may roll, will act to provide a cover to the eroding soil surface by requiring water to flow around them. Neglect of this cover effect would tend to overestimate c_t .

Furthermore, at the ViSCA high slope bare soil sites in particular, very high sediment concentrations were recorded. So high were some concentrations that theory developed by Rose et al. (1997) indicated that a significant fraction of the streampower would be used in providing momentum to re-entrained saltating particles, reducing the streampower effective in erosion. Furthermore some of this reduced effective streampower would be dissipated in flowing around incompletely immersed larger sediment, as discussed earlier, and only the remaining fraction is available for erosion.

Theory has been developed by Rose et al. (1997) seeking to incorporate these modifying effects which can become important at the very low water depths and high sediment concentrations typical of data from the high-slope bare plots at the ViSCA site, though much less common at other sites in this ACIAR project.

The GUEST+ manual gives the full equations resulting from this theory development, and they are not reproduced here. It may be noted, however, that this more developed theory incorporated into GUEST+ avoids the problem, which emerged in the use of the Misra and Rose (1992) version of GUEST with ViSCA high slope data, that c_t tended to unrealistically high values as depth of water in overland flow tended toward very low values. This will be illustrated later.

Another kind of change was introduced in the program for GUEST+ that arose from the much greater power of portable computers used in ACIAR program 9201 compared to that available during program 8551. Because of such computing capacity limitations, earlier versions of GUEST used a pre-processed value of effective average runoff rate. As shown in Equation (13) of Ciesiolka et al. (1995a), for a given situation, c_t can be expressed as:

$$c_t = kQ^{0.4}$$

where k is a constant, and Q is runoff rate per unit area.

Ciesiolka et al. (1995a) also show that the appropriate flux-weighted value of c_t averaged over an erosion event, \bar{c}_t , is given by:

$$\bar{c}_t = k \frac{\Sigma Q^{1.4}}{\Sigma Q}$$

It follows from these two expressions that an effective average value of Q for the event would be given by \bar{Q} , where \bar{Q} is not a time average value of Q , but given by:

$$\begin{aligned} \bar{Q}^{0.4} &= \Sigma Q^{1.4} / \Sigma Q, \text{ or} \\ \bar{Q} &= \left(\frac{\Sigma Q^{1.4}}{\Sigma Q} \right)^{2.5} \end{aligned} \quad (14)$$

There is possible error introduced in using \bar{Q} , perhaps mainly due to the fact that ϕ_e is not linearly related to Q . Thus, in GUEST+, this use of \bar{Q} was abandoned, c_t was calculated for each set of minute data. Theoretical sediment flux at the transport limit was then calculated for each minute, summed over the event, and divided by total runoff to yield \bar{c}_t for the event. \bar{c}_t was used in the calculation of β using Equation (4).

To illustrate the possible change in calculated values of c_t (and thus β) due solely to the use of one minute calculations in GUEST in comparison to the

use of \bar{Q} , five events from the Kemaman site were analysed. In this analysis the type of theory used was as in GUEST+, the only difference being the use of one minute Q versus \bar{Q} . The difference is illustrated in the last four columns of Table 1 (which also illustrates the effect of use of the different versions of GUEST described in this section). From Table 1 it follows that in this comparison use of one minute data reduced c_t by 3.0% on average over the five events, and β was increased by 1.3%, differences appearing only in the second significant figure for β . This illustration is believed to provide a typical indication of the likely magnitude of change arising from this particular development included in GUEST+, and such change is judged to be of no practical significance. (The use of \bar{Q} increases both ϕ_e and the fraction $(1 - C)$, and the resulting change in c_t and β can be in either direction.)

While this conclusion on the effect of use of one minute Q versus \bar{Q} is believed to hold in most situations, it is possible that somewhat greater differences may emerge under conditions of very low flow depths.

Comparison of the effect of using the three versions of GUEST

Table 1 makes this comparison between using the three versions of GUEST for the five events at the Kemaman bare soil site. For this set of data there was no difference in β given to two significant figures (a level of representation deemed to be of realistic value). However these two earlier versions of GUEST gave values of β some 5% lower than GUEST+ (with 1 minute data). In the context of decisions on soil conservation management this difference is unlikely to be of any significance.

Figure 4a shows the same data on c_t as in Table 1, with the calculation of c_t from GUEST+ using \bar{Q} rather than the 1 minute data since \bar{Q} was used in

Table 1. Comparison of Hairsine and Rose, Misra and Rose, and GUEST+ (using 1 minute runoff data, and using flux weighted average runoff rate). Data from Kemaman bare soil plot (Hashim et al. 1995).

EVENT	c (kg/m ³)	\bar{Q} (mm/hr)	D_w (for \bar{Q}) (mm)	GUEST (Hairsine & Rose)		GUEST (Misra & Rose)		GUEST+			
				c_t (kg/m ³)	β	c_t (kg/m ³)	β	Using 1 minute data		Using \bar{Q}	
								c_t (kg/m ³)	β	c_t (kg/m ³)	β
K070290	1.62	7.45	1.641	72.02	0.11	98.48	0.11	78.91	0.11	82.23	0.11
K130790	10.15	40.84	4.692	134.08	0.47	138.76	0.47	105.54	0.50	108.82	0.49
K021092	2.47	65.69	6.329	157.43	0.18	154.12	0.18	110.16	0.19	113.19	0.19
K111092	6.04	35.71	4.315	127.96	0.37	134.61	0.37	104.51	0.39	107.16	0.38
K081194	7.23	42.45	4.807	135.88	0.40	139.93	0.40	105.96	0.42	109.24	0.42

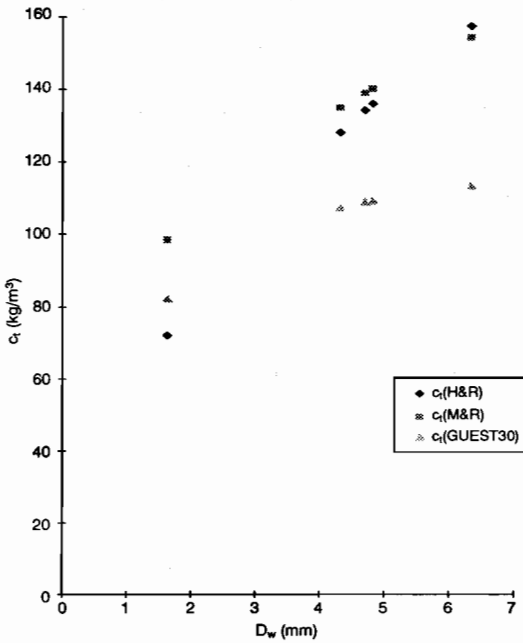

Figure 4a. Comparison of the values of c_t calculated for the three versions of GUEST and the five erosion events at Kemaman given in Table 1, plotted against the corresponding value of D_w . All calculations are based on the use of the flux-weighted mean runoff rate per unit area, \bar{Q} . Symbols used are: \blacklozenge , Hairsine and Rose (1992a, b); \blacksquare , Misra and Rose (1992); \blacktriangle , GUEST+.

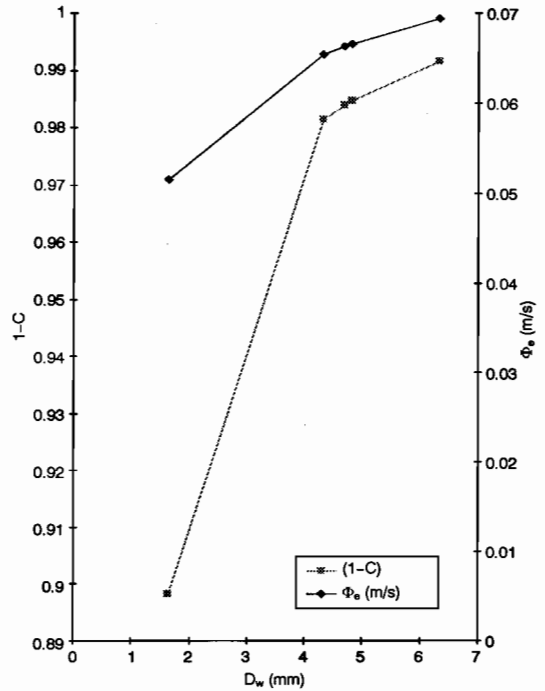

Figure 4b. Values of ϕ_e and $(1-C)$ for the soil at Kemaman to which Figure 4a refers, shown as a function of water depth, D_w .

the other two versions of GUEST. Over most of the range of D_w , the Misra and Rose (1992) version of GUEST gave higher values of c_t . As D_w increased beyond about 2 mm GUEST+ predicted values of c_t which diverged below the other two earlier versions of GUEST. As shown in Figure 4b, at greater depths ≈ 6 mm, $\phi_e = \phi$, and virtually all sediment was submerged, so that the difference in c_t at larger values of D_w in these data are expected to be due to the affect of saltation stress described in Rose et al. (1996).

However 'typical' the conclusions based on the data from Kemaman discussed above, it is necessary to explore other ACIAR data where these differences can be of sufficient magnitude to be quite significant.

Data from ViSCA sites provide a dramatic illustration of two extremes: very low water depth (D_w), and very high sediment concentrations, which GUEST+ was designed to cope with. Figures 5 to 8 show calculated values of c_t for the measured erosion events on the 10% slope, 50% and 70% slope plots respectively, the presence of rectangular rills being recognised on the 50% and 70% plots. For the 10% slope site, calculated c_t is for events in which no rills

were observed, so the flow geometry was assumed planar. For each plot of given slope, a consistent pattern emerges when plotted against average water depth D_w calculated from \bar{Q} .

Figures 5 to 8 show a much closer similarity between calculations of c_t from GUEST+ and the Hairsine and Rose versions of GUEST than for the Misra and Rose version. The data in Figure 8 are the same as in Figure 7, but for clarity use a different scale for the Misra and Rose version and the other two versions. The failure of the Misra and Rose (1992) version at the very low depths in these experiments is very evident, with the behaviour of the solution becoming more unrealistic as D_w decreases. At the greatest measured values of D_w , still only ≈ 2 mm, the discrepancy between the Misra and Rose (1992) version and GUEST+ becomes much less. An analysis based on the theory behind GUEST+ (Rose et al. 1997) suggests that the agreement in trend between the Hairsine and Rose version and GUEST+ is due to a fortunate approximate cancellation of the effect of omissions in the simpler

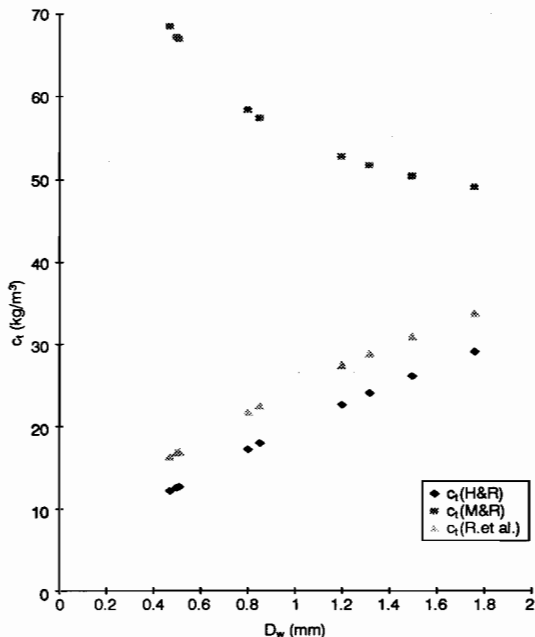

Figure 5. Comparison of the values of c_t calculated for the three versions of GUEST for erosion events on the bare 10% slope plot at ViSCA, when the soil surface was unripped (plane geometry). Symbols are: \blacklozenge , Hairsine and Rose (1992a, b); \blacksquare , Misra and Rose (1992); \blacktriangle , GUEST+.

theory which are important at shallow depths or with high sediment concentrations, but not otherwise. The same analysis also indicates that the dramatic divergence of the Misra and Rose (1992) version at very low water depths results from the inclusion of some valid improvements in the theory (e.g., recognition that ϕ_e can be $< \phi$), but non-inclusion of other effects (such as non-immersion of larger aggregates) which can become important at shallow water depths. This left the theory unbalanced when water depths were very low (< 2 mm approximately), and resulted in increasingly unrealistic behaviour as water depth decreased toward zero.

The third set of data, presented in Figure 9, is from the Imbil site, where D_w ranged from about 2 mm to 14 mm. At $D_w \approx 2$ mm, as found in the data site from ViSCA and Kemaman, all three versions of GUEST did not differ markedly in their estimate of c_t (and thus of β). However, as for the Kemaman data shown in Figure 4, Figure 9 shows the value of c_t computed using GUEST+ to be lower than that predicted by either of the other two versions of GUEST, and presumably for the same reason given for Figure 4, namely due to the effect of saltation stress.

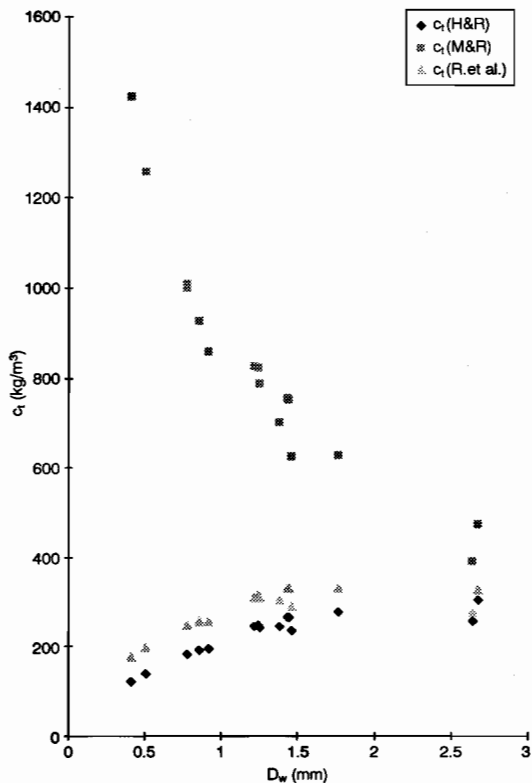

Figure 6. Comparison of the values of c_t calculated for the three versions of GUEST for erosion events on the bare 50% slope plot at ViSCA when rectangular rills were developed on the soil surface. Symbols are: \blacklozenge , Hairsine and Rose (1992a, b); \blacksquare , Misra and Rose (1992); \blacktriangle , GUEST+.

Inputs to GUEST

Data on Q

As mentioned previously, GUEST+ uses the 1 minute data adopted as the standard time base for rate measurement in ACIAR projects 8851 and 9201, these data being provided by DATALOG version 5.2. Both the earlier versions of GUEST due to Hairsine and Rose and Misra and Rose used the single flow-weighted average runoff rate per unit area, \bar{Q} , defined in Equation (14) and prepared for GUEST by program DATAMAN.

As discussed earlier, the choice between these two types of input appears to have little significant effect on β , though the use of minute data in GUEST+ has a theoretical advantage.

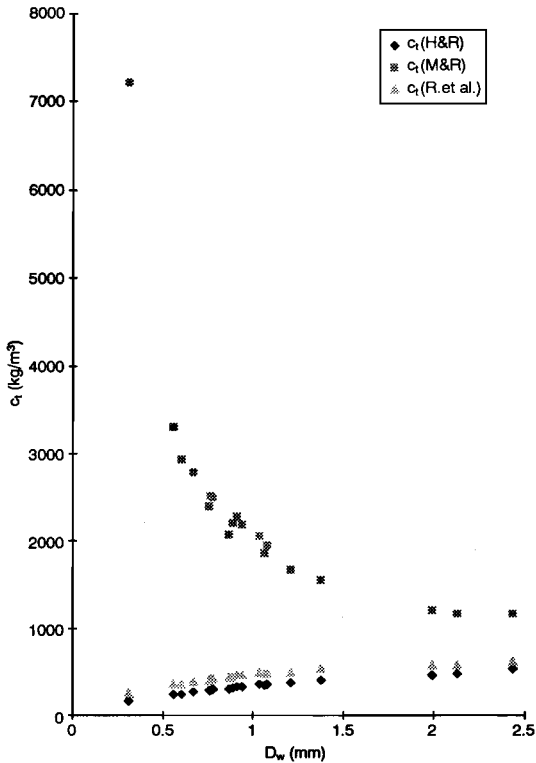

Figure 7. Comparison of the values of c_t calculated for the three versions of GUEST for erosion events on the bare 70% slope plot at ViSCA when rectangular rills were developed on the soil surface. Symbols are: \blacklozenge , Hairsine and Rose (1992a, b); \blacksquare , Misra and Rose (1992); \blacktriangle , GUEST+.

There would be an advantage in a minor program modification to GUEST+ which would allow use of *either* form of input, or which allowed an alternative choice of time, such as the value of 6 minutes used in some long-term data bases.

Geometry of erosion features

As described in the GUEST+ Manual, both the hydrologic and sediment transport components of GUEST allow data processing to proceed where field observation suggests that erosion appears to have occurred from an essentially plane surface (the choice being referred to as 'plane geometry'), or in rills of either rectangular or trapezoidal shape.

It is possible for rills to have been present during an erosion event and for these to be partly or completely 'drowned' or filled with sediment by the end of the event. This was specifically noticed at the

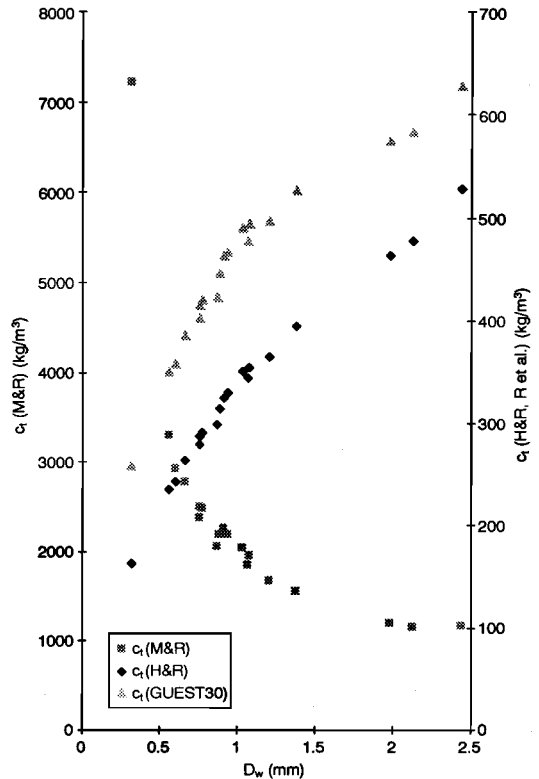

Figure 8. The same data as in Figure 7 but shown for clarity with different scales for calculations based on Misra and Rose (1992), with symbols \blacksquare , and for calculations of c_t based on the two other versions of GUEST.

ViSCA site, but could occur more widely. Adoption of plane geometry is obviously an idealisation. Another idealisation is that irregularity in rill spacing is not acknowledged. Also, rill geometry will obviously change during an erosion event. If geometry measured after the erosion event is a good indication of rill geometry during maximum erosion situation(s), this may be the most appropriate single measurement to use.

GUEST+ output provides a warning if the calculated depth of water in a rill exceeds the rill depth, which might indicate an inadequacy of input measurement.

Wet density of sediment

The wet density of sediment, σ , is an important parameter in Equation (5), which is used to calculate the sediment concentration at the transport limit, c_t .

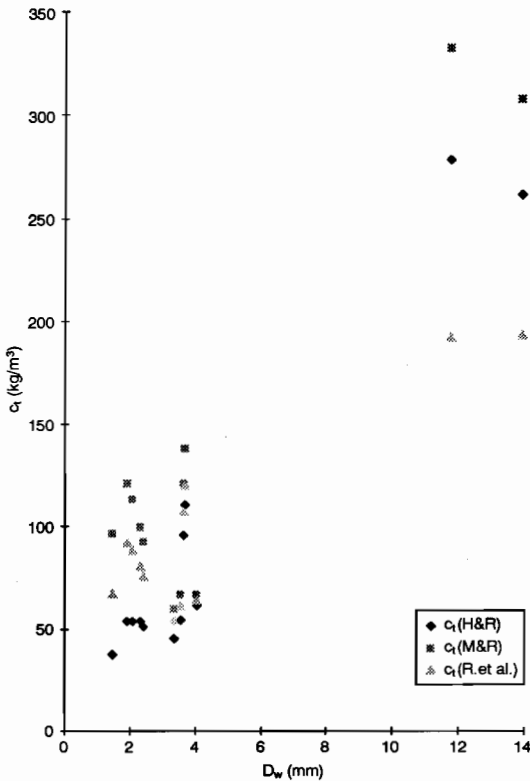

Figure 9. Comparison of the values of c_i calculated for the three versions of GUEST for erosion events on the Imbil, Queensland, pineapple plots, where flow is in the trapezoidal channels produced for pineapple culture. Symbols are: \blacklozenge , Hairsine and Rose (1992a, b); \blacksquare , Misra and Rose (1992); \blacktriangle , GUEST+.

The Hairsine and Rose version of GUEST used a constant value of σ of 2000 kg/m^3 . However, there is considerable data in the literature suggesting that σ may vary from 1500 kg/m^3 to 2650 kg/m^3 , depending on sediment size and texture.

The CREAMS model (Knisel, 1980 p. 226) uses values of $1600\text{--}1800 \text{ kg/m}^3$, for aggregates $>0.02 \text{ mm}$, which constituted greater than 80% by weight of sediment in the soils studied. A value of $2600\text{--}2650 \text{ kg/m}^3$ is used for primary silt and clay particles.

Loch and Rosewell (1992) estimated σ for 13 Australian soils from a comparison of wet sieving measurements (using sieves ranging from 0.125 to 5.0 mm) with settling velocity determined using the top entry tube. Settling velocity is converted to 'equivalent sand size' using algorithms contained in CREAMS. The algorithms include wet density as a parameter. Measured size distributions from wet

sieving were matched with calculated size distributions from settling velocity, and average σ for each soil was estimated from the best matching of measured and calculated size distribution.

Loch and Rosewell (1992) developed an equation relating σ to percentage of primary (sand) particles $>0.02 \text{ mm}$. The equation was:

$$\sigma = 1462 + 48 (1.03259)^X \quad (15)$$

where $X = \% \text{ primary particles } >0.02 \text{ mm}$.

Values calculated from this equation, or values obtained from experience or measurement, may be input into current versions of GUEST and GUDPRO, where it is required to convert water stable aggregate data (if measured) into settling velocity distributions.

Information related to settling velocity characteristics

GUDPRO 3.1, the Griffith University Depositability Program, performs calculations on laboratory measurements relating to settling velocity characteristics of waterstable soil aggregates. It can accept Modified Bottom Withdrawal Tube data (Lovell and Rose 1988), Top Entry Tube data (Hairsine and McTainsh 1986) or Wet Sieving data. GUDPRO will estimate a settling velocity distribution (and optionally a grain size distribution), and provides a table of values of effective depositability, (see equations (8) and (11) for input into GUEST (Misra and Rose 1992).

The second type of information provided by GUDPRO 3.1 (Lisle et al. 1995) is the fraction of the soil surface covered by aggregates which are immersed by water, and assumed therefore to be erodible. In situations where water depth D_w is less than the size of the largest waterstable soil particle, the theory for entrainment is modified in two ways. First, not all particles can participate in the entrainment process. As a first approximation, it may be assumed that particles with diameter $D_p > D_w$ cannot be entrained by runoff processes. If particles with a settling velocity of $v \geq v_{max}$ are too large to be entrained, the summation of velocities for size classes v_i in calculation of ϕ must be carried out only up to the velocity v_{max} . The settling velocity curve is then effectively truncated to include all sediment finer than or having settling velocity $v = v_{max}$. That truncated part of settling velocity curve with $v \leq v_{max}$ is then divided into I equal size classes. Then the appropriate depositability of sediment, termed the effective depositability ϕ_e , is given by the summation

$$\phi_e = \sum_{i=1}^I \bar{v}_i / I$$

where \bar{v}_i relates to the new division into size classes, not being the same as the values of v_i used for calculating ϕ when the entire settling velocity curve is used (and also divided into I equal size classes). Further details are given in the GUDPRO 3.1 Manual (Lisle et al. 1995).

The second adjustment when the overland flow in an erosion event does not submerge all potentially erodible soil aggregates is as follows. Suppose of the total I size classes, only those classes up to m are submerged. The fraction of the surface shear stress acting on potentially erodible particles of size less than or equal to the depth of flowing water is assumed proportional to the fractional area of the soil surface occupied by these particles. Denoting the fraction of the soil surface covered by non-erodible larger aggregates by C , the fraction covered by erodible aggregates is $(1 - C)$.

As shown in the GUEST+ Manual, the fraction $(1 - C)$ can be calculated from the distribution of settling velocity v and particle diameters D_p from:

$$1 - C = \left(\sum_{i=1}^m v_i / D_{pi} \right) / \left(\sum_{i=1}^I v_i / D_{pi} \right)$$

GUDPRO 3.1 calculates $(1 - C)$ using the Rubey-Watson relationship between v and D_p described in the GUDPRO Manual. This information is passed on to program GUEST+ in such a way that GUEST+ has available a value of $(1 - C)$ for any value of water depth D_w . The GUEST+ Manual then shows that:

$$c_t \propto \frac{1 - C}{\phi_e}$$

It should be noted that, as D_w decreases, both $(1 - C)$ and ϕ_e are reduced, so that the effect on c_t of varying D_w in isolation is not immediately apparent, except at very low values of D_w .

Note that even if $D_p > D_w$, it is possible that particles may move by rolling along the soil surface or by mass movement under gravity. These processes are not represented in GUEST+.

Kemaman site

Settling velocity characteristics, and thus the depositability ϕ can vary with treatment and soil type. Variation with treatment is illustrated by data from Kemaman where measurement of ϕ on samples from treatments T1 and T2 in September 1995 showed a significantly higher value of ϕ in the grassed treatment T2. This difference in ϕ is probably due to stable earthworm casts in T2, since it

has been shown (Chapter 7) that earthworm numbers are higher in T2 and that earthworm casts are much more water stable than the bulk soil.

Settling velocities for T1 and T2 are shown in Table 2.

Table 2. Settling velocity distribution for treatment plots, Kemaman.

Settling velocity (m/s)	% <	
	T1	T2
0.2	100	94
0.1	97	69
0.05	80	35
0.01	23	20
0.002	16	18

Depositabilities for T1 and T2 at the maximum calculated average water depths were 0.028 and 0.068 m/s respectively. Calculations show that this increase in ϕ decreases c_t by about 70%.

The role and determination of Manning's n

The maximum sediment concentration which can be produced due to soil erosion driven by overland flow and rainfall, called the sediment concentration at the transport limit, c_b , is proportional to the velocity of overland flow, V (Rose 1993). In evaluating the erodibility of soil, β , it is necessary to estimate c_t and thus V , which is not a quantity normally measured in field studies of soil erosion.

For overland sheet flow, flow velocity V is related to the depth of flow, D , by Manning's equation:

$$V = \frac{S^{1/2}}{n} D^{2/3} \quad (16)$$

where S is the land slope (the sine of the slope angle), and n is Manning's roughness coefficient. Also mass conservation requires that:

$$q = DV \quad (17)$$

where q is the volumetric flux per unit width of flow. From equations (16) and (17) it follows that:

$$V = \left(\frac{S^{1/2}}{n} \right)^{3/5} q^{2/5} \quad (18)$$

Should flow be contained in a channel of hydraulic radius R , Manning's equation corresponding to (16) is:

$$V = \frac{1}{n} S^{\frac{2}{3}} R^{\frac{2}{3}} \quad (19)$$

with the volumetric flux, G , in the channel, where the cross-sectional area of flow is A being given by:

$$G = AV \\ = A \frac{1}{n} S^{\frac{2}{3}} R^{\frac{2}{3}} \quad (20)$$

In erosion studies on runoff plots of the type described in this report, what is measured is q (or runoff rate per unit area, Q , to which q is related by $q = QL$, where L is the length of runoff). As is illustrated by Equation (18) in order to calculate V from measured q and S , Manning's n is required to be known.

In principle it is possible using Equation (17) to determine V from measured q if flow depth D is also measured. However in practice the measurement of overland flow depth is difficult to automate, and even with manual measurement is subject to significant error. This is partly because of the spatially-variable depths of flow typical in runoff plot experimentation and to experimental difficulty in accurately defining the soil-water interface.

For these reasons it is desirable, where possible, to determine Manning's n and to evaluate it in a manner not dependent on the measurement of flow depth. An illustration of the importance of the value of Manning's n on calculated value of c_t (and thus of β) is illustrated in Table 3 for a typical runoff event at the Imbil, Gympie site.

Table 3. Calculated sediment concentrations using Manning's n as a variable for typical runoff event.

Manning's n $m^{-\frac{1}{3}} s$	Sediment concentration \bar{c}_t (kg/m ³)
0.015	99.6
0.030	67
0.050	48.4

This range of Manning's n values is well within the range measures for bare soils.

Values of Manning's n tabulated for example in hydraulic texts are usually for much greater depths of channel flow than is common in overland flow. Such tabulated values provide some guide but do not remove the need to experimentally determine Manning's n .

In order to evaluate Manning's n the use of a coloured dye or an electrolyte (e.g., common salt) as

a tracer has been found to be suitable. Especially when determining n for flow through living vegetation it is preferable to use a dye such as fluorescence, rather than salt. For studies with bare soils in the field or in the GUTSR facility, the addition of salt solution has advantages in accuracy and convenience as will be discussed below.

In general the value of Manning's n is found to decrease with increasing velocity, becoming somewhat constant at higher velocities of flow. This general feature is illustrated in the data analyses presented below.

Experimental Studies

Dye measurement of flow velocity

Flow velocity measured using dyes is usually determined by adding a band of dye and timing the passage of the band of dye between two measuring stations. Dispersion of the dye band can make assessment of the transit time uncertain.

Figure 10 shows results for Manning's n at two ACIAR sites, Los Baños and Kemaman. All data shown, except for the bare soil treatment, had surface contact covers in the range 40–50%. The spatial patterns of flow over cultivation ridges and through and around mulch or hedgerows in treatments T2 and T4 at Los Baños were closely observed and recorded and found to be quite complex.

In the experiments at Los Baños, water was pumped to the top of a 1 m wide transect of the treatment bay. The average velocity of flow between two stations some 3 m apart was determined using dye tracing, and the average depth of flow was measured at 2.5 cm intervals across these two stations and at an intermediate station. These data were used to determine Manning's n using Equation (16).

At Kemaman, dye tracing experiments were carried out in areas of flow concentration in the treatment plots during a storm event. Volumetric flux q was measured (rather than flow depth) by a timed volume of runoff from a 1 m wide strip, and Equation (18) used to calculate n .

Data thus obtained on Manning's n from the two sites are shown in Figure 10 fitted using a single solid curve with an exponentially decreasing segment changing to a constant value of $n = 0.05 \text{ m}^{-1/3} \text{ s}$ for $V > 0.25 \text{ m/s}$. A detailed description of the various treatments referred to for the two sites is given in Paningbatan et al. (1995) for Los Baños, and in Hashim et al. (1995) for Kemaman. The dashed curve is for bare or less vegetated plots at Los Baños. See the figure legend for details.

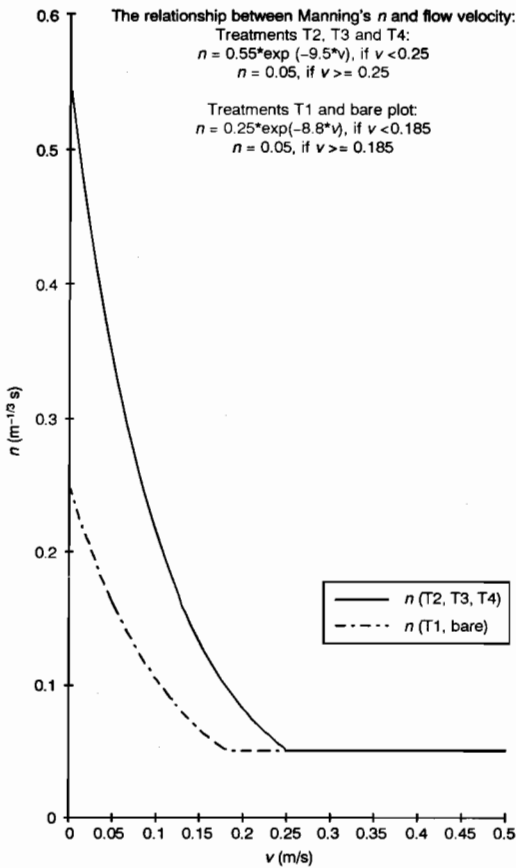

Figure 10. Relationships fitted to experimentally determined values of Manning's n for various cropping treatments at Los Baños (described by Paningbatan et al. 1995), and at Kemaman (described by Hashim et al. 1995). The solid curve is for treatments T2, T3, and T4 at Los Baños, and the dashed curve for bare soil and treatments T1 and bare soil. Experiments carried out at Kemaman indicated that the lower (dashed) curve was appropriate for the small bare soil plot and also for treatment T1. The upper (solid) curve was appropriate for treatment T2 (with ground cover). Surface contact cover for T1 was <10%, consisting of dry leaves; cover for T2 had >70% cover by grass.

Dye tracing techniques were also used to determine Manning's n for flow in furrows formed in pineapple cultivation at the Goomboorian site. At this site, Manning's n was calculated for pumped water inflow using Equation (18), with q being measured by tipping bucket technology. Results of these field experiments will be given in Figure 12 to compare with data obtained using a different technique but with the same soil type.

Measurement of flow velocity over bare soil surfaces by electrolyte addition

The electrolyte used was a 25% sodium chloride (NaCl) solution. As noted by Luk and Merz (1992), the main advantage of the salt tracing technique is that the mean velocity, or strictly the temporal pattern of conductivity change at the measured site, is more objectively determined than the visually-estimated arrival of a dye front. The salt-tracing technique was used in experiments using the Griffith flume (GUTSR) which is 8 m long and 1 m wide. Experiments were carried out with runoff generated by rainfall alone, and with runoff generated by a constant inflow at the top of the flume, without rainfall.

Experimental procedure

Prior to each flume experiment the soil bed in the flume was saturated with water, so that there was no infiltration.

At the starting time of each flume experiment (denoted as $t = 0$), 500 mL of 10% NaCl solution was introduced across the 1 m width of the flume, 4 m from the flume exit. Electrical conductivity (EC) of runoff water was monitored at the exit with an EC meter, with output recorded on an electronic data logger.

Figure 11 illustrates how electrical conductivity measured at the end of the flume varies with time, results being for runoff at the top of the flume with the soil bed at the three slopes shown.

Theory

Briefly, experiments in the GUTSR to determine n were performed in a number of different ways, but always with pre-saturated soil in the bed so that there is no infiltration. Types of experiment included:

- (i) No rainfall and water supplied as run-on at the top of the flume.

In this type of experiment:

$$n = \frac{S^{0.5} q^{0.667}}{V^{1.67}} \quad (21)$$

where S is slope, q volumetric water flux per unit width (constant down the flume), and V the velocity of flow.

- (ii) With rainfall and no run-on.

Let x denote distance downslope from the top of the flume, with $x = L$ at the exit from the flume. Denote the value of x at which an electrolyte is added to overland flow by x_e .

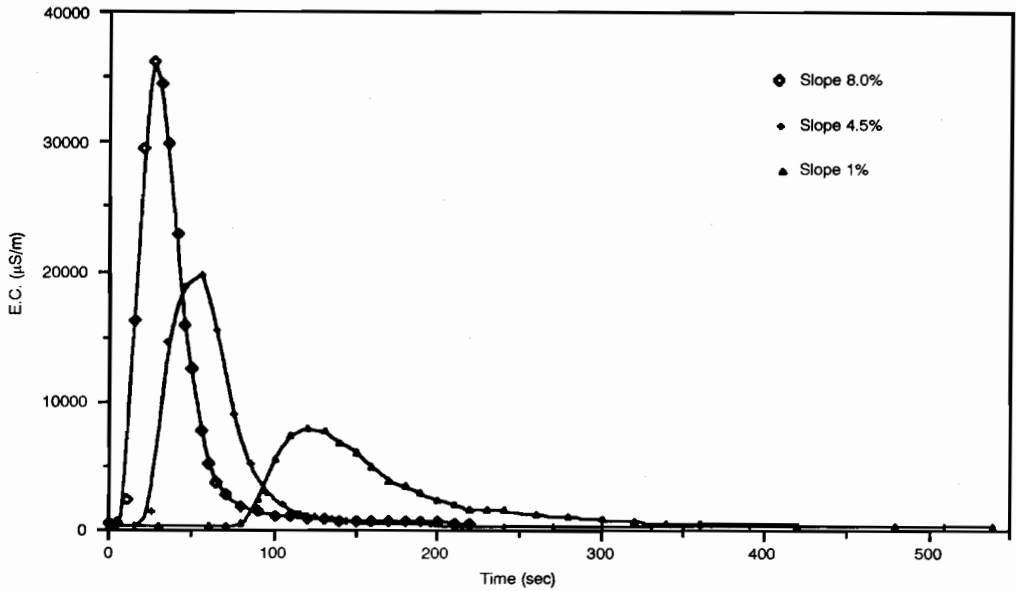

Figure 11. Variation of electric conductivity (E.C.) measured through time in flume experiments at the three different slopes shown in the Figure.

Then it can be shown that:

$$n^{0.6} = \frac{S^{0.3} Q^{0.4} (L^{1.4} - x_e^{1.4})}{(L - x_e) \bar{V}^{1.4}} \quad (22)$$

where the average velocity of flow from $x = x_e$ to $x = L$ is calculated from:

$$\bar{V} = \frac{L - x_e}{\bar{t}}$$

where \bar{t} is the transit time for the electrolyte to move from $x = x_e$ to $x = L$.

Results

An example of the results obtained from experiments with run-on only are given in Table 4. Calculated Manning's n from these runs were plotted against velocity (Figure 12) together with data from field

Table 4. Results from three GUTSR experiments with soil from the Goomboorian site.

Date	Slope %	Average q (m ² /s)	t (s)	Average V (m/s)	n (m ^{-1/3} s)
8/4/94	1.0	0.00010	120	0.0333	0.0810
7/3/94	4.5	0.00010	55	0.0727	0.0381
14/3/94	8.0	0.00011	25	0.1600	0.0140

measurements carried out by Ciesiolka on the same soil (Goomboorian) and for a different soil (Imbil). Figure 12 illustrates that field data for the Goomboorian soil extrapolate the curved relationship for the flume experiments, suggesting that the two methods of estimating Manning's n give consistent results.

Field results from the Imbil soil (Figure 12) show relatively higher values of Manning's n . This is expected because of the breccia or conglomerate which accumulates on the surface of this soil, adding to its surface roughness. For both soils, Manning's n decreases with increasing flow velocity.

Figure 12 illustrates that in general the functional relationship between Manning's n and flow velocity, V , i.e. $n = n(V)$ should be determined for each experimental site. In general the value of n decreases with V until some approximately constant value of n is achieved at higher flow rates (see Figures 10 and 12). Furthermore, if rilling occurs, the functional relationship is similar in general shape, but gives higher values of n for the same value of V than if no rilling occurred.

The use of Manning's n in GUEST+

In GUEST only a constant value of n could be used in analysis. In GUEST+ there is the capacity to enter

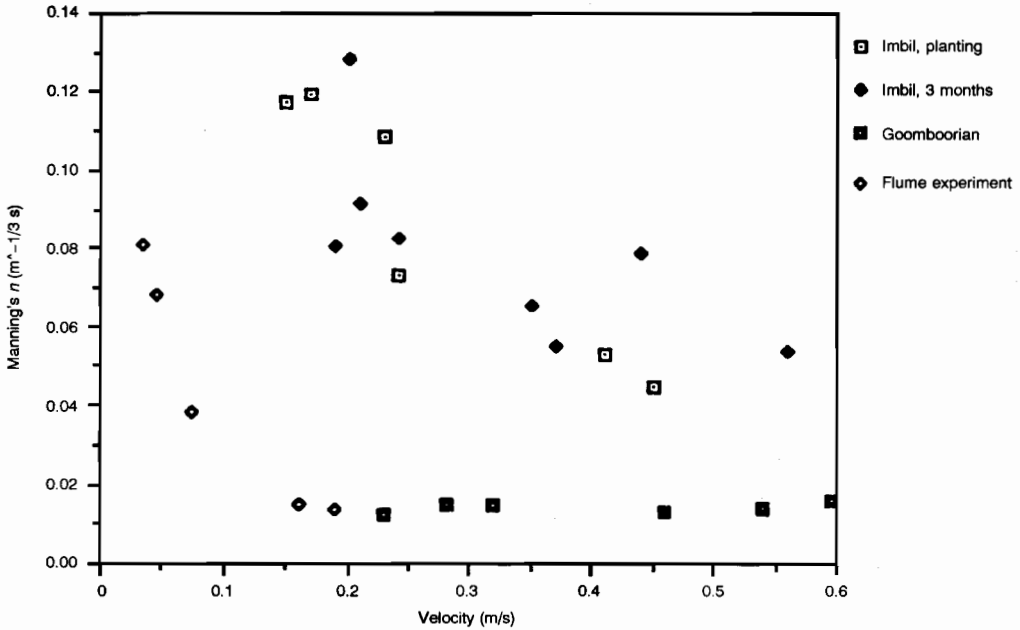

Figure 12. The relationship between the value of Manning's n calculated from experimental data and velocity of flow. The lower continuous relationship is for experiments in the GUTSR using added electrolyte as illustrated in Figure 11, \blacklozenge , and field measurements from the Goomboorian pineapple site using added dye, \blacksquare . The data showing higher values of Manning's n are from the Imbil pineapple site, following planting, \square , and three months later, \blacklozenge .

any value of n estimated to be the most appropriate for the event and location. Even though c_r is calculated minute by minute in response to fluctuations in Q , fluctuation in Manning's n at this time scale are not computed. Rather, the program DATASUM is used to calculate the flux-weighted average runoff rate per unit area, \bar{Q} defined as:

$$\bar{Q} = \left(\frac{\sum Q^{1.4}}{\sum Q} \right)^{2.5} \quad (23)$$

which follows from theoretical considerations given by Ciesiolka et al. (1995a).

The average flow velocity, \bar{V} , effective for the storm event which corresponds to the value of \bar{Q} calculated from Equation (23), is then calculated using formulae which depend on whether flow is in rills or is better approximated by sheet flow.

Denote the appropriate experimentally-determined dependence of n on V (as illustrated in Figures 10 and 12) by $n(V)$.

Then the calculation of \bar{V} from \bar{Q} for sheet flow can be shown to be:

$$\bar{V} = (\bar{Q}L)^{0.4} \frac{S^{0.3}}{[n(\bar{V})]^{0.6}} \quad (\text{Sheet flow}) \quad (24)$$

where L is plot length.

Should flow be in rills, approximately described by rectangular rills of width W_b , with N rills per metal width, then it may be shown that:

$$\bar{V} = \frac{S^{0.5}}{n(\bar{V})} \left[\frac{W_b}{2 + \frac{W_b^2 NV}{QL}} \right]^{\frac{2}{3}} \quad (\text{Rill flow}) \quad (25)$$

With the appropriate value of \bar{V} determined using Equation (24) or (25), then the relevant relation for $n(\bar{V})$ can be interrogated to yield the effective average value of Manning's n to use in GUEST+.

Results Obtained from the Analysis of β

Results will first be presented for each of the sites involved in ACIAR program 9201, and then some generalisations made. The section will conclude with consideration of the possible relationship between β and soil strength, and the wider uses of program GUEST.

Kemaman site

The characteristics of these sites have been described in Hashim et al. (1995). The variation in β for the

bare soil plot at this site is shown for the period 10/1989–4/1995 in Figure 13.

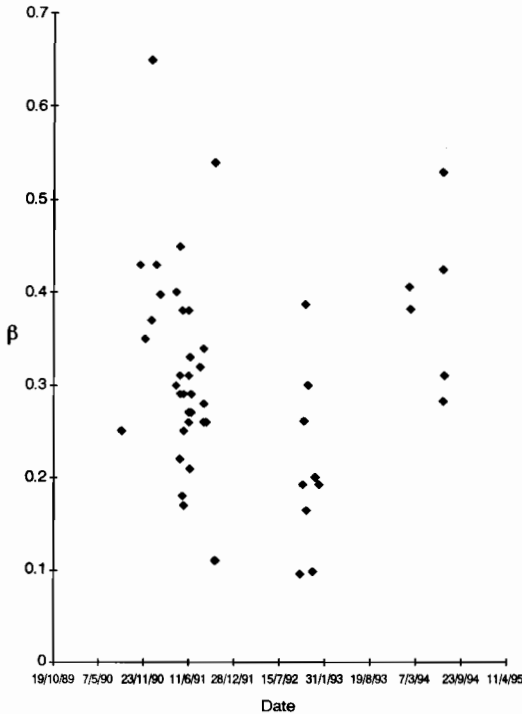

Figure 13. The erodibility parameter β plotted as a function of time for the bare soil plot, Kemaman site.

Figure 13 indicates both a short-time variability in calculated values of β , combined with a possible longer-term trend. This long-term trend is for the average value of β to be in the range 0.3–0.4 in the first year, during which a good deal of top soil was lost from the plot. The data obtained in late 1992 indicate a decline in average β to ≈ 0.2 , followed by an increase to ≈ 0.4 by mid 1994. At this later stage, much of the top soil had been lost and the eroding surface was highly weathered subsoil with evidence of the decomposing rock material from which it was formed.

Calculation of β for the large treatment plots T1 and T2 is less certain due to uncertainties in cover in the preferred pathways, and in their flow geometry. Despite these uncertainties there was no consistent difference between the values of β estimated for the treatment T1 and the small bare soil plot, both of which experienced high soil losses. There was also a

tendency for the values of β to be higher for treatment T2 (average value 0.6). This is consistent with the friable surface soils with high biological activity noted on this treatment plot. Though more erodible, soil loss was lower due to increased infiltration and less runoff as shown in Tables 1 and 4 in Chapter 6.

Los Baños

The details of this site are given in Paningbatan et al. (1995), in which the variation in β for 1990 was presented. The bare soil plot, from which data β is derived, received the same type and frequency of cultivation as the crops whose growing period is shown as a horizontal line in Figure 14. Figures 15–16 show values of β through time for the years 1991 and 1993 also.

There are examples of a substantial increase in β following cultivation (e.g., following the first cultivation in 1990), and values of β greater than unity obtained in 1990 and 1993 were not repeated in 1991, where the average value of β is ≈ 0.7 . The interpretation of $\beta > 1$ is that some erosion process other than that due to overland flow, such as rainfall detachment and redetachment, mass movement or cultivation effects may be leading to soil loss. There is growing evidence of the importance of cultivation in redistributing soil within the alley of hedgerow systems, but whether or not this enhances soil loss from the plot by means other than the effect of cultivation on increasing β is uncertain.

In both 1991 and 1993 there was a general tendency for the value of β to decline during the year. Paningbatan et al. (1995) may be consulted for further comment.

ViSCA

Details of the bare soil plots at this site are given in Presbitero et al. (1995), where the values of β for the site of 10% slope are presented and discussed. These results are also shown in Figure 17.

Results on β for the plots of high slope (50%, 60% and 70%) will be given in a PhD thesis in preparation by A. Presbitero.

Queensland sites

(a) Imbil

The description and results for β obtained at this site have been given by Ciesiolka et al. (1995b), for the period 1989 to early 1991.

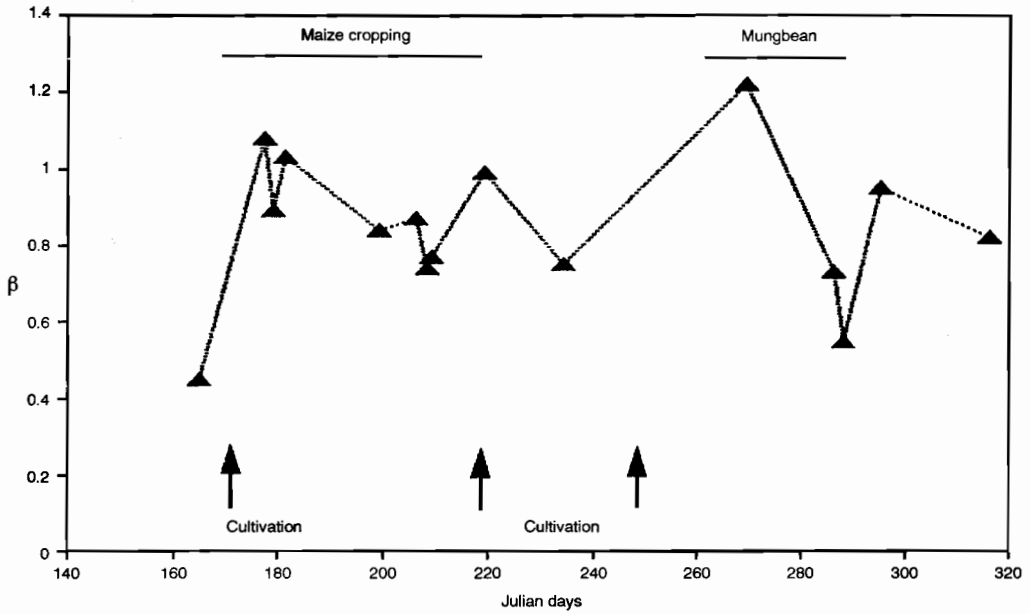

Figure 14. The erodibility parameter β plotted as a function of time for the bare soil plot at Los Baños, for 1990. The plot was cultivated at times indicated, in phase with cultivations carried out on adjacent plots with maize followed by mungbean.

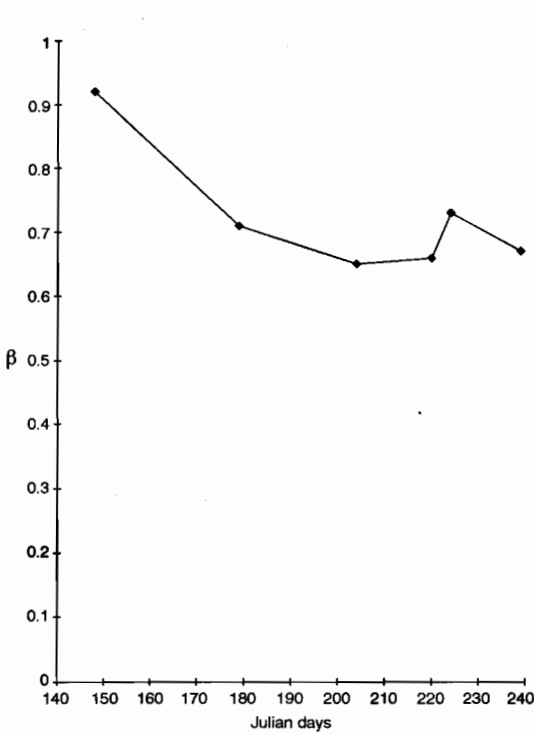

Figure 15. The erodibility parameter β plotted as a function of time for the bare soil plot, Los Baños, during 1991.

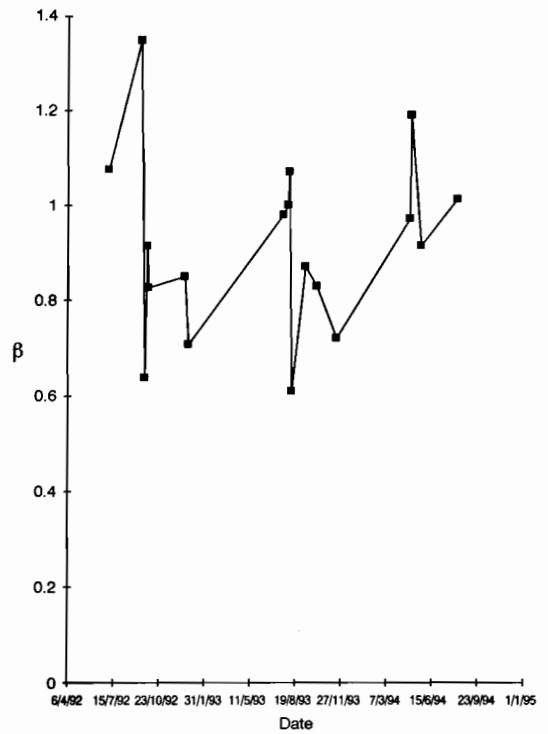

Figure 16. The erodibility parameter β plotted as a function of time for the bare soil plot, Los Baños, during 1993.

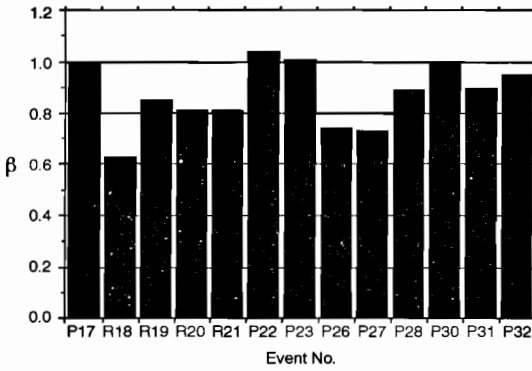

Figure 17. Variations in the erodibility parameter β for a number of erosion events on the 10% slope bare soil plots at the ViSCA site. The letters R and P prior to event numbers indicated rilled (R) and unrilled or plane (P) events over the period 1989 to 1991.

(b) Goomboorian

At this site pineapples are grown on a bed/furrow system with sloping sidewalls. The slope of this system of cultivation for the bare plot was 5%, and slope length 36 metres. The soil type was a loamy sand or Albic Arenosol (FAO classification). Following cultivation and formation of the

bed/furrow system, sediment lost from the cultivation system is believed to result chiefly from erosion of the unconsolidated sidewalls of beds, which deliver sediment to the furrows. As sidewalls consolidate, material from the furrow base or channel is believed to provide more of the sediment lost from the system. There was evidence, both from the bare plots and plots protected from rainfall impact by porous Sarlon sheet, that the streampower of flow in the furrow was sufficient for flow-driven erosion processes to play a significant, though possibly not dominant, role in erosion in comparison with erosion driven by rainfall impact.

The experiments were located on farms where the conservation practices and layouts were already recognised to be of a high standard in the industry. Consequently, when the mulch and tied ridge treatments reduced soil loss to 8–10 t/ha over the 40-month period compared with 150 t/ha over the same period for the conventional treatment, growers have shown a keen interest in the techniques. Average sediment concentrations for the bare, conventional and mulched plots were 75, 32 and 2 kg/m³.

Two experiments using a shade cloth and live pineapple leaves found that raindrop detachment in conjunction with runoff moved more soil out of the plots than with runoff alone protected from raindrop impact.

Figure 18 shows the variation in β for the bare plot at this site from mid-1992 to the end of 1995. Following formation of the ridge/furrow system on

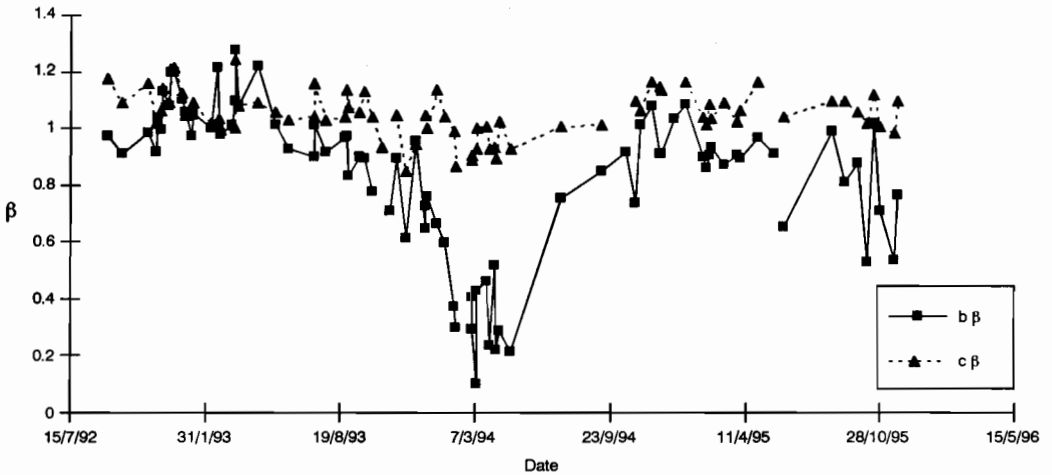

Figure 18. Variation with time in values of the erodibility parameter β at the Goomboorian pineapple site, Queensland. The dashed line joins data points for the bare plot; the solid line joins data points for the conventionally cropped plots.

22/8/92 there was no subsequent cultivation, weeds being chemically controlled. The figure shows a slow decline in β for the bare soil from about 1.1 at the commencement of the experimental period to about 1.0 at the period end, presumably reflecting a steady consolidation and strengthening of the soil, as discussed in the next section. The highest value of β early in the experimental period was obtained following an intense hailstorm in which large hail would have been expected to cut up the soil surface, making it more erodible. The temporal fluctuations evident in Figure 18 for β derived from data collected on the bare plot were paralleled both in direction and in timing on the adjacent plot with pineapples. Thus these fluctuations in β would appear to be real, and not random in nature. The cause of these fluctuations is uncertain, but could be associated with 'pulsing' of eroded sediment through the 36 metre long ridge/furrow system.

To investigate whether or not the fluctuations in β might be associated with variation in the relative importance of flow versus rainfall-driven erosion processes, β was plotted against the ratio of the flux-weighted average values of runoff rate per unit area and rainfall rate, with results in Figure 19. These results do not indicate strong support for this possible cause of temporal fluctuations in β . However, when $\beta > 1$ a possible reason for this is a contribution by rainfall impact to sediment concentration.

Examining the possible relationship between β and soil strength

As explained by Rose (1993), there can be a relationship between the erodibility parameter β and soil strength. Such a relationship is more likely to be evident in situations where the eroding surface is reasonably stable, without too active rilling, and in the absence of active rill processes such as head cutting or rill wall collapse. Such active rill processes lead to sediment concentration fluctuating substantially through time between an upper limit set by the sediment concentration at the transport limit, c_t , and a lower limit, the source limit, as is illustrated in Figure 20.

In situations of this kind, the strength of the soil is likely to be involved in the value of the lower source limit, but will not be at all well related to the average sediment concentration on which the value of β depends, as shown in Equation (3). Under such circumstances, no relationship would be expected between β and soil strength.

As shown in Hairsine and Rose (1992a, b) and in Rose (1993), the strength of the soil is expected to be related to the specific energy of entrainment, J , defined as the energy required per unit mass of soil to entrain sediment. If flow-driven erosion processes are not too vigorous, then sediment concentration will be at the source limit (which can vary with time

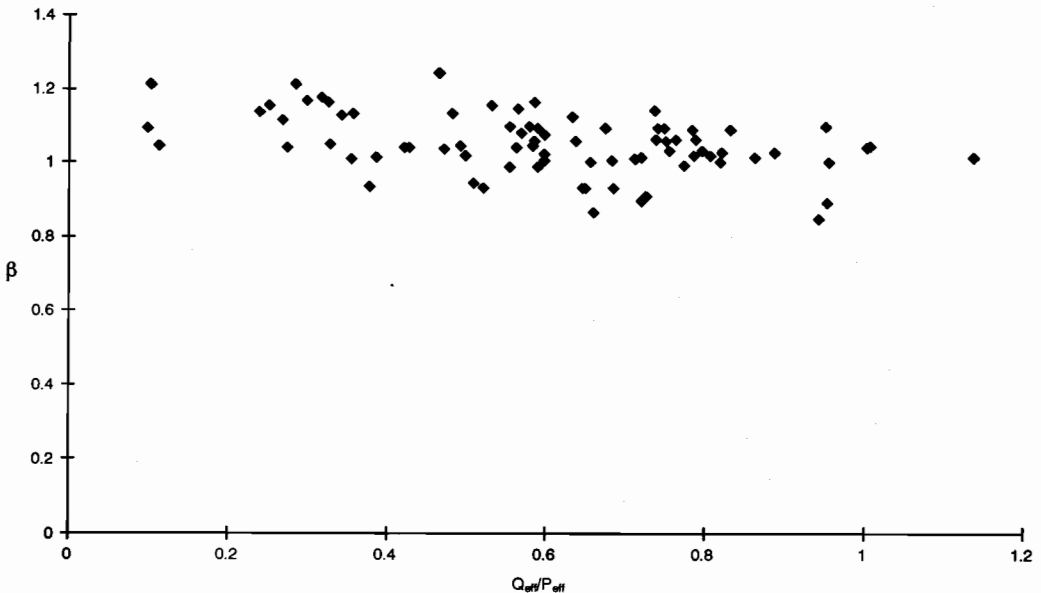

Figure 19. The data shown in Figure 18 plotted against the ratio of flux weighted values of Q and P.

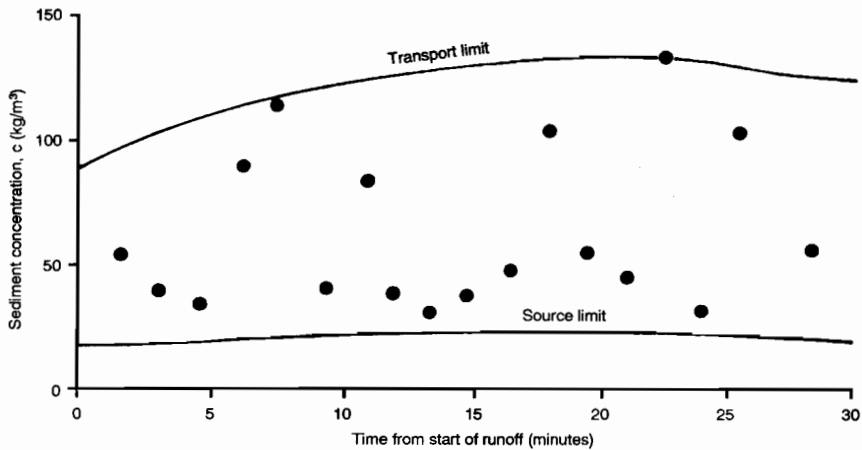

Figure 20. Total concentration for sediment eroded with active rilling from a soil, initially air dry with a plane surface, wet with simulated rainfall, and then subject to 100 mm/hr rainfall and clear-water overland inflow at the top of a 6m long flume. The flume slope was 6%, and streampower 0.5 W/m^2 at the flume outlet. Soil was a Udic Pellustert in the Vertisol soil order. Continuous curves are theoretically structural relations for the (upper) transport limit and (lower) source limit (from Rose et al. 1990).

during an erosion event), and a relationship between β and J , and thus soil strength would be expected.

Even if erosion by rainfall impact is important in comparison with flow-driven erosion, soil strength will affect sediment concentration, although J is not exactly the appropriate physical parameter involved. Thus a relation between soil strength and β which may apply for a particular soil type and condition in the restricted circumstances described earlier would be expected to be modified should erosion by rainfall detachment dominate over that by flow processes.

In summary, a useful relationship between β and soil strength will not always be found, but in circumstances where flow-driven processes are not too vigorous, but nevertheless dominate rainfall impact-driven erosion processes, then such a relationship could be expected for a given soil. If such a relationship can be established, this opens up the possibility that a conveniently-made field measurement of soil strength may well provide a useful indication of the erodibility of the soil. If no such relationship is found, then the history of variation in β in response to management, soil consolidation or other processes is the best guide to soil erodibility in the future.

Investigations of soil strength at the various ACIAR 9201 sites are reviewed next.

Kemaman

Treatments at this site have been described by Hashim et al. (1995). Soil strength was measured by

Tor Vane on wet soil in the small bare soil plot, and the three large treatment plots (T2–T4) on 25 occasions during the period 5/5/1993 to 21/12/1994 with results shown in Figure 21. Each point in the Figure is the average of 10–15 measurements. These results show a decline in soil strength during the dry season of mid-1994 at which time organic matter decomposition and soil redistribution by soil faunal activity took place. These processes accumulated material on the soil surface expected to be easily erodible, and the observed increase in soil strength towards the end of 1994 may indicate its removal (Figure 21).

Despite the very considerable scatter in the data, these observations on change in soil strength would lead to an expectation of lower values of erodibility β being indicated when rains commence after the mid-year dry season. There is some support in Figure 13 for this expectation, although, as for soil strength, there is considerable scatter in the data.

Los Baños

The treatments at this site have been described by Paningbatan et al. (1995). Soil strength of the pre-saturated soil was measured by a Tor Vane apparatus. As shown in Figure 22, soil strength increased monotonically with time since the last cultivation. Also soil strength tended to be higher in the bare and T1 treatments than mulched (T3 and

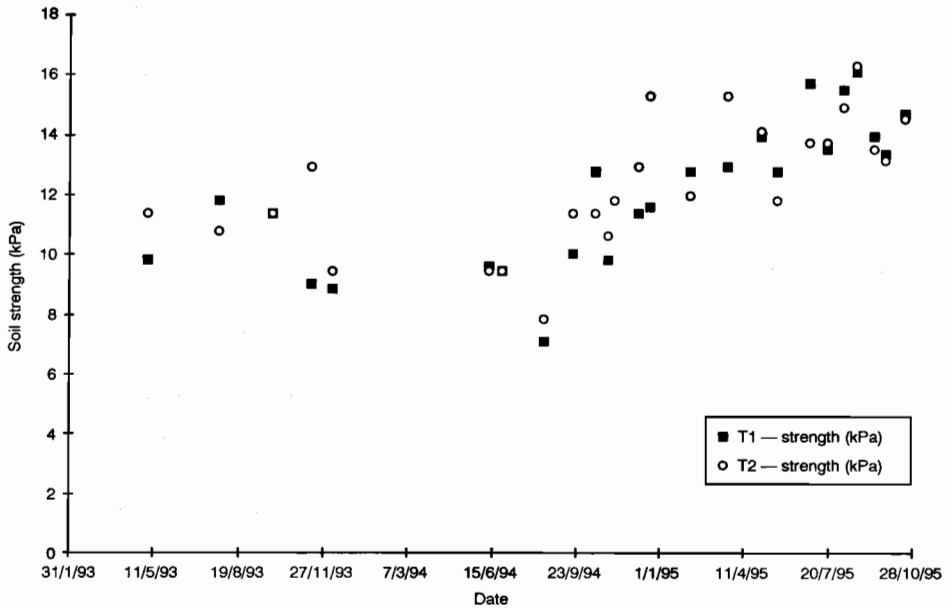

Figure 21. Variation with time in soil strength measured on treatment T1 and T2 plots at the Kemaman site.

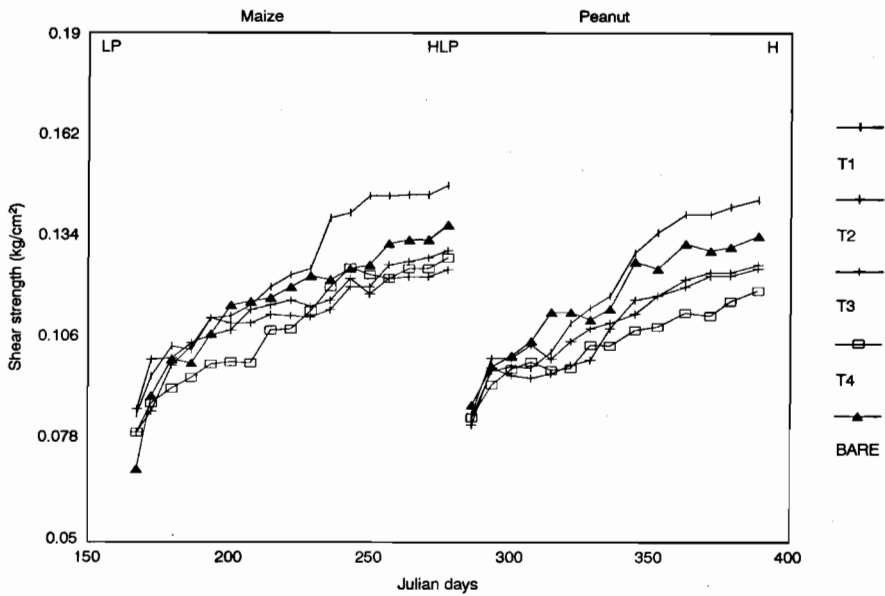

Figure 22. Variation with time in bare soil strength following cultivation at the Los Baños site in 1993.

T4) treatments indicating greater compaction or consolidation. Stubble mulching may have prevented soil compaction, crusting or consolidation, and when decomposed, this mulch could well have contributed to higher soil organic matter which helped in the maintenance of softer soil structure. As will be shown in Chapter 7, the mulched treatments T3 and T4 have significantly higher soil organic matter content than T1 and T2.

Figure 16 shows the values of β for same year, 1993, as that when the soil strength measurements were made. In the first period following cultivation (in which maize was the main crop in treatment plots), there is an indication of a decline in β (Figure 16) as soil shear strength increased (Figure 22). There was an insufficient number of runoff events in the second period, when peanut was the main crop in the treatment plots, in order to obtain clear evidence of a time trend in β , but again the trend is downward in time.

In conclusion, the data from Los Baños provide some evidence that the trend in time of soil strength measured with a Tor Vane is paralleled with an expected time trend in β , though there is somewhat more scatter in β than might be expected from the monotonic time trend in soil shear strength (c.f., Figures 16 and 22).

Goomboorian

Soil strength was measured at this site of pineapple cultivation using two types of equipment designed for field measurement of soil shear strength. This is the Tor Vane, which measured the shear strength of the top of 4 mm of soil approximately, and the Shear Vane with a measurement depth of 10 mm. Since soil erosion at this site involved surface layers (there being no deeply incised rills), then the Tor Vane data are believed to be of most relevance. Also pineapple cultivation involved the formation of ridges and furrows, the top of the ridge forming a horizontal bed on which the pineapple sites can be planted. Soil shear strength was measured both in the furrow bottom and in the horizontal bed over the period of some 40 months for which measurements to calculate β were made. These results are given in Figure 23 for both instrument types and locations, and for a site near to the experimental plots.

Data for soil shear strength as measured by the Tor Vane, believed to be the more relevant of the two instrument types, indicated a general rise in strength over the period, with the strength of the bed consistently exceeding that of the furrow. This difference due to measurement location is expected since the bed sheds sediment, and this sediment,

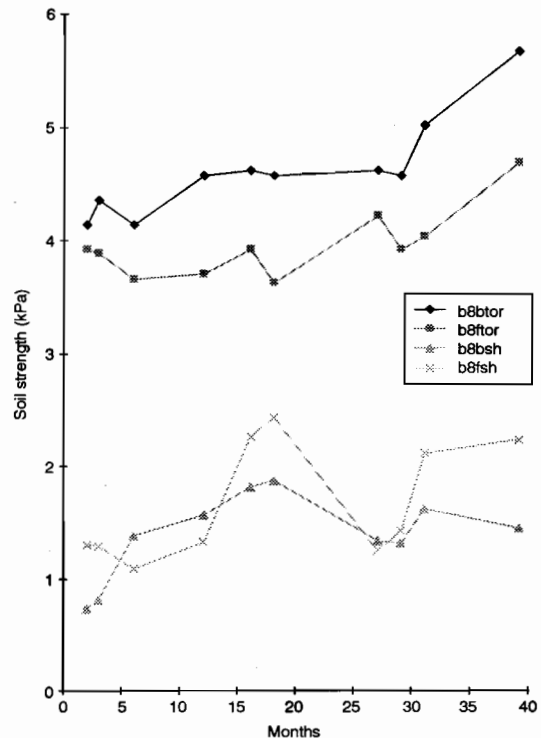

Figure 23. Variation in soil strength with time following establishment of a pineapple crop at the Goomboorian site. Symbol ■ indicates strength measurement in the bed and ◆ in the furrow, both measurements being by Tor Vane. Symbol ▲ and X indicated strength measurement by Shear Vane in bed and furrow respectively. Measurements were made at a site near to the experimental plots.

together with that of the ridge sideslopes, collects in the furrow where it is subject to transport by flow down the furrow. Thus strength measurement in the furrow would be expected to be reduced to some degree by weaker eroded sediment remaining on the surface of the furrow. While both furrow and bed could consolidate, the somewhat greater rate of increase of soil strength in the bed compared with in the furrow shown in Figure 23 would be expected to be due to the influence of weaker deposited material on the furrow floor, which also appeared to be the source of greater spatial variability of furrow soil strength than was evident in the bed. Figure 24 shows very similar results for soil strength were obtained in the experimental plots, though measurement was commenced at a later date to minimise plot disturbance.

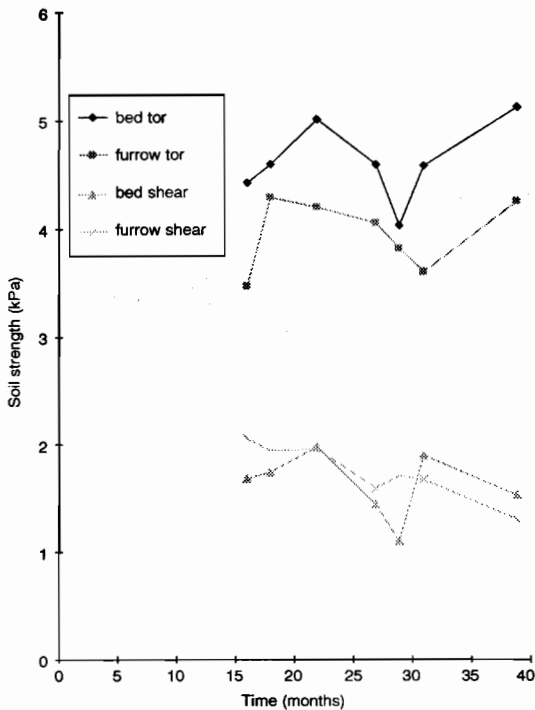

Figure 24. As for Figure 23 but measurements were made in the experimental plots.

Empirical relationships can be developed relating β to soil strength and/or other parameters which affect soil strength (e.g., Ciesiolka et al. 1995b). However, until wider experience with such relationships is gained, they may be somewhat site-specific.

Summary

Earlier discussions have compared variations in the parameter β for bare plots over time. For cultivated plots, values of β are commonly in the range 0.7–1.0 and tend to be higher after cultivation or weeding. In uncultivated situations, initial values of β are high, but decrease to values normally <0.5 after the surface soil has consolidated, particularly if the surface is not incised by rills.

The erodibility parameter β is much more definitive than the K factor in USLE. β is largely related to soil strength. The depositability, ϕ , of surface soil aggregates is also involved in erosion. The K factor is a lumped parameter which is dependent upon:

- infiltration characteristics, which determine runoff amount ΣQ (mm) and runoff rate, Q , (mm/hr);
- Manning's roughness coefficient, n , which affects both Q , and velocity (V) for a given Q ;

- the tendency for a soil to form rills, or for water to flow in preferred pathways on the hillslope. This increases velocity and depth of water flow for a given Q , and hence increases sediment transport;
- the stability of soil aggregates to rainfall, which determines the size and average settling velocity (depositability, ϕ) of soil particles contributing to erosion;
- the tendency of a soil to consolidate and develop strength (reflected in erodibility parameter β).

The USLE assumes that K is not altered by soil treatment, and that treatment affects soil loss by reducing effective slope length (L) or slope amount (S), by increasing soil vegetative cover (the C factor) or by practices such as contour cultivation or banks (the P factor). This methodology allows the effect of management practices to be assessed through the effect on each of the above-listed components of the factor β .

Surface cover may increase infiltration rate by protecting the surface from raindrop impact or by increasing the organic matter content of surface aggregates; surface contact cover reduces flow velocity V for a given runoff rate per unit area, Q , hence increasing calculated Manning's n ; reductions in Q and V with surface contact cover or contour cultivation may reduce rill initiation. Reduced or zero cultivation may increase aggregation, soil consolidation and soil strength. Alternatively, zero cultivation may increase biological activity maintaining the surface soil in a friable and fairly erodible condition, so that the effect of zero cultivation on β is uncertain.

If reduced or zero cultivation leads to an increased value of β , there is an apparent anomaly where soil erodibility according to our definition and measurement of β is increased by soil conserving methods, although soil loss resulting from such a treatment may be markedly reduced. This arises because our methodology is better able to analyse the various processes contributing to soil loss. This is illustrated by the possibly extreme situation where little soil is lost in one treatment (and a friable surface soil is retained) even though the soil erodibility inferred from the parameter β may be greater than that for a treatment where the friable surface soil has been removed exposing a dense and consolidated subsoil with little biological activity.

Wider Application of GUEST

Assumptions, limitations and applications

The assumptions in the theoretical basis behind the erodibility parameter β are given earlier in the

section headed 'Indication of theoretical bases for β '. The value of β has a more definite physical basis if the flow-driven erosion processes of entrainment and re-entrainment dominate those of rainfall impact (i.e., detachment and redetachment). Also the theory assumes that erosion processes occur as a series of steady rates so that non-equilibrium effects are not explicitly represented. However, even if these assumptions are not satisfied, a value of β will be obtained, and since in most practical situations where soil erosion is of concern, flow-driven processes are important, the value of β will generally have a physical meaning.

At low streampowers (e.g., low slopes and modest slope lengths) it is possible that rainfall can dislodge sediment at a greater rate than it can be transported. This appeared to be the case at the Khon Kaen site in Thailand in ACIAR Project 8551, where bare soil plot slope was 4%. As reported by Sombatpanit et al. (1995), the rate of supply of sediment from rainfall detachment and redetachment exceeded the transport capacity of the rills, and so β was unity. This is one situation in which the value of β can be uninfluenced by soil.

The big advantage of the approach to determining soil erodibility via GUEST is that it is event-based, yielding a value for erodibility β for each event, so that for annual crops values of β which have long-term significance can be obtained in one year. With longer-term perennial crops, such as pineapples, of course it is desirable to investigate changes in β for the crop cycle (4 years in the case of pineapples). Especially over longer periods of time the depositability characteristic of the soil may drift due to structural changes, but this can be readily monitored.

Alternatives

While the various forms of GUEST have been prepared in the form of a computer program, calculations can also be carried out in simple spreadsheet form. Use of a spreadsheet form has been found to be useful in checking the accuracy of program forms of GUEST, the latter having advantages for routine use.

The alternative experimental methods for determining the depositability ϕ have been described in the GUDPRO Manual, and of determining wet particle density α from particle size analysis in the section 'Wet density of sediment'.

As mentioned in the section 'Data on Q ', GUEST+ assumes data on runoff and rainfall rates are collected on a 1 minute time base. However, use of a flow-weighted event average runoff rate, \bar{Q} , is also possible as an alternative in the two earlier versions of GUEST, and the spreadsheet version of GUEST+. (This alternative may also be incorporated in the program version of GUEST+ in the future.)

The use of \bar{Q} instead of time varying data appears to introduce no error of practical significance in β . The use of \bar{Q} in GUEST opens up the possibility of using GUEST to interpret a large body of data collected by IBSRAM on its runoff plots.

In the IBSRAM type of runoff plot studies, rainfall rate was recorded, but runoff rate was not measured, so that \bar{Q} cannot be calculated directly from such data. However, \bar{Q} could be approximately estimated with an accuracy which could be adequate for many purposes. This approximation to \bar{Q} would be obtained from:

$$\bar{Q} \approx \frac{\Sigma Q}{\text{Duration of rainfall}} \quad (26)$$

In some rainfall events, rainfall can persist for a long time at very low rates, which could lead to unrealistically low values of \bar{Q} . To guard against the possible source of bias, it would be more reliable to estimate an approximate value of \bar{Q} from the alternative equation:

$$\bar{Q} \approx \frac{\Sigma Q}{\text{Duration of rainfall at rates } > x \text{ mm/h}} \quad (27)$$

where x mm/hr is a low value that could be chosen from experience of comparing \bar{Q} estimated using Equation (27) with \bar{Q} in situations where minute data are available. It is possible that $x \approx 5$ mm/hr may emerge from such a comparison, which has not yet been done.

An alternative possibility to the use of Equations (26) or (27) to estimate \bar{Q} is to generate an approximate synthetic runoff hydrograph which distributes the known total runoff (ΣQ) using rainfall rate history which is collected in IBSRAM experimentation. A FORTRAN 77 program called GOSH (Generation Of Synthetic Hydrograph) has been written in order to do this (Crawford and Rose, unpublished NSCP project report: GUEST Users' Manual, 1986), but this is now being improved.

Use of one or other of these described alternatives would enable interpretation of the extensive IBSRAM runoff plot database using the GUEST methodology. Such a project would involve collaboration between ACIAR and IBSRAM.

Chapter 6

The Role of Cover in Soil Conservation

C.W. Rose, K.J. Coughlan, C.A.A. Ciesiolka and B. Fentie

SOIL conservation involves far more than the implementation of particular land management practices that conserve the soil resource; however, such implementation is a crucial element if the soil resource is to be conserved. The suite of constraints within which farmers operate in any context limits the range of soil conserving practices that they may feel able to adopt, so that soil conservation measures need to be adapted to function within these constraints.

The inclusion of protective soil cover in an acceptable, feasible and economically viable form is one of the most widespread and effective soil conserving practices, particularly suitable for the humid tropics where production of vegetation in excess of that required for other purposes is more readily achieved than can be the case in more arid environments. Thus it was an important objective of soil erosion research in this ACIAR Project to further investigate the degree of protection provided by the various forms of cover thought to be feasible and effective by collaborators in the various countries involved. This protection can be expressed in terms of reduced runoff and reduced loss of soil and nutrients. Reasons for the effectiveness of such protection are also sought in terms of the understanding of relevant processes that scientific experimentation and research can provide.

The flux of sediment, q_s (kg/m/s) is given by the product of the volumetric flux of water, q (m³/m/s) and the sediment concentration, c (kg/m³), so that:

$$q_s = qc \text{ (kg/m/s)} \quad (1)$$

Thus the loss of soil from an experimental plot, for example, during the period T of an erosion event will be given by:

$$\int_0^T q_s dt = \int_0^T qc \quad (2)$$

$$= \Sigma q \bar{c}$$

$$\text{where } \Sigma q = \int_0^T q dt \quad (3)$$

$$= L\Sigma Q$$

where ΣQ is total runoff per unit area from a plot of length L . Also \bar{c} is the average concentration of sediment in runoff from the plot.

Soil loss by erosion, commonly expressed in soil loss per unit area, M , is given by:

$$\left(\int_0^T q_s dt \right) / L, \text{ so that, using Equation (3),}$$

soil loss/area, $M = (\Sigma q/L) \bar{c}$, or

$$M = \Sigma Q \cdot \bar{c} \text{ (kg/m}^2\text{)} \quad (4)$$

with 1 t/ha = 0.1 kg/m².

Equation (4) shows that soil loss per unit area depends equally on the hydrologic term, ΣQ , and the average sediment concentration, \bar{c} , which, because of its definition and measurement is given by:

$$\bar{c} = \frac{\int_0^T q c dt}{\int_0^T q dt} \quad (5)$$

which indicates \bar{c} to be a flux-weighted mean value.

Cover of various kinds can affect both ΣQ and \bar{c} , and this chapter is divided into two parts on this basis.

Firstly, the effect of cover on runoff characteristics will be considered. These cover effects can be of two kinds:

(a) The effect of cover on changing surface roughness and impeding overland flow. This effect

was reported in Chapter 5, 'The Role and Determination of Manning's n '.

- (b) The effect of cover or vegetation in changing the infiltration behaviour of its supporting soil, which can occur through both direct protection and indirect effects, such as on soil organisms.

Secondly, the effects of various kinds and levels of cover on \bar{c} will be reported. Although in practice it is commonly difficult to make an absolutely clear-cut distinction, it is of conceptual and practical importance to distinguish between 'aerial cover', which intercepts raindrops but has no effect on overland flow, and 'surface contact cover', which is so close to the soil surface that it impedes overland flow (and also intercepts raindrops). This distinction implies that aerial cover reduces the processes of erosion driven by rainfall impact, but has no effect on erosion driven by overland flow. Surface contact cover, on the other hand, is effective in reducing erosion driven both by overland flow and by raindrop impact. It is also observed that surface contact cover is effective in reducing the likelihood of rill formation, so further reducing \bar{c} .

Effects of Cover on Runoff and Infiltration

Los Baños

As described more fully in Paningbatan et al. (1995) the four treatments for this site with relatively high organic matter from 1989–1992 were:

T1 = Farmer's practice, a traditional practice of upland farmers that involves up-and-down slope tillage operations and clean or weed-free culture.

T2 = Alley cropping in which the tillage operations were performed along the contour, and the crop and weed residues were removed from the soil between alley crops.

T3 = Alley cropping in which the tillage operations were performed along the contour (as in T2), but the hedgerow trimmings and crop residues were used as mulch in the alleyway.

T4 = Alley cropping and zero tillage, with the hedgerow trimmings and crop residues used as mulch in the alleyway.

Paningbatan et al. (1995) also illustrate the seasonal variation in contact cover percentage associated with each treatment. While there was some difference in contact cover with crop type, being maize in the wet season and mungbean or peanuts in the dry season, the contact cover for treatment T1 was never more than 12%, in contrast to the higher range of from 17% to nearly 50% for the other three treatments.

The hydrological effects of surface contact cover were investigated in two ways. Firstly, Figure 1 shows how the runoff coefficient varies with surface contact cover for all four treatments, where this coefficient is the ratio of total runoff to total rainfall for any given runoff event. Figure 1 shows the considerable variability in runoff coefficient, higher values of the coefficient no doubt being associated with wetter soil profiles, as has been shown to be the case for the Goomborian site (see later). An interesting outcome of Figure 1 is that when surface contact cover exceeds about 32%, the runoff coefficient is quite low, then being less than 0.1 or 10% in all events recorded in 1990.

The second investigation of the effect of surface contact cover at this site is in Figure 2 where total runoff from treatments T2 to T4 is presented as a ratio to the treatment with least cover, treatment T1. Although surface contact cover levels in treatments T2 to T4 (plotted as the abscissa) always exceeded that for T1, runoff from the higher cover level plots could exceed that from T1 on a number of occasions, as shown by the ratio exceeding unity (see Figure 2).

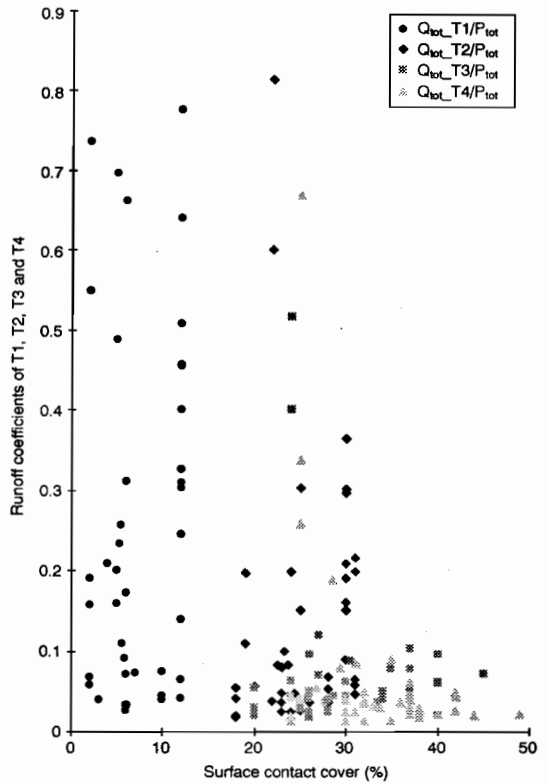

Figure 1. The variation with surface contact cover (%) of the runoff coefficient for treatments T1, T2, T3 and T4 at the Los Baños site.

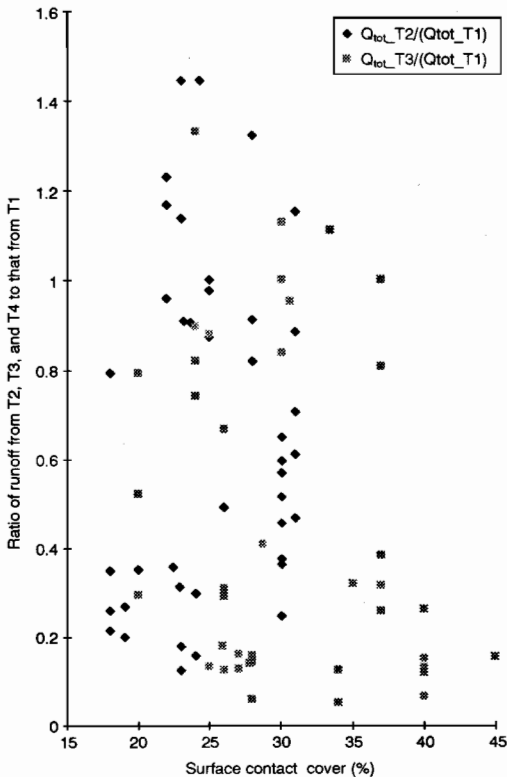

Figure 2. The ratio of total event runoff from treatments T2 and T3 to total runoff from treatment T1 shown plotted against the respective surface contact cover (%) for Los Baños.

This outcome is expected to be the result of spatial variation in plot infiltration characteristics and events with high antecedent water contents in treatments T2 to T4 compared with T1, though soil water contents were not measured.

Figure 2 also shows that the plotted ratio of runoffs were low for both treatments T3 and T4 when surface contact cover exceeded about 37%.

For the entire 1990 season, total runoff from treatments T1, T2, T3 and T4 was 525, 374, 213 and 236 mm respectively. Treatments T1 to T3 were all tilled, T2 and T3 on the contour, but T4 was untilled. Tillage was on day 140 (mid-May) for the corn crop, and day 240 (late August) for mungbean, leaving the cultivated treatments in a rough friable condition. During such a period (1/9/90) in a wet period, data from Paningbatan et al. (1995) showed runoff from treatment T4 at 21.1 mm to be about four times higher than from the cultivated plots, indicating why annual runoff was higher from T4 than T3. This is

the high outlying point in Figure 2. However, as the cultivated treatments consolidated, runoff generation increased and became higher than from T4, especially in the case of T1.

ViSCA

As described more fully in Presbitero et al. (1995) the four treatments were:

T1 = Bare plot, weeded and cultivated by hand, being-recultivated if rills formed.

T2 = Up and downslope cultivation of corn (*Zea mays*) simulating farmer's practice.

T3 = Corn with contour hand cultivation, with leguminous hedgerows at both ends of runoff plots whose trimmings were returned to the plot.

T4 = As for T3 but with peanut (*Arachis hypogaea*) grown as an intercrop or rotation crop with corn.

Soil at this site, an Oxic Dystropept, had particularly high and sustained infiltration rates, with most runoff coefficients being less than 0.1 or 10%, being higher on a few occasions for treatments T1 and T2.

Total runoff from treatments T1 and T2 always exceeded that from treatments T3 and T4 with cover and hedgerows. The highest total runoff for individual storms could be either from treatment T2 or T1, but was higher for T2 for the complete data set, runoff from T1 being substantially influenced by cultivation. The permanent up-and-down slope channels between the rows of corn in treatment T2 would have favoured high rates and amounts of runoff compared to all other treatments, including the bare soil treatment T1. This is consistent with most experience at the Los Baños site reported earlier.

So permeable is the soil at this site that despite storm average rainfall rates being as high as 54 mm/h, runoff rates were typically so low that calculated depths of overland flow were less than 2 mm, and frequently much less. Estimation of surface contact cover is very difficult in circumstances of such low water depth, and is therefore susceptible to significant but uncertain error.

Figure 3 gives the ratio of storm runoff from plots with treatments T2, T3 and T4 to runoff from the bare plot (T1), shown plotted against surface contact cover of the respective treatment (i.e., T2, T3 or T4). In these calculations, data from the three high slope experiments at 50, 60 and 70% were pooled, since trends with treatment were similar for each of these slopes. While the value of these runoff ratios is most commonly less than one (Figure 3), for some events the ratio can be much greater than one, especially if the bare soil plot had been recently cultivated. Thus

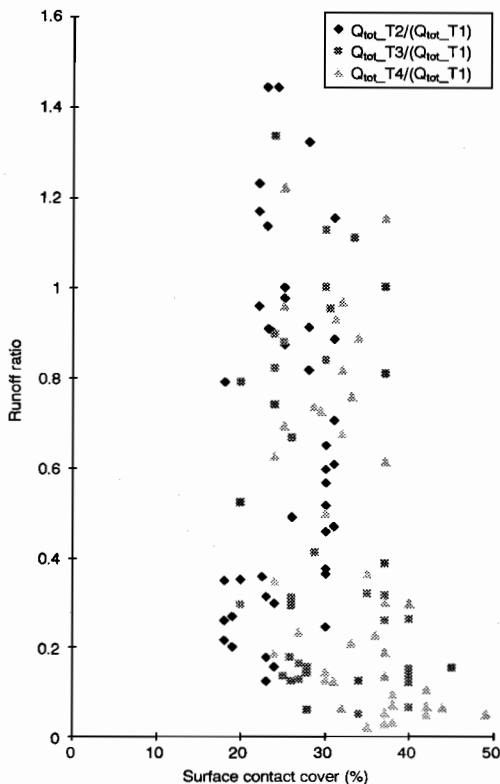

Figure 3. The ratio of total event runoff from treatments T2, T3, and T4 to total runoff from the bare plot (T1), shown plotted against the respective surface contact cover (%) for the ViSCA site.

any trend in Figure 3 may have more to do with recency of cultivation of T1 plots rather than with cover of the other treatment plots.

Plots of the same type of runoff ratio as shown in Figure 3 but for T3/T2 and T4/T2 showed no clear relationship with cover of the variable treatment. This lack of relationship is interpreted as indicating that at this site differences in total runoff between treatments were not dominantly due to cover, but to the other treatment differences in T3 and T4 such as the use of contour cultivation and leguminous hedgerows. The 8% contribution of hedgerows to cover was included, but it would appear that the hydrologic effects of hedgerows, which can be significant, is not explained simply in terms of their contribution to cover (assumed complete for the hedgerow footprint). The contribution of hedgerows to biological activity and hydraulic conductivity is reported for the Los Baños site in the section 'Soil loss' in Chapter 3.

Kemaman

The main crop of interest at this site in Peninsular Malaysia was a tree crop, cocoa, normally grown on a more extensive scale than other crops investigated in this project (Hashim et al. 1995). Hence a direct comparison with a bare plot of similar dimensions to the cropped plots was not sensible or environmentally desirable. Thus three treatment plots are compared — a 20 m² bare plot, a 1000 m² cocoa-glyricidia plot with leaf litter surface contact cover (T1) and a similar plot where surface contact cover consists of living grass cover in addition to leaf litter (T2). With soil erosion, rills formed in the bare plot, while three broad-based preferred pathways in T1 became more well defined with time. The small initial pathways in T2 have become less well defined with time due to sediment deposition, and the surface geometry (required for runoff routing) may be considered as approximately planar.

Runoff from the about 17 500 mm of rainfall for the approximately 5¹/₂ year period from July 1989 to December 1994 is shown in Table 1.

Table 1. Total runoff from the bare and treatment plots (T1 and T2) at Kemaman for the period July 1989 to December 1994.

Treatment	Bare	T1	T2
Runoff (mm)	10 625	6420	2 220

Cover in the treatment plots varied markedly over the measurement period. Aerial cover from cocoa and the associated glyricidia increased to 80% by December 1994, while average surface contact cover over the plots was reasonably constant in T2 (>70%) and increased from <40% to 60%–70% over time in T1.

Table 1 shows that both treatment plots with aerial cover (T1 and T2) have reduced runoff (ΣQ) substantially, presumably as a result of cover protecting the soil surface from rainfall impact, and consequently reducing surface sealing. Treatment T2 is far more effective in reducing runoff, not only because surface contact cover is higher earlier in the period, but also because the living contact cover remains in position even during periods of large runoff. In contrast, leaf litter is washed away in T1, especially in the preferred pathways, as illustrated in Table 2. During the wet period in November, the contact cover in preferred pathways of overland flow is reduced to <5%, being much higher in the non-monsoon period (May).

Table 2. Comparison of contact cover in and between preferred pathways at Kemaman.

Year	Contact cover in T1 (%)			
	(November) (NE Monsoon)		(May) (Non-Monsoon)	
	Pathway	Between pathways	Pathway	Between pathways
1992	2	52	23	23
1993	5	70	71	71
1994	5	68	61	61

Because of the lower ΣQ in T1 and T2, maximum 1 minute runoff rates are also markedly reduced. Maximum runoff rate in 1990 from the bare plot is 146 mm/hr, from the T1 plot 28 mm/hr and maximum for T2, 6 mm/hr. As will be shown later, the reductions in ΣQ and Q_{max} in T1 and T2 have reduced soil loss per unit area to values below that in the bare plot.

Goomboorian

This experimental site is on a commercial pineapple farm in the Gympie district some 160 km north of Brisbane, Queensland, with an annual summer dominant rainfall of 1200 to 1300 mm. In contrast to another pineapple farm on a steep gravelly Entric Regosol (FAO), where results were reported by Ciesiolka et al. (1995b), the farm from which results are reported here was on a sandy soil, an Albic Arenosol (FAO) on a rolling landscape with slope gradients of 4%–12%. Despite relatively modest slopes, this soil type was previously thought to be so erodible that pineapple cultivation would not be a suitable land use.

Pineapple plants are grown on beds 0.9 m in width raised approximately 0.2–0.25 m above the furrow bottoms. Furrow slope was 5%, and slope length (approx. 36 m). There were five treatments:

Bare = Bare soil with formed pineapple beds.

Conventional = Conventional farmer's practice in pineapple production in which leaves of the growing pineapple plant provide aerial or canopy cover which expands with time, with mature or senescent leaves ultimately providing additional cover in the form of surface contact cover.

Modified

Conventional = Conventional cultivation but pineapple leaves were then clipped to provide a constant aerial cover of about 55%.

Mulch = Conventional cultivation but with a mulch of shredded pineapple plants at 8 t/ha applied pre-plant.

Sarlon mesh = Bare soil treatment covered with Sarlon mesh which allowed all rainfall to reach the soil surface, but broke up raindrops into a fine mist of small drops. The Sarlon mesh was rated as a 90% sunlight filter, with apertures of approximately 5 mm. The mesh was suspended 0.15 m above beds and 0.35 m above the furrows, and after stretching in the weather, depressions in the mesh allowed drip points to develop. Comparison of the results from this treatment with those from the bare soil treatment was designed to elucidate the effectiveness of canopy cover through evaluating the role of rainfall impact, both in modifying infiltration characteristics, and in contributing to soil erosion.

Method of measurement of different types of cover

Canopy cover provided by the pineapple leaves was estimated as follows. The diameter of the approximate circle within which leaf cover was complete was measured, defining the area with 100% cover. Next, the diameter of the circle that encompassed the tips of the outermost leaves was measured, and the area between these two complete circles assigned a cover of 50%. While this method, carried out weekly, was the major data source, alternative methods of canopy cover estimation were also employed as a check.

Surface contact cover was provided by applied mulch, by senescing leaves in the furrow, or by leaves which droop and make contact with the furrow. This last type became significant after harvest of the plant crop. The chief method of contact cover estimation involved use of a small quadrat placed over the furrow. When mulch or senescing leaves were covered by soil, the soil-covered area was ignored in evaluating surface contact cover percentage. All measurements were replicated. Contact cover from drooping leaves was based upon counts of the number of leaves per metre touching the soil.

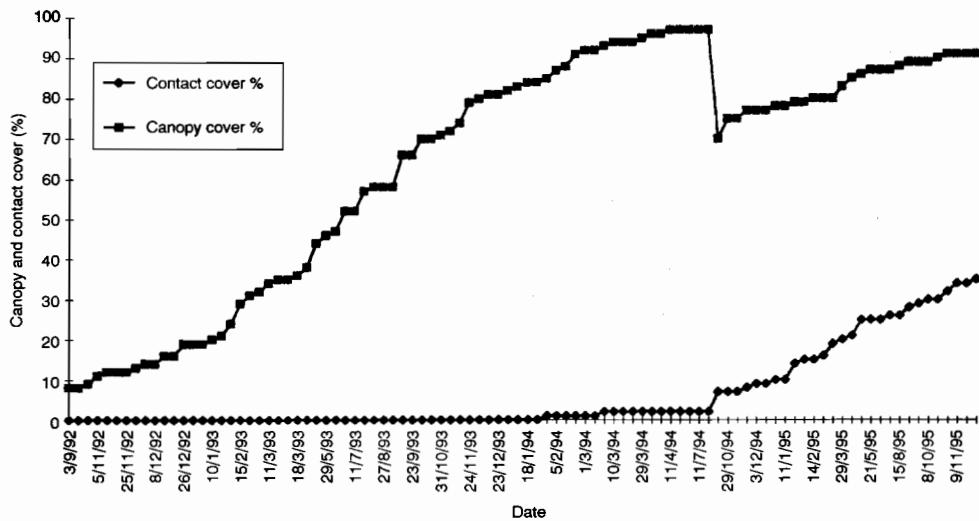

Figure 4. The growth through time in pineapple canopy cover following planting on 18/8/92 and the later development of surface contact cover for the conventional treatment at Goomboorian.

Cover provided in various treatments

Figure 4 shows the growth in canopy cover, and the later development of surface contact cover through time following planting on 18 August 1992. Canopy cover exceeds 90% before any significant contact cover from pineapple plants develops. The substantial decrease in canopy cover and increase in contact cover in mid-1994 was caused by the first harvest of pineapples. Figure 5 shows a similar rise in canopy cover to Figure 4, but trimming of pineapple leaves on 1 July 1994 led to canopy cover falling to a level of 55% at which it was manually maintained.

Figure 6 shows how mulch initially provided 100% contact cover, but that as this cover declined growth of the pineapple plants led to a steady increase in canopy cover to nearly 100%, the abrupt decline again being due to harvest activity.

Hydrologic consequences of cover

Comparing Figure 7 with Figure 1, it can be seen that at the Goomboorian site there was even less dependence of the runoff coefficient on surface contact cover than at Los Baños. Data in Figure 7 are for mulch and conventional treatments, and all events in the recorded period 3/9/92 to 25/11/95. There was also no strong dependence of runoff coefficient on the amount of rainfall received in the event.

The typical type of relationship between rainfall and runoff totals is illustrated for 1993–94 in Figure 8. There is evidence of up to 10 mm of rainfall being required to induce runoff, and considerable variation in the relationship between runoff and rainfall amounts, with antecedent water content and rainfall rate no doubt having a significant effect on this relationship. This question was investigated in more detail in the chapter on hydrology (Chapter 4).

The possible effect of cover on the ratio of total individual event runoff from the various treatment plots to that from bare soil was investigated by plotting this ratio against cover percentage. Relationships between this runoff ratio and either canopy cover, surface contact cover, or the sum of both these covers were not particularly strong as is illustrated in Figure 9 for the conventional to bare soil runoff ratio versus canopy cover of the conventional treatment. The ratio tends to decline as canopy cover increased. This relationship was strengthened if data for wet periods were removed, presumably because if the soil profile is near saturation, the effect of treatment differences on infiltration is much less. The same conventional to bare soil runoff ratio tended to decline with increase in dry period duration between successive rainfalls, presumably since the greater rate of water removal by pineapple plants compared to bare soil reduced antecedent water content in the conventional treatment.

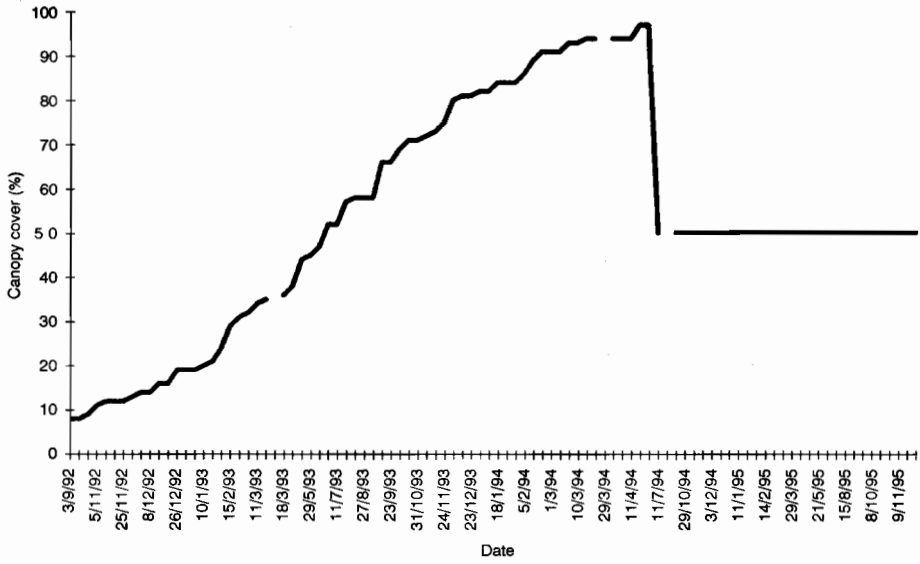

Figure 5. As for Figure 4, but for the modified conventional treatment with leaf trimming to maintain a canopy cover of 55% after 1/7/94.

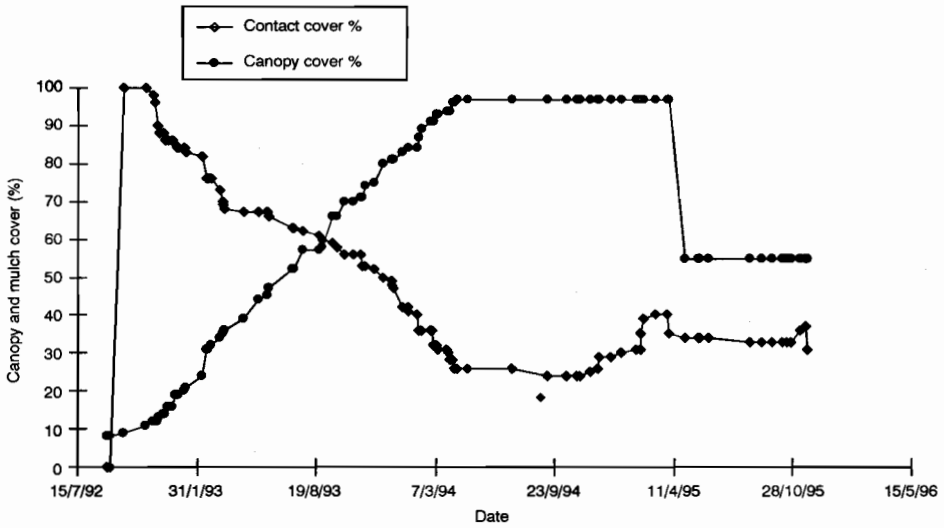

Figure 6. The change through time in canopy and mulch cover for the mulch treatment at the Goomboorian site.

Figure 10 shows the runoff ratio to bare soil from the modified conventional plots as a function of the canopy cover provided by pineapple plants. There is some indication of a decrease in this runoff ratio with increase in canopy cover. Note that in Figure 10 only that part of the data up to leaf clipping was used as there was a constant 55% cover after that. The same runoff ratio for the mulch treatment was less well related to mulch cover (Figure 11), possibly due to interaction with canopy cover effects.

The effect of cover on the ratio between treatments of total infiltration (rather than runoff) is illustrated in Figures 12 and 13.

Figure 12 shows the infiltration ratio for bare soil/conventional treatments against canopy cover provided in the conventional treatment, a similar relationship holding if the later-developing contact cover shown in Figure 4 is included. There is some indication that infiltration into the conventional treatment increases relative to that into bare soil as cover increases, but there is considerable scatter, no doubt in part associated with variation in antecedent water content.

Figure 13 shows that for the infiltration ratio bare soil/mulch the relationship is similar to that in Figure 12, so that similar conclusions to those for Figure 12 can be made.

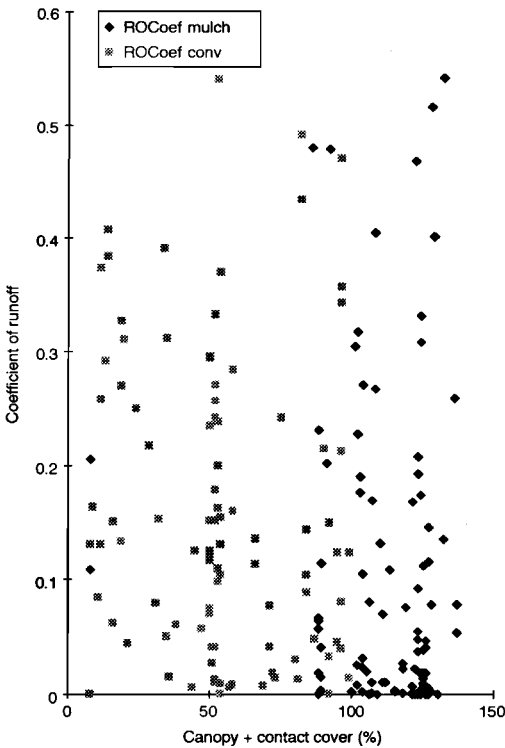

Figure 7. The variation in runoff coefficient for the mulch and conventional treatments with the sum of canopy and contact cover (%) at the Goomboorian site.

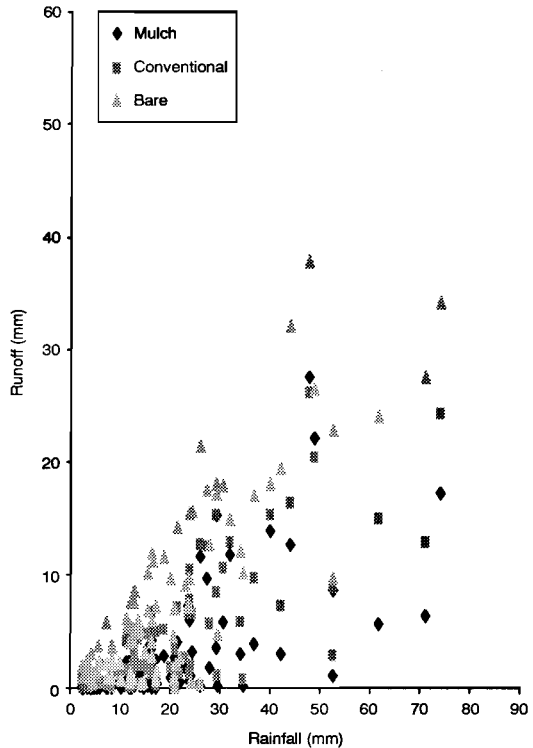

Figure 8. Event runoff plotted against event rainfall for bare soil, mulch and conventional treatments at the Goomboorian site.

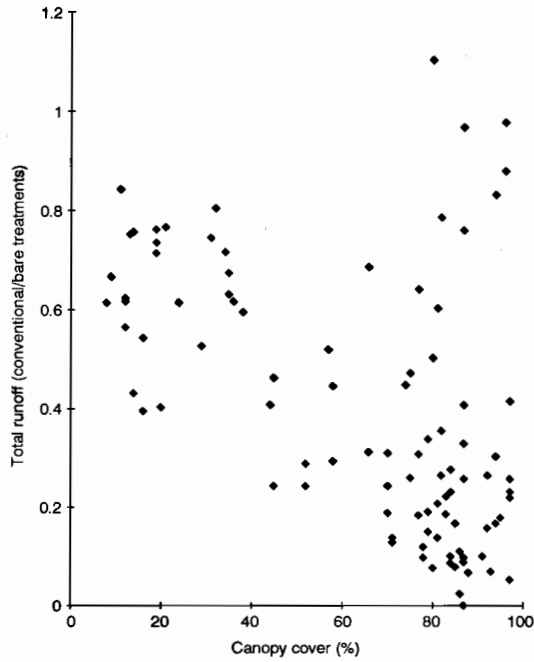

Figure 9. Ratio of total runoff from conventional to bare soil treatments as a function of canopy cover (%) for the conventional treatment at the Goomboorian site.

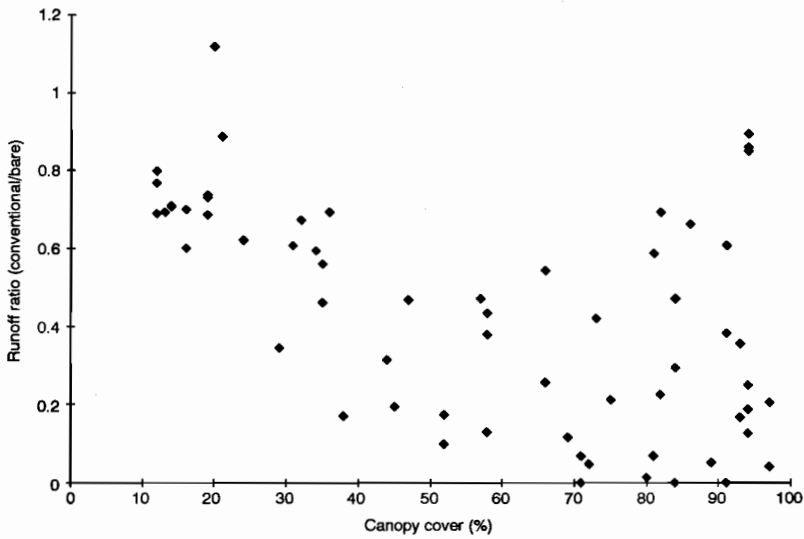

Figure 10. As for Figure 9 but for modified conventional to bare soil runoff ratio.

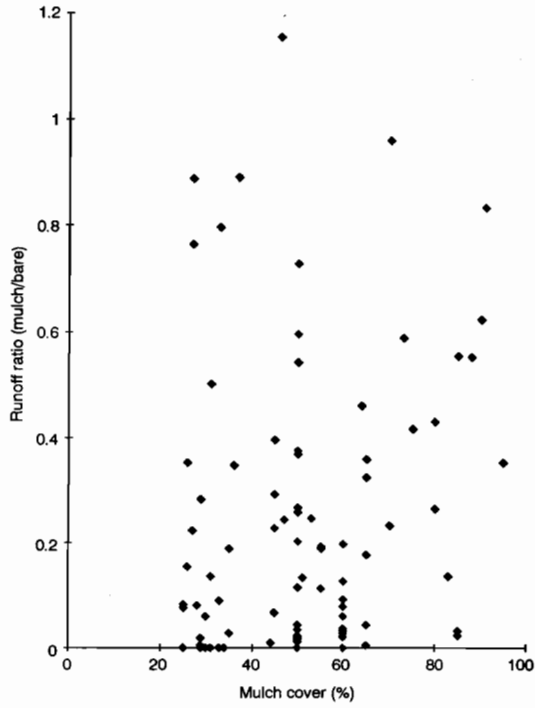

Figure 11. As for Figure 9 but for mulch to bare soil runoff ratio, the cover being mulch cover (%).

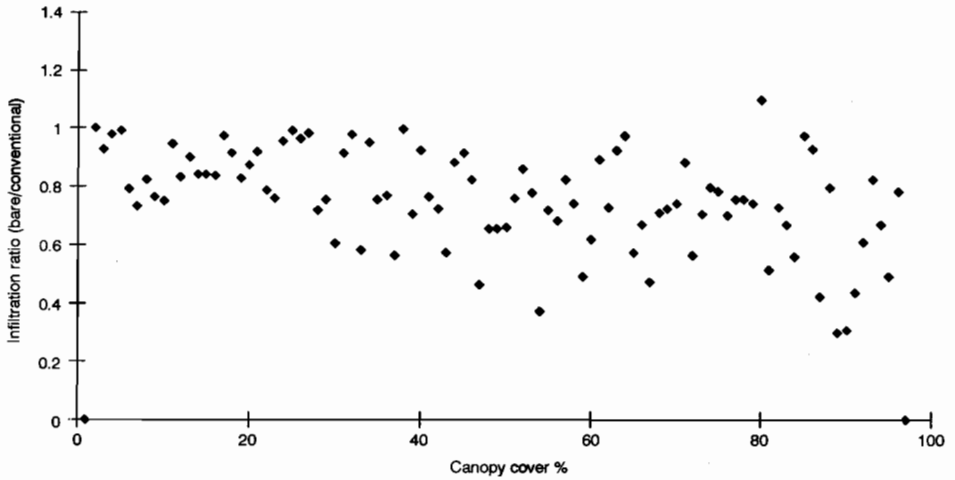

Figure 12. The ratio of total event infiltration from bare soil to the conventional treatment as a function of canopy cover (%) at the Gomboorian site.

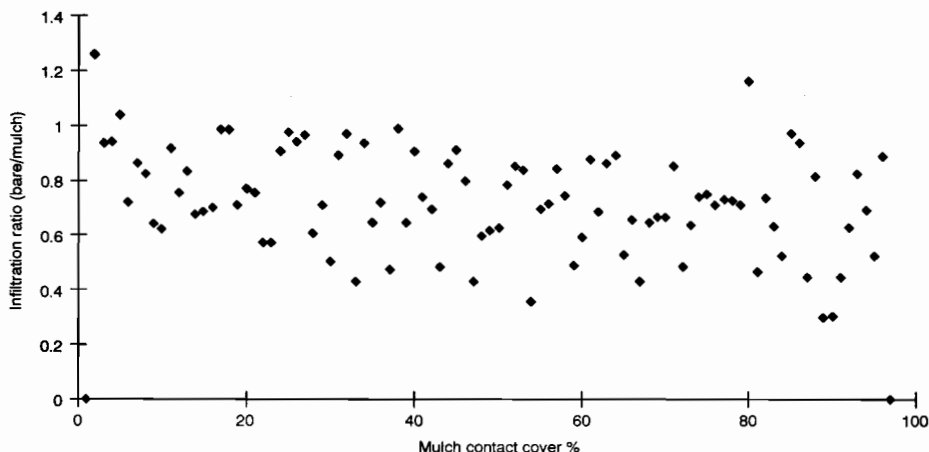

Figure 13. As for Figure 12 but for the bare to mulch infiltration ratio.

Effects of Cover on Sediment Concentration and Soil Loss

Los Baños

As indicated previously for Los Baños, surface contact cover in the experiments at this site was provided in a number of different ways, including hedgerow trimmings, crop residues, and hedgerows themselves. Figure 14 from Paningbatan et al. (1995) illustrates the typical relationship between surface contact cover and the ratio of sediment concentration with any level of contact cover to the concentration from a bare plot (c/c_b). Despite considerable scatter, no doubt in part due to the great variety in form of contact cover and consequent estimation difficulties, the exponential relationship:

$$c/c_b = \exp [-k.C_s] \quad (6)$$

where C_s is the contact cover fraction, provides a useful summary of the form of the relationship, with $k = 10$ for these data. These results show that quite low levels of surface contact cover can have a dramatic effect in reducing sediment concentration in runoff; e.g., 10% cover reduces sediment concentration to 30%–50% of that measured in bare plots, while for 30% cover, sediment concentration is reduced by 90%. These results are consistent with the high degree of non-linearity commonly observed in such relationships when erosion is dominantly driven by overland flow.

Experiments in this project were designed primarily to investigate the soil conserving effectiveness of management options deemed to be acceptable and productive, rather than to differentiate clearly between the effectiveness of surface contact cover and canopy cover. This differentiation is confused by the complex time-changing relationship that exists between the two types of cover as is illustrated in Figure 15a for the year 1993.

For treatment T1, Figure 15a shows a somewhat linear relationship between surface contact cover (C_s) and canopy cover (C_c), with C_s being less than 20% when C_c is 80%. The relationship between C_s and C_c is less linear for treatment T2, and quite complex for treatments T3 and T4.

Figure 15b shows c/c_b plotted against C_s for the same year, 1993, as for Figure 15a. The relationship shown in Figure 15b has general similarities to that of Figure 14 for 1990 data.

When the same concentration ratio c/c_b is plotted against canopy cover C_c (Figure 15c) there are some similarities and differences to Figure 15b. For treatment T1 in which there is a simpler relationship between C_s and C_c (see Figure 15a), the relationship between c/c_b and C_c is more linear than is the case for other treatments (Figure 15c). For other treatments in which there is a more complex relationship between C_s and C_c (Figure 15a) the relationship between c/c_b and C_c shown in Figure 15c is also more complex, as might be expected.

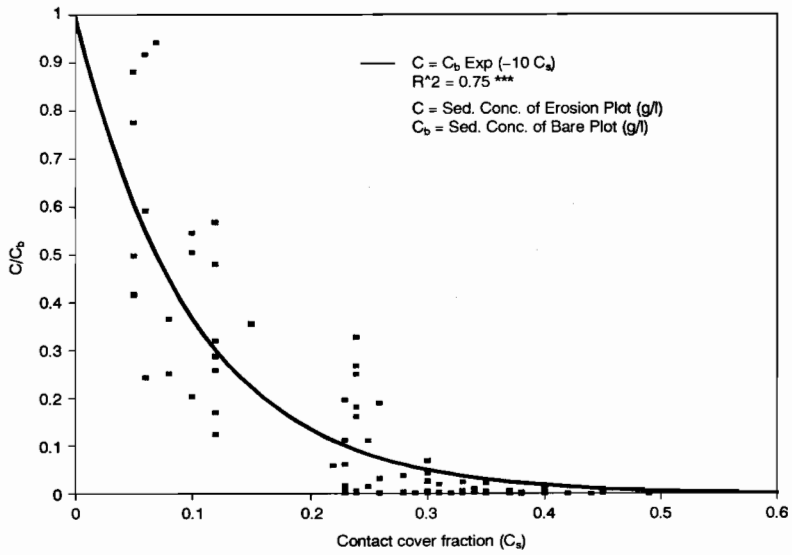

Figure 14. The ratio of sediment concentration with any level of contact cover fraction (C_a), to that from bare soil, as a function of contact cover fraction. Data from Los Baños site, 1990.

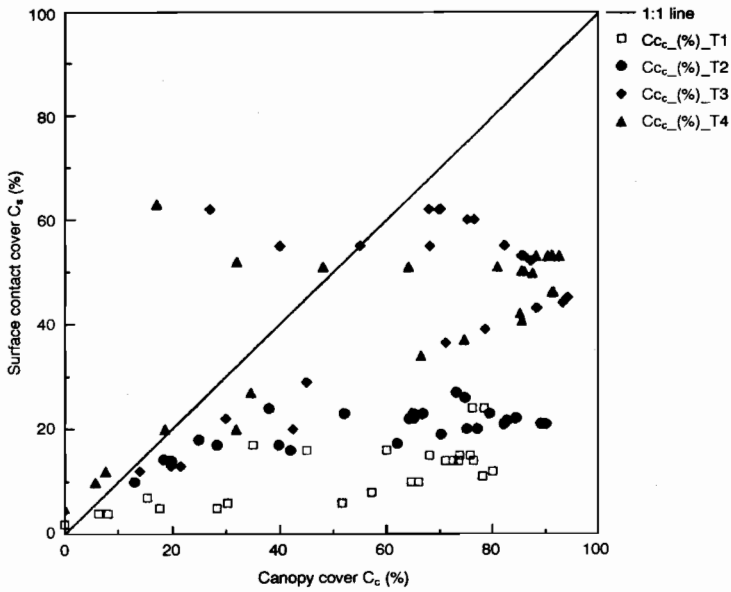

Figure 15a. The relationship between the surface contact cover, C_s (%), and canopy cover, C_c (%), for the four treatments T1 to T4 at the Los Baños site.

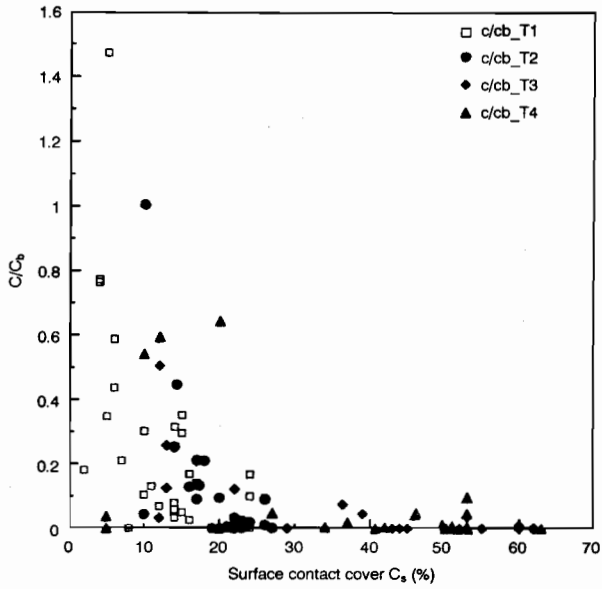

Figure 15b. The ratio of the sediment concentration from any particular treatment to that from the bare soil plot as a function of the surface contact cover (%) for that treatment at the Los Baños site, 1993.

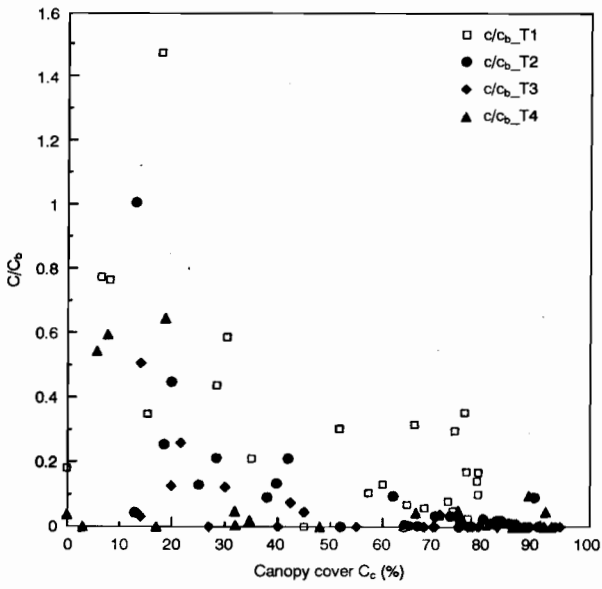

Figure 15c. The same as Figure 15b but shown as a function of canopy cover (%).

In conclusion, while statistical analysis supports a greater linearity for the relation between the variables in Figure 15c than in Figure 15b, the complex relations between C_s and C_c in these experiments do not provide a single clear picture of the relative roles of these two types of cover in reducing sediment concentration. Nevertheless, comparison of Figures 15b and 15c shows that, for the types of cover and conditions at this site, a canopy cover of some 80% was required in order to be as effective in reducing c/c_b to the low levels achieved by a surface contact cover of about 20%.

While somewhat confused by the complex cover relationships in these experiments, the relationships are in general agreement with conclusions derived from the wider literature that c/c_b is more linearly related to C_c and non-linearly related to C_s .

Figure 2 showed that at least for higher levels of contact cover runoff was also reduced, so that from Equation (4), soil loss also will be strongly dependent on contact cover fraction.

Annual and average data for rainfall, soil loss and runoff for treatments T1 to T4 are given in Table 3. These results have shown that at Los Baños the relatively heavy crop residues, combined with hedgerow clippings applied to the soil surface in the alleys, are very effective in reducing soil loss from an average of 18 t/ha/yr if crop residues and hedgerow clippings are removed (T2) to 2 t/ha/yr for the improved treatments (T3 and T4) in Table 3. Surface application of heavier mulches has a number of advantages including:

- (i) It provides maximum soil-erosion reduction benefit.
- (ii) It discourages weed growth.
- (iii) The need for cultivation to incorporate residues, which reduces soil strength and reduces biological activity in the surface soil, is minimised.

Whether or not treatment had a substantial effect on the ratio of suspended load to bedload in eroded sediment from the experimental plots is investigated in Table 4. This table gives annual totals for 1993

Table 3. Annual rainfall, runoff and soil loss, 1989–1992. UPLB-ACIAR Project 9201 site in Bay, Laguna, Philippines.

Year	Rainfall (mm)	Soil loss (t/ha)				Runoff (mm)			
		T1	T2	T3	T4	T1	T2	T3	T4
1989	2220	124	40	3	0.2	347	184	75	32
1990	2769	198	25	3	5	490	304	197	270
1991	2072	99	4	0.4	0.1	302	115	72	62
1992	1632	97	4	0.5	0.2	402	132	92	107
Avg.	2173	130	18	2	2	385	84	109	118

Slope: 14%–21%.

Soil classification: Tropudalf.

T1 Farmer's practice, up-and-down the slope cultivation.

T2 Alley cropping, contour cultivation without mulching.

T3 Alley cropping, contour cultivation with mulching.

T4 Alley cropping with contour cultivation, mulching and minimum tillage.

Table 4. The effect of treatment on bedload and suspended load totals for 1993, 1994, at Los Baños.

Year	Load and load ratio	T1	T2	T3	T4	Bare
1993	Bedload (t/ha)	104	18	5	25	232
	Suspended load (t/ha)	0.8	0.23	0.08	0.24	1.64
	Ratio $\left(\frac{\text{Suspended}}{\text{Bedload}}\right) \times 100(\%)$	0.8	1.3	1.6	1.0	0.7
1994	Bedload (t/ha)	95	22	25	56	118
	Suspended load (t/ha)	0.33	0.17	0.07	0.19	0.14
	Ratio $\left(\frac{\text{Suspended}}{\text{Bedload}}\right) \times 100(\%)$	0.3	0.8	0.3	0.3	0.1

and 1994 of bedload and suspended load for the various treatments, and also for the bare soil plot. There was not a wide variation with treatment in the ratio of the two sediment load components in either of the two years, though the (suspended:bedload) ratio appeared to be less in 1994 than in 1993.

ViSCA

As mentioned previously, runoff was greatest from the up-and-down slope cultivation of corn (Treatment T2), runoff from the bare soil plots (T1) being greatly affected by cultivation carried out to control weeds and remove rills. Since contact cover was also low in T2, being typically less than 13%, data from these plots rather than T1 are used in the comparison between treatments of sediment concentration and soil loss given in what follows.

Figure 16 shows the ratios of storm-average sediment concentration for treatments T1, T3 and T4 to that from plots with treatment T2 plotted against

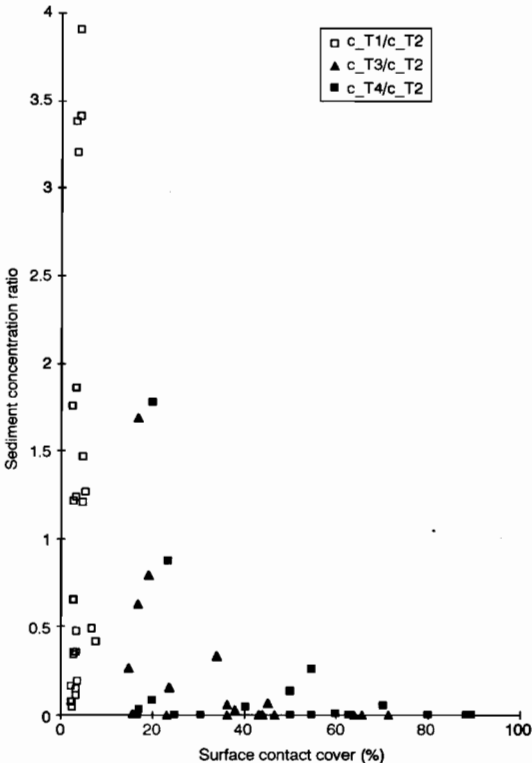

Figure 16. The ratio of sediment concentration from bare soil (T1) and treatments T3 and T4 to that of the farmers' practice (T2) at the ViSCA site, shown as a function of the surface contact cover (%), not being zero for treatment T1 because of weed growth.

surface contact cover. It may be noted the sediment concentration of bare soil treatment T1 can considerably exceed or be less than that of T2, whereas, except where hedgerows have failed, the sediment concentrations of the other treatments were less than that of T2.

In the previous section on ViSCA, it was seen that no strong relationship of runoff to surface contact cover was indicated. From Equation (4) it follows that soil loss would be expected to be dominantly affected by sediment concentration, and that the dependence of soil loss on surface contact cover would follow a similar form to that shown in Figure 1. This expectation is confirmed by Figure 17 where the soil loss from treatments T1, T3 and T4 divided by the corresponding loss from T2 (averaged over the three high slope experiments) is plotted against surface contact cover. Wherever soil loss from T3 exceeded that from T2 it was due to observed failure of the hedgerow in plots with treatment T3. The expected great similarity in form between Figures 16 and 17 is evident.

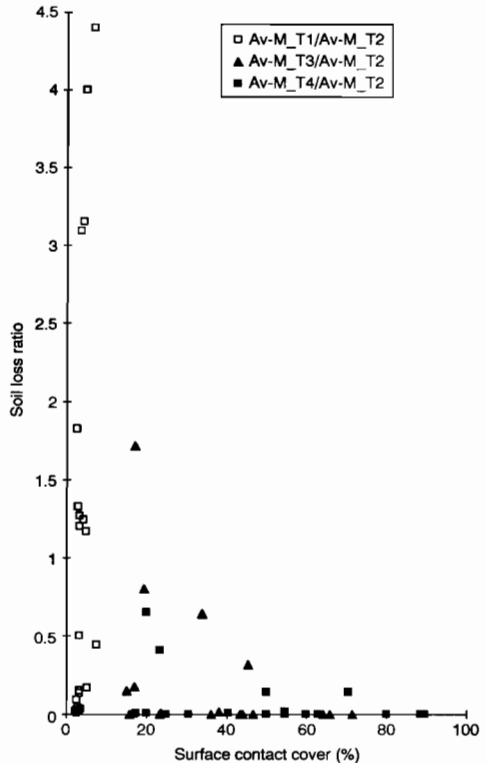

Figure 17. Ratio of event soil loss from plots with treatments T1, T3 and T4 to that from treatment T2 (farmers' practice) averaged over the three high slope experiments (50%, 60% and 70% slope) and plotted against the relevant surface contact cover ViSCA site.

Kemaman

Table 5 gives data for the small bare soil plot and for the two treatments of cocoa at Kemaman for the period July 1989 to December 1994.

Table 5. Runoff, soil loss and sediment concentrations generated by Kemaman plots (July 1989–December 1994).

Treatment	Runoff (mm)	Soil loss (t/ha)	Sediment concentration (kg/m ³)	
			Average	Event maximum
Bare	10 625	580	5.5	25.6
T1	6 420	430	7	9.7
T2	2 220	90	4.0	11.7

The differences in sediment concentration between the treatments (Table 5) are not large, and need to be analysed using the methodology outlined earlier, particularly to compare the two large plots T1 and T2. The GUEST+ program is used for this purpose taking into account the natural differences in surface geometry of the T1 and T2 plots, and results are discussed in Chapter 5.

Goomboorian

The variation through time during the experimental period of canopy cover and surface contact cover for the various treatments is given in Figures 4, 5 and 6. For the conventional treatment (Figure 4), the sum of canopy and contact covers, separately measured, exceeds 100% for about the last six months of the

experimental period. By the time canopy cover is some 97%, the sediment concentration ratio for the conventional treatment to bare soil is very low, as shown in Figure 18. Though the simple addition of canopy and contact cover is of doubtful physical meaning, Figure 19 shows the same ratio of sediment concentrations plotted against the sum of cover percentages. Data in these figures are shown fitted by a curve of logarithmic form, which yields an increase of about 0.1 in R² compared to a fitted curve of exponential form.

A plot similar to Figure 18 but for the sediment concentration ratio for the modified conventional to bare treatment gave somewhat similar results to Figure 18. While mulch cover in the mulch treatment varied from 100% early in the experimental period to a low of about 25% (Figure 6), the sediment concentration from the mulch plot was only about 3% of that from the bare soil plots, and did not vary in any consistent way with the level of mulch cover. Thus even 25% cover in the form of mulch leads to very low levels of sediment concentration, whereas, as shown in Figure 18, 20% canopy cover only reduces the concentration ratio by about a half. This indicated that mulch cover was much more effective than canopy cover in reducing sediment concentration in water leaving the plot. Since mulch cover is a form of contact cover, this conclusion would be in line with general experience (e.g., that at Los Baños) that surface contact cover is much more effective than canopy cover in reducing sediment concentration. While this interpretation may well be valid, it should be recognised that as shown in Figure 6, as mulch cover decreased through time due to decomposition, canopy cover was increasing. Thus it

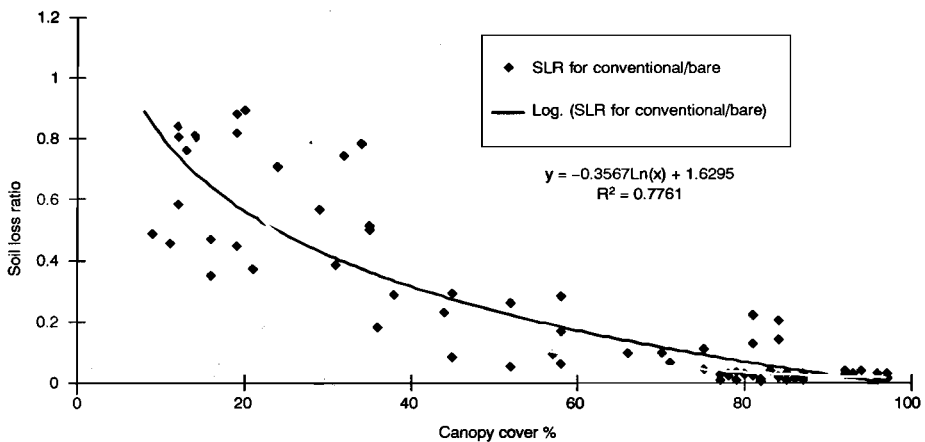

Figure 18. Ratio of event soil loss (conventional/bare soil) versus canopy cover (%) for Goomboorian pineapple site (5.5% slope).

is possible that a reduction in effectiveness of the mulch cover as its percentage declined was compensated by the contemporary increase in canopy cover.

At least for the conventional and modified conventional treatments, runoff was somewhat reduced by increased cover, as shown in Figures 9 and 10 respectively. Thus, from Equation (4), soil loss would also be expected to be significantly reduced by increased canopy cover, and for soil loss to be very low in the presence of mulch cover. Figure 20 confirms this expectation. Figure 20 shows two results.

Firstly, the logarithmic curve is fitted to the relationship between the ratio of soil loss from the conventional to the bare soil plot and the sum of canopy plus contact cover (restricted to a maximum of 100%).

Secondly, Figure 20 also shows the very low level of the soil loss ratio for the mulch treatment to bare soil plotted against the mulch cover. As noted for the concentration ratio, the very low value of the soil loss ratio appears to be unaffected by the level of the mulch cover, at least over the range 25%–100% investigated.

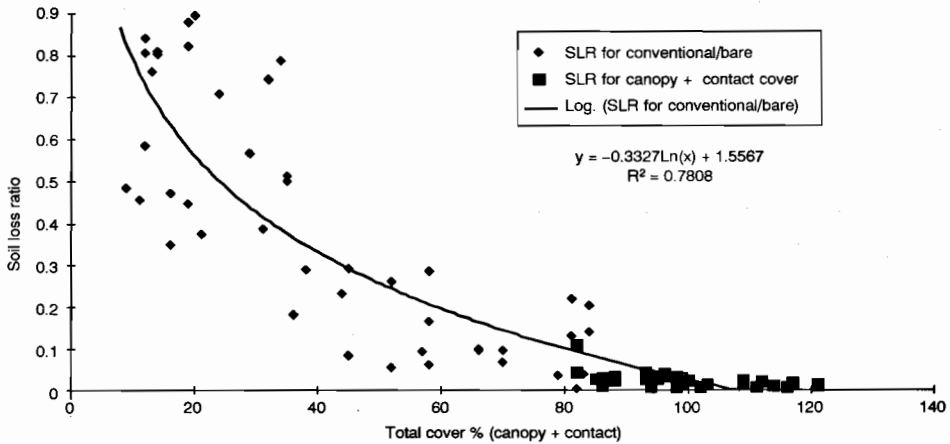

Figure 19. As for Figure 18 but plotted against total cover (the sum of canopy and contact cover) in per cent.

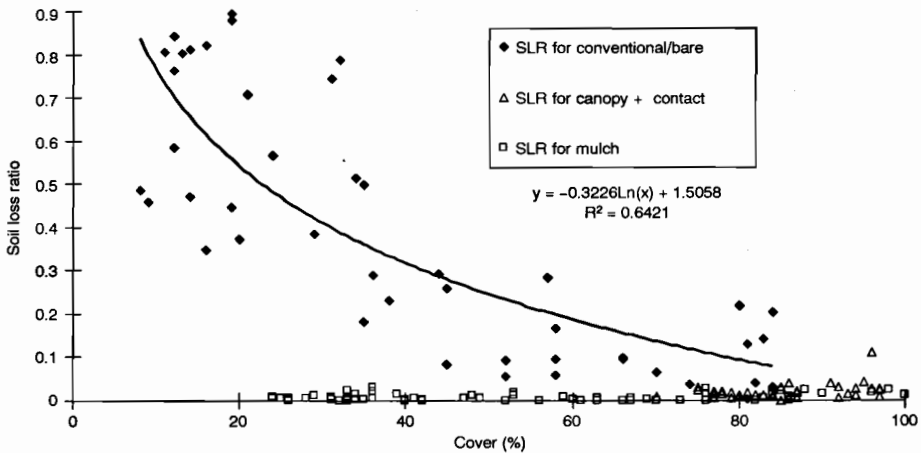

Figure 20. Reproduces the data from Figure 19 restricted to a maximum of 100% (also fitted with a logarithmic curve); also plotted is the soil loss ratio (mulch/bare soil) versus mulch cover (%).

As explained in Chapter 5, the soil erodibility parameter β was introduced and defined for a bare soil situation. However, a value of β can be calculated in situations with cover using exactly the same equation (Equation 3, Chapter 5). While such a value of β is no longer a soil-related characteristic, it is still an empirical indicator of the susceptibility to erosion of the particular soil-cover or soil-plant system from which experimental data were obtained.

For the experimental period, Figure 21 shows the time variation in β for the bare soil and conventional treatments (also reported in Figure 18, Chapter 5), but also shows the value of β obtained using Equation (3) (Chapter 5) for the mulch treatment.

Figure 21 shows that the time variations in β for the bare soil and conventional plots with pineapples vary in phase, completely so until 25/8/93, and with few exceptions after that date. This would seem to indicate that the same type of processes which lead to the observed modest fluctuations in the bare soil plots also occur in the plots of conventionally-grown pineapples. The reason for these fluctuations is uncertain. One possibility is that these fluctuations reflect pulses of more highly erodible material when β is high, followed by periods with some accumulation of sediment in the furrows. Visual observation provides anecdotal support for this explanation of apparent erodibility variation. Great similarity between bare soil plots and the conventionally grown pineapples, especially in the early stages, also makes this a plausible explanation.

Relationship between ACIAR Experimental Findings and Other Literature

Experiments on farmers' fields on the Darling Downs, Queensland, Australia, on black earth soils or vertisols, have shown that the effect of mulch cover from crop residues has an even greater effect on soil loss (Rose and Freebairn 1985) than it does on runoff (Freebairn and Boughton 1981). Figure 22 shows data from Freebairn and Wockner (1986) on how annual mean sediment concentration, collected over six years, is reduced by mulch cover.

Lang (pers. comm.), at the Department of Conservation and Land Management Research Centre at Gunnedah, NSW, collected data over eight years for plots at Scone, NSW, showing the effect of different levels of pasture cover on runoff and soil loss from standard Wischmeier plots. The average annual figures for this period as well as the results for individual years are shown plotted in Figures 23 and 24.

Results from these two agricultural sites in Australia show a greater dependence of runoff on ground cover or mulch cover than has been found at any of the ACIAR 9201 experimental sites. The reasons for this general difference are uncertain and may vary between sites. The strong effect of ground cover in reducing runoff at Gunnedah in particular may be because the soil at this location may possess a greater tendency to seal under rainfall than is the case at ACIAR sites. If so, then protection by mulch cover could greatly aid infiltration. In contrast, the

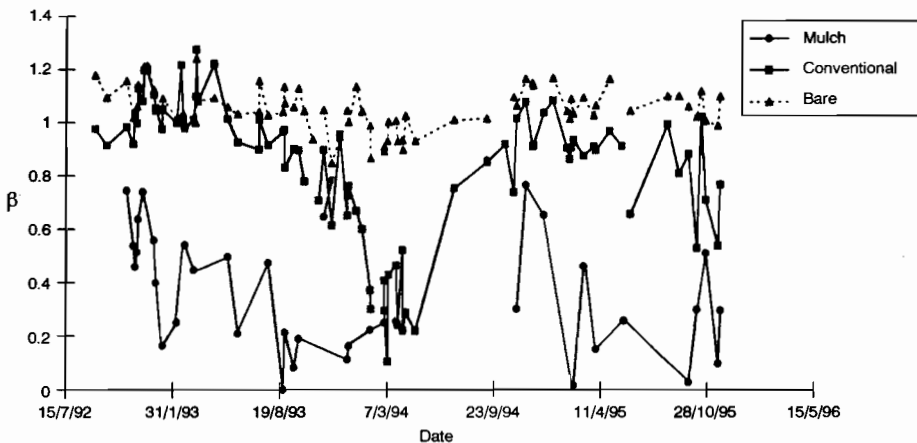

Figure 21. Value of β versus time for the bare soil plot (\blacktriangle), the conventional treatment (\blacksquare) (as in Figure 18, Chapter 5), together with β for the mulch treatment at the Goolboorian site (\bullet).

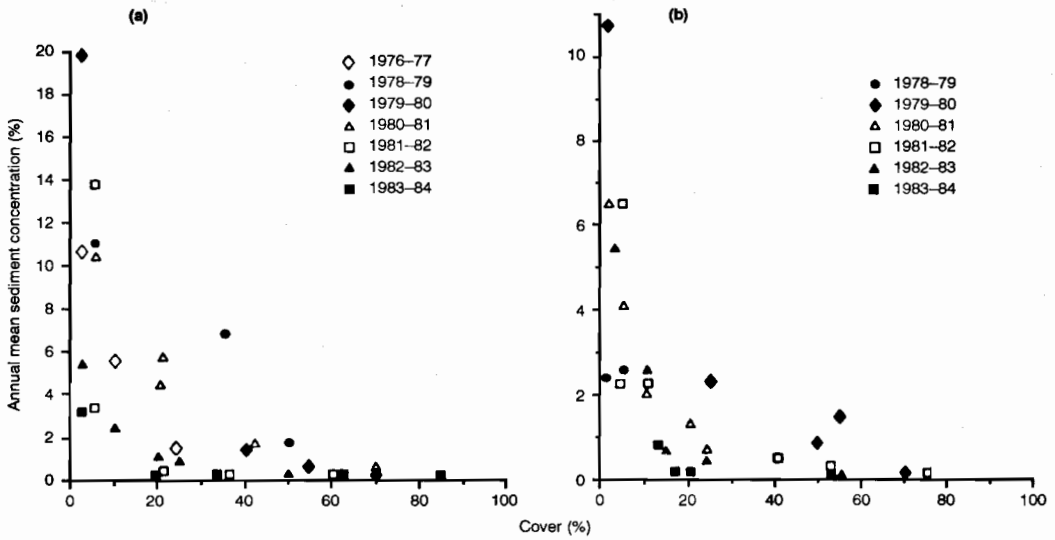

Figure 22. Annual mean sediment concentration in runoff entering the contour channel from a contour-banked sub-catchment (area ≈ 1 ha) versus cover by stubble (%). Data collected over the years 1976-1984 for two sites (a) a black earth at Greenmount, and (b) a grey clay at Greenwood, both in the Darling Downs, Queensland. (From Freebairn and Wockner 1986).

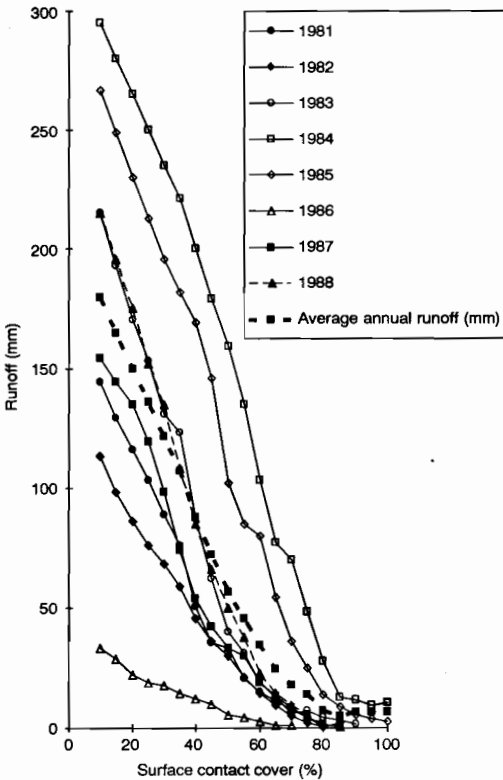

Figure 23. Runoff as a function of surface contact cover (%) measured over individual years 1981-1988 for plots at Scone, New South Wales. Average over the time period is also shown. (Source: Lang, pers. comm.)

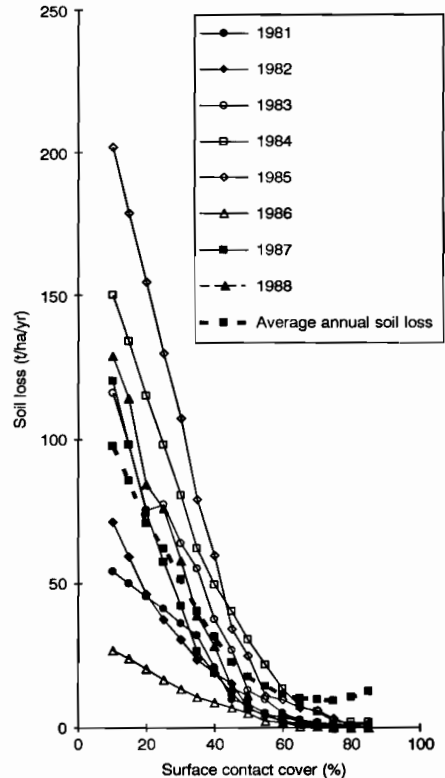

Figure 24. As for Figure 23, but presenting soil loss.

sandy soil at Goomboorian would not be expected to seal. The presence of cover on the vertisols of the Darling Downs may also delay infilling or closure of soil cracks that play a vital role in infiltration into this soil type. No vertisols were present at ACIAR 9201 sites.

Without attempting here to survey the literature on the sensitivity of runoff to contact or surface cover in Australia, or even world-wide, the sensitivity of runoff to levels of such cover in the ACIAR 9201 sites appears to be less than is the case from some agriculturally important cropping situations in New South Wales and southeast Queensland. If this generalisation holds with respect to runoff, there is much greater similarity in the response to contact cover of both sediment concentration and soil loss at these two chosen agricultural sites in Australia and the ACIAR 9201 sites, both in Australia and overseas. For sediment concentration, this can be seen by comparing Figures 14, 16 and 19 for ACIAR sites

with Figure 22 for the Darling Downs. Also for soil loss this can be confirmed by comparing Figures 15b, 17 and 20 for ACIAR sites with Figure 24 for Scone.

This general similarity in the form of the relationship of sediment concentration and soil loss ratios to surface contact cover in particular is encouraging, and supports the ability to extrapolate. Reason for the form of this relationship can be understood in general terms. However, it remains a challenge to fundamental research to understand better the processes responsible for these similarities.

Based on this general form of relationship, critical cover values, above which erosion is small, have been quoted, though such critical values can vary with location, soil type and type of geometry of ground cover. When cover is provided by pasture, not only overall cover percentage, but also the degree to which areas of bare soil can link up hydraulically, can be important.

Chapter 7

Loss of Chemical Nutrients by Soil Erosion

G.M. Hashim, C.A.A. Ciesiolka, C.W. Rose, K.J. Coughlan and B. Fentie

WATER erosion of soil can have significant effects on productivity. Physical removal of soil reduces the depth of soil that can be exploited by roots. However, in the short term at least, the most serious effect of soil erosion is the removal of plant nutrients which are concentrated in the surface soil layers. In addition to this, it is commonly observed that sediment transported by water erosion contains a higher concentration of nutrients than the soil layer from which the sediment was derived (see for example, Palis et al. 1990 a, b). This is termed nutrient enrichment of sediment.

Therefore, if erosion removes the immediate surface layer of the soil and if nutrient enrichment is significant, nutrient loss from soil erosion may be much greater (and consequently its effect on soil properties greater) than that which would be expected from the amount of soil loss and a chemical analysis of the 0–10 cm or 0–20 cm soil layers.

A summary of nutrient inputs and harvest outputs in these three systems is given in Table 1.

Table 1. A comparison of nutrient inputs and harvest outputs at three sites.

Site	Inputs		Harvest
	Fertiliser	Others	
Kemaman	Moderate	Legume	Low*
Los Baños	Low–Moderate	Legume, Mulch	High
Goomboorian	High	Mulch	High

* Low to date because cocoa trees are young.

This chapter concentrates on data from three sites — Kemaman, Los Baños and Gympie (Goomboorian) — where data on soil and sediment properties are available over a period of time. The three sites also provide contrasts in management from Kemaman (moderate input plantation crop), to Los Baños (low-medium input annual cropping), to Goomboorian (very high input perennial pineapple cropping).

Table 1 indicates the general levels of nutrient inputs and harvest outputs. At Goomboorian, for example, the sandy soil and high inputs of soluble inorganic fertiliser led to the expectation (correctly) that losses in soluble form would be high. Similarly, soil losses of 80–100 t/ha/yr at Los Baños and Kemaman led to the belief that losses from sediment would be greater than those in a soluble form.

An area of general uncertainty is the relative importance of nutrient loss in soluble form, in contrast to loss in forms associated directly with soil loss. Nor are factors affecting the relative importance of these two forms of loss well understood. Most data available to address this question were obtained at the Goomboorian site, and will be discussed later. At Kemaman, for Treatment T1, a comparison of loss of K with soil and in soluble form was made for the event on 18/12/94, the soluble form being estimated from filtered runoff samples. Loss of soluble K during this event was calculated to be 1.1 kg/ha compared to 0.16 kg/ha with suspended and bed load sediment. Hence for this particular event and treatment 87% of total K loss was in soluble form. The concentrations of K in soluble form was only 2.53 mg/L. It follows that although soluble nutrient concentrations in runoff water may be low, soluble loss in runoff can still be a very significant source of nutrient loss in environments such as Kemaman where runoff is high. An annual average estimate of the percentage loss of K in soluble form for the same treatment (T1) gives a figure of 61%, somewhat lower than for the recorded event of 18/12/94, but still substantial.

Thus, although data from Kemaman on the relative importance of soluble and soil-associated nutrient loss are limited, the data are enough to indicate the importance of monitoring nutrient loss in soluble as well as soil-associated forms, at least for soluble nutrient forms. This issue will receive further consideration when data from the Goomboorian site are presented.

Nutrient Balances

An assessment of the losses and gains of plant nutrients is an important facet in study of the stability of agricultural ecosystems. The significance of the various components, however, varies according to site, as illustrated in part by Table 1.

Two major nutrient inputs are fertiliser and atmospheric nitrogen fixed by leguminous plants. Fertiliser input is usually large in intensive agricultural industries such as pineapple production in Queensland. In Asia, where small-scale agriculture is practised, fertiliser application is usually small, sometimes limited only to manure and compost. However, there are some systems that incorporate legumes capable of significant biological nitrogen fixation.

In tropical hilly lands, alley cropping using leguminous shrubs, such as *Desmanthus* and *Gliricidia*, resulted in substantial increases in the soil's organic matter and nutrient status. Leguminous creepers such as *Pueraria phaseloides*, *Calapogonium caeruleum* and *Centrosema pubescens* have been used successfully as cover crops in tropical tree-crop plantations. The experience of the Malaysian rubber industry has shown that these creepers return at least 300 kg of nitrogen/ha/yr (Chin 1977).

In alley cropping, in pineapple production as well as in the cocoa-*Gliricidia* ecosystem, some recycling of organic matter and nutrients takes place, either through the return of hedgerow trimmings and crop residue to the soil or through litterfall. Fixation of atmospheric nitrogen by legumes can certainly be regarded as a nutrient input.

In situations where overland flow is strong enough to transport substantial amounts of litter or mulch, an outflow of nutrients from the system occurs, in addition to nutrient loss by net loss of soil. A mature cocoa stand produces 4.5 to 6.5 tonnes of dry matter/ha/yr. The litter returns 75 to 94 kg of nitrogen, 4 to 5 kg of phosphorus and 84 to 100 kg of potassium/ha/yr (Ling 1986). In addition, *Gliricidia*

litter in a mature cocoa stand returns 45 kg of nitrogen/ha/yr (Ling 1986). Ling also found that *Gliricidia* nodulates well and the nitrogen content of the nodules is 4.6% to 5.2%.

Outflow of nutrients occurs mainly through the transport of sediment out of the system and through crop harvest. However, in cases such as Gympie, where the soil is sandy and fertiliser application is high, or in Kemaman, where runoff is very high, nutrient loss in soluble or fine suspended material form can be substantial. Possible loss by leaching was not investigated in this project.

Nutrient outflow through harvest varies with the crop, but is generally high, most of the nutrients taken up by plants being used in fruit or grain formation. For example, large quantities of nutrients, in particular nitrogen and potassium, are involved in cocoa pod formation. The total amounts of major nutrients in pods in a crop of 1000 kg of dry beans/ha/yr are 31 kg/ha/yr of nitrogen, 4.9 kg/ha/yr of phosphorus and 53.8 kg/ha/yr of potassium (Thong and Ng 1978). However, if the pod husks are left in the field, and only the beans are taken away, the outflow of nutrients associated with a 1000 kg/ha/yr crop is reduced to 20.4 kg/ha/yr of nitrogen, 3.6 kg/ha/yr of phosphorus, and 10.5 kg/ha/yr of potassium (Thong and Ng 1978).

Since the major soil chemical aim of this project was to study the losses of nutrients in sediment with respect to the surface soil, comprehensive nutrient balance data were not available from this project. For example, data were not available for N inputs from N-fixation by *Gliricidia* at Kemaman and Los Baños, nor for deep drainage losses at all sites. However, data are given below for the three sites to illustrate the magnitude of at least some components in the nutrient balance sheet.

Kemaman

A partial nitrogen balance for plots T1 and T2 at Kemaman is given in Table 2.

Table 2. Nitrogen balance components at Kemaman in 1994 (all in kg/ha/yr).

	Inflows						Outflows	
	Atmospheric fixed N a	Cocoa c	Litter <i>Gliricidia</i> d	Rainfall e	Rainwash f	Fertiliser b	Sediment g	Crop h
T1	—	51	21	12	12	180	194	1.5
T2	?	79	26	12	12	184	93	5.8

Note:

a Though atmosphere N fixation by *Gliricidia* was not determined in this project it could be significant for T2.

b Total fertiliser added to cocoa, banana and *Gliricidia* in 1994.

c Amount of litter estimated based on work of Ling (1986) and on the fact the age and rainfall regime affect litter production. Assume T1 produced 5 t, T2 4.75 t. Assume 25% mobilised by runoff in T1 and 5% in T2. N contents measured.

d Based on figures by Ling (1986) and density of *Gliricidia* trees, the following estimates were made. (T1 1.4 t, 30% mobilised; T2 1.4t, 10% mobilised). N contents measured.

e, f Based on work of Ling (1986). Differences in rainfall amount taken into consideration; f-nutrients washed from leaves by rain.

g sum of loss (bedload plus suspended load).

h harvest.

The difference between the inputs and outputs of nutrients is stored in the standing biomass, and this can be considerable in this cropping system. According to Ling (1986), the mass of N in the biomass of mature *Gliricidia*-shaded cocoa is 423 kg/ha.

In considering inputs given in Table 2, it should be noted that in fertilised systems, adding the input from litter (particularly cocoa litter) to the nutrient input is double-counting because fertiliser N would be a major source of plant uptake. Also, unless soil N is extracted from below the depth of normal rooting (which is not the case here) nutrient recycling through leaf litter is not strictly an addition to the N balance. It is interesting to note the significant addition of N by rainfall and rainwash in this high rainfall environment.

Table 2 shows that the loss of N to the system from soil erosion in T1 was greater than the input from fertilisers. Inputs from N-fixation are likely to be quite low because of significant application of N fertilisers, and losses in soluble form are likely to be significant as discussed earlier. Therefore, the overall nutrient balance in plot T1 is likely to be negative.

Los Baños

A partial nitrogen balance for farmers' practice (T1) and improved hedgerow practice (T3) is given for Los Baños in Table 3. As for Kemaman, no information on N-fixation and losses from deep drainage and denitrification was available — neither was loss in runoff measured.

The dramatic change in partial N balance from highly negative in T1 to highly positive in T3 is due partly to a large decrease in losses in sediment in T3, and partly to a large increase in inputs from crop residues and hedgerow clippings. As noted earlier, not all of this increase is a gain to the N balance since an unknown proportion of N is merely recycling within the crop root zone. However, some N fixation is probably reflected in the N input from *Gliricidia* hedgerow clippings.

Even in T3, additions by fertiliser (30 kg/ha/yr) are significantly less than losses in crop and sedi-

ment (67 kg/ha/yr). The balance does not take into account gaseous and aqueous losses of N which may be significant in this humid environment. With fertiliser addition (which could reduce N-fixation by *Gliricidia*), it is possible that N fixation and recycling of N by hedgerows from below the depth of rooting of the annual crop are insufficient to create a positive balance even in treatment T3.

Goomboorian (the Gympie pineapple site)

As for other sites, evaluation of the nutritional balance can only be partial, since losses through leaching and nutrient transformation did not form part of the objectives of this project. However, the inputs and outputs in this high nutrient input system of pineapple production presented in this subsection are based on measurement or information-based estimates, and are thought to be the major components of the nutrient balance.

The nutrient inputs and outputs are given in kg/ha/yr and these average annual figures are based on the normal four-year cycle of the pineapple crop. At the end of this four-year cycle, during which there are a number of fruit harvests, the considerable body of above- and below-ground crop is vigorously cultivated into a cultivation layer of soil, usually by rotary hoe cultivation. Should leaf sprouting occur, this is controlled by further cultivation, weed growth during the period of plant growth being controlled chemically by herbicides. Thus, the balance components considered are annual average figures for the time from planting of pineapple sets, through the period of growth, fertiliser application, and nutrient loss, and include several fruit harvests terminated by incorporation of the considerable standing biomass into the soil.

Nutrient balance components are limited to nutrient inputs and outputs of the kind described earlier, and do not consider the issue of change in storage of nutrients in the soil, an issue addressed in a later section headed 'Change over time in soil properties'.

Table 3. Balance for N (kg/ha/yr) for two treatments at Los Baños in 1990.

Treatment	Fertiliser	Residues Crops (hedgerow)	Crop removal*	Sediment	Balance
T1	+30	+61 (0) ^W	-63	-296	-268
T3	+30	+207 (122)	-56	-11	+170

* Very roughly assuming mungbean and green corn to contain 1% N.

^W From hedgerow clippings.

Measured losses of nutrients were of two kinds, those associated with soil (in both bedload, BL, and suspended load, SL, components), and those in soluble form. Nutrient loss associated with soil loss in either BL or SL components was not measured for every one of the 96 erosion events in the approximately 3.2 year experimental period in which soil loss and runoff were measured.

The data presented later on nutrient loss in BL and SL are based on the number of measurements given in Table 4.

Table 4. Number of erosion events for which chemical analyses were made for N, P and K in BL and SL for the various treatments.

Treatment	Bedload (BL)			Suspended load (SL)		
	N	P	K	N	P	K
Bare	34	35	37	10	14	10
Conventional	33	32	36	15	20	18
Mulched	32	26	29	1	1	1

While there was analysis for only one suspended load sample for the mulched treatment, this was partly because the amount of soil lost as suspended load from this treatment was small.

Measured nutrient losses were averaged for recorded events, and this average loss per event (or measurement period) was assumed to provide an average loss for all events, including those in which nutrient loss was not measured. Nutrient concentration of bedload was measured on soil deposited in the Gerlach trough after the erosion event, subsampled if the deposited amount was large. A flow-weighted suspended sample was collected via a flow splitter that received outflow from the tipping bucket device. Loss of nutrients by suspended load was based on chemical analysis of the dried suspended soil material. Drying of both bedload and suspended load was at a temperature of 90°C, possibly high enough for some loss of nutrient. Results are given in Table 5.

Table 5. Average annual loss of nutrients N, P and K in bedload (BL) and suspended load (SL) for the three plot treatments at Goomboorian. Conventional and mulched refers to pineapple cultivation.

Treatment	Average annual nutrient loss (kg/ha/yr)					
	Nitrogen		Phosphorus		Potassium	
	BL	SL	BL	SL	BL	SL
Bare	17.1	15.6	25.1	3.1	50.4	8.3
Conventional	18.6	11.6	11.6	0.8	33.8	8.3
Mulched	0.7	0.8	0.4	0.04	1.6	0.2

Table 5 shows average annual nutrient losses to be greatest for the bare soil treatment, as would be

expected, losses from the mulched treatment being quite small. Loss of nutrients in the bedload generally exceeded that in suspended load, except for N from the bare plot, where the reverse was the case.

Table 5 gives no indication of the variability through time in the relative contribution of bedload to suspended load for the three elements N, P and K. This variation is shown in Figures 1 to 6 for the bare and conventional treatments. Especially for N, individual events can be of great importance, especially if fertiliser application is followed by major rainfall. For P, loss is always greater in the bedload (Figures 3 and 4), and this is also dominantly the case for K (Figures 5 and 6). Figures 1 to 6 are for events when both BL and SL data are available. As shown in Table 4, the number of erosion events (or service periods) varied, especially between BL and SL.

Data for nitrogen loss as kgN/ha/service period (not presented) show that for bare soil, large losses of N as SL were much more frequent than smaller losses. In contrast, SL losses of N from the conventional treatment occurred in both low and high levels.

For phosphorus in the SL there is significant frequency only of small losses of P (as kgP/ha/service period). Strong adsorption of P to soil could be the reason for this. For BL, there were as many large as small losses, with intermediate amounts of loss being less frequent.

For K losses were frequently high, especially for BL. This reflects the large loss of this element compared to other elements.

Prior to separation of the suspended load solids from its associated water, its collection container was shaken to distribute suspended material throughout the container volume, and electrical conductivity (E.C.) measured in that volume. Because of this method of sample preparation, nutrients associated with the SL would have contributed to the measured E.C. E.C. data were converted to an equivalent loss of the sum of major nutrients (N + P + K) using the relationship:

$$\text{nutrient loss (kg/ha)} = (0.64/100) \text{ EC } (\mu\text{S/cm}) \times \text{runoff (mm)}$$

where the figure 0.64 is an average for the range of available nutrients.

In this soil, because of its very low clay content, nutrients are associated mostly with organic matter rather than being more tightly bonded to clay. Hence, it is assumed that the nutrients measured in the SL also contributed fully to the measured electrical conductivity. Therefore, measured EC (in converted nutrient loss form) was corrected by subtracting the SL contribution as is illustrated in Table 6. All loss components in this table have been converted to common units of kg/ha/yr. Implicit in Table 6 is the assumption that SL losses of N, P and K all contributed equally in adding to measured electrical conductivity.

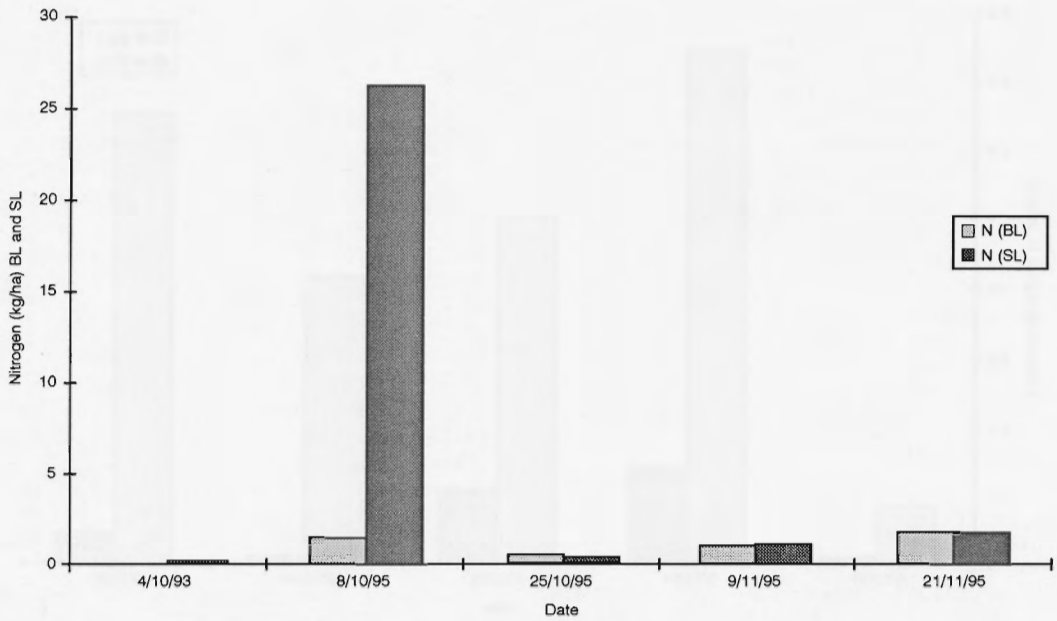

Figure 1. Nitrogen associated with bedload and suspended load (kg/ha) from the bare plot at Goomboorian through time.

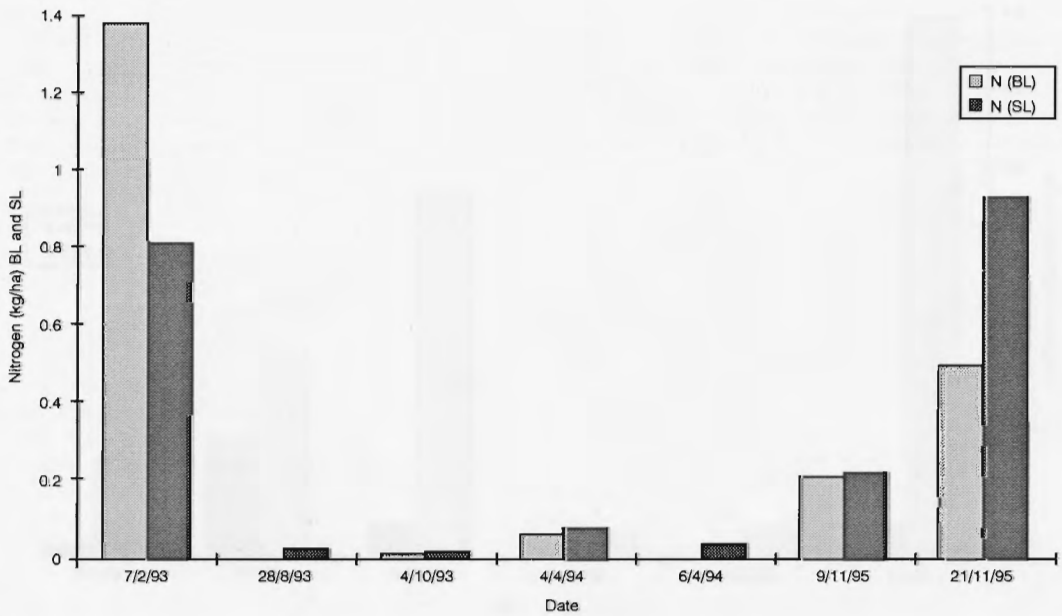

Figure 2. Nitrogen associated with bedload and suspended load (kg/ha) from the conventional treatment at Goomboorian through time.

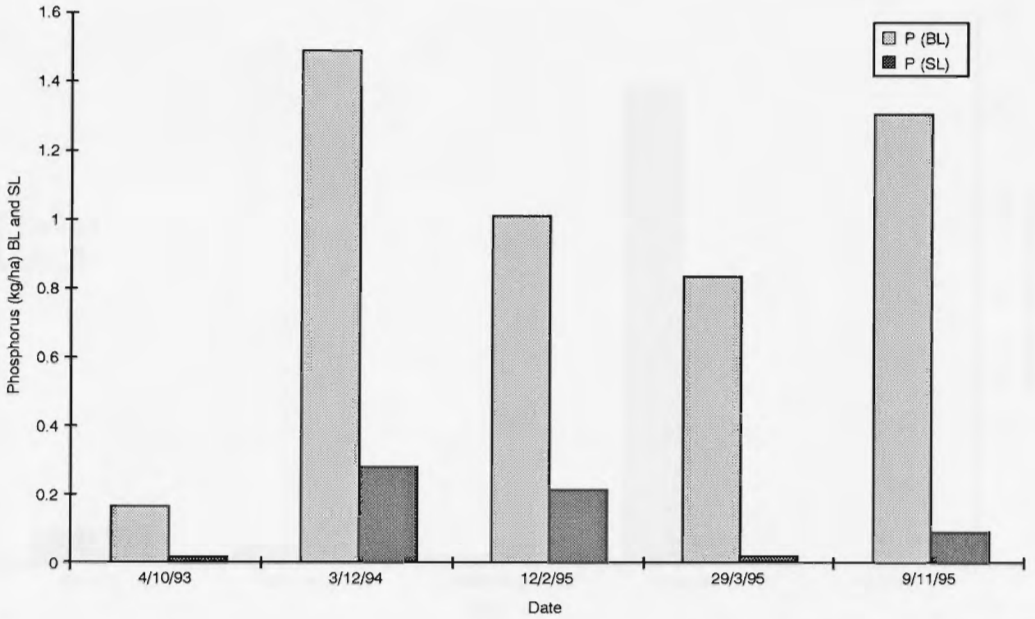

Figure 3. Phosphorus associated with bedload and suspended load (kg/ha) from the bare plot at Goomboorian through time.

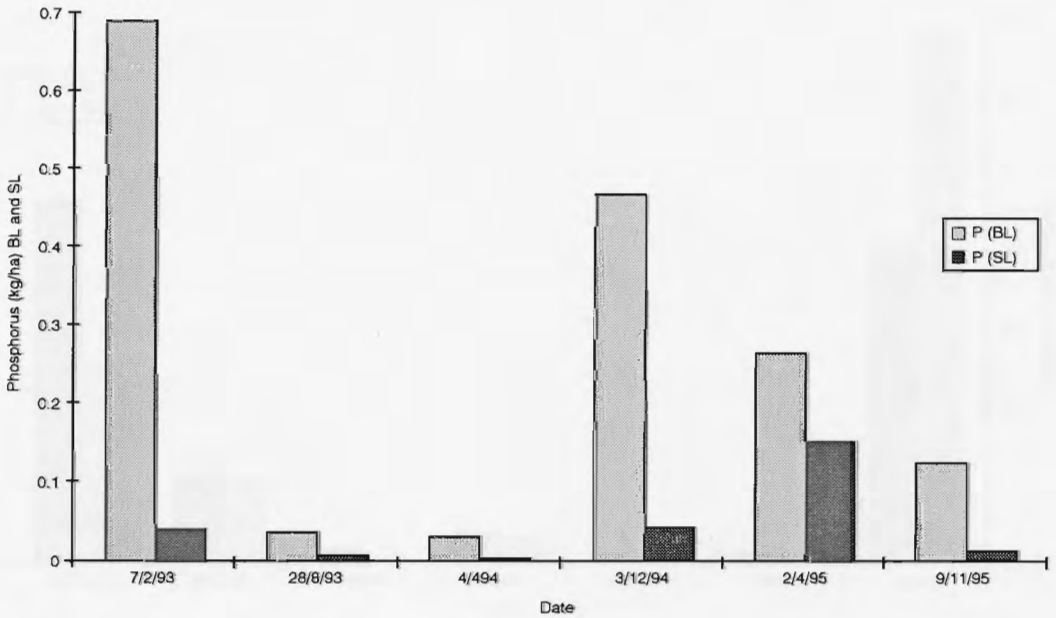

Figure 4. Phosphorus associated with bedload and suspended load (kg/ha) from the conventional treatment at Goomboorian through time.

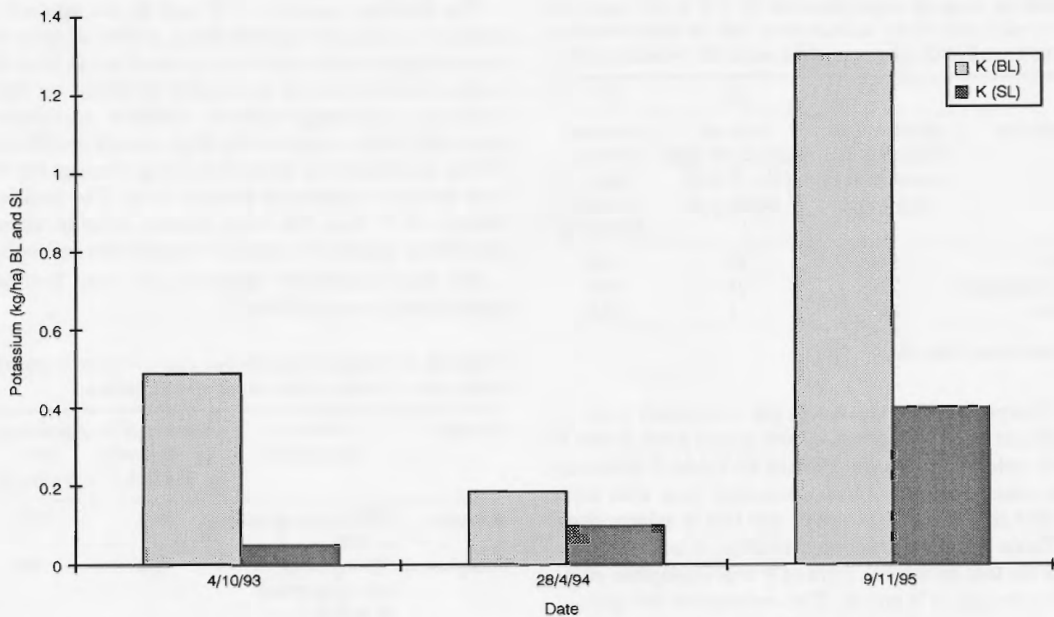

Figure 5. Potassium associated with bedload and suspended load (kg/ha) from the conventional treatment at Goomboorian through time.

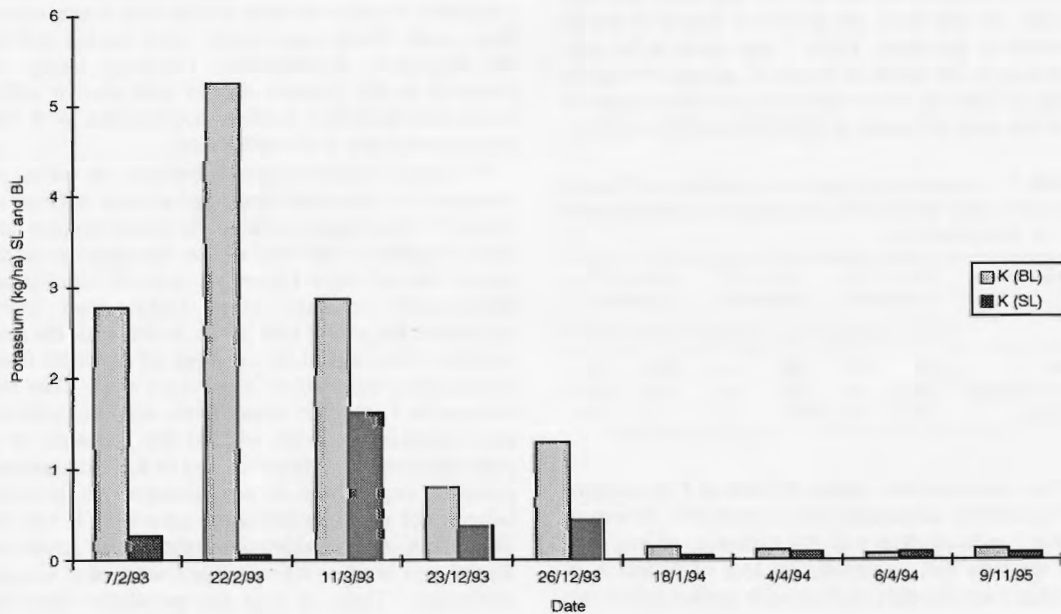

Figure 6. Associated with bedload and suspended load (kg/ha) from the conventional treatment at Goomboorian through time.

Table 6. Loss of major nutrients (N + P + K) based on electrical conductivity measurement, and its correction due to the contribution of suspended load to EC measurement.

Treatment	(1)	(2)	(3)
	Nutrient loss based on EC measurement (kg/ha/yr)	Loss on suspended* load (N + P + K) (kg/ha/yr)	Corrected soluble loss = (1) - (2) (kg/ha/yr)
Bare	345	27	318
Conventional	227	21	206
Mulch	185	1	184

* Data from Table 5

Comparing the estimated (or corrected) loss of nutrients in soluble form in plot runoff from Table 6 with nutrient loss with the soil in Table 5 indicates that loss in soluble form dominates over loss with eroded soil, either BL or SL, and this is summarised in Table 7. In constructing this table, it was assumed that the loss in soluble form of P was negligible compared to loss of N and K. This assumption recognised the far more soluble forms of fertiliser application for N and K than for P, and that the amount of P applied was almost an order of magnitude less than for N and K, as shown in Table 8. Furthermore, N was applied as urea, and K as KCl. McNeal et al. (1970) indicate that the relationship between ion concentration and electrical conductivity for K^+ , Cl^- and NO_3^- are very similar. On this basis, the fractional loss of N and K assumed in preparing Table 7 was taken to be proportional to the mass of N and K applied (which is given in Table 8). From this table, the ratio of applied N to the total of (N+K) is $(287/(287+429)) = 0.401$.

Table 7. Comparison of the loss of nutrients N, P and K associated with the soil (BL and SL) and in soluble form, for the three treatments.

Treatment	Loss of N (kg/ha/yr)		Loss of P (kg/ha/yr)		Loss of K (kg/ha/yr)	
	BL+SL	Soluble	BL+SL	Soluble	BL+SL	Soluble
Bare	33	127	28	—	59	191
Conventional	30	83	12	—	42	123
Mulched	2	74	0.4	—	2	110

For reasons given earlier, the loss of P is assumed to be entirely associated with loss of soil. However, Table 7 indicates that with the exception of loss of N for the bare soil treatment, the loss of N and K in soluble form exceeds the loss with eroded soil in this high fertiliser application crop. Averaged over all three treatments, the ratio of loss in soluble to soil associated form is 3.8 for N, and 3.7 for K.

The fertiliser sources of N and K are applied to pineapple plants in a soluble form, partly because the plant foliage is believed to be more effective than the limited root system of pineapples in taking up these nutrients. This large soluble fertiliser application, combined with a reasonably high runoff coefficient (Table 2, Chapter 4), would be a major reason for the high loss of nutrients in soluble form. The fertiliser source of P was the very slowly soluble superphosphate, applied in granular form to the soil bed.

All three treatments received the same fertiliser application given in Table 8.

Table 8. Information on fertiliser application to treatments during the 3.5 years of the experimental period.

Element	Form of application	Amount of N in 3.5 years (kg/ha)	Application rate (kg/ha/yr)
Nitrogen	2308 kg/ha as urea at 46% N	1062	303
Phosphorus	593 kg/ha as superphosphate at 26% P	154	44
Potassium	3002 kg/ha mostly as KCl at 50% K	1500	429

The dominance of fertiliser loss in soluble form from the cropped area shown in Table 7 was consistent with the findings of experiments carried out at a separate location on soils which were loams rather than sands. These experiments were carried out by the Pineapple Sustainability Landcare Group at Beerwah in the Gympie district with similar cultivation practices and fertiliser applications as at the experimental site at Goomborian.

A partial nutrient annual balance in terms of measured or estimable inputs and outputs is given in Table 9. The figures entered for plant biomass are from analysis at the end of the four-year growing cycle. Use of these figures as nutrient input is an overestimate because other losses than those accounted for would take place. At least for the first planting there would be no input of nutrients from the standing biomass of a previous crop. Thus the balance in Table 9 is shown both with and without this contribution. Even without the inclusion of a plant biomass input from residue of the incorporated previous crop, there is a substantial net positive balance for all three nutrients, especially K and N. Thus there is a considerable potential for losses by leaching or in other ways in this system of pineapple cultivation. There is also the possibility that the excess of inputs over outputs could partly be stored in the soil profile, and this possibility is explored in the next section.

For nitrogen, there is the possibility of loss in gaseous form due to denitrification. However, this would not be expected to be the major source of loss due to the highly permeable sandy soils at this site. Thus the major source of loss of the large positive balances of N and K shown in Table 9 is expected to be by leaching to subsurface waters which are usually a metre or so below the pineapple root zone in the experimental area.

To provide an independent check on this likelihood of substantial leaching loss of the more mobile nutrients (N and K in particular), consecutive samples were taken at two sites within the experimental sub-catchments, and also elsewhere in the pineapple farm as discussed below.

Figure 7 shows the time history during 12/2/96 of concentration of NO_3^- and K^+ in water samples withdrawn from the top of the saturated zone at a depth of 1 metre beneath the soil surface. The concentration data in Figure 7 were recorded after a substantial rainfall of 79 mm which would have resulted in significant leaching, as runoff was 13 mm. The data in Figure 7 are interpreted as recording the passage of a classical convection-dispersion pulse of NO_3^- and K^+ through the sandy soil profile at the measurement depth of 1 metre. Concentrations prior to and after the measurement period shown in Figure 7 were not available; but if this interpretation is correct, then a time lapse of some six hours is indicated between significant infiltration and the measurement of a soluble

Table 9. Average annual inputs and losses of nutrients N, P and K for the three treatments at Goomboorian.

Treatment	Inputs (kg/ha/yr)						Outputs (kg/ha/yr)						Balance (kg/ha/yr)					
	Fertiliser			Plant biomass			Total loss* (soluble + soil)			Harvested fruit			With plant biomass			Without plant biomass		
	N	P	K	N	P	K	N	P	K	N	P	K	N	P	K	N	P	K
Bare	303	44	429	0	0	0	160	28	250	0	0	0	143	16	179	143	16	179
Conventional	303	44	429	114	9	177	113	12	165	37	4	97	267	37	344	153	28	167
Mulch	303	44	429	114	9	177	76	0.4	112	37	4	97	304	49	397	190	40	220

*From Table 7.

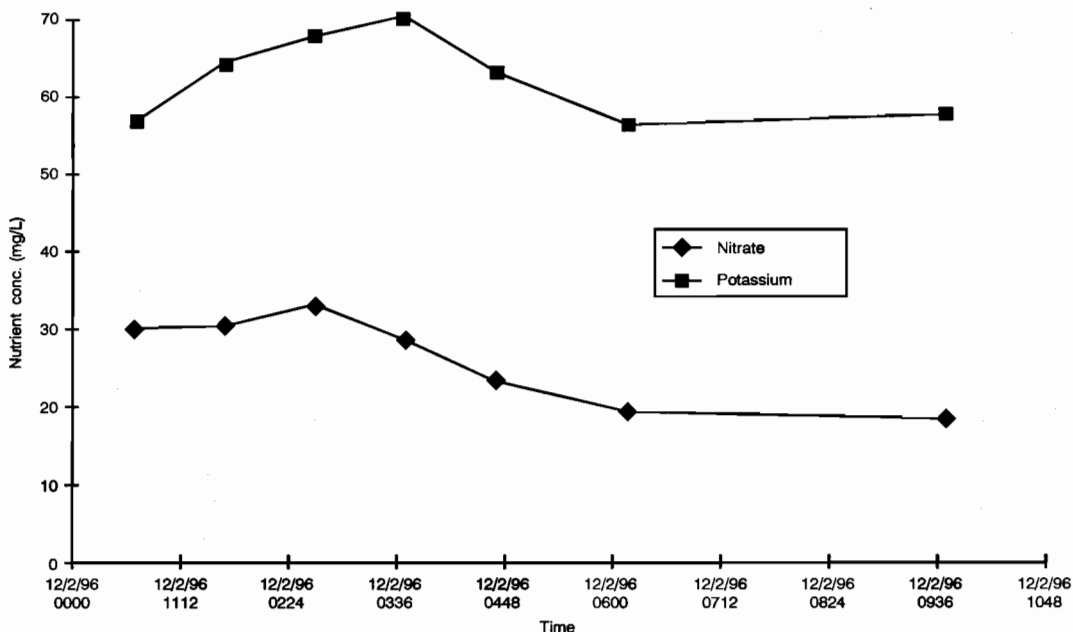

Figure 7. Variations in subsurface nutrient concentrations through time at 1 metre, conventional plot, Goomboorian.

peak concentration at a depth of 1 metre. This would indicate substantial leaching of applied N and K fertiliser at a rate of vertically downward movement of about 0.17 m/hr, a plausible figure for such a relatively coarse sandy soil.

These data on time variation in the concentration of NO_3^- and K^+ in the sub-surface water provide supportive evidence of the expectation of substantial loss of these elements by leaching which was indicated by the nutrient balance considerations summarised in Table 9.

During leaching of NO_3^- , the concentration in sub-surface water at 1 metre depth was of an order 15 times higher than in the surface waters of the prior runoff event which led to the nutrient leaching. For K^+ this same ratio was of order 5, possibly due to somewhat stronger adsorption of K^+ than for NO_3^- . However, there was a necessary difference in timing between the collection of runoff samples and the later sampling of sub-surface water at the time the water table rose in response to infiltration during the runoff event. The concentration profiles during leaching of the surface-applied fertilisers would be changing rapidly if the peak concentration reached 1 metre in two days, as appears to be the case, and the dynamics of these profiles right up to the soil surface would control the nutrient concentration ratio of nutrients measured in subsurface waters at 1 metre and in prior runoff. Such detailed data were not collected in this project and so it is not possible to interpret positively the implication of these reported concentration ratios.

The experimental site was on an upper slope of the pineapple farm. Measurements of EC and nutrient concentrations were made at locations downslope of the experimental site, and at a depth of 1 metre. These downslope sites lay between the

experimental sites and a smaller formed surface drain that collected surface runoff and subsurface seepage and fed it into a farm dam. These downslope sites were recently planted and thus had not received the heavy fertilisation of the experimental sub-catchments with their established crop. Analysis of subsurface water samples taken at 1 metre at these downslope sites indicated a greater stability in concentration and EC than at the experimental site. A farm dam collected surface and subsurface flow from the complete farmed area which formed a catchment. Concentration of NO_3^- in the dam water fluctuated more than the concentration of K^+ .

Both N and P concentrations measured in the dam water were greatest when the dam was accepting flow from the farmed area which consisted of a mosaic of areas in terms of the timing and amount of fertiliser application. Concentrations of N and K in the dam waters were less than in the subsurface water collected from under the recently-fertilised experimental sub-catchments. Fertiliser application to the more recently planted sections of the farm would be much less than applications to the experimental crop area, giving a possible explanation of why dam water concentrations were lower than in subsurface water at the experimental sub-catchments.

Change over Time in Soil Properties

Kemaman

Changes in soil chemical properties over time should reflect the nutrient balances for different treatments shown in the previous section. At Kemaman, variation within the plots in nutrient content of the surface soil, both spatially and temporally, makes it difficult to detect any long-term trends. An example of these variations is shown in Table 10. As discussed in

Table 10. Comparison of topsoil nutrient contents at Kemaman (0–2 cm, after removal of leaf litter) during periods of low and high soil loss.

Nutrient element	T1								T2							
	July 1992 (after low soil loss)				Jan 1993 (after high soil loss)				July 1992				Jan 1993			
	I ₁	I ₂	P ₁	P ₂	I ₁	I ₂	P ₁	P ₂	I ₁	I ₂	P ₁	P ₂	I ₁	I ₂	P ₁	P ₂
Organic C (%)	0.47	0.93	0.60	1.16	0.61	1.20	0.22	0.59	1.48	1.13	1.37	1.31	0.98	1.05	0.58	0.52
N (%)	0.05	0.10	0.07	0.09	0.07	0.05	0.02	0.06	0.18	0.12	0.13	0.13	0.10	0.10	0.05	0.06
Exchangeable K (Cmole(+)/kg)	0.21	0.22	0.11	0.14	0.08	0.05	0.04	0.08	0.33	0.39	0.23	0.42	0.09	0.08	0.21	0.06

I = inter-pathway area.

P = pathway.

Chapter 3, the large plots at Kemaman had well-developed preferred pathways for water flow. In these pathways, runoff and soil loss during the wettest period of the year (November–December) removes leaf litter and nutrient-enriched surface soil, resulting in large falls in nutrient concentration in the pathways. This is demonstrated for organic carbon in treatment T1. Despite the fact that duplicate measurements are very variable, average values for organic carbon are:

After low soil loss,
 Pathway = 0.88%
 Inter-pathway = 0.70%
 After high soil loss,
 Pathway = 0.41%
 Inter-pathway = 0.90%

Similar differences are noted for N and K in Table 10.

Another problem in looking at trends in chemical properties of the surface soil was that cocoa litter increased the fertility of the immediate surface soil only in the last two years of the project. This would obviously counteract the effect of any long-term decline in chemical status, at least in the immediate surface (0–2 cm) layer.

Data on organic carbon at initial sampling in September 1988 and in May 1995 are shown in Table 11. Plot organic carbon for 1995 is calculated from strategic sampling of pathway and inter-pathway by assuming that pathways are 5% of total plot area in both T1 and T2.

Table 11. Organic carbon (%) of two plots at Kemaman in 1988 and 1995.

Treatment	September 1988	May 1995
T1	0.98	0.84
T2	0.95	1.23

Although apparent trends are in the expected direction given the nutrient balance data in the previous section, changes over time are not statistically significant. This is possibly due to high variability in replicate results. For example, in May 1995, inter-pathway organic carbons in T1 were 0.74% and 0.94%, compared with 0.98% and 1.52% in T2.

Los Baños

At Los Baños, variation in soil properties over time is much more consistent and marked than for Kemaman, with larger decreases in both organic matter and available phosphorus being noted in all treatments over the monitoring period 1 January 1990 to 8 February 1994 (Figures 8a, b). Levels in T3 and particularly T4, where hedgerow clippings were returned to the soil surface, are significantly greater than in T1 and T2. However, the reduction in organic matter and available P over the period suggests that in none of the treatments was a positive

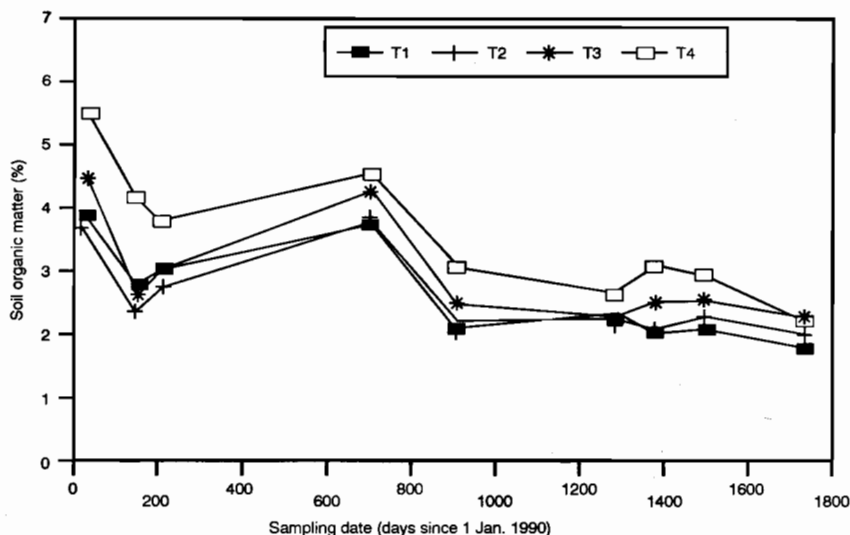

Figure 8a. Organic matter (%) content of the soil through time, Los Baños.

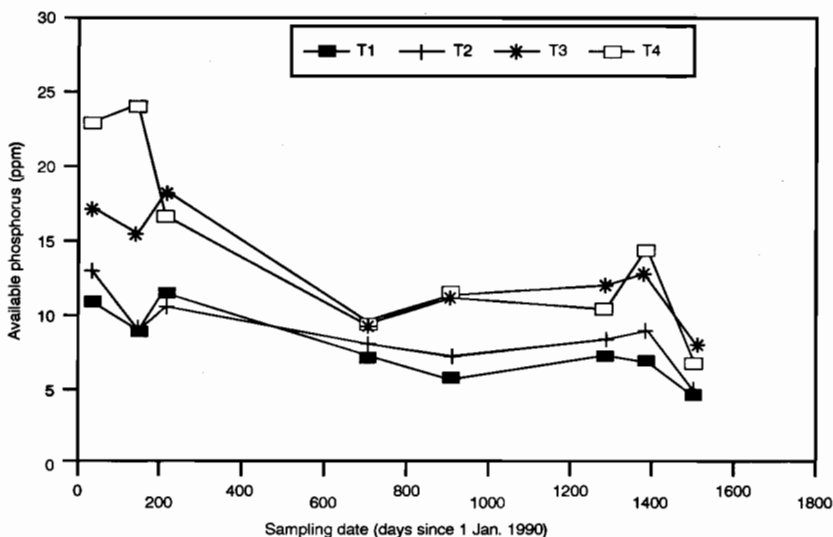

Figure 8b. Available phosphorus (ppm) content of the soil through time, Los Baños.

nutrient balance achieved. The rapid reduction in organic matter after about day 1400 in T4 reflects a change in treatment. Hedgerows were removed in September 1993, and hence return of hedgerow clippings to the alley was discontinued.

Soil pH remained approximately constant over the monitoring period, varying apparently randomly from 5.3–6.2. Exchangeable potassium decreased gradually during the monitoring period, and values for T3 and T4 (average 2.0 c mole +/kg) were significantly greater than for T1 and T2 (average 1.5 c mole +/kg) where hedgerow clippings had not been placed on the soil surface.

All treatments at Los Baños appear to be showing fertility decline, but this may be largely a function of the very high initial fertility of this site. At this stage only available P levels appear to be limiting. The long-term sustainability of cropping at this site is examined for selected treatments in Chapter 9, using cropping systems simulation techniques.

Goomboorian

This subsection presents data on change in soil physical and chemical characteristics over the experimental period.

Soil physical characteristics

The biggest contrast expected in soil characteristics would be between the bare and mulch treatments.

The better aggregation which would be expected to occur under the mulch treatment over the 3.5 year period of the experiment is supported by the following comparison in physical measurements:

- (i) Gravimetric water content of a 0.3 m deep in situ soil profile subject to rainfall was some 14% higher for the treatment receiving mulch than for the bare soil.
- (ii) The percentage of aggregates of size >2 mm was about 23% higher for the mulched site than for bare soil.
- (iii) In support of (ii), the percentage of soil with a settling velocity less than 0.15 m/s was some 11% higher for bare soil than the mulched treatment.

Soil chemical characteristics

As in physical characteristics, the greatest difference through time in chemical characteristics is expected between the mulched and bare soil treatments, and results for these two treatments are given in Table 12 for three samplings during the experimental period from November 1992 to August 1995.

Soil samples were taken 0–0.1 m, all the initial fore-plant fertiliser having been applied before the November 1992 sampling. Table 12 shows that all measures of nutrients increased through time in the mulch treatment. For the bare soil, in contrast, some nutrients declined through time or experienced little change. Also, the increase in organic matter was much greater for the mulched plot than for bare soil.

Table 12. Variation in a range of chemical nutrients through time in 0–0.1 m soil layer at Goomboorian.

Date	Total N %		Nitrate cmol/kg		Total P (%) %		Available P mg/kg		Total K %		Exchange K cmol/kg		Organic carbon %	
	Bare	Mulch	Bare	Mulch	Bare	Mulch	Bare	Mulch	Bare	Mulch	Bare	Mulch	Bare	Mulch
Nov 1992	0.02	0.02	2.0	2.0	0.008	0.005	5.0	7.0	0.031	0.02	0.09	0.05	0.5	0.46
Mar 1994	0.02	0.03	2.0	14.0	0.007	0.011	18	24	0.022	0.066	0.21	0.36	0.58	1.2
Aug 1995	0.02	0.08	4.0	32.0	0.004	0.049	7.0	61.0	0.023	0.117	0.16	0.58	0.68	2.8

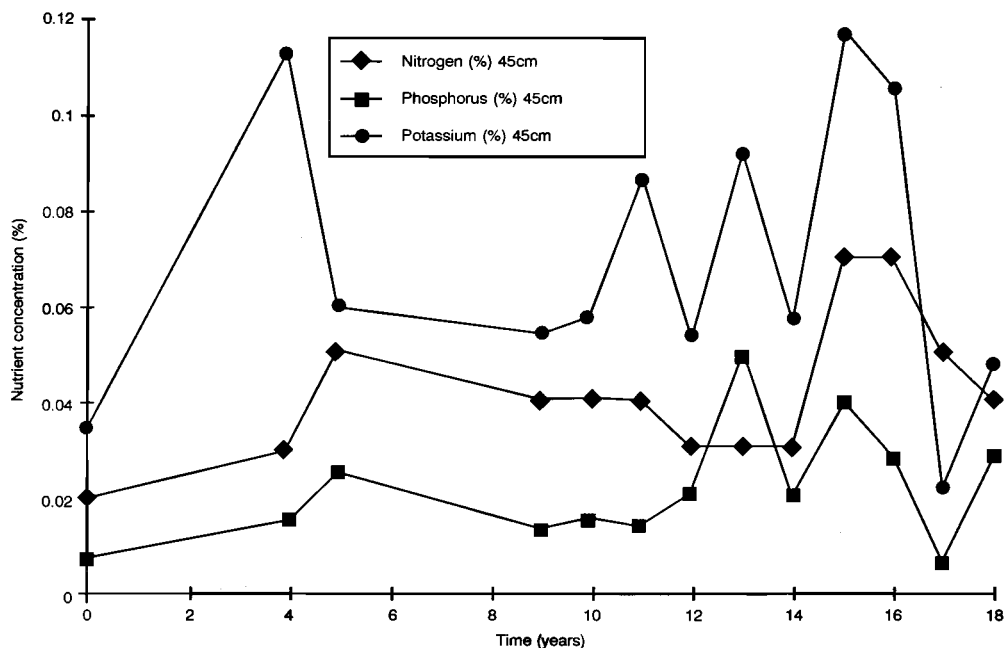

Figure 9. Long-term nutrient concentrations at 0.45 m, Goomboorian.

Although the chosen duration of a single crop of pineapple is four years (after which productivity declines), crops are normally grown in a sequence, one after another. Since pineapple planting has commenced at different times on the farm, samples were taken representing a range of periods of continuous pineapple cultivation, and analysed for nutrient concentration and organic carbon. Sampling was carried out both for 0–0.1 m and centred at 0.24 m depth. The results of such analysis for the 0.45 m depth samples are shown in Figure 9. The data at year zero are from an adjacent timbered site, prior to clearing for pineapple production. This figure indicated considerable oscillation in values, associated with the substantial applications of fertiliser, but there is nevertheless some indication of an upward trend

through time, at least for N and K. This trend is consistent with the observed upward trend with time of cultivation in the yield of pineapples. For the 0–0.1 m depth sampling there was more oscillation and little evidence of an upward trend.

Thus, from the point of view of pineapple production, there is no indication of lack of nutritional sustainability in this production system, and there is no evidence of degradation in the physical or chemical characteristics of the soil with duration of cropping, and some evidence of improvement.

Thus, if problems arise, they are more likely to be on-site or off-site issues associated with the substantial leaching of mobile nutrients in this very permeable deep sandy soil.

Nutrient Enrichment in Sediment

A major aim of the studies on nutrient content of sediment was to develop a methodology to predict nutrient loss from bulk soil loss. A central concept to this prediction is that of Enrichment Ratio, defined as:

$$E_R = \frac{\text{concentration of nutrient in eroded sediment}}{\text{concentration of nutrient in surface soil}}$$

One problem in precise measurement of E_R is the definition of 'surface soil'. Unless rills are formed, often cutting to the depth of the disturbed cultivated zone, soil removed by both raindrop detachment and runoff entrainment is commonly from the surface few millimetres. If surface accumulation of nutrients is strong, and soil analysis is carried out to a greater depth, the calculated E_R may overestimate the true value. At Kemaman, where the soil is not cultivated, the attempt was made to overcome this problem by analysing the 0–2 cm soil layer. At Los Baños, where soil is cultivated to 20 cm depth, and the cultivated layer is likely to be more nearly homogeneous, the 0–20 cm layer analysis used for standard fertility purposes was also used for E_R calculation.

Separate analysis of bedload (BL) and suspended load (SL) (see Chapters 2 and 3) was also carried out for soils which produced a significant proportion of suspended load. The SL is commonly strongly enriched in nutrients compared with the surface soil, while the BL may contain fewer nutrients than the surface soil. This phenomenon is well illustrated for the Kemaman site in Table 13.

For all elements, Table 13 shows that concentration of nutrients in the SL is markedly higher than that in the soil by a factor of up to 2.9. Apparent clay percentage of SL (as inferred from air-dried water content, compared with samples of known clay content) was 60%–80% compared with 19% in the surface soil, and absorption of nutrients onto clay in the

SL may partly explain the nutrient enrichment. In contrast, nutrient levels in BL are commonly lower than those measured in the surface soil (Table 13).

The magnitude of E_R for the total eroded sediment (suspended and bedload) has been determined for a range of sites and erosion events, and data are given below.

Kemaman

There are at least two important features of the Kemaman site that distinguish it from all other ACIAR 9201 sites. The first feature is the size of the experimental unit, 1000 m² at Kemaman, compared to 72 m² at Los Baños for example, a ratio difference of more than an order of magnitude. The second difference is the establishment of a plantation crop, cocoa, and associated shade tree, *Gliricidia*.

Associated with the larger scale experimental plot is a definite three-dimensionality involving the presence of major pathways of flow that collected and preferentially channelled a major fraction of plot runoff, leading to major variation in overland flow, soil, and nutrient loss characteristics over space as well as in time.

Associated with the tree crops characterising this site is a relatively large leaf fall which continues irregularly throughout the year. This results in a substantial initially well-distributed supply of what quickly becomes decomposed leaf litter. However, this decomposed leaf litter in particular is collected by and transported in the flow pathways.

Treatment T2 had substantially more contact cover than T1, leading to much lower loss of N in T2 than T1, as shown previously in Table 2.

At Kemaman, E_R for organic carbon, total nitrogen and exchangeable potassium were calculated for a number of individual events (9 for T1, 4 for T2) in 1993. Data are given in Tables 7.14a and b.

Table 13. Nutrient concentration data, 14 October 1990 to 17 December 1990, Kemaman.

Treatment	Element	Concentration in soil	Concentration in bedload	Concentration in suspended load
T1	Total N	0.09%	0.05%	0.19%
	Exch. K*	0.10	0.10	0.16
	Org. C	0.98%	0.47%	1.52%
T2	Total N	0.08%	0.04%	0.23%
	Exch. K*	0.12	0.14	0.22
	Org. C	0.95%	0.36%	1.65%

Note: * cmol (+)/kg

Table 14. Enrichment ratios (E_R) for different elements on two plots at Kemaman.

(a) Treatment T1 (low contact cover)

Date	Enrichment ratio (E_R)		
	Organic carbon	Total nitrogen	Exchangeable K
11/3/93	2.72	2.84	1.00
13/3/93	2.50	2.03	0.80
14/9/93	1.79	2.35	2.57
28/10/93	2.25	2.39	2.14
31/10/93	3.45	2.39	1.57
1/11/93	2.58	2.27	1.29
2/11/93	2.19	1.70	1.14
4/11/93	2.12	2.16	1.29
9/11/93	2.78	2.27	1.43
Average	2.49	2.27	1.47

(b) Treatment T2 (high contact cover)

31/10/93	7.92	4.00	4.00
1/11/93	6.40	3.50	3.40
2/11/93	5.73	2.90	2.40
4/11/93	6.90	3.20	2.40
Average	6.74	3.40	3.05

These data show that enrichment ratios for all elements are generally higher in treatment T2, even if comparison is restricted to data collected on the same days. Because of surface cover in T2, soil erosion was less and litter from leaf fall would tend to accumulate on the soil surface. The high E_R in all elements (including K, which accumulates in plant leaves) indicates that leaf litter may make a significant contribution to nutrient enrichment in T2. Also, Palis et al. (1990b) found that as the residue cover percentage increased, the percentage of fine sediment produced also increased. The higher nutrient concentration in SL is well illustrated in Table 13 and a higher fraction of sediment loss is in the suspended component with higher surface contact cover.

Los Baños and other sites

For the clay soil at Los Baños, E_R was measured for three individual events for treatment T1. Enrichment ratios for organic matter, phosphorus and potassium were 1.13, 1.09 and 0.82 respectively. Data from another clay soil near Chiang Mai in Thailand (Frances Turkelboom, pers. comm.) measured E_R for organic matter, total nitrogen available P and extractable K of 1.03, 1.01, 1.93 and 1.32 (average of two sites).

E_R data are also available from some very sandy soils on the site at Khon Kaen, Thailand (Sombatpanit et al. 1995), and from a soil erosion trial on an

Alfisol at ICRISAT in India (K.P.C. Rama Rao, pers. comm.). At Khon Kaen, E_R varied markedly between elements, but varied from 3.4–6.3 for organic matter for different treatments in the 1991 cropping season. For a bare plot, E_R was only 1.9, suggesting that transport of light-fraction plant residues make a significant contribution to enrichment in the treatment plots. At ICRISAT, E_R for organic carbon was consistently greater than 1.5, and varied up to 4.5 in treatments when seasonal soil loss was low.

The data presented suggest a strong soil type effect on E_R , with cultivated clay soils having an E_R approaching 1 and sandy soils having E_R for organic matter of up to 5 or 6. This factor and other variables affecting enrichment ratio are considered later.

Goomboorian

For total nitrogen and organic carbon, enrichment ratio data are available for all three treatments, bare soil, conventional, and mulched, during the experimental period. For bare soil, E_R for both total nitrogen (Figure 10) and organic carbon (Figure 13) lay between zero and 2, giving the impression of little enrichment in general despite considerable variability in E_R shown as a function of time in these figures. Indeed, for the data in Figure 13, the average value of E_R is less than one. A similar summary to that given above for the bare soil treatment also may be given for the conventional treatment in Figures 11 and 14, except for the single unexplainable very high value of E_R for total N (Figure 11).

The story is different for the mulched treatment, a single application of mulch to the furrows being made in September 1992. During the experimental period, the applied mulch became increasingly buried with soil eroded from the more elevated planting bed. This gradual burial of the mulch with soil is very likely to be the explanation of the decrease with time in E_R shown more convincingly in Figure 12 (for total nitrogen), but also in Figure 15 (for organic carbon).

High values of E_R for the mulched treatment are no doubt due to the ability of the mulch to restrict erosion of all but the finer fraction, which is commonly the fraction most highly enriched. These results are in agreement with the finding of Palis et al. (1990b) who found E_R increased with the level of surface contact cover.

E_R for potassium is available only for bare soil (Figure 16). The value of E_R for potassium is generally higher than for total N (Figure 10), but the limited data for potassium make the significance of this difference uncertain.

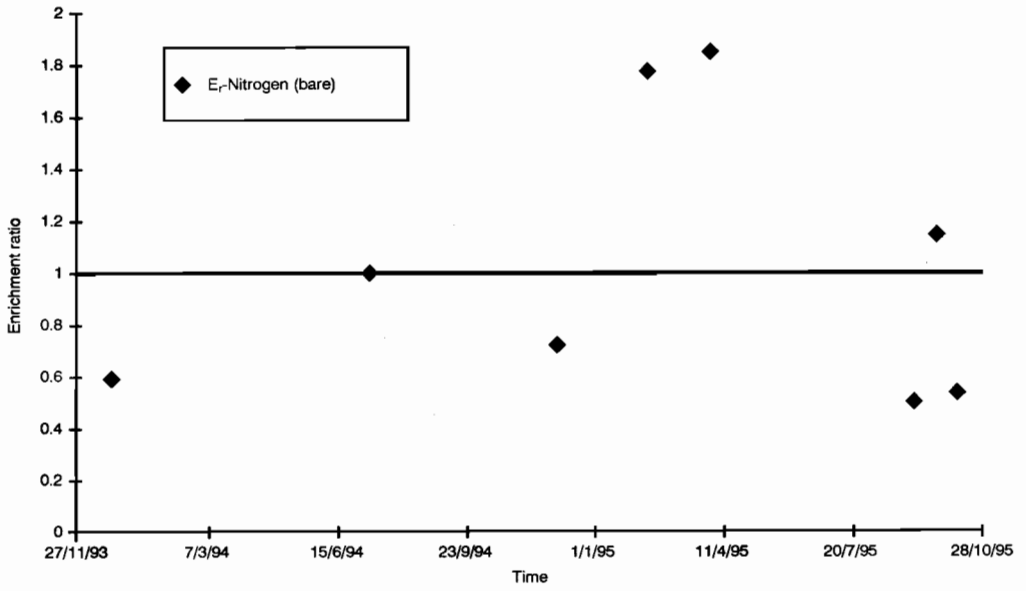

Figure 10. Enrichment ratio for total nitrogen (bare), Goomboorian.

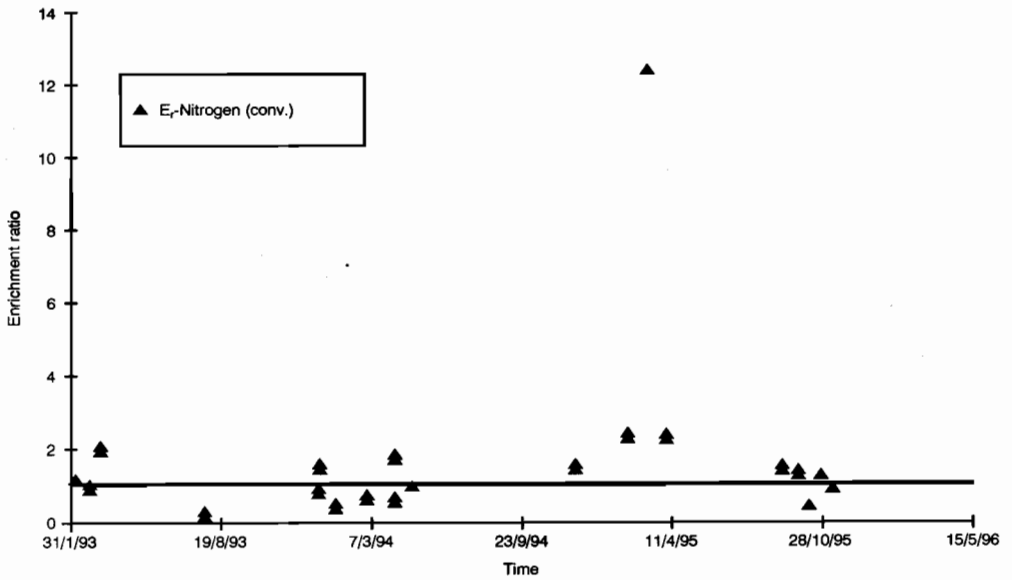

Figure 11. Enrichment ratio for total nitrogen (conventional), Goomboorian.

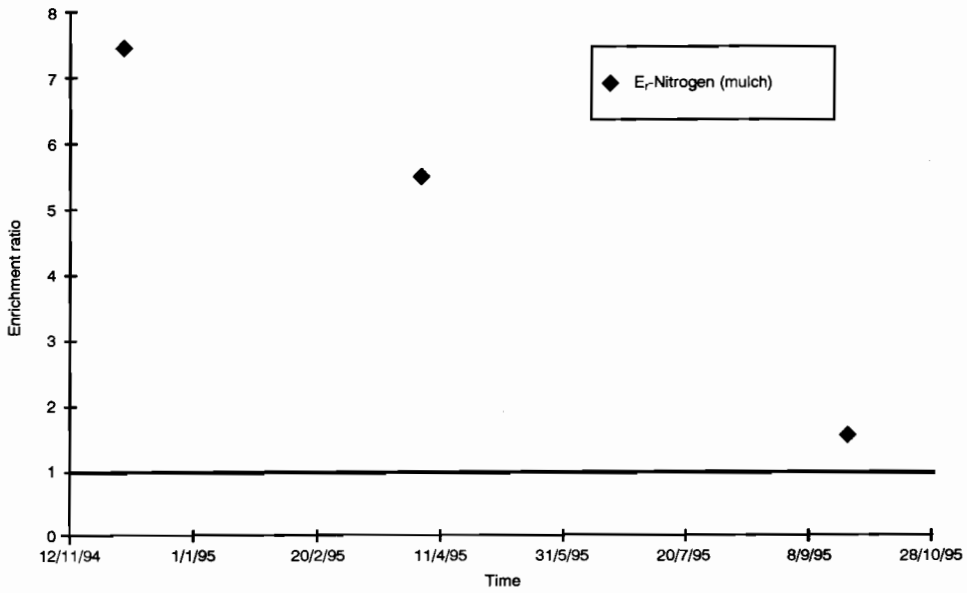

Figure 12. Enrichment ratio for total nitrogen (mulch), Goomboorian.

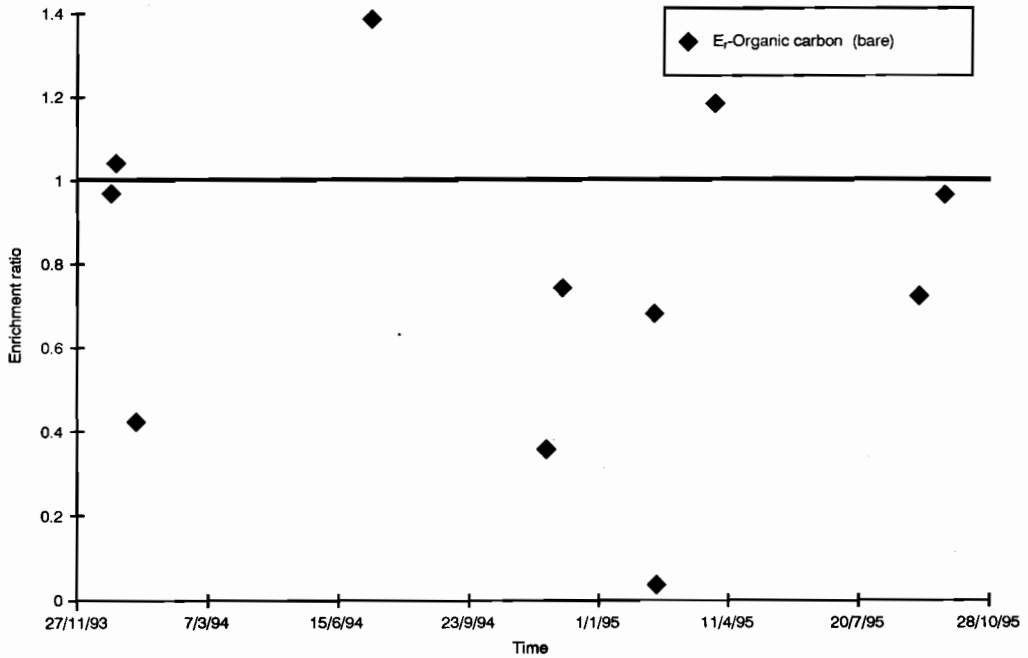

Figure 13. Enrichment ratio for organic carbon (bare), Goomboorian.

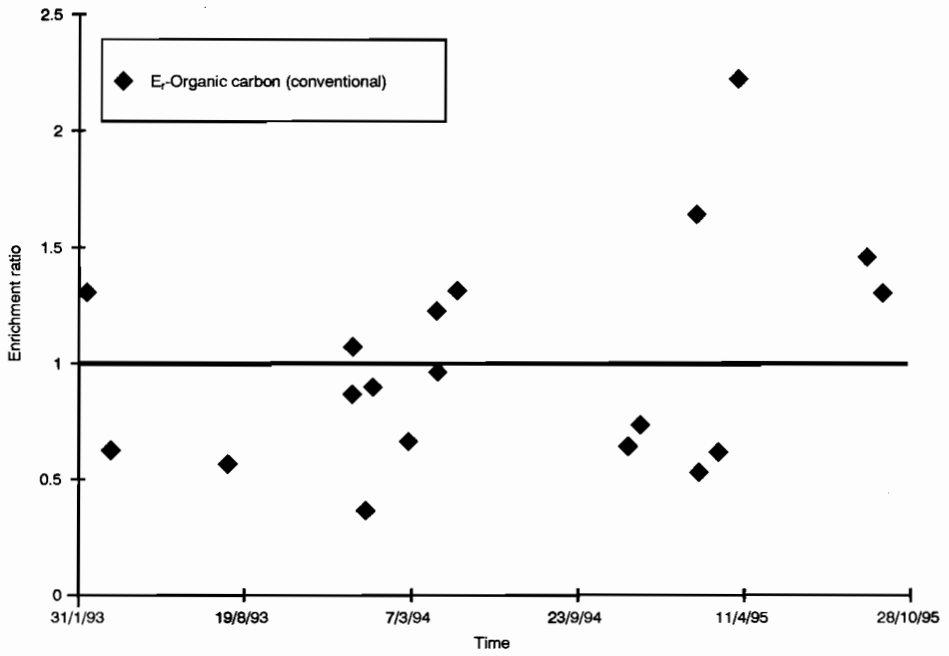

Figure 14. Enrichment ratio for organic carbon (conventional), Goomboorian.

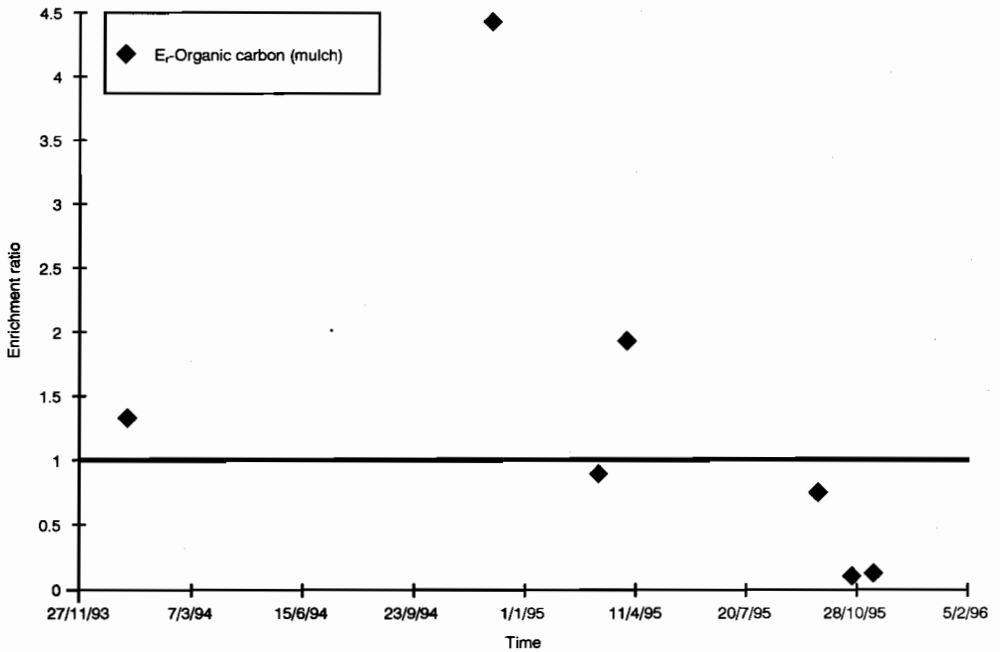

Figure 15. Enrichment ratio for organic carbon (mulch), Goomboorian.

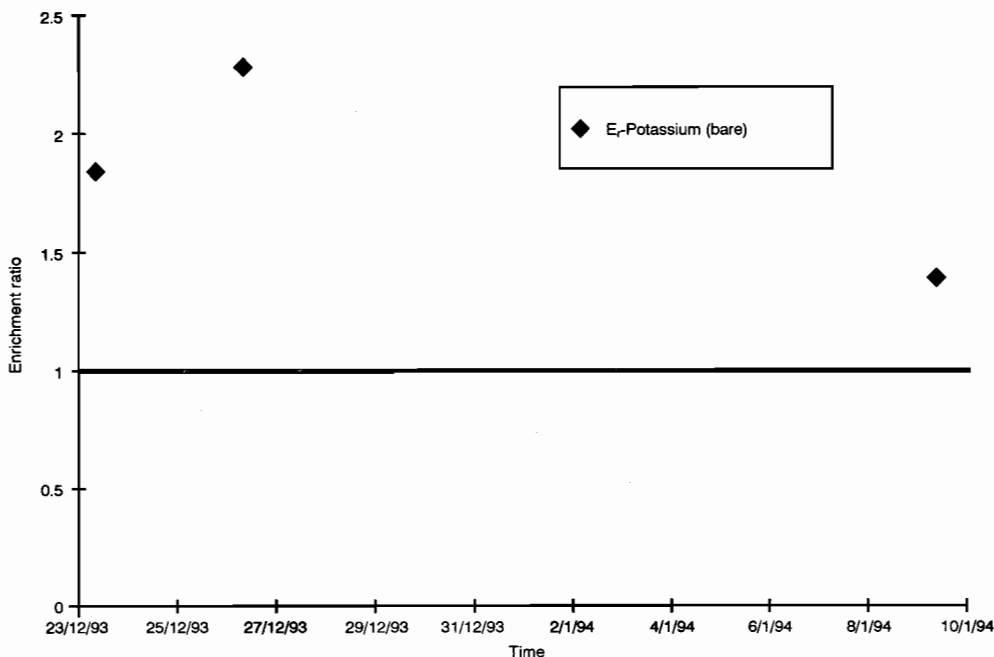

Figure 16. Enrichment ratio for potassium (bare), Goomboorian.

Factors Affecting Enrichment Ratio

Much of the experimental work in factors affecting enrichment ratio reported in the literature is at a scale closer to that of the plots at Los Baños than at Kemaman. This smaller-scale work has shown that any process causing size sorting of sediment into classes with different chemical compositions during production or transport across the soil surface to the point of exit from a measurement area will result in sediment having a chemical composition different from the soil from which it was divided. Even though the erosion or soil removal processes by either rainfall impact or overland flow appear to be non-selective with respect to aggregate size (in the erodible range), both experiments at a small plot scale and fundamental non-steady erosion theory indicate that size sorting is stronger and lasts much longer when rainfall impact is the erosion agent, compared with overland flow. While there are similarities between both erosion processes, differences between the characteristics of sediment generated when either erosion process dominates are marked at short times and can persist for the duration of an erosion event. The characteristic difference is that sediment eroded when rainfall impact is the

dominant erosion agent results in a sediment which is finer or slower-settling than the original soil being eroded, whereas, if this occurs at all with erosion eroded by flow, it is very short-lived, with the size characteristics of eroded sediment being very similar to that of the soil being eroded. Palis et al. (1990a, b) and Proffitt et al. (1991) provide illustrations of the effect, but Onstad and Moldenhauer (1975) noted earlier the characteristic finer nature of sediment from inter-rill areas (where rainfall impact is likely to be the dominant erosion mechanism), compared to that generated by rill flow.

However, this characteristic difference in sediment size distribution generated by the two erosion processes would have no chemical enrichment consequences if all sizes of aggregates had the same composition.

As outlined by Palis et al. (1990a) it would be expected that nutrient enrichment would only occur if the following two conditions apply:

- Sediment has a range of settling velocities. If this is not the case, no selective deposition of sediment can occur. In natural soils, sediment always has a most significant range of settling velocities.
- Material of different settling velocities has a different chemical composition.

It is especially the second of these two criteria which gives soil type such an important role to play in determining the level of chemical enrichment associated with soil erosion. As is illustrated in the review by Rose and Dalal (1988), by the time clay content of soil reaches about 50%, there is very little if any chemical enrichment, or $E_R = 1$, whatever the erosion processes.

This conclusion is supported in this project by the data given in the previous section, where the cultivated clay soils were shown to have values of approximately unity for E_R . No doubt the reason for this is that with the possible exception of sand particles (>0.1 mm), non-clay particles tend to be incorporated within the clay matrix of the soil aggregates (Coughlan and Fox 1977; Coughlan et al. 1978). Also, in the authors' experience, sediment with a lower settling velocity always has a higher or similar concentration of nutrients compared with higher settling velocity sediment. It follows that provided clay is well aggregated and dispersion is minimal, the particle size composition of different aggregates will be similar. Especially at clay percentages <30%–40%, non-clay particles will tend to separate from clay aggregates and selective deposition of non-clay particles (which have lower absorbed nutrients) will occur, resulting in higher E_R in low clay soils.

This simple model is in agreement with the E_R data presented for a range of soils in the previous section.

Another cause of nutrient enrichment of sediment, established at smaller scale by Ghadiri and Rose (1991), is where raindrop impact strips the enriched surface layer from large, water-stable aggregates. This is called 'raindrop stripping'. This is another example, different from, but with a similar end result to, the one given in the previous section for removal of thin surface soil layers, where sediment is being removed from a part of the soil which differs from that analysed as 'surface'. At Kemaman, the immediate surface of the uncultivated soil under cocoa was high in nutrient-rich organic matter.

Apart from the soil type and erosion mechanism effects on E_R described above, the following factors may influence nutrient enrichment:

- size of erosion event;
- plot measurement area size; and
- (in uncultivated perennial crops) timing of events.

It is well established that in general E_R declines as the accumulated mass of soil (M) in any erosion event increases. Knisel (1980) and many others have found E_R to vary with M according to:

$$E_R = AM^{-B} \quad (1)$$

where A and B are empirically fitted parameters. Equation (1) implies a linear relationship between $\ln E_R$ and $\ln M$ of slope B and intercept A . Some evidence of this form of relationship also came from data at the Kemaman site.

In soils of higher clay content, parameter A can approach unity and B zero if raindrop stripping or removal of enriched surface layer is not active. One reason for the form of equation (1), well established by smaller-scale experimentation, is that the eroded sediment produced at early times (or smaller values of M) is finer or has a lower average settling velocity than the original soil. This is especially true if rainfall detachment is the dominant erosion mechanism, and this is so initially under natural rainfall, even if, later in the erosion event, erosion is dominantly driven by overland flow. As time proceeds during the erosion event, and M increases, the settling velocity distribution of eroded sediment approaches that of the original soil, so that E_R tends towards unity. This change in settling velocity distribution with time is much slower for events and situations where rainfall detachment remains the major erosion mechanism, as shown by Palis et al. (1990a, b).

A notable feature of the Kemaman site is the readily visible evidence of very active soil faunal activity, the activity of earthworms being particularly noticeable. Soil faunal activities not only affect soil fertility and soil structure but also have a role in nutrient loss through erosion. Some species, such as earthworms, ingest soil material and subsequently deposit it as casts on the soil surface. These casts are light enough to be entrained by large overland flows, though a contribution from inter-pathway areas is also possible. As their chemistry shows them to be nutrient-enriched relative to the original soil (Table 15), they will play some role in nutrient enrichment of sediments.

Table 15. Nutrient contents of earthworm casts and of surface soil in T1 and T2, Kemaman.

	T1			T2		
	C(%)	K(x)	N(%)	C(%)	K(x)	N(%)
June 1993	0.96	0.48	0.11	1.38	2.06	1.15
October 1993	1.09	—	0.11	1.77	—	0.13
July 1994	1.06	0.31	0.10	1.35	0.36	0.12
Mean	1.04	0.40	0.11	1.50	1.21	0.13
Surface soil (0–2 cm) sampled in November 1993						
Pathway	0.13	0.05	0.04	0.41	0.10	0.09
Interpathway	0.91	0.19	0.09	0.66	0.14	0.10

$x = C$ mole (+)/kg.

The casts, especially those in T2, contain relatively high concentrations of potassium and organic carbon. This suggests that soil reworking by earthworms involves the mixing of soil material with vegetative matter (see Table 15).

Measurement at the larger scale at Kemaman appears to provide a second reason for the decline in E_R with the mass of soil lost, described in equation (1).

A common feature of monsoonal climates such as that at Kemaman is that large rain storms tend to

cluster together to form wet spells of two or three days duration. Results of nutrient loss measurement on an event basis at Kemaman provided evidence of a decline with successive erosion events in nutrient and organic carbon contents as illustrated in Figure 17. The data are total N (%) and organic C (%) for three erosion sequences in 1993.

In each case, the sequence of runoff events in Figure 17 is preceded by a 'dry spell', i.e., a period of at least one to two weeks with no significant

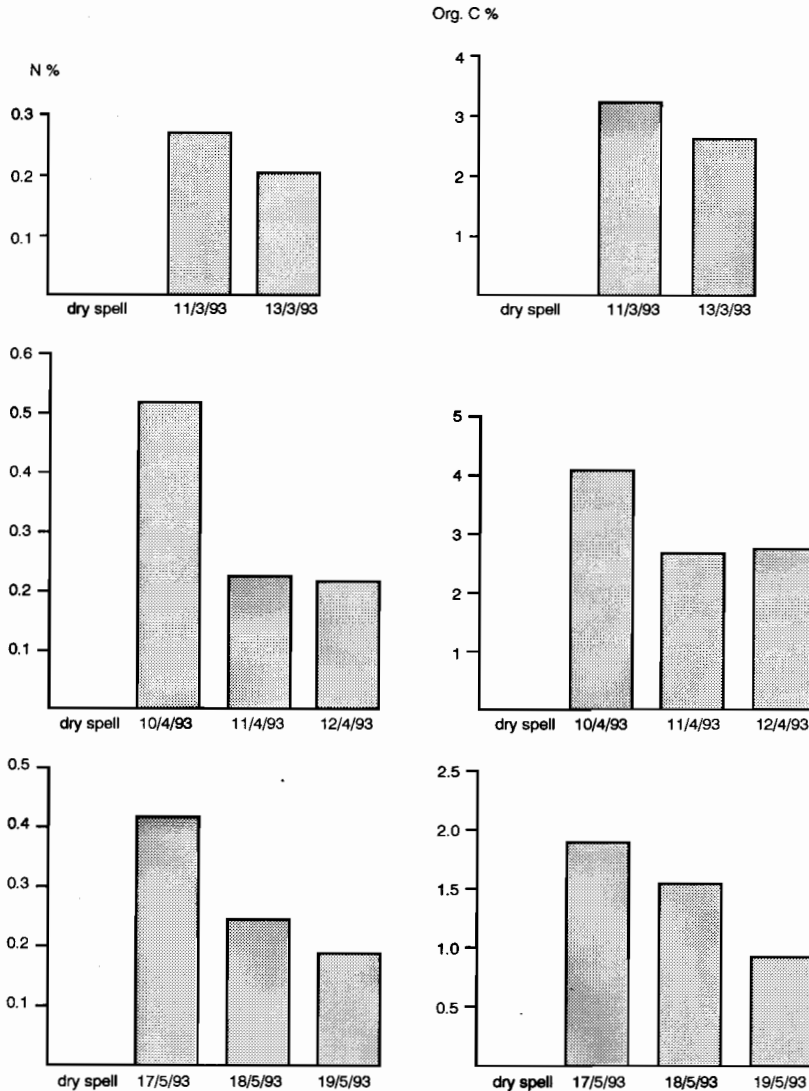

Figure 17. Nutrient contents in T1 suspended load sediment.

erosion. Figure 17 shows that for each sequence there is a decrease in the nutrient content of sediment for each subsequent event. Field observation showed that during 'dry spells' rapid decomposition of leaf litter took place, presumably aided by the action of earthworms and termites. This decomposition resulted in the formation of weak aggregates that are readily removed by subsequent runoff-erosion events, as would be the nutritionally enriched earthworm casts and products of other soil faunal activity. Leaf litter material is apparently dominant in erosion after 'dry spells' because organic C% and total N% in sediment is much higher than that in the slightly enriched earthworm casts.

Thus, at least for this Kemaman site, the timing of sequences of erosion events can have a substantial effect on the nutrient concentration of eroded sediment (Figure 17) and thus on E_R .

Another factor or feature of experimentation which could have an effect on E_R is the size of the plot from which sediment is collected in the determination of E_R . While the topographic feature of pathways and the effect of a perennial tree crop at Kemaman may have had as much influence as the larger plot size (1000 m²) at this site, even without such effects the effect of plot size on E_R may be confounded by two effects:

- As plot size increases, the possibility of selective deposition increases. This tends to increase E_R .
- An increase in plot size also tends to increase the dominance of runoff entrainment processes, reducing E_R for any erosion event.

Thus the overall effect of plot size on E_R at a field scale is uncertain.

The data on E_R for lighter-textured soils, shown in Table 14 for Kemaman, and by Sombatpanit et al. (1995) for the sandy soil at Khon Kaen, show large differences in E_R for different nutrients and for different treatments. These data suggest that simple clay enrichment is unlikely to completely explain E_R in

most light textured soils. If clay enrichment were dominant, E_R for different chemical elements would be expected to be similar.

Despite the soil type at Goomboorian being sandy, E_R for bare soil is not as high as has been measured for other sandy soils, for example, at Khon Kaen. In spite of the fact that soil type can have a significant effect on E_R , the erosion mechanism is also important, with lower values of E_R being observed when flow-driven erosion dominates erosion due to rainfall impact, which would be the case in the 36 m long rows at 5% slope used in the experimental plots at Goomboorian.

Conclusion

The results presented and discussed in this chapter, together with the literature on this topic, indicate that the enrichment ratio for any nutrient is influenced by a large number of factors. Nevertheless, the data on E_R obtained in this project have some degree of consonance with other literature on this subject. The complex range and nature of factors which can affect E_R could best be evaluated using an 'expert system' approach rather than a mathematical formula based on factors such as soil type, size of erosion event, event timing in a sequence, degree of fractional contact cover, etc. A simple example would be that for a bare cultivated clay soil a default value of 1.0–1.5 for E_R could be acceptable. In other contexts, some guidance could be provided, even though site-specific factors could play a significant modifying role, especially at larger scales where flow pathway affects as experienced at Kemaman can play a significant role.

Such an 'expert system' has not been formally developed on this project, but the experience provided on values and variations in E_R obtained in the project significantly extends the range of experience and data available for the humid tropics and semi-tropics.

Chapter 8

Runoff and Soil Loss Prediction

B. Yu, C.W. Rose, K.J. Coughlan and B. Fentie

WHILE this report of ACIAR Project 9201 focuses on the development of and results obtained with a new soil erosion and conservation technology in its multi-country context, it also opens up the possibility of prediction of runoff, soil loss, and, with a knowledge of appropriate enrichment ratios, of nutrient loss. There are two different kinds of challenges to prediction: firstly, prediction over a longer time period at a site where a period of measurement adequate to directly apply the technology has been made; secondly, prediction at sites where such measurement is inadequate or possibly non-existent.

While this chapter discusses both types of challenges to prediction, it focuses on the first, also briefly describing a predictive aid to soil conservation design.

Hydrological Data Requirements for Soil Loss Prediction Using GUEST Technology

While Chapter 4 reported attempts to model the dynamics of runoff processes at the small time interval of one minute, arbitrarily adopted for ACIAR Project 9201, this chapter examines the question of what hydrological inputs are needed in order to use the GUEST technology with commonly available input data, and how these required hydrological inputs can be estimated using a minimum amount of rainfall data.

The potential data requirements using GUEST technology

True prediction of soil losses is about future soil erosion rate at various time scales. In other words, soil erosion prediction makes statements about the future removal of soils from a given area on a time scale that may vary from one minute, event, monthly, or annual basis. Legitimate prediction of soil erosion also includes an estimation of soil loss rate at various time intervals for sites where no soil losses have been measured and other relevant

information on rainfall intensity or runoff rate is limited. Therefore, the prediction issue can arise in a range of circumstances with a corresponding range of data availability.

In the GUEST environment, although sediment concentration is assumed to vary within an event as a function of stream power among other things, measurements of sediment concentration over time were not taken for this project, and, in any event, only the average sediment concentration is of practical interest. It appears, therefore, that the case for detailed hydrological information, such as runoff rate at one minute intervals, is that the GUEST model implies that such variation in runoff rate affects sediment concentration.

Table 1 summarises a variety of possible prediction contexts. Cases I, II and III are concerned with experimental sites designed for model development and validation. There is less need to predict soil losses at these sites, except in order to extrapolate to long-term from limited-period measurements. While Case IV seems to present a real challenge for hydrologists to predict runoff rates given rainfall rates, for purposes of widespread application, Case V and Case VI are most relevant because, in most places in Australia, elsewhere in the south Pacific region and Southeast Asia where predicting soil loss is needed, there may be no rainfall data at all. Generally, a limited amount of daily rainfall data for a period of 10 to 30 years is the only kind of climatic data available. The essential data input requirements of GUEST will be examined in the context of these possible prediction scenarios.

Essential data requirements for using GUEST technology

As an event-based process model, GUEST assumes that:

- a fixed fraction, $F = 0.1$, of total energy expenditure of surface runoff is involved in

Table 1. Possible soil erosion prediction scenarios using GUEST technology.

Case	Data	Data availability	Prediction requirement
I	One minute rainfall intensity and runoff rate	Not available anywhere at the plot scale apart from ACIAR sites	No prediction is needed
II	Rainfall intensity data (break-point or 6 minute) and runoff totals only	Available for some experimental plots in USA, Australia.	The known runoff coefficient can be applied to the rainfall data. Apart from validation exercises, there is no need to predict the soil losses for experimental sites.
III	One minute rainfall intensity data	Not routinely available anywhere	Use SSRRM, or Green-Ampt model, or similar
IV	Rainfall rate at six-minute (AUS) and 15 minute (USA)	In Australia, about 5% of rainfall stations have some 6 minute data. Record length is usually less than 20 years	Use SSRRM at different time scales, or use water balance model to determine runoff total and use peak rainfall intensity to determine the effective runoff rate
V	Rainfall totals only	Data on daily rainfall totals for long period of time are widely available in Australia as in many other sites in the world	Use water balance model to predict runoff amount, use precipitation type or season to determine the peak rainfall rate as a function of rainfall total
VI	No rainfall data at the site	—	Use regional parameters and climate and weather generators

sustaining a sediment concentration of c_t when sediment is non-cohesive and the supply is not limiting (Proffitt et al. 1993);

- during major storm events, sediment entrainment and transport due to runoff are the predominant rainfall-driven erosion process (Proffitt and Rose 1991). With these assumptions, and for sheet flow only, the sediment concentration at the transport limit can be expressed in terms of slope, S , velocity, V , sediment depositability, ϕ , in the form:

$$c_t = \frac{F \sigma SV}{(\sigma/\rho - 1)\phi} \quad (1)$$

where σ and ρ are sediment and water density, respectively. Assuming that the surface runoff is fully turbulent and the Manning's formula is applicable, velocity and runoff rate per unit area, Q , are related:

$$V = \left(\frac{\sqrt{S}}{n}\right)^{3/5} L^{2/5} Q^{2/5} \quad (2)$$

Combining equations (1) and (2) results in a simple expression relating c_t and Q :

$$c_t = k Q^{0.4} \quad (3)$$

where k is given by

$$k = \frac{F \sigma S L^{2/5}}{(\sigma/\rho - 1)\phi} \left(\frac{\sqrt{S}}{n}\right)^{3/5} \quad (4)$$

Thus the parameter k depends on such factors as the slope, Manning's roughness coefficient, slope length, and depositability. Recent development of GUEST involved a modification of the parameter k in Equation (4) to take into account the effect of saltation stress which can become significant at high sediment concentrations (Rose et al. in prep.). Furthermore, since the depositability is the mean settling velocity of only those sediments that are fully immersed in the flow, its value depends on the water depth, hence the runoff rate. Therefore, although k is principally a function of the plot dimension, slope and sediment characteristics that do not vary between runoff events, it can vary mildly with the runoff rate due to its dependence on the sediment concentration and mean water depth, D_w . For practical purposes, however, k is essentially independent of the runoff rate and can be regarded as a constant for each plot.

For the Goomboorian site, the authors computed the parameter k as defined in equation (4) for a runoff rate up to 100 mm/hr using GUEST+. Plot dimension and soil characteristics needed to compute the sediment concentration at the transport limit are:

- length, $L = 35.8$ m;
- slope, $S = 5.5\%$;
- Manning's $n = 0.03$;

- depositability ϕ when water depth equals 1 cm = 0.036 m/s;
- sediment density $\sigma = 2450 \text{ kg/m}^3$;
- water density, $\rho = 1000 \text{ kg/m}^3$.

The parameter k as a function of the runoff rate is shown in Figure 1. Note that with these sheet flow assumptions, k is not strongly dependent on Q_{eff} , where Q_{eff} is defined in Equation 1, Chapter 4, and written as Q in Chapter 5.

With the sediment concentration at the transport limit determined, the total sediment flux is given by:

$$\Sigma k Q^{0.4} Q$$

and the flow-weighted mean sediment concentration is by definition:

$$\bar{c}_t = \frac{\Sigma k Q^{1.4}}{\Sigma Q}$$

Assuming that k is a constant within the event, then the mean sediment concentration and the effective runoff rate are related by:

$$\bar{c}_t = k Q_{eff}^{0.4} \quad (5)$$

Thus, the effective runoff rate can be interpreted as the effective steady-state runoff rate to compute the average sediment concentration during a storm event. For cohesive sediments, the energy required to erode the same amount of sediment would be higher

and the actual concentration would be lower than that at the transport limit. In order to quantify this effect, an empirical parameter β was introduced (Rose 1993). It is approximately related to the amount of work required to entrain unit mass of cohesive sediment. The actual flow-weighted sediment concentration can be related to that at the transport limit:

$$\bar{c} = \bar{c}_t^\beta \quad (6)$$

Finally, the total soil loss during a runoff event can be determined by:

$$\Sigma q_s = \bar{c}_t^\beta \Sigma Q \quad (7)$$

To use GUEST in a predictive mode, the following information is therefore needed:

Plot geometry:

- length, L ;
- slope, S ; and if rilling occurs, then information is also needed on
- rill density and geometry.

(The effect of rilling is not considered in detail here, but in Chapter 5.)

Sediment properties:

- sediment density ($\sigma = 2450 \text{ kg/m}^3$ can be assumed, but see Chapter 5);

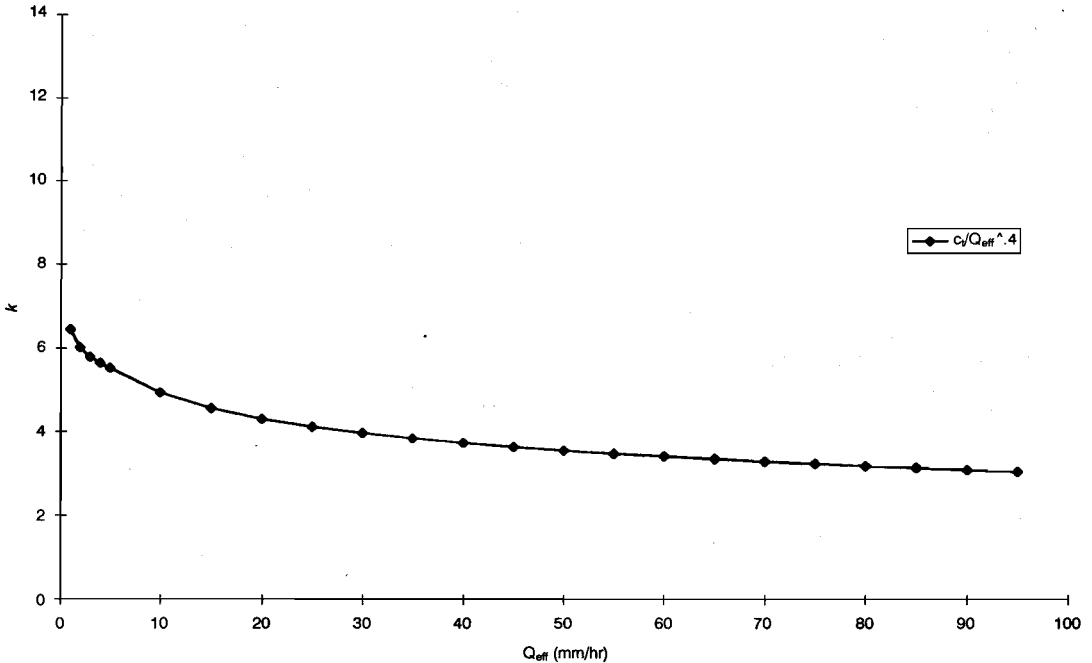

Figure 1. Parameter k ($= \bar{c}_t / Q_{eff}^{0.4}$) as a function of the runoff rate for the bare plot at the Goomboorian site.

- depositability, ϕ (calculated using program GUDPRO, see Chapter 5).

Roughness characteristics:

- Manning's n (see Chapter 5).

Erodibility characteristics:

- erodibility β .

Hydrological variables:

- effective runoff rate, Q_{eff}
- total runoff amount, ΣQ .

Therefore, the hydrological prediction needs for GUEST are the effective runoff rate and total runoff amount on an event basis. Of the two, total runoff amount is apparently more important because the effect of a prediction error in Q_{eff} is reduced due to the power relationship between the mean sediment concentration and the effective runoff rate, and the fact that $\beta \leq 1$ if the assumption about the transport limit is applicable. A flow chart for soil erosion prediction using GUEST is shown in Figure 2.

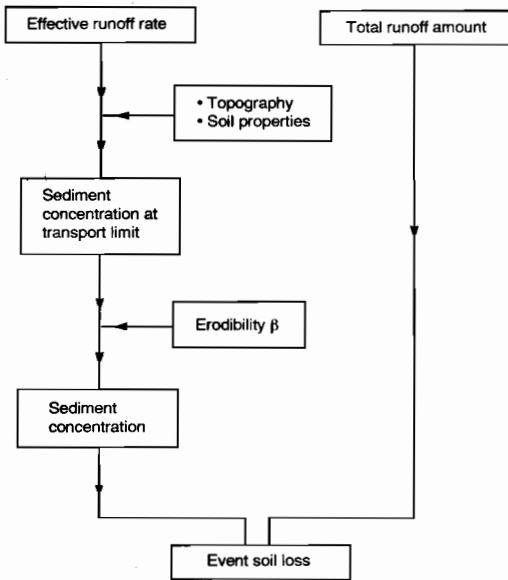

Figure 2. Flow chart for soil erosion prediction using GUEST technology.

What follows is an attempt to model and predict the total runoff amount and the effective runoff rate separately. Continuous rainfall and runoff data for all events are needed to predict runoff amount using a water balance model, and as such data are most

readily available for the Goomborian site, the prediction technique for that site is illustrated.

A water balance model for predicting runoff amount

A simple water balance model was used to determine the runoff amount for each event. Let S_0 be the initial amount of moisture in store, S_c be apparent storage capacity and ΣP be the event rainfall amount. The model assumes that if $(S_0 + \Sigma P) > S_c$, then the total runoff during the event, $\Sigma Q = R_c * (S_0 + \Sigma P - S_c)$, where R_c is a runoff coefficient. It is implied that the total infiltration amount equals

$$(1 - R_c) * (S_0 + \Sigma P - S_c).$$

The observed relationship between rainfall intensity and runoff rate will be used to show why it is appropriate to assume that the infiltration amount is proportional to the total moisture excess $(S_0 + \Sigma P - S_c)$. During periods of no rain when depletion of moisture in store occurs as a result of evapotranspiration, it was assumed that the rate of moisture depletion was proportional to the amount of moisture in store and the pan evaporation rate. Let E_a and E_p be actual and pan evaporation, respectively, then E_a is simply given by:

$$E_a = E_p \frac{S}{S_c}$$

This suggests that the rate of evapotranspiration decreases as the amount of moisture in store decreases. Since S_0 is the initial moisture in store, then at the end of the first time interval for which the potential evaporation is given by E_p , the amount of moisture in store, S_1 , would become:

$$\begin{aligned} S_1 &= S_0 - E_p \frac{S_0}{S_c} \\ &= S_0 \left(1 - \frac{E_p}{S_c}\right) \end{aligned}$$

Similarly, the amount of moisture in store at the end of the second time interval, S_2 , is given by:

$$\begin{aligned} S_2 &= S_1 - \frac{E_p}{S_c} S_1 \\ &= S_1 \left(1 - \frac{E_p}{S_c}\right) \\ &= S_0 \left(1 - \frac{E_p}{S_c}\right)^2 \end{aligned}$$

In general, the amount of moisture in store at the end of a period Δt , $S_{\Delta t}$ is related to the initial moisture in store, S_0 , by:

$$S_{\Delta t} = S_0 \left(1 - \frac{E_p}{S_c}\right)^{\Delta t}$$

For application of this simple water balance model, S_0 would be the amount of moisture at the end of a rainfall event, while $S_{\Delta t}$ would be the

amount of moisture at the beginning of the following rainfall event. Units for the daily potential evaporation, E_p , could be mm/day, S_c , the storage capacity in mm, and Δt the number of days between successive rainfall events.

There are only two parameters, storage capacity S_c and runoff coefficient R_c , for the model, and they can be estimated by minimising the sum of the squared difference between observed and modelled event runoff amounts. That is:

$$\text{Min} \sum_{i=1}^N (\Sigma Q^{(i)}_{obs} - \Sigma Q^{(i)}_{mod})^2$$

where the superscript i indicates the event sequence number and N is the total number of events.

A runoff model was chosen whereby runoff was in direct proportion to the rainfall because the observed runoff rate essentially increases linearly with rainfall intensity. Figure 3 shows the relationship between runoff rate and rainfall intensity at six minute intervals. The six minute interval was used to reduce the effect of the lag between rainfall excess and runoff rate. The 21/11/92 event was an intensive

thunderstorm in early summer that lasted for about three-and-a-half hours with a peak intensity well above 100 mm/hr. The gross runoff coefficient was 37% for the event. The 11/2/95 event was a result of a tropical depression. It was long in duration (nearly 19 hours), but low in intensity (<50 mm/hr). The gross runoff coefficient was only 19%. Although the two storms are quite different in terms of their duration, intensity and the amount of runoff produced, for given rainfall intensity, the runoff rate or, equivalently, the apparent infiltration rate is about the same or about half the rainfall intensity (Figure 3). One datum point in Figure 3 for 21/11/92 event is an outlier. This event had a runoff rate of 9 mm/hr and a rainfall intensity of 61 mm/hr for the second time interval when the runoff is just about to commence. This strongly suggests that the runoff as well as the infiltration rate was proportional to the rainfall intensity. The relationship between rainfall intensity and runoff rate for a large number of events was examined. It appears that a simple runoff coefficient to convert moisture excess to runoff is the best approximation in terms of parameter efficiency.

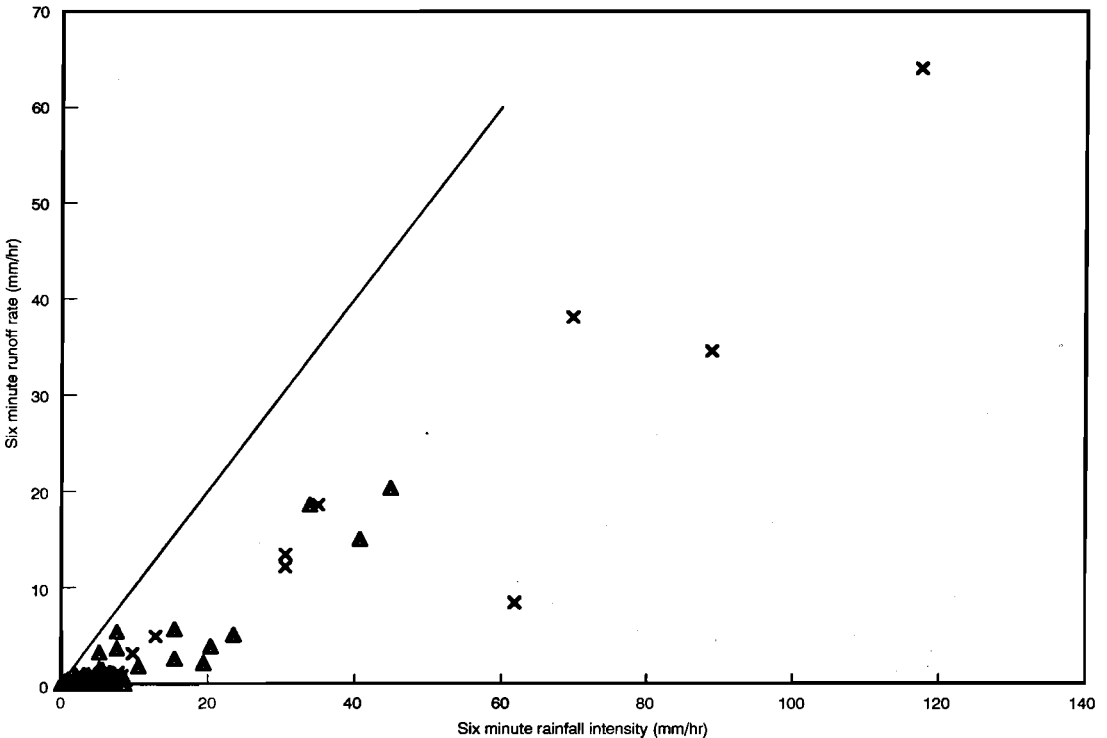

Figure 3. Runoff rate versus rainfall intensity at 6 minute intervals during the 21 Nov. 1992 event (x) and the 11 Feb. 1995 event (▲).

Parameter values for the three treatments at the Goomboorian site were estimated using observed runoff data for the period 18/11/92–6/6/95 and the model was then used to predict the runoff for replicate plots (BB4 and BB5). The results are presented in Table 2 and Figures 4 and 5 show the observed versus predicted runoff amounts for BB4 and BB5, respectively.

The model efficiency is very high and standard error is quite low. The results appear to be very impressive. However, the quality of model performance may be exaggerated because runoff amount for the 13/2/95 event was so much larger in comparison to all other events in the period. If the model can fit the largest event well, model efficiency would usually be high.

Table 2. Estimated apparent storage capacity and runoff coefficient for three different treatments at the Goomboorian site and water balance model efficiency.

Plot	Treatment	Method	<i>n</i>	<i>S_c</i> (mm)	<i>R_c</i>	<i>E</i>	<i>se</i> (mm)
BB1	Mulch	Calibration	889	58.8	0.562	0.93	1.0
BB2	Conventional	Calibration	889	43.6	0.543	0.92	1.1
BB3	Bare	Calibration	888	5.2	0.485	0.85	1.2
BB4	Conventional	Prediction	889	—	—	0.91	1.5
BB5	Mulch	Prediction	889	—	—	0.94	1.0

n — number of events. *E* — model efficiency. *se* — standard error of estimates.

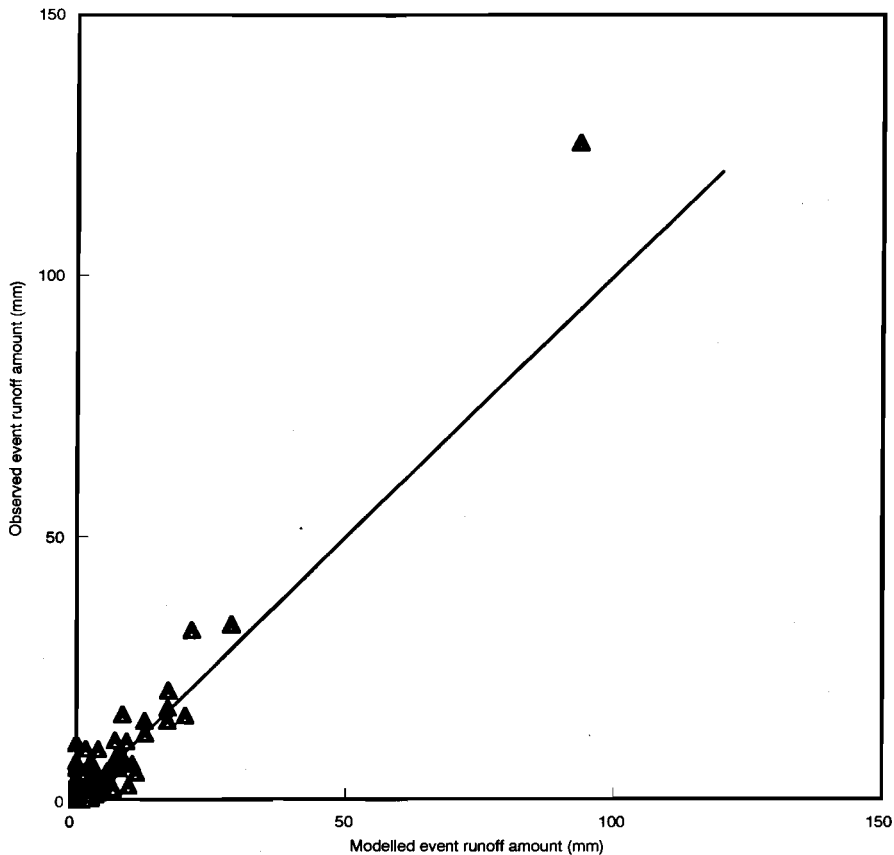

Figure 4. Observed versus predicted runoff amount for BB4 (farmers' practice). Line is 1:1.

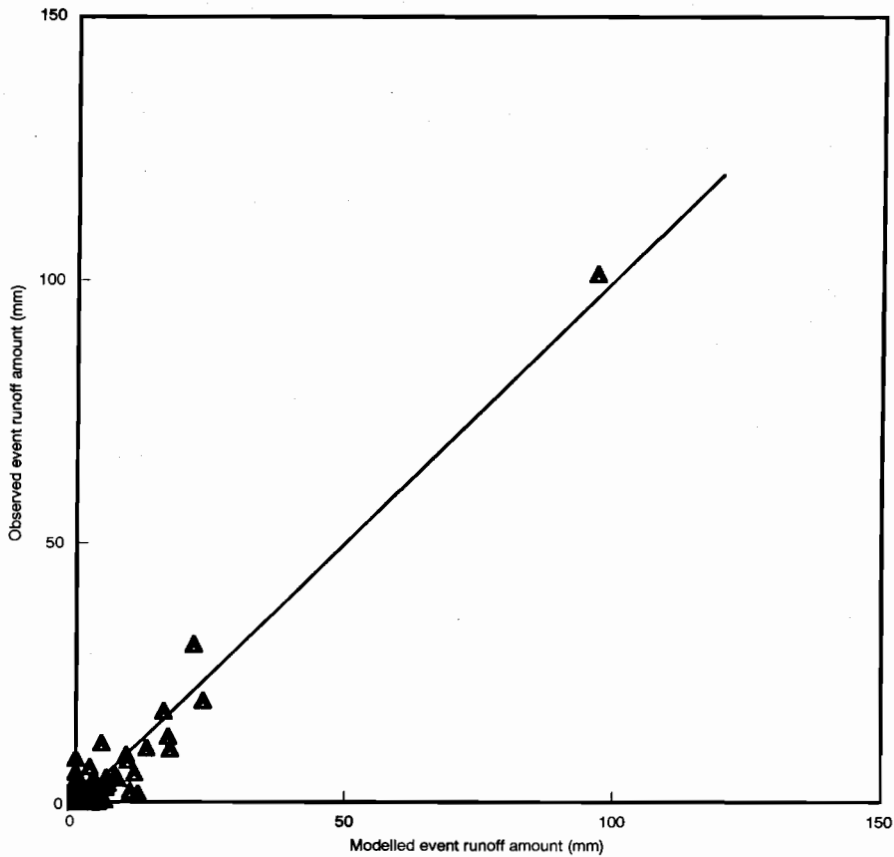

Figure 5. Observed versus predicted runoff amount for BB5 (mulch). Line is 1:1.

A regression model for predicting the effective runoff rate

A number of rainfall characteristics were considered to be important in determining the effective runoff rate. They include the effective rainfall intensity, P_{eff} , defined as:

$$P_{eff} = \frac{\sum P^2}{\sum P}$$

where P is the instantaneous rainfall intensity. The effective rainfall is similar to the modified Fournier index (Arnoldus 1977) and it can be shown that

$$P_{eff} = \bar{P}(1 + Cv^2)$$

In other words, the effective rainfall intensity is a function of the average rainfall intensity and variability of the rainfall intensity (Cv) within an event. Peak rainfall intensity at a variety of time intervals was also included as a variable that could be effective in determining the effective runoff rate.

Examination of plots of the effective runoff rate against various rainfall characteristics shows that the relationship is essentially linear. A model of the following form is therefore proposed:

$$Q_{eff} = b(P^* - P_0^*)$$

where P^* is a particular rainfall characteristic, and b and P_0^* are model parameters. Correlation results between the effective runoff rate and rainfall characteristics using data for the 30 events and for each of the three treatments are summarised in Table 3. There are excellent relationships between the effective runoff rate and peak rainfall intensity or the effective rainfall intensity. From the table it can be seen that peak 1 minute rainfall intensity is an inferior determinant of the effective runoff rate. Although 30 minute peak intensity works best for BB3 and P_{eff} works best for the bare plot, their correlation with the effective runoff rate is not consistent for all treatments. Peak rainfall intensities at

six or 15 minute intervals are better estimators because of their consistency for all three treatments. Peak rainfall intensity at six minute intervals is the preferred estimator because:

- historical 6 minute pluviograph data are readily available from Bureau of Meteorology data archives;
- the r^2 value is marginally higher for the bare plot for which the prediction of the effective runoff rate is most needed.

Figure 6 shows the modelled versus the observed effective runoff rate using six minute peak rainfall intensity. The overall fit is satisfactory apart from the lower end of the effective runoff rate where modelled effective runoff rate can become negative. Occurrence of negative values is due to the linear model used. A better model structure can eliminate this minor problem.

Discussion of hydrologic variable prediction

As noted previously ('Essential data requirements for using GUEST technology'), the two hydrologic variables required in the GUEST technology for erosion events are the total amount of runoff, ΣQ , and the effective runoff rate, Q_{eff} .

In order to predict ΣQ with good efficiency, it is necessary to keep track of water stored in the upper layer of the soil, since antecedent water content has a substantial effect on the amount of runoff for any given rainfall. Another earlier section ('A water balance model for predicting runoff amount') reports a simple water balance model with input data requirements of rainfall amount and pan evaporation. The prediction model for ΣQ then requires two parameters, which were evaluated by fitting the model to data at the Goomboorian site, and these parameters were then shown to be effective in the prediction of ΣQ in other events at the site.

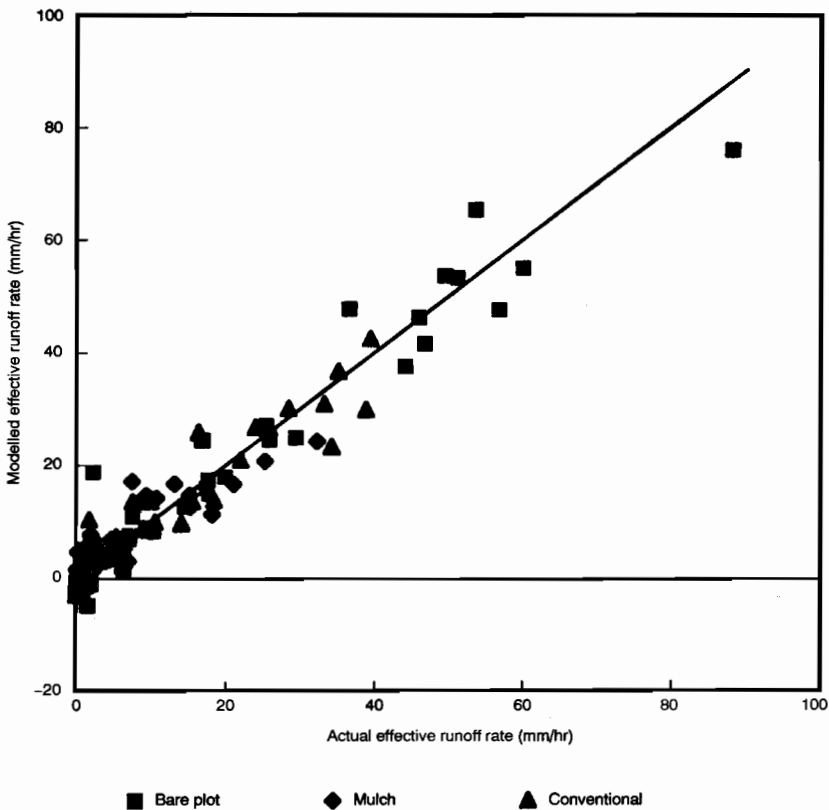

Figure 6. Observed versus modelled effective runoff rate for BB1, BB2 and BB3.

The first of these two parameters, the apparent maximum storage capacity, S_c , was found to depend strongly on surface treatment, being an order of magnitude greater with a substantial mulch cover than for bare soil, when S_c was the amount of water that could be stored in about 10 mm of soil. Greater experience in the use of this model might allow a realistic estimate of S_c to be made in the absence of hydrological data.

Table 3. Parameter values for predicting the effective runoff rate using rainfall characteristics at Goomboorian.

Treatment	P^*	b	P_0^* (mm/hr)	r^2
BB1 (mulch)	P_{eff}	0.279	8.10	0.71
	P_1	0.166	32.6	0.71
	P_6	0.209	21.5	0.76
	P_{15}	0.284	14.7	0.80
	P_{30}	0.436	10.9	0.81
BB2 (conv)	P_{eff}	0.484	4.79	0.89
	P_1	0.280	25.2	0.84
	P_6	0.350	15.6	0.88
	P_{15}	0.456	10.0	0.90
	P_{30}	0.670	6.23	0.79
BB3 (bare)	P_{eff}	0.867	4.68	0.94
	P_1	0.487	23.6	0.83
	P_6	0.623	15.2	0.92
	P_{15}	0.806	8.65	0.89
	P_{30}	1.17	5.69	0.80

The second of the two parameters in the model for ΣQ was the runoff coefficient for excess rainfall, R_c . For the Goomboorian site, R_c was a more stable parameter than S_c (as shown in Table 2), but the adequate evaluation of R_c would seem to require some data for the particular climate/soil/management situation of interest.

It has been demonstrated previously that it is possible to model effective runoff rate, Q_{eff} , using peak rainfall rates based on 6 minute data, available for some rainfall stations in Australia at least. The model again has two parameters of which one, P_0 , was reasonably stable over treatments, and the second, b , varied somewhat with treatment in an expected direction (Table 3).

The greater importance of ΣQ than Q_{eff} in soil loss prediction noted earlier indicates the importance of the runoff coefficient, R_c , in prediction. The amount of work involved in plot runoff measurement to yield R_c may be no more than that involved in determining effective infiltration characteristics by replicated infiltrometer measurements, and R_c determined under natural rainfall is likely to be more relevant

and reliable than infiltration estimates, though the two are obviously related.

A computer program, GNFIL+ (Ward and Rose 1990), allows the calculation of infiltration rate from the measurement of rainfall and runoff rates, allowing the extension of this calculation to situations where runoff is not measured directly at the bottom of a plot, but is measured following collection in a contour bank or graded channel for example. Such experimentation also yields the runoff coefficient, R_c , under natural rainfall.

Soil loss prediction using GUEST technology

A previous section considered the hydrological data requirements for soil loss prediction. It follows from Equations (5) and (7) that the total soil loss from bare soil during a runoff event is:

$$\Sigma q_s = (k Q_{eff}^{0.4})^\beta \Sigma Q \quad (8)$$

The quantity k in (8) is defined in Equation (4). Determination of depositability ϕ and Manning's n was considered in Chapter 5, in which experience gained in ACIAR Project 9201 on the erodibility parameter β was also reported. The value of ϕ can be readily obtained by measurement on soil samples. Chapter 5 and published work by Misra and Rose (1995) and Ciesiolka et al. (1995) illustrate the possibility of predicting the value of β from other parameters, including soil strength or strength-related parameters. As use of the GUEST technology continues, the generality of the ability to estimate β will continue to be tested.

Thus it may be concluded that significant progress has been made in ACIAR Project 9201 in the ability to predict the quantities in Equation (8) determining the soil loss in any runoff event. However, the prediction of ΣQ for an event, and its prediction in the longer term, based on available rainfall data, remain crucial to the long-term prediction of bare soil loss.

Soil loss from a bare plot provides both a worst-case scenario and a baseline to which losses with soil conserving treatments may be compared. As shown in Chapter 6, one major soil conserving method is covering some fraction (C_s) of the soil surface with contact cover. Results reported in Chapter 6 showed that the soil loss in the presence of such cover could be well described by

$$M = \Sigma q_s = (k Q_{eff}^{0.4})^\beta \Sigma Q \exp(-\kappa C_s) \quad (9)$$

where κ is an experimentally determined parameter, with $5 < \kappa < 15$ defining a common range. Equations (8) and (9) assume that rilling does not occur, and when it does, some modification to the equations, as detailed in the GUEST manual, is required. Prediction of the occurrence and characteristics of rill

formation is currently limited, although rilling characteristics appear to be reasonably repeatable once observed.

GEMS

A simple computer program, GEMS (Griffith Erosion Management System), developed originally by Misra and Rose (1992), has been devised with two objectives:

- to facilitate comparison of existing management practices in terms of their effectiveness in reducing soil erosion;
- to assist in the design of management systems that reduce soil loss to a nominated value.

These two objectives are represented by two types of analyses, referred to as Type 1 and Type 2 respectively, which assume simple planar plots and which are briefly outlined below.

Type 1: System comparison

Inputs to this program are the plot slope (S) and plot length (L), β , the fractional soil contact cover C_s and the parameter κ for treatments to be compared. The plot is then subject to a design storm, for which default values are provided. The expected soil loss from plots with the range of treatments considered is then calculated by the program using Equation (9), allowing a comparison to be made of the conservation effectiveness of the treatments represented.

Type 2: System design

This type of analysis assists in the design of management systems where surface contact cover is the conservation method, indicating a range of options whereby a nominated soil loss should not be exceeded. With similar inputs as for Type 1 analysis, Type 2 analysis yields compatible combinations of slope length and surface contact cover which meet the soil loss objective.

Conclusion

The GUEST technology has been codified and applied in a context of multi-country experimentation spreading across ACIAR Projects 8551 and

9201. Key questions addressed were how to evaluate soil erodibility and the effectiveness of alternative conservation systems without requiring the long-term acquisition of data implicit in the USLE approach. The experimental technology also gave data on rainfall and runoff at one minute time resolution. This fine-time resolution allowed the investigation of those surface hydrologic processes important to soil loss in a way that would not be possible with coarser time resolution. This investigation has been pursued by the development and testing of models of runoff with a large body of data from the very different sites participating in the project. This model development and testing has focused on the prediction of the two runoff-related quantities required for the GUEST technology, namely the effective rate and total amount of runoff.

Models for these two quantities have been based on the input of more generally available rainfall data, the model structures also involving parameters which were limited in number and which were related to identifiable physical characteristics of the soil or its surface management. Some consideration is given to the various levels of rainfall data available, though more could and should be done in this direction with daily data on rainfall totals being by far the most commonly available. However, the focus of consideration has been on the prediction of runoff and soil loss over a longer time than the experimental period. Some of these data in the experimental period have been used to evaluate unknown parameters in the models, with other collected data being used to test the stability and effectiveness of these parameters, with encouraging results. Thus a methodology has been established which, given long-term climatic data (on rainfall and pan evaporation in particular), can use long-term simulation to yield long-term estimates of runoff and soil loss. While not carried out (long-term data not being available at some sites), long-term simulations of course assume some stability or knowledge of change in factors such as soil erodibility, rainfall rates and amounts. While these assumptions may not be fully satisfied, the guidance given by such investigations is likely to be of adequate accuracy in practice, given other uncertainties in soil conservation management.

Chapter 9

Long-term Effects of Land Management on Soil Erosion, Crop Yield and On-farm Economics in The Philippines

R.A. Nelson, J.D. Dimes, D.M. Silburn, E.P. Paningbatan, Jr., R.A. Cramb
and M.A. Mamicpic

AS seen in the framework provided in Figure 1, Chapter 1, land management research on sloping lands (where a major threat is loss of soil fertility and top-soil through soil erosion) must provide bio-physical and economic information to allow land users and land use planners to make judgments on the viability of different farming practices.

This project has measured and predicted soil and nutrient losses under a range of management systems. From these data, it is possible to use cropping systems simulation models and economic analysis to predict long-term effects of land management on soil properties, yield and economic return. The Los Baños site in the Philippines (referred to as the Tranca site in subsequent sections) is ideal for this purpose because hydrology, soil erosion and crop yield data are available for a seven-year period, and the major crop grown, maize, has reliable crop growth models available, e.g., CERES-Maize.

A special project was developed linking two existing ACIAR projects for this purpose. The project reported in the bulk of the publication (PN 9201 — Sustainable Cropping Systems in Tropical Steeplands) provided bio-physical data, and PN 9211 (On-farm Socioeconomic Evaluation of Soil Conservation Practices for Marginal Uplands of Southeast Asia) provided expertise for socioeconomic analyses, while the cropping systems simulation capacity was developed in collaboration with the Agricultural Production Systems Research Unit, Toowoomba, Australia.

The remainder of this chapter is a report on the outcomes of this special project. It focuses on the comparison of traditional farming practices with a particular agronomic soil conserving management system in which the crop of interest is intercropped between leguminous hedgerows planted on the

contour to form an alley-cropping system. The project provides a good example of the use of data from soil erosion research to predict long-term outcomes. However, because it was carried out over the same period as PN 9201, some recent developments in terms of hydrology and soil erosion modelling are not used in the cropping systems simulation modelling, e.g., curve number for daily runoff is used instead of event hydrology parameters, while GUESS (Rose 1985) was used for erosion modelling rather than the GUEST program used elsewhere in this publication. While more up-to-date algorithms may be readily incorporated into the Agricultural Production Systems Simulator (APSIM) modelling environment used in this exercise, it is quite likely that this would not alter the more general on-farm economic conclusions reached.

This chapter is drawn from five working papers (Nelson et al. 1996a,b,c,d,e) and other publications (e.g., Nelson, 1996; Carberry et al. 1996; McCown et al. 1996).

The Agricultural Production Systems Simulator

APSIM is a cropping systems software-modelling environment with a capacity to model a range of crops (McCown et al. 1996). In this section, the structure and function of a version of APSIM capable of modelling maize farming is described. Conceptual issues raised in this section concerning the application of APSIM to hedgerow intercropping have important implications for:

- parameterisation of the model;
- simulation of soil erosion and maize yields; and
- economic viability of hedgerow intercropping relative to traditional open-field farming.

For this application, version 0.1 of APSIM was configured to simulate erosion and maize yields from the hedgerow intercropping and open-field farming systems trialed at the Tranca research station, and used in the economic survey of maize farmers in Timugan. The simulations of hedgerow intercropping therefore focused on maize production, with hedgerow prunings applied as mulch to the cropping alleys rather than removed from the field as livestock forage. Consideration of livestock production would have required an alternative model structure and resulted in different outcomes to those presented in this analysis.

A feature of APSIM is that the soil, rather than the crop, forms the central unit on which all the processes described in the model operate (Figure 1). Management operations such as planting and tillage are entered using a manager module, referenced to Julian days or conditional upon cumulative rainfall or previous operations. APSIM is a point scale model driven by daily rainfall, radiation, and maximum and minimum temperature data. A modular software structure around a central 'engine' and standardised programming protocols were designed to enable rapid adaptation of the model to new applications (McCown et al. 1996).

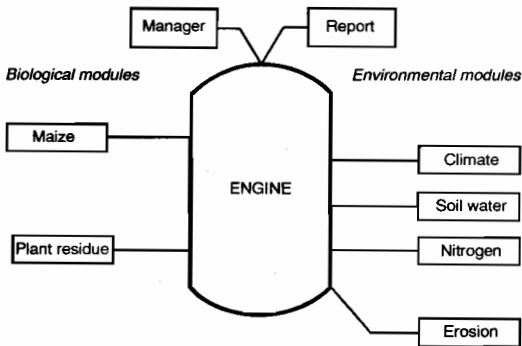

Figure 1. The structure of APSIM (adapted from McCown et al. 1995).

APSIM's modules

Water balance module

The soil water balance module of APSIM was known as APSWAT in this version of APSIM, and has since been renamed SOILWAT in release version 1.0. This module is based on the CERES-Maize water balance model (Jones and Kiniry 1986) with improvements derived from the development of PERFECT (Littleboy et al. 1989) and CREAMS (Knisel 1980). Key differences between APSIM and

its precursors are outlined in Probert et al. (1996), and include:

- surface residues and crop cover modify runoff response and reduce potential soil evaporation;
- small rainfall events are lost as first stage evaporation rather than by the slower process of second stage evaporation; and
- there is greater flexibility for describing differences in long-term soil drying due to soil texture and environmental effects.

Some operational differences have resulted from combining PERFECT with AUSIM (McCown and Williams 1989). In particular, the PERFECT model assumed that excess infiltration was added to runoff whereas, in APSIM, excess water is assumed to flow through the soil profile and to be lost as deep drainage. This reflects a greater reliance on the CREAMS curve number approach to predict runoff in APSIM compared to PERFECT.

A feature of CERES-Maize that has been included in APSIM is that potential evapotranspiration is estimated from soil albedo, solar radiation and ambient air temperature using the Priestly-Taylor method (Jones and Kiniry 1986), a reliable method for estimating potential evapotranspiration without daily pan evaporation data.

Runoff in APSIM is determined from daily rainfall, antecedent soil water and cover conditions using the CREAMS curve number approach described in Littleboy et al. (1989). The curve number approach involves deriving an empirical relationship between runoff, rainfall and maximum potential infiltration for a soil during periods with known soil surface cover.

Two significant modifications to the curve number approach described in Littleboy et al. (1989) were required for this application of APSIM. Cover data indicated that crop canopy had negligible effect on runoff and so its influence on curve number was removed from the model. In contrast, weed and hedgerow cover was found to have a significant effect on runoff. A surface cover factor was introduced to the model so that ground cover data could be entered and tied to cultivation and weeding events. The cover factor only accounts for the surface cover provided by weeds and hedgerows, and their water use was not simulated. However, an empirical adjustment for maize yields was estimated to account for the competitive interaction between hedgerows and maize crops.

This version of APSIM also includes a facility to vary curve number at tillage events in order to capture the effect of changing surface roughness on runoff.

APSIM simulates soil water processes in a sequence that begins with daily rainfall data. Daily rainfall is partitioned into runoff and infiltration using the curve number method. Water infiltrating the soil profile is redistributed as drainage commensurate with the storage capacity of each soil layer. If the amount of water infiltrating the surface layer exceeds the storage capacity of layers below, then this water is passed through the profile as deep drainage.

Daily evaporation from the soil surface is simulated from potential evapotranspiration modified for ground cover and crop canopy cover, and limited by the soil water content of the uppermost soil layer. Soil evaporation contributes to moisture gradients that drive unsaturated flow of water upward through the soil profile layer. Unsaturated flow can also redistribute water downwards through the soil profile if lower layers drain more rapidly than upper soil layers.

The final process modelled each day is transpiration. Transpiration is a function of demand for water by a crop, limited by the amount of water available in each soil layer. Demand for water is determined in the maize module from the leaf area of the crop and the density of roots in each soil layer.

Movement of nitrate within and out of the profile is simulated in the water balance model. Nitrate moves with both drained and unsaturated flows of water assuming a uniform concentration of nitrate in each soil layer before and after each flow.

Nitrogen module

The nitrogen module in this version of APSIM was NIT1, renamed SOILN in APSIM release version 1.0. The nitrogen module in APSIM is derived from the nitrogen balance model in CERES-Maize (Jones and Kiniry 1986). Nitrogen was not considered in the PERFECT model. The origins and function of SOILN, the successor of NIT1, have been described in detail by Probert et al. (1996).

The principal difference between the nitrogen balance module of APSIM and those of the CERES models is that soil organic matter has been divided into three pools instead of one. A microbial biomass pool enables more realistic simulation of the flows of carbon into the biomass and stable pools of soil organic matter as fresh residues decompose (Dimes 1996). An inert pool is included to minimise the mineralisation of organic nitrogen deep in the profile.

Residue module

The residue module of APSIM is based on components of PERFECT, with modifications to surface

residue decomposition to maintain carbon and nitrogen balances in the plant/soil system.

The residue module has been described in detail by Probert et al. (1996). The amount, type and nitrogen content of residue added from the maize module or following management operations such as weeding and pruning of hedgerows are inputs to the residue module. The decomposition of surface residues is governed by average daily temperature, a moisture factor sensitive to cumulative evapotranspiration and the carbon to nitrogen ratio of the surface soil layer. Tillage events specified by the user incorporate surface residues to a nominated depth, and adjust the amount of residue retained on the soil surface. Burning removes a nominated fraction of surface residues. Carbon and nitrogen from residue incorporated through tillage are added to the fresh organic matter pool of the nitrogen module. Carbon and nitrogen retained in the system as a result of microbial decomposition of surface residue are added to the biomass and humic pools in the topsoil.

The residue module converts the daily balance of surface residue from dry matter mass to percentage surface cover which is used in the soil water and erosion modules for the prediction of runoff, soil water evaporation and erosion.

Erosion module

The erosion module in this version of APSIM is the same as the erosion module described in the PERFECT manual (Littleboy et al. 1989).¹ Littleboy et al. (1989) included four methods of estimating erosion in the PERFECT model. For this application of APSIM, the Rose sediment concentration equation (Rose 1985) was used instead of a modified universal soil loss equation (MUSLE) or the Freebairn cover-concentration relationship. The Williams or Onstad-Foster MUSLEs could not be used because of a lack of rainfall erosivity or peak runoff data (Onstad and Foster 1975; Williams 1975). The Freebairn cover-concentration relationship is a derivation of the MUSLE approach that does not require prediction of peak runoff rate. However, the Freebairn relationship is specifically designed for contour-bank farming systems on vertisols in southeast Queensland and was considered inappropriate for application to the Philippine uplands.

This version of APSIM uses the Rose equation (Rose 1985) to predict erosion (Figure 2). The Rose equation is an attempt to capture the process of erosion as a mathematical function of slope, runoff,

1. The code was reengineered for APSIM by Peter Devoil and Mark Silburn.

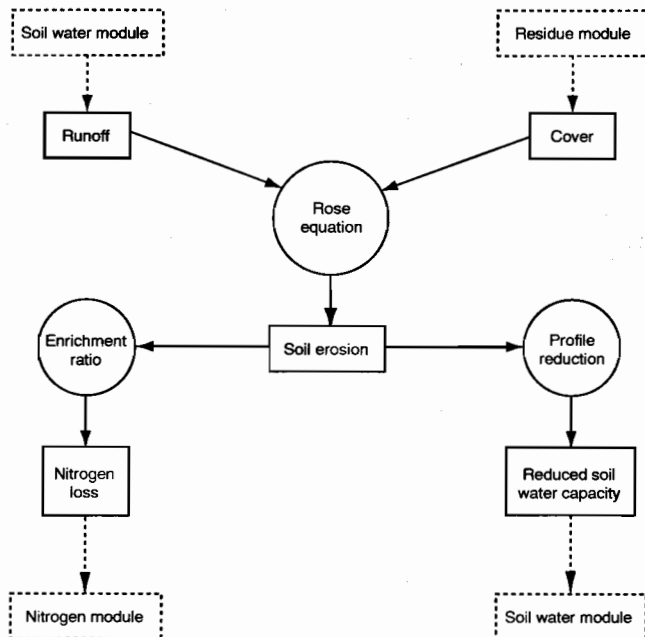

Figure 2. APSIM's soil erosion module.

cover, and the efficiency of entrainment of surface runoff. The efficiency of entrainment, λ , is analogous to the soil erodibility factor, K , in the MUSLE approach, and is derived empirically for each soil type. The derivation of the λ /cover relationship for each soil type in the erosion module is similar to the derivation of the curve number/cover relationship in the water balance module. Rose (1985) derived a functional form for the relationship between (and cover). A facility to modify the parameters of the Rose equation with daily rainfall was introduced to simulate the potential for rills to breakthrough hedgerows during large rainfall events, as discussed in more detail below.

Erosion reduces the amount of soil nitrogen and water available for plant uptake. An enrichment ratio is used to describe the preferential loss of nitrogen with fine organic sediments. The enrichment ratio for nitrogen declines as soil loss increases for a given runoff event. This approach to nitrogen lost in sediment is based on the CREAMS model (Knisel 1980).

Reduction of the amount of nitrogen available for plant uptake is represented by moving the soil layers downwards through the soil profile. Each soil layer takes on the nutrient characteristics of the layer below in proportion to the depth increment gained from that layer. If a bedrock depth is not specified, each soil layer takes on the nutrient properties of the

one below until all layers have the nutrient properties of the lowest subsoil layer. If the accumulated loss of soil depth exceeds a given total soil depth, the nutrient content of the last soil layer diminishes (Peter Devoil, unpublished programming notes).

Loss of soil depth is calculated from the volume of soil loss and the bulk density of the uppermost soil layer. Soil loss reduces the depth of soil available to store water for plant uptake. Available soil water per unit of soil volume generally decreases with depth as bulk density increases. Soil water capacity is removed from the lowest soil layer first, assuming that there would be some amelioration of soil water-holding capacity as successive soil layers are exposed by erosion.

Daily rainfall is used to predict runoff and erosion in APSIM. This can lead to poor prediction of erosion on an event basis because rainfall intensity is not considered. Accurate predictions of long-term erosion can be achieved by parameterising the model to cumulative erosion over cropping seasons for which accurate cover data are available (Silburn and Loch 1992).

Reductions in soil nitrogen and soil water due to erosion are returned each day to the nitrogen and water balance modules after the primary crop/soil interactions in those modules are complete.

Maize module

The maize module is the most complex module of this version of APSIM, but also the most referenced in the literature. The maize module is based on development and testing of the CERES-Maize model (Jones and Kiniry 1986) for application to the semi-arid tropics (Carberry et al. 1989) with the modifications described in Carberry and Abrecht (1991). Modification and development of the model to tropical conditions outside Australia has included applications in Kenya (Keating et al. 1992a, b).

Potential growth of maize is determined by simulating photosynthesis from daily solar radiation. Growth of the maize plant is partitioned into leaf, stem, cob, grain and roots depending on the stage of phenological development. Phenological development and potential leaf area are controlled by daily maximum and minimum temperature. Potential growth determines the demand for nitrogen and water by maize under ideal conditions. Actual growth is determined from the ratio of available nitrogen and water in the soil profile relative to the amount of nitrogen and water demanded at potential growth levels. Nitrogen and water taken up by the maize module reduce daily stocks in the nitrogen and water modules. Erosion reduces the stocks of soil nitrogen and water that limit actual maize growth.

The variety of maize, density and depth of sowing are specified by the user in the manager module. Sowing dates can be specified using Julian days or through more complex rules referencing cumulative rainfall and previous operations such as burning and tillage.

Application of APSIM to hedgerow intercropping

APSIM simulates a single point in a cropping field making the assumption that the processes taking place at that point are representative of those across the whole field. As soil is eroded, soil nitrogen and water-holding capacity are degraded uniformly across an entire field. This is a reasonable conceptual model of maize monocultures where spatial variation is limited to slight changes in soil characteristics and micro-relief.

APSIM as a cropping systems software environment does have a capacity to simulate the mutual competitive interaction of intercrops (Carberry et al. 1994). However, a module capable of simulating hedgerows as an intercrop had not been yet developed at the time this research was conducted. Consequently, hedgerow intercropping was modelled by modifying an open-field version of APSIM to simulate the key agronomic effects of hedgerow intercropping on maize yields. APSIM was parameterised

to simulate maize yields from a point in the centre of the cropping alleys, by parameterising the runoff and erosion modules to predict runoff and erosion from fields with hedgerows. The effect of adding hedgerow prunings was simulated by adding legume biomass from outside the plant-soil system at a rate measured from hedgerow intercropping trials.

Average maize yields predicted by APSIM for a point in the centre of the cropping alleys were adjusted to reflect the intensity of hedgerow/crop competition using row by row crop data from research trials. Row by row yield data from trials of hedgerow intercropping in Claveria, Mindanao, suggested that overall yield decline from hedgerow/crop competition prior to terrace formation was around 10% (ICRAF n.d.). On acid soils, data reported by Garrity et al. (1992) indicated an overall yield decline of 26% following terrace formation on acid soils.

Parameterisation of APSIM

The APSIM model was parameterised using data from a comparative trial of open-field farming and hedgerow intercropping at Tranca, near Los Baños, Philippines (Figure 3)². The research trial at Tranca has similar agronomic conditions to those of the nearby community of Timugan, and was used to define the farming operations for the economic analysis described below. This ensured that the model was parameterised to simulate maize yields consistent with the amount of labour and material inputs invested in farming.

The trial of hedgerow intercropping at Tranca was established in 1988 in a collaborative research project funded by the Australian Centre for International Agricultural Research (ACIAR)³. Tranca is typical of upland areas with moderately fertile soils of relatively high erodibility. At a latitude of 14° 13' north and an altitude of 30 m, the climate at Tranca is humid tropical with an average annual rainfall of 2060 mm (1959–1995). The soil is an alfisol, high in clay, with imperfect drainage and a pH of 5.5–6.0. The average slope gradient of the trial was 17%.

Detailed descriptions of the experimental design and results of the trial at the Tranca research station

2. Tranca is a small rural community rarely featured on maps or other official documents, and is sometimes spelled 'Tranka'.

3. Projects 8551 and 9201 of the Australian Centre for International Agricultural Research were conducted by the University of the Philippines, Los Baños, Griffith University and the Queensland Department of Primary Industries.

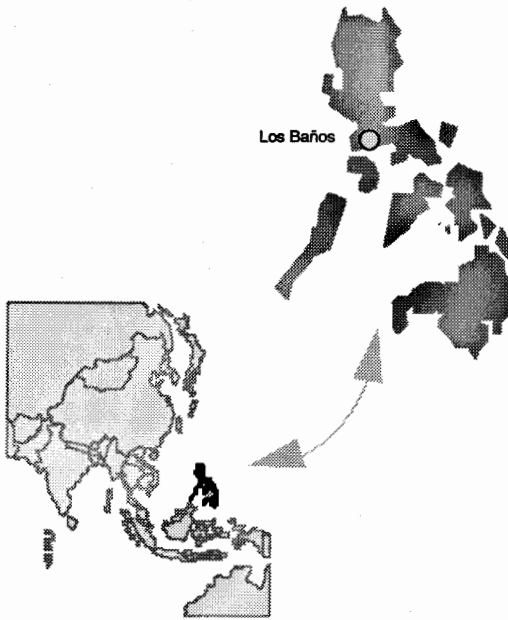

Figure 3. Location of the Tranca research trial, Los Baños.

have been provided by Comia et al. (1994), Ciesolka et al. (1995) and Paningbatan et al. (1995). The trial was a replicated small plot experiment including traditional open-field maize farming without hedgerows, three variants of hedgerow intercropping with *Desmanthus virgatus* (desmanthus) hedgerows, and a plot maintained as bare soil without plant cover.

A long fallow dominated by *Imperata* grass (*Imperata cylindrica*) and lantana (*Lantana camara*) preceded the trial, and a green manure crop of sesbania (*Sesbania rostrata*) was grown in 1988 while sediment troughs and tipping buckets were installed. The cover crop of sesbania resulted in high levels of soil mineral nitrogen and carbon at the beginning of the experiment.

The farming system trialed at Tranca was a maize-peanut rotation. Maize was planted at the beginning of the wet season in May followed by peanuts in the drier season towards the end of the calendar year. The fields were fallowed in the dry months of January to April. Maize was sown at a spacing of 75 cm between rows and 20 cm along each row. A local maize variety, Lagkitan, was sown in the wet seasons of 1989 to 1992 and received 30 kg ha/crop of elemental nitrogen as urea at sowing. A hybrid variety, IPB193, was sown with 60 kg ha/crop of elemental nitrogen in the wet

seasons of 1993 and 1994. Draught animal power was used for ploughing, harrowing and furrowing the fields before sowing each crop. All other farming operations, such as sowing, weeding and harvesting, were performed manually.

Cropping and tillage operations in the open-field plots were performed up and down the slope, consistent with a traditional practice in the uplands that has only recently begun to be replaced by farming across the slope. Hedgerow treatments 2 and 3 were tilled along the contour within the cropping alleys. Hedgerow treatment 4 combined hedgerow intercropping with minimum tillage in the cropping alleys.

The hedgerows of treatments 2–4 comprised double hedgerows of desmanthus one metre wide and spaced at six-metre intervals down the slope, so that the hedgerows occupied around 17% of field area. The hedgerows were pruned to a height of 50 cm at the planting of each maize crop, and as required during each cropping season. Hedgerow prunings were removed from the field in treatment 2, to separate the effect of mulching from the effect of the hedgerows forming barriers to surface water runoff and erosion. For treatments 3 and 4, hedgerow prunings were evenly distributed across the cropping alleys.

Daily climate data including rainfall, solar radiation, and maximum and minimum temperatures were available from a climate station three kilometres from Tranca.⁴ Daily rainfall was measured at the research trial from 1990 to 1993. Weekly measurements of soil water were taken for the 0–20 cm and 20–50 cm soil profile layers during the crop seasons of 1993 and 1994. Runoff and soil loss were measured using tipping buckets and sediment troughs from 1990 to 1994. Near-ground and crop canopy cover data were collected during the cropping seasons of 1990 and 1993. Annual biomass production for maize crops and hedgerows was measured from 1989 to 1994.

Methodology

The various modules of APSIM described earlier require a large number of input parameters. To accurately simulate the effects of farming practices on crop yields, the various component processes of a cropping system need to be reliably predicted. Interaction between the various modules of APSIM requires a step-wise approach to deriving and testing model parameters.

4. The climate data were provided by the International Rice Research Institute.

The order in which parameters were derived or calibrated reflected their order of dependency within the model. Whenever possible, parameters for the model were determined from measured or standard values for this type of environment. Many of the model's parameters are *state* variables that were measured directly, such as slope and soil depth, or were derived from field measurements, such as bulk density and soil water-holding capacity. Other parameters, such as those controlling rates of soil carbon and nitrogen transformation, were derived from empirical research and modelling experience in tropical environments (Dimes 1996; Probert et al. 1996).

The remaining parameters were derived using stepwise calibration, where one or two parameters were calibrated against closely related measured data. Parameters derived by calibration included a soil water drainage coefficient, runoff curve number (CNII), surface cover, maize phenology and grain yield parameters.

APSIM was parameterised to simulate open-field farming of a wet season maize crop using data from treatment 1 of the trial at Tranca. The model was parameterised to simulate hedgerow intercropping of a wet season maize crop based on hedgerow treatment 3. Data from the bare plot, and hedgerow treatments 2 and 4, were used to assist parameterisation of the model where appropriate.

Soil water, evaporation and drainage

A root depth of 100 cm was used for simulating water extraction by maize, represented by five soil layers in the model (Appendix 1). Layer thickness was specified to be consistent with measured soil water data in the 0–20 and 20–50 cm layers, and maximum root depth was based on knowledge of the soil profile.

Parameters for soil water-holding capacity were derived from measured soil water content for the open-field treatment and hedgerow treatment 3 during the 1993 and 1994 wet season maize crops. Estimates of soil water content at saturation (SAT) were based on measured soil water content following high rainfall. Total porosity was calculated from measured maximum soil water content using a particle density of 2.65. Drained upper limit (DUL) was derived from average soil water measurements three to five days after rainfall. The lower limit of plant extractable water (ll15) was estimated from measured soil water content in relatively dry periods. Air dry (AD) soil water content was estimated from experience with similar soils.

To define soil water evaporation and drainage parameters, measured daily runoff data were entered into the model, partitioning daily rainfall into runoff and infiltration. Accurate partitioning of rainfall reduces the unknown variables determining soil water content to evapotranspiration and drainage. Ideally, soil water evaporation and drainage parameters are best derived using measured soil water from a bare plot without crops so that the influence of transpiration can be eliminated. While soil water and runoff data were available for a bare soil plot, its water-holding characteristics were different from those of the cropped plots due to greater cumulative soil erosion. It was therefore necessary to determine soil water and evaporation parameters using measured soil water content from the open-field treatment and hedgerow treatment 3.

Accurate prediction of soil water evaporation and drainage under crops requires reasonable simulation of water uptake by maize crops and hedgerows. Phenological and grain yield parameters for maize were determined from the characteristics of the maize varieties sown in the research trial, and by calibration against measured yields. High rainfall during the 1993 wet season and the addition of nitrogen fertiliser enabled the phenological and growth parameters for maize to be calibrated independently of soil water and nitrogen constraints. With confidence in simulated transpiration, the unknown components of the soil water balance were reduced to soil evaporation and drainage.

Coefficients for first and second stage evaporation were set at the typical values recommended for the CERES-Maize model in tropical environments (Jones and Kiniry 1986). Evaporative drying of soil deeper than the surface layer was included in the simulation of unsaturated flow between soil layers. Unsaturated flow is controlled by two parameters in the model, a diffusivity constant and a diffusivity slope, which were assigned values based on experience simulating water balance for tropical soils with similar water-holding capacity (Probert et al. 1996).

The soil water drainage coefficient was calibrated to predict measured soil water content in the top two layers of the soil profile beneath open-field farming in the wet season of 1993. A limited quantity of consistent soil water and rainfall data were available from the 1994 wet season maize crop to evaluate the prediction of soil water content.

Residue

An advantage of using measured runoff to parameterise soil water evaporation and drainage parameters is that surface cover does not have to be simulated, reducing the number of unknown

variables. However, accurate prediction of runoff using APSIM requires accurate simulation of surface cover, because surface cover protects the soil from rainfall and overland water flows. Residue additions from weeding and hedgerow pruning were entered in the model. Other changes in surface cover, such as reductions from tillage and burning, were calibrated against measured changes in cover during the maize crops of 1990 and 1993. The potential rate of decomposition for surface residue was derived from experience with similar types of residue in tropical environments (Dimes 1996).

Runoff

Using the best estimates of soil water parameters from above, the runoff component of the soil water module was calibrated by developing an empirical relationship between curve number (CNII) and soil surface cover. Curve number is a parameter that represents the runoff response for average antecedent soil moisture conditions from a particular soil type and surface roughness (Littleboy et al. 1989). The relationship between curve number and surface cover is defined by the curve number for bare soil and the maximum possible reduction in curve number due to cover.

Runoff and cover data for the maize crops of 1990 and 1993 were used to calibrate curve number/cover relationships for open-field farming and hedgerow intercropping. Data from all three hedgerow treatments were used to calibrate runoff response over the greatest possible range of surface cover levels. The model was run with a series of fixed curve numbers (CNII not adjusted for cover) during periods with constant surface residue cover until measured runoff was accurately predicted. Linear regression was used to establish a relationship between curve number and surface cover for the open-field and hedgerow treatments. Curve number was calibrated separately for periods following tillage when surface roughness altered runoff response. Validation was performed against measured runoff data from 1991 and 1992.

Erosion

Erosion in this version of APSIM is calculated from slope, runoff and surface cover using the Rose sediment concentration equation (Rose 1985). The efficiency of entrainment for bare soil, λ_{bare} , and a coefficient of exponential decline in sediment concentration with cover, b_2 , were derived empirically. Measured runoff, soil loss and cover data from the 1993 wet season were used to estimate values of λ_{bare} and b_2 for open-field farming and hedgerow intercropping. Data from hedgerow treatment two, were used to isolate the barrier effect of hedgerows on the

efficiency of entrainment from the effect of surface cover provided by hedgerow prunings.

Rose (1985) fitted an equation relating λ_{bare} and b_2 to event λ and cover data. For this application, the value of λ_{bare} and b_2 in the equation were optimised to minimise root mean square error in the prediction of daily soil loss.⁵ Optimising λ_{bare} and b_2 to predict daily soil loss weights the parameters toward predicting larger soil loss events, giving better predictions of cumulative soil loss. Erosion predictions were validated against cumulative soil loss for the 1990 to 1992 maize crops.

Parameters for nutrient enrichment were derived from measured soil and sediment nutrient data (Comia et al. 1994). An equation relating enrichment ratio to soil loss was fitted to data in a spreadsheet.

Nitrogen

Calibrating the nitrogen balance module of APSIM requires data on soil nitrogen levels through time. No experimental data were available for soil mineral nitrogen at Tranca. Parameters for the soil nitrogen module were derived by integrating measured soil organic matter levels with knowledge of the soil and previous experience in modelling legume and non-legume cropping systems (Dimes 1996, Probert et al. 1996). Initial state variables for the nitrogen module were based on measured differences between soil organic carbon levels under the open-field treatment and hedgerow treatment three (Paningbatan 1995).

Maize

The maize module was parameterised to simulate the phenology and growth of two maize varieties — a local variety, Lagkitan, and a hybrid variety, IPB193. Maize yields were parameterised for the cropping area only, excluding the area that would be occupied by hedgerows. The number of thermal degree days from emergence to juvenile stage, and from flowering to maturity, and photoperiod sensitivity were adjusted until the phenology of Lagkitan and IPB193 were accurately simulated. The potential number of grains and rate of grain filling were calibrated against measured maize yields from the open-field treatment and hedgerow treatment three.

5. RMSE is the root mean square error, the average absolute difference between predicted and observed values. The advantage of this statistic is that it is in the same units

as the original data. $RMSE = \sqrt{\frac{(X - \bar{X})^2}{N}}$ where X and \bar{X} are the predicted and measured values respectively, and N is the number of events in the sample.

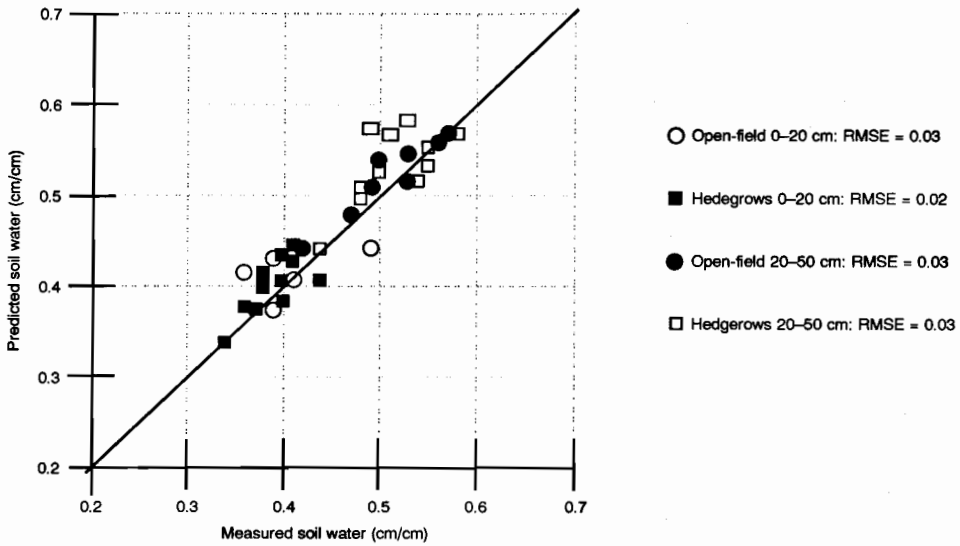

Figure 4. Soil water content predicted using APSIM, 1993.

Results

Soil water, evaporation and drainage

The parameters derived for soil water holding, evaporation and drainage produced accurate predictions of soil water content beneath the open-field farming treatment during the wet season of 1993 (Figure 4). The parameters also produced accurate predictions of soil water content in the centre of the cropping alleys of hedgerow treatment three, despite no consideration of water use by the hedgerows. Water use by the hedgerows had little influence on measured soil water content during the 1993 wet season because high rainfall kept soil moisture above the drained upper limit.

Runoff

A relationship between curve number and surface cover was established using measured cover for the 1990 and 1993 wet season maize crops. The available data from which to establish a relationship between curve number and surface cover were limited because there were few periods of constant cover. The available data suggest a strong relationship between curve number and surface cover. The values derived for bare soil curve number were 93.1 for open-field farming and 83.2 for hedgerow intercropping. No cover data above 45% were available. APSIM allows an upper limit of surface cover to be set beyond which curve number ceases to decline,

and this was set at 60%. A large range in the response of curve number to surface cover reflects very low measured runoff from the hedgerow treatments with mulch retained. A lower curve number for each level of cover beneath hedgerow intercropping compared to open-field farming reflects a lower runoff response from daily rainfall.

In 1992-93, the hedgerows of *desmanthus* senesced and were replaced. During the wet season maize crop following reestablishment of the hedgerows, runoff response from the hedgerow intercropping treatments was similar to that from the open-field treatment on days with rainfall exceeding 40 mm. Accurate predictions of runoff following hedgerow replacement were obtained by setting the curve number parameters for hedgerow intercropping equal to those for open-field farming for days with rainfall greater than 40 mm. A capacity to modify curve number parameters with rainfall was added to the manager module.

Measured runoff was low for both hedgerow intercropping and open-field farming following tillage. The reduction in runoff caused by increased surface roughness was accurately predicted by reducing the bare soil curve number by 30 for 30 days following tillage.

The curve number parameters derived above produced accurate predictions of cumulative runoff from both the open-field treatment and hedgerow treatment 3 during the maize crops of 1990 and 1993 (Table 1).

The accuracy of cumulative runoff predictions was influenced by using data from these years to derive soil water and curve number parameters. The soil water, surface residue and curve number parameters derived above accurately predicted measured runoff from the open-field treatment and hedgerow treatment 3 during the 1991 and 1992 maize crops. As expected, prediction of daily runoff was imprecise because runoff was predicted from daily measurements of the amount, but not the intensity, of rainfall.

Table 1. Summary of APSIM's runoff predictions.

Year	Cumulative runoff (mm)		Predicted/ Observed ratio	RMSE of daily runoff
	Measured	Predicted		
Hedgerows				
1990*	23	34	1.50	5.6
1991	101	112	1.11	7.2
1992	17	20	1.15	2.2
1993*	126	110	0.87	7.0
Open field				
1990*	210	181	0.86	8.2
1991	317	360	1.14	8.6
1992	98	105	1.07	6.1
1993*	319	343	1.07	6.9

*Soil water parameters and curve numbers were derived using data from 1990 and 1993.

Erosion

The values derived for the parameters λ_{bare} and b_2 using measured soil loss, runoff and cover data from the open-field treatment during the 1993 maize crop

were 0.55 and 0.27 (Figure 5). For hedgerow treatment 2, the values of λ_{bare} and b_2 were 0.29 and 0.35. The values derived for λ_{bare} and b_2 accurately predicted daily soil loss from the open-field treatment, but were less precise for hedgerow treatment 2 (Table 2). The lower precision (r^2) of soil loss predictions for hedgerow intercropping reflects the difficulty of predicting very small soil loss events.

Table 2. Predicted daily soil loss statistics.

Daily soil loss statistics	Open-field	Hedgerows (T2)
Predicted (P) vs measured (M)	$P = 0.96M + 0.25$	$P = 0.67M + 0.37$
r^2	0.95	0.57
Predicted/ Observed ratio	1.0	1.0
RMSE	1.9	1.2

Hedgerows are a physical barrier to water flow and promote the redeposition of sediments carried across the cropping alleys. The lower λ_{bare} for hedgerow intercropping indicated that hedgerows significantly reduced the efficiency of entrainment of surface water flows. The higher b_2 for hedgerow intercropping indicated that hedgerows enhanced the effectiveness of surface cover in protecting the soil surface from erosion.

Surface cover beneath the maize crops had a strong influence on erosion. Soil loss was reduced to very low levels when surface cover exceeded 20% for open-field farming, and 10% in the cropping alleys of the hedgerow intercropping treatments.

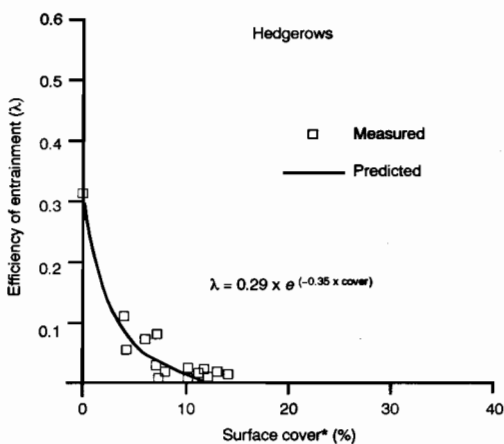
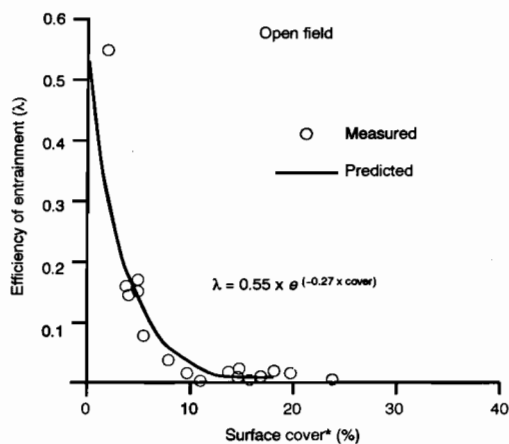

* Surface cover is the near ground cover in the cropping alleys, and does not include the cover provided by the hedgerows.

Figure 5. Derivation of λ_{bare} and b_2 .

The values of λ_{bare} and b_2 derived for open-field farming produced accurate predictions of cumulative soil loss during the wet season maize crop of 1993 (Table 3). Validating the model using measured soil loss data from open-field farming for 1990 to 1992 also produced accurate predictions of cumulative soil loss. Accurate prediction of cumulative soil loss required accurate prediction of runoff and surface cover, adding confidence to the parameterisation of those components of APSIM.

The values of λ_{bare} and b_2 derived from hedgerow treatment 2 produced accurate predictions of cumulative soil loss from hedgerow treatment 3 for the years 1990 to 1992. From 1990 to 1992, the desmanthus hedgerows were vigorous and reduced soil loss to negligible levels which the model accurately predicted (Table 3).

Table 3. Summary of APSIM's soil loss predictions.

Year	Cumulative soil loss (t/ha)		Predicted/ Observed ratio	RMSE of daily soil loss
	Measured	Predicted		
Hedgerows				
1990	0	0.005	n.a. [†]	n.a.
1991	0	0.065	n.a.	n.a.
1992	0	0.004	n.a.	n.a.
1993*	7.1	5.51	0.78	3.7
Open-field				
1990	79	74	0.93	6.1
1991	111	128	1.15	4.2
1992	13	19	1.46	1.9
1993*	95	92	0.97	3.8

* The efficiency of entrainment was calibrated against measured surface cover for 1993.

[†] Could not be calculated because there was no measured soil loss.

The values of λ_{bare} and b_2 derived empirically using data from hedgerow treatment 2 under-predicted cumulative soil loss when used in APSIM to simulate hedgerow treatment 3 during the wet season maize crop of 1993. In 1992–93, the desmanthus hedgerows senesced and were replaced, reducing their effectiveness in controlling soil erosion. Early in the cropping season when surface cover was low, some high rainfall events caused rills to break through the hedgerows, producing high runoff and soil loss. The reduced effectiveness of replanted hedgerows for controlling erosion was accurately modelled using values of λ_{bare} and b_2 of 0.55 and 0.2 for days on which rainfall exceeded 40 mm (Table 3). As expected, the difficulty of accurately predicting runoff from daily rainfall resulted in imprecise predictions of daily soil loss.

Nitrogen

The parameters derived for the nitrogen module reflect the moderate fertility of the soil at Tranca (Appendix 1). Initial levels of soil nitrate in APSIM for 1990 were set to levels consistent with high residual organic matter from a sesbania cover crop. For 1991 to 1993, initial soil nitrate levels were adjusted to reflect the quantity and nitrogen content of peanut residues added in the dry season. The biomass of peanut stover varied with seasonal conditions, averaging around 2 t/ha/yr from 1989 to 1993, with an average nitrogen content of 2%. Nitrogen contributions via the root systems of leguminous hedgerows were included by specifying higher initial organic carbon and labile nitrogen pools in the soil (Appendix 1). The magnitudes of these adjustments were estimated subjectively, but drew upon past experience simulating legume–non-legume systems in tropical environments (Probert et al. 1996).

Contributions of nitrogen to maize crops via hedgerow prunings were included by specifying the date, amount and nitrogen content of biomass added following each hedgerow pruning. Residues from hedgerow pruning biomass were added from outside the plant–soil system being modelled. The desmanthus hedgerows were not pruned in the year of establishment, 1988. In the three years following establishment, 1989–1991, the biomass of hedgerow prunings varied with seasonal conditions from 2.5–3.5 t/ha/yr. The hedgerows senesced during the fifth year following establishment (1992), and only produced 0.6–0.9 t/ha/yr. Foliar analysis of *Desmanthus* revealed an average nitrogen content of around 2.5%. In 1993, the hedgerows were partially replanted using a *Tephrosia* sp., and yielded negligible pruning biomass in that year.

No soil nitrate data were available for testing nitrogen simulation and therefore no model testing results are presented.

Maize

The phenological parameters derived for the two maize varieties, Lagkitan and IPB193, accurately predicted the development of each variety through the juvenile and flowering stages to maturity (Appendix 1). APSIM accurately predicted fluctuation in maize yields associated with seasonal climatic variation, but overpredicted the magnitude of yields in 1991 and 1992 (Figure 6). Lower yields in 1991 have been attributed to restricted flowering because of ash falls during the eruption of Mt Pinatubo (Comia et al. 1994). Delays in funding reduced the intensity of weeding and pest control in 1992.

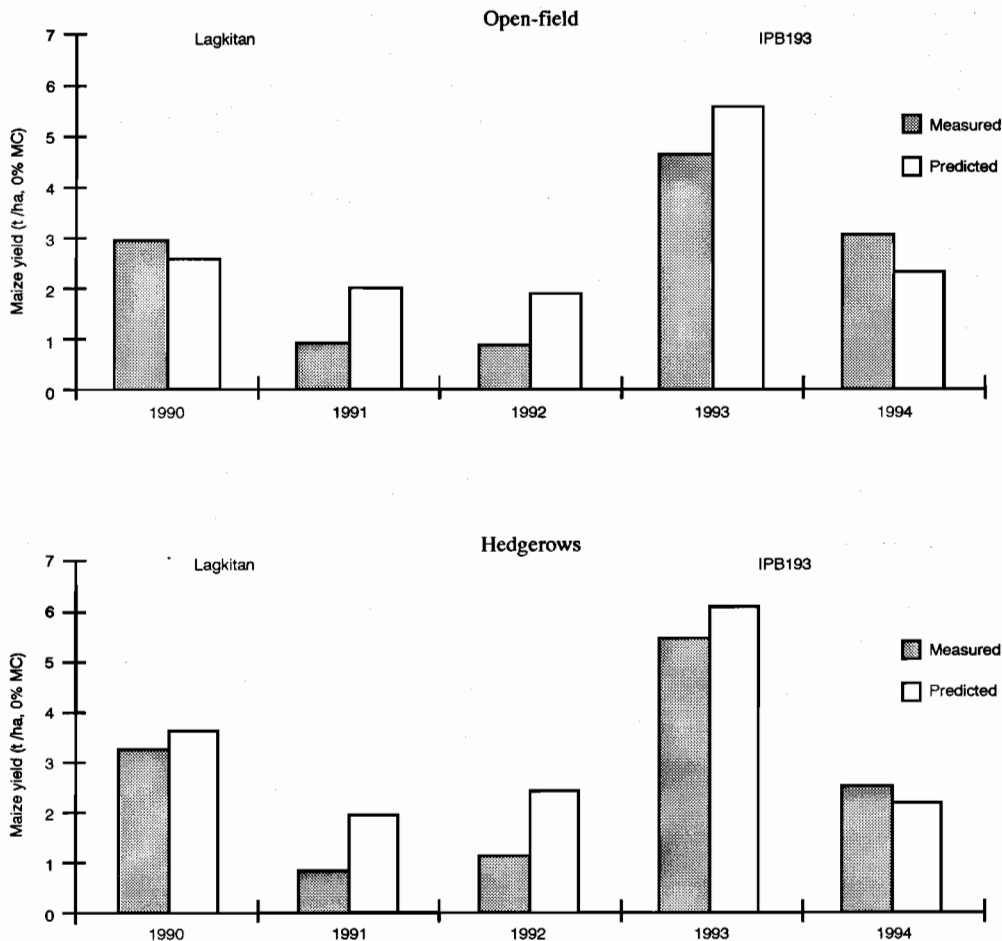

Figure 6. Maize yields predicted using APSIM compared with measured.

Maize yields were sensitive to initial levels of soil nitrate at the start of each crop season. Adjusting soil nitrate levels at the start of the 1990, 1993 and 1994 wet seasons to levels consistent with higher inputs from previous crops of sesbania (1990) and peanut (1993, 1994) enabled APSIM to predict maize yields better in those years. Maize yields were less sensitive to changes in soil water parameters because high rainfall maintained soil moisture close to saturation.

The yields predicted for hedgerow intercropping are reported on the basis of cropped area only (Figure 6). APSIM accurately predicted higher yields per unit of cropped area from hedgerow intercropping compared to open-field farming.

Discussion

Applications of cropping systems models to humid tropical farming systems in developing countries are

rare. Most cropping systems models have been developed for temperate or semi-arid tropical environments, and the comprehensive data sets required to parameterise and test the models for humid tropical environments are rarely available in developing countries. The detail and scope of the data used in this study were unusual, allowing a range of system parameters controlling crop growth, soil water and erosion to be derived and tested.

Modelling open-field farming

APSIM was developed to model open-field farming systems in the semi-arid tropics. This application extended the model into a humid tropical environment where high rainfall maintained soil moisture content close to saturation. Parameterising the model for saturated soil conditions reduced confidence in the parameters defining the lower limits of soil

water-holding capacity, reducing the reliability of the model for predicting dry season maize yields.

Where multiple processes interact, there can be a range of parameter combinations that give equally accurate predictions of measured data. Parameterisation of APSIM produced impressive agreement between predicted and measured data. Ideally, however, more measured data would be required to minimise the number of unknown variables and improve confidence in the predicted output. This was of particular concern for soil nitrogen dynamics, for which there were no measured data, because predicted maize yields were sensitive to soil nitrate levels.

APSIM is likely to overpredict maize yields from open-field farming because it models the full potential response of maize crops to soil water and nitrogen levels which, in the field, would be moderated by other constraints to plant growth. Constraints such as nutrients other than nitrogen, pests, diseases and environmental extremes were not considered. An element of management imprecision can be incorporated using planting and tillage rules based on cumulative rainfall, but these cannot capture the complex decision-making process of farmers.

Modelling hedgerow intercropping

The ability of this version of APSIM to simulate maize yields from hedgerow intercropping was discussed earlier. In the absence of an APSIM module capable of simulating hedgerows as an intercrop, an open-field model was parameterised to predict runoff, erosion and crop growth measured from a field with hedgerows.

The relationship between runoff curve number and surface cover derived for hedgerow intercropping indicated that hedgerows can greatly enhance the effectiveness of surface cover in reducing runoff, but may be less effective as physical barriers to runoff. Hedgerow stems reduced runoff curve number for bare soil by around 10, whereas high levels of surface cover from hedgerow prunings caused much greater reductions in runoff response compared to open-field farming. Although the barrier effect of hedgerows on runoff was small, hedgerows can significantly reduce the efficiency of entrainment of water flows by reducing their concentration, leading to a reduction in the incidence of rills. The surface cover provided by hedgerow prunings protects the soil surface from erosive rainfall and water flows.

Legume shrub hedgerows senesce and require replacement or infill replanting at varying intervals

depending on the hedgerow species and environment. Hedgerows that are newly replaced or repaired are less effective in controlling runoff and erosion. Under high intensity rainfall, concentrated water flows break through weak points in the hedgerows to form rills. Hedgerow failure in periods following replanting can be modelled using runoff and erosion parameters similar to those for open-field farming on days with high rainfall.

As discussed earlier, this version of APSIM models the beneficial effects of hedgerow intercropping on maize yields, but does not model the competitive hedgerow-crop interactions that are likely to reduce yields. Hedgerow prunings were added from outside the plant-soil system being simulated, and no account was taken of the water or nitrogen taken up by the hedgerows. Hedgerows were not explicitly modelled as an intercrop, and their interception of solar radiation was not considered. However, maize yields predicted by APSIM can be adjusted for hedgerow-crop competition, which can reduce maize yields by 10% to 25% depending on soil fertility and the degree of terrace formation induced by the hedgerows.

Competition for soil water and nitrogen between the hedgerows and adjacent maize crops was not evident in the maize yields measured at Tranca. This was due to the fertility of the soil, high rainfall and the addition of nitrogen fertiliser. In drier conditions, with less fertile soils or lower nitrogen additions, hedgerow-crop competition could be expected to have a greater effect on maize yields. The potential effect of hedgerow-crop competition on maize yields for different soil types was discussed earlier.

Erosion/crop productivity simulation with APSIM

The version of APSIM described and parameterised above was used to simulate soil erosion and long-term maize yields from traditional open-field farming and hedgerow intercropping. The farming systems simulated are the same as those on which the economic analysis was based, and the model was parameterised to data from nearby trials of hedgerow intercropping with similar agronomic conditions. Open-field farming is simulated with and without fallow years to reflect the most common maize farming practices in the Philippine uplands. Intercropping of maize between shrub legume hedgerows is simulated to investigate the sustainability of the most commonly promoted form of hedgerow intercropping in the Philippine uplands. In this form of hedgerow intercropping, hedgerow prunings are applied as mulch to the cropping alleys rather than fed to livestock.

Methodology

Two variants of open-field farming were simulated using APSIM: continuous and fallow (Table 4). In densely populated upland areas, most arable land has been under constant use to provide crops for subsistence and sale. Simulating repeated cropping every year without fallow years is, in these cases, an accurate model of farmer circumstances. Continuous open-field farming also provides a useful comparison with hedgerow intercropping, which has usually been promoted without fallow years.

In less populated communities, land has been relatively abundant and maize farmers have rotated cropping between two or three fields. The area cropped each year has been limited by the availability of farm family labour. For comparison with continuous cropping of a single hectare of land, it was assumed that farmers practising field rotation have two fields, each one hectare in size, and that the availability of labour permits one hectare to be cropped each year. Farmers were assumed to rotate the two fields alternately through two years of maize cropping and two years of fallow. The two years of fallow were assumed to be dominated by *Imperata cylindrica* (Imperata grass), and provide no direct economic returns to the farmer. The analysis of fallow farming is therefore based on two hectares of land, rather than the single hectare considered for the other farming methods.

It was assumed that 1000 kg/ha of weed residues accumulated over each dry season fallow (January to April) with a nitrogen content of 10 kg/ha (1.0%). Prior to cultivation, 75% of weed residues were burnt. Cultivation was simulated in the model by incorporating 80% of the remaining surface residues to a depth of 20 cm. Cumulative rainfall of 30 mm over seven days was required to initiate cultivation, and cultivation was repeated after 21 days if cumulative rainfall was insufficient for sowing.

A maize-maize crop rotation was simulated because maize has been the most widely planted crop in the Philippine uplands. Local varieties have domi-

nated the more expensive hybrid varieties in the small-holder maize farming systems of the uplands, and so a local variety of maize, Lagkitan, was simulated. The first crop was planted at the beginning of the wet season in May and a second crop was planted in September or October provided there was sufficient rainfall after harvesting of the wet season crop. Sowing took place between five and 21 days after tillage provided at least 30 mm of rainfall over seven days was received. Maize was sown at a spacing of 20 cm along rows and 75 cm between rows to produce a density of 66 000 plants per hectare. Maize was harvested at maturity and the stubble from harvesting retained in the field.

Biomass production of Imperata grass during the two-year fallow periods of fallow open-field farming was based on the estimates of Sajise (1980). Sajise reported above-ground dry matter production of Imperata in the Philippines averaging 4 t/ha/yr with an average nitrogen content of 0.94%. Assuming that annual burning prevents the accumulation of above-ground biomass, fallows of Imperata grass were simulated by applying 4 t/ha of residue at the end of each fallow. High cover levels were specified during the two-year fallow periods.

The cropping and tillage operations simulated for hedgerow intercropping were the same as those for open-field farming except that residues were incorporated rather than burnt at land preparation. Based on the lifecycle of desmanthus in the Tranca trial, it was assumed that hedgerows senesced and required partial (50%) replacement every five years. As discussed earlier, the hedgerows were simulated to be less effective in controlling erosion in years of establishment, infill replanting and senescence. No fallow years were included in the hedgerow intercropping model, because the technology has usually been promoted to upland farmers as a method of sustaining continuous cropping.

The biomass of hedgerow prunings was assumed to vary with hedgerow vigour over a five year lifecycle, based on pruning biomass measured at Tranca.

Table 4. Description of the maize farming methods simulated using APSIM, Tranca.

Method of farming	Description
Continuous open-field farming (open-field)	Repeated annual cropping, without fallow years, of a maize-maize crop rotation in a field without hedgerows.
Fallow open-field farming (fallow)	Annual cropping of a maize-maize crop rotation in a field without hedgerows for two years, followed by two years during which the field was left to revert to shrubby grassland dominated by Imperata grass.
Hedgerow intercropping (hedgerows)	Repeated annual cropping, without fallow years, of a maize-maize crop rotation in the alleys formed by leguminous shrub hedgerows.

Hedgerows were assumed to produce no pruning biomass in years of establishment, infill replanting or senescence. In years two to four, 3000 kg/ha/yr of prunings were added containing 75 kg of nitrogen per hectare (2.5%).

Maize yields predicted by APSIM were reduced by 10% to reflect the effect of hedgerow-crop competition on soils of moderate acidity, as discussed earlier. Maize yields from hedgerow intercropping are reported on a whole-area basis, including the field area occupied by the hedgerows.

Thirty-six years of historical climate data (1959-94) were available to run APSIM.⁶ The three farming methods were simulated over 25 years (1959-83) to compare predicted soil loss, and the effect of soil loss on maize yields. Each simulation commenced with one metre of moderately fertile soil similar to the soil at Tranca prior to the research trial, when the land had been fallowed for some time. The simulations of continuous open-field farming and hedgerow intercropping were extended to 50 years to investigate the long-term effects of continuous cropping on maize production. A 50-year climate data set was generated by random resampling of the 36 years of historical climate data.

The interaction of cyclical and seasonal climatic variation and soil quality on the distribution of expected maize yields was investigated by repeated simulations of the three farming methods with different starting years in the historical climate data set.

6. The climate data were provided by the International Rice Research Institute, Los Baños, Philippines.

Thirty-six years of climate data enabled each farming method to be simulated 12 times over 25 years (Figure 7). The distribution of maize yields from repeated simulation indicates the risk of crop failure from the alternative farming methods.

Results

Maize yields

Annual maize yields predicted from continuous open-field farming were initially high but declined dramatically in the first few years of cropping as erosion removed soil organic matter and reduced soil fertility (Figure 8). High maize yields from fallow open-field farming in the first four years of cropping reflect the high initial productivity of two separate maize fields. In the long term, predicted maize yields for fallow open-field farming declined to slightly higher levels than those predicted from continuous open-field farming. Hedgerow intercropping was predicted to sustain potential yields around initial levels, though actual yields were sensitive to seasonal climatic fluctuations. Yields from hedgerow intercropping were predicted to fall below those of open-field farming in years of drought, when soil water limited the response of maize crops to higher nitrogen levels (e.g., Year 12, Figure 8). Yields from hedgerow intercropping were initially lower than those from continuous and fallow open-field farming because of the cropping area occupied by hedgerows, and because maize yields were suppressed by hedgerow/crop competition for light, nutrients and

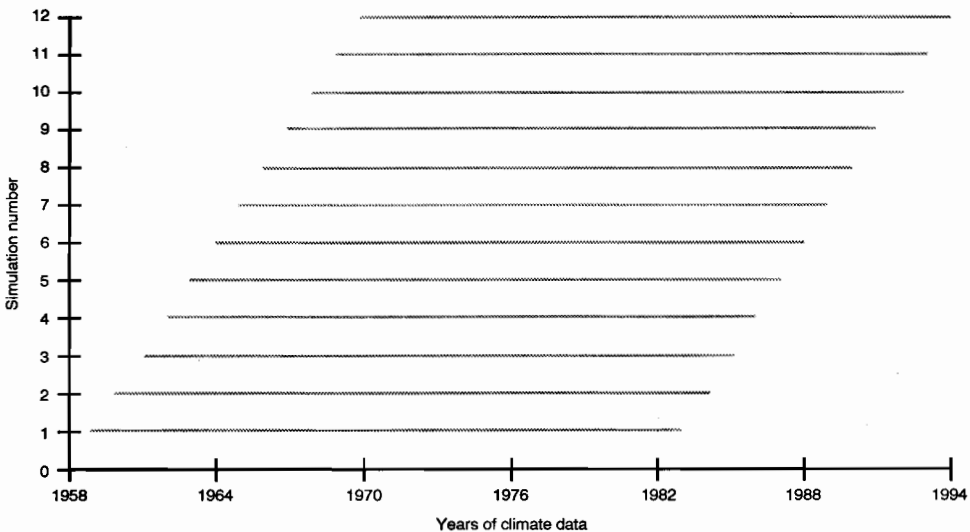

Figure 7. Simulations to derive a distribution of predicted maize yields.

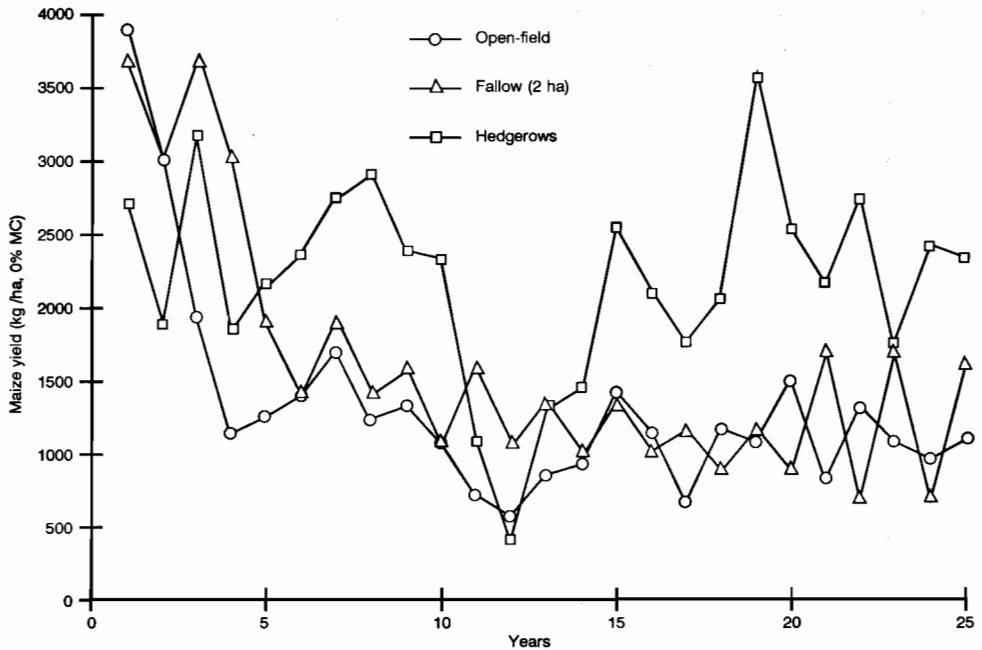

Figure 8. Annual maize yields predicted using APSIM.

water. After three or four years, yields from hedgerow intercropping were consistently greater than those from continuous and fallow open-field farming.

Soil erosion

APSIM predicted a soil depth decline of 540 mm over 25 years under continuous open-field farming, resulting from average soil loss of 190 t/ha/yr (Figure 9). Fallow open-field farming effectively spread declining soil depth over twice the cropping area, halving soil depth decline. The lower average rate of soil loss from fallow open-field farming is a composite of two rates: an average of 175 t/ha/yr in years of cropping, compared to very low predicted erosion in fallow years. The decline in soil depth predicted under hedgerow intercropping was negligible, with soil loss averaging 1 t/ha/yr.

Erosion from open-field farming was predicted to be high because the soil surface cover was low during periods of high rainfall (Figure 10). Grass cover during fallow years reduced predicted erosion from fallow open-field farming, but erosion was high in cropping years because surface cover management was the same as continuous open-field farming.

Hedgerows provide surface cover for the proportion of cropping area that they occupy, and hedgerow prunings provide surface cover for the cropping alleys.

Soil water

By reducing soil depth, erosion reduces the amount of water available for plant uptake. Predicted maximum annual plant extractable water declined significantly under continuous and fallow open-field farming, in similar proportion to the rate of soil depth decline. Maximum plant extractable water remained unchanged under hedgerow intercropping because of negligible soil loss.

Soil nitrogen

Erosion reduces the amount of nitrogen available for plant uptake. The maximum annual amount of soil nitrate available for plant uptake declined rapidly to low levels under continuous open-field farming as the topsoil was removed in the first few years of cropping. An average 95 kg/ha/yr of nitrogen removed in eroded sediments from continuous open-field farming was significant relative to the 30 kg/ha/crop added as urea.

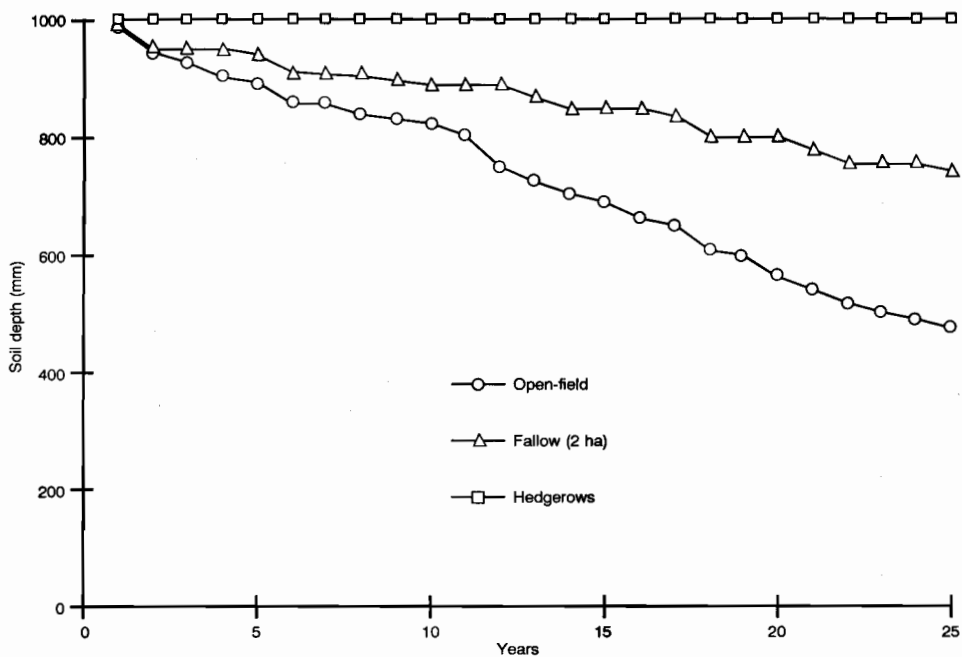

Figure 9. Soil depth predicted using APSIM.

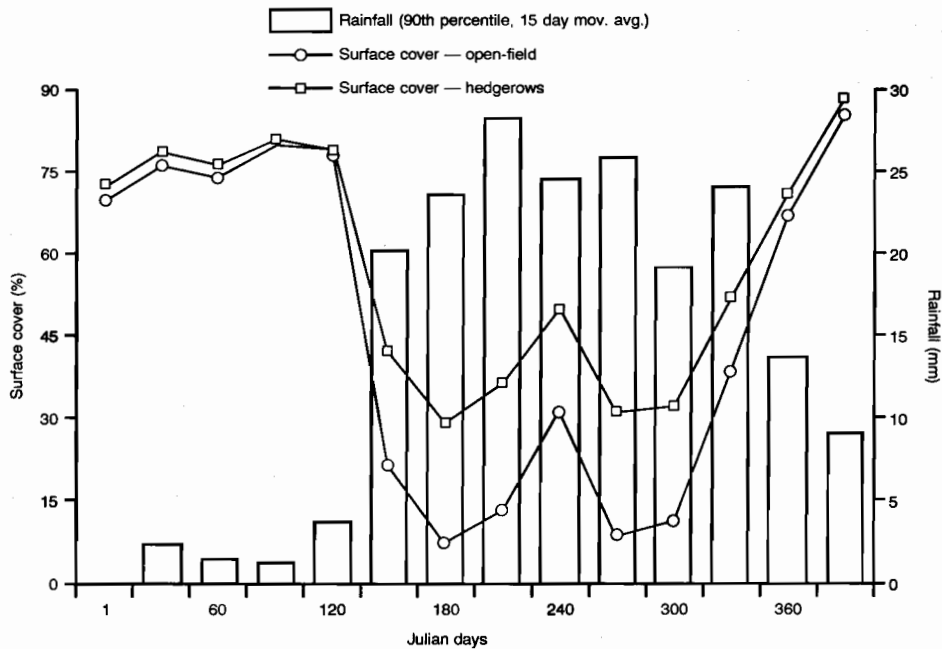

Figure 10. Average surface cover predicted using APSIM.

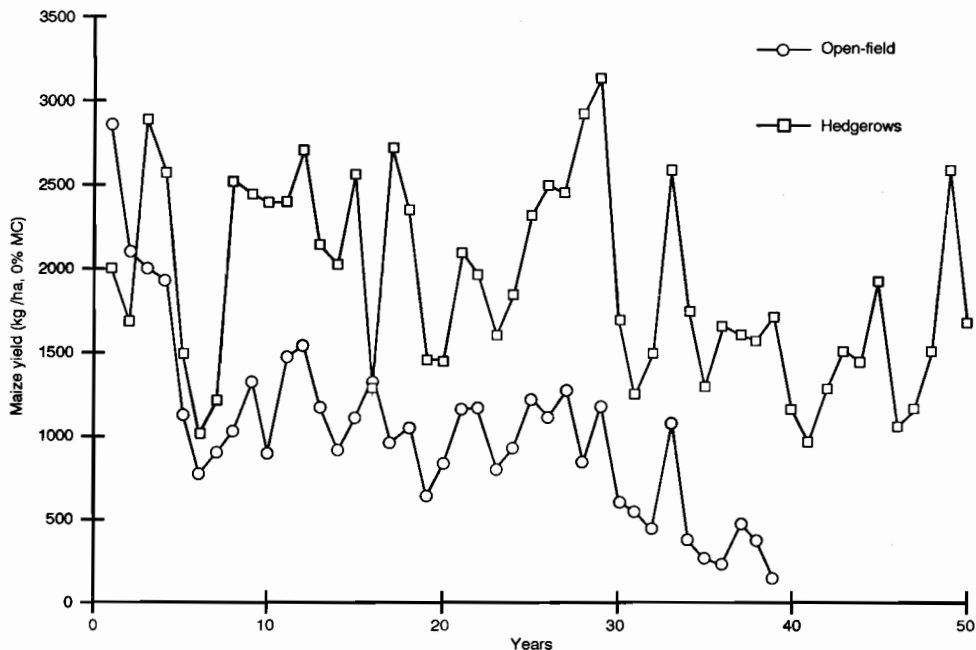

Figure 11. Maize yields predicted using APSIM over 50 years.

The simulated two-year Imperata fallows had a negligible effect on predicted maximum annual soil nitrate under fallow open-field farming, explaining why predicted maize yields were similar to those for continuous open-field farming. Most of the 40 kg/ha of nitrogen added with Imperata residue after each two-year fallow was lost by burning prior to land preparation for the wet season maize crop. Nitrogen lost in eroded sediments averaged 60 kg/ha/yr in all years, and 110 kg/ha/yr in years of maize cropping.

Very low rates of soil loss under hedgerow intercropping maintained predicted maximum annual soil nitrate around initial levels. Predicted loss of nitrogen in eroded sediments from hedgerow intercropping was negligible over 25 years of simulation. Plant-available nitrate under hedgerow intercropping fluctuated in response to cyclical variation in crop uptake, pruning biomass and seasonal conditions for organic matter decomposition and fertiliser mineralisation. Soil nitrate levels under hedgerow intercropping were sustained by the 75 kg/ha/yr of nitrogen added in hedgerow prunings during years two to four of each hedgerow lifecycle.

Extended simulations

Predicted maize yields from continuous open-field farming using 50 years of randomly ordered climate data declined rapidly to low levels in the first few

years of cropping (Figure 11). After 30 years of cropping, predicted maize yields again fell rapidly as the soil eroded at an average rate of around 220 kg/ha/yr until crop production was no longer possible. Low rates of soil loss predicted for hedgerow intercropping sustained predicted maize yields over 50 years, which varied with seasonal conditions.

Distribution of maize yields

The interquartile range from the distributions of predicted maize yields from the alternative farming methods are presented in Figure 12. The distribution of predicted maize yields from continuous open-field farming over 12 simulations was narrowly dispersed during the first 15 years of cropping. Rapidly reducing profile depth and loss of soil nitrogen reduced predicted yield response to favourable seasonal conditions. After 15 years of cropping, the probability of crop failure was high because soil organic carbon levels were reduced to very low levels. The distribution of predicted maize yields predicted from fallow open-field farming was similar to that predicted from continuous open-field farming in the short to medium term. In the long term, however, fallowing reduced the probability of crop failure by conserving soil depth and maintaining soil carbon levels.

The distribution of predicted maize yields from hedgerow intercropping was more widely dispersed than those from continuous and fallow open-field farming (Figure 12). Hedgerow intercropping reduced predicted soil loss, maintaining soil water-holding capacity and nitrate levels, and enabling predicted maize yields to respond to favourable seasonal conditions. Predicted maize yields from hedgerow intercropping can be low in years of unfavourable rainfall distribution. However, cycling of organic matter and nitrogen through hedgerow prunings reduced the probability of crop failure in the long term. The five-year lifecycle imposed on hedgerow biomass production produced a five-year cycle in expected maize yields from hedgerow intercropping.

Discussion

Sustainability of maize production

Continuous open-field maize farming in the Philippine uplands is unlikely to be sustainable in the long term. Intense rainfall can cause high rates of erosion when surface cover is low, even on moderate slope gradients. Although nutrient decline is important, an overriding concern is the potential to lose all arable soil from intensively cultivated maize fields after around 30 years of cropping. Vast areas of the uplands have been deforested and converted to sedentary agriculture in the last 30 or 40 years.

Predicted erosion of 190 t/ha/yr for open-field farming of a maize–maize rotation was higher than the average 106 t/ha/yr measured from a maize–peanut rotation at Tranca between 1990 and 1994. Although partly due to the difference in crop rotation, the greater erosion was also due to repeated tillage simulated in years when sowing was delayed by insufficient rainfall. A greater number of tillage events simulated by APSIM was more representative of traditional farmer practice than the strictly controlled management of the research trial. Farmers in the Philippine uplands have favoured clean cultivation through repeated ploughing, and fields left bare by tillage are highly susceptible to erosion. The dramatic loss of soil depth predicted by APSIM under open-field farming is similar to that reported by O’Sullivan (1985) for maize farmers in Mindanao, and other estimates reviewed in Nelson (1996).

Fallow open-field farming has been a common practice of maize farmers in less populated areas of the uplands who have two or more parcels of land, although it has progressively given way to continuous cropping as population growth has forced more intensive land use. The simulation results indicate that fallowing in Imperata grasslands for brief periods can prolong cropping by spreading soil

loss over a greater land area. However, Imperata grass is very low in nitrogen and has little potential to improve the fertility of soil during limited fallow periods of two or three years. This is consistent with an observed decline in productivity and increasing reliance on external inputs in shifting cultivation systems with reduced fallow periods.

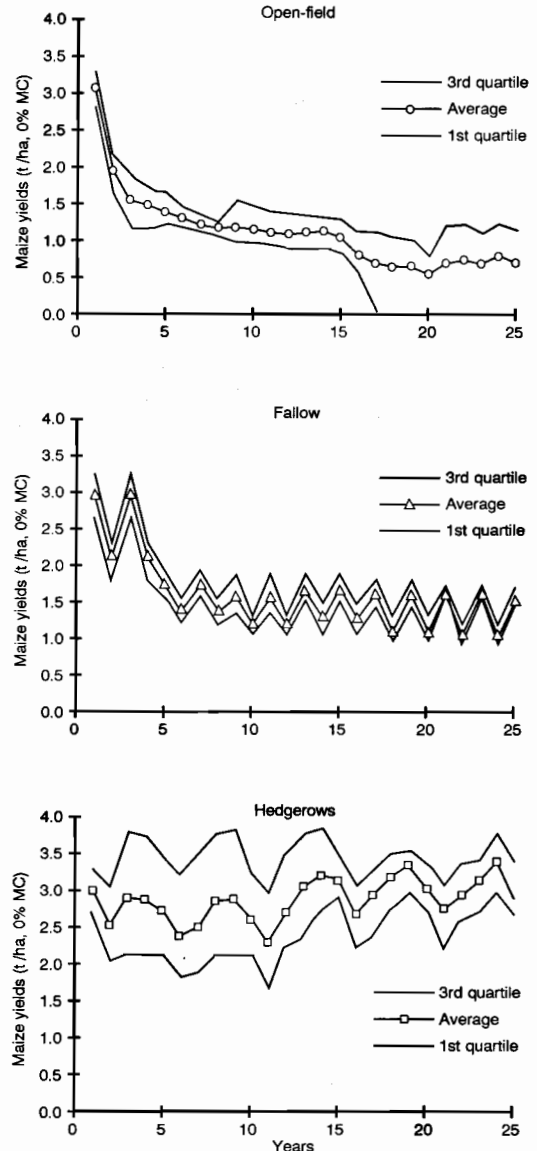

Figure 12. Distribution of maize yields predicted using APSIM.

Simulation with APSIM suggests that hedgerow intercropping has potential to sustain maize yields in

the Philippine uplands by greatly reducing soil loss and contributing nitrogen to the cropping alleys. Hedgerow intercropping reduces erosion by maintaining soil surface cover during periods of intense rainfall. By reducing soil loss, hedgerow intercropping can maintain soil water-holding capacity and nitrate levels. As well as providing surface cover and reducing erosion, mulch from hedgerow prunings can contribute significant amounts of nitrogen and organic matter to the cropping alleys. This is consistent with the findings of the fields trials of hedgerow intercropping in the Philippines and elsewhere.

Average soil loss from hedgerow intercropping of a maize–maize rotation predicted using APSIM was 1 t/ha/yr, lower than the 6.4 t/ha/yr from the maize–peanut rotation of the Tranca trial from 1990 to 1994. However, this comparison needs to be interpreted with consideration of the lifecycle of the hedgerows in the research trial. The higher rate measured at Tranca included no measured erosion from 1990 to 1992, 7.1 t/ha in 1993 and 24.7 t/ha in 1994. In 1993, the hedgerows senesced and were replaced, reducing their effectiveness in controlling erosion. In 1994, the replacement species failed, further reducing the effectiveness of the hedgerows in controlling erosion. The senescence of shrub legumes and associated failure of hedgerows in controlling erosion are important characteristics of hedgerow intercropping. APSIM was therefore parameterised to simulate hedgerow failure in years of senescence and reestablishment, and predicted up to 5 t/ha/yr of erosion in those years. The very low rates of erosion simulated from hedgerow intercropping reduce the practical significance of the potential to overstate soil loss by assuming a constant slope for the Rose equation.

Distribution of maize yields

The predicted distributions of maize yields suggest that the productivity of continuous open-field farming can be relatively stable in the medium term, after an initial rapid decline as fertile topsoil is lost. High rates of erosion reduce soil productivity, limiting the response of maize crops to favourable seasonal conditions. In the long term, low soil organic matter levels increase the probability of crop failure. Fallow open-field farming may be attractive to farmers with sufficient land because it reduces the probability of crop failure in the long term. The probability of crop failure may be as important as the expected value of maize yields to farmers operating on the margin of economic survival.

Hedgerow intercropping may increase the variability of maize yields relative to open-field farming by conserving soil productivity and

maintaining a potential for maize crops to respond to favourable seasonal conditions. However, maize yields from hedgerow intercropping may not respond to high levels of nitrogen in years when soil water is limiting to plant growth. There may also be a cyclical component of the seasonal variation in maize yields from hedgerow intercropping associated with hedgerow biomass production over the lifecycle of the hedgerow species.

Limitations of the analysis

APSIM was parameterised using data from the wet season maize crops of the maize–peanut rotation planted in the trial at Tranca, and model parameters were not tested under dry season conditions. During the simulation exercise, APSIM predicted consistent failure of dry season maize crops when a hybrid maize variety was simulated as the wet season crop, because hybrid varieties were predicted to exhaust plant extractable soil water. A consistent failure of dry season maize crops may explain why only six of the nineteen farmers interviewed in Timugan regularly planted dry season maize crops, three of them using local maize varieties in the wet season. For this analysis, a maize–maize rotation was simulated using a local variety, and predicted dry season yields were reasonable when compared to the yields reported by the farmers in Timugan. APSIM's predictions of dry season yields were reasonable when a local variety was simulated as the wet season crop, because local varieties mature over a shorter period and exhaust soil water reserves less frequently.

Maize yields predicted using APSIM were sensitive to soil nitrogen levels because APSIM does not simulate constraints on plant growth such as nutrients other than nitrogen, pests, diseases, management limitations or environmental extremes. For example, farmers in the uplands rarely apply sufficient chemical inputs to effectively control pests and diseases. Environmental extremes, especially typhoons, regularly destroy maize crops in some parts of the Philippine uplands. The conditional rules within APSIM provide some degree of management variability in response to rainfall, but cannot capture the full complexity of farmer decision-making.

For this application, APSIM was parameterised for moderately acid subsoils on which hedgerow/crop competition was not strongly expressed in measured maize yields. A relatively small hedgerow–crop competition factor of 10% derived for this type of environment was therefore used to adjust maize yields from hedgerow intercropping. On less fertile soils, phosphorus and other mineral limitations may reduce the potential of hedgerow intercropping to sustain maize production (Garrity 1993, Palm 1995). For example, on strongly acid

soils, intense hedgerow-crop competition in the shallow topsoil may limit the cycling of phosphorus through hedgerow prunings below the level required to sustain continuous cropping (Garrity 1994).

The predicted ability of hedgerow intercropping to reduce the risk of crop failure is partly due to the use of a constant hedgerow-crop competition factor to adjust predicted maize yields. A constant factor is likely to overstate competition in seasons favourable for plant growth, and understate competition in unfavourable seasons. In the field, the intensity of hedgerow-crop competition is likely to vary seasonally with the abundance of soil water and nitrogen. In unfavourable seasons, hedgerow-crop competition for soil water and nutrients may result in crop failure that would not occur in open-fields. An important objective for future research is therefore to develop a capacity to model hedgerows explicitly as an intercrop.

APSIM is a point scale model, simulating physical processes at the field level. An implicit assumption in the simulations reported in this chapter is that there is no water flowing onto the field from those above. An important limitation of hedgerow intercropping in the Philippine uplands has been a tendency for hedgerows to fail when there has been significant run-on of surface water from fields higher in the catchment (John Bee, pers. comm.⁷). Further investigation and refinement of hedgerow intercropping at the whole farm and catchment levels is required.

Bioeconomic analysis of hedgerow intercropping

Cost-benefit analysis was used to investigate the economic viability of hedgerow intercropping in areas of the uplands that are remote or relatively inaccessible from urban centres because of poor transport infrastructure. The returns from maize farming with and without hedgerows are derived from maize yields simulated using APSIM. The costs of maize farming were estimated using economic data from maize farmers in the communities of Timugan and Claveria, presented in Nelson et al. (1996a). The economic returns to investments in hedgerow intercropping with shrub legumes relative to traditional open-field farming are analysed by comparing net present value over 25 years. The economic incentives to adopt hedgerow intercropping revealed by the cost-benefit analysis are interpreted in terms of farmers' other decision criteria and socioeconomic constraints. In particular, the relative risk of the alternative farming methods is investigated by analysing the distribution of predicted net returns over 25 years.

7. International Client Services, Queensland Department of Primary Industries, Brisbane.

Methodology

Economic data

The surveys of maize farmers in Timugan and Claveria, and the economic data obtained from them, are described in Nelson et al. (1996a). Estimates of labour and material inputs from the Timugan survey were used because they were compatible with the agronomic conditions of the Tranca trials, for which APSIM was parameterised. Costs and prices reported by farmers in Claveria were used to analyse the economic viability of hedgerow intercropping under the economic conditions prevailing in relatively inaccessible upland areas. Vast areas of the uplands are relatively inaccessible from urban centres, restricting the marketing and employment opportunities available to farmers. The production of maize grain for subsistence and sale as animal feed dominates agriculture in these areas, and poor accessibility limits off-farm employment opportunities, significantly reducing the cost of labour.

Farmers in Claveria sell their maize on-farm as grain at a moisture content of around 18% (Sayre 1992). Maize yields predicted using APSIM were converted to 18% moisture content and valued using the real farm-gate price of white maize for Northern Mindanao (CRC 1987-88, 1992-93). Two maize price scenarios were used to assess the effect of relevant policy options on the economic viability of the alternative farming methods: removing trade protection from maize imports, and improving transport and marketing infrastructure. David (1996) demonstrated that tariffs and restrictions on maize imports caused the warehouse price of maize in Manila to exceed the border price by an average of 76% between 1990 and 1994. The adjusted farm-gate price of maize per kilogram after removing trade protection, P_F^* , is given by:

$$P_F^* = \frac{P_W}{1.76} - C_M$$

where P_W is the warehouse price of maize in Manila, and C_M is marketing costs.

Infrastructure improvements are often advocated as an effective means of improving the farm-gate price of maize (Sayre 1992). The effect of improving transport and marketing infrastructure was investigated by assuming improvements that halve marketing costs between farm-gate and wholesale prices in Manila.

The expected farm-gate price of maize was ₱5.50 per kilogram in the wet season, and ₱5.90 per kilogram in the dry season (CRC 1987-88, 1992-93). Sayre (1992) reported that marketing costs to Manila for maize originating in Bukidnon, a province adjacent to Misamis Oriental where Claveria is located, were ₱1.60 per kilogram in 1992, equivalent

to ₱1.80 per kilogram in 1994 prices. Using this marketing cost, removing trade protection from maize could reduce the expected farm-gate price of maize from ₱5.50 to ₱2.30 per kilogram in the wet season, and from ₱5.90 to ₱2.60 per kilogram in the dry season. Improvements in transport and marketing infrastructure that halved marketing costs could increase the expected farm-gate price of maize to ₱6.40 per kilogram in the wet season and ₱6.85 per kilogram in the dry season.

Many upland farmers do not own the land that they cultivate, and share cropping has been an important form of tenancy (Lara and Morales 1990). In some cases, tenants have been discouraged from implementing land improvements such as hedgerow intercropping to protect the ownership claims of absentee landlords. To investigate the implications of share-tenancy for the economic viability of hedgerow intercropping, it was assumed that landlords contribute 50% of the cost of external inputs for maize cropping including seed, fertiliser and animal power in exchange for 50% of each crop harvested. Share tenants were assumed to bear the manual labour costs of maize cropping and the full cost of hedgerow establishment.

Two discount rates were used for this analysis based on the cost of capital reported by farmers in Claveria, and described in Nelson et al. (1996a). A real discount rate of 25% was derived from the cost of interlinked credit from traders. A lower discount rate of 10% was used to reflect the potential of government-sponsored farmer cooperatives to reduce the cost of capital to upland farmers.

Cost-benefit analysis

The cost-benefit analysis was calculated in an *Excel* spreadsheet (Microsoft Corporation 1993). Related software, *@Risk* (Palisade Corporation 1995), was used to consider uncertainty associated with the quantity and cost of labour and material inputs, and the seasonal variability of maize yields predicted using APSIM. *@Risk* calculates probability distributions for output variables from repeated random sampling of input variable distributions. Probability distributions for input variables were estimated using *Bestfit* (Palisade Corporation 1994).

Probability distributions for the amount of labour required for each farming operation were derived from labour estimates provided by Timugan farmers, a summary of which was presented in Nelson et al. (1996a). The median of farmers' estimates for the cost of urea fertiliser, labour and animal power were accepted as expected values, with probability distributions estimated from published time series data (Intal and Power 1990, Balisacan 1993). Published time series data for Northern Mindanao from 1984 to

1992 were used to estimate a probability distribution for white-maize prices (CRC 1987–88, 1992–93). Probability distributions for wet season and dry season maize yields were derived by simulating each farming method 12 times with different starting years of historical climate data, as described earlier.

The annual net returns to land from maize farming were calculated by subtracting the annual cost of material inputs and labour, including draught animal power, from the gross farm-gate value of maize yields. Draught animal power represents the most important capital cost in upland farming systems, and was valued using market prices. The capital cost of hand tools is negligible and was not included in the analysis.

The decision of farmers to adopt a new farming method may be heavily influenced by the possibility of negative returns in any year, even if expected net present value is positive. The probability of negative returns from the alternative farming methods was assessed by analysing the distribution of annual net returns predicted over 25 years. Each scenario of the cost-benefit analysis is presented graphically as the expected net present value from each farming method over 25 years. Graphing net present value over time reveals a range of planning horizons, and the influence of major assumptions on the ranking of the various farming methods. The resale value of land after 25 years was not considered. Discounting greatly reduces the significance of resale values over long periods of analysis.

The distribution of net present value was used to indicate the risk associated with adopting each farming method, and to analyse sources of risk. Multivariate step-wise regression analysis was used to assess the sensitivity of net present value over 25 years to the probability distributions entered for the input variables. Stochastic dominance analysis (Anderson et al. 1977) was applied to these distributions to assess the preferred farming methods over 5, 10 and 25-year planning horizons. First-degree stochastic dominance (FSD) assumes only that farmers prefer farming methods that produce higher net present value. FSD holds if the cumulative distribution function (CDF) of net present value for one farming method is greater over all possible values than the CDF of net present value for an alternative method. This implies that the probability of net present value for the dominant farming method being lower than a given value is less for all values of net present value than it is for a dominated alternative. For second-degree stochastic dominance (SSD), farmers are assumed to prefer higher net present value and to be risk averse. SSD holds if the cumulative area defined by the CDF of net present value for one farming method is greater than that of an alternative method for all values of net present value.

Results

Net returns

Net returns predicted for open-field farming and hedgerow intercropping relate closely to simulated maize yields predicted using APSIM, described earlier. Expected net returns predicted from continuous open-field farming were initially high, but declined rapidly and became negative as erosion reduced predicted maize yields (Figure 13). Predicted net returns from fallow open-field farming

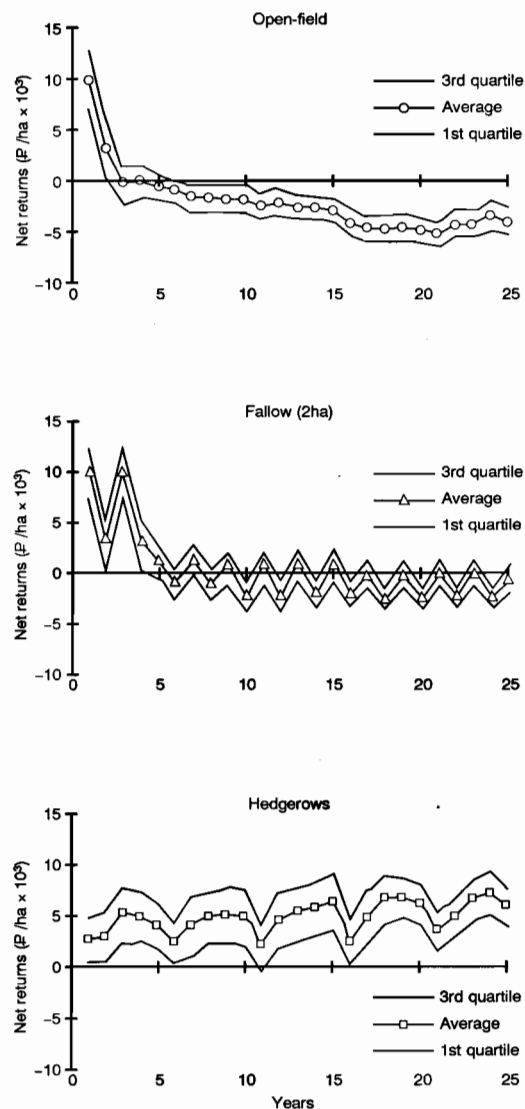

Figure 13. Distribution of annual net returns predicted for an inaccessible community using APSIM.

were high in the first four years of cropping because of high initial maize yields from two separate fields. In contrast to continuous open-field farming, fallow open-field farming sustained net returns around break-even point by spreading the impact of erosion over a larger cropping area. In the long term, predicted net returns from hedgerow intercropping were high because of reduced soil loss and sustained maize yields. In the short term, net returns from hedgerow intercropping were lower than those from continuous and fallow open-field farming because of establishment costs. A five-year cycle in net returns predicted from hedgerow intercropping reflected the cyclical nature of hedgerow biomass production and establishment costs.

The risk of negative returns from the alternative farming methods was highlighted by the lower quartile of the distribution of net returns (Figure 13). The probability of negative returns predicted for continuous open-field farming exceeded 25% after three or four years of cropping, while fallow open-field farming deferred a similar probability of negative returns to around five or six years of cropping. The risk of negative returns from hedgerow intercropping was predicted to be less than 25% in the long term, except in years when hedgerow establishment coincided with poor seasonal conditions.

Net present value

A discount rate of 25% emphasised high returns from continuous open-field farming in the first few years of cropping, and reduced the present value of negative net returns caused by erosion-induced productivity decline in the long term (Figure 14). Fallow open-field farming provided high returns from two separate fields in the first four years of cropping, and was predicted to provide high net present value to farmers with sufficient land in the long term. Sustained returns from hedgerow intercropping produced high net present value in the long term, exceeding net present value from continuous open-field farming after five years of cropping, and approaching net present value from fallow open-field farming after 20 years. In the short term, however, establishment and maintenance costs significantly reduced predicted net present value from hedgerow intercropping relative to the two types of open-field farming.

With a discount rate of 10%, declining maize yields caused by high cumulative soil loss had a significant impact on expected net present value from continuous open-field farming (Figure 15). However, farmers would require planning horizons of around 20 years for the prospect of negative net present value from continuous open-field farming to affect

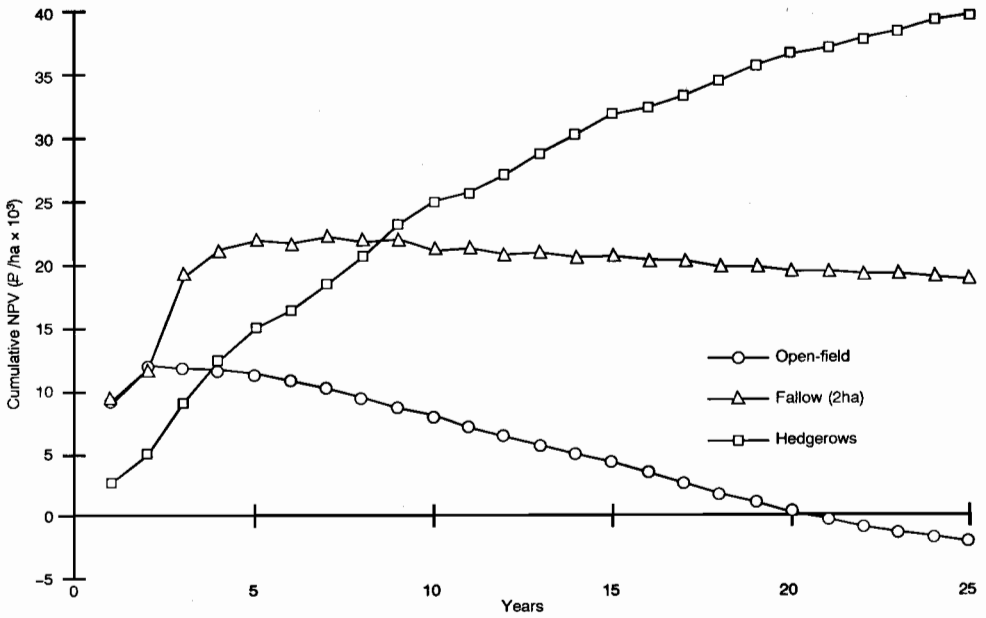

Figure 14. Expected net present value predicted for an inaccessible community using APSIM, with a discount rate of 25%.

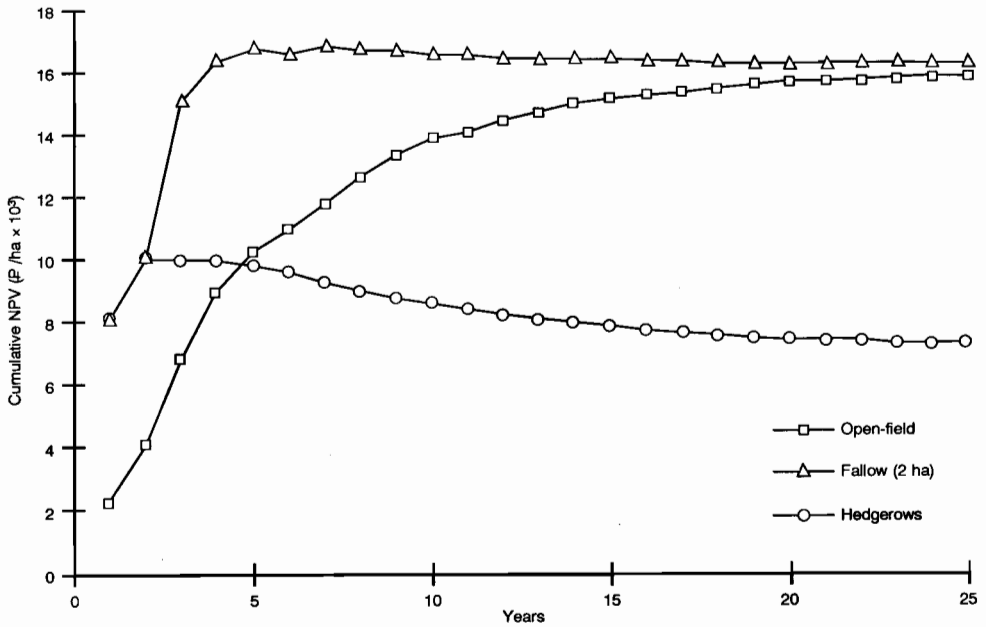

Figure 15. Expected net present value predicted for an inaccessible community using APSIM, with a discount rate of 10%.

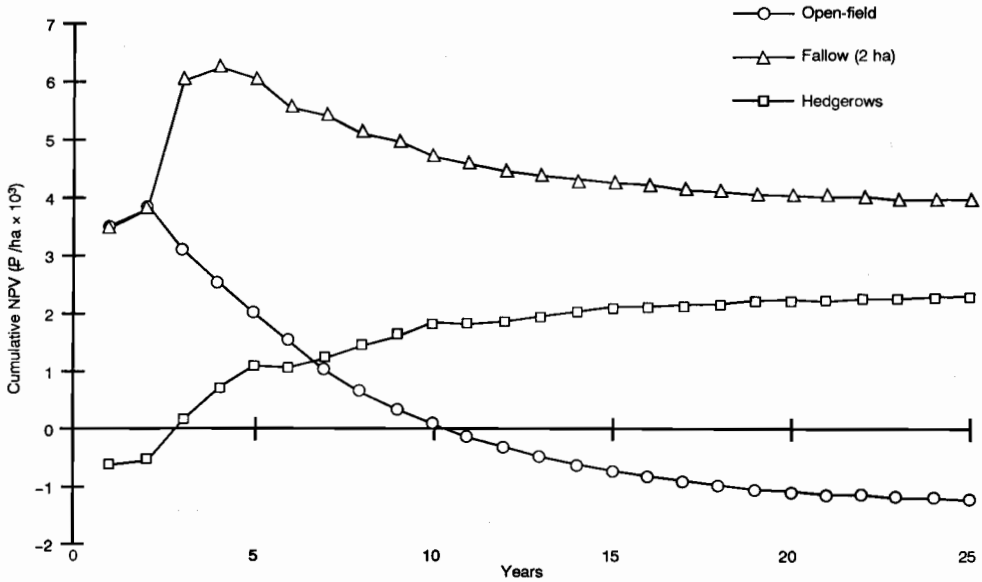

Figure 16. Expected net present value predicted for an inaccessible community using APSIM, under share tenancy (discount rate = 25%).

their current decision making. Net present value from fallow open-field farming was dominated by high returns in the first four years of cropping, with a slight decline in the long term as erosion reduced productivity. A low discount rate emphasised the high present value of sustained yields from hedgerow intercropping in the long term, producing higher net present value than continuous and fallow open-field farming after four and nine years of cropping, respectively.

The lower prices that could result from removing trade protection from maize greatly reduced the present value of net returns from maize farming. Neither open-field farming nor hedgerow intercropping were predicted to provide positive net returns over 25 years, which could motivate farmers to switch to alternative activities. In contrast, improvements in transport and marketing infrastructure have little potential to alter the farm-gate price of maize. Halving marketing costs produced higher predicted net present value from each of the farming methods, but their ranking was unaltered from the analysis of Figure 14.

Share tenancy was predicted to reduce the returns accruing to farmers from all three farming methods significantly (Figure 16). Share tenancy involves a disproportionate sharing of costs because landlords do not contribute to labour for maize cropping.

Hence the net present value from continuous open-field farming was predicted to be negative for planning horizons longer than ten years because of erosion-induced productivity decline. For farmers with sufficient land, fallow open-field farming was predicted to be economically attractive because of sustained returns. Share tenancy was predicted to reduce the economic viability of hedgerow intercropping relative to continuous and fallow open-field farming, because it was assumed that landlords do not contribute to establishment costs. Nevertheless, the net present value predicted from hedgerow intercropping exceeded that from continuous open-field farming for planning horizons longer than seven years.

Uncertainty and risk

The uncertainty associated with the quantity and cost of labour and material inputs, and the seasonal variability of maize yields and prices, produced a distribution of net present value from the alternative farming methods. The spread of the distribution of net present value predicted from continuous open-field farming was significant, but was less than the spread of the distribution predicted from fallow open-field farming because soil erosion limited the response of maize crops to favourable seasonal conditions. The distribution of net present value

Table 5. Sources of variability in net present value over 25 years predicted for an inaccessible community using APSIM.

Open-field		<i>r</i>	Fallow		<i>r</i>	Hedgerows		<i>r</i>
1	Maize price (WS*)	0.72	Maize price (WS)	0.76	Maize price (WS)	0.79		
2	Maize yield (WS, year 2)	0.28	Maize yield (WS, year 2)	0.29	Maize price (DS)	0.29		
3	Maize price (DS**)	0.27	Maize yield (WS, year 1)	0.27	Wage	-0.23		
4	Wage	-0.24	Maize price (DS)	0.24	Maize yield (WS, year 2)	0.17		
5	Maize yield (WS, year 1)	0.22	Wage	-0.21	Maize yield (WS, year 1)	0.16		
6	Maize yield (DS, year 1)	0.15	Maize yield (DS, year 1)	0.20	Maize yield (WS, year 3)	0.14		
7	Cost of urea fertiliser	-0.14	Maize yield (DS, year 2)	0.13	Maize yield (WS, year 5)	0.11		
8	Maize yield (WS, year 3)	0.13	Cost of urea fertiliser	-0.12	Cost of urea fertiliser	-0.10		
9	Labour for land preparation (WS)	-0.12	Labour for land preparation (WS)	-0.10	Maize yield (WS, year 4)	0.10		
10	Labour for hand weeding (DS)	-0.09	Cost of animal power	-0.08	Maize yield (DS, year 3)	0.10		

*Wet season.

**Dry season.

r is the Pearson correlation coefficient.

predicted from fallow open-field farming reflected a response of maize yields to seasonal conditions and varying nitrogen mineralisation following fallow periods. The distribution of net present value predicted from hedgerow intercropping increased over time, because soil fertility and water-holding capacity were maintained, enabling maize to respond to favourable seasonal conditions.

The input variables predicted to influence the distribution of net present value over 25 years were ranked according to the Pearson correlation coefficients from multivariate step-wise regression analysis, and the ten most significant input distributions are listed in Table 5. Net present value was predicted to be most strongly influenced by the distribution of wet season maize prices. Other variables predicted to have a significant influence on net present value included the dry season maize price, maize yields in the first few years of cropping, and the cost of labour.

The first degree stochastic dominance (FSD) rule was used to compare the probability distributions of net present value predicted for the alternative farming methods after 5, 10 and 25 years with a discount rate of 25%, and after 25 years with a discount rate of 10%. With a discount rate of 25%, fallow open-field farming dominated both continuous open-field farming and hedgerow intercropping after five years (Figure 17a). After 10 years, continuous open-field farming was dominated by both fallow open-field farming and hedgerow intercropping (Figure 17b). The cumulative distribution functions of fallow open-field farming and hedgerow intercropping were predicted to converge over 25 years (Figure 17c). With a discount rate of 10%, hedgerow intercropping dominated both continuous and fallow open-field farming after 25 years (Figure 17d).

Discussion

Implications for adoption

The economic incentives revealed in the cost-benefit analysis help to explain why farmers in relatively inaccessible areas of the Philippine uplands have preferred traditional open-field maize farming to hedgerow intercropping. Upland farmers have had limited planning horizons because of insecure land tenure, which has reduced their confidence in realising long-term economic returns from land improvements. Over planning horizons of less than five years, hedgerow intercropping is uneconomic relative to continuous and fallow open-field farming because sustained yields are not realised rapidly enough to compensate farmers for establishment costs. Over longer planning horizons, hedgerow intercropping provides higher economic returns than continuous open-field farming. However, high discount rates reduce the economic attractiveness to farmers of hedgerow intercropping relative to fallow open-field farming. Similarly, share-tenancy arrangements in which landlords do not contribute to establishment costs also reduce the economic viability of hedgerow intercropping relative to both continuous and fallow open-field farming. Hence farmers with sufficient land to practise fallowing are unlikely to invest in hedgerows. The analysis of risk did not alter the ranking of alternatives based on expected net returns.

Limitations of the analysis

The analysis presented in this chapter may overstate the potential productivity and economic viability of hedgerow intercropping relative to open-field farming. This is due to the structure of the model and

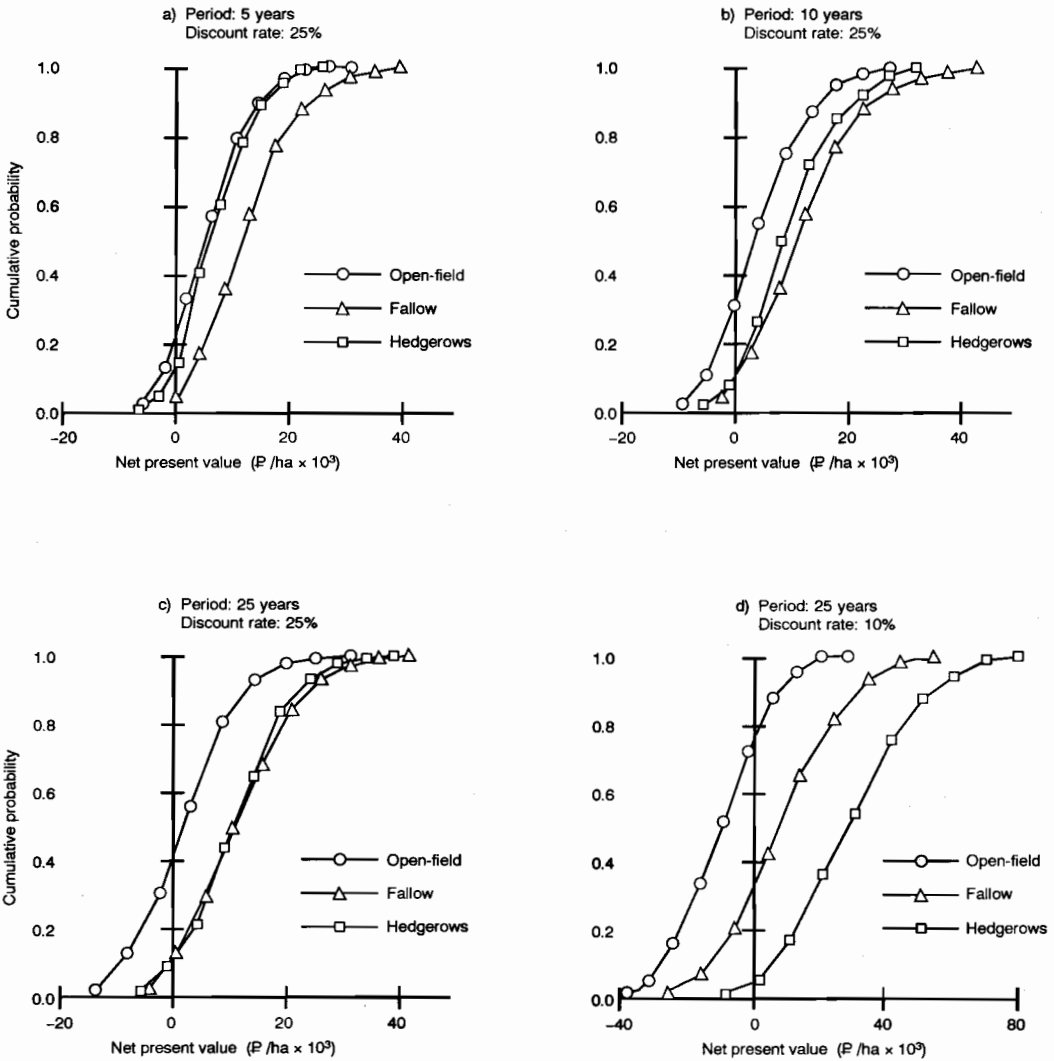

Figure 17a-d. Stochastic dominance analysis of net present value predicted for an inaccessible community using APSIM.

because the moderately fertile and erodible soils of the Tranca trial provide a favourable scenario in which to simulate the benefits of hedgerow intercropping for maize production. As discussed earlier, APSIM predicts the full potential response of maize crops to soil water and nitrogen levels without considering other constraints to plant growth. While other nutrients are unlikely to limit plant growth on moderately fertile soils such as those at Tranca, less fertile soils may induce intense hedgerow/crop competition. On strongly acid soils, for example, hedgerow/crop competition may limit the cycling of phosphorus through hedgerow prunings below the level required to sustain continuous cropping

(Garrity 1994). In addition, the relatively high erodibility of the soils at Tranca under continuous open-field farming enhances the potential productivity advantages of hedgerow intercropping. The effectiveness of hedgerows in reducing erosion may also be overstated because APSIM does not consider water flowing onto the field from those above. Hedgerows tend to fail when there is significant runoff of surface water from fields higher in the catchment (John Bee, pers. comm.⁸).

8. International Client Services, Queensland Department of Primary Industries.

The ability of hedgerow intercropping to reduce the risk of negative returns from maize farming is partly due to the use of a constant hedgerow/crop competition factor to adjust predicted maize yields using APSIM. In the field, the intensity of hedgerow/crop competition is likely to vary seasonally with the abundance of soil water and nitrogen. Hedgerow/crop competition for soil water and nutrients in unfavourable seasons may result in crop failure that would not occur in open-fields, increasing the risk of negative returns from hedgerow intercropping.

The results of the economic analysis indicate that hedgerow intercropping is not economically viable for farmers despite the favourable environment and the likelihood that APSIM overstates the long-term benefits of hedgerow intercropping for maize production. If hedgerow intercropping was less effective than predicted using APSIM, predicted returns would be lower, reducing the net present value from hedgerow intercropping relative to continuous and fallow open-field farming in each scenario of the cost-benefit analysis.

Conclusion

APSIM is a point-scale cropping systems model simulating soil physical and crop growth processes on a daily time step. A feature of APSIM is that the soil, rather than the crop, forms the central unit on which all the processes described in the model operate. Management operations such as planting and tillage are entered using a manager module, referenced to Julian days or conditional upon cumulative rainfall or previous operations.

The purpose of assembling this version of APSIM was to compare the productivity of traditional open-field farming relative to hedgerow intercropping of maize in the Philippine uplands. APSIM was parameterised to give acceptable predictions of maize yields and soil loss from open-field farming and hedgerow intercropping using data from a comparative trial at Tranca, near the community of Timugan. A large number of parameters were derived and tested for the components of a maize cropping system including soil water-holding capacity, surface water runoff, surface residues, and soil nitrogen.

Maize yields simulated using APSIM over 25 years provide an insight into the sustainability of maize production from traditional open-field farming and hedgerow intercropping in the Philippine uplands. Low but stable maize yields from continuous open-field farming may provide little warning to farmers of an imminent collapse in soil productivity due to erosion. Fallow open-field farming has little potential to improve maize yields relative to continuous open-field farming, but may sustain low levels of production and reduce the probability of crop failure over long periods. Hedgerow intercropping has potential to sustain maize yields in the uplands by protecting the soil from erosion, and contributing organic matter and nitrogen to the cropping alleys.

The capacity of the soil to support maize production is only one aspect of sustainability. Hedgerow intercropping, for example, may have the potential to sustain maize yields by reducing soil loss, but only at the cost of higher labour inputs and reduced cropping area. The bioeconomic analysis presented in this chapter helps to explain why fallow open-field farming has been economically attractive to farmers in the relatively inaccessible upland areas, where land is relatively abundant. Fallow open-field farming can provide high returns to farmers with sufficient land in the short term by spreading the impact of erosion over a larger cropping area. While the potential for hedgerow intercropping to sustain maize yields is significantly greater than for fallow open-field farming, returns from sustained yields are not realised rapidly enough to compensate farmers for establishment and maintenance costs. High discount rates, insecure land tenure and share tenancy reduce the value to farmers of sustained economic returns from hedgerow intercropping in the long term.

In contrast, farmers in densely populated communities with restricted access to land may be forced to crop each field continuously without fallowing, resulting in rapid productivity decline due to erosion. On erodible soils, hedgerow intercropping may be an economically attractive means of sustaining continuous cropping in the long term, by reducing soil erosion and contributing nitrogen to the cropping alleys. However, secure land tenure is a prerequisite for farmers to be able to consider the potential long-term benefits of hedgerow intercropping.

Appendix 1: APSIM parameters

Soil water parameters

	Soil profile layer				
	1	2	3	4	5
Depth of layer (mm)	200	300	150	150	200
Water content at 15 bars (cm/cm). Lower limit of extractable water for maize	0.30	0.44	0.44	0.44	0.44
Drained upper limit (cm/cm)	0.40	0.50	0.50	0.50	0.50
Saturated water content (cm/cm)	0.54	0.62	0.62	0.62	0.62
Air dry water content (cm/cm)	0.21	0.44	0.44	0.44	0.44
Initial soil water content (cm/cm)	0.32	0.42	0.50	0.50	0.50
Rate of saturated soil water drainage (%/day)	0.70	0.70	0.70	0.70	0.70
Bulk density (g/cm ³)	1.00	1.10	0.90	0.90	0.90

Runoff, evaporation and drainage parameters

	Open-field	Hedgerows
Stage 1 soil evaporation (mm)	6	6
Stage 2 soil evaporation (mm)	3.5	3.5
Curve number (CNII)	93	83
Maximum curve number reduction	58	61
Maximum cover for curve number (%)	60	60

Erosion parameters

	Open-field	Hedgerows
Slope gradient (%)	17.60	16.12
Slope length (m)	12	12
Profile depth (mm)	1000	1000
Enrichment coefficient 'a'	6	6
Enrichment coefficient 'b'	0.17	0.17
Rose (1985) λ_{bare}	0.55	0.29
Rose (1985) b_2	0.30	0.35

Soil nitrogen parameters

	Soil profile layer				
	1	2	3	4	5
Depth of layer (mm)	200	300	150	150	200
Organic carbon (%)	0.80	0.32	0.24	0.20	0.13
pH	5.86	6.00	6.20	6.20	6.20
Soil ammonium (ppm)	0.600	0.100	0.100	0.100	0.100
Soil nitrate (ppm)					
<i>Hedgerows</i>	10.0	2.0	1.0	0.5	0.5
<i>Open-field</i>	5.0	1.0	0.5	0.5	0.5
Initial fraction of soil carbon in the biomass pool					
<i>Hedgerows</i>	0.06	0.015	0.01	0.01	0.01
<i>Open-field</i>	0.03	0.015	0.01	0.01	0.01
Initial fraction of soil carbon that is not subject to mineralisation	0.45	0.52	0.62	0.74	0.93

Soil nitrogen parameter continued:

	Open-field	Hedgerows
Initial root residues (kg/ha)	300	300
Root C:N ratio	35	35
Soil C:N ratio	12	12
Initial surface residues (kg/ha)	200	500
Surface residue C:N ratio	35	35
Temperature amplitude (°C)	3.7	3.7
Mean annual temperature (°C)	27.3	27.3
Potential decomposition rate (%/day)	0.05	0.05

Maize parameters

	Lagkitan	IPB193
Timing to end of juvenile stage (°Cd)	170	270
Photoperiod sensitivity (° Cd/h)	41	41
Grain filling period (°Cd)	550	983
Potential grain number	610	700
Potential grain growth (mg/kernel/day/)	10.5	12.0

Chapter 10

Conclusion

C.W. Rose and K.J. Coughlan

THIS ACIAR Technical Report documents what may become something of a watershed in terms of the field investigation of soil erosion and soil conservation in biophysical terms. Prior to the commencement of ACIAR Projects 8551 and 9201, soil erosion research was dominated by the concepts incorporated in the methodology of the Universal Soil Loss Equation—that water erosion is due to rainfall impact, the role of overland flow being simply to transport such eroded material (Rose 1993). With this concept, it follows logically that the rate characteristic to measure is rainfall rate.

The erosion methodology employed in the studies reviewed in this Report is based on concepts that recognise that overland flow itself, in addition to rainfall impact, is an erosion agent of particular potency in tropical steplands. This methodology is described, and its application in ACIAR Project 8551 reported, in the special issue of *Soil Technology* (1995).

This new methodology puts emphasis on the measurement of another rate process, runoff rate, in addition to rainfall rate. While it has been shown to be quite feasible to measure runoff rate from experimental plots, it is recognised that, in general, there are fewer data available on runoff rate than on rainfall rate. It is for this reason that the project gave some attention to understanding and modelling the connection between these two vital rate quantities.

To develop and test model development, data are needed. The ACIAR projects PN 8551 and PN 9201 have provided a large database in which both rainfall and runoff rates (as well as other factors) were measured. With the data logging and computer interpretation methodology employed, measurement of these rates was made on a 1 minute time scale. These data and their fine-time resolution allowed programs such as GUEST (Griffith University Erosion System Template) to be applied with measured input rates. Such data also allowed investigation of the effects of

data aggregation over longer time scales, which is adopted in some equipment types.

However, in order to be applied more widely, programs such as GUEST need to be able to be provided not only with measured runoff rate data, but also with simulated runoff rate data, based on rainfall rate. As shown in Ciesiolka et al. (1995a), GUEST can also work effectively with a single theoretically-based runoff rate for an erosion event.

In WEPP 1995 (the Water Erosion Prediction Project of the USDA) rainfall events are stylised, and the Green-Ampt infiltration model used to compute an assumed steady maximum runoff rate. The Green-Ampt infiltration model assumes a steep wetting front across which the rate of water movement, which determines the infiltration rate, is determined by the gradient in hydraulic potential, which is dominated by the capillary 'pull' at the wetting front (e.g., pages 115–116 in Marshall et al. 1996). This infiltration equation predicts very little sensitivity to depth of ponded water (assumed spatially uniform), which implies very little sensitivity to rainfall rate. In contrast to this theoretical expectation, all data collected at all ACIAR sites to yield infiltration rate show a strong and dominant dependence on rainfall rate.

Thus it is clear that the assumptions made in deriving the Green-Ampt equation are inadequate to explain data such as those from the ACIAR sites (though this conclusion is not unique to ACIAR site data); alternatively, or in addition, processes not considered in deriving the Green-Ampt equation may dominate the nature of infiltration rate variation. The infiltration model derived and applied in Chapter 4 assumes that the dominant reason for change in infiltration rate is due to spatial variation in infiltration rate of a form that is sensitive to rainfall rate. A simple physical interpretation of this model is that the infiltration rate increases with rainfall rate up to a maximum value, when the entire plot is generating

runoff, but the fraction of the surface generating runoff decreases as rainfall rate decreases, the infiltration rate of the remaining fraction being the rainfall rate. Thus the excess rainfall rate, the source of runoff, increases with rainfall rate, in the upper limit increasing at the same rate as rainfall rate.

Since responsiveness of infiltration rate to rainfall rate appears to be a widespread characteristic of data from the tropics and semi-tropics, it would seem that the approach developed to modelling infiltration and runoff rates in this ACIAR project has a potential for widespread application.

Looking toward broader application of this methodology, it is recognised that data, even on rainfall rate, are quite limited. How this methodology of soil erosion and its management might be applied in contexts with limited data availability is an ongoing research activity at Griffith University.

With two exceptions, at all ACIAR sites unacceptably high erosion losses from bare soil plots of over 100 t/ha/y were measured. All better management practices investigated were agronomic rather than structural in type, their effectiveness in reducing soil loss being dominated by the degree to which the practice provided surface contact cover so close to the ground surface that it impeded overland flow. At the smaller plot scale of experimentation characteristic of all sites except Kemaman, the degree of effectiveness of surface contact cover in reducing sediment concentration appears to be related to contact cover fraction in a form (Figure 14, Chapter 6) similar to that which has been found elsewhere in Australia and overseas. Though the relative improvement in soil loss reduction due to surface contact cover versus hedgerows cannot be unequivocally ascertained from the data collected, the reduction in soil loss due to hedgerows is greater than would be expected due to the accompanied reduction in runoff alone.

The soil erodibility parameter β calculated using program GUEST varied depending on soil type, cultivation and time since last cultivation, the method of weed control (cultivation vs chemical use), and probably on other factors. Such other factors are likely to include soil strength and the consolidation of soil through time. In the absence of rainfall, and with erosion due to overland flow-driven processes alone, the theoretical maximum value of β should be unity. Especially at lower slope plots (e.g., Goomboorian) β was found to be as high as 1.1 for intensively cultivated soil. The value of β fluctuated more in soils with clay texture (Los Baños and ViSCA) than for the loamy sand of Goomboorian, apparently due to soil weakening associated with weed control by cultivation at these two Philippine sites. For these two sites, the average value of β during the experimental

period was less than for the Goomboorian site, presumably due to soil type differences and the use of periodic cultivation for weed control, in contrast to the chemical control of weeds at Goomboorian and the consequent lack of soil surface disturbance.

The link between soil erosion and nutrient loss is complicated by nutrient enrichment of eroded soil, most important for soils of lighter texture (e.g., Goomboorian and Khon Kaen sites). There is a simpler direct relation between soil and nutrient loss for clay soils and limited fertiliser application (e.g., Philippine sites). If soluble fertiliser applications are substantial, as was certainly the case for pineapple production at Goomboorian, and perhaps for cocoa at Kemaman, then nutrient loss in soluble form has also been shown to be an important source of loss.

It is recognised that providing a physically based interpretation of soil and nutrient loss and its management is only the first link in a long chain of issues which are involved in the achievement of sustainable crop production; each link in that chain is as important as any other, since even one weak link can inhibit achievement of this objective. This long chain clearly stretches from the biophysical to the socio-economic, with governmental policies and activity also playing an important role. This Report on ACIAR Project 9201 focuses on the biophysical end of this chain, but the data from this project have been built on to provide an economic case study of alternative land management practices in the context of the Philippine uplands.

Soil-conserving options investigated in this report were those thought to be technically effective, realistic in terms of adoption feasibility, socially acceptable by land users in the various regions of Asia and Australia, and economically justifiable. This judgment was made in conjunction with the collaborating scientists in the countries involved. The effectiveness of options was evaluated, not only in terms of soil and water loss, but also in terms of nutrient loss and in crop yield. At the time of project planning, a thorough assessment of the economic implications of alternative management options was not available. For that reason, it was planned to seek such ex-post assessment for at least one of the countries involved in Project 9201; the Philippines was chosen as that country, making use of the rich data base, including economic factors, collected by Dr E. Paningbatan Jr at the Los Baños ACIAR site.

Chapter 9 gives the outcome of collaboration between PN 9201 and staff with the necessary economic and crop modelling skills in PN 9211 in seeking to extend PN 9201 data to give the expected long-term effects of adopted land management options on soil erosion, crop yield, and on-farm economics. The results and implications of the

cost-benefit analysis carried out depend crucially on the appropriate or adopted value of the discount rate, r , the rate at which farmers discount future income relative to present income. The economic consequences of a wide range of values of r were investigated to cover the uncertainty in its value due to land tenure and other socio-political factors. It was shown that under typical conditions for upland farmers in the Philippines, it was the high value of r that made uneconomic any system of land management that increases the labour input required compared to traditional alternatives. As shown in Chapter 9, it was the labour input required in the establishment of a hedgerow system that made it economically less attractive to poor farmers with no access to formal credit markets. Though not economically investigated in this study, soil-conserving systems

with less labour input required than for hedgerow systems were investigated in biophysical terms in Project PN 9201. These included the return of maize crop residue into contour cultivation (at the Los Baños site), and trash-line cultivation (at the Nan site). An analysis of such soil-conserving systems with lower labour input would appear warranted using a simulation-based cost-benefit methodology similar to that reported in Chapter 9 for a hedgerow intercropping system.

The case study based on data from the Los Baños site reported in Chapter 9 is an important contribution to the literature which indicates that, in order to be widely adopted, a soil-covering land management system must be economically attractive as well as meeting other requirements, including effectiveness in biophysical terms.

References

- Anderson, J.R., Dillon, J.L. and Hardaker, J.B. 1977. *Agricultural decision analysis*. Ames, The Iowa State University Press.
- Arnoldus, J.M.J. 1977. Methodology used to determine the maximum potential average annual soil loss due to sheet and rill erosion in Morocco. *FAO Soils Bulletin*, 34, 39–51.
- Bagnold, R.A. 1977. *Bedload transport by natural rivers*. Water Resources Research, 13, 303–311.
- Balisacan, A.M. 1993. Agricultural growth, landlessness, off-farm employment, and rural poverty in the Philippines. *Economic Development and Cultural Change*, 41:3, 533–562.
- Bruce, R.C. and Rayment, G.E. 1982. Analytical methods and interpretations used by the Agricultural Chemistry Branch for Soil and Land Use Surveys. *Queensland Dept Primary Industries Bulletin QB82004*.
- Carberry, P.S., Adiku, S.G.K., McCown, R.L. and Keating, B.A. 1996. Application of the APSIM cropping systems model to intercropping systems. In: Ito, O., Johanesen, C., Adu-Gyamfi, J.J., Katayama, K., Kumar Rao, J.V.D.K. and Rego, T.J., eds., *Dynamics of roots and nitrogen in cropping systems of the Semi-Arid Tropics*. Japan International Research Center for Agricultural Sciences, International Agriculture Series No. 3.
- Carberry, P.S., Muchow, R.C. and McCown, R.L. 1989. Testing the CERES-Maize simulation model in a semi-arid environment. *Field Crops Research*, 20, 297–315.
- Carberry, P.S. and Abrecht, D.G. 1991. Tailoring crop models to the semiarid tropics. In: Muchow, R.C. and Bellamy, J.A., eds., *Climatic risk in crop production: models and management in the semiarid tropics*. Wallingford, Oxon, CAB International, 157–182.
- Chin, S.L. 1977. Leguminous cover crops for rubber small-holdings. *Rubber Research Institute of Malaysia. Planters' Bulletin no. 150*, 83–97.
- Chow, V.T., Maidment, D.R. and Mays, L.W. 1988. *Applied Hydrology*. New York, McGraw-Hill.
- Ciesiolka, C.A., Coughlan, K.J., Rose, C.W. and Smith, G.D. 1997. Sustainable pineapple production on steepplands in Queensland, Australia. *Proc. 8th ISCO Conference, New Delhi, December 1994*. (In press)
- Ciesiolka, C.A.A., Coughlan, K.J., Rose, C.W. and Smith, G.D. 1995b. Erosion and hydrology of steepplands under commercial pineapple production. *Soil Technology*, 8, 243–258.
- Ciesiolka, C.A., Coughlan, K.J., Rose, C.W., Escalante, M.C., Hashim, G.M., Paningbatan, E.P., Sombatpanit, S. 1995a. Methodology for a multi-country study of soil erosion management. *Soil Technology* 8, 179–192.
- Comia, R.A., Paningbatan, E.P. and Hakansson, I. 1994. Erosion and crop yield response to soil conditions under alley cropping systems in the Philippines. *Soil and Tillage Research*, 31, 249–261.
- Coughlan, K.J., Rose, C.W., Ciesiolka, C.A. and Smith, G.D. 1997. A framework for studies of water erosion. *Proc. 8th International Soil Conservation Conference, New Delhi, December 1994*. (In press)
- Coughlan, K.J. 1995. The ACIAR network on soil erosion — development, approaches and outputs. *International Workshop on Conservation Farming for Sloping Uplands in South-East Asia: Challenges, Opportunities and Prospects, Manila, Philippines, December 1994*.
- Coughlan, K.J. and Fox, W.E. 1977. Measurement of aggregate size. *Australian Journal of Soil Research*, 15, 211–219.
- Coughlan, K.J., Loch, R.J. and Fox, W.E. 1978. Binary packing theory and the physical properties of aggregates. *Australian Journal of Soil Research*, 16, 283–289.
- CRC. 1987–88. *Philippine agribusiness factbook and directory 1987–88*, Centre for Research and Communication, Manila.
- CRC. 1992–93. *Philippine agribusiness factbook and directory 1992–93*, Centre for Research and Communication, Manila.
- David, C.C. 1996. Food policy: its role in price stability and food security. Presented at the annual conference of the Philippine Economic Society, Price stability and sustainable growth: policy issues and trade-offs, Hotel Nikko, Makati, 9 February.
- Dimes, J.P. 1996. Simulation of mineral nitrogen supply to no-till crops in the semi-arid tropics, Ph.D. Thesis, Griffith University.
- Foster, G.R. and Lane, L.J. 1987. User requirements: USDA–Water erosion prediction project (WEPP), NSERL Report No. 1, Sept. 1, 1987. USDA–ARS National Soil Erosion Research Lab. Purdue Univ., West Lafayette, IN. 43 pp.
- Foster, G.R. 1982. Modelling the erosion processes. In: Hann, C.T., ed, *Hydrologic Modelling of Small Watersheds*. St. Joseph, Michigan, American Society of Agricultural Engineering Monograph No. 5, 297–379.
- Freebairn, D.M. and Wockner, G.H. 1986. A study of Soil Erosion on Vertisols on the Eastern Darling Downs, Queensland. I. Effect of surface conditions on soil movement within contour bay catchments. *Australian Journal of Soil Research*, 24, 135–158.
- Freebairn, D.M. and Boughton, W.C. 1981. Surface runoff experiments on the eastern Darling Downs. *Australian Journal of Soil Research*, 19, 133–146.
- Garrity, D.P., Mercado, A. (Jnr) and Solera, C. 1992. The nature of species interference and soil changes in contour hedgerow systems on sloping acidic lands. Paper presented at the International Conference on Alley Farming in IITA, Ibadan, Nigeria, 14–18 September.
- Garrity, D.P. 1993. Sustainable land-use systems for sloping uplands in Southeast Asia. In: *Technologies for sustainable agriculture in the tropics*. ASA special publication 56, American Society of Agronomy, Crop Science Society of America and Soil Science Society of America, Madison, WI.
- Garrity, D.P. 1994. Tree–soil–crop interactions on slopes. In: Huxley, P. and Ong, C., eds., *Tree–crop interactions*. London, Commonwealth Agricultural Bureau.

- Ghadiri, H. and Rose, C.W. 1991. Sorbed chemical transport in overland flow. I. A. nutrient and pesticide enrichment mechanism. *Journal of Environmental Quality*, 20, 628–633.
- Hairsine, P.B. and Rose, C.W. 1991. Rainfall detachment and deposition: Sediment transport in the absence of flow-driven processes. *Soil Science Society of America Journal*, 55, 320–324.
- Hairsine, P.B. and Rose, C.W. 1992a. Modelling water erosion due to overland flow using physical principles: I. Uniform flow. *Water Resources Research*, 28, 237–243.
- Hairsine, P.B. and Rose, C.W. 1992b. Modelling water erosion due to overland flow using physical principles. II. Rill flow. *Water Resources Research*, 28, 245–250.
- Hairsine, P.B. and McTainsh, G. 1986. The Griffith Tube: A simple settling tube for the measurement of settling velocity of soil aggregates. AES Working Paper 3/86. Griffith University, Nathan, Queensland, 4111, Australia.
- Hashim, G.M., Ciesiolka, C.A.A., Yusoff, W.A., Nafis, A.W., Mispan, M.R., Rose, C.W. and Coughlan, K.J. 1995. Soil erosion processes in sloping land in the east coast Peninsular of Malaysia. *Soil Technology*, 8, 215–233.
- Hawkins, R.H. and Cundy, T.W. 1987. Steady-state analysis of infiltration and overland flow for spatially-varied hillslopes. *Water Resources Bulletin*, 23, 251–256.
- Hawkins, R.H. 1982. Interpretation of source-area variability in rainfall–runoff relationships. In: Singh, V.P., ed., *Rainfall–Runoff Relationships*. Fort Collins, Colorado, Water Resources Publications, 303–324.
- Hudson, N. 1973. *Soil conservation*. London. B.T. Batsford Ltd.
- ICRAF. n.d. Productivity and sustainability of forage legumes and grasses, contour hedgerow systems, and amelioration of scouring effect. International Centre for Research into Agroforestry, Claveria, Philippines.
- Intal, P.S. and Power, J.H. 1990. Trade, exchange rate, and agricultural pricing policies in the Philippines, World Bank Comparative Studies, World Bank, Washington DC.
- Jakeman, A.J. and Hornberger, G.M. 1993. How much complexity is warranted in a rainfall–runoff model? *Water Resources Research*, 29, 2637–2649.
- Jones, C.A. and Kiniry, J.R., eds., 1986. *CERES–Maize, A simulation model of maize growth and development*. College Station, Texas, Texas University Press.
- Keating, B.A., Wafula, B.M. and Watiki, J.M. 1992a. Development of a modelling capability for maize in semi-arid eastern Kenya. In: Probert M.E., ed., *A search for strategies for sustainable dryland cropping in semi-arid eastern Kenya*. Canberra, Australian Centre for International Agricultural Research, Proceedings No. 41, 26–33.
- Keating, B.A., Wafula, B.M. and Watiki, J.M. 1992b. Exploring strategies for increased productivity — the case for maize in semi-arid eastern Kenya. In: Probert, M.E., ed., *A search for strategies for sustainable dryland cropping in semi-arid eastern Kenya*. Canberra, Australian Centre for International Agricultural Research, Proceedings No. 41, 90–100.
- Knisel, W.G. 1980. *CREAMS: A field-scale model for chemicals, runoff, and erosion from agricultural management systems*. United States Department of Agriculture, Conservation Research Report 26.
- Lara, F. and Morales, H.R. 1990. The peasant movement and the challenge of rural democratisation in the Philippines. *Journal of Development Studies*, 26:4, 143–162.
- Ling, A.H. 1986. Litter production and nutrient cycling in a mature cocoa plantation on inland soils of Peninsular Malaysia. In: Pushparajah, E. and Chew, P.S., eds., *Cocoa and Coconuts: Progress and Outlook*. Kuala Lumpur, Incorporated Society of Planters, 451–466.
- Lisle, I.G., Coughlan, K.J. and Rose, C.W. 1995. *GUDPRO 3.1. User Guide and Reference Manual*. Faculty of Environmental Sciences, Griffith University, Nathan, Queensland 4111.
- Littleboy, M., Silburn, D.M., Freebairn, D.M., Woodruff, D.R. and Hammer, G.L. 1989. *PERFECT: A computer simulation model of productivity erosion runoff functions to evaluate conservation techniques*. Queensland Department of Primary Industries, Brisbane.
- Loague, K.M. and Freeze, R.A. 1985. A comparison of rainfall–runoff modelling techniques on small upland catchments. *Water Resources Research*, 21, 229–248.
- Loague, K. and Gander, G.A. 1990. R–5 revisited 1. Spatial variability of infiltration on a small rangeland catchment. *Water Resources Research*, 26, 957–971.
- Loch, R.J. and Thomas, E.C. 1987. Resistance to rill erosion: observations on the efficiency of rill erosion on a tilled clay soil under simulated rain and run-on water. *Catena supplement*, 8, 71–83.
- Loch, R.J. and Rosewell, C.J. 1992. Laboratory methods for measurement of soil erodibilities (K factors) for the Universal Soil Loss Equation. *Australian Journal of Soil Research*, 30, 233–248.
- Loch, R.J. 1996. Using rill/interill comparisons to infer likely responses of erosion to slope length: implications for land management. *Australian Journal of Soil Research*, 34, 489–502.
- Lovell, C.J. and Rose, C.W. 1988. Measurement of soil aggregate settling velocities I. A Modified Bottom Withdrawal Tube. *Australian Journal of Soil Research*, 26, 55–71.
- Luk, S.H. and Merz, W. 1992. Use of the salt tracing technique to determine the velocity of overland flow. *Soil Technology*, 5, 289–301.
- Marshall, T.J., Holmes, J.W. and Rose, C.W. 1996. *Soil Physics*. Cambridge, Cambridge University Press, 453 p.
- McCown, R.L. and Williams, J. 1989. AUSIM: A cropping systems model for operational research. Proceedings SSA IMACS 1989 Biennial conference on modelling and simulation, Australian National University, Canberra, ACT, 25–27 September.
- McCown, R.L., Hammer, G.L., Hargreaves, J.N.G., Holzworth, D.P. and Freebairn, D.M. 1996. APSIM: A novel software system for model development, model testing, and simulation in agricultural systems research. *Agricultural Systems*, 50, 255–271.
- McNeal, B.L., Oster, J.D. and Hatcher, J.T. 1970. Calculation of electrical conductivity from solution composition data as an aid to in-situ estimation of soil salinity. *Soil Science*, 110, 405–414.

- Medalla, E.M., Del Rosario, C.M., Pineda, V.S., Querubin, R.G. and Tan, E.S. 1990. Reestimation of shadow prices for the Philippines, Working Paper 90-16, Philippine Institute of Development Studies.
- Microsoft Corporation. 1993. Microsoft Excel Version 5.0.
- Misra, R.K. and Rose, C.W. 1995. An examination of the relationship between erodibility parameters and soil strength. *Australian Journal of Soil Research*, 33, 715-732.
- Misra, R.K. and Rose, C.W. 1992a. A guide for the use of erosion-deposition programs. Faculty of Environmental Sciences, Griffith University, Nathan, Brisbane, Queensland 4111, Australia. 150 p.
- Misra, R.K. and Rose, C.W. 1992b. Manual for program GEMS (Griffith Erosion Management System). Report, Faculty of Environmental Sciences, Griffith University, Nathan, Queensland 4111, Australia, 14 p.
- Morgan, R.P.C., Quentin, J.N. and Rickson, R.J. 1992. EUROSEM: Documentation Manual. Silsoe College, Silsoe, U.K.
- Moss, A.J. 1979. Thin-flow transportation of solids in arid and non-arid areas: a comparison. In: Symposium on the hydrology of areas of low precipitation. International Association of Hydrologic Science (IAHS), Publication Number 128, 435-445.
- Nash, J.E. and Sutcliffe, J.V. 1970. River flow forecasting through conceptual models, Part 1: A discussion of principles. *Journal of Hydrology*, 10, 282-290.
- Nearing, M.A., Foster, G.R., Lane, L.J. and Finkner, S.C. 1989. A process based erosion model for USDA water erosion prediction project technology. *Transactions of the American Society of Agricultural Engineers*, 32, 1587-1593.
- Nelson, R.A. 1996. Bioeconomic analysis of hedgerow intercropping in the Philippine uplands. PhD Thesis, Department of Agriculture, University of Queensland.
- Nelson, R.A., Cramb, R.A. and Mamicpic, M.A. 1996a. Costs and returns of hedgerow intercropping and open-field maize farming in the Philippine uplands, SEARCA-UQ Uplands Research Project, Working Paper No. 11, Los Baños, the Philippines.
- Nelson, R.A., Dimes, J.P., Silburn, D.M. and Carberry, P.S. 1996b. Erosion/productivity modelling of maize farming in the Philippine uplands. Part I: A simple description of the Agricultural Production Systems Simulator, SEARCA-UQ Uplands Research Project, Working Paper No. 12, Los Baños, the Philippines.
- Nelson, R.A., Dimes, J.P., Silburn, D.M. and Carberry, P.S. 1996c. Erosion/productivity modelling of maize farming in the Philippine uplands. Part II: Parameterising the Agricultural Production Systems Simulator, SEARCA-UQ Uplands Research Project, Working Paper No. 13, Los Baños, the Philippines.
- Nelson, R.A., Dimes, J.P., Silburn, D.M., Paningbatan, E.P. and Cramb, R.A. 1996d. Erosion/productivity modelling of maize farming in the Philippine uplands. Part III: Simulation of alternative farming methods, SEARCA-UQ Uplands Research Project, Working Paper No. 14, Los Baños, the Philippines.
- Nelson, R.A., Cramb, R.A. and Mamicpic, M.A. 1996e. Erosion/productivity modelling of maize farming in the Philippine uplands. Part IV: Economic analysis of alternative farming methods, SEARCA-UQ Uplands Research Project, Working Paper No. 15, Los Baños, the Philippines.
- Nielsen, D.R., Biggar, J.W. and Erb, K.T. 1973. Spatial variability of field-measured soil-water properties. *Hilgardie*, 42, 215-259.
- O'Sullivan, T. 1985. Farming systems and soil management: the Philippines-Australian Development Assistance Program experience. In: Craswell, E.T., Remenyi, J.V. and Nallana, L.G., eds., Soil erosion management. Proceedings of a Workshop held at PCARRD, Los Baños, Philippines, 3-5 December 1984, ACIAR Proceedings series, No. 6, ACIAR, Canberra.
- Onstad, C.A. and Moldenhauer, W.C. 1975. Watershed soil detachment and transportation factors. *Journal of Environmental Quality*, 4, 29-33.
- Onstad, C.A. and Foster, G.R. 1975. Erosion modelling on a watershed. *Transactions of the American Society of Agricultural Engineers*, 18, 288-292.
- Palis, R.G., Okwach, G., Rose, C.W. and Saffigna, P.G. 1990a. Soil erosion processes and nutrient loss I. The interpretation of enrichment ratio and nitrogen loss in runoff sediment. *Australian Journal of Soil Research*, 28, 623-639.
- Palis, R.G., Okwach, G., Rose, C.W. and Saffigna, P.G. 1990b. Soil erosion processes and nutrient loss II. The effect of surface contact cover and erosion processes on enrichment ratio and nitrogen loss in eroded sediment. *Australian Journal of Soil Research*, 28, 641-658.
- Palisade Corporation. 1995. @RISK — Risk analysis and simulation add-in for Microsoft Excel or Lotus 1-2-3, Windows Version, February 1, 1995.
- Palisade Corporation. 1994. Bestfit — Distribution fitting software for Windows, Release 1.02, June 1994.
- Palm, C.A. 1995. Contribution of agroforestry trees to nutrient requirements of intercropped plants. *Agroforestry Systems*, 30, 105-124.
- Paningbatan, E.P. 1995. ACIAR 9201 Sustainable cropping systems in tropical steepplands, Country report: Philippines, presented at the final review of the project April 1995, Subic Bay.
- Paningbatan, E.P., Ciesiolka, C.A., Coughlan, K.J. and Rose, C.W. 1995. Alley cropping for managing soil erosion of hilly lands in the Philippines. *Soil Technology*, 8, 193-204.
- Pilgram, D.H. and Cordery, I. 1992. Flood Runoff. In: Maidment, D.R., ed., *Handbook of Hydrology*, 9.1-9.41.
- Presbitero, A.L., Escalante, M.C., Rose, C.W., Coughlan, K.J. and Ciesiolka, C.A.A. 1995. Erodibility evaluation and the effect of land management practices on soil erosion from steep slopes in Leyte, the Philippines. *Soil Technology*, 8, 205-213.
- Press, W.H., Flannery, B.P., Teukolsky, S.A. and Vetterling, W.T. 1989. *Numerical Recipes: The Art of Scientific Computing*. Cambridge, U.K., Cambridge University Press.

- Probert, M.E., Dimes, J.P., Keating, R.C., Dalal, R.C. and Strong, W.M. 1996. APSIM's water and nitrogen modules and simulation of the dynamics of water and nitrogen in fallow systems. (In press)
- Proffitt, A.P.B., Rose, C.W. and Hairsine, P.B. 1991. Rainfall detachment and deposition: Experiments with low slopes and significant water depths. *Soil Science Society of America Journal*, 55, 325-332.
- Proffitt, A.P.B., Hairsine, P.B. and Rose, C.W. 1993. Modelling soil erosion by overland flow: application over a range of hydraulic conditions. *Trans. ASAE*, 36, 1743-1753.
- Proffitt, A.P.B. and Rose, C.W. 1991. Soil erosion processes. I. The relative importance of rainfall detachment and runoff entrainment. *Australian Journal of Soil Research*, 29, 671-683.
- Risse, L.M., Nearing, M.A., Nicks, A.D. and Lafen, J.M. 1993. Error assessment in the Universal Soil Loss Equation. *Soil Science Society of America Journal*, 57, 825-833.
- Risse, L.M., Nearing, M.A. and Zhang, X.C. 1995. Variation in Green-Ampt effective hydraulic conductivity under fallow conditions. *Journal of Hydrology*, 169, 1-24.
- Rose, C.W. and Hairsine, P.B. 1988. Processes of water erosion. In: Steffen, W.L. and Denmead, O.T., eds., *Flow and Transport in the Natural Environment*. Berlin, Springer-Verlag, 312-316.
- Rose, C.W. and Dalal, R.C. 1988. Erosion and runoff of nitrogen. In: Wilson, R.J., ed., *Advances in Nitrogen Cycling in Agricultural Ecosystems*. Wallingford, U.K., C.A.B. International, 212-233.
- Rose, C.W., Hairsine, P.B., Proffitt, A.P.B. and Misra, R.K. 1990. Interpreting the role of soil strength in erosion processes. *Catena Supplement*, 17, 153-165.
- Rose, C.W., Coughlan, K.J., Ciesiolka, C.A. and Misra, R.K. 1997. Developments in soil erosion theory used in tropical conservation projects. *Proc. 8th International Soil Conservation Conference*, New Delhi, December 1994. (In press)
- Rose, C.W. 1985. Developments in soil erosion and deposition models. *Advances in Soil Science*, 2, 1-63.
- Rose, C.W. 1993. Erosion and sedimentation. In: Bonnell, M., Hufschmidt, M.M. and Gladwell, J.S., eds., *Hydrology and Water Management in the Humid Tropics — Hydrological Research Issues and Strategies for Water Management*. Cambridge, U.K., Cambridge University Press, 301-343.
- Rose, C.W., Coughlan, K.J., Ciesiolka, C.A. and Misra, R.K. 1997. Developments in soil-erosion theory used in tropical soil conservation projects. *Proc. 8th International Soil Conservation Conference*, New Delhi, December 1994. (In press).
- Rose, C.W. and Freebairn, D.M. 1985. A new mathematical model of soil erosion and deposition processes with applications to field data. In: El Swaify, S.A., Moldenhauer, W.C. and Lo, A., eds., *Soil Erosion and Conservation*. Ankeny, Iowa, Soil Conservation Society of America, 549-557.
- Rose, C.W., Parlange, J.Y., Sander, G.C., Campbell, S.Y. and Barry, D.S. 1983. Kinematic flow approximation to runoff on a plane: an approximate analytical solution. *Journal of Hydrology*, 62, 363-369.
- Rose, C.W., Presbitero, A.L., Coughlan, K.J., Lisle, I., Fentie, B. and Ciesiolka, C.A. 1997. Saltation and effective shear stresses in soil erosion due to overland water flow. (In preparation)
- Sajise, P.E. 1980. Alang-Alang (*Imperata cylindrica* L. Beauv.) and upland agriculture, *Proceedings of BIOTROP workshop on Alang-Alang*, BIOTROP special publication No. 5, BIOTROP, Bogor, Indonesia.
- Sayre, E.V. 1992. Corn industry and market study for TRIPARRD in Bukidnon, Institute of Market Analysis, Xavier University, Cagayan de Oro, the Philippines.
- Sharma, M.L., Gander, G.A. and Hunt, C.C. 1980. Spatial variability of infiltration in a watershed. *Journal of Hydrology*, 45, 101-122.
- Silburn, D.M. and Loch, R.J. 1992. Present capabilities and constraints in modelling soil erosion. In: Hamilton, G.J., Howes, K.M. and Attwater, R., eds., *Erosion/productivity and erosion prediction workshop*. *Proceedings of the 5th Australian Soil Conservation Conference*, volume 3, 116-122.
- Sombatpanit, S., Rose, C.W., Ciesiolka, C.A. and Coughlan, K.J. 1995. Soil and nutrient loss under Rozelle (*Hibiscus subdariffa* L. var. *Altissima*) at Khon Kaen, Thailand. *Soil Technology*, 8, 235-242.
- Thong, K.C. and Ng, W.L. 1978. Growth and nutrient composition of monocrop cocoa plants on inland Malaysian soils. In: *Proceedings of the International Conference on Cocoa and Coconuts, 1978*, Kuala Lumpur. Malaysian Agricultural Research and Development Institute and Incorporated Society of Planters, 262-286.
- Ward, D.P. and Rose, C.W. 1990. Computing infiltration rate from field hydrological data: GNFIL+, a Griffith University Program. Report, Faculty of Environmental Sciences, Griffith University, Nathan, Queensland 4111, Australia, 29 p.
- WEPP User Summary, 1995. USDA-Water erosion prediction project, NSERL Report No. 11, July 1995. USDA-ARS National Soil Erosion Research Lab. Purdue Univ., West Lafayette, IN. 131 p.
- Williams, J.R. 1975. Sediment-yield prediction with universal equation using runoff energy factor, in present and prospective technology for predicting sediment yields and sources, United States Department of Agriculture, ARS-S-40, 244-252.
- Wischmeier, W.H. and Smith, D.D. 1978. *Predicting Rainfall Erosion Losses — a Guide to Conservation Planning*, USDA Agric. Handbook No. 537, U.S. Gov. Print. Office, Washington D.C.
- Yang, C.T. 1972. Unit stream power and sediment transport. *Journal of Hydraulics*. Division of the American Society of Civil Engineers, 78 (HY10), 1805-1826.
- Young, A. and Muraya, P. 1990. *Soil Changes Under Agroforestry*. Computer program with user's handbook. Version 2, ICRAF, Nairobi.
- Zhang, X.C., Nearing, M.A. and Risse, L.M. 1995a. Estimation of Green-Ampt conductivity parameters: Part I. Row Crops. *Trans. ASAE*, 38, 1069-1077.
- Zhang, X.C., Nearing, M.A. and Risse, L.M. 1995b. Estimation of Green-Ampt conductivity parameters: Part II. Perennial Crops. *Trans. ASAE*, 38, 1079-1087.