

# Reservoir Fisheries and Aquaculture Development for Resettlement in Indonesia

Edited by

Barry A. Costa-Pierce  
Otto Soemarwoto

## Integrated tropical reservoir fisheries management

Hatchery development

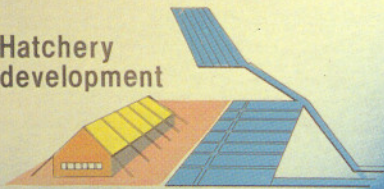

Watershed agro-ecology programs

Tree forest farming

Bamboo/Soil stabilization program



Cage culture

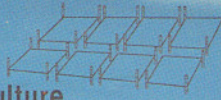

Floating net culture



"Bay" nurseries

Fence/Bay culture

Fish ranching

Fisheries enhancement

Aquatic weed control



Intensive aquaculture



Dam



Drawdown agri-aquaculture

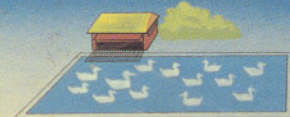

- Feed mills
- Equipment industries
- Processing

Riparian stabilization program

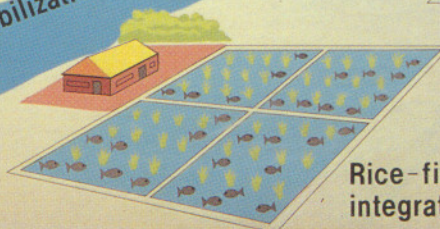

Rice-fish integrated farming

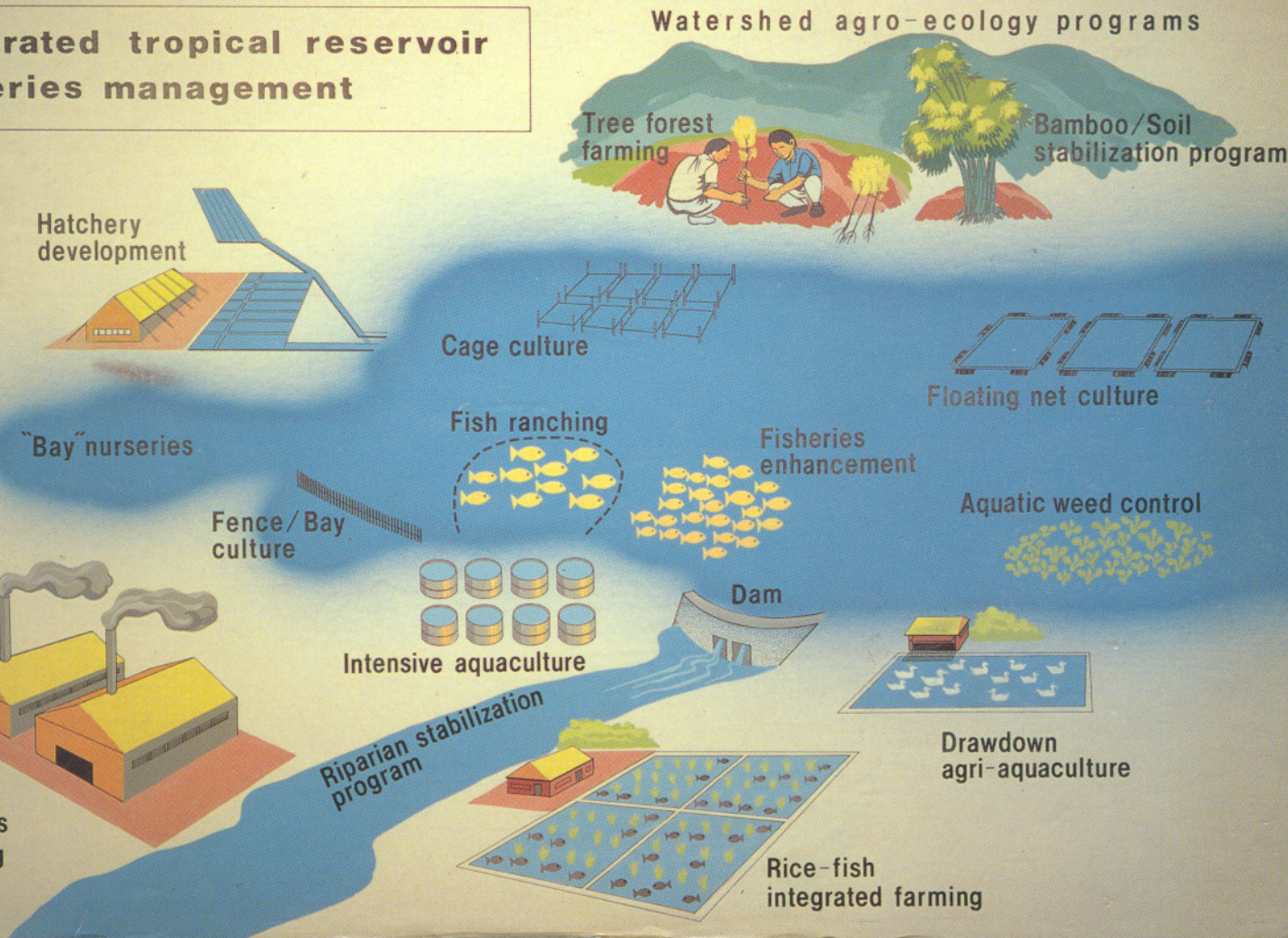



*in Ag '91  
pic  
edit and  
pic*

**Reservoir Fisheries and Aquaculture Development  
for Resettlement in Indonesia**

Edited by

Barry A. Costa-Pierce  
Otto Soemarwoto

1990

**PERUSAHAAN UMUM LISTRIK NEGARA  
JAKARTA, INDONESIA**

**INSTITUTE OF ECOLOGY, PADJADJARAN UNIVERSITY  
BANDUNG, INDONESIA**

**INTERNATIONAL CENTER FOR LIVING AQUATIC RESOURCES MANAGEMENT  
MANILA, PHILIPPINES**

54  
224  
701  
#23  
11

APR 11 1991

# **Reservoir Fisheries and Aquaculture Development for Resettlement in Indonesia**

Edited by

**B.A. COSTA-PIERCE  
O. SOEMARWOTO**

1990

Printed in Manila, Philippines

Published by Perusahaan Umum Listrik Negara, Jakarta, Indonesia; Institute of Ecology, Padjadjaran University, Jl. Sekeloa Selatan 1, Bandung, Indonesia; and the International Center for Living Aquatic Resources Management, MC P.O. Box 1501, Makati, Metro Manila, Philippines

Costa-Pierce, B.A. and O. Soemarwoto, Editors. 1990.  
Reservoir fisheries and aquaculture development  
for resettlement in Indonesia. ICLARM Tech. Rep. 23,  
378 p.

ISSN 0115-5547  
ISBN 971-1022-50-8

Cover: Idealized view of component fisheries, agriculture,  
conservation and community industrial systems  
integrated to accomplish reservoir restoration  
and social rehabilitation of displaced persons.  
Artwork by Ovidio F. Espiritu, Jr.

ICLARM Contribution No. 612.

8837



### *DEDICATION*

*We dedicate all of the hard work collectively put into this project, the human, natural, and spiritual energy expended, to the memory of Dr. Ian R. Smith, Director General, ICLARM, 1985 to 1989.*

*We who have shared and been touched by your vision have been honored by the chance to meet a Brother in the Struggle for Dignity ... one so dedicated to the triumph of the human spirit over immense adversity.*

*Thank you ever so much, Ian, for helping our planet, our collective home, and its peoples.*



## Contents

Foreword • <i>Roger S.V. Pullin</i> . . . . .	vi
Introduction • <i>Otto Soemarwoto</i> . . . . .	1
Population Density and General Socioeconomic Conditions Around Saguling and Cirata Reservoirs • <i>Opan S. Suwartapradja</i> and <i>Hisyam Achmad</i> . . . . .	7
✓ Water Quality Suitability of Saguling and Cirata Reservoirs for Develop- ment of Floating Net Cage Aquaculture • <i>Otto Soemarwoto, Cecep</i> <i>M. Roem, Titin Herawati</i> and <i>Barry A. Costa-Pierce</i> . . . . .	18
✓ Research on Cage Aquaculture Systems in the Saguling Reservoir, West Java, Indonesia • <i>Barry A. Costa-Pierce</i> and <i>Herri Y. Hadikusumah</i> . . . . .	112
✓ Economics of Floating Net Cage Common Carp Culture in the Saguling Reservoir, West Java, Indonesia • <i>Rusydi</i> and <i>Harlan C. Lampe</i> . . . . .	218
Marketing of Common Carp from the Saguling Reservoir • <i>Engkus W.</i> <i>Kusnadi</i> and <i>Harlan C. Lampe</i> . . . . .	240
✓ Waste Production and Efficiency of Feed Use in Floating Net Cages in a Eutrophic Tropical Reservoir • <i>Barry A. Costa-Pierce</i> and <i>Cecep M. Roem</i> . . . . .	257
Use of Earthworm Composts and Introduction of New Systems and Tech- niques to Improve Production in Hatcheries and Nurseries for Common Carp ( <i>Cyprinus carpio</i> ) • <i>Bambang Sudiarto, Budi R.</i> <i>Zakaria</i> and <i>Barry A. Costa-Pierce</i> . . . . .	272
Fisheries of the Saguling Reservoir and A Preliminary Appraisal of Manage- ment Options • <i>John L. Munro, Iskandar</i> and <i>Barry A. Costa-Pierce</i> . . . . .	285
Biotechnical Feasibility Studies on the Importation of <i>Clupeichthys aesar-</i> <i>nensis</i> Wongratana, 1983 from Northeastern Thailand to the Saguling Reservoir, West Java, Indonesia • <i>Barry A. Costa-Pierce</i> and <i>Otto</i> <i>Soemarwoto</i> . . . . .	329
Extension of Traditional Postharvest Fish Processing Techniques • <i>Yedi Arifin</i> . . . . .	364
Integrated System for Environmental Management in the Saguling/Cirata Reservoir Region • <i>Maskana, Sri Astuty, Bambang Sudiarto</i> and <i>Otto Soemarwoto</i> . . . . .	370

## Foreword

This Technical Report describes a success story in reservoir aquaculture and fisheries research and development. There have, of course, been other examples of new reservoirs creating valuable fisheries and aquaculture opportunities, but the work reported here - a highly fruitful cooperation between the Indonesian State Electric Company (PLN), the Institute of Ecology (IOE) of Padjadjaran University, Bandung, the West Java Provincial Fisheries Agency and its Technical Management Unit for Saguling and Cirata (UPTD) and the International Center for Living Aquatic Resources Management, with the farsighted support of the World Bank - is a rare, if not unique example of an effort to develop reservoir fish production technology for a clearly identified and resourceful target group (those displaced by the reservoir development) whose interests, resources and aptitudes were considered from the earliest inception of the reservoir construction planning. Moreover, the need for adequate institutional and technical support, training and extension as the aquaculture and fisheries technologies evolved and sustained support to farmers and fishermen thereafter, were also recognized and emphasized by all concerned.

Any new reservoir is like a big 'experiment' with respect to its aquaculture and capture fisheries potential. No one can predict with certainty how productive the ecosystem will be, which species will predominate, which (if any) should be introduced, how the entry to capture fisheries and aquaculture should be managed, which regulations to enact, whether the original fishermen and fish farmers will persevere or will leave their operations for others to continue, the possible risks of fish kills, diseases, conflicts between different users, and myriad other questions. Indeed any new aquatic ecosystem, its exploiters and beneficiaries comprise a highly dynamic and evolving situation. What looks promising early in the life of the reservoir may not be sustainable. This underlines the need for sustained institutional support and constant monitoring of the ecology of new reservoirs and their catchments.

The objectives of this project were to identify appropriate aquaculture and fisheries methods for resettled families; to conduct research for the development of aquaculture technology that would create employment; to provide technology transfer, training and extension advice to farmers and scientists; and to complete a comprehensive fisheries and aquaculture development plan for two reservoirs. All these objectives were achieved. As the development plan went to press and the Cirata Reservoir was filling, 1,083 displaced families from the Saguling area were involved in fish production, 2,081 persons had been trained, and the reservoir was supplying over 20% of the freshwater fish entering the Bandung district, an area with over three million people. Equally rapid development is anticipated in the Cirata Reservoir. Moreover, these developments have had a flow-on effect in that fish seed supply (especially from rice-fish culture systems), feed supply and fish handling operations have expanded and benefited more people over a wide area.

In addition to the comprehensive development plan, there were additional benefits in the form of advances in research methodology and scientific and extension publications that will have much wider impact than in the Saguling-Cirata target area alone or indeed in Indonesia. A list of these publications is appended (Appendix 1). These together with this Technical Report can help the planning and execution of tropical reservoir fisheries and aquaculture development elsewhere.

PLN-IOE-UPTD-ICLARM teamwork made these results possible. All concerned hope that the start made through this project towards aquaculture and fisheries development in the Saguling and Cirata Reservoirs will result in a sustainable improvement in the livelihood of those who live around them and will point the way to similar developments elsewhere.

Roger S.V. Pullin  
Director, Aquaculture Program  
ICLARM



## Appendix 1

### LIST OF PUBLICATIONS

- Costa-Pierce, B.A., Rusydi, A. Safari and G. Wira Atmadja. 1989. Small-scale hatchery for common carp. ICLARM Education Series 8, 42 p. Institute of Ecology, Indonesian State Electric Company and ICLARM Manila, Philippines. Also printed as: Buku petunjuk. Pembenhian ukuran kecil ikan mas. (In Indonesian).
- Costa-Pierce, B.A., M.A. Bimbao, S. Zainal and P. Effendi. 1989. ICLARM and south-south technology transfer: Philippine aquaculture technology and Indonesia. Part II. Naga, the ICLARM Quarterly 12(1): 14-16.
- Costa-Pierce, B.A., H.Y. Hadikusumah and Y. Dhahiyat. 1989. Tilapia (*Oreochromis* sp.) and carp (*Cyprinus carpio*) production in cage systems in West Java, Indonesia, p. 84-96. In E.A. Huisman, N. Zonneveld and A.H.M. Bouwmans (eds.) Aquacultural research in Asia: management techniques and nutrition. Proceedings of the Asian seminar on aquaculture organized by IFS, Malang, Indonesia, 14-18 November 1988. Centre for Agricultural Publishing and Documentation, Pudoc Wageningen, The Netherlands.
- Costa-Pierce, B.A., Rusydi, A. Safari and G. Wira Atmadja. 1989. Culture of common carp in floating net cages. ICLARM Education Series 7, 42 p. Institute of Ecology, Indonesian State Electric Company (IOE UNPAD-PLN), Bandung, Indonesia and ICLARM, Manila, Philippines. Also printed as: Miara lauk emas dina jaring terapung di bendungan Saguling-Cirata. (In Sundanese).
- Costa-Pierce, B.A., Rusydi, A. Safari and G. Wira Atmadja. 1989. Growing fish in pen systems. ICLARM Education Series 9, 40 p. Institute of Ecology, Indonesian State Electric Company (IOE UNPAD-PLN), Bandung, Indonesia, and ICLARM, Manila, Philippines. Also printed as: Miara lauk sistem pager. (In Sundanese).
- Costa-Pierce, B.A., G. Wira Atmadja, Rusydi and Apih Safari. 1989. Growing fish in cages. ICLARM Education Series 10, 43 p. Institute of Ecology, Indonesian State Electric Company (IOE UNPAD-PLN), Bandung, Indonesia, and ICLARM, Manila, Philippines. Also printed as: Tungtunan praktek. Miara lauk dina karamba. (In Sundanese).
- Costa-Pierce, B.A., G. Wira Atmadja, P. Effendi and S. Zainal. 1988. Integrated aquaculture systems in the Saguling Reservoir, West Java, Indonesia, p. 224-233. In Sena S. De Silva (ed.) Reservoir fishery management and development in Asia: Proceedings of a workshop held in Kathmandu, Nepal, 23-28 November 1987. International Development Research Centre, Ottawa, Canada.
- Costa-Pierce, B.A. 1988. Traditional fisheries and dualism in Indonesia. Naga, the ICLARM Quarterly 11(2): 3-4.
- Costa-Pierce, B.A. and P. Effendi. 1988. Sewage fish cages of Kota Cianjur, Indonesia. Naga, the ICLARM Quarterly 11(2): 7-9.
- Costa-Pierce, B.A., S. Zainal and P. Effendi. 1988. ICLARM and south-south technology transfer: Philippine aquaculture technology and Indonesia. Part I. Naga, the ICLARM Quarterly 11(4): 10-11.
- Costa-Pierce, B.A. and O. Soemarwoto. 1987. Proliferation of Asian reservoirs: the need for integrated management. Naga, the ICLARM Quarterly 10(1): 9-10.
- Costa-Pierce, B.A. Chairman's report of the working group "on-station research". In C. Lightfoot, B.A. Costa-Pierce, C. dela Cruz and V. Carangal (eds.) Rice-fish research and development in Asia. ICLARM, IRRI and CLSU, Philippines. (In press).
- Costa-Pierce, B.A. 1990. Aquaculture development as a means of large-scale resettlement in Indonesia: farmer participatory, extension, training, and institutional roles. Special Session on User Participation in Aquaculture Research and Development, World Aquaculture Society, June 10-14.
- Costa-Pierce, B.A. 1990. Rice-fish systems as intensive nurseries. In C. Lightfoot, B.A. Costa-Pierce, C. dela Cruz and V. Carangal (eds.) Rice-fish research and development in Asia. ICLARM, IRRI and CLSU, Philippines. (In press).
- Costa-Pierce, B.A., B. Sudiarto, O. Soemarwoto and C. dela Cruz. 1990. Improved traditional hatchery technology for common carp (*Cyprinus carpio* L.) in West Java, Indonesia, p. 217-220. In R. Hirano and I. Hanyu (eds.) The Second Asian Fisheries Forum. 991 p. Asian Fisheries Society, Manila, Philippines.
- dela Cruz, C.R. 1988. Consultancy report on aquaculture research and development in Saguling and Cirata Reservoirs. Bandung, West Java, Indonesia.
- IOE-UNPAD and ICLARM. 1989. Final report. Development of aquaculture and fisheries activities for resettlement of families from the Saguling and Cirata Reservoirs. Volume 1: Executive summary and management plan. Institute of Ecology, Bandung, Indonesia and ICLARM, Manila, Philippines, 50 p.
- IOE-UNPAD and ICLARM. 1989. Development of aquaculture and fisheries activities for resettlement of families from the Saguling and Cirata Reservoirs. Volume 2: Main report. Institute of Ecology, Bandung, Indonesia and ICLARM, Manila, Philippines, 400 p.
- IOE-UNPAD and ICLARM. 1989. Development of aquaculture and fisheries activities for resettlement of families from the Saguling and Cirata Reservoirs. Volume 3: Main report, appendices 1-18. Institute of Ecology, Bandung, Indonesia and ICLARM, Manila, Philippines.

- Koesoemadinata, S. and B.A. Costa-Pierce. 1990. Status of rice-fish culture in Indonesia. *In* C. Lightfoot, B.A. Costa-Pierce, C. dela Cruz and V. Carangal (eds.) Rice-fish research and development in Asia. ICLARM, IRRI and CLSU, Philippines. (In press).
- Soemarwoto, O. et al. 1988. Pemukiman kembali penduduk Saguling dan Cirata melalui pengembangan perikanan. (Resettlement of the population from the Saguling and Cirata Reservoir regions through the development of fisheries). Institute of Ecology, Padjadjaran University, Bandung, Indonesia. 93 p. (In Indonesian).
- Sutandar, Z., B.A. Costa-Pierce, Iskandar, Rusydi and Herri Hadikusumah. 1990. The aquaculture resettlement option in the Saguling Reservoir, Indonesia: its contribution to an environmentally-oriented hydropower project, p. 253-258. *In* R. Hirano and I. Hanyu (eds.) The Second Asian Fisheries Forum. 991 p. Asian Fisheries Society, Manila, Philippines.

**Editors' note:**

The Indonesian Rupiah (Rp), during the period of the work reported here, went through one major devaluation in 1986 then a slower, consistent loss in value from the period 1986 to 1990.

The buying rates per US dollar for the years of work reported here were:

1985	1,131
1986	1,655
1987	1,647
1988	1,711
1989	1,796
1990	1,817



## Introduction

**OTTO SOEMARWOTO**

*Institute of Ecology, Padjadjaran University  
Jl. Sekeloa Selatan 1  
Bandung 40132, Indonesia*

SOEMARWOTO, O. 1990. Introduction, p. 1-6. In B.A. Costa-Pierce and O. Soemarwoto (eds.) Reservoir fisheries and aquaculture development for resettlement in Indonesia. ICLARM Tech. Rep. 23, 378 p.

## Background

The Saguling and Cirata Reservoirs were formed as the result of two high dams on the upper watershed area of the Citarum River, West Java, Indonesia (Fig. 1). The main purpose of dam construction was the provision of hydroelectric power to heavily-populated Java. The Saguling hydroelectric station, with the capacity of 700 MW, was completed in 1985 and generates an average of  $2,156 \times 10^3$  MW/hour/year. The Cirata hydroelectric station was completed in 1988 and has a capacity of 500 MW, generating an average of  $1,438 \times 10^3$  MW/hour/year.

The Saguling Reservoir flooded 5,607 ha of land while the infrastructure for its power station took 718 ha. The Cirata Reservoir covered 6,716 ha and the power station 749 ha. The majority of lands lost were settled areas and agricultural lands. Consequently, 3,308 households consisting of 13,737 people had to move from the Saguling area, and 6,335 households of 27,978 people from Cirata. Resettlement and creation of alternative means of living have become complicated problems that can erupt into social conflicts. Such a major conflict is currently taking place in Central Java at the Kedungombo Reservoir. Creating alternative means of employment is absolutely essential.

Resettlement of people from Saguling and Cirata has been conducted through environmental impact analyses (EIAs). In 1978, the Indonesian State Electric Company (PLN) contracted the Institute of Ecology (IOE) (now called The Research Center for Natural Resources and the Environment), Padjadjaran University, to carry out extensive EIAs on the Saguling region and its people. EIAs were conducted under Act No. 4 (1982) and Indonesian Government Regulation No. 29 (1986) which detail procedures and define regulations regarding the exploitation of natural resources and the requirements for EIAs.

PLN contracted the Saguling EIAs as part of the requirements for obtaining a loan for dam construction from the World Bank (International Bank for Reconstruction and Development).

Implementation of the Saguling EIAs was delayed. Engineering and economic feasibility studies had already commenced. Based on a feasibility study, the government and PLN decided to formulate a plan for reservoir construction. A reservoir at 645 m above sea level was decided.

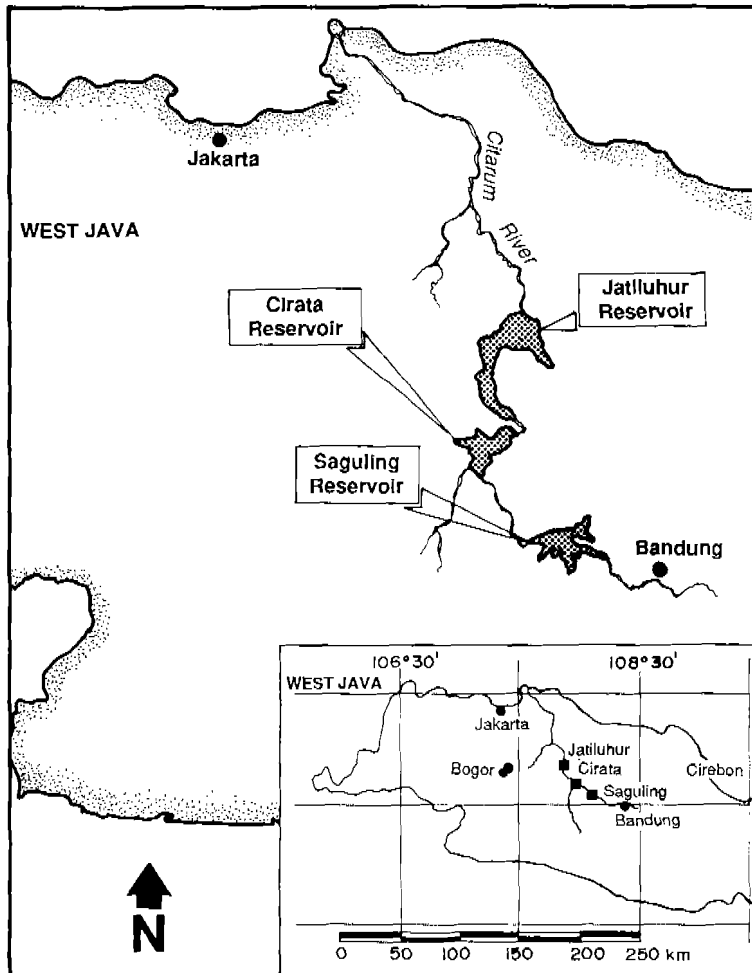

Fig. 1. Location map of the three hydropower reservoirs on the Citarum River in West Java, Indonesia. Saguling and Cirata were the subject of studies detailed in this technical report. The Jatiluhur dam was closed in 1965.

Therefore the Saguling EIA did not advise PLN about the height of the dam. However, IOE was truly grateful that PLN relied on us to do research, make recommendations and suggestions during dam construction.

We were aware that implementing the EIA would interfere with the process of dam construction such as scheduling, and would have political and economic implications. In addition it was obvious that the project would have tremendous environmental and social impacts. The EIAs may have been a hindrance to the construction schedule, and for this reason there was sufficient motivation to conduct careful surveys which could be criticized from any number of agencies and people.

A major constraint faced by the Institute of Ecology was that at that time of the first EIAs there were no governmental regulations on EIAs, so that no guidelines were available. Only a few incomplete EIAs existed in Indonesia (Soemarwoto 1974; Turner 1975). Fortunately the writer, acting as the team leader, frequently attended conferences and workshops on EIA overseas, and was particularly affected by discussions held at a workshop called SCOPE (*Scientific Committee on Problems of the Environment*) held in Victoria Harbour, Canada. The workshop produced a book titled *Environmental Impact Assessment* (Munn 1975). These experiences and the literature were used as the basis of the EIAs implemented for the Saguling and Cirata Reservoirs.

## **Main Problems**

The main problems identified in EIAs completed for Saguling were that:

1. a great number of people had to resettle. Only 4% of the total number of households were willing to transmigrate to the outer islands of Indonesia;
2. a great loss of fertile farm land occurred;
3. a great loss of jobs and living resources occurred;
4. the amount of erosion in the Citarum River basin was highest at the head of the watershed which included the catchment area of the Saguling Reservoir. The erosion rate was also increasing;
5. the increasing rate of erosion was due to the high population pressure; and
6. a high risk of aquatic weed problems existed in the catchment area in the reservoir, especially water hyacinth, *Salvinia molesta*, and *Hydrilla verticillata* (IOE 1979, 1980).

The problems identified above were extremely complicated. The high population growth and increasing erosion rates were making a potentially explosive situation. The EIAs drew the conclusion that these two combined factors were leading to a total environmental destruction of the Citarum River basin. In addition reservoir construction had brought other consequences such as loss of farm land, the dislocation of thousands of people, and other social problems.

To overcome this dilemma, it was proposed that dam construction must fulfill an essential requirement, i.e., that it must increase the people's welfare and reduce the population pressure. This means that the reservoir should become an agent of development and positive change in the area as well as a vehicle for national development.

## **Analysis Approach**

The approach employed in the EIA surveys was an integrated ecosystems approach. The ecosystems analyzed comprised villages, rivers, farm lands and forests. These components were individual subsystems but were also interactive within a whole. For example a village had the subcomponents of its people, the houses, and the gardens. A change in one component will affect others. Therefore, in the EIA surveys, we focused on the interactive impacts that occurred. Potential impacts were identified taking a systems approach that analyzed the routes of impacts from one component to another (IOE 1979).

For example, construction of the reservoir displaced thousands of people. People moved and occupied forest and marginal lands, causing species extinctions, increasing erosion and impacting riverine ecosystems by sedimentation, clogging irrigation drains, muddying fishponds (which led to decreased fish production), causing turbid water for households, and created an uncertain future for the hydropower reservoir. A number of people migrate to the city and increase the number of slums in the cities. The increase in urban residents causes more un- and underemployment; the crime rate rises. This example shows how interrelated changes are in rural and urban areas, and how cities are impacted by events in far-off villages, farm lands, rivers and forests.

The use of ecological or "systems thinking" to identify impacts was used as a guide to formulate a method of measuring environmental impact. The focus of the method was concentrated on the people, making use of the project for them. This was in line with the purpose of development in general; that is to improve the people's welfare. Consequently, the project supported its development objectives by provision of "strategic subsidies".

Dam construction was expected to give equal benefits to all; this requirement is written into the Indonesian State Guide Lines (GBHN). The project was challenged to decrease the population pressure and help halt the river basin destruction by developing a scheme that would provide methods so that sustainable development could be achieved.



## Resettlement Scheme

Government policy for people who are displaced by such major projects as dam construction is transmigration to the outer islands of Indonesia. It is thought that the transmigrants would lead a better life in rural areas with more land resources. However, many of the transmigration sites in the outer islands are located in infertile areas, and have insufficient infrastructure such as irrigation and market systems. No wonder only 4% of the people displaced by Saguling, and 11% in Cirata were willing to transmigrate! In addition, surveys showed that of the 4% (118 families) who actually did transmigrate from Saguling 40 (33%) of them returned to the Saguling area (IOE 1985). IOE, therefore, had to find alternative means of resettlement.

Although the reservoir had caused the loss of farm lands, it could actually provide new living resources – aquatic resources. Surveys showed that fisheries has been a traditional source of living from generation to generation in Indonesia. A new reservoir could increase the opportunities to develop productive fisheries. Based upon this consideration, we recommended to the State Electric Company (PLN) that fisheries should be considered as one alternative resettlement option. The suggested kinds of fisheries were :

- a. capture fisheries in the reservoir,
- b. floating net cage aquaculture,
- c. agri-aquaculture in the drawdown area; that is fisheries during the flood period, and crops in the drawdown period (IOE 1979, 1980).

PLN agreed with these recommendations, and the approval of the Governor of West Java was obtained by a decree, No. 938/KS-400 Pem/SK/80 dated 19 July 1980, which formalized as government policy that fisheries development could be used as one alternative means of resettlement for the people who were displaced by the Saguling Reservoir. Table 1 shows the resettlement alternatives and the resettlement targets to be achieved according to the Governor's decree. The same policy was also applied in the Cirata Reservoir region with the Governor's Statement No. 593.82/SK.1639 Pem-Um/81 dated 10 July 1982.

Table 1. Resettlement alternatives for the population displaced from the Saguling Reservoir area.

Alternatives	Number of people (>645 m)	Number of people (<645 m)	Total
1. Transmigration	1,400	600	2,000
2. Estate work	575	50	625
3. Agri-aquaculture	350	1,150	1,500
4. Construction	200	400	600
5. Local resettlement	250	0	250
6. Ordinary compensation	263	5,426	5,689
Total	3,038	7,626	10,664

A planned means of resettlement seems to have many benefits when one compares it to other projects such as the Wonogiri Reservoir in Central Java. Table 2 gives such a comparison. Fig. 2 shows the concept of the resettlement scheme; it comprises the development of living resources, of electricity, of agriculture, and the development of tourism in the area of Citarum upper river basin.

Since the resettlement of large numbers of people through a planned program of aquaculture and fisheries development was the first policy ever to be adopted, a preliminary survey was required to find a basic methodology on how to carry it out. PLN, supported by the World Bank, contracted the Institute of Ecology, which, in turn signed an agreement with the

Table 2. Contrasting policies on the processes of resettlement of people from the Wonogiri and Saguling Reservoirs.

Activities	Wonogiri	Saguling
Comprehensive EIA for resettlement	not done 1. One alternative only – transmigration 2. Only the people in the flooded area involved in the program	done 1. Five alternatives: a. transmigration b. local transmigration in West Java c. people trained and employed in dam construction d. development of capture fisheries, aquaculture and agri-aquaculture e. Small industry development 2. The people from the flooded area as well as people who lost jobs in the flooded area involved the project
Compensation	1. For land, house and crops 2. No compensation for the loss of work opportunities	1. For land, house and crops 2. For the loss of work opportunities; given new training
Erosion control	1. Restricted to the reservoir area	1. Suggested in the context of the whole Citarum River watershed basin 2. Integrated into the development of fisheries
Water level and quality	No planning	Suggested planning
Disease control	No planning	Suggested planning
Regional planning	No planning	Suggested planning
Monitoring	No planning	Planned and conducted

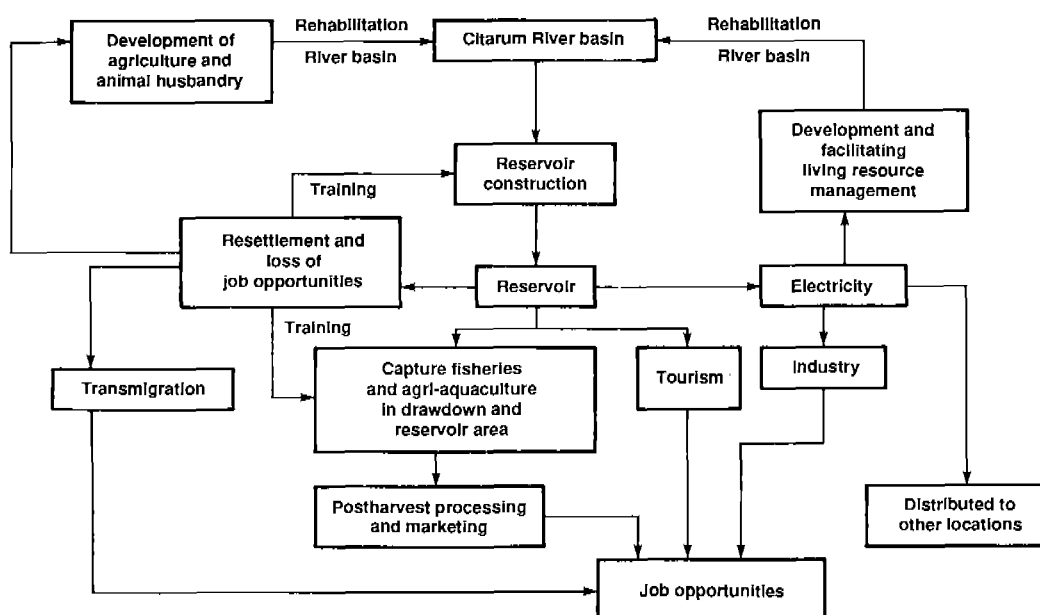

Fig. 2. Resettlement scheme in Saguling and Cirata.

International Center for Living Aquatic Resources Management (ICLARM), Manila, Philippines, to conduct surveys, basic and applied research based on contract No. PJ 039/PST/86 dated 23 January 1986.

Our scientific reports on research, management and surveys are compiled in two publications. The first, *A management plan for the Saguling and Cirata Reservoirs for resettlement using the development of fisheries*, contains the management recommendations for the Saguling and Cirata Reservoirs. The management plan distilled the research and survey results presented in this technical report. Research covered three years during which the reservoirs were not yet stable. The reservoir stabilization process is still in progress; therefore, the result of the research and planning processes are still temporary. Regular monitoring is conducted to validate the results so that this can give inputs to complete the resettlement process. In this way, an adaptive environmental management can be developed, as suggested by Holling (1978). The purpose of this adaptive process is to prevent environmental destruction due to unexpected factors. As we can never tell what the future will be no matter how well we plan, adaptive planning will help to carry out our plans with the flexibility to include new and promising possibilities, such as the development of aquaculture and fisheries.

## References

- Holling, C.S., editor. 1978. Adaptive environmental assessment management. International Series on Applied Systems Analysis 3. John Wiley and Sons, New York.
- IOE (Institute of Ecology). 1979. Environmental impact analysis of the Saguling dam. Final Report to Perusahaan Umum Listrik Negara, Jakarta, Indonesia. Volume IIA; Main report. Institute of Ecology, Padjadjaran University, Bandung, Indonesia.
- IOE (Institute of Ecology). 1980. Environmental impact analysis of the Saguling dam: mitigation of impacts. Final Report to Perusahaan Umum Listrik Negara, Jakarta, Indonesia. Volume IIA: Main report. Institute of Ecology, Padjadjaran University, Bandung, Indonesia.
- IOE (Institute of Ecology). 1985. Environmental impact analysis of the Saguling dam. Final report to Perusahaan Umum Listrik Negara, Jakarta, Indonesia. Volume II. Main Report. Institute of Ecology, Padjadjaran University, Bandung, Indonesia.
- Munn, R.E. 1975. Environmental impact assessment. Principles and procedures, First ed. SCOPE Report No. 5. John Wiley and Sons, New York.
- Soemarwoto, O., H. Haeruman, Supratignjo, Sukartadiredja, Subagyo and Alikodra. 1974. Laporan penaksiran pengaruh lingkungan proyek pabrik semen di Cilacap, industrial estate di Cilacap dan proyek pengembangan wilayah Sungai Citanduy, Lembaga Ekologi, UNPAD, Bandung.
- Turner, R.E. 1975. The Segara Anakan reclamation project. The impact on commercial fisheries. Report to Engineering Consultants, Inc., Denver.



# Population Density and General Socioeconomic Conditions Around the Saguling and Cirata Reservoirs

OPAN S. SUWARTAPRADJA

HISYAM ACHMAD

*Institute of Ecology*

*Padjadjaran University*

*Jl. Sekeloa Selatan 1*

*Bandung 40132, Indonesia*

SUWARTAPRADJA, O.S. and H. ACHMAD. 1990. Population density and general socioeconomic conditions around the Saguling and Cirata Reservoirs, p. 7-17. In B.A. Costa-Pierce and O. Soemarwoto (eds.) Reservoir fisheries and aquaculture development for resettlement in Indonesia. ICLARM Tech. Rep. 23, 378 p.

## Abstract

The majority of people to be resettled from the Saguling and Cirata Reservoirs remained in surrounding villages, moving to marginal lands above flood level. In Saguling dramatic reductions in the area of arable lands and ricefields increased village population densities 2-3 times, from a range of 237-1,691 (pre-inundation) to 476-4,292 persons/km<sup>2</sup> (post). New job opportunities were few and as natural resources were depleted, household incomes dropped and the number of landless increased.

In Saguling the displaced poor (58% of those monitored) who used compensation monies to buy agricultural land remained poor five years after resettlement, and 10% of the people previously classified as middle income farmers became poor. Increased socioeconomic status was seen only among displaced persons who took up non-agricultural jobs such as trading, work in village centers, or floating net cage aquaculture.

Development of floating net cage aquaculture could help decrease population pressure and environmental destruction by offering alternative employment not requiring land. For its development, however, aquaculture requires credit sources; these could be created by fish farmer's associations using traditional patron-client relationships.

## Introduction

This report compares the social dynamics and economic changes of people displaced from two reservoirs, Saguling and Cirata, five years after inundation in Saguling and two years in Cirata. In preparing this report, the authors have used previous data of *Environmental Impact Assessment Reports* (EIAs) carried out by the Institute of Ecology of Padjadjaran University from 1976 to 1988, and other relevant secondary data.

## Population Density Around the Reservoirs

The main pattern of resettlement chosen by the displaced people from Saguling and Cirata was to choose "safety first rule of thumb" strategies (Achmad 1987). Of the displaced people 78% in the Saguling reservoir area (IOE 1987a) and 68% in Cirata (IOE 1988a) remained in the reservoir areas. This flood of people dramatically increased the population density of villages around the reservoirs. Villages in the Saguling Reservoir area lost 15 to 47% of their original area due to the reservoir and population sizes increased. As a result, population densities doubled or tripled compared to the situation before the reservoirs existed (Table 1).

Table 1. Changes in demography, ricefield area and population density before and after the inundation of the Saguling Reservoir.

Subdistrict/village	Population (persons) post inundation	Total (families) post inundation	Total area (ha) post inundation	Ricefield area (ha)		Number of families with no agricultural land	Land inundated by the dams (ha)	Density of population before inundation in 1977/1978 (persons/km <sup>2</sup> )	Density of population post inundation in 1987/1988 (persons/km <sup>2</sup> )
				Pre inun.	Post inun.				
<b>Cillin subdistrict</b>									
Karanganyar	4,997	1,076	387.7	32	31	25	59.9	827	1,289
Mekarjaya	6,916	1,659	265.0	48	41	20	55.8	814	2,609
Cipatik	4,184	919	154.0	83	61	49	14.0	1,395	2,716
Citapen	6,585	1,367	285.0	60	58	45	13.6	1,626	2,310
Budiharja*	4,429	895	250.0	89	-	45	-	-	1,772
Singajaya	3,801	756	285.0	47	45	26	5.3	-	1,334
Cillin	9,076	1,558	264.9	35	50	22	29.7	1,175	3,426
Bongas	5,684	1,414	235.0	8	37	61	63.0	700	2,419
Tanjungjaya	4,885	1,395	121.2	100	61	30	80.6	770	4,031
Rancapanggung	7,308	1,657	401.9	51	40	34	22.1	1,635	1,818
Karangtanjung	3,912	867	455.0	21	27	35	8.1	783	860
Cihampelas	8,452	1,820	382.0	46	52	15	17.3	1,370	2,213
Batulayang*	5,869	1,420	642.6	18	-	60	-	-	913
Mekarmukti*	7,605	1,566	341.2	68	-	80	-	-	2,229
Pataruman*	5,807	1,134	229.0	43	-	56	-	-	2,536
Mukapayung*	7,019	1,600	632.7	40	-	13	-	-	1,109
<b>Subtotal</b>	<b>96,529</b>	<b>21,103</b>	<b>5,332.2</b>	<b>789</b>	<b>503</b>	<b>596</b>	<b>369.4</b>	<b>Mean 1,109</b>	<b>Mean 2,099</b>
<b>Cipongkor subdistrict</b>									
Baranangsiang	5,802	1,275	417.3	42	14	75	51.4	547	1,392
Cijambu	4,799	847	376.6	45	51	38	28.6	502	1,274
Sarinagen	5,236	1,141	345.9	50	24	50	33.4	687	1,513
Mekarsari*	3,517	717	360.3	59	-	78	-	-	476
Citalan	6,239	1,519	493.2	64	59	5	10.2	814	1,265
Sukarmulya*	3,288	714	374.3	40	-	46	-	-	879
Cicangkanghilir	3,827	894	369.0	30	44	30	35.5	984	1,037
<b>Subtotal</b>	<b>32,708</b>	<b>7,107</b>	<b>2,736.5</b>	<b>330</b>	<b>192</b>	<b>322</b>	<b>159.1</b>	<b>Mean 707</b>	<b>Mean 1,120</b>
<b>Batujajar subdistrict</b>									
Pangauban*	6,527	1,530	384.5	54	-	67	-	-	1,697
Girimukti*	6,024	1,573	1,037.6	37	-	29	-	-	581
Selacau	5,465	1,135	365.0	41	37	60	10.1	1,210	1,497
Jati	7,632	1,815	1,349.0	29	40	11	18.1	237	566
Batujajar Barat	6,333	1,314	174.8	32	-	30	-	1,691	3,623
Galanggang	8,740	1,916	203.6	11	29	77	31.6	1,955	4,292
Cangkorah	4,976	1,208	184.8	67	44	27	54.6	992	2,692
Cikande	6,147	1,504	765.0	26	65	14	8.3	499	804
Ginasih*	4,760	1,018	344.0	61	-	51	-	-	1,384
<b>Subtotal</b>	<b>56,604</b>	<b>13,013</b>	<b>4,808.3</b>	<b>358</b>	<b>215</b>	<b>366</b>	<b>122.7</b>	<b>Mean 1,097</b>	<b>Mean 1,904</b>
<b>Padalarang subdistrict</b>									
Cipeundeuy	5,238	856	587.5	41	37	47	17.5	676	892
Kertajaya*	10,476	2,419	371.6	55	-	12	-	-	2,820
Cimerang	4,399	1,310	400.0	25	40	24	20.0	839	1,100
Laksanamekar*	6,017	1,422	471.7	41	-	54	-	-	1,276
<b>Subtotal</b>	<b>26,130</b>	<b>6,007</b>	<b>1,830.8</b>	<b>162</b>	<b>77</b>	<b>137</b>	<b>37.5</b>	<b>Mean 757</b>	<b>Mean 1,522</b>
<b>Total</b>	<b>211,971</b>	<b>47,230</b>	<b>14,707.8</b>	<b>1,639</b>	<b>987</b>	<b>1,421</b>	<b>688.7</b>	<b>Grand Mean 917</b>	<b>Grand Mean 1,661</b>

\*New villages after inundation.

Sources: Population Census, Province of West Java (1980); Field Data from Subdistrict Villages; Interviews with Village Heads.

In Cirata, although a complete registration of the exact area of villages inundated has not been finished, the increased population density in villages around the reservoir is not much different from the situation in the Saguling area. Before the inundation of Cirata, the population density was already high (Table 2) (Dhahiyat et al. 1976).

Table 2. Number and population density before the Cirata Reservoir.

Subdistrict/ village	Population (persons)	Number of families	Area (km <sup>2</sup> )	Population density (km <sup>2</sup> )
<b>Cikalongkulon subdistrict</b>				
Gudang	4,822	1,285	4.88	988
Kamurang	3,072	685	1.99	1,544
Warudoyong	2,820	712	3.43	822
Subtotal	10,714	2,682	10.30	Mean 1,118
<b>Mande subdistrict</b>				
Cikidang Byb	4,645	929	7.22	643
Mande	5,497	1,099	5.10	1,078
Leuwikoja	5,568	1,262	7.02	793
Subtotal	15,710	3,290	19.34	Mean 838
<b>Ciranjang subdistrict</b>				
Ciranjang	14,130	3,258	8	1,793
Sindangjaya	6,683	1,455	8	828
Sindangraja	3,661	928	5	771
Cibanteng	8,510	1,894	10	875
Mekarjaya	2,872	678	3	945
Subtotal	35,856	8,213	34	Mean 1,042
<b>Karantengah subdistrict</b>				
Hegarmanah	4,054	960	3	1,304
Subtotal	4,054	960	3	1,304
<b>Bojongpicung subdistrict</b>				
Cihea	4,306	1,187	26.75	161
Jati	5,206	993	4.68	1,112
Haurwangi	8,409	1,918	7.20	1,168
Cikondang	6,081	997	7.19	846
Subtotal	24,002	5,095	45.82	Mean 822
<b>Cipeundeuy subdistrict</b>				
Nanggaleng	10,143	2,029	33	312
Ciroyom	7,119	1,583	11	627
Margalaksana	5,771	1,159	14	399
Cipeundeuy	6,409	1,280	5	1,369
Subtotal	29,442	6,051	63	Mean 677
<b>Plered subdistrict</b>				
Liunggunung	7,334	1,649	7.71	951
Citamiang	7,316	1,730	10.48	698
Gandamekar	1,565	385	2.28	686
Sinargalih	4,547	1,101	7.43	612
Subtotal	20,762	4,865	27.9	Mean 737
<b>Total</b>	<b>140,540</b>	<b>31,156</b>	<b>203.36</b>	<b>Grand Mean 934</b>

Sources: Population Census, Bandung (1980); Population Census, Cianjur (1980); Population Census, Purwakarta (1980); IOE (1985).

After inundation of Saguling, the area of ricefields ranged from 10 to 60% of the village area; and in Cirata, it was between 10 and 80%. The ricefield area is generally dependent on the amount of seasonal rainfall (for rainfed ricefields), while the area of technically-irrigated ricefields has remained nearly constant. Before inundation, the ricefield area in Saguling was 10 to 80% of the village cropland, and 60 to 90% in Cirata. In the Saguling region, ricefields can be planted with one crop of traditional rice during the rainy season, and fields rotated to second crops ("palawija") such as vegetables or cassava during the dry season. In Cirata, however, more abundant water resources and a better network of technical irrigation exists, and the ricefield area can yield two crops of rice a year.

In the rice agroecosystem a great amount of labor is absorbed during the early preparatory activities of the crop, i.e., tilling the land ("ngabaladah") and planting ("tandur") done by male workers; later activities such as weeding and retilling are carried out by female workers. In Saguling use of ricefields for one crop of rice and a second crop of dry season produce caused an increase in the area under cultivation. The second or *palawija* crop, however, generally needed more labor, and this job was mainly carried out by female workers. In Cirata, with a nonseasonal cropping pattern and two crops of rice per year from the paddy area, the period after the harvest of the first rice crop and the planting of the second was considered "free time". This condition meant that people had relatively more time to devote to other activities in the Cirata area than in Saguling.

### Socioeconomic Changes Among the Displaced Peoples

The main socioeconomic change of the peoples from the inundated area of Saguling five years after their forced migration from traditional villages was the shifting of their livelihoods from people wholly dependent on the agricultural sector to increased activities in the nonagricultural sector.

Before dam construction, 70% of Saguling people and 40% of Cirata were classified as poor (IOE 1980; IOE 1985). For both the poor and middle-income economic levels two-thirds of the household income was from the agricultural sector. Sajogyo (1976) defined Indonesian incomes of 240 kg equivalent rice per capita per year as poor; 240-320 kg/capita/year as medium income; above 320 kg/capita/year as high income level. Five years after inundation, monitoring of the same respondents in Saguling showed that 17% of the displaced people, who were previously classified as poor, were able to elevate their status into the middle-income level. The remaining 58% were still poor. The status of the 25% of the displaced people who were previously classified as high income level was still the same. The success of elevating the economic conditions of some of the poor was a direct result of increased income they obtained from nonagricultural sources (Table 3).

Data in Table 3 show that the increased income was not obtained from working outside their new or traditional villages. For poor households the increased income mainly depended on three major areas: working in the village, ricefield work and trading. For middle-income households, income came from three areas: civil servant/military, working in the village, and trading. The role of agricultural income for middle-income people was not significant.

One interesting point was the economic stability of middle-income households, and the increased economic status of the poor households who became middle-income level households. For the middle-income level people economic stability mainly resulted from the income coming from working as civil servants or the military. The middle-income households did not increase their involvement in local trade, mainly due to their high rate of indebtedness (Achmad 1979).

Table 3. Percentages of household income of the displaced people in 1987 (N = 232).

Sources of income	Social status	
	Poor (N = 134)	Middle-income (N=98)
<b>Agriculture:</b>		
Ricefields	18	11
Dry land agriculture	6	3
Home gardens	3	1
Livestock	9	9
Ricefield labor	9	2
<b>Subtotal</b>	<b>45</b>	<b>26</b>
<b>Other:</b>		
Trading	16	16
Other work in the village	22	17
Work in other villages	1	6
Civil servants/military	2	28
Household handicrafts	5	1
Families' support	9	6
<b>Subtotal</b>	<b>55</b>	<b>74</b>
<b>Total (%)</b>	<b>100</b>	<b>100</b>

Source: IOE (1987a).

Notes: Poor households number in 1981 = 173. The main income resource for the poor and middle-income households was from agriculture (80%).

The importance of income obtained from the nonagricultural sector was shown by displaced people who moved to another village area within the Saguling villages. Their success in obtaining income from the nonagricultural sector (Table 4) increased their socioeconomic status. In contrast, 10% of the middle-income households who were displaced and who remained wholly dependent on agriculture fell in economic status from middle-income (before inundation) to poor households (Table 5) (IOE 1988b).

One thing which should be explained from Tables 4 and 5 was that a large number of poor people moved to areas outside the immediate villages of the Saguling area. Results of interviews with them showed that they moved to follow their extended families, either from their husband or wife's side of the family who were also displaced by the reservoir.

The socioeconomic changes of displaced people in the Cirata region one year after inundation did not show such dramatic changes as discussed above for Saguling. The source of their household incomes was still the same, and changes that did occur did not show the same tendencies. This situation could be understood because in such a short period after inundation of their lands, the people are not yet in a stable condition ("ngalemah") for their economic and social well-being (Schuder 1984). According to the experiences of local people, the stabilization process will take at least 3 years.

If the socioeconomic changes that have occurred with the displaced people from Saguling are used to predict the socioeconomic conditions to occur in Cirata, the elevation of only 17% of the displaced population from poor to middle-income level is quite low. But it should be mentioned here that during this time, the floating net cage aquaculture activities had not yet developed, and opportunities for working in the villages around the reservoirs were still very limited.

Table 4. Percentage of income of respondents from Saguling and Cirata based upon socioeconomic status.

Household income resources	Socioeconomic status			
	I (n=38)	II (n=18)	III (n=7)	IV (n=7)
<b>Agriculture:</b>				
Ricefields	61.5	38.5	24.9	22.3
Dry land agriculture	0.1	0.2	4.9	0.5
Home garden	1.0	0.6	0.2	0.4
Livestock	4.1	6.6	17.9	0.4
Ricefield workers	6.8	0.5	4.0	4.6
<b>Subtotal</b>	<b>73.5</b>	<b>46.4</b>	<b>51.9</b>	<b>28.2</b>
<b>Other:</b>				
Trading	6.9	15.2	26.9	15.3
Work outside village	5.7	1.5	17.8	31.9
Work in other villages	0.2	3.6	0	3.8
Civil servant/military	0	26.5	0	19.6
Household handicrafts	7.9	5.2	1.7	0
Family support	5.8	1.6	1.7	1.1
<b>Subtotal</b>	<b>26.5</b>	<b>53.6</b>	<b>48.1</b>	<b>71.1</b>
<b>Total (%)</b>	<b>100.0</b>	<b>100.0</b>	<b>100.0</b>	<b>100.0</b>

Source: IOE (1987b).

Notes:

- I : Previously and now poor
- II : Previously poor, now middle-income
- III : Previously middle-income, now poor
- IV : Previously and now middle-income

Table 5. Socioeconomic conditions of Saguling and Cirata's displaced people in 1987.

Socioeconomic condition	Number	%
Previously poor, now poor	38	54
Previously poor, now middle-income	18	26
<b>Subtotal previously poor</b>	<b>56</b>	<b>80</b>
Previously middle-income, now poor	7	10
Previously and now middle-income	7	10
<b>Subtotal previously middle-income</b>	<b>14</b>	<b>20</b>
<b>Subtotal now middle-income</b>	<b>25</b>	<b>36</b>
<b>Subtotal now poor</b>	<b>45</b>	<b>64</b>

Source: IOE (1987b).

### Future Prospects of Socioeconomic Changes and Labor Absorption

The future socioeconomic changes of the displaced people in the new area will be very much influenced by the availability of new, nonagricultural labor opportunities in the Saguling and Cirata Reservoir regions.



Monitoring of Saguling's (IOE 1987b) and Cirata's (IOE 1988b) people showed that two-thirds of the compensation money obtained from the State Electric Company (PLN) for lands and assets lost to the reservoir was used to buy ricefields, mixed gardens ("kebun") or home gardens. In Cirata, some people used their compensation money for capital expenses, such as buying private transportation or investing the money in the bank (Table 6).

The capacity of Cirata's displaced people to use compensation money to buy a new piece of land was greater than in Saguling because a greater number of displaced residents received more money. In Saguling, almost all the displaced people received less than 6 million rupiah

Table 6. Utilization of compensation money by Saguling and Cirata's displaced people.

Utilization of compensation money	Saguling (%)	Cirata (%)
To buy ricefields and dry land	41	72
Buying home garden only	33	0
Could not afford to buy land; using money for daily needs	12	7
Buying transportation	0	3
Investing in the bank	0	15
Unknown	14	3
Total	100	100

Source: IOE (1980, 1987a).

(Table 7). It can thereby be hypothesized that people in Saguling had enough money to buy only a home garden. No one in the Saguling region used compensation monies for investing in the bank. Indeed large numbers of people used their compensation monies for daily needs.

Twenty-one per cent of the people in Cirata did not receive any compensation money (Table 7). Before the dam project began in Cirata, many households were landless (Table 8). The large number of landless households in Cirata was caused by the fact that in this area there were many fertile private plantations and large, technically-irrigated ricefield areas. Many landless people worked for the plantations. As a result, a large number of farmer households in Cirata, particularly in the subdistricts of Mande, Cikalongkulon and Cipeundeuy were middle-income or above due to plantation work, as was shown in the agricultural census of 1983 (Tables 9 and 10).

An inventory of land ownership of displaced people in Cirata showed that the average landholding per head of household was less than 0.5 ha; while in Saguling the landholdings were larger. However, lands in Saguling were generally of a lower fertility and ricefields were outside of the immediate Saguling area. Because of this, Saguling residents had to divide the land into two parts with the local communities (Achmad and Suwartapradja 1988).

Other factors which will determine the future chances of the displaced people to increase their socioeconomic status will be the capacity of the villages where people resettled to absorb an increased labor force. A study on job opportunities in villages in Cirata which measured labor absorption one year after filling of the reservoir showed the absorption of labor into the nonagricultural sector was small, only 2% of the estimated total labor force available (IOE 1988b).

A very preliminary inventory of the people involved in the new floating net cage aquaculture, capture fisheries, postharvest fish processing, hatcheries and fish feed industries showed that the involvement of people affected by the dam was mainly in noncapital activities, such as gill-net fisheries, and as laborers and traders in the cage aquaculture systems. Capital-requiring activities, such as ownership of aquaculture systems, postharvest processing, hatcheries and fish trading were carried out more by people from the villages surrounding the reservoir which were not directly affected by the dam.

Table 7. Amount of compensation money received by Saguling and Cirata's people.

Compensation money (Indonesian rupiah)	Saguling (%)	Cirata (%)
< 6 million	92	49
> 6 million	8	30
Did not receive compensation money	0	21
Total	100	100

Sources: IOE (1987, 1988b).

Note: In Sept. 1986 US\$ 1 = Rp 1,640.

Table 8. Land ownership before and after the Cirata Reservoir flooding.

Explanation	Number	%
Previously had, now do not have	947	20
Previously and now have	1,142	24
Previously did not have, now have	206	4
Previously and now do not have (landless)	2,450	52
Total	4,745	100

Source: IOE (1988a).

Table 9. Number of households owning agricultural land according to the subdistrict around the Cirata Reservoir.

Area (ha)	Plerod		Cipeundeuy		Ciranjang		Mande		Cikalongkulon	
	Total	%	Total	%	Total	%	Total	%	Total	%
<0.05	1,175	9.2	1,000	7.4	654	5.8	781	11.3	1,144	11.4
0.05-0.09	1,880	14.7	1,695	12.6	1,193	10.5	604	8.7	991	9.9
0.10-0.24	4,025	31.4	4,105	30.5	3,564	31.3	1,868	27.0	2,090	20.8
0.25-0.49	2,540	19.8	3,009	22.3	3,092	27.2	1,500	21.7	2,269	22.6
Subtotal	9,620	75.0	9,809	72.8	8,503	74.8	4,753	68.7	6,494	64.6
0.50-0.74	1,240	9.7	1,460	10.8	1,224	10.8	848	12.3	1,119	11.1
0.75-0.99	670	5.2	925	6.9	483	4.2	398	5.7	535	5.3
1.00-1.99	915	7.1	959	7.1	924	8.1	583	8.4	1,293	12.9
2-2.99	225	1.8	205	1.5	187	1.6	176	2.5	307	3.1
> 3	155	1.2	112	0.8	51	0.4	164	2.4	297	3.0
Subtotal	3,205	25.0	3,662	27.2	2,864	25.2	2,169	31.3	3,551	35.4
Total	12,825	100.0	13,471	100.0	11,372	100.0	6,922	100.0	10,045	100.0

Sources: Agriculture Census, Cianjur (1983); Agriculture Census, Purwakarta (1983).

Table 10. Land ownership in the subdistricts surrounding the Saguling Reservoir.

Area (ha)	Subdistrict											
	Cillin			Sindangkerta			Gununghalu			Batuajar		
	Total	%	%	Total	%	%	Total	%	%	Total	%	%
< 0.05	1,749	10.7	27.4	1,066	15.2	16.7	1,795	8.1	28.2	216	3.7	3.4
0.05 - 0.09	2,195	13.4	26.0	816	11.6	9.7	3,260	14.8	38.7	637	3.7	7.6
0.10 - 0.24	4,577	27.9	23.3	1,841	26.3	9.4	8,240	37.4	41.9	1,499	26.0	7.6
0.25 - 0.49	3,190	19.4	21.2	1,714	24.4	11.4	5,010	22.7	33.3	1,499	26.0	10.0
Subtotal	1,171	71.4	23.7	5,437	77.5	11.0	18,305	83.1	37.0	3,851	66.7	7.8
0.50 - 0.74	1,793	10.9	23.9	678	9.7	9.0	1,850	8.9	24.7	809	14.0	10.8
0.75 - 0.99	1,029	6.3	26.9	296	4.2	7.7	765	3.5	20.1	412	7.1	10.8
1.00 - 1.99	1,318	8.0	28.0	469	6.7	10.0	945	4.3	20.1	465	8.1	9.9
2.00 - 2.99	328	2.0	32.0	102	1.5	10.0	125	0.6	12.2	162	2.8	15.8
>3	230	1.4	44.7	30	0.4	5.8	50	0.2	9.7	73	1.3	14.2
Subtotal	4,698	28.6	26.8	1,575	22.5	9.0	3,735	16.9	21.3	1,921	33.3	10.9
Total	16,409	100.0	24.5	7,012	100.0	10.5	22,040	100.0	32.9	5,772	100.0	8.6

Area (ha)	Subdistrict								
	Padalarang			Cipongkor			Total		
	Total	%	%	Total	%	%	Total	%	%
< 0.05	923	15.7	14.5	625	6.3	9.8	6,374	100	9.5
0.05 - 0.09	745	12.7	8.8	775	9.2	9.2	8,428	100	12.6
0.10 - 0.24	1,255	21.4	6.4	2,255	22.6	11.5	19,667	100	29.3
0.25 - 0.49	1,311	22.4	6.7	2,310	23.2	15.4	15,034	100	22.4
Subtotal	4,234	72.8	8.6	596	59.9	12.0	49,503	100	73.8
0.50 - 0.74	689	11.7	9.2	1,680	16.9	22.4	7,499	100	11.2
0.75 - 0.99	382	6.5	10.0	940	9.4	29.6	3,824	100	5.7
1.00 - 1.99	372	6.3	7.9	1,130	11.3	24.0	4,699	100	7.0
2.00 - 2.99	122	2.1	11.9	185	1.9	18.1	1,024	100	1.5
>3	66	1.1	12.8	65	0.7	12.6	514	100	0.8
Subtotal	1,631	27.8	9.3	4,000	40.1	22.9	17,560	100	26.2
Total	5,865	100.0	8.8	9,965	100.0	14.9	67,063	100	100.0

Source : Agriculture Census, Bandung (1983).

## Conclusions and Recommendations

It can be concluded that displacement of two-thirds of the population from villages in and around the reservoirs has reduced the area of agricultural lands and decreased job opportunities in the agricultural sector. The socioeconomic burden on the displaced people has increased, especially when considering that most of the people were poor before the reservoir; they had small landholdings, many were landless and received little or no compensation.

The experience in Saguling showed that some success in achieving a higher socioeconomic status for people may be realized if a shift from the agricultural sector to nonagricultural activities could be made. If the capture and culture fisheries sector in the reservoirs could develop to its maximum potential, there is a possibility that this nonagricultural sector will further help the economic status of poor households. One problem which was found, however, was that the new working opportunities in floating net cage aquaculture in the reservoirs was mainly carried out by permanent residents of the villages of Saguling relatively unaffected by reservoir inundation. In addition, these new opportunities were dominated by male workers.

In relation to these problems, it is recommended that:

1. there should be an increased effort to involve the displaced people in fisheries. This could be accomplished by forming small associations to obtain capital aid from outside parties. Without outside aid there is little hope for the majority of displaced people to be involved since they have little or no capital. Many are using their compensation monies for daily needs.
2. there should be an increased effort to create new job opportunities in nonagricultural activities. In particular, the creation of activities which will widen the relationship between the people and their new environment (the reservoir and its watershed) so that new, innovative opportunities can arise. These activities could be considered as interactive groups: groups which have activities related to production processes (including fish and animal feed development), trading and marketing, and other groups in postharvest processing and associated activities. The former (production) activities could be dominated by male workers (except for feed development) while the latter activities could be carried out by female workers.

## References

- Achmad, H. 1979. Aspek sosial budaya pekarangan (Social cultural aspects of homegardens). Seminar Pekarangan II, Institute of Ecology, Padjadjaran University (unpublished).
- Achmad, H. 1987. Adaptation strategies of Saguling's people to forced resettlement. M.Sc. Thesis, Boston University, Boston, MA, U.S.A.
- Achmad, H. and O. Suwartapradja. 1988. Aspek sosial budaya perikanan di situ Saguling (Social cultural aspects of fisheries in Saguling). Institute of Ecology, Padjadjaran University (unpublished).
- Agriculture Census, Bandung. 1983. Hasil sensus pertanian Kabupaten Bandung (Results of the agricultural census of the Bandung Regency). Book Al. Biro Pusat Statistik, Bandung.
- Agriculture Census, Cianjur. 1983. Hasil sensus pertanian Kabupaten Cianjur (Results of the agricultural census of the Cianjur Regency). Book Al. Biro Pusat Statistik, Cianjur.
- Agriculture Census, Purwakarta. 1983. Hasil sensus pertanian Kabupaten Purwakarta (Results of the agricultural census of the Purwakarta Regency). Biro Pusat Statistik, Purwakarta.
- Dhahiyat, Y. 1976. Education, research and public service. Report on the project on soil erosion control in the Jatiluhur area, West Java. IOE, Padjadjaran University, Bandung and Royal Tropical Institute, Amsterdam.
- IOE (Institute of Ecology). 1980. Environmental impact analysis of the Saguling dam. Mitigation of impact. Institute of Ecology, Padjadjaran University, Bandung.
- IOE. 1985. Environmental impacts of the Saguling dam. Monitoring of impacts. IOE, Padjadjaran University, Bandung.
- IOE. 1987a. Environmental impacts of the Saguling dam. Monitoring of impacts. IOE, Padjadjaran University, Bandung.
- IOE. 1987b. Environmental impacts of the Cirata dam. Monitoring of impacts. IOE, Padjadjaran University, Bandung.
- IOE. 1988a. Hasil inventarisasi penduduk pindahan dari genangan Cirata (Results of an inventory of the population moved from the flooded area of Cirata). IOE, Padjadjaran University, Bandung.
- IOE. 1988b. Environmental impacts of the Cirata dam. Monitoring of impacts. IOE, Padjadjaran University, Bandung.

- Population Census, Province of West Java. 1980. Hasil sensus penduduk Jawa Barat (Results of population census of West Java). Biro Pusat Statistik, Province of West Java, Bandung.
- Population Census, Bandung. 1980. Hasil sensus penduduk Kabupaten Bandung (Results of population census of the Bandung Regency). Biro Pusat Statistik, Bandung.
- Population Census, Cianjur. 1980. Hasil sensus penduduk Kabupaten Cianjur (Results of population census of the Cianjur Regency). Biro Pusat Statistik, Cianjur.
- Population Census, Purwakarta. 1980. Hasil sensus penduduk Kabupaten Purwakarta (Results of population census of the Purwakarta Regency). Biro Pusat Statistik, Purwakarta.
- Sajogyo. 1976. Garis kemiskinan dan kebutuhan minimum pangan (The poverty line and minimum food needs). Institut Pertanian Bogor (unpublished).
- Schuder, T. 1984. The development potential of new lands settlement in the tropics and subtropics: a global state-of-the-art evaluation with special emphasis on policy implications. US Agency for International Development Paper No. 21, Washington, DC, USA.

# Water Quality Suitability of Saguling and Cirata Reservoirs for Development of Floating Net Cage Aquaculture\*

**OTTO SOEMARWOTO**

**CECEP M. ROEM**

**TITIN HERAWATI**

*Institute of Ecology, Padjadjaran University  
Jl. Sekeloa Selatan 1, Bandung 40132, Indonesia*

**BARRY A. COSTA-PIERCE**

*International Center for Living Aquatic Resources Management  
MC P.O. Box 1501, Makati, Metro Manila, Philippines*

SOEMARWOTO, O., C.M. ROEM, T. HERAWATI and B.A. COSTA-PIERCE. 1990. Water quality suitability of Saguling and Cirata Reservoirs for development of floating net cage aquaculture, p. 18-111. *In* B.A. Costa-Pierce and O. Soemarwoto (eds.) Reservoir fisheries and aquaculture development for resettlement in Indonesia. ICLARM Tech. Rep. 23, 378 p.

## Abstract

A three-year (1986 to 1989) water quality monitoring program for 16 parameters at 10 stations in the Saguling Reservoir and for 13 parameters at 11 stations in 1988 for the new Cirata Reservoir was accomplished. In addition, diurnal water quality changes at three cage culture sites in Saguling were monitored monthly in 1988. All data are summarized in a complete three-part Appendix, and are available on disk from ICLARM.

Saguling was found to be a warm polymictic reservoir, experiencing destratification at onset of the western monsoon. Due to sewage inputs from nearby urban centers as well as the fact that it flooded thousands of hectares of organic-rich ricefields, the reservoir is hypereutrophic, with Secchi disk visibilities less than 170 cm, green and blue-green algal blooms exceeding 100 million cells/l, and experiencing wide fluctuations in physicochemical and biological parameters causing environmental nuisances.

A water quality suitability index (WQSI) for cage aquaculture using lethal and optimal thresholds for common carp for dissolved oxygen, pH, carbon dioxide, nitrite, ammonia, and hydrogen sulfide, along with the length of exposure to these thresholds was developed. The WQSI for all stations in Cirata was found to be higher than in Saguling. Stations in the southern sector of Saguling had a higher WQSI than those in the northern sector and the former Citarum River basin.

## Introduction

Dam construction in the upper watershed of the Citarum River created the Saguling and Cirata Reservoirs in West Java, Indonesia. At their high water levels (HWL), the reservoirs flooded a total of 11,540 ha of land: 5,340 ha by Saguling (PLN 1986) and 6,200 ha by Cirata (PLN 1989). Construction was undertaken by the Indonesian State Electric Company, Perusahaan Umum Listrik Negara (PLN), in an effort to maximize potential uses of the Citarum River for heavily-populated West Java, and for the power needs of Java island as well. The dams increased the supply of hydroelectricity, thereby increasing and stabilizing the grid, or

---

\*ICLARM Contribution No. 614.



base load electric power supply (Saguling 700 MW and Cirata 500 MW capacity). In addition, the dams allowed expansion of electric service to rural areas in West Java for the first time, and provided additional flood control for Greater Jakarta.

The dams were created in the uplands of West Java, an area of complex, mountainous terrain of many deep river valleys in easily-weathered volcanic soils. Elevation at the top of Saguling's dam is 650.5 m above sea level (ASL), and Cirata is 225.0 m. Placement of a high dam at Saguling, in such a mountainous area with abundant river valleys, led to the development of a very dendritic lake (Fig. 1). Cirata, on the other hand, is located downstream of Saguling in a broad, flat plain at lower elevation, surrounded by mountains (Cirata means "flat" in the local Sundanese dialect). As a result, the shape of the reservoir is much more circular (Fig. 2).

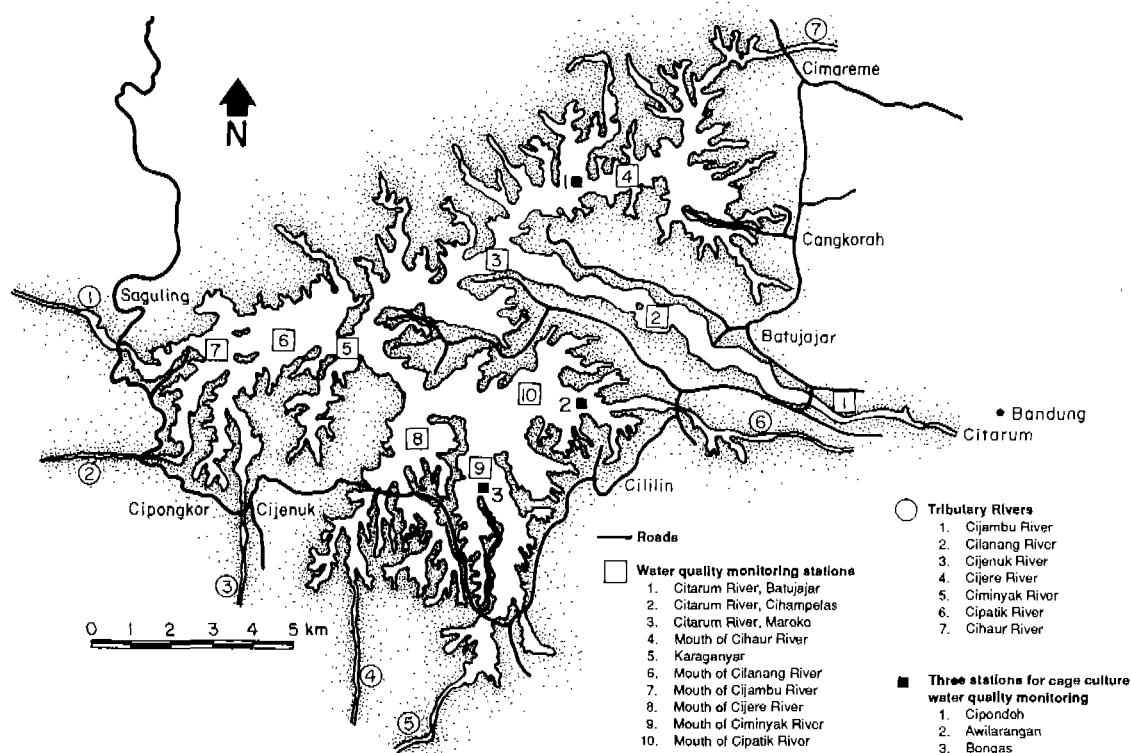

Fig. 1. Overview of the Saguling Reservoir, West Java, showing the locations of ten water quality monitoring stations, tributary rivers entering, and locations of three cage aquaculture water quality monitoring sites. Roads and place names of major towns are also indicated.

The dams displaced over 40,000 persons from their homes or jobs (Soemarwoto, this vol.) As a result of *Environmental Impact and Assessment (EIA)* recommendations on resettlement (IOE 1979; Soemarwoto, this vol.), PLN implemented a local resettlement scheme unique to Indonesia. Local resettlement in aquaculture, tourism, and small-scale industry using the electricity provided by Saguling was planned, in addition to the more commonly-used resettlement options of simple cash compensation and transmigration to the sparsely-populated Outer Islands of Indonesia. Development of cage aquaculture and capture fisheries was initiated to provide rural jobs and to maximize all possible productive uses of the new water resources. The "aquaculture resettlement option" was a priority of PLN/IOE/ICLARM/World Bank efforts (Soemarwoto, this vol.; Sutandar et al. 1990).

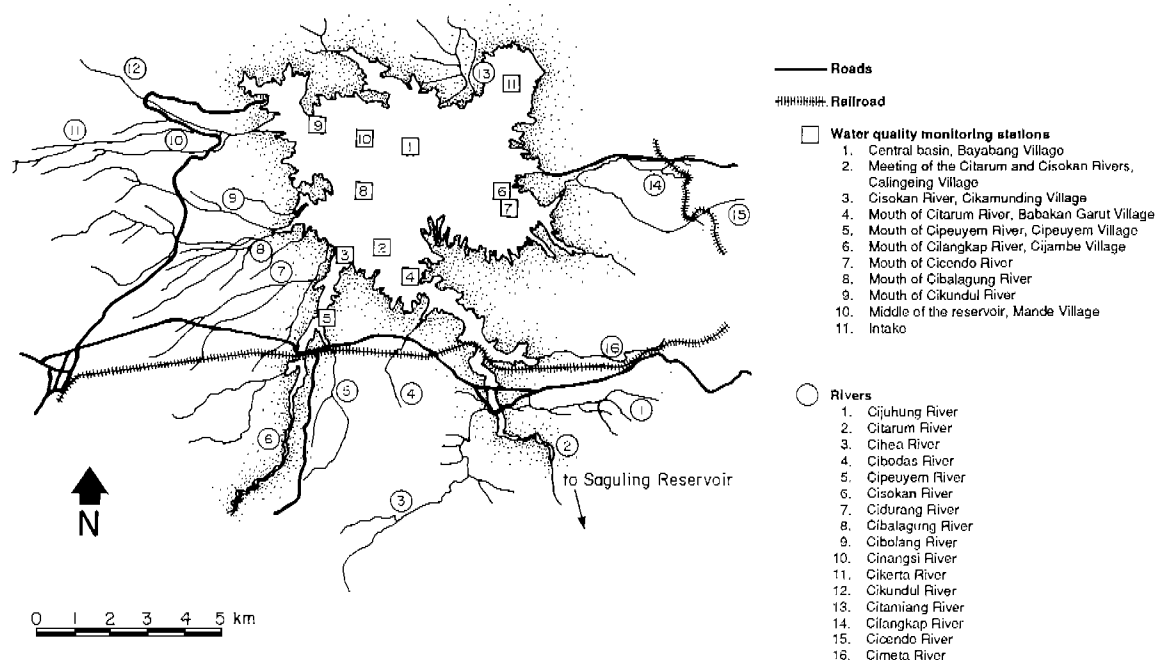

Fig. 2. Overview of the Cirata Reservoir, West Java, showing locations of eleven water quality monitoring stations, main Citarum River and fifteen rivers entering the reservoir.

Operations of aquaculture systems chosen for development in the reservoirs had to fit within the hydroelectric station's normal operating procedures. Floating net cage culture of common carp (*Cyprinus carpio*) fit this prerequisite. Common carp are universally appreciated by all segments of West Java's population, have established markets, are in great demand, and are of high economic value. In addition, the technology for growing common carp in floating net cages had been previously demonstrated in other areas of Indonesia (IOE 1981; Costa-Pierce and Hadikusumah, this vol.). Success, however, of the new aquaculture businesses greatly depended upon the suitability of the reservoir's water quality, its water quality variabilities, pollution, and seasonal climatic and mixing events occurring in the new aquatic ecosystem.

In February 1985, the Saguling Reservoir began filling, and the aquatic ecosystem rapidly changed from its primal flowing water (lotic) system to a new, static-water ecosystem (lentic). The reservoir flooded vast quantities of organic matter and rich volcanic soils which, in the first three years after flooding, caused an explosion of living aquatic organisms from the nutrients washed out of soils, and from nutrients released by the decomposition of flooded organic matter.

Mass mortalities of fish in floating net cages owned by small-scale fish farmers occurred in the Saguling Reservoir in 1986-1988. These mortalities occurred during onset of the Indonesian rainy season (western monsoon) and during a severe drawdown of Saguling accomplished in 1988 to fill the new, downstream Cirata Reservoir. The unusual drawdown was accompanied by a strong and lengthy dry season, which decreased water levels below those predicted by PLN.

Given these limnological and hydrological vagaries and the large fish mortalities initially observed (but unrecorded) in 1986, a comprehensive water quality program was initiated by the Institute of Ecology (IOE)/ICLARM to understand the limnology and aquatic ecology of the new reservoirs. The program contained three parts: (1) monitoring of 10 stations of Saguling, from 1986 to 1988; (2) monitoring of Cirata at 11 stations in 1988; and (3) diurnal vertical profiles at three important centers of the cage culture industry in Saguling (Cipondoh, Awilarangan and Bongas).

In this chapter we develop a new water quality suitability index (WQSI) for floating net cage aquaculture using the data from parts 1 and 2 of our monitoring program in Saguling (1986-1988) and Cirata (1988). Further analyses of research findings from the program will be published elsewhere. A complete, three-part Appendix with all original water quality data from the program is included; all data are also available on disk from ICLARM.

It is hoped that the water quality suitability index will assist cage aquaculturists and planners of resettlement aquaculture programs to develop better management guidelines for the location and seasonal operations of cage aquaculture in reservoirs, and further stimulate monitoring and ecological modelling work to understand the limnological and water quality dynamics occurring in new reservoirs with commercial cage aquaculture operations.

### ***Construction, Environment and Hydromorphology***

Saguling is located in the Bandung regency of the province of West Java, Indonesia, on the Citarum River, approximately 100 km southeast of Jakarta, and 30 km west of Bandung. Cirata is approximately 45 km downstream of Saguling, and Jatiluhur some 50 km downstream of Cirata (see Fig. 1 in Soemarwoto, this vol.).

The Citarum River, with a total watershed area of 6,000 km<sup>2</sup> and total length of 350 km, is the third largest river on the island of Java. Saguling and Cirata are the second and third dams on the Citarum River, respectively; the 8,300 ha Jatiluhur dam built for flood control, irrigation and power generation, has existed since 1965.

The Saguling dam is a 99 m high, rock-fill type dam constructed at 301.4 m across the Citarum River at 650.5 m ASL (top of the dam). The dam was closed on 15 February 1985, and the reservoir reached its HWL of 643 m on 13 May 1985. Saguling has two turbines with a total generating capacity of 700 MW. The turbines are located at 51 m and 69 m, with a level of center 58 m above the bottom. A concrete spillway 440 m long has three gates, all 10 m long, which are normally closed. The top of the gates are 78 m above the reservoir bottom. Damming created a 5,340 ha reservoir with a total volume of 982 million m<sup>3</sup> at HWL. The dam flooded the main basin of the Citarum River, and also submerged 7 small tributary rivers (Cijambu, Cilanang, Cijenuk, Cijere, Ciminyak, Cipatik, Cihaur) (Fig. 1).

The Cirata Reservoir was formed by a 125.0 m high rock-fill dam 453.5 m across the Citarum River having surface layers of waterproofed cement as sealant at 225 m ASL. The area of the reservoir is 6,200 ha, with a total volume of 2,165 million m<sup>3</sup> at its HWL. Cirata's catchment area covers 4,074 km<sup>2</sup>. In addition to the main Citarum River, over fifteen small rivers were flooded by the reservoir (Fig. 2). The dam was closed on 1 September 1987 and a HWL of 220 m ASL was reached on 15 February 1988. Filling of Cirata was delayed some 3-4 months because of an unusually lengthy, hot dry season in 1987-1988 which necessitated a 25 m drawdown of Saguling to fill Cirata. The relationships between water level and volume in the Saguling and Cirata Reservoirs are shown in Table 1.

Other morphometric and hydrological data on the Saguling and Cirata Reservoirs are listed together with data from the Jatiluhur Reservoir in Table 2. Examination of the data shows that Saguling has a number of unusual morphometric characteristics. The most striking are: (1) an unusually high  $D_L$  value, or "development of the shore line" ratio (Hutchinson 1957), sometimes referred to as dendriticity; (2) an abnormally small depth ratio; (3) generally steep bank slopes, especially along the former bed of the Citarum River; and (4) a huge drawdown area.

Examination of the available literature shows that Saguling has one of the highest dendriticities ( $D_L$ ) reported. Hutchinson (1957) mentions that very high  $D_L$  values result from the flooding of a tilting basin, in a valley which is not "over-deepened". In the case of Saguling, the basin tilts towards the dam, and the reservoir flooded numerous shallow river valleys. In addition, Saguling has a depth ratio less than 0.33, or the value that its basin would have if it

Table 1. Relationship of water levels and water volumes in the Saguling and Cirata Reservoirs.

Saguling		Cirata	
Elevation (m)	Volume ( $1 \times 10^6 \text{ m}^3$ )	Elevation (m)	Volume ( $1 \times 10^6 \text{ m}^3$ )
650	1,296,993	250	4,440
647.5	1,125,617	245	3,929
645	981,913	240	3,462
(HWL - 643)		235	3,038
642.5	855,773	230	2,652
640	744,436	225	2,132
635	559,838	(HWL = 220)	1,973
630	416,853	217.5	1,821
625	306,125	215	1,677
(LWL = 623)		210	1,411
620	220,677	(LWL = 205)	1,177
615	154,454	200	971
610	103,484	195	790
605	65,560	190	630
600	38,396		

Regression of water level and volume ( $x$  = water level;  $y$  = volume;  $r^2$  = regression coefficient):

a) Saguling :  $\text{Log } y = -9.947 + 0.029 X$ ;  $r^2 = 0.99$

b) Cirata :  $\text{Log } y = 6.028 + 0.014 X$ ;  $r^2 = 0.94$

Table 2. Morphometric and hydrological data on the three existing Citarum River reservoirs in West Java, Indonesia.

Reservoir	Area (ha)	Max length (km)	Mean breadth (km)	Max depth (m)	Mean depth (m)	Shoreline length (km)	Max volume ( $\times 10^6 \text{ m}^3$ )	Mean slope (%)	Depth ratio	Relative depth (%)	Dev. volume	Dev. shoreline ( $D_L$ )	Watershed area ( $\text{km}^2$ )	Drawdown area (ha)
Saguling	5,607	18.4	3.0	90	17.5	473	982	4	0.2	106	0.58	17.8	2,315	3,700
Cirata	6,200	14.5	4.3	106	34.9	181	2,165	8	0.3	119	0.99	6.5	4,119	581
Jatiluhur	8,300	36.5	2.3	95	36.4	163	2,970	30	0.4	92	1.15	5.0	4,607	3,100

Formulas taken from Hutchinson (1957).

Data for Saguling from IOE (1980), PLN (1986).

Data for Cirata from PLN (1989).

Data for Jatiluhur from Tjahjo (1986).

was a cone. Hutchinson (1957) states that values lower than 0.33 indicate that a number of "deeps", or separate individual basins exist. Another unusual feature of Saguling is its huge drawdown area, estimated at 3,700 ha, or some 66% of its total area (IOE 1980; Tjahjo 1986).

The total catchment area discharging into Saguling is 2,285 km<sup>2</sup>, with 75.2% coming from the Citarum River, 22.5% from small tributary rivers, and 2.3% from other areas surrounding Saguling (PLN, unpublished data). The discharge of the Citarum River into Saguling varied from 9 (at Nanjung monitoring station, in September 1987 and 1988) to 340 m<sup>3</sup>/second (March 1986), implying an average total inflow of 174 m<sup>3</sup>/second. The average residence time of water at HWL in Saguling is therefore 65 days (0.2 year).

It can be expected from these morphometric data that the limnology and aquatic ecology of Saguling would be extremely complex since its numerous bays and deeps could have individual, seasonal, and possibly daily differences in their temperature and chemical stratifications. Presence of a huge drawdown area and the extreme dendricity of Saguling would indicate that the littoral and limnetic zones are in intimate contact, and that much of the epilimnion is likely to be in the euphotic zone. Under these morphometric conditions it is likely that Saguling will remain a highly eutrophic reservoir. Tjahjo (1986), although working with a different data set for Saguling, came to the same conclusion.

## **Materials and Methods**

### ***Monitoring Program***

Ten routine and three cage culture water quality monitoring stations (Cipondoh, Awilarangan, and Bongas) were established in Saguling (Fig. 1), and 11 monitoring stations in Cirata (Fig. 2). Stations at the cage culture sites in Cipondoh (northeast), Awilarangan (southeast) and in Bongas (south central) were all locations of significant numbers of experimental (Cipondoh, Awilarangan), or privately-owned community small-scale cage aquaculture (Awilarangan, Bongas) (Rusydi and Lampe, this vol.).

Sixteen water quality parameters in Saguling were monitored irregularly in 1986, and monthly (with few exceptions) in 1987-1988. For Cirata, 13 parameters were monitored monthly in 1988 only, since filling of Cirata was delayed due to the lengthy dry season (Saguling, which was drawn down to fill Cirata returned to its normal HWL on 15 February 1988). At the three cage culture stations, samples were taken monthly in 1988 at the same cage culture site at 1200, 1800, 2400, 0600 hours. All other monitoring in Saguling and Cirata was conducted between 1200 and 1700 hours from a boat. All stations were repeatedly relocated by distinguishing landmarks on the shore line.

Sampling at every station was conducted by using a 3-l capacity Kimmerer sampling bottle at water depths of 0.2 and 5.0 m. At the cage sites sampling was done at 0.2 m, and at every 2.0 m depth until 10.0 m.

Methods used for all physical, chemical and biological parameters are listed in Table 3. Water temperature, dissolved oxygen (DO), carbon dioxide (CO<sub>2</sub>), pH, temperature, and Secchi disk visibility (SDV) measurements were done in the field using the appropriate meters, instruments, tools, and methods detailed in Table 3. All other solids, gases, and nutrients were analyzed on water samples brought from the field to the Aquatic Ecology Laboratory, Institute of Ecology (IOE), Padjadjaran University in Bandung (approx. 2 hours from Saguling, and 3 hours from Cirata).

Plankton samples were taken by using a 3-l Kimmerer bottle. Ten samples of water at 0.2 m depth were taken, and water was filtered through a number 25 plankton net. The plankton net had a 30-ml bottle at its bottom which concentrated the suspended materials. This concentrate was preserved in 4% formalin in the field. At the IOE laboratory 1-ml samples of the concentrate

Table 3. Analysis methods used for the water quality monitoring.

Parameter	Units	Methods
Temperature	°C	Glass thermometer
Secchi disk visibility	cm	Secchi disk
Conductivity	µmhos/cm	YSI meter
pH	unit	Digital meter
Dissolved oxygen	mg/l	Digital meter (Horiba U7)
Alkalinity	mg/l	Titration in field; APHA (1975)
Silicate	mg/l	APHA (1975)
Ammonia	µg/l	APHA (1975)
Nitrite	µg/l	APHA (1975)
Nitrate	µg/l	APHA (1975)
Orthophosphate	µg/l	APHA (1975)
Total phosphorous	µg/l	APHA (1975)
Total nitrogen	µg/l	APHA (1975); Kjeldahl
Hydrogen sulfide	µg/l	APHA (1975); Complexometric
Biological oxygen demand	mg/l	APHA (1975); Winkler
Chemical oxygen demand	mg/l	APHA (1975); Permanganate
Suspended solids	mg/l	APHA (1975); Imhoff Cones

were put into a Sedgwick-Rafter counter and visual fields were examined under a compound microscope at 40-400x. Plankton analyses involved identification of species and counts of density (Vollenweider 1969).

### **Water Quality Suitability Index**

Costa-Pierce et al. (1989) developed a score to evaluate water quality suitability for cage aquaculture development. This score, however, accounted only for water quality parameters exceeding threshold values for survival and growth. The WQSI developed here also takes into account the length of exposure.

Table 4 presents threshold values for growth and mortality for several important water quality parameters taken from several authors. The table shows that common carp (*Cyprinus carpio*) is generally more sensitive to poor water quality than the Nile tilapia (*Oreochromis niloticus*) and other freshwater fish. As common carp are the predominant fish cultured in the Saguling and Cirata Reservoirs (Rusydi and Lampe, this vol.), and have higher sensitivity to adverse environmental conditions, the lethal threshold values for this fish were used to assess water quality suitability of the two reservoirs for floating net cage aquaculture. For dissolved oxygen (DO) and pH, threshold values for optimum growth were used in addition to lethal threshold values.

Although the lethal threshold value of a certain water quality parameter may be exceeded, fish mortalities do not always occur, since mortality is determined not only by the absolute concentration but also by the length of exposure along with other synergistic factors and fish health. Because of the uncertainty involved in judging whether water quality problems will occur or not, these adverse water quality factors are defined as "mortality risk factors" (MRF). It is assumed if more MRFs exceed the threshold value, the greater the risk of fish mortalities. The water quality analysis used here therefore takes into account the number of factors which exceed their respective threshold values as well as the intensity of this overshoot.

Ranking of water quality suitability for cage aquaculture at the monitoring stations where a long-term program of water quality monitoring was carried out was arranged as follows. At a certain station, a water quality factor which at any one time exceeded its threshold value was considered a potential constraint (C). For every station and for every parameter the intensity of

Table 4. Water quality criteria used to determine feasibility for aquaculture development of common carp (*Cyprinus carpio*), Nile tilapia (*Oreochromis niloticus*) and other freshwater fishes.

Parameter	Common carp	Nile tilapia	Other freshwater fishes	Criteria
Water temperatures	> 37°C 25 - 27 °C	< 16 and > 42 °C 25 - 30 °C	20 - 32 °C	Lethal temperatures Growth optimum
DO	< 0.7 mg/l 3 mg/l 5 mg/l > 6 mg/l	< 0.5 mg/l < 3 mg/l > 5 mg/l	< 0.3 - 1 mg/l < 3 mg/l > 5 mg/l	Lethal concentration Can live, but the growth influenced Suboptimal growth Growth optimum
pH	< 4 and > 10.8 6.8 - 7.5	< 4 and > 11 6.5 - 8	< 4 and > 11 6.0 - 8.0	Lethal value Growth optimum
Carbon dioxide (CO <sub>2</sub> )	20 mg/l at pH 5 - 6 > 25 mg/l	-	> 25 mg/l at pH 5.0 - 6.0	Can live, but the growth influenced Cause fish deaths
Ammonia (NH <sub>3</sub> -N)	> 660 µg/l 500 µg/l	> 600 - 3,000 µg/l 430 - 530 µg/l	-	Cause fish deaths Cause fish stress
Hydrogen sulfide (H <sub>2</sub> S)	400 - 500 µg/l	600 - 700 µg/l	500 - 700 µg/l	Cause fish deaths
Nitrite (NO <sub>2</sub> -N)	500 µg/l	-	500 - 1,200 µg/l	Cause fish deaths
Conductivity	-	150 - 500 µmhos/cm	- 500 µmhos/cm > 1,000 µmhos/cm	Tolerance Cause fish stress Cause fish deaths

Sources : Alabaster and Lloyd (1980); Bardach et al. (1972); Boyd (1982); Chervinski (1982); Meade (1985).



overshoot (I) above the threshold value (TV) (see Table 4) was calculated using the following formula:

$$I = \left| \frac{a - TV}{TV} \right| \times 100\%$$

I = Intensity of overshoot

a = Observed value of parameter exceeding the threshold value

TV = Threshold value

Ranking sectors of the reservoirs based on their water quality suitability was based on a suitability index (S):

$$S = \frac{1}{(\text{Total intensity [\%]} \times (\# \text{ of constraints [\%]}))} = \frac{1}{\sum I \times C} \quad (\times 100)$$

Fig. 3 shows the percentages of water quality observations exceeding TVs in Saguling at Station 1, located at Selacau Village at the mouth of the Citarum River (Fig. 1). Five of the six water quality parameters used to calculate the WQSI exceeded the TVs for optimum growth. Therefore, the value of C was 5/6 or 83.3% (in the case of N-NO<sub>2</sub> the adjusted curve is below

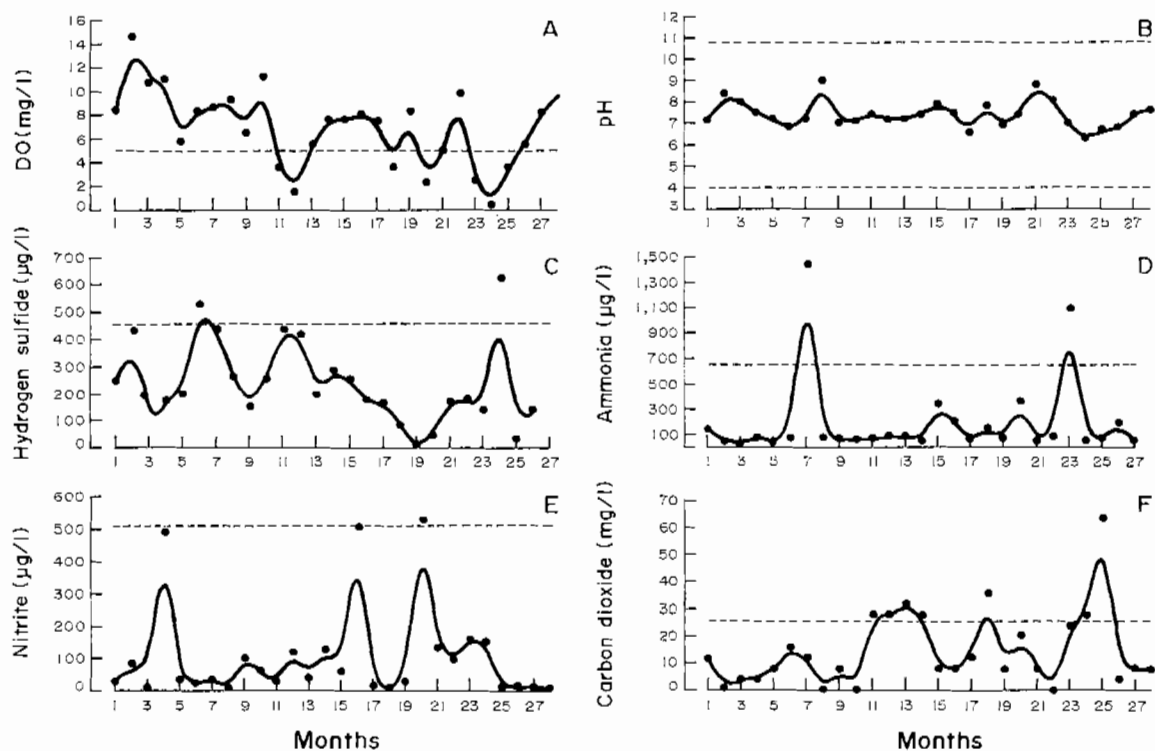

Fig. 3. Threshold values (TVs) for the water quality suitability index at the heavily polluted station 1 in the Saguling Reservoir. The dashed lines indicate DO and pH (A and B) TVs (listed in Table 4) for common carp for optimal growth. TVs for lethal effects are shown for the other water quality parameters (C to F). [A] TVs for DO for optimal growth over a 27-month period, 1986 to 1988. [B] TVs for pH for 28 months. [C] TVs for hydrogen sulfide for 26 months. [D] TVs for ammonia for 27 months. [E] TVs for nitrite-nitrogen for 28 months. [F] TVs for carbon dioxide for 28 months.

the TV, but sample numbers 4, 16 and 20 equalled or exceeded the TV). The intensity of overshoot (I) for each parameter was calculated by the formula shown on p. 26. This was 429.9% for DO, using a TV for optimal growth of greater than 5 mg/l (Table 4) and the data in Appendix 1. The  $\Sigma I$  for station 1 was 1,093.2%.

Therefore the suitability index (S) over a 3-year period was:

$$S = \frac{1}{1,093.2\% \times 83.3\%} \times 100 = 9 \quad \text{or} \quad \frac{1}{10.932 \times 0.833} \times 100 = 9$$

The higher the suitability index, the more suitable the water quality for development of floating net cage aquaculture.

In this suitability assessment monitoring results for DO, carbon dioxide (CO<sub>2</sub>), pH, hydrogen sulfide (H<sub>2</sub>S), ammonia (NH<sub>3</sub>-N) and nitrite (NO<sub>2</sub>-N) were taken from an extensive program of water quality monitoring whose data are detailed in Appendices 1 and 2.

## Results

Table 5 presents the percentages of water quality observations in Saguling (Table 5a) and Cirata (Table 5b) which exceeded the threshold values (TVs). Table 5a shows that in Saguling there was no ideal station for aquaculture development. All stations had parameters which exceeded threshold values. Although DO and pH never exceeded lethal threshold values, the pH at 9 stations and the DOs at 8 stations exceeded thresholds for optimum growth.

All stations in Saguling ran the risk of fish mortalities due to H<sub>2</sub>S. The highest risk of fish mortalities was at station 3 with 25% of the total observations exceeding the threshold value. The lowest risk was at station 7 with 7%. H<sub>2</sub>S toxicity is influenced by pH, with a lower pH increasing toxicity. The lowest pH recorded was 5.0 at station 8 in March 1988. However, at that time the H<sub>2</sub>S concentration was low.

In Cirata during January to December 1988 no lethal overshoots were observed. However all monitoring stations recorded pH values which were outside threshold values for optimum growth. Similar observations were found for DOs at 8 stations.

Table 5a. Percentage of water quality observations that exceeded the threshold values (TVs) in Saguling Reservoir (1986-1988).

Stations	Parameters					
	1) DO	1) pH	2) H <sub>2</sub> S	2) NH <sub>3</sub>	2) NO <sub>2</sub>	2) CO <sub>2</sub>
1	29.6	0.0	7.7	7.4	10.7	25.0
2	17.9	3.6	21.4	0.0	10.7	7.1
3	3.6	3.6	25.0	3.6	3.6	0.0
4	7.1	3.6	17.9	3.6	3.6	0.0
5	7.1	7.1	14.3	0.0	0.0	0.0
6	0.0	3.6	17.9	0.0	3.6	0.0
7	7.1	3.6	7.1	0.0	7.1	0.0
8	3.6	3.6	21.4	0.0	0.0	0.0
9	7.1	3.6	17.9	10.7	0.0	0.0
10	0.0	0.0	17.7	14.3	0.0	0.0

Notes: 1) TVs for optimal growth (see Table 4).  
2) TVs for lethal effects. The TV-lethal for H<sub>2</sub>S was chosen as 450 µg/l.

Table 5b. Percentage of water quality observations that exceeded the threshold values (TVs) in Cirata Reservoir (in 1988).

Stations	Parameters					
	1) DO	1) pH	2) H <sub>2</sub> S	2) NH <sub>3</sub>	2) NO <sub>2</sub>	2) CO <sub>2</sub>
1	8.3	83.3	0	0	0	0
2	16.7	75.0	0	0	0	0
3	8.3	91.7	0	0	0	0
4	0.0	91.7	0	0	0	0
5	0.0	58.3	0	0	0	0
6	8.3	66.7	0	0	0	0
7	8.3	75.0	0	0	0	0
8	0.0	91.7	0	0	0	0
9	16.7	75.0	0	0	0	0
10	8.3	75.0	0	0	0	0
11	8.3	91.7	0	0	0	0

Notes : 1) TVs for optimal growth (see Table 4).  
 2) TVs for fish mortalities.  
 Measurements done at water depth of 0.2 m.

The water quality suitability indices of Saguling and Cirata are presented in Table 6a and b. Suitability indices in Cirata (Table 6b) are higher than in Saguling (Table 6a). The lowest suitability index in Cirata was found at the mouth of the Cisokan River (224), while the highest in Saguling was at the mouth of the Cijere River, with a suitability index of 55. It can thereby be concluded that, at the current time, the water quality of Cirata is more suitable for floating net cage aquaculture than Saguling.

Based on the above analysis the suitability ranking in Saguling Reservoir from the highest to the lowest are (by station): St.8 > St.6 > St.5 > St.10 > St.9 > St.4 > St.7 > St.3 > St.2 > St.1 (see Fig. 1).

The main Citarum River from its mouth to Maroko and the Cihaur River, also the mouth of the Cijambu River have low water quality suitabilities. The southern sector of Saguling (see Munro et al., this vol. for sector delineations) has higher suitability indices than northern sectors. The lowest suitability is found at the mouth of the Citarum River as it enters Saguling.

The order of suitability indices in Cirata from high to low are (by station): St.5 > St.10 > St.4 > St.6 > St.11 > St.9 > St.1 > St.7 > St.6 > St.2 > St.3 (see Fig. 2).

## Discussion

The low water quality suitability indices of the Saguling Reservoir are most likely caused by untreated sewage entering the reservoir via the main Citarum River from the Bandung-Cimahi-Padalarang urban complex. The worst water quality suitability index was found at the mouth of the Citarum River. The area from the river mouth along the main stream of the former river bed to Maroko has poor water quality suitability indices. On the basis of these findings, the area from Selacau to Cihampelas is not recommended for cage aquaculture of common carp.

The Cihaur River also had a low suitability index; but the index was higher than at the mouth of the Citarum River, likely because there was less sewage entering from the urban centers of Padalarang and Batujajar than from Bandung and Cimahi. Padalarang and Batujajar are less densely populated and have less heavy industry than the Bandung-Cimahi urban complex. The cause of the low water quality suitability index at the mouth of the Cijambu River was presumably due to market wastes spilling into the river.

Table 6A. Water quality suitability of 10 stations in Saguling Reservoir for floating net cage aquaculture development.

Station No.	Deviation intensity, I (%)							Potential constraints		Suitability index ↑ ----- ΣI x C (x 100)	Ranking of stations
	DO	CO <sub>2</sub>	pH	H <sub>2</sub> S	NH <sub>3</sub> -N	NO <sub>2</sub> -N	Total (ΣI)	(C)	(%)		
1	429.9	266.0	86.4	120.0	183.9	7.0	1,093.2	6	100.0	9	10
2	95.3	14.0	160.0	347.4	-	92.2	708.9	5	83.3	17	9
3	10.0	-	186.8	348.1	48.8	16.6	610.3	5	83.3	20	8
4	28.4	-	209.5	201.6	3.5	6.6	449.6	5	83.3	27	6
5	26.7	-	177.2	240.4	-	-	444.3	3	50.0	45	3
6	-	-	241.8	120.6	-	54.6	417.0	3	50.0	48	2
7	11.7	-	227.7	244.8	-	197.2	681.4	4	66.6	22	7
8	17.7	-	223.9	121.8	-	-	363.4	3	50.0	55	1
9	76.6	-	201.1	233.0	32.8	-	543.5	4	66.6	28	5
10	-	-	187.8	253.7	82.0	-	523.5	3	50.0	38	4

Table 6B. Water quality suitability of 11 stations in Cirata Reservoir for floating net cage aquaculture development.

Station No.	Deviation intensity, I (%)							Potential constraints		Suitability index ↑ ----- ΣI x C (x 100)	Ranking of stations
	DO	CO <sub>2</sub>	pH	H <sub>2</sub> S	NH <sub>3</sub> -N	NO <sub>2</sub> -N	Total (ΣI)	(C)	(%)		
1	6.7	-	92.1	-	-	-	98.8	2	33.3	304	7
2	11.7	-	93.3	-	-	-	105.0	2	33.3	286	10
3	1.7	-	132.0	-	-	-	133.7	2	33.3	224	11
4	-	-	101.4	-	-	-	101.4	1	16.7	592	3
5	-	-	73.3	-	-	-	73.3	1	16.7	820	1
6	18.3	-	84.1	-	-	-	84.1	2	33.3	293	9
7	21.7	-	77.4	-	-	-	99.1	2	33.3	303	8
8	-	-	118.7	-	-	-	118.7	1	16.7	505	4
9	11.6	-	80.1	-	-	-	91.7	2	33.3	327	6
10	-	-	89.4	-	-	-	89.4	1	16.7	617	2
11	16.7	-	68.0	-	-	-	84.7	2	33.3	355	5

In general the water quality suitability index of the northern sectors of Saguling was lower than the southern sectors. The mouth of Ciminyak River, which now is the predominant center of the Saguling floating net cage aquaculture industry (Rusydi and Lampe, this vol.), actually ranks fifth. It is proposed that the success of the floating net cage systems in this area is thereby not due to better water quality factors, but due to socioeconomic and infrastructural factors. The Bongas village area has inspirational community leaders which have motivated people to take advantage of the new floating net cage developments; and Bongas has a good transportation network that was already well established for agricultural products before the advent of commercially successful floating net cage aquaculture.

Examination of reservoir areas with good water quality suitability indices in Saguling (see Fig. 1) shows that the floating net cages can be more evenly distributed from the crowded Bongas area to other areas which have higher water quality suitability indices, such as the mouth of Cijere River (Station 8), the mouth of Cilang River (Station 6), Karang Anyar (Station 5), and the mouth of Cipatik River (Station 10).

The higher suitability indices in Cirata compared to Saguling were because of urban pollutants from Bandung-Cimahi-Padalarang that enter the Saguling Reservoir and are trapped.

All stations in Cirata are suitable for aquaculture development. However, since at the mouth of Cisokan River much city waste was found, particularly in the rainy season, it is advisable not to develop floating net cage aquaculture in this area. This station had the lowest water quality suitability index in the Cirata Reservoir. The next lowest rank was the mouth of Cilangkap River which receives sewage from Cipeundeuy.

DO and CO<sub>2</sub> show diurnal changes, since they are related to phytoplankton photosynthesis and respiration. Maximum DO is during day and the minimum in the morning just before sunrise. The reverse is true for CO<sub>2</sub>. It is, therefore, important to monitor diurnal DO and CO<sub>2</sub> levels in evaluating the suitability of reservoirs for aquaculture development. A small portion of the data summarized in Appendix 3 was used to determine how diurnal changes affected the water quality suitability indices.

Fig. 4 provides an example of DO and CO<sub>2</sub> at 0600 hours at 0.2 m and 2 m water depths at three cage culture sites in Saguling: Bongas, Awilarangan and Cipondoh. During the monitoring period CO<sub>2</sub> was always below the lethal threshold of 25 mg/l. During the night, however, DOs were above the lethal threshold level, but were mostly below the threshold value for optimum growth, i.e., 75%, 66% and 75% of the total observations at Bongas, Awilarangan and Cipondoh, respectively. (Figure not shown but data in Appendix 3). The lowest DO was found in Bongas. This was possibly due to the fact that the measurements were taken in the water spaces between the floating net cages.

Since at night DOs were often below the threshold value for optimum growth, and fish were stressed, the fish presumably did not attain maximum growth in the three areas. It can be assumed that at other stations similar conditions of DO and CO<sub>2</sub> would be found as at Bongas, Awilarangan and Cipondoh. Our WQSI's were based upon daytime values and can thereby be regarded as conservative.

Because the water quality in Saguling is suboptimal for floating net cage aquaculture, it is recommended to diversify fish culture technology by cultivating the Nile tilapia in addition to the common carp, since this fish can tolerate lower water quality. The northern sectors of Saguling should be allocated for the cultivation of Nile tilapia during the time of seasonal plankton blooms (June to August; see below); while common carp is best grown in the southern sectors, except at the time of plankton blooms.

Massive growth of plankton has occurred periodically in the Saguling and Cirata Reservoirs, with concentrations reaching more than 100 million cells per liter in the Saguling Reservoir (Table 7). Plankton blooms are seasonally dominated by *Peridinium*, *Cylindrotheca*, *Sirogonium* and *Microcystis* (Table 7). In Saguling, plankton peaks occurred from June to August in 1986-1987, but occurred randomly in 1988 during the severe drawdown (Table 8), when *Microcystis* became a larger percentage of the total phytoplankton of Saguling (Table 9).

Fig. 5 provides an example of a massive growth of plankton (a bloom) which occurred at the mouth of Citarum River at Batujajar and at Cihampelas in Saguling. Peak growth was from June to July, which is the dry season in West Java, and was the time of reservoir drawdown. The massive bloom was presumably caused by the concentration of nutrient inputs from sewage, and from water column destratification events (turnovers) due to onset of the Indonesian rainy season (discussed below).

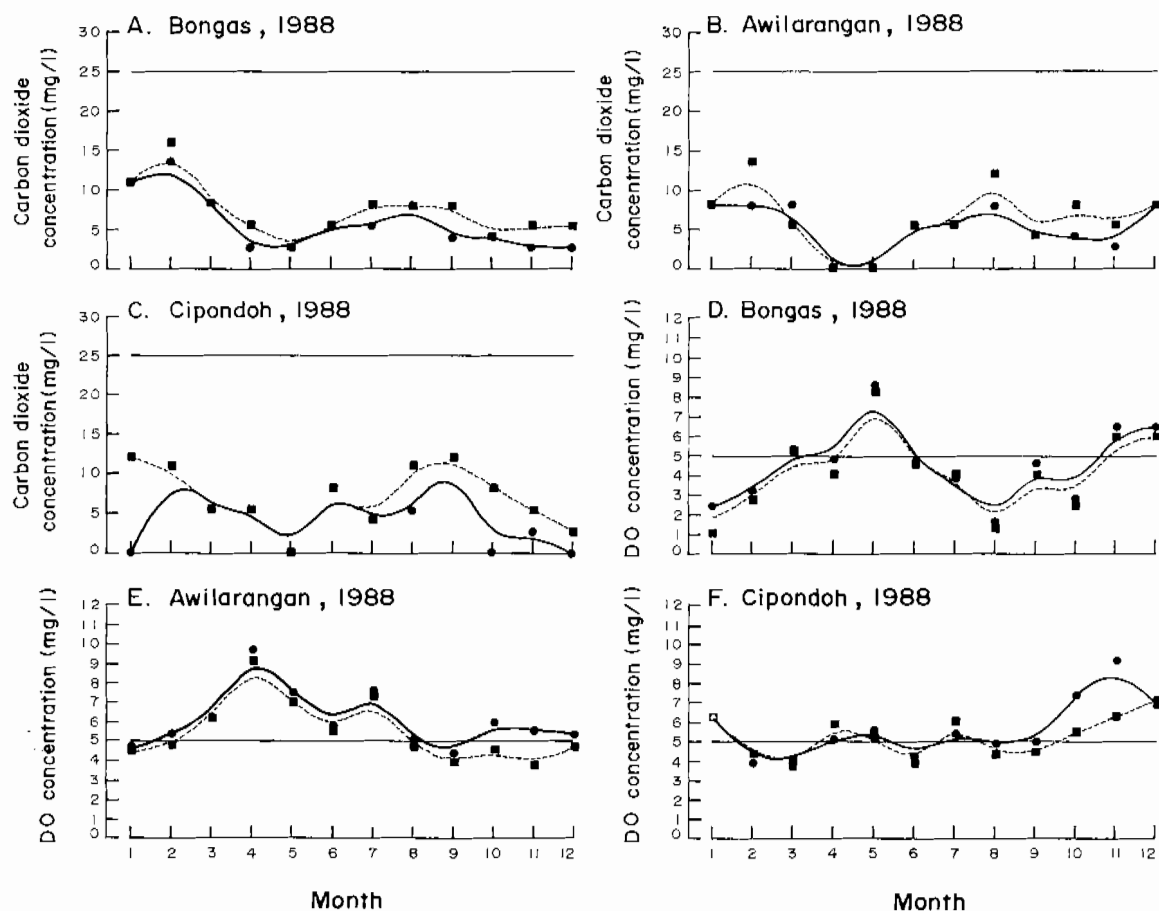

Fig. 4. Early morning (0600 hours) water quality at two depths for three stations in the Saguling Reservoir with significant cage experimental (Awilarangan and Cipondoh) or commercial (Bongas) operations over a 12-month period in 1988. Dashed lines and closed boxes are water quality readings at 2.0 m depth, and the closed circles and dark lines water quality parameters at 0.2 m depth.

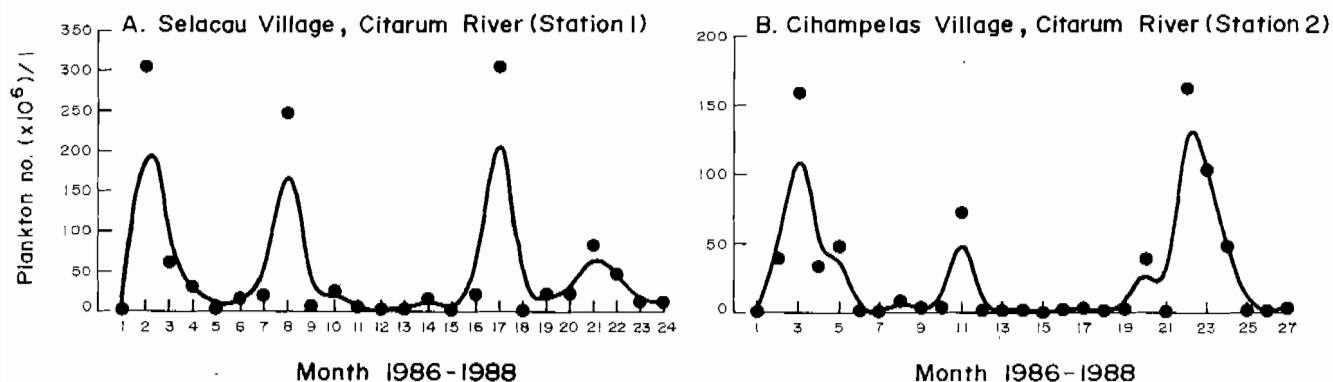

Fig. 5. Total phytoplankton counts at station 1 (Selacau Village) and station 2 (Cihampelas Village) located in the main stream of the Citarum River as it enters the Saguling Reservoir for 24 months [A] and 27 months [B] in 1986-1988. For locations, see Fig. 1.

Table 7. Plankton densities/liter (1,000x) of the dominant plankton observed at two stations in the Saguling Reservoir (sampled at 20 cm water depth in 1988).

Station	Genus	January		February		March		April		May		June	
		Total	%	Total	%	Total	%	Total	%	Total	%	Total	%
3	<u>Phytoplankton:</u>												
	<i>Cylindrotheca</i> sp.	136		15		154		2,675		20,208		64	
	<i>Microcystis</i> sp.	30		36		10		378		240		80	
	<i>Pediastrum</i> sp.	0		0		2		0		0		0	
	<i>Peridinium</i> sp.	782		1,371		63		0		1,449		0	
	<i>Sirogonium</i> sp.	2		3		664		1,227		63		1	
	<i>Staurastrum</i> sp.	146		636		0		4		33		0	
	Total	1,096	94	2,061	97	893	96	4,284	89	21,993	99	145	44
	<u>Zooplankton:</u>												
	<i>Brachionus</i> sp.	45		27		10		499		215		145	
	<i>Cyclops</i> sp.	11		9		10		5		33		27	
	<i>Nauplius</i> sp.	15		27		15		5		67		8	
	<i>Moina</i> sp.	3		9		3		2		12		1	
	Total	74	6	72	3	38	4	511	11	327	1	181	56
	Total plankton	1,170		2,133		931		4,795		22,320		326	
4	<u>Phytoplankton:</u>												
	<i>Cylindrotheca</i> sp.	4		3		3		2,976		12,705		51	
	<i>Microcystis</i> sp.	1		24		129		6		27		2	
	<i>Pediastrum</i> sp.	0		3		3		0		0		0	
	<i>Peridinium</i> sp.	175		72		806		567		360		0	
	<i>Sirogonium</i> sp.	8		3		559		20		39		0	
	<i>Staurastrum</i> sp.	44		96		27		2		27		0	
	Total	232	61	201	38	1,527	90	3,571	99	13,158	96	53	52
	<u>Zooplankton:</u>												
	<i>Brachionus</i> sp.	64		287		0		29		446		42	
	<i>Cyclops</i> sp.	68		15		63		10		19		4	
	<i>Nauplius</i> sp.	10		21		90		6		42		2	
	<i>Moina</i> sp.	5		9		21		3		3		0	
	Total	147	39	332	62	174	10	48	1	510	4	48	48
	Total plankton	379		533		1,701		3,619		13,668		101	



Table 7. (Continued)

Station	Genus	July		August		September		October		November		December	
		Total	%	Total	%	Total	%	Total	%	Total	%	Total	%
3	<u>Phytoplankton:</u>												
	<i>Cylindrotheca</i> sp.	133,830		6,030		13,155		1,410		56		15	
	<i>Microcystis</i> sp.	540		300		25		334		830		898	
	<i>Pediastrum</i> sp.	4		110		10		14		13		9	
	<i>Peridinium</i> sp.	30,240		5,250		4,050		300		22		54	
	<i>Sirogonium</i> sp.	441		9,153		13,695		0		460		2	
	<i>Staurastrum</i> sp.	810		477		525		132		53		48	
	Total	165,865	99.6	21,320	98	31,460	96	2,190	87	1,434	95	1,026	75
	<u>Zooplankton:</u>												
	<i>Brachionus</i> sp.	93		60		630		236		16		291	
	<i>Cyclops</i> sp.	360		150		135		31		16		20	
	<i>Nauplius</i> sp.	180		120		510		42		36		21	
	<i>Moina</i> sp.	0		15		75		18		0		6	
	Total	633	0.4	345	2	1,350	4	327	13	68	5	338	25
	Total plankton	166,498		21,665		32,810		2,517		1,502		1,364	
4	<u>Phytoplankton:</u>												
	<i>Cylindrotheca</i> sp.	7,560		6,720		3,465		981		8		153	
	<i>Microcystis</i> sp.	1		46		500		30		62		37	
	<i>Pediastrum</i> sp.	0		100		0		3		9		0	
	<i>Peridinium</i> sp.	2,970		54,900		11,940		300		143		21	
	<i>Sirogonium</i> sp.	0		880		0		0		776		2	
	<i>Staurastrum</i> sp.	22		80		15		14		18		12	
	Total	10,553	95	62,726	99.5	15,920	98	1,328	90	1,016	93	225	39
	<u>Zooplankton:</u>												
	<i>Brachionus</i> sp.	177		30		150		98		62		195	
	<i>Cyclops</i> sp.	90		120		75		33		10		86	
	<i>Nauplius</i> sp.	270		79		45		17		6		72	
	<i>Moina</i> sp.	6		60		20		0		0		2	
	Total	543	5	289	0.5	290	2	148	10	78	7	355	61
	Total plankton	11,096		63,015		16,210		1,476		1,094		580	

Table 8. Month of maximum plankton concentrations in ten stations of the Saguling Reservoir, 1986 to 1989.

Station No.	Phytoplankton <sup>1</sup>					Zooplankton <sup>2</sup>						
	1986	Number	1987	Number	1988	Number	1986	Number	1987	Number	1988	Number
1	5	30.0	8	24.3	4	1.8	5	351	9	360	10	102
2	6/7	157.0	8	71.5	3	5.4	9	1,065	1	3,414	9	2,241
3	6/7	166.6	8	12.2	10	5.0	9	1,305	8	519	9	747
4	8	61.7	8	7.4	4	3.0	6/7	540	10	372	7	945
5	6/7	30.2	8	19.4	9	0.8	9	1,110	10	852	5	252
6	9	12.3	8	3.1	4	1.5	6/7	1,080	10	398	2	666
7	9	20.8	8	11.3	4/5	0.6	6/7	720	9	249	4/5	738
8	6/7	36.5	8	4.8	9	3.2	6/7	3,120	8	385	4/5	738
9	6/7	124.2	8	36.5	8	6.4	6/7	470	8	751	8	955
10	6/7	8.9	8	4.6	9	0.3	6/7	720	8	1,660	9	2,824
1 to 5	1		0		5		1		1		4	
6 to 8	7		10		1		9		4		2	
9 to 12	2		0		4		0		5		4	

<sup>1</sup>Number of cells of phytoplankton is  $\times 10^6$ /liter.

<sup>2</sup>Number of cells of zooplankton is  $\times 10^3$ /liter.

Massive plankton growth can cause problems of DO depletion at night and the production of ammonia, H<sub>2</sub>S and other toxins. These blooms are also subject to massive and sudden death due to self-shading and nutrient depletion.

However, the high density of plankton could support development of cage culture in Nile tilapia, since the fish can feed on *Microcystis* as its natural food (Moriarty and Moriarty 1973; Costa-Pierce and Hadikusumah, this vol.). The mixed culture or the alternate cultivation of Nile tilapia and common carp can be done in the Saguling Reservoir, especially from May to September during the plankton blooms.

### Lake Stratification and Mixis (Turnovers)

Generally, tropical lakes at high altitudes (1,000 m ASL) are polymictic (Hutchinson 1957; Löffler 1964). Lakes located in the humid tropical lowlands are generally oligomictic, while those small to medium size lakes intermediate in elevation, and located above 100 m ASL, have a possibility for water turnover, or destratification (warm monomictic). At altitudes between 100 and 1,000 m ASL, lake circulation patterns can be intermediate between polymictic and warm monomictic.

Osgood (1988) defined the following formulae for determining the mixing status of lakes, based mainly on temperate lakes:

$$\text{epilimnetic depth } (Z_e) = 3.02A_0^{0.5} + 1.108;$$

$$\text{epilimnetic volume } (V_e) = -7.89\bar{z}/A_0^{0.5} + 108;$$

$$\text{duration of stratification } (T_s) = 17.6\bar{z}/A_0^{0.5} - 5.5.$$

where  $A_0$  is km<sup>2</sup>,  $Z_e$  is m, and  $\bar{z}$  is mean depth in m.

Lewis (1983) defined polymictic lakes as those where:  $\bar{z}/A_0^{0.5} < 3$  and have a  $V_e > 84\%$  and  $T_s < 47$  days, and dimictic lakes as having  $\bar{z}/A_0^{0.5} > 9$ ,  $V_e < 37\%$ ,  $T_s > 153$  days.

Given these formulae, Saguling is a distinctly polymictic lake, since it has a  $\bar{z}/A_0^{0.5} = 2.4$ ,  $V_e = 89\%$ ,  $T_s = 36$  days.

In the humid tropics like Indonesia, small temperature differences between surface and bottom waters are enough to cause stable stratification in small and medium lakes (Ruttner 1931). Saguling has characteristically small temperature differences between surface and

Table 9. Density (cells/liter) (x 1,000) of *Microcystis* in the Saguling Reservoir, 1986 to 1988.

Station	Depth (m)	1986								
		March	May	July	August	September	October	November	December	
1	0.2	0	1,380	0	0	135	0	0	0	
	5.0	18	1,731	0	0	45	0	6	15	
2	0.2	0	1,575	408	0	45	0	9	3	
	5.0	0	567	450	30	15	0	0	15	
3	0.2	0	240	0	0	0	3	3	0	
	5.0	3	0	540	0	30	9	3	0	
4	0.2	129	27	0	0	0	0	0	3	
	5.0	0	15	0	60	0	0	3	0	
5	0.2	366	6	0	0	0	0	3	0	
	5.0	159	6	90	0	0	0	9	15	
6	0.2	78	18	0	0	0	0	0	0	
	5.0	510	3	0	0	0	0	0	0	
7	0.2	3	0	0	0	0	0	0	0	
	5.0	12	3	0	0	0	0	0	0	
8	0.2	15	3	120	0	0	0	0	0	
	5.0	3	0	0	0	0	0	0	0	
9	0.2	0	0	0	0	0	0	0	0	
	5.0	0	3	0	0	0	0	0	0	
10	0.2	9	3	60	0	0	0	0	0	
	5.0	48	0	60	0	0	0	0	0	
Minimum	0.2	0	0	0	0	0	0	0	0	
Maximum		366	1,575	408	0	135	3	9	3	
Mean		60	325	59	0	18	0	2	1	
Minimum		0	0	0	0	0	0	0	0	
Maximum	5.0	510	1,731	540	60	30	9	9	15	
Mean		75	233	114	9	5	1	2	4	

Note: Values are means of 3 months from 1986 to 1989 except for the period Jan. to June when only 2 months were monitored; data from April is one month only.

Table 9. (1987 continued).

Station	Depth (m)	1987								
		January	February	June	August	September	October	November	December	
1	0.2	0	12	8	0	0	2	246	0	
	5.0	3	39	12	0	90	14	120	0	
2	0.2	3	12	21	0	3	10	610	2	
	5.0	0	0	11	0	0	0	1,044	0	
3	0.2	0	12	71	0	0	8	830	0	
	5.0	0	9	23	60	0	10	2,690	0	
4	0.2	0	9	1	0	0	12	12	0	
	5.0	0	0	0	0	0	0	8	0	
5	0.2	0	3	0	0	0	32	14	0	
	5.0	0	8	0	0	0	0	24	0	
6	0.2	3	9	2	20	0	6	0	0	
	5.0	0	9	0	0	0	2	2	0	
7	0.2	0	0	1	0	0	24	2	6	
	5.0	0	0	0	0	0	2	4	0	
8	0.2	0	6	0	0	0	0	2	0	
	5.0	0	78	0	0	0	0	0	0	
9	0.2	0	0	0	0	0	0	4	0	
	5.0	0	0	0	0	0	2	0	0	
10	0.2	0	15	0	0	0	8	14	0	
	5.0	0	3	0	0	3	8	2	0	
Minimum	0.2	0	0	0	0	0	0	0	0	
Maximum		3	15	71	20	3	32	830	6	
Mean		1	8	10	2	0	10	173	1	
Minimum		0	0	0	0	0	0	0	0	
Maximum	5.0	3	78	23	60	90	14	2,690	0	
Mean		0	15	5	6	9	4	389	0	

Table 9. (1988 continued).

Station	Depth (m)	1988											
		January	February	March	April	May	June	July	August	September	October	November	December
1	0.2	0	10	4	5	0	3	33	20	0	44	20	72
	5.0	1	0	10	4	0	38	6	16	28	25	65	26
2	0.2	0	4	1,295	165	506	0	17	102	68	7	45	18
	5.0	0	18	1	60	148	896	8	572	71	45	68	22
3	0.2	20	0	2	378	83	8	1	25	25	334	830	898
	5.0	0	0	0	33	1	1	1	1,082	90	186	269	107
4	0.2	1	0	0	6	11	2	2	46	500	1	62	37
	5.0	1	24	0	0	6	0	0	172	121	9	8	18
5	0.2	652	0	3	1	162	0	0	16	812	110	34	0
	5.0	5	0	4	6	39	0	1	13	106	66	18	0
6	0.2	0	0	0	201	201	2	0	52	927	293	82	0
	5.0	0	0	1	1	1	2	9	56	241	82	78	0
7	0.2	388	0	0	31	31	4	0	1	38	288	24	0
	5.0	1	0	0	20	0	23	0	27	106	56	30	0
8	0.2	2	0	0	71	71	8	0	11	2,486	281	35	0
	5.0	0	0	0	1	1	0	0	99	71	0	30	0
9	0.2	0	219	194	4	18	128	0	487	593	72	35	14
	5.0	1	2	0	2	8	0	0	202	2	0	62	28
10	0.2	0	115	0	217	10	14	0	206	1	1	13	0
	5.0	0	0	0	27	149	5	0	88	142	0	7	0
Minimum	0.2	0	0	0	1	0	0	0	1	0	1	13	0
Maximum		652	219	1,295	378	506	128	33	487	2,486	334	830	898
Mean		106	35	150	108	109	17	5	97	545	143	118	104
Minimum		0	0	0	0	0	0	0	13	2	0	7	0
Maximum	5.0	5	24	10	60	149	896	8	1,082	241	186	269	107
Mean		1	4	2	15	35	97	2	233	106	49	63	19

Table 10. Estimated losses of common carp (*Cyprinus carpio*) in floating net cages due to turnover events in the Saguling Reservoir, 1986-1988.

Date	Location	Estimated Loss (t)
January 1986	Cicalengka Village, Bongas (Southern Sector)	Not recorded
28 September 1987	Cicalengka Village, Bongas (Southern Sector)	1.5
26 November 1987	Cilengkrang Village Bongas (Southern Sector)	6.0
15 December 1987	Cirambai, Warung Awi (Bongas); Leuwinutung (Batulayang) (Southern Sector)	16.0
24 December 1987	Suramanggala (Baranangsiang) (Southern Sector)	< 1.0
18 July 1988	Ugrem, Balong, Warung Awi (Bongas) (Southern Sector)	2.0
10 August 1988	Ugrem, Balong, Warung Awi (Bongas) (Southern Sector)	25.0
5 September 1988	Ugrem, Balong, Warung Awi (Bongas) (Southern Sector)	12.0

bottom waters. During the period of monitoring the surface temperature of Saguling varied between 21.3°C and 32.5°C, and the hypolimnion varied between 20.1°C and 27.0°C (Appendix 3).

Lake turnovers occurred with catastrophic fish mortalities in the cage culture industry in January 1986, September-December 1987, and July-September 1988 in Saguling (Table 10). While the turnovers in 1986 and 1987 were coincident with the onset of the Indonesia rainy season (which was delayed in 1986), turnovers in 1988 also occurred during the cool dry season. This was likely due to the dramatic lowering of Saguling conducted by PLN to fill the new downstream Cirata Reservoir; but could additionally be caused by low nighttime air temperatures during clear days in the dry season or a combination of these factors.

Given these facts it could be assumed that Saguling was a warm polymictic reservoir (turning over irregularly during the onset of the cool, rainy monsoon season), that, due to the unusual drawdown in 1988, combined with a particularly noteworthy cool dry season, turned polymictic in the dry season.

Mixing characteristics in Saguling were, however, much more complex than expected of a regularly-shaped or circular-shaped water body during the "normal" years of 1986-1987. This can be shown by examination of the water temperature profile data in Appendix 3. During these years it was noted that due to the unusual mountainous topography of the region, localized heavy rainfall and thunderstorms could be expected at any season. The unusually dendritic reservoir has many shallow bays with "dish-shaped" bottom contours and a few deep bays with "V-shaped" bottoms. Bays of both types (some bays are intermediate between these two extremes) may be connected or unconnected to streams or small rivers flooded by the reservoir. During periods of localized rains, which were invariably more intense in the mountains surrounding the reservoir, it was observed that river water entering the reservoir from the mountains could be 3-5°C cooler than the surface waters of the reservoir, and that the water was very turbid. During one such event we measured a conductivity of the river water entering

one bay of Saguling of 578  $\mu\text{mhos/cm}$ . The mean conductivity over a three-year period from 1986-1988 was 206  $\mu\text{mhos/cm}$  in Saguling (Appendix 1).

The implication is that river inflows of cool, turbid water caused "density currents" and forced to the surface deoxygenated hypolimnetic waters, causing fish kills. This phenomenon requires further study as no other known reports of such a turnover mechanism in tropical lakes has been found.

It is forecast that during normal operations (15 m drawdown during the dry season) some bays of Saguling could turnover frequently due to lowered water levels; and that Saguling will turnover sometime in the beginning of each wet season in normal years. It is forecast that the new Cirata Reservoir which is located at 222 m ASL would have a stable oligomictic stratification.

### Conclusions and Recommendations

The Saguling Reservoir has an unusual morphometry that would lead to a very high potential for the development of capture and culture fisheries. However, the reservoir ecosystem is currently threatened by sewage pollution from the Bandung-Cimahi-Padalarang urban complex. As a result, Saguling's daytime water quality suitability indices for aquaculture at all 10 stations monitored from 1986 to 1988 were below those for the downstream Cirata Reservoir.

Saguling is acting like "a big filter" for Citarum River water which courses through it going downstream, and enters the Cirata and Jatiluhur Reservoirs.

Saguling is a hypereutrophic reservoir according to definitions given by Barica and Mur (1980). Secchi disk visibilities were less than 170 cm and mean total phosphorus concentrations exceeded 40  $\mu\text{g/l}$ . The reservoir had blooms of green and blue-green algae exceeding 100 million cells/l, and experienced wide fluctuations in physicochemical and biological parameters, especially along the main stream of the former Citarum River basin, causing blooms of aquatic weeds and other environmental nuisances.

Saguling can be classified as a warm polymictic lake experiencing destratification events (turnovers) at the onset of the monsoon season. During the unusual 25 m drawdown and cool dry season in 1988, Saguling became a fully polymictic reservoir, or able to experience a turnover event at any time of the year. The physical limnology of Saguling is, however, extremely complex due to its dendritic shape, low depth ratio, and localized tropical geography and climatology. Certain bays of Saguling may be fully polymictic, while others only warm polymictic.

The Saguling Reservoir is generally suitable for the development of floating net cage aquaculture using the water quality suitability index developed here, although it is not an optimal environment. This is because:

- 1) at night DOs are below the threshold value for optimum growth;
- 2) pH often fluctuates beyond the threshold for optimum growth;
- 3) there are risks of fish mortalities because of toxic substances ( $\text{CO}_2$ ,  $\text{H}_2\text{S}$ ,  $\text{NH}_3\text{-N}$ ,  $\text{NO}_2\text{-N}$ ) which often exceeded lethal thresholds. The risk increases at the time of water column destratification, or turnover, because at that time the intensity of each toxic factor increases. Furthermore, synergistic effects occur among these toxins.

The water quality suitability of the mouth of the Ciminyak River, which has become the center for floating net cage aquaculture, ranks fifth out of the 10 stations in Saguling. While "self-pollution" from the cages does not appear to be a problem at the present time (Costa-Pierce and Roem, this vol.), it is advisable to disperse the floating net cages to other areas which have higher water quality suitabilities than the Ciminyak River. In doing so, ample attention should be given to socioeconomic aspects of dispersal.

Cirata currently has better water quality conditions than Saguling, and all areas monitored were found suitable for floating net cage aquaculture.

Since the water quality conditions of Saguling were found suboptimal, it is recommended to diversify the currently practiced fish culture systems by cultivating Nile tilapia which have higher resistance to adverse water quality, and can consume the abundant natural phytoplankton feed. This fish should primarily be cultivated in the northern sectors of Saguling and at the time of massive plankton growth from June to September. However, during drawdown periods and during the cool dry season (as occurred in 1988), Nile tilapia could be grown anywhere in the reservoir with little additional feed inputs (rice bran only; see Costa-Pierce and Hadikusumah, this vol.). Cultivation of Nile tilapia may also assist to control plankton growth, reducing the production of H<sub>2</sub>S and other toxins at the time the plankton mass dies, thereby lowering the risk of fish mortalities.

It is important to note that the above conclusions are based on monitoring data taken during a 3-year period when the two reservoirs were still unstable, especially Cirata. Therefore, results of the analyses for both reservoirs should be considered tentative. It is recommended to carry out a long-term monitoring program as the basis for further refining and developing an adaptive management plan for the changes that will occur.

## References

- Alabaster, J.S. and R. Lloyd. 1980. Water quality criteria for freshwater fish. FAO, Butterworth, London.
- APHA (American Public Health Association). 1975. Standard methods for the examination of water and wastewater, 12th edition. New York.
- Bardach, J., J. Ryther, and W.O. McLaren. 1972. Aquaculture. J. Wiley and Sons, New York.
- Barica, J. and L.R. Mur, editors. 1980. Hypertrophic systems. Developments in hydrobiology, Volume 2. Dr. W. Junk b.v. Publishers, The Hague.
- Boyd, C.E. 1982. Water quality in warmwater fish ponds. Elsevier Press, The Hague.
- Chervinski, J. 1982. Environmental physiology of tilapia, p. 119-128. In R.S.V. Pullin and R.H. Lowe-McConnell (eds.) The biology and culture of tilapias. ICLARM Conf. Proc. 7. ICLARM, Manila, Philippines.
- Costa-Pierce, B.A., H.Y. Hadikusumah and Y. Dhahiyat. 1989. Tilapia (*Oreochromis* spp.) and carp (*Cyprinus carpio*) production in cage systems in West Java, Indonesia, p. 84-96. In E.A. Huisman, N. Zonneveld and A.H.M. Bouwmans (eds.) Aquacultural research in Asia: management techniques and nutrition. Proceedings of the Asian Seminar on Aquaculture Organized by IFS, Malang, Indonesia. Centre for Agricultural Publishing and Documentation, Pudoc, Wageningen, The Netherlands.
- Hutchinson, G.E. 1957. A treatise on limnology. Vol. 1. Geography, physics and chemistry. Wiley and Sons, Inc., New York.
- IOE (Institute of Ecology). 1979. Environmental impact analysis of the Saguling dam. Final report to Perusahaan Umum Listrik Negara, Jakarta, Indonesia. Main Report. Institute of Ecology, Padjadjaran University, Bandung, Indonesia.
- IOE (Institute of Ecology). 1980. Environmental impact analysis of the Saguling dam. Final report to Perusahaan Umum Listrik Negara, Jakarta, Indonesia. Main Report. Institute of Ecology, Padjadjaran University, Bandung, Indonesia.
- IOE (Institute of Ecology). 1981. Environmental impact analysis of the Saguling dam. Final report to Perusahaan Umum Listrik Negara, Jakarta, Indonesia. Main Report. Institute of Ecology, Padjadjaran University, Bandung, Indonesia.
- Lewis, W.M., Jr. 1983. A revised classification of lakes based on mixing. Can. J. Fish. Aquat. Sci. 40: 1779-1787.
- Löffler, H. 1964. The limnology of tropical high-mountain lakes. Verh. Internat. Verein. Limnol. 15: 176-193.
- Meade, J.W. 1985. Allowable ammonia for fish culture. Prog. Fish.-Cult. 47: 135-145.
- Moriarty, D.J.W. and C.M. Moriarty. 1973. The assimilation of carbon from phytoplankton by two herbivorous fishes: *Tilapia nilotica* and *Haplochromis nigripinnis*. J. Zool. Lond. 171: 41-55.
- Osgood, R.A. 1988. Lake mixing and internal phosphorus dynamics. Arch. Hydrobiol. 113: 629-638.
- PLN. 1986. PLTA Saguling 700 MW. Perusahaan Umum Listrik Negara, Bandung, Indonesia (brochure).
- PLN. 1989. PLTA Cirata 500 MW. Perusahaan Umum Listrik Negara, Bandung, Indonesia (brochure).
- Ruttner, F. 1931. Hydrographische und hydrochemische beobachtungen auf Java, Sumatra und Bali. Arch. Hydrobiol. Suppl. 8: 197-454.
- Sutandar, Z., B.A. Costa-Pierce, Iskandar, Rusydi, and H. Hadikusumah. 1990. The aquaculture resettlement option in the Saguling reservoir, Indonesia: its contribution to an environmentally-oriented hydropower project, p. 253-258. In R. Hirano and I. Hanyu (eds.) The Second Asian Fisheries Forum. 991 p. Asian Fisheries Society, Manila, Philippines.
- Tjahjo, D.W.H. 1986. Ciri-ciri morfologi dan potensi pengembangan perikanan waduk Saguling, Jatiluhur dan Wonogiri. Bull. Penelitian Perikanan 5: 47-55.
- Vollenweider, R.A., editor. 1969. A manual for measuring primary production in aquatic environments. International Biological Programme (IBP), London, 219 p.



## Appendix 1

Water temperature (°C) at 10 stations and two depths in the Saguling Reservoir, 1986.

Station	Water Depth (m)	Jan.	Feb.	Mar.	Apr.	May	June	July	Aug.	Sept.	Oct.	Nov.	Dec.	Min.	Max.	Mean
1	0.2			25.0		28.0		28.0	27.3	27.0	29.0	24.5	29.0	24.5	29.0	26.8
	5.0			25.7		26.8		26.0	25.1	25.6	20.0	25.0	26.4	20.0	26.8	23.4
2	0.2			28.0		29.0		27.5	28.2	27.0	28.0	28.5	29.0	27.0	29.0	28.0
	5.0			26.5		26.6		25.9	26.0	25.8	20.2	24.3	26.0	20.2	26.6	23.4
3	0.2			27.0		28.5		27.0	26.0	27.0	31.5	28.0	30.0	26.0	31.5	28.8
	5.0			26.3		27.7		26.2	25.9	25.8	20.3	25.0	27.1	20.3	27.7	24.0
4	0.2			29.5		25.5		27.0	26.0	27.0	28.0	28.0	28.5	25.5	29.5	27.5
	5.0			26.5		27.1		26.4	25.8	25.9	20.0	26.0	27.2	20.0	27.2	23.6
5	0.2			30.0		25.0		28.0	26.5	27.5	31.0	27.5	26.5	25.0	31.0	28.0
	5.0			26.3		28.6		26.2	25.9	26.2	27.5	27.0	27.1	25.9	28.6	27.3
6	0.2			30.0		30.0		27.5	26.5	26.0	30.0	29.0	29.5	26.0	30.0	28.0
	5.0			26.8		27.8		26.2	25.8	26.2	28.1	27.2	27.4	25.8	28.1	27.0
7	0.2			29.5		29.0		28.0	26.0	27.5	30.0	29.5	28.5	26.0	30.0	28.0
	5.0			27.0		26.9		26.1	25.9	26.0	27.0	26.2	27.4	25.9	27.4	26.7
8	0.2			29.0		29.0		28.0	26.0	29.5	31.0	29.0	29.0	26.0	31.0	28.5
	5.0			26.9		28.0		26.5	25.6	26.0	27.6	27.0	27.4	25.6	28.0	26.8
9	0.2			30.0		29.0		28.5	26.0	27.5	32.0	31.0	30.0	26.0	32.0	29.0
	5.0			27.0		28.3		25.9	25.9	26.0	28.0	26.4	27.8	25.9	28.3	27.1
10	0.2			29.5		28.0		28.5	26.0	28.0	32.5	30.0	28.5	26.0	32.5	29.3
	5.0			27.1		28.5		26.1	25.6	26.5	28.0	27.8	27.8	25.6	28.5	27.1
Minimum	0.2			25.0		25.0		27.0	26.0	26.0	28.0	24.5	26.5	24.5	29.0	26.8
Maximum				30.0		30.0		28.5	28.2	29.5	32.5	31.0	30.0	27.0	32.5	29.3
Mean				27.5		27.5		27.8	27.1	27.8	30.3	27.8	28.3	25.8	30.8	28.3
Minimum	5.0			25.7		26.6		25.9	25.1	25.6	20.0	24.3	26.0	20.0	26.6	20.0
Maximum				27.1		28.6		26.5	26.0	26.5	28.1	27.8	27.8	25.9	28.6	28.6
Mean				26.4		27.6		26.2	25.6	26.1	24.1	26.1	26.9	23.0	27.6	25.3

Water temperature (°C) in the Saguling Reservoir, 1987.

Station	Water Depth (m)	Jan.	Feb.	Mar.	Apr.	May	June	July	Aug.	Sept.	Oct.	Nov.	Dec.	Min.	Max.	Mean
1	0.2	26.0	28.0		26.0			29.5	29.0	29.0	-	26.0	29.0	26.0	29.5	24.7
	5.0	26.0	26.5		26.5			27.5	28.0	28.0	28.0	27.0	-	26.0	28.0	24.2
2	0.2	26.5	27.0		28.0			29.0	28.0	28.0	29.0	27.0	25.5	25.5	29.0	27.6
	5.0	26.5	26.0		27.0			27.5	27.0	27.5	27.5	26.5	24.5	24.5	27.5	26.7
3	0.2	26.0	27.0		28.0			27.5	27.0	28.0	28.5	28.0	26.0	26.0	28.5	27.3
	5.0	26.0	25.0		26.0			27.0	26.0	27.0	26.0	27.0	25.0	25.0	27.0	26.1
4	0.2	26.0	28.0		31.0			28.0	26.0	28.0	28.5	28.5	26.5	26.0	31.0	27.8
	5.0	26.2	25.0		30.0			27.0	26.0	27.0	26.0	27.0	26.0	25.0	30.0	26.7
5	0.2	26.5	28.0		30.5			28.0	26.0	28.0	28.0	28.0	26.0	26.0	30.5	27.7
	5.0	26.0	26.5		29.0			26.5	26.0	27.0	28.5	27.0	25.5	25.5	29.0	26.9
6	0.2	25.5	28.0		29.0			27.0	26.0	27.0	29.0	29.0	26.0	25.5	29.0	27.4
	5.0	26.5	27.5		28.0			27.0	26.0	27.0	27.0	27.0	25.5	25.5	28.0	26.8
7	0.2	26.0	27.0		30.0			27.5	26.0	28.0	30.0	28.5	26.0	26.0	30.0	27.7
	5.0	26.1	26.0		29.0			27.0	26.0	27.0	28.0	26.5	26.0	26.0	29.0	26.8
8	0.2	26.5	29.0		-			29.0	26.0	29.0	31.0	29.5	26.5	26.0	31.0	25.2
	5.0	26.4	27.0		-			27.5	26.0	28.0	30.0	27.5	26.0	26.0	30.0	24.3
9	0.2	27.0	29.0		-			28.0	28.0	27.0	32.0	30.0	26.0	26.0	32.0	25.2
	5.0	26.7	26.5		-			28.0	27.0	29.0	29.5	28.0	24.0	24.0	29.5	24.3
10	0.2	28.1	29.0		-			28.0	27.0	29.0	30.0	29.0	29.0	27.0	30.0	25.5
	5.0	25.9	27.0		-			27.5	27.0	28.6	28.0	28.0	26.0	25.9	28.6	24.2
Minimum	0.2	25.5	27.0		26.0			27.0	26.0	27.0	28.0	27.0	25.5	25.5	28.0	26.6
Maximum		28.1	29.0		31.0			29.5	29.0	29.0	32.0	30.0	29.0	28.1	32.0	29.6
Mean		26.4	28.0		28.9			28.2	26.9	28.1	29.6	28.6	26.4	26.4	29.6	27.9
Minimum	5.0	25.9	25.0		26.0			26.5	26.0	27.0	26.0	26.5	24.0	24.0	27.0	25.9
Maximum		26.7	27.5		30.0			28.0	28.0	29.0	30.0	28.0	26.0	26.0	30.0	28.1
Mean		26.2	26.3		27.9			27.3	26.5	27.6	27.9	27.2	25.4	25.4	27.9	26.9

Water temperature (°C) in the Saguling Reservoir, 1988.

Station	Water Depth (m)	Jan.	Feb.	Mar.	Apr.	May	June	July	Aug.	Sept.	Oct.	Nov.	Dec.	Min.	Max.	Mean
1	0.2	27.0	27.0	25.0	28.5	28.0	27.6	26.5	26.0	25.5	25.7	26.7	27.0	25.0	28.5	26.8
	5.0	26.0	26.0	25.0	27.5	29.0	25.3	26.0	25.4	-	24.1	25.7	25.5	24.1	29.0	26.6
2	0.2	27.0	29.0	28.5	28.0	27.0	29.8	28.0	26.1	28.5	27.0	28.2	27.0	26.1	29.8	28.0
	5.0	26.0	27.0	26.5	26.5	25.5	27.2	26.5	25.0	26.6	24.9	24.9	25.0	24.9	27.2	26.1
3	0.2	28.0	30.0	29.5	26.5	28.5	29.5	28.0	25.8	27.6	27.0	28.0	27.0	25.8	30.0	27.9
	5.0	26.5	26.5	26.0	26.5	27.0	27.8	26.2	25.6	26.2	26.2	25.6	25.0	25.0	27.8	26.4
4	0.2	28.5	31.5	29.5	28.5	29.0	28.8	28.0	26.5	29.4	26.4	29.0	27.5	26.4	31.5	29.0
	5.0	27.0	27.0	27.0	27.0	27.0	27.6	26.5	25.3	26.2	25.9	25.8	26.0	25.3	27.6	26.5
5	0.2	28.5	29.0	29.0	27.5	29.0	29.1	28.0	26.6	28.6	26.0	27.8	27.0	26.0	29.1	27.6
	5.0	26.5	29.0	29.0	26.0	27.0	26.4	26.5	25.9	26.1	26.5	25.5	25.0	25.0	29.0	27.0
6	0.2	28.0	28.0	28.0	28.0	30.5	27.9	28.3	25.0	28.0	26.4	29.1	28.0	25.0	30.5	27.8
	5.0	26.5	25.5	25.5	26.0	27.5	26.4	26.0	25.8	25.7	25.2	25.7	25.0	25.0	27.5	26.3
7	0.2	28.0	29.0	29.0	27.5	30.5	28.9	28.0	26.1	28.0	-	-	-	26.1	30.5	28.3
	5.0	26.5	26.0	26.0	26.0	27.5	26.5	26.0	25.4	25.4	-	-	-	25.4	27.5	26.5
8	0.2	29.5	27.5	27.5	28.0	30.0	29.2	29.5	27.4	27.4	26.6	29.7	29.0	26.6	30.0	28.3
	5.0	26.5	26.5	26.5	25.0	27.0	26.3	26.7	27.0	26.2	25.4	25.9	25.0	25.0	27.0	26.0
9	0.2	29.5	29.0	29.0	29.0	26.5	29.1	29.5	27.2	31.0	-	-	-	26.5	31.0	28.8
	5.0	27.0	26.0	26.0	27.0	26.0	26.4	27.0	25.4	27.0	-	-	-	25.4	27.0	26.2
10	0.2	30.0	32.5	32.5	28.5	29.0	29.4	28.0	26.0	27.0	27.8	28.5	29.0	26.0	32.5	29.3
	5.0	27.0	27.0	27.0	27.0	26.5	26.4	26.0	27.0	26.0	26.4	26.9	26.0	26.0	27.0	26.5
Minimum		27.0	27.0	25.0	26.5	26.5	27.6	26.5	25.0	25.5	25.7	26.7	27.0	25.0	28.5	26.8
Maximum	0.2	30.0	32.5	32.5	29.0	30.5	29.8	29.5	27.4	31.0	27.8	29.7	29.0	26.6	32.5	29.3
Mean		28.5	29.8	28.8	27.8	28.5	28.7	28.0	26.2	28.3	26.8	28.2	28.0	25.8	30.5	28.0
Minimum		26.0	25.5	25.0	25.0	25.5	25.3	26.0	25.0	0.0	24.1	24.9	25.0	24.1	27.0	26.0
Maximum	5.0	27.0	29.0	29.0	27.5	29.0	27.8	27.0	27.0	27.0	26.5	26.9	26.0	26.0	29.0	27.0
Mean		26.5	27.3	27.0	26.3	27.3	26.6	26.5	26.0	13.5	25.3	25.9	25.5	25.1	28.0	26.5

Conductivity (µmhos/cm) in the Saguling Reservoir in 1986.

Station	Water Depth (m)	Jan.	Feb.	Mar.	Apr.	May	June	July	Aug.	Sept.	Oct.	Nov.	Dec.	Min.	Max.	Mean
1	0.2			140		220		225	251	275	250	185	210	140	275	208
	5.0			144		245		240	280	240	249	190	230	144	280	212
2	0.2			150		205		185	250	250	225	250	210	150	250	200
	5.0			144		230		170	240	280	250	180	225	144	280	212
3	0.2			156		182		175	249	250	230	250	220	156	250	203
	5.0			146		200		175	230	280	250	270	215	146	280	213
4	0.2			200		210		190	295	250	245	275	220	190	295	243
	5.0			157		220		230	300	220	340	300	225	157	340	249
5	0.2			169		185		175	220	250	199	225	205	169	250	210
	5.0			149		185		160	205	250	248	251	210	149	251	200
6	0.2			176		190		174	249	210	240	250	220	174	250	212
	5.0			165		150		186	225	230	250	250	240	150	250	200
7	0.2			190		200		175	240	215	245	250	190	175	250	213
	5.0			180		199		175	255	210	252	260	230	175	260	218
8	0.2			180		195		164	230	146	205	225	190	146	230	188
	5.0			167		195		186	230	125	240	240	200	125	240	183
9	0.2			164		175		151	200	142	200	150	180	142	200	171
	5.0			146		150		141	195	130	225	225	180	130	225	178
10	0.2			189		170		149	235	150	235	175	210	149	235	192
	5.0			170		205		169	210	145	260	200	210	145	260	203
Minimum				140		170		149	200	142	199	150	180	140	200	171
Maximum	0.2			200		220		225	295	275	250	275	220	190	295	243
Mean				170		195		187	248	209	225	213	200	165	248	207
Minimum				144		150		141	195	125	225	180	180	125	225	178
Maximum	5.0			180		245		240	300	280	340	300	240	175	340	249
Mean				162		198		191	248	203	283	240	210	150	283	213

Conductivity ( $\mu\text{mhos/cm}$ ) in the Saguling Reservoir in 1987.

Station	Water Depth (m)	Jan.	Feb.	Mar.	July	Aug.	Sept.	Oct.	Nov.	Dec.	Min.	Max.	Mean
1	0.2	175	270		285	292	385	364	315	170	170	385	302
	5.0	172	265		305	310	410	367	374	-	305	410	353
2	0.2	175	305		210	240	350	331	327	180	180	350	273
	5.0	174	300		215	240	347	318	267	155	155	347	257
3	0.2	174	295		185	205	306	285	310	245	185	310	256
	5.0	171	345		190	205	285	283	294	210	190	294	245
4	0.2	201	350		210	210	256	261	303	285	210	303	254
	5.0	201	355		215	215	310	270	273	290	215	310	262
5	0.2	166	325		165	160	208	224	245	240	160	245	207
	5.0	163	325		160	155	192	261	280	245	155	280	216
6	0.2	165	315		185	180	201	223	260	220	180	260	212
	5.0	164	320		185	160	205	276	235	190	160	276	209
7	0.2	197	340		200	220	200	229	276	230	200	276	226
	5.0	194	350		195	212	240	235	270	220	195	270	229
8	0.2	172	300		165	130	170	281	219	190	130	281	193
	5.0	158	300		175	130	174	-	210	175	130	210	173
9	0.2	143	300		165	190	162	171	165	130	130	190	164
	5.0	145	305		170	190	174	189	150	110	110	190	164
10	0.2	157	315		190	195	205	186	266	220	186	266	210
	5.0	162	345		180	180	230	288	285	190	180	288	226
Minimum		143	270		465	130	162	171	165	130	130	190	164
Maximum	0.2	201	350		285	292	385	364	327	285	210	385	302
Mean		173	312		196	202	244	256	269	211	173	287	230
Minimum		145	265		160	130	174	189	150	110	110	190	164
Maximum	0.5	201	355		305	310	410	367	374	291	305	410	353
Mean		170	321		199	200	257	276	264	198	180	288	233

Conductivity ( $\mu\text{mhos/cm}$ ) in the Saguling Reservoir in 1988.

Station	Water Depth (m)	Jan.	Feb.	Mar.	Apr.	May	June	July	Aug.	Sept.	Oct.	Nov.	Dec.	Min.	Max.	Mean
1	0.2	140	70	130	205	138	179	218	400	309	205	229	200	70	400	199
	5.0	139	90	135	80	138	198	223	375	-	204	237	210	80	375	153
2	0.2	130	102	152	200	200	146	234	365	392	258	207	201	102	392	213
	5.0	125	115	130	200	180	159	232	339	405	223	225	211	115	405	209
3	0.2	140	100	135	170	195	154	130	288	315	266	211	200	100	315	181
	5.0	129	105	110	190	190	206	185	282	294	252	233	220	105	294	188
4	0.2	220	125	160	173	195	187	219	272	302	287	319	229	125	302	206
	5.0	220	138	150	218	280	206	223	262	293	268	381	293	138	293	221
5	0.2	150	107	145	153	170	151	140	175	275	225	225	176	107	275	163
	5.0	150	102	100	175	190	153	120	185	254	250	227	182	100	254	159
6	0.2	149	103	140	150	170	150	162	194	217	232	234	198	103	217	159
	5.0	150	102	120	150	165	154	150	192	203	203	249	173	102	203	154
7	0.2	105	105	120	150	170	173	203	213	204	203	213	204	105	213	160
	5.0	170	110	155	155	170	200	220	216	199	220	216	199	110	220	188
8	0.2	155	105	105	140	145	140	140	164	341	178	119	152	105	341	159
	5.0	135	102	95	130	140	157	220	163	207	176	190	148	95	220	150
9	0.2	160	96	100	122	120	118	131	151	152	131	151	152	96	160	128
	5.0	134	98	170	112	115	113	135	164	152	135	164	152	98	170	133
10	0.2	186	90	90	140	150	124	151	160	195	183	205	115	90	195	143
	5.0	182	100	130	130	175	155	222	189	194	179	170	131	100	222	164
Minimum		105	70	90	122	120	118	130	151	152	131	119	115	70	160	128
Maximum	0.2	220	125	160	205	200	187	234	400	392	287	319	229	125	400	213
Mean		163	98	125	164	160	153	182	276	272	209	219	172	98	280	171
Minimum		125	90	95	80	115	113	120	163	152	135	164	131	80	170	133
Maximum	5.0	220	138	170	218	280	206	232	375	405	268	381	293	138	405	221
Mean		173	114	133	149	198	160	176	269	279	202	273	212	109	288	177

Secchi disk visibility (cm) in the Saguling Reservoir in 1986.

Station	Jan.	Feb.	Mar.	Apr.	May	June	July	Aug.	Sept.	Oct.	Nov.	Dec.	Min.	Max.	Mean
1			18		55		86	62	20	47	13	50	13	86	44
2			30		62		156	122	104	69	67	56	30	156	83
3			55		88		450	386	295	109	140	114	55	450	205
4			61		111		126	133	95	67	72	110	61	133	97
5			67		255		285	240	256	152	365	125	67	365	218
6			87		326		345	250	268	195	420	187	87	420	260
7			355		210		280	305	340	150	326	170	150	355	267
8			134		195		145	138	142	150	345	110	110	345	170
9			121		205		186	286	296	112	115	142	112	296	183
10			137		132		210	129	120	105	265	100	100	265	150
Minimum			18		55		86	62	20	47	13	50	13	86	44
Maximum			355		326		450	386	340	195	420	187	150	450	267
Mean			107		164		227	194	194	116	196	116	79	287	168

Secchi disk visibility (cm) in the Saguling Reservoir in 1987.

Station	Jan.	Feb.	Mar.	July	Aug.	Sept.	Oct.	Nov.	Dec.	Min.	Max.	Mean
1	110	60		30	10	18	26	35	17	10	35	23
2	140	120		70	100	86	92	45	50	45	100	74
3	180	130		170	150	95	54	45	50	45	170	94
4	210	100		60	75	83	57	56	50	50	83	64
5	140	150		70	110	143	71	78	56	56	143	88
6	200	190		80	120	128	82	75	64	64	128	92
7	200	140		120	140	96	88	67	74	67	140	98
8	150	120		85	100	128	66	58	40	40	128	80
9	170	170		60	80	67	27	52	58	27	80	57
10	120	200		60	70	53	42	68	40	40	70	56
Minimum	110	60		30	10	18	26	36	17	10	35	23
Maximum	210	200		170	150	143	92	78	74	67	170	98
Mean	162	138		81	96	90	61	58	50	44	108	72

Secchi disk visibility (cm) in the Saguling Reservoir in 1988.

Station	Jan.	Feb.	Mar.	Apr.	May	June	July	Aug.	Sept.	Oct.	Nov.	Dec.	Min.	Max.	Mean
1	12	-	11	82	10	54	32	28	2	45	28	2	2	82	42
2	33	72	55	75	58	40	75	58	82	100	65	82	33	100	67
3	35	65	51	73	50	54	58	56	69	82	70	90	35	90	63
4	25	20	19	50	60	127	96	65	47	64	50	60	19	127	73
5	49	45	53	82	49	73	66	70	44	52	55	80	44	82	63
6	43	50	45	52	55	83	95	55	70	53	55	105	43	105	74
7	65	40	34	48	55	110	120	75	59	-	-	-	34	120	77
8	61	45	25	65	58	87	63	72	50	48	52	70	25	87	56
9	83	40	32	30	52	47	40	62	34	-	-	-	30	83	57
10	62	57	29	27	35	50	52	52	42	50	40	40	27	62	45
Minimum	12	20	11	27	10	40	32	28	2	45	28	2	2	62	32
Maximum	83	72	55	82	60	127	120	75	82	100	70	105	44	127	86
Mean	48	46	33	55	35	84	76	52	42	73	49	54	23	95	59

Settleable solids (mg/liter) in the Saguling Reservoir in 1986.

Station	Water Depth (m)	Jan.	Feb.	Mar.	Apr.	May	June	July	Aug.	Sept.	Oct.	Nov.	Dec.	Min.	Max.	Mean
1	0.2			228		88		172	152	288	108	112	205	88	288	169
	5.0			184		112		200	176	300	232	162	230	112	300	200
2	0.2			154		92		144	132	172	96	124	220	92	220	142
	5.0			112		116		108	116	188	248	184	200	108	248	159
3	0.2			167		88		156	136	116	92	96	185	88	185	130
	5.0			312		96		124	132	164	272	124	230	96	312	182
4	0.2			104		92		196	164	180	112	104	104	92	196	132
	5.0			152		96		144	136	152	208	136	146	96	208	146
5	0.2			100		92		128	120	152	92	96	236	92	236	127
	5.0			52		88		172	148	144	220	116	250	52	250	149
6	0.2			236		60		112	116	108	76	88	102	60	236	112
	5.0			236		76		152	140	140	180	108	106	76	236	142
7	0.2			220		92		120	124	170	44	68	98	44	220	117
	5.0			100		96		156	136	164	212	142	128	96	212	142
8	0.2			176		312		96	104	116	80	72	88	72	312	131
	5.0			188		56		168	152	116	260	132	166	56	260	155
9	0.2			44		48		112	96	120	96	86	140	44	140	93
	5.0			592		56		112	104	128	220	148	182	56	592	193
10	0.2			252		132		168	152	84	340	124	208	84	340	183
	5.0			176		244		156	148	148	212	136	248	136	248	184
Minimum				44		48		96	96	84	44	68	88	44	140	93
Maximum	0.2			252		312		196	164	288	340	124	236	92	340	183
Mean				148		180		146	130	186	192	96	162	68	240	138
Minimum				52		56		108	104	116	180	108	106	52	208	142
Maximum	5.0			592		244		200	176	300	272	184	250	136	592	200
Mean				322		150		154	140	208	226	146	178	94	400	171

Settleable solids (mg/liter) in the Saguling Reservoir in 1987.

Station	Water Depth (m)	Jan.	Feb.	Mar.	July	Aug.	Sept.	Oct.	Nov.	Dec.	Min.	Max.	Mean
1	0.2	64	128		196	120	1,524	212	172	232	64	1,524	794
	5.0	184	240		184	116	4,184	80	640	-	80	4,184	2,132
2	0.2	52	36		120	96	64	192	20	172	20	192	106
	5.0	52	32		80	96	80	108	212	176	32	212	122
3	0.2	64	36		40	80	80	176	148	260	36	260	148
	5.0	96	40		60	80	64	80	1,044	168	40	1,044	542
4	0.2	104	44		32	80	56	152	176	204	32	204	118
	5.0	136	24		52	80	56	64	212	252	24	252	138
5	0.2	100	-		40	76	56	112	140	216	40	216	128
	5.0	80	-		56	84	40	84	228	192	40	228	134
6	0.2	104	-		36	72	28	124	104	180	28	180	104
	5.0	96	4		40	71	36	172	249	144	4	249	127
7	0.2	108	8		44	76	32	96	148	176	8	176	92
	5.0	92	8		44	71	40	16	396	184	8	396	202
8	0.2	80	28		36	60	20	132	120	180	20	180	100
	5.0	84	-		40	60	24	-	100	208	24	208	116
9	0.2	96	96		32	80	40	40	140	116	32	140	86
	5.0	92	96		36	60	28	80	64	172	28	172	100
10	0.2	108	92		32	90	36	80	84	180	32	180	106
	5.0	84	-		36	64	32	84	324	272	32	324	178
Minimum		52	8		32	60	20	40	20	116	8	140	86
Maximum	0.2	108	128		196	120	1,524	212	176	260	64	1,524	794
Mean		80	68		114	90	772	126	98	188	36	832	440
Minimum		52	4		36	60	24	16	64	144	4	172	100
Maximum	0.5	184	240		184	116	4,184	172	1,044	272	80	4,184	2,132
Mean		118	122		63	78	458	85	347	196	45	727	219

Settleable solids (mg/liter) in the Saguling Reservoir in 1988.

Station	Water Depth (m)	Jan.	Feb.	Mar.	Apr.	May	June	July	Aug.	Sept.	Oct.	Nov.	Dec.	Min.	Max.	Mean
1	0.2	320	72	200	352	436	176	436	425	425	425	420	425	72	436	254
	5.0	296	152	164	203	620	420	439	430	-	428	430	504	152	620	386
2	0.2	180	140	152	416	308	284	308	300	300	347	300	300	140	416	278
	5.0	320	116	132	96	364	416	344	320	305	348	320	305	96	416	256
3	0.2	208	128	180	308	512	316	212	310	200	415	310	200	128	512	320
	5.0	240	160	144	164	412	292	314	315	212	430	315	212	144	430	287
4	0.2	252	152	64	408	344	256	212	208	270	315	315	270	64	408	236
	5.0	148	152	164	320	512	404	312	230	320	320	320	320	148	512	330
5	0.2	164	92	24	296	308	224	344	240	315	350	350	315	24	350	187
	5.0	320	-	24	388	308	448	368	290	310	375	290	310	24	448	236
6	0.2	160	116	116	152	348	356	308	-	300	325	285	300	116	356	236
	5.0	204	144	72	460	304	388	340	300	235	340	345	235	72	460	266
7	0.2	128	188	54	356	212	824	212	220	210	212	220	210	54	824	439
	5.0	152	104	164	348	312	400	312	250	325	312	250	325	104	400	252
8	0.2	84	156	136	340	328	356	328	205	300	290	205	300	84	356	220
	5.0	232	108	176	372	252	320	382	220	212	300	290	212	108	382	245
9	0.2	104	116	136	344	240	376	240	250	205	240	250	205	104	376	240
	5.0	100	148	104	292	368	424	364	300	260	364	300	260	100	424	262
10	0.2	120	144	132	308	364	308	304	302	205	365	302	205	120	365	243
	5.0	176	116	108	392	364	424	300	330	280	375	365	280	108	424	266
Minimum		84	72	24	152	212	176	212	205	200	212	205	200	24	350	187
Maximum	0.2	320	188	200	416	512	824	436	425	425	425	420	425	140	824	439
Mean		202	130	112	284	362	500	324	315	313	319	313	313	82	587	313
Minimum		100	104	24	96	252	292	300	220	212	300	250	212	24	382	236
Maximum	5.0	320	160	176	460	620	448	439	430	325	430	430	504	152	620	386
Mean		210	132	100	278	436	370	370	325	269	365	340	358	88	501	311

Dissolved oxygen (mg/liter) in the Saguling Reservoir in 1986.

Station	Water Depth (m)	Dissolved oxygen (mg/liter) in the Saguling Reservoir in 1986.												Min.	Max.	Mean
		Jan.	Feb.	Mar.	Apr.	May	June	July	Aug.	Sept.	Oct.	Nov.	Dec.			
1	0.2			8.4		14.6		10.7	11.1	5.8	8.3	8.6	9.2	5.8	14.6	9.6
	5.0			7.1		5.8		5.0	3.9	5.0	7.8	6.9	5.5	3.9	7.8	5.9
2	0.2			10.4		13.1		8.8	11.1	10.8	9.9	9.7	10.6	8.8	13.1	10.6
	5.0			4.7		2.1		1.8	5.0	1.8	4.7	5.9	5.7	1.8	5.9	4.0
3	0.2			7.9		9.2		8.3	8.1	8.5	9.4	8.5	8.4	7.9	9.4	8.5
	5.0			5.8		5.5		2.8	6.2	2.0	6.0	5.2	5.5	2.0	6.2	4.9
4	0.2			8.3		7.3		9.1	9.1	8.2	7.3	7.5	7.3	7.3	9.1	8.0
	5.0			3.1		1.0		1.6	3.1	1.9	2.1	2.1	4.8	1.0	4.8	2.5
5	0.2			11.0		6.9		7.9	8.0	8.0	7.8	7.9	7.0	6.9	11.0	8.1
	5.0			4.7		6.8		1.5	6.3	2.2	7.8	5.1	5.1	1.5	7.8	4.9
6	0.2			9.9		7.1		7.3	8.8	7.5	7.6	9.7	6.3	6.3	9.9	8.0
	5.0			4.0		6.8		5.5	4.7	1.8	7.0	1.5	4.6	1.5	7.0	4.5
7	0.2			7.5		7.5		8.8	9.6	6.7	8.1	8.5	6.6	6.6	9.6	7.9
	5.0			1.3		5.5		3.7	3.4	1.6	3.9	2.8	4.1	1.3	5.5	3.3
8	0.2			7.5		6.8		6.7	7.8	7.5	7.1	9.6	8.2	6.7	9.6	7.7
	5.0			2.9		1.9		3.4	7.6	1.5	3.9	1.7	3.7	1.5	7.6	3.3
9	0.2			10.7		6.7		6.3	7.6	8.7	7.8	10.0	6.3	6.3	10.7	8.0
	5.0			10.2		3.1		5.8	1.5	1.8	3.1	2.9	4.3	1.5	10.2	4.1
10	0.2			7.8		7.5		7.0	7.0	9.0	9.1	9.7	7.2	7.0	9.7	8.0
	5.0			4.2		2.9		5.2	1.3	1.3	3.4	2.0	4.9	1.3	5.2	3.2
Minimum				7.5		6.7		6.3	7.0	5.8	7.1	7.5	6.3	5.8	9.1	7.7
Maximum	0.2			11.0		14.6		10.7	11.1	10.8	9.9	10.0	10.6	8.8	14.6	10.6
Mean				8.9		8.7		8.1	8.8	8.1	8.2	9.0	7.7	7.0	10.7	8.4
Minimum				1.3		1.0		1.5	1.3	1.3	2.1	1.5	3.7	1.0	4.8	2.5
Maximum	5.0			10.2		6.8		5.8	6.3	5.0	7.8	6.9	5.7	3.9	10.2	5.9
Mean				4.8		4.1		3.6	4.3	2.1	5.0	3.6	4.8	1.7	6.8	4.0

Dissolved oxygen (mg/liter) in the Saguling Reservoir in 1987.

Station	Water Depth (m)	Dissolved oxygen (mg/liter) in the Saguling Reservoir in 1987.												Min.	Max.	Mean
		Jan.	Feb.	Mar.	Apr.	May	June	July	Aug.	Sept.	Oct.	Nov.	Dec.			
1	0.2	6.5	11.2		2.0			3.6	1.9	5.5	7.6	7.6	8.0	1.9	11.2	6.0
	5.0	5.8	8.5		3.2			3.1	1.4	1.6	2.9	6.0	-	1.4	8.5	3.6
2	0.2	5.8	10.5		1.8			7.9	5.6	5.8	7.2	8.5	3.8	1.8	10.5	6.3
	5.0	5.0	5.4		1.8			5.3	4.7	5.2	6.8	5.0	4.2	1.8	6.8	4.8
3	0.2	7.0	9.9		2.4			8.2	6.4	6.5	10.6	10.6	5.4	2.4	10.6	7.4
	5.0	6.8	4.3		2.2			9.3	5.4	7.9	5.7	3.3	4.2	2.2	9.3	5.5
4	0.2	5.0	8.6		2.8			7.1	5.3	7.6	9.8	8.7	6.4	2.8	9.8	6.8
	5.0	4.0	4.1		2.2			5.3	4.7	2.4	3.4	4.0	3.0	2.2	5.3	3.7
5	0.2	6.5	5.7		1.6			6.7	4.7	10.8	9.3	9.6	6.0	1.6	10.8	6.8
	5.0	5.3	3.5		1.8			5.4	4.7	7.9	6.2	3.3	2.8	1.8	7.9	4.5
6	0.2	7.5	6.7		7.0			11.0	7.2	7.1	9.9	9.3	6.8	6.7	11.0	8.1
	5.0	8.1	5.6		7.8			9.0	6.1	2.6	2.3	3.0	3.4	2.3	9.0	5.3
7	0.2	8.4	8.5		6.8			7.4	5.3	7.7	7.6	8.0	8.2	5.3	8.5	7.5
	5.0	6.8	3.2		7.2			5.7	5.1	1.6	7.6	3.7	3.2	1.6	7.6	4.9
8	0.2	8.1	7.8		-			7.7	7.6	7.1	5.9	8.7	8.4	5.9	8.7	6.8
	5.0	6.2	4.3		-			1.7	4.4	3.9	5.9	3.9	5.4	1.7	6.2	4.0
9	0.2	6.6	7.2		-			9.9	8.6	7.7	8.6	8.4	8.8	6.6	9.9	7.3
	5.0	1.6	5.9		-			7.0	1.4	5.9	7.7	4.2	7.4	1.4	7.7	4.6
10	0.2	6.5	8.0		-			9.6	9.4	9.1	9.2	8.3	9.3	6.5	9.6	7.7
	5.0	6.2	3.0		-			7.5	4.4	5.5	4.1	4.1	6.1	3.0	7.5	4.5
Minimum		5.0	5.7		1.6			3.6	1.9	5.5	5.9	7.6	3.8	1.6	8.5	6.0
Maximum	0.2	8.4	11.2		7.0			11.0	9.4	10.8	10.6	10.6	9.3	6.7	11.2	8.1
Mean		6.8	8.4		3.5			7.9	6.2	7.5	8.6	8.8	7.1	4.2	10.1	7.1
Minimum		1.6	3.0		1.8			1.7	1.4	1.6	2.3	3.0	2.8	1.4	5.3	3.6
Maximum	5.0	8.1	8.5		7.8			9.3	6.1	7.9	7.7	6.0	7.4	3.0	9.3	5.5
Mean		5.6	4.8		3.7			5.9	4.2	4.5	5.3	4.1	4.0	1.9	7.6	4.5

Dissolved oxygen (mg/liter) in the Saguling Reservoir in 1988.

Station	Water Depth (m)	Jan.	Feb.	Mar.	Apr.	May	June	July	Aug.	Sept.	Oct.	Nov.	Dec.	Min.	Max.	Mean
1	0.2	7.5	3.6	8.3	2.3	5.0	9.8	2.5	0.4	3.6	5.5	8.2	9.6	0.4	9.8	4.8
	5.0	6.0	5.3	8.0	5.5	5.0	3.4	3.4	0.9	-	5.5	6.1	4.7	0.9	8.0	4.2
2	0.2	4.6	13.0	8.8	10.5	8.8	11.6	4.9	4.1	9.0	6.5	10.8	10.0	4.1	13.0	8.4
	5.0	4.9	6.8	5.8	2.3	4.8	5.1	4.9	3.2	4.3	4.0	6.2	4.7	2.3	6.8	4.7
3	0.2	15.0	11.8	13.0	9.9	11.4	9.4	7.7	6.9	8.0	7.0	9.2	8.9	6.9	15.0	10.3
	5.0	6.0	7.0	5.5	2.8	5.9	9.2	7.4	7.2	4.0	1.0	2.3	3.8	2.8	9.2	6.1
4	0.2	9.1	14.6	9.0	8.2	8.2	7.3	9.3	7.4	9.0	7.2	8.4	9.7	7.3	14.6	9.1
	5.0	4.0	3.0	2.0	2.3	1.8	4.8	3.4	4.1	2.6	2.6	1.9	2.8	1.8	4.8	3.1
5	0.2	9.9	10.0	11.4	9.1	10.0	7.0	6.8	7.2	10.2	7.6	6.1	7.7	6.8	11.4	9.1
	5.0	7.0	7.0	11.4	2.7	4.8	5.8	5.8	6.1	6.0	2.9	1.7	2.1	2.7	11.4	6.3
6	0.2	9.2	11.7	11.0	8.8	10.0	7.3	8.3	6.4	8.1	7.7	10.5	8.0	6.4	11.7	9.0
	5.0	5.6	4.6	1.9	3.8	5.2	4.0	5.2	5.2	4.1	0.8	1.6	2.0	1.9	5.6	4.4
7	0.2	8.4	11.8	12.2	8.1	9.8	6.7	6.8	6.7	7.5	6.8	6.7	7.5	6.7	12.2	8.7
	5.0	3.7	6.6	5.4	4.6	2.8	3.0	4.5	6.6	4.0	4.5	6.6	4.0	2.8	6.6	4.6
8	0.2	10.6	11.3	7.2	9.0	8.4	6.8	7.8	8.1	8.5	7.4	7.3	8.8	6.8	11.3	8.6
	5.0	5.6	4.2	6.2	2.3	4.4	2.7	6.6	2.9	3.8	0.5	2.5	4.4	2.3	6.6	4.3
9	0.2	6.8	10.0	11.1	9.2	8.8	8.6	10.1	7.5	5.8	10.1	7.5	5.8	5.8	11.1	8.7
	5.0	3.4	6.4	6.9	5.6	4.7	2.9	5.4	1.3	4.3	5.4	1.3	4.3	1.3	6.9	4.5
10	0.2	8.0	10.8	9.5	9.0	8.6	10.2	8.1	6.5	6.7	6.3	8.5	10.3	6.5	10.8	8.6
	5.0	3.8	3.6	6.8	5.3	6.2	2.0	3.4	4.4	5.2	1.4	3.0	3.0	2.0	6.8	4.5
Minimum		4.6	3.6	7.2	2.3	5.0	6.7	2.5	0.4	3.6	5.5	6.1	5.8	0.4	9.8	4.8
Maximum	0.2	15.0	14.6	13.0	10.5	11.4	11.6	10.1	8.1	10.2	10.1	10.8	10.3	7.3	15.0	10.3
Mean		8.9	10.9	10.2	8.4	8.9	8.5	7.2	6.1	7.6	7.2	8.3	8.6	5.8	12.1	8.5
Minimum		3.4	3.0	1.9	2.3	1.8	2.0	3.4	0.9	2.6	0.5	1.3	2.0	0.9	4.8	3.1
Maximum	5.0	7.0	7.0	11.4	5.6	6.2	9.2	7.4	7.2	6.0	5.4	6.6	4.7	2.8	11.4	6.3
Mean		5.0	5.5	6.0	3.7	4.6	4.3	5.0	4.2	4.3	2.6	3.0	3.5	2.1	7.3	4.7

pH in the Saguling Reservoir in 1986.

Station	Water Depth (m)	Jan.	Feb.	Mar.	Apr.	May	June	July	Aug.	Sept.	Oct.	Nov.	Dec.	Min.	Max.	Mean
1	0.2			7.1		8.4		8.0	7.5	7.2	6.8	7.2	9.0	6.8	9.0	7.7
	5.0			7.1		7.4		6.8	6.7	7.2	5.9	7.6	7.9	5.9	7.9	7.1
2	0.2			7.2		8.9		7.9	7.3	7.7	7.9	8.0	9.1	7.2	9.1	8.0
	5.0			7.1		7.3		6.5	6.1	6.9	6.4	7.4	7.8	6.1	7.8	6.9
3	0.2			7.4		8.6		7.9	6.9	7.7	7.9	7.0	8.4	6.9	8.6	7.7
	5.0			7.2		8.3		7.3	6.6	7.3	7.1	7.5	7.6	6.6	8.3	7.4
4	0.2			7.4		8.5		7.9	7.2	7.9	7.1	6.8	8.3	6.8	8.5	7.6
	5.0			7.1		7.6		6.8	6.7	7.4	6.5	7.8	7.6	6.5	7.8	7.2
5	0.2			8.0		8.0		7.8	7.2	7.7	7.4	6.3	8.3	6.3	8.3	7.6
	5.0			7.2		7.7		6.6	6.7	7.4	6.9	6.2	7.7	6.2	7.7	7.1
6	0.2			8.1		7.8		7.6	8.0	7.7	8.2	7.9	8.1	7.6	8.2	7.9
	5.0			7.3		8.1		7.1	7.3	7.0	-	7.5	7.3	7.0	8.1	6.5
7	0.2			8.2		8.3		7.7	8.4	7.6	-	7.2	8.5	7.2	8.5	7.0
	5.0			7.4		7.9		7.5	7.4	6.9	-	7.4	7.7	6.9	7.9	6.5
8	0.2			8.0		8.0		7.6	7.4	8.0	6.8	7.9	8.5	6.8	8.5	7.8
	5.0			7.4		7.4		6.8	6.9	7.4	6.5	6.9	7.8	6.5	7.8	7.1
9	0.2			8.4		8.0		7.3	8.2	8.3	7.7	7.2	8.7	7.2	8.7	8.0
	5.0			8.0		7.7		7.0	7.0	7.4	6.7	7.6	8.0	6.7	8.0	7.4
10	0.2			8.0		8.2		7.5	7.3	8.1	7.6	7.1	8.5	7.1	8.5	7.8
	5.0			7.4		7.4		6.7	6.5	7.4	6.5	7.8	7.9	6.5	7.9	7.2
Minimum				7.1		7.8		7.3	6.9	7.2	6.8	6.3	8.1	6.3	8.2	7.0
Maximum	0.2			8.4		8.9		8.0	8.4	8.3	8.2	8.0	9.1	7.6	9.1	8.0
Mean				7.8		8.4		7.7	7.7	7.8	7.5	7.2	8.6	7.0	8.7	7.5
Minimum				7.1		7.3		6.5	6.1	6.9	5.9	6.2	7.3	5.9	7.7	6.5
Maximum	5.0			8.0		8.3		7.5	7.4	7.4	7.1	7.8	8.0	7.0	8.3	7.4
Mean				7.6		7.8		7.0	6.8	7.2	6.5	7.0	7.7	6.5	8.0	6.9



pH in the Saguling Reservoir in 1987.

Station	Water Depth (m)	Jan.	Feb.	Mar.	Apr.	May	June	July	Aug.	Sept.	Oct.	Nov.	Dec.	Min.	Max.	Mean
1	0.2	7.0	7.1					7.4	7.2	7.2	7.4	7.9	7.5	7.2	7.9	7.4
	5.0	7.0	7.1					7.1	6.8	7.0	7.3	7.8	-	6.8	7.8	6.0
2	0.2	7.0	7.2					7.6	7.1	7.3	7.6	8.1	8.1	7.1	8.1	7.6
	5.0	7.0	7.0					7.5	7.0	7.4	7.3	7.4	8.0	7.0	8.0	7.4
3	0.2	7.0	7.2					7.8	7.2	7.5	7.6	9.3	8.0	7.2	9.3	7.9
	5.0	7.0	7.0					7.8	7.2	7.6	7.4	7.6	7.7	7.2	7.8	7.6
4	0.2	7.0	7.3					7.9	7.2	7.9	7.8	9.2	8.0	7.2	9.2	8.0
	5.0	7.0	7.1					7.6	7.2	7.4	7.2	7.6	7.8	7.2	7.8	7.5
5	0.2	7.0	6.5					7.9	7.3	7.8	7.7	9.4	8.0	7.3	9.4	8.0
	5.0	7.0	6.6					7.7	7.2	7.6	7.4	7.6	7.7	7.2	7.7	7.5
6	0.2	6.5	7.0					8.3	7.5	7.9	7.8	9.5	7.9	7.5	9.5	8.2
	5.0	6.5	7.1					8.1	7.4	7.6	7.4	7.4	7.6	7.4	8.1	7.6
7	0.2	6.0	7.7					8.3	7.2	8.3	7.9	9.0	7.7	7.2	9.0	8.1
	5.0	6.0	7.0					8.0	7.1	7.9	7.5	7.7	7.8	7.1	8.0	7.7
8	0.2	6.8	8.1					8.3	7.1	8.0	7.1	8.8	7.8	7.1	8.8	7.9
	5.0	6.5	6.9					7.2	6.9	7.7	7.1	7.3	7.7	6.9	7.7	7.3
9	0.2	7.0	7.5					7.6	7.5	7.9	7.5	8.5	8.2	7.5	8.5	7.9
	5.0	7.0	6.9					7.2	6.7	7.7	7.4	7.4	8.0	6.7	8.0	7.4
10	0.2	7.0	7.4					7.8	7.6	7.8	7.7	-	7.8	7.6	7.8	6.5
	5.0	7.0	6.9					7.4	7.2	7.6	7.4	7.5	7.5	7.2	7.6	7.4
Minimum		6.0	6.5					7.4	7.1	7.2	7.1	7.9	7.5	7.1	7.8	6.5
Maximum	0.2	7.0	8.1					8.3	7.6	8.3	7.9	9.5	8.2	7.6	9.5	8.2
Mean		6.5	7.3					7.9	7.4	7.8	7.5	8.7	7.9	7.4	8.7	7.3
Minimum		6.0	6.6					7.1	6.7	7.0	7.1	7.3	7.5	6.7	7.6	6.0
Maximum	5.0	7.0	7.1					8.1	7.4	7.9	7.5	7.8	8.0	7.4	8.1	7.7
Mean		6.5	6.9					7.6	7.1	7.5	7.3	7.6	7.8	7.1	7.9	6.8

pH in the Saguling Reservoir in 1988.

Station	Water Depth (m)	Jan.	Feb.	Mar.	Apr.	May	June	July	Aug.	Sept.	Oct.	Nov.	Dec.	Min.	Max.	Mean
1	0.2	6.6	7.8	6.9	7.4	8.8	8.1	7.0	6.3	6.7	6.8	7.4	7.6	6.3	8.8	7.3
	5.0	6.8	8.0	6.9	7.8	9.2	6.7	7.3	6.7	-	6.8	6.9	7.2	6.7	9.2	6.6
2	0.2	6.9	8.4	6.9	8.4	9.4	8.1	7.3	6.7	7.6	7.2	8.2	8.4	6.7	9.4	7.8
	5.0	7.1	7.3	7.0	7.2	8.7	6.4	7.4	6.8	6.9	6.8	7.0	7.5	6.4	8.7	7.2
3	0.2	7.2	9.0	7.1	8.5	10.0	8.2	8.3	6.7	7.8	7.5	8.1	8.3	6.7	10.0	8.1
	5.0	7.1	7.9	7.1	7.0	8.8	8.8	7.9	6.8	6.9	6.9	6.9	7.6	6.8	8.8	7.5
4	0.2	7.1	9.1	7.3	8.7	9.9	7.7	8.1	6.7	8.4	8.0	8.3	9.0	6.7	9.9	8.2
	5.0	7.1	7.9	6.7	8.2	9.2	7.1	7.5	6.7	6.8	7.4	7.8	7.8	6.7	9.2	7.5
5	0.2	7.5	8.5	7.2	8.9	8.8	8.0	7.8	7.0	8.5	8.5	7.1	7.8	7.0	8.9	8.0
	5.0	7.0	7.4	7.2	7.8	8.3	7.2	7.7	6.7	7.7	7.1	6.4	7.3	6.4	8.3	7.3
6	0.2	8.0	8.8	7.3	9.0	9.4	8.7	8.3	7.0	8.3	8.6	8.1	8.3	7.0	9.4	8.3
	5.0	7.3	7.4	7.1	7.5	8.8	7.5	7.3	6.8	6.9	7.1	6.8	7.6	6.8	8.8	7.3
7	0.2	7.9	8.7	7.3	9.2	9.4	8.5	8.0	7.0	8.2	8.0	7.1	8.2	7.0	9.4	8.1
	5.0	7.3	7.5	7.1	7.3	8.3	7.3	7.3	6.8	7.6	7.3	6.8	7.6	6.8	8.3	7.3
8	0.2	8.3	8.5	5.0	8.4	9.5	8.1	7.7	7.0	8.2	8.5	7.7	8.4	5.0	9.5	7.9
	5.0	7.6	7.5	6.8	7.6	8.8	6.8	7.3	6.7	6.9	7.2	6.8	7.1	6.7	8.8	7.2
9	0.2	7.2	8.5	7.1	9.1	9.5	9.0	8.3	7.0	7.7	8.3	7.0	7.7	7.0	9.5	8.1
	5.0	7.0	8.1	7.1	8.4	8.9	7.2	7.2	6.6	6.6	7.2	6.6	6.6	6.6	8.9	7.2
10	0.2	7.2	8.1	6.9	8.8	10.1	8.5	7.8	7.4	7.2	8.3	7.9	9.1	6.9	10.1	8.2
	5.0	6.8	7.0	6.9	7.8	9.1	7.0	7.1	7.3	7.6	7.2	6.4	7.7	6.4	9.1	7.4
Minimum		6.6	7.8	5.0	7.4	8.8	7.7	7.0	6.3	6.7	6.8	7.0	7.6	5.0	8.8	7.3
Maximum	0.2	8.3	9.1	7.3	9.2	10.1	9.0	8.3	7.4	8.5	8.6	8.3	9.1	7.0	10.1	8.3
Mean		7.5	8.5	6.2	8.3	9.5	8.4	7.7	6.9	7.6	7.7	7.7	8.4	6.0	9.5	7.8
Minimum		6.8	7.0	6.7	7.0	8.3	6.4	7.1	6.6	6.6	6.8	6.4	6.6	6.4	8.3	6.6
Maximum	5.0	7.6	8.1	7.2	8.4	9.2	8.8	7.9	7.3	7.7	7.4	7.8	7.8	6.8	9.2	7.5
Mean		7.2	7.6	7.0	7.7	8.8	7.6	7.5	7.0	7.2	7.1	7.1	7.2	6.6	8.8	7.0

Alkalinity (mg/liter) in the Saguling Reservoir in 1986.

Station	Water Depth (m)	Jan.	Feb.	Mar.	Apr.	May	June	July	Aug.	Sept.	Oct.	Nov.	Dec.	Min.	Max.	Mean
1	0.2			72.1		44.3		94.2	77.6	94.2	127.4	60.9	66.5	44.3	127.4	85.9
	5.0			61.0		33.2		38.8	72.0	121.9	160.7	44.3	77.6	33.2	160.7	97.0
2	0.2			66.5		49.9		88.6	83.1	116.3	138.5	72.0	49.9	49.9	138.5	94.2
	5.0			72.1		55.5		83.1	88.6	110.9	132.9	49.9	66.5	49.9	132.9	91.4
3	0.2			66.5		66.5		88.6	94.2	116.3	138.5	83.1	72.0	66.5	138.5	102.5
	5.0			66.5		60.9		72.0	94.2	127.4	127.4	77.6	60.9	60.9	127.4	94.2
4	0.2			44.4		88.5		99.7	99.7	132.9	155.1	88.6	77.6	44.4	155.1	99.8
	5.0			38.8		66.5		94.2	105.3	121.9	188.4	83.1	88.6	38.8	188.4	113.6
5	0.2			49.9		77.6		88.6	88.6	105.3	110.8	60.9	72.0	49.9	110.8	80.4
	5.0			33.3		44.3		88.6	83.1	99.7	94.2	72.0	66.5	33.3	99.7	66.5
6	0.2			55.5		38.8		77.6	88.6	99.7	116.3	66.5	60.9	38.8	116.3	77.6
	5.0			33.3		60.9		88.6	72.0	99.7	105.3	77.6	60.9	33.3	105.3	69.3
7	0.2			44.4		77.6		83.1	94.2	99.7	127.4	72.0	72.0	44.4	127.4	85.9
	5.0			33.3		60.9		99.7	105.3	77.6	121.9	88.6	94.2	33.3	121.9	77.6
8	0.2			61.0		55.4		72.0	83.1	77.6	99.7	72.0	60.9	55.4	99.7	77.6
	5.0			38.9		49.9		88.6	94.2	94.2	116.3	72.0	55.4	38.9	116.3	77.6
9	0.2			49.9		66.5		66.5	66.5	66.5	127.4	60.9	66.5	49.9	127.4	88.7
	5.0			55.5		38.8		66.5	66.5	61.9	88.6	72.0	60.9	38.8	88.6	63.7
10	0.2			61.0		77.6		83.1	72.0	77.6	132.9	55.4	72.0	55.4	132.9	94.2
	5.0			44.4		60.9		166.2	55.4	99.7	138.5	49.9	66.5	44.4	166.2	105.3
Minimum				44.4		38.8		66.5	66.5	66.5	99.7	55.4	49.9	38.8	99.7	77.6
Maximum	0.2			72.1		88.5		99.7	99.7	132.9	155.1	88.6	77.6	66.5	155.1	102.5
Mean				58.3		63.7		83.1	83.1	99.7	127.4	72.0	63.8	52.7	127.4	90.0
Minimum				33.3		33.2		38.8	55.4	61.9	88.6	44.3	55.4	33.2	88.6	33.2
Maximum	5.0			72.1		66.5		166.2	105.3	127.4	188.4	88.6	94.2	60.9	188.4	188.4
Mean				52.7		49.9		102.5	80.4	94.7	138.5	66.5	74.8	47.1	138.5	92.8

Alkalinity (mg/liter) in the Saguling Reservoir in 1987.

Station	Water Depth (m)	Jan.	Feb.	Mar.	Apr.	May	June	July	Aug.	Sept.	Oct.	Nov.	Dec.	Min.	Max.	Mean
1	0.2	55.4	88.6					144.0	55.4	110.8	115.2	79.8	66.5	55.4	144.0	99.7
	5.0	38.8	60.9					127.4	88.6	94.2	150.7	101.9	-	38.8	150.7	94.8
2	0.2	49.9	72.3					83.1	72.0	83.1	101.9	57.6	44.3	44.3	101.9	73.1
	5.0	55.4	66.5					105.3	72.0	121.9	93.1	66.5	44.3	44.3	121.9	83.1
3	0.2	72.0	66.7					72.0	66.5	88.6	66.5	75.3	72.0	66.5	88.6	77.6
	5.0	55.4	60.9					83.1	72.0	77.6	70.9	101.9	66.5	55.4	101.9	78.7
4	0.2	105.3	66.7					83.1	72.0	83.1	75.3	66.5	77.6	66.5	105.3	85.9
	5.0	77.6	99.7					83.1	77.6	94.2	88.6	93.1	88.6	77.6	99.7	88.7
5	0.2	77.6	55.4					66.5	49.9	55.4	75.3	66.5	94.2	49.9	94.2	72.1
	5.0	66.5	55.4					72.0	49.9	55.4	66.5	84.2	77.6	49.9	84.2	67.1
6	0.2	72.0	66.7					66.5	60.9	60.9	66.5	57.6	60.9	57.6	72.0	64.8
	5.0	60.9	72.0					83.1	49.9	60.9	106.4	75.3	83.1	49.9	106.4	78.2
7	0.2	66.5	66.7					83.1	72.0	66.5	66.5	79.8	88.6	66.5	88.6	77.6
	5.0	72.0	60.9					77.6	66.5	88.6	75.3	88.6	99.7	60.9	99.7	80.3
8	0.2	72.0	72.0					66.5	66.5	49.9	53.2	53.2	49.9	49.9	72.0	61.0
	5.0	66.5	60.9					83.1	55.4	49.9	53.2	66.5	55.4	49.9	83.1	66.5
9	0.2	60.9	66.7					77.6	55.4	55.4	57.6	44.3	38.8	38.8	77.6	58.2
	5.0	77.6	77.6					94.2	60.9	55.4	53.2	53.2	44.3	44.3	94.2	69.3
10	0.2	60.9	44.5					72.0	72.0	66.5	48.8	57.6	83.1	44.5	83.1	63.8
	5.0	66.5	88.6					77.6	66.5	55.4	75.3	66.5	44.3	44.3	88.6	66.5
Minimum		49.9	44.5					66.5	49.9	49.9	48.8	44.3	38.8	38.8	72.0	58.2
Maximum	0.2	105.3	88.6					144.0	72.0	110.8	115.2	79.8	94.2	66.5	144.0	99.7
Mean		77.6	66.6					105.3	61.0	80.4	82.0	62.1	66.5	52.7	108.0	80.3
Minimum		38.8	55.4					72.0	49.9	49.9	53.2	53.2	44.3	38.8	83.1	38.8
Maximum	5.0	77.6	99.7					127.4	88.6	121.9	150.7	101.9	99.7	77.6	150.7	150.7
Mean		58.2	77.6					99.7	69.3	85.9	102.0	77.6	72.0	58.2	116.9	87.6

Alkalinity (mg/liter) in the Saguling Reservoir in 1988.

Station	Water Depth (m)	Jan.	Feb.	Mar.	Apr.	May	June	July	Aug.	Sept.	Oct.	Nov.	Dec.	Min.	Max.	Mean
1	0.2	38.8	83.1	49.9	72.0	55.4	55.9	110.8	116.2	199.4	66.5	67.1	72.0	38.8	199.4	119.1
	5.0	38.8	94.2	55.4	44.3	49.9	52.2	149.6	171.7	-	88.6	70.8	77.6	38.8	171.7	105.3
2	0.2	44.3	66.5	38.8	99.7	77.6	41.0	110.8	138.5	166.2	83.1	63.3	94.2	38.8	166.2	102.5
	5.0	55.4	72.0	55.4	72.0	49.9	41.0	99.7	99.7	188.4	72.1	63.3	99.7	41.0	188.4	114.7
3	0.2	49.9	49.9	60.9	88.3	60.9	48.5	99.7	127.4	138.5	110.8	67.1	110.8	48.5	138.5	93.5
	5.0	33.2	49.9	38.8	99.7	49.9	48.5	88.6	116.3	144.0	121.9	59.7	94.2	33.2	144.0	88.6
4	0.2	88.6	72.0	55.4	72.0	44.3	52.2	132.9	99.7	121.9	121.9	85.8	105.3	44.3	132.9	88.6
	5.0	83.1	105.3	83.1	110.8	55.4	59.7	116.3	116.3	144.0	127.4	119.5	116.3	55.4	144.0	99.7
5	0.2	66.5	49.9	55.4	72.0	49.9	37.3	49.9	72.0	110.9	99.7	74.6	105.3	37.3	110.9	74.1
	5.0	60.9	44.3	55.4	72.0	55.4	37.3	83.1	94.2	105.3	121.9	85.8	105.3	37.3	121.9	79.6
6	0.2	60.9	66.5	72.0	66.5	83.1	37.3	77.6	99.7	94.2	88.6	67.1	99.7	37.3	99.7	68.5
	5.0	49.9	66.5	72.0	55.4	60.9	37.3	60.9	110.8	99.7	121.9	70.9	105.3	37.3	121.9	79.6
7	0.2	66.5	99.7	49.9	66.5	72.0	44.7	110.8	99.7	105.3	110.8	99.7	105.3	44.7	110.8	77.8
	5.0	77.5	77.5	77.5	83.1	60.9	63.4	110.8	99.7	105.3	110.8	99.7	105.7	60.9	110.8	85.9
8	0.2	60.9	88.6	55.4	77.6	72.0	41.0	55.4	72.0	83.1	94.2	78.3	77.6	41.0	94.2	67.6
	5.0	49.9	99.7	72.0	72.0	77.6	48.5	72.0	99.7	99.8	116.3	67.1	83.1	48.5	116.3	82.4
9	0.2	55.4	77.6	55.4	60.9	55.6	33.6	72.0	77.6	77.6	72.0	77.6	77.6	33.6	77.6	55.6
	5.0	55.4	88.6	44.3	60.9	49.9	44.5	77.6	83.1	105.3	77.6	83.1	105.3	44.3	105.3	74.8
10	0.2	55.4	88.6	49.9	55.4	49.9	37.3	66.5	60.9	99.7	72.1	74.6	83.1	37.3	99.7	68.5
	5.0	55.4	66.5	55.4	44.3	38.8	37.3	83.1	121.9	133.0	88.6	55.9	94.2	37.3	133.0	85.2
Minimum	0.2	38.8	49.9	38.8	55.4	44.3	33.6	49.9	60.9	77.6	66.5	63.3	72.0	33.6	77.6	55.6
Maximum		88.6	99.7	72.0	99.7	83.1	55.9	132.9	138.5	199.4	121.9	99.7	110.8	48.5	199.4	119.1
Mean		63.7	74.8	55.4	77.6	63.7	44.8	91.4	99.7	138.5	94.2	81.5	91.4	41.1	138.5	89.8
Minimum	5.0	33.2	44.3	38.8	44.3	38.8	37.3	60.9	83.1	99.7	72.1	55.9	77.6	33.2	105.3	33.2
Maximum		83.1	105.3	83.1	110.8	77.6	63.4	149.6	171.7	188.4	127.4	119.5	116.3	60.9	188.4	188.4
Mean		58.2	74.8	61.0	77.6	58.2	50.4	105.3	127.4	144.1	99.8	87.7	97.0	47.1	146.9	97.0

Carbon dioxide (mg/liter) in the Saguling Reservoir in 1986.

Station	Water Depth (m)	Jan.	Feb.	Mar.	Apr.	May	June	July	Aug.	Sept.	Oct.	Nov.	Dec.	Min.	Max.	Mean
1	0.2			12.0		0.0		4.0	4.0	7.9	15.9	11.9	0.0	4.0	15.9	7.0
	5.0			16.0		11.8		11.9	7.9	0.0	23.8	11.9	15.8	7.9	23.8	12.4
2	0.2			12.0		0.0		0.0	0.0	0.0	11.9	7.9	11.9	7.9	12.0	5.5
	5.0			16.0		15.8		23.8	15.8	11.9	19.8	11.9	11.9	11.9	23.8	15.9
3	0.2			8.0		0.0		4.0	0.0	0.0	23.8	4.0	4.0	4.0	23.8	5.5
	5.0			24.0		7.9		31.9	11.9	11.9	23.8	11.9	7.9	7.9	31.9	16.4
4	0.2			4.0		4.0		11.9	0.0	0.0	15.8	7.9	7.9	4.0	15.8	6.4
	5.0			8.0		11.9		23.8	15.8	11.9	43.6	7.9	11.9	7.9	43.6	16.9
5	0.2			4.0		4.0		0.0	4.0	0.0	11.9	4.0	4.0	4.0	11.9	4.0
	5.0			12.0		11.9		27.2	15.8	0.0	4.0	11.9	11.9	4.0	27.2	11.8
6	0.2			4.0		4.0		0.0	7.9	0.0	7.9	4.0	4.0	4.0	7.9	4.0
	5.0			12.0		7.9		19.8	7.9	7.9	4.0	7.9	11.9	4.0	19.8	9.9
7	0.2			4.0		4.0		7.9	0.0	4.0	4.0	4.0	4.0	4.0	7.9	4.0
	5.0			20.0		7.9		15.8	11.9	4.0	4.0	11.9	15.8	4.0	20.0	11.4
8	0.2			8.0		4.0		11.9	4.0	0.0	7.9	4.0	4.0	4.0	11.9	5.5
	5.0			12.0		15.8		31.7	7.9	11.9	15.8	11.9	7.9	7.9	31.7	14.4
9	0.2			4.0		4.0		11.9	0.0	0.0	11.9	4.0	4.0	4.0	11.9	5.0
	5.0			4.0		11.9		27.7	11.9	8.0	15.8	7.9	7.9	4.0	27.7	11.9
10	0.2			8.0		4.0		4.0	7.9	0.0	7.9	4.0	4.0	4.0	8.0	5.0
	5.0			8.0		11.9		47.5	15.8	7.9	23.7	11.9	11.9	7.9	47.5	17.3
Minimum	0.2			4.0		4.0		4.0	4.0	4.0	7.9	4.0	4.0	4.0	7.9	4.0
Maximum				12.0		4.0		11.9	7.9	7.9	23.8	11.9	11.9	7.9	23.8	7.0
Mean				8.0		4.0		7.9	6.0	6.0	15.9	8.0	8.0	6.0	15.9	5.5
Minimum	5.0			4.0		7.9		11.9	7.9	4.0	4.0	7.9	7.9	4.0	19.8	9.9
Maximum				24.0		15.8		47.5	15.8	11.9	43.6	11.9	15.8	11.9	47.5	17.3
Mean				14.0		11.9		29.7	11.9	8.0	23.8	9.9	11.9	8.0	33.7	13.6

Carbon dioxide (mg/liter) in the Saguling Reservoir in 1987.

Station	Water Depth (m)	Jan.	Feb.	Mar.	Apr.	May	June	July	Aug.	Sept.	Oct.	Nov.	Dec.	Min.	Max.	Mean
1	0.2	7.9	0.0					27.7	27.7	31.7	27.7	7.9	7.9	7.9	31.7	21.8
	5.0	7.9	4.0					35.6	75.2	47.5	43.6	11.9	0.0	4.0	75.2	35.6
2	0.2	7.9	0.0					7.9	11.9	15.8	27.7	4.0	11.9	4.0	27.7	13.2
	5.0	7.9	11.9					7.9	11.9	19.8	27.7	7.9	15.8	7.9	27.7	15.2
3	0.2	4.0	7.9					11.9	7.9	11.9	7.9	0.0	7.9	4.0	11.9	7.9
	5.0	7.9	7.9					4.0	7.9	4.0	11.9	11.9	11.9	4.0	11.9	8.6
4	0.2	4.0	0.0					7.9	7.9	4.0	4.0	0.0	4.0	4.0	7.9	4.6
	5.0	7.9	7.9					7.9	15.8	19.8	15.8	7.9	7.9	7.9	19.8	12.5
5	0.2	7.9	7.9					4.0	4.0	4.0	7.9	0.0	7.9	4.0	7.9	4.6
	5.0	7.9	7.9					4.0	7.9	4.0	11.9	7.9	11.9	4.0	11.9	7.9
6	0.2	4.0	4.0					11.9	7.9	4.0	4.0	0.0	7.9	4.0	11.9	6.0
	5.0	4.0	7.9					7.9	4.0	4.0	27.7	7.9	11.9	4.0	27.7	10.6
7	0.2	4.0	4.0					4.0	7.9	7.9	4.0	0.0	4.0	4.0	7.9	4.6
	5.0	11.9	7.9					7.9	7.9	23.7	7.9	7.9	11.9	7.9	23.7	11.2
8	0.2	4.0	7.9					7.9	11.9	7.9	4.0	4.0	7.9	4.0	11.9	7.3
	5.0	7.9	7.9					7.9	11.9	11.9	7.9	7.9	7.9	7.9	11.9	9.2
9	0.2	4.0	4.0					4.0	7.9	7.9	4.0	0.0	4.0	4.0	7.9	4.6
	5.0	7.9	11.9					7.9	11.9	7.9	7.9	7.9	7.9	7.9	11.9	8.6
10	0.2	4.0	4.0					7.9	7.9	7.9	4.0	4.0	4.0	4.0	7.9	6.0
	5.0	7.9	19.8					7.9	11.9	11.9	15.8	7.9	7.9	7.9	15.8	10.6
Minimum		4.0	4.0					4.0	4.0	4.0	4.0	4.0	4.0	4.0	7.9	4.6
Maximum	0.2	7.9	7.9					27.7	27.7	31.7	27.7	7.9	11.9	7.9	31.7	21.8
Mean		6.0	6.0					15.9	15.9	17.9	15.9	6.0	8.0	6.0	19.8	13.2
Minimum		4.0	4.0					4.0	4.0	4.0	7.9	7.9	7.9	4.0	11.9	7.9
Maximum	5.0	11.9	19.8					35.6	75.2	47.5	43.6	11.9	15.8	7.9	75.2	35.6
Mean		8.0	11.9					19.8	39.6	25.8	25.8	9.9	11.9	6.0	43.6	21.8

Carbon dioxide (mg/liter) in the Saguling Reservoir in 1988.

Station	Water Depth (m)	Jan.	Feb.	Mar.	Apr.	May	June	July	Aug.	Sept.	Oct.	Nov.	Dec.	Min.	Max.	Mean
1	0.2	11.9	35.6	7.9	19.9	8.0	0.0	23.8	27.7	63.4	4.0	8.1	7.9	4.0	63.4	33.7
	5.0	7.9	15.0	11.9	7.9	7.9	5.4	15.8	31.9	-	7.9	10.8	15.8	5.4	31.9	18.7
2	0.2	19.8	0.0	23.8	0.0	4.0	0.0	19.8	25.8	4.0	7.9	0.0	0.0	4.0	25.8	14.9
	5.0	16.8	15.8	12.8	11.9	11.9	5.4	27.7	19.8	7.9	7.9	10.8	7.9	5.4	27.7	16.6
3	0.2	7.9	0.0	0.0	0.0	0.0	0.0	4.0	15.8	0.0	7.9	0.0	7.9	4.0	15.8	9.9
	5.0	11.9	7.9	7.9	11.9	15.8	0.0	11.9	15.8	11.9	19.8	10.8	11.9	7.9	19.8	13.9
4	0.2	7.9	0.0	11.9	0.0	0.0	5.4	7.9	11.9	0.0	7.9	0.0	0.0	5.4	11.9	8.7
	5.0	19.8	11.9	23.8	11.9	15.8	10.8	19.8	15.8	4.0	7.9	10.8	11.9	4.0	23.8	13.9
5	0.2	4.0	0.0	0.0	0.0	0.0	2.7	7.9	7.9	0.0	0.0	8.1	0.0	2.7	8.1	5.4
	5.0	19.8	7.9	0.0	7.9	15.8	5.4	15.8	7.9	7.9	11.9	10.8	15.8	5.4	15.8	10.6
6	0.2	0.0	0.0	0.0	0.0	0.0	0.0	7.9	11.9	0.0	0.0	0.0	0.0	7.9	11.9	9.9
	5.0	7.9	15.8	23.8	7.9	7.9	10.8	11.9	11.9	7.9	15.8	15.5	11.9	7.9	23.8	15.9
7	0.2	0.0	0.0	0.0	0.0	0.0	0.0	7.9	3.9	0.0	7.9	4.0	0.0	3.9	7.9	5.9
	5.0	19.8	23.8	11.9	11.9	11.9	8.1	19.8	11.9	7.9	19.8	11.9	7.9	7.9	19.8	13.9
8	0.2	0.0	0.0	7.9	0.0	0.0	2.7	7.9	3.9	0.0	0.0	5.4	0.0	2.7	7.9	5.3
	5.0	7.9	15.8	7.9	11.9	7.9	18.9	7.9	15.8	23.8	11.9	10.8	11.9	7.9	23.8	15.9
9	0.2	7.9	0.0	0.0	0.0	0.0	0.0	0.0	0.0	0.0	0.0	0.0	0.0	7.9	7.9	7.9
	5.0	11.9	11.9	15.8	7.9	4.0	10.8	11.9	27.7	15.8	11.9	27.7	23.8	4.0	27.7	15.9
10	0.2	7.9	0.0	7.9	0.0	0.0	0.0	7.9	11.9	6.7	0.0	0.0	0.0	6.7	11.9	9.3
	5.0	11.9	11.9	11.9	7.9	11.9	8.1	15.8	15.8	5.2	7.9	18.9	15.8	5.2	18.9	12.1
Minimum		4.0	35.6	7.9	19.9	4.0	2.7	4.0	3.9	4.0	4.0	4.0	7.9	2.7	35.6	19.2
Maximum	0.2	19.8	35.6	23.8	19.9	8.0	5.4	23.8	27.7	63.4	7.9	8.1	7.9	7.9	63.4	35.7
Mean		11.9	35.6	15.9	19.9	6.0	4.1	13.9	15.8	33.7	3.5	2.7	2.0	5.3	49.5	27.4
Minimum		7.9	7.9	7.9	7.9	4.0	5.4	7.9	7.9	4.0	7.9	10.8	7.9	4.0	15.8	4.0
Maximum	5.0	19.8	23.8	23.8	20.0	15.8	18.9	27.7	31.9	23.8	19.8	18.9	15.8	7.9	31.9	31.9
Mean		13.9	15.9	15.9	14.0	9.9	12.2	17.8	19.9	13.9	11.4	12.4	12.9	6.0	23.9	14.9

Total nitrogen ( $\mu\text{g/liter}$ ) in the Saguling Reservoir in 1986.

Station	Water Depth (m)	Jan.	Feb.	Mar.	Apr.	May	June	July	Aug.	Sept.	Oct.	Nov.	Dec.	Min.	Max.	Mean
1	0.2					2,016		1,630	2,605	1,512	1,736	840	5,544	840	5,544	3,192
	5.0					896		5,419	1,462	2,164	392	448	2,240	392	5,419	2,906
2	0.2					2,128		1,515	1,394	1,836	1,624	616	4,704	616	4,704	2,660
	5.0					728		1,332	1,531	1,494	560	448	1,904	448	1,904	1,176
3	0.2					784		1,378	1,112	1,680	1,288	280	3,080	280	3,080	1,680
	5.0					560		1,240	914	2,524	280	448	2,128	280	2,524	1,402
4	0.2					896		2,158	1,234	1,372	616	448	2,856	448	2,856	1,652
	5.0					952		1,332	3,153	1,803	504	616	2,520	504	3,153	1,829
5	0.2					560		1,332	1,325	1,484	1,512	-	2,856	560	2,856	1,708
	5.0					672		1,424	1,211	2,370	560	336	1,568	336	2,370	1,353
6	0.2					960		1,286	1,371	1,260	672	784	3,584	672	3,584	2,128
	5.0					616		1,171	1,051	1,958	448	336	1,904	336	1,958	1,147
7	0.2					1,176		1,240	1,417	1,120	392	448	2,464	392	2,464	1,428
	5.0					1,064		1,332	777	1,443	224	392	1,624	224	1,624	924
8	0.2					1,232		8,679	937	1,344	560	560	2,296	560	8,679	4,620
	5.0					840		5,878	982	1,649	504	280	1,344	280	5,878	3,079
9	0.2					1,176		1,194	1,279	1,855	952	224	1,848	224	1,855	1,040
	5.0					896		1,424	1,028	2,164	280	224	1,232	224	2,164	1,194
10	0.2					672		1,814	1,188	1,906	840	504	2,308	504	2,308	1,406
	5.0					1,008		1,378	1,142	2,164	616	672	1,288	616	2,164	1,390
Minimum						560		1,194	937	1,120	392	224	1,848	224	1,855	1,040
Maximum	0.2					2,128		8,679	2,605	1,906	1,736	840	5,544	840	8,679	4,620
Mean						1,344		4,937	1,771	1,513	1,064	532	3,696	532	5,267	2,900
Minimum						560		1,171	777	1,443	224	224	1,232	224	1,624	224
Maximum	5.0					1,064		5,878	3,153	2,524	616	672	2,520	616	5,878	5,878
Mean						812		3,525	1,965	1,984	420	448	1,876	420	3,751	2,086

Total nitrogen ( $\mu\text{g/liter}$ ) in the Saguling Reservoir in 1987.

Station	Water Depth (m)	Jan.	Feb.	Mar.	Apr.	May	June	July	Aug.	Sept.	Oct.	Nov.	Dec.	Min.	Max.	Mean
1	0.2	5,320						3,304	4,480	1,456	756	1,378	1,428	756	5,320	3,038
	5.0	2,688						2,635	5,656	6,972	972	634	-	634	6,972	3,803
2	0.2	11,312						1,736	3,360	1,288	23,159	441	976	441	23,159	11,800
	5.0	4,032						1,064	2,352	2,604	1,350	1,928	1,036	1,036	4,032	2,534
3	0.2	1,792						1,344	2,016	1,344	1,080	3,138	728	728	3,138	1,933
	5.0	6,496						1,120	840	1,400	943	3,474	504	504	6,496	3,500
4	0.2	1,792						1,736	1,176	1,736	1,161	1,074	1,036	1,036	1,792	1,414
	5.0	1,456						840	672	1,288	1,080	992	2,282	672	2,282	1,477
5	0.2	2,744						1,736	952	1,428	702	468	832	468	2,744	1,606
	5.0	8,456						672	1,400	1,232	1,296	523	2,504	523	8,456	4,490
6	0.2	2,240						1,232	840	1,120	945	2,976	1,400	840	2,976	1,908
	5.0	2,464						672	1,232	1,680	1,026	936	1,288	672	2,464	1,568
7	0.2	2,520						896	1,064	1,064	891	689	644	644	2,520	1,582
	5.0	1,904						1,120	1,232	2,072	1,107	551	1,084	551	2,072	1,312
8	0.2	2,464						1,512	1,120	1,176	972	1,902	1,484	972	2,464	1,718
	5.0	1,232						840	1,232	2,352	-	441	1,504	441	2,352	1,397
9	0.2	2,184						1,512	1,120	1,344	999	1,074	1,092	999	2,184	1,592
	5.0	-						1,512	1,904	3,304	1,404	1,350	1,316	1,316	3,304	2,310
10	0.2	1,736						1,176	1,064	1,120	621	1,240	1,120	621	1,736	1,179
	5.0	1,400						1,008	2,016	2,408	1,457	882	1,812	882	2,408	1,645
Minimum								896	840	1,064	621	441	644	441	1,736	1,179
Maximum	0.2							3,304	4,480	1,736	23,159	3,138	1,484	1,036	23,159	11,800
Mean								2,100	2,660	1,400	11,890	1,790	1,064	739	12,448	6,593
Minimum								672	672	1,232	943	22	504	441	2,072	441
Maximum	5.0							2,635	5,656	6,972	1,457	3,474	2,504	1,316	8,456	8,456
Mean								1,654	3,164	4,102	1,200	1,748	1,504	879	5,264	3,071

Total nitrogen ( $\mu\text{g/liter}$ ) in the Saguling Reservoir in 1988.

Station	Water	Jan.	Feb.	Mar.	Apr.	May	June	July	Aug.	Sept.	Oct.	Nov.	Dec.	Min.	Max.	Mean
	Depth (m)															
1	0.2	1,344	2,688	616				1,904	2,128					616	2,688	1,652
	5.0	1,232	1,176	1,568				2,632	1,680					1,176	2,632	1,904
2	0.2	1,456	2,912	728				1,736	1,624					728	2,912	1,820
	5.0	1,456	1,680	448				1,008	3,080					448	3,080	1,764
3	0.2	2,464	2,520	1,008				2,016	1,960					1,008	2,520	1,764
	5.0	1,792	1,736	448				2,520	1,960					448	2,520	1,484
4	0.2	2,408	3,472	728				4,144	2,408					728	4,144	2,436
	5.0	1,568	3,024	672				4,256	2,296					672	4,256	2,464
5	0.2	1,792	2,184	1,400				3,080	1,848					1,400	3,080	2,240
	5.0	1,344	560	616				1,960	1,568					560	1,960	1,260
6	0.2	896	1,792	1,904				1,848	1,400					896	1,904	1,400
	5.0	1,232	1,176	392				336	1,456					336	1,456	896
7	0.2	1,400	3,304	1,008				1,792	1,736					1,008	3,304	2,156
	5.0	1,512	1,904	448				1,786	1,624					448	1,904	1,176
8	0.2	1,736	1,792	448				728	1,904					448	1,904	1,176
	5.0	1,680	1,792	1,008				1,176	1,904					1,008	1,904	1,456
9	0.2	1,848	2,912	1,288				672	2,296					672	2,912	1,792
	5.0	952	4,312	896				1,176	1,624					896	4,312	2,604
10	0.2	2,184	2,016	1,400				1,064	1,568					1,064	2,184	1,624
	5.0	1,400	3,304	8,008				1,624	2,128					1,400	8,008	4,704
Minimum	0.2	896	1,792	448				672	1,400					448	1,904	1,176
Maximum		2,464	3,472	1,904				4,144	2,408					1,400	4,144	2,436
Mean		1,680	2,632	1,176				2,408	1,904					924	3,024	1,974
Minimum	5.0	1,232	560	392				336	1,456					336	1,456	336
Maximum		1,792	4,312	8,008				4,256	3,080					1,400	8,008	8,008
Mean		1,512	2,436	4,200				2,296	2,268					868	4,732	2,800

Ammonia-nitrogen ( $\mu\text{g/liter}$ ) in the Saguling Reservoir in 1986.

Station	Water	Jan.	Feb.	Mar.	Apr.	May	June	July	Aug.	Sept.	Oct.	Nov.	Dec.	Min.	Max.	Mean
	Depth (m)															
1	0.2			140		43		32	77	44	75	1,433	82	32	1,433	733
	5.0			123		28		42	77	89	55	211	86	28	211	120
2	0.2			119		22		29	77	50	71	31	71	22	119	71
	5.0			128		31		37	77	122	54	172	98	31	172	102
3	0.2			189		22		26	67	77	53	18	59	18	189	104
	5.0			98		23		32	111	111	51	1	61	1	111	56
4	0.2			77		22		26	67	89	52	28	63	22	89	56
	5.0			119		22		35	100	44	53	101	77	22	119	71
5	0.2			70		18		24	100	33	60	9	61	9	100	55
	5.0			111		21		37	89	66	46	61	51	21	111	66
6	0.2			77		19		26	67	44	51	12	63	12	77	45
	5.0			95		15		39	56	50	40	33	82	15	95	55
7	0.2			56		19		32	67	33	53	31	59	19	67	43
	5.0			70		20		37	67	44	43	31	59	20	70	45
8	0.2			56		19		32	67	50	57	20	79	19	79	49
	5.0			84		26		43	77	61	53	36	92	26	92	59
9	0.2			60		15		33	56	44	48	34	61	15	61	38
	5.0			69		30		40	89	55	53	125	65	30	125	78
10	0.2			61		26		27	67	55	71	66	79	26	79	53
	5.0			105		21		55	77	55	98	41	82	21	105	63
Minimum	0.2			56		15		24	56	33	48	9	59	9	61	38
Maximum		189		43		33	100	89	75	1,433	82	32	1,433	733		
Mean		123		29		29	78	61	62	721	71	21	747	385		
Minimum	5.0			70		15		32	56	44	40	1	51	1	70	45
Maximum		128		31		55	111	122	98	211	98	31	211	733		
Mean		99		23		44	84	83	69	106	75	16	141	389		

Ammonia-nitrogen ( $\mu\text{g/liter}$ ) in the Saguling Reservoir in 1987.

Station	Water Depth (m)	Jan.	Feb.	Mar.	Apr.	May	June	July	Aug.	Sept.	Oct.	Nov.	Dec.	Min.	Max.	Mean
1	0.2	66	64					74		89	90	51	349	51	349	200
	5.0	69	104					80		163	170	34	-	34	170	102
2	0.2	76	57					91		106	85	51	207	51	207	129
	5.0	66	84					72		115	112	61	207	61	207	134
3	0.2	72	59					67		106	70	339	88	59	339	199
	5.0	69	74					57		99	98	53	105	53	105	79
4	0.2	77	62					57		145	67	257	683	57	683	370
	5.0	69	74					74		114	472	30	989	30	989	510
5	0.2	69	64					57		122	56	34	325	34	325	180
	5.0	101	121					53		96	67	51	961	51	961	506
6	0.2	75	68					57		85	79	271	646	57	646	352
	5.0	83	62					59		96	119	500	751	59	751	405
7	0.2	57	74					57		96	47	38	70	38	96	67
	5.0	99	87					38		89	79	61	87	38	99	69
8	0.2	66	69					48		98	67	51	122	48	122	85
	5.0	80	82					48		98	-	42	209	42	209	126
9	0.2	53	111					57		98	63	51	80	51	111	81
	5.0	86	79					38		89	79	59	380	38	380	209
10	0.2	79	96					46		98	67	53	114	46	114	80
	5.0	83	87					36		96	67	111	452	36	452	244
Minimum		53	57					46		85	47	34	70	34	96	67
Maximum	0.2	79	111					91		145	90	339	683	59	683	370
Mean		66	84					69		115	69	187	377	47	390	219
Minimum		66	62					36		89	67	30	87	30	99	69
Maximum	5.0	101	121					80		163	472	500	989	61	989	510
Mean		84	92					58		126	270	265	538	46	544	289

Ammonia-nitrogen ( $\mu\text{g/liter}$ ) in the Saguling Reservoir in 1988.

Station	Water Depth (m)	Jan.	Feb.	Mar.	Apr.	May	June	July	Aug.	Sept.	Oct.	Nov.	Dec.	Min.	Max.	Mean
1	0.2	207	46	157	65	367	55	87	1,101	57	87	204	57	46	1,101	574
	5.0	222	58	278	121	338	55	98	143	-	98	143	125	55	338	197
2	0.2	184	54	123	299	65	152	87	87	97	87	87	97	54	299	177
	5.0	222	54	215	126	83	55	87	143	117	87	143	117	54	222	138
3	0.2	113	46	91	82	49	98	98	131	74	98	131	74	46	131	89
	5.0	188	46	203	145	68	82	77	143	87	76	143	87	46	203	125
4	0.2	113	87	252	159	44	51	76	143	58	76	143	58	44	252	148
	5.0	217	205	324	288	106	62	87	143	101	87	143	101	62	324	193
5	0.2	52	38	80	90	53	51	65	143	58	65	143	58	38	143	91
	5.0	92	46	118	126	44	51	87	119	68	31	119	68	31	126	79
6	0.2	68	54	80	178	13	65	32	131	68	32	131	68	13	178	96
	5.0	96	62	123	126	26	51	32	109	77	32	109	77	26	126	76
7	0.2	46	54	55	99	17	40	54	98	62	54	98	62	17	99	58
	5.0	68	46	209	121	39	36	43	98	107	43	98	107	36	209	123
8	0.2	52	71	271	69	17	42	43	154	158	43	154	158	17	271	144
	5.0	257	100	331	117	30	143	43	98	81	43	98	81	30	331	181
9	0.2	88	62	70	183	21	106	43	308	74	43	308	74	21	308	165
	5.0	56	38	129	48	40	43	32	143	113	32	143	113	32	143	88
10	0.2	48	54	75	396	44	51	43	143	158	43	143	158	43	396	220
	5.0	143	34	134	82	85	62	43	119	87	43	119	87	34	143	89
Minimum		46	38	55	65	13	40	32	87	57	32	87	57	13	99	58
Maximum	0.2	207	87	271	396	367	152	98	1,101	158	98	308	158	54	1,101	574
Mean		127	63	163	231	190	96	65	594	108	65	198	108	34	600	316
Minimum		68	34	118	82	26	36	32	98	68	31	98	68	26	126	76

Nitrite-nitrogen ( $\mu\text{g/liter}$ ) in the Saguling Reservoir in 1986.

Station	Water Depth (m)	Jan.	Feb.	Mar.	Apr.	May	June	July	Aug.	Sept.	Oct.	Nov.	Dec.	Min.	Max.	Mean
1	0.2			31		83		8	492	32	26	38	5	5	492	249
	5.0			6		20		8	16	19	32	87	7	6	87	47
2	0.2			7		81		5	365	30	23	25	2	2	365	184
	5.0			5		88		16	18	16	32	87	7	5	88	47
3	0.2			7		20		9	237	9	26	39	4	4	237	121
	5.0			8		59		8	47	15	26	65	185	8	185	97
4	0.2			7		5		5	62	8	26	25	4	4	62	33
	5.0			29		29		19	16	17	26	76	15	15	76	46
5	0.2			8		5		2	11	8	29	13	7	2	29	16
	5.0			10		2		11	9	13	29	63	207	2	207	105
6	0.2			7		5		7	11	8	29	51	1	1	51	26
	5.0			10		2		8	11	16	26	57	26	2	57	30
7	0.2			7		5		8	7	9	26	32	103	5	103	54
	5.0			8		10		8	11	13	26	41	7	7	41	24
8	0.2			10		2		8	9	8	29	32	9	2	32	17
	5.0			7		2		4	41	15	26	60	8	2	60	31
9	0.2			9		7		8	8	10	23	51	4	4	51	28
	5.0			6		17		55	11	18	32	65	7	6	65	36
10	0.2			7		17		8	18	8	26	19	4	4	26	15
	5.0			5		5		12	14	19	40	46	74	5	74	40
Minimum				7		2		2	7	8	23	13	1	1	26	15
Maximum	0.2			31		83		9	492	32	29	51	103	5	492	249
Mean				19		43		6	250	20	26	32	52	3	259	132
Minimum				5		2		4	9	13	26	41	7	2	41	24
Maximum	5.0			29		88		55	47	19	40	87	207	15	207	105
Mean				17		45		30	28	16	33	64	107	9	124	64

Nitrite-nitrogen ( $\mu\text{g/liter}$ ) in the Saguling Reservoir in 1987.

Station	Water Depth (m)	Jan.	Feb.	Mar.	Apr.	May	June	July	Aug.	Sept.	Oct.	Nov.	Dec.	Min.	Max.	Mean
1	0.2	100	62					22	120	42	130	61	505	22	505	264
	5.0	32	124					99	81	33	152	135	-	32	152	92
2	0.2	87	80					797	633	66	96	75	531	66	797	432
	5.0	65	136					797	277	1	43	161	328	1	797	399
3	0.2	6	72					38	200	228	24	290	583	6	583	295
	5.0	20	152					31	47	1	23	320	90	1	320	161
4	0.2	1	55					110	533	59	9	230	90	1	533	267
	5.0	1	124					178	133	564	3	20	152	1	564	283
5	0.2	4	58					13	17	3	7	17	388	3	388	196
	5.0	4	112					8	32	13	110	57	618	4	618	311
6	0.2	3	67					13	14	3	9	219	243	3	243	123
	5.0	11	135					24	27	13	26	51	71	11	135	73
7	0.2	3	67					5	29	3	6	23	100	3	100	52
	5.0	3	141					5	5	13	4	106	71	3	141	72
8	0.2	3	55					43	14	3	1	26	110	1	110	56
	5.0	2	138					5	67	220	-	52	337	2	337	170
9	0.2	5	152					15	39	63	28	-	139	5	152	79
	5.0	94	135					445	247	83	26	25	319	25	445	235
10	0.2	10	145					288	39	13	4	32	388	4	388	196
	5.0	6	124					10	25	1652	15	94	645	6	1652	829
Minimum		1	55					5	14	3	1	17	90	1	100	52
Maximum	0.2	100	152					797	633	228	130	290	583	66	797	432
Mean		51	104					401	324	116	66	154	337	34	449	242
Minimum		1	112					5	5	1	3	20	71	1	135	72
Maximum	5.0	94	152					797	277	1652	152	320	645	32	1652	829
Mean		48	132					401	141	827	78	170	358	17	894	451



Nitrite-nitrogen ( $\mu\text{g}/\text{liter}$ ) in the Saguling Reservoir in 1988.

Station	Water Depth (m)	Month												Min.	Max.	Mean
		Jan.	Feb.	Mar.	Apr.	May	June	July	Aug.	Sept.	Oct.	Nov.	Dec.			
1	0.2	16	4	29	530	137	97	165	157	9	15	14	9	4	530	267
	5.0	14	11	65	423	133	142	173	178	-	31	11	24	11	423	217
2	0.2	19	3	26	211	38	258	138	165	12	377	117	12	3	377	190
	5.0	13	5	36	402	50	82	178	138	10	23	52	10	5	402	204
3	0.2	5	12	29	226	94	84	94	94	18	28	12	18	5	226	116
	5.0	17	19	67	383	31	80	178	138	7	19	16	7	7	383	195
4	0.2	12	21	63	45	26	76	117	78	247	16	144	247	12	247	130
	5.0	18	59	54	16	47	128	165	125	11	14	24	11	11	165	88
5	0.2	3	308	40	146	26	79	117	90	171	13	10	171	3	308	156
	5.0	10	9	22	18	25	452	165	178	6	0	33	6	6	452	229
6	0.2	1	13	89	20	773	74	43	281	6	15	41	6	1	773	387
	5.0	9	10	18	21	31	85	165	117	6	29	11	6	6	165	86
7	0.2	0	978	1,008	30	125	73	78	224	8	78	224	8	8	1,008	508
	5.0	4	22	221	20	24	70	101	186	5	101	186	5	4	221	113
8	0.2	1	11	65	20	34	77	114	117	17	211	81	17	1	211	106
	5.0	23	7	62	18	12	78	157	157	6	78	19	6	6	157	82
9	0.2	1	8	104	15	22	70	157	474	10	157	474	10	1	474	238
	5.0	3	5	36	59	19	86	138	141	15	138	141	15	3	141	72
10	0.2	0	7	28	15	42	75	165	157	13	302	142	113	7	302	155
	5.0	11	0	40	48	72	97	109	165	7	126	35	7	7	165	86
Minimum		1	3	26	15	22	70	43	78	6	13	10	6	1	211	106
Maximum	0.2	19	978	1,008	530	773	258	165	474	247	377	474	247	12	1,008	508
Mean		10	491	517	273	398	164	104	276	127	195	242	127	7	610	307
Minimum		4	5	18	16	12	70	101	117	5	14	11	5	3	141	72
Maximum	5.0	2	59	221	423	133	452	178	186	15	138	186	24	11	452	508
Mean		3	32	120	220	73	261	140	152	10	76	99	15	7	297	290

Nitrate-nitrogen ( $\mu\text{g}/\text{liter}$ ) in the Saguling Reservoir in 1988.

Station	Water Depth (m)	Month												Min.	Max.	Mean
		Jan.	Feb.	Mar.	Apr.	May	June	July	Aug.	Sept.	Oct.	Nov.	Dec.			
1	0.2			400		464		200	220	240	216	80		80	464	272
	5.0			350		760		240	122	440	303	200		122	760	441
2	0.2			175		760		200	98	1,560	234	100		98	1,560	829
	5.0			375		600		250	98	520	216	180		98	600	349
3	0.2			450		488		210	122	200	173	60		60	488	274
	5.0			412		784		300	293	680	199	148		148	784	466
4	0.2			-		488		300	73	400	173	80		73	488	281
	5.0			350		440		250	171	320	238	200		171	440	306
5	0.2			362		496		250	98	400	195	60		60	496	278
	5.0			345		544		250	151	560	195	180		151	560	356
6	0.2			350		336		220	146	240	171	90		90	350	220
	5.0			225		568		300	156	880	173	180		156	880	518
7	0.2			462		464		200	171	1,440	175	160		160	1,440	800
	5.0			175		464		350	220	320	173	142		142	464	303
8	0.2			-		400		200	98	560	199	100		98	560	329
	5.0			325		544		250	146	400	195	160		146	544	345
9	0.2			575		320		300	73	250	216	100		73	575	324
	5.0			355		366		200	98	320	205	198		98	366	232
10	0.2			750		494		310	146	520	260	88		88	750	419
	5.0			287		560		200	98	280	195	170		98	560	329
Minimum				175		320		200	73	200	171	60		60	350	220
Maximum	0.2			750		760		310	220	1,560	260	160		160	1,560	829
Mean				463		540		255	147	880	216	110		110	955	525
Minimum				175		440		200	98	280	173	142		98	366	232
Maximum	5.0			412		784		350	293	880	303	200		171	880	829
Mean				294		612		275	196	580	238	171		135	623	531

Nitrate-nitrogen ( $\mu\text{g}/\text{liter}$ ) in the Saguling Reservoir in 1987.

Station	Water Depth (m)	Jan.	Feb.	Mar.	Apr.	May	June	July	Aug.	Sept.	Oct.	Nov.	Dec.	Min.	Max.	Mean
1	0.2	867	640					380	375	1,240	347	195		195	1,240	718
	5.0	436	400					440	500	1,360	542	255		255	1,360	808
2	0.2	593	400					360	250	1,000	302	287		250	1,000	625
	5.0	345	400					400	225	960	356	1,575		225	1,575	900
3	0.2	500	640					240	225	960	267	2,062		225	2,062	1,144
	5.0	291	760					300	500	960	213	3,252		213	3,252	1,733
4	0.2	450	500					400	250	520	196	175		175	520	348
	5.0	345	400					400	250	440	231	1,012		231	1,012	622
5	0.2	383	600					400	225	720	298	195		195	720	458
	5.0	382	500					400	300	440	276	200		200	500	350
6	0.2	417	800					380	375	520	169	1,550		169	1,550	860
	5.0	291	420					400	300	440	302	180		180	440	310
7	0.2	273	300					400	375	520	204	137		137	520	329
	5.0	455	580					380	500	400	302	150		150	580	365
8	0.2	500	600					380	375	480	244	1,125		244	1,125	685
	5.0	591	360					360	375	400	-	195		195	591	393
9	0.2	360	680					360	250	400	302	150		150	680	415
	5.0	355	400					320	275	760	387	200		200	760	480
10	0.2	333	420					400	300	520	311	162		162	520	341
	5.0	318	600					360	225	480	409	195		195	600	398
Minimum		273	300					240	225	400	169	137		137	520	329
Maximum	0.2	867	800					400	375	1,240	347	2,062		250	2,062	1,144
Mean		570	550					320	300	820	258	1,100		194	1,291	736
Minimum		291	360					300	225	400	213	150		150	440	310
Maximum	5.0	591	760					440	500	1,360	542	3,252		255	3,252	1,733
Mean		441	560					370	363	880	378	1,701		203	1,846	1,021

Nitrate-nitrogen ( $\mu\text{g}/\text{liter}$ ) in the Saguling Reservoir in 1988.

Station	Water Depth (m)	Jan.	Feb.	Mar.	Apr.	May	June	July	Aug.	Sept.	Oct.	Nov.	Dec.	Min.	Max.	Mean
1	0.2	87	123	111	148		235	419	398	274				87	419	253
	5.0	125	92	200	192		238	463	442	303				92	463	278
2	0.2	100	92	120	107		215	363	450	230				92	450	271
	5.0	125	123	178	167		185	338	694	362				123	694	409
3	0.2	62	123	150	115		204	375	338	201				62	375	219
	5.0	106	138	156	200		177	375	392	303				106	392	249
4	0.2	100	154	128	107		185	313	268	303				100	313	207
	5.0	200	169	167	179		192	275	352	274				167	352	260
5	0.2	81	162	133	148		177	431	282	259				81	431	256
	5.0	156	154	156	128		135	413	338	325				128	413	271
6	0.2	112	131	200	174		235	363	324	230				112	363	238
	5.0	100	108	156	154		165	375	408	274				100	408	254
7	0.2	75	92	178	107		185	306	408	288				75	408	242
	5.0	112	123	167	148		204	300	464	310				112	464	288
8	0.2	100	108	222	148		208	313	173	347				100	347	224
	5.0	237	123	211	148		273	388	295	347				123	388	256
9	0.2	50	108	178	141		165	300	214	573				50	573	312
	5.0	106	77	194	148		158	325	324	325				77	325	201
10	0.2	75	154	200	123		196	325	338	377				75	377	226
	5.0	125	123	216	182		154	275	392	303				123	392	258
Minimum		50	92	111	107		165	300	173	201	32	87	87	50	313	207
Maximum	0.2	112	162	222	174		235	431	450	573	98	204	158	112	573	312
Mean		81	127	167	141		200	366	312	387	66	142	91	81	443	259
Minimum		100	92	156	128		135	275	295	274	31	98	68	77	325	201
Maximum	5.0	237	169	216	200		273	463	694	362	98	143	125	167	694	409
Mean		169	131	186	164		204	369	495	318	62	127	93	122	510	305

Total phosphorus ( $\mu\text{g/liter}$ ) in the Saguling Reservoir in 1986.

Station	Water Depth (m)	Jan.	Feb.	Mar.	Apr.	May	June	July	Aug.	Sept.	Oct.	Nov.	Dec.	Min.	Max.	Mean
1	0.2			127		533		342	426	204	420	249	506	127	533	330
	5.0			159		458		348	461	237	394	242	419	159	461	310
2	0.2			129		740		511	497	184	389	370	456	129	740	435
	5.0			221		429		408	378	349	460	246	605	221	605	413
3	0.2			151		606		240	436	130	434	211	562	130	606	368
	5.0			89		450		424	411	518	406	160	495	89	518	304
4	0.2			75		428		435	497	242	423	219	515	75	515	295
	5.0			114		483		549	327	230	420	245	413	114	549	332
5	0.2			220		1,029		511	408	149	383	308	463	149	1,029	589
	5.0			89		791		168	485	228	369	249	472	89	791	440
6	0.2			209		606		475	515	126	389	347	536	126	606	366
	5.0			168		442		511	543	250	774	232	468	168	774	471
7	0.2			257		634		549	438	154	349	319	452	154	634	394
	5.0			169		476		377	549	212	431	309	451	169	549	359
8	0.2			192		618		381	364	427	369	394	454	192	618	405
	5.0			141		504		264	450	243	311	310	415	141	504	323
9	0.2			194		558		517	524	255	614	283	489	194	614	404
	5.0			129		376		275	329	186	437	376	372	129	437	283
10	0.2			268		580		411	435	247	426	272	506	247	580	414
	5.0			119		418		164	181	163	474	218	403	119	474	297
Minimum				75		428		240	364	126	349	211	452	75	515	295
Maximum	0.2			268		1,029		549	524	427	614	394	562	247	1,029	589
Mean				172		729		395	444	277	482	303	507	161	772	442
Minimum				89		418		164	181	163	311	160	403	89	437	283
Maximum	5.0			221		791		549	549	518	774	376	605	221	791	589
Mean				155		605		357	365	341	543	268	504	155	614	436

Total phosphorus ( $\mu\text{g/liter}$ ) in the Saguling Reservoir in 1987.

Station	Water Depth (m)	Jan.	Feb.	Mar.	Apr.	May	June	July	Aug.	Sept.	Oct.	Nov.	Dec.	Min.	Max.	Mean
1	0.2	496						270	158	132	579	412		132	579	356
	5.0	358						224	90	121	461	320		90	461	276
2	0.2	589						261	175	152	629	378		152	629	391
	5.0	592						235	175	167	947	609		167	947	557
3	0.2	613						205	134	126	576	450		126	613	370
	5.0	584						244	68	91	724	487		68	724	396
4	0.2	511						204	136	99	447	479		99	511	305
	5.0	656						214	90	228	818	450		90	818	454
5	0.2	357						165	72	172	566	587		72	587	330
	5.0	503						294	203	159	1,053	609		159	1,053	606
6	0.2	627						117	126	78	395	412		78	627	353
	5.0	647						184	180	68	1,163	609		68	1,163	616
7	0.2	212						147	108	71	658	437		71	658	365
	5.0	530						248	110	78	1,316	295		78	1,316	697
8	0.2	355						158	223	185	645	450		158	645	402
	5.0	386						171	164	66	-	479		66	479	273
9	0.2	601						218	124	91	842	378		91	842	467
	5.0	-						211	79	83	776	312		79	776	428
10	0.2	541						281	124	159	658	431		124	658	391
	5.0	587						212	149	51	1,118	183		51	1,118	585
Minimum								117	72	71	395	378		71	511	305
Maximum	0.2							281	223	185	842	587		158	842	467
Mean								199	148	128	619	483		115	677	386
Minimum								171	68	51	461	183		51	461	273
Maximum	5.0							294	203	228	1,316	609		167	1,316	697
Mean								233	136	140	889	396		109	889	485

Total phosphorus ( $\mu\text{g}/\text{liter}$ ) in the Saguling Reservoir in 1988.

Station	Water Depth (m)	Jan.	Feb.	Mar.	Apr.	May	June	July	Aug.	Sept.	Oct.	Nov.	Dec.	Min.	Max.	Mean
1	0.2	316	516					191	327	272				191	516	354
	5.0	417	340					273	273	272				272	417	345
2	0.2	417	376					273	361	272				272	417	345
	5.0	373	320					242	211	271				211	373	292
3	0.2	448	423					248	344	262				248	448	348
	5.0	402	429					305	247	594				247	594	421
4	0.2	282	374					186	277	300				186	374	280
	5.0	296	317					348	274	305				274	348	311
5	0.2	302	417					360	277	395				277	417	347
	5.0	448	240					320	256	254				240	448	344
6	0.2	600	466					252	382	256				252	600	426
	5.0	358	354					382	294	245				245	382	314
7	0.2	402	493					235	279	270				235	493	364
	5.0	387	292					392	253	222				222	392	307
8	0.2	289	411					221	261	277				221	411	316
	5.0	187	292					491	450	260				187	491	339
9	0.2	330	480					216	325	245				216	480	348
	5.0	302	326					247	400	173				173	400	287
10	0.2	344	320					370	257	275				257	370	314
	5.0	448	344					376	237	260				237	448	343
Minimum	0.2	282	320					186	257	245				186	370	280
Maximum	0.2	600	516					370	382	395				277	600	426
Mean	0.2	441	418					278	320	320				232	485	353
Minimum	5.0	187	240					242	211	222				173	348	287
Maximum	5.0	448	429					491	450	594				274	594	426
Mean	5.0	318	335					367	331	408				224	471	356

Orthophosphate ( $\mu\text{g}/\text{liter}$ ) in the Saguling Reservoir in 1986.

Station	Water Depth (m)	Jan.	Feb.	Mar.	Apr.	May	June	July	Aug.	Sept.	Oct.	Nov.	Dec.	Min.	Max.	Mean
1	0.2			112		56		134	127	234	279	227	215	56	279	168
	5.0			92		135		5	162	187	287	226	238	5	287	146
2	0.2			95		118		128	185	223	346	189	231	95	346	221
	5.0			85		138		103	162	233	254	191	223	85	254	170
3	0.2			84		141		168	180	185	324	141	219	84	324	204
	5.0			78		155		168	163	239	360	160	211	78	360	219
4	0.2			84		115		158	154	250	384	190	218	84	384	234
	5.0			94		107		132	141	222	361	242	166	94	361	228
5	0.2			84		112		124	177	196	347	188	225	84	347	216
	5.0			87		129		148	181	182	346	244	227	87	346	217
6	0.2			77		129		188	152	179	344	188	200	77	344	211
	5.0			79		146		134	116	170	394	170	226	79	394	237
7	0.2			87		146		133	135	183	327	187	208	87	327	207
	5.0			76		129		153	91	191	374	176	224	76	374	225
8	0.2			69		135		119	168	156	357	181	191	69	357	213
	5.0			78		144		169	114	176	290	166	212	78	290	184
9	0.2			59		129		158	110	196	313	199	190	59	313	186
	5.0			66		129		159	90	200	421	214	238	66	421	244
10	0.2			90		129		178	172	222	340	200	205	90	340	215
	5.0			79		141		139	121	261	459	177	218	79	459	269
Minimum	0.2			59		56		119	110	156	279	141	190	56	279	168
Maximum	0.2			112		146		188	185	250	384	227	231	95	384	234
Mean	0.2			86		101		154	148	203	332	184	211	76	332	201
Minimum	5.0			66		107		5	90	170	254	160	166	5	254	146
Maximum	5.0			94		155		169	181	261	459	244	238	94	459	269
Mean	5.0			80		131		87	136	216	357	202	202	50	357	208

Orthophosphate ( $\mu\text{g/liter}$ ) in the Saguling Reservoir in 1987.

Station	Water Depth (m)	Jan.	Feb.	Mar.	Apr.	May	June	July	Aug.	Sept.	Oct.	Nov.	Dec.	Min.	Max.	Mean
1	0.2	229	254					45	105	114	22	104	169	22	254	138
	5.0	227	223					52	30	67	18	113	-	18	227	123
2	0.2	210	261					76	89	67	18	69	194	18	261	140
	5.0	213	274					80	72	76	29	59	202	29	274	152
3	0.2	220	283					97	96	14	132	93	226	14	283	149
	5.0	180	174					108	37	81	127	104	189	37	189	113
4	0.2	221	272					132	103	62	138	20	38	20	272	146
	5.0	205	189					127	82	17	196	96	268	17	268	143
5	0.2	207	184					123	66	91	248	76	146	66	248	157
	5.0	184	186					124	84	47	26	80	226	26	226	126
6	0.2	45	203					115	87	54	246	26	213	26	246	136
	5.0	167	234					96	87	47	95	92	15	15	234	125
7	0.2	212	204					133	103	52	246	96	235	52	246	149
	5.0	189	210					94	99	41	202	89	158	41	210	126
8	0.2	182	212					115	77	73	185	82	239	73	239	156
	5.0	183	248					126	100	64	-	74	184	64	248	156
9	0.2	191	220					139	101	62	163	92	208	62	220	141
	5.0	194	226					109	68	60	147	107	163	60	226	143
10	0.2	227	256					160	101	54	273	137	256	54	273	164
	5.0	217	206					127	94	20	187	111	232	20	232	126
Minimum		45	184					45	66	14	18	20	38	14	220	136
Maximum	0.2	229	283					160	105	114	273	137	256	73	283	164
Mean		137	234					103	86	64	146	79	147	44	252	150
Minimum		167	174					52	30	17	18	59	15	15	189	113
Maximum	5.0	227	274					127	100	81	202	113	268	64	274	156
Mean		197	224					90	65	49	110	86	142	40	232	135

Orthophosphate ( $\mu\text{g/liter}$ ) in the Saguling Reservoir in 1988.

Station	Water Depth (m)	Jan.	Feb.	Mar.	Apr.	May	June	July	Aug.	Sept.	Oct.	Nov.	Dec.	Min.	Max.	Mean
1	0.2	201	211		286	223	75	80	141	138	266	161	138	75	286	181
	5.0	224	203		181	317	-	93	166	-	183	184	179	93	317	205
2	0.2	280	192		26	188	36	199	348	163	915	26	163	26	915	471
	5.0	201	254		196	273	32	148	171	165	163	259	165	32	273	153
3	0.2	220	214		219	148	55	189	211	200	151	189	200	55	220	138
	5.0	205	220		42	284	48	185	206	134	106	179	134	42	284	163
4	0.2	138	230		49	240	60	185	171	26	224	15	16	15	240	128
	5.0	240	192		160	326	93	195	151	151	157	331	151	93	331	212
5	0.2	151	172		178	254	85	180	211	21	119	213	21	21	254	138
	5.0	151	258		189	313	-	189	169	161	189	103	161	103	313	208
6	0.2	194	200		37	58	108	185	88	147	94	30	147	30	200	115
	5.0	144	192		203	265	87	238	273	134	119	281	134	87	281	184
7	0.2	131	179		160	206	109	233	269	148	23	269	148	23	269	146
	5.0	151	187		379	300	62	199	252	126	199	252	126	62	379	221
8	0.2	118	136		54	213	56	201	232	145	23	23	145	23	232	128
	5.0	186	179		174	288	164	192	206	192	64	208	192	64	288	176
9	0.2	176	262		42	273	152	176	209	139	176	209	139	42	273	158
	5.0	100	146		170	247	125	171	215	122	171	215	122	100	247	174
10	0.2	131	262		32	68	197	194	217	175	34	23	175	23	262	143
	5.0	125	223		160	340	131	89	181	157	119	319	157	89	340	215
Minimum		118	136		26	58	36	80	88	21	23	15	16	15	200	115
Maximum	0.2	280	262		286	273	197	233	348	200	915	269	200	75	915	471
Mean		199	199		156	166	117	157	218	111	469	142	108	45	558	293
Minimum		100	146		42	247	32	89	151	122	64	103	122	32	247	153
Maximum	5.0	240	258		379	340	164	238	273	192	199	331	192	103	379	221
Mean		170	202		211	294	98	164	212	157	132	217	157	68	313	187

Silicate (mg/liter) as SiO<sub>2</sub> in the Saguling Reservoir in 1986.

Station	Water Depth (m)	Jan.	Feb.	Mar.	Apr.	May	June	July	Aug.	Sept.	Oct.	Nov.	Dec.	Min.	Max.	Mean
1	0.2			52.0		0.0		31.5	29.0	34.7	31.5	24.0	14.0	0.0	52.0	27.1
	5.0			62.7		4.0		28.0	20.5	25.0	24.0	32.5	16.5	4.0	62.7	26.7
2	0.2		22.0		1.0			23.5	28.0	31.5	28.0	13.0	20.5	1.0	31.5	20.9
	5.0		42.0		2.5			21.0	25.0	31.5	27.0	37.0	23.0	2.5	42.0	26.1
3	0.2		14.0		2.5			23.5	20.5	35.5	31.5	10.5	11.5	2.5	35.5	18.7
	5.0		30.7		1.0			17.0	31.5	27.0	29.0	20.5	20.5	1.0	31.5	22.2
4	0.2		28.0		0.0			26.0	24.0	32.5	32.5	9.7	18.0	0.0	32.5	21.3
	5.0		26.0		0.0			21.0	28.0	24.0	31.5	13.0	18.0	0.0	31.5	20.2
5	0.2		19.5		6.0			28.0	16.5	33.5	31.5	6.5	21.0	6.0	33.5	20.3
	5.0		30.0		2.0			24.0	32.5	25.0	31.5	9.7	15.0	2.0	32.5	21.2
6	0.2		26.0		1.0			18.0	11.5	27.0	30.7	3.5	16.5	1.0	30.7	16.8
	5.0		30.0		3.5			17.0	31.5	24.0	26.0	16.5	13.0	3.5	31.5	20.2
7	0.2		15.0		1.0			28.0	29.0	22.0	28.0	3.5	22.0	1.0	29.0	18.6
	5.0		23.0		2.5			17.0	29.0	28.0	28.0	14.0	14.0	2.5	29.0	19.4
8	0.2		22.5		0.0			21.0	29.0	22.0	28.0	7.5	16.5	0.0	29.0	18.3
	5.0		26.0		2.0			28.0	17.0	34.7	26.0	15.0	16.0	2.0	34.7	20.6
9	0.2		17.0		2.5			25.0	35.5	26.0	29.0	3.5	15.0	2.5	35.5	19.2
	5.0		29.0		1.0			33.5	28.0	32.5	26.0	24.0	19.5	1.0	33.5	24.2
10	0.2		15.0		5.0			17.0	26.0	30.7	25.0	18.0	16.5	5.0	30.7	19.2
	5.0		26.0		1.0			37.0	34.7	28.0	31.5	13.0	16.5	1.0	37.0	23.5
Minimum				14.0		0.0		17.0	11.5	22.0	25.0	3.5	11.5	0.0	29.0	16.8
Maximum	0.2			52.0		6.0		31.5	35.5	35.5	32.5	24.0	22.0	6.0	52.0	27.1
Mean				23.1		1.9		24.2	24.9	29.5	29.6	10.4	17.2	1.9	34.0	20.0
Minimum				23.0		0.0		17.0	17.0	24.0	24.0	9.7	13.0	0.0	29.0	19.4
Maximum	5.0			62.7		4.0		37.0	34.7	34.7	31.5	37.0	23.0	4.0	62.7	26.7
Mean				32.5		2.0		24.4	27.8	28.0	28.1	19.5	17.2	2.0	36.6	22.4

Silicate (mg/liter) as SiO<sub>2</sub> in the Saguling Reservoir in 1987.

Station	Water Depth (m)	Jan.	Feb.	Mar.	July	Aug.	Sept.	Oct.	Nov.	Dec.	Min.	Max.	Mean		
1	0.2	18.0	6.5		21.0	35.5	24.0	16.5	31.5	70.0	16.5	70.0	33.1		
	5.0	2.5	6.5		16.0	49.0	24.0	18.0	75.5	-	16.0	75.5	30.4		
2	0.2	20.5	6.5		18.0	29.0	15.0	15.0	42.0	26.0	15.0	42.0	24.2		
	5.0	2.0	6.0		23.0	25.0	20.5	13.0	31.5	28.7	13.0	31.5	23.6		
3	0.2	20.5	4.0		22.0	26.0	11.5	15.0	37.0	26.0	11.5	37.0	22.9		
	5.0	0.0	4.0		19.5	16.5	14.0	19.5	37.0	36.7	14.0	37.0	23.9		
4	0.2	24.0	13.0		18.0	26.0	13.0	18.0	37.0	20.5	13.0	37.0	22.1		
	5.0	2.0	9.0		25.0	19.5	30.0	16.0	32.5	29.0	16.0	32.5	25.3		
5	0.2	11.5	6.5		22.0	27.0	7.5	15.0	26.0	18.0	7.5	27.0	19.3		
	5.0	0.0	2.5		14.0	20.5	9.0	18.0	29.0	15.8	9.0	29.0	17.7		
6	0.2	11.5	6.0		21.0	24.0	6.5	15.0	34.8	18.0	6.5	34.8	19.9		
	5.0	0.0	6.5		16.5	16.0	12.0	17.0	31.5	14.5	12.0	31.5	17.9		
7	0.2	25.0	6.0		17.0	25.0	9.8	11.5	31.5	18.0	9.8	31.5	18.8		
	5.0	1.0	5.0		22.0	24.0	14.0	17.0	45.0	28.8	14.0	45.0	25.1		
8	0.2	36.5	18.0		19.5	24.0	15.0	16.5	40.0	19.5	15.0	40.0	22.4		
	5.0	0.0	17.0		19.5	25.0	12.0	-	35.5	21.0	12.0	35.5	18.8		
9	0.2	9.0	12.0		21.0	18.0	11.5	24.0	31.5	27.0	11.5	31.5	22.2		
	5.0	0.0	6.0		19.5	20.5	16.0	30.0	42.8	24.5	16.0	42.8	25.6		
10	0.2	7.5	8.0		16.0	21.0	13.0	24.0	31.5	19.5	13.0	31.5	20.8		
	5.0	0.0	9.8		21.0	19.5	16.0	22.0	50.0	23.3	16.0	50.0	25.3		
Minimum				7.5	4.0		16.0	18.0	6.5	11.5	6.5	27.0	18.8		
Maximum	0.2			36.5	18.0		22.0	35.5	24.0	24.0	70.0	16.5	70.0		
Mean				22.0	11.0		19.0	26.8	15.3	17.8	34.0	44.0	11.5	48.5	25.9
Minimum				1.0	2.5		14.0	16.0	9.0	13.0	29.0	14.5	9.0	29.0	17.7
Maximum	5.0			2.5	17.0		25.0	49.0	30.0	30.0	75.5	36.7	16.0	75.5	30.4
Mean				1.8	9.8		19.5	32.5	19.5	21.5	52.3	25.6	12.5	52.3	24.1

Silicate (mg/liter) as SiO<sub>2</sub> in the Saguling Reservoir in 1988.

Station	Water Depth (m)	Jan.	Feb.	Mar.	Apr.	May	June	July	Aug.	Sept.	Oct.	Nov.	Dec.	Min.	Max.	Mean
1	0.2	70.0	9.0	42.7	13.0	87.5	19.5	5.0	6.5		43.5	66.5	11.5	5.0	87.5	46.3
	5.0	113.5	5.6	82.5	17.0	92.5	24.0	9.7	11.5		61.5	70.0	56.5	5.6	113.5	59.6
2	0.2	47.0	12.0	31.5	19.5	21.0	28.0	8.0	8.0		15.0	20.5	9.7	8.0	47.0	27.5
	5.0	56.0	9.7	42.0	15.0	60.0	20.5	8.0	6.5		16.5	16.5	11.5	6.5	60.0	33.3
3	0.2	40.0	12.0	28.0	19.5	19.5	35.5	5.0	6.5		6.5	8.0	11.5	5.0	40.0	22.5
	5.0	49.0	6.5	27.0	15.0	42.8	32.5	11.5	13.0		16.0	15.0	16.5	6.5	49.0	27.8
4	0.2	57.0	16.5	38.5	30.0	24.0	16.5	6.5	5.0		5.0	6.5	11.5	5.0	57.0	31.0
	5.0	67.0	33.5	45.5	37.0	42.8	24.0	20.5	43.5		8.0	9.7	33.5	8.0	67.0	37.5
5	0.2	52.0	24.0	28.0	24.0	22.0	22.0	15.0	16.5		11.5	16.5	16.5	11.5	52.0	31.8
	5.0	20.5	-	28.0	16.5	30.8	24.0	13.0	15.0		2.6	15.0	16.5	2.6	30.8	16.7
6	0.2	20.5	26.0	23.0	23.0	24.0	22.0	3.5	6.5		28.0	28.0	8.0	3.5	28.0	15.8
	5.0	28.0	14.0	27.0	16.5	20.5	25.0	11.5	16.5		9.8	15.0	15.0	9.8	28.0	18.9
7	0.2	21.0	33.5	37.0	30.0	25.0	26.0	3.5	5.0		3.5	5.0	8.0	3.5	37.0	20.3
	5.0	34.0	12.0	31.5	30.5	25.0	25.0	5.0	6.5		5.0	6.5	8.0	5.0	34.0	19.5
8	0.2	20.5	24.0	43.5	21.0	23.0	21.0	3.5	3.5		24.0	30.0	6.1	3.5	43.5	23.5
	5.0	84.0	23.0	45.5	26.0	19.5	19.5	3.5	5.0		11.5	15.0	8.0	3.5	84.0	43.8
9	0.2	19.5	27.0	30.0	24.0	24.0	32.5	8.0	8.0		8.0	8.0	9.7	8.0	32.5	20.3
	5.0	20.5	21.0	45.0	48.0	27.0	21.0	8.0	9.7		8.0	9.7	9.7	8.0	48.0	28.0
10	0.2	24.0	19.5	30.0	34.8	27.0	31.5	5.0	6.5		9.8	13.0	15.0	5.0	34.8	19.9
	5.0	37.0	12.0	37.0	23.0	18.0	20.9	8.0	3.5		22.0	30.0	16.5	3.5	37.0	20.3
Minimum		19.5	9.0	23.0	13.0	19.5	16.5	3.5	3.5		3.5	5.0	6.1	3.5	28.0	15.8
Maximum	0.2	70.0	33.5	43.5	34.8	87.5	35.5	15.0	16.5		43.5	66.5	16.5	11.5	87.5	46.3
Mean		44.8	21.3	33.3	23.9	53.5	26.0	9.3	10.0		23.5	35.8	11.3	7.5	57.8	31.0
Minimum		20.5	5.6	27.0	15.0	18.0	19.5	3.5	3.5		2.6	6.5	8.0	2.6	28.0	16.7
Maximum	5.0	113.5	33.5	82.5	48.0	92.5	32.5	20.5	43.5		61.5	70.0	56.5	9.8	113.5	59.6
Mean		67.0	19.6	54.8	31.5	55.3	26.0	12.0	23.5		32.1	38.3	32.3	6.2	70.8	38.1

Hydrogen sulfide (µg/liter) in the Saguling Reservoir in 1986.

Station	Water Depth (m)	Jan.	Feb.	Mar.	Apr.	May	June	July	Aug.	Sept.	Oct.	Nov.	Dec.	Min.	Max.	Mean
1	0.2			249		432		58	176	200	528	436	264	58	528	293
	5.0			282		512		0	432	176	264	306	296	264	512	388
2	0.2			242		440		189	256	400	320	409	224	189	440	315
	5.0			289		312		110	256	194	272	423	416	110	423	267
3	0.2			206		448		255	320	208	480	494	232	206	494	350
	5.0			222		400		116	400	136	504	418	192	116	504	310
4	0.2			282		416		36	192	240	424	495	296	36	495	266
	5.0			114		472		160	336	176	424	418	336	114	472	293
5	0.2			202		352		44	336	64	400	405	400	44	405	225
	5.0			202		304		131	304	240	400	396	376	131	400	266
6	0.2			215		336		73	144	32	432	423	288	32	432	232
	5.0			336		384		175	304	64	344	297	264	64	384	224
7	0.2			390		552		131	176	128	432	337	368	128	552	340
	5.0			444		436		164	272	144	416	402	272	144	444	294
8	0.2			242		472		15	320	80	456	402	312	15	472	244
	5.0			276		360		146	416	126	384	432	272	126	432	279
9	0.2			215		432		42	224	192	184	335	304	42	432	237
	5.0			349		408		160	128	£0	224	484	176	80	484	282
10	0.2			430		528		65	176	250	264	389	256	65	528	297
	5.0			309		400		131	288	32	304	508	320	32	508	270
Minimum				202		336		15	144	32	184	335	224	15	405	225
Maximum	0.2			430		552		255	336	400	528	495	400	206	552	350
Mean				316		444		135	240	216	356	415	312	111	479	287
Minimum				114		304		110	128	32	224	297	176	32	384	224
Maximum	5.0			444		512		175	432	240	504	508	416	264	512	388
Mean				279		408		143	280	136	364	403	296	148	448	306

Hydrogen sulfide ( $\mu\text{g/liter}$ ) in the Saguling Reservoir in 1987.

Station	Water Depth (m)	Jan.	Feb.	Mar.	Apr.	May	June	July	Aug.	Sept.	Oct.	Nov.	Dec.	Min.	Max.	Mean
1	0.2	152	258					438	422	198	288	256	176	152	438	295
	5.0	612	50					438	384	277	400	528	-	50	612	331
2	0.2	177	915					637	346	644	240	144	216	144	915	530
	5.0	34	278					677	460	118	464	368	96	34	677	356
3	0.2	-	965					478	537	79	160	192	80	79	965	522
	5.0	231	163					637	576	454	224	400	16	16	637	327
4	0.2	170	190					677	768	422	464	184	144	144	768	456
	5.0	245	61					757	768	386	448	32	64	32	768	400
5	0.2	6	269					677	537	703	160	32	32	6	703	355
	5.0	204	172					637	346	395	336	368	16	16	637	327
6	0.2	-	40					518	576	533	176	144	16	16	576	296
	5.0	197	81					657	537	79	720	362	32	32	720	376
7	0.2	367	115					597	96	316	432	288	16	16	597	307
	5.0	109	95					677	158	310	504	224	32	32	677	355
8	0.2	68	235					438	406	553	544	416	16	16	553	285
	5.0	326	95					837	79	138	-	256	16	16	837	427
9	0.2	612	149					837	158	301	576	320	32	32	837	435
	5.0	252	108					438	79	176	392	400	16	16	438	227
10	0.2	314	102					657	316	92	560	192	32	32	657	345
	5.0	626	95					637	576	305	408	160	240	95	637	366
Minimum		6	40					438	96	79	160	32	16	6	438	285
Maximum	0.2	612	965					837	768	703	576	416	216	152	965	530
Mean		309	503					638	432	391	368	224	116	79	702	407
Minimum		34	50					438	79	79	224	32	16	16	438	227
Maximum	5.0	626	278					837	768	454	720	528	240	95	837	427
Mean		330	164					638	424	267	472	280	128	56	638	327

Hydrogen sulfide ( $\mu\text{g/liter}$ ) in the Saguling Reservoir in 1988.

Station	Water Depth (m)	Jan.	Feb.	Mar.	Apr.	May	June	July	Aug.	Sept.	Oct.	Nov.	Dec.	Min.	Max.	Mean
1	0.2	168			84	3	47	173	184	143	624	33	143	3	624	314
	5.0	256			11	4	350	84	225	-	679	837	732	4	837	421
2	0.2	224			3	44	17	79	163	46	624	3	46	3	624	314
	5.0	168			125	12	498	78	136	84	584	744	84	12	744	378
3	0.2	336			10	3	54	11	269	12	97	4	12	3	336	170
	5.0	272			63	5	56	41	144	53	777	17	53	5	777	391
4	0.2	160			9	4	121	31	266	4	113	4	4	4	266	135
	5.0	160			15	4	243	85	177	44	801	147	44	4	801	403
5	0.2	112			4	4	37	32	193	6	35	16	6	4	193	99
	5.0	160			14	8	133	94	188	25	801	758	25	8	801	405
6	0.2	248			2	4	14	10	154	5	11	9	5	2	248	125
	5.0	160			36	3	91	87	148	20	825	8	20	3	825	414
7	0.2	272			2	4	47	29	128	15	29	128	15	2	272	137
	5.0	112			34	8	101	92	155	18	92	155	18	8	155	82
8	0.2	240			2	4	48	80	17	6	37	3	6	2	240	121
	5.0	168			68	4	221	77	252	44	793	758	44	4	793	399
9	0.2	288			7	4	40	6	159	4	7	159	4	4	288	146
	5.0	160			5	4	196	178	284	132	178	284	132	4	284	144
10	0.2	256			9	4	14	25	83	37	84	1	37	1	256	129
	5.0	256			13	5	189	178	111	21	801	139	21	5	801	403
Minimum		112			2	3	14	6	17	4	7	1	4	1	193	99
Maximum	0.2	336			84	44	121	173	269	143	624	159	143	4	624	314
Mean		224			43	24	68	90	143	74	316	80	74	3	409	206
Minimum		112			5	3	56	41	111	18	92	8	18	3	155	82
Maximum	5.0	272			125	12	498	178	284	132	825	837	732	12	837	421
Mean		192			65	8	277	110	198	75	758	426	128	8	496	251



Biological oxygen demand (mg/liter) in the Saguling Reservoir in 1986.

Station	Water Depth (m)	Jan.	Feb.	Mar.	Apr.	May	June	July	Aug.	Sept.	Oct.	Nov.	Dec.	Min.	Max.	Mean
1	0.2			5.4		1.9		7.7	8.1	9.7	1.6	1.0	14.9	1.0	14.9	8.0
	5.0			4.4		1.9		7.3	7.3	7.7	2.5	4.6	11.5	1.9	11.5	6.7
2	0.2			3.9		1.9		6.5	7.3	8.1	0.4	3.7	13.9	0.4	13.9	7.2
	5.0			5.4		1.5		6.5	8.1	5.3	2.0	6.5	15.0	1.5	15.0	8.3
3	0.2			5.4		1.5		3.7	9.7	5.3	5.3	1.4	3.5	1.4	9.7	5.6
	5.0			4.1		1.0		4.1	12.2	9.3	6.1	1.8	6.6	1.0	12.2	6.6
4	0.2			4.1		0.5		4.9	5.7	7.3	3.3	1.8	1.2	0.5	7.3	3.9
	5.0			3.9		2.4		4.5	4.1	7.3	2.4	5.5	3.5	2.4	7.3	4.9
5	0.2			5.4		3.4		6.1	4.1	4.9	1.6	5.5	7.6	1.6	7.6	4.6
	5.0			3.4		2.4		9.7	4.1	3.7	2.0	5.5	5.5	2.0	9.7	5.9
6	0.2			5.6		1.9		14.2	12.2	2.0	3.3	7.4	11.7	1.9	14.2	8.1
	5.0			4.6		1.9		7.3	7.3	6.1	5.7	1.5	12.1	1.5	12.1	6.8
7	0.2			3.2		1.9		3.2	2.4	8.1	2.4	4.2	13.3	1.9	13.3	7.6
	5.0			4.9		1.5		8.5	3.2	8.5	5.3	6.5	15.8	1.5	15.8	8.7
8	0.2			3.2		1.5		8.9	4.9	8.1	1.6	4.6	12.9	1.5	12.9	7.2
	5.0			1.9		2.4		10.1	12.2	4.9	2.4	2.8	3.9	1.9	12.2	7.1
9	0.2			4.9		1.9		4.9	12.2	8.6	0.8	3.2	13.9	0.8	13.9	7.4
	5.0			4.6		1.5		4.1	20.3	6.9	4.1	6.5	11.8	1.5	20.3	10.9
10	0.2			4.4		2.4		6.5	2.4	2.8	5.7	5.5	10.4	2.4	10.4	6.4
	5.0			3.7		1.9		11.0	8.1	5.3	6.5	4.6	9.0	1.9	11.0	6.5
Minimum				3.2		0.5		3.2	2.4	2.0	0.4	1.0	1.2	0.4	7.3	3.9
Maximum	0.2			5.6		3.4		14.2	12.2	9.7	5.7	7.4	14.9	2.4	14.9	8.1
Mean				4.4		2.0		8.7	7.3	5.9	3.1	4.2	8.1	1.4	11.1	6.0
Minimum				1.9		1.0		4.1	3.2	3.7	2.0	1.5	3.5	1.0	7.3	4.9
Maximum	5.0			5.4		2.4		11.0	20.3	9.3	6.5	6.5	15.8	2.4	20.3	10.9
Mean				3.7		1.7		7.6	11.8	6.5	4.3	4.0	9.7	1.7	13.8	7.9

Biological oxygen demand (mg/liter) in the Saguling Reservoir in 1987.

Station	Water Depth (m)	Jan.	Feb.	Mar.	Apr.	May	June	July	Aug.	Sept.	Oct.	Nov.	Dec.	Min.	Max.	Mean
1	0.2	12.8	0.8					13.1	2.7	12.0	6.5	10.6	45.5	0.8	45.5	23.2
	5.0	14.4	0.8					5.9	1.0	13.1	1.6	6.5	-	0.8	14.4	7.6
2	0.2	14.4	0.8					13.4	4.1	3.8	2.4	5.7	2.9	0.8	14.4	7.6
	5.0	15.2	0.8					13.1	3.4	3.6	8.9	4.1	9.5	0.8	15.2	8.0
3	0.2	8.0	4.0					10.2	5.4	8.3	1.6	6.5	14.7	1.6	14.7	8.2
	5.0	19.2	2.4					8.6	4.1	3.8	0.8	16.3	1.5	0.8	19.2	10.0
4	0.2	15.2	1.6					16.7	0.7	0.6	3.3	4.9	4.4	0.6	16.7	8.7
	5.0	12.0	3.2					8.6	0.7	5.1	5.7	8.1	8.1	0.7	12.0	6.4
5	0.2	16.8	0.8					10.8	0.7	6.2	1.6	4.9	9.5	0.7	16.8	8.8
	5.0	17.6	0.8					11.6	0.7	3.4	7.3	17.5	4.4	0.7	17.6	9.2
6	0.2	11.2	1.6					12.3	6.1	5.5	8.1	5.7	3.7	1.6	12.3	7.0
	5.0	17.6	0.8					10.4	2.0	1.6	11.0	1.6	1.5	0.8	17.6	9.2
7	0.2	16.8	1.6					10.3	0.7	6.7	0.4	4.1	8.1	0.4	16.8	8.6
	5.0	16.8	15.4					11.5	3.4	1.5	8.1	4.1	52.8	1.5	52.8	27.2
8	0.2	15.2	1.6					11.1	0.7	4.5	6.5	3.3	26.4	0.7	26.4	13.6
	5.0	13.6	0.8					15.4	3.4	7.5	-	7.3	12.5	0.8	15.4	8.1
9	0.2	17.6	0.8					11.4	0.7	8.7	4.9	4.1	6.6	0.7	17.6	9.2
	5.0	14.4	2.4					11.9	9.1	5.6	13.0	5.7	5.1	2.4	14.4	8.4
10	0.2	12.8	0.8					4.3	1.4	4.6	1.6	4.9	6.0	0.8	12.8	6.8
	5.0	16.8	1.6					10.6	5.7	5.9	32.5	5.7	15.4	1.6	32.5	17.1
Minimum			8.0	0.8				4.3	0.7	0.6	0.4	3.3	2.9	0.4	12.3	6.8
Maximum	0.2	17.6	4.0					16.7	6.1	12.0	8.1	10.6	45.5	1.6	45.5	23.2
Mean		12.8	2.4					10.5	3.4	6.3	4.3	7.0	24.2	1.0	28.9	15.0
Minimum			12.0	0.8				5.9	0.7	1.5	0.8	1.6	1.5	0.7	12.0	6.4
Maximum	5.0	19.2	15.4					15.4	9.1	13.1	32.5	17.5	52.8	2.4	52.8	27.2
Mean		15.6	8.1					10.7	4.9	7.3	16.7	9.6	27.2	1.6	32.4	16.8

Biological oxygen demand (mg/liter) in the Saguling Reservoir in 1988.

Station	Water Depth (m)	Jan.	Feb.	Mar.	Apr.	May	June	July	Aug.	Sept.	Oct.	Nov.	Dec.	Min.	Max.	Mean
1	0.2	8.9	9.7	2.8	2.5	3.0	5.4	5.9	3.7	17.3	0.3	4.6	17.3	0.3	17.3	8.8
	5.0	4.9	4.1	2.8	3.5	2.0	2.2	5.3	12.9	-	1.3	3.8	3.2	1.3	12.9	7.1
2	0.2	7.3	6.0	1.6	4.2	1.0	4.0	4.5	6.8	12.0	1.6	3.5	12.0	1.0	12.0	6.5
	5.0	2.4	2.4	3.9	1.5	2.8	3.2	4.1	7.1	4.7	1.2	2.4	4.7	1.2	7.1	4.2
3	0.2	9.7	11.4	0.4	2.8	3.0	2.7	0.3	4.6	3.0	4.2	3.0	3.0	0.3	11.4	5.9
	5.0	11.4	13.8	2.8	1.2	3.1	2.6	7.2	8.7	1.0	1.8	2.2	1.0	1.0	13.8	7.4
4	0.2	2.4	1.6	2.8	2.7	2.6	2.7	3.8	1.3	5.9	0.5	3.3	5.9	0.5	5.9	3.2
	5.0	13.0	15.4	3.4	1.2	1.7	2.6	2.2	3.9	4.1	1.9	3.9	4.1	1.2	15.4	8.3
5	0.2	1.6	0.8	0.8	4.3	7.8	2.0	3.7	3.1	5.2	2.9	2.6	5.2	0.8	7.8	4.3
	5.0	8.1	0.8	0.8	2.3	3.0	1.6	2.6	4.7	3.2	11.9	3.7	3.2	0.8	11.9	6.4
6	0.2	0.8	0.8	2.0	4.0	3.7	2.4	2.8	4.4	4.6	0.5	1.9	4.6	0.5	4.6	2.6
	5.0	10.7	8.9	9.9	1.4	1.5	1.7	4.7	3.2	2.2	3.3	3.4	2.2	1.4	10.7	6.1
7	0.2	13.8	39.2	0.4	3.5	3.9	2.1	0.3	4.1	3.3	0.3	4.1	3.3	0.3	39.2	19.8
	5.0	13.8	12.2	6.3	3.5	2.7	1.7	3.6	2.1	1.7	3.6	2.1	1.7	1.7	13.8	7.8
8	0.2	0.8	0.8	8.3	2.4	2.8	2.6	18.0	4.0	3.1	2.9	3.5	3.1	0.8	18.0	9.4
	5.0	11.4	12.2	5.5	2.5	2.2	1.5	3.8	8.9	0.7	2.9	4.7	0.7	0.7	12.2	6.5
9	0.2	0.8	0.8	4.3	4.6	2.7	2.8	5.2	3.8	4.8	5.2	3.8	4.8	0.8	5.2	3.0
	5.0	3.2	2.4	5.1	4.4	2.1	0.6	7.2	6.7	3.8	7.2	6.7	3.8	0.6	7.2	3.9
10	0.2	4.1	3.2	5.5	5.8	7.5	2.8	3.2	5.1	1.4	4.7	3.1	1.4	1.4	7.5	4.5
	5.0	1.6	0.8	6.7	1.8	2.2	2.5	2.2	6.4	1.8	5.1	3.2	1.8	0.8	6.7	3.8
Minimum		0.8	0.8	0.4	2.4	1.0	2.0	0.3	1.3	1.4	0.3	1.9	1.4	0.3	4.6	2.6
Maximum	0.2	13.8	39.2	8.3	5.8	7.8	5.4	18.0	6.8	17.3	5.2	4.6	17.3	1.4	39.2	19.8
Mean		7.3	20.0	4.4	4.1	4.4	3.7	9.2	4.1	9.4	2.8	3.3	9.4	0.9	21.9	11.2
Minimum		1.6	0.8	0.8	1.2	1.5	0.6	2.2	2.1	0.7	1.2	2.1	0.7	0.6	6.7	3.8
Maximum	5.0	13.8	15.4	9.9	4.4	3.1	3.2	7.2	12.9	4.7	11.9	6.7	4.7	1.7	15.4	8.3
Mean		7.7	8.1	5.4	2.8	2.3	1.9	4.7	7.5	2.7	6.6	4.4	2.7	1.2	11.1	6.0

Chemical oxygen demand (mg/liter) in the Saguling Reservoir in 1986.

Station	Water Depth (m)	Jan.	Feb.	Mar.	Apr.	May	June	July	Aug.	Sept.	Oct.	Nov.	Dec.	Min.	Max.	Mean
1	0.2			42.0		12.3		33.8	29.2	24.8	22.6	27.2	18.0	12.3	42.0	27.2
	5.0			34.2		22.3		24.6	26.8	31.0	18.6	29.9	30.2	18.6	34.2	26.4
2	0.2			24.9		18.5		21.5	26.1	37.2	22.6	24.5	15.0	15.0	37.2	26.1
	5.0			37.4		15.4		21.5	20.9	21.7	27.9	29.9	50.2	15.4	50.2	32.8
3	0.2			18.7		15.4		29.2	24.6	12.4	16.1	40.9	9.0	9.0	40.9	25.0
	5.0			38.9		18.5		18.4	18.4	12.4	15.5	35.4	51.1	12.4	51.1	31.8
4	0.2			14.0		15.4		26.1	27.6	21.7	24.2	62.6	16.5	14.0	62.6	38.3
	5.0			48.3		18.5		13.8	15.3	24.8	27.9	29.9	47.0	13.8	48.3	31.1
5	0.2			29.6		18.5		24.6	22.4	24.8	21.0	24.5	16.5	16.5	29.6	23.1
	5.0			26.5		16.9		16.9	13.2	24.8	21.7	32.7	22.6	13.2	32.7	23.0
6	0.2			37.4		15.4		27.6	21.5	21.7	27.4	46.3	15.0	15.0	46.3	30.7
	5.0			28.0		18.5		18.4	11.7	24.8	24.8	32.7	37.3	11.7	37.3	24.5
7	0.2			28.0		12.3		18.4	18.4	27.9	17.4	24.5	15.0	12.3	28.0	20.2
	5.0			15.6		15.4		15.3	15.3	27.9	27.9	35.4	28.8	15.3	35.4	25.4
8	0.2			7.8		15.4		15.4	20.9	18.6	21.0	24.5	13.5	7.8	24.5	16.2
	5.0			21.8		15.4		18.4	18.4	21.7	24.8	27.2	40.5	15.4	40.5	28.0
9	0.2			23.3		16.9		12.3	14.3	21.7	27.4	32.7	12.0	12.0	32.7	22.4
	5.0			28.0		12.3		12.3	8.8	31.0	31.0	29.9	42.1	8.8	42.1	25.5
10	0.2			7.8		11.5		6.1	17.8	18.6	22.6	29.9	13.5	6.1	29.9	18.0
	5.0			26.5		15.4		13.8	16.9	15.5	18.6	26.4	45.4	13.8	45.4	29.6
Minimum				7.8		11.5		6.1	14.3	12.4	16.1	24.5	9.0	6.1	24.5	16.2
Maximum	0.2			42.0		18.5		33.8	29.2	37.2	27.4	62.6	18.0	16.5	62.6	38.3
Mean				24.9		15.0		20.0	21.8	24.8	21.8	43.6	13.5	11.3	43.6	27.2
Minimum				15.6		12.3		12.3	8.8	12.4	15.5	26.4	22.6	8.8	32.7	23.0
Maximum	5.0			48.3		22.3		24.6	26.8	31.0	31.0	35.4	51.1	18.6	51.1	32.8
Mean				32.0		17.3		18.5	17.8	21.7	23.3	30.9	36.9	13.7	41.9	27.9

Chemical oxygen demand (mg/liter) in the Saguling Reservoir in 1987.

Station	Water Depth (m)	Jan.	Feb.	Mar.	Apr.	May	June	July	Aug.	Sept.	Oct.	Nov.	Dec.	Min.	Max.	Mean
1	0.2							54.5	55.8	31.0	63.2	22.1	34.8	22.1	63.2	42.7
	5.0							54.5	61.1	40.1	65.6	53.7	-	40.1	65.6	52.9
2	0.2							48.4	24.0	40.9	54.9	31.6	19.0	19.0	54.9	37.0
	5.0							49.9	20.8	67.4	57.3	37.9	31.6	20.8	67.4	44.1
3	0.2							116.7	35.7	33.8	59.6	28.4	34.8	28.4	116.7	72.6
	5.0							48.4	32.4	38.9	49.0	25.3	37.9	25.3	49.0	37.2
4	0.2							45.4	55.7	31.8	53.7	28.4	31.6	28.4	55.7	42.1
	5.0							95.4	44.1	34.4	34.8	25.3	22.1	22.1	95.4	58.8
5	0.2							39.3	40.7	28.7	50.2	25.3	28.4	25.3	50.2	37.8
	5.0							48.4	47.5	45.2	49.0	19.0	31.6	19.0	49.0	34.0
6	0.2							54.5	50.9	32.4	52.5	34.8	31.6	31.6	54.5	43.1
	5.0							54.5	49.2	33.2	45.4	37.9	34.8	33.2	54.5	43.9
7	0.2							60.6	59.3	36.7	44.2	37.9	31.6	31.6	60.6	46.1
	5.0							39.3	52.6	57.2	47.8	28.4	28.4	28.4	57.2	42.8
8	0.2							48.4	32.3	38.1	46.6	22.1	22.1	22.1	48.4	35.3
	5.0							39.3	45.8	39.5	-	22.1	19.0	19.0	45.8	32.4
9	0.2							51.5	52.6	30.4	49.0	28.4	28.4	28.4	52.6	40.5
	5.0							42.3	49.2	38.1	37.1	31.6	91.6	31.6	91.6	61.6
10	0.2							45.4	45.8	19.6	72.7	31.6	28.3	19.6	72.7	46.2
	5.0							87.9	42.4	46.6	31.2	31.6	34.8	31.2	87.9	59.6
Minimum								39.3	24.0	19.6	44.2	22.1	19.0	19.0	48.4	35.3
Maximum	0.2							116.7	59.3	40.9	72.7	37.9	34.8	31.6	116.7	72.6
Mean								78.0	41.7	30.3	58.5	30.0	26.9	25.3	82.6	53.9
Minimum								39.3	20.8	33.2	31.2	19.0	19.0	19.0	45.8	32.4
Maximum	5.0							95.4	61.1	67.4	65.6	53.7	91.6	40.1	95.4	72.6
Mean								67.4	41.0	50.3	48.4	36.4	55.3	29.6	70.6	52.5

Chemical oxygen demand (mg/liter) in the Saguling Reservoir in 1988.

Station	Water Depth (m)	Jan.	Feb.	Mar.	Apr.	May	June	July	Aug.	Sept.	Oct.	Nov.	Dec.	Min.	Max.	Mean
1	0.2	20.7			12.3	62.5	28.1	19.3	34.6	141.6	24.6	35.6	141.7	12.3	141.7	77.0
	5.0	121.1			8.9	-	43.8	11.1	29.9	-	29.9	32.9	28.6	8.9	121.1	65.0
2	0.2	20.7			12.3	21.4	18.7	35.7	21.7	16.4	38.7	17.5	16.4	12.3	38.7	25.5
	5.0	81.6			18.1	15.8	12.5	30.4	24.2	13.0	27.8	18.8	12.9	12.5	81.6	47.1
3	0.2	14.5			112.1	21.9	25.0	38.1	20.1	56.6	17.8	15.1	56.6	14.5	112.1	63.3
	5.0	68.5			52.9	-	21.9	44.9	23.6	27.8	14.7	17.5	27.8	14.7	68.5	41.6
4	0.2	20.5			72.6	18.7	18.7	33.3	26.7	32.5	28.7	30.5	32.5	18.7	72.6	45.7
	5.0	61.5			85.8	18.7	15.7	42.0	28.0	19.0	27.1	20.9	19.0	15.7	85.8	50.8
5	0.2	14.7			5.5	25.5	25.0	57.9	24.5	28.1	18.4	18.8	28.1	5.5	57.9	31.7
	5.0	8.8			28.1	5.5	28.1	34.7	26.1	18.3	151.0	12.3	18.3	5.5	151.0	78.3
6	0.2	23.4			5.5	25.0	21.9	42.5	23.9	22.6	14.3	13.4	22.0	5.5	42.5	24.0
	5.0	71.8			2.1	25.0	21.9	30.0	25.5	7.9	37.4	22.6	7.9	2.1	71.8	37.0
7	0.2	11.7			8.9	15.6	12.4	20.3	25.1	15.2	20.3	25.2	15.2	8.9	25.2	17.1
	5.0	45.5			2.1	15.6	15.7	22.2	24.8	28.9	22.2	24.8	28.9	2.1	45.5	23.8
8	0.2	8.8			8.9	15.6	25.0	20.3	19.2	10.1	19.3	22.9	10.1	8.8	25.0	16.9
	5.0	26.4			4.1	15.6	34.4	25.6	17.9	14.2	13.1	19.5	14.2	4.1	34.4	19.3
9	0.2	41.5			2.1	18.7	18.7	79.6	23.9	15.5	79.6	23.9	15.5	2.1	79.6	40.9
	5.0	55.4			8.9	12.9	25.0	45.3	20.1	11.7	45.3	20.1	11.7	8.9	55.4	32.2
10	0.2	52.1			5.5	25.0	21.9	25.1	13.1	18.9	16.8	16.1	18.9	5.5	52.1	28.8
	5.0	52.1			8.9	18.7	15.7	18.3	13.4	14.5	15.0	22.9	14.5	8.9	52.1	30.5
Minimum					2.1	15.6	12.4	19.3	13.1	10.1	14.3	13.4	10.1	2.1	25.0	16.9
Maximum	0.2	52.1			112.1	62.5	28.1	79.6	34.6	141.6	79.6	35.6	141.7	18.7	141.7	77.0
Mean		30.5			57.1	39.1	20.3	49.5	23.9	75.9	47.0	24.5	75.9	10.4	83.4	47.0
Minimum					2.1	5.5	12.5	11.1	13.4	7.9	13.1	12.3	7.9	2.1	34.4	19.3
Maximum	5.0	121.1			85.8	25.0	43.8	45.3	29.9	28.9	151.0	32.9	28.9	15.7	151.0	78.3
Mean		65.0			44.0	15.3	28.2	28.2	21.7	18.4	82.1	22.6	18.4	8.9	92.7	48.8

## Appendix 2

Water temperature (°C) of Cirata Reservoir in 1988.

Station	Water Depth (m)	Jan.	Feb.	Mar.	Apr.	May	June	July	Aug.	Sept.	Oct.	Nov.	Dec.	Min.	Max.	Mean
1	0.2	31.0	28.0	26.0	29.0	30.6	30.7	29.0	29.5	28.8	28.2	28.7	29.7	26.0	31.0	28.5
	5.0	28.5	27.6	27.5	28.0	29.7	29.4	28.5	27.5	28.6	27.8	27.5	27.8	27.5	29.7	28.6
2	0.2	31.0	28.3	28.0	29.2	31.0	30.7	29.0	29.2	30.2	28.0	27.2	29.5	27.2	31.0	29.1
	5.0	28.0	27.4	27.5	28.0	29.5	29.5	28.0	27.9	28.7	27.8	26.7	28.5	26.7	29.5	28.1
3	0.2	32.0	27.8	28.0	29.8	30.9	31.8	28.0	30.6	33.2	28.0	27.8	29.4	27.8	33.2	30.5
	5.0	28.0	25.6	25.5	28.2	29.7	29.6	28.0	27.8	29.2	27.5	25.4	27.7	25.4	29.7	27.6
4	0.2	31.0	28.7	28.5	29.6	30.6	30.7	29.0	30.0	30.4	29.0	29.5	29.4	28.5	31.0	29.8
	5.0	28.0	27.7	28.0	28.0	29.0	29.5	28.0	27.5	28.9	28.0	27.8	29.0	27.5	29.5	28.5
5	0.2	27.0	26.0	28.0	30.7	27.4	31.1	29.5	30.2	31.3	29.5	30.4	28.7	26.0	31.3	28.7
	5.0	27.0	25.9	27.5	27.5	26.4	29.4	28.0	28.3	29.0	27.0	26.7	28.5	25.9	29.4	27.7
6	0.2	32.0	30.8	28.5	29.0	31.8	31.5	29.5	30.5	30.5	30.0	29.6	29.5	28.5	32.0	30.3
	5.0	27.0	29.4	28.0	28.0	29.4	29.4	28.5	28.1	28.6	28.5	27.8	27.9	27.0	29.4	28.2
7	0.2	33.0	30.9	29.5	29.5	31.5	31.0	30.5	30.3	31.7	29.5	28.5	29.8	28.5	33.0	30.8
	5.0	30.0	29.3	28.0	28.0	29.8	29.7	29.5	28.5	28.6	28.5	27.9	28.6	27.9	30.0	29.0
8	0.2	31.0	28.1	28.0	30.0	32.0	31.0	28.5	29.5	30.9	28.3	29.5	30.9	28.0	32.0	30.0
	5.0	28.5	27.5	28.0	28.4	29.7	29.2	28.0	27.9	28.4	28.0	27.9	28.4	27.5	29.7	28.6
9	0.2	31.0	28.6	28.5	29.2	31.5	31.8	30.0	30.6	30.8	28.1	28.9	28.9	28.1	31.8	30.0
	5.0	26.5	26.9	25.0	28.5	29.5	29.1	28.0	29.4	28.2	28.0	27.0	28.0	25.0	29.5	27.3
10	0.2	30.5	28.5	28.5	29.0	30.6	30.9	28.8	29.4	28.6	28.3	28.4	28.7	28.3	30.9	29.6
	5.0	28.0	27.5	28.5	28.0	29.7	29.1	28.0	29.3	27.8	27.9	27.3	28.1	27.3	29.7	28.5
11	0.2	30.5	29.1	29.0	28.8	29.1	30.0	28.5	29.1	28.4	28.7	28.3	28.1	28.1	30.5	29.3
	0.5	28.5	27.7	28.5	28.0	25.0	28.0	28.0	27.8	28.0	28.0	27.3	27.8	25.0	28.5	26.8
Minimum	0.2	27.0	26.0	26.0	28.8	27.4	30.0	28.0	29.1	28.4	28.0	27.2	28.1	26.0	30.5	28.5
Maximum		33.0	30.9	29.5	30.7	32.0	31.8	30.5	33.2	30.0	30.4	30.9	28.5	33.2	30.8	
Mean		30.0	28.5	27.8	29.8	29.7	30.9	29.3	29.9	30.8	29.0	28.8	29.5	27.3	31.9	29.6
Minimum	5.0	26.5	25.6	25.0	27.5	25.0	28.0	26.0	27.5	27.8	27.0	25.4	27.7	25.0	28.5	26.8
Maximum		30.0	29.4	28.5	28.5	29.8	29.7	29.5	29.4	29.2	28.5	27.9	29.0	27.9	30.0	29.0
Mean		28.3	27.5	26.8	28.0	27.4	28.9	28.8	28.5	28.5	27.8	26.7	28.4	26.5	29.3	27.9

Conductivity ( $\mu\text{mhos/cm}$ ) of Cirata Reservoir in 1988.

Station	Water Depth (m)	Jan.	Feb.	Mar.	Apr.	May	June	July	Aug.	Sept.	Oct.	Nov.	Dec.	Min.	Max.	Mean
1	0.2	195	172	178	158	155	178	176	179	175	175	1	239	1	239	120
	5.0	185	173	179	155	153	174	179	178	172	185	178	254	153	254	204
2	0.2	190	171	173	162	155	178	172	180	181	185	180	234	155	234	195
	5.0	165	169	175	160	152	175	173	187	179	187	17	230	17	230	124
3	0.2	170	159	165	170	154	184	178	230	217	185	1	230	1	230	116
	5.0	155	135	123	164	154	182	185	225	220	188	203	234	123	234	179
4	0.2	185	171	187	160	152	175	169	183	184	190	1	231	1	231	116
	5.0	185	169	175	170	152	173	178	177	189	193	230	231	152	231	192
5	0.2	173	123	176	162	150	180	183	184	210	200	260	210	123	260	192
	5.0	170	123	175	153	147	177	176	189	215	280	252	225	123	280	202
6	0.2	178	178	185	168	164	175	175	186	185	292	3	223	3	292	148
	5.0	135	170	195	175	173	180	190	203	190	178	198	203	135	203	169
7	0.2	200	192	182	168	152	171	183	183	185	197	192	220	152	220	186
	5.0	230	180	198	172	147	169	180	179	184	175	229	244	147	244	196
8	0.2	190	169	178	166	158	177	170	183	182	183	183	182	158	190	174
	5.0	200	173	177	156	151	174	175	177	181	175	177	181	151	200	176
9	0.2	203	174	185	172	160	191	186	181	189	183	229	229	160	229	195
	5.0	210	161	182	162	158	195	190	199	184	187	245	220	158	245	202
10	0.2	190	181	185	158	155	183	170	177	179	185	221	227	155	227	191
	5.0	200	175	180	164	154	178	175	171	175	183	224	223	154	224	189
11	0.2	185	179	189	160	146	178	118	173	174	178	216	227	118	227	173
	0.5	190	179	193	154	146	173	115	169	173	180	222	220	115	222	169
Minimum	0.2	170	123	165	158	146	171	118	173	174	175	1	182	1	190	116
Maximum		203	192	189	172	164	191	186	230	217	292	260	239	160	292	195
Mean		187	158	177	165	155	181	152	202	196	234	131	211	81	241	155
Minimum	5.0	135	123	123	153	146	169	115	169	172	175	17	181	17	200	124
Maximum		230	180	198	175	173	195	190	225	220	280	252	254	158	280	204
Mean		183	152	161	164	160	182	153	197	196	228	135	218	88	240	164

Secchi disk visibility (cm) of Cirata Reservoir in 1988.

Station	Water Depth (m)	Jan.	Feb.	Mar.	Apr.	May	June	July	Aug.	Sept.	Oct.	Nov.	Dec.	Min.	Max.	Mean
1	0.2	155	145	181	158	175	175	140	124	152	180	237	150	124	237	181
2	0.2	185	140	180	160	170	170	130	125	115	175	220	225	115	225	170
3	0.2	21	80	55	100	178	178	100	60	71	75	15	160	15	178	97
4	0.2	115	145	192	130	160	160	142	115	127	170	140	230	115	230	173
5	0.2	30	35	109	110	39	39	110	81	60	130	61	195	30	195	113
6	0.2	120	122	150	155	120	120	160	130	102	165	182	160	102	182	142
7	0.2	75	145	150	150	115	115	135	110	130	160	192	240	75	240	158
8	0.2	145	140	190	150	140	140	135	95	100	175	95	100	95	190	143
9	0.2	14	125	163	145	158	158	75	90	96	75	63	100	14	163	89
10	0.2	155	140	174	157	170	170	135	120	125	175	250	230	120	250	185
11	0.2	135	180	200	150	178	178	145	140	145	180	278	195	135	278	207
Minimum		14	35	55	100	39	39	75	60	60	75	15	100	14	163	89
Maximum	0.2	185	180	200	160	178	178	160	140	152	180	278	240	135	278	207
Mean		100	108	128	130	109	109	118	100	106	128	147	170	75	221	148

Suspended solids (mg/l) of Cirata Reservoir in 1988.

Station	Water Depth (m)	Jan.	Feb.	Mar.	Apr.	May	June	July	Aug.	Sept.	Oct.	Nov.	Dec.	Min.	Max.	Mean
1	0.2	32	112	84	40	192	160	112	102	90	140	213	90	32	213	123
	5.0	140	136	68	16	208	144	136	120	110	138	120	110	16	208	112
2	0.2	20	112	40	16	172	160	115	110	100	130	6	100	6	172	89
	5.0	180	164	72	100	232	148	164	150	125	125	223	125	72	232	152
3	0.2	16	112	-	64	176	148	148	130	120	150	232	120	16	232	124
	5.0	260	164	220	64	156	168	120	170	130	142	130	130	64	260	162
4	0.2	124	112	44	16	96	108	176	156	140	180	223	140	16	223	120
	5.0	188	164	148	4	164	192	196	187	175	179	170	175	4	196	100
5	0.2	248	112	76	56	232	46	164	162	170	175	170	229	46	248	147
	5.0	108	164	40	20	148	136	184	196	180	165	160	180	20	196	108
6	0.2	168	112	36	4	180	20	144	136	120	145	205	120	4	205	105
	5.0	232	164	292	52	264	468	236	230	121	140	130	121	52	468	260
7	0.2	732	112	24	20	184	188	120	110	130	135	130	130	20	732	376
	5.0	312	164	360	80	128	128	186	195	140	130	195	140	80	360	220
8	0.2	196	112	24	32	176	192	124	134	140	136	134	140	24	196	110
	5.0	120	164	176	68	232	136	208	218	156	208	218	156	68	232	150
9	0.2	176	140	56	40	172	140	140	120	146	150	120	146	40	176	108
	5.0	452	208	120	80	244	140	188	168	152	142	188	152	80	452	266
10	0.2	196	128	28	52	152	136	128	129	146	136	129	146	28	196	112
	5.0	348	188	92	24	28	116	196	186	130	128	186	130	24	348	186
11	0.2	260	176	140	4	148	152	168	130	150	170	170	150	4	260	132
	0.5	84	168	64	292	12	196	176	170	172	160	170	172	12	292	152
Minimum		16	112	24	4	96	20	112	102	90	130	6	90	4	172	89
Maximum	0.2	732	176	140	64	232	192	176	162	170	180	232	229	46	732	376
Mean		374	144	82	34	164	106	144	132	130	155	119	160	25	452	233
Minimum		84	136	40	4	12	116	120	120	110	125	120	110	4	196	100
Maximum	5.0	452	208	360	292	264	468	236	230	180	208	223	180	80	468	266
Mean		268	172	200	148	138	292	178	175	145	167	172	145	42	332	183

Dissolved oxygen (mg/l) of Cirata Reservoir in 1988.

Station	Water Depth (m)	Jan.	Feb.	Mar.	Apr.	May	June	July	Aug.	Sept.	Oct.	Nov.	Dec.	Min.	Max.	Mean
1	0.2	8.0	6.6	8.4	8.2	10.6	9.4	8.3	7.9	6.5	5.6	6.7	6.5	5.6	10.6	8.1
	5.0	1.9	5.8	4.9	5.6	7.7	7.2	7.8	6.6	5.8	5.5	4.8	5.8	1.9	7.8	4.9
2	0.2	9.0	7.0	6.3	8.2	12.5	9.4	11.7	7.6	6.8	5.6	5.7	6.8	5.6	12.5	9.1
	5.0	4.2	5.8	4.7	1.6	4.1	7.5	7.9	5.7	4.5	5.9	3.7	4.5	1.6	7.9	4.8
3	0.2	11.2	7.3	7.0	8.7	12.0	12.0	10.1	7.1	8.8	5.9	6.3	8.8	5.9	12.0	9.0
	5.0	6.6	6.6	6.7	4.4	5.4	8.1	5.9	5.4	3.3	5.5	5.8	3.3	3.3	8.1	5.7
4	0.2	8.8	7.2	7.7	7.6	10.0	9.7	9.9	6.7	8.5	6.1	7.7	8.5	6.1	10.0	8.1
	5.0	5.6	5.6	5.7	2.2	3.5	7.5	8.6	2.7	4.0	4.9	3.6	4.0	2.2	8.6	5.4
5	0.2	8.0	5.6	8.0	8.4	7.7	10.3	9.9	9.2	8.3	6.3	7.8	8.3	5.6	10.3	8.0
	5.0	6.8	5.4	5.4	5.8	5.3	6.5	8.3	5.9	5.0	6.3	5.5	5.0	5.0	8.3	6.7
6	0.2	6.0	6.4	7.5	8.0	11.8	8.6	8.6	10.0	6.5	4.9	7.0	6.5	4.9	11.8	8.4
	5.0	1.8	3.3	3.3	1.0	5.0	2.9	3.4	1.5	2.4	4.8	2.5	2.4	1.0	5.0	3.0
7	0.2	7.4	6.4	7.6	9.0	12.7	8.0	6.8	8.5	6.8	4.7	7.8	6.8	4.7	12.7	8.7
	5.0	5.2	2.5	3.7	2.0	4.0	2.8	4.2	5.0	3.7	1.5	1.8	3.7	1.5	5.2	3.4
8	0.2	8.3	7.5	7.3	8.4	10.7	9.4	8.8	8.6	8.0	6.1	8.6	8.0	6.1	10.7	8.4
	5.0	2.6	5.4	5.4	2.2	3.0	7.2	5.7	4.6	1.2	5.7	4.6	1.2	1.2	7.2	4.2
9	0.2	7.2	6.4	7.7	7.8	8.7	9.1	10.4	8.2	6.3	5.5	5.8	6.3	5.5	10.4	8.0
	5.0	7.4	5.9	6.5	2.6	4.2	5.9	9.0	6.7	4.1	6.2	5.4	8.1	2.6	9.0	5.8
10	0.2	6.8	7.1	7.1	8.6	10.2	9.4	8.4	7.6	6.8	6.3	5.0	6.8	5.0	10.2	7.6
	5.0	3.6	4.0	5.5	5.0	6.4	6.2	6.4	6.8	5.8	5.6	3.7	5.8	3.6	6.8	5.2
11	0.2	7.5	7.1	7.4	8.5	8.8	8.8	10.5	7.4	6.7	5.0	6.3	6.7	5.0	10.5	7.8
	0.5	2.3	5.1	5.5	6.4	10.5	6.5	7.5	6.9	6.0	5.3	3.2	6.0	2.3	10.5	6.4
Minimum		6.0	5.6	6.3	7.6	7.7	8.0	6.8	6.7	6.3	4.7	5.0	6.3	4.7	10.0	7.6
Maximum	0.2	11.2	7.5	8.4	9.0	12.7	12.0	11.7	10.0	8.8	6.3	8.6	8.8	6.1	12.7	9.1
Mean		8.6	6.6	7.4	8.3	10.2	10.0	9.3	8.4	7.6	5.5	6.8	7.6	5.4	11.4	8.3
Minimum		1.8	2.5	3.3	1.0	3.0	2.8	3.4	1.5	1.2	1.5	1.8	1.2	1.0	5.0	3.0
Maximum	5.0	7.4	6.6	6.7	6.4	10.5	8.1	9.0	6.9	6.0	6.3	5.8	8.1	5.0	10.5	6.7
Mean		4.6	4.6	5.0	3.7	6.8	5.5	6.2	4.2	3.6	3.9	3.8	4.7	3.0	7.8	4.8

pH (unit) of Cirata Reservoir in 1988.

Station	Water Depth (m)	Jan.	Feb.	Mar.	Apr.	May	June	July	Aug.	Sept.	Oct.	Nov.	Dec.	Min.	Max.	Mean
1	0.2	7.8	7.3	7.3	8.3	8.3	8.2	8.4	8.3	8.4	7.6	7.7	8.9	7.3	8.9	8.1
	5.0	7.1	7.2	7.2	8.1	8.2	8.0	8.1	8.0	8.4	7.6	7.5	7.9	7.1	8.4	7.8
2	0.2	8.2	7.5	7.3	8.4	8.5	8.2	8.4	8.4	8.3	7.8	7.3	8.3	7.3	8.5	7.9
	5.0	7.2	7.4	7.2	7.3	7.5	8.2	8.3	7.9	8.3	7.6	7.0	8.3	7.0	8.3	7.7
3	0.2	8.1	7.7	7.2	8.5	8.6	8.8	9.1	8.1	8.7	7.7	8.4	8.7	7.2	9.1	8.2
	5.0	7.7	7.5	7.3	8.0	7.8	8.4	8.3	7.8	7.2	7.6	7.4	7.6	7.2	8.4	7.8
4	0.2	8.2	7.7	7.5	8.4	8.4	8.4	8.4	8.2	8.4	7.7	7.7	8.6	7.5	8.6	8.1
	5.0	7.6	7.5	7.4	7.2	7.4	8.2	8.1	7.3	7.4	7.4	7.4	8.5	7.2	8.5	7.9
5	0.2	7.1	7.2	7.2	8.6	7.3	8.5	8.4	8.5	7.9	7.8	7.2	8.3	7.1	8.6	7.9
	5.0	7.3	7.1	7.1	8.0	7.3	8.0	8.2	7.8	7.5	7.4	7.0	8.2	7.0	8.2	7.6
6	0.2	7.4	7.5	7.4	8.3	8.5	8.0	8.4	8.6	8.3	7.5	7.8	8.4	7.4	8.6	8.0
	5.0	7.1	7.0	6.9	6.9	7.6	7.0	7.4	7.3	7.5	7.3	7.2	7.0	6.9	7.6	7.3
7	0.2	7.7	7.4	7.4	8.5	8.4	7.8	8.0	8.3	8.4	7.5	7.7	8.5	7.4	8.5	8.0
	5.0	7.5	7.0	7.0	7.1	7.5	7.0	7.3	7.5	8.0	7.1	7.1	7.1	7.0	8.0	7.5
8	0.2	8.3	7.6	7.3	8.5	8.3	8.3	8.3	8.5	8.7	7.7	8.5	8.7	7.3	8.7	8.0
	5.0	7.2	7.5	7.2	6.9	7.3	8.0	8.1	7.7	7.2	8.1	7.7	7.2	6.9	8.1	7.5
9	0.2	7.5	7.4	7.4	8.6	8.0	8.0	8.1	8.5	8.3	7.7	6.2	8.3	6.2	8.6	7.4
	5.0	7.4	7.3	7.1	7.6	7.5	7.4	8.1	7.9	7.5	7.8	6.9	8.1	6.9	8.1	7.5
10	0.2	8.0	7.2	7.4	8.4	8.2	8.3	8.5	8.5	8.3	7.7	7.2	8.3	7.2	8.5	7.9
	5.0	7.2	7.0	7.2	7.9	7.9	7.7	7.7	8.4	8.1	7.8	7.1	8.2	7.0	8.4	7.7
11	0.2	7.9	7.7	7.3	8.4	8.2	8.1	7.6	8.3	8.4	7.7	8.0	8.2	7.3	8.4	7.9
	0.5	7.6	7.4	7.1	8.2	7.6	7.9	8.1	8.0	8.4	7.7	7.7	8.2	7.1	8.4	7.8
Minimum		7.1	7.2	7.2	8.3	7.3	7.8	7.6	8.1	7.9	7.5	6.2	8.2	6.2	8.4	7.4
Maximum	0.2	8.3	7.7	7.5	8.6	8.6	8.8	9.1	8.6	8.7	7.8	8.5	8.9	7.5	9.1	8.2
Mean		7.7	7.5	7.4	8.5	8.0	8.3	8.4	8.4	8.3	7.7	7.4	8.6	6.9	8.8	7.8
Minimum		7.1	7.0	6.9	6.9	7.3	7.0	7.3	7.3	7.2	7.1	6.9	7.0	6.9	7.6	7.3
Maximum	5.0	7.7	7.5	7.4	8.2	8.2	8.4	8.3	8.4	8.4	8.1	7.7	8.5	7.2	8.5	7.9
Mean		7.4	7.3	7.2	7.6	7.8	7.7	7.8	7.9	7.8	7.6	7.3	7.8	7.1	8.1	7.6



Total nitrogen ( $\mu\text{g/l}$ ) of Cirata Reservoir in 1988.

Station	Water Depth (m)	Jan.	Feb.	Mar.	Apr.	May	June	July	Aug.	Sept.	Oct.	Nov.	Dec.	Min.	Max.	Mean
1	0.2	840	1,288	1,288				1,064	1,176					840	1,288	1,064
	5.0	1,232	616	1,792				1,008	1,456					616	1,792	1,204
2	0.2	784	952	2,912				1,400	1,344					784	2,912	1,848
	5.0	1,288	672	3,248				1,064	1,344					672	3,248	1,960
3	0.2	448	952	2,296				1,232	1,512					448	2,296	1,372
	5.0	1,736	616	2,296				1,344	1,624					616	2,296	1,456
4	0.2	728	1,120	3,752				1,736	784					728	3,752	2,240
	5.0	616	672	2,800				504	1,680					504	2,800	1,652
5	0.2	1,232	952	1,680				784	1,736					784	1,736	1,260
	5.0	1,008	952	4,032				1,400	1,904					952	4,032	2,492
6	0.2	1,008	952	1,792				1,568	1,120					952	1,792	1,372
	5.0	1,232	616	2,408				1,008	1,344					616	2,408	1,512
7	0.2	952	1,008	2,744				1,792	1,568					952	2,744	1,848
	5.0	1,120	280	2,072				896	1,736					280	2,072	1,176
8	0.2	1,232	840	1,232				1,232	1,512					840	1,512	1,176
	5.0	616	1,008	2,352				1,792	1,904					616	2,352	1,484
9	0.2	1,232	840	1,736				1,848	1,232					840	1,848	1,344
	5.0	896	2,520	2,968				896	1,904					896	2,968	1,932
10	0.2	288	616	1,736				952	1,344					288	1,736	1,012
	5.0	1,064	952	3,248				1,008	2,016					952	3,248	2,100
11	0.2	1,176	840	952				1,960	1,232					840	1,960	1,400
	0.5	1,456	1,064	2,408				1,400	1,456					1,064	2,408	1,736
Minimum		288	616	952				784	784					288	1,288	1,012
Maximum	0.2	1,232	1,288	3,752				1,960	1,736					952	3,752	2,240
Mean		760	952	2,352				1,372	1,260					620	2,520	1,626
Minimum		616	280	1,792				504	1,344					280	1,792	1,176
Maximum	5.0	1,736	2,520	4,032				1,792	2,016					1,064	4,032	2,492
Mean		1,176	1,400	2,912				1,148	1,680					672	2,912	1,834

Ammonia ( $\mu\text{g/l}$ ) of Cirata Reservoir in 1988.

Station	Water Depth (m)	Jan.	Feb.	Mar.	Apr.	May	June	July	Aug.	Sept.	Oct.	Nov.	Dec.	Min.	Max.	Mean
1	0.2	132	16	70	32	51	36	79	73	77	79	73	77	16	132	74
	5.0	92	7	70	99	72	55	40	123	68	40	189	68	7	189	98
2	0.2	68	11	86	32	51	36	40	86	87	40	194	87	11	194	103
	5.0	130	18	75	99	63	58	396	110	58	54	110	58	18	396	207
3	0.2	108	23	70	28	63	47	40	86	77	40	86	77	23	108	66
	5.0	149	40	509	163	85	62	79	123	107	79	123	107	40	509	275
4	0.2	178	21	70	73	48	36	40	86	58	40	86	58	21	178	100
	5.0	393	25	96	90	69	174	158	110	68	158	110	68	25	393	209
5	0.2	222	65	75	65	63	36	158	86	77	158	86	77	36	222	129
	5.0	167	65	168	193	97	58	396	123	68	396	123	68	58	396	227
6	0.2	154	27	86	73	16	36	40	73	68	40	73	68	16	154	85
	5.0	88	27	96	126	97	66	158	123	58	158	123	58	27	158	93
7	0.2	84	25	89	65	5	55	119	86	107	119	86	107	5	119	62
	5.0	154	18	86	168	33	43	79	110	77	79	110	77	18	168	93
8	0.2	81	25	91	56	48	58	4	86	87	4	86	87	4	91	48
	5.0	174	27	80	108	39	47	63	123	68	63	123	60	27	174	101
9	0.2	44	27	80	40	45	51	79	136	67	10	136	67	10	136	73
	5.0	33	21	163	117	25	58	79	123	138	79	79	89	21	163	92
10	0.2	33	14	65	173	39	55	119	73	77	119	73	77	14	173	94
	5.0	90	21	186	126	36	51	79	164	77	79	164	77	21	186	104
11	0.2	77	14	75	117	33	47	160	98	74	160	98	74	14	160	87
	0.5	88	20	102	135	45	47	119	98	58	119	98	58	20	135	78
Minimum		33	11	65	28	5	36	4	73	58	4	73	58	4	91	48
Maximum	0.2	222	65	91	173	63	58	160	136	107	160	194	107	36	222	129
Mean		128	38	78	101	34	47	82	105	83	82	134	83	20	157	88
Minimum		33	7	70	90	25	43	40	98	58	40	79	58	7	135	78
Maximum	5.0	393	65	509	193	97	174	396	164	138	396	189	107	58	509	275
Mean		213	36	290	142	61	109	218	131	98	218	134	83	33	322	176



Nitrite ( $\mu\text{g/l}$ ) of Cirata Reservoir in 1988.

Station	Water Depth (m)	Jan.	Feb.	Mar.	Apr.	May	June	July	Aug.	Sept.	Oct.	Nov.	Dec.	Min.	Max.	Mean
1	0.2	2	20	19	117	38	68	394	202	7	20	23	7	2	394	198
	5.0	5	20	13	70	33	69	109	257	6	18	20	6	5	257	131
2	0.2	3	9	13	31	16	73	86	297	10	35	22	10	3	297	150
	5.0	5	14	13	53	25	64	82	390	12	54	23	12	5	390	198
3	0.2	13	10	33	70	146	65	98	157	8	14	32	8	8	157	83
	5.0	9	21	205	55	29	91	98	194	49	15	52	49	9	205	107
4	0.2	16	12	14	55	29	65	478	296	4	22	33	4	4	478	241
	5.0	6	15	17	134	35	79	78	125	5	15	22	5	5	134	70
5	0.2	2	31	26	70	31	75	109	302	5	13	51	5	2	302	152
	5.0	11	31	22	20	55	84	119	117	44	17	35	44	11	119	65
6	0.2	22	388	14	134	49	68	106	203	6	15	22	6	6	388	197
	5.0	7	19	19	214	49	73	117	125	10	14	27	10	7	214	111
7	0.2	5	13	16	25	30	64	86	203	27	14	21	27	5	203	104
	5.0	10	11	16	129	82	74	86	117	7	13	22	7	7	129	68
8	0.2	4	12	16	435	29	66	117	310	7	17	310	7	4	435	220
	5.0	11	13	14	473	25	80	114	198	4	114	198	4	4	473	239
9	0.2	9	15	13	23	49	79	106	355	28	39	22	28	9	355	182
	5.0	12	14	202	59	283	96	101	109	10	20	27	4	4	283	144
10	0.2	1	14	8	188	48	71	78	365	7	117	24	7	1	365	183
	5.0	9	2	16	91	61	69	114	254	6	133	21	6	2	254	128
11	0.2	7	16	6	120	45	68	86	365	9	14	23	9	6	365	186
	0.5	10	12	14	75	49	79	255	264	5	13	20	5	5	264	135
Minimum		1	9	6	23	16	64	78	157	4	13	21	4	1	157	83
Maximum	0.2	22	388	33	435	146	79	478	365	28	117	310	28	9	478	241
Mean		12	199	20	229	81	72	278	261	16	65	166	16	5	318	162
Minimum		5	2	13	20	25	64	78	109	4	13	20	4	2	119	65
Maximum	5.0	12	31	205	473	283	96	255	390	49	133	198	49	11	473	239
Mean		9	17	109	247	154	80	167	250	27	73	109	27	7	296	152

Nitrate ( $\mu\text{g/l}$ ) of Cirata Reservoir in 1988.

Station	Water Depth (m)	Jan.	Feb.	Mar.	Apr.	May	June	July	Aug.	Sept.	Oct.	Nov.	Dec.	Min.	Max.	Mean
1	0.2	79	231	156	185		276	384	403	271				79	403	241
	5.0	71	154	88	154		269	460	341	303				71	460	266
2	0.2	57	262	56	246		294	365	386	230				56	386	221
	5.0	71	154	122	215		234	449	414	362				71	449	260
3	0.2	93	185	78	215		271	282	241	201				78	282	180
	5.0	89	188	144	215		294	328	327	303				89	328	209
4	0.2	71	185	78	231		229	264	341	303				71	341	206
	5.0	86	223	178	240		275	357	303	274				86	357	222
5	0.2	64	215	100	209		212	375	386	259				64	386	225
	5.0	79	215	88	246		269	338	241	325				79	338	209
6	0.2	71	192	100	200		200	460	386	230				71	460	266
	5.0	64	322	144	185		234	431	341	274				64	431	248
7	0.2	96	246	88	154		247	431	261	288				88	431	260
	5.0	100	277	144	200		325	365	368	310				100	368	234
8	0.2	86	262	111	169		247	384	335	347				86	384	235
	5.0	79	400	133	185		269	412	353	347				79	412	246
9	0.2	71	185	88	169		224	449	386	573				71	573	322
	5.0	129	308	100	209		306	441	344	325				100	441	271
10	0.2	43	308	78	154		294	441	395	377				43	441	242
	5.0	100	285	78	200		269	384	312	303				78	384	231
11	0.2	57	308	156	169		263	291	435	230				57	435	246
	0.5	57	492	111	215		231	365	314	310				57	492	275
Minimum		43	185	56	154		200	264	241	201				43	282	180
Maximum	0.2	96	308	156	246		294	460	435	573				88	573	322
Mean		70	247	106	200		247	362	338	387				66	428	251
Minimum		57	154	78	154		231	328	241	274				57	328	209
Maximum	5.0	129	492	178	246		325	460	414	362				100	492	275
Mean		93	323	128	200		278	394	328	318				79	410	242

Total phosphorus ( $\mu\text{g/liter}$ ) of Cirata Reservoir in 1988.

Station	Water Depth (m)	Jan.	Feb.	Mar.	April	May	June	July	Aug.	Sept.	Oct.	Nov.	Dec.	Min.	Max.	Mean
1	0.2	496	258					320	263	272				258	496	377
	5.0	140	212					312	287	272				140	312	226
2	0.2	486	231					279	361	272				231	486	359
	5.0	316	240					273	246	271				240	316	278
3	0.2	425	215					141	293	262				141	425	283
	5.0	224	169					286	269	594				169	594	382
4	0.2	564	212					267	279	300				212	564	388
	5.0	464	212					282	314	305				212	464	338
5	0.2	456	269					252	252	395				252	456	354
	5.0	358	193					222	318	254				193	358	276
6	0.2	373	354					300	306	256				256	373	315
	5.0	358	155					273	329	245				155	358	257
7	0.2	530	234					297	316	270				234	530	382
	5.0	556	240					279	464	222				222	556	389
8	0.2	344	289					338	263	277				263	344	304
	5.0	316	183					246	505	260				183	505	344
9	0.2	417	244					273	273	245				244	417	331
	5.0	244	95					299	494	170				95	494	295
10	0.2	351	224					316	316	275				224	351	288
	5.0	316	293					279	551	260				260	551	406
11	0.2	780	212					318	266	371				212	780	496
	0.5	600	224					252	505	287				224	600	412
Minimum		344	212					141	252	245				141	344	283
Maximum	0.2	780	354					338	361	395				263	780	496
Mean		562	283					240	307	320				202	562	390
Minimum		140	95					222	246	170				95	312	226
Maximum	5.0	600	293					312	551	594				260	600	412
Mean		370	194					267	399	382				178	456	319

Orthophosphate ( $\mu\text{g/l}$ ) of Cirata Reservoir in 1988.

Station	Water Depth (m)	Jan.	Feb.	Mar.	Apr.	May	June	July	Aug.	Sept.	Oct.	Nov.	Dec.	Min.	Max.	Mean
1	0.2	70	204		265	75	124	148	205	173	1,947	198	173	70	1,947	1,009
	5.0	103	204		194	213	24	128	266	153	190	9	153	9	266	138
2	0.2	109	225		184	191	153	189	271	158	1,914	10	158	10	1,914	962
	5.0	109	180		303	229	105	133	211	171	192	204	171	105	303	204
3	0.2	103	189		168	159	161	111	217	165	185	156	165	103	217	160
	5.0	131	73		290	210	64	124	232	154	216	165	154	64	290	177
4	0.2	79	189		265	276	66	243	261	164	173	175	164	66	276	171
	5.0	112	94		257	162	62	179	232	141	190	244	141	62	257	160
5	0.2	118	220		269	288	85	121	123	161	197	161	161	85	288	187
	5.0	122	171		223	182	103	168	246	183	223	259	183	103	259	181
6	0.2	106	33		326	292	69	179	273	178	183	233	178	33	326	180
	5.0	88	73		85	210	94	153	227	164	194	286	164	73	286	180
7	0.2	106	183		219	284	122	200	297	166	193	249	166	106	297	202
	5.0	138	186		277	216	94	232	295	180	193	223	180	94	295	195
8	0.2	91	186		205	288	117	184	133	174	188	133	174	91	288	190
	5.0	97	189		395	284	85	232	288	116	232	288	116	85	395	240
9	0.2	112	127		146	247	-	174	123	173	191	297	173	112	297	205
	5.0	100	98		265	159	135	243	269	10	207	297	10	10	297	154
10	0.2	125	186		116	269	62	179	311	176	190	239	176	62	311	187
	5.0	106	235		226	276	78	189	191	178	171	103	178	78	276	177
11	0.2	50	177		226	250	109	189	223	185	204	228	185	50	250	150
	0.5	53	174		146	284	71	210	271	157	196	233	157	53	284	169
Minimum		50	33		116	75	62	111	123	158	173	10	158	10	217	150
Maximum	0.2	125	225		326	292	161	243	311	185	1,947	297	185	112	1,947	1,009
Mean		88	129		221	184	112	177	217	172	1,060	154	172	61	1,082	579
Minimum		53	73		85	159	24	124	191	10	171	9	10	9	257	138
Maximum	5.0	138	235		395	284	135	243	295	183	232	297	183	105	395	240
Mean		96	154		240	222	80	184	243	97	202	153	97	57	326	189

Silicate (mg/l) of Cirata Reservoir in 1988.

Station	Water Depth (m)	Month												Min.	Max.	Mean
		Jan.	Feb.	Mar.	Apr.	May	June	July	Aug.	Sept.	Oct.	Nov.	Dec.			
1	0.2	19.5	20.5	16.5	16.0	21.0	24.0	15.0	16.5	18.0	24.0	33.5	18.0	15.0	33.5	24.3
	5.0	13.0	20.5	17.0	19.5	24.0	21.0	15.0	13.0	15.0	16.5	220.0	15.0	13.0	220.0	116.5
2	0.2	14.0	10.5	15.0	18.0	20.5	19.5	11.5	9.8	9.7	15.0	72.0	9.7	9.7	72.0	40.9
	5.0	22.0	8.0	16.5	22.0	21.0	21.0	11.5	8.0	9.7	15.0	13.0	9.7	8.0	22.0	15.0
3	0.2	21.0	19.5	19.5	14.0	23.0	24.0	11.5	9.8	11.5	16.5	16.5	11.5	9.8	24.0	16.9
	5.0	54.5	31.5	102.0	28.0	28.0	23.0	9.8	6.5	8.0	9.8	11.5	8.0	6.5	102.0	54.3
4	0.2	14.0	14.0	25.0	19.5	23.0	23.0	6.5	5.0	8.0	11.5	13.0	8.0	5.0	25.0	15.0
	5.0	9.7	19.5	20.5	22.0	28.0	31.5	9.8	11.5	11.5	11.5	13.0	11.5	9.7	31.5	20.6
5	0.2	19.5	29.0	17.0	20.5	32.5	26.0	8.0	6.5	8.0	8.0	9.8	6.5	6.5	32.5	19.5
	5.0	30.0	31.5	20.5	24.0	27.0	25.0	13.0	11.5	11.5	11.5	11.5	11.5	11.5	31.5	21.5
6	0.2	11.5	15.0	16.5	16.0	26.0	19.5	8.0	6.5	6.5	13.0	13.0	8.0	6.5	26.0	16.3
	5.0	16.5	18.0	17.0	18.0	51.0	23.0	11.5	11.5	11.5	15.0	15.0	13.0	11.5	51.0	31.3
7	0.2	20.5	16.0	8.0	22.0	24.0	22.0	9.8	8.0	8.0	8.0	9.8	8.0	8.0	24.0	16.0
	5.0	55.0	21.0	16.0	30.0	24.0	21.0	8.0	9.8	13.0	16.5	18.0	9.7	8.0	55.0	31.5
8	0.2	20.5	13.0	16.5	19.5	23.0	24.0	11.5	11.5	8.0	13.0	11.5	11.5	8.0	24.0	16.0
	5.0	29.0	16.5	14.0	19.5	25.0	22.0	9.8	6.5	9.7	9.8	6.5	8.0	6.5	29.0	17.8
9	0.2	30.0	27.0	15.0	19.5	23.0	19.5	9.8	8.0	11.5	9.8	11.5	9.7	8.0	30.0	19.0
	5.0	25.0	31.5	29.0	19.5	24.0	24.0	8.0	8.0	8.0	9.8	11.5	11.5	8.0	31.5	19.8
10	0.2	15.0	16.0	19.5	20.5	24.0	18.0	6.5	6.5	9.7	13.0	15.0	8.0	6.5	24.0	15.3
	5.0	15.0	20.5	15.0	24.0	16.0	16.5	11.5	9.8	11.5	15.0	16.5	13.0	9.8	24.0	16.9
11	0.2	16.5	20.5	16.0	28.0	27.0	28.0	8.0	6.5	8.0	8.0	9.8	6.5	6.5	28.0	17.3
	0.5	16.5	31.5	16.0	18.5	26.0	20.5	11.5	9.9	13.0	16.5	18.0	11.5	9.9	31.5	20.7
Minimum		11.5	10.5	8.0	14.0	20.5	18.0	6.5	5.0	6.5	8.0	9.8	6.5	5.0	24.0	15.0
Maximum	0.2	30.0	29.0	25.0	28.0	32.5	28.0	15.0	16.5	18.0	24.0	72.0	18.0	15.0	72.0	40.9
Mean		20.8	19.8	16.5	21.0	26.5	23.0	10.8	10.8	12.3	16.0	40.9	12.3	10.0	48.0	27.9
Minimum		9.7	8.0	14.0	16.5	16.0	16.5	8.0	6.5	8.0	9.8	6.5	8.0	6.5	22.0	15.0
Maximum	5.0	55.0	31.5	102.0	30.0	51.0	31.5	15.0	13.0	15.0	16.5	220.0	15.0	13.0	220.0	116.5
Mean		32.4	19.8	58.0	23.3	33.5	24.0	11.5	9.8	11.5	13.2	113.3	11.5	9.8	121.0	65.8

Hydrogen sulfide ( $\mu\text{g/l}$ ) of Cirata Reservoir in 1988.

Station	Water Depth (m)	Month												Min.	Max.	Mean
		Jan.	Feb.	Mar.	Apr.	May	June	July	Aug.	Sept.	Oct.	Nov.	Dec.			
1	0.2	192			6	9	43	11	8	4	46	8	4	4	192	98
	5.0	112			11	10	38	25	33	1	85	33	1	1	112	57
2	0.2	192			4	13	13	12	9	2	14	-	2	2	192	97
	5.0	80			15	72	38	8	32	6	15	32	6	6	80	43
3	0.2	16			7	12	5	2	20	4	144	20	4	2	144	73
	5.0	160			13	31	11	8	35	23	358	34	23	8	358	183
4	0.2	104			3	12	11	4	23	2	124	23	2	2	124	63
	5.0	216			48	37	43	35	183	26	33	66	26	26	216	121
5	0.2	112			2	95	15	12	9	12	92	24	12	2	112	57
	5.0	160			7	64	46	25	34	14	49	51	14	7	160	84
6	0.2	6			2	7	46	11	9	3	26	9	3	2	46	24
	5.0	192			16	66	209	33	90	12	801	16	12	12	801	407
7	0.2	216			11	11	34	33	6	10	366	3	10	3	366	185
	5.0	6			28	65	183	64	52	4	801	82	4	4	801	403
8	0.2	64			9	11	15	8	13	5	377	13	5	5	377	191
	5.0	16			64	61	47	17	83	21	17	83	21	16	83	50
9	0.2	6			5	44	40	26	11	4	15	31	4	4	44	24
	5.0	256			241	88	126	23	41	27	6	33	27	6	256	131
10	0.2	80			5	31	13	7	8	2	9	25	2	2	80	41
	5.0	6			53	31	72	74	13	1	8	25	1	1	74	38
11	0.2	32			2	120	38	-	37	2	12	9	2	2	120	61
	0.5	160			17	93	31	4	30	3	146	6	3	3	160	82
Minimum		6			2	7	5	2	6	2	9	3	2	2	44	24
Maximum	0.2	216			11	120	46	33	37	12	377	31	12	5	377	191
Mean		111			7	64	26	18	22	7	193	17	7	4	211	108
Minimum		6			7	10	11	4	13	1	6	6	1	1	74	38
Maximum	5.0	256			241	93	209	74	183	27	801	83	27	26	801	407
Mean		131			124	52	110	39	98	14	404	45	14	14	438	222

Biological oxygen demand (BOD) (mg/l) of Cirata Reservoir in 1988.

Station	Water Depth (m)	Jan.	Feb.	Mar.	Apr.	May	June	July	Aug.	Sept.	Oct.	Nov.	Dec.	Min.	Max.	Mean
1	0.2	2.0	3.2	11.8	1.1	2.3	4.2	1.5	4.3	2.5	0.9	5.7	2.5	0.9	11.8	6.4
	5.0	11.4	13.0	5.5	0.7	2.7	2.3	2.5	1.9	1.8	3.1	20.5	1.8	0.7	20.5	10.6
2	0.2	6.1	13.0	1.6	1.2	1.0	2.7	1.1	2.1	2.2	6.3	15.0	2.2	1.0	15.0	8.0
	5.0	4.9	13.8	14.6	0.6	2.1	2.0	2.0	3.8	1.8	3.1	5.1	1.8	0.6	14.6	7.6
3	0.2	4.9	7.4	2.4	0.4	2.7	2.8	6.1	3.1	3.0	3.6	5.2	3.0	0.4	7.4	3.9
	5.0	14.6	6.6	15.8	0.6	1.3	2.8	7.2	3.9	2.3	0.4	3.6	2.3	0.4	15.8	8.1
4	0.2	2.4	41.5	4.7	0.4	1.1	2.6	6.7	5.3	2.4	1.2	6.2	2.4	0.4	41.5	21.0
	5.0	7.3	13.8	0.4	0.2	1.7	3.3	4.3	3.3	4.6	0.9	5.1	4.6	0.2	13.8	7.0
5	0.2	0.8	15.4	7.1	0.2	1.4	2.1	4.2	2.1	0.4	1.3	2.8	0.4	0.2	15.4	7.8
	5.0	4.1	13.0	5.1	0.4	7.3	3.6	2.5	3.6	3.9	1.1	5.5	3.9	0.4	13.0	6.7
6	0.2	0.8	10.6	47.3	1.0	3.0	2.7	5.5	1.7	2.5	3.3	3.8	2.5	0.8	47.3	24.1
	5.0	1.6	10.6	2.8	1.0	2.9	2.4	0.3	0.6	2.9	2.7	5.9	2.9	0.3	10.6	5.5
7	0.2	4.9	5.7	1.6	2.5	1.9	2.7	1.3	5.0	2.0	3.2	5.8	2.0	1.3	5.8	3.6
	5.0	8.1	13.0	4.3	1.6	2.4	3.4	2.9	3.5	1.1	3.2	5.9	1.1	1.1	13.0	7.1
8	0.2	0.8	9.7	3.1	1.9	8.8	2.4	3.7	3.2	4.1	3.4	3.2	4.1	0.8	9.7	5.3
	5.0	10.6	11.4	61.1	1.9	2.9	2.7	0.2	3.7	2.2	0.2	3.7	2.2	0.2	61.1	30.7
9	0.2	16.3	8.9	18.1	12.3	2.7	2.7	7.8	9.2	3.0	7.0	7.0	3.0	2.7	18.1	10.4
	5.0	12.2	16.3	5.5	0.8	3.1	2.9	6.0	2.0	6.1	4.5	7.4	6.1	0.8	16.3	8.6
10	0.2	4.1	17.1	1.6	1.4	1.4	2.8	11.1	9.7	6.4	1.0	5.0	6.4	1.0	17.1	9.1
	5.0	11.4	17.1	8.7	1.3	2.6	2.7	8.4	9.8	1.8	4.0	5.3	1.8	1.3	17.1	9.2
11	0.2	6.5	13.0	29.2	0.9	0.8	1.7	7.7	1.8	0.5	6.7	5.4	0.5	0.5	29.2	14.9
	0.5	13.8	4.1	9.5	1.9	1.1	3.0	2.3	2.5	5.1	4.3	5.1	5.1	1.1	13.8	7.5
Minimum		0.8	3.2	1.6	0.2	0.8	1.7	1.1	1.7	0.4	0.9	2.8	0.4	0.2	5.8	3.6
Maximum	0.2	16.3	41.5	47.3	12.3	8.8	4.2	11.1	9.7	6.4	7.0	15.0	6.4	2.7	47.3	24.1
Mean		8.6	22.4	24.5	6.3	4.8	3.0	6.1	5.7	3.4	4.0	8.9	3.4	1.5	26.6	13.8
Minimum		1.6	4.1	0.4	0.2	1.1	2.0	0.2	0.6	1.1	0.2	3.6	1.1	0.2	10.6	5.5
Maximum	5.0	14.6	17.1	61.1	1.9	7.3	3.6	8.4	9.8	6.1	4.5	20.5	6.1	1.3	61.1	30.7
Mean		8.1	10.6	30.8	1.1	4.2	2.8	4.3	5.2	3.6	2.4	12.1	3.6	0.8	35.9	18.1

Chemical oxygen demand (COD) (mg/l) of Cirata Reservoir in 1988.

Station	Water Depth (m)	Jan.	Feb.	Mar.	Apr.	May	June	July	Aug.	Sept.	Oct.	Nov.	Dec.	Min.	Max.	Mean
1	0.2	28.7			18.3	21.9	15.6	21.2	23.0	24.7	5.0	9.2	24.7	5.0	28.7	16.9
	5.0	38.3			27.0	21.9	21.9	18.5	20.4	23.1	15.7	5.9	23.1	5.9	38.3	22.1
2	0.2	38.3			25.3	25.0	25.0	20.8	27.4	20.4	10.3	3.8	20.4	3.8	38.3	21.1
	5.0	44.6			18.3	28.1	31.2	19.2	21.0	20.7	10.3	9.6	20.7	9.6	44.6	27.1
3	0.2	57.4			25.3	21.9	21.9	23.5	21.4	21.5	4.4	17.7	21.5	4.4	57.4	30.9
	5.0	51.0			15.8	21.9	21.9	19.9	19.8	21.8	16.8	13.3	21.8	13.3	51.0	32.2
4	0.2	41.5			24.1	21.9	18.7	23.8	18.2	24.4	13.1	10.0	24.4	10.0	41.5	25.8
	5.0	38.3			18.3	50.0	53.1	20.8	18.8	23.4	15.6	11.5	23.4	11.5	53.1	32.3
5	0.2	41.5			27.0	47.4	43.8	22.5	16.0	27.1	5.9	22.2	27.1	5.9	47.4	26.7
	5.0	35.1			27.0	25.0	34.4	22.2	16.4	25.2	12.7	21.3	25.2	12.7	35.1	23.9
6	0.2	41.5			15.4	34.4	21.9	22.5	16.0	27.1	14.8	14.2	27.1	14.2	41.5	27.9
	5.0	38.3			18.3	25.0	34.4	21.8	16.0	28.7	16.8	22.2	28.7	16.0	38.3	27.2
7	0.2	31.9			15.4	21.9	18.7	21.5	20.8	26.6	8.9	21.9	26.6	8.9	31.9	20.4
	5.0	38.3			18.3	21.9	25.0	18.9	14.5	28.7	14.8	18.9	28.7	14.5	38.3	26.4
8	0.2	31.9			24.1	17.2	53.1	26.8	12.6	23.6	11.8	12.6	23.6	11.8	53.1	32.5
	5.0	52.6			9.7	40.6	31.2	19.2	17.9	28.7	19.2	17.9	28.7	9.7	52.6	31.2
9	0.2	38.3			18.3	25.0	18.7	21.8	43.1	23.9	10.0	18.9	23.9	10.0	43.1	26.6
	5.0	66.9			18.3	28.1	34.4	19.8	29.2	19.9	13.1	20.7	19.9	13.1	66.9	40.0
10	0.2	31.9			18.3	18.7	34.4	25.1	23.0	41.7	14.8	17.7	41.7	14.8	41.7	28.3
	5.0	51.0			27.0	24.9	21.9	20.5	23.6	25.5	12.4	19.2	25.5	12.4	51.0	31.7
11	0.2	44.6			18.3	18.7	15.6	20.5	24.5	23.9	15.7	11.8	23.9	11.8	44.6	28.2
	0.5	39.9			27.0	78.2	51.2	18.2	19.5	26.0	18.3	14.8	26.0	14.8	78.2	46.5
Minimum		28.7			15.4	17.2	15.6	20.5	12.6	20.4	4.4	3.8	20.4	3.8	28.7	16.9
Maximum	0.2	57.4			27.0	47.4	53.1	26.8	43.1	41.7	15.7	22.2	41.7	14.8	57.4	32.5
Mean		43.1			21.2	32.3	34.4	23.7	27.9	31.1	10.1	13.0	31.1	9.3	43.1	24.7
Minimum		35.1			9.7	21.9	21.9	18.2	14.5	19.9	10.3	5.9	19.9	5.9	35.1	22.1
Maximum	5.0	66.9			27.0	78.2	53.1	22.2	29.2	28.7	19.2	22.2	28.7	16.0	78.2	46.5
Mean		51.0			18.4	50.1	37.5	20.2	21.9	24.3	14.8	14.1	24.3	11.0	56.7	34.3

## Appendix 3

Water temperature (°C) at Cipondoh, Saguling Reservoir, 1988.

Monitoring Time	Water Depth (m)	Jan.	Feb.	Mar.	Apr.	May	June	July	Aug.	Sept.	Oct.	Nov.	Dec.	Min.	Max.	Mean
1200	0.2	29.2	28.8	32.7	29.5	29.0	27.0	30.0	26.7	25.4	29.3	29.1	27.6	25.4	32.7	29.1
	2.0	28.0	27.1	28.6	28.5	28.0	27.0	28.1	26.4	25.0	27.6	27.7	26.8	25.0	28.6	26.8
	4.0	27.5	26.3	27.6	27.0	27.0	26.0	26.0	25.6	24.9	26.0	26.1	26.8	24.9	27.6	26.3
	6.0	27.0	25.7	26.7	26.5	26.0	26.0	25.0	25.4	24.8	25.8	25.9	26.1	24.8	27.0	25.9
	8.0	27.0	25.3	26.5	26.0	26.0	25.5	25.0	25.2	24.8	25.4	25.6	25.8	24.8	27.0	25.9
1800	10.0	26.8	25.1	26.6	25.5	25.5	25.0	25.0	25.2	24.8	25.2	25.6	25.5	24.8	26.8	25.8
	0.2	29.5	26.4	28.1	29.5	28.0	26.5	27.9	26.2	24.9	29.2	28.2	26.2	24.9	29.5	27.2
	2.0	27.5	26.0	27.4	28.0	28.5	26.5	27.8	26.2	24.9	27.8	27.8	25.8	24.9	28.5	26.7
	4.0	29.0	26.0	26.5	26.5	27.5	26.0	27.3	25.8	24.8	26.0	27.0	25.8	24.8	29.0	26.9
	6.0	26.5	25.3	25.4	25.5	26.5	26.0	26.5	25.4	24.7	25.9	26.0	25.7	24.7	26.5	25.6
2400	8.0	26.3	24.8	25.4	25.0	26.0	25.0	26.5	25.2	24.6	25.7	25.4	25.6	24.6	26.5	25.6
	10.0	26.1	24.6	25.3	25.0	26.0	25.0	26.2	24.8	24.6	25.3	25.4	25.5	24.6	26.2	25.4
	0.2	27.8	24.7	25.7	27.5	28.0	26.0	27.8	25.4	24.9	28.4	28.0	26.3	24.7	28.4	26.6
	2.0	27.2	25.3	26.4	27.0	28.0	26.0	27.4	25.6	24.9	26.6	27.9	26.3	24.9	28.0	26.5
	4.0	26.4	25.4	26.2	26.5	27.0	26.0	27.8	25.4	24.9	26.1	26.4	25.6	24.9	27.8	26.4
0600	6.0	26.2	25.3	25.9	25.5	26.0	26.0	26.7	25.0	24.7	25.9	26.0	25.6	24.7	26.7	25.7
	8.0	26.1	24.9	25.5	25.0	26.0	25.0	26.5	24.7	24.7	25.6	25.7	25.2	24.7	26.5	25.6
	10.0	26.1	24.6	24.8	25.0	26.0	25.0	26.3	24.7	24.7	25.4	26.5	25.0	24.6	26.5	25.6
	0.2	26.8	24.9	24.9	27.5	27.0	26.0	26.6	24.8	25.0	27.8	27.6	26.2	24.8	27.8	26.3
	2.0	26.8	24.6	25.7	27.0	27.0	27.0	27.0	24.8	24.8	27.0	27.6	26.0	24.6	27.6	26.1
Minimum Maximum Mean	4.0	26.5	25.0	25.8	25.5	27.0	27.0	26.9	25.0	24.8	26.1	26.6	25.7	24.8	27.0	25.9
	6.0	26.0	24.7	25.5	25.0	27.0	26.0	26.5	24.9	25.0	25.8	26.3	25.4	24.7	27.0	25.9
	8.0	26.0	24.5	25.5	25.0	26.0	26.0	26.3	24.7	24.9	25.5	26.0	25.0	24.5	26.3	25.4
	10.0	25.8	24.3	24.7	24.5	26.0	26.0	26.1	24.7	24.9	25.3	25.8	25.0	24.3	26.1	25.2
	0.2	26.8	24.7	24.9	27.5	27.0	26.0	26.6	24.8	24.9	27.8	27.6	26.2	24.7	27.8	26.3
Minimum Maximum Mean	2.0	29.5	28.8	32.7	29.5	29.0	27.0	30.0	26.7	25.4	29.3	29.1	27.6	25.4	32.7	29.1
	4.0	28.2	26.8	28.8	28.5	28.0	26.5	28.3	25.8	25.2	28.6	28.4	26.9	25.1	30.3	27.7
	6.0	26.8	24.6	25.7	27.0	27.0	26.0	27.0	24.8	24.8	26.6	27.6	25.8	24.6	27.6	26.1
Minimum Maximum Mean	8.0	28.0	27.1	28.6	28.5	28.5	27.0	28.1	26.4	25.0	27.8	27.9	26.8	25.0	28.6	26.8
	10.0	27.4	25.9	27.2	27.8	27.8	26.5	27.6	25.6	24.9	27.2	27.8	26.3	24.8	28.1	26.5
	0.2	26.4	25.0	25.8	25.5	27.0	26.0	26.0	25.0	24.8	26.0	26.1	25.6	24.8	27.0	25.9
Minimum Maximum Mean	4.0	29.0	26.3	27.6	27.0	27.5	27.0	27.8	25.8	24.9	26.1	27.0	26.8	24.9	29.0	26.9
	6.0	27.7	25.7	26.7	26.3	27.3	26.5	26.9	25.4	24.9	26.1	26.6	26.2	24.9	28.0	26.4
	8.0	26.0	24.7	25.4	25.0	26.0	26.0	25.0	24.9	24.7	25.8	25.9	25.4	24.7	26.5	25.6
Minimum Maximum Mean	10.0	27.0	25.7	26.7	26.5	27.0	26.0	26.7	25.4	25.0	25.9	26.3	26.1	24.8	27.0	25.9
	0.2	26.5	25.2	26.1	25.8	26.5	26.0	25.9	25.2	24.9	25.9	26.1	25.8	24.8	26.8	25.8
	4.0	26.0	24.5	25.4	25.0	26.0	25.0	25.0	24.7	24.6	25.4	25.4	25.0	24.5	26.3	25.4
Minimum Maximum Mean	6.0	27.0	25.3	26.5	26.0	26.0	26.0	26.5	25.2	24.9	25.7	26.0	25.8	24.8	27.0	25.9
	8.0	26.5	24.9	26.0	25.5	26.0	25.5	25.8	25.0	24.8	25.6	25.7	25.4	24.7	26.7	25.7
	10.0	25.8	24.3	24.7	24.5	25.5	25.0	25.0	24.7	24.6	25.2	25.4	25.0	24.3	26.1	25.2
Minimum Maximum Mean	0.2	26.8	24.6	25.7	27.0	27.0	26.0	27.0	24.8	24.8	26.6	27.6	25.8	24.6	27.6	26.1
	4.0	28.0	27.1	28.6	28.5	28.5	27.0	28.1	26.4	25.0	27.8	27.9	26.8	25.0	28.6	26.8
	6.0	27.4	25.9	27.2	27.8	27.8	26.5	27.6	25.6	24.9	27.2	27.8	26.3	24.8	28.1	26.5
Minimum Maximum Mean	8.0	26.4	25.0	25.8	25.5	27.0	26.0	26.0	25.0	24.8	26.0	26.1	25.6	24.8	27.0	25.9
	10.0	29.0	26.3	27.6	27.0	27.5	27.0	27.8	25.8	24.9	26.1	27.0	26.8	24.9	29.0	26.9
	0.2	27.7	25.7	26.7	26.3	27.3	26.5	26.9	25.4	24.9	26.1	26.6	26.2	24.9	28.0	26.4
Minimum Maximum Mean	4.0	26.0	24.7	25.4	25.0	26.0	26.0	25.0	24.9	24.7	25.8	25.9	25.4	24.7	26.5	25.6
	6.0	27.0	25.7	26.7	26.5	27.0	26.0	26.7	25.4	25.0	25.9	26.3	26.1	24.8	27.0	25.9
	8.0	26.5	25.2	26.1	25.8	26.5	26.0	25.9	25.2	24.9	25.9	26.1	25.8	24.8	26.8	25.8
Minimum Maximum Mean	10.0	26.0	24.5	25.4	25.0	26.0	25.0	25.0	24.7	24.6	25.4	25.4	25.0	24.5	26.3	25.4
	0.2	27.0	25.3	26.5	26.0	26.0	26.0	26.5	25.2	24.9	25.7	26.0	25.8	24.8	27.0	25.9
	4.0	26.5	24.9	26.0	25.5	26.0	25.5	25.8	25.0	24.8	25.6	25.7	25.4	24.7	26.7	25.7
Minimum Maximum Mean	6.0	25.8	24.3	24.7	24.5	25.5	25.0	25.0	24.7	24.6	25.2	25.4	25.0	24.3	26.1	25.2
	8.0	26.8	25.1	26.6	25.5	26.0	26.0	26.3	25.2	24.9	25.4	26.5	25.5	24.8	26.8	25.8
	10.0	26.3	24.7	25.7	25.0	25.8	25.5	25.7	25.0	24.8	25.3	26.0	25.3	24.6	26.5	25.5

Conductivity ( $\mu\text{mhos/cm}$ ) at Cipondoh, Saguling Reservoir, 1988.

Monitoring Time	Water Depth (m)	Conductivity ( $\mu\text{mhos/cm}$ )												Min.	Max.	Mean
		Jan.	Feb.	Mar.	Apr.	May	June	July	Aug.	Sept.	Oct.	Nov.	Dec.			
1200	0.2	285	200	235	175	187	225	245	273	257	312	349	336	175	349	262
	2.0	290	198	235	175	187	230	245	265	259	316	351	376	175	376	276
	4.0	307	199	270	180	227	245	260	255	259	316	375	373	180	375	278
	6.0	342	194	275	185	273	265	255	265	257	330	407	452	185	452	319
	8.0	384	180	265	185	288	250	260	313	257	361	413	443	180	443	312
	10.0	412	190	225	200	287	240	260	369	259	364	419	426	190	426	308
1800	0.2	295	210	220	170	189	220	225	282	273	268	332	347	170	347	259
	2.0	282	210	240	175	188	220	240	263	265	279	335	339	175	339	257
	4.0	271	200	282	175	243	222	250	260	263	275	369	403	175	403	289
	6.0	314	202	290	185	287	255	255	268	263	350	379	451	185	451	318
	8.0	365	202	278	190	286	250	260	323	259	360	403	427	190	427	309
	10.0	394	202	270	200	253	240	265	396	260	370	403	424	200	424	312
2400	0.2	274	195	235	174	189	225	225	265	247	300	324	331	174	331	253
	2.0	292	190	238	178	190	220	240	264	255	303	329	335	178	335	257
	4.0	283	192	276	180	260	220	260	258	259	303	357	417	180	417	299
	6.0	381	198	272	190	287	260	255	267	259	320	385	460	190	460	325
	8.0	351	190	250	185	286	252	255	317	259	373	399	441	185	441	313
	10.0	391	185	198	188	287	245	265	392	259	375	399	464	185	464	325
0600	0.2	271	188	235	180	195	225	220	250	249	290	319	337	180	337	259
	2.0	271	190	240	180	195	225	230	253	254	300	334	330	180	334	257
	4.0	225	192	270	180	253	220	255	253	257	312	366	435	180	435	308
	6.0	381	192	270	185	199	265	245	264	259	338	401	445	185	445	315
	8.0	369	182	255	183	286	260	260	311	257	372	410	440	182	440	311
	10.0	390	185	195	188	291	245	265	378	259	380	409	445	185	445	315
Minimum		271	188	220	170	187	220	220	250	247	268	319	331	170	331	253
Maximum	0.2	295	210	235	180	195	225	245	282	273	312	349	347	180	349	262
Mean		283	199	228	175	191	223	233	266	260	290	334	339	175	340	257
Minimum		271	190	235	175	187	220	230	253	254	279	329	330	175	334	257
Maximum	2.0	292	210	240	180	195	230	245	265	265	316	351	376	180	376	276
Mean		282	200	238	178	191	225	238	259	260	298	340	353	178	355	266
Minimum		225	192	270	175	227	220	250	253	257	275	357	373	175	375	278
Maximum	4.0	307	200	282	180	260	245	260	260	263	316	375	435	180	435	308
Mean		266	196	276	178	244	233	255	257	260	296	366	404	178	405	293
Minimum		314	192	270	185	199	255	245	264	257	320	379	445	185	445	315
Maximum	6.0	381	202	290	190	287	265	255	268	263	350	407	460	190	460	325
Mean		348	197	280	188	243	260	250	266	260	335	393	453	188	453	320
Minimum		351	180	250	183	286	250	255	311	257	360	399	427	180	427	309
Maximum	8.0	384	202	278	190	288	260	260	323	259	373	413	443	190	443	313
Mean		368	191	264	187	287	255	258	317	258	367	406	435	185	435	311
Minimum		390	185	195	188	253	240	260	369	259	364	399	424	185	424	308
Maximum	10.0	412	202	270	200	291	245	265	396	260	380	419	464	200	464	325
Mean		401	194	233	194	272	243	263	383	260	372	409	444	193	444	316

Dissolved oxygen (mg/l) at Cipondoh, Saguling Reservoir, 1988.

Monitoring Time	Water															
	Depth (m)	Jan.	Feb.	Mar.	Apr.	May	June	July	Aug.	Sept.	Oct.	Nov.	Dec.	Min.	Max.	Mean
1200	0.2	11.1	5.6	6.9	8.2	7.8	7.8	7.3	5.5	7.0	10.8	11.0	9.1	5.5	11.1	8.3
	2.0	7.2	4.6	4.2	8.8	7.0	4.7	7.7	4.0	5.0	4.0	5.3	7.4	4.0	8.8	6.4
	4.0	2.9	4.0	1.8	4.0	5.3	0.9	3.2	1.9	4.2	1.5	1.3	4.8	0.9	5.3	3.1
	6.0	2.0	1.5	1.6	2.2	4.1	0.0	1.3	1.0	4.0	0.6	0.9	1.4	0.6	4.1	2.4
	8.0	2.0	0.7	1.2	2.0	2.8	0.0	1.2	1.2	3.6	0.2	0.7	1.3	0.2	3.6	1.9
	10.0	2.0	0.6	2.2	1.8	3.8	0.0	1.3	1.0	2.6	0.1	0.4	1.3	0.1	3.8	2.0
1800	0.2	9.9	8.5	6.8	7.5	8.0	4.5	8.0	6.2	4.6	10.5	10.6	10.2	4.5	10.6	7.6
	2.0	7.0	5.4	5.1	7.6	7.8	3.9	7.2	6.0	4.4	7.8	9.6	7.9	3.9	9.6	6.8
	4.0	3.4	4.8	1.8	6.4	4.8	0.0	5.2	3.3	3.9	1.6	1.3	3.9	1.3	6.4	3.9
	6.0	2.4	1.6	1.5	2.4	3.6	0.0	2.2	1.3	3.2	1.2	0.9	3.2	0.9	3.6	2.3
	8.0	2.4	1.2	0.6	2.0	3.5	0.0	1.5	0.8	2.8	0.9	0.8	2.3	0.6	3.5	2.1
	10.0	2.3	1.5	1.3	1.8	6.6	0.0	1.4	0.8	2.9	0.3	0.6	2.3	0.3	6.6	3.5
2400	0.2	7.2	5.1	6.0	5.4	6.5	4.2	7.0	5.1	5.1	7.7	9.4	8.5	4.2	9.4	6.8
	2.0	5.1	4.9	5.3	7.7	6.2	3.8	6.7	5.1	5.0	3.6	7.7	8.2	3.6	8.2	5.9
	4.0	2.8	4.5	2.8	4.0	2.9	1.1	3.7	2.5	4.7	1.3	1.4	2.2	1.1	4.7	2.9
	6.0	1.8	2.7	1.8	2.1	2.4	0.0	1.9	1.2	3.2	0.7	0.8	2.7	0.7	3.2	2.0
	8.0	2.2	2.1	2.2	1.9	2.3	0.0	1.5	1.3	3.1	0.5	0.6	1.8	0.5	3.1	1.8
	10.0	1.9	1.4	2.5	1.6	2.2	0.0	2.1	0.8	2.9	0.1	0.5	1.6	0.1	2.9	1.5
0600	0.2	6.3	3.9	4.1	5.1	5.6	4.2	5.4	4.9	5.0	7.4	9.2	6.9	3.9	9.2	6.6
	2.0	6.2	4.3	3.7	5.9	5.2	3.8	6.0	4.3	4.4	5.5	6.3	7.1	3.7	7.1	5.4
	4.0	4.2	4.6	1.8	3.4	4.2	2.2	3.0	3.0	4.2	1.3	2.0	3.0	1.3	4.6	3.0
	6.0	2.8	1.2	1.0	2.0	2.3	0.0	2.1	1.0	4.1	0.9	1.4	1.2	0.9	4.1	2.5
	8.0	2.1	0.7	1.7	2.3	1.9	0.0	1.4	0.7	3.0	0.5	0.8	1.1	0.5	3.0	1.8
	10.0	1.9	0.7	2.9	1.8	2.7	0.0	1.3	1.1	2.8	0.1	0.6	0.9	0.1	2.9	1.5
Minimum		6.3	3.9	4.1	5.1	5.6	4.2	5.4	4.9	4.6	7.4	9.2	6.9	3.9	9.2	6.6
Maximum	0.2	11.1	8.5	6.9	8.2	8.0	7.8	8.0	6.2	7.0	10.8	11.0	10.2	5.5	11.1	8.3
Mean		8.7	6.2	5.5	6.7	6.8	6.0	6.7	5.6	5.8	9.1	10.1	8.6	4.7	10.2	7.4
Minimum		5.1	4.3	3.7	5.9	5.2	3.8	6.0	4.0	4.4	3.6	5.3	7.1	3.6	7.1	5.4
Maximum	2.0	7.2	5.4	5.3	8.8	7.8	4.7	7.7	6.0	5.0	7.8	9.6	8.2	4.0	9.6	6.8
Mean		6.2	4.9	4.5	7.4	6.5	4.3	6.9	5.0	4.7	5.7	7.5	7.7	3.8	8.4	6.1
Minimum		2.8	4.0	1.8	3.4	2.9	0.9	3.0	1.9	3.9	1.3	1.3	2.2	0.9	4.6	2.9
Maximum	4.0	4.2	4.8	2.8	6.4	5.3	2.2	5.2	3.3	4.7	1.6	2.0	4.8	1.3	6.4	3.9
Mean		3.5	4.4	2.3	4.9	4.1	1.6	4.1	2.6	4.3	1.5	1.7	3.5	1.1	5.5	3.4
Minimum		1.8	1.2	1.0	2.0	2.3	0.0	1.3	1.0	3.2	0.6	0.8	1.2	0.6	3.2	2.0
Maximum	6.0	2.8	2.7	1.8	2.4	4.1	0.0	2.2	1.3	4.1	1.2	1.4	3.2	0.9	4.1	2.5
Mean		2.3	2.0	1.4	2.2	3.2	0.0	1.8	1.2	3.7	0.9	1.1	2.2	0.8	3.7	2.2
Minimum		2.0	0.7	0.6	1.9	1.9	0.0	1.2	0.7	2.8	0.2	0.6	1.1	0.2	3.0	1.8
Maximum	8.0	2.4	2.1	2.2	2.3	3.5	0.0	1.5	1.3	3.6	0.9	0.8	2.3	0.6	3.6	2.1
Mean		2.2	1.4	1.4	2.1	2.7	0.0	1.4	1.0	3.2	0.6	0.7	1.7	0.4	3.3	1.9
Minimum		1.9	0.6	1.3	1.6	2.2	0.0	1.3	0.8	2.6	0.1	0.4	0.9	0.1	2.9	1.5
Maximum	10.0	2.3	1.5	2.9	1.8	6.6	0.0	2.1	1.1	2.9	0.3	0.6	2.3	0.3	6.6	3.5
Mean		2.1	1.1	2.1	1.7	4.4	0.0	1.7	1.0	2.8	0.2	0.5	1.6	0.2	4.8	2.5

pH (unit) at Cipondoh, Saguling Reservoir, 1988.

Monitoring Time	Water												Min.	Max.	Mean	
	Depth (m)	Jan.	Feb.	Mar.	Apr.	May	June	July	Aug.	Sept.	Oct.	Nov.				Dec.
1200	0.2	8.9	8.1	8.8	8.8	9.2	8.0	6.7	7.9	7.3	9.0	8.8	8.3	6.7	9.2	8.0
	2.0	8.4	7.6	8.5	8.5	9.0	7.8	6.7	7.4	7.0	8.4	8.0	8.2	6.7	9.0	7.9
	4.0	7.7	7.3	7.8	7.2	7.7	7.6	6.6	7.0	6.9	8.0	7.4	7.5	6.6	8.0	7.3
	6.0	7.5	7.3	7.7	7.0	7.6	7.3	6.6	6.9	6.9	7.8	7.2	7.3	6.6	7.8	7.2
	8.0	7.4	7.1	7.5	7.0	7.4	7.3	6.7	6.9	6.8	7.8	6.9	7.2	6.7	7.8	7.3
1800	10.0	7.7	7.2	7.4	7.0	7.2	7.3	6.6	7.0	6.7	7.8	6.9	7.2	6.6	7.8	7.2
	0.2	7.8	9.0	9.2	8.9	9.0	7.9	7.0	8.0	7.6	9.0	8.6	8.6	7.0	9.2	8.1
	2.0	7.6	7.8	9.0	8.7	8.9	7.8	6.9	8.0	7.3	9.0	8.3	8.5	6.9	9.0	8.0
	4.0	7.5	7.8	8.2	7.3	7.9	7.5	6.8	7.2	7.2	8.1	7.7	7.4	6.8	8.2	7.5
	6.0	7.5	7.2	7.7	7.1	7.3	7.5	6.7	6.9	7.2	7.8	7.9	7.2	6.7	7.9	7.3
2400	8.0	7.4	7.1	7.4	7.0	7.3	7.4	6.7	6.9	7.3	7.7	7.1	7.3	6.7	7.7	7.2
	10.0	7.5	7.1	7.4	7.1	7.5	7.4	6.7	6.9	7.3	7.6	7.0	7.9	6.7	7.9	7.3
	0.2	8.7	7.9	9.0	8.7	8.9	8.1	7.0	7.8	7.6	8.9	8.6	8.4	7.0	9.0	8.0
	2.0	8.1	7.7	9.0	8.6	8.8	8.1	7.1	7.6	7.6	8.6	8.3	8.4	7.1	9.0	8.1
	4.0	7.7	7.6	8.1	7.7	7.6	7.8	7.0	7.1	7.5	7.9	7.4	7.6	7.0	8.1	7.6
0600	6.0	7.3	7.4	7.8	7.1	7.5	7.6	7.1	6.9	7.4	7.7	7.2	7.3	6.9	7.8	7.4
	8.0	7.3	7.2	7.6	7.1	7.4	7.4	7.1	6.9	7.3	7.7	6.9	7.3	6.9	7.7	7.3
	10.0	7.6	7.2	7.4	7.1	7.4	7.4	7.0	7.0	7.3	7.7	6.9	7.7	6.9	7.7	7.3
	0.2	8.6	7.8	8.9	8.5	9.1	7.9	6.7	7.6	7.5	8.9	8.5	8.5	6.7	9.1	7.9
	2.0	8.3	7.5	8.9	8.6	9.1	7.9	6.9	7.5	7.5	8.8	8.3	8.3	6.9	9.1	8.0
Minimum Maximum Mean	4.0	7.4	7.6	8.8	7.3	8.0	7.8	7.0	7.2	7.5	7.8	7.5	7.9	7.0	8.8	7.9
	6.0	7.4	7.3	7.8	7.1	8.5	7.7	7.1	6.9	7.4	7.6	7.2	7.4	6.9	8.5	7.7
	8.0	7.5	7.1	7.8	7.1	7.3	7.4	7.1	7.0	7.3	7.6	7.1	7.3	7.0	7.8	7.4
Minimum Maximum Mean	10.0	7.6	7.3	7.7	7.1	7.2	7.4	7.1	7.1	7.3	7.5	7.0	7.4	7.0	7.7	7.4
	0.2	7.8	7.8	8.8	8.5	8.9	7.9	6.7	7.6	7.3	8.9	8.5	8.3	6.7	9.0	7.9
	8.9	9.0	9.2	8.9	9.2	8.1	7.0	8.0	7.6	9.0	8.8	8.6	7.0	9.2	8.1	
Minimum Maximum Mean	2.0	8.4	8.4	9.0	8.7	9.1	8.0	6.9	7.8	7.5	9.0	8.7	8.5	6.9	9.1	8.0
	7.6	7.5	8.5	8.5	8.8	7.8	6.7	7.4	7.0	8.4	8.0	8.2	6.7	9.0	7.9	
	8.4	7.8	9.0	8.7	9.1	8.1	7.1	8.0	7.6	9.0	8.3	8.5	7.1	9.1	8.1	
Minimum Maximum Mean	4.0	8.0	7.7	8.8	8.6	9.0	8.0	6.9	7.7	7.3	8.7	8.2	8.4	6.9	9.1	8.0
	7.4	7.3	7.8	7.2	7.6	7.5	6.6	7.0	6.9	7.8	7.4	7.4	6.6	8.0	7.3	
	7.7	7.8	8.8	7.7	8.0	7.8	7.0	7.2	7.5	8.1	7.7	7.9	7.0	8.8	7.9	
Minimum Maximum Mean	6.0	7.6	7.6	8.3	7.5	7.8	7.7	6.8	7.1	7.2	8.0	7.6	7.7	6.8	8.4	7.6
	7.3	7.2	7.7	7.0	7.3	7.3	6.6	6.9	6.9	7.6	7.2	7.2	6.6	7.8	7.2	
	7.5	7.4	7.8	7.1	8.5	7.7	7.1	6.9	7.4	7.8	7.9	7.4	6.9	8.5	7.7	
Minimum Maximum Mean	8.0	7.4	7.3	7.8	7.1	7.9	7.5	6.9	6.9	7.2	7.7	7.6	7.3	6.8	8.2	7.5
	7.3	7.1	7.4	7.0	7.3	7.3	6.7	6.9	6.8	7.6	6.9	7.2	6.7	7.7	7.2	
	7.5	7.2	7.8	7.1	7.4	7.4	7.1	7.0	7.3	7.8	7.1	7.3	7.0	7.8	7.4	
Minimum Maximum Mean	10.0	7.4	7.2	7.6	7.1	7.4	7.4	6.9	7.0	7.1	7.7	7.0	7.3	6.9	7.8	7.3
	7.5	7.1	7.4	7.0	7.2	7.3	6.6	6.9	6.7	7.5	6.9	7.2	6.6	7.7	7.2	
	7.7	7.3	7.7	7.1	7.5	7.4	7.1	7.1	7.3	7.8	7.0	7.9	7.0	7.9	7.4	
Minimum Mean	7.6	7.2	7.6	7.1	7.4	7.4	6.9	7.0	7.0	7.7	7.0	7.6	6.8	7.8	7.3	
	7.6	7.2	7.6	7.1	7.4	7.4	6.9	7.0	7.0	7.7	7.0	7.6	6.8	7.8	7.3	



Alkalinity (mg/l) at Cipondoh, Saguling Reservoir, 1988.

Monitoring Time	Water												Min.	Max.	Mean	
	Depth (m)	Jan.	Feb.	Mar.	Apr.	May	June	July	Aug.	Sept.	Oct.	Nov.				Dec.
1200	0.2	72.7	61.3	66.8	46.0	51.1	67.7	66.8	61.7					46.0	72.7	59.4
	2.0	73.8	62.7	66.1	48.8	51.7	63.2	64.3	70.7					48.8	73.8	61.3
	4.0	68.4	61.3	75.8	46.8	65.3	70.7	48.8	60.4					46.8	75.8	61.3
	6.0	95.5	61.3	83.5	51.1	85.1	80.2	66.8	65.5					51.1	95.5	73.3
	8.0	103.5	58.4	72.0	51.7	96.4	77.1	74.5	55.3					51.7	103.5	77.6
	10.0	136.8	61.3	52.9	56.0	98.9	74.5	65.5	95.1					52.9	136.8	94.9
1800	0.2	74.8	66.6	68.7	46.0	51.4	61.7	56.5	68.1					46.0	74.8	60.4
	2.0	74.8	62.7	69.4	46.3	51.4	73.5	59.1	60.4					46.3	74.8	60.6
	4.0	63.3	62.7	87.4	47.3	68.6	62.7	66.8	64.3					47.3	87.4	67.4
	6.0	75.5	62.7	91.2	51.4	85.6	79.7	60.4	66.8					51.4	91.2	71.3
	8.0	94.0	57.0	86.1	52.4	94.3	75.8	74.5	83.5					52.4	94.3	73.4
	10.0	105.5	57.0	72.0	56.8	81.7	73.0	78.4	97.7					56.8	105.5	81.2
2400	0.2	69.8	61.3	70.7	46.8	51.9	62.5	56.5	60.4					46.8	70.7	58.8
	2.0	66.7	61.3	69.4	46.3	54.0	62.2	59.1	66.8					46.3	69.4	57.9
	4.0	67.8	59.9	82.2	45.5	78.4	75.0	68.1	65.5					45.5	82.2	63.9
	6.0	81.2	62.7	95.1	95.1	86.4	63.0	66.8	65.5					62.7	95.1	78.9
	8.0	94.0	58.4	66.8	50.1	97.7	77.9	70.7	86.7					50.1	97.7	73.9
	10.0	109.7	57.0	41.1	50.4	97.4	73.8	73.2	86.1					41.1	109.7	75.4
0600	0.2	67.8	59.9	69.4	45.0	52.7	59.4	64.3	48.8					45.0	69.4	57.2
	2.0	70.7	60.1	69.4	47.0	52.7	59.3	59.1	55.3					47.0	70.7	58.9
	4.0	82.7	60.4	84.8	46.8	74.0	61.9	59.1	63.0					46.8	84.8	65.8
	6.0	79.8	62.7	81.0	50.4	55.3	77.1	73.2	66.8					50.4	81.0	65.7
	8.0	99.8	57.6	66.8	69.1	94.3	78.4	73.2	110.5					57.6	110.5	84.1
	10.0	124.0	58.4	38.6	51.9	97.7	75.6	70.7	91.2					38.6	124.0	81.3
Minimum		67.8	59.9	66.8	45.0	51.1	59.4	56.5	48.8					45.0	69.4	57.2
Maximum	0.2	74.8	66.6	70.7	46.8	52.7	67.7	66.8	68.1					46.8	74.8	60.4
Mean		71.3	63.3	68.8	45.9	51.9	63.6	61.7	58.5					45.9	72.1	58.8
Minimum		66.7	60.1	66.1	46.3	51.4	59.3	59.1	55.3					46.3	69.4	57.9
Maximum	2.0	74.8	62.7	69.4	48.8	54.0	73.5	64.3	70.7					48.8	74.8	61.3
Mean		70.8	61.4	67.8	47.6	52.7	66.4	61.7	63.0					47.6	72.1	59.6
Minimum		63.3	59.9	75.8	45.5	65.3	61.9	48.8	60.4					45.5	75.8	61.3
Maximum	4.0	82.7	62.7	87.4	47.3	78.4	75.0	68.1	65.5					47.3	87.4	67.4
Mean		73.0	61.3	81.6	46.4	71.9	68.5	58.5	63.0					46.4	81.6	64.3
Minimum		75.5	61.3	81.0	50.4	55.3	63.0	60.4	65.5					50.4	81.0	65.7
Maximum	6.0	95.5	62.7	95.1	95.1	86.4	80.2	73.2	66.8					62.7	95.5	78.9
Mean		85.5	62.0	88.1	72.8	70.9	71.6	66.8	66.2					56.6	88.3	72.3
Minimum		94.0	57.0	66.8	50.1	94.3	75.8	70.7	55.3					50.1	94.3	73.4
Maximum	8.0	103.5	58.4	86.1	69.1	97.7	78.4	74.5	110.5					57.6	110.5	84.1
Mean		98.8	57.7	76.5	59.6	96.0	77.1	72.6	82.9					53.9	102.4	78.7
Minimum		105.5	57.0	38.6	50.4	81.7	73.0	65.5	86.1					38.6	105.5	75.4
Maximum	10.0	136.8	61.3	72.0	56.8	98.9	75.6	78.4	97.7					56.8	136.8	94.9
Mean		121.2	59.2	55.3	53.6	90.3	74.3	72.0	91.9					47.7	121.2	85.1

Carbon dioxide (mg/l) at Cipondoh, Saguling Reservoir, 1988.

Monitoring Time	Water Depth (m)	Carbon dioxide (mg/l)												Min.	Max.	Mean
		Jan.	Feb.	Mar.	Apr.	May	June	July	Aug.	Sept.	Oct.	Nov.	Dec.			
1200	0.2	0.0	10.8	5.4	2.7	0.0	5.4	11.9	5.4	7.9	0.0	0.0	0.0	2.7	11.9	7.3
	2.0	0.0	10.8	5.4	2.7	0.0	5.4	7.9	5.4	11.9	2.7	0.0	0.0	2.7	11.9	7.3
	4.0	19.8	13.5	8.1	8.1	8.1	8.1	15.8	8.1	11.9	10.8	5.4	8.1	5.4	19.8	12.6
	6.0	27.7	13.5	10.8	10.8	8.1	13.5	19.8	10.8	11.9	10.8	8.1	13.5	8.1	27.7	17.9
	8.0	27.7	16.2	13.5	10.8	13.5	18.9	23.8	16.2	11.9	10.8	10.8	13.5	10.8	27.7	19.3
	10.0	31.7	16.2	13.5	10.8	13.5	21.6	19.8	18.9	11.9	13.5	10.8	13.5	10.8	31.7	21.3
1800	0.2	0.0	8.1	0.0	2.7	0.0	8.1	4.0	0.0	11.9	0.0	0.0	2.7	2.7	11.9	7.3
	2.0	7.9	10.8	2.7	2.7	0.0	5.4	4.0	2.7	11.9	0.0	0.0	2.7	2.7	11.9	7.3
	4.0	15.8	10.8	8.1	8.1	8.1	18.9	11.9	8.1	11.9	8.1	10.8	10.8	8.1	18.9	13.5
	6.0	27.7	13.5	10.8	10.8	8.1	18.9	19.8	16.2	11.9	10.8	8.1	16.2	8.1	27.7	17.9
	8.0	31.7	16.2	13.5	13.5	8.1	10.8	19.8	18.9	7.9	13.5	5.4	18.9	5.4	31.7	18.6
	10.0	35.6	18.9	16.2	10.8	5.4	10.8	23.8	18.9	15.8	16.2	8.1	21.5	5.4	35.6	20.5
2400	0.2	7.9	13.5	5.4	5.4	0.0	10.8	7.9	2.7	11.9	0.0	0.0	0.0	2.7	13.5	8.1
	2.0	11.9	13.5	5.4	5.4	0.0	10.8	7.9	8.1	15.8	8.1	0.0	2.7	2.7	15.8	9.3
	4.0	23.7	13.5	10.8	8.1	5.4	13.5	11.9	10.8	11.9	13.5	5.4	13.5	5.4	23.7	14.6
	6.0	31.7	13.5	13.5	10.8	5.4	13.5	15.8	10.8	11.9	13.5	5.4	21.6	5.4	31.7	18.6
	8.0	31.7	16.2	16.2	13.5	5.4	18.9	19.8	16.2	15.8	13.5	8.1	21.6	5.4	31.7	18.6
	10.0	35.6	16.2	16.2	13.5	8.1	18.9	19.8	24.3	15.8	13.5	8.1	24.3	8.1	35.6	21.9
0600	0.2	0.0	10.8	5.4	5.4	0.0	8.1	4.0	5.4	11.9	2.7	0.0	0.0	2.7	11.9	7.3
	2.0	11.9	10.8	5.4	5.4	0.0	8.1	4.0	10.8	11.9	8.1	5.4	2.7	2.7	11.9	7.3
	4.0	19.8	10.8	8.1	8.1	0.0	8.1	8.0	10.8	11.9	13.5	8.1	10.8	8.0	19.8	13.9
	6.0	19.8	13.5	10.8	10.8	2.7	13.5	11.9	13.5	11.9	13.5	8.1	13.5	2.7	19.8	11.3
	8.0	27.7	10.8	13.5	13.5	8.1	13.5	11.9	16.2	11.9	13.5	8.1	16.2	8.1	27.7	17.9
	10.0	35.6	13.5	16.2	10.8	8.1	13.5	11.9	18.9	11.9	13.5	8.1	13.5	8.1	35.6	21.9
Minimum		7.9	8.1	5.4	2.7	0.0	5.4	4.0	2.7	7.9	2.7	0.0	2.7	2.7	11.9	7.3
Maximum	0.2	7.9	13.5	5.4	5.4	0.0	10.8	11.9	5.4	11.9	2.7	0.0	2.7	2.7	13.5	8.1
Mean		7.9	10.8	5.4	4.1	0.0	8.1	8.0	4.1	9.9	2.7	0.0	2.7	2.7	12.7	7.7
Minimum		7.9	10.8	2.7	2.7	0.0	5.4	4.0	2.7	11.9	2.7	5.4	2.7	2.7	11.9	7.3
Maximum	2.0	11.9	13.5	5.4	5.4	0.0	10.8	7.9	8.1	15.8	8.1	5.4	2.7	2.7	15.8	9.3
Mean		9.9	12.2	4.1	4.1	0.0	8.1	6.0	5.4	13.9	5.4	5.4	2.7	2.7	13.9	8.3
Minimum		15.8	10.8	8.1	8.1	5.4	8.1	8.0	8.1	11.9	8.1	5.4	8.1	5.4	18.9	12.6
Maximum	4.0	23.7	13.5	10.8	8.1	8.1	18.9	15.8	10.8	11.9	13.5	10.8	13.5	8.1	23.7	14.6
Mean		19.8	12.2	9.5	8.1	6.8	13.5	11.9	9.5	11.9	10.8	8.1	10.8	6.8	21.3	13.6
Minimum		19.8	13.5	10.8	10.8	2.7	13.5	11.9	10.8	11.9	10.8	5.4	13.5	2.7	19.8	11.3
Maximum	6.0	31.7	13.5	13.5	10.8	8.1	18.9	19.8	16.2	11.9	13.5	8.1	21.6	8.1	31.7	18.6
Mean		25.8	13.5	12.2	10.8	5.4	16.2	15.9	13.5	11.9	12.2	6.8	17.6	5.4	25.8	14.9
Minimum		27.7	10.8	13.5	10.8	5.4	10.8	11.9	13.5	7.9	10.8	5.4	13.5	5.4	27.7	17.9
Maximum	8.0	31.7	16.2	16.2	13.5	13.5	18.9	23.8	18.9	15.8	13.5	10.8	21.6	10.8	31.7	19.3
Mean		29.7	13.5	14.9	12.2	9.5	14.9	17.9	16.2	11.9	12.2	8.1	17.6	8.1	29.7	18.6
Minimum		31.7	13.5	13.5	10.8	5.4	10.8	11.9	16.2	11.9	13.5	8.1	13.5	5.4	31.7	20.5
Maximum	10.0	35.6	18.9	16.2	13.5	13.5	21.6	23.8	24.3	15.8	16.2	10.8	24.3	10.8	35.6	21.9
Mean		33.7	16.2	14.9	12.2	9.5	16.2	17.9	20.3	13.9	14.9	9.5	18.9	8.1	33.7	21.2

Ammonia ( $\mu\text{g/l}$ ) at Cipondoh, Saguling Reservoir, 1988.

Monitoring Time	Water	Jan.	Feb.	Mar.	Apr.	May	June	July	Aug.	Sept.	Oct.	Nov.	Dec.	Min.	Max.	Mean
	Depth (m)															
1200	0.2	123	108	192	81	222	43	200	43	97	79	42	62	42	222	132
	2.0	108	108	93	61	213	39	301	65	58	71	48	67	39	301	170
	4.0	431	120	172	81	164	66	200	76	68	71	55	82	55	431	243
	6.0	108	131	246	167	287	236	301	87	77	63	61	95	61	301	181
	8.0	182	131	582	178	296	261	301	76	77	79	189	243	76	582	329
	10.0	200	120	1,262	207	34	270	402	76	97	82	204	243	34	1,262	648
1800	0.2	71	246	121	67	16	189	200	32	93	74	42	68	16	246	131
	2.0	323	115	143	67	51	167	606	54	58	74	56	85	51	606	329
	4.0	77	120	180	111	48	129	301	65	58	79	67	87	48	301	175
	6.0	97	120	146	178	48	52	301	76	58	79	83	105	48	301	175
	8.0	115	117	282	215	28	66	402	76	58	55	187	253	28	402	215
	10.0	169	153	626	190	91	93	301	87	58	87	223	264	58	626	342
2400	0.2	92	108	326	67	51	49	200	87	38	63	53	73	38	326	182
	2.0	89	108	134	51	5	38	504	54	48	55	58	77	5	504	255
	4.0	89	131	233	98	110	97	200	65	48	59	75	108	48	233	141
	6.0	97	231	339	155	51	220	200	65	58	51	96	114	51	339	195
	8.0	123	231	802	174	81	201	402	76	58	47	194	267	47	802	425
	10.0	231	323	1,521	194	88	133	301	54	58	59	264	324	54	1,521	788
0600	0.2	89	123	171	74	69	64	402	131	58	74	73	75	58	402	230
	2.0	71	131	154	61	36	81	504	65	58	74	73	79	36	504	270
	4.0	69	135	164	111	63	113	402	86	58	74	84	84	58	402	230
	6.0	123	246	197	174	28	58	402	54	77	87	112	132	28	402	215
	8.0	108	138	632	159	28	64	301	473	58	99	127	169	28	632	330
	10.0	203	146	1,553	194	81	81	504	65	38	79	132	346	38	1,553	796
Minimum Maximum Mean	0.2	71	108	121	67	16	43	200	32	38	63	42	62	16	222	131
		123	246	326	81	222	189	402	131	97	79	73	75	58	402	230
Minimum Maximum Mean	2.0	71	108	93	51	5	38	301	54	48	55	48	67	5	301	170
		323	131	154	67	213	167	606	65	58	74	73	85	51	606	329
Minimum Maximum Mean	4.0	69	120	164	81	48	66	200	65	48	59	55	82	48	233	141
		431	135	233	111	164	129	402	86	68	79	84	108	58	431	243
Minimum Maximum Mean	6.0	97	120	146	155	28	52	200	54	58	51	61	95	28	301	175
		123	246	339	178	287	236	402	87	77	87	112	132	61	402	215
Minimum Maximum Mean	8.0	108	117	282	159	28	64	301	76	58	47	127	169	28	402	215
		182	231	802	215	296	261	402	473	77	99	194	267	76	802	425
Minimum Maximum Mean	10.0	145	174	542	187	162	163	352	275	68	73	161	218	52	602	320
		169	120	626	190	34	81	301	54	38	59	132	243	34	626	342
Minimum Maximum Mean	10.0	231	323	1,553	207	91	270	504	87	97	87	264	346	58	1,553	796
		200	222	1,090	199	63	176	403	71	68	73	198	295	46	1,090	569

Nitrite ( $\mu\text{g/l}$ ) at Cipondoh, Saguling Reservoir, 1988.

Monitoring Time	Water Depth (m)	Jan.	Feb.	Mar.	Apr.	May	June	July	Aug.	Sept.	Oct.	Nov.	Dec.	Min.	Max.	Mean
1200	0.2	149	77	496	379	29	410	79	152	17	17	14	0	14	496	255
	2.0	142	78	21	43	29	77	71	141	17	19	36	8	8	142	75
	4.0	79	79	19	29	30	81	71	131	16	19	32	16	16	131	74
	6.0	181	87	37	51	30	82	63	141	18	20	33	28	18	181	100
	8.0	118	79	147	1,009	377	91	79	131	18	29	65	37	18	1,009	514
10.0	346	87	131	60	430	98	82	131	17	168	74	42	17	430	224	
1800	0.2	181	77	24	28	40	83	74	141	16	20	17	2	2	181	92
	2.0	181	5	19	27	39	79	74	163	16	14	17	8	5	181	93
	4.0	24	29	118	40	36	85	79	152	18	15	59	19	15	152	84
	6.0	31	77	60	24	58	94	79	185	56	17	57	26	17	185	101
	8.0	433	78	328	65	297	83	55	163	20	26	63	38	20	433	227
10.0	528	87	171	56	490	96	87	152	17	171	68	53	17	528	273	
2400	0.2	132	77	45	46	25	99	63	131	16	17	14	2	2	132	67
	2.0	38	47	25	45	33	89	55	141	17	18	45	12	12	141	77
	4.0	31	35	140	36	40	590	59	152	17	18	47	17	17	590	304
	6.0	118	59	321	38	119	109	51	152	16	19	74	18	16	321	169
	8.0	55	59	364	46	325	86	47	131	16	28	70	56	16	364	190
10.0	181	79	212	63	616	93	59	141	17	164	63	79	17	616	317	
0600	0.2	102	24	248	124	32	387	74	131	17	15	16	7	7	387	197
	2.0	30	38	31	30	36	459	74	131	18	15	26	18	15	459	237
	4.0	79	83	39	57	77	263	74	141	21	16	43	23	16	263	140
	6.0	67	63	106	51	44	97	87	136	18	17	63	28	17	136	77
	8.0	142	87	32	48	347	95	99	264	17	23	58	42	17	347	182
10.0	672	75	396	70	632	91	79	163	18	111	61	87	18	672	345	
Minimum	0.2	102	24	24	28	25	63	63	131	16	15	14	2	2	132	67
Maximum	0.2	181	77	496	379	40	410	79	152	17	20	17	7	14	496	255
Mean	0.2	142	51	260	204	33	247	71	142	17	18	16	5	8	314	161
Minimum	2.0	30	5	19	27	29	77	55	131	16	14	17	8	5	141	75
Maximum	2.0	181	78	31	45	39	459	74	163	18	19	45	18	15	459	237
Mean	2.0	106	42	25	36	34	268	65	147	17	17	31	13	10	300	156
Minimum	4.0	24	29	19	29	30	81	59	131	16	15	32	16	15	131	74
Maximum	4.0	79	83	140	57	77	590	79	152	21	19	59	23	17	590	304
Mean	4.0	52	56	80	43	54	336	69	142	19	17	46	20	16	361	189
Minimum	6.0	31	59	37	24	30	82	51	136	16	17	33	18	16	136	77
Maximum	6.0	181	87	321	51	119	109	87	185	56	20	74	28	18	321	169
Mean	6.0	106	73	179	38	75	96	69	161	36	19	54	23	17	229	123
Minimum	8.0	55	59	32	46	297	83	47	131	16	23	58	37	16	347	182
Maximum	8.0	433	87	364	1,009	377	95	99	264	20	29	70	56	20	1,009	514
Mean	8.0	244	73	198	528	337	89	73	198	18	26	64	47	18	678	348
Minimum	10.0	181	75	131	56	430	91	59	131	17	111	61	42	17	430	224
Maximum	10.0	672	87	396	70	632	98	87	163	18	171	74	87	18	672	345
Mean	10.0	427	81	264	63	531	95	73	147	18	141	68	65	18	551	284

Nitrate ( $\mu\text{g/l}$ ) at Cipondoh, Saguling Reservoir, 1988.

Monitoring Time	Water Depth (m)	Jan.	Feb.	Mar.	Apr.	May	June	July	Aug.	Sept.	Oct.	Nov.	Dec.	Min.	Max.	Mean
1200	0.2	200	80	629	110	120		322						80	629	355
	2.0	200	200	503	148	173		282						148	503	326
	4.0	120	120	491	97	115		355						97	491	294
	6.0	140	160	514	138	160		305						138	514	326
	8.0	200	120	846	146	160		265						120	846	483
	10.0	60	160	480	153	173		389						60	480	270
1800	0.2	232	80	389	141	115		331						80	389	235
	2.0	300	100	514	148	160		389						100	514	307
	4.0	160	160	697	161	147		373						147	697	422
	6.0	120	120	800	153	160		355						120	800	460
	8.0	260	160	571	148	255		315						148	571	360
	10.0	172	160	914	161	173		322						160	914	537
2400	0.2	172	160	434	89	107		357						89	434	262
	2.0	160	160	314	153	173		346						153	346	250
	4.0	220	480	846	123	133		375						123	846	485
	6.0	160	480	91	136	147		365						91	480	286
	8.0	180	160	1,143	141	252		384						141	1,143	642
	10.0	252	200	2,137	161	187		423						161	2,137	1,149
0600	0.2	160	80	720	141	160		375						80	720	400
	2.0	60	200	777	107	120		357						60	777	419
	4.0	129	120	571	115	133		365						115	571	343
	6.0	129	120	706	123	147		365						120	706	413
	8.0	200	120	1,051	148	160		423						120	1,051	586
	10.0	120	120	1,851	159	173		497						120	1,851	986
Minimum		160	80	389	89	107		322						80	389	235
Maximum	0.2	232	160	720	141	160		375						89	720	400
Mean		196	120	555	115	134		349						85	555	317
Minimum		60	100	314	107	120		282						60	346	250
Maximum	2.0	300	200	777	153	173		389						153	777	419
Mean		180	150	546	130	147		336						107	562	334
Minimum		120	120	491	97	115		355						97	491	294
Maximum	4.0	220	480	846	161	147		375						147	846	485
Mean		170	300	669	129	131		365						122	669	389
Minimum		120	120	91	123	147		305						91	480	286
Maximum	6.0	160	480	800	153	160		365						138	800	460
Mean		140	300	446	138	154		335						115	640	373
Minimum		180	120	571	141	147		265						120	571	360
Maximum	8.0	260	160	1,143	148	255		423						148	1,143	642
Mean		220	140	857	145	201		344						134	857	501
Minimum		60	120	480	153	173		322						60	480	270
Maximum	10.0	252	200	2,137	161	187		497						161	2,137	1,149
Mean		156	160	1,309	157	180		410						111	1,309	710

Orthophosphate ( $\mu\text{g/l}$ ) at Cipondoh, Saguling Reservoir, 1988.

Monitoring Time	Water	Jan.	Feb.	Mar.	Apr.	May	June	July	Aug.	Sept.	Oct.	Nov.	Dec.	Min.	Max.	Mean
	Depth (m)															
1200	0.2	51	23	152	203	222	85	225	97	227	149	190	132	23	227	125
	2.0	45	45	174	167	213	66	222	169	128	194	138	142	45	222	134
	4.0	21	60	193	146	164	75	216	168	183	201	150	156	21	216	119
	6.0	53	75	179	207	287	85	205	241	263	221	213	236	53	287	170
	8.0	38	75	137	153	296	67	203	226	264	208	223	287	38	296	167
	10.0	60	75	165	130	34	57	43	222	218	195	254	354	34	354	194
1800	0.2	45	23	220	347	259	82	238	158	212	149	239	136	23	347	185
	2.0	30	45	209	243	259	146	199	160	210	191	291	154	30	291	161
	4.0	75	60	218	260	271	64	189	210	231	164	380	168	60	380	220
	6.0	79	75	239	211	255	64	184	253	253	192	194	248	64	255	160
	8.0	30	75	103	227	231	62	173	204	266	218	239	283	30	283	157
	10.0	36	83	238	120	238	80	168	127	276	189	225	369	36	369	203
2400	0.2	600	53	202	304	196	75	267	267	260	178	213	129	53	600	327
	2.0	53	53	184	189	117	44	247	133	224	187	230	162	44	247	146
	4.0	53	48	186	160	234	75	244	175	260	202	112	162	48	260	154
	6.0	53	60	223	153	196	80	210	196	259	199	189	248	53	259	156
	8.0	83	60	206	189	279	0	202	169	257	234	303	291	60	303	182
	10.0	23	68	239	189	266	53	32	156	230	204	314	365	23	365	194
0600	0.2	45	51	199	174	255	80	216	237	218	149	179	141	45	255	150
	2.0	68	47	161	211	79	78	179	233	180	187	179	178	47	233	140
	4.0	60	53	172	146	199	92	173	277	198	201	179	186	53	277	165
	6.0	53	68	187	174	228	49	173	155	119	214	165	186	49	228	139
	8.0	48	53	108	185	225	62	32	125	271	236	213	289	32	289	161
	10.0	75	72	37	189	306	104	26	107	259	210	259	365	26	365	196
Minimum	0.2	45	23	152	174	196	75	216	97	212	149	179	129	23	227	125
Maximum		600	53	220	347	259	85	267	267	260	178	239	141	53	600	327
Mean		323	38	186	261	228	80	242	182	236	164	209	135	38	414	226
Minimum	2.0	30	45	161	167	79	44	179	133	128	187	138	142	30	222	134
Maximum		68	53	209	243	259	146	247	233	224	194	291	178	47	291	161
Mean		49	49	185	205	169	95	213	183	176	191	215	160	39	257	147
Minimum	4.0	21	48	172	146	164	64	173	168	183	164	112	156	21	216	119
Maximum		75	60	218	260	271	92	244	277	260	202	380	186	60	380	220
Mean		48	54	195	203	218	78	209	223	222	183	246	171	41	298	169
Minimum	6.0	53	60	179	153	196	49	173	155	119	192	165	186	49	228	139
Maximum		79	75	239	211	287	85	210	253	263	221	213	248	64	287	170
Mean		66	68	209	182	242	67	192	204	191	207	189	217	57	258	154
Minimum	8.0	30	53	103	153	225	62	32	125	257	208	213	283	30	283	157
Maximum		83	75	206	227	296	67	203	226	271	236	303	291	60	303	182
Mean		57	64	155	190	261	65	118	176	264	222	258	287	45	293	169
Minimum	10.0	23	68	37	120	34	53	26	107	218	189	225	354	23	354	194
Maximum		75	83	239	189	306	104	168	222	276	210	314	369	36	369	203
Mean		49	76	138	155	170	79	97	165	247	200	270	362	30	362	198

Hydrogen sulfide ( $\mu\text{g/l}$ ) at Cipondoh, Saguling Reservoir, 1988.

Monitoring Time	Water												Min.	Max.	Mean	
	Depth (m)	Jan.	Feb.	Mar.	Apr.	May	June	July	Aug.	Sept.	Oct.	Nov.				Dec.
1200	0.2	2	26	4	9	4	34	94	28	129	1	14	34	1	129	65
	2.0	5	72	8	6	4	23	194	43	135	7	68	67	4	194	99
	4.0	54	14	27	8	110	87	131	156	154	138	76	86	8	156	82
	6.0	41	24	14	75	107	83	103	205	78	143	78	97	14	205	110
	8.0	75	51	68	83	111	71	212	226	12	143	78	126	12	226	119
10.0	18	85	68	167	107	89	251	215	234	154	95	286	18	286	152	
1800	0.2	25	2	2	2	3	23	64	31	42	6	7	42	2	64	33
	2.0	78	19	2	5	3	42	161	43	76	7	8	76	2	161	82
	4.0	76	21	26	56	94	83	114	206	117	28	14	97	14	206	110
	6.0	47	140	61	109	79	91	201	221	108	54	24	113	24	221	123
	8.0	78	122	70	110	119	93	212	241	78	47	67	125	47	241	144
10.0	32	156	41	85	91	65	163	202	101	134	85	314	32	314	173	
2400	0.2	10	18	2	8	5	28	173	88	36	7	7	44	2	173	88
	2.0	30	58	2	10	4	21	217	59	58	24	8	76	2	217	110
	4.0	69	74	23	64	62	15	153	93	63	28	16	102	15	153	84
	6.0	58	80	26	134	75	67	227	222	57	57	31	135	26	227	127
	8.0	24	125	68	93	79	65	224	268	52	142	87	144	24	268	146
10.0	14	178	70	93	79	32	214	293	56	140	124	296	14	296	155	
0600	0.2	6	30	3	5	3	18	181	40	41	14	16	51	3	181	92
	2.0	4	129	3	10	5	12	202	54	61	18	68	82	3	202	103
	4.0	47	77	20	52	30	13	134	77	65	139	69	98	13	139	76
	6.0	32	145	93	169	14	24	199	92	61	144	95	122	14	199	107
	8.0	44	96	41	169	119	47	249	170	131	373	79	128	41	373	207
10.0	142	98	41	95	115	28	189	188	127	357	79	289	28	357	193	
Minimum		2	2	2	2	3	18	64	28	36	1	7	34	1	64	33
Maximum	0.2	25	30	4	9	5	34	181	88	129	14	16	51	3	181	92
Mean		14	16	3	6	4	26	123	58	83	8	12	43	2	123	63
Minimum		4	19	2	5	3	12	161	43	58	7	8	67	2	161	82
Maximum	2.0	78	129	8	10	5	42	217	59	135	24	68	82	4	217	110
Mean		41	74	5	8	4	27	189	51	97	16	38	75	3	189	96
Minimum		47	14	20	8	30	13	114	77	63	28	14	86	8	139	76
Maximum	4.0	76	77	27	64	110	87	153	206	154	139	76	102	15	206	110
Mean		62	46	24	36	70	50	134	142	109	84	45	94	12	173	93
Minimum		32	24	14	75	14	24	103	92	57	54	24	97	14	199	107
Maximum	6.0	58	145	93	169	107	91	227	222	108	144	95	135	26	227	127
Mean		45	85	54	122	61	58	165	157	83	99	60	116	20	213	117
Minimum		24	51	41	83	79	47	212	170	12	47	67	125	12	226	119
Maximum	8.0	78	125	70	169	119	93	249	268	131	373	87	144	47	373	207
Mean		51	88	56	126	99	70	231	219	72	210	77	135	30	300	163
Minimum		14	85	41	85	79	28	163	188	56	134	79	286	14	286	152
Maximum	10.0	142	178	70	167	115	89	251	293	234	357	124	314	32	357	193
Mean		78	132	56	126	97	59	207	241	145	246	102	300	23	322	172

Water temperature (°C) at Awilarangan, Saguling Reservoir, 1988.

Monitoring Time	Water Depth (m)	Jan.	Feb.	Mar.	Apr.	May	June	July	Aug.	Sept.	Oct.	Nov.	Dec.	Min.	Max.	Mean
1200	0.2	29.7	25.6	30.9	29.9	30.5	29.0	28.3	28.0	27.3	29.7	30.3	27.2	25.6	30.9	28.3
	2.0	28.4	26.1	28.5	28.8	28.1	27.5	27.9	26.5	26.5	27.8	28.3	26.4	26.1	28.8	27.5
	4.0	27.5	25.6	26.9	27.4	27.9	27.1	27.2	25.4	25.8	26.0	26.4	26.6	25.4	27.9	26.7
	6.0	26.2	25.2	26.0	26.1	26.4	25.9	26.6	25.3	25.5	25.5	25.9	25.3	25.2	26.6	25.9
	8.0	25.7	24.8	25.3	25.7	25.9	25.6	26.3	24.8	25.1	24.9	25.5	25.3	24.8	26.3	25.6
	10.0	25.3	24.4	25.0	25.9	25.7	25.4	26.2	24.7	25.1	24.9	25.3	25.0	24.4	26.2	25.3
1800	0.2	30.9	27.2	28.5	28.7	28.9	27.4	28.5	26.9	26.8	28.0	28.0	26.1	26.1	30.9	28.5
	2.0	28.6	25.3	28.5	28.4	28.1	27.3	27.9	26.1	26.1	26.8	28.0	26.1	25.3	28.6	27.0
	4.0	27.6	25.2	25.0	27.3	27.5	27.0	27.3	25.6	25.6	26.2	24.8	25.4	24.8	27.6	26.2
	6.0	27.3	25.2	24.5	25.8	26.6	26.0	26.5	24.9	25.3	25.6	24.8	25.5	24.5	27.3	25.9
	8.0	26.7	24.8	24.0	25.6	26.0	25.7	26.3	24.7	25.2	25.2	24.4	25.0	24.0	26.7	25.4
	10.0	25.2	24.7	24.0	25.3	25.6	25.5	26.1	24.6	25.0	25.1	24.4	24.8	24.0	26.1	25.1
2400	0.2	26.8	25.5	28.0	28.0	28.1	27.4	27.8	26.4	26.3	26.4	28.7	25.9	25.5	28.7	27.1
	2.0	27.4	26.2	28.0	28.1	27.6	27.3	27.2	26.0	25.8	26.2	27.9	26.0	25.8	28.1	27.0
	4.0	26.8	25.7	26.5	27.5	27.4	27.2	26.9	25.5	25.5	25.8	25.5	25.8	25.5	27.5	26.5
	6.0	26.0	25.5	26.0	26.1	26.2	26.1	26.4	25.0	24.9	24.9	25.2	25.4	24.9	26.4	25.7
	8.0	25.9	25.0	25.2	25.7	25.9	25.8	26.2	24.8	24.7	24.9	25.0	25.0	24.7	26.2	25.5
	10.0	25.1	24.7	25.0	25.3	25.5	25.6	25.9	24.6	24.7	24.6	25.0	24.8	24.6	25.9	25.3
0600	0.2	26.8	26.4	27.5	28.1	27.8	27.1	27.5	26.1	25.3	26.7	27.5	25.3	25.3	28.1	26.7
	2.0	27.2	26.2	27.5	28.0	27.3	27.1	27.0	25.6	25.5	26.4	27.5	25.5	25.5	28.0	26.8
	4.0	26.2	26.2	27.0	26.9	27.3	26.8	27.0	25.5	25.6	26.1	25.9	25.7	25.5	27.3	26.4
	6.0	25.7	25.6	26.5	26.0	26.4	26.1	26.5	25.2	25.3	25.7	25.5	25.5	25.2	26.5	25.9
	8.0	25.2	24.9	26.5	25.6	25.7	25.7	26.3	24.8	25.1	25.2	25.0	25.1	24.8	26.5	25.7
	10.0	24.8	24.7	25.3	25.4	25.4	25.5	26.0	24.6	24.9	25.0	25.0	25.3	24.6	26.0	25.3
Minimum Maximum Mean	0.2	26.8 30.9 28.9	25.5 27.2 26.4	27.5 30.9 29.2	28.0 29.9 29.0	27.8 30.5 29.2	27.1 29.0 28.1	27.5 29.0 28.0	26.1 28.5 27.1	25.3 28.0 26.3	26.4 27.3 28.1	27.5 30.3 28.9	25.3 27.2 26.3	25.3 26.1 25.7	28.1 30.9 29.5	26.7 28.5 27.6
Minimum Maximum Mean	2.0	27.2 28.6 27.9	25.3 26.2 25.8	27.5 28.5 28.0	28.0 28.8 28.4	27.3 28.1 27.7	27.1 27.5 27.3	27.0 27.9 27.5	25.6 26.5 26.1	25.5 26.5 26.0	26.2 27.8 27.0	27.5 28.3 27.9	25.5 26.4 26.0	25.3 26.1 25.7	28.0 28.8 28.4	26.8 27.5 27.1
Minimum Maximum Mean	4.0	26.2 27.6 26.9	25.2 26.2 25.7	25.0 27.0 26.0	26.9 27.5 27.2	27.3 27.9 27.6	26.8 27.2 27.0	26.9 27.3 27.1	25.4 25.6 25.5	25.5 25.8 25.7	25.8 26.2 26.0	24.8 26.4 25.6	25.4 26.6 26.0	24.8 25.5 25.2	27.3 27.9 27.6	26.2 26.7 26.4
Minimum Maximum Mean	6.0	25.7 27.3 26.5	25.2 25.6 25.4	24.5 26.5 25.5	25.8 26.1 26.0	26.2 26.6 26.4	25.9 26.1 26.0	26.4 26.6 26.5	24.9 25.3 25.1	24.9 25.5 25.2	24.9 25.7 25.3	24.8 25.9 25.4	25.3 25.5 25.4	24.5 25.2 24.9	26.4 27.3 26.9	25.7 25.9 25.8
Minimum Maximum Mean	8.0	25.2 26.7 26.0	24.8 25.0 24.9	24.0 26.5 25.3	25.6 25.7 25.7	25.7 26.0 25.9	25.6 25.8 25.7	26.2 26.3 26.3	24.7 24.8 24.8	24.7 25.2 25.0	24.9 25.2 25.1	24.4 25.5 25.0	25.0 25.3 25.2	24.0 24.8 24.4	26.2 26.7 26.5	25.4 25.7 25.5
Minimum Maximum Mean	10.0	24.8 25.3 25.1	24.4 24.7 24.6	24.0 25.3 24.7	25.3 25.9 25.6	25.4 25.7 25.6	25.4 25.6 25.5	25.9 26.2 26.1	24.6 24.7 24.7	24.7 25.1 24.9	24.6 25.1 24.9	24.4 25.3 24.9	24.8 25.3 25.1	24.0 24.6 24.3	25.9 26.2 26.1	25.1 25.3 25.2



Conductivity ( $\mu\text{mhos/cm}$ ) at Awilarangan, Saguling Reservoir, 1988.

Monitoring Time	Water Depth (m)	Jan.	Feb.	Mar.	Apr.	May	June	July	Aug.	Sept.	Oct.	Nov.	Dec.	Min.	Max.	Mean
1200	0.2	190	132	168	150	140	147	143	179	190	190	225	218	132	225	179
	2.0	175	165	165	144	138	140	141	179	183	184	224	216	138	224	181
	4.0	170	165	135	140	135	133	141	179	180	181	239	208	133	239	186
	6.0	180	160	132	140	150	149	151	183	181	204	243	216	132	243	188
	8.0	174	148	150	134	142	140	149	195	197	213	245	216	134	245	190
1800	10.0	178	140	150	130	132	140	147	196	222	217	245	216	130	245	188
	0.2	165	120	146	145	140	133	140	179	191	185	221	204	120	221	171
	2.0	190	162	158	140	139	138	140	175	187	181	219	208	138	219	179
	4.0	180	162	142	140	138	140	140	175	184	185	234	207	138	234	186
	6.0	176	162	144	138	155	149	151	185	190	207	239	220	138	239	189
2400	8.0	176	152	150	132	145	141	150	195	200	212	243	211	132	243	188
	10.0	180	145	150	128	138	140	148	196	229	219	244	212	128	244	186
	0.2	185	162	155	142	132	130	140	173	189	177	215	203	130	215	173
	2.0	185	164	160	142	131	130	139	175	189	175	220	206	130	220	175
	4.0	160	164	140	140	131	130	138	175	180	185	232	205	130	232	181
0600	6.0	178	162	155	140	162	135	148	179	189	207	238	215	135	238	187
	8.0	174	162	149	134	142	139	144	194	201	209	242	214	134	242	188
	10.0	174	150	150	130	133	140	144	197	221	219	238	214	130	238	184
	0.2	182	165	152	145	131	130	140	172	180	174	212	206	130	212	171
	2.0	182	165	152	145	132	132	139	174	180	175	216	233	132	233	183
Minimum Maximum Mean	0.2	160	165	139	142	133	133	139	174	187	179	230	187	133	230	182
		175	160	150	140	149	149	150	179	187	208	235	208	140	235	188
Minimum Maximum Mean	4.0	170	150	152	135	140	140	149	193	200	212	241	215	135	241	188
		180	145	151	132	135	140	146	190	227	217	235	213	132	235	184
Minimum Maximum Mean	2.0	165	120	146	142	131	130	140	172	180	174	212	203	120	212	171
		190	165	168	150	140	147	143	179	191	190	225	218	132	225	179
Minimum Maximum Mean	6.0	178	143	157	146	136	139	142	176	186	182	219	211	126	219	175
		175	162	152	140	131	130	139	174	180	175	216	206	130	219	175
Minimum Maximum Mean	8.0	190	165	165	145	139	140	141	179	189	184	224	233	138	233	183
		183	164	159	143	135	135	140	177	185	180	220	220	134	226	179
Minimum Maximum Mean	10.0	160	162	135	140	131	130	138	174	180	179	230	187	130	230	181
		180	165	142	142	138	140	141	179	187	185	239	208	138	239	186
Minimum Maximum Mean	10.0	170	164	139	141	135	135	140	177	184	182	235	198	134	235	184
		175	160	132	138	149	135	148	179	181	204	235	208	132	235	187
Minimum Maximum Mean	10.0	180	162	155	140	162	149	151	185	190	208	243	220	140	243	189
		178	161	144	139	156	142	150	182	186	206	239	214	136	239	188
Minimum Maximum Mean	10.0	170	148	149	132	140	139	144	193	197	209	241	211	132	241	188
		176	162	152	135	145	141	150	195	201	213	245	216	135	245	190
Minimum Maximum Mean	10.0	173	155	151	134	143	140	147	194	199	211	243	214	134	243	189
		174	140	150	128	132	140	144	190	221	217	235	212	128	235	184
Minimum Maximum Mean	10.0	180	150	151	132	138	140	148	197	229	219	245	216	132	245	188
		177	145	151	130	135	140	146	194	225	218	240	214	130	240	186

Dissolved oxygen (mg/l) at Awilarangan, Saguling Reservoir, 1988.

Monitoring Time	Water Depth (m)	Dissolved oxygen (mg/l)												Min.	Max.	Mean
		Jan.	Feb.	Mar.	Apr.	May	June	July	Aug.	Sept.	Oct.	Nov.	Dec.			
1200	0.2	5.3	5.6	8.6	12.2	9.2	5.5	10.6	9.4	7.8	8.7	8.5	7.0	5.3	12.2	8.8
	2.0	5.0	5.0	7.4	8.8	9.0	4.2	9.3	5.9	5.0	7.1	4.5	5.3	4.2	9.3	6.8
	4.0	3.0	4.6	6.8	6.2	6.2	3.8	7.1	2.9	3.1	2.5	1.3	2.9	1.3	7.1	4.2
	6.0	2.1	2.6	6.4	2.5	1.2	1.5	2.0	1.3	1.6	1.2	1.1	1.1	1.1	6.4	3.8
	8.0	1.6	1.0	1.0	0.7	1.3	1.2	1.2	0.8	0.6	0.7	1.0	0.7	0.6	1.6	1.1
	10.0	1.3	1.0	0.6	0.6	1.0	1.0	0.9	0.7	0.4	0.7	1.0	0.4	0.4	1.3	0.9
1800	0.2	6.2	6.5	9.5	9.7	11.3	5.5	10.2	6.4	7.0	7.3	7.7	6.3	5.5	11.3	8.4
	2.0	5.8	6.3	7.2	8.0	8.7	5.4	8.1	6.0	4.8	5.3	6.0	4.3	4.3	8.7	6.5
	4.0	3.2	5.1	4.6	6.6	6.7	4.0	6.0	3.7	3.5	2.1	1.4	2.2	1.4	6.7	4.1
	6.0	1.0	1.8	3.4	2.6	1.6	1.2	1.5	0.9	1.5	0.9	0.9	1.0	0.9	3.4	2.2
	8.0	0.8	1.5	0.8	1.2	1.5	1.2	1.0	0.6	1.0	0.9	0.8	0.9	0.6	1.5	1.1
	10.0	1.6	0.7	0.8	0.5	0.9	1.2	0.9	0.5	0.8	0.7	0.8	0.5	0.5	1.6	1.1
2400	0.2	5.9	6.1	6.7	9.7	8.1	6.1	9.2	6.3	5.5	5.4	7.2	5.2	5.2	9.7	7.5
	2.0	5.7	5.7	6.6	8.5	7.8	5.9	8.5	5.5	4.3	5.0	4.3	4.0	4.0	8.5	6.3
	4.0	3.1	5.1	5.9	7.5	6.2	5.3	6.4	2.9	3.8	1.1	1.1	1.0	1.0	7.5	4.3
	6.0	1.1	2.6	2.7	1.9	1.2	1.7	2.0	0.9	2.2	0.5	1.0	0.8	0.5	2.7	1.6
	8.0	0.7	0.8	1.4	0.8	1.1	1.3	1.3	0.6	1.5	0.5	0.8	0.5	0.5	1.5	1.0
	10.0	1.1	0.7	1.0	0.6	0.9	1.1	1.2	0.5	0.7	0.5	0.8	0.5	0.5	1.2	0.9
0600	0.2	4.6	5.3	6.1	9.6	7.5	5.7	7.6	5.0	4.3	5.9	5.5	5.3	4.3	9.6	7.0
	2.0	4.4	4.7	6.1	9.0	6.9	5.4	7.2	4.6	3.8	4.5	3.7	4.6	3.7	9.0	6.4
	4.0	2.8	4.5	5.5	5.7	6.7	4.3	6.0	3.2	3.6	1.8	1.2	1.0	1.0	6.7	3.9
	6.0	0.7	1.7	1.3	2.0	1.7	1.5	2.2	1.4	2.8	0.7	0.8	1.0	0.7	2.8	1.8
	8.0	0.7	0.9	0.7	0.6	1.2	1.1	1.2	0.8	1.4	0.6	0.8	0.6	0.6	1.4	1.0
	10.0	0.9	0.8	0.7	0.5	1.2	1.1	1.2	0.5	1.2	0.6	0.7	0.5	0.5	1.2	0.9
Minimum		4.6	5.3	6.1	9.6	7.5	5.5	7.6	5.0	4.3	5.4	5.5	5.2	4.3	9.6	7.0
Maximum	0.2	6.2	6.5	9.5	12.2	11.3	6.1	10.6	9.4	7.8	8.7	8.5	7.0	5.5	12.2	8.8
Mean		5.4	5.9	7.8	10.9	9.4	5.8	9.1	7.2	6.1	7.1	7.0	6.1	4.9	10.9	7.9
Minimum		4.4	4.7	6.1	8.0	6.9	4.2	7.2	4.6	3.8	4.5	3.7	4.0	3.7	8.5	6.3
Maximum	2.0	5.8	6.3	7.4	9.0	9.0	5.9	9.3	6.0	5.0	7.1	6.0	5.3	4.3	9.3	6.8
Mean		5.1	5.5	6.8	8.5	8.0	5.1	8.3	5.3	4.4	5.8	4.9	4.7	4.0	8.9	6.5
Minimum		2.8	4.5	4.6	5.7	6.2	3.8	6.0	2.9	3.1	1.1	1.1	1.0	1.0	6.7	3.9
Maximum	4.0	3.2	5.1	6.8	7.5	6.7	5.3	7.1	3.7	3.8	2.5	1.4	2.9	1.4	7.5	4.3
Mean		3.0	4.8	5.7	6.6	6.5	4.6	6.6	3.3	3.5	1.8	1.3	2.0	1.2	7.1	4.1
Minimum		0.7	1.7	1.3	1.9	1.2	1.2	1.5	0.9	1.5	0.5	0.8	0.8	0.5	2.7	1.6
Maximum	6.0	2.1	2.6	6.4	2.6	1.7	1.7	2.2	1.4	2.8	1.2	1.1	1.1	1.1	6.4	3.8
Mean		1.4	2.2	3.9	2.3	1.5	1.5	1.9	1.2	2.2	0.9	1.0	1.0	0.8	4.6	2.7
Minimum		0.7	0.8	0.7	0.6	1.1	1.1	1.0	0.6	0.6	0.5	0.8	0.5	0.5	1.4	1.0
Maximum	8.0	1.6	1.5	1.4	1.2	1.5	1.3	1.3	0.8	1.5	0.9	1.0	0.9	0.6	1.6	1.1
Mean		1.2	1.2	1.1	0.9	1.3	1.2	1.2	0.7	1.1	0.7	0.9	0.7	0.6	1.5	1.1
Minimum		0.9	0.7	0.6	0.5	0.9	1.0	0.9	0.5	0.4	0.5	0.7	0.4	0.4	1.2	0.9
Maximum	10.0	1.6	1.0	1.0	0.6	1.2	1.2	1.2	0.7	1.2	0.7	1.0	0.5	0.5	1.6	1.1
Mean		1.3	0.9	0.8	0.6	1.1	1.1	1.1	0.6	0.8	0.6	0.9	0.5	0.5	1.4	1.0

pH (unit) at Awilarangan, Saguling Reservoir, 1988.

Monitoring Time	Water Depth (m)	Jan.	Feb.	Mar.	Apr.	May	June	July	Aug.	Sept.	Oct.	Nov.	Dec.	Min.	Max.	Mean
1200	0.2	7.4	7.7	8.4	9.2	8.9	7.7	8.1	8.3	7.2	8.7	8.4	7.4	7.2	9.2	8.2
	2.0	7.4	7.7	7.8	9.2	8.9	7.4	8.0	7.7	7.3	8.5	7.8	7.2	7.2	9.2	8.2
	4.0	7.2	7.4	7.5	8.0	8.7	7.1	7.4	7.1	7.1	7.3	7.5	7.1	7.1	8.7	7.9
	6.0	7.2	7.3	7.2	7.0	7.0	6.6	6.9	6.9	7.0	6.9	7.1	6.7	6.6	7.3	7.0
	8.0	7.3	7.0	6.8	6.7	7.0	6.4	6.9	6.8	6.7	6.6	6.8	6.5	6.4	7.3	6.9
	10.0	7.4	7.1	6.8	6.5	6.9	6.4	6.8	6.6	6.5	6.6	7.0	6.5	6.4	7.4	6.9
1800	0.2	7.5	8.4	8.5	9.4	9.1	8.2	8.1	8.0	7.3	8.4	8.9	6.2	6.2	9.4	7.8
	2.0	7.4	7.8	8.1	9.1	9.0	6.6	7.8	7.5	7.1	8.0	8.4	6.5	6.5	9.1	7.8
	4.0	7.4	7.6	7.1	8.1	8.6	5.9	7.3	7.2	7.0	7.2	7.2	7.0	5.9	8.6	7.3
	6.0	7.5	7.2	6.9	7.1	7.3	5.2	6.9	6.8	6.8	6.8	6.9	6.5	5.2	7.5	6.4
	8.0	7.1	7.0	6.8	6.8	7.1	5.2	6.9	6.7	6.7	6.6	6.8	6.5	5.2	7.1	6.2
	10.0	7.2	7.1	6.8	6.7	7.0	4.9	6.8	6.6	6.6	6.4	6.8	6.5	4.9	7.2	6.1
2400	0.2	7.4	7.9	7.7	9.2	9.0	7.8	8.1	7.5	7.5	8.4	8.7	7.5	7.4	9.2	8.3
	2.0	7.4	7.9	7.7	9.1	9.0	7.8	8.0	7.6	7.3	8.2	8.0	7.3	7.3	9.1	8.2
	4.0	7.3	7.8	7.3	8.3	8.8	7.4	7.4	7.1	7.1	7.2	7.3	6.9	6.9	8.8	7.9
	6.0	7.3	7.2	6.9	7.0	7.2	6.8	7.0	6.8	6.9	6.9	7.0	6.8	6.8	7.3	7.1
	8.0	7.4	6.9	6.8	6.8	7.0	6.6	6.9	6.8	6.7	6.7	6.9	6.6	6.6	7.4	7.0
	10.0	7.4	7.0	6.8	6.7	7.0	6.5	6.9	6.6	6.6	6.5	6.8	6.5	6.5	7.4	7.0
0600	0.2	7.3	7.7	7.4	9.2	8.9	8.0	7.2	7.3	7.2	7.8	8.3	7.1	7.1	9.2	8.2
	2.0	7.4	7.7	7.3	9.1	8.9	7.6	7.6	7.3	7.1	7.9	7.6	7.0	7.0	9.1	8.1
	4.0	7.3	7.7	7.4	7.9	8.8	7.4	7.3	7.0	7.1	7.3	7.3	6.9	6.9	8.8	7.9
	6.0	7.2	7.2	7.4	7.1	7.3	6.9	7.0	6.8	7.0	7.0	6.8	6.7	6.7	7.4	7.1
	8.0	7.1	6.9	7.3	6.8	7.1	6.8	7.0	6.7	6.7	6.7	6.7	6.6	6.6	7.3	7.0
	10.0	7.2	7.0	7.3	6.7	7.1	6.8	0.9	6.6	6.5	6.6	6.7	6.5	0.9	7.3	4.1
Minimum		7.3	7.7	7.4	9.2	8.9	7.7	7.2	7.3	7.2	7.8	8.3	6.2	6.2	9.2	7.8
Maximum	0.2	7.5	8.4	8.5	9.4	9.1	8.2	8.1	8.3	7.5	8.7	8.9	7.5	7.4	9.4	8.3
Mean		7.4	8.1	8.0	9.3	9.0	8.0	7.7	7.8	7.4	8.3	8.6	6.9	6.8	9.3	8.1
Minimum		7.4	7.7	7.3	9.1	8.9	6.6	7.6	7.3	7.1	7.9	7.6	6.5	6.5	9.1	7.8
Maximum	2.0	7.4	7.9	8.1	9.2	9.0	7.8	8.0	7.7	7.3	8.5	8.4	7.3	7.3	9.2	8.2
Mean		7.4	7.8	7.7	9.2	9.0	7.2	7.8	7.5	7.2	8.2	8.0	6.9	6.9	9.2	8.0
Minimum		7.2	7.4	7.1	7.9	8.6	5.9	7.3	7.0	7.0	7.2	7.2	6.9	5.9	8.6	7.3
Maximum	4.0	7.4	7.8	7.5	8.3	8.8	7.4	7.4	7.2	7.1	7.3	7.5	7.1	7.1	8.8	7.9
Mean		7.3	7.6	7.3	8.1	8.7	6.7	7.4	7.1	7.1	7.3	7.4	7.0	6.5	8.7	7.6
Minimum		7.2	7.2	6.9	7.0	7.0	5.2	6.9	6.8	6.8	6.8	6.8	6.5	5.2	7.3	6.4
Maximum	6.0	7.5	7.3	7.4	7.1	7.3	6.9	7.0	6.9	7.0	7.0	7.1	6.8	6.8	7.5	7.1
Mean		7.4	7.3	7.2	7.1	7.2	6.1	7.0	6.9	6.9	6.9	7.0	6.7	6.0	7.4	6.7
Minimum		7.1	6.9	6.8	6.7	7.0	5.2	6.9	6.7	6.7	6.6	6.7	6.5	5.2	7.1	6.2
Maximum	8.0	7.4	7.0	7.3	6.8	7.1	6.8	7.0	6.8	6.7	6.7	6.9	6.6	6.6	7.4	7.0
Mean		7.3	7.0	7.1	6.8	7.1	6.0	7.0	6.8	6.7	6.7	6.8	6.6	5.9	7.3	6.6
Minimum		7.2	7.0	6.8	6.5	6.9	4.9	0.9	6.6	6.5	6.4	6.7	6.5	0.9	7.2	4.1
Maximum	10.0	7.4	7.1	7.3	6.7	7.1	6.8	6.9	6.6	6.6	6.6	7.0	6.5	6.5	7.4	7.0
Mean		7.3	7.1	7.1	6.6	7.0	5.9	3.9	6.6	6.6	6.5	6.9	6.5	3.7	7.3	5.5

Alkalinity (mg/l) at Awilarangan, Saguling Reservoir, 1988.

Monitoring Time	Water Depth (m)	Alkalinity (mg/l)												Min.	Max.	Mean
		Jan.	Feb.	Mar.	Apr.	May	June	July	Aug.	Sept.	Oct.	Nov.	Dec.			
1200	0.2	48.5	49.9	46.3	39.8	36.5	37.3	41.1	45.0					36.5	49.9	43.2
	2.0	45.6	49.3	39.8	41.1	37.5	36.0	37.3	39.8					36.0	49.3	42.7
	4.0	42.5	49.9	34.7	37.5	39.1	37.3	37.3	50.1					34.7	50.1	42.4
	6.0	52.7	51.6	37.3	38.3	51.1	43.7	45.0	51.4					37.3	52.7	45.0
	8.0	51.3	51.6	46.3	40.3	51.7	42.7	43.7	56.8					40.3	56.8	48.6
	10.0	54.2	51.3	46.3	39.1	42.9	41.9	43.7	56.8					39.1	56.8	48.0
1800	0.2	28.5	48.0	48.8	38.8	39.1	36.5	56.0	42.4					28.5	56.0	42.3
	2.0	48.5	47.0	46.3	41.1	37.0	41.1	37.3	39.8					37.0	48.5	42.8
	4.0	44.2	48.5	42.4	37.3	38.3	37.0	32.1	50.1					32.1	50.1	41.1
	6.0	48.5	52.2	38.6	39.1	48.3	44.7	48.8	43.7					38.6	52.2	45.4
	8.0	48.5	50.5	42.4	40.1	45.0	42.4	43.7	42.4					40.1	50.5	45.3
	10.0	54.2	47.3	36.0	39.1	42.4	42.4	43.7	45.0					36.0	54.2	45.1
2400	0.2	48.5	48.5	46.3	39.3	36.2	37.3	37.3	37.3					36.2	48.5	42.4
	2.0	49.3	49.3	47.5	40.1	37.3	36.8	32.1	41.1					32.1	49.3	40.7
	4.0	35.6	48.5	46.3	38.6	37.3	37.8	39.8	41.1					35.6	48.5	42.1
	6.0	61.9	52.7	36.0	38.1	48.8	44.2	43.7	43.7					36.0	61.9	49.0
	8.0	51.0	52.7	42.4	39.6	47.8	42.9	43.7	65.5					39.6	65.5	52.6
	10.0	52.7	48.5	42.4	40.6	43.7	41.6	48.8	55.3					40.6	55.3	48.0
0600	0.2	49.9	48.5	38.6	40.6	38.0	38.5	34.7	42.4					34.7	49.9	42.3
	2.0	48.5	54.4	41.8	40.3	37.5	37.5	36.0	41.1					36.0	54.4	45.2
	4.0	35.6	49.9	38.6	39.6	38.3	36.2	39.8	38.6					35.6	49.9	42.8
	6.0	47.0	82.7	37.3	39.8	45.0	45.5	43.7	50.1					37.3	82.7	60.0
	8.0	49.0	59.9	48.8	40.3	50.1	44.2	38.6	39.8					38.6	59.9	49.3
	10.0	47.0	50.5	47.5	38.6	42.4	42.4	42.4	43.7					38.6	50.5	44.6
Minimum		28.5	48.0	38.6	38.8	36.2	36.5	34.7	37.3					28.5	48.5	42.3
Maximum	0.2	49.9	49.9	48.8	40.6	39.1	38.5	56.0	45.0					36.5	56.0	43.2
Mean		39.2	49.0	43.7	39.7	37.7	37.5	45.4	41.2					32.5	52.3	42.7
Minimum		45.6	47.0	39.8	40.1	37.0	36.0	32.1	39.8					32.1	48.5	40.7
Maximum	2.0	49.3	54.4	47.5	41.1	37.5	41.1	37.3	41.1					37.0	54.4	45.2
Mean		47.5	50.7	43.7	40.6	37.3	38.6	34.7	40.5					34.6	51.5	43.0
Minimum		35.6	48.5	34.7	37.3	37.3	36.2	32.1	38.6					32.1	48.5	41.1
Maximum	4.0	44.2	49.9	46.3	39.6	39.1	37.8	39.8	50.1					35.6	50.1	42.8
Mean		39.9	49.2	40.5	38.5	38.2	37.0	36.0	44.4					33.9	49.3	41.9
Minimum		47.0	51.6	36.0	38.1	45.0	43.7	43.7	43.7					36.0	52.2	45.0
Maximum	6.0	61.9	82.7	38.6	39.8	51.1	45.5	48.8	51.4					38.6	82.7	60.0
Mean		54.5	67.2	37.3	39.0	48.1	44.6	46.3	47.6					37.3	67.5	52.5
Minimum		48.5	50.5	42.4	39.6	45.0	42.4	38.6	39.8					38.6	50.5	45.3
Maximum	8.0	51.3	59.9	48.8	40.3	51.7	44.2	43.7	65.5					40.3	65.5	52.6
Mean		49.9	55.2	45.6	40.0	48.4	43.3	41.2	52.7					39.5	58.0	48.9
Minimum		47.0	47.3	36.0	38.6	42.4	41.6	42.4	43.7					36.0	50.5	44.6
Maximum	10.0	54.2	51.3	47.5	40.6	43.7	42.4	48.8	56.8					40.6	56.8	48.0
Mean		50.6	49.3	41.8	39.6	43.1	42.0	45.6	50.3					38.3	53.7	46.3

Carbon dioxide (mg/l) at Awilarangan, Saguling Reservoir, 1988.

Monitoring Time	Water													Min.	Max.	Mean
	Depth (m)	Jan.	Feb.	Mar.	Apr.	May	June	July	Aug.	Sept.	Oct.	Nov.	Dec.			
1200	0.2	8.1	5.4	5.4	0.0	0.0	10.8	2.7	0.0	7.9	0.0	0.0	4.0	2.7	10.8	6.8
	2.0	10.8	5.4	8.1	0.0	0.0	10.8	5.4	4.0	7.9	0.0	5.4	8.0	4.0	10.8	7.4
	4.0	13.5	5.4	8.1	5.4	0.0	8.1	8.1	11.9	7.9	7.9	10.8	7.8	5.4	13.5	9.5
	6.0	18.9	10.8	10.8	8.1	10.8	10.8	16.2	11.9	7.9	19.8	16.2	19.8	7.9	19.8	13.9
	8.0	18.9	16.2	16.2	18.6	10.8	13.5	18.9	15.8	19.8	27.7	21.6	27.7	10.8	27.7	19.3
10.0	13.5	16.2	13.5	18.6	10.8	13.5	18.9	43.6	43.6	35.6	24.3	23.8	10.8	43.6	27.2	
1800	0.2	5.4	5.4	5.4	0.0	0.0	0.0	2.7	4.0	4.0	0.0	0.0	4.0	2.7	5.4	4.1
	2.0	8.1	5.4	8.1	0.0	0.0	2.7	8.1	11.9	7.9	7.9	0.0	11.9	2.7	11.9	7.3
	4.0	10.8	8.1	13.5	5.4	0.0	8.1	8.1	19.8	7.9	11.9	10.8	11.9	5.4	19.8	12.6
	6.0	13.5	10.8	13.5	10.8	8.1	13.5	21.6	23.8	15.8	19.8	18.9	23.8	8.1	23.8	16.0
	8.0	16.2	10.8	21.6	13.5	10.8	16.2	24.3	31.7	19.8	27.7	21.6	27.7	10.8	31.7	21.3
10.0	16.2	13.5	21.6	13.5	13.5	16.2	24.3	43.6	47.5	31.7	27.0	43.6	13.5	47.5	30.5	
2400	0.2	5.4	8.1	5.4	0.0	0.0	8.1	8.1	7.9	4.0	0.0	0.0	11.9	4.0	11.9	8.0
	2.0	5.4	8.1	10.8	0.0	0.0	8.1	8.1	7.9	4.0	4.0	5.4	11.9	4.0	11.9	8.0
	4.0	10.8	8.1	13.5	5.4	0.0	8.1	10.8	11.9	7.9	19.8	10.8	15.8	5.4	19.8	12.6
	6.0	10.8	13.5	18.9	10.8	8.1	13.5	16.3	15.8	7.9	19.8	18.9	15.8	7.9	19.8	13.9
	8.0	13.5	16.2	16.2	13.5	13.5	16.2	18.9	23.8	23.8	35.6	27.0	19.0	13.5	35.6	24.6
10.0	13.5	16.2	18.9	16.2	13.5	16.2	18.9	35.6	51.5	59.4	27.0	31.7	13.5	59.4	36.5	
0600	0.2	8.1	8.1	8.1	0.0	0.0	5.4	5.4	7.9	4.0	4.0	2.7	7.9	2.7	8.1	5.4
	2.0	8.1	13.5	5.4	0.0	0.0	5.4	5.4	11.9	4.0	7.9	5.4	7.9	4.0	13.5	8.8
	4.0	10.8	10.8	5.4	5.4	0.0	5.4	8.1	19.8	4.0	7.9	10.8	11.9	4.0	19.8	11.9
	6.0	13.5	16.2	10.8	10.8	8.1	8.1	10.8	23.8	15.8	19.8	13.5	15.8	8.1	23.8	16.0
	8.0	13.5	16.2	13.5	10.8	10.8	8.1	16.2	39.6	15.8	27.7	21.6	23.8	8.1	39.6	23.9
10.0	13.5	16.2	13.5	10.8	10.8	8.1	16.2	47.5	31.7	39.6	21.6	23.8	8.1	47.5	27.8	
Minimum	0.2	5.4	5.4	5.4	0.0	0.0	5.4	2.7	4.0	4.0	4.0	2.7	4.0	2.7	5.4	4.1
Maximum		8.1	8.1	8.1	0.0	0.0	10.8	8.1	7.9	7.9	4.0	2.7	11.9	4.0	11.9	8.0
Mean		6.8	6.8	6.8	0.0	0.0	8.1	5.4	6.0	6.0	4.0	2.7	8.0	3.4	8.7	6.0
Minimum	2.0	5.4	5.4	5.4	0.0	0.0	2.7	5.4	4.0	4.0	4.0	5.4	7.9	2.7	10.8	7.3
Maximum		10.8	13.5	10.8	0.0	0.0	10.8	8.1	11.9	7.9	7.9	5.4	11.9	4.0	13.5	8.8
Mean		8.1	9.5	8.1	0.0	0.0	6.8	6.8	8.0	6.0	6.0	5.4	9.9	3.4	12.2	8.0
Minimum	4.0	10.8	5.4	5.4	5.4	0.0	5.4	8.1	11.9	4.0	7.9	10.8	7.8	4.0	13.5	9.5
Maximum		13.5	10.8	13.5	5.4	0.0	8.1	10.8	19.8	7.9	19.8	10.8	15.8	5.4	19.8	12.6
Mean		12.2	8.1	9.5	5.4	0.0	6.8	9.5	15.9	6.0	13.9	10.8	11.8	4.7	16.7	11.0
Minimum	6.0	10.8	10.8	10.8	8.1	8.1	8.1	10.8	11.9	7.9	19.8	13.5	15.8	7.9	19.8	13.9
Maximum		18.9	16.2	18.9	10.8	10.8	13.5	21.6	23.8	15.8	19.8	18.9	23.8	8.1	23.8	16.0
Mean		14.9	13.5	14.9	9.5	9.5	10.8	16.2	17.9	11.9	19.8	16.2	19.8	8.0	21.8	14.9
Minimum	8.0	13.5	10.8	13.5	10.8	10.8	8.1	16.2	15.8	15.8	27.7	21.6	19.0	8.1	27.7	19.3
Maximum		18.9	16.2	21.6	18.6	13.5	16.2	24.3	39.6	23.8	35.6	27.0	27.7	13.5	39.6	24.6
Mean		16.2	13.5	17.6	14.7	12.2	12.2	20.3	27.7	19.8	31.7	24.3	23.4	10.8	33.7	21.9
Minimum	10.0	13.5	13.5	13.5	10.8	10.8	8.1	16.2	35.6	31.7	31.7	21.6	23.8	8.1	43.6	27.2
Maximum		16.2	16.2	21.6	18.6	13.5	16.2	24.3	47.5	51.5	59.4	27.0	43.6	13.5	59.4	36.5
Mean		14.9	14.9	17.6	14.7	12.2	12.2	20.3	41.6	41.6	45.6	24.3	33.7	10.8	51.5	31.8

Ammonia ( $\mu\text{g/l}$ ) at Awilarangan, Saguling Reservoir, 1988.

Monitoring Time	Water Depth (m)	Jan.	Feb.	Mar.	Apr.	May	June	July	Aug.	Sept.	Oct.	Nov.	Dec.	Min.	Max.	Mean
1200	0.2	62	54	73	183	66	49	200	98	79	48	64	73	48	200	124
	2.0	77	54	86	213	72	46	504	200	88	56	67	77	46	504	275
	4.0	123	105	139	99	57	88	402	109	97	67	87	126	57	402	230
	6.0	123	58	152	65	48	340	301	131	88	96	89	114	48	340	194
	8.0	108	169	323	213	117	174	504	120	687	112	245	262	108	687	398
	10.0	200	169	100	244	155	340	504	1,387	181	264	244	320	100	1,387	744
1800	0.2	105	46	420	346	16	78	504	109	52	44	63	75	16	504	260
	2.0	62	31	246	561	63	78	709	271	52	74	59	81	31	709	370
	4.0	79	46	120	126	51	139	709	76	43	102	62	84	43	709	376
	6.0	105	46	152	163	57	236	606	98	66	135	98	132	46	606	326
	8.0	185	92	95	255	120	66	709	98	760	144	102	160	66	760	413
	10.0	123	92	182	293	75	384	709	65	1,376	124	132	328	65	1,376	721
2400	0.2	62	46	434	492	120	46	504	43	49	51	71	84	43	504	274
	2.0	58	46	386	409	258	41	402	370	52	82	71	93	41	409	225
	4.0	215	46	266	183	104	88	402	54	61	93	74	113	46	402	224
	6.0	108	58	116	277	94	721	301	54	70	112	114	204	54	721	388
	8.0	185	92	121	371	134	732	709	87	877	128	132	212	87	877	482
	10.0	185	46	109	436	75	593	812	98	106	267	268	272	46	812	429
0600	0.2	46	54	113	682	104	292	606	87	70	606	87	74	46	682	364
	2.0	46	54	143	552	155	273	402	247	70	402	247	82	46	552	299
	4.0	185	92	145	266	48	110	301	87	70	301	87	106	48	301	175
	6.0	108	54	164	140	101	250	301	65	61	301	65	204	54	301	178
	8.0	15	108	173	203	138	75	200	980	540	200	980	212	15	980	498
	10.0	162	108	309	266	81	355	200	120	1,189	200	120	268	81	1,189	635
Minimum		46	46	73	183	16	46	200	43	49	44	63	73	16	200	124
Maximum	0.2	105	54	434	682	120	292	606	109	79	606	87	84	48	682	364
Mean		76	50	254	433	68	169	403	76	64	325	75	79	32	441	244
Minimum		46	31	86	213	63	41	402	200	52	56	59	77	31	409	225
Maximum	2.0	77	54	386	561	258	273	709	370	88	402	247	93	46	709	370
Mean		62	43	236	387	161	157	556	285	70	229	153	85	39	559	298
Minimum		79	46	120	99	48	88	301	54	43	67	62	84	43	301	175
Maximum	4.0	215	105	266	266	104	139	709	109	97	301	87	126	57	709	376
Mean		147	76	193	183	76	114	505	82	70	184	75	105	50	505	275
Minimum		105	46	116	65	48	236	301	54	61	96	65	114	46	301	178
Maximum	6.0	123	58	164	277	101	721	606	131	88	301	114	204	54	721	388
Mean		114	52	140	171	75	479	454	93	75	199	90	159	50	511	283
Minimum		15	92	95	203	117	66	200	87	540	112	102	160	15	687	398
Maximum	8.0	185	169	323	371	138	732	709	980	877	200	980	262	108	980	498
Mean		100	131	209	287	128	399	455	534	709	156	541	211	62	834	448
Minimum		123	46	100	244	75	340	200	65	106	124	120	268	46	812	429
Maximum	10.0	200	169	309	436	155	593	812	1,387	1,376	267	268	328	100	1,387	744
Mean		162	108	205	340	115	467	506	726	741	196	194	298	73	1,100	586

Nitrite ( $\mu\text{g/l}$ ) at Awilarangan, Saguling Reservoir, 1988.

Monitoring Time	Water Depth (m)	Jan.	Feb.	Mar.	Apr.	May	June	July	Aug.	Sept.	Oct.	Nov.	Dec.	Min.	Max.	Mean
1200	0.2	57	24	14	16	23	72	71	141	27	31	23	14	14	141	78
	2.0	71	16	26	37	15	79	110	109	52	166	26	14	14	166	90
	4.0	71	54	30	20	18	344	87	134	19	140	26	27	18	344	181
	6.0	71	19	49	279	24	76	74	159	115	175	89	38	19	279	149
	8.0	55	31	410	46	47	76	192	159	187	195	128	41	31	410	221
	10.0	87	39	515	55	29	78	87	171	19	237	128	96	19	515	267
1800	0.2	315	94	23	119	17	68	71	695	7	42	21	31	7	695	351
	2.0	315	142	15	60	15	68	118	112	7	21	22	48	7	315	161
	4.0	16	94	17	18	11	104	118	112	18	24	24	52	11	118	65
	6.0	28	94	26	23	14	140	110	141	100	29	69	71	14	141	78
	8.0	57	39	17	39	15	62	123	127	171	222	41	63	15	222	119
	10.0	113	71	23	47	33	118	118	124	307	215	70	69	23	307	165
2400	0.2	181	71	32	13	9	70	102	141	8	32	22	28	8	181	95
	2.0	213	94	19	18	10	67	151	134	7	17	29	32	7	213	110
	4.0	47	134	46	123	9	300	118	141	7	18	30	43	7	300	154
	6.0	87	134	14	24	11	81	184	181	7	71	34	58	7	184	96
	8.0	244	39	90	40	31	88	151	141	93	175	147	168	31	244	138
	10.0	189	47	23	54	22	80	167	141	8	228	163	189	8	228	118
0600	0.2	89	94	12	14	6	67	115	141	7	58	34	26	6	141	74
	2.0	55	142	92	16	10	75	87	134	7	26	24	39	7	142	75
	4.0	24	94	84	24	2	248	99	141	37	27	57	42	2	248	125
	6.0	55	94	19	26	4	71	118	134	7	28	41	58	4	134	69
	8.0	55	94	165	40	13	63	118	171	15	59	87	108	13	171	92
	10.0	47	71	23	73	84	799	115	112	10	92	91	124	10	799	405
Minimum		57	24	12	13	6	67	71	141	7	31	21	14	6	141	74
Maximum	0.2	315	94	32	119	23	72	115	695	27	58	34	31	14	695	351
Mean		186	59	22	66	15	70	93	418	17	45	28	23	10	418	212
Minimum		55	16	15	16	10	67	87	109	7	17	22	14	7	142	75
Maximum	2.0	315	142	92	60	15	79	151	134	52	166	29	48	14	315	161
Mean		185	79	54	38	13	73	119	122	30	92	26	31	11	229	118
Minimum		16	54	17	18	2	104	87	112	7	18	24	27	2	118	65
Maximum	4.0	71	134	84	123	18	344	118	141	37	140	57	52	18	344	181
Mean		44	94	51	71	10	224	103	127	22	79	41	40	10	231	123
Minimum		28	19	14	23	4	71	74	134	7	28	34	38	4	134	69
Maximum	6.0	87	134	49	279	24	140	184	181	115	175	89	71	19	279	149
Mean		58	77	32	151	14	106	129	158	61	102	62	55	12	207	109
Minimum		55	31	17	39	13	62	118	127	15	59	41	41	13	171	92
Maximum	8.0	244	94	410	46	47	88	192	171	187	222	147	168	31	410	221
Mean		150	63	214	43	30	75	155	149	101	141	94	105	22	291	156
Minimum		47	39	23	47	22	78	87	112	8	92	70	69	8	228	118
Maximum	10.0	189	71	515	73	84	799	167	171	307	237	163	189	23	799	405
Mean		118	55	269	60	53	439	127	142	158	165	117	129	16	514	261

Nitrate ( $\mu\text{g/l}$ ) at Awilarangan, Saguling Reservoir, 1988.

Monitoring Time	Water												Min.	Max.	Mean	
	Depth (m)	Jan.	Feb.	Mar.	Apr.	May	June	July	Aug.	Sept.	Oct.	Nov.				Dec.
1200	0.2	120	120	191	110	120	51	344						51	344	198
	2.0	120	120	271	148	173	76	363						76	363	220
	4.0	120	120	205	97	115	47	325						47	325	186
	6.0	112	80	200	138	160	55	288						55	288	172
	8.0	220	80	205	146	160	47	300						47	300	174
	10.0	220	120	152	153	173	47	338						47	338	193
1800	0.2	192	120	214	141	155	62	306						62	306	184
	2.0	160	120	143	148	160	40	300						40	300	170
	4.0	120	120	191	161	147	51	313						51	313	182
	6.0	172	80	219	153	160	62	300						62	300	181
	8.0	160	80	195	148	155	55	275						55	275	165
	10.0	172	120	219	161	173	51	250						51	250	151
2400	0.2	480	80	243	89	107	73	396						73	480	277
	2.0	80	80	219	153	173	58	405						58	405	232
	4.0	280	100	171	123	133	73	373						73	373	223
	6.0	160	80	291	136	147	51	373						51	373	212
	8.0	120	100	171	141	152	36	322						36	322	179
	10.0	120	100	195	161	187	47	338						47	338	193
0600	0.2	112	120	205	141	160	47	405						47	405	226
	2.0	200	120	195	107	120	55	289						55	289	172
	4.0	120	120	219	115	133	58	315						58	315	187
	6.0	120	80	267	123	147	105	282						80	282	181
	8.0	120	80	105	148	160	36	305						36	305	171
	10.0	70	120	171	159	173	47	331						47	331	189
Minimum		112	80	191	89	107	47	306						47	306	184
Maximum	0.2	480	120	243	141	160	73	405						73	480	277
Mean		296	100	217	115	134	60	356						60	393	230
Minimum		80	80	143	107	120	40	289						40	289	170
Maximum	2.0	200	120	271	153	173	76	405						76	405	232
Mean		140	100	207	130	147	58	347						58	347	201
Minimum		120	100	171	97	115	47	313						47	313	182
Maximum	4.0	280	120	219	161	147	73	373						73	373	223
Mean		200	110	195	129	131	60	343						60	343	203
Minimum		112	80	200	123	147	51	282						51	282	172
Maximum	6.0	172	80	291	153	160	105	373						80	373	212
Mean		142	80	246	138	154	78	328						66	328	192
Minimum		120	80	105	141	152	36	275						36	275	165
Maximum	8.0	220	100	205	148	160	55	322						55	322	179
Mean		170	90	155	145	156	46	299						46	299	172
Minimum		70	100	152	153	173	47	250						47	250	151
Maximum	10.0	220	120	219	161	187	51	338						51	338	193
Mean		145	110	186	157	180	49	294						49	294	172



Orthophosphate ( $\mu\text{g/l}$ ) at Awilarangan, Saguling Reservoir, 1988.

Monitoring Time	Water															
	Depth (m)	Jan.	Feb.	Mar.	Apr.	May	June	July	Aug.	Sept.	Oct.	Nov.	Dec.	Min.	Max.	Mean
1200	0.2	30	45	253	265	210	73	266	76	227				30	266	148
	2.0	23	49	247	234	51	68	247	76	97				23	247	135
	4.0	53	51	250	149	39	60	166	69	281				39	281	160
	6.0	30	51	155	223	225	81	50	89	263				30	263	147
	8.0	53	53	56	241	266	87	94	124	183				53	266	160
	10.0	45	59	26	212	296	73	41	138	235				26	296	161
1800	0.2	45	25	141	226	279	103	181	120	307				25	307	166
	2.0	38	25	163	265	279	64	222	82	310				25	310	168
	4.0	113	57	121	249	263	75	260	99	262				57	263	160
	6.0	75	54	172	249	311	0	141	96	298				54	311	183
	8.0	60	25	139	325	279	31	151	106	294				25	325	175
	10.0	45	30	164	273	255	269	151	149	267				30	273	152
2400	0.2	45	38	250	265	26	97	168	124	204				26	265	146
	2.0	30	30	162	249	196	101	173	65	161				30	249	140
	4.0	38	25	171	219	216	47	156	82	318				25	318	172
	6.0	91	25	142	265	216	277	196	93	253				25	277	151
	8.0	75	59	168	249	287	0	113	134	363				59	363	211
	10.0	26	59	182	226	183	15	65	152	300				15	300	158
0600	0.2	30	49	168	122	89	50	196	79	44				30	196	113
	2.0	30	49	171	191	244	47	191	89	256				30	256	143
	4.0	60	51	139	238	51	89	217	99	268				51	268	160
	6.0	57	53	187	282	117	60	176	96	310				53	310	182
	8.0	36	53	142	294	296	91	103	120	222				36	296	166
	10.0	64	45	178	282	271	0	163	127	44				44	282	163
Minimum		30	25	141	122	26	50	168	76	44				25	196	113
Maximum	0.2	45	49	253	265	279	103	266	124	307				30	307	166
Mean		38	37	197	194	153	77	217	100	176				28	252	140
Minimum		23	25	162	191	51	47	173	65	97				23	247	135
Maximum	2.0	38	49	247	265	279	101	247	89	310				30	310	168
Mean		31	37	205	228	165	74	210	77	204				27	279	151
Minimum		38	25	121	149	39	47	156	69	262				25	263	160
Maximum	4.0	113	57	250	249	263	89	260	99	318				57	318	172
Mean		76	41	186	199	151	68	208	84	290				41	291	166
Minimum		30	25	142	223	117	60	50	89	253				25	263	147
Maximum	6.0	91	54	187	282	311	277	196	96	310				54	311	183
Mean		61	40	165	253	214	169	123	93	282				40	287	165
Minimum		36	25	56	241	266	31	94	106	183				25	266	160
Maximum	8.0	75	59	168	325	296	91	151	134	363				59	363	211
Mean		56	42	112	283	281	61	123	120	273				42	315	185
Minimum		26	30	26	212	183	15	41	127	44				15	273	152
Maximum	10.0	64	59	182	282	296	269	163	152	300				44	300	163
Mean		45	45	104	247	240	142	102	140	172				30	287	157

Silicate (mg/l) at Awilarangan, Saguling Reservoir, 1988.

Monitoring Time	Water												Min.	Max.	Mean	
	Depth (m)	Jan.	Feb.	Mar.	Apr.	May	June	July	Aug.	Sept.	Oct.	Nov.				Dec.
1200	0.2				24.0	18.0	29.0							18.0	29.0	23.5
	2.0				26.0	19.5	19.5							19.5	26.0	22.8
	4.0				18.0	22.0	21.0							18.0	22.0	20.0
	6.0				29.0	23.0	28.0							23.0	29.0	26.0
	8.0				49.0	30.0	16.0							16.0	49.0	32.5
	10.0				67.0	37.0	26.0							26.0	67.0	46.5
1800	0.2				21.0	20.5	29.0							20.5	29.0	24.8
	2.0				23.0	32.5	21.0							21.0	32.5	26.8
	4.0				13.0	19.5	33.5							13.0	33.5	23.3
	6.0				33.5	27.0	28.0							27.0	33.5	30.3
	8.0				47.0	21.0	26.0							21.0	47.0	34.0
	10.0				61.5	24.0	25.0							24.0	61.5	42.8
2400	0.2				30.0	26.0	33.5							26.0	33.5	29.8
	2.0				23.0	23.0	28.0							23.0	28.0	25.5
	4.0				24.0	27.0	15.0							15.0	27.0	21.0
	6.0				27.0	23.0	25.0							23.0	27.0	25.0
	8.0				49.0	28.0	27.0							27.0	49.0	38.0
	10.0				65.0	25.0	27.0							25.0	65.0	45.0
0600	0.2				19.5	30.0	26.0							19.5	30.0	24.8
	2.0				17.0	24.0	33.5							17.0	33.5	25.3
	4.0				28.0	26.0	34.8							26.0	34.8	30.4
	6.0				34.8	24.0	27.0							24.0	34.8	29.4
	8.0				49.0	32.5	20.5							20.5	49.0	34.8
	10.0				62.8	28.0	24.0							24.0	62.8	43.4
Minimum				19.5	18.0	26.0								18.0	29.0	23.5
Maximum	0.2				30.0	30.0	33.5							26.0	33.5	29.8
Mean				24.8	24.0	29.8								22.0	31.3	26.6
Minimum				17.0	19.5	19.5								17.0	26.0	22.8
Maximum	2.0				26.0	32.5	33.5							23.0	33.5	26.8
Mean				21.5	26.0	26.5								20.0	29.8	24.8
Minimum				13.0	19.5	15.0								13.0	22.0	20.0
Maximum	4.0				28.0	27.0	34.8							26.0	34.8	30.4
Mean				20.5	23.3	24.9								19.5	28.4	25.2
Minimum				27.0	23.0	25.0								23.0	27.0	25.0
Maximum	6.0				34.8	27.0	28.0							27.0	34.8	30.3
Mean				30.9	25.0	26.5								25.0	30.9	27.6
Minimum				47.0	21.0	16.0								16.0	47.0	32.5
Maximum	8.0				49.0	32.5	27.0							27.0	49.0	38.0
Mean				48.0	26.8	21.5								21.5	48.0	35.3
Minimum				61.5	24.0	24.0								24.0	61.5	42.8
Maximum	10.0				67.0	37.0	27.0							26.0	67.0	46.5
Mean				64.3	30.5	25.5								25.0	64.3	44.6

Hydrogen sulfide ( $\mu\text{g/l}$ ) at Awilarangan, Saguling Reservoir, 1988

Monitoring Time	Water Depth (m)	Hydrogen sulfide ( $\mu\text{g/l}$ )												Min.	Max.	Mean
		Jan.	Feb.	Mar.	Apr.	May	June	July	Aug.	Sept.	Oct.	Nov.	Dec.			
1200	0.2	73	56	6	2	4	92	27	55	137	2	15	9	2	137	70
	2.0	66	59	16	2	3	94	17	11	35	2	18	14	2	94	48
	4.0	106	63	66	19	8	219	69	235	83	32	724	22	8	724	366
	6.0	34	29	93	104	182	315	95	178	83	724	716	36	29	724	377
	8.0	13	38	100	51	116	366	225	109	21	1,092	717	61	13	1,092	553
	10.0	16	56	170	103	157	353	263	365	10	1,176	1,033	137	10	1,176	593
1800	0.2	64	7	5	3	3	41	22	31	43	16	2	4	2	64	33
	2.0	53	25	8	2	4	375	8	91	110	11	9	11	2	375	189
	4.0	57	59	64	34	19	422	42	201	63	32	33	22	19	422	221
	6.0	29	96	93	84	71	445	160	175	52	160	168	18	18	445	232
	8.0	57	51	93	167	141	757	239	228	123	620	641	382	51	757	404
	10.0	21	72	138	117	173	824	185	448	205	1,036	1,250	462	21	1,250	636
2400	0.2	47	22	29	2	3	73	29	91	44	4	4	7	2	91	47
	2.0	104	19	72	2	3	73	26	70	72	4	4	8	2	104	53
	4.0	36	21	72	6	3	66	62	165	148	16	732	24	3	732	368
	6.0	51	92	85	92	132	166	166	166	27	115	747	63	27	747	387
	8.0	74	81	117	58	166	290	214	170	79	736	1,650	68	58	1,650	854
	10.0	52	83	153	58	157	340	239	364	298	1,158	1,111	154	52	1,158	605
0600	0.2	26	29	38	2	3	35	132	162	77	1	2	32	1	162	82
	2.0	49	59	38	2	3	85	69	202	89	7	7	45	2	202	102
	4.0	32	74	21	37	2	70	86	177	83	56	779	87	2	779	391
	6.0	30	28	38	54	71	331	121	158	66	779	739	87	28	779	404
	8.0	-	57	43	121	107	273	173	138	205	739	708	126	43	739	391
	10.0	35	33	49	173	107	289	138	397	389	1,096	1,056	145	33	1,096	565
Minimum		26	7	5	2	3	35	22	31	43	1	2	4	1	64	33
Maximum	0.2	73	56	38	3	4	92	132	162	137	16	15	32	2	162	82
Mean		50	32	22	3	4	64	77	97	90	9	9	18	2	113	57
Minimum		49	19	8	2	3	73	8	11	35	2	4	8	2	94	48
Maximum	2.0	104	59	72	2	4	375	69	202	110	11	18	45	2	375	189
Mean		77	39	40	2	4	224	39	107	73	7	11	27	2	235	118
Minimum		32	21	21	6	2	66	42	165	63	16	33	22	2	422	221
Maximum	4.0	106	74	72	37	19	422	86	235	148	56	779	87	19	779	391
Mean		69	48	47	22	11	244	64	200	106	36	406	55	11	601	306
Minimum		29	28	38	54	71	166	95	158	27	115	168	18	18	445	232
Maximum	6.0	51	96	93	104	182	445	166	178	83	779	747	87	29	779	404
Mean		40	62	66	79	127	306	131	168	55	447	458	53	24	612	318
Minimum		13	38	43	51	107	273	173	109	21	620	641	61	13	739	391
Maximum	8.0	74	81	117	167	166	757	239	228	205	1,092	1,650	382	58	1,650	854
Mean		44	60	80	109	137	515	206	169	113	856	1,146	222	36	1,195	623
Minimum		16	33	49	58	107	289	138	364	10	1,036	1,033	137	10	1,096	565
Maximum	10.0	52	83	170	173	173	824	263	448	389	1,176	1,250	462	52	1,250	636
Mean		34	58	110	116	140	557	201	406	200	1,106	1,142	300	31	1,173	600

Water temperature (°C) of Bongas Station in 1988.

Monitoring Time	Water Depth (m)	Jan.	Feb.	Mar.	Apr.	May	June	July	Aug.	Sept.	Oct.	Nov.	Dec.	Min.	Max.	Mean
1200	0.2	28.8		28.2	29.6	29.5	28.2	29.7	27.9	27.8	26.5	27.3	28.9	26.5	29.7	28.1
	2.0	28.1		28.0	28.1	28.5	26.5	28.6	26.2	27.3	27.0	27.0	27.0	26.2	28.6	27.4
	4.0	27.1		27.4	27.2	27.7	26.0	27.8	25.9	26.0	26.5	26.0	26.7	25.9	27.8	26.9
	6.0	26.6		26.3	26.2	26.3	25.4	26.8	25.0	25.4	25.5	25.3	25.3	25.0	26.8	25.9
	8.0	25.7		26.3	25.5	26.8	24.7	26.2	24.8	25.3	25.5	25.1	25.2	24.7	26.8	25.8
	10.0	25.6		25.3	25.1	25.9	24.4	26.9	24.6	25.3	25.5	24.8	25.2	24.4	26.9	25.7
1800	0.2	28.7		28.0	28.5	28.0	26.9	28.4	26.5	26.6	26.5	27.6	27.0	26.5	28.7	27.6
	2.0	28.1		27.5	28.3	28.0	26.6	28.3	26.0	26.5	26.5	27.3	26.4	26.0	28.3	27.2
	4.0	27.1		26.7	27.4	27.2	25.9	27.8	26.0	25.6	26.3	25.9	25.9	25.6	27.8	26.7
	6.0	25.5		26.0	26.3	26.2	24.9	26.8	25.2	25.3	26.0	25.3	25.7	24.9	26.8	25.9
	8.0	25.0		25.4	25.8	25.7	24.5	26.3	24.9	25.0	25.5	24.9	25.2	24.5	26.3	25.4
	10.0	25.0		25.1	24.8	25.4	24.4	26.1	24.7	24.8	24.9	24.7	24.8	24.4	26.1	25.3
2400	0.2	26.9		27.2	27.6	28.2	25.5	28.0	24.7	25.8	26.0	26.9	27.4	24.7	28.2	26.5
	2.0	27.4		27.8	27.5	28.2	25.8	28.0	25.2	25.8	27.0	26.8	27.1	25.2	28.2	26.7
	4.0	26.4		26.9	27.5	27.4	25.6	27.7	25.5	25.6	26.8	26.2	26.1	25.5	27.7	26.6
	6.0	25.4		26.3	26.1	26.3	25.0	26.8	24.6	25.3	26.5	25.5	25.3	24.6	26.8	25.7
	8.0	24.8		25.5	25.4	25.7	24.6	26.6	24.5	25.0	25.0	25.1	25.1	24.5	26.8	25.7
	10.0	24.7		25.0	24.9	25.4	24.4	26.0	24.3	24.8	25.0	25.1	24.7	24.3	26.0	25.2
0600	0.2	26.3		26.3	26.6	27.7	24.6	27.9	25.9	25.4	27.9	26.0	27.4	24.6	27.9	26.3
	2.0	25.5		27.1	27.2	27.1	25.1	27.8	25.5	25.4	27.8	26.9	26.3	25.1	27.8	26.5
	4.0	25.8		26.7	26.9	26.7	25.1	26.7	24.8	25.3	26.7	25.7	26.3	24.8	26.9	25.9
	6.0	25.4		25.7	25.8	25.7	24.7	26.7	24.6	24.8	26.7	25.1	24.5	24.5	26.7	25.6
	8.0	24.9		25.1	25.4	25.5	24.2	26.3	24.8	24.6	26.3	24.9	24.9	24.2	26.3	25.3
	10.0	24.6		24.8	24.8	25.2	24.0	26.8	24.2	24.5	26.1	24.9	24.5	24.0	26.8	25.4
Minimum Maximum Mean	0.2	26.3 28.8 27.6		26.3 28.2 27.3	26.6 29.6 28.1	27.7 29.5 28.6	24.6 28.2 26.4	27.9 29.7 28.8	24.7 27.9 26.3	25.4 27.8 26.6	26.0 27.9 27.0	26.0 28.9 26.8	27.0 26.5 28.0	24.6 26.5 25.6	27.9 29.7 28.8	26.3 28.1 27.2
Minimum Maximum Mean	2.0	25.5 28.1 26.8		27.1 28.0 27.6	27.2 28.3 27.8	27.1 28.5 27.8	25.1 26.6 25.9	27.8 28.6 28.2	25.2 26.2 25.7	25.4 27.3 26.4	26.5 27.8 27.2	26.8 27.3 27.1	26.3 27.1 26.7	25.1 26.2 25.7	27.8 28.6 28.2	26.5 27.4 26.9
Minimum Maximum Mean	4.0	25.8 27.1 26.5		26.7 27.4 27.1	26.9 27.5 27.2	26.7 27.7 27.2	25.1 26.0 25.6	26.7 27.8 27.3	24.8 26.0 25.4	25.3 26.0 25.7	26.3 26.8 26.6	25.7 26.2 26.0	25.9 26.7 26.3	24.8 25.9 25.4	26.9 27.8 27.4	25.9 26.9 26.4
Minimum Maximum Mean	6.0	25.4 26.6 26.0		25.7 26.3 26.0	25.8 26.3 26.1	25.7 26.3 26.0	24.7 25.4 25.1	26.7 26.8 26.8	24.6 25.2 24.9	24.8 25.4 25.1	25.5 26.7 26.1	25.1 25.5 25.3	24.5 25.7 25.1	24.5 25.0 24.8	26.7 26.8 26.8	25.6 25.9 25.8
Minimum Maximum Mean	8.0	24.8 25.7 25.3		25.1 26.3 25.7	25.4 25.8 25.6	25.5 26.8 26.2	24.2 24.7 24.5	26.2 26.8 26.5	24.5 24.9 24.7	24.6 25.3 25.0	25.0 26.3 25.7	24.9 25.1 25.0	24.9 25.2 25.1	24.2 24.7 24.5	26.3 26.8 26.6	25.3 25.8 25.5
Minimum Maximum Mean	10.0	24.6 25.6 25.1		24.8 25.3 25.1	24.8 25.1 25.0	25.2 25.9 25.6	24.0 24.4 24.2	26.0 26.9 26.5	24.2 24.7 24.5	24.5 25.3 24.9	24.9 26.1 25.5	24.7 25.1 24.9	24.5 25.2 24.9	24.0 24.4 24.2	26.0 26.9 26.5	25.2 25.7 25.4

Conductivity ( $\mu\text{mhos/cm}$ ) of Bongas Station in 1988.

Monitoring Time	Water Depth (m)	Jan.	Feb.	Mar.	Apr.	May	June	July	Aug.	Sept.	Oct.	Nov.	Dec.	Min.	Max.	Mean
1200	0.2	155		130	125	127	116	114	154	165	145	172	180	114	180	147
	2.0	155		130	118	122	116	109	154	151	145	166	178	109	178	144
	4.0	132		128	120	121	117	106	153	147	155	147	176	106	176	141
	6.0	125		128	112	113	118	108	173	164	149	135	167	108	173	141
	8.0	110		125	115	113	115	108	187	178	118	129	157	108	187	148
	10.0	102		120	115	110	113	109	188	183	101	121	163	101	188	145
1800	0.2	152		135	128	116	123	105	152	147	139	174	178	105	178	142
	2.0	160		130	128	120	120	107	152	146	139	169	185	107	185	146
	4.0	145		228	120	119	117	104	152	145	139	143	176	104	228	166
	6.0	110		125	115	112	119	108	174	163	154	135	146	108	174	141
	8.0	100		125	114	111	114	108	172	173	139	127	158	100	173	137
	10.0	100		120	112	110	113	109	285	183	113	152	158	100	285	193
2400	0.2	150		130	123	120	120	101	149	147	140	194	176	101	194	148
	2.0	158		130	123	119	119	104	149	147	142	171	172	104	172	138
	4.0	138		124	123	119	116	104	155	146	149	153	164	104	164	134
	6.0	126		120	112	114	118	111	172	165	156	138	165	111	172	142
	8.0	100		120	112	113	114	108	172	178	140	132	158	100	178	139
	10.0	100		116	110	111	113	109	190	185	141	128	161	100	190	145
0600	0.2	80		130	120	119	122	100	147	144	141	177	177	80	177	129
	2.0	150		131	122	119	117	103	150	145	141	169	176	103	176	140
	4.0	132		128	120	117	116	104	166	145	153	138	175	104	175	140
	6.0	120		125	115	110	119	110	173	166	145	129	158	110	173	142
	8.0	112		122	110	109	115	109	169	172	147	124	153	109	172	141
	10.0	100		112	112	109	113	110	188	182	140	128	167	100	188	144
Minimum		80		130	120	116	116	100	147	144	139	172	176	80	177	129
Maximum	0.2	155		135	128	127	123	114	154	165	145	194	180	114	194	148
Mean		118		133	124	122	120	107	151	155	142	183	178	97	186	138
Minimum		150		130	118	119	116	103	149	145	139	166	172	103	172	138
Maximum	2.0	160		131	128	122	120	109	154	151	145	171	185	109	185	146
Mean		155		131	123	121	118	106	152	148	142	169	179	106	179	142
Minimum		132		124	120	117	116	104	152	145	139	138	164	104	164	134
Maximum	4.0	145		228	123	121	117	106	166	147	155	153	176	106	228	166
Mean		139		176	122	119	117	105	159	146	147	146	170	105	196	150
Minimum		110		120	112	110	118	108	172	163	145	129	135	108	172	141
Maximum	6.0	126		128	115	114	119	111	174	166	156	149	165	111	174	142
Mean		118		124	114	112	119	110	173	165	151	139	150	110	173	141
Minimum		100		120	110	109	114	108	169	172	118	118	129	100	172	137
Maximum	8.0	112		125	115	113	115	109	187	178	147	132	158	109	187	148
Mean		106		123	113	111	115	109	178	175	133	125	144	105	180	142
Minimum		100		112	110	109	113	109	188	182	101	101	121	100	188	144
Maximum	10.0	102		120	115	111	113	110	285	185	141	152	167	101	285	193
Mean		101		116	113	110	113	110	237	184	121	127	144	101	237	168

Dissolved oxygen (mg/l) of Bongas Station in 1988.

Monitoring Time	Water	Jan.	Feb.	Mar.	Apr.	May	June	July	Aug.	Sept.	Oct.	Nov.	Dec.	Min.	Max.	Mean
	Depth (m)															
1200	0.2	7.4		6.3	10.3	11.0	7.2	7.1	2.4	7.1	4.8	8.1	7.1	2.4	11.0	6.7
	2.0	5.6		5.8	7.6	7.8	5.0	4.7	1.5	5.5	3.9	3.9	6.3	1.5	7.8	4.7
	4.0	2.0		4.0	3.9	4.0	3.5	2.6	1.0	2.6	1.0	2.2	3.4	1.0	4.0	2.5
	6.0	1.5		2.2	1.9	1.9	1.8	0.3	0.6	2.1	0.5	1.5	2.3	0.3	2.3	1.3
	8.0	1.1		1.6	1.2	1.6	1.3	0.0	0.4	1.5	0.5	1.5	2.5	0.4	2.5	1.5
	10.0	2.0		0.7	1.2	1.3	0.9	0.0	0.4	1.3	0.5	1.3	2.2	0.4	2.2	1.3
1800	0.2	7.6		8.1	6.1	9.0	6.2	6.5	4.8	4.5	2.8	8.6	8.4	2.8	9.0	5.9
	2.0	5.6		6.2	5.4	7.0	4.7	5.0	4.4	4.4	2.4	5.8	6.1	2.4	7.0	4.7
	4.0	3.7		2.8	2.8	3.5	3.3	3.7	2.6	3.3	0.9	2.4	4.4	0.9	4.4	2.7
	6.0	1.9		2.0	1.4	1.8	1.2	0.5	0.6	1.9	0.5	1.5	2.4	0.5	2.4	1.5
	8.0	1.2		1.6	0.8	1.4	1.0	0.4	0.4	1.2	0.1	1.2	2.5	0.1	2.5	1.3
	10.0	2.5		1.5	0.6	1.3	1.0	0.4	0.4	1.0	0.1	1.5	2.1	0.1	2.5	1.3
2400	0.2	6.3		5.9	7.1	8.9	5.3	5.9	2.5	5.2	3.7	6.4	6.4	2.5	8.9	5.7
	2.0	5.5		6.7	6.7	8.0	4.8	5.4	2.2	5.2	3.6	4.5	4.5	2.2	8.0	5.1
	4.0	2.3		2.7	3.6	4.4	3.0	3.6	2.2	2.5	2.3	2.5	2.5	2.2	4.4	3.3
	6.0	1.0		1.9	1.7	1.9	1.3	0.6	0.8	1.2	0.7	1.7	1.7	0.6	1.9	1.3
	8.0	1.0		1.7	1.4	1.2	0.9	0.0	0.4	0.8	0.5	1.5	1.5	0.0	1.7	0.9
	10.0	1.6		1.2	1.2	1.2	0.8	0.2	0.3	0.7	0.4	1.0	1.0	0.2	1.6	0.9
0600	0.2	2.4		5.3	4.8	8.6	4.6	3.7	1.6	4.6	2.8	6.4	6.4	1.6	8.6	5.1
	2.0	5.8		5.2	4.0	8.2	4.5	4.0	1.2	4.0	2.4	5.9	5.9	1.2	8.2	4.7
	4.0	1.8		4.0	2.8	3.8	4.0	2.2	0.6	1.8	0.9	4.0	4.0	0.6	4.0	2.3
	6.0	1.5		1.3	1.1	1.5	1.7	1.2	0.4	1.1	0.5	2.0	2.0	0.4	2.0	1.2
	8.0	1.0		1.2	0.8	1.2	1.0	0.0	0.6	0.8	0.1	1.2	1.7	0.1	1.7	0.9
	10.0	1.5		1.2	0.7	1.2	0.9	0.6	0.4	0.6	0.9	1.2	1.2	0.4	1.5	1.0
Minimum		2.4		5.3	4.8	8.6	4.6	3.7	1.6	4.6	2.8	6.4	6.4	1.6	8.6	5.1
Maximum	0.2	7.6		8.1	10.3	11.0	7.2	7.1	4.8	7.1	4.8	8.6	8.4	2.8	11.0	6.7
Mean		5.0		6.7	7.6	9.8	5.9	5.4	3.2	5.8	3.8	7.5	7.4	2.2	9.8	5.9
Minimum		5.5		5.2	4.0	7.0	4.5	4.0	1.2	4.0	2.4	3.9	4.5	1.2	7.0	4.7
Maximum	2.0	5.8		6.7	7.6	8.2	5.0	5.4	4.4	5.5	3.9	5.9	6.3	2.4	8.2	5.1
Mean		5.7		6.0	5.8	7.6	4.8	4.7	2.8	4.8	3.2	4.9	5.4	1.8	7.6	4.9
Minimum		1.8		2.7	2.8	3.5	3.0	2.2	0.6	1.8	0.9	2.2	2.5	0.6	4.0	2.3
Maximum	4.0	3.7		4.0	3.9	4.4	4.0	3.7	2.6	3.3	2.3	4.0	4.4	2.2	4.4	3.3
Mean		2.8		3.4	3.4	4.0	3.5	3.0	1.6	2.6	1.6	3.1	3.5	1.4	4.2	2.8
Minimum		1.0		1.3	1.1	1.5	1.2	0.3	0.4	1.1	0.5	0.5	1.5	0.3	1.9	1.2
Maximum	6.0	1.9		2.2	1.9	1.9	1.8	1.2	0.8	2.1	0.7	2.0	2.4	0.6	2.4	1.5
Mean		1.5		1.8	1.5	1.7	1.5	0.8	0.6	1.6	0.6	1.3	2.0	0.5	2.2	1.3
Minimum		1.0		1.2	0.8	1.2	0.9	0.4	0.4	0.8	0.1	0.5	1.5	0.0	1.7	0.9
Maximum	8.0	1.2		1.7	1.4	1.6	1.3	0.4	0.6	1.5	0.5	1.5	2.5	0.4	2.5	1.5
Mean		1.1		1.5	1.1	1.4	1.1	0.4	0.5	1.2	0.3	1.0	2.0	0.2	2.1	1.2
Minimum		1.5		0.7	0.6	1.2	0.8	0.2	0.3	0.6	0.1	0.5	1.0	0.1	1.5	0.9
Maximum	10.0	2.5		1.5	1.2	1.3	1.0	0.6	0.4	1.3	0.9	1.5	2.1	0.4	2.5	1.3
Mean		2.0		1.1	0.9	1.3	0.9	0.4	0.4	1.0	0.5	1.0	1.6	0.3	2.0	1.1

pH (unit) of Bongas Station in 1988.

Monitoring Time	Water Depth (m)	Jan.	Feb.	Mar.	Apr.	May	June	July	Aug.	Sept.	Oct.	Nov.	Dec.	Min.	Max.	Mean
		0.2	6.6		8.1	8.4	8.3	8.2	7.7	7.1	7.1	6.8	8.0	8.3	6.6	8.4
1200	2.0	6.3		7.8	7.5	7.6	8.2	7.5	6.9	7.0	6.6	6.8	8.2	6.3	8.2	7.3
	4.0	5.6		7.4	7.2	6.9	7.9	7.2	6.8	6.6	6.6	6.8	7.1	5.6	7.9	6.8
	6.0	5.4		7.2	7.0	6.7	7.8	7.0	6.5	6.0	6.5	6.7	6.8	5.4	7.8	6.6
	8.0	5.2		7.2	6.9	6.7	7.6	6.9	6.4	5.8	6.5	6.6	6.9	5.2	7.6	6.4
	10.0	5.2		7.2	6.9	6.5	7.5	6.9	6.3	5.8	6.6	6.4	6.9	5.2	7.5	6.4
1800	0.2	8.5		8.6	7.8	7.7	8.1	7.3	6.9	6.7	6.7	7.9	8.2	6.7	8.6	7.7
	2.0	8.2		8.1	7.8	7.2	7.3	7.2	7.3	6.7	6.8	7.2	8.0	6.7	8.2	7.5
	4.0	7.4		7.8	7.2	6.7	7.3	7.1	7.0	6.7	6.5	6.9	7.2	6.5	7.8	7.2
	6.0	7.0		7.2	7.0	6.6	6.8	6.9	6.6	6.1	6.5	6.9	6.8	6.1	7.2	6.7
	8.0	7.0		7.1	6.9	6.5	6.7	6.8	6.5	6.0	6.5	6.8	6.5	6.0	7.1	6.6
10.0	8.0		7.1	6.9	6.4	6.7	6.7	6.3	5.9	6.6	6.8	6.5	5.9	8.0	7.0	
2400	0.2	8.1		7.6	7.8	7.7	8.0	7.3	7.0	7.0	6.7	7.7	8.2	6.7	8.2	7.5
	2.0	7.9		7.7	7.5	7.6	7.6	7.3	7.0	7.0	6.8	7.1	7.6	6.8	7.9	7.4
	4.0	7.1		7.5	7.4	6.8	7.6	7.1	6.9	6.7	6.7	6.6	6.7	6.6	7.6	7.1
	6.0	6.9		7.2	7.3	6.6	7.2	6.9	6.6	6.1	6.5	6.6	7.0	6.1	7.3	6.7
	8.0	8.0		7.1	7.3	6.5	7.2	6.8	6.3	6.0	6.5	6.8	7.0	6.0	8.0	7.0
10.0	7.1		7.0	7.2	6.5	7.1	6.8	6.3	5.9	6.6	6.5	6.9	5.9	7.2	6.6	
0600	0.2	7.3		7.5	7.4	7.4	8.1	7.1	6.9	6.8	6.7	7.3	7.9	6.7	8.1	7.4
	2.0	7.7		7.7	7.4	7.4	7.8	7.2	6.9	6.8	6.8	6.9	7.8	6.8	7.8	7.3
	4.0	7.1		7.5	7.1	6.8	7.8	7.1	6.6	6.6	6.7	6.4	7.3	6.4	7.8	7.1
	6.0	7.1		7.3	6.9	6.7	7.6	7.0	6.4	6.2	6.5	6.4	6.8	6.2	7.6	6.9
	8.0	7.0		7.3	6.9	6.6	7.2	6.9	6.5	6.0	6.5	6.3	6.7	6.0	7.3	6.7
10.0	7.0		7.3	6.9	6.6	7.2	6.8	6.4	5.9	6.6	6.3	6.4	5.9	7.3	6.6	
Minimum		6.6		7.5	7.4	7.4	8.0	7.1	6.9	6.7	6.7	7.3	7.9	6.6	8.1	7.4
Maximum	0.2	8.5		8.6	8.4	8.3	8.2	7.7	7.1	7.1	6.8	8.0	8.3	6.7	8.6	7.7
Mean		7.6		8.1	7.9	7.9	8.1	7.4	7.0	6.9	6.8	7.7	8.1	6.7	8.4	7.5
Minimum		6.3		7.7	7.4	7.2	7.3	7.2	6.9	6.7	6.6	6.8	7.6	6.3	7.8	7.3
Maximum	2.0	8.2		8.1	7.8	7.6	8.2	7.5	7.3	7.0	6.8	7.2	8.2	6.8	8.2	7.5
Mean		7.3		7.9	7.6	7.4	7.8	7.4	7.1	6.9	6.7	7.0	7.9	6.6	8.0	7.4
Minimum		5.6		7.4	7.1	6.7	7.3	7.1	6.6	6.6	6.5	6.4	6.7	5.6	7.6	6.8
Maximum	4.0	7.4		7.8	7.4	6.9	7.9	7.2	7.0	6.7	6.7	6.9	7.3	6.6	7.9	7.2
Mean		6.5		7.6	7.3	6.8	7.6	7.2	6.8	6.7	6.6	6.7	7.0	6.1	7.8	7.0
Minimum		5.4		7.2	6.9	6.6	6.8	6.9	6.4	6.0	6.5	6.4	6.8	5.4	7.2	6.6
Maximum	6.0	7.1		7.3	7.3	6.7	7.8	7.0	6.6	6.2	6.5	6.9	7.0	6.2	7.8	6.9
Mean		6.3		7.3	7.1	6.7	7.3	7.0	6.5	6.1	6.5	6.7	6.9	5.8	7.5	6.8
Minimum		5.2		7.1	6.9	6.5	6.7	6.8	6.3	5.8	6.5	6.3	6.5	5.2	7.1	6.4
Maximum	8.0	8.0		7.3	7.3	6.7	7.6	6.9	6.5	6.0	6.5	6.8	7.0	6.0	8.0	7.0
Mean		6.6		7.2	7.1	6.6	7.2	6.9	6.4	5.9	6.5	6.6	6.8	5.6	7.6	6.7
Minimum		5.2		7.0	6.9	6.4	6.7	6.7	6.3	5.8	6.6	6.3	6.4	5.2	7.2	6.4
Maximum	10.0	8.0		7.3	7.2	6.6	7.5	6.9	6.4	5.9	6.6	6.8	6.9	5.9	8.0	7.0
Mean		6.6		7.2	7.1	6.5	7.1	6.8	6.4	5.9	6.6	6.6	6.7	5.6	7.6	6.7

Alkalinity (mg/l) of Bongas Station in 1988.

Monitoring Time	Water Depth (m)	Jan.	Feb.	Mar.	Apr.	May	June	July	Aug.	Sept.	Oct.	Nov.	Dec.	Min.	Max.	Mean
1200	0.2	53.9		41.1	37.3	38.6	33.9	41.1	47.5					33.9	53.9	43.9
	2.0	53.9		41.1	43.4	39.8	34.7	43.7	55.3					34.7	55.3	45.0
	4.0	49.9		45.0	37.3	41.1	34.9	41.1	43.7					34.9	49.9	42.4
	6.0	46.7		43.7	42.4	41.1	36.5	41.1	59.1					36.5	59.1	47.8
	8.0	41.3		45.0	37.5	41.1	37.5	48.8	55.3					37.5	55.3	46.4
	10.0	39.9		45.0	38.8	47.5	39.6	47.5	50.1					38.8	50.1	44.5
1800	0.2	52.7		39.8	38.8	38.8	37.3	42.4	46.4					37.3	52.7	45.0
	2.0	54.2		39.8	39.8	42.4	34.7	46.4	43.7					34.7	54.2	44.5
	4.0	52.7		38.6	37.3	40.9	34.4	43.7	41.1					34.4	52.7	43.6
	6.0	42.8		42.4	39.6	42.1	38.8	46.4	50.1					38.8	50.1	44.5
	8.0	40.2		41.1	52.9	41.1	39.6	46.4	48.8					39.6	52.9	46.3
	10.0	39.6		46.3	39.6	42.4	37.5	37.3	54.0					37.3	54.0	45.7
2400	0.2	55.6		45.0	38.6	39.8	41.1	36.0	41.1					36.0	55.6	45.8
	2.0	54.4		43.7	38.6	38.6	34.7	39.8	42.4					34.7	54.4	44.6
	4.0	49.9		43.7	38.3	39.8	34.7	37.3	42.4					34.7	49.9	42.3
	6.0	49.9		47.5	38.0	42.1	38.3	43.7	48.8					38.0	49.9	44.0
	8.0	41.3		45.0	51.4	41.4	36.2	46.4	51.4					36.2	51.4	43.8
	10.0	39.9		43.7	39.6	41.4	34.7	37.3	61.7					34.7	61.7	48.2
0600	0.2	-		41.1	37.3	38.3	34.4	29.6	30.8					29.6	41.1	35.4
	2.0	54.1		39.8	48.5	47.5	35.7	33.4	41.1					33.4	54.1	43.8
	4.0	49.9		42.4	44.7	39.8	45.7	38.6	46.4					38.6	49.9	44.3
	6.0	45.6		41.1	48.5	41.6	36.7	43.7	50.1					36.7	50.1	43.4
	8.0	44.2		42.4	48.5	42.1	38.3	41.1	39.8					38.3	48.5	43.4
	10.0	42.5		47.5	48.5	47.8	38.8	56.8	56.5					38.8	56.8	47.8
Minimum		52.7		39.8	37.3	38.3	33.9	29.6	30.8					29.6	41.1	35.4
Maximum	0.2	55.6		45.0	38.8	39.8	41.1	42.4	47.5					37.3	55.6	45.8
Mean		54.2		42.4	38.1	39.1	37.5	36.0	39.2					33.5	48.4	40.6
Minimum		53.9		39.8	38.6	38.6	34.7	33.4	41.1					33.4	54.1	43.8
Maximum	2.0	54.4		43.7	48.5	47.5	35.7	46.4	55.3					34.7	55.3	45.0
Mean		54.2		41.8	43.6	43.1	35.2	39.9	48.2					34.1	54.7	44.4
Minimum		49.9		38.6	37.3	39.8	34.4	37.3	41.1					34.4	49.9	42.3
Maximum	4.0	52.7		45.0	44.7	41.1	45.7	43.7	46.4					38.6	52.7	44.3
Mean		51.3		41.8	41.0	40.5	40.1	40.5	43.8					36.5	51.3	43.3
Minimum		42.8		41.1	38.0	41.1	36.5	41.1	48.8					36.5	49.9	43.4
Maximum	6.0	49.9		47.5	48.5	42.1	38.8	46.4	59.1					38.8	59.1	47.8
Mean		46.4		44.3	43.3	41.6	37.7	43.8	54.0					37.7	54.5	45.6
Minimum		40.2		41.1	37.5	41.1	36.2	41.1	39.8					36.2	48.5	43.4
Maximum	8.0	44.2		45.0	52.9	42.1	39.6	48.8	55.3					39.6	55.3	46.4
Mean		42.2		43.1	45.2	41.6	37.9	45.0	47.6					37.9	51.9	44.9
Minimum		39.6		43.7	38.8	41.4	34.7	37.3	50.1					34.7	50.1	44.5
Maximum	10.0	42.5		47.5	48.5	47.8	39.6	56.8	61.7					38.8	61.7	48.2
Mean		41.1		45.6	43.7	44.6	37.2	47.1	55.9					36.8	55.9	46.3



Carbon dioxide (mg/l) of Bongas Station in 1988.

Monitoring Time	Water													Min.	Max.	Mean
	Depth (m)	Jan.	Feb.	Mar.	Apr.	May	June	July	Aug.	Sept.	Oct.	Nov.	Dec.			
1200	0.2	8.1		5.4	0.0	2.7	0.0	2.7	11.9	4.6	4.0	0.0	0.0	2.7	11.9	7.3
	2.0	10.8		8.1	2.7	5.4	0.0	2.7	7.9	7.9	8.0	2.7	2.7	2.7	10.8	6.8
	4.0	13.5		10.8	8.1	5.4	5.4	5.4	7.9	15.8	23.8	5.4	5.4	5.4	23.8	14.6
	6.0	16.2		13.5	10.8	8.1	8.1	16.2	19.8	57.7	31.7	5.4	8.1	5.4	57.7	31.6
	8.0	16.2		18.9	10.8	8.1	10.8	18.9	31.7	39.6	19.8	5.4	5.4	5.4	39.6	22.5
	10.0	16.2		18.9	10.8	13.5	13.5	21.6	35.6	35.6	11.9	5.4	5.4	5.4	35.6	20.5
1800	0.2	5.4		5.4	0.0	5.4	0.0	5.4	7.9	11.9	4.0	0.0	0.0	4.0	11.9	8.0
	2.0	5.4		5.4	2.7	5.4	2.7	8.1	7.9	11.9	4.0	5.4	2.7	2.7	11.9	7.3
	4.0	10.8		8.1	5.4	8.1	2.7	10.8	7.9	15.8	19.8	8.1	8.1	2.7	19.8	11.3
	6.0	10.8		10.8	8.1	10.8	9.1	16.2	23.8	23.8	23.8	5.4	5.4	5.4	23.8	14.6
	8.0	13.5		13.5	13.5	10.8	10.8	24.3	23.8	35.6	23.8	8.1	5.4	5.4	35.6	20.5
	10.0	13.5		18.9	13.5	13.5	13.5	29.7	39.6	43.6	11.9	2.7	8.1	2.7	43.6	23.2
2400	0.2	10.8		8.1	2.7	5.4	2.7	5.4	11.9	11.9	4.0	2.7	0.0	2.7	11.9	7.3
	2.0	13.5		8.1	2.7	5.4	5.4	5.4	7.9	15.8	4.0	5.4	2.7	2.7	15.8	9.3
	4.0	13.5		10.8	5.4	8.1	5.4	10.8	7.9	15.8	11.9	5.4	8.1	5.4	15.8	10.6
	6.0	16.2		13.5	8.1	13.5	13.5	16.2	19.8	27.7	27.7	5.4	5.4	5.4	27.7	16.6
	8.0	16.2		16.2	8.1	13.5	13.5	18.9	23.8	47.5	31.7	5.4	5.4	5.4	47.5	26.5
	10.0	18.9		18.9	10.8	13.5	16.2	21.6	47.5	55.4	11.9	5.4	8.1	5.4	55.4	30.4
0600	0.2	10.8		8.1	2.7	2.7	5.4	5.4	7.9	4.0	4.0	2.7	2.7	2.7	10.8	6.8
	2.0	10.8		8.1	5.4	2.7	5.4	8.1	7.9	7.9	4.0	5.4	5.4	2.7	10.8	6.8
	4.0	16.2		8.1	8.1	5.4	5.4	13.5	23.8	15.8	19.8	5.4	2.7	2.7	23.8	13.3
	6.0	16.2		13.5	10.8	8.1	8.1	16.2	35.6	31.7	23.8	5.4	5.4	5.4	35.6	20.5
	8.0	18.9		16.2	10.8	8.1	13.5	18.9	23.8	47.5	23.8	5.4	8.1	5.4	47.5	26.5
	10.0	13.5		18.9	10.8	13.5	13.5	21.6	39.6	43.6	11.9	5.4	5.4	5.4	43.6	24.5
Minimum		5.4		5.4	2.7	2.7	2.7	7.9	4.0	4.0	2.7	2.7	2.7	10.8	6.8	
Maximum	0.2	10.8		8.1	2.7	5.4	5.4	11.9	11.9	4.0	2.7	2.7	4.0	11.9	8.0	
Mean		8.1		6.8	2.7	4.1	4.1	4.1	9.9	8.0	4.0	2.7	2.7	3.4	11.4	7.4
Minimum		5.4		5.4	2.7	2.7	2.7	7.9	7.9	4.0	2.7	2.7	2.7	10.8	6.8	
Maximum	2.0	13.5		8.1	5.4	5.4	5.4	8.1	7.9	15.8	8.0	5.4	5.4	2.7	15.8	9.3
Mean		9.5		6.8	4.1	4.1	4.1	5.4	7.9	11.9	6.0	4.1	4.1	2.7	13.3	8.0
Minimum		10.8		8.1	5.4	5.4	2.7	5.4	7.9	15.8	11.9	5.4	2.7	2.7	15.8	10.6
Maximum	4.0	16.2		10.8	8.1	8.1	5.4	13.5	23.8	27.7	23.8	8.1	8.1	5.4	23.8	14.6
Mean		13.5		9.5	6.8	6.8	4.1	9.5	15.9	21.8	17.9	6.8	5.4	4.1	19.8	12.6
Minimum		10.8		10.8	8.1	8.1	8.1	16.2	19.8	23.8	23.8	5.4	5.4	5.4	23.8	14.6
Maximum	6.0	16.2		13.5	10.8	13.5	13.5	16.2	35.6	57.7	31.7	5.4	8.1	5.4	57.7	31.6
Mean		13.5		12.2	9.5	10.8	10.8	16.2	27.7	40.8	27.8	5.4	6.8	5.4	40.8	23.1
Minimum		13.5		13.5	8.1	8.1	10.8	18.9	23.8	35.6	19.8	5.4	5.4	5.4	35.6	20.5
Maximum	8.0	18.9		18.9	13.5	13.5	13.5	24.3	31.7	55.4	31.7	8.1	8.1	5.4	47.5	26.5
Mean		16.2		16.2	10.8	10.8	12.2	21.6	27.8	45.5	25.8	6.8	6.8	5.4	41.6	23.5
Minimum		13.5		18.9	10.8	13.5	13.5	21.6	35.6	35.6	11.9	2.7	5.4	2.7	35.6	20.5
Maximum	10.0	18.9		18.9	13.5	13.5	16.2	29.7	47.5	55.4	11.9	5.4	8.1	5.4	55.4	30.4
Mean		16.2		18.9	12.2	13.5	14.9	25.7	41.6	45.5	11.9	4.1	6.8	4.1	45.5	25.5

Ammonia ( $\mu\text{g/l}$ ) of Bongas Station in 1988.

Monitoring Time	Water												Min.	Max.	Mean	
	Depth (m)	Jan.	Feb.	Mar.	Apr.	May	June	July	Aug.	Sept.	Oct.	Nov.				Dec.
1200	0.2	131		324	98	26	46	23	109	79	67	35	41	23	324	174
	2.0	223		250	61	17	61	23	120	88	74	38	52	17	250	134
	4.0	323		92	55	44	64	68	308	70	98	47	63	44	323	184
	6.0	123		218	61	227	274	45	1,601	79	112	43	68	43	1,601	822
	8.0	108		340	18	161	330	68	2,109	88	152	163	257	18	2,109	1,064
	10.0	131		180	21	63	464	57	2,052	115	158	187	324	21	2,052	1,037
1800	0.2	338		112	71	53	46	46	610	88	83	43	48	43	610	327
	2.0	262		364	697	56	85	34	527	88	95	48	55	34	697	366
	4.0	292		82	45	143	66	68	527	106	141	65	76	45	527	286
	6.0	85		364	39	183	330	34	1,428	88	166	98	84	34	1,428	731
	8.0	77		446	55	61	433	27	1,535	70	183	135	154	27	1,535	781
	10.0	77		624	18	44	439	46	2,078	97	236	313	387	18	2,078	1,048
2400	0.2	338		172	55	53	38	34	119	97	68	52	49	34	338	186
	2.0	246		376	61	37	72	57	98	70	79	63	51	37	376	207
	4.0	200		92	30	78	81	41	109	70	93	71	51	30	200	115
	6.0	77		162	74	149	345	23	1,387	65	118	83	67	23	1,387	705
	8.0	62		72	61	269	186	27	1,693	70	183	165	68	27	1,693	860
	10.0	123		552	24	39	404	34	2,416	70	358	324	113	24	2,416	1,220
0600	0.2	46		358	67	17	79	23	109	86	98	86	69	17	358	188
	2.0	46		370	55	4	61	41	120	88	112	95	76	4	370	187
	4.0	185		338	39	78	66	46	109	471	186	136	78	39	471	255
	6.0	108		172	61	96	248	23	131	70	154	147	84	23	248	136
	8.0	15		564	36	294	376	46	1,491	793	283	214	92	15	1,491	753
	10.0	162		564	30	120	457	68	2,416	2,379	359	318	287	30	2,416	1,223
Minimum		46		112	55	17	38	23	109	79	67	35	41	17	324	174
Maximum	0.2	338		358	98	53	79	46	610	97	98	86	69	43	610	327
Mean		192		235	77	35	59	35	360	88	83	61	55	30	467	250
Minimum		46		250	55	4	61	23	98	70	74	38	51	4	250	134
Maximum	2.0	262		376	697	56	85	57	527	88	112	95	76	37	697	366
Mean		154		313	376	30	73	40	313	79	93	67	64	21	474	250
Minimum		185		82	30	44	64	41	109	70	93	47	51	30	200	115
Maximum	4.0	323		338	55	143	81	68	527	471	186	136	78	45	527	286
Mean		254		210	43	94	73	55	318	271	140	92	65	38	364	201
Minimum		77		162	39	96	248	23	131	65	112	43	67	23	248	136
Maximum	6.0	123		364	74	227	345	45	1,601	88	166	147	84	43	1,601	822
Mean		100		263	57	162	297	34	866	77	139	95	76	33	925	479
Minimum		15		72	18	61	186	27	1,491	70	152	135	68	15	1,491	753
Maximum	8.0	108		564	61	294	433	68	2,109	793	283	214	257	27	2,109	1,064
Mean		62		318	40	178	310	48	1,800	432	218	175	163	21	1,800	908
Minimum		77		180	18	39	404	34	2,052	70	158	187	113	18	2,052	1,037
Maximum	10.0	162		624	30	120	464	68	2,416	2,379	359	324	387	30	2,416	1,223
Mean		120		402	24	80	434	51	2,234	1,225	259	256	250	24	2,234	1,130

Nitrite ( $\mu\text{g/l}$ ) of Bongas Station in 1988.

Monitoring Time	Water															
	Depth (m)	Jan.	Feb.	Mar.	Apr.	May	June	July	Aug.	Sept.	Oct.	Nov.	Dec.	Min.	Max.	Mean
1200	0.2	31		17	10	23	88	79	136	15	29	15	36	10	136	73
	2.0	55		18	808	24	89	74	131	18	36	19	38	18	808	413
	4.0	67		670	565	27	104	82	131	16	38	17	41	16	670	343
	6.0	157		724	142	39	102	79	136	15	39	23	54	15	724	370
	8.0	157		11	10	41	582	79	131	18	65	58	78	10	582	296
	10.0	59		807	19	914	369	82	131	19	133	118	265	19	914	467
1800	0.2	63		112	8	30	92	74	136	16	23	14	42	8	136	72
	2.0	157		43	74	33	82	74	131	15	35	14	39	14	157	86
	4.0	71		835	7	42	90	82	131	21	22	23	47	7	835	421
	6.0	157		91	13	285	376	79	136	17	28	17	58	13	376	195
	8.0	24		460	17	839	463	87	136	17	61	288	134	17	839	428
	10.0	24		70	10	1,020	468	82	207	15	65	311	382	10	1,020	515
2400	0.2	59		155	8	14	293	71	136	18	21	17	45	8	293	151
	2.0	71		25	8	17	87	71	136	66	22	15	47	8	136	72
	4.0	157		578	21	24	87	66	163	17	35	17	53	17	578	298
	6.0	71		709	14	38	759	62	207	22	32	33	64	14	759	387
	8.0	31		824	1	47	99	62	152	29	75	83	91	1	824	413
	10.0	31		164	8	192	437	62	141	21	76	330	328	8	437	223
0600	0.2	59		51	681	25	87	66	131	18	24	15	53	15	681	348
	2.0	67		61	34	49	480	62	141	19	35	15	56	15	480	248
	4.0	157		378	11	67	376	138	152	29	22	14	72	11	378	195
	6.0	157		791	151	131	121	62	152	25	63	18	85	18	791	405
	8.0	39		35	1	181	759	66	158	22	63	118	116	1	759	380
	10.0	31		535	37	583	463	79	131	169	219	141	167	31	583	307
Minimum		31		17	8	14	87	66	131	15	21	14	36	8	136	72
Maximum	0.2	63		155	681	30	293	79	136	18	29	17	53	15	681	348
Mean		47		86	345	22	190	73	134	17	25	16	45	12	409	210
Minimum		55		18	8	17	82	62	131	15	22	14	38	8	136	72
Maximum	2.0	157		61	808	49	480	74	141	66	36	19	56	18	808	413
Mean		106		40	408	33	281	68	136	41	29	17	47	13	472	243
Minimum		67		378	7	24	87	66	131	16	22	14	41	7	378	195
Maximum	4.0	157		835	565	67	376	138	163	29	38	23	72	17	835	421
Mean		112		607	286	46	232	102	147	23	30	19	57	12	607	308
Minimum		71		91	13	38	102	62	136	15	28	17	54	13	376	195
Maximum	6.0	157		791	151	285	759	79	207	25	63	33	85	18	791	405
Mean		114		441	82	162	431	71	172	20	46	25	70	16	584	300
Minimum		24		11	1	41	99	62	131	17	61	58	78	1	582	296
Maximum	8.0	157		824	17	839	759	87	158	29	75	288	134	17	839	428
Mean		91		418	9	440	429	75	145	23	68	173	106	9	711	362
Minimum		24		70	8	192	369	62	131	15	65	118	167	8	437	223
Maximum	10.0	59		807	37	1,020	468	82	207	169	219	330	382	31	1,020	515
Mean		42		439	23	606	419	72	169	92	142	224	275	20	729	369

Nitrate ( $\mu\text{g/l}$ ) of Bongas Station in 1988.

Monitoring Time	Water Depth (m)	Jan.	Feb.	Mar.	Apr.	May	June	July	Aug.	Sept.	Oct.	Nov.	Dec.	Min.	Max.	Mean
1200	0.2	253		213	200	215	234	326						200	326	263
	2.0	253		259	261	215	173	266						173	266	220
	4.0	253		118	206	231	154	317						118	317	218
	6.0	200		171	215	200	212	300						171	300	236
	8.0	200		197	231	215	192	334						192	334	263
	10.0	167		167	261	225	200	404						167	404	286
1800	0.2	253		203	215	231	173	292						173	292	233
	2.0	253		262	246	231	142	317						142	317	230
	4.0	253		233	212	231	154	334						154	334	244
	6.0	200		200	200	206	212	334						200	334	267
	8.0	200		249	215	200	300	334						200	334	267
	10.0	253		233	246	231	231	394						231	394	313
2400	0.2	253		167	200	231	45	385						45	385	215
	2.0	253		180	246	215	43	346						43	346	195
	4.0	200		118	231	215	54	375						54	375	215
	6.0	167		187	215	206	50	282						50	282	166
	8.0	167		112	200	215	62	291						62	291	177
	10.0	200		207	261	215	73	375						73	375	224
0600	0.2	253		167	231	246	134	320						134	320	227
	2.0	253		213	231	200	192	320						192	320	256
	4.0	200		134	215	215	162	328						134	328	231
	6.0	167		105	215	215	204	412						105	412	259
	8.0	167		89	215	215	185	384						89	384	237
	10.0	200		151	261	200	196	423						151	423	287
Minimum		253		167	200	215	45	292						45	292	215
Maximum	0.2	253		213	231	246	234	385						200	385	263
Mean		253		190	216	231	140	339						123	339	239
Minimum		253		180	231	200	43	266						43	266	195
Maximum	2.0	253		262	261	231	192	346						192	346	256
Mean		253		221	246	216	118	306						118	306	225
Minimum		200		118	206	215	54	317						54	317	215
Maximum	4.0	253		233	231	231	162	375						154	375	244
Mean		227		176	219	223	108	346						104	346	229
Minimum		167		105	200	200	50	282						50	282	166
Maximum	6.0	200		200	215	215	212	412						200	412	267
Mean		184		153	208	208	131	347						125	347	217
Minimum		167		89	200	200	62	291						62	291	177
Maximum	8.0	200		249	231	215	300	384						200	384	267
Mean		184		169	216	208	181	338						131	338	222
Minimum		167		151	246	200	73	375						73	375	224
Maximum	10.0	253		233	261	231	231	423						231	423	313
Mean		210		192	254	216	152	399						152	399	268

Orthophosphate ( $\mu\text{g/l}$ ) of Bongas Station in 1988.

Monitoring Time	Water Depth (m)	Jan.	Feb.	Mar.	Apr.	May	June	July	Aug.	Sept.	Oct.	Nov.	Dec.	Min.	Max.	Mean
1200	0.2	533		152	213	288	31	67	475	184				31	533	282
	2.0	500		252	201	288	27	98	379	184				27	500	264
	4.0	533		87	153	173	22	187	100	162				22	533	278
	6.0	600		74	199	149	25	190	83	157				25	600	313
	8.0	600		213	160	135	0	202	166	148				135	600	368
	10.0	600		63	196	89	0	136	177	145				63	600	332
1800	0.2	600		213	94	128	56	197	159	159				56	600	328
	2.0	500		213	139	151	58	59	241	147				58	500	279
	4.0	533		53	143	77	52	114	216	138				52	533	293
	6.0	450		276	131	169	68	55	108	135				55	450	253
	8.0	600		122	210	149	0	50	108	130				50	600	325
	10.0	700		237	155	120	0	120	213	115				115	700	408
2400	0.2	700		176	160	141	85	198	186	139				85	700	393
	2.0	533		259	183	166	43	63	196	12				12	533	273
	4.0	467		90	178	193	53	78	192	133				53	467	260
	6.0	500		47	231	147	0	144	199	13				13	500	257
	8.0	533		39	193	28	73	51	276	9				9	533	271
	10.0	667		162	225	210	0	56	186	108				56	667	362
0600	0.2	600		213	349	169	49	103	115	130				49	600	325
	2.0	500		239	85	193	19	128	277	127				19	500	260
	4.0	533		93	255	169	0	168	213	24				24	533	279
	6.0	500		39	225	222	47	140	206	119				39	500	270
	8.0	533		126	222	306	0	60	387	25				25	533	279
	10.0	533		71	164	91	0	158	162	9				9	533	271
Minimum	0.2	533		152	94	128	31	67	115	130				31	533	282
Maximum		700		213	349	288	85	198	475	184				85	700	393
Mean		617		183	222	208	58	133	295	157				58	617	337
Minimum	2.0	500		213	85	151	19	59	196	12				12	500	260
Maximum		533		259	201	288	58	128	379	184				58	533	279
Mean		517		236	143	220	39	94	288	98				35	517	269
Minimum	4.0	467		53	143	77	22	78	100	24				22	467	260
Maximum		533		93	255	193	53	187	216	162				53	533	293
Mean		500		73	199	135	38	133	158	93				38	500	276
Minimum	6.0	450		39	131	147	25	55	83	13				13	450	253
Maximum		600		276	231	222	68	190	206	157				55	600	313
Mean		525		158	181	185	47	123	145	85				34	525	283
Minimum	8.0	533		39	160	28	73	50	108	9				9	533	271
Maximum		600		213	222	306	73	202	387	148				135	600	368
Mean		567		126	191	167	73	126	248	79				72	567	319
Minimum	10.0	533		63	155	89		56	162	9				9	533	271
Maximum		700		237	225	210		158	213	145				115	700	408
Mean		617		150	190	150		107	188	77				62	617	339

Hydrogen sulfide ( $\mu\text{g/l}$ ) of Bongas Station in 1988.

Monitoring Time	Water Depth (m)	Jan.	Feb.	Mar.	Apr.	May	June	July	Aug.	Sept.	Oct.	Nov.	Dec.	Min.	Max.	Mean
1200	0.2	316		24	8	29	42	116	198	38	126	4	32	4	316	160
	2.0	412		24	64	91	45	92	182	46	129	48	46	24	412	218
	4.0	431		51	146	176	45	211	172	97	145	61	97	45	431	238
	6.0	415		150	149	248	91	330	532	57	1,286	37	87	37	1,286	662
	8.0	316		317	182	275	91	406	553	126	1,221	61	126	61	1,221	641
	10.0	376		323	186	568	264	451	491	65	1,227	61	165	61	1,227	644
1800	0.2	6		6	44	102	40	110	183	98	84	4	67	4	183	94
	2.0	22		29	35	321	236	187	157	47	67	4	74	4	321	163
	4.0	78		40	179	236	240	214	181	51	109	72	86	40	240	140
	6.0	130		192	198	505	341	251	523	45	103	87	112	45	523	284
	8.0	134		692	116	505	519	388	647	53	103	120	128	53	692	373
	10.0	34		459	311	381	875	417	646	803	1,243	174	286	34	1,243	639
2400	0.2	23		66	42	128	47	87	191	40	67	40	53	23	191	107
	2.0	26		24	98	106	155	96	140	31	118	46	67	24	155	90
	4.0	145		70	91	244	112	169	141	42	834	33	89	33	834	434
	6.0	137		150	103	441	361	324	520	24	673	33	113	24	673	349
	8.0	30		317	97	505	485	429	584	571	1,154	33	467	30	1,154	592
	10.0	132		314	98	509	413	405	754	287	1,247	58	586	58	1,247	653
0600	0.2	81		72	71	106	43	223	198	96	223	7	96	7	223	115
	2.0	36		18	73	106	43	136	189	56	136	7	98	7	189	98
	4.0	95		47	163	232	43	165	243	22	165	58	112	22	243	133
	6.0	84		48	182	248	121	219	434	26	219	64	268	26	434	230
	8.0	86		144	168	378	518	351	406	100	351	73	326	73	518	296
	10.0	52		186	252	381	492	308	254	86	308	254	365	52	492	272
Minimum		6		6	8	29	40	87	183	38	67	4	32	4	183	94
Maximum	0.2	316		72	71	128	47	223	198	98	223	40	96	23	316	160
Mean		161		39	40	79	44	155	191	68	145	22	64	14	250	127
Minimum		22		18	35	91	43	92	140	31	67	4	46	4	155	90
Maximum	2.0	412		29	98	321	236	187	189	56	136	48	98	24	412	218
Mean		217		24	67	206	140	140	165	44	102	26	72	14	284	154
Minimum		78		40	91	176	43	165	141	22	109	33	86	22	240	133
Maximum	4.0	431		70	179	244	240	214	243	97	834	72	112	45	834	434
Mean		255		55	135	210	142	190	192	60	472	53	99	34	537	283
Minimum		84		48	103	248	91	219	434	24	103	33	87	24	434	230
Maximum	6.0	415		192	198	505	361	330	532	57	1,286	87	268	45	1,286	662
Mean		250		120	151	377	226	275	483	41	695	60	178	35	860	446
Minimum		30		144	97	275	91	351	406	53	103	33	126	30	518	296
Maximum	8.0	316		692	182	505	519	429	647	571	1,221	120	467	73	1,221	641
Mean		173		418	140	390	305	390	527	312	662	77	297	52	870	468
Minimum		34		186	98	381	264	308	254	65	308	58	165	34	492	272
Maximum	10.0	376		459	311	568	875	451	754	803	1,247	254	586	61	1,247	653
Mean		205		323	205	475	570	380	504	434	778	156	376	48	870	462

Silicate (mg/l) as SiO<sub>2</sub> of Bongas Station in 1988.

Monitoring Time	Water Depth (m)	Jan.	Feb.	Mar.	Apr.	May	June	July	Aug.	Sept.	Oct.	Nov.	Dec.	Min.	Max.	Mean
1200	0.2				24.0	24.0	20.5							20.5	24.0	22.3
	2.0				22.0	18.0	23.0							18.0	23.0	20.5
	4.0				13.0	29.0	18.0							13.0	29.0	21.0
	6.0				19.5	28.0	13.0							13.0	28.0	20.5
	8.0				20.5	27.0	17.0							17.0	27.0	22.0
	10.0				17.0	29.0	25.0							17.0	29.0	23.0
1800	0.2				26.0	25.0	26.0							25.0	26.0	25.5
	2.0				17.0	24.0	22.0							17.0	24.0	20.5
	4.0				19.5	21.0	24.0							19.5	24.0	21.8
	6.0				20.5	27.0	21.0							20.5	27.0	23.8
	8.0				21.0	22.0	25.0							21.0	25.0	23.0
	10.0				20.5	20.5	23.0							20.5	23.0	21.8
2400	0.2				16.5	17.0	23.0							16.5	23.0	19.8
	2.0				16.5	19.5	15.0							15.0	19.5	17.3
	4.0				18.0	27.0	22.0							18.0	27.0	22.5
	6.0				24.0	25.0	19.5							19.5	25.0	22.3
	8.0				13.0	28.0	30.8							13.0	30.8	21.9
	10.0				20.5	29.0	34.8							20.5	34.8	27.7
0600	0.2				20.5	28.0	22.0							20.5	28.0	24.3
	2.0				12.0	21.0	15.0							12.0	21.0	16.5
	4.0				22.0	27.0	20.5							20.5	27.0	23.8
	6.0				24.0	30.0	24.0							24.0	30.0	27.0
	8.0				16.0	34.8	26.5							16.0	34.8	25.4
	10.0				20.5	38.5	25.0							20.5	38.5	29.5
Minimum	0.2				16.5	17.0	20.5							16.5	23.0	19.8
Maximum		26.0	28.0	26.0										25.0	28.0	25.5
Mean		21.3	22.5	23.3										20.8	25.5	22.6
Minimum	2.0				12.0	18.0	15.0							12.0	19.5	16.5
Maximum		22.0	24.0	23.0										18.0	24.0	20.5
Mean		17.0	21.0	19.0										15.0	21.8	18.5
Minimum	4.0				13.0	21.0	18.0							13.0	24.0	21.0
Maximum		22.0	29.0	24.0										20.5	29.0	23.8
Mean		17.5	25.0	21.0										16.8	26.5	22.4
Minimum	6.0				19.5	25.0	13.0							13.0	25.0	20.5
Maximum		24.0	30.0	24.0										24.0	30.0	27.0
Mean		21.8	27.5	18.5										18.5	27.5	23.8
Minimum	8.0				13.0	22.0	17.0							13.0	25.0	21.9
Maximum		21.0	34.8	30.8										21.0	34.8	25.4
Mean		17.0	28.4	23.9										17.0	29.9	23.7
Minimum	10.0				17.0	20.5	23.0							17.0	23.0	21.8
Maximum		20.5	38.5	34.8										20.5	38.5	29.5
Mean		18.8	29.5	28.9										18.8	30.8	25.6

# Research on Cage Aquaculture Systems in the Saguling Reservoir, West Java, Indonesia\*

**BARRY A. COSTA-PIERCE**  
*International Center for Living Aquatic  
Resources Management  
MC P.O. Box 1501, Makati  
Metro Manila, Philippines*

**HERRI Y. HADIKUSUMAH**  
*Institute of Ecology, Padjadjaran University  
Jl. Sekeloa Selatan 1  
Bandung 40132, Indonesia*

COSTA-PIERCE, B.A. and H.Y. HADIKUSUMAH. 1990. Research on cage aquaculture systems in the Saguling Reservoir, West Java, Indonesia, p. 112-217. In B.A. Costa-Pierce and O. Soemarwoto (eds.) Reservoir fisheries and aquaculture development for resettlement in Indonesia. ICLARM Tech. Rep. 23, 378 p.

## Abstract

Research is reported on floating net cage hatchery, nursery and growout systems for common carp (*Cyprinus carpio* L.) and hybrid red tilapia (HRT) (*Oreochromis* sp.) conducted from 1986 to 1989 in the Saguling Reservoir, West Java, Indonesia, in 9 subject areas, comprising 13 experiments of 93 individual cage units. All data are summarized in a detailed Appendix, and are available on disk from ICLARM.

Based upon field work from 1986 to 1989 a historical perspective on the changing aquaculture production network for common carp (*Cyprinus carpio*) in the Bandung-Bogor area of West Java, Indonesia is presented. Increasing market demands for freshwater fish in the province, and the advent of economically-viable running water systems and reservoir cage culture to meet the increased demand for fish have concomitantly increased demands for seed fish (fry and fingerlings). Large expansion in rice-fish culture as the central fish nursery system, and in the number and semi-intensification of traditional methods for pond hatcheries and nurseries are the keys to the future development of aquaculture in West Java.

Production of fry and fingerlings using double net *hapa* hatcheries for HRT averaged 4.51/female spawner/day (range, 0-14.98) or 6.76/m<sup>2</sup>/day (range, 0-22.47) over 12 male and female broodstock rotations of 14-32 day periods. Broodstock rotations of 14-15 days produced significantly higher ( $P < 0.01$ ) numbers of fry and fingerlings than longer rotation times. In nursery experiments, fingerling HRT had a net fish yield of 9.7-11.9 kg/m<sup>3</sup>, specific growth rates (SGRs) of 3.4-3.5%/day and food conversion ratios (FCRs) of 3.3-3.6 in 95 days in a site where early morning dissolved oxygen (DO) dropped below 3.0 mg/l. Common carp, however, showed statistically significant reductions ( $P < 0.05$ ) in net fish production, average weight at harvest, and increased FCRs in low DO concentrations. Yield characteristics (net production, average weight at harvest, SGRs and survival) of HRT fingerlings were not significantly different ( $P > 0.05$ ) in low and high DOs. HRT had significantly higher ( $P < 0.05$ ) yield characteristics, and lower FCRs when compared with common carp under both DO conditions. Use of a simple light attractor did not improve yield parameters for either fingerling common carp or HRT, but HRT again statistically ( $P < 0.05$ ) outperformed common carp in all yield characteristics except for survival rates ( $P > 0.05$ ). Feasibility of a new, combined culture system of common carp nurseries floating above a growout cage culturing HRT was demonstrated. HRT cleaned the outside walls of the small-meshed common carp nursery cages to a limited degree, possibly because of the heavy fouling by attached *aufwuchs* in the hypereutrophic reservoir. However, significantly higher ( $P < 0.05$ ) common carp fingerling net production, and mean fish weight at harvest were observed in nursery cages stocked with small HRT ( $83.6 \pm 8.2$ , mean  $\pm$  S.D.) on the outside when compared with controls with no

\*ICLARM Contribution No. 548.



HRT. Use of rice bran alone and in combination with a commercial 24-26% crude protein feed was demonstrated for HRT in nursery and growout cages. A 50% rice bran/50% commercial feed mixture (dry weight) produced individual HRT over 300 g from 96 g at start in just 96 days. Rice bran (12% protein) produced 39.5-40.5 g fingerlings from 4.8-4.9 g stock in 119 days in nursery cages. Significant linear regressions were obtained between the calculated per cent protein of the feed mixtures and mean fish weight at harvest ( $r = 0.95$ ;  $P < 0.05$ ) and net fish production ( $r = 0.95$ ;  $P < 0.05$ ), per cent survival ( $r = 0.94$ ;  $P < 0.05$ , and FCRs ( $r = -0.88$ ;  $P < 0.05$ ) for HRT fingerlings stocked at  $0.5 \text{ kg/m}^3$ , and grown for 119 days.

Growout experiments with common carp in  $7 \times 7 \times 2.5 \text{ m}$  floating net cages produced a mean yield of  $1,070 \pm 131 \text{ kg}$  ( $\pm \text{S.D.}$ ) of  $259.2 \pm 31.0 \text{ g}$  fish in 88 days with 97% survival, and an FCR of 2.0 from initial stocking (300 kg of  $70.7 \pm 2.8 \text{ g}$ ).

Two new, low-cost models for floating net cages using bamboo or banana logs for flotation were developed that reduced total construction costs from Rp 491,200 to Rp 182,500. Experiments with decreasing stocking rates or changing feeding frequencies showed that optimal stocking density might be reduced from  $2.4 \text{ kg/m}^3$  to  $1.0 \text{ kg/m}^3$ ; larger mean fish size at harvest and lower FCRs were obtained (but not significantly different); better system efficiency is forecasted. Feeding fish to satiation three times a day significantly increased ( $P < 0.05$ ) the net and total fish production, mean fish size at harvest, and SGRs of common carp in 102 days, but significantly increased ( $P < 0.05$ ) the FCR from 2.3 to 2.6 when compared to feeding 3% body weight per day three times a day.

Experiments with small-scale common carp culture in  $17.0\text{-}17.5 \text{ m}^3$  bamboo, net and or wire cages showed that  $135.8\text{-}153.0 \text{ kg}$  of fish could be produced in just 86-90 days. An Indonesian family of five (current family size in 1989), using a "fish per person per day" management system would need to manage just two cages to provide their entire annual animal protein needs.

## Introduction

### Background

Indonesia has the greatest potential in Southeast Asia for the expansion of inland aquaculture. The nation contains about 72% of the total area of all freshwater ecosystems in the Association of Southeast Asian Nations (ASEAN) (Baluyut 1983), with 1.8 million ha of natural lakes, which includes an estimated 53,000 ha of reservoirs (Hardjamulia and Suwignyo 1988). In Java, where over 50% of the Indonesian population lives, large urban and rural fish markets exist, and three large, multipurpose reservoirs (Saguling, Cirata and Jatiluhur) are available for fisheries and aquaculture development. Two of these three reservoirs are primarily for hydropower (Saguling and Cirata) but are also used for irrigation and recreation; both are new since 1985.

Indonesia is known, historically, as one center of tropical cage aquaculture (Beveridge 1987). The culture of common carp (*Cyprinus carpio*) in bamboo cages in eutrophic streams without feeding was present by the turn of the century (Vaas and Sachlan 1957), and is still practiced in West Java (Costa-Pierce and Effendi 1988). During the study of Costa-Pierce and Effendi (1988) numerous villagers told stories about cage culture which would trace Indonesian cage culture to the mid-1700s. Modern cage aquaculture is well developed, and is centered in the province of West Java. West Java produced an estimated 92% of the fish from cage culture in Indonesia in 1987 (Cholik 1988).

Floating net cage culture (FNCC) in West Java is, at present, the most dynamic, new, and exciting sector of Indonesian aquaculture. Its percentage growth in 1987-1988 far exceeded that of all other sectors, and has surpassed even the most recent projections of national fisheries officials. According to the Indonesian Directorate General of Fisheries (DGF) (1988), growth of all sectors of Indonesian aquaculture would range from 10.5 to 12.0% in 1987 to 1988. Cage aquaculture production was forecast to grow just 11.5% (from 900 to 1,000 t). However, FNCC rapidly expanded in two, new, hydropower reservoirs in West Java, Saguling and Cirata in 1986-1989. From zero fish production in 1985, FNCC in Saguling Reservoir produced 1,437 t of common carp in 1987 and 2,554 t in 1988 (Sutandar et al. 1990). Fish production in 1988 from cages in Saguling alone increased caged fish production in Indonesia 184% from the reported 1987 production.

Rapid development of FNCC in West Java followed research, extension and farmer training efforts by a number of Indonesian fisheries institutions. From 1982 to 1985 cage aquaculture was examined by the Research Institute for Inland Fisheries (RIIF, Bogor), the West Java Fisheries Agency (WJFA, Bandung), and the Research Institute of Padjadjaran University (RIPU) in Lakes Ciburial, Cikoneng and Lido, and at the Jatiluhur Reservoir (Joenoos and Achmad 1974; Jangkaru and Djajadiredja 1979; Djajadiredja et al. 1982; RIIF 1983). Financial

support to these institutions for FNCC development in lakes and reservoirs in West Java came from the Indonesian State Electric Company (PLN) and the national government.

The close involvement of an electric company in the development of aquaculture in its hydropower reservoirs has been unprecedented. Before the main part of the Saguling Reservoir was flooded in February 1985 PLN created a "fisheries dike area" for experiments in FNCC and fish hatcheries (Rifai 1985). After complete flooding, research and development in FNCC was continued by the RPU (Rifai 1985; RPU 1986, 1987) and the WJFA through its Technical Management Unit (UPTD) specially created for aquaculture and fisheries development in the Saguling and Cirata Reservoirs (Effendi 1988).

In 1986, a new reservoir fisheries and aquaculture project, funded as part of a World Bank loan to PLN for dam construction at Cirata, was initiated by the Institute of Ecology of Padjadjaran University (IOE, Bandung). IOE, in turn, associated with the International Center for Living Aquatic Resources Management (ICLARM) (Manila, Philippines) to implement the project (Costa-Pierce and Soemarwoto 1987; Soemarwoto, this vol.). The project was to conduct interdisciplinary research, extension, and farmer training in FNCC, its supporting land-based industries (feed mills, supply industries, etc.), and drawdown agriculture and aquaculture systems. Development of new, and improvement of existing aquaculture systems with sufficient potential for large-scale job creation in the Saguling-Cirata Reservoir region of West Java was required by the project to meet the "aquaculture resettlement" objectives set by the Indonesian government and PLN (Soemarwoto, this vol.).

This chapter reports on research results obtained by the IOE/ICLARM project during 1986-1989 in reservoir-based cage aquaculture systems in the Saguling Reservoir, West Java, Indonesia.

### ***Aquaculture Species***

IOE/ICLARM research in 1986-89 focused on problems in and development of land and reservoir-based aquaculture systems for common carp and tilapia. It was widely agreed by all project participants that these two fish species have the greatest market potential in the Saguling-Cirata project region (Effendi 1988).

The priority fish species for aquaculture research and development activities was the common carp (*Cyprinus carpio* L.). Common carp is the best-known, most easily marketed and most preferred fish species of the local Sundanese people in West Java. The technology for its controlled farming is widely known by farmers. In 1987, common carp comprised 53% (50,282 t) of all the fish produced by inland aquaculture in the province (DPPJB 1988). More importantly for our studies, common carp were cultured by almost 100% of the fish farmers operating the approximately 1,300 cage units (7 x 7 x 2.5 m deep) in the Saguling Reservoir at the time of the research project (Rusydi and Lampe, this vol.).

Common carp is a high-priced commodity food item in West Java. The fresh wholesale price of common carp can exceed that of fresh ocean shrimp (*Metapenaeus* sp.) (Cholik 1988). During the period of this study, prices for common carp were not strongly related to peak volumes marketed; and markets were judged capable of handling an increase in fish production from cages (Kusnadi and Lampe, this vol.). Because common carp is such an expensive and choice food commodity this species was less available to the target group of the project, i.e., the displaced residents and laborers from the reservoir inundated regions. For this reason we also chose to research and introduce modern methods in tilapia aquaculture to the Saguling-Cirata region.

Indonesia is the world's largest aquaculture producer of Java tilapia (*Oreochromis mossambicus*), producing an estimated 36,642 t in 1986 (FAO 1989). The fish, locally known as *mujair*, are a very important source of protein to poor villagers in Java (Costa-Pierce et al. 1988b). Prices of Java tilapia are low, quoted at Rp 343/kg in 1985 (Cholik 1988), and are well within the family budgets of the poorest of residents in the project region. However, market acceptance of Java tilapia among the growing Indonesian middle class is poor, probably because of its image as a "poor man's food" or other, highly entrenched sociological reasons.

In July 1969 Nile tilapia (*Oreochromis niloticus*) was imported to Indonesia and its superior growth rates and appearance quickly led to distinct recognition by farmers and consumers resulting in higher market prices than Java tilapia (Jangkaru 1986a). It quickly acquired a distinct market niche (e.g., was recognized as distinctly different product from Java tilapia). In addition, RIIIF (1983) studies noted that Nile tilapia had superior growth and production than common carp in FNCC trials in the Jatiluhur Reservoir. Nile tilapia hybrids have recently developed into an Indonesian export commodity, with "red" tilapia (*Oreochromis* sp.) going to Singapore and Taiwan. Widespread interest in Nile tilapia aquaculture was expressed to IOE/ICLARM project scientists in preliminary interviews with Saguling farmers in 1986. For these reasons, and the other well-known advantages of tilapia aquaculture (Pullin 1985), development of hybrid red tilapia (HRT) aquaculture was undertaken as the second priority research and development task by the project.

Genetic deterioration and introgressive inbreeding is currently a major concern in all farm stocks of Asian tilapias (Pullin 1988). In the IOE/ICLARM project, a red tilapia variety locally called *nila* ("Nile tilapia") were purchased from the Cisaat, Sukabumi fish seed center in West Java. However, upon breeding the fish we noted that a consistent percentage of recruits were distinctly 3-spined, big-headed, big-lipped, Java tilapia (*O. mossambicus*) (see key in Pullin 1988, p. 96-108). From our observations of tilapia stocks in many aquafarms and small seed centers in West Java it is apparent that hybridization of the Nile and Java tilapia stocks has occurred nearly everywhere. This fact, however, is not represented in the latest Indonesian aquaculture statistics (Table 1). Increased popularity (and, unfortunately, mixing) of tilapias is, however, being recognized worldwide. Of the total world tilapia aquaculture production reported by FAO (1989), 59%, or an estimated 164,370 t, was either *Oreochromis* or *Sarotherodon* spp.

The hybrid tilapia used in all our experimental work reported here was a red color variety, likely an *O. niloticus*/*O. mossambicus* hybrid (R.S.V. Pullin, pers. comm.). In this report we will thereby refer to the tilapia as a "hybrid red tilapia" (HRT) (*Oreochromis* sp.).

### **Aquaculture Production Networks in West Java**

West Java is the most important center of traditional and modern Indonesian aquaculture development. West Java produces more fish of more species from inland aquaculture than any other province, estimated at 95,017 t in 1986 (Table 1) (DPPJB 1987).

One traditional aquaculture production network for the farming of common carp in West Java links pond hatcheries and nurseries, rice-fish and pond growout systems to the end consumer (Fig. 1A). Rice-fish systems function in the traditional aquaculture network as growout systems producing small (50-100 g) common carp as a local protein staple. Fish are harvested from rice-fish systems, sold and distributed locally within the rich rice-producing districts (Koesoemadinata and Costa-Pierce, in press). The reasons for eating small fish are both cultural and/or economic; the Sundanese people of West Java prefer to eat, have a special cuisine for, and/or can only afford to purchase small fish. Socially in West Java the adage, "a fish per person", is also very important. With small fish everyone gets a whole fish: no one gets "just the head", or "just the tail" of the fish, and the negative social connotations that go along with this.

In the traditional aquaculture production networks, large fish (250 g and up) produced in backyard or larger ponds are considered by the rural populace as luxury commodities. Large common carp are sold to the cities and restaurants. These fish are rarely eaten by rural villagers in West Java (only at very special festival times) but are sold to buy other essential foods and commodities, such as cheap, salted ocean fish. Sale of large fish is viewed as one of the most attractive ways of earning cash in rural areas, where few cash-producing opportunities exist. Large amounts of underemployment occurs in crowded Java and labor surpluses are common (Collier et al. 1977).

Traditional inland aquaculture networks still exist in many areas of West Java; however, since 1976 these have undergone great changes due to market forces and two, new, and highly

Table 1. Freshwater fish aquaculture production by species in the province of West Java, Indonesia, from 1980 to 1986 (DPPJB 1987).

No.	Species	YEAR													
		1980	%	1981	%	1982	%	1983	%	1984	%	1985	%	1986	%
1	<i>Cyprinus carpio</i>	27,229.2	39.1	33,143.7	43.9	29,495.1	47.7	35,057.8	47.9	39,997.1	48.9	45,523.8	50.6	50,282.1	52.9
2	<i>Puntius javanicus</i>	7,722.9	11.1	7,909.2	10.5	7,793.1	12.6	8,523.3	11.6	9,051.0	11.0	8,893.3	9.7	8,711.9	9.2
3	<i>Oreochromis mossambicus</i>	11,771.5	16.9	11,880.4	15.4	8,873.9	14.4	9,856.4	13.2	10,868.4	13.3	11,154.9	12.4	10,344.9	10.9
4	<i>Channa striatus</i>	409.6	0.6	498.9	0.7	336.8	0.6	954.7	0.5	312.8	0.4	432.0	0.5	281.2	0.3
5	<i>Trichogaster pectoralis</i>	657.3	0.9	725.6	1.0	770.6	1.2	660.4	0.9	772.6	1.8	1,161.1	1.3	921.2	1.0
6	<i>Osphronemus gouramy</i>	2,083.7	3.0	1,793.7	2.4	1,418.7	2.3	1,239.3	1.7	1,442.7	8.6	1,808.0	2.0	2,322.1	2.4
7	<i>Osteochilus hasselti</i>	7,129.9	10.2	6,667.8	8.8	4,700.2	7.6	8,705.6	9.2	7,070.2	8.3	7,797.0	8.7	7,793.0	8.2
8	<i>Oreochromis niloticus</i>	5,273.4	7.6	4,840.0	6.4	3,908.2	6.3	4,664.4	6.4	5,160.7	5.1	5,589.3	6.2	5,291.4	5.6
9	<i>Halostoma temminckii</i>	4,368.5	6.3	4,658.3	6.2	3,062.1	5.0	3,316.2	4.5	4,197.4	3.8	4,458.6	5.0	5,056.0	5.3
10	Other fish	2,950.8	4.2	3,551.4	4.7	1,418.6	2.3	2,990.1	4.1	3,125.1	3.7	3,353.5	3.7	4,013.3	4.2
Total		69,536.8	100.0	75,450.0	100.0	61,777.3	100.0	73,168.2	100.0	81,988.0	100.0	99,971.5	100.0	95,017.0	100.0

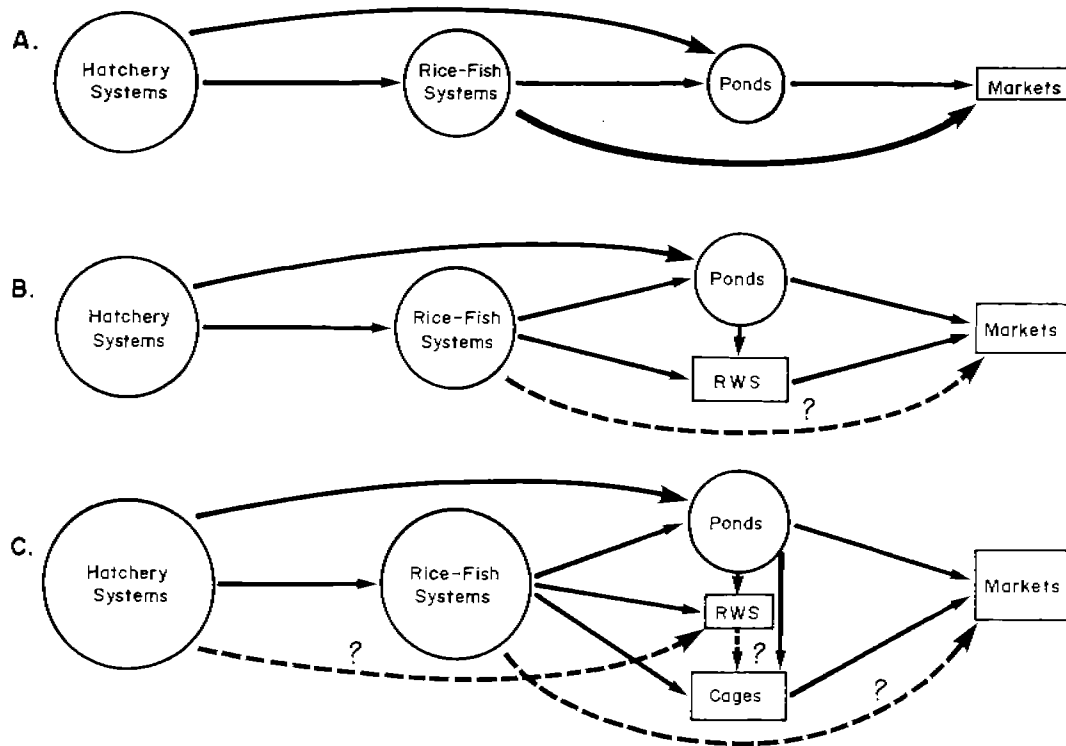

Fig 1. Development of the aquaculture production network for common carp (*Cyprinus carpio*) in West Java from about 1900 to the present. (A) Traditional production network until about 1975-1976. Rice-fish systems supplied seed fish for further growout in small-scale family ponds, but the majority of fish production from rice-fish was sold directly as small fish (50-100 g) to local markets for direct consumption by people living within the rice-growing districts. Backyard ponds were widely distributed and population pressure was less. (B) Changing network from mid-1970s to 1985-1986. Markets have expanded in size due to rapid population growth and increasing demands for fish. Intensive running water systems (RWS) have moved from the laboratory to commercial viability, increasing the demand for seed fish (50-100 g in size). Increased seed demand increases the area of rice-fish culture and the number and extent of ponds used as nurseries. The dashed line indicates the decrease in direct marketing of small fish as direct human food to markets in the rice-growing regions because of the increased demand and higher prices offered by better-off RWS operators. (C) Changing aquaculture production network from 1985 to present. Demands for freshwater fish continue to expand, and markets grow rapidly, but the number of traditional backyard fishponds does not increase much due to urbanization and population pressure. The number of RWS drops suddenly due to rising production costs, and the advent and commercial success of reservoir floating net cage culture (FNCC), which outcompetes RWS in the marketplace. Increased demands for seed fish causes a sharp rise in the extent of rice-fish culture as nurseries. Rice-fish systems now play a minor role as a growout system supplying fish to people in the rice-growing regions. Question marks indicate possible future changes or routes that may occur, and dashed lines represent new, developing connections observed by early 1988.

successful, especially in the Bandung and Bogor regencies, aquaculture growout systems (Fig. 1B and 1C).

By 1976, the commercial feasibility of running water systems (RWS) for the intensive growout of common carp had been demonstrated (Suprayitno 1986). RWS are simple 10-100 m<sup>2</sup> concrete raceways connected to a year-round water source, usually an irrigation ditch, which supplies continuously flowing water to fish enclosed in a raceway "single-pass system". From 1976 on the number of RWS grew rapidly in the Bogor, Bandung and Subang districts of West Java, and by 1987 RWS located in these three regencies produced a total of 3,770 t of common carp (DPPJB 1988).

Expansion of RWSs created a large demand for 50-100 g size common carp ("seed fish") for stocking. Increased demand for seed fish in turn increased the importance of rice-fish systems as the central fish nursery system in West Java (Costa-Pierce, in press). Increased demand has fueled a mini-boom in rice-fish culture in West Java.

The commercial profitability of FNCC in the Saguling Reservoir was demonstrated by 1985 (Rifai 1985). Nearly all of the seed fish (50-100 g) used in the FNCC industry originated from rice-fish culture during the period from 1986 to 1988. However, due to the increased profitability of fish nurseries, a growing amount of seed fish are coming from rice fields converted into year-round fish nursery ponds, especially in the Buahbatu area of the Bandung regency.

Projected demand for seed fish to support the future expansion of reservoir FNCC and RWS will increase. Total fish production from FNCC in the Saguling-Cirata Reservoirs is planned to reach 12,928 t/year by 1992 (Sutandar et al. 1990). This production will require a minimum annual input of 2,585 t of fish seed for FNCC in these two reservoirs alone. Accelerated demand for seed fish for stocking FNCC growout systems in the Saguling-Cirata Reservoir region will further add to the expansion of pond hatcheries, nurseries and rice-fish culture in the region. A clear need exists to plan, expand, improve and intensify traditional hatchery and nursery technologies for common carp to support cage and RWS grow-out systems in West Java.

## A Double-Net Hapa Hatchery System for Tilapias

### Introduction

Development of small-scale Nile tilapia (*Oreochromis niloticus*) hapa hatcheries in the Philippines has increased rapidly to meet the demands of an expanding aquaculture industry. Increased demand for fingerlings ("seed fish") in the Philippines is largely driven by the estimated 1,000 ha of tilapia cage and pen aquaculture in Laguna de Bay (Pullin 1981; Guerrero 1986, 1987). The annual fingerling requirement is estimated at 50 million for the cages and net pens of Laguna de Bay (Bautista 1987).

Current Indonesian tilapia hatcheries (Sugiarto 1988) use earthen ponds where broodstock selection, control of mating and predators, and harvesting of fingerlings are problematic. In 1987 IOE/ICLARM project scientists travelled to the Philippines to observe and document tilapia hapa hatchery technology firsthand with the intention of returning to Indonesia and conducting adaptive research in the Saguling and Cirata Reservoirs. It was concluded by the "tilapia mission" scientists (Costa-Pierce et al. 1988b; Costa-Pierce et al. 1989a) that the hapa hatchery technology was potentially more productive and manageable than traditional tilapia hatcheries. Beveridge (1984) reported that, in the Philippines, hapa hatcheries outperformed pond hatcheries, producing 70-240 fry/m<sup>2</sup>/month vs. 10-240 fry/m<sup>2</sup>/month. The hapa system for *O. niloticus* was also judged to be superior to ponds and tanks by Hughes and Behrends (1983).

The hapa hatcheries are sufficiently simple and low-cost so that the technology can be transferred almost directly to Indonesia with little further modifications or expensive testing.

Some important factors affecting the direct adoption of the technology were that the hapa hatcheries are small scale, low cost, require little labor, and can be made fully "floating". Creation of new hatchery businesses could potentially increase employment opportunities for the poorer residents in the project region by further intensifying the productive uses of the reservoir water surface.

Four hapa hatcheries were set up to test and adapt the new technology to Indonesia. This section presents the results of 12 matings conducted in 1988-1989 and makes comparisons with modern systems in the Philippines and elsewhere.

## Materials and Methods

From 1 November 1988 to 7 March 1989 12 matings were conducted in 4 hapa nets located at the IOE/ICLARM station, Cipondoh, Saguling Reservoir. A "double hapa net system" was used. All 4 hapa hatchery nets had rectangular inner nets 2 x 2 x 1.0 m the four sides of which were 1.5" mesh, with a mesh of 2-3 mm on the bottom. The bottom of the insert net was weighted so that it laid flush with the bottom of the outside net. On the outside of these nets were set fine mesh nets (2-3 mm) measuring 3 x 3 x 1.0 m.

Broodstock hybrid red tilapia (*Oreochromis* sp.) (HRT) were stocked in all 4 insert nets at 0.5 kg/m<sup>3</sup> with a 3:1 female:male ratio on 1 November 1988. Females were stocked at an average size (250 g) approximately equal to males. All broodstock (in and out of the hatchery) were fed a commercial 24-26% crude protein feed (Comfeed, Cirebon, Indonesia) at 3% of the standing crop fish biomass in the cage per day (BWD). Fry and fingerlings 0.5-5 cm in size were harvested with a small-meshed hand net every 14 to 32 days. Harvesting was done by raising the hapa net, scooping all fry and fingerlings present, counting them, then transferring and stocking these small fish into another nursery hapa of the same size as the outer net of hatchery hapa at a rate of 200 fish/m<sup>3</sup>.

At the time of fry and fingerling harvests the insert net and its broodstock were removed and new broodstock added into the hatchery from broodstock holding nets. Two separate 3.5 x 3.5 x 2.5 m broodstock holding nets of 1.5" mesh size held male and female broodstock separately. New broodstock of approximately the same mean weight were selected and restocked into the hatchery from the broodstock holding nets at the time of fry and fingerling harvests. New male and female broodstock were rotated into the hatchery at periods ranging from 14 to 32 days.

## Results

Production of fry and fingerlings 0.5-5 cm in size during the 12 spawnings is shown in Table 2. Mean production was 4.51/female spawner/day. Fingerling production was, however, very variable, ranging from 0 to 22.47/m<sup>2</sup>/day, or 0 to 14.98/female/day.

Fry and fingerling numbers obtained for each period of time that broodstock were left in the nets are shown in Fig. 2. The highest number of fingerlings was obtained when broodstock were left in the hatchery for 14 (1,116 fingerlings) or 15 days (1,348 fingerlings). On two occasions, however, no fry or fingerlings were obtained using 14-day broodstock rotation times. On these two dates, very strong winds and large waves severely disturbed the hatchery. If these two dates are removed, a mean fry and fingerling production of 8.09/m<sup>2</sup>/day or 5.41/female/day was obtained.

The fry and fingerlings obtained were divided into two groups to test if 14-15 day ( $n_2 = 4$ ) broodstock rotation times produced more fingerlings than broodstock rotation times 16 days or longer ( $n_1 = 6$ ). The two zero yields were excluded from this analysis. The non-parametric Wilcoxon two-sample test (Sokal and Rohlf 1969) was used for comparison. Shorter broodstock rotation times (14-15 days) were found to produce significantly greater number of fry and fingerlings than longer rotation times ( $P < 0.01$ ).

## Discussion

Abella and Batao (1989) found that a 21-day male and female broodstock rotation time produced significantly greater numbers of eggs and fry than no broodstock rotation. In this study, shorter (14-15 day) male and female broodstock rotations produced greater numbers of fry and fingerlings than rotation times of 16 days or longer.

Table 2. Daily production of fry and fingerlings of hybrid red tilapia (*Oreochromis* sp.) by cage area, standing crop female biomass, and per number of females stocked in double net cage *hapa* hatcheries in the eutrophic Saguling Reservoir, West Java, Indonesia Male and female fish averaged 250 g; stocking rate of inner *hapas* was 0.5 kg/m<sup>3</sup>; and broodstock were added at a 3:1 female/male ratio.

Spawning number	Days in hapa	Total No. fingerlings	No./m <sup>2</sup> /day	No./kg female/day	No./female/day
1	14	1116	19.93	53.14	13.29
2	14	0	0.00	0.00	0.00
3	14	0	0.00	0.00	0.00
4	21	508	6.05	16.13	4.03
5	32	270	2.11	5.63	1.41
6	16	326	5.09	13.58	3.40
7	14	650	11.61	30.95	7.74
8	30	300	2.50	6.67	1.67
9	21	25	0.30	0.79	0.20
10	14	495	8.84	23.57	5.89
11	31	280	2.26	6.02	1.51
12	15	1348	22.47	59.91	14.98
Maximum	32	1348	22.47	59.91	14.98
Minimum	14	0	0.00	0.00	0.00
Mean	20	443	6.76	18.03	4.51
S.D.	7	406	7.33	19.54	4.89

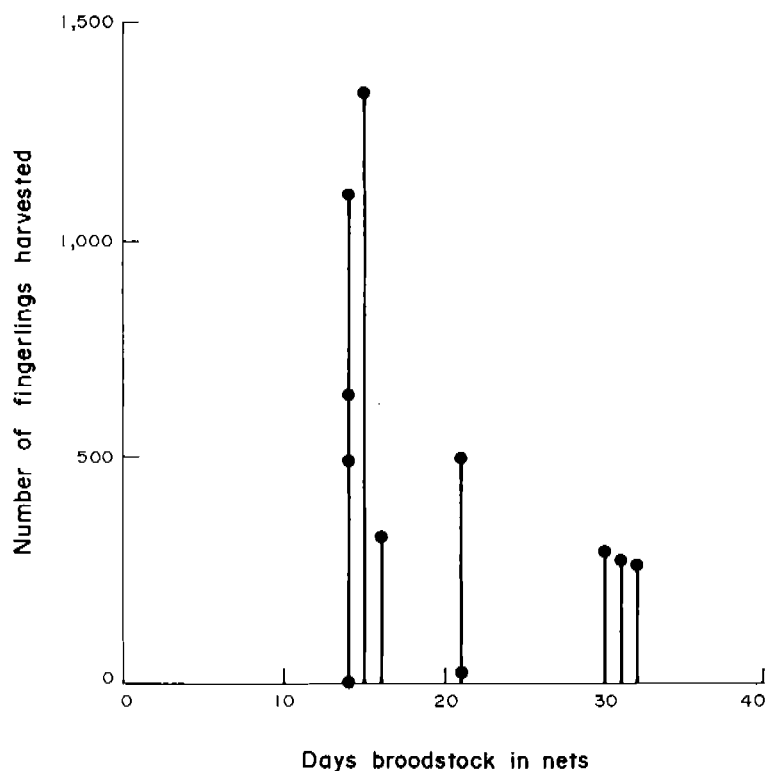

Fig. 2. Fry and fingerling production of hybrid red tilapia (*Oreochromis* sp.) according to the number of days that male and female broodstock were held in 2 x 2 x 1.0 m deep inner nets (1.5" mesh) in double net *hapa* hatcheries (outer nets 3 x 3 x 1.0 m deep) (mesh size 2-3 mm) in the Saguling Reservoir, West Java. Broodstock were stocked in all nets at 0.5 kg/m<sup>3</sup> at 3:1 female:male ratio, with both sexes stocked at approximately 250 g average weight.

Recent studies on *O. niloticus* seed production in hapa hatcheries have found that lower female:male sex ratios (2 or 3:1 versus 4:1 and greater), and lower broodstock densities generally gave higher seed production (Guerrero and Garcia 1983; Hughes and Behrends 1983; Bautista et al. 1988). These and other studies with single and double net hapa hatchery systems are summarized in Table 3.

From the data in Table 3 and results of this study, the mean HRT fry and fingerling production obtained in our double net hapa hatchery was higher than that obtained in other single or double net hapa hatcheries harvesting fry and fingerlings. In our hatchery, we used lower female broodstock densities and larger individual male and female broodstock than in other studies. Guerrero and Garcia (1983) found that increasing broodstock size decreased fry production in the double net hapa system but these authors used a female broodstock density twice that used in our hatchery (Table 3). Siraj et al. (1983) also found that fingerling output and reproductive efficiency was greater in female broodstock 48.5 g vs. 156.5 g and 293.5 g individuals, but they determined these increased efficiencies by artificially incubating eggs taken from female mouths. Incubation is known to increase hatchability and fry survival so that this study is not comparable to that reported here.

One reason why our fry and fingerling production was so high may be that the double net hapa hatchery system dramatically reduced predation on new recruits. Guerrero and Garcia (1983) noted that double net hapa systems produced as many fry as a single net system stocked with twice as many broodstock (see Table 3). Another reason for the high production of fry and fingerlings may have been the continuously high plankton densities present in Saguling (Soemarwoto et al., this vol.). The phytoplankton of Saguling during the experimental period was dominated by *Microcystis aeruginosa* which reached densities of over 100 million cells/l; during our hatchery experiment the Secchi disk visibility in the reservoir waters during one period dropped to a mere 2 cm! *Microcystis* is widely known as a natural food of *Oreochromis* sp. (Moriarty 1973; Getachew 1987), and has produced good growth rates with tilapia grown in tanks (Colman and Edwards 1987).

## **Effects of Oxygen Conditions on Nursery Culture of Common Carp (*Cyprinus carpio*) and Hybrid Red Tilapia (*Oreochromis* sp.) Fingerlings in Cages**

### **Introduction**

New reservoirs in the tropics submerge vast quantities of organic matter which, when decomposed, can cause localized or complete depletions of dissolved oxygen (DO). In February 1985, the Saguling Reservoir flooded 5,600 ha of agricultural land, of which approximately 2,200 ha was organically-rich ricefields. Every year since, localized DO depletions have occurred in some bays of the dendritic reservoir due to localized destratification events ("turnovers").

Tolerance of low dissolved oxygen (DO) conditions is one of the primary criteria for choosing candidate species for warmwater aquaculture. It is well known that both common carp and tilapia can survive low oxygen conditions that lead to the death or sharply reduced growth rates of other, more sensitive fish species. Caged Nile tilapia (*Oreochromis niloticus*) have survived 0.7 mg DO/l for several days but died at 0.5 mg/l (Coche 1982). Common carp have been known to adapt to and grow well at 3.0 mg DO/l for extended periods and survive concentrations as low as 0.5 mg/l for several hours (Sarig 1966).

Low DO concentrations can, however, markedly affect fish growth, food consumption and assimilation efficiencies. In laboratory studies, Tsadik and Kutty (1987) found that Nile tilapia fingerlings ( $8.1 \pm 0.5$  g) reared at  $3.4 \pm 1.0$  mg DO/l (means  $\pm$  S.D.) had significant reductions in production, food assimilation and growth rates and had an increased food conversion ratio (FCR) when compared with fish reared at  $7.3 \pm 2.6$  mg DO/l. Kim and Kim (1986) found that 3.5-4.0 mg DO/l was optimal for growth of an Israeli strain of common carp in a recirculating system and that food consumption and fish growth rates decreased markedly below 3.0 mg DO/l.



Table 3. Summary of published reports on seed production for *Oreochromis niloticus* in studies using various sex ratios, broodstock densities, sizes, feed types and feeding rates in single and double net hapa hatcheries.

Hatchery system	FBD (per m <sup>2</sup> )	Sex ratio (F:Male)	Broodstock size (g)		Feeding type and rate (% Prot. & BWD)	Seed, fry or fingerlings (harvesting times)	Prod. per breeder (per day)	Ref.
			Male	Female				
SN	5.0	4:1	88.8	98.3	21% CM @ 5%	S (21 d)	4.96	Bautista et al. (1988)
	5.2	7:1	88.8	98.3	21% CM @ 5%	S (21 d)	4.24	
	5.0	10:1	88.8	98.3	21% CM @ 5%	S (21 d)	5.04	
	4.0	4:1	81.8	90.5	21% CM @ 5%	S (21 d)	5.77	
	7.0	4:1	81.8	90.5	21% CM @ 5%	S (21 d)	2.52	
	10.0	4:1	81.8	90.5	21% CM @ 5%	S (21 d)	2.17	
SN	3.0	3:1	50.0	75.0	12% RB @ 2.5%	FR (daily)	0.73	Guerrero and Garcia (1983)
	3.0	3:1	102.8	117.5	12% RB @ 2.5%	FR (daily)	1.21	
	3.0	3:1	50.0	75.0	20% CM @ 1.5%	FR (daily)	1.89	
	3.0	3:1	102.8	117.5	20% CM @ 1.5%	FR (daily)	1.08	
SN	9.0	3:1	?	?	31% CM @ 5%	FR (daily)	1.55	Otubusin (1988)
SN	3.3	2:1	46	58	35% CM @ 3%	S (10-18 d)	12.4	Hughes and Behrends (1983)
	3.3	2:1	185	58	35% CM @ 3%	S (10-18 d)	19.9	
	3.3	2:1	46 & 185	58	35% CM @ 3%	S (10-18 d)	20.4	
	6.7	2:1	46 & 185	58	35% CM @ 3%	S (10-18 d)	4.6	
	3.7	3:1	46 & 185	58	35% CM @ 3%	S (10-18 d)	4.8	
	7.5	3:1	46 & 185	58	35% CM @ 3%	S (10-18 d)	5.8	
SN	2.3	3:1	121	212	13% FM and 87% BSM @ 10%	S (21 d) BE	3.63	Abella and Batao (1989)
						S (21 d) FE	2.63	
						S (21 d) ME	2.37	
						S (21 d) NO	2.51	
DN	3.0	3:1	50.0	75.0	12% RB @ 2.5%	FR (daily)	3.05	Guerrero and Garcia (1983)
	3.0	3:1	102.8	117.5	12% RB @ 2.5%	FR (daily)	3.23	
	3.0	3:1	50.0	75.0	20% CM @ 1.5%	FR (daily)	3.05	
	3.0	3:1	102.8	117.5	20% CM @ 1.5%	FR (daily)	2.34	
	3.3	5:1	207.3-223.8	266.6-284.2	12% RB @ 2.5%	FR (daily)	1.18	
	3.3	5:1	207.3-223.8	266.6-284.2	12% RB @ 2.5%	FR (daily)	1.30	
	3.3	5:1	207.3-223.8	266.6-284.2	12% RB @ 2.5%	FR (daily)	0.92	
	3.0	3:1	207.3-223.8	266.6-284.2	12% RB @ 2.5%	FR (daily)	1.73	
	3.0	3:1	207.3-223.8	266.6-284.2	12% RB @ 2.5%	FR (daily)	1.22	
	3.0	3:1	207.3-223.8	266.6-284.2	12% RB @ 2.5%	FR (daily)	1.61	
	DN	1.5	3:1	250	250	25% CM @ 3%	FR & FI (14-32 d)	

NOTES: FBD = female broodstock density.  
 SN, DN = single net, double net hapa hatchery system.  
 CM, RB, FM, BSM = commercial feed, rice bran, fish meal, broiler starter mash.  
 S, FR, FI = seed (eggs and sac fry), fry, fingerlings.  
 BE, FE, ME, NO = male and female broodstock exchange, female exchange, male exchange, no exchange.  
 BWD = body weight per day.

Objectives of the current experiment were two-fold. From water quality monitoring of 10 stations in Saguling during 1986-1988 it was noted that some stations exhibited lethal or suboptimal DO conditions for development of cage carp and tilapia aquaculture (Soemarwoto et al., this vol.). If a representative Saguling station with poor DO conditions was monitored and these conditions were found to sufficiently slow or deter fish growth and production, further delineation of the carrying capacity of the Saguling Reservoir for cage aquaculture could be made. Secondly, it was not known how fingerlings of tilapia and common carp would perform in the chosen fish nursery system used during this study, small mesh *hapa* nets.

## Materials and Methods

Two stations were chosen which consistently exhibited, "good" and "poor" DO concentrations in the Saguling Reservoir. A "poor" station was defined where measured early morning (0500-0600 hours) (AM DOs) concentrations were consistently below 3.0 mg/l. A "good" station consistently exhibited AM DOs above 7.0 mg/l. To locate two such stations, AM DOs were measured from a boat at three of the 10 IOE/ICLARM water quality monitoring stations in the Saguling Reservoir (used by Soemarwoto et al., this vol.) with a YSI No. 57 oxygen meter at 20 cm water depth. AM DOs were measured once a month during a three-month period to find two stations for locating cages.

A factorial design consisting of two locations ("good" and "poor" AM DOs) x two species (common carp and HRT) with two replicate cages was used. The experiment was run during a 95-day period from 18 January to 23 April 1988. Cages of 11.5-m<sup>3</sup> capacity (4.0 x 2.4 x 1.2 m) were stocked at 0.5 kg/m<sup>3</sup> with  $4.2 \pm 0.8$  g common carp (*Cyprinus carpio*) and  $6.8 \pm 1.8$  g HRT (*Oreochromis* sp.) fingerlings (average weight  $\pm$  S.D.) in both "good" and "poor" stations.

Fish were fed daily a ground (1-3 mm size) commercial feed (Comfeed, Cirebon, Indonesia) of 24-26% crude protein content three times a day (morning, noon, sunset) at 3% of the fish biomass in each cage (BWD). Fish were sampled every two weeks by weighing and counting the entire fish biomass in each cage. Feeding rates were adjusted biweekly to the increased fish biomass at the time of sampling. Fish mortalities were recorded daily.

At harvest, 100 fish from each cage were individually weighed. For HRT, fish 200 g and above were considered as "harvestable size", or capable of being sold directly to local markets. Fish weighing greater than 50 g were considered "seed fish", or sufficiently large to be resold for further growout in floating net cages or running water systems.

## Results

Yield statistics are presented in Table 4, and the original data tables are shown in Appendix 1.0 on p. 161-164. Common carp fingerlings performed poorly in the cage nursery in both good and poor DOs when compared with the HRT. Common carp had significantly ( $P < 0.05$ ; paired t-tests) lower mean net production, mean weight at harvest, survival, specific growth rates (SGRs), and a higher mean food conversion ratio (FCRs) in comparison with HRT.

The effects of poor DO conditions on common carp fingerlings were recorded. Only 22% of the common carp reached "seed fish" size at the poor DO station vs. 56% at the good DO station (Fig. 3A). Mean net production and average weight at harvest in 95 days significantly ( $P < 0.05$ , paired t-test) decreased at the poor DO station. FCRs significantly increased ( $P < 0.05$ ). SGRs decreased (but not significantly) from 1.8 to 1.2 %/day. Carp mortalities were higher in cages located at the "good" DO station.

In contrast, poor DO conditions had no significant effects on the yield characteristics (net production, average weight at harvest, survival, SGRs) of HRT in cages. FCR were, however, significantly higher ( $P < 0.05$ ) during poor DO conditions. Mean fish survival did decrease from 92% to 82%, but these differences were not significant, possibly due to the few number of replicate cages used. SGRs for HRTs were excellent in both DO conditions, 3.5%/day in good

Table 4. Yield characteristics of hybrid red tilapia (*Oreochromis* sp.) (HRT) and common carp (*Cyprinus carpio*) (CARP) fingerlings in 115-m<sup>3</sup> cages (4.0 x 2.4 x 1.2 m) over a 95-day period in "good" (morning DOs < 3.0 mg/l) and "poor" (DOs > 7.0 mg/l) water quality.

Cage number and treatments	Stocking					Harvest					Number days	% Survival	Net fish production (kg/m <sup>3</sup> )	Specific G.R.* (%/day)	Feed (kg)	FCR
	kg	Ave. wt. (g)	Number (fish)	No./m <sup>3</sup>	kg/m <sup>3</sup>	kg	Ave. wt. (g)	Number (fish)	No./m <sup>3</sup>	kg/m <sup>3</sup>						
1A (HRT; GOOD)	5.7	5.0	1,144	99	0.5	156.0	144.7	1,078	94	13.6	95	94	13.1	3.5	498.0	3.3
1B (HRT; GOOD)	5.7	5.9	963	84	0.5	128.0	148.1	864	75	11.1	95	90	10.6	3.4	409.1	3.3
MEAN	5.7	5.5	1,054	92	0.5	142.0	146.4	971	84	12.3	95	92	11.9	3.5	453.6	3.3
2A (HRT; POOR)	5.7	9.2	620	54	0.5	125.0	209.4	597	52	10.9	95	96	10.4	3.3	430.0	3.6
2B (HRT; POOR)	5.7	7.1	799	69	0.5	109.0	191.2	570	50	9.5	95	71	9.0	3.5	380.7	3.7
MEAN	5.7	8.2	710	62	0.5	117.0	200.3	584	51	10.2	95	82	9.7	3.4	405.4	3.6
3A (CARP; GOOD)	5.7	4.5	1,260	10	0.5	27.6	34.1	809	70	2.4	95	64	1.9	2.1	162.2	7.4
3B (CARP; GOOD)	5.7	3.1	1,843	60	0.5	25.4	27.6	919	80	2.2	95	50	1.7	2.3	155.3	7.9
MEAN	5.7	3.8	1,552	35	0.5	26.5	30.9	864	75	2.3	95	56	1.8	2.2	158.8	7.6
4A (CARP; POOR)	5.7	4.8	1,195	04	0.5	20.5	29.2	701	61	1.8	95	59	1.3	1.9	140.7	9.5
4B (CARP; POOR)	5.7	4.6	1,245	08	0.5	17.5	22.5	778	68	1.5	95	62	1.0	1.7	119.2	10.1
MEAN	5.7	4.7	1,220	06	0.5	19.0	25.9	740	64	1.7	95	61	1.2	1.8	130.0	9.8

\*Specific G.R. (%/day) =  $\ln(W/W_0)/t \times 100$  (Brett and Groves 1979); FCR = feed conversion ratio.

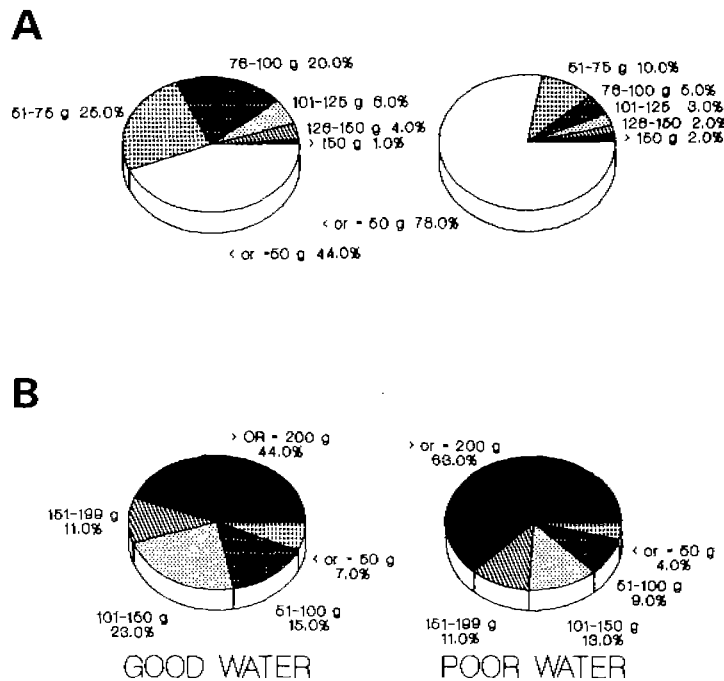

Fig. 3. Weight distribution of (A) common carp (*Cyprinus carpio*) and (B) hybrid red tilapia (*Oreochromis* sp.) at harvest for fish grown in "good" water (early morning DO > 7.0 mg/l) or "poor" water (early morning DO < 3.0 mg/l). Fish were grown for 95 days in replicate 4.0 x 2.4 x 1.2 m deep (mesh size 3-4 mm) hapa nets stocked at 0.5 kg/m<sup>3</sup> at an average weight of 5.5 ± 1.9 g.

DOs and 3.4%/day in poor. The percentage of harvestable fish, however, was higher for HRT in poor DO conditions. This was likely due to the higher fish mortalities which decreased fish densities, leading to higher individual fish growth rates (Table 4; Fig. 3B).

## Discussion

Our yield statistics indicate that the cage nursery system, fish size, feeds and feeding schedule chosen during the experiment were suitable for excellent production and growth for the HRT but inadequate for the good growth and production of common carp fingerlings.

Mean HRT SGRs at harvest ranged from 3.4 to 3.5%/day with FCRs of 3.3-3.6, at a net production ranging from 9.7 to 11.9 kg/m<sup>3</sup>. Survival was high. In good DO conditions, 44% of the HRT reached harvestable size (defined as greater than, or equal to 200 g individual weight), and 63% under poor DO conditions in 95 days. These yield statistics, when compared with those summarized by Coche (1982; his Tables 16 and 17) for intensive cage systems stocked with small fingerlings show that the HRT growth rates and FCRs obtained under both DO conditions examined here are excellent. Indeed the reported growth rates are equal to or higher than most other studies of tilapia cage culture summarized by Coche (1982). However the stocking rates used in this study are in the lower one-third of the studies reported by Coche (1982) in his Table 16.

Comparisons of this study with other authors also show the excellent performance of the HRT in nursery cages. Guerrero et al. (1987) studied tilapia fingerling cage culture in Laguna de Bay, Philippines. Tilapia fingerlings (6.4 g average weight) were stocked at 200/m<sup>2</sup> and given a 24% crude protein moist diet comprised of 25% fish meal and 75% rice bran at 5%/day. Fish survival was 75.5%, average fish growth rate 0.3 g/day and an FCR of 6.3 was obtained. Guerrero (1980) obtained low tilapia growth rates (0.3 g/day) at a slightly smaller fingerling size (2.6 g) but at a comparable stocking rate (100/m<sup>2</sup>) to that used in this experiment, and obtained a superior FCR (1.7) to that reported here.

One possible reason why we obtained good tilapia growth rates and FCRs may have been the constant, dense blooms of *Microcystis aeruginosa* that were present throughout the course of this study (Soemarwoto et al., this vol.). These algae were actively consumed by the caged HRT as shown by gut content examinations (see data in Table 6). Nile tilapia have been shown to grow on *Microcystis* in tanks at 3.7 g/m<sup>2</sup>/day with an FCR of 2.0 (Colman and Edwards 1987). To compare these figures for the 9.6 m<sup>2</sup> hapa nets used here, the tilapia growth documented by Colman and Edwards (1987) would have contributed approximately 0.4 g/day from *Microcystis* alone to the HRT in the nursery cages.

The gross primary productivity during 1988 in the Saguling Reservoir averaged 3.1 gC/m<sup>2</sup>/day (data not presented). Bautista (1987) mentioned that when the primary productivity of Laguna de Bay reached 3 gC/m<sup>2</sup>/day, supplemental feeding of tilapia in cages is stopped.

In contrast to the promising results obtained with HRT in this work, common carp fingerlings had a high mortality, exhibited poor mean net production and growth rates, and had a high mean FCR in the nursery cages, using the food and feeding schedules in this study. Only 22% (poor DO) to 56% (good DO) of the fish reached "seed" sizes. One reason for this poor performance may be the inadequate composition of the feed used for carp fingerlings. Comfeed (Cirebon, Indonesia) is reputed to have a mean crude protein content of 24-26%, crude fat 6-8%, and a metabolizable energy (ME) content of 2.6-2.8 kcal/g.

Previous studies and reviews on the nutrition of fingerling common carp in laboratory and tank studies with fish of a similar size have shown that fingerling carp require a higher protein content and ME content than used in this study. Sin (1973a, 1973b) showed that common carp of 4-7 g had an optimum protein requirement of 38.4% protein at ME of 2.70 kcal/g, and 33% protein content at ME level of 3.06 kcal/g. Jauncey (1979) mentioned that a crude protein level of 35-38% was adequate if the level of ME was between 2.70 and 3.06 kcal/g. Ogino and Saito (1970) gave a 38% protein content as optimal for common carp fingerlings. O'Grady and Spillett (1987) reared common carp fingerlings (average weight 5.3-7.1 g) in fiberglass tanks in

the laboratory and fed them a 40% protein trout diet over 63 days at 3-12.5% BWD. A feeding rate of 5% BWD gave a growth rate of 0.22 g/day and an FCR of 1.99. In Indonesia, Suhenda (1982) reared 4.4 g average weight common carp in 74 x 58 cm fiberglass tanks with feeds containing 25-45% crude protein content for 52 days, giving feed at 5% BWD five times a day. Fish performed worst on a 25% protein diet, having a 43% mortality, a growth rate of 0.06 g/day, and an FCR of 7.08. A 35% protein diet resulted in 15% mortality, a growth rate of 0.1 g/day, and an FCR of 3.09.

The most widespread common carp nursery system in Indonesia is the rice-fish culture system (Costa-Pierce, in press). Growth rates of common carp of a similar stocking size to that used in this study, when grown in ricefields, are superior to those reported herein. De la Cruz (1986) reported growth rates of 5-7 g common carp fingerlings ranging from 1.8 to 3.1 g/day with survival rates from 54 to 63% at fish stocking rates from 3,000 to 7,000 fish/ha in northern Sumatra ricefields where fish received supplemental feeds and manure fertilization. Fingerlings reached mean weights of 157-288 g in three months. One possible reason for the superior performance of common carp fingerlings in ricefields compared to the cage nursery system tested herein is that fish have access to abundant supplies of benthic worm larvae. Common carp fingerlings of the size used in this study grow well on benthic worms (Zur 1980).

## Conclusions and Recommendations

Superior HRT growth and production were obtained using 11.5-m<sup>3</sup> cages in both good and poor DO conditions. The poor DO conditions tested would not deter the widespread development of tilapia culture throughout the Saguling Reservoir. In contrast, small, fish nursery cages for common carp, using the feed and feeding schedules tested here, produced suboptimal fish survival and yields, growth rates, and FCRs when compared with the most popular and economical fish nursery system, the ricefield fish nursery system. Further work with higher quality complete diets or supplementing the food of carp in cages with natural food produced at a low cost is recommended.

### **Aquaculture of Common Carp (*Cyprinus carpio*) and Hybrid Red Tilapia (*Oreochromis* sp.) Fingerlings in Net Cages with and without Light Attractors**

#### Introduction

Modern fry and fingerling production uses natural or artificial foods alone or in combination. In particular, pond production of carp (*Cyprinus carpio*) fingerlings relies heavily upon cultured live foods. Cage methods for rearing common carp seed are less widespread and rely largely upon formulated, complete feeds that, while successful, are very expensive for small-scale farmers and, in many countries such as Indonesia, are difficult to obtain on a regular basis.

In the 1970s a nursery method using illuminated cages for rearing fish, such as coregonids that require constant supplies of zooplankton, was developed in Central European lakes (Mamcarz and Nowak 1987). The method attracts zooplankton to 50,000 fish larvae enclosed in 1.5-m diameter cylindrical cages 3.5 m deep using a submersible, waterproof, electric light (24V/60W or 24V/100 W). The depth of bulb immersion can be regulated.

The idea was modified to test the possibility of rearing common carp fingerlings and hybrid red tilapia (*Oreochromis* sp.) (HRT) in cages in the Saguling Reservoir. It was hypothesized that additional live foods such as zooplankton (with positive phototaxis) and flying insects could be attracted to the cages and become fish food. Provision of additional natural food could possibly supplement the fish diet, increase growth and production of caged fingerlings. Feeding live feed together with an artificial feed has been reported to increase the efficiency of rearing common carp larvae (Lubzens et al. 1984).

## Materials and Methods

Eight hapa nursery cages of 2.4 x 4.0 x 1.2 m size were located at Awilarangan, Saguling Reservoir. A factorial block design was set up with two treatments (attractor, no attractor) x two fish species (common carp, HRT), each with two replicates. The block design grouped the two attractor treatments together so that the effects of light would be separated. The experiment was run over an 86-day period from 2 March to 27 May 1988.

All cages were stocked with fingerling common carp and HRT at 0.5 kg/m<sup>3</sup>. Carp averaged 5.3 ± 0.2 g and HRT 11.5 ± 0.1 g (mean ± S.D.) in size. All fish received a hand ground 24-26% protein commercial feed (Comfeed, Cirebon, Indonesia) at 3% BWD. Fish were sampled biweekly by weighing and counting the entire biomass of fish in each cage. Feeding rates were adjusted biweekly to the new biomass in the cage at the time of sampling. Fish mortalities were recorded daily.

Cages with attractors were each outfitted with a pressurized kerosene lamp (Petromax, Bandung, Indonesia) containing 1.5 l of kerosene. Lamps were suspended by a wood frame so that they hung in the center of the cages approximately 50 cm above the water. Lamps were lit daily after sunset (1800-1900 hours) and extinguished at sunrise (0500-0600 hours).

At the end of the experiment, five common carp and HRT averaging 140 g and 43 g, respectively, were randomly harvested from the two treatments. Guts were removed by washing them into a small petri dish with a squirt bottle. Gut contents of each five fish were pooled separately by species. Phytoplankton and zooplankton genera were identified and counted using a binocular microscope at 4-100 x.

## Results

Light attractors had no significant effects ( $P > 0.05$ , paired t-tests) on any yield characteristic or conversion ratio (net production, survival, mean weight at harvest, SGRs, or FCRs) for HRT or common carp fingerlings during the 86-day period of this study (Table 5; see original data tables in Appendix 2.0 on p. 165-168).

Yield characteristics were significantly higher ( $P < 0.05$ , paired t-tests) for HRT fingerlings than common carp. Survival rates were, however, not significantly different ( $P > 0.05$ ). Net production of HRT fingerlings was 5.0 kg/m<sup>3</sup> (attractor) to 5.1 kg/m<sup>3</sup> (no), mean SGR 2.9%/day (with and without an attractor), survival 94% (attractor) to 95% (no), and FCR 4.0 (attractor) to 3.9 (no) (Table 5). Net production of common carp was 3.1 kg/m<sup>3</sup> (attractor) to 2.6 kg/m<sup>3</sup> (no), SGR 2.5%/day (attractor) to 2.4%/day (no), fish survival rate 91% (attractor) to 85% (no), and FCR 4.7 (attractor) to 4.8 (no) (Table 5).

Phytoplankton identified in the guts of HRT was nearly exclusively *Microcystis aeruginosa*, comprising 88% of the gut phytoplankton from fish in cages with attractors, and 94% in cages without attractors (Table 6). *M. aeruginosa* comprised 40% of the phytoplankton found in common carp guts with attractors, 36% without.

Zooplankton in the guts of common carp was dominated by *Diaptomus* (92% with attractors, 97% without). The zooplankton composition in the guts of HRT was more diverse than in common carp: eight genera (with attractors) and four (without).

## Discussion

Attractors did not have any significant effects on yield parameters or food (input) conversions of the HRT or common carp under the conditions of this study.

Attractors did, however, show some signs of possible benefits on yield of common carp fingerlings, although these differences were not significant (possibly due to the few number of cage replicates used). In one cage all common carp fingerlings survived the entire 86-day

Table 5. Yield characteristics of hybrid red tilapia (*Oreochromis sp.*) (HRT) and common carp (*Cyprinus carpio*) (CARP) fingerlings in 11.5 m<sup>3</sup> cages (4.0 x 2.4 x 1.2 m) over an 86-day period with (YES) and without (NO) simple pressurized ("Petromax") kerosene lamps as light attractors. Lamps were suspended at a height of approximately 50 cm over the water surface of the cages daily from 1800-1900 to 0500-0600 hours.

Cage number and treatments	Stocking					Harvest					Number days	% Survival	Net fish production (kg/m <sup>3</sup> )	Specific G.R. (%/day)	Feed (kg)	FCR
	kg	Ave. wt. (g)	Number (fish)	No./m <sup>3</sup>	kg/m <sup>3</sup>	kg	Ave. wt. (g)	Number (fish)	No./m <sup>3</sup>	kg/m <sup>3</sup>						
1A (HRT; NO)	5.5	11.5	479	42	0.5	67.0	147.3	455	40	5.8	86	95	5.3	3.0	234.0	3.8
1B (HRT; NO)	5.5	11.5	479	42	0.5	61.8	135.2	457	40	5.4	86	95	4.9	2.9	224.1	4.0
MEAN	5.5	11.5	479	42	0.5	64.4	141.2	456	40	5.6	86	95	5.1	2.9	229.1	3.9
2A (HRT; YES)	5.5	11.6	475	41	0.5	65.6	138.1	475	41	5.7	86	100	5.2	2.9	235.6	3.9
2B (HRT; YES)	5.5	11.6	474	41	0.5	61.4	147.6	416	36	5.3	86	88	4.9	3.0	226.3	4.0
MEAN	5.5	11.6	475	41	0.5	63.5	142.9	446	39	5.5	86	94	5.0	2.9	231.0	4.0
3A (CARP; NO)	5.5	5.5	1,003	87	0.5	36.6	43.8	835	73	3.2	86	83	2.7	2.4	143.7	4.6
3B (CARP; NO)	5.5	5.5	1,001	87	0.5	35.6	40.5	878	76	3.1	86	88	2.6	2.3	148.8	4.9
MEAN	5.5	5.5	1,002	87	0.5	36.1	42.2	857	74	3.1	86	85	2.7	2.4	146.3	4.8
4A (CARP; YES)	5.5	5.2	1,060	92	0.5	41.0	38.7	1,060	92	3.6	86	100	3.1	2.3	169.4	4.6
4B (CARP; YES)	5.5	5.2	1,065	93	0.5	42.0	47.6	883	77	3.7	86	83	3.2	2.6	167.3	4.6
MEAN	5.5	5.2	1,063	92	0.5	41.5	43.1	972	84	3.6	86	91	3.1	2.5	168.4	4.7

Table 6. Gut contents of common carp and hybrid red tilapia (HRT) at harvest from 11.5 m<sup>3</sup> nursery cages with (WA) and without (NA) light attractors. Gut contents of five fish of each species averaging 140 g and 43 g, respectively, at harvest were pooled separately by species, and phytoplankton and zooplankton identified. Mean numbers of identified organisms were divided by the five fish sampled to obtain a mean number of plankton per fish gut.

Phytoplankton	Mean numbers of plankton per fish				Zooplankton	Mean numbers of plankton per fish			
	Common carp		HRT			Common carp		HRT	
	WA	NA	WA	NA		WA	NA	WA	NA
1. Achnanthes	5	-	-	-	1. Arcella	-	-	-	5
2. Amphora	10	10	-	-	2. Asplanchna	-	-	-	5
3. Anabaena	10	5	320	65	3. Astramoeba	-	-	-	5
4. Bacillaria	75	35	400	-	4. Brachionus	-	-	15	5
5. Cylindrotheca	25	15	0	74	5. Ceriodaphnia	5	-	-	-
6. Gloeotrichia	10	-	10	-	6. Cyclops	20	15	5	15
7. Gomphonoidis	25	-	10	5	7. Diaptomus	280	445	15	45
8. Merismopedia	-	-	-	-	8. Keratella	-	-	10	-
9. Microcystis aeruginosa	175	75	7,215	14,975	9. Nauplius	-	-	-	5
10. Navicula	5	-	10	25	10. Tendipes	-	-	-	5
11. Peridinium	45	15	25	-					
12. Phormidium	5	5	100	25					
13. Sirogonium	-	-	-	10					
14. Spirogyra	35	30	5	5					
15. Staurastrum	-	5	15	30					
16. Surirella	-	10	-	-					
17. Synedra	15	-	50	50					
18. Trachelomonas	-	5	45	35					
19. Zygnema	-	-	20	10					
					Total	305	460	45	90
Total	440	210	8,225	15,975	Mean weight (g) of stomach contents	36.5	36.7	72.5	72.5

experiment, and use of the attractor slightly increased net production and survival rates for common carp fingerlings; however, these differences were not significantly different.

HRT significantly ( $P < 0.05$ ) outperformed common carp fingerlings in yield and conversion parameters measured in this experiment, possibly due to the excellent natural foods available. Gut contents of the HRT showed that *Microcystis* was the dominant food and that diverse populations of zooplankton were also available.

Better production and fish survival occurred in the common carp cages in this experiment than in the previous one conducted in good and poor DO conditions under similar feeding rates and water quality conditions (compare Tables 4 and 5). However, these improved results cannot be attributed to any beneficial effects of attractors since experimental conditions were not comparable (e.g., experiments were done at a different time of year at different sites).

Due to the costs of installing and monitoring these lamps they seem inappropriate for use in this kind of HRT or common carp fingerling production system.

## Conclusions and Recommendations

HRT and common carp fingerling production in net cages was not significantly increased by light attractors. However, further experiments to optimize light attractor operations could be useful. Studies on the modification by light of common carp fry and fingerling behavior are suggested. Limnological studies to explore the migration of lake zooplankton and the variations in zooplankton community structure under differing natural and artificial light regimes are recommended. If the zooplankton community was found to be of adequate size and quantity to feed common carp larvae, further experiments could be made with carp larval rearing using lights for fish nursery cages.

## **Utilization of Feed Mixtures by Hybrid Red Tilapia (*Oreochromis* sp.) at Different Stocking Densities in Cages in a Hypereutrophic Reservoir**

### Introduction

Tilapia can utilize a wide variety of feeds, from a diet of natural plankton and detrital materials, agricultural and domestic wastes, to complete, high protein formulated feeds. Optimal protein concentrations for the best growth of 0.5-1.0 g tilapia fingerlings and tilapias above 30 g are 35-40% and 30-35% dry diet, respectively (Jauncey and Ross 1982). However, such high protein fish feeds, especially those containing fish meal, are often prohibitively expensive, especially in developing countries. Many of the natural food organisms that tilapia can utilize are high in protein. With the flexible, changing and omnivorous feeding habits of many of the tilapias and economic factors in mind, Coche (1977) recommended that supplemental feeds for tilapias grown in eutrophic waters should contain a high percentage of carbohydrate, i.e., be mainly an energy rather than a protein source.

In many cases "optimal economic" protein levels for fish feeds may be lower than "biologically optimal" protein levels in aquaculture (De Silva 1989). Indeed Jauncey and Ross (1982) point out that a feed protein level of only 24% still produces 80% of the maximum growth rate for 0.5-10 g *Oreochromis mossambicus* fingerlings. The great nutritional flexibility of the tilapias concomitantly increases our flexibility in the provision of lower cost alternatives or feed mixtures, especially where fish are grown in eutrophic environments.

In this study two sizes of hybrid red tilapia (HRT) (*Oreochromis* sp.) fingerlings were grown with various mixtures of a commercial feed and a fine rice bran in cages located in a hypereutrophic tropical reservoir. One experiment used fine rice bran and commercial feed mixtures at a single fish stocking density while the other tested effects of feed combinations



using three different fish stocking densities. The objective was to examine how reduction of protein content of a commercial feed and substitution with a low-cost, carbohydrate-rich agricultural byproduct (rice bran) would interact with stocking densities and the large quantities of available natural food in the hypereutrophic reservoir to affect fish yield and conversion characteristics.

## Materials and Methods

Two simple factorial design experiments compared feed combinations and stocking densities of HRT fingerlings. The first experiment was conducted in 10 cages measuring 2.4 x 4.0 x 1.2 m deep of 2-3 mm mesh size. Five different feed combinations were fed to fingerlings at a single stocking density in duplicate cages (5 feeds x 1 density x 2 replicates).

Feeding treatments were combinations of a commercial feed (CF) of 24-26% crude protein content and fine rice bran (RB) as follows: 100CF/0RB, 75CF/25RB, 50CF/50RB, 25CF/75RB, 0CF/100RB. Control was 100% CF and no RB (100CF/0RB). Fish were stocked on 21 July at 4.8-4.9 g average weight at 0.5 kg/m<sup>3</sup> density and batch harvested 119 days later on 17 October 1988. Fish were fed initially at 12% BWD three times a day (morning, noon, sunset) as recommended by Melard and Philippart (1980). Every two weeks, the total biomass of fish in each cage was weighed and feeding rates were readjusted 2.5% BWD downwards for the new calculated fish biomass until the next sampling. When a feeding rate of 3% BWD was reached, this feeding rate was kept constant until the end of the experiment.

The second experiment was a factorial design of three fish stocking densities of three CF/RB combinations conducted in duplicate cages (3 feeds x 3 densities x 2 replicates) using large HRT for stocking ( $93.0 \pm 9.0$  g [mean  $\pm$  SD]). Eighteen 1 x 1 x 1 m cages of 1.5" mesh were stocked with HRT at densities of 2.0, 6.0 and 10.0 kg/m<sup>3</sup>. Treatments comprised fish stocked at the three densities and fed diet combinations of: 100CF/0RB, 75CF/25RB, 50CF/50RB. Controls were all three fish densities fed 100% CF. In the second experiment, fish were fed 3% BWD throughout the experiment. Fish were sampled as described for the first experiment.

All experimental feeds were formulated as dry pellets, 2-3 mm diameter. Feed batches were made weekly. The commercial feed and rice bran were individually ground to a fine powder and sieved through a 2-3 mm mesh screen. These two ingredients were then completely and uniformly mixed by hand with water and repelleted using a commercial food mixer. Feeds were sundried and stored in dry conditions until used.

The crude protein concentrations of the feeds were calculated by assuming a mean protein level of 25% for the commercial feed and 12% for the fine rice bran. Protein efficiency ratios (PER = kg weight gain/kg protein intake) were calculated for each feed formulation.

## Results

Mean yield statistics for experiment 1 are detailed in Table 7 (original data tables in Appendix 3.0, p. 169-177) and experiment 2 in Table 8 (data in Appendix 4.0, p. 178-182).

In experiment 1, with 0.5 kg/m<sup>3</sup> stocking density and five feed mixtures, decreases in the mean individual weight at harvest, net fish production and SGRs occurred with increasing incorporation of rice bran into commercial feed (Fig. 4). FCRs increased with increasing amounts of rice bran incorporated into the diets. Significant linear regressions of calculated per cent protein (assuming CF protein = 25%; RB = 12%) in the feed combinations, using mean weight at harvest ( $r = 0.95$ ;  $P < 0.05$ ), net production ( $r = 0.95$ ;  $P < 0.05$ ), per cent survival ( $r = 0.94$ ;  $P < 0.05$ ), and FCRs ( $r = -0.88$ ;  $P < 0.05$ ) as dependent variables were calculated. A regression of the calculated per cent protein content of the feeds and SGRs was, however, not significant ( $r = 0.87$ ;  $P > 0.05$ ).

A nonparametric Kruskal-Wallis one-way ANOVA (Zar 1984) showed that treatments did not have any significant effect on mean fish weight at harvest, per cent survival, net production,

Table 7. Yield characteristics of fingerling hybrid red tilapia (*Oreochromis* sp.) in 11.5 m<sup>3</sup> cages (4.0 x 2.4 x 1.2 m) stocked at 0.5 kg/m<sup>3</sup> and fed five different mixtures of a commercial (24-26% crude protein) feed (C) and fine rice bran (12% crude protein) (RB). The experiment was conducted over 119 days, with fish fed daily on a sliding scale from 12% BWD to 3% BWD adjusted 2.5% downwards every 2 weeks at the time of fish sampling.

Treatments	Stocking					Harvest					Number days	% Survival	Net fish production (kg/m <sup>3</sup> )	Specific G.R. (%/day)	Feed (kg)	FCR
	kg	Ave. wt. (g)	Number (fish)	No./m <sup>3</sup>	kg/m <sup>3</sup>	kg	Ave. wt. (g)	Number (fish)	No./m <sup>3</sup>	kg/m <sup>3</sup>						
100C/ORB	5.5	4.8	1,140	99	0.5	51.9	52.8	983	85	4.5	119	86	4.0	2.0	172.7	3.7
100C/ORB	5.5	4.9	1,132	98	0.5	56.6	58.5	967	84	4.9	119	85	4.4	2.1	171.0	3.3
MEAN	5.5	4.8	1,136	99	0.5	54.3	55.7	975	85	4.7	119	86	4.2	2.1	171.9	3.5
75C/25RB	5.5	4.9	1,120	97	0.5	46.4	48.2	963	84	4.0	119	86	3.6	1.9	165.4	4.0
75C/25RB	5.5	4.9	1,118	97	0.5	47.8	49.9	957	83	4.2	119	86	3.7	1.9	168.3	4.0
MEAN	5.5	4.9	1,119	97	0.5	47.1	49.1	960	83	4.1	119	86	3.6	1.9	166.9	4.0
50C/50RB	5.5	4.8	1,140	99	0.5	44.5	46.4	960	83	3.9	119	84	3.4	1.9	157.3	4.0
50C/50RB	5.5	4.9	1,121	97	0.5	48.0	51.4	934	81	4.2	119	83	3.7	2.0	163.2	3.8
MEAN	5.5	4.9	1,131	98	0.5	46.3	48.9	947	82	4.0	119	84	3.5	1.9	160.3	3.9
25C/75RB	5.5	4.9	1,119	97	0.5	45.3	47.6	952	83	3.9	119	85	3.5	1.9	161.0	3.9
25C/75RB	5.5	4.8	1,142	99	0.5	45.0	47.4	950	83	3.9	119	83	3.4	1.9	160.6	4.1
MEAN	5.5	4.9	1,131	98	0.5	45.2	47.5	951	83	3.9	119	84	3.4	1.9	160.8	4.1
100RB/0C	5.5	4.9	1,120	97	0.5	39.5	44.1	895	78	3.4	119	80	3.0	1.8	137.6	4.0
100RB/0C	5.5	4.8	1,147	100	0.5	40.5	42.3	957	83	3.5	119	83	3.0	1.8	153.5	4.4
MEAN	5.5	4.9	1,134	99	0.5	40.0	43.2	926	81	3.5	119	82	3.0	1.8	145.6	4.2

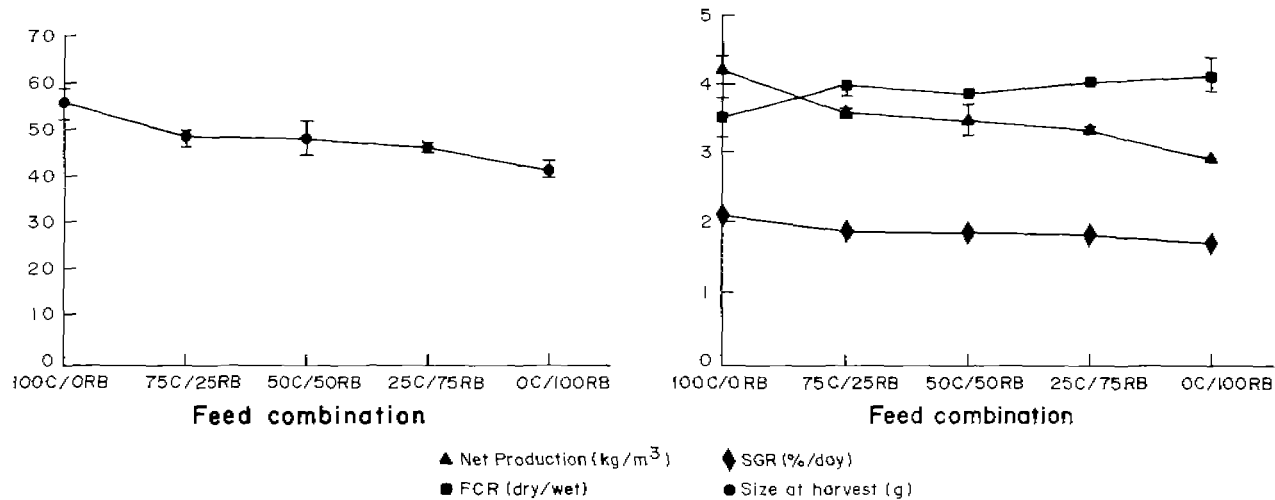

Fig. 4a and 4b. Yield characteristics for hybrid red tilapia (*Oreochromis* spp.) fed five feed combinations of rice bran (RB) and a 24-26% protein commercial feed (C). Fish were stocked at 4.8-4.9 g average weight into 4.0 x 2.4 x 1.2 m *hapa* nets (mesh size 3-4 mm) at 0.5 kg/m<sup>3</sup> density and batch harvested 119 days later. Bars are ranges from the two replicate nets. Where no bars are shown the ranges are the same as the mean or are encompassed by the point.

SGRs and FCRs ( $P > 0.05$ ). Nonparametric analyses of variances (ANOVAs) were used because the data collected violated a number of assumptions for the use of parametric ANOVAs; namely, small number of replicates, non-normality of the data, and heterogeneity of variances over time due to fish growth (Sokal and Rohlf 1969). If more cage replicates were present, however, it is likely that all treatments (feed combinations) would have had significant effects on the above-mentioned yield parameters and FCRs; a parametric ANOVA applied to the ranks obtained in the Kruskal-Wallis test for 4 degrees of freedom showed significant treatment effects on yield parameters and FCRs at the 95% level of significance.

In the second experiment, the largest mean fish size at harvest was observed at a 2.0 kg/m<sup>3</sup> stocking density for all three feed combinations (Fig. 5A). Increasing stocking density to 6.0 kg/m<sup>3</sup> decreased the mean fish size at harvest at all stocking densities; however, fish sizes at 6.0 and 10.0 kg/m<sup>3</sup> densities given 100% CF or 75%CF/25%RB were not significantly different (paired t-test,  $P > 0.05$ ) (Fig. 5A). Mean fish size at harvest for 10 kg/m<sup>3</sup> was significantly higher ( $P < 0.05$ ) for fish fed 100% CF compared with a 50/50 feed combination (Fig. 5A). Highest fish growth rates were observed at the lowest stocking density and SGRs were not significantly different for the three feed combinations at this density ( $P > 0.05$ ) (Fig. 5B). Fish growth rates decreased at 6 and 10 kg/m<sup>3</sup> stocking densities for the 75CF/25RB and 50CF/50RB diets but remained significantly higher ( $P < 0.05$ ) in the 100C/0RB feed combination than the other two densities, and constant with increasing fish densities in the fish cages fed 100C/0RB.

Net fish production increased with stocking density for all treatments (Fig. 5C). Fish production for the 100C/0RB combination at 10 kg/m<sup>3</sup> was significantly higher than all other stocking and feed combinations (which did not differ) (paired t-tests,  $P > 0.05$ ). FCRs increased

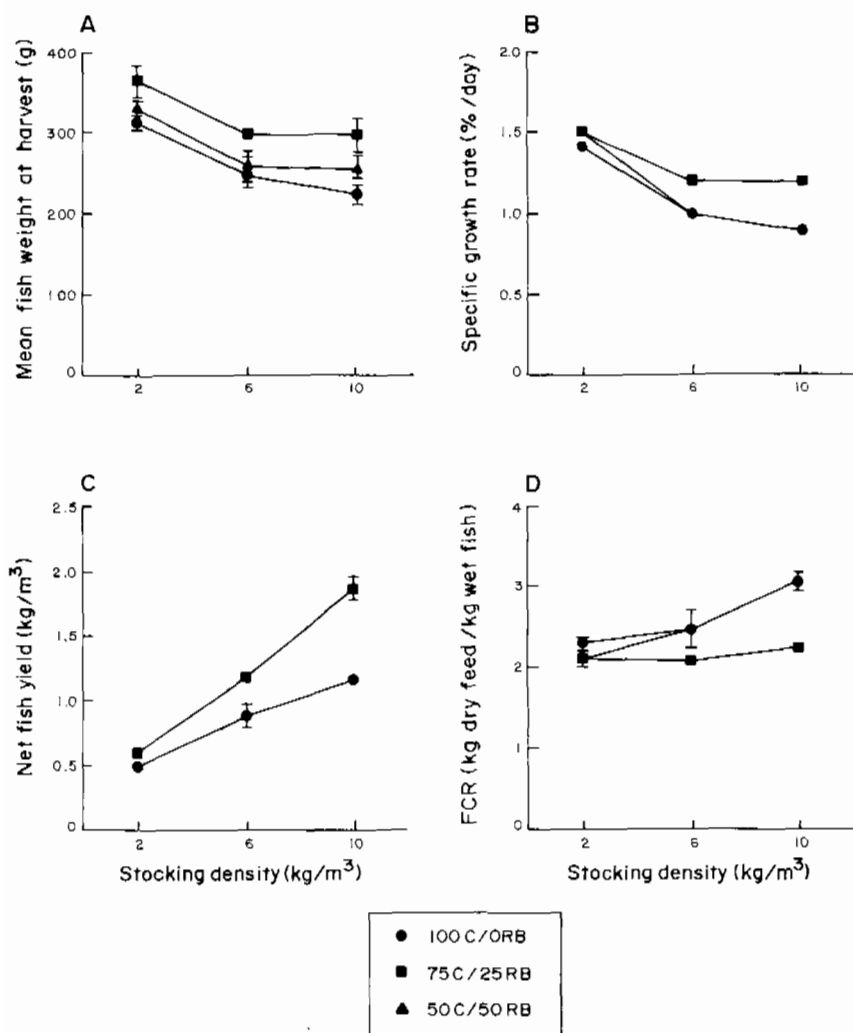

Fig. 5. Yield characteristics for hybrid red tilapia (*Oreochromis* sp.) grown at three stocking densities with three different feed combinations of rice bran and 24-26% protein commercial feed (RB and C, respectively). Fish were stocked at a mean weight of  $93.0 \pm 9.0$  g (mean  $\pm$  S.D.) into replicate 1 x 1 x 1 m cages of 1.5" mesh size with hybrid red tilapia at three densities and batch harvested 96 days later. (A) weight at harvest; (B) net fish yield (kg/m<sup>3</sup>); (C) specific growth rates. Points for 75C/25RB and 50C/50RB are identical. (D) food conversion ratio (FCR). Error bars as in Fig. 4. Points are mean of two replicates.

as stocking density increased for each feed combination tested (Fig. 5D). The FCR at 10 kg/m<sup>3</sup> was significantly ( $P < 0.05$ ) lower than the other two treatments, but no differences were observed between the 6.0 and 10.0 kg/m<sup>3</sup> densities fed 75% CF/25% RB and 50% CF/ 25% RB, or all densities when stocked at 2.0 kg/m<sup>3</sup> (Fig. 5D).

A multiple regression of calculated protein content of the feed combinations, using yield parameters and FCRs as dependent variables, all showed a highly significant relationships. Interestingly density explained more of the variance in the multiple regression (e.g., had higher partial  $r^2$ ) than protein content of the diet for every yield parameter tested. Mean fish weight at harvest had a multiple regression of  $r = 0.93$  ( $P = 0.003$ ; partial  $r^2$  for protein content = 0.71, for density = 0.79; adjusted  $r^2 = 0.81$ ); net production multiple  $r = 0.94$  ( $P = 0.002$ ; partial  $r^2$  for protein content = 0.52, for density = 0.87; adjusted  $r^2 = 0.84$ ); SGRs multiple  $r = 0.90$  ( $P = 0.006$ ; partial  $r^2$  for protein = 0.41, for density = 0.79; adjusted  $r^2 = 0.75$ ); FCRs multiple  $r = 0.88$  ( $P = 0.009$ ; partial  $r^2$  for protein = 0.55, for density = 0.71; adjusted  $r^2 = 0.88$ ).

A linear regression of PERs and calculated per cent protein in mixed diets at 0.5 kg/m<sup>3</sup> stocking density showed that PERs significantly decreased with increasing protein content ( $r = -0.96$ ;  $P < 0.05$ ) (Fig. 6). PERs were, however, unchanged when diets containing 21.7 and 25% protein content were used. PERs decreased with increasing stocking rates and per cent protein in feed combinations at 2.0 kg/m<sup>3</sup> stocking density (Fig. 7). A multiple regression of PERs with calculated protein and stocking densities was significant at  $P < 0.05$  ( $r = 0.84$ ). However, the significance of the multiple regression relationship was only due to a significant relationship between stocking density and PERs. The partial  $r^2$  between protein and PERs (0.28) was not significant ( $P > 0.05$ ), while the partial  $r^2$  was 0.68 for density. PERs were highly significant ( $P = 0.01$ ).

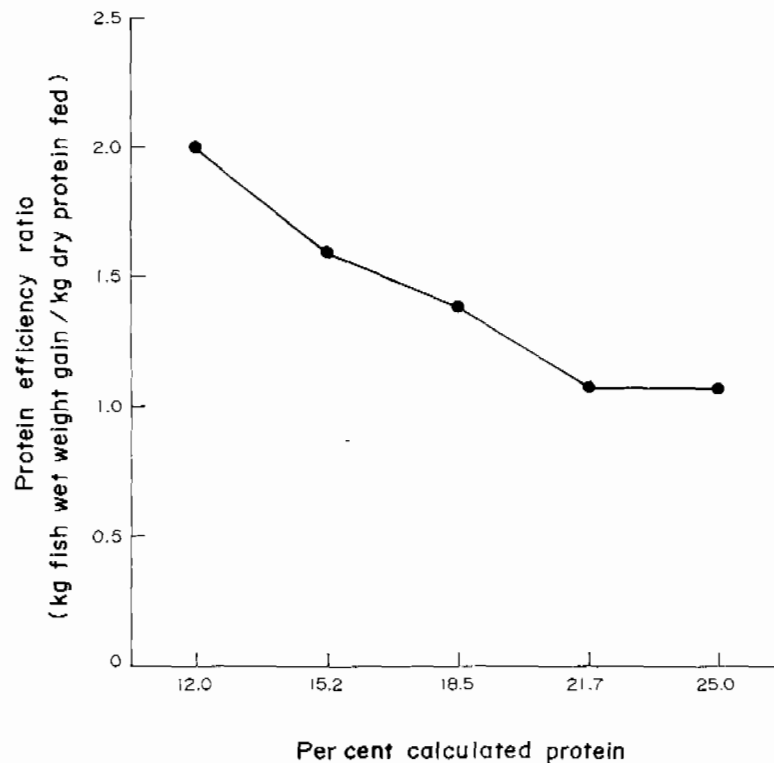

Fig. 6. Relationship between protein efficiency ratio (PER = kg weight gain/kg protein fed) and calculated per cent protein content of 5 feed combinations (RB = rice bran; C = 24-26% protein commercial feed). Diets were fed to fingerling hybrid red tilapia (*Oreochromis* sp.) whose yield characteristics are shown in Fig. 4. A linear regression of PERs and calculated protein content is significant at  $P < 0.05$  ( $r = 0.96$ ; Df = 3).

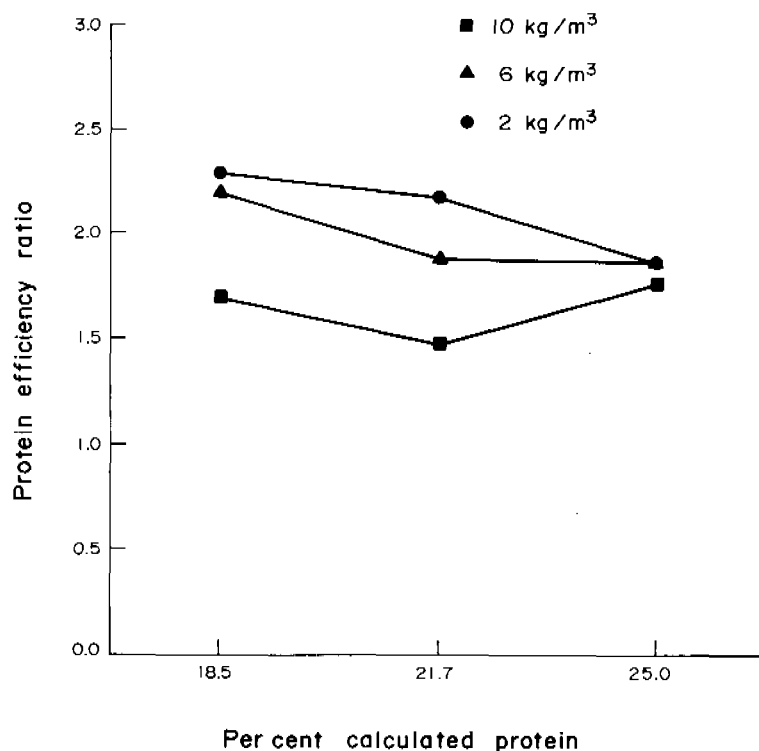

Fig. 7. Relationship between PER and calculated per cent protein content of three feed combinations for three stocking rates of  $93.0 \pm 9.0$  g (mean weight  $\pm$  S.D. at stocking) hybrid red tilapia (*Oreochromis* sp.). Yield characteristics for these fish are shown in Fig. 5. A multiple regression of calculated protein content in feeds and stocking density was significant at  $P < 0.05$  ( $r = -0.84$ ), but individual analysis showed this was due to a significant relationship of density and PERs ( $r = -0.78$ ;  $P < 0.05$ ), not calculated protein content ( $r = -0.33$ ;  $P > 0.05$ ).

## Discussion

Increasing the percentage of rice bran incorporated into fish diets containing 24-26% crude protein increased dietary carbohydrate and decreased (from a mean of 25%) the calculated protein content of feeds tested. We assumed our rice bran to have a mean protein content of 12% (B. Sudiarto, pers. comm.). Carbohydrate could possibly serve as an energy source to balance protein coming from the abundant natural foods from eutrophic waters and utilized by tilapia. In this study, incorporation of rice bran to increase carbohydrate and available energy for two sizes of HRT in cages located in a hypereutrophic reservoir caused observable decreases in fish mean size at harvest, growth, net production and increased FCRs at 6.0 and 10.0 kg/m<sup>3</sup>. However, no significant differences were observed in any yield parameter when fish were stocked at 2.0 kg/m<sup>3</sup>. HRT stocking density of 2.0 kg/m<sup>3</sup> could be used with a 50CF/50RB feed mixture to produce fish over 300 g in just 96 days under these trophic conditions.

While rice bran contains a significant amount of protein, increased incorporation of rice bran in diets tested decreased the calculated amount of protein in the feeds to 15.2 (75% RB), 18.5 (50% RB) and 21.7% (25% RB), and the cost of the feed. Growth and net yields were lower but not significantly, while significantly increased protein efficiency ratios (PERs) occurred (Fig. 5). It is hypothesized that increased dietary carbohydrate had a "protein sparing effect", or increased utilization of the abundant, high protein natural foods or an effect resulting from a combination of both factors occurred. PERs increased from a mean of 1.1 for 25% protein diets to 2.0 for the 12% protein (100% rice bran) diet at 0.5 kg/m<sup>3</sup> stocking density. Similar results were obtained in the second experiment at 2.0 kg/m<sup>3</sup> stocking density but higher PERs were noted with higher protein feeds at 10 kg/m<sup>3</sup>. It is likely stocking densities of HRT greater than 6.0 kg/m<sup>3</sup> are too high for the natural food concentrations present to take advantage of any sparing effect or increased utilization of natural foods due to increased dietary carbohydrate (Fig. 7).

Coche (1982) summarized results of semi-intensive cage culture where tilapia have been fed a wide variety of locally available ingredients and commercial feeds. Cages receiving a 25% commercial feed in this study (100CF/0RB) show similar mean SGRs, 2.0-2.1%/day, to those observed by Campbell (1978) in Cote d'Ivoire (1.7-2.1%/day) for similar stocking densities (71-186 fish/m<sup>3</sup> Cote d'Ivoire vs. 98-99 here, see Table 7), culture periods (78-131 days vs. 119

days here), and cage sizes (6-20 m<sup>3</sup> vs. 11.5 m<sup>3</sup> here). The slightly higher SGRs reported here may be due to the smaller size fish stocked (here 4.8-4.9 g vs. 22-36 g). Campbell (1978) however recorded lower FCRs (1.9-2.4 vs. 3.3-3.7 here).

Guerrero (1979) reported that commercial, low-cost cage culture of Nile tilapia (*Oreochromis niloticus*) in lakes in the Philippines relying on natural foods only with occasional additions of rice bran could produce 100-150 g fish in 6 months from 5-10 g stocking size. This would mean SGRs of 1.3-1.9%/day. Guerrero (1980) formulated diets as a dry mash containing 65-75% fine rice bran and 25-35% fish meal and fed these to caged Nile tilapia (*Oreochromis niloticus*) at 5% BWD in four portions per day, daily for 8 weeks. Fish were stocked at 0.3 kg/m<sup>3</sup> density in 4 m<sup>3</sup> cages. Net production ranged from 0.9 to 1.4 kg/m<sup>3</sup>, SGRs ranged from 3.2 to 3.6%/day, and FCRs from 1.7 to 1.9. These results are superior to those obtained here: SGRs, 1.8-2.1%/day and FCRs 3.5-4.2 (Table 7). However, the higher SGRs reported by Guerrero (1980) were likely because Guerrero used a much lower stocking density than used here (0.25-0.27 vs. 0.5 kg/m<sup>3</sup>).

Guerrero et al. (1987) reported feeding rice bran (12% crude protein content) at 5% BWD twice daily to 5.5 g Nile tilapia stocked in 2 x 2 x 1 m cages in the eutrophic lake Laguna de Bay (Secchi disk = 10.5-30.0 cm) at 0.3 kg/m<sup>3</sup> for 60 days. A calculated SGR of 3.5%/day was obtained at 81% survival and an FCR of 4.7. Very comparable figures were obtained here for feeding 100% RB (Table 7): mean SGR 1.8%/day, survival 82%, mean FCR 4.2. The higher growth rates could be due to the lower stocking densities used by Guerrero et al. (1987) and/or differences in plankton production between the two environments. Indeed the experiments of Guerrero et al. (1987) were reported to have taken place during the productive season (May to October).

## Conclusions and Recommendations

Using 100% rice bran, a cheap, readily available agricultural by-product in Indonesia, farmers could, as demonstrated in this study, rear HRT from 4.8-4.9 g to 39.5-40.5 g in 119 days. This fish size is sufficiently large to restock net cage units of a 1.5" (4 cm) mesh net size for further growout to commercial market size. While the effects of adding increasing amounts of rice bran to commercial feeds decreased HRT fingerling growth, production and increased FCRs, these observed decreases would not deter the development of nursery systems using the combinations detailed in this study. Yield figures for HRT obtained here using lower cost feed combinations are comparable or higher to those reported for tilapias elsewhere.

Feed combinations of rice bran and commercial feeds in the hypereutrophic Saguling Reservoir could significantly improve the economics of tilapia cage aquaculture where feed is the major operating cost.

In addition, it has been found that poor villagers in West Java will readily buy and consume as "fish crackers" small 40-50 g tilapia. Therefore the tilapia nursery system described here using 0.5 kg/m<sup>3</sup> and feeding fish 100% rice bran could also serve as a low-cost growout system for local community protein production.

## Floating Net Cage Culture in the Saguling Reservoir: Replication of Existing, and Construction of New Cage Models

### Introduction

In Indonesia research on freshwater floating net cage culture (FNCC) for the culture for common carp (*Cyprinus carpio*) was initiated in 1972-1974 by the Research Institute for Inland Fisheries (RIIF, Bogor, Indonesia) (Sarnita and Yoenoes 1979; Zulkifli and Djajadiredja 1979; Djajadiredja et al. 1982). Commercial FNCC operations first appeared in West Java on a small

Table 8. Yield characteristics of hybrid red tilapia (*Oreochromis* sp.) (HRT) in duplicate (A and B) 1 m<sup>3</sup> (1 x 1 x 1 m) growout cages of 1.5" mesh over a 96-day experimental period. HRT were stocked at three densities (10, 6 and 2 kg/m<sup>3</sup>) and fed daily three feed mixtures of a commercial feed (24-26% crude protein) (C) and a fine rice bran (12% crude protein) (RB) at 3% BWD throughout the experiment.

Cage number and treatments	Stocking					Harvest					Number days	% Survival	Net fish production (kg/m <sup>3</sup> )	Specific G.R. (%/day)	Feed (kg)	FCR
	kg	Ave. wt. (g)	Number (fish)	No./m <sup>3</sup>	kg/m <sup>3</sup>	kg	Ave. wt. (g)	Number (fish)	No./m <sup>3</sup>	kg/m <sup>3</sup>						
10A (100C/ORB)	10.0	99.0	101	9	0.9	33.0	326.7	101	9	2.9	96	100	2.0	1.2	51.4	2.2
10B (100C/ORB)	10.0	91.7	109	9	0.9	30.5	279.8	109	9	2.7	96	100	1.8	1.2	47.4	2.3
MEAN	10.0	95.4	105	9	0.9	31.6	303.3	105	9	2.8	96	100	1.9	1.2	49.4	2.3
6A (100C/ORB)	6.0	95.2	63	5	0.5	19.3	306.3	63	5	1.7	96	100	1.2	1.2	27.3	2.1
6B (100C/ORB)	6.0	92.3	65	6	0.5	19.5	300.0	65	6	1.7	96	100	1.2	1.2	28.9	2.1
MEAN	6.0	93.8	64	6	0.5	19.4	303.2	64	6	1.7	96	100	1.2	1.2	28.1	2.1
2A (100C/ORB)	2.0	80.0	25	2	0.2	8.7	348.0	25	2	0.8	96	100	0.6	1.5	14.6	2.2
2B (100C/ORB)	2.0	90.9	22	2	0.2	8.5	386.4	22	2	0.7	96	100	0.6	1.5	13.2	2.0
MEAN	2.0	85.5	24	2	0.2	8.6	367.2	24	2	0.7	96	100	0.6	1.5	13.9	2.1
10A (75C/25RB)	10.0	111.1	90	8	0.9	24.0	266.7	90	8	2.1	96	100	1.2	0.9	41.4	3.0
10B (75C/25RB)	10.0	111.1	90	8	0.9	22.5	250.0	90	8	2.0	96	100	1.1	0.8	39.5	3.2
MEAN	10.0	111.1	90	8	0.9	23.3	258.3	90	8	2.0	96	100	1.2	0.9	40.5	3.1
6A (75C/25RB)	6.0	95.2	63	5	0.5	17.5	277.8	63	5	1.5	96	100	1.0	1.1	26.2	2.3
6B (75C/25RB)	6.0	96.8	62	5	0.5	15.0	241.9	62	5	1.3	96	100	0.8	1.0	24.5	2.7
MEAN	6.0	96.0	63	5	0.5	16.3	259.9	63	5	1.4	96	100	0.9	1.0	25.4	2.5
2A (75C/25RB)	2.0	76.9	26	2	0.2	8.2	315.4	26	2	0.7	96	100	0.5	1.5	13.3	2.1
2B (75C/25RB)	2.0	83.3	24	2	0.2	8.3	345.8	24	2	0.7	96	100	0.5	1.5	12.6	2.0
MEAN	2.0	80.1	25	2	0.2	8.3	330.6	25	2	0.7	96	100	0.5	1.5	13.0	2.1
10A (50C/50RB)	10.0	97.1	103	9	0.9	23.0	223.3	103	9	2.0	96	100	1.1	0.9	41.4	3.2
10B (50C/50RB)	10.0	98.0	102	9	0.9	24.0	235.3	102	9	2.1	96	100	1.2	0.9	42.4	3.0
MEAN	10.0	97.6	103	9	0.9	23.5	229.3	103	9	2.0	96	100	1.2	0.9	41.9	3.1
6A (50C/50RB)	6.0	93.8	64	6	0.5	15.3	239.1	64	6	1.3	96	100	0.8	1.0	24.9	2.7
6B (50C/50RB)	6.0	90.9	66	6	0.5	17.2	260.6	66	6	1.5	96	100	1.0	1.1	26.4	2.4
MEAN	6.0	92.3	65	6	0.5	16.3	249.8	65	6	1.4	96	100	0.9	1.0	25.7	2.5
2A (50C/50RB)	2.0	80.0	25	2	0.2	7.8	312.0	25	2	0.7	96	100	0.5	1.4	12.8	2.2
2B (50C/50RB)	2.0	90.9	22	2	0.2	7.0	318.2	22	2	0.6	96	100	0.4	1.3	11.5	2.3
MEAN	2.0	85.5	24	2	0.2	7.4	315.1	24	2	0.6	96	100	0.5	1.4	12.2	2.3

scale in the Cigombong and Ciburuy lakes in 1982. Since that time accelerated research, development, extension and training of farmers in FNCC have been conducted by a number of government and university groups in West Java.

As a result of sustained efforts to popularize and improve the system, FNCC has grown dramatically in lakes and reservoirs in the Bogor-Bandung region of West Java. By the end of 1988, FNCC had spread to more than ten water bodies and was producing over 3,000 t/year of common carp, the bulk of which was sold live to markets in Bandung-Jakarta corridor (Kusnadi and Lampe, this vol.). Fish production from reservoir cage aquaculture now equals approximately 20% of the total inland fish produced in the Bandung regency, an urban metropolis of nearly 3 million persons (Sutandar et al. 1990).

While FNCC has become a rapid commercial success, it is still a very new form of aquaculture in West Java, and lacks a strong research base. The objective of this study was to replicate the current technology existing in the Saguling Reservoir (Costa-Pierce et al. 1988a; Sutandar et al. 1990) by constructing an FNCC field research station, and then to perform controlled yield trials using realistic stocking, feeding and management practices. In addition construction of new, lower cost FNCC models were to be developed. From the results, we hoped to address some timely economic and management issues, especially stock and feeding practices, that might have potential for further increasing the financial margin in the existing reservoir FNCC.

## Materials and Methods

An informal survey of over thirty FNCC farmers was conducted in July-October 1986. After examining the data, it was decided to replicate the existing FNCC technology on station to analyze the system firsthand, document problems as they arose, and then delineate research objectives. Some further guidelines for our replication of existing FNCC technology were the available published information on the system.

A field station to conduct FNCC research was constructed in November-December 1986 at Cangkorah, Saguling Reservoir. Cages were constructed with simple, low-cost bamboo rafts and recycled oil drums for flotation (see photo section). At the center of a 9 x 9 m raft with bamboo catwalks was located a 7 x 7 m net, 2.5 m deep. Nets were 1.5" (4 cm) mesh. Twelve 7 x 7 m net cages were constructed initially at Cangkorah.

From 25 December 1986 to 5 January 1987 four such 7 x 7 x 2.5 m FNCC units were stocked with common carp (*Cyprinus carpio*) weighing a total of 300.0 kg, equalling a fish stocking density of 2.4 kg/m<sup>3</sup>. Fish were 70.7 ± 2.8 g (mean ± S.D.) in size. The experiment was run for about 88 days (range, 82 to 90 days). Fish were fed a commercial feed of 24-26% crude protein (Comfeed, Cirebon, Indonesia) at 3% BWD in equal portions given three times a day (morning, noon, sunset). Fish were sampled biweekly by taking a sample of 10% of the total biomass in each net and individually weighing each fish. Feeding rates were adjusted at each sampling. Fish mortalities were recorded daily.

A study tour to the Philippines was organized in 1987 and 1989 to document low-cost methods of tilapia aquaculture and cage construction (Costa-Pierce et al. 1988b, 1989a). In addition an ICLARM consultant designed a net cage using only bamboo for flotation (dela Cruz 1987). Methods of constructing low-cost models of floating net cages using bamboo and banana trunks for flotation were tested in 1988-1989 in the Saguling Reservoir.

## Results and Discussion

Results of our informal survey indicated that farming practices were very uniform. One reason was that nearly all farmers were very new to the business, having invested monies obtained from land compensation deals with PLN (Indonesian State Electric Company), and initiated cage aquaculture shortly after the reservoir was inundated in early 1985. Nearly all



farmers we talked to in 1986 had received training or information from government or university programs. This extension information recommended 7 x 7 x 2.5 m cage units be stocked with 300 kg of 50-100 g common carp, fish fed a 24-26% crude protein feed (basically chicken broiler feed) at 3% BWD in three equal feedings, and fish grown until attaining a mean size of approximately 0.5 kg (3-4 months) (Rifai 1985). These stocking, feeding, management recommendations and cage unit sizes were followed almost universally in the Saguling Reservoir at the time of our informal interviews in 1986.

Previous data for FNCC of common carp in lakes and reservoirs in Indonesia are summarized in Table 9. Previous workers stocked common carp at a range of 60 to 136 g at 0.7-4.0 kg/m<sup>3</sup>, and in 90-180 days obtained a mean harvest of 928 kg (range, 66-2,631 kg) of 408 g fish (range, 224-783 g) in 121 days (range, 90-180 days). Fish mortalities were low in all cases except for the study of Sarnita and Yoenoës (1979) who reported turtle predation on fish in net cages in Jatiluhur Reservoir. The highest yield of 2,631 kg was obtained by Jangkaru (1986b) in Lake Toba, Sumatra, in 180 days at a fish stocking density of 3.1 kg/m<sup>3</sup> of 59.6 g fish. Jangkaru (1986b) reported an FCR of 2.2 with an SGR of 1.2%/day (Table 9).

Yield statistics for the current experiment are shown in Table 10 (original data tables in Appendix 5.0, p. 183-184). Mean ( $\pm$  S.D.) production was 1,070  $\pm$  131 kg of mean weight 259.2 ( $\pm$  31.0) g fish ( $n = 4$  cages) in 88 days (range, 82-90 days). Mean fish survival was 97% ( $\pm$  3%) (range, 92-99%). Mean FCR was 2.0 ( $\pm$  0.2). The mean SGR was 1.5 ( $\pm$  0.2) %/day (range, 1.2-1.7%/day). These data are very comparable to the mean data presented in Table 9.

Examination of the data accumulated at fish sampling, however, shows that our fish growth rates were extremely variable (see individual cage data in Appendix 5.0, p. 183-184). One possible reason may be overstocking of the net cage. Examination of the data summarized in Table 10 does not, however, span a wide enough range of stocking densities to allow any meaningful analyses of this possibility.

Two new models of floating net cages were designed and built (Fig. 8A and 8B), and construction costs for these documented and compared to farmer's construction costs (Table 11). The first new model developed (model A) substituted 1.4 mm wire fasteners for wood to attach a decreased number of oil drums to a bamboo raft and had a total cost of Rp 274,500. In this model a narrow diameter bamboo, called "temen" was used; 26 pieces are normally required to construct the raft. The second model (model B) cost Rp 177,500 and used six pieces of "gombong" bamboo (a sturdy, wide-diameter bamboo) to float the raft, and oil palm fiber rope instead of wire to lash it together (Fig. 8A). A modification of model B used banana trunks to assist in flotation (Fig. 8B) (see photo section).

## Conclusions and Recommendations

Replication of existing FNCC technology on-station confirmed its fundamental productivity in the Saguling Reservoir. A mean yield of 1,070 kg of 259.2 g fish was obtained in just 88 days at a mean FCR of 2.0 with 97% fish survival. A survey of published experiments in FNCC in Indonesia showed a mean yield of 928 kg of 408 g fish in 121 days with a mean FCR of 1.6 and 93% survival. Mean SGRs were 1.5%/day in our experiment and 1.3%/day in a survey of 27 cage experiments from 1979 to 1986.

There was large variation in growth rates, which could be due to overstocking. An SGR of 2.3%/day was reported by Sarnita and Yoenoës (1979) at 0.7 kg/m<sup>3</sup>. Further experiments to investigate fish stocking rates are recommended.

Fish consumed a mean amount of 1,496.1 kg of feed. This is likely to be the highest variable cost of production in FNCC. Experiments in feed formulation, frequency of feeding and presentation to optimize feeding economics are recommended.

All new cage models using bamboo and banana trunks were enthusiastically and rapidly adopted by farmers. The addition of banana trunks to the bamboo raft was said to give extra stability and flotation. Both cage models are now an important part of FNCC in the Saguling Reservoir.

Table 9. Summary of published reports detailing the performance and yield characteristics of common carp (*Cyprinus carpio*) grown in floating net cage culture in reservoirs and lakes in Indonesia.

Author (Year)	No. cages	Cage size (m) <sup>1</sup>	Volume (m <sup>3</sup> )	Stocking			Harvest			% Survival	Specific G.R. (%/day)	Feed (kg)	FCR	Number days	
				kg	Density (kg/m <sup>3</sup> )	Number	Ave. wt. (g)	kg	Number						Ave. wt. (g)
Djajadiredja et al. (1982)	10	7 X 7 X 2	98	300.0	3.1	4,098	73.2	939.9	4,007	234.6	2	0.8	1,589.0	2.5	150
Jangkaru (1986b)	1	7 X 7 X 2	98	300.0	3.1	5,036	59.6	2,631.3	5,027	523.4	0	1.2	5,195.0	2.2	180
Rilif (1983)	1	7 X 7 X 2	98	290.5	2.4	3,191	72.2	892.4	3,191	279.7	0	1.2	1,511.5	2.3	112
	1	7 X 7 X 2	98	294.0	3.0	2,159	136.2	994.6	2,128	467.4	1	1.1	1,824.2	2.6	112
	1	7 X 7 X 2	98	294.0	3.0	3,317	88.6	1,113.5	3,256	342.0	2	1.2	1,926.0	2.4	112
	1	7 X 7 X 2	98	294.0	3.0	4,933	59.6	1,106.1	4,933	224.2	0	1.2	1,899.1	2.3	112
Sarnita and Yoenoos (1979)	1	9 X 9 X 1.5	121.5	86.0	0.7	858	100.2	392.2	501	782.8	42	2.3	382.7	1.2	90
Zulkifli and Djajadiredja (1979) <sup>2</sup>	3	3 X 3 X 1.5	13.5	18.0	1.3	135	130.0	66.1	135	489.6	0	1.0	NR	NR	126
	3	3 X 3 X 1.5	13.5	36.0	2.6	279	130.0	144.0	279	516.1	0	1.1	NR	NR	126
	3	3 X 3 X 1.5	13.5	54.0	4.0	414	130.0	256.5	414	620.0	0	1.2	NR	NR	126
Rifai (1985)	2	7 X 7 X 2	98	300.0	3.1	3,000	100.0	1,668.7	?	?	?	1.9	2,308.2	1.7	90
Total	27														
Mean			77.1	200.6	2.6	2,492.7	98.2	927.8	3,292	407.7	7	1.3	1,512.3	1.6	121
Standard deviation			39.5	117.5	0.9	1,757.8	28.4	714.6	1,482	185.9	14	0.4	1,438.3	1.0	25
Maximum			121.5	300.0	4.0	5,036.0	136.2	2,631.3	5,027	782.8	42	2.3	5,195.0	2.6	180
Minimum			13.5	18.0	0.7	135.0	59.6	66.1	501	224.2	0	0.8	0.0	0.0	90

<sup>1</sup> Last figure is cage depth.<sup>2</sup> Data for survival were not provided so 100% has been assumed.

NR = not reported.

Table 10. Yield characteristics of common carp (*Cyprinus carpio*) in 122.5 m<sup>3</sup> (7 x 7 x 2.5 m) floating net cages stocked at 2.4 kg/m<sup>3</sup> (300 kg/cage) and fed daily at 3% BWD with a commercial feed of 24-26% crude protein. Stocking and management followed the practices used by the majority of farmers in the cage culture industry documented in Bongas, Saguling Reservoir.

Cage number	Stocking					Harvest					% Survival	Net fish production (kg/m <sup>3</sup> )	Specific G.R. (%/day)	Feed (kg)	FCR	
	kg	Ave. wt. (g)	Number (fish)	No./m <sup>3</sup>	kg/m <sup>3</sup>	kg	Ave. wt. (g)	Number (fish)	No./m <sup>3</sup>	kg/m <sup>3</sup>						Number days
1	300.0	71.6	4,190	34	2.4	905.0	217.4	4,162	34	7.4	90	99	4.9	1.2	1,328.2	2.2
2	300.0	68.1	4,407	36	2.4	1,225.0	283.8	4,316	35	10.0	82	98	7.6	1.7	1,536.5	1.7
3	300.0	68.2	4,397	36	2.4	982.0	241.8	4,062	33	8.0	90	92	5.6	1.4	1,441.9	2.1
4	300.0	74.8	4,009	33	2.4	1,168.0	293.6	3,978	32	9.5	89	99	7.1	1.5	1,677.8	1.9
MEAN	300.0	70.7	4,251	35	2.4	1,070.0	259.2	4,130	34	8.7	88	97	6.3	1.5	1,496.1	2.0
MAX		74.8	4,407	36		1,225.0	293.6	4,316	35	10.0	90	99	7.6	1.7	1,677.8	2.2
MIN		68.1	4,009	33		905.0	217.4	3,978	32	7.4	82	92	4.9	1.2	1,328.2	1.7
S.D.		2.8	164	1		131.0	31.0	126	1	1.1		3	1.1	0.2	128.2	0.2

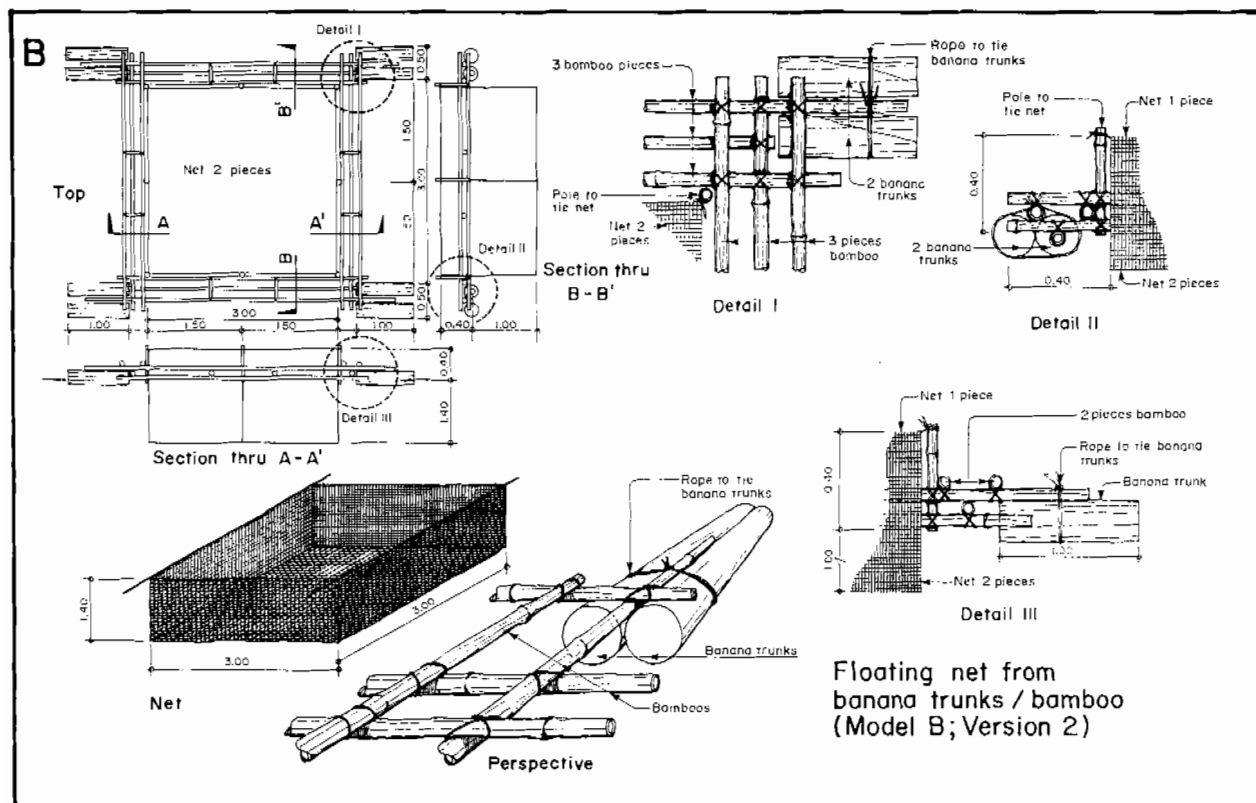
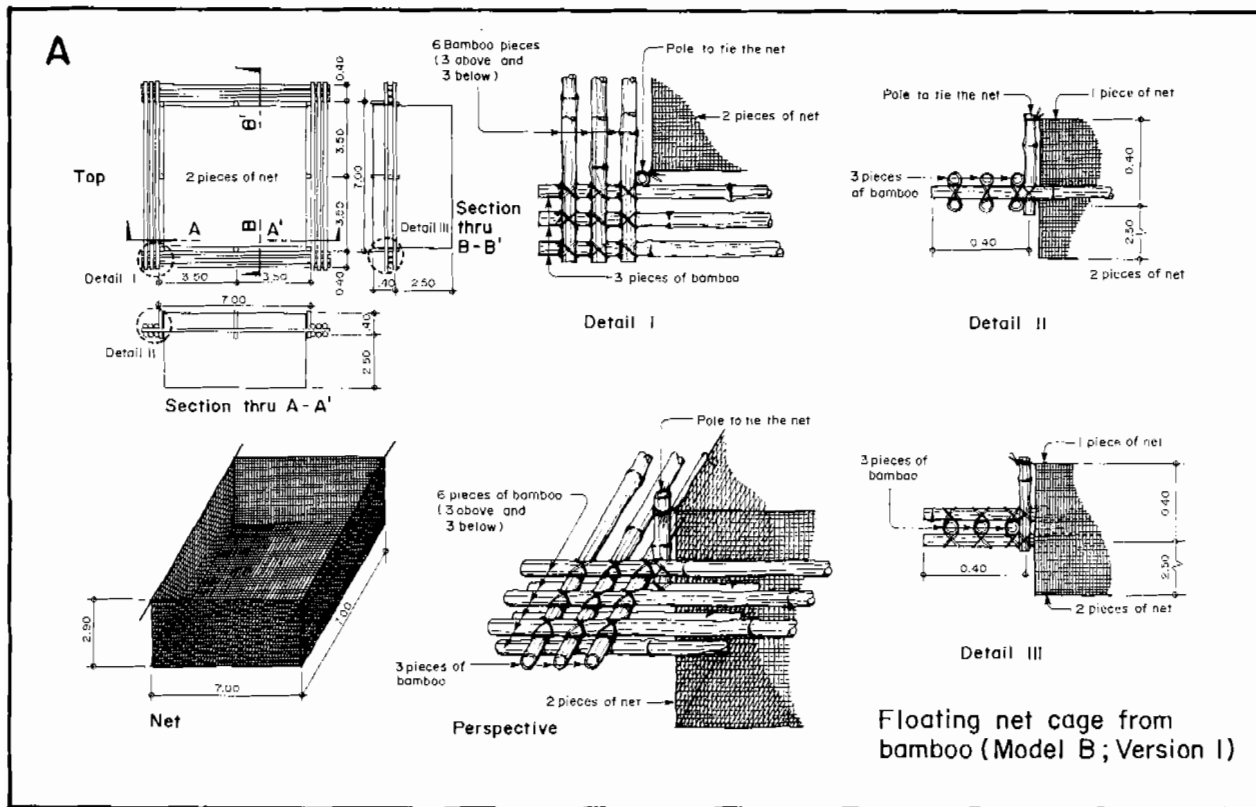

Fig. 8. Construction diagrams for floating net cages constructed from bamboo (Fig. 8A), or from bamboo and banana trunks for flotation (Fig. 8B). Total cost of construction of a single 7.0 x 7.0 m cage was Rp 177,500 (see notes in Table 11).

Table 11. Total construction costs (in Indonesian Rupiah in March 1989) for a single 7.0 x 7.0 x 2.5 m floating net cage using different materials, new construction techniques and flotation to decrease costs, provide greater stability and durability. Costs for the new cages are compared with the costs for constructing a cage in the existing cage industry.

Materials or labor	Model A	Rp	Model B <sup>1</sup>	Rp	Farmer's cage	Rp
Oil drums	8 @ Rp 8,000	64,000	-	-	12 @ Rp 8,000	96,000
Fasteners	5 kg 1.4 mm wire @ Rp 1,500	7,500	2 rolls oil palm fiber rope @ Rp 4,000	8,000	30 pieces 4 x 4 m x 300 cm wood @ Rp 1,500;	49,200
Wood	-	-	-	-	3 kg, 7 cm nails @ Rp 1,400	
Net	12.5 kg @ Rp 10,000	125,000	as "A"	125,000	25 kg @ Rp 10,000	250,000
Bamboo	26 pieces @ Rp 1,750	45,500	6 pieces @ Rp 3,000	18,000	as "A"	45,500
Plastic rope	2 kg @ Rp 4,250	8,500	as "A"	8,500	as "A"	8,500
Cans	4 @ Rp 1,500	6,000	as "A"	6,000	as "A"	6,000
Labor	9 hrs. @ Rp 2,000	18,000	4 hrs. @ Rp 2,000	8,000	18 hrs. @ Rp 2,000	36,000
Total construction cost (Rp)		274,500		177,500		491,200

<sup>1</sup>Model B has two versions to replace oil drums for flotation: (1) bamboo, (2) bamboo/banana trunk flotation (see Figs. 8a and 8b). The model developed with bamboo/banana trunks (Version 2) had a total net depth of 1.8 m, while the bamboo (Version 1) had a total net depth of 2.9 m. Although the net cost was obviously lower for Version 2, an equal cost was assumed here.

## Experiments with Stocking Density and Polyculture of Common Carp (*Cyprinus carpio*) and Hybrid Red Tilapia (*Oreochromis* sp.) in Floating Net Cage Culture

### Introduction

Previous experiments with the culture of common carp (*Cyprinus carpio*) in floating net cage culture (FNCC) in Indonesia showed that an optimal stocking density for highest fish growth and production was 6.0 kg/m<sup>3</sup> (Zulkifli and Djajadiredja 1979). Our initial experiments at 2.4 kg/m<sup>3</sup> stocking density in the Saguling Reservoir showed that fish growth rates were very variable throughout an 82-90 day culture period, and sometimes actually decreased, possibly due to competition for food and space (see Appendix 5.0, p. 183-184). This and the high operating costs for fish seed and feed that accompany intensification of FNCC (see Rusydi and Lampe, this vol.) suggested further studies on stocking density. Whereas the biologically optimal stocking density might be as high as 6.0 kg/m<sup>3</sup>, few FNCC farmers in the Saguling Reservoir would be able to afford to buy the amount of feed and seed required for this level of intensification. Lower fish densities might give higher individual growth rates and a shorter culture period to market size. Fish seed and feed costs would also be substantially reduced at lower densities.

In addition, the possible benefits of polyculture in FNCC has been little tested. It was felt that common carp and hybrid red tilapia (HRT) (*Oreochromis* sp.) might make an excellent, synergistic polyculture combination in fish cages.

### Materials and Methods

Four FNCC experiments were accomplished in the Saguling Reservoir; three testing stocking densities and one on polyculture. All experiments except for the first one used floating net cages 7 x 7 x 2.5 m deep.

The first experiment tested net cages of 9 x 9 x 2.5 m at low fish stocking densities of 0.2-0.5 kg/m<sup>3</sup>. One cage was operated "on station" by the project over an 87-day period from 27 January to 24 April 1987 and the two other cages were managed by fish farmer cooperators over 59-day (4 July-1 September 1987), and 82-day periods (1 June-1 September 1987). Controls for these systems were results obtained from the four 7 x 7 x 2.5 nets stocked at 2.4 kg/m<sup>3</sup> and operated as described previously.

Fish were stocked at mean weights of 63.5 g at 0.5 kg/m<sup>3</sup> "on station", and at 89.7 g and 172.5 g at 0.2 and 0.4 kg/m<sup>3</sup> in the "on farm" experiments, respectively. All fish were fed with a commercial feed of 24-26% crude protein content (Comfeed, Cirebon, Indonesia) at 3% BWD in three equal feedings (morning, noon, and sunset). Fish were sampled every two weeks by taking a sample of 10% of the fish in the cage, individually weighing and counting them. Feeding rates were readjusted to the fish biomass at the time of sampling. Fish mortalities were recorded daily.

The second experiment tested stocking densities of 0.5 kg/m<sup>3</sup> vs. 1.0 kg/m<sup>3</sup> for common carp fingerlings averaging ( $\pm$  S.D.) 95.5  $\pm$  8.5 g and 83.3  $\pm$  3.4 g, respectively, in duplicate cages. Fish were fed, sampled, and managed as described above.

A third experiment tested stocking densities of 0.5, 1.0 and 2.4 kg/m<sup>3</sup> for common carp fingerlings of 50.4  $\pm$  3.8 g average size in duplicate cages. Fish were fed, sampled and managed as described for the above experiments.

The fourth experiment tested polycultures of HRT and common carp in duplicate cages vs. a single cage containing a common carp monoculture. Both polyculture and monoculture cages were stocked at 0.5 kg/m<sup>3</sup>. HRT of a mean weight of 44.7  $\pm$  3.2 g comprised 0.3 kg/m<sup>3</sup> of the 0.5 kg/m<sup>3</sup> total stocking density in the polyculture cages. Common carp were stocked at a mean weight of 179.5  $\pm$  5.8 g in the polyculture cages and 48.7 g in the single monoculture cage.

## Results

In the first experiment, decreasing stocking density below 2.4 kg/m<sup>3</sup> had positive effects on average fish weight at harvest, SGRs, and decreased FCRs when compared to values reported previously (compare data in Tables 10 and 12) (original data in Appendixes 5.0 and 6.0, p. 185-186). No statistical comparisons can be made since only one cage of each stocking density was used, and the experiment at 2.4 kg/m<sup>3</sup> was conducted at a different time and place. However, as a guideline for further work it was noted that mean SGRs were highest (2.6%/day) at a 0.5 kg/m<sup>3</sup> density. A low FCR of 1.1 was achieved at 0.5 kg/m<sup>3</sup>, and FCRs averaged 1.4 in the three cages (Table 12).

In the second experiment, no significant differences ( $P > 0.05$ , paired t-tests) were noted in any of the yield parameters (average weight, survival, SGRs) or FCRs obtained at harvest except for net yield ( $P < 0.05$ ); however, the latter is a meaningless statistic as far as this experiment is concerned due to the different initial stocking densities used (Table 13; original data in Appendix 7.0, p. 186-188). It was notable, however, that some improvement in mean fish size at harvest was noted at 0.5 kg/m<sup>3</sup> stocking density (353.1 vs. 323.9 g).

Analysis of results in the third experiment (Table 14; original data in Appendix 8.0, p. 188-191) showed that no significant differences occurred between any yield parameter or FCRs at any stocking density ( $P > 0.05$ , Kruskal-Wallis one-way ANOVA). However, this could have been a function of the few number of replicates since parametric, paired t-tests indicated significant differences would likely have been obtained with a larger number of replicates. Mean fish weight at harvest was, however, significantly ( $P < 0.05$ ) lower for the 2.4 kg/m<sup>3</sup> density than for either of the two lower densities, and FCRs significantly higher ( $P < 0.05$ ).

Polyculture showed some potential in decreasing the total FCR and improving total fish yields. Monoculture of common carp gave a net fish production of 1.0 kg/m<sup>3</sup> of 153.3 g average weight at harvest with 94% survival in 84 days, while polyculture of HRT and common carp gave a net production of 1.9 kg/m<sup>3</sup> in 82 days (Table 15; data in Appendix 9.0, p. 191-193). Common carp had a mean SGR of 1.4%/day in monoculture and 0.8-1.0%/day in polyculture. Total FCRs were 2.2 in monoculture and 1.9-2.0 in polyculture. All these figures are not strictly comparable and statistical analyses cannot be performed, however, due to the problem of vastly different mean fish sizes at stocking.

## Discussion

It is well known that fish stocking density in cages can have significant impact on the mean individual fish weight at harvest, growth rate, survival rate, and FCR (Teng and Chua 1978; Chua and Teng 1979). What is less studied is the reported phenomena of high fish growth rates and fish production attained at a specific, or optimal, stocking density because of a fish "grouping effect". Teng and Chua (1978) observed this effect with the estuarine grouper (*Epinephelus salmoides*) where fish stocked at 15-30 fish/m<sup>3</sup> did not show significantly better growth than fish stocked at a higher density of 60/m<sup>3</sup>.

In the present studies, no significant differences between fish growth and FCRs occurred in two experiments with common carp stocked at densities between 0.5 and 1.0 kg/m<sup>3</sup>. Mortalities of fish were low in all treatments. Net fish production, SGR, and mean fish size at harvest were lower, and FCRs increased at 2.4 kg/m<sup>3</sup> stocking density, but these differences were not significant. The lack of statistical significance is probably due to the few replicates used in the studies. This choice was made because of pressure on the project team to produce results quickly that could be immediately transferable to the farmers with few "extrapolation factors". This is an unfortunate "fact of life" in research for rapid development.

Zulkifli and Djajadiredja (1979) recommended stocking common carp in FNCC at 6.0 kg/m<sup>3</sup> on the basis of a fish yield of 256.5 kg of 620 g fish, and a SGR of 1.2%/day, over a 126-day growth period using 130 g common carp at stocking. Fish were fed a 32% protein diet to satiation each day. In our studies a mean SGR of 1.4%/day at 0.5kg/m<sup>3</sup>, 1.3%/day for 1.0 kg/m<sup>3</sup>

Table 12. Results of farmer participatory research with a larger net cage size (9 x 9 x 2.5 m) and lower fish stocking rates (0.2-0.5 kg/m<sup>3</sup>). Cage 1 was operated on station over an 87-day period while the two other cages were operated by fish farmer cooperators over 59- and 82-day periods. Fish were fed daily a commercial feed (24-26% crude protein) at 3% BWD throughout the experiment.

Cage	Stocking					Harvest					Number days	% Survival	Net fish production (kg/m <sup>3</sup> )	Specific G.R. (%/day)	Feed (kg)	FCR
	kg	Ave. wt. (g)	Number (fish)	No./m <sup>3</sup>	kg/m <sup>3</sup>	kg	Ave. wt. (g)	Number (fish)	No./m <sup>3</sup>	kg/m <sup>3</sup>						
1	100.0	63.5	1,576	8	0.5	975.6	633.5	1,540	8	4.8	87	98	4.3	2.6	969.2	1.1
2	87.3	172.5	506	2	0.4	244.0	490.0	498	2	1.2	59	98	0.8	1.8	235.8	1.5
3	40.0	89.7	446	2	0.2	186.5	418.2	446	2	0.9	82	100	0.7	1.9	218.2	1.5
MEAN	75.8	108.6	843	4	0.4	468.7	513.9	828	4	2.3	76	99	1.9	2.1	474.4	1.4
MAX	100.0	172.5	1,576	8	0.5	975.6	633.5	1,540	8	4.8	87	100	4.3	2.6	969.2	1.5
MIN	40.0	63.5	446	2	0.2	186.5	418.2	446	2	0.9	59	98	0.7	1.8	218.2	1.1
S.D.	25.8	46.5	519	3	0.1	359.2	89.5	504	2	1.8	12	1	1.7	0.4	350.0	0.2

Table 13. Yield characteristics of common carp (*Cyprinus carpio*) in 122.5 m<sup>3</sup> (7 x 7 x 2.5 m) floating net cages stocked at 0.5 and 1.0 kg/m<sup>3</sup> over a 95-day experimental period. Fish were fed daily a commercial feed (24-26% crude protein) at 3% BWD throughout the experiment.

Cage number and treatments	Stocking					Harvest					Number days	% Survival	Net fish production (kg/m <sup>3</sup> )	Specific G.R. (%/day)	Feed (kg)	FCR
	kg	Ave. wt. (g)	Number (fish)	No./m <sup>3</sup>	kg/m <sup>3</sup>	kg	Ave. wt. (g)	Number (fish)	No./m <sup>3</sup>	kg/m <sup>3</sup>						
1 (0.5)	61.5	101.5	606	5	0.5	219.0	369.9	592	5	1.8	95	98	1.3	1.4	357.2	2.3
2 (0.5)	61.5	89.5	687	6	0.5	227.0	336.3	675	6	1.9	95	98	1.4	1.4	382.5	2.3
MEAN	61.5	95.5	647	5	0.5	223.0	353.1	634	5	1.8	95	98	1.3	1.4	369.9	2.3
3 (1.0)	61.5	85.7	718	12	1.0	255.0	357.6	713	12	4.2	95	99	3.2	1.5	420.8	2.2
4 (1.0)	61.5	80.9	760	12	1.0	220.0	290.2	758	12	3.6	95	100	2.6	1.3	327.9	2.1
MEAN	61.5	83.3	739	12	1.0	237.5	323.9	736	12	3.9	95	100	2.9	1.4	374.4	2.1

Table 14. Yield characteristics of common carp (*Cyprinus carpio*) in 122.5 m<sup>3</sup> (7 x 7 x 2.5 m) floating net cages stocked at 0.5, 1.0 and 2.4 kg/m<sup>3</sup> over an 84-day experimental period. Fish were fed a commercial feed (24-26% crude protein) at 3% BWD throughout the experiment.

Cage number and treatments	Stocking					Harvest					Number days	% Survival	Net fish production (kg/m <sup>3</sup> )	Specific G.R. (%/day)	Feed (kg)	FCR
	kg	Ave. wt. (g)	Number (fish)	No./m <sup>3</sup>	kg/m <sup>3</sup>	kg	Ave. wt. (g)	Number (fish)	No./m <sup>3</sup>	kg/m <sup>3</sup>						
1 (0.5)	61.5	52.3	1,177	10	0.5	180.0	162.3	1,109	9	1.5	84	94	1.0	1.3	265.7	2.2
2 (0.5)	61.5	45.6	1,348	11	0.5	182.0	145.4	1,252	10	1.5	84	93	1.0	1.4	271.6	2.3
3 (1.0)	122.5	51.3	2,390	20	1.0	395.0	172.1	2,295	19	3.2	84	96	2.2	1.4	528.5	1.9
4 (1.0)	122.5	55.9	2,193	18	1.0	340.0	159.6	2,130	17	2.8	84	97	1.8	1.2	506.0	2.3
5 (2.4)	294.0	50.6	5,808	47	2.4	720.0	127.1	5,664	46	5.9	84	98	3.5	1.1	1,136.9	2.7
6 (2.4)	294.0	46.7	6,293	51	2.4	757.0	123.2	6,144	50	6.2	84	98	3.8	1.2	1,239.1	2.7
MEAN	(0.5)	50.4	1,263	10	0.5	181.0	153.8	1,181	10	1.5	84	94	1.0	1.4	268.7	2.2
	(1.0)		2,292	19	1.0	367.5	165.9	2,213	18	3.0	84	97	2.0	1.3	517.3	2.1
	(2.4)		6,051	49	2.4	738.5	125.2	5,904	48	6.0	84	98	3.6	1.1	1,188.0	2.7

Table 15. Yield characteristics of hybrid red tilapia (*Oreochromis sp.*) (HRT) and common carp (*Cyprinus carpio*) (CARP) in two polyculture cages (122.5 m<sup>3</sup>, 7 x 7 x 2.5 m) compared with common carp in monoculture in a single cage. Total stocking densities in all cages was 0.5 kg/m<sup>3</sup>. Fish were fed a commercial feed (24-26% crude protein) at 3% BWD throughout the experiment.

Cage numbers and treatments	Stocking					Harvest					Number days	% Survival	Net fish production (kg/m <sup>3</sup> )	Specific G.R. (%/day)	Feed (kg)	FCR
	kg	Ave. wt. (g)	Number (fish)	No./m <sup>3</sup>	kg/m <sup>3</sup>	kg	Ave. wt. (g)	Number (fish)	No./m <sup>3</sup>	kg/m <sup>3</sup>						
1A (HRT)	38.0	47.0	809	7	0.3	250.0	312.5	800	7	2.0	82	99	1.7	2.3	352.5	1.7
1B (CARP)	23.5	183.6	128	1	0.2	43.0	344.0	125	1	0.4	82	98	0.2	0.8	87.9	4.5
Total 1	61.5	115.3	937	8	0.5	293.0	328.3	925	8	2.4	82	99	1.9	1.3	440.4	1.9
2A (HRT)	38.0	42.4	896	7	0.3	249.0	317.2	785	6	2.0	82	88	1.7	2.5	376.2	1.8
2B (CARP)	23.5	175.4	134	1	0.2	49.0	408.3	120	1	0.4	82	90	0.2	1.0	90.0	3.5
Total 2	61.5	108.9	1,030	8	0.5	298.0	362.8	905	7	2.4	82	88	1.9	1.5	466.2	2.0
3 (CARP)	61.5	48.7	1,263	10	0.5	181.0	153.3	1,181	10	1.5	84	94	1.0	1.4	268.7	2.2



and 1.1%/day at 2.4 kg/m<sup>3</sup> were obtained in the third experiment, and 1.4%/day at 0.5 and 1.0 kg/m<sup>3</sup> in the second experiment. The first experiment with much lower stocking rates had higher SGRs (range, 1.8-2.6%/day).

It is possible that the optimal stocking density for common carp in FNCC was not encompassed by the range used here. From the farmer's viewpoint, the choice of stocking densities of fish, however, must also include consideration of economic factors. An optimal economic stocking rate is likely to be lower than the optimal biological stocking rate. For this FNCC system, mean fish size at harvest, FCR, and more importantly, the reductions in operating costs for seed and feed that will be realized, a "good" stocking density appears to be 1.0 kg/m<sup>3</sup>. Examination of the data in Tables 13 and 14 indicates that stocking at 1.0 kg/m<sup>3</sup> saves substantial quantities of feed and seed fish and produces larger fish so that continuous sale can be made at a quicker turnaround time; and still gives high total yields. A stocking density of 1.0 kg/m<sup>3</sup> is less than half that currently used in the Saguling Reservoir FNCC.

Few studies have been conducted with polyculture in cages. Sarnita and Yoenoes (1979) tested polyculture of common carp and Nile tilapia (*Oreochromis niloticus*) in 9 x 9 x 1.5 m floating net cages in the Jatiluhur Reservoir. They stocked 45.0 g tilapia and 50.2 g common carp at 0.4 kg/m<sup>3</sup>. Their results, were, however, confounded by high loss of fish: 46% of the common carp and 16% of the tilapia, due to holes in the nets made by turtles and iguanas. However, they reported that common carp had a mean SGR of 2.7%/day in polyculture compared with 1.7%/day in monoculture. The SGR of the tilapia in polyculture was 2.1%/day. In our polyculture, common carp had lower mean SGRs of 0.8-1.0%/day in polyculture compared with 1.4%/day in monoculture. HRT in polyculture had mean SGRs of 2.3-2.5%/day. These differences could have been caused by many factors including differences in environment and in species stocking ratios.

Sarnita and Yoenoes (1979) had a 66% tilapia/34% carp biomass stocking ratio, while in our study a 50%/50% ratio was used. Dela Cruz (1979) reported that a similar polyculture to ours was attempted in Taiwan in 144 m<sup>3</sup> cages over 110 days, but at a much higher stocking rate (1.7 kg/m<sup>3</sup> for tilapia and 3.2 kg/m<sup>3</sup> for carp), and a 65% carp/35% tilapia stocking ratio. The reported SGR for the Nile tilapia was 2.2%/day, comparable to that shown in this study, but the SGR of common carp in polyculture (2.3%/day) was higher than the tilapia. The SGRs of common carp in our polyculture (0.8-1.0%/day) were less than half the rate reported by dela Cruz (1979).

## Conclusions and Recommendations

A stocking density of common carp of 1.0 kg/m<sup>3</sup> is recommended for FNCC in the Saguling Reservoir. This is a 42% decrease in the stocking density used to date. The reasons for this lower density are that better individual fish growth and a lowered FCR will likely result, while sufficiently high total fish production will still be obtained. Decreasing stocking density will lower operating costs for seed and feed. This will be particularly appropriate for the main target group of the project (the poorer, displaced residents) as it will lower their operating costs and improve cash flows, since individual fish growth rates will likely be improved and fish ready for sale more quickly.

Polyculture of HRT and common carp in FNCC promises higher total fish yields and total growth rates than common carp monoculture. Apparently the HRT utilize feed resources of no use to the carp. Further work, however, is needed to define optimal species stocking ratios and culture periods.

## Experiments in Feeding Strategies for Common Carp (*Cyprinus carpio* L.) in Floating Net Cage Culture

### Introduction

Feed costs in floating net cage culture (FNCC) in the Saguling Reservoir exceed 50% of the total variable costs of production (Rusydi and Lampe, this vol.). Reduction of feed costs is usually attempted by searching for lower cost alternative protein sources to fish meal, the highest cost ingredient in nearly all feed formulations for cultured fish. Soybean meal, for example, has been shown to have potential for replacing a large quantity of fish meal in diets for common carp (Viola et al. 1981). However, this strategy may not lead to lower feed prices. For small-scale farmers, small feed mills using alternative protein sources are usually not economically viable because of the large initial capital investment required. Many promising, home-made or alternative fish feeds can be more expensive than those available commercially.

While research and development efforts to improve and lower the costs of feeds for fish must continue, it may be possible to realize more immediate savings by improving feeding techniques and fish stock management. Comparatively little research has been done on this.

### Materials and Methods

Two experiments testing two different feeding patterns were conducted for common carp in floating net cages. Both experiments used 7 x 7 x 2.5 m deep cages. The first experiment compared feeding fish every other day at 3% BWD with daily feeding at 3% BWD ("skipping experiment"). The second experiment compared daily satiation feeding with daily feeding at 3% BWD ("satiation experiment").

In the "skipping" experiment, common carp of  $99.0 \pm 6.4$  g (mean  $\pm$  S.D.) were stocked at  $0.5 \text{ kg/m}^3$  in four cages on 24 August 1988 and harvested 95 days later on 27 November 1988. In duplicate cages fish were either fed every day at 3% BWD in three equal feedings (morning, noon, sunset) or were fed 3% BWD every other day in three equal feedings at the same times. All cages were sampled every 2 weeks by weighing and counting a 10% sample of fish. Feeding rates were adjusted to the new fish biomass in the cage at the time of sampling. Fish mortalities were recorded daily.

In the "satiation" experiment, common carp fingerlings of  $57.0 \pm 5.2$  g (mean  $\pm$  S.D.) were stocked into duplicate cages for the two treatments at  $0.5 \text{ kg/m}^3$  on 14 July 1988 and grown for 102 days until 24 October 1988. The two control cages received a commercial feed of 24-26% protein at 3% BWD in three equal feedings (morning, noon, sunset). In the two other cages, fish were fed daily to satiation at the same times. Fish were fed until they had stopped surfacing and/or noticeably spit out feed. The amount of feed given was weighed after each feeding period. Fish were sampled by weighing and counting the entire contents of the cage every two weeks. Feeding rates for the controls were 3% BWD adjusted to the new fish biomass every 2 weeks. Fish mortalities were recorded daily.

### Results

Yield statistics are shown in Table 16 (original data in Appendix 10.0, p. 193-194) for the skipping experiment and in Table 17 (p. 194-196, Appendix 11.0) for the satiation experiment.

Skipping one day of feeding reduced the mean total feed given only 15%, from 369.9 to 313.8 kg in the 95-day experiment (Table 16). However significant decreases ( $P < 0.05$ , one-tailed, paired t-test) in total fish production (139.0 kg vs. 223.0 kg), net production (0.6 vs. 1.3

Table 16. Yield characteristics of common carp (*Cyprinus carpio*) in 122.5 m<sup>3</sup> (7 x 7 x 2.5 m) floating net cages given two different feeding patterns over a 95-day experimental period. Fish were either fed 3% BWD every other day (skip) or daily at 3% BWD (daily).

Cage numbers and treatments	Stocking					Harvest					Number days	% Survival	Net fish production (kg/m <sup>3</sup> )	Specific G.R. (%/day)	Feed (kg)	FCR
	kg	Ave. wt. (g)	Number (fish)	No./m <sup>3</sup>	kg/m <sup>3</sup>	kg	Ave. wt. (g)	Number (fish)	No./m <sup>3</sup>	kg/m <sup>3</sup>						
1 (skip)	61.5	101.5	606	5	0.5	145.0	244.9	592	5	1.2	95	98	0.7	0.9	357.2	4.3
2 (skip)	61.5	103.7	593	5	0.5	133.0	235.4	565	5	1.1	95	95	0.6	0.9	270.3	3.8
3 (daily)	61.5	101.5	606	5	0.5	219.0	369.9	592	5	1.8	95	98	1.3	1.4	357.2	2.3
4 (daily)	61.5	89.5	687	6	0.5	227.0	336.3	675	6	1.9	95	98	1.4	1.4	382.5	2.3
MEAN	(skip)	102.6	600	5	0.5	139.0	240.2	579	5	1	95	96	0.6	0.9	313.8	4.0
	(daily)	95.5	647	5	0.5	223.0	353.1	634	5	2	95	98	1.3	1.4	369.9	2.3

Table 17. Yield characteristics of common carp (*Cyprinus carpio*) in 122.5 m<sup>3</sup> (7 x 7 x 2.5 m) floating net cages with two different feeding patterns over a 102-day experimental period. Fish were fed daily either to satiation (satiated) or at 3% of their BWD (3%) in three equal feeding portions each day. In satiation feeding fish were fed until they stopped surfacing or until they spit out feed.

Cage numbers and treatments	Stocking					Harvest					Number days	% Survival	Net fish production (kg/m <sup>3</sup> )	Specific G.R. (%/day)	Feed (kg)	FCR
	kg	Ave. wt. (g)	Number (fish)	No./m <sup>3</sup>	kg/m <sup>3</sup>	kg	Ave. wt. (g)	Number (fish)	No./m <sup>3</sup>	kg/m <sup>3</sup>						
1 (satiated)	122.5	58.1	2,109	17	1.0	592.5	301.5	1,965	16	4.8	102	93	3.8	1.6	1,251.0	2.7
2 (satiated)	122.5	52.0	2,355	19	1.0	617.5	280.4	2,202	18	5.0	102	94	4.0	1.7	1,283.0	2.6
MEAN	122.5	55.1	2,232	18	1.0	605.0	291.0	2,084	17	4.9	102	93	3.9	1.6	1,267.0	2.6
3 (3%)	122.5	54.0	2,270	19	1.0	371.5	171.4	2,167	18	3.0	102	95	2.0	1.1	581.1	2.3
4 (3%)	122.5	63.9	1,916	16	1.0	392.0	217.4	1,803	15	3.2	102	94	2.2	1.2	606.7	2.2
MEAN	122.5	59.0	2,093	17	1.0	381.8	194.4	1,985	16	3.1	102	95	2.1	1.2	593.6	2.3

kg/m<sup>3</sup>), mean fish weight at harvest (240.2 g vs. 353.1 g) and fish growth rates (SGRs = 0.6%/day vs. 1.4%/day) occurred. FCRs increased significantly ( $P < 0.05$ ) from 2.3 in the 3% BWD treatment to 4.0 in the skipping treatment. Survival rates, however, were not significantly affected ( $P > 0.05$ ).

Satiation feeding increased the mean total feed given 113%, from 593.6 kg in the control to 1,267.0 kg. This increased feed produced significant increases ( $P < 0.05$ , one-tailed, paired t-tests) in net and total fish production, mean fish weight at harvest, and fish SGRs. Total fish production rose from 381.8 kg (at 3% BWD) to 605.0 kg (satiation), and mean fish weight at harvest was 291.0 g (satiation) and 194.4 g (3% BWD). Mean SGR was 1.6%/day in the satiation treatment and 1.2%/day in the 3% BWD. The FCR was significantly higher ( $P < 0.05$ ) for satiation feeding, 2.6 vs. 2.3 for 3% BWD.

## Discussion

Feed management in aquaculture includes optimization of the total daily feeding amount and feeding times per day; the amount fed at each feeding; feeding frequencies, and feed type (wet/dry ratio, pellet size, etc.). All of these practices require some knowledge of fish feeding behavior. Stomachless fish such as common carp do not consume large volumes of food but will accept food consistently if fed over longer time spans.

Srikanth et al. (1989) showed that feeding 1.9 g average weight common carp one day with a 16.4% protein diet then feeding for three days with a 31.0% protein diet gave as good growth as fish fed continuously on a 31.0% protein diet. This demonstrates the scope for economic improvement.

In our experiments, however, skipping one day of feeding for common carp in cages was found to be a bad practice. Significantly ( $P < 0.05$ ) decreased total and net fish production, mean fish weight at harvest, SGRs, and increased FCRs resulted from decreasing the frequency of feeding: there was no overlap in the data between the treatments. Skipping a day decreased the total feed used only 15% compared with daily feeding at 3% BWD. Similar results were also noted for common carp in floating net cages in Lido Lake, West Java, by Chan (1980). He found that carp production in 60 days decreased from 13.19 kg/cage to 0.80 kg/cage when feeding rates were decreased from three times a day to once every two days. Skipping a day of feeding or "starving" the carp for a day produced no notable "compensatory growth" effect as has been noted for some fish species in the temperate zone (Dobson and Holmes 1984).

Satiation feeding, however, significantly ( $P < 0.05$ ) increased total and net fish production, mean size at harvest and SGRs of common carp, but at a higher FCR: again there was no overlap in the data between treatments. Extrapolating from the fish production obtained, and the feed used over the 102-day culture period shows that feed was given at 6.4% BWD in the satiation experiment. Jauncey (1979) showed that increasing the feeding rate from 3% to 6% BWD at 28°C produced a large increase in the SGR of common carp. Further increasing the feeding rate from 6% to 9% BWD increased the SGR even further, but the increase was comparatively much smaller, suggesting that a plateau for the effect of feeding rate on SGRs was approached. Huisman (1969) demonstrated decreased growth rates for common carp at 23°C with feeding rates above 8% BWD. An optimum feeding rate of 6.5% BWD has been reported for common carp (Huisman 1976; Huisman et al. 1978). This is very close to the rate used in our satiation experiment.

## Conclusions and Recommendations

Skipping a day from the normal daily feeding pattern of common carp is detrimental to fish production, growth and food conversion. Daily feeding at 3% BWD is significantly more productive.

Satiation feeding to more than double the total feed given to common carp in net cages significantly improves fish production and growth, albeit at higher food conversion ratios. Doubling the feeding rate, however, would likely increase the costs of operation substantially.

Further testing of new feed management patterns for common carp using combinations of low and high protein feeds fed at different times of day and on different days is recommended.

## Combining Common Carp Nursery and Hybrid Red Tilapia Growout Operations in Floating Net Cages

### Introduction

Tilapias are well-known for their diverse and adaptable feeding habits (Jauncey and Ross 1982; Maitipe and De Silva 1985). In cages, they are commonly observed cleaning the netting. Cage nurseries for common carp (*Cyprinus carpio*) in the Saguling Reservoir have used mesh sizes of 2 to 3 mm. In this hypereutrophic environment, cage walls commonly became clogged with algal and detrital growth, necessitating daily cleaning of the outer surfaces to maintain good water exchange. Microscopic examination of the fouling organisms showed a diverse community of attached diatoms, rotifers and filamentous algae, all potential tilapia food items.

It was hypothesized that a system combining smaller, net cage nurseries for common carp within the 7 x 7 x 2.5 m net cages used for HRT growout could be a productive solution to the problem of clogging of the nursery nets. The nursery cages would also occupy little-used space in the upper portion of the growout cages.

### Materials and Methods

A factorial experiment was set up to test the effects of two different size hybrid red tilapia (HRT) (*Oreochromis* sp.) on common carp nursery cage fouling and fingerling production, growth and food conversion. In addition the reciprocal effects of common carp nurseries on tilapia were followed.

Treatments were: (1) two common carp nursery cages within one growout cage stocked with small HRT fingerlings; (2) the same with large HRT fingerlings. Controls were: (1) growout cages with the two sizes of HRT fingerlings and two, empty common carp nursery cages, or (2) two stocked common carp nursery cages in unstocked HRT growout cages. All the common carp nursery cages were 2.4 x 4.0 x 1.2 m deep. Two of these were placed in each 7 x 7 x 2.5 m growout cage. All experimental treatments and controls were duplicated.

All fish were stocked on 12 July 1988 and harvested on 16 October 1988 for a total experimental period of 96 days. The stocking density in the nursery cages was 0.5 kg/m<sup>3</sup> of 5.4 g mean weight common carp. Two sizes of HRT were stocked in the growout cages: small (average weight  $\pm$  S.D., 83.6  $\pm$  8.2 g) and large (208.4  $\pm$  9.8 g). The stocking density for both sizes averaged 0.9 kg/m<sup>3</sup>. A finely-ground 24-26% crude protein feed (Comfeed, Cirebon, Indonesia) was given to the common carp fingerlings, initially at 7% BWD in five equal feedings. Comfeed was also fed to the HRT at 1% BWD in 3 equal feedings (morning, noon, sunset). Every 2 weeks the entire biomasses of fish in the nurseries and the outside cages were weighed and counted. Feeding rates were then adjusted in the nurseries 1% downwards every sampling time until a 3% BWD was reached. Thereafter, this rate was kept until the end of the experiment. Feeding percentages were kept at 1% BWD for the HRT throughout the experiment and adjusted only to the new fish biomass after each sampling. There was abundant phytoplankton as additional feed for the HRT.

To measure the amount of attached materials eaten by HRT, the nursery and growout nets were weighed before and after the experiment as follows. At the beginning of the experimental

period all nets were soaked in water until saturated, hung until no water dripped from them (24-30 hours), and then reweighed. At harvest, nets were also hung until no water dripped from them then weighed. Percentage increases in the wet weight of the net from stocking to harvesting were calculated.

## Results

Yield statistics are summarized in Table 18 (original data in Appendix 12.0, p. 196-208). Common carp nurseries ( $n = 4$ ) with small HRT stocked on the outside had significantly higher (Mann-Whitney U-test; Zar 1984) net production ( $P < 0.05$ ), mean fish weight at harvest ( $P < 0.01$ ), and lower FCRs ( $P < 0.01$ ) than control common carp nurseries with no small HRT on the outside. Nurseries produced 25.0 kg of 28.9 g common carp fingerlings with a survival rate of 83% in 96 days. Control common carp nursery nets without HRT ( $n = 8$ ) produced a total mean yield of 20.7 kg of 24.5 g average weight common carp fingerlings with a survival rate of 75% during the same time period. Survival rates were not significantly different ( $P > 0.05$ ). SGRs were not significantly different: in controls they averaged 1.6%/day at a mean food conversion ratio (FCR) of 7.0; in the nursery cages in the combined system with small HRT SGRs averaged 1.7%/day with an FCR of 6.1.

In contrast common carp fingerlings in combined nurseries with large HRT outside showed no significant differences ( $P \geq 0.05$ ) in total and net production, average fish weight at harvest, survival rates, SGRs, the total amount of feed used and FCRs compared to controls.

Stocking common carp in two nursery cages had no significant effects on any yield, survival or conversion parameter for small or large HRT stocked in the outside 7 x 7 x 2.5 m cages. However, FCRs were notably lower (0.9-1.2) than those recorded in any other study during the three years of the project. Small HRT with no common carp nurseries produced a total yield of 273.3 kg of 243.5 g mean weight fish with a survival rate of 94% in 96 days. Their SGR averaged 1.1%/day. With common carp nurseries located above them, small HRT produced 267.1 kg of 247.8 g fish with a survival rate of 91%. Their SGR averaged 1.1%/day with a very low FCR of 0.9.

Control large HRT in 7 x 7 x 2.5 m nets with unstocked common carp nurseries produced 216.3 kg of 446.9 g fish at a survival rate of 98%. Their SGR averaged 0.8%/day with an FCR of 1.2. With stocked common carp nurseries, large HRT produced 218.8 kg of 483.9 g fish with a survival rate of 98%. Their SGR averaged 0.8%/day with an FCR of 1.2.

## Discussion

Common carp nursery cages within small HRT stocked in outer growout cages gave significantly higher net production and mean weight at harvest over controls with no small HRT grazing outside. Highest net yield and largest mean fish weight at harvest for common carp fingerlings recorded from all combinations tested was for the common carp nurseries with small HRT growing on the outside. Stocking large HRT outside did not increase common carp fingerling net production, average fish weight at harvest, or SGRs.

There were no significant effects of the common carp nurseries on the production, growth, food conversion or survival of large or small HRTs. However, FCRs were very low. The increased area for grazing, the outputs of feces and waste feed from the common carp nurseries, or the excellent natural food available in the hypereutrophic reservoir could have had an impact on FCRs for the HRTs.

HRTs had little effect on grazing or cleaning the materials attached to the common carp fingerling nets. Comparison of percentages in Table 19 shows that while small and large HRTs decreased the mean fouling rate (defined as per cent wet weight increases) compared to controls 79% (small HRT) and 43% (large HRT), stocking common carp in the nursery nets also decreased fouling (44% where small HRT are on the outside; 108% for large HRT). Small and

18. Yield characteristics of fingerling common carp (*Cyprinus carpio*) (CARP) in small-mesh (2-3 mm) nursery cages (4.0 x 2.4 x 1.2 m) combined or not combined (NO) with two sizes of hybrid red tilapia floating net cages on the outside of the nursery cages. Two sizes of HRT were stocked in the outer floating net cages, small (mean weight, 83.6 g) (SM TIL), or large (mean weight 208.4 g) (LARGE TIL) and fingerling common carp in nursery cages stocked alone. The order of abbreviations in the table follows the text. Common carp were fed on a sliding scale initially from 7% BWD reduced by 1% BW was reached. HRT were fed at 1% BWD throughout the 96-day experimental period.

Treatments	Stocking					Harvest					Number days	% Survival	Specific G.R. (%/day)	Feed (kg)	FCR
	kg	Ave. wt. (g)	Number (fish)	No./m <sup>3</sup>	kg/m <sup>3</sup>	kg	Ave. wt. (g)	Number (fish)	No./m <sup>3</sup>	kg/m <sup>3</sup>					
ARP; SM TIL)	5.8	5.6	1,027	89	0.5	26.2	29.2	898	78	2.3	96	87	1.7	121.2	5.9
ARP; SM TIL)	5.8	5.3	1,086	94	0.5	23.6	32.4	728	63	2.1	96	87	1.9	111.8	8.3
ARP; SM TIL)	5.8	5.7	1,012	88	0.5	24.4	26.9	906	79	2.1	96	90	1.6	108.2	5.8
ARP; SM TIL)	5.8	5.2	1,105	96	0.5	25.9	27.0	959	83	2.3	96	87	1.7	124.7	6.2
	5.8	5.5	1,058	92	0.5	25.0	28.9	873	76	2.2	96	83	1.7	116.5	6.1
TIL; CARP)	99.5	89.6	1,110	11	1.0	276.0	265.4	1,040	10	2.6	96	94	1.1	150.4	0.9
TIL; CARP)	99.5	79.1	1,258	13	1.0	258.2	230.2	1,122	11	2.6	96	89	1.1	142.5	0.9
	99.5	84.4	1,184	12	1.0	267.1	247.8	1,081	11	2.7	96	91	1.1	146.5	0.9
TIL; NO)	99.5	74.3	1,340	11	0.8	273.5	214.0	1,278	10	2.2	96	95	1.1	152.4	0.9
TIL; NO)	99.5	91.3	1,090	9	0.8	273.0	273.0	1,000	8	2.2	96	92	1.1	143.1	0.8
	99.5	82.2	1,215	10	0.8	273.3	243.5	1,139	9	2.2	96	94	1.1	147.8	0.9
ARP; LARGE TIL)	5.8	5.8	999	87	0.5	21.8	25.6	853	74	1.9	96	85	1.5	108.1	6.8
ARP; LARGE TIL)	5.8	5.6	1,042	91	0.5	23.1	25.4	909	79	2.0	96	87	1.6	115.7	6.7
ARP; LARGE TIL)	5.8	5.5	1,049	91	0.5	22.5	28.3	794	69	2.0	96	76	1.7	104.1	6.2
ARP; LARGE TIL)	5.8	5.9	990	86	0.5	23.2	29.0	801	70	2.0	96	81	1.7	111.7	6.4
	5.8	5.7	1,020	89	0.5	22.7	27.1	839	73	2.0	96	82	1.6	109.9	6.5
LARGE TIL; CARP)	99.5	222.6	447	4	1.0	215.0	495.4	434	4	2.2	96	97	0.8	137.7	1.2
LARGE TIL; CARP)	99.5	206.9	481	5	1.0	222.5	472.4	471	5	2.2	96	98	0.9	139.9	1.1
	99.5	214.7	464	5	1.0	218.8	483.9	453	5	2.2	96	98	0.8	138.3	1.2
SM TIL; NO)	99.5	203.1	490	4	0.8	221.0	466.5	482	4	1.8	96	98	0.8	140.3	1.2
SM TIL; NO)	99.5	201.0	495	4	0.8	211.6	435.4	486	4	1.7	96	98	0.8	136.6	1.2
	99.5	202.0	493	4	0.8	216.3	446.9	484	4	1.8	96	98	0.8	138.5	1.2
ARP)	5.8	5.3	1,103	96	0.5	22.0	26.7	823	72	1.9	96	75	1.7	105.8	6.5
ARP)	5.8	5.2	1,114	97	0.5	20.7	26.8	773	67	1.8	96	69	1.7	102.7	6.9
ARP)	5.8	5.1	1,139	99	0.5	19.1	24.3	787	68	1.7	96	69	1.6	103.5	7.8
ARP)	5.8	5.6	1,036	90	0.5	21.2	25.1	844	73	1.8	96	81	1.6	106.1	6.9
ARP)	5.8	5.1	1,135	99	0.5	16.8	23.2	725	63	1.5	96	64	1.6	85.4	7.8
ARP)	5.8	5.0	1,164	101	0.5	19.1	21.4	891	77	1.7	96	77	1.5	91.7	6.9
ARP)	5.8	5.0	1,164	101	0.5	24.0	24.9	964	84	2.1	96	83	1.7	126.0	6.9
ARP)	5.8	4.9	1,174	102	0.5	23.0	23.9	961	84	2.0	96	82	1.6	112.8	6.6
	5.8	5.1	1,129	98	0.5	20.7	24.5	846	74	1.8	96	75	1.6	104.3	7.0

nis sp.) (HRT) stocked in 122.5 m<sup>3</sup> (7 x 7 x 2.5 m) floating net cages on the outside of the nursery cages. Two sizes of HRT were stocked in the outer floating net cages, small (mean weight, 83.6 g) (SM TIL), or large (mean weight 208.4 g) (LARGE TIL) and fingerling common carp in nursery cages stocked alone. The order of abbreviations in the table follows the text. Common carp were fed on a sliding scale initially from 7% BWD reduced by 1% BW was reached. HRT were fed at 1% BWD throughout the 96-day experimental period.

Table 19. Effects of hybrid red tilapia (*Oreochromis* sp.) (HRT) on the fouling of nursery cages for common carp (*Cyprinus carpio*) expressed as the mean wet weight increase per net before stocking, and at the end of a 96-day experimental period. Two nursery cages, 4.0 x 2.4 x 1.2 m (2-3 mm mesh), were floated above and in growout floating net cages 7.0 x 7.0 x 2.5 m (1.5" mesh). Two sizes of HRT were stocked on the outside of the common carp nursery cages (small, 83.6 g; large, 208.3 g). Controls were nursery cages stocked with and without common carp and with and without HRT on the outside.

Treatments	Net weighed	Combination	Mean per cent weight increase per net
1	Nursery	2 Nurseries/No HRT	215
2	Nursery	2 Nurseries/Small HRT	136
3	Nursery	2 Nurseries/Large HRT	172
4	Nursery	Small HRT	180
5	Nursery	Large HRT	280
6	Growout	2 Nurseries/No HRT	184
7	Growout	2 Nurseries/Small HRT	187
8	Growout	2 Nurseries/Large HRT	188
9	Growout	Small HRT	136
10	Growout	Large HRT	162

large HRTs also had no effects on decreasing the fouling rate of the outer 7 x 7 x 2.5 m nets. Curiously when common carp fingerlings were added to the nurseries fouling of the outer nets increased 51% (small HRTs) and 26% (large HRTs). This lack of fouling control by HRTs was likely due to the high fouling rate of nets, and/or due to the high fertility of the reservoir. In addition, the outer parts of some nurseries were fouled by unidentified bryozoans which were not eaten by the HRTs.

## Conclusions and Recommendations

Combining common carp nursery nets within small-sized hybrid red tilapia (HRT) growout cages increased the production and mean fish size at harvest of carp fingerlings. Small tilapia fingerlings (84.4 g mean stocking size) significantly improved the production and size of common carp fingerlings while large HRT fingerlings (214.7 g) did not.

Further work is recommended to optimize common carp and HRT fingerling stocking combinations, feeds and feed quality in such combined nursery and growout systems.

## Performance of Small Low-Cost Fish Cages in the Saguling Reservoir

### Introduction

Small-scale, low-cost aquaculture is often a neglected area of rural development although of potentially far-reaching importance to poor villagers in developing countries. This is particularly true in Asia where fish are the main source of animal protein, and there is a large bank of traditional knowledge about fish farming. There are also abundant agricultural by-products suitable for use in fish farming in many developing nations in Asia.

Success of aquaculture is typically judged by governments, economists and aid agencies in terms of profit and tonnages of saleable commodities traded in established markets. The stated rationale for many aquaculture development projects is increasing protein sources and improving nutrition for the poor. It is assumed that, as fish production increases, increased family income will improve family nutrition. However, this may not be so, as villagers may



prioritize the use of this newly-found disposable income. The purchase of expensive protein (fish) can be far down on the line of the family "wish list".

Good strategies to develop and evaluate increases in protein food availability for poor communities through rural aquaculture are generally lacking.

Indonesia has a long history in cage culture but both traditional and modern cage culture are largely restricted to West Java and the vicinity of Malang in East Java. This is not unusual: aquaculture is still a very localized enterprise everywhere in Asia (Edwards 1983).

Cage culture operations have been little developed because cage culture is often thought to be too capital intensive. However successful demonstration of low cost or "no feed" cage culture for plankton-feeding fish such as: the Nile tilapia (*Oreochromis niloticus*) in the Philippines (Guerrero 1983), bighead and silver carp in Nepal (Pullin 1986), China (Hai and Zweig 1987) and in Singapore (Chookajorn 1982), using locally available materials such as bamboo, wire and netting, has shown that low-cost cage aquaculture can be well within the village economies of many areas of Asia.

The purpose of this study was to test some designs for small cages and monitor their production of common carp in the Saguling Reservoir. Small cages for HRTs fed rice bran feeds have been described earlier. Common carp is the most widely accepted food fish, both culturally and economically in the vicinity. Carp feeds were readily available in the villages targetted for cage culture. A technology package was developed cooperatively with villagers. It included technical information, information on the food value of the fish to the families, and how they could eat fish every day by using small-scale cage culture (Costa-Pierce et al. 1989b). Technology packages were also developed in floating net cage culture, reservoir pen systems and small-scale hatcheries (Costa-Pierce et al. 1989c, 1989d, 1989e).

## Materials and Methods

Eight 17-18 m<sup>3</sup> rigid cages (4 x 2.4 x 1.8 m) were constructed: 4 of bamboo, 2 of a square-meshed fencing wire (2 mm rigid square openings), and 2 of diamond-shaped netting (1" mesh) in three villages in the Saguling Reservoir (see photos).

Four bamboo cages were stocked at 2.2 kg/m<sup>3</sup> with 69.5 g average weight common carp on 18 January 1987 and harvested 90 days later on 18 April 1987. Two wire cages were stocked at 2.1 kg/m<sup>3</sup> with 92.8 g common carp on 16 July 1988 and harvested 59 days later on 13 September 1987. Two net cages were stocked at 2.1 kg/m<sup>3</sup> with 147.4 g common carp on 18 January 1987 and harvested 90 days later on 18 April 1987.

All fish were fed a 24-26% crude protein commercial feed (Comfeed, Cirebon, Indonesia) at 3% BWD in three equal feedings (morning, noon, sunset). Fish were sampled every two weeks by weighing and counting 10% of the fish in each cage. Feeding rates were adjusted to the fish biomass in the cages at the time of sampling. Fish mortalities were recorded daily.

## Results

Yield statistics for all eight cages are summarized in Table 20 (original data in Appendix 13.0, p. 208-212). Bamboo cages produced a net fish yield of 135.8 kg of 264.9 g mean size fish in 86 days. Net cages produced 153.0 kg of 288.2 g fish in 90 days. Wire cages produced 92.8 kg of 398.1 g fish in 59 days. Mean specific growth rates (SGRs) were highest in the wire cages (1.7%/day), followed by the bamboo cages (1.6%/day) and the net cages (1.4%/day). Fish mortalities were low in all cages, ranging from 2 to 4%. Lowest mean FCR was obtained in the wire cages (1.7) followed by bamboo (2.0) and net cages (2.1).

The wire cages were judged unsuitable for further experimentation because the cheap wire used became weak after just one production cycle. In one of the cages during this experiment we experienced a loss of fish just 59 days into the experiment due to a hole worn in the cage.

Table 20. Yield characteristics for the growout of common carp (*Cyprinus carpio*) in small low-cost fish cages made of various materials (bamboo, wire, netting) using 1.8-2.4 kg/m<sup>3</sup> stocking densities over 100-120 days. Fish were fed a commercial feed (24-26% crude protein) at 3% BWD throughout the experiments.

BAMBOO Cage number	Stocking				Harvest				Number days	% Survival	Specific R. (day)	Feed (kg)	FCR	
	kg	Ave. wt. (g)	Number (fish)	No./m <sup>3</sup>	kg/m <sup>3</sup>	kg	Ave. wt. (g)	Number (fish)						No./m <sup>3</sup>
	68.9	537	32	2.2	148.0	280.8	527	31	8.7	86	98	.6	195.8	1.8
	69.8	530	31	2.2	134.0	262.7	510	30	7.9	86	96	.5	193.2	2.0
	71.6	517	30	2.2	127.0	259.2	490	29	7.5	86	95	.5	184.6	2.1
	67.6	547	32	2.2	134.0	256.7	522	31	7.9	86	95	.6	198.8	2.0
	69.5	533	31	2.2	135.6	264.9	512	30	8.0	86	96	.6	193.1	2.0
	71.6	547	32		148.0	280.8	527	31	8.7	86	98	.6	198.8	2.1
	67.6	517	30		127.0	256.7	490	29	7.5	86	95	.5	184.6	1.8
	1.4	11	1		7.6	9.5	14	1	0.4		1	0.0	5.3	0.1
	147.7	237	14	2.1	92.0	396.6	232	14	5.4	59	98	.7	93.0	1.6
	147.7	238	14	2.1	93.5	399.6	234	14	5.5	59	98	.7	100.4	1.7
	147.36	238	14	2.1	92.8	398.1	233	14	5.5	59	98	.7	96.7	1.7
	82.0	500	29	2.4	136.5	276.3	494	29	8.0	90	99	.3	215.8	2.3
	75.5	583	32	1.8	169.5	300.0	565	31	9.4	90	97	.5	251.6	2.0
	78.735	542	31	2.1	153.0	288.2	530	30	8.7	90	98	.4	233.7	2.1

Bamboo and net cages were sturdy and have lasted over 2 years in the reservoir (6 cycles; 3 cycles per year 1987-1989) with minor rehabilitation (replacing bamboo, drums).

## Discussion

Fish growth rates and FCRs obtained for common carp in all the cages were comparable to those observed in larger floating net cage culture (FNCC) (compare data in Tables 9, 10 and 20). The mean SGR and fish weight at harvest (264.9 g) after 86 days in the bamboo cages were higher than those obtained in our previous replication of farmers' technology for FNCC (Table 10). Given these data, the potential of small-scale cage culture in the Saguling Reservoir can be examined.

Low-cost aquaculture can be examined in terms of its contribution to human protein needs. Protein can be obtained from plant and animal sources, but it is generally accepted in nonvegetarian societies, that animal protein must be one-third of the total protein consumed (NESDB 1977 in Edwards 1983). If the average Indonesian family size is 5 persons and their protein daily needs is assumed to be 50 g dry protein/person, this family would require 91.2 kg dry protein/year. If one-third of this is animal protein the family would require 30.4 kg dry animal protein/year.

Fish production in our cages produced 92.8 kg in 59 days (wire cages) and 135.8-153.0 kg in 86-90 days (bamboo and net cages). Three fish crops a year could be obtained in 90-day cycles with bamboo or net-type cages, giving extrapolated total annual fish yields of 407.4-459.0 kg. If we assume fish are 18% dry matter and have a 70% protein content (NESDB 1977 in Edwards 1983), the annual dry protein yield per cage would be 51.3-57.8 kg. Just one such subsistence bamboo or net cages would therefore be capable of producing the entire annual animal protein requirements for an Indonesian family of five over a one-year period.

Villagers, however, did not understand this seemingly concise rationale and certainly did not quantify their food needs in such a manner. The concept of one fish per person per day was simpler and more acceptable.

If we approach this by assuming that three fish of 250 g size are needed every day for each family of five persons, the family would need 1,095 fish/year. From our data, one bamboo or net cage could produce 512-530 fish of 264.9-288.2 g every 90 days. In these terms two such cages would be needed to give one family full animal protein self-sufficiency. Management of two cages could be on rotational, 90-day cycles. After the first 90-day cycle one cage would hold the fish crop of about 500 fish so that fish could be harvested as needed from this cage every day. This cage would be the family's "live hold" of protein. Its fish could be maintained or grown further on cheap, coarse rice bran while a second crop of fish was being produced in the second cage in 90 days.

## Acknowledgements

The authors wish to acknowledge the faithful hard work, experimental assistance and dedication of Mr. Gelar Wira Atmadja and Mr. Yaya Yuhana in all the studies conducted. The plankton analysis of fish gut contents was accomplished by Mr. Ade Pandi.

## References

- Abella, T.A. and M.N. Batao. 1989. Broodstock exchange techniques for maximum production of *Oreochromis niloticus* egg and fry in hapas, p. 9-18. In E.A. Huisman, N. Zonneveld and A.H.M. Bouwmans (eds.) Aquacultural research in Asia: management techniques and nutrition. Centre for Agricultural Publishing and Documentation, Pudoc, Wageningen, The Netherlands.
- Baluyut, E.A. 1983. Stocking and introduction of fish in lakes and reservoirs in the ASEAN (Association of Southeast Asian Nations) countries. FAO Fish. Tech. Pap. 236.

- Dobson, S.H. and R.M. Holmes. 1984. Compensatory growth in the rainbow trout, *Salmo gairdneri* Richardson. J. Fish Biol. 25: 649-656.
- DPPJB (Dinas Perikanan Propinsi Jawa Barat). 1987. Fisheries statistics 1986. DPPJB, Bandung, Indonesia. (In Indonesian).
- DPPJB (Dinas Perikanan Propinsi Jawa Barat). 1988. Fisheries statistics 1987. DPPJB, Bandung, Indonesia. (In Indonesian).
- Edwards, P. 1983. The future of integrated farming systems in Asia. Proc. 5th WCAP 1: 273-281.
- Effendi, P. 1988. Fisheries development program in Cirata during the national 5 year plan 1989-1993. Dinas Perikanan Propinsi Jawa Barat, Bandung. (In Indonesian).
- FAO. 1989. Aquaculture production (1984-1986). FAO Fish. Circ. No. 815. FAO, Rome.
- Getachew, T. 1987. A study on an herbivorous fish, *Oreochromis niloticus* L., diet and its quality in two Ethiopian rift valley lakes, Awasa and Zwai. J. Fish Biol. 30: 439-449.
- Guerrero, R.D. III. 1979. Cage culture of tilapia in the Philippines. Asian Aquaculture 2: 6.
- Guerrero, R.D. III. 1980. Studies on the feeding of *Tilapia nilotica* in floating cages. Aquaculture 20: 169-175.
- Guerrero, R.D. III. 1983. A comparative study on the cage culture of *Tilapia nilotica* and *T. nilotica* x *T. aurea* hybrids in Laguna de Bay. Trans. Nat. Acad. Sci. and Tech. (Philis.) 5: 217-220.
- Guerrero, R.D. III. 1986. Production of Nile tilapia fry and fingerlings in earthen ponds at Pila, Laguna, Philippines, p. 49-52. In J.L. Maclean, L.B. Dizon and L.V. Hosillos (eds.) The First Asian Fisheries Forum. Asian Fisheries Society, Manila, Philippines.
- Guerrero, R.D. III. 1987. Commercial production of tilapia in freshwater ponds and cages in the Philippines, p. 14-20. In R.D. Guerrero III, D.L. de Guzman and C.M. Lantican (eds.) Proceedings First National Symposium and Workshop on Tilapia Farming. Philippine Council for Agriculture and Resources Research and Development, Bureau of Fisheries and Aquatic Resources and Southeast Asian Fisheries Development Center. PCARRD Book Series No. 48, PCARRD, BFAR and SEAFDEC Aquaculture Department, Los Baños, Philippines.
- Guerrero, R.D. III and A.M. Garcia. 1983. Studies on the fry production of *Sarotherodon niloticus* in a lake-based hatchery, p. 388-393. In L. Fishelson and Z. Yaron (comps.) Proceedings of the International Symposium on Tilapia in Aquaculture, Nazareth, Israel, 8-13 May 1983. Tel Aviv University, Israel.
- Guerrero, R.D. III, R.C. Sevilleja and A.M. Tolentino. 1987. Studies on the cage culture of the Nile tilapia in Aya Reservoir and Laguna de Bay. Arch. Hydrobiol. 28: 355-358.
- Hai, L.Y. and R. Zweig. 1987. Cage culture in Kummung: an effective means of resource recovery. Aquacult. Mag. 13: 28-31.
- Hardjamulia, A. and P. Suwignyo. 1988. The present status of the reservoir fishery in Indonesia, p. 8-13. In S. De Silva (ed.) Reservoir fishery management and development in Asia. Proceedings of a workshop held in Kathmandu, Nepal, 23-28 November 1987. International Development Research Centre, Ottawa, Canada.
- Hughes, D.G. and L.L. Behrends. 1983. Mass production of *Tilapia nilotica* seed in suspended net enclosures, 394-401. In L. Fishelson and Z. Yaron (comps.), Proceedings of the International Symposium on Tilapia in Aquaculture, Nazareth, Israel, 8-13 May 1983. Tel Aviv University, Israel.
- Huisman, E.A. 1969. A study on the possibility of breeding carp in flow recirculation tanks (1968/69). Annual report of the OVB, Netherlands.
- Huisman, E.A. 1976. Food conversion efficiencies at maintenance and production levels for carp (*Cyprinus carpio* L.) and rainbow trout (*Salmo gairdneri* Richardson). Aquaculture 9: 259-273.
- Huisman, E.A., J.G.P. Klein Breteler, M.M. Vismans and E. Kánis. 1978. Retention of energy, protein, fat and ash in growing carp (*Cyprinus carpio* L.) under different feeding and temperature regimes. EIFAC Symp. Finfish Nutrition and Feed Technology. EIFAC/78/Symp.E/12. Hamburg, Germany.
- Jangkaru, Z. 1986a. The optimum stocking density of Nile tilapia in floating net cage culture in Lido Lake, West Java. Bull. Penelitian Perikanan Darat 5: 85-92. (In Indonesian).
- Jangkaru, Z. 1986b. Experiment in the grow-out of common carp in floating nets in Lake Toba. Research Institute for Inland Fisheries, Bogor, Indonesia. (In Indonesian).
- Jangkaru, Z. and R. Djajadiredja. 1979. Common carp in floating net cages, p. 55-60. In Proceedings of the International Workshop on Pen and Cage Culture of Fish, Iloilo, Philippines, 11-12 February 1979. International Development Research Centre, Ottawa, Canada and Southeast Asian Fisheries Development Center, Iloilo, Philippines.
- Jauncey, K. 1979. Growth and nutrition of carp in heated effluents. University of Aston, Birmingham, England. Ph.D. Thesis.
- Jauncey, K. and B. Ross. 1982. A guide to tilapia feeds and feeding. Institute of Aquaculture, University of Stirling, Scotland.
- Joenoës and S. Achmad. 1974. Preliminary experiments on common carp and *Tilapia nilotica* in floating net cages in Lake Jatiluhur. Research Institute for Inland Fisheries Report No. 18, Bogor, Indonesia. (In Indonesian).
- Kim, I.B. and P.K. Kim. 1986. Optimum dissolved oxygen level for the growth of the Israeli strain of common carp, *Cyprinus carpio* in the recirculating water system. Bull. Korean Fish. Soc. 19: 581-585.
- Koesoemadinata, S. and B.A. Costa-Pierce. Development of rice-fish farming in Indonesia; past, present and future. In C. Lightfoot, B.A. Costa-Pierce, C. dela Cruz and V. Carangal (eds.) Rice-fish research and development. ICLARM, IRRI and CLSU. (In press).
- Lubzens, E., G. Sagie, G. Minkoff, G. Meragelman and A. Schneller. 1984. Rotifers (*Brachionus plicatilis*) improve growth rate of carp (*Cyprinus carpio*) larvae. Bamidgeh 36: 41-46.
- Maitipe, P. and S.S. De Silva. 1985. Switches between zoophagy, phytophagy, and detritivory of *Sarotherodon mossambicus* (Peters) populations in twelve man-made Sri Lankan lakes. J. Fish Biol. 26: 49-61.
- Mamcarz, A. and M. Nowak. 1987. New version of an illuminated cage for coregonid rearing. Aquaculture 65: 183-188.
- Melard, C. and J.C. Philippart. 1980. Pisciculture intensive de *Sarotherodon niloticus* dans les effluents thermiques d'une centrale nucléaire en Belgique. Paper presented at the FAO/EIFAC Symposium on New Development in the Utilization of Heated Effluents and of Recirculation Systems for Intensive Aquaculture, 28-30 May 1980, Stavanger, Norway. EIFAC/80/Symp/Doc.E/11. 20 p.
- Moriarty, D.J.W. 1973. The physiology of digestion of blue-green algae in the cichlid fish *Tilapia nilotica*. J. Zool. 171: 25-39.
- NESDB. 1977. Technical information and base-line data for the formulation of a national plan on food and nutrition development (1977-1981), Bangkok, Thailand.

- Bautista, A.M. 1987. Tilapia hatchery and nursery systems: operation and management, p. 8-13. *In* R.D. Guerrero III, D.L. de Guzman, C.M. Lantin (eds.) Proceedings First National Symposium and Workshop on Tilapia Farming. Philippine Council for Agriculture and Resources Research and Development, Bureau of Fisheries and Aquatic Resources and Southeast Asian Fisheries Development Center. PCARRD Book Series No. 48, PCARRD, BFAR and SEAFDEC Aquaculture Department, Los Baños, Philippines.
- Bautista, A.M., M.H. Carlos and A.I. San Antonio. 1988. Hatchery production of *Oreochromis niloticus* L. at different sex ratios and stocking densities. *Aquaculture* 73: 85-95.
- Beveridge, M. 1984. Lake-based or land-based tilapia hatcheries? *ICLARM Newsletter* 7(1): 10-11.
- Beveridge, M. 1987. Cage aquaculture. Fishing News Books, Ltd., Surrey, England, UK.
- Brett, J.R. and T.D.D. Groves. 1979. Physiological energetics, p. 280-352. *In* W.S. Hoar, D.J. Randall and J.R. Brett (eds.) *Fish physiology*. Vol VIII. Bioenergetics and growth. Academic Press, New York.
- Campbell, D. 1978. Formulation des aliments destinés à l'élevage de *Tilapia nilotica* (L.) en cages dans le lac de Kossou. Côte d'Ivoire. *Rapp. Tech.* 46, 26 p. Autorité Aménagement Vallée du Bandama, Centre, Dével. Pêches Lac Kossou.
- Chan, E.H. 1980. The response of *Cyprinus carpio* L. to different feeding frequencies in floating net cages. BIOTROP-SEAMEO Regional Center for Tropical Biology, Bogor, Indonesia.
- Chua, T.E. and S.K. Teng. 1979. Relative growth and production of the estuary grouper, *Epinephelus salmoides*, under different stocking densities in floating-net cages. *Mar. Biol.* 54: 362-372.
- Cholik, F. 1988. Review of the status of aquaculture in Indonesia. Indo-Pac. Fish. Coun. WPA/WP 4, Bangkok, Thailand.
- Chookajorn, T. 1982. Cage fish culture in reservoirs in Singapore. *Thai Fish. Gaz.* 35: 661-665.
- Coche, A.G. 1977. Premiers résultats de l'élevage en cages de *Tilapia nilotica* (L.) dans le Lac Kossou, Côte d'Ivoire. *Aquaculture* 10: 109-140.
- Coche, A.G. 1982. Cage culture of tilapias, p. 205-246. *In* R.S.V. Pullin and R.H. Lowe-McConnell (eds.) *The biology and culture of tilapias*. ICLARM Conference Proceedings 7. International Center for Living Aquatic Resources Management, Manila, Philippines.
- Collier, W.L., H. Hadikoesworo and S. Saropie. 1977. Income, employment, and food systems in Javanese coastal villages. Pap. No. 44, Center for International Studies, Ohio University, Athens, Ohio, USA.
- Colman, J. and P. Edwards. 1987. Feeding pathways and environmental constraints in waste-fed aquaculture: balance and optimization, p. 240-281. *In* D.J.W. Moriarty and R.S.V. Pullin (eds.) *Detritus and microbial ecology in aquaculture*. ICLARM Conference Proceedings 14. International Center for Living Aquatic Resources Management, Manila, Philippines.
- Costa-Pierce, B.A. Rice-fish systems as intensive nurseries. *In* C. Lightfoot, B.A. Costa-Pierce, C. dela Cruz and V. Carangal (eds.) *Rice-fish research and development in Asia*. ICLARM, IRRI and CLSU. (In press).
- Costa-Pierce, B.A. and O. Soemarwoto. 1987. Proliferation of Asian reservoirs: the need for integrated management. *Naga, The ICLARM Quarterly* 10(1): 9-10.
- Costa-Pierce, B.A. and P. Effendi. 1988. Sewage cages of Kota Cianjur. *Naga, The ICLARM Quarterly* 11(2): 7-9.
- Costa-Pierce, B.A., G. Wira Atmadja, P. Effendi and S. Zainal. 1988a. Integrated aquaculture systems in the Saguling Reservoir, West Java, Indonesia, p. 224-233. *In* S. De Silva (ed.) *Reservoir fishery management and development in Asia*. Proceedings of a workshop held in Kathmandu, Nepal, 23-28 November 1987. International Development Research Centre, Ottawa, Canada.
- Costa-Pierce, B.A., S. Zainal and P. Effendi. 1988b. ICLARM and south-south technology transfer: Philippine aquaculture technology and Indonesia. Part I. *Naga, The ICLARM Quarterly* 11(3): 10-11.
- Costa-Pierce, B.A., M.A. Bimbao, S. Zainal and P. Effendi. 1989a. ICLARM and south-south technology transfer: Philippine aquaculture technology and Indonesia. Part 2. *Naga, The ICLARM Quarterly* 12(1): 14-16.
- Costa-Pierce, B.A., G.W. Atmadja, Rusydi and A. Safari. 1989b. Growing fish in cages. *ICLARM Education Series* 10, 43 p. Institute of Ecology, Indonesian State Electric Company (IOE UNPAD-PLN), Bandung, Indonesia, and International Center for Living Aquatic Resources Management, Manila, Philippines.
- Costa-Pierce, B.A., Rusydi, A. Safari and G.W. Atmadja. 1989c. Culture of common carp in floating net cages. *ICLARM Education Series* 7, 42 p. Institute of Ecology, Indonesian State Electric Company (IOE UNPAD-PLN), Bandung, Indonesia, and International Center for Living Aquatic Resources Management, Manila, Philippines.
- Costa-Pierce, B.A., Rusydi, A. Safari and G.W. Atmadja. 1989d. Growing fish in pen systems. *ICLARM Education Series* 9, 40 p. Institute of Ecology, Indonesian State Electric Company (IOE UNPAD-PLN), Bandung, Indonesia, and International Center for Living Aquatic Resources Management, Manila, Philippines.
- Costa-Pierce, B.A., Rusydi, A. Safari and G.W. Atmadja. 1989e. A small-scale hatchery for common carp. *ICLARM Education Series* 8, 42 p. Institute of Ecology, Indonesian State Electric Company (IOE UNPAD-PLN), Bandung, Indonesia, and International Center for Living Aquatic Resources Management, Manila, Philippines.
- dela Cruz, C.R. 1979. Observations on freshwater aquaculture and extension in Malaysia, Thailand, Japan and Taiwan. *ICLARM Newsletter* 2: 6-8.
- dela Cruz, C.R. 1986. Petunjuk pelaksanaan budidaya mina-padi. Proyek kerjasama antara USAID dengan Direktorat Jenderal Perikanan, Indonesia, 1986. (Final report. Small-scale fisheries development project. Rice-fish culture sub-project). USAID/ARD Project No. 497-0286. Jakarta, Indonesia.
- dela Cruz, C.R. 1987. Consultancy report on aquaculture research and development in Saguling and Cirata Reservoirs, Bandung, West Java. Unpublished ICLARM Consultancy Report. 29 p.
- De Silva, S.S. 1989. Reducing feed costs in semi-intensive aquaculture systems in the tropics. *Naga, the ICLARM Quarterly* 12(4): 6-7.
- DGF (Directorate General of Fisheries). 1988. Increasing the development of fisheries production years 1988/1989. DGF, Jakarta, Indonesia.
- Djajadiredja, R., Z. Jangkaru and G. Wira Atmadja. 1982. Floating net, floating cage and pen fish culture: an experiment in supporting the resettlement program of PLTA Saguling project. PLN, Jakarta, Indonesia and Research Institute for Inland Fisheries, Bogor, Indonesia.

- Otubusin, S.O. 1988. Hybridization trials using *Oreochromis niloticus* and *Sarotherodon galilaeus* in floating bamboo net-hapas in Kainji Lake Basin, Nigeria. *Aquaculture* 74: 233-237.
- Ogino, C. and K. Saito. 1970. Protein utilization in fish. I. The utilization of dietary protein by carp. *J. Japan Soc. Sci. Fish.* 36: 250-254.
- O'Grady, K.T. and P.B. Spillett. 1987. Pond and tank feeding trials with carp, *Cyprinus carpio* L.: gross nutrition, conversion efficiency and cost-effective diets. *Aquacult. Fish. Manage.* 18: 73-93.
- Pullin, R.S.V. 1981. Fish pens of Laguna de Bay, Philippines. *ICLARM Newsletter* 4: 11-13.
- Pullin, R.S.V. 1985. Tilapia: "Everyman's fish". *Biologist* 35: 84-88.
- Pullin, R.S.V. 1986. Aquaculture development in Nepal-pointers for success. *NAGA, The ICLARM Quarterly* 9: 9-10.
- Pullin, R.S.V. 1988. Tilapia genetic resources for aquaculture. *ICLARM Conference Proceedings* 16. International Center for Living Aquatic Resources Management, Manila, Philippines.
- Rifai, S. 1985. Experimental project on floating net cages in the Saguling Reservoir. Bank of Indonesia, Bandung Branch, Bandung, Indonesia, and the Research Institute, Padjadjaran University, Bandung. (In Indonesian).
- RILF (Research Institute for Inland Fisheries). 1983. Live net fish culture and breeding in Juanda Lake, an experiment in supporting the resettlement program of PLTA Saguling project. PLN, Jakarta, Indonesia.
- RIPU (Research Institute, Padjadjaran University). 1986. Training in aquaculture practices to support the resettlement scheme of PLTA Cirata. PLN, Jakarta, Indonesia. (In Indonesian).
- RIPU. 1987. Research in the administrative area of the Saguling reservoir in fisheries and drawdown agriculture to support the resettlement scheme. PLN, Jakarta, Indonesia. (In Indonesian).
- Sarnita, A. and Yoenoes. 1979. Growing common carp and Nile tilapia in floating net cages in the Jatiluhur reservoir. Report of the Inland Fisheries Research Institute 1: 31-34. (In Indonesian).
- Sarig, S. 1966. Synopsis of biological data on common carp *Cyprinus carpio* L. (Near East and Europe). *FAO Fish. Synop.* 31.2.
- Sin, A.W. 1973a. The dietary protein requirements for growth of young carp (*Cyprinus carpio*). *Hong Kong Fish. Bull.* 3: 77-81.
- Sin, A.W. 1973b. The utilization of dietary protein for growth of young carp (*Cyprinus carpio*) in relation to variations in fat intake. *Hong Kong Fish. Bull.* 3: 83-88.
- Siraj, S.S., R.O. Smitherman, S. Castillo-Gallusser and R.A. Dunham. 1983. Reproductive traits for three year classes of *Tilapia nilotica* and maternal effects on their progeny, p. 210-218. *In* L. Fishelson and Z. Yaron (comps.) *Proceedings of the International Symposium on Tilapia in Aquaculture*, Nazareth, Israel, 8-13 May 1983. Tel Aviv University, Israel.
- Sokal, R.R. and F.J. Rohlf. 1969. *Biometry*. W.H. Freeman and Co., San Francisco, California.
- Srikanth, G.K., M.C. Nandeesha, P. Keshavanath, T.J. Varghese, H.P.C. Shetty and N. Basavaraja. 1989. On the applicability of mixed feeding schedule in common carp, *Cyprinus carpio* var. *communis*, p. 254-260. *In* E.A. Huisman, N. Zonneveld and A.H.M. Bouwmans (eds.) *Aquacultural research in Asia: management techniques and nutrition*. Centre for Agricultural Publishing and Documentation, Pudoc, Wageningen, The Netherlands.
- Sugiarto. 1988. *Hatchery techniques for Oreochromis mossambicus and O. niloticus*. C.V. Simplex, Jakarta, Indonesia.
- Suhenda, N. 1982. Quantitative dietary protein requirement for the growth of common carp fry (*Cyprinus carpio* L.). *Bull. Penelitian Perikanan Darat* 3: 1-6. (In Indonesian).
- Suprayitno, T. 1986. Culture of common carp in running water. Directorate General of Fisheries, Jakarta, Indonesia, and International Development Research Centre, Ottawa, Canada.
- Sutandar, Z., B.A. Costa-Pierce, Rusydi and H. Hadikusumah. 1990. The aquaculture resettlement option in the Saguling Reservoir - its contribution to an environmentally oriented hydropower project, p. 253-258. *In* R. Hirano and I. Hanyu (eds.) *The Second Asian Fisheries Forum*. 991 p. Asian Fisheries Society, Manila, Philippines.
- Teng, S.K. and T.E. Chua. 1978. Effect of stocking density on the growth of estuary grouper, *Epinephelus salmoides* Maxwell, cultures in floating-net cages. *Aquaculture* 15: 273-287.
- Tsodik, G.G. and M.N. Kutty. 1987. Influence of ambient oxygen on feeding and growth of the tilapia, *Oreochromis niloticus* (Linnaeus). *ARAC/87/WR/10*. African Regional Aquaculture Centre, Port Harcourt, Nigeria.
- Vaas, K.R. and M. Sachlan. 1957. Cultivation of common carp in running water in West Java. *Proc. Indo-Pac. Fish. Coun.* 6: 187-196.
- Viola, S., J. Arieli, U. Rappaport and S. Mokady. 1981. Experiments in the nutrition of carp. Replacement of fish meal by soybean meal. *Bamidgeh* 33: 35-49.
- Zar, J.H. 1984. *Biostatistical analysis*. Second edition. Prentice-Hall, Inc., New Jersey.
- Zulkifli, J. and R. Djajadiredja. 1979. Culturing common carp in floating cages. Report of the Inland Fisheries Research Institute 1: 35-41. (In Indonesian).
- Zur, O. 1980. The importance of chironomid larvae as natural feed and as a biological indicator of soil condition in ponds containing common carp (*Cyprinus carpio*) and tilapia (*Sarotherodon aureus*). *Bamidgeh* 32: 66-77.

## APPENDIX

### AQUACULTURE DATA FILES AND COMPUTER IDENTIFICATIONS

- 1.0 Nursery Experiments with Common Carp and Tilapia Hybrids in Good and Poor Water Quality
- |     |       |       |  |
|-----|-------|-------|--|
| 1.1 | File: | NURS1 | ID: Cage 13, 0.5 kg/m <sup>3</sup> tilapia, good |
| 1.2 | File: | NURS2 | ID: Cage 10, 0.5 tilapia, good                   |
| 1.3 | File: | NURS3 | ID: Cage 15, 0.5 tilapia, poor                   |
| 1.4 | File: | NURS4 | ID: Cage 17, 0.5 tilapia, poor                   |
| 1.5 | File: | NURS5 | ID: Cage 11, 0.5 kg/m <sup>3</sup> carp, good    |
| 1.6 | File: | NURS6 | ID: Cage 12, 0.5 carp, good                      |
| 1.7 | File: | NURS7 | ID: Cage 14, 0.5 carp, poor                      |
| 1.8 | File: | NURS8 | ID: Cage 16, 0.5 carp, poor                      |
- 2.0 Nursery Experiments with Common Carp and Tilapia Hybrids with and without Light Attractor
- |     |       |        |   |
|-----|-------|--------|---|
| 2.1 | File: | NURS9  | ID: Cage MC1, 0.5 kg/m <sup>3</sup> carp, without |
| 2.2 | File: | NURS10 | ID: Cage MC2, 0.5 carp, without                   |
| 2.3 | File: | NURS11 | ID: Cage MAC1, 0.5 carp, with                     |
| 2.4 | File: | NURS12 | ID: Cage MAC2, 0.5 carp, with                     |
| 2.5 | File: | NURS13 | ID: Cage NC1, 0.5 tilapia, without                |
| 2.6 | File: | NURS14 | ID: Cage NC2, 0.5 tilapia, without                |
| 2.7 | File: | NURS15 | ID: Cage NAC1, 0.5 tilapia, with                  |
| 2.8 | File: | NURS16 | ID: Cage NAC2, 0.5 tilapia, with                  |
- 3.0 Growout of Tilapia Hybrids using Rice Bran Mixed with Commercial Feed in Rich Water at Different Stocking Densities
- |      |       |       |  |
|------|-------|-------|--|
| 3.1  | File: | TIL1  | ID: Com 100, 10 kg/m <sup>3</sup>      |
| 3.2  | File: | TIL2  | ID: Com 100, 10                        |
| 3.3  | File: | TIL3  | ID: Com 100, 6                         |
| 3.4  | File: | TIL4  | ID: Com 100, 6                         |
| 3.5  | File: | TIL5  | ID: Com 100, 2                         |
| 3.6  | File: | TIL6  | ID: Com 100, 2                         |
| 3.7  | File: | TIL7  | ID: Com 75/Br 25, 10 kg/m <sup>3</sup> |
| 3.8  | File: | TIL8  | ID: Com 75/Br 25, 10                   |
| 3.9  | File: | TIL9  | ID: Com 75/Br 25, 6                    |
| 3.10 | File: | TIL10 | ID: Com 75/Br 25, 6                    |
| 3.11 | File: | TIL11 | ID: Com 75/Br 25, 2                    |
| 3.12 | File: | TIL12 | ID: Com 75/Br 25, 2                    |
| 3.13 | File: | TIL13 | ID: Com 50/Br 50, 10 kg/m <sup>3</sup> |
| 3.14 | File: | TIL14 | ID: Com 50/Br 50, 10                   |
| 3.15 | File: | TIL15 | ID: Com 50/Br 50, 6                    |
| 3.16 | File: | TIL16 | ID: Com 50/Br 50, 6                    |
| 3.17 | File: | TIL17 | ID: Com 50/Br 50, 2                    |
| 3.18 | File: | TIL18 | ID: Com 50/Br 50, 2                    |
- 4.0 Nursery Experiment with Tilapia Hybrids at One Stocking Density Using Mixture of Commercial Feed and Rice Bran
- |      |       |        |                                     |
|------|-------|--------|-------------------------------------|
| 4.1  | File: | NURS17 | ID: 0.5 kg/m <sup>3</sup> , Com 100 |
| 4.2  | File: | NURS18 | ID: 0.5, Com 100                    |
| 4.3  | File: | NURS19 | ID: 0.5, Com 75/Br 25               |
| 4.4  | File: | NURS20 | ID: 0.5, Com 75/Br 25               |
| 4.5  | File: | NURS21 | ID: 0.5, Com 50/Br 50               |
| 4.6  | File: | NURS22 | ID: 0.5, Com 50/Br 50               |
| 4.7  | File: | NURS23 | ID: 0.5, Com 25/Br 75               |
| 4.8  | File: | NURS24 | ID: 0.5, Com 25/Br 75               |
| 4.9  | File: | NURS25 | ID: 0.5, Br 100                     |
| 4.10 | File: | NURS26 | ID: 0.5, Br 100                     |

- 5.0 Replicate Trial of Farmer's Technology
- 5.1 File: Grout1 ID: Cage 1, 2.4 kg/m<sup>3</sup>
- 5.2 File: Grout2 ID: Cage 2, 2.4 kg/m<sup>3</sup>
- 5.3 File: Grout3 ID: Cage 3, 2.4 kg/m<sup>3</sup>
- 5.4 File: Grout4 ID: Cage 4, 2.4 kg/m<sup>3</sup>
- 6.0 Preliminary Test of New Net Size Cage and Lower Stocking Rate
- 6.1 File: 9X9 ID: Project Cage, 0.5 kg/m<sup>3</sup>
- 6.2 File: 9X9A ID: Awilarangan Community Group 1
- 6.3 File: 9X9B ID: Awilarangan Community Group 2
- 7.0 Experiment I on Stocking Density
- 7.1 File: DENS1 ID: Cage 1, 0.5 kg/m<sup>3</sup>
- 7.2 File: DENS2 ID: Cage 3, 0.5
- 7.3 File: DENS3 ID: Cage 2, 1.0
- 7.4 File: DENS4 ID: Cage 4, 1.0
- 8.0 Experiment II on Stocking Density
- 8.1 File: DENS5 ID: Cage 19, 0.5 kg/m<sup>3</sup>
- 8.2 File: DENS6 ID: Cage 22, 0.5
- 8.3 File: DENS7 ID: Cage 18, 1.0
- 8.4 File: DENS8 ID: Cage 20, 1.0
- 8.5 File: DENS9 ID: Cage 21, 2.4
- 8.6 File: DENS10 ID: Cage 23, 2.4
- 9.0 Polyculture Experiment Common Carp and Tilapia Hybrids
- 9.1 File: POLY1 ID: Cage 6, 0.5 kg/m<sup>3</sup>, Nile Tilapia
- 9.2 File: POLY2 ID: Cage 6, 0.5 Common Carp
- 9.3 File: POLY3 ID: Cage 8, 0.5 kg/m<sup>3</sup>, Nile Tilapia
- 9.4 File: POLY4 ID: Cage 8, 0.5 Common Carp
- 10.0 Experiment with Feed Management
- 10.1 File: FEED1 ID: Cage 7, 0.5 kg/m<sup>3</sup>, Skip Day
- 10.2 File: FEED2 ID: Cage 9, 0.5, Skip Day
- 11.0 Comparison of Two Feeding Patterns for Common Carp
- 11.1 File: FEED3 ID: Satiation, 1.0 kg/m<sup>3</sup>, Cage 10
- 11.2 File: FEED4 ID: Satiation, 1.0 kg/m<sup>3</sup>, Cage 11
- 11.3 File: FEED5 ID: 3% BWD, 1.0 kg/m<sup>3</sup>, Cage 14
- 11.4 File: FEED6 ID: 3% BWD, 1.0 kg/m<sup>3</sup>, Cage 15
- 12.0 Combination of Common Carp Nurseries in Floating Net Cages Stocked with Two Sizes of Tilapia Hybrids
- 12.1 File: BI1 ID: Cage X1, 0.5 kg/m<sup>3</sup> carp, sm tilapia
- 12.2 File: BI2 ID: Cage Y1, 0.5 carp, sm tilapia
- 12.3 File: BI3 ID: Cage 1, 1.0 kg/m<sup>3</sup>, sm tilapia
- 12.4 File: BI4 ID: Cage X2, 0.5 carp
- 12.5 File: BI5 ID: Cage Y2, 0.5 carp
- 12.6 File: BI6 ID: Cage X3, 0.5 carp
- 12.7 File: BI7 ID: Cage Y3, 0.5 carp
- 12.8 File: BI8 ID: Cage X4, 0.5 carp, sm tilapia
- 12.9 File: BI9 ID: Cage Y4, 0.5 carp, sm tilapia
- 12.10 File: BI10 ID: Cage 4, 1.0 kg/m<sup>3</sup>, sm tilapia
- 12.11 File: BI11 ID: Cage 5, 1.0 sm tilapia
- 12.12 File: BI12 ID: Cage X6, 0.5 carp
- 12.13 File: BI13 ID: Cage Y6, 0.5 carp
- 12.14 File: BI14 ID: Cage X7, 0.5 carp
- 12.15 File: BI15 ID: Cage Y7, 0.5 carp
- 12.16 File: BI16 ID: Cage 8, 1.0 kg/m<sup>3</sup>, sm tilapia
- 12.17 File: BI17 ID: Cage X9, 0.5 carp, big tilapia
- 12.18 File: BI18 ID: Cage Y9, 0.5 carp, big tilapia
- 12.19 File: BI19 ID: Cage 9, 1.0 kg/m<sup>3</sup>, big tilapia



12.20 File: BI20 ID: Cage X12, 0.5 carp, big tilapia  
 12.21 File: BI21 ID: Cage Y12, 0.5 carp, big tilapia  
 12.22 File: BI22 ID: Cage 12, 1.0 big tilapia  
 12.23 File: BI23 ID: Cage 13, 1.0 big tilapia  
 12.24 File: BI24 ID: Cage 16, 1.0 big tilapia

13.0 Small Cage Trials--Bamboo, Net, Wire Cages

13.1 File: SMCAGE1 ID: Cage 1  
 13.2 File: SMCAGE2 ID: Cage 2  
 13.3 File: SMCAGE3 ID: Cage 3  
 13.4 File: SMCAGE4 ID: Cage 4  
 13.5 File: SMCAGE5 ID: Cage "A"  
 13.6 File: SMCAGE6 ID: Cage "B"  
 13.7 File: SMCAGE7 ID: Cage "1"  
 13.8 File: SMCAGE8 ID: Cage "2"

1.0 Nursery experiment with common carp and tilapia hybrids in good and poor water quality  
 Cage 13, 0.5 kg/m<sup>3</sup>, tilapia, good water

1.1 File: NURS1

Date	Days sample	Days elapsed	kg	Fish number	Growth (g/fish/day)	kg feed	kg fish	FCR-P
Jan 18	0	0	5.7	1,144				
Feb 1	14	14	14.6	1,119	0.6	16.1	8.9	1.8
Feb 16	15	29	27.1	1,119	0.7	38.3	12.5	3.1
Mar 2	14	43	46.3	1,119	1.2	56.8	19.3	2.9
Mar 17	15	58	76.9	1,119	1.8	86.9	30.6	2.8
Apr 1	15	73	117.3	1,119	2.4	115.5	40.4	2.9
Apr 16	15	88	150.0	1,115	2.0	132.0	32.7	4.0
Apr 23	7	95	156.0	1,078	0.8	52.5	6.0	8.8
% Mortality				5.8				
FCR-Net	3.3							
Total	82	82	249.0	785		498.0		
Mean					1.4	71.1	21.5	3.8
Max					2.4	132.0	40.4	8.8
Min					0.6	16.1	6.0	1.8
STD					0.7	38.9	12.3	2.1

Notes: FCR-P = food conversion ratio for the period between samplings.  
 FCR-Net = net food conversion ratio for the entire experimental period, e.g., using stocking vs. harvesting data.  
 STD = standard deviation.

1.0 Nursery experiment with common carp and tilapia hybrids in good and poor water quality  
 Cage 10, 0.5 kg/m<sup>3</sup>, tilapia, good water

1.2 File: NURS2

Date	Days sample	Days elapsed	kg	Fish number	Growth (g/fish/day)	kg feed	kg fish	FCR-P
Jan 18	0	0	5.7	963				
Feb 1	14	14	14.3	906	0.7	16.1	8.6	1.9
Feb 16	15	29	21.3	901	0.5	37.5	7.1	5.3
Mar 2	14	43	37.0	892	1.3	44.8	15.7	2.9
Mar 17	15	58	61.2	884	1.8	69.3	24.3	2.9
Apr 1	15	73	94.3	878	2.5	91.8	33.1	2.8
Apr 16	15	88	123.0	858	2.2	106.5	28.7	3.7
Apr 23	7	95	128.0	864	0.8	43.1	5.0	8.6
% Mortality				10.3				
FCR-Net	3.3							
Total	95	95	128.0	864		409.1		
Mean					1.4	58.4	17.5	4.0
Max					2.5	106.5	33.1	8.6
Min					0.5	16.1	5.0	1.9
STD					0.7	29.7	10.4	2.1

Notes: FCR-P = food conversion ratio for the period between samplings.  
 FCR-Net = net food conversion ratio for the entire experimental period, e.g., using stocking vs. harvesting data.  
 STD = standard deviation.

1.0 Nursery experiment with common carp and tilapia hybrids in good and poor water quality  
Cage 15, 0.5 kg/m<sup>3</sup>, tilapia, poor water

## 1.3 File: NURS3

Date	Days sample	Days elapsed	kg	Fish number	Growth (g/fish/day)	kg feed	kg fish	FCR-P
Jan 18	0	0	5.7	620				
Feb 1	14	14	14.6	614	1.0	16.1	8.9	1.8
Feb 16	15	29	22.8	613	0.9	38.4	8.2	4.7
Mar 2	14	43	43.0	612	2.4	47.9	20.2	2.4
Mar 17	15	58	68.1	604	2.8	80.7	25.1	3.2
Apr 1	15	73	90.3	599	2.5	102.0	22.2	4.6
Apr 16	15	88	122.5	597	3.6	102.0	32.2	3.2
Apr 23	7	95	125.0	597	0.6	42.9	2.5	17.2
% Mortality				3.7				
FCR-Net	3.6							
Total	95	95	125.0	597		430.0		
Mean					2.0	61.4	17.0	5.3
Max					3.6	102.0	32.2	17.2
Min					0.6	16.1	2.5	1.8
STD					1.0	31.1	9.9	4.9

Notes: FCR-P = food conversion ratio for the period between samplings.  
FCR-Net = net food conversion ratio for the entire experimental period, e.g., using stocking vs. harvesting data.  
STD = standard deviation.

1.0 Nursery experiment with common carp and tilapia hybrids in good and poor water quality  
Cage 17, 0.5 kg/m<sup>3</sup>, tilapia, poor water

## 1.4 File: NURS4

Date	Days sample	Days elapsed	kg	Fish number	Growth (g/fish/day)	kg feed	kg fish	FCR-P
Jan 18	0	0	5.7	799				
Feb 1	14	14	13.2	795	0.7	16.1	7.5	2.2
Feb 16	15	29	22.1	792	0.8	34.5	9.0	3.9
Mar 2	14	43	37.7	783	1.4	46.5	15.6	3.0
Mar 17	15	58	57.8	781	1.7	70.7	20.1	3.5
Apr 1	15	73	78.8	779	1.8	86.7	21.0	4.1
Apr 16	15	88	108.0	779	2.5	88.5	29.2	3.0
Apr 23	7	95	109.0	570	0.3	37.8	1.0	37.8
% Mortality				28.7				
FCR-Net	3.7							
Total	95	95	109.0	570		380.7		
Mean					1.3	54.4	14.8	8.2
Max					2.5	88.5	29.2	37.8
Min					0.3	16.1	1.0	2.2
STD					0.7	25.8	8.9	12.1

Notes: FCR-P = food conversion ratio for the period between samplings.  
FCR-Net = net food conversion ratio for the entire experimental period, e.g., using stocking vs. harvesting data.  
STD = standard deviation.

1.0 Nursery experiment with common carp and tilapia hybrids in good and poor water quality  
Cage 11, 0.5 kg/m<sup>3</sup>, carp, good water

1.5 File: NURS5

Date	Days sample	Days elapsed	kg	Fish number	Growth (g/fish/day)	kg feed	kg fish	FCR-P
Jan 18	0	0	5.7	1,260				
Feb 1	14	14	8.7	1,236	0.2	16.1	3.0	5.4
Feb 16	15	29	12.6	1,233	0.2	22.8	3.9	5.8
Mar 2	14	43	16.3	1,219	0.2	26.5	3.7	7.2
Mar 17	15	58	20.2	1,210	0.2	30.5	4.0	7.6
Apr 1	15	73	23.6	1,200	0.2	30.3	3.4	9.0
Apr 16	15	88	26.0	1,779	0.1	27.0	2.4	11.3
Apr 23	7	95	27.6	809	0.3	9.1	1.6	5.7
% Mortality				35.8				
FCR-Net		7.4						
Total		95	95	27.6	809	162.2		
Mean					0.2	23.2	3.1	7.4
Max					0.3	30.5	4.0	11.3
Min					0.1	9.1	1.6	5.4
STD					0.0	7.3	0.8	2.0

Notes: FCR-P = food conversion ratio for the period between samplings.  
FCR-Net = net food conversion ratio for the entire experimental period, e.g., using stocking vs. harvesting data.  
STD = standard deviation.

1.0 Nursery experiment with common carp and tilapia hybrids in good and poor water quality  
Cage 12, 0.5 kg/m<sup>3</sup>, carp, good water

1.6 File: NURS6

Date	Days sample	Days elapsed	kg	Fish number	Growth (g/fish/day)	kg feed	kg fish	FCR-P
Jan 18	0	0	5.7	1,843				
Feb 1	14	14	8.7	1,648	0.1	16.1	3.0	5.4
Feb 16	15	29	12.3	1,646	0.1	22.8	3.6	6.3
Mar 2	14	43	15.0	1,636	0.1	25.8	2.7	9.5
Mar 17	15	58	18.9	1,627	0.2	28.2	3.9	7.3
Apr 1	15	73	22.6	1,619	0.2	28.5	3.7	7.7
Apr 16	15	88	24.0	1,596	0.1	25.5	1.4	18.2
Apr 23	7	95	25.4	919	0.2	8.4	1.4	6.0
% Mortality				50.1				
FCR-Net		7.9						
Total		95	95	25.4	919	155.3		
Mean					0.1	22.2	2.8	8.6
Max					0.2	28.5	3.9	18.2
Min					0.1	8.4	1.4	5.4
STD					0.0	6.8	1.0	4.1

Notes: FCR-P = food conversion ratio for the period between samplings.  
FCR-Net = net food conversion ratio for the entire experimental period, e.g., using stocking vs. harvesting data.  
STD = standard deviation.

1.0 Nursery experiment with common carp and tilapia hybrids in good and poor water quality  
Cage 14, 0.5 kg/m<sup>3</sup>, carp, poor water

1.7 File: NURS7

Date	Days sample	Days elapsed	kg	Fish number	Growth (g/fish/day)	kg feed	kg fish	FCR-P
Jan 18	0	0	5.7	1,195				
Feb 1	14	14	8.8	1,151	0.2	16.1	3.1	5.3
Feb 16	15	29	11.0	1,121	0.1	23.0	2.3	10.2
Mar 2	14	43	14.5	1,092	0.2	23.1	3.5	6.7
Mar 17	15	58	15.6	1,080	0.1	27.0	1.1	23.7
Apr 1	15	73	18.2	1,069	0.2	24.0	2.6	9.2
Apr 16	15	88	20.3	1,056	0.1	20.4	2.1	9.7
Apr 23	7	95	20.5	701	0.0	7.1	0.2	35.7
% Mortality				41.3				
FCR-Net	9.5							
Total	95	95	20.5	701		140.7		
Mean					0.1	20.1	2.1	14.4
Max					0.2	27.0	3.5	35.7
Min					0.1	7.1	0.2	5.3
STD					0.0	6.1	1.0	10.3

Notes: FCR-P = food conversion ratio for the period between samplings.

FCR-Net = net food conversion ratio for the entire experimental period, e.g., using stocking vs. harvesting data.

STD = standard deviation.

1.0 Nursery experiment with common carp and tilapia hybrids in good and poor water quality  
Cage 16, 0.5 kg/m<sup>3</sup>, carp, poor water

1.8 File: NURS8

Date	Days sample	Days elapsed	kg	Fish number	Growth (g/fish/day)	kg feed	kg fish	FCR-P
Jan 18	0	0	5.7	1,245				
Feb 1	14	14	8.0	1,235	0.1	16.1	2.3	7.0
Feb 16	15	29	9.6	1,227	0.1	21.0	1.6	13.1
Mar 2	14	43	11.3	1,178	0.1	20.2	1.7	11.9
Mar 17	15	58	12.6	1,146	0.1	21.2	1.3	16.3
Apr 1	15	73	14.1	1,114	0.1	18.9	1.5	12.6
Apr 16	15	88	17.0	1,102	0.2	15.9	2.9	5.5
Apr 23	7	95	17.5	778	0.1	6.0	0.5	11.9
% Mortality				37.5				
FCR-Net	10.1							
Total	95	95	17.5	778		119.2		
Mean					0.1	17.0	1.7	11.2
Max					0.2	21.2	2.9	16.3
Min					0.1	6.0	0.5	5.5
STD					0.0	4.9	0.7	3.4

Notes: FCR-P = food conversion ratio for the period between samplings.

FCR-Net = net food conversion ratio for the entire experimental period, e.g., using stocking vs. harvesting data.

STD = standard deviation.

2.0 Nursery experiment with common carp and tilapia hybrids with and without light attractor  
Cage MC1, carp, without

2.1 File: NURS9

Date	Days sample	Days elapsed	kg	Fish number	Growth (g/fish/day)	kg feed	kg fish	FCR-P
Mar 2	0	0	5.5	1,003				
Mar 18	16	16	6.9	860	0.1	17.6	1.4	12.6
Apr 1	14	30	10.9	842	0.3	16.8	4.0	4.2
Apr 15	14	44	15.6	840	0.4	22.4	4.7	4.8
Apr 29	14	58	21.8	840	0.5	27.0	6.2	4.4
May 13	14	72	28.0	838	0.5	30.5	6.2	4.9
May 27	14	86	36.6	835	0.7	29.4	8.6	3.4
% Mortality				16.7				
FCR-Net	4.6							
Total	86	86	36.6	835		143.7		
Mean					0.4	24.0	5.2	5.7
Max					0.7	30.5	8.6	12.6
Min					0.1	16.8	1.4	3.4
STD					0.2	5.4	2.2	3.1

Notes: FCR-P = food conversion ratio for the period between samplings.  
FCR-Net = net food conversion ratio for the entire experimental period, e.g., using stocking vs. harvesting data.  
STD = standard deviation.

2.0 Nursery experiment with common carp and tilapia hybrids with and without light attractor  
Cage MC2, carp, without

2.2 File: NURS10

Date	Days sample	Days elapsed	kg	Fish number	Growth (g/fish/day)	kg feed	kg fish	FCR-P
Mar 2	0	0	5.5	1,001				
Mar 18	16	16	7.1	893	0.1	17.6	1.6	11.0
Apr 1	14	30	11.8	883	0.4	16.8	4.7	3.6
Apr 15	14	44	16.1	881	0.3	23.8	4.3	5.5
Apr 29	14	58	22.7	881	0.5	28.1	6.5	4.3
May 13	14	72	28.7	881	0.5	31.6	6.1	5.2
May 27	14	86	35.6	878	0.6	30.8	6.9	4.5
% Mortality				12.3				
FCR-Net	4.9							
Total	86	86	35.6	878		148.8		
Mean					0.4	24.8	5.0	5.7
Max					0.6	31.6	6.9	11.0
Min					0.1	16.8	1.6	3.6
STD					0.2	5.9	1.8	2.5

Notes: FCR-P = food conversion ratio for the period between samplings.  
FCR-Net = net food conversion ratio for the entire experimental period, e.g., using stocking vs. harvesting data.  
STD = standard deviation.

2.0 Nursery experiment with common carp and tilapia hybrids with and without light attractor  
Cage MAC1, carp, with

## 2.3 File: NURS11

Date	Days sample	Days elapsed	kg	Fish number	Growth (g/fish/day)	kg feed	kg fish	FCR-P
Mar 2	0	0	5.5	1,060				
Mar 18	16	16	8.9	933	0.2	17.6	3.4	5.2
Apr 1	14	30	13.4	912	0.4	21.0	4.5	4.7
Apr 15	14	44	19.6	907	0.5	28.0	6.2	4.6
Apr 29	14	58	25.0	907	0.4	34.2	5.5	6.3
May 13	14	72	32.0	907	0.6	35.0	7.0	5.0
May 27	14	86	41.0	905	0.7	33.6	9.0	3.7
% Mortality				14.6				
FCR-Net		4.8						
Total		86	86	41.0		169.4		
Mean					0.5	28.2	5.9	4.9
Max					0.7	35.0	9.0	6.3
Min					0.2	17.6	3.4	3.7
STD					0.2	6.8	1.8	0.8

Notes: FCR-P = food conversion ratio for the period between samplings.

FCR-Net = net food conversion ratio for the entire experimental period, e.g., using stocking vs. harvesting data.

STD = standard deviation.

2.0 Nursery experiment with common carp and tilapia hybrids with and without light attractor  
Cage MAC2, carp, with

## 2.4 File: NURS12

Date	Days sample	Days elapsed	kg	Fish number	Growth (g/fish/day)	kg feed	kg fish	FCR-P
Mar 2	0	0	5.5	1,065				
Mar 18	16	16	8.0	922	0.2	17.6	2.5	7.2
Apr 1	14	30	13.0	891	0.4	19.6	5.1	3.9
Apr 15	14	44	18.5	886	0.4	27.3	5.5	5.0
Apr 29	14	58	25.3	886	0.5	32.3	6.8	4.8
May 13	14	72	34.0	886	0.7	35.4	8.7	4.1
May 27	14	86	42.0	883	0.6	35.0	8.0	4.4
% Mortality				17.1				
FCR-Net		4.6						
Total		86	86	42.0		167.3		
Mean					0.5	27.9	6.1	4.9
Max					0.7	35.4	8.7	7.2
Min					0.2	17.6	2.5	3.9
STD					0.2	7.1	2.1	1.1

Notes: FCR-P = food conversion ratio for the period between samplings.

FCR-Net = net food conversion ratio for the entire experimental period, e.g., using stocking vs. harvesting data.

STD = standard deviation.

2.0 Nursery experiment with common carp and tilapia hybrids with and without light attractor  
Cage NC1, tilapia, without

2.5 File: NURS13

Date	Days sample	Days elapsed	kg	Fish number	Growth (g/fish/day)	kg feed	kg fish	FCR-P
Mar 2	0	0	5.5	479				
Mar 18	16	16	9.9	466	0.6	17.6	4.4	4.0
Apr 1	14	30	16.9	459	1.1	23.8	7.0	3.4
Apr 15	14	44	26.2	457	1.5	35.0	9.3	3.8
Apr 29	14	58	40.0	457	2.2	45.9	13.8	3.3
May 13	14	72	53.1	457	2.0	56.0	13.1	4.3
May 27	14	86	67.0	455	2.2	55.7	13.9	4.0
% Mortality				5.0				
FCR-Net		3.8						
Total		86	86	67.0		234.0		
Mean					1.6	39.0	10.3	3.8
Max					2.2	56.0	13.9	4.3
Min					0.6	17.6	4.4	3.3
STD					0.6	14.8	3.6	0.3

Notes: FCR-P = food conversion ratio for the period between samplings.  
FCR-Net = net food conversion ratio for the entire experimental period, e.g., using stocking vs. harvesting data.  
STD = standard deviation.

2.0 Nursery experiment with common carp and tilapia hybrids with and without light attractor  
Cage NC2, tilapia, without

2.6 File: NURS14

Date	Days sample	Days elapsed	kg	Fish number	Growth (g/fish/day)	kg feed	kg fish	FCR-P
Mar 2	0	0	5.5	479				
Mar 18	16	16	9.5	462	0.5	17.6	4.0	4.4
Apr 1	14	30	16.3	460	1.1	22.4	6.8	3.3
Apr 15	14	44	26.1	460	1.5	33.6	9.8	3.4
Apr 29	14	58	37.4	460	1.8	45.6	11.3	4.0
May 13	14	72	50.0	460	2.0	52.4	12.6	4.2
May 27	14	86	61.8	457	1.8	52.5	11.8	4.4
% Mortality				4.6				
FCR-Net		4.0						
Total		86	86	61.8		224.1		
Mean					1.4	37.4	9.4	4.0
Max					2.0	52.5	12.6	4.4
Min					0.5	17.6	4.0	3.3
STD					0.5	13.9	3.0	0.4

Notes: FCR-P = food conversion ratio for the period between samplings.  
FCR-Net = net food conversion ratio for the entire experimental period, e.g., using stocking vs. harvesting data.  
STD = standard deviation.

2.0 Nursery experiment with common carp and tilapia hybrids with and without light attractor  
Cage NAC1, tilapia, with

2.7 File: NURS15

Date	Days sample	Days elapsed	kg	Fish number	Growth (g/fish/day)	kg feed	kg fish	FCR-P
Mar 2	0	0	5.5	475				
Mar 18	16	16	9.4	454	0.5	17.6	3.9	4.5
Apr 1	14	30	17.2	443	1.3	25.2	7.8	3.2
Apr 15	14	44	26.5	441	1.5	35.0	9.3	3.8
Apr 29	14	58	41.1	441	2.4	44.7	14.6	3.1
May 13	14	72	53.0	438	1.9	57.5	11.9	4.8
May 27	14	86	65.6	435	2.1	55.6	12.6	4.4
% Mortality				8.4				
FCR-Net		3.9						
Total	86	86	65.6	435		235.6		
Mean					1.6	39.3	10.0	4.0
Max					2.4	57.5	14.6	4.8
Min					0.5	17.6	3.9	3.1
STD					0.6	14.8	3.5	0.7

Notes: FCR-P = food conversion ratio for the period between samplings.

FCR-Net = net food conversion ratio for the entire experimental period, e.g., using stocking vs. harvesting data.

STD = standard deviation.

2.0 Nursery experiment with common carp and tilapia hybrids with and without light attractor  
Cage NAC2, tilapia, with

2.8 File: NURS16

Date	Days sample	Days elapsed	kg	Fish number	Growth (g/fish/day)	kg feed	kg fish	FCR-P
Mar 2	0	0	5.5	474				
Mar 18	16	16	10.1	423	0.7	17.6	4.6	3.8
Apr 1	14	30	16.4	420	1.1	22.4	6.3	3.6
Apr 15	14	44	27.0	418	1.8	33.6	10.6	3.2
Apr 29	14	58	37.8	418	1.8	47.3	10.8	4.4
May 13	14	72	50.0	418	2.1	52.9	12.2	4.3
May 27	14	86	61.4	416	2.0	52.5	11.4	4.6
% Mortality				12.2				
FCR-Net		4.0						
Total	86	86	61.4	416		226.3		
Mean					1.6	37.7	9.3	4.0
Max					2.1	52.9	12.2	4.6
Min					0.7	17.6	4.6	3.2
STD					0.5	14.1	2.8	0.5

Notes: FCR-P = food conversion ratio for the period between samplings.

FCR-Net = net food conversion ratio for the entire experimental period, e.g., using stocking vs. harvesting data.

STD = standard deviation.



3.0 Grow-out of tilapia hybrids using rice bran mixed with commercial feed in rich water at different stocking densities.  
10 kg/m<sup>3</sup>; 100% COMFEED

3.1 File: TIL1

Date	Days sample	Days elapsed	kg	Fish number	Growth (g/fish/day)	Total feed per period	kg fish	FCR-P
Jul 18	0	0	10.0	101				
Jul 26	8	8	13.6	101	4.5	2.1	3.6	0.6
Aug 3	8	16	14.5	101	1.1	2.9	0.9	3.1
Aug 11	8	24	16.7	101	2.7	3.1	2.2	1.4
Aug 19	8	32	18.3	101	2.0	3.5	1.6	2.2
Aug 27	8	40	18.9	101	0.7	3.8	0.6	6.4
Sep 4	8	48	21.4	101	3.1	4.0	2.5	1.6
Sep 12	8	56	21.9	101	0.6	4.5	0.5	9.0
Sep 20	8	64	23.1	101	1.5	4.6	1.2	3.8
Sep 28	8	72	25.9	101	3.5	4.9	2.8	1.7
Oct 8	10	82	29.8	101	3.9	5.4	3.9	1.4
Oct 14	6	88	30.8	101	1.7	6.3	1.0	6.3
Oct 22	8	96	33.0	101	2.7	6.5	2.2	2.9
% Mortality				0.0				
FCR-Net	2.2							
Total	96	96	33.0	101		51.4		
Mean					2.3	4.3	1.9	3.4
Max					4.5	6.5	3.9	9.0
Min					0.6	2.1	0.5	0.6
STD					1.2	1.3	1.1	2.5

Notes: FCR-P = food conversion ratio for the period between samplings.

FCR-Net = net food conversion ratio for the entire experimental period, e.g., using stocking vs. harvesting data.

STD = standard deviation.

3.0 Grow-out of tilapia hybrids using rice bran mixed with commercial feed in rich water at different stocking densities.  
10 kg/m<sup>3</sup>; 100% COMFEED

3.2 File: TIL2

Date	Days sample	Days elapsed	kg	Fish number	Growth (g/fish/day)	Total feed per period	kg fish	FCR-P
Jul 18	0	0	10.0	109				
Jul 26	8	8	13.4	109	3.8	2.1	3.4	0.6
Aug 3	8	16	14.1	109	0.9	2.8	0.8	3.7
Aug 11	8	24	15.3	109	1.4	3.0	1.2	2.5
Aug 19	8	32	15.9	109	0.7	3.2	0.6	5.4
Aug 27	8	40	16.8	109	1.0	3.3	0.9	3.7
Sep 4	8	48	18.4	109	1.8	3.5	1.6	2.2
Sep 12	8	56	21.0	109	3.0	3.9	2.6	1.5
Sep 20	8	64	23.0	109	2.3	4.4	2.0	2.2
Sep 28	8	72	24.7	109	1.9	4.8	1.7	2.8
Oct 8	10	82	25.6	109	0.8	5.2	0.9	5.8
Oct 14	6	88	27.5	109	2.9	5.4	1.9	2.8
Oct 22	8	96	30.5	109	3.4	5.8	3.0	1.9
% Mortality				0.0				
FCR-Net	2.3							
Total	96	96	30.5	109		47.4		
Mean					2.0	3.9	1.7	2.9
Max					3.8	5.8	3.4	5.8
Min					0.7	2.1	0.6	0.6
STD					1.0	1.1	0.9	1.4

Notes: FCR-P = food conversion ratio for the period between samplings.

FCR-Net = net food conversion ratio for the entire experimental period, e.g., using stocking vs. harvesting data.

STD = standard deviation.

3.0 Grow-out of tilapia hybrids using rice bran mixed with commercial feed in rich water at different stocking densities.  
6 kg/m<sup>3</sup>; 100% COMFEED

3.3 File: TIL3

Date	Days sample	Days elapsed	kg	Fish number	Growth (g/fish/day)	Total feed per period	kg fish	FCR-P
Jul 18	0	0	6.0	63				
Jul 26	8	8	8.2	63	4.4	1.3	2.2	0.6
Aug 3	8	16	8.8	63	1.1	1.7	0.6	3.1
Aug 11	8	24	9.3	63	1.1	1.8	0.6	3.3
Aug 19	8	32	9.7	63	0.7	2.0	0.3	5.6
Aug 27	8	40	10.1	63	0.9	2.0	0.4	4.5
Sep 4	8	48	10.6	63	1.0	2.1	0.5	4.2
Sep 12	8	56	12.1	63	3.0	2.2	1.5	1.5
Sep 20	8	64	13.4	63	2.6	1.5	1.3	1.2
Sep 28	8	72	13.8	63	0.8	2.8	0.4	7.0
Oct 8	10	82	15.2	63	2.2	2.9	1.4	2.1
Oct 14	6	88	17.5	63	6.1	3.2	2.3	1.4
Oct 22	8	96	19.3	63	3.6	3.7	1.8	2.0
% Mortality				0.0				
FCR-Net	2.1							
Total	96	96	19.3	63		27.3		
Mean					2.3	2.3	1.1	3.0
Max					6.1	3.7	2.3	7.0
Min					0.7	1.3	0.3	0.6
STD					1.6	0.7	0.7	1.9

Notes: FCR-P = food conversion ratio for the period between samplings.

FCR-Net = net food conversion ratio for the entire experimental period, e.g., using stocking vs. harvesting data.

STD = standard deviation.

3.0 Grow-out of tilapia hybrids using rice bran mixed with commercial feed in rich water at different stocking densities.  
6 kg/m<sup>3</sup>; 100% COMFEED

3.4 File: TIL4

Date	Days sample	Days elapsed	kg	Fish number	Growth (g/fish/day)	Total feed per period	kg fish	FCR-P
Jul 18	0	0	6.0	65				
Jul 26	8	8	8.2	65	4.2	1.3	2.2	0.6
Aug 3	8	16	8.8	65	1.0	1.7	0.5	3.4
Aug 11	8	24	9.3	65	1.2	1.8	0.6	3.1
Aug 19	8	32	10.0	65	1.3	2.0	0.7	2.8
Aug 27	8	40	10.4	65	0.8	2.1	0.4	5.2
Sep 4	8	48	10.8	65	0.8	2.2	0.4	5.4
Sep 12	8	56	11.8	65	1.9	2.3	1.0	2.3
Sep 20	8	64	13.6	65	3.5	2.5	1.8	1.4
Sep 28	8	72	15.3	65	3.3	2.9	1.7	1.7
Oct 8	10	82	15.8	65	0.8	3.2	0.5	6.4
Oct 14	6	88	17.8	65	5.1	3.3	2.0	1.7
Oct 22	8	96	19.5	65	3.3	3.7	1.7	2.2
% Mortality				0.0				
FCR-Net	2.1							
Total	96	96	19.5	65		28.9		
Mean					2.3	2.4	1.1	3.0
Max					5.1	3.7	2.2	6.4
Min					0.8	1.3	0.4	0.6
STD					1.5	0.7	0.7	1.7

Notes: FCR-P = food conversion ratio for the period between samplings.

FCR-Net = net food conversion ratio for the entire experimental period, e.g., using stocking vs. harvesting data.

STD = standard deviation.

3.0 Grow-out of tilapia hybrids using rice bran mixed with commercial feed in rich water at different stocking densities.  
2 kg/m<sup>3</sup>; 100% COMFEED

3.5 File: TIL5

Date	Days sample	Days elapsed	kg	Fish number	Growth (g/fish/day)	Total feed per period	kg fish	FCR-P
Jul 18	0	0	2.0	25				
Jul 26	8	8	3.6	25	8.0	0.8	1.6	0.5
Aug 3	8	16	3.9	25	1.3	0.8	0.3	3.2
Aug 11	8	24	4.1	25	1.0	0.9	0.2	4.3
Aug 19	8	32	4.5	25	2.3	1.0	0.5	2.1
Aug 27	8	40	4.8	25	1.5	1.0	0.3	3.4
Sep 4	8	48	5.2	25	2.0	1.1	0.4	2.7
Sep 12	8	56	5.7	25	2.5	1.2	0.5	2.4
Sep 20	8	64	6.4	25	3.5	1.3	0.7	1.9
Sep 28	8	72	7.0	25	3.0	1.5	0.6	2.5
Oct 8	10	82	7.5	25	2.0	1.6	0.5	3.2
Oct 14	6	88	8.2	25	4.7	1.7	0.7	2.5
Oct 22	8	96	8.7	25	2.5	1.8	0.5	3.7
% Mortality				0.0				
FCR-Net		2.2						
Total		96	96	8.7	25	14.6		
Mean					2.8	1.2	0.6	2.7
Max					8.0	1.8	1.6	4.3
Min					1.0	0.8	0.2	0.5
STD					1.8	0.4	0.3	0.9

Notes: FCR-P = food conversion ratio for the period between samplings.

FCR-Net = net food conversion ratio for the entire experimental period, e.g., using stocking vs. harvesting data.

STD = standard deviation.

3.0 Grow-out of tilapia hybrids using rice bran mixed with commercial feed in rich water at different stocking densities.  
2 kg/m<sup>3</sup>; 100% COMFEED

3.6 File: TIL6

Date	Days sample	Days elapsed	kg	Fish number	Growth (g/fish/day)	Total feed per period	kg fish	FCR-P
Jul 18	0	0	2.0	22				
Jul 26	8	8	2.8	22	4.5	0.6	0.8	0.7
Aug 3	8	16	3.1	22	1.6	0.7	0.3	2.2
Aug 11	8	24	3.2	22	0.6	0.7	0.1	6.1
Aug 19	8	32	3.7	22	2.8	0.8	0.5	1.6
Aug 27	8	40	4.1	22	2.3	0.9	0.4	2.2
Sep 4	8	48	4.5	22	2.3	1.0	0.4	2.4
Sep 12	8	56	4.8	22	1.7	1.0	0.3	3.4
Sep 20	8	64	6.0	22	6.8	1.3	1.2	1.1
Sep 28	8	72	6.8	22	4.5	1.4	0.8	1.8
Oct 8	10	82	7.3	22	2.3	1.5	0.5	3.1
Oct 14	6	88	7.8	22	3.8	1.6	0.5	3.3
Oct 22	8	96	8.5	22	4.0	1.8	0.7	2.6
% Mortality				0.0				
FCR-Net		2.0						
Total		96	96	8.5	22	13.2		
Mean					3.1	1.1	0.5	2.5
Max					6.8	1.8	1.2	6.1
Min					0.6	0.6	0.1	0.7
STD					1.6	0.4	0.3	1.3

Notes: FCR-P = food conversion ratio for the period between samplings.

FCR-Net = net food conversion ratio for the entire experimental period, e.g., using stocking vs. harvesting data.

STD = standard deviation.

3.0 Grow-out of tilapia hybrids using rice bran mixed with commercial feed in rich water at different stocking densities.  
10 kg/m<sup>3</sup>; 75% COMFEED; BRAN 25%

3.7 File: TIL7

Date	Days sample	Days elapsed	kg	Fish number	Growth (g/fish/day)	Total feed per period	kg fish	FCR-P
Jul 18	0	0	10.0	90				
Jul 26	8	8	12.6	90	3.6	2.1	2.6	0.8
Aug 3	8	16	13.4	90	1.0	2.7	0.8	3.5
Aug 11	8	24	14.8	90	1.9	2.8	1.4	2.0
Aug 19	8	32	14.9	90	0.2	3.1	0.2	20.7
Aug 27	8	40	15.9	90	1.4	3.1	1.0	3.1
Sep 4	8	48	16.5	90	0.8	3.3	0.6	5.6
Sep 12	8	56	17.0	90	0.7	3.5	0.5	6.9
Sep 20	8	64	18.0	90	1.4	3.6	1.0	3.6
Sep 28	8	72	20.4	90	3.3	3.8	2.4	1.6
Oct 8	10	82	21.5	90	1.2	4.3	1.1	3.9
Oct 14	6	88	22.0	90	0.9	4.5	0.5	9.0
Oct 22	8	96	24.0	90	2.8	4.6	2.0	2.3
% Mortality				0.0				
FCR-Net	3.0							
Total	96	96	24.0	90	41.4			
Mean					1.6	3.4	1.2	5.3
Max					3.6	4.6	2.6	20.7
Min					0.2	2.1	0.2	0.8
STD					1.0	0.7	0.8	5.2

Notes: FCR-P = food conversion ratio for the period between samplings.

FCR-Net = net food conversion ratio for the entire experimental period, e.g., using stocking vs. harvesting data.

STD = standard deviation.

3.0 Grow-out of tilapia hybrids using rice bran mixed with commercial feed in rich water at different stocking densities.  
10 kg/m<sup>3</sup>; 75% COMFEED; BRAN 25%

3.8 File: TIL8

Date	Days sample	Days elapsed	kg	Fish number	Growth (g/fish/day)	Total feed per period	kg fish	FCR-P
Jul 18	0	0	10.0	90				
Jul 26	8	8	12.5	90	3.5	2.1	2.5	0.8
Aug 3	8	16	13.7	90	1.7	2.6	1.2	2.2
Aug 11	8	24	14.5	90	1.1	2.9	0.8	3.6
Aug 19	8	32	14.8	90	0.4	3.1	0.3	10.2
Aug 27	8	40	15.3	90	0.7	3.1	0.5	6.2
Sep 4	8	48	15.9	90	0.8	3.2	0.6	5.4
Sep 12	8	56	16.5	90	0.8	3.3	0.6	5.6
Sep 20	8	64	17.6	90	1.5	3.5	1.1	3.2
Sep 28	8	72	18.0	90	0.6	3.7	0.4	9.3
Oct 8	10	82	19.0	90	1.1	3.8	1.0	3.8
Oct 14	6	88	20.0	90	1.9	4.0	1.0	4.0
Oct 22	8	96	22.5	90	3.5	4.2	2.5	1.7
% Mortality				0.0				
FCR-Net	3.2							
Total	96	96	22.5	90	39.5			
Mean					1.5	3.3	1.0	4.6
Max					3.5	4.2	2.5	10.2
Min					0.4	2.1	0.3	0.8
STD					1.0	0.6	0.7	2.7

Notes: FCR-P = food conversion ratio for the period between samplings.

FCR-Net = net food conversion ratio for the entire experimental period, e.g., using stocking vs. harvesting data.

STD = standard deviation.

3.0 Grow-out of tilapia hybrids using rice bran mixed with commercial feed in rich water at different stocking densities.  
6 kg/m<sup>3</sup>; 75% COMFEED; BRAN 25%

3.9 File: TIL9

Date	Days sample	Days elapsed	kg	Fish number	Growth (g/fish/day)	Total feed per period	kg fish	FCR-P
Jul 18	0	0	6.0	63				
Jul 26	8	8	7.7	63	3.4	1.3	1.7	0.7
Aug 3	8	16	8.2	63	0.8	1.6	0.4	3.9
Aug 11	8	24	8.4	63	0.4	1.7	0.2	8.6
Aug 19	8	32	9.2	63	1.7	1.8	0.8	2.1
Aug 27	8	40	9.5	63	0.6	1.9	0.3	6.4
Sep 4	8	48	9.6	63	0.2	2.0	0.1	20.0
Sep 12	8	56	11.4	63	3.6	2.0	1.8	1.1
Sep 20	8	64	12.0	63	1.2	2.4	0.6	4.0
Sep 28	8	72	12.9	63	1.8	2.5	0.9	2.8
Oct 8	10	82	14.3	63	2.2	2.7	1.4	1.9
Oct 14	6	88	15.8	63	4.0	3.0	1.5	2.0
Oct 22	8	96	17.5	63	3.4	3.3	1.7	2.0
% Mortality				0.0				
FCR-Net	2.3							
Total	96	96	17.5	63		26.2		
Mean					1.9	2.2	1.0	4.6
Max					4.0	3.3	1.8	20.0
Min					0.2	1.3	0.2	0.7
STD					1.3	0.6	0.6	5.1

Notes: FCR-P = food conversion ratio for the period between samplings.

FCR-Net = net food conversion ratio for the entire experimental period, e.g., using stocking vs. harvesting data.

STD = standard deviation.

3.0 Grow-out of tilapia hybrids using rice bran mixed with commercial feed in rich water at different stocking densities.  
6 kg/m<sup>3</sup>; 75% COMFEED; BRAN 25%

3.10 File: TIL10

Date	Days sample	Days elapsed	kg	Fish number	Growth (g/fish/day)	Total feed per period	kg fish	FCR-P
Jul 18	0	0	6.0	62				
Jul 26	8	8	8.0	62	4.0	1.3	2.0	0.6
Aug 3	8	16	8.2	62	0.4	1.7	0.2	7.6
Aug 11	8	24	8.5	62	0.6	1.7	0.3	6.2
Aug 19	8	32	8.7	62	0.4	1.8	0.2	9.0
Aug 27	8	40	9.2	62	1.0	1.8	0.5	3.7
Sep 4	8	48	9.6	62	0.8	1.9	0.4	4.8
Sep 12	8	56	10.6	62	2.0	2.0	1.0	2.0
Sep 20	8	64	11.0	62	0.8	2.2	0.4	5.6
Sep 28	8	72	11.5	62	1.0	2.3	0.5	4.6
Oct 8	10	82	12.2	62	1.1	2.4	0.7	3.5
Oct 14	6	88	13.0	62	2.2	2.6	0.8	3.2
Oct 22	8	96	15.0	62	4.0	2.7	2.0	1.4
% Mortality				0.0				
FCR-Net	2.7							
Total	96	96	15.0	62		24.5		
Mean					1.5	2.0	0.8	4.3
Max					4.0	2.7	2.0	9.0
Min					0.4	1.3	0.2	0.6
STD					1.2	0.4	0.6	2.4

Notes: FCR-P = food conversion ratio for the period between samplings.

FCR-Net = net food conversion ratio for the entire experimental period, e.g., using stocking vs. harvesting data.

STD = standard deviation.

3.0 Grow-out of tilapia hybrids using rice bran mixed with commercial feed in rich water at different stocking densities.  
2 kg/m<sup>3</sup>; 75% COMFEED; BRAN 25%

3.11 File: TIL11

Date	Days sample	Days elapsed	kg	Fish number	Growth (g/fish/day)	Total feed per period	kg fish	FCR-P
Jul 18	0	0	2.0	26				
Jul 26	8	8	3.0	26	4.8	0.6	1.0	0.6
Aug 3	8	16	3.3	26	1.2	0.7	0.3	2.7
Aug 11	8	24	3.8	26	2.6	0.8	0.5	1.5
Aug 19	8	32	4.2	26	1.9	0.9	0.4	2.2
Aug 27	8	40	4.5	26	1.4	1.0	0.3	3.2
Sep 4	8	48	4.8	26	1.4	1.0	0.3	3.4
Sep 12	8	56	5.2	26	1.9	1.1	0.4	2.7
Sep 20	8	64	5.7	26	2.4	1.2	0.5	2.4
Sep 28	8	72	6.2	26	2.4	1.3	0.5	2.6
Oct 8	10	82	6.7	26	1.9	1.4	0.5	2.8
Oct 14	6	88	7.5	26	5.1	1.6	0.8	2.0
Oct 22	8	96	8.2	26	3.4	1.7	0.7	2.5
% Mortality				0.0				
FCR-Net	2.1							
Total	96	96	8.2	26		13.3		
Mean					2.6	1.1	0.5	2.4
Max					5.1	1.7	1.0	3.4
Min					1.2	0.6	0.3	0.6
STD					1.2	0.3	0.2	0.7

Notes: FCR-P = food conversion ratio for the period between samplings.

FCR-Net = net food conversion ratio for the entire experimental period, e.g., using stocking vs. harvesting data.

STD = standard deviation.

3.0 Grow-out of tilapia hybrids using rice bran mixed with commercial feed in rich water at different stocking densities.  
2 kg/m<sup>3</sup>; 75% COMFEED; BRAN 25%

3.12 File: TIL12

Date	Days sample	Days elapsed	kg	Fish number	Growth (g/fish/day)	Total feed per period	kg fish	FCR-P
Jul 18	0	0	2.0	24				
Jul 26	8	8	2.5	24	2.6	0.5	0.5	1.1
Aug 3	8	16	3.0	24	2.4	0.6	0.5	1.3
Aug 11	8	24	3.6	24	3.3	0.8	0.6	1.2
Aug 19	8	32	4.0	24	2.1	0.8	0.4	2.1
Aug 27	8	40	4.3	24	1.3	0.9	0.3	3.6
Sep 4	8	48	4.5	24	1.3	1.0	0.3	3.8
Sep 12	8	56	4.8	24	1.6	1.0	0.3	3.4
Sep 20	8	64	5.5	24	3.6	1.2	0.7	1.7
Sep 28	8	72	5.9	24	2.1	1.2	0.4	3.1
Oct 8	10	82	6.5	24	2.5	1.4	0.6	2.3
Oct 14	6	88	7.0	24	3.5	1.5	0.5	2.9
Oct 22	8	96	8.3	24	6.8	1.7	1.3	1.3
% Mortality				0.0				
FCR-Net	2.0							
Total	96	96	8.3	24		12.6		
Mean					2.8	1.0	0.5	2.3
Max					6.8	1.7	1.3	3.8
Min					1.3	0.5	0.3	1.1
STD					1.4	0.3	0.3	1.0

Notes: FCR-P = food conversion ratio for the period between samplings.

FCR-Net = net food conversion ratio for the entire experimental period, e.g., using stocking vs. harvesting data.

STD = standard deviation.

3.0 Grow-out of tilapia hybrids using rice bran mixed with commercial feed in rich water at different stocking densities.  
10 kg/m<sup>3</sup>; 50% COMFEED; BRAN 50%

3.13 File: TIL13

Date	Days sample	Days elapsed	kg	Fish number	Growth (g/fish/day)	Total feed per period	kg fish	FCR-P
Jul 18	0	0	10.0	103				
Jul 26	8	8	12.6	103	3.2	2.1	2.6	0.8
Aug 3	8	16	13.3	103	0.8	2.7	0.7	4.1
Aug 11	8	24	14.5	103	1.5	2.8	1.3	2.2
Aug 19	8	32	14.9	103	0.5	3.1	0.4	7.6
Aug 27	8	40	15.5	103	0.7	3.1	0.6	5.2
Sep 4	8	48	16.6	103	1.3	3.3	1.1	3.0
Sep 12	8	56	18.0	103	1.7	3.5	1.4	2.5
Sep 20	8	64	18.6	103	0.7	3.8	0.6	6.3
Sep 28	8	72	20.2	103	1.9	3.9	1.6	2.4
Oct 8	10	82	21.0	103	0.8	4.2	0.8	5.3
Oct 14	6	88	22.0	103	1.6	4.4	1.0	4.4
Oct 22	8	96	23.0	103	1.2	4.6	1.0	4.6
% Mortality				0.0				
FCR-Net	3.2							
Total	96	96	23.0	103		41.4		
Mean					1.3	3.5	1.1	4.0
Max					3.2	4.6	2.6	7.6
Min					0.5	2.1	0.4	0.8
STD					0.7	0.7	0.6	1.9

Notes: FCR-P = food conversion ratio for the period between samplings.

FCR-Net = net food conversion ratio for the entire experimental period, e.g., using stocking vs. harvesting data.

STD = standard deviation.

3.0 Grow-out of tilapia hybrids using rice bran mixed with commercial feed in rich water at different stocking densities.  
10 kg/m<sup>3</sup>; 50% COMFEED; BRAN 50%

3.14 File: TIL14

Date	Days sample	Days elapsed	kg	Fish number	Growth (g/fish/day)	Total feed per period	kg fish	FCR-P
Jul 18	0	0	10.0	102				
Jul 26	8	8	11.4	102	1.7	2.1	1.4	1.5
Aug 3	8	16	13.2	102	2.2	2.4	1.8	1.3
Aug 11	8	24	14.9	102	2.0	2.8	1.7	1.7
Aug 19	8	32	16.1	102	1.5	3.1	1.3	2.5
Aug 27	8	40	16.8	102	0.9	3.4	0.7	4.8
Sep 4	8	48	17.3	102	0.6	3.5	0.4	7.8
Sep 12	8	56	18.0	102	0.9	3.6	0.8	4.8
Sep 20	8	64	19.4	102	1.7	3.8	1.4	2.7
Sep 28	8	72	20.1	102	0.9	4.1	0.7	5.8
Oct 8	10	82	21.9	102	1.8	4.2	1.8	2.3
Oct 14	6	88	23.0	102	1.8	4.6	1.1	4.2
Oct 22	8	96	24.0	102	1.2	4.8	1.0	4.8
% Mortality				0.0				
FCR-Net	3.0							
Total	96	96	24.0	102		42.4		
Mean					1.4	3.5	1.2	3.7
Max					2.2	4.8	1.8	7.8
Min					0.6	2.1	0.4	1.3
STD					0.5	0.8	0.4	1.9

Notes: FCR-P = food conversion ratio for the period between samplings.

FCR-Net = net food conversion ratio for the entire experimental period, e.g., using stocking vs. harvesting data.

STD = standard deviation.

3.0 Grow-out of tilapia hybrids using rice bran mixed with commercial feed in rich water at different stocking densities.  
6 kg/m<sup>3</sup>; 50% COMFEED; BRAN 50%

3.15 File: TIL15

Date	Days sample	Days elapsed	kg	Fish number	Growth (g/fish/day)	Total feed per period	kg fish	FCR-P
Jul 18	0	0	6.0	64				
Jul 26	8	8	7.8	64	3.4	1.3	1.8	0.7
Aug 3	8	16	8.1	64	0.6	1.6	0.3	5.4
Aug 11	8	24	8.1	64	0.1	1.7	.0	33.8
Aug 19	8	32	8.6	64	1.0	1.7	0.5	3.4
Aug 27	8	40	9.3	64	1.4	1.8	0.7	2.6
Sep 4	8	48	9.8	64	1.0	2.0	0.5	3.9
Sep-12	8	56	10.8	64	2.0	2.1	1.0	2.1
Sep 20	8	64	11.2	64	0.8	2.3	0.4	5.7
Sep 28	8	72	12.0	64	1.6	2.4	0.8	2.9
Oct 8	10	82	13.0	64	1.6	2.5	1.0	2.5
Oct 14	6	88	14.0	64	2.6	2.7	1.0	2.7
Oct 22	8	96	15.3	64	2.5	2.9	1.3	2.3
% Mortality				0.0				
FCR-Net	2.7							
Total	96	96	15.3	64		24.9		
Mean					1.5	2.1	0.8	5.7
Max					3.4	2.9	1.8	33.8
Min					0.1	1.3	.0	0.7
STD					0.9	0.5	0.4	8.6

Notes: FCR-P = food conversion ratio for the period between samplings.  
FCR-Net = net food conversion ratio for the entire experimental period, e.g., using stocking vs. harvesting data.  
STD = standard deviation.

3.0 Grow-out of tilapia hybrids using rice bran mixed with commercial feed in rich water at different stocking densities.  
6 kg/m<sup>3</sup>; 50% COMFEED; BRAN 50%

3.16 File: TIL16

Date	Days sample	Days elapsed	kg	Fish number	Growth (g/fish/day)	Total feed per period	kg fish	FCR-P
Jul 18	0	0	6.0	66				
Jul 26	8	8	7.8	66	3.3	1.3	1.8	0.7
Aug 3	8	16	8.2	66	0.8	1.6	0.4	4.1
Aug 11	8	24	8.5	66	0.7	1.7	0.3	4.8
Aug 19	8	32	9.0	66	0.9	1.8	0.5	3.6
Aug 27	8	40	9.7	66	1.3	1.9	0.7	2.7
Sep 4	8	48	9.8	66	0.2	2.0	0.1	20.4
Sep 12	8	56	11.5	66	3.2	2.1	1.7	1.2
Sep 20	8	64	12.0	66	0.9	2.4	0.5	4.8
Sep 28	8	72	13.0	66	1.9	2.5	1.0	2.5
Oct 8	10	82	14.7	66	2.6	2.7	1.7	1.6
Oct 14	6	88	15.5	66	2.0	3.1	0.8	3.9
Oct 22	8	96	17.2	66	3.2	3.3	1.7	1.9
% Mortality				0.0				
FCR-Net	2.4							
Total	96	96	17.2	66		26.4		
Mean					1.8	2.2	0.9	4.4
Max					3.3	3.3	1.8	20.4
Min					0.2	1.3	0.1	0.7
STD					1.1	0.6	0.6	5.0

Notes: FCR-P = food conversion ratio for the period between samplings.  
FCR-Net = net food conversion ratio for the entire experimental period, e.g., using stocking vs. harvesting data.  
STD = standard deviation.



3.0 Grow-out of tilapia hybrids using rice bran mixed with commercial feed in rich water at different stocking densities.  
2 kg/m<sup>3</sup>; 50% COMFEED; BRAN 50%

3.17 File: TIL17

Date	Days sample	Days elapsed	kg	Fish number	Growth (g/fish/day)	Total feed per period	kg fish	FCR-P
Jul 18	0	0	2.0	25				
Jul 26	8	8	2.6	25	3.0	0.6	0.6	0.9
Aug 3	8	16	2.9	25	1.5	0.6	0.3	2.0
Aug 11	8	24	3.5	25	3.0	0.7	0.6	1.2
Aug 19	8	32	3.9	25	1.8	0.8	0.4	2.3
Aug 27	8	40	4.3	25	2.0	0.9	0.4	2.2
Sep 4	8	48	4.7	25	2.3	1.0	0.5	2.2
Sep 12	8	56	5.0	25	1.5	1.1	0.3	3.5
Sep 20	8	64	5.7	25	3.5	1.2	0.7	1.7
Sep 28	8	72	6.2	25	2.5	1.3	0.5	2.6
Oct 8	10	82	7.0	25	3.2	1.5	0.8	1.8
Oct 14	6	88	7.5	25	3.3	1.6	0.5	3.2
Oct 22	8	96	7.8	25	1.5	1.6	0.3	5.5
% Mortality				0.0				
FCR-Net	2.2							
Total	96	96	7.8	25		12.8		
Mean					2.4	1.1	0.5	2.4
Max					3.5	1.6	0.8	5.5
Min					1.5	0.6	0.3	0.9
STD					0.7	0.4	0.2	1.1

Notes: FCR-P = food conversion ratio for the period between samplings  
FCR-Net = net food conversion ratio for the entire experimental period, e.g., using stocking vs. harvesting data.  
STD = standard deviation.

3.0 Grow-out of tilapia hybrids using rice bran mixed with commercial feed in rich water at different stocking densities.  
2 kg/m<sup>3</sup>; 50% COMFEED; BRAN 50%

3.18 File: TIL18

Date	Days sample	Days elapsed	kg	Fish number	Growth (g/fish/day)	Total feed per period	kg fish	FCR-P
Jul 18	0	0	2.0	22				
Jul 26	8	8	2.5	22	2.8	0.5	0.5	1.1
Aug 3	8	16	2.9	22	2.0	0.6	0.4	1.7
Aug 11	8	24	3.3	22	2.3	0.7	0.4	1.7
Aug 19	8	32	3.6	22	1.7	0.8	0.3	2.5
Aug 27	8	40	3.9	22	1.7	0.8	0.3	2.7
Sep 4	8	48	4.3	22	2.3	0.9	0.4	2.2
Sep 12	8	56	4.5	22	1.4	1.0	0.3	3.8
Sep 20	8	64	5.0	22	2.8	1.1	0.5	2.1
Sep 28	8	72	5.5	22	2.8	1.2	0.5	2.3
Oct 8	10	82	6.0	22	2.3	1.3	0.5	2.5
Oct 14	6	88	6.5	22	3.8	1.4	0.5	2.7
Oct 22	8	96	7.0	22	2.8	1.5	0.5	2.9
% Mortality				0.0				
FCR-Net	2.3							
Total	96	96	7.0	22		11.5		
Mean					2.4	1.0	0.4	2.4
Max					3.8	1.5	0.5	3.8
Min					1.4	0.5	0.3	1.1
STD					0.6	0.3	0.1	0.7

Notes: FCR-P = food conversion ratio for the period between samplings.  
FCR-Net = net food conversion ratio for the entire experimental period, e.g., using stocking vs. harvesting data.  
STD = standard deviation.

4.0 Nursery experiment tilapia hybrids at one stocking density using mixture of commercial feed and rice bran.  
0.5 kg/m<sup>3</sup>; 100% COMFEED

4.1 File: NURS17

Date	Days sample	Days elapsed	kg	Fish number	Growth (g/fish/day)	Total feed per period	kg fish	FCR-P
Jul 21	0	0	5.5	1,140				
Jul 28	7	7	7.8	1,135	0.3	2.7	2.3	1.2
Aug 5	8	15	9.1	1,115	0.1	3.8	1.3	2.9
Aug 13	8	23	11.2	1,089	0.2	4.5	2.1	2.1
Aug 21	8	31	12.8	1,058	0.2	5.5	1.6	3.4
Aug 29	8	39	14.5	1,041	0.2	6.3	1.7	3.7
Sep 6	8	47	17.8	1,035	0.4	7.1	3.3	2.2
Sep 14	8	55	22.0	1,026	0.5	8.7	4.2	2.1
Sep 22	8	63	24.0	1,008	0.2	10.8	2.0	5.4
Sep 30	8	71	28.3	998	0.5	11.8	4.3	2.7
Oct 8	8	79	30.5	992	0.3	13.9	2.2	6.3
Oct 16	8	87	36.0	992	0.7	15.0	5.5	2.7
Oct 24	8	95	40.5	990	0.6	17.6	4.5	3.9
Nov 1	8	103	44.0	989	0.4	19.85	3.5	5.7
Nov 9	8	111	48.3	984	0.5	21.56	4.3	5.0
Nov 17	8	119	51.9	983	0.5	23.67	3.6	6.6
% Mortality				13.8				
FCR-Net	3.7							
Total	119	119	51.9	983		172.7		
Mean					0.4	11.5	3.1	3.7
Max					0.7	23.7	5.5	6.6
Min					0.1	2.7	1.3	1.2
STD					0.2	6.6	1.2	1.6

Notes: FCR-P = food conversion ratio for the period between samplings.

FCR-Net = net food conversion ratio for the entire experimental period, e.g., using stocking vs. harvesting data.

STD = standard deviation.

4.0 Nursery experiment tilapia hybrids at one stocking density using mixture of commercial feed and rice bran.  
0.5 kg/m<sup>3</sup>; 100% COMFEED

4.2 File: NURS18

Date	Days sample	Days elapsed	kg	Fish number	Growth (g/fish/day)	Total feed per period	kg fish	FCR-P
Jul 21	0	0	5.5	1,132				
Jul 28	7	7	7.5	1,128	0.3	2.7	2.0	1.4
Aug 5	8	15	9.1	1,098	0.2	3.7	1.6	2.3
Aug 13	8	23	10.0	1,080	0.1	4.5	0.8	5.2
Aug 21	8	31	11.6	1,047	0.2	3.9	1.7	2.4
Aug 29	8	39	15.0	1,031	0.4	5.7	3.4	1.7
Sep 6	8	47	17.0	1,021	0.2	7.4	2.0	3.7
Sep 14	8	55	20.2	1,005	0.4	8.3	3.2	2.6
Sep 22	8	63	24.2	981	0.5	9.9	4.0	2.5
Sep 30	8	71	27.7	980	0.4	11.9	3.5	3.4
Oct 8	8	79	32.6	973	0.6	13.6	4.9	2.8
Oct 16	8	87	36.5	973	0.5	16.0	3.9	4.1
Oct 24	8	95	38.5	973	0.3	17.9	2.0	8.9
Nov 1	8	103	46.5	971	1.0	18.9	8.0	2.4
Nov 9	8	111	49.2	967	0.3	22.8	2.7	8.4
Nov 17	8	119	56.6	967	1.0	24.1	7.4	3.3
% Mortality				14.6				
FCR-Net	3.3							
Total	119	119	56.6	967		171.0		
Mean					0.4	11.4	3.4	3.7
Max					1.0	24.1	8.0	8.9
Min					0.1	2.7	0.8	1.4
STD					0.3	6.9	2.0	2.2

Notes: FCR-P = food conversion ratio for the period between samplings.

FCR-Net = net food conversion ratio for the entire experimental period, e.g., using stocking vs. harvesting data.

STD = standard deviation.

4.0 Nursery experiment tilapia hybrids at one stocking density using mixture of commercial feed and rice bran.  
COMFEED 75%; BRAN 25%

4.3 File: NURS19

Date	Days sample	Days elapsed	kg	Fish number	Growth (g/fish/day)	Total feed per period	kg fish	FCR-P
Jul 21	0	0	5.5	1,120				
Jul 28	7	7	7.9	1,114	0.3	2.7	2.4	1.1
Aug 5	8	15	9.2	1,074	0.2	3.9	1.3	3.0
Aug 13	8	23	10.2	1,057	0.1	4.5	1.0	4.5
Aug 21	8	31	11.9	1,019	0.2	5.0	1.7	2.9
Aug 29	8	39	15.0	1,007	0.4	5.8	3.1	1.9
Sep 6	8	47	17.0	998	0.3	7.4	2.0	3.7
Sep 14	8	55	20.5	985	0.4	8.3	3.5	2.4
Sep 22	8	63	24.0	975	0.4	10.1	3.5	2.9
Sep 30	8	71	26.3	975	0.3	11.8	2.3	5.1
Oct 8	8	79	31.6	975	0.7	12.9	5.3	2.4
Oct 16	8	87	34.5	973	0.4	15.5	2.9	5.3
Oct 24	8	95	37.9	972	0.4	16.9	3.4	5.0
Nov 1	8	103	41.8	970	0.5	18.6	3.9	4.8
Nov 9	8	111	44.3	965	0.3	20.5	2.5	8.2
Nov 17	8	119	46.6	963	0.3	21.7	2.1	10.3
% Mortality				14.0				
FCR-Net	4.0							
Total	119	119	46.4	963		165.4		
Mean					0.3	11.0	2.7	4.2
Max					0.7	21.7	5.3	10.3
Min					0.1	2.7	1.0	1.1
STD					0.1	6.1	1.1	2.4

Notes: FCR-P = food conversion ratio for the period between samplings.

FCR-Net = net food conversion ratio for the entire experimental period, e.g., using stocking vs. harvesting data.

STD = standard deviation.

4.0 Nursery experiment tilapia hybrids at one stocking density using mixture of commercial feed and rice bran.  
COMFEED 75%; BRAN 25%

4.4 File: NURS20

Date	Days sample	Days elapsed	kg	Fish number	Growth (g/fish/day)	Total feed per period	kg fish	FCR-P
Jul 21	0	0	5.5	1,118				
Jul 28	7	7	8.1	1,112	0.3	2.7	2.6	1.0
Aug 5	8	15	9.6	1,084	0.2	4.0	1.5	2.6
Aug 13	8	23	11.0	1,058	0.2	4.7	1.4	3.4
Aug 21	8	31	11.9	1,033	0.1	5.4	0.9	6.0
Aug 29	8	39	16.0	1,010	0.5	5.8	4.1	1.4
Sep 6	8	47	16.5	999	0.1	7.8	0.5	15.7
Sep 14	8	55	20.0	978	0.4	8.1	3.5	2.3
Sep 22	8	63	23.2	978	0.4	9.8	3.2	3.1
Sep 30	8	71	27.3	978	0.5	11.4	4.1	2.8
Oct 8	8	79	31.6	973	0.6	13.4	4.3	3.1
Oct 16	8	87	35.0	971	0.4	15.5	3.4	4.6
Oct 24	8	95	37.7	969	0.3	17.2	2.7	6.4
Nov 1	8	103	44.5	984	0.9	18.5	6.8	2.7
Nov 9	8	111	45.5	958	0.1	21.8	1.0	21.8
Nov 17	8	119	47.8	957	0.3	22.3	2.3	9.7
% Mortality				14.4				
FCR-Net	4.0							
Total	119	119	47.8	957		168.3		
Mean					0.4	11.2	2.8	5.8
Max					0.9	22.3	6.8	21.8
Min					0.1	2.7	0.5	1.0
STD					0.2	6.3	1.6	5.6

Notes: FCR-P = food conversion ratio for the period between samplings.

FCR-Net = net food conversion ratio for the entire experimental period, e.g., using stocking vs. harvesting data.

STD = standard deviation.

4.0 Nursery experiment tilapia hybrids at one stocking density using mixture of commercial feed and rice bran.  
COMFEED 50%; BRAN 50%

## 4.5 File: NURS21

Date	Days sample	Days elapsed	kg	Fish number	Growth (g/fish/day)	Total feed per period	kg fish	FCR-P
Jul 21	0	0	5.5	1,140				
Jul 28	7	7	7.3	1,130	0.2	2.7	1.8	1.5
Aug 5	8	15	8.7	1,103	0.2	3.6	1.4	2.4
Aug 13	8	23	10.4	1,072	0.2	4.3	1.7	2.5
Aug 21	8	31	12.2	1,013	0.2	5.1	1.8	2.8
Aug 29	8	39	15.0	1,023	0.3	6.0	2.8	2.1
Sep 6	8	47	16.6	1,015	0.2	7.4	1.6	4.6
Sep 14	8	55	19.6	999	0.4	8.1	3.0	2.7
Sep 22	8	63	23.4	987	0.5	9.6	3.8	2.5
Sep 30	8	71	26.5	984	0.4	11.5	3.1	3.7
Oct 8	8	79	27.8	978	0.2	13.0	1.3	10.0
Oct 16	8	87	32.7	975	0.6	13.6	4.9	2.8
Oct 24	8	95	35.3	973	0.3	16.0	2.6	6.2
Nov 1	8	103	38.8	971	0.5	17.3	3.5	4.9
Nov 9	8	111	41.2	963	0.3	19.0	2.4	7.9
Nov 17	8	119	44.5	960	0.4	20.2	3.3	6.1
% Mortality				15.8				
FCR-Net	4.0							
Total	119	119	44.5	960		157.3		
Mean					0.3	10.5	2.6	4.2
Max					0.6	20.2	4.9	10.0
Min					0.2	2.7	1.3	1.5
STD					0.1	5.6	1.0	2.3

Notes: FCR-P = food conversion ratio for the period between samplings.

FCR-Net = net food conversion ratio for the entire experimental period, e.g., using stocking vs. harvesting data.

STD = standard deviation.

4.0 Nursery experiment tilapia hybrids at one stocking density using mixture of commercial feed and rice bran.  
COMFEED 50%; BRAN 50%

## 4.6 File: NURS22

Date	Days sample	Days elapsed	kg	Fish number	Growth (g/fish/day)	Total feed per period	kg fish	FCR-P
Jul 21	0	0	5.5	1,121				
Jul 28	7	7	8.3	1,114	0.4	2.7	2.8	1.0
Aug 5	8	15	9.1	1,082	0.1	4.0	0.8	4.8
Aug 13	8	23	10.4	1,051	0.2	4.5	1.3	3.4
Aug 21	8	31	13.0	1,034	0.3	5.1	2.6	2.0
Aug 29	8	39	15.6	994	0.3	6.4	2.6	2.5
Sep 6	8	47	16.9	985	0.2	7.6	1.3	5.9
Sep 14	8	55	19.3	978	0.3	8.3	2.4	3.4
Sep 22	8	63	24.0	961	0.6	9.5	4.7	2.0
Sep 30	8	71	27.0	961	0.4	11.8	3.0	3.9
Oct 8	8	79	30.2	958	0.4	13.2	3.2	4.1
Oct 16	8	87	33.0	955	0.4	14.8	2.8	5.3
Oct 24	8	95	36.5	951	0.5	16.2	3.5	4.6
Nov 1	8	103	39.8	944	0.4	17.9	3.3	5.4
Nov 9	8	111	44.5	937	0.6	19.5	4.7	4.1
Nov 17	8	119	48.0	934	0.5	21.8	3.5	6.2
% Mortality				16.7				
FCR-Net	3.8							
Total	119	119	48.0	934		163.2		
Mean					0.4	10.9	2.8	3.9
Max					0.6	21.8	4.7	6.2
Min					0.1	2.7	0.8	1.0
STD					0.1	5.9	1.1	1.5

Notes: FCR-P = food conversion ratio for the period between samplings.

FCR-Net = net food conversion ratio for the entire experimental period, e.g., using stocking vs. harvesting data.

STD = standard deviation.

4.0 Nursery experiment tilapia hybrids at one stocking density using mixture of commercial feed and rice bran.  
COMFEED 25%; BRAN 75%

4.7 File: NURS23

Date	Days sample	Days elapsed	kg	Fish number	Growth (g/fish/day)	Total feed per period	kg fish	FCR-P
Jul 21	0	0	5.5	1,119				
Jul 28	7	7	7.5	1,110	0.3	2.7	2.0	1.4
Aug 5	8	15	9.0	1,115	0.2	3.7	1.5	2.5
Aug 13	8	23	10.1	1,069	0.1	4.4	1.1	4.0
Aug 21	8	31	11.0	1,036	0.1	5.0	0.9	5.5
Aug 29	8	39	15.0	1,021	0.5	5.4	4.0	1.3
Sep 6	8	47	17.6	1,009	0.3	7.4	2.6	2.8
Sep 14	8	55	20.8	1,002	0.4	8.6	3.2	2.7
Sep 22	8	63	23.0	986	0.3	10.2	2.2	4.6
Sep 30	8	71	24.7	980	0.2	11.3	1.7	6.6
Oct 8	8	79	28.6	979	0.5	12.1	3.9	3.1
Oct 16	8	87	34.0	975	0.7	14.0	5.4	2.6
Oct 24	8	95	37.5	972	0.5	16.7	3.5	4.8
Nov 1	8	103	41.2	969	0.5	18.4	3.7	5.0
Nov 9	8	111	43.0	963	0.2	20.2	1.8	11.2
Nov 17	8	119	45.3	957	0.3	21.1	2.3	9.2
% Mortality				14.5				
FCR-Net		4.0						
Total		119	119	45.3	957	161.0		
Mean					0.3	10.7	2.7	4.5
Max					0.7	21.1	5.4	11.2
Min					0.1	2.7	0.9	1.3
STD					0.2	6.0	1.2	2.7

Notes: FCR-P = food conversion ratio for the period between samplings.

FCR-Net = net food conversion ratio for the entire experimental period, e.g., using stocking vs. harvesting data.

STD = standard deviation.

4.0 Nursery experiment tilapia hybrids at one stocking density using mixture of commercial feed and rice bran.  
COMFEED 25%; BRAN 75%

4.8 File: NURS24

Date	Days sample	Days elapsed	kg	Fish number	Growth (g/fish/day)	Total feed per period	kg fish	FCR-P
Jul 21	0	0	5.5	1,142				
Jul 28	7	7	8.1	1,134	0.3	2.7	2.6	1.0
Aug 5	8	15	9.6	1,086	0.2	4.0	1.5	2.6
Aug 13	8	23	10.1	1,066	0.1	4.7	0.5	9.4
Aug 21	8	31	12.0	1,032	0.2	5.0	1.9	2.6
Aug 29	8	39	14.6	1,017	0.3	5.9	2.6	2.3
Sep 6	8	47	16.9	1,015	0.3	7.2	2.3	3.1
Sep 14	8	55	20.0	996	0.4	8.3	3.1	2.7
Sep 22	8	63	23.2	979	0.4	9.8	3.2	3.1
Sep 30	8	71	26.5	979	0.4	11.4	3.3	3.4
Oct 8	8	79	30.0	976	0.4	13.0	3.5	3.7
Oct 16	8	87	32.5	972	0.3	14.7	2.5	5.9
Oct 24	8	95	35.7	969	0.4	15.9	3.2	5.0
Nov 1	8	103	39.5	963	0.5	17.5	3.8	4.6
Nov 9	8	111	43.5	955	0.5	19.4	4.0	4.8
Nov 17	8	119	45.0	950	0.2	21.3	1.5	14.2
% Mortality				14.5				
FCR-Net		4.1						
Total		119	119	45.0	950	160.6		
Mean					0.3	10.7	2.6	4.6
Max					0.5	21.3	4.0	14.2
Min					0.1	2.7	0.5	1.0
STD					0.1	5.8	0.9	3.2

Notes: FCR-P = food conversion ratio for the period between samplings.

FCR-Net = net food conversion ratio for the entire experimental period, e.g., using stocking vs. harvesting data.

STD = standard deviation.

4.0 Nursery experiment tilapia hybrids at one stocking density using mixture of commercial feed and rice bran.  
BRAN 100%

4.9 File: NURS25

Date	Days sample	Days elapsed	kg	Fish number	Growth (g/fish/day)	Total feed per period	kg fish	FCR-P
Jul 21	0	0	5.5	1,120				
Jul 28	7	7	6.9	1,135	0.2	1.4	1.9	1.4
Aug 5	8	15	8.8	1,085	0.2	1.9	1.8	2.5
Aug 13	8	23	9.7	1,034	0.1	0.9	4.8	4.0
Aug 21	8	31	11.9	1,002	0.3	2.2	2.2	5.5
Aug 29	8	39	13.0	974	0.1	1.1	5.3	1.3
Sep 6	8	47	14.0	971	0.1	1.0	6.4	2.8
Sep 14	8	55	15.2	951	0.2	1.2	5.7	2.7
Sep 22	8	63	18.4	933	0.4	3.2	2.3	4.6
Sep 30	8	71	21.5	931	0.4	3.1	2.9	6.6
Oct 8	8	79	22.2	930	0.1	0.7	15.1	3.1
Oct 16	8	87	27.5	925	0.7	5.3	2.1	2.6
Oct 24	8	95	32.8	919	0.7	5.3	2.6	4.8
Nov 1	8	103	34.5	911	0.2	1.8	9.2	5.0
Nov 9	8	111	39.0	902	0.6	4.5	3.8	11.2
Nov 17	8	119	39.5	895	0.1	0.5	38.2	9.2
% Mortality				20.1				
FCR-Net	4.0							
Total	119	119	39.5	895	137.6			
Mean					0.3	9.2	2.3	6.9
Max					0.7	19.1	5.3	38.2
Min					0.1	2.7	0.5	1.8
STD					0.2	5.0	1.6	9.0

Notes: FCR-P = food conversion ratio for the period between samplings.

FCR-Net = net food conversion ratio for the entire experimental period, e.g., using stocking vs. harvesting data.

STD = standard deviation.

4.0 Nursery experiment tilapia hybrids at one stocking density using mixture of commercial feed and rice bran.  
BRAN 100%

4.10 File: NURS26

Date	Days sample	Days elapsed	kg	Fish number	Growth (g/fish/day)	Total feed per period	kg fish	FCR-P
Jul 21	0	0	5.5	1,147				
Jul 28	7	7	8.0	1,141	0.3	2.7	2.5	1.1
Aug 5	8	15	9.2	1,107	0.1	3.9	1.2	3.4
Aug 13	8	23	10.4	1,058	0.1	4.5	1.3	3.6
Aug 21	8	31	12.2	1,051	0.2	5.1	1.8	2.8
Aug 29	8	39	14.6	1,035	0.3	6.0	2.4	2.5
Sep 6	8	47	17.2	1,025	0.3	7.2	2.6	2.8
Sep 14	8	55	20.0	1,020	0.3	8.4	2.8	3.0
Sep 22	8	63	22.5	994	0.3	9.8	2.5	3.9
Sep 30	8	71	24.9	990	0.3	11.0	2.4	4.6
Oct 8	8	79	25.8	990	0.1	12.2	0.9	13.6
Oct 16	8	87	31.5	986	0.7	12.6	5.7	2.2
Oct 24	8	95	34.2	981	0.3	15.4	2.7	5.7
Nov 1	8	103	37.3	973	0.4	16.8	3.1	5.4
Nov 9	8	111	40.0	962	0.4	18.3	2.7	6.8
Nov 17	8	119	40.5	957	0.1	19.6	0.5	39.2
% Mortality				16.6				
FCR-Net	4.4							
Total	119	119	40.5	957	153.5			
Mean					0.3	10.2	2.3	6.7
Max					0.7	19.6	5.7	39.2
Min					0.1	2.7	0.5	1.1
STD					0.2	5.3	1.2	9.1

Notes: FCR-P = food conversion ratio for the period between samplings.

FCR-Net = net food conversion ratio for the entire experimental period, e.g., using stocking vs. harvesting data.

STD = standard deviation.

5.0 Replicate Trial of Farmer's Technology  
Cage 1

5.1 File: Grout1

Date	Days sample	Days elapsed	kg	Fish number	Growth (g/fish/day)	kg feed	kg fish	FCR-P
Dec 25	0	0	300.0	4,190				
Jan 14	21	21	354.8	4,182	0.6	189.0	54.8	3.4
Jan 28	14	35	411.0	4,180	1.0	149.0	56.2	2.7
Feb 4	7	42	464.0	4,178	1.8	86.3	53.0	1.6
Feb 12	8	50	514.9	4,178	1.5	111.4	50.9	2.2
Feb 18	6	56	593.1	4,178	3.1	92.7	78.2	1.2
Feb 25	7	63	613.0	4,173	0.7	124.5	19.9	6.3
Mar 3	6	69	633.4	4,172	0.8	110.3	20.4	5.4
Mar 10	7	76	764.1	4,167	4.5	133.0	130.7	1.0
Mar 17	7	83	816.7	4,163	1.8	160.5	52.6	3.1
Mar 24	7	90	905.0	4,162	3.0	171.5	88.3	1.9
% Mortality				0.7				
FCR-Net		2.2						
Total		90	90	905.0	4,162	1,328.2		
Mean					1.9	132.8	60.5	2.9
Max					4.5	189.0	130.7	6.3
Min					0.6	86.3	19.9	1.0
STD					1.2	32.4	30.9	1.7

Notes: FCR-P = food conversion ratio for the period between samplings.  
FCR-Net = net food conversion ratio for the entire experimental period, e.g., using stocking vs. harvesting data.  
STD = standard deviation.

5.0 Replicate Trial of Farmer's Technology  
Cage 2

5.2 File: Grout2

Date	Days sample	Days elapsed	kg	Fish number	Growth (g/fish/day)	kg feed	kg fish	FCR-P
Jan 5	0	0	300.0	4,407				
Jan 14	9	9	372.8	4,390	1.8	81.0	72.8	1.1
Jan 28	14	23	458.0	4,386	1.4	156.6	85.2	1.8
Feb 4	7	30	527.8	4,386	2.3	96.2	69.8	1.4
Feb 12	8	38	565.0	4,336	1.1	126.7	37.2	3.4
Feb 18	6	44	608.0	4,336	1.7	101.7	43.0	2.4
Feb 25	7	51	750.0	4,335	4.7	127.7	142.0	0.9
Mar 10	13	64	902.6	4,322	2.7	292.5	152.6	1.9
Mar 17	7	71	1,069.2	4,318	5.5	189.5	166.6	1.1
Mar 24	7	78	1,184.9	4,317	3.8	224.5	115.7	1.9
Apr 4	4	82	1,225.0	4,316	2.3	140.1	40.1	3.5
% Mortality				2.1				
FCR-Net		1.7						
Total		82	82	1,225.0	4,316	1,536.5		
Mean					2.7	153.7	92.5	1.9
Max					5.5	292.5	166.6	3.5
Min					1.1	81.0	37.2	0.9
STD					1.4	62.0	46.2	0.9

Notes: FCR-P = food conversion ratio for the period between samplings.  
FCR-Net = net food conversion ratio for the entire experimental period, e.g., using stocking vs. harvesting data.  
STD = standard deviation.

5.0 Replicate Trial of Farmer's Technology  
Cage 3

## 5.3 File: Grout3

Date	Days sample	Days elapsed	kg	Fish number	Growth (g/fish/day)	kg feed	kg fish	FCR-P
Jan 1	0	0	300.0	4,397				
Jan 14	13	13	339.7	4,359	0.7	126.0	39.7	3.2
Jan 28	14	27	373.6	4,354	0.6	142.7	33.9	4.2
Feb 4	7	34	434.5	4,354	2.0	78.5	60.9	1.3
Feb 12	8	42	484.2	4,353	1.4	104.3	49.7	2.1
Feb 18	6	48	550.6	4,353	2.5	87.2	66.4	1.3
Feb 25	7	55	612.5	4,249	2.1	115.6	61.9	1.9
Mar 3	6	61	584.1	4,242	-1.1	91.9	-28.4	-3.2
Mar 10	7	68	820.6	4,237	8.0	122.7	236.5	0.5
Mar 17	7	75	843.7	4,236	0.8	172.3	23.1	7.5
Mar 24	7	82	917.6	4,236	2.5	369.9	73.9	5.0
Apr 1	8	90	982.0	4,062	2.0	30.8	64.4	0.5
% Mortality				7.6				
FCR-Net	2.1							
Total	90	90	982.0	4,062		1,441.9		
Mean					1.9	131.1	62.0	2.2
Max					8.0	369.9	236.5	7.5
Min					-1.1	30.8	-28.4	-3.2
STD					2.2	83.2	61.6	2.7

Notes: FCR-P = food conversion ratio for the period between samplings.

FCR-Net = net food conversion ratio for the entire experimental period, e.g., using stocking vs. harvesting data.

STD = standard deviation.

5.0 Replicate Trial of Farmer's Technology  
Net 4

## 5.4 File: Grout4

Date	Days sample	Days elapsed	kg	Fish number	Growth (g/fish/day)	kg feed	kg fish	FCR-P
Jan 5	0	0	300.0	4,009				
Jan 14	9	9	380.0	4,008	2.2	90.0	80.0	1.1
Jan 28	14	23	516.6	4,004	2.4	159.6	136.6	1.2
Feb 4	7	30	535.6	4,003	0.7	108.5	19.0	5.7
Feb 12	8	38	549.1	3,990	0.4	128.5	13.5	9.5
Feb 18	6	44	598.6	3,990	2.1	98.8	49.5	2.0
Feb 25	7	51	693.4	3,987	3.4	125.7	94.8	1.3
Mar 3	6	57	719.1	3,982	1.1	104.0	25.7	4.0
Mar 10	7	64	844.3	3,980	4.5	151.0	125.2	1.2
Mar 17	7	71	908.7	3,979	2.3	177.3	64.4	2.8
Mar 24	7	78	950.2	3,978	1.5	190.8	41.5	4.6
Apr 4	11	89	1,168.0	3,978	5.0	343.6	217.8	1.6
% Mortality				0.8				
FCR-Net	1.9							
Total	89	89	1,168.0	3,978		1,677.8		
Mean					2.3	152.5	78.9	3.2
Max					5.0	343.6	217.8	9.5
Min					0.4	90.0	13.5	1.1
STD					1.4	68.1	58.9	2.5

Notes: FCR-P = food conversion ratio for the period between samplings.

FCR-Net = net food conversion ratio for the entire experimental period, e.g., using stocking vs. harvesting data.

STD = standard deviation.



## 6.0 Preliminary test of new size cage and lower stocking rate.

## 6.1 File: 9 X 9

Date	Days sample	Days elapse	kg	Fish number	Growth (g/fish/day)	kg feed	kg fish	FCR-P
Jan 27	0	0	100.0	1,576				
Feb 10	14	14	130.8	1,576	1.4	42.0	54.8	3.4
Feb 25	15	29	246.3	1,569	4.9	58.5	19.9	6.3
Mar 11	14	43	407.1	1,566	7.3	103.6	20.4	5.4
Mar 25	14	57	532.0	1,540	5.8	170.8	130.7	1.0
Apr 9	15	72	702.5	1,540	7.4	239.4	78.2	1.2
Apr 17	8	80	890.1	1,540	15.2	168.0	52.6	3.1
Apr 24	7	87	975.6	1,540	7.9	186.9	88.3	1.9
% Mortality				0.7				
FCR-Net	1.1							
Total	87	87	975.6	1,540		969.2		
Mean					7.1	138.5	125.1	1.2
Max					15.2	239.4	187.6	2.2
Min					1.4	42.0	30.7	0.5
STD					3.9	66.9	50.4	0.5

Notes: FCR-P = food conversion ratio for the period between samplings.

FCR-Net = net food conversion ratio for the entire experimental period, e.g., using stocking vs. harvesting data.

STD = standard deviation.

## 6.0 Preliminary test of new size cage and lower stocking rate.

## 6.2 File: 9 X 9A

Date	Days sample	Days elapse	kg	Fish number	Growth (g/fish/day)	kg feed	kg fish	FCR-P
Jul 4	0	0	87.3	506				
Jul 18	14	14	110.0	505	3.2	36.7	22.7	1.6
Aug 1	14	28	142.0	498	4.6	46.2	32.0	1.4
Aug 17	16	44	184.0	498	5.3	70.4	42.0	1.7
Sep 1	15	59	244.0	498	8.0	82.5	60.0	1.4
% Mortality				1.6				
FCR-Net	1.5							
Total	59	59	244.0	498		235.8		
Mean					5.3	59.0	39.2	1.5
Max					8.0	82.5	60.0	1.7
Min					3.2	36.7	22.7	1.4
STD					1.8	18.3	13.8	0.1

Notes: FCR-P = food conversion ratio for the period between samplings.

FCR-Net = net food conversion ratio for the entire experimental period, e.g., using stocking vs. harvesting data.

STD = standard deviation.

## 6.0 Preliminary test of new size cage and lower stocking rate.

## 6.3 File: 9 X 9B

Date	Days sample	Days elapsed	kg	Fish number	Growth (g/fish/day)	kg feed	kg fish	FCR-P
Jun 1	0	0	40.0	446				
Jun 21	20	20	55.0	446	1.7	24.0	15.0	1.6
Jul 14	13	33	94.0	446	6.7	20.8	39.0	0.5
Jul 28	14	47	112.0	446	2.9	39.2	18.0	2.2
Aug 15	18	65	145.7	446	4.2	59.4	33.7	1.8
Sep 1	17	82	186.5	446	5.4	74.8	40.8	1.8
% Mortality				0.0				
FCR-Net	1.5							
Total	82	82	186.5	446		218.2		
Mean					4.2	43.6	29.3	1.6
Max					6.7	74.8	40.8	2.2
Min					1.7	20.8	15.0	0.5
STD					1.8	20.7	10.8	0.6

Notes: FCR-P = food conversion ratio for the period between samplings.

FCR-Net = net food conversion ratio for the entire experimental period, e.g., using stocking vs. harvesting data.

STD = standard deviation.

## 7.0 Experiment I on Stocking Density

Cage 1, 0.5 kg/m<sup>3</sup>

## 7.1 File: DENS1

Date	Days sample	Days elapsed	kg	Fish number	Growth (g/fish/day)	kg feed per day	kg fish	FCR-P
Aug 24	0	0	61.5	606				
Aug 31	7	7	72.1	593	2.6	12.9	10.6	1.2
Sep 8	8	15	84.6	592	2.6	17.3	12.5	1.4
Sep 16	8	23	90.3	592	1.2	20.3	5.7	3.6
Sep 24	8	31	109.5	592	4.1	21.7	19.2	1.1
Oct 2	8	39	124.0	592	3.1	26.3	14.5	1.8
Oct 10	8	47	124.0	592	0.0	29.8	0.0	0.0
Oct 18	8	55	132.5	592	1.8	29.8	8.5	3.5
Oct 26	8	63	145.0	592	2.6	31.8	12.5	2.5
Nov 3	8	71	159.4	592	3.0	34.8	14.4	2.4
Nov 11	8	79	195.0	592	7.5	38.2	35.6	1.1
Nov 19	8	87	198.0	592	0.6	46.8	3.0	15.6
Nov 27	8	95	219.0	592	4.4	47.5	21.0	2.3
% Mortality				2.3				
FCR-Net	2.3							
Total	95	95	219.0	592		357.2		
Mean					2.8	29.8	13.1	3.0
Max					7.5	47.5	35.6	15.6
Min					0.0	12.9	0.0	0.0
STD					1.9	10.5	9.0	3.9

Notes: FCR-P = food conversion ratio for the period between samplings.

FCR-Net = net food conversion ratio for the entire experimental period, e.g., using stocking vs. harvesting data.

STD = standard deviation.

7.0 Experiment I on Stocking Density  
Cage 1, 0.5 kg/m<sup>3</sup>

## 7.2 File: DENS2

Date	Days sample	Days elapsed	kg	Fish number	Growth (g/fish/day)	Tot. feed per day	kg fish	FCR-P
Aug 24	0	0	61.5	687				
Aug 31	7	7	71.3	683	2.0	12.9	9.8	1.3
Sep 8	8	15	84.6	677	2.5	17.3	13.3	1.3
Sep 16	8	23	95.1	675	1.9	20.3	10.5	1.9
Sep 24	8	31	110.7	675	2.9	22.8	15.6	1.5
Oct 2	8	39	143.0	675	6.0	26.3	32.3	0.8
Oct 10	8	47	145.5	675	0.5	34.3	2.5	0.0
Oct 18	8	55	151.0	675	1.0	34.9	5.5	6.3
Oct 26	8	63	160.9	675	1.8	36.2	9.9	3.7
Nov 3	8	71	174.0	675	2.4	38.4	13.1	2.9
Nov 11	8	79	191.0	675	3.1	41.8	17.0	2.5
Nov 19	8	87	215.0	675	4.4	45.8	24.0	1.9
Nov 27	8	95	227.0	675	2.2	51.6	12.0	4.3
<hr/>								
% Mortality				1.7				
FCR-Net	2.3							
Total	95	95	227.0	675		382.5		
Mean					2.6	31.9	13.8	2.4
Max					6.0	51.6	32.3	6.3
Min					0.5	12.9	2.5	0.0
STD					1.4	11.5	7.7	1.7

Notes: FCR-P = food conversion ratio for the period between samplings.  
FCR-Net = net food conversion ratio for the entire experimental period, e.g., using stocking vs. harvesting data.  
STD = standard deviation.

7.0 Experiment I on Stocking Density  
Cage 2, 1.0 kg/m<sup>3</sup>

## 7.3 File: DENS3

Date	Days sample	Days elapsed	kg	Fish number	Growth (g/fish/day)	kg feed	kg fish	FCR-P
Sep 5	0	0	61.5	718				
Sep 12	7	7	65.2	715	0.7	12.9	3.7	3.5
Sep 20	8	15	97.2	713	5.6	15.6	32.0	0.5
Sep 28	8	23	108.3	713	1.9	23.3	11.1	2.1
Oct 6	8	31	129.7	713	3.8	25.9	21.4	1.2
Oct 14	8	39	134.0	713	0.8	31.1	4.3	7.2
Oct 22	8	47	147.6	713	2.4	32.2	13.6	0.0
Oct 30	8	55	175.4	713	4.9	35.3	27.8	1.3
Nov 7	8	63	184.2	713	1.5	42.1	8.8	4.8
Nov 15	8	71	198.0	713	2.4	44.2	13.8	3.2
Nov 23	8	79	221.0	713	4.0	47.5	23.0	2.1
Dec 1	8	87	240.3	713	3.4	53.0	19.3	2.7
Dec 9	8	95	255.0	713	2.6	57.6	14.7	3.9
<hr/>								
% Mortality				0.7				
FCR-Net	2.2							
Total	95	95	255.0	713		420.8		
Mean					2.8	35.1	16.1	2.7
Max					5.6	57.6	32.0	7.2
Min					0.7	12.9	3.7	0.0
STD					1.5	13.6	8.5	1.9

Notes: Cage suffered a failure at harvest.  
FCR-P = food conversion ratio for the period between samplings.  
FCR-Net = net food conversion ratio for the entire experimental period, e.g., using stocking vs. harvesting data.  
STD = standard deviation.

7.0 Experiment I on Stocking Density  
Cage 2, 1.0 kg/m<sup>3</sup>

7.4 File: DEN54

Date	Days sample	Days elapsed	kg	number	Growth (g/fish/day)	kg feed	kg fish	FCR-P
Sep 5	0	0	61.5	760				
Sep 12	7	7	71.5	758	1.9	12.9	10.0	1.3
Sep 20	8	15	87.9	758	2.7	17.2	16.4	1.0
Sep 28	8	23	95.5	758	1.3	21.0	7.6	2.8
Oct 6	8	31	115.2	758	3.2	22.9	19.7	1.2
Oct 14	8	39	116.0	758	0.1	27.7	0.8	34.6
Oct 22	8	47	138.0	758	3.6	27.8	22.0	0.0
Oct 30	8	55	151.6	758	2.2	33.1	13.6	2.4
Nov 7	8	63	161.5	758	1.6	36.4	9.9	3.7
Nov 15	8	71	181.0	758	3.2	38.8	19.5	2.0
Nov 23	8	79	194.0	758	2.1	43.4	13.0	3.3
Dec 1	8	87	220.0	758	4.3	46.6	26.0	1.8
% Mortality				0.3				
FCR-Net	2.1							
Total	87	87	220.0	758	327.9			
Mean					2.4	29.8	14.4	4.9
Max					4.3	46.6	26.0	34.6
Min					0.1	12.9	0.8	0.0
STD					1.1	10.4	6.9	9.4

Notes: FCR-P = food conversion ratio for the period between samplings.

FCR-Net = net food conversion ratio for the entire experimental period, e.g., using stocking vs. harvesting data.

STD = standard deviation.

8.0 Experiment II on Stocking Density  
Cage 19, 0.5 kg/m<sup>3</sup>

8.1 File: DEN55

Date	Days sample	Days elapsed	kg	Fish number	Growth (g/fish/day)	kg feed	kg fish	FCR-P
1	0	0	61.5	1,177				
2	7	7	70.3	1,175	1.1	12.9	8.8	1.5
3	7	14	71.0	1,175	0.1	14.7	0.7	21.0
4	7	21	83.0	1,173	1.5	14.9	12.0	1.2
5	7	28	87.0	1,172	0.5	17.5	4.0	4.4
6	7	35	96.0	1,171	1.1	18.2	9.0	2.0
7	7	42	106.0	1,171	1.2	20.2	10.0	2.0
8	7	49	113.5	1,159	0.9	22.3	7.5	3.0
9	7	56	126.0	1,147	1.6	23.8	12.5	1.9
10	7	63	143.0	1,135	2.1	26.5	17.0	1.6
11	7	70	148.0	1,128	0.6	30.0	5.0	6.0
12	7	77	160.0	1,112	1.5	31.1	12.0	2.6
13	7	84	180.0	1,109	2.6	33.6	20.0	1.7
% Mortality				5.8				
FCR-Net	2.2							
Total	84	84	180.0	1,109	265.7			
Mean					1.2	22.1	9.9	4.1
Max					2.6	33.6	22.0	21.0
Min					0.1	12.9	0.7	1.2
STD					0.7	6.6	5.2	5.3

Notes: FCR-P = food conversion ratio for the period between samplings.

FCR-Net = net food conversion ratio for the entire experimental period, e.g., using stocking vs. harvesting data.

STD = standard deviation.

8.0 Experiment II on Stocking Density  
Cage 22, 0.5 kg/m<sup>3</sup>

8.2 File: DENS6

Date	Days sample	Days elapsed	kg	Fish number	Growth (g/fish/day)	kg feed	kg fish	FCR-P
1	0	0	61.5	1,348				
2	7	7	72.6	1,327	1.2	12.9	11.1	1.2
3	7	14	73.0	1,324	0.0	15.2	0.4	38.0
4	7	21	83.0	1,323	1.1	15.3	10.0	1.5
5	7	28	85.8	1,322	0.3	17.5	2.8	6.3
6	7	35	102.0	1,321	1.8	18.0	16.2	1.1
7	7	42	115.5	1,313	1.5	21.4	13.5	1.6
8	7	49	121.0	1,300	0.6	24.3	5.5	4.4
9	7	56	125.0	1,289	0.4	25.4	4.0	6.4
10	7	63	138.0	1,274	1.5	26.2	13.0	2.0
11	7	70	149.0	1,269	1.2	29.0	11.0	2.6
12	7	77	167.0	1,252	2.1	31.3	18.0	1.7
13	7	84	182.0	1,252	1.7	35.1	15.0	2.3
% Mortality				7.1				
FCR-Net		2.3						
Total		84	84	182.0	1,252	271.6		
Mean					1.1	22.6	10.0	5.8
Max					2.1	35.1	18.0	38.0
Min					0.0	12.9	0.4	1.1
STD					0.6	6.8	5.4	9.9

Notes: FCR-P = food conversion ratio for the period between samplings.

FCR-Net = net food conversion ratio for the entire experimental period, e.g., using stocking vs. harvesting data.

STD = standard deviation.

8.0 Experiment II on Stocking Density  
Cage 18, 1.0 kg/m<sup>3</sup>

8.3 File: DENS7

Date	Days sample	Days elapsed	kg	Fish number	Growth (g/fish/day)	kg feed	kg fish	FCR-P
1	0	0	122.5	2,390				
2	7	7	127.8	2,384	0.3	25.7	5.3	4.8
3	7	14	133.0	2,383	0.3	26.8	5.2	5.2
4	7	21	150.0	2,381	1.0	28.0	17.0	1.6
5	7	28	171.5	2,381	1.3	31.5	21.5	1.5
6	7	35	199.0	2,380	1.7	36.0	27.5	1.3
7	7	42	212.0	2,377	0.8	41.8	13.0	3.2
8	7	49	232.5	2,366	1.2	44.5	20.5	2.2
9	7	56	247.0	2,353	0.9	48.8	14.5	3.4
10	7	63	280.5	2,339	2.0	51.9	33.5	1.5
11	7	70	310.0	2,325	1.8	58.9	29.5	2.0
12	7	77	331.0	2,300	1.3	65.1	21.0	3.1
13	7	84	395.0	2,295	4.0	69.5	64.0	1.1
% Mortality				4.0				
FCR-Net		1.9						
Total		84	84	395.0	2,295	528.5		
Mean					1.4	44.0	22.7	2.6
Max					4.0	69.5	64.0	5.2
Min					0.3	25.7	5.2	1.1
STD					0.9	14.5	15.0	1.3

Notes: FCR-P = food conversion ratio for the period between samplings.

FCR-Net = net food conversion ratio for the entire experimental period, e.g., using stocking vs. harvesting data.

STD = standard deviation.

8.0 Experiment II on Stocking Density  
Cage 20, 1.0 kg/m<sup>3</sup>

## 8.4 File: DENS8

Date	Days sample	Days elapsed	kg	Fish number	Growth (g/fish/day)	kg feed	kg fish	FCR-P
1	0	0	122.5	2,193				
2	7	7	137.5	2,183	1.0	25.7	15.0	1.7
3	7	14	142.0	2,182	0.3	28.9	4.5	6.4
4	7	21	148.0	2,181	0.4	29.8	6.0	5.0
5	7	28	167.4	2,180	1.3	31.1	19.4	1.6
6	7	35	182.5	2,179	1.0	43.1	15.1	2.9
7	7	42	203.0	2,179	1.3	30.3	20.5	1.5
8	7	49	225.5	2,163	1.5	42.7	22.0	1.9
9	7	56	238.0	2,158	0.9	47.2	13.0	3.6
10	7	63	268.5	2,148	2.0	50.0	30.5	1.6
11	7	70	274.5	2,143	0.4	56.4	6.0	9.4
12	7	77	301.0	2,130	1.8	57.6	26.5	2.2
13	7	84	340.0	2,130	2.6	63.2	39.0	1.6
% Mortality				2.9				
FCR-Net	2.3							
Total	84	84	340.0	2,130		506.0		
Mean					1.2	42.2	18.1	3.3
Max					2.6	63.2	39.0	9.4
Min					0.3	25.7	4.5	1.5
STD					0.7	12.4	10.0	2.4

Notes: FCR-P = food conversion ratio for the period between samplings.  
FCR-Net = net food conversion ratio for the entire experimental period, e.g., using stocking vs. harvesting data.  
STD = standard deviation.

8.0 Experiment II on Stocking Density  
Cage 21, 2.4 kg/m<sup>3</sup>

## 8.5 File: DENS9

Date	Days sample	Days elapsed	kg	Fish number	Growth (g/fish/day)	kg feed	kg fish	FCR-P
1	0	0	294.0	5,808				
2	7	7	297.5	5,797	0.1	61.7	3.5	17.6
3	7	14	310.0	5,793	0.3	62.5	12.5	5.0
4	7	21	347.5	5,793	0.9	65.1	37.5	1.7
5	7	28	393.0	5,792	1.1	73.0	45.5	1.6
6	7	35	420.0	5,780	0.7	82.5	27.0	3.1
7	7	42	462.0	5,765	1.0	88.2	42.0	2.1
8	7	49	491.0	5,750	0.7	97.0	29.0	3.3
9	7	56	522.0	5,733	0.8	103.2	31.0	3.3
10	7	63	585.0	5,717	1.6	109.6	63.0	1.7
11	7	70	636.0	5,699	1.3	122.8	51.0	2.4
12	7	77	656.0	5,671	0.5	133.6	20.0	6.7
13	7	84	720.0	5,664	1.6	1,137.7	64.0	2.2
% Mortality				2.5				
FCR-Net	2.7							
Total	84	84	720.0	5,664		1,136.9		
Mean					0.9	94.7	35.5	4.2
Max					1.6	137.7	64.0	17.6
Min					0.1	61.7	3.5	1.6
STD					0.5	26.0	18.0	4.3

Notes: FCR-P = food conversion ratio for the period between samplings.  
FCR-Net = net food conversion ratio for the entire experimental period, e.g., using stocking vs. harvesting data.  
STD = standard deviation.

8.0 Experiment II on Stocking Density  
Cage 23, 2.4 kg/m<sup>3</sup>

## 8.6 File: DENS10

Date	Days sample	Days elapsed	kg	Fish number	Growth (g/fish/day)	kg feed	kg fish	FCR-P
1	0	0	294.0	6,293				
2	7	7	330.0	6,282	0.8	61.7	36.0	1.7
3	7	14	343.0	6,281	0.3	131.0	13.0	5.3
4	7	21	370.0	6,279	0.6	203.1	27.0	2.7
5	7	28	400.0	6,277	0.7	280.8	30.0	2.6
6	7	35	499.0	6,271	2.3	364.8	99.0	0.8
7	7	42	524.0	6,258	0.6	469.6	25.0	4.2
8	7	49	542.5	6,236	0.4	579.6	18.5	5.9
9	7	56	568.0	6,220	0.6	693.5	25.5	4.5
10	7	63	662.0	6,202	2.2	812.8	94.0	1.3
11	7	70	677.0	6,186	0.3	951.8	15.0	9.3
12	7	77	691.5	6,159	0.3	1,093.9	14.5	9.8
13	7	84	757.0	6,144	1.5	1,239.1	65.5	2.2
% Mortality				2.4				
FCR-Net	2.7							
Total	84	84	757.0	6,144		1,239.1		
Mean					0.9	103.3	38.6	4.2
Max					2.3	145.2	99.0	9.8
Min					0.3	61.7	13.0	0.8
STD					0.7	28.6	29.2	2.8

Notes: FCR-P = food conversion ratio for the period between samplings.

FCR-Net = net food conversion ratio for the entire experimental period, e.g., using stocking vs. harvesting data.

STD = standard deviation.

9.0 Polyculture experiment common carp and tilapia hybrids  
Cage 6, 0.5 kg/m<sup>3</sup>; Nile tilapia

## 9.1 File: POLY1

Date	Days sample	Days elapsed	kg	Fish number	Growth (g/fish/day)	kg feed	kg fish	FCR-P
Oct 27	0	0	38.0	809				
Nov 3	7	7	64.7	809	4.7	8.0	26.7	0.3
Nov 11	8	15	67.1	809	0.4	15.5	2.4	6.5
Nov 19	8	23	103.0	809	5.5	16.8	35.9	0.5
Nov 27	8	31	111.0	809	1.2	24.7	8.0	3.1
Dec 5	8	39	124.5	809	2.1	26.6	13.5	2.0
Dec 13	8	47	150.0	809	3.9	39.0	25.5	1.5
Dec 21	8	55	170.0	809	3.1	45.3	20.0	2.3
Dec 29	8	63	168.0	809	-0.3	50.1	-2.0	-25.0
Jan 6	8	71	180.0	809	1.9	50.6	12.0	4.2
Jan 14	8	79	199.0	809	2.9	53.8	19.0	2.8
Jan 17	3	82	250.0	800	21.3	22.1	51.0	0.4
% Mortality				1.1				
FCR-Net	1.7							
Total	82	82	250.0	800		325.5		-1.5
Mean					4.2	32.0	19.3	-0.1
Max					21.2	53.8	51.0	6.5
Min					-0.3	8.0	-2.0	-25.0
STD					5.6	15.5	14.5	8.1

Notes: FCR-P = food conversion ratio for the period between samplings.

FCR-Net = net food conversion ratio for the entire experimental period, e.g., using stocking vs. harvesting data.

STD = standard deviation.

9.0 Polyculture experiment common carp and tilapia hybrids  
Cage 6, 0.5 kg/m<sup>3</sup>; common carp

## 9.2 File: POLY2

Date	Days sample	Days elapsed	kg	Fish number	Growth (g/fish/day)	kg feed	kg fish	FCR-P
Oct 27	0	0	23.5	128				
Nov 3	7	7	26.6	128	3.5	4.9	3.1	1.6
Nov 11	8	15	26.5	128	-0.1	6.4	-0.1	-64.0
Nov 19	8	23	28.3	128	1.8	6.4	1.8	3.6
Nov 27	8	31	35.5	128	7.0	6.8	7.2	0.9
Dec 5	8	39	38.0	128	2.4	8.5	2.5	3.4
Dec 13	8	47	38.8	128	0.8	9.3	0.8	11.6
Dec 21	8	55	39.7	128	0.9	9.5	0.9	10.6
Dec 29	8	63	43.0	128	3.2	10.3	3.3	3.1
Jan 6	8	71	44.0	128	1.0	10.6	1.0	10.6
Jan 14	8	79	47.0	128	2.9	11.3	3.0	3.8
Jan 17	3	82	43.0	125	-10.7	3.9	-4.0	-1.0
% Mortality				2.3				
FCR-Net		4.5						
Total		82	82	43.0	125	87.9		-15.8
Mean					1.2	8.0	1.8	-1.4
Max					7.2	11.3	7.2	11.6
Min					-10.7	3.9	-4.0	-64.0
STD					4.2	2.3	2.6	20.2

Notes: FCR-P = food conversion ratio for the period between samplings.  
FCR-Net = net food conversion ratio for the entire experimental period, e.g., using stocking vs. harvesting data.  
STD = standard deviation.

9.0 Polyculture experiment common carp and tilapia hybrids  
Cage 8, 0.5 kg/m<sup>3</sup>; Nile tilapia

## 9.3 File: POLY3

Date	Days sample	Days elapsed	kg	Fish number	Growth (g/fish/day)	kg feed	kg fish	FCR-P
Oct 27	0	0	38.0	896				
Nov 3	7	7	61.2	896	3.7	8.0	23.0	0.3
Nov 11	8	15	72.5	896	1.6	14.7	11.4	1.3
Nov 19	8	23	106.0	896	4.7	17.4	33.4	0.5
Nov 27	8	31	123.6	896	2.5	25.4	17.6	1.4
Dec 5	8	39	137.0	896	1.9	37.8	13.4	2.8
Dec 13	8	47	145.0	896	1.1	42.0	8.0	5.3
Dec 21	8	55	154.0	896	1.3	44.2	9.0	4.9
Dec 29	8	63	183.0	896	4.0	46.8	29.0	1.6
Jan 6	8	71	190.0	896	1.0	54.0	7.0	7.7
Jan 14	8	79	220.0	896	4.2	61.6	30.0	2.1
Jan 17	3	82	249.0	785	12.3	24.2	29.0	0.8
% Mortality				12.4				
FCR-Net		1.8						
Total		82	82	249.0	785	376.2		28.8
Mean					3.5	34.2	19.2	2.6
Max					12.3	61.6	33.4	7.7
Min					1.7	8.0	7.0	0.3
STD					3.1	16.5	9.5	2.2

Notes: FCR-P = food conversion ratio for the period between samplings.  
FCR-Net = net food conversion ratio for the entire experimental period, e.g., using stocking vs. harvesting data.  
STD = standard deviation.



9.0 Polyculture experiment common carp and tilapia hybrids  
Cage 8, 0.5 kg/m<sup>3</sup>; common carp

## 9.4 File: POLY4

Date	Days sample	Days elapsed	kg	Fish number	Growth (g/fish/day)	kg feed	kg fish	FCR-P
Oct 27	0	0	23.0	134				
Nov 3	7	7	27.4	134	4.2	4.9	3.9	1.3
Nov 11	8	15	28.0	134	0.6	6.6	0.6	10.9
Nov 19	8	23	30.0	134	1.9	6.7	2.0	3.4
Nov 27	8	31	34.0	134	3.7	7.2	4.0	1.8
Dec 5	8	39	38.0	134	3.7	8.2	4.0	2.0
Dec 13	8	47	39.0	134	0.9	9.4	1.0	9.4
Dec 21	8	55	41.0	134	1.9	9.8	2.0	4.9
Dec 29	8	63	42.0	134	0.9	10.1	1.0	10.1
Jan 6	8	71	45.8	134	3.5	11.0	3.8	2.9
Jan 14	8	79	49.0	134	3.0	11.8	3.2	3.7
Jan 17	3	82	49.0	120	0.0	4.4	0.0	0.0
% Mortality				10.4				
FCR-Net	3.5							
Total	82	82	49.0	120		90.0		50.3
Mean					2.2	8.2	2.3	4.6
Max					4.2	11.8	4.0	10.9
Min					0.0	4.4	0.0	0.0
STD					1.4	2.3	1.5	3.6

Notes: FCR-P = food conversion ratio for the period between samplings.  
FCR-Net = net food conversion ratio for the entire experimental period, e.g., using stocking vs. harvesting data.  
STD = standard deviation.

10.0 Experiment with feed management  
Cage 7, 0.5 kg/m<sup>3</sup>

## 10.1 File: FEED1

Date	Days sample	Days elapsed	kg	Fish number	Growth (g/fish/day)	kg feed	kg fish	FCR-P
Aug 24	0	0	61.5	606				
Aug 31	7	7	67.1	593	1.3	12.9	5.6	2.3
Sep 8	8	15	77.0	592	2.1	17.3	9.9	1.7
Sep 16	8	23	87.1	592	2.1	20.3	10.1	2.0
Sep 24	8	31	88.7	592	0.3	21.7	1.6	13.5
Oct 2	8	39	107.0	592	3.9	26.3	18.3	1.4
Oct 10	8	47	109.0	592	0.4	29.8	2.0	0.0
Oct 18	8	55	118.0	592	1.9	29.8	9.0	3.3
Oct 26	8	63	118.8	592	0.2	31.8	0.8	39.8
Nov 3	8	71	123.2	592	0.9	34.8	4.4	7.9
Nov 11	8	79	133.7	592	2.2	38.2	10.5	3.6
Nov 19	8	87	138.6	592	1.0	46.8	4.9	9.6
Nov 27	8	95	145.0	592	1.4	47.5	6.4	7.4
% Mortality				2.3				
FCR-Net	4.3							
Total	95	95	145.0	592		357.2		
Mean					1.5	29.8	7.0	7.7
Max					3.9	47.5	18.3	39.8
Min					0.2	12.9	0.8	0.0
STD					1.0	10.5	4.7	10.4

Notes: FCR-P = food conversion ratio for the period between samplings.  
FCR-Net = net food conversion ratio for the entire experimental period, e.g., using stocking vs. harvesting data.  
STD = standard deviation.

10.0 Experiment with feed management  
Cage 9, 0.5 kg/m<sup>3</sup>

## 10.2 File: FEED2

Date	Days sample	Days elapsed	kg	Fish number	Growth (g/fish/day)	kg feed	kg fish	FCR-P
Aug 24	0	0	61.5	593				
Aug 31	7	7	71.0	572	2.4	12.9	9.5	1.4
Sep 8	8	15	62.9	567	-1.8	17.0	-8.1	-2.1
Sep 16	8	23	80.2	565	3.8	17.0	17.3	1.0
Sep 24	8	31	81.4	565	0.3	19.2	1.2	16.0
Oct 2	8	39	99.4	565	4.0	19.5	18.0	1.1
Oct 10	8	47	95.5	565	-0.9	23.8	-3.9	0.0
Oct 18	8	55	97.2	565	0.4	22.9	1.7	13.5
Oct 26	8	63	115.0	565	3.9	23.4	17.8	1.3
Nov 3	8	71	130.0	565	3.3	27.6	15.0	1.8
Nov 11	8	79	102.0	565	-6.2	31.2	-28.0	-1.1
Nov 19	8	87	130.0	565	6.2	24.5	28.0	0.9
Nov 27	8	95	133.0	565	0.7	31.2	3.0	10.4
<hr/>								
% Mortality				4.7				
FCR-Net	3.8							
Total	95	95	133.0	565		270.3		
Mean					1.3	22.5	6.0	3.7
Max					6.2	31.2	28.0	16.0
Min					-6.2	12.9	-28.0	-2.1
STD					3.2	5.4	14.4	5.8

Notes: FCR-P = food conversion ratio for the period between samplings.

FCR-Net = net food conversion ratio for the entire experimental period, e.g., using stocking vs. harvesting data.

STD = standard deviation.

11.0 Comparison of two feeding patterns for common carp.  
Cage 10, 1.0 kg/m<sup>3</sup>

## 11.1 File: FEED3

Date	Days sample	Days elapsed	kg	Fish number	Growth (g/fish/day)	kg feed	kg fish	FCR-P
Jul 14	0	0	122.5	2,109				
Jul 21	7	7	124.0	2,057	0.1	28.3	1.5	18.9
Jul 29	8	15	143.0	2,053	1.2	40.5	19.0	2.1
Aug 8	10	25	158.0	2,050	0.7	51.3	15.0	3.4
Aug 14	6	31	188.0	2,049	2.4	62.0	30.0	2.1
Aug 22	8	39	216.1	2,046	1.7	74.4	28.1	2.6
Aug 30	8	47	256.0	2,041	2.4	85.1	39.9	0.0
Sep 7	8	55	295.7	2,035	2.4	95.1	39.7	2.4
Sep 15	8	63	343.9	2,029	3.0	109.4	48.2	2.3
Sep 23	8	71	392.0	2,020	3.0	126.8	48.1	2.6
Oct 1	8	79	449.0	2,011	3.5	132.2	57.0	2.3
Oct 9	8	87	481.0	2,003	2.0	138.2	32.0	4.3
Oct 17	8	95	543.0	1,979	3.9	146.8	62.0	2.4
Oct 24	7	102	592.5	1,965	3.6	160.9	49.5	3.3
<hr/>								
% Mortality				6.8				
FCR-Net	2.7							
Total	102	102	592.5	1,965		1,251.0		
Mean					2.3	96.2	36.2	3.7
Max					3.9	160.9	62.0	18.9
Min					0.1	28.3	1.5	0.0
STD					1.1	41.5	16.8	4.5

Notes: FCR-P = food conversion ratio for the period between samplings.

FCR-Net = net food conversion ratio for the entire experimental period, e.g., using stocking vs. harvesting data.

STD = standard deviation.

11.0 Comparison of two feeding patterns for common carp.  
Cage 11, 1.0 kg/m<sup>3</sup>

11.2 File: FEED4

Date	Days sample	Days elapsed	kg	Fish number	Growth (g/fish/day)	kg feed	kg fish	FCR-P
Jul 14	0	0	122.5	2,355				
Jul 21	7	7	128.0	2,331	0.3	32.1	5.5	5.8
Jul 29	8	15	151.7	2,325	1.3	43.3	23.7	1.8
Aug 8	10	25	164.9	2,324	0.6	53.2	13.2	4.0
Aug 14	6	31	194.9	2,322	2.2	67.7	30.0	2.3
Aug 22	8	39	219.6	2,314	1.3	80.7	24.7	3.3
Aug 30	8	47	261.0	2,303	2.2	87.0	41.4	0.0
Sep 7	8	55	296.2	2,294	1.9	96.6	35.2	2.7
Sep 15	8	63	352.9	2,285	3.1	109.8	56.7	1.9
Sep 23	8	71	393.0	2,274	2.2	124.8	40.1	3.1
Oct 1	8	79	457.5	2,263	3.6	133.0	64.5	2.1
Oct 9	8	87	499.5	2,256	2.3	139.0	42.0	3.3
Oct 17	8	95	549.5	2,229	2.8	146.6	50.0	2.9
Oct 24	7	102	617.5	2,202	4.4	169.2	68.0	2.5
% Mortality				6.5				
FCR-Net		2.6						
Total		102	102	617.5	2,202	1,283.0		
Mean					2.2	98.7	38.1	2.8
Max					4.4	169.2	68.0	5.8
Min					0.3	32.1	5.5	0.0
STD					1.1	41.0	18.1	1.3

Notes: FCR-P = food conversion ratio for the period between samplings.  
FCR-Net = net food conversion ratio for the entire experimental period, e.g., using stocking vs. harvesting data.  
STD = standard deviation.

11.0 Comparison of two feeding patterns for common carp.  
Cage 14, 1.0 kg/m<sup>3</sup>

11.3 File: FEED5

Date	Days sample	Days elapsed	kg	Fish number	Growth (g/fish/day)	kg feed	kg fish	FCR-P
Jul 14	0	0	122.5	2,270				
Jul 21	7	7	130.0	2,268	0.5	25.7	7.5	3.4
Jul 29	8	15	136.9	2,265	0.4	27.3	6.9	4.0
Aug 8	10	25	143.6	2,261	0.3	28.7	6.7	4.3
Aug 14	6	31	158.4	2,260	1.1	30.2	14.8	2.0
Aug 22	8	39	174.0	2,256	0.9	33.3	15.6	2.1
Aug 30	8	47	204.0	2,253	1.7	36.5	30.0	0.0
Sep 7	8	55	220.1	2,245	0.9	42.8	16.1	2.7
Sep 15	8	63	248.8	2,245	1.6	46.2	28.7	1.6
Sep 23	8	71	273.8	2,237	1.4	52.5	25.0	2.1
Oct 1	8	79	297.7	2,231	1.3	57.5	23.9	2.4
Oct 9	8	87	314.1	2,226	0.9	62.5	16.4	3.8
Oct 17	8	95	344.0	2,196	1.7	66.0	29.9	2.2
Oct 24	7	102	371.5	2,167	1.8	72.2	27.5	2.6
% Mortality				4.5				
FCR-Net		2.3						
Total		102	102	371.5	2,167	581.1		
Mean					1.1	44.7	19.2	2.6
Max					1.8	72.7	30.0	4.3
Min					0.3	25.7	6.7	0.0
STD					0.5	15.4	8.5	1.1

Notes: FCR-P = food conversion ratio for the period between samplings.  
FCR-Net = net food conversion ratio for the entire experimental period, e.g., using stocking vs. harvesting data.  
STD = standard deviation.

11.0 Comparison of two feeding patterns for common carp.  
Cage 15, 1.0 kg/m<sup>3</sup>

## 11.4 File: FEED6

Date	Days sample	Days elapsed	kg	Fish number	Growth (g/fish/day)	kg feed	kg fish	FCR-P
Jul 14	0	0	122.5	1,916				
Jul 21	7	7	125.5	1,907	0.2	25.7	3.0	8.6
Jul 29	8	15	138.6	1,904	0.9	26.4	13.1	2.0
Aug 8	10	25	150.2	1,902	0.6	29.1	11.6	2.5
Aug 14	6	31	163.1	1,898	1.1	31.5	12.9	2.4
Aug 22	8	39	182.2	1,895	1.3	34.5	19.1	1.8
Aug 30	8	47	213.0	1,890	2.0	38.3	30.8	0.0
Sep 7	8	55	233.4	1,887	1.4	44.7	20.4	2.2
Sep 15	8	63	258.6	1,880	1.7	49.0	25.2	1.9
Sep 23	8	71	285.7	1,871	1.8	54.3	27.1	2.0
Oct 1	8	79	312.6	1,865	1.8	60.0	26.9	2.2
Oct 9	8	87	336.5	1,861	1.6	65.6	23.9	2.7
Oct 17	8	95	363.0	1,830	1.8	70.7	26.5	2.7
Oct 24	7	102	392.0	1,803	2.3	76.2	29.0	2.6
% Mortality				5.9				
FCR-Net	2.2							
Total	102	102	392	1,803		606.0		
Mean					1.4	46.6	20.7	2.6
Max					2.3	76.2	30.8	8.6
Min					0.2	25.7	3.0	0.0
STD					0.6	16.8	8.0	1.8

Notes: FCR-P = food conversion ratio for the period between samplings.

FCR-Net = net food conversion ratio for the entire experimental period, e.g., using stocking vs. harvesting data.

STD = standard deviation.

12.0 Combination of common carp nurseries in floating net cages stocked with two sizes of tilapia hybrids.  
Cage X1, 0.5 kg/m<sup>3</sup>, carp, sm tilapia

## 12.1 File: B11

Date	Days sample	Days elapsed	kg	Fish number	Growth (g/fish/day)	kg feed	kg fish	FCR-P
Jul 12	0	0	5.8	1,027				
Jul 26	14	14	7.4	944	0.1	16.1	1.6	10.0
Aug 10	15	29	9.0	928	0.1	18.0	1.7	10.7
Aug 25	15	44	11.6	917	0.2	19.0	2.6	7.3
Sep 9	15	59	14.6	908	0.2	20.4	3.0	6.9
Sep 24	15	74	19.1	907	0.3	20.5	4.4	4.6
Oct 9	15	89	24.0	901	0.4	20.0	5.0	4.0
Oct 16	7	96	26.2	898	0.3	7.2	2.2	3.3
% Mortality				12.2				
FCR-Net	5.9							
Total	96	96	26.2	898		121.2		
Mean					0.2	17.3	2.9	6.7
Max					0.4	20.5	5.0	10.7
Min					0.1	7.2	1.6	3.3
STD					0.1	4.4	1.2	2.7

Notes: FCR-P = food conversion ratio for the period between samplings.

FCR-Net = net food conversion ratio for the entire experimental period, e.g., using stocking vs. harvesting data.

STD = standard deviation.

12.0 Combination of common carp nurseries in floating net cages stocked with two sizes of tilapia hybrids.  
Cage Y1, 0.5 kg/m<sup>3</sup>, carp, sm tilapia

12.2 File: BI2

Date	Days sample	Days elapsed	kg	Fish number	Growth (g/fish/day)	kg feed	kg fish	FCR-P
Jul 12	0	0	5.8	1,086				
Jul 26	14	14	6.5	761	0.1	16.1	0.7	21.8
Aug 10	15	29	8.1	747	0.1	15.9	1.6	9.9
Aug 25	15	44	11.4	743	0.3	17.0	3.4	5.1
Sep 9	15	59	12.6	736	0.1	20.0	1.1	17.5
Sep 24	15	74	18.0	735	0.5	17.6	5.4	3.2
Oct 9	15	89	21.0	730	0.3	18.9	3.0	6.3
Oct 16	7	96	23.6	728	0.5	6.3	2.6	2.4
% Mortality				33.0				
FCR-Net	6.3							
Total	96	96	23.6	728		111.8		
Mean					0.3	16.0	2.6	9.5
Max					0.5	20.0	5.4	21.8
Min					0.1	6.3	0.7	2.4
STD					0.2	4.2	1.5	6.9

Notes: FCR-P = food conversion ratio for the period between samplings.  
FCR-Net = net food conversion ratio for the entire experimental period, e.g., using stocking vs. harvesting data.  
STD = standard deviation.

12.0 Combination of common carp nurseries in floating net cages stocked with two sizes of tilapia hybrids.  
Cage 1, 1.0 kg/m<sup>3</sup>, carp, sm tilapia

12.3 File: BI3

Date	Days sample	Days elapsed	kg	Fish number	Growth (g/fish/day)	kg feed	kg fish	FCR-P
Jul 12	0	0	99.5	1,110				
Jul 26	14	14	128.7	1,084	1.9	14.0	29.2	0.5
Aug 10	15	29	142.3	1,075	0.8	18.0	13.6	1.3
Aug 25	15	44	165.9	1,064	1.5	19.9	23.6	0.8
Sep 9	15	59	198.5	1,058	2.1	23.2	32.6	0.7
Sep 24	15	74	226.2	1,050	1.8	27.8	27.7	1.0
Oct 9	15	89	264.0	1,041	2.4	31.7	37.8	0.8
Oct 16	7	96	276.0	1,040	1.6	15.8	12.0	1.3
% Mortality				6.3				
FCR-Net	0.9							
Total	96	96	276.0	1,040		150.4		
Mean					1.7	21.5	25.2	0.9
Max					2.4	31.7	37.8	1.3
Min					0.8	14.0	12.0	0.5
STD					0.5	6.0	8.8	0.3

Notes: FCR-P = food conversion ratio for the period between samplings.  
FCR-Net = net food conversion ratio for the entire experimental period, e.g., using stocking vs. harvesting data.  
STD = standard deviation.

12.0 Combination of common carp nurseries in floating net cages stocked with two sizes of tilapia hybrids.  
Cage X2, 0.5 kg/m<sup>3</sup>, carp

12.4 File: B14

Date	Days sample	Days elapsed	kg	Fish number	Growth (g/fish/day)	kg feed	kg fish	FCR-P
Jul 12	0	0	5.8	1,103				
Jul 26	14	14	6.0	867	0.0	16.1	0.3	59.6
Aug 10	15	29	7.6	849	0.1	14.7	1.6	9.4
Aug 25	15	44	10.4	844	0.2	15.9	2.8	5.6
Sep 9	15	59	12.5	837	0.2	18.2	2.1	8.8
Sep 24	15	74	16.3	831	0.3	17.5	3.8	4.6
Oct 9	15	89	21.1	826	0.4	17.1	4.8	3.6
Oct 16	7	96	22.0	823	0.2	6.3	0.9	7.0
% Mortality				25.4				
FCR-Net	6.5							
Total	96	96	22.0	823		105.8		
Mean					0.2	15.1	2.3	14.1
Max					0.4	18.2	4.8	59.6
Min					0.0	6.3	0.3	3.6
STD					0.1	3.8	1.5	18.7

Notes: FCR-P = food conversion ratio for the period between samplings.

FCR-Net = net food conversion ratio for the entire experimental period, e.g., using stocking vs. harvesting data.

STD = standard deviation.

12.0 Combination of common carp nurseries in floating net cages stocked with two sizes of tilapia hybrids.  
Cage Y2, 0.5 kg/m<sup>3</sup>, carp

12.5 File: B15

Date	Days sample	Days elapsed	kg	Fish number	Growth (g/fish/day)	kg feed	kg fish	FCR-P
Jul 12	0	0	5.8	1,114				
Jul 26	14	14	5.7	817	0.0	16.1	-0.1	-178.9
Aug 10	15	29	7.6	808	0.2	13.9	2.0	7.1
Aug 25	15	44	10.1	799	0.2	16.0	2.5	6.5
Sep 9	15	59	11.9	790	0.2	17.6	1.9	9.5
Sep 24	15	74	15.8	783	0.3	16.7	3.9	4.3
Oct 9	15	89	19.3	776	0.3	16.6	3.5	4.8
Oct 16	7	96	20.7	773	0.3	5.8	1.4	4.1
% Mortality				30.6				
FCR-Net	6.9							
Total	96	96	20.7	773		102.7		
Mean					0.2	14.7	2.1	-20.4
Max					0.3	17.6	3.9	9.5
Min					0.0	5.8	-0.1	-178.9
STD					0.1	3.8	1.2	64.7

Notes: FCR-P = food conversion ratio for the period between samplings.

FCR-Net = net food conversion ratio for the entire experimental period, e.g., using stocking vs. harvesting data.

STD = standard deviation.

12.0 Combination of common carp nurseries in floating net cages stocked with two sizes of tilapia hybrids.  
Cage X3, 0.5 kg/m<sup>3</sup>, carp

12.6 File: B16

Date	Days sample	Days elapsed	kg	Fish number	Growth (g/fish/day)	kg feed	kg fish	FCR-P
Jul 12	0	0	5.8	1,139				
Jul 26	14	14	6.2	847	0.0	16.1	0.5	35.0
Aug 10	15	29	7.7	828	0.1	15.2	1.5	10.1
Aug 25	15	44	10.0	813	0.2	16.2	2.3	7.2
Sep 9	15	59	12.5	805	0.2	17.4	2.5	7.0
Sep 24	15	74	15.0	800	0.2	17.4	2.6	6.8
Oct 9	15	89	18.1	793	0.3	15.8	3.0	5.2
Oct 16	7	96	19.1	787	0.2	5.4	1.0	5.2
% Mortality				30.9				
FCR-Net		7.8						
Total		96	96	19.1		103.5		
Mean					0.2	14.8	1.9	10.9
Max					0.3	17.4	3.0	35.0
Min					0.0	5.4	0.5	5.2
STD					0.1	3.9	0.9	9.9

Notes: FCR-P = food conversion ratio for the period between samplings.

FCR-Net = net food conversion ratio for the entire experimental period, e.g., using stocking vs. harvesting data.

STD = standard deviation.

12.0 Combination of common carp nurseries in floating net cages stocked with two sizes of tilapia hybrids.  
Cage Y3, 0.5 kg/m<sup>3</sup>, carp

12.7 File: B17

Date	Days sample	Days elapsed	kg	Fish number	Growth (g/fish/day)	kg feed	kg fish	FCR-P
Jul 12	0	0	5.8	1,036				
Jul 26	14	14	6.4	864	0.1	16.1	0.6	26.0
Aug 10	15	29	8.3	870	0.2	15.6	2.0	7.9
Aug 25	15	44	10.4	863	0.2	17.5	2.0	8.7
Sep 9	15	59	11.5	852	0.1	18.1	1.2	15.5
Sep 24	15	74	15.9	850	0.3	16.1	4.4	3.7
Oct 9	15	89	20.0	845	0.3	16.7	4.1	4.0
Oct 16	7	96	21.2	844	0.2	6.0	1.2	5.1
% Mortality				18.5				
FCR-Net		6.9						
Total		96	96	21.2		106.1		
Mean					0.2	15.2	2.2	10.1
Max					0.3	18.1	4.4	26.0
Min					0.1	6.0	0.6	3.7
STD					0.1	3.8	1.4	7.5

Notes: FCR-P = food conversion ratio for the period between samplings.

FCR-Net = net food conversion ratio for the entire experimental period, e.g., using stocking vs. harvesting data.

STD = standard deviation.

12.0 Combination of common carp nurseries in floating net cages stocked with two sizes of tilapia hybrids.  
Cage X4, 0.5 kg/m<sup>3</sup>, carp, sm tilapia

12.8 File: B18

Date	Days sample	Days elapsed	kg	Fish number	Growth (g/fish/day)	kg feed	kg fish	FCR-P
Jul 12	0	0	5.8	1,012				
Jul 26	14	14	6.6	940	0.1	16.1	0.9	18.3
Aug 10	15	29	7.7	932	0.1	16.2	1.1	15.1
Aug 25	15	44	10.1	928	0.2	16.2	2.4	6.7
Sep 9	15	59	12.9	916	0.2	17.7	2.8	6.4
Sep 24	15	74	16.8	913	0.3	18.1	3.9	4.7
Oct 9	15	89	21.0	908	0.3	17.6	4.2	4.2
Oct 16	7	96	24.4	906	0.5	6.3	3.4	1.9
% Mortality				10.5				
FCR-Net		5.8						
Total		96	96	24.4	906	108.2		
Mean					0.2	15.5	2.7	8.2
Max					0.5	18.1	4.2	18.3
Min					0.1	6.3	0.9	1.9
STD					0.1	3.8	1.2	5.7

Notes: FCR-P = food conversion ratio for the period between samplings.  
FCR-Net = net food conversion ratio for the entire experimental period, e.g., using stocking vs. harvesting data.  
STD = standard deviation.

12.0 Combination of common carp nurseries in floating net cages stocked with two sizes of tilapia hybrids.  
Cage Y4, 0.5 kg/m<sup>3</sup>, carp, sm tilapia

12.9 File: B19

Date	Days sample	Days elapsed	kg	Fish number	Growth (g/fish/day)	kg feed	kg fish	FCR-P
Jul 12	0	0	5.8	1,105				
Jul 26	14	14	8.0	985	0.2	16.1	2.2	7.3
Aug 10	15	29	9.3	981	0.1	19.5	1.4	14.4
Aug 25	15	44	12.1	976	0.2	19.6	2.8	7.1
Sep 9	15	59	14.7	967	0.2	21.1	2.6	8.0
Sep 24	15	74	19.6	966	0.3	20.6	4.9	4.2
Oct 9	15	89	24.0	961	0.3	20.6	4.4	4.7
Oct 16	7	96	25.9	959	0.3	7.2	1.9	3.8
% Mortality				13.2				
FCR-Net		6.2						
Total		96	96	25.9	959	124.7		
Mean					0.2	17.8	2.9	7.1
Max					0.3	21.1	4.9	14.4
Min					0.1	7.2	1.4	3.8
STD					0.1	4.6	1.2	3.4

Notes: FCR-P = food conversion ratio for the period between samplings.  
FCR-Net = net food conversion ratio for the entire experimental period, e.g., using stocking vs. harvesting data.  
STD = standard deviation.



12.0 Combination of common carp nurseries in floating net cages stocked with two sizes of tilapia hybrids.  
Cage 4, 1.0 kg/m<sup>3</sup>, sm tilapia

12.10 File: Bl10

Date	Days sample	Days elapsed	kg	Fish number	Growth (g/fish/day)	kg feed	kg fish	FCR-P
Jul 12	0	0	99.5	1,258				
Jul 26	14	14	121.3	1,193	1.3	14.0	21.8	0.6
Aug 10	15	29	140.6	1,190	1.1	17.0	19.3	0.9
Aug 25	15	44	153.7	1,171	0.7	19.7	13.1	1.5
Sep 9	15	59	183.2	1,150	1.7	21.5	29.5	0.7
Sep 24	15	74	219.5	1,140	2.1	25.6	36.3	0.7
Oct 9	15	89	233.5	1,123	0.8	30.7	14.0	2.2
Oct 16	7	96	258.2	1,122	3.1	14.0	24.7	0.6
% Mortality				10.8				
FCR-Net	0.9							
Total	96	96	258.2	1,122		142.5		
Mean					1.6	20.4	22.7	1.0
Max					3.1	30.7	36.3	2.2
Min					0.7	14.0	13.1	0.6
STD					0.8	5.7	7.7	0.6

Notes: FCR-P = food conversion ratio for the period between samplings.  
FCR-Net = net food conversion ratio for the entire experimental period, e.g., using stocking vs. harvesting data.  
STD = standard deviation.

12.0 Combination of common carp nurseries in floating net cages stocked with two sizes of tilapia hybrids.  
Cage 5, 1.0 kg/m<sup>3</sup>, sm tilapia

12.11 File: Bl11

Date	Days sample	Days elapsed	kg	Fish number	Growth (g/fish/day)	kg feed	kg fish	FCR-P
Jul 12	0	0	99.5	1,340				
Jul 26	14	14	129.3	1,318	1.6	14.0	29.8	0.5
Aug 10	15	29	147.1	1,313	0.9	18.1	17.8	1.0
Aug 25	15	44	169.4	1,300	1.1	20.6	22.3	0.9
Sep 9	15	59	199.4	1,292	1.5	23.7	30.0	0.8
Sep 24	15	74	230.7	1,286	1.6	27.9	31.3	0.9
Oct 9	15	89	263.0	1,278	1.7	32.3	32.3	1.0
Oct 16	7	96	273.5	1,278	1.2	15.8	10.5	1.5
% Mortality				4.6				
FCR-Net	0.9							
Total	96	96	273.5	1,278		152.4		
Mean					1.4	21.8	24.9	0.9
Max					1.7	32.3	32.3	1.5
Min					0.9	14.0	10.5	0.5
STD					0.3	6.1	7.7	0.3

Notes: FCR-P = food conversion ratio for the period between samplings.  
FCR-Net = net food conversion ratio for the entire experimental period, e.g., using stocking vs. harvesting data.  
STD = standard deviation.

12.0 Combination of common carp nurseries in floating net cages stocked with two sizes of tilapia hybrids.  
Cage X6, 0.5 kg/m<sup>3</sup>, carp

12.12 File: BI12

Date	Days sample	Days elapsed	kg	Fish number	Growth (g/fish/day)	kg feed	kg fish	FCR-P
Jul 12	0	0	5.8	1,135				
Jul 26	14	14	4.8	759	-0.1	16.1	-1.0	-16.8
Aug 10	15	29	5.7	744	0.1	11.7	0.9	12.4
Aug 25	15	44	7.9	741	0.2	12.0	2.2	5.4
Sep 9	15	59	9.4	737	0.1	13.9	1.5	9.5
Sep 24	15	74	12.9	736	0.3	13.2	3.5	3.8
Oct 9	15	89	16.6	729	0.3	13.5	3.7	3.6
Oct 16	7	96	16.8	725	.0	5.0	0.2	25.0
% Mortality				36.1				
FCR-Net	7.7							
Total	96	96	16.8	725		85.4		
Mean					0.1	12.2	1.6	6.1
Max					0.3	16.1	3.7	25.0
Min					-0.1	5.0	-1.0	-16.8
STD					0.1	3.2	1.6	11.6

Notes: FCR-P = food conversion ratio for the period between samplings.  
FCR-Net = net food conversion ratio for the entire experimental period, e.g., using stocking vs. harvesting data.  
STD = standard deviation.

12.0 Combination of common carp nurseries in floating net cages stocked with two sizes of tilapia hybrids.  
Cage Y6, 0.5 kg/m<sup>3</sup>, carp

12.13 File: BI13

Date	Days sample	Days elapsed	kg	Fish number	Growth (g/fish/day)	kg feed	kg fish	FCR-P
Jul 12	0	0	5.8	1,164				
Jul 26	14	14	5.3	915	0.0	16.1	-0.4	-39.3
Aug 10	15	29	6.6	912	0.1	13.1	1.3	10.1
Aug 25	15	44	8.3	909	0.1	14.0	1.7	8.3
Sep 9	15	59	10.0	903	0.1	14.6	1.7	8.7
Sep 24	15	74	13.7	900	0.3	14.0	3.7	3.7
Oct 9	15	89	18.3	894	0.3	14.4	4.5	3.2
Oct 16	7	96	19.1	891	0.1	5.5	0.9	6.5
% Mortality				23.5				
FCR-Net	6.9							
Total	96	96	19.1	891		91.7		
Mean					0.2	13.1	1.9	0.2
Max					0.3	16.1	4.5	10.1
Min					0.0	5.5	-0.4	-39.3
STD					0.1	3.2	1.6	16.3

Notes: FCR-P = food conversion ratio for the period between samplings.  
FCR-Net = net food conversion ratio for the entire experimental period, e.g., using stocking vs. harvesting data.  
STD = standard deviation.

12.0 Combination of common carp nurseries in floating net cages stocked with two sizes of tilapia hybrids.  
Cage X7, 0.5 kg/m<sup>3</sup>, carp

12.14 File: BI14

Date	Days sample	Days elapsed	kg	Fish number	Growth (g/fish/day)	kg feed	kg fish	FCR-P
Jul 12	0	0	5.8	1,164				
Jul 26	14	14	8.1	1,043	0.2	16.1	2.4	6.7
Aug 10	15	29	10.1	1,016	0.1	20.0	1.9	10.5
Aug 25	15	44	12.1	1,011	0.1	21.1	2.0	10.4
Sep 9	15	59	14.9	1,001	0.2	21.1	2.9	7.4
Sep 24	15	74	18.8	999	0.3	20.9	3.9	5.4
Oct 9	15	89	23.4	982	0.3	19.8	4.6	4.3
Oct 16	7	96	24.0	964	0.1	7.0	0.6	11.7
% Mortality				17.2				
FCR-Net	6.9							
Total	96	96	24.0	964		126.0		
Mean					0.2	18.0	2.6	8.1
Max					0.3	21.1	4.6	11.7
Min					0.1	7.0	0.6	4.3
STD					0.1	4.8	1.2	2.6

Notes: FCR-P = food conversion ratio for the period between samplings.  
FCR-Net = net food conversion ratio for the entire experimental period, e.g., using stocking vs. harvesting data.  
STD = standard deviation.

12.0 Combination of common carp nurseries in floating net cages stocked with two sizes of tilapia hybrids.  
Net Y7, 0.5 kg/m<sup>3</sup>, carp

12.15 File: BI15

Date	Days sample	Days elapsed	kg	Fish number	Growth (g/fish/day)	kg feed	kg fish	FCR-P
Jul 12	0	0	5.8	1,174				
Jul 26	14	14	6.9	1,076	0.1	16.1	1.2	13.5
Aug 10	15	29	8.4	1,053	0.1	17.0	1.5	11.6
Aug 25	15	44	10.9	1,041	0.2	17.6	2.5	7.0
Sep 9	15	59	12.9	1,034	0.1	19.1	2.0	9.6
Sep 24	15	74	17.6	1,031	0.3	18.0	4.7	3.8
Oct 9	15	89	21.7	997	0.3	18.5	4.1	4.5
Oct 16	7	96	23.0	961	0.2	6.5	1.3	5.0
% Mortality				18.1				
FCR-Net	6.5							
Total	96	96	23.0	961		112.8		
Mean					0.2	16.1	2.5	7.9
Max					0.3	19.1	4.7	13.5
Min					0.1	6.5	1.2	3.8
STD					0.1	4.0	1.3	3.5

Notes: FCR-P = food conversion ratio for the period between samplings.  
FCR-Net = net food conversion ratio for the entire experimental period, e.g., using stocking vs. harvesting data.  
STD = standard deviation.

12.0 Combination of common carp nurseries in floating net cages stocked with two sizes of tilapia hybrids.  
Cage 8, 1.0 kg/m<sup>3</sup>, sm tilapia

12.16 File: BI16

Date	Days sample	Days elapsed	kg	Fish number	Growth (g/fish/day)	kg feed	kg fish	FCR-P
Jul 12	0	0	99.5	1,090				
Jul 26	14	14	124.0	1,059	1.7	14.0	24.5	0.6
Aug 10	15	29	141.4	1,050	1.1	17.4	17.4	1.0
Aug 25	15	44	157.3	1,042	1.0	19.8	15.9	1.2
Sep 9	15	59	185.8	1,024	1.9	22.0	28.5	0.8
Sep 24	15	74	212.3	1,013	1.7	26.0	26.5	1.0
Oct 9	15	89	236.0	1,000	1.6	29.7	23.7	1.3
Oct 16	7	96	273.0	1,000	5.3	14.2	37.0	0.4
% Mortality				8.3				
FCR-Net	0.8							
Total	96	96	273.0	1,000		143.1		
Mean					2.0	20.4	24.8	0.9
Max					5.3	29.7	37.0	1.3
Min					1.0	14.0	15.9	0.4
STD					1.4	5.5	6.6	0.3

Notes: FCR-P = food conversion ratio for the period between samplings.  
FCR-Net = net food conversion ratio for the entire experimental period, e.g., using stocking vs. harvesting data.  
STD = standard deviation.

12.0 Combination of common carp nurseries in floating net cages stocked with two sizes of tilapia hybrids.  
Cage X9, 0.5 kg/m<sup>3</sup> carp: big tilapia

12.17 File: BI17

Date	Days sample	Days elapsed	kg	Fish number	Growth (g/fish/day)	kg feed	kg fish	FCR-P
Jul 12	0	0	5.8	999				
Jul 26	14	14	6.3	888	0.0	16.1	0.5	30.4
Aug 10	15	29	7.8	876	0.1	15.4	1.5	10.0
Aug 25	15	44	10.7	868	0.2	16.4	2.8	5.8
Sep 9	15	59	12.8	862	0.2	18.6	2.2	8.6
Sep 24	15	74	16.8	857	0.3	17.9	4.0	4.5
Oct 9	15	89	20.2	853	0.3	17.6	3.4	5.1
Oct 16	7	96	21.8	853	0.3	6.1	1.6	3.8
% Mortality				14.6				
FCR-Net	6.7							
Total	96	96	21.8	853		108.1		
Mean					0.2	15.4	2.3	9.7
Max					0.3	18.6	4.0	30.4
Min					0.0	6.1	0.5	3.8
STD					0.1	4.0	1.1	8.7

Notes: FCR-P = food conversion ratio for the period between samplings.  
FCR-Net = net food conversion ratio for the entire experimental period, e.g., using stocking vs. harvesting data.  
STD = standard deviation.

12.0 Combination of common carp nurseries in floating net cages stocked with two sizes of tilapia hybrids.  
Cage X9, 0.5 kg/m<sup>3</sup> carp: big tilapia

12.18 File: BI18

Date	Days sample	Days elapsed	kg	Fish number	Growth (g/fish/day)	kg feed	kg fish	FCR-P	
Jul 12	0	0	5.8	1,042					
Jul 26	14	14	6.8	942	0.1	16.1	1.0	15.9	
Aug 10	15	29	8.5	932	0.1	16.6	1.7	9.5	
Aug 25	15	44	11.8	927	0.2	17.9	3.3	5.5	
Sep 9	15	59	14.2	920	0.2	20.6	2.4	8.6	
Sep 24	15	74	17.7	916	0.3	19.8	3.5	5.6	
Oct 9	15	89	21.4	911	0.3	18.3	3.7	5.0	
Oct 16	7	96	23.1	909	0.3	6.4	1.7	3.7	
% Mortality				12.8					
FCR-Net		6.7							
Total		96		96		23.1		909	
Mean						115.7			
Max						0.2		16.5	
Min						0.3		20.6	
STD						0.1		6.4	
								1.0	
								3.7	
								3.9	

Notes: FCR-P = food conversion ratio for the period between samplings.

FCR-Net = net food conversion ratio for the entire experimental period, e.g., using stocking vs. harvesting data.

STD = standard deviation.

12.0 Combination of common carp nurseries in floating net cages stocked with two sizes of tilapia hybrids.  
Cage 9, 1.0 kg/m<sup>3</sup>, big tilapia

12.19 File: BI19

Date	Days sample	Days elapsed	kg	Fish number	Growth (g/fish/day)	kg feed	kg fish	FCR-P	
Jul 12	0	0	99.5	447					
Jul 26	14	14	126.7	440	4.4	14.0	27.2	0.5	
Aug 10	15	29	140.2	440	2.0	17.7	13.5	1.3	
Aug 25	15	44	155.9	439	2.4	19.6	15.7	1.2	
Sep 9	15	59	177.1	437	3.2	21.8	21.2	1.0	
Sep 24	15	74	195.0	436	2.7	24.8	17.9	1.4	
Oct 9	15	89	208.0	434	2.0	27.3	13.0	2.1	
Oct 16	7	96	215.0	434	2.3	12.5	7.0	1.8	
% Mortality				2.9					
FCR-Net		1.2							
Total		96		96		215.0		434	
Mean						137.7			
Max						2.7		19.7	
Min						4.4		27.3	
STD						2.0		12.5	
						0.8		5.0	
								6.0	
								0.5	

Notes: FCR-P = food conversion ratio for the period between samplings.

FCR-Net = net food conversion ratio for the entire experimental period, e.g., using stocking vs. harvesting data.

STD = standard deviation.

12.0 Combination of common carp nurseries in floating net cages stocked with two sizes of tilapia hybrids.  
Cage X12, 0.5 kg/m<sup>3</sup>, carp, big tilapia

12.20 File: BI20

Date	Days sample	Days elapsed	kg	Fish number	Growth (g/fish/day)	kg feed	kg fish	FCR-P
Jul 12	0	0	5.8	1,049				
Jul 26	14	14	5.9	839	0.0	16.1	0.1	115.0
Aug 10	15	29	7.2	818	0.1	14.4	1.3	10.7
Aug 25	15	44	10.2	811	0.2	15.2	3.0	5.1
Sep 9	15	59	12.1	804	0.2	17.9	1.9	9.5
Sep 24	15	74	16.6	801	0.4	17.0	4.5	3.8
Oct 9	15	89	20.4	796	0.3	17.4	3.9	4.5
Oct 16	7	96	22.5	794	0.4	6.1	2.1	3.0
% Mortality				24.3				
FCR-Net		6.2						
Total		96	96	22.5	794	104.1		
Mean				0.2		14.9	2.4	21.7
Max				0.4		17.9	4.5	115.0
Min				0.0		6.1	0.1	3.0
STD				0.1		3.8	1.4	38.2

Notes: FCR-P = food conversion ratio for the period between samplings.

FCR-Net = net food conversion ratio for the entire experimental period, e.g., using stocking vs. harvesting data.

STD = standard deviation.

12.0 Combination of common carp nurseries in floating net cages stocked with two sizes of tilapia hybrids.  
Cage Y12, 0.5 kg/m<sup>3</sup>, carp, big tilapia

12.21 File: BI21

Date	Days sample	Days elapsed	kg	Fish number	Growth (g/fish/day)	kg feed	kg fish	FCR-P
Jul 12	0	0	5.8	990				
Jul 26	14	14	6.5	837	0.1	16.1	0.8	20.9
Aug 10	15	29	8.0	824	0.1	16.0	1.5	10.7
Aug 25	15	44	10.8	821	0.2	16.8	2.8	5.9
Sep 9	15	59	13.6	813	0.2	19.0	2.7	7.0
Sep 24	15	74	17.5	810	0.3	19.0	3.9	4.8
Oct 9	15	89	21.4	803	0.3	18.4	3.9	4.7
Oct 16	7	96	23.2	801	0.3	6.4	1.8	3.6
% Mortality				19.1				
FCR-Net		6.4						
Total		96	96	23.2	801	111.7		
Mean				0.2		16.0	2.5	8.2
Max				0.3		19.0	3.9	20.9
Min				0.1		6.4	0.8	3.6
STD				0.1		4.1	1.1	5.6

Notes: FCR-P = food conversion ratio for the period between samplings.

FCR-Net = net food conversion ratio for the entire experimental period, e.g., using stocking vs. harvesting data.

STD = standard deviation.

12.0 Combination of common carp nurseries in floating net cages stocked with two sizes of tilapia hybrids.  
Cage 12, 1.0 kg/m<sup>3</sup>, big tilapia

12.22 File: BI22

Date	Days sample	Days elapsed	kg	Fish number	Growth (g/fish/day)	kg feed	kg fish	FCR-P
Jul 12	0	0	99.5	481				
Jul 26	14	14	124.9	479	3.8	14.0	25.4	0.6
Aug 10	15	29	139.9	476	2.1	17.5	15.0	1.2
Aug 25	15	44	158.6	475	2.6	19.6	18.7	1.0
Sep 9	15	59	177.3	475	2.6	22.2	18.7	1.2
Sep 24	15	74	201.0	475	3.3	24.8	23.7	1.0
Oct 9	15	89	218.5	471	2.5	28.1	17.5	1.6
Oct 16	7	96	222.5	471	1.2	12.7	4.0	3.2
% Mortality				2.1				
FCR-Net	1.1							
Total	96	96	222.5	471		138.9		
Mean					2.6	19.8	17.6	1.4
Max					3.8	28.1	25.4	3.2
Min					1.2	12.7	4.0	0.6
STD					0.8	5.2	6.5	0.8

Notes: FCR-P = food conversion ratio for the period between samplings.

FCR-Net = net food conversion ratio for the entire experimental period, e.g., using stocking vs. harvesting data.

STD = standard deviation.

12.0 Combination of common carp nurseries in floating net cages stocked with two sizes of tilapia hybrids.  
Cage 13, 1.0 kg/m<sup>3</sup>, big tilapia

12.23 File: BI23

Date	Days sample	Days elapsed	kg	Fish number	Growth (g/fish/day)	kg feed	kg fish	FCR-P
Jul 12	0	0	99.5	490				
Jul 26	14	14	128.5	486	4.3	14.0	29.0	0.5
Aug 10	15	29	143.3	486	2.0	18.0	14.8	1.2
Aug 25	15	44	159.8	485	2.3	20.1	16.5	1.2
Sep 9	15	59	177.5	484	2.4	22.4	17.7	1.3
Sep 24	15	74	199.5	484	3.0	24.9	22.0	1.1
Oct 9	15	89	216.5	483	2.3	27.9	17.0	1.6
Oct 16	7	96	221.0	482	1.3	13.0	4.5	2.9
% Mortality				1.6				
FCR-Net	1.2							
Total	96	96	221.0	482		140.3		
Mean					2.5	20.0	17.4	1.4
Max					4.3	27.9	29.0	2.9
Min					1.3	13.0	4.5	0.5
STD					0.8	5.1	6.9	0.7

Notes: FCR-P = food conversion ratio for the period between samplings.

FCR-Net = net food conversion ratio for the entire experimental period, e.g., using stocking vs. harvesting data.

STD = standard deviation.

12.0 Combination of common carp nurseries in floating net cages stocked with two sizes of tilapia hybrids.  
Cage 16, 1.0 kg/m<sup>3</sup>, big tilapia

12.24 File: BI24

Date	Days sample	Days elapsed	kg	Fish number	Growth (g/fish/day)	kg feed	kg fish	FCR-P
Jul 12	0	0	99.5	495				
Jul 26	14	14	122.9	492	3.4	14.0	23.4	0.6
Aug 10	15	29	139.1	491	2.2	17.2	16.2	1.1
Aug 25	15	44	154.9	491	2.1	19.5	15.8	1.2
Sep 9	15	59	178.2	490	3.2	21.7	23.3	0.9
Sep 24	15	74	190.0	488	1.6	25.0	11.8	2.1
Oct 9	15	89	210.5	487	2.8	26.6	20.5	1.3
Oct 16	7	96	211.6	486	0.3	12.6	1.1	11.5
% Mortality				1.8				
FCR-Net	1.2							
Total	96	96	221.6	486		136.6		
Mean					2.2	19.5	16.0	2.7
Max					3.4	26.6	23.4	11.5
Min					0.3	12.6	1.1	0.6
STD					1.0	4.9	7.3	3.6

Notes: FCR-P = food conversion ratio for the period between samplings.

FCR-Net = net food conversion ratio for the entire experimental period, e.g., using stocking vs. harvesting data.

STD = standard deviation.

13.0 Small cage trials - Bamboo, Net, Wire Cages

Cage 1

13.1 File: SMCAGE1

Date	Days sample	Days elapsed	kg	Fish number	Growth (g/fish/day)	kg feed	kg fish	FCR-P
Jan 3	0	0	37.0	537				
Jan 18	15	15	47.4	530	1.3	18.0	10.4	1.7
Feb 2	15	30	62.2	530	1.9	21.0	14.8	1.4
Feb 16	14	44	78.7	530	2.2	26.6	16.5	1.6
Mar 2	14	58	115.5	530	5.0	33.6	36.8	0.9
Mar 16	14	72	119.2	530	0.5	47.6	3.7	12.9
Mar 30	14	86	148.0	527	3.9	49.0	28.8	1.7
% Mortality				1.9				
FCR-Net	1.8							
Total	86	86	148.0	527		195.8		
Mean					2.5	32.6	18.5	3.4
Max					5.0	49.0	36.8	12.9
Min					0.5	18.0	3.7	0.9
STD					1.5	12.1	11.1	4.3

Notes: FCR-P = food conversion ratio for the period between samplings.

FCR-Net = net food conversion ratio for the entire experimental period, e.g., using stocking vs. harvesting data.

STD = standard deviation.



13.0 Small cage trials - Bamboo, Net, Wire Cages  
Cage 2

13.2 File: SMCAGE2

Date	Days sample	Days elapsed	kg	Fish number	Growth (g/fish/day)	kg feed	kg fish	FCR-P
Jan 3	0	0	37.0	530				
Jan 18	15	15	53.6	515	2.1	18.0	16.6	1.1
Feb 2	15	30	59.9	514	0.8	24.0	6.3	3.8
Feb 16	14	44	79.7	514	2.8	25.2	19.8	1.3
Mar 2	14	58	97.6	514	2.5	33.6	17.9	1.9
Mar 16	14	72	123.6	513	3.6	40.6	26.0	1.6
Mar 30	14	86	134.0	510	1.5	51.8	10.4	5.0
% Mortality				3.8				
FCR-Net	2.0							
Total	86	86	134.0	510		193.2		
Mean					2.2	32.2	16.2	2.4
Max					3.6	51.8	26.0	5.0
Min					0.8	18.0	6.3	1.1
STD					0.9	11.4	6.4	1.5

Notes: FCR-P = food conversion ratio for the period between samplings.  
FCR-Net = net food conversion ratio for the entire experimental period, e.g., using stocking vs. harvesting data.  
STD = standard deviation.

13.0 Small cage trials - Bamboo, Net, Wire Cages  
Cage 3

13.3 File: SMCAGE3

Date	Days sample	Days elapsed	kg	Fish number	Growth (g/fish/day)	kg feed	kg fish	FCR-P
Jan 3	0	0	37.0	517				
Jan 18	15	15	46.6	503	1.3	18.0	9.6	1.9
Feb 2	15	30	60.5	498	1.9	21.0	13.9	1.5
Feb 16	14	44	82.7	498	3.2	25.2	22.2	1.1
Mar 2	14	58	95.1	498	1.8	35.0	12.4	2.8
Mar 16	14	72	112.7	498	2.5	39.2	17.6	2.2
Mar 30	14	86	127.0	490	2.1	46.2	14.3	3.2
% Mortality				5.2				
FCR-Net	2.1							
Total	86	86	127.0	490		184.6		
Mean					2.1	30.8	15.0	2.1
Max					3.2	46.2	22.2	3.2
Min					1.3	18.0	9.6	1.1
STD					0.6	10.1	4.0	0.7

Notes: FCR-P = food conversion ratio for the period between samplings.  
FCR-Net = net food conversion ratio for the entire experimental period, e.g., using stocking vs. harvesting data.  
STD = standard deviation.

13.0 Small cages trials - Bamboo, Net, Wire Cages  
Cage 4

## 13.4 File: SMCAGE4

Date	Days sample	Days elapsed	kg	Fish number	Growth (g/fish/day)	kg feed	kg fish	FCR-P
Jan 3	0	0	37.0	547				
Jan 18	15	15	53.2	532	2.0	18.0	16.2	1.1
Feb 2	15	30	69.9	532	2.1	24.0	16.7	1.4
Feb 16	14	44	76.7	532	0.9	29.4	6.8	4.3
Mar 2	14	58	100.9	531	3.3	33.6	24.2	1.4
Mar 16	14	72	122.9	531	3.0	42.0	22.0	1.9
Mar 30	14	86	134.0	522	1.5	51.8	11.1	4.7
% Mortality				4.6				
FCR-Net		2.0						
Total		86	86	134.0	522	198.8		
Mean					2.1	33.1	16.2	2.5
Max					3.3	51.8	24.2	4.7
Min					0.9	18.0	6.8	1.1
STD					0.8	11.2	5.9	1.5

Notes: FCR-P = food conversion ratio for the period between samplings.  
FCR-Net = net food conversion ratio for the entire experimental period, e.g., using stocking vs. harvesting data.  
STD = standard deviation.

13.0 Small cage trials - Bamboo, Net, Wire Cages  
Cage "A"

## 13.5 File: SMCAGE5

Date	Days sample	Days elapsed	kg	Fish number	Growth (g/fish/day)	kg feed	kg fish	FCR-P
Jan 18	0	0	41.0	500				
Feb 3	16	15	51.0	499	1.3	19.7	10.0	2.0
Feb 17	14	30	71.5	497	2.9	21.4	20.5	1.0
Mar 3	14	44	79.0	495	1.1	30.0	7.5	4.0
Mar 17	14	58	99.5	494	3.0	33.2	20.5	1.6
Mar 31	14	72	129.0	494	4.3	41.8	29.5	1.4
Apr 18	18	90	136.5	494	0.8	69.7	7.5	9.3
% Mortality				1.2				
FCR-Net		2.3						
Total		90	90	136.5	494	215.8		
Mean					2.2	36.0	15.9	3.2
Max					4.3	69.7	29.5	9.3
Min					0.8	19.7	7.5	1.0
STD					1.3	16.8	8.2	2.9

Notes: FCR-P = food conversion ratio for the period between samplings.  
FCR-Net = net food conversion ratio for the entire experimental period, e.g., using stocking vs. harvesting data.  
STD = standard deviation.

13.0 Small cage trials - Bamboo, Net, Wire Cages  
Cage "B"

## 13.6 File: SMCAGE6

Date	Days sample	Days elapsed	kg	Fish number	Growth (g/fish/day)	kg feed	kg fish	FCR-P
Jan 18	0	0	44.0	583				
Feb 3	16	16	64.5	582	2.2	21.1	20.5	1.0
Feb 17	14	30	75.0	582	1.3	27.1	10.5	2.6
Mar 3	14	44	89.0	580	1.7	31.5	14.0	2.3
Mar 17	14	58	126.0	579	4.6	37.4	37.0	1.0
Mar 31	14	72	151.0	578	3.1	52.9	25.0	2.1
Apr 18	18	90	169.5	565	1.8	81.5	18.5	4.4
% Mortality				3.1				
FCR-Net	2.0							
Total	90	90	169.5	565		251.6		
Mean					2.4	41.9	20.9	2.2
Max					4.6	81.5	37.0	4.4
Min					1.3	21.1	10.5	1.0
STD					1.1	20.3	8.5	1.1

Notes: FCR-P = food conversion ratio for the period between samplings.

FCR-Net = net food conversion ratio for the entire experimental period, e.g., using stocking vs. harvesting data.

STD = standard deviation.

13.0 Small cage trials - Bamboo, Net, Wire Cages  
Cage "1"

## 13.7 File: SMCAGE7

Date	Days sample	Days elapsed	kg	Fish number	Growth (g/fish/day)	kg feed	kg fish	FCR-P
Jul 16	0	0	35.0	237				
Jul 29	13	13	39.0	232	1.3	13.7	4.0	3.4
Aug 15	17	30	58.0	232	4.8	19.9	19.0	1.0
Aug 31	16	46	81.2	232	6.3	27.8	23.2	1.2
Sep 13	13	59	92.0	232	3.6	31.7	10.8	2.9
% Mortality				2.1				
FCR-Net	1.6							
Total	59	59	92.0	232		93.0		
Mean					4.0	23.3	14.3	2.1
Max					6.3	31.7	23.2	3.4
Min					1.3	13.7	4.0	1.0
STD					1.8	7.0	7.5	1.0

Notes: FCR-P = food conversion ratio for the period between samplings.

FCR-Net = net food conversion ratio for the entire experimental period, e.g., using stocking vs. harvesting data.

STD = standard deviation.

13.0 Small cage trials - Bamboo, Net, Wire Cages  
Cage "2"

13.8 File: SMCAGE8

Date	Days sample	Days elapsed	kg	Fish number	Growth (g/fish/day)	kg feed	kg fish	FCR-P
Jul 16	0	0	35.0	238				
Jul 29	13	13	52.4	234	5.7	13.7	17.4	0.8
Aug 15	17	30	58.5	234	1.5	26.7	6.1	4.4
Aug 31	16	46	81.9	234	6.3	28.1	23.4	1.2
Sep 13	13	59	93.5	234	3.8	31.9	11.6	2.8
% Mortality				1.7				
FCR-Net	1.7							
Total	59	59	93.5	234		100.4		
Mean					4.3	25.1	14.6	2.3
Max					6.3	31.9	23.4	4.4
Min					1.5	13.7	6.1	0.8
STD					1.9	6.9	6.5	1.4

Notes: FCR-P = food conversion ratio for the period between samplings.  
FCR-Net = net food conversion ratio for the entire experimental period, e.g., using stocking vs. harvesting data.  
STD = standard deviation.

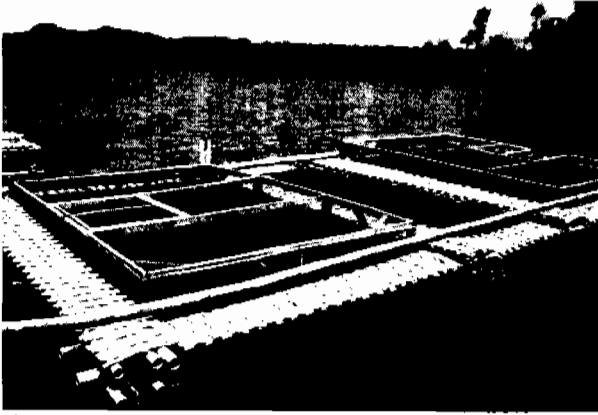

1



2

3

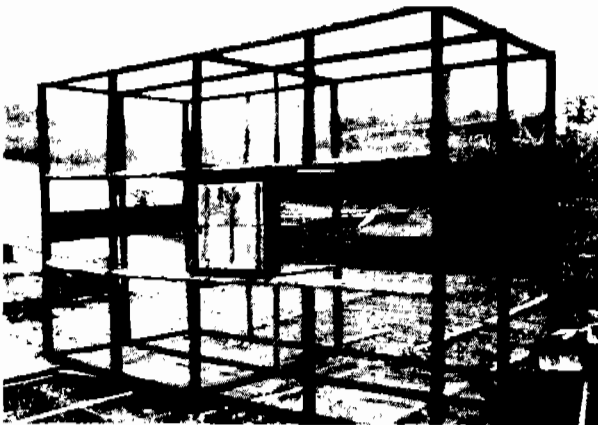

4

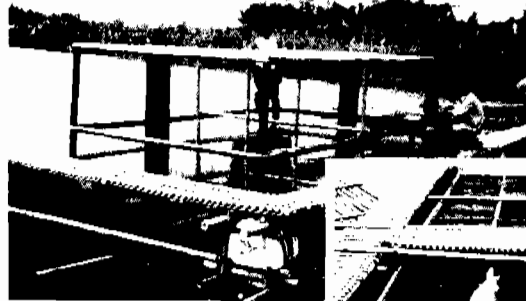

5

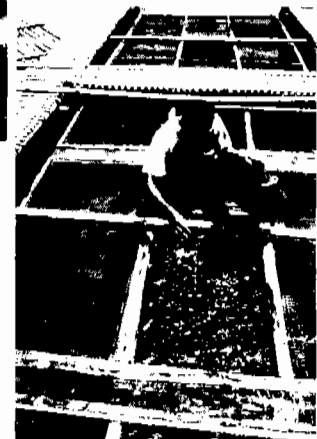

6

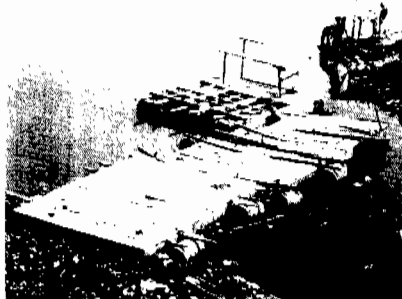

7

1. Two 4.0 x 2.4 x 1.8 m net cages with side walls of 1" mesh netting used for culture of common carp. Bamboo is used for flotation. Each cage produced a mean of 153 kg of 288 g fish in 90 days. Two cages producing this amount of fish was sufficient for the entire annual animal protein needs of an Indonesian family of 5 persons. 2 and 3. Bamboo cages 4.0 x 2.4 x 1.8 m under construction in Awilarangan village, Saguling Reservoir, West Java, and the finished cage in the reservoir. Each bamboo cage produced a mean of 136 kg of 265 g fish (from 69 g fish) in 86 days. 4. Galvanized fencing wire cage 4.0 x 2.4 x 1.8 m, with rigid wire mesh openings 2 mm wide, under construction in Cipondoh village, Saguling Reservoir. Wire cages produced 93 kg of 398 g fish in 59 days. The wire became weak after just one production cycle and holes allowed the escape of fish after just 59 days. 5 and 6. Wire cages and a woven, split bamboo catwalk were floated using recycled oil drums, and fish were fed with a commercial 24-26% crude protein feed at 3% BWD. Community members fed the cages daily, and sampled fish fortnightly to determine growth and adjust feeding rates. 7. Small bamboo cages developed by a community at Cililin, Saguling Reservoir. Bamboo cages were sturdy, and have lasted over 2 years (6 fish production cycles) in the reservoir, when the first replacement of bamboo was necessary. All photos and captions by Barry A. Costa-Pierce.

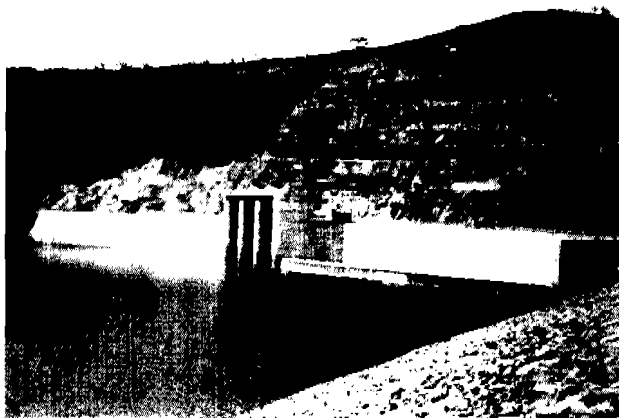

1



2

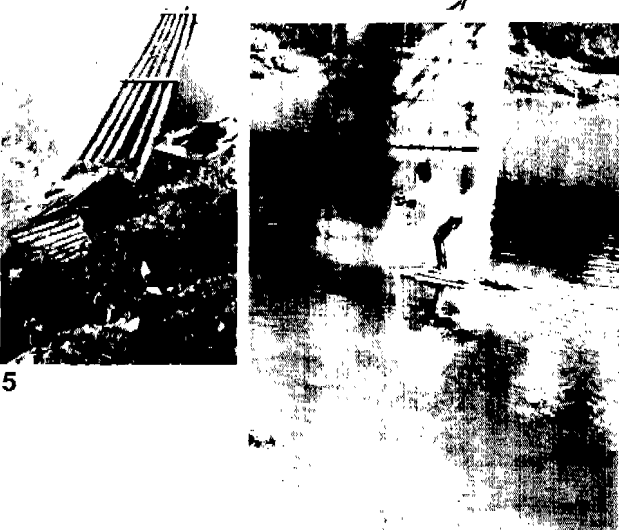

5

6



3



4

1. The 700 MW Saguling hydropower dam on the Citarum River, West Java, Indonesia, at 645 m elevation. Hydroelectricity from the dam stabilized the electric power grid of Java and provided electricity to small villages in West Java for the first time. 2, 3 and 4. Social and environmental impacts of the dam were enormous - some 5,600 ha of rich farmlands were flooded, and nearly 14,000 persons displaced. Less than 4% of the displaced population chose to transmigrate. Landslides occurred. People attempting to make a living cut virgin forests, causing widespread environmental degradation, threatening the predicted longevity of the dam. 5. The bridge at Batujajar where the Citarum River enters the Saguling Reservoir after passing through the urban metropolis of Bandung-Cimahi-Padalarang (population 3 million in 1988). Much of Bandung's untreated, raw sewage entered directly into the Citarum River, then into Saguling at this point. 6. A fisherman checking his nets at the bridge. Fish native to the Citarum (mainly small cyprinids), attempting to spawn, ran up the Citarum River but were caught by small-meshed gill nets strung across this spawning area. The native cyprinid fish fauna was rapidly depleted by the combination of overfishing and pollution and stocks collapsed.



7



8

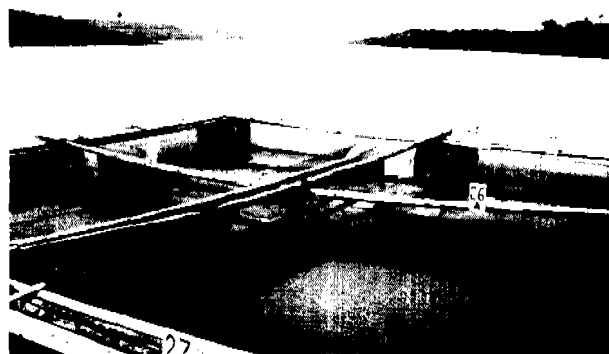

9

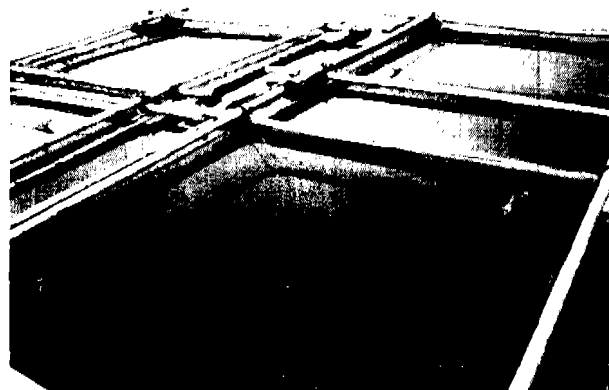

10

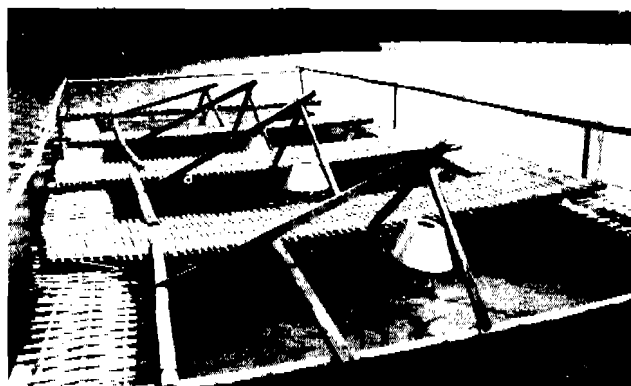

12

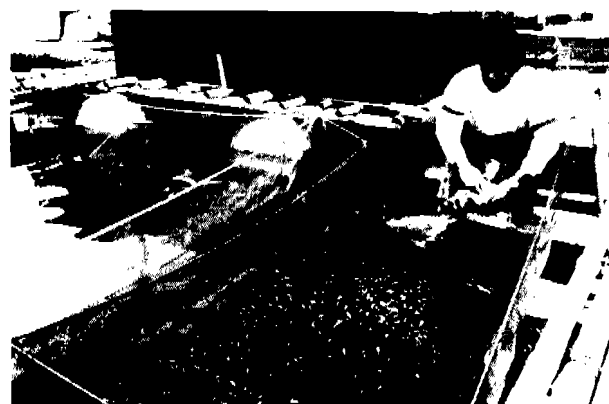

11

7 and 8. Constant input of nutrients from sewage and the decomposition of drowned plant materials when the area was flooded released tonnes of soluble nutrients, causing explosions of plankton. Secchi disk depths went as low as 2 cm and blue-green algal populations over 100 million cells per liter during the 3-year studies. Note the brilliant green water color. 9, 10 and 11. Double net floating *hapa* hatcheries for hybrid red tilapia were developed to take advantage of the excellent natural plankton feeds available. The first models developed used drums for flotation. Lower cost models used bamboo and banana trunks. Villagers found that tilapia hatcheries were productive and fish grew well at stocking densities as high as 10 kg/m<sup>3</sup> using rice bran and natural plankton foods only. 12. Light attractors (simple pressurized kerosene lamps) to increase natural foods and flying insects to common carp and hybrid red tilapia in nursery cages were tested, and were found to be unsuccessful under the conditions and the criteria chosen.



13



15



16



17



18



19



20

13 and 14. Combinations of two 11.5 m<sup>3</sup> common carp nurseries floating in 122.5 m<sup>3</sup> growout cages stocked with two sizes of hybrid red tilapia were tested. Higher net production and average fish weight at harvest of common carp fingerlings were achieved when small hybrid tilapia were stocked in the larger growout cage on the outside of the common carp nursery cages. However, hybrid red tilapia had little effect on cleaning the fouling of the common carp nursery cages, possibly due to the richness of the water and colonization of the carp nursery cages by bryozoans not eaten by the tilapia. 15, 16 and 17. Construction of floating net cages for common carp growout used recycled oil drums, here mounted with wood frames and fixed to a bamboo raft with plastic rope and nails. An improved, lower-cost method used simple 1.7 mm wire to attach the drums to two parallel pieces of bamboo, dispensing with all wood. Costs for this improved farmer version (Model (A)) are given in Table 11. 18. A low-cost floating net cage using just bamboo or bamboo and banana trunks for flotation was developed. This cage model was introduced to the poorer cage farmers. 19 and 20. Permits were issued by the West Java Fisheries Service for displaced families to have 4 cages per family (7 x 7 x 2.5 m cages). Cage culture developed so rapidly that by the end of 1989, 2,554 t of common carp were produced, and 1,236 cage units were developed (see Sutandar et al. 1990). Revenue from fish was estimated at Rp 5 billion/year, over twice (Rp 1.9 billion) the revenue obtained from the 2,250 ha of rice flooded by the dam.





21



22



23



24

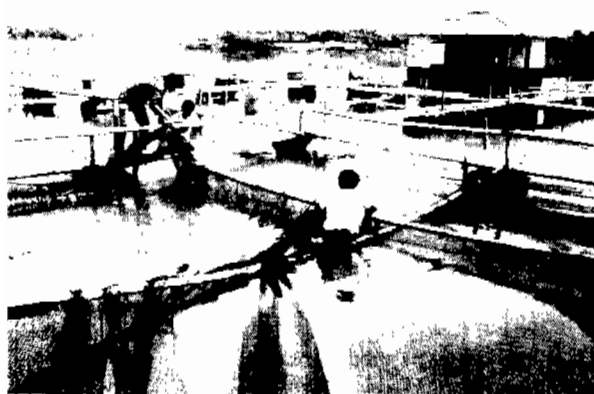

25



27



26

21. In 1988 the Saguling Reservoir was drawn down over 20 m to fill a new downstream reservoir, the Cirata Reservoir. During this time experimentation by IOE/ICLARM continued at the Cipondoh station in the northeastern sector of the reservoir, shown here. Because of this drawdown and its adverse impacts on water quality, it is likely that the results reported by aquaculture studies in this report are a "worst case scenario" and that better yield parameters could be expected from the cage culture industry when Saguling's water levels rise to normal. 22 and 23. Stocking a floating net cage. Common carp of 50-100 g size are stocked at 2.4 kg/m<sup>3</sup> in the commercial sector. Seed fish originate from rice-fish culture or semi-intensive nursery ponds in the Bandung-Subang regencies and are transported in plastic bags with oxygen by truck, then by boat to the cages. 24. Common carp are hand-fed a commercial 24-26% crude protein formulated feed similar in composition to broiler chicken feed at 3% fish BWD at morning, noon and sunset. Food conversion ratios range from 2 to 4. 25, 26 and 27. Harvesting of the cages is accomplished using long bamboo poles to crowd fish into a corner of the cages, then scooping them out using hand nets. Fish are marketed live by transporting in plastic bags with water and oxygen to markets, mainly in Bandung and Jakarta. All photos and captions by Barry A. Costa-Pierce.

# **Economics of Floating Net Cage Common Carp Culture in the Saguling Reservoir, West Java, Indonesia\***

**RUSYDI**

*Institute of Ecology, Padjadjaran University  
Jl. Sekeloa Selatan 1, Bandung 40132, Indonesia*

**HARLAN C. LAMPE\*\***

*International Center for Living Aquatic Resources Management  
MC P.O. Box 1501  
Makati, Metro Manila, Philippines*

RUSYDI and H.C. LAMPE. 1990. Economics of floating net cage common carp culture in the Saguling Reservoir, West Java, Indonesia, p. 218-239. *In* B.A. Costa-Pierce and O. Soemarwoto (eds.) Reservoir fisheries and aquaculture development for resettlement in Indonesia. ICLARM Tech. Rep. 23, 378 p.

## **Abstract**

Three hundred and fifty floating net cage common carp farms at the Saguling Reservoir were surveyed in early 1988 and their economic performance monitored over seven months. One-third of the farms had one cage and the average cage ownership was three. Investment was about 300,000 Rupiah per cage. The study encompassed a period of drawdown to fill the new Cirata Reservoir. Subsequent water quality problems due to the drawdown taxed the technical and economic skill of farmers new to the business. Many stopped or reduced the scale of their operations during the difficult period to avoid losses and maintain profits. Cage culture of common carp was profitable and an average size three-cage farm could support an Indonesian family of five well above the national poverty level.

## **Introduction**

This chapter is divided into two parts. The first part deals with the structure, organization and enterprise investment, and the second examines the economics of cage culture operations.

## **Organization, Investment and Linkages of the Floating Net Cage Culture System**

### ***Introduction***

Floating net cage culture developed rapidly in the Saguling Reservoir despite the fact that it required adoption by the population of a heretofore unknown technology. Prior to the construction of the dam and the filling of the reservoir the residents were largely paddy and cassava farmers.

---

\*ICLARM Contribution No. 579.

\*\*Present address: Vermilion International, Suite 2411, 67 Wall St., New York, NY 10005, USA.

While the rapid development of cage culture suggested that it provided a profitable opportunity for the residents of the area, no reliable information was available. This segment of the report focuses on our findings regarding the enterprises as a unit, the investment required to establish one, the structure of the culture system, and the linkages of the fish culture enterprises to other economic activities.

### ***The Database***

The database for this analysis was generated from a census survey of 350 owners and/or operators of fish cages at Saguling Reservoir. The concentration of potential survey respondents and the availability of lists of all approved applications for the construction and use of cages made a complete census feasible.

Particular attention was given to obtaining cost information for the construction of cages and to the sources of investment funds. In addition all other assets and employment were assayed.

Every effort was made to obtain a clear picture of the economic status of the cage culture operators and their linkages to other income generating activities.

## ANALYSIS AND DATA PROCESSING

Survey data were transferred directly from the questionnaires to microcomputer files using DBaseIII and later DBaseIII+. Analyses employed these programs along with Lotus 1-2-3.

### ***The Organization and Structure of the Cage Culture System***

The general features of the cage culture activity are reviewed in this section with a focus on the location, enterprise size and investments required.

## THE LOCATION OF ACTIVITY

Cage culture activities are concentrated in a very limited area of Saguling Reservoir. More than 90% of the operators are found in the Cililin district. Most of these are found near Bongas village with more than 80% of the existing nets in the Ciminyak River.

This concentration is supported by an excellent road network that makes almost all locations accessible to four-wheel drive vehicles in all seasons. However most places in Cililin do not require such special vehicles. The river and the road network along with the locations of cage concentration are shown on Fig. 1 (see Table 1 for details of ownership distribution).

Emulation probably accounts for the unusual concentration at Bongas. The leaders in development participated in the very earliest programs sponsored to interest farmers in fish culture. These farmers were early and successful adopters and adaptors of the cage culture technology. Their success, leadership and advice undoubtedly accounts for some if not all of the obvious interest in cage culture of carp.

Also, some of these leaders are both buyers of fish and sellers of feed and seed. Hence they are in a position to encourage development and investment by providing production credit as well as a product market.

Another factor that may contribute to this concentration is the general economic well being of the people at Bongas and in the vicinity (IOE 1980).

Table 1. The residence of owners of floating net cages on Saguling Reservoir classified by political subdivision, March 1980.

No.	Subdistrict/village	Floating net cage farmers	
		Number	%
<b>Cililin Subdistrict</b>			
1.	Cililin	8	2.3
2.	Budiharja	40	11.4
3.	Bongas	170	48.6
4.	Batulayang	42	12.0
5.	Cihampelas	7	2.0
6.	Mekarmukti	2	0.6
7.	Mekarjaya	4	1.1
8.	Rancapanggung	23	9.4
9.	Mukapayang	9	2.6
10.	Pataruman	1	0.3
11.	Tanjungjaya	7	2.0
12.	Citapen	1	0.3
	Subtotal	324	92.6
<b>Batujajar Subdistrict</b>			
13.	Batujajar Barat	1	0.3
14.	Pangauban	3	0.9
15.	Selacau	1	0.3
	Subtotal	5	1.4
<b>Cipongkor Subdistrict</b>			
16.	Cicangkanghilir	10	2.9
17.	Sukamulya	4	1.1
18.	Citalem	1	0.3
	Subtotal	15	4.6
<b>Outside owners</b>			
19.	Bandung, Jakarta, etc.	5	1.4
	Total	349	100.0

There appear to have been ample resources to provide funds for investment in floating cage culture. It will be noted later that the number and size of outstanding loans is small, and that relatively little borrowing was necessary to begin cage culture businesses.

#### ENTERPRISE SIZE AND LINKAGES

The 349 owners surveyed collectively owned 865 cages. One hundred and thirty-three farmers (38%) owned a single cage and another 93 (27%) owned two cages. Thus 65% of the farmers owned 37% of the cages. The distribution of farms and cages for farms of various sizes is shown in Fig. 2.

The largest single operator owned 16 cages and a total of 11 farmers had more than six cages (see Table 2 for details). It is natural to suspect that economies of size in the construction and/or operations have compelled some operators to develop very large units and 68 (19%) of the operators to construct four, five and six cages. The implications of this will be examined later.

An unanticipated development that also suggests some advantages in larger operations has been the extensive collaboration among farmers in joining their units together. Two hundred and thirty farmers have joined with one or more others in their common interest (Table 3). Table 3 reveals a fascinating story. There are 120 farmers of various sizes operating alone at one end of the spectrum and at the other there are eight farmers who have joined their rafts together into

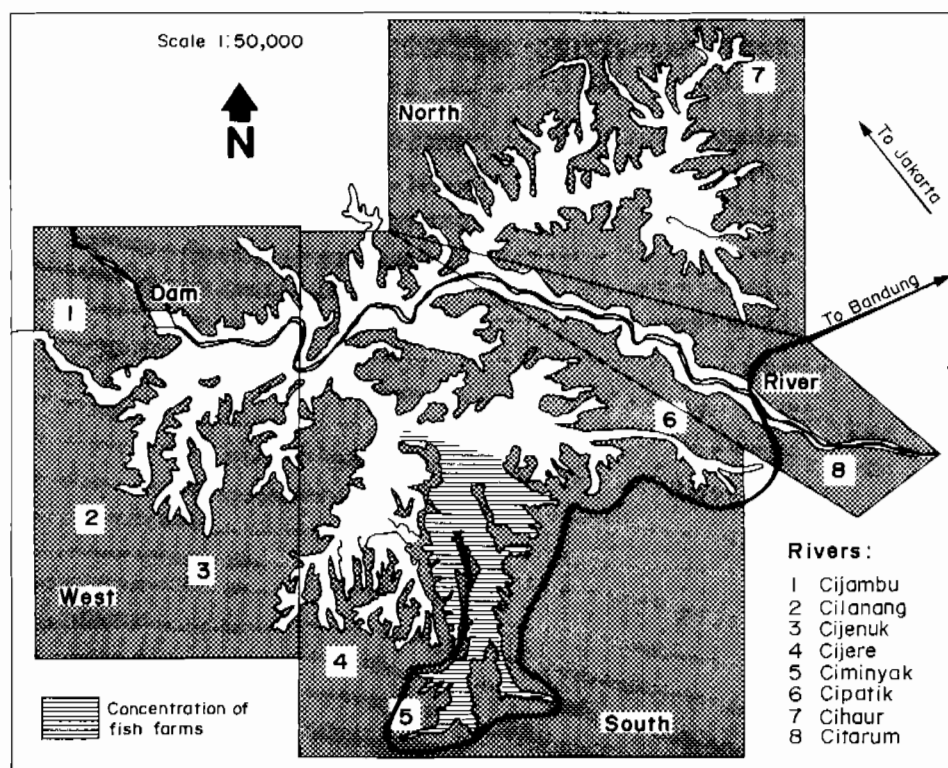

Fig. 1. A map showing concentrations of cage culture activity at Saguling Reservoir and farm to market road network, 1989.

Table 2. Saguling cage culture enterprises and cage numbers classified by number of cages per farm, March 1988.

Farm size by number of cages	Number of farms	Number of cages in farm class	Per cent of farms in class	Per cent of cages in class	Cumulative per cent of farms	Cumulative per cent of cages
0	2	0	1	0	1	0
1	133	133	38	15	39	15
2	93	186	27	22	65	37
3	43	129	12	15	77	52
4	32	128	9	15	87	67
5	24	120	7	14	93	80
6	12	72	3	8	97	89
7	4	28	1	3	98	92
8	3	24	1	3	99	95
9	2	18	1	2	99	97
10	0	0	0	0	99	97
11	1	11	0	1	100	98
12	0	0	0	0	100	98
13	0	0	0	0	100	98
14	0	0	0	0	100	98
15	0	0	0	0	100	98
16	1	16	0	2	100	100
<b>Total</b>	<b>350</b>	<b>865</b>	<b>100</b>	<b>100</b>		

Table 3. The size distribution of fish farmer groups, Saguling Reservoir, March 1988.

Members in group	Number of groups	Farmers in size group	Per cent of farmers
1	120	120	34
2	45	90	26
3	18	54	15
4	7	28	8
5	6	30	9
6	1	6	2
7	2	14	4
8	1	8	2
Total	200	350	

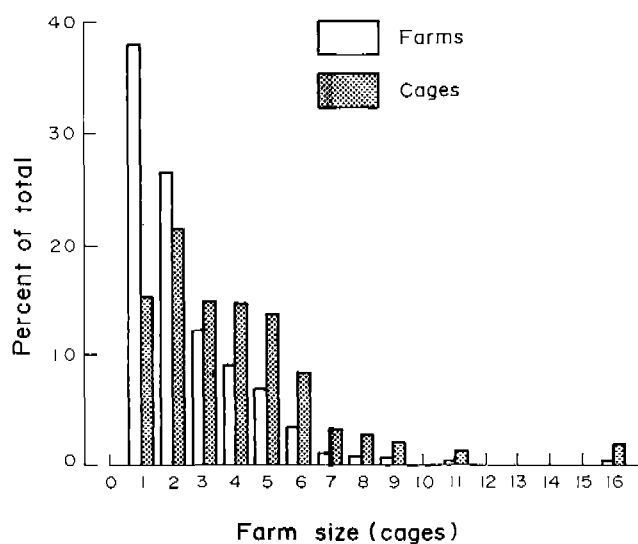

Fig. 2. Farm size and cage numbers as per cent distribution by farm size.

a substantial complex. This collaboration is a natural development of what is called the "gotong royong" or collective-help system in Indonesia.

This grouping provides some obvious benefits to the farmers. Among them are: (1) cost savings in construction especially of the guardhouse; (2) greater security in maintaining night watch; (3) easier communication in technological and marketing affairs; and perhaps (4) a certain comfort in sharing a common fate for good or ill.

The foundations for collaboration appear to be found in the family and village social structure. Most associations of several farmers are based on family relationships. Natural children, in-laws and other relatives join together under the leadership of a senior family member. Farmers in the group who own the guardhouses are usually trusted farmers and are respected within the group. They can be called nuclear farmers. They also play an important role in the transfer and adaptation of new technology. However, there are respected farmers who are also leaders in the community who are not part of a collaborative group.

## EDUCATION AND TRAINING

The fish farmers of Saguling are well educated with 94% having completed elementary school and only 2.3% who have had no schooling. Twenty-five per cent of the farmers have had education beyond elementary school and five (1.4%) farmers have completed university (Table 4). It is tempting to attribute the rapid and successful adoption of a new fish culture technology among the farmers to their high level of education. Certainly the farmers' ability to benefit from the short courses offered by extension workers and the materials distributed by these workers was enhanced by their education. Discussions with the farmers during the course of this study indicated a clear understanding of the technology they were employing, and a very substantial amount of production analysis based upon arithmetic of inputs and outputs. The scope of farmers' understanding of the problems with which they were confronted was impressive. This can be attributed to things other than formal education of course. Extension and other programs have contributed to both the management of the technology and to its understanding.

Table 4. Education of Saguling fish farmers by farm size, March 1988.

Education	Cage ownership group									Total	%
	1	2	3	4	5	6	7	8	>9		
No formal education	5	1	2	-	-	-	-	-	-	8	2.3
Not completed elementary school	8	3	-	-	1	-	-	-	-	12	3.4
Elementary school	97	67	30	21	14	9	2	-	2	242	39.3
Junior high school	7	8	3	6	4	-	-	-	1	29	8.3
Senior high school	13	17	8	3	4	2	2	2	2	53	15.2
University	2			1	1	1	-	-	-	5	1.4
Total	132	96	43	31	24	12	4	2	5	349	100.0

Information has been made available to farmers through training, demonstration and extension programs. About 90% of the farmers with one cage participated in training programs and 44% of all farmers got information from training or extension programs. Two of the three largest farmers received training and have provided considerable leadership in the development of the program. With the concentration of cage culture activities, the demonstration effect can also be assumed to have had a considerable impact on some of the potential investors.

The high educational level is also linked to the relative youth of the fish farmers. Eleven per cent of the farmers are less than 25 years old and most farmers (52%) are between 25 and 45 years old. Only 8% are over sixty. Age selection may result from the fact that displaced farmers in their later years who have been compensated for their land losses may feel little need to begin a new and risky career. Younger farmers with families to support for a longer time horizon need something more than the compensation money received from the electric company to survive and have taken the risks associated with a new technology offering.

## EMPLOYMENT AND INCOME OF FARMERS

While fish farming offers an excellent opportunity for displaced and other farmers in the Saguling area, it is clear that fish farming is a secondary activity in most cases and that incomes are substantially supplemented from other sources.

*Employment*

Most Saguling fish farmers are engaged in other income-generating activities. Fish farming is considered the principal activity of only 107 or 30% of the 350 farmers surveyed. Fish farming is the second most important activity of 204 (58%) of the farmers and the third activity of 35 farmers (10%). Trading was the main work of 22% of the farmers, and agriculture for 11%. Other occupations included teaching and government service which accounted for 40 of the farmers (Table 5). It is important to note that most of the farmers got their main income from other sources than fish farming and that relatively few were laborers. This suggests that fish farming did not provide a new opportunity for those without skills and resources. Rather it provided an opportunity for those already with resources and demonstrated entrepreneurial skills. Table 5 provides, however, some evidence that people from a variety of backgrounds are willing to risk investing in the cage culture of carp.

Table 5. Principal occupations of Saguling fish cage farm operators by farm size, March 1988.

Stated main occupation	Number cages in farm									Total	%
	1	2	3	4	5	6	7	8	>9		
Fish farmer	43	33	8	10	11	4	-	-	1	110	31.5
Farmer	19	9	4	4	3	-	-	-	-	39	11.2
Farm labor	2	3	1	-	-	-	-	-	-	6	1.7
Labor	18	5	4	4	-	-	-	-	-	30	8.6
Skilled labor	8	1	-	1	-	-	-	-	-	10	2.9
Trader	15	26	15	9	3	4	2	-	-	74	21.2
Entrepreneur	5	5	2	1	1	1	-	-	2	17	4.9
Pensioner	5	1	5	1	3	2	-	-	1	18	5.2
Govt. official	12	13	4	2	3	1	2	2	1	40	11.4
Handicraft	4	-	-	-	-	-	-	-	-	4	1.1
Student	1	-	-	-	-	-	-	-	-	1	0.3
Total	132	96	43	31	24	12	4	2	5	349	

*Income*

Only 71 farmers (21%) reported no income from other sources than fish farming (see Fig. 3a) during the prior year. Fig. 3a also shows that 151 cage fish farmers had additional incomes up to one million rupiah from either agricultural or nonagricultural sources.

Among the farmers, nonagricultural income was far greater than income from agriculture. Income from agriculture for cage fish farmers that had nonagricultural income was less than one million rupiah for all but a few (14) (see Fig. 3c). For those cage fish farmers with nonagricultural income (e.g., government service, fish trading, labor, etc.), 94 had incomes of more than one million rupiah (Fig. 3b) and several of those had incomes of more than seven million rupiah.

There were 41 (12%) farmers with income from both farm and nonfarm sources but for these farmers nonfarm income was even more dominant, accounting for 94% of the total outside income. Also a substantial number of farmers had income from at least two other sources within



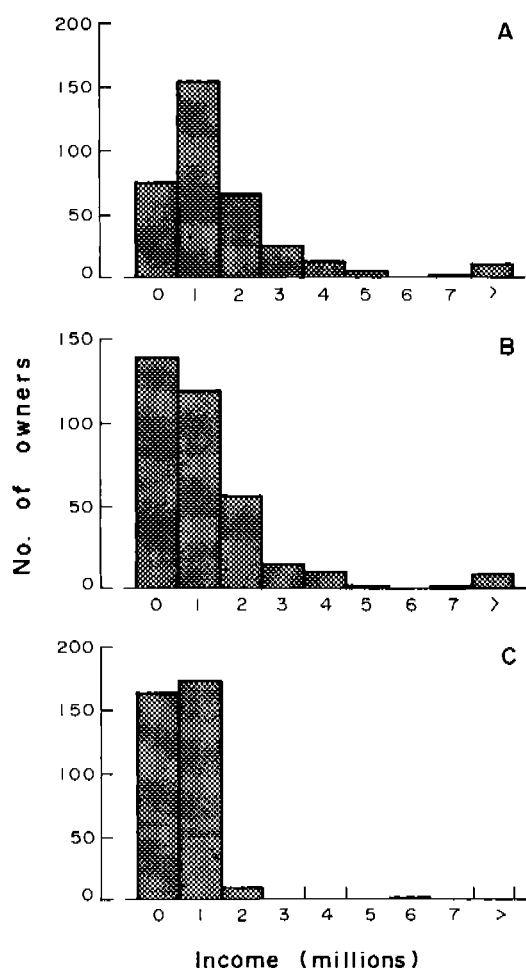

Fig. 3a. All other income of cage owners, Saguling, March 1988 (n = 350). 3b. Nonagricultural income of cage owners, Saguling, March 1988 (n = 350). 3c. Agricultural income of cage owners, Saguling, March 1988 (n = 350).

agriculture such as growing rice, fruits and vegetable or animals. This was also true of those with nonagricultural income where cage fish farmers were involved in several different kinds of trading or had more than one job.

While many of the fish farm operators have been farmers and some still are it is clear that nonfarming activity is of great importance in advancing and maintaining their economic position. Some of the nonfarm activity is linked to the development of cage culture as the farmers have begun to trade in farm inputs like feed and fish seed as well as marketing fish from the operations.

Ancillary studies indicate that incomes have increased dramatically as a result of introducing cage culture. Prior to floating net cage development, average family income was 90,300 rupiah a month and currently family income is estimated to be 629,900 a month.

### ***Investment and Its Sources***

#### **THE COST OF CAGES**

One of the indicators of the effectiveness of the extension and training programs conducted for Saguling farmers is the uniformity of the design and construction of the floating net cages. The cages have been described in detail in Costa-Pierce and Hadikusumah (this vol.). The size

of cages is virtually identical in all cases, the small differences in the net size being minor. Bamboo is a universal material for the catwalk and framework of the floating net cages and the framework is fastened with wire. Used fuel drums support the floating structure and the frames used to hold them in place vary among rafts. A small guardhouse for the farmer and his family or workers and for supplies is another common feature, and it is usually made of plywood roofed with corrugated metal. The floating net cage must be anchored which requires a substantial amount of rope as does the rope lead to the shore which guides a transport raft that is a normal adjunct of a floating net cage operation.

When fish farmers bring their cages together economies of scale can arise because only one raft and one shelter (guardhouse) is required to serve the combined cages and less anchoring is required for the several cages together than separately. It was not possible to assess these savings because of the great variability in reported construction costs. Fig. 4 gives some indication of the variability in the reported costs among all farmers, and Fig. 5 shows the great variation in costs among the smaller farmers, or those with one or two cages. The dataset for Fig. 5 contains all records except three that unaccountably showed no cages (they may not yet have been constructed); whereas, Fig. 4 uses a dataset that has been edited to remove records that obviously lacked essential items in the cost list, such as nets. Most of the records rejected were from farms with one or two cages (58). Over 30% of the one-cage farm records were rejected.

The lower cost extremes certainly underestimate the costs and probably result from inability to recall all of the items necessary or their cost. Inexperienced enumerators may also have failed to pursue matters fully. The extremely high costs for some operators are difficult to explain but may be the result of deferred payment, or loan "sharking".

The major elements in the construction of cages with their respective shares of the total cost of cages for the 268 selected observations were:

Netting	34%
Metal drums	17%
Bamboo	7%
Rope	5%
Wood	4%

Total 67%

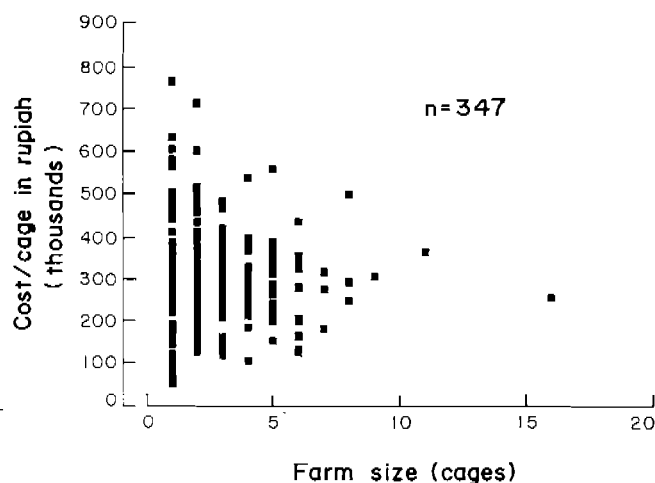
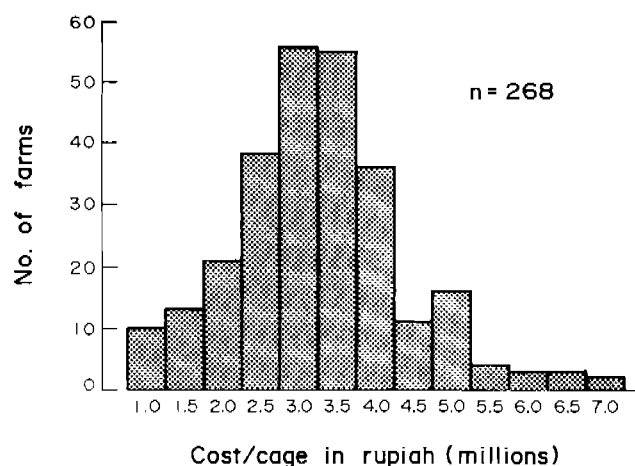

Fig. 4. Average cage cost distribution, Saguling, March 1988 (n = 268).

Fig. 5. Average cage cost by farm size, Saguling, March 1988 (n = 347).

These are only part of a list of 29 items about which farmers were asked, but comprised the majority of the costs.

The average cost per cage for all cages in the 268 farm sample was 300,095 rupiah. A similar picture emerges if one examines the relationship between cage cost and farm size. This is shown in Fig. 6 where total farm cost is regressed on farm size with an intercept of zero ( $r^2 = .77$ ).

The regression coefficient suggests a cost per cage of 296,289 rupiah which is not significantly different from the estimate above. Using an exchange rate of 1,700 rupiah per US dollar the cost per cage is about US\$175.

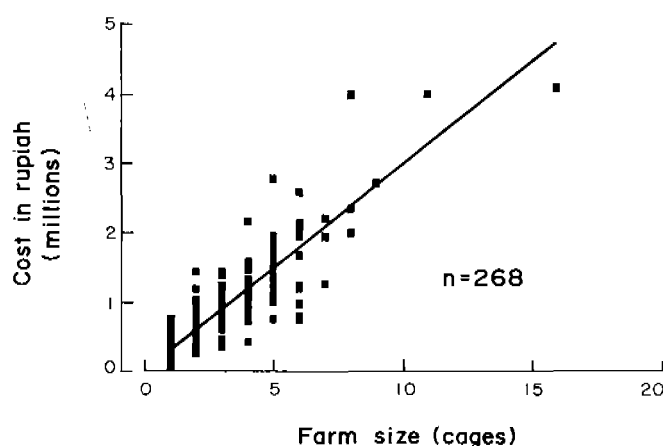

Fig. 6. Farm cost and farm size, Saguling, March 1988 ( $n = 268$ ).

## FARM DEBT

One of the more surprising features of the group of farmers at Saguling is their lack of debt. That is, about half the farmers have no debt at all. Fig. 7 gives a rather clear picture of the farm debt position. However, while most farmers have no debt, those that do have a rather substantial amount with the debt amounting to 57% of the reported farm cost of 350 farmers. Further analysis shows that the 108 indebted farmers have debts that are 140% the cost of the cages.

There are several possible explanations for this. Farmers were asked about their debts without specific reference to the cages alone so debt for all purposes was reported, some of which may have been production credit for feed and seed or for agricultural or housing purposes. The size distribution of farmers in debt does not differ significantly from the size distribution of all farmers. One-cage farmers constituted 38% of all farmers and 37% of those indebted. Two-cage farmers were 27% and 32% with three-cage farmers 12% and 14% of all and indebted fish farmers, respectively.

While physical assets were enumerated, no attempt was made to value any but those related to fish farming. However, given the general prosperity of the fish farmers and their position with respect to physical assets their current debt does not appear to be a major burden.

## SOURCES OF FUNDS

Farmers made effective use of a variety of funding sources, with compensation from the electric company (PLN) for displacement providing the largest nonfamily source. For the larger

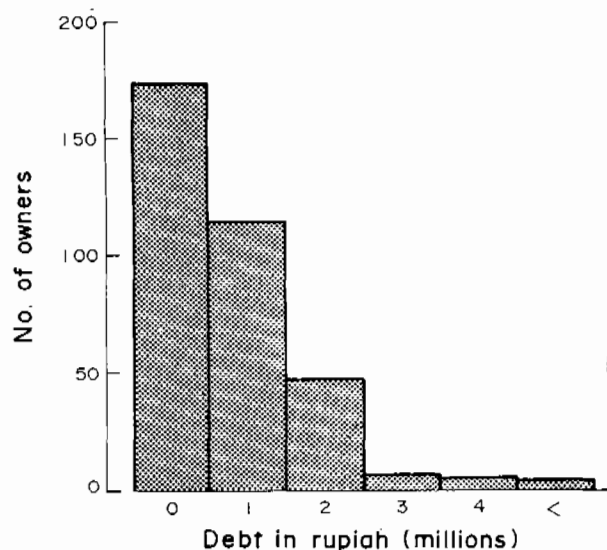

Fig. 7. External debt of cage owners, Saguling, March 1988 (n = 350).

farmers their own funds provided a significant input as did funds from trading. It is significant that midsized farmers made quite a substantial use of bank sources. This is a credit to the willingness of banks to lend to small operators and having procedures that make it a reasonable source for farmers. Table 6 indicates that farmers were capable of obtaining and managing credit from a variety of sources.

Table 6. Sources of funds for floating net cage culture at Saguling, per cent of funds from each source by farm size (n = 349).

Farm size	Funding sources							Total
	Own funds	Traders	Compensation	Saving	Children	Bank loans	Nonbank loans	
1	8.6	11.4	20.5	11.8	35.3	2.6	9.8	100.0
2	6.2	16.8	27.6	3.9	30.3	6.8	8.4	100.0
3	3.6	1.7	32.7	6.3	31.2	20.5	4.0	100.0
4	3.1	9.6	22.5	1.6	42.5	19.1	1.6	100.0
5	7.3	9.3	26.2	4.3	18.5	27.7	6.7	100.0
6	-	22.1	46.7	4.5	-	23.0	3.7	100.0
7	-	-	40.9	33.8	-	-	25.3	100.0
8	28.1	20.6	-	51.3	-	-	-	100.0
>9	23.6	13.6	-	-	54.7	8.1	-	100.0
All	6.6	11.5	25.7	6.8	30.3	12.8	6.3	100.0

## Farm Management and Operation

### Introduction

The operations of a floating net cage system are not particularly complex and farmers have available excellent guidelines and extension services to assist them in these operations. It is interesting to observe, however, just how varied the systems employed by farmers are and how they have adapted the technology to their use.

The management of operations involves a host of decisions concerning the stocking, feeding and selling of the fish produced in the cages as well as many others concerning labor, the care and maintenance of equipment, as well as the fish. Some management decisions seem to press the limits of good culture practice such as mixing soil with feed before selling the fish; however, we were not in a position to analyze curiosities such as these. We have, however, attempted to evaluate the farm operations and assess the results of management on the profitability of these operations.

### ***The Database***

Data were collected from a selected sample of farmers which was biased in favor of the larger producers. This was done for two principal reasons. The larger farmers account for proportionately more of the fish produced hence reflect the economics of production for a larger part of the system. Also, it was thought that the larger producers would reflect the technology managed at its best and therefore provide a good indication of the economic potential of the cage culture system. Data on operations: the purchase of inputs, their use, the sale of outputs and the maintenance of the physical facility were all the subject of a weekly program of data collection for some producers and a monthly regime for others. The period for data collection began in May 1988 and continued through November of that year. It was thought to be desirable to capture a longer, seasonal difference in farm operations but the monitoring period was shortened by unforeseen delays in completing the survey.

The sample was constructed as shown below. Numbers indicate the number of farms or observations made in each category.

Farm Size	Weekly	Monthly
1-2	1	32
3-5	11	31
≥6	3	2

The weekly sample encompassed 62 cages and the monthly 189 of the 865 cages in the system (Fig. 8).

Of considerable import over the period of data collection was the drawdown of the Saguling Reservoir to provide water for the Cirata Reservoir. The consequent reduction in area drove a

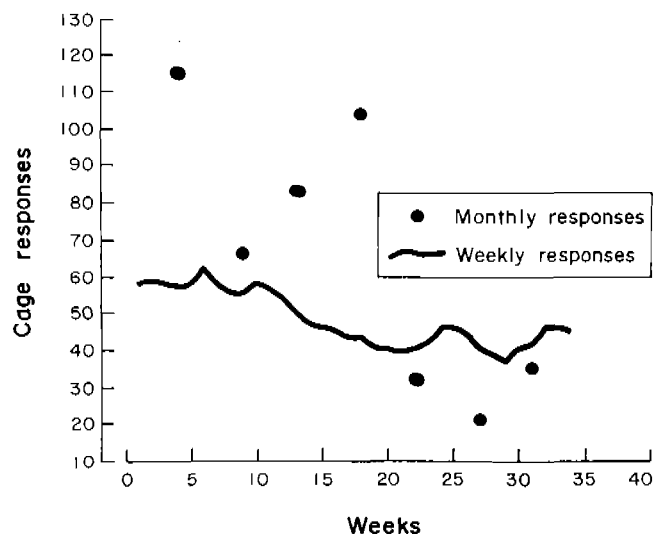

Fig. 8. Cage responses for weeks and months, Saguling, May-December 1988.

number of operators to discontinue operations for a considerable period so the time series generated to evaluate growth rates and management response to market conditions are incomplete and confounded with an event that is not expected to occur again. So, while the monitoring system was designed to capture seasonal differences it was impaired by unexpected events.

It turned out that the data collection scheme was perhaps more complex than necessary since within group variability turned out to be so great as to make it virtually impossible to detect any differences among groups or over time.

### ***Data Management and Analysis***

The volume of data generated, while anticipated, was difficult to manage. As a consequence the database is somewhat less definitive than one would like. DBaseIII, III+ and IV were used to manage the data and to produce some of the analyses. Files were transferred to Lotus 1-2-3 as necessary for more effective treatment using that system and for the preparation of initial graphs. Communication between the two programs, DBase and Lotus, was substantially simplified late in the project with the use of DESQview.

Until the appearance of DBaseIV, considerable practical difficulty was experienced in managing the several database files using queries. It was practically necessary to use several smaller database files rather than very large ones in the interest of reasonable speed. Also, the transfer of large databases to 1-2-3 on the microcomputers available was not possible.

### ***Fish Seed***

Seed fish are an obviously essential part of the culture system. There has been considerable concern expressed from time to time concerning the adequacy of supplies and the quality of those supplies (Costa-Pierce and Hadikusumah, this vol.). This report cannot address those issues but will present some of the information obtained in monitoring the performance of farmers that reflects their stocking practices. Those practices were quite variable and it would appear that farmers are seeking economically sensible solutions as seed prices fluctuate.

The monitoring program produced data that indicated average stocking rates are about 253 kg per cage of 7 x 7 x 2.5 m (2 kg/m<sup>3</sup>), and that cages produced an average of 619 kg in about three months. Subsequent investigation (May 1989) showed a 47% increase in the cost of seed with the stocking density declining to 1.4 kg/m<sup>3</sup> or 173 kg for each cage. Fish growth rates, however, appear to have remained about the same. That is, the harvest weight was 2.44 times the stocking weight during the monitoring and 2.49 times the stocking in the May 1989 evaluation.

#### SEED SOURCES

The source of seed fish for the farmers of Saguling is in the immediate area of Bongas where most of the farmers live. This is because the seed is brought in from the outside and acclimatized by the vendors before the farmer purchases it. This is attractive because of the greatly reduced mortality achieved by acclimatization. Most of the remainder comes from the nearby Bandung area. Table 7 shows the concentration of seed sources. The primary seed sources are Buahbatu and Cikoneng subdistricts in the Bandung regency, with about 40% of the seed coming from each area.

Table 7. Places where seed fish were bought by Saguling fish farmers, May-June 1988.

Places of origin	Quantity	Per cent
Bandung	51	14.6
Cigereleng	3	0.9
Majalaya	8	2.3
Bongas	165	47.2
Rancapanggung	58	16.6
Batulayang	46	13.2
Cihampelas	5	1.4
Cikampek	3	0.9
Other (7)	7	2.0
no stocking yet	3	0.9
Total	349	100.0

## SEED SIZE

The modal size of seed fish for cage culture is about 67 g or 15 fish per kilogram. Eighty-four per cent of all stock fish range from 10 to 25 fish/kg or from 40 to 100 g, a very considerable range. When larger fish are stocked, the time required to reach a marketable size is, *ceteris paribus*, shorter and one would expect the feed conversion rate to be lower. With smaller fish the growing period is longer to market size and feed conversions should be higher. In addition, during the shorter growing period risks are reduced. During the survey in February and March of 1988 (Table 8) 47% of the farmers stocked 10 to 15 per kg fish and 30%, 15 to 20 per kg size fish. However, analysis of all purchases of seed fish during the monitoring period of seven months in 1988 showed some differences. The 527 weekly and monthly observations totalled 70% in these two classes with perhaps a slight shift favoring even smaller size seed fish.

One might have expected the rigors of the drawdown to favor the stocking of larger fish which perhaps would be better able to withstand the deteriorating water quality conditions. However a careful evaluation of the reported stocking size of fish for the seven-month period showed no changes associated with the drawdown, but the variance of the sizes chosen did decline a bit over time. Farmers appear to have been coming to a common conclusion concerning the optimum stocking sizes.

Table 8. Sizes of seed fish used by Saguling floating net cage operators during February-March 1988.

Size of seed (fish/kg)	Number of farmer	Per cent
<5	7	2.0
5-10	18	5.2
10-15	165	47.3
15-20	105	30.1
20-25	26	7.4
25-40	21	6.0
>40	7	2.0
Total	349	100.0

## STOCKING DENSITY

Some experimental work has been done to try to find optimum stocking densities to guide farmers in their production planning (Costa-Pierce and Hadikusumah, this vol.). Farmers have also been experimenting. Overall the weekly data show a very slight tendency for stocking

densities to decline over a period of 34 weeks in 1988. It is difficult to assay the reasons for this from the data but lower stocking densities reduced the risk during the rather difficult period of the drawdown.

Farmers have, however, adopted stocking densities that are lower than anticipated and recommended in the earlier stages of development. These densities average 168 kg a cage or 1.4 kg/m<sup>3</sup>. While there are some very low densities (<50 kg) and some very high densities (500 kg) most of the stocking is between 100 and 200 kg per cage, or 0.8 to 1.6 kg/m<sup>3</sup>. These estimates are based upon a review of the records where the stock was grown for a reasonable period of time. There are many records of fish being placed in cages for a few days or a week awaiting later sale and records that show the use of cages for holding fish before transfer to other cages. One is struck, in reviewing the cage records, with the extraordinary variability in stocking densities and holding or growing periods. Farmers do not simply buy seed, grow it for two or three months and sell it.

### ***Growing Period***

Farmers have also adopted shorter growth periods than had been anticipated and recommended earlier. The range of periods, as has been mentioned, is great. Cage records show periods from one to twenty-two weeks although most of the records show periods between four and ten weeks. The average period is 7.4 weeks. This estimate excludes those records where the cage was used simply for holding fish prior to stocking or sale. Some observers have reported that in 1986-1987 typical growing periods were much longer such as three months (Effendi, pers. comm.). Our data indicate farmers apparently do not find these longer periods to be economically feasible.

### ***Growth***

Growth is stated in a variety of ways in different reports and this one will give a variety of these measures from several sources.

Weekly cage data showed an average harvest of 442 kg that was 263% of the stocked weight of 168 kg for an average 7.4-week period. Weekly aggregate farm data showed harvests at 247% of stocks and aggregate monthly data showed a harvest of 272% of fish seed input.

The average weight increase each week for each kilogram of fish stocked is 0.22 and this translates into a daily growth rate of 1.9% for the period. This appears to be on the high side compared with results of previous experiments conducted in Indonesia in floating net cage aquaculture reviewed by Costa-Pierce and Hadikusumah (this vol.). The farmers obtain these rather high growth rates over fairly short periods; if they kept fish for three months it is estimated that the daily growth rate would decline to about 1.5%.

The variability in growth rates among cages is very large indeed. The weekly growth per stocked kilogram numbers range from small negatives to 0.6 with a few abberants at about 0.8. During the changing period in which the monitoring was conducted a substantial variability is not surprising; however, some may be attributable to errors in the data collection process. In any event these variable growth rates show no relationship to stocking densities nor to the length of the growing period.

### ***Feeding***

The high growth rates may come at the cost of feed. Costa-Pierce and Hadikusumah (this vol.) review feed conversion ratios in floating net cage aquaculture of  $2.3 \pm 0.5$  (mean  $\pm$  S.D.).



The farm data give feed conversion ratios ranging from 2.2 to 2.9 depending upon what measure of feed is used.

Farmers use both commercial and other feeds such as cassava leaves and rice bran. They also mix their own feeds with various ingredients (including soil!) and in general show great ingenuity in trying to reduce the cost of the second-most-costly input to the operation. There are also some differences in the results from the monthly and the weekly data. Within the weekly data there are two sources of feed information: purchases and feeding practices.

The feed conversion ratios (FCR) for all feed based upon the weekly use reported is 2.2 but based upon the purchase report is 2.9, a very substantial difference. Monthly reports which provide feed purchases give an intermediate FCR of 2.5.

Commercial feeds were of three major brands: Cargill, Comfeed and Sinta and all farmers use them. These feeds are expensive at 460-462 rupiah per kilogram; so expensive that farmers are seeking ways to avoid using them. The FCR for commercial feeds from weekly purchase reports is 2.5 and for monthly reports 2.3. The differences between the weekly and monthly data may reflect the failures to recall past purchases and this is reflected in the lower FCRs. In subsequent analyses results of both will be shown but the weekly-based data analysis will be both more conservative and probably more accurate.

### ***Operating Costs and Earnings***

The basic inputs of feed and seed constitute the principal costs of operating a fish farm and the efficiency with which they are used will largely determine the profitability of operations.

The most favorable estimate of returns over the cost of feed and seed per kilogram is 414 rupiah based upon reported feeding rates. This would yield a return for each cage crop of about 183,000 rupiah about eight weeks after stocking. The less promising estimates are based upon feed purchases reported weekly and monthly giving 203 and 214 rupiah per kilogram, respectively. If one assumes that the accuracy of the weekly data is superior to that of monthly data and that purchase information is more accurate than feeding practice information, then the return over feed and seed costs of 203 would give a cage return of 89,614 rupiah for each eight-week crop.

Costs and returns in Tables 9a and 9b show a picture of returns over feed and seed costs that is satisfactory but not one that shows extraordinary promise. The tables summarize the cage and crop data in an attempt to put this information into the framework of an operating year and a farm. The parameters developed have been used to synthesize an operating unit of a single cage for a year and a three-cage farm. Normally, logistical matters do not come to the fore in economic analyses but Table 9a shows that about 8 tonnes of fish seed and feed have to be moved to and from each floating cage each year. This is typically moved on a bamboo raft and requires labor which will be discussed in the next section.

The single cycle column in Tables 9a and 9b also gives some insight into the working capital requirements of a fish farm. About 325,000 rupiah are required to meet the seed costs which, in this synthesis, would not be recovered for about two months. Feed is bought at frequent intervals so the total feed bill does not come due at the beginning of the production cycle. By the end of the period the farmer would have about 625,000 rupiah in feed and seed committed to each cage, a substantial sum.

A three-cage farm represents a fairly large enterprise with an annual gross return of almost 13 million rupiah and periodic costs for feed and seed of almost two million rupiah.

### ***Labor***

From a development point of view, the more displaced labor employed in the fish cage culture sector the better. Labor is required several times a day for feeding and less often for

Table 9a. Cage summary of earnings and seed and feed costs, Saguling 1988 (approx. 1,770 rupiah = US\$1 at time of study).

	Single cycle	Full year
	<u>Single cage</u>	
<u>Output</u>		
Volume, kg	442	2,652
Price	1,620	1620
Total value	716,040	4,296,240
<u>Seed</u>		
Total kilos	168	1,008
Price	1,932	1,932
Total cost	324,576	1,947,456
Cost/kg output		734
<u>Feed</u>		
All feed (kg)	691	4,145
Price	437	437
Total cost	301,860	1,811,157
Cost/kg output		683
Commercial feeds	627	3,765
Price	460	460
Total cost	288,632	1,731,790
Cost/kg output		653
<u>Labor</u>		
Input (mo.)	2	12
Price (mo.)	32,500	32,500
Total cost	65,000	390,000
Cost/kg output		147
<u>Maintenance</u>		
Cage (weeks)	8	52
Price	699	699
Total cost	5,589	32,328
Cost/kg output		13
<u>Returns/kilo, over all costs</u>		
All feed		42
Commercial feed		73
<u>Feed conversion ratio</u>		
All feed		2.52
Commercial feed		2.29

transporting cage inputs and outputs. Labor is also necessary for maintenance. Much of the labor is family labor (83%) and the owner operator may provide most of it. However, it is important to recall that few of the owners are principally fish farmers.

The servicing of the cage culture industry offers substantial opportunities for work. Data obtained by May 1989 from 457 floating net farmers at Saguling revealed in addition to creating work that the operating units also created linked employment for other activities including cage construction which used 2.1 workers, net knitting required 1.1, with feed and seed supplies using 1.6 workers per operating unit (Table 10).

The operating labor, or a worker employed full time in feeding, seeding and maintaining cage operations is paid from 15,000 to 50,000 rupiah a month including food. The lower rate pays younger workers who do little more than feed and guard the cage facility, while the higher rate pays those mature workers who essentially manage the cage operation. For purposes of

Table 9b. Farm summary of earnings and seed and feed costs (in rupiah), Saguling 1988 (approx. 1,770 rupiah = US\$1 at time of study).

	Single cycle	Full year
<u>Three cage farm</u>		
<u>Output</u>		
Volume (kg)	1,326	7,956
Price	1,620	1,620
Total value	2,148,120	12,888,720
<u>Seed</u>		
Total kilos	504	3,024
Price	1,932	1,932
Total cost	973,728	5,842,368
Cost/kg output		734
<u>Feed</u>		
All feed (kg)	2,072	12,434
Price	437	437
Total cost	905,578	5,433,471
Cost/kg output		683
Commercial feeds	1,882	11,294
Price	460	460
Total cost	865,895	5,195,369
Cost/kg output		653
<u>Labor</u>		
Input (mo.)	6	36
Price (mo.)	32,500	32,500
Total cost	195,000	1,170,000
Cost/kg output		147
<u>Maintenance</u>		
Cage (weeks)	24	156
Price	699	699
Total cost	16,767	108,983
Cost/kg output		13

Table 10. Number of workers used by floating net cage operators at Saguling, March 1988-May 1989.

Kind of activity performed	Average absorption (person per activity)
Operator and owner	1.3
Operating labor	0.2
Construction	2.1
Net knitter	1.1
Seeds supplier	1.6
Total	6.3

operating cost calculations, 32,500 rupiah will be used as the mean monthly wage for labor. The survey data indicate that about 1.5 workers are employed on the average unit of 3 cages. Observation suggested that these workers are not employed full time and for purposes of calculating costs two-thirds time employment was assumed. Only 0.2 of this is hired labor and the remainder is family labor. Our estimates of costs and earnings show all operating labor, and include an imputed opportunity cost of labor, not the cash cost.

## **Maintenance**

Maintenance is always an elusive expense to document where intervals between interviews are long so every effort was made to obtain information on this cost in the weekly interviews. For the 1,636 cage-weeks reported, there were 86 reports of maintenance expenses. These costs averaged 699 rupiah per cage week. It has been observed that the cage framework deteriorates fairly rapidly and this suggests that the cost estimates may be low. However, with no basis for altering the estimates they are used in Tables 9a and 9b where the cost per kilogram of fish produced is a low 13 rupiah.

## **Profitability**

Costs and earnings information presented in Tables 9a and 9b presents a picture of a profitable activity where a single cage could support a wife and husband at a level above subsistence defined as the income equivalent to 320 kg of rice per person per year (Sayogyo 1978), or a family operating income of 423,000 rupiah. A three-cage enterprise would support about 7.6 people at the minimum standard, a number well beyond the average family size. A three-cage farm would provide an operating income of 1,269,000 rupiah a year. In these calculations there is no imputed labor charge and income could be called the return to capital, management and family labor. Since maintenance has been treated here as a variable cost there are few fixed costs to consider, debt service being one. However, since most of the debt is within the family with no formal terms and the terms of the formal debt are not well recorded no effort has been made to include it in the synthesis at this level.

If a charge is made for family labor assuming the going wage rate as a cost, then the remainder is a return to capital and management. A three-cage farm would produce an operating income of 333,000 rupiah per year as the return to capital and management.

As indicated above, there are some costs that have not been considered such as the cost of debt service. To assess the potential of the enterprise to manage the modest debt that it has, the net present value of the income stream and the internal rate of return were calculated for a ten-year period. The net present value of the operating income stream (with family labor charged at going rates) from a cage at an interest rate of 16% is 1,613,807 rupiah, well beyond the cage cost of about 300,000 rupiah. A three-cage farm that requires an investment of about 900,000 rupiah yields an internal rate of return of 35%, one high enough to warrant some risk. If the costs of three cages rose to 1,500,000 rupiah the internal rate of return falls to 17%.

Where family labor is not charged at current rates the net present value of a three-cage farm operating income stream for ten years is 5,854,964 rupiah at 16% and 5,078,754 rupiah at 20%. The internal rate of return is very high indeed under these conditions, 80% when cages cost 500,000 rupiah each.

The very rapid and continuing growth of the cage culture activity supports the argument that profits in cage culture are substantial.

However cage aquaculture is quite price sensitive if one considers the family labor charge a cost to the enterprise. A product price decline of 2.6% would eliminate profits as would a feed price increase of 6.4%. A seed price increase of 5.8% would accomplish the same unfortunate results. Because the farmer does not have to meet these labor costs with cash the system is more resistant to price changes and a fish price decline of 9.3% could be managed without loss as could a 15.5% seed price increase and a 22.1% feed price rise, each one being incurred separately, of course.

The price picture during the period of development has not, however, been a bleak one. Fish prices have risen steadily throughout the period as the marketing system has been able to effectively absorb and distribute the fish from Saguling. Input prices have not risen at the same rate so farmers have fared quite well.

## The Family Economy

Most families have sources of income other than fish farming and assets other than those for this activity. A survey conducted in May and June of 1989 showed a similar income picture to that obtained earlier (see Table 11). Of particular importance is the income reported by fish farmers. For example a three-cage farm would have an annual income of 1,460,000 rupiah from fish farming alone which is slightly higher than 1,269,000 rupiah annual income estimated from the earlier monitoring data. The more recent data indicate that a farm of three cages could support a family of nine at minimum levels. The data may represent a real increase in income from one year to another; certainly conditions have improved as water levels in Saguling have risen again. However, one suspects that the income reported may not fully reflect the costs of farming. In any event, the 1989 data continue to present a picture of a prosperous community.

## Summary and Conclusions

The census survey of all 350 operating cage culture units at Saguling Reservoir in early 1988 and the subsequent seven months of monitoring from May through December of that year produced a database that revealed a picture of extraordinary dynamism and considerable prosperity among the participants in the development, many of whom add fish farming to another major occupation. Many of those who are principally fish farmers participate in other economic activities as well. A substantial number of all participants are also involved in trading of some kind.

It is a bit misleading to identify the development as that of the Saguling Reservoir since most of the activity is concentrated in only a very small part of the whole near the village of Bongas.

The objective of monitoring the operations of the farmers was to capture the effects of seasonal changes on the farmers and their decisionmaking. The changes were far greater than anticipated since the Saguling Reservoir was drawn down to provide water for the new Cirata Reservoir just downstream. This resulted in many farmers either temporarily halting production or reducing the number of cage farms. The rather dramatic changes led to behavior that was difficult to follow even with the weekly monitoring of a subset of farmers. The number of fish movements among some farmers was extraordinarily large and frequently not for the purposes of growing fish but maintaining them for seeding or for sale.

The investment required for an average size farm of three cages is about 900,000 rupiah or about 300,000 rupiah per cage, and farmers have been able to establish themselves without incurring substantial debt. Most of the debt they have incurred has come from family sources while the main source of investment funds was the compensation for displacement received by many participants. Most farmers have other assets in farm land and homes in addition to their floating cage farms.

A notable institutional development among the farmers was joining their cages together into larger units. This sharing of such things as rafts, anchors, guardhouses and perhaps labor and supervision is economically sound and reflects a mutual trust and respect among the program participants.

Farmers showed independence of judgement in their stocking, feeding and harvesting decisions. They generally opted for lower stocking rates, shorter growout periods and fairly high feeding rates. The short periods and low stocking rates appear to be a rational response to rapidly changing conditions in which they found themselves during the period of this study. Farmers appear also to be very willing to experiment in feed and feeding methods. For this reason it was a bit problematic to assess the effectiveness with which farmers fed fish. The use of many additional locally available ingredients such as rice bran and cassava leaves made

Table 11. Average incomes of fish cage farmers from various sources classified by farm size, Saguling, May-June 1989. (Approx. 1,770 rupiah = US\$1 at time of study).

Number of cages	Monthly income (rupiah)														Income/capita/year (as equivalent kg rice)
	Labor	%	Trader	%	Fish	%	Farmer	%	Gov. off.	%	Driver	%	Total	%	
1	176,938	34	93,512	18	90,495	17	28,039	5	66,778	13	70,000	13	525,762	8	2,524
2	80,278	12	128,922	20	130,438	20	31,967	5	126,303	20	150,000	23	649,908	9	3,120
3	97,625	21	76,607	17	121,707	26	31,140	7	132,500	29			459,579	7	2,206
4	126,944	16	118,333	15	103,026	13	46,376	6	300,144	38	100,000	13	795,425	11	3,818
5			187,500	33	192,944	34	39,950	7	140,000	25			560,394	8	2,690
6	300,000	34	129,375	15	268,106	33	39,719	5	125,000	14			882,200	13	4,235
7			150,000	35	249,500	56	30,638	7					430,138	6	2,065
8			172,500	38	202,917	45	79,950	16					449,367	6	2,157
9			60,000	10	368,750	59	37,300	6	159,500	25			625,550	9	3,003
10					356,250	43	55,000	7	418,000	50			829,250	12	3,980
>10			218,000	30	317,500	44	21,550	3	164,667	23			721,717	10	3,464
Total	781,785		111,334,749		192,421,633	35	436,231		61,634,892	24	320,000		56,929,290	100	
Average	71,071		121,341		220,148		39,657		148,627		29,091		629,935		3,024

feeding difficult to evaluate. Experimental evaluation might be more effective than trying to monitor farm performance with unusual feeds.

The great variability in performance and behavior masked any economies of size that might exist. The variability within groups was very large relative to that between groups.

Fish cage culture is a profitable activity and the continuing entry of farmers into the field supports this contention. However, a substantial part of the income to fish farming can be considered to be operator's labor earnings plus family labor earnings. Were farmers to be paying cash or in kind wages the enterprises would be much more sensitive to price changes for outputs and inputs. A three-cage fish farm can amply provide for an average family of about five people if family labor is used.

The cage culture development around Bongas, Saguling Reservoir is an excellent example of the response and ability of farmers, well advised, to adopt a wholly new technology and then to quickly adapt to the economic and technical environment within which they work. The fish farmers of Saguling maintained profitable operations during a very difficult period through the effective exercise of managerial skills. The development has been a successful model of what a good idea, well managed can generate, and the farmers have been central to this success.

## References

- IOE (Institute of Ecology). 1980. Environmental impact analysis of the Saguling dam: mitigation of impacts. Final Report to Perusahaan Umum Listrik Negara, Jakarta, Indonesia. Volume IIA: Main report. Institute of Ecology, Padjadjaran University, Bandung, Indonesia.
- Sayogyo. 1978. Lapisan masyarakat yang paling lemah di pedesaan Jawa (The weakest social stratum in rural Java). *Prisma* 3: 3-14.

# Marketing of Common Carp from the Saguling Reservoir\*

**ENKUS W. KUSNADI**

*Institute of Ecology, Padjadjaran University  
Jl. Sekeloa Selatan 1, Bandung 40132, Indonesia*

**HARLAN C. LAMPE\*\***

*International Center for Living Aquatic Resources Management  
MC P.O. Box 1501  
Makati, Metro Manila, Philippines*

KUSNADI, E.W. and H.C. LAMPE. 1990. Marketing of common carp from the Saguling Reservoir, p. 240-256. *In* B.A. Costa-Pierce and O. Soemarwoto (eds.) Reservoir fisheries and aquaculture development for resettlement in Indonesia. ICLARM Tech. Rep. 23, 378 p.

## Abstract

The structure, costs and margins of the marketing system for common carp from floating net cages in the Saguling Reservoir are evaluated. Local traders, retailers and government officials all cooperated in the study. The system responded effectively to changing conditions and markets fish quite efficiently at a low cost and with small marketing margins at the local trader and the retail levels examined.

## Introduction

Effective development of the floating net cage culture system for common carp in the Saguling Reservoir depends upon the marketability of the output. At the outset, it was not clear if the marketing system would evolve in a manner that adequately served the farmers, nor was it clear what the costs would be for fish marketing. Studies conducted during the latter half of 1988 were designed to describe the marketing system, identify the significant stages of the system and the operators at those stages, and to assess the costs and efficiency of the marketing system.

There was a concern that the Saguling fish supply would depress prices in the marketplace although most researchers; Chow (1982), The Faculty of Agriculture of Padjadjaran University (1983), and the Institute for Community Dedication (1984) all concluded that the Saguling supply would not adversely influence market prices.

This report examines the marketing organization and structure, addresses some questions of efficiency, and estimates marketing margins. A brief review on the seed supply is also given.

---

\*ICLARM Contribution No. 617.

\*\*Present address: Vermilion International, Suite 2411, 67 Wall St., New York, NY 10005, USA.



## The Database

The Provincial Fisheries Department of West Java, and its Technical Management Unit for Saguling and Cirata (UPTD), and the Jakarta Metropolitan Fisheries Department were the sources of secondary data. Primary data was obtained by interviewing local traders, wholesalers and retailers occasionally from May through September 1988. Fifteen local traders provided information. The market reporters at the Sukabumi fish market provided particularly useful information.

## The Supply Response

The supply of freshwater fish in West Java has increased by 5% annually from 70,000 t in 1980 to 95,000 t in 1986. This increase was the result of both an expansion in culture area, and increased productivity. Common carp production increased relative to other species during this period, increasing from 39% of the total in 1980 to 53% in 1986, with production concentrated in a few regencies. The principal producing areas were Cianjur with 16%, Bandung and Sukabumi both with 14%, Tasikmalaya with 12%, Bogor 11%, and Subang 10%. Together they accounted for 77% of all common carp produced in West Java.

The major contributor to the increase in common carp output was running water culture, particularly in the Bogor regency. From 1980 to 1985 output from running water culture in Bogor increased from 494 t to 2,400 t for an annual growth rate of 37%. This growth rate was dramatically reduced to 8% from 1985 to 1987 when production reached 2,788 t. Growers in Bogor are near their markets in Jakarta and Bogor itself, and low transport costs result in favorable prices relative to more distant areas. The Saguling floating net cage aquaculture development, although more distant, competes effectively with Bogor, and some Bogor operators are shifting into cage culture.

Bandung running water common carp production contributed to the sector growth, and in 1985 exceeded 1,000 t. However, this has fallen rapidly for a variety of reasons with over investment in facilities and a consequent inability to make loan payments major factors, and with water and seed problems and the development of floating net cage aquaculture also contributing to the decline.

## Marketing Operations

The marketing system for common carp from cage aquaculture in Saguling is not particularly complex, and given the long history of inland fish culture in the area no real marketing innovations were necessary.

### **Market Structure**

The principal marketing channel for common carp from Saguling begins with a farm sale to a local trader from whom the fish passes through wholesalers and retailers on the way to consumers. Local traders, of which there are 17 (15 participated in the study) may also sell directly to retailers (in the area and Bandung) or to consumers, and a few farm sales are made directly to consumers. The wholesale trade at the Cibaraja market in Sukabumi is dominated by four traders to whom most of the regular traders sell. These traders in turn sell to retailers and

wholesalers elsewhere, principally in Jakarta. Local traders may have several marketing roles since some also supply feed and seed and, as expected in such circumstances, supply production credit.

### Marketing Area

During the study period from October to November 1988 most of the sales of local traders were in the Bandung area (city and district) followed by Sukabumi and Jakarta. Fig. 1 reflects the product flows from Saguling and Table 1 shows the details of sales during the period. It is interesting to note that while sales were declining dramatically in October and November, those

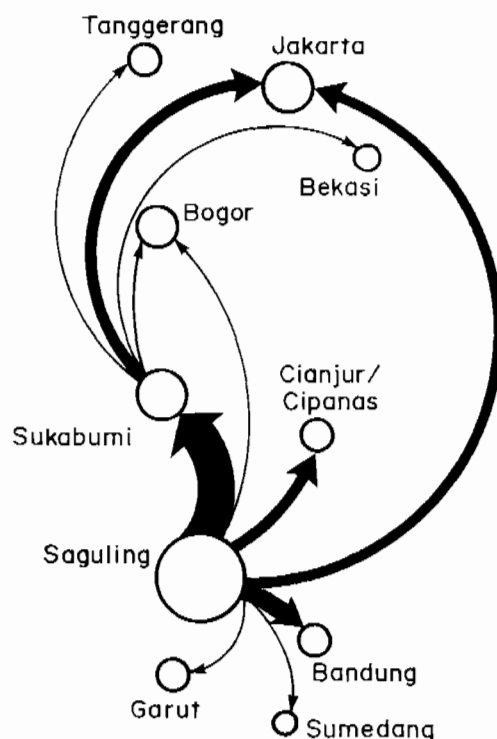

Fig. 1. Market flows of common carp originating from floating net cage aquaculture in Saguling.

Table 1. Amount of fish reported sold by fifteen local traders by market area and interview periods in 1988.

Periods	Market area						Total
	Bandung municipal	Bandung district	Garut	Sukabumi	Jakarta	Other	
Early August	12,400	2,350	7,850	14,200	5,500	4,450	44,900
End of August	15,300	4,820	6,500	23,058	5,800	2,100	57,578
Early September	12,275	5,715	6,950	10,876	7,050	3,000	45,866
End of September	11,100	3,040	1,500	8,479	6,050	1,200	32,369
Early October	8,625	2,775	1,000	2,674	4,600	1,650	21,324
End of October	6,800	1,100	3,500	3,324	5,400	1,500	21,624
Early November	4,050	925	-	4,076	4,030	-	13,081
End of November	3,670	650	-	4,833	3,100	-	12,253
Total	74,220	21,375	27,300	71,520	41,530	13,900	248,995
Per cent	30	9	11	29	17	6	100

to Jakarta declined much less. This suggests that the direct links to Jakarta of the local traders were being strengthened at the cost of sales through wholesalers in Sukabumi which also are largely destined for Jakarta. Such a change should have the effect of reducing marketing costs.

The number of local traders changes from time to time in the markets as trading volume varies and even major wholesalers were affected. One of the four major wholesalers in Sukabumi stopped trading during the course of the study, since his enterprise was not able to compete for a limited supply of fish. This suggests that it would not be easy to enter a market like Sukabumi as a wholesale trader. Table 2 shows the details of change in the number of local traders during the four month study period. What is clear is that each local trader deals in a number of markets and is not confined to a single market. This flexibility reflects a responsiveness to market conditions and the fact that market entry for local traders is not particularly restricted.

Table 2. Local traders selling from floating net cage aquaculture of common carp in selected communities of Saguling, 1988 (n = 15).

Time	Market area					
	Bandung municipal	Bandung district	Garut	Sukabumi	Jakarta	Other
Early August	10	4	3	5	2	3
End of August	7	5	3	5	4	2
Early September	6	6	3	5	4	2
End of September	5	5	1	5	4	2
Early October	5	3	1	2	3	1
End of October	5	3	1	2	3	1
Early November	3	3	-	3	3	-
End of November	4	1	-	3	2	-

Note: Two local traders were not interviewed.

### ***Payment System and Credit***

Payments for fish to the farmer are often partial or delayed until the fish are sold by the trader. The local trader may also receive only partial payment upon delivery, or payment may be delayed for several days. Some traders have managed their affairs badly and failed, and in failure have been unable to pay farmers who in turn, have suffered. Obviously, entry into a system based upon future payment is simpler than entry into a system requiring adequate working capital to make cash payments at the time of sale.

Those fish traders who supply feed and fish seed also provide credit to farmers. Some farmers in effect become contract farmers with the trader supplying feed and seed and determining the time of sale. Feeding practices, however, appeared to remain under the control of the farmer. At time of sale payments for feed and seed are deducted from the value of the sale. To the extent that both the paying prices for feed and seed and the selling prices for fish are competitive this system is an effective way of meeting farm capital needs. However, it is a system subject to abuse. It has been suggested that such abuse exists in the form of high feed and seed prices and low paying prices but the available data do not permit an analysis of this issue. Since the trader assumes a significant risk and commits substantial capital to each production period, there are significant costs incurred. These costs will be recovered in one way or another.

The capital-short farmer has only two defenses against discrimination if it arises. One is to take his business to another trader, and the other is to find new capital sources. It was difficult to assay just how competitive the traders were; so it was also difficult to judge how feasible it is for farmers to change. However, given what are usually significant economies of scale in marketing

fish, even at this small scale, fairly fierce competition is likely to exist. If a farmer has a good record, he might have little difficulty in changing. Poor performers will always have trouble.

### **Transport**

Fish harvested from cages are transported live from the farm to market and consumer. Plastic bags charged with oxygen constitute the most common transportation method for fish seed as well. These bags may be moved in many ways including using carrying poles, bicycles, motorbikes, pushcarts, rafts, boats and pickup trucks. All begin the journey to market with a trip by raft from the floating net cage to the shore. Some trucks have tanks with water circulating systems that obviate the need for plastic bags.

## **Costs and Marketing Margins**

### **Shrinkage and Mortality**

The common carp from Saguling are sold and marketed live as are most (if not all) common carp in Indonesia. As a consequence there are losses in weight, due to mortality in the process of marketing, to which poor water quality, transportation techniques, and/or the condition of the fish may contribute. There are also body weight losses that can be very large if fish have been fed just before sale. This loss may be more substantial if the fish have been fed soil mixed with the feed, just before harvest. Weight losses range from less than one to more than six per cent, and average three per cent. Table 3 shows the estimated losses reported by local traders during the study period in 1988. Unfortunately the data do not permit a separate evaluation of body weight loss and mortality. A total loss of three per cent in the first marketing stage is not insignificant. The first stage of fish transport, during which the process takes the recently struggling and perhaps damaged fish by boat or raft from the cages to land, and then over roads that are very rough in some places to markets that may be several hours away, is when most weight losses might be expected.

Table 3. Average weight loss (in %) during transportation from producers to wholesalers; local traders estimates (n = 13).

Time	Market areas					
	Bandung municipal	Bandung district	Garut	Sukabumi	Jakarta	Other
Early August	3.3	2.8	0.7	2.6	1.3	4.5
End of August	2.8	1.8	2.4	2.5	2.4	1.5
Early September	3.1	2.3	1.9	4.2	4.6	2.3
End of September	3.5	2.4	3.0	5.2	3.9	3.1
Early October	3.5	2.9	3.1	-	6.4	2.2
End of October	2.8	2.8	2.6	2.4	4.6	2.6
Early November	3.7	2.8	-	2.4	3.4	-
End of November	1.1	2.9	-	2.5	3.6	-
Average*	3.1	2.4	1.8	3.0	3.8	3.0

\*Average weighted by volumes in Table 1; combined average of all observations was 3.0%.

### **Marketing Costs**

To gain some insight into the cost structure of the marketing system both the costs of local traders getting fish from farm to the various markets and the costs of retailers working from the Cibaraja market in Sukabumi were examined. Cost information reflects only the direct operating

costs of selling fish. These are only a subset of the total costs but nevertheless provide some insights into those factors of immediate significance. What is clear from examining the summary in Table 4 is that transportation is the most significant single cost (data in Appendix Tables 1, 2, 3). For the local trader transport costs range from 16 to 65 rupiah/kg, with the lower cost for transport to Bandung and the higher to Jakarta. Transport to the nearby market in Bandung is proportionately less at 23% of operating costs than to Jakarta at 47%. For the local trader labor also is a substantial cost with a narrow range of 18 to 22 rupiah/kg among all traders. This cost is incurred in packing fish for transport, loading fish onto rafts or boats for transport to shore, and the subsequent loading and unloading for land transport.

Table 4. Summary of operating costs (rupiah per kilogram) of ten local traders from Saguling selling in selected markets, July 1988.

Locality (km away)	Average volume (kg)	Transport		Packing		Fees	Labor	Others	Total
		by land	by water	Plastic	Oxygen				
Bandung (43)	288	16	10	8	5	4	19	5	67
Sukabumi (100)	725	34	6	5	5	1	13	4	66
Jakarta (180)	733	44	5	9	6	8	15	5	91
Saguling (0)	633	0	5	0	9	0	12	1	27

Note: See Appendix Tables 1, 2 and 3 for details.

Table 5. Summary of costs for retailers from the Sukabumi market, May-June 1988. Data are from 60 retailer trips to the market. All costs are in Indonesian rupiah (Rp).

	Transport	Packing	Distribution	Water	Plastic	Labor	Other	Total
Cost per kilogram	87	10	8	3	10	3	0	121
Per cent of total	72	8	6	2	8	3	0	100

Retail transportation costs, as reported by merchants buying in Sukabumi, are even higher than those of local traders (Tables 4 and 5). Transport constitutes 72% of the operating costs of Sukabumi's retailers and is 87 rupiah/kg, more than twice the average of 34 rupiah/kg for local traders. Labor costs for retailing are very low, constituting only 3% of the operating costs; however, transport costs mask a great deal of labor use, and perhaps part of the high cost results from the labor-intensive nature of many operations. The motorcycle and tricycle operators who provide the main retail transport participate in the loading and unloading. In the case of tricycles, they also provide the propulsion.

Operating costs as reported by wholesalers and retailers mostly reflect the cash or out-of-pocket costs of the merchants incurred in operations and do not reflect other costs of doing business. Nevertheless they serve to focus attention on some significant elements in the marketing scheme.

An interesting supplement to the cost information is information on the trading volumes provided by intermediate wholesalers in the Sukabumi market (Table 6). Their sales were monitored for 35 weeks from May through December in 1988, and their performance reflects the testing of the Saguling cage culture operators during a difficult period when the reservoir was severely drawdown to fill the new downstream Cirata Reservoir (Soemarwoto et al., this vol.). Fig. 2 shows the dramatic decline in the volume of trade. During this period one trader ceased doing business (see Table 2).

Prices reported showed very little fluctuation, with an increase beginning in August. The stability of prices may be an artifact of the price recording system but may also reflect the fact that the Saguling supplies are not of sufficient volume in the final market, Jakarta, to influence matters.

Table 6. Weekly sales volumes and prices for four Saguling traders in common carp from floating net cage aquaculture (May-December 1988).

Weeks	Quantity of fish (kg)				Total	Price (Rp/kg)
	A	B	C	D		
1	15,109	5,128	3,959	0	24,196	1,900
2	13,198	3,929	3,767	0	20,894	1,900
3	7,386	1,900	1,432	1,912	12,630	1,950
4	12,066	3,486	3,529	3,308	22,389	1,900
5	11,898	4,078	3,722	2,821	22,519	1,900
6	12,648	3,517	4,185	3,016	23,366	1,900
7	12,910	3,300	3,250	3,627	23,087	1,900
8	9,449	2,920	4,130	3,078	19,577	1,900
9	12,504	2,931	4,555	2,520	22,510	1,900
10	10,374	2,806	3,120	2,797	19,097	1,900
11	10,922	5,378	3,169	926	20,395	1,900
12	9,855	2,400	3,447	1,771	17,473	1,900
13	10,060	3,308	3,655	2,096	19,119	1,900
14	12,052	4,046	3,400	3,066	22,564	1,900
15	9,951	2,800	3,000	2,303	18,054	1,900
16	11,534	4,423	3,400	1,170	20,527	1,900
17	9,105	3,600	3,300	2,269	18,274	1,900
18	10,162	4,730	2,790	1,832	19,514	1,900
19	10,007	3,244	1,775	446	15,472	1,950
20	9,751	3,473	1,898	440	15,562	1,950
21	11,304	3,545	785	0	15,634	1,950
22	6,178	3,419	0	0	9,597	1,975
23	8,951	3,168	0	0	12,119	1,975
24	4,985	500	0	0	5,485	2,000
25	4,049	0	0	0	4,049	2,000
26	5,728	1,000	0	1,725	8,453	1,975
27	4,711	2,886	0	1,976	9,573	1,975
28	4,849	3,298	0	1,159	9,306	1,975
29	8,242	3,563	0	1,994	13,799	1,975
30	3,375	1,500	0	816	5,691	1,975
31	375	787	0	0	1,162	2,075
32	7,660	4,931	0	1,026	13,617	2,075
33	1,317	5,899	0	1,037	8,252	2,075
34	4,981	5,733	0	2,829	13,543	2,075
35	5,054	5,101	0	3,483	13,638	2,075
Maximum	15,109	5,899	4,555	3,627	24,196	2,075
Minimum	375	0	0	0	1,162	1,900

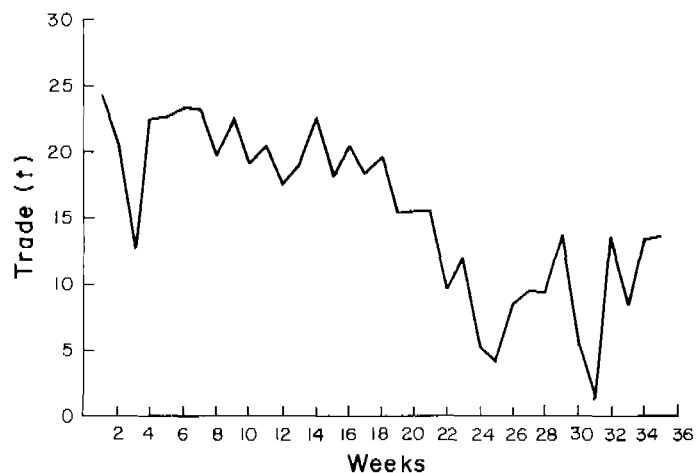

Fig. 2. Volume of trade reported by four wholesalers at Sukabumi, May-December 1988.

## Prices and Margins

There is a substantial difference between the costs reported by retailers and local traders and the marketing margins at the different market stages. Table 7 illustrates the very substantial differences between margins and costs in the retail sector. The gross margin for trades of all sizes averages 374 rupiah/kg. This reflects differences in buying and selling prices adjusted for the loss of volume between purchase and sale. The retailers' operating costs average 121 rupiah/kg (Table 5) and the net margin is 252 rupiah/kg (Table 7). The net margin in this case means "net margin of reported costs" and cannot be construed to be a measure of profits. It represents an amount available to defray the costs of capital, unreported labor and other costs, management and risk, with a remainder for profits. A more careful measurement of costs was beyond the scope of this study. A gross retail margin of 16% of the selling price, however, is not large and the net margin of 11% appears to be a reasonable one to account for the additional costs indicated above.

Margins for the local traders are shown in Tables 8 and 9 and are lower than those at retail averaging 218 rupiah/kg or about 11% of the selling prices. When reported operating costs are subtracted from the gross margin a "net" margin of 143 rupiah/kg is obtained which is about 8% of the selling price (see Table 4 for average marketing costs). Margins for the three major markets are:

Margins (Rupiah)					
<u>Markets</u>	<u>Gross</u>	<u>%</u>	<u>Net</u>	<u>%</u>	<u>Price</u>
Bandung	205	11	138	7	1,885
Sukabumi	204	11	98	5	1,881
Jakarta	269	14	132	7	1,949

The Sukabumi market does not appear to be as promising as Bandung and Jakarta. In both cases the local trader shortens the marketing chain by going more directly to the final wholesaler or retailer. The Sukabumi market provided the Saguling fish traders an existing outlet that could readily absorb the cage culture production. It is, however, at some distance and imposes one more level of wholesale transactions in the market system and additional costs. One might anticipate more and more direct selling in end markets, particularly Jakarta, as production continues to increase. It would be a mistake to tax the available data with more speculation on the future development of the markets for common carp from Saguling.

## Seed Market

Seed production is highly seasonal and the rise in price from August through November shown in Table 10 is an indication of a reduced supply of seed. The selling price of common carp at fish nurseries, which are in the Buahbatu area of Bandung, increased from Rp 1,650/kg in early August 1988 to Rp 1,925/kg at the end of November 1988. A prolonged dry season resulted in reduced nursery output. Another source of seed for the cage culture systems of Saguling is rice-fish nursery culture (Costa-Pierce and Hadikusumah, this vol.). Seed production from this system is also seasonal with a peak period in May to July which closely parallels the peak fry production period of April to June. Tables 11 and 12 show the details of the location and timing of fry and rice-fish production. One should note that the areas of fry production are not the same as the areas of rice-fish seed production.

The Saguling-Cirata development places a very heavy burden on the rice-fish seed production system. The average rice-fish yield is 187 kg/ha/month (Faculty of Agriculture,

Table 7. Summary of gross and net margins of retailers grouped by size of purchases from 60 retailer trips to market in May and June 1988. (All costs are in Indonesian rupiah (Rp)).

Size of purchase (kg)	Number of responses	Cost of good sold			Sales				Gross margin per kilogram (Rp/kg)	Operating costs (Rp)	Average net margin (Rp)	Net margin per kilogram (Rp/kg)
		Average quantity (kg)	Average cost (Rp)	Average price (Rp/kg)	Average quantity (kg)	Average value (Rp)	Average price (Rp/kg)	Average gross margin (Rp)				
<50	32	39	72,536	1,876	38	89,297	2,341	16,761	430	7,830	8,931	229
51-100	21	81	153,131	1,900	79	184,169	2,325	31,038	383	9,505	21,533	266
101-200	6	143	260,150	1,825	141	321,325	2,286	61,175	428	8,694	52,481	367
>200	2	450	855,000	1,900	450	956,850	2,133	101,850	226	35,799	66,051	147
<b>Total</b>	<b>61</b>	<b>77</b>	<b>144,390</b>	<b>1,871</b>	<b>76</b>	<b>173,225</b>	<b>2,287</b>	<b>28,834</b>	<b>374</b>	<b>9,409</b>	<b>19,426</b>	<b>252</b>

Table 8. Average margins from farm to wholesale level in selected communities. Data reported by 15 local traders in 1988 (rupiah/kg).\*

Periods	Market					Average
	Municipal Bandung	Bandung district	Garut	Sukabumi	Jakarta	
Early August	214	222	184	209	184	208
Late August	202	192	172	205	322	230
Early September	180	183	250	183	275	232
Late September	221	163	233	158	283	225
Early October	200	167	200	-	267	212
Late October	200	238	150	250	300	215
Early November	212	137	-	212	262	206
Late November	212	129	-	212	262	204
<b>Average</b>	<b>205</b>	<b>179</b>	<b>198</b>	<b>204</b>	<b>269</b>	<b>218</b>

\*See Table 9 for prices from which these margins were derived.



Table 9. Average prices paid to farmers and average selling prices for common carp in selected markets reported by 15 local traders in 1988 (prices in rupiah/kg).

Time	Paid at Saguling	Market				
		Municipal Bandung	Bandung District	Garut	Sukabumi	Jakarta
Early August	1,616	1,830	1,838	1,800	1,825	1,800
Late August	1,628	1,830	1,820	1,800	1,833	1,950
Early September	1,650	1,830	1,833	1,900	1,833	1,925
Late September	1,667	1,888	1,830	1,900	1,825	1,950
Early October	1,700	1,900	1,867	1,900	-	1,967
Late October	1,700	1,900	1,938	1,850	1,950	2,000
Early November	1,738	1,950	1,875	-	1,950	2,000
Late November	1,738	1,950	1,867	-	1,950	2,000

Table 10. Average purchase price and sales price of fish seed to Saguling fish cage operators, reported by 18 seed traders, 1988 (prices in rupiah/kg).

Period	Purchase price		Sales price at Saguling (3)	Margin (Rp)		Mark-up (%) against sales price to the farmers	
	at Buahbatu (1)	at Saguling (2)		(4=3-1)	(5=3-2)	(6=4/3 x 100)	(7=5/3 x 100)
Early August	1,650	1,769	1,873	250	104	13	6
Late August	1,700	1,800	1,896	200	95	11	5
Early September	1,750	1,800	1,896	200	91	10	5
Late September	1,800	1,843	1,938	150	93	8	5
Early October	-	1,931	2,038	-	106	-	5
Late October	1,850	1,929	2,056	250	121	12	6
Early November	1,900	1,988	2,108	225	118	11	5
Late November	1,917	1,983	2,117	233	117	11	6

Table 11. Rice-fish production each month during 1988 in the Bandung district by subdistrict.

Subdistrict	Jan	Feb	Mar	Apr	May	Jun	Jul	Aug	Sep	Oct	Nov	Dec	Total
Lembang	1	-	0	-	-	0	-	-	-	-	-	-	2
Cisarua	1	-	0	-	-	0	-	-	-	-	-	-	1
Cimahi Utara	2	1	1	1	1	1	1	1	1	2	1	-	14
Cimahi Tengah	-	-	-	-	-	1	-	-	-	-	-	-	1
Cimahi Selatan	1	1	1	1	1	-	1	1	1	1	1	-	11
Padalarang	2	-	-	-	-	-	-	-	-	-	-	-	2
Ujungberung	8	6	43	11	28	26	55	66	77	44	67	42	471
Cicadas	1	-	-	-	-	8	3	8	-	-	11	-	30
Buahbatu	88	159	133	93	162	184	184	104	116	106	118	134	1,579
Dayeuhkolot	43	36	34	25	43	27	134	-	34	-	-	118	494
Cikalongwetan	2	-	4	-	7	-	3	-	-	-	-	-	16
Cipenduy	3	-	3	-	-	-	1	-	-	-	-	-	7
Cipatat	6	13	9	-	9	18	2	11	-	4	4	-	74
Ciliin	3	-	-	-	-	-	1	-	-	-	-	-	4
Sindangkerta	0	2	2	0	2	1	1	1	1	1	1	1	14
Cipongkor	0	3	2	2	2	2	2	2	2	2	2	2	22
Gununghalu	0	2	2	2	2	2	2	2	2	2	2	2	19
Soreang	3	8	10	-	4	4	0	-	-	0	6	7	42
Pasirjambu	3	-	0	-	-	21	3	-	-	-	-	2	29
Ciwidey	5	-	0	-	-	23	4	-	-	-	-	24	55
Banjaran	3	0	1	-	-	2	-	-	-	-	2	-	8
Pangalengan	1	-	0	1	1	2	0	-	-	0	0	0	6
Pamengpeuk	21	19	7	-	8	-	-	-	-	8	-	-	62
Katapang	6	9	2	-	3	-	5	-	-	-	-	-	25
Ciparay	10	18	21	13	31	6	7	-	-	1	12	9	127
Majalaya	4	10	24	41	18	5	6	7	-	1	22	39	178
Pacet	34	9	5	-	20	16	25	-	-	18	-	9	135
Cikancung	1	0	1	-	5	3	2	-	-	4	-	36	52
Kertasari	1	-	-	-	-	-	5	-	-	-	-	-	6
Cicalengka	3	-	1	-	25	92	6	-	-	-	3	-	129
Rancaek	31	-	1	85	39	84	9	-	-	4	110	-	361
Paseh	1	15	1	-	7	-	-	-	2	10	-	-	36
Ibun	4	2	1	-	10	5	0	0	-	5	3	5	34
Total	291	312	310	274	427	531	460	201	235	209	257	540	4,045

Sources: Monthly reports of Fisheries Department, Bandung District (1988).

Table 12. Fry production (x 10,000 fish) each month during 1988 in the Bandung district by subdistrict.

Subdistrict	Months												Total	%
	Jan	Feb	Mar	Apr	May	Jun	Jul	Aug	Sep	Oct	Nov	Dec		
Cimahi Utara	90	90	90	95	85	85	80	80	80	80	80	80	1,015	2
Cimahi Tengah	340	460	440	450	250	510	235	235	80	160	240	235	3,635	7
Cimahi Selatan	215	215	215	210	90	190	170	170	120	130	140	175	2,040	4
Padalarang	-	-	-	-	-	-	-	-	-	10	-	-	10	<1
Ngaprah	-	-	-	-	-	16	-	16	-	-	16	-	48	<1
Ujungberung	209	59	138	1,038	-	85	-	32	36	-	38	56	1,689	3
Cikalongwetan	89	-	80	-	-	30	-	36	83	-	-	-	318	1
Cipendeuy	93	-	170	114	114	59	40	48	101	128	-	101	967	2
Cipatat	196	100	39	197	268	179	187	127	248	-	67	60	1,666	3
Cililin	-	-	9	-	-	-	-	-	-	-	-	-	9	<1
Sindangkerta	15	24	9	24	45	75	18	39	4	39	45	33	370	1
Cipongkor	15	36	33	24	42	29	21	38	4	35	51	36	363	1
Gununghalu	52	75	125	90	1,000	75	90	105	75	126	105	60	1,978	4
Soreang	-	-	20	250	73	85	90	100	115	151	160	155	1,199	2
Pasirjambu	12	13	1	13	53	25	25	24	25	25	25	25	264	<1
Ciwidey	27	35	4	35	25	71	53	71	53	71	53	71	569	1
Banjaran	-	-	95	90	69	1,060	50	-	-	-	-	121	1,485	3
Pangalengan	9	8	4	4	5	17	8	-	3	7	6	4	71	<1
Pamengpeuk	222	223	65	-	178	110	-	-	73	-	-	-	870	2
Katapang	40	42	44	-	44	5	-	-	-	-	-	-	174	<1
Ciparay	641	991	1,426	1,426	1,206	1,001	1,213	-	-	811	1,136	1,329	11,178	21
Majalaya	-	490	175	284	250	230	215	295	-	-	-	-	1,939	4
Pacet	1,641	145	723	723	789	883	986	1,395	352	1,400	-	666	9,701	18
Cikancung	422	492	492	508	490	534	528	345	222	487	567	610	5,694	11
Kertasari	29	27	-	27	-	13	15	35	-	-	-	-	145	<1
Cicalengka	-	18	13	7	85	33	-	-	-	-	32	61	247	<1
Paseh	332	666	280	472	538	384	477	368	452	467	521	538	5,492	10
Ibun	27	32	28	11	28	226	24	13	32	19	32	51	522	1
<b>Total</b>	<b>4,712</b>	<b>4,238</b>	<b>4,715</b>	<b>6,088</b>	<b>5,725</b>	<b>6,006</b>	<b>4,523</b>	<b>3,571</b>	<b>2,157</b>	<b>4,143</b>	<b>3,313</b>	<b>4,465</b>	<b>53,655</b>	<b>100</b>

Source: Calculated from the monthly reports of Fisheries Department, Bandung District (1988).

Padjadjaran University 1988). If each floating net cage requires 200 kg of seed every two months, each floating net cage will require a 0.5 ha of land in rice-fish culture to produce fish seed. If the Saguling-based floating net cage aquaculture occupies 1% of reservoir area with approximately 6,600 units, it will require 3,300 ha of land for rice-fish nurseries. This factor may become a limitation in the effort to increase the number of floating net cages for common carp, especially in Saguling.

### Market Determinants: Jakarta

While the nearby Bandung market cannot, and has not, been ignored by the traders from Saguling, the future of the market for live common carp from floating net cage aquaculture in Saguling and the new Cirata Reservoir will depend largely on Jakarta. Jakarta, a city of more than eight million people, continues to grow and incomes generally continue to increase. The people of Jakarta consume about 14 kilograms of fish a year most of which is fresh from the sea. Fresh inland fish constitutes about 16% of the total.

The flow of common carp into Jakarta in recent years has been somewhat irregular but has been generally increasing (Fig. 3). During this period prices have declined and there appears to be a slight price response to the increasing volume of sales (Fig. 4). The relationship is not statistically significant, but interesting to observe. The observation leads to some apprehension concerning the future of market prices in the face of continuing expansion of production. However, one should note that the response one observes in Fig. 4 is a short run response. Fig. 3 shows that the strong peak supplies have, thus far, not been maintained. Moreover, the price response is very small in the face of these fluctuations. One should also note that the price response in the face of major changes in the Sukabumi market volume were also very small indeed.

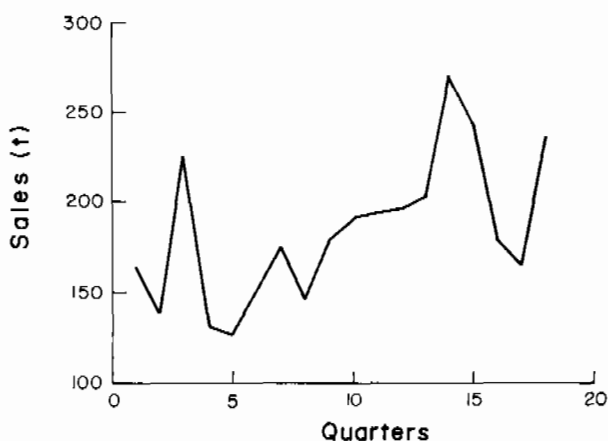

Fig. 3. Market sales of common carp in Jakarta reported quarterly, 1984-1988.

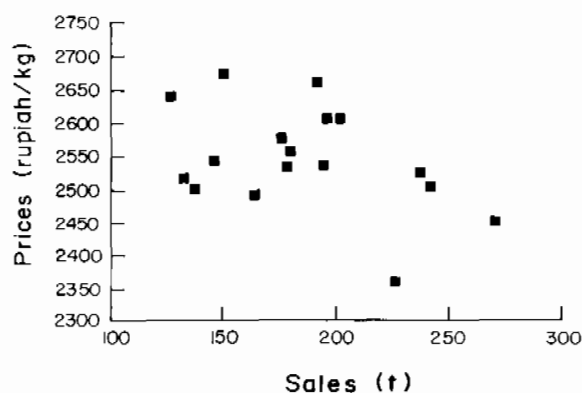

Fig. 4. Market prices and volume of common carp in Jakarta; quarterly data, 1984-1988.

### Market Opportunities

With the anticipated expansion in common carp supplies there has been some concern about the future of the markets. This, coupled with the significant contribution of transportation to market costs led to an assessment of the possibility of marketing dead fish rather than live fish, and the consideration of some processing.

The distribution and sale of processed fish such as "dendeng", smoked, fermented, and "pepes" is very limited. However, the potential for marketing processed fish, chiefly "ikan pepes"

(spicy steamed fish in banana leaves), showed a good potential, because it is much favored in the community and its value added by processing is high. Two experienced processors had costs of 450 and 700 rupiah/kg of fish, and enhanced prices by 4,200 and 1,300 rupiah, respectively (Table 13). While the data from two processors for "ikan pepes" are hardly conclusive they suggest a potential that can be explored. A synthesis of the cost of fish and ingredients and what minor equipment is necessary indicated a total cost of 3,404 rupiah/kg of fish ready for sale. This appears to be well below the market price for "ikan pepes". Since the process requires herbs, spices and banana leaves there would also be some employment multiplier effects if farmers develop the cultivation of these spices in the area.

Table 13. Costs and prices of processed Saguling common carp as reported by operators in June 1989 (costs and prices in rupiah/kg).

Process- ing type	No. of respon- dents	Location	Experience (year)	Source of fish	Marketing area	Sales volume (kg)	Fish sizes (number per kg)	Fish price (Rp)	Price of material and equipment (Rp)	Sales price (Rp)	Difference (Rp)
"Pepes"	1	Cibogo, Bobojong, Mando Cirata	1	Fishermen	Jangan, Mande	4	8	2,200	450	6,400	4,200
	2	Margaluyu, Cipeundeuy Cirata	2	Fish farmer	Cipeundeuy	3	2	2,700	700	4,000	1,300
		Average	1.5	-	-	4		2,414	557	5,371	2,957
Fermented fish	1	Margaluyu, Cipeundeuy Cirata	2	Fish farmer	Cipeundeuy	3	15	2,617	617	4,500	1,883
	2	Balong, Bongas, Cililin Saguling	1	Seed traders/ fish farmer/ fishermen	Rancapanggung and Sindang-	5	15	1,800	380	2,250	450
	3	Balong, Bongas, Cililin Saguling	6 months	Seed traders/ fish farmer/ fishermen	Cililin, Citalen, Cijenuk and Saguling market	5	15	1,530	330	2,250	720
	4	Bongas, Cililin, Saguling	6 months	Seed traders	Rancapanggung and Sindangkorta market	20	10	1,435	135	2,000	565
	5	Balong, Bongas, Saguling	2	Seed traders/ fish farmer	Batuajar market	5	12	1,870	330	2,400	530
	6	Balong, Bongas, Saguling	6 months	Seed traders/ fish farmer	Batuajar market	5	15	1,820	330	2,250	430
	7	Luwintug, Batulayang	3 months	Seed traders/ fish farmer	Batuajar market	3	15	2,183	550	2,250	67
	8	Rancapanggung, Saguling	5	Seed traders/ fishermen	Rancapanggung vil- lage market ("warung")	4	15	3,363	563	5,250	1,888
	9	Perias, Bongas, Saguling	38	fish farmer	Sindangkerta, Cijenuk	20	15	1,353	103	2,250	898
	Average		5.6	-	-	8	12	1,696	248	2,457	761

Fermented fish, produced by nine operators, generated average costs of 248 rupiah/kg that enhanced prices to 761 rupiah/kg.

A separate study of the potentials of postharvest processing for freshwater fish from Saguling and Cirata has been reported (Arifin, this vol.).

Another possible change in the market process that has been considered is that of marketing dead fish. A synthesis of the costs of marketing iced fish from Saguling in Bandung gave costs of 109 rupiah/kg (Table 14). Icing costs constitute 46% of the total costs at an icing rate of one kilo of ice for one kilo of fish. One would expect traders to reduce this icing rate to reduce costs. This in turn would probably reduce quality, particularly in hot weather. The current reported costs of marketing live fish in Bandung (city) of 67 rupiah/kg are below the projected costs of marketing iced fish. The prospect for marketing iced fish does not seem very promising at this time

Table 14. Estimated costs (rupiah) of marketing iced dead fish from Saguling cage culture to Bandung (based on a 400 kilogram consignment).

Type of costs	Costs		Percent of total
	Total	Unit	
Transportation by vehicle	7,500	19	17
Transportation by boat	4,000	10	9
Ice, 400 kg @Rp 50	20,000	50	46
Labor, 3 person @Rp 2,500	7,500	19	17
Fees	2,000	5	5
Others	2,500	6	6
<b>Total</b>	<b>43,500</b>	<b>109</b>	<b>100</b>

Appendix Table 1. The costs of sales of fish from Saguling floating net cage aquaculture at selected markets reported by local traders, July 1988 (costs in rupiah).

Locality (No. traders)	Fish volume (kg)	Distance (km)	Transport cost		Packing cost		Fees	Labor	Others	Total
			inland	in reservoir	Plastic	Oxygen				
I. Delivered to:										
A. Bandung 43										
(3)	500		4,800	4,000	4,166	5,000	2,000	12,500	5,000	37,466
(5)	150		3,000	3,000	1,100	1,200	300	2,250	0	10,850
(6)	300		6,000	2,000	2,100	0	600	5,000	800	16,500
(7)	200		5,000	2,000	1,466	0	1,500	2,000	0	11,966
Total	1,150		18,800	11,000	8,832	6,200	4,400	21,750	5,800	76,782
Average	288		4,700	2,750	2,208	1,550	1,100	5,438	1,450	19,196
B. Sukabumi 100										
(1)	1,100		10,000	4,000	0	0	2,000	12,500	5,000	33,500
(3)	600		8,000	4,000	4,166	5,000	2,000	12,500	5,000	40,666
(5)	500		40,000	3,000	5,383	4,000	0	7,500	500	60,383
(8)	700		40,000	5,000	5,000	4,333	0	3,750	0	58,083
Total	2,900		9,8000	16,000	14,549	13,333	4,000	36,250	10,500	192,632
Average	725		39,200	6,400	5,820	5,333	1,600	14,500	4,200	77,053
C. Jakarta 180										
(3)	700		20,000	4,000	9,166	5,600	7,400	12,500	5,000	63,666
(4)	1,000		60,000	3,000	4,400	4,000	2,500	7,500	1,000	82,400
(1)	500		16,000	4,000	5,866	4,000	7,800	12,500	5,000	55,166
Total	2,200		96,000	11,000	19,432	13,600	17,700	32,500	11,000	201,232
Average	733		48,000	5,500	9,716	6,800	8,850	16,250	5,500	100,616
II. On the spot 0										
(1)	500		0	0	0	4,000	0	3,000	0	7,000
(9)	500		0	4,000	0	4,333	0	10,000	0	18,333
(10)	400		0	3,000	0	4,000	0	5,500	0	12,500
(2)	1,000		0	3,000	0	8,000	0	7,500	1,500	20,000
Total	1,900		0	10,000	0	16,333	0	23,000	1,500	50,833
Average	633		0	5,000	0	8,167	0	11,500	750	25,417

Appendix Table 2. The per kilogram costs (Rp/kg) for sales of fish from Saguling floating net cage aquaculture to selected markets, reported by local traders, July 1988.

Locality (No. traders)	Fish volume (kg)	Dis- tance (km)	Transport cost		Packing cost		Fees	Labor	Others	Total
			inland	in reservoir	Plastic	Oxygen				
I. Delivered to:										
A. Bandung										
		43								
(3)	500		10	8	8	10	4	25	10	75
(5)	150		20	20	7	8	2	15	0	72
(6)	300		20	7	7	0	2	17	3	55
(7)	200		25	10	7	0	8	10	0	60
Average			16	10	8	5	4	19	5	67
B. Sukabumi										
		100								
(1)	1,100		9	4	0	0	2	11	5	30
(3)	600		13	7	7	8	3	21	8	68
(5)	500		80	6	11	8	0	15	1	121
(8)	700		57	7	7	6	0	5	0	83
Average			34	6	5	5	1	13	4	66
C. Jakarta										
		180								
(3)	700		29	6	13	8	11	18	7	91
(4)	1,000		60	3	4	4	3	8	1	82
(1)	500		32	8	12	8	16	25	10	110
Average			44	5	9	6	8	15	5	91
II. On the spot										
		0								
(1)	500		0	0	0	8	0	6	0	14
(9)	500		0	8	0	9	0	20	0	37
(10)	400		0	8	0	10	0	14	0	31
(2)	1,000		0	3	0	8	0	8	2	20
Average			0	5	0	9	0	12	1	27

Appendix Table 3. Per cent of marketing costs in each expense class for sales of fish from floating net cage aquaculture by local traders from Saguling to selected markets, July 1988.

Locality (No. traders)	Fish volume (kg)	Dis- tance (km)	Transport cost		Packing cost		Fees	Labor	Others	Total
			inland	in reservoir	Plastic	Oxygen				
i. Delivered to:										
A. Bandung		43								
(3)	500		13	11	11	13	5	33	13	100
(5)	150		28	28	10	11	3	21	0	100
(6)	300		36	12	13	0	4	30	5	100
(7)	200		42	17	12	0	13	17	0	100
Total	1,150		24	14	12	8	6	28	8	100
B. Sukabumi		100								
(1)	1,100		30	12	0	0	6	37	15	100
(3)	600		20	10	10	12	5	31	12	100
(5)	500		66	5	9	7	0	12	1	100
(8)	700		69	9	9	7	0	6	0	100
Total	2,900		51	8	8	7	2	19	5	100
C. Jakarta		180								
(3)	700		31	6	14	9	12	20	8	100
(4)	1,000		73	4	5	5	3	9	1	100
(1)	500		29	7	11	7	14	23	9	100
Total	2,200		48	5	10	7	9	16	5	100
ii. On the spot										
		0								
(1)	500		0	0	0	57	0	43	0	100
(9)	500		0	22	0	24	0	55	0	100
(10)	400		0	24	0	32	0	44	0	100
(2)	1,000		0	15	0	40	0	38	8	100
Total	1,900		0	20	0	32	0	45	3	100

## Summary and Conclusions

Just as the farmers of Saguling responded effectively to opportunities so has the marketing system. The system must be said to have served the farmers well during the rapid development of cage aquaculture, even during the trying period of the severe reservoir drawdown. The marketing margins and costs appear to be reasonable and if the traders are taking advantage of the farmers it is not obvious from the data.

It would appear that the traders are developing the experience and confidence to deal directly in the Jakarta market. As their size increases with further expansion in both Saguling and Cirata one can expect even more direct marketing to take place. There is reason to believe and evidence to suggest that the Jakarta market can absorb the increased output without serious price declines. The Bandung market, as well, can probably be further exploited.

The economy of Indonesia has been developing effectively with resulting increases in incomes. With anticipated continued economic growth the promise for an expanding market for fish from the cages of Saguling and Cirata looks promising. The marketing system has already demonstrated its capacity to deal with both success and adversity and there is reason to believe that it will continue to meet the need of farmers.

The marketing system as it has evolved appears to be reasonably efficient. There is no clear need to interfere in the process that is effectively developing on its own. There are no obvious institutional improvements that might be made at this time.

## References

- Chow, F.C. 1982. Economic and marketing feasibility analysis of fisheries program. Interim report. Perusahaan Umum Listrik Negara, Bandung, Indonesia. (In Indonesian).
- Faculty of Agriculture, Padjadjaran University. 1983. Studi masalah pengembangan dan pemasaran ikan di Jawa Barat dikaitkan dengan rencana pengembangan akuakultur di waduk Saguling dalam rangka program resettlement. Laporan penelitian. Kerjasama antara Fakultas Pertanian UNPAD dan Balai Penelitian Perikanan Darat Bogor. (In Indonesian).
- Fisheries Department, Bandung District. 1988. Monthly reports, Jan.-Dec. 1988. West Java Provincial Fisheries Department, Bandung.
- Institute for Community Dedication. 1984. Laporan survai pemasaran ikan basah dan hidup di Jawa Barat tahun 1980-81. Kerjasama antara Fakultas Pertanian UNPAD dan Dinas Perikanan Propinsi DT Jawa Barat, Bandung. (In Indonesian).



# Waste Production and Efficiency of Feed Use in Floating Net Cages in a Eutrophic Tropical Reservoir\*

**BARRY A. COSTA-PIERCE**  
*International Center for Living Aquatic  
Resources Management  
MC P.O. Box 1501, Makati  
Metro Manila, Philippines*

**CECEP M. ROEM**  
*Institute of Ecology  
Padjadjaran University  
Jl. Sekeloa Selatan 1  
Bandung 40132, Indonesia*

COSTA-PIERCE, B.A. and C.M. ROEM. 1990. Waste production and efficiency of feed use in floating net cages in a eutrophic tropical reservoir, p. 257-271. In B.A. Costa-Pierce and O. Soemarwoto (eds.) *Reservoir fisheries and aquaculture development for resettlement in Indonesia*. ICLARM Tech. Rep. 23, 378 p.

## Abstract

Waste production from floating net cages culturing common carp (*Cyprinus carpio*) in a eutrophic tropical reservoir was studied by use of sediment traps and results compared with similar studies in the temperate zone. Mean total and carbon sedimentation rates from cages were significantly greater than controls ( $P < 0.01$ , paired t-tests,  $N = 11$ ) while total nitrogen and phosphorus sedimentation rates were not. Mean total carbon, nitrogen and phosphorus concentrations in the sedimenting materials were significantly higher ( $P < 0.05$ ) from controls than from cages. Sedimenting materials from controls had a mean nutrient composition of 38.2% C, 9.0% N and 0.2% P compared to 26.4% C, 3.0% N, and 0.02% P from the cages. Per cent loss of the nutrients contained in feed was low, but very variable, with mean losses of only 5.4% C, 3.5% N, and 0.0% P. Complete original data are included in an Appendix.

Comparable data from temperate zone cage aquaculture show higher sediment and nutrient loss rates, and higher nutrient densities in sedimenting materials from cages than in the controls. Differences are hypothesized to be due to the constant blooms of *Microcystis aeruginosa* present in the tropical reservoir studied and the higher phosphorus concentrations in feeds used in temperate zone cage culture.

## Introduction

Wastes from uneaten or unused feeds used to increase production of fish in semi- or intensive cage culture can have significant environmental impacts. Eutrophication of natural waters can result (Beveridge 1984). Cage structures can increase siltation rates due to their physical slowing of water currents. Solids from cages accumulate below cages and decrease sedimentary oxygen concentrations, decrease redox potentials and disrupt aerobic chemical pathways (Enell 1982; Merican 1983). All of these processes could adversely affect natural aquatic environments by qualitatively or quantitatively altering populations of pelagic and benthic flora and fauna, and, by implication, the aquatic food webs leading to higher organisms.

\*ICLARM Contribution No. 547.

Merican and Phillips (1985) reported that 35.6% carbon, 21.8% nitrogen and 65.9% of the phosphorus contained in feeds given to fish cultured in Scottish lochs was lost to the environment. They concluded that present diets for cage culture of rainbow trout (*Salmo gairdnerii*) contain excessive amounts of phosphorus (mean = 19.0 mg P/g dry weight feed; range = 14.1-23.9) and recommended reductions of phosphorus concentrations in feeds to lessen the adverse nutrient impacts of cage culture. In response to these environmental concerns a number of feed companies now produce feeds for cage culture with 1.0% or less total phosphorus content.

If waste production from cage culture results in lower oxygen, increased ammonia, phosphorus, organic carbon and nitrogen concentrations in the environment surrounding cages (reviewed by Beveridge 1984), growth of fish confined in cages can be slowed, or toxic conditions result. Excessive waste production by cage culture can thereby be self-limiting, especially in bays or reservoirs where flow restrictions occasionally occur. In these circumstances understanding waste production could help predict the carrying capacity of a water body for cage aquaculture development, and, in addition, could help quantify efficiency of feed utilization. Management measures would then be taken to reduce wasted feed.

Few quantitative studies of waste production, feed efficiency and water quality impacts of cage culture have been undertaken in the tropics. Comparison of environmental impacts of cage culture in tropical and temperate situations may be valuable to develop and refine models of impact and elucidate changes in natural environments (Beveridge 1984; Phillips et al. 1985).

This study quantitatively examines waste production from cages culturing common carp (*Cyprinus carpio*) in a eutrophic tropical reservoir with a deoxygenated hypolimnion in West Java, Indonesia. Comparisons are made with results of cage culture in the temperate zone.

## Materials and Methods

Waste production from floating net cages was measured at 9 sites from 29 April to 22 December 1988 in the southern sector of the Saguling Reservoir, West Java, Indonesia. Cages monitored were privately owned by farmers or were part of an experimental program to culture common carp (*Cyprinus carpio*) (Costa-Pierce et al. 1988; Costa-Pierce and Hadikusumah, this vol.). At the time of the study over 80% of the 1,300 cage units ("unit" = 7 x 7 x 2.5 m) were located in the southern sector of Saguling (Rusydi and Lampe, this vol.). Annual fish production from cages in Saguling in 1988 reached 2,550 t.

Triplicate sediment traps 1 x 1 m in size were set underneath the floating net cages for a 24-hour period. Traps were collapsible so that each 1-m<sup>2</sup> frame laid flat on the net cage bottom at 2.5 m depth when set. Each sediment trap had walls constructed of a very fine mesh (1-2 mm). Traps were cone shaped and tapered to a point where a 600-ml plastic bottle was fixed that collected sedimenting materials. Each trap contained 1 m<sup>3</sup> of water, and when retrieved, concentrated settled materials into the 600-ml bottle.

Concurrently triplicate control sediment traps were set in an area at a 2.5 m water depth over the same 24-hour period. These control traps were set more than 20 m away from any floating net cages.

Bottles containing samples were returned to the laboratory at the Institute of Ecology, Padjadjaran University, where sedimented materials were dried at 105°C to

determine dry weight. Dried materials were analyzed using standard methods for total carbon, nitrogen and phosphorus (APHA 1975).

Means of triplicate cage and control samples were multiplied by 0.6 to render the figures to a square meter basis (numbers expressed as g/m<sup>2</sup>/day). Mean sedimentation rates for control samples were subtracted from cage samples to obtain sedimentation rates for the cages. Farmers were interviewed during the sampling period and fish feeding rates, standing crop fish biomasses, stocking and sampling statistics recorded. These numbers were used to calculate sedimentation rates per kg of feed given and per kg of standing crop fish biomass at the time of sedimentation sampling. Significant differences were isolated using paired t-tests comparing cages and controls. On two dates in one net cage fish were fed to satiation three times a day and compared to another cage where fish were fed 3% of the standing crop fish biomass three times a day to get an upper limit on waste production. These cages were included in the paired statistical analyses.

## Results

Mean total, carbon, nitrogen and phosphorus sedimentation rates at cage and control sites are listed in Table 1. Mean ( $\pm 1$  standard deviation [S.D.]) total

Table 1. Mean total, carbon (C), nitrogen (N), and phosphorus (P) sedimentation rates (g/m<sup>2</sup>/day) collected from sedimentation traps set below eleven farmer and station floating net cages 7 x 7 x 2.5 m deep (mesh size 1.5") growing common carp (*Cyprinus carpio*) and control sites more than 20 m away from the influence of any cages over an 8-month period in the Saguling Reservoir, West Java, Indonesia.

Sample number	Date	Place	Total (g/m <sup>2</sup> /day)	Mean rates		
				C (g/m <sup>2</sup> /day)	N (mg/m <sup>2</sup> /day)	P (mg/m <sup>2</sup> /day)
1	29-30/4/88	Farmer	14.4	2.6	398.6	2.1
		control	0.7	0.2	37.7	0.6
2	29-30/5/88	Farmer	14.3	2.4	294.4	0.3
		control	1.3	0.3	130.7	2.4
3	28-29/6/88	Farmer	5.1	1.1	239.9	0.3
		control	0.3	0.1	65.9	2.4
4	29-30/7/88	Farmer	7.6	1.2	335.3	0.4
		control	1.0	0.4	91.0	2.4
5	27-28/8/88	Farmer	2.0	0.0	0.0	2.5
		control	1.5	0.6	146.6	2.3
6a	27-28/8/88	Station*	25.0	4.2	1,375.5	0.3
6b	28-29/8/88	Station	24.1	3.6	1,032.2	0.2
		control	0.9	0.2	95.5	2.7
7a	28-29/9/88	Station*	13.5	8.2	206.2	0.5
7b	28-29/9/88	Station	13.4	4.9	228.8	0.2
		control	4.2	2.2	403.2	0.3
8	7-8/11/88	Farmer	18.8	8.1	577.6	1.0
		control	3.3	1.8	74.4	0.4
9	21-22/12/88	Farmer	8.5	3.9	282.9	0.4
		control	1.8	0.9	46.5	0.3
		Cages				
		Max	25.0	8.2	1,375.5	2.5
		Min	2.0	0.0	0.0	0.2
		Mean	13.3	3.7	451.9	0.7
		SD	7.0	2.5	385.5	0.8
		Controls				
		Max	4.2	2.2	403.2	2.7
		Min	0.3	0.1	37.7	0.3
		Mean	1.7	0.7	121.3	1.5
		SD	1.2	0.7	105.2	1.0

Station\* = feed was fed until fish were satiated.

sedimentation rate from the cages was  $13.3 \pm 7.0$  g/m<sup>2</sup>/day and ranged widely (range [R] = 2.0-25.0). Total mean sedimentation rate in the control sites was significantly lower,  $1.7 \pm 1.2$  g/m<sup>2</sup>/day (R = 0.3-4.2) ( $P < 0.01$ , paired t-test, N = 11). Significantly higher mean sedimentation rates for cages over controls were also obtained for total carbon ( $P < 0.01$ ), but mean concentrations for total nitrogen and phosphorus did not differ significantly ( $P > 0.05$ , paired t-test) (Table 1). Examination of the data in Table 1 shows a great deal of variability, especially in total nitrogen and phosphorus concentrations (note standard deviations). Curiously, phosphorus sedimentation rates obtained at control stations,  $1.5 \pm 1.0$  mg P/m<sup>2</sup>/day (R = 0.3-2.7), were not significantly different than sedimentation rates from the cages  $0.7 \pm 0.8$  mg P/m<sup>2</sup>/day (R = 0.2-2.5).

Comparison of mean sedimentation rates from the two cages fed to satiation and farmers' cages (n = 9) showed no significant difference ( $P > 0.05$ , Mann-Whitney U-test, (Zar 1984)). Significantly higher mean total and carbon sedimentation rates over controls were obtained ( $P < 0.01$ ), but mean concentrations for total nitrogen and phosphorus did not differ.

Mean total concentrations of carbon, nitrogen and phosphorus in sedimenting materials (e.g nutrient density) at control stations were significantly greater than nutrient contents of sedimenting matter from the cages ( $P < 0.05$ , paired t-tests) (Table 2). Mean

Table 2. Mean carbon (C), nitrogen (N), and phosphorus (P) concentrations (g or mg/g dry weight) in sedimenting materials collected from sediment traps.

Sample number	Date	Place	Total (g/m <sup>2</sup> /day)	Mean rates (from Table 1)			Mean waste nutrient content (mg/g dry wt)		
				C (g/m <sup>2</sup> /day)	N (mg/m <sup>2</sup> /day)	P (mg/m <sup>2</sup> /day)	C	N	P
1	29-30/4/88	Farmer	14.4	2.6	398.6	2.1	180.6	27.7	0.1
		control	0.7	0.2	37.7	0.6	285.7	53.9	0.9
2	29-30/5/88	Farmer	14.3	2.4	294.4	0.3	167.8	20.6	0.0
		control	1.3	0.3	130.7	2.4	230.8	100.5	1.8
3	28-29/6/88	Farmer	5.1	1.1	239.9	0.3	215.7	47.0	0.1
		control	0.3	0.1	65.9	2.4	333.3	219.7	8.0
4	29-30/7/88	Farmer	7.6	1.2	335.3	0.4	157.9	44.1	0.1
		control	1.0	0.4	91.0	2.4	400.0	91.0	2.4
5	27-28/8/88	Farmer	2.0	0.0	0.0	2.5	0.0	0.0	1.3
		control	1.5	0.6	146.6	2.3	400.0	97.7	1.5
6a	27-28/8/88	Station*	25.0	4.2	1,375.5	0.3	168.0	55.0	0.0
6b	28-29/8/88	Station	24.1	3.6	1,032.2	0.2	149.4	42.8	0.0
		control	0.9	0.2	95.5	2.7	222.2	106.1	3.0
7a	28-29/9/88	Station*	13.5	8.2	206.2	0.5	607.4	15.3	0.0
7b	28-29/9/88	Station	13.4	4.9	228.8	0.2	365.7	17.1	0.0
		control	4.2	2.2	403.2	0.3	523.8	96.0	0.1
8	7-8/11/88	Farmer	18.8	8.1	577.6	1.0	430.9	30.7	0.1
		control	3.3	1.8	74.4	0.4	545.5	22.5	0.1
9	21-22/12/88	Farmer	8.5	3.9	282.9	0.4	458.8	33.3	0.0
		control	1.8	0.9	46.5	0.3	500.0	25.8	0.2
Cages		Max	25.0	8.2	1,375.5	2.5	607.4	55.0	1.3
		Min	2.0	0.0	0.0	0.2	0.0	0.0	0.0
		Mean	13.3	3.7	451.9	0.7	263.8	30.3	0.2
		SD	7.0	2.5	385.5	0.8	169.5	15.6	0.3
Controls		Max	4.2	2.2	403.2	2.7	545.5	219.7	8.0
		Min	0.3	0.1	37.7	0.3	222.2	22.5	0.1
		Mean	1.7	0.7	121.3	1.5	382.4	90.4	2.0
		SD	1.2	0.7	105.2	1.0	116.2	55.0	2.3

Station\* = feed was fed until fish were satiated.

nutrient content for materials from the cages was 26.4 % C, 3.0 % N, and 0.02 % P. Materials collected from controls (environment) were 38.2% C, 9.0% N, and 0.2 % P.

Waste loadings to the reservoir per standing crop biomass of fish present in the cages and per feed given per day are presented in Table 3. Mean total waste loadings averaged  $2.7 \pm 1.8$  g/kg fish/day and  $80.6 \pm 59.9$  g/kg feed/day. Phosphorus loading per kg fish biomass in the cages was undetectable in 3 of the 11 cages monitored. A great amount of variability was present in the data, some of which was curiously unexplainable. One cage monitored on 27-28 August 1988 (sample number 5) having a low feeding rate and a small standing crop biomass produced an undetectable amount of carbon and nitrogen load but produced 0.7 mg P/kg fish/day (Table 3). In contrast a cage monitored on 28-29 August 1988 (sample number 6b) with a similarly low biomass and feeding rate had high total carbon (0.9 g/kg fish/day) and nitrogen (262.1 mg/kg fish/day) loads.

Percentage of the nutrients lost from those contained in the feed was low and variable. Mean loss rates of carbon of  $5.4 \pm 4.7\%$  ( $R = 0.0-15.1\%$ ), nitrogen  $3.5 \pm 3.3\%$  ( $R = 0.0-11.8$ ), and phosphorus  $0.0 \pm 0.1\%$  ( $R = 0.0-0.2$ ) were obtained (Table 4). No measurable (detectable by methods used here) phosphorus was lost from feeds in 8 of the 11 cages monitored.

## Discussion

This study was modelled after the study of Merican and Phillips (1985) so that some direct quantitative comparisons could be made between tropical and temperate zone studies in widely differing environments, fish species and feeds used.

Merican and Phillips (1985) studied the same production and efficiency parameters for rainbow trout cage culture in a natural lake in a cold temperate climate. Recognizing the completely different nature of the two environments, comparison of this study with theirs could be instructive since both cage systems are semi-intensive and the central environmental concern in both cases is that of accelerated eutrophication. One main concern in our study was to understand if the current cage industry can be expanded further in a concentrated area without decreasing water quality and limiting carrying capacity of the reservoir for aquaculture development. Concentration of cage aquaculture in a limited area is essential since the Saguling Reservoir has multiple uses which can conflict.

Canfield et al. (1982) reported that natural sedimentation rates ranged from 0.1 to 203.0 g/m<sup>2</sup>/day. Merican and Phillips (1985) reported higher total mean sedimentation rates in environmental (control) stations (8.0 g/m<sup>2</sup>/day) than reported here (1.7 g/m<sup>2</sup>/day). However, both of these values are well within the range expected of mesotrophic to eutrophic lakes. Comparable mean total carbon (0.8 vs. 0.7 g C/m<sup>2</sup>/day here) and nitrogen (103.5 vs. 121.3 mg N/m<sup>2</sup>/day here) sedimentation rates were obtained from control stations in both studies. The mean phosphorus sedimentation rate in controls reported by Merican and Phillips (1985), 42 mg P/m<sup>2</sup>/day was, however, over an order of magnitude higher than the 1.5 mg P/m<sup>2</sup>/day reported in this study.

The mean total sedimentation rate from cages in this study (13.3 g/m<sup>2</sup>/day;  $R = 2.0-25.0$ ) was generally lower than reported in the literature for temperate zone cage culture. Merican and Phillips (1985) reported a mean of 149.6 g/m<sup>2</sup>/day ( $R = 61.5-295.9$ ), while Enell and Lof (1983) reported 17-26 g/m<sup>2</sup>/day.

Table 3. Mean total, carbon (C), nitrogen (N) and phosphorus (P) solid waste loadings per 7 x 7 x 2.5 m floating net cage growing common carp (*Cyprinus carpio*) reported per kg of fish biomass in the cage at the time of waste sampling and per kg of feed fed daily to the fish at time of waste sampling.

Sample Number	Date	Place	Kg feed per day	Mean rates (from Table 1)				Waste loadings per kg food fed (from Table 3)				Per cent nutrient losses		
				Total (g/m <sup>2</sup> /day)	C (g/m <sup>2</sup> /day)	N (mg/m <sup>2</sup> /day)	P (mg/m <sup>2</sup> /day)	Total (g/kg food fed/day)	C (g/kg food fed/day)	N (mg/kg food fed/day)	P (mg/kg food fed/day)	C (%)	N (%)	P (%)
1	29-30/4/88	Farmer control	20	14.4 0.7	2.6 0.2	398.6 37.7	2.1 0.6	35.3	6.4	976.6	5.1	1.5	1.3	0.1
2	29-30/5/88	Farmer control	12	14.3 1.3	2.4 0.3	294.4 130.7	0.3 2.4	58.4	9.8	1,202.1	1.2	2.3	1.6	0.0
3	28-29/6/88	Farmer control	12	5.1 0.3	1.1 0.1	239.9 65.9	0.3 2.4	20.8	4.5	979.6	1.2	1.0	1.3	0.0
4	29-30/7/88	Farmer control	12	7.6 1.0	1.2 0.4	395.3 91.0	0.4 2.4	31.0	4.9	1,369.1	1.6	1.1	1.9	0.0
5	27-28/8/88	Farmer control	5.5	2.0 1.5	0.0 0.6	0.0 146.6	2.5 2.3	17.8	0.0	0.0	22.3	0.0	0.0	0.2
6a	27-28/8/88	Station*	12.8	25.0	4.2	1,375.5	0.3	95.7	16.1	5,265.6	1.1	3.7	7.1	0.0
6b	28-29/8/88	Station control	5.8	24.1 0.9	3.6 0.2	1,032.2 95.5	0.2 2.7	203.6	30.4	8,720.3	1.7	7.1	11.8	0.0
7a	28-29/9/88	Station*	14.3	13.5	8.2	206.2	0.5	46.3	28.1	706.6	1.7	6.5	1.0	0.0
7b	28-29/9/88	Station control	3.7	13.4 4.2	4.9 2.2	228.8 403.2	0.2 0.3	177.5	64.9	3,030.1	2.6	15.1	4.1	0.0
8	7-8/11/88	Farmer control	10.5	18.8 3.3	8.1 1.8	577.6 74.4	1.0 0.4	87.7	37.8	2,695.5	4.7	8.8	3.6	0.0
9	21-22/12/88	Farmer control	3.7	8.5 1.8	3.9 0.9	282.9 46.5	0.4 0.3	112.6	51.6	3,746.5	5.3	12.0	5.1	0.1
Cages		Max		25.0	8.2	1,375.5	2.5	203.6	64.9	8,720.3	22.3	15.1	11.8	0.2
		Min		2.0	0.0	0.0	0.2	17.8	0.0	0.0	1.1	0.0	0.0	0.0
		Mean		13.3	3.7	451.9	0.7	80.6	23.1	2,608.4	4.4	5.4	3.5	0.0
		SD		7.0	2.5	385.5	0.8	59.9	20.4	2,433.6	5.9	4.7	3.3	0.1
Controls		Max		4.2	2.2	403.2	2.7							
		Min		0.3	0.1	37.7	0.3							
		Mean		1.7	0.7	121.3	1.5							
		SD		1.2	0.7	105.2	1.0							

Station\* = feed was fed until fish were satiated.

Table 4. Percentage nutrient losses of carbon (C), nitrogen (N) and phosphorus (P) from feed fed to caged common carp (*Cyprinus carpio*).

Sample Number	Date	Place	Kg fish biomass	Kg feed per day	Mean rates (from Table 1)				Waste loadings per kg fish biomass				Waste loadings per kg food fed			
					Total (g/m <sup>2</sup> /day)	C (g/m <sup>2</sup> /day)	N (mg/m <sup>2</sup> /day)	P (mg/m <sup>2</sup> /day)	Total (g/kg fish/day)	C (g/kg fish/day)	N (mg/kg fish/day)	P (mg/kg fish/day)	Total (g/kg food fed/day)	C (g/kg food fed/day)	N (mg/kg food fed/day)	P (mg/kg food fed/day)
1	29-30/4/88	Farmer control	600	20.0	14.4	2.6	398.6	2.1	1.2	0.2	32.6	0.2	35.3	6.4	976.6	5.1
2	29-30/5/88	Farmer control	400	12.0	14.3	2.4	294.4	0.3	1.8	0.3	36.1	0.0	58.4	9.8	1,202.1	1.2
3	28-29/6/88	Farmer control	400	12.0	5.1	1.1	239.9	0.3	0.6	0.1	29.4	0.0	20.8	4.5	979.6	1.2
4	29-30/7/88	Farmer control	400	12.0	7.6	1.2	335.3	0.4	0.9	0.1	41.1	0.0	31.0	4.9	1,369.1	1.6
5	27-28/8/88	Farmer control	184	5.5	2.0	0.0	0.0	2.5	0.5	0.0	0.0	0.7	17.8	0.0	0.0	22.3
6a	27-28/8/88	Station*	238	12.8	25.0	4.2	1,375.5	0.3	5.1	0.9	283.2	0.1	96.7	16.1	5,265.6	1.1
6b	28-29/8/88	Station control	193	5.8	24.1	3.6	1,032.2	0.2	6.1	0.9	262.1	0.1	203.6	30.4	8,720.3	1.7
7a	28-29/9/88	Station*	190	14.3	13.5	8.2	206.2	0.5	3.5	2.1	53.2	0.1	46.3	28.1	706.6	1.7
7b	28-29/9/88	Station control	165	3.7	13.4	4.9	228.8	0.2	4.0	1.5	67.9	0.1	177.5	64.9	3,030.1	2.6
8	7-8/11/88	Farmer control	386	10.5	18.8	8.1	577.6	1.0	2.4	1.0	73.3	0.1	87.7	37.8	2,695.5	4.7
9	21-22/12/88	Farmer control	122	3.7	8.5	3.9	282.9	0.4	3.4	1.6	113.6	0.2	112.6	51.6	3,746.5	5.3
Cages					25.0	8.2	1,375.5	2.5	6.1	2.1	283.2	0.7	203.6	64.9	8,720.3	22.3
Min					2.0	0.0	0.0	0.2	0.5	0.0	0.0	0.0	17.8	0.0	0.0	1.1
Mean					13.3	3.7	451.9	0.7	2.7	0.8	90.2	0.1	80.6	23.1	2,608.4	4.4
SD					7.0	2.5	385.5	0.8	1.8	0.7	90.4	0.2	59.9	20.4	2,433.6	5.9
Controls					4.2	2.2	403.2	2.7								
Min					0.3	0.1	37.7	0.3								
Mean					1.7	0.7	121.3	1.5								
SD					1.2	0.7	105.2	1.0								

Mean commercial feed composition = 43.1% C, 7.4% N, 1.0% P

Station\* = feed was fed until fish were satiated.

The chemical contents of settled materials from cages and controls in this study were markedly different from those collected and analyzed by Merican and Phillips (1985) in the temperate zone. Mean total carbon, nitrogen and phosphorus concentrations were, in all cases examined, more concentrated (e.g., more nutrient dense) in the settled materials from controls than from the cages (Table 2). Exactly opposite results were found in the studies of Merican and Phillips (1985).

The likely reason for the high nutrient density of sedimenting materials from the reservoir environment studied herein is the fact that, during the course of this study, the Saguling Reservoir was dominated by luxuriant blooms of *Microcystis aeruginosa*. During this study Saguling was drawn down nearly 20 m, and lake turnovers occurred which brought large concentrations of ammonia-nitrogen to the euphotic zone. In addition the reservoir continually receives an estimated 150,000 m<sup>3</sup>/day of concentrated organic waste from the nearby city of Bandung. High nutrient concentrations and continuous *Microcystis* blooms were a result (see Soemarwoto et al., this vol.). In our occasional microscopic examinations of the sedimented materials, algal detritus from *Microcystis* comprised the majority of all sedimenting materials collected in control sediment traps.

*Microcystis* is well-known for its high nutrient content (Gerloff and Skoog 1954), concentrations of carbohydrate and protein (Hama and Handa 1982, 1983), nitrogen (Kappers 1980), and its ability to "luxury consume" phosphorus (Kuhl 1974) under conditions of high external nutrient concentrations. Phosphorus was especially concentrated in sedimenting materials from control stations, comprising a mean of 2.0 mg P/g dry weight compared to 0.2 mg P/g dry weight in sedimenting materials collected from the cages (Table 2).

The fact that increased feeding of fish to satiation seemed to have no significant effects on mean total, nitrogen, and phosphorus sedimentation rates was most interesting. Given the fact that sedimenting materials from the reservoir environment have a greater nutrient density, however, this is understandable. Settling materials from reservoir plankton contribute a greater environmental impact than cages in this study.

Mean total carbon and nitrogen waste outputs per biomass of fish and kg per food fed reported in this study were less than half of the amounts reported by Merican and Phillips (1985), but a large range of values was observed. The highest values observed for waste output were, however, comparable to or exceeded mean values reported by Merican and Phillips (1985). The major difference was, however, phosphorus. Mean waste loadings of phosphorus reported in this study were more than an order of magnitude less than those reported by Merican and Phillips (1985).

One possible reason for these differences was that the nutrient composition of the feed used in the common carp cage industry in Indonesia was remarkably similar to the mean feed composition reportedly used by farmers in Scotland with one major exception--phosphorus. Mean nutrient composition in both studies contained approximately 43% C and 7% N dry weight; however, the mean composition of the feeds used in Scotland reported by Merican and Phillips (1985) contained almost double the phosphorus, 1.9% vs. 1.0% in Indonesia.

Per cent loss of carbon and nitrogen to the environment from feeds used in Scotland was much higher than the cages examined in Indonesia. In Indonesia a mean loss of 5.4% C (R = 0.0-15.1%), 3.5% N (R = 0.0-11.8) and 0.0% P (R = 0.0-0.2) of the nutrients contained in the commercial feed was obtained (Table 4). Merican and Phillips



(1985) reported that 35.6% C, 21.8% N and 65.9% P contained in feeds given to caged rainbow trout was lost to the environment.

Our inability to detect a significant loss of phosphorus from feeds given to caged common carp in 8 out of the 11 cages monitored during this study is particularly surprising (see Table 4). It is hypothesized that a negligible quantity of phosphorus lost from feeds given to caged fish in the tropical reservoir studied is due to a combination of at least three factors: (1) high ambient water temperatures increased decomposition processes (surface water = 25.0-29.0°C; mean = 26.4°C in 1988, N = 179), (2) rapid decomposition and nutrient recycling of wastes from cages to phytoplankton/bacteria occur, (3) the high biomass of fish efficiently assimilate the low amount of phosphorus in feeds. It is postulated that a "pelagic nutrient recycling system" is occurring between the cages and the planktonic ecosystem. Very high densities of *Microcystis* with their notably rapid nutrient uptake kinetics (Kappers 1980) could absorb nearly all of the available (from decomposition) phosphorus and a large amount of the available nitrogen from the cage wastes before sedimenting.

### Conclusions and Recommendations

We conclude from these studies that the efficiency of feed utilization in the floating net cages is excellent given the current, hypereutrophic aquatic ecosystem. Waste loadings to the reservoir environment of biologically important nutrients, and consequently eutrophication from the floating net cages, is low due to the high efficiency of feed utilization and hypothesized nutrient cycling pathways from fish to plankton. Much greater accelerated eutrophication of the Saguling Reservoir is currently resulting from massive inputs of sediments and associated nutrients from erosion, organic wastes from the city of Bandung, and concentrated nutrient inputs resulting from the sedimentation of unutilized *Microcystis* blooms.

Introductions of a blue-green algal feeding fish such as *Oreochromis niloticus* or *Clupeichthys aesarnensis* could assist in curbing the *Microcystis* populations and, by implication, possibly increase the carrying capacity of Saguling for floating net cage aquaculture.

### Acknowledgement

The authors wish to gratefully acknowledge the assistance of Mrs. Titin Herawati in the field and laboratory analyses conducted in these studies.

### References

- APHA. 1975. Standard methods for the examination of water and wastewater. 14th ed., American Public Health Association, Washington, DC.
- Beveridge, M.C.M. 1984. Cage and pen fish farming. Carrying capacity models and environmental impact. FAO Fish. Tech. Pap. 255. 131 p.
- Canfield, D.F., J.R. Jones and R.W. Bachman. 1982. Sedimentary losses of phosphorus in some natural and artificial Iowa lakes. *Hydrobiologia* 87: 65-76.
- Costa-Pierce, B.A., G. Wiraatmadja, P. Effendi and S. Zainal. 1988. Integrated aquaculture systems in the Saguling reservoir, West Java, Indonesia, p. 224-233. In S. De Silva (ed.) Reservoir fishery management and development in Asia: Proceedings of a workshop held in Kathmandu, Nepal, 23-28 November 1987. International Development Research Centre, Ottawa, Canada.

- Enell, M. 1982. Changes in sediment dynamics caused by cage culture activities, p. 72-88. In I. Bergstromm, J. Kettunen and M. Stenmark (eds.) Proceedings of the Tenth Nordic Symposium on Sediments, Tvarminne, Finland, 5-8 May 1982. Onanieni, Finland.
- Enell, M. and J. Lof. 1983. Miljöeffekter av vattenbruk-sedimentation och narsaltbelastning from fishkassodlingar. Vatten 39: 364-375.
- Gerloff, G.C. and F. Skoog. 1954. Cell contents of nitrogen and phosphorus as a measure of the availability for growth of *Microcystis aeruginosa*. Ecology 35: 348-353.
- Hama, T. and N. Handa. 1982. The seasonal variation of organic constituents in a eutrophic lake, Lake Suwa, Japan. Part 1. Particulate organic matter. Arch. Hydrobiol. 93: 446-465.
- Hama, T. and N. Handa. 1983. The seasonal variation of organic constituents in a eutrophic lake, Lake Suwa, Japan. Part 2. Dissolved organic matter. Arch. Hydrobiol. 98: 443-462.
- Kappers, F.I. 1980. The cyanobacterium *Microcystis aeruginosa* and the nitrogen cycle of the hypertrophic Lake Brielle (The Netherlands), p. 37-43. In J. Barica and L.R. Mur (eds.) Hypereutrophic ecosystems. Developments in hydrobiology. Vol. 2. Dr. W. Junk Publishers, The Hague.
- Kuhl, A. 1974. Phosphorus, p. 636-654. In W. Stewart (ed.) Algal physiology and biochemistry. Blackwell Scientific, Oxford.
- Merican, Z.O. 1983. A study of solid waste production from freshwater fish cage culture. University of Stirling, Scotland, 61 p. M.Sc. Thesis.
- Merican, Z.O. and M. Phillips. 1985. Solid waste production from rainbow trout, *Salmo gairdneri* Richardson, cage culture. Aquacult. Fish. Manage. 1: 55-69.
- Phillips, M.J., M.C.M. Beveridge and L.G. Ross. 1985. The environmental impact of salmonid cage culture on inland fisheries: present status and future trends. J. Fish Biol. 27(Supplement A): 123-137.
- Zar, J.H. 1984. Biostatistical analysis. Second edition. Prentice-Hall, Englewood Cliffs, New Jersey.

## Appendix

Waste production by floating net cages in the Saguling Reservoir, Indonesia.  
Date: 29-30 April 88

Parameter	Sample number					Control-environment				
	1	2	3	Mean	SD	1	2	3	Mean	SD
Dry solids (g/l)	10.9	24.4	40.3	25.2	12.0	1.3	0.9	1.5	1.2	0.2
Total C (g/l)	2.0	6.1	6.2	4.8	1.9	0.4	0.3	0.5	0.4	0.1
Total N (mg/l)	406.6	511.8	1,263.4	727.3	381.5	82.9	52.6	53.2	62.9	14.1
Total P (mg/l)	3.4	3.7	6.2	4.4	1.3	1.9	0.7	0.4	1.0	0.6

	g or mg/ m <sup>2</sup> /day	Floating net cage					g or mg/ m <sup>2</sup> /day	Loading rates	
		1	2	3	Mean	SD		g or mg per kg fish/day	g or mg per kg feed/day
Dry solids (g/l)	0.7	9.6	23.5	38.8	24.0	11.9	14.4	1.2	35.3
Total C (g/l)	0.2	1.6	5.8	5.7	4.4	1.9	2.6	0.2	6.4
Total N (mg/l)	37.7	323.7	459.2	1,210.2	664.4	389.9	398.6	32.6	976.6
Total P (mg/l)	0.6	1.5	3.0	5.8	3.4	1.8	2.1	0.2	5.0

Cage Data: 7 x 7 x 2.5 m  
600 kg biomass  
3%/day  
20 kg feed/day

Waste production by floating net cages in the Saguling Reservoir, Indonesia.  
Date: 29-30 May 88

Parameter	Sample number					Control-environment				
	1	2	3	Mean	SD	1	2	3	Mean	SD
Dry solids (g/l)	26.7	26.4	24.8	26.0	0.8	2.1	1.6	2.9	2.2	0.5
Total C (g/l)	4.7	4.7	4.4	4.6	0.1	0.5	0.5	0.7	0.6	0.1
Total N (mg/l)	642.3	426.0	1,057.2	708.5	261.8	250.1	164.4	238.7	217.9	37.8
Total P (mg/l)	4.3	4.3	4.5	4.4	0.1	3.4	4.3	4.1	3.9	0.4

	g or mg/ m <sup>2</sup> /day	Per cage Mean	Loading rates		
			g or mg/ m <sup>2</sup> /day	per kg fish/day	per kg feed/day
Dry solids (g/l)	1.3	23.8	14.3	1.7	7.1
Total C (g/l)	0.3	4.0	2.4	0.3	1.2
Total N (mg/l)	130.7	490.6	294.4	36.1	147.3
Total P (mg/l)	2.4	0.4	0.3	.0	0.1

Cage Data: 7 x 7 x 2.5 m  
Biomass: 400 kg  
Feed: 3%/day; 12 kg/day

Waste production by floating net cages in the Saguling Reservoir, Indonesia.  
Date: 28-29 June 88

Parameter	Sample number					Control-environment				
	1	2	3	Mean	SD	1	2	3	Mean	SD
Dry solids (g/l)	8.9	9.2	8.9	9.0	0.1	0.6	0.6	0.5	0.6	.0
Total C (g/l)	2.0	2.1	2.1	2.1	.0	0.3	0.3	0.1	0.2	0.1
Total N (mg/l)	522.9	500.2	505.9	509.7	9.6	119.4	102.3	108.0	109.9	7.1
Total P (mg/l)	4.5	4.8	4.3	4.5	0.2	3.9	4.1	3.9	4.0	0.1

	g or mg/ m <sup>2</sup> /day	Per cage Mean	Loading rates		
			g or mg/ m <sup>2</sup> /day	per kg fish/day	per kg feed/day
Dry solids (g/l)	0.3	8.4	5.1	0.6	2.5
Total C (g/l)	0.1	1.9	1.1	0.1	0.6
Total N (mg/l)	65.9	399.8	239.9	29.4	120.0
Total P (mg/l)	2.4	0.5	0.3	.0	0.2

Cage Data: 7 x 7 x 2.5 m  
Biomass: 400 kg  
Feed: 3%/day; 12 kg/day

Waste production by floating net cages in the Saguling Reservoir, Indonesia.  
Date: 29-30 July 88

Parameter	Sample number					Control-environment				
	1	2	3	Mean	SD	1	2	3	Mean	SD
Dry solids (g/l)	15.0	14.5	13.7	14.4	0.5	1.8	1.9	1.3	1.7	0.3
Total C (g/l)	2.8	2.7	2.5	2.7	0.1	0.7	0.8	0.6	0.7	0.1
Total N (mg/l)	744.6	852.6	534.3	710.5	132.2	136.4	125.5	193.3	151.7	29.7
Total P (mg/l)	4.9	4.5	4.3	4.6	0.2	3.7	4.5	3.9	4.0	0.3

	g or mg/ m <sup>2</sup> /day	Per cage Mean	Loading rates		
			g or mg/ m <sup>2</sup> /day	per kg fish/day	per kg feed/day
Dry solids (g/l)	1.0	12.7	7.6	0.9	3.8
Total C (g/l)	0.4	2.0	1.2	0.1	0.6
Total N (mg/l)	91.0	558.8	335.3	41.1	167.7
Total P (mg/l)	2.4	0.6	0.4	.0	0.2

Cage Data: 7 x 7 x 2.5 m  
Biomass: 400 kg  
Feed: 3%/day; 12 kg/day

Waste production by floating net cages in the Saguling Reservoir, Indonesia.  
Date: 27-28 August 88

Parameter	Sample number					Control-environment				
	1	2	3	Mean	SD	1	2	3	Mean	SD
Dry solids (g/l)	3.6	3.4	3.2	3.4	0.2	3.9	2.0	1.4	2.4	1.1
Total C (g/l)	0.7	0.5	0.5	0.6	0.1	1.7	0.8	0.5	1.0	0.5
Total N (mg/l)	170.5	164.8	176.2	170.5	4.7	267.1	147.8	318.3	244.4	71.4
Total P (mg/l)	4.5	3.9	4.1	4.2	0.2	4.1	3.6	3.9	3.9	0.2

	g or mg/ m <sup>2</sup> /day	Per cage Mean	Loading rates		
			g or mg/ m <sup>2</sup> /day	per kg fish/day	per kg feed/day
Dry solids (g/l)	1.5	1.0	2.0	0.5	4.8
Total C (g/l)	0.6	0.0	0.0	0.0	0.0
Total N (mg/l)	146.6	0.0	0.0	0.0	0.0
Total P (mg/l)	2.3	0.3	2.5	0.7	5.9

Cage Data: 7 x 7 x 2.5 m  
Biomass: 184 kg  
Feed: 3%/day; 12 kg/day

Waste production by floating net cages in the Saguling Reservoir, Indonesia.  
Date: 27-28 August 88

Parameter	Sample number					Control-environment				
	1	2	3	Mean	SD	1	2	3	Mean	SD
Dry solids (g/l)	49.2	40.5	39.5	43.1	4.4	1.4	1.5	1.4	1.4	.0
Total C (g/l)	7.9	7.4	7.1	7.5	0.3	0.3	0.5	0.4	0.4	0.1
Total N (mg/l)	2,120.1	2,540.7	2,694.2	2,451.7	242.7	153.5	147.8	176.2	159.2	12.3
Total P (mg/l)	4.7	4.7	5.4	4.9	0.3	4.3	4.7	4.5	4.5	0.2

	g or mg/ m <sup>2</sup> /day	Per cage Mean	Loading rates		
			g or mg/ m <sup>2</sup> /day	per kg fish/day	per kg feed/day
Dry solids (g/l)	0.9	41.7	25.0	5.2	19.7
Total C (g/l)	0.2	7.1	4.2	0.9	3.3
Total N (mg/l)	95.5	2,292.5	1,375.5	283.2	1,084.1
Total P (mg/l)	2.7	0.4	0.3	0.1	0.2

Cage Data: 7 x 7 x 2.5 m  
Biomass: 238 kg  
Feed: Satiation Feeding; 12.8 kg/day

Waste production by floating net cages in the Saguling Reservoir, Indonesia.  
Date: 28-29 August 88

Parameter	Sample number					Control-environment				
	1	2	3	Mean	SD	1	2	3	Mean	SD
Dry solids (g/l)	45.7	38.7	40.4	41.6	3.0	1.4	1.5	1.4	1.4	.0
Total C (g/l)	6.7	6.0	6.3	6.3	0.3	0.3	0.5	0.4	0.4	0.1
Total N (mg/l)	1,591.5	2,415.7	1,631.3	1,879.5	379.5	153.5	147.8	176.2	159.2	12.3
Total P (mg/l)	4.7	5.4	4.3	4.8	0.5	4.3	4.7	4.5	4.5	0.2

	g or mg/ m <sup>2</sup> /day	Per cage Mean	Loading rates		
			g or mg/ m <sup>2</sup> /day	per kg fish/day	per kg feed/day
Dry solids (g/l)	0.9	40.2	24.1	6.1	51.7
Total C (g/l)	0.2	5.9	3.6	0.9	7.6
Total N (mg/l)	95.5	1,720.3	1,032.2	262.1	2,214.0
Total P (mg/l)	2.7	0.3	0.2	.0	0.4

Cage Data: 7 x 7 x 2.5 m  
Biomass: 193 kg  
Feed: 3%/day; 5.8 kg/day

## Waste production by floating net cages in the Saguling Reservoir, Indonesia.

Date: 28-29 September 88

Parameter	Sample number					Control-environment				
	1	2	3	Mean	SD	1	2	3	Mean	SD
Dry solids (g/l)	34.4	26.4	27.4	29.4	3.6	6.9	6.9	7.1	7.0	0.1
Total C (g/l)	17.9	16.7	17.4	17.3	0.5	4.1	3.1	3.9	3.7	0.4
Total N (mg/l)	940.8	1,192.8	904.4	1,012.7	128.2	728.0	756.0	523.0	669.0	103.9
Total P (mg/l)	1.5	1.3	1.2	1.3	0.1	0.6	0.5	0.3	0.5	0.1

	g or mg/ m <sup>2</sup> /day	Per cage Mean	Loading rates		
			g or mg/ m <sup>2</sup> /day	per kg fish/day	per kg feed/day
Dry solids (g/l)	4.2	22.4	13.5	3.5	11.9
Total C (g/l)	2.2	13.6	8.2	2.1	7.2
Total N (mg/l)	401.4	343.7	206.2	53.0	181.7
Total P (mg/l)	0.3	0.9	0.5	0.1	0.5

Cage Data: 7 x 7 x 2.5 m

Biomass: 190.5 kg

Feed: Satiation Feeding; 14.3 kg/day

## Waste production by floating net cages in the Saguling Reservoir, Indonesia.

Date: 28-29 September 88

Parameter	Sample number					Control-environment				
	1	2	3	Mean	SD	1	2	3	Mean	SD
Dry solids (g/l)	29.1	28.7	30.2	29.3	0.6	6.9	6.9	7.1	7.0	0.1
Total C (g/l)	11.8	11.6	12.2	11.9	0.2	4.1	3.1	3.9	3.7	0.4
Total N (mg/l)	952.0	1,260.0	948.0	1,053.3	146.1	728.0	756.0	523.0	672.0	99.7
Total P (mg/l)	1.1	1.1	0.4	0.9	0.3	0.6	0.5	0.3	0.5	0.1

	g or mg/ m <sup>2</sup> /day	Per cage Mean	Loading rates		
			g or mg/ m <sup>2</sup> /day	per kg fish/day	per kg feed/day
Dry solids (g/l)	4.2	22.4	13.4	4.0	38.9
Total C (g/l)	2.2	8.2	4.9	1.5	14.2
Total N (mg/l)	403.2	381.3	228.8	67.7	663.9
Total P (mg/l)	0.3	0.4	0.2	0.1	0.7

Cage Data: 7 x 7 x 2.5 m

Biomass: 165.5 kg

Feed: 3%/day; 5.0 kg/day

Waste production by floating net cages in the Saguling Reservoir, Indonesia.  
Date: 7-8 November 88

Parameter	Sample number					Control-environment				
	1	2	3	Mean	SD	1	2	3	Mean	SD
Dry solids (g/l)	38.6	34.2	37.5	36.8	1.9	6.5	4.7	5.3	5.5	0.7
Total C (g/l)	16.5	17.1	15.8	16.5	0.5	3.2	2.8	3.1	3.0	0.2
Total N (mg/l)	1,264.5	1,008.5	987.2	1,086.7	126.0	161.4	98.3	112.5	124.1	27.0
Total P (mg/l)	2.4	2.7	1.9	2.3	0.3	0.6	0.8	0.5	0.6	0.1

	g or mg/ m <sup>2</sup> /day	Per cage Mean	Loading rates		
			g or mg/ m <sup>2</sup> /day	per kg fish/day	per kg feed/day
Dry solids (g/l)	3.3	31.3	18.8	5.6	54.4
Total C (g/l)	1.8	13.4	8.1	2.4	23.4
Total N (mg/l)	74.4	962.7	577.6	171.0	1,675.9
Total P (mg/l)	0.4	1.7	1.0	0.3	3.0

Cage Data: 7 x 7 x 2.5 m  
Biomass: 248 kg  
Feed: 3%/day; 10.5 kg/day

Waste production by floating net cages in the Saguling Reservoir, Indonesia.  
Date: 21-22 December 88

Parameter	Sample number					Control-environment				
	1	2	3	Mean	SD	1	2	3	Mean	SD
Dry solids (g/l)	16.7	15.6	19.0	17.1	1.4	2.4	3.1	3.3	2.9	0.4
Total C (g/l)	7.9	6.3	9.5	7.9	1.3	1.2	1.7	1.4	1.4	0.2
Total N (mg/l)	526.0	487.0	634.0	549.0	62.2	92.6	78.5	61.4	77.5	12.8
Total P (mg/l)	1.0	1.2	0.9	1.0	0.2	0.4	0.4	0.5	0.4	.0

	g or mg/ m <sup>2</sup> /day	Per cage Mean	Loading rates		
			g or mg/ m <sup>2</sup> /day	per kg fish/day	per kg feed/day
Dry solids (g/l)	1.8	14.2	8.5	2.5	24.7
Total C (g/l)	0.9	6.5	3.9	1.1	11.3
Total N (mg/l)	46.5	471.5	282.9	83.8	820.8
Total P (mg/l)	0.3	0.6	0.4	0.1	1.1

Cage Data: 7 x 7 x 2.5 m  
Biomass: 122.5 kg  
Feed: 3%/day; 3.7 kg/day

# Use of Earthworm Composts and Introduction of New Systems and Techniques to Improve Production in Hatcheries and Nurseries for Common Carp (*Cyprinus carpio*)\*

**BAMBANG SUDIARTO**  
**BUDI R. ZAKARIA**  
*Institute of Ecology*  
*Padjadjaran University*  
*Jl. Sekeloa Selatan 1*  
*Bandung 40132, Indonesia*

**BARRY A. COSTA-PIERCE**  
*International Center for Living*  
*Aquatic Resources Management*  
*MC P.O. Box 1501, Makati*  
*Metro Manila, Philippines*

SUDIARTO, B., B.R. ZAKARIA and B.A. COSTA-PIERCE. 1990. Use of earthworm composts and introduction of new systems and techniques to improve production in hatcheries and nurseries for common carp (*Cyprinus carpio*), p. 272-284. In B.A. Costa-Pierce and O. Soemarwoto (eds.) Reservoir fisheries and aquaculture development for resettlement in Indonesia. ICLARM Tech. Rep. 23, 378 p.

## Abstract

Experiments to improve seed production in common carp (*Cyprinus carpio*) hatchery and nursery systems were conducted to help meet escalating demands for fish seed for expanding inland aquaculture in the Saguling-Cirata Reservoir region.

Earthworm composts using water hyacinths, rice straw, or chopped banana trunks as basic materials were applied to 40-m<sup>2</sup> hatchery-cum-nursery ponds four times over a 21-day cycle. All earthworm composts significantly ( $P < 0.05$ ; Duncan's New Multiple Range Test (DNMRT)) increased egg to fry survival rates and fingerling yields (total weight, volume) when compared to treatments where fertilizers or feeds were used alone (urea, triple superphosphate (TSP), rice bran: coconut oil cake); 13,500 to 14,500 fingerlings (1-3 cm TL) were harvested per 40-m<sup>2</sup> pond using earthworm composts compared to 1,000-8,500 for fertilizers/feeds.

Increasing canal size from 5 to 15% of rice paddy area had no significant ( $P > 0.05$ ; DNMRT) effect on fingerling survival or production over a 30-day nursery period in rice-fish culture. Significantly greater production over no feed controls was obtained, however, in paddies with 5% canal area where fingerlings were fed 20% body weight per day (BWD) of a fine rice bran for 30 days. Rice yields were not significantly different in both 5 and 15% canal sizes due to the "endong" planting method chosen.

Use of running water systems as intensive nursery systems was demonstrated. In 18- and 30-m<sup>2</sup> concrete raceway tanks, with a water flow of approximately 5 l/second and a fish stocking density of 20/m<sup>2</sup>, fish reached a mean size of 78.3-78.7 g in 30 days using a 7% to 4% BWD sliding scale of feeding (weekly downwards 1% BWD) of a 24-26% protein feed. Average individual fish weight at harvest was significantly lower ( $P < 0.05$ ; DNMRT) in the 60/m<sup>2</sup> stocking density treatments in both 18- and 30-m<sup>2</sup> tanks.

Supplemental feeding of female broodstock with 4 unconventional protein sources (earthworm, rabbit meal, *Tenebrio molitor* larvae, and *T. molitor* adult insects) mixed at 3% of the total diet with a 24-26% crude protein commercial feed for 15 days before spawning was tested. Additions of earthworm meal or *T. molitor* adult insects significantly increased ( $P < 0.05$ ; DNMRT) mean egg production per kg broodstock (17,960-24,440 vs. 11,320-13,830). Use of earthworm meal significantly increased mean fry production per kg broodstock (measured 7 days after egg hatching; 20,620 vs. 6,310-11,260).

Integration of earthworm composting and use of some readily-available on farm or waste agricultural by-products in hatchery and nursery systems for common carp could likely be a very profitable village enterprise in rural Java where these inputs would be available for labor costs only. Adding rice bran to concurrent rice-fish systems would significantly increase fingerling survival and production for little or no cost. Whole-scale conversion of running water systems (RWSs) from growout to intensive fish nursery systems may be warranted since the profitability of intensive nursery culture may be high given accelerating demands for seed fish, and market competition RWSs face from floating net cages.

\*ICLARM Contribution No. 613



## Introduction

Rapid development of intensive cage aquaculture in the Saguling and Cirata Reservoirs, West Java, has occurred from 1985 to 1989. Floating net cage aquaculture production reached 2,554 t in 1988 from 0 in 1985 (Sutandar et al. 1990). Cages used in the reservoir are largely "feedlot" growout systems which require fish seed of a 50-100 g size at stocking. It is understood that with the large increase in cage aquaculture production a concomitant increase in the requirements for fish seed to stock the cages has occurred (Costa-Pierce and Hadikusumah, this vol.; Kusnadi and Lampe, this vol.). In order for the new cage culture industry to be sustainable over the long term, research in methods to increase the availability both quantity and quality of fish seed is needed. Traditional fish nursery systems in Indonesia (rice-fish culture systems and shallow nursery ponds) give low fingerling production, and have been identified as a "bottleneck" to the efficient operation of aquaculture production networks, both in Northern Sumatra (dela Cruz 1986, 1989) and West Java (Costa-Pierce and Hadikusumah, this vol.). Therefore, improvement of fry and fingerling production in traditional hatchery and nursery systems, and introduction of modified systems, were the main objectives of our studies.

Traditional fish hatchery and nursery farmers in West Java do not prepare separate spawning or nursery ponds, but place broodstock together in a single pond with egg collectors ("kakabans"). Broodstock are removed from the pond after spawning, while egg collectors remain in the spawning pond, which becomes a nursery pond when eggs hatch 4-5 days later. After 20-30 days in the spawning-cum-first nursery pond, fish known as "kebul" (1-3 cm total length [TL]) are harvested and restocked either in concurrent rice-fish culture ("minapadi"), or in rice paddies whose dikes have been raised so it becomes a shallow pond. If these shallow, second phase nursery ponds are made between two crops of rice, the practice is called "penyelang", or, if after one crop of rice, the practice is called "palawija ikan". Due to increased market demands for fingerlings to stock the growing inland aquaculture industry of West Java, rice-fish nursery systems are becoming the central nursery systems used to grow fish to a size sufficient for resale to intensive cage, pond, or running water systems (Costa-Pierce, in press). A complete review of rice-fish systems in West Java, and their roles in Indonesian aquaculture has been recently accomplished by Koesoemadinata and Costa-Pierce (in press).

Considering that the central fish nursery system in West Java requires rice fields, fish seed production can be limited by the planting and management times for rice. This situation can result in surpluses of fish seed during certain seasons and a lack of fish in other seasons (Kusnadi and Lampe, this vol.). It is thereby necessary to develop other types of alternative fish nursery systems and management techniques that are not dependent upon the production and ecological vagaries of the rice agroecosystem.

Efficient fish hatchery operations entail the processes of broodstock care and feeding, mating, spawning, fry and fingerling nursery operations. Rice-fish culture in West Java, however, not only produces fish for further resale to farmers on-growing them to a larger size, but also produces small fish ("common carp sardines") for direct consumption by poor people. This dual role of rice-fish culture in producing seed fish and small-sized fish for direct human consumption by poor villagers in the rich rice-growing regions of West Java has been little appreciated. The total demand for small fish is not only for seed fish to restock feedlot-type inland aquaculture systems, but is also compounded by the demand for small fish for direct consumption.

Spawning, including broodstock care, mating, egg production and hatching, is a key activity in a chain of events from broodstock rearing to fry harvest. Factors which affect the success or failure of spawning include, among others, adequate land and unpolluted water resources, availability of quality broodstock, facilities and infrastructure, and the necessary knowledge and skills to operate a hatchery. In general, traditional fish farmers in West Java do not encounter significant obstacles with any of these requirements, and fish succeed in producing large

numbers of eggs due to the inherent high fecundity of common carp. However, under traditional management, eggs produced do not always hatch in great numbers, and fry production in the subsequent first and second phase nursery ponds is quite low (Suwartono 1983; Costa-Pierce et al. 1990).

In nature common carp make nests to lay their eggs. The function of these nests is to stimulate male activity and the mating process, and for egg attachment. In West Java fibers of oil palm trees (*Arenga pinnata* and *A. saccharifera*) are used as the basic materials (called "injuk") to form common carp egg collectors. Utilization of these fibers as egg collectors for common carp is unique to Indonesia. "Ijuk" has certain advantages as a material for an egg collector: it does not deteriorate rapidly and does not release any deleterious substances if submerged in water for a long time. To form egg collectors "injuk" are arranged into a rectangle by first cutting them, then combing the fibers with a wire brush. The fibers are clipped and arranged vertically across horizontal strips of split bamboo to become a "kakaban". Techniques of making "kakabans" are illustrated in Costa-Pierce et al. (1989). The sizes of "kakabans" vary immensely, depending on the region, situation, and farmers preference. The recommended size is 1 m long and 30-40 cm wide.

Newly-hatched common carp are weak and require good water quality. In order for a good egg hatch, clear, running water with a high oxygen content, a neutral pH and without environmental poisons is required (Jhingran and Pullin 1985). In addition, water used in egg hatching ponds should be filtered or chemically treated to free it from insect predators. After hatching, common carp larvae (yolk sac fry) will consume stored energy reserves for a period of 3-4 days (Sarono 1976; Atmadja 1978; Jhingran and Pullin 1985), then require immediate feeding. During the initial feeding period feed should be frequently presented at a size, quantity and quality required for further fish development. New fry at first feeding require feeds of a very high nutritional value, especially food high in protein. In nature fry feeds consist of small, slow-moving zooplankton, especially rotifers, with the size of prey increasing with the size of fry (FAO 1985a; Jhingran and Pullin 1985). Good quality feeds are also necessary to prevent fish diseases.

Plankton production in fry to fingerling nursery ponds can be improved by giving inorganic fertilizers such as urea and N-P-K, and organic fertilizers such as manures (Atmadja 1978; Das and Sinha 1985; Jhingran and Pullin 1985). Improved fingerling production can be accomplished by applying fertilizers and low concentrations of biodegradable insecticides at frequent intervals to kill insect predators and keep natural food concentrations high (dela Cruz 1986; Costa-Pierce et al. 1989, 1990). Frequent fertilization and destruction of fry predators have, however, not received serious attention by traditional hatchery farmers in West Java.

It was our intent to conduct research on some promising low-cost methods to increase fry and fingerling production in traditional common carp hatcheries and nurseries in West Java. A new, more intensive nursery system was also tested. Specific objectives of the studies reported here were: (1) to improve egg and fry production by improving broodstock feeds; (2) to introduce a new intensive fingerling production system; (3) to improve fingerling production in both traditional pond and concurrent rice-fish nursery systems.

## **Use of Earthworm Composts and Agricultural By-Products in Traditional Nursery Ponds**

### ***Materials and Methods***

Experiments tested the feasibility of using earthworm composts made from three readily-available agricultural by-products from farms in the Saguling-Cirata Reservoir region of West Java (rice straw, banana trunks, water hyacinths). The experimental design used for both

experiments was a group random design. Treatment effects were isolated by use of the Duncan's New Multiple Range Test (DNMRT).

Two experiments were conducted in 40-m<sup>2</sup> nursery ponds with a water depth of 35 cm using common carp (*Cyprinus carpio*) of the Majalaya strain. A broodstock spawning pond of 26-m<sup>2</sup> (4.0 x 6.5 m) was used for all fish spawning. Spawning and nursery ponds were sundried for 3 days before using, and water was added at a constant rate during daytime (1200-1300 hours). Water entering all ponds was filtered by using "ijuk" fibers to screen out sediment and potential predators. No water was added to the spawning pond, however, the first three days after "kakabans" full of eggs were added to prevent the loss of fry.

In the spawning pond "kakabans" were arranged and used as shown in Costa-Pierce et al. (1989). For each kg of adult female fish, 4-6 "kakaban" egg collectors 1 m long and 30 cm wide were added. One "kakaban" full of eggs (on both top and bottom surfaces) was stocked for each 40-m<sup>2</sup> pond in all experiments: 12 in the first experiment, 18 for the second. Adult broodstock ready to spawn (selected according to criteria set by FAO 1985b) were added to the spawning pond at 1300-1400 hours. Beginning about 0200 hours to just before sunrise female broodstock completed egg laying. After egg laying one "kakaban" full of eggs was transferred to a specially prepared (Sarono 1976) 40-m<sup>2</sup> egg hatching-cum-first nursery pond, and broodstock moved to separate holding ponds.

In experiment 1 a total weight of 6 kg of carp female broodstock were mated with 6 kg carp male broodstock in a 26-m<sup>2</sup> concrete pond with 24 "kakabans"; and 12 "kakabans" were selected that were full of eggs and moved to 12 hatching/nursery ponds. Four treatments were arranged, each replicated in three 40-m<sup>2</sup> ponds: 1) control--urea applied at 25 g/m<sup>2</sup> and triple superphosphate (TSP) at 12.5 g/m<sup>2</sup>; 2) water hyacinth earthworm compost (WHEC) at 925 g/m<sup>2</sup>; 3) urea at 25 g/m<sup>2</sup>, TSP at 12.5 g/m<sup>2</sup>, and a feed of rice bran and coconut oil cake mixed at a 1:1 ratio; 4) urea applied at 25 g/m<sup>2</sup>, TSP 12.5 g/m<sup>2</sup> and a mixed feed of rice bran and Ultrafint (1 kg rice bran:250 ml Ultrafint). Ultrafint is a commercially-available plant fertilizer. In treatments 3 and 4 the amount of feed was changed every 5 days: day 1-5, 20 g/pond, day 5-10, 50 g/pond, day 11-15, 60 g/pond, day 16-20, 110 g/pond as suggested by dela Cruz (1986).

In experiment 2 a total of 8 kg of carp female broodstock were mated with 8 kg of males with 32 "kakabans"; 18 "kakabans" full of eggs were moved to eighteen, 40-m<sup>2</sup> ponds. Six treatments, each replicated 3 times were: (1) urea and TSP, 1x application/spraying; (2) urea and TSP, 4x; (3) urea, TSP, rice bran: coconut oil cake, 4x; (4) water hyacinth earthworm compost (WHEC), 4x; (5) rice straw earthworm compost (RSEC), 4x; (6) banana trunk earthworm compost (BTEC), 4x. All organic and fertilizer inputs were applied at the same rates and schedules as experiment 1.

## **Results and Discussion**

Fingerling (or "kebul", fingerlings 1-3 cm total length) production reported here using composts and 4 sprayings of Sumithion EC 50 was superior on a square meter basis (337-362/m<sup>2</sup>) to production obtained by use of urea and TSP fertilizers alone (72-162/m<sup>2</sup>) (Table 1). Our results for fingerling production using chemical fertilizers alone were higher than those reported by Sulit (1957), who obtained 50 fish/m<sup>2</sup> using inorganic fertilizers of an N-P-K ratio of 8:18:4.

Using earthworm composts in this study, fry production per 40-m<sup>2</sup> pond ranged from 14,000 to 14,500, or 350 to 362 fry/m<sup>2</sup> for WHEC, and 13,500 to 13,900 (337-347/m<sup>2</sup>) in the RSE and WHE composts, respectively (Table 1). These yields were significantly greater than all other treatments tested except for the urea/TSP/coconut oil:rice bran in Experiment 1.

Fry production in traditional 20-30 day pond hatchery-cum-first nursery systems in Java is low, ranging from 16 to 69 fish/m<sup>2</sup> (1-3 cm TL per m<sup>2</sup>) (Costa-Pierce et al. 1990). The Fisheries

Table 1. Summary of two experiments on the increased use of fertilizers, a biodegradable insecticide, and earthworm composts to increase common carp fingerling production and survival 21 days after spawning in 40-m<sup>2</sup> hatchery-cum-list nursery ponds.

	Range of no. eggs per 30 x 100 cm "kakaban"	Range of egg hatching rates (%)	Range of survival rate of eggs to 21-day old fingerlings (%)	Survival Mean ± 1 S.D.	Range of total weight (g)	Range of total volume (l)	Range of total number (x 1,000 fish)	Mean length (cm)					
	Mean ± 1 S.D.	Mean ± 1 S.D.	Mean ± 1 S.D.	Mean ± 1 S.D.	Mean ± 1 S.D.	Mean ± 1 S.D.	Mean ± 1 S.D.	Mean ± 1 S.D.					
<b>Ex 1</b>													
1.	19,786-21,194	20,272 ± 799 (a)	81-93	86 ± 6 (a)	15-17	16 ± 1 (b)	213-247	225 ± 18 (b)	0.30-0.40	0.33 ± 0.06 (b)	2.6- 3.1	2.9 ± 0.3 (b)	1.9 ± 0.1 (a)
2.	19,396-23,704	21,604 ± 2,156 (a)	86-99	94 ± 7 (a)	49-89	69 ± 21 (a)	557-810	630 ± 177 (a)	1.00-1.30	1.13 ± 0.15 (a)	1.1- 1.7	14.0 ± 2.8 (a)	1.3 ± 0.1 (c)
3.	20,042-21,756	20,790 ± 878 (a)	78-96	89 ± 10 (a)	21-86	49 ± 33 (a)	279-808	531 ± 266 (a)	0.50-1.25	0.93 ± 0.39 (a)	4.1-13.0	8.5 ± 4.7 (a)	1.6 ± 0.1 (b)
4.	19,312-23,082	21,119 ± 1,889 (a)	90-94	92 ± 2 (a)	4- 6	5 ± 1 (c)	84- 95	88 ± 6 (c)	0.13-0.15	0.14 ± 0.01 (c)	0.9- 1.1	1.0 ± 0.1 (c)	1.9 ± 0.1 (a)
<b>Ex 2</b>													
1.	22,472-24,706	23,926 ± 1,260 (a)	80-87	83 ± 4 (a)	22-51	32 ± 16 (b)	294-619	404 ± 186 (b)	0.55-1.12	0.75 ± 0.32 (ab)	4.5-10.0	6.5 ± 3.1 (b)	1.6 ± 0.1 (a)
2.	20,780-22,999	22,478 ± 1,507 (a)	89-92	87 ± 6 (a)	24-31	29 ± 3 (b)	329-461	395 ± 66 (b)	0.57-0.80	0.69 ± 0.12 (b)	4.7- 6.5	5.6 ± 0.9 (b)	1.7 ± 0.1 (a)
3.	21,940-24,100	22,670 ± 1,239 (a)	85-87	86 ± 1 (a)	34-49	41 ± 7 (b)	405-578	489 ± 87 (b)	0.70-1.02	0.86 ± 0.16 (b)	6.5- 9.2	8.0 ± 1.3 (b)	1.7 ± 0.1 (a)
4.	20,298-22,882	21,980 ± 1,458 (a)	93-97	94 ± 2 (a)	56-82	70 ± 11 (a)	608-746	679 ± 69 (a)	1.09-1.30	1.22 ± 0.12 (a)	12.9-16.1	14.5 ± 1.6 (a)	1.3 ± 0.1 (b)
5.	21,940-24,230	22,963 ± 1,164 (a)	83-90	86 ± 4 (a)	57-83	68 ± 13 (a)	571-690	613 ± 86 (a)	1.11-1.28	1.17 ± 0.09 (a)	12.5-15.5	13.5 ± 1.7 (a)	1.3 ± 0.1 (b)
6.	22,600-24,760	23,450 ± 1,151 (a)	84-92	90 ± 5 (a)	55-87	66 ± 17 (a)	583-754	645 ± 94 (a)	1.12-1.59	1.28 ± 0.27 (a)	12.4-16.8	13.9 ± 2.5 (a)	1.3 ± 0.1 (b)

Office, Cianjur (1985) reported that fry production in the regency amounted to 244,455,000 fish in a nursery area of 138.7 ha, for an average fry yield of 176 fish/m<sup>2</sup>.

Use of earthworm composts applied just four times during a 21-day fish nursery period and made from widely-available agricultural by-products (rice straw, banana trunks) and a nuisance aquatic weed (water hyacinths) available for labor costs alone, could approximately double the fry production per unit area of nursery ponds existing in West Java. Integration of earthworm composting and small-scale nurseries in the rich rice-growing regions surrounding the two new reservoirs in West Java, Saguling and Cirata, could likely be a profitable village enterprise given current demands for seed fish. In addition, the Saguling Reservoir in 1988 had approximately 40 ha covered with water hyacinths, and its rapid growth was a major concern of Electric Company, Health, and Transportation authorities. Increased frequency of fertilizer use in aquaculture would cost the farmer additional operating expenses. In rural Java, farmers conserve their extremely limited cash resources as much as possible and generally avoid all risks involving new cash expenses (Edmundson and Anderson 1986). Composts would be available for labor costs alone. If villagers in the densely-populated reservoir regions could see the value of these largely neglected wastes as feed/fertilizer resources for profitable fish culture, it is anticipated they would be widely channelled into fish culture.

### **Use of Rice Bran and Wider Trenches in Concurrent Rice-Fish Culture, and the Feasibility of an Intensive Nursery System**

The traditional aquaculture production network in West Java uses rice fields as the central nursery system (Costa-Pierce, in press; Sastradiwirja, in press). After fish have reached the "kebul" size they are harvested from hatching-cum-first nursery ponds and restocked into a variety of rice-fish systems as second phase nurseries (Koesoemadinata and Costa-Pierce, in press; Costa-Pierce, in press). While fish cultivation in rice fields dates from the middle of the 19th century in West Java (Ardiwinata 1957), farmers still report low fingerling yields due to poor survival rates.

If survival rates were improved in rice-fish systems, yields of fingerlings in these nursery systems would likely increase. Yield improvement is forecast because natural fish foods are plentiful in rice fields due to frequent fertilization, plowing and drying of paddy fields in rice cultivation. The abundance of natural foods in rice fields does not mean, however, that food shortages cannot occur during the period that fish are cultivated in rice fields, since high stocking densities of fish are used, and ecological conditions can change rapidly in rice fields. The amount of natural foods is influenced by the basal fertility of the water and soils which, however, can be under the direct control of the farmer.

The need to expand rice-fish culture and increase fish production in existing systems to ensure the stability and future expansion of floating net cage aquaculture has been discussed by Kusanadi and Lampe (this vol.).

Apart from rice-fish nursery culture, the need for an intensive nursery system to enhance the fish seed supply in West Java is becoming more apparent as fish seed demands escalate. It is possible that the intensive running water systems (RWSs), a single-pass raceway system now used exclusively as a growout system (Suprayitno 1986), could become an intensive common carp nursery. According to Cruz (1986), RWSs in Indonesia can be better used for this purpose.

Nearly half of the RWSs in West Java have recently gone bankrupt due to fierce competition from cheaper fish originating from floating net cages in the Saguling and Cirata Reservoirs, and poor financial management (West Java Fisheries Agency, pers. comm.). Converting these RWSs into nursery systems could help revitalize this subsector, and help provide more fish seed for the rapidly-growing reservoir cage culture industry.

## **Materials and Methods**

### CONCURRENT RICE-FISH CULTURE EXPERIMENT

Four treatments were arranged to test if canal size and use of a readily-available agricultural by-product (rice bran) could increase fingerling production. In addition, the effects on rice yields from creating different canal sizes and using rice bran were evaluated.

Four treatments were completely randomized in duplicate rice fields: (1) 5% canal area, no feed; (2) 5% canal area, fed rice bran; (3) 15% canal area, not fed; (4) 15% canal area, fed rice bran. Feeding of rice bran was done once daily at a rate of 20% of the fish biomass at stocking throughout the experimental period. Fish yields after 30 days and rice yields after 110 days were analyzed using Duncan's New Multiple Range Test (DNMRT). The stocking density in all rice paddies was 5/m<sup>2</sup> of 1-3 cm TL (20-30 days old) common carp of the Majalaya strain at 270 g per 200 m<sup>2</sup> paddy. Controls were duplicate rice fields with canals comprising 5% of the total area of 200-m<sup>2</sup>, and fish not fed.

To conserve rice yields a planting technique devised by rice-fish farmers in West Java was used, known as the "endong" planting method. Traditionally rice plants are planted in the paddy at distances of 25 x 25 cm. Canals for fish are commonly 50 cm in width, so a row of rice plants is lost if the traditional planting method and one single trench stretching across the rice field area is used. With "endong" planting, however, the plants that are lost from the fish canal area are moved to the two rows of plants alongside of the canal for fish. The planting density in these two rows is thereby doubled, e.g., plants are spaced at 12.5 cm. Farmers reported that this planting scheme does not lead to any decrease in rice yields in concurrent rice-fish culture, and in some cases higher rice yields have been reported. In this experiment two canal widths were chosen, 50 and 150 cm. In the latter treatment 5 rows of rice plants were lost. This necessitated that all plants in the entire 200-m<sup>2</sup> experimental paddies be planted at a 12.5 cm spacing.

All rice paddies used in this experiment were fertilized at a rate commonly used by farmers: urea (250 kg/ha) and TSP (100 kg/ha). Fertilizing was done by hand three times, when rice plants were 1 week, 3 weeks, and 45 days old, with the same quantity at each application. Use of insecticide (Diazinon) was made according to "integrated pest management" (IPM) procedures. In IPM the amount of insecticide used is adjusted to the extent of insect damage. During our experiment no spraying was necessary as the rice was not attacked by insects.

### RUNNING WATER SYSTEM NURSERY EXPERIMENT

In this experiment common carp of the Majalaya strain were used. Mean fish size ( $\pm 1SD$ ) was  $30 \pm 5$  g. Four treatments were tested, each in triplicate concrete tanks, over a 30-day period. Two size tanks and two different fish stocking densities were chosen. Treatments were: (1) 20 fish/m<sup>2</sup>, tank size 30-m<sup>2</sup>; (2) 20 fish/m<sup>2</sup>, tank 18-m<sup>2</sup>; (3) 60 fish/m<sup>2</sup>, tank 30-m<sup>2</sup>; (4) 60 fish/m<sup>2</sup>, tank 18-m<sup>2</sup>. All tanks had a water depth of 80 cm with a water flow rate of approximately 4-6 l/second. Fish were fed a commercial 24-26% protein feed at 7% fish body weight per day (BWD) of the initial fish stocking weight for the first week. After this, fish feeding rates were decreased 1% per week each week until the final, fourth week of the experiment. Feeding rates were adjusted weekly by draining all water from the tanks to obtain a total weight of the fish. The daily ration of feed was given in three equal portions at sunrise-0800, 1200-1400, and 1600-1800 hours.

Treatment differences were isolated using DNMRT.

## Results

### CONCURRENT RICE-FISH CULTURE EXPERIMENT

Fish survival rates and weight increases for all treatments are shown in Table 2.

Survival rates were significantly increased by increasing canal size or feeding rice bran. Feeding or increasing canal size alone significantly increased ( $P < 0.05$ ; DNMRT) fingerling production and fish growth rates over the control (Table 2). The data indicate that no additional benefit was derived from simultaneously feeding rice bran with an increased canal size.

Data on rice production are shown in Table 3. No significant differences in rice production were noted among the treatments.

Table 2. Mean growth rate (weight increase in per cent), increase in volume, and survival rates for common carp fingerlings in concurrent rice-fish culture with different size canals and feeding rice bran or not. Fingerlings 1-3 cm TL were stocked in all treatments.

Treatment (canal size; feeding)	Total stocking weight (g)	Harvest weight (g)	Net gain (g)	% Gain	Total stocking number	Range of number at harvest	Mean number at harvest	Mean survival (%)
5%; No feeding (control)	270	1,900	1,630	604 (b)	1,000	570-734	652	65 (b)
5%; Fed rice bran	270	2,900	2,630	974 (a)	1,000	729-755	742	74 (a)
15%; No feeding	270	2,620	2,350	870 (a)	1,000	723-739	731	73 (a)
15%; Fed rice bran	270	2,500	2,230	826 (a)	1,000	502-609	556	56 (b)

Note: Different letters following numbers indicate significant differences at the 95% level.

Table 3. Effects of canal size on rice production (kg) in 110 days in concurrent rice-fish culture. Plots were 200 m<sup>2</sup>.

Treatment	Range (kg/200 m <sup>2</sup> )	Rice production (kg/200 m <sup>2</sup> )
No feeding	159-165	162 a
Canal size 5%; no feed	164-169	167 a
Canal size 5%; with rice bran	166-172	169 a
Canal size 15%; no feed	164-166	165 a
Canal size 15%; with rice bran	166-168	167 a

### RUNNING WATER SYSTEMS NURSERY EXPERIMENT

Fingerling production in the RWSs is shown in Table 4.

A stocking rate of 20/m<sup>2</sup> gave significantly larger mean weight and TL fish after 4 weeks in both 18 and 30-m<sup>2</sup> tank sizes.

Treatments with the largest total net weight gains produced smaller mean individual weights at harvest (Table 4). No significant differences occurred between food conversion ratios for any treatment (range = 1.7-2.0).

## Discussion

For concurrent rice-fish culture a ditch size 50-100 cm wide with a depth of 40-50 cm and length of 10-15 m are recommended (dela Cruz 1986). Water flow should range between 2 and 5 l/second per 500-1,000-m<sup>2</sup> of land, especially during the day to prevent high water temperatures in the shallow water. Traditionally in Indonesia 2-4% (Sastradiwirja, in press), or 5-10%

Table 4. Summary of intensive common carp nursery experiment in 18 and 30 m<sup>2</sup> running water systems over a 30-day rearing period using different stocking densities.

Treatments (Tank size; Stocking rate)	Total stocking weight (kg) ± 1 S.D.	Total harvest weight (kg) ± 1 S.D.	Mean net weight gains (kg)	Mean ± 1 S.D. feed used (kg)	Mean ± 1 S.D. food conversion ratio	Mean ± 1 S.D. increase in fish length (cm)	Mean ± 1 S.D. individual fish weight at harvest (g)
- 30 m <sup>2</sup> , 60 fish/m <sup>2</sup>	55.1 ± 0.6	118.3 ± 5.8	63.2 (a)	116.6 ± 2.6 (a)	1.8 ± 0.2 (a)	2.6 ± 0.2 (a)	65.7 ± 3.2 (b)
- 30 m <sup>2</sup> , 20 fish/m <sup>2</sup>	19.1 ± 0.1	47.0 ± 6.6	27.9 (c)	44.3 ± 1.9 (c)	1.7 ± 0.5 (a)	3.0 ± 0.2 (a)	78.3 ± 10.9 (ab)
- 18 m <sup>2</sup> , 60 fish/m <sup>2</sup>	33.8 ± 0.1	71.0 ± 3.6	37.2 (b)	72.6 ± 7.7 (b)	2.0 ± 0.2 (a)	2.7 ± 0.4 (a)	65.7 ± 3.3 (b)
- 18 m <sup>2</sup> , 20 fish/m <sup>2</sup>	11.2 ± 0.1	28.4 ± 2.9	17.2 (d)	29.1 ± 1.4 (d)	1.7 ± 0.3 (a)	3.0 ± 0.2 (a)	78.7 ± 8.0 (a)

Note: Different letters following numbers indicate significant differences at the 95% level.

(Khoo and Tan 1980), of the total area of a rice field in concurrent rice-fish culture is taken up by refuge canals created for fish when rice fields are drained for weeding.

Our results with concurrent rice-fish culture do not completely conform to the assumption that the greater the canal size, the greater the fish survival rate and production (de la Cruz 1986). Fish survival was improved by either increasing canal size from 5 to 15% of the total area of the paddy, or by feeding rice bran. Fish survival did not increase beyond these levels by combining larger canal size and feeding rice bran because of an increase in the numbers and kinds of predators eating fish in these paddies (observational data only). Increased numbers of water birds, insect predators, snakes, predatory fish (snakeheads), freshwater eels (*Fluta alba*), and frogs occurred as the canal size was increased from 5 to 15%.

Mechanical methods may be used to decrease some of these predators in concurrent rice-fish culture. Bamboo traps have been shown effective for capturing snakes and eels by the Research Institute for Food Crops (Sukamandi, West Java). In Banjarnegara, Central Java (field visit, 1984) a bamboo trap was positioned near pond inlets to capture water insect larvae (*Hydrophilus* sp.).

Surprisingly no significant differences in rice production occurred. This result means that rice planting distances can be decreased to accommodate fish production; rice yields will remain approximately the same if plants are relocated in the paddy. It is possible that increased fish swimming and "rooting" activities assisted in distributing nutrients more "uniformly" within the densely-planted rice. According to Suriapermana (1988) rice production in concurrent rice-fish farming over 110 days was higher (11,708 kg/ha) in comparison with rice monoculture (11,268 kg/ha). Rice yields in our experiments were substantially lower than this, extrapolated to 8.1 to 8.4 t/ha, possibly due to the different (local, not HYVs) varieties used.

On the basis of results obtained in this experiment, it is recommended to keep rice fields with the traditional canal size, approximately 5% of the area of the paddy, and feed fish daily a finely-ground rice bran at 20% of the initial stocking weight. Rice planting in concurrent rice-fish culture should use the "endong" method to conserve total rice yields.

Conversion of running water systems from an intensive growout to intensive nursery system for common carp shows potential for revitalizing a troubled segment of the aquaculture production network for common carp in West Java. In the experiment conducted in 18- and 30-m<sup>2</sup> concrete tanks with fish stocked at 20/m<sup>2</sup> the mean weight of fish increased from 30.0 g at stocking to 78.3-78.7 g over a 30-day period. The mean food conversion ratio (FCR) was 1.7.

Cruz (1986) reported the use of a 34-m<sup>2</sup> RWS tank having a continuous water flow rate of 60-65 l/second for the nursery culture of common carp in North Sumatra, Indonesia. Fish were stocked at a mean weight of 28.7 g, at a density of 30/m<sup>2</sup> and fed at 7% BWD of a 30.3% crude protein feed given five times daily, in five unequal portions (0700 hours = 15% of ration; 0930 = 17.5%; 1200 = 22.5%; 1430 = 22.5%; 1700 = 22.5%) throughout the trial. More feed was given in the afternoon since it was found that fish fed more actively at this time. After 35 days, fish had increased to a mean size of 216.5 g, at an FCR of 1.3. Growth rate was 5.4 g/day.



These figures are far superior to the trial we conducted. It is recommended that in nursery culture in RWSs a higher protein feed be fed at more frequent intervals as in Cruz (1986), and that higher water flows, if possible at a particular site, be used. However, the mean size of fish obtained in our experiment after 30 days using a lower protein feed (24-26%) fed less frequently, and at very reduced water flow rates, are large enough to stock directly into floating net cages for further growout.

Based on the two experiments carried out here, it can be concluded that efforts to increase common carp fish seed production can be accomplished by addition of rice bran to existing concurrent rice-fish systems and the conversion of RWSs to intensive nurseries. These very simple techniques and others like them can be accomplished for little additional operational costs or major governmental investments in new infrastructure, and can greatly assist the requirements of the region's fish farmers for increased quantity and quality of fish seed to stock the expanding numbers of floating net cages in the Saguling and Cirata Reservoirs. Extension and training programs to demonstrate the methods of earthworm composts in hatchery-cum-first nursery ponds, the use rice bran in rice-fish culture, and procedures on how to convert the disused or economically-failing running water systems into intensive common carp nursery systems are recommended.

### **Use of Unconventional Protein Sources as Supplemental Food for Common Carp Broodstock**

A successful fish hatchery operation must pay proper attention to broodstock feeding and care (FAO 1985b). Broodstock feeds can influence the amount of egg production and survival of fry and fingerlings. Poor quality broodstock feeds can lead to decreased fecundity, poor fry survival and fingerling diseases.

Post (1977) and Jhingran and Pullin (1985) have shown that the protein content for common carp broodstock should be 28-32%, and of a quality that contains the 10 essential amino acids. Lack of one or more amino acids can cause poor health and decreased fry production. FAO (1985b) reported that to achieve good egg production from common carp broodstock it is necessary to feed a mixed feed comprised of 50% animal protein and 50% carbohydrate, supplemented by a vitamin and mineral mix. Animal proteins that have been used are: fish, meat or blood meal, fresh blood, slaughterhouse wastes, frogs, insects, earthworms, and silk pupae.

To date common carp hatchery operations conducted by farmers in West Java ignore the special needs of adequate broodstock nutrition. Broodstock are fed with feeds as they are available, oftentimes of a very low protein content. Several farmers interviewed during the course of this study said they used a commercial feed having a protein content averaging 30%. However it appeared that this expensive feed was not always available due to the farmer's lack of cash.

In this connection an experiment on supplemental feeding of common carp broodstock was carried out to test the use of some unconventional animal and insect protein sources as supplemental feeds for common carp broodstock. The sources used were earthworm, rabbit, adult "Hong Kong" insects (*Tenebrio molitor*), and larval *T. molitor*. All of these protein sources except the latter two were newly available in villages surrounding the Saguling and Cirata Reservoirs due to the current IOE/ICLARM research and development program (see Maskana et al., this vol.).

### **Materials and Methods**

Female broodstock used in this experiment were of the Majalaya strain. Females were 2 years old, 1.5-2.4 kg, while males averaged 1.6-3.2 kg/fish. Four treatments were set up

comprising: (1) 97% Comfeed and 3% rabbit meal; (2) 97% Comfeed and 3% earthworms; (3) 97% Comfeed and 3% adult *Tenebrio molitor*; (4) 97% Comfeed and 3% *T. molitor* larvae. The control was broodstock fed 100% commercial feed (Comfeed, Cirebon, Indonesia) having a reported 24-26% crude protein content. Each treatment was replicated 3 times.

Broodstock were fed 3% of their initial body weight at stocking twice a day (early morning, sunset). After a 15-day period of feeding broodstock were spawned at the same time. One pond was used for each individual female broodstock stocked at 1:1 on a total weight basis with several male broodstock using methods outlined previously in this chapter, and shown in Costa-Pierce et al. (1989). The numbers of "kakaban" for each pond was adjusted to the female broodstock weight. Four "kakabans" were used for each kg of female weight stocked. All "kakabans" measured 100 cm long and 30 cm wide. After each female spawned, the number of eggs produced were counted on each "kakaban" according to the methods outlined in Costa-Pierce et al. (1990). Each "kakaban" was then individually added to a single 40-m<sup>2</sup> nursery pond, and eggs hatched. Following hatching, fry were reared for 3 days in the nursery ponds with no additions of feeds or other management inputs. At this time all ponds were drained and the number of fish counted.

## Results

Supplementary feeding of earthworms significantly increased ( $P < 0.05$ ; DNMRT) the mean production of eggs and fry per kg of female broodstock when compared with other animal protein supplements tested (Table 5). Mean egg production per kg of female broodstock was, however, not significantly different at the 95% level of probability between the earthworm and *T. molitor* supplemental protein sources. Supplementation of earthworms also significantly increased male and female broodstock weight gain in 15 days (Table 5).

Table 5. Effects on egg and fry production of giving some unconventional protein sources as supplements to a 24-26% crude protein commercial feed to common carp broodstock for 15 days.

Feed treatment	Initial broodstock weight (kg)				Final broodstock weight (kg)			
	Males		Females		Males		Females	
	Range	$\bar{X} \pm 1$ S.D.	Range	$\bar{X} \pm 1$ S.D.	Range	$\bar{X} \pm 1$ S.D.	Range	$\bar{X} \pm 1$ S.D.
Comfeed	1.97-3.10	2.42 $\pm$ 0.60	1.50-2.18	1.93 $\pm$ 0.37	2.25-3.40	2.72 $\pm$ 0.61	1.65-2.20	2.02 $\pm$ 0.32
Comfeed + Rabbit meal	2.10-2.80	2.40 $\pm$ 0.36	1.80-2.30	2.07 $\pm$ 0.25	2.30-3.20	2.67 $\pm$ 0.47	2.00-2.50	2.30 $\pm$ 0.26
Comfeed + Earthworm meal	1.60-3.20	2.37 $\pm$ 0.80	1.55-2.33	1.94 $\pm$ 0.39	2.10-3.90	2.93 $\pm$ 0.91	2.00-2.70	2.33 $\pm$ 0.35
Comfeed + <i>Tenebrio molitor</i> adults	2.25-2.90	2.48 $\pm$ 0.36	1.70-2.20	2.00 $\pm$ 0.27	2.50-3.30	2.78 $\pm$ 0.45	1.90-2.40	2.23 $\pm$ 0.29
Comfeed + <i>T. molitor</i> larvae	2.30-2.50	2.42 $\pm$ 0.10	1.70-2.40	1.97 $\pm$ 0.38	2.53-2.74	2.62 $\pm$ 0.11	1.75-2.60	2.18 $\pm$ 0.43

Feed treatment	Mean of broodstock weight gain $\pm 1$ S.D.				Range of egg production (1,000 eggs/kg broodstock)	Mean egg production $\pm 1$ S.D. (1,000 eggs/kg broodstock)	Range of fry production (1,000 eggs/kg broodstock)	Mean fry production $\pm 1$ S.D. (1,000 fish/kg broodstock)
	Males (kg)	Males (%)	Females (kg)	Females (%)				
Comfeed	0.29 $\pm$ 0.01	12.5 $\pm$ 2.44 (b)	0.09 $\pm$ 0.06	5.30 $\pm$ 4.45 (c)	4.42-15.40	11.32 $\pm$ 6.01 (b)	3.28- 8.74	6.31 $\pm$ 2.78 (b)
Comfeed + Rabbit meal	0.27 $\pm$ 0.12	10.8 $\pm$ 3.03 (b)	0.23 $\pm$ 0.06	11.37 $\pm$ 2.80 (ab)	10.13-13.59	12.12 $\pm$ 1.79 (b)	7.75-11.31	9.07 $\pm$ 1.95 (b)
Comfeed + Earthworm meal	0.57 $\pm$ 0.12	24.9 $\pm$ 5.49 (a)	0.39 $\pm$ 0.05	21.04 $\pm$ 6.98 (a)	19.91-27.09	24.44 $\pm$ 3.94 (a)	15.14-24.42	20.62 $\pm$ 4.96 (a)
Comfeed + <i>Tenebrio molitor</i> adults	0.30 $\pm$ 0.09	11.9 $\pm$ 1.62 (b)	0.23 $\pm$ 0.06	11.72 $\pm$ 2.60 (ab)	11.43-21.24	17.96 $\pm$ 5.65 (ab)	6.85-13.90	11.26 $\pm$ 3.85 (b)
Comfeed + <i>T. molitor</i> larvae	0.21 $\pm$ 0.05	8.6 $\pm$ 2.15 (bc)	0.36 $\pm$ 0.15	19.99 $\pm$ 10.72 (ab)	11.96-15.19	13.83 $\pm$ 1.69 (b)	7.87-10.39	8.84 $\pm$ 1.36 (b)

Note: Different letters following numbers indicate significant differences at the 95% level.

## Discussion

FAO (1985b) recommends that broodstock feeds for common carp be 30-40% protein to ensure rapid egg development and prevent the accumulation of fat in the gonads. Fish feeds widely available in villages surrounding the Saguling and Cirata Reservoirs are low in protein, 24-25%. Addition of small amounts of an animal protein meal to these feeds could markedly increase egg and fry production from common carp broodstock in village hatcheries.

A development program has been carried out to promote the culture of rabbits, earthworms, and *T. molitor* in villages surrounding the new reservoirs (Maskana et al., this vol.). These animals may have market potential not only as human food, and fish food for small-scale growout operations, but also as a supplemental food for common carp broodstock to increase broodstock egg and fry production. In the case of growing earthworms, this animal can sufficiently upgrade the nutrient value of some readily-available agricultural by-products and nuisance aquatic weeds by composting. These composts have been shown to be valuable inputs for common carp nursery ponds. In addition the adult worms can be used to supplement broodstock rations in small-scale common carp hatcheries.

## Acknowledgements

We acknowledge the hard work and long hours in the field and at the computer of Ms. Iyay Syamsiah in these experiments. Dr. C.R. dela Cruz and Ir. Gelar Wiraatmadja assisted with designs and ideas of the experimental work.

The secretarial assistance of Yati, Sri and Oboy are gratefully acknowledged.

## References

- Ardiwinata. 1957. Fish culture in paddy fields in Indonesia. Indo-Pacific Fisheries Council Proceedings 7th Session, Bandung, Indonesia, 13-27 May 1957.
- Atmadja, H. 1978. Budidaya ikan mas, ikan tawes, ikan nilem. Sekolah Usaha Perikanan Menengah Budidaya, Bogor.
- Costa Pierce, B. A. Rice fish systems as intensive nurseries. In C. Lightfoot, B.A. Costa-Pierce, C. dela Cruz and V. Carangal (eds.) Rice-fish research and development in Asia. ICLARM, IRRI and CLSU, Philippines. (In press).
- Costa-Pierce, B.A., Rusydi, A. Safari and G. Wira Atmadja. 1989. A small-scale hatchery for common carp. ICLARM Education Series 8, 42 p. Institute of Ecology, Indonesian State Electric Company (IOE UNPAD-PLN), Bandung Indonesia, and International Center for Living Aquatic Resources Management, Manila, Philippines.
- Costa-Pierce, B.A., B. Sudiarto, O. Soemarwoto and C.R. dela Cruz. 1990. Improved traditional hatchery technology for common carp (*Cyprinus carpio*) in West Java, Indonesia, p. 217-220. In R. Hirano p. 217-220. In R. Hirano and I. Hanyu (eds.) The Second Asian Fisheries Forum. 991 p. Asian Fisheries Society, Manila, Philippines.
- Cruz, E.M. 1986. Report on the feeding trial in running water system at BBI Sentral, Karasaan. Simalungun, North Sumatra. (Unpublished).
- Das, P. and M. Sinha. 1985. Package of practices for increasing production. Information and extension divisions of CIFRI. Central Inland Fisheries Research Institute, Barrackpore-743101, India.
- dela Cruz, C.R. 1986. Petunjuk pelaksanaan budidaya mina-padi. Proyek kerjasama antara USAID dengan Direktorat Jenderal Perikanan, Indonesia, 1986. (Final report. Small-scale fisheries development project. Rice-fish culture sub-project). USAID/ARD Project No. 497-0286, Jakarta, Indonesia.
- dela Cruz, C.R. 1989. Fingerling production trials in rice fields in North Sumatra, Indonesia, p. 97-109. In E.A. Huisman, N. Zonneveld and A.H.M. Bouwmans (eds.) Aquacultural research in Asia: management techniques and nutrition. Centre for Agricultural Publishing and Documentation. Pudoc Wageningen, The Netherlands.
- Edmundson, W.C. and S. Anderson. 1986. Geographic variation and changing economic status in two Javanese villages. Singapore J. Trop. Geog. 7: 28-39.
- FAO. 1985a. Common carp. 2. Mass production of advanced fry and fingerlings in ponds. FAO Training Series 9, Rome, Italy.
- FAO. 1985b. Common carp. 1. Mass production of egg and early fry. FAO Training Series 8, Rome, Italy.
- Fisheries Office, Cianjur. 1985. Annual report, 1985. West Java Fisheries Agency, Bandung, Indonesia. (In Indonesian).
- Jhingran, V.G. and R.S.V. Pullin. 1985. A hatchery manual for the common, Chinese and Indian major carps. ICLARM Studies and Reviews 11. 191 p. Asian Development Bank, Manila and International Center for Living Aquatic Resources Management, Manila, Philippines.
- Kho, K.H. and E.S.P. Tan. 1980. Review of rice-fish culture in Southeast Asia, p. 1-14. In R.S.V. Pullin and Z.H. Shehadeh (eds.) Integrated agriculture-aquaculture farming systems. ICLARM Conference Proceedings 4, 258 p. International Center for Living Aquatic Resources Management, Manila, and the Southeast Asian Center for Graduate Study and Research in Agriculture, Laguna, Philippines.

- Koesoemadinata, S. and B.A. Costa-Pierce. Status of rice-fish culture in Indonesia. *In* C. Lightfoot, B.A. Costa-Pierce, C. dela Cruz and V. Carangal (eds.) Rice-fish research and development in Asia. ICLARM, IRRI and CLSU, Philippines. (In press).
- Post, G. 1977. Nutrient requirements of warm water fishes. National Academy of Sciences, Washington, DC, USA.
- Sarono, A. 1976. Dasar-dasar perikanan umum dan pengembangannya. Teknik pembenihan ikan dan non ikan. Sekolah Usaha Perikanan Menengah Bogor.
- Sastradiwirja, F. Resource utilization in rice-fish farming. *In* C. Lightfoot, B.A. Costa-Pierce, C. dela Cruz and V. Carangal (eds.) Rice-fish research and development in Asia. ICLARM, IRRI and CLSU, Philippines. (In press).
- Sulit, J.I., R.S. Esguerra and H.P. Rabanal. 1958. Fertilization of "bangos" nursery ponds with commercial chemical fertilizer. Abstract, Seventh Session, Indo-Pacific Fisheries Council Proceedings, 13-27 May 1957, Bandung, Indonesia. IFPC Secretariat, Bangkok, Thailand.
- Suprayitno, S.H. 1986. Manual of running water fish culture. ASEAN/UNDP/FAO Manual No. 1. Regional Small-Scale Coastal Fisheries Development Project, Manila, Philippines.
- Suriapermana, S. 1988. Optimasi daya dukung lahan dengan sistem usaha tani terpadu mina-padi dan itik pada lahan sawah beririgasi. Simposium Penelitian Tanaman Pangan II, Bogor, 21-23 Maret 1988.
- Sutandar, Z., B.A. Costa-Pierce, Iskandar, Rusydi and H. Hadikusumah. 1990. The aquaculture resettlement option in the Saguling Reservoir, Indonesia: its contribution to an environmentally-oriented hydropower project, p. 253-258. *In* R. Hirano and I. Hanyu (eds.) The Second Asian Fisheries Forum. 991 p. Asian Fisheries Society, Manila, Philippines.
- Suwartono, D. 1983. Practices with common carp (*Cyprinus carpio*) broodstock in fish hatcheries in Banjarnegara, Magelang regencies (Central Java), Malang and Blitar regencies (East Java). Institut Pertanian Bogor. 68 p. M.Sc. thesis. (In Indonesian).

# Fisheries of the Saguling Reservoir and A Preliminary Appraisal of Management Options\*

**JOHN L. MUNRO**

*ICLARM South Pacific Office  
P.O. Box 438  
Honiara, Solomon Islands*

**ISKANDAR\*\***

*Institute of Ecology  
Padjadjaran University  
Jl. Sekeloa Selatan 1  
Bandung 40132, Indonesia*

**BARRY A. COSTA-PIERCE**

*International Center for Living Aquatic  
Resources Management  
MC P.O. Box 1501  
Makati, Metro Manila, Philippines*

MUNRO, J.L., ISKANDAR and B.A. COSTA-PIERCE. 1990. Fisheries of the Saguling Reservoir and a preliminary appraisal of management options, p. 285-328. In B.A. Costa-Pierce and O. Soemarwoto (eds.) Reservoir fisheries and aquaculture development for resettlement in Indonesia. ICLARM Tech. Rep. 23, 378 p.

## Abstract

An intensive study of the fish stocks of Saguling Reservoir over a one-year period showed that stocks were very sparse and it is surmised that unstable and adverse environmental conditions in the newly filled reservoir, combined with heavy fishing, has prevented the establishment of substantial fish stocks.

*Hampala macrolepidota*, a predatory cyprinid, totally dominates the fish fauna. Mesh selection curves, growth and mortality rates and yield-per-recruit curves were estimated for this species.

Management recommendations include the introduction of a planktivorous clupeid and of *Tilapia rendalli*, the supplementation of natural recruitment of desirable species by stocking hatchery-reared juvenile carp and tilapia, the creation of protected areas and the implementation of a management regime which would include the issue of individual, saleable, transferable fishing licenses to fishermen currently participating in the fishery.

## Introduction

Three large multipurpose reservoirs have been constructed on the Citarum River, West Java, Indonesia. Two of these, Saguling and Cirata, are new since 1985. This report is a preliminary appraisal of the status of fish stocks in the Saguling Reservoir and of possible mechanisms for enhancing capture fisheries of the reservoirs. It must be recognized that both

---

\*ICLARM Contribution No. 521.

\*\*Present address: Department of Fisheries, Faculty of Agriculture, Padjadjaran University, Jatinangor, Sumedang 45363, Indonesia.

reservoirs are in highly unstable phases. Saguling Reservoir was drawn down to nearly a third of its maximum area in order to fill the new downstream Cirata Reservoir from July to December 1987. Saguling was planned to return to its mean high water level (HWL) by July 1988 but, due to an abnormally dry year, the reservoir remained 10-15 m below its HWL in November 1988. Cirata reached its HWL at the end of December 1987 but its level dropped quickly due to the lengthy dry season in 1988 and the needs of the electric company to test its new turbines. As a result of good rains in the 1988-1989 rainy season, both reservoirs were close to capacity by the end of March 1989.

The consequence of this destabilization is that the reproductive cycles of most fish species will have been seriously disrupted in Saguling Reservoir. Cirata is still stabilizing and fish stocks building up from a zero base. Certain actions can be taken at this time to ameliorate the effects of destabilization of Saguling and to enhance possible outputs from Cirata. These are discussed in detail in the following sections.

### ***Limits to Production***

One of the most important points to be recognized in any fishery is that limits to fish production are imposed by the aquatic ecosystem and that no amount of management and enhancement will increase production of wild fish stocks beyond certain biologically imposed limits. Thus, in a well-managed shallow tropical reservoir, fishery harvests do not normally exceed 50-150 kg/ha/year and deeper reservoirs can expect substantially less because much of the bottom lies in the deoxygenated hypolimnion below the thermocline. Yap (1987) has pointed out that fish yields from Asian reservoirs are usually very low and seldom exceed 50 kg/ha/year.

The morpho-edaphic index (MEI) devised by Ryder (1965) was extended to the prediction of fish yields from tropical lakes and reservoirs by Henderson and Welcomme (1974) and further developed by Toews and Griffiths (1979).

The MEI = conductivity/mean depth and

$$\text{Yield} = 14.3136 \text{ MEI}^{0.4681}$$

Alternatively,

$$\text{Log } Y = 1.4071 + 0.3697 \log \text{MEI} - 0.00004565 A_0$$

where  $A_0$  is the area of the reservoir in km<sup>2</sup>.

These formulae are known to be conservative in cases where there is a high loading of organic pollutants such as sewage draining into a lake (Marshall 1984).

Monthly monitoring of ten stations throughout 1987-88 (see Table 3) showed that Saguling's conductivity at 20 cm water depth averaged 230  $\mu\text{mhos/cm}$  (range 130-385) in 1987 and 171  $\mu\text{mhos/cm}$  (range 70-400) in 1988. Calculating MEIs and yields from the formulae above using a mean depth of Saguling of 17.5 m gives a predicted fish production of 42-48 kg/ha/year, or 235-269 t/year.

Thus, it can be predicted that the capture fisheries in the 5,607-ha Saguling Reservoir are very unlikely to yield more than 841 t/year (150 kg/ha/year), even with expert management, and that a total harvest of as little as 168 t/year (30 kg/ha/year) is not unlikely if the fishery is not managed. A "most likely" estimate based upon the MEI and observations elsewhere suggests that a reference figure of 252 t/year (45 kg/ha/year) be taken as a preliminary target.

The Cirata Reservoir has an area of 6,200 ha and an average depth of 34.9 m and is thus much deeper than Saguling, much less dendritic, and has a far greater pelagic environment. Capture fisheries are likely to be confined to the littoral zone within depths of 10 m or less unless new species can be introduced to fill vacant pelagic niches. At a first guess harvests of

demersal fishes are highly unlikely to exceed 300 t/year (about 50 kg/ha/year) and would be more likely to be around half that value (150 t/year or 25 kg/ha/year).

The Jatiluhur Reservoir (8,300 ha and 36.4 m average depth) in the lower reaches of the Citarum River produced 182 t/year over a 15-year period (Krismono et al. 1983), thus averaging 22 kg/ha/year. The 545 fishermen each caught 334 kg/year (Sarnita 1976). Jatiluhur fish production dropped to 10-18 kg/ha/year from 1972 to 1978 (Kartamihardja and Hardjamulia 1983), but Hardjamulia et al. (1988) report that a production rate of 28-30 kg/ha/year has been attained in recent years.

## Objectives

The objectives of this study were to make a preliminary appraisal of the status of the fish stocks in the Saguling Reservoir and to formulate recommendations for the management of the stocks. Management recommendations were to include introductions of fish species which might contribute to the efficient use of the trophic resources of the reservoir.

A secondary objective was to utilize the experience gained in Saguling to anticipate management problems which may arise in the newer Cirata Reservoir, downstream from Saguling.

Overlying all of the above is the primary objective of gaining the maximum economic return from the reservoir in order to benefit those members of the local communities who have turned to fishing the open waters of these reservoirs as a source of livelihood.

It is emphasized that no final appraisal of the fisheries potential of Saguling is currently possible because the fish stocks have not stabilized and have been further disrupted by the recent drawdown of Saguling in order to fill Cirata.

## Methods

After preliminary investigations from February to August 1987, a regular sampling program was established. Preliminaries included the following:

- a) division of the reservoir into four sectors: North, River, South, West (Fig. 1), and identification of a base station at a site near the predicted lower limits of the expected drawdown and located as conveniently as possible relative to Bandung to minimize travel time;
- b) construction of four fleets each consisting of nine different mesh size gill nets (a total of 36 nets) of exact specifications (1", 1.5", 2", 2.5", 3", 3.5", 4", 4.5", 5");
- c) acquisition of a 6-m long outboard powered skiff for fishing. This is a very simple flat-bottomed work boat, with a small foredeck, open space in the front half for nets and a covered rear portion. Equipment included lifejackets for all crew, an anchor and anchor line, a 25-hp outboard motor, two fuel tanks and a simple tool kit;
- d) acquisition of all scientific gear necessary for the program, such as log books, measuring boards, scales and fluorescent lanterns.

From 4 August 1987 to 8 August 1988 the main sampling program was executed. This involved:

- a) implementation of a regular weekly sampling program on a four-weekly (lunar monthly) cycle, in which the Southern, River, Northern and Western Sectors of Saguling Reservoir were sampled on successive weeks, starting in the week of 2 August and continuing for the next 53 weeks, except for a break in the week starting 28 December. This break was to permit the sampling in the River Sector to again fall within the full moon period. The routine order of sampling remained basically unchanged so that each sector was fished on the same lunar quarter throughout the period. This served to eliminate lunar variability in catch rates at each sampling station from the data. Time did not permit a comparative experiment to check lunar variability in one area over a full lunar month but this could be set up at a later time;

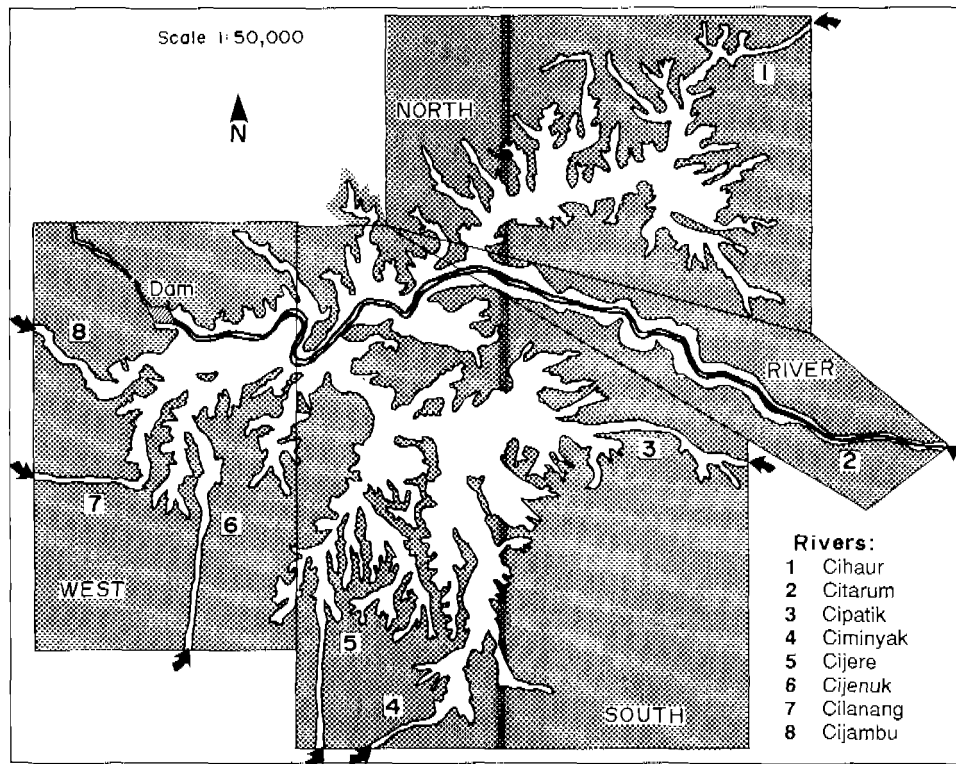

Fig. 1. Map of the Saguling Reservoir showing rivers emptying into it and the division of the reservoir into four sectors for sampling purposes. The bold line shows the former river bed. The arrows designate the inflowing rivers.

b) accurately recording all catch information on computer using a spreadsheet program and making preliminary analyses of the data.

The basic fishing schedule and concurrent physical and chemical observations are summarized in Table 1.

## Physical and Biological Characteristics

### Physical Characteristics

The basic morphological characteristics of Saguling are detailed in Table 2. Saguling is an elongated, extremely dendritic lake (see Fig. 1), with a shoreline development index ( $D_L$ ) of 17.8. The  $D_L$  of a lake is the ratio of the length of its shoreline ( $L$ ) to the circumference of a circle of equal area ( $A$ ) to the lake; thus  $D_L = L / (2 \cdot \sqrt{\pi A})$ . A lake of four circular basins just in contact would have a  $D_L$  of 2.0. Elongation is usually more important in increasing a lake's  $D_L$  than sinuosity (Hutchinson 1967).

Saguling's dendricity results from its high dam (flood water level [FWL] = 645.0 m above sea level) having flooded numerous tributary valleys in a very mountainous region. The Jatiluhur Reservoir with a FWL of 111.6 m has a  $D_L$  = 5.0 and is classified as a subrectangular elongate basin (Hutchinson 1967).

Saguling has an irregular bottom contour, with a mean depth of only 17.5 m, a maximum depth of 90.0 m and an abnormally small depth ratio (average depth/maximum depth) of 0.2. The majority of lake basins have depth ratios greater than 0.33 (Hutchinson 1967). A depth ratio of 0.33 equals the value of a cone-shaped lake. Lakes with small depth ratios have many deeps



Table 1. Synopsis of physical and chemical data collected at fish sampling stations between September 1987 and September 1988.

Date	Sector	Lunar day	Water level (m)	Air temp. (deg)	Water temp. (deg)	O <sub>2</sub> (mg/L)	CO <sub>2</sub> (mg/L)	pH	Secchi disk (cm)	H <sub>2</sub> S (µg/l)
09/10/87	2	16	630.53	33.5	28.0	5.8	15.8	7.3	86	198
09/17/87	3	23	629.30	33.0	27.0	7.7	7.9	7.9	67	301
09/24/87	4	30	628.06	30.0	28.0	7.7	7.9	8.3	96	316
10/01/87	1	7	627.33	26.5	28.5	9.8	4.0	7.8	57	38
10/08/87	2	14	626.66	27.5	27.5	7.2	27.7	7.6	92	53
10/20/87	3	26	625.98	25.5	27.5	8.2	4.0	7.5	80	119
10/22/87	4	28	625.73	25.5	27.5	7.6	4.0	7.9	88	35
10/27/87	1	4	624.94	24.0	26.5	9.8	4.0	7.8	57	38
11/03/87	2	11	623.93	25.0	26.5	8.5	4.0	8.1	45	13
11/10/87	3	18	623.61	26.0	27.0	8.4	0.0	8.8	52	29
11/19/87	4	27	624.09	24.0	26.0	7.9	0.0	8.9	67	26
11/25/87	1	3	624.38	25.5	26.5	8.7	0.0	9.2	56	17
12/01/87	2	9	625.86	25.0	27.0	3.8	11.9	8.1	50	216
12/08/87	38	16	628.18	24.0	26.0	8.8	4.0	8.2	68	32
12/15/87	4	23	630.52	25.0	26.0	8.2	4.0	7.7	74	16
12/22/87	1	1	631.23	24.5	26.5	6.4	4.0	8.0	50	144
01/12/88	2	22	626.21	27.0	27.0	4.6	19.8	7.2	33	224
01/26/88	3	6	630.25	26.0	27.5	6.8	7.9	7.2	83	288
01/28/88	4	8	631.04	27.0	28.0	8.4	0.0	7.9	65	272
02/03/88	1	14	633.29	27.0	28.0	14.6	0.0	9.1	20	-
02/09/88	2	20	633.52	25.0	27.0	13.0	0.0	8.4	72	-
02/12/88	3	23	632.91	24.0	24.0	10.0	0.0	8.5	40	-
02/16/88	4	27	632.37	24.0	26.0	11.8	0.0	7.5	40	-
03/02/88	1	13	626.97	25.0	28.0	9.0	11.9	7.3	45	-
03/08/88	2	19	626.53	25.0	26.0	8.8	23.8	6.9	55	-
03/15/88	3	26	629.50	26.0	27.0	11.1	0.0	7.1	50	-
03/17/88	4	28	629.77	25.0	27.0	11.1	0.0	7.1	64	-
03/22/88	1	3	631.27	26.0	26.0	9.0	11.9	7.3	30	-
03/29/88	2	10	631.95	25.0	27.0	8.8	23.8	6.9	70	-
04/05/88	3	17	632.18	25.0	27.0	9.2	0.0	9.1	65	7
04/12/88	4	24	631.28	25.0	26.0	8.1	0.0	9.2	79	2
04/20/88	1	3	630.73	25.0	26.5	8.2	0.0	8.7	70	9
04/26/88	2	9	629.80	24.0	25.0	8.8	4.0	9.4	110	44
05/04/88	3	17	631.06	23.5	26.5	8.8	0.0	9.5	85	4
05/12/88	4	25	632.16	25.0	25.0	9.8	0.0	9.4	110	4
05/25/88	1	8	633.54	25.0	27.0	8.2	0.0	9.9	95	4
06/01/88	2	15	634.42	25.0	27.0	11.6	0.0	8.1	60	17
06/07/88	3	20	634.18	25.0	26.0	7.3	5.4	7.7	78	121
06/14/88	4	28	634.13	25.0	26.5	6.7	0.0	8.5	110	47
06/21/88	1	6	633.43	24.0	24.5	7.3	5.4	7.7	130	121
06/28/88	2	13	632.50	25.0	26.0	11.6	0.0	8.1	45	17
07/05/88	3	20	631.05	23.0	25.0	10.1	0.0	7.0	70	6
07/12/88	4	27	629.52	24.0	25.0	6.8	7.8	8.0	120	29
07/19/88	1	4	628.09	25.0	25.5	9.3	7.9	8.1	120	31
07/26/88	2	11	626.83	23.0	25.5	4.9	19.8	7.3	75	79
08/02/88	3	18	625.76	24.0	25.5	7.5	0.0	7.0	70	159
08/09/88	4	25	625.66	24.0	24.5	6.7	3.9	7.0	110	128
08/16/88	1	3	624.61	23.5	25.0	7.4	11.9	6.7	110	266
08/23/88	2	10	624.16	23.0	24.5	4.1	25.8	6.7	75	163
08/30/88	3	17	624.13	24.0	25.0	7.5	0.0	7.0	62	159
09/06/88	4	24	623.91	23.0	25.0	7.5	0.0	8.2	85	15
Min			623.61	23.0	24.0	3.8	0.0	6.7	20	0
Max			634.42	33.5	28.5	14.6	27.7	9.9	130	316

Note: Sector 1 = North; 2 = River; 3 = South; 4 = West.

Table 2. Morphologies of the Saguling and Jatiluhur Reservoirs on the Citarum River, West Java, Indonesia. (See also Table 2; Soemarwoto et al., this vol.).

Parameter	Saguling	Jatiluhur
(1) Area (ha)	5,607	8,300
(2) Volume (x 10 <sup>6</sup> m <sup>3</sup> )	982	2,970
(3) Maximum length (km)	18.4	36.5
(4) Shore length (km)	473	163
(5) Mean depth (m)	17.5	36.4
(6) Maximum depth (m)	90	95
(7) Depth ratio	0.2	0.4
(8) Mean breadth (km)	3.0	2.3
(9) Mean slope (%)	4	30
(10) Dendnicity (D <sub>L</sub> )	17.8	5.0

or isolated basins. Lakes with a number of deeps can have a variety of water stratifications, differing turnover times and individual basin chemistries.

Saguling has a 4% slope of its drawdown area and is suitable for the development of drawdown agriculture, while Jatiluhur is a steep-sided basin with a high potential for erosion (IOE 1980).

The hydromorphology and mixing dynamics of Saguling are discussed in detail in Soemarwoto et al. (this vol.).

### Limnology and Water Quality

Saguling is a warm polymictic lake that experienced turnovers of its water column (certain bays only) at the beginnings of the Indonesian rainy seasons in 1986 to 1988. Turnovers caused losses of cultured fish in each year, with approximately 34 t lost in these years in the southern sector of the reservoir (Soemarwoto et al., this vol.).

Major water quality parameters of Saguling in 1987-1988 are summarized in Table 3. Saguling is a very eutrophic ecosystem, as characterized by its low Secchi disk visibilities (mean 72 cm in 1987 decreasing to 54 cm in 1988), high conductivities, high total nitrogen content (mean 1,996 µg/l in 1987 and 1,830 µg/l in 1988 at 0.2 m depth) and total phosphorus (mean 372 µg/l in 1987 and 323 µg/l in 1988 at 0.2 m depth). High H<sub>2</sub>S values (mean = 328 µg/l at 0.2 m depth) were common in 1987, less than two years after reaching its FWL, but H<sub>2</sub>S decreased to a mean of 76 µg/l in 1988. Mean COD and BOD values fell in 1988 to nearly half the mean values recorded in 1987. Stations at 0.2 m water depth in the Citarum River, which receives organic wastes from the city of Bandung, had very high values of 116.7 mg COD/l in 1987 increasing to 141.6 mg/l in 1988 (Table 3). Stations in the Citarum River receiving this organic load became nearly anoxic during the dry season in 1988, with oxygen concentrations decreasing to a mean of 0.4 mg DO/l.

A full treatment of the water quality of Saguling can be found in Soemarwoto et al. (this vol.).

Table 3. Water quality in the Saguling Reservoir, 1987-88.

Parameter	1987				No. obser.	1988				No. obser.
	0.2 m		5.0 m			0.2 m		5.0 m		
	Mean	Range	Mean	Range		Mean	Range	Mean	Range	
Water temperature (°C)	27.9	25.5-32.0	26.9	24.0-30.0	173	28.8	25.0-32.5	26.4	25.0-29.0	179
Secchi disk (cm)	72	10-170	-	-	80	54	2-127	-	-	89
Conductivity (µmhos/cm)	230	130-385	233	110-410	159	171	70-400	171	80-405	179
Dry sediment (mg/l)	131	20-1524	219	16-4184	159	252	24-824	274	24-620	179
D.O. (mg/l)	7.4	1.6-11.0	4.9	1.4-9.3	173	8.5	0.4-15.0	4.7	0.9-11.4	179
pH	7.7	7.3-7.8	7.3	7.1-7.4	159	8.0	5.0-10.1	7.4	6.4-9.2	179
Carbon dioxide (mg/l)	6.1	0.0-27.7	10.1	0.0-27.7	159	5.5	0.0-63.4	12.6	0.0-31.9	179
Alkalinity (mg/l)	69.3	57.0-85.8	73.2	62.5-87.7	159	65.7	33.6-199.4	69.5	33.2-188.4	179
Total nitrogen (µg/l)	1,996	441-23,159	1,756	441-8,456	139	1,830	448-4,144	1,743	336-8,008	100
Ammonia-N (µg/l)	109	34-683	140	30-989	139	108	13-1,101	111	26-338	179
Nitrite (µg/l)	122	33-324	149	47-365	159	111	0-1,008	81	0-452	179
Nitrate (µg/l)	492	137-2,062	488	150-3,252	140	210	50-573	234	77-694	160
Total phosphorus (µg/l)	372	71-842	424	51-1,316	120	323	186-600	321	173-594	100
Orthophosphate (µg/l)	135	14-273	120	15-268	159	161	21-348	187	32-379	157
Hydrogen sulfide (µg/l)	328	6-965	315	16-837	159	76	2-336	111	3-498	139
COD (mg/l)	41.1	19.0-116.7	43.3	19.0-95.4	119	27.2	2.1-141.6	27.8	2.1-121.1	137
BOD (mg/l)	7.0	0.4-45.5	6.1	0.7-52.8	159	4.5	0.3-39.2	4.5	0.6-20.0	179

Source: Aquatic Ecology Laboratory, IOE.

### Biological Communities

#### PLANKTON AND BENTHOS

The genera of phyto- and zooplankton found in Saguling in 1987-1988 are listed in Table 4. Phytoplankton populations are seasonally dominated by *Peridinium*, *Cylindrotheca*, *Sirogonium*, and *Microcystis*. Zooplankton populations are dominated by small cladocerans (see Soemarwoto et al., this vol.; Costa-Pierce and Soemarwoto, this vol.).

Table 4. Phytoplankton and zooplankton genera observed in the Saguling Reservoir, 1987-88.

Phytoplankton	Zooplankton	Phytoplankton	Zooplankton
<i>Acnante</i> sp.	<i>Arcella</i> sp.	<i>Microcystis</i> sp.	<i>Simocephalus</i> sp.
<i>Amphora</i> sp.	<i>Asplancha</i> sp.	<i>Navicula</i> sp.	<i>Thecacineta</i> sp.
<i>Anabaena</i> sp.	<i>Astramoeba</i> sp.	<i>Neidium</i> sp.	<i>Tendipes</i> sp.
<i>Ankistrodesmus</i> sp.	<i>Bosmina</i> sp.	<i>Nitzschia</i> sp.	<i>Trichocerca</i> sp.
<i>Asterionella</i> sp.	<i>Brachionus</i> sp.	<i>Nostoc</i> sp.	<i>Tripleuchanis</i> sp.
<i>Bacillaria</i> sp.	<i>Bursaria</i> sp.	<i>Oscillatoria</i> sp.	
<i>Caloneis</i> sp.	<i>Campanella</i> sp.	<i>Pandorina</i> sp.	
<i>Ceratium</i> sp.	<i>Centropyxis</i> sp.	<i>Pediastrum</i> sp.	
<i>Cholorococcum</i> sp.	<i>Cephalodella</i> sp.	<i>Peridinium</i> sp.	
<i>Chlorotylum</i> sp.	<i>Ceriodaphnia</i> sp.	<i>Phacus</i> sp.	
<i>Closteriopsis</i> sp.	<i>Colurella</i> sp.	<i>Phaeothamnion</i> sp.	
<i>Closterium</i> sp.	<i>Chironomus</i> sp.	<i>Phormidium</i> sp.	
<i>Coscinodiscus</i> sp.	<i>Cucurbitella</i> sp.	<i>Pinullaria</i> sp.	
<i>Cosmarium</i> sp.	<i>Cyclops</i> sp.	<i>Pleodorina</i> sp.	
<i>Cylindrotheca</i> sp.	<i>Cypris</i> sp.	<i>Rhizoclonium</i> sp.	
<i>Denticula</i> sp.	<i>Diaphtomus</i> sp.	<i>Sirogonium</i> sp.	
<i>Dinobryon</i> sp.	<i>Diffugia</i> sp.	<i>Sphaerocystis</i> sp.	
<i>Dispora</i> sp.	<i>Diplois</i> sp.	<i>Sphaeroplea</i> sp.	
<i>Eremosphaera</i> sp.	<i>Epistylis</i> sp.	<i>Spirogyra</i> sp.	
<i>Euastrum</i> sp.	<i>Filinia</i> sp.	<i>Spirulina</i> sp.	
<i>Eudorina</i> sp.	<i>Keratella</i> sp.	<i>Spondylosium</i> sp.	
<i>Eglena</i> sp.	<i>Lecane</i> sp.	<i>Staurastrum</i> sp.	
<i>Fragilaria</i> sp.	<i>Lemnea</i> sp.	<i>Strichotricha</i> sp.	
<i>Gomphonensis</i> sp.	<i>Limnocalanus</i> sp.	<i>Suirella</i> sp.	
<i>Gloesotrichia</i> sp.	<i>Moina</i> sp.	<i>Symploca</i> sp.	
<i>Gyrosigma</i> sp.	<i>Monostyla</i> sp.	<i>Synendra</i> sp.	
<i>Hormidium</i> sp.	<i>Nauplius</i>	<i>Tabellaria</i> sp.	
<i>Hyalotheca</i> sp.	<i>Notholca</i> sp.	<i>Terpsinoe</i> sp.	
<i>Hydrosera</i> sp.	<i>Paraquadrula</i> sp.	<i>Thalassiothrix</i> sp.	
<i>Kyliniella</i> sp.	<i>Philodina</i> sp.	<i>Trachelomonas</i> sp.	
<i>L yngbya</i> sp.	<i>Polyartha</i> sp.	<i>Volvox</i> sp.	
<i>Merismopoedia</i> sp.	<i>Rotaria</i> sp.	<i>Zygnema</i> sp.	

Source: Aquatic Ecology Laboratory, Institute of Ecology.

No regular monitoring of benthic communities has been conducted in Saguling. However, the littoral zone does contain abundant populations of aquatic insect larvae, as shown by the gut contents of fish caught during the fisheries sampling program (see below).

#### HIGHER AQUATIC PLANTS

Aquatic plants found in Saguling are listed in Table 5. The most important and most troublesome aquatic plant in Saguling is the water hyacinth. In 1987, water hyacinth invaded the lower reaches of the Citarum River where the river empties to the reservoir. This region is heavily polluted with organic wastes, and is shallow enough for water hyacinth to become rooted. As a consequence, water hyacinth developed rapidly and luxuriantly and, by 1988, water hyacinth covered an estimated 40 ha of the river sector (Citarum River region).

#### FISH COMMUNITY

One of the most important features of reservoir fisheries development is that they start off with a riverine fish fauna which is normally poorly adapted to the lacustrine environment (Fernando and Holcık 1982). If new species are not introduced, the riverine species tend to be

Table 5. List of aquatic plants observed in the Saguling Reservoir, 1987-88.

Family	Species	Indonesian name	Habitat
Araceae	<i>Pistia stratiotes</i>	ki apu	fw
Ceratophyllaceae	<i>Ceratophyllum demersum</i>	cemara air	atw
Convolvulaceae	<i>Ipomea aquatica</i>	kangkung	atw
Lemnaceae	<i>Lemna</i> sp.	gulma itik	fw
Pontederiaceae	<i>Eichornia crassipes</i>	eceng gondok	atw, fw
Salviniaceae	<i>Salvinia molesta</i>	kayambang	fw
Salviniaceae	<i>Azolla pinnata</i>	lukut cai	fw
Hydrocharitaceae	<i>Hydrilla verticillata</i>	ganggeng	sbw

Source: Institute of Ecology (IOE) (1986).

## Notes:

- atw : attached weeds  
 sbw : submerged weeds  
 fw : floating weeds

concentrated in dendritic riverine portions of the lake, leaving very large areas sparsely inhabited by a few species.

Table 6 shows a list of fish species known to be present in the Saguling Reservoir and in the watershed of the Citarum River above the reservoir. A total of 23 fish species are known from the area of which 21 have been reported from Saguling. In addition, there are one or more species of the freshwater prawn, *Macrobrachium* sp.

Ten of the 23 fish species have been introduced, including two predators, *Clarias gariepinus* and *Oxyeleotris marmorata*. Options for new species introductions are somewhat preempted by previous introductions but there is nevertheless scope for attempts to further fill the vacant niches. In particular, the trophic resources of the pelagic zone of Saguling appear to be mostly unutilized by any fish species.

An important qualification of the latter observation is that in April 1989, following the refilling of the Saguling Reservoir, the "paray", *Rasbora argyrotaenia*, appeared in large numbers in the

Table 6. Native and introduced fish species recorded from the Citarum River and Saguling Reservoir.

Family	Species	Local name	Citarum River	Saguling Reservoir	Broad ecological niches				Native	Introduced
					O	H	B	P		
Anabantidae	<i>Anabas testudineus</i>	Belok	+	+	+				+	
Anabantidae	<i>Helostoma temminckii</i>	Tambakan		+		+				
Anabantidae	<i>Trichogaster pectoralis</i>	Sepat siam		+		+			+	
Bagridae	<i>Macronos micracanthus</i>	Kebogorarang	+	+			+	+		
Bagridae	<i>Macronos nemurus</i>	Tagih	+	+			+	+		
Channidae	<i>Channa striata</i>	Gabus	+	+			+	+		
Clariidae	<i>Clarias batrachus</i>	Lele	+	+			+	+		
Clariidae	<i>Clarias gariepinus</i>	Lele dumbo		+			+			
Cichlidae	<i>Oreochromis niloticus</i>	Nila	+	+		+			+	
Cichlidae	<i>Oreochromis mossambicus</i>	Mujair	+	+		+			+	
Cyprinidae	<i>Aristichthys temminckii</i>	Karper cina		+	+				+	
Cyprinidae	<i>Otenopharyngodon idalla</i>	Karper rumput		+	+				+	
Cyprinidae	<i>Cyprinus carpio</i>	Mas	+	+	+				+	
Cyprinidae	<i>Hampala macrolepidota</i>	Hampal	+	+			+	+		
Cyprinidae	<i>Hypophthalmichthys molitrix</i>	Mola		+		+			+	
Cyprinidae	<i>Labeobarbus duranensis</i>	Kancra/soro	+	+	+			+		
Cyprinidae	<i>Mystacoleucus marginatus</i>	Gonggehek	+	+	+			+		
Cyprinidae	<i>Puntius binotatus</i>	Beuntour	+	+	+			+		
Cyprinidae	<i>Puntius bramaoides</i>	Lalawak	+	+	+			+		
Cyprinidae	<i>Puntius javanicus</i>	Tawes	+	+	+			+		
Cyprinidae	<i>Rasbora argyrotaenia</i>	Paray	+	+	+			+		
Cyprinidae	<i>Osteochilus hasselti</i>	Nilem	+	+		+		+		
Eleotridae	<i>Oxyeleotris marmorata</i>	Batutu		+			+		+	
Total			16	19	6	9	1	7	13	10

Remark: O = omnivore  
 H = herbivore  
 B = periphyton feeder  
 P = predator

Northern and River Sectors of the reservoir (Fig. 1) and could be observed schooling at the surface in the narrow dendritic arms of the reservoir. It therefore seems possible that this species will colonize the pelagic habitat to some degree. However, this is not known to have occurred downstream in the well-established Jatiluhur Reservoir (Krismono et al. 1983).

#### FISHING COMMUNITY

It was estimated that 53 fishermen were operating in the Saguling Reservoir in March 1988. The majority of fishermen had three gill nets of 3.8 to 6.4 cm (1.5 to 2.5") mesh. The estimated number of gill nets in use in the reservoir is given in Table 7. The nets were very primitive, weighted by rocks and floated by waste pieces of styrofoam. However, 18 gill-net fishermen were reported to be operating by September 1988 when the reservoir was drawn down to a very low level and in April 1989 fishing effort appeared to still be at a low level.

Table 7. Estimated numbers of gill nets in use at Saguling Reservoir in March 1988.

Mesh size (inch)	Units	Total	%
1.5	11		6.9
2.0	38		23.9
2.5	31		19.5
3.0	5		3.1
3.5	1		0.6
4.0	16		10.1
4.5	2		1.3
5.0	17		10.7
5.5	6		3.8
6.0	18		11.3
6.5	0		0.0
7.0	8		5.0
7.5	0		0.0
8.0	3		1.9
8.5	0		0.0
9.0	1		0.6
9.5	0		0.0
10.0	1		0.6
10.5	0		0.0
11.0	0		0.0
11.5	0		0.0
12.0	1		0.6
Sum	159		100
No. of fishermen	53		
Average number of nets/fishermen	3		

### Status of the Fish Stocks

#### *Analytical Methods*

Catch length-frequency data for each species were grouped on a lunar monthly basis by mesh size and adjusted to the catch from four nets of each size fished at each station.

As the samples are derived from gill nets, the first task was to derive estimates of the selection curves for each species and mesh size and the combined probabilities of capture of each length group in the fleet of nets used for sampling (four of each mesh size from 2.5 cm (1") to 12.5 cm (5") in 1.25 cm (0.5") increments), and in the artisanal gill-net fleet (Table 7). The latter is achieved by weighting the selection curves according to the number of nets used.

Estimation of selection curves has been reviewed by Hamley (1975). For species without significant entanglement of larger fishes and thus having approximately normal selection curves with a constant standard deviation, estimates can be based upon the method of Holt (1963). Where the standard deviation increases with increasing mesh size the method of Regier and Robson (1966) is more appropriate.

Monthly size-frequency distributions are divided by the probabilities of capture in the fleet of nets used for sampling to get estimates of the true size-frequency distributions of the stocks. This routine is available in the ELEFAN software series (Gayanilo et al. 1988).

Growth curves are traced through the data set using the ELEFAN I routine if there is a suitable modal progression. Natural and total mortality rates and yield-per-recruit estimates are derived using ELEFAN II and ELEFAN IV routines. All of the foregoing assume that the samples adequately represent the size composition of the catches.

### **Catch Composition and Trophic Ecology**

Table 8a-e summarizes the catches taken by the project's fleet of gill nets between September 1987 and September 1988. A summary of the data on a lunar monthly basis is given in Appendix 1. It is evident that the catches are overwhelmingly dominated by *Hampala macrolepidota*, a predatory cyprinid, which in total comprised 86.6% by weight of the catch and 93.0% by numbers.

The data in Table 8a-e show that the catch composition varied with mesh size. Very few juveniles of any of the larger species were captured, suggesting that there has been no successful colonization of the lake by any species other than *H. macrolepidota*.

Previous studies of this species have shown that it is a predator. Abidin (1986a) reports that the diet of juveniles contained a small component of phytoplankton and zooplankton but that adults fed mostly on fish with a small contribution from *Macrobrachium* sp. in the Zoo Negara Lake, Malaysia. Yap (1988) classified *H. macrolepidota* as a piscivore in the Bukit Merah Reservoir in Malaysia. Wahyu and Hardjamulia (1983) and Hardjamulia et al. (1988) recorded the consumption of zooplankton and crustaceans (including *Macrobrachium* sp.) in the Jatiluhur Reservoir in West Java.

Stomachs of 131 specimens examined during the present study showed that aquatic insects comprised 74% of the diet of *H. macrolepidota* in Saguling. Benthic larval stages of water boatman (*Corixa* sp.), water bugs (*Lethocerus* sp.), caddisflies (*Hydrobius* sp.) and lake fly larvae (*Chaoborus* sp. and chironomids) were predominant and a small number of fish were consumed (Table 9; Appendix 2). A previous study of the diet of 104 *H. macrolepidota* in Saguling (Krismono et al. 1987) found nearly identical results (Table 9).

Examination of the stomachs of 21 nilam carp (*Osteochilus hasselti*) showed that 78% of its diet was various periphytic and planktonic algae with a smaller component (7%) of detritus (Table 9, Appendix 2). The previous data of Krismono et al. (1987) showed that nilam carp in Saguling ate more detritus (68%) than shown in this study (Table 9). Yap (1988) found a somewhat broader diet for this species in the Bukit Merah Reservoir.

Based on reports in the general literature (Mohsin and Ambak 1983) the general trophic niches of the remaining species are indicated in Table 6. Our observations in Saguling (Table 9; Appendix 2) conform with these deductions. However, there is a strong indication that the predatory species are more heavily reliant upon insects in Saguling than elsewhere, probably reflecting the sparse fish stocks and low levels of abundance of juvenile fishes.

In the absence of significant stocks of any species other than *H. macrolepidota* it is obvious that management of the fishery must be directed towards optimization of harvests of this species and enhancement of recruitment of other desirable species by selective restocking and fishery management programs.

Samples of species other than *H. macrolepidota* were inadequate for estimation of any stock assessment parameters.

Table 8a. Synopsis of catches taken in Sector 1 of the Saguling Reservoir between September 1987 and September 1988, using fleets of gill nets of between 1" and 5" stretched mesh size.

Sector: North  
Lunar month: 2-13

Family	Species	1"		1.5"		2"		2.5"		3"		3.5"		4"		4.5"		5"		Total		Percentage	
		#	Wt	#	Wt	#	Wt	#	Wt	#	Wt	#	Wt	#	Wt	#	Wt	#	Wt	#	Wt	#	Wt
A	<i>Anabas testudineus</i>																			0	0	0.0	0
	<i>Trichogaster pectoralis</i>																			0	0	0.0	0
B	<i>Macrones micrakanthus</i>			1	32															1	32	0.1	+
	<i>Macrones nemurus</i>	1	43	3	213															4	256	0.6	+
Ch	<i>Channa striata</i>			1	250															1	250	0.1	+
Ci	<i>Oreochromis mossambicus</i>							1	100											1	100	0.1	+
	<i>Oreochromis niloticus</i>									2	311			1	385					3	696	0.4	1
Cl	<i>Clarias batrachus</i>																			0	0	0.0	0
Cy	<i>Cyprinus carpio</i>															1	680			1	680	0.1	1
	<i>Hampala macrolepidota</i>	277	4,113	149	7,095	140	15,085	54	7,393	3	1,130	3	1,660							626	36,476	92.2	85
	<i>Osteochilus hasselti</i>	1	13			1	196	6	1,665	2	900									10	2,774	1.5	6
	<i>Rasbora argyrotænia</i>	1	13																	1	13	0.1	+
E	<i>Oxyeleotris marmorata</i>	25	614	4	265	2	322													31	1,201	4.6	2
	Total	305	4,796	158	7,855	143	15,603	61	9,158	7	2,341	3	1,660	1	385	1	680	0	0	679	42,478		
	Number of nets	42	42	39	39	40	40	38	38	38	38	38	38	36	36	28	28	23	23	322	322		
	Catch/net/night	7.3	114.2	4.1	201.4	3.6	390.1	1.6	241.0	0.2	61.6	0.1	43.7	+	10.7	+	24.3	0.0	0.0	2.1	131.9		

Remarks: A = Anabantidae; B = Bagridae; Ch = Channidae; Ci = Cichlidae; Cl = Clariidae; Cy = Cyprinidae; E = Eleotridae; + = < 0.1

Species reported from the reservoir but which were never captured in the gill nets include the following:

Cyprinidae:	<i>Hypophthalmichthys molitrix</i>	<i>Puntius binotatus</i>
	<i>Labeobarbus duranensis</i>	<i>Puntius bramoides</i>
	<i>Mystacoleucus marginatus</i>	<i>Puntius javanicus</i>
	<i>Aristichthys temmincki</i>	<i>Ctenopharyngodon idella</i>
Anabantidae:	<i>Helostoma temmincki</i>	

Table 8b. Synopsis of catches taken in Sector 2 of the Saguling Reservoir between September 1987 and September 1988, using fleets of gill nets of between 1" and 5" stretched mesh size.

Sector: River  
Lunar month: 1-13

Family	Species	1"		1.5"		2"		2.5"		3"		3.5"		4"		4.5"		5"		Total		Percentage	
		#	Wt	#	Wt	#	Wt	#	Wt	#	Wt	#	Wt	#	Wt	#	Wt	#	Wt	#	Wt	#	Wt
A	<i>Anabas testudineus</i>	6	180	14	420	5	345	1	68											26	1,013	2.9	3.0
	<i>Trichogaster pectoralis</i>																			0	0	0.0	0.0
B	<i>Macrones micrakanthus</i>			4	154															4	154	0.4	0.5
	<i>Macrones nemurus</i>	2	79	7	707	5	824	2	209											16	1,819	1.8	5.5
Ch	<i>Channa striata</i>					1	225													1	225	0.1	0.7
Cl	<i>Oreochromis mossambicus</i>																			0	0	0.0	0.0
	<i>Oreochromis niloticus</i>																	1	700	1	700	0.1	2.1
Cl	<i>Clarias batrachus</i>			1	70															1	70	0.1	0.2
Cy	<i>Cyprinus carpio</i>												1	540						1	540	0.1	1.6
	<i>Hampala macrolepidota</i>	177	2,710	138	6,729	451	7,601	22	4,572	5	1,090	1	630							794	23,332	88.9	70.0
	<i>Osteochilus hasselti</i>	4	41	4	188	7	878	7	1,596	2	790	3	915							27	4,408	3.0	13.2
	<i>Rasbora argyrotaenia</i>	1	11																	1	11	0.1	+
E	<i>Oxyeleotris marmorata</i>	18	502	2	112			1	460											21	1,074	2.4	3.2
	Total	208	3,523	170	8,380	469	9,873	33	6,905	7	1,880	4	1,545	1	540	0	0	1	700	893	33,346		
	Number of nets	39	39	35	35	40	40	38	38	39	39	39	39	32	32	23	23	27	27	312	312		
	Catch/net/night	5.3	90.3	4.9	239.4	11.7	246.8	0.9	181.7	0.2	48.2	0.1	39.6	+	16.9	0.0	0.0	+	25.9	2.9	106.9		

Remarks: A = Anabantidae; B = Bagridae; Ch = Channidae; Cl = Cichlidae; Cl = Clariidae; Cy = Cyprinidae; E = Eleotridae; + = < 0.1.

Species reported from the reservoir but which were never captured in the gill nets include the following:

Cyprinidae:	<i>Hypophthalmichthys molitrix</i>	<i>Puntius binotatus</i>
	<i>Laboobarbus ourenensis</i>	<i>Puntius bramoides</i>
	<i>Mystacoleucus marginatus</i>	<i>Puntius javanicus</i>
	<i>Aristichthys temminckii</i>	<i>Ctenopharyngodon idella</i>
Anabantidae:	<i>Helostoma temminckii</i>	
Clariidae:	<i>Clarias gariepinus</i>	



Table 8c. Synopsis of catches taken in Sector 3 of the Saguling Reservoir between September 1987 and September 1988, using fleets of gill nets of between 1" and 5" stretched mesh size.

Sector: South  
Lunar month: 1-13

Family	Species	1"		1.5"		2"		2.5"		3"		3.5"		4"		4.5"		5"		Total		Percentage	
		#	Wt	#	Wt	#	Wt	#	Wt	#	Wt	#	Wt	#	Wt	#	Wt	#	Wt	#	Wt	#	Wt
A	<i>Anabas testudineus</i>			1	30															1	30	0.2	0.1
	<i>Trichogaster pectoralis</i>	1	9																	1	9	0.2	+
B	<i>Macrones micracanthus</i>																			0	0	0.0	0.0
	<i>Macrones nemurus</i>					2	249													2	249	0.3	0.5
Ch	<i>Channa striata</i>							1	290											1	290	0.2	0.6
Ci	<i>Oreochromis mossambicus</i>																			0	0	0.0	0.0
	<i>Oreochromis niloticus</i>									1	303			2	1,560					3	1,863	0.5	4.0
Cl	<i>Clarias batrachus</i>																			0	0	0.0	0.0
Cy	<i>Cyprinus carpio</i>	1	8			3	154			2	444									6	606	1.0	1.3
	<i>Hampala macrolepidota</i>	272	5,022	107	6,267	164	19,192	46	8,019	2	785	3	1,730							594	41,015	95.3	87.7
	<i>Osteochilus hasseltii</i>	1	14					2	760	1	330	1	400	2	870					7	2,374	1.1	5.1
	<i>Rasbora argyrotaenia</i>																			0	0	0.0	0.0
E	<i>Oxyeleotris marmorata</i>	6	221	2	107															8	328	1.3	0.7
	<b>Total</b>	281	5,274	110	6,404	169	19,595	49	9,069	5	1,558	5	2,433	2	870	2	1,560	0	0	623	46,764		
	Number of nets	45	45	41	41	46	46	41	41	42	42	42	42	32	32	24	24	23	23	336	336		
	Catch/net/night	6.2	117.2	2.7	156.2	3.7	426.0	1.2	221.2	0.1	37.1	0.1	57.9	0.1	27.2	0.1	65.0	0.0	0.0	1.9	139.2		

Remarks: A = Anabantidae; B = Bagridae; Ch = Channidae; Ci = Cichlidae; Cl = Clariidae; Cy = Cyprinidae; E = Eleotridae; + = < 0.1.

Species reported from the reservoir but which were never captured in the gill nets include the following:

Cyprinidae:	<i>Hypophthalmichthys molitrix</i>	<i>Puntius binotatus</i>
	<i>Laboobarbus dutanensis</i>	<i>Puntius bramoides</i>
	<i>Mystacoleucus marginatus</i>	<i>Puntius javanicus</i>
	<i>Aristichthys temmincki</i>	<i>Ctenopharyngodon idella</i>
Anabantidae:	<i>Helostoma temmincki</i>	
Clariidae:	<i>Clarias gariepinus</i>	

Table 8d. Synopsis of catches taken in Sector 4 of the Saguling Reservoir between September 1987 and September 1988, using fleets of gill nets of between 1" and 5" stretched mesh size.

Sector: West  
Lunar month: 1-13

Family	Species	1"		1.5"		2"		2.5"		3"		3.5"		4"		4.5"		5"		Total		Percentage	
		#	Wt	#	Wt	#	Wt	#	Wt	#	Wt	#	Wt	#	Wt	#	Wt	#	Wt	#	Wt	#	Wt
A	<i>Anabas testudineus</i>																			0	0	0.0	0.0
	<i>Trichogaster pectoralis</i>																			0	0	0.0	0.0
B	<i>Macrones micracanthus</i>																			0	0	0.0	0.0
	<i>Macrones nemurus</i>	1	32	9	653	1	130												11	815	1.3	1.5	
Ch	<i>Channa striata</i>																			0	0	0.0	0.0
Ci	<i>Oreochromis mossambicus</i>									1	300									1	300	0.1	0.6
	<i>Oreochromis niloticus</i>																			0	0	0.0	0.0
Cl	<i>Clarias batrachus</i>																			0	0	0.0	0.0
Cy	<i>Cyprinus carpio</i>																			0	0	0.0	0.0
	<i>Hampala macrolepidota</i>	336	5,625	262	14,687	119	14,240	72	14,638	5	1,632	2	1,250							796	52,072	96.4	96.4
	<i>Osteochilus hasselti</i>			3	116			1	119											4	235	0.5	0.4
	<i>Rasbora argyrotaenia</i>																			0	0	0.0	0.0
E	<i>Oxyeleotris marmorata</i>	6	292	6	311															14	603	1.7	1.1
	Total	345	5,949	280	15,767	120	14,370	73	14,757	6	1,932	2	1,250	0	0	0	0	0	0	826	54,025		
	Number of nets	47	47	43	43	45	45	41	41	39	39	46	46	39	39	31	31	26	26	357	357		
	Catch/net/night	7.3	126.6	6.5	366.7	2.7	319.3	1.8	359.9	0.2	49.5	+	27.2	0.0	0.0	0.0	0.0	0.0	0.0	2.3	151.3		

Remarks: A = Anabantidae; B = Bagridae; Ch = Channidae; Ci = Cichlidae; Cl = Clariidae; Cy = Cyprinidae; E = Eleotridae; + = < 0.1.

Species reported from the reservoir but which were never captured in the gill nets include the following:

Cyprinidae:	<i>Hypophthalmichthys molitrix</i>	<i>Puntius binotatus</i>
	<i>Laboobarbus duranensis</i>	<i>Puntius bramoides</i>
	<i>Mystacoleucus marginatus</i>	<i>Puntius javanicus</i>
	<i>Aristichthys temminckii</i>	<i>Ctenopharyngodon idella</i>
Anabantidae:	<i>Helostoma temminckii</i>	
Clariidae:	<i>Clarias gariepinus</i>	

Table 8e. Synopsis of catches taken in the four sectors of the Saguling Reservoir between September 1987 and September 1988, using fleets of gill nets of between 1" and 5" stretched mesh size.

All sectors  
Lunar month: 1-13

Family	Species	1"		1.5"		2"		2.5"		3"		3.5"		4"		4.5"		5"		Total		Percentage	
		#	Wt	#	Wt	#	Wt	#	Wt	#	Wt	#	Wt	#	Wt	#	Wt	#	Wt	#	Wt	#	Wt
A	<i>Anabas testudineus</i>	6	180	15	450	5	345	1	68											27	1,043	0.9	0.6
	<i>Trichogaster pectoralis</i>	1	9																	1	9	+	+
B	<i>Macrones micracanthus</i>			5	186															5	186	0.2	0.1
	<i>Macrones nemurus</i>	4	154	19	1,573	8	1,203	2	209											33	3,139	1.1	1.8
Ch	<i>Channa striata</i>			1	250	1	225	1	290											3	765	0.1	0.4
Ci	<i>Oreochromis mossambicus</i>							1	100	1	300									2	400	0.1	0.2
	<i>Oreochromis niloticus</i>									2	311	1	303	1	385	2	1,560	1	700	7	3,259	0.2	1.8
Cl	<i>Clarias batrachus</i>			1	70															1	70	+	+
Cy	<i>Cyprinus carpio</i>	1	8			3	154			2	444			1	540	1	680			8	1,826	0.3	1.0
	<i>Hampala macrolepidota</i>	1,062	17,470	656	34,778	874	56,118	194	34,622	15	4,637	9	5,270							2,810	152,895	93.0	86.6
	<i>Osteochilus hasselti</i>	6	68	7	304	8	1,074	16	4,140	5	2,020	4	1,315	2	870					48	9,791	1.6	5.5
	<i>Rasbora argyrotaenia</i>	2	24																	2	24	0.1	+
E	<i>Oxyeleotris marmorata</i>	57	1,629	14	795	2	322	1	460											74	3,2063	2.4	1.8
	<b>Total</b>	<b>1,139</b>	<b>19,542</b>	<b>718</b>	<b>38,406</b>	<b>901</b>	<b>59,441</b>	<b>216</b>	<b>39,839</b>	<b>25</b>	<b>7,712</b>	<b>14</b>	<b>6,888</b>	<b>4</b>	<b>1,795</b>	<b>3</b>	<b>2,240</b>	<b>1</b>	<b>700</b>	<b>3,021</b>	<b>176,613</b>		
	Number of nets	173	173	158	158	171	171	158	158	158	158	165	165	139	139	106	106	99	99	1,327	1,327		
	Catch/net/night	6.6	113.0	4.5	243.1	5.3	347.6	1.4	252.5	0.2	48.8	0.1	41.7	+	12.9	+	21.1	+	7.1	2.3	133.1		

Remarks: A = Anabantidae; B = Bagridae; Ch = Channidae; Ci = Cichlidae; Cl = Clariidae; Cy = Cyprinidae; E = Eleotridae; + = < 0.1.

Species reported from the reservoir but which were never captured in the gill nets include the following:

Cyprinidae:	<i>Hypophthalmichthys molitrix</i>	<i>Puntius binotatus</i>
	<i>Labeobarbus duranensis</i>	<i>Puntius bramoides</i>
	<i>Mystacoleucus marginatus</i>	<i>Puntius javanicus</i>
	<i>Aristichthys temmincki</i>	<i>Ctenopharyngodon idella</i>
Anabantidae:	<i>Helostoma temmincki</i>	
Clariidae:	<i>Clarias gariepinus</i>	

Table 9. Gut contents of Saguling Reservoir fish species recorded as per cent occurrences compared with results of Krismono et al. (1987).

Organisms	<i>Osteochilus hasselti</i>		<i>Hampala macrolepidota</i>		<i>Oxyeleotris marmorata</i>	<i>Cyprinus carpio</i>		<i>Puntius javanicus</i>	<i>Oreochromis niloticus</i>	<i>Anabas testudineus</i>	<i>Oreochromis mossambicus</i>
	1	2	1	2	2	1	2	1	2	2	1
Detritus	68	17		7		54	9	92	14	17	s41
Algae											
Chrysophyta	13	68					25	4	43		24
Chlorophyta	3	7					25	1	10		11
Cyanophyta		2					8		4		2
Euglenophyta		1						3	5		
Pyrophyta	15								14		20
Zooplankton	1		19			2	8		10		2
Insects			74	74	44	16				33	
Molluscs				2	11	28	17			8	
Shrimp			7	1	11						
Fish				6	23					8	
Unidentified/empty		5		10	11		8			34	
No. fish	46	21	104	131	8	8	4	7	3	6	6

<sup>1</sup>Krismono et al. (1987).

<sup>2</sup>This study.

### Biology and Ecology of *Hampala macrolepidota*

Previous studies on the biology and ecology of this species include the works of Abidin (1984, 1986a, 1986b) and Abidin and Ang Kok Jee (1984), mostly concerned with reproductive biology and feeding.

Abidin (1984) defined the length (L, in mm)-weight (W, in g) relationships as follows:

$$\begin{aligned} \text{males} & : W = (6.77 \times 10^{-6})L^{3.144} \\ \text{females} & : W = (9.40 \times 10^{-7})L^{3.461} \end{aligned}$$

Abidin (1986b) gives data on the relationships between length, weight and fecundity (F). However, the equation which he gives to describe the length-fecundity relationship is erroneous. Based on the data presented in his paper the relationship is:

$$F = 0.01123L^{2.63}$$

and the weight-fecundity relationship is given as:

$$F = 8215 + 74.64W$$

The latter figures agree with the estimates presented earlier by Abidin and Ang Kok Jee (1984), presumably referring to the same data.

Hardjamulia et al. (1988) cite length-weight relationships as follows:

$$\begin{aligned} \text{males} & : W = (2.33 \times 10^{-5})L^{2.8821} \text{ (length range 18.5-34.0 cm)} \\ \text{females} & : W = (3.18 \times 10^{-5})L^{2.8242} \text{ (length range 19.8-50.7 cm)} \end{aligned}$$

### Mesh Selection

Table 10 summarizes the size-frequency distributions of the catches in the 2.5 cm (1") to 6.4 cm (2.5") mesh gill nets. No catches of this species were obtained in the 11.4 cm (4.5") to 12.5 cm (5") mesh sizes and catches in 7.5 cm (3"), 8.9 cm (3.5") and 10 cm (4") meshes were

Table 10. Length-frequency distributions of the total catch of *Hampala macrolepidota* in 1", 1.5", 2" and 2.5" mesh gill nets in Saguling Reservoir. Frequencies have been adjusted to the catch from four nets of each size in cases where fewer than four nets of each size were set at a sampling station.

Mesh size	1.0	1.5	2.0	2.5
Length (cm)				
1				
2				
3				
4				
5				
6				
7				
8	141.6			
9	506.4			
10	357.5		1.3	1.3
11	113.3	6.3	0.0	0.0
12	43.7	63.6	0.0	0.0
13	8.0	173.2	0.0	0.0
14	3.7	215.5	1.3	0.0
15	1.3	165.2	7.0	1.3
16	1.0	133.9	32.6	1.3
17		76.6	119.5	17.6
18		21.0	154.1	18.0
19		3.0	127.5	28.9
20			71.9	30.6
21			32.3	56.3
22			17.3	24.3
23			4.7	19.3
24			6.0	23.6
25			0.0	13.0
26			1.3	8.3
27			1.3	1.3
28			0.0	
29			0.0	
30			1.3	

insufficient for analysis. It is evident that the size-frequency curves are fairly symmetrical and normal in shape but that the spread, or standard deviation of the curves, increases with increasing mesh size. Although this is a common phenomenon in gill net fisheries, the standard method for analysis (Garrod 1961; Holt 1963) assumes that the S.D. will be constant. The approach here has been to use the method of Holt (1963), as incorporated into the calculator program of Pauly (1984) to estimate the selection curves of three successive pairs of mesh sizes, namely, 2.5 x 3.8 cm (1" x 1.5"), 3.8 x 5 cm (1.5" x 2") and 5.0 x 6.4 cm (2" x 2.5").

The selection curves derived from each comparison refer to an intermediate mesh size e.g., 3.2 cm (1.25") mesh for the 2.5 x 3.8 cm (1" x 1.5") comparison. Maximum retention lengths (MRL), standard deviations and the parameters of the Holt equation were obtained from each comparison. This basically follows the approach of Regier and Robson (1966). The length-to-MRL and length-to-S.D. relationships were established (Fig. 2):

$$\text{MRL (in cm)} = 0.20 + 3.78 \text{ mesh (in cm)}$$

$$\text{S.D. (in cm)} = -0.14 + 0.53 \text{ mesh (in cm)}$$

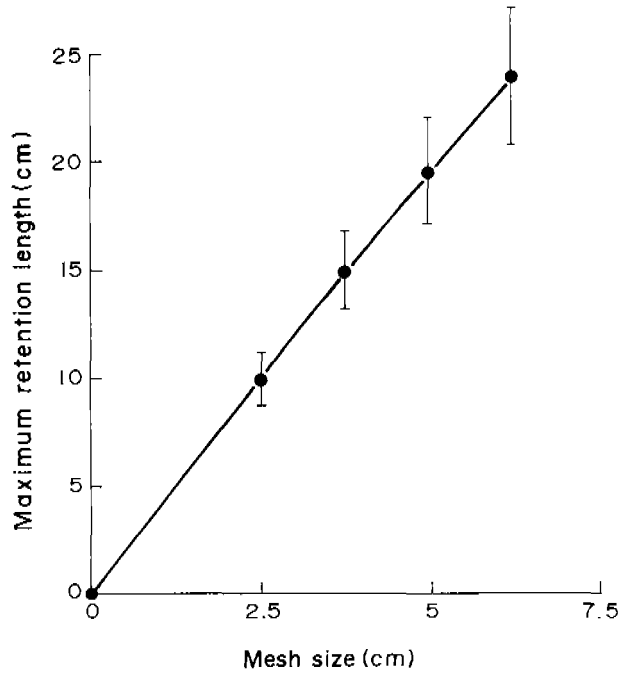

Fig. 2. Calculated relationships between mesh size and maximum retention length and standard deviation of the gill net selection curves for *Hampala macrolepidota*.

Fig. 3 shows the calculated selection curves from 2.5-cm (1") to 10-cm (4") mesh nets and the sum of the probabilities of retention of successive length groups in the combined fleet of sampling gill nets. Table 11a shows the calculated probabilities of retention for successive length groups and the overall probability of retention by the sampling gear.

Table 11b shows the calculated probability of retention by the nets in use by the small-scale fishermen, based on the numbers of nets of different sizes in use in March 1988 (Table 7).

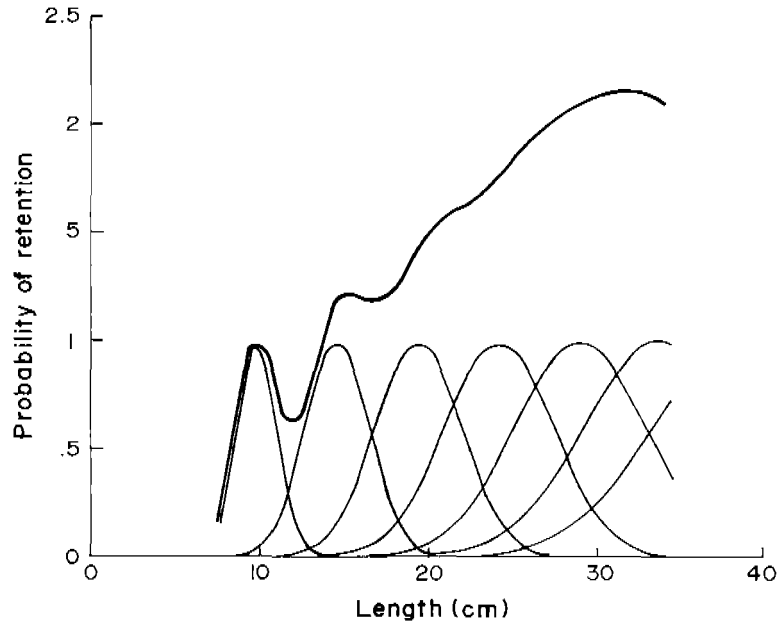

Fig. 3. Calculated selection curves for *Hampala macrolepidota* in 2.5 cm (1") to 10 cm (4") mesh gill nets and the summed probability of retention in the combined fleet of nets.

Table 11a. Calculated selection curves for *Hampala macrolepidota* in 1" to 5" mesh gill nets showing the sums of probabilities of retention of successive 1 cm size classes and the probabilities of retention relative to the maximum at 32.5 cm fork length. The data are also arranged into 2 cm size classes.

Mesh - (inches) - (cm)	1.0 2.5	1.5 3.8	2.0 5.0	2.5 6.3	3.0 7.5	3.5 8.8	4.0 10.0	All meshes combined			
MRL (cm) SD (calc.)	9.810 1.2	14.615 1.87	19.420 2.54	24.225 3.21	29.030 3.88	33.835 4.55	38.640 5.22				
Class mid length	Probability of Retention ( $P_i$ )							Sum of $P_i$	Relative $P_i$ 1 cm grp	Class mid length	Relative $P_i$ 2 cm grp
7.5	0.157	0.001	0.000	0.000	0.000	0.000	0.000	0.158	0.073	7	0.036
8.5	0.551	0.005	0.000	0.000	0.000	0.000	0.000	0.556	0.257	9	0.357
9.5	0.967	0.024	0.000	0.000	0.000	0.000	0.000	0.991	0.458		
10.5	0.848	0.089	0.002	0.000	0.000	0.000	0.000	0.939	0.434	11	0.362
11.5	0.371	0.250	0.008	0.000	0.000	0.000	0.000	0.629	0.290		
12.5	0.081	0.528	0.024	0.001	0.000	0.000	0.000	0.634	0.293	13	0.358
13.5	0.009	0.837	0.066	0.004	0.000	0.000	0.000	0.916	0.423		
14.5	0.000	0.998	0.153	0.010	0.001	0.000	0.000	1.163	0.537	15	0.552
15.5	0.000	0.894	0.304	0.025	0.002	0.000	0.000	1.226	0.566		
16.5	0.000	0.602	0.516	0.055	0.005	0.001	0.000	1.180	0.545	17	0.545
17.5	0.000	0.304	0.751	0.111	0.012	0.002	0.000	1.181	0.546		
18.5	0.000	0.116	0.937	0.204	0.025	0.003	0.001	1.285	0.594	19	0.627
19.5	0.000	0.033	1.000	0.338	0.049	0.007	0.001	1.428	0.660		
20.5	0.000	0.007	0.914	0.510	0.089	0.014	0.002	1.536	0.709	21	0.723
21.5	0.000	0.001	0.715	0.697	0.152	0.025	0.005	1.596	0.737		
22.5	0.000	0.000	0.479	0.866	0.243	0.045	0.008	1.641	0.758	23	0.772
23.5	0.000	0.000	0.275	0.975	0.362	0.076	0.015	1.703	0.787		
24.5	0.000	0.000	0.135	0.996	0.506	0.122	0.026	1.785	0.824	25	0.844
25.5	0.000	0.000	0.057	0.924	0.661	0.187	0.042	1.871	0.864		
26.5	0.000	0.000	0.021	0.778	0.808	0.273	0.067	1.947	0.899	27	0.913
27.5	0.000	0.000	0.006	0.594	0.925	0.379	0.103	2.008	0.927		
28.5	0.000	0.000	0.002	0.412	0.991	0.503	0.152	2.059	0.951	29	0.961
29.5	0.000	0.000	0.000	0.259	0.993	0.635	0.216	2.103	0.972		
30.5	0.000	0.000	0.000	0.148	0.931	0.764	0.296	2.140	0.988	31	0.994
31.5	0.000	0.000	0.000	0.077	0.817	0.877	0.392	2.162	0.999		
32.5	0.000	0.000	0.000	0.036	0.670	0.958	0.501	2.165	1.000	33	0.995
33.5	0.000	0.000	0.000	0.015	0.515	0.997	0.616	2.143	0.990		
34.5	0.000	0.000	0.000	0.006	0.370	0.989	0.730	2.096	0.968	35	0.957

Table 11b. Calculated overall selection curve for *Hampala macrolepidota* in the artisanal fishing fleet in Saguling Reservoir, weighted according to the relative number of different mesh sizes in use. The data are also arranged in 2 cm size classes.

Mesh Nets used (f)	1.5 11	2.0 38	2.5 31	3.0 5	3.5 1	4.0 16	Artisanal Fishing Fleet			
Class mid length	Probability of Retention ( $P_i$ )						Sum of $P_i$	Relative $P_i$ 1 cm grp	Length mid length	Relative $P_i$ 2 cm grp
7.5	0.008	0.001	0.000	0.000	0.000	0.000	0.009	0.000		
8.5	0.052	0.004	0.000	0.000	0.000	0.000	0.056	0.001	9	0.003
9.5	0.261	0.019	0.001	0.000	0.000	0.000	0.280	0.005		
10.5	0.977	0.080	0.003	0.000	0.000	0.000	14.060	0.021	11	0.040
11.5	2.747	0.294	0.012	0.000	0.000	0.000	3.053	0.060		
12.5	5.803	0.929	0.039	0.001	0.000	0.000	6.772	0.133	13	0.182
13.5	9.209	2.513	0.1117	0.002	0.000	0.000	11.840	0.232		
14.5	10.979	5.822	0.315	0.005	0.000	0.000	17.121	0.335	15	0.384
15.5	9.835	11.550	0.771	0.011	0.000	0.001	22.168	0.434		
16.5	6.618	19.625	1.713	0.027	0.001	0.002	27.986	0.548	17	0.620
17.5	3.348	28.557	3.454	0.060	0.002	0.004	35.423	0.693		
18.5	1.271	35.587	6.319	0.126	0.003	0.009	43.316	0.848	19	0.904
19.5	0.363	37.981	10.492	0.245	0.007	0.019	49.107	0.961		
20.5	0.078	34.716	15.811	0.446	0.014	0.038	51.102	1.000	21	0.986
21.5	0.013	27.175	21.621	0.761	0.025	0.073	49.667	0.972		
22.5	0.002	18.218	26.832	1.213	0.045	0.134	46.444	0.909	23	0.873
23.5	0.000	10.459	30.219	1.811	0.076	0.238	42.804	0.838		
24.5	0.000	5.143	30.866	2.529	0.122	0.408	39.088	0.765	25	0.725
25.5	0.000	2.166	28.649	3.305	0.187	0.673	34.980	0.685		
26.5	0.000	0.781	24.115	4.042	0.273	1.071	30.282	0.593	27	0.544
27.5	0.000	0.241	18.422	4.626	0.379	1.641	25.309	0.495		
28.5	0.000	0.064	12.771	4.954	0.503	2.425	20.716	0.405	29	0.370
29.5	0.000	0.014	8.035	4.963	0.635	3.454	17.102	0.335		
30.5	0.000	0.003	4.587	4.654	0.764	4.743	14.752	0.289	31	0.278
31.5	0.000	0.000	2.377	4.083	0.877	6.278	13.615	0.266		
32.5	0.000	0.000	1.118	3.352	0.958	8.011	13.438	0.263	33	0.268
33.5	0.000	0.000	0.477	2.575	0.997	9.853	13.902	0.272		
34.5	0.000	0.000	0.185	1.851	0.989	11.682	14.707	0.288	35	0.144

Some larger mesh sizes of up to 30.5 cm (12") stretched mesh are also used but would not retain *H. macrolepidota*. Owing to the predominance of small-meshed nets, fish of around 20.5 cm fork length have the greatest probability of being captured by the fishermen.

## Growth

There are surprisingly few published estimates of the growth rates of any wild stocks of tropical cyprinids. Dwiponggo et al. (1986) estimated growth parameters for *H. macrolepidota* in the Jatiluhur Reservoir, but the estimates were based on very small samples. Yap (1984) estimated growth parameters of *Osteochilus hasselti* in Bukit Merah Reservoir in Malaysia and found  $L_{\infty} = 27.8$  cm and  $K = 1.15$ . The growth performance index,  $\phi'$  (Pauly and Munro 1984) is therefore 2.95. If the  $L_{\infty}$  for *H. macrolepidota* is around 36 cm and  $\phi' = 2.95$ , the coefficient of growth,  $K$ , would be expected to be about 0.7.

Watson and Balon (1985) produced a series of estimates of growth of various stream fishes in northern Borneo, including *H. macrolepidota*. Estimates were based on marks on scales. However, the annual increments which they derived are extremely small. Either their interpretations are erroneous or the streams sampled are extremely hostile environments.

In order to derive estimates of the growth of *H. macrolepidota* the data were first examined to see if they could be usefully broken down by sex. However, the bulk of the catch was of immature fish of indeterminate sex and all data were therefore combined on a lunar monthly basis and expressed in terms of the catch of each mesh size at each sampling site.

Table 12a shows the size-frequency data for the catches taken in four nets of each mesh size in successive lunar months. Table 12b gives the frequencies, corrected by the estimated combined probability of retention by the gill-net fleet used for sampling. However, with the data split into 1-cm size classes the ELEFAN I program yielded a low "goodness of fit" ( $R_n = 0.19$ ) and low values of  $K = 0.15 - 0.20$  and  $L_1 = 40$  cm.

Recombination of the data into 2-cm size classes eliminated a number of apparently spurious peaks and provided a fairly clear progression from around 12 cm in September 1987 to around 18.5 cm the following March, but the value of  $R_n$  remained low at 0.207. The analysis yielded estimates of  $L_{\infty} = 35.4$  and  $K = 0.635$ . This gives a  $\phi'$  value of 2.90, close to that obtained for *O. hasselti* (Yap 1984). The fit of the calculated growth curves to the length-frequency data is shown in Figs. 4 and 5.

The spread of the size-frequency distributions suggested that the spawning season might have been somewhat extended in early 1987. Alternatively there are two spawning peaks each year. However, as *H. macrolepidota* appears to be a species which migrates up rivers to spawn in flooded grassy margins, it seems unlikely to have two spawning seasons in a monsoonal climate. Additionally, it is possible that the typical spawning pattern was not seen here as the reservoir was filling in early 1987 when the cohort was presumably spawned. This would have

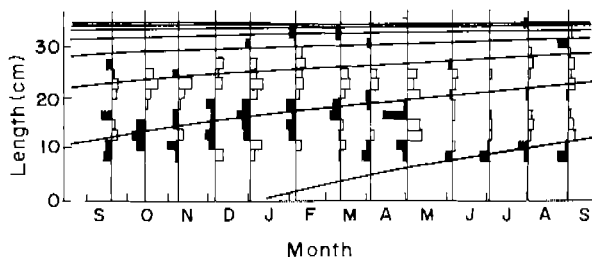

Fig. 4. Best fit of a von Bertalanffy growth curve to the length-frequency data for *Hampala macrolepidota* (after combining into 2 cm size groups and restructuring). The fit is obtained using the ELEFAN I program and yields estimates of  $K = 0.635$  and  $L_{\infty} = 35.4$  cm, with a "goodness-of-fit" of  $R_n = 0.209$ .

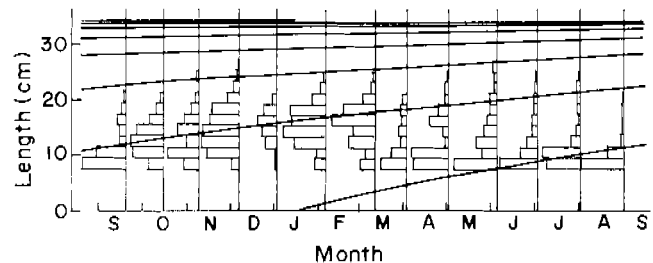

Fig. 5. Fit of the von Bertalanffy growth curve to the estimated true size frequencies of *Hampala macrolepidota* (as given in Table 12b; data combined into 2 cm size groups). Estimated  $K = 0.635$  and  $L_{\infty} = 35.4$  cm.



Table 12a. Size-frequency distributions of *Hampala macrolepidota* in successive lunar monthly samples in Saguling Reservoir. Frequencies are expressed as the catch of each length group in four nets of each mesh size of between 1" and 5" mesh, in 0.5" increments.

ML/Date	9/17/87	10/13/87	11/7/87	12/5/87	1/2/88	2/5/88	3/11/88	4/2/88	5/1/88	6/4/88	7/2/88	7/30/88	8/27/88
8.5	13.00	5.00	1.00			3.66		6.65	12.49	17.30	40.00	13.00	38.00
9.5	86.00	19.00	16.00	7.33	4.00	6.32	10.60	42.60	29.45	53.60	60.00	57.00	128.00
10.5	57.00	42.00	24.00	23.31	4.00	4.99	2.66	25.30	26.46	15.00	32.00	57.00	59.30
11.5	10.00	12.00	12.00	11.31	0.00	4.33	3.99	3.99	18.15	8.65	14.00	23.00	11.00
12.5	6.00	21.00	5.00	9.33	5.33	4.00	5.32	7.98	2.66	18.50	16.00	10.00	7.00
13.5	7.00	35.00	10.00	30.66	17.30	25.70	14.30	2.66	1.33	16.50	10.30	9.32	5.33
14.5	13.00	40.00	26.00	31.33	24.00	23.70	10.30	12.00	2.66	18.50	17.30	6.65	8.00
15.5	6.00	30.00	11.00	29.00	21.30	37.00	15.50	7.98	5.32	15.50	1.33	3.99	6.66
16.5	16.00	18.00	8.00	25.00	24.00	19.30	20.30	9.31	10.64	19.20	6.66	1.00	5.33
17.5	12.00	18.00	17.00	22.65	31.30	29.00	29.60	6.65	22.61	3.33	10.00	6.33	7.00
18.5	8.00	14.00	10.00	25.30	33.30	28.00	23.30	10.60	15.96	5.99	7.33	3.33	8.00
19.5	7.00	7.00	6.00	25.62	10.70	29.30	20.00	7.98	3.99	12.30	6.33	7.99	4.00
20.5	4.00	5.00	4.00	11.66	9.32	10.30	13.30	9.31	2.66	17.60	5.66	3.66	4.99
21.5	0.00	4.00	5.00	15.00	7.33	14.30	5.99	6.65	2.66	3.66	8.32	7.98	6.93
22.5	0.00	1.00	1.00	5.99	4.66	7.98	3.66	0.00	2.66	3.66	4.99	4.99	2.33
23.5	1.00	0.00	1.00	5.33	0.00	2.66	2.00	1.33	2.66	2.66	2.66	2.66	0.00
24.5	1.33	0.00	5.00	3.33	3.33	3.99	0.00	1.33	1.33	3.66	2.66	2.33	2.66
25.5	0.00	1.40	1.00	4.00	0.00	1.33	2.66	0.00	0.00	0.00	1.33	2.33	1.33
26.5	2.33		0.00	2.00	1.33	1.33	0.00	0.00	0.00	6.65		0.00	1.33
27.5			0.00		0.00	0.00	0.00	1.33	0.00	1.33		1.33	0.00
28.5			0.00		0.00	1.33	0.00	0.00	0.00			0.00	0.00
29.5			2.00		0.00	0.00	0.00	0.00	0.00			1.00	3.00
30.5					1.33	1.33	0.00	1.33	0.00			0.00	2.00
31.5						0.00	0.00		0.00			0.00	0.00
32.5						0.00	1.33		0.00			0.00	1.00
33.5						2.00			0.00			0.00	
34.5									0.00			1.00	
35.5									1.33				
Sum	249.66	272.00	165.00	288.15	202.53	261.85	184.81	164.98	165.02	243.59	246.87	225.89	313.25

n = 2,983.60

Table 12b. Estimated true size-frequency distributions of *Hampala macrolepidota* in successive lunar months in Saguling Reservoir, derived by dividing the frequencies given in Table 12a, by the estimated probability of retention of each size class in the gill nets used for sampling.

ML/Date	9/17/87	10/13/87	11/7/87	12/5/87	1/2/88	2/5/88	3/11/88	4/2/88	5/1/88	6/4/88	7/2/88	7/30/88	8/27/88
8.5	50.62	19.47	3.89			14.25		25.89	48.64	67.36	155.76	50.62	147.97
9.5	187.88	41.51	34.96	16.01	8.74	13.81	23.16	93.07	64.34	117.10	131.08	124.53	279.64
10.5	131.42	96.84	55.34	53.74	9.22	11.51	6.13	58.33	61.01	34.58	73.78	131.42	136.72
11.5	34.42	41.30	41.30	38.93	0.00	14.90	13.73	13.73	62.47	29.77	48.19	79.17	37.86
12.5	20.49	71.71	17.07	31.86	18.20	13.66	18.17	27.25	9.08	63.17	54.64	34.15	23.90
13.5	16.54	82.72	23.64	72.47	40.83	60.74	33.80	6.29	3.14	39.00	24.34	22.03	12.60
14.5	24.20	74.46	48.40	58.32	44.68	44.12	19.17	22.34	4.95	34.44	32.21	12.38	14.89
15.5	10.60	0.00	19.43	51.21	37.61	65.34	27.02	14.09	9.39	27.37	2.35	7.05	11.76
16.5	29.36	55.04	14.68	45.87	44.03	35.41	37.25	17.08	19.52	35.23	12.22	1.83	9.78
17.5	22.00	33.00	31.16	41.52	57.38	53.16	54.26	12.19	41.45	6.10	18.33	11.60	12.83
18.5	13.48	30.33	16.85	42.63	56.10	47.18	39.26	17.86	26.89	10.09	12.35	5.61	13.48
19.5	10.67	21.34	9.15	39.06	16.31	44.67	30.49	12.17	24.33	18.75	9.65	12.18	6.10
20.5	5.64	9.87	5.64	46.43	13.14	14.52	18.75	13.12	5.62	24.81	7.98	5.16	7.03
21.5	0.00	6.78	6.78	20.35	9.94	19.40	8.13	8.89	3.61	4.96	11.29	10.83	9.48
22.5	0.00	5.28	1.32	7.90	6.15	10.53	4.83	0.00	3.51	4.83	6.58	6.58	3.07
23.5	1.27	1.27	1.27	6.78	0.00	3.38	2.54	1.69	3.38	3.38	3.38	3.38	0.00
24.5	1.61	0.00	6.06	4.04	4.04	4.84	0.00	1.61	3.23	4.44	3.23	2.83	3.23
25.5	0.00	0.00	1.16	4.63	0.00	1.54	3.08	0.00	1.54	0.00	1.54	2.70	1.54
26.5	2.59	1.11	0.00	2.22	1.48	1.48	0.00	0.00	0.00	7.39	0.00	0.00	1.48
27.5			0.00		0.00	0.00	0.00	1.43	0.00	1.43		1.43	0.00
28.5			0.00		0.00	1.40	0.00	0.00	0.00			0.00	0.00
29.5			2.06		0.00	0.00	0.00	0.00	0.00			1.03	3.09
30.5					1.35	1.35	0.00	1.35	0.00			0.00	2.02
31.5						0.00	0.00		0.00			0.00	0.00
32.5						0.00	1.33		0.00			0.00	1.00
33.5						2.02			0.00			0.00	
34.5									0.00			1.03	
35.5									1.41				
Sum	562.79	592.03	340.16	553.97	369.26	479.21	341.10	348.38	397.51	534.20	608.90	527.54	739.47

n = 6,394.52

provided extensive areas of flooded vegetation and possibly favorable conditions for spawning and larval survival.

It is emphasized that the basis for these growth parameter estimates is far from satisfactory. However some degree of confirmation is obtainable by examining the data on catch per unit of effort in different size gill nets. It is known that gill nets are highly selective and catch rates should peak in a gill net when the mean size of a cohort reaches the maximum retention length (MRL) in a gill net. This applies particularly to rapidly growing species passing through a range of relatively small mesh sizes. In large-meshed nets (12.5 cm or more) it would be expected that several cohorts would be catchable and the peak in catch per unit of effort obscured.

From the mesh selection analyses the MRLs are known (Fig. 2), as are the expected modal sizes in successive months (Table 13). If the growth estimates are accurate, catches should peak in the nets on the following schedule:

Mesh	MRL	Expected peak	Observed peak
2.5 (1")	9.8	July	Sept
3.8 (1.5")	14.6	Nov	Oct & Dec
5.0 (2")	19.4	April	April
6.4 (2.5")	24.2	Nov	?
7.5 (3")	29.0	Sept	?

Table 13. Calculated lengths attained by *Hampala macrolepidota* in successive months when  $L_{\infty} = 35.4$  cm,  $K = 0.635$  and cohorts originate in early January.

Age	0+	1+	2+	3+	4+	5+	6+
Jan	0.45	16.88	25.59	30.20	32.65	33.94	34.63
Feb	2.28	17.85	26.10	30.48	32.79	34.02	34.67
Mar	3.86	18.69	26.55	30.71	32.92	34.09	34.71
Apr	5.51	19.57	27.01	30.96	33.05	34.16	34.74
May	7.03	20.37	27.44	31.18	33.17	34.22	34.78
Jun	8.52	21.16	27.86	31.40	33.29	34.28	34.87
Jul	9.89	21.88	28.24	31.61	33.39	34.34	34.84
Aug	11.23	22.59	28.62	31.81	33.50	34.39	34.87
Sep	12.50	23.27	28.97	32.00	33.60	34.45	34.90
Oct	13.66	23.88	29.30	32.17	33.69	34.50	34.92
Nov	14.81	24.49	29.62	32.34	33.78	34.54	34.95
Dec	15.85	25.04	29.91	32.50	33.86	34.59	34.97

Fig. 6 shows a succession of peaks in catch per unit of effort at around the expected times. However, the discrepancy in the observed and expected peaks in catch rates in the 2.5-cm mesh nets is quite large and again lends some uncertainty to the estimates.

The estimate of  $K = 0.635$  and  $L_{\infty} = 35.4$  cm is therefore taken as the best interim estimate until such time as estimates based on larger stocks or a more intensive sampling program are available. It is emphasized that they are close to the values derived from the estimate of  $\phi'$ .

### **Mortality Rates**

Given estimates of growth parameters the mortality rates can be estimated using several computer programs in the ELEFAN suite. First, as the selection probabilities are known both for

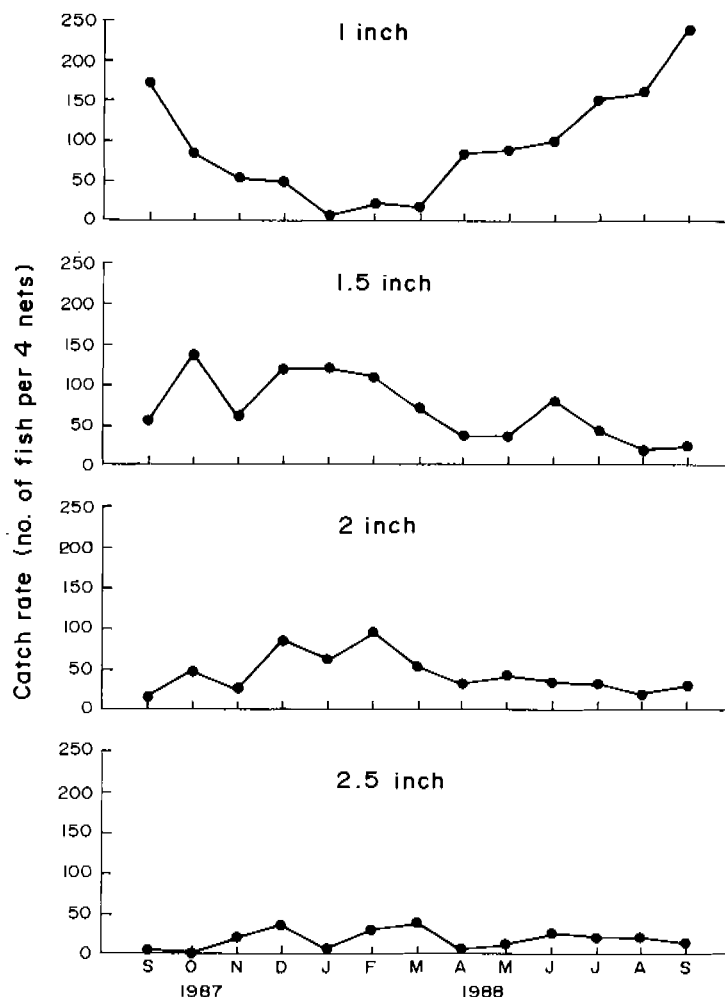

Fig. 6. Intra-annual change in catch rate of *Hampala macrolepidota* in 2.5-6.4 cm (1"-2.5") mesh gill nets in Saguling Reservoir. Note that peak catches are attained in different months in different mesh sizes. The peaks are presumed to correspond to the full recruitment of a cohort to that mesh size.

the sampling fleet (Table 11a) and the small-scale fleet (Table 11b) of gill nets, the ELEFAN IV routine was attempted. In this approach, the size-specific mortality rate is expected to be proportional to  $P$ , the probability of retention of a particular length group, in the small-scale fleet. Two analytical methods are available: the original method of Munro (1984) and a modification suggested by Moreau (1988).

Fig. 7a, based on the data grouped into 2-cm size classes, shows that the length-converted catch curve is indeed steepest in the mid-range corresponding to the small-scale fleet's predominant size of gill nets. The regression of  $P$  against  $Z$  for successive size groups gives positive regressions for both of the analytical methods and yield estimates of natural mortality of 1.79 and 1.73 (Fig. 7b and 7c), respectively. These are credible values, but poorly based in any statistical sense, because the correlation coefficients are not high.

For assessment purposes the value of  $M$  has been set at the median value of  $M = 1.76$ . This compares fairly well with the value of  $M = 1.24$  estimated from Pauly's (1980) empirical equation.

Fig. 8 shows that the average total mortality rate,  $Z$ , over the main part of the exploited range (between the lengths of 16 and 26 cm, at which  $P \geq 0.50$ ),  $Z = 3.507$ , and the rate of exploitation  $E (= (Z-M)/Z = F/Z) = 0.498$ .

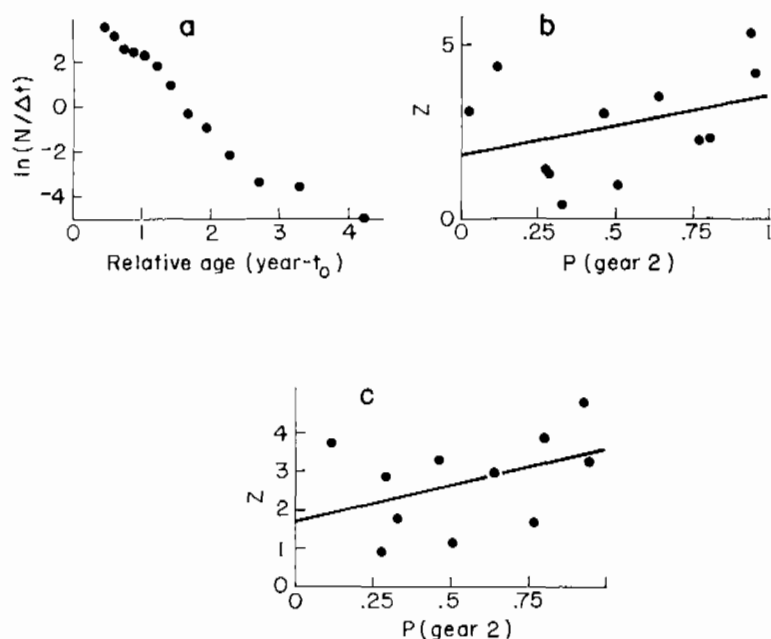

Fig. 7. Output of the ELEFAN IV computer program for the estimation of natural mortality rates. a. Length-converted catch curve indicating age- or size-specific changes in mortality rates, based on estimated true size frequencies (in 2 cm size classes) of *Hampala macrolepidota* in the Saguling Reservoir. b. Regression of estimated total mortality rates of successive size classes against the probability of capture in the small-scale gill net fleet using Munro's method.  $M = 1.789$ ; S.E. = 0.892;  $Z = 1.789 + 1.75 P$ . c. As in Fig. 7b, using Moreau's method.  $M = 1.729$ ; S.E. = 0.835;  $Z = 1.729 + 1.83 P$ .

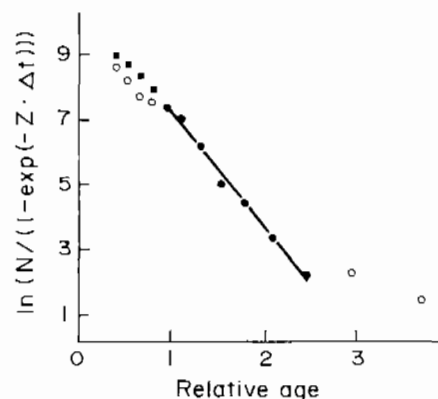

Fig. 8. Output of ELEFAN II computer program showing length-converted catch curve for *Hampala macrolepidota* in Saguling Reservoir. Assuming knife-edge selection the fishes enter the small-scale fleet (i.e.,  $P = 0.50$ ) at 16 cm and leave it at 28 cm fork length. Over that range  $Z = 3.507$  and if  $M = 1.76$ , the rate of exploitation  $E = F/Z = 0.498$  when  $K = 0.635$  and  $L_{\infty} = 35.4$  cm.

### Yield Per Recruit

Analyses were made of likely relative yields based on a range of smallest permissible mesh sizes, ranging from 12.5 cm (1") to 7.5 cm (3") stretched mesh. The analysis assumes that meshes larger than the minimum permitted size will be used as long as such meshes produce satisfactory catches. Fig. 9 shows that harvests per recruit will be maximized by using a minimum mesh size of 3.8 cm (1.5") stretched mesh when the marginal exploitation rate,  $E_{0.1}$ , is around 0.51. This is very close to the exploitation rate estimated for the fishery and also accords with the minimum mesh size used and it can therefore be concluded that the stock of *H. macrolepidota* is currently nearly optimally exploited. This would appear to indicate a high vulnerability to capture because the small-scale fleet appeared to be declining (in response to poor catch rates) during the sampling period. In short, optimum rates of exploitation for this species will be achieved at relatively low levels of fishing effort. Fig. 9 shows that the relative yield will decline dramatically if fishing effort is increased beyond present levels. Likewise, biomass and hence catch rates will decline in response to any increase in the rate of exploitation.

Fig. 9 also shows that the yields in 5-cm (2") mesh nets will be almost as high as in the 1.5" mesh and the larger mesh size would therefore be theoretically preferable in terms of maximizing the spawning stock. However, it is not desirable to maximize the stock of predators at the present time.

It is most strongly emphasized that if the fish community of the reservoir is enhanced by selected introductions of more desirable species, the minimum permissible mesh size will certainly be larger than 3.8 cm (1.5").

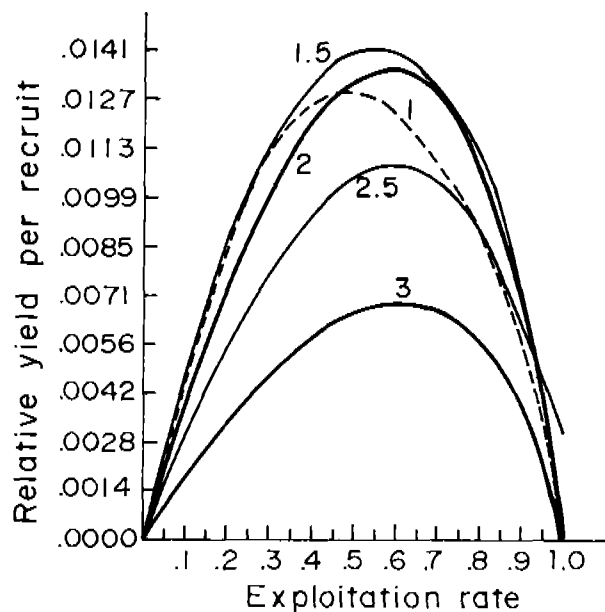

Fig. 9. Calculated yield per recruit of *Hampala macrolepidota* when minimum permitted mesh sizes range from 1" to 3" (2.5 to 7.5 cm) stretched mesh. Maximum yield per recruit is attained in 3.8 cm (1.5") mesh nets when  $E = 0.55$ , but 5 cm (2") mesh nets would give almost the same yield per recruit and larger average fish sizes.

### Community Dynamics and Management

The present study, undertaken during the initial filling of Saguling and subsequent drawdown to fill Cirata Reservoir, has been useful in providing a basic insight into the mechanics of sampling, the methodologies of appropriate sampling and methods for data analysis in the future.

The low stock densities encountered should not be surprising. The Citarum River has been transformed from a highly polluted river to a eutrophic reservoir within a very short period. The riverine fishes present had a greatly increased area of water available to them. However, the trophic resources of a newly formed, unstable reservoir are largely in the form of plankton and terrestrial insects and it is therefore unsurprising that few species, in this case only *H. macrolepidota*, have been able to expand to partially fill the habitat.

It is highly likely that the ability of *H. macrolepidota* to turn to insects as a source of food is a major factor in their success. Abidin (1984) and Yap (1988) both describe this species as a piscivore in reservoirs in Malaysia. Clearly the ability to utilize insects as a food source combined with a piscivorous proclivity suggests that *H. macrolepidota* should be well placed to succeed in a new impoundment, whilst keeping possible prey species at a low level of abundance. This is confirmed by the catch rates of the sampling program. It should be added that the reported occasional captures of large common carp (*Cyprinus carpio*) are very likely to be the result of escapement from aquaculture activities. The scarcity of small carp in the gill-net catches shows that recruitment to the reservoir population has been minimal.

Thus, there is this every indication that the stocks of fish in the reservoir have not built up much since impoundment. Current levels of fishing intensity might ensure that this situation remains unchanged until effective management practices are instituted. A review of possible

management practices is given by Munro and Williams (1986) in relation to coral reef fisheries, but almost all of the considerations can be applied to reservoirs. Both ecosystems are circumscribed and amenable to a wide array of management options. Reservoir fisheries lend themselves to stocking and species introductions to a much greater degree than do coral reefs but otherwise the principles are identical.

The accelerating pollution of the inflowing rivers to Saguling, especially the main branch of the Citarum River, is a major cause for concern (see Soemarwoto et al., this vol.). During the long drawdown period in 1987-88 to fill the new downstream Cirata Reservoir, the Citarum became a "black water", anoxic river for 1-2 km as it exited the urban metropolis of Bandung and emptied into Saguling. The main Citarum River is the biological home for the original fish populations of the reservoir. Most of these species undertake spawning migrations upriver during the onset of the rainy season. Severe organic pollution of the Citarum certainly could have a major detrimental effect on fish survival, spawning success and recruitment. To develop sustainable capture fisheries in Saguling, future attention must be paid to water quality factors, especially the reduction of discharges of domestic wastes and industrial pollutants. No amount of management will produce fish from an uninhabitable or highly stressed environment.

## **Stock Enhancement**

### SPECIES INTRODUCTION

The present array of 23 fish species currently known from the Saguling Reservoir and the inflowing Citarum River includes 10 exotic species. Two predatory species, *Clarias gariepinus* and *Oxyeleotris marmorata*, are included in the exotics. Indigenous predators include *Hampala macrolepidota*, *Macrones micracanthus*, *M. nemurus*, *C. batrachus* and *Channa striata*. Future introductions of predatory species should be strictly prohibited.

Species present in the Citarum River below Saguling include all of the species currently inhabiting the Jatiluhur Reservoir, the headwaters of which will reach to the wall of the Cirata Reservoir, plus species in the catchment of the Citarum River. Baluyut (1983) gives a list of species introduced to Jatiluhur Reservoir. These include *Osphronemus gouramy* and *Trichogaster trichopterus*, which have not been recorded from Saguling.

As there is already a wide array of detritus feeders and benthic omnivores in the system it is obvious that aquatic macrophyte feeders and planktivores should be a prime focus for future introductions, particularly if species can be identified which will adopt a pelagic habitat. Each introduction needs to be carefully considered on its individual merits.

Species which appear to offer some potentials include the Thai freshwater sardine, *Clupeichthys aesarnensis*, the likely introduction of which has been discussed in detail by Costa-Pierce (1988) and Costa-Pierce and Soemarwoto (this vol.), who provide details of its feeding, breeding habits and fisheries ecology. It appears likely to be able to utilize abundant blue-green algae and small zooplankton of the reservoir and form the basis of a pelagic fishery. One problem in establishing this species is the unknown impact of predation by *H. macrolepidota*.

An additional species which should be considered is *Tilapia rendalli*, which has a diet in which aquatic macrophytes predominate. If this were to be combined with the introduction of the grass, *Panicum repens*, which thrives in drawdown areas (Caulton 1977), an additional trophic level would be established. The grass carp, *Ctenopharyngon idella*, which is already in the system, although extremely rare, might compete with *T. rendalli*, but the tilapia would have a somewhat better chance of successful reproduction in the reservoir habitat.

### STOCKING SYSTEMS

The need for the creation of a stocking system is indicated by the apparently poor success of any species other than *H. macrolepidota* in establishing substantial stocks. The reasons for

this are likely to include the presence of a dominant predator in the form of *H. macrolepidota*, disruption of spawning activities by the erratic drawdown of the reservoir and the immediate emergence of a substantial fishery exploiting the very sparse stocks. Without some form of intervention it is unlikely that the reservoir will ever develop substantial stocks.

Three possible methods of stock enhancement appear to have potential. These include the release of hatchery-reared fingerlings of selected species of herbivores and detritus feeders, the establishment of breeding pens in the reservoir, and the creation of protected areas. All are aimed at enhancing the stocks of juvenile fishes. However, all will fail if not accompanied by appropriate management techniques.

Stocking hatchery-reared juveniles is likely to be expensive owing to the demand for stock by the aquaculture industry and the fact that juveniles stocked would need some form of protection from capture in order to reach a reasonably large, postmaturity, size. However, if funds were available, a stocking program could assist in establishing desirable species in the reservoir. An annual Nile tilapia stocking program in Jatiluhur has been successful in increasing capture fisheries production from 10-18 kg/ha/year (average 1972-1978) to 22-37 kg/ha/year in 1979-1982 (Kartamihardja and Hardjamulia 1983).

The alternative is to establish protected floating breeding cages or pens within the lake for species such as the carp and tilapia. These would need to be carefully constructed and sited in selected areas so that the structures could be moved to appropriate depths when the reservoir levels rose or fell. The net floor would need to rest on the lake bed in order for tilapia to reproduce and the area selected would need to be free of obstructions which could entangle and tear the nets. Cages situated on moderately sloping bottom and thus covering a substantial drawdown range would be most versatile. The mesh size would be sufficiently large to permit the escape of juvenile carp or tilapia. Juveniles would thus filter out into the reservoir system and supplement the numbers of fishes spawned by wild stocks. Such cages would need to be carefully tended and predators controlled locally by selective fishing.

A further permutation would be to establish protected areas in which fishing was entirely prohibited. Preferably such areas would also have breeding cages and would be the prime areas into which hatchery-reared juveniles were released. A further disincentive to fishing in protected areas would be the deployment of random arrays of submerged barbed wire which would ruin gill nets set illegally in areas likely to be frequented by juvenile and subadult fishes.

## ***Management***

For the fishery in Saguling to succeed in producing anything approaching its potential, it is essential that an effective management system be established for the fishery. All of the possible options are detailed by Munro and Williams (1986) and summarized in Table 14. Their practicality will depend on local factors. No single measure will suffice.

The basic objective is to ensure that substantial, self-reproducing stocks of desirable species are established in Saguling and Cirata Reservoirs. As fishes in reservoirs are extremely vulnerable to capture in modern gill nets, this will be achieved by regulating both fishing effort and mesh sizes. It is recommended that management focus on the establishment of protected areas and the imposition of a minimum mesh size in the first instance.

It would be essential that fish wardens be appointed with an active role in preventing poaching within protected areas and in the enforcement of minimum mesh sizes.

Areas particularly suited for protected areas would include all major rivers and their inflows where many of the species would tend to congregate prior to upstream spawning migrations, usually coinciding with the onset of monsoon rains. Portions of the reservoir with a moderately sloping shallow floor would also be suitable because these would afford good spawning areas for the tilapias.

It is recommended that a system of individual transferable licenses be instituted. These should be issued *free* to all registered, locally resident fishermen and would permit an individual

to operate a limited array of fishing gears. The objective of such a system is to vest the ownership of the fishery into the hands of a fairly large number of individuals and to prevent the fishery being taken over by relatively large-scale fishing enterprises. The essence of the system is that the license becomes an asset which can be sold or transferred to another individual or to the fisheries agency when a fisherman decides to retire from the fishery. The system therefore

Table 14. A synopsis of management options for the Saguling Reservoir.

#### STOCK ENHANCEMENT

##### Environmental management

- \* Maintenance of water quality
  - e.g. pollution control
  - sewage treatment
  - diversion of sewers
- \* Physical changes
  - e.g. creation of nursery areas
  - construction of spawning beds

##### Stocking systems

- \* Breeding cages
  - e.g. floating nets or cages stocked with selected broodstock
- \* Direct introductions
  - e.g. introductions of fingerlings of selected species
- \* Predator control
  - e.g. selective fishing for predators
- \* Species introductions
  - e.g. introduction of new species to fill unoccupied trophic niches or habitats

#### RESTRICTIONS

##### Catch restrictions

- Total catch quota
  - e.g. quota set for entire fishery and fishery closed when quota attained
- \* Individual catch quotas
  - e.g. individual fishermen or boats have quotas and are excluded from fishery when quota is attained
- Closed seasons
  - e.g. fishery is closed at selected periods, usually to protect spawning stock or to protect new recruits
- \* Closed areas
  - e.g. areas are closed to fishing either temporarily or permanently

##### Gear restrictions

- \* Gear prohibitions
  - e.g. certain fishing gears are prohibited
- \* Gear limitations
  - e.g. numbers of units of fishing gear per individual or boat is limited

##### Size restrictions

- Mesh size
  - e.g. minimum (and sometimes maximum) mesh size is specified
- \* Fish size
  - e.g. possession of fishes below a certain size is prohibited

#### INDIRECT ADMINISTRATIVE METHODS

- \* Annual renewable licenses
  - e.g. each fisherman or boat is required to have a fishing license
- Permanent individual transferable licenses
  - e.g. all fishermen are initially issued with a free license which is thereafter transferable by sale when the fisherman retires from fishing
- \* Individual transferable quotas
  - e.g. individual fisherman or boats have a quota entitlement which can be sold
- Marketing restrictions
  - e.g. maximum prices



becomes self-policing in that the local community themselves will enforce acceptable regulations.

The investigations have conclusively shown that the Saguling Reservoir has no substantial fish stocks of any species and consequently is producing a small fraction of its potential fish yield. This is attributed to the fact that the combination of intensive fishing of the newly formed lake and the presence of a major piscivore have combined to ensure that the stocks of adult fish of all species have remained at minimal levels. The reservoir fishery is thus recruitment limited. It is recommended that protected areas be established in selected parts of the reservoir, combined with minimum mesh sizes and an active system of operation of breeding pens for tilapias and carps and the protection of juvenile fishes from exploitation.

### Acknowledgements

The authors wish to acknowledge the field assistance of Mr. Iwa Kuswaeri and Mr. Asep Suryana who participated in all of the field work over the one-year study.

### References

- Abidin, A.Z. 1984. Some aspects of *Hampala macrolepidota* (van Hasselt) with reference to its food, feeding habits and reproduction from Zoo Negara Lake, Kuala Lumpur, Malaysia. Universiti Pertanian Malaysia. M.Sc. thesis.
- Abidin, A.Z. 1986a. Aspects of the biology of a tropical cyprinid, *Hampala macrolepidota* (Van Hasselt), with reference to food, feeding habits and reproduction, p. 515-518. In J.L. Maclean, L.B. Dizon and L.V. Hosillos (eds.) The First Asian Fisheries Forum. Asian Fisheries Society, Manila, Philippines.
- Abidin, A.Z. 1986b. The reproductive biology of a tropical cyprinid, *Hampala macrolepidota* (Van Hasselt), from Zoo Negara Lake, Kuala Lumpur, Malaysia. J. Fish Biol. 29: 381-391.
- Abidin, A.Z. and Ang Kok Jee. 1984. Induced breeding of ikan sebarau. *Pertanika* 57: 11-118.
- Baluyut, E.A. 1983. Stocking and introduction of fish in lakes and reservoirs in the ASEAN (Association of Southeast Asian Nations) countries. FAO Fish. Tech. Pap. 236. Rome.
- Caulton, M.S. 1977. A quantitative assessment of the daily ingestion of *Panicum repens* L. by *Tilapia rendalli* Boulenger (Cichlidae) in Lake Kariba. *Trans. Rhod. Scient. Assoc.* 58: 38-42.
- Costa-Pierce, B.A. 1988. Study mission to northeast Thailand for assessment of a pelagic freshwater sardine, *Clupeichthys aesarnensis*. IOE/ICLARM Consultancy Report, Bandung, Indonesia. 63 p.
- Dwiponggo, A., T. Hariati, S. Kartimahardja, E.S. Banon, M.L. Palomares and D. Pauly. 1986. Growth, mortality and recruitment of commercially important fishes and penaeid shrimps in Indonesian waters. ICLARM Technical Reports 17, 91 p. Research Institute for Marine Fisheries, Jakarta, Indonesia, and International Center for Living Aquatic Resources Management, Manila, Philippines.
- Fernando, C.H. and J. Holcik. 1982. The nature of fish communities: a factor influencing the fishery potential and yields of tropical lakes and reservoirs. *Hydrobiologia* 97: 127-140.
- Garrod, D.J. 1961. The selection characteristics of nylon gill net for *Tilapia esculenta* Graham. *J. Cons. CIEM* 26: 195-203.
- Gayaniilo, F.C., M. Soriano and D. Pauly. 1988. A draft guide to the Compleat ELEFAN. ICLARM Software 2, 65 p. International Center for Living Aquatic Resources Management, Manila, Philippines.
- Hamley, J. 1975. Review of gill net selectivity. *J. Fish. Res. Board Can.* 32: 1943-1969.
- Hardjamulia, A., K.E. Setiadi, and N.S. Rabegnatar. 1988. Some biological aspects of the predominant fish species in the Jatiluhur Reservoir, West Java, Indonesia, p. 98-104. In S. De Silva (ed.) Reservoir fishery management and development in Asia. International Development Research Centre, Ottawa, Canada.
- Henderson, H.F. and R.A. Welcomme. 1974. The relationship of yield to morpho-edaphic index and numbers of fishermen in African inland fisheries. *CIFA Occas. Pap.* 1. 19 p.
- Holt, S.J. 1963. A method for determining gear selectivity and its application. *ICNAF Spec. Publ.* 5:106-115. (Also presented 1957 at Joint Sci. Meeting, ICNAF, ICES and FAO, Lisbon. S-15: 21 p.)
- Hutchinson, G.E. 1967. Treatise on limnology. Volume 1. Part 1. Geography and physics of lakes. John Wiley, New York.
- IOE. 1980. Environmental impact analysis of mitigation of impact. Final report to Perusahaan Umum Listrik Negara, Jakarta, Indonesia. Volume IIA. Main report. Institute of Ecology, Padjadjaran University, Bandung, Indonesia.
- IOE. 1986. Environmental impact analysis of the Saguling dam. Final report to Perusahaan Umum Listrik Negara, Jakarta, Indonesia. Volume II. Main report. Institute of Ecology, Padjadjaran University, Bandung, Indonesia.
- Kartamahardja, E.S. and A. Hardjamulia. 1983. Kontribusi penebaran ikan nila (*Oreochromis niloticus*) terhadap produksi ikan waduk Jatiluhur, Jawa Barat. (Contribution of Nile tilapia (*Oreochromis niloticus*) stocking to fish production in the man-made lake Jatiluhur, West Java). *Bull. Penelitian Perikanan Darat* 4: 37-40. (In Indonesian).
- Krismono, K., Adriani and H. Atmadja. 1983. Penelitian populasi ikan di Waduk Jatiluhur, Jawa Barat. (A study on fish population in the man-made lake Jatiluhur, West Java). *Bull. Penelitian Perikanan* 4(2): 50-53. (In Indonesian).
- Krismono, D.W.H. Tjahjo, A. Hardjamulia, S. Nuroniah and C. Umar. 1987. Penelitian limno-biologis Waduk Saguling pada tahap post-inundasi. (Limno-biological research on the Saguling Reservoir after inundation). *Bull. Penelitian Perikanan Darat (Edisi Khusus)* 6: 1-31.

- Marshall, B.E. 1984. Predicting ecology and fish yields in African reservoirs from preimpoundment physico-chemical data. CIFA Tech. Pap. 12. 68 p.
- Mohsin, A.K. and M. Ambak. 1983. Freshwater fishes of Peninsular Malaysia. Penerbit Universiti Pertanian Malaysia, Selangor, Malaysia.
- Moreau, J. 1988. Estimation of natural mortality from selection and catch length-frequency data: a modification of Munro's method and application example. Fishbyte 6: 10-12.
- Munro, J.L. 1984. Estimation of natural mortality rates from selectivity and catch length-frequency data. Fishbyte 2: 13-15.
- Munro, J.L. and D. McB. Williams. 1985. Assessment and management of coral reef fisheries: biological, environmental and sociological aspects. Proc. 5th Int. Coral Reef Congr. Tahiti 4: 545-578.
- Pauly, D. 1980. On the interrelationships between natural mortality and growth parameters and mean environmental temperatures in 175 fish stocks. J. Cons. CIEM 39(3): 175-192.
- Pauly, D. 1984. Fish population dynamics in tropical waters: a manual for use with programmable calculators. ICLARM Studies and Reviews 8, 325 p. International Center for Living Aquatic Resources Management, Manila, Philippines.
- Pauly, D. and J.L. Munro 1984. Once more on growth comparison in fish and invertebrates. Fishbyte 2(1): 21.
- Regier, H.A. and D.S. Robson. 1966. Selectivity of gill nets, especially to lake whitefish. J. Fish. Res. Board Can. 23: 423-454.
- Ryder, R.A. 1965. A method for estimating the potential fish production of north-temperate lakes. Trans. Am. Fish. Soc. 94: 214-218.
- Sarnita, A. 1976. Some aspects of the fisheries in the man-made lake Jatiluhur. Proc. Indo-Pacif. Fish. Coun. 17: 272-291.
- Toews, D.A. and J.S. Griffiths. 1979. Empirical estimates of potential fish yields for the Lake Bangweulu system, Zambia, Central Africa. Trans. Am. Fish. Soc. 108: 241-252.
- Wahyu, H.T.D. and H. Atmadja. 1983. Periode makan dan aktivitas ikan hampal (*Hampala macrolepidota*) di Waduk Jatiluhur, Jawa Barat (Feeding periodicity and activity of hampal (*Hampala macrolepidota*) in the man-made lake Jatiluhur, West Java). Bull. Penelitian Perikanan 4: 54-58. (In Indonesian).
- Watson, D.J. and E.K. Balon. 1985. Determination of age and growth in stream fishes in northern Borneo. Environmental Biology of Fishes 13: 59-70.
- Yap, S.-Y. 1984. Cohort analysis on a freshwater fish *Osteochilus hasselti* C. & V. (Cyprinidae) at Bukit Merah Reservoir, Malaysia. Fish. Res. 2: 299-314.
- Yap, S.-Y. 1987. Recent developments in reservoir fisheries research in tropical Asia. Arch. Hydrobiol. Beih. Ergebn. Limnol. 28: 295-303.
- Yap, S.-Y. 1988. Food resource utilization partitioning of fifteen fish species at Bukit Merah reservoir, Malaysia. Hydrobiologia 157: 143-160.

Appendix 1a. Synopsis of catches by lunar month in Sector 1 (North) of the Saguling Reservoir. Weights are in grams.

Month/year	9/87	10/87	11/87	12/87	1/88	2/88					
Lunar month	1	2	3	4	5	6					
Family	Species	Total		Total		Total		Total		Total	
		#	Wt	#	Wt	#	Wt	#	Wt	#	Wt
A	<i>Anabas</i>										
	<i>testudineus</i>	0	0	0	0	0	0	0	0	0	0
	<i>Trichogaster</i>										
	<i>pectoralis</i>	0	0	0	0	0	0	0	0	0	0
B	<i>Macrones</i>										
	<i>micracanthus</i>	0	0	0	0	0	0	0	0	0	0
	<i>Macrones</i>										
	<i>nemurus</i>	1	43	0	0	1	66	0	0	1	80
Ch	<i>Channa</i>										
	<i>striata</i>	0	0	0	0	0	0	0	0	1	250
Ci	<i>Oreochromis</i>										
	<i>mossambicus</i>	0	0	0	0	0	0	0	0	0	0
	<i>Oreochromis</i>										
	<i>niloticus</i>	0	0	0	0	0	0	0	0	0	0
Cl	<i>Clarias</i>										
	<i>batrachus</i>	0	0	0	0	0	0	0	0	0	0
Cy	<i>Ctenopharyngodon</i>										
	<i>idella</i>	0	0	0	0	0	0	0	0	0	0
	<i>Cyprinus</i>										
	<i>carpio</i>	0	0	0	0	0	0	0	0	0	0
	<i>Hampala</i>										
	<i>macrolepidota</i>	47	1,521	27	1,971	40	4,169	53	4,086	51	4,185
	<i>Osteochilus</i>										
	<i>hasselti</i>	0	0	0	0	0	0	1	184	0	0
	<i>Rasbora</i>										
	<i>argyrotaenia</i>	0	0	0	0	0	0	0	0	0	0
E	<i>Oxyeleotris</i>										
	<i>marmorata</i>	2	96	1	52	0	0	2	50	3	157
	Total										
	Number of nets	0	0	36	36	32	32	30	30	13	13
	Catch/net/night			1.4	46.1	.9	63.2	1.4	141.2	4.3	332.3
				50	1,660	28	2,023	41	4,235	56	4,320
				56	4,320	56	4,672	56	4,672	56	4,672

Remarks: A = Anabantidae; B = Bagridae; Ch = Channidae; Ci = Cichlidae; Cl = Clariidae; Cy = Cyprinidae; E = Eleotridae.

Continued

Month/year		3/88		4/88		5/88		6/88		7/88		8/88		9/88		All months	
Lunar month		7		8		9		10		11		12		13			
Family	Species	Total		Total		Total		Total		Total		Total		Total		Total	
		#	Wt	#	Wt	#	Wt	#	Wt	#	Wt	#	Wt	#	Wt	#	Wt
A	<i>Anabas</i>	0	0	0	0	0	0	0	0	0	0	0	0	0	0	0	0
	<i>testudineus</i>																
	<i>Trichogaster</i>	0	0	0	0	0	0	0	0	0	0	0	0	0	0	0	0
	<i>pectoralis</i>																
B	<i>Macrones</i>	0	0	1	32	0	0	0	0	0	0	0	0	0	0	1	32
	<i>micracanthus</i>																
	<i>Macrones</i>	1	67	0	0	0	0	0	0	0	0	0	0	0	0	4	256
	<i>nemurus</i>																
Ch	<i>Channa</i>	0	0	1	100	0	0	0	0	0	0	0	0	0	0	1	100
	<i>striata</i>																
Ci	<i>Oreochromis</i>	1	385	0	0	0	0	0	0	0	0	2	311	0	0	3	696
	<i>mossambicus</i>																
	<i>Oreochromis</i>	0	0	0	0	0	0	0	0	0	0	0	0	0	0	0	0
	<i>niloticus</i>																
Cl	<i>Clarias</i>	0	0	0	0	0	0	0	0	0	0	0	0	0	0	0	0
	<i>batrachus</i>																
Cy	<i>Ctenopharyngodon</i>	0	0	0	0	0	0	1	680	0	0	0	0	0	0	1	680
	<i>idella</i>																
	<i>Cyprinus</i>	73	6,396	22	1,541	27	2,379	49	1,696	20	755	36	2,635	181	5,142	626	36,476
	<i>carpio</i>																
	<i>Hampala</i>	1	199	0	0	0	0	7	2,378	0	0	0	0	1	13	10	2,774
	<i>macrolepidota</i>																
	<i>Osteochilus</i>	0	0	1	13	0	0	0	0	0	0	0	0	0	0	1	13
	<i>hasselti</i>																
	<i>Rasbora</i>	0	0	2	44	3	138	2	57	1	17	0	0	15	590	31	1,201
	<i>argyrotaenia</i>																
E	<i>Oxyeleotris</i>	0	0	0	0	0	0	0	0	0	0	0	0	0	0	1	250
	<i>marmorata</i>																
	Total	76	7,047	27	1,730	30	2,517	59	4,811	21	772	38	2,946	197	5,745	679	42,478
	Number of nets	26	26	25	25	26	26	25	25	28	28	26	26	29	29	322	322
	Catch/net/night	2.9	271.0	1.1	69.2	1.2	96.8	2.4	192.4	.8	27.6	1.5	113.3	6.8	198.1	2.1	131.9

Remarks: A = Anabantidae; B = Bagridae; Ch = Channidae; Ci = Cichlidae; Cl = Clariidae; Cy = Cyprinidae; E = Eleotridae.

Appendix 1b. Synopsis of catches by lunar month in Sector 2 (River) of the Saguling Reservoir. Weights are in grams.

Month/year	3/88		4/88		5/88		6/88		7/88		8/88		9/88		All months		
Lunar month	7		8		9		10		11		12		13				
Family	Species	#	Total Wt	#	Total Wt	#	Total Wt	#	Total Wt	#	Total Wt	#	Total Wt	#	Total Wt	#	Total Wt
A	<i>Anabas testudineus</i>	10	381	5	240	1	24	1	28	0	0	0	0	0	0	26	1,013
	<i>Trichogaster pectoralis</i>	0	0	0	0	0	0	0	0	0	0	0	0	0	0	0	0
B	<i>Macrones micracanthus</i>	0	0	1	40	3	114	0	0	0	0	0	0	0	0	4	154
	<i>Macrones nemurus</i>	2	343	0	0	2	160	1	32	1	220	0	0	0	0	16	1,819
Ch	<i>Channa striata</i>	0	0	0	0	0	0	0	0	0	0	0	0	0	0	0	0
Ci	<i>Oreochromis mossambicus</i>	0	0	0	0	1	700	0	0	0	0	0	0	0	0	1	700
	<i>Oreochromis niloticus</i>	0	0	0	0	0	0	0	0	1	70	0	0	0	0	1	70
Cl	<i>Clarias batrachus</i>	0	0	0	0	0	0	0	0	0	0	0	0	0	0	1	540
Cy	<i>Cyprinus carpio</i>	17	1,308	28	1,381	391	37	27	1,832	65	1,995	29	1,210	34	1,872	794	23,332
	<i>Hampala macrolepidota</i>	0	0	1	14	2	82	1	400	5	236	1	450	2	270	27	4,408
	<i>Osteochilus hasselti</i>	0	0	0	0	0	0	0	0	0	0	0	0	0	0	1	11
	<i>Rasbora argyrotaenia</i>	8	227	0	0	2	33	1	50	3	88	2	84	0	0	21	1,0740
E	<i>Oxyeleotris marmorata</i>	0	0	0	0	0	0	0	0	0	0	0	0	0	0	1	225
	Total	37	2,259	35	1,675	402	1,150	31	2,342	75	2,609	32	1,744	36	2,142	893	33,346
	Number of nets	24	24	25	25	25	25	26	26	28	28	29	29	27	27	312	312
	Catch/net/night	1.5	94.1	1.4	67.0	16.1	46.0	1.2	90.1	2.7	93.2	1.1	60.1	1.3	79.3	2.9	106.9

Remarks: A = Anabantidae; B = Bagridae; Ch = Channidae; Ci = Cichlidae; Cl = Clariidae; Cy = Cyprinidae; E = Eleotridae.

Continued

Month/year Lunar month		3/88 7	4/88 8	5/88 9	6/88 10	7/88 11	8/88 12	9/88 13	All months								
Family	Species	Total		Total		Total		Total		Total		Total		Total		Total	
		#	Wt	#	Wt	#	Wt	#	Wt	#	Wt	#	Wt	#	Wt	#	Wt
A	<i>Anabas testudineus</i>	10	381	5	240	1	24	1	28	0	0	0	0	0	0	26	1,013
	<i>Trichogaster pectoralis</i>	0	0	0	0	0	0	0	0	0	0	0	0	0	0	0	0
B	<i>Macrones micracanthus</i>	0	0	1	40	3	114	0	0	0	0	0	0	0	0	4	154
	<i>Macrones nemurus</i>	2	343	0	0	2	160	1	32	1	220	0	0	0	0	16	1,819
Ch	<i>Channa striata</i>	0	0	0	0	0	0	0	0	0	0	0	0	0	0	0	0
Ci	<i>Oreochromis mossambicus</i>	0	0	0	0	1	700	0	0	0	0	0	0	0	0	1	700
	<i>Oreochromis niloticus</i>	0	0	0	0	0	0	0	0	1	70	0	0	0	0	1	70
Cl	<i>Clarias batrachus</i>	0	0	0	0	0	0	0	0	0	0	0	0	0	0	1	540
Cy	<i>Cyprinus carpio</i>	17	1,308	28	1,381	391	37	27	1,832	65	1,995	29	1,210	34	1,872	794	23,332
	<i>Hampala macrolepidota</i>	0	0	1	14	2	82	1	400	5	236	1	450	2	270	27	4,408
	<i>Osteochilus hasselti</i>	0	0	0	0	0	0	0	0	0	0	0	0	0	0	1	11
	<i>Rasbora argyrotaenia</i>	8	227	0	0	2	33	1	50	3	88	2	84	0	0	21	1,0740
E	<i>Oxyeleotris marmorata</i>	0	0	0	0	0	0	0	0	0	0	0	0	0	0	1	225
	Total	37	2,259	35	1,675	402	1,150	31	2,342	75	2,609	32	1,744	36	2,142	893	33,346
	Number of nets	24	24	25	25	25	25	26	26	28	28	29	29	27	27	312	312
	Catch/net/night	1.5	94.1	1.4	67.0	16.1	46.0	1.2	90.1	2.7	93.2	1.1	60.1	1.3	79.3	2.9	106.9

Remarks: A = Anabantidae; B = Bagridae; Ch = Channidae; Ci = Cichlidae; Cl = Clariidae; Cy = Cyprinidae; E = Electridae.

Appendix 1c. Synopsis of catches by lunar month in Sector 3 (South) of the Saguling Reservoir. Weights are in grams.

Month/year		9/87		10/87		11/87		12/87		1/88		2/88	
Lunar month		1		2		3		4		5		6	
Family	Species	Total		Total		Total		Total		Total		Total	
		#	Wt	#	Wt	#	Wt	#	Wt	#	Wt	#	Wt
A	<i>Anabas</i>												
	<i>testudineus</i>	0	0	0	0	0	0	0	0	0	0	0	0
	<i>Trichogaster</i>												
	<i>pectoralis</i>	0	0	0	0	0	0	0	0	0	0	0	0
B	<i>Macrones</i>												
	<i>micracanthus</i>	0	0	0	0	0	0	0	0	0	0	0	0
	<i>Macrones</i>												
	<i>nemurus</i>	0	0	0	0	1	117	0	0	0	0	0	0
Ch	<i>Channa</i>												
	<i>striata</i>	0	0	0	0	0	0	0	0	0	0	0	0
Ci	<i>Oreochromis</i>												
	<i>mossambicus</i>	0	0	0	0	0	0	0	0	0	0	0	0
	<i>Oreochromis</i>												
	<i>niloticus</i>	2	1,023	0	0	0	0	0	0	0	0	0	0
Cl	<i>Clarias</i>												
	<i>batrachus</i>	0	0	0	0	0	0	0	0	0	0	0	0
Cy	<i>Cyprinus</i>												
	<i>carpio</i>	1	234	0	0	0	0	0	0	0	0	0	0
	<i>Hampala</i>												
	<i>macrolepidota</i>	65	2,549	26	1,752	18	1,386	22	2,402	9	994	26	2,850
	<i>Osteochilus</i>												
	<i>hasselti</i>	0	0	0	0	0	0	2	870	3	1,160	0	0
	<i>Rasbora</i>												
	<i>argyrotaenia</i>	0	0	0	0	0	0	0	0	0	0	0	0
E	<i>Oxyeleotris</i>												
	<i>marmorata</i>	1	53	0	0	0	0	0	0	0	0	0	0
	Total	69	3,859	26	1,752	19	1,503	24	3,272	12	2,154	26	2,850
	Number of nets	32	32	33	33	24	24	20	20	20	20	21	21
	Catch/net/night	2.2	120.6	.8	53.1	.8	62.6	1.2	163.6			.5	67.6

Remarks: A = Anabantidae; B = Bagridae; Ch = Channidae; Ci = Cichlidae; Cl = Clariidae; Cy = Cyprinidae; E = Eleotridae.

Continued

Month/year	3/88	4/88	5/88	6/88	7/88	8/88	9/88	All									
Lunar month	7	8	9	10	11	12	13	months									
Family	Species	Total		Total		Total		Total		Total		Total		Total			
		#	Wt	#	Wt	#	Wt	#	Wt	#	Wt	#	Wt	#	Wt		
A	<i>Anabas</i>	0	0	0	0	1	30	0	0	0	0	0	0	0	0	1	30
	<i>testudineus</i>																
	<i>Trichogaster</i>	0	0	0	0	0	0	0	0	1	9	0	0	0	0	1	9
	<i>pectoralis</i>																
B	<i>Macrones</i>	0	0	0	0	0	0	0	0	0	0	0	0	0	0	0	0
	<i>micracanthus</i>																
	<i>Macrones</i>	0	0	0	0	0	0	0	0	1	132	0	0	0	0	2	249
	<i>nemurus</i>																
Ch	<i>Channa</i>	0	0	0	0	0	0	0	0	0	0	0	0	0	0	0	0
	<i>striata</i>																
Ci	<i>Oreochromis</i>	0	0	0	0	0	0	0	0	0	0	1	840	0	0	3	1,863
	<i>mossambicus</i>																
	<i>Oreochromis</i>	0	0	0	0	0	0	0	0	0	0	0	0	0	0	0	0
	<i>niloticus</i>																
Cl	<i>Clarias</i>	0	0	1	54	0	0	3	268	0	0	1	50	0	0	6	606
	<i>batrachus</i>																
Cy	<i>Cyprinus</i>	57	6,759	39	2,159	43	3,064	43	3,233	42	4,797	135	5,231	69	3,838	603	42,009
	<i>carpio</i>																
	<i>Hampala</i>	1	330	0	0	0	0	0	0	1	14	0	0	0	0	10	3,534
	<i>macrolepidota</i>																
	<i>Osteochilus</i>	0	0	0	0	0	0	0	0	0	0	0	0	0	0	0	0
	<i>hasselti</i>																
	<i>Rasbora</i>	0	0	0	0	3	140	2	30	2	105	0	0	0	0	8	328
	<i>argyrotaenia</i>																
E	<i>Oxyeleotris</i>	0	0	0	1	290	0	0	0	0	0	0	0	0	1	290	
	<i>marmorata</i>																
	Total	58	7,089	40	2,213	48	3,524	48	3,531	47	5,057	137	6,121	69	3,838	635	48,918
	Number of nets	29	29	26	26	24	24	30	30	27	27	28	28	26	26	352	352
	Catch/net/weight	2.0	244.4	1.5	85.1	2.0	146.8	1.6	117.7	1.7	187.3	4.9	218.6	2.7	147.6	1.8	139

Remarks: A = Anabantidae; B = Bagridae; Ch = Channidae; Ci = Cichlidae; Cl = Clariidae; Cy = Cyprinidae; E = Electridae.



Appendix 1d. Synopsis of catches by lunar month in Sector 4 (West) of the Saguling Reservoir. Weights are in grams.

Month/year	9/87		10/87		11/87		12/87		1/88		2/88		
Lunar month	1		2		3		4		5		6		
Family	Species	Total	Total	Total	Total	Total	Total	Total	Total	Total	Total	Total	
		#	Wt	#	Wt	#	Wt	#	Wt	#	Wt	#	Wt
A	<i>Anabas</i>												
	<i>testudineus</i>	0	0	0	0	0	0	0	0	0	0	0	0
	<i>Trichogaster</i>												
	<i>pectoralis</i>	0	0	0	0	0	0	0	0	0	0	0	0
B	<i>Macrones</i>												
	<i>micracanthus</i>	0	0	0	0	0	0	0	0	0	0	0	0
	<i>Macrones</i>												
	<i>nemurus</i>	1	32	1	86	0	0	6	333	0	0	0	0
Ch	<i>Channa</i>												
	<i>striata</i>	0	0	0	0	0	0	0	0	0	0	0	0
Ci	<i>Oreochromis</i>												
	<i>mossambicus</i>	0	0	0	0	0	0	0	0	1	300	0	0
	<i>Oreochromis</i>												
	<i>niloticus</i>	0	0	0	0	0	0	0	0	0	0	0	0
Cl	<i>Clarias</i>												
	<i>batrachus</i>	0	0	0	0	0	0	0	0	0	0	0	0
Cy	<i>Cyprinus</i>												
	<i>carpio</i>	0	0	0	0	0	0	0	0	0	0	0	0
	<i>Hampala</i>												
	<i>macrolepidota</i>	182	6,306	103	5,100	89	5,860	69	5,191	66	7,843	53	4,310
	<i>Osteochilus</i>												
	<i>hasselti</i>	0	0	0	0	0	0	0	0	0	0	0	0
	<i>Rasbora</i>												
	<i>argyrotaenia</i>	0	0	0	0	0	0	0	0	0	0	0	0
E	<i>Oxyeleotris</i>												
	<i>marmorata</i>	6	311	0	0	1	24	2	60	1	18	1	18
	Total	189	6,649	104	5,186	90	5,884	77	5,584	68	8,161	53	4,310
	Number of nets	35	35	32	32	30	30	17	17	23	23	29	29
	Catch/net/night	5.4	190.0	3.3	162.1	3.0	196.1	4.5	328.5	3.0	354.8	1.8	148.0

Remarks: A = Anabantidae; B = Bagridae; Ch = Channidae; Ci = Cichlidae; Cl = Clariidae; Cy = Cyprinidae; E = Eleotridae.

Continued

Month/year		3/88		4/88		5/88		6/88		7/88		8/88		9/88		All months	
Lunar month		7		8		9		10		11		12		13			
Family	Species	Total		Total		Total		Total		Total		Total		Total		Total	
		#	Wt	#	Wt	#	Wt	#	Wt	#	Wt	#	Wt	#	Wt	#	Wt
A	<i>Anabas testudineus</i>	0	0	0	0	0	0	0	0	0	0	0	0	0	0	0	0
	<i>Trichogaster pectoralis</i>	0	0	0	0	0	0	0	0	0	0	0	0	0	0	0	0
B	<i>Macrones micracanthus</i>	0	0	0	0	0	0	0	0	0	0	0	0	0	0	0	0
	<i>Macrones nemurus</i>	1	130	0	0	1	92	0	0	1	142	0	0	0	0	11	815
Ch	<i>Channa striata</i>	0	0	0	0	0	0	0	0	0	0	0	0	0	0	2	600
Ci	<i>Oreochromis mossambicus</i>	0	0	0	0	0	0	0	0	0	0	0	0	0	0	0	0
	<i>Oreochromis niloticus</i>	0	0	0	0	0	0	0	0	0	0	0	0	0	0	0	0
Cl	<i>Clarias batrachus</i>	0	0	0	0	0	0	0	0	0	0	0	0	0	0	0	0
Cy	<i>Cyprinus carpio</i>	35	2,953	36	1,678	25	3,023	36	4,020	74	3,048	15	1,360	13	1,380	862	59,915
	<i>Hampala macrolepidota</i>	0	0	1	32	1	30	0	0	2	173	0	0	0	0	4	235
	<i>Osteochilus hasselti</i>	0	0	0	0	0	0	0	0	0	0	0	0	0	0	0	0
	<i>Rasbora argyrotaenia</i>	2	119	1	22	0	0	1	49	0	0	0	0	0	0	15	621
E	<i>Oxyeleotris marmorata</i>	0	0	0	0	0	0	0	0	0	0	0	0	0	0	0	0
	Total	38	3,202	38	1,732	27	3,145	37	4,069	77	3,363	15	1,360	13	1,380	894	62,186
	Number of nets	29	29	25	25	26	26	29	29	29	29	27	27	26	26	357	357
	Catch/net/weight	1.3	110.4	1.5	69.3	1.0	121.0	1.3	140.3	2.7	116.0	.6	50.4	.5	53.1	2.5	174.2

Remarks: A = Anabantidae; B = Bagridae; Ch = Channidae; Ci = Cichlidae; Cl = Clariidae; Cy = Cyprinidae; E = Electridae.

Appendix 2. Summary of observations on the gut contents of various fish species in the Saguling Reservoir in 1987 and 1988. Sectors: 1 = North, 2 = River, 3 = South and 4 = West.

*Hampala macrolepidota*

Date	Sector	Weight (g)	Length (cm)	Gut volume (ml)	% full	Number	Gut contents
18 Sep 87	2			.7	10		<i>Corixa</i>
18 Sep 87	2			.6	15		<i>Corixa</i> , detritus
18 Sep 87	2			2.0	75		<i>Corixa</i> , detritus
18 Sep 87	2			2.0	50		<i>Corixa</i>
18 Sep 87	2			?			fish parts
18 Sep 87	2			.2	15		<i>Corixa</i>
18 Sep 87	2			1.5	60		<i>Corixa</i>
18 Sep 87	2			1.4	30		<i>Corixa</i>
18 Sep 87	2			.1	50		detritus
18 Sep 87	2			1.4	15		<i>Corixa</i> , detritus
18 Sep 87	2			.6	15		<i>Corixa</i>
18 Sep 87	2			2.1	50		<i>Corixa</i>
18 Sep 87	2			.2	40		<i>Corixa</i>
09 Oct 87	2	24.0	12.2			109	<i>Corixa</i>
09 Oct 87	2	75.0	17.0			49	<i>Corixa</i>
09 Oct 87	2	73.0	16.7			37	<i>Corixa</i>
09 Oct 87	2	160.0	21.9			21	<i>Corixa</i>
09 Oct 87	2	17.0	10.0			121	<i>Corixa</i>
09 Oct 87	2	130.0	24.2			33	<i>Corixa</i>
09 Oct 87	2	160.0	21.9			1	detritus
09 Oct 87	2	50.0	14.2			53	<i>Corixa</i>
09 Oct 87	2	43.0	14.5			123	<i>Corixa</i>
09 Oct 87	2	160.0	21.4			31	detritus
09 Oct 87	2	94.0	18.1			191	<i>Corixa</i>
25 Oct 87	4	12.0	9.0			63	<i>Corixa</i>
25 Oct 87	4	113.0	18.6			232	<i>Corixa</i>
25 Oct 87	4	46.0	14.1			48	<i>Corixa</i>
25 Oct 87	4	172.0	20.7			241	<i>Corixa</i>
25 Oct 87	4	260.0	24.5			104	<i>Corixa</i>
25 Oct 87	4	352.0	26.5			220	<i>Corixa</i>
25 Oct 87	4	81.0	16.4			284	<i>Chaoborus</i>
25 Oct 87	4	88.0	17.3			288	<i>Chaoborus</i>
25 Oct 87	4	282.0	26.0			436	<i>Chaoborus</i>
25 Oct 87	4	222.0	23.9			296	<i>Chaoborus</i>
25 Oct 87	4	30.0	12.2			279	<i>Corixa</i>
25 Oct 87	4	?	?				empty
25 Oct 87	4	?	?			136	<i>Corixa</i>
18 Oct 87	3	4.5	3.0	.7	10		<i>Corixa</i>
18 Oct 87	3	18.5	3.0	.6	15		<i>Corixa</i> , detritus
18 Oct 87	3	18.5	3.0	2.0	75		<i>Corixa</i> , detritus
18 Oct 87	3	15.0	3.7	2.0	50		<i>Corixa</i>
18 Oct 87	3	9.0	2.5	.2	15		<i>Corixa</i>
18 Oct 87	3	10.0	3.0	1.5	60		<i>Corixa</i>
18 Oct 87	3	4.8	.5	.1	50		detritus
18 Oct 87	3	18.5	3.0	1.4	15		<i>Corixa</i> , detritus
18 Oct 87	3	9.0	1.0	.6	15		<i>Corixa</i>
18 Oct 87	3	13.5	3.0	2.1	50		<i>Corixa</i>
18 Oct 87	3	4.5	2.0	.2	40		<i>Corixa</i>
02 Oct 87	1	54	14.8	.01		18	<i>Chaoborus</i>
				.5			unidentifiable
02 Oct 87	1	93	19.8	.3			insect, not idd.
				.2			unidentifiable
02 Oct 87	1	102	18.2	.15		45	<i>Lethocerus</i>
				.01		7	insect eggs
				.35			unidentifiable
02 Oct 87	1	19	10.5	.2		184	<i>Lethocerus</i>
02 Oct 87	1	86	17.7	.5			unidentifiable

Continued

## Appendix 2. Continued

Date	Sector	Weight (g)	Length (cm)	Gut volume (ml)	% full	Number	Gut contents
09 Oct 87	2	43	13.7				empty
21 Oct 88	3	17	10	.2			insect, not idd.
21 Oct 87	3	85	17	.15		36	<i>Chaoborus</i>
21 Oct 87	3	102	18.1	.25			insect, not idd.
21 Oct 87	3	200	22.8	1.85		1	Coleoptera, not idd.
23 Oct 87	4	74	16.6	.01		1	<i>Lethocerus</i>
				.05		7	<i>Tendipes</i>
				.25		35	<i>Chaoborus</i>
23 Oct 87	4	15	10.1	.2			insect, not idd.
23 Oct 87	4	19	10.6	.25		17	<i>Tendipes</i>
23 Oct 87	4	60	15.7	.25		125	<i>Lethocerus</i>
				.2		55	<i>Chaoborus</i>
23 Oct 87	4	57	14.8	.4		217	<i>Chaoborus</i>
23 Oct 87	4	64	16.1	.55		105	<i>Lethocerus</i>
				.2		74	<i>Chaoborus</i>
23 Oct 87	4	295	15.2				empty
23 Oct 87	4	14	9.7				empty
23 Oct 87	4	70	16.9	.01		5	<i>Lethocerus</i>
				.25		170	<i>Chaoborus</i>
23 Oct 87	4	18	10.3	.05			insect, not idd.
28 Oct 87	1	22	11.1	.5		726	<i>Lethocerus</i>
28 Oct 87	1	104	17.4	.2		75	<i>Lethocerus</i>
				.3			insect, not idd.
3 Nov 87	2	26	11.6	.05		12	<i>Tendipes</i>
3 Nov 87	2	37	14	.1			insect, not idd.
13 Jan 88	2	60	16.1	.4		1	fish parts
13 Jan 88	2	240	25.6	.5		1	Coleoptera, not idd.
13 Jan 88	2	163	22.2	2.2		47	<i>Gyraulus</i>
13 Jan 88	2	265	24.9	.52		2	Hemiptera, not idd.
29 Jan 88	4	132	19.7				empty
29 Jan 88	4	90	17	.5		1	Coleoptera, not idd.
29 Jan 88	4	70	21.5	.45		150	<i>Chaoborus</i>
29 Jan 88	4	93	17	.25			insect, not idd.
29 Jan 88	4	130	22	.25			insect, not idd.
04 Feb 88	1	76	17.4	.2		1	<i>Hydrobius</i>
04 Feb 88	1	100	19	.1		1	<i>Hydrobius</i>
04 Feb 88	1	66	17.7	.2			insect, not idd.
04 Feb 88	1	100	14				empty
04 Feb 88	1	38	13	.2			insect, not idd.
09 Feb 88	2	51	15	.4			gastropod, not idd.
09 Feb 88	2	16	9.5	.1			insect, not idd.
09 Feb 88	2	38	13.3	.1			insect, not idd.
13 Feb 88	3	275	25	.5		329	<i>Chaoborus</i>
13 Feb 88	3	70	15.5	.4		28	fish parts
13 Feb 88	3	50	15.5	1		451	<i>Chaoborus</i>
13 Feb 88	3	144	19.5	1.6		1800	<i>Chaoborus</i>
13 Feb 88	3	100	18	2.3		944	<i>Chaoborus</i>
16 Feb 88	4	100	18	1		715	<i>Chaoborus</i>
16 Feb 88	4	110	18	.6		375	<i>Chaoborus</i>
17 Feb 88	4	115	16.9	.2		30	<i>Chaoborus</i>
17 Feb 88	4	88	17.4	.5		336	<i>Chaoborus</i>
17 Feb 88	4	88	17.8	.1		20	<i>Chaoborus</i>
				.1		1	fish parts
17 Feb 88	4	220	24.8	.5		205	<i>Chaoborus</i>
17 Feb 88	4	140	20.8				empty
17 Feb 88	4	20	10.8				empty
03 Mar 88	1	47	14.1	.5			fish parts
09 Mar 88	2	10	9	.3		4	fish parts
09 Mar 88	2	90	17	1		18	<i>Lymnaea</i>
16 Mar 88	3	168	21.4	1			fish parts

Continued

## Appendix 2. Continued

Date	Sector	Weight (g)	Length (cm)	Gut volume (ml)	% full	Number	Gut contents
16 Mar 88	3	230	23.8	.1			fish parts
18 Mar 88	4	204	22.5	.3			crustacean, not idd.
21 Apr 88	1	760	34.3				empty
05 May 88	3	88	16.6	.5		520	<i>Chaoborus</i>
05 May 88	3	86	17.5	.2			Coleoptera, not idd.
05 May 88	3	126	19	.5		265	<i>Chaoborus</i>
05 May 88	3	108	18	.3		250	<i>Chaoborus</i>
05 May 88	3	54	15	.5			fish parts
05 May 88	3	14	10	.1			Hemiptera, not idd.
05 May 88	3	136	19.8	.1		112	<i>Chaoborus</i>
05 May 88	3	112	18	.3		188	<i>Chaoborus</i>
26 May 88	4	150	27	.6		1	<i>Helocordulia</i>
26 May 88	4	80	14	.15		84	<i>Chaoborus</i>
26 May 88	4	17	11	.05		75	<i>Chaoborus</i>
26 May 88	4	12	9.6	.2			insect, not idd.
26 May 88	4	14	9.6	.1		125	<i>Chaoborus</i>
26 May 88	4	42	14	.05			insect, not idd.
26 May 88	4	19	10.5	.2			insect, not idd.
26 May 88	4	13	9.6				insect, not idd.
02 Jun 88	2	20	10.8	.5			empty
02 Jun 88	2	310	26.2	.7			insect, not idd.
02 Jun 88	2	22	11.4	.2			insect, not idd.
08 Jun 88	3	135	19	.5		510	<i>Chaoborus</i>
08 Jun 88	3	40	13	.2			Diptera, not idd.
08 Jun 88	3	80	22.5	.05			Diptera, not idd.
<i>Osteochilus hasseltii</i>							
10 Jul 87	2	?	25.8				empty
10 Sep 87	2	188	22.2	14	13.1	52	<i>Melosira</i>
					0.5	2	<i>Cymbella</i>
					1.5	6	<i>Cyclotella</i>
					0.2	1	<i>Trachelomonas</i>
					1.3	5	<i>Synedra</i>
					0.2	1	<i>Pinnularia</i>
					83.1	330	detritus
10 Sep 87	2	243	23.3	0			empty
10 Sep 87	2	100	18.5	0			empty
10 Sep 87	2	89	17.7	0			empty
10 Sep 87	2	61	16.1	10	25.6	42	<i>Melosira</i>
					73.2	120	detritus
					1.2	2	<i>Synedra</i>
10 Sep 87	2	80	17	7	24.2	37	<i>Melosira</i>
					54.9	84	detritus
					3.9	6	<i>Scenedesmus</i>
					5.2	8	<i>Chlorococcus</i>
					0.6	1	<i>Synedra</i>
					0.6	1	<i>Navicula</i>
					10.4	16	<i>Crucigenia</i>
09 Oct 87	2	350	26.2			2.6	detritus
27 Jan 88	3	260	25.2		78.0		detritus
					8.6		<i>Cymbella</i>
					4.0		<i>Fragilaria</i>
					3.0		<i>Rhopalodia</i>
					3.0		<i>Gomphonema</i>
					2.0		<i>Nitzschia</i>
					0.8		<i>Rhaicosphenia</i>
					0.6		<i>Cyclotella</i>
27 Jan 88	3	500	31				empty
09 Feb 88	2	250	24		80		plant parts
					20		detritus

Continued

## Appendix 2. Continued

Date	Sector	Weight (g)	Length (cm)	Gut volume (ml)	% full	Number	Gut contents
10 Feb 88	2	106	19		80		plant parts
					20		detritus
03 Mar 88	1	199	23		100		detritus
16 Mar 88	3	330	25.8		10		<i>Synedra</i>
					8		<i>Navicula</i>
					6		<i>Rhopalodia</i>
					6		<i>Closterium</i>
					5		<i>Nitzschia</i>
					1		<i>Cyclotella</i>
					1		<i>Rhoicasphenia</i>
					63		detritus
26 Apr 88	2	44	13.9		90		detritus
					6		<i>Melosira</i>
					4		<i>Navicula</i>
26 Apr 88	2	38	12.8		70		detritus
					26		<i>Melosira</i>
					2		<i>Cyclotella</i>
					2		<i>Synedra</i>
26 May 88	1	300	24.2		31.9		detritus
					1.7		<i>Phormidium</i>
					0.5		<i>Staurastrum</i>
					0.5		<i>Closterium</i>
					0.9		<i>Nitzschia</i>
					6.7		<i>Microcystis</i>
					0.5		<i>Navicula</i>
					2.8		<i>Gomphonema</i>
					0.5		<i>Pinnularia</i>
					3.3		<i>Synedra</i>
					5.8		<i>Cymbella</i>
					0.5		<i>Fragilaria</i>
					44.4		macrophytes
26 May 88	1	252	23.7		53.6		detritus
					5.0		<i>Cosmarium</i>
					3.0		<i>Staurastrum</i>
					3.6		<i>Rhopalodia</i>
					5.4		<i>Nitzschia</i>
					9.6		<i>Navicula</i>
					4.0		<i>Gyrosigma</i>
					3.0		<i>Tabellaria</i>
					5.4		<i>Synedra</i>
					5.4		<i>Cymbella</i>
					1.0		<i>Rhoicasphenia</i>
26 May 88	1	600	29.1		42.8		detritus
					1.1		<i>Cosmarium</i>
					1.1		<i>Staurastrum</i>
					2.8		<i>Fragilaria</i>
					2.2		<i>Rhopalodia</i>
					1.1		<i>Tabellaria</i>
					1.7		<i>Synedra</i>
					2.8		<i>Cymbella</i>
					44.4		macrophytes
26 May 88	1	300	25		66.2		detritus
					16.6		macrophytes
					0.6		<i>Cosmarium</i>
					2.5		<i>Staurastrum</i>
					0.8		<i>Nitzschia</i>
					1.7		<i>Navicula</i>
					3.3		<i>Tabellaria</i>
					4.2		<i>Synedra</i>
					4.2		<i>Cymbella</i>

Continued

## Appendix 2. Continued

Date	Sector	Weight (g)	Length (cm)	Gut volume (ml)	% full	Number	Gut contents
02 Jun 88	2	400	27.5		82.0 13.0 2.0 1.0 2.0		detritus <i>Microcystis</i> <i>Melosira</i> <i>Navicula</i> <i>Synedra</i>
<i>Oreochromis mossambicus</i>							
29 Jan 88	4	300	24.5		80.4 4.6 2.0 1.0 1.0 1.0 1.0 2.0 1.0 2.0 1.0 1.0		detritus <i>Closterium</i> <i>Elakatothrix</i> <i>Scenedesmus</i> <i>Tetraodon</i> <i>Actinastrum</i> <i>Kirchneriella</i> <i>Ankistrodesmus</i> <i>Closteriopsis</i> <i>Synedra</i> <i>Nitzschia</i> <i>Cyclotella</i> empty
23 Mar 88	1	100	16.8				
<i>Oreochromis niloticus</i>							
18 Sep 87	3	303	23		60 30 30 1 1		detritus <i>Synedra</i> <i>Peridinium</i> <i>Melosira</i> <i>Sarastrium</i>
18 Sep 87	3	720	32.5		32 31 1 40 1 1 1 1 1 1 1 1		misc. green algae detritus <i>Peridinium</i> <i>Melosira</i> <i>Synedra</i> <i>Rhopalodia</i> <i>Euglena</i> copepoda <i>Ceratium</i> <i>Starastrium</i> <i>Nais</i>
26 Apr 88	2	700	31		16.9 2.1 4.2 16.8 60.0		<i>Melosira</i> <i>Cyclotella</i> <i>Scenedesmus</i> <i>Oscillatoria</i> detritus
<i>Channa striata</i>							
13 Jan 88	2	225	30.8	1.5			Coleoptera
<i>Cyprinus carpio</i>							
18 Sep 87	3	235	18.5				detritus <i>Navicula</i> <i>Ulothrix</i> <i>Spirogyra</i> <i>Synedra</i> <i>Mougeotia</i> <i>Oedogonium</i> <i>Rhopalodia</i> copepoda

Continued

## Appendix 2. Continued

Date	Sector	Weight (g)	Length (cm)	Gut volume (ml)	% full	Number	Gut contents
26 May 88	1	680	34	.5			Gastropoda, not idd.
08 Jun 88	3	210	20	.7			Gastropoda, not idd.
08 Jun 88	3	50	12.6				empty
<i>Oxyeleotris marmoratus</i>							
18 Sep 87	3	53	16.5				fish parts
03 Feb 88	1	119	20.5	.1			unidentifiable
03 Feb 88	1	20	11.5	.4			fish parts
18 Mar 88	4	78	17.6	.2			Hemiptera
21 Apr 88	1	54	16.2	.2			Hemiptera
05 May 88	3	22	12.5	.05			Hemiptera
05 May 88	3	69	18.5	.15			<i>Lymnaea</i> - Gastropoda
02 Jun 88	2	50	16	.3			<i>Macrobrachium</i> - Crustacea
08 Jun 88	3	14	11	.2			<i>Helocordulia</i> - Odonata
<i>Anabas testudineus</i>							
03 Nov 87	2	31	12.3	.25			insect, not idd.
03 Nov 87	2	25	11.4	.5			insect, not idd.
10 Feb 88	2	22	15	.1			fish parts
				.05			unidentifiable
09 Mar 88	2	25	17	.1			plant matter
30 Mar 88	2	46	17.5	.1			<i>Anentome</i> - Gastropoda
				.1			unidentifiable
04 May 88	3	30	12	.2			unidentifiable
<i>Macrones nemurus</i>							
09 Oct 87	2	27	14.3				detritus
18 Mar 88	4	130	12	.1			plant matter



# Biotechnical Feasibility Studies on the Importation of *Clupeichthys aesarnensis* Wongratana, 1983 from Northeastern Thailand to the Saguling Reservoir, West Java, Indonesia\*

**BARRY A. COSTA-PIERCE**

*International Center for Living Aquatic  
Resources Management  
MC P.O. Box 1501  
Makati, Metro Manila, Philippines*

**OTTO SOEMARWOTO**

*Institute of Ecology  
Padjadjaran University  
Jl. Sekeloa Selatan 1  
Bandung 40132, Indonesia*

COSTA-PIERCE, B.A. and O. SOEMARWOTO. 1990. Biotechnical feasibility studies on the importation of *Clupeichthys aesarnensis* Wongratana, 1983 from northeastern Thailand to the Saguling Reservoir, West Java, Indonesia, p. 329-363. In B.A. Costa-Pierce and O. Soemarwoto (eds.) Reservoir fisheries and aquaculture development for resettlement in Indonesia. ICLARM Tech. Rep. 23, 378 p.

## Abstract

Capture fisheries in the new Saguling Reservoir, West Java, Indonesia, will not be able to support a productive fishery for the thousands of poor displaced residents from the inundated regions. Tropical reservoirs are notably poor in small pelagic fish, having a "riverine" fish species composition which, in general, inhabit the littoral zone of new reservoirs, leaving a large pelagic zone. A large pelagic niche exists in the Saguling Reservoir that remains unoccupied due to the lack of native planktivorous fish that would inhabit, feed and reproduce in this zone.

This report summarizes an importation proposal, drafted for Indonesian and international review, on the social and biotechnical feasibility of importing the Thai river sprat (*Clupeichthys aesarnensis* Wongratana, 1983) from the Ubolratana Reservoir in Khon Kaen, northeastern Thailand to the Saguling Reservoir. Potential environmental, social and health impacts and fish transportation and importation procedures are reviewed. Results from a biotechnical study mission to Ubolratana that examined the history, limnology and water quality of the reservoir are summarized. Plankton populations from the Saguling and Ubolratana Reservoirs were studied over a 15-month period and compared. Forty phytoplankton genera were found in Saguling and 38 in Ubolratana. Eighteen genera were shared between the two reservoirs, with most of the shared phytoplankton blue-green algal genera. Ubolratana had 21 genera of zooplankton and Saguling 30. The majority of zooplankton in both reservoirs were small, in the 40-690  $\mu\text{m}$  size category (76% in Ubolratana; 80% in Saguling). Examination of the gut contents of 121 Thai river sprat showed that small zooplankton were the dominant zooplankton food with 82% of the zooplankton in the gut being less than 500  $\mu\text{m}$  in size. *Microcystis* sp. comprised 45% of the phytoplankton identified in the guts. All phytoplankton and zooplankton genera observed in the guts of fish from Ubolratana were part of the flora and fauna observed in the plankton of Saguling over a 15-month sampling period.

Comments received from international experts representing three standing bodies of the world fisheries community concerned with fish transfers were solicited and are summarized in an Appendix. Importation of the Thai river sprat from Thailand to Indonesia was approved by the Indonesian Directorate General of Fisheries in late 1989 and will likely proceed in 1990.

---

\*ICLARM Contribution No. 520.

## Introduction

The fisheries biology of new reservoirs has been little studied in Southeast Asia. However, it is well known that all reservoirs undergo a nutrient-rich (eutrophic) stage for 1-2 years after filling due to the decomposition of organic matter and subsequent leaching of nutrients from drowned organic matter (Petr 1975). Initial eutrophy can lead to dramatic increases in fish populations, impressive fisheries productivity and catch per unit effort in the early years following inundation. Initial high fisheries production is usually followed by a decline in fish yield, then recovery and stabilization at a newer and lower level of production (Balon and Coche 1974). Fish populations and the natural food webs become adjusted to the permanent basic fertility of the new basin, nutrient and organic inputs from water level fluctuations, and the watershed. In Indonesia, Sarnita (1976) reported that reservoir fish yields reached their peaks during the first few years after impoundment. The Jatiluhur Reservoir in West Java recorded its maximum catch 4 years after impoundment.

Efforts have been made to enhance the fisheries potential of reservoirs in Indonesia (Sarnita 1976; Baluyut 1983). Estimated yields of Indonesian reservoirs vary widely, from 22 to 353 kg/ha/year (Sarnita 1976, 1978). Efforts to date, however, have focused mainly upon fish restocking and have produced mixed results. Stocking of Nile tilapia (*Oreochromis niloticus*) in the Jatiluhur Reservoir increased tilapia yields from 0 kg in 1976 to 11,310 kg in 1982 (Kartamihardja and Hardjamulia 1983). Baluyut (1983) however, concluded that, on the whole, stocking of lakes and reservoirs in Indonesia was not successful due to: (1) high predation pressure by native carnivores, (2) severe drawdown occurring in some reservoirs, and (3) lack of suitable spawning areas.

Baseline research on the capture fisheries of the Saguling Reservoir has been completed (Munro et al., this vol.). Findings were: (1) Gill nets were the major and most important fishing gear used. (2) Gill nets were primitive in construction and techniques of setting nets were often improper. Nets were set using sections of banana trees or waste pieces of styrofoam as floats, rocks or discarded metal as anchors and the majority of gill nets were set floating or fixed above the bottom in the top 1.0 m of the water column. Many fishermen set fixed gill nets using trees or shoreline debris to fix the top of the net with no anchoring of net bottoms. (3) Capture fisheries yields were extremely low. (4) The large majority of catches (greater than 90% of biomass and numbers) from a 1-year sampling program consisted of a small cyprinid (*Hampala macrolepidota*) inhabiting the littoral zone. (5) Native fish in Saguling were of riverine origin (see Munro et al., this vol.), and it was forecast that none of the species present would colonize the open waters of the reservoir. (6) A large, unoccupied, pelagic niche existed in the reservoir. No evidence of native zooplanktivorous fish that would be capable of colonizing the pelagic waters of the reservoir was found.

An importation feasibility study was undertaken to establish a sustainable pelagic fish stock in the Saguling Reservoir. Although stocking of tilapia has been successful in reservoirs in Sri Lanka (De Silva 1985, 1987) and Indonesia (Umaly 1988), it was forecast that continual restocking of Saguling would be required since the reservoir is steep-sided, having an average slope of the drawdown area of 4% (IOE 1980), and would thereby have limited suitable spawning grounds for tilapia. Fernando and Holcik (1982) have shown that small fish from the family Clupeidae have high production in tropical reservoirs and may be excellent candidate species for stocking reservoirs, especially in regions where small sardine-like fish are widely appreciated. In particular the clupeid *Limnothrissa miodon* in Lake Kariba, Zimbabwe, which now produces about 20,000 t/year, and *Clupeichthys aesarnensis* in the Ubolratana Reservoir in northeastern Thailand, which increased production from 33.8-48.5 kg/ha/year to 53.0 kg/ha/year were described. Importation of *Limnothrissa miodon* was first considered by our program. However upon internal IOE and ICLARM review, it was decided that importation of the fish from Africa would be expensive, technically questionable and ecologically risky.

Preliminary information was obtained from Thai colleagues (Chookajorn and Bhukaswan, pers. comm.) regarding the Thai river sprat, *Clupeichthys aesarnensis*. This information was sufficiently promising for IOE/ICLARM to circulate a preliminary proposal for importing the fish to Indonesia to enhance the capture fisheries of the Saguling-Cirata Reservoir complex in West Java (Soemarwoto and Costa-Pierce 1988). The proposal was reviewed internationally and nationally. Results of the reviews led to a study mission to the Ubolratana Reservoir in north-eastern Thailand in March-April 1988 (Costa-Pierce 1988). Fish biology, life history, fishing techniques, lake limnology and water quality, and the social, biological and technical feasibility of importation were studied.

This report summarizes the importation proposal, drafted for national and international review, on the biotechnical feasibility of importation, potential environmental and social impacts, and benefits of importing the Thai river sprat to Indonesian reservoirs for fisheries enhancement. Comments were solicited from scientists representing three standing bodies of the world fisheries community concerned with international fish transfers, and are summarized in an Appendix. The Thai river sprat (*Clupeichthys aesarnensis*) was approved for importation from the Ubolratana Reservoir, Thailand, into an Indonesian reservoir, the Saguling Reservoir in West Java, and will likely be stocked in 1990.

## Background Studies of the Ubolratana Reservoir, Thailand

### General

The Ubolratana Reservoir is a large, shallow reservoir created by damming the confluence of the Pong and Phrom Rivers in Khon Kaen Province, northeastern Thailand, about 500 km north of Bangkok (Fig. 1). Northeastern Thailand is the largest of Thailand's regions, having about one-third of the national population. It is also Thailand's poorest region. Soils are infertile sand and sandy loams. Annual per capita income is only about 6,000 Baht (US\$ 250) per year. During each dry season the region exports thousands of its inhabitants to overcrowded Bangkok looking for jobs. Ubolratana is located in a broad valley with gently rolling hills. It is the largest reservoir in Thailand with an area of approximately 41,000 ha and is located at 182 m above mean sea level (MSL). Vital morphological statistics of the dam and reservoir are summarized in Table 1.

Because of the regional topography, the catchment area of the reservoir is huge, estimated at 14,000 km<sup>2</sup>. The reservoir is drawn down yearly to 176 m MSL which, due to the terrain, exposes a large drawdown area and shrinks the reservoir area to only 16,000 ha. At 182 m MSL the mean depth is 16 m. Ubolratana is an "open water" type reservoir with a large pelagic zone and 60 small bays of 1-3 ha in size.

The multipurpose dam was closed in January 1965. It is a rockfill-clay core type dam with a peak elevation located at 188 m MSL (only 35.1 m high) and fills an 855.0 long span. The main purposes of the dam are power generation, flood mitigation, irrigation and fisheries. However, due to the small height of the dam, total hydroelectric power generated is low. Indeed in some years the total worth of Ubolratana's productive capture fisheries exceeds the total income from electric power! In 1978, for example, total fish landings of 2,500 t were worth approximately 40 million Baht while total receipts from the sale of electricity yielded 30 million Baht.

Unusually heavy monsoon rains from 1984 to 1987 caused the dam to weaken dangerously. By 1987 the dam was threatened with catastrophic collapse. Reservoir water levels were dropped to reconstruct the dam and raise its height by more than 3 m in 1987. In 1988 water levels were returned to normal.

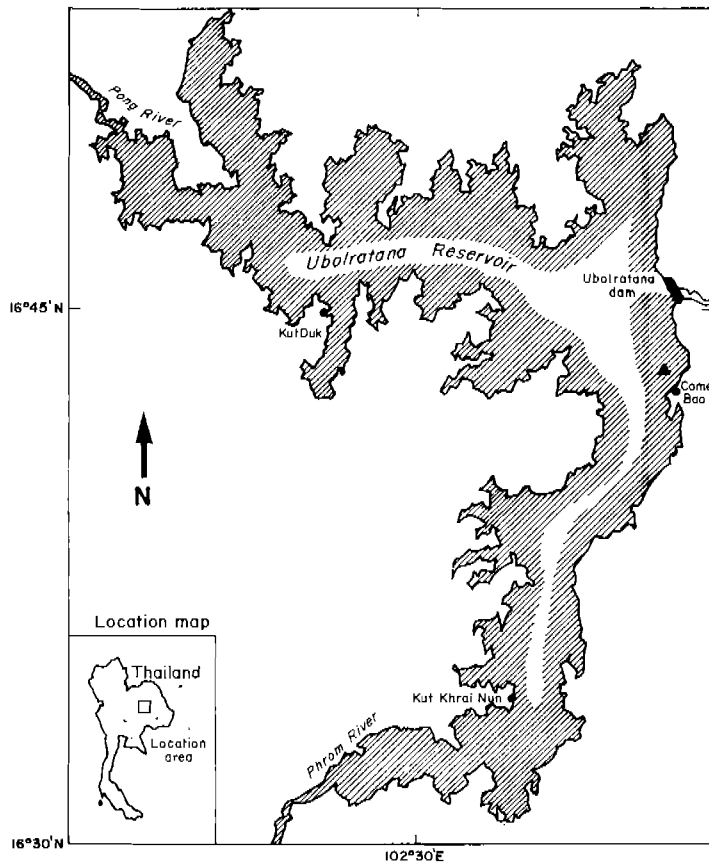

Fig. 1. Ubolratana Reservoir in northeastern Thailand dammed the confluence of the Pong and Phrom Rivers.

Table 1. Morphological and other characteristics of the Ubolratana Reservoir.

Area	:	182 m MSL 176 m MSL	41,000 ha 16,700 ha
Volume	:	2,550 x 10 <sup>6</sup> m <sup>3</sup> at 182 m 2,004 x 10 <sup>6</sup> m <sup>3</sup> at 176 m	
Mean Depth	:	16 m at 182 m 12 m at 176 m	
Catchment Area	:	14,000 km <sup>2</sup>	
Annual Inflow	:	1,750 x 10 <sup>6</sup> m <sup>3</sup>	

### ***Limnology and Water Quality***

Ubolratana is a eutrophic reservoir with a seasonally modified thermal stratification. From their examination of the water quality and trophic state of Ubolratana, Varikul and Suraswadi (1980) concluded that the "Ubolratana Reservoir is still in a stage of high production". Seasonal water quality dynamics have been summarized by Bhukaswan and Pholprasith (1977) and Varikul and Suraswadi (1980). Average water quality conditions from 8 surface stations are summarized in Table 2.

Table 2. Average water quality parameters from 8 surface stations in the Ubolratana Reservoir in 1977.

Air temperature	31.0- 34.0°C
Water temperature	26.6- 28.3°C
Secchi disk	47.0-106.0 cm
Dissolved oxygen	5.4- 6.9 ppm
Carbon dioxide	2.8- 6.4 ppm
Total alkalinity	70.0- 85.5 ppm
pH	7.3- 7.5
Soluble phosphate	0.08- 0.12 ppm
Soluble nitrate	34.0- 39.0 ppm

Source: LIFDS (1977).

A shallow thermocline between 4 and 7 m water depth forms during the dry season (October-April) which breaks down at the onset of the wet season. Srisuwanataj (1970) observed a homothermal distribution of water temperature throughout the rainy season from May to December (Fig. 2). Rapid and continuous turnovers of the entire water column occur throughout the rainy season when strong winds continually buffet the region. The homothermal water structure allows dissolved oxygen (DO) to penetrate the hypolimnion daily throughout the rainy season ensuring a well oxygenated water column (Fig. 2). Regular turnovers of the water column and penetration of DO to sediments would oxidize and mobilize nitrogen from the organic-rich sediments, causing rich plankton blooms during the rainy season. Indeed mean Secchi disc transparencies decrease from 106 cm in the dry season to 47 cm in the wet season (LIFDS 1977).

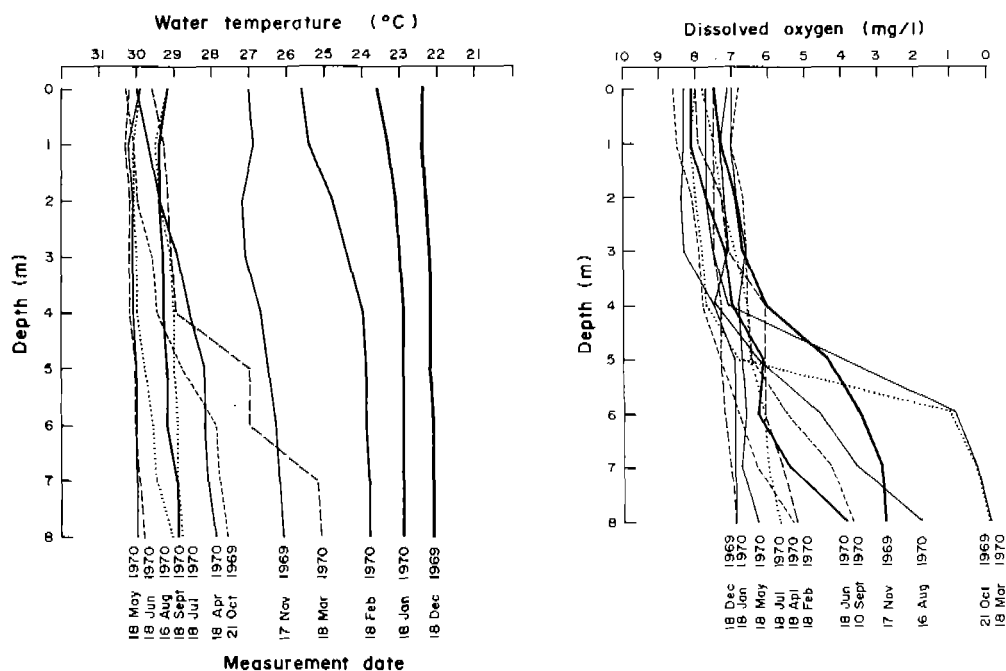

Fig. 2. Stratification of the water column in the Ubolratana Reservoir during wet and dry seasons, and associated dissolved oxygen concentrations (after Srisuwanataj 1970).

## Capture Fisheries

The fisheries biology and management of fish stocks of Ubolratana have been reviewed by Varikul and Suraswadi (1980). Bhukaswan and Pholprasith (1977) reviewed the first 10 years of Ubolratana's fisheries.

The fish fauna of Ubolratana is remarkably diverse, totalling 92 species, 18 of which are considered economically important (Table 3). Fish catches have increased from 791.4 t in 1967 to 1,351.7 t in 1987 and show large amounts of variation from year to year (Fig. 3). Catches are dominated by small cyprinids (80.5%) and clupeids (14.1%).

Table 3. Fish in Ubolratana Reservoir (1988).

Total Species	101
- Preimpoundment	75
- Postimpoundment	92
Common species	52
Economic species	18
- <i>Morulius chrysophekadion</i>	
- <i>Puntius gonionotus</i>	
- <i>Osteochilus hasselti</i>	
- <i>Osteochilus melanopleura</i>	
- <i>Cirrhinus jullieni</i>	
- <i>Puntioplites proctozyon</i>	
- <i>Clupeichthys aesarnensis</i>	
- <i>Hampala macrolepidota</i>	
- <i>Hampala dispar</i>	
- <i>Channa striata</i>	
- <i>Ophiocephalus micropeltes</i>	
- <i>Kryptopterus apogon</i>	
- <i>Kryptopterus bleekeri</i>	
- <i>Ompok bimaculatus</i>	
- <i>Mystus nemurus</i>	
- <i>Wallagonia attu</i>	
- <i>Oxyeleotris marmorata</i>	
- <i>Notopterus notopterus</i>	

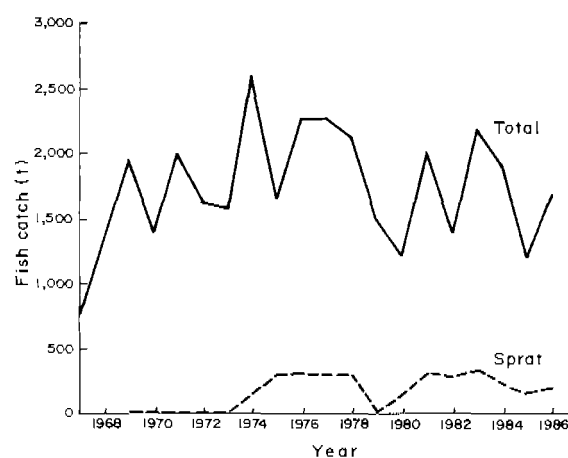

Fig. 3. Total fisheries catch and catch of the Thai river sprat from 1969 to 1986 in the Ubolratana Reservoir (after Sriputniphon et al. 1986).

Fisheries production of the Thai river sprat (*Clupeichthys aesarnensis*) from 1969 to 1986 ranged from a trace (1969-1973) to a high of 344.6 t in 1983 (Fig. 3). Seasonal weather conditions control the effort of fishermen catching sprat (described below). Other controls on the sprat populations are: (1) seasonal nutrient flows associated with water level fluctuations, (2) presence/absence of predatory fish, (3) changes in habitats, (4) fishing pressure. Of these factors the impact of predatory fish is currently thought to be the most important control (Varikul and Suraswadi 1980). Sprat abundances were negatively correlated with *Hampala* and *Oxyeleotris* abundances at the 95% level of significance (Varikul and Suraswadi 1980).

Major changes in fish species composition have occurred since the review of Bhukaswan and Pholprasith (1977). These changes seem to have enhanced the sprat fishery (Table 4). Expansion of the littoral zone gill-net fishery has occurred from 1974 to the present. Populations of predatory fish such as *Hampala*, *Channa*, *Wallagonia* and *Kryptopterus* declined substantially after 1974. The gill-net fishery uses small mesh gill nets which could selectively fish many predatory fish that spawn in the littoral zone (Varikul and Suraswadi 1980).

Table 4. Changes in fisheries in the Ubolratana Reservoir, 1981-1985.

Year	Standing crop (kg/ha)	F/C	Percentage of population			
			Carps	Catfish	Murrels	Others
1981	177	4.0	75.8	13.8	1.5	9.0
1982	170	2.9	71.6	6.4	7.7	14.3
1983	66	2.3	43.5	5.6	23.8	27.1
1984	207	2.7	32.7	3.9	10.2	53.2
1985	77	1.4	37.3	0.3	30.7	31.7

Source: LIFDS (1985).

Fisheries are managed by the Large Impoundment Fisheries Development Station (LIFDS), of the Inland Fisheries Division, Department of Fisheries, Ministry of Agriculture and Cooperatives, Thailand. The objectives of this station and its management programs are detailed in Table 5.

Table 5. Objectives, organization and current programs of the LIFDS, Ubolratana Reservoir, Thailand in 1988.

I.	The objectives of the station are as follows:
1.	To find the ways and means to improve fisheries production in the Ubolratana Reservoir and to conserve these resources for maximum fisheries benefit for the people in this region.
2.	To carry out research and investigation on fisheries, limnology, ecology, etc. in the large impoundment in order to obtain adequate information for management of other large impoundments in Thailand.
3.	To develop the fisheries industry in this area to increase the average income, as well as improve nutrition of the population in this region.
II.	The station consists of the following sections:
1.	Research section.
2.	Aquatic animal seed production section.
3.	Fisheries management section.
4.	Fisheries resources conservation section.
5.	Extension section.
III.	Management programs:
1.	Artificial fluctuation of water level program.
2.	Spawning season and seed rearing period protection program.
3.	Spawning grounds protection program.
4.	Broodstock area protection program.
5.	Controlling type of fishing gears and fishing methods.
6.	Law enforcement program.
7.	Fish resources conservation program.
8.	Stocking program.
9.	Aquatic weed control program.
10.	Fish landing statistics program.
11.	Landing places administration program.

## Fisheries Biology of *Clupeichthys aesarnensis*

### **Taxonomy**

The taxonomy of small clupeid fishes is notably difficult, especially for a little-studied and often neglected group of small marine and freshwater fish collectively known as the sprats. FAO (1985) briefly mentioned *Clupeichthys aesarnensis*, as having "perhaps no" interest to fisheries.

Indeed the Thai river sprat (*pla seiw kaew* in Thai) has, more than once, been the object of confusion, and has been commonly misidentified in the fisheries literature both within and outside Thailand. This is not unexpected since word of changes in fish taxonomy can take years to enter the mainstream of fisheries science, unless a fish suddenly becomes commercially important.

In all the original communications we received regarding the freshwater Thai river sprat fishery in Ubolratana, the fish was named *Corica goniognathus*. It was not until the study mission arrived at Ubolratana did we find out that Wonogratana (1983) had proposed reclassifying the Thai river sprat as a distinct genus based on the facts that it had fewer lower gill rakers and sharp canine teeth in contrast to *Corica* (Fig. 4). FAO (1985) in their review *Clupeoid Species of the World* have accepted this reclassification.

The fact that the clupeid found in Ubolratana was a distinct but closely related species to *Corica goniognathus* was important to our importation proposal since this latter species does exist in Kalimantan and Sumatra islands along with another very closely related fish species, *Clupeichthys bleekeri*. However no fishery currently exists for any of these species in Indonesia. To gather a sizeable founder stock for importation of any of these fish from the isolated rivers in the outer islands which have poor transportation networks was deemed more expensive and fraught with more technical problems than bringing *Clupeichthys aesarnensis* from Thailand. In contrast, the Thai river sprat comprise a very productive fishery in Ubolratana, have been the subject of research in transportation techniques, and are located close to international airlinks to Indonesia.

#### *Clupeichthys aesarnensis* Wongratana 1983

*Clupeichthys aesarnensis* Wongratana 1983, Japan. J. Ichthyol. 29(4): 388, fig. 2 (Ubolratana reservoir, Khon Kaen, also Hualuang near Udon Thani and Lampoa reservoir, Karasint, Thailand).

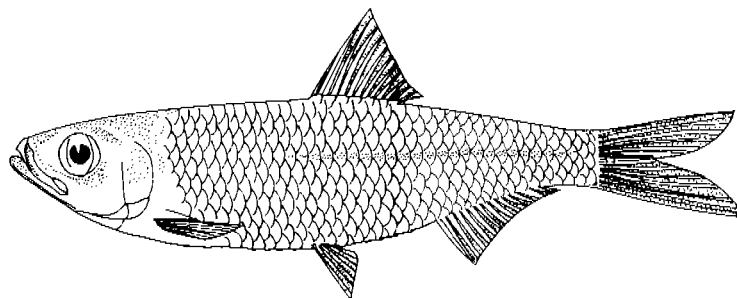

**Diagnostic Features:** Body moderately elongated, belly keeled, with 8 to 10 + 6 to 8 scutes. Snout blunt, pre-maxillae small and toothed, prominent teeth at symphysis and along sides of lower jaw; second supra-maxilla spatulate, about half length of maxilla blade. Lower gillrakers 17 to 19. Pectoral axillary scale less than half length of fin; pelvic finrays i 7; last two anal finrays forming a separate finlet. Resembles *C. goniognathus* (but lower gillrakers only 15 or 16), and *C. bleekeri* (but pectoral axillary scale more than half length of fin); *C. perakensis* has only i 6 pelvic finrays. Species of *Corica* also have a separate anal finlet, but the jaw teeth are small or minute and there are more lower gillrakers (19 to 27).

**FAO Name:** Thai river sprat.

**Geographical Distribution:** Thailand (reservoirs in north-eastern part, Mekong drainage).

**Habitat and Biology:** Freshwater, in reservoirs, presumably also in rivers.

**Size:** To 4.6 cm standard length.

**Local Name:** Pla seiw kaew.

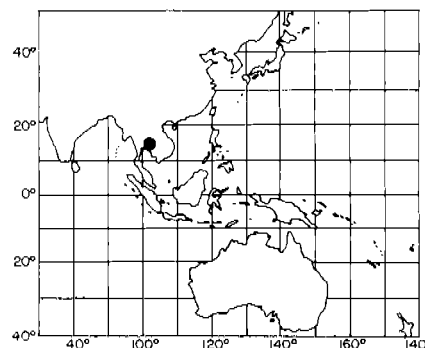

Fig. 4. Taxonomy of the Thai river sprat, *Clupeichthys aesarnensis* (after FAO 1985) (redrawn with permission from FAO, Rome).



## Life History

The Thai river sprat are native to nearly all river systems in northeastern Thailand and now comprise an important fishery in at least five reservoirs in the region (Chookajorn, pers. comm.). In the Ubolratana Reservoir they form dense populations in the reservoir pelagic region, and, to a much lesser extent, in the two riverine regions that were flooded by damming. Sprat have pelagic, floating eggs that are witnessed in the plankton throughout the year. No attempts, however, have been made to regularly collect eggs or fry of the sprat from the reservoir to rear in captivity.

Reproductive biology of the sprat has been studied by Sriputnipon et al. (1987). Fish fecundity (F) was found to be closely related ( $r = 0.92$ ) to fish length (L) by the equation,  $\log F = -1.67 + 2.86 \log L$ . Females of 33 mm in total length had 461 eggs while 52 mm females had an average of 1,690 eggs. Studies of the gonadosomatic index (GSI) during a 14-month period from April 1986 to June 1987, covering 15 lunar months, showed that a portion of the sprat population had eggs at all times, with GSI's = 0.0-10.7 (Fig. 5). From these data it would appear that some part of the sprat population in Ubolratana remains reproductively active throughout the year.

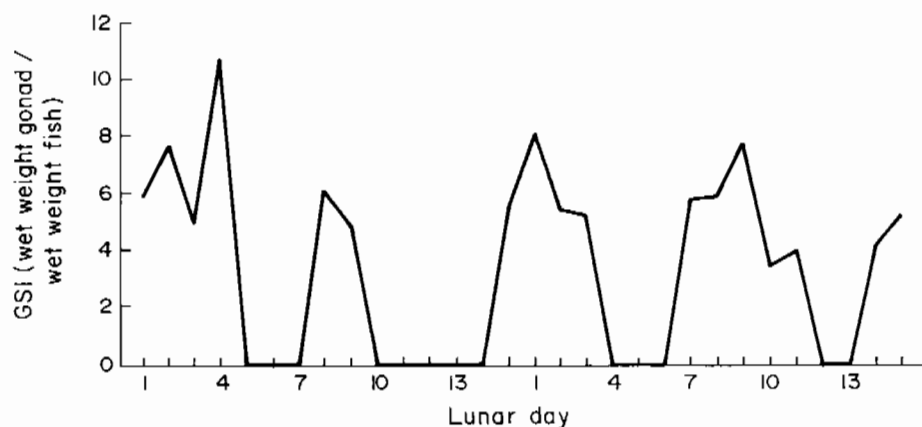

Fig. 5. Average gonadosomatic index (GSI) for the Thai river sprat during moon cycles from April 1986 to June 1987 (after Sriputnipon et al. 1987).

The sprat has a very short life cycle (ca. 9 months) with a high fecundity and exhibits rapid growth enabling it to withstand intensive fishing pressure. Rapid growth allows it to take advantage of seasonally available nutrients when the stratification of Ubolratana breaks down and river flows increase during the rainy season. Organic matter and nutrients are then circulated into the epilimnion increasing plankton productivities. The short-lived, rapidly proliferating sprat quickly respond to these transient increases in plankton productivity, feeding directly on it.

## Feeding and Spatial Niche

The diurnal behavior of the pelagic freshwater sprat is distinctly affected by illumination. During the day it descends into the water column and populations shoal at depth. At night fish come to the surface and are distributed from the surface to the thermocline. Sprat feed actively on zooplankton at night.

The feeding niche of the sprat in Ubolratana was studied by Sriputnipon et al. (1987). They examined the gut contents of 129 fish from 20 mm to greater than 50 mm total length over a period of one year. Major food items for the sprat throughout its life cycle consisted of small

zooplankton followed by phytoplankton and insect larvae (Table 6). Food habits changed with total fish length, with fish increasing their intake of zooplankton and insects as they grew larger. For example, the diet of fish of 20-29 mm total length consisted of 45% zooplankton and 40% phytoplankton, while fish greater than 50 mm average length ate 60% zooplankton, 20% phytoplankton and 15% insects.

Table 6. Gut contents of Thai river sprat in Ubolratana Reservoir.

Range fish total length (mm)	Ave. total length intestine (mm)	Ave. ratio intestine/fish length	Food (% gut contents)			
			Phyto-plankton	Zoo-plankton	Insects	Other
20-29	10	0.40	40	45	0	15
30-39	16	0.46	45	52	0	3
40-49	20	0.45	25	60	15	0
> 50	23	0.46	20	60	15	5

Source: Sriputnipon et al. (1987).

### ***Comparisons of Plankton Populations and Gut Contents***

Little information was available in Thailand on the sizes and species of plankton ingested. For this reason samples of Thai river sprat were collected during two evenings, 28-29 March 1988 from light fishing operations in the Ubolratana Reservoir. Fish samples were preserved in 5% formalin and one portion brought to the laboratory for fish diseases at the National Inland Fisheries Institute (NIFI), Bangkok, Thailand, and the other portion transported to the Institute of Ecology (IOE), Padjadjaran University, Bandung, Indonesia. Fish samples were also sent to scientists at the British Museum of Natural History in London and to ICLARM, Manila, Philippines.

In addition, a comparison of the natural plankton populations in the Ubolranata Reservoir and the plankton in the proposed recipient reservoir, the Saguling Reservoir, was also undertaken.

At IOE 121 fish were examined. Fish sizes ranged from 20.8 to 51.1 cm total length, with an average of  $34.6 \pm 4.4$  cm (Mean  $\pm$  1 S.D.). The majority of fish examined were between 30.9 and 33.7 cm total length (Fig. 6). Fish stomachs were removed and gut contents washed out with a squirt bottle and made to a 30% suspension. Aliquots were added to a Sedgewick-Rafter counting chamber and organisms examined using a compound microscope at 40-400x magnification. Phytoplankton were identified to genus using Edmondson (1965) and zooplankton identified by referencing Sharma (1979, 1980a, 1980b), Lai and Fernando (1980), Fernando and Lankai (1981) and Idris and Fernando (1981). Phytoplankton genera were classified into divisions and population structures compared in Ubolratana to the Saguling Reservoir. Zooplankton were classified using the references mentioned above into three size categories: small (40-690  $\mu$ m), medium (691-1,340  $\mu$ m), and large (> 1,341  $\mu$ m).

Plankton were collected from 10 stations in the Saguling Reservoir during a 15-month period from January 1987 to March 1988. During the 11 months of sampling 220 samples were analyzed. No samples were taken during a 4-month period from March to June 1987. Samples were taken at 0 and 5 m depths at each station. Depth samples were taken by using a 10-l Kimmerer bottle. Three samples were collected and poured into the plankton net (30 l total). Plankton was retained at the bottom of the net on a screen (70 meshes/cm<sup>2</sup>). This material was carefully washed into a 30-ml jar and plankton preserved in 5% formalin. Samples were transported to and analyzed at the IOE laboratory. At the laboratory counts of plankton cells were made according to APHA (1985).

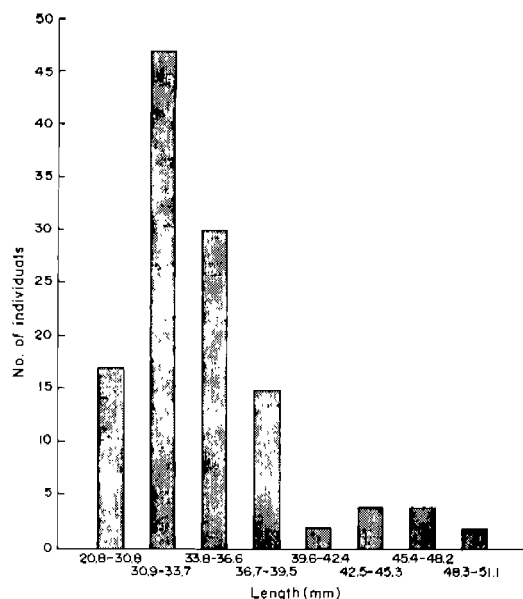

Fig. 6. Size classes of Thai river sprat (*Clupeichthys aesarnensis*) sampled for gut content analysis.

A comparison of phytoplankton genera in the two reservoirs is summarized in Table 7, and phytoplankton divisions summarized in Table 8. Forty phytoplankton genera are present in Saguling and 38 in Ubolratana. Eighteen genera are shared between the two reservoirs, with most of the shared phytoplankton blue-green algae. Comparison of zooplankton genera shows that Ubolratana has 21 genera and Saguling 30 (Table 9). The majority of zooplankton in both reservoirs are small, in the 40-690  $\mu\text{m}$  size category (76% in Ubolratana and 80% in Saguling).

Table 7. Comparison of phytoplankton genera in Ubolratana and Saguling Reservoirs.

Phytoplankton genera	Ubolratana	Saguling
<b>CHLOROPHYTA</b>		
Ankistrodesmus	Y	
Botryococcus	Y	
Carteria	Y	
Chlorella	Y	Y
Closteriopsis		Y
Closterium		Y
Chroococcus	Y	
Coelastrum	Y	
Cosmarium		Y
Desmidium	Y	
Dictyosphaerium	Y	
Dinobryan	Y	
Euastrum		Y
Eudorina		Y
Gyrosigma		Y
Merismopedia	Y	
Oedogonium	Y	
Pediastrum	Y	Y
Pleodorina		Y
Pleurotaenium	Y	Y
Scenedesmus	Y	Y
Sirogonium		Y
Sphaerocystis	Y	Y
Spirogyra	Y	

Continued

Table 7. Continued

Tetraedron	Y		
Tetrastrum	Y		
Volvox			Y
Zygnema			Y
<b>TOTAL GENERA</b>	<b>18</b>		<b>15</b>
Shared Genera		5	
<b>CHRYSTOPHYTA</b>			
Achnanthes	Y		
Amphora	Y		Y
Bacillaria			Y
Cylindrotheca			Y
Denticula			Y
Fragilaria			Y
Gomphoneis			Y
Gonatozygon	Y		
Melosira	Y		
Micrasterias			Y
Navicula	Y		Y
Neidium			Y
Nitzschia	Y		Y
Pinnularia			Y
Staurastrum	Y		Y
Surirella	Y		Y
Synedra	Y		Y
Tabellaria	Y		
Terpsinoe			Y
<b>TOTAL GENERA</b>	<b>10</b>		<b>15</b>
Shared Genera		6	
<b>CYANOPHYTA</b>			
Anabena	Y		Y
Arthrospira	Y		
Lyngbya	Y		
Microcystis	Y		Y
Oscillatoria	Y		Y
Phormidium			Y
Spirulina	Y		Y
<b>TOTAL GENERA</b>	<b>6</b>		<b>5</b>
Shared Genera		4	
<b>PYRRHOPHYTA</b>			
Ceratium	Y		Y
Gonyaulax	Y		
Peridinium	Y		Y
<b>TOTAL GENERA</b>	<b>3</b>		<b>2</b>
Shared Genera		2	
<b>EUGLENOPHYTA</b>			
Euglena			Y
Phacus	Y		Y
<b>RHODOPHYTA</b>			
Lemanea			Y
<b>TOTAL OTHER GENERA</b>	<b>1</b>		<b>3</b>
Shared Genera		1	

Table 8. Phytoplankton genera in the Ubolratana and Saguling Reservoirs.

Phytoplankton division	Number of phytoplankton genera		
	Ubolratana	Saguling	Shared
Chlorophyta	18	15	5
Chrysophyta	10	15	6
Cyanophyta	6	5	4
Euglenophyta	1	2	1
Pyrrhophyta	3	2	2
Rhodophyta	0	1	0
Total genera	38	40	18

Table 9. Comparison of zooplankton size structure in Ubolratana and Saguling.

Zooplankton genera	Ubolratana Thailand	Zooplankton genera	Saguling Indonesia	Common genera
Arcella	-	Arcella	-	**
Ascomorpha	+	Asplancha	+	
Bosminopsis	-	Astramoeba	-	
Brachionus	-	Bosmina	-	
Chydorus	-	Brachionus	-	**
Colurella	-	Bursaria	0	
Conochilus	-	Campanella	-	
Diaphanosoma	0	Ceriodaphnia	-	
Diaptomus	0	Chaetonotus	-	
Diffugia	-	Coleps	-	
Euchlanis	-	Colurella	-	**
Filina	-	Cururbitella	-	
Keratella	-	Cyclops	0	
Monostyla	-	Diaptomus	0	**
Notholca	-	Diffugia	-	**
Philodina	-	Filinia	-	**
Ploesoma	-	Keratella	-	**
Pleuroxus	0	Lecane	-	
Polyarthra	-	Moina	-	
Scapholeberis	0	Monostyla	-	**
Trichocerca	-	Nauplius	0	
		Notholca	-	**
		Panagrolaimus	0	
		Paramecium	-	
		Philodina	-	
		Platylas	-	
		Polyarthra	-	**
		Proales	-	
		Trachelenglypha	-	
		Trichocerca	-	**
TOTAL GENERA	21		30	11
Small (40-690 $\mu\text{m}$ )	16		24	
Medium (691-1,340 $\mu\text{m}$ )	4		5	
Large (> 1,341 $\mu\text{m}$ )	1		1	

Small = -, Medium = 0, Large = +.

Gut contents of 121 fish were examined and percentage occurrences tabulated (Table 10). Blue-green algae, a diatom, and three small zooplankton species comprised the largest percentage of the gut contents. Small zooplankton were the dominant food, with 82% of the zooplankton observed in the gut contents being <500  $\mu\text{m}$  in size. All species of phytoplankton and zooplankton observed in fish stomachs are part of the planktonic flora and fauna observed in the Saguling Reservoir.

Table 10. Results of gut contents analyses of *Clupeichthys aesarnensis* from the Ubolratana Reservoir.

Plankton genera	% Gut contents	Largest size ( $\mu\text{m}$ )	Present in Saguling
<b>PHYTOPLANKTON</b>			
Chlorella	12.5		Y
Cylindrotheca	35.0		Y
Microcystis	45.0		Y
Oscillatoria	5.0		Y
Scenedesmus	2.5		
<b>ZOOPLANKTON</b>			
Arcella	9.0	90- 146	Y
Colurella	28.0	50- 150	Y
Diaptomus	18.0	1,000-1,900	Y
Diffugia	9.0	100- 400	Y
Keratella	9.0	80- 120	Y
Notholca	9.0	to 180	Y
Philodina	18.0	to 500	Y

Plankton population dynamics in the Saguling Reservoir over a 15-month period (11 months sampled) are summarized in Table 11 for the 5 species of phytoplankton and 7 species of zooplankton found in fish stomachs recorded in Table 10. The most abundant phytoplankton in order of abundance and occurrence in the 220 samples examined throughout the period were *Cylindrotheca* (in 71% of the samples), *Microcystis* (41%) and *Oscillatoria* (7%). *Cylindrotheca* and *Microcystis* comprised 80% of the phytoplankton observed in stomach contents of the 121 sprat examined (Table 10). The most abundant zooplankton observed were *Colurella* (in 49% of the samples), *Diaptomus* (24%), *Keratella* (23%) and *Diffugia* (6%). These four genera comprised 66% of the total volume of zooplankton observed in fish stomachs (Table 10).

### **Fishing Technology and Fish Processing**

According to fishermen interviewed at the Ubolratana Reservoir, a fishery for the sprat existed before the rivers were inundated by the reservoir. Fishermen suspended kerosene lights off the front of small boats to attract fish. Small-meshed hand nets were used to capture fish attracted to the lamps. Yields were said to be much lower than fishermen currently experience. No studies have been found which document this fishery.

Modern fishing methods for the sprat are very simple, using small mesh nets and kerosene lamps. It is believed, however, that current light fishing methods evolved not from traditional ones existing before the reservoir, but were brought to the northeast by seasonally migrating workers and fishermen from the coastal areas of Thailand where light fishing methods are well developed (Bhukaswan, pers. comm.).

The Ubolratana Reservoir has a very irregular bottom because of the rolling terrain that was flooded. Many areas shallower than its mean depth of 16 m exist throughout. Shallow areas

Table 11. Densities of selected plankton genera found in the Saguling Reservoir known to be eaten by the Thai river sprat, 1987-88.

Phytoplankton	Jan 1987		Feb 1987		Jul 1987		Aug 1987		Sept 1987		Oct 1987	
	R	#O	R	#O	R	#O	R	#O	R	#O	R	#O
Chlorella	0	0	0	0	0	0	0	0	0	0	0	0
Cylindrotheca	3-271	20	3-132	20	2-147	13	10-27,560	15	1-382	16	2-32	14
Microcystis	3	3	3-78	15	1-23	8	60	1	3-90	3	2-32	14
Oscillatoria	3	1	0	0	8-26	2	0	0	0	0	4-2,204	4
Scenedesmus	0	0	0	0	1	1	0	0	0	0	0	0
Zooplankton												
Arcella	0	0	0	0	3	2	0	0	10	1	0	0
Colourella	0	0	0	0	3-139	16	1-52	14	1-52	11	0	0
Diaptomous	0	0	0	0	2-137	17	2-144	14	1-128	12	2	1
Diffugia	0	0	0	0	1-4	5	2-20	2	1-4	5	4-18	2
Keratella	3-6	7	3	2	1-8	16	1-40	8	1-40	10	2	2
Notholca	0	0	0	0	0	0	0	0	0	0	0	0
Philodina	0	0	0	0	2	2	0	0	0	0	0	0

R = range of cells if phytoplankton or organisms per liter if zooplankton, phytoplankton x 1,000.  
 #O = number of stations organisms observed (220 in this report).

Phytoplankton	Nov 1987		Dec 1987		Jan 1988		Feb 1988		Mar 1988		Total number of stations observed	% Observed
	R	#O	R	#O	R	#O	R	#O	R	#O		
Chlorella	0	0	0	0	0	0	0	0	0	0	0	0
Cylindrotheca	2-662	12	2-24	6	1-14	7	1-158	17	1-302	17	157	71
Microcystis	2-2,690	19	2-6	2	1-652	10	2-219	7	1-1,295	9	91	41
Oscillatoria	2-146	5	2-6	3	0	0	0	0	0	0	15	7
Scenedesmus	0	0	0	0	0	0	0	0	0	0	1	<1
Zooplankton												
Arcella	0	0	0	0	0	0	0	0	0	0	3	1
Colourella	0	0	0	0	0	0	0	0	0	0	41	49
Diaptomous	2-4	3	2	1	0	0	1-3	0	0	0	52	24
Diffugia	0	0	0	0	0	0	0	0	0	0	14	6
Keratella	0	0	1	1	1-2	2	0	0	1	2	50	23
Notholca	0	0	0	0	0	0	0	0	0	0	0	0
Philodina	2	2	0	0	1	1	0	0	1	1	6	3

allow the staking of 10-20 m long bamboo or wooden poles into the reservoir bottom, even in the center of the large pelagic zone. Sprat fishermen stake these poles into the bottom and hang a simple pressurized (hand-pumped) kerosene lamp onto a hook or a Y made from bamboo that is fixed horizontally onto the side of the pole about 1-1.5 m above the water surface.

Kerosene lamps are suspended after dark on the hook of each pole. Some fishermen suspend lamps throughout the night after sunset until sunrise, but most fishermen set lamps at midnight and begin fishing at 0100 hours until sunrise. In their experience sprat school around the lamps after midnight. In addition fishermen know the lamps consume more kerosene than their equivalent worth in fish catch if run continuously from sunset (each lamp contains 1-1.5 l of kerosene). According to fishermen a nocturnal pattern of fish behavior exists with fish catches from sunset to 2400 hours much less than from 0100 hours to sunrise.

Fishermen set lamps and wait one hour before beginning to scoop fish schooling at 1-2 m depth near the lamp, then return to scoop fish and repump the lamps every hour until sunrise. Each hour a fisherman arrives at his or her pole (there were several women fishing), ties a flat-bottomed boat to it and puts a small circular cloth covering over the top of the lamp to focus light on his/her activities. He/she then takes a large scoop net and thrusts it vertically into the water next to the lamp to the extent of its handle length. He/she then raises the net horizontally through the water until it surfaces. Then in one motion he/she reverses his/her body and the net to scoop on the other side of the narrow boat. Previously caught fish from the first scoop are retained by the deep net and the motion of rapid net reversal.

Scoop nets have handles of about 2.5 m in length with two metal braces holding a 5-mm mesh net into the shape of a large Y about 3 m across (see photos). The depth of the net is 0.5-1 m, or deep enough to hold 10-20 kg of fish caught on the first scoop and with no loss in the reverse motion performed from first to second scoop.

Fish caught are put directly into the bottom of the boat and quickly die. After performing the two scoops at one lamp, fishermen repump the lamp, remove the lamp covering and row to the next lamp. This fishing pattern is repeated until sunrise. Some fishermen observed caught 10-20 kg on two scoops, or just one "lamp visit". On good nights when winds are calm, fishermen report catching 20-30 kg/lamp visit (or approximately per hour). The two fishermen followed closely during the study mission caught 33 kg wet weight/5 lamps (said to be a "bad night") and 73 kg/4 lamps (said to be "average").

Most fishermen set 3-5 lamps, although a few operate 8. It was said that everyone in the villages surrounding the reservoir knows who owns the poles, lamps and the small fishing territory surrounding them. These resources were all said to be "privately owned". Each fisherman pays a yearly fee of 10 Baht/scoop net/year to the LIFDS.

From the experience of the fishermen and scientists at the LIFDS, lamps are thought to modify the behavior of migrating zooplankton populations and, in turn, the sprat which follow them. Zooplankton populations are thought to naturally migrate to the water surface at sunrise and sunset, descending at night. The lamps affect zooplankton by attracting them to the water surface at night. Sprat school at 1-2 m water depth to follow dense zooplankton migrations affected by the light.

Catches of sprat vary with seasonal and lunar cycles. Catches are highest during periods of the new moon and decrease to low levels at full moon. Full moon periods are said to affect schooling behavior by scattering the fish. Total monthly catches are highest during the dry season (October to June) when winds are calm. During the rainy season strong winds make the setting of lamps impossible and fish catches drop (Fig. 7). In addition many residents of the villages surrounding Ubolratana are seasonal fishermen, leaving to grow rice for subsistence and economic reasons during the rainy season, so total fishing effort decreases. Current opinion of Thai fisheries scientists is that fishing pressure on sprat is low and that light fishing efforts could be greatly increased without any large changes in catch per unit effort. It is likely that current seasonal fishing pressure is not coincident with, or suitable to, the ecology of Ubolratana



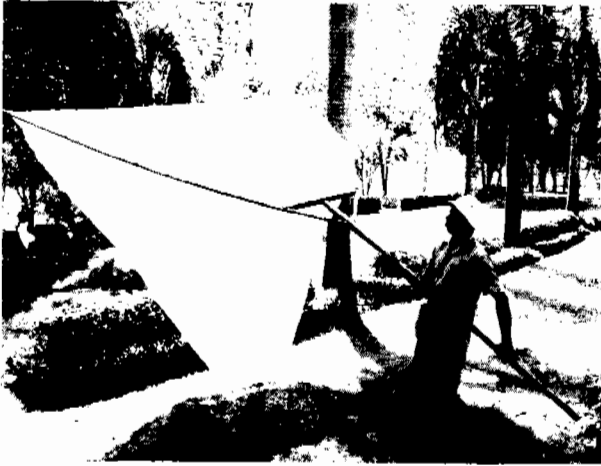

1



2



3



4



5

1. Fisherman for the Thai river sprat (*Clupeichthys aesarnensis*) demonstrating the use of a 3 m wide fishing net. Note the long handle (2.5 m long in this case) and net depth (1.2 m here). The mesh size is 5 mm.

2. Detail of the metal braces used to hold the bamboo Y poles at the end of the net.

3. Landing beach for small-scale fishermen selling the Thai river sprat (*Clupeichthys aesarnensis*). Note the long flat bottoms and narrow width of the boats so that fishermen can rapidly scoop fish with the long handled nets on either side of the boat in one swift reversing motion.

4. Scooping fresh dead fish into bamboo baskets (made locally for the purpose) for direct sale from fishermen to buyers from Bangkok who line the shores waiting in the early morning. The fish have a reputation as making a tasty fish sauce.

5. Buyers weigh the Thai river sprat fresh and transport it in bamboo baskets covered with simple banana leaves directly to Bangkok. Fresh fish price was 3.5 Baht/kg on this day. Fishermen reported that fish prices have varied from 3 to 4 Baht/kg in 1987-1988. (All photos by Barry A. Costa-Pierce).

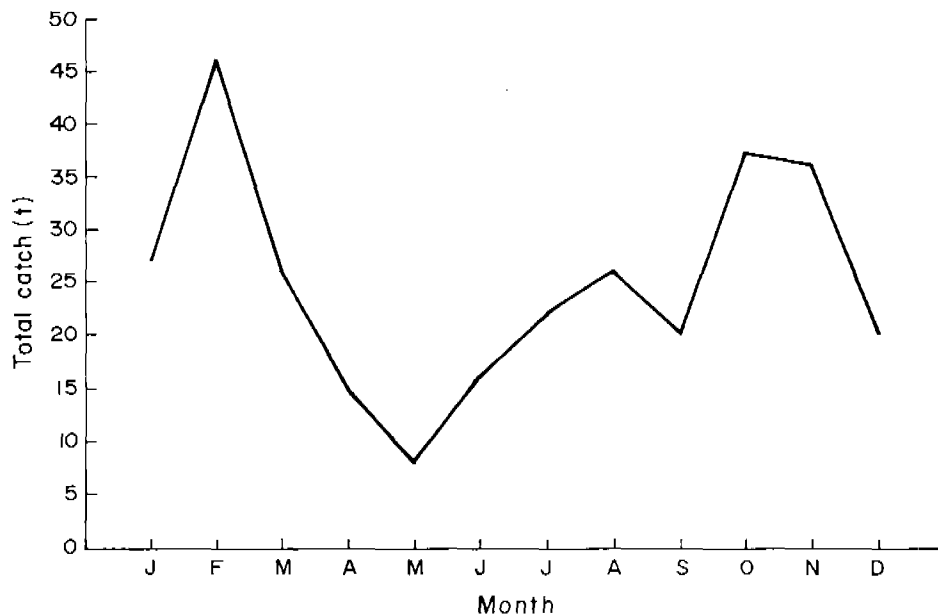

Fig. 7. Average monthly yields of Thai river sprat in the Ubolratana Reservoir during 1980-1986 (Sriputnipon et al. 1987).

since highest seasonal plankton production, and presumably, fish production of the reservoir would be during the rainy season when frequent lake mixing, nutrient mobilization and highest plankton productivities occur.

Marketing and processing the sardines is as simple as the fishing techniques. Most of the fish are sold fresh and are highly regarded. At sunrise buyers from Bangkok line the shore of the reservoir (see photos). Before going to the buyers, however, fishermen divide the catch at their shoreline villages, with a portion set aside for family needs, but the bulk travels to the landing port for sale. One such landing site was observed where a reported 60% of the sprat are sold. Fresh fish price on this day was 3.5 Baht/kg. Prices have fluctuated from 3-4 Baht/kg from 1987 to 1988. Current price for dried sprat was 25 Baht/kg. It takes 3-4 kg of wet sprat for each kg of dried fish.

For local consumption fish are simply sun dried on racks for 24-28 hours, or until the fish lose 65-70% of their wet weight. Old fish (brought to market after 0900 hours) are fermented into fish sauce. The fish sauce home industry is a very important source of employment for women in the villages surrounding the reservoir; however, the number of women fishermen was also said to be increasing. For making fish sauce, 3-4 kg of fresh sprat are added to 1 kg of salt in a clay pot (made locally). This pot is covered with a piece of plastic or a slab of cement and kept for about 1 year. It was reported that total nitrogen reached 10-20% in the sauce after 1 year.

It was estimated during the study mission that for a total capital outlay and operating investment of 7,825 Baht a sprat fisherman can obtain a net benefit of 200,925 Baht over a five-year period (Table 12). Given the fact that the average income of residents in the northeast of Thailand is 6,000 Baht/year, sprat fishing is a very attractive occupation.

Indeed a steady migration of people to the reservoir has occurred from throughout the region. Increases in population densities of the villages from in-migration has been noted by workers at the LIFDS, especially since 1980. It was also reported that more people were residing year-round rather than taking the costly and risky venture of seeking jobs in Bangkok during the dry season. However the majority of residents still seasonally fish and switch to rice farming in the wet season.

Table 12. Economic benefits of sprat fishing.

I. Year One (all in Thai Baht; 24 Baht = 1 US\$)				
1)	Capital Costs			
a)	boat (used)			1,500
b)	lamps 5 @ 1,200			6,000
c)	scoop			
	* 5 mm netting, 4 m @ 45 Baht/m	180		
	* 2 pieces bamboo @ 6 Baht ea.	12		
	* 2.5 m wood handle, 2 metal braces	30		
	* rope for sewing	5		
d)	fishing fee @ 10 Baht/scoop/year			10
Total Capital Costs				7,737
2)	Operational Costs			
a)	fuel 1 liter/night x 8 Baht/liter x 250 nights/year			2,000
Total Costs				9,737
3)	Gross Return			
	50 kg/night x 250 nights/year x 3.5 Baht/kg			43,750
4)	Net Technical Margin, Year 1		34,013	
II. Years 2-5 (Capital costs are replacing bamboo on scoop and paying fee; assume operational costs and net returns same Years 2-5)				
Operational year	Total capital costs	Operating costs	Gross returns	Net margin
1	7,737	2,000	43,750	34,013
2	22	2,000	43,750	41,728
3	22	2,000	43,750	41,728
4	22	2,000	43,750	41,728
5	22	2,000	43,750	41,728
TOTALS	7,825	10,000	218,750	200,925

## Importation Considerations and Procedures

### Potential Impacts of Fish Importation

In general the possible risks that are presented in fish introductions may be classified as follows (Sindermann 1986; Welcomme 1986):

- (1) *Pathological Risks*: potential for introduction of diseases and parasites impacting human and natural ecosystems;
- (2) *Ecological Risks*: potential naturalization of the exotic fish and subsequent changing of native aquatic communities by competition, food chain disruption, niche displacement, or lowering of natural environmental carrying capacity;
- (3) *Genetic Risks*: potential for inbreeding with natural stocks;
- (4) *Totally Unpredictable Impacts*: impacts of a wide-ranging sociocultural, economic, or ecological nature.

Judgement of these risks is largely subjective, and is often dependent upon the viewpoints and experiences of many different scientists, environmental organizations and certain user groups. The opinions of all who review any importation proposal can never be expected to be unanimous. In addition, evaluators of importation proposals must be aware of the multisided and interdisciplinary nature of issues involved, especially in evaluating proposed fish introductions to protein-hungry tropical developing nations. However, any complete proposal must not be overly biased by existing social conditions in any nation that could outweigh preservation of future and globally-important biotic diversity. All importation proposals must attempt to address the most important possible impacts of importation so that evaluators can make a proper risk appraisal. Possible impacts will likely include some, if not all, issues classified in the above-mentioned "risk list".

The risks and merits of the transfer and introduction of any living organism from one environment to another must be fully evaluated on a technical, ecological, human health, economic and political basis. In the current proposal the terminology of Shafland and Lewis (1984) is chosen to define "exotic": an organism whose entire range is outside the country to which it is introduced.

Potential hazards of the proposed introduction of an exotic fish from the Ubolratana Reservoir in Thailand to Indonesia should not be taken lightly, nor should the potential technical problems of such an unprecedented and innovative transfer be underestimated. No long distance transfer of such a fragile, small and seemingly insignificant fish has ever occurred in Asia. Therefore in addition to a host of direct impacts that could result from this introduction, such as disease transfer, disruption of native aquatic communities, or a range of unpredictable, undesirable side effects, the technical viability of such a transfer is open to debate. Clearly the opinions and technical guidance of a qualified committee of experts must be consulted. In addition all parties that could possibly be impacted by the importation must be informed of the progress of any proposal in order to assist a committee of fisheries experts in evaluating potential impacts of the importation.

### ***Potential Environmental Impacts***

A freshwater clupeid (*Limnothrissa miodon*) introduced upstream into African reservoirs survived passage through hydroelectric turbines, migrated downstream into the Zambezi River, and colonized a new downstream reservoir (Cabora Bassa Reservoir) (Kenmuir 1973). The possibility thereby exists that, if the proposed introduction was successful into the upstream Saguling Reservoir, that some freshwater clupeids could survive passage through Saguling's turbines and make their way downstream into the Citarum River. Migration downstream could have adverse or positive impacts on the environment and fish populations in the river.

Downstream fish communities of Saguling have been highly impacted by massive releases of toxic hydrogen sulfide and ammonia discharged from its outlet in 1985 (PLN, pers. comm.). In addition, the Citarum River is heavily polluted along its entire length by raw sewage waste from densely populated cities along its banks. Riverine fish communities consist of few species of native Cyprinids and many introduced species (see Munro et al., this vol.). No endangered species exist in the Citarum River.

Weighing these factors it is concluded that environmental conditions in the Citarum River are suboptimal, or possibly lethal for the freshwater clupeid. However, if introduction of the fish to Saguling was successful, and if proper environmental conditions exist in the river for their survival, the fish could find its way downstream to the next Citarum River Reservoir, the new Cirata Reservoir, and colonize it. If the sardine continued further downstream, it would enter a third reservoir, the Jatiluhur Reservoir, and colonize it. Further downstream it could enter heavily

polluted irrigation canals at Tarum Barat and Tarum Timur. If the fish survived to colonize these canals in the heavily polluted and urbanized region 20-30 km south of Jakarta any aquatic ecological shifts that would occur would most likely be beneficial. The canals are highly eutrophic and currently present health hazards to the human population in the areas. A planktivorous fish established in the canals could assist in controlling insect and plankton populations, not to mention provide another fish for the thousands of young children who daily fish poor quality Java tilapia (*Oreochromis mossambicus*) from the canals as a protein source for their families.

It is concluded that the sardine would not pose any major or unusual threat to riverine fish communities than that which has already been imposed by the construction of three large dams (Saguling, Cirata, Jatiluhur) on the Citarum River, and the massive quantities of domestic pollution that enter the river from its heavily populated riparian areas.

### **Potential Impacts on Human Health**

The greatest concern of transfer of the sprat to Indonesia is that accompanying deleterious organisms will cause irreparable damage to the Indonesian human ecosystem. No room for error is possible since any disease transmission (to both human and natural ecosystems) to Indonesia would render any benefits from the importation meaningless.

The sprat is not known to carry any fish or human diseases. However, no complete studies have been conducted which specifically addressed the presence or absence of any human or fish parasites, fungi, bacteria, or any other diseases carried externally or internally by the sprat (Sitdhi Boonyaratpalin, pers. comm.).

The region of the Ubolratana Reservoir is rife with liver flukes, *Opisthorchis viverrini* (Vichasri et al. 1982). These serious human parasites use three species of freshwater snails as first hosts, and various species of cyprinid fish as secondary hosts in the Ubolratana Reservoir. The parasite is spread to people in Ubolratana by eating cyprinid fish. These fish eat snails during some part of their life cycle and incorporate metacercariae into their flesh. People who eat raw, uncooked fish flesh are particularly in danger, incorporating this parasite into their system from eating the fish. A popular local delicacy in northeastern Thailand is raw cyprinid fish spiced with chili and lime and eaten with sticky rice. The route of parasite transmission is clear. Cooking or fermenting fish before consuming it would break this unfortunate cycle.

Since the sprat is a pelagic planktivore/insectivore it is unlikely it would have a role in disease transmission of this parasite. However the fish could harbor metacercariae in its liver. With this in mind a sample of 20 adult fish was given to Dr. Sitdhi, fish disease expert at NIFI, Bangkok, Thailand, for analysis during the study mission. Dr. Sitdhi examined the fish internally and externally and found no metacercariae.

The Thai river sprat is not known to harbor any fish diseases. Over 101 species of freshwater fish exist in Ubolratana, including all fish species that exist in the Saguling Reservoir. No current or past fish diseases have been reported in Ubolratana (Benjakara and Kunchit, pers. comm.).

However to prevent any such possible occurrence, a highly-qualified tropical disease expert from the Indonesian Ministry of Health will be contracted to examine fish and water coming from Thailand to Indonesia. In addition, it is proposed to hold the imported sprat in a completely closed fish quarantine station in cooperation with the Indonesian Directorate General of Fisheries. Strict quarantining procedures as defined in the procedures required by recently enacted Indonesian policies regarding fish introductions (Djajadiredja et al. 1983) will all be followed.

## Potential Benefits

Economic and nutritional benefits of the introduction to and successful establishment of the sprat to Indonesia are expected to be high. Intensification of the reservoir ecosystem by filling all available ecological niches in the fisheries ecosystem could yield multiplicative benefits in addition to simple provision of additional jobs and money. Much greater regional and national benefits could accrue to Indonesia if introductions of the sprat to Saguling were successful and this success was extended to other freshwater reservoirs in the nation.

The Thai river sprat is the most important fish for the poor people in the heavily populated villages surrounding the Ubolratana Reservoir. While Thai national fish consumption averages 20.2 kg/capita/year, annual fish consumption of the villagers who surround Ubolratana averages 45.3 kg/capita/year (LIFDS, pers. comm.). Fish are consumed dried or fermented. Dried sprat are 67% protein, 7.8% fat, 5.4% water and 19.7% ash (Kunchit Watanadilokkul, unpublished data). In Ubolratana the majority of the 5,628 fishermen in the 41,000-ha reservoir are supported both financially and nutritionally by the sprat fishery. The fishery in the reservoir employs hundreds of other people in the processing and marketing of the product and in the net and boat building industries. These productive industries occur in a remote region where few jobs existed, and where the local population previously had little access to cheap supplies of protein. If the sprat developed in Indonesia, a new protein source would be available within the budget of the poorest residents. It is also assumed that the nutrition of Indonesian rural people in the reservoir regions would be greatly enhanced. A cheap, readily available, new source of animal protein that has a long shelf life, and is easily transported, would be created.

The major animal protein source for the rural poor in Indonesia is small (5-15 cm), salted, dried fish. Supplies of this staple in inland areas fluctuate due to fluctuating marine catches and the fact that inland areas are remote from sources of supply. It is anticipated that a new source of dried salted fish would not only be readily accepted by the local population, but that any surpluses could also be rapidly absorbed by existing markets throughout Indonesia.

## Recommended Importation Procedures

### Studies in Fish Transportation

Benjakara and Sripitnipon (1986) studied methods for successful transportation of the Thai river sprat at LIFDS. They found that fish of 3.5-5.0 cm could be successfully transported at a density of 150-300 per 5 l of water in plastic bags with oxygen up to 15 hours with 100% survival if an acclimatization procedure was followed before transport (Table 13).

Table 13. Survival rates of the Thai river sprat after transport in different densities of water.

Fish density (per bag)	Hours held	Fish survival (%)
150	15	100
300	15	100
550	12	40
650	12	30

Sprat must first be acclimatized to being in a container with walls for at least 2 days before transport. This is accomplished by positioning a 2 x 2 m "hapa" net of 2-3 mm "blue nylon" in the reservoir and staking it to two bamboo poles in the reservoir. The net is tied to the poles so it can be pulled up on them, and is weighted. The net is sunk to 2-3 m water depth during the day and lifted to the water surface to catch fish on the first night of acclimatization. With the net at depth, a lamp is set over the cage during the time of night fishing. The cage is then slowly lifted and the captured sprat held in it for 2 days. After 2 days acclimatization period, fish are scooped out of the cage using large kitchen bowls (never using hand nets) and added directly to plastic bags with 5 l of water and oxygen. Fish survival rates are shown in Table 13. Bags with 300 fish experienced 100% survival for 15 hours. One bag of this water/fish combination weighs about 5 kg.

Sprat have also been held in 25,000-l tanks at LIFDS with low mortalities if the above acclimatization procedure was used. Fish were added at 60/l and fed rice bran (daily) and *Moina* (zooplankton) (every 4 days). After 2 months, however, fish mortalities in the tanks rise sharply. *Moina* sp. is cultured at LIFDS by adding 5 kg of chicken manure and 2 kg of soybean meal to 50-m<sup>2</sup> tanks 50 cm deep. *Moina* sp. are harvested using a plankton net from the culture tanks and fed to sprat every 4 days.

Importation protocols have recently been adopted by the International Council for the Exploration of the Sea (ICES) (Working Group on Introductions and Transfers of Marine Organisms 1984) (Fig. 8). These protocols state that (point 2a) the introduced organism must be reproduced "in an approved quarantine situation" and the F<sub>1</sub> offspring used for introductions to the natural environment. Since the Thai river sprat has never been reproduced in captivity we formulated an alternative proposal, no less rigid than the original ICES guidelines, requiring: strict quarantine, treatment, examination, certification, and direct stocking of original stocks from Thailand into Indonesian reservoirs.

Importation procedures were proposed as follows:

- (1) Collect 10,000 adult fish from the Ubolratana Reservoir, Khon Kaen Province, Thailand. The fish are collected and acclimatized by known procedures of fisheries scientists of the Ubolratana LIFDS. Fish are held in 25,000-l tanks at 50-60/l at the station for 1 week and tanks treated daily with formalin (0.5 mg/l). After 1 week a sample of 25 live fish is air shipped to NIFI, Bangkok.
- (2) Fish are examined by a fish disease expert at NIFI and certified for export. NIFI scientist notifies LIFDS scientists and IOE (Indonesia) of clearance.
- (3) Air shipment of 10,000 adult fish to Jakarta, with shipment met by scientists from the Research Institute for Freshwater Fisheries (Bogor), Institute of Ecology (IOE) and Department of Quarantine (Jakarta); then fish are transported to a carefully prepared IOE quarantine field facility at Sawahgirang, Cirata, West Java.
- (4) Fish are added to concrete tanks using large kitchen bowls at the quarantine facility. All accompanying transport water is heavily chlorinated, and kept tightly sealed for 24 hours in the same transport bags, then disposed of on land. Plastic bags and boxes are burned. Water flow in tanks is kept to zero or a bare minimum and all drainage water chlorinated and disposed of on land. Fish are held for 2 weeks and receive formalin (0.5 mg/l) each day. At the end of the period a fish and human disease expert are sent samples of fish.
- (5) Fish receive a "clean bill of health" from fisheries and human health experts, or are held longer in quarantine until such a determination can be made. If dangerous organisms (to fish or human health) are found, the entire shipment is immediately and unconditionally destroyed. All holding tanks are heavily chlorinated, drained, then rechlorinated, and not used further until completely sundried for a period of not less than 1 week. All handling containers are to be burned and disposed on land. All water is disposed of on land.

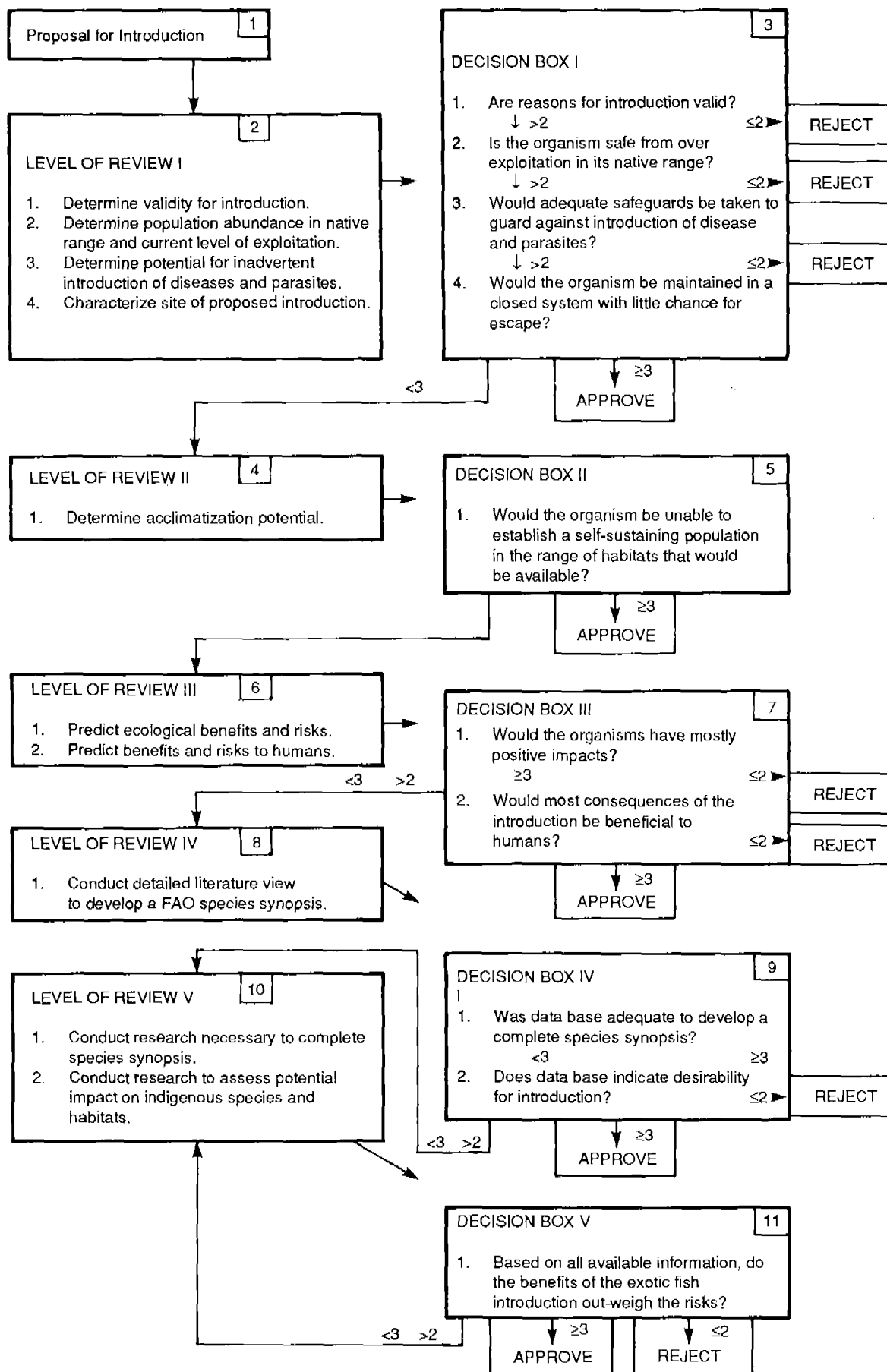

Fig. 8. Protocol used by the ICES to evaluate fish importation proposals (from Kohler and Stanley 1984).



- (6) If found to be free of harmful organisms, fish are transported by tank with aeration to the Saguling Reservoir, and 10,000 fish released at the dam site.
- (7) During a 6-month period an IOE fisheries management team surveys capture fishermen in the reservoirs and buys predator fish. Ten fishermen are contacted on a weekly basis. Fish gut contents are observed at the IOE laboratory and examined for remains of the freshwater sprat.
- (8) During the seventh months after importation experimental light fishing is begun by the fisheries management team every 2 weeks at the dam site region. Experimental light fishing is continued until month 12 when a preliminary evaluation of the success or failure of the importation is made.

### **Evaluation of Importation Proposal**

Three working groups have recently addressed the complex issues that arise from the introduction of exotic species. These working groups are: (1) Exotic Fish Section, American Fisheries Society (AFS), (2) Working Group on Introductions and Transfer of Marine Organisms, International Council for the Exploration of the Sea (ICES), (3) Working Party on Stock Enhancement, European Inland Fisheries Advisory Commission (EIFAC) (EIFAC 1984; Sindermann 1986; Welcomme 1986). These groups have recently enacted the following measures regarding transfers and introductions of exotic species:

- (1) EIFAC: Formulated a code of practice for fish introductions to Europe and established a working group to consider proposals for any further introductions of aquatic organisms into the European region.
- (2) ICES: Adopted in 1979 a comprehensive "Code of Practice to Reduce the Risks of Adverse Effects Arising from Introduction of Non-Indigenous Marine Species".
- (3) AFS: Established a protocol for evaluating exotic fish introductions into the United States (Kohler and Stanley 1984). This protocol has also become part of the protocol adopted by the EIFAC working party (EIFAC 1984; Welcomme et al. 1983).

In March-May 1988 our importation proposal (Soemarwoto and Costa-Pierce 1988) was submitted to 20 senior scientists from these international committees and others for comment. Fifteen detailed comments were received. A general summary of the comments received could be made as follows:

- (1) proposal is too rushed; more study is required in Thailand on the biology, ecology, feeding habits and diseases of wild fish stocks;
- (2) evaluate this proposal independently by contacting an outside reviewer and not a person from the group requesting importation;
- (3) evaluate the tolerance of sprat to suboptimal limnological and water quality conditions;
- (4) fish could contain potentially harmful internal parasites new to Indonesia and these would escape proposed quarantine conditions;
- (5) evaluate the possible trophic competition with introduced planktivores already present in the reservoirs;
- (6) make a small-scale trial before putting the fish into big reservoirs;
- (7) Saguling may be too small for a zooplankton-feeding clupeid;
- (8) Saguling is too new to say it will not develop pelagic fish populations.

Responses received from scientists are more fully detailed in Appendix 1.

Upon receiving these comments, a study mission to the Ubolratana Reservoir was conducted (Costa-Pierce 1988). Six months of further preparations followed this mission including arrangements within Indonesia and between Indonesia and Thailand. The fish will likely be imported into Indonesia in 1990 and seeded into the Saguling Reservoir.

## Acknowledgments

The authors would like to warmly thank numerous scientists in Thailand and Indonesia for assisting coordination, field work and information gathered for this study. In particular Mr. Manoch Benjakara, Chief, Ubolratana Reservoir Fishery Station, and Mr. Kunchit Watanadilokkul, Fisheries Biologist, greatly assisted our two missions to Thailand to study the fish and the Ubolratana Reservoir. In Bangkok, Dr. Tawan Chookajorn, Dr. Sitdhi Boonyaratpalin, and Dr. Revadee Sriprasert gave our missions warm welcome and advice. Dr. Sitdhi Boonyaratpalin gratefully completed an analysis at NIFI to check the fish for liver flukes. Dr. Thiraphan Bhukasawan gave us the original hint that a pelagic sardine existed in Asia similar to *Limnothrissa* in Africa during a stimulating discussion in Kathmandu in 1987; and we sought his valuable advice throughout the study.

In Indonesia the assistance of Mr. Iskandar, Mr. Edi Tri Haryanto and Mr. Johan Iskandar is greatly appreciated.

Lastly, the authors wish to extend their thanks to senior scientists from the EIFAC, FAO, ICLARM, British Museum (Natural History), University of Waterloo, Southern Illinois University, University of Ruhuna (Sri Lanka), University of Göttingen (Germany), and the Indonesian Department of Agriculture for their valuable comments on the original importation proposals.

The expert secretarial assistance of Mr. Dayat Hermanto and Ms. Suryati Indyah Winarni is acknowledged.

## References

- APHA. 1985. Standard methods for the examination of water and wastes. American Public Health Association, Washington, USA.
- Balon, E.K. and A.G. Coche. 1974. Lake Kariba, a man-made ecosystem in Central Africa. Monogr. Biol. 24: 767 p.
- Baluyut, E.A. 1983. Stocking and introduction of fish in lakes and reservoirs in the ASEAN countries. FAO Fish. Tech. Pap. 236: 82 p.
- Benjakara, M. and N. Sriputnipon. 1986. Successful transportation of *Clupeichthys aesamensis*. LIFDS, mimeo, 3 p.
- Bhukasawan, T. and S. Pholprasith. 1977. The fisheries of Ubolratana Reservoir in the first ten years of impoundment. Proc. Indo-Pacific Fish. Comm. 17: 195-205.
- Costa-Pierce, B.A. 1988. Study mission to northeast Thailand for assessment of a pelagic freshwater sardine, *Clupeichthys aesamensis*. Consultancy Report, Institute of Ecology, Bandung, Indonesia, and the International Center for Living Aquatic Resources Management, Manila, Philippines. 63 p.
- De Silva, S. 1985. Status of the introduced cichlid *Sarotherodon mossambicus* (Peters) in the reservoir fishery of Sri Lanka: a management strategy and ecological implications. Aquacult. Fish. Manage. 1: 91-102.
- De Silva, S. 1987. Impact of exotics on the inland fishery resources of Sri Lanka. Arch. Hydrobiol. Beih. Ergebn. Limnol. 28: 273-293.
- Djajadiredja, R. and others. 1983. Indonesia country report, p. 19-30. In F.B. Davy and A. Chouinard (eds.) Fish quarantine and fish diseases in Southeast Asia. International Development Research Centre, Ottawa, Canada.
- Dumont, H.J. 1986. The Tanganyika sardine in Lake Kivu: another ecodisaster for Africa? Environ. Conserv. 13: 143-148.
- Edmondson, W.T. 1965. Freshwater biology. Wiley and Sons, New York.
- EIFAC. 1984. Report of the EIFAC working party on stock enhancement. EIFAC Tech. Pap. 44. FAO, Rome, Italy.
- FAO. 1985. FAO species catalogue-clupeoid fishes of the world. An annotated and illustrated catalogue of the herrings, sardines, pilchards, sprats, anchovies and wolf herrings. Part 1. Chirocentridae, Clupeidae and Pristigasteridae. FAO Fish. Synop. 125. Vol. 7. Rome.
- Fernando, C.H. and N.P. Lankai. 1981. The rotifera of Malaysia and Singapore with remarks on some species. Hydrobiologia 78: 205-219.
- Fernando, C.H. and J. Holcik. 1982. The nature of fish communities: a factor influencing the fishery potential and yields of tropical lakes and reservoirs. Hydrobiologia 97: 127-140.
- Idris, B.A.G. and C.H. Fernando. 1981. Cladocera of Malaysia and Singapore with new records, redescrptions and remarks on some species. Hydrobiologia 77: 233-256.
- IOE. 1980. Environmental impact analysis of the Saguling dam: studies for implementation of mitigation of impact and monitoring. Institute of Ecology, Padjadjaran University, Bandung, Indonesia.
- Kartamihardja, E.S. and A. Hardjamulia. 1983. Kontribusi penebaran ikan nila (*Oreochromis niloticus*) terhadap produksi ikan waduk Jatiluhur, Jawa Barat. (Contribution of Nile tilapia (*Oreochromis niloticus*) stocking to fish production of the man-made lake Jatiluhur of West Java). Bull. Penelitian Perikanan Darat 4: 37-40. (In Indonesian)
- Kenmuir, H.S. 1973. Sardines in Cabora Bassa Lake? New Sci. 13 February 1973: 379-380.

- Kohler, C.C. and J.G. Stanley. 1984. A suggested protocol for evaluating proposed exotic fish introductions in the United States, p. 387-406. *In* W.R. Courtenay and J.R. Stauffer (eds.) *Distribution, biology, and management of exotic fishes*. Johns Hopkins University Press, Maryland.
- Lai, H.C. and C.H. Fernando. 1980. Zoogeographical distribution of Southeast Asian freshwater Calanoida. *Hydrobiologia* 74: 53-66.
- LIFDS. 1977. Annual Report. Large Impoundment Fisheries Development Station, Department of Fisheries, Khon Kaen, Thailand.
- McKaye, K.R., R.D. Makminja, W.W. Menyani and O.K. Mhone. 1985. On the possible introduction of non-indigenous zooplankton-feeding fishes into Lake Malawi, Africa. *Biol. Conserv.* 33: 289-307.
- Petr, T. 1975. On some factors associated with the initial high fish catches in new African man-made lakes. *Arch. Hydrobiol.* 75: 32-48.
- Sarnita, A. 1976. Some aspects of fisheries and their development in man-made lakes in Indonesia with special reference to Lake Jatiluhur, West Java. *Proc. Indo-Pacific Fish. Coun.* 17: 272-291.
- Sarnita, A. 1978. Fisheries management of several man-made lakes under the Brantas Project. Paper presented at the Seminar on Water Management of Man-made Lakes, Jakarta, Indonesia, mimeo.
- Shafland, P.L. and W.M. Lewis. 1984. Terminology associated with introduced organisms. *Fisheries* 9: 17-18.
- Sharma, B.K. 1979. Rotifers from West Bengal. IV. Further contributions to the Eurotatoria. *Hydrobiologia* 65: 39-47.
- Sharma, B.K. 1980a. Taxonomic notes on some freshwater Gastrotricha from West Bengal, India. *Hydrobiologia* 70: 265-267.
- Sharma, B.K. 1980b. Contributions to the Rotifer fauna of Orissa, India. *Hydrobiologia* 70: 225-233.
- Sindermann, C.J. 1986. Strategies for reducing risks from introductions of aquatic organisms: a marine perspective. *Fisheries* 11: 10-15.
- Soemarwoto, O. and B.A. Costa-Pierce. 1988. Importation of a pelagic freshwater sardine, *Corica goniognatus*, to Indonesian reservoirs for fisheries enhancement. IOE/ICLARM Consultancy Report, Bandung, Indonesia. 30 p.
- Sripitnison, V., K. Watanadilokkul, and L. Moonkao. 1987. Life history of *Clupeichthys aesarnensis* Wongratana in the Ubolratana Reservoir. LIFDS, mimeo.
- Srisuwanataj, W. 1970. Hydrobiological studies of Ubolratana Reservoir. Annual Report of the Fisheries Biological Survey Unit, Inland Fisheries Division, Department of Fisheries, Bangkok.
- Umary, R. 1988. A review of a decade (1978-1988) SEAMEO-BIOTROP researches on man-made lakes in Java, Indonesia and their significance. BIOTROP, Bogor, Indonesia.
- Vanderpuyve, C.J. 1984. Part II. Syntheses of information of selected African reservoirs. Volta Lake (Ghana), p. 261-320. *In* J.M. Kapetsky and T. Petr (eds.) *Status of African reservoir fisheries*. CIFA Tech. Pap. 10. 326 p. Rome.
- Varikul, V. and P. Suraswadi. 1980. Nam Pong environmental management research project. Working Document 12, Water weeds and studies on fish, fish production and productivity. Mekong Secretariat, Bangkok.
- Vichasri, S., V. Viyanant and E.S. Upatham. 1982. *Opisthorchis viverrini*: intensity and rates of infection in cyprinoid fish from an endemic focus in northeast Thailand. *S.E. Asian J. Trop. Med. Health* 13: 138-141.
- Welcomme, R.L. 1986. International measures for the control introductions of aquatic organisms. *Fisheries* 11: 4-9.
- Welcomme, R.L., C.C. Kohler and W.R. Courtenay. 1983. Stock enhancement in the management of freshwater fisheries: a European perspective. *N. Am. J. Fish. Manage.* 3: 265-275.
- Wongratana, T. 1983. Diagnoses of 24 new species and proposal of a new name for a species of Indo-Pacific clupeoid fish. *Japan J. Ichthyol.* 29: 385-407.
- Working Group on Introductions and Transfers of Marine Organisms. 1984. Guidelines for implementing the ICES code of practice concerning introductions and transfers of marine species. Cooperative Research Report No. 130, International Council for the Exploration of the Sea (ICES), Copenhagen, Denmark.

## Appendix I: Summarized Comments on Importation Proposal of Soemarwoto and Costa-Pierce (1988)

### Comments Reviewer 1:

1. Acting with undue haste is to be avoided. Your statement that you can make arrangements in March for the import of the species gives the impression that the introduction is a foregone conclusion. Certainly there is insufficient time to collect and evaluate opinions between now and March.
2. The opinions should be evaluated by a single referee who is not from those requesting import. He should then advise the petitioners as to the advice of the other experts.
3. The proposal as a whole is well prepared and examines benefits and risks in moderate detail. However, much concrete information on several aspects of the biology of the species is lacking and this might be crucial to the evaluation of the introduction. The three major items of information that are not provided are:
  - (a) Disease in pathogenic organisms that are associated with wild stocks of this species in Thailand. The proposal does provide for adequate quarantine and shipment procedures to avoid introduction of parasites and disease organisms but this lack may not be overly important.

- (b) The details of the feeding habits of this species, particularly with regard to prey size selection, are not addressed. This point is particularly important in that other introductions of pelagics in Africa have been attacked on the basis of predator/prey interactions in Lake Kivu. Dumont (1986) considered introduction of *Limnothrissa* to Lake Kivu as inappropriate because of the inability of local Crustacea to support its populations and in Lake Malaŵi the introduction of *Stolothrissa/Limnothrissa* was rejected on the basis of competition between the introduced and already existing resident stocks of zooplankton-eating cichlids (McKaye et al. 1985).
- (c) Tolerance of the species to adverse circumstances, particularly low dissolved oxygen and temperature. This point is important because the highly eutrophicated condition of some of the waters within the target river basin may influence survival and distribution of the introduced species.

Turning to the levels of review and decision model in the EIFAC Code of Practice (see Fig. 8), the answers would be as follows:

#### Level I

- 1 Yes, the need is valid.
- 2 The species is safe from exploitation in its intended region.
- 3 Safeguards are adequate to guard against diseases and parasites. However, as the species is an inshore spawner, might it not be possible to collect ship and hatch the fish as eggs thereby reducing transport mortality and disease?

#### Level II

- 4 It is unlikely that the introduction would be restricted to the river system of the country; it would diffuse from the river basin to which it was introduced and this appears to be the intention in that it would in this manner colonize other reservoirs. Furthermore, presumably if the species is successful in the Citarum River, it would be transferred to other reservoirs in Indonesia.
- 5 The species would most probably set up self-sustained populations and if it did not it would not fulfil the purpose of the introduction.

#### Level III

- 6 It is difficult to foresee negative economic implications of this species. The system into which the species is to be introduced is already highly modified by dam construction and pollution and 30% of the species occupying it are themselves introduced. There is no resident zooplanktonophage so direct competition for food is unlikely to occur. Indeed the major question is the species' ability to survive due to: (a) predation, (b) poor water quality, and (c) availability of suitably-sized zooplankters.
- 7 The introduction would be beneficial socioeconomically.

#### Level IV

- 8 No species synopsis seems to be available and there is a pronounced lack of data. However, this may not be critical in view of the arguments outlined above.

#### Level V

- 9/10 On the whole the benefits of this introduction would appear to outweigh the risks on the information available and I feel that it would be permissible to proceed with this introduction. (Please note that this is a personal opinion and it is not an official opinion.)

#### Comments Reviewer 2:

I am strongly in favor of finding a fish to fill the pelagic niche in reservoirs. However, I have two problems with the proposal:

- a) The transfer of wild fish between countries carries many risks. The fry will have internal parasites, many of which will be strains or species exotic to Indonesia and, while not fatally harmful to *C. goniognathus*, might well have adverse effects on the local fish fauna. Your screening program

will not detect such parasites in healthy-looking fishes. The way around this is to import eggs or hatch eggs in Thailand under clean conditions.

- b) I note a conspicuous absence of citations about this species in the proposal. What are the sources of the biological data? Are we sure that it is a zooplankton feeder? If so, how can it relate that closely to the nutrient inflows? Is the Ubolratana Reservoir eutrophic? Does it remotely resemble Saguling? Is the species found elsewhere in Thailand? If so, where and under what conditions? It does seem that more evidence is required about its biological/ecological characteristics before an introduction is planned. No evidence is given that other species have been considered and found less suitable. Is a preparatory study in Thailand a possibility?

### Comments Reviewer 3:

Thank you for inviting me to comment on the proposed introduction of the clupeoid fish *Corica goniognathus* into various reservoirs in Java. Incidentally, the correct name for the taxon now is *Clupeichthys aesarnensis* (see FAO 1985).

Regrettably, I find it difficult to make constructive comments and criticisms of your proposal. The difficulties stem from the absence of empirical or quantitative data relating to several aspects of the proposal. These data I would consider to be essential for any adequate appraisal of your scheme but I can find none in the literature or in the proposal itself which would answer several of the queries in my mind.

For example:

- 1) There is no precise information given about the trophic regime of *C. goniognathus*, either in its natural habitats or in the Thai impoundments. The species is referred to as a plankton feeder, but I would need to know precisely what elements of the plankton (phyto- and zoo-) are consumed and what part of the ingested material is actually utilized as food (that is digested). Note is made of the species having small gill rakers and a large gape. That the gill rakers are short and few in number (relative to, say, those in *Limnothrissa*) and that the jaws are well toothed, might suggest that the species feeds on the larger elements in the zooplankton, but that assumption could be misleading. If there are detailed data on its feeding habits (and I can find none in the literature) is it known what similar potential food organisms are present in the reservoirs where it is to be introduced? Also, one would want an estimate for the levels of productivity of these organisms in the new habitat in order to reach any conclusions about its trophic suitability for the introduction.
- 2) What are the habitat preferences of *C. goniognathus*, and do similar habitats exist in the new localities? I find the statement regarding its diel migrations rather confusing and am left uncertain as to where it spends the daylight hours and whether feeding only occurs at night.
- 3) How does the macro-faunal composition (especially the species of fish) of the Thai localities compare with that in the Java dams? In particular I would question whether or not there is likely to be interspecific trophic competition in the Javanese sites since at least two of the cyprinids there (*Hypophthalmichthys* and *Aristichthys*) and the two cichlid species present can be rated as planktivores under certain environmental conditions. Also, what data are available, on a comparative basis for the various sites, on predators which might feed on *C. goniognathus*? There would seem to be a number of potential predators listed in the fish fauna of Saguling.
- 4) No data are given on the quality and chemical composition of the water in the Thai dams or those in Java. Could there be some chemical or physical factor (or factors) in the Java localities which might adversely affect *C. goniognathus*, or which differ markedly from those in the Thai dams?

Apart from those specific questions there are one or two other points which I find unsettling. For example:

- (1) Has there been any pilot transplantation experiment carried out in Thailand, or even *in vitro* experiments in which the hydrological and other environmental factors of the Java sites have been simulated?
- (2) Is it not perhaps dangerous to extrapolate too far from the Tanganyikan clupeoid *Limnothrissa* to *Clupeichthys*? The two taxa have rather different orobranchial anatomies (especially with regard to gill raker length and number) and, as far as I can judge from the data available for *Clupeichthys*, rather different natural habitats and biologies. Thus some of the comments in

your report, and which are derived from research on *Limnothrissa*, may not be directly applicable to the biology and management of *Clupeichthys*.

- (3) You clearly have reservations about the accuracy and applicability of the M.E.I. to Asian dams. Thus is there any point in basing your estimates on fisheries production/plankton production on this formula? Furthermore, the figures quoted for production in the Rawa Penang Reservoir in Java and the lake in China, are not based on fisheries for *Clupeichthys* and therefore do not seem relevant in this particular context (but I would not deny their relevance to enhanced production resulting from careful and natural fisheries management).

Fundamentally I am opposed to introductions since these are, in essence, irreversible experiments. However, there are cases like Lake Kariba, a purely artificial lake in which a fauna can be "constructed" and which have a high degree of physical isolation from natural waters, where I would view the subject more sympathetically. In many respects the case for the Saguling and Cirata Reservoirs can be likened to that of Lake Kariba. In that sense, and in that sense alone, I can sympathize with your proposal. But, in the light of what I consider to be inadequate information about the ecology and hydrology of the impoundments, about the biology of *C. goniognathus*, and the absence of any pilot experiments, I could not give the proposal my support.

Incidentally since *C. goniognathus* occurs naturally in Sumatra (see FAO 1985) is it necessary to import the species from Thailand and thus incur not only additional expense but get involved with the problems of transporting delicate fish over considerable distances?

#### Comments Reviewer 4:

I have read your proposal. I find it very informative and based on sound scientific principles. You have gone to extraordinary lengths to protect the environment from future ill effects of any introductions. I think your proposal is safe, viable and has a good chance of success. I would suggest though that a study be made of the phyto- and zooplankton but more preferably primary and secondary production for estimating potential yield. MEI does not seem to be reliable as a predictor of yield.

The choice of *Corica goniognathus* for introduction seems very logical to me. It has been successful in Thailand and the yields it has given are quite high for a pelagic fish. If it fails you will have the option of attempting the introduction of other clupeids. Some years ago I visited Lake Toba. I think it would be a very good site for introduction of a pelagic clupeid. The same applies to Lake Lanao in the Philippines and many large and deep reservoirs in Asia with extensive pelagic areas. Also in Lake Toba I noted that the fish yield was low and the main component was *Oreochromis mossambicus*. The cichlids are capable of giving very high yields in shallow reservoirs. They seem to need a considerable area of breeding grounds which is shallow. The culture of carp in cages may supplant some of the littoral catch but cultured fish are expensive as a rule. I would suggest experimenting with a high yielding self-reproducing herbivore-omnivore for the littoral, if there is a littoral!

#### Comments Reviewer 5:

First, the proposal, although well written and logically stated, does not provide enough detail to adequately evaluate the advisability of introducing the sardine. The fish is stated to be zooplanktivorous. Does that also include consuming larval fish? Fry? What are the projected competitive interactions of the exotic sardine with the native fish fauna? If the sardine is a size-selective zooplanktivore, it can indirectly limit recruitment of other fishes whose younger stages may require that resource. Regarding *before* importation studies: is there any plan to study the biology of the sardine in its native habitat? Is the literature cited in your proposal fairly complete or is some of the information gap I have alluded to available in Thailand?

In your proposal you have stated that the sardine cannot be spawned under artificial conditions. Yet the 1961 article cited apparently refers to an aquarium system. What about earthen ponds? Perhaps you could use experimental earthen ponds for quarantine and  $F_1$  production. Use of indoor recycle systems would be the safest course of action but I suspect practicality will require using more natural holding systems. My experience in holding larval fish in recycle systems is that you have to feed them almost constantly. Are they cannibalistic? Probably!

As stated in your proposal, movement of the sardine larvae could be a logistical headache. Some stages of larval fish move better than others. For example, we found that we could transport 1-day old striped bass (*Morone saxatilis*) and 6-day olds and older. We got 100% mortality when we transported 2-5 day old larvae. Needless to say, a lot of time, effort and money goes in to learning these things. Also, when transporting larvae in plastic bags one needs to be careful about opening the bags mid-route. I suggest you use pure oxygen as the atmosphere inside the bags. The fish will be releasing ammonia and CO<sub>2</sub>. The oxygen-rich atmosphere will keep the CO<sub>2</sub> from interfering with respiration. However, the increased CO<sub>2</sub> will reduce pH. That is good because with reduced pH the ammonia stays in the ionized form which is not toxic. However, when you open the bag the CO<sub>2</sub> level decreases, pH rises, and some of the NH<sub>4</sub>-H converts to toxic NH<sub>3</sub>. Consequently, it is best to get the fish out after you open the bag. Be sure to chlorinate the transport water before it is discarded after use.

In summary, my gut feeling is that the introduction is probably warranted but that you are rushing into it. This may be because your funding agency wants quick results. I recommend slowing the process down a bit and obtaining more information and experience with the sardine. This is where your Thai colleagues and other consultants can help. Why not find out more about the food habits of the sardine in Thailand? It should be possible to determine if the sardine will spawn in earthen ponds in Thailand. Likewise, critical stages for movement could also be determined without even introducing them outside their normal range. I could foresee you losing a year in working out the transport and quarantine protocol. Why not invest that time, energy and money in getting some of these answers beforehand?

#### Comments Reviewer 6:

I found the report to be very informative and all in all it is convincing. In spite of my being involved in research on a reservoir fishery that is almost exclusively based on an exotic viz. *Oreochromis mossambicus*, I am bit cautious of introductions. My specific observations on the report and on the proposed introductions are as follows:

- (1) Although it is claimed that the projected production is based on plankton production, this information is not included. This in my view is important because the zooplankton production in most Asian reservoirs does not necessarily reach high levels and moreover might not include suitable food species for fish (e.g., work of Fernando).
- (2) I am inclined to infer that one of the primary reasons for the proposed introduction is the non-colonization of the reservoir habitat by the indigenous species. It is perhaps too early to arrive at this inference as the Saguling reservoir is relatively recent. The indigenous riverine fauna takes more time to establish fishable, self-sustaining populations. *Corica*, a species (riverine) native to Thailand, has taken nearly 12 years to reach substantial levels. In the same token there is increasing evidence from Africa (Vanderpuye 1984) and from Sri Lanka (De Silva 1987) that the indigenous stocks, with maturity of the reservoirs, are able to support profitable fisheries.
- (3) The available evidence from tropical reservoirs suggest that there is an apparent reservoir size effect and success of zooplankton feeding introductions. In this context Saguling might be too small for a zooplankton feeding clupeid.
- (4) It is in the above context that I wish to be cautious and would favor a few more years (from impoundment up to 10 years) of 'wait-and-see' attitude. This is not to be inferred that more extensive limnological and experimental fishing should not be conducted in the reservoir(s) in the interim period; a final evaluation should be made based on these long-term findings.

I must add that incorporation of more details of the experimental fishing surveys in the report could have been useful.

#### Comments Reviewer 7:

Being to some extent familiar with the fishery problem in both Southeast Asia and particularly in Africa, I would support your effort to introduce a fish to habitate the "empty" pelagic space of the reservoir.

**Comments Reviewer 8:**

As it is formulated we appear to consider the introduction of an allochthonous species within a riverine ecosystem, that, with the exception of the reservoirs present, is depleted of fish due to eutrophication and toxicants. Also it appears evident that the introduction would be highly beneficial from the point of view of economics and national health. With respect to this, one is tempted very much to approve the proposal. However certain doubts remain. They concern the ecological impacts and the aspects of disease transfer and are the following:

- Have autochthonous species been scrutinized as an alternative and if so why the lack of that information?
- Fish kills never seem to be complete. What is the present state of the fishery downstream of the reservoir?
- Once the freshwater sardine is introduced in Indonesia it is bound to gain the status of an autochthonous species one day. Transfer to other reservoirs is then only a question of time. Therefore, what should be considered also is the impact of this species in other river systems.
- In view of the risks involved an attempt to strip adult females and males caught during the spawning season and to fertilize eggs artificially appears worthwhile.

Based on the presented information I would therefore hesitate to approve the introduction. It seems to me that an autochthonous alternative is worthwhile looking for.

Also - in case an exotic species seems the only solution - more elegant would be the introduction of eggs, preferably triploid ones. A short-term research program directed at the production of these eggs appears worthwhile to consider.

**Comments Reviewer 9:**

I enclose a copy of the EIFAC Code of Practice with my suggested circles around the response numbers (attached). When thereafter applying the decision model I have come to the conclusion that the introduction should be approved.

However, I have had some concern with respect to question no. 6 in the table (Would the organism have only positive ecological impacts?). My concern relates to the zooplanktivorous habits of the species, especially in relation to its apparently high reproductive power.

The reservoir in question is said to be highly eutrophic, partly because of the decomposition of organic matter and the subsequent leaching of nutrients from drowned organic matter, partly by the supply of nutrients which are washed into the reservoir especially with increased river flows during the rainy season.

In a stable ecological situation the resulting algal blooms will support a rich zooplankton community which in its turn will graze down the phytoplankton, and this interaction will maintain a relatively stable balance in the water mass. By introducing into this balance an obligatory zooplanktivorous species like *Corica* which furthermore has a high reproductive capacity there will be a serious risk that the zooplankton is grazed away before the zooplankters have reduced the algal blooms. The result may therefore be that the reservoir will suffer from increasing algal blooms which thus will add seriously to eutrophication. The adverse effects of this situation will probably depend on the turnover rate.

I think that it is necessary to bear this - possibly adverse - effect in mind when introducing this fish into the reservoir, also bearing in mind that the fish most probably will spread rapidly downstream to the other two reservoirs and to the described, heavily polluted irrigation canals at Tarum Barat and Tarum Timur.

In this respect I have some doubt about the justice of the statement where it is said that "A planktivorous fish established in the canals would likely assist in controlling insect and plankton populations and slow the process of eutrophication in the canals". With respect to the latter I fear that on the contrary it will speed up the eutrophication.

Still I think that the proposed introduction of *Corica goniognatus* into the reservoir should be approved, first of all because of the obvious socio-economic benefit to the population in the densely populated region. This is the reason for my circling response no. 3 to question no. 10 in the table.



Opinionnaire for appraisal of introductions of aquatic organisms. Each member of an evaluation board circles the number most nearly matching his/her opinion about the probability for the occurrence of the event. If information is unavailable or too uncertain: "don't know" is marked (Köhler and Stanley 1984). Circles surrounding the options for appraisal are the opinion of Reviewer 9.

	Response					
	No	Unlikely	Possibly	Probably	Yes	Don't know
1. Is the need valid and are no native species available that could serve the stated need?	1	2	3	4	5	X
2. Is the organism safe from over-exploitation in its native range?	1	2	3	4	5	X
3. Are safeguards adequate to guard against importation of disease/parasites?	1	2	3	4	5	X
4. Would the introduction be limited to closed system?	1	2	3	4	5	X
5. Would the organism be unable to establish a self-sustaining population in the range of habitats that would be available?	1	2	3	4	5	X
6. Would the organism have only positive ecological impacts?	1	2	3	4	5	X
7. Would all consequences of the introduction be beneficial to humans?	1	2	3	4	5	X
8. Is there a species synopsis and is it complete?	1	2	3	4	5	X
9. Does data base indicate desirability for introduction?	1	2	3	4	5	X
10. Would benefits exceed risks?	1	2	3	4	5	X

### Comments Reviewer 10:

It is evident that the proposed introduction should be rejected if the code of practice by Köhler and Stanley (1984) (also accepted by the EIFAC) is strictly followed. The safeguards to guard the inland waters of Java against importation of diseases and/or parasites are most probably inadequate. It is also unlikely that the introduction could be limited only to the Saguling Reservoir. If the introduction is successful, the introduced freshwater sardine will establish a self-sustaining population in the Saguling Reservoir. The data base presented in the report is not complete, too.

However, I feel that the IOE/ICLARM staff have carefully considered the possible risks involved, and the implementation plan of the proposed introduction minimizes the pathological risks. The Saguling water system is large, but far from the natural state. Water pollution seems to be a problem in some areas. There are many man-made lakes and irrigation canals in the area. Further many new species have already been introduced into the Saguling Reservoir.

In concluding, I am of the opinion that in this case the forecasted benefits justify the possible ecological and pathological risks involved. Therefore I propose that if EIFAC gives a comment on the case, so it would be a positive one.

**Comments Reviewer 11:**

Review and decision for the introduction of *Corica goniognathus* proposal into Indonesian reservoirs (scale values of response are in brackets and in the Opionnaire)

Level of review I (see Fig. 8).

- (a) Reasons for introduction of this species to Indonesian reservoirs are valid: (5);
- (b) Species is widely distributed in its native range, so there is no danger of its extinction. Experience from the Ubolratana Reservoir indicates that this clupeid is preadapted for lacustrine conditions as it increased in abundance after the filling of reservoir: (5);
- (c) Safeguards explained in the proposal for introduction are well planned, so there is a little danger to transfer parasites or diseases: (5);
- (d) In spite of fact that the fish will certainly escape from reservoirs and will spread downstream the Citarum River, there is almost no possibility of its survival as the river system is heavily polluted along its entire length: (4);

Decision I: The proposal for introduction is approved.

Level of review II

In all probability this clupeid is able to create a self-sustaining population. This depends, however, on environmental conditions. Saguling is considerably smaller than the Ubolratana Reservoir in Thailand (5,340 and 41,000 ha respectively). There are indications (Marshall, B.E. 1984: Kariba (Zimbabwe/Zambia). In J.M. Kapetsky and T. Petr (eds.) Status of African Reservoir Fisheries. CIFA Tech. Pap. 10: 105-153 (see especially his Table 13!!!); Fernando, C.H. and J. Holcík 1988: Fish in Reservoirs. Proc. Int. Conf. on Res. Ecol. and Water Quality, České Budejovice (in press) that the success of pelagic fish introductions is under the direct influence of pelagic zone size: the smaller the reservoir the less the density of pelagic fish, as in a small reservoir the pelagic zone is less extensive. Another condition influencing the formation of self-sustaining autoreproductive populations in the pelagic zone is width of reservoir. If the reservoir under consideration is only several hundred meters wide in maximum, there is a real danger that the riverine fishes inhabiting the reservoir will occur also in its central part and will destroy the introduced pelagic *Corica*. In other words, pelagic stock has to be spatially segregated from the littoral one: (1);

Decision II: The proposal for introduction is approved.

Level of review III

- (a) in all probability the species proposed for introduction will have predominantly positive impacts. There is no danger that *Corica* would be dangerous for the native species of fish: (4);
- (b) Most consequences of this introduction will be beneficial to the local inhabitants. With regard to the small size of Saguling Reservoir the real harvest of pelagic fish (if any) will be much less than expected: (3);

Decision III: The proposal for introduction is approved.

Level of review IV

- (a) An FAO Species Synopsis for *Corica goniognathus* does not exist but the data base presented in the proposal seems to be sufficient. Moreover, the ecology of the freshwater clupeids is surprisingly similar regardless of differences in their geographical distribution and taxonomic status. This is confirmed by their successful occupation of reservoirs in different latitudes and continents: (4);
- (b) All available information supports the idea to introduce this species to Indonesian reservoirs.

Decision IV: The proposal for introduction is approved.

Level of review V

Based on all available information the benefits of the *Corica goniognathus* outweigh the potential risks, except that due to the small size of Saguling Reservoir, this introduction is facing a possibility of failure.

Decision V: this experiment is recommended in order to bring more information and data on the possibility of introduction of a pelagic fish into small reservoirs. Repeated introductions are recommended each year in sufficient number during 3-4 years providing that each imported party will be quarantined under conditions described in proposal and only then planted into a reservoir. Observations and investigations focused on the ecology of both *Corica* and the native fishes in reservoir(s) under consideration should be carefully conducted. The assistance of FAO experts is highly desirable.

#### Comments Reviewer 12:

I wish to inform you that I found it difficult to agree with the proposed introduction in employing the decision model of EIFAC on Introductions, since there are high risks of introducing diseases; also the impact of the new species on the existing ichthyofauna can not be clearly predicted. On the other hand, judging on strictly socioeconomic terms it seems welcome that income, etc. that could be provided by the new species, if it manages to establish itself. The proposed quantity of the new species is rather small to safeguard the targets of its introduction.

So I think that finally it depends on the local authorities to decide, taking into consideration the cons and the pros of the proposed introduction as highlighted, amongs other, by EIFAC.

#### Comments Reviewer 13:

I think I can close my file regarding the introduction of a new species into Indonesia. Enclosed are 7 replies of members of the EIFAC Working Party on Introductions.

Most of the replies are positive, but saying that in view of the socio-economic situation in Indonesia they would be in favor despite the relative small information base. My own feeling is that the socio-economic situation in whatever country should not give sufficient justification for rushing decisions and not undertaking further activities to broaden the basis for decision making. Principally I do not see any good reason to deal in a different manner with a proposal, e.g., in the Federal Republic of Germany or in Indonesia because, if a mistake is being made, it would have the same consequences in both countries. Necessary time for a careful evaluation should not be a limiting factor. So I should like to follow the view to slow the process down a bit and obtain more information experience with the sardine.

#### Comments Reviewer 14:

According to regulation No. 819/KPTS/UM/131/1980 dated 15 November 1980 importing live fish to Indonesia only can be performed by having permission first from the Ministry of Agriculture through the Directorate General of Fisheries.

In addition permission from the Agriculture Quarantine office must be obtained according to regulation No. 265/KPTS/LB/703/1986.

Since the quarantine office does not have facilities for holding live fish, therefore these activities are carried out by the Research Institute for Inland Fisheries and all costs for these activities must be borne by the importer of the fish.

#### Comments Reviewer 15:

The proposed importation has good potential benefits from both economic and health sides. From the health side, besides becoming a new protein source, also control of insects and insect vectors are potential benefits.

It is necessary to examine fish that can also have human parasites and pathogens such as *Clonorchis* sp., which uses freshwater fish as a host.

Is it best to bring such small fish or would not it be better to import larger fish?

Remembering that are very many species of fish in the Cirata Lake (22 fish species and 1 shrimp species), would the freshwater sardine encounter competition? It's necessary to remember that Cirata Lake has many predatory fish.

Suggestion: try a small-scale introduction first before introducing the fish to the Cirata Lake.

# Extension of Traditional Postharvest Fish Processing Techniques

**YEDI ARIFIN**  
*Institute of Ecology*  
*Padjadjaran University*  
*Jl. Sekeloa Selatan 1*  
*Bandung 40132, Indonesia*

ARIFIN, Y. 1990. Extension of traditional postharvest fish processing techniques, p. 364-369. In B.A. Costa-Pierce and O. Soemarwoto (eds.) Reservoir fisheries and aquaculture development for resettlement in Indonesia. ICLARM Tech. Rep. 23, 378 p.

## Abstract

Extension to 438 persons of traditional Indonesian methods for preparing and preserving freshwater fish were carried out with *pindang* (fermented), *dendeng* (spicy dried), and smoked (nontraditional method) fish from the Saguling Reservoir. The majority of people ranked the appearance, taste and color in the order: *pindang* > *dendeng* > smoked.

Survey of 26 small-scale fish processors with experience in postharvest techniques ranging from 1 week to 30 years showed a range of sale prices from Rp 50 to 3,000/fish, with a net margin of Rp 70 to 4,200.

## Introduction

Various kinds of traditional freshwater fish processing techniques are widely known to villagers in West Java. The type of fish processing chosen by the people, however, is subject to location, cost and preference. Some of the aims of fish processing are:

1. to prevent fish losses when the harvest is excessive and not completely sold, and also at periods when large quantities of fish suddenly die in great numbers;
2. to secure and keep a stock of good quality protein food;
3. as a stock in case of need;
4. to make food available to people unable to prepare food or lack time to prepare food; and
5. as a source of earnings.

There are two types of fish processing, with the goals of: i) changing of taste, aroma and presentation for a short period, called cooking; ii) keeping fish longer with no decline of its quality during storage, called preserving.

Since floating net cage culture of fish in the Saguling Reservoir has increased rapidly (Sutandar et al. 1990), it is necessary to consider fish processing so that at times of surpluses the excess produce can be processed and preserved to avoid an oversupply of fresh fish in the market. In addition processing fish may increase rural incomes if the procedures used could lead to higher prices for the end products, e.g. "value-added" products.

## Extension and training

A postharvest fish processing team conducted extension and training in various simple and cheap methods of freshwater fish processing and taught these to villagers. The methods chosen were widely known by the people and were likely affordable by a large number of them. The

processing methods were: *dendeng* (spicy dried before fried) fish, *pindang* (fermented) fish, smoked fish, *pepes* (boiled with spices) fish, salted fish, fish crackers, *abon* (grated spicy fried) fish, and fish sauce.

The target group of extension efforts were people displaced by the Saguling Reservoir and people residing in areas adjacent to the reservoir.

Participants in the extension and training are listed in Table 1. Examination of the list showed that in both 1987 and 1988, the majority of participants were female. This was probably due to sociocultural reasons since people in West Java consider fish processing as female work.

Table 1. Number of participants in postharvest freshwater fish processing extension and training.

Subdistrict/ village	Number of participants					
	1987			1988		
	Male	Female	Total	Male	Female	Total
<b>Cililin subdistrict</b>						
Cipatik	6	27	33	9	20	29
Cihampelas	12	21	33	0	9	9
Citapen	0	28	28	3	17	20
Tanjungjaya	25	19	44	11	3	14
Bongas	13	0	13	*	*	*
Batulayang	8	11	19	*	*	*
Mekarjaya	3	10	13	*	*	*
Mekarmukti	25	4	29	*	*	*
<b>Batujajar subdistrict</b>						
Galanggang	5	28	33	*	*	*
Batujajar Barat	4	24	28	*	*	*
Pangauban	10	32	42	1	3	4
Selacau	20	16	36	0	11	11
Total	131	220	351	24	63	87
Percentage	37	63	100	28	72	100

Note: \* No further extension and training conducted.

Materials given during the training comprised 6 components as follows:

1. Introduction of the raw materials and processing equipment;
2. Fresh fish handling before processing;
3. Techniques in fish processing and cleaning fish;
4. Packing, storing, and transportation techniques;
5. Management techniques and operational analyses; and
6. Marketing.

The main problem encountered by participants during the training was the lack of start-up capital to begin their own postharvest fish processing operations. Credit to finance start-up and buying an initial batch of freshwater fish would be needed for many small businesses to begin in the Saguling area. Competition with processed ocean fish available in large quantities in the market was identified as another problem.

### Preference Testing

In addition to extension and training a preference test was conducted to find out which types of processed fish are favored by people in the area. The method applied was an organoleptic test using 7 scales (Soewarno 1981).

Three types of processed fish were tested:

- a) *Dendeng* dry fish processing using sun drying or artificial heating;
- b) *Pindang* fish processing by cooking with spices; and
- c) Fish smoking.

People acting as panelists in the preference testing were taken from 4 villages. Each village was represented by 30 persons. The villages were: Pangauban and Selacau, which are remote from any town center; and Galanggang and Batujajar that have town centers. All villages were located near the new Saguling Reservoir.

Taste and color were also tested because it is possible that villagers may naturally favor a processed product, but would be unsure about its taste and color. In this test the taste tested was a "standard fish taste", not a sweet or salty taste.

Results of the preference analysis are shown in Tables 3, 4 and 5. Statistics for the organoleptic test in each village are shown in Table 2.

Table 2. Statistical values for differences among 30 panelists from each village for preference, taste, and color of *dendeng*, *pindang* and smoked fish in each village tested during the extension program.

Village	F values		
	Preference	Taste	Color
1. Pangauban	13.4*	27.6*	16.0*
2. Galanggang	6.2*	6.1*	0.7
3. Batujajar Barat	53.7*	53.5*	0.9
4. Selacau	12.2*	1.0	0.8

Note: The critical F value at  $P < 0.05$  was 3.15. A star indicates significant values at this 95% level of probability.

Table 3. Preferences of fish appearance for 3 types of processed freshwater fish from the Saguling Reservoir (N=120).

Preferences	<i>Pindang</i> fish		Smoked fish		<i>Dendeng</i> fish	
	No. of panelists	%	No. of panelists	%	No. of panelists	%
Greatly like	18	15	14	12	32	27
Very much like	20	17	3	2	29	24
Like	71	59	32	27	54	45
Rather like	9	8	40	33	4	3
Dislike	2	2	29	24	1	1
Very much dislike	0	0	2	2	0	0
Greatly dislike	0	0	0	0	0	0

Table 5. Preferences of people for the color of 3 types of processed freshwater fish (N=120).

Preference	<i>Pindang</i> fish		Smoked fish		<i>Dendeng</i> fish	
	No. of panelists	%	No. of panelists	%	No. of panelists	%
Greatly like	20	17	11	9	23	19
Very much like	13	11	8	7	23	19
Like	69	57	35	29	66	55
Rather like	14	12	29	24	5	4
Dislike	4	3	30	25	2	2
Very much dislike	0	0	7	6	1	1
Greatly dislike	0	0	0	0	0	0

Table 4. Preferences of people for tastes of 3 types of processed freshwater fish (N=120).

Preferences	<i>Pindang</i> fish		Smoked fish		<i>Dendeng</i> fish	
	No. of panelists	%	No. of panelists	%	No. of panelists	%
Greatly like	16	13	12	10	30	25
Very much like	26	27	8	7	35	29
Like	64	53	28	23	48	40
Rather like	13	11	40	33	5	4
Dislike	1	1	30	25	1	1
Very much dislike	0	0	2	2	1	1
Greatly dislike	0	0	0	0	0	0

From Table 2 it can be seen that among the 3 types of fish processing, differences occurred in preference among all villages. Taste preference also occurred in all villages except in Selacau village. In contrast no preferences by color were noted except for Pangauban village. The number of people stating very strong preferences either preferred a particular kind of processed fish or a taste. In Pangauban village a strong preference for the color of *dendeng* fish was noted. The order preference of processed fish from most to least favored was:

1. *Dendeng* fish
2. *Pindang* fish
3. Smoked fish.

Smoked fish was least favored because of the smoke smell and the fact that people had never tried it.

Based on these results it is likely that freshwater fish processing could develop and value-added products could become popular in the villages. If (or when) an overproduction of fish occurs in Saguling and Cirata, the excess could be preserved and marketed as processed fish at the same or even higher prices than the original fresh product.

From preliminary observations in villages around the Saguling Reservoir, especially in Balong Pasir village, there are many people currently processing fish. Dead fish scooped from the floating net cages and dead fingerlings at stocking are also being processed. Fish are beginning to be processed from capture fisheries in Cirata. A survey of 26 freshwater fish processors having 1 week to 30 years experience, processing 1 to 25 kg, showed a range of sale prices from Rp 50 to 3,000 per fish, with a net margin of Rp 70 to 4,200. Twelve species of freshwater fish were being processed. A complete summary of the survey is found in Tables 6a and 6b.

Table 6b. Survey results of capital costs and revenues from processing freshwater fish from the Saguling and Cirata Reservoirs.

Name	Volume of fish (kg)	Size of fish (number/kg)	Price of fish (Rp/kg)	Capital Cost of Spices (Rp)	Equipment (Rp)	Labor (Rp/day)	Transport/day (Rp)	Income Total (Rp)	Sale after processing (Rp)	Total of sale (Rp)	Net margin per kg (Rp)	Remarks
Uye	20	12	2,000	2,850	200	-	1,000	44,050	200fish	48,000	202.5	not sell everyday
Iml	9.5	30	1,600	1,300	200	-	1,000	33,700	70fish	40,950	371.8	one time every 9 days
Dede	5	4	2,500	1,000	150	-	-	13,650	1,000fish	20,000	1,270	every day
Masriah	20	5	2,800	2,500	500	1,000	1,400	61,400	850fish	85,000	1,180	one time every 9 days
Alifah	10	10	2,000	1,500	200	-	750	22,450	250fish	25,000	255	every day
Engkar	3	15	2,500	500	100	-	-	8,100	250fish	11,250	1,050	
	2	15	2,500	500	100	-	-	9,100	350fish	10,500	1,200	
Isud	10	2	2,500	1,500	250	-	-	26,750	2000ekor	40,000	1,325	
H. Titin Nuryati	4	1	2,250	1,000	200	-	-	10,200	3000fish	12,000	450	
	3	14	1,000	100	50	-	-	3,150	2,800/kg	3,360	70	
Aceng	25	20	700	1,250	150	5,000	500	24,400	60fish	30,000	224	every day
	10	30	1,000	1,250	150	5,000	500	16,900	70fish	21,000	410	Sells until 100 kg reached
Siti Nuraeni	4	4	2,500	250	100	-	200	10,550	1,000fish	16,000	1,362.5	
Suharya	17	4	800	-	-	-	-	-	-	-	-	
	-	3	800	-	-	-	-	-	-	-	-	
	4	10	800	2,000	150	-	-	22,150	1,200kg	30,000	314	Sold to pindang broker
	1	6	800	-	-	-	-	-	-	-	-	
	1	20	800	-	-	-	-	-	-	-	-	
	2	2	1,500	-	-	-	-	-	-	-	-	
Ema Alfiah-	4	8	1,750	1,500	300	-	-	8,800	800fish	25,600	4,200	Sells every day
	10	1	1,750	2,500	300	-	-	20,300	2,100fish	24,000	370	
	1	15	1,250	500	300	-	-	2,050	200fish	3,000	950	
Mala	3	4	1,000	1,000	100	-	-	4,100	500fish	6,000	833.3	Sells every day if have fish
Arnli	4	4	800	500	100	-	-	3,800	400fish	6,400	650	Depends on catches from fisherman
Engguh	3	15	2,000	1,750	100	-	-	7,850	300fish	13,500	1,833.3	If have fish once every 2 days
	3	2	2,000	2,000	100	-	-	7,850	2,000fish	12,000	1,383.3	
	3	30	700	500	100	-	-	2,700	50fish	4,500	600	
	3	15	2,000	1,750	100	-	-	7,850	250fish	11,250	1,133.3	
	-	15	1,300	-	-	-	-	-	-	-	-	
Yayah	5	4	1,000	1,750	150	-	600	9,000	150fish	11,250	450	Source from dead fish seed stocked into cages
	-	4	1,000	-	-	-	-	-	-	-	-	
Inah	3	15	1,500	1,500	150	-	400	6,550	150fish	6,750	66.7	Source from dead fish seed stocked into cages
Kokom	5	15	1,000	1,500	150	-	1,000	7,650	150fish	11,250	720	Source from dead fish seed stocked into cages
	-	4	700	-	-	-	-	-	-	-	-	
Ahim	20	10	1,250	2,500	200	-	1,000	28,700	200fish	40,000	565	Source from dead fish seed stocked into cages
Isah	5	12	1,300	1,500	150	-	1,200	9,350	200fish	12,000	530	Source from dead fish seed
	-	20	-	-	-	-	-	-	-	-	-	
Komale (Inot)	5	15	1,250	1,500	150	-	1,200	9,100	150fish	11,250	430	Depends on if any dead fish seed
Enur	4	15	2,800	2,100	150	-	-	13,310	350fish	21,000	1,922.5	Sells every day
Sjaefulloh	20	15	1,200	4,750	300	-	1,000	30,050	150fish	45,000	747.5	Depends on if any dead fish seed



Table 6a. Survey results of fish processing in areas surrounding the Saguling and Cirata Reservoirs, West Java, Indonesia.

Name	Age (years)	Kind of fish processing	Experience	Fish species	Source of fish	Sale location
Uye	40	<i>Pindang</i>	30 years	<i>Cyprinus carpio</i>	Fish farmers and fish traders	Majalaya market, Bandung
Imi	60	<i>Pindang</i>	1 month	<i>Osteochilus hasselti</i>	Fish farmers and fish traders	Majalaya market, Bandung
Dede	26	<i>Pindang</i>	1 year	<i>Cyprinus carpio</i>	from market at Garut district	Jl. Siliwangi, Garut
Masriah	60	<i>Pindang</i>	10 years	<i>Cyprinus carpio</i>	from market at Garut district	Kp. Cidatar, Cidatar, Cisurupan, Garut
Atikah	45	<i>Pindang</i>	2 years	<i>Cyprinus carpio</i>	Fish farmers and fish traders	Moh. Toha market, Bandung
Engkar	45	<i>Pindang</i>	7 years	<i>Cyprinus carpio</i>	from market at Cianjur district	Cianjur district market
Engkar		<i>Pepes</i>		<i>Cyprinus carpio</i>		Cianjur district market
Icud	35	<i>Pepes</i>	2 years	<i>Cyprinus carpio</i>	from district market	Jl. Stasiun, Cianjur
H. Titin Nuryati	27	<i>Pepes</i>	1 year	<i>Macrones nemurus</i>	from fishermen at Cirata Reservoir	Kp. Maleber Gudang Cki, kulon Cianjur (Cirata)
H. Titin Nuryati		Salted		<i>Hampala macrolepidota</i>		Kp. Maleber, Gudang Cki, kulon Cianjur (Cirata)
M. Aceng	35	<i>Dendeng</i>	5 years	<i>Oreochromis mossambicus</i>	Fish farmers and fish traders	Shops at Cianjur district
M. Aceng		<i>Dendeng</i>		<i>Fluta alba</i>	from fishermen at Cirata Reservoir	Shops at Cianjur district
Siti Nuraeni	18	Fried	2 years	<i>Cyprinus carpio</i>	from Batujajar market	Jl. Citapen, Cililin, Cililin
Suharya	60	<i>Pindang</i>	2 years	<i>Hampala macrolepidota</i> <i>Mystacoleucus marginatus</i> <i>Macrones micracanthus</i> <i>Oxyeleotris marmorata</i> <i>Puntius bramoides</i> <i>Macrones nemurus</i>	from fishermen at Cirata Reservoir	Kp. Calingcing, Sindangjaya, Ciranjang (Cirata)
R. Erna Alfiah	52	<i>Pepes</i>	1 year	<i>Cyprinus carpio</i> <i>Macrones nemurus</i> <i>Puntius javanicus</i>	from fishermen at Cirata Reservoir	Jangari, Desa Bobojong, Mandé
Mala	58	<i>Pindang</i>	5 years	<i>Hampala macrolepidota</i> <i>Mystacoleucus marginatus</i> <i>Puntius javanicus</i>	from traders (wholesalers) at Citarum River and Cirata Reservoir	Blok Talang, Sirnagalih, Cipeundeuy (Cirata)
Ami	45	<i>Pindang</i>	1 week	<i>Hampala macrolepidota</i> <i>Macrones micracanthus</i> <i>Trichogaster pectoralis</i> <i>Puntius javanicus</i> <i>Mystacoleucus marginatus</i>	from fishermen at Cirata Reservoir	Ds. Citamiang, Maniis, Maniis
Engguh	55	<i>Pindang</i> <i>Pepes</i> <i>Dendeng</i>	2 years	<i>Cyprinus carpio</i> <i>Cyprinus carpio</i> <i>Oreochromis mossambicus</i> <i>Puntius javanicus</i>	from fish farmers at Cirata	Cipeundeuy
Yayah	35	<i>Pindang</i> <i>Pindang</i>	1 year	<i>Cyprinus carpio</i> <i>Oreochromis niloticus</i> <i>Hampala macrolepidota</i>	from fish seed traders, cage farmers and fishermen at Saguling	Rancapanggung and Sindangkerta market
Inah	33	<i>Pindang</i>	3 months	<i>Cyprinus carpio</i>	from fish seed traders and cage farmers at Saguling	Batujajar market
Kokom	28	<i>Pindang</i>	5 months	<i>Cyprinus carpio</i> <i>Hampala macrolepidota</i>	from fish seed traders, cage farmers and fishermen at Saguling	Cililin, Citallem and Cijenuk market
Ahim	50	<i>Pindang</i>	6 months	<i>Cyprinus carpio</i>	from fish seed traders at Saguling	Rancapanggung and Sindangkerta market
Isah	40	<i>Pindang</i>	2 years	<i>Cyprinus carpio</i>	from fish seed traders and cage farmers at Saguling	Batujajar market
Komala (Inot)	30	<i>Pindang</i>	4 months	<i>Cyprinus carpio</i>	from fish seed traders and cage farmers at Saguling	Batujajar market
Enur	30	<i>Pindang</i> <i>Pepes</i>		<i>Cyprinus carpio</i>	from fish traders and fishermen at Saguling	Rancapanggung minishop themselves
H. Sjaefulloh	60	<i>Pindang</i>	38 years	<i>Cyprinus carpio</i>	cage farmers at Saguling	Sindangkerta, Cijenuk, Citallem & Bunder market

## References

- Soewarno, T.S. 1981. Penelitian organoleptik untuk industri pangan dan hasil pertanian. Pusat Pengembangan Teknologi Pangan, Institut Pertanian Bogor, Bogor, Indonesia.
- Sutandar, Z., B.A. Costa-Pierce, Iskandar, Rusydi and H. Hadikusumah. 1990. The aquaculture resettlement option in the Saguling Reservoir, Indonesia: its contribution to an environmentally-oriented hydropower project, p. 253-258. In R. Hirano and I. Hanyu (eds.) The Second Asian Fisheries Forum. 991p. Asian Fisheries Society, Manila, Philippines.

# Integrated System for Environmental Management in the Saguling-Cirata Reservoir Region

MASKANA  
SRI ASTUTY  
BAMBANG SUDIARTO  
OTTO SOEMARWOTO

*Institute of Ecology, Padjadjaran University  
Jl. Sekeloa Selatan 1, Bandung 40132, Indonesia*

MASKANA, S. ASTUTY, B. SUDIARTO and O. SOEMARWOTO. 1990. Integrated system for environmental management in the Saguling-Cirata Reservoir Region, p. 370-378. In B.A. Costa-Pierce and O. Soemarwoto (eds.) Reservoir fisheries and aquaculture development for resettlement in Indonesia. ICLARM Tech. Rep. 23, 378 p.

## Abstract

An integrated system cultivating green plants, rabbits, insect larvae, and earthworms was developed to assist in creating new employment opportunities for displaced persons, and in environmental rehabilitation from dam construction. Green plants would assist in erosion control and serve as rabbit feeds, while rabbits would produce meat, hides and feces. Feces are then used to cultivate earthworms grown in media made of composted rice straw, water hyacinths, and banana trunks, respectively. Extension and training efforts were conducted with the system.

On-stations low-cost cultivation techniques were developed for New Zealand white rabbits, common (*Lumbricus* sp.) earthworms and *Tenebrio molitor* insect larvae. Using composts made from hand-chopped rice straw, banana trunks or water hyacinths, earthworms grew 254-319%/month, with significantly better growth on rice straw (t-test;  $P < 0.05$ ). Earthworm breeders (70.65 kg) were distributed to 351 persons in 18 villages. Rabbit breeders (566) were distributed to 375 persons in 11 villages in 1988. An "integrated culture" contest was held that had 362 participants growing rabbits, earthworms and composting.

Three mixed planting combinations of nitrogen-fixing shrubs and trees mixed with ground covers were tested: (1) *Setaria sphacelata* and *Centrosema pubescens*; (2) *Leucaena leucocephala*, *Brachiaria decumbens*, and *Calopogonium mucunoides*; (3) *Calliandra calothyrsus*, *Setaria sphacelata*, and *Centrosema pubescens*. The mixed planting decreased erosion from 37.1 g/m<sup>2</sup> (open land) to 2.9-4.7 g/m<sup>2</sup> on land of 15% slope; from 173.9 g/m<sup>2</sup> to 37.1-60.1 g/m<sup>2</sup> (30% slope); and from 209.5 g/m<sup>2</sup> to 40.3-62.9 g/m<sup>2</sup> (45% slope).

## Introduction

One alternative to expensive fish feeds is to develop a low-cost but good quality fish feed whose feed components are easy to obtain, do not compete with human needs and could be produced on a small-scale renewable basis to help rehabilitate the environment in villages surrounding the Saguling and Cirata Reservoirs. Feed processing would also create more job opportunities for villagers.

In a previous survey of the potential animals that could be easily grown by poor villagers to be processed into fish feeds for floating net cage aquaculture in the Saguling Reservoir, it was decided that rabbits, earthworms and insect larvae of *Tenebrio molitor* (locally known as "Hong

Kong larvae") could possibly be utilized as animal protein sources in fish feeds because they had good nutrient contents (Table 1) and essential amino acid compositions (Table 2). Previous research on rabbits, earthworms, and *Tenebrio* as protein sources for fish feeds has been conducted by IOE and by Guerrero (1981) and Tacon et al. (1983).

In addition, on the basis of their inherent value to feed low on the food web and not compete with human needs, these animals were deemed good animals to introduce into the villages.

Table 1. Nutrient contents of three potential animal protein sources for fish feeds. Earthworm and *Tenebrio* data from IOE, unpublished.

Component	Nutrient Content ( % )			
	Earthworms	<i>Tenebrio</i> insects	Rabbit meat	
			Wet	Dry
Water	9.4	60.7	75.2	-
Ash	4.5	5.3	5.2	20.9
Protein	84.0	39.9	19.6	79.1
Fat	6.7	37.7	8.0	-
Coarse fiber	0.4	3.6	-	-
N-free Ext.	4.3	13.4	-	-
Calcium	1.3	-	-	-
P	1.1	-	-	-
Energy (kcal/kg)	5,290	6,931	-	-

Table 2. Comparisons of essential amino acids of earthworms, cattle meat and rabbit meals.

Essential amino acid	Earthworm (%)	Meat (%)	Rabbit (%)
Arginine	4.1	3.5	3.9
Cystine	2.3	1.1	0.8
Glycine	2.9	7.1	4.4
Histidine	1.6	1.0	1.5
Isoleucine	2.6	1.3	3.6
Leucine	4.8	3.5	5.1
Lysine	4.3	3.1	6.4
Methionine	2.2	1.5	1.8
Phenylalanine	2.3	2.2	2.6
Serine	2.9	2.2	-
Threonine	3.0	1.8	2.8
Tyrosine	1.4	1.3	1.8
Valine	3.0	2.2	3.5

Source: Catalan (1981).

The cultivation of green plants, species of the families Graminae and Leguminosae, was also investigated. These plants were chosen for study due to their potential in controlling erosion in the drawdown and steeply-sloping shores of the reservoir, and as possible fish feed components.

In order to introduce farmers to animal husbandry techniques and integrated management systems for these animal and plant materials, an on-station program in participatory research, a farmer extension and training program, an "integrated systems farmer contest" and a distribution schedule of rabbits, earthworms, *Tenebrio* and green plants was accomplished.

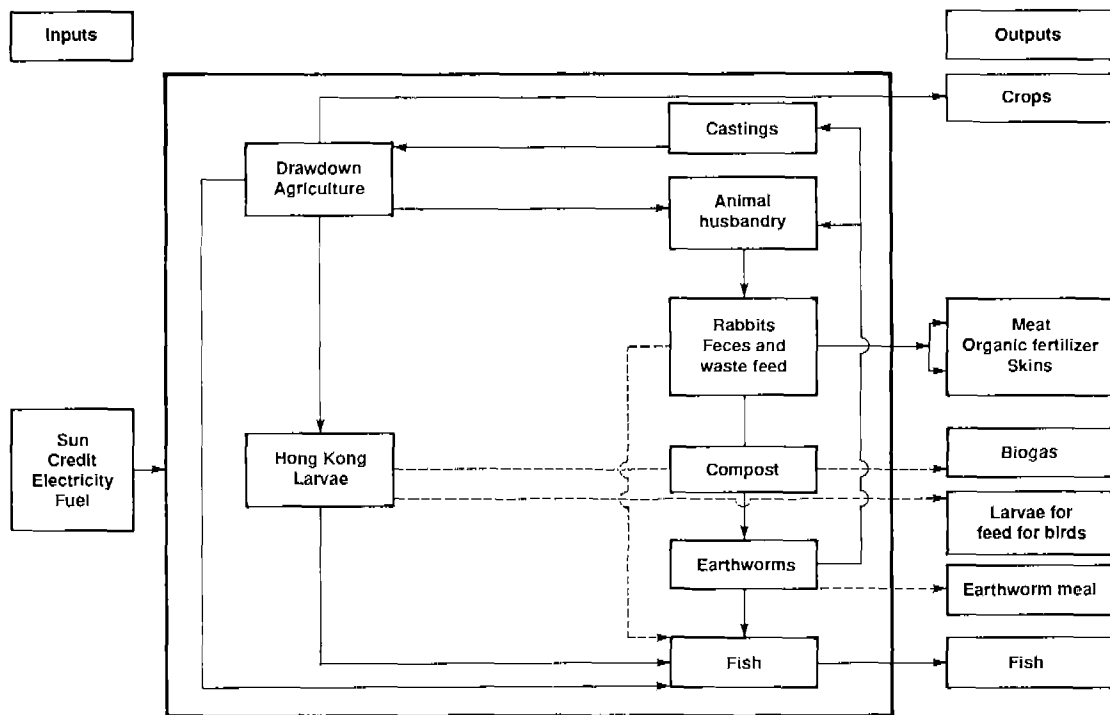

Fig. 1. Integrated system for agriculture, animal husbandry and fisheries for resettlement of displaced populations from reservoir construction. Dashed lines indicate some questions of future feasibilities in West Java from experiences reported here.

## Animal Husbandry

### *Rabbit Breeding and Extension Program*

Breeding and cultivation of rabbits in Indonesia has been a special program of the national government which issued Government Instruction (SK) No. 20 in 1979 to encourage rabbit cultivation within the framework of improving rural nutrition. When the research project started in 1981, consumption of rabbits in villages in the Saguling area was uncommon due to cultural reasons (many people thought they were rats). Therefore the utilization of rabbit meat in fish feeds became a possibility.

Rabbits are fast-growing herbivores that are easy to reproduce year-round in the tropics (polyestrus) and are fecund. If rabbit culture became common new village-based businesses could appear.

From the experiences developed on-station, each female rabbit would give birth to approximately 6 young at a 1:1 sex ratio. Rabbits matured at an age of 6 months or more. Young rabbits could be safely distributed at 2 months age. After 1 month's rest, an adult female could be mated again so that each female can mate 4x per year. Rabbit weight after two months (postweaning) was about 1 kg. The wet weight of the carcass at 1 kg was 55% of the total, and dry carcass weight for rabbit meal was 25%.

Rabbits were grown in 90 x 70 x 60 cm split bamboo cages. An improved breed, New Zealand whites, were used. Rabbits were fed three times daily (morning, noon, sunset) at 10% of their body weight consisting of 60% green plants (local grasses collected around the station growing on rice paddy bunds) and 40% "concentrated" food (70% rice bran:30% corn meal).

Rabbits were grown for 1 year at IOE/ICLARM stations at Awilarangan and Cipondoh, Saguling Reservoir. From a total 6 males and 17 females, 211 young were produced. These results are lower than those reported previously by IOE (1984), likely since lower quality feeds were used, and young rabbits not remated on a rapid, fixed schedule.

Two methods were used to promote rabbit culture in the Saguling and Cirata Reservoir regions. The first was through creation of an on-station experimental breeding program, with an information and distribution center at the IOE/ICLARM research stations in Awilarangan and Cangkorah, Saguling. Both stations had the function of educational centers for the surrounding villages. The second promotion method was through a community-based participatory effort. The major task accomplished in this regard was a Saguling and Cirata-wide contest. The contest enrolled groups of farmers who were to practice "integrated culture" of rabbits, earthworms and green plants. The contest had 362 participants, all members of communities around the Saguling and Cirata Reservoirs, divided into 56 "breeder" groups. Monitoring of rabbit breeding, population development and young rabbit weight increases showed good results. Among the participants rabbit populations increased 73% and young rabbit weight increased 88% during the contest; 75% of the farmer groups distributed rabbits to other farmer groups.

The IOE/ICLARM stations distributed 566 rabbit breeders to 375 persons in 11 villages in 1988.

Results showed that rabbit culture had a chance of developing in the Saguling and Cirata areas, but there were marketing problems. However, at the time of this writing (1990), rabbits have been accepted in some rural markets; the sale price for meat is Rp 1,000/kg, while a high quality female rabbit breeder costs Rp 5,000-10,000.

Utilization of rabbit meat in fish feeds in communities around Saguling and Cirata has not developed because: (1) the quantity available is not sufficient to meet the needs of any aquaculture system; (2) the aquaculture systems are large scale and the alternative feed industry is small scale; (3) farmers began to sell or eat rabbits for family needs.

Rabbits produce other utilizable products such as leather and feces. Rabbit leather can be processed through tanning to become useful village handicrafts. Tanning rabbit leather and its quality control has been carried out by the Research and Industry Center for Leather, Rubber and Plastic Goods in Yogyakarta, Central Java, Indonesia. Samples were sent to this institution for evaluation of rabbit leather from rabbits aged 2, 4, and 6 months, and consisting of 2 processing types (woolen, clean). Evaluations showed that tanning rabbits of 2 months of age was optimal, and was closer to the standards of the institute (Table 3).

### **Earthworm Cultivation**

Earthworms were grown in compost media with animal feces since earthworms eat decaying organic materials (Catalan 1981). An integrated culture system was developed with

Table 3. Evaluation of rabbit tannery products based on different age rabbits.

Evaluation	Woolen tannery			Clean tannery		
	2 mo.	4 mo.	6 mo.	2 mo.	4 mo.	6 mo.
Organoleptic						
-fur condition	strong	strong	strong	-	-	-
-meat left	fair	poor	fair	clean	poor	clean
-smoothness	poor	fair	poor	smooth	smooth	smooth
Physical						
-stretch kg/cm	125	107	121	169	110	138
-elasticity (%)	24	35	50	42	70	56
Chemistry						
-ash content(%)	3.3	3.2	10.3	6.1	5.1	5.2
-Cr <sub>2</sub> O <sub>3</sub> (%)	1.9	1.7	2.0	2.0	2.1	1.9

rabbit feces and rabbit feed waste used as the feed and media for earthworm culture. Rabbit feces would provide carbon dioxide and cellulose, and have a high protein content and enzymes which would help the earthworms break down the materials (Gaddie and Douglas 1975). Analyses of fecal materials from rabbits and some other common farm animals are shown in Table 4. Use of rabbit feces for earthworm culture has been shown to give better production than chicken, cow or horse feces (Maskana 1987).

Table 4. Nutrient contents (%) of animal feces.

Animal	Organic content	N	P <sub>2</sub> O <sub>5</sub>	K <sub>2</sub> O	Protein
Rabbit	50	2.0	1.33	1.20	12.50
Cow	30	0.7	0.30	0.65	4.38
Goat	60	2.7	1.78	2.88	17.31
Pig	30	1.0	0.75	0.85	6.25
Horse	60	0.7	0.34	0.52	4.38
Chicken	50	1.6	1.25	0.90	10.00
Sheep	60	2.0	0.54	1.54	12.50

Source: Gaddie and Douglas (1975).

Media for earthworms should contain green plants. According to Catalan (1981), for earthworm culture the ratio between animal feces and green plants should be 70:30. Common earthworms (*Lumbricus* sp.) were grown in 60 x 40 x 30 cm wooden boxes. Rice straw, cut pieces of banana trunks and water hyacinths were used as the three media, comprising 70% of the volume of 60 l. Thirty per cent of the volume consisted of rabbit feces. Each box was stocked with earthworms at 200 g/l. Each day an amount of rabbit feces equal to the stocked weight of worms (200 g) was added. Each month the media were emptied in each box and used as vegetable fertilizer, and the media renewed at a 70:30 ratio. Earthworms were harvested after 1 month of age in all boxes.

Earthworm production obtained on-station using media made from the three agricultural or waste by-products with rabbit feces are shown in Table 5.

Table 5. Earthworms growth in three kinds of media over a one-month period of cultivation.

Media	Crop weight		Net percentage growth (%)	Significance (P < 0.05)
	Stock (g)	Harvest (g)		
Rice straw	1,800	7,540	319	a
Banana trunks	1,750	6,200	254	b
Water hyacinth	1,500	3,850	257	b

According to Catalan (1981), earthworms with an initial weight of 1 kg could develop into 15 kg in six months (233%/month). Our results in Table 5 showed comparable but slightly higher growth (254-319%).

Earthworm stocks were supplied to villages surrounding the research stations of Cangkorah and Awilarangan, Saguling in 1988; 351 persons in 18 villages received a total of 70.65 kg of earthworm breeders. Growing earthworms was also part of the "integrated culture" contest. Of the 56 farmer groups enrolled, earthworm populations increased 66% and 16 groups (29%) distributed earthworms to other farmers.

Floating net cage fish farmers could utilize earthworms directly or mix them in a supplementary feed. Information obtained from breeders of *Clarias batrachus* (walking catfish, or *lele*) described that broodstock fed on earthworms had fast growth, high fertility, low

mortalities and a high resistance to disease. For fish hatchery operators earthworms can be given fresh or mixed into broodstock feeds, and earthworm castings can be utilized as fertilizers in fish nursery ponds (Costa-Pierce et al. 1989; Sudiarto et al., this vol.). Earthworm castings are also a valuable plant fertilizer.

Earthworm castings can increase the basal nutrient contents of the original media (Table 6). According to Catalan (1981), earthworm castings have a beneficial influence on plants due to growth hormones such as auxin. Carmody (1978) (in Catalan [1981]) illustrated that, through earthworm digestion processes, pathogens such as *Escherichia coli* and *Salmonella typhimurium* were killed.

Table 6. Nutrient content of earthworm media before and after composting.

Parameter	Before (Original soil)	After composting
pH	6.4	6.7
Phosphate (ppm)	37.3	53.9
Calcium (ppm)	193.0	294.0
Ammonia-N (ppm)	33.0	49.0
CaO (%)	1.9	2.4
Total Nitrogen (%)	0.05	0.15
Organic content (%)	1.2	1.5

Source: P.C. Puh in Rismunandar (1984).

### **Culture of *Tenebrio molitor* larvae**

Like many insects, *Tenebrio molitor* has three phases of its life cycle - larvae, pupae and adult. *T. molitor* adults pupate from a cocoon before hatching. To culture the insects, larval "seed" is first obtained. Culture of *T. molitor* has been developed by villagers in West Java since marketing was easy and prices were high (Rp 3,500-10,000/kg). Larvae are sold for shrimp broodstock and bird feeds.

Larvae were experimentally cultured in 36 x 28 x 12 cm plastic trays. Each tray was stocked with 0.5 kg of larvae and fed daily at 25% of the stocking weight with a mixture of 25% rice bran and 75% household vegetable wastes. Each day every tray was cleaned of uneaten food remains.

Production of *T. molitor* are shown in Table 7.

Table 7. Biomass of *Tenebrio molitor* stages harvested at the Awilarangan station during 9 months of cultivation. *T. molitor* was distributed to the surrounding Saguling communities in 1988.

Cultivation period	Harvest weight (kg)			Distributed (kg)
	Larvae	Pupae	Adult	
April-June 1988	1.50	0.50	1.50	0
July-September 1988	10.15	1.50	0.50	1.20
October-December 1988	23.50	0.20	2.20	0.60

Introduction of *T. molitor* to Saguling communities was carried out carefully, first by obtaining information from: the Agricultural Quarantine Center; Department of Agriculture; Health Ecology Research Center of the Department of Health; and by conducting a survey of six locations in the Bandung municipality, nine locations in West Java, and one location in the Jakarta region. Information obtained showed that *T. molitor* had already existed in Indonesia for a long time and that the insect was not an agricultural pest.

Surveys during November-December 1987 in West Java showed that cultivation of *T. molitor* was found in Bandung and its districts, Pameungpeuk, Cirebon, Subang, Cianjur, Sukabumi and Jakarta. The largest number of *T. molitor* breeders was found in the Cijerokaso and Sukahaji areas in the municipality of Bandung (37 breeders). Results from surveys indicated that growers could obtain 60 kg of larvae from each kg of adults in 6 months, a far superior production to that reported here. Growers used waste household feed, likely of a higher quality than the rice bran/vegetable waste feed used at the Awilarangan station.

### ***Cultivation of Green Plants for Feeds and Erosion Control***

The rationales for growing green plants were: (1) preservation of reservoir slopes and banks against erosion and landslides; (2) production of fuel for cooking, feed and eventual postharvest fish processing; (3) generating possible new income resources for the communities cultivating them such as supplying green plants for rabbit feed or incorporating green plants into fish feeds.

Reservoir drawdown areas are the legal property of the State Electric Company (PLN). These areas have, however, been extensively utilized by the communities around the reservoirs as agricultural areas. Many farmers grow annual food crops on lands with slopes of more than 8% with no land conservation efforts. Farmers who till these slopes are hard pressed for land, are landless, or are so poor that they need food for their families. They practice farming in an area which they know is legally the property of PLN.

Uncontrolled cultivation of all the steep slopes of the reservoirs will increase erosion and cause enhanced sedimentation of the reservoirs. It could also harm water quality and have a major influence on the new fisheries and aquaculture businesses in the reservoirs.

One alternative was an effort to develop a cropping system in the reservoir drawdown areas which would have dual functions, e.g., erosion control and green plant food/feed supply.

Plants used were well known forage grasses and legumes which when planted in various combinations could increase the productivity of the plants themselves as well as help control erosion and give some benefits to the communities.

Research carried out in Gunung Halu in the Cilang watershed showed that *Pennisetum purpureum* could decrease runoff volume and land erosion. On a plot planted with 20% *Pennisetum purpureum* the decrease in runoff was 30% and land erosion 69% (Lembaga Ekologi 1985/1986). Similar research with *Brachiaria decumbens* and *Paspalum notatum* was carried out on latosols at the Experimental Garden of the Institut Pertanian Bogor (Bogor Agricultural University, Darmaga, Bogor), on land slopes of 15-22%. *Brachiaria decumbens* strips decreased erosion to zero by the second year, while for *Paspalum notatum* erosion went to zero by the fourth year (Abujamin et al. 1983).

Nitrogen-fixing legumes in mixed planting schemes with grasses could improve soil fertility and increase the productivity of the grasses. Mixed planting could also be carried out with food crops so that the planting area could be more effectively utilized (Siregar 1987). Siregar (1987) also showed that crop wastes were useful for animal feed. Runoff and erosion decreased, and dry matter production was most effective using a single pattern of *Brachiaria species*, or a mixed plant combination of *Brachiaria* and *Leguminosa centro*. Combinations with perennials such as *Calliandra calothyrsus*, *Leucaena leucocephala*, *Sesbania grandiflora* and *Bauhinia purpurea* would not only provide vegetable leaf materials for cattle and fish feeds, but also fuel wood which could be used in the production of fish feed and postharvest processing of fish.

The mulch from the leaf litter would increase soil microbial activity and would also reduce the rate of runoff and soil erosion.



## Testing of Mixed Plantings

The use of weed strips is effective in reducing land erosion and runoff. According to Abujamin et al. (1983), terraces reduce the flow of runoff but are not effective in reducing total water runoff.

Research was performed on the slopes of the Saguling Reservoir on the effect on runoff and soil erosion of three mixed plantings of grasses and nitrogen-fixing trees on different land slopes. Erosion research methods for the 11 x 3 m lands used in the study followed Lembaga Ekologi (1985/1986). Combinations tested were: (1) *Setaria sphacelata* and *Centrosema pubescens*; (2) *Leucaena leucocephala*, *Brachiaria decumbens* and *Calopogonium mucunoides*; (3) *Calliandra calothyrsus*, *Setaria sphacelata*, and *Centrosema pubescens*. All combinations were replicated twice and planted on parallel contour lines at 15%, 30% and 45% slopes without terracing. The monitoring period extended from March to November 1988. Erosion readings were taken each rainy day during the period.

All plant combinations effectively decreased runoff and erosion to low levels, even on slopes of 45% (Tables 8 and 9). Significant differences in the volume of runoff and land erosion

Table 8. Runoff and land erosion from different planting schemes used in the drawdown area of Cangkorah Village, Saguling Reservoir.

Planting Scheme	Slope 15%				Slope 30%				Slope 45%			
	Runoff		Erosion		Runoff		Erosion		Runoff		Erosion	
	% RF	% OL	g/m <sup>2</sup>	% OL	% RF	% OL	g/m <sup>2</sup>	% OL	% RF	% OL	g/m <sup>2</sup>	% OL
Open Land (OL)	11.6 (bc)	100.0	37.1 (bcd)	100.0	16.0 (ab)	100.0	173.9 (a)	100.0	18.2 (a)	100.0	209.5 (a)	100.0
<i>Setaria sphacelata</i> ; <i>Centrosema pubescens</i>	5.1 (c)	44.0	4.3 (d)	11.6	5.9 (c)	36.9	23.0 (bcd)	13.2	9.2 (bc)	50.5	62.9 (b)	30.0
<i>Leucaena leucocephala</i> ; <i>Brachiaria decumbens</i> ; <i>Calopogonium mucunoides</i>	4.5 (c)	38.8	2.9 (d)	7.8	8.3 (bc)	51.9	15.1 (cd)	8.7	10.3 (bc)	56.6	60.6 (bc)	28.9
<i>Calliandra calothyrsus</i> ; <i>Setaria sphacelata</i> ; <i>Centrosema pubescens</i>	5.2 (c)	44.8	4.7 (d)	12.7	9.6 (c)	60.0	21.0 (bcd)	12.1	9.6 (bc)	52.7	40.3 (bcd)	19.2

Notes: Different letters designate significant differences at the 99% level of probability.  
RF = rainfall; OL = open land.

Table 9. Estimated quantities of land eroded for each land slope and planting combination tested on the drawdown area of the Saguling Reservoir.

Planting combinations	15% slope		30% slope		45% slope	
	t/ha/year	% OL	t/ha/year	% OL	t/ha/year	% OL
(1) Open land (OL)	48.30	100	226.03	100	272.35	100
(2) <i>Setaria sphacelata</i> , <i>Centrosema pubescens</i>	5.64	11.7	29.93	13.2	81.78	30.0
(3) <i>Leucaena leucocephala</i> , <i>Brachiaria decumbens</i> , <i>Calopogonium mucunoides</i>	3.82	7.9	19.63	8.7	78.82	28.9
(4) <i>Calliandra calothyrsus</i> , <i>Setaria sphacelata</i> , <i>Centrosema pubescens</i>	6.06	12.5	76.58	12.1	27.27	19.2

on each land slope were observed. As expected, results show that the steeper the land slope, the larger the volume of runoff and land erosion. Coster (1938) also found that land slope had a positive correlation with the volume of land erosion. Research on latosols at Citayan, Bogor showed that plant combinations decreased the volume of land erosion from 500 t/ha/year to 220-280 t/ha/year, and from 157 t/ha/year to 78 t/ha/year. Coster (1938) noted that plants of the family Graminae were best in decreasing land erosion to 0.2 t/ha/year in andosols, at Ciwidey, West Java and to 0.5 t/ha/year and 0.8 t/ha/year for land slopes of 14% and 38% in Grumusol soil in Lembang, West Java.

## References

- Abujamin, S., A. Adi and U. Kurnia. 1983. Strip rumput permanen sebagai salah satu cara konservasi tanah. Pemberitaan Penelitian Tanah dan Pupuk, Pusat Penelitian Tanah, Bogor, Indonesia.
- Catalan, I.G. 1981. Earthworms, a new source of protein. Philippine Earthworm Center, Manila, Philippines.
- Costa-Pierce, B.A., B. Sudiarto, O. Soemarwoto and C. dela Cruz. 1989. Improved traditional hatchery technology for common carp (*Cyprinus carpio* L.) in West Java, Indonesia, p. 217-220. In R. Hirano and I. Hanyu (eds.) The Second Asian Fisheries Forum. 991 p. Asian Fisheries Society, Manila, Philippines.
- Coster, C. 1938. Superficial run-off and erosion on Java. *Tectona* 31: 613-728.
- Gaddie, E.R. and D.E. Douglas. 1975. Earthworms for ecology and profit, Volume I. Scientific Earthworm Farming. Bookworm Publishing Company, Ontario, California, USA.
- Guerrero, R. 1981. Earthworm meal fed to tilapia fingerlings. *Monitor* 9: 8.
- IOE (Institute of Ecology). 1984. Environmental impact analysis of the Cirata dam. Report to Perusahaan Umum Listrik Negara, Jakarta, Indonesia. Institute of Ecology, Padjadjaran University, Bandung, Indonesia.
- Lembaga Ekologi. 1985/1986. Penelitian metoda peningkatan kualitas air sungai. Proyek penelitian pengembangan sumber daya air dan pencemaran perairan tawar. Kantor Menteri Negara Kependudukan dan Lingkungan Hidup. Lembaga Ekologi, Padjadjaran University, Bandung, Indonesia.
- Maskana. 1987. Pengaruh berbagai kotoran ternak terhadap pertumbuhan cacing tanah *Pheretima asiatica* dalam media sampah pasar. Skripsi Fakultas Biologi Unsoed, Purwokerto.
- Rismunandar. 1984. Tanah dan seluk beluknya bagi pertanian. Sinar Baru, Bandung.
- Siregar, M.E. 1987. Produktivitas dan kemampuan menahan erosi species rumput dan leguminosa terpilih sebagai pakan yang ditanam pada sampingan teras bangku di das Citarum, Ciamis. Disertasi, Universitas Padjadjaran, Bandung.
- Tacon, A.G.J., E.A. Stafford and C.A. Edwards. 1983. A preliminary investigation of the nutritive value of three terrestrial lumbricid worms for rainbow trout. *Aquaculture* 35: 187-199.

## TITLES IN THIS SERIES

- The economics of catfish farming in Central Thailand.** T. Panayotou, S. Wattanutchanya, S. Isvilanonda and R. Tokrisna. 1982. Reprinted 1985. ICLARM Technical Reports 4, 60 p. US\$6.50 surface; \$10 airmail.
- The ICLARM-CLSU integrated animal-fish farming project: final report.** K.D. Hopkins and E.M. Cruz. 1982. ICLARM Technical Reports 5, 96 p. \$7.75 surface; \$14.85 airmail.
- Production and marketing of milkfish in Taiwan: an economic analysis.** C.-S. Lee. 1983. ICLARM Technical Reports 6, 41 p. \$6.30 surface; \$9.50 airmail.
- Small-scale fisheries of San Miguel Bay, Philippines: biology and stock assessment.** D. Pauly and A.N. Mines, Editors. 1982. ICLARM Technical Reports 7, 124 p. \$9 surface; \$16 airmail.
- Small-scale fisheries of San Miguel Bay, Philippines: economics of production and marketing.** I.R. Smith and A.N. Mines, Editors. 1982. ICLARM Technical Reports 8, 143 p. \$12 surface; \$25 airmail.
- Small-scale fisheries of San Miguel Bay, Philippines: social aspects of production and marketing.** C. Bailey, Editor. 1982. ICLARM Technical Reports 9, 57 p. \$8 surface; \$14 airmail.
- Small-scale fisheries of San Miguel Bay, Philippines: occupational and geographic mobility.** C. Bailey. 1982. ICLARM Technical Reports 10, 57 p. \$7 surface; \$11.50 airmail.
- Small-scale fisheries of San Miguel Bay, Philippines: options for management and research.** I.R. Smith, D. Pauly and A.N. Mines. 1982. ICLARM Technical Reports 11, 80 p. \$6.30 surface; \$9.50 airmail.
- A Japanese fishing joint venture: worker experience and national development in the Solomon Islands.** S.K. Meltzoff and E.S. Lipuma. 1983. ICLARM Technical Reports 12, 63 p. \$6.55 surface; \$10.90 airmail.
- An atlas of the growth, mortality and recruitment of Philippine fishes.** J. Ingles and D. Pauly. 1985. ICLARM Technical Reports 13, 127 p. \$6.55 surface; \$10.90 airmail.
- Experimental rearing of Nile tilapia fry (*Oreochromis niloticus*) for saltwater culture.** W.O. Watanabe, C.-M. Kuo and M.-C. Huang. 1984. ICLARM Technical Reports 14, 28 p. \$3 surface; \$6 airmail.
- Milkfish production dualism in the Philippines: a multidisciplinary perspective on continuous low yields and constraints to aquaculture development.** K.-C. Chong, M.S. Lizarondo, Z.S. dela Cruz, C.V. Guerrero and I.R. Smith. 1984. ICLARM Technical Reports 15, 70 p. \$7 surface; \$10.50 airmail.
- Salinity tolerance of the tilapias *Oreochromis niloticus* (L.) and an *O. mossambicus* x *O. niloticus* hybrid.** W.O. Watanabe, C.-M. Kuo and M.-C. Huang. 1985. ICLARM Technical Reports 16, 22 p. \$3 surface; \$7 airmail.
- Growth, mortality and recruitment of commercially important fishes and penaeid shrimps in Indonesian waters.** A. Dwiponggo, T. Hariati, S. Banon, M.L. Palomares and D. Pauly. 1986. ICLARM Technical Reports 17, 91 p. \$4.50 surface; \$8.50 airmail.
- Bivalve mollusc culture research in Thailand.** E.W. McCoy and T. Chongpeepien, Editors. 1988. ICLARM Technical Reports 19, 170 p. \$7.50 surface; \$13 airmail.
- The coastal environmental profile of Ban Don Bay and Phangnga Bay, Thailand.** J.N. Paw, S. Bunpapong, A.T. White and M.S.M. Sadorra, Editors. 1988. ICLARM Technical Reports 20, 79 p. \$1 surface; \$5 airmail.
- The coastal environmental profile of Singapore.** L.S. Chia, K. Habibullah and L.M. Chou. 1988. ICLARM Technical Reports 21, 92 p. \$1 surface; \$5 airmail.
- Reservoir fisheries and aquaculture development for resettlement in Indonesia.** B.A. Costa-Pierce and O. Soemarwoto. 1990. ICLARM Technical Reports 23, 378 p. \$13.50 surface; \$32 airmail.
- The coastal environmental profile of Segara Anakan-Cilacap, South Java, Indonesia.** A.T. White, P. Martosubroto and M.S.M. Sadorra, Editors. 1989. ICLARM Technical Reports 25, 82 p. \$1 surface; \$5 airmail.
- Bibliographic impact of ICLARM.** J.L. Maclean, R.M. Temprosa, N.J. Jhocson and A.F. Diaz. 1989. ICLARM Technical Reports 26, 19 p. \$2 surface; \$3 airmail.

### HOW TO ORDER

Enquirers from the USA should order directly from our exclusive distributor there, International Specialized Book Services, 5602 N.E. Hassalo T., Portland, Oregon 97213-3640, to whom payment should be directed using the **airmail price**. Persons in Canada and Central and South America may also find ISBS a conventional source.

Enquirers from Europe may order from **S. Toeche-Mittler GmbH**, Versandbuchhandlung, Hindenburgstrasse 33, D-6100 Darmstadt, Federal Republic of Germany using the **airmail price**.

Enquirers elsewhere should address orders and payment (payable to ICLARM) in US\$ by international money order, bankdraft or UNESCO coupons to: The Editor, ICLARM, MC P.O. Box 1501, Makati, Metro Manila, Philippines. We can accept US\$ checks only if from a US-based bank due to high clearance fees of other banks. Write for a free catalogue of all ICLARM publications.