

# MPRA

Munich Personal RePEc Archive

## Group Reputation and the Dynamics of Statistical Discrimination

Kim, Young Chul and Loury, Glenn  
Brown University, Korea Development Institute

01. May 2009

Online at <http://mpra.ub.uni-muenchen.de/18765/>  
MPRA Paper No. 18765, posted 20. November 2009 / 10:41

# Group Reputation and the Dynamics of Statistical Discrimination

Young Chul Kim<sup>\*</sup>  
Korea Development Institute

Glenn C. Loury<sup>‡</sup>  
Brown University

November 12, 2009

## Abstract

Previous literature on statistical discrimination explained stereotypes based on the existence of multiple equilibria, in which principals have different self-confirming beliefs about different social groups (Arrow, 1973; Coate and Loury, 1993). However, the literature has not provided an account of where the principals' prior beliefs come from. Moreover, the static models dominating the literature do not offer relevant information about the dynamic paths that lead to each equilibrium. This paper develops a dynamic version of statistical discrimination in which economic players' forward-looking behaviors determine the dynamic paths to each equilibrium. Defining "Group Reputation" as the objective information shared by principals regarding the average characteristics of agents belonging to each group, this study identifies groups as advantaged or disadvantaged, based on their initial reputation states, and provides conditions by which a group can switch from one reputation state to another. By understanding this dynamic structure of reputation evolution, we examine the strategy that well-coordinated principals may voluntarily utilize to maximize their profits, helping the group in the reputation trap to improve its skill investment rate.

KEYWORDS: Statistical Discrimination, Group Reputation, Reputation Trap, Affirmative Action, Forward-Looking Behavior.

---

\*We are grateful to Rajiv Sethi, Oded Galor, Kenneth Chay and Woojin Lee for helpful comments and suggestions. We also thank the participants at the ninth international conference of Public Economic Theory, the Applied Microeconomics Seminar at Brown University, Economics Special Workshop at MIT and the 2009 Summer School at Universidad de los Andes.

<sup>†</sup>Korea Development Institute, P.O. Box 113, Hoegiro 49, Dongdaemun-gu, Seoul 130-650, South Korea. Email: yckim@kdi.re.kr.

<sup>‡</sup>Department of Economics, Box B, Brown University, Providence, RI 02912, USA. Email: Glenn.Loury@brown.edu.

# 1 Introduction

Previous literature on statistical discrimination explained stereotypes based on the existence of multiple equilibria, in which principals have different self-confirming beliefs about different social groups (Arrow, 1973, Coate and Loury, 1993). However, the literature has not provided an account of where the principals' prior beliefs come from, nor an account of which particular groups should be expected to have an advantage when unequal group stereotypes become confirmed in equilibrium (Moro and Norman, 2004, Chaudhuri and Sethi, 2008). Moreover, the static models dominating the literature cannot be used to understand the dynamic paths that lead to each equilibrium. In this paper, we develop a dynamic version of statistical discrimination in which economic players' forward-looking behaviors determine the dynamic path to each equilibrium. With the paths identified, the self-confirming belief is explained by the consequence of the historical development of the overall quality of each group.

The developed dynamic model can provide conditions to reach each equilibrium point and to switch from one equilibrium point to another. Consequently, we can identify groups to be advantaged or disadvantaged, based on their initial historical positions. By understanding the dynamic mechanism, we can provide a richer analysis of egalitarian policies than static models can, by reflecting on the forward-looking decision making of principals and agents.

We start by distinguishing *group reputation* from *individual reputation*. Group reputation is defined as the average characteristics of the group members, which is shared by principals. Individual reputation is defined as the probability that an individual is qualified for a certain task, given his group identity and his personal records, which is assessed by the principals who hire him. The essential point is that an individual's reputation is influenced by the reputation of the group to which he belongs, when his personal records are insufficient to clarify his qualification for the task. The more insufficient the records are, the more the principals rely on the average characteristics of the group in their assignment decision. Therefore, given the same personal records, an individual with a good group reputation is treated more favorably than one with a bad group reputation.

This implies that an individual's decision for skill investment to be qualified for a task is affected by others' skill investment in the same identity group; each individual makes his investment decision by considering the expected group reputation in the future, which is determined by other group members' skill investment now and in the future. If more of them are expected to invest, he has more incentive to invest in the qualification for the task because the expected payoff will be greater. This externality of group reputation implies the possibility of collective action to improve or worsen group reputation, which is simply a self-fulfilling process: if each group member believes that other group members will invest, the expected payoff is high and it is likely that more members will invest, but if each of them

doubts that others will invest, the expected payoff is low and it is likely that few will invest.

This work identifies the multiple steady states, as most statistical discrimination models do. Then, we will check how these dynamic aspects of group reputation help to explain the dynamic paths to reach each steady state.

For a concrete analysis, we adopted a basic set-up of job assignment models introduced by Coate and Loury (1993). There are two jobs, task one and task zero, and task one is the more rewarding and demanding job. Principals determine who will be assigned to task one. Given the bell-shaped distribution of investment cost among the population, we identify three steady states. The dynamic system engaged with the externality of group reputation proves that two are saddle points and one is an unstable source. The dynamic path that leads to each saddle point is easily traced in the phase diagram. By having two equilibrium paths to two saddle points, high and low reputation steady states, we define the overlap of the two paths. Within the overlap, either the good or bad reputation steady state can be reached, which means that if a group shares an optimistic view about the future, the high reputation state is gradually realized in the future, while the bad reputation state is realized if the group shares a pessimistic view toward the future. Outside the overlap, the historical position, an initial reputation level, determines the final reputation state; the group with an initial reputation above the overlap range converges to the high reputation steady state, while the group with initial reputation below it converges to the low reputation state.

By using this dynamic structure of group reputation, we explain the persistent racial inequality in the United States. When the overt discrimination in the past results in a very low reputation of the black group, the group will improve its reputation over time as the practice of overt discrimination disappears. However, the reputation of the group may improve only up to the low reputation steady state and stay persistently there because of the non-existence of a path to the high reputation steady state. The white group, which is initially better positioned than the black group, is advantaged by being given the path to the high reputation level.

The high reputation steady state is *pareto* dominant to the low state, in that both principals and agents are better off in the high reputation state. Principals may have an incentive to help the disadvantaged group in the reputation trap to improve its skill investment rate, so that principals can increase their profits. We distinguish monopolistic principals from competitive principals (Loury 2002). Competitive principals cannot change the status of the disadvantaged group because the size of each principal is relatively insignificant and one's actions cannot affect the overall behavior of numerous agents. However, monopolistic principals, which are defined as a very small number of principals in the economy or principals well coordinated by a mediator such as government, are able to change

the structure of the economy and affect the behavior of the disadvantaged group. We investigate two possible strategies that principals may consider: applying a favorable hiring standard and subsidizing the training cost. Each may incur some cost to principals. Principals, if they are well coordinated, may decide which one is to be chosen by comparing the costs and increased profits of the strategies.

This paper was inspired by an insight of Jean Tirole (1996), who examined the persistent corrupt behaviors of group members. He derived the existence of multiple stereotypes from “history dependence” rather than from self-confirming prior belief, which statistical discrimination literature had been based on since the seminal work of Arrow (1973). A member’s past behavior is imperfectly observed by principals. Thus, principals use collective reputation as well as the member’s imperfect track record in the determination of hiring. Poor collective behavior in the past may make the current good behavior a low-yield individual investment and thus generates poor collective behavior in the future. Tirole concludes that a negative stereotype, once developed, can be long lasting: a one-time, non-recurrent shock due to the behavior of a group can prevent the group from ever returning to a satisfactory state, even long after the people affected by the original shock have died. Tirole’s game-theoretical approach, however, ignores the importance of group expectations about the future: over some range of initial reputation, either a good reputation steady state or a bad reputation steady state can be a final destination of the group, depending on the shared beliefs among group members about the future. For example, under some circumstances, even a group with a good reputation may fall to the bad reputation steady state if pessimism prevails among group members. This coordination issue is not addressed properly in his work.

We are indebted to Krugman’s insight about the interpretation of two equilibrium paths leading to two steady states (Krugman 1991). In the seminal paper entitled “History Versus Expectations,” he argues that, within the overlap, *expectation* determines the final state, while, outside the overlap, the final state is determined by *history*, the initial position. Being inspired by Krugman’s work, Kim (2008) develops a dynamic model of social mobility with network externality, in which Krugman’s history versus expectation structure is combined with the overlapping generation model of Bowles, Loury and Sethi (2007). This paper adopts a dynamic framework similar to that of Kim (2008), in which *overlap* is generated by the forward-looking behaviors of agents in an overlapping generational model. In this line of research, Levin (2009) also develops a stochastic version of Tirole’s (1996) collective reputation model and illustrates how history can be decisive in structuring expectations and influencing behavior at any point in time.

This paper is organized into the following sections. Section 2 describes the motivation of this research. Section 3 develops the dynamic reputation model. Section 4 shows the applications of

the model. Section 5 describes the strategies of monopolistic principals. Section 6 presents further discussions. Section 7 contains the conclusion.

## 2 Motivation

In this section, we identify the multiple steady states in a job assignment model introduced by Coate and Loury (1993) and argue the limitation of static statistical discrimination models.

Imagine a large number of identical employers and a larger population of workers. Each employer will be randomly matched with many workers from this population. Employers assign each worker to one of two jobs, called task one and task zero. Task one is a more demanding and rewarding assignment: workers get the gross benefit  $w$  if assigned to task one. All workers prefer to be assigned to task one, whether or not they are qualified for the task. Employers gain a net return  $X_q$  if they assign a qualified worker to task one and suffer a net loss  $X_u$  if they assign an unqualified worker to task one. Define  $\rho \equiv X_q/X_u$  to be the ratio of net gain to loss. A worker's gross returns and an employer's net return from an assignment to task zero are normalized to zero.

Employers are unable to observe whether a worker is qualified for task one. Employers observe each worker's group identity and a noisy signal  $\theta \in [0, \bar{\theta}]$ . The distribution of  $\theta$  depends on whether or not a worker is qualified. The signal might be the result of a test, an interview, or some form of on-the-job monitoring. The signal is distributed for a qualified worker as  $f_q(\theta)$ , and for an unqualified worker as  $f_u(\theta)$ , as displayed in Panel A of Figure 1. Define  $\psi(\theta) \equiv f_u(\theta)/f_q(\theta)$ , to be the likelihood ratio at  $\theta$ . We assume that  $\psi(\theta)$  is nonincreasing on  $[0, \bar{\theta}]$ , which implies  $F_q(\theta) \leq F_u(\theta)$  for all  $\theta$ .

Employers' assignment policies will be characterized by the choice of hiring standard  $s$  for each group, such that only those workers with a signal observed to exceed the standard are assigned to the more demanding task. Given the proportion of qualified workers  $\Pi^i$  among group  $i$  population, employers assign a group  $i$  worker who "emits" signal  $\theta$  to task one position if the expected payoff,  $X_q \cdot Prob[\text{qualified}|\theta] - X_u \cdot Prob[\text{unqualified}|\theta]$ , is nonnegative. Using Bayes' rule, the posterior probability that he is qualified is  $\frac{\Pi^i f_q(\theta)}{\Pi^i f_q(\theta) + (1 - \Pi^i) f_u(\theta)}$ . Therefore, the hiring standard  $s$  is a function of  $\Pi^i$ :

$$s^*(\Pi^i) \equiv \min \left\{ \theta \in [0, \bar{\theta}] \mid \psi(\theta) \leq \frac{\rho \Pi^i}{1 - \Pi^i} \right\}, \quad (1)$$

where  $s^*(\Pi^i)$  is a nonincreasing function of  $\Pi^i$ . Note that  $s^*(0) \leq \bar{\theta}$  and  $s^*(1) = 0$ .

We now turn to a worker's investment decision. Workers are qualified only if they made some ex ante investment. The cost of becoming qualified varies among workers and is distributed as CDF  $G(c)$  in  $(0, \infty)$ . We assume that  $G(0) > 0$  and  $G(W) < 1$ , which implies that there is a fraction of

the workers who will invest for very tiny expected benefits of investment, and there is a fraction of workers who will not invest even for the highest possible benefits  $W$ . If the assignment standard is  $s$ , the probability of assignment is  $1 - F_q(s)$  when qualified, and  $1 - F_u(s)$  when unqualified. A worker with investment cost  $c$  invests if and only if the net return of being qualified is greater or equal to the net return of being unqualified; invest if and only if  $W[F_u(s) - F_q(s)] \geq c$ . Thus, among all workers facing the standard  $s$ , the proportion that becomes qualified is  $G(\tilde{\beta}(s))$ , denoting  $\tilde{\beta}(s) \equiv W[F_u(s) - F_q(s)]$ . Note that  $G(\tilde{\beta}(0)) = G(\tilde{\beta}(\bar{\theta})) > 0$ .

Figure 1 describes the multiple steady states given two noisy signals  $f_u(\theta)$  and  $f_q(\theta)$ . Checking the boundary conditions of  $s^*(\Pi^i)$  and  $G(\tilde{\beta}(s))$ , it is obvious that at least one steady state exists. It is most likely that there are three steady states if the number of steady states is not unique.

**Proposition 1** (Multiple Steady States). *Assume that  $\psi(\theta)$  is continuous and strictly decreasing on  $[0, \bar{\theta}]$ , and  $G(c)$  is continuous and satisfies  $G(0) > 0$ . If there are  $s^1$  and  $s^2$  in  $[0, \bar{\theta}]$  for which  $G(\tilde{\beta}(s^1)) > \frac{\psi(s^1)}{\rho + \psi(s^1)}$ ,  $G(\tilde{\beta}(s^2)) < \frac{\psi(s^2)}{\rho + \psi(s^2)}$  and  $s^1 < s^2$ , then at least three steady states exist.*

For the same parameters and  $G(c)$  function, if signal functions  $f_u$  and  $f_q$  are more informative, that is, signals are less noisy, there tends to be a unique steady state. Note that the steady states are identified in  $(\Pi, \tilde{\beta})$  domain as well, which is mainly used in later parts of the paper. In this domain displayed in Panel B of Figure 1, the dotted curve represents the expected benefits of investment that is determined by employers' hiring standard  $s^*(\Pi^i)$ . The S-shaped solid curve indicates the proportion of workers who will invest given the benefits of investment  $\tilde{\beta}$ .

In the previous statistical discrimination literature, those steady states are explained by self-confirming prior beliefs: employers' beliefs about the likelihood of a group's members being qualified will determine the hiring standard for the group, and the standard will determine the fraction of each group who become qualified. When workers from one group (B's, say) are believed less likely to be qualified, the belief for group B will be self conformed at the lower steady state, while workers from the other group (W's, say) are believed more likely to be qualified, the belief for group W will be self confirmed at the higher steady state, as displayed in Figure 1. This is a situation of discriminatory behavior by employers and persistent skill disparity between two groups.

However, the static model does not provide an explanation for where the employers' prior beliefs come from, and why employers start to have different beliefs about different social groups. Also, it cannot explain the case that the initial employers' belief is not at one of those steady states. The belief will be updated over time and may converge to one of the steady states. The model does not provide the evolution path from an initial state that is not a steady state. Also, one group stuck in one steady state may move to another steady state under some circumstances. The model cannot analyze

the condition that enables the switch from one steady state to another. Above all, it ignores the forward looking behavior of group members. In the static model, it assumes that workers react to the employers' prior belief without accounting for expected payoff in the future. This myopic assumption limits the dynamic analysis of the model. In sum, the static model does not provide any explanation except the possible scenario on each steady state. Nothing can be discussed for the states other than the steady states. For these reasons, its analysis on the policy implication is restricted around the steady states and limited by employers' prior beliefs, for which the model does not provide an account. In this paper, we try to overcome the shortcomings of the static models of statistical discrimination by introducing the fully dynamic framework with the economic agents' forward looking decision making reflected.

### 3 Dynamic Reputation Model

In this section, we develop a dynamic version of statistical discrimination with an insight that an individual's reputation is influenced by the collective reputation of the group to which he belongs.

#### 3.1 Group Reputation and Individual Reputation

Instead of relying on the employers' prior beliefs, we propose that employers use the objective information about the overall quality of each group in their decision to set up the hiring standard applied to a group. The overall quality is the proportion of qualified workers  $\Pi^i$  in the market in the given job assignment model. The objective information for the overall quality is directly computed from the following formula:  $F^i(\theta) = \Pi^i F_q(\theta) + (1 - \Pi^i) F_u(\theta)$ .  $F^i(\theta)$  represents the fraction of group  $i$  workers who emit a signal below  $\theta$ , which is easily observed by employers who are matched with a large population of each group. Assuming that  $F_q(\theta)$  and  $F_u(\theta)$  are common knowledge, each employer can obtain the information about the proportion of qualified workers among group  $i$  members in the market using the aggregate information  $F^i(\theta)$ ,

$$\Pi^i = \frac{F_u(\theta) - F^i(\theta)}{F_u(\theta) - F_q(\theta)}, \forall \theta. \quad (2)$$

Let us call the quality of group  $\Pi^i$ , which is shared among employers, *group reputation*. Facing a job candidate of group identity  $i$  and signal  $\theta$ , an employer will try to calculate the probability that he is qualified, so that he can make a decision of whether to assign him to task one. Let us call it an *individual reputation* of group identity  $i$  and signal  $\theta$ , and denote it by  $R(i, \theta)$ :

$$R(i, \theta) = \frac{\Pi^i f_q(\theta)}{\Pi^i f_q(\theta) + (1 - \Pi^i) f_u(\theta)}. \quad (3)$$



Direct observation is that an individual reputation  $R(i, \theta)$  is an increasing function of group reputation  $\Pi^i$ :  $\frac{\partial R(i, \theta)}{\partial \Pi^i} > 0$ . The higher the expected individual reputation, the more incentive each individual has to make skill investment. Consequently, an individual's skill investment is affected by the expected group reputation in the future. Each individual will consider others' investment decisions now and in the future, in his current decision of skill investment. This externality of group reputation contains the possibility of collective action to build up better group reputation together, or to drag down the good group reputation to the worse reputation state. In the following section, we will examine these dynamic aspects of group reputation, and will try to find the answers to the questions raised for the static models in the earlier section.

### 3.2 Dynamic System

In the dynamic model, we assume that each worker makes skill investment at the early stage of his life and then works for the rest of his life. He is subject to a ‘‘Poisson death process’’ with parameter  $\lambda$  (Kim 2008, Tirole 1996): in a unit period, each individual faces a probability of death  $\lambda$ . We assume that the total population of each group is constant. Therefore, in a unit period, a fraction  $\lambda$  of workers are replaced by newborn agents. Suppose that each individual discounts future payoffs at the rate  $\delta$ , and employers discount future payoffs at the rate  $r$ . Suppose that a worker is randomly matched with employers every period, which implies that he will go through the regular screening process every period. The condition for the screening process is identical for each period. In the appendix, we will loosen this assumption by introducing a market learning process, in which the true characteristic of each worker is more likely to be revealed as he spends more time in the market.

The expected extra benefit to being qualified at time  $\tau$  ( $\beta_\tau$ ) is  $\omega[F_u(s_\tau) - F_q(s_\tau)]$ , where  $\omega$  is the wage rate at task 1. Employers gain a net return  $x_q$  from the correct assignment and incur a net loss  $x_u$  from incorrect assignment. Note that  $\omega$ ,  $x_q$  and  $x_u$  in the dynamic model with the infinite time horizon is analogous to  $W$ ,  $X_q$  and  $X_u$  in the one-time static model in the section on motivation. For consistency's sake, we suggest that they satisfy the followings:  $W \equiv \int_t^\infty \omega e^{-(\delta+\lambda)(\tau-t)} d\tau$ ,  $X_q \equiv \int_t^\infty x_q e^{-r(\tau-t)} d\tau$  and  $X_u \equiv \int_t^\infty x_u e^{-r(\tau-t)} d\tau$ . Note that  $\rho \equiv X_q/X_u = x_q/x_u$ . The expected lifetime benefits of investment for workers born at time  $t$  is  $\int_t^\infty \beta_\tau e^{-(\delta+\lambda)(\tau-t)} d\tau$ . For convenience, we denote as  $V_t$  the ‘‘normalized’’ lifetime benefits of investment:

$$V_t = (\delta + \lambda) \int_t^\infty \beta_\tau e^{-(\delta+\lambda)(\tau-t)} d\tau. \quad (4)$$

Taking a derivative with respect to  $t$ , we can describe how  $V_t$  evolves over time,

$$\dot{V}_t = (\delta + \lambda)[V_t - \beta_t]. \quad (5)$$

Let  $\phi_t$  denote the fraction of workers born at time  $t$  who invest and become qualified. Since  $\lambda$  of the total population is replaced with newborn agents in a unit period,  $\Pi_t$  evolves in short time interval  $\Delta t$  in the following way,

$$\Pi_{t+\Delta t} \approx \lambda \Delta t \cdot \left( \frac{\phi_t + \phi_{t+\Delta t}}{2} \right) + (1 - \lambda \Delta t) \cdot \Pi_t. \quad (6)$$

By the rearrangement of this equation, we have

$$\frac{\Delta \Pi_t}{\Delta t} \equiv \frac{\Pi_{t+\Delta t} - \Pi_t}{\Delta t} \approx \lambda \left[ \frac{\phi_t + \phi_{t+\Delta t}}{2} - \Pi_t \right].$$

Taking  $\Delta t \rightarrow 0$ , we can express how  $\Pi_t$  evolves over time,

$$\dot{\Pi}_t = \lambda[\phi_t - \Pi_t]. \quad (7)$$

Note that there is a direct way to achieve the same result. We can define  $\Pi_t$  as  $\Pi_t \equiv \int_{-\infty}^t \lambda \phi_\tau e^{-\lambda(t-\tau)} d\tau$ , and taking a derivative with respect to  $t$ , we have  $\dot{\Pi}_t = \lambda[\phi_t - \Pi_t]$ . Thus, we have a dynamic system.

**Theorem 1** (Dynamic System). *The dynamic system with a flow variable  $\Pi_t$  and a jumping variable  $V_t$  is summarized by the following two-variable differential equations:*

$$\begin{aligned} \dot{\Pi}_t &= \lambda[\phi_t - \Pi_t] \\ \dot{V}_t &= (\delta + \lambda)[V_t - \beta_t], \end{aligned} \quad (8)$$

*with demarcation loci of*

$$\begin{aligned} \dot{\Pi}_t = 0 \text{ Locus} &: \Pi_t = \phi_t \\ \dot{V}_t = 0 \text{ Locus} &: V_t = \beta_t. \end{aligned} \quad (9)$$

We can interpret the theorem as follows: the difference between the investment rate of the newborn cohort and the overall qualification ratio of group  $i$  workers determines the speed of group reputation change. The change in accrued benefits of investment at time  $t$  is determined by the difference between the accrued benefits of investment at time  $t$  and the time  $t$  level of the benefits of being qualified. Note that there is no change in group reputation if the fraction of the newborn cohorts who invest

is exactly the same as the level of group reputation, and there is no change in lifetime benefits of investment if the current benefits of being qualified is exactly equal to the level of lifetime benefits of investment.

### 3.3 Simple Reputation Model

In order to understand the dynamic system correctly, we will start with the simplest functional forms that do not hurt the essential structure of the economy:  $f_u(\theta)$  is uniformly distributed in  $[0, \theta_u]$  and  $f_q(\theta)$  is uniformly distributed in  $[\theta_q, \bar{\theta}]$ , where  $\theta_q < \theta_u$ . The population of each group is constituted of three types of agents:  $\Pi_l$  fraction of workers whose investment cost is very small and close to zero,  $1 - \Pi_h$  fraction of workers whose investment cost is very high and beyond the highest possible benefit from investment  $\frac{\omega}{\delta + \lambda}$ , and  $\Pi_h - \Pi_l$  fraction of workers whose investment cost is intermediate and fixed as  $c_m$ . Then, cost distribution  $G(c)$  is  $\Pi_l$  for  $c \in (\epsilon, c_m)$ , and  $\Pi_h$  for  $c \in (c_m, \omega/(\delta + \lambda))$ .

In this case, employers will set the hiring standard as either  $\theta_u$  or  $\theta_q$ . If the signal is below  $\theta_q$ , the worker must be unqualified, and, if the signal is above  $\theta_u$ , the worker must be qualified. If the signal is between  $\theta_q$  and  $\theta_u$ , the signal is unable to tell the true characteristic of the worker. Let us denote the probability that, if a worker does invest, his test outcome proves that he is qualified by  $P_q (= \frac{\bar{\theta} - \theta_u}{\bar{\theta} - \theta_q})$  and the probability that, if a worker does not invest, his test outcome proves that he is unqualified by  $P_u (= \frac{\theta_q}{\theta_u})$ .

**Assumption 1** (Imperfect Information). *A qualified worker's signal is less informative, compared to an unqualified worker's signal. This is, the payoff uncertainty is greater for qualified workers compared to for unqualified workers:  $P_q < P_u$ , and equivalently,  $\theta_q + \theta_u > \bar{\theta}$ .*

From this assumption, we propose that non-qualification of workers is easily detected by employers. However, qualification of workers is relatively hard for employers to confirm. This is an essential part of the imperfect information in the labor market. If the investment of workers can be easily confirmed, workers do not have to worry that their chance to be assigned to a good job is affected by their group's reputation.

Employers must make a decision on whether or not to give the benefit of the doubt (BOD) if the signal is unclear. If they give BOD to a group, the hiring standard for the group is  $\theta_u$ , but, if not, the hiring standard for the group is  $\theta_q$ . Employers' decision to give BOD is determined by the sign of expected payoff,  $x_q \cdot Prob[\text{qualified}|\theta] - x_u \cdot Prob[\text{unqualified}|\theta]$ , for  $\theta_q < \theta < \theta_u$ . Using Bayes' rule, the posterior probability that the worker with group identity  $i$  and an unclear signal ( $\theta_q < \theta < \theta_u$ ) is qualified is  $\frac{\Pi^i(1-P_q)}{\Pi^i(1-P_q) + (1-\Pi^i)(1-P_u)}$ . Thus, we can find the threshold level  $\Pi^*$ , above which employers give BOD and below which they do not give BOD, where  $\Pi^* \equiv \frac{1-P_u}{\rho(1-P_q) + 1-P_u}$  with  $\rho = \frac{x_q}{x_u}$ . Note that

the threshold level can be obtained using equation (1) as well:  $\Pi^* \equiv \frac{\bar{\theta} - \theta_q}{\rho\theta_u + \bar{\theta} - \theta_q}$ , which is identical to the above.

If agents with unclear signals are assigned to task one, that is, BOD is given, the extra benefit  $\beta_\tau$  to being qualified is  $\omega P_u$ , because the expected benefit to being qualified is  $\omega$  and that to being unqualified is  $\omega(1 - P_u)$ , or because  $\beta_\tau = \omega[F_u(\theta_q) - F_q(\theta_q)] = \omega\theta_q/\theta_u$ . If agents with unclear signals are not assigned, that is, BOD is not given, the extra benefit to being qualified is  $\omega P_q$ , because the expected benefit to being qualified is  $\omega P_q$  and that to being unqualified is zero, or because  $\beta_\tau = \omega[F_u(\theta_u) - F_q(\theta_u)] = \omega(\bar{\theta} - \theta_u)/(\bar{\theta} - \theta_q)$ . Therefore, at time  $t$  the extra benefit to being qualified is summarized by

$$\beta_t(\Pi_t) = \begin{cases} \omega P_u & \text{for } \Pi_t \in [\Pi^*, 1] \\ \omega P_q & \text{for } \Pi_t \in [0, \Pi^*]. \end{cases} \quad (10)$$

Given the cost distribution  $G(c)$  among the newborn cohort, the fraction of newborn agents who become qualified is

$$\phi_t = G\left(\frac{V_t}{\delta + \lambda}\right). \quad (11)$$

Using  $\beta_t$  and  $\phi_t$ , we can draw demarcation loci as displayed in Panel A of Figure 2. In the left (right) side of  $\beta_t$  locus, the movement of  $V$  is westward (eastward). Above (below)  $\phi_t$  locus, the movement of  $\Pi$  is southward (northward). As far as  $\Pi^*$  is between  $\Pi_h$  and  $\Pi_l$  and  $(\delta + \lambda)c_m$  is between  $\omega P_q$  and  $\omega P_u$ , there will be multiple steady states, which are denoted as  $Q_h(\omega P_u, \Pi_h)$ ,  $Q_m((\delta + \lambda)c_m, \Pi^*)$  and  $Q_l(\omega P_q, \Pi_l)$  in the panel. Note that the middle one  $Q_m((\delta + \lambda)c_m, \Pi^*)$  is a “conditional” steady state: that is, it becomes steady state only when  $\phi_t = \Pi^*$  for  $V_t = (\delta + \lambda)c_m$  and  $\beta_t = (\delta + \lambda)c_m$  for  $\Pi_t = \Pi^*$ .<sup>1</sup> In the following sections, we will assume that  $\Pi^* \in (\Pi_l, \Pi_h)$  and  $(\delta + \lambda)c_m \in (\omega P_q, \omega P_u)$ . Otherwise, there is a unique steady state and nothing to be discussed because there will be no reputation disparity between social groups. In Panel B of Figure 2, we display the equilibrium path that leads to each steady state,  $Q_h$  and  $Q_l$ . In the next sections, we will provide concrete explanations about this dynamic structure and the economic meanings of equilibrium paths.

### 3.3.1 Properties of Simple Reputation Model

In order to have a deeper analysis of the dynamic model, we will focus on the gray box in Panel B of Figure 2, within which meaningful dynamic structure is constructed, by the adjustment of the scaling of  $V_t$ . Let us define  $v_t$  as a linear transformation of  $V_t$  such as  $V_t = \omega P_q + \omega(P_u - P_q)v_t$ .

<sup>1</sup>The first condition implies that the fraction of the newborn worker who invest is  $\Pi^*$  so that there is no change in the overall group reputation. The second condition implies the principals’ mixed strategy assigns only a fraction  $v^* (= \frac{(\delta + \lambda)c_m - \omega P_q}{\omega(P_u - P_q)})$  of workers who emit an unclear signal to the task 1 position. Note that the latter is not consistent with the hiring standard rule defined in equation (1), in which  $s^*(\Pi^*) = \theta_q$  and  $\beta_t = \omega P_u$ .

Then, as  $v_t$  ranges over  $[0, 1]$ ,  $V_t$  ranges over  $[\omega P_q, \omega P_u]$ , which is the entire range of the gray box. Let us denote by  $\xi_t$  the indicator of giving BOD:  $\xi_t = 1$  if  $\Pi_t > \Pi^*$  and  $\xi_t = 0$  if  $\Pi_t < \Pi^*$ . Since  $\beta_t = wP_u \cdot \xi_t + wP_q \cdot (1 - \xi_t)$ , applying to equation (4), we have

$$V_t = \omega P_q + \omega(P_u - P_q)(\delta + \lambda) \int_t^\infty \xi_\tau e^{-(\delta+\lambda)(\tau-t)} d\tau$$

Thus,  $v_t$  simply indicates the normalized lifetime BOD:

$$v_t = (\delta + \lambda) \int_t^\infty \xi_\tau e^{-(\delta+\lambda)(\tau-t)} d\tau.$$

The dynamic system in this modified model with a flow variable  $\Pi_t$  and a jumping variable  $v_t$  is

$$\begin{aligned} \dot{\Pi}_t &= \lambda[\phi_t - \Pi_t] \\ \dot{v}_t &= (\delta + \lambda)[v_t - \xi_t], \end{aligned}$$

with demarcation loci of

$$\begin{aligned} \dot{\Pi}_t = 0 \text{ Locus} &: \Pi_t = \phi_t \\ \dot{v}_t = 0 \text{ Locus} &: v_t = \xi_t. \end{aligned}$$

The critical level of  $V_t$ ,  $(\delta + \lambda)c_m$ , is denoted in this  $(v_t, \Pi_t)$  domain as

$$v^* \equiv \frac{(\delta + \lambda)c_m - wP_q}{w(P_u - P_q)}.$$

The differential equations in each region are divided by two lines  $v_t = v^*$  and  $\Pi_t = \Pi^*$  and are displayed in Figure 3, named by regions I, II, III and IV, going counterclockwise. The corresponding steady states are  $Q_h(1, \Pi_h)$ ,  $Q_m(v^*, \Pi^*)$  and  $Q_l(0, \Pi_l)$ . In regions I and II, principals give BOD, which they do not give BOD in other regions. In regions II and III, only a fraction  $\Pi_l$  of the newborn cohort invests, while a fraction  $\Pi_h$  of the newborn cohort invest in regions I and IV.

**Definition 1** (Economically Stable State). *A state  $(V', \Pi')$  is an economically stable state if there exists an equilibrium path that converges to the state for any  $\Pi$  in the neighborhood of  $\Pi'$ .*

This means that a state is defined as “economically stable” if when nearby to the state, economic agents can find a reasonable equilibrium path that converges to it, even though the state itself is mathematically unstable: it is a saddle point in general (Kim 2008).

**Lemma 1** (Spiraling Out Paths). *In the simple reputation model, the state  $Q_m(v^*, \Pi^*)$  is unstable, and the phase paths around it spiral out.*

*Proof.* See the proof in the appendix. ■

**Lemma 2** (Curvature of Paths). *In the simple reputation model, the equilibrium paths are concave on the right hand side of the  $v = v^*$  line, and convex on the left hand side of the  $v = v^*$  line.*

*Proof.* See the proof in the appendix. ■

Using direction arrows in Panel A of Figure 2, we can easily identify the equilibrium paths to the steady states  $Q_h$  and  $Q_l$ , which are vertical straight lines nearby the states. Lemma 1 tells us that the paths spiral out around the state  $Q_m$ .

**Proposition 2** (Dual Economically Stable States). *In the simple reputation model, there exist two economically stable states,  $Q_h(1, \Pi_h)$  and  $Q_l(0, \Pi_l)$ .*

Because there are two economically stable states, group members with group reputation  $\Pi_0 \in [0, 1]$  may rationally conjecture that the final state should be either the high reputation state  $Q_h$  or the reputation state  $Q_l$ . Let us suppose that group members can make a consensus about the future state all together. Suppose that, once the consensus is built up, it can be passed to the next generations. For example, group members with its group reputation around  $\Pi^*$  may hold an optimistic view that the final state would be  $Q_h$  instead of  $Q_l$ . Then, by rational reasoning, they will find the optimal path that leads to the high reputation state. Based on the optimal path and the expected high payoff, a newborn cohort will make an investment decision. Generations following will make an investment decision based on the same optimal path leading to  $Q_h$ , as far as the optimistic consensus is passed to the next generations. By this self-confirming process, the group will gradually approach the state  $Q_h$ , improving its collective reputation. However, if the group shares the pessimistic view toward the future and the pessimistic consensus is passed to the next generations, the reputation of the group may gradually fall down to the low reputation level  $\Pi_l$ .

Since either  $Q_h$  or  $Q_l$  is realized in the future for any given initial reputation level, it is worth checking which is superior to the other.

**Proposition 3** (Pareto Dominance). *In the simple reputation model,  $Q_h$  is strictly Pareto dominant to  $Q_l$ ; all economic agents, including employers and workers with different investment costs, are better off when the group state  $(v_t, \Pi_t)$  stays at  $Q_h$  than at  $Q_l$ .*

*Proof.* See the proof in the appendix. ■

Thus, the high reputation state  $Q_h$  is socially more desirable than the low reputation state  $Q_l$ . It is noteworthy that all types are better off at the high reputation state; even high investment cost individuals who will never invest for the job qualification are better off in this state. One interesting point is that employers are better off when group reputation is good than bad.

### 3.3.2 Interpretation of Simple Reputation Model

Denote the lower boundary of the equilibrium path to  $Q_h$  as  $\pi^o$ , and the upper boundary of the equilibrium path to  $Q_l$  as  $\pi^p$ . Denote the initial reputation level of group  $i$  as  $\Pi_0^i$ . At any initial reputation level  $\Pi_0^i \in [\pi^o, 1]$ , group  $i$  can converge to the high reputation state  $\Pi_h$  by sharing an optimistic view of the future among group members. At any initial reputation level  $\Pi_0^i \in [0, \pi^p]$ , group  $i$  can converge to the low reputation state  $\Pi_l$  by sharing a pessimistic view of the future among group members. Thus, we call the equilibrium path to  $Q_h$  the “optimistic path”, and the equilibrium path to  $Q_l$  the “pessimistic path”.

In the given simple reputation model, the optimistic path passes through  $(1, \Pi^*)$ . The overall shape of the optimistic path is determined by how much the concave curve in region IV is bent. If the path passes through between  $\Pi_l$  and  $\Pi^*$  at  $v = v^*$ , the path changes its direction entering region III, and  $\pi^o$  becomes greater than  $\Pi_l$ . Otherwise, the path maintains its direction entering the region and  $\pi^o$  becomes zero. The pessimistic path passes through  $(0, \Pi^*)$ . The overall shape of the path is determined by how much the convex curve in region II is bent. If the path passes through between  $\Pi_h$  and  $\Pi^*$  at  $v = v^*$ , the path changes its direction entering region I, and  $\pi^p$  becomes smaller than  $\Pi_h$ . Otherwise, the paths maintains its direction entering the region and  $\pi^p$  becomes one.

**Definition 2** (Overlap). *The range of group reputation level  $[\pi^o, \pi^p]$  is called “overlap”; if the initial group reputation  $\Pi_0^i$  is within the overlap, group  $i$  can converge either to the high reputation state  $Q_h$  by sharing an optimistic view among group members, or to the low reputation state  $Q_l$  by sharing a pessimistic view among them.*

Note that, with an initial reputation level  $\Pi_0^i \in (\pi_p, 1]$ , group  $i$  “must” converge to the high reputation state  $Q_h$  because the optimistic path is the only reasonable path. With an initial reputation level  $\Pi_0^i \in [0, \pi_o)$ , group  $i$  “must” converge to the low reputation state  $Q_l$  because the pessimistic path is the only reasonable path. Therefore, those ranges,  $(\pi_p, 1]$  and  $[0, \pi_o)$ , are respectively called a deterministic range for  $Q_h$  and a deterministic range for  $Q_l$ .

**Definition 3** (Reputation Trap). *The low reputation state  $Q_l$  is called a “reputation trap” if  $\Pi_l$  belongs to the deterministic range for  $Q_l$ ,  $[0, \pi_o)$ , namely below the overlap  $[\pi_o, \pi_p]$ .*

Thus, if a group is in the reputation trap, there is no way to recover its reputation without a change in the dynamic structure.

**Lemma 3** (Separation). *In the simple reputation model, if  $\pi^o > \Pi_l$  and  $\pi^p < \Pi_h$ , that is, the two economically stable states  $Q_h$  and  $Q_l$  are “separate” from each other; a group in either state cannot move to the other state by changing its expectations:*

$$\frac{\delta}{\lambda} > \frac{\max\{-\ln(1-v^*), -\ln(v^*)\} - 1}{\ln(\Pi_h - \Pi_l) - \ln(\Pi^* - \Pi_l)}.$$

*Proof.* Using  $\pi^o$  and  $\pi^p$  listed below, the condition is directly obtained. ■

In order to analyze the properties of overlap, let us suppose  $\delta$  is big enough that two economically stable states are “separate” from each other. Then, the lower boundary of the optimistic path and the upper boundary of the pessimistic path are

$$\begin{aligned}\pi^o &= \Pi_h + (\Pi^* - \Pi_h)v^{*-\frac{\lambda}{\delta+\lambda}}, \\ \pi^p &= \Pi_l + (\Pi^* - \Pi_l)(1-v^*)^{-\frac{\lambda}{\delta+\lambda}}.\end{aligned}$$

The size of overlap  $L(\equiv \pi^p - \pi^o)$  is directly computed as

$$L = \Pi_l - \Pi_h + (\Pi^* - \Pi_l)(1-v^*)^{-\frac{\lambda}{\delta+\lambda}} + (\Pi_h - \Pi^*)v^{*-\frac{\lambda}{\delta+\lambda}}. \quad (12)$$

Therefore, we have the following properties of overlap size:  $\frac{\partial L}{\partial \delta} < 0$  and  $\frac{\partial L}{\partial \lambda} > 0$ . This implies that, the more weight that workers place on future payoffs (lower  $\delta$ ), or the faster generations are replaced by newborns (higher  $\lambda$ ), the size of the overlap tends to be bigger (bigger  $L$ ), which means that the expectation toward the future plays a greater role in the determination of the final economic outcome. Also, the overlap shifts up with higher level of investment cost:  $\frac{\partial \pi^p}{\partial c_m} > 0$  and  $\frac{\partial \pi^o}{\partial c_m} > 0$ . This implies that the higher (lower) the investment cost, the more likely that a group converges to the low (high) reputation state  $Q_l$  ( $Q_h$ ).

**Proposition 4** (Properties of Overlap). *Under Lemma 3, the size of overlap tends to be bigger with the smaller  $\delta$ , and the larger  $\lambda$ : expectation toward the future tends to plays a bigger role if workers discount the future payoff less, and if generations are replaced faster. The range of overlap tends to shift up with bigger  $c_m$ : social groups are more likely to converge to the low reputation state  $Q_l$  when investment cost is bigger.*



### 3.4 Generalization of Simple Reputation Model

Now let us come back to the static statistical reputation model of Coate and Loury (1993) introduced in the section on motivation. Given the noisy signals  $f_u(\theta)$  and  $f_q(\theta)$  displayed in Panel A of Figure 1, we have identified three steady states in Panel B of the same figure. However, in the static model, we could not answer questions about the dynamic paths that lead to those steady states, and conditions under which a group can switch from one state to the other. Using the developed dynamic model, we will answer those questions.

As Theorem 1 says, the demarcation loci are  $\phi_t$  and  $\beta_t$ .  $\phi_t$  is  $G\left(\frac{V_t}{\delta+\lambda}\right)$ , as noted in equation (11).  $\beta_t$  is  $\omega[F_u(s_t) - F_q(s_t)]$  and  $s_t$  is a function of  $\Pi_t$ , as noted in equation (1). Those two demarcation loci are displayed in Panel A of Figure 5 with direction arrows. In Panel B of the same Figure, we can identify three steady states out of the demarcation loci. Note that those steady states are exactly the same as the steady states identified in the static model displayed in Figure 1.<sup>2</sup> Let us denote the steady states as  $Q_h(V_h, \Pi_h)$ ,  $Q_m(V_m, \Pi_m)$  and  $Q_l(V_l, \Pi_l)$ .

**Lemma 4** (Saddle Points). *Among three steady states,  $Q_h$ ,  $Q_m$  and  $Q_l$ ,  $Q_h$  and  $Q_l$  are saddle points and  $Q_m$  is a source.*

*Proof.* See the proof in the appendix. ■

We might wonder whether the equilibrium paths around  $Q_m$  spiral out or not. The following lemma shows that it depends on the relative size of  $\delta$  and  $\lambda$ .

**Lemma 5** (Spiraling Out). *There exists a critical level of  $(\delta/\lambda)^*$  below which equilibrium paths spiral out in the neighborhood of  $Q_m$ , where  $(\delta/\lambda)^*$  satisfies  $(1 + \frac{\lambda}{\delta}) \frac{\lambda}{\delta} = \frac{1}{4(\phi'_t \beta'_t - 1)} \Big|_{(V_m, \Pi_m)}$ .*

*Proof.* See the proof in the appendix. ■

This implies that the less workers discount the future payoffs, the more likely that the equilibrium paths will spiral out around  $Q_m$ .

**Theorem 2** (Dual Economically Stable States). *Under Lemma 4, there exist two economically stable states, and equilibrium paths to those states overlap for a certain range of  $\Pi$ .*

*Proof.* Two states are saddle points, and consequently economically stable states. Using the phase diagram in Figure 5, the existence of overlap is directly proven. ■

---

<sup>2</sup>Compared to the  $\tilde{\beta}(\equiv w[F_u(s) - F_q(s)])$  in Panel B of Figure 1,  $\beta_t$  is scaled down as much as  $(\delta + \lambda)$  because  $W \equiv \int_t^\infty \omega e^{-(\delta+\lambda)(\tau-t)} d\tau$ . Compared to  $G(\beta)$  in the same figure,  $\phi_t$  is scaled down as much as  $(\delta + \lambda)$  in the horizontal direction. Therefore, two demarcation loci are identical to the “scaled down” reaction curves in the static model.

In Panel A of Figure 6, we display the optimistic path to  $Q_h$  and the pessimistic path to  $Q_l$ . In Panel B of the same figure, we identify the overlap of the two equilibrium paths and the reputation trap. Note  $Q_l$  becomes a reputation trap when  $\Pi_l$  is located below the overlap, as discussed earlier. Once a group is in the trap, the group cannot move out of the trap unless there is a structural change in the labor market. If the overlap is between  $\Pi_l$  and  $\Pi_h$ , then a group in either economically stable state cannot move to the other state even through the collective action by the group. Also, if an economically stable state is covered by the overlap, a group in the state can move to the other economically stable state.

## 4 Applications: US Racial Disparity

In this section, we try to explain a real world issue using the developed dynamic reputation model. Over the Jim Crow period and until the civil right movement in the 1960s, African-Americans were discriminated against in an overt manner in the US labor market. This discrimination decreased significantly over the last decades. However, we still observe the persistent black-white disparity of skill achievement. The advocates of the black group insist that they are discriminated against continuously. The dynamic reputation model explains one possible origin of the persistent disparity, and the continuing “statistical” discrimination practice in the market, which uses the “group reputation” under the imperfect information about the job candidates.

When overt discrimination in the American history results in a very low ratio of qualified workers among blacks (very low  $\Pi_0^B$ ), the quality of the group will improve over time after the disappearance of taste-based discriminatory practice. However, as Figure 7 displays, the group reputation or the quality of the group may improve only up to the low reputation state  $\Pi_l$ , which is a reputation trap under some circumstances. If the group is in the trap and is continuously disadvantaged by the market’s “statistical” discriminatory practice, the group may stay permanently in the state. The collective action of building up the better group reputation cannot work in this situation, because rational agents know that other group members will not invest for the change of group reputation when their skill achievement is not paid back enough in the future due to the low group reputation.

Some might wonder why the white group is advantaged with the group’s higher reputation over the same time frame. The initial group reputation of the white group should be much higher than that of the black group. As Figure 7 displays, if the initial group reputation is higher and belongs to the overlap, the group can take the optimistic path that leads to the high reputation state  $Q_h$  by sharing the optimistic view toward the future together. They will invest more than the black group in skill achievement, because the expected benefits of investment are greater due to the market’s favor for the

higher group reputation. The white group is advantaged with the market’s “statistical” discriminatory practice, while the black group is disadvantaged with that.

Note that we have assumed that the underlying characteristics of the two groups are identical. Thus, the disparity between groups originates solely from the reputation role embedded in the market structure. One important implication of the dynamic model is that the reputation gap between two groups can even grow over time by the agglomeration effects of collective reputation. This should be an absurd argument to the people who believe that the elimination of market discrimination of taste shrinks group disparity. The dynamic model claims that it does not need to be true all the time: depending on the initial reputation levels of groups, the gap between two groups can grow or shrink over time.

## 5 Monopolistic Principals

In Proposition 3, we have shown that  $Q_h$  is *pareto* dominant to  $Q_l$  in the simple reputation model: employers can make bigger profits when a social group is at the high reputation state  $Q_h$  than at the low reputation state  $Q_l$ .<sup>3</sup> Suppose a group B is at the reputation trap  $Q_l$ , as described in Figure 4. Since employers prefer the group’s staying at  $Q_h$  to its staying at  $Q_l$ , they might help the group to move out of the trap and improve the group’s qualification ratio. However, this never happens in the *competitive situation*, which is defined as the market condition in which there are numerous employers and the size of each employer is relatively insignificant. In this situation, one’s action does not affect the overall behavior of group members. Each employer just accepts the market structure, and determines whether to give BOD based on the group reputation of B.

Now suppose that they are in the *monopolistic situation*, which is the market condition in which there are a small number of employers, or employers are well coordinated by a mediator (eg. government). Let us call employers in the monopolistic situation “monopolistic principals”, as defined in Loury (2002). Monopolistic principals can change the market structure and affect the behavior of the group in the reputation trap. When the group is stuck in the reputation trap, the principals make profits as much as

$$Y_{Q_l} = \int_{t_0}^{\infty} P_q \Pi_l x_q \cdot e^{-r(\tau-t_0)} d\tau = \frac{P_q \Pi_l x_q}{r}.$$

If their action can make the expected profit greater than  $Y_{Q_l}$ , they will take the action and help the group to move out of the trap. In this section, we will examine the two strategies that they can take: adjustment of reputation threshold (favorable treatment) and subsidy of training cost.

---

<sup>3</sup>Compare employers’ profits for a group at  $Q_h$  and those at  $Q_l$  for a unit period:  $\Pi_h x_q - (1 - \Pi_h)(1 - P_u)x_u > \Pi_l P_q x_q$ , given  $\Pi_l < \Pi^* < \Pi_h$ .

Note that the farsightedness of principals and the credibility of their actions are required for the effective implementation of each strategy. If principals are myopic to anticipate the far future, they will not be able to implement the long-term policy that gradually improves the qualification ratio of group B workers. Also, if principals' "promise" to continue the actions is not considered credible, group B members may not change the conjecture about the expected benefits of investment, so that their skill investment rate will not be improved. Finally, we assume that the group in the reputation trap will move to the high reputation state  $Q_h$  as soon as the optimistic path to the state is available to the group, which means that the group members await the chance to recover the reputation.

First, monopolistic principals have an incentive to lower the reputation threshold if the policy can increase profits by helping the disadvantaged group to move out of the reputation trap. In order to help the group to move toward the high reputation state  $Q_h$ , the reputation threshold for BOD needs to be lowered from  $\Pi^*$  to  $\Pi^{*'}$ , where  $\Pi^{*'} = \Pi_h - (\Pi_h - \Pi_l)v^* \frac{\lambda}{\delta + \lambda}$ , as displayed in Panel A of Figure 8. The state of group B will move along the following points in the panel as the group members share the optimistic view toward the future:  $Q_l \rightarrow_{jump} a \rightarrow b \rightarrow c \rightarrow Q_h$ . Principals may suffer in the interval  $(b, c)$  by placing agents with unclear signals on task one, because the expected payoff of the assignment is negative with  $\Pi_t < \Pi^*$ . Let us call the corresponding reputation level  $[\Pi^{*'}, \Pi^*]$  *loss area*. If they take this action, the total profits accrued over time will be

$$Y(\Pi^{*'}) = \int_{t_0}^{t_b} P_q \Pi_\tau x_q \cdot e^{-r(\tau-t_0)} d\tau + \int_{t_b}^{\infty} [\Pi_\tau x_q - (1 - P_u)(1 - \Pi_\tau)x_u] \cdot e^{-r(\tau-t_0)} d\tau, \quad (13)$$

where  $t_b = -\frac{\ln v^*}{\delta + \lambda} + t_0$  and  $\Pi_\tau = \Pi_h - (\Pi_h - \Pi_l) \cdot e^{-\lambda(\tau-t_0)}$ . Therefore, principals will take the threshold adjustment strategy when  $Y(\Pi^{*'}) \geq Y_{Q_l}$ .

Second, monopolistic principals have an incentive to support the training cost of group B members if the policy can increase profits by helping the group move out of the trap. If the training cost is subsidized enough by principals, the optimistic path can be available to the group in the trap, as displayed in Panel B of Figure 8. Then, the state of group B will move along the following points in the panel as the group members share the optimistic view toward the future:  $Q_l \rightarrow_{jump} a \rightarrow b \rightarrow c \rightarrow Q_h$ . The training cost for the group should be lowered enough so that  $v^{*'} = \left( \frac{\Pi_h - \Pi^*}{\Pi_h - \Pi_l} \right)^{\frac{\delta + \lambda}{\lambda}}$ . Since  $v^* = \frac{(\delta + \lambda)c_m - wP_u}{w(P_u - P_q)}$ , the required size of subsidy ( $S'$ ) is

$$S' (\equiv c_m - c'_m) = \frac{(v^* - v^{*'})w(P_u - P_q)}{\delta + \lambda}, \text{ with } v^{*'} = \left( \frac{\Pi_h - \Pi^*}{\Pi_h - \Pi_l} \right)^{\frac{\delta + \lambda}{\lambda}}.$$

The training subsidy should be implemented for the interval  $(a, b)$ . Assuming the size of subsidy is constant as the group state moves from the point  $a$  to  $b$ , the total cost that the principals incur will

be

$$TC(v^{*'}) = \int_{t_0}^{t_b} S' \lambda \cdot e^{-r(\tau-t_0)} d\tau = S' \lambda \left[ \frac{1 - e^{-r(t_b-t_0)}}{r} \right],$$

where  $t_b = \frac{\ln v^{*'}}{\delta + \lambda} + \frac{1}{\lambda} \cdot \ln \frac{\Pi_h - \Pi_l}{\Pi_h - \Pi^*} + t_0$ . The total revenue that the principals benefit from this strategy is

$$Y(v^{*'}) = \int_{t_0}^{t_c} P_q \Pi_\tau x_q \cdot e^{-r(\tau-t_0)} d\tau + \int_{t_c}^{\infty} [\Pi_\tau x_q - (1 - P_u)(1 - \Pi_\tau)x_u] \cdot e^{-r(\tau-t_0)} d\tau, \quad (14)$$

where  $t_c = \frac{1}{\lambda} \cdot \ln \frac{\Pi_h - \Pi_l}{\Pi_h - \Pi^*} + t_0$  and  $\Pi_\tau = \Pi_h - (\Pi_h - \Pi_l) \cdot e^{-\lambda(\tau-t_0)}$ . Therefore, principals will take the training subsidy strategy when  $Y(v^{*'}) - TC(v^{*'}) \geq Y_{Q_l}$ .

**Proposition 5.** *In the simple reputation model, well-coordinated monopolistic principals have an incentive to lower the reputation threshold for BOD of group B from  $\Pi^*$  to  $\Pi^{*'}$  if and only if  $Y(\Pi^{*'}) \geq Y_{Q_l}$ , and to subsidize the training cost of group B members as much as  $S'$  if and only if  $Y(v^{*'}) - TC(v^{*'}) \geq Y_{Q_l}$ .*

## 6 Further Discussion

Note that so far we have not discussed fully the spiraling out equilibrium paths. As denoted in Panel A of Figure 6, there often exist multiple points of lifetime benefits of investment  $V_t$  that are available to a group for a given level of initial group reputation. In the first graph, the group with a certain level of initial reputation may choose either point  $a$  or point  $b$  (or others if available) on the optimistic path to the high reputation state  $Q_h$ . What would make the difference between choosing  $a$  as an expected  $V_t$  or choosing  $b$ ? The answer is related to the expectation about the length of time to arrive at  $Q_h$ . Choosing point  $b$  means that the group believes that the high reputation level  $\Pi_h$  will be realized as soon as it can. This is a case of *strong optimism*. Choosing point  $a$  means that the group believes that the level  $\Pi_h$  may take longer to come. If they believe in that way, the benefits of investment would be lowered and less of newborn cohorts will have an incentive to invest, causing the group reputation level to drop for a while, even when they have an optimistic view that the group will arrive at  $Q_h$  in the long run. Therefore, this is a case of *weaker optimism*. In principal, the weaker the optimism that a group possesses, the more time it may take to arrive at  $Q_h$  and the more likely that the group reputation fluctuates over time. In the same way, we can interpret the cases for group pessimism. The point  $c$  indicates the case of *strong pessimism* that the miserable future  $Q_l$  may come very soon. With this view, the expected benefits of investment would be very low and, consequently, a smaller percentage of the newborn cohort may invest, leading to the decline of the reputation. However, suppose that they believe that the state  $Q_l$  may arrive someday, but it may take much longer to come. If then, we

may observe the increase of group reputation for a while until it starts to decline. Point  $d$  represents this case, namely *weaker pessimism*.

In the developed reputation model, we have simplified the labor market by the assumption that each worker is randomly assigned to an employer every period and each of them gets through the regular screening process repeatedly. In this assumption, the true characteristic of each worker is never revealed in the market, no matter how long he spends in the workplace. In order to correct this point, we will add an additional assumption about the market learning process in which, the more time a worker spends in the workplace, the more likely the market learns his true characteristic. Once a market learns the true characteristic of a worker, he will not get through the regular screening process anymore. Instead, he is assigned according to his qualification. We use the poisson process to represent the random arrival of market learning for a worker's true characteristic. This additional development is summarized in Appendix A. The critical difference from the original model is that the demarcation locus of  $\dot{V}_t = 0$  shifts to the right and the equilibrium levels of group reputation,  $\Pi_h$  and  $\Pi_l$ , shift up.

Finally, the model can be directly applied to the issue of heterogeneous “tipping points” of white flight in the US housing market. Card et al. (2007) discuss this issue and conclude that the different white attitudes toward minority groups, the “racist” preference, explain the different tipping points across cities in the US. However, they do not explain the origin of the different white attitudes across cities, and the expected price change in the housing market is not reflected in their examination. The developed group reputation model provides a different perspective to the issue and suggests an empirical meaningful research agenda to overcome the limit of the previous tipping point literature. White residents may use the overall quality of the move-in minority group in their calculation of the expected housing price in the future, which means that they decide whether to flight out or not considering the collective reputation of the move-in group. (The different white attitudes mentioned above may simply reflect the different collective reputation of the move-in minority group.) If we can collect data on the quality of the move-in group, such as crime rate or educational achievement at each period of time for each city, we might be able to give an explanation for the heterogeneous tipping points across cities and periods in the US.

## 7 Conclusion

This paper developed the dynamic version of statistical discrimination (Coate and Loury 1993). We have shown the importance of both the historical position and the expectation toward the future for the determination of the final group reputation, which is the overall qualification ratio of a group in

the long run. By identifying two stable states of high and low reputations and dynamic paths leading to them, we have defined an overlap in which both optimistic and pessimistic paths are available to a group, and determined the conditions under which the low reputation state is a reputation trap, in which a group cannot move out of the trap unless the market structure is adjusted. We have argued how a black group in a white-dominant society can be positioned in the reputation trap based on the initial level of group reputation and the non-existence of the optimistic path at the level.

We have determined that a high reputation state is *pareto* dominant to the low reputation state in a simple reputation model. Principals can make bigger profits when a social group is at a higher reputation state. By distinguishing monopolistic principals from competitive principals, we have examined the strategy of profit-maximizing monopolistic principals to change the market structure and help the disadvantaged group escape the reputation trap. We have emphasized that the farsightedness of principals and the credibility of their actions are pre-conditions for the effective implementation of the strategy. If those are not fulfilled or the coordination cost across employers is very high, the plight of a disadvantaged group will persist and the government intervention is necessary for the achievement of the egalitarian society. The policies may include colorblind hiring enforcement, quota system and asymmetric training subsidy. The examination of those policies in the given dynamic framework are left for the further research.

This dynamic reputation model is unique for explaining the collective reputation and the corresponding collective action to change the reputation. The model can be adjusted to examine other subjects concerned with collective reputation. Racial reputation for crime can be examined as O'Flaherty and Sethi (2004) do in a static model. Racial reputation for crime affects the reaction of victims and, in turn, affects the behavior of criminals. Collective action can be discussed for the change of racial representation for crime. Brand is another topic that involves collective reputation. Enterprises may be concerned with how to build up a valuable brand that represents heterogeneous products of the company. Similar work is done in Tirole (1996) in a game-theoretical manner. Institutional reputation such as college reputation may be an interesting subject of study, because the overall quality of alumni determines the collective reputation, and the reputation affects the quality of entering students and their willingness to pay the tuition. By identifying the multiple equilibria and dynamic paths, we can discuss the strategies for building the reputation of an institution.

## 8 Appendix A: Market Learning Process

In the reputation model developed in this paper, we assume that the true characteristics of each worker is not fully revealed in the market, even after he spends a long time in the workplace. To lose this assumption, we introduce the “market learning” process, in which the true characteristic of each worker is revealed and confirmed in the market under the Poisson process with parameter  $\eta$ : in a unit period, a worker faces average  $\eta$  chances to reveal his true characteristic in the market. Suppose that, once his true characteristic is revealed, he does not go through the regular screening process anymore, where signal  $\theta$  and identity  $i$  determine the chances to be assigned to task 1. Instead, after the revelation, he is always assigned to task one if he is a qualified worker, and to task zero if he is not.

Note that over  $T$  periods of time, the probability that his true characteristic is not revealed is  $e^{-\eta T}$ , and the probability that it is revealed is  $1 - e^{-\eta T}$  under the Poisson process of market learning. A worker with investment cost  $c$  invests only when the expected lifetime payoff of investment is greater than that of non-investment:

$$\text{Lifetime Payoff} = \begin{cases} \int_t^\infty [e^{-\eta(\tau-t)}\beta_q(\Pi_\tau) + (1 - e^{-\eta(\tau-t)})w] e^{-(\delta+\lambda)(\tau-t)} d\tau - c, & \text{(Investment.)} \\ \int_t^\infty [e^{-\eta(\tau-t)}\beta_u(\Pi_\tau) + (1 - e^{-\eta(\tau-t)})0] e^{-(\delta+\lambda)(\tau-t)} d\tau. & \text{(Non-investment.)} \end{cases}$$

Therefore, a worker with investment cost  $c$  invests only when, noting  $\beta_\tau = \beta_q(\Pi_\tau) - \beta_u(\Pi_\tau)$ ,

$$\int_t^\infty \beta_\tau e^{-(\delta+\lambda+\eta)(\tau-t)} d\tau + \frac{\eta w}{(\delta + \lambda)(\delta + \lambda + \eta)} > c.$$

Using this, we have a normalized lifetime benefits of investment  $V_t$ ,

$$V_t = (\delta + \lambda) \int_t^\infty \beta_\tau e^{-(\delta+\lambda+\eta)(\tau-t)} d\tau + \frac{\eta w}{\delta + \lambda + \eta}.$$

Taking the derivative, we have the evolution of lifetime benefits of investment,

$$\dot{V}_t = (\delta + \lambda + \eta) \left[ V_t - \frac{\delta + \lambda}{\delta + \lambda + \eta} \beta_t - \frac{\eta w}{\delta + \lambda + \eta} \right].$$

Since  $\dot{\Pi}_t$  is the same to the original model, dynamic system with the consideration of market



learning becomes,

$$\begin{aligned}\dot{\Pi}_t &= \lambda[\phi_t - \Pi_t] \\ \dot{V}_t &= (\delta + \lambda + \eta) \left[ V_t - \frac{\delta + \lambda}{\delta + \lambda + \eta} \beta_t - \frac{\eta w}{\delta + \lambda + \eta} \right],\end{aligned}$$

with demarcation loci of

$$\begin{aligned}\dot{\Pi}_t = 0 \text{ Locus} &: \Pi_t = \phi_t \\ \dot{V}_t = 0 \text{ Locus} &: V_t = \frac{\delta + \lambda}{\delta + \lambda + \eta} \beta_t + \frac{\eta w}{\delta + \lambda + \eta}.\end{aligned}$$

The dynamic paths with positive  $\eta$  are described in Appendix Figure 1. The revelation of workers' true characteristics does not make a big difference to the original reputation model. The only difference is that the demarcation locus of  $\dot{V}_t = 0$ , denoted by  $\tilde{V}_t(\Pi_t)$ , shifts to the right with the market learning consideration. The more the true characteristic of a worker is likely to be revealed, the more the demarcation locus shifts to the right:  $\frac{\partial \tilde{V}_t(\Pi_t)}{\partial \eta} > 0$ , which implies that two equilibrium levels of group reputations ( $\Pi_h, \Pi_l$ ) and their corresponding benefits of investment ( $V_h, V_l$ ) increase with the higher degree of market learning.

If you apply this to the simplified model with uniform distributions of  $f_u(\theta)$  and  $f_q(\theta)$ , we can evaluate how overlap changes with the introduction of market learning:  $\frac{\partial \pi_p}{\partial \eta} < 0$ , which means that the deterministic range for  $Q_h$  expands with the higher degree of market learning. (Refer to Appendix B for the proof.) The change is described in Panel B in the same figure. Therefore, a group is more likely to converge to the high reputation state  $Q_h$  when the market learns workers' true characteristics faster.<sup>4</sup>

Note that there exists a degree of market learning  $\eta^*$  above which the lower reputation state  $Q_l$  is not economically stable:  $Q_l$  is not stable with  $\eta > \frac{(\delta + \lambda)((\delta + \lambda)c_m - wP_q)}{w - (\delta + \lambda)c_m} (= \eta^*)$ . (Refer to Appendix B for the proof.) This implies that all social groups will converge to the high reputation state  $Q_h$ , regardless of their initial group reputations, when the degree of market leaning is high enough. Therefore, if the market can learn the true characteristics of workers very quickly, there will be no group disparity caused by the difference of initial group reputations or statistical discrimination practice in the market.

---

<sup>4</sup>Note that the sign of  $\frac{\partial \pi_p}{\partial \eta}$  is not clear in the simplified reputation model.

## 9 Appendix B: Proofs

### 9.1 Proof of Lemma 1

Suppose a starting point  $a$  on the  $\Pi = \Pi^*$  line nearby the state  $(v^*, \Pi^*)$ :  $a(v_a, \Pi^*)$ . The initial state at  $a$  moves counterclockwise according to the direction arrows depicted in Panel A of Appendix Figure 2. Suppose the path starting from  $a$  passes across the  $v = v^*$  line at  $b(v^*, \Pi_b)$ , the  $\Pi = \Pi^*$  line at  $c(v_c, \Pi^*)$ , the  $v = v^*$  line at  $d(v^*, \Pi_d)$  and the  $\Pi = \Pi^*$  line at  $a'(v_{a'}, \Pi^*)$ , as described in the same panel. The first-order differential system in each region is described in Figure 3. In region I, the slope of the phase path is represented by  $\frac{\dot{v}}{\dot{\Pi}} = \frac{(\delta+\lambda)(v_t-1)}{\lambda(\Pi_h-\Pi_t)}$ . Thus, we can find the relationship between  $v_a$  and  $\Pi_b$ ,

$$\int_{v_a}^{v^*} \frac{dv}{(\delta+\lambda)(v-1)} = \int_{\Pi^*}^{\Pi_b} \frac{d\Pi}{\lambda(\Pi_h-\Pi)} \implies \left(\frac{1-v_a}{1-v^*}\right)^{\frac{\lambda}{\delta+\lambda}} = \frac{\Pi_h-\Pi_b}{\Pi_h-\Pi^*}. \quad (15)$$

Also, in region II, the slope of the phase path is represented by  $\frac{\dot{v}}{\dot{\Pi}} = \frac{(\delta+\lambda)(v_t-1)}{\lambda(\Pi_l-\Pi_t)}$ . Thus, we can find the relationship between  $v_c$  and  $\Pi_b$ ,

$$\int_{v^*}^{v_c} \frac{dv}{(\delta+\lambda)(v-1)} = \int_{\Pi_b}^{\Pi^*} \frac{d\Pi}{\lambda(\Pi_l-\Pi_s)} \implies \left(\frac{1-v_c}{1-v^*}\right)^{\frac{\lambda}{\delta+\lambda}} = \frac{\Pi_b-\Pi_l}{\Pi^*-\Pi_l}. \quad (16)$$

From (15) and (16), we can derive the relationship between  $v_a$  and  $v_c$ , taking  $\Pi_b$  out. The following formula summarizes the result, denoting  $\frac{\lambda}{\delta+\lambda}$  as  $\rho'$ :

$$(1-v_a)^{\rho'}(\Pi_h-\Pi^*) + (1-v_c)^{\rho'}(\Pi^*-\Pi_l) = (1-v^*)^{\rho'}(\Pi_h-\Pi_l). \quad (17)$$

Therefore,  $v_a$  is a function of  $v_c$  in  $v_c \in [0, v^*]$ :  $v_a(v_c)$ . Note that  $v_a(v^*) = v^*$ . In the same way, out of regions III and IV, we can derive the relationship between  $v'_a$  and  $v_c$ , taking  $\Pi_d$  out. In region III, the slope of the phase path is represented by  $\frac{\dot{v}}{\dot{\Pi}} = \frac{(\delta+\lambda)v_t}{\lambda(\Pi_l-\Pi_t)}$ . Thus, we can find the relationship between  $v_c$  and  $\Pi_d$ ,

$$\int_{v_c}^{v^*} \frac{dv}{(\delta+\lambda)v} = \int_{\Pi^*}^{\Pi_d} \frac{d\Pi}{\lambda(\Pi_l-\Pi)} \implies \left(\frac{v_c}{v^*}\right)^{\frac{\lambda}{\delta+\lambda}} = \frac{\Pi_d-\Pi_l}{\Pi^*-\Pi_l}. \quad (18)$$

Also, in region IV, the slope of the phase path is represented by  $\frac{\dot{v}}{\dot{\Pi}} = \frac{(\delta+\lambda)v_t}{\lambda(\Pi_h-\Pi_t)}$ . Thus, we can find the relationship between  $v_{a'}$  and  $\Pi_d$ ,

$$\int_{v^*}^{v_{a'}} \frac{dv}{(\delta+\lambda)v} = \int_{\Pi_d}^{\Pi^*} \frac{d\Pi}{\lambda(\Pi_h-\Pi)} \implies \left(\frac{v'_{a'}}{v^*}\right)^{\frac{\lambda}{\delta+\lambda}} = \frac{\Pi_h-\Pi_d}{\Pi_h-\Pi^*}. \quad (19)$$

From (18) and (19), we have the following formula that indicates the relationship between  $v_{a'}$  and  $v_c$ , denoting  $\frac{\lambda}{\delta+\lambda}$  as  $\rho'$ :

$$v_{a'}^{\rho'}(\Pi_h-\Pi^*) + v_c^{\rho'}(\Pi^*-\Pi_l) = v^{\rho'}(\Pi_h-\Pi_l). \quad (20)$$

Therefore,  $v_{a'}$  is a function of  $v_c$  in  $v_c \in [0, v^*]$ :  $v_{a'}(v_c)$ . Note that  $v_{a'}(v^*) = v^*$ .

To prove Lemma 1, we need the following two conditions to be satisfied, as depicted in Panel B of

Appendix Figure 2:

- **Condition 1:** Two curves  $v_a(v_c)$  and  $v_{a'}(v_c)$  are tangent at  $(v^*, v^*)$ :  $\left. \frac{dv_a}{dv_c} \right|_{(v^*, v^*)} = \left. \frac{dv_{a'}}{dv_c} \right|_{(v^*, v^*)}$

- **Condition 2:**  $v_a(v_c)$  is concave and  $v_{a'}(v_c)$  is convex in  $[0, v^*]$ :  $\frac{d^2 v_a}{dv_c^2} < 0$  and  $\frac{d^2 v_{a'}}{dv_c^2} > 0, \forall v_c \in [0, v^*]$ .

**Proof of Condition 1.** From equation (17), let us define the function F,  $F = (1 - v_a)^{\rho'}(\Pi_h - \Pi^*) + (1 - v_c)^{\rho'}(\Pi^* - \Pi_l) - (1 - v^*)^{\rho'}(\Pi_h - \Pi_l) = 0$ . By the implicit function theorem,  $F_{v_a} dv_a + F_{v_c} dv_c = 0$ . Therefore, we have

$$\frac{dv_a}{dv_c} = - \frac{(1 - v_c)^{\rho'-1}}{(1 - v_a)^{\rho'-1}} \cdot \frac{\Pi^* - \Pi_l}{\Pi_h - \Pi^*}. \quad (21)$$

This gives the slope of the curve  $v_a(v_c)$  at  $(v^*, v^*)$ :  $\left. \frac{dv_a}{dv_c} \right|_{(v^*, v^*)} = - \frac{\Pi^* - \Pi_l}{\Pi_h - \Pi^*}$ . From equation (20), let us define the function G,  $G = v_{a'}^{\rho'}(\Pi_h - \Pi^*) + v_c^{\rho'}(\Pi^* - \Pi_l) - v^* \rho'(\Pi_h - \Pi_l) = 0$ . By the implicit function theorem,  $G_{v_{a'}} dv_{a'} + G_{v_c} dv_c = 0$ . Therefore, we have

$$\frac{dv_{a'}}{dv_c} = - \frac{v_c^{\rho'-1}}{v_{a'}^{\rho'-1}} \cdot \frac{\Pi^* - \Pi_l}{\Pi_h - \Pi^*}. \quad (22)$$

This gives the slope of the curve  $v_{a'}(v_c)$  at  $(v^*, v^*)$ :  $\left. \frac{dv_{a'}}{dv_c} \right|_{(v^*, v^*)} = - \frac{\Pi^* - \Pi_l}{\Pi_h - \Pi^*}$ . Therefore, condition 1 is satisfied.

**Proof of Condition 2.** From equations (17) and (21),  $\frac{dv_a}{dv_c}$  can be expressed in terms of  $v_c$ ,

$$\frac{dv_a}{dv_c} = - \frac{(1 - v_c)^{\rho'-1}}{[-(1 - v_c)^{\rho'}(\Pi^* - \Pi_l) + (1 - v^*)^{\rho'}(\Pi_h - \Pi_l)]^{\frac{\rho'-1}{\rho'}}} \cdot \frac{\Pi^* - \Pi_l}{(\Pi_h - \Pi^*)^{\frac{1}{\rho'}}}.$$

Taking the second derivative with respect to  $v_c$ , the following result follows:  $\frac{d^2 v_a}{dv_c^2} < 0$  as far as  $\delta > 0$ . From (20) and (22),  $\frac{dv_{a'}}{dv_c}$  can be expressed in terms of  $v_c$ ,

$$\frac{dv_{a'}}{dv_c} = - \frac{v_c^{\rho'-1}}{[-v_c^{\rho'}(\Pi^* - \Pi_l) + v^* \rho'(\Pi_h - \Pi_l)]^{\frac{\rho'-1}{\rho'}}} \cdot \frac{\Pi^* - \Pi_l}{(\Pi_h - \Pi^*)^{\frac{1}{\rho'}}}.$$

Taking the second derivative with respect to  $v_c$ , the following result follows:  $\frac{d^2 v_{a'}}{dv_c^2} > 0$  as far as  $\delta > 0$ . Therefore, condition 2 is satisfied.

The results imply that when starting in a neighborhood around  $(s^*, v^*)$ , the equilibrium path spirals out. Therefore, the state  $(s^*, v^*)$  is unstable because any tiny perturbation to the state will make the state  $(s_t, v_t)$  move away from it. (However, note that  $\frac{d^2 v_a}{dv_c^2} = \frac{d^2 v_{a'}}{dv_c^2} = 0$  if  $\delta = 0$ . This implies that the equilibrium paths are cyclical, like a vortex, if the time discount rate( $\delta$ ) is zero.) QED.

## 9.2 Proof of Lemma 2

The slope of the equilibrium path in region  $IV$  is  $\frac{\dot{v}}{v}|_{IV} = \frac{\lambda(\Pi_h - \Pi_t)}{(\delta + \lambda)v_t}$ . The first derivative of the slope is

$$\frac{d}{dv_t} \left[ \frac{\dot{v}}{v}|_{IV} \right] = -\frac{\lambda(\Pi_h - \Pi_t)}{(\delta + \lambda)v_t^2} - \frac{\lambda\Pi_h}{(\delta + \lambda)v_t} \cdot \frac{d\Pi_t}{dv_t} < 0.$$

Therefore, in region  $IV$ , the equilibrium paths are concave.

The slope of the equilibrium path in region  $I$  is  $\frac{\dot{v}}{v}|_I = \frac{\lambda(\Pi_h - \Pi_t)}{(\delta + \lambda)(v_t - 1)}$ . The first derivative of the slope is

$$\frac{d}{dv_t} \left[ \frac{\dot{v}}{v}|_I \right] = -\frac{\lambda(\Pi_h - \Pi_t)}{(\delta + \lambda)(v_t - 1)^2} - \frac{\lambda\Pi_h}{(\delta + \lambda)(v_t - 1)} \cdot \frac{d\Pi_t}{dv_t} < 0.$$

Therefore, in region  $I$ , the equilibrium paths are concave. In sum, at the righthand side of the  $v_t = v^*$  line, equilibrium paths are concave. In the same way, we can prove that equilibrium paths are convex at the lefthand side of the  $v_t = v^*$  line. QED.

## 9.3 Proof of Proposition 3

First, let us check expected benefits at  $Q_h$  and  $Q_l$  for workers with different investment cost levels:

1. Agents with Low Investment Cost

They invest at either  $Q_h$  or  $Q_l$ . At  $Q_h$ , the size of normalized lifetime benefits is  $\omega$ . At  $Q_l$ , it is  $\omega P_q$ .

2. Agents with High Investment Cost

They do not invest at either  $Q_h$  or  $Q_l$ . At  $Q_h$ , the size of normalized lifetime benefits is  $\omega(1 - P_u)$ . At  $Q_l$ , it is zero.

3. Agents with Medium Level of Investment Cost

They invest at  $Q_h$ , but do not invest at  $Q_l$ . At  $Q_h$ , the size of normalized lifetime benefits is  $\omega - (\delta + \lambda)c_m$ , which is positive in the given dynamic structure. At  $Q_l$ , it is zero.

Second, let us check the profits of principals:

1. Profits at  $Q_h$ : Principals give the benefit of doubt to agents with unclear signals. Thus, at point of time  $\tau$ , the expected profits from the workers with low investment cost is  $\Pi_l x_q$ , the expected profit from the workers with high investment cost is  $(1 - \Pi_h)(1 - P_u)(-x_u)$ , and the expected profit from the medium cost workers is  $(\Pi_h - \Pi_l)x_q$  because they invest at  $Q_h$ . Therefore, the total profit at time  $\tau$  is  $Y_\tau(Q_h) = -(1 - \Pi_h)(1 - P_u)x_u + \Pi_h x_q$ .

2. Profits at  $Q_l$ : Principals do not give the benefit of doubt. Thus, at point of time  $\tau$ , the expected profit from the workers with low investment cost is  $\Pi_l P_q x_q$ , the expected profit from the workers with high investment cost or medium investment cost is zero, because they do not invest and principals do not give BOD. Therefore, the total profit at time  $\tau$  is  $Y_\tau(Q_l) = \Pi_l P_q x_q$ .

The given condition  $\Pi_l < \Pi^* < \Pi_h$  implies that  $Y_\tau(Q_h) > Y_\tau(Q_l)$ . Thus, all workers with different investment cost and principals are better off at  $Q_h$  than at  $Q_l$ . QED.

#### 9.4 Proof of Lemma 4

Given the dynamic system in equations (1), its linearization around a steady state  $(\bar{v}, \bar{\Pi})$  is

$$\begin{aligned}\dot{V}_t &= (\delta + \lambda)(\bar{V} - \beta_t(\bar{\Pi})) - (\delta + \lambda)\beta'_t(\bar{\Pi})(\Pi_t - \bar{\Pi}) + (\delta + \lambda)(V_t - \bar{V}) \\ \dot{\Pi}_t &= \lambda(\phi_t(\bar{V}) - \bar{\Pi}) - \lambda(\Pi_t - \bar{\Pi}) + \lambda\phi'_t(\bar{V})(V_t - \bar{V}).\end{aligned}$$

Since  $(\bar{V}, \bar{\Pi})$  is a steady state, it is

$$\begin{aligned}\dot{V}_t &= (\delta + \lambda)V_t - (\delta + \lambda)\beta'_t(\bar{\Pi})\Pi_t + (\delta + \lambda)[- \bar{V} + \beta'_t(\bar{\Pi})\bar{\Pi}] \\ \dot{\Pi}_t &= \lambda\phi'_t(\bar{V})V_t - \lambda\Pi_t + \lambda[-\phi'_t(\bar{V})\bar{V} + \bar{\Pi}].\end{aligned}$$

Therefore, the Jacobian matrix  $J_E$  evaluated at a steady state is

$$J_E \equiv \begin{bmatrix} \delta + \lambda & -(\delta + \lambda)\beta'_t \\ \lambda\phi'_t & -\lambda \end{bmatrix}_{(\bar{V}, \bar{\Pi})}.$$

Consequently, its transpose is  $tr J_E = \delta$  and the determinant is  $|J_E| = \lambda(\delta + \lambda)[\beta'_t\phi'_t - 1]$ . Since  $tr J_E$  is positive, every steady state is unstable. Note that  $|J_E|$  is negative if and only if  $\frac{\partial\beta_t}{\partial\Pi_t} < \left(\frac{\partial\phi_t}{\partial V_t}\right)^{-1}$  at  $(\bar{V}, \bar{\Pi})$ . This is true for the two steady states  $Q_h$  and  $Q_l$  as easily confirmed in Panel B of Figure 5. Therefore, the characteristic roots for  $Q_h$  and  $Q_l$  are one positive and one negative. Therefore, those are saddle points. In the same way, we can confirm that  $|J_E|$  is positive at  $Q_m$ , which means two positive characteristics. Therefore,  $Q_m$  is a source, either unstable node or unstable focus. QED.

#### 9.5 Proof of Lemma 5

Note that the characteristic roots are, based on the proof of Lemma 4,

$$r_1, r_2 = \frac{\delta \pm \sqrt{\delta^2 - 4\lambda(\delta + \lambda)[\beta'_t\phi'_t - 1]}}{2}.$$

Since we already shown that  $Q_m$  is a source in the same lemma, if both  $r_1$  and  $r_2$  are imaginary numbers, then the trajectories around  $Q_m$  spiral out. Therefore, if  $\delta^2 - 4\lambda(\delta + \lambda)[\beta'_t\phi'_t - 1](\equiv D)$  is negative, they spiral out. The condition is summarized as follows:

$$D < 0 \iff \left(1 + \frac{\lambda}{\delta}\right) \frac{\lambda}{\delta} > \frac{1}{4(\phi'_t\beta'_t - 1)} \Big|_{(V_m, \Pi_m)}.$$

QED.

## 9.6 Proof of Appendix A

First, we prove that  $\frac{\partial \pi_p}{\partial \eta} < 0$ . If we transpose the dynamic system with  $V_t = \frac{\delta+\lambda}{\delta+\lambda+\eta} \omega P_q + \frac{\eta w}{\delta+\lambda+\eta} + \frac{\delta+\lambda}{\delta+\lambda+\eta} \omega (P_u - P_q) v_t$ , we can use the following result in section 3.3.2 directly from the simple reputation model developed in this paper:  $\pi^p = \Pi_l + (\Pi^* - \Pi_l)(1 - v^{*'})^{-\frac{\lambda}{\delta+\lambda+\eta}}$ , where  $v^{*'} = \frac{(\delta+\lambda+\eta)(\delta+\lambda)c_m - (\delta+\lambda)\omega P_q - \eta w}{(\delta+\lambda)(\omega P_u - \omega P_q)}$ . (Note that the differential equations with the transpose are identical to those in Figure 3, except using  $(\delta + \lambda + \eta)$  instead of using  $(\delta + \lambda)$ .) The partial derivative with respect to  $\eta$  gives  $\frac{\partial \pi_p}{\partial \eta} < 0$ .

Secondly, we prove that there exists  $\eta^*$  above which  $Q_l$  is not economically stable, where  $\eta^* = \frac{(\delta+\lambda)((\delta+\lambda)c_m - wP_q)}{w - (\delta+\lambda)c_m}$ . You can check that the demarcation locus of  $\dot{V}_t = 0$  below  $\Pi^*$ , which is  $\frac{\delta+\lambda}{\delta+\lambda+\eta} \omega P_q + \frac{\eta w}{\delta+\lambda+\eta}$ , becomes greater than  $(\delta + \lambda)c_m$ , when  $\eta > \eta^*$ . The other way is to check the sign of  $v^{*'}$ : when  $v^{*'}$  is negative,  $Q_l$  cannot be stable, as the dynamic system of the simple reputation model in Figures 4 and 5 implies. QED.

## Reference

- Adsera, A and D. Ray (1998). "History and Coordination Failure," *Journal of Economic Growth* 3: 267-276.
- Arrow, K.J. (1973). "The Theory of Discrimination," In Ashenfelter and Rees, editions, *Discrimination in Labor Markets*.
- Bowles, S., G.C. Loury and R. Sethi (2007). "Group Inequality," Unpublished Manuscript, Barnard College, Columbia University.
- Blume, Lawrence (2006), "The Dynamics of Statistical Discrimination," *Economic Journal* 116: F480 - F498.
- Card, D., A. Mas and J. Rothstein (2007). "Tipping and the Dynamics of Segregation," NBER working paper 13502.
- Chaudhuri, S. and R. Sethi (2008). "Statistical Discrimination with Peer Effects: Can Integration Eliminate Negative Stereotypes?" *Review of Economic Studies* 78: 579 - 596.
- Coate, S. and G.C. Loury (1993). "Will Affirmative-Action Policies Eliminate Negative Stereotype?" *American Economic Review* 83: 1220-1240.
- Fryer, Roland, Glenn C. Loury and Tolga Yuret (2006). "An Economic Analysis of Color-Blind Affirmative Action," *Journal of Law, Economics and Organization*, forthcoming.
- Fryer, Roland and Glenn C. Loury (2005). "Affirmative Action and Its Mythology," *Journal of Economic Perspectives* 19.
- Kim, Young Chul (2008). "Network Externality and Dynamics of Group Inequality," Unpublished Manuscript, Brown University.
- Krugman, Paul (1991). "History Versus Expectations," *Quarterly Journal of Economics* 106: 651-667.
- Levin, Jonathan (2009). "The Dynamics of Collective Reputation," *The B.E. Journal of Theoretical Economics* 9.
- Loury, Glenn C. (1977). "A Dynamic Theory of Racial Income Differences," In *Women, Minorities and Employment Discrimination*, edited by Phyllis Wallace and Annette LaMond.
- Loury, Glenn C. (1995). "Economic Discrimination: Getting to the Core of the Problem," in *One By One From the Inside Out: Essays and Reviews on Race and Responsibility in America*. New York: The Free Press.
- Loury, Glenn C. (2002). *The Anatomy of Racial Inequality*, Harvard University Press
- Moro, A. and P. Norman (2003). "Affirmative Action in a Competitive Economy," *Journal of Public Economics* 87: 567-594.

- Moro, A. and P. Norman (2003). "A General Equilibrium Model of Statistical Discrimination," *Journal of Economic Theory* 114: 1-30.
- Myrdal, Gunnar. (1962), *An American Dilemma: The Negro Problem and Modern Democracy*. New York: Pantheon Books.
- Norman, P. (2003). "Statistical Discrimination and Efficiency," *Review of Economic Studies* 70: 615-627.
- O'Flaherty, D. and R. Sethi (2008). "Racial Stereotypes and Robbery," *Journal of Economic Behavior & Organization*, forthcoming.
- Phelps, E. (1972). "The Statistical Theory of Racism and Sexism," *American Economic Review* 62: 659-661.
- Schwab, S. (1986). "Is Statistical Discrimination Efficient?" *American Economic Review* 76: 229-234.
- Spence, Michael A. (1974). *Market Signaling: Information Transfer in Hiring and Related Screening Processes*, Cambridge, MA: Harvard University Press.
- Tirole, Jean (1996). "A Theory of Collective Reputation," *Review of Economic Studies* 63: 1-22.



Figure 1. Multiple Steady States with Noisy Signals

Panel A. Noisy Signals

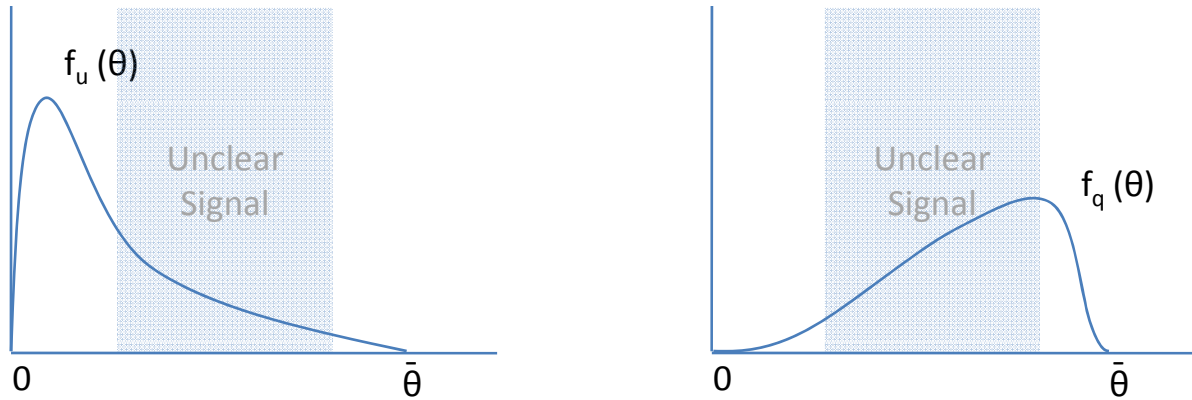

Panel B. Three Steady States

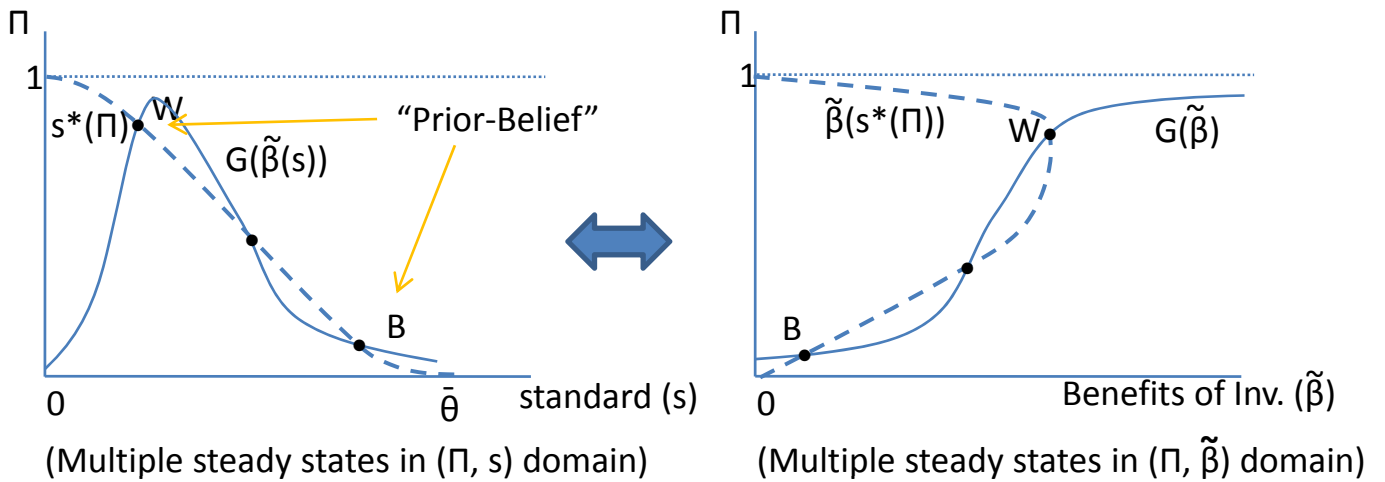
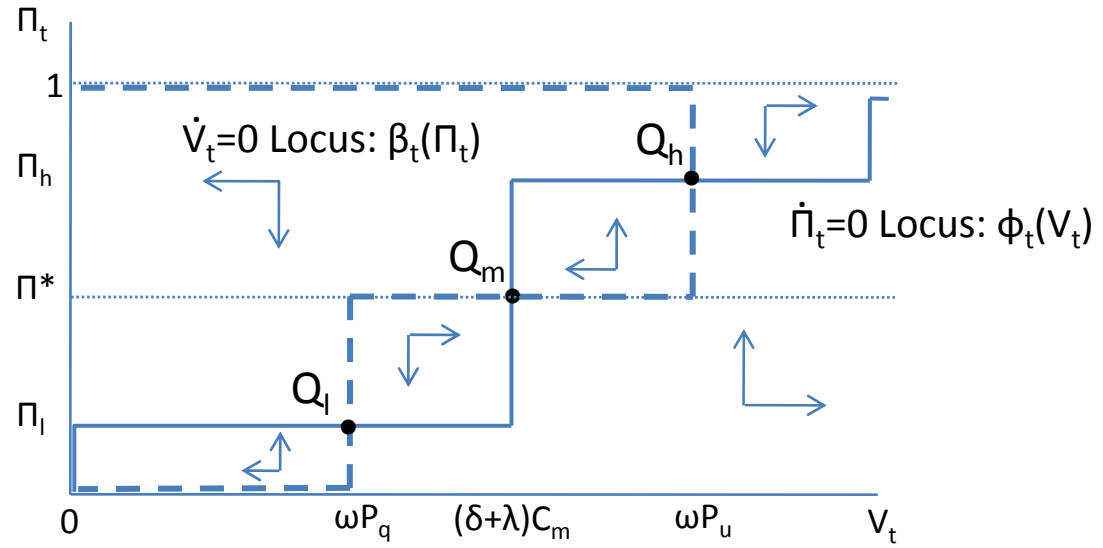

Figure 2. Phase Space in Simple Model

Panel A. Phase Diagram



Panel B. Equilibrium Paths

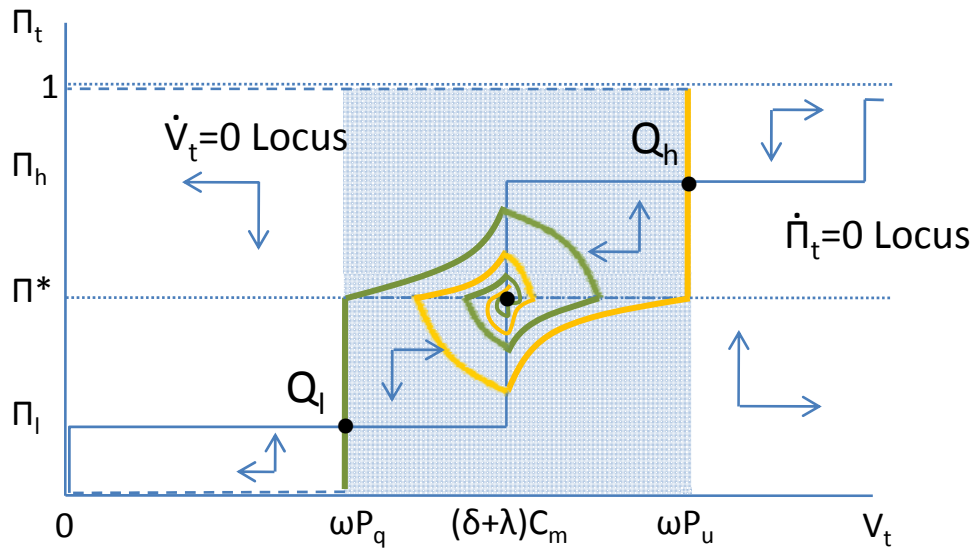

Figure 3. Differential Equations in Modified Simple Model

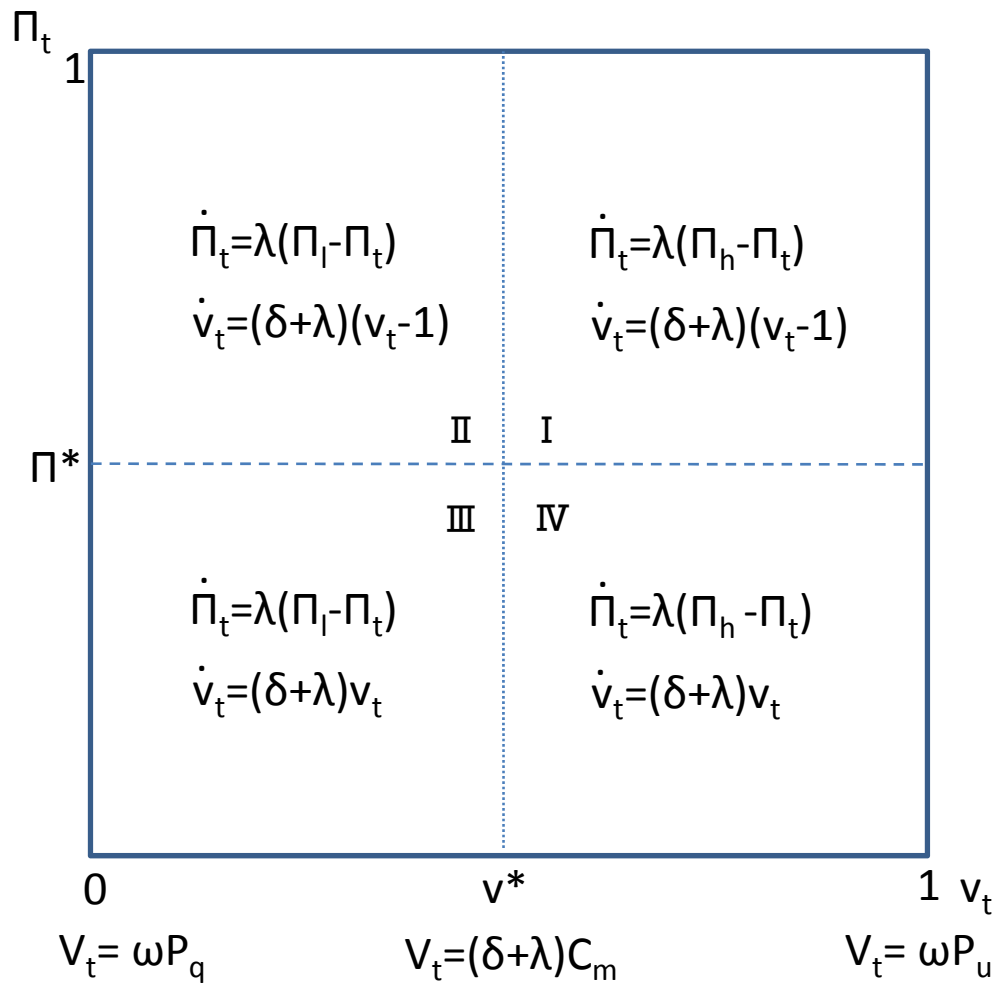

Figure 4. Phase Space in Modified Simple Model

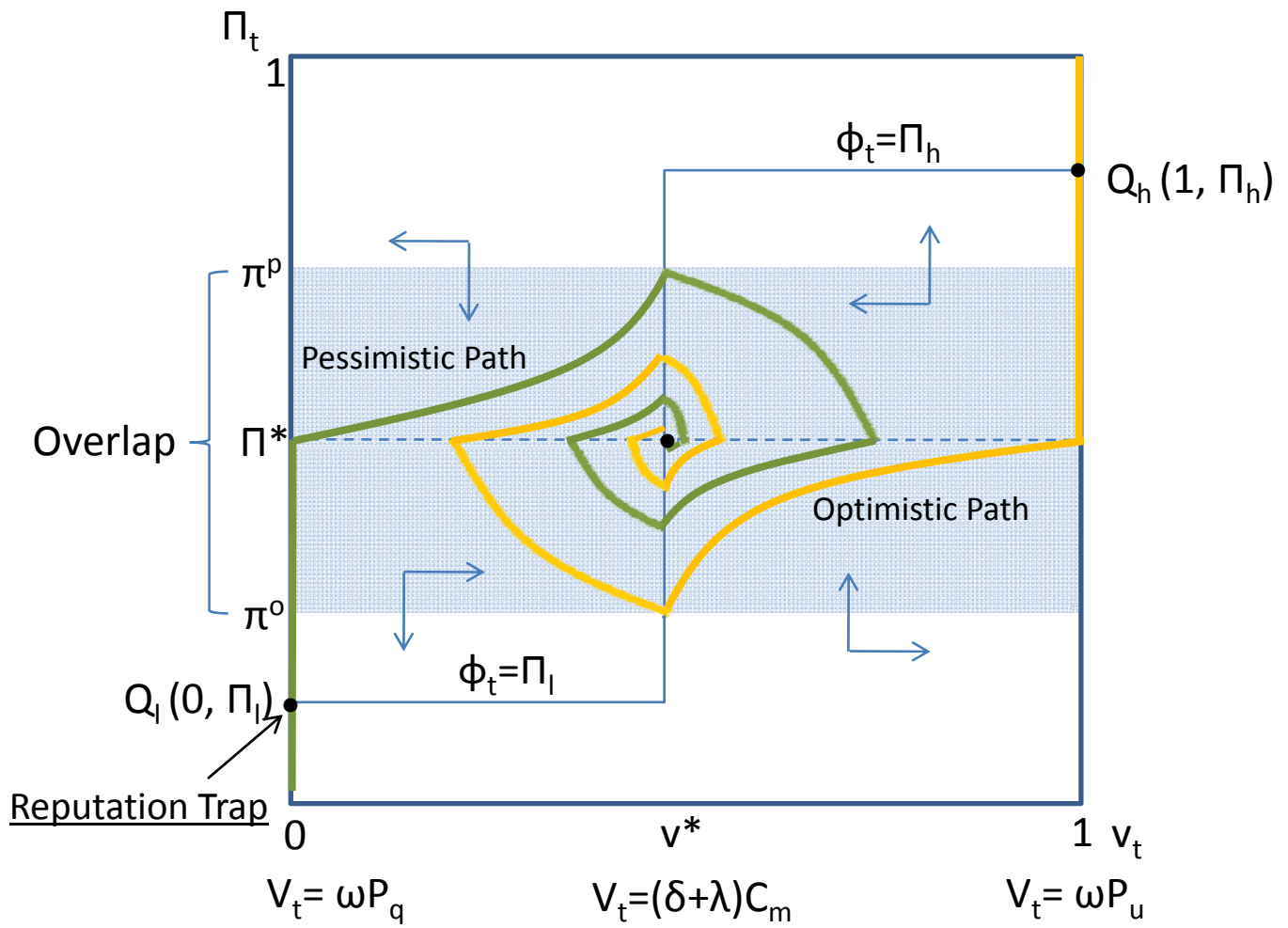
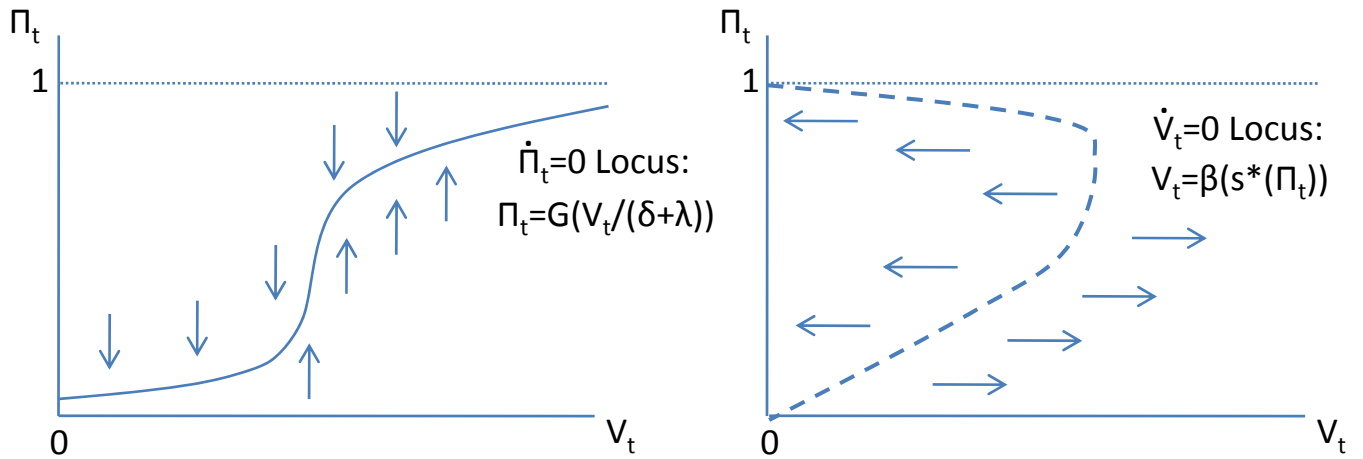

Figure 5. Phase Diagram in Generalized Model

Panel A. Demarcation Loci



Panel B. Phase Diagram

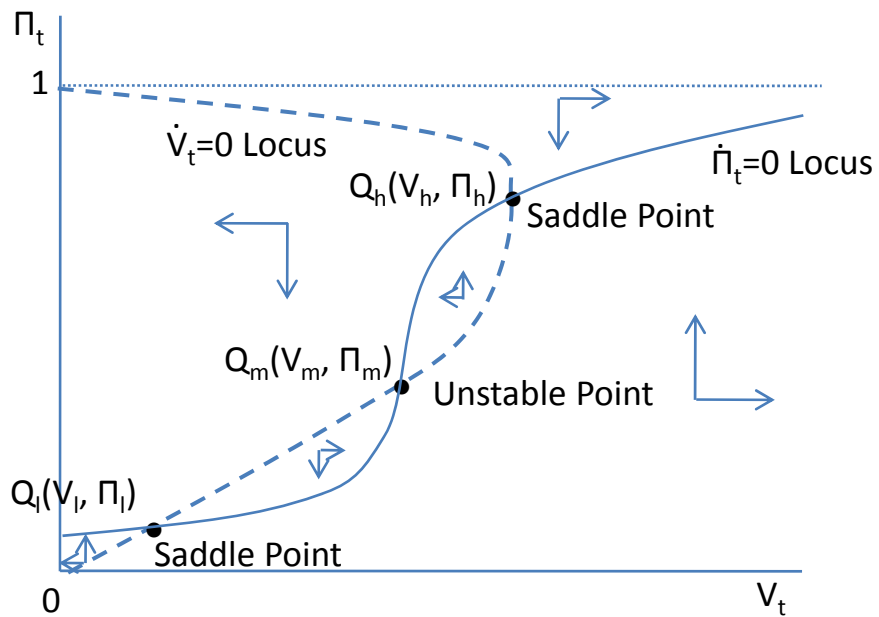
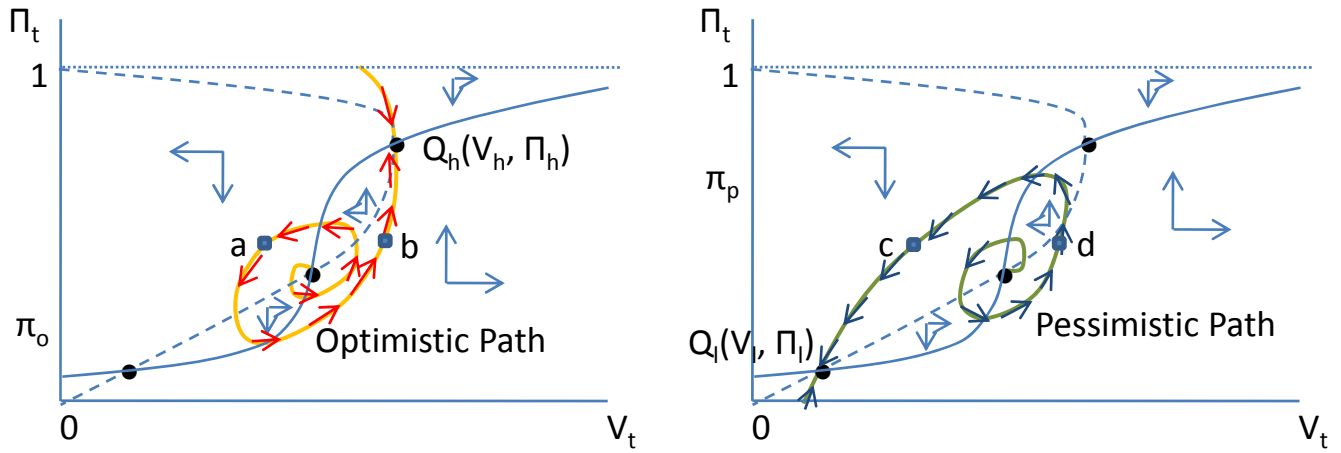

Figure 6. Equilibrium Paths in Generalized Model

Panel A. Equilibrium Paths



Panel B. Overlap and Reputation Trap

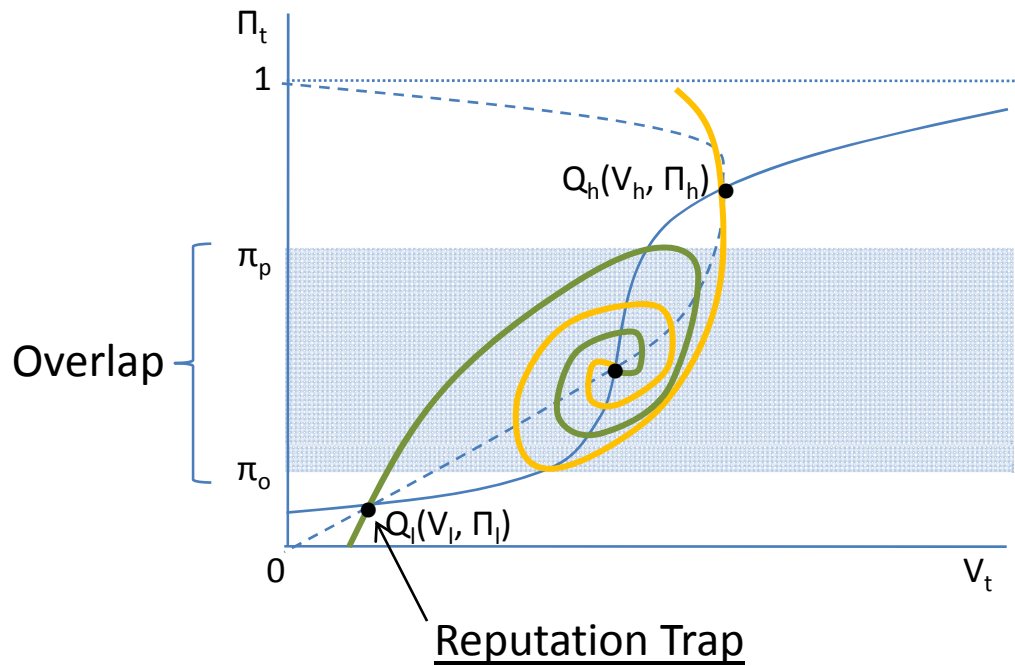

Figure 7. Development of US Racial Disparity

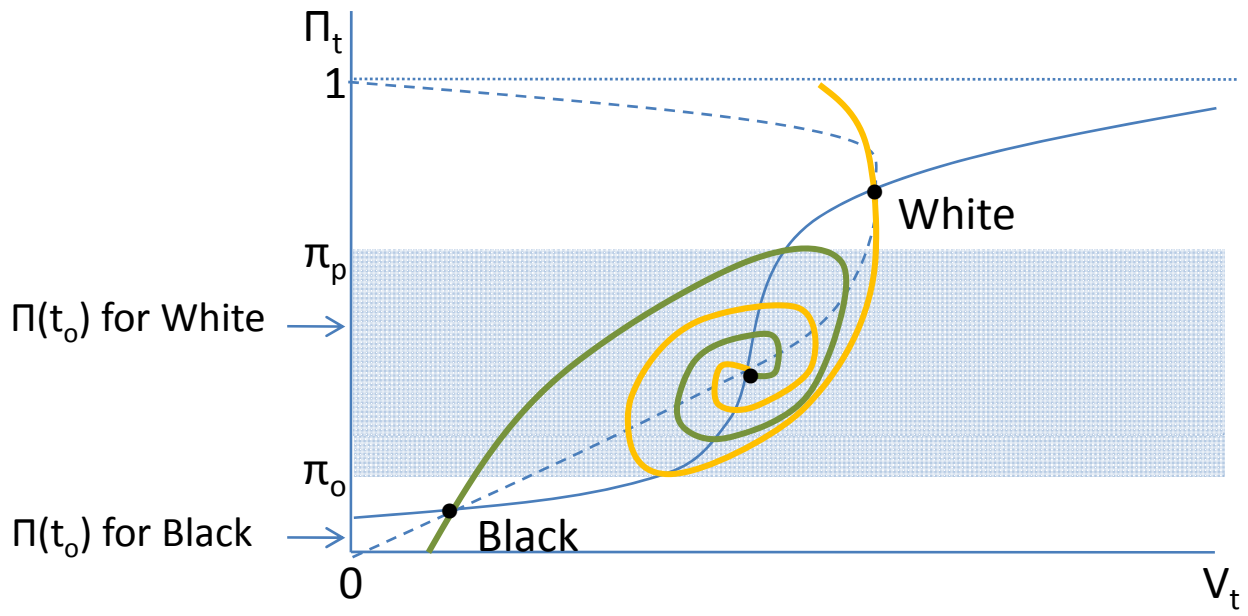
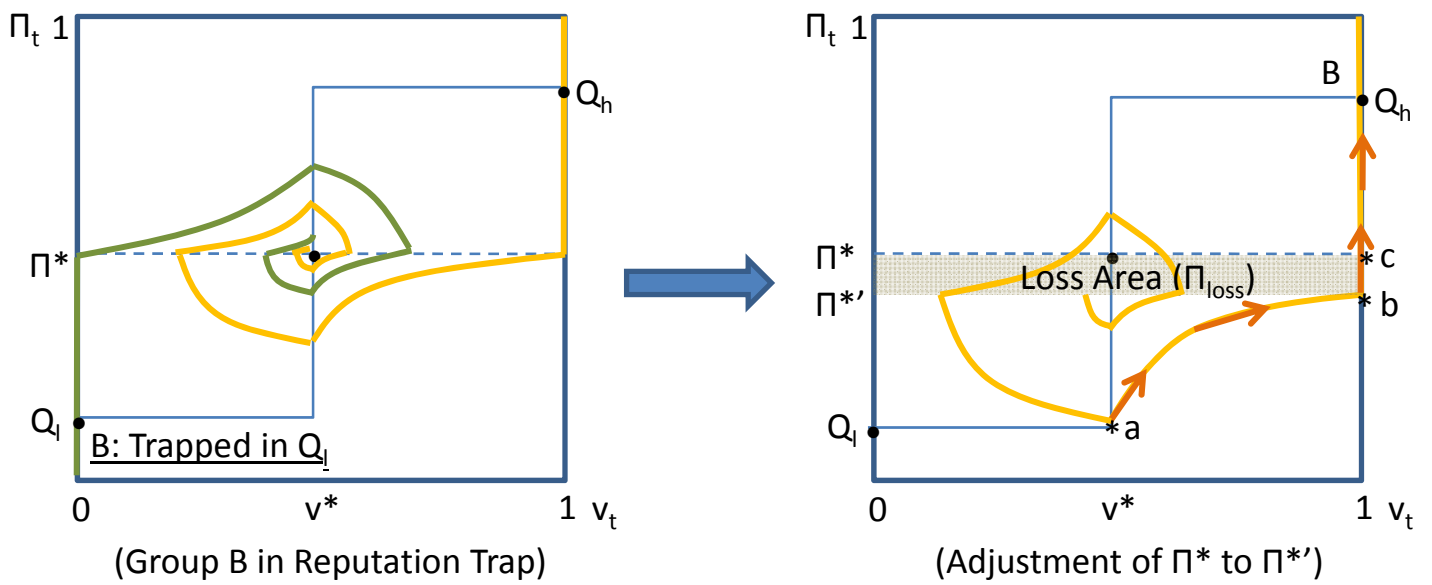
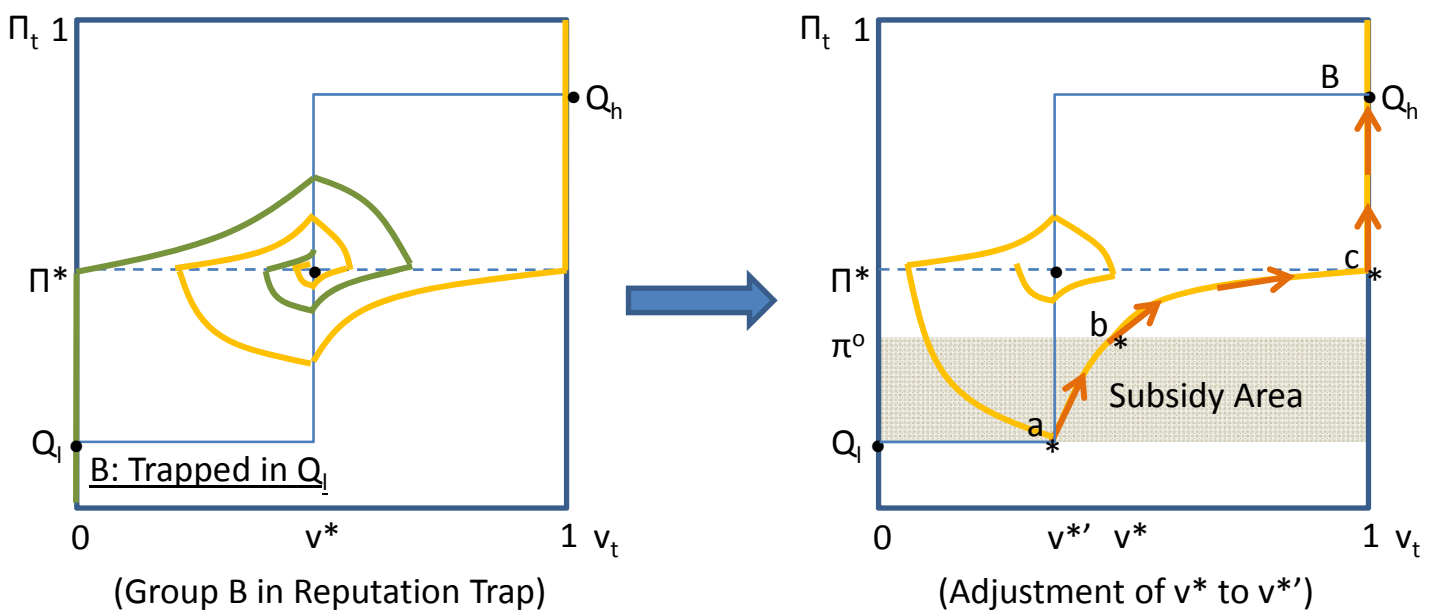

Figure 8. Strategy of Monopolistic Principals

Panel A. Adjustment of Reputation Threshold



Panel B. Training Subsidy





# [Appendix Figure 1] Market Learning Process

## Panel A. Market Learning in General Model

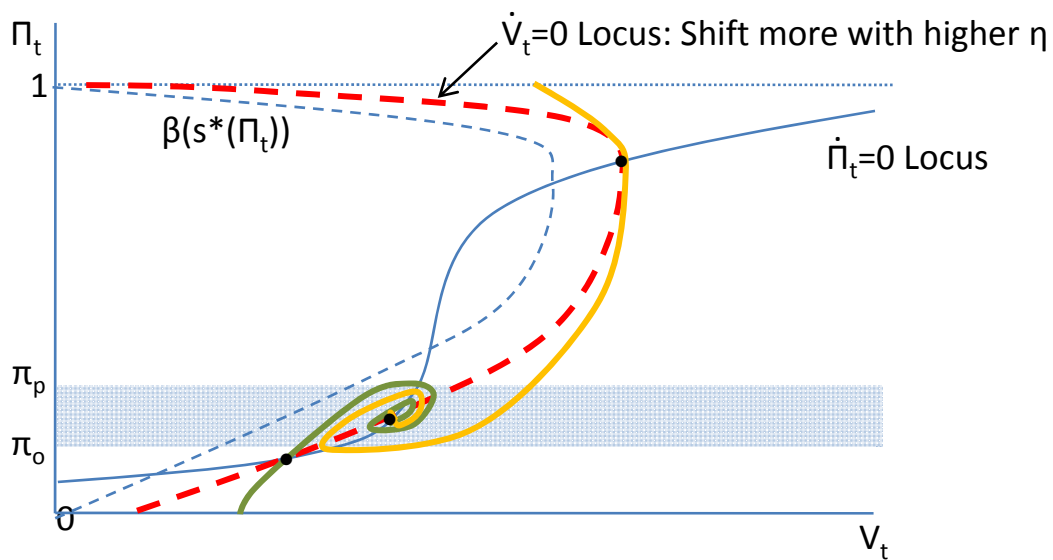

## Panel B. Market Learning in Simple Model

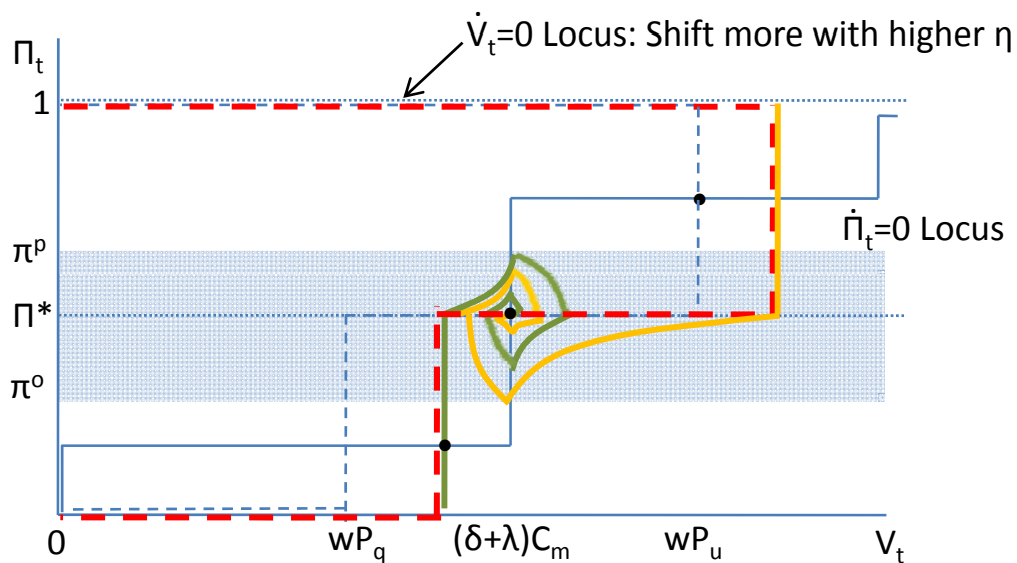

[Appendix Figure 2] Proof of Lemma 1

Panel A Phase Path Passing  $a$

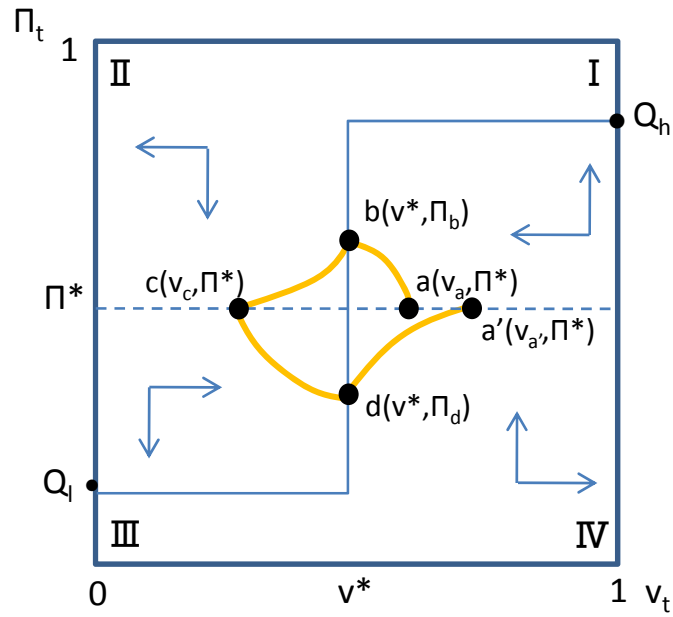

Panel B Compare  $v_a$  and  $v_{a'}$

