

268

**Reihe Ökonomie
Economics Series**

The Tragedy of Annuity

Ben J. Heijdra, Jochen O. Mierau, Laurie S. M. Reijnders



**INSTITUT FÜR HÖHERE STUDIEN
INSTITUTE FOR ADVANCED STUDIES
Vienna**

268

**Reihe Ökonomie
Economics Series**

The Tragedy of Annuity

Ben J. Heijdra, Jochen O. Mierau, Laurie S. M. Reijnders

May 2011

**Institut für Höhere Studien (IHS), Wien
Institute for Advanced Studies, Vienna**

Contact:

Ben J. Heijdra
Faculty of Economics and Business
University of Groningen
P.O. Box 800
9700 AV Groningen, The Netherlands
☎: +31/50/363-7303
Fax: +31/50/363-7337
email: info@heijdra.org
and
Institute for Advanced Studies, CESifo, Netspar

Jochen O. Mierau
Faculty of Economics and Business
University of Groningen
P.O. Box 800
9700 AV Groningen, The Netherlands
☎: +31/50/363-8534
Fax: +31/50/363-7337
email: j.o.mierau@rug.nl

Laurie S.M. Reijnders
Faculty of Economics and Business
University of Groningen
P.O. Box 800
9700 AV Groningen, The Netherlands
☎: +31/50/363-4001
Fax: +31/50/363-7337
email: lauriereijnders@gmail.co

Founded in 1963 by two prominent Austrians living in exile – the sociologist Paul F. Lazarsfeld and the economist Oskar Morgenstern – with the financial support from the Ford Foundation, the Austrian Federal Ministry of Education and the City of Vienna, the Institute for Advanced Studies (IHS) is the first institution for postgraduate education and research in economics and the social sciences in Austria. The **Economics Series** presents research done at the Department of Economics and Finance and aims to share “work in progress” in a timely way before formal publication. As usual, authors bear full responsibility for the content of their contributions.

Das Institut für Höhere Studien (IHS) wurde im Jahr 1963 von zwei prominenten Exilösterreichern – dem Soziologen Paul F. Lazarsfeld und dem Ökonomen Oskar Morgenstern – mit Hilfe der Ford-Stiftung, des Österreichischen Bundesministeriums für Unterricht und der Stadt Wien gegründet und ist somit die erste nachuniversitäre Lehr- und Forschungsstätte für die Sozial- und Wirtschaftswissenschaften in Österreich. Die **Reihe Ökonomie** bietet Einblick in die Forschungsarbeit der Abteilung für Ökonomie und Finanzwirtschaft und verfolgt das Ziel, abteilungsinterne Diskussionsbeiträge einer breiteren fachinternen Öffentlichkeit zugänglich zu machen. Die inhaltliche Verantwortung für die veröffentlichten Beiträge liegt bei den Autoren und Autorinnen.

Abstract

We construct a tractable discrete-time overlapping generations model of a closed economy and use it to study government redistribution of accidental bequests and private annuities in general equilibrium. Individuals face longevity risk as there is a positive probability of passing away before the retirement period. We find non-pathological cases where it is better for long-run welfare to waste accidental bequests than to give them to the elderly. Next we study the introduction of a perfectly competitive life insurance market offering actuarially fair annuities. There exists a tragedy of annuitization: although full annuitization of assets is privately optimal it is not socially beneficial due to adverse general equilibrium repercussions.

Keywords

Longevity risk, risk sharing, overlapping generations, intergenerational transfers, annuity markets

JEL Classification

D52, D91, E10, J20

Contents

1	Introduction	1
2	The model	3
	2.1 Consumers	3
	2.2 Demography	5
	2.3 Production	5
	2.4 Government	6
	2.5 Equilibrium	7
3	The exogenous growth model	8
	3.1 Stability and transition	8
	3.1.1 Transfers to the old	14
	3.1.2 Transfers to the young	18
	3.2 Welfare analysis	20
	3.2.1 Transfers to the old	21
	3.2.2 Transfers to the young	26
4	Tragedy of annuitization	27
	4.1 From wasteful expenditure to perfect annuities	28
	4.2 From transfers to the young to perfect annuities	31
	4.3 Discussion	37
5	The endogenous growth model	38
6	Conclusion	42
	References	44

1 Introduction

Although death is one of the true certainties in life, the date at which it occurs is unknown to all but the most desperate individuals. Faced with life-time uncertainty, rational non-altruistic agents must balance the risk of leaving unconsumed wealth in the form of unintended (accidental) bequests against the risk of running out of resources in old age. As was shown in the classic analysis of Yaari (1965) and more recently by Davidoff et al. (2005), life annuities are very attractive insurance instruments in the presence of longevity risk. Intuitively, annuities allow for risk sharing between lucky (long-lived) and unlucky (short-lived) individuals (Kotlikoff et al., 1986). These increased risk-sharing opportunities ensure that life annuities are welfare maximizing from a microeconomic perspective, i.e. in a partial equilibrium setting.

From a macroeconomic perspective, however, it is not immediately clear whether or not annuities are welfare improving. There are two key mechanisms that are ignored in a partial equilibrium analysis. First, in the absence of private annuities there will be accidental bequests which, provided they are redistributed in one way or another to surviving agents, boost the consumption opportunities of such agents. See, among others, Sheshinski and Weiss (1981), Abel (1985), Pecchenino and Pollard (1997), and Fehr and Habermann (2008) on this point. Second, the availability of annuities affects the rate of return on an individual's savings. As a result, aggregate capital accumulation will generally depend on whether or not annuity opportunities are available. Capital accumulation in turn determines wages and the interest rate if factor prices are endogenous.

The objective of this paper is to study the general equilibrium effects of life annuities. Our model has the following features. First, we postulate a simple general equilibrium model of a closed economy. On the production side we allow for a capital accumulation externality of the form proposed by Romer (1989). The production model is quite flexible in that it can accommodate both the exogenous and the endogenous growth models as special cases.

Second, we assume that the economy is populated by overlapping generations of two-period-lived agents facing longevity risk. Just as in the Diamond (1965) model life consists of two phases, namely youth and old age, but unlike that model there is a positive probability of death at the end of youth. At birth, agents are identical in the sense that they feature the same preferences, have the same labour productivity, and face the same death probability.

Third, in the absence of annuities we assume that the resulting accidental bequests flow to

the government. We investigate the general equilibrium effects of three prototypical revenue recycling schemes. In particular, the policy maker can (a) engage in wasteful expenditure (the WE scenario), (b) give lump-sum transfers to the old (the TO scenario), or (c) provide lump-sum transfers to the young (the TY scenario).

Fourth, we compare the different revenue recycling schemes with the case in which annuities are available. In particular, we assume that private annuity markets are perfectly competitive. With perfect annuities (the PA scenario) the probability of death determines the wedge between the rate of return on physical capital and the annuity rate of return. Since the latter exceeds the former, rational non-altruistic individuals fully annuitize their savings.

The main finding of the paper concerns the phenomenon which we call the *tragedy of annuitization*: although full annuitization of assets is privately optimal it may not be socially beneficial due to adverse general equilibrium repercussions. If all agents invest their financial wealth in the annuity market then the resulting long-run equilibrium leaves everyone worse off compared to the case where annuities are absent and accidental bequests are redistributed to the young (or even wasted by the government). In the exogenous growth model we demonstrate the existence of two versions of the tragedy. In the *strong* version, opening up perfect annuity markets in an economy in which accidental bequests initially go to waste (switch from WE to PA) results in a decrease in steady-state welfare of newborns. Interestingly, this rather surprising result holds for a reasonable (i.e., low) value of the intertemporal substitution elasticity. In such a case the beneficial effects of annuitization are more than offset by a substantial drop in the long-run capital intensity and in wages. Future newborns would have been better off if no annuity markets had been opened.

There is also a *weak* version of the tragedy in the exogenous growth model. If the economy is initially in the equilibrium with accidental bequests flowing to the young, then opening up annuity markets will reduce steady-state welfare regardless of the magnitude of the intertemporal substitution elasticity. Intuitively, private annuities redistribute assets from deceased to surviving elderly in an actuarially fair way whereas transferring unintended bequests to the young constitutes an intergenerational transfer. This intergenerational transfer induces beneficial savings effects, which, in the end, lead to higher welfare.

In the endogenous growth model and restricting attention to realistic values for the intertemporal substitution elasticity, both versions of the tragedy show up in terms of the

macroeconomic growth rate. Growth is highest in the TY case, and the rate under the WE case exceeds the one for the PA scenario.

The structure of the paper is as follows. Section 2 presents the model in its most general form. Section 3 studies the analytical properties of the exogenous growth version of the model. It also computes, both analytically and quantitatively, the allocation and welfare effects of scenario switches. Section 4 is the core of the paper. It shows what happens to allocation and welfare if a perfectly competitive annuity market is opened up at some point in time. It also highlights the importance of initial conditions, i.e. it demonstrates that the results depend not only on the availability of annuities but also on the scenario that is replaced by these insurance markets. Section 5 briefly discusses the effects of annuitization in the endogenous growth version of the model. Section 6 restates the main results and presents some possible extensions. All mathematical details can be found in Heijdra, Mierau, and Reijnders (2010).

2 The model

2.1 Consumers

Each agent lives for a maximum of two periods and faces a positive probability of death between the first and the second period. Agents work full-time during the first period of their lives (termed “youth”) and – if they survive – retire in the second period (“old age”). The expected lifetime utility of an individual born at time t is given by:

$$\mathbb{E}\Lambda_t^y \equiv U(C_t^y) + \frac{1-\pi}{1+\rho}U(C_{t+1}^o), \quad (1)$$

where C_t^y and C_{t+1}^o are consumption during youth and old age, respectively, $\rho > 0$ is the pure rate of time preference, and $\pi > 0$ is the probability of death. Individuals have no bequest motive and, therefore, attach no utility to savings that remain after they die. We assume that the utility function is of the CRRA type:

$$U(C) = \begin{cases} \frac{C^{1-1/\sigma} - 1}{1 - 1/\sigma} & \text{if } \sigma > 0, \sigma \neq 1, \\ \ln C & \text{if } \sigma = 1, \end{cases} \quad (2)$$

where σ is the elasticity of intertemporal substitution. The agent's budget identities for youth and old age are given by:

$$C_t^y + S_t = w_t + Z_t^y, \quad (3a)$$

$$C_{t+1}^o = Z_{t+1}^o + (1 + r_{t+1})S_t, \quad (3b)$$

where w_t is the wage rate, r_t is the interest rate, S_t denotes the level of savings, and Z_t^y and Z_{t+1}^o are transfers received from the government during either youth or old age (see below). Combining the equations in (3) yields the consolidated lifetime budget constraint:

$$C_t^y + \frac{C_{t+1}^o}{1 + r_{t+1}} = w_t + Z_t^y + \frac{Z_{t+1}^o}{1 + r_{t+1}}. \quad (4)$$

If an agent dies before reaching old age his savings flow to the government in the form of an accidental bequest. Due to mortality risk agents are not allowed to hold negative savings (i.e. loans). In case of premature death their loans would be unaccounted for.

The agent chooses C_t^y , C_{t+1}^o and S_t in order to maximize expected lifetime utility (1) subject to the budget constraint (4) and a non-negativity constraint on savings. Assuming an interior optimum ($S_t > 0$), the agent's optimal plans are fully characterized by:

$$C_t^y = \Phi(r_{t+1}) \left[w_t + Z_t^y + \frac{Z_{t+1}^o}{1 + r_{t+1}} \right], \quad (5)$$

$$\frac{C_{t+1}^o}{1 + r_{t+1}} = [1 - \Phi(r_{t+1})] \left[w_t + Z_t^y + \frac{Z_{t+1}^o}{1 + r_{t+1}} \right], \quad (6)$$

$$S_t = [1 - \Phi(r_{t+1})] [w_t + Z_t^y] - \Phi(r_{t+1}) \frac{Z_{t+1}^o}{1 + r_{t+1}}, \quad (7)$$

where $\Phi(r_{t+1})$ is the marginal propensity to consume out of total wealth (wage income and transfers) in the first period:

$$\Phi(r_{t+1}) \equiv \left[1 + \left(\frac{1 - \pi}{1 + \rho} \right)^\sigma (1 + r_{t+1})^{\sigma-1} \right]^{-1}, \quad 0 < \Phi(\cdot) < 1. \quad (8)$$

Note that the impact of a change in the future interest rate on current savings is fully determined by the elasticity of intertemporal substitution σ . For the special case with $\sigma = 1$ (logarithmic utility) savings are completely independent of the interest rate.¹ The income

¹If the government provides transfers to the old ($Z_{t+1}^o > 0$) there is also a positive human wealth effect on saving. In this paper, however, such transfers are proportional to the interest factor, $1 + r_{t+1}$, so that this human wealth effect is not operative. If the agent would also work in old age then the human wealth effects would result in an increase in the savings elasticity.

effect of a higher interest rate is exactly offset by the substitution effect induced by a lower price of second period consumption. In the more general case with $\sigma > 1$ savings increase as the interest increases because the substitution effect dominates the income effect. If, on the other hand, $\sigma < 1$ the income effect is stronger than the substitution effect and savings decline as the interest rate rises.²

2.2 Demography

The population grows at an exogenous rate $n > 0$ so that every period a cohort of $L_t = (1 + n)L_{t-1}$ young agents is born. In principle each generation lives for two periods, but not all of its members survive the transition from youth to old age. The total population at time t is equal to $P_t \equiv (1 - \pi)L_{t-1} + L_t$.

2.3 Production

There is a constant and large number of identical and perfectly competitive firms. The technology available to each individual firm i is given by:

$$Y_{it} = \Omega_t K_{it}^\alpha N_{it}^{1-\alpha}, \quad 0 < \alpha < 1, \quad (9)$$

where Y_{it} is output, K_{it} is the employed capital stock, N_{it} is the amount of labour used in the production process, α is the capital share of output and Ω_t is the aggregate level of technology in the economy which is considered as given by individual firms. Factor demands of the individual firm are given by the following marginal productivity conditions:

$$w_t = (1 - \alpha)\Omega_t k_{it}^\alpha, \quad (10a)$$

$$r_t + \delta = \alpha\Omega_t k_{it}^{\alpha-1}, \quad (10b)$$

where $k_{it} \equiv K_{it}/N_{it}$ is the capital intensity of firm i and $\delta > 0$ is the depreciation rate. Under the assumption of perfect competition in both factor markets all firms face the same factor prices and, therefore, they all choose the same level of capital intensity $k_{it} = k_t$.

²From the empirical perspective the most relevant case appears to be the one with $0 < \sigma < 1$. See, for example, Skinner (1985) and Attanasio and Weber (1995) who report estimates ranging between, respectively, 0.3 to 0.5, and 0.6 to 0.7.

Generalizing the insights of Pecchenino and Pollard (1997, p. 28) to a growing population we postulate that the inter-firm investment externality takes the following form:

$$\Omega_t = \Omega_0 k_t^\eta, \quad 0 < \eta \leq 1 - \alpha, \quad (11)$$

where Ω_0 is a constant, $k_t \equiv K_t/N_t$ is the economy-wide capital intensity, $K_t \equiv \sum_i K_{it}$ is the total stock of capital and $N_t \equiv \sum_i N_{it}$ is the total labour force.

According to (11) total factor productivity increases in line with the aggregate capital intensity in the economy. That is, if an individual firm increases its capital stock all firms benefit through a boost in the general productivity level Ω_t . The strength of this inter-firm investment externality is governed by the parameter η . If $0 \leq \eta < 1 - \alpha$ then the long-run growth rate in per capita variables is exogenously determined and equal to zero. In the knife-edge case with $\eta = 1 - \alpha$ the investment externality exactly offsets the decrease in marginal productivity following an addition to the capital stock. The aggregate production sector then exhibits single-sector endogenous growth of the type described in Romer (1989).

Using the general productivity index (11) we can write output (9) and factor prices (10) in aggregate terms:

$$y_t = \Omega_0 k_t^{\alpha+\eta}, \quad (12)$$

$$w_t = (1 - \alpha) \Omega_0 k_t^{\alpha+\eta}, \quad (13)$$

$$r_t = \alpha \Omega_0 k_t^{\alpha+\eta-1} - \delta, \quad (14)$$

where $y_t \equiv Y_t/N_t$ is the level of output per worker and $Y_t \equiv \sum_i Y_{it}$ is aggregate output. We assume that the economy is sufficiently productive to assure a positive interest rate even when the investment externality attains its knife-edge value, i.e. $\alpha \Omega_0 > \delta$.

2.4 Government

The government administers the allocation of the accidental bequests, maintains a period-by-period balanced budget, and does not issue debt or retain funds. The government's budget constraint is therefore given by:

$$\pi (1 + r_t) L_{t-1} S_{t-1} = (1 - \pi) L_{t-1} Z_t^o + L_t Z_t^y + G_t. \quad (15)$$

That is, the total assets left behind by the agents who perish before reaching old age (left-hand side) are used to finance total transfers to the survivors Z_t^o , transfers to the newly arrived

young Z_t^y , and unproductive government expenditure G_t .

We assume that the government can choose between two financing scenarios. Either it redistributes all its proceeds among the surviving agents in the form of lump-sum transfers or it uses the funds solely for unproductive government spending.

Transfer scenario. The government can either give the revenues exclusively to the young or exclusively to the old.³

(TY) If all the proceeds go to the young then $Z_t^o = G_t = 0$ in (15) and transfers to the young are given by:

$$Z_t^y = \frac{\pi(1+r_t)L_{t-1}S_{t-1}}{L_t}. \quad (16a)$$

(TO) If all the transfers accrue to the elderly, both $Z_t^y = G_t = 0$ in (15) and transfers to the old are given by:

$$Z_t^o = \frac{\pi(1+r_t)L_{t-1}S_{t-1}}{(1-\pi)L_{t-1}}. \quad (16b)$$

Unproductive spending scenario.

(WE) If the full receipts from accidental bequests are used for unproductive government spending then $Z_t^y = Z_t^o = 0$ in (15) and wasteful government expenditures are:

$$G_t = \pi(1+r_t)L_{t-1}S_{t-1}. \quad (16c)$$

2.5 Equilibrium

In equilibrium both factor markets must clear. As all young agents work full-time and all old agents are retired, the labour market equilibrium condition simply states that the total labour force must equal the total number of young agents, i.e. $N_t = L_t$. The capital market clearing condition implies that aggregate savings of the generation born at time $t-1$ must be equal to the total stock of productive capital in period t , i.e. $K_t = L_{t-1}S_{t-1}$. It immediately follows

³Any convex combination of these two options is also feasible. We focus on the two extreme cases for ease of illustration.

that, in equilibrium, the three revenue recycling scenarios implied by (16a)-(16c) above can be rewritten as:

$$Z_t^y = \pi (1 + r_t) k_t, \quad (17a)$$

$$Z_t^o = \frac{1+n}{1-\pi} \pi (1 + r_t) k_t, \quad (17b)$$

$$g_t = \pi (1 + r_t) k_t, \quad (17c)$$

where $g_t \equiv G_t/L_t$ are per worker government expenditures.

Substituting per capita savings (7) into the capital market clearing condition and using the aggregate factor prices (13) and (14) provides the fundamental difference equation of the model:

$$(1+n) k_{t+1} = [1 - \Phi(r_{t+1})] [w_t + Z_t^y] - \Phi(r_{t+1}) \frac{Z_{t+1}^o}{1+r_{t+1}}. \quad (18)$$

For future reference we summarize the system of equations that characterizes the macroeconomic equilibrium in Table 1. Equations (T1.1)–(T1.3) are the consumption and saving demand functions, (T1.4) states the definition for the marginal propensity to consume, equations (T1.5) and (T1.6) are the factor prices, (T1.7) is the government budget constraint with capital market equilibrium imposed, and (T1.8) is the fundamental difference equation.

3 The exogenous growth model

In this section and the next we study the exogenous growth version of our model, i.e. we assume that the capital accumulation externality parameter satisfies $0 \leq \eta < 1 - \alpha$ so that there are diminishing returns to the macroeconomic capital stock. (The knife-edge model with $\eta = 1 - \alpha$ is briefly discussed in Section 5 below.) Throughout the paper we assume that the steady-state interest rate exceeds the rate of population growth. Empirical support for this assumption is provided by Abel et al. (1987).

Assumption 1 [*Dynamic efficiency*] For each scenario the corresponding steady-state interest rate \hat{r} satisfies $\hat{r} > n$.

3.1 Stability and transition

We first study the dynamic properties of the model under the assumption that the government wastes the revenues from accidental bequests (the WE scenario). One of the crucial structural

Table 1: The general model

(a) *Individual choices:*

$$C_t^y = \Phi(r_{t+1}) \left[w_t + Z_t^y + \frac{Z_{t+1}^o}{1+r_{t+1}} \right] \quad (\text{T1.1})$$

$$\frac{C_{t+1}^o}{1+r_{t+1}} = [1 - \Phi(r_{t+1})] \left[w_t + Z_t^y + \frac{Z_{t+1}^o}{1+r_{t+1}} \right] \quad (\text{T1.2})$$

$$S_t = [1 - \Phi(r_{t+1})] [w_t + Z_t^y] - \Phi(r_{t+1}) \frac{Z_{t+1}^o}{1+r_{t+1}} \quad (\text{T1.3})$$

$$\Phi(r_{t+1}) \equiv \left[1 + \left(\frac{1-\pi}{1+\rho} \right)^\sigma (1+r_{t+1})^{\sigma-1} \right]^{-1} \quad (\text{T1.4})$$

(b) *Factor prices and redistribution scheme:*

$$r_t = \alpha \Omega_0 k_t^{\alpha+\eta-1} - \delta \quad (\text{T1.5})$$

$$w_t = (1-\alpha) \Omega_0 k_t^{\alpha+\eta} \quad (\text{T1.6})$$

$$\pi(1+r_t)k_t = \frac{1-\pi}{1+n} Z_t^o + Z_t^y + g_t \quad (\text{T1.7})$$

(c) *Fundamental difference equation:*

$$(1+n)k_{t+1} = [1 - \Phi(r_{t+1})] [w_t + Z_t^y] - \Phi(r_{t+1}) \frac{Z_{t+1}^o}{1+r_{t+1}} \quad (\text{T1.8})$$

Definitions: Endogenous are C_t^y , C_{t+1}^o , S_t , r_{t+1} , w_t , k_t , and – depending on the redistribution scheme – one of Z_t^y or Z_t^o or g_t . Parameters: mortality rate π , population growth rate n , rate of time preference ρ , capital coefficient in the technology α , investment externality coefficient η , scale factor in the technology Ω_0 , and depreciation rate of capital δ .

parameters is the intertemporal substitution elasticity, σ . Whilst the model can accommodate a wide range of values for σ , we nevertheless make the following assumption.

Assumption 2 [*Admissible values for σ*] *The intertemporal substitution elasticity satisfies:*

$$0 < \sigma \leq \bar{\sigma} \equiv \frac{2 - \alpha - \eta}{1 - \alpha - \eta}.$$

We defend this assumption on two grounds. First, the restriction is very mild. Indeed, empirical evidence suggests that σ falls well short of unity whereas – even in the absence of external effects ($\eta = 0$) – $\bar{\sigma}$ is much larger than unity. For example, for a capital share of $\alpha = 0.3$ we find that $\bar{\sigma} = 2.43$. In the presence of external effects ($\eta > 0$) $\bar{\sigma}$ is even larger. Second, by restricting the range of admissible values for σ the existence and stability proofs are simplified substantially.

The fundamental difference equation under the WE scenario can be written as follows:

$$[\Psi(k_{t+1}) \equiv] \frac{k_{t+1}}{1 - \Phi(k_{t+1})} = \frac{(1 - \alpha)\Omega_0}{1 + n} k_t^{\alpha + \eta} \quad [\equiv \Gamma(k_t)], \quad (19)$$

where $\Phi(k)$ is given by:⁴

$$\Phi(k) \equiv \left[1 + \left(\frac{1 - \pi}{1 + \rho} \right)^\sigma (1 - \delta + \alpha\Omega_0 k^{\alpha + \eta - 1})^{\sigma - 1} \right]^{-1}. \quad (20)$$

It is easy to show that $\Psi' > 0$ and $\Gamma' > 0$. We can prove the following proposition.

Proposition 1 [*Existence and stability of the WE model*] *Consider the WE model as given in (19)–(20) and adopt Assumption 2. The following properties can be established:*

- (i) *The model has two steady-state solutions; the trivial one features $k_{t+1} = k_t = 0$, and the economically relevant satisfies $k_{t+1} = k_t = \hat{k}^{WE}$, where \hat{k}^{WE} is the solution to:*

$$\frac{\hat{k}^{WE}}{1 - \Phi(\hat{k}^{WE})} = \frac{(1 - \alpha)\Omega_0}{1 + n} (\hat{k}^{WE})^{\alpha + \eta}.$$

- (ii) *The trivial steady-state solution is unstable whilst the non-trivial solution is stable:*

$$0 < \frac{dk_{t+1}}{dk_t} < 1, \quad \text{for } k_{t+1} = k_t = \hat{k}^{WE}.$$

For any positive initial value the capital intensity converges monotonically to \hat{k}^{WE} .

⁴Equation (20) is obtained by substituting (T1.5) into (8).

Proof: See Heijdra et al. (2010, Appendix A). □

We visualize the corresponding phase diagram in Figure 1(a) for different values of the intertemporal substitution elasticity. This figure is based on the following plausible parameter values that are used throughout much of the paper. In the *benchmark* case we assume that the elasticity of intertemporal substitution is $\sigma = 1$ (i.e. log-utility), and that the investment externality is absent ($\eta = 0$). Each phase of life covers 40 years, the population grows by one percent per annum (so that $n = (1 + 0.01)^{40} - 1 = 0.49$), individuals face a probability of death between youth and old age of thirty percent ($\pi = 0.3$), the capital share of output is thirty percent ($\alpha = 0.3$), and the depreciation rate of capital is six percent per annum ($\delta = 0.92$). We set the production function constant and time preference rate such that output per worker is equal to unity and the interest rate is four percent per annum ($\hat{r} = 3.80$) in the WE scenario. We obtain $\Omega_0 = 2.29$ and $\rho = 3.47$ or 3.82% annually. The resulting steady-state values of the key variables of the model are given in Table 2(a).⁵ Note that Assumptions 1 and 2 are both satisfied for this calibration.

In Figure 1(a) the solid line represents the fundamental difference equation (19) (for $\sigma = 1$) and the dotted line is the steady-state condition $k_{t+1} = k_t$.⁶ The economically relevant steady-state equilibrium is at point E where the slope of (19) is strictly less than unity. Figure 1(b) plots $\Psi(k)$ (for different values of σ) and $\Gamma(k)$ separately. It conveniently illustrates the existence and stability properties of the two steady-state equilibria. In particular, it visualizes Proposition 1(ii) which proves that $\Gamma(k)$ is steeper (flatter) than $\Psi(k)$ around $k = 0$ ($k = \hat{k}$) for all feasible values of σ .

Suppose that at some time t the economy has converged to the steady-state implied by the WE scenario, i.e. $k_t = \hat{k}^{WE}$. What would happen at impact, during transition, and in the long run if the government were to switch to a transfer scenario? We study two such policy switches in turn, namely from WE to TO and from WE to TY.

⁵For different values of σ we re-calibrate the model (by choice of ρ and Ω_0) such that output and the interest rate remain the same in the WE scenario.

⁶The dash-dotted and dashed lines in Figure 1(a) represent the fundamental difference equation for different values of the intertemporal substitution elasticity, σ . Mathematically, these lines are described by $k_{t+1} = \Psi^{-1}(\Gamma(k_t))$.

Figure 1: Phase diagram and steady-state equilibria

(a) Phase diagram

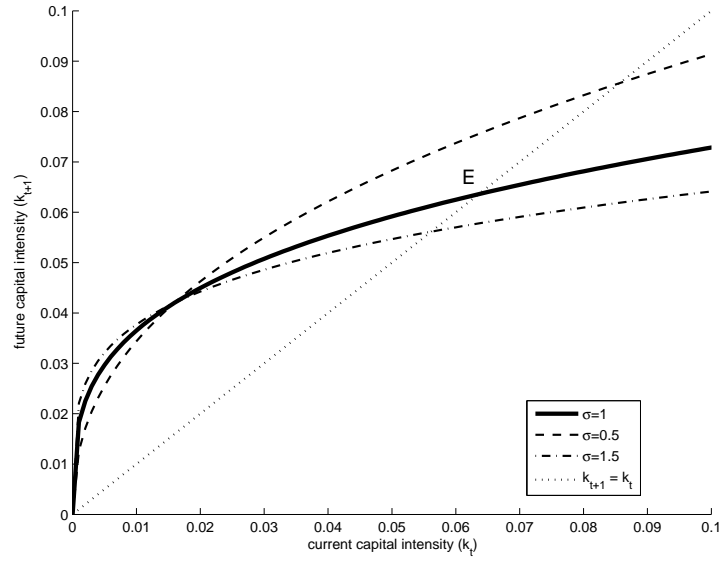

(b) Steady-state equilibria

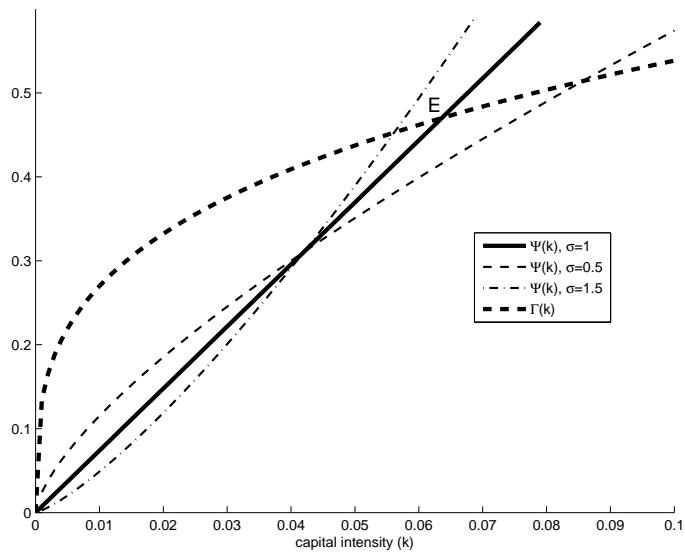

Table 2: Steady-state values with exogenous growth*

	Panel A: $\eta = 0, \sigma = 1$				Panel B: $\eta = 0, \sigma = \frac{1}{2}$				Panel C: $\eta = 0, \sigma = \frac{3}{2}$			
	(a)	(b)	(c)	(d)	(e)	(f)	(g)	(h)	(i)	(j)	(k)	(l)
	WE	TO	TY	PA	WE	TO	TY	PA	WE	TO	TY	PA
\hat{C}^y	0.6053	0.5512	0.7218	0.6053	0.6053	0.5057	0.7393	0.5577	0.6053	0.5681	0.7145	0.6226
\hat{C}^o	0.4546	0.5647	0.4804	0.6495	0.4546	0.5040	0.5002	0.5741	0.4546	0.5893	0.4725	0.6815
\hat{S}	0.0947	0.0604	0.1129	0.0947	0.0947	0.0417	0.1284	0.0746	0.0947	0.0693	0.1071	0.1104
\hat{Z}^o		0.1694				0.1512				0.1768		
\hat{Z}^y			0.0968				0.1008				0.0952	
\hat{y}	1.0000	0.8736	1.0542	1.0000	1.0000	0.7821	1.0957	0.8877	1.0000	0.9105	1.0377	1.0472
\hat{k}	0.0636	0.0405	0.0758	0.0636	0.0636	0.0280	0.0862	0.0428	0.0636	0.0465	0.0720	0.0742
\hat{w}	0.7000	0.6115	0.7380	0.7000	0.7000	0.5474	0.7670	0.6214	0.7000	0.6374	0.7264	0.7330
\hat{r}	3.8010	5.5491	3.2541	3.8010	3.8010	7.4546	2.8954	5.3121	3.8010	4.9544	3.4106	3.3198
\hat{r}_a	4.00	4.81	3.69	4.00	4.00	5.48	3.46	4.71	4.00	4.56	3.78	3.73
\hat{r}_a^A				4.93				5.65				4.65
$\widehat{\mathbb{E}\Lambda}^y$	-0.6253	-0.6851	-0.4406	-0.5695	-0.7930	-1.0930	-0.4699	-0.8801	-0.5816	-0.5988	-0.4322	-0.5003

*Hats denote steady-state values. To facilitate interpretation, \hat{r}_a and \hat{r}_a^A are reported as annual percentage rates of return.

3.1.1 Transfers to the old

The effects of a policy switch from the WE scenario to the TO scenario can be studied with the aid of the following fundamental difference equation:

$$[\Psi(k_{t+1}, z_1) \equiv] \frac{1 + z_1 \frac{\pi}{1-\pi} \Phi(k_{t+1})}{1 - \Phi(k_{t+1})} k_{t+1} = \Gamma(k_t), \quad (21)$$

where $\Gamma(k_t)$ is defined in (19) above, z_1 is a perturbation parameter ($0 \leq z_1 \leq 1$) and $\Psi(k_{t+1}, z_1)$ features positive partial derivatives $\Psi_k > 0$ and $\Psi_{z_1} > 0$. The case with $z_1 = 0$ is the WE scenario whilst for $z_1 = 1$ the TO case is obtained. The policy switch thus consists of a unit increase in z_1 occurring at time t in combination with the initial condition $k_t = \hat{k}^{WE}$. We provide the following proposition.

Proposition 2 [*Existence and stability of the TO model*] Consider the TO model as given in (21) and adopt Assumption 2. The following properties can be established:

- (i) The model has two steady-state solutions; the trivial one features $k_{t+1} = k_t = 0$, and the economically relevant one satisfies $k_{t+1} = k_t = \hat{k}^{TO}$, where \hat{k}^{TO} is the solution to:

$$\frac{1 + \frac{\pi}{1-\pi} \Phi(\hat{k}^{TO})}{1 - \Phi(\hat{k}^{TO})} \hat{k}^{TO} = \frac{(1 - \alpha) \Omega_0}{1 + n} (\hat{k}^{TO})^{\alpha+\eta}.$$

- (ii) The trivial steady-state solution is unstable whilst the non-trivial solution is stable:

$$0 < \frac{dk_{t+1}}{dk_t} < 1, \quad \text{for } k_{t+1} = k_t = \hat{k}^{TO}.$$

For any positive initial value the capital intensity converges monotonically to \hat{k}^{TO} .

- (iii) The steady-state capital intensity satisfies the following inequality:

$$0 < \hat{k}^{TO} < \hat{k}^{WE}.$$

Proof: See Heijdra et al. (2010, Appendix B). □

For $\sigma = 1$ we visualize the transitional dynamics of the capital intensity in Figure 2(a) whilst the quantitative long-run results are reported in Table 2(b). In Figure 2(a) the horizontal axis records post-shock time τ and the vertical axis gives the values of $k_{t+\tau}$. By giving transfers to old agents, the old at the time of the policy switch ($\tau = 0$) are able to

Figure 2: Transitional dynamics in the exogenous growth model

Panel A: Benchmark: $\sigma = 1$

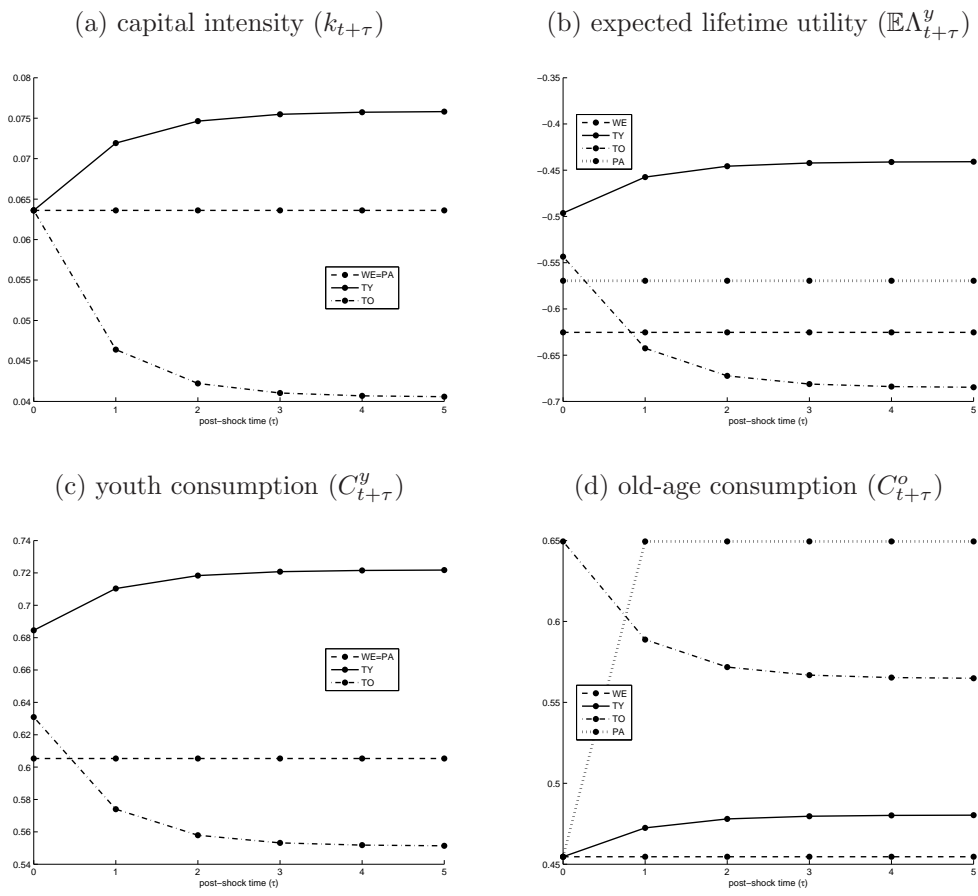

(Figure 2, continued)

Panel B: Weak intertemporal substitution effect: $\sigma = \frac{1}{2}$

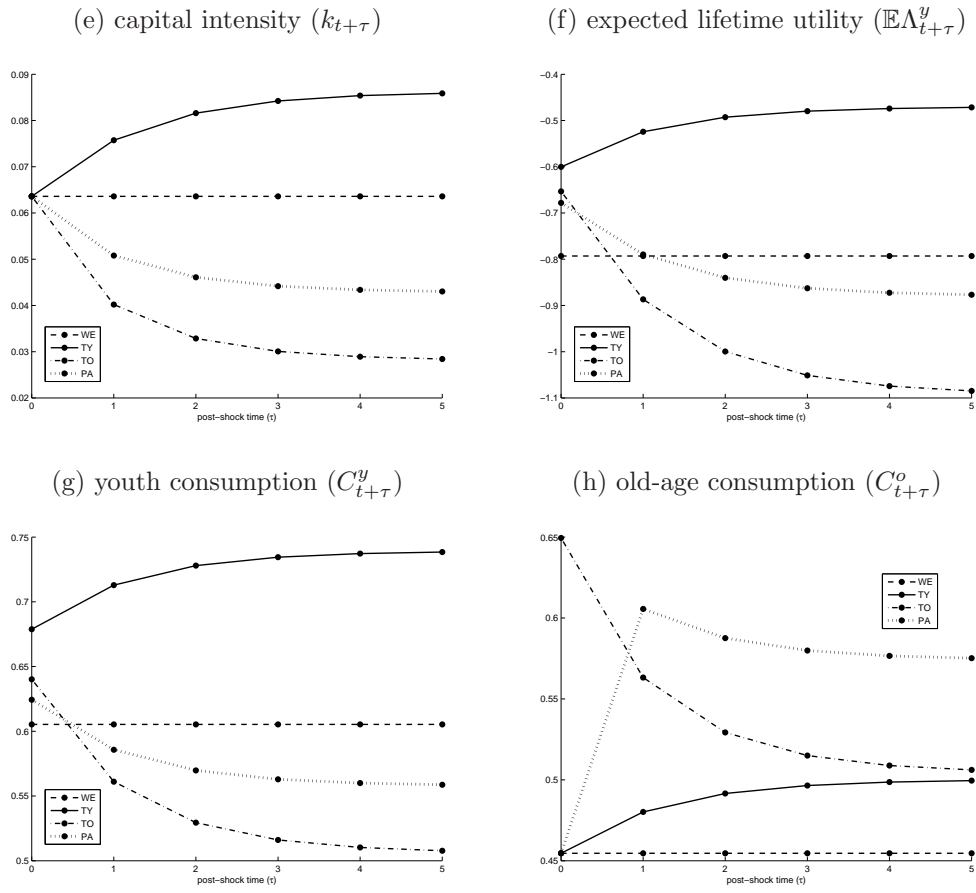

(Figure 2, continued)

Panel C: Strong intertemporal substitution effect: $\sigma = \frac{3}{2}$

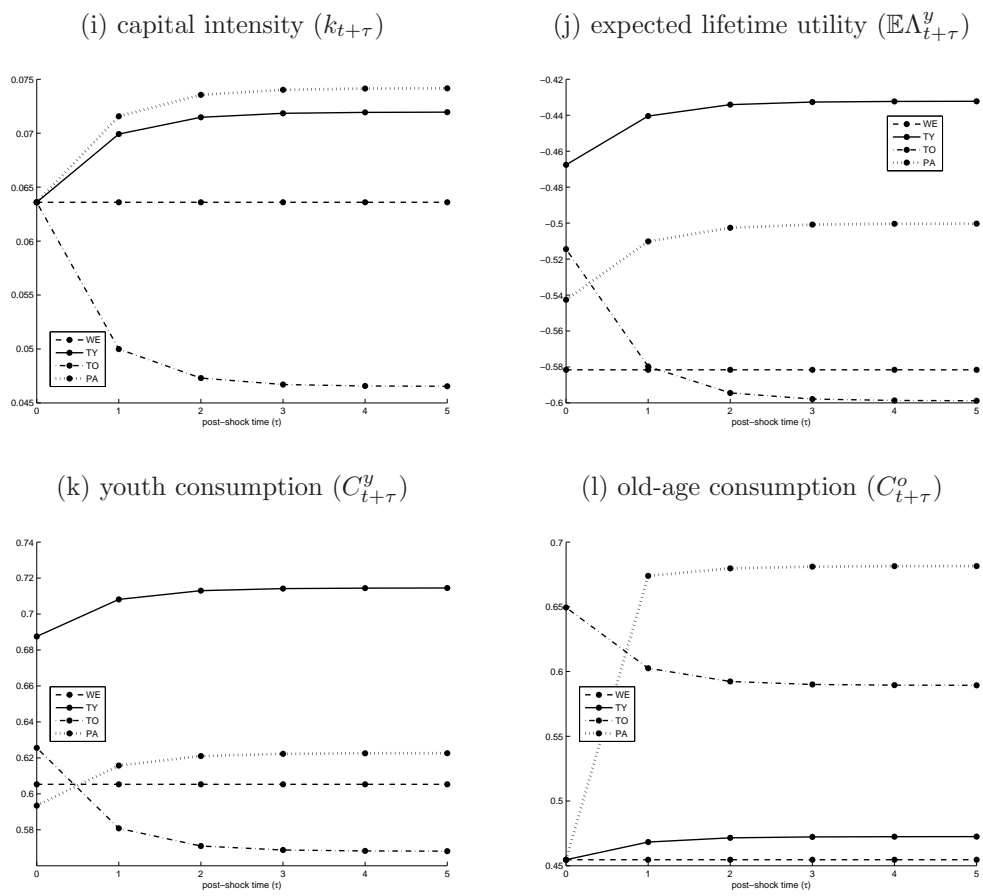

increase their consumption as they had not anticipated this windfall gain (see Figure 2(d)). The young at the time of the shock, however, react to the transfers they will receive in old age by reducing their saving below what it would have been under the WE scenario. This explains why the capital intensity drops substantially for $\tau = 1$ and beyond. Indeed, by using (21) we find the impact and long-run effects:

$$\left. \frac{dk_{t+1}}{dz_1} \right|_{k_t = \hat{k}^{WE}} = -\frac{\Psi_{z_1}}{\Psi_k} < 0, \quad \left. \frac{dk_{t+\infty}}{dz_1} \right|_{k_t = \hat{k}^{WE}} = -\frac{\Psi_{z_1}}{\Psi_k - \Gamma'} < 0, \quad (22)$$

where $\lim_{\tau \rightarrow \infty} k_{t+\tau} = \hat{k}^{TO}$. As the information in Table 2(a)–(b) reveals, compared to the WE scenario, long-run output per worker falls by almost thirteen percent under the TO case. Whereas the steady-state consumption profile is downward sloping under the WE scenario ($C^o < C^y$), it is upward sloping for the TO case ($C^o > C^y$). This result follows from the sharp increase in the interest rate that occurs in the TO scenario.⁷

Panels B and C in Table 2 and Figure 2 quantify and visualize the cases with, respectively, a weak intertemporal substitution effect (Panel B featuring $\sigma = \frac{1}{2}$) and a strong intertemporal substitution effect (Panel C featuring $\sigma = \frac{3}{2}$). The results are qualitatively the same as for the case with $\sigma = 1$. Quantitatively a relatively low (high) intertemporal substitution effect exacerbates (mitigates) the crowding-out effect on the capital intensity.

3.1.2 Transfers to the young

A policy switch from the WE case to the TY scenario can be studied with the following fundamental difference equation for the capital intensity:

$$\Psi(k_{t+1}) = \frac{[1 - \alpha(1 - z_2\pi)]\Omega_0 k_t^{\alpha+\eta} + z_2\pi(1 - \delta)k_t}{1 + n} \quad [\equiv \Gamma(k_t, z_2)], \quad (23)$$

where $\Psi(k_{t+1})$ is defined on the left-hand side of (19), z_2 is a perturbation parameter ($0 \leq z_2 \leq 1$) and $\Gamma(k_t, z_2)$ features positive partial derivatives $\Gamma_k > 0$ and $\Gamma_{z_2} > 0$. At time t there is a unit increase in z_2 and $k_t = \hat{k}^{WE}$ is the initial condition. We provide the following proposition.

⁷The optimal consumption Euler equation is given by:

$$\frac{C_{t+1}^o}{C_t^y} = \left[\frac{(1 - \pi)(1 + r_{t+1})}{1 + \rho} \right]^\sigma.$$

Proposition 3 [*Existence and stability of the TY model*] Consider the TY model as given in (23) and adopt Assumption 2. The following properties can be established:

(i) The model has two steady-state solutions; the trivial one features $k_{t+1} = k_t = 0$, and the economically relevant satisfies $k_{t+1} = k_t = \hat{k}^{TY}$, where \hat{k}^{TY} is the solution to:

$$\frac{\hat{k}^{TY}}{1 - \Phi(\hat{k}^{TY})} = \frac{[1 - \alpha(1 - \pi)]\Omega_0(\hat{k}^{TY})^{\alpha+\eta} + \pi(1 - \delta)\hat{k}^{TY}}{1 + n}.$$

(ii) The trivial steady-state solution is unstable whilst the non-trivial solution is stable:

$$0 < \frac{dk_{t+1}}{dk_t} < 1, \quad \text{for } k_{t+1} = k_t = \hat{k}^{TY}.$$

For any positive initial value the capital intensity converges monotonically to \hat{k}^{TY} .

(iii) The steady-state capital intensity satisfies the following inequality:

$$0 < \hat{k}^{WE} < \hat{k}^{TY}.$$

Proof: See Heijdra et al. (2010, Appendix C). □

For $\sigma = 1$ we visualize the transitional dynamics of the capital intensity in Figure 2(a) whilst the quantitative long-run results are reported in Table 2(c). As Figure 2(a) shows, the capital intensity increases over time. By giving transfers to young agents only, the old at the time of the policy switch ($\tau = 0$) experience no effect at all. They just execute the plans conceived during their youth. In contrast, the shock-time young react to these transfers by increasing their saving above what it would have been under the WE scenario. This explains why the capital intensity increases dramatically for $\tau = 1$ and beyond – see the solid line in Figure 2(a). By using (23) we find the impact and long-run effects of the policy change on the capital intensity:

$$\left. \frac{dk_{t+1}}{dz_2} \right|_{k_t = \hat{k}^{WE}} = \frac{\Gamma_{z_2}}{\Psi'} > 0, \quad \left. \frac{dk_{t+\infty}}{dz_2} \right|_{k_t = \hat{k}^{WE}} = \frac{\Gamma_{z_2}}{\Psi' - \Gamma_k} > 0, \quad (24)$$

where $\lim_{\tau \rightarrow \infty} k_{t+\tau} = \hat{k}^{TY}$. As the information in Table 2(a) and (c) reveals, compared to the WE scenario, long-run output per worker increases by more than five percent under the TY case. Because the steady-state interest rate falls, the long-run consumption profile becomes more downward sloping than it was in the WE scenario.⁸

⁸Panels B and C in Table 2 and Figure 2 confirm that the magnitude of σ affects the quantitative but not the qualitative conclusions.

3.2 Welfare analysis

In this section we study the welfare implications of the different scenarios. With bounded externalities ($0 \leq \eta < 1 - \alpha$) consumption by young and old agents ultimately converges to time-invariant steady-state values. As a result we can compare the welfare effects of the separate regimes by focusing on the life-time utility of newborns, both along the transition path and in the steady state. The welfare effect for the old at the time of the shock follows trivially from their budget identity (3b) which can be rewritten as:

$$C_t^o = Z_t^o + (1 + r_t)(1 + n)k_t, \quad (25)$$

where we have used the fact that $S_{t-1} = (1 + n)k_t$. For the shock-time old agents all terms featuring in (25) are predetermined except the transfers to the old, Z_t^o , occurring exclusively in the TO scenario. Hence, C_t^o will not change following a policy change except if the switch is to the TO case.

The (indirect) lifetime utility function of current and future newborns can be written as follows (for $\tau = 0, 1, \dots$):

$$\mathbb{E}\Lambda_{t+\tau}^y \equiv \begin{cases} \frac{\Phi(r_{t+\tau+1})^{-1/\sigma} (H_{t+\tau}^y)^{1-1/\sigma} - \frac{2 + \rho - \pi}{1 + \rho}}{1 - 1/\sigma} & \text{for } \sigma > 0, \sigma \neq 1 \\ \Xi_0 + \frac{2 + \rho - \pi}{1 + \rho} \ln H_{t+\tau}^y + \frac{1 - \pi}{1 + \rho} \ln(1 + r_{t+\tau+1}) & \text{for } \sigma = 1 \end{cases} \quad (26)$$

where Ξ_0 is a constant⁹ and human wealth at birth of agents born τ periods after the policy change is given by:

$$H_{t+\tau}^y \equiv w_{t+\tau} + Z_{t+\tau}^y + \frac{Z_{t+\tau+1}^o}{1 + r_{t+\tau+1}}. \quad (27)$$

The expressions in (25)–(27) are used to compute the transitions paths in Figures 2(b), (f), and (j) and the entries for $\widehat{\mathbb{E}\Lambda}^y$ in the final row of Table 2. For the analytical welfare effects at impact and in the long run, however, we employ the envelope theorem (see Heijdra et al., 2010). We consider each scenario change in turn.

⁹The definition of Ξ_0 is:

$$\Xi_0 \equiv \ln \left[\frac{1 + \rho}{2 + \rho - \pi} \right] + \frac{1 - \pi}{1 + \rho} \ln \left[\frac{1 - \pi}{2 + \rho - \pi} \right].$$

3.2.1 Transfers to the old

First we consider the welfare effects of a switch from the steady state of the WE case to the TO scenario. In what follows, \hat{C}^o , \hat{C}^y , \hat{r} , \hat{w} , and \hat{k} denote steady-state values associated with the WE scenario. The welfare effect on the old at time t is equal to:

$$\frac{d\mathbb{E}\Lambda_{t-1}^y(z_1)}{dz_1} = \frac{1+n}{1+\rho} U'(\hat{C}^o) \pi (1+\hat{r}) \hat{k} > 0. \quad (28)$$

The shock-time old are unambiguously better off because they receive a windfall transfer from the government. The welfare effect on the young at time t is more complicated because they can still alter their consumption and savings decisions in the light of the policy change. Although the wage rate faced by these agents is predetermined, their revised saving plans will induce a change in the future interest rate. After some manipulation we find:

$$\frac{d\mathbb{E}\Lambda_t^y(z_1)}{dz_1} = U'(\hat{C}^y) (1+n) \hat{k} \left[\frac{\pi}{1-\pi} + \frac{1}{1+\hat{r}} \frac{dr_{t+1}}{dz_1} \right] > 0. \quad (29)$$

The first term in square brackets represents the *direct effect* of the lump-sum transfer received in old age. Taken in isolation, this transfer expands the choice set and thus increases expected lifetime utility of shock-time newborns. The direct effect can be explained with the aid of Figure 3(a). The original budget line passes through E_0 , which is the initial equilibrium. The shock-time young anticipate transfers in old age equal to Z_{t+1}^0 . This shifts up the budget line in a parallel fashion.¹⁰ Holding constant the initially expected future interest rate, the optimal point shifts from E_0 to E' . But this is not the end of the story because it is only the partial equilibrium effect.

The second term in square brackets on the right-hand side of (29) represents the *general equilibrium effect* of the policy switch. It follows from (22) that the future capital stock is lower and the interest rate is higher as a result of the switch. In terms of Figure 3(a) the budget line pivots in a clockwise fashion around point A_0 and optimal consumption moves from E' to E_1 . At impact the general equilibrium effect thus brings about a further expansion of the choice set faced by the shock-time young. Not surprisingly, therefore, the change in welfare at impact is unambiguously positive for such agents. In terms of Figure 2(b) the dash-dotted line lies above the dashed line at post-shock time $\tau = 0$.

¹⁰Remember that agents are not allowed to borrow and that, therefore, consumption bundles with $C_t^y > w_t$ remain unattainable.

Figure 3: Effect of government transfers in the exogenous growth model

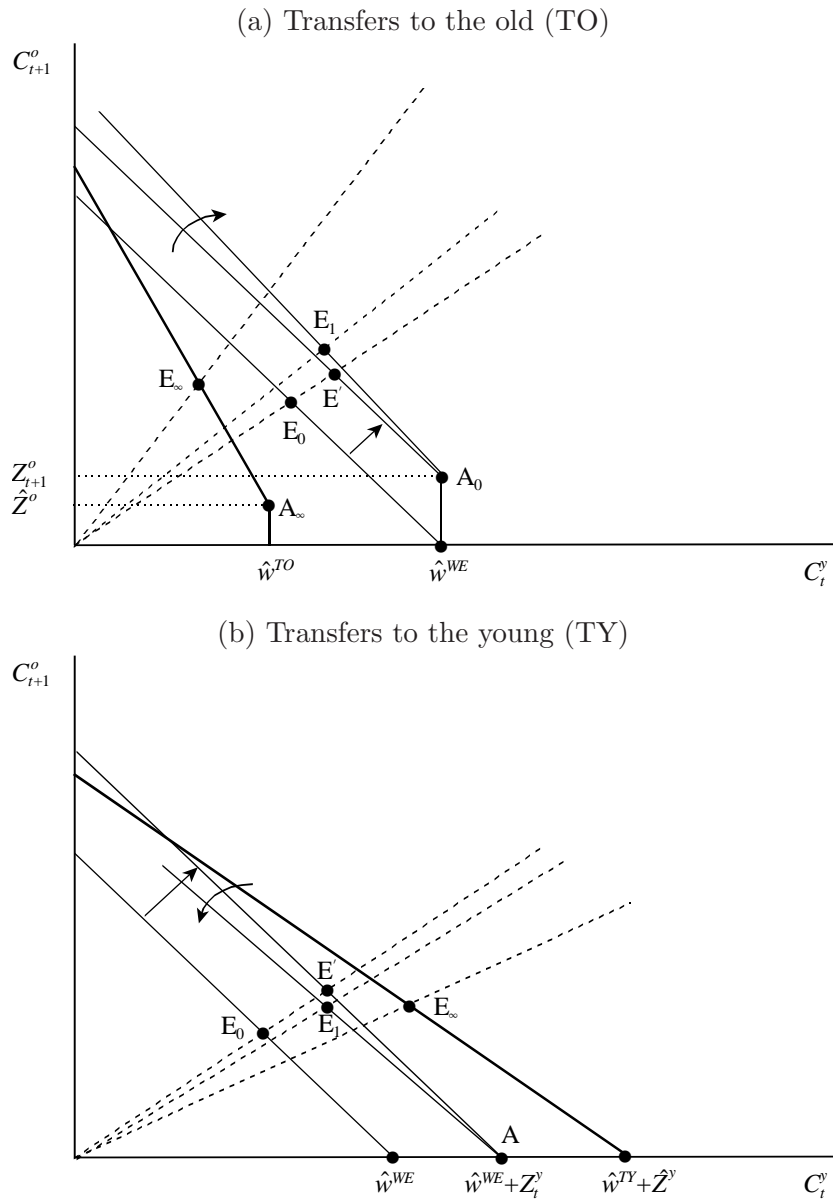

Before turning to the long-run welfare effects we first introduce the following lemma exploiting an important property of the factor-price frontier.

Lemma 1 [*Implications of the factor price frontier*] Assume that $0 \leq \eta < 1 - \alpha$ (exogenous growth model), the economy is initially in the steady state associated with the WE or TY scenario, and adopt Assumption 1 ($\hat{r} > n$, dynamic efficiency). Let $dk_{t+\infty}/dz_i$ denote the long-run effect on the capital intensity of a unit perturbation in z_i occurring at shock-time $\tau = 0$ and evaluated at $z_i = 0$. It follows that the long-run effect on weighted factor prices can be written as:

$$\frac{\hat{C}^o}{(1 + \hat{r})^2} \frac{dr_{t+\infty}}{dz_i} + \frac{dw_{t+\infty}}{dz_i} = \Delta \frac{dk_{t+\infty}}{dz_i}, \quad (\text{L1.1})$$

where Δ is a positive constant:

$$\Delta \equiv \left[\eta + \alpha(1 - \alpha - \eta) \frac{\hat{r} - n}{1 + \hat{r}} \right] \frac{\hat{r} + \delta}{\alpha} > 0. \quad (\text{L1.2})$$

Proof: See Heijdra et al. (2010, Appendix E). □

The welfare effect experienced by future steady-state generations can be written as:

$$\frac{d\mathbb{E}\Lambda_{t+\infty}^y(z_1)}{dz_1} = U'(\hat{C}^y) \left[\frac{\pi(1+n)}{1-\pi} \hat{k} + \Delta \frac{dk_{t+\infty}}{dz_1} \right] \begin{matrix} \geq \\ \leq \end{matrix} 0, \quad (30)$$

where we have used Lemma 1 and note that $\lim_{\tau \rightarrow \infty} k_{t+\tau} = \hat{k}^{TO}$. The first term in brackets represents the steady-state direct effect, which is positive. The second term comprises the general equilibrium effect, which is negative because capital is crowded out in the long run (see (22) above). On the one hand the reduction in the long-run capital intensity increases the interest rate which positively affects welfare. But on the other hand it also reduces the wage rate, which lowers welfare. In terms of Figure 3(a), the budget line shifts to the left because of the fall in the long-run wage ($\hat{w}^{TO} < \hat{w}^{WE}$). In addition, long-run transfers are lower than anticipated transfers at impact ($\hat{Z}^o < Z_{t+1}^o$) so that point A_∞ lies south-west from A_0 . The steady-state interest rate exceeds the future rate faced by shock-time newborns ($\hat{r}^{TO} > r_{t+1}$), i.e. the budget line is steeper than at impact. The steady-state equilibrium is at point E_∞ .

Comparing columns (a) and (b) of Table 2 reveals that the long-run welfare effect of the policy switch is negative, i.e. the crowding out of capital induces a very strong reduction in wages which dominates the joint effect of the transfers and the interest rate. Ignoring agents

who are alive at the time of the shock, it is thus better to let the accidental bequests go to waste than to give them to the elderly. To better understand the intuition behind this remarkable result, we first state the following lemma on the key features of the steady-state first-best social optimum (FBSO).

Lemma 2 [*Golden rules*] *Assume that $0 \leq \eta < 1 - \alpha$ (exogenous growth model), and define steady-state welfare of a young agent (L2.1), the economy-wide resource constraint (L2.2), and the macroeconomic production function (L2.3) as follows:*

$$\mathbb{E}\Lambda^y \equiv U(C^y) + \frac{1 - \pi}{1 + \rho} U(C^o), \quad (\text{L2.1})$$

$$f(k) - (\delta + n)k = C^y + \frac{1 - \pi}{1 + n} C^o + g, \quad (\text{L2.2})$$

$$f(k) = \Omega_0 k^{\alpha + \eta}. \quad (\text{L2.3})$$

The social planner chooses non-negative values for C^y , C^o , k , and g in order to maximize $\mathbb{E}\Lambda^y$ subject to the constraints (L2.2)–(L2.3). In addition to satisfying the constraints the first-best social optimum has the following features:

$$\frac{U'(\tilde{C}^y)}{U'(\tilde{C}^o)} = \frac{1 + n}{1 + \rho}, \quad (\text{S1})$$

$$f'(\tilde{k}) = n + \delta, \quad (\text{S2})$$

$$\tilde{g} = 0. \quad (\text{S3})$$

Proof: See Heijdra et al. (2010, Appendix F). □

Using the terminology of Samuelson (1968), we refer to requirement (S1) of the FBSO as the Biological-Interest-Rate Golden Rule (BGR), and to requirement (S2) as the Production Golden Rule (PGR). Of course, requirement (S3) just states that the social planner does not waste valuable resources.

Armed with Lemma 2 we can investigate the efficiency properties of the market economy. In the decentralized equilibrium for the WE scenario the steady-state equilibrium satisfies the resource constraint (L2.2) as well as the following conditions:

$$\frac{U'(\hat{C}^y)}{U'(\hat{C}^o)} = \frac{(1 - \pi)(1 + \hat{r})}{1 + \rho}, \quad (\text{W1})$$

$$\frac{\alpha}{\alpha + \eta} f'(\hat{k}) = \hat{r} + \delta, \quad (\text{W2})$$

$$\hat{g} = \pi(1 + \hat{r})\hat{k}. \quad (\text{W3})$$

Comparing (W1)–(W3) to (S1)–(S3) we find that the WE equilibrium features three distortions. First, the government engages in wasteful expenditure ($\hat{g} > \tilde{g} = 0$). Second, the death probability affects the consumption Euler equation in the decentralized equilibrium i.e. π features in (W1) but not in (S1). There is a missing market in that agents cannot insure against longevity risk. Third, if η is strictly positive the decentralized economy underinvests in physical capital because the capital externality is not internalized by individual agents.

We can rewrite the welfare effect on future steady-state generations – given in (30) – as follows:

$$\frac{d\mathbb{E}\Lambda_{t+\infty}^y(z_1)}{dz_1} = U'(\hat{C}^y) \frac{\pi(1+n)\hat{k}}{1-\pi} [1 - \Theta], \quad (31)$$

where Θ is defined as follows:

$$\Theta \equiv \left[\frac{\eta}{\alpha(1-\alpha-\eta)} + \frac{\hat{r}-n}{1+\hat{r}} \right] \frac{1+\hat{r}}{1+n} \frac{\frac{\hat{r}+\delta}{1+\hat{r}}\Phi(\hat{k})}{1-(1-\sigma)\frac{\hat{r}+\delta}{1+\hat{r}}\Phi(\hat{k})} \geq 0. \quad (32)$$

In combination with Lemma 2, the expressions in (31)–(32) can be used to build intuition on the long-run welfare effect of the policy switch from WE to TO. In adopting the TO scenario wasteful government expenditure is eliminated which implies that one distortion is removed, i.e. (S3) holds for the TO case and $\hat{g}^{TO} = \tilde{g} = 0$. If there were no capital externality ($\eta = 0$) and the steady-state interest rate would equal the rate of population growth ($\hat{r}^{TO} = n$) then (S2) would also hold under the TO case, i.e. $\hat{k}^{TO} = \tilde{k}$. The only distortion that would remain is the one resulting from the missing insurance market, i.e. $(1-\pi)(1+\hat{r}^{TO}) < 1+n$. For $\hat{r} = n$ and $\eta = 0$ we find from (32) that $\Theta = 0$ and from (31) that the long-run welfare effect is strictly positive. The switch from WE to TO benefits all generations to the same extent in this hypothetical case because waste is eliminated, there is no transitional dynamics in the capital stock (and thus in factor prices), and the additional resources lead to an equiproportionate increase in youth and old-age consumption.

Matters are much more complicated if we adopt Assumption 1. For $\hat{r} > n$ it follows from (32) that Θ is strictly positive and, ceteris paribus \hat{r} and \hat{k} , increasing in the externality parameter η . If $\eta = 0$ then WE and TO share two distortions, namely the missing insurance market and the violation of the BGR. It is a straightforward application of the theory of the second best that the welfare ranking between WE and TO is ambiguous in that case. In Table 3(a) we compute Θ for several values of the intertemporal substitution elasticity. Interestingly, Θ is strictly larger than unity for all but the most extreme values of σ . And for

a relatively small capital externality (Table 3(b) with $\eta = \frac{1}{10}$) the same conclusion holds for *all* admissible values of σ !

In a plausibly parameterized dynamically efficient economy ($\hat{r} > n$) the switch from WE to TO is welfare decreasing because it induces a decrease in the capital intensity and an increase in the interest rate in the long run. Hence, the policy switch moves the economy further away from the FBSO.

3.2.2 Transfers to the young

We consider the welfare effects of a switch from the steady state of the WE case to the TY scenario and let \hat{C}^o , \hat{C}^y , \hat{r} , \hat{w} , and \hat{k} denote the steady-state values associated with WE. In the TY scenario the shock-time old do not receive any additional resources, i.e. $d\mathbb{E}\Lambda_{t-1}^y(z_2) / dz_2 = 0$. The welfare effect on the young at the time of the policy switch is given by:

$$\frac{d\mathbb{E}\Lambda_t^y(z_2)}{dz_2} = U'(\hat{C}^y) (1+n) \hat{k} \left[\pi \frac{1+\hat{r}}{1+n} + \frac{1}{1+\hat{r}} \frac{dr_{t+1}}{dz_2} \right] > 0, \quad (33)$$

where the first term in square brackets is the direct effect and the second term is the general equilibrium effect. The direct effect is positive but the general equilibrium effect is negative because the policy switch boosts capital accumulation which leads to a reduction in the future interest rate. It is not difficult to show, however, that the direct effect is dominant so that welfare rises at impact. In terms of Figure 3(b) the initial budget line passes through point E_0 , the lump-sum transfer shifts the line in a parallel fashion to the right, and the decrease in the future interest rate rotates it in a counter-clockwise fashion around point A. The direct

Table 3: Value of Θ

$$\hat{r} > n$$

	(a)	(b)	(c)
	$\eta = 0$	$\eta = \frac{1}{10}$	$\eta = \frac{1}{3}$
$\sigma = \frac{1}{2}$	3.29	5.93	17.72
$\sigma = 1$	1.89	3.41	10.19
$\sigma = \frac{3}{2}$	1.33	2.39	7.15
$\sigma = \bar{\sigma}$	0.85	1.41	3.07

effect consists of the move from E_0 to E' and the general equilibrium effect is the move from E' to E_1 .

The change in welfare of the future steady-state generations can be written as:

$$\frac{d\mathbb{E}\Lambda_{t+\infty}^y(z_2)}{dz_2} = U'(\hat{C}^y) \left[\pi(1 + \hat{r})\hat{k} + \Delta \frac{dk_{t+\infty}}{dz_2} \right] > \frac{d\mathbb{E}\Lambda_t^y(z_2)}{dz_2} > 0, \quad (34)$$

where we have used Lemma 1 ($\Delta > 0$) and note that $\lim_{\tau \rightarrow \infty} k_{t+\tau} = \hat{k}^{TY}$. Both terms in square brackets are positive so that welfare ambiguously rises in the long run. Indeed, the general equilibrium effect ensures that future generations gain even more than the shock-time generation. The quantitative effects in columns (c), (g), and (k) of Table 2 confirm that, regardless of the magnitude of the intertemporal substitution elasticity, expected lifetime utility increases dramatically as a result of the policy switch. In terms of Figure 3(b), the budget line shifts further to the right in the long run both because the wage increases and transfers are boosted. The decreased interest rate further rotates the budget line but this effect is not large enough to lead to a reduction in the choice set for future generations. Figures 2(b), (f), and (j) illustrate the transition paths of expected lifetime utility for different values of the intertemporal substitution elasticity. Welfare rises monotonically.

In order to develop the economic intuition behind the strong steady-state welfare gain, we rewrite (34) as follows:

$$\frac{d\mathbb{E}\Lambda_{t+\infty}^y(z_2)}{dz_2} = U'(\hat{C}^y) \frac{\pi(1+n)\hat{k}}{1-\pi} \left[1 + \Theta \frac{1-\Phi(\hat{k})}{\Phi(\hat{k})} \right] > 0, \quad (35)$$

where Θ is defined in (32) above. The switch from WE to TY is welfare increasing because it induces an increase in the capital intensity and a decrease in the interest rate in the long run, i.e. the policy switch moves the economy closer to the FBSO.

4 Tragedy of annuitization

In this section we step away from the assumption that the government redistributes accidental bequests or wastes them completely. Instead we analyze the introduction of a private annuity market. An annuity is a financial asset which pays a given return contingent upon survival of the annuitant to the second period of life. If the annuitant dies prematurely then his assets accrue to the annuity firm. Let r_{t+1}^A denote the net rate of return on annuities. Assuming

perfect competition among annuity firms, the zero-profit condition is given by $1 + r_{t+1} = (1 - \pi)(1 + r_{t+1}^A)$ which implies:

$$1 + r_{t+1}^A = \frac{1 + r_{t+1}}{1 - \pi}. \quad (36)$$

It follows that $1 + r_{t+1}^A > 1 + r_{t+1}$, i.e. the return on annuities exceeds the return on regular assets. Hence, in the absence of a bequest motive, it is optimal for the agent to fully annuitize his financial wealth. This confirms findings by *inter alia* Yaari (1965) and Davidoff et al. (2005). Under full annuitization agents will no longer leave accidental bequests. In terms of Table 1, the government budget constraint (T1.7) becomes redundant. Savings S_t are replaced one-for-one by annuity holdings A_t , so that (T1.1)-(T1.3) become:

$$C_t^y = \Phi(r_{t+1}^A) w_t, \quad (T1.1')$$

$$\frac{C_{t+1}^o}{1 + r_{t+1}^A} = [1 - \Phi(r_{t+1}^A)] w_t, \quad (T1.2')$$

$$A_t = [1 - \Phi(r_{t+1}^A)] w_t. \quad (T1.3')$$

Furthermore, the fundamental difference equation for the capital intensity (T1.8) is replaced by:

$$(1 + n) k_{t+1} = [1 - \Phi(r_{t+1}^A)] w_t. \quad (T1.8')$$

In the remainder of this section we study the allocation and welfare effects of opening up a perfect annuity (PA) market at time t . We first study the case for which the initial scenario is WE, i.e. the switch is from WE to PA and the initial capital stock features $k_t = \hat{k}^{WE}$. Next we study the case in which the switch is from the TY scenario to perfect annuities. In this case the initial capital stock satisfies $k_t = \hat{k}^{TY}$.

4.1 From wasteful expenditure to perfect annuities

Using (36) and (T1.5)–(T1.6) in (T1.8'), the fundamental difference equation can be rewritten as follows:

$$[\Psi(k_{t+1}, z_3) \equiv] \frac{k_{t+1}}{1 - \Phi(k_{t+1}, z_3)} = \Gamma(k_t), \quad (37)$$

where $\Gamma(k_t)$ is defined in (19) above, $\Phi(k, z_3)$ is given by:

$$\Phi(k, z_3) \equiv \left[1 + (1 - z_3\pi)^{1-\sigma} \left(\frac{1-\pi}{1+\rho} \right)^\sigma (1 - \delta + \alpha\Omega_0 k^{\alpha+\eta-1})^{\sigma-1} \right]^{-1}, \quad (38)$$

and z_3 is a perturbation parameter ($0 \leq z_3 \leq 1$). The partial derivative of $\Psi(k_{t+1}, z_3)$ with respect to the capital intensity is positive, $\Psi_k > 0$, but the partial derivative for the perturbation parameter depends on the magnitude of the intertemporal substitution elasticity:

$$\Psi_{z_3} \begin{matrix} \leq \\ \geq \end{matrix} 0 \quad \Leftrightarrow \quad \sigma \begin{matrix} \geq \\ \leq \end{matrix} 1. \quad (39)$$

We provide the following proposition.

Proposition 4 [*Existence and stability of the PA model*] Consider the PA model as given in (37)–(38) and adopt Assumption 2. The following properties can be established:

- (i) The model has two steady-state solutions; the trivial one features $k_{t+1} = k_t = 0$, and the economically relevant satisfies $k_{t+1} = k_t = \hat{k}^{PA}$, where \hat{k}^{PA} is the solution to:

$$\frac{\hat{k}^{PA}}{1 - \Phi(\hat{k}^{PA}, 1)} = \frac{(1 - \alpha) \Omega_0 (\hat{k}^{PA})^{\alpha + \eta}}{1 + n}.$$

- (ii) The trivial steady-state solution is unstable whilst the non-trivial solution is stable:

$$0 < \frac{dk_{t+1}}{dk_t} < 1, \quad \text{for } k_{t+1} = k_t = \hat{k}^{PA}.$$

For any given positive initial value the capital intensity converges monotonically to \hat{k}^{PA} .

- (iii) The steady-state capital intensity satisfies the following inequality:

$$\hat{k}^{PA} \begin{matrix} \leq \\ \geq \end{matrix} \hat{k}^{WE} \quad \Leftrightarrow \quad \sigma \begin{matrix} \leq \\ \geq \end{matrix} 1$$

Proof: See Heijdra et al. (2010, Appendix D). □

In the benchmark case the intertemporal substitution elasticity is equal to unity, so that it follows from (39) that the opening up of annuity markets has no effect on the fundamental difference equation (37). There is no transitional dynamics and the economy with perfect annuities features the same steady-state capital intensity as under the WE scenario, i.e. $k_t = \hat{k}^{PA} = \hat{k}^{WE}$ for all t . In terms of Figure 4(a), the initial equilibrium is at point E_0 . Full annuitization rotates the budget line in a clockwise fashion and the new equilibrium is at point E_∞ which lies directly above E_1 (since $\sigma = 1$). The additional resources resulting from annuitization are thus shifted entirely to old age.

Figure 2(d) and Table 2(d) confirm that old-age consumption is significantly higher following the policy shock. Note also from Figure 2(d) that the switch from WE to PA is quite different from the switch from WE to TO even though both constitute risk sharing among old agents. In the latter case the anticipated transfers in old age lead to reduced saving during youth which ultimately results in capital crowding out. In contrast, in the former case the savings rate is unaffected by the policy change.

Since transfers are absent both before and after the opening up of annuity markets, the shock-time old are unaffected by this event, i.e. $d\mathbb{E}\Lambda_{t-1}^y(z_3)/dz_3 = 0$. The welfare effect on the young at the time of the policy switch is given by:

$$\frac{d\mathbb{E}\Lambda_t^y(z_3)}{dz_3} = U'(\hat{C}^y) (1+n) \hat{k} \left[\pi + \frac{1}{1+\hat{r}} \frac{dr_{t+1}}{dz_3} \right] > 0, \quad (40)$$

where the first term in square brackets is the direct effect and the second term is the general equilibrium effect. In the special case with $\sigma = 1$ and $k_t = \hat{k}^{PA}$ the latter effect is absent. It is easy to show that for all admissible values of σ welfare unambiguously rises for all post-shock generations – see also Table 2(d) and Figures 2(b), (f), and (j).

The long-run welfare effect is given by:

$$\frac{d\mathbb{E}\Lambda_{t+\infty}^y(z_3)}{dz_3} = U'(\hat{C}^y) \left[\pi (1+n) \hat{k} + \Delta \frac{dk_{t+\infty}}{dz_3} \right] \begin{matrix} \geq \\ \leq \end{matrix} 0, \quad (41)$$

where we have used Lemma 1 ($\Delta > 0$) and note that $\lim_{\tau \rightarrow \infty} k_{t+\tau} = \hat{k}^{PA}$. The second term in square brackets represents the general equilibrium effect on factor prices. Of course, for $\sigma = 1$ these effects are absent and the impact and long-run effects coincide.

Empirical evidence, however, suggests that σ falls well short of unity. It follows readily from (37) and (39) that for $\sigma < 1$ the impact and long-run effects on the capital intensity of the opening up of annuity markets are both negative:

$$\left. \frac{dk_{t+1}}{dz_3} \right|_{k_t = \hat{k}^{WE}} = -\frac{\Psi_{z_3}}{\Psi_k} < 0, \quad \left. \frac{dk_{t+\infty}}{dz_3} \right|_{k_t = \hat{k}^{WE}} = -\frac{\Psi_{z_3}}{\Psi_k - \Gamma'} < 0, \quad (42)$$

where $\lim_{\tau \rightarrow \infty} k_{t+\tau} = \hat{k}^{PA}$. Equation (40) shows that welfare of the shock-time young increases both because of the direct effect and because of the increase in the future interest rate. In the long run, however, capital crowding out results in a reduction in wages which shrinks the choice set and reduces welfare for future generations. Figures 2(e)–(h) depict the transition paths and Panel B of Table 2 provides quantitative evidence for the case with

$\sigma = \frac{1}{2}$. As the comparison between columns (e) and (h) of Table 2 reveals, capital crowding out is so strong that steady-state welfare is lower under perfect annuities than it is under the WE scenario! This is the first instance of a phenomenon which we call “the tragedy of annuitization.” Even though it is individually advantageous to make use of annuity products if they are available, their long-run general equilibrium effects lead to a reduction in welfare of future generations.

The intuition behind the tragedy is not hard to come by. In the PA case the decentralized steady-state equilibrium is characterized by the resource constraint (L2.2) in Lemma 2 as well as the following conditions:

$$\frac{U'(\hat{C}^y)}{U'(\hat{C}^o)} = \frac{(1 - \pi)(1 + \hat{r}^A)}{1 + \rho} = \frac{1 + \hat{r}}{1 + \rho}, \quad (\text{P1})$$

$$\frac{\alpha}{\alpha + \eta} f'(\hat{k}) = \hat{r} + \delta, \quad (\text{P2})$$

$$\hat{g} = 0. \quad (\text{P3})$$

The PA equilibrium removes two of the distortions plaguing the WE equilibrium. First, the availability of annuities eliminates the missing-market distortion, i.e. π does not feature in (P1) whereas it does in (W1). Second, there are no wasteful government expenditures. Indeed, in the absence of the capital externality ($\eta = 0$) and if $\hat{r} = n$ then the PA equilibrium decentralizes the FBSO – compare (S1)–(S3) to (P1)–(P3). But starting from a dynamically efficient economy ($\hat{r} > n$) featuring a plausible value of the intertemporal substitution elasticity ($\sigma = \frac{1}{2}$), the switch from WE to PA is welfare decreasing because it induces capital crowding out and an increase in the interest rate in the long run. Hence, the policy switch moves the economy further away from the FBSO.

4.2 From transfers to the young to perfect annuities

We return to the benchmark case (with $\sigma = 1$) and assume that annuity markets are opened up with the economy located in the steady-state equilibrium of the TY scenario, i.e. $k_t = \hat{k}^{TY}$ initially. A policy switch from the TY case to the PA scenario now involves two distinct changes. On the one hand, the availability of annuities boosts the rate at which the young can save. On the other hand, full annuitization implies that accidental bequests are absent so that the transfers to the *future* young are eliminated, i.e. $Z_{t+\tau}^y = 0$ for $\tau = 1, 2, \dots$. The combined effect of these shocks can be studied with the aid of the following fundamental

difference equations:

$$\Psi(k_{t+1}, z_3) = \Gamma(k_t, 1), \quad \Psi(k_{t+\tau+1}, z_3) = \Gamma(k_{t+\tau}), \quad \tau = 2, 3, \dots, \quad (43)$$

where $\Gamma(k_t)$, $\Gamma(k_t, 1)$, and $\Psi(k_{t+1}, z_3)$ are defined in, respectively, (19), (23) and (37) above. At time t there is a permanent switch from $z_3 = 0$ to $z_3 = 1$. From $t+1$ onwards transfers are absent and the second expression in (43) describes the dynamic law of motion. The resulting difference equations are solved using $k_t = \hat{k}^{TY}$ as the initial condition.

Since $\sigma = 1$ the marginal propensity to save out of current resources is constant. The shock-time young still receive transfers. It follows that there is no effect on saving, i.e. $k_{t+1} = \hat{k}^{TY}$. Of course the young from period $t+1$ onward no longer receive transfers and these generations will reduce their saving. Over time the economy monotonically converges to \hat{k}^{PA} which is strictly less than \hat{k}^{TY} (since, for $\sigma = 1$, $\hat{k}^{PA} = \hat{k}^{WE}$ and $\hat{k}^{TY} > \hat{k}^{WE}$ by Proposition 3(iv)). Using (43) we find the impact and long-run effects of the policy change on the capital intensity:

$$\left. \frac{dk_{t+1}}{dz_3} \right|_{k_t = \hat{k}^{TY}} = -\frac{\Psi_{z_3}}{\Psi_k}, \quad \left. \frac{dk_{t+\infty}}{dz_3} \right|_{k_t = \hat{k}^{TY}} = -\frac{\Psi_{z_3} + \Gamma_{z_2}}{\Psi_k - \Gamma'}, \quad (44)$$

where $\lim_{\tau \rightarrow \infty} k_{t+\tau} = \hat{k}^{PA}$. Recall that $\Psi_k > 0$, $\Gamma' > 0$, $\Gamma_{z_2} > 0$ and $\Psi_{z_3} \leq 0 \Leftrightarrow \sigma \geq 1$. It follows that there is capital crowding out both at impact and in the long run for realistic values of σ (i.e., $\sigma < 1$) since Ψ_{z_3} is positive in that case.

The key effects can be explained with the aid of Figure 4(b). The initial steady state is at E_0 and income during youth is equal to $\hat{w}^{TY} + \hat{Z}^y$. At impact the transfers are predetermined but the interest rate at which the young save increases, i.e. the budget line rotates in a clockwise direction. The new equilibrium is at point E_1 which lies directly above point E_0 (since $\sigma = 1$). In the long run, transfers are eliminated, capital is crowded out, the interest rate rises and the wage rate falls. The long-run budget constraint passes through E_∞ which is the new steady-state equilibrium.

We visualize the transitional dynamics (for the case with $\sigma = 1$) in Panel A of Figure 5. The quantitative effects are summarized in Table 2(d). Figure 5(a) confirms the strong crowding-out effect on the capital intensity. Youth consumption of all but the shock-time young falls as a result of the elimination of transfers (panel (c)) and old-age consumption of survivors increases due to the higher return on savings (panel (d)). Comparing columns (c) and (d) in Table 2 we find that long-run output per worker falls by more than five percent.

Since the old do not get any transfers both before and after the opening up of an annuity market and they no longer save, the shock-time old are unaffected by this event, i.e. $d\mathbb{E}\Lambda_{t-1}^y(z_3)/dz_3 = 0$. The welfare effect on the young at the time of the policy switch is given by:

$$\frac{d\mathbb{E}\Lambda_t^y(z_3)}{dz_3} = U'(\hat{C}^y) (1+n) \hat{k} \left[\pi + \frac{1}{1+\hat{r}} \frac{dr_{t+1}}{dz_3} \right] > 0. \quad (45)$$

The shock-time young benefit for all admissible values of σ , i.e. regardless of whether next period's capital intensity falls ($\sigma < 1$) or rises ($\sigma > 1$). To this generation the benefits of annuitization are clear and simple.

Matters are not so clear-cut for future generations. Indeed, the long-run welfare effect is equal to:

$$\frac{d\mathbb{E}\Lambda_{t+\infty}^y(z_3)}{dz_3} = U'(\hat{C}^y) \left[-\pi(\hat{r}-n)\hat{k} + \Delta \frac{dk_{t+\infty}}{dz_3} \right] \begin{matrix} \leq \\ \geq \end{matrix} 0. \quad (46)$$

where we have used Lemma 1 ($\Delta > 0$) and note that $\lim_{\tau \rightarrow \infty} k_{t+\tau} = \hat{k}^{PA}$. The first term in square brackets is negative in a dynamically efficient economy but the sign of the second term depends on the strength of the intertemporal substitution effect. For the empirically relevant case, however, we have $0 < \sigma < 1$, capital is crowded out in the long run, and long-run welfare unambiguously falls.¹¹

Figure 5(b) shows (for $\sigma = 1$) that lifetime welfare is reduced for all future generations if a private annuity market is opened up. Only the shock-time young benefit from annuitization. Effectively, private annuities redistribute assets from deceased to surviving elderly in an actuarially fair way whereas transferring unintended bequests to the young constitutes an intergenerational transfer. This intergenerational transfer induces beneficial savings effects, which, in the end, lead to higher welfare. This is the second example of a *tragedy of annuitization*. Even though it is individually rational to fully annuitize, this is not optimal from a social point of view. If all agents invest their financial wealth in the annuity market then the resulting long-run equilibrium leaves everyone worse off compared to the case where annuities are absent and accidental bequests are redistributed to the young.

¹¹Indeed, the results in Table 2 confirm that the same conclusion holds for $\sigma = \frac{3}{2}$ – compare columns (j) and (l). Of course in that case the capital intensity rises somewhat so that the welfare loss from the switch from TY to PA is smaller.

Figure 4: Private annuities in the exogenous growth model

(a) From wasteful expenditure to perfect annuities ($\sigma = 1$)

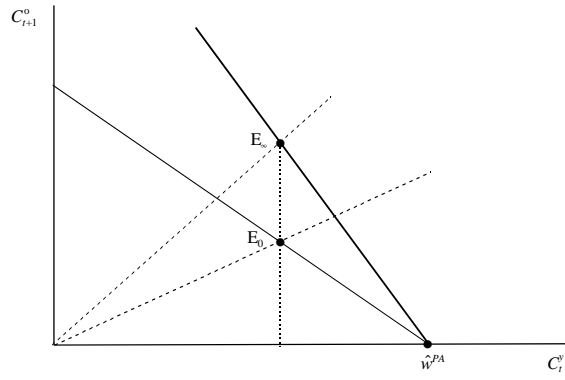

(b) From transfers to the young to perfect annuities ($\sigma = 1$)

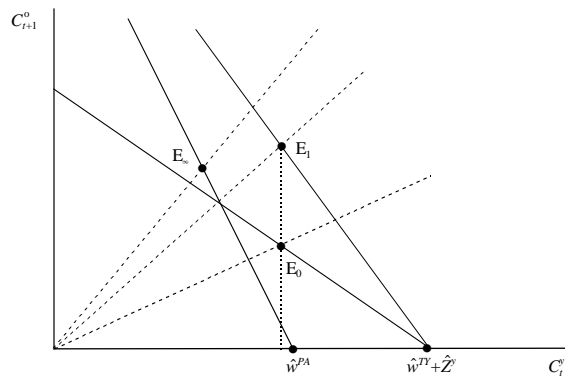

(c) From transfers to the old to perfect annuities ($\sigma = 1$)

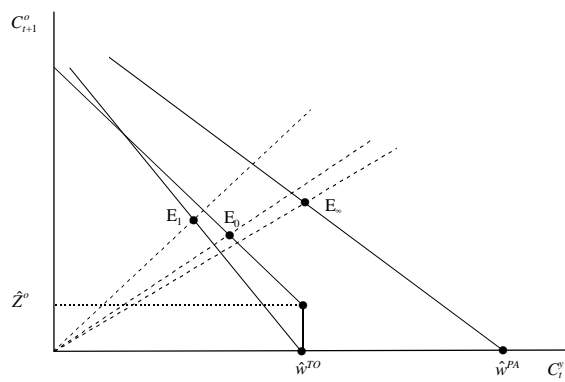
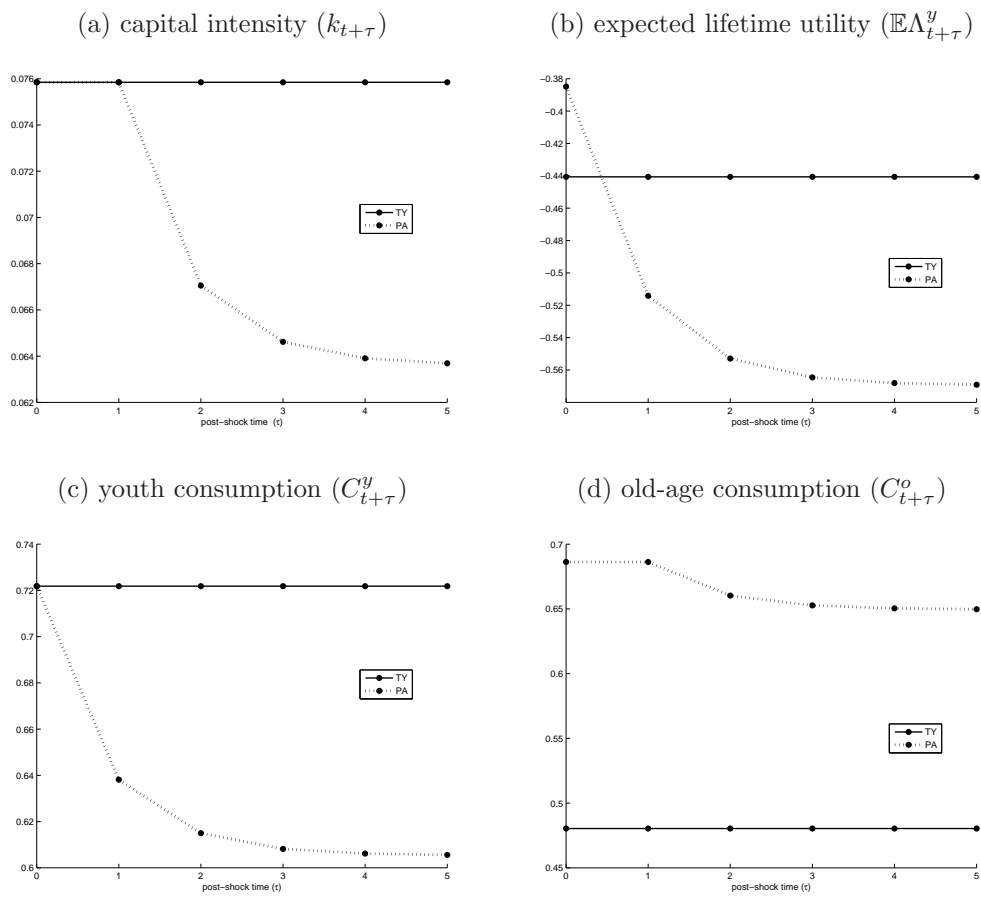

Figure 5: Transition from transfers to annuities in the exogenous growth model

Panel A: from TY to PA ($\sigma = 1$)



(Figure 5, continued)

Panel B: from TO to PA ($\sigma = 1$)

(e) capital intensity ($k_{t+\tau}$)

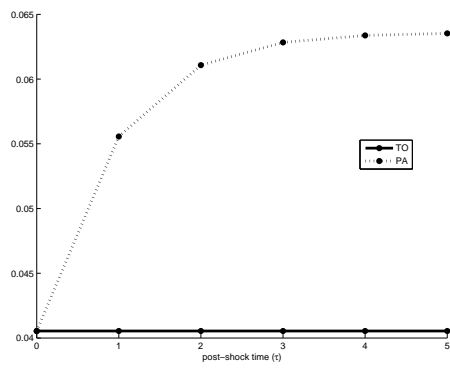

(f) expected lifetime utility ($\mathbb{E}\Lambda_{t+\tau}^y$)

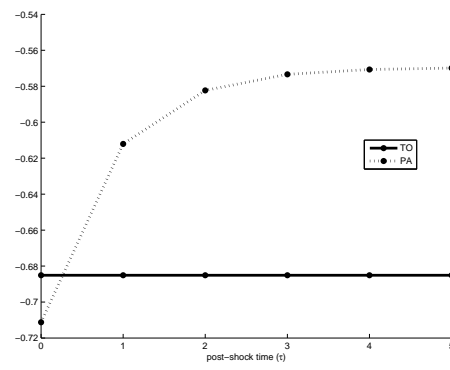

(g) youth consumption ($C_{t+\tau}^y$)

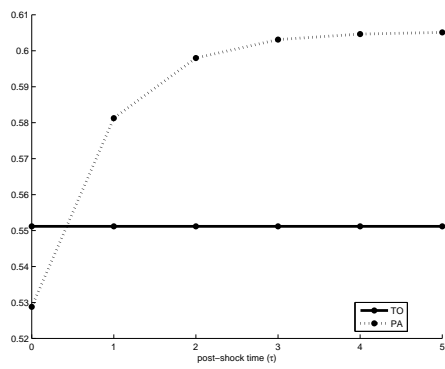

(h) old-age consumption ($C_{t+\tau}^o$)

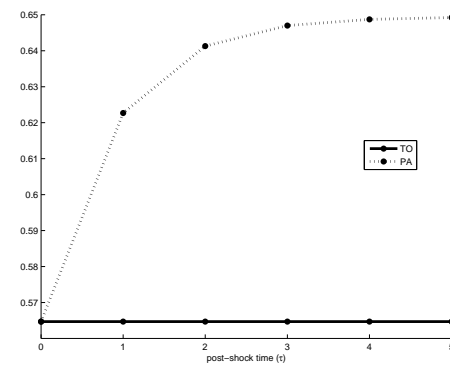

4.3 Discussion

In the previous subsections we have seen two instances of the tragedy of annuitization. The first (from WE to PA) can be considered the *strong* version and the second (from TY to PA) the *weak* version. The remaining question that must be answered is whether or not the tragedy is inescapable. Does the introduction of a perfect annuity market always make future generations worse off?

To answer this question we start by noting that in Table 2 steady-state welfare is lowest for all scenarios considered in the case where accidental bequests are transferred to the old (the TO scenario). If the switch from TO to PA would still give rise to the tragedy then this would be an even stronger version than the one resulting from the change from WE to PA. It turns out, however, that the tragedy does not arise when annuity markets are opened under the TO scenario.

Formally, the switch from TO to PA again involves two distinct changes. First, full annuitization implies that accidental bequests are absent so that the transfers to all but the shock-time old are eliminated, i.e. $Z_{t+\tau}^o = 0$ for $\tau = 1, 2, \dots$. Second, the availability of annuities boosts the rate at which the young can save. The combined effect of these shocks can be studied with the aid of (37). At time t there is a permanent change from $z_3 = 0$ to $z_3 = 1$ and (37) is solved using $k_t = \hat{k}^{TO}$ as the initial condition. Since $\sigma = 1$ in the benchmark case, the marginal propensity to save out of current resources is constant. The elimination of old-age transfers then immediately leads to an increase in saving by the shock-time young, i.e. $k_{t+1} > \hat{k}^{TO}$. Over time the economy monotonically converges to \hat{k}^{PA} which exceeds \hat{k}^{TO} (since, for $\sigma = 1$, $\hat{k}^{PA} = \hat{k}^{WE}$ and $\hat{k}^{TO} < \hat{k}^{WE}$ by Proposition 2(iii)).

In the interest of brevity we restrict attention to the key features of the shock. In Figure 4(c) the initial steady state is at E_0 , and non-asset income during youth and old-age is, respectively \hat{w}^{TO} and \hat{Z}^o . At impact *future* transfers to the shock-time young and all generations thereafter are eliminated and the rate at which the young save increases, i.e. the budget line shifts down and becomes steeper. The new equilibrium is at point E_1 . In the long run, the capital intensity increases further, the interest rate falls and the wage rate increases. The long-run budget constraint passes through E_∞ which is the steady-state equilibrium.

We visualize the transitional dynamics (for the case with $\sigma = 1$) in Panel B of Figure 5 and summarize the quantitative results in Table 2(d). Figure 5(e) confirms the strong

expansionary effect on the capital intensity. Youth consumption falls at impact as a result of the elimination of old-age transfers (panel (g)) but rises strongly thereafter. Old-age consumption of survivors increases monotonically as a result of the expansion in the choice set made possible by strong capital accumulation (panel (h)). Comparing columns (b) and (d) in Table 2 we find that long-run output per worker increases by almost fifteen percent. Figure 5(f) shows the welfare effect on shock-time and future newborns. Interestingly, the shock-time young are worse off as a result of the introduction of annuity products. For these agents the increase in old-age consumption is insufficiently large to offset the strong decrease in youth consumption. All future newborns, however, are better off as a result of annuitization opportunities.

In Panels B and C of Table 2 we present some steady-state evidence for different values of σ . We find that PA always welfare dominates TO in the long run, regardless of whether the intertemporal substitution effect is weak ($\sigma = \frac{1}{2}$ in Panel B) or strong ($\sigma = \frac{3}{2}$ in Panel C).

The findings in this subsection bear a strong resemblance to the literature on the reform of PAYG pensions. In a dynamically efficient economy, a PAYG system is Pareto efficient. A pension reform in the direction of a fully funded system increases welfare of steady-state generations but harms the shock-time old and possibly the young generations born close to the time of the reform. The scenario considered here differs from the pension reform case because the shock is not policy induced but results from the emergence of a new longevity insurance market.

5 The endogenous growth model

In this section we briefly consider the knife-edge case featuring $\eta = 1 - \alpha$. The model then exhibits growth which is driven endogenously by the rate of capital accumulation. We can solve (18) for the equilibrium growth rate:

$$(1+n)(1+\gamma) = [1 - \Phi(\bar{r})] \left[(1-\alpha)\Omega_0 + \frac{Z_t^y}{k_t} \right] - \frac{\Phi(\bar{r})}{1+\bar{r}} \frac{Z_{t+1}^o}{k_t}, \quad (47)$$

where $\gamma \equiv k_{t+1}/k_t - 1$ is the (time-invariant) equilibrium growth rate and we have used the fact that the interest rate is constant in this scenario such that $r_t = \bar{r} \equiv \alpha\Omega_0 - \delta$ for all t . Using the expressions in (47) we can derive the equilibrium growth rates under the three revenue recycling schemes and after the introduction of a private annuity market.

(WE) If the government uses the proceeds from the accidental bequests for wasteful government expenditures the growth rate becomes:

$$1 + \gamma^{WE} = \frac{1 - \Phi(\bar{r})}{1 + n} (1 - \alpha) \Omega_0. \quad (48a)$$

(TY) If instead the proceeds are redistributed to the young we find:

$$1 + \gamma^{TY} = \frac{1 - \Phi(\bar{r})}{1 + n} [(1 - \alpha) \Omega_0 + \pi (1 + \bar{r})]. \quad (48b)$$

(TO) If the accidental bequests go the elderly then the growth rate is given by

$$1 + \gamma^{TO} = \frac{1 + \gamma^{WE}}{1 + \Phi(\bar{r}) \frac{\pi}{1 - \pi}}. \quad (48c)$$

(PA) Finally, if a private annuity market is introduced we have:

$$1 + \gamma^{PA} = \frac{1 - \Phi(\bar{r}^A)}{1 + n} (1 - \alpha) \Omega_0. \quad (48d)$$

Straightforward inspection of the growth rates reveals that $\gamma^{TY} > \gamma^{WE} > \gamma^{TO}$ for all admissible values of σ . Hence, in terms of growth, it is better to give the accidental bequests to the young than to use them for wasteful expenditures, yet it is better to let the accidental bequests go to waste than to give them to the elderly.

Comparison with the private annuities scenario is more subtle. The introduction of private annuities increases the rate against which individuals save. The savings response of consumers, and thereby the growth rate in the perfect annuities scenario relative to the various recycling schemes, depends on the value of the intertemporal elasticity of substitution σ . For the benchmark case with $\sigma = 1$ savings are independent of the interest rate and $\gamma^{TY} > \gamma^{PA} = \gamma^{WE} > \gamma^{TO}$. If $0 < \sigma < 1$ the higher interest rate will lead to less savings than in the benchmark scenario so that we get $\gamma^{TY} > \gamma^{WE} > \gamma^{PA} > \gamma^{TO}$. Finally, if $\sigma > 1$ the higher interest rate will lead to more savings which results in $\gamma^{PA} > \gamma^{WE} > \gamma^{TO}$ and, depending on the exact magnitude of σ , $\gamma^{PA} \gtrless \gamma^{TY}$.

In order to compare consumer welfare across the various scenarios we must recognize the fact that steady-state expected lifetime utility grows at a scenario-dependent rate in an endogenous growth model. To see this, note that if $\eta = 1 - \alpha$ we can write the consumption demand equations (5) and (6) under scenario i as:

$$C_{t+\tau}^{y,i} \equiv \Phi(r^i) \theta^i w_{t+\tau}^i, \quad C_{t+\tau+1}^{o,i} \equiv (1 + r^i) [1 - \Phi(r^i)] \theta^i w_{t+\tau}^i, \quad (49)$$

where $r^i = \bar{r}$ for $i \in \{\text{WE}, \text{TY}, \text{TO}\}$ and $r^i = \bar{r}^A$ for $i = \text{PA}$. The value of the parameter θ^i depends on the specific scenario $i \in \{\text{WE}, \text{TY}, \text{TO}, \text{PA}\}$.¹² Wages grow over time according to the equilibrium growth rate associated with scenario i :

$$w_{t+\tau}^i = (1 + \gamma^i)^\tau w_t. \quad (50)$$

Consider an economy that is initially in the WE scenario and features a wage rate at time t equal to w_t . Expected lifetime utility of future newborns under scenario i can then be written as:

$$\widehat{\mathbb{E}}\Lambda_{t+\tau}^{y,i} \equiv \begin{cases} \frac{\Phi (r^i)^{-1/\sigma} \left[\theta^i (1 + \gamma^i)^\tau w_t \right]^{1-1/\sigma} - \frac{2 + \rho - \pi}{1 + \rho}}{1 - 1/\sigma} & \text{for } \sigma > 0, \sigma \neq 1 \\ \Xi_0 + \frac{2 + \rho - \pi}{1 + \rho} \left[\theta^i (1 + \gamma^i)^\tau w_t \right] + \frac{1 - \pi}{1 + \rho} \ln (1 + r^i) & \text{for } \sigma = 1 \end{cases} \quad (51)$$

We call this welfare metric normalized utility. Clearly, $\widehat{\mathbb{E}}\Lambda_{t+\tau}^{y,i}$ depends both on post-shock time τ and on the scenario-dependent (endogenous) value of γ^i . From equation (51) we observe that with the introduction of a transfer regime or an annuity market there is both a *level* effect (represented by a change in the θ^i parameter) and a *growth* effect (induced by a change in γ^i). However, over time the growth effect will always dominate the level effect.

In order to quantify the growth and welfare effects we adopt the following approach. For n , π , α , δ , and r we use the same values as for the exogenous growth model (see the text below Proposition 1). We calibrate an annual growth rate of one percent in the WE scenario ($\gamma^{WE} = 0.49$) and obtain $\Omega_0 = 15.72$ and $\rho = 1.78$ (or 2.58% annually). The equilibrium growth rate under the various policy schemes is reported in Table 4 for different values of σ and the corresponding welfare paths are depicted in Figure 6.

In line with the exogenous growth model we find that if the economy exhibits endogenous growth and the intertemporal substitution elasticity is in the realistic range ($0 < \sigma \leq 1$) then it is better to transfer the proceeds of accidental bequests to the young than to open up a private annuity market – see Table 4 and Figure 6. In addition we find that for low values of σ it may even be better to waste the accidental bequests than to have a system of private

¹²For the three public policy regimes we get $\theta^{WE} = 1$, $\theta^{TY} = \left[1 + \frac{\pi(1+\bar{r})}{(1-\alpha)\Omega_0} \right]$, and $\theta^{TO} = \left[1 + \pi \frac{1+n}{1-\pi} \frac{1+\gamma^{TO}}{(1-\alpha)\Omega_0} \right]$. For private annuities $r^i = \bar{r}^A$ and $\theta^{PA} = 1$.

Figure 6: Welfare paths in the endogenous growth model

(a) Weak intertemporal substitution effect: $\sigma = \frac{1}{2}$

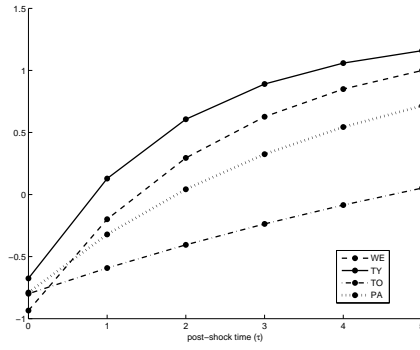

(b) Benchmark: $\sigma = 1$

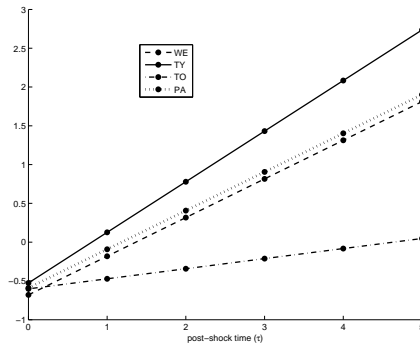

(c) Strong intertemporal substitution effect: $\sigma = \frac{3}{2}$

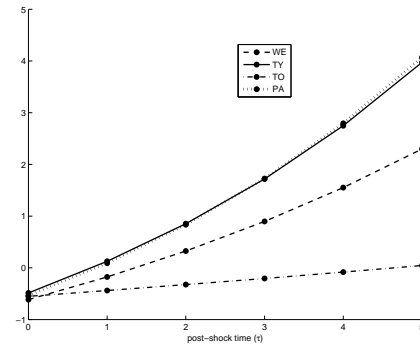

annuities. Hence, both the weak and the strong version of the tragedy of annuitization show up in terms of economic growth rates.

Finally, we find that only if σ is unrealistically high (e.g., $\sigma = \frac{3}{2}$) private annuities slightly outperform transfers to the young in terms of growth – see Table 4(c). However, in terms of welfare, PA only outpaces the TY scenario after three periods (i.e. 120 years) and even then only marginally so – see Figure 6(c).

6 Conclusion

We construct a tractable discrete-time overlapping generations model of a closed economy featuring endogenous capital accumulation. We use this model to study government redistribution and private annuities in general equilibrium. Individuals face longevity risk as there is a positive probability of passing away before the retirement period. With an uncertain life expectancy, non-altruistic agents engage in precautionary saving to avoid running out of assets in old age. While they refrain from leaving intentional bequests to their offspring, they will generally make *unintended* bequests which we assume to flow to the government. Starting from a case in which the government initially wastes these resources we investigate the effects on allocation and welfare of various revenue recycling schemes. Interestingly, we find non-pathological cases where it is better for long-run welfare to waste accidental bequests than to give them to the elderly. This is because transfers received in old age cause the individual to reduce saving which at the macroeconomic level results in a dramatic fall in the

Table 4: Annual steady-state growth rates with endogenous growth

$$\eta = 1 - \alpha$$

	(a)	(b)	(c)
	$\sigma = \frac{1}{2}$	$\sigma = 1$	$\sigma = \frac{3}{2}$
WE	1.00	1.00	1.00
TO	0.26	0.26	0.26
TY	1.31	1.31	1.31
PA	0.64	1.00	1.35

capital intensity and in wages.

Next we study the introduction of a perfectly competitive annuity market offering actuarially fair annuitization products. We demonstrate that there exists a *tragedy of annuitization*: although full annuitization of assets is privately optimal it may not be socially beneficial due to adverse general equilibrium repercussions. For example, if the economy is initially in the equilibrium with accidental bequests flowing to the young, then opening up annuity markets will reduce steady-state welfare regardless of the magnitude of the intertemporal substitution elasticity. Intuitively, private annuities redistribute assets from deceased (unlucky) individuals to surviving (lucky) elderly in an actuarially fair way whereas transferring unintended bequests to the young constitutes an intergenerational transfer. This intergenerational transfer induces beneficial savings effects, which, in the end, lead to higher welfare.

The existence of the tragedy is the rule rather than the exception. We find an even stronger version which states that revenue wasting dominates perfect annuitization, and we show that it also turns up in an endogenous growth context. We investigate the robustness of our conclusions by considering various constellations of the structural parameters.

In future work we hope to pursue the following extensions. First, we wish to endogenize the labour supply decision in order to investigate the retirement effects of accidental bequests, recycling schemes, and the annuity market. In that context we will also introduce social annuities – such as a PAYG pension system – which is an example of a scenario whereby transfers flow from the young to the old. Second, we wish to investigate the tragedy of annuitization in an adverse selection economy. Following the insights of Heijdra and Reijnders (2009), we will extend the model to include agents who differ in health type. If health status is unobservable to annuity firms the only feasible perfectly competitive annuity market equilibrium involves risk pooling by healthy and unhealthy agents. We anticipate that the market imperfection in the annuity market will only serve to provide further support for the validity of the tragedy of annuitization.

References

- Abel, A. B. (1985). Precautionary saving and accidental bequests. *American Economic Review*, 75:777–791.
- Abel, A. B., Mankiw, N. G., Summers, L. H., and Zeckhauser, R. (1989). Assessing dynamic efficiency: Theory and evidence. *Review of Economic Studies*, 56:1–19.
- Attanasio, O. P. and Weber, G. (1995). Is consumption growth consistent with intertemporal optimization? Evidence from the consumer expenditure survey. *Journal of Political Economy*, 103:1121–1157.
- Davidoff, T., Brown, J. R., and Diamond, P. A. (2005). Annuities and individual welfare. *American Economic Review*, 95:1573–1590.
- Diamond, P. A. (1965). National debt in a neoclassical growth model. *American Economic Review*, 55:1126–1150.
- Fehr, H. and Habermann, C. (2008). Welfare effects of life annuities: Some clarifications. *Economics Letters*, 99:177–180.
- Heijdra, B. J., Mierau, J. O., and Reijnders, L. S. M. (2010). The tragedy of annuitization: Mathematical appendix. Faculty of Economics and Business, University of Groningen, July.
- Heijdra, B. J. and Reijnders, L. S. M. (2009). Economic growth and longevity risk with adverse selection. Working Paper 2898, CESifo, München.
- Kotlikoff, L. J., Shoven, J., and Spivak, A. (1986). The effect of annuity insurance on savings and inequality. *Journal of Labor Economics*, 4:S183–207.
- Pecchenino, R. A. and Pollard, P. S. (1997). The effects of annuities, bequests, and aging in an overlapping generations model with endogenous growth. *Economic Journal*, 107:26–46.
- Romer, P. M. (1989). Capital accumulation in the theory of long-run growth. In Barro, R. J., editor, *Modern Business Cycle Theory*, pages 51–127. Basil Blackwell, Oxford.
- Samuelson, P. A. (1968). The two-part golden rule deduced as the asymptotic turnpike of catenary motions. *Western Economic Journal*, 6:85–89.

- Sheshinski, E. and Weiss, Y. (1981). Uncertainty and optimal social security systems. *Quarterly Journal of Economics*, 96:189–206.
- Skinner, J. (1985). Variable lifespan and the intertemporal elasticity of consumption. *Review of Economics and Statistics*, 67:616–623.
- Yaari, M. E. (1965). Uncertain lifetime, life insurance, and the theory of the consumer. *Review of Economic Studies*, 32:137–150.

Authors: Ben J. Heijdra, Jochen O. Mierau, Laurie S.M. Reijnders

Title: The Tragedy of Annuity

Reihe Ökonomie / Economics Series 268

Editor: Robert M. Kunst (Econometrics)

Associate Editors: Walter Fisher (Macroeconomics), Klaus Ritzberger (Microeconomics)

ISSN: 1605-7996

© 2011 by the Department of Economics and Finance, Institute for Advanced Studies (IHS),
Stumpergasse 56, A-1060 Vienna • ☎ +43 1 59991-0 • Fax +43 1 59991-555 • <http://www.ihs.ac.at>
