

Efficiency of Infrastructure: The Case of Container Ports

Santiago Herrera

The World Bank, Washington, DC, USA

Gaobo Pang

Research Associate at Watson Wyatt, USA

Abstract

This paper gauges efficiency in container ports. Using non-parametric methods, we estimate efficiency frontiers based on information from 86 ports across the world. Three attractive features of the method are: 1) it is based on an aggregated measure of efficiency despite the existence of multiple inputs; 2) it does not assume particular input-output functional relationships; and 3) it does not rely on a-priori peer selection to construct the benchmark. Results show that the most inefficient ports use inputs in excess of 20 to 40 percent. Since infrastructure costs represent about 40 percent of total maritime transport costs, these could be reduced by 12 percent by moving from the inefficient extreme of the distribution to the efficient one.

Keywords: Container Ports, Efficiency Frontiers, Non-Parametric Methods

JEL Classification: H54, D24

Resumo

Este trabalho mede a eficiência nos portos que usam containers. Utilizando métodos não paramétricos, estimamos as fronteiras de eficiência baseado em informação de 86 portos distribuídos pelo mundo. Três aspectos positivos do método são: 1) baseado em uma medida agregada de eficiência apesar da existência de múltiplos insumos; 2) não assume relações funcionais particulares de insumo-produto; e 3) não se baseia em seleção a priori dos pares para construir o marco de referência. Os resultados mostram que os portos mais ineficientes usam insumos em excesso de 20 a 40 por cento. Tendo em vista que os custos de infraestrutura representam 40 por cento do total dos custos de transporte marítimo, estes poderiam ser reduzidos em cerca de 12 por cento movendo-se do extremo ineficiente da distribuição para o extremo eficiente.

* Submitted in November 2006, accepted in August 2007. The authors wish to thank comments by anonymous referees of this journal.

E-mail address: sherrera@worldbank.org.

1. Motivation and Introduction

Transport costs are a barrier to trade. To a large extent, they are determined by the efficiency of port infrastructure. Poor port efficiency will increase import prices and reduce the competitiveness of the country's exports in world markets. Hence, port efficiency is a critical link between the domestic economy and the rest of the world. Lowering transport costs will, presumably, increase trade volume and, consequently, enhance the productivity of domestic factors of production, leading to higher growth rates.

A fundamental task for policymakers and other stakeholders is to gauge and monitor efficiency of the port services. This is a difficult task in a fluid environment. Technological change has made the shipping business very different from what it used to be. Containerization transformed the cargo management operation from a break-bulk process into a bulk and unitized one. From a labor intensive activity, it switched into a capital intensive one. In this changing environment, monitoring efficiency based on historical performance might be misleading, and comparing port performance with peers from around the world may be more informative. This is reflected in the recent interest of policymakers and the academic community in international benchmarking of container ports.

The object of this paper is to gauge efficiency of container terminals across the world. Based on non-parametric methods, the paper estimates the maximum attainable output for a given input level and gauges efficiency as the distance from the observed input-output combinations to this frontier. Three attractive features of this approach are:

- 1) it is based on an aggregated measure of efficiency despite the existence of multiple inputs;
 - 2) it does not assume any particular functional relationship between inputs and outputs; and
 - 3) it does not rely on a-priori peer selection to construct the benchmark.
- Compared with previous work that has used similar methods, this paper specifically examines the performance of ports in developing countries and makes the comparison among a larger group of countries.

The paper has three chapters following this Introduction. The first one presents the methodology of the non-parametric methods, namely the Free Disposable Hull (FDH) and Data Envelopment Analysis (DEA) techniques. The second chapter describes the data and estimates the efficiency frontiers. Both input-efficiency (excess input consumption to achieve a given level of output) and output-efficiency (output shortfall for a given level of inputs) are scored. The chapter presents both the single input-single-output and the multiple-inputs frameworks. The third and last chapter summarizes the findings and concludes.

2. Methodology and Overview of Precursor Papers

The object of this chapter is to briefly describe the methodology applied in this paper and to survey previous studies of port efficiency. Both theoretical and empirical measures of efficiency are based on ratios of observed output levels to the maximum that could have been obtained, given the inputs utilized. This maximum constitutes the efficient frontier which will be the benchmark for measuring the relative efficiency of the observations. There are multiple techniques to estimate this frontier, surveyed recently by Murillo-Zamorano (2004), and the methods have been recently applied to examine port efficiency. These two topics are explored in the next two sections.

2.1. *Methods for measuring efficiency*

The origin of the modern discussion of efficiency measurement dates back to Farrell (1957), who identified two different ways in which productive agents could be inefficient: one, they could use more inputs than technically required to obtain a given level of output, or two, they could use a sub-optimal input combination given the input prices and their marginal productivities. The first type of inefficiency is termed technical inefficiency while the second one is known as allocative inefficiency.

These two types of inefficiency can be represented graphically by means of the unit isoquant curve in Figure 1. The set of minimum inputs required for a unit of output lies on the isoquant curve YY' . An agent's input-output combination defined by bundle P produces one unit of output using input quantities X_1 and X_2 . Since the same output can be achieved by consuming less of both inputs along the radial back to bundle R , the segment RP represents the inefficiency in resource utilization. The technical efficiency (TE), input-oriented, is therefore defined as $TE = OR/OP$. Furthermore, the producer could achieve additional cost reduction by choosing a different input combination. The least cost combination of inputs that produces one unit of output is given by point T , where the marginal rate of technical substitution is equal to the input price ratio. To achieve this cost level implicit in the optimal combination of inputs, input use needs to be contracted to bundle S . The input allocative efficiency (AE) is defined as $AE = OS/OR$.

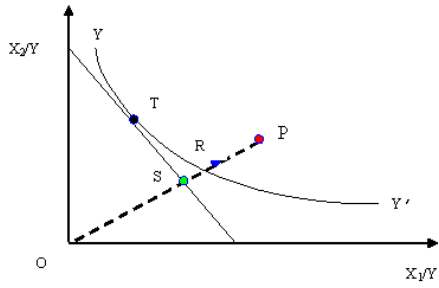

Fig. 1. Technical and allocative inefficiency

The focus of this paper is measuring technical efficiency, given the lack of comparable input prices across the countries. This concept of efficiency is narrower than the one implicit in social welfare analysis. That is, countries may be producing the wrong output very efficiently (at low cost). We abstract from this consideration (discussed by Tanzi (2004), focusing on the narrow concept of efficiency).

Numerous techniques have been developed over the past decades to tackle the empirical problem of estimating the unknown and unobservable efficient frontier (in this case the isoquant YY''). These may be classified using several taxonomies. The two most widely used catalog methods into parametric or non-parametric, and into stochastic or deterministic. The parametric approach assumes a specific functional form for the relationship between the inputs and the outputs as well as for the inefficiency term incorporated in the deviation of the observed values from the frontier. The non-parametric approach calculates the frontier directly from the data without imposing specific functional restrictions. The first approach is based on econometric methods, while the second one uses mathematical programming techniques. The deterministic approach considers all deviations from the frontier explained by inefficiency, while the stochastic focus considers those deviations a combination of inefficiency and random shocks outside the control of the decision maker.

This paper uses non-parametric methods to avoid assuming specific functional forms for the relationship between inputs and outputs or for the inefficiency terms. The remainder of the section briefly describes the two methods: the Free Disposable Hull (FDH) and the Data Envelopment Analysis (DEA). The FDH method imposes the least amount of restrictions on the data, as it only assumes free-disposability of resources. Figure 2 illustrates the single-input single-output case of FDH production possibility frontier.

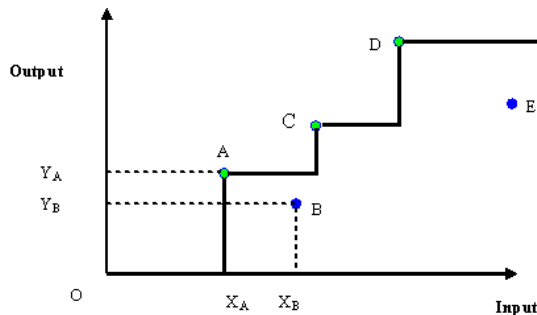

Fig. 2. Free Disposal Hull (FDH) production possibility frontier

Countries A and B use input X_A and X_B to produce outputs Y_A and Y_B , respectively. The *input efficiency* score for country B is defined as the quotient X_A/X_B . The *output efficiency* score is given by the quotient Y_B/Y_A . A score of one implies that the country is on the frontier. An input efficiency score of 0.75 indicates that this particular country uses inputs in excess of the most efficient producer to

achieve the same output level. An output efficiency score of 0.75 indicates that the inefficient producer attains 75 percent of the output obtained by the most efficient producer with the same input intake. Multiple input and output efficiency tests can be defined in an analogous way.

The second approach, Data Envelopment Analysis (DEA), assumes that linear combinations of the observed input-output bundles are feasible. Hence it assumes convexity of the production set to construct an envelope around the observed combinations. Figure 3 illustrates the single input-single output DEA production possibility frontier. In contrast to the vertical step-ups of FDH frontier, DEA frontier is a piecewise linear locus connecting all the efficient decision-making units (DMU). The feasibility assumption, displayed by the piecewise linearity, implies that the efficiency of *C*, for instance, is not only ranked against the real performers *A* and *D*, called the peers of *C* in the literature, but also evaluated with a virtual decision maker, *V*, which employs a weighted collection of *A* and *D* inputs to yield a virtual output. DMU *C*, which would have been considered to be efficient by FDH, is now lying below the variable returns to scale (VRS, further defined below) efficiency frontier, *XADF*, by DEA ranking. This example shows that FDH tends to assign efficiency to more DMUs than DEA does. The input-oriented technical efficiency of *C* is now defined by $TE = YV/YC$.



Fig. 3. DEA production possibility frontier

If constant returns to scale (CRS) characterize the production set, the frontier may be represented by a ray extending from the origin through the efficient DMU (ray *OA*). By this standard, only *A* would be rated efficient. The important feature of the *XADF* frontier is that this frontier reflects variable returns to scale. The segment *XA* reflects locally increasing returns to scale (IRS), that is, an increase in the inputs results in a greater than proportionate increase in output. Segments *AD*

and DF reflect decreasing returns to scale. It is worth noticing that constant returns to scale technical efficiency (CRSTE) is equal to the product of variable returns to scale technical efficiency (VRSTE) and scale efficiency (SE). Accordingly, DMU D is technically efficient but scale inefficient, while DMU C is neither technically efficient nor scale efficient. The scale efficiency of C is calculated as YN/YV . For more detailed exploration of returns to scale, readers are referred to Charnes et al. (1978) and Banker et al. (1984), among others.¹

The shipping business and port services are characterized by scale economies, as the cost of mobilizing a 40-foot container is more or less the same as mobilizing a 20-foot one. For those ports that are inefficient, the adjustment path towards the efficiency frontier will depend on their location with respect to the increasing returns to scale (IRS) or decreasing returns to scale (DRS) portions of the efficiency frontier. Figure 4 represents the different possibilities.² Both ports E and F are classified as inefficient. However, their production levels differ because E lies in the IRS portion while F is characterized by DRS. Hence, to achieve benchmark efficiency level, port E should increase output level until point E' , while port F should decrease input consumption until reaching F' .

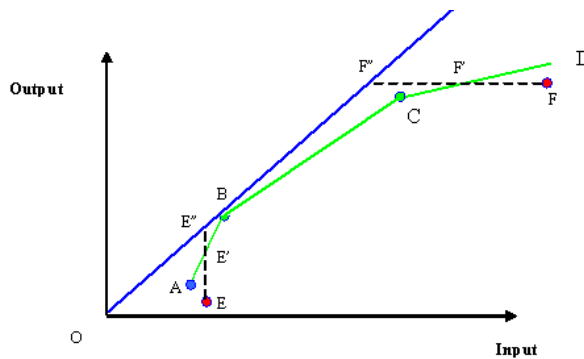

Fig. 4. Efficiency and Returns to Scale

Finally, the selection of peers for the construction of the benchmark depends on whether the efficiency measurement is output-oriented or input-oriented, and on the specific situation of the port with respect to other agents and the frontier. Figure 5 illustrates the different possibilities. For instance, both ports M and N are inefficient. For port M , A and D serve as the benchmark peers when measuring input efficiency, and D and F are peers when measuring output efficiency. For

¹ The technical Appendix A provides more detailed exploration of the Data Envelopment Analysis, which shows how the peers are identified, how the virtual DMUs are constructed, and how weights to the different efficient DMUs and efficiency scores are calculated.

² Following Golany and Thore (1997) graphical exposition.

port N , the measurement of both input and output inefficiencies is based on the combinations of ports D and F .

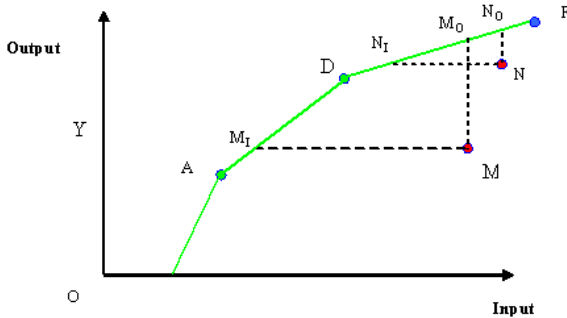

Fig. 5. Selection of peers

The limitations of the non-parametric method derive mostly from the sensitivity of the results to sampling variability, to the quality of the data and to the presence of outliers. This has led recent literature to explore the relationship between statistical analysis and non-parametric methods (Simar and Wilson 2000). Some solutions have been advanced. For instance, confidence intervals for the efficiency scores can be estimated using asymptotic theory in the single input case (for input-efficiency estimators) or single-output (in the output efficiency) case, given these are shown to be maximum likelihood estimators (Banker (1993) and Grosskopf (1996)). For multiple input-output cases the distribution of the efficiency estimators is unknown or quite complicated and analysts recommend constructing the empirical distribution of the scores by means of bootstrapping methods (Simar and Wilson 2000). Other solutions to the outlier or noisy data consist in constructing a frontier that does not envelop all the data point, building an expected minimum input function or expected maximum output functions (Cazals et al. (2002), and Wheelock and Wilson (2003)).

2.2. Overview of precursor papers

This section will not attempt an exhaustive survey of the applied literature on the measurement of port efficiency, as this is covered in three recent papers: Gonzalez and Trujillo (2005), Tovar et al. (2003) and Wang et al. (2002). Instead, it will do taxonomy useful to guide the reader through the present paper.

The various papers can be classified either by the method or by the sample they use. The papers use either the stochastic frontier methods or non-parametric methods. The first two surveys refer mostly to other papers using this method, while the Wang et al. (2002) paper surveys exclusively papers using the DEA method.

Additionally, the papers can be classified according to the samples. Papers are based on samples coming from a single country, or they can include ports of different countries. Within the single-country sample, the most recent are Park and De (2004) study of Korean ports, Cullinane and Dong (2003) analysis of Korean ports, Gonzalez and Trujillo (2005) study of Spanish ports, and Estache et al. (2001) study of Mexican ports. These papers have relatively few ports and a long time series. The paper on Mexico has the largest number of ports (13) while the paper on Spanish ports covers the longest time span (1990-2002). These papers have an output variable and use some proxies for capital, labor and other intermediate products as inputs.

Alternatively, the sample can cover ports from around the world. Among this group of papers we have Cullinane et al. (2004), including the largest 30 container ports. Valentine (2001) study of 15 African ports, Valentine and Gray (2001) that study 31 container ports across the world, and Notteboom et al. (2000) that included 36 European container terminals and 4 Asian terminals. All of these studies use DEA techniques, except Notteboom et al. (2000). They all use as inputs the number of cranes, the terminal area, and the container berth length. None of these papers uses labor input, except Notteboom et al. (2000). They report no statistical significance for this input and attribute the result to the co-linearity of this variable with cranes. In turn, most of the papers cover developed nations, with the exception of Estache et al. (2001) and Valentine (2001) referenced above.

Finally, though using a completely different methodology to estimate port efficiency, Clark et al. (2002) have an interesting application of their efficiency measure by relating it to maritime transport costs. Their result of higher efficiency associated with lower transport costs is statistically significant and of substantial impact. The main limitation, acknowledged by the authors, derives from the lack of “comparable information about port efficiency-at port level – to be used in cross-country analysis”. The authors construct alternative aggregate measure of port efficiency at the country level, consisting of a one-to-seven index from the Global Competitiveness Report (GCR). The authors also examine the time necessary for customs clearance based on surveys performed by the World Bank and measures on the prevalence of organized crime.

3. Data and Results

3.1. Data description

The service delivered by a container terminal is the transfer of cargo from a ship to an inland transportation system. In the past decades, the maritime transportation business changed dramatically due to the containerization process. From a break-bulk operation consisting in the transport of thousands of loose packages in small consignments, the operation moved to one of bulk and unitized trades. While the first type of operation was labor intensive and did not require

much investment in equipment or technology, the second is just the opposite (Martin and Thomas 2001).

In the process of mobilizing the cargo, which is the main output indicator, there are several stages that require different inputs. First, in the quay, the key input is the sea-to shore-gantry. Given the enormous differences between the volume of cargo that a ship can carry and that the land vehicles can carry, the terminal area is critical for storage purposes. The yard cranes are important inputs, as well as tractors and trailers to mobilize the cargo within the terminal. Therefore, the combination of equipment, land and labor will determine the efficiency of each terminal.

As an output, we used the cargo throughput, which is measured by the number of twenty-foot equivalent units (TEU), the most common standard size for a container of 20 feet long. As inputs, we considered the terminal area (A), and three types of equipment: the number of ship-to-shore gantries (SSG), the number of quay, yard and mobile gantries (QYM), and the number of tractors and trailers (TT). All the information comes from several issues of the Containerization International Yearbooks. The full set of information on throughput and the four inputs is available for a sample of 51 ports. The sample may be expanded to 82 ports if only the area is considered as the input, or to 70 ports in the case of ship-to-shore gantry. The four inputs are positively correlated, indicating their complementary nature in the production process (Figure 6 and Appendix B).

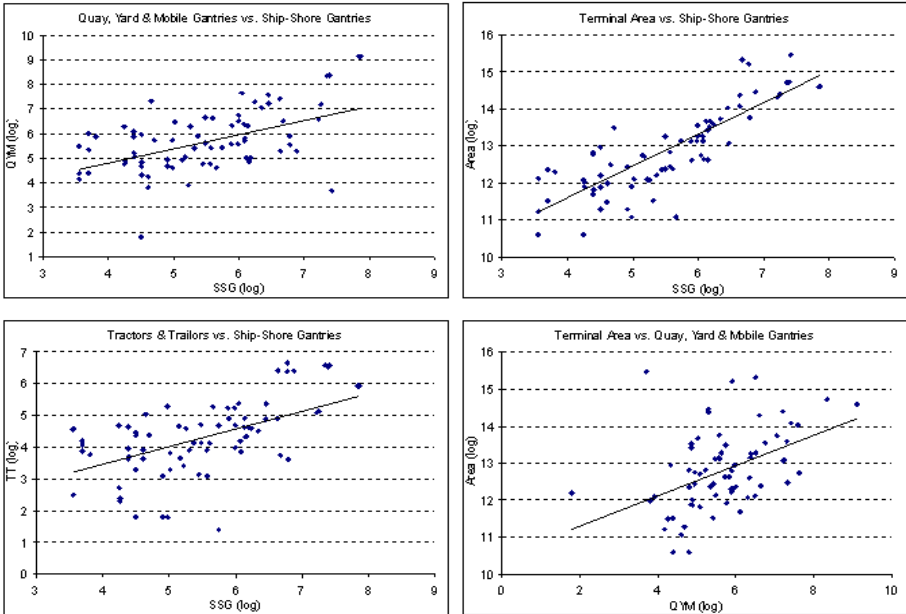

Fig. 6. Combinations of different inputs across countries

Cross-country comparisons assume some homogeneity across the world in the production technology of container terminal services.³ There are two particular aspects in which the homogeneity assumption is important. First, the comparison assumes that there is a small number of factors of production that are the same across countries. Any omission of an important factor will yield as a result a high efficiency ranking of the country that uses more of the omitted input. Second, the comparison requires that the quality of the inputs is more or less the same, with the efficiency scores biased in favor of countries where the quality is of higher grade.

The present paper omits labor as a factor of production because of the unavailability of comparable data across countries. It might not be a critical omission because:

- a) technological change that has reduced the importance of this factor;
- b) there is a stable relationship between some of the port equipment and the number of staff, and to the extent that we include this equipment (*e.g.*, TT) we capture the labor effect; and
- c) we check the results reported in the next section for any correlation with the capital labor ratio of the country and find no evidence of a significant correlation.⁴

Factor heterogeneity will not be a problem as long as it is evenly distributed across countries. It will be problematic if there are differences between countries in the average quality of a factor (Farrell 1957). One factor that is not evenly distributed is geographical location. This is a major limitation, but still there are major differences in efficiency in ports in the same bay (Buenos Aires and Montevideo).

A final issue is the consideration of returns to scale of the production function. We used DEA to allow possibilities of variable returns to scale.

3.2. *Results of efficiency estimates*

This section presents the single-input results, while a longer version of the paper reports the multiple input analysis. Similarly, this version of the paper reports results for a restricted sample of 51 ports, while the longer version of the paper reports results for enlarged samples of up to 82 ports. A third subsection discusses the adjustment towards the efficiency frontier based on whether the port exhibits increasing or decreasing returns to scale.

3.2.1. *Single input (restricted Sample – 51 ports)*

We first restrict the estimation to the sample of 51 ports with full information in order to minimize the possibility of sample variability biasing our results. We

³ See Appendix B for the list of container ports included in the study.

⁴ This supposes that the capital-labor ratio of the country is similar to the specific port.

use both the FDH and DEA methods to estimate the efficiency frontiers depicted in Figure 7.

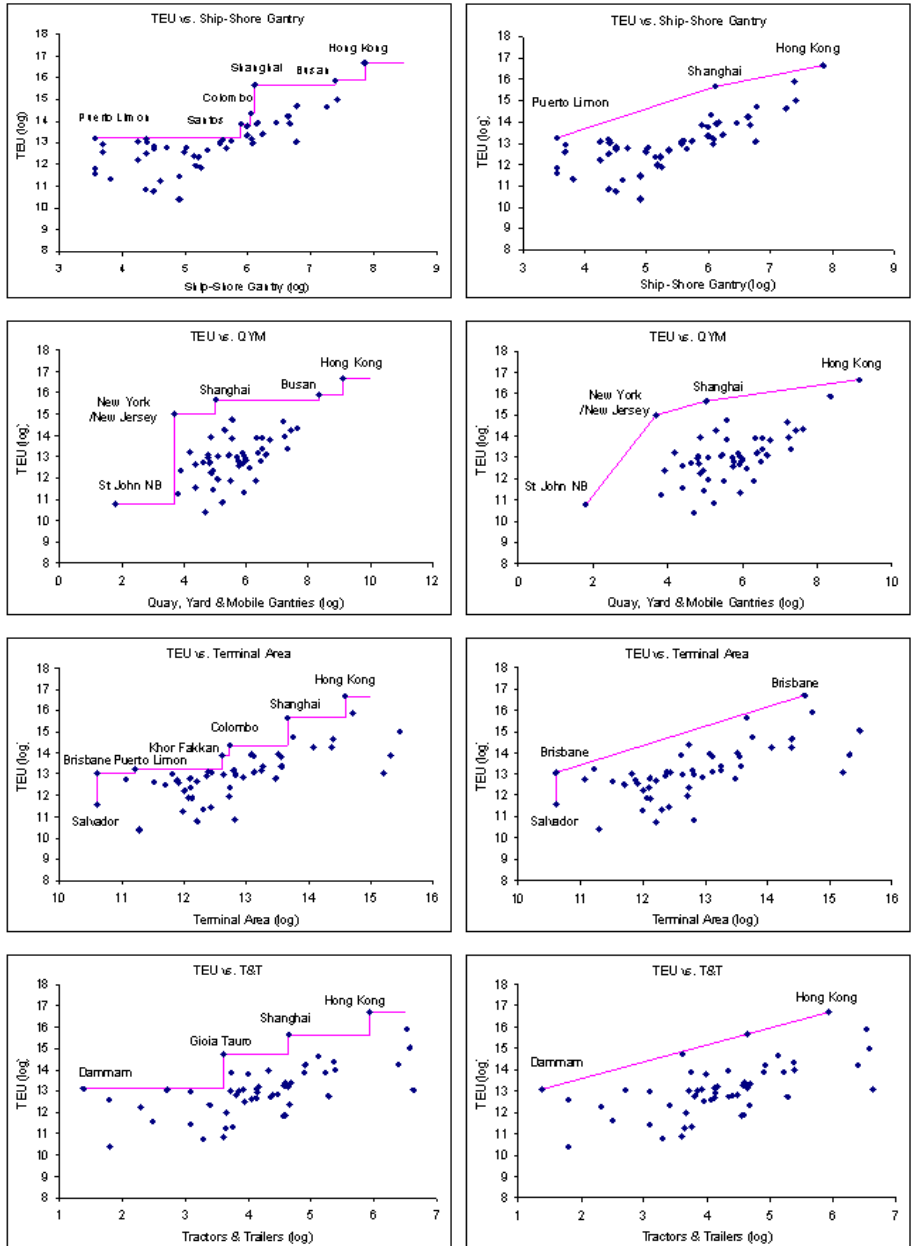

Fig. 7. Efficiency frontiers – Single input – Restricted sample

The goodness-of-fit of each model was gauged based on the frequency distribution of the inefficiency measures, as suggested by Farrell (1957) and Varian (1990). Comparing the distributions of the efficiency scores (Figure 8) it is clear that the terminal area is the input that produces the distribution more skewed towards the right. These distributions are preferable because it is less plausible that there are more inefficient agents (ports) than efficient ones.

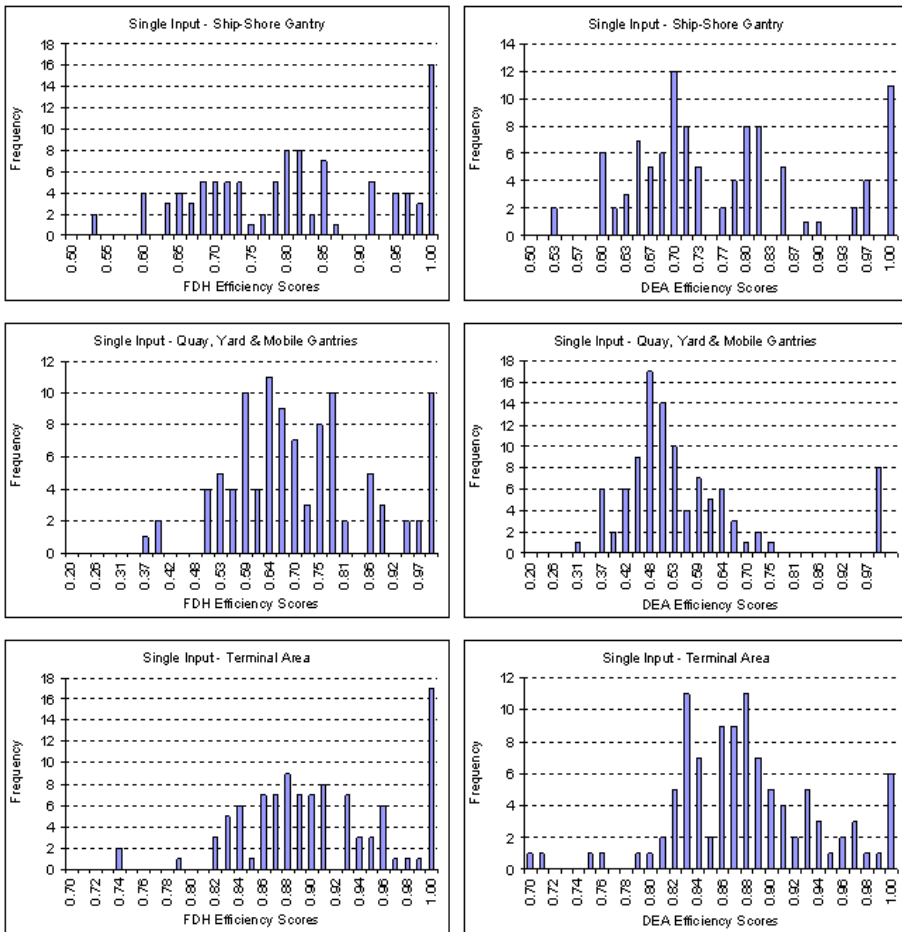

Fig. 8. Distribution of efficiency scores

These distributions correspond to the input-efficiency estimates of the scores. The rankings of the ports are very similar: the FDH and DEA scores for the 4 single input models have correlation coefficients of .45 and .65 for both input and output scores. We begin by discussing the input efficiency scores to emphasize the cost-reduction nature of adjustment, as the volume of throughput is generally not

a decision variable.

The four single-input single-output models, using both the FDH and DEA methods produce eight alternative rankings of efficiency. Most of pairs of rankings are positively correlated and the individual scoring for each of the ports can be found in Appendix C. To examine the possible empirical regularities of the four DEA input efficiency scores (one set of efficiency scores for each of the four inputs), we correlated them with the level of inputs and the level of output of each container terminal. Recall that, in the case of an omitted factor of production, the efficiency scores will be biased in favor of the DMU that use intensively this omitted input. The correlation with the output is computed to examine if there is any relationship between the efficiency scores and the scale of operation of the terminal.

Table 1 reports the correlation coefficients of the four efficiency scores with the four inputs, namely, the area, sea-to-shore gantries (SSG), quay, yard and mobile gantries (QYM), and tractors and trailers (T&T). Additionally, it reports the correlation coefficient of the scores and the output indicator (mobilized cargo in TEU). These correlations indicate:

- a) the area and SSG are the inputs that produce efficiency scores with no bias, given the low and insignificant values of the correlation coefficients. The other two inputs (QYM and T&T) produce efficiency scores that show bias in favor of units using the omitted factors of production;
- b) there is mixed evidence on the relationship between terminal size and efficiency.

The Area and SSG efficiency scores are uncorrelated with the volume of cargo, but the other efficiency scores are positively correlated with it. Other sections explore in more detail this crucial topic.

Table 1

Correlation coefficients between input-efficiency scores and input and output levels

Inputs or output indicator	Efficiency score-area	Efficiency score-SSG	Efficiency score-QYM	Efficiency score-T&T
Area	-.53	-.29	.29	.32
SSG	-.12	-.48	.33	.46
QYM	-.04	-.10	-.28	.22
T&T	-.19	-.03	.29	-.19
TEU	.14	.04	.50	.50

Examining the 25th percentile (most efficient) ports of the different efficiency scores distributions, as well as the bottom quartile (least efficient ports) in each ranking, there are some ports that are repeatedly classified in one group or the other. Table 2 reports the ports more commonly appearing in the efficient and inefficient clusters, with the number of times they appeared in that category.

Table 2

Most efficient ports and least efficient ports (common-restricted sample)

Most efficient	Busan (8), Hong Kong (8) , Shanghai (8), Puerto
	Limon (7), Salvador (6), Montevideo (5) Gioia
	Tauro (5), Brisbane (4), Southhampton (4)
Least efficient	Baltimore (6), Halifax (5), Savannah (5),
	Shimizu (5), Thamesport (4). Limassol (4),
	Buenos Aires (4), Aden (4), Rio Grande (4),
	Dublín (4), Le Havre (4)

The average efficiency score of the bottom 25th percentile varies depending on the selected input. For instance, when terminal area is considered, the average score of the least efficient group is .82 while the average score of the top 25th percentile is .96, implying that moving from one end of the distribution to the other would entail using less terminal area by 17 percent. When the number of sea-to-shore gantries is considered, the potential for cost reduction is even larger: the average score of the inefficient group is .63, while the more efficient average score is .93.

Considering that infrastructure costs represent about 40 percent of total shipping costs (Limao and Venables 2000), the potential for input reduction in the least efficient quartile reported above of the order of 20 percent (average of area and SSG) would imply a potential shipping cost reduction of the order of 13 percent,⁵ very similar to estimates reported by previous authors. For instance, Clark et al. (2002) estimated a cost reduction of 15 percent in the shift from the least efficient to the more efficient tail of the distribution. However, these estimates of potential cost reduction of transport costs seem much lower than those reported by Limao and Venables, who report potential cost increases of 12 percent by moving from the median to the most inefficient group.

The clustering reported in Table 2 shows interesting results to further exploration in in-depth case studies. For instance, regarding geographical location, it is notable that 3 Asian ports (Busan, Hong Kong, and Shanghai) are ranked unambiguously in the most efficient category, while 3 North American ports (Baltimore, Halifax, Savannah) on the Atlantic coast appear in the least efficient set. Geographical location with respect to production and consumption centers is generally regarded as a factor determining port traffic.

The above discussion leads to the relationship between traffic (size) and efficiency, as the Asian ports have substantial traffic and high efficiency scores. What is the relationship between traffic and efficiency? There seems to be evidence that in northern Europe higher efficiency attracted traffic (ESPO (1996), Notteboom et al. (2000)). And in India, there is some evidence of causality from port performance

⁵ An average reduction of input utilization of 32 percent described in the previous paragraph, multiplied by the weight of infrastructure cost (40 percent) in total shipping cost

to port traffic (De and Ghosh 2003). This indicates that policies that promote efficiency are preferable than those that promote more extensive use of resources.

On the relationship between size and efficiency, Figure 9 shows the scatter plot of the input-efficiency scores and the volume of cargo. When the area or ship-to-shore gantries (SSG) are omitted, there is a strong correlation between efficiency and volume of cargo. These estimates are biased in favor of the ports that use more intensively those omitted factors, which are the larger ports. Hence, these results do not allow verification of any clear and simple relationship between port size and efficiency.

Other puzzles related to geographical location refer to the fact that ports across the same bay (Mar del Plata), but in different countries, appear in opposite extremes: Montevideo is classified in the efficient group while Buenos Aires is ranked among the least efficient. Similarly, it is interesting to note that different ports within the same country appear in both extremes of the distribution: in Brazil, Salvador appears in the most efficient group, while Rio Grande shows in the opposite extreme.

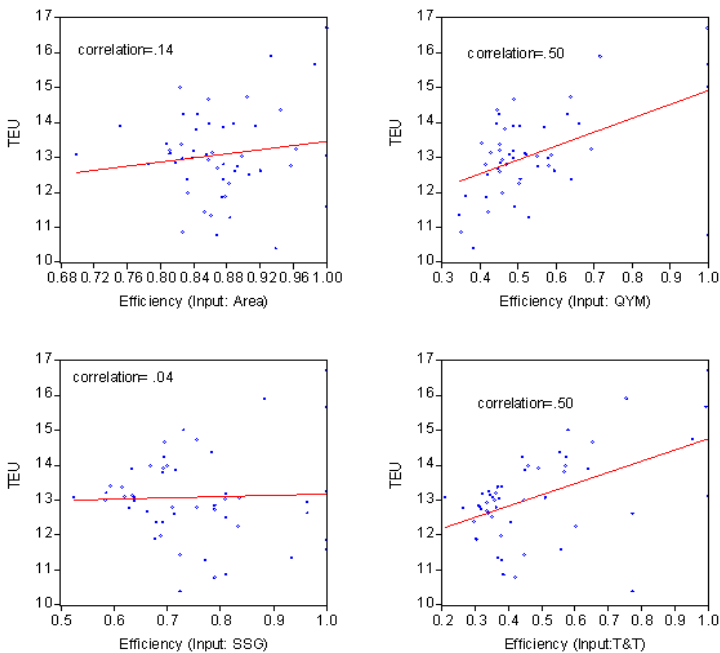

Fig. 9. Scatterplot of efficiency levels and (LOG) container throughput

Examining the output efficiency scores, there are similarities and differences with the input-efficiency scores. Among the similarities, we find that the correlation of the efficiency scores with each of the inputs is lower when the scores are computed with the area as single input (Table 3), the ship-to-shore gantry (SSG) factor yields slightly higher correlations and the other two show clear bias in favor of ports using the omitted factors of production.

Among the differences between the output-oriented efficiency scores and the input-oriented ones is the positive and significant correlation between the scores and the level of output. Figure 10 shows the unambiguous relationship indicating that, based on this simple examination, larger ports tend to be more efficient than smaller ones.

Table 3
Correlation coefficients between output-efficiency scores and input and output levels

Inputs or output levels	Efficiency score-area	Efficiency score-SSG	Efficiency score-QYM	Efficiency score-T&T
Area	-.08	.18	.56	.42
SSG	.21	.11	.62	.56
QYM	.28	.33	.13	.41
T&T	.23	.38	.51	.02
TEU	.67	.73	.81	.80

Table 4
Most output-efficient ports and least output-efficient units (common-restricted sample)

Most efficient	Hong Kong (8), Shanghai (8), Busan (7), Goia Tauro (6), Brisbane (6), Yokohama (4), Southhampton (4), Puerto Limon (4) New York/New Jersey (4), Colombo, Manzanillo (4), Khor Fakkan (4)
Least efficiency	Klaipeda (8), Maputo(8), Rauma (8), Willemstad (8), Koper (7), Ravenna (7), Baltimore (6), Limassol (6), St. John (6), Port Sultan Qaboos (6), Vigo (6)

3.2.2. *Increasing or decreasing returns to scale*

Adjustment of a particular inefficient port towards the efficiency frontier depends on whether it is located on the increasing returns to scale (IRS) or decreasing returns (DRS) portion of the production frontier. As described in the previous chapter (Fig. 4), if the port stands in the IRS portion, then increasing the scale of operation will be optimal since it will reduce average cost per unit of output. If the port is located on the DRS side, then a contraction of the amount of inputs is the recommended strategy to move towards the efficiency frontier.

The reduction of scale inefficiency can be achieved either by reducing input consumption (*i.e.* the scale of operation) or by increasing it. It is a port-specific situation, as reported in Appendix D. Table D.1 reports the single-input case and Table D. 2 reports the multiple-input case. In general, both estimates coincide. Most of the ports in the developing countries would reduce scale inefficiency by increasing the scale of operation, while about one third of them would reduce scale inefficiency by contracting the level of input consumption. This is the case for Buenos Aires, Colombo, Damietta, Khor Fakkan, Kingston, Santos and Shanghai.

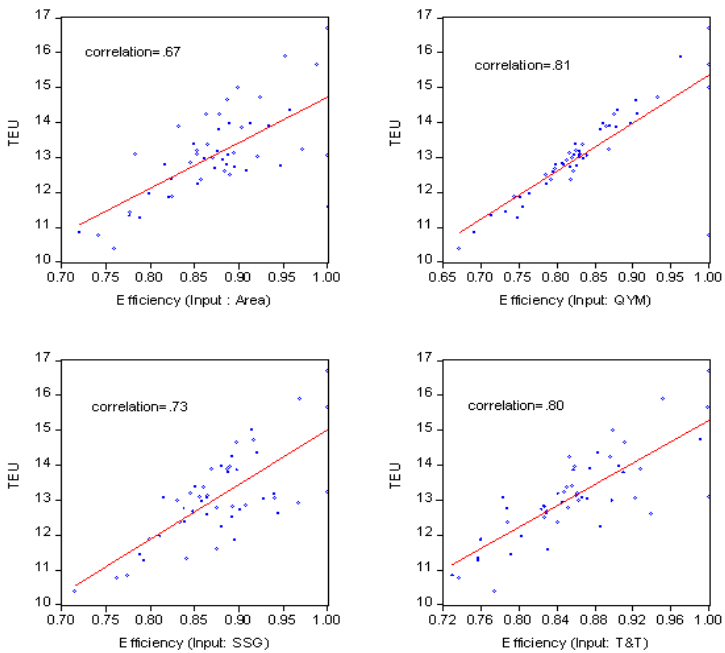

Fig. 10. Scatterplot of output-efficiency and container throughput

4. Conclusions and Directions for Future Work

The efficiency scores computed in the paper uncover that the margin for cost reduction is significant. The most inefficient ports use inputs in excess of 20 to 40 percent of the level used in the most efficient ports. Given that infrastructure costs represent about 40 percent of total maritime transport costs, total maritime costs could be reduced by approximately 12 percent by moving from one extreme of the distribution to the other.

Geographical location seems to be a determinant of efficiency but with puzzles. For instance, some Asian ports appeared as the most efficient, while North American ports appeared as inefficient. Whether this is due to proximity to the production or consumption centers deserves further study. Similarly, further study would be needed to clarify if the larger participation of the private sector in the terminals of those ports, is in fact a major differentiating factor with respect to the North American ports where port services are mostly publicly provided.

Evidence supports the hypothesis that larger ports are more efficient than smaller ones. However, the question of causality is crucial. Evidence from European ports and Indian ports seem to indicate that efficiency and performance are the leading variable.

The results indicate that most ports in developing countries in our sample could reduce scale inefficiency by increasing the scale of operations. However, about one third of the ports in the sample would reduce the inefficiency by contracting the scale of operation.

References

- Banker, R. (1993). Maximum likelihood, consistency and data envelopment analysis: A statistical foundation. *Management Science*, 39(10):1–16.
- Banker, R. D., Charnes, A., & Cooper, W. (1984). Models for estimation of technical and scale inefficiencies in data envelopment analysis. *Management Science*, 30:1078–1092.
- Bowlin, W. F. (1998). Measuring performance: A introduction to data envelopment analysis (DEA). *Journal of Cost Analysis*, Fall:3–27.
- Cazals, C., Florens, J., & Simar, L. (2002). Non-parametric frontier estimation: A robust approach. *Journal of Econometrics*, 106(1):1–25.
- Charnes, A., Cooper, W., & Rhodes, E. (1978). Measuring efficiency of decision-making units. *European Journal of Operational Research*, 3:429–444.
- Clark, X., Dollar, D., & Micco, A. (2002). Maritime transport costs and port efficiency. Policy Research Working Paper 2781, February. The World Bank.
- Coelli, T. (1996). A guide to DEAP version 2.1: A data envelopment analysis (computer) program. Center for Efficiency and Productivity Analysis, CEPA, Working paper 96/08.

- Cullinane, K. & Dong, D. (2003). A stochastic frontier model of the productive efficiency of Korean container terminals. *Applied Economics*, 35:251–267.
- Cullinane, K., Song, D., Ji, P., & Wang, T. (2004). An application of DEA windows analysis to container port production efficiency. *Review of Network Economics*, 3(2):186–208.
- De, P. & Ghosh, B. (2003). Causality between performance and traffic: An investigation with Indian ports. *Maritime Policy & Management*, 30(1):5–27.
- ESPO (1996). Report on the enquiry into the current situation in the major community seaports. Brussels European Seaports Organization.
- Estache, A., Gonzalez, M., & Trujillo, L. (2001). Technical efficiency gains from port reform. Policy Research Working Papers 2637, July, The World Bank.
- Farrell, M. (1957). The measurement of productive efficiency. *Journal of the Royal Statistical Society, Series A*, 120(3):253–290.
- Golany, B. & Thore, S. (1997). The economic and social performance of nations: Efficiency and returns to scale. *Socio Economic Planning Science*, 31(3):191–204.
- Gonzalez, M. & Trujillo, L. (2005). Reforms and infrastructure efficiency in Spain's container ports. Policy Research Working Paper 3515, February, The World Bank.
- Grosskopf, S. (1996). Statistical inference and non-parametric efficiency: A selective survey. *The Journal of Productivity Analysis*, 7:161–176.
- Limao, N. & Venables, A. (2000). Infrastructure, geographical disadvantage, transport costs and trade. Mimeo, December.
- Martin, J. & Thomas, B. (2001). The container terminal community. *Maritime Policy & Management*, 28(3):279–292.
- Murillo-Zamorano, L. (2004). Economic efficiency and frontier techniques. *Journal of Economic Surveys*, 18(1):33–77.
- Notteboom, T., Coeck, C., & Van Den Broeck, J. (2000). Measuring and explaining the relative efficiency of container terminals by means of Bayesian stochastic frontier models. *International Journal of Maritime Economics*, 2:83–106.
- Park, R. & De, P. (2004). An alternative approach to efficiency measurement of seaports. *Maritime Economics & Logistics*, 6:53–69.
- Simar, L. & Wilson, P. (2000). Statistical inference in non-parametric frontier models: The state of the art. *Journal of Productivity Analysis*, 13:49–78.
- Tanzi, V. (2004). Measuring efficiency in public expenditure. Paper presented in Conference on Public Expenditure Evaluation and Growth. The World Bank, October.
- Tovar, B., Jara-Diaz, S., & Trujillo, L. (2003). Production and cost functions and their applications to the port sector: A literature survey. Policy Research Working Paper 3123, August, The World Bank.
- Valentine, V. F. (2001). A comparison of African port performance. Mimeo presented at the 2001 National Maritime Conference.
- Valentine, V. F. & Gray, R. (2001). The measurement of port efficiency using data envelopment analysis. World Conference on Transport Research, Seoul, South Korea, July.

- Varian, H. (1990). Goodness-of-fit in optimizing models. *Journal of Econometrics*, 46:125–140.
- Wang, T., Song, D., & Cullinane, K. (2002). The applicability of data envelopment analysis to efficiency measurement of container ports. Mimeo.
- Wheelock, D. & Wilson, P. (2003). Robust non-parametric estimation of efficiency and technical change in U.S. commercial banking. Working Paper, Federal Reserve Bank of Sr. Louis, November.

Appendix A.

Data Envelopment Analysis (DEA) Model ⁶

A measure of production efficiency, perhaps the simplest one, is defined as the ratio of output to input. It is, however, inadequate to deal with the existence of multiple inputs and outputs. The relative efficiency for all decision-making units (DMUs), $j = 1, \dots, n$, is then modified as the ratio of weighted outputs to weighted inputs, as proposed by Farrell (1957), more precisely,

$$\text{Relative efficiency} = \frac{\sum_{r=1}^s u_r y_{rj}}{\sum_{i=1}^m v_i x_{ij}} \quad (\text{A.1})$$

where x and y are inputs and outputs, respectively, and u and v are the common weights assigned to outputs and inputs, respectively. A challenge to this measure immediately follows: it is difficult to justify the common weights given that DMUs may value inputs and outputs differently.

The seminal paper by Charnes et al. (1978) proposes the following ratio form to allow for difference in weights across DMUs, which establishes the foundation of data envelopment analysis (DEA).

$$\begin{aligned} \text{Max } h_0 &= \frac{\sum_{r=1}^s \mu_r y_{r0}}{\sum_{i=1}^m v_i x_{i0}} \\ \text{subject to} & \\ & \frac{\sum_{r=1}^s \mu_r y_{rj}}{\sum_{i=1}^m v_i x_{ij}} \leq 1, j = 1, \dots, n \\ & \mu_r \geq \epsilon, r = 1, \dots, s \\ & v_i \geq \epsilon, i = 1, \dots, m \\ & \epsilon > 0 \end{aligned} \quad (\text{A.2})$$

In the model, there are $j = 1, \dots, n$ observed DMUs which employ $i = 1, \dots, m$ inputs to produce $r = 1, \dots, s$ outputs. One DMU is singled out each time, designated as DMU₀, to be evaluated against the observed performance of all DMUs. The objective of model (A.2) is to find the most favorable weights, μ_r and v_i , for DMU₀ to maximize the relative efficiency. The constraints are that the weights will make ratio for every DMU be less than or equal to unity. The solution value of the ratio must be $0 \leq h_0^* \leq 1$. DMU₀ is efficient if and only if $h_0^* = 1$, otherwise it is considered as relatively inefficient. One problem with the ratio formulation is that there are an infinite number of solutions: if μ_r and v_i are solutions to (A.2), so are $\alpha\mu_r$ and αv_i , $\forall \alpha > 0$.

⁶ For more technical expositions, see Farrell (1957), Charnes et al. (1978), Coelli (1996), Bowlin (1998), and Murillo-Zamorano (2004).

It is worth observing one important feature of model (A.2): in maximizing the objective function, it is the relative magnitude of the numerator and the denominator that really matters and not their particular values. It is thus equivalent to setting the denominator to a constant, say 1, and maximizing the numerator. This transformation will not only lead to the uniqueness of solution but also convert the fractional formulation of model (A.2) into a linear programming problem in model (A.3).

$$\begin{aligned}
 & \text{Max} && \sum_{r=1}^s \mu_r y_{r0} \\
 & \text{subject to} && \\
 & \sum_{i=1}^m v_i x_{i0} = 1 && \tag{A.3} \\
 & \sum_{r=1}^s \mu_r y_{rj} - \sum_{i=1}^m v_i x_{ij} \leq 0, j = 1, \dots, n \\
 & -\mu_r \leq -\epsilon, r = 1, \dots, s \\
 & -v_i \leq -\epsilon, i = 1, \dots, m
 \end{aligned}$$

Model (A.3) facilitates straightforward interpretation in terms of economics. The objective is now to maximize the weighted output per unit weighted input under various conditions, the most critical one being that the virtual output does not exceed the virtual input for any DMU. The optimal value of $\sum_{r=1}^s \mu_r^* y_{r0}$ indicates the efficiency of DMU₀. Since model (A.3) is a linear programming, one may convert the maximization problem into a minimization problem, namely a *dual* problem, by assigning a dual variable to each constraint in the *primal* (A.3). Specifically, dual variables $\theta, \lambda_j, \eta_r, \gamma_i$ are assigned as follows.

Max	$\sum_{r=1}^s \mu_r y_{r0}$	Dual variable
subject to	$\sum_{i=1}^m v_i x_{i0} = 1$	θ
	$\sum_{r=1}^s \mu_r y_{rj} - \sum_{i=1}^m v_i x_{ij} \leq 0, j = 1, \dots, n$	λ_j
	$-\mu_r \leq \epsilon, r = 1, \dots, s$	η_r
	$-v_i \leq -\epsilon, i = 1, \dots, m$	γ_i

A *dual* minimization problem is thus derived as model (A.4). It is clear that model (A.4) has $m + s$ constraints while model (A.3) has $n + m + s + 1$ constraints.

Since n (the number of DMUs) is usually considerably larger than $m + s$ (number of inputs and outputs), the dual DEA significantly reduces the computational burden and is easier to solve than the primal.

$$\begin{aligned}
 \text{Min} \quad & \theta - \epsilon \left[\sum_{i=1}^m \gamma_i + \sum_{r=1}^s \eta_r \right] \\
 \text{subject to} \quad & \\
 \theta x_{i0} - \sum_{j=1}^n x_{ij} \lambda_j - \gamma_i = 0 & \quad (A.4) \\
 y_{r0} = \sum_{j=1}^n y_{rj} \lambda_j - \eta_r & \\
 \lambda_j \geq 0, \eta_r \geq 0, \gamma_i \geq 0 & \\
 i = 1, \dots, m, r = 1, \dots, s, j = 1, \dots, n &
 \end{aligned}$$

More importantly, the duality theorem of linear programming states that the solution value to the objective function in (A.4) is exactly equal to that in (A.3). And, the dual variables, $(\lambda_1, \lambda_2, \dots, \lambda_n)$, have the interpretation of Lagrange multipliers. That is, the value of a dual variable is equal to the shadow price of Lagrange Multiplier. It is also known that, from standard constrained optimization problem, generally $\lambda_j > 0$ when the constraint in (A.3) is binding and $\lambda_j = 0$ if not. Note that the binding constraint in (A.3) implies that the corresponding DMU is efficient. In another word, efficient units are identified by positive λ 's while inefficient units are given λ 's of zero. The DMU in question in model (A.4) is thus compared with the efficient DMUs only, named as comparison *peers* in the literature. The solution values of λ 's reflect the exact weights assigned to each peer in the evaluation of DMU₀.

Since only efficient DMUs exert effective constraints in model (A.4), as argued above, the input-output bundle, $(\sum_{j=1}^n x_{ij} \lambda_j, \sum_{j=1}^n y_{rj} \lambda_j)$, $i = 1, \dots, m$ and $r = 1, \dots, s$, is the most efficient combination for. To achieve an output level y_{r0} , which is as close as possible to $\sum_{j=1}^n y_{rj} \lambda_j$, DMU₀ has to use an input bundle to meet the minimum requirement, $\sum_{j=1}^n x_{ij} \lambda_j$. This further implies that the solution θ^* is the lowest proportion of the current input bundle, x_{i0} used by DMU₀, which is actually required to meet the minimum input requirement and produce target output y_{r0} . The solution θ^* is defined as the efficiency score for DMU₀. For instance, $\theta^* = 0.60$ implies that 40 percent of current input is a waste of resources.

Model (A.4) also offers the explanation why the data envelopment analysis is so named. The first constraint in (A.4) defines a lower limit of inputs and the second constraint an upper limit of outputs for DMU₀, and within the limits θ is minimized. The set of solutions to all DMUs forms an upper bound that envelops all observations.

Appendix B.**List of Ports**

Table B.1
Constant sample – 51 ports

No. Port	Country	No. Port	Country		
1	Aden	Yemen	27	Manzanillo	Mexico
2	Altamira	Mexico	28	Maputo	Mozambique
3	Balboa	Panama	29	Marsaxlokk	Malta
4	Baltimore	USA	30	Montevideo	Uruguay
5	Brisbane	Australia	31	New York/New Jersey	USA
6	Buenos Aires	Argentina	32	Port Sultan Qaboos	Oman
7	Busan	South Korea	33	Port of Spain	Trinidad & Tobago
8	Cartagena	Colombia	34	Puerto Cortes	Honduras
9	Casablanca	Morocco	35	Puerto Limon	Costa Rica
10	Colombo	Sri Lanka	36	Rauma	Finland
11	Damietta	Egypt	37	Ravenna	Italy
12	Dammam	Saudi Arabia	38	Rio Grande	Brazil
13	Dublin	Ireland	39	Salvador	Brazil
14	Genoa	Italy	40	Santos	Brazil
15	Gioia Tauro	Italy	41	Savannah	USA
16	Guayaquil	Ecuador	42	Shanghai	China
17	Halifax	Canada	43	Shimizu	Japan
18	Hong Kong	China	44	Southampton	UK
19	Khor Fakkan	UAE	45	St John NB	Canada
20	Kingston	Jamaica	46	St Petersburg	Russia
21	Klaipeda	Lithuania	47	Thamesport	UK
22	Koper	Slovenia	48	Thessaloniki	Greece
23	Le Havre	France	49	Vigo	Spain
24	Leixoes	Portugal	50	Willemstad	Netherlands Antilles
25	Limassol	Cyprus	51	Yokohama	Japan
26	Lisbon	Portugal			

Table B.2
Variable sample – 82 ports at maximum

Port	Country	Port	Country
Abidjan	Cote d'Ivoire	Kristiansand	Norway
Aden	Yemen	Kumport	Turkey
Alexandria	Egypt	Le Havre	France
Altamira	Mexico	Leixoes	Portugal
Balboa	Panama	Limassol	Cyprus
Baltimore	USA	Lisbon	Portugal
Bangkok	Thailand	Liverpool	UK
Barranquilla	Colombia	Manzanillo	Mexico
Beira	Mozambique	Maputo	Mozambique
Brisbane	Australia	Marsaxlokk	Malta
Buenos Aires	Argentina	Montevideo	Uruguay
Busan	South Korea	Nagoya	Japan
Callao	Peru	New York/New Jersey	USA
Cape Town	South Africa	Oranjestad	Aruba
Cartagena	Colombia	Palma de Mallorca	Balearic Is
Casablanca	Morocco	Port Sultan	Qaboos Oman
Colombo	Sri Lanka	Port of Spain	Trinidad & Tobago
Damietta	Egypt	Puerto Cortes	Honduras
Dammam	Saudi Arabia	Puerto Limon	Costa Rica
Djibouti	Djibouti	Puerto Manzanillo	Panama
Dubai	UAE	Rauma	Finland
Dublin	Ireland	Ravenna	Italy
Fort-de-France	Martinique	Rio Grande	Brazil
Fortaleza	Brazil	Salvador	Brazil
Fraser Port	Canada	San Antonio	Chile
Fredrikstad	Norway	Santo Tomas de Castilla	Guatemala
Freeport2	Bahamas	Santos	Brazil
Genoa	Italy	Savannah	USA
Gioia Tauro	Italy	Seattle	USA
Guayaquil	Ecuador	Shanghai	China
Hakata	Japan	Shimizu	Japan
Halifax	Canada	Southampton	UK
Helsinki	Finland	St John NB	Canada
Heraklion	Greece	St John's NF	Canada
Hong Kong	China	St Petersburg	Russia
Keelung	Taiwan	Thamesport	UK
Khor Fakkan	UAE	Thessaloniki	Greece
Kingston	Jamaica	Tilbury	UK
Kitakyushu	Japan	Vigo	Spain
Klaipeda	Lithuania	Willemstad	Netherlands Antilles
Koper	Slovenia	Yokohama	Japan

Appendix C.

Input oriented efficiency scores – Constant sample – 51 ports

		Single input						Two inputs			
		Ship-shore gantry		Quay, yard & mobile gantry		Terminal area		Tractors & trailers		Ship-shore gantry + terminal area	
Port	Year	FDH	DEA	FDH	DEA	FDH	DEA	FDH	DEA	FDH	DEA
Aden	2000	0.790	0.790	0.850	0.587	0.820	0.819	0.400	0.401	0.867	0.833
Altamira	2000	0.835	0.835	0.760	0.493	0.890	0.893	0.750	0.747	0.945	0.895
Balboa	2000	0.709	0.710	0.570	0.296	0.880	0.875	0.540	0.544	0.875	0.875
Baltimore	2000	0.525	0.525	0.620	0.484	0.740	0.705	0.570	0.354	0.738	0.705
Brisbane	2000	0.837	0.837	0.770	0.586	1.000	1.000	1.000	0.799	1.000	1.000
Buenos Aires	2000	0.722	0.590	0.490	0.401	0.890	0.795	0.740	0.527	0.890	0.795
Busan	2000	1.000	0.899	1.000	0.726	0.990	0.927	0.900	0.742	1.000	0.931
Cartagena	2000	0.811	0.811	0.630	0.474	0.830	0.829	0.590	0.460	0.878	0.857
Casablanca	2000	0.714	0.714	0.800	0.575	0.960	0.958	0.510	0.355	0.958	0.958
Colombo	2000	1.000	1.000	0.500	0.468	1.000	0.968	0.720	0.648	1.000	1.000
Damietta	2000	0.849	0.662	0.660	0.526	0.940	0.826	0.760	0.515	0.941	0.827
Dammam	2000	0.620	0.620	0.680	0.516	0.860	0.810	0.770	0.466	0.856	0.810
Dublin	2000	0.654	0.654	0.770	0.587	0.910	0.859	1.000	0.690	0.909	0.859
Genoa	2000	0.734	0.712	0.520	0.477	0.910	0.8687	0.800	0.698	0.908	0.868
Gioia Tauro	2000	0.911	0.768	0.660	0.652	0.990	0.910	1.000	1.000	0.993	0.910
Guayaquil	2000	0.964	0.964	0.690	0.519	0.860	0.858	0.700	0.541	0.965	0.964
Halifax	2000	0.586	0.586	0.580	0.454	0.860	0.825	0.870	0.558	0.855	0.825
Hong Kong	2000	1.000	1.000	1.000	1.000	1.000	1.000	1.000	1.000	1.000	1.000
Khor Fakkan	2000	0.790	0.700	0.580	0.503	0.990	0.911	0.740	0.578	0.990	0.911
Kingston	2000	0.777	0.641	0.550	0.453	0.920	0.826	0.900	0.653	0.921	0.826
Klaipeda	2000	0.811	0.811	0.340	0.343	0.830	0.827	0.500	0.496	0.827	0.827
Koper	2000	0.725	0.725	0.750	0.416	0.850	0.853	0.580	0.580	0.853	0.853
Le Havre	2000	0.677	0.652	0.700	0.634	0.860	0.822	0.560	0.489	0.863	0.822
Leixoes	2000	0.714	0.714	0.640	0.452	0.890	0.890	1.000	1.000	0.890	0.890
Limassol	2000	0.692	0.692	0.750	0.517	0.830	0.832	0.380	0.384	0.833	0.832
Lisbon	2000	0.585	0.585	0.630	0.472	0.840	0.839	0.700	0.531	0.839	0.839
Manzanillo1	2000	0.809	0.809	0.730	0.550	0.900	0.898	0.730	0.573	0.951	0.912
Maputo	2000	0.790	0.790	0.380	0.383	0.940	0.939	1.000	1.000	0.939	0.939
Marsaxlokk	2000	0.721	0.641	0.510	0.441	0.950	0.881	0.670	0.532	0.955	0.881
Montevideo	2000	0.964	0.964	0.840	0.595	0.920	0.921	0.650	0.430	0.976	0.964
New York/New Jersey	2000	0.833	0.727	1.000	1.000	0.880	0.819	0.710	0.575	0.883	0.820
Port Sultan Qaboos	2000	0.837	0.837	0.590	0.356	0.880	0.878	0.380	0.383	0.930	0.878
Port of Spain	2000	0.811	0.811	0.600	0.426	0.910	0.907	0.450	0.454	0.960	0.910
Puerto Cortes	2000	0.790	0.790	0.760	0.560	0.890	0.893	0.620	0.454	0.944	0.899
Puerto Limon	2000	1.000	1.000	0.880	0.701	1.000	0.969	0.790	0.518	1.000	1.000
Rauma	2000	0.934	0.934	0.630	0.354	0.860	0.861	0.480	0.476	0.934	0.934
Ravenna	2000	0.688	0.688	0.730	0.472	0.830	0.833	0.490	0.489	0.834	0.833
Rio Grande	2000	0.772	0.772	0.870	0.624	0.920	0.923	0.690	0.483	0.923	0.923
Salvador	2000	1.000	1.000	0.840	0.480	1.000	1.000	0.720	0.721	1.000	1.000
Santos	2000	0.779	0.685	0.660	0.570	0.950	0.873	0.690	0.538	0.950	0.873

Input oriented efficiency scores – Constant sample – 51 ports (cont.)

Savannah	2000	0.697	0.609	0.570	0.485	0.810	0.746	0.970	0.744	0.814	0.746
Shanghai	2000	1.000	1.000	1.000	1.000	1.000	0.976	1.000	0.973	1.000	1.000
Shimizu	2000	0.663	0.663	0.630	0.460	0.870	0.869	0.660	0.484	0.869	0.869
Southampton	2000	0.758	0.678	0.760	0.659	0.930	0.860	0.830	0.662	0.930	0.860
St John NB	2000	0.790	0.790	1.000	1.000	0.870	0.868	0.540	0.544	0.868	0.868
St Petersburg	2000	0.670	0.670	0.680	0.483	0.920	0.921	0.690	0.464	0.922	0.921
Thamesport	2000	0.649	0.649	0.550	0.434	0.910	0.871	0.870	0.558	0.906	0.871
Thessaloniki	2000	0.681	0.681	0.940	0.640	0.880	0.876	0.530	0.527	0.877	0.876
Vigo	2000	1.000	1.000	0.670	0.419	0.870	0.874	0.390	0.393	1.000	1.000
Willemstad	2000	0.772	0.772	0.970	0.520	0.880	0.884	0.490	0.493	0.885	0.884
Yokohama	2000	0.857	0.698	0.560	0.540	0.960	0.866	0.710	0.690	0.955	0.866
Aden	2001	0.790	0.790	0.620	0.454	0.820	0.819	0.310	0.310	0.867	0.841
Altamira	2001	0.835	0.835	0.760	0.503	0.880	0.883	0.600	0.602	0.935	0.888
Balboa	2001	0.709	0.710	0.570	0.416	0.880	0.876	0.360	0.364	0.876	0.876
Baltimore	2001	0.525	0.525	0.620	0.477	0.740	0.699	0.210	0.209	0.738	0.699
Brisbane	2001	0.837	0.837	0.770	0.588	1.000	1.000	0.510	0.512	1.000	1.000
Buenos Aires	2001	0.944	0.594	0.510	0.405	0.930	0.808	0.780	0.380	0.966	0.808
Busan	2001	1.000	0.883	1.000	0.717	0.990	0.933	0.910	0.755	1.000	0.936
Cartagenal	2001	0.811	0.811	0.630	0.488	0.880	0.840	0.780	0.321	0.878	0.862
Casablanca	2001	0.629	0.629	0.800	0.582	0.960	0.958	0.260	0.263	0.958	0.958
Colombo	2001	1.000	0.784	0.480	0.445	1.000	0.945	0.670	0.555	1.000	0.945
Damietta	2001	0.982	0.616	0.570	0.453	0.950	0.826	0.770	0.368	0.989	0.826
Dammam	2001	0.620	0.620	0.680	0.519	0.860	0.812	1.000	1.000	0.856	0.812
Dublin	2001	0.639	0.639	0.770	0.581	0.830	0.827	0.450	0.448	0.828	0.827
Genoa	2001	0.912	0.695	0.500	0.450	0.900	0.845	0.740	0.575	0.911	0.845
Gioia Tauro	2001	0.902	0.756	0.660	0.640	0.990	0.904	1.000	0.954	0.993	0.904
Guayaquil	2001	0.964	0.964	0.620	0.460	0.860	0.858	0.340	0.335	0.965	0.964
Halifax	2001	0.586	0.586	0.580	0.451	0.850	0.812	0.870	0.363	0.848	0.812
Hong Kong	2001	1.000	1.000	1.000	1.000	1.000	1.000	1.000	1.000	1.000	1.000
Khor Fakkan	2001	0.985	0.693	0.580	0.504	1.000	0.915	0.740	0.490	1.000	0.915
Kingston	2001	0.982	0.692	0.550	0.466	0.930	0.843	0.900	0.569	0.982	0.843

Input oriented efficiency scores – Constant sample – 51 ports (cont.)

Klaipeda	2001	0.811	0.811	0.710	0.350	0.830	0.827	0.390	0.384	0.827	0.827
Koper	2001	0.725	0.725	0.750	0.423	0.850	0.853	0.450	0.448	0.853	0.853
Le Havre	2001	0.911	0.695	0.700	0.632	0.890	0.828	0.560	0.442	0.911	0.828
Leixoes	2001	0.714	0.714	0.640	0.453	0.890	0.890	0.780	0.774	0.890	0.890
Limassol	2001	0.692	0.692	0.750	0.507	0.830	0.832	0.300	0.297	0.833	0.832
Lisbon	2001	0.585	0.585	0.650	0.488	0.840	0.839	0.360	0.360	0.839	0.839
Manzanillo1	2001	0.809	0.809	0.730	0.552	0.900	0.898	0.370	0.373	0.951	0.913
Maputo	2001	0.725	0.725	0.380	0.383	0.940	0.939	0.780	0.774	0.939	0.939
Marsaxlokk	2001	0.936	0.669	0.510	0.445	0.970	0.888	0.670	0.461	0.975	0.888
Montevideo	2001	0.964	0.964	0.840	0.597	0.920	0.921	0.340	0.341	0.976	0.964
New York/New Jersey	2001	0.825	0.732	1.000	1.000	0.880	0.824	0.710	0.580	0.883	0.825
Port Sultan Qaboos	2001	0.678	0.678	0.590	0.363	0.880	0.878	0.300	0.302	0.879	0.878
Port of Spain	2001	0.811	0.811	0.600	0.421	0.910	0.907	0.350	0.351	0.960	0.908
Puerto Cortes	2001	0.790	0.790	0.760	0.553	0.890	0.893	0.320	0.318	0.944	0.897
Puerto Limon	2001	1.000	1.000	0.880	0.694	1.000	0.963	0.790	0.342	1.000	1.000
Rauma	2001	0.934	0.934	0.620	0.346	0.860	0.861	0.370	0.369	0.934	0.934
Ravenna	2001	0.688	0.688	0.730	0.459	0.830	0.833	0.380	0.378	0.834	0.833
Rio Grande	2001	0.756	0.756	0.640	0.470	0.790	0.786	0.320	0.315	0.832	0.806
Salvador	2001	1.000	1.000	0.840	0.492	1.000	1.000	0.560	0.558	1.000	1.000
Santos	2001	1.000	0.716	0.660	0.570	0.960	0.876	0.690	0.450	1.000	0.876
Savannah	2001	0.906	0.635	0.570	0.489	0.820	0.752	0.970	0.638	0.906	0.753
Shanghai	2001	1.000	1.000	1.000	1.000	1.000	0.986	1.000	0.996	1.000	1.000
Shimizu	2001	0.663	0.663	0.630	0.448	0.870	0.869	0.340	0.336	0.869	0.869
Southampton	2001	0.981	0.701	0.760	0.662	0.940	0.859	0.830	0.573	0.981	0.859
St John NB	2001	0.790	0.790	1.000	1.000	0.870	0.868	0.420	0.421	0.868	0.868
St Petersburg	2001	0.638	0.638	0.680	0.522	0.900	0.855	0.360	0.354	0.903	0.855
Thamesport	2001	0.635	0.635	0.550	0.428	0.910	0.863	0.870	0.345	0.906	0.863
Thessaloniki	2001	0.681	0.681	0.940	0.640	0.880	0.876	0.410	0.408	0.877	0.876
Vigo	2001	1.000	1.000	0.670	0.416	0.870	0.874	0.310	0.304	1.000	1.000
Willemstad	2001	0.772	0.772	0.970	0.529	0.880	0.884	0.380	0.381	0.885	0.884
Yokohama	2001	0.843	0.696	0.510	0.490	0.949	0.858	0.705	0.653	0.949	0.858