



Fondazione Eni Enrico Mattei

**Analysing Regional Sustainability  
Through a Systemic Approach:  
The Lombardy Case Study**

Pietro Caratti and Ludovico Ferraguto

NOTA DI LAVORO 43.2008

**MAY 2008**

SIEV – Sustainability Indicators and Environmental Valuation
---

Pietro Caratti, *Fondazione Eni Enrico Mattei and Regione Lombardia*  
Ludovico Ferraguto, *I-COM, Istituto per la Competitività*

This paper can be downloaded without charge at:

The Fondazione Eni Enrico Mattei Note di Lavoro Series Index:  
<http://www.feem.it/Feem/Pub/Publications/WPapers/default.htm>

Social Science Research Network Electronic Paper Collection:  
<http://ssrn.com/abstract=1140637>

The opinions expressed in this paper do not necessarily reflect the position of  
Fondazione Eni Enrico Mattei  
Corso Magenta, 63, 20123 Milano (I), web site: [www.feem.it](http://www.feem.it), e-mail: [working.papers@feem.it](mailto:working.papers@feem.it)

# **Analysing Regional Sustainability Through a Systemic Approach: The Lombardy Case Study**

## **Summary**

The intrinsic complexity of the sustainability concept challenges research towards more sophisticated ways to model and assess the dimensions underlying it. However, currently adopted modelling techniques and indicators frameworks are not able to give an integrated assessment through the different components of sustainability, providing incomplete visuals of the reality that they aim to catch. This paper tries to assess how the INSURE methodology can provide a contribution in the analysis of sustainability through indicator frameworks, describing its application to the Lombardy region (Italy). Developed on the course of a 6th European Framework Program – financed project to measure sustainability in the European regions, the methodology provides two distinct sustainability representations, based on a quantitative “top-down” System Dynamics model and on a qualitative “bottom-up” System Thinking approach. The models are then linked to a hierarchical indicator framework setting policy priorities. The overall objective is thus to create a set of regional indicators, adapting the models of regional sustainability to different policy agendas. The purpose of the paper is twofold: defining a new approach to sustainability appraisal, and assessing how the Region is holistically behaving towards sustainable development. Starting from a basis analysis of the main shortcomings highlighted by the use of most adopted methodologies, the paper will verify the contribution given by the INSURE methodology to research in the fields of modelling and indicators approaches, providing insights over methodological adjustments and the results obtained from the application to Lombardy. The conclusions will show how the methodology has tried to overcome identified constraints in current models, like the strong dependence on existing datasets of the obtained representations, the under-coverage of “immaterial factors” role and the scarce integration between sustainability dimensions.

**Keywords:** Sustainable Development, Regional Economics, Econometric and Input Output Models, Development Planning and Policy, Regional Analyses

**JEL Classification:** Q01, R, R15, O2, O18

*Address for correspondence:*

Pietro Caratti  
Fondazione Eni Enrico Mattei  
Corso Magenta 63  
20123 Milano  
Italy  
E-mail: [pietro.caratti@feem.it](mailto:pietro.caratti@feem.it)

# ANALYSING REGIONAL SUSTAINABILITY THROUGH A SYSTEMIC APPROACH: THE LOMBARDY CASE STUDY

## TABLE OF CONTENTS

1. Introduction.....	2
2. The INSURE Methodological approach: the System Toolkit .....	4
<b>2.1. The INSURE Methodological approach: meaning and integration of the tools .....</b>	<b>5</b>
3. System Mapping: application to Lombardy Case Study.....	7
<b>3.1. Identification of regional sustainability discourses.....</b>	<b>8</b>
<b>3.2. Maps drawing.....</b>	<b>8</b>
<b>3.3. Characterization of the maps.....</b>	<b>10</b>
<b>3.4. SMA assessment .....</b>	<b>11</b>
4. Quantitative modelling.....	12
<b>4.1. Steps for adaptation .....</b>	<b>13</b>
<b>4.2. System model results: perspective trends .....</b>	<b>15</b>
5. System Indicators.....	18
<b>5.1. Filtering Maps through hierarchical framework.....</b>	<b>19</b>
<b>5.2. Indicators selection .....</b>	<b>21</b>
<b>5.3. Assessment of S-IND results .....</b>	<b>21</b>
6. Final considerations .....	23
7. References.....	25

## LIST OF FIGURES

Figure: INSURE System Toolkit .....	5
Figure: example of sheet from SMA Matrix .....	7
Figure: Example of C-map: "Education, work and competitiveness" .....	9
Figure: C-Maps drawn for the Lombardy Region .....	9
Figure: example of dependency degree assignment.....	10
Figure: modules composing the INSURE System Model.....	13
Figure: Division of Lombardy into settlements corresponding to its provinces .....	14
Figure: System Model results - Development of regional economic totals including GVA .....	16
Figure: System model results – Demographic dynamics.....	16
Figure: System model results – Validation of Demographic Trends until 2040 .....	17
Figure: System model results – Environmental pressures.....	17
Figure: INSURE System Model – Validation of energy demand trends until 2015 .....	18
Figure: Scheme of the connection between S-Mapping and S-Indicator framework.....	19
Figure: Lombardy’s regional dashboard.....	22

## 1. Introduction

Sustainable development is a comprehensive and cross-cutting concept: any type of behaviour or change in conditions, to any aspect of the physical, biological, economic, social or cultural environment can be interpreted in terms of sustainability (Ravetz et al., 2005). Due to its complexity, several studies have tackled it through sectoral approaches and tools, lacking of an overall vision. Sustainability, then, has been represented and dealt with as the juxtaposition of different analytical frameworks, trying to strike a balance between different exigencies (Jiliberto, 2006). Starting from these intrinsic complexities, fundamental challenges for research are represented by adopting proper models to define the scope of sustainability and by providing adequate and integrated frameworks to assess by means of indicators and other quantifying tools the phenomena within.

Numerous approaches have tried to cope with these two fundamental challenges. Concerning modelling experiences, Boulanger and Bréchet (2005) provide a thorough assessment of the main adopted methodologies for Sustainable Development representations, and of their effectiveness in providing support to policy-making. Though they only consider quantitative modelling experiences, what emerges from their analysis is that, while a “one-size-fits-all” model doesn’t exist, characteristics that make models fitter for purpose are a bottom-up focus, interdisciplinarity, and easiness to use. The possibility to involve relevant stakeholders into modelling experience is also seen as an asset of those models which are such devised, as System Dynamics modelling<sup>1</sup>.

However, models alone are seldom useful to obtain relevant and complete information over sustainability, since their outcomes can be not directly exploitable, and thus easily interpreted and incorporated into policy agendas (Pinter et al., 2005). In addition, complex quantitative models like the ones exemplified by Boulanger and Bréchet (system dynamics models, multi-agent simulation, macro-economic models), often lack of comprehensiveness in representing sustainability. In fact, they’re often not able to catch and assess the relevance “non-quantifiable” factors - like beliefs, culture and personal behaviours - have on sustainable development<sup>2</sup>.

Research efforts must then concentrate on the necessity of defining more comprehensive, flexible modelling and representation techniques for sustainability analysis. A solution is represented by recourse to indicators’ framework linking sustainability information to defined policy targets, in order to monitor their implementation (OECD 2004). These frameworks concretely “clarify what to measure, what to expect from measurement and what kind of indicators to use” (Pinter et al., 2005). Provided the difficulty in obtaining a single set of indicators which may be adopted for all of the cases, it seems feasible that the research focus may shift from providing a comparison by means of common indicators (or indicators retrieved by means of the same measuring techniques) to the creation of a common framework for sustainable indicators (Giovannini, 2004). This would help in

---

<sup>1</sup> System Dynamics is a modelling concept which aims to depict reality as a system of stocks and flows, with closed loops relations connecting the elements in the system (see also *infra* Chapter 3). Its stakeholder focus derives from the possibility to devise a participatory approach for model building. System Dynamics is particularly suitable for this purpose, since it emphasises the root-causes that mark sustainability problematic, and clearly highlights policy levers which can be used to manage system’s problems. For an in-depth analysis of System Dynamics implementation in a participatory framework, see Stave (2002).

<sup>2</sup> A relevant exception is constituted by a recent development of a system dynamics model which is based on Amartya Sen’s theory of capability approach as basis for the assessment of human well being. See Canova et al., (2005).

overcoming constraints like the scarcity in data availability from national or international databases, and contemporarily, the often changing definitions and metrics for the same indicators from different sources. One of the most prominent initiatives in this field is constituted by the Millennium Development Goals Indicators<sup>3</sup>, but also EU<sup>4</sup>, together with various national and sub-national governments have defined sets of indicators for monitoring sustainability strategies and assess the impact of policies and plans in terms of sustainability<sup>5</sup>. However, also these kinds of tools often lack an integrated vision, and seeks to manage different pillars of sustainability as if they were separate entities, without catching the trade off's and interactions existing among the various sectors. For these reasons, the general models and the indicator frameworks should not be seen as concurrent tools, but as complementary.

Given these fundamental premises, this paper seeks to investigate how the INSURE methodology may constitute a significant contribution to the methodologies used to assess sustainability, which are based on indicator frameworks, through the description of its application to the Lombardy region, in Italy. The methodology, which has been developed under the 6<sup>th</sup> Research Framework Programme - Funded European Project denominated INSURE<sup>6</sup>, is targeted for explaining dynamics of sustainability within European Regions. The regional level of analysis is in fact increasingly becoming a matter of greater concern within the EU sustainability strategy, since it constitutes a basic level of observation for the dynamics proper of sustainability (Ravetz et al., 2005), which then are replied at higher levels, State and European Union. However, the methodology is not intended to be limited to regional territories, but may be adapted even to higher or lower levels of territorial aggregation. The intent of the paper is thus to explain the meaning of the INSURE methodology through its application in a case study, and to assess how this approach can contribute to overcome traditional difficulties of research on sustainability issues. In particular, it is sought to understand how the methodology will deal with constraints like scarcity of data, weak integration between sustainability dimensions and taking "non quantifiable" factors into account, when depicting the reality under examination.

The paper will be structured along four sections. After this introduction, the first section will present the INSURE methodology as a whole, in order to understand the specific functions absolved by the devised tools. The following parts will instead deal in detail with each of the tools, firstly presenting their main features, and then describing how they have been adapted for the Lombardy case study. The intent of this setting is to provide an overview of the features that have been attributed to the instruments during the process of applying the INSURE methodology, so that users and practitioners could gain insights over the methodological innovation there contained.

---

<sup>3</sup> Millennium Development Goals (MDG) have been launched on 2000, in the course of the UN Millennium Declaration by the UN General Assembly. They represent an effort to define measurable and time-bond fundamental targets to struggle against poverty, hunger, disease, illiteracy, environmental degradation and sexual discrimination. The indicators measuring these targets have then been directly derived from the set of policy objectives. For further information: <http://www.un.org/millenniumgoals>

<sup>4</sup> See also "Communication from Mr. Almunia to the Members of the Commission Sustainable Development Indicators to monitor the implementation of the EU Sustainable Development Strategy", SEC(2005) 161

<sup>5</sup> For National initiatives, see e.g. UK Government sustainable development strategy (available at <http://www.sustainable-development.gov.uk/publications/uk-strategy/index.htm>)

<sup>6</sup> INSURE Project – A flexible framework for Indicators for Sustainability in Regions using System Dynamics Modelling aims to develop a "flexible framework" based on "soft" and "hard" modelling approaches, linked to an indicator scheme based on policy priorities. It has been conducted by a Research Consortium of 9 partners across Europe. Started on April 2004, the project was concluded on January 2007. The developed methodology has been tested in four case-study regions: Limburg (The Netherlands), Pardubice (Czech Republic), Lombardy (Italy), Antalya (Turkey). More information at [www.insure-project.net](http://www.insure-project.net)

Furthermore, each section will evaluate how the main areas that affect the sustainability of the Region (e.g., economy, demographic dynamics, environment, and so on) are currently characterized, according to the peculiar perspective provided by each of the INSURE modules.

Finally, the conclusions will try to assess the real contribution to improvement in developing modelling techniques and indicator frameworks for policy-making, highlighting the lessons learned from the case study modelling experience. This experience will be then assessed by a methodological point of view, reporting on the potential arising from the application of the proposed approach.

## **2. The INSURE Methodological approach: the System Toolkit**

The objective of the INSURE approach is to provide regional sustainability indicators, which adapt the representation models of regional sustainability based on Systems dynamics and more qualitative modelling approaches, to different political agendas. What characterises it, is the systematic understanding of the problems the sustainability indicator systems currently face. The construction of the indicator system is thus driven bottom-up, instead of top-down, since the main focus is given by an interpretation of SD issues based on the “real” emergent problematic.

This systemic approach has the advantage to reproduce the integration of the different components that make up sustainability, and then to transfer this integrated and systemic view to a conventional and hierarchical indicators thematic framework, oriented by policy priorities. Thus, the trends obtained are determined not only by statistical data; being the trends interpreted by the way they are linked to other elements in the regional system, they are able to be expressed in terms of sustainability. Trends are, in other words, understood as ‘sustainability trends’ (Ravetz et al., 2005): thus, it will be possible to assess not only if a single aspect is well performing, but also which influence it exerts on the other aspects of sustainability.

The INSURE Toolkit is composed by three different tools.

- 1) INSURE System Mapping Model is a qualitative modelling technique which develops cognitive / conceptual maps of the regional sustainability system considered as a whole, integrated entity. Starting from an analysis of the sustainability situation within a Region, which delimits the representation to issues that represent a relevant concern for the territory, this technique aims to develop a net of themes (or discourses of regional sustainability) linking concepts and elements. These are connected through dependency relations showing the influence each element has on the others: the relations are then characterised as desirable/undesirable under a sustainability point of view. The output of this tool is to provide information concerning relevance of regional discourses, to be incorporated into an indicator framework which reflects policy targets.
- 2) INSURE System Model is a System Dynamics quantitative model which has been developed to evaluate the sustainability performances of different regions under a unique framework. It provides quantitative indicators to measure and describe regional sustainable development considering the complex interactions within a single region. These indicators may also be adopted as basis information for the indicator framework. The System Model has a perspective focus, i.e. its indicators depict potential future trends in the region in the long term.
- 3) INSURE System Indicators framework incorporates information deriving from the two developed models and organise them into a hierarchy illustrating policy priorities for sustainable development. This hierarchical framework – which may be pre-defined or specifically developed – allows to aggregate the systemic values obtained through modelling from detailed targets to more general ones, providing a consistent and coherent vision of

sustainable development. Each of the inputs obtained from System Mapping (or System Model) is then quantified by means of retrospective indicators assumed from public databases, or by the same perspective indicators coming from the System Model. The output is presented in the form of a “sustainability dashboard”.

In the figure, the three tools with their main features and interrelations are described.

**Figure: INSURE System Toolkit**

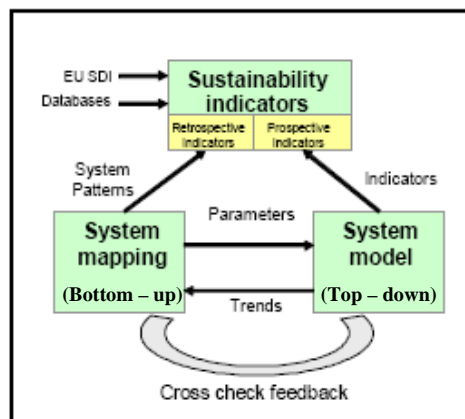

## 2.1. The INSURE Methodological approach: meaning and integration of the tools

The INSURE approach is founded on two main concepts/theoretical basis.

- I) a System Thinking – under the form of conceptual maps - and Systems Dynamics modelling approach as a means of obtaining a representation of regional sustainability;
- II) a flexible framework for integrating the results of the System Thinking and Systems Dynamics modelling approaches in standard indicator structures.

Two distinct modelling techniques are then adopted for representing regional sustainability: the System Dynamics quantitative approach is in fact sided by a “softer”, qualitative model. This demarcation plays a fundamental role in order to gain complete knowledge over regional systems under scrutiny. In fact, the first one permits to rely on a set of equations which determine the mutual influence of elements included in it, whose entity is furthermore quantified through statistics; the second one, instead, explores the fuzzy and controversial relations existing within each system, under a sustainability vision. This twofold modelling approach was also adopted in order to enhance comparability of the Regions applying the System Toolkit: the System Model permits to assess them by means of the same indicators, while the System Mapping allows to take into account their specificity and to highlight the different meanings that similar aspects present in each regional system.

The link between system model and system mapping is intended as a “soft link”, where the system mapping provides specific insights for the system model concerning the feasibility to implement certain policies. In the opposite direction from the system model to system mapping the exchange would include indicator values for selected issues that play a significant role in the regional discourses and that are not quantified by the system mapping.

The System Indicator framework is instead characterised by the attempt to overcome common difficulties faced by indicator systems. These, in fact, are usually of two types. A first category includes systems developed on lists of indicators structured on some sectoral themes for SD, which allow to know current trends of those priority SD issues, but which present key issues as isolated, thus making not possible an integrated reading of the information they provide. A second category, which comprises some of the current indicators systems developed to include an integrated view of sustainability (e.g. this is the case of the *ecological footprint*<sup>7</sup> or of the graphical *dashboard*<sup>8</sup> representation), instead, is characterized by the scarce provided information on connections among indicators in a SD context: moreover, their methodology is not always easy to understand, with consequent lack of coherence and transparency. The INSURE Indicator system, instead, goes beyond these systems to interpret and understand indicators and trends in connection with the system as a whole, but also according to a policy agenda framework.

The following table resumes the content of the three tools composing the INSURE toolkit, according to their main functions, approaches and perspective offered for analysis of sustainability.

Table: Features of the Models included in the INSURE System Toolkit

<b>Main Features</b>	<b>System Mapping</b>	<b>System Model</b>	<b>System Indicators</b>
<i>Approach</i>	Qualitative: it assesses the fuzzy interrelations of the regional system organized into “sustainability discourses”	Quantitative: it provides indicators fed by statistical data and determined by a set of equations	Policy : it is built as a hierarchical set of policy priorities, which takes into account representation of reality which stems from the models
<i>Main functions within the system</i>	Provides information in the form of emergent system patterns to the System Indicator framework.	It provides perspective indicators to System Indicator. It is cross-checked with System Mapping	Incorporates qualitative information from System Mapping. It is also fed by indicators derived from System Model.
<i>Reference timeline</i>	Retrospective: it offers a perception of the region which is based on policy documents , stakeholders’ point of view and analysis.	Perspective: it provides forecasting of the sustainability trends, based on regional, national and EU databases.	Retrospective/Perspective: based on most recent time series for chosen indicators for System Mapping information, on perspective System Model trends otherwise.
<i>Comparability</i>	Limited comparability,	High: the same model	Through the adoption of

<sup>7</sup> Ecological footprint was developed in the midst of 1990’s by Rees and Wackernagel as an integrated tool for assessing the use of natural resources by a given population, measured through the earth capacity of regenerating those consumed resources. It is calculated as the amount of land and marine area which is necessary to sustain a population, or manufacture a given product. For more information, see <http://www.footprintnetwork.org/>

<sup>8</sup> The Dashboard of Sustainability is a non-commercial software created by the Consultative Group on Sustainable Development Indicators to show in a simplified way the performance of a given country with regards to selected sustainability priorities. It recalls the metaphor of a “control panel”, to present complex relationships between economic, social and environmental issues in a highly communicative format. More Info and product download at <http://esl.jrc.it/envind/dashbrds.htm>



	process of map building is very open	is applied and the same indicators are obtained	the same policy target hierarchical framework
<i>Differences between regions</i>	Taken into account by different possible structure of the maps	Expressed by different parameterisation of the regional systems.	Potentially devised as different policy frameworks or through the adoption of different indicators for the selected phenomena.
<i>Outputs</i>	Provides most influential elements and patterns of the sustainability system under examination.	Projections for selected indicators. Policy simulations to create scenarios of regional system.	Integrated indicator framework of sustainability for policy priorities. Results are presented in the form of a “Dashboard”
<i>Interface used</i>	C-Map software; MS Excel S- Mapping Matrix, to insert all retrieved relations and their characterisation.	Vensim® Software; a set of MS Access and Excel matrix is prepared in order to filter the data inputs.	MS Excel S-Indicator Matrix, linked to S-Mapping Matrix, to organise information into the hierarchical framework.

### 3. System Mapping: application to Lombardy Case Study

The System Mapping (SMA hereafter) of a region models the common understanding of unwanted social side effects caused by a low integration level among the root-sustainability systems (environment-economy-society). Therefore, this description tries to capture the relationships and dependencies among the elements that are behind this problematic.

The set of maps which has been produced for Lombardy has tried to catch the most relevant “regional discourses” on the basis of an holistic analysis of the regional system, and to connect them according to a basic logical framework. The depicted system appears as characterized by a hub of connections and mutual influences between the factors composing it. These influences have then been organized into sub-systems, each dealing with a specific issue (like e.g. safety, education, environment). While the maps have represented the most visible outcome of the process, all the information about characterization (mutual interrelations, level of presence in the system, desirability of the observed relations) was introduced into a pre-defined Microsoft Excel SMA matrix. The SMA matrix is a fundamental support for devising this tool, since it will be successively linked to System Indicator framework, constituting its input information.

**Figure: example of sheet from SMA Matrix**

DEPENDENCE DEGREE				
ELEMENT EXPLAINED	SUBSYSTEMS EXPLAINING	RESIDUAL EXPLANATION	ELEMENT 1 EXPLAINING	ELEMENT 2 EXPLAINING

### 3.1. Identification of regional sustainability discourses

The process started with the analysis of the current regional situation. Two main inputs have been used as starting point: the official documents of the Region itself, namely the PRS (Regional Development Plan, which is the document detailing the overall targets and the objectives that the Regional administration aims to tackle on its period of office) and the DPFER (Document for regional Economic and Financial Programming, containing detailed plans and areas of actions for those targets and objectives which have been set in the PRS); and consultations with regional stakeholder, to structure a concerted vision of the regional system.

An insight view from technical experts from the Region <sup>9</sup> was felt necessary in order to define driving forces and development processes in place in Lombardia. The interaction was established at two different stages:

- 1) The first involvement took place at the very beginning of the mapping process. When the first, general map of the region had been drawn, in fact, it was checked and validated with the help of the regional officers, who provided corrections and hints for the development of the work, especially regarding the partition of the regional system into subsystems.
- 2) In a second stage, instead, meetings were organized at the end of the mapping process, in the phase of the maps revision. In this case, the interaction was more aimed at the correction of some of the discourses, or at a different interpretation of trends. Furthermore, the second stage served to show to regional officers the final output of the process, and to assess the correctness of the interpretations included in the maps.

### 3.2. Maps drawing

Six maps were developed, to show how the most important factors that lay behind the major regional evolutionary dynamics are interrelated one each other. The maps - drawn with the help of the C-Map<sup>10</sup> software - have been divided according to political concern for aggregated macro-areas, as specified in the reference documents:

- 1) Education, work and competitiveness
- 2) Safety
- 3) Family and immigration
- 4) Sanity and health care
- 5) Territory and infrastructures
- 6) Environment

The following figure exemplifies the content of a map, namely the one corresponding to the “Education, work and competitiveness” subsystem. This depicts the discourses individuated for one of the main problems affecting the region, and concerning the world of work and the elements related to the introduction into it (such as education). All of these elements have also been related to

---

<sup>9</sup> The opinions expressed by regional experts were personal views and did not necessarily reflect the position of Regione Lombardia.

<sup>10</sup> This software is developed by Florida Institute for Human & Machine Cognition and is freely available at <http://cmap.ihmc.us/>

social problems (social integration and attention to young people). Following that, the remaining maps drawn for Lombardy are shown.

Figure: Example of C-map: "Education, work and competitiveness"

Commento: Can these be seen in print? If not there is no point in including them.

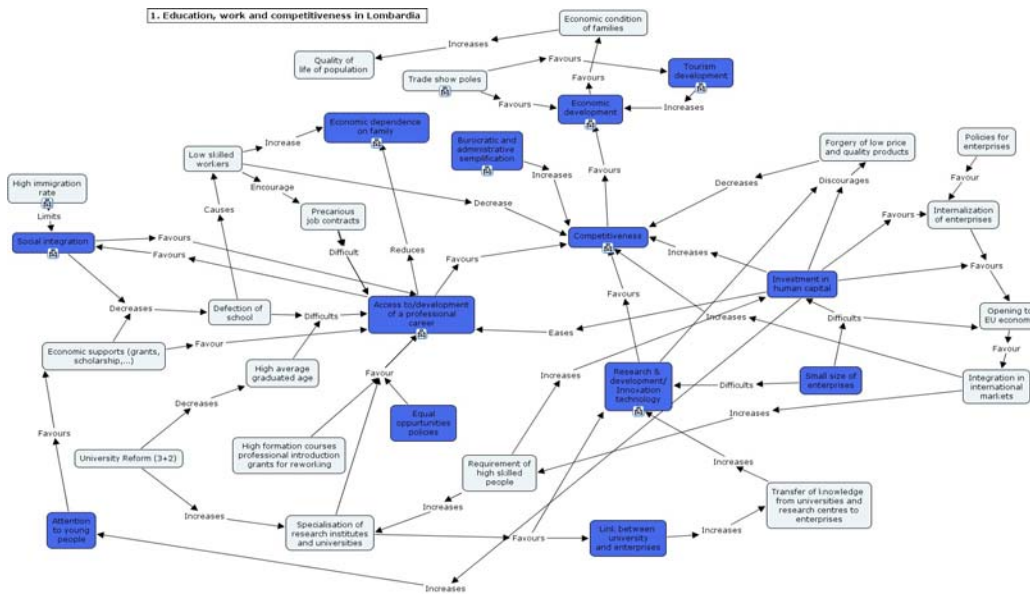
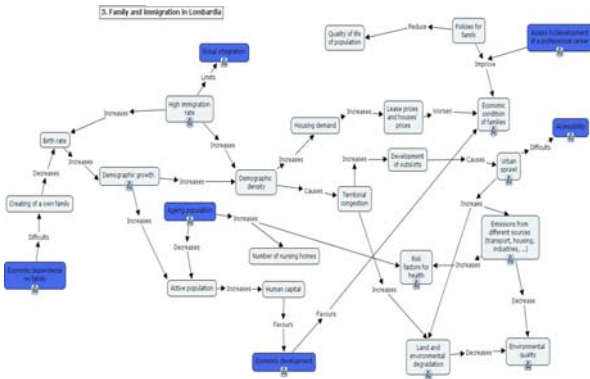
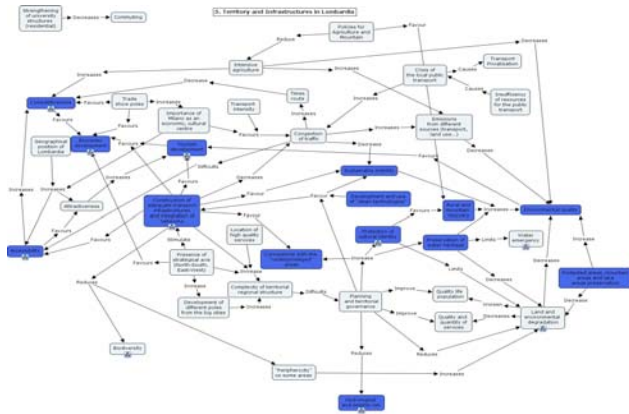

Figure: C-Maps drawn for the Lombardy Region

Family and Immigration



Territory and infrastructures



Safety

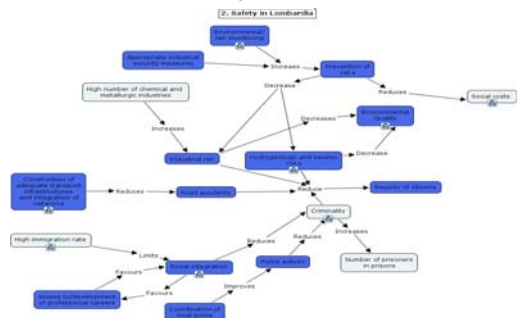

Sanity and Health

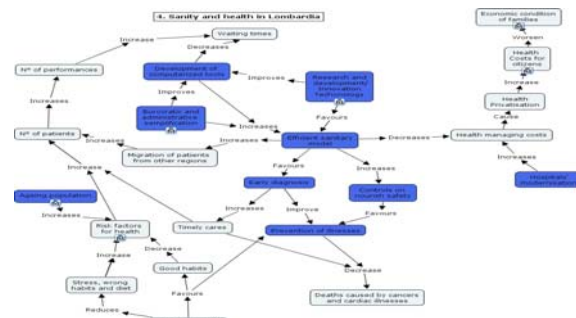

### Environment

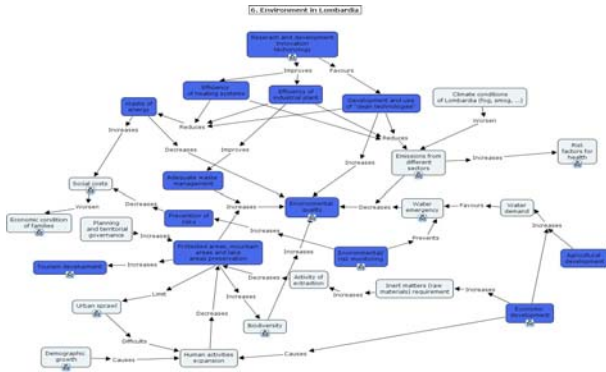

### Education, work and competitiveness

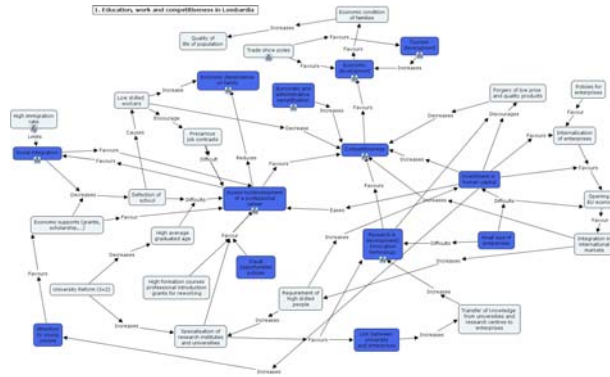

### 3.3. Characterization of the maps

Once the maps have been drawn, the relations identified between elements were qualified. This phase can be divided into three main operations. At first, an *influence* percentage expressing how much a single element is influenced by the others connected to it was set. Then the *Desirability/Undesirability* of the relations was evaluated; finally the so called “*Current State*”, i.e. the presence of a given relation was assigned. The general objective of the characterisation phase is to assess the system described by the maps and the discourses there existing, in order to see which ones are more influential, and how are they behaving towards sustainability. This is to be intended in a qualitative way: in fact, the information about the system is assumed from policy documents or analysis, and it doesn't aim at defining the relations in quantitative terms, on the basis of a common metric, but just to understand the pattern of relations which has been identified.

The idea at the base of the *influence* identification is that the whole system can be represented as a web: some of the nodes in the web are more powerful and therefore they will have a greater influence in the dynamics of the system. In order to avoid arbitrary attributions, it was firstly assumed that the set of elements that directly influence a specific factor only partially explains its behaviour. Therefore, there will always be a residual explanation, which should be assessed on a case by case basis depending on the number of relations identified for a given element. After the identification of the minimum residual explanation, each of the other connections was assigned a specific percentage: in this case, the attribution was further on oriented by the number of existing connections (in order to avoid unbalances in the distribution) and by consultation with regional stakeholders<sup>11</sup>.

**Figure: example of dependency degree assignment**

<sup>11</sup> The assignment of *influence* percentage has a focal importance in the application of the whole INSURE methodology, constituting the basis for the devising of the S-Indicator tool (see *infra* page 17).

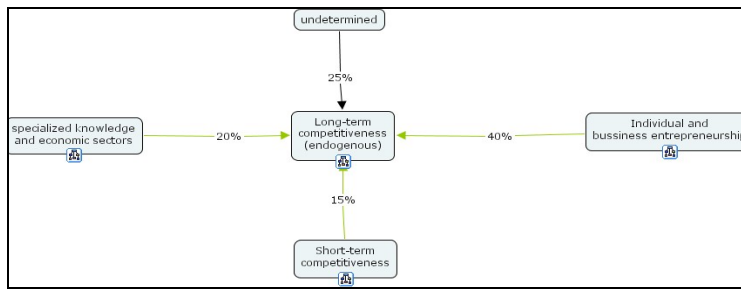

The definition of ‘*desirability*’ of the relations, aims at characterizing the identified relations from a univocal sustainable point of view, qualifying them as “strengthening” or “weakening” sustainability. To achieve this purpose it was necessary to adopt a broad but quite intuitive conception of sustainability, including the three dimensions (environment-economy-society). Each relation was then qualified separately, assuming no other linkage with the rest to avoid possible distortions in the sustainability meaning deriving from multiple linkages.

The final step was the evaluation of the *current state* of the relations. The current state is intended as the degree of presence of a relation in the regional system, assessed with reference to the specific sources or documents of the work (mainly, the DPFER and the PRS). This operation basically differs from the influence assessment, since through the latter the assessment is targeted to give information over the single elements composing the system, while the current state qualification refers to the existing relations, taken as unitary elements. The current state of the relation can be then weakly present (when the relation is hardly noticed), present (when it is present at a normal rate) or strongly present (when the relation is strongly present in the regional system). To each of the three state a value is assigned, from 1 (weakly present) to 3 (strongly present)<sup>12</sup>.

### 3.4. SMA assessment

Through the analysis of the relations and the connections depicted in the maps it is possible to identify which hubs are more relevant for number of relations involved and current state, covering all major issues involved in sustainability. This will help in providing a first diagnosis of the system, and of the phenomena there contained.

In the wider economic area, nodes identified as relevant for the Region attain the **Competitiveness and Access to work** areas. Competitiveness is linked to various items like R&D investments, bureaucratic simplification, tourism development and integration in international markets. This means that the factor of competitiveness is to be intended in the regional system as directed towards a highly specialized tertiary economy.

Social issues in the Region relate to **Sanity and health** and **Demographic Dynamics**. The first is clearly expressed by a main area of concern for the improvement of healthcare structures, including elements which relate to the development of new tools for patient treatment, and the recoils that the healthcare system has on population. **Demographic dynamics** are instead characterised by a cross relevance over other aspects of the global system. The most relevant concern two combined trends: demographic growth led by new immigration, primary cause of increasing density and territorial

<sup>12</sup> Most relations were judged to be present at a normal rate (42%), 34% of the relations were strongly present and the remaining 24%, instead, weakly present.

congestion; secondly, the node of ageing population, which is directly related to an average decrease of active population, and then leads to negative consequences in the economic sphere.

The nodes concerning **Environment and territory** comprise a first major area of development linked to an increasing application of innovative technologies to all processes with an implication to the environment. The other fundamental node instead takes into account the dimension of environmental quality preservation in the Region as a consequence of human and spatial development (pressure exerted by urban sprawl and human activities expansion on land and environment, with consequences on environmental degradation, natural resources and biodiversity).

The maps also allow to identify some cross-sector issues presenting a deep overall influence. **R&D and Innovation**, for example, is perceived as a crucial factor in three major areas: at first in economic competitiveness, to push the regional economy towards a highly specialized and integrated in regional markets dimension; it is also decisive in the establishment of a working and attractive healthcare system as a key to develop tools improving performance. Finally, a third area is environmental protection, due to the connection between the adoption of environmental technology and the serial effects of improving the efficiency of industrial plants and the ecological treatment of waste and water. **Construction of adequate infrastructures** has also effects on various dimensions of sustainability in the Region. First of all, a recoil can be observed in the enhancement of competitiveness, providing necessary integration into international markets. Secondly, the relevance of this element is evident in spatial dimension of the system, and bears consequences on eco-systems.

What emerges from this analysis of the outcomes is that the main feature of the SMA is its instrumental nature: the main function is linked to providing patterns of relations to be incorporated in following analysis developed by the other tools included in the INSURE Toolkit<sup>13</sup>. In this sense, it has been particularly useful to identify cross-sector relations which are able to highly influence the rest of the system, issues which can be examined also through the other tools. As a separated tool of analysis, the importance of the SMA exercise relies on the possibility given to analysts to obtain a different view of the regional system than what would emerge by the examination of documents; this point is of the greatest importance, since it also permits to approach with a deeper knowledge the rest of the Toolkit application.

#### **4. Quantitative modelling**

The INSURE System Model (SMO) aims to describe the development of selected European regions until 2040 and to provide indicators to measure the level of achievement of sustainable development in those regions up to that date. It is developed using the System Dynamics methodology and is implemented through the Vensim®<sup>14</sup> system dynamics standard software package. System Dynamics methodology has proven, along the years, particularly useful for sustainability modelling purposes (Boulanger and Bréchet, 2005). In fact, this methodology is highly suitable to connect a wide variety of scientific disciplines within one tool, in a holistic way. Its basic philosophy (according to which a system is composed by a web of negative and positive feedback loops) is moreover useful

---

<sup>13</sup> See *infra* at chapter 4

<sup>14</sup> This software, in addition, permits to perform policy simulations, to see how a single policy intervention may exert influence over the whole system. More information at [www.ventana.com](http://www.ventana.com)

to understand not only direct effects in a complex system, but also those indirect relations and consequences generated by a single change in pattern of behaviour.

The System model integrates two main modules driving the development of regions, population and economy, with six further modules (infrastructures, spatial dynamics, energy, water, transport and environment). Basic idea of the modelling approach is to provide a structural framework of equations that is equal for any region implemented in the model, and characterizes the regions by varying the parameterisation. Parameters were largely collected from databases that are available for all European regions. In particular, the EUROSTAT Regio database has been used as a basis to establish the input data for the model parameters.

The Figure presents an overview of the eight modules, their major interrelationships and variables:

**Figure: modules composing the INSURE System Model**

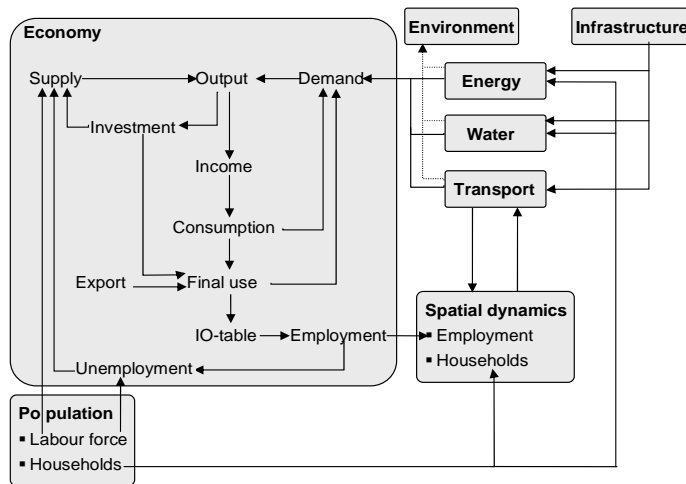

The major feedbacks are contained within the economic module, which consists of a demand side, a supply side and a sectoral interchange model applying input-output table calculations, and between the economic and spatial dynamics module where economic influences alter the spatial settlement patterns of the region which in turn exerts an impact on the economic evolution. Further important feedbacks run from the economic module via the infrastructure module to the sectoral modules affecting demand of energy, water and transport and feeding back into the economic module.

The INSURE system model has been furthermore implemented using two distinct spatial structures: first, the region as a whole, and second, a zoning system representing the largest settlements of a region plus a rural zone for the remaining area of the region.

**4.1. Steps for adaptation**

The steps required for adapting the System Model to Lombardy were essentially linked to the definition of the spatial structure for Lombardy, and to calculating new parameters for the Region in four of the modules.

Concerning the first phase, Lombardy (a complex region from the territorial point of view, with many areas characterised by a multiple-functional vocation) was divided into 11 settlements,

corresponding to the administrative provinces of the Region. This was seen as a reasonable compromise between the opposite necessities of granting an accurate coverage of the Regional territory on one hand, and of obtaining all the relevant information for each settlement, which otherwise could have been more complicated to obtain and manage.

**Figure: Division of Lombardy into settlements corresponding to its provinces**

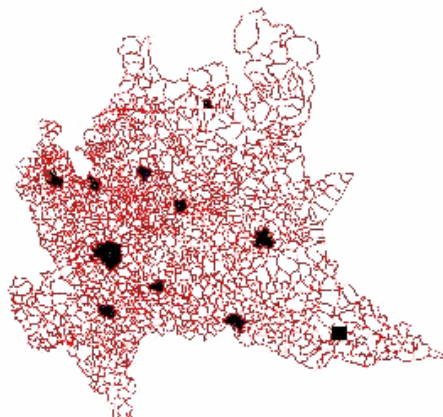

The parameterisation required instead some manual adaptations of the content of the model in order to update values with those specific for Lombardy. Data were mainly obtained from EUROSTAT databases, though for transport module, instead, national and regional sources were used. All necessary parameters have been obtained through further processing into ad-hoc MS Access and Excel queries and tables.

Population module: it represents one of the two most important modules in the whole S-MOD, because it constitutes one of the main drivers for economic and environmental impacts in the region. Given greater data availability than other elements in the model, it permits to simplify some modelling aspects of the two previously mentioned dimensions (Schade et al., 2006). The adaptation for this part of the model required to introduce specific regional parameters concerning regional population, migrations (both from foreign countries and internal migration), births and deaths. These data could be easily found on the EUROSTAT REGIO database<sup>15</sup>. Data were processed into ad-hoc prepared MS Access databases and queries, in order to define the proper classes, and transferred into the model.

Economic module: the basic concept in this case is to describe the behaviour of the regional economy according to the evolution of 16 main sectors of activity. The steps required at first obtaining data on the regional importance of the sectors compared with the national totals based on gross-value-added, i.e. the share of an economic sector of the region compared to the national total of this sector. At second, it was calculated the distribution of importance between the sectors within a region, based on gross-value-added, i.e. the share of an economic sector of the total of all sectors of the region under analysis. The regional output was obtained from a national Input-Output table, to be then processed according to regional main sectors and shares on national economy. Another important adaptation step concerned the aggregation of the 25 sectors composing the NACE-CLIO 25 European classification into 16 sectors. Within these 16 sectors, 12 were defined for all the

---

<sup>15</sup> [http://epp.eurostat.ec.europa.eu/portal/page?\\_pageid=1335,47078146&\\_dad=portal&\\_schema=PORTAL](http://epp.eurostat.ec.europa.eu/portal/page?_pageid=1335,47078146&_dad=portal&_schema=PORTAL)



Regions, and the remaining 4 instead were chosen among those with the highest output in the Region. Once the sectors have been defined, the corresponding output value was then transferred into the model.

Transport module: transport is modelled for both passenger and freight transport. Passenger transport is following the approach of a classical four stage transport model, but omitting the fourth stage such that transport generation, distribution and modal-split are modelled (Schade et al., 2006). The main drivers of the model are population, employment and car-ownership, which is provided exogenously. Freight transport model is instead less differentiated, taking into account only transports within the region and exchanges into the rest of the world.

The adaptation for this module constituted the most critical one, requiring a higher number of manual adaptations and also to perform various collections of data coming from different sources. After the selection of the spatial regional structure, data concerning the time and distances for the transfers among them were stored into matrixes defining the distances, time, costs and quality within the settlement of the Region, for each transport mode. Additional inputs added to the model were the parameters for the yearly number of trips per person, and the modal split between different transport modalities.

Environment: lastly, the environmental module is basically constituted from the inputs deriving from the energy, population, water and transport modules, adapting their outputs through the use of specific emission factor. Then, the adaptation performed consisted in the insertion of the emission factors for considered pollutants (CO<sub>2</sub>, CO, NO<sub>x</sub> and VOC) based on the Handbook Emission Factors for Road Transport (HBEFA)<sup>16</sup>, and on the German Physical Make-Use Input-Output Table with Environmental Accounting updated with the corresponding values for Italy. This calculation considered specific age and structure of the national vehicle fleets, in order to adjust the factors. Finally, the existing values in the model were replaced with the new ones.

#### 4.2. System model results: perspective trends

The results obtained by the System Model allow to evaluate the potential outputs of the Region in the long-term. Being its main characteristic to provide quantitative assessment of the regional sustainability, the System Model doesn't cover aspects which are hardly defined by statistics: in our case, no information was available for quite relevant issues like sanity, or safety and security. The trends presented here are comprised within "business as usual" scenarios, resulting from policy and technical assumptions specific to each module. More specifically:

- Population trends are obtained through the combined influence of exogenous values (fertility rate, immigration and women in child bearing age) and endogenous factors, such as income and female occupation rate, which are assumed to have a negative influence on births;
- Economic outputs are given by the interrelation of the demand side model, where gross regional product drives income and consumption, and of the supply side model based on sectoral production, considering labour force, capital stock and endogenous technical progress (Schade et al., 2006);
- The regional transport model is constituted by a classic 4-stage modelling approach (trip generation and attraction, trip distribution and modal split). In order to link this module to the others, the transports are considered to be influenced by economy and population, and to have a direct influence on water and energy demand (Kraill and Schade, 2007).

**Commento:** How are these scenarios arrived at? What are the basic policy assumptions?

---

<sup>16</sup> <http://www.hbefa.net/>

Concerning the perspectives on **competitiveness**, the trends highlight a marked increase in global economic development in its main aggregated indices, as witnessed by the high growth of GRP and GVA.

**Figure: System Model results - Development of regional economic totals including GVA**

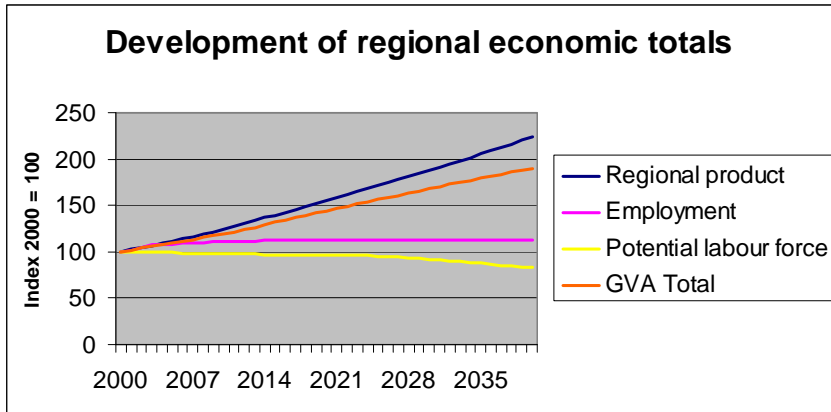

Concerning instead **access to work**, the situation of employment in the Region shows how this particular feature of regional economy is destined to remain constant in the considered period. In fact, though a decrease in potential Labour Force will likely characterise the system, the level of employment will remain constant. The potential explication may be an increase in efficiency of the system, granting potential access to work also for those sectors in society which yet cannot have one (e.g. female workers, or people belonging to disadvantaged population).

**Demographic dynamics** foresee a slight modification in population and its composition:

**Figure: System model results – Demographic dynamics**

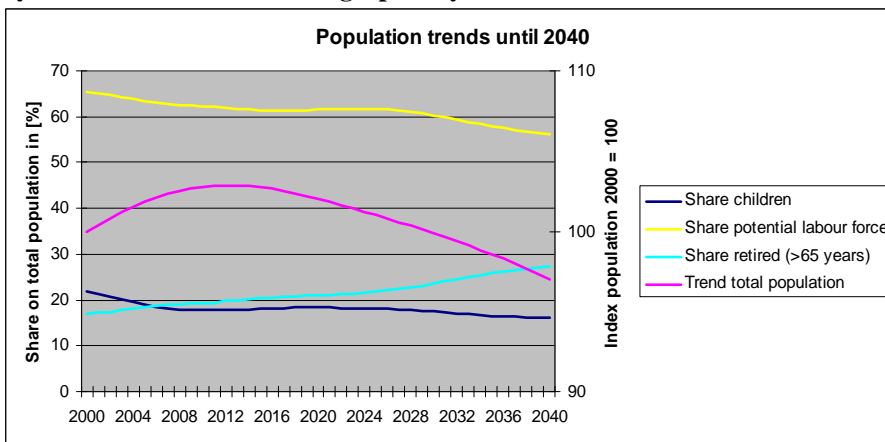

There is a low birth rate, which however finds compensation in the growth of immigrants in the Region, causing the overall increase of population in the first years. The trend, is finally destined to lower, while it is expected a constantly increasing share of retired population, which confirms the concern towards the progressive ageing of the population.

The trend of total population can be validated by putting it in comparison with a similar projection obtained from data extrapolation based on official demographic projections for Lombardy provided by the Italian National Institute for Statistics (ISTAT)<sup>17</sup>:

**Figure: System model results – Validation of Demographic Trends until 2040** (Source: *INSURE System Model – Extrapolation from ISTAT Forecasting for Resident Population*)

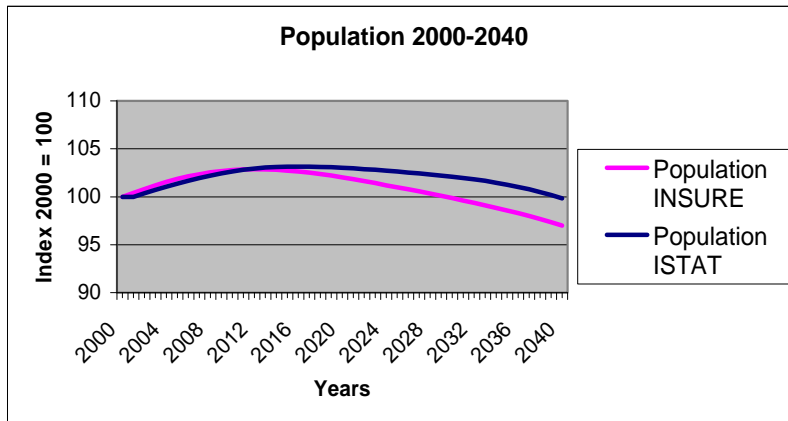

Finally, it is possible to assess the expected performance of the System with respect to **environmental pressures** in the Region.

**Figure: System model results – Environmental pressures**

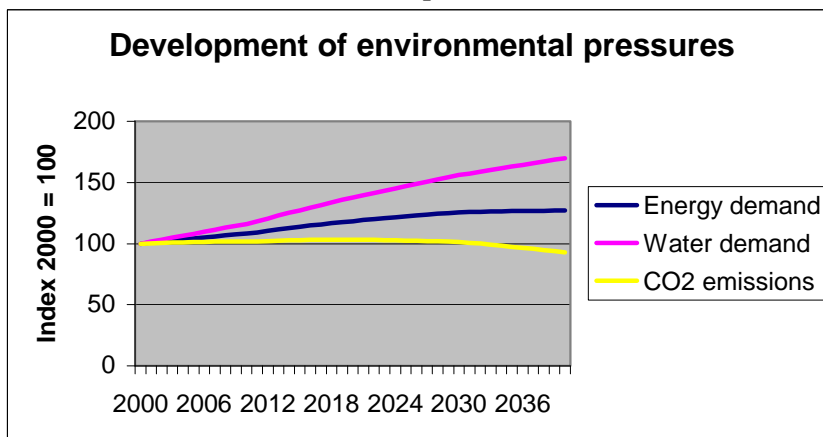

What emerges, is an initial confirmation of the increasing trend in consumptions and use of natural resources, which also leads to a first increase of CO2 emissions. In the longer term, instead, it is expected an improvement in efficient processes, finally leading to a steady trend in Energy demand and CO2 emissions. Instead, concerning water demand, the efficiency improvement is expected to be less marked, so that the trend will be constantly increasing.

<sup>17</sup> Database available at <http://demo.istat.it/prev/index.html>

Once again, some of the results of the INSURE S-MOD may be validated against other projections available for the region, in this case obtained by a research project on GHG impact of Lombardy denominated “Kyoto Lombardia Project”<sup>18</sup>:

**Figure: INSURE System Model – Validation of energy demand trends until 2015** (Source: *INSURE System Model – Kyoto Lombardia Project forecasting for Energy demand*)

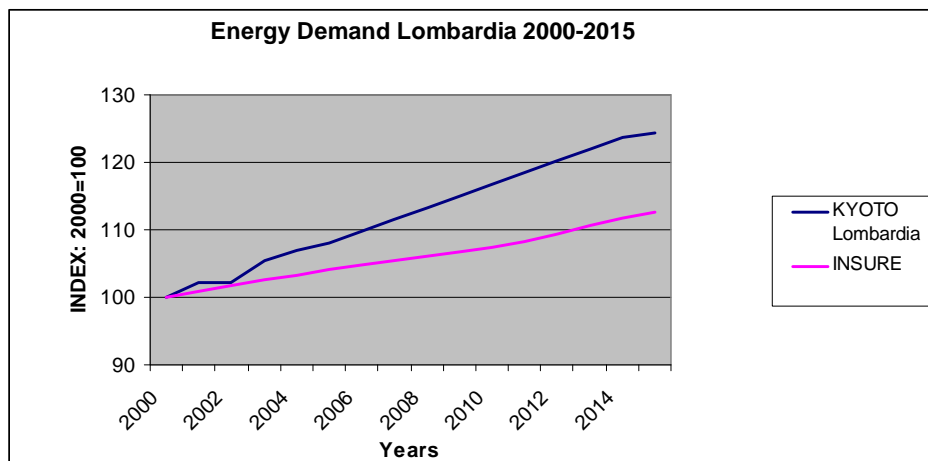

In this case, the trend do not substantially match, since the INSURE project has put higher emphasis on efficiency gains coming from industrial and transport; in any case, both trends show similar trends of evolution.

## 5. System Indicators

The INSURE System indicators (S-IND)’s objective is to link the systemic view representing how the most important elements operating in the region are integrated, with the regional SD policy priorities — ordered around a hierarchical thematic framework, i.e. a framework with different level of target aggregation. This means to understand how the different components of regional SD are connected among themselves and how they influence the behaviour of the system in relation to the policy priorities identified.

INSURE develops an ‘indicator filter’ which selects from the System Mapping the most relevant elements for regional development, and systematizes them under a list of defined policy priorities hierarchically organised (like, e.g., the EU SDI Scheme). The integration with the System Mapping also allows to reproduce into the indicator system the influence values, represented by the intensity values of the relations and +/- signs expressing their meaning: the more the more (+) and the more the less (-). However, if the SMA focuses on “relations” which constitute the basic units of the system, the S-IND is instead based on “elements” individuated in the maps, which become “areas to be addressed” (ABA) in the SDI framework.

The reason for this different focus is due to epistemological differences between the two models. In fact, SMA is a dynamic model, where the most relevant information is constituted by the influence

---

<sup>18</sup> For information on this project: <http://www.kyotolombardia.org/> (in Italian)

exerted on the system by its basic units. S-IND, instead, aims to provide a quantification of policy issues by means of indicators, where both policy issues and indicators are externally defined. Nonetheless, it is designed to incorporate the systemic information coming by SMA, which provides indication for integration of that element within the regional system; thus – by means of an iterative calculation performed through the interface MS Excel S-Indicator matrix – it transposes the values of influence from relations to elements.

**Figure: Scheme of the connection between S-Mapping and S-Indicator framework**

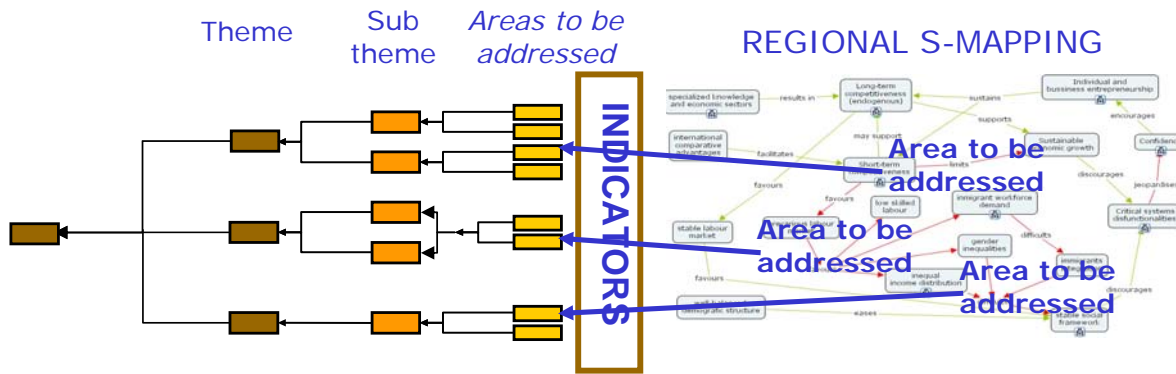

The S-IND is structured among different levels, following the partition in Themes and Sub-themes of EU SDI scheme: at the basis, the ABA’s constitute the basic units of the system, which are attributed specifically related indicators, in order to assess their sustainability trend. At upper levels than ABA’s, sub-themes represent the broader area of policy concern. Themes, instead, constitute the macro-areas of general interest of policy agenda. For each Theme and Sub-theme, all the influence values of ABA are aggregated, in order to provide an evaluation of the sustainability also for those levels. The final index, denominated “Regional Sustainability Index”, permits to assess in an aggregated way the sustainability of the entire regional territory.

### 5.1. Filtering Maps through hierarchical framework

The chosen hierarchical framework is the SD Indicator Scheme adopted by the European Commission in its Communication SEC (2005) 161 to monitor the implementation of the European Sustainable Development Strategy<sup>19</sup>. This scheme was reputed as the most suitable to address a systemic view of the regional sustainability since it ensures the possibility of a comparison between the different regional performances against common targets. Moreover, the adoption of such a scheme permits a more general evaluation of the performance of European Regions towards the objectives and the areas of interest for sustainability set by the Community. Here is reported a list of all the themes and sub-themes which have been chosen for the Lombardy S-Indicator matrix:

Table: List of themes and sub-themes consistent with Lombardia’s S-Indicator framework (from EU SDI Scheme)

---

<sup>19</sup> See supra at page 2

**THEMES**

**SUB-THEMES**

1. Economic Development	1.1 Investment
	1.2 Competitiveness
	1.3 Employment
2. Poverty and social exclusion	2.1 Monetary poverty
	2.2 Access to labour market
	2.3 Other aspects of social exclusion
3. Ageing society	3.1 <i>Pensions adequacy</i>
	3.2 Demographic changes
	<b>3.3 Public finance sustainability</b>
4. Public Health	4.1 Human health protection and lifestyles
	<b>4.2 Food safety and quality</b>
	4.3 Chemicals management
	4.4 Health risks due to environmental conditions
5. <i>Climate change and energy</i>	5.1 <i>Climate change</i>
	5.2 <i>Energy</i>
6. Production and consumption patterns	6.1 Eco-efficiency
	6.2 Consumption patterns
	6.3 Agriculture
	<b>6.4 Corporate responsibility</b>
7. Management of natural resources	7.1 Biodiversity
	<b>7.2 Marine ecosystems</b>
	7.3 Fresh water resources
	7.4 Land use
8. Transport	8.1 Transport growth
	8.2 <i>Transport prices</i>
	8.3 Social and environmental impact of transport
9. Good governance	9.1 Policy coherence
	<b>9.2 Public participation</b>
10. Global partnership	10.1 Globalisation of trade
	<b>10.2 Financing for SD</b>
	<b>10.3 Resources management</b>

The issues highlighted in Bold have scarce relevance in the observed regional system, while those aspects in Italic are not coherent with the territorial level of the Region, representing a matter of national competence or (as in the case of Climate Change) a trans-national phenomenon. Among the issues which have been disregarded as not relevant for the observed regional system, there are two possible cases: either the issue is not present in the Region (it is the case of Marine ecosystems) or instead the issue doesn't represent a priority in the Regional agenda.

The process of identification of the Areas to be Addressed (ABA), has been performed on the ground of three guiding principles: completeness, relevance and prevalence. The principle of "completeness" is to be meant as the necessity that all the selected ABA's cover all potential aspects of the sub-theme. Since not each of the sub-themes or themes in the EU SDI scheme was taken into account, this meant that they did could be excluded from the hierarchical scheme, applying the principle of "relevance". The elements firstly identified are then properly "filtered", on the basis of the criteria of "prevalence", by which it is meant the prevalence (or influence) of one ABA on the other should be adopted as basic criterion for the choice. As an example, for the sub-

theme “Biodiversity”, the ABA “Protected areas” was chosen instead of “Biodiversity” itself, since on the system the previous was significantly influencing the latter.

## 5.2. Indicators selection

Selection of indicators in the INSURE concept basically means to elicit those *data trends* obtained from statistics and transforming them into *SD trends* (Álvarez and Mirón, 2006), expressing progress of a given element (chosen as ABA) towards sustainability. Adopting those data whose trends are most suitable to represent each of the ABA requires the evaluation and balancing of four different criteria. As a working step, in the process developed for Lombardy, a short-list with alternative proposals for an indicator was defined, comparing them against 4 criteria: *relevance* (pertinence of indicator towards an issue), *accuracy* (if the indicator is calculated or obtained in a trustworthy manner), *availability* (i.e. availability of the source) and *comparability over time* (completeness of the time series). As an example, for the ABA “Agricultural development”, two indicators were potentially available: GVA of agricultural production or Number of employees in agricultural sector. In this case, the choice was done in favour of the first indicator, since it scored higher in relevance and comparability over time.

### BOX 1: Indicators sources

Though the preference was accorded to lists of international indicators validated by international organisations (such as UN CSD, Blue Plan strategy, EUROSTAT), the Lombardy case study shown indeed that many of them weren't available for the regional level.

Among the indicators' sources, national and regional *databases* represented the most reliable source available. The fields of greatest coverage have been demographic, economic and social statistics, with limited availability, instead, for other thematic indicators, like environmental ones. *Reports*, i.e. official statements by public institutions on sectoral issues, have been quite enough used, providing an important insight over sectors which are not covered by statistical databases. In particular, the annual reports from Regional Agency for Environmental Protection (ARPA<sup>20</sup>) have constituted a very useful source on environmental issues, generally not available on databases. Selected *research papers* issued by research groups or institutions provided a high level of detail for some more sophisticated issues (e.g. bureaucratic simplification, link between enterprises and universities).

## 5.3. Assessment of S-IND results

The S-IND permits to develop a multi-level, integrated analysis of the sustainability situation of a region. Its results necessitate to be shown in a manner which is at the same time easy to comprehend, comparable, and which permit to address both multi-level framework and the different relevance of the components of the framework. A graphical scheme, similar to JRC's “Sustainability Dashboard”<sup>21</sup>, is particularly suited for matching all of these purposes, and thus it has been adopted as communication tool for the indicator framework. The most external blocks represent the ABA's, while the inner circle is the “Regional Sustainability Index”. The width of the areas represent the influence each of them exerts over the system in terms of sustainability, while the colour constitutes the sustainability trend (ranging from -2 to +2).

---

<sup>20</sup> [www.arpa-lombardia.it](http://www.arpa-lombardia.it)

<sup>21</sup> See footnote at page 3

Figure: Lombardy's regional dashboard

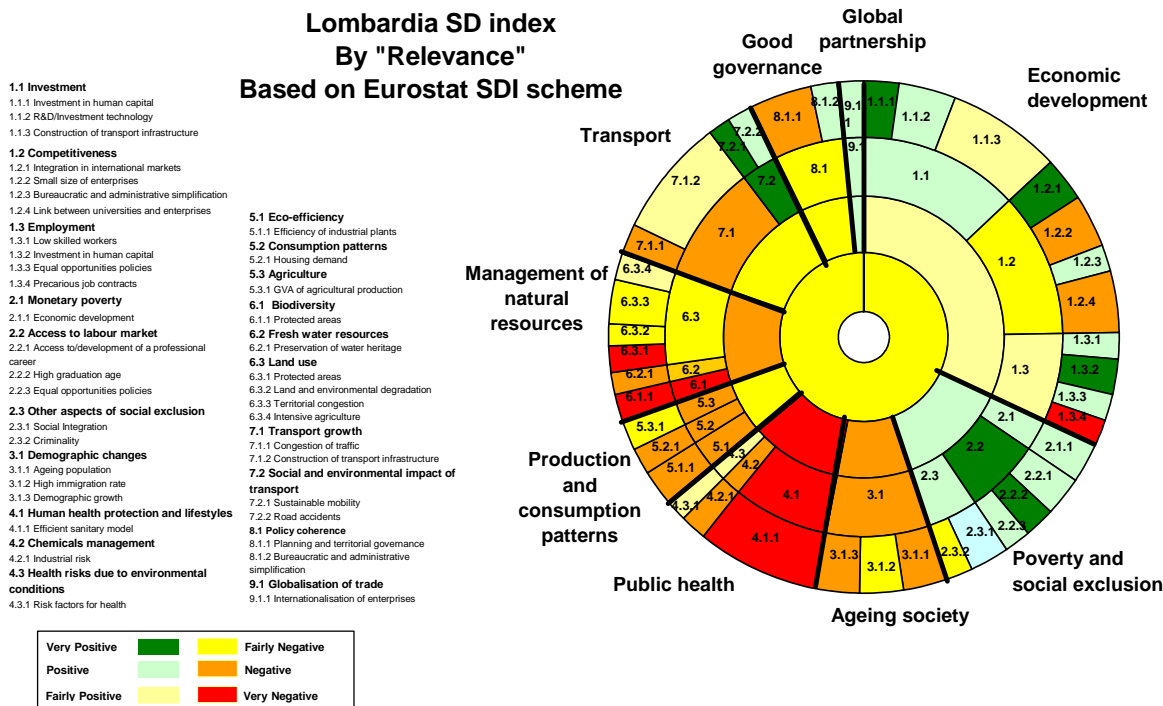

Starting by the **competitiveness** factor (Sectors. 1.1 and 1.2 in the dashboard), some improvements could be observed for bureaucratic and administrative simplification, investment in R&D, and integration in International markets. The situation for competitiveness in the Region appears then quite positive in its strategic elements, but it also registers a poor performance in potentially relevant issues, as Dimension of Enterprises. The second area intended as determining for regional economic development is that related to **access to work** (Sectors 2.2 and 2.3). In this case the evolution is more straight-forward, since the related elements in the dashboard show the issue in the Region has a positive performance.

Passing on to the main **social issues** the sustainable trend for the crucial factors is generally negative. This happens in the health sector (Sector 4.1.1), but also in safety and security areas (4.2.1), linked in this case to presence of increasingly high levels of criminality and industrial risk. **Demographic dynamics** (Sectors 3.1) in the Region have instead registered a negative development over the last years. This is evident for all of the relevant nodes, being more marked for ageing population and birth rate, and instead a bit less accentuated for immigration rate. As it was remarked in the analysis of maps nodes, an increase in housing demand is evident in the Region as a consequence.

The last issue to examine involves the **environment and territory** sphere. In this case, the situation appears rather negative. The energy efficiency of plants is still increasing (Sector 5.1) and in addition, the major human pressures have consequences on the situation of water heritage, whose situation appears quite poor (6.2.1), and also on land degradation. However, a second result in the field of environment is in contrast to the previous considerations. In fact, it may also be observed a decrease in risk factors for health, constituted by the emission into air of PM10 (4.3.1).



Concerning the cross-sectoral issues that were identified at the previous level of qualitative analysis, investment in **R&D and innovation** has an increasing trend, but the analysis of the other sectors where it exerted its influence reveals that innovation in fields other than production or services wasn't implemented on a large scale, or lacked to produce its effects on the involved sectors. This calls for a better distribution of efforts in innovation. Even though major rail and road infrastructures are in the short term, **construction of transport infrastructures** has a steady trend. This doesn't seem to affect very much the integration in international markets, highly increasing, and only vaguely the competitiveness of the system. Much more affected is instead the situation of territory and land use. The transport growth, and territorial congestion in fact could be partially resolved with the recourse to enlargement of existing networks.

A general picture of Lombardy, shows how, from one side, economic performance are on positive way both in access to work and competitiveness issues. Social aspects show, on the opposite, negative trends, and environmental performances as well are not on the right track, though some relevant exceptions exist. As a consequence, through the Regional Sustainability index it is possible to conclude that the global situation for Lombardy is on neutral stance, due to the intersection of the above described phenomena, and in comparison to the greater relevance exerted on the system as a whole by economic aspects.

## **6. Final considerations**

At the end of the experience of the Lombardy Case Study, it is possible to produce an assessment over the strengths of the INSURE approach, examining, through the evidence provided by the sustainability performance of the Region, the contribution it may give to the state of the art in the field of sustainability modelling and measuring. First of all, it needs to be clarified that the INSURE approach is meant to be viewed as a unitary tool. Only the application of the three modules composing it gives the wider picture of the system's reality which is meant to be extracted.

The application of the INSURE methodology has portrayed a fairly complete picture of the most relevant issues in sustainability for the Region. As seen in sections 2 and 4, it has been possible to define a clear hypothesis about the system's configuration, and about the main critical nodes present in the Region, and then to evaluate their behaviour from a systemic perspective. The combined approach also made it possible to identify some cross-sector issues<sup>22</sup>, whose performance towards sustainability is specially influential in the regional system. This capacity can be seen as a particular expression of the interconnectedness among the various dimensions of sustainability, one of the core assumptions of the INSURE modelling approach.

Concerning the quantitative part, the validation against existing forecasting related to Lombardy<sup>23</sup> has permitted to assess the degree of correspondence with some of the demographic and energetic trends which are expected for the Region. However, as an additional feature, the INSURE S-MOD also makes it possible to produce basic explanations for the observed evolution of the trends, linking them to other phenomena, not only in the same area, but also in other fields.

Another expected outcome of INSURE methodology application was an adequate coverage for immaterial factors, to see how much they could affect regional sustainable performances. In the provided sample map<sup>24</sup>, it is possible to notice that elements like "Economic dependence from family", or "Development of a professional career" (which encompasses also a dimension linked to

---

<sup>22</sup> See *supra*, pages 10 and 20

<sup>23</sup> See *supra*, pages 15 and 16

<sup>24</sup> See *supra*, page 8

personal welfare) have been taken into account in the SMA framework, and their relations in the system identified. This reveals, once again, the “behavioural” epistemology of the SMA, since it is mainly focused in depicting a pattern of relations characterised under a sustainability point of view, instead of a catalogue of measurable elements in the Regional territory. This insertion in the maps also clarified the influence which stems from other factors more commonly adopted in Sustainability modelling, linking them to less intuitive aspects, thus enriching their causal explanations (e.g., in the sample map it is possible to notice how the element of “Competitiveness” is directly influenced by “Bureaucratic simplification”).

Overcoming constraints provided by data scarcity constitutes one of the main objectives of INSURE, which makes use of limited indicator inputs in its modules. From the evidence of the Case Study, the methodological approach followed in the S-IND has actually constituted an advancement since it permits a high degree of flexibility in choosing the most suitable *data trends* for the regional case. In case the most appropriate indicators were not available, it was possible to adopt second or even third-best solutions without compromising the effectiveness of the representations. This is made possible because the S-IND defines since the beginning of the indicator scheme’s construction *SD trends*, represented by an ABA and derived from previous modelling exercises. Then, consequentially, the choice for the single *data trend* will not constitute a problem, since it will be performed at the end of the process, when the lack of data is more effectively controlled (Álvarez and Mirón, 2006).

More in general, the case study has shown how this approach allows a step further the traditional search for indicators, characterised by arbitrariness implicit in the choice for single indicators, and by sectoral biases leading to higher availability for some sectors, and wide gaps in others (Bossel, 2001). In this case, the indicators are balanced among the different dimensions, and the influence of these dimensions is determined by their systemic behaviour. The improvement is also observed in the typology of indicators which may be adopted. In some cases it was possible to define qualitative indicators, or to exploit various sources like reports and papers. This particular configuration is even more useful considering the application for the regional level, and the great use which has been made of environmental and social indicators: both kinds of indicators in fact usually constitute only a minor part of indicator databases (Caratti et al., 2006).

The Lombardy case study has also highlighted some points of improvement in the structure of the INSURE methodology. As a first instance, some steps in the S-IND model building appear quite delicate. Choice for ABA’s is one of them, given that the number of the Areas and the criteria by which selection may be performed are discretionary. It must be added that interpretation of indicators’ trend is not automatic, but it is left to individual assessment. In this sense, the S-IND matrix might be improved by e.g. introducing automatic calculation systems for the trend, once input values are provided.

Another important issue concerns the interpretation of the results coming from both models. Implementation of tools to analyse trade-off’s between targets, and to solve conflicts among them will help to better understand results and then to exploit the potential of having an holistically integrated approach within different dimensions of sustainability. In addition, the role that in the models should be assigned to institutional context i.e. the influence exerted by the institutional setting of the region and the capacity of public sector to intervene on the sustainability system could be further explored. The importance of the institutional context is in fact usually neglected in sustainability models, but it represents nevertheless a crucial dimension, because it is implied in any activity that is part of sustainability holistically intended (Spangenberg, 2004).

Some final remarks include the stakeholder involvement and knowledge sharing emerged from the process, a phase which is crucial to gain consensus over the methodology. As remarked, stakeholder involvement has been pursued in the SMA-drawing stage, since the process of identification of critical points in the Region was conducted with the help of Regional officers. This cooperation proved fruitful in the clarification of the issues and in the definition of those areas constituting a

priority of intervention for the Regional administration. A major involvement in different phases of the methodology application, like in indicators' choice (Reed et al., 2005) and in results interpretation would represent steps forward in this process. They would in fact entail a greater commitment of the stakeholders, thus making the potential users of the results parts of the problems definition and interpretation.

The evidence of the Lombardy Case Study has then demonstrated how the application of the INSURE approach can provide a detailed and varied portrait of regional dynamics, fostering the diffusion of modelling techniques which represent the reality of events as faithfully as possible, as well as avoiding typical shortcomings of indicators and systemic models. Some future refinements in the definition and application of the methodological tools could help improving its spreading among operators, and enhancing an even higher interpretative effectiveness.

## 7. References

- ✓ Álvarez M. and Mirón I. (2006), *A flexible framework for regional sustainable development indicators using system thinking criteria (INSURE)*, Revista Internacional de Sostenibilidad, Tecnología y Humanismo, n.1 – 2006
- ✓ Bossel H. (2001), *Assessing viability and sustainability: a systems-based approach for deriving comprehensive indicator sets*, Conservation Ecology 5(2), available online at: <http://www.consecol.org/vol5/iss2/art12/>
- ✓ Boulanger P.M., Bréchet T. (2005), *Models for policy-making in sustainable development: the state of the art and perspectives for research – methodological analysis*, Ecological Economics, Volume 55 Issue 3
- ✓ Canova L., Grasso M., Vaglio A., Di Giulio E., Migliavacca S., Lelli S., Pareglio S. (2005), *Operationalising Senian capability approach by modelling human development*, MPRA RePEc Paper, (available at [mpra.ub.uni-muenchen.de/251/01/MPRA\\_paper\\_251.pdf](http://mpra.ub.uni-muenchen.de/251/01/MPRA_paper_251.pdf))
- ✓ Caratti P., Ferraguto L., Riboldi C. (2006), *Sustainable development data availability on the Internet*, FEEM Working Paper 125/06
- ✓ European Commission (2005), *Communication from Mr. Almunia to the Members of the Commission Sustainable Development Indicators to monitor the implementation of the EU Sustainable Development Strategy*, SEC(2005) 161
- ✓ Giovannini E. (2004), *Accounting frameworks for sustainable development: what have we learnt?*, in OECD (2004), *cit.*
- ✓ ISTAT, *Proiezioni demografiche per la popolazione residente*, available at <http://demo.istat.it/prev/index.html>
- ✓ Jiliberto R. (2006), *A new system epistemology for sustainable development analysis*, International Journal of Sustainable Development (IJSD), Vol. 9, No. 3, 2006
- ✓ Krail M., Schade W. (2007), *A generic model for socio-economic and environmental analysis of European regions focusing on regional passenger and freight transport*, paper presented at the 11<sup>th</sup> World Conference on Transport Research (WCTR 2007), June 24<sup>th</sup> – 28<sup>th</sup>, Berkeley, US
- ✓ Organisation for Economic Cooperation and Development (OECD) (2004), *Measuring Sustainable Development. Integrated economic, environmental and social frameworks*, available at <http://www.oecd.org/dataoecd/37/22/33703829.pdf>

- ✓ Pinter L., Hardi P., Bartelmus P. (2005), *Sustainable development indicators. Proposals for a way forward*, International Institute for Sustainable Development - Paper prepared for the United Nations Division for Sustainable Development (UN-DSD) (available at [www.un.org/esa/sustdev/natlinfo/indicators/egmIndicators/laszlo.pdf](http://www.un.org/esa/sustdev/natlinfo/indicators/egmIndicators/laszlo.pdf))
- ✓ Ravetz J., Caratti P., Álvarez M., Schade W. (2005), *Bringing Sustainable Development vision into evaluation practice: a 'flexible framework' toolkit for assessing and benchmarking sustainability performance of European regions*, Paper presented at the EASY-ECO Conference in Manchester, 15-17 June 2005 (available at <http://www.wu-wien.ac.at/inst/fsnu/manchester/papers/abstracts/caratti.pdf>)
- ✓ Reed M., Fraser E.D.G., Morse S., Dougill A.J. (2005), *Integrating methods for developing sustainability indicators to facilitate learning and action*, Ecology and Society 10(1), available at <http://www.ecologyandsociety.org/vol10/iss1/resp3/>
- ✓ Schade W., Krail M., Caratti P., Riboldi C. (2006), *INSURE system model: a generic model for socio-economic and environmental analysis of European regions*, Paper presented at the ECOMOD Conference, Brussels 1-3 June 2006 (available at [http://www.insure-project.net/attach/INSURE\\_System\\_Model\\_060404.pdf](http://www.insure-project.net/attach/INSURE_System_Model_060404.pdf))
- ✓ Spangenberg J. (2004), *Sustainability beyond environmentalism: the missing dimensions*, GoSD Working Paper N.2, May 2004
- ✓ Stave, K.A. (2002), *Using System Dynamics to Improve Public Participation in Environmental Decisions*, System Dynamics Review 18(2)

## NOTE DI LAVORO DELLA FONDAZIONE ENI ENRICO MATTEI

### Fondazione Eni Enrico Mattei Working Paper Series

Our Note di Lavoro are available on the Internet at the following addresses:

<http://www.feem.it/Feem/Pub/Publications/WPapers/default.htm>

<http://www.ssrn.com/link/feem.html>

<http://www.repec.org>

<http://agecon.lib.umn.edu>

<http://www.bepress.com/feem/>

### NOTE DI LAVORO PUBLISHED IN 2008

CCMP	1.2008	<i>Valentina Bosetti, Carlo Carraro and Emanuele Massetti</i> : <u>Banking Permits: Economic Efficiency and Distributional Effects</u>
CCMP	2.2008	<i>Ruslana Palatnik and Mordechai Shechter</i> : <u>Can Climate Change Mitigation Policy Benefit the Israeli Economy? A Computable General Equilibrium Analysis</u>
KTHC	3.2008	<i>Lorenzo Casaburi, Valeria Gattai and G. Alfredo Minerva</i> : <u>Firms' International Status and Heterogeneity in Performance: Evidence From Italy</u>
KTHC	4.2008	<i>Fabio Sabatini</i> : <u>Does Social Capital Mitigate Precariousness?</u>
SIEV	5.2008	<i>Wisdom Akpalu</i> : <u>On the Economics of Rational Self-Medication</u>
CCMP	6.2008	<i>Carlo Carraro and Alessandra Sgobbi</i> : <u>Climate Change Impacts and Adaptation Strategies In Italy. An Economic Assessment</u>
ETA	7.2008	<i>Elodie Rouvière and Raphaël Soubeyran</i> : <u>Collective Reputation, Entry and Minimum Quality Standard</u>
IEM	8.2008	<i>Cristina Cattaneo, Matteo Manera and Elisa Scarpa</i> : <u>Industrial Coal Demand in China: A Provincial Analysis</u>
IEM	9.2008	<i>Massimiliano Serati, Matteo Manera and Michele Plotegher</i> : <u>Econometric Models for Electricity Prices: A Critical Survey</u>
CCMP	10.2008	<i>Bob van der Zwaan and Reyer Gerlagh</i> : <u>The Economics of Geological CO<sub>2</sub> Storage and Leakage</u>
KTHC	11.2008	<i>Maria Francesca Cracolici and Teodora Erika Uberti</i> : <u>Geographical Distribution of Crime in Italian Provinces: A Spatial Econometric Analysis</u>
KTHC	12.2008	<i>Victor Ginsburgh, Shlomo Weber and Sheila Weyers</i> : <u>Economics of Literary Translation. A Simple Theory and Evidence</u>
NRM	13.2008	<i>Carlo Giupponi, Jaroslav Mysiak and Alessandra Sgobbi</i> : <u>Participatory Modelling and Decision Support for Natural Resources Management in Climate Change Research</u>
NRM	14.2008	<i>Yaella Depietri and Carlo Giupponi</i> : <u>Science-Policy Communication for Improved Water Resources Management: Contributions of the Nostrum-DSS Project</u>
CCMP	15.2008	<i>Valentina Bosetti, Alexander Golub, Anil Markandya, Emanuele Massetti and Massimo Tavoni</i> : <u>Abatement Cost Uncertainty and Policy Instrument Selection under a Stringent Climate Policy. A Dynamic Analysis</u>
KTHC	16.2008	<i>Francesco D'Amuri, Gianmarco I.P. Ottaviano and Giovanni Peri</i> : <u>The Labor Market Impact of Immigration in Western Germany in the 1990's</u>
KTHC	17.2008	<i>Jean Gabszewicz, Victor Ginsburgh and Shlomo Weber</i> : <u>Bilingualism and Communicative Benefits</u>
CCMP	18.2008	<i>Benno Torgler, María A.GarcíaValiñas and Alison Macintyre</i> : <u>Differences in Preferences Towards the Environment: The Impact of a Gender, Age and Parental Effect</u>
PRCG	19.2008	<i>Gian Luigi Albano and Berardino Cesi</i> : <u>Past Performance Evaluation in Repeated Procurement: A Simple Model of Handicapping</u>
CTN	20.2008	<i>Pedro Pintassilgo, Michael Finus, Marko Lindroos and Gordon Munro (lxxxiv)</i> : <u>Stability and Success of Regional Fisheries Management Organizations</u>
CTN	21.2008	<i>Hubert Kempf and Leopold von Thadden (lxxxiv)</i> : <u>On Policy Interactions Among Nations: When Do Cooperation and Commitment Matter?</u>
CTN	22.2008	<i>Markus Kinaterder (lxxxiv)</i> : <u>Repeated Games Played in a Network</u>
CTN	23.2008	<i>Taiji Furusawa and Hideo Konishi (lxxxiv)</i> : <u>Contributing or Free-Riding? A Theory of Endogenous Lobby Formation</u>
CTN	24.2008	<i>Paolo Pin, Silvio Franz and Matteo Marsili (lxxxiv)</i> : <u>Opportunity and Choice in Social Networks</u>
CTN	25.2008	<i>Vasileios Zikos (lxxxiv)</i> : <u>R&amp;D Collaboration Networks in Mixed Oligopoly</u>
CTN	26.2008	<i>Hans-Peter Weikard and Rob Dellink (lxxxiv)</i> : <u>Sticks and Carrots for the Design of International Climate Agreements with Renegotiations</u>
CTN	27.2008	<i>Jingang Zhao (lxxxiv)</i> : <u>The Maximal Payoff and Coalition Formation in Coalitional Games</u>
CTN	28.2008	<i>Giacomo Pasini, Paolo Pin and Simon Weidenholzer (lxxxiv)</i> : <u>A Network Model of Price Dispersion</u>
CTN	29.2008	<i>Ana Mauleon, Vincent Vannetelbosch and Wouter Vergote (lxxxiv)</i> : <u>Von Neumann-Morgenstern Farsightedly Stable Sets in Two-Sided Matching</u>
CTN	30.2008	<i>Rahmi İlkiliç (lxxxiv)</i> : <u>Network of Commons</u>
CTN	31.2008	<i>Marco J. van der Leij and I. Sebastian Buhai (lxxxiv)</i> : <u>A Social Network Analysis of Occupational Segregation</u>
CTN	32.2008	<i>Billand Pascal, Frachisse David and Massard Nadine (lxxxiv)</i> : <u>The Sixth Framework Program as an Affiliation Network: Representation and Analysis</u>
CTN	33.2008	<i>Michèle Breton, Lucia Sbragia and Georges Zaccour (lxxxiv)</i> : <u>Dynamic Models for International Environmental Agreements</u>

PRCG	34.2008	<i>Carmine Guerriero: <u>The Political Economy of Incentive Regulation: Theory and Evidence from US States</u></i>
IEM	35.2008	<i>Irene Valsecchi: <u>Learning from Experts</u></i>
PRCG	36.2008	<i>P. A. Ferrari and S. Salini: <u>Measuring Service Quality: The Opinion of Europeans about Utilities</u></i>
ETA	37.2008	<i>Michele Moretto and Gianpaolo Rossini: <u>Vertical Integration and Operational Flexibility</u></i>
CCMP	38.2008	<i>William K. Jaeger and Van Kolpin: <u>The Environmental Kuznets Curve from Multiple Perspectives</u></i>
PRCG	39.2008	<i>Benno Torgler and Bin Dong: <u>Corruption and Political Interest: Empirical Evidence at the Micro Level</u></i>
KTHC	40.2008	<i>Laura Onofri, Paulo A.L.D. Nunes, Jasone Cenoz and Durk Gorter: <u>Language Diversity in Urban Landscapes: An econometric study</u></i>
CTN	41.2008	<i>Michel Le Breton, Valery Makarov, Alexei Savvateev and Shlomo Weber (lxxxiv): <u>Multiple Membership and Federal Structures</u></i>
NRM	42.2008	<i>Gideon Kruseman and Lorenzo Pellegrini: <u>Institutions and Forest Management: A Case Study from Swat, Pakistan</u></i>
SIEV	43.2008	<i>Pietro Caratti and Ludovico Ferraguto: <u>Analysing Regional Sustainability Through a Systemic Approach: The Lombardy Case Study</u></i>

(lxxxiv) This paper was presented at the 13th Coalition Theory Network Workshop organised by the Fondazione Eni Enrico Mattei (FEEM), held in Venice, Italy on 24-25 January 2008.

#### 2008 SERIES

<b>CCMP</b>	<i>Climate Change Modelling and Policy</i> (Editor: Carlo Carraro)
<b>SIEV</b>	<i>Sustainability Indicators and Environmental Valuation</i> (Editor: Anil Markandya)
<b>NRM</b>	<i>Natural Resources Management</i> (Editor: Carlo Giupponi)
<b>KTHC</b>	<i>Knowledge, Technology, Human Capital</i> (Editor: Gianmarco Ottaviano)
<b>IEM</b>	<i>International Energy Markets</i> (Editor: Matteo Manera)
<b>CSR</b>	<i>Corporate Social Responsibility and Sustainable Management</i> (Editor: Giulio Sapelli)
<b>PRCG</b>	<i>Privatisation Regulation Corporate Governance</i> (Editor: Bernardo Bortolotti)
<b>ETA</b>	<i>Economic Theory and Applications</i> (Editor: Carlo Carraro)
<b>CTN</b>	<i>Coalition Theory Network</i>