

Slow Magic

Agricultural R&D a Century After Mendel

Philip G. Pardey
Nienke M. Beintema

Agricultural Science and Technology Indicators Initiative

International Food Policy Research Institute

Washington, D.C.
October 26, 2001

Contents

Acknowledgments	iv
Preface	v
Introduction	1
A History of Public Agricultural R&D	3
The Growing Private Sector	10
Research Intensities	13
Global Gaps in Stocks of Scientific Knowledge	15
Agricultural Biotechnologies	18
The Rights to Research	20
Conclusion	22
Notes	23
References	26
Acronyms	30

Acknowledgments

This report was prepared under the auspices of the Consultative Group on International Agricultural Research (CGIAR's) Agricultural Science and Technology Indicators (ASTI) initiative. An earlier version was prepared as a background paper to the Human Development Report 2001, Channeling Technology for Human Development, with support from the United Nations Development Programme (UNDP). Significant additional funding was provided by the CGIAR Finance Committee, the Australian Centre for International Agricultural Research (ACIAR), the Ford Foundation, the United States Agency for International Development (USAID), and the Swedish International Development Agency.

The authors are grateful to Patricia Zambrano and Connie Chan-Kang for their excellent research assistance, as well as Kathleen Sheridan, Joanna Berkman, and Mary-Jane Banks for their editorial input, and thank Julian Alston, Howard Elliott, Curt Farrar, Peter Hazell, Han Roseboom, Ford Runge, Jim Ryan, Ben Senauer, and Brian Wright for their useful comments on prior drafts.

Preface

Standing on the brink of a biotechnology revolution in agriculture, it is timely to take stock of the investments and institutional trends regarding agricultural R&D worldwide. In this report we assemble and assess new and updated evidence regarding investments in agricultural R&D by public and private agencies, contrasting developments in rich and poor countries. The payoffs to investments in agricultural research are considerable, and appear to remain so, but there are new policy concerns about the roles of the public and private sectors in funding and carrying out the research, especially in light of the revolutionary changes in the underlying sciences and the incentives facing research (as intellectual property regimes become stronger and international trade in science and technologies grows).

This report tracks trends in agricultural R&D over the past several decades. We also put research policies in a much longer timeframe, highlighting the critical importance that the accumulated stock of scientific knowledge has on today's productivity performance and its effect on innovation and economic growth in the future.

Introduction

To Thomas Malthus, the math was compelling: exponential population growth outrunning linear growth in food supplies—the latter dependent on land area, a resource that must inevitably reach a physical limit—with catastrophic consequences. Writing in 1798, Malthus had no way of anticipating how different the future path of food supply would be from the past. Yet his vision of the future is surprisingly resilient, persisting in the minds of many despite two centuries of evidence to the contrary. Predictions of the inevitability of world famine have been proven wrong by the dramatic increases in agricultural productivity, especially in the later half of the 20th century (Box 1). The growth in productivity has enabled world food supplies to outpace the unprecedented increase in food demand caused by jumps in the growth rate of world income, and the doubling and redoubling of the human population.

The miracle of the past four decades is that today's farmers are feeding almost twice as many people far better from virtually the same cropland base. The world used about 1.4 billion hectares of land for crops in 1961 and only 1.5 billion hectares in 1998 to get twice the amount of grain and oilseeds. Producing today's food supply with 1960 crop yields would probably require at least an additional 300 million hectares of land, an area equal to the entire land mass of Western Europe.

At the same time, food prices have declined to the lowest levels in history, to the benefit of consumers who are able to eat better while spending less and less of their budget on food. Although, unconscionably, hundreds of millions of people are still food-insecure, this is not related to lack of overall production but more to the location of production and the access to food by countries, households, and individuals living on the edge of subsistence.

The current favorable dynamic balance between overall food supply and demand was not inevitable; neither was it a triumph of Adam Smith's invisible hand. Nor should it be taken for granted that it will persist. It has been the result of successful interactions among farmers, input suppliers, and an overwhelmingly publicly supported research and extension system that furnished innovations and relevant knowledge for free. Little land remains for the expansion of agricultural production (and some of the land, water, and other natural resources needed for agriculture are being degraded and diverted to other uses in other sectors), so crop and livestock yields must continue to increase for the

decades ahead. They must then be maintained—at these much higher levels—for the foreseeable future against environmental, biological, and other factors that undermine past gains in production. Continued strong performance in research and innovation is needed to maintain a favorable food balance if, in addition to the 6 billion people we already have, we are to feed 3 billion more over the next half century.

As the 20th century dawned, whole new vistas in agricultural R&D were opening up. Public funding for research was on the rise, initially in the rich countries, then gradually spreading to colonial countries and eventually to other parts of the developing world. A century later, the agricultural sciences are again shifting gears, delving deeper into the genetics of life. But now the public purpose in agricultural R&D is less focused and more closely scrutinized compared to a century ago. Complacency has crept in, too: some question the need for continued public funding, thinking the world's food problems are solved or constrained by things other than R&D or that the private sector will do the job. None of these views is correct. Moreover, the public policy choices made now have far-reaching ramifications, just as the same choices did a hundred years ago.

Despite the buzz about biotechnology, informatics, and a myriad other technologies, the lag between investing in innovation and reaping the rewards is still substantial—measured in decades, not years. This is especially true for biologically based sciences like agriculture. It is timely to take stock of the state of agricultural R&D and to get a global perspective, not least because

of increasing international interdependence regarding agricultural R&D. In this report, we provide new estimates of investments in agricultural research worldwide, updating our views of public roles and contrasting them with private efforts.

To the public, science seems to progress through a series of breakthroughs. The occasional genius does make a great leap forward, but the magic of science stems from the patient and persistent accretion of new knowledge. Today's scientists stand firmly on the shoulders of those who went before them. While invest-

ments in research give rise to new ideas, know-how, and innovations in the near term, these innovations draw directly on the efforts of past research. It is the *accumulation* of research results over the long haul that accounts for the differences in agricultural productivity observed around the world. We developed money measures to quantify the stocks of knowledge that resulted from agricultural R&D spending in the United States and Africa to illustrate this growth and to encourage policy-makers to think in the long term

Box I

MENDEL'S LEGACY

For thousands of years, farmers eked out yield gains by collecting and selecting the best and most productive seeds and by improving cultivation and organic fertilization techniques. The expansion of cultivated areas accounted for most of the increases in total production. A century ago, Gregor Mendel's research describing the pattern of genetic inheritance, first published by the Austrian botanist and monk in 1865, was rediscovered and reconfirmed. Thus the modern era of scientific breeding began.

Starting in the late 19th century, yields of major crops in North America, Europe, and Japan began to increase at rates well beyond historical precedent. For example, beginning with an average wheat yield of 15 bushels per acre in 1866 (the earliest year for which data are available), it took 103 years, until 1969, for US yields to double (Figure B1). Yield growth accelerated in the second half of the 20th century; it took only 43 years for US wheat yields to double and reach the much higher 43 bushels per acre reaped in 1999. Similar yield accelerations occurred in many other crops in the United States.

Many crops in developed countries saw a sharp up-turn in their yield performance in the middle of the century as an increasing number of genetically improved varieties, targeted to particular agroecologies, became available. Beginning in the 1950s and continuing at an accelerated pace in the 1960s and 1970s, improved varieties also became available from international and national agricultural research centers to many more developing-country farmers, and yields took off in many, but not all, of those countries as well (for example, see Figure B1 for wheat).

A key to these widespread yield gains was the rapid spread of modern (often short-statured, so-called semi-dwarf) rice and wheat varieties throughout the developing world, initially through the adoption of cultivars developed in international research centers over wide areas with favorable environments, and then via adaptation of this germplasm to local ecologies and consumer preferences. Asia was quickest to embrace these new varieties, while varietal change lagged in sub-Saharan Africa, partly because of the great diversity in agroecologies.

Globally, yields have climbed steadily in all major cereals, at least since the 1960s. About 95 percent of the production gains since 1961 have come from increasing yields, except in Africa where about half the gains have come from expanding the area of cultivation.

Figure B1 Wheat yields

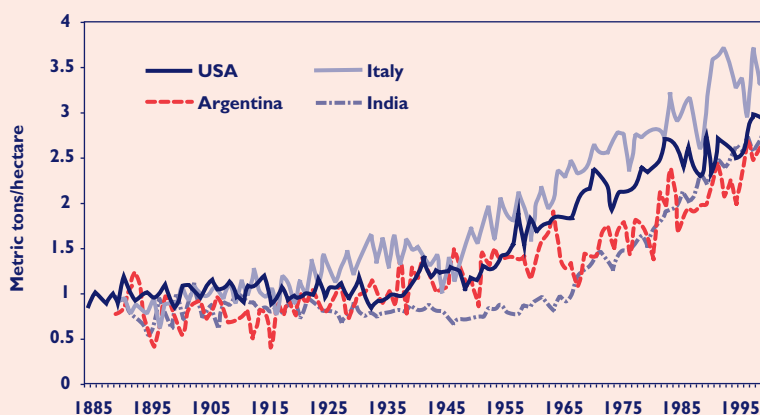

SOURCE: Pardey, Chang-Kang, and Alston (in preparation).

A History of Public Agricultural R&D

In the broad sweep of agricultural history, organized scientific research is a recent phenomenon, although farmers have tinkered with different techniques for over 10,000 years, and kings and emperors have collected plants on an ad hoc basis for millennia. In the late 18th century, Thomas Jefferson, risking penalty of death, smuggled rice seeds out of Italy in the lining of his coat to encourage cultivation of the crop in South Carolina.¹ Science-based solutions to agricultural problems did not take root until the formation of agricultural societies throughout the United Kingdom and Europe in the early to mid-1700s. By the mid-1800s, the evolution of these societies gave rise to agricultural “experiment stations,” beginning in Germany and England and spreading to the rest of Europe and, eventually, to the New World. Colonization spread them to the developing world. Japan, a much less-developed country than America or Europe for the 19th and most of the 20th century, measured by per capita income,² paralleled developments in the West by publicly funding and conducting agricultural research beginning in the mid-1800s.

Scientific agriculture developed hand in hand with these research institutions. Darwin’s theory of evolution, the pure-line theory of Johansson, the mutation theory of de Vries, and the rediscovery of Mendel’s laws of inheritance all contributed to the rise of plant breeding in the beginning of the 20th century. Pasteur’s germ theory of disease and the development of vaccines opened up lines of research in the veterinary sciences. The effectiveness of this body of science in raising yields and solving farmers’ production problems became evident in the first half of the 20th century.

Progress in the science of genetics sped up around the middle of the 20th century after Hersey and Chase, Watson and Crick, and others uncovered the role and structure of DNA. These findings engendered a huge research effort, largely publicly funded, that was directed mainly at the application of modern recombinant DNA methods to human health. Progress in this area also led to the development of genetic markers and transformation techniques useful to agriculture. The result was a wave of biological innovations, which, combined with changes in controls on intellectual property rights, attracted private investment.

Taken together, these developments are fundamentally changing the nature of the agricultural sciences, public and private roles, and the balance between locally provided and internationally traded R&D goods and services. And they will continue to affect all these aspects as we move into the 21st century.

Recent Public Research Trends

Worldwide, public investments in agricultural research nearly doubled, in inflation-adjusted terms, from an estimated \$11.8 billion (1993 international dollars)³ in 1976 to nearly \$21.7 billion in 1995 (Table 1).⁴ Yet for many parts of the world, growth in spending during the 1990s slowed dramatically. In the rich countries, public investment grew just 0.2 percent annually between 1991 and 1996, compared with 2.2 percent per year during the 1980s. In Africa, there was no growth at all—the continuation of a longer-run trend, with more rapid growth in spending in the 1960s (a post-independence period of institution building for many African countries, underwritten with funds from the North)⁵ gradually giving way to debt crises in the 1980s and curbs on government spending and waning donor support through the 1990s. In Asia, the 1990s figure was 4.4 percent, compared with 7.5 percent the previous decade. Growth slowed in the Middle East and North Africa as well.

China is an exception. Growth in spending during the first half of the 1990s rebounded from a period of lower growth during the last half of the 1980s.⁶ Things look a little better in Latin America, too, with growth in spending of 2.9 percent per year from 1991 to 1996, following little or no growth during the dismal decade of the 1980s. But the recovery seems fragile and is not shared widely throughout the region.⁷ Public research in countries like Brazil and Colombia, which did better in the early 1990s, suffered cutbacks in the later part of the decade, and

many of the poorer (and smaller) countries have failed to experience any sustained growth in funding for the past several decades.

The distribution of spending on agricultural research has shifted as well. In the 1990s, for the first time, developing countries as a group spent more than the developed countries on public agricultural research (Figure 1). Among the rich countries, \$10.2 billion in public spending was concentrated in just a handful of countries. In 1995, the United States, Japan, France, and Germany accounted for two-thirds of this public research, about the same as two decades before. Just three developing countries—China, India, and Brazil—spent 44 percent of the developing world’s public agricultural research money in 1995, up from 35 percent in the mid-1970s.

These regional totals mask even more variation among countries. For example, more than 40 percent of 19 African countries spent less than \$20 million on agricultural R&D in 1991.⁸ Only two countries (Kenya and South Africa) spent more than \$100 million. Among 15 Latin American countries, four spent less than \$10 million in 1995, while the two largest countries, Brazil and Mexico, spent about \$900 million and \$300 million, respectively.

Geography is one way to group countries; another way is to group them according to per capita income. Figure 2 gives a breakdown of agricultural R&D spending for high-, middle-, and low-income countries. The research shares for high-income countries are equivalent to those noted for developed countries in Figure 1. Spending by

Table 1—Global public agricultural research expenditures, 1976-95

<i>Expenditures</i>	1976	1985^a	1995^a		
	<i>(million 1993 international dollars)</i>				
Developing Countries (119)^b	4,738	7,676	11,469		
Sub-Saharan Africa (44)	993	1,181	1,270		
China	709	1,396	2,063		
Asia and Pacific, Excluding China (23)	1,321	2,453	4,619		
Latin America and the Caribbean (35)	1,087	1,583	1,947		
Middle East and North Africa (15)	582	981	1,521		
Developed Countries (34)	7,099	8,748	10,215		
TOTAL (153)	11,837	16,424	21,692		
<i>Annual Growth Rates</i>	1976-81	1981-86	1986-91	1991-96	1976-96
	<i>(percent per year)</i>				
Developing Countries (119)	7.0	3.9	3.9	3.6	4.5
Sub-Saharan Africa (44)	1.7	1.4	0.5	-0.2	1.5
China	7.8	8.9	2.8	5.5	5.2
Asia and Pacific, Excluding China (23)	8.2	5.1	7.5	4.4	6.5
Latin America and the Caribbean (35)	9.5	0.5	0.4	2.9	2.5
Middle East and North Africa (15)	7.4	4.0	4.2	3.5	4.8
Developed Countries (34)	2.5	1.9	2.2	0.2	1.9
TOTAL (153)	4.5	2.9	3.0	2.0	3.2

SOURCES: **Sub-Saharan Africa:** 1976-91 data based on Pardey, Roseboom, and Beintema (1997); 1992-96 estimates represent an extrapolation based on trends in total government spending in Africa from World Bank (2000), adjusted for an estimated continuing decline in the share of agricultural research in total government spending, based on Pardey, Roseboom, and Beintema (1997). **China:** 1976-96 from Fan, Qian, and Zhang (2001). **Asia and Pacific, excluding China:** 1976-92 based on Pardey and Roseboom (1989) and Pardey, Roseboom, and Fan (1998); 1992-96 estimates used data for Bangladesh from Ahmed and Karim (2001), India from Pray and Basant (1999), Indonesia from Fuglie (1999), Malaysia from Fuglie (1998a), South Korea from Choi (2000), and Thailand from Fuglie (1998b). **Latin America and the Caribbean:** 1976-96 from Beintema, Avila, and Pardey (2001), Beintema, Romano, and Pardey (2000), Beintema, Zambrano et al. (2000), Beintema, Hareau, et al. (2000), Beintema, Pardey et al. (2001a, b), Roseboom, Cremers, and Lauckner (2001), and unpublished survey returns. **Middle East and North Africa:** 1976-85 from Pardey and Roseboom (1989); 1986-96 estimates based on data for Egypt, Iran, and Turkey (an estimated 50 percent of the region’s total agricultural R&D investments in 1985) from ICARDA et al. (1999). **Developed countries:** authors’ estimates based on Pardey, Roseboom, and Craig (1999), Pardey and Roseboom (1989), OECD (2000). **US data** compiled from various USDA sources (including USDA-CRIS, various issues), and other specific country sources for Belgium, France, Italy, and the Netherlands.

NOTES: These are provisional estimates and exclude Eastern European and former Soviet Union countries. Developed countries include only high-income countries specified by the World Bank in 1996, the latest year of our data series. The number of countries included in regional totals are shown in Parentheses.

^a Three-year averages centered on 1985 and 1995.

^b Developing-country total includes Greece, designated as a middle-income country in 1996 by the World Bank (1996) criteria we used to group the countries here.

A YARDSTICK FOR AGRICULTURAL R&D

Cross-country comparisons of agricultural R&D expenditures, like most international comparisons of economic activity, are confounded by substantial differences in price levels among countries. Converting research expenditures from different countries to a single currency using official exchange rates tends to understate the quantity of research resources used in economies with relatively low prices, while overstating the quantity of resources used in countries with high prices.¹ This is particularly a problem when valuing something like expenditures on agricultural R&D, where typically 60 to 70 percent of the expenditures are on local scientists and support staff, not capital or other goods and services that are commonly traded internationally.²

Most of the research expenditures in this report are denominated in 1993 “international dollars” using purchasing-power parities (PPPs) to do the currency conversions. At present, there is no entirely satisfactory method for comparing consumption or expenditures among countries at different points in time (or for that matter, at the same point in time). Unfortunately, the choice of deflator and currency converter can have substantial consequences for both the measure obtained and its interpretation. We use a procedure described by Pardey, Roseboom, and Craig (1992) that first deflates research expenditures expressed in

current local currency units to a base year set of prices (1993, in our case) using a local price deflator and then converts to a common currency unit (specifically, international dollars) using PPPs for 1993 obtained from the World Bank (2000) rather than the more familiar official exchange rates. For convenience of interpretation, the reference currency—here an international dollar—is set equal to a US dollar in the benchmark year. Figure B2 contrasts the regional expenditure shares when using PPPs versus official exchange rates to do the currency conversion. The right-hand panel denotes total 1996 research spending in international dollars and the corresponding regional shares obtained using PPPs. The US dollar estimates in the left-hand panel were obtained using the same underlying R&D data together with official exchange rates. Taking the PPP estimates to be more representative of the amount of research resources committed to research, the US dollar estimates overstate the share of developed-country research resources in the global total and grossly understate the African, Chinese, and other Asia and Pacific shares.

Figure B2 Public research spending in US versus international dollars, 1996

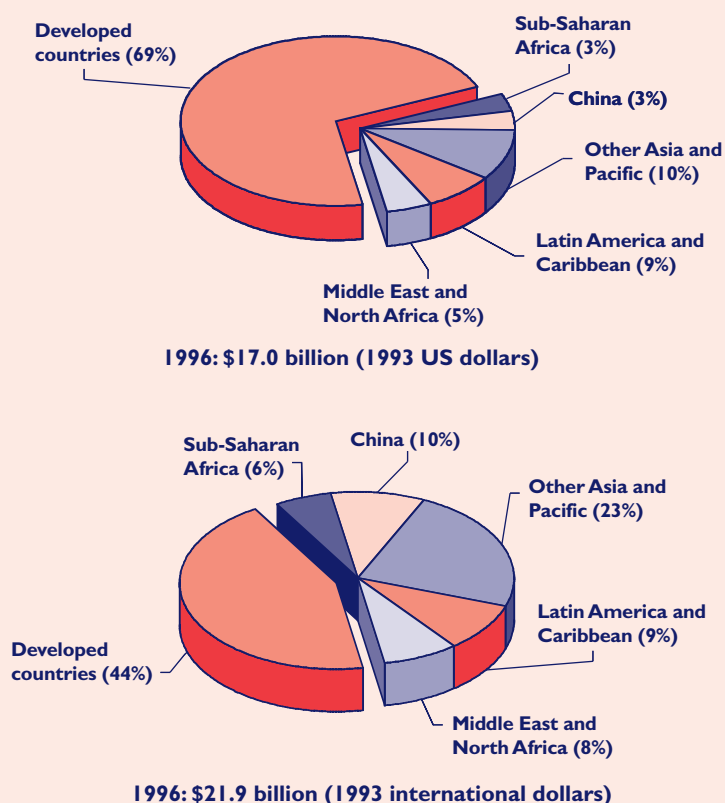

SOURCE: See Table 1. US dollar exchange rate for 1996 is from the World Bank (2000).

NOTE: See Table 1.

¹ A country's international price level is the ratio of its purchasing-power parity (PPP) rate to its official currency exchange rate for US dollars. In other words, the international price level is an index of the costs of goods in one country at the current rate of exchange relative to the costs of the same bundle of goods in a numeraire country, in this case the United States. For example, in 1993 the ratio of PPP to exchange rate for Japan was 1.57, indicating that average prices in Japan were 57 percent higher than they were in the United States. The corresponding ratio for Kenya was 0.20, meaning that a bundle of goods and services purchased for \$100 in the United States cost only \$20 dollars in Kenya.

² In 1992, the average salary and fringe benefits paid professors working at large public institutions in the United States was \$56,300 (1992 prices). A comparable annual salary and benefits for a Kenyan scientist with a PhD working for KARI (the national government's main agricultural research institute) was 143,400 Kenyan shillings (equivalent to 13,548 international dollars when converted using PPPs or only US\$2,760 when converted using official exchange rates), while a Brazilian PhD working for Embrapa earned an average of 102 million cruzeiros (38,916 international dollars or US\$25,284).

Figure 1 Regional shares in public agricultural research expenditures, 1976 and 1995

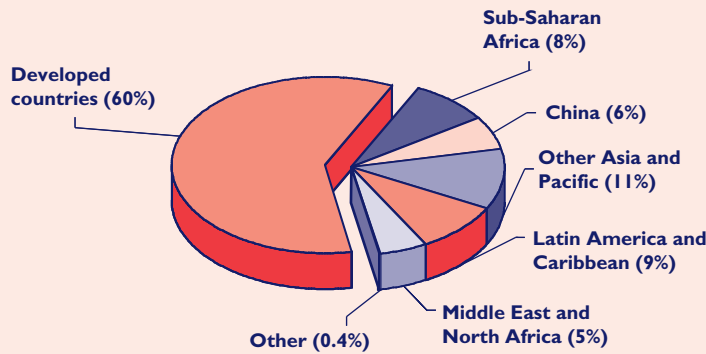

1976: \$11.8 billion (1993 international dollars)

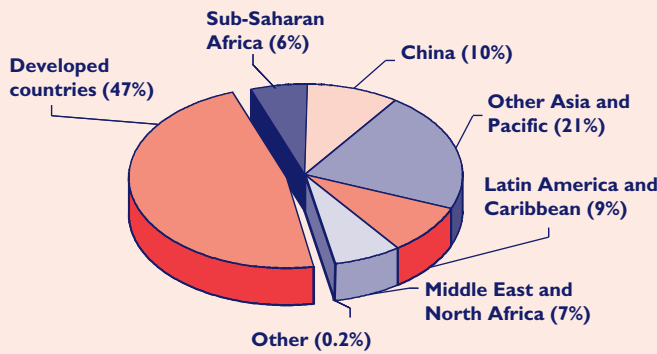

1995: \$21.7 billion (1993 international dollars)

SOURCE: See Table 1.

NOTES: See Table 1. Shares for 1995 represent three-year averages centered on this year.

Figure 2 Public agricultural research spending by income class, 1976-95

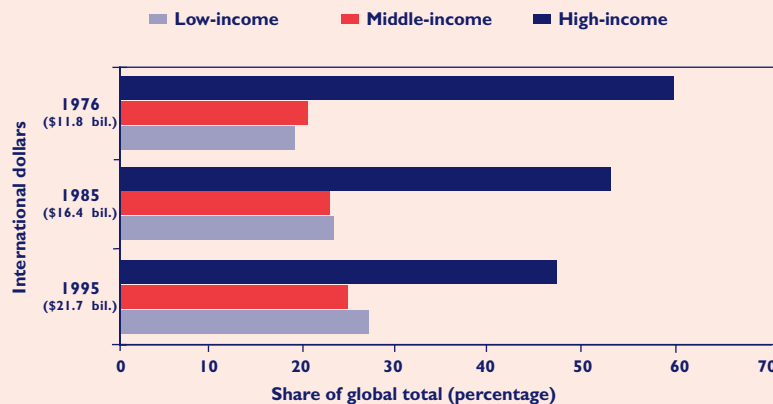

SOURCE: See Table 1.

NOTES: See Table 1. Income classes are specified by the World Bank (1996).
 low-income = < \$726 per capita/year
 middle-income = \$726-8,955 per capita/year
 high-income = > \$8,955 per capita/year

low-income countries grew fastest, so their combined share of the global total increased from 19 percent in 1976 to 28 percent in the mid-1990s. However, this trend is deceiving, reflecting the comparatively rapid growth of India and China, two large countries whose developments dominate the group average. In fact, the low-income countries as a group, excluding China and India, lost some ground. Their share of global agricultural R&D spending dropped from 8.7 percent in 1976 to 8.3 percent in 1996.

Research and agroecologies

The figures above refer to national investments, but agricultural innovation need not be home grown. A striking feature of the history of agricultural development is that technology can be bought, borrowed, or as Jefferson showed, stolen. The result is that it moves across borders, both by design and by accident. Nonetheless, most agricultural technologies are sensitive to local climate, soil, and other biophysical attributes, making them less easily transferable. Soybeans are day-length sensitive, so different varieties must be developed for different latitudes. Likewise, many tropical soils are naturally acidic, a less prevalent problem in temperate areas, and consequently, crops that thrive in temperate soils can fail or falter under tropical conditions.⁹

Unlike medical and mechanical innovations that are applicable from Tijuana to Tokyo, it is usually necessary to adapt agricultural technologies to local conditions. This has implications for the diffusion of agricultural research results and for the biases that are introduced when research is concentrated in relatively few places. The more similar countries are in terms of their agroecological attributes, the more likely it is that research done in one country will be applicable, with comparatively little adaptation, in the other country. For these reasons, it can be useful to group countries according to their agroecology. One option is to divide them into tropical countries (which have year-round adjusted temperatures greater than 18 degrees Celsius on average¹⁰) and nontropical countries. In 1997, about 1.44 billion hectares (62 percent of the world's agricultural land) and 2.6 billion people (45 percent of the world's population) were in

Figure 3 Tropical and nontropical perspectives on public agricultural R&D spending, 1976 and 1995

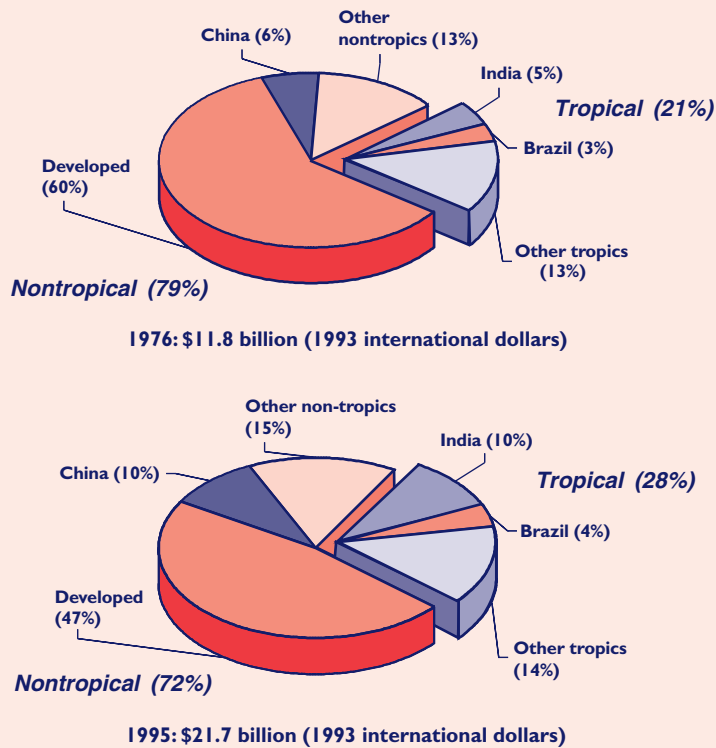

SOURCE: See Table 1.

NOTES: See Table 1. Shares for 1995 represent three-year averages centered on this year.

Figure 4 The institutional orientation of public agricultural research, 1981-96

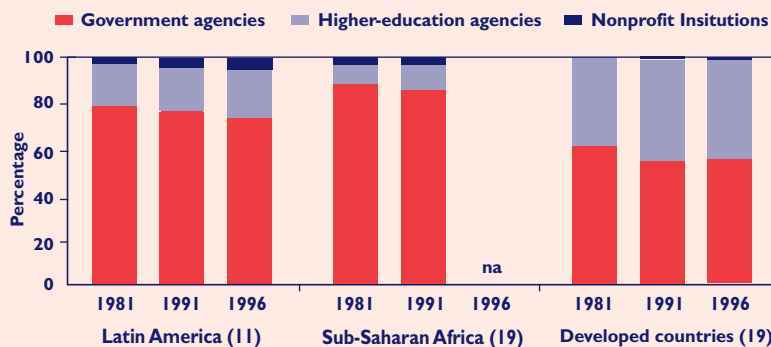

SOURCES: **Latin America:** Beintema, Avila, and Pardey (2001), Beintema, Romano, and Pardey (2000), Beintema, Zambrano et al. (2000), Beintema, Hareau et al. (2000), Beintema, Pardey et al. (2001a, b); **Sub-Saharan Africa:** Pardey, Roseboom, and Beintema (1997). **Developed countries:** Pardey, Roseboom, and Craig (1999) and OECD (2000).

NOTES: Number of countries included in regional totals are shown in parentheses. Sub-Saharan Africa shares are based on data for the 19 countries in Table 1 in Pardey, Roseboom, and Beintema (1997). The developed-country shares may understate the role of nonprofit institutions. Data for nonprofit agencies were absent for some countries, and spending by some nonprofits may have been reported in the government agency category. na stands for not available.

tropical countries.¹¹ By value, this greatly exceeds the tropical-country share of public research spending (about 28 percent) but almost exactly matches the share of agricultural output that comes from the tropics, almost all of it from the developing countries (Figure 3).

About 65 percent of the nontropical world's agricultural research occurs in developed countries. Developing countries such as Argentina, China, and South Korea, with broadly similar growing conditions, will find this research relatively easy to adapt. However, transferring technologies from nontropical regions to tropical countries like Brazil, India, and many parts of Africa often requires research fitted to local realities.

Who does the public research?

In developed countries, about 43 percent of the public research was done by universities in the mid-1990s, compared with 25 percent in Latin America and only 10 percent in Africa (in 1991) (Figure 4). The eleven Latin American countries in our sample have moved more in the direction of the developed countries, with universities playing an ever greater role.

Most of the public research in Africa is done by government agencies; at least that was the situation in 1991 (and for many years before that). However, in Africa as well as Latin America, nonprofit institutions perform more of the public research than they do in developed countries. Many of these nonprofits are linked to producer organizations, conducting research on beverage crops like tea and coffee or fiber crops like cotton, and are funded largely from taxes levied on production or exports or by voluntary contributions made by producers. In 1996, Colombia had 12 nonprofits conducting about one-quarter of the country's agricultural R&D. Many of these Colombian agencies initiated research several decades ago, while in Central American countries like Costa Rica, Guatemala, and Honduras, nonprofit research is a much more recent phenomenon. In the mid-1970s, nonprofits spent only 5 percent of the agricultural R&D dollars in these Central American countries; two decades later, they represented 45 percent of total R&D spending.¹²

International Research

To overcome the biases against the development and diffusion of agricultural technologies among developing countries, agricultural research that was internationally conceived and funded began in the mid-1940s. It expanded through the 1950s as the Ford and Rockefeller Foundations placed agricultural staff in less-developed countries to work alongside scientists in national research organizations on joint-venture research. These efforts became the model for subsequent programs in international agricultural research, as they evolved into the International Rice Research Institute (IRRI) in the Philippines in 1960 and the International Maize and Wheat Improvement Center (CIMMYT) in Mexico in 1967. Hoping to show that the model of international agricultural research could achieve success in broad agroecological regions as well as specific commodities, other international centers were established in Nigeria (the International Institute of Tropical Agriculture, IITA) in 1967 and Colombia (the International Center for Tropical Agriculture, CIAT) in 1968.

The further development of international agricultural research centers took place largely under the auspices of the Consultative Group on International Agricultural Research (CGIAR, or CG for short), established in 1971 as bilateral and multilateral donors bought into the model.¹³ The CG system began modestly. Between 1960

and 1964, of the institutes that would become the CG, only IRRI was operating as such. By 1970, the budgets of the four founding centers totaled US\$15 million. During the next decade, the progressive expansion of the total number of centers, and the funding per center, involved a tenfold increase in nominal funding, to US\$141 million in 1980. During the 1980s, funding continued to grow, more than doubling in nominal terms, to reach US\$305 million in 1990, and although the rate of growth had slowed, it was still impressive. In the 1990s, two decades of growth came to an abrupt end. The number of centers continued to grow—from 13 to 18 at one point, but now 16—but funding did not grow enough in inflation-adjusted terms to maintain the real funding per center, let alone the rate of growth. In 2000, the CG spent US\$305 million (in 1993 prices, or US\$338 million in nominal terms), less than the US\$334 million (1993 prices) it spent in 1990 (Figure 5). If funding for the CG had kept pace with the growth in agricultural R&D investment in rich countries, the system would have spent US\$377 million (in nominal terms) in 2000. If its growth had matched that of agricultural R&D spending in the less-developed countries, this would have been US\$526 million.

Although the CG markedly accelerated the spread of new varieties of wheat, rice, and other technologies (commonly called the Green Revolution), it spent only a

small, and of late, declining, fraction of the global agricultural research investment. In 1995, it represented just 1.5 percent of the nearly \$22 billion spent on public-sector agricultural research by national agencies—or 2.8 percent of the research spending of the less-developed countries, down from its 3.8 percent share in 1985.¹⁴

Figure 5 Real expenditures of the CGIAR, 1960-2000

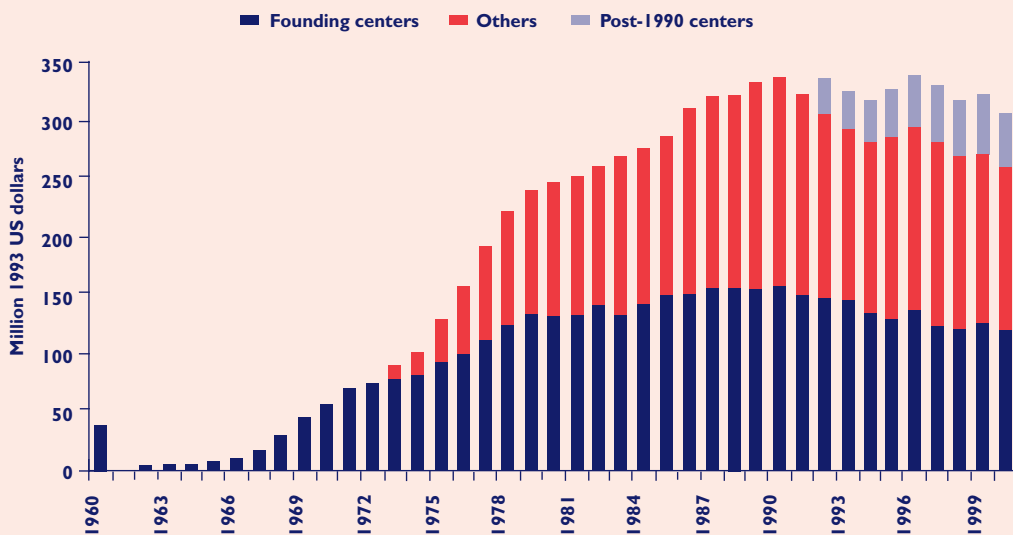

SOURCES: Alston and Pardey (1999) and CGIAR (2000 and 2001).

NOTES: Expenditures for years pre-1972 represent funds going to precursor international research institutes (IRRI from 1960, CIMMYT from 1966, CIAT from 1966, and IITA from 1971). Nominal US dollars are deflated to 1993 base-year prices using the 1960-98 implicit GDP deflator from the World Bank (2000); 1999 and 2000 deflators are from BEA (2001).

INTERNATIONAL RESEARCH AID

International donor and aid agencies no longer give agriculture, and with it agricultural R&D, the attention they once did. Precise data are hard to come by, but the evidence suggests that after several decades of strong support, international funding for agriculture and agricultural research began to decline around the mid-1980s as support for economic infrastructure as well as health, education, and other social services began to grow. Regions of the world such as Africa, where agricultural R&D relied on donors for more than 40 percent of their total funding in the early 1990s, were particularly hard hit.¹

The following quantitative highlights show the disconcerting decline in international aid for agriculture and the research that directly supports the sector:

- Even though the European Community (EC) increased overall aid to developing countries during the period 1987-98, aid to agriculture declined substantially. Agriculture accounted for 12 percent of total EC contributions in the late 1980s, but only 4 percent during 1996-98.²
- Over the past two decades, World Bank lending to the rural sector has been erratic, but after adjusting for inflation the general trend has been downward. Agriculture's share of total lending has also declined (from an average of 26 percent during the first half of the 1980s to only 10 percent in 2000).³

- There is no discernable pattern in the amount of World Bank lending authorized for agricultural R&D, other than a temporary increase in loan approvals in the late 1980s, early 1990s, and an exceptionally large amount of lending in 1998, resulting mostly from loans with large research components approved for India (\$136 million, current prices), China (\$68 million), and Ethiopia (\$60 million) (Figure B.3, panel a).⁴ The size of each loan has been highly variable, ranging from \$0.1 million for Argentina in 1992 and Niger in 1997, to \$136 million for India in 1998.
- The amount of funding USAID directed toward agricultural research in LDCs declined by 75 percent from the mid-1980s to 1996 (Figure B.3, panel b). Asian countries suffered the largest losses, from around \$57 million (in 1993 prices) in the mid-1980s to only \$1.4 million in 1996. Support to Africa and Latin America and the Caribbean was cut less severely but by 1996, funding had fallen to only 42 percent of mid-1980s levels for Africa, and 32 percent for Latin America and the Caribbean. Since 1996, USAID funding for agriculture has failed to regain the ground it lost, and we expect funding for agricultural R&D has fared no better.⁵

Figure B3 World Bank and USAID funding of agricultural research, by region

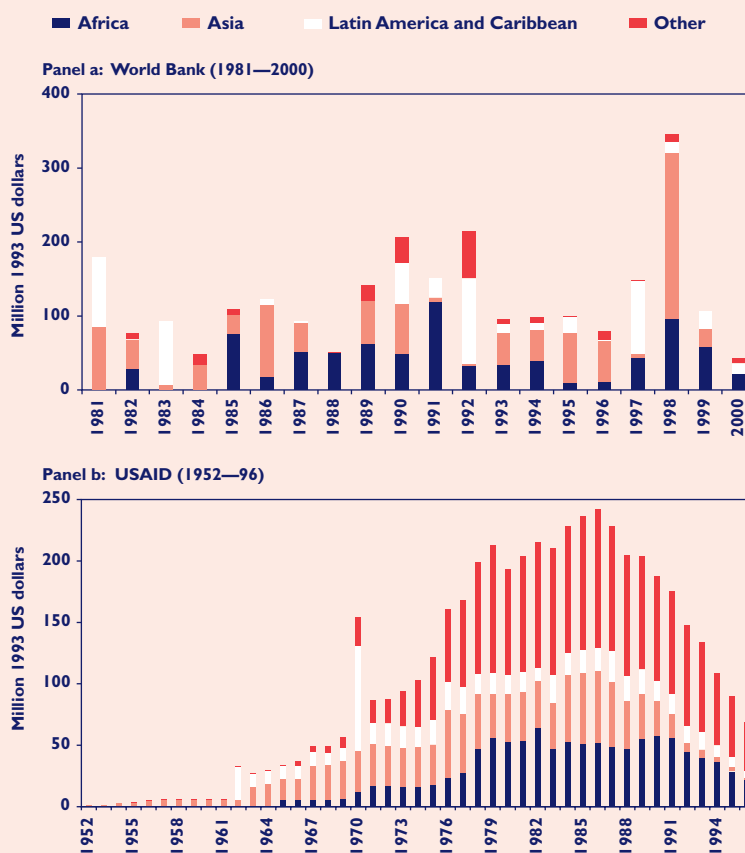

SOURCES: USAID data from Alex (1997) and Dalrymple (2000). World Bank data are authors' calculation based on World Bank, Rural Development Department (2001).

NOTES: Nominal US dollars deflated to 1993 base-year prices using implicit GDP deflator for World Bank (2000) and BEA (2001). World Bank funding includes IBRD and IDA commitments to research only (that is, excluding extension and education), and omits funds provided to the CGIAR from the Development Grant Facility. Other includes Europe and Middle East. For USAID, global programs, CGIAR support, and CRSP programs are also included under other.

¹ Pardey, Roseboom, and Beintema (1997).

² Cox and Chapman (1999).

³ World Bank Rural Development Department (2001).

⁴ These figures give no indication of the pattern of disbursements, a more meaningful measure for assessing the World Bank resources actually used to support research. Total project costs (that is, World Bank lending and other—often local-government—contributions) of less than \$5 million earmarked for agricultural research, extension, and education were excluded from these calculations.

⁵ USAID (2000).

The Growing Private Sector

The efforts of individual innovators and companies in agriculture have always played a key role. In the United States, entrepreneurs such as John Deere, Cyrus McCormick, and the Wallace family (founders of Wallace Seed Corn, later Pioneer) are part of agriculture’s long affair with capitalism. Most herbicides, insecticides, and veterinary medicines were developed in the private sector¹⁵ (although they drew on discoveries made by public research), as well as many food-storage, -transport, and -processing technologies, including the refrigerated railroad car and the grain elevator, to name but two. Private investment in chemical, mechanical, and food-processing research is now substantial and rose rapidly in the latter part of the 20th century, at least until very recently.

Attention is presently riveted on biotechnology research. In 1994 the commercially unsuccessful Flavr-Savr™ tomato (genetically engineered to retain its “fresh-picked” flavor)¹⁶ heralded the beginning of a series of innovations derived from genetic engineering. In the mid-to late 1990s, commercially successful herbicide- and insect-tolerant crop varieties such as Roundup Ready® or Liberty Link® corn, cotton, and canola, or Bt corn and cotton followed.

In stark contrast to private research done in many other sectors (like electronics, engineering, information, and most of medicine), the agricultural research carried out by private biotechnology and life sciences firms is controversial.¹⁷ However, little if anything is known about the total private spending on agricultural research worldwide, the overall mix of research in terms of its commodity and technology focus, or aspects of its indus-

trial organization such as the size of the firms, their local or multinational character, and the location of the research (especially in terms of developed versus developing countries). In addition to biotechnology research, large amounts are also spent on agrochemical research and machinery related to agriculture, as well as very sizable investments in food-processing research by private firms. Our estimates on private R&D spending span this broader range of activities, highlighting private spending totals and the location of the research.

By the mid-1990s, about one-third of the \$33 billion total investment in agricultural research worldwide was private (Table 2). But little of this research takes place in developing countries. The overwhelming majority (\$10.8 billion, or 94 percent of the global total) is conducted in developed countries.¹⁸ In the less-developed countries (LDCs), the private share of research is just 5.5 percent,

Table 2—Estimated global public and private agricultural R&D investments, circa 1995

	Expenditures			Shares		
	PUBLIC	PRIVATE	TOTAL	PUBLIC	PRIVATE	TOTAL
	<i>(million 1993 international dollars)</i>			<i>(percent)</i>		
Developing Countries	11,469	672	12,141	94.5	5.5	100
Developed Countries	10,215	10,829	21,044	48.5	51.5	100
TOTAL	21,692	11,511	33,204	65.3	34.7	100

SOURCES: See Table 1 for details on public expenditures, which represent an annual average for the 1994-96 period. Private-sector estimates for developed countries are also an annual average of 1994-96. Developing-country data for private research are either 1995 or 1996 estimates. Estimates for nine Latin American countries are from Beintema and Pardey (2001). For China and five other Asian countries (India, Indonesia, Malaysia, Pakistan, and Thailand), estimates are based on country-specific references listed in Table 1. For other Asian countries (except South Korea) and Latin American countries, as well as all the Middle East and North African countries, we assumed their private-sector shares of total science spending were 3.8 percent, the estimated share for the nine Latin American countries. For South Korea, we assumed its private-sector share was 9.1 percent, the same as our five-country Asian average. We took the share of private-sector spending in Sub-Saharan Africa to be 2 percent of the total (that is, public and private) spending based on information obtained from various sources.

NOTES: Drawing together estimates from various sources meant there were unavoidable discrepancies in what constitutes “private” and “public” research. For example, in the data made available to us, private spending in Asia included nonprofit producer organizations, whereas we opted to include research done by nonprofit agencies as part of public research in Latin America and elsewhere when possible.

and public funds are still the major source of support (and remain a significant source of support in rich countries, too, accounting for about half their total funding).

Innovation systems are bound to involve duplication and competition between the public and private sectors, some of which helps spur science. But with some exceptions, private and public labs largely do different types of research, even in rich countries. In the early 1990s, around 12 percent of private research dealt with farm-focused technologies, whereas over 80 percent of public research had that orientation.¹⁹ Food and other postharvest research accounted for 30 to 90 percent of private agricultural R&D in rich countries, and in countries like Australia, Japan, New Zealand, and the Netherlands, it was the dominant focus of private agricultural research.

Chemical research was of comparatively minor importance in Australia and New Zealand, but it accounted for more than 40 percent of private research in the United Kingdom and the United States and nearly three-quarters of private agricultural research in Germany.

There is a concentration of research in private firms doing different types of research in different countries (see Box 5). In the early 1990s, Japan, the United States, and France account for 33 percent, 27 percent, and 8 percent, respectively, of all food-processing research carried out by the private sector in the countries that form the Organisation for Economic Co-operation and Development (OECD). Chemical research related to agriculture is even more concentrated geographically: the United States, Japan, and Germany respectively represent

Box 4

AGRICULTURE'S SLICE OF THE GLOBAL SCIENCE PIE

Table B4 reports our best efforts to construct a global estimate of private and public spending on all science. We generated direct estimates for 70 countries, including the most significant countries in science.¹ Taking the 70-country total at face value and scaling it up to represent a 139-country total, we estimate that in 1995 about \$490 billion were spent on all the sciences worldwide, about 1.6 percent of global GDP in that year. Rich countries did the preponderance of this research: about 85 percent of the total, compared with only 0.6 percent in Africa, just 2.5 percent in Latin American countries, and 9.9 percent for Asia.

There are some similarities but some stark differences, too, in the geographical pattern of spending on agricultural science (see Tables 1 and 3) and the sciences more generally. To summarize,

- The share of LDCs in the world's agricultural science (37 percent, from Table 2) is much higher than their share in science in general (15 percent, from Table B4).
- Science in the South emphasizes agriculture much more than science in the North. About 17 percent of Southern science relates directly to agriculture, whereas less than 3 percent of Northern science is so oriented.
- Like the agricultural sciences, overall research spending is concentrated in just a handful of countries. About three-quarters of all Southern science is done by just four countries: India, China, South Korea, and Brazil. Similarly, three rich countries dominate scientific research in the North: The United States, Japan and Germany did 71 percent of the total, with the United States alone accounting for 42 percent of that total.

¹ The exceptions are the countries of the former Soviet Union and Eastern Europe for which data were not available. According to Salomon, Sagasti, and Sachs-Jeantet (1994), in 1988 these countries collectively accounted for 17.3 percent of global science spending, well down from the estimated 33 percent they spent in 1973.

Table B4—Global spending on science, circa 1995

REGION	Science expenditures		
	TOTAL	SHARE OF TOTAL	SHARE OF GDP
	(million 1993 international dollars)	(percentage)	
Developing countries (109)^a	72,460	14.7	0.61
Africa (24)	2,818	0.6	0.34
Asia (43)	48,994	9.9	0.70
Latin America (28)	12,521	2.5	0.50
Middle East and North Africa (12)	7,472	1.5	0.57
Developed countries (30)	420,217	85.3	2.31
TOTAL (139)	492,677	100.0	1.64

SOURCES: UNESCO (1999), RICYT (2001), and OECD (2000).

NOTES: The number of countries included in regional totals are shown in parentheses. UNESCO data for Africa, Asia, and Middle East and North Africa reported as R&D spending as a percent of gross national product (GNP). Estimates of R&D expenditures were formed using GNP data from World Bank (2000). Where available, RICYT data were compiled in local currency units and converted to international dollars using PPPs from World Bank (2000). Estimates for 1995 for some Latin American countries were formed using observations for prior years. For 70 countries, it was possible to form a direct, mostly 1995, estimate. For the remaining 69 countries, per capita income was estimated for all countries using World Bank GNP and FAO population data. Countries were grouped into several income classes, and using the direct estimates, we formed averages of science spending as a share of GDP for each group. These group averages were deemed representative of the spending shares for all the countries in each group for which direct observations were unavailable and then applied to the respective GDP figure to estimate the amount of spending on science.

^a Developing-country total includes Bermuda and Greece, designated as middle-income countries by the World Bank (1996) criteria used to group the countries here.

41 percent, 20 percent, and 10 percent of all reported private-sector research along these lines.²⁰

The type of R&D done by private firms has changed over time. For example, in the United States, where time-series data are available, research on agricultural machinery dropped from 36 percent of the private-share total in 1960 to just 13 percent in 1966. Postharvest food-processing research contracted, too, from 44 percent to 29 percent. Two of the more significant growth areas were plant breeding and veterinary and pharmaceutical research. Research spending on agricultural chemicals grew as well, and now accounts for more than one-third of total private agricultural R&D.

For those concerned about the plight of poor people and poor countries, the present preoccupation with private roles in agricultural R&D is misguided. As profitable markets develop over the long run, the private sector will no doubt play a much bigger role, but it is folly to think that private research will substantively replace public science in Southern countries anytime soon. Agricultural R&D—like many other areas of research—still relies on significant amounts of public support and is likely to continue to do so for many years (perhaps always). This is especially true in the poorer parts of the world where the incentives for privately financed research are weak for reasons that will

take considerable time to change. And even in rich countries, much private science involves chemical and food-processing concerns and crop and animal technologies more suited to capital-intensive forms of commercial agriculture with high, off-farm, value-added aspects. It is more than likely the scope of private biotechnology research will expand (pending public acceptance and regulatory approval), but much of the pretechnology research and certain types of biotechnologies for which it is hard to appropriate the benefits privately will continue to be a problem of public policy in rich and poor countries alike.

There are prospects for public funding of private research to tackle poor-country problems. Just as large amounts of public funds are used to underwrite privately performed health, defense, and other research with public-good elements in rich countries, so too can subsidies, cofinancing arrangements, joint ventures, contract research, or other institutional instruments be used to tap private research for the benefit of poor people. Private, not-for-profit research is one largely unexplored option. Private non-profits offer real promise for creatively bridging the public-private divide that stems from different research cultures and objectives as well as differing incentives and abilities to address the changing intellectual property regimes surrounding agricultural R&D.

Box 5

RESEARCH CONCENTRATION

Many have expressed concerns about the concentration of private agricultural science in fewer firms and fewer countries. It makes economic sense for there to be significant concentration in some aspects of agricultural R&D. In many farm-input technologies (such as information processing, agricultural machinery, and various herbicide, pesticide, and fertilizer formulations), the returns to scale for research are such that bigger research agencies tend to have lower unit costs. In addition, the results of the research may be widely applicable in countries other than where the research was done. Because of these scale and spillover features, the production economics of many agricultural technologies have much in common with other industrial R&D.

However, agriculture has three distinguishing features: the biological base of the industry, long production cycles, and the jointness of agricultural enterprises. More particularly, the performance of some important agricultural technologies (for example, many improved seed varieties, some agricultural machinery and chemical technologies, and all sorts of farming practices) is site-specific and strongly affected by agroecological conditions. This defines the size of the relevant market in ways that are much less common in technologies arising from industrial R&D.

One way to think of this is in terms of the unit costs of making local research results applicable to other locations (say, by adaptive research), which must be added to the local research costs.¹ Such costs grow with the size of the market. A close analogy can be drawn with spatial market models of food processing in which processing costs fall with throughput but input and output transportation costs rise with throughput so that when the two elements of costs are combined, a U-shaped average cost function is derived.² Economies of size, scale, and scope in research mean that unit costs fall with the size of the R&D enterprise, but these economies must be traded off against the diseconomies of distance and adapting site-specific results (the costs of "transporting" the research results to economically "more distant" locations). Thus, as the size of the research enterprise increases, unit costs are likely to decline at first (because economies of size are relatively important) but will eventually rise (as the costs of economic distance become ever-more important).

¹ Alston and Pardey (1996).

² See for example Sexton (1990).

Research Intensities

One way to gauge the commitment of funds to either public or private agricultural research is to compare it to national agricultural output, rather than measuring it in absolute terms, much as development aid is often measured as a percentage of national gross domestic product (GDP). This relative measure indicates the intensity of investment in agricultural research, not just the amount of total research spending.

This measure helps capture the complementary nature of research investments, much as measuring labor productivity as output per unit of labor carries with it returns to the use of complementary land, capital, and other purchased inputs.²¹ By analogy, research produces new know-how and new and improved techniques that act like additional inputs and raise productivity. Likewise, R&D can improve the quality of an existing output (such as enhancing the vitamin A content of rice), which can be seen as increasing the amount of a bundle of outputs (which includes both rice and vitamin A), thus raising productivity.

The left-hand panel of Table 3 presents a measure of agricultural research intensity (ARI), specifically, agricultural research expenditures as percentages of agricultural GDP. Figure 6 depicts the same information graphically.²² In 1995, as a group, developed countries spent \$2.64 on public agricultural R&D for every \$100 of agricultural output, a sizable increase over the \$1.53 they spent per \$100 of output two decades earlier. Since 1975, research intensities rose for the developing countries as a group, but unevenly. Despite gaining a greater absolute share of

the developing world's total agricultural research spending (see Figure 1), China's agricultural research intensity in the mid-1990s was no greater than it was in the mid-1980s. In other words, China's research spending grew, but its agricultural sector grew just as fast. Although public research throughout the rest of Asia and Latin America appears to have grown in intensity during the last decade of our data, Africa has lost considerable ground, with research intensities lower than in the 1970s.

The large and growing gap in research intensity between rich and poor countries continues to widen further in terms of total (private and public) spending (Figure 7). In 1995, total spending intensities were more than eight times higher in rich countries than they were in poor ones; they were four times higher when only public spending was used as the basis of the intensity calculation.²³

Richer countries invest public funds in agricultural R&D more intensively than do poorer ones, but many low-income countries invest more intensively in public agricultural research than per capita income alone would suggest. Public agricultural research intensities have a

Table 3—Selected public research intensity ratios, 1976-95

	Expenditures as a share of AgGDP			Expenditures per capita			Expenditures per economically active agricultural population		
	1976	1985 ^a	1995 ^a	1976	1985 ^a	1995 ^a	1976	1985 ^a	1995 ^a
	(percent)			(1993 international dollars)					
Developing countries	0.44	0.53	0.62	1.5	2.0	2.5	4.6	6.5	8.5
Sub-Saharan Africa	0.91	0.95	0.85	3.5	3.0	2.4	11.3	10.6	9.4
China	0.41	0.42	0.43	0.7	1.3	1.7	1.8	3.1	4.1
Other Asia	0.31	0.44	0.63	1.1	1.7	2.6	3.8	6.1	10.2
Latin America	0.55	0.72	0.98	3.4	4.0	4.6	26.0	36.0	45.9
Developed Countries	1.53	2.13	2.64	9.6	11.0	12.0	238.5	371.0	594.1
TOTAL	0.83	0.95	1.04	3.3	3.8	4.2	12.9	15.3	17.7

SOURCES: See Table 1. Agricultural GDP from World Bank (2000); Total and economically active agricultural population from FAO (2000).

NOTES: See Table 1.

^a Three-year averages centered on 1985 and 1995.

Figure 6 Public agricultural research intensities, regional comparisons, 1976–95

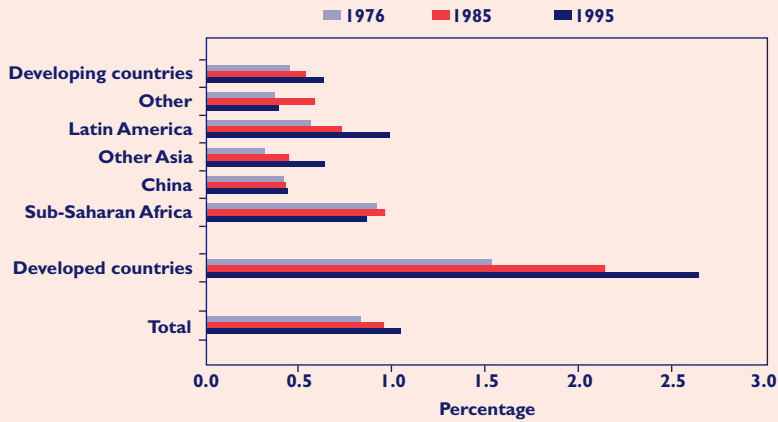

SOURCES: See Table 3.

NOTES: See Table 3. Amounts shown for 1995 and 1985 are based on three-year averages centered on each of those two years.

Figure 7 Public, private, and total agricultural research intensities, 1995

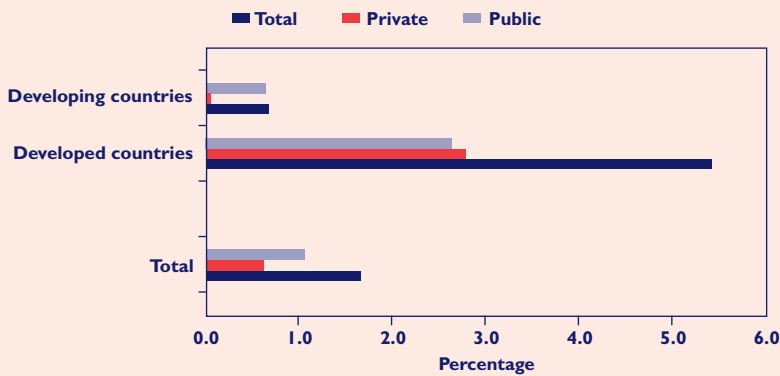

SOURCES: See Tables 2 and 3.

NOTES: See Table 2. Data represent three-year average centered on 1995.

Figure 8 US research intensities and agricultural output shares, 1865–2000

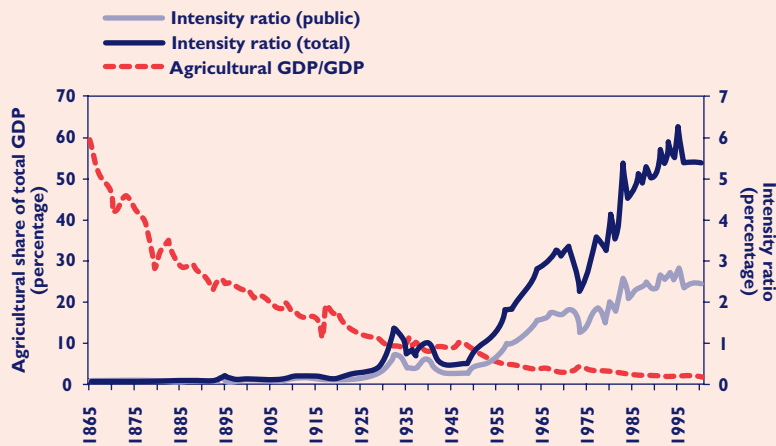

SOURCES: Constructed by the authors using public agricultural research data from USDA-CRIS (various years), Alston and Pardey (1996), and an updated and revised version of the private research series from Klotz, Fuglie, and Pray (1995) backcast for years prior to 1960 using data from Huffman and Evenson (1993).

tendency to decline as the importance of agriculture in the domestic economy (agricultural GDP as a share of total GDP) increases, with, seemingly, a looser link between agricultural research intensities and per capita income.²⁴ For example, some low-income countries with comparatively small agricultural sectors invest quite intensively in agricultural R&D: Botswana, South Africa, Swaziland, and Zambia all had intensity ratios between 2.2 percent and 3.7 percent in the early 1990s, comparable to those of Germany, Japan, and the United States.²⁵ The information shown in Figure 8 uses long-run data for the United States to dramatically reinforce the notion of an inverse relationship. The general pattern is clear, although there have been periodic reversals in the trends of the constituent series or the relationships between them.

Other research-intensity or spending ratios can be calculated; two of these are reported in Table 3. One measures agricultural R&D spending relative to the size of the economically active agricultural population; the other, relative to total population. In 1995, rich countries spent more than nearly \$590 per agricultural worker, more than double the corresponding 1976 ratio. Poor countries spent just \$8.50 per agricultural worker in 1995, less than double the 1976 figure. These rich-poor country differences are, perhaps, not too surprising. A much smaller share of the rich-country workforce is employed in agriculture, and the absolute number of agricultural workers declined more rapidly in rich countries than it did in the poor countries.

Agricultural research spending per capita rose, too, by an average of 25 percent for developed countries (from \$9.60 per capita in 1975 to \$12.00 in 1995) and 79 percent in developing countries (from \$1.50 per capita in 1975 to \$2.50 in 1995). Notably, per capita research spending (in terms of both total population and agricultural workers) declined in Africa, the only region of the world where this occurred.

Global Gaps in Stocks of Scientific Knowledge

The eightfold difference in total research intensities illustrates the present gap in agriculture between rich and poor countries. Moreover, the situation is growing worse. The difference in public research-intensity ratios was 3.4-fold in the 1970s, compared with 4.2-fold now (it would be an even wider gap if private spending were factored in).

These trends may actually understate the gap in scientific knowledge. Science is a cumulative endeavor, with a snowball effect. Innovations beget new ideas and further rounds of innovation or additions to the cumulative stock of knowledge. The mutually beneficial effects of accumulating and exchanging ideas is why lone innovators have largely given way to institutional approaches to research, why scientific disciplines formed professional organizations and spawned journals to capture and carry forward findings, and why scientists seek out other scientists at conferences, via the internet or other venues. And so the size of the accumulated stock of knowledge, not merely the amount of investment in current research and innovative activity, gives a more meaningful measure of a country's technological capacity.

The current stock of knowledge and the contribution of past research spending to that stock is sensitive to the types of science being done, the institutional structures surrounding the science, and the economic context that affects the use of this stock. Some science spending makes persistent and even perpetual contributions to the changing stock of locally produced knowledge: the same spending in societies ravaged by wars, institutional instability, and outright collapse may have a much more ephemeral effect.

The sequential and cumulative nature of scientific progress and knowledge is starkly illustrated by crop improvement. It typically takes 7 to 10 years of breeding to develop a uniform, stable, and superior variety of wheat, rice, or corn (with improved yield, grain quality, or other attributes). Today's breeders build on an accumulation of knowledge built up by the breeders of yesterday. Breeding lines from earlier research are used to develop new varieties, so research of the distant past is still feeding today's research. New crops not only carry forward the genes of earlier varieties, they also carry the crop-breeding and -selection strategies made by earlier breeders, whether they are the farmers who made the selections over the first 10,000 years or the scientific crosses and selections made by researchers during the past 100 years.

Figure 9 shows a partial pedigree of the wheat variety *Pioneer 2375*, released in February 1989 by Pioneer-Hybrid International, the private company mentioned in connection with the Wallace family (now part of Dupont). *Pioneer 2375* was one of several commercially significant wheat varieties in Minnesota during the early 1990s.²⁶ This pedigree reveals the persistent effects of research spending in the distant past on current innovative activity. *Pioneer 2375* was developed by crossing the varieties *Olaf/Era/Suquamuxi68* and *Chris/ND487/Lark*. Moving back through successive generations reveals that varieties developed or discovered as long ago as 1873 (*Turkey Red*), 1901 (*Federation*), and 1935 (*Norin 10*) are part of this pedigree. Over 14 percent of the varieties or breeding lines incorporated into *Pioneer 2375*'s pedigree were available prior to 1900, and at least 36 percent before 1940.²⁷ The cumulative nature of this process means that past discoveries and related research are an integral part of contemporary agricultural innovations. Conversely, the loss of a variety (or the details of the breeding histories that brought it about) means the loss of accumulated past research from the present stock of knowledge.

Providing adequate funding for research is thus only part of the story. Putting in place the policies and practices to *accumulate* innovations and increase the stock of knowledge is an equally important and almost universally unappreciated foundation. Discoveries and data that are improperly documented or inaccessible (and effectively exist only in the mind of the researcher) are lost from the historical record when researchers retire from science. These "hidden" losses seem particularly prevalent in cash-strapped research agencies in the developing world, where inadequate and often irregular amounts of funding limit the functioning of libraries, data banks, and genebanks, and hasten staff turnover.

There can be catastrophic losses, too, tied to the political instability that is also a cause of hunger. Civil strife and wars cause an exodus of scientific staff, or at least a flight from practicing science. Most of Uganda's scientific facilities, for example, were in ruins when its

Figure 9 Partial pedigree for Pioneer 2375

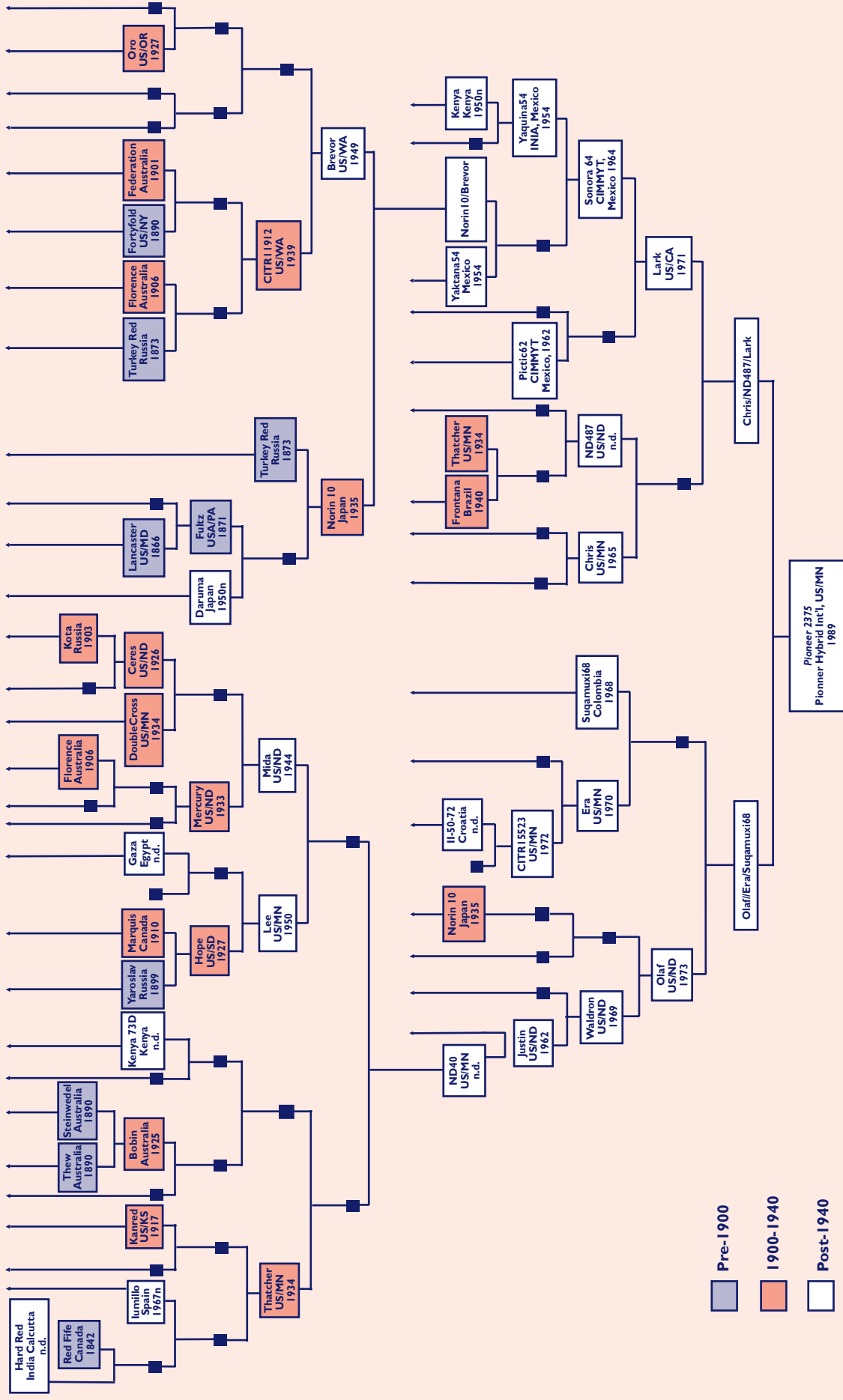

SOURCE: Pardey, Chang-Kang, and Alston (in preparation) based on information downloaded from GrainGenes.
 NOTES: n following some dates signifies the date that the variety was introduced in the United States, but not necessarily the date of development.

civil war ended in the early 1980s. It is hard to imagine that today's Congo once had among the most sophisticated scientific infrastructure in colonial Africa, comparable to the facilities and quality of staff found in most developed countries at the time.²⁸

To construct money metrics of the knowledge stocks for US agriculture, we developed an annual series of public agricultural R&D spending from 1862 (the first year of operation of the United States Department of Agriculture and federal funding for the land-grant universities) to 2000.²⁹ The private-sector R&D series stretches back to 1850. Private research (often an individual initiative in its earlier years) is a long-established feature of US agriculture, beginning well before governments got directly involved and, for most years, spending more than the public sector.³⁰

Agricultural research in Africa started in Britain's Central and Eastern African colonies at the turn of the 20th century, with renewed spurts of spending after World War II (when the Colonial Research Fund became operational in the early 1940s) and again in the 1960s as large injections of donor dollars underwrote the shift to independent, postcolonial governments. The French government began investing in agricultural research in its West African colonies after 1943 (a little later than the British), mainly when it created the Office de la Recherche Scientifique Coloniale.³¹ Our African agricultural research series runs from 1900 to 2000 (the figures for public research are based on direct estimates since 1960 and synthetic estimates for earlier years, with a synthetic series for private research since 1900).

We generated money measures of the stock of scientific knowledge based on research performed in the United States (assuming a baseline depreciation rate of 3

percent per annum) and Africa (assuming the same 3 percent baseline depreciation rate and also a depreciation rate of 6 percent per year, perhaps more realistic given the instability and lack of infrastructure for R&D throughout much of the region).³² Knowledge stocks in 1995—representing a discounted accumulation of research spending from 1850 for the United States and from 1900 for Africa—were expressed as percentages of 1995 AgGDP to normalize for differences in the size of the respective agricultural sectors (Figure 10). The accumulated stock of knowledge in the United States was about 11 times more than the amount of agricultural output produced in 1995. In other words, for every \$100 of agricultural output, there existed a \$1,100 stock of knowledge to draw upon. In Africa, the stock of scientific knowledge in 1995 was actually less than the value of African agricultural output that year. The ratio of the US knowledge stock relative to US agricultural output in 1995 was nearly 12 times higher than the corresponding amount for Africa. If a depreciation rate for Africa of 6 percent instead of 3 percent is used, the gap in American and African ratios is more than fourteenfold.

These measures suggest the immensity, if not the outright impossibility, of playing catch-up, and the consequent need to transmit knowledge across borders and continents. The measures also underscore the need to raise current levels of funding for agricultural R&D throughout the region while also developing the policy and infrastructure needed to accelerate the rate of knowledge accumulation in Africa over the long haul. Developing local capacity to carry forward findings will yield a double dividend: increasing local innovative capacities while also enhancing the ability of African science to tap discoveries made elsewhere. Not least, this calls for increasing investments in primary, secondary, and higher education, which is essential if the generation and accumulation of knowledge is to gain the momentum required, putting economies on a path to lift people out of poverty.³³

Figure 10 Knowledge stock intensities, 1995

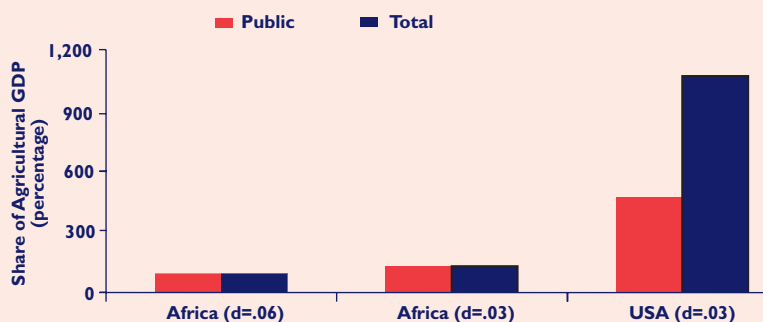

SOURCE: Constructed by the authors.

NOTE: d = depreciation rate.

Agricultural Biotechnologies

How are the LDCs faring regarding the new biotechnologies? Reliable investment data do not yet exist, not least because of difficulties in pinning down exactly what is meant by “agricultural biotechnology.” Some of the measurement problems are related to the prominent role of the private sector. Firms are reluctant to reveal much information for fear of revealing too much to their competitors. Table 4 provides some indications of the extent of experimentation, the rate of release, and the speed of uptake of these new technologies, contrasting the situation in rich and poor countries.

By the end of 2000, over 11,500 field trials for transgenic crop technologies had occurred in 39 countries. While the number of countries permitting field trials was evenly divided between developed and developing countries, the location of the trials was not. Much more of the technology testing takes place in rich countries, where over 80 percent of the trials occurred, with the United States accounting for more than half the world total. Less than 20 percent of the trials were conducted in the LDCs.

Likewise, the location of approved “events” is somewhat lopsided. An “event” involves the insertion of a specific gene in a particular crop, resulting in the expression of a desired trait in that crop. For example, insertion

of the Bt cryI(c) protein producing gene into a particular cotton variety is considered an event. By the end of 2000, more than 180 crop events involving 15 basic phenotypic (physical) characteristics had been deregulated or approved for planting, feed, or food use in at least one of 27 countries and for at least one of 14 crops. Successfully modified traits important for the major agricultural crops include delayed ripening, herbicide tolerance, insect resistance, modified color or oil, male sterility/fertilizer restoration (used, for example, in breeding hybrid varieties of corn and other crops), and virus resistance. Most of the approvals have been issued in the United States and Canada, with few so far in developing countries.

Table 4—Biotechnology indicators

	FIELD TRIALS ^a				NUMBER OF APPROVED EVENTS/CROPS ^a			AREA UNDER TRANSGENICS ^b				
	Number of		Share of		Countries	Events	Crops	Number of		Share of		
	Countries	Trials	Global total	Private in-country total				Crops	Area	Crop within country/region ^c	Global total	
			(percentage)							(million acres)	(percentage)	
Developed Countries	20	9,701	84.2	na	19	160	14	7	na	77.5	na	74.2
United States	1	6,337	55.0	83.4	1	49	14	1	3	69.6	41.0	66.6
Canada	1	1,233	10.7	63.9	1	49	4	1	4	7.4	17.6	7.1
All others	18	2,131	18.5	na	17	62	5	5	na	0.5	na	0.5
Developing countries	19	1,822	15.8	na	8	23	4	8	na	26.9	na	25.8
Argentina	1	393	3.4	90.1	1	7	3	1	3	24.7	84.1	23.7
China	1	45	0.4	na	1	5	4	1	1	1.2	12.4	1.2
All others	17	1,384	12.0	na	6	11	3	6	na	1.0	na	0.9
TOTAL	39	11,523	100.0	na	27	183	14	15	na	104.4	na	100.0

SOURCE: Pardey and Zambrano (in preparation).

NOTES: na stands for not available.

^a Data through to December 2000, when available. For the United States, Canada, and perhaps other countries, a single “trial” may consist of tests conducted at multiple (sometimes many) different sites.

^b Area for year 2000.

^c Indicates share of transgenic acreage for crops with some transgenic varieties.

These geographical imbalances carry through to the technology-use stage as well. Although transgenic crops were grown in eight LDCs by the end of 2000 (compared with only seven developed countries), almost three-quarters of the world's transgenic acreage was located in rich countries. The United States alone accounted for two-thirds of the world's transgenic crop acreage. Close to 60 percent of US transgenic crop acreage was sown to herbicide-resistant soybeans (mainly Roundup Ready®), followed by corn at 28 percent (mostly insect resistant), and cotton at 18 percent. Argentina came second with nearly 24 percent of the global transgenic crop total (virtually all Roundup Ready® soybeans), Canada was third with 7 percent (predominantly herbicide-tolerant canola), and China, fourth with 1.2 percent (all transgenic cotton).

The transgenic share of a particular crop in a particular country is quite variable. About 84 percent of the combined soybean, cotton, and maize acreage in Argentina is sown to transgenic varieties, although most of this acreage consists of herbicide-tolerant soybeans. In 2000 about 12 percent of the Chinese cotton crop is planted with insect-resistant strains. In the United States, 41 percent of the combined cotton, corn, and soybean acreage was transgenic. This increased to 49 percent in 2001, with a quarter of the corn acreage, and two-thirds of both the cotton and soybean acreage planted to transgenic varieties that year.³⁴ The absence of regulatory

approvals for the commercial use of transgenic varieties (as distinct from trials) is a major reason why LDCs are lagging behind. Another is the lag in getting genetic traits into varieties appropriate for different regions, which also accounts for substantial regional differences in the rate of uptake within a country such as the United States. Finally, the lack of desirable traits in crops of significance to poor people is a serious constraint. Virus resistance in several noncommercial potato varieties is being tested in trials in Mexico, as is virus resistance in yams in Africa (with vitamin-A-enhanced rice and other quality-enhanced crops targeted to poor consumers still some way off), but as yet, none are ready for release to farmers. Moreover, the pipeline of biotechnologies suitable for LDCs has barely been primed, which is not at all surprising given the comparatively small sums of money invested to date. For example, in 1998, the CG centers collectively spent just \$25 million on biotechnology research.³⁵ That same year, Monsanto invested \$1.26 billion in R&D.

The Rights to Research

Although nations have sometimes monopolized key genetic resources, until recently, agricultural technologies (including new plant varieties and the processes and parent material required to develop them) have been unencumbered by proprietary claims and freely available to all. Beginning in the 1980s, a revolution occurred in the effective protection of proprietary claims, particularly in agricultural biotechnology, where the scope of intellectual property was extended to encompass biological material. The geographic scope of the claims has been increasing, too. All 141 members of the World Trade Organization (WTO), including the poorest of the LDCs, ostensibly must comply with their commitment to Trade-Related Aspects of Intellectual Property (TRIPS) by 2005, although this timetable seems to be slipping and the status of plants as patentable subject matter remains unclear and controversial. There are 114 members of the Patent Cooperation Treaty (PCT) administered by the United Nation's World Intellectual Property Organization (WIPO) that ensures basic and reciprocal standards for intellectual property protection among countries, and 49 countries, including 28 LDCs, are signatories to the UPOV Convention (the International Union for the Protection of New Plant Varieties) that extends certain property rights to plant breeders (Table 5).

The protection of intellectual property can be a mixed blessing. On the one hand, granting rights to intellectual property provides incentives to innovate and to reveal new knowledge that may otherwise be kept secret. On the other hand, the cumulative nature of agricultural research means that the proliferation of patents makes it increasingly difficult for public institutions and private start-ups to be active participants in biotechnology research. Moreover, the needs of industry and

agricultural progress are yet to be properly reconciled with the rights of indigenous peoples and poor farmers who maintained many of the landraces on which today's improved varieties depend.

In agricultural biotechnology, the most visible and controversial field of agricultural research, the portion of the key technology protected as intellectual property is now highly concentrated in the hands of a small number of large, multinational corporations based in North

Table 5—Intellectual property indicators

Region	Total number of countries ^a	Number of World Trade Organization members ^b	Number of Patent Cooperation Treaty members ^b	Number of International Union for the Protection of New Plant Varieties members ^b
Developed countries	50	31	30	22
Developing countries	157	110	84	27
TOTAL	207	141	114	49

SOURCE: Pardey and Zambrano (in preparation).

NOTES:

^a Represents number of countries identified in World Bank (2000).

^b Represents country status as of August 2001.

America and Western Europe. Now, the very intellectual property rights that were associated with the surge of private research in biotechnology may block access to new developments by public-sector and nonprofit researchers.

As patenting becomes more prevalent, the number of separate rights needed to produce a new innovation proliferates. If ownership of these rights is diffuse and uncertain, the multilateral bargaining problem can become difficult to resolve. Instead of overexploitation of a common property with low entry costs, there is underexploitation of a pool of intellectual property due to the high costs of access—a manifestation of the so-called “tragedy of the anticommons,” which occurs when too many individuals have rights of exclusion in a scarce resource. This is a problem that plagues not just agriculture but also research in the health sciences.³⁶

Many think the international proliferation of intellectual property rights and regimes currently impedes agricultural research that is conducted in, or of consequence to, developing countries. Answering this question requires an understanding of the jurisdictional extent of intellectual property, the geographic pattern of production, and the extent and nature of South-North trade flows. Rights to intellectual property are confined to the jurisdictions where they are granted. There is no such thing as an international patent. Gaining patent rights in the United States confers no intellectual property rights in China; a patent in China must also be sought and awarded to confer rights in that jurisdiction.

The extent of freedom to operate (the ability to practice or use an innovation) in less-developed countries is not well understood. For example, the recent innovation involving vitamin A in rice reportedly required permission for more than 70 patent rights. The well-publicized donations of their relevant technologies by major corporations left a strong impression that enforcement of large numbers of crucial patents was being relinquished in favor of the poor in developing countries. In fact, in some major rice-consuming countries, there are no valid relevant patents. There are very few, if any, in the countries where most poor, malnourished consumers reside.

Freedom to operate depends on specific circumstances. The intellectual property rights assigned to the key enabling technologies currently used to transform crops are mainly held in, and therefore primarily relevant to, rich-country jurisdictions.³⁷ Thus, for most of the staple crops that matter for food security in poor countries, the researcher’s freedom to operate in such nations is currently not the main issue. However, as poorer developing countries become compliant with their intellectual property commitments to the WTO, patent applications are increasingly lodged in developing countries, and the lines between nonprofit and commercial research become more blurred, there will most certainly be problems for research on some staple food crops. There are options to address the problems of access to technology, but they are yet to be fully developed and often require access to professionals who are well-versed in intellectual property and in woefully short supply in most LDCs.³⁸

Conclusion

At the beginning of a new century, public investment and institutional initiatives for agricultural R&D in the South are waning and the South-North gap is no longer shrinking. Agricultural science spending, be it public or private, has slowed in many regions of the world, and for many countries within these regions. During the 1990s, public spending actually shrank in Africa and stalled in the rich countries, while many aid agencies reduced their support for agricultural R&D for Southern agriculture. Consequently, growth in the stock of publicly generated knowledge in the North is slowing, thereby limiting the pool of science and technologies that can spill over to the South. It also has less relevance for the South now that much public research in rich countries is focused not on traditional agricultural production technologies but on local environmental and food-safety concerns and on the quality of foods preferred by richer people. Moreover, the slowdown of science in the South limits the potential of poor countries to develop locally relevant technologies and tap into Northern knowledge stocks.

The debate surrounding intellectual property rights and agricultural R&D must be placed in a longer-term framework. The role of the private sector in agricultural research is increasing, but private investment covers only a small subset of the needs and is mostly a complement, not a substitute, for continued public and other nonprofit research. For many developing countries, the performance of the latter is now hampered more by lack of funding than by issues related to intellectual property rights.

The social payoffs to investing in agricultural R&D have been high for rich and poor countries alike.³⁹ Although some think the easy gains have been made, with diminished returns to more recent research, there is no evidence in the extensive impact assessment literature to bear this out. The estimated returns to agricultural R&D are as high now as they ever were, high enough to justify an even greater investment of public funds.

Reinvigorating support for Southern science is unquestionably the top priority. But funding alone is not sufficient to close the South-North gap. Developing effective public-private partnerships—certainly much easier said than done, but by no means impossible—is another requirement; making efficient and effective use of the dollars invested in Southern science is yet another. Getting the political commitment to deal seriously with these problems is tough, and tougher still because of the long-term nature of the commitment required. Science, especially for agriculture, is not a stop-start affair: a sizable and sustained effort is needed, beginning now and continuing for decades to come if the prospects for growth and development that science has to offer the South are to materialize. Unquestionably, another century is too long to wait.

Notes

1. Fowler (1994).
2. Maddison (2001).
3. Unless otherwise stated, all data on research expenditures are reported in 1993 prices and in international dollars (see Box 2).
4. Wherever possible, we have used the internationally accepted statistical procedures and definitions developed by the OECD (1994) and UNESCO (1984) for compiling R&D statistics. We grouped our estimates into three major institutional categories: government agencies, agencies of higher education, and business enterprises. The latter category includes two subcategories of relevance for our study: private enterprises and nonprofit institutions. We have defined public agricultural research to include government agencies, agencies of higher education, and nonprofit institutions.
5. Pardey, Roseboom, and Anderson (1991).
6. Work underway by Fan, Qian, and Zhang (2001) points to continued growth in agricultural R&D spending in China during the latter part of the 1990s.
7. Beintema and Pardey (2001).
8. Pardey, Roseboom, and Beintema (1997).
9. Of course, economic aspects, such as differences in relative factor prices (say the price of labor versus capital), mean that different locations are more or less suitable for different production methods, agricultural or not. For example, when labor is expensive relative to land or capital, farmers tend to demand and adopt technologies like larger tractors or chemical or genetic methods of weed control that save labor relative to the less expensive factors of production.
10. More refined agroecologies using rainfall, soil type, and land slope and elevation, among other things, are often required to meaningfully assess the impact and spillover potential of agricultural technology, as described by Alston et al. (2000b) in the context of Latin America.
11. Based on data summarized in Wood, Sebastian, and Scherr (2000).
12. This change in shares represents the combined effect of a significant increase in spending by nonprofits and a contraction in spending by government agencies, especially since the mid-1980s.
13. For more details on institutional developments related to the CGIAR, see Baum (1986), Gryseels and Anderson (1991), Anderson (1998), and Alston and Pardey (1999).
14. The CGIAR is not the only organization doing agricultural R&D for developing countries. Two large, French agencies engaged in tropical agricultural research are the *Centre de Coopération Internationale en Recherche Agronomique pour le Développement* (CIRAD), established in 1984 from a merger of various French institutes operating mainly in Africa, many since the 1940s, and the *Institut de Recherche pour le Développement* (IRD), formerly *Office de la Recherche Scientifique et Technique Outre-mer*, (ORSTOM). In 1998, these two agencies spent a total of \$154 million (1993 international dollars) on agricultural R&D, about half the total expenditure of the CGIAR in that year. IRD does mainly basic research, with about 40 percent of its research directed toward agriculture and the rest related to environmental, health, and social issues. CIRAD focuses almost exclusively on internationally traded cash crops, such as cotton, oil palm, coffee, cocoa, and rubber, and has a more applied approach. Little of CIRAD's and IRD's spending involves direct financial support to developing-country organizations. Most of their resources are spent on the salaries of French research staff, the majority of whom are now based in France. More than one-half of each agency's operating and capital budget is also spent in France. Thus, much of the French government support to agricultural R&D in LDCs via CIRAD and IRD now takes the form of in-kind rather than cash contributions.
15. In this report, private research denotes research performed by private, for-profit enterprises.
16. Although the tomatoes achieved the delayed-softening and taste-retention objectives of their developers, yields were poor, mechanical handling equipment turned most of them into mush before they got to market, and consumers weren't willing to pay enough of a premium over conventional fresh tomatoes to cover costs. The biotechnology protests started with the *Flavr-Savr*TM when Jeremy Rifkin (author of *The Biotech Century*) managed to persuade Campbell's Soup not to use biotech tomatoes in its products (Kasler and Lau 2000).

17. Allegedly much of the opposition stems from concerns about the food safety and environmental consequences of the technologies. However, some of the concerns seem to relate to the private-for-profit nature of the research itself, including presumptions about the exercise of monopoly power. Jefferson (2001) discusses and elaborates on this idea.
18. In contrast, in 1996 the private sector footed the bill for two-thirds of *total* science spending for 22 member countries of the Organisation for Economic Co-operation and Development (OECD) (Pardey, Roseboom, and Craig 1999).
19. Pardey, Roseboom, and Craig (1999).
20. These data exclude Switzerland, whose share of agricultural chemical R&D is likely to be substantial but unlikely to place it in the top three performers.
21. For example, a farmer working just half a hectare of land is likely to produce more if she has a whole hectare to farm (the productivity of labor increases as the intensity of land use relative to labor increases). Similarly, the amount of rice harvested from a quarter of a hectare is likely to be higher if nitrogen fertilizer is applied than if it is not used (land productivity increases as the intensity of fertilizer use relative to land increases.)
22. Agricultural GDP is a “value-added” measure of agricultural output that represents the gross value of output minus the value of purchased inputs such as fertilizer, pesticides, and machinery. Hence, these research-intensity ratios are higher than, and not directly comparable with, other research-intensity ratios that divide agricultural research spending by the *gross* value of output.
23. We estimate a research intensity of 5.43 percent for rich countries in 1995 when using the total of public and private spending to form the measure, compared with 0.66 percent for poor countries.
24. Pardey, Roseboom, and Craig (1992).
25. In 1994-96, agricultural GDP was about 17 percent of total African GDP, and the region’s average per capita income was US\$551 (in 1995 prices). If Africa followed the historical pattern of the United States, based on a consideration of per capita income alone, its public research intensity would be well less than 0.05 percent, the US figure for 1900 (estimating Africa’s per capita income in 2000 to be \$1,375, less than the \$3,182 per capita in the United States in 1900. Both figures are in 1993 international dollars.) Based on agricultural output shares, Africa’s research intensity would be in the range of 0.05-0.09 percent (the US figure for most of the first decade of the 20th century when agriculture was about 22 percent of the gross domestic product). In fact, Africa’s research intensity was 0.85.
26. *Pioneer 2375* was the leading variety in Minnesota during the 1990s and was planted on nearly half the state’s wheat acreage by the middle of the decade.
27. Another distinctive aspect of the pedigree is the pool of international expertise and germplasm that *Pioneer 2375* represents. It includes material developed in Russia, Australia, Japan, Canada, and parts of the United States outside Minnesota. In fact, 7.5 percent of the 133 nodes in the pedigree that we could trace involved material from Africa, 9 percent from Europe, 11 percent from Latin America, and 27 percent from US states other than Minnesota.
28. These same problems constrain not only the accumulation but the generation of knowledge. The effectiveness of science spending in developing new knowledge is also affected by the composition of funding (too many LDCs employ scientists with insufficient funds to plant or maintain field trials, properly stock laboratories, and so on). In addition, the downtime doing research is often higher in LDCs than in rich countries because of the poorer infrastructure for communications and transport, for example. Lower (and “lost” or late) salaries also lower the quality of scientific staff that can be hired or retained.
29. The series includes spending on intramural USDA research, as well as research conducted by the US Forest Service and the state agricultural experiment stations located within the land-grant universities.
30. At least according to the estimates developed by Huffman and Evenson (1993). Policies to promote private science date back at least to the US Constitution, ratified in 1788, which lays down the legal authority for the US patent system by giving Congress the power “To promote the Progress of Science and useful Arts, by securing for limited Times to Authors and Inventors the exclusive Right to their respective Writings and Discoveries.”

31. Belgium, not the British or French, had the largest and most sustained commitment to agricultural research in Africa prior to 1960. These activities were centered in the Belgian Congo and formalized in 1933 when Belgium established the *Institute National pour l'Étude Agronomique du Congo Belge*, which eventually established a network of 36 research stations throughout the Congo. See Pardey, Roseboom, and Anderson (1991) for more details.
32. The lag length relating innovations, I_t , to present and past research expenditures, R_{t-s} , was taken to be 10 years for both regions, so the stock of knowledge for year t , K_t , was formed as $K_t = (1-d) K_{t-1} + I_t$, where d is the rate of knowledge depreciation and $I_t = \sum_{s=0}^{10} R_{t-s}$.
33. See Beintema, Pardey, and Roseboom (1998) for a description of the woeful state of many agricultural universities throughout Africa.
34. NASS (2001).
35. Morris and Hoisington (2000).
36. Heller and Eisenberg (1998).
37. Binenbaum et al. (2000).
38. Nottenburg, Pardey, and Wright (2001).
39. Alston et al. (2000a).

References

- Ahmed, R. and Z. Karim. 2001. *Agricultural research and development in Bangladesh*. Washington, D.C.: International Food Policy Research Institute. (Unpublished draft).
- Alex, G. 1997. *USAID and agricultural research—Review of USAID support for agricultural research, 1952-96*. Special Report No. 3, Washington, D.C.: Environmentally Sustainable Development Agricultural Research and Extension Group at the World Bank.
- Alston, J. M. and P. G. Pardey. 1999. *International approaches to agricultural R&D: The CGIAR*. Paper prepared for the Office of Science and Technology Policy, Executive Office of the President of the United States, February 9.
- Alston, J. M. and P. G. Pardey. 1996. *Making science pay: The economics of agricultural R&D policy*. Washington, D.C.: AEI Press.
- Alston, J. M., C. Chan-Kang, M. C. Marra, P. G. Pardey, and T.J. Wyatt. 2000a. *A meta analysis of rates of return to agricultural R&D: Ex pede Herculem?* IFPRI Research Report No. 113. Washington, D.C.: International Food Policy Research Institute.
- Alston, J. M., P. G. Pardey, S. Wood, and L. You. 2000b. *Strategic technology investments for LAC agriculture: A framework for evaluating the local and spillover effects of R&D*. Report prepared for the Inter-American Development Bank, Washington, DC: International Food Policy Research Institute.
- Anderson, J. R. 1998. Selected policy issues in international agricultural research: On striving for international public goods in an era of donor fatigue. *World Development* Vol. 26(6):1149-62.
- Baum, W. C. 1986. *Partners against hunger: The Consultative Group for International Agricultural Research*. Washington, D.C.: World Bank.
- BEA. 2001. Current-dollar and “real” Gross Domestic Product. Bureau of Economic Analysis, United States Chamber of Commerce. Available at <<http://bea.doc.gov/bea/dn/gdplev.xls>>. Accessed August 23, 2001.
- Beintema, N. M. and P. G. Pardey. 2001. Recent developments in the conduct of Latin American agricultural research. Paper prepared for the International Conference on Agricultural Science and Technology, Beijing, November 7-9, 2001.
- Beintema, N. M., A. F. D. Avila, and P. G. Pardey. 2001. *Agricultural R&D in Brazil: Policy, investments, and institutional profile*. Washington, D.C.: International Food Policy Research Institute, Empresa Brasileira de Pesquisa Agropecuária, and Regional Fund for Agricultural Technology (Forthcoming).
- Beintema, N. M., P. G. Pardey, and J. Roseboom. 1998. *Educating agricultural researchers: A review of the role of African universities*. EPTD Discussion Paper No. 36. Washington, D.C.: International Food Policy Research Institute.
- Beintema, N. M., G. G. Hareau, M. Bianco, and P. G. Pardey. 2000. *Agricultural R&D in Uruguay: Policy, investments, and institutional profile*. Washington, D.C.: International Food Policy Research Institute, Instituto Nacional de Investigación Agropecuaria, and Regional Fund for Agricultural Technology.
- Beintema, N. M., P. G. Pardey, L. A. Rodríguez del Bosque, and G. Moctezuma. 2001a. *Agricultural R&D in Mexico: Policy, investments, and institutional profile*. Washington, D.C.: International Food Policy Research Institute, Instituto Nacional de Investigaciones Forestales, Agrícolas, y Pecuarias, and Regional Fund for Agricultural Technology (Unpublished draft).
- Beintema, N. M., P. G. Pardey, A. Zumbado, and H. Medina. 2001b. *Agricultural R&D in four Central American countries: Policy, investments, and institutional profile*. Washington, D.C.: International Food Policy Research Institute and Regional Fund for Agricultural Technology (Unpublished draft).
- Beintema, N. M., L. J. Romano, and P. G. Pardey. 2000. *Agricultural R&D in Colombia: Policy, investments, and institutional profile*. Washington, D.C.: International Food Policy Research Institute and Regional Fund for Agricultural Technology.

- Beintema, N. M., P. Zambrano, M. Nuñez, and P. G. Pardey. 2000. *Agricultural R&D in Paraguay: Policy, investments, and institutional profile*. Washington, D.C.: International Food Policy Research Institute, Dirección de Investigación Agrícola, and Regional Fund for Agricultural Technology.
- Binenbaum, E., C. Nottenburg, P. G. Pardey, B. D. Wright, and P. Zambrano. 2000. South-North trade, intellectual property jurisdictions, and freedom to operate in agricultural research on staple crops. EPTD Discussion Paper No. 71. Washington, D.C.: International Food Policy Research Institute.
- CGIAR. 2000. *CGIAR financial report 1999*. Washington, D.C.: Consultative Group on International Agricultural Research, Secretariat.
- CGIAR. 2001. *The challenge of climate risk change: Poor farmers at risk. CGIAR Annual Report 2000*. Washington, D.C.: Consultative Group on International Agricultural Research Secretariat.
- Choi, J.-S. 2000. Agricultural R&D policy in Korea. Paper presented at the mid-term review workshop on Priorities of Public Investments in Chinese Agriculture, Wuxi, China, November 2-3, 2000.
- Cox, A. and J. Chapman. 1999. *The European Community external cooperation programmes: Policies, management, and distribution*. London: Overseas Development Institute.
- Dalrymple, D. G. 2000. The role of public agricultural research in international development. In *Warren E. Kronstad Honorary Symposium*, edited by R. Karow and B. Reed. Special Report 1017. Corvallis, Oregon: Oregon State University Extension Service.
- Fan, S., K. Qian, and X. Zhang. 2001. Financing, institutional, and policy reforms of the Chinese agricultural R&D system. Washington, D.C.: International Food Policy Research Institute (Incomplete draft).
- FAO. 2000. FAOSTAT (September 19). Food and Agriculture Organization of the United Nations. Available at <<http://faostat.fao.org/default.htm>>. Accessed January 17, 2001.
- Fowler C. 1994. *Unnatural selection: technology, politics, and plant evolution*. Switzerland: Gordon and Breach.
- Fuglie, K. O. 1999. Private sector agricultural research and technology transfer in Indonesia. Washington, D.C: US Department of Agriculture, Economic Research Service (Unpublished mimeo).
- Fuglie, K.O. 1998a. Private sector agricultural research in Malaysia. Washington, D.C: US Department of Agriculture, Economic Research Service (Unpublished mimeo).
- Fuglie, K. O. 1998b. Private sector agricultural research in Thailand. Washington, D.C: US Department of Agriculture, Economic Research Service (Unpublished mimeo).
- Gryseels, G. and J. R. Anderson. 1991. International agricultural research. In *Agricultural research policy: International quantitative perspectives*, edited by P. G. Pardey, J. Roseboom, and J. R. Anderson. Cambridge, U.K.: Cambridge University Press.
- Heller, M.A. and R. S. Eisenberg. 1998. Can patents deter innovation? The anticommons in biomedical research. *Science* 280 (May 1):698-701.
- Huffman, W. E. and R. E. Evenson. 1993. *Science for agriculture: A long-term perspective*. Ames, Iowa: Iowa State University Press.
- ICARDA, FAO, AARINENA, and CIHEAM. 1999. *The national agricultural research systems in the West Asia and North Africa region*. Aleppo, Syria: International Center for Agricultural Research in the Dry Areas.
- Jefferson, R.A. 2001. Transcending Transgenics — Are there “babies in the bathwater,” or is that a dorsal fin? In *The future of food: Biotechnology markets and policies in an international setting*, edited by P. G. Pardey. Washington, D.C.: International Food Policy Research Institute. (Forthcoming).

- Kasler, D. and E. Lau. 2000. At Calgene, a harvest of uncertainty. *Sacramento Bee* (May 7, 2000). Available at <<http://www.sacbee.com/news/projects/biotechnology/>>. Accessed June 15, 2001.
- Klotz, C., K. Fuglie, and C. Pray. 1995. *Private-sector agricultural research expenditures in the United States, 1960-92*. ERS Staff Paper No. 9525. Washington D.C.: USDA Economic Research Service.
- Maddison, A. 2001. *The world economy: A millennial perspective*. Paris: OECD Development Centre.
- Morris, M. L. and D. A. Hoisington. 2000. Bringing the benefits of biotechnology to the poor: The role of the CGIAR centers. In *Agricultural biotechnology in developing countries: Towards optimizing the benefits for the poor*, edited by M. Qaim, A. Krattinger, and J. von Braun. Boston: Kluwer Academic Publishers.
- NASS. 2001. Crop production—acreage—supplement (PCP-BB). (Acreage, June 1996–2001, text and pdf files). National Agricultural Statistics Service of the United States Department of Agriculture. Available at <<http://jan.mannlib.cornell.edu/reports/nassr/field/pcp-bba/>>. Accessed July, 2001.
- Nottenburg, C., P. G. Pardey, and B. D. Wright. 2001. Addressing freedom-to-operate questions for International Agricultural R&D. In *The future of food: Biotechnology markets and policies in an international setting*, edited by P. G. Pardey. Washington, D.C.: International Food Policy Research Institute (Forthcoming).
- OECD. 2000. *OECD science & technology indicators 2000*. Paris: Organisation for Economic Co-operation and Development. CD-ROM.
- OECD. 1994. *The measurement of scientific and technical activities 1993: Standard practice for surveys of research and experimental development—Frascati manual*. Paris: Organisation for Economic Co-operation and Development.
- Pardey, P. G., and J. Roseboom. 1989. *ISNAR agricultural research indicator series: A global data base on national agricultural research systems*. Cambridge, U.K.: Cambridge University Press.
- Pardey, P. G. and P. Zambrano. (In preparation.) Global biotechnology and intellectual property indicators. Washington, D.C.: International Food Policy Research Institute.
- Pardey, P. G., C. Chan-Kang, and J. M. Alston. (In preparation.) Donor and developing-country benefits from international agricultural research: Double dividend? Washington, D.C.: International Food Policy Research Institute.
- Pardey, P. G., J. Roseboom, and J. R. Anderson. 1991. Regional perspectives on national agricultural research. In *Agricultural research policy: International quantitative perspectives*, edited by P. G. Pardey, J. Roseboom, and J. R. Anderson. Cambridge, U.K.: Cambridge University Press.
- Pardey, P. G., J. Roseboom, and N. M. Beintema. 1997. Investments in African agricultural research. *World Development* Vol. 25 (March):409-423.
- Pardey, P. G., J. Roseboom, and B. J. Craig. 1999. Agricultural R&D investments and impacts. In *Paying for agricultural productivity*, edited J. M. Alston, P. G. Pardey, and V. H. Smith. Baltimore: Johns Hopkins University Press.
- Pardey, P. G., J. Roseboom, and B. J. Craig. 1992. A yardstick for international comparisons: An application to national agricultural research expenditures. *Economic Development and Cultural Change* Vol. 40(2):333-349.
- Pardey, P. G., J. Roseboom, and S. Fan. 1998. Trends in financing Asian and Australian agricultural research. In *Financing agricultural research: A sourcebook*, edited by S. R. Tabor, W. Janssen, and H. Bruneau. The Hague: International Service for National Agricultural Research.
- Pray, C. E. and R. Basant. 1999. Agricultural research and technology transfer by the private sector in India. New Brunswick: Rutgers University (Unpublished mimeo).

- RICYT. 2001. Indicadores) de ciencia y tecnología (Science and Technology indicators). Red Iberoamericana de Indicadores de Ciencia y tecnología. Available at <<http://www.ricyt.edu.ar/indicadores.html>>. Accessed March 2001.
- Roseboom, J., M. Cremers, and B. Lauckner. 2001. *Agricultural R&D in the Caribbean: An institutional and statistical profile*. ISNAR Research Report No. 19. The Hague: International Service for National Agricultural Research.
- Salomon, J.-J., F. R. Sagasti, and C. Sachs-Jeantet. 1994. *The uncertain quest: science, technology, and development*. Tokyo: United Nations University Press.
- Sexton, R. J. 1990. Imperfect competition in agricultural markets and the role of cooperatives: A spatial analysis. *American Journal of Agricultural Economics* Vol. 72 (August):709-720.
- UNESCO. 1999. *UNESCO annual statistical yearbook 1999*. Paris: United Nations Educational, Scientific and Cultural Organization.
- UNESCO. 1984. *Manual for statistics on scientific and technological activities*. Paris: United Nations Educational, Scientific and Cultural Organization, Division of Statistics on Science and Technology.
- USAID. 2000. *Report to congress on Title XII: Famine prevention and freedom from hunger. Fiscal year (FY) 1999*. Washington, D.C.: United States Agency for International Development.
- USDA-CRIS. Various years. *Inventory of agricultural research*. Washington, D.C.: US Department of Agriculture, Current Research Information System.
- Wood, S., K. Sebastian, and S. J. Scherr. 2000. *Pilot analysis of global ecosystems: Agroecosystems*. Washington, D.C.: International Food Policy Research Institute and World Resources Institute.
- World Bank. 2000. *World Development Indicators 2000*. Washington, D.C.: World Bank. CD-ROM.
- World Bank. 1996. *World development report 1996: From plan to market*. Washington, D.C.: World Bank.
- World Bank—Rural Development Department. 2001. *AKIS database*. Washington, D.C.: World Bank (Unpublished data).

Acronyms

AgGDP	agricultural gross domestic product
ARI	agricultural research intensity
CGIAR	Consultative Group on International Agricultural Research
CIAT	Centro Internacional de Agricultura Tropical
CIMMYT	Centro Internacional de Mejoramiento de Maíz y Trigo
CIRAD	Centre de Coopération Internationale en Recherche Agronomique pour le Développement
CRSP	Collaborative Research Support Program
FTE	full-time equivalent
GDP	gross domestic product
GNP	gross national product
EC	European Community
IITA	International Institute of Tropical Agriculture
IMF	International Monetary Fund
IP	intellectual property
IRD	Institut de Recherche pour le Développement
IRRI	International Rice Research Institute
LDC	less-developed countries
OECD	Organisation for Economic Co-operation and Development
ORSTOM	Office de la Recherche Scientifique et Technique Outre-mer
PFP	partial-factor productivity
PPP	purchasing-power parity
R&D	research and development
TRIP	trade-related aspects of intellectual property
SPS	sanitary and phytosanitary
TBT	technical barriers to trade
US	United States
USAID	United States Agency for International Development
WIPO	World Intellectual Property Organization
WTO	World Trade Organization