



Aalborg Universitet

AALBORG UNIVERSITY  
DENMARK

## On the Potential of Full Duplex Performance in 5G Ultra-Dense Small Cell Networks

Gatnau, Marta; Fleischer, Marko; Berardinelli, Gilberto; Mahmood, Nurul Huda; Mogensen, Preben Elgaard; Heinz, Helmut

*Published in:*  
Signal Processing Conference (EUSIPCO), 2016 24th European

*DOI (link to publication from Publisher):*  
[10.1109/EUSIPCO.2016.7760351](https://doi.org/10.1109/EUSIPCO.2016.7760351)

*Publication date:*  
2016

*Document Version*  
Early version, also known as pre-print

[Link to publication from Aalborg University](#)

*Citation for published version (APA):*  
Gatnau, M., Fleischer, M., Berardinelli, G., Mahmood, N. H., Mogensen, P. E., & Heinz, H. (2016). On the Potential of Full Duplex Performance in 5G Ultra-Dense Small Cell Networks. In Signal Processing Conference (EUSIPCO), 2016 24th European IEEE. (European Signal Processing Conference (EUSIPCO)). DOI: 10.1109/EUSIPCO.2016.7760351

### General rights

Copyright and moral rights for the publications made accessible in the public portal are retained by the authors and/or other copyright owners and it is a condition of accessing publications that users recognise and abide by the legal requirements associated with these rights.

- ? Users may download and print one copy of any publication from the public portal for the purpose of private study or research.
- ? You may not further distribute the material or use it for any profit-making activity or commercial gain
- ? You may freely distribute the URL identifying the publication in the public portal ?

### Take down policy

If you believe that this document breaches copyright please contact us at [vbn@aub.aau.dk](mailto:vbn@aub.aau.dk) providing details, and we will remove access to the work immediately and investigate your claim.

# On the Potential of Full Duplex Performance in 5G Ultra-Dense Small Cell Networks

Marta Gatnau Sarret<sup>1</sup>, Marko Fleischer<sup>2</sup>, Gilberto Berardinelli<sup>1</sup>, N. H. Mahmood<sup>1</sup>,  
Preben Mogensen<sup>1,3</sup>, Helmut Heinz<sup>2</sup>

<sup>1</sup>Department of Electronic Systems, Aalborg University, Denmark, <sup>2</sup>Nokia Networks, Ulm, Germany,

<sup>3</sup>Nokia Bell Labs, Aalborg, Denmark

{mgs, gb, nhm, pm}@es.aau.dk, {marko.1.fleischer, helmut.heinz}@nokia.com

**Abstract**—Full duplex allows a device to transmit and receive simultaneously in the same frequency band, theoretically doubling the throughput compared to traditional half duplex systems. However, several limitations restrict the promised full duplex gain: non-ideal self-interference cancellation, increased inter-cell interference and traffic constraints. In this paper, we first study the self-interference cancellation capabilities by using a real demonstrator. Results show that achieving  $\sim 110$  dB of cancellation is already possible with the current available technology, thus providing the required level of isolation to build an operational full duplex node. Secondly, we investigate the inter-cell interference and traffic constraints impact on the full duplex performance in 5<sup>th</sup> generation systems. System level results show that both the traffic and the inter-cell interference can significantly reduce the potential gain of full duplex with respect to half duplex. However, for large traffic asymmetry, full duplex can boost the performance of the lightly loaded link.

## I. INTRODUCTION

The number of devices requiring wireless connection is increasing day by day. Latest forecasts show that the global mobile data traffic will increase approximately eightfold between 2015 and 2020 [1]. An attractive solution to accommodate such traffic demand is full duplex (FD) technology. FD allows a device to simultaneously transmit and receive in the same frequency channel, thus, theoretically, doubling the throughput of traditional half duplex (HD) systems. Given its potential, FD is considered as a technology component of future 5th generation (5G) systems.

A FD device generates interference from the transmitter chain to the receiver chain located in the same device, named as self-interference (SI). Such type of interference must be suppressed in order to build an operational FD node. Recent studies [2], [3] show that current levels of SI cancellation (SIC) are in the order of 110 dB, which is already sufficient to build an operational FD node. However, the gain that FD can provide over HD may be affected by the residual SI among other limitations [3], [4]. Since FD doubles the amount of interfering streams, it leads to an increased inter-cell interference (ICI). Furthermore, exploiting FD is only possible when there is data traffic in both link directions, uplink (UL) and downlink (DL).

The authors in [2] evaluated SIC performance using a 20 MHz signal with a maximum transmit power of 24 dBm, showing that an isolation of  $\sim 100$  dB is sufficient to consider ideal SIC. The physical FD performance in WLAN systems is studied in [5], considering ideal SIC and bidirectional FD,

i.e., the case when user equipments (UEs) and access points (APs) are both FD capable. The authors have concluded that the gain that FD may provide over HD is below the theoretical 100% in the majority of cases. In [6], the FD performance in Long Term Evolution (LTE) time division duplex (TDD) with full buffer traffic and File Transfer Protocol (FTP) traffic is analyzed. The authors have evaluated the case where only the AP is FD capable, showing that FD always outperforms HD. Nevertheless, such results may be biased because the assumed isolation among cells may mitigate the ICI effect. In [8], the impact of symmetric and asymmetric traffic in a multi-cell scenario is presented. The authors show that the FD throughput gain reduces with the perceived ICI and the traffic asymmetry. Nevertheless, it is important to notice that the mentioned work does not consider a complete system with all layers active. Furthermore, features such as link adaptation and recovery mechanisms are not used.

The goal of the paper is twofold. First, an experimental study is carried out using a test bed to show current levels of achievable SIC. Second, an overview of the bidirectional FD performance in our envisioned 5G ultra-dense small cell network is presented. In [9], we have described such system, optimized for dense local area deployments. TDD has been chosen as the operational mode, with all the nodes in the network synchronized in time and frequency and equipped with multiple-input multiple-output (MIMO) antennas and interference suppression receivers. The results presented in this paper are extracted from a system level simulator, which includes all the system layers active and features such as link adaptation and recovery mechanisms. The gain that FD may provide over HD in different scenarios is studied, in order to evaluate the impact of the ICI and the traffic asymmetry.

The paper is structured as follows. Section II presents the envisioned 5G system and the limitations that FD brings in achieving the promised double throughput gain. Section III describes the test bed experiment and the SIC results. Section IV introduces the simulation environment and the system level results are shown in Section V. Finally, Section VI concludes the paper and states the future work.

## II. FULL DUPLEX IN 5G SMALL CELLS

The proposed 5G radio access technology (RAT) described in [9] was originally designed as a HD TDD system, targeting a massive and uncoordinated deployment of small cells, where

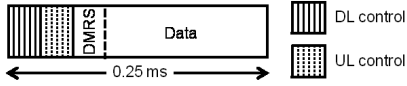

Fig. 1: Envisioned 5G frame structure

all the nodes are synchronized in time and frequency. A novel frame structure of duration 0.25 ms is introduced. Such frame is defined as the Transmission Time Interval (TTI) and is divided in a control part followed by the data part, as shown in Figure 1. A scheduling grant (SG) is transmitted within the DL control symbol. The SG contains transmission parameters such as the link direction, the Modulation and Coding Scheme (MCS) and the number of transmission streams (often referred as the transmission *rank*). Within the UL control symbol, UEs transmit the scheduling request, with specific information regarding the channel and the buffer state and the Hybrid Automatic Repeat and Request (HARQ) feedback. The data part, which includes the demodulation reference signal (DMRS) used for channel estimation, carries UL or DL data in case of HD, and both DL and UL in case of FD. It is assumed that the transmission direction can change at each TTI, independently of previous decisions. Consequently, a TTI can be DL HD, UL HD or FD.

All nodes are equipped with  $4 \times 4$  MIMO antenna configuration and Interference Rejection Combining (IRC) receivers [10]. Such receivers aim at suppressing incoming interference by using the degrees of freedom from the antenna domain.

In this paper we study the performance of bidirectional FD, which corresponds to the case where both the AP and the UEs are FD capable. To quantify the practical gains that FD may bring over traditional HD systems, three limitations must be considered:

- Self-interference cancellation. For a FD node to be effective, a high level of isolation between the transmitter antenna and the receiver antenna located in the same device is required.
- Inter-cell interference. FD doubles the amount of interfering streams compared to HD, meaning that FD will perceive stronger ICI than HD. The stronger the ICI is, the lower are the data rates and hence a larger number of TTIs are required to transmit the same amount of data.
- Simultaneous UL and DL data. The occurrence of UL and DL traffic at the same time dictates the probability of exploiting FD. Consequently, the FD gain will be impacted by large asymmetries between UL and DL.

In the next section, a description of the experiment carried out with our test bed will be presented, to show the current levels of achievable SIC.

### III. SELF-INTERFERENCE CANCELLATION

The self-interference signal power in a FD scenario could easily exceed the receive signal power level by 100 dB or more. Therefore, managing SIC is a fundamental requirement for the success of FD. The use of higher frequencies beyond today's LTE limits and intended broadband LTE channels of 80 to 100 MHz, together with massive MIMO, add additional obstacles in achieving a high degree of SIC. A test system was developed at Nokia Ulm, for demonstration purposes, to identify the potential limits of SIC. The concept of a pre-mixer approach with an additional transmit chain for analogue

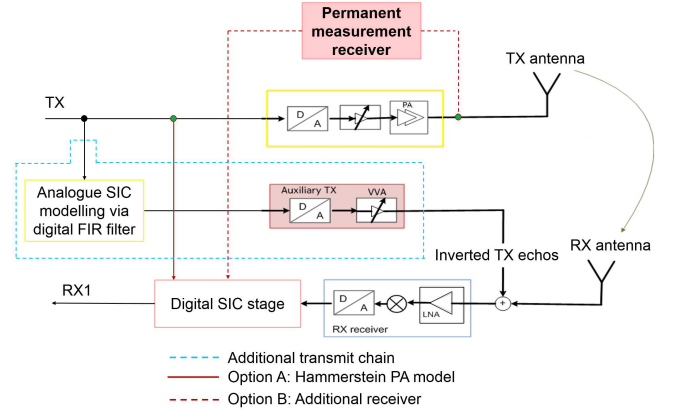

Fig. 2: Auxiliary transmitter concept for receiver protection with two options for RF impairments modeling

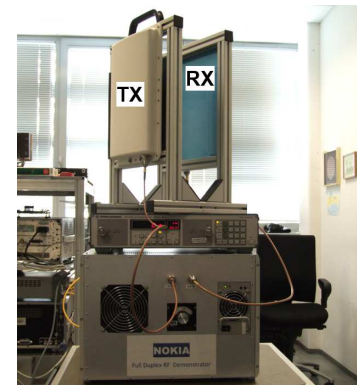

Fig. 3: SIC hardware platform

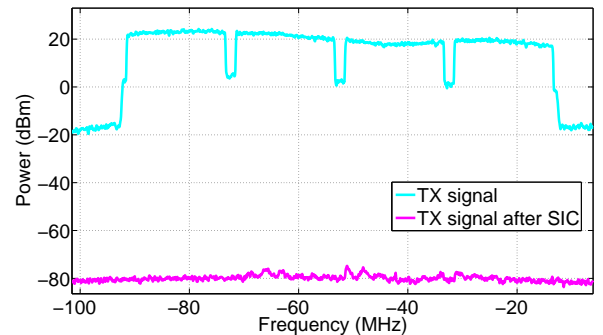

Fig. 4: SIC for a 20 dBm  $4 \times 20$  MHz LTE signal

compensation and a final digital cancellation stage has been build and studied. Such concept was proposed in [11] and is depicted in Figure 2. The system can handle up to 100 MHz contiguous bandwidth and is typically operating in the 2.4 GHz band. The practical antenna isolation from the transmitter (TX) to the receiver (RX) is  $\sim 50$  dB. Such isolation is based on physical antenna separation, as shown in Figure 3, and appropriate passive means. Furthermore, a common clocking domain, same mixer stage for up and down conversion and radio frequency (RF) delay compensation is essential to push the phase noise limits [12].

The hardware in use is upper bounded by  $\sim 70$  dB active

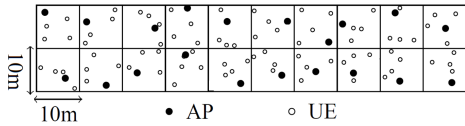

Fig. 5: Simulated multi-cell scenario

TABLE I: Used parameters to run the simulations

Parameter	Value/State/Type
System parameters	BW = 200MHz; $f_c = 3.5$ GHz
Frequency reuse	1 (whole band)
Propagation model	WINNER II A1 w/fast fading [14]
Antenna configuration	4x4
Receiver type	IRC
Transmission power	10 dBm (AP and UE)
Self-interference cancellation	Ideal
Link adaptation filter	Log average of 5 samples
Rank adaptation	Taxation-based [15]
HARQ max retransmissions	4
RLC mode	Acknowledged [16]
Transport protocol	UDP
Traffic type	Symmetric and asymmetric (6:1) finite buffer
Simulation time per drop	1-12 seconds
Number of drops	50

cancellation gain for a 20 MHz LTE signal (LTE20) with respect to phase noise. The practical active cancellation limit is given by the power amplifier (PA) non-linearity and auxiliary transmitter dynamic. An active cancellation gain of 63 dB for LTE20 could be demonstrated, which is split between the analogue cancellation stage and the time domain digital cancellation. This gain demands the use of nonlinear intermodulation modeling via Hammerstein PA model by using the digital signal as input to the digital SIC stage [13] (option A in Figure 2) or the PA signal as direct input with the need of an additional receiver (option B in Figure 2). In the latter approach, the measurement receiver contains the transmitter RF impairments and is common in a typical commercial RF design for PA linearization purposes.

The approach of using an additional transmit chain is intended to protect the receiver against saturation. This approach has the advantage that it scales only with the number of transmit antennas, which is appropriate in a MIMO context. In addition, all transmitted antenna streams are input to the same analogue and digital SIC modeling block, thus avoiding extra complexity and providing simpler hardware integration.

Figure 4 depicts a total cancellation of  $\sim 100$  dB for a 20 dBm  $4 \times$  LTE20 signal, showing the SI level close to receiver noise floor limits and hence demonstrating the potential of this hardware concept. It justifies the approach to treat SIC as ideal in FD networks, as long as the transmit output power does not exceed home or local area AP limits (up to 24 dBm).

#### IV. SIMULATION ENVIRONMENT

The simulated results are extracted from our event-driven system level simulator. It includes the envisioned 5G physical (PHY) and medium access control (MAC) design described in Section II. Moreover, it includes a detailed implementation of the radio link control (RLC), the user datagram protocol (UDP) and the transport control protocol (TCP) layers, and a vertical radio resource management (RRM) layer. The role of the RRM is to collect information from the PHY, MAC and RLC layers to extract the most appropriate scheduling decision

in each TTI, such as node identifier, link direction, MCS and rank. The Internet protocol (IP) layer is modeled as overhead and the application layer generates different types of traffic.

Features such as link adaptation, rank adaptation and the HARQ recovery mechanism are implemented on top of the PHY and MAC design described in Section II. The link adaptation algorithm keeps track of the latest five channel measurements to extract an accurate MCS. The rank adaptation algorithm [15] determines, based on the incoming interference, how many streams will be used for data transmission and consequently, the MIMO degrees of freedom in the receiver that will be used for interference suppression. For further details, please refer to [15].

The extraction of the transmission direction in HD is based on the amount of data which is currently in the buffers (UL and DL) and previous decisions. Thus, the optimal direction can be  $DL$  or  $UL$  if there is data in at least one of the buffers, or  $MUTE$  if there is no data in either of them. In case of FD, the transmission direction is only based on the buffer size. This means that the optimal transmission direction will be  $DL+UL$  if there is data in both buffers,  $DL$  ( $UL$ ) if the  $UL$  ( $DL$ ) buffer is empty, or  $MUTE$  if both buffers are empty. The reader can refer to [17] for further details on the algorithm to extract the optimal transmission direction. Finally, the user scheduler in time domain is round robin, and no user frequency multiplexing is considered in this work.

Two scenarios are studied, a single small cell and a multi-cell network. The latter corresponds to  $10 \times 2$  grid of small cells (Figure 5). Each small cell refers to a  $10 \times 10$  m<sup>2</sup> room containing one AP and four UEs randomly deployed. The UEs are always affiliated to the AP in the same cell (closed subscriber group). Ideal SIC is considered, according to Section III and [2], given the short distances among nodes and the low transmit power, set to 10 dBm for both APs and UEs. The RLC mode is set to Acknowledged [16] and the transport protocol to UDP. The RLC ACK is transmitted within the control channel and its overhead is therefore not included in the throughput calculation. The remaining simulation parameters are detailed in Table I.

This work compares the performance of HD and FD under different conditions. Two types of traffic are considered, full buffer traffic and FTP traffic [7]. For the latter, two cases are studied: symmetric, where the offered load is the same in UL and DL (1DL:1UL), and asymmetric, where the offered load in DL is six times bigger than in UL (6DL:1UL). Furthermore, three load levels are simulated for each case: low, medium and high, which approximately correspond to 25%, 50% and 75% channel occupancy under ideal interference conditions, respectively. Results are presented numerically in a table format and/or in terms of cumulative distribution function (CDF). Tables show the gain that FD provides over HD, in percentage. The studied key performance indicators are the average session throughput (TP) and the packet delay. The former corresponds to the average of the individual session TPs per link (UL or DL) or per cell (UL+DL). The session TP is defined as the amount of time required to successfully transmit a session, and a session is characterized by the packet size and the  $t_{arrival}$  parameters, which are negatively exponential distributed [7]. The average packet size is 2 megabytes, and the average  $t_{arrival}$  is set to obtain the loads described above. The packet delay is the time between the generation of a packet and its successful reception, including the buffering time.

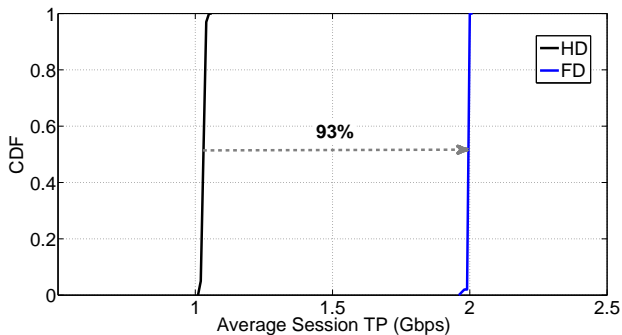

Fig. 6: Single cell TP with 100% FD probability

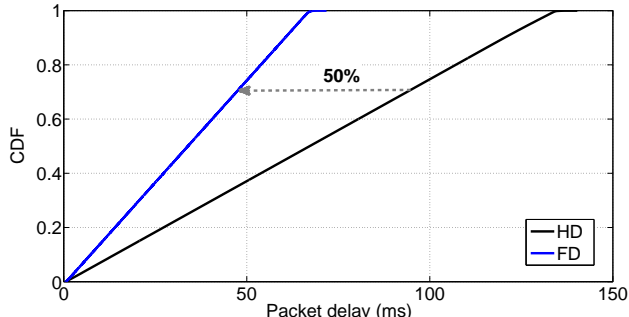

Fig. 7: Single cell delay with 100% FD probability

## V. PERFORMANCE EVALUATION

The results presented in this section show the impact of traffic and ICI. In the first three subsections, the impact of these limitations are studied in an isolated manner. Then, in the last subsection, the performance of HD and FD is evaluated considering both effects.

### A. Single cell with 100% FD probability

In this first case we focus on the performance of FD and HD in a single cell scenario, to avoid ICI. The traffic generator is configured with fixed packet size and  $t_{arrival}$  time, the same in both UL and DL, so the probability of having simultaneous traffic in both directions is 100%. Figure 6 and Figure 7 show the cell TP and average delay, respectively. We observe that, if neither ICI nor SI are present and the FD probability is 100%, the delay can be reduced by 50% with FD, while the theoretical FD TP gain can be almost achieved (93%), due to the fact that the HD baseline is optimized, as explained in Section IV. If the HD baseline is a fixed 1DL:1UL time slot allocation, then the achieved FD gain is 100%. Therefore, it is important to notice that the theoretical FD gain is possible to be achieved, but only under specific conditions.

### B. Single cell with less than 100% FD probability

This subsection moves a step forward from the previous one by considering the negatively exponential distributed traffic model described in Section IV. Note that from an interference perspective, ICI and SI are still not present. Table II shows the TP and delay gains of FD over HD in percentage, for both symmetric and asymmetric traffic. Numerical results show that FD always outperforms HD under ideal interference conditions, and such gain increases with the offered load of the system. This is because the probability of having simultaneous

TABLE II: Gain of FD over HD in a single cell scenario

Load	Symmetric		Asymmetric			
	TP	Delay	DL TP	UL TP	DL delay	UL delay
Low	6%	11%	2%	13%	6%	23%
Med	13%	19%	4%	28%	9%	35%
High	38%	41%	9%	62%	13%	57%

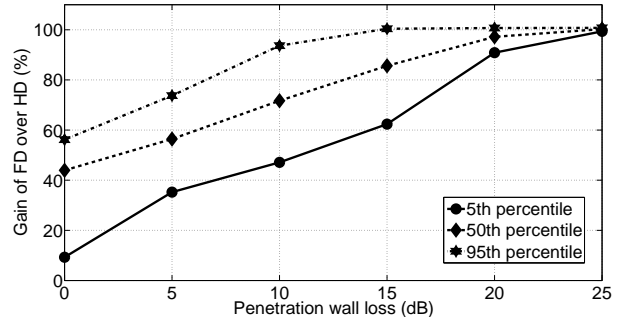

Fig. 8: Multi-cell TP with full buffer traffic

UL and DL is higher when the offered load increases, and therefore FD can be exploited more often. In the asymmetric traffic case, we observe that the FD gain in UL is higher than in DL. With FD, the lightly loaded link gets, on average, six times more resources than with HD. On the contrary, the highly loaded link gets only, on average, one extra resource with FD.

From this analysis we conclude that the FD gain is negatively impacted by the traffic profile, being limited to 38% in case of symmetric traffic. This is because the probability of having simultaneous UL and DL data is below 100% and hence the chances to exploit FD decrease.

### C. Multi-cell with 100% FD probability

The next step after studying the impact of traffic is to analyze how ICI affects the FD performance, by considering the multi-cell scenario. To avoid the traffic impact, the full buffer model is considered and the transmission rank is fixed to one. The analysis is done by varying the penetration wall loss, which defines the isolation between the cells. Such wall loss ranges from 0 dB, which would correspond to an open space scenario, to 25 dB, which refers to an almost isolated cell. Figure 8 shows the gain of FD over HD according to the wall penetration loss. The figure shows the gain in the 5<sup>th</sup>, 50<sup>th</sup> and 95<sup>th</sup> percentiles, where the former refers to the outage performance, i.e., the performance of the users perceiving worse channel conditions. As expected, we observe that, as the isolation among cells is higher, the gain that FD can provide over HD increases. This is because FD doubles the amount of interfering streams, thus showing a higher ICI than HD. Finally, it is interesting to notice that, even in the worst case (open space scenario), the outage users can improve their performance with FD by 9%, while the users perceiving the best channel conditions can improve their performance by 56% by using FD.

### D. Multi-cell without 100% FD probability

The last step is to consider both traffic constraints and ICI. Hence, the negatively exponential distributed traffic model and the multi-cell scenario with a penetration wall loss of 5 dB

TABLE III: Gain of FD over HD in a multi-cell scenario

Load	Symmetric		Asymmetric			
	TP	Delay	DL TP	UL TP	DL delay	UL delay
Low	1%	8%	1%	3%	4%	12%
Med	14%	23%	4%	17%	6%	35%
High	34%	29%	17%	130%	28%	84%

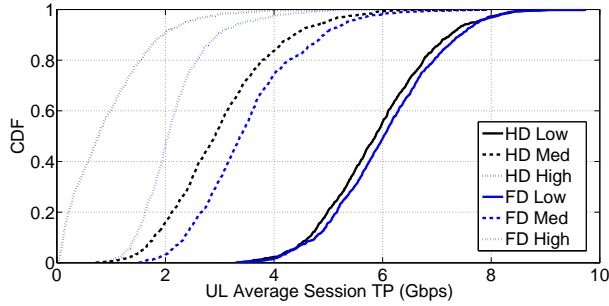

Fig. 9: UL TP with asymmetric traffic

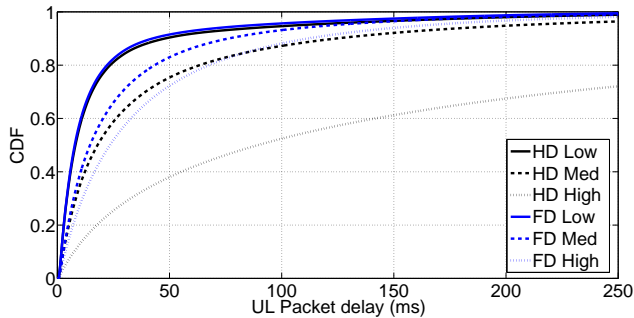

Fig. 10: UL delay with asymmetric traffic

[14] are used. Numerical results are shown in Table III. As in the previous analysis, we observe that the FD gain increases with the offered load. However, in case of symmetric traffic, the maximum TP gain is 34%, thus below the theoretical FD gain, and the maximum delay reduction is 29%. In case of asymmetric traffic, while the DL performance gain is limited to 23% and 16% in terms of TP and delay respectively (see Table III), the UL performance is boosted with FD, since it mitigates the impact of buffering, thus transmitting more data with lower delay. Figure 9 and Figure 10 show the CDF of the UL TP and delay, respectively, of the asymmetric traffic case. Results show that both starvation and buffering problems can be mitigated with FD, specially at high load, since in HD the UL data starves while with FD it is transmitted immediately. Therefore, FD is an attractive solution for applications where the performance of the lightly loaded link shall be improved.

## VI. CONCLUSIONS AND FUTURE WORK

In this paper, we first investigated self-interference cancellation capabilities by using our own developed test bed. The carried experiment shows that up to  $\sim 100$  dB of isolation are currently achievable, thus validating the assumption of ideal self-interference cancellation in a dense small cell scenario. Secondly, we investigated the potential of full duplex in 5G

ultra-dense small cell networks. We show that the theoretical 100% FD gain is achievable only under specific assumptions, namely ideal SIC, isolated cells and full buffer traffic model. Under realistic assumptions, the promised gains of FD are reduced by the traffic constraints and the inter-cell interference. System level results show that FD can always outperform HD in the considered scenarios, though the gains are limited. In case of symmetric traffic, such gains go up to 38% and 41% in throughput and delay, respectively. Furthermore, in case of asymmetric traffic, FD has the potential of boosting the lightly loaded link, specially in terms of delay, since it mitigates the buffering effect. Future work will focus on the usage of full duplex in providing fast discovery in device-to-device type of communication.

## REFERENCES

- [1] "Cisco visual networking index: Global mobile data traffic forecast update, 2015-2020," Cisco, Tech. Rep. White paper, 2016.
- [2] M. Heino *et al.*, "Recent advances in antenna design and interference cancellation algorithms for in-band full duplex relays," *IEEE Communications Magazine*, vol. 53, no. 5, pp. 91–101, 2015.
- [3] K. Thilina *et al.*, "Medium access control design for full duplex wireless systems: challenges and approaches," *IEEE Communications Magazine*, vol. 53, no. 5, pp. 112–120, 2015.
- [4] L. Wang *et al.*, "Exploiting full duplex for device-to-device communications in heterogeneous networks," *IEEE Communications Magazine*, vol. 53, no. 5, pp. 146–152, 2015.
- [5] X. Xie and X. Zhang, "Does full-duplex double the capacity of wireless networks?" in *Proc. of IEEE INFOCOM*, April 2014, pp. 253–261.
- [6] S. Goyal *et al.*, "Full duplex cellular systems: will doubling interference prevent doubling capacity?" *IEEE Communications Magazine*, vol. 53, no. 5, pp. 121–127, 2015.
- [7] "Further advancements for E-UTRA physical layer aspects," 3rd Generation Partnership Project, Tech. Rep. TR 36.814, V9.0.0, 2010.
- [8] N. H. Mahmood *et al.*, "Throughput analysis of full duplex communication with asymmetric traffic in small cell systems," in *11th International Conference on Wireless and Mobile Communications*, October 2015.
- [9] P. Mogensen *et al.*, "Centimeter-wave concept for 5G ultra-dense small cells," in *Proc. of IEEE 79th Vehicular Technology Conference*, May 2014.
- [10] "Technical specification group radio access network; enhanced performance requirement for LTE user equipment (UE)," 3rd Generation Partnership Project, Tech. Rep. TR 36.829, V11.1.0, 2013.
- [11] M. Duarte, C. Dick, and A. Sabharwal, "Experiment-driven characterization of full-duplex wireless systems," *IEEE Transactions on Wireless Communications*, vol. 11, no. 12, pp. 4296–4307, 2012.
- [12] A. Sahai, G. Patel, C. Dick, and A. Sabharwal, "On the impact of phase noise on active cancellation in wireless full-duplex," *IEEE Transactions on Vehicular Technology*, vol. 62, no. 9, pp. 4494–4510, 2013.
- [13] L. Anttila *et al.*, "Modeling and efficient cancellation of nonlinear self-interference in MIMO full-duplex transceivers," in *Globecom Workshops*, December 2014, pp. 777–783.
- [14] "WINNER II channel models," Wireless World Initiative New Radio, Tech. Rep. Deliverable 1.1.2, V.1.2, 2008.
- [15] D. Catania *et al.*, "A distributed taxation based rank adaptation scheme for 5G small cells," in *Proc. of IEEE 81st Vehicular Technology Conference*, May 2015.
- [16] "Technical specification group radio access network; evolved universal terrestrial radio access (E-UTRA) radio link control (RLC) protocol specification," 3rd Generation Partnership Project, Tech. Rep. TR 36.322, V8.0.0, 2007.
- [17] M. Gatnau *et al.*, "Can full duplex boost throughput and delay of 5G ultra-dense small cell networks?" in *Proc. of IEEE 83rd Vehicular Technology Conference (VTC Spring)*, May 2016.