



# University of HUDDERSFIELD

## University of Huddersfield Repository

Mian, Naeem, Fletcher, Simon, Longstaff, Andrew P., Myers, Alan and Pislaru, Crinela

Efficient Offline Thermal Modelling for Accurate Assessment of Machine Tool Thermal Behaviour

### Original Citation

Mian, Naeem, Fletcher, Simon, Longstaff, Andrew P., Myers, Alan and Pislaru, Crinela (2009) Efficient Offline Thermal Modelling for Accurate Assessment of Machine Tool Thermal Behaviour. In: Laser Metrology and Machine Performance. Euspen, Euspen Headquarters, Cranfield University, pp. 9-18. ISBN 978-0-9553082-7-7

This version is available at <http://eprints.hud.ac.uk/5558/>

The University Repository is a digital collection of the research output of the University, available on Open Access. Copyright and Moral Rights for the items on this site are retained by the individual author and/or other copyright owners. Users may access full items free of charge; copies of full text items generally can be reproduced, displayed or performed and given to third parties in any format or medium for personal research or study, educational or not-for-profit purposes without prior permission or charge, provided:

- The authors, title and full bibliographic details is credited in any copy;
- A hyperlink and/or URL is included for the original metadata page; and
- The content is not changed in any way.

For more information, including our policy and submission procedure, please contact the Repository Team at: [E.mailbox@hud.ac.uk](mailto:E.mailbox@hud.ac.uk).

<http://eprints.hud.ac.uk/>

# **EFFICIENT OFFLINE THERMAL MODELLING FOR ACCURATE ASSESSMENT OF MACHINE TOOL THERMAL BEHAVIOUR**

N. S. Mian, S. Fletcher, A. P. Longstaff, A. Myers, C. Pislaru

University of Huddersfield, Queensgate, Huddersfield HD1 3DH, UK

[n.s.mian@hud.ac.uk](mailto:n.s.mian@hud.ac.uk)

## **Abstract**

Thermal gradients from internal and external heat sources cause instabilities which affect the machine tool positional accuracy. Positioning error results from deformation of the machine structure due to linear thermal expansions of some machine parts combined with the thermal behaviour of associated complex discrete structures producing non linear thermal distortions. Thermal gradients due to internally generated heat and varying environmental conditions pass through structural linkages and mechanical joints where the roughness and form of the contacting surfaces act as resistance to thermal flow and affect the heat transfer coefficients. Measurement of long term thermal behaviour and associated thermal deformations in the machine structure is a time consuming procedure and most often requires machine downtime and is therefore considered a dominant issue for this type of activity, whether for characterisation or correction. This paper presents a novel offline technique using Finite Element Analysis (FEA) to simulate the combined effects of the internal and external heat sources on a small vertical milling machine (VMC). Detailed long term experimental testing of the effects of temperature distribution in the machine structure and in-depth heat transfer work to obtain accurate values of heat transfer coefficients across joints is reported. Simplified models have been created offline using FEA software and the evaluated experimental results applied for offline simulation of the thermal behaviour of the machine structure. The FEA simulated results obtained are in close correlation with the obtained experimental results. FEA simulation enables quick and efficient offline assessments of temperature distribution and displacement in the machine tool structures along with characterisation of the machine under variable environmental conditions. This results in a significant reduction in machine non productive downtime and can provide significantly more thermal data for the creation and validation of robust long term error compensation models.

## **1. INTRODUCTION**

Machine tool structures are susceptible to temperature changes which occur due to the heat produced internally from machining processes and externally from environmental changes. The heat flows through the structural elements and produces inevitable temperature gradients which cause deformations often in a very complex manner, resulting in unwanted displacements of the cutting tool relative to the work piece known as thermal errors. It has been reported that thermal errors can represent 70% of the total volumetric error [1]. Three main causes of structural temperature changes are 1) Internal heat generation with possible heating sources such as bearings, motors, belt drives etc. 2) Environmental variations with possible heat sources such as direct sunlight,

workshop heating etc. Typically in non-temperature controlled environments, the 24 hours day and night cycle resulting from these sources are the most dominating long term variations. 3) Radiant heating with possible sources such as infrared workshop heating, direct sunlight striking the machine [2]. Figures 1 to 3 below shows possible affect heat sources.

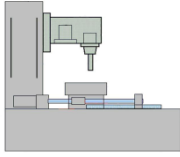

Figure 1: Original machine tool structural profile [2]

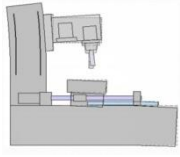

Figure 2: Deformation example due to internal heat sources [2]

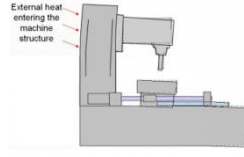

Figure 3: Deformation example due to heat sources [2]

A broad range of research has been carried out to compensate thermal errors. Mian et al. [3] discussed the usage of techniques such as Neural Networks, linear regressions, multiple linear regression and Finite Element Analysis (FEA) with their capabilities, results and complexities associated with machine downtime and cost. It was also discussed that FEA has been used as part of the research as a validation tool on discrete structural elements but not on a full CNC machine for thermal compensation however it has proved its significance in predicting thermal errors in reduced time scales which leads to reduced machine downtime. Mian [3] showed machine tool offline thermal assessment strategy using FEA which can reduce machine downtime. Assessment was carried on assembled machine models of spindle, carrier head, bearings tool and column of a small vertical milling machine. Abaqus 6.7-1 [4] simulated results showed well matched simulation results with experimental tests for one hour heat and one hour cool down. In order for this strategy to be able to predict results more accurately and efficiently, it was required to use this strategy on the full optimized machine model with simulations for longer periods to match the long term industrial operating conditions.

## 2. THERMAL CONTACT RESISTANCE TESTING

Heat flows through machine structure and passes through structural joints and contacts. Mian [3] showed TCR testing results using two steel plates tested in dry and oiled conditions to replicate the precision and accuracy used in assembly of the relevant components of a typical machine tool. The results were used to carry out accurate FEA simulations. TCR values were calculated using equation 1.

$$h_c = \frac{Q}{(AK \Delta T - 2Q \Delta L)} \quad (1)$$

Where  $h_c$  is TCR and K is the conductivity of steel, Q is the heat energy,  $\Delta T$  is temperature difference and  $\Delta L$  is the distance.

### 3. ABAQUS MODELS

Optimised and idealised machine models of base, table and saddle were created and assembled with previously created models [3] to a full machine model. Idealization includes halving of the full model due to its symmetrical nature over X axis. Figure 4 and Figure 5 shows the full and halved machine CAD model. Bearings, belt drives and motor supporting structure were simplified and represented as heat generation sources in the machine CAD model.

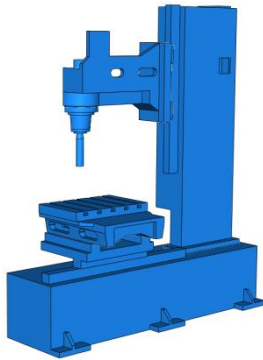

Figure 5: Full machine CAD model created in ABAQUS 6.7-1

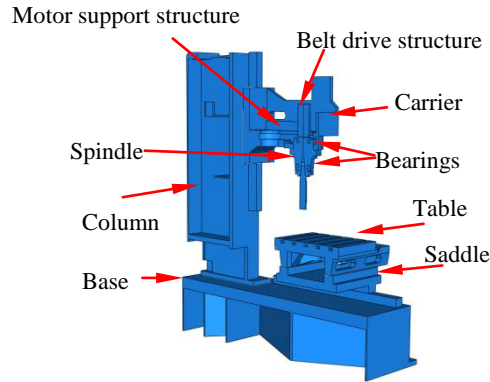

Figure 6: Halved model (Symmetry)

### 4. MACHINE TOOL TESTING

For more accuracy in results obtained [3], it was required to devise an efficient strategy to calculate the convective heat transfer coefficient (h) due to airflow across test mandrels or even generic tooling. A thermal imaging camera was set up to view the spindle and mandrel rotating at 4000rpm. The heating and cooling cycle data was recorded with high speed imaging (per second) and h was calculated using equation 2 and 3. The values obtained were 55W/m<sup>2</sup>C and 9W/m<sup>2</sup>C respectively which were used to simulate thermal distribution across the mandrel.

$$Q = mC_p\Delta T \quad (2) \qquad Q = hA\Delta T \quad (3)$$

Where Q is the energy, m is mass, C<sub>p</sub> is specific heat capacity of a material, h is convective heat transfer coefficient, A is area and ΔT is temperature difference.

#### 4.1 Thermal testing (Online test)

Optimised values for heat transfer coefficients were applied to the machine based on new experimental results. One hour heat and one hour cooling test was repeated and the spindle was rotated at 4000rpm. Thermal data was recorded using 61 thermal sensors in strips located at the surface of the carrier and spindle boss considered as thermal key points explained by White et al. [5]. Thermal imaging was also used to capture temperature data at the surface and

places where thermal sensors are hard to install. The data obtained is presented in section 5.1 (Figure 12) for reviewing them in direct comparison with the obtained simulated profiles. Figure 7 shows the thermal sensors location on the machine. Figure 8 shows the thermal image showing thermal distribution in the spindle motor and the belt drive.

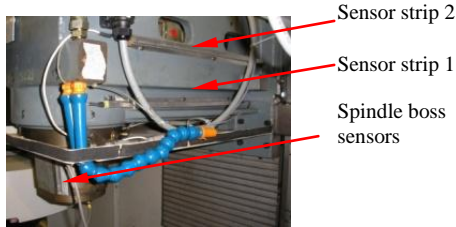

Figure 7: Thermal sensors location on the machine

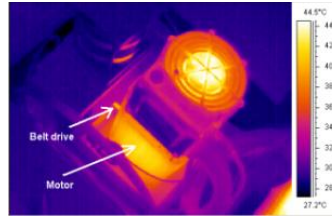

Figure 8: Thermal distribution (top) showing spindle motor and belt drive

#### 4.2 Displacement testing (Online test)

Five Non Contact Displacement Transducers (NCDTs) were placed around a test mandrel (see Figure 9) to monitor the displacements of the tool in X, Y and Z axes during the test. Again the results are presented in section 5.1 (Figure 13) for reviewing them in direct comparison with the obtained simulated results.

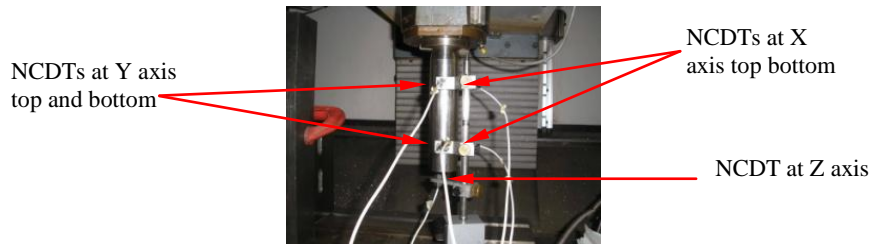

Figure 9: NCDTs located around the tool

### 5. ABAQUS SIMULATIONS (OFFLINE ASSESSMENTS)

The thermal information was converted into thermal loads for applying as body heat flux generated from the heat sources in the software [3]. TCR values [3] were applied at the assembly contacting surfaces and the simulation was set for 1 hour heating and 1 hour cooling.

#### 5.1 Temperature and Displacement Simulations (Offline assessment)

Temperature and displacement results were extracted from the nodes located at similar positions to the actual sensor locations on the machine (both thermal sensors and NCDTs). The results showed improved accuracy in temperature and displacement profiles compared with previous results [3]. Simulation time was also reduced to 3 minutes and 7 minutes for thermal and displacement analyses in Abaqus respectively. A very good correlation of 82% can be observed in both experimental and simulated displacement profiles and

magnitude values (Figure 12 and 13). Figure 10 shows the simulated temperature distribution in the spindle carrier assembly and Figure 11 shows the simulated machine behaviour due to thermal distribution.

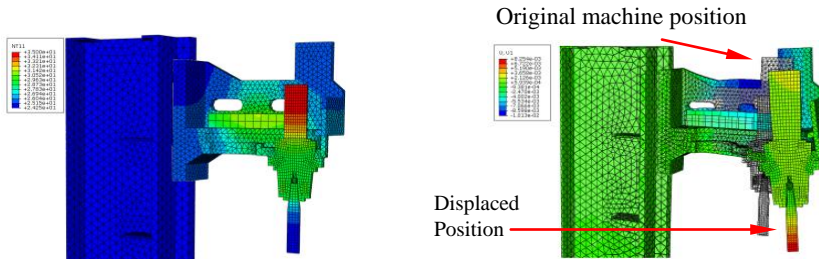

Figure 10: Temperature distribution in the machine structure during heating cycle. (Red=hot, Blue=cold)

Figure 11: Deformations in the machine due to thermal distribution

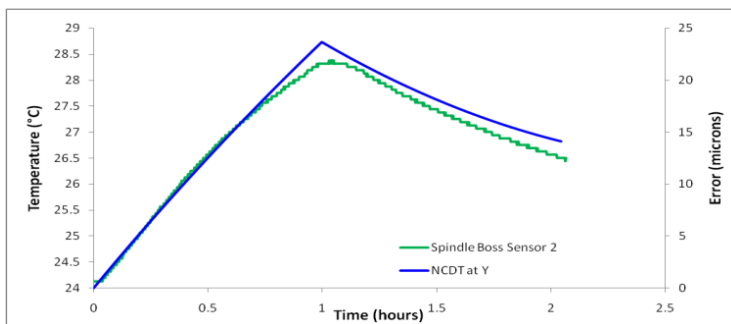

Figure 12: Experimental temperature and displacement profiles for 1 hour heat and 1 hour cooling cycle

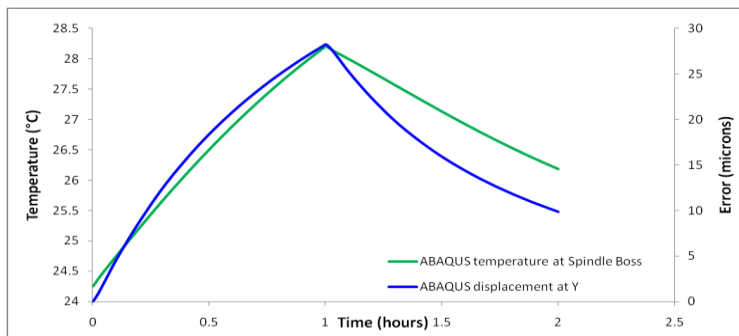

Figure 13: Simulated temperature and displacement profiles for 1 hour heat and 1 hour cooling cycle

## 6. LONG TERM TESTS

As machine down time is involved with carrying out extended thermal trials on production machine tools, one of the greatest advantages of improving offline simulation capability is to enable characterisation of the machine to a reasonable accuracy over medium and long term periods over which, on-

machine testing becomes impractical. The machine was set for a heating test with spindle rotated at 4000rpm constant speed for 3 hours followed by 2 hours cooling phase. NCDTs were setup for measurement of long term thermal drifts at the test mandrel (see Fig 9). Heat transfer coefficients for air were applied (see section 4). Figure 14 and Figure 15 shows the comparison graphs of experimental and simulated thermal and displacement profiles respectively. The Abaqus simulation took 5 minutes for thermal and 10 minutes for displacement analysis. Again good correlation of 74% can be observed in both experimental and simulated displacement profiles and magnitude values.

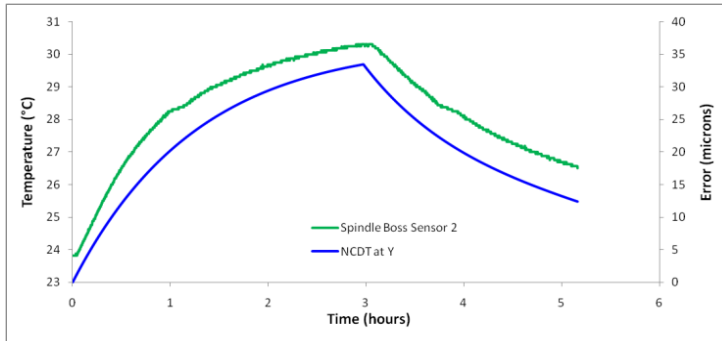

Figure 14: Experimental temperature and displacement profiles for 3 hour heat and 2 hour cooling cycle

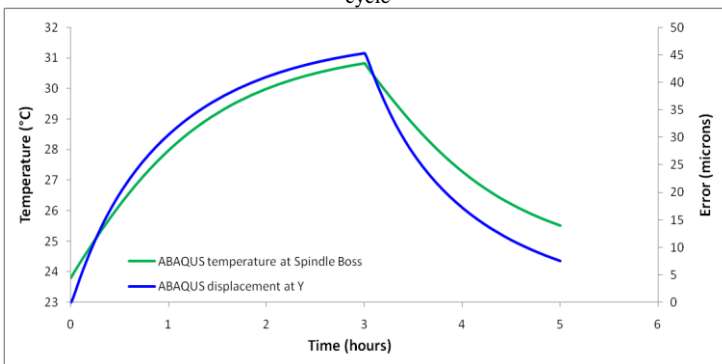

Figure 15: Simulated temperature and displacement profiles for 3 hour heat and 2 hour cooling cycle

## 7. STEP HEAT AND COOL TEST

The complexity of the duty cycle was increased to more closely match operating conditions over much longer test periods. The spindle was rotated in steps at 4000rpm with two 2 hours heating cycles with 1 hour cooling gap. The total test length was 6 hours. Figure 16 And Figure 17 shows the obtained experimental and simulated thermal and displacement profiles respectively. The Abaqus simulation took 8 minutes for thermal and 12 minutes for displacement analysis. Again excellent correlation of 86% can be observed in both experimental and simulated displacement profiles and magnitude values.

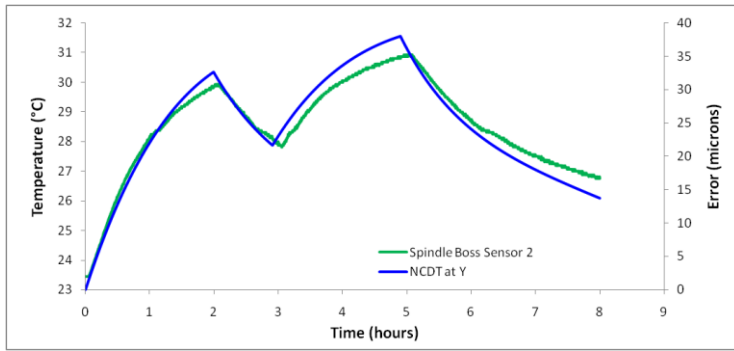

Figure 16: Experimental temperature and displacement profiles step heat and cool cycles

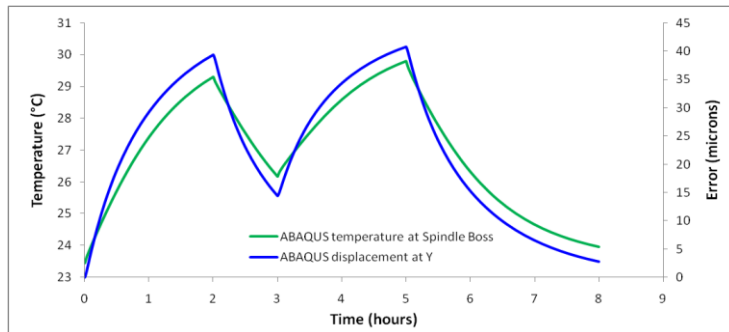

Figure 17: Simulated temperature and displacement profiles for step heat and cool cycle

## 8. ENVIRONMENTAL TESTING

The machine was tested over 3 day period for thermal drifts due to variation in environmental temperatures. Numbers of thermal sensors increased and were placed at mandrel's surface, table surface, machine's base and two sensors placed inside the machine to measure ambient temperature variations. Ambient temperatures were used to calculate convective heat transfer coefficient inside the machine enclosure and was obtained  $6\text{W}/\text{m}^2\text{C}$ . The displacement was measured at mandrel's Z direction. Figure 18 shows experimental thermal profiles obtained for 3 days. The overall temperatures varied approx.  $\pm 2^\circ\text{C}$  noted in the head assembly and approx.  $\pm 0.5^\circ\text{C}$  at the bed (base) during the 3 day period. The results confirm that the environmental temperature variations exist and play an important role in producing thermal drifts over longer production periods.



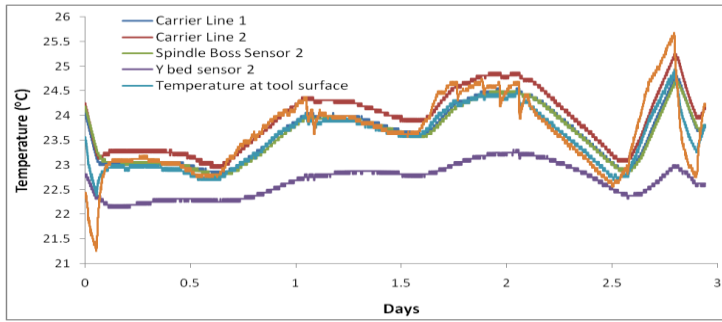

Figure 18: Environmental temperature variations recorded over 3 days

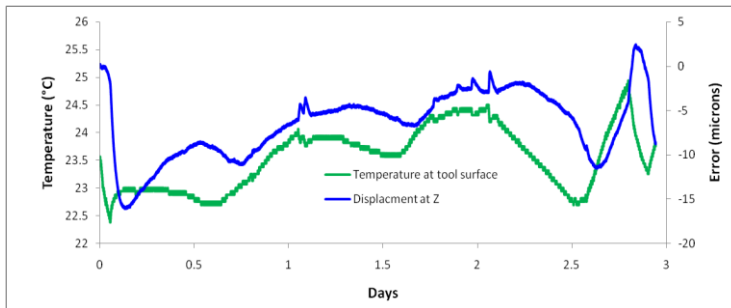

Figure 19: Experimental temperature and displacement profiles recorded over 3 days at mandrel's Z axis

Figure 19 shows the experimental temperature and displacement at the mandrel where displacement followed the temperature variation and varied approx 15 microns in z negative direction over 3 days. This gives a clear picture of machine structure bending sensitivity to environmental variations. The displacement profile's lag is due to the response time of the structure to the temperature variation. Data obtained from environmental testing was applied into Abaqus along with convective heat transfer coefficient measured (section 8). Simulation for thermal and displacement testing took 15 and 22 minutes respectively. Simulated temperature and displacement profiles are shown in Figure 20. Very good correlation of 70% can be observed in both experimental and simulated displacement profiles and magnitude values.

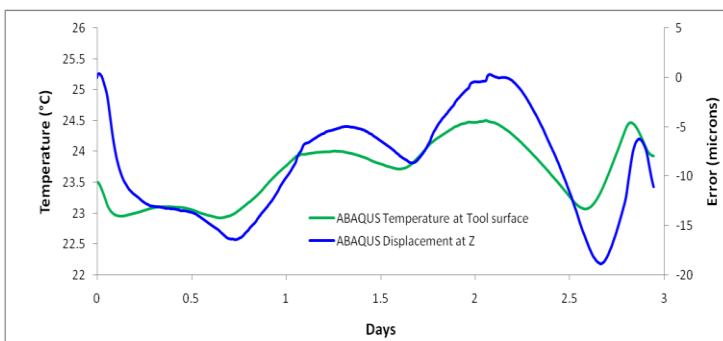

Figure 20: Simulated temperature and displacement profiles recorded over 3 days at mandrel's Z axis

## 5. CONCLUSIONS

Thermal distribution and its associated error in a small VMC CNC machine tool was studied and analysed experimentally and predicted offline using FEA techniques. Heat transfer experiments between contacting surfaces in assemblies and structural linkages were given high importance to evaluate values as accurate as possible in order to obtain accurate FEA results. In depth experimental work has been carried out to obtain the thermal behaviour in the machine structure by running the machine and carefully extracting detailed temperature and displacement data. The machine and FEA model was tested for long term heating and cooling cycles using only the data from initial short terms tests (one hour). Environmental testing was carried out over a 3 day period to record temperature variations and thermal drifts. The results obtained from experiments were analysed and applied in the FEA simulation software Abaqus 6.7-1. The results from FEA matches very well with the experimental results obtained. The simulated FEA technique enabled offline assessments of the temperature distribution and displacements in a machine tool reducing machine non productive downtime and can provide significantly more thermal data for the creation and validation of robust long term thermal error compensation models.

## 6. REFERENCES

- [1] Bryan J, 'International status of thermal error research' Ann. CIRP, 39, 645-656, 1990.
- [2] Ramesh R., Mannan M.A, Poo A.N, 'Error compensation in machine tools – a review Part II: thermal error', International Journal of Machine Tools & Manufacture, v40, pp 1257-1284, 2000.
- [3] Mian N.S, Fletcher S, Longstaff AP, Myers A, Pislaru C, 'Novel and efficient thermal error reduction strategy for machine tool performance improvement', CEARC'08, November 2008, University of Huddersfield, ISBN: 978-1-96218-067-3.
- [4] Dassault Systemes 2007, ABAQUS 6.7-1 FEA software, ABAQUS, Inc.
- [5] White AJ, Postlethwaite SR and Ford D, 'Measuring and Modelling Thermal Distortion on CNC Machine Tools', Fifth International Conference on Laser Metrology and Machine Performance-Lamdmap 2001, University of Birmingham, pp 69 – 79.