

Palladium complexes with a tridentate PNO ligand. Synthesis of η^1 -allyl complexes and cross-coupling reactions promoted by boron compounds†

Bruno Crociani,*^a Simonetta Antonaroli,^a Marcello Burattini,^a Paola Paoli^b and Patrizia Rossi^b

Received 6th July 2009, Accepted 27th January 2010

First published as an Advance Article on the web 8th March 2010

DOI: 10.1039/b913130b

The iminophosphine 2-(2-Ph₂P)C₆H₄N=CHC₆H₄OH (P-N-OH) reacts with [Pd(μ -Cl)(η^3 -C₃H₅)₂] yielding [PdCl(P-N-O)] and propene. In the presence of NEt₃, the reaction of P-N-OH with [Pd(μ -Cl)(η^3 -1-R¹,3-R²C₃H₃)₂] (R¹ = R² = H, Ph; R¹ = H, R² = Ph) affords the η^1 -allyl derivatives [Pd(η^1 -1-R¹,3-R²C₃H₃)(P-N-O)] (R¹ = R² = H: **1**; R¹ = H, R² = Ph: **2**; R¹ = R² = Ph: **3**). In solution, the complexes **1** and **3** undergo a slow dynamic process which interconverts the bonding site of the allyl ligand. The X-ray structural analysis of **1** indicates a square-planar coordination geometry around the palladium centre with a *P,N,O*-tridentate ligand and a σ bonded allyl group. The complexes [PdR(P-N-O)] (R = C₆H₄Me-4, C \equiv CPh) react slowly with *p*-bromoanisole in the presence of *p*-tolylboronic acid to give [PdBr(P-N-O)] and the coupling product RC₆H₄OMe-4. The latter reactions also proceed at a low rate under catalytic conditions. The coupling of allyl bromide with *p*-tolylboronic acid is catalyzed by [PdCl(P-N-O)]/K₂CO₃ to give 4-allyltoluene.

Introduction

In recent years there has been a considerable interest in the coordination chemistry of tridentate PNO ligands which combine both hard and soft donor atoms.¹ Some complexes have been applied in catalytic reactions such as hydrogenation of carbon-carbon multiple bonds,^{1b,1g} oligomerization of ethylene^{1a} and addition of benzoic acid to alkynes.^{1m} Other complexes with chiral PNO ligands are able to catalyze asymmetric transfer hydrogenation^{1e,1r} or asymmetric addition of diethylzinc to aromatic aldehydes.^{1m} Most of the ligands comprise a phosphino group, an imino nitrogen atom and a C=O or OR (R = H, Me) functions. Among the ligands of the latter type, the iminophosphine 2-(2-Ph₂P)C₆H₄N=CHC₆H₄OH (indicated thereafter as P-N-OH) was synthesised by Dilworth and coworkers^{1a} and palladium complexes of its deprotonated form, [PdX(P-N-O)] [X = Cl, OAc, OC₆F₅, SR (R = alkyl and aryl group)]^{1d,1p} and [Pd(P-N-O)L]⁺ (L = tertiary phosphine),^{1p} have been studied. Due to our interest in the chemistry and catalytic properties of iminophosphine-palladium derivatives,² we report here the synthesis and structural characterization of the complexes [PdR(P-N-O)] (R = η^1 -allyl, alkynyl or aryl group) along with their cross-coupling reactions promoted by boron compounds.

Results and discussion

Preparation and characterization of the complexes [PdR(P-N-O)]

The ligand P-N-OH reacts with the η^3 -allyl dimers [Pd(μ -Cl)(η^3 -1-R¹,3-R²C₃H₃)₂] (R¹ = R² = H, Ph; R¹ = H,

R² = Ph) (molar ratio P-N-OH/Pd = 1:1) as reported in Scheme 1.

The initial ¹H NMR spectra of the reaction mixtures in CDCl₃ indicate the presence of fast equilibria (on the NMR time scale) among various species containing η^3 - and η^1 -allyl ligands. In the reaction with [Pd(μ -Cl)(η^3 -C₃H₅)₂], the equilibria bring about the exchange of all the terminal allylic protons which are detected as a broad band at *ca.* 3.3 ppm [spectrum (a) of Fig. 1].

This spectral feature can be accounted for by formation of a cationic species [Pd(η^3 -C₃H₅)(P-N-OH)]⁺ with a *P,N*-chelate ligand, which undergoes a selective η^3 - η^1 - η^3 interconversion through rupture of the Pd-CH₂ bond *trans* to phosphorus,^{2a} and a *P,N* ligand site exchange through a species with a *P*-monodentate iminophosphine^{2b} formed by cleavage of the Pd-N bond. The simultaneous occurrence of such dynamic processes results in *syn-anti* and *syn-syn*, *anti-anti* exchanges of the protons of both the CH₂ allylic units. In this context, it is to be mentioned that complexes of the type [PdCl(η^1 -C₃H₅)(P-N)] (P-N = *P,N*-chelate ligand) with the η^1 -allyl group *trans* to nitrogen have been isolated and characterized.³ The ¹H and ³¹P NMR spectra of the reaction mixture at different times show that a further and slower reaction takes place [reaction (1) of Scheme 1] yielding the well-known complex [PdCl(P-N-O)]^{1d,1p} [ν (C=N) at 1583 cm⁻¹ and ν (Pd-Cl) at 344 cm⁻¹; δ (CH=N) as a doublet at 8.53 ppm with a ³J(PH) of 2.8 Hz, and δ_p as a singlet at 32.5 ppm in CDCl₃ at 25 °C] and propene identified by its typical proton resonances [spectrum (c) of Fig. 1]. Formation of [PdCl(P-N-O)] also occurs in the analogous reaction of P-N-OH with [Pd(μ -Cl)(η^3 -1-PhC₃H₄)₂] but at a considerably lower rate. As a matter of fact, the reaction is not complete even after 4 h at 40 °C in CDCl₃. Formation of [PdCl(P-N-O)], if it occurs, is extremely slow in the reaction of P-N-OH with [Pd(μ -Cl)(η^3 -1,3-Ph₂C₃H₃)₂]. In this case, the cationic complex **4** with a *P,N*-chelate ligand can be isolated and characterized upon addition of NaBF₄ to the mixture [reaction (3) of Scheme 1].

^aDipartimento di Scienze e Tecnologie Chimiche, Università di Roma "Tor Vergata", Via della Ricerca Scientifica, 00133, Roma, Italy. E-mail: crociani@stc.uniroma2.it; Fax: +39 06 72594328

^bDipartimento di Energetica, Università di Firenze, Via S. Marta 3, 50139, Firenze, Italy

† CCDC reference number 739327. For crystallographic data in CIF or other electronic format see DOI: 10.1039/b913130b

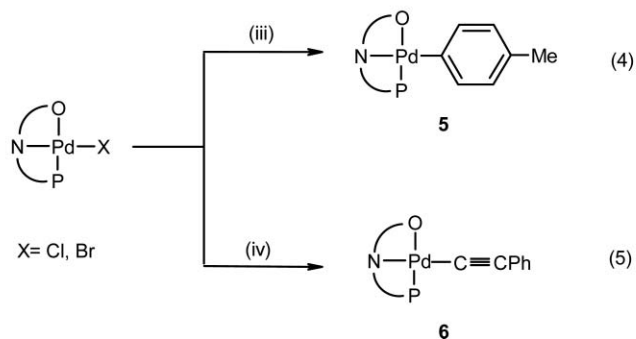
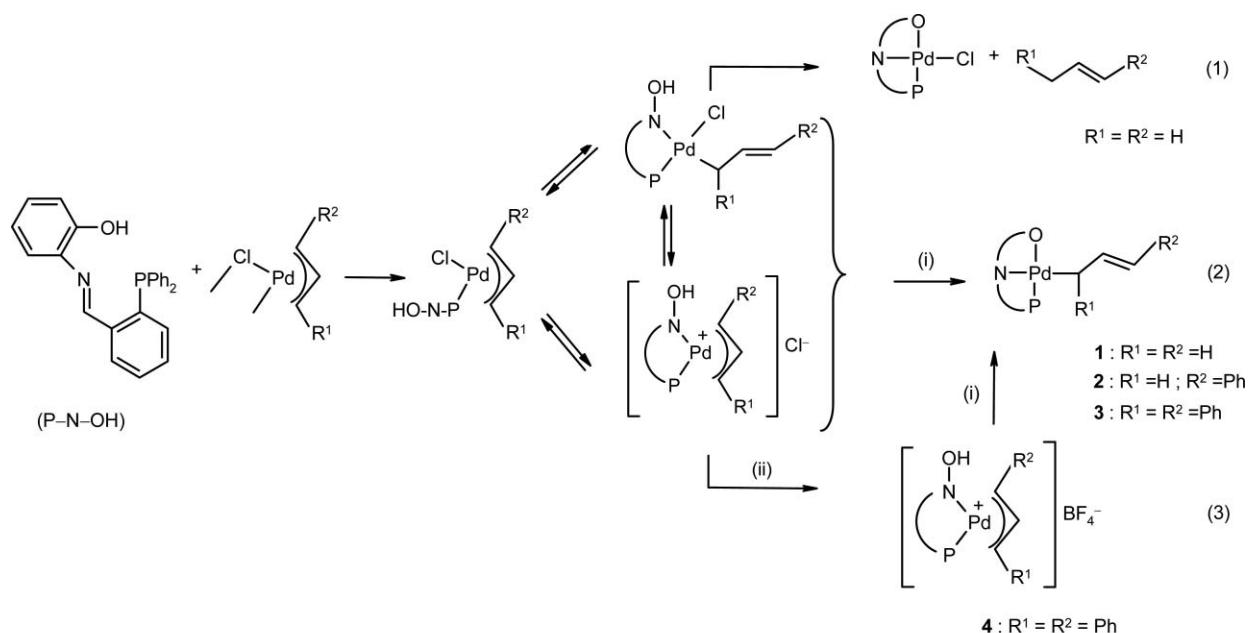

Scheme 1 (i) + NEt₃; (ii) + NaBF₄, -NaCl; (iii) + 4-MeC₆H₄B(OH)₂, + K₂CO₃ (iv) + Bu₂SnC≡CPh.

When the reaction of P-N-OH with the allyl dimers is carried out in the presence of a slight excess of triethylamine (molar ratio P-N-OH/NEt₃ = 1 : 2) the complexes **1–3** are readily formed [reaction (2) of Scheme 1]. Complex **3** can also be obtained in the deprotonation of **4** by NEt₃. As shown by X-ray structural analysis (*vide infra*), in the solid state the complexes **1** and **3** contain a *P,N,O*-tridentate iminophosphine ligand and an η¹-bonded allyl group. According to ¹H and ¹³C NMR spectral data, the η¹-coordination of the allyl ligand is retained also in solution for all the complexes **1–3**. The ¹H NMR spectra (Table 1) are characterized by a Pd–CHR¹ resonance at higher field relative to those of the uncoordinated olefinic moiety CH=CHR².

This signal appears as a doublet of doublets due to coupling with the central allylic proton and the *cis* phosphorus atom. The ¹H NMR data of the allyl group in complex **1** are in agreement with those reported in the literature for η¹-C₃H₅ palladium derivatives.⁴ Furthermore, the ¹³C NMR chemical shifts of the allylic carbons of **1** at 35.6 (Pd–CH₂), 108.4 (=CH₂) and 141.5 ppm (–CH=) are characteristic for the η¹-bonding mode of the ligand.^{3a–3c,4} Like other palladium complexes with substituents on the terminal carbon atom of the η¹-allyl ligand, such as Pd–CH₂–CH=CHMe,⁴ Pd–CH₂–CH=CMe₂,⁴ and Pd–CH₂–CH=CPh₂,^{3b} in **2** the allyl

Table 1 Proton resonances of the η¹-allyl ligand in complexes **1–3**^a

Complex	Pd–CHR ¹	=CH	=CHR ²
1 (R ¹ = R ² = H)	2.36 dd (8.3) ^b (4.2) ^c	6.25 m	4.40 d ^d , 4.57 d ^e (16.8) ^b (9.9) ^c
2 (R ¹ = H, R ² = Ph)	2.59 dd (8.6) ^b (3.6) ^c	6.67 dt	5.45 d ^d (15.4) ^b
3 (R ¹ = R ² = Ph)	3.78 dd (10.5) ^b (10.5) ^c	mk ^f	5.95 d ^d (15.6) ^b

^a In CDCl₃ at 25 °C; chemical shifts in ppm and coupling constants in Hz. ^b ³J(HH). ^c ³J(PH). ^d Signal of proton *trans* to the central allyl proton. ^e Signal of proton *cis* to the central allylic proton. ^f Masked by the aryl proton resonances in the range 7.0–7.7 ppm.

group is σ bonded to palladium through the less substituted CH₂ terminus, as can be inferred by the coupling of the Pd–CH₂ protons with the *cis* phosphorus atom. The ¹H NMR spectrum of **3** in the allyl protons range is markedly different from that of the η³-allyl complex **4**, where the *anti* proton *trans* to P appears as a doublet of doublets at 5.58 ppm and the *anti* proton *cis* to P as a doublet

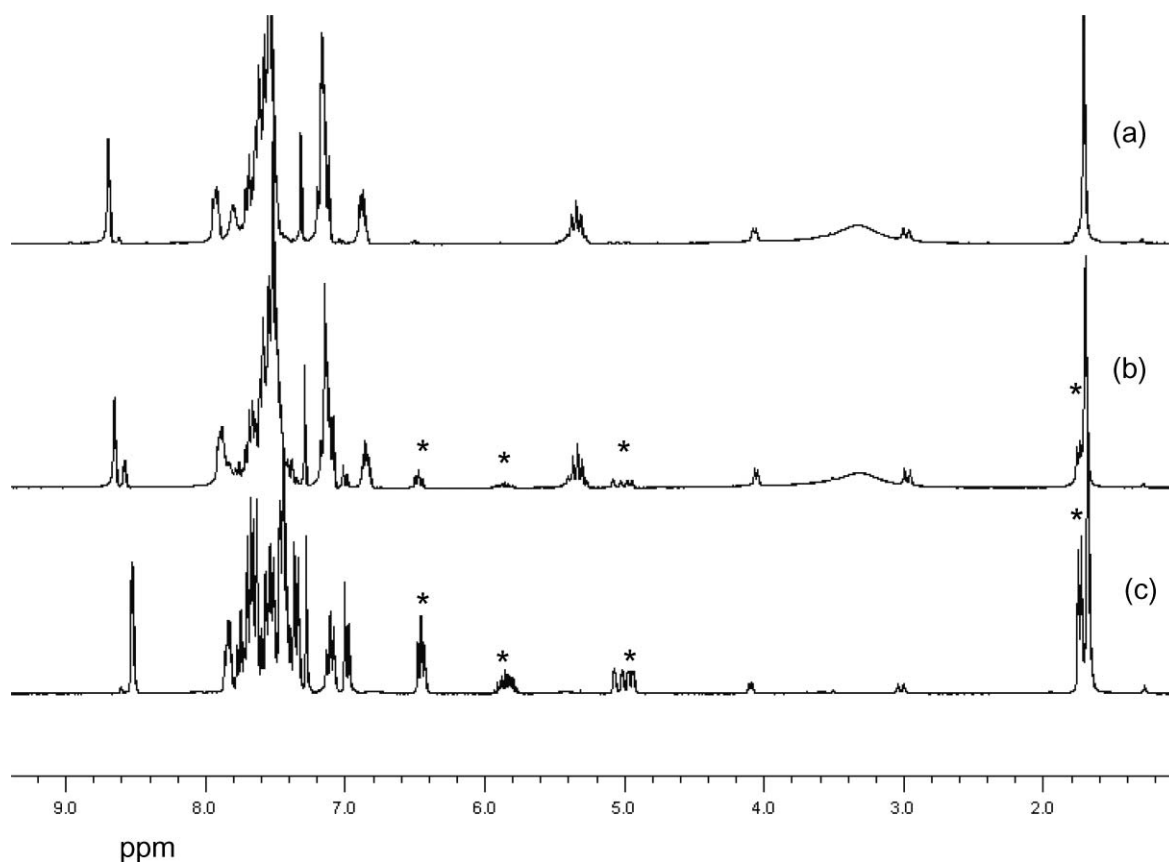

Fig. 1 ^1H NMR spectra of the reaction of P-N-OH with $[\text{Pd}(\mu\text{-Cl})(\eta^3\text{-C}_3\text{H}_5)_2]$ (molar ratio 1 : 0.5) in CDCl_3 at 25°C : (a) after 5 min from mixing of the reactants; (b) after 15 min; (c) after 3.5 h; * Signals of propene.

at 4.55 ppm in CD_2Cl_2 (see Experimental). The observed changes are consistent with a change in bonding mode from η^3 in **4** to η^1 in **3**.

The dynamic behaviour of the complexes **1** and **3** in CDCl_3 solution is explored by phase-sensitive 2D ^1H -NMR NOESY spectra. In both cases, we detect exchange cross-peaks between the terminal allylic protons, namely between the Pd- CH_2 and $=\text{CH}_2$ protons of **1**, and between the Pd- CHPh and $=\text{CHPh}$ protons of **3** (Fig. 2).

These data indicate the occurrence of a slow dynamic process which interconverts the bonding site of the allyl ligand presumably through a transient (or activation state) in which the ligand is η^3 -bound to the metal. The ^1H NMR spectra of **3** in toluene- d_8 show a progressive broadening and loss of fine structure for the allylic proton signals when the temperature is increased from 25 to 100°C . The lack of coalescence in this temperature range suggests that a free activation energy higher than 70 kJ mol^{-1} is required for the observed dynamic process.⁵

The *p*-tolyl complex **5** and the alkynyl complex **6** can be prepared from the classical transmetalation reactions (4) and (5) of Scheme 1, respectively. For later discussion, however, it is noted that reaction (4) proceeds only in the presence of K_2CO_3 .

Solid state molecular structure of complex **1**

The crystal lattice is made up of neutral palladium complexes (Fig. 3). The three donor atoms provided by the P-N-O ligand,

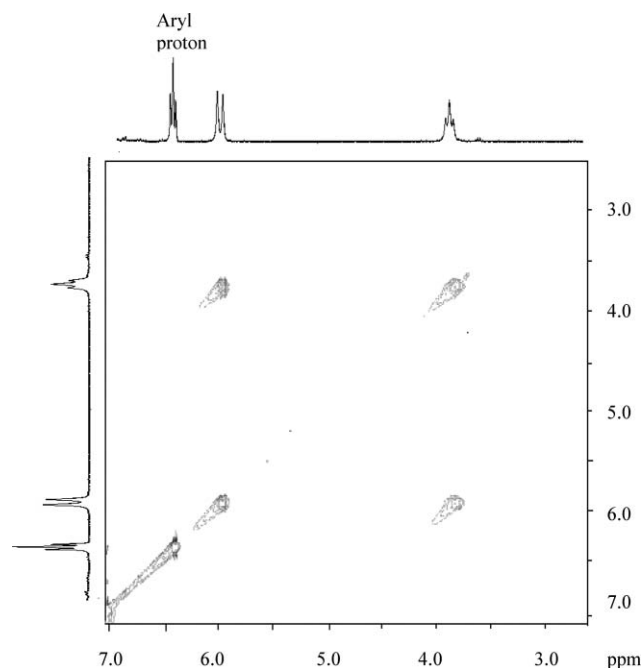

Fig. 2 Phase-sensitive 2D ^1H NMR NOESY spectrum of complex **3** in CDCl_3 at 25°C , in the region of the allylic proton signals.

namely P(1), N(1) and O(1) and the terminal carbon atom C(14) belonging to the allyl group describe a square planar coordination

Table 2 Selected bond distances (Å) and angles (°) about the coordination sphere of the palladium ion in **1**

Pd(1)–P(1)	2.1815(7)
Pd(1)–O(1)	2.074(2)
Pd(1)–N(1)	2.089(2)
Pd(1)–C(14)	2.065(3)
P(1)–Pd(1)–O(1)	175.83(5)
P(1)–Pd(1)–N(1)	96.98(6)
P(1)–Pd(1)–C(14)	90.53(8)
O(1)–Pd(1)–N(1)	81.97(7)
O(1)–Pd(1)–C(14)	90.84(9)
N(1)–Pd(1)–C(14)	171.33(9)

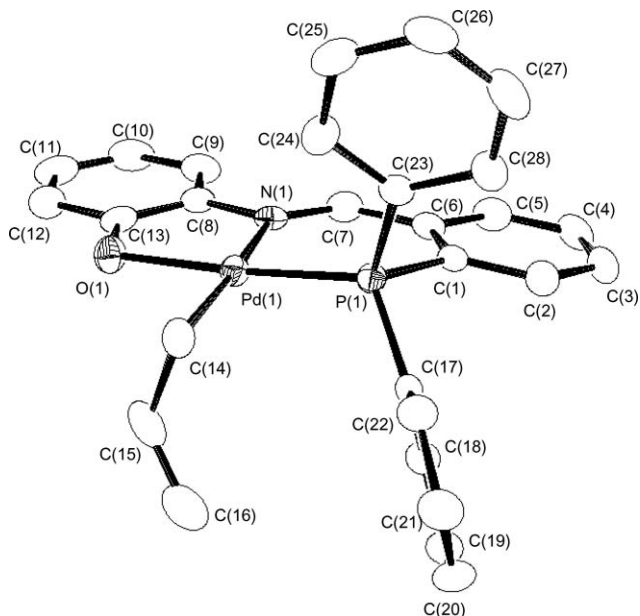

Fig. 3 Molecular structure of **1** in the crystal. Thermal ellipsoids are shown at the 30% probability level. Hydrogen atoms have been omitted for clarity.

sphere about the palladium ion. The latter is well in the mean plane passing through the four donors, its deviation being 0.0366(1) Å.

Bond distances and angles about the metal ion (Table 2) compare well with the literature reference values retrieved from the Cambridge Structural Database (CSD, v5.30 (2009)⁶ and unambiguously show an η^1 -coordination mode for the allyl fragment: Pd(1)–C(14) 2.065(3) vs. Pd(1)–C(15), 2.772(3) and Pd(1)–C(16), 3.695(4) Å. The Pd(II) ion occupies the fourth tetrahedral position about C(14) with the allyl group almost perpendicularly disposed with respect to the mean plane described by the Pd(1), P(1), N(1) and O(1) atoms (78.5(2)° is the angle formed with the C(14)–C(15)–C(16) plane) as usually found in similar metal complexes.⁶

The geometries of both the *P,N,O*-tridentate ligand and the allyl moiety compare well with those already reported in the CSD. The aromatic rings of the diphenylphosphine moiety are \pm *gauche* disposed with respect to the conjugate backbone of the *P-N-O* ligand (their mean planes form an angle of 72.4(1)°). A nice intramolecular C–H... π interaction⁷ exists between the allyl hydrogen atom H(16A) and the facing phenyl: 2.80(4) Å is the C(16)H(16A)...ring centroid distance and 145.2(3)° the angle, while 55.6(3)° is the angle formed by the planes described by the

allyl and phenyl groupings.⁸ Finally in the crystal lattice there are no further important intermolecular interactions.

Single crystals of the palladium complex **3** were also analyzed by X-ray diffraction.⁹ In spite of the diffracted data quality, which was not good enough to allow publication, the structural refinement show that the coordination sphere about the palladium ion is almost superimposable with that of **1**: with the 1,3-diphenylallyl group η^1 -coordinated to the metal ion and perpendicular to the Pd(*P-N-O*) moiety.¹⁰

Cross-coupling reactions promoted by boron compounds

The diorganopalladium(II) complexes are known to react with organic halides yielding cross-coupling products through a proposed mechanism which involves oxidative addition to a palladium(IV) intermediate followed by reductive elimination.¹¹ The same reaction hardly occurs for monorganopalladium(II) derivatives. In line with such a reduced reactivity, no reaction is found to occur between complexes **5** or **6** and a ten-fold excess of 4-bromoanisole even after prolonged heating in toluene at 90 °C. However, in the presence of *p*-tolylboronic acid the reaction with *p*-bromoanisole proceeds slowly according to eqn (6):

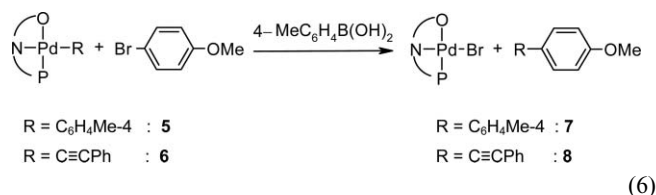

In the absence of K_2CO_3 , the product [PdBr(*P-N-O*)] does not undergo transmetalation with *p*-tolylboronic acid, and it can be isolated and characterized by comparison with an authentic sample independently prepared (see Experimental). The coupling products **7** and **8** are identified by GC-MS analysis of the reaction mixtures and by comparison of their ¹H NMR spectra in the product mixtures with those of samples isolated in the catalytic reactions (*vide infra*). It is evident that the *p*-tolylboronic acid exerts an activating function which may be ascribed to an increased electrophilic character of the carbon atom linked to bromine by formation of a Lewis adduct between *p*-bromoanisole and the boronic acid. The association of aryl bromides with trigonal boron has been proposed as a possible explanation of chemoselectivity in Suzuki–Miyaura reactions.¹² The reaction (6) with complex **5** does not occur with *p*-chloroanisole, whereas with *p*-iodoanisole it proceeds at a comparable rate to that of *p*-bromoanisole under the same experimental conditions (*ca.* 24 h for completion). In the absence of experimental data, we cannot propose any mechanism for reaction (6), which may involve either oxidative addition and reductive elimination steps or direct electrophilic attack at the Pd–C σ bond of the starting complexes by the activated aryl bromide. In both cases, the cross-coupling reaction will be promoted by the enhanced electrophilic properties of the aryl bromide.

We have tried to carry out the coupling of *p*-bromoanisole or allyl bromide with *p*-tolylboronic acid in the presence of K_2CO_3 and that of *p*-bromoanisole with $\text{Bu}_3\text{SnC}\equiv\text{CPh}$ in the presence of various boron compounds under catalytic conditions using [PdCl(*P-N-O*)] as catalyst precursor (Scheme 2).

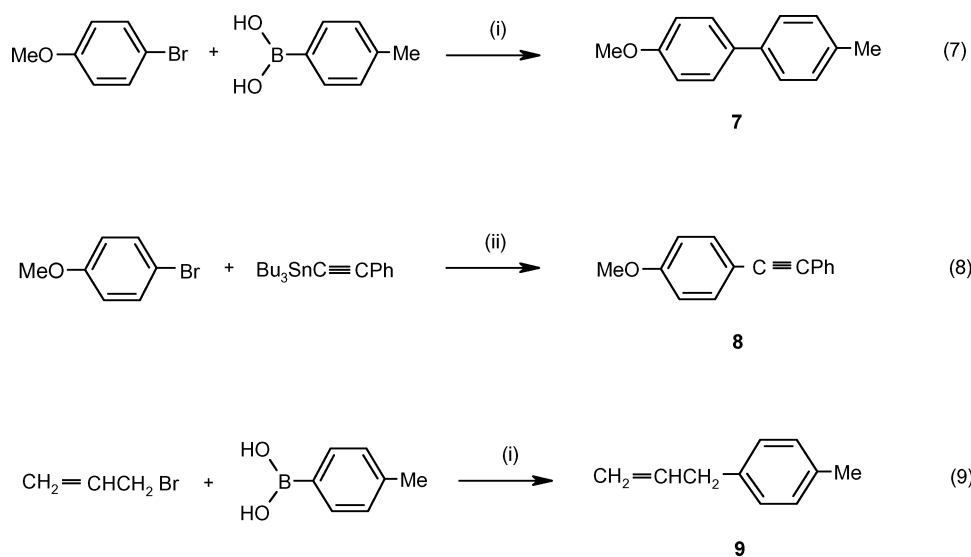

Scheme 2 (i) + [PdCl(P-N-O)], + K₂CO₃; (ii) + [PdCl(P-N-O)], + Boron compound.

Table 3 Catalytic data for the cross-coupling reactions (7)–(9)

Entry	Boron compound	Coupling product	Conversion (%)
1 ^a		7	47 ^b
2 ^c		8	76 ^b
3 ^{e,d}		8	35 ^b
4 ^e		8	10 ^b
5 ^e		9	56 ^f

^a Reaction (7) with a [PdCl(P-N-O)]/BrC₆H₄OMe-4/4-MeC₆H₄B(OH)₂/K₂CO₃ molar ratio of 1 : 15 : 15 : 15 in toluene at 90 °C; reaction time, 24 h. ^b Calculated from integration of δ(OMe) signals at 3.80 ppm for BrC₆H₄OMe-4, at 3.87 ppm for **7** and of 3.85 ppm for **8**, in the ¹H NMR spectra (CDCl₃) of the reaction mixture. ^c Reaction (8) with a [PdCl(P-N-O)]/BrC₆H₄OMe-4/ Bu₃SnC≡CPh/boron compound molar ratio of 1 : 15 : 15 : 15 in toluene at 90 °C; reaction time, 24 h. ^d The same reaction in dry toluene and under dry N₂ atmosphere gives the same conversion. ^e Reaction (9) with a [PdCl(P-N-O)]/BrC₂H₅/4-MeC₆H₄B(OH)₂/K₂CO₃ molar ratio of 1 : 15 : 15 : 15 in toluene at 90 °C; reaction time, 24 h. ^f Yield of isolated product.

Unfortunately, the reactions turned out to be rather slow, and even after 24 h at 90 °C in toluene the substrate conversion did not exceed 76% with a palladium complex load of *ca.* 6.5% (Table 3).

This is undoubtedly due to the slow rate of reaction (6). In fact, throughout the course of reaction (7) and that of reaction (8) in the presence of 4-MeC₆H₄B(OH)₂ (Scheme 2), the *p*-tolylpalladium complex **5** (characterized by a δ_p singlet at 33.2 ppm) and the

alkynylpalladium complex **6** (characterized by a δ_p singlet at 34.2 ppm) are respectively present in the mixtures as they are readily formed from [PdX(P-N-O)] (X = Cl, Br) according to reactions (4) and (5) of Scheme 1. Other boron compounds, such as triethylborate and boric acid, have been used in the coupling of 4-bromoanisole with Bu₃SnC≡CPh. However, their efficiency proved to be lower than that of *p*-tolylboronic acid (entries 2–4 of Table 3).

Conclusion

The reactions of the iminophosphine 2-(2-Ph₂P)C₆H₄N=CHC₆H₄OH (P-N-OH) with [Pd(μ-Cl)(η³-1-R¹,3-R²C₃H₃)₂] (R¹ = R² = H, Ph; R¹ = H, R² = Ph) are reported. With [Pd(μ-Cl)(η³-C₃H₃)₂], the reaction yields [PdCl(P-N-O)] and propene. In the presence of NEt₃, the complexes [Pd(η¹-1-R¹,3-R²C₃H₃)(P-N-O)] are obtained. The *P,N,O*-tridentate coordination of the deprotonated iminophosphine and the η¹-bonding mode of the allyl group in the solid is confirmed by X-ray structural analysis of [Pd(η¹-C₃H₃)(P-N-O)]. The complexes [PdR(P-N-O)] (R = C₆H₄Me-4, C≡CPh) react slowly with *p*-bromoanisole in the presence of *p*-tolylboronic acid yielding [PdBr(P-N-O)] and the coupling product RC₆H₄OMe-4. By using [PdCl(P-N-O)] as catalyst or catalyst precursor, the coupling of allyl bromide with *p*-tolylboronic acid in the presence of K₂CO₃ can be carried out under catalytic conditions to give a satisfactory yield of 4-allyltoluene.

Experimental

¹H NMR spectra were recorded on Bruker AM400 or Bruker Avance 300 spectrometers operating at 400.13 and 300.13 MHz, respectively. ³¹P{¹H} and ¹³C{¹H} NMR spectra were recorded on a Bruker Avance 300 spectrometer operating at 121.49 MHz and 65.47 MHz, respectively. Chemical shifts are reported in ppm downfield from SiMe₄ for ¹H and ¹³C, and from H₃PO₄ as an external standard for ³¹P. The spectra were run at 25 °C except when noted. IR spectra were recorded on a Perkin-Elmer

Spectrum One FT-IR spectrometer. The GC-MS (electron impact) analyses were performed with a VG Quattro spectrometer. All the reactions were carried out under N₂. Toluene was distilled over sodium/benzophenone, and triethylamine over anhydrous KOH. The other solvents and the commercially available chemicals, such as *p*-bromoanisole, *p*-tolylboronic acid, triethylborate, boric acid, tributyl(phenylethynyl)tin and anhydrous potassium carbonate, were used without further purification. The iminophosphine P-N-OH and the complexes [Pd(μ-Cl)(η³-1-R¹,3-R²C₃H₃)₂] (R¹ = R² = H, Ph; R¹ = H, R² = Ph) were prepared by literature methods.^{1a, 13-15}

Reaction of P-N-OH with [Pd(μ-Cl)(η³-C₃H₃)₂]

The ligand P-N-OH (0.381 g, 1 mmol) and [Pd(μ-Cl)(η³-C₃H₃)₂] (0.183 g, 0.5 mmol) were dissolved in CH₂Cl₂ (50 cm³) and the solution was stirred for 4 h at room temperature. During this time the colour turned deep-red due to formation of the strongly coloured product [PdCl(P-N-O)],^{14,19} which was precipitated as a red solid (0.49 g, 94%) upon addition of Et₂O to the concentrated solution. When the reaction was carried out in CDCl₃ with the same molar ratio of the reactants, the formation of propene was apparent from its ¹H NMR spectrum: δ_H (300 MHz) 1.74 (3 H, t, ³J(HH) = 6.5 Hz, CH₃), 4.96 (1 H, d, ³J(HH) = 9.9 Hz, =CH₂ proton *trans* to CH₃), 5.08 (1 H, d, ³J(HH) = 15.0 Hz, =CH₂ proton *cis* to CH₃), 5.85 (1 H, m, =CH).

Preparation of [Pd(η³-1-R¹,3-R²C₃H₃)(P-N-O)] (R¹ = R² = H, Ph; R¹ = H, R² = Ph)

The ligand P-N-OH (0.381 g, 1 mmol) and the complex [Pd(μ-Cl)(η³-1-R¹,3-R²C₃H₃)₂] (0.5 mmol) were added to a solution of NEt₃ (0.203 g, 2 mmol) in CH₂Cl₂ (50 cm³). After stirring for 1 h at room temperature, the solvent was evaporated to dryness at reduced pressure. The solid residue was washed with water (3 × 10 ml) and dried *in vacuo*. The red-orange complexes were purified by precipitation from CH₂Cl₂-Et₂O followed by a further precipitation from CH₂Cl₂-MeOH.

Crystals of **1** and **3** were obtained by slow diffusion of Et₂O into a CH₂Cl₂ solution of the corresponding complex.

Complex 1 (R¹ = R² = H) (0.45 g, 85%) (Found C 63.45, H 4.48, N 2.60; C₂₈H₂₄NO₂Pd requires C, 63.71; H, 4.58; N, 2.65%); v_{\max} (Nujol)/cm⁻¹ 1582 (C=N); δ_H (300 MHz; CDCl₃) 2.36 (2 H, dd, ³J(HH) = 8.3 Hz, ³J(PH) = 4.2 Hz, Pd-CH₂), 4.40 (1 H, d, ³J(HH) = 16.8 Hz, =CH₂ proton *trans* to the central allylic proton), 4.57 (1 H, d, ³J(HH) = 9.9 Hz, =CH₂ proton *cis* to the central allylic proton), 6.25 (1 H, m, =CH), 6.4–6.6 (1 H, m, aryl proton), 7.0–7.7 (17 H, aryl protons), 8.62 (1 H, s, N=CH); δ_P (CDCl₃) 38.1 (s).

Complex 2 (R¹ = H; R² = Ph) (0.53 g, 87%) (Found C 67.01, H 4.58, N 2.36; C₃₄H₂₈NO₂Pd requires C, 67.61; H, 4.67; N, 2.32%); v_{\max} (Nujol)/cm⁻¹ 1593 (C=N); δ_H (300 MHz; CDCl₃) 2.59 (2 H, dd, ³J(HH) = 8.6 Hz, ³J(PH) = 3.6 Hz, Pd-CH₂), 5.45 (1 H, d, ³J(HH) = 15.4 Hz, =CHPh proton *trans* to the central allylic proton), 6.4–6.6 (1 H, m, aryl proton), 6.67 (1 H, m, =CH), 7.0–7.7 (22 H, aryl protons), 8.63 (1 H, s, N=CH); δ_P (CDCl₃) 38.5 (s).

Complex 3 (R¹ = R² = Ph) (0.45 g, 85%) (Found C 69.88, H 4.64, N 1.95; C₄₀H₃₂NO₂Pd requires C, 70.64; H, 4.74; N, 2.06%);

v_{\max} (Nujol)/cm⁻¹ 1592 (C=N); δ_H (300 MHz; CDCl₃) 3.78 (1 H, dd, ³J(HH) = ³J(PH) = 10.5 Hz, Pd-CHPh), 5.95 (1 H, d, ³J(HH) = 15.6 Hz, =CHPh proton *trans* to the central allylic proton), 6.3–6.5 (1 H, m, aryl proton), 7.0–7.7 (28 H, central allylic proton and aryl protons), 8.49 (1 H, s, N=CH); δ_P (CDCl₃) 35.5 (s).

Preparation of [Pd(η³-1,3-Ph₂C₃H₃)(P-N-O)]BF₄ (**4**)

A solution of NaBF₄ (0.132 g, 1.2 mmol) in MeOH (10 cm³) was added to a solution of P-N-OH (0.381 g, 1 mmol) and [Pd(μ-Cl)(η³-1,3-Ph₂C₃H₃)₂] (0.335 g, 0.5 mmol) in CH₂Cl₂ (30 cm³). The mixture was stirred for 3 h at room temperature and the solvent was evaporated to dryness at reduced pressure. The solid residue was extracted with CH₂Cl₂ (20 cm³). After filtration, the solution was concentrated to a small volume (*ca.* 3 cm³) and diluted with Et₂O to precipitate the product as a yellow solid. The complex was purified by a further precipitation from CH₂Cl₂-Et₂O (0.67 g, 87%) (Found C 61.86, H 4.27, N 1.79, C₄₀H₃₃BF₄NO₂Pd requires C, 62.54; H, 4.33; N, 1.82%); v_{\max} (Nujol)/cm⁻¹ 3353 (O-H), 1615 (OH bending mode), 1588 (C=N), 1096 and 1061 (B-F); Λ_M 122 S cm² mol⁻¹ for a 1 × 10⁻³ mol/dm³ MeOH solution at 25 °C; δ_H (300 MHz; CD₂Cl₂) 4.55 (1 H, d, ³J(HH) = 11.2 Hz, allylic *anti* proton *cis* to phosphorus), 5.58 (1 H, dd, ³J(HH) = 12.7 Hz, ³J(PH) = 9.5 Hz, allylic *anti* proton *trans* to phosphorus), 6.3–6.5 (2 H, m, aryl protons), 6.6–6.8 (1 H, m, central allylic proton), 6.9–7.8 (26 H, m, aryl protons), 8.15 (1 H, br s, OH), 8.21 (1 H, d, ⁴J(PH) = 3.7 Hz, N=CH); δ_P (CD₂Cl₂) 25.8 (s).

Reaction of [Pd(η³-1,3-Ph₂C₃H₃)(P-N-O)]BF₄ with NEt₃

When triethylamine (0.010 g, 0.1 mmol) was added to a solution of [Pd(η³-1,3-Ph₂C₃H₃)(P-N-O)]BF₄ (0.016 g, 0.02 mmol) in CDCl₃ (1.2 cm³), an almost immediate reaction took place as indicated by the colour change from yellow to deep-red. The ¹H and ³¹P NMR spectra of the mixture confirmed the quantitative formation of complex **3**.

Preparation of [PdBr(P-N-O)]

Potassium bromide (0.179 g, 1.5 mmol) was added to a solution of [PdCl(P-N-O)] (0.157 g, 0.3 mmol) in CH₂Cl₂-acetone (20 cm³, 1 : 1 v/v) and the mixture was stirred overnight at room temperature. After filtration on activated charcoal, the clear solution was concentrated to a small volume (*ca.* 2 cm³) and diluted with Et₂O-hexane (1 : 1 v/v) to precipitate the product as a red-purple solid. The complex was purified by precipitation from a CH₂Cl₂-MeOH solvent mixture (0.16 g, 85%). (Found C 52.60, H 3.43, N 2.38, C₂₅H₁₉BrNO₂Pd requires C, 52.98; H, 3.38; N, 2.47%); v_{\max} (Nujol)/cm⁻¹ 1582 (C=N); 308 (Pd-Br); δ_H (300 MHz; CDCl₃) 6.4–6.5 (1 H, m, aryl proton), 6.9–7.2 (2 H, m, aryl protons), 7.3–7.9 (15 H, aryl protons), 8.50 (1 H, d, ⁴J(PH) = 2.8 Hz, N=CH); δ_P (CDCl₃) 33.5 (s) and δ_P (toluene-*d*₈) 33.0 (s).

Preparation of [Pd(C₆H₄Me-4)(P-N-O)] (**5**)

p-Tolylboronic acid (0.680 g, 5 mmol) and potassium carbonate (1.380 g, 10 mmol) were added to a solution of [PdCl(P-N-O)] (0.522 g, 1 mmol) in dry toluene (50 cm³). After stirring at 90 °C for 1.5 h, the solvent was evaporated to dryness and the solid

residue was extracted with CH_2Cl_2 (20 ml) in the presence of activated charcoal. After filtration on Celite, the solution was concentrated to a small volume (*ca.* 3 cm^3) and diluted with Et_2O to precipitate the product as a red-purple solid. The complex was purified by precipitation from CH_2Cl_2 - Et_2O and by a further precipitation from CH_2Cl_2 -MeOH (0.48 g, 83%) (Found C 66.13, H 4.58, N 2.39, $\text{C}_{32}\text{H}_{26}\text{NOPPd}$ requires C, 66.50; H, 4.53; N, 2.42%); ν_{max} (Nujol)/ cm^{-1} 1582 (C=N), δ_{H} (300 MHz; CDCl_3) 2.13 (3 H, s, CH_3), 6.5–6.7 (3 H, m, aryl protons), 6.9–7.7 (19, H, m, aryl protons), 8.77 (1 H, s, N=CH); δ_{P} (CDCl_3) 34.6 (s) and δ_{P} (toluene- d_8) 33.2 (s). The same procedure was used for the preparation of **5** from [PdBr(P-N-O)] with a comparable yield.

Preparation of [Pd(C≡CPh)(P-N-O)] (**6**)

Tributyl(phenylethynyl)tin (0.782, 2 mmol) was added to a solution of [PdCl(P-N-O)] (0.209 g, 0.4 mmol) in acetonitrile (30 cm^3). After stirring for 5 h at 45 °C the solution was concentrated to a small volume (*ca.* 2 cm^3) and diluted with Et_2O to precipitate the product as a red solid. The complex was purified by precipitation from a CH_2Cl_2 -MeOH solvent mixture (0.19 g, 81%) (Found C 66.85, H 3.94, N 2.29, $\text{C}_{33}\text{H}_{24}\text{NOPPd}$ requires C, 67.41; H, 4.11; N, 2.38%); ν_{max} (Nujol)/ cm^{-1} 2117 (C≡N), 1582 (C=N); δ_{H} (300 MHz; CDCl_3) 6.5–6.6 (1 H, m, aryl proton), 6.8–7.8 (22, H, m, aryl protons), 8.65 (1 H, s, N=CH); δ_{P} (CDCl_3) 34.1 (s) and δ_{P} (toluene- d_8) 34.2 (s). The same procedure was used for the preparation of **6** from [PdBr(P-N-O)] with a comparable yield.

Reaction of [Pd(C₆H₄Me-4)(P-N-O)] with *p*-bromoanisole in the presence of *p*-tolylboronic acid

A solution of [Pd(C₆H₄Me-4)(P-N-O)] (0.116 g, 0.2 mmol), *p*-bromoanisole (0.561 g, 3 mmol) and *p*-tolylboronic acid (0.272 g, 2 mmol) in toluene (40 cm^3) was heated at 90 °C for 24 h. The GC-MS analysis of the resulting mixture revealed the presence of the biaryl **7** [m/z 198 (M^+ , 99%), 183 ($\text{M}^+ - \text{CH}_3$, 11)]. The solution was concentrated to a small volume (*ca.* 2 cm^3) and diluted with Et_2O -hexane (1 : 1 v/v) to precipitate the complex [PdBr(P-N-O)] (0.095 g, 84%) which was purified as described above and identified by its IR, ^1H and ^{31}P NMR spectra. After filtration of [PdBr(P-N-O)], the mother liquor was evaporated to dryness at reduced pressure. The residue was extracted with 10 cm^3 of diethyl ether and filtered through a silica gel column (10 cm). The clear solution was evaporated to dryness and the residue was dissolved in CDCl_3 . The ^1H NMR spectrum showed the presence of a mixture of *p*-bromoanisole/**7** in the molar ratio of 7.5 : 1.

Reaction of [Pd(C≡CPh)(P-N-O)] with *p*-bromoanisole in the presence of *p*-tolylboronic acid

A solution of [Pd(C≡CPh)(P-N-O)] (0.118 g, 0.2 mmol), *p*-bromoanisole (0.561 g, 3 mmol) and *p*-tolylboronic acid (0.272 g, 2 mmol) in toluene (40 cm^3) was heated at 90 °C for 24 h. The GC-MS analysis of the resulting mixture revealed the presence of the product **8** [m/z 208 (M^+ , 98%), 193 ($\text{M}^+ - \text{CH}_3$, 12)]. The solution was worked up as described above for the analogous reaction of [Pd(C₆H₄Me-4)(P-N-O)] to give the complex [PdBr(P-N-O)] (0.090 g, 79%) and a mixture of *p*-bromoanisole/**8** in the molar ratio of 8 : 1.

Catalytic reactions

For the coupling of *p*-bromoanisole with *p*-tolylboronic acid (entry 1 of Table 3), a 50 cm^3 glass reactor was charged with [PdCl(P-N-O)] (0.157 g, 0.3 mmol), *p*-bromoanisole (0.842 g, 4.5 mmol), *p*-tolylboronic acid (0.612 g, 4.5 mmol), K_2CO_3 (0.622 g, 4.5 mmol) and toluene (20 cm^3). The mixture was heated under magnetic stirring at 90 °C for 24 h. After cooling to room temperature, the formation of the biaryl **7** was confirmed by GC-MS analysis of a solution sample. The solvent was evaporated at reduced pressure and a small sample of the residue was dissolved in CDCl_3 for ^1H NMR analysis in the range 3.5–4.0 ppm. The product **7** was isolated by column chromatography of the remaining residue on silica gel with a mixture of hexane- Et_2O (9 : 1 v/v) as an eluent, and identified by ^1H NMR spectroscopy: δ_{H} (300 MHz; CDCl_3) 2.41 (3 H, s, CH_3), 3.87 (3 H, s, OCH_3), 6.9–7.6 (8 H, m, aryl protons as two AA'BB' spin systems). A similar procedure was used for the coupling of *p*-bromoanisole with tributyl(phenylethynyl)tin (entries 2–4 of Table 3). In this case, the solution of [PdCl(P-N-O)] (0.157 g, 0.3 mmol), *p*-bromoanisole (0.842 g, 4.5 mmol), tributyl(phenylethynyl)tin (1.760 g, 4.5 mmol) and the boron compound (4.5 mmol) in toluene (20 cm^3) was heated under magnetic stirring at 90 °C for 24 h, and the formation of the coupling compound **8** was confirmed by GC-MS and ^1H NMR analyses of the reaction mixture. However, the product **8** could not be purified by column chromatography on silica gel as it was always obtained together with a certain amount (*ca.* 20%) of unreacted *p*-bromoanisole: ^1H NMR spectrum of **8**: δ_{H} (300 MHz; CDCl_3) 3.85 (3 H, s, OCH_3), 6.8–6.9 (2 H, m, symmetrical side of the AA'BB' spin system of the C₆H₄OMe-4 aryl protons), 7.3–7.6 (7 H, m, C₆H₅ and symmetrical side of the AA'BB' spin system of the C₆H₄OMe-4 aryl protons). The coupling of allyl bromide with *p*-tolylboronic acid (entry 5 of Table 3) was carried out as described above for the analogous coupling with *p*-bromoanisole starting from 4.5 mmol (0.545 g) of allyl bromide. After 24 h at 90 °C, the reaction mixture was worked up to give 0.408 g of crude product which was purified by column chromatography on silica gel. The pure 4-allyltoluene **9** (0.335 g, 56% yield based on the initial amount of allyl bromide) was identified by ^1H NMR and MS spectra: δ_{H} (300 MHz; CDCl_3) 2.38 (3 H, s, CH_3), 3.41 (2 H, d, $^3J(\text{HH}) = 6.7$ Hz, CH_2), 5.11 (1 H, d, $^3J(\text{HH}) = 9.2$ Hz, =CH₂ proton *cis* to the central allylic proton), 5.13 (1 H, d, $^3J(\text{HH}) = 18.8$ Hz, =CH₂ proton *trans* to the central allylic proton), 6.01 (1 H, m, =CH), 7.1–7.2 (4 H, m, symmetrical AA'BB' spin system of the C₆H₄Me-4 aryl protons); m/z 132 (M^+ , 98%), 117 ($\text{M}^+ - \text{CH}_3$, 100), 91 ($\text{M}^+ - \text{C}_3\text{H}_5$, 60).

X-Ray crystallography

Data for **1** were collected on an Oxford Diffraction Xcalibur3 diffractometer equipped with a CCD area detector and Mo-K α radiation ($\lambda = 0.71073$ Å). Data collection was carried out at 173 K by means of the program CrysAlis CCD¹⁶ and data were reduced with the program CrysAlis RED.¹⁷ The absorption correction was applied through the routine ABSPACK in the CrysAlis RED program. The structure was solved with the direct methods of the SIR97¹⁸ package and refined by full-matrix least squares against F^2 with the program SHELX-97.¹⁹ All the non-hydrogen atoms were given anisotropic displacement parameters; all the hydrogen atoms

Table 4 X-Ray diffraction measurement and refinement data of **1**

	1
Chemical Formula	C ₂₈ H ₂₄ NOPPd
<i>M_r</i> /g mol ⁻¹	527.85
Crystal size/mm	0.56 × 0.44 × 0.38
Crystal system	Monoclinic
Space group	<i>P</i> 2 ₁ / <i>n</i>
<i>a</i> /Å	9.8186(3)
<i>b</i> /Å	18.2721(5)
<i>c</i> /Å	12.9970(4)
α (°)	90
β (°)	102.043(3)
γ (°)	90
<i>U</i> /Å ³	2280.4(1)
<i>Z</i>	4
<i>D_c</i> /Mg m ⁻³	1.537
<i>μ</i> /mm ⁻¹	0.905
λ/Å	0.71073
<i>T</i> /K	173
θ-range/°	3.67–32.49
Index range (<i>hkl</i>)	–14 to 14 –27 to 24 –19 to 16
Reflections collected/unique	16704/7446
Goodness-of-fit on <i>F</i> ²	0.829
<i>R</i> ₁ , <i>wR</i> ₂ [<i>I</i> > 2σ(<i>I</i>)]	0.0367/0.0591
<i>R</i> ₁ , <i>wR</i> ₂ [all data]	0.0776/0.0655
Δρ _{max/min} /e Å ⁻³	0.856/–0.612

were found in the Fourier synthesis and fully refined with isotropic thermal parameters. Geometrical calculations were performed by PARST97²⁰ and the molecular plot was produced by the program ORTEP3.²¹ Crystallographic data and refinement parameters for **1** are reported in Table 4.

References

- (a) J. R. Dilworth, S. D. Howe, A. J. Hutson, J. R. Miller, J. Silver, R. M. Thompson, M. Harman and M. B. Hursthouse, *J. Chem. Soc., Dalton Trans.*, 1994, 3553–3562; (b) A. Bacchi, M. Carcelli, M. Costa, A. Leporati, E. Leporati, P. Pelagatti, C. Pelizzi and G. Pelizzi, *J. Organomet. Chem.*, 1997, **535**, 107–120; (c) E. K. Van Den Beuken, N. Veldman, W. J. J. Smeets, A. L. Spek and B. L. Feringa, *Organometallics*, 1998, **17**, 636–644; (d) P. Bhattacharyya, J. Parr and A. M. Z. Slawin, *J. Chem. Soc., Dalton Trans.*, 1998, 3609–3614; (e) H.-L. Kwong, W.-S. Lee and W.-T. Wong, *Inorg. Chem. Commun.*, 1999, **2**, 66–69; (f) P. Bhattacharyya, M. L. Loza, J. Parr and A. M. Z. Slawin, *J. Chem. Soc., Dalton Trans.*, 1999, 2917–2921; (g) P. Pelagatti, A. Bacchi, M. Carcelli, M. Costa, A. Fochi, P. Ghidini, E. Leporati, M. Masi, C. Pelizzi and G. Pelizzi, *J. Organomet. Chem.*, 1999, **583**, 94–105; (h) J. D. G. Correia, A. Domingos, A. Paulo and I. Santos, *J. Chem. Soc., Dalton Trans.*, 2000, 2477–2482; (i) A. Bacchi, M. Carcelli, M. Costa, A. Fochi, C. Monici, P. Pelagatti, C. Pelizzi, G. Pelizzi and L. M. Sanjuan Roca, *J. Organomet. Chem.*, 2000, **593–594**, 180–191; (j) P. Pelagatti, A. Bacchi, C. Bobbio, M. Carcelli, M. Costa, C. Pelizzi and C. Vivorio, *Organometallics*, 2000, **19**, 5440–5446; (k) J. Parr and A. M. Z. Slawin, *Inorg. Chim. Acta*, 2000, **303**, 116–120; (l) J. W. Faller, G. Mason and J. Parr, *J. Organomet. Chem.*, 2001, **626**, 181–185; (m) T.-J. Kim, H.-Y. Lee, E.-S. Ryu, D.-K. Park, C. S. Cho, S. C. Shim and J. H. Jeong, *J. Organomet. Chem.*, 2002, **649**, 258–267; (n) P. Pelagatti, A. Bacchi, M. Carcelli, M. Costa, H.-W. Frühauf, K. Goubitz, C. Pelizzi, M. Triplisti and K. Vrieze, *Eur. J. Inorg. Chem.*, 2002, 439–446; (o) M. Ahmad, S. D. Perera, B. L. Shaw and M. Thorton-Pett, *J. Chem. Soc., Dalton Trans.*, 2002, 1954–1962; (p) G. Sánchez, F. Mombloima, J. L. Serrano, L. García, E. Pérez, J. Pérez and G. López, *J. Coord. Chem.*, 2002, **55**, 917–923; (q) P.-Y. Shi, Y.-H. Liu, S.-M. Peng and S.-T. Liu, *Organometallics*, 2002, **21**, 3203–3207; (r) H. Dai, X. Hu, H. Chen, C. Bai and Z. Zheng, *Tetrahedron: Asymmetry*, 2003, **14**, 1467–1472; (s) O. M. Ni Dhubhghaill, J. Lennon and M. G. B. Drew, *Dalton Trans.*, 2005, 3213–3220; (t) S. R. Korupoju, R.-Y. Lai, Y.-H. Liu, S.-M. Peng and S. T. Liu, *Inorg. Chim. Acta*, 2005, **358**, 3003–3008; (u) P. Pelagatti, A. Bacchi, M. Balordi, S. Bolaño, F. Calbiani, L. Elviri, L. Gonsalvi, C. Pelizzi, M. Peruzzini and D. Rogolino, *Eur. J. Inorg. Chem.*, 2006, 2422–2436; (v) P. Pelagatti, A. Bacchi, M. Balordi, A. Caneschi, M. Giannetto, C. Pelizzi, L. Gonsalvi, M. Peruzzini and F. Ugozzoli, *Eur. J. Inorg. Chem.*, 2007, 162–171; (w) S. R. Bayly, A. R. Cowley, J. R. Dilworth and C. V. Ward, *Dalton Trans.*, 2008, 2190–2198.
- (a) B. Crociani, S. Antonaroli, L. Canovese, F. Visentin and P. Uguagliati, *Inorg. Chim. Acta*, 2001, **315**, 172–182; (b) B. Crociani, S. Antonaroli, L. Canovese, P. Uguagliati and F. Visentin, *Eur. J. Inorg. Chem.*, 2004, 732–742; (c) A. Scriveranti, V. Seghetto, U. Matteoli, S. Antonaroli, A. Marini and B. Crociani, *Tetrahedron*, 2005, **61**, 9752–9758; (d) B. Crociani, S. Antonaroli, A. Marini, U. Matteoli and A. Scriveranti, *Dalton Trans.*, 2006, 2698–2705.
- (a) P. Braunstein, F. Naud, A. Dedieu, M.-M. Rohmer, A. Decian and S. J. Retting, *Organometallics*, 2001, **20**, 2966–2981; (b) M. Kollmar and G. Helmchem, *Organometallics*, 2002, **21**, 4771–4775; (c) P. Braunstein, J. Zhang and R. Welter, *Dalton Trans.*, 2003, 507–509; (d) J. Zhang, P. Braunstein and R. Welter, *Inorg. Chem.*, 2004, **43**, 4172–4177.
- L. Barloy, S. Ramdeehul, J. A. Osborn, C. Carloti, F. Taulelle, A. De Cian and J. Fischer, *Eur. J. Inorg. Chem.*, 2000, 2523–2532.
- M. Hesse, H. Meier and B. Zeeh, *Metodi Spettroscopici nella Chimica Organica*, EdISES, Napoli, 5th edn, 1996, ch. 3, pp. 99.
- F. H. Allen, *Acta Crystallogr., Sect. B: Struct. Sci.*, 2002, **B58**, 380–388.
- O. Takahashi, Y. Kohno, S. Iwasaki, K. Saito, M. Iwaoka, S. Tomoda, Y. Umezawa, S. Tsuboyama and M. Nishio, *Bull. Chem. Soc. Jpn.*, 2001, **74**, 2421–2430.
- The hydrogen atoms were found in the Fourier synthesis and then fully refined.
- Crystal data for **3**: crystal system tetragonal, *a* = *b* = 24.942(3), *c* = 10.446(2) Å, α = β = γ = 90°, *U* = 6498(2) Å³, space group *P*4₂*c*, *Z* = 8.
- The main axis of the 1,3-diphenylallyl ligand is almost perpendicular with respect to the metal coordination plane; the angle formed between the mean plane described by the carbon atoms of the Ph-CH=CH-CHPh group and the metal coordination sphere is 90°. In this case also the aromatic rings of the diphenylphosphine moiety are almost *gauche* disposed with respect to the conjugate backbone of the P–N–O ligand (their mean planes form an angle of 72(1)°), however they are rotated of about 90° about the P–C_{aromatic} bond with respect to the corresponding rings in complex **1** (may be in order to minimize the steric repulsions with the bulky allylic ligand).
- A. J. Canty, in *Comprehensive Organometallic Chemistry II*, ed. E. W. Abel, F. G. A. Stone and G. Wilkinson, Pergamon, Oxford, 1995, vol. 9, ch. 5, pp. 266–268.
- G. Espino, A. Kurbangalieva and J. M. Brown, *Chem. Commun.*, 2007, 1742–1744.
- R. Hartley and S. R. Jones, *J. Organomet. Chem.*, 1974, **66**, 465–473.
- M. C. Ashraf, T. G. Burrows and W. R. Jackson, *Aust. J. Chem.*, 1976, **29**, 2643–2649.
- P. Barbaro, P. S. Pregosin, R. Salzmann, A. Albinati and R. W. Kunz, *Organometallics*, 1995, **14**, 5160–5170.
- CrysAlis CCD, Oxford Diffraction Ltd., Version 1.171.31.2 (release 07-07-2006 CrysAlis171.NET) (compiled Jul 10 2006,00:11:42).
- CrysAlis RED, Oxford Diffraction Ltd., Version 1.171.31.2 (release 07-07-2006 CrysAlis171.NET) (compiled Jul 10 2006,00:11:42).
- A. Altomare, G. L. Casciarano, C. Giacovazzo, A. Guagliardi, A. G. Moliterni, M. C. Burla, G. Polidori, M. Camalli and R. Spagna, *J. Appl. Crystallogr.*, 1999, **32**, 115–119.
- G. M. Sheldrick, *SHELX 97*, University of Göttingen, Germany, 1997.
- M. Nardelli, *J. Appl. Crystallogr.*, 1995, **28**, 659.
- L. J. Farrugia, *J. Appl. Crystallogr.*, 1997, **30**, 565.