



EEMD-based wind turbine bearing failure detection using the generator stator current homopolar component

Yassine Amirat, Vincent Choqueuse, Mohamed Benbouzid

► **To cite this version:**

Yassine Amirat, Vincent Choqueuse, Mohamed Benbouzid. EEMD-based wind turbine bearing failure detection using the generator stator current homopolar component. Mechanical Systems and Signal Processing, Elsevier, 2013, 41 (1-2), pp.667-678. <10.1016/j.ymssp.2013.06.012>. <hal-00874031>

HAL Id: hal-00874031

<https://hal.archives-ouvertes.fr/hal-00874031>

Submitted on 17 Oct 2013

HAL is a multi-disciplinary open access archive for the deposit and dissemination of scientific research documents, whether they are published or not. The documents may come from teaching and research institutions in France or abroad, or from public or private research centers.

L'archive ouverte pluridisciplinaire **HAL**, est destinée au dépôt et à la diffusion de documents scientifiques de niveau recherche, publiés ou non, émanant des établissements d'enseignement et de recherche français ou étrangers, des laboratoires publics ou privés.

EEMD-based wind turbine bearing failure detection using the generator stator current homopolar component

Yassine Amirat^{1,2}, Vincent Choqueuse² and Mohamed Benbouzid^{2,*}

¹ISEN, EA 4325 LBMS, 20, Rue Cuirassé Bretagne, 29200 Brest, France

²University of Brest, EA 4325 LBMS, Rue de Kergoat, CS 93837, 29238 Brest, France

*Corresponding author: Tel. +33 2 98 01 80 07 – Fax: +33 2 98 01 66 43 – Email: Mohamed.Benbouzid@univ-brest.fr

ABSTRACT

Failure detection has always been a demanding task in the electrical machines community; it has become more challenging in wind energy conversion systems because sustainability and viability of wind farms are highly dependent on the reduction of the operational and maintenance costs. Indeed the most efficient way of reducing these costs would be to continuously monitor the condition of these systems. This allows for early detection of the generator health degeneration, facilitating a proactive response, minimizing downtime, and maximizing productivity. This paper provides then an assessment of a failure detection techniques based on the homopolar component of the generator stator current and attempts to highlight the use of the ensemble empirical mode decomposition as a tool for failure detection in wind turbine generators for stationary and non stationary cases.

Keyword: Wind turbine, induction generator, bearing failure, ensemble empirical mode decomposition, stator current, homopolar current.

Nomenclature

- WECS = Wind Energy Conversion Systems;
- FFT = Fast Fourier Transform;
- PSD = Power Spectral Density;
- TFR = Time Frequency Representation;
- TKEO = Teager-Kaiser Energy Operator;
- HT = Hilbert Transform;
- CT = Concordia Transform;
- PCA = Principal Component Analysis;
- EMD = Empirical Mode Decomposition;
- EEMD = Ensemble Empirical Mode Decomposition;
- IMF = Intrinsic Mode Function;

1. Introduction

Wind energy conversion systems are the fastest-growing sources of new electric generation in the world and it is expected to remain so for some time, and those sources are becoming a reliable competitor of classical power generation systems, which are facing to constantly changing operating parameters, such as fuel cost, multiple fuel tradeoffs and maintaining older systems becomes more costly. WECS offer an alternative and emerging solution by deploying wind farms offshore or onshore, where there are substantial wind resources, leading to a best electricity generating opportunities. However, the offshore or onshore environments impose a high demand for reliability on the installed equipment because they are hardly accessible or even inaccessible [1].

1.1. Wind turbine failure detection context

Many techniques and tools have been developed for wind turbine electric generator condition monitoring in order to prolong their life span as reviewed in [2]. Some of these techniques used the existing and pre-installed sensors, which may measure speed, output torque, vibrations, temperature, flux densities, etc. These sensors are managed together in different architectures and coupled with algorithms to allow an efficient monitoring of the system condition [3]. Those methods have shown their effectiveness in electric motor condition monitoring. From the theoretical and experimental point of view, the well-established methods are: electrical quantities signature analysis (current, power, etc.), vibration monitoring, temperature monitoring and oil monitoring.

In the case of wind turbines, it has been shown that failures in the drive train could be diagnosed from the generator electrical quantities [1]. The advantage of signature analysis of the generator electrical quantities is that those quantities are easily accessible during operation (i.e. the current can be acquired by current transformer or Hall effect device, the voltage via a voltage transformer, and the power by computation). For steady-state operations, the FFT, the PSD, and other techniques based upon them, are widely used in the literature [4]. However, in the case of variable speed wind turbines, FFT is difficult to interpret and it is difficult to extract the variation features in time-domain, since the operation is predominately non stationary due the stochastic behavior of the wind speed. To overcome this problem, failure detection procedures based on time-frequency representation (Spectrogram, Quadratic TFR, etc...) or time-scale analysis (wavelet) have been proposed [5-9]. Nevertheless, these techniques have drawbacks such as high complexity, poor resolution or may suffer from artifacts (cross-terms, etc). Moreover, failure frequencies tracking is not an easy task [10].

1.2. Bearing failures importance

Since induction machine rotors are under high stresses, including thermal stresses, mechanical stresses, and electrical stresses, they are statistically more vulnerable compared to the stator. Particularly, bearings are the most frequently failed component [11]. Moreover, in the wind power industry context, bearing failures have been a persistent problem which account for a significant proportion of all failures in wind turbines [1]. Bearing failure of WECS generators is the most common failure mode associated with a long downtime.

Bearing failure is typically caused by some misalignment in the drive train, which gives rise to abnormal loading and accelerates bearing wear. Because of their construction, rolling element bearings generate precisely identifiable signature on vibration with characteristic frequencies. Those frequencies present an effective route for monitoring progressive bearing degradation. It is therefore possible to detect on the stator side the frequencies associated with the bearings using accelerometers mounted directly on the bearing housing, which is not often easily accessible [12]. Nonintrusive condition monitoring techniques, which monitor the bearing condition using only the generator currents or voltages, are preferred due to their nonintrusiveness and also low cost. To tackle this problem, numerous failure detection techniques have proposed by analyzing the stator side electrical quantities; such as the current [13] or the instantaneous power factor [14].

In this important and particular context, this paper will focus on bearing failure detection. As this failure leads to stator current modulation [15], it is therefore proposed to assess the efficiency of the EEMD using the homopolar current as a failure detection tool.

2. Failure detection using advanced signal processing techniques

2.1. Why monitoring the homopolar current?

In theory the homopolar current occurs only for unbalanced three-phase machines. However, in real world industry applications, this component is present regardless the machine condition (healthy or faulty). This study suggests then the use of this current as the variable to be monitored for failure detection. Indeed, majority of failures lead to an obvious unbalance behavior of a three-phase machine. This will give rise to a homopolar component of the current. This component could be very useful if the neutral point is connected allowing the use of one current sensors. In a wind turbine application, no homopolar current is produced by the generator (i.e. doubly-fed induction generator) since the neutral point is disconnected. However, the component could be computed and therefore monitored.

The homopolar current I_0 is computed through the Clarke transform and is given by

$$\begin{bmatrix} I_0 \\ I_\alpha \\ I_\beta \end{bmatrix} = \sqrt{\frac{2}{3}} \begin{bmatrix} \frac{1}{\sqrt{2}} & \frac{1}{\sqrt{2}} & \frac{1}{\sqrt{2}} \\ 1 & \frac{-1}{2} & \frac{-1}{2} \\ 0 & \frac{\sqrt{3}}{2} & \frac{-\sqrt{3}}{2} \end{bmatrix} \begin{bmatrix} I_a \\ I_b \\ I_c \end{bmatrix} \quad (1)$$

where $I_{a,b,c}$ are the three-phase currents. Hence

$$I_0 = \frac{1}{\sqrt{3}}(I_a + I_b + I_c) \quad (2)$$

2.2. Current modulation vs failure detection technique

Most of electric machine failures lead to current modulation (amplitude and/or phase) [12]. This is the particular case of bearing failures [16]. Indeed, a bearing failure is assumed to produce an air gap eccentricity and hence producing an unbalanced magnetic pull that leads to stator current modulation [17]. In this context, a demodulation technique is a well-suited tool for failure detection.

For modulated signals, the most popular techniques are TKEO [18], HT, and it has been recently shown that the CT can be used for demodulation [19-20]. Those techniques were investigated in many research works for failure detection tasks. However, TKEO and HT do not exploit the stator current multidimensional nature, while CT is reliable only for balanced three-phase system. To go besides those constraints, innovative techniques are investigated for tracking the fault component, such as PCA [21]. However, all of these techniques assume mono-component signals and they are unable to demodulate multi-component signals.

Unfortunately, in typical electric machines, stator current dominant components are the supply fundamental, eccentricity harmonics, slot harmonics, saturation harmonics, and other components from unknown sources including environmental noise. These components could be considered as noise in the context of bearing failure detection [22].

Under these considerations and in order to track the dominant component introduced by the bearing failure in the homopolar current, it is proposed to investigate an emerging signal decomposition technique known as the EMD.

2.3. The EMD briefly

The EMD method has recently focused considerable attention and been widely indexed to rotating machinery fault detection [23-25]. The EMD technique is an adaptive time-frequency data analysis method for multi-component, nonlinear and non-stationary signals. It decomposes the signal into a number of IMFs, each of which is a mono-component function. The multi-components signal (the current i in our case) is then decomposed into M intrinsic modes and a residue R_M [25-27].

$$i(n) = \sum_{m=1}^M imf_m(n) + R_M(n) \quad (3)$$

The procedure for extracting the IMFs from a signal is illustrated in Fig. 1.

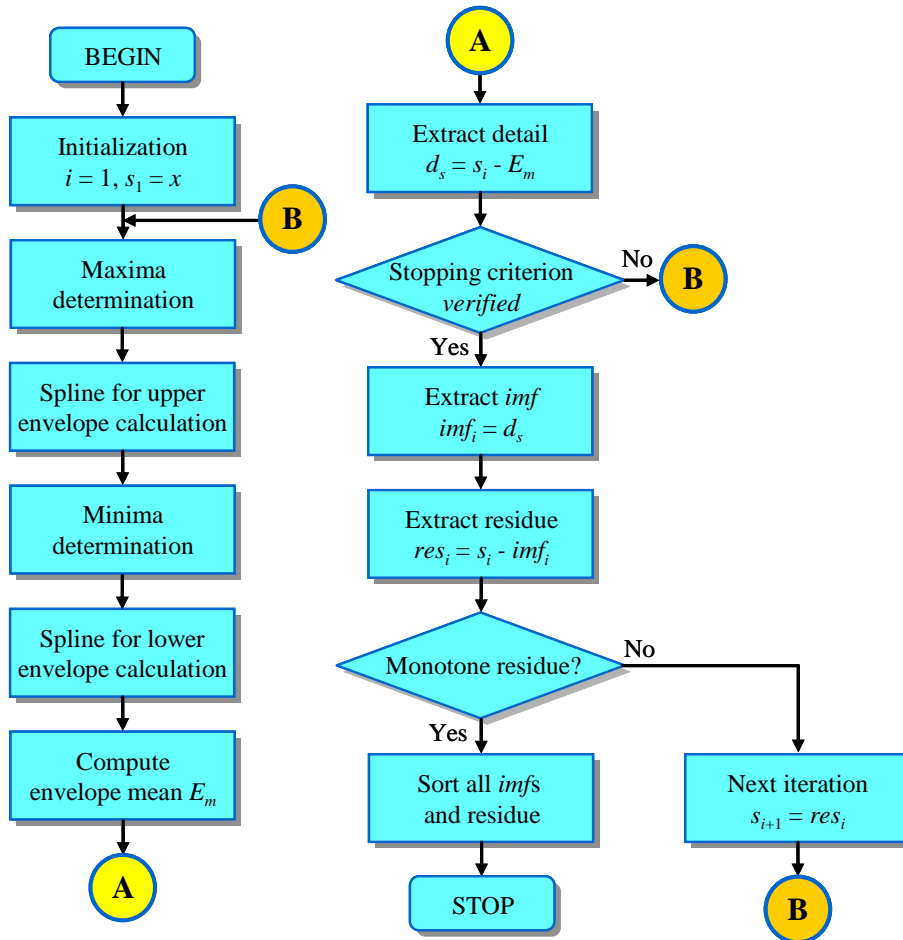

Fig. 1. Flow chart of the EMD process for signal decomposition.

In addition, the implementation of EMD is a data-driven process, not requiring any pre-knowledge of the signal or the machine [28]. This particular advantage in wind turbines context drive the EMD to be a promising tool for delivering improved condition monitoring [29]. The EMD method has however several drawbacks. Choice of a relevant stopping criterion and mode-mixing problem are the most important topics that need to be addressed in order to improve the EMD algorithm [30]. In particular, mode-mixing is the major drawback. Indeed, a detail related to one scale can appear in two different intrinsic modes. This makes an individual IMF devoid of physical meanings.

To illustrate the EMD concept let us assume the synthesized signal $x(t)$

$$x(t) = \underbrace{a_1 \sin \omega_1 t}_{\text{Component 1}} + \underbrace{a_2 \sin \omega_2 t}_{\text{Component 2}} \quad (4)$$

$x(t)$ decomposition leads to IMFs and residue illustrated by Fig. 2. It clearly shows that equation (4) two components ($a_1 \sin \omega_1 t$ and $a_2 \sin \omega_2 t$) are present in the 1st and 2nd IMFs. Unfortunately, real signals are always corrupted by noises. Let us now consider the $x(t)$ signal corrupted by a white Gaussian noise (AWGN)

$$x(t) = \underbrace{a_1 \sin \omega_1 t}_{\text{Component 1}} + \underbrace{a_2 \sin \omega_2 t}_{\text{Component 2}} + AWGN \quad (5)$$

The corresponding IMFs and residue are given by Fig. 3. It should be firstly noted *Component 1* occurrence into at least two consecutive IMFs (4th and 5th).

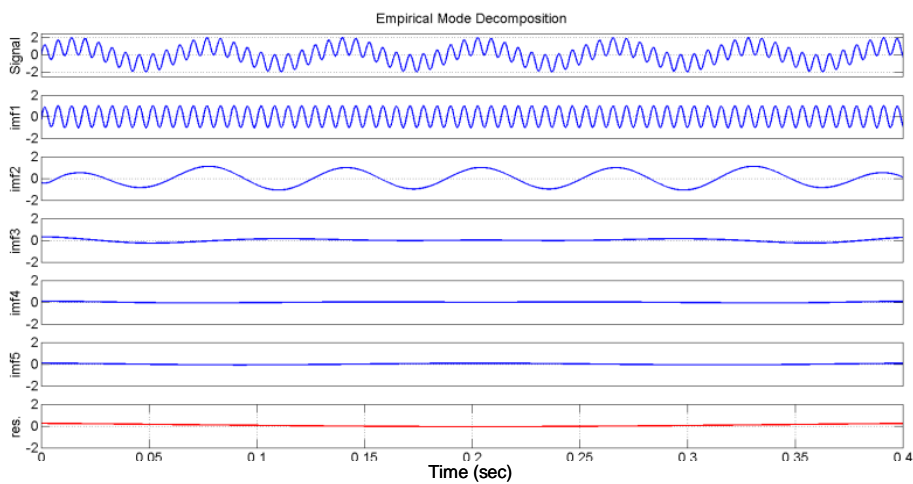

Fig. 2. EMD synthetic signal.

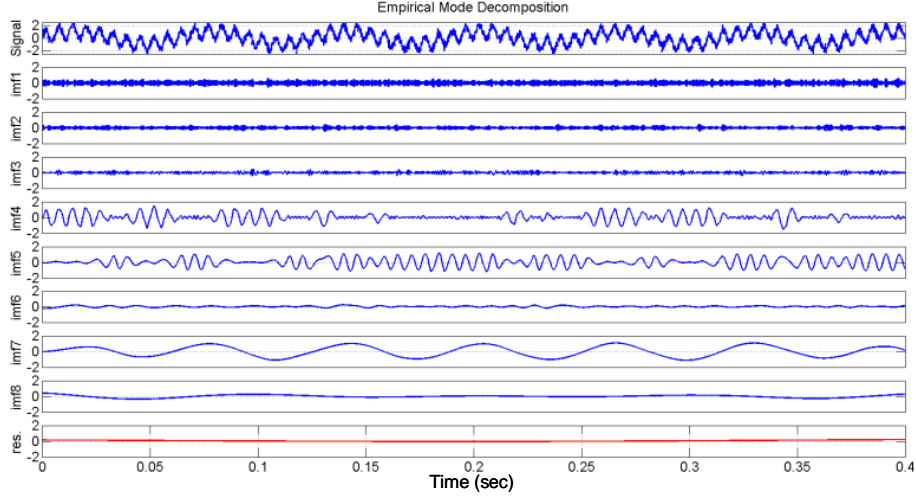

Fig. 3. EMD for an AWGN corrupted synthetic signal.

This is the above-mentioned phenomenon known as mode-mixing or intermittency. While *Component 2* IMF is shifted from the 2nd to the 7th rank. Moreover, due to the added noise, high frequency oscillations are introduced at the 1st, 2nd, and 3rd IMFs.

To overcome the mode-mixing problem, the Ensemble EMD (EEMD) was introduced [31-32].

2.4. The EEMD versus the EMD

The EEMD is a noise-assisted data analysis method. It defines true IMFs as the mean of an ensemble of trials. Each trial consists of the decomposition results of the signal adding a finite amplitude white noise. In this context, it is demonstrated that noise could help data analysis in the EMD method and therefore automatically mitigates mode-mixing [33]. The EEMD procedure for extracting the IMFs from a signal is illustrated in Fig. 4.

The EEMD reliability depends on the choice of the ensemble number N and the noise amplitude a . Those two parameters are linked by [33]

$$e_n = \frac{a}{\sqrt{N}} \quad (6)$$

where e_n is the standard deviation error and is defined as the discrepancy between the input signal and the corresponding *imf*.

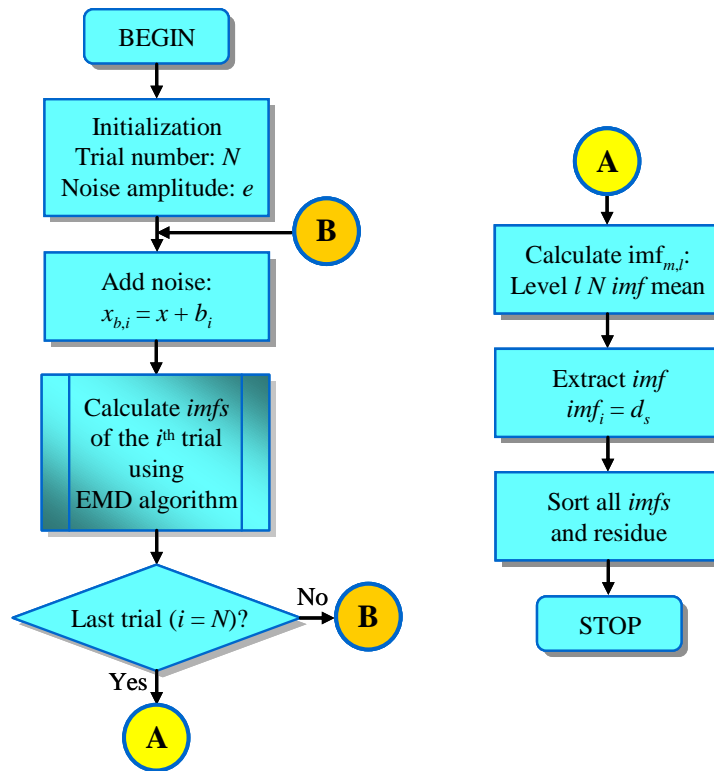

Fig. 4. Flow chart of the EEMD process for signal decomposition.

Let us apply the EEMD to the signals respectively defined by (4) and (5). Then results are depicted in Figs. 5 and 6. In this case, it is clearly shown that the noise does not affect the time-scale decomposition. Moreover, it should be mentioned the obvious mode-mixing removal.

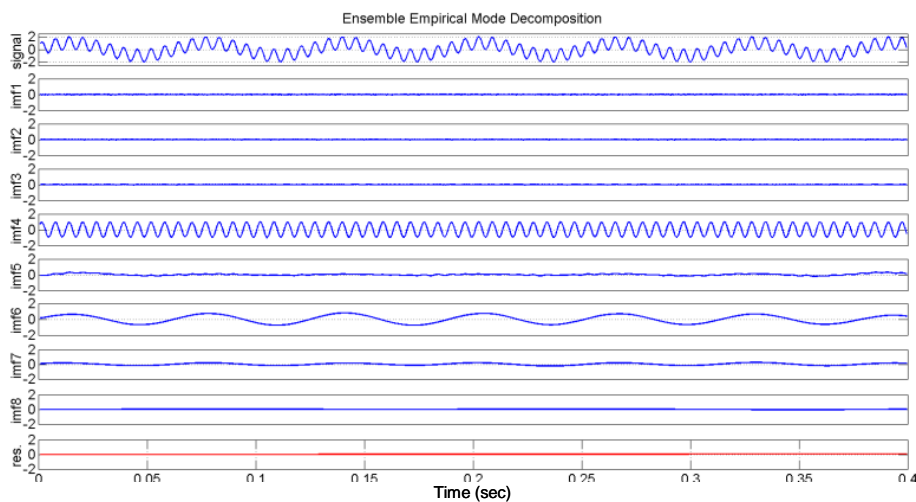

Fig. 5. EEMD synthetic signal.

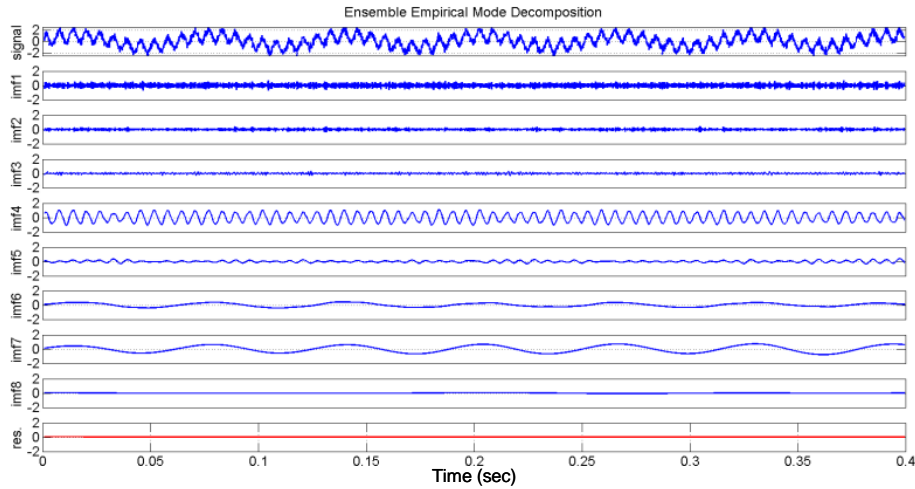

Fig. 6. EEMD for an *AWGN* corrupted synthetic signal.

2.5. What is specifically proposed?

For failure detection several fault detectors based on amplitude demodulation have been proposed in the available literature. However, most of them assume that a training database is available. This can be very difficult to obtain for WECS. Indeed, it has been mentioned in a number of previously published paper, that one of the main difficulties in real word testing of developed condition monitoring technique, is the lack of collaboration needed with wind turbine operators and manufacturers, due to data confidentiality, particularly when failures are present [3].

In this paper, the authors propose a low complexity failure detector which does not require any training sequence. Indeed, the proposed detector is based on the dominant *imf* variance.

3. Experimental evaluation of the EEMD-based failure detection approach

3.1. Test facility description

A conventional 0.75-kW induction machine drive test bed is used in order to test the proposed EEMD-based fault detection approach (Fig. 7). The test bed mechanical part is composed by a synchronous and an induction machines. The induction machine is fed by the synchronous generator.

The induction machine (0.75-kW, 220/380 V, 1.95/3.4 A, 2780 rpm, 50 Hz, 2 poles, Y-connected) has two 6204.2ZR type bearings (single row and deep groove ball bearings) with the following parameters: outside diameter is 47 mm, inside diameter is 20 mm, and pitch diameter D is 31.85 mm. A bearing has 8 balls with an approximate diameter d of 12 mm and a contact angle α of 0° .

Bearing faults are obtained by simply drilling holes in different parts (Fig. 8).

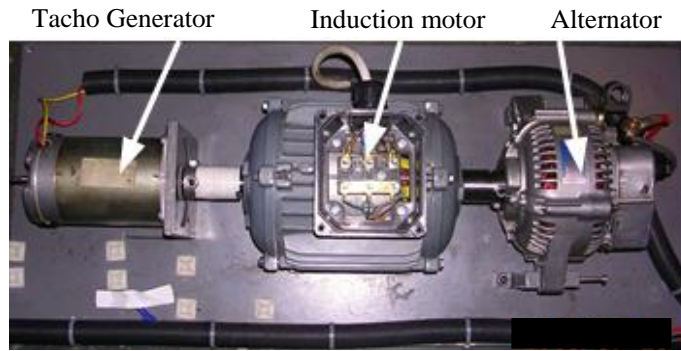

(a) Mechanical part.

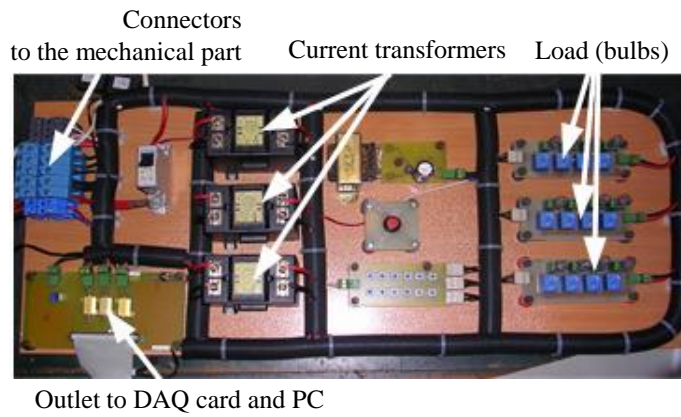

(b) Electrical part.

Fig. 7. Experimental setup.

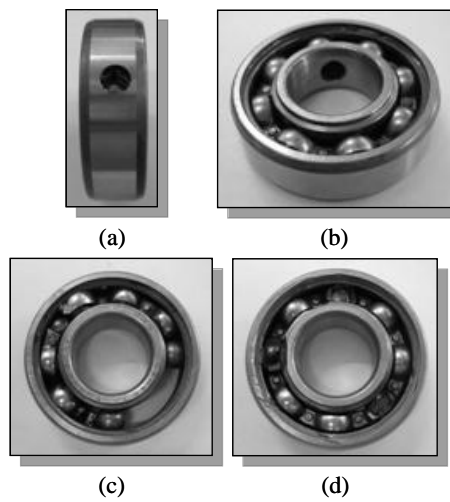

Fig. 8. Artificially deteriorated bearings: (a) outer race deterioration, (b) inner race deterioration, (c) cage deterioration, (d) ball deterioration.

3.2. Experimental results

Figures 9 and 10 show the three-phase and the homopolar currents, for healthy and faulty bearings (failure c), respectively.

After adjusting the EEMD parameters respectively the noise amplitude a and the ensemble number N according to [33]; the decomposition is applied to the homopolar current computed through (2), for several loads during the induction machine operation with healthy and faulty bearing.

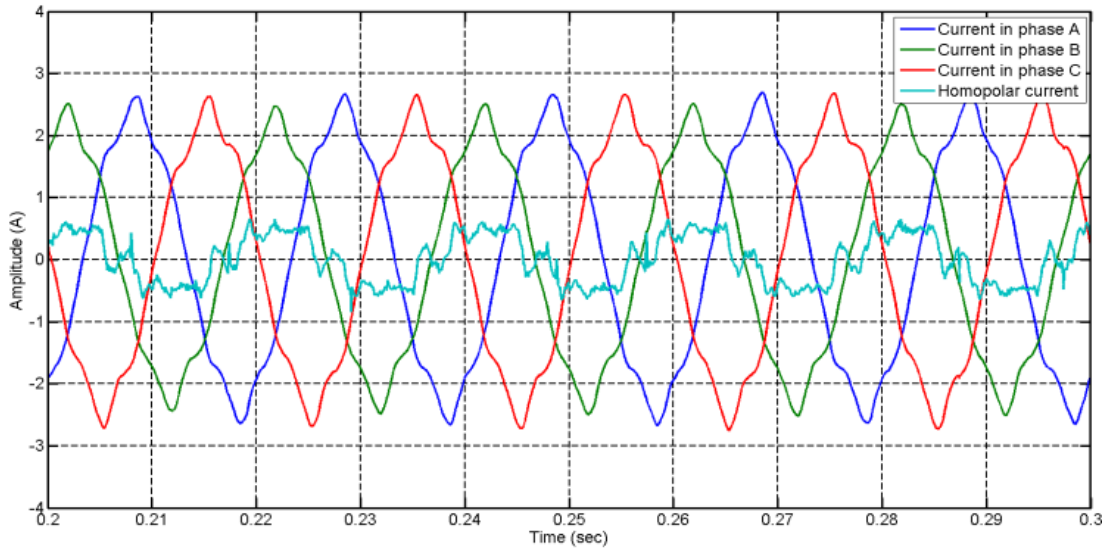

Fig. 9. The healthy case currents (the homopolar current is multiplied by 20).

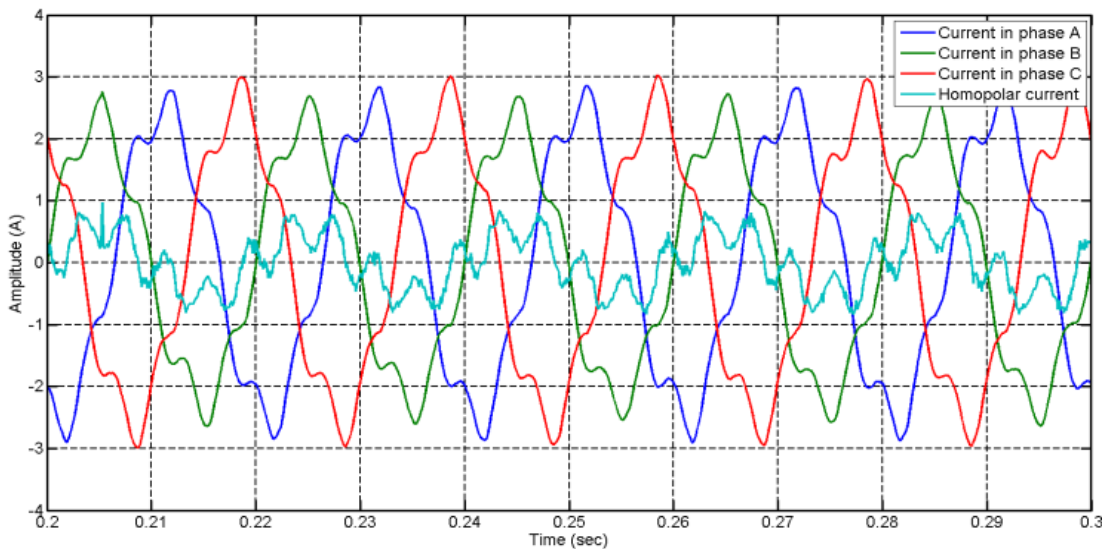
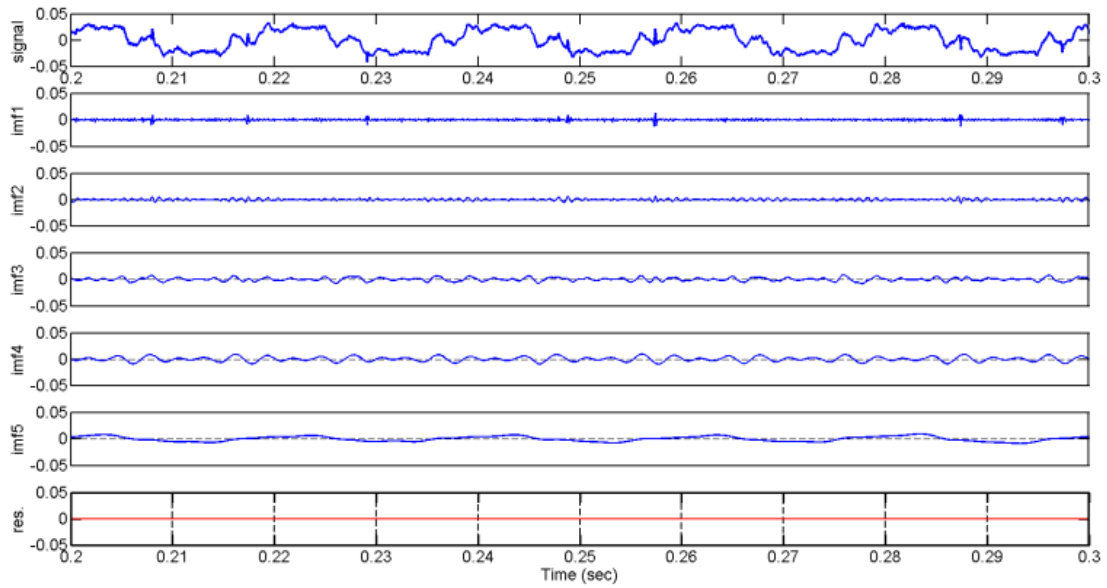
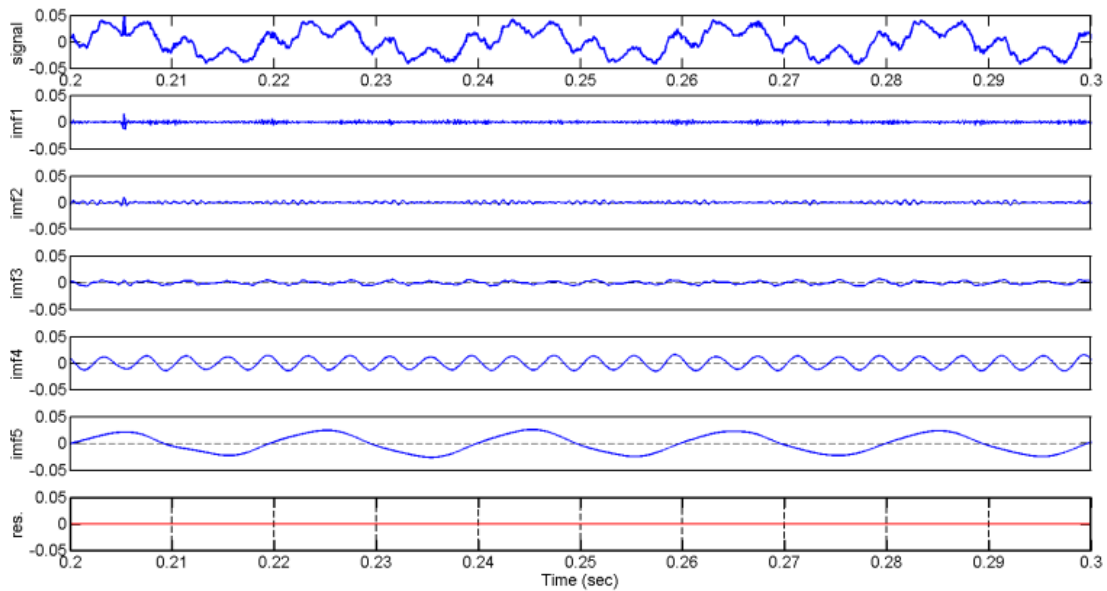

Fig. 10. The faulty case (failure c) currents (the homopolar current is multiplied by 20).

For illustration, Fig. 11 shows EEMD sequential extraction-based of homopolar current local oscillations. Those local oscillations are represented by the first 5 IMFs and the residue when the induction machine is loaded by 40% of the nominal load.



(a) Healthy bearings.



(b) Faulty bearings (failure c).

Fig. 11. Homopolar current EEMD decomposition.

It seems therefore that in presence of a bearing failure the 4th and the 5th IMFs are more energized.

Since two different IMFs are influenced by the bearing fault presence, it seems wise to investigate each IMF separately.

3.3. 4th IMF investigation

Figure 12 clearly illustrates strong oscillations of the 4th IMF. In order to quantify those oscillations, the statistical variance σ^2 of this IMF is computed for all the failures for several loads using the following equation

$$\sigma_{imf_4}^2 = \frac{1}{N} \sum_{n=0}^{N-1} [imf_4(n) - \mu_{imf_4}]^2 \quad (7)$$

where μ_{imf_4} is the mean of $imf_4(n)$.

The obtained results are summarized by Table 1 and Fig. 13. It should be first mentioned that the variance is not strictly equal to zero for healthy bearings. This could be simply explained by the induction machine natural unbalances in one hand and in another hand by the fact that stator current could contain unknown noises. However when a bearing failure occurs, this criteria is multiplied by about 5. These results clearly demonstrate that the 4th IMF can be used an effective indicator for bearing health monitoring. The exception is failure (a), which needs further investigations in regard to artificially created failures. Table 2 confirms the achieved tendencies.

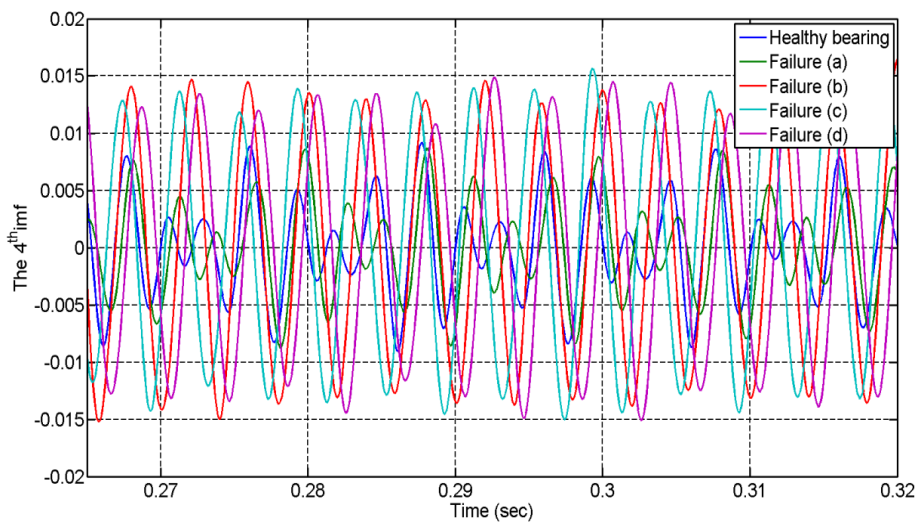

Fig. 12. Homopolar current 4th IMF for healthy and faulty bearings.

Table 1. Homopolar current 4th IMF variance.

	σ^2				
Load	Healthy bearing	Failure (a)	Failure (b)	Failure (c)	Failure (d)
00.00%	2.20E-05	1.30E-05	7.02E-05	7.04E-05	7.48E-05
26.66%	1.58E-05	1.46E-05	7.53E-05	7.55E-05	7.22E-05
40.00%	1.77E-05	1.59E-05	9.05E-05	8.83E-05	8.82E-05
53.33%	2.45E-05	2.21E-05	1.07E-04	1.10E-04	1.14E-04

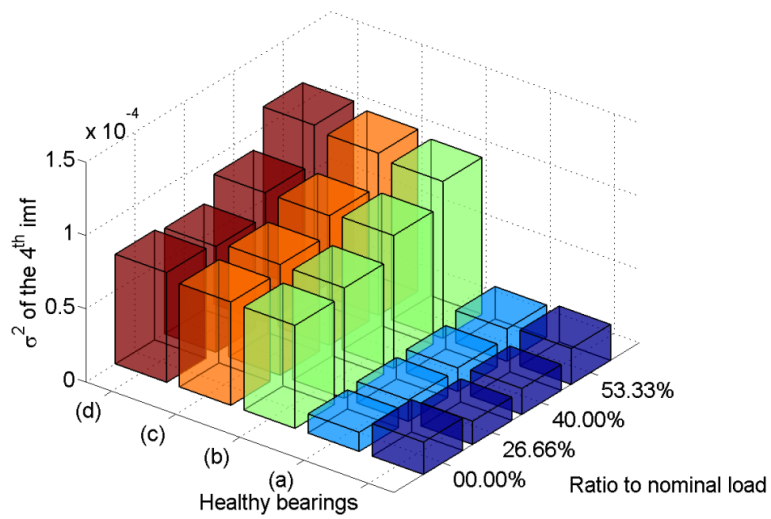

Fig. 13. Homopolar current 4th IMF variance for healthy and faulty bearings.

Table 2. Homopolar current 4th IMF variance error.

	$e_v = \frac{(\sigma_{imf_faulty}^2 - \sigma_{imf_healthy}^2)}{\sigma_{imf_healthy}^2}$			
Load	Failure (a)	Failure (b)	Failure (c)	Failure (d)
00.00%	41%	218%	219%	239%
26.66%	8%	375%	377%	356%
40.00%	10%	413%	400%	400%
53.33%	10%	337%	351%	366%

3.4. 5th IMF investigation

Figures 14 and 15 show that the 5th IMF is evolving at the stator current frequency and is more energized at the fault occurrence. This is clearly illustrated by Fig. 16. These impacts could be explained by the fact that a bearing failure will cause a mechanical vibration, essential equivalent to a dynamic eccentricity [34]. This will lead to an unbalanced magnetic pull that gives rise to unbalanced three-phase currents.

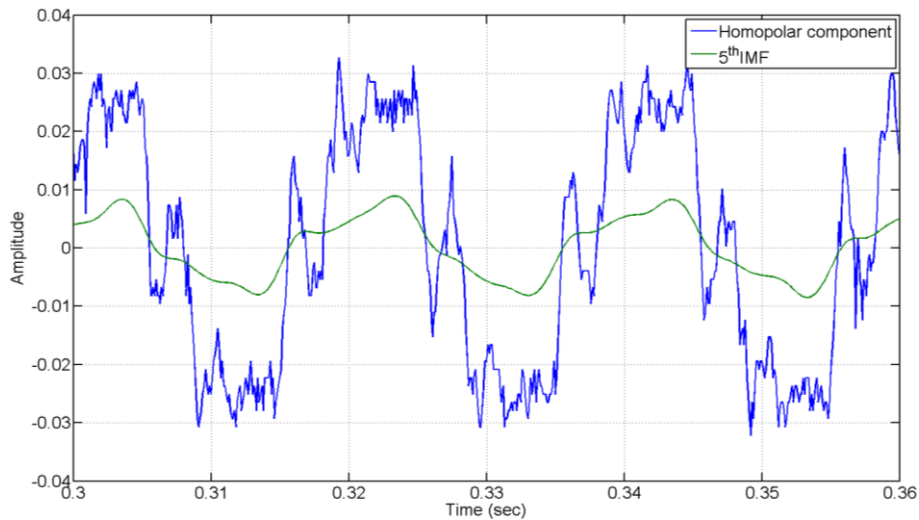

Fig. 14. Homopolar current and its 5th IMF for healthy bearings.

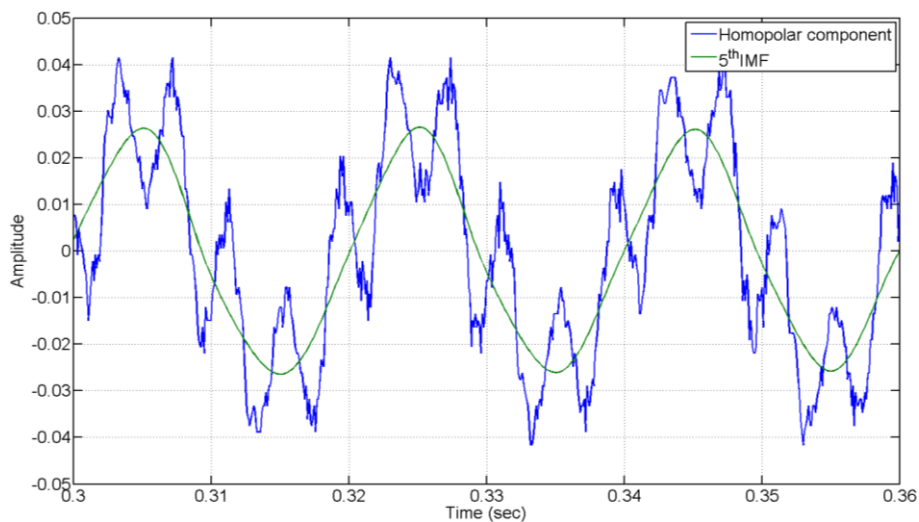

Fig. 15. Homopolar current and its 5th IMF for faulty bearings.

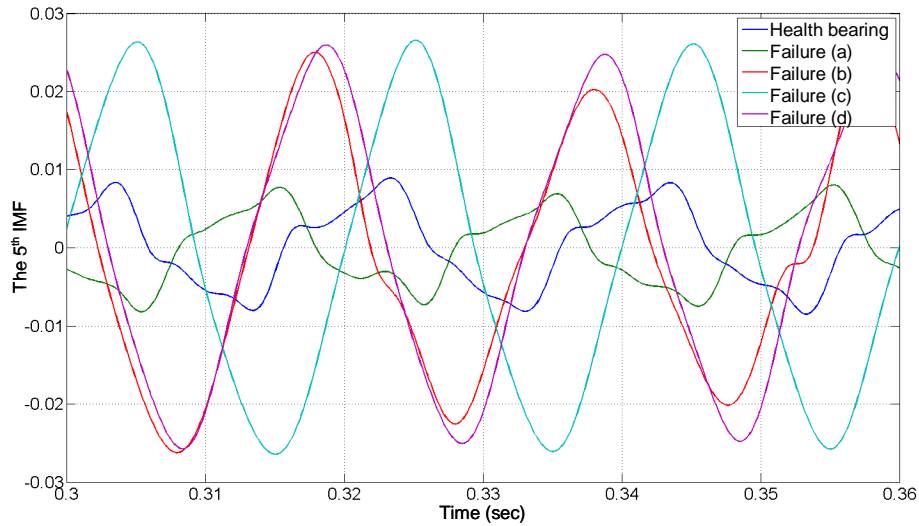

Fig. 16. Homopolar current 5th IMFs for healthy and faulty bearings.

3.5. Discussion

At this stage and according to the achieved results for the 4th and 5th IMFs, it seems that the 4th IMF, as a high-frequency component, is a quite sufficient and efficient fault indicator that could be used with quite confidence. Indeed, the 5th IMF that is also impacted by bearing failures could however lead to misleading results in a fault diagnosis procedure as an eccentricity failure could be erroneously diagnosed as a bearing one. Therefore for failure diagnosis purposes further investigations must be carried-out.

4. Conclusion

This paper dealt with induction machine bearing failures detection using the homopolar current. This component is first decomposed into intrinsic mode functions through the EEMD which is the EMD free mixed mode version. It was then found that the 4th and 5th IMFs are the most energized modes when a bearing failure occurs. The 4th IMF mode was then analyzed using a statistical criterion on experimental data. The achieved results clearly demonstrate that the 4th IMF can be used as an effective indicator for bearing health monitoring.

The obtained results seem very promising for wind turbines monitoring using the generator current. Indeed, the proposed EEMD-based and low complexity failure detector does not require any training database. However further investigations must be done towards the detection of other type of faults.

References

- [1] Y. Amirat, M. Benbouzid, E. Al-Ahmar, B. Bensaker, and S. Turri, "A brief status on condition monitoring and fault diagnosis in wind energy conversion systems," *Renewable and Sustainable Energy Reviews*, vol. 13, no. 9, pp. 2629–2636, 2009.
- [2] B. Lu, Y. Li, X. Wu and Z. Yang, "A review of recent advances in wind turbine condition monitoring and fault diagnosis", in *Proceedings of the 2009 IEEE PEMWA*, Lincoln (USA), pp. 1-7, June 2009.
- [3] W. Yang, P.J. Tavner, C.J. Crabtree and M. Wilkinson, "Cost-effective condition monitoring for wind turbines," *IEEE Trans. Industrial Electronics*, vol. 57, n°1, pp. 263-271, January 2010.
- [4] M. Benbouzid, "A review of induction motors signature analysis as a medium for faults detection," *IEEE Trans. Industrial Electronics*, vol. 47, no. 5, pp. 984–993, October 2000.
- [5] J. Antonino-Daviu, M. Riera-Guasp, M. Pineda-Sanchez, and R.B. Perez, "A critical comparison between DWT and Hilbert-Huang-based methods for the diagnosis of rotor bar failures in induction machines," *IEEE Trans. Industry Applications*, vol. 45, n°5, pp. 1794-1803, September/October 2009.
- [6] S. Rajagopalan, J. A. Restrepo, J. Aller, T. Habetler, and R. Harley, "Non stationary motor fault detection using recent quadratic time frequency representations," *IEEE Trans. Industry Applications*, vol. 44, n°3, pp. 735-744, May/June 2008.
- [7] J. Cusido, L. Romeral, J.A. Ortega, J.A. Rosero and A.G. Espinosa, "Fault detection in induction machines using power spectral density in wavelet decomposition," *IEEE Trans. Industrial Electronics*, vol. 55, no. 2, pp. 633–643, February 2008.
- [8] M. Blodt, D. Bonacci, J. Regnier, M. Chabert, and J. Faucher, "On-line monitoring of mechanical faults in variable-speed induction motor drives using the Wigner distribution," *IEEE Trans. Industrial Electronics*, vol. 55, n°2, pp., 522-533, February 2008.
- [9] B. Tang, W. Liu and T. Song, "Wind turbine fault diagnosis based on Morlet wavelet transformation and Wigner-Ville distribution," *Renewable Energy*, vol. 35, n°12, pp. 2862-2866, December 2010.
- [10] E.H. El Bouchikhi, V. Choqueuse, M.E.H. Benbouzid, J.F Charpentier and G. Barakat, "A comparative study of time-frequency representations for fault detection in wind turbine," in *Proceedings of the 2011 IEEE IECON*, Melbourne (Australia), pp. 3584-3589, November 2011.
- [11] P. Zhang; Y. Du; T.G. Habetler and B. Lu, "A survey of condition monitoring and protection methods for medium-voltage induction motors," *IEEE Trans. Industry Applications*, vol. 47, n°1, pp. 34-46, January/February 2011.
- [12] P.J. Tavner, "Review of condition monitoring of rotating electrical machines," *IET Electric Power Applications*, vol. 2, n°4, pp. 215-247, July 2008.
- [13] F. Immovilli, A. Bellini, R. Rubini and C. Tassoni, "Diagnosis of bearing faults in induction machines by vibration or current signals: A critical comparison," *IEEE Trans. Industry Applications*, vol. 46, n°4, pp. 1350-1359, July/August 2010.
- [14] A. Ibrahim, M. El Badaoui, F. Guillet and F. Bonnardot, "A New bearing fault detection method in induction machines based on instantaneous power factor," *IEEE Trans. Industrial Electronics*, vol. 55, n°12, pp.4252-4259, December 2008.
- [15] Y. Amirat, V. Choqueuse and M.E.H. Benbouzid, "Condition monitoring of wind turbines based on amplitude demodulation," in *Proceedings of the 2010 IEEE ECCE'10*, Atlanta (USA), pp. 2417-2421, September 2010.
- [16] J.R. Stack, R.G. Harley and T.G. Habetler, "An amplitude modulation detector for fault diagnosis in rolling element bearings," *IEEE Trans. Industrial Electronics*, vol. 51, n°5, pp. 1097–1102, October 2004.

- [17] L. Frosini and E. Bassi, "Stator current and motor efficiency as indicators for different types of bearing fault in induction motor," *IEEE Trans. Industrial Electronics*, vol. 57, n°1, pp. 244-251, January 2010.
- [18] I. Kamwa, A.K. Pradhan and G. Joos, "Robust detection and analysis of power system oscillations using the Teager-Kaiser energy operator," *IEEE Trans. Power Systems*, vol. 26, n°1, pp. 323-333, February 2011.
- [19] B. Trajin, M. Chabert, J. Regnier, and J. Faucher, "Hilbert versus Concordia transform for three phase machine stator current time-frequency monitoring," *Mechanical Systems & Signal Processing*, vol. 23, n°8, pp. 2648-2657, November 2009.
- [20] I.Y. Önel and M.E.H. Benbouzid, "Induction motor bearing failure detection and diagnosis: Park and Concordia transform approaches comparative study," *IEEE/ASME Trans. Mechatronics*, vol. 13, n°2, pp. 257-262, April 2008.
- [21] V. Choqueuse, M.E.H. Benbouzid, Y. Amirat and S. Turri, "Diagnosis of three-phase electrical machines using multidimensional demodulation techniques," *IEEE Trans. Industrial Electronics*, vol. 59, issue 4, pp. 2014-2023, April 2012.
- [22] W. Zhou, T.G. Habetler and R.G. Harley, "Bearing fault detection via stator current noise cancellation and statistical control," *IEEE Trans. Industrial Electronics*, vol. 55, n°4, pp. 4260-269, December 2008.
- [23] R. Ricci and P. Pennacchi, "Diagnostics of gear faults based on EMD and automatic selection of intrinsic mode functions," *Mechanical Systems & Signal Processing*, vol. 25, n°3, pp. 821-838, April 2011.
- [24] J.A. Antonino-Daviu, M. Riera-Guasp, J. Pons-Llinares, J. Roger-Folch, R.B. Perez and C. Charlton-Perez, "Toward condition monitoring of damper windings in synchronous motors via EMD analysis," *IEEE Trans. Energy Conversion*, vol. 27, n°2, pp. 432-439, June 2012.
- [25] J.A. Rosero, L. Romeral, J.A. Ortega and E. Rosero, "Short-circuit detection by means of empirical mode decomposition and Wigner-Ville distribution for PMSM running under dynamic condition," *IEEE Trans. Industrial Electronics*, vol. 56, n°11, pp. 4534-4547, November 2009.
- [26] Q. Gao, C. Duan, H. Fan and Q. Meng, "Rotating machine fault diagnosis using empirical mode decomposition," *Mechanical Systems & Signal Processing*, vol. 22, n°5, pp. 1072-1081, July 2008.
- [27] Y. Amirat, V. Choqueuse and M.E.H. Benbouzid, "Bearing fault detection in DFIG-based wind turbines using the first intrinsic mode function," in *Proceedings of the 2010 ICEM*, Rome (Italy), pp. 1-6, September 2010.
- [28] A. Boudraa and J. C. Cexus, "EMD-based signal filtering," *IEEE Trans. Instrumentation and Measurement*, vol. 56, n°6, pp. 2196-2202, December 2007.
- [29] W. Yang, R. Court, P.J. Tavner and C.J. Crabtree, "Bivariate empirical mode decomposition and its contribution to wind turbine condition monitoring," *Journal of Sound and Vibration*, vol. 330, n°15, pp. 3766-3782, July 2011.
- [30] X. Hu, S. Peng and W.-L. Hwang, "EMD revisited: A new understanding of the envelope and resolving the mode-mixing problem in AM-FM signals," *IEEE Trans. Signal Processing*, vol. 60, n°3, pp. 1075-1086, March 2012.
- [31] Y. Amirat, V. Choqueuse and M.E.H. Benbouzid, "Wind turbine bearing failure detection using generator stator current homopolar component ensemble empirical mode decomposition," in *Proceedings of the 2010 IEEE IECON 2012*, Montreal (Canada), pp. 3937-3942, October 2012.
- [32] Y. Lei, Z. He and Y. Zi, "Application of the EEMD method to rotor fault diagnosis of rotating machinery," *Mechanical Systems & Signal Processing*, Vol. 23, n° 4, pp. 1327-1338, May 2009.

- [33] Z.H. Wu and N.E. Huang, "Ensemble empirical mode decomposition: A noise-assisted data analysis method", *Advances in Adaptive Data Analysis*, vol. 1, n°1, pp. 1-41, 2009.
- [34] A.M. Knight and S.P. Bertani, "Mechanical fault detection in a medium-sized induction motor using stator current monitoring," *IEEE Trans. Energy Conversion*, vol. 29, n°4, pp. 753-760, December 2005.