

University of Warwick institutional repository: <http://go.warwick.ac.uk/wrap>

A Thesis Submitted for the Degree of PhD at the University of Warwick

<http://go.warwick.ac.uk/wrap/2000>

This thesis is made available online and is protected by original copyright.

Please scroll down to view the document itself.

Please refer to the repository record for this item for information to help you to cite it. Our policy information is available from the repository home page.

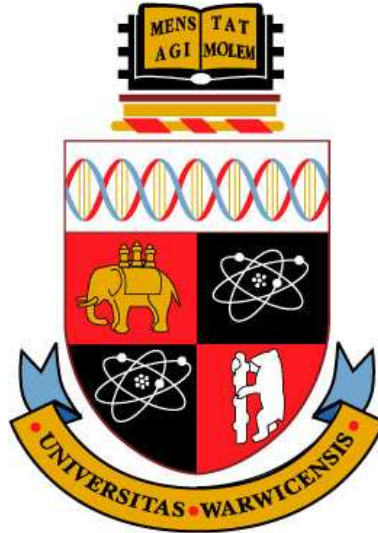

Dihedral groups and G -Hilbert schemes

Álvaro Nolla de Celis

A thesis submitted to the University of Warwick for the
degree of Doctor of Philosophy

Mathematics Department, University of Warwick

September 2008

THE UNIVERSITY OF
WARWICK

Contents

Acknowledgements	5
Declaration	6
List of Figures	6
List of Tables	8
1 Introduction	11
2 Preliminaries	13
2.1 Du Val singularities	13
2.2 The McKay correspondence	14
2.3 Ito and Nakamura Hilbert schemes $G\text{-Hilb}(\mathbb{C}^2)$	15
2.4 The $GL(2, \mathbb{C})$ case and the special McKay correspondence	16
2.5 Explicit methods	16
2.6 Background material	17
2.6.1 Cyclic quotient singularities	17
2.6.2 Quivers and the moduli of quiver representations	19
2.6.3 $\mathcal{M}_\theta(Q, R)$ and $G\text{-Hilb}$	23
3 Dihedral groups in $GL(2, \mathbb{C})$	25
3.1 Definition	25
3.2 Resolution of dihedral singularities	27
3.3 Classification of small binary dihedral groups in $GL(2, \mathbb{C})$	29
3.3.1 Brieskorn classification	33
3.4 $BD_{2n}(a)$ groups	34
3.4.1 Representation theory for $BD_{2n}(a)$ groups	39
3.4.2 Semi-invariant polynomials	42

4	<i>G</i>-graphs for $\text{BD}_{2n}(a)$ groups	45
4.1	Introduction	45
4.2	The cyclic case	48
4.3	qG -graphs	49
4.4	G -graphs from qG -graphs	54
4.4.1	Type A	55
4.4.2	Type B	60
	Type $B.1$	62
	Type $B.2$	63
4.4.3	Remaining G -graphs: types C and D	64
	G -graphs of type D	65
	G -graphs of type C	67
4.5	Walking along the exceptional divisor	69
4.6	Special representations	76
5	Explicit $G\text{-Hilb}(\mathbb{C}^2)$ via quiver representations	79
5.1	McKay quivers for $\text{BD}_{2n}(a)$ groups	79
5.1.1	Orbifold McKay quiver	80
5.1.2	BSW Relations	83
5.2	Explicit calculation of $G\text{-Hilb}(\mathbb{C}^2)$	86
5.2.1	First case: $D_4 \subset \text{SL}(2, \mathbb{C})$	86
5.2.2	$\text{BD}_{2n}(n+1)$ groups	95
	Case $A(0, 2n; 1, n+1)$	96
	Case C^+	98
	Case C^-	100
	Case D	100
5.2.3	The general case: First steps	101
5.2.4	From G -graphs to representations of quivers	102
5.3	Examples	104
5.3.1	Type $C^+(2, 8; 5, 5)$ in $\text{BD}_{30}(11)$	105
5.3.2	Type $B1(1, 13; 4, 10)$ in $\text{BD}_{42}(13)$	105

Acknowledgements

Firstly I would like to thank Miles Reid for his supervision during my Ph.D. This work would not have been possible without his constant encouragement, generous support and hospitality during all these years. His enthusiasm and dedication has been a constant source of inspiration.

I want to give special thanks to Alejandro Melle Hernandez. Without his advice and support I wouldn't have ended up in Warwick having this great experience. Gracias Ale!

I want to express my gratitude to Alastair Craw, Gavin Brown, Ignacio de Gregorio, Cristina Lopez Martín, Diane Maclagan, Jorge Victoria and Michael Wemyss for all their patient explanations and useful conversations.

Special thanks to Stephen Coughlan for all the blackboards and teas in the common room. It was always tremendously fruitful, even when sometimes the handwriting was more important than the maths. Thanks also for all the trips to exotic conferences, always great fun!

They had been very exciting years and the list of people that I want to mention is very long. From the very beginning with Alicia, Bruno, Dan, Ellen, James, Kostas, Masoumeh, Niklas, Pavel, Rik and Tims Honeywill and Hobson, passing through Anestis, Ayse, Beskos, Eleonora, GAeL and its liberté, Hamid, Jorge, Lucie, Michalis, Mirela, Niha, Thomas, Patrick, Paul, Peter, Yang, the Westwood Tugs... until the very end, Michele and Sara, thanks for your inspiring breakfasts! and Elisa, Sarah, Shengtian, Sohail, Stephen and Umar, thanks for sharing much more than a supervisor and a yellow book.

A very special mention to Cristina, Javier, Nacho and Miguel, for all the great moments we shared all these years, que no sea la última! and for all the Whoberlians: Anita, Banu, Cornelio, Georgia, Ivo, Doctor Tim, Ofelia, Peter, Samuel... and in particular James and Kostas. It was always a pleasure to come back home.

I would also like to thank Sarah Davis and James Bichard for careful proof-reading of this thesis. They have been very kind and patient with my lack of english grammar.

And finally I would like to express all my gratitude to my family and specially to my parents. Their unlimited love and support had been extremely important. Thanks to them I could always find the strength to continue. Os quiero mucho.

This thesis is dedicated to Elena, mi amor y vida. Siempre, siempre.

Declaration

I declare that, to the best of my knowledge, the material contained in this thesis is original work of the author except where otherwise indicated.

List of Figures

4.1	Resolution of singularities Y of the cyclic singularity of type $\frac{1}{12}(1, 7)$	49
4.2	A -graphs for the group $A = \langle \frac{1}{12}(1, 7) \rangle$	49
4.3	Action of β on $A\text{-Hilb}(\mathbb{C}^2)$ in terms of A -graphs.	50
4.4	qG -graphs for the group $\text{BD}_{2n}(a)$	51
4.5	Extension from a qG -graph to a G -graph of type A by the elements in the overlap.	58
4.6	G -graphs of type B.1 and B.2 according to the size of the overlap.	61
4.7	G -graph of type B.1. The “twin region” is denoted by B	62
4.8	G -graph of type B.2. The overlap in this case is extended without twin regions.	64
4.9	G -graph of type D . The monomials x^q and y^q are identified.	66
4.10	G -graph of type C when Γ_l is (a) of type B.1. and (b) of type B.2.	69
5.1	McKay quiver for $\text{BD}_{2n}(a)$ groups	81
5.2	McKay quiver for the Abelian group $\frac{1}{30}(1, 19)$	82
5.3	McKay quiver for the group $\text{BD}_{30}(19)$. Top and bottom rows are identified.	83
5.4	Paths of length two in the McKay quiver for $\text{BD}_{2n}(a)$ groups.	85
5.5	D_4 -graph of type A , and the corresponding open set in $\mathcal{M}_\theta(Q, R)$	88
5.6	D_4 -graph of type C^+ , and the corresponding open set in $\mathcal{M}_\theta(Q, R)$	91
5.7	D_4 -graph of type C^- , and the corresponding open set in $\mathcal{M}_\theta(Q, R)$	92
5.8	D_4 -graph of type D^+ , and the corresponding open set in $\mathcal{M}_\theta(Q, R)$	93
5.9	D_4 -graph of type D^- , and the corresponding open set in $\mathcal{M}_\theta(Q, R)$	94
5.10	McKay quiver for $\text{BD}_{2n}(n+1)$ groups	95
5.11	Representation corresponding to $\text{BD}_{2n}(n+1)$ -graph of type $A(0, 2n; 1, n+1)$	98
5.12	Representation corresponding to the $\text{BD}_{2n}(n+1)$ -graph of type C^+	99
5.13	Representation corresponding the $\text{BD}_{2n}(n+1)$ -graphs of type D^+ and D^-	101

5.14	Basis elements in the G -graph Γ_A and the corresponding choices in the representation space.	104
5.15	Open set in $\mathcal{M}_\theta(Q, R)$ corresponding to the $\text{BD}_{30}(11)$ -graph $\Gamma_{C^+}(2, 8; 5, 5)$.	106
5.16	Open set in $\mathcal{M}_\theta(Q, R)$ corresponding to the $\text{BD}_{42}(13)$ -graph $\Gamma_{B,1}(1, 13; 4, 10)$.	107

List of Tables

2.1	The Du Val singularities	14
3.1	Fixed locus in $Y = \langle \alpha \rangle$ -Hilb(\mathbb{C}^2) by the action of β	37
3.2	Small binary dihedral groups in $GL(2, \mathbb{C})$ of order ≤ 60	40
3.3	Character table for the group $BD_{12}(7)$	42
3.4	Representation theory for $\frac{1}{12}(1, 7)$ and the generators for S_ρ	43
3.5	Some semi-invariant elements in each S_ρ for $BD_{12}(7)$	44
4.1	Irreducible representations of D_4 with some polynomials belonging to them.	47
5.1	Basis elements for the G -graph of type A	89
5.2	Type C^+ representations and basis elements	92
5.3	Type D^+ representations and basis elements	93
5.4	Basis elements of the G -graph $\Gamma_{C^+}(2, 8; 5, 5)$	106
5.5	Basis elements of the G -graph $\Gamma_{C^+}(2, 8; 5, 5)$, with $(+) = x^7 - iy^7$ and $(-) = x^7 + iy^7$	108

Chapter 1

Introduction

Let $G \subset \mathrm{GL}(2, \mathbb{C})$ be a finite subgroup acting on the complex plane \mathbb{C}^2 , and consider the following diagram

$$\begin{array}{ccc} & & \mathbb{C}^2 \\ & & \downarrow \\ \pi: Y & \rightarrow & X \end{array}$$

where π is the minimal resolution of singularities. Since Du Val in the 1930s the explicit calculation of Y was made from X by blowing up the singularity at the origin, where we lose any information about the group G in the process. But, is there a direct relation between the resolution Y and the group G ?

McKay [McK80] in the late 1970s was the first to realise the link between the group action and the resolution Y , thus giving birth to the so called McKay correspondence. This beautiful correspondence establishes an equivalence between the geometry of the minimal resolution Y of the quotient singularity \mathbb{C}^2/G , and the G -equivariant geometry of \mathbb{C}^2 .

In 1996, Ito and Nakamura [IN96] introduced the Hilbert scheme of G -clusters $G\text{-Hilb}(\mathbb{C}^2)$ and proved that for $G \subset \mathrm{SL}(2, \mathbb{C})$ it is the minimal resolution Y . This provided a moduli interpretation of the problem. The extension of Ito and Nakamura's result to the case $G \subset \mathrm{GL}(2, \mathbb{C})$ was proved by Ishii in [Ish02] as an equivalence of derived categories.

Apart from the Abelian case, where the situation is well understood, there are not many explicit descriptions of $G\text{-Hilb}(\mathbb{C}^2)$. For dihedral groups $G \subset \mathrm{SL}(2, \mathbb{C})$, Becky Leng in her thesis [Len02] constructed an affine cover of $G\text{-Hilb}(\mathbb{C}^2)$ given by smooth surfaces in \mathbb{C}^4 . This thesis extends the explicit description of $G\text{-Hilb}(\mathbb{C}^2)$ to binary dihedral groups in $\mathrm{GL}(2, \mathbb{C})$, in the same spirit as [Len02].

The explicit construction of $G\text{-Hilb}(\mathbb{C}^2)$ for small binary dihedral subgroups $G \subset \text{GL}(2, \mathbb{C})$, which we provide in this thesis, uses the well-known interpretation of $G\text{-Hilb}(\mathbb{C}^2)$ as the moduli space of stable representations of the McKay quiver $\mathcal{M}_\theta(Q, R)$. We assign to any G -graph an open set in $\mathcal{M}_\theta(Q, R)$, and by classifying every possible G -graph, we are able to calculate an affine open cover of $\mathcal{M}_\theta(Q, R)$.

In Chapter 1 we give a brief introduction to the McKay correspondence paying particular attention to Ito and Nakamura's $G\text{-Hilb}(\mathbb{C}^2)$. We also present some well-known background material about cyclic quotient singularities, quivers and the moduli space of quiver representations.

In Chapter 2 we study the small dihedral groups $G \subset \text{GL}(2, \mathbb{C})$, classifying them into two families, $\text{BD}_{2n}(a)$ and $\text{BD}_{2n}(a, q)$. In this thesis we focus on the family of groups $\text{BD}_{2n}(a)$, and the last few sections of the chapter contains a study of the minimal resolution of the singularity $\mathbb{C}^2/\text{BD}_{2n}(a)$ and the representation theory of the $\text{BD}_{2n}(a)$ groups.

We believe that similar methods to those used in this thesis will apply to the family $\text{BD}_{2n}(a, q)$.

In Chapter 3 we describe every possible G -graph for a given $\text{BD}_{2n}(a)$ group, classifying them into the types A , B , C and D . We prove that any G -cluster $\mathcal{Z} \in G\text{-Hilb}(\mathbb{C}^2)$ admits as basis for $\mathcal{O}_{\mathcal{Z}}$ a G -graph of one of these types. The chapter concludes with a description of the special irreducible representations in terms of the continued fraction $\frac{2n}{a}$.

Chapter 4 contains the explicit calculation of $G\text{-Hilb}(\mathbb{C}^2)$ obtained by assigning to every G -graph an open set in $\mathcal{M}_\theta(Q, R)$. The calculation of the open sets in $\mathcal{M}_\theta(Q, R)$ corresponding to the G -graphs of type A , B , C and D , is given here, and we obtain an affine open cover of $G\text{-Hilb}(\mathbb{C}^2)$.

Chapter 2

Preliminaries

The content of this chapter is expository. From Section 2.1 to Section 2.5 we give a brief introduction to the McKay correspondence, focussing on the Ito and Nakamura approach by G -invariant Hilbert schemes.

Section 2.6 contains the background material needed in the following chapters. In Section 2.6.1 we introduce cyclic quotient singularities and their resolution by Hirzebruch–Jung continued fractions, and Sections 2.6.2 and 2.6.3 are dedicated to the moduli of quiver representations and its relation with the G -Hilbert scheme.

2.1 Du Val singularities

Finite subgroups $G \subset \mathrm{SL}(2, \mathbb{C})$ were classified by Felix Klein in the late 19th century. Up to conjugacy these groups are either *cyclic* \mathbb{Z}_n of order n , *binary dihedral* \mathbb{D}_{4n} of order $4n$, or a binary group corresponding to the Platonic solids: *binary tetrahedral* \mathbb{T} , *binary octahedral* \mathbb{O} or *binary icosahedral* \mathbb{I} , of orders 24, 48 and 120 respectively.

The quotient varieties $X := \mathbb{C}^2/G$, known as *Du Val singularities*, *rational double points* or *simple singularities*, have been studied in a great variety of contexts since Du Val and Coxeter in the 1930s. The quotient singularity X is isomorphic to a germ of a hypersurface in \mathbb{C}^3 situated at the origin. These are listed in Table 2.1.

Let $\pi: Y \rightarrow X$ be the minimal resolution, i.e. there are no -1 -curves in Y . Then the exceptional divisor $E \subset Y$ consists of several rational curves E_i intersecting transversally and such that $E_i^2 = -2$. We can describe the configuration of the exceptional curves in E by using the *Dynkin diagram*, which consists of a vertex for each E_i , and two vertices are

Type	Group G	Equation for X
A_n	Cyclic \mathbb{Z}_{n+1}	$x^2 + y^2 + z^n$
D_n	Binary dihedral $\mathbb{D}_{4(n-2)}$	$x^2 + y^2z + z^{n-1}$
E_6	Binary tetrahedral \mathbb{T}	$x^2 + y^3 + z^4$
E_7	Binary octahedral \mathbb{O}	$x^2 + y^3 + yz^3$
E_8	Binary icosahedral \mathbb{I}	$x^2 + y^3 + z^5$

Table 2.1: The Du Val singularities

joined by an edge if and only if their corresponding curves intersect. The Dynkin diagrams are one of the various characterisations of Du Val singularities (see Durfee [Dur79]).

2.2 The McKay correspondence

In this set up, McKay [McK80] realised that one can recover the same Dynkin graph for Du Val singularities purely in terms of the representation theory of G , without passing through the geometry of X .

Let G be a finite subgroup in $\mathrm{SL}(2, \mathbb{C})$ and let $\mathrm{Irr} G = \{\rho_0, \rho_1, \dots, \rho_n\}$ the set of irreducible representations of G . The action of G on \mathbb{C}^2 defines a 2-dimensional representation V , called the *natural representation*, which maps G injectively into $\mathrm{SL}(2, \mathbb{C})$. Any representation of G over \mathbb{C} can be written as a combination of irreducible representations up to equivalence. Therefore, for any $\rho_i \in \mathrm{Irr} G$, we have

$$\rho_i \otimes V = \sum_{\rho_j \in \mathrm{Irr} G} a_{i,j} \rho_j$$

where $a_{i,j} = \dim_{\mathbb{C}} \mathrm{Hom}_G(\rho_j, V \otimes \rho_i)$.

Definition 2.1. The *McKay quiver* of G is the directed graph with one vertex for every $\rho \in \mathrm{Irr} G$, and $a_{i,j}$ arrows from vertex ρ_j to ρ_i .

McKay showed that the graph obtained in this way without the trivial representation ρ_0 is the Dynkin diagram of the quotient singularity $X = \mathbb{C}^2/G$. In other words, we have the following one-to-one correspondence

$$\{\text{Exceptional curves } E_i\} \longleftrightarrow \{\text{Nontrivial } \rho_i \in \mathrm{Irr} G\}$$

also called the *classical McKay correspondence* for $G \subset \mathrm{SL}(2, \mathbb{C})$.

Since then, there have been several interpretations and generalisations of this beautiful correspondence from different areas of mathematics and physics. For nice introductions and related topics we recommend A. Craw’s thesis [Cra01] and M. Reid’s Bourbaki talk [Rei02].

As an slogan, we can read the correspondence as an equivalence between the geometry of the minimal resolution of X and the G -equivariant geometry of \mathbb{C}^2 (see [Rei02]).

2.3 Ito and Nakamura Hilbert schemes $G\text{-Hilb}(\mathbb{C}^2)$

Around 1996 Ito and Nakamura [IN96] introduce a new twist to the story: the *Hilbert scheme* $G\text{-Hilb}(\mathbb{C}^2)$ of G -clusters. They proved that for $G \subset \mathrm{SL}(2, \mathbb{C})$, $G\text{-Hilb}(\mathbb{C}^2)$ is the minimal resolution of singularities for \mathbb{C}^2/G , providing a new approach to the McKay correspondence.

There are two different notions of $G\text{-Hilb}(\mathbb{C}^2)$ in the literature (see also [CR02] §4.1): the “dynamic” denoted by Hilb^G and the “algebraic”, denoted by $G\text{-Hilb}$. In the former, and originally studied by Ito and Nakamura, consider first the Hilbert scheme $\mathrm{Hilb}^n \mathbb{C}^2$ of all 0-dimensional subschemes of length n . Then taking $n = |G|$, we define Hilb^G to be the irreducible component of $(\mathrm{Hilb}^n \mathbb{C}^2)^G$ containing the general G -orbit, so birational to \mathbb{C}^2/G (See [IN99] for details). In this case, a *cluster* is a flat deformation of a genuine G -orbit of n distinct points. The latter, and the one used in this thesis, is the *G -Hilbert scheme*: here a G -cluster \mathcal{Z} is a G -invariant 0-dimensional subscheme of \mathbb{C}^2 such that $\mathcal{O}_{\mathcal{Z}}$ is the regular representation of G .

Remark 2.2. Ito and Nakamura proved that any “dynamic” G -cluster satisfies the algebraic condition so $\mathrm{Hilb}^G \subset G\text{-Hilb}(\mathbb{C}^2)$, but the converse is not true in general (see for example [CMT07a], [CMT07b] for examples in the Abelian case). Nevertheless, both definitions agree for $G \subset \mathrm{GL}(2, \mathbb{C})$ by Ishii [Ish02], and for $G \subset \mathrm{SL}(3, \mathbb{C})$ by Bridgeland, King and Reid [BKR01].

In higher dimensions it is known that $G\text{-Hilb}(\mathbb{C}^2)$ is a crepant resolution for finite subgroups $G \subset \mathrm{SL}(3, \mathbb{C})$ (first proved by Nakamura [Nak01] for G Abelian and by Bridge-

land, King and Reid [BKR01] for G in general), but this result already fail to hold for finite subgroups in $\mathrm{SL}(4, \mathbb{C})$. For example, the cyclic quotient singularity $\mathbb{C}^4/\mathbb{Z}_r$ of type $\frac{1}{r}(1, r-1, i, r-i)$ does not have a crepant resolution. On the other hand, M. Sebestean [Seb05] shows in her thesis that $\mathbb{Z}_{2^{n-1}}\text{-Hilb}(\mathbb{C}^2)$ is a crepant resolution for the cyclic quotient singularity $\mathbb{C}^n/\mathbb{Z}_{2^{n-1}}$ of type $\frac{1}{2^{n-1}}(1, 2, 2^2, \dots, 2^{n-1})$.

2.4 The $\mathrm{GL}(2, \mathbb{C})$ case and the special McKay correspondence

In attempting to extend the McKay correspondence to finite groups $G \subset \mathrm{GL}(2, \mathbb{C})$, one immediately observes that the number of irreducible representation of G is greater than the number of irreducible components of the exceptional divisor E . Nevertheless, among the irreducible representations exists a subset that does indeed verify the McKay correspondence as in 2.2. In this set up, Wunram [Wun88] and Riemenschneider introduce the notion of *special* irreducible representation, and stated the *Special McKay correspondence* for $G \subset \mathrm{GL}(2, \mathbb{C})$ as:

$$\{\text{Exceptional curves } E_i\} \xleftrightarrow{1\text{-to-1}} \{\text{Nontrivial special } \rho_i \in \mathrm{Irr} G\}$$

If $G \subset \mathrm{SL}(2, \mathbb{C})$ every representation is special, so we recover the classical McKay correspondence. When G is Abelian, Ito in [Ito02] gives a nice combinatorial description of these special representations, and in a recent paper Iyama and Wemyss [IW08] classify them for any two dimensional quotient singularity.

In the Abelian case Kidoh [Kid01] proved that the $G\text{-Hilb}(\mathbb{C}^2)$ is the minimal resolution of \mathbb{C}^2/G , and finally in 2002 Ishii [Ish02] showed that $G\text{-Hilb}(\mathbb{C}^2)$ is the minimal resolution for any finite small subgroup $G \subset \mathrm{GL}(2, \mathbb{C})$, using derived categories machinery.

2.5 Explicit methods

When the group G is Abelian, the direct calculations of $G\text{-Hilb}(\mathbb{C}^2)$ are well understood in dimensions two and three (see for example [Ito02] in dimension two, and [Nak01], [CR02] for nice descriptions in dimension three). More recently, the $G\text{-Hilb}$ has been obtained explicitly as the moduli space of stable representations $\mathcal{M}_\theta(Q, R)$ of different quivers: [CMT07a], [CMT07b] use the McKay quiver for Abelian subgroups in $\mathrm{GL}(n, \mathbb{C})$, [Cra07]

with the Special McKay quiver of sections and [Wem07] using reconstruction algebras, the last two studying Abelian subgroups in $GL(2, \mathbb{C})$.

The non Abelian case has been treated much less, apart from Ito and Nakamura's original calculations [IN99] for non Abelian subgroups $G \subset SL(2, \mathbb{C})$ and Becky Leng's thesis [Len02] for binary dihedral and trihedral subgroups in $SL(2, \mathbb{C})$ and $SL(3, \mathbb{C})$ respectively. While Ito and Nakamura's description focuses only on the exceptional divisor, Leng gives an affine cover of $G\text{-Hilb}(\mathbb{C}^2)$ for binary dihedral subgroups $G \subset SL(2, \mathbb{C})$ consisting of smooth surfaces in \mathbb{C}^4 .

2.6 Background material

2.6.1 Cyclic quotient singularities

In this section we describe the cyclic quotient singularities and their resolutions using Hirzebruch–Jung continued fractions, which will be needed in following chapters. This material is taken from [Rei].

Let G be a finite group acting on an affine variety M with coordinate ring $k[M]$. Then the quotient $X = M/G$ is an affine variety whose points correspond one-to-one with G -orbits and such that $k[X] = k[M]^G$. In other words, $X = \text{Spec } k[M]^G$.

A *cyclic quotient singularity* X of type $\frac{1}{r}(1, a)$ at the origin is $X = \mathbb{A}_{x,y}^2/\mu_r$, where the diagonalised action of μ_r is given by $\alpha : (x, y) \mapsto (\varepsilon x, \varepsilon^a y)$ with $(r, a) = 1$, and ε is a primitive r -th root of unity (see also [Rei87] §4, for a more general setting).

Definition 2.3. Let r, a be coprime integers with $r > a > 0$. Then the Hirzebruch–Jung continued fraction of r/a is the expression

$$\frac{r}{a} = b_1 - \frac{1}{b_2 - \frac{1}{b_3 - \dots}} = [b_1, b_2, \dots, b_k]$$

Consider the lattice $L = \mathbb{Z}^2 + \mathbb{Z} \cdot \frac{1}{r}(1, a) \subset \mathbb{R}^2$. We define the Newton polygon of L as the convex hull in \mathbb{R}^2 of all nonzero lattice points in the positive quadrant. Then, the lattice

points in the boundary of the Newton polygon of L are

$$e_0 = (0, 1), e_1 = \frac{1}{r}(1, a), e_2, \dots, e_k, e_{k+1} = (1, 0)$$

Any two consecutive lattice points e_i, e_{i+1} for $i = 0, \dots, k$ form an oriented basis of L , and they satisfy

$$e_{i-1} + e_{i+1} = b_i e_i \tag{2.1}$$

where the integers b_i are the entries of the continued fraction $\frac{r}{a} = [b_1, \dots, b_k]$.

The resolution of singularities $Y \rightarrow X$ is constructed as follows: for each $i = 0, \dots, k$ let λ_i, μ_i be the monomials forming the dual basis M to e_i, e_{i+1} , i.e.

$$e_i(\lambda_i) = 1, e_i(\mu_i) = 0, \text{ and } e_{i+1}(\lambda_i) = 0, e_{i+1}(\mu_i) = 1$$

Then $Y = Y_0 \cup Y_1 \cup \dots \cup Y_k$ where each $Y_i \cong \mathbb{C}^2$ with coordinates λ_i, μ_i , and the glueing

$$Y_i \setminus (\mu_i = 0) \rightarrow Y_{i+1} \setminus (\lambda_{i+1} = 0)$$

is the isomorphism defined by

$$\begin{cases} \lambda_{i+1} &= \mu^{-1} \\ \mu_{i+1} &= \lambda \mu^{b_i} \end{cases}$$

It follows that the resolution Y has the following exceptional divisor:

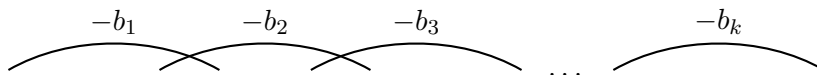

where the $-b_i$ denote the self-intersections of each of the rational curves.

Example 2.4. Consider $\frac{1}{7}(1, 2)$. The continued fraction $\frac{7}{2} = [4, 2]$ so $e_0 = (0, 1)$, $e_1 = \frac{1}{7}(1, 2)$, $e_2 = \frac{1}{7}(4, 1)$ and $e_3 = (1, 0)$. The lattice L and its Newton polygon is shown in the following diagram:

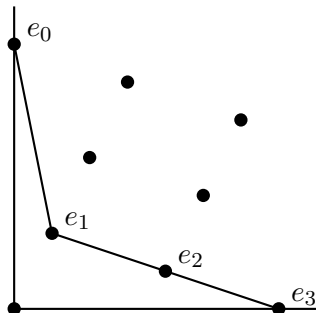

The dual basis for each pair of consecutive points in the boundary of the Newton polygon is

$$\lambda_0 = x^7, \mu_0 = y/x^2, \quad \lambda_1 = x^2/y, \mu_1 = y^4/x, \quad \lambda_2 = x/y^4, \mu_2 = y^7$$

The resolution is therefore $Y = Y_0 \cup Y_1 \cup Y_2$ where $Y_i = \mathbb{C}_{(\lambda_i, \mu_i)}^2$ for $i = 0, 1, 2$, and the exceptional divisor consists of two rational curves $E_1 \cong \mathbb{P}_{(y:x^2)}^1$ and $E_2 \cong \mathbb{P}_{(y^4:x)}^1$ with self-intersections -4 and -2 respectively.

As we have just seen, the continued fraction $\frac{r}{a}$ tells us very useful information about the resolution of singularities of $X = \mathbb{C}^2/(\mathbb{Z}/r)$ where the action of (\mathbb{Z}/r) is of type $\frac{1}{r}(1, a)$. Now we are going to see how we can use the continued fraction $\frac{r}{r-a}$ to calculate X itself.

The invariant monomials of the action are generated by

$$u_0 = x^r, u_1 = x^{r-a}y, u_2, \dots, u_l, u_{l+1} = y^r$$

satisfying the relations

$$u_{i-1}u_{i+1} = u_i^{a_i} \tag{2.2}$$

where the exponents a_i are the entries of the continued fraction $\frac{r}{r-a} = [a_1 \dots, a_l]$.

The ring of invariant monomials $\mathbb{C}[x, y]^G$ is generated by the monomials u_i , and the relations 2.2 are enough to determine $X = \text{Spec } \mathbb{C}[x, y]^G \subset \mathbb{C}^{k+2}$ set-theoretically (for a full set of generators we also need relations for $u_i u_j$ with $|i - j| \geq 2$).

2.6.2 Quivers and the moduli of quiver representations

For an introduction to quivers and their representation see for example [CB] or [ASS06]. Most of this section and the following is taken from [Cra08].

Definition 2.5. A *quiver* Q is an oriented graph with Q_0 the set vertices and Q_1 the set of arrows, together with the maps $h, t : Q_1 \rightarrow Q_0$ giving the tail and head of every arrow.

We suppose that Q_0 and Q_1 are both finite sets, and that the quiver is connected, i.e. the graph obtained by forgetting the arrows is connected.

A *path* in Q is a sequence of arrows $a_1 a_2 \dots a_k$ such that $h(a_i) = t(a_{i+1})$ for every $1 \leq i \leq k - 1$. At every vertex $i \in Q_0$ there exists the trivial path denoted by e_i such that $t(e_i) = h(e_i) = i$.

Definition 2.6. The *path algebra* $\mathbb{k}Q$ is the \mathbb{k} -algebra with basis the paths in Q . The multiplication in $\mathbb{k}Q$ is given by the concatenation of paths if they are consecutive, and zero if not. The identity element is $\sum e_i$.

Note that the path algebra is finite dimensional if and only if Q has no oriented cycles.

Definition 2.7. A *representation of a quiver* Q is $W = ((W_i)_{i \in Q_0}, (\varphi_a)_{a \in Q_1})$ where W_i is a \mathbb{k} -vector space for each vertex in Q and $\varphi_a : W_i \rightarrow W_j$ is a \mathbb{k} -linear map for every arrow $a : i \rightarrow j$.

We denote by $\mathbf{d} = (d_i)_{i \in Q_0} = (\dim W_i)_{i \in Q_0}$ the *dimension vector* of W . A representation is finite dimensional if every vector space W_i is finite dimensional.

A map between representations W and W' is a family $\psi_i : W_i \rightarrow W'_i$ for each vertex $i \in Q_0$ of \mathbb{k} -linear maps such that for every arrow $a : i \rightarrow j$ the following square commutes:

$$\begin{array}{ccc} W_{t(a)} & \xrightarrow{\varphi_a} & W_{h(a)} \\ \downarrow \psi_{t(a)} & & \downarrow \psi_{h(a)} \\ W'_{t(a)} & \xrightarrow{\varphi'_a} & W'_{h(a)} \end{array}$$

We denote by $\text{rep}_{\mathbb{k}}(Q)$ the category of finite dimensional representations of Q .

A *relation* in a quiver Q (with coefficients in \mathbb{k}) is a \mathbb{k} -linear combination of paths of length at least 2, each with the same head and the same tail. Any finite set of relations R in Q determines a two-sided ideal $\langle R \rangle$ in $\mathbb{k}Q$. The quiver (Q, R) is called the *bound quiver* or *quiver with relations*, and a representation of (Q, R) is a representation of Q where each relation must be satisfied by the homomorphisms between the vector spaces W_i for $i \in Q_0$. The category of finite dimensional representations of (Q, R) is denoted by $\text{rep}_{\mathbb{k}}(Q, R)$.

Proposition 2.8. *The category $\text{rep}_{\mathbb{k}}(Q, R)$ is equivalent to the category of finite dimensional left $\mathbb{k}Q/\langle R \rangle$ -modules.*

Proof. ([ASS06]) Let $I = \langle R \rangle$ be the two sided ideal, $A = \mathbb{k}Q/I$ and M be an A -module. We define

$$W_M := (M_i, \varphi_a)_{i \in Q_0, a \in Q_1}$$

to be the corresponding representation of Q , where $M_i := M\bar{e}_i$ with $\bar{e}_i = e_i + I$ the primitive idempotent in A . For the maps φ_a between the modules M_i , if $(a : i \rightarrow j) \in Q_1$ and $\bar{a} = a + I$ its class modulo I , then define $\varphi_a : M_i \rightarrow M_j$ as $\varphi_a(x) = x\bar{a} := xe_i\bar{a}e_j$, for

$x \in M_i$.

We need to check that φ_a are \mathbb{k} -linear and that they satisfy the relations given by I :

$$\begin{aligned}\varphi_a(\lambda x + \mu y) &= (\lambda x + \mu y)e_i \bar{a} e_j \\ &= \lambda x e_i \bar{a} e_j + \mu y e_i \bar{a} e_j \quad \text{since } M_i \text{ is an } A\text{-module} \\ &= \varphi_a(x) + \varphi_a(y)\end{aligned}$$

for any $x, y \in M_i$, $\lambda, \mu \in \mathbb{k}$.

Finally, if $\rho = \sum \lambda_i \rho_i$ is a relation in I , where $\rho_i = a_{i,1} a_{i,2} \dots a_{i,l_i}$ are paths in Q , then

$$\begin{aligned}\varphi_\rho(x) &= \sum \lambda_i \varphi_{\rho_i}(x) \quad \text{by linearity} \\ &= \sum \lambda_i \varphi_{a_{i,l_i}} \dots \varphi_{a_{i,1}}(x) = \sum \lambda_i x \bar{a}_{i,1} \dots \bar{a}_{i,l_i} \\ &= x \sum \lambda_i \bar{a}_{i,1} \dots \bar{a}_{i,l_i} = x \bar{\rho} = 0.\end{aligned}$$

Conversely, if we have a representation $W = (W_i, \varphi_a)$ of Q , we associate to it the A -module $M_W := \bigoplus_{i \in Q_0} M_i$. The module structure comes as follows: Let $x = (x_i)_{i \in Q_0} \in M_W$ and $\rho \in \mathbb{k}Q$, then

$$x \cdot \rho := \begin{cases} \text{If } \rho = e_i & , x \cdot \rho = x e_i = x_i \\ \text{If } \rho = a_1 \dots a_l & , (x \cdot \rho)_i = \delta_{h(\rho), i} \varphi_\rho(x_{t(\rho)}) \end{cases}$$

where $\varphi_\rho = \varphi_{a_l} \dots \varphi_{a_1}$.

Note that if $\rho \in I$ nontrivial then

$$x \cdot \rho = (0, \dots, 0, \varphi_\rho(x_{t(\rho)}), 0, \dots, 0) = (0, \dots, 0, \varphi_{a_l} \dots \varphi_{a_1}(x_{t(\rho)}), 0, \dots, 0) = 0$$

and M_W is an A -module by $x \cdot (\rho + I) := x \cdot \rho$. □

Fix the dimension vector \mathbf{d} and consider the set of representations of Q with such dimension vector. By choosing a basis of each vector space W_i , we can identify $W_i \cong \mathbb{k}^{d_i}$ and every map φ_a is a matrix of size $d_{t(a)} \times d_{h(a)}$. Then the *representation space* is

$$\bigoplus_{a \in Q_1} \text{Mat}_{d_{t(a)}, d_{h(a)}} \cong \mathbb{A}_{\mathbb{k}}^N$$

where $N := \sum_{a \in Q_1} d_{t(a)} d_{h(a)}$. The isomorphism classes of such representations are orbits by the action of the change of basis group $G = \prod_{i \in Q_0} \text{GL}(W_i)$, where $m = (m_i)_{i \in Q_0} \in G$

acts on $\psi = (\psi_a)_{a \in Q_1}$ as

$$(m \cdot \psi)_a = m_{h(a)} \psi_a m_{t(a)}^{-1}$$

To construct an algebraic variety parametrising these isomorphism classes, we need to avoid the well-known problem of having orbits which are not closed, that is, we need need to parametrise orbits under certain notion of stability. This is the subject of Geometric Invariant Theory (the standard reference is [MFK94]).

The notion of stability for representations of a quiver is due to A. King [Kin94]. Let $\theta \in \mathbb{Q}^{Q_0}$ and define $\theta(W) := \sum_{i \in Q_0} \theta_i d_i$, for any representation W of Q of dimension vector $\mathbf{d} = (d_i)_{i \in Q_0}$. Then W is said to be θ -semistable if $\theta(W) = 0$ and if for every proper nonzero subrepresentation $W' \subset W$ we have $\theta(W') \geq 0$. The notion of θ -stability is obtained by replacing \geq by $>$ as usual.

In the same way, we define a point $w \in \mathbb{A}^N$ to be θ -(semi)stable if the corresponding representation W is θ -(semi)stable.

Remark 2.9. Let Q be a quiver with a distinguished source, denoted by $\rho_0 \in Q_0$, that admits a path to every other vertex in Q . Consider any stability condition $\theta \in \mathbb{Q}^{Q_0}$ with $\theta_i > 0$ for $i \neq 0$ (and hence $\theta_0 < 0$). Then

1. θ is *generic*, i.e. every θ -semistable point is θ -stable.
2. A representation W of Q is stable if and only if, as a $\mathbb{k}Q/\langle R \rangle$ -module, W is generated from ρ_0 .

Let (Q, R) be a bound quiver. Consider the \mathbb{k} -linear map $\phi : \mathbb{k}Q \rightarrow \mathbb{k}[x_{a_{ij}} : a = (a_{ij}) \in Q_1]$ that sends a path $p = p_1 \cdots p_k \in \mathbb{k}Q$ to the polynomial obtained by multiplying the corresponding matrices and identifying the entry a_{ij} with the monomial $x_{a_{ij}}$. Let the ideal I_R be the image of $\langle R \rangle$ under ϕ . Thus, a point in \mathbb{A}^N corresponds to a representation of the bound quiver (Q, R) if and only if it lies in the subscheme $\mathbb{V}(I_r)$ cut out by the ideal I_R . Then,

$$\mathbb{V}(I_R) //_{\theta} G = \text{Proj} \left(\bigoplus_{j \in \mathbb{N}} (\mathbb{k}[x_{a_{ij}} : a = (a_{ij}) \in Q_1] / I_R)_{j\theta} \right)$$

is the *categorical* quotient (G -orbit closures of θ -semistable points) of the open subscheme $\mathbb{V}(I_R)_{\theta}^{\text{ss}} \subseteq \mathbb{V}(I_R)$ parametrising θ -semistable representations of (Q, R) .

If θ is generic we define

$$\mathcal{M}_\theta(Q, R) := \mathbb{V}(I_R) //_\theta G$$

the *geometric* quotient (the restriction to the θ -stable locus) parametrising θ -stable representations of (Q, R) . Since θ is generic it represents a functor ([Kin94], see also [Cra08] Theorem 4.15, Exercise 4.18) so it is a fine moduli space.

Remark 2.10. Craw-Maclagan-Thomas observed that the ideal I_R may not be prime, and therefore $\mathbb{V}(I_R) //_\theta G$ may be reducible. See [CMT07b] Example 4.12, for a reducible $\mathcal{M}_\theta(Q, R)$ given the McKay quiver of the group $\frac{1}{14}(1, 9, 11)$ in $\mathrm{GL}(3, \mathbb{C})$.

2.6.3 $\mathcal{M}_\theta(Q, R)$ and G -Hilb

Let $S = \mathbb{k}[x_1, \dots, x_n]$ and $G \subset \mathrm{GL}(n, \mathbb{C})$ be small and finite. Let Q be the McKay quiver of G (see Definition 2.1) and consider the bound McKay quiver (Q, R) (see Section 5.1.2 for the relations R) with distinguished vertex the one corresponding to the trivial representation ρ_0 .

Definition 2.11. An S -module M is G -equivariant if and only it carries a G -action verifying

$$g \cdot (sm) = (g \cdot s)(g \cdot m) \quad \text{for } g \in G, s \in S, \text{ and } m \in M.$$

The *skew group algebra* $S * G$ is the free S -module with basis G and ring structure given by $(sg) \cdot (s'g') := s(g \cdot s')gg'$ for $s, s' \in S$ and $g, g' \in G$.

The quotient algebra $\mathbb{k}Q/\langle R \rangle$ is known to be *Morita equivalent* to the skew group algebra $S * G$ (see for example [Yos90] Chapter 10), i.e. there is an additive equivalence between the category of left $\mathbb{k}Q/\langle R \rangle$ -modules and the category of left $S * G$ -modules. But notice that left $S * G$ -modules, or equivalently representations of (Q, R) , are precisely G -equivariant S -modules.

On the other hand, for any cluster $\mathcal{Z} \in G\text{-Hilb}(\mathbb{C}^n)$ we can interpret the ring $\mathcal{O}_{\mathcal{Z}} = S/I_{\mathcal{Z}}$ as a G -equivariant S -module. Moreover, as an S -module, $\mathcal{O}_{\mathcal{Z}}$ is generated by 1 mod $I_{\mathcal{Z}}$. Therefore, we can consider the following definition for the G -invariant Hilbert scheme

$$G\text{-Hilb}(\mathbb{C}^n) := \{G\text{-equivariant modules } M = \mathbb{k}[x_1, \dots, x_n]/I \text{ with } M \cong_{\mathbb{k}G} \mathbb{k}G\}$$

If we take any stability condition θ such that $\theta_i > 0$ for $i \neq 0$, and $\theta_0 < 0$, the Remark 2.9 implies that a θ -stable representation is a cyclic $S * G$ -module with generator the trivial representation. Thus,

$$G\text{-Hilb}(\mathbb{C}^n) \cong \mathcal{M}_\theta(Q, R)$$

is the moduli space of θ -stable representations of the bound McKay quiver.

Chapter 3

Dihedral groups in $GL(2, \mathbb{C})$

In this chapter we define the finite dihedral subgroups $G \subset GL(2, \mathbb{C})$, and we explain in Section 3.2 the method of resolution of the quotient singularity \mathbb{C}^2/G that will be used to construct $G\text{-Hilb}(\mathbb{C}^2)$. For this purpose, we give in Theorem 3.11 a classification of the small binary dihedral subgroups $G \subset GL(2, \mathbb{C})$ in terms of a (choice of) maximal cyclic normal subgroup of G , and show how to recover the standard classification given by Brieskorn [Bri68].

In Section 3.4 we focus our attention on the $BD_{2n}(a)$ groups. They form one of the two distinguished families of small binary dihedral groups in $GL(2, \mathbb{C})$ and are the groups considered in Chapters 4 and 5. In Theorem 3.15 we describe the minimal resolution of the quotient singularity $\mathbb{C}^2/BD_{2n}(a)$. The last two sections, 3.4.1 and 3.4.2, are dedicated to the study of the representation theory of $BD_{2n}(a)$ groups.

3.1 Definition

Definition 3.1. A finite group $G \subset GL(2, \mathbb{C})$ is *dihedral* if there exists a coordinate system where, for any element $g \in G$,

either $g \in A$ where $A \trianglelefteq G$ is an Abelian subgroup of index 2,

$$\mathbf{or} \quad g = \begin{pmatrix} 0 & \beta_1 \\ \beta_2 & 0 \end{pmatrix}, \text{ with } g^2 \in A.$$

A dihedral group is *binary* if it contains the element $-I$, where I is the identity matrix. If n is the order of A , then we have $|G| = 2n$.

We may assume for simplicity that A is cyclic, i.e. after diagonalising we have that $A = \langle \frac{1}{n}(1, a) \rangle$ with $0 \leq a < n$. In addition, by changing coordinates we may also assume that $\beta_1 = 1$. We then have the following consequences:

Proposition 3.2. *Let G a dihedral group. Then*

(1) $G = \left\langle \alpha = \frac{1}{n}(1, a), \beta = \begin{pmatrix} 0 & 1 \\ \varepsilon^j & 0 \end{pmatrix} \right\rangle$, where $j \equiv aj \pmod{n}$ and ε is a primitive n -th root of unity.

(2) $a^2 \equiv 1 \pmod{n}$ and $\alpha\beta = \beta\alpha^a$.

(3) $(a, n) = 1$.

Proof. (1). Since A has index 2 in G we have $G = \{A, \beta A\}$. Now the condition $g^2 \in A$ implies $g^2 = \begin{pmatrix} \beta_2 & 0 \\ 0 & \beta_2 \end{pmatrix} = \begin{pmatrix} \varepsilon^j & 0 \\ 0 & \varepsilon^{aj} \end{pmatrix}$, i.e. $\beta_2 = \varepsilon^j = \varepsilon^{aj}$ for some $j \in [0, \dots, n-1]$.

(2) and (3). Note that $\alpha\beta \in \beta A$ since it is not diagonal, so there exist a relation of the form $\alpha\beta = \beta\alpha^i$ for some $i \in [0, \dots, n-1]$. Then for some j such that $j \equiv aj \pmod{n}$ we have

$$\begin{aligned} \begin{pmatrix} \varepsilon & 0 \\ 0 & \varepsilon^a \end{pmatrix} \begin{pmatrix} 0 & 1 \\ \varepsilon^j & 0 \end{pmatrix} &= \begin{pmatrix} 0 & 1 \\ \varepsilon^j & 0 \end{pmatrix} \begin{pmatrix} \varepsilon^i & 0 \\ 0 & \varepsilon^{ai} \end{pmatrix} \\ \begin{pmatrix} 0 & \varepsilon \\ \varepsilon^{a+j} & 0 \end{pmatrix} &= \begin{pmatrix} 0 & \varepsilon^{ai} \\ \varepsilon^{i+j} & 0 \end{pmatrix} \end{aligned}$$

so that $\varepsilon = \varepsilon^{ai}$ and $\varepsilon^{a+j} = \varepsilon^{i+j}$. Equivalently, $ai \equiv 1$ and $a \equiv i \pmod{n}$, which implies that $(a, n) = 1$ and $a^2 \equiv 1 \pmod{n}$ respectively. \square

Definition 3.3. An element $g \in G \subset \text{GL}(2, \mathbb{C})$ is a *quasireflection* if the matrix $g - I$ has rank 1, where I denotes the $n \times n$ identity matrix. In other words, g is a quasireflection if it fixes a hyperplane. A group G is said to be *small* if it does not contain quasireflections.

A cyclic group of the form $\langle \frac{1}{n}(1, a) \rangle$ is small if and only if $(a, n) = 1$. Hence, by Proposition 3.2 (3), the normal subgroup A of a dihedral group is small.

The following theorem, due to Chevalley, Shephard and Todd, has traditionally reduced the study of quotients \mathbb{C}^n/G to the case when G is small.

Theorem 3.4 ([ST54]). *Let $G \subset \mathrm{GL}(2, \mathbb{C})$ and H be the maximal subgroup of G generated by quasireflections. Then $\mathbb{C}^n/H \cong \mathbb{C}^n$.*

3.2 Resolution of dihedral singularities

Let us now look at the geometric construction of the resolution of a dihedral singularity \mathbb{C}^2/G . Let G be a dihedral group with cyclic maximal subgroup $A = \langle \alpha \rangle \trianglelefteq G$.

Consider first the action of A on \mathbb{C}^2 . The quotient affine variety $X = \mathbb{C}^2/A$ is the toric quotient singularity of type $\frac{1}{n}(1, a)$, with an isolated singular point at the origin. The resolution of singularities $Y = A\text{-Hilb}(\mathbb{C}^2) \rightarrow X$ is given by the Hirzebruch–Jung continued fraction $\frac{n}{a} = [b_1, \dots, b_k]$ (see Section 2.6.1). Then $Y = Y_0 \cup \dots \cup Y_k$, where each $Y_i \cong \mathbb{C}^2$ and the exceptional divisor on Y is $E = \bigcup_{i=1}^k E_i$ with $E_i \cong \mathbb{P}^1$ and $E_i^2 = -b_i$.

We start with an easy Lemma and a Proposition showing how the condition $a^2 \equiv 1 \pmod{n}$ creates a lot of symmetry in Y .

Lemma 3.5. *Let $e_i = (p_i, q_i)$ be a point in the Newton polygon of the singularity $\frac{1}{n}(1, a)$ such that $a^2 \equiv 1 \pmod{n}$. Then $ap_i \equiv q_i \pmod{n}$ and $aq_i \equiv p_i \pmod{n}$.*

Proof. (i) $ap_i \equiv q_i \pmod{n}$ is true by definition of the lattice $L = \mathbb{Z} + \frac{1}{n}(1, a) \cdot \mathbb{Z}$, and multiplying by a we have $a^2 p_i \equiv p_i \equiv a q_i \pmod{n}$. \square

Proposition 3.6. *If $a^2 \equiv 1 \pmod{n}$ then the continued fraction $\frac{n}{a}$ is symmetric with respect to the middle term, i.e.*

$$\frac{n}{a} = [b_1, b_2, \dots, b_{m-1}, b_m, b_{m-1}, \dots, b_2, b_1]$$

Proof. Let L be the lattice of weights and M the dual lattice of monomials, and consider the continued fractions $\frac{n}{n-a} = [a_1, \dots, a_s]$ and $\frac{n}{a} = [b_1, \dots, b_r]$. If a monomial $x^i y^j$ is $\frac{1}{n}(1, a)$ -invariant then $i + aj \equiv 0 \pmod{n}$, and by the assumption $a^2 \equiv 1 \pmod{2n}$, $x^j y^i$ is also invariant. Therefore, the continued fraction $\frac{n}{n-a}$ is symmetric, i.e. $a_i = a_{r-i}$. Indeed, let $u_{i-1} = x^{k'} y^{l'}$, $u_i = x^k y^l$, $u_{i+1} = x^{k''} y^{l''}$ be three consecutive invariant monomials

and $u_{r-(i+1)} = x^{l''} y^{k''}$, $u_{r-i} = x^l y^k$, $u_{r-(i-1)} = x^{l'} y^{k'}$ their symmetric partners. Since $u_{k-1} u_{k+1} = u_k^{a_k}$ we have

$$k' + k'' = a_i k = a_{r-i} k \quad \text{and} \quad l' + l'' = a_i l = a_{r-i} l$$

and then $a_i = a_{r-i}$ for all i .

The symmetry of $\frac{n}{n-a}$ implies the symmetry of $\frac{n}{a}$ (see [Rie74]) and we are done. \square

At the moment we have only considered the cyclic part $A = \langle \alpha \rangle$ of the dihedral group G . To complete its action on \mathbb{C}^2 we need to act with $G/A \cong \mathbb{Z}/2\mathbb{Z}$ on $Y = A\text{-Hilb}(\mathbb{C}^2)$, and since $G/A = \{A, \beta_j A\}$ it remains to act with the involution β_j on Y .

The action of β by $(x, y) \mapsto (y, \varepsilon^{jq} x)$ interchanges the coordinates x and y . But notice that the symmetry in the continued fraction $\frac{n}{a}$ implies that the coordinates along the exceptional curves Y_i in the resolution $Y \rightarrow \mathbb{C}^2/A$ are also symmetric, i.e. β_j identifies the affine subsets $Y_i \cong \mathbb{C}_{(x^r/y^s, y^u/x^v)}^2$ with $Y_{r-i} \cong \mathbb{C}_{(x^u/y^v, y^r/x^s)}^2$. Furthermore, the rational exceptional curves in E covered by these affine patches are identified.

In the case when the number of rational curves in Y is even, i.e. l is even, there exists a middle affine set Y_m covering the intersection of the two middle rational curves E_{m-1} and E_m . The $\mathbb{Z}/2$ -action of β_j identifies Y_m with itself, fixing the point $E_{m-1} \cap E_m$. In fact, this fixed point will not be singular in the quotient since we have the following lemma.

Proposition 3.7. *Suppose that the continued fraction $\frac{n}{a}$ has an even number of elements. Then G has quasireflections.*

Proof. Let $\{Y_i\}_{i=1, \dots, r}$ be the open affine covering of $A\text{-Hilb}(\mathbb{C}^2)$ with middle open set $Y_m \cong \mathbb{C}_{\lambda, \mu}^2$, where $\lambda = x^u/y^v$ and $\mu = y^u/x^v$.

The action of β_j on this open set is

$$\begin{cases} \lambda = x^u/y^v & \mapsto \varepsilon^{-jqv} y^u/x^v = \varepsilon^{-jqv} \mu \\ \mu = y^u/x^v & \mapsto \varepsilon^{jqv} x^u/y^v = \varepsilon^{jqv} \lambda \end{cases}$$

Hence the action is given by the matrix $M = \begin{pmatrix} 0 & \varepsilon^{-jqv} \\ \varepsilon^{jqv} & 0 \end{pmatrix}$, where

$$\det M = -\varepsilon^{-jqv+jqv} = -\varepsilon^{-jqv+jqv} = -\varepsilon^{-jqv+jqv} = -1$$

i.e. M is a reflection. By Theorem 3.4 we have $Y_m/\langle\beta_j\rangle \cong \mathbb{C}^2$, and the group is not small. \square

From now on we suppose that $\frac{n}{a}$ has odd number of elements. Therefore, the exceptional divisor $E \subset Y$ has an odd number of irreducible components E_i , and there exists a middle rational curve $E_m \cong \mathbb{P}^1$ with coordinate ratio $(x^q : y^q)$, covered by Y_{m-1} and Y_m . Then β_j identifies Y_{m-1} with Y_m and it is an involution on E_m . Thus, after acting with β_j we have two fixed points on E_m which are singular on $Y/\langle\beta_j\rangle$ depending on whether or not there are quasireflections. If there are quasireflections, the resolution will have a type A Dynkin diagram. If there are no quasireflections, $Y/\langle\beta_j\rangle$ has 2 singular A_1 points, and blowing them up we obtain the Dynkin diagram of type D that we were looking for.

Remark 3.8. Since $G\text{-Hilb}(\mathbb{C}^2)$ is the minimal resolution of \mathbb{C}^2/G ([Ish02]) and by the uniqueness of minimal models in dimension 2, the previous construction can be expressed in the following diagram:

$$\begin{array}{ccc}
 & & \mathbb{C}^2 \curvearrowright A \trianglelefteq G \subset GL(2, \mathbb{C}) \\
 & & \downarrow \\
 G/A \curvearrowright A\text{-Hilb}(\mathbb{C}^2) & \longrightarrow & \mathbb{C}^2/A \\
 \downarrow & & \\
 G\text{-Hilb}(\mathbb{C}^2) & \longrightarrow & \tilde{Y}
 \end{array}$$

In other words, we have that

$$G\text{-Hilb}(\mathbb{C}^2) \cong (G/A)\text{-Hilb}(A\text{-Hilb}(\mathbb{C}^2))$$

3.3 Classification of small binary dihedral groups in $GL(2, \mathbb{C})$

We start by giving a criteria for a dihedral group to be small.

Proposition 3.9. *Let G be a dihedral group. Then*

$$G \text{ is small} \iff \gcd(a+1, n) \nmid j$$

Proof. The elements of G are of the form α^i and $\alpha^i\beta$ for $i = 0, \dots, n-1$ (note that $\beta^2 = \alpha^j$ for some j). Since the subgroup $A = \langle\alpha\rangle$ is small, the quasireflections can only

occur among the elements of the form $\alpha^i \beta$ (except for $i = n$), and

$$\begin{aligned} \alpha^i \beta \text{ is a quasireflection} &\iff \det(\alpha^i \beta - I) = 0 \\ &\iff \begin{vmatrix} -1 & \varepsilon^i \\ -\varepsilon^{ai+j} & -1 \end{vmatrix} = 1 - \varepsilon^{(a+1)i+j} = 0 \\ &\iff (a+1)i \equiv -j \pmod{n} \end{aligned}$$

Therefore, G has no quasireflections if and only do not exist any solutions to the equation $(a+1)x \equiv -j \pmod{n}$. As a linear congruence, it only has solutions if the $\gcd(a+1, n)$ divides j . Indeed, if $g = \gcd(a+1, n)$ and u is a solution then $(a+1)u \equiv -j \pmod{g}$ and so $(a+1)u \equiv -j \equiv 0 \pmod{g}$, which only can happen if $g|j$. \square

Proposition-Definition 3.10. *Consider the subgroup*

$$\mathcal{J} = \{j \in [0, \dots, n-1] : j \equiv aj \pmod{n}\} \subset \mathbb{Z}/n\mathbb{Z}$$

Then \mathcal{J} is cyclic and we define q to be the smallest generator of \mathcal{J} .

In other words, for any element $j \in \mathcal{J}$ there exists a matrix $\alpha^j = \text{diag}(\varepsilon^j, \varepsilon^j) \in \frac{1}{n}(1, a)$, and the intersection of $\frac{1}{n}(1, a)$ with the scalar diagonal matrices is the cyclic subgroup generated by α^q .

Proof. First note that $\mathcal{J} \neq \emptyset$ since $0 \in \mathcal{J}$. The statement \mathcal{J} is a subgroup of $\mathbb{Z}/n\mathbb{Z}$ is clear. We need to check that it is cyclic.

The toric analog says that the points in the diagonal of the positive quadrant of the lattice $L = \mathbb{Z}^2 + \frac{1}{n}(1, a) \cdot \mathbb{Z}$ are multiples of the point $P = \frac{1}{n}(q, q)$. If the only element in the diagonal is the origin $(0, 0)$ then $\mathcal{J} = \{0\}$, which is trivially cyclic, and $q = 0$.

Suppose that exists a point in the diagonal different than the origin. Then there are two possibilities, either P is in the boundary of the Newton polygon or not. If it is in boundary then $P = e_i$ and $e_{i+1} = \frac{1}{n}(u, v)$ form a basis of L , for some i . If there exists another point $P' = \frac{1}{n}(q', q')$ in the diagonal but not a multiple of P then $(q', q') = k_1(q, q) + k_2(u, v)$ for some k_1, k_2 positive, which implies that e_{i+1} is also in the diagonal. This is a contradiction.

If P is not in the Newton polygon, then $P = k_1 e_i + k_2 e_{i+1}$ for two consecutive points e_i, e_{i+1} and some k_1, k_2 positive. Suppose there exists another P' in the diagonal and not multiple of P as before. The point $P'' = P' - P = \frac{1}{n}(q'', q'')$ with $q'' = q' + q$, lies in

the diagonal but not a multiple of P . On the other hand, $P'' \in \mathcal{J}$ so if $q'' < q$ we get a contradiction with the minimality of P , and if $q'' > q$ then we argue by induction to end up in the same contradiction. \square

Theorem 3.11. (i) Let $G = \langle \frac{1}{2n}(1, a), \beta \rangle$ be a small binary dihedral group.

- If $n = 2iq$, then $G = \mathrm{BD}_{2n}(a, q) := \langle \frac{1}{2n}(1, a), \beta_q \rangle$.
- If $n = (2i + 1)q$, then $G = \mathrm{BD}_{2n}(a) := \langle \frac{1}{2n}(1, a), \beta_n \rangle$,

where $\beta_n = \begin{pmatrix} 0 & 1 \\ -1 & 0 \end{pmatrix}$ and $\beta_q = \begin{pmatrix} 0 & 1 \\ \varepsilon^q & 0 \end{pmatrix}$ with ε a primitive $2n$ -th root of unity.

(ii) If G is not binary then G has quasireflections.

Proof. By Proposition 3.10 there exists $r \in \mathbb{N} \cup \{0\}$ such that $rq = n$, and we know that for $i = 0, 1, \dots, r-1$ the element $\beta_i = \begin{pmatrix} 0 & 1 \\ \varepsilon^{iq} & 0 \end{pmatrix}$ verifies the condition $\beta_i^2 = \alpha^{iq} \in \frac{1}{2n}(1, a)$. Hence any dihedral group is of the form $G_i = \langle \frac{1}{2n}(1, a), \beta_i \rangle$. We group the different steps of the proof into the following Lemma:

Lemma 3.12. (a) $G_0 \cong G_2 \cong \dots \cong G_{2i}$ and $G_1 \cong G_3 \cong \dots \cong G_{2i+1}$, where \cong means conjugacy of subgroups in $\mathrm{GL}(2, \mathbb{C})$.

- (b) If G is not binary then $G_0 \cong G_1$.
- (c) G_0 has quasireflections.
- (d) If G is binary then G_1 is small.

It is clear that the Lemma proves the Theorem. Indeed, the part (a) imply that we up to conjugacy there are at most only to dihedral groups with a given maximal cyclic subgroup generated with $\frac{1}{2n}(1, a)$. If the group is not binary, (b) and (c) imply that there is only one group up to conjugacy and it is not small. In the case when G is binary, by (d) any group in the conjugacy class represented by G_1 is small, while by (c) any element in the class represented by G_0 is not small. \square

Proof of the Lemma. (a) In both cases the conjugacy is given by the matrix $M = \begin{pmatrix} \varepsilon^{-iq} & 0 \\ 0 & 1 \end{pmatrix}$. Indeed, $M\alpha^j M^{-1} = \alpha^j$ for all j since all the matrices are diagonal. For the groups G_i

with i even we have

$$M\alpha^j\beta_0M^{-1} = \begin{pmatrix} \varepsilon^{-iq} & 0 \\ 0 & 1 \end{pmatrix} \begin{pmatrix} 0 & \varepsilon^j \\ \varepsilon^{aj} & 0 \end{pmatrix} \begin{pmatrix} \varepsilon^{iq} & 0 \\ 0 & 1 \end{pmatrix} = \begin{pmatrix} 0 & \varepsilon^{j-iq} \\ \varepsilon^{aj+iq} & 0 \end{pmatrix}$$

which is equal to $\alpha^k\beta_{2i} = \begin{pmatrix} 0 & \varepsilon^k \\ \varepsilon^{ak+2iq} & 0 \end{pmatrix}$ by taking $k \equiv j - iq \pmod{n}$ because

$$ak + 2iq \equiv a(j - iq) + 2iq = aj - aiq + 2iq \equiv aj - iq + 2iq = aj + iq \pmod{n}.$$

For the groups G_i with i odd we have

$$M\alpha^j\beta_1M^{-1} = \begin{pmatrix} \varepsilon^{-iq} & 0 \\ 0 & 1 \end{pmatrix} \begin{pmatrix} 0 & \varepsilon^j \\ \varepsilon^{aj+q} & 0 \end{pmatrix} \begin{pmatrix} \varepsilon^{iq} & 0 \\ 0 & 1 \end{pmatrix} = \begin{pmatrix} 0 & \varepsilon^{j-iq} \\ \varepsilon^{aj+iq+q} & 0 \end{pmatrix}$$

which is equal to $\alpha^k\beta_{2i+1} = \begin{pmatrix} 0 & \varepsilon^k \\ \varepsilon^{ak+(2i+1)q} & 0 \end{pmatrix}$ by taking $k \equiv j - iq \pmod{n}$ because

$$ak + (2i + 1)q = a(j - iq) + (2i + 1)q = aj - aiq + 2iq + q \equiv aj + iq + q \pmod{n}.$$

(b) The group G is not binary so n is odd (otherwise $\frac{1}{n}(n/2, n/2) = -I \in G$), and since $rq = n$ we have that r and q are also odd. Therefore, we can take the matrix

$$M = \begin{pmatrix} 0 & \varepsilon^{\frac{r-1}{2}q} \\ 1 & 0 \end{pmatrix} \text{ to obtain}$$

$$M\alpha^iM^{-1} = \begin{pmatrix} 0 & \varepsilon^{\frac{r-1}{2}q} \\ 1 & 0 \end{pmatrix} \begin{pmatrix} \varepsilon^i & 0 \\ 0 & \varepsilon^{ai} \end{pmatrix} \begin{pmatrix} 0 & 1 \\ \varepsilon^{-\frac{r-1}{2}q} & 0 \end{pmatrix} = \begin{pmatrix} \varepsilon^i & 0 \\ 0 & \varepsilon^i \end{pmatrix} = \alpha^{ai}$$

and

$$M\alpha^j\beta_0M^{-1} = \begin{pmatrix} 0 & \varepsilon^{\frac{r-1}{2}q} \\ 1 & 0 \end{pmatrix} \begin{pmatrix} 0 & \varepsilon^j \\ \varepsilon^{aj} & 0 \end{pmatrix} \begin{pmatrix} 0 & 1 \\ \varepsilon^{-\frac{r-1}{2}q} & 0 \end{pmatrix} = \begin{pmatrix} 0 & \varepsilon^{\frac{r-1}{2}q+aj} \\ \varepsilon^{j-\frac{r-1}{2}q} & 0 \end{pmatrix}$$

which is equal to $\alpha^k\beta_1 = \begin{pmatrix} 0 & \varepsilon^k \\ \varepsilon^{ak+q} & 0 \end{pmatrix}$ by taking $k \equiv \frac{r-1}{2}q + aj \pmod{n}$. Indeed,

$$ak + q \equiv a\left(\frac{r-1}{2}q + aj\right) + q \equiv j + \frac{r+1}{2}q \equiv j - \frac{r-1}{2}q \pmod{n},$$

where the last equivalence comes from the fact that $\varepsilon^{-\frac{r-1}{2}} = \varepsilon^{\frac{r+1}{2}}$.

(c) $\det(\beta_0) = -1$, so that β_0 is a reflection.

(d) Now n is even and $-I = \frac{1}{n}(\frac{r}{2}q, \frac{r}{2}q) \in G$, so r is also even and the matrix M in (b) does not work this time. For elements of the form $\alpha^i \beta_1$ we have that

$$\begin{aligned} \alpha^i \beta_1 \text{ is a quasireflection} &\iff (a+1)i + q \equiv 0 \pmod{n} && \text{(by Proposition 3.9)} \\ &\iff j + i + q \equiv 0 \pmod{n} && \text{(since } ai \equiv j \pmod{n}\text{)} \\ &\iff b_m q + q \equiv 0 \pmod{n} && \text{(since } i + j = b_m q\text{)} \\ &\iff n = r q \text{ divides } (b_m + 1)q \\ &\iff r \text{ divides } (b_m + 1) \end{aligned}$$

If b_m is even then the condition above cannot be satisfied since r is even.

Now suppose $b_m = 2k + 1$. If the group does not have quasireflections then the action of β on $\langle \alpha \rangle$ - $\mathrm{Hilb}(\mathbb{C}^2)$ gives two fixed points in the middle curve of the exceptional divisor, which become two singular points in the quotient (see Section 3.2). The exceptional curve C with these two A_1 singularities will have selfintersection $\frac{2k+1}{2}$, and after the blow up we have that $(2k+1)/2 = (\tilde{C} + E_1/2 + E_2/2)^2 = \tilde{C}^2 + E_1^2/4 + E_2^2/4 + \tilde{C}E_1 + \tilde{C}E_2 = \tilde{C}^2 + 1$, where E_1, E_2 exceptional and \tilde{C} the strict transform. Then $\tilde{C}^2 \notin \mathbb{N}$, a contradiction. \square

3.3.1 Brieskorn classification

Quotient surface singularities were originally classified by Brieskorn in [Bri68] (see also [Rie77]). His construction starts by considering a finite subgroup $G \subset \mathrm{SL}(2, \mathbb{C})$ and then uses the surjective group homomorphism $Z(\mathrm{GL}(2, \mathbb{C})) \times \mathrm{SL}(2, \mathbb{C}) \rightarrow \mathrm{GL}(2, \mathbb{C})$ where $Z(\mathrm{GL}(2, \mathbb{C}))$ denotes the center of $\mathrm{GL}(2, \mathbb{C})$. In the case of small binary dihedral groups, this procedure gives the following description:

$$D_{N,q} := \begin{cases} \langle \psi_{2q}, \tau, \phi_{2k} \rangle, & \text{if } k : N - q \equiv 1 \pmod{2} \\ \langle \psi_{2q}, \tau \circ \phi_{4k} \rangle, & \text{if } k \equiv 0 \pmod{2} \end{cases}$$

where

$$\psi_r = \begin{pmatrix} \varepsilon_r & 0 \\ 0 & \varepsilon_r^{-1} \end{pmatrix}, \tau = \begin{pmatrix} 0 & i \\ i & 0 \end{pmatrix}, \phi_r = \begin{pmatrix} \varepsilon_r & 0 \\ 0 & \varepsilon_r \end{pmatrix},$$

with $\varepsilon_r = \exp \frac{2\pi i}{r}$ and $|D_{N,q}| = 4kq$.

The natural numbers N and q represent selfintersection numbers in the exceptional divisor in the resolution of singularities. More precisely, the Dynkin diagram is

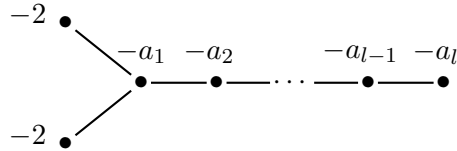

where $\frac{N}{q} = [a_1, a_2, \dots, a_{l-1}, a_l]$.

Note that taking $k = 2i$ even or $k = 2i + 1$ odd, this classification and the one given in Theorem 3.11 agree. Indeed, using the construction of dihedral singularities as in Section 3.2 and doing a calculation with selfintersection numbers (see Theorem 3.15) we get the equivalence as follows: given a $D_{N,q}$ group with $\frac{N}{q} = [a_1, \dots, a_l]$ we have that

$$D_{N,q} := \begin{cases} \text{BD}_{2n}(a) & \text{if } k := N - q \equiv 1 \pmod{2} \\ \text{BD}_{2n}(a, q) & \text{if } k \equiv 0 \pmod{2} \end{cases}$$

where n and a are such that $\frac{2n}{a} = [a_l, \dots, a_2, 2(a_1 - 1), a_2, \dots, a_l]$.

Conversely, given a small dihedral group $\text{BD}_{2n}(a)$ or $\text{BD}_{2n}(a, q)$ with continued fraction $\frac{2n}{a} = [b_1, \dots, b_m, \dots, b_1]$, the corresponding group is $D_{N,q}$ where $\frac{N}{q} = [\frac{b_m+2}{2}, b_{m-1}, \dots, b_1]$.

3.4 $\text{BD}_{2n}(a)$ groups

From now on we restrict ourselves to the case of small binary dihedral groups of the form $\text{BD}_{2n}(a)$. In terms of their action on the complex plane \mathbb{C}^2 they have the following representation as a subgroup of $GL(2, \mathbb{C})$:

$$\text{BD}_{2n}(a) = \left\langle \alpha = \begin{pmatrix} \varepsilon & 0 \\ 0 & \varepsilon^a \end{pmatrix}, \beta = \begin{pmatrix} 0 & 1 \\ -1 & 0 \end{pmatrix} : \varepsilon^{2n} = 1 \text{ primitive, } a^2 \equiv 1 \pmod{2n} \right\rangle$$

In other words, $\text{BD}_{2n}(a)$ is the group of order $4n$ generated by the cyclic group $\frac{1}{2n}(1, a)$ and the dihedral symmetry β which interchanges the coordinates x and y .

As we have seen in the previous section the quasireflections play an important role in the different types of singularities we can obtain when acting on \mathbb{C}^2 with a binary dihedral subgroup in $\text{GL}(2, \mathbb{C})$. We start with an example.

Example 3.13. Consider $\text{BD}_4(1) = \langle \alpha = \frac{1}{4}(1, 1), \beta \rangle = \langle \left(\begin{smallmatrix} i & 0 \\ 0 & i \end{smallmatrix} \right), \left(\begin{smallmatrix} 0 & 1 \\ -1 & 0 \end{smallmatrix} \right) \rangle$. Its quasireflections are $\alpha\beta$ and $\alpha^3\beta$, both elements of order 2. Thus, if H the subgroup generated by them, we have $H \cong \mathbb{Z}/2\mathbb{Z} \oplus \mathbb{Z}/2\mathbb{Z}$, and by the theorem 3.4 we know that $\mathbb{C}^2/H \cong \mathbb{C}^2$. Indeed, if we take x and y as the coordinates in \mathbb{C}^2 , the ring of invariants is given by $\mathbb{C}[x, y]^H = \mathbb{C}[u, v]$ where $u = x^2 - y^2$ and $v = xy$, so that $\mathbb{C}_{x,y}^2/H \cong \mathbb{C}_{u,v}^2$.

Also, since $\alpha^2 = -I \in H$, to complete the action of $\text{BD}_4(1) = \langle H, \alpha \rangle$ it remains to act by α on $\mathbb{C}_{u,v}^2$. In the new coordinates we have that $\alpha(u, v) = (-u, -v)$, so the action is essentially $\frac{1}{2}(1, 1)$.

This example can be generalise with the following proposition.

Proposition 3.14. *Consider the Abelian groups $\text{BD}_{2n}(1) = \langle \alpha = \frac{1}{2n}(1, 1), \beta \rangle$. Then*

- (i) $\text{BD}_{2n}(1)$ is small if and only if n is odd.
- (ii) If n is even, the normal subgroup of $\text{BD}_{4n}(1)$ generated by the quasireflections is $H = \langle \alpha^n\beta, \alpha^{3n}\beta \rangle \cong \mathbb{Z}/2\mathbb{Z} \oplus \mathbb{Z}/2\mathbb{Z}$ and $\text{BD}_{4n}(1)/H \cong \frac{1}{2n}(1, 1)$.
- (iii) The minimal resolution $Y \rightarrow \mathbb{C}^2/\text{BD}_{4n}(1)$ has exceptional locus of type $A_{2n,1}$, i.e. it consists of a single \mathbb{P}^1 with selfintersection $-2n$.

Proof. (i) Use Proposition 3.9.

(ii) The quasireflections can only occur in elements of the form $\alpha^i\beta$ with $i \neq n$ and that happens if and only if $\det(\alpha^i\beta - I) = 1 + \varepsilon^{2i} = 0$, if and only if $2i \equiv 2n \pmod{4n}$ for $1 \leq i \leq 4n$, if and only if $i = n, 3n$. Both generators have order 2 and $\alpha^n\beta\alpha^{3n}\beta = \alpha^{4n}\beta^2 = -Id$.

Since $\beta^2 = \alpha^2 = -I$ we know that $\text{BD}_{4n}(1)/H$ has order $2n$. It only remains to prove that it is cyclic. Indeed, the quotient group is generated by the coset αH .

(iii) By Theorem 3.4 we have $\mathbb{C}^2/H \cong \mathbb{C}^2$ and now the quotient of it by $\frac{1}{2n}(1, 1)$ is isomorphic to the affine cone over the rational normal curve of degree $2n$ in \mathbb{P}^{2n} , which has one rational curve with selfintersection $-2n$ in its resolution of singularities. \square

The following theorem describes the different configurations of exceptional locus that can occur in the resolution of $\mathbb{C}^2/\text{BD}_{2n}(a)$.

Theorem 3.15. *Let $\mathrm{BD}_{2n}(a)$ be a binary dihedral group and E be the exceptional divisor in $\mathrm{BD}_{2n}(a)\text{-Hilb}(\mathbb{C}^2)$, the minimal resolution of $\mathbb{C}^2/\mathrm{BD}_{2n}(a)$.*

Case 1: $\mathrm{BD}_{2n}(a)$ is not small. Then

(i) $\frac{2n}{a} = [b_1, \dots, b_{m-1}, b_{m-1}, \dots, b_1]$ has an even number of terms. Then E is of type

$$\begin{array}{ccccccc} -b_1 & -b_2 & & -b_{m-2} & -b_{m-1} & +1 \\ \bullet & \text{---} & \bullet & \text{---} & \dots & \text{---} & \bullet & \text{---} & \bullet \end{array}$$

(ii) $\frac{2n}{a} = [b_1, \dots, b_{m-1}, b_m, b_{m-1}, \dots, b_1]$ has an odd number of terms. Then,

(a) if b_m is odd, E is of type

$$\begin{array}{ccccccc} -b_1 & -b_2 & & -b_{m-1} & -\frac{b_m+1}{2} \\ \bullet & \text{---} & \bullet & \text{---} & \dots & \text{---} & \bullet & \text{---} & \bullet \end{array}$$

(b) if b_m is even, E is of type

$$\begin{array}{ccccccc} -b_1 & -b_2 & & -b_{m-1} & -\frac{b_m}{2} \\ \bullet & \text{---} & \bullet & \text{---} & \dots & \text{---} & \bullet & \text{---} & \bullet \end{array}$$

Case 2: $\mathrm{BD}_{2n}(a)$ is small. Then b_m is even and E has the Dynkin diagram of type D

$$\begin{array}{ccccccc} & & & & & & \bullet & -2 \\ -b_1 & -b_2 & & -b_{m-1} & -\frac{b_m+2}{2} & & / & \\ \bullet & \text{---} & \bullet & \text{---} & \dots & \text{---} & \bullet & \text{---} & \bullet \\ & & & & & & \backslash & \\ & & & & & & \bullet & -2 \end{array}$$

Proof. let $X = \langle \alpha \rangle\text{-Hilb}(\mathbb{C}^2)$ and $\pi: X \rightarrow X/\langle \beta \rangle$ be the quotient map, and denote by E_i , $i = 1, \dots, r$ the exceptional curves in $\langle \alpha \rangle\text{-Hilb}(\mathbb{C}^2)$ where $E_i^2 = E_{r-i}^2 = -b_i$. Denote also by \tilde{E}_j the exceptional curves in $X/\langle \beta \rangle$ for $j = 1, \dots, m-1$.

Suppose that the number of elements in the continued fraction $\frac{2n}{a}$ is even. Then by Proposition 3.7 the group is not small. For the selfintersections, if $i \neq m-1$ we have $(\pi^* \tilde{E}_i)^2 = (E_i + E_{r-i})^2 = E_i^2 + 2E_i E_{r-i} + E_{r-i}^2 = -2b_i$. Hence $\tilde{E}_i = -2b_i/2 = -b_i$. And if $i = m-1$ then $(\pi^* \tilde{E}_{m-1})^2 = (E_{m-1} + E_m)^2 = E_{m-1}^2 + 2E_{m-1} E_m + E_m^2 = -2b_{m-1} + 2$, and therefore $\tilde{E}_{m-1} = -b_{m-1} + 1$.

When the number of elements in the continued fraction $\frac{2n}{a}$ is odd, we have a middle rational curve E_m in the exceptional locus of $\langle \alpha \rangle\text{-Hilb}(\mathbb{C}^2)$, covered by affine charts $Y_m \cong \mathbb{C}_{(\lambda, \mu)}^2$ and $Y_{m+1} \cong \mathbb{C}_{(\lambda', \mu')}^2$, where $\lambda = x^i/y^j$, $\mu = y^q/x^q$, $\lambda' = x^q/y^q$ and $\mu' = y^i/x^j$. Using the fact that (i, j) and (q, q) are consecutive points in the Newton polygon of $\frac{1}{2n}(1, a)$, we

know that $i + j = b_m q$, and the action of β in this case is

$$\begin{cases} \lambda \mapsto (-1)^j y^i / x^j = (-1)^j \lambda \mu^{b_m} \\ \mu \mapsto (-1)^q x^q / y^q = (-1)^q 1 / \mu \end{cases}$$

To see whether or not there exist quasireflections we must study the fixed locus of the action. The coordinate μ is fixed if and only if $\mu^2 = (-1)^q$, that is, either $\mu = \pm 1$ when q is even, or $\mu = \pm i$ when q is odd. To have the coordinate λ fixed the relation $\lambda = (-1)^j \lambda \mu^{b_m}$ must be verified, so we also need to take into account the parity of j and b_m .

In fact, we can eliminate most of the possibilities. First note that i and j have the same parity (as a consequence of Lemma 3.5). Then, since $i + j = b_m q$, we have that b_m and q cannot be both odd. In addition, j and q cannot be both even. Indeed, let

$$(0, 2n), (1, a), \dots, (r, s), (u, v), \dots, (j, i), (q, q), (i, j), \dots, (a, 1), (2n, 0)$$

the sequence of points in the boundary of the Newton polygon for $\frac{1}{2n}(1, a)$. Then q, j (and therefore i) even implies $u = b_{m-1}j - q$ is even, $r = b_{m-2}u - j$ is even, and by induction 1 is even, a contradiction. Hence, the only possibilities for fixed locus of the action of β on $\langle \alpha \rangle\text{-Hilb}(\mathbb{C}^2)$ are shown in Table 3.4.

q	j	b_m	Fixed locus	$\text{BD}_{2n}(a)$
even	odd	even	Points $(0, 1)$ and $(0, -1)$ fixed	small
		odd	Point $(0, 1)$ and line $\mu = -1$ fixed	not small
odd	even	$\equiv 0 \pmod{4}$	Lines $\mu = i$ and $\mu = -i$ fixed	not small
		$\equiv 2 \pmod{4}$	Points $(0, i)$ and $(0, -i)$ fixed	small
odd	odd	$\equiv 0 \pmod{4}$	Points $(0, i)$ and $(0, -i)$ fixed	small
		$\equiv 2 \pmod{4}$	Lines $\mu = i$ and $\mu = -i$ fixed	not small

Table 3.1: Fixed locus in $Y = \langle \alpha \rangle\text{-Hilb}(\mathbb{C}^2)$ by the action of β

To calculate the selfintersections we split into the cases $\text{BD}_{2n}(a)$ small and $\text{BD}_{2n}(a)$ not small. Let $\pi : X \rightarrow X/\langle \beta \rangle$ the quotient map as before, and $f : Y \rightarrow X/\langle \beta \rangle$ the resolution of singularities with exceptional divisor $E = \cup E'_i$.

$\text{BD}_{2n}(a)$ **not small:** We have two cases:

1. b_m is odd. Then the involution β fixes a point P and a line L , and f is the blow up of $X/\langle \beta \rangle$ at the singular A_1 point P . We call C the new rational curve on Y with $C^2 = -2$.

Similar to the previous case, $\tilde{E}_i^2 = E'_i = -b_i$ if $i \neq m$, and $\tilde{E}_i^2 = -b_i/2$ if $i = m$.

Then

$$(f^* \tilde{E}_m)^2 = (E'_m + C/2)^2 = E'_m + 1 - 1/2$$

Hence $(E'_m)^2 = -(b_m + 1)/2$.

2. b_m is even. Then the involution β fixes two lines L_1 and L_2 , and by Theorem 3.4 the quotient $X/\langle\beta\rangle$ is nonsingular. In this case $(\pi^* \tilde{E}_m)^2 = E_m^2 = -b_m$, hence $(\tilde{E}_m)^2 = -b_m/2$.

BD $_{2n}(a)$ small: In this case $X/\langle\beta\rangle$ has two singular A_1 points along $\tilde{E}_m \cong \mathbb{P}^1$ with $\tilde{E} = -b_m/2$. Then f is the blow up of $X/\langle\beta\rangle$ at these two points. We call C_1 and C_2 the corresponding rational curves in Y . Then

$$-b_m/2 = (E'_m + C_1/2 + C_2/2)^2 = (E'_m)^2 + C_1^2/4 + C_2^2/4 + E'_m C_1 + E'_m C_2 = (E'_m)^2 + 1$$

and $(E'_m)^2 = -(b_m + 2)/2$.

□

Remark 3.16. If $a = 1$ the group $\mathrm{BD}_{2n}(a)$ is Abelian, and by Proposition 3.14 it is small if and only if n is odd. Therefore, Y has a type A Dynkin diagram of the form

$$\begin{array}{ccc} -2 & -(n+1) & -2 \\ \bullet & \text{---} & \bullet \text{---} \bullet \end{array}$$

Remark 3.17. Note that when the group is not small we can have a (-1) -curve in E (more precisely, when $b_{m-1} = 2$ in Case (1.i), or $b_m = 2$ in Case (1.ii.b)). In these cases, in order to get a minimal resolution we need to contract the -1 -curve, decreasing by one the selfintersection of the adjacent curve. To illustrate this, consider the non small group $\mathrm{BD}_{12}(5)$. We have $\frac{12}{5} = [3, 2, 3]$ so that E is of the form

$$\begin{array}{ccc} -3 & & -1 \\ \bullet & \text{---} & \bullet \end{array}$$

and after contraction the -1 -curve, we obtain a single \mathbb{P}^1 with selfintersection -2 in the minimal resolution. To see this more explicitly, the group of its quasireflections is generated by

$$H = \langle \alpha\beta, \alpha^3\beta, \alpha^5\beta, \alpha^7\beta, \alpha^9\beta, \alpha^{11}\beta \rangle$$

which has order 12. The quotient is $\mathbb{C}_{x,y}^2/H \cong \mathbb{C}_{u,v}^2$ where $u = x^6 - y^6$ and $v = xy$. Now the action of α in the new coordinates is

$$(u, v) \mapsto (\varepsilon^6 u, \varepsilon^6 v)$$

In other words, the action is $\frac{1}{12}(6, 6) \cong \frac{1}{2}(1, 1)$, and the exceptional divisor in the minimal resolution of $\mathbb{C}^2/\text{BD}_{12}(5)$ consists of just one \mathbb{P}^1 with selfintersection -2 .

Example 3.18. In Table 3.2 we present all small binary dihedral groups $G \subset \text{GL}(2, \mathbb{C})$ of order ≤ 60 , together with the graph of the exceptional divisor in the resolution of \mathbb{C}^2/G .

3.4.1 Representation theory for $\text{BD}_{2n}(a)$ groups

Let $G = \text{BD}_{2n}(a) \subset \text{GL}(2, \mathbb{C})$ be a small binary dihedral group. As an abstract group it has the following presentation:

$$\text{BD}_{2n}(a) = \langle \alpha, \beta : \alpha^{2n} = \beta^4 = 1, \alpha^n = \beta^2, \alpha\beta = \beta\alpha^a \rangle$$

Therefore any representation $\rho : G \rightarrow \text{GL}(n, \mathbb{C})$ of G must also satisfy $\rho(\alpha)^{2n} = \rho(\beta)^4 = 1$, $\rho(\alpha)^n = \rho(\beta)^2$ and $\rho(\alpha)\rho(\beta) = \rho(\beta)\rho(\alpha)^a$. So if ρ is a 1-dimensional representation, $\rho(\alpha)$ is a $2n$ -th root of unity and $\rho(\beta)$ is a 4-th root of unity.

If we denote by ρ_j^\pm the 1-dimensional irreducible representations, we have

$$\begin{aligned} \rho_j^+(\alpha) &= \varepsilon^j, & \rho_j^+(\beta) &= i^n \\ \rho_j^-(\alpha) &= \varepsilon^j, & \rho_j^-(\beta) &= -i^n \end{aligned}$$

and for the irreducible 2-dimensional representations V_k we get

$$V_k(\alpha) = \begin{pmatrix} \varepsilon^k & 0 \\ 0 & \varepsilon^{ak} \end{pmatrix}, \quad V_k(\beta) = \begin{pmatrix} 0 & 1 \\ (-1)^k & 0 \end{pmatrix}$$

By the definition of the groups $\text{BD}_{2n}(a)$ in terms of their action on \mathbb{C}^2 (see Theorem 3.11), the natural representation is V_1 , which we will denote by Q .

About the number of one and two dimensional irreducible representations, let us look

Table 3.2: Small binary dihedral groups in $GL(2, \mathbb{C})$ of order ≤ 60

Order	Group	Cyclic type $\frac{2n}{a}$	$D_{n,q}$	Resolution graph
8	$BD_4(3)$	A_3	$D_{3,2}$	D_4
12	$BD_6(5)$	A_5	$D_{4,3}$	D_5
16	$BD_8(7)$	A_7	$D_{5,4}$	D_6
20	$BD_{10}(9)$	A_9	$D_{6,5}$	D_7
24	$BD_{12}(5, 3)$	$[3, 2, 3]$	$D_{5,3}$	
	$BD_{12}(7)$	$[2, 4, 2]$	$D_{5,2}$	
	$BD_{12}(11)$	A_{11}	$D_{7,6}$	D_8
28	$BD_{14}(13)$	A_{13}	$D_{8,7}$	D_9
32	$BD_{16}(15)$	A_{15}	$D_{9,8}$	D_{10}
36	$BD_{18}(17)$	A_{17}	$D_{10,9}$	D_{11}
40	$BD_{20}(9, 5)$	$[3, 2, 2, 2, 3]$	$D_{7,5}$	
	$BD_{20}(11)$	$[2, 6, 2]$	$D_{7,2}$	
	$BD_{20}(19)$	A_{19}	$D_{11,10}$	D_{12}
44	$BD_{22}(21)$	A_{21}	$D_{12,11}$	D_{13}
48	$BD_{24}(7)$	$[4, 2, 4]$	$D_{7,4}$	
	$BD_{24}(17, 3)$	$[2, 2, 4, 2, 2]$	$D_{7,3}$	
	$BD_{24}(23)$	A_{23}	$D_{13,12}$	D_{14}
52	$BD_{26}(25)$	A_{25}	$D_{14,13}$	D_{15}
56	$BD_{28}(13, 7)$	$[3, 2, 2, 2, 2, 2, 3]$	$D_{9,7}$	
	$BD_{28}(15)$	$[2, 8, 2]$	$D_{9,2}$	
	$BD_{28}(27)$	A_{27}	$D_{15,14}$	D_{16}
60	$BD_{30}(11)$	$[3, 4, 3]$	$D_{8,3}$	
	$BD_{30}(19)$	$[2, 3, 2, 3, 2]$	$D_{8,5}$	
	$BD_{30}(29)$	A_{29}	$D_{16,15}$	D_{17}

at the formula

$$|G| = \sum_{\rho \in \text{Irr}G} (\dim \rho)^2$$

where $\text{Irr}G$ is the set of irreducible representations of G (see for example [JL01] §11). Recall from Proposition 3.10 that $2n = rq$ for some $r \in \mathbb{N}$. Therefore we have r scalar diagonal elements in $\frac{1}{2n}(1, a)$, and the number of 1-dimensional representations is $2r$. If we call d the number of 2-dimensional irreducible representations, by the previous formula we have $4n = 2r + 4d$. This implies that the number of 2-dimensional elements is $d = n - \frac{r}{2}$.

Remark 3.19. The representation theory of G can be easily derived from that of the maximal cyclic subgroup $A = \langle \alpha \rangle \trianglelefteq G$. Let ρ_i for $i = 0, \dots, 2n - 1$ be the irreducible representations of A . The group G acts on A by conjugation, i.e. $g \cdot h = ghg^{-1}$ for $g \in G$, $h \in A$, which induces an action of $G/A \cong \mathbb{Z}/2$ generated by β on A by $\beta \cdot h := \beta h \beta^{-1}$, for any $h \in A$.

This action induces an action on $\text{Irr}A$ as follows: using the relation $\alpha\beta = \beta\alpha^a$ we have that $\alpha^{ai}\beta = \alpha^{ai-1}\beta\alpha^a = \alpha^{ai-2}\beta\alpha^{2a} = \dots = \beta\alpha^{a^2i} = \beta\alpha^i$, which implies $\beta\alpha^i\beta^{-1} = \alpha^{ai}\beta\beta^{-1} = \alpha^{ai}$, so that α^i and α^{ai} are conjugates. Hence, for any irreducible representation $\rho_k \in \text{Irr}A$ we have that $\rho_k(\beta)\rho_k(\alpha^i)\rho_k(\beta^{-1}) = \rho_k(\alpha^{ai}) = \rho_k(\alpha)^{ai} = (\varepsilon^k)^{ai} = (\varepsilon^i)^{ak} = \rho_{ak}(\alpha^i)$ and G/A acts on $\text{Irr}A$ by

$$\beta \cdot \rho_k := \rho_{ak}$$

for $\rho_k \in \text{Irr}A$.

Every fixed point ρ_j by this action will give two 1-dimensional irreducible representations ρ_j^+ and ρ_j^- of G , while every free orbit consisting of two irreducible representations ρ_k and ρ_l identified by β produces the 2-dimensional representation V_k .

Example 3.20. Consider the group $\text{BD}_{12}(7)$ generated by $\alpha = \text{diag}(\varepsilon, \varepsilon^7)$ with ε a primitive 12-th root of unity, and $\beta = \begin{pmatrix} 0 & 1 \\ -1 & 0 \end{pmatrix}$. Table 3.20 shows the character table for the group.

The irreducible representations for the cyclic subgroup $A = \langle \alpha \rangle$ are given by $\rho_i(\alpha) = \varepsilon^i$ for $i = 0, \dots, 11$, and we can see that representations ρ_i and $\rho_{\overline{7i}}$ are identified by β , where $\overline{7i}$ denotes $7i \bmod 12$. When i is even the representation is fixed, and we obtain the 1-dimensional representations ρ_i^\pm . Also $\beta(\rho_1) = \rho_7$, $\beta(\rho_3) = \rho_9$ and $\beta(\rho_5) = \rho_{11}$ (and vice

versa), giving V_1, V_2 and V_3 .

Class	{1}	{-1}	{ α^8 }	{ α^4 }	{ α^3 }	{ β }	{ $\alpha^3\beta$ }	{ α^{10} }	{ α^2 }	{ α }	{ $\alpha\beta$ }	{ α^5 }	{ $\alpha^5\beta$ }	{ $\alpha^2\beta$ }	{ $\alpha^4\beta$ }
Size	1	1	1	1	2	2	2	1	1	2	2	2	2	2	2
Order	1	2	3	3	4	4	4	6	6	12	12	12	12	12	12
ρ_0^+	1	1	1	1	1	1	1	1	1	1	1	1	1	1	1
ρ_0^-	1	1	1	1	-1	-1	1	1	1	-1	1	1	-1	-1	-1
ρ_2^+	1	1	ε^4	$-\varepsilon^2$	-1	1	-1	$-\varepsilon^2$	ε^4	ε^2	ε^2	$-\varepsilon^4$	$-\varepsilon^4$	ε^4	$-\varepsilon^2$
ρ_2^-	1	1	ε^4	$-\varepsilon^2$	-1	-1	1	$-\varepsilon^2$	ε^4	ε^2	$-\varepsilon^2$	$-\varepsilon^4$	ε^4	$-\varepsilon^4$	ε^2
ρ_4^+	1	1	$-\varepsilon^2$	ε^4	1	1	1	ε^4	$-\varepsilon^2$	ε^4	ε^4	$-\varepsilon^2$	$-\varepsilon^2$	$-\varepsilon^2$	ε^4
ρ_4^-	1	1	$-\varepsilon^2$	ε^4	1	-1	-1	ε^4	$-\varepsilon^2$	ε^4	$-\varepsilon^4$	$-\varepsilon^2$	ε^2	ε^2	$-\varepsilon^4$
ρ_6^+	1	1	1	1	-1	1	-1	1	1	-1	-1	-1	-1	1	1
ρ_6^-	1	1	1	1	-1	-1	1	1	1	-1	1	-1	1	-1	-1
ρ_8^+	1	1	ε^4	$-\varepsilon^2$	1	1	1	$-\varepsilon^2$	ε^4	$-\varepsilon^2$	$-\varepsilon^2$	ε^4	ε^4	ε^4	$-\varepsilon^2$
ρ_8^-	1	1	ε^4	$-\varepsilon^2$	1	-1	-1	$-\varepsilon^2$	ε^4	$-\varepsilon^2$	ε^2	ε^4	$-\varepsilon^4$	$-\varepsilon^4$	ε^2
ρ_{10}^+	1	1	$-\varepsilon^2$	ε^4	-1	1	-1	ε^4	$-\varepsilon^8$	$-\varepsilon^4$	$-\varepsilon^4$	ε^2	ε^2	$-\varepsilon^2$	ε^4
ρ_{10}^-	1	1	$-\varepsilon^2$	ε^4	-1	-1	1	ε^4	$-\varepsilon^2$	$-\varepsilon^4$	ε^4	ε^2	$-\varepsilon^2$	ε^2	$-\varepsilon^4$
V_1	2	-2	$-2\varepsilon^2$	$2\varepsilon^4$	0	0	0	$-2\varepsilon^4$	$2\varepsilon^2$	0	0	0	0	0	0
V_3	2	-2	2	2	0	0	0	-2	-2	0	0	0	0	0	0
V_5	2	-2	$2\varepsilon^4$	$-2\varepsilon^2$	0	0	0	$2\varepsilon^2$	$-2\varepsilon^4$	0	0	0	0	0	0

Table 3.3: Character table for the group $BD_{12}(7)$

3.4.2 Semi-invariant polynomials

The group G acts on the complex plane $\mathbb{C}_{x,y}^2$, so it will also act on the polynomial ring $\mathbb{C}[x, y]$ breaking it into different eigenspaces.

Definition 3.21. We say that a polynomial $f \in \mathbb{C}[x, y]$ belongs to a representation ρ (or f is ρ -invariant or f is semi-invariant with respect to ρ), if

$$f(g \cdot P) = \rho(g)f(P) \quad \text{for all } g \in G, P \in \mathbb{C}_{x,y}^2 \quad (3.1)$$

(compare [Muk03], Definition 6.10). We denote by $S_\rho := \{f \in \mathbb{C}[x, y] : f \in \rho\}$ the $\mathbb{C}[x, y]^G$ -module of ρ -invariants.

Let $P=(x_0, y_0)$, then $\alpha \cdot P = (\varepsilon x_0, \varepsilon^a y_0)$ and $\beta \cdot P = (y_0, -x_0)$. Then for the 1-dimensional representations we have

$$\begin{aligned} f(x, y) \in \rho_i^\pm &\iff f(\alpha \cdot P) = \rho_i^\pm(\alpha)f(P) \text{ and } f(\beta \cdot P) = \rho_i^\pm(\beta)f(P) \text{ for all } P \in \mathbb{C}_{x,y}^2 \\ &\iff \alpha(f) = \varepsilon^j f \text{ and } \beta(f) = \pm i^n f \end{aligned} \quad (3.2)$$

where we are making the abuse of notation¹ $\alpha(f(x, y)) = f(\alpha(x), \alpha(y)) = f(\varepsilon x, \varepsilon^a y)$ and $\beta(f(x, y)) = f(\beta(x), \beta(y)) = f(y, -x)$.

For the 2-dimensional representations V_k we have to consider pairs of polynomials:

$$\begin{aligned} (f, g) \text{ belong to } V_k &\iff (f(\alpha \cdot P), g(\alpha \cdot P)) = V_k(\alpha)(f(P), g(P)) \text{ and} \\ &(f(\beta \cdot P), g(\beta \cdot P)) = V_k(\beta)(f(P), g(P)) \text{ for all } P \in \mathbb{C}_{x,y}^2 \\ &\iff (\alpha(f), \alpha(g)) = (\varepsilon^k f, \varepsilon^{ak} \alpha(g)) \text{ and} \\ &(\beta(f), \beta(g)) = (g, (-1)^k f) \end{aligned}$$

Looking at the last equality we set $g = \beta(f)$ and we see that $\beta(g) = (-1)^k f$ can be obtained using the rest of relations: $\beta(g) = \beta(\beta(f)) = \beta^2(f) = \alpha^n(f) = (\alpha(f))^n = (\varepsilon^k f)^n = (\varepsilon^n)^k f = (-1)^k f$. Hence we have

$$(f, \beta(f)) \text{ belong to } V_k \iff \alpha(f, \beta(f)) = (\varepsilon^k f, \varepsilon^{ak} \beta(f)) \quad (3.3)$$

Example 3.22. Continuing with Example 3.20, the maximal cyclic subgroup of $\text{BD}_{12}(7)$ is $A = \langle \alpha \rangle$ with $\alpha = \frac{1}{2n}(1, a)$. In Table 3.4 we show the irreducible representations and the generators of the corresponding modules, apart from the trivial module $S_{\rho_0} = \mathbb{C}[x, y]^G$ which is generated by the element 1.

Table 3.4: Representation theory for $\frac{1}{12}(1, 7)$ and the generators for S_ρ

	α	S_ρ		α	S_ρ		α	S_ρ
ρ_0	1	$1, x^{12}, x^5 y, x^3 y^3, xy^5, y^{12}$	ρ_4	ε^4	x^4, y^4	ρ_8	ε^8	x^8, y^8
ρ_1	ε	x, y^7	ρ_5	ε^5	x^5, y^{11}	ρ_9	ε^9	x^9, y^3
ρ_2	ε^2	x^2, y^2	ρ_6	ε^6	x^6, y^6	ρ_{10}	ε^{10}	x^{10}, y^{10}
ρ_3	ε^3	x^3, y^9	ρ_7	ε^7	x^7, y	ρ_{11}	ε^{11}	x^{11}, y^{11}

Again we see how S_{ρ_i} and $S_{\rho_{\overline{7i}}}$ are identified by β , where $\overline{7i}$ denotes $7i \bmod 12$, and $\beta(S_{\rho_1}) = S_{\rho_7}$, $\beta(S_{\rho_3}) = S_{\rho_9}$ and $\beta(S_{\rho_5}) = S_{\rho_{11}}$ (and vice versa), giving S_{V_1} , S_{V_2} and S_{V_3} respectively (compare with Table 3.22).

¹The abuse of notation comes from the fact that the action of $g \in G$ on $f \in \mathbb{C}[x, y]$ is given by $g \cdot f = \rho(g^{-1})f$. Equation 3.1 is obtained because when a group G acts on $X = \text{Spec} R$ then G acts dually on R via $(g \cdot f)(P) = f(g^{-1} \cdot P)$ for $g \in G$, $f \in R$ and $P \in X$. See also [Do103].

	α	β	S_ρ
ρ_0^+	1	1	$1, x^{12} + y^{12}, x^5y - xy^5, x^6y^6, x^8y^4 + x^4y^8$
ρ_0^-	1	-1	$x^{12} - y^{12}, x^5y + xy^5, x^3y^3$
ρ_1^+	ε^2	1	$x^2 + y^2, x^7y - xy^7$
ρ_1^-	ε^2	-1	$x^2 - y^2, x^7y + xy^7$
ρ_2^+	ε^4	1	$x^4 + y^4, x^9y - xy^9, x^2y^2$
ρ_2^-	ε^4	-1	$x^4 - y^4, x^9y + xy^9, x^5y^5$
ρ_3^+	-1	1	$x^6 + y^6, x^{11}y - xy^{11}, x^4y^2 + x^2y^4$
ρ_3^-	-1	-1	$x^6 - y^6, x^{11}y + xy^{11}, x^4y^2 - x^2y^4$
ρ_4^+	ε^8	1	$x^8 + y^8, x^6y^2 + x^2y^6, x^4y^4$
ρ_4^-	ε^8	-1	$x^8 - y^8, x^6y^2 - x^2y^6, xy$
ρ_5^+	ε^{10}	1	$x^{10} + y^{10}, x^3y - xy^3$
ρ_5^-	ε^{10}	-1	$x^{10} - y^{10}, x^3y + xy^3$
V_1	$\begin{pmatrix} \varepsilon & 0 \\ 0 & \varepsilon^7 \end{pmatrix}$	$\begin{pmatrix} 0 & 1 \\ -1 & 0 \end{pmatrix}$	$(x, y), (y^7, -x^7), (x^6y, -xy^6), (x^2y^5, -x^5y^2)$
V_2	$\begin{pmatrix} \varepsilon^3 & 0 \\ 0 & \varepsilon^9 \end{pmatrix}$	$\begin{pmatrix} 0 & 1 \\ -1 & 0 \end{pmatrix}$	$(x^3, y^3), (y^9, -x^9), (xy^2, x^2y), (x^8y, -xy^8)$
V_3	$\begin{pmatrix} \varepsilon^5 & 0 \\ 0 & \varepsilon^{11} \end{pmatrix}$	$\begin{pmatrix} 0 & 1 \\ -1 & 0 \end{pmatrix}$	$(x^5, y^5), (y^{11}, -x^{11}), (xy^4, x^4y), (x^{10}y, -xy^{10})$

Table 3.5: Some semi-invariant elements in each S_ρ for $BD_{12}(7)$

Chapter 4

G -graphs for $\mathrm{BD}_{2n}(a)$ groups

In this Chapter we describe all possible G -graphs for $G = \mathrm{BD}_{2n}(a)$ groups, classified into the types A , B , C and D . In Theorem 4.21 we give a full description of the G -graphs along the exceptional divisor in $G\text{-Hilb}(\mathbb{C}^2)$, and in Theorem 4.22 we prove that for any G -clusters $\mathcal{Z} \in G\text{-Hilb}(\mathbb{C}^2)$, the vector space $\mathcal{O}_{\mathcal{Z}}$ admits for basis one of these types.

Using the construction of the resolution of singularities of \mathbb{C}^2/G described in Section 3.2, the description of the G -graphs is given in terms of the continued fraction $\frac{2n}{a}$ corresponding to the subgroup $A = \langle \frac{1}{2n}(1, a) \rangle \triangleleft G$. In Theorem 4.25 we give the list of special representations of G purely in terms of the maximal cyclic subgroup A .

4.1 Introduction

Definition 4.1. Let $G \subset \mathrm{GL}(2, \mathbb{C})$ a finite subgroup. A G -cluster is a G -invariant zero dimensional subscheme $\mathcal{Z} \subset \mathbb{C}^2$ defined by an ideal $I_{\mathcal{Z}} \subset \mathbb{C}[x, y]$, such that $\mathcal{O}_{\mathcal{Z}} = \mathbb{C}[x, y]/I_{\mathcal{Z}} \cong \mathbb{C}G$ the regular representation as $\mathbb{C}G$ -modules.

The *G -Hilbert scheme* $G\text{-Hilb}(\mathbb{C}^2)$ is the moduli space parametrising G -clusters.

Recall that the regular representation $\mathbb{C}G$ is a direct sum of irreducible representations ρ_i , where every irreducible ρ_i appears $(\dim \rho_i)$ times in the sum. That is

$$\mathbb{C}G = \bigoplus_{\rho_i \in \mathrm{Irr}G} (\rho_i)^{\dim \rho_i}$$

Therefore if $I_{\mathcal{Z}}$ is an ideal defining a G -cluster, or a point in $G\text{-Hilb}(\mathbb{C}^2)$, then the vector space $\mathbb{C}[x, y]/I_{\mathcal{Z}}$ has in its basis $(\dim \rho_i)$ elements in each irreducible representation ρ_i (see

Definition 3.21). To describe distinguished basis with this property for these coordinate rings, it is convenient to use the notion of G -graph.

Definition 4.2. Let $G = \text{BD}_{2n}(a)$ a binary dihedral subgroup of $\text{GL}(2, \mathbb{C})$. A G -graph is a subset $\Gamma \subset \mathbb{C}[x, y]$ satisfying the following two conditions:

1. It contains $(\dim \rho)$ number of elements in each irreducible representation ρ .
2. If a monomial $x^{\lambda_1} y^{\lambda_2}$ is a summand of a polynomial $P \in \Gamma$, then for every $0 \leq i_j \leq \lambda_j$ the monomial $x^{i_1} y^{i_2}$ must be a summand of some polynomial $Q_{i_1, i_2} \in \Gamma$.

Note that given any ideal $I \subset \mathbb{C}[x, y]$, we can choose a basis for the vector space $\mathbb{C}[x, y]/I$ which is a G -graph. This choice will never be unique.

For dihedral groups, and non-Abelian groups in general, the elements of the G -graphs can no longer be chosen to be all monomial. Nevertheless, we can identify any G -graph with its “monomial” representation in the lattice of monomials in the same spirit as in the toric case, where every monomial in it represents an element in the G -graph. This way of representing G -graphs will be useful for the rest of the Chapter.

Representation of a G -graph

When the group G is Abelian, every irreducible representation ρ_i of G is 1-dimensional for $i = 1, \dots, |G|$, and every monomial in $\mathbb{C}[x, y]$ belongs to some ρ_i . Therefore the G -graphs for Abelian groups are *represented* in the lattice of monomials M by the monomials contained in Γ . For example, the following picture represents the $\frac{1}{6}(1, 5)$ -graph $\Gamma = \{1, x, x^2, x^3, x^4, y\}$:

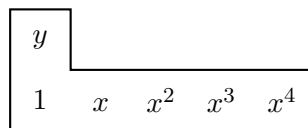

As the figure suggests, the representation of Γ consists of all monomials in $\mathbb{C}[x, y]$ which do not belong to the ideal $I = (x^5, xy, y^2)$, so we may also say that the G -graph Γ is *defined by the ideal I* .

When G is non-Abelian, irreducible representations may not contain monomials, and the elements in G -graphs consist of sums of monomials. In this case, a *representation* of

a G -graphs is also drawn on the lattice of monomials M but now using the following rule: a monomial $x^i y^j$ is contained in the representation of a G -graph Γ if it is contained as a summand in some polynomial $P \in \Gamma$.

For example, consider the binary dihedral group $D_4 = \text{BD}_4(3)$ and the D_4 -graph $\Gamma = \{1, x^4 - y^4, x^2 + y^2, x^2 - y^2, (x, y), (y^3, -x^3)\}$. Note that it has one element in each 1-dimensional representation and two elements in the 2-dimensional representation V (see Table 4.1). In this case, Γ is represented by the following figure

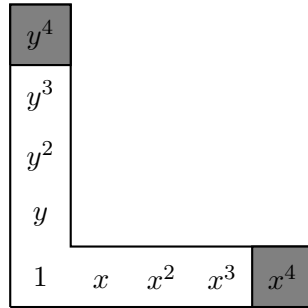

where the basis elements $x^2 + y^2 \in \rho_1^+$ and $x^2 - y^2 \in \rho_1^-$ are represented by x^2 and y^2 respectively. We also say that Γ is defined by the ideal $I = (xy, x^4 + y^4)$.

Counting the number of monomials in the figure we have that $|\Gamma| = 9 > |D_4| = 8$, but notice that $x^4 - y^4$ belongs to the basis of $\mathbb{C}[x, y]/I$, so we cannot exclude x^4 and y^4 . On the other hand we have the relation $x^4 + y^4 = 0$, i.e. $x^4 = -y^4$ and both monomials count as one in the basis. We say that x^4 and y^4 are “twins”.

	α	β	S_ρ
ρ_0^+	1	1	$1, x^4 + y^4, x^2 y^2, xy(x^4 - y^4), \dots$
ρ_0^-	1	-1	$xy, x^4 - y^4, \dots$
ρ_1^+	-1	1	$x^2 + y^2, xy(x^2 - y^2), \dots$
ρ_1^-	-1	-1	$x^2 - y^2, xy(x^2 + y^2), \dots$
V	$\begin{pmatrix} \varepsilon & 0 \\ 0 & \varepsilon^3 \end{pmatrix}$	$\begin{pmatrix} 0 & 1 \\ -1 & 0 \end{pmatrix}$	$(x, y), (y^3, -x^3), (x^2 y, -x y^2), \dots$

Table 4.1: Irreducible representations of D_4 with some polynomials belonging to them.

4.2 The cyclic case

Let $A = \langle \frac{1}{2n}(1, a) \rangle$ be the cyclic group with $(2n, a) = 1$. In this section we describe how the A -graphs are completely determined by the positive nonzero lattice points e_i on the boundary of the Newton polygon of $L = \mathbb{Z}^2 + \frac{1}{2n}(1, a) \cdot \mathbb{Z}$ (see also [Kid01][Ito02]). Let $\frac{2n}{a} = [b_1, \dots, b_m, \dots, b_1]$. We have $2m - 1$ exceptional curves in $A\text{-Hilb}(\mathbb{C}^2)$ covered by $2m$ affine open sets. Let $e_i = (r, s)$ and $e_{i+1} = (u, v)$ be two consecutive boundary lattice points of L , then the corresponding open set in Y is of the form $Y_i \cong \mathbb{C}_{(\xi_i, \eta_i)}$, where $\xi_i = x^s/y^r$ and $\eta_i = y^u/x^v$ (see Section 2.6.1). Then every point $(\xi_i, \eta_i) \in Y_i$ corresponds to the A -cluster $\mathcal{Z}_{\xi_i, \eta_i}$ defined by the ideal

$$I_{\xi_i, \eta_i} = (x^s - \xi_i y^r, y^u - \eta_i x^v, x^{s-v} y^{u-r} - \xi_i \eta_i)$$

The A -graph Γ is obtained by setting $\xi_i = \eta_i = 0$, giving the following “stair” shape:

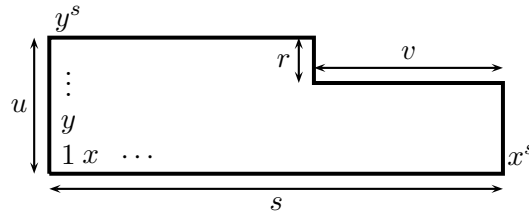

For any $(\xi_i, \eta_i) \in \mathbb{C}^2$, modulo the ideal $I_{\mathcal{Z}_{\xi_i, \eta_i}}$ we have that any monomial in $\mathbb{C}[x, y]$ can be written in terms of elements in Γ . In other words, the vector space $\mathbb{C}[x, y]/I_{\mathcal{Z}_{\xi_i, \eta_i}}$ has Γ as basis. Note also that $2n = su - rv$, so the number of elements agrees with the order of the group. Thus $\mathbb{C}_{\xi_i, \eta_i}^2$ is an open set in $A\text{-Hilb}(\mathbb{C}^2)$.

Example: Consider the group $A = \langle \frac{1}{12}(1, 7) \rangle$. We have $\frac{12}{7} = [2, 4, 2]$ and therefore the resolution of singularities $Y = A\text{-Hilb}(\mathbb{C}^2) \rightarrow \mathbb{C}^2/G$ is of the form $Y = Y_0 \cup Y_1 \cup Y_2 \cup Y_3$, where each $Y_i \cong \mathbb{C}_{(\xi_i, \eta_i)}^2$, $i = 0, \dots, 3$. See Figure 4.1.

The corresponding A -clusters for these affine pieces are defined by the following ideals:

$$I_{\xi_0, \eta_0} = \begin{pmatrix} x^{12} - \xi_0 \\ y - \eta_0 x^7 \end{pmatrix} \quad I_{\xi_1, \eta_1} = \begin{pmatrix} x^7 - \xi_1 y \\ y^2 - \eta_1 x^2 \\ x^5 y - \xi_1 \eta_1 \end{pmatrix} \quad I_{\xi_2, \eta_2} = \begin{pmatrix} x^2 - \xi_2 y^2 \\ y^7 - \eta_2 x \\ xy^5 - \xi_2 \eta_2 \end{pmatrix} \quad I_{\xi_3, \eta_3} = \begin{pmatrix} x - \xi_3 y^7 \\ y^{12} - \eta_3 \end{pmatrix}$$

so each of the complex planes Y_i parametrize an open set in $A\text{-Hilb}(\mathbb{C}^2)$. To see which A -graph corresponds to each of the open sets, it is useful to look at the origin in each of

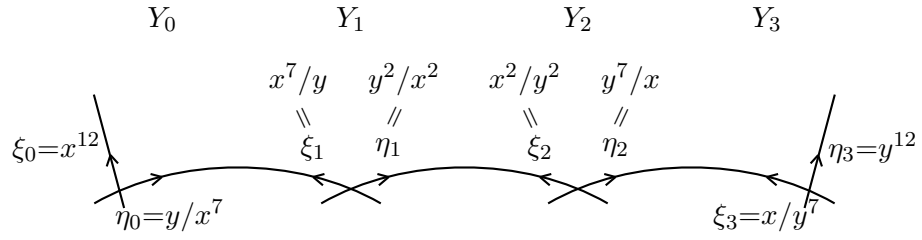

Figure 4.1: Resolution of singularities Y of the cyclic singularity of type $\frac{1}{12}(1, 7)$.

the Y_i , for $i = 0, 1, 2, 3$, i.e. consider $\xi_i = \eta_i = 0$. Then we obtain the A -graphs Γ_i for $i = 0, \dots, 3$ shown in Figure 4.2.

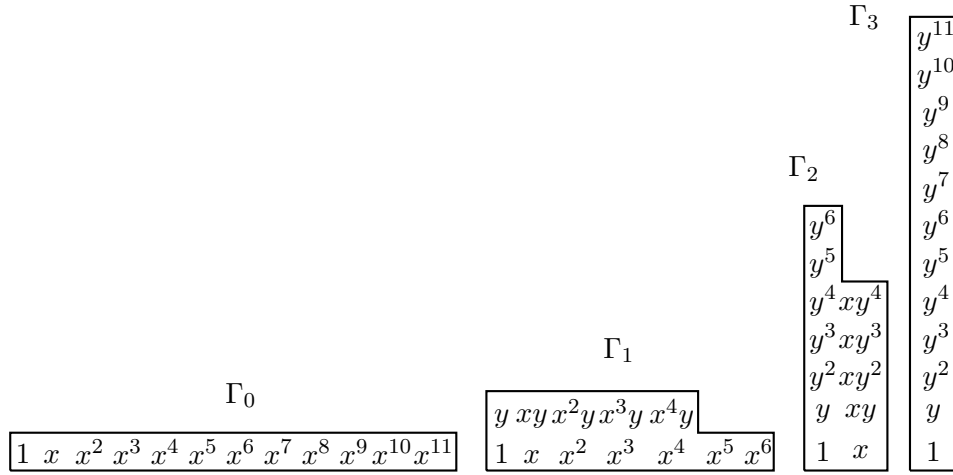

Figure 4.2: A -graphs for the group $A = \langle \frac{1}{12}(1, 7) \rangle$.

4.3 qG -graphs

Let $G = \text{BD}_{2n}(a)$ be a small binary dihedral group and let $A = \langle \alpha \rangle = \langle \frac{1}{2n}(1, a) \rangle$ be the maximal normal cyclic subgroup of order $2n$. As we have seen in Section 3.2, we are going to construct the resolution $Y \rightarrow \mathbb{C}^2/G$ by acting with β on $A\text{-Hilb}(\mathbb{C}^2)$.

Recall that $\beta : (x, y) \mapsto (y, -x)$ interchanges the coordinates x and y . The symmetry along the coordinates of the exceptional divisor in $A\text{-Hilb}(\mathbb{C}^2) = \bigcup_{i=0}^{2m} Y_i$ implies that β identifies Y_i with Y_{2m-i} , as well as identifying the corresponding A -graphs contained in those affine pieces.

Let \mathcal{Z}_i be an A -cluster in Y_i and $\beta(\mathcal{Z}_i)$ its image under β , with ideals $I_{\mathcal{Z}_i}$ and $I_{\beta(\mathcal{Z}_i)}$ respectively. Denote also by \mathcal{Z} the point in the quotient $A\text{-Hilb}(\mathbb{C}^2)/\langle\beta\rangle$ corresponding to the orbit $\{\mathcal{Z}_i, \beta(\mathcal{Z}_i)\}$. See Figure 4.3.

Suppose that \mathcal{Z}_i and $\beta(\mathcal{Z}_i)$ are not any of the points in $A\text{-Hilb}(\mathbb{C}^2)$ that are fixed by β . Therefore, \mathcal{Z} is not one of the singular A_1 points in the quotient and, since $G\text{-Hilb}(\mathbb{C}^2)$ is the minimal resolution, \mathcal{Z} corresponds one-to-one with a G -cluster.

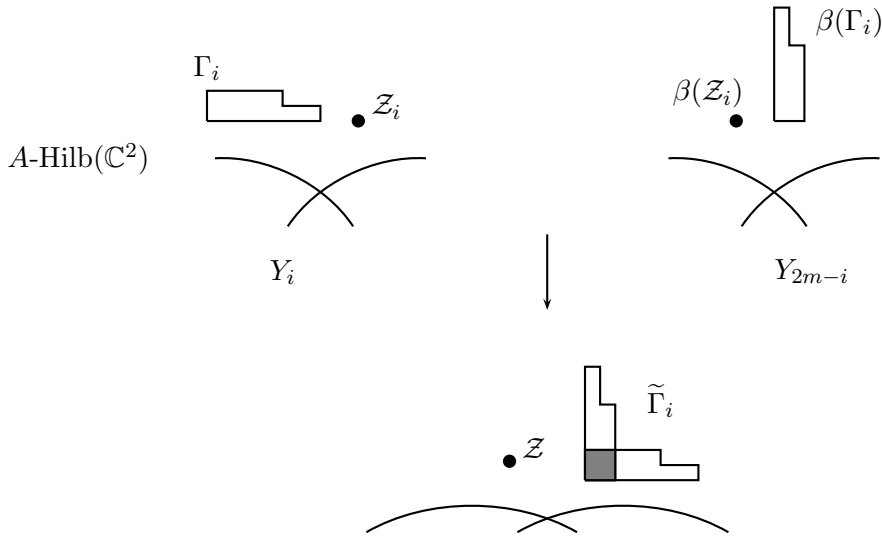

Figure 4.3: Action of β on $A\text{-Hilb}(\mathbb{C}^2)$ in terms of A -graphs.

As clusters in \mathbb{C}^2 , we have that

$$\mathcal{Z} \supset \mathcal{Z}_i \cup \beta(\mathcal{Z}_i)$$

or equivalently

$$I_{\mathcal{Z}} \subset I_{\mathcal{Z}_i} \cap I_{\beta(\mathcal{Z}_i)}$$

In terms of graphs, if we denote by Γ , Γ_i and $\beta(\Gamma_i)$ the A -graphs corresponding to the ideals $I_{\mathcal{Z}}$, $I_{\mathcal{Z}_i}$ and $I_{\beta(\mathcal{Z}_i)}$ respectively, we have that

$$\Gamma \supset \Gamma_i \cup \beta(\Gamma_i) = \tilde{\Gamma}_i$$

where $\tilde{\Gamma}_i$ is a G -invariant graph symmetric with respect to the diagonal. But, notice that $\tilde{\Gamma}_i$ it is not a G -graph. Indeed, Γ_i and $\beta(\Gamma_i)$ have an overlap (their common basis

elements), so the number of elements of $\tilde{\Gamma}_i$ is always smaller than $|G| = 2 \cdot |A|$. We will call these new graphs “*quasi G -graphs*” (qG -graphs).

Remark 4.3. Since every qG -graph is given by two symmetric A -graphs, or equivalently, given by two symmetric pairs of consecutive lattice points in the boundary of the Newton polygon of L , we need only consider half of the lattice points. More precisely, we just have to look at the qG -graphs coming from the points $e_0 = (0, 2n)$, $e_1 = (1, a)$, \dots , $e_{m-1} = (q, q)$.

Example 4.4. Continuing with the previous example, the action of β glues together Γ_0 with Γ_3 and Γ_1 with Γ_2 , obtaining the qG -graphs $\tilde{\Gamma}_0$ and $\tilde{\Gamma}_1$. See Figure 4.4.

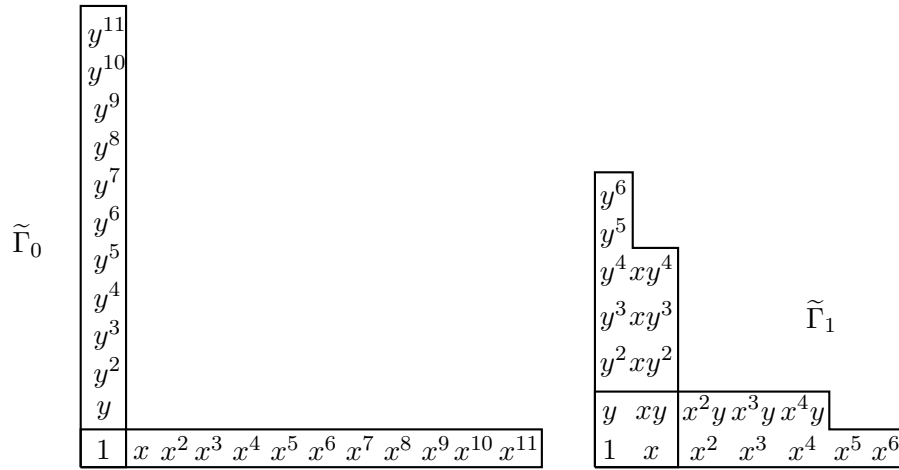

Figure 4.4: qG -graphs for the group $BD_{2n}(a)$.

Now we look at how two symmetric A -graphs can merge together into a qG -graph. The following proposition shows that there are only two types of gluing.

Proposition 4.5. *Let $G = BD_{2n}(a) \subset GL(2, \mathbb{C})$ a small binary dihedral group. Let Γ be the A -graph defined by the consecutive Newton polygon points $e_i = (r, s)$ and $e_{i+1} = (u, v)$. Then*

$$\begin{aligned} \tilde{\Gamma} \text{ is of type A if } & s - v > u \\ \tilde{\Gamma} \text{ is of type B if } & s - v = u - r \end{aligned}$$

Their shape is shown in the following diagram:

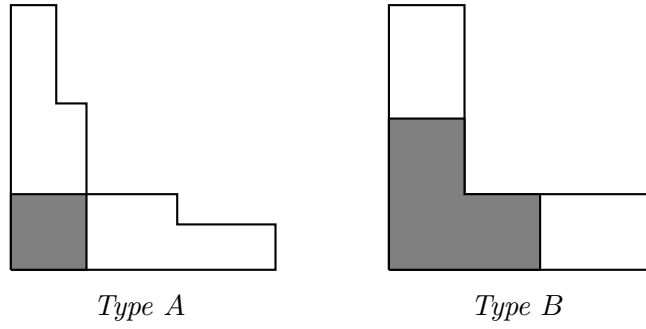

The coloured area represents the overlap between the A -graphs.

Proof. Let $e_{i+1} = (t, w)$ the next point in the boundary of the Newton polygon. Since any $\tilde{\Gamma}$ is the union of two symmetric A -graphs with respect to the diagonal, the shape of the qG -graph will depend on the relation between $s - v$ and u .

Suppose that $s - v \leq u$. This means that $s - v = u - k$ for some $0 \leq k < u$. Then

$$k = u + v - s = u + (1 - b_{i+1})v + w$$

which implies $b_{i+1} = 2$ (otherwise, since we always have that $v \geq u$ and $v > w$, then $k < 0$, a contradiction). Now,

$$k = u - v + w$$

and applying the same argument to w and so on, we obtain that $b_{i+1} = b_{i+2} = \dots = b_m = 2$, that is, $\frac{2n}{a} = [b_1, \dots, b_i, 2, \dots, 2, b_i, \dots, b_1]$.

And finally, this chain of 2s in the middle of the continued fraction gives us the value of k : Let $e_{m-1} = (p, q)$, $e_m = (j, j)$, $e_{m+1} = (q, p)$ be the three middle Newton polygon points. Then proceeding with the previous argument we get

$$\begin{aligned}
 k &= u - q + j \\
 &= u - (2j - p) + j \\
 &= u - j + p \\
 &\vdots \\
 &= u - t + u \\
 &= 2u - t \\
 &= r
 \end{aligned}$$

which gives the qG -graph of type B. □

Remark 4.6. From the previous proof, we can deduce that the distribution of the qG -graphs of type A and B in the exceptional locus depend on the number of 2s in the middle of the continued fraction $\frac{2n}{a}$. For example, the continued fraction $[\dots, b, 2, 2, 2, 2, 2, b, \dots]$ with $b \neq 2$, gives three qG -graphs of type B .

Let $\tilde{\Gamma}_0, \tilde{\Gamma}_1, \dots, \tilde{\Gamma}_{m-1}$ be the sequence of qG -graphs, then if $b_i = 2$ for $k \leq i \leq m$ and $b_{k-1} \neq 2$, we have that $\tilde{\Gamma}_0, \tilde{\Gamma}_1, \dots, \tilde{\Gamma}_{k-1}$ are of type A and $\tilde{\Gamma}_k, \tilde{\Gamma}_{k+1}, \dots, \tilde{\Gamma}_{m-1}$ are of type B .

As a consequence we get the following corollary.

Corollary 4.7. *There are no type B qG -graphs if and only if the middle entry b_m in the continued fraction $\frac{2n}{a} = [b_0, \dots, b_m, \dots, b_0]$ is different from 2.*

In the case $a = 2n - 1$, i.e. $\text{BD}_{2n}(2n - 1) \subset \text{SL}(2, \mathbb{C})$, then the coefficients of the continued fraction $\frac{2n}{2n-1}$ are all 2, and every qG -graph is of type B .

There is also a relation between types A and B , and the dimension of the corresponding irreducible special representations. Let $E = \bigcup E_i \subset \text{BD}_{2n}(a)\text{-Hilb}(\mathbb{C}^2)$ be the exceptional divisor. By [Wun88], the dimension of the special representations ρ_i corresponding to E_i is equal to the coefficient of E_i in the fundamental cycle Z_{fund} (the smallest effective divisor such that $Z_{\text{fund}} \cdot E_i \leq 0$). Let $-2, -2, -a_m, \dots, -a_2, -a_1$ be the selfintersections along the minimal resolution of $G/\text{BD}_{2n}(a)$, where the first two -2 s correspond to the ‘‘horns’’ of the Dynkin diagram (compare with the Brieskorn notation in Section 3.3.1, and Section 4.6).

Corollary 4.8. *The special irreducible representations of $\text{BD}_{2n}(a)$ are all 1-dimensional if and only if the middle entry b_m in the continued fraction $\frac{2n}{a} = [b_1, \dots, b_m, \dots, b_1]$ is different from 2.*

Proof. Let $Z_{\text{fund}} = \sum c_i E_i$ for $i = 1, \dots, m + 2$ and $c_i \geq 0$. Then we have to find the

minimum integers a_i such that

$$\begin{aligned}
& -a_1c_1 + c_2 \leq 0 \\
& c_1 - a_2c_2 + c_3 \leq 0 \\
& c_2 - a_3c_3 + c_4 \leq 0 \\
& \quad \vdots \\
& c_{m-2} - a_{m-1}c_{m-1} + c_m \leq 0 \\
& c_{m-1} - a_m c_m + c_{m+1} + c_{m+2} \leq 0 \\
& c_m - 2c_{m+1} \leq 0 \\
& c_m - 2c_{m+2} \leq 0.
\end{aligned}$$

First note that if $c_i = 0$ for some i , then $c_i = 0$ for all i . Also, the value of c_i corresponds to the dimension of an irreducible representation, so it is at most 2. Thus $1 \leq c_i \leq 2$.

By minimality $c_{m+1} = c_{m+2} = 1$ and $c_m = 1$ if and only if $a_m > 2$. The same argument shows that if $a_i > 2$ for some i then we can take $c_j = 1$ for $j \leq i$. Therefore, if $c_m > 2$ we have that $c_j = 1$ for all j , so every special representation is 1-dimensional.

By Theorem 3.15 we know that $a_m = \frac{b_m+2}{2}$, so $a_m = 2$ if and only if $b_m = 2$ and the result is proved. \square

Thus we have a one-to-one correspondence between type A qG -graphs and 1-dimensional special representations (except the two corresponding to the ‘‘horns’’, which are also 1-dimensional), and another correspondence between type B qG -graphs and 2-dimensional special representations.

4.4 G -graphs from qG -graphs

In this section we will construct the G -graph corresponding to a given qG -graph. Every element of the qG -graph is obviously in the G -graph, and the number of elements that we have to add to the qG -graph is exactly the number of elements in the overlap M . We will find these new members by looking at the representations of G that are contained in M .

Let I be an ideal defining a G -cluster and Γ_I its graph. Then the elements of Γ_I form a basis for the vector space $\mathbb{C}[x, y]/I$, and every irreducible representation ρ has $(\dim \rho)$

number of elements in Γ_I . Suppose for simplicity that ρ is a 1-dimensional irreducible representation of G . Then ρ can be considered as a 1-dimensional vector space with basis g , and whenever an element f is not basis of ρ we have a relation of the form $f = a \cdot g$ for some $a \in \mathbb{C}$. In particular $f - ag \in I$.

In order to easily describe the G -graph we can take $a = 0$, so that $f = 0$ in $\mathbb{C}[x, y]/I$. More precisely, choosing to take all constants to be equal to zero for a given G -cluster corresponds to looking at the origin of the affine open set defined by the G -graph. The set of these G -clusters describes the 0-dimensional strata of $G\text{-Hilb}(\mathbb{C}^2)$.

As we have seen in Section 3.4.2, instead of having monomials in every irreducible representation we can have sums of monomials. This creates the new phenomenon of “twin” elements in the G -graphs which does not appear in the Abelian case.

For example, let $f = x^i y^j - x^j y^i$ with $i > j$ be an element in some 1-dimensional representation ρ . If f is not the basis for ρ , then $x^i y^j = x^j y^i$ and both monomials become the same element in $\mathbb{C}[x, y]/I$, that is, they are “twins”. Moreover, multiplying the above equality by $x^p y^q$ for any positive integers p and q , we have $x^{i+p} y^{j+q} = x^{j+p} y^{i+q}$, which means that once we have a pair of symmetric twin elements we get a pair of symmetric “twin regions”. Thus, in order to count the number of basis elements when this phenomenon occurs, a pair of twin elements will count as a single basis element.

4.4.1 Type A

Suppose that $\tilde{\Gamma}$ is a qG -graph of type A and let $e_i = (r, s)$ and $e_{i+1} = (u, v)$ be the corresponding lattice points in the Newton polygon. Then $\tilde{\Gamma} = \Gamma_{I_i} \cup \Gamma_{\beta(I_i)}$ where $I_i = (x^s, y^u, x^{s-v} y^{u-r})$ and $\beta(I_i) = (x^u, y^s, x^{u-r} y^{s-v})$ define the $\frac{1}{2n}(1, a)$ -graphs. In addition, we have the inequalities $r < u \leq v < s$ and $u < s - v$, coming from the lattice L and the type A condition respectively.

The general shape for a type A qG -graph is the following:

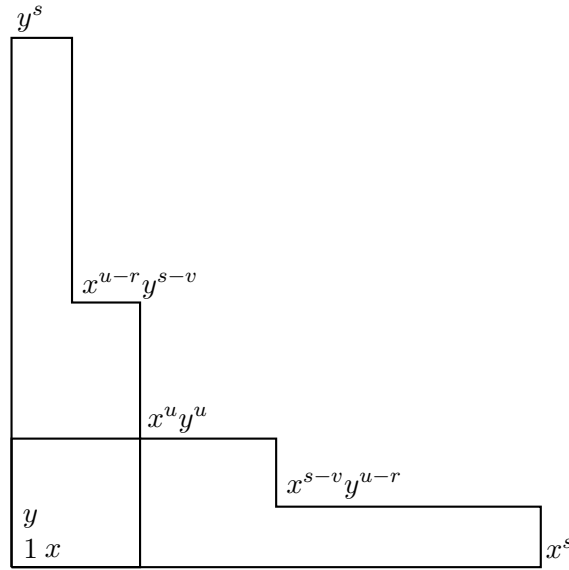

If we call $M = \Gamma_I \cap \Gamma_{\beta(I)}$ the overlap, clearly $\#\tilde{\Gamma} = 2 \cdot \#\Gamma_I - \#M < 2n$. Then, in order for $\tilde{\Gamma}$ to be a G -graph it needs to be extended by $\#M = u^2$ elements, and these extra elements belong to the irreducible representations appearing in M .

Let us denote by Γ (or by $\Gamma_A(r, s; u, v)$ when a reference to the lattice points is necessary) the G -graph corresponding to $\tilde{\Gamma}$, and by I its defining ideal. The following lemmas show that we just need to look at some key representations.

Lemma 4.9. *The polynomial $x^{s-v}y^{u-r} + (-1)^{u-r}x^{u-r}y^{s-v}$ is G -invariant, i.e. it belongs to I .*

Proof. We need to show that $x^{s-v}y^{u-r} + (-1)^{u-r}x^{u-r}y^{s-v}$ is invariant under the action of α and β . By Lemma 3.5 we know that $ar \equiv s$ and $au \equiv v \pmod{2n}$, then

$$\begin{aligned} \alpha(x^{s-v}y^{u-r} + (-1)^{u-r}x^{u-r}y^{s-v}) &= \varepsilon^{s-v+au-ar}x^{s-v}y^{u-r} + (-1)^{u-r}\varepsilon^{u-r+as-av}x^{u-r}y^{s-v} \\ &= x^{s-v}y^{u-r} + (-1)^{u-r}x^{u-r}y^{s-v} \end{aligned}$$

and

$$\begin{aligned} \beta(x^{s-v}y^{u-r} + (-1)^{u-r}x^{u-r}y^{s-v}) &= (-1)^{u-r}x^{u-r}y^{s-v} + (-1)^{u-r+s-v}x^{s-v}y^{u-r} \\ &= x^{s-v}y^{u-r} + (-1)^{u-r}x^{u-r}y^{s-v}. \end{aligned}$$

In the last equality we are using the fact that $s - v$ and $u - r$ must have the same parity, again by Lemma 3.5. \square

Lemma 4.10. *The monomial $x^u y^u$ is not in the G -graph Γ .*

Proof. Suppose that $x^u y^u \notin I$. Notice that $x^u y^u$ and $x^{u+v} + (-1)^u y^{u+v}$ are in the same 1-dimensional representation ρ_{u+v} , so $x^{u+v} + (-1)^u y^{u+v} \in I$ and it forms a twin region. Observe also that the following elements belong to the same 2-dimensional representation:

$$(x^u y^{u+1}, (-1)^u x^{u+1} y^u), (y^{u+v+1}, -x^{u+v+1}), (x^l, y^l) \in V_l$$

for some $0 < l < u + v + 1$. Since the monomials $y^{u+v+1}, x^{u+v+1}, x^l, y^l \in \tilde{\Gamma}$ they must belong to Γ so the pair $(x^u y^{u+1}, (-1)^u x^{u+1} y^u) \notin \Gamma$, hence $x^u y^{u+1}, x^{u+1} y^u \in I$.

This last condition implies that on the diagonal, the qG -graph can only be extended with the element $x^u y^u$. We claim the and along the sides it cannot be extended enough to obtain a G -graph. Indeed, by the previous lemma we know that $x^{s-v} y^{u-r} + (-1)^{u-r} x^{u-r} y^{s-v} \in I$ so it forms a pair of twin regions. Also $x^r (x^{s-v} y^{u-r} + (-1)^{u-r} x^{u-r} y^{s-v}) = x^{s+r-v} y^{u-r} + (-1)^{u-r} x^r y^{s-v} \in I$. Now, the type A condition $u < s - v$ implies that $x^u y^{s-v} \in I$, and therefore $x^{s+r-v} y^{u-r} \in I$ (same for $x^{u-r} y^{s+r-v}$). Thus the twin regions have r^2 elements each.

In the same way, the element $x^{u+v} + (-1)^u y^{u+v}$ forms another twin region, and since $u + u < s$, their size is at most $(u - r)^2 - (u - r)$. So, the qG -graph is extended with at most $r^2 + (u - r)^2 - (u - r) + 1 < u^2 = \#M$ monomials, and this is a contradiction. \square

As a consequence we have that $x^{s-v} y^{u-r} + (-1)^{u-r} x^{u-r} y^{s-v}$ creates a twin region T_1 of size r^2 . The following lemma shows that there exists another polynomial creating a second twin region.

Lemma 4.11. *The polynomial $x^{r+s} + (-1)^r y^{r+s} \in I$ and creates a twin region T_2 of size $(u - r)^2$.*

Proof. By Lemma 3.5 is easy to see that $x^r y^r$ and $x^{r+s} + (-1)^r y^{r+s}$ are in the same representation ρ_{r+s} . But $x^r y^r$ belongs to the qG -graph so it must be in Γ , and therefore $x^{r+s} + (-1)^r y^{r+s} \in I$.

Now combining the previous lemmas we see that $x^{s+u}, y^{s+u} \in I$ and the size of the twin region T_2 is equal to $(u - r)^2$. \square

Hence, the extension to a G -graph from any type A qG -graph has two twin regions T_1 and T_2 , except for the first qG -graph given by $e_0 = (0, 2n)$ and $e_1 = (1, a)$ where only

T_2 appears ($r = 0$ in this case). Figure 4.5 represents the shape of the G -graph we were looking for.

Proposition 4.12. *The ideal*

$$I_A = (x^u y^u, x^{s-v} y^{u-r} + (-1)^{u-r} x^{u-r} y^{s-v}, x^{r+s} + (-1)^r y^{r+s})$$

defines a G -graph $\Gamma_A(r, s; u, v)$ of type A .

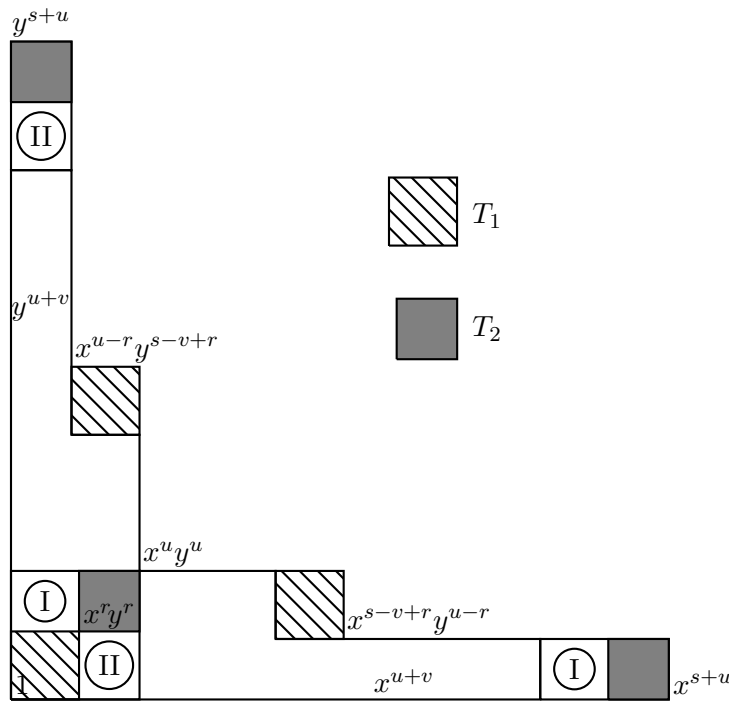

Figure 4.5: Extension from a qG -graph to a G -graph of type A by the elements in the overlap.

Proof. The previous lemmas show that the qG -graph only expands along its sides, and it does not grow further than the twin regions T_1 and T_2 . Then, the number of elements added is

$$\#T_1 + \#T_2 + \#I + \#II = r^2 + (r - u)^2 + 2r(u - r) = u^2$$

exactly the number of elements in the overlap.

We still have to prove that Γ contains 1 polynomial for each 1-dimensional irreducible representation ρ_k and 2 pairs of polynomials for each 2-dimensional irreducible representation V_j . Since the qG -graph is made from two cyclic graphs symmetric with respect to

the diagonal, every representation not appearing in the overlap will appear twice, as required. Therefore we need only check that the representations of the new extended blocks correspond exactly to the ones in the overlap.

Every representation contained in regions I and II is 2-dimensional, and we have one basis element coming from the overlap M and a second from the extended region.

In the twin regions T_1 and T_2 it looks like we have doubled the basis elements, but the presence of the twin relations gives the correct number. We show in diagram below the configuration of the representations contained in the twin region T_1 . The case of T_2 is analogous.

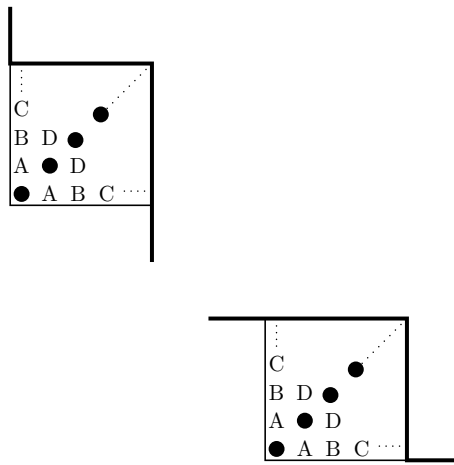

The elements on the diagonals (marked by dots) are in 1-dimensional representations. The rest (marked by letters) are in 2-dimensional representation pairs, that is, a monomial $x^i y^j$ and its symmetric with respect to the diagonal $x^j y^i$, will form an element in some 2-dimensional representation (we omit the sign here). Elements with the same letter are in the same representation.

Since twin symmetric regions count as one, we can see how the representations of the overlap are fully represented in the extension. Note also that in these twin regions, there are three pairs of elements in the graph for each 2-dimensional representation when we should have only two. For this, observe that the twin relations $x^{s-v} y^{u-r} + (-1)^{u-r} x^{u-r} y^{s-v} = 0$ and $x^{r+s} + (-1)^r y^{r+s} = 0$ identify two of these pairs, and therefore we have a G -graph.

Therefore, for every 2-dimensional representation contained in a twin region we have one basis element coming from the overlap region and a second basis element coming from a combination of elements in the outer twin regions. □

4.4.2 Type B

Suppose that the qG -graph $\tilde{\Gamma}$ defined by $e_i = (r, s)$ and $e_{i+1} = (u, v)$ is of type B, that is, we can define $m := s - v = u - r$. As before, we will denote by Γ , or $\Gamma_B(r, s; u, v)$, the G -graph corresponding to $\tilde{\Gamma}$. The general shape for a type B qG -graph is the following:

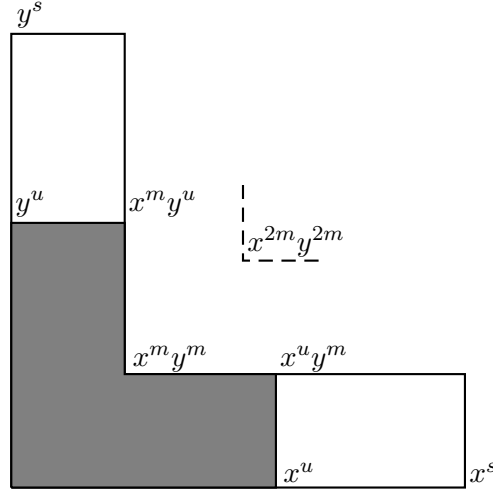

In addition, we suppose that $x^u y^m$ and $x^m y^u$ are not in Γ , that is,

$$x^u y^m = x^m y^u = 0$$

Note that $\alpha(x^u y^m) = \varepsilon^{u+as-av} x^u y^m = \varepsilon^{u+r-u} x^u y^m = \varepsilon^r x^u y^m$, which implies that the pair $(x^u y^m, (-1)^m x^m y^u)$ belongs to the 2-dimensional representation V_r .

Remark 4.13. This assumption characterises the G -graph. If we consider them as part of the basis, i.e. $x^u y^m, x^m y^u \in \Gamma$, we will be dealing with the next type B G -graph in the exceptional locus of the resolution $Y = G\text{-Hilb}(\mathbb{C}^2)$.

Lemma 4.14. *Let $G = \text{BD}_{2n}(a)$ and let $\Gamma = \Gamma_B(r, s; u, v)$ be a qG -graph of type B. Then the monomial $x^m y^m$ is $\langle \alpha \rangle$ -invariant with m odd, and $x^{2m} y^{2m}$ is G -invariant.*

Proof. We have that $\alpha(x^m y^m) = \varepsilon^{s-v+a(u-r)} x^m y^m = \varepsilon^{s-v+v-s} x^m y^m = x^m y^m$, so it is $\langle \alpha \rangle$ -invariant.

By definition we know that $2m = s - r$, and since the last qG -graph is defined by the lattice points (r, s) and (q, q) , we also know that $2n = q(r - s)$. Then $n = qm$, and since $G = \text{BD}_{2n}(a)$ we conclude that m is odd by Theorem 3.11. Therefore, $\beta(x^m y^m) = -x^m y^m$ so the G -invariant monomial is $x^{2m} y^{2m}$. \square

Note also that m remains the same for every qG -graph of type B (if it exists). Indeed, if we consider the next type B qG -graph $\Gamma_B(u, v; t, w)$, we have that $w = 2v - s$ so that $v - w = s - v = m$.

Now we split up the type B graphs into two different cases as follows: type $B.1$ will be the case when $u < 2m$, and type $B.2$ the case when $u \geq 2m$. See Figure 4.6

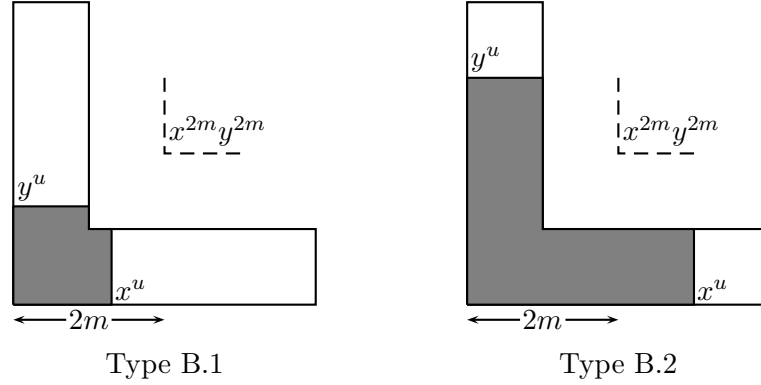

Figure 4.6: G -graphs of type $B.1$ and $B.2$ according to the size of the overlap.

Remark 4.15. Let $\tilde{\Gamma}_0, \tilde{\Gamma}_1, \dots, \tilde{\Gamma}_{l-1}$ be the sequence of qG -graphs for a given group $G = \text{BD}_{2n}(a)$. Let $\frac{2n}{a} = [b_1, \dots, b_l, \dots, b_1]$ and suppose that $b_i = 2$ for $k \leq i \leq l-1$ and $b_{k-1} \neq 2$, for some $0 \leq k \leq l-1$. By Remark 4.6 the qG -graphs $\tilde{\Gamma}_i$ are of type A for $i \leq k-1$, and of type B for $k \leq i \leq l-1$. We claim that $\tilde{\Gamma}_k$ is always of type $B.1$, while $\tilde{\Gamma}_i$ for $k < i \leq l-1$ is of type $B.2$.

Indeed, let $\tilde{\Gamma}_{k-1} = \tilde{\Gamma}_A(p, q; r, s)$ a G -graph of type A and $\tilde{\Gamma}_k = \tilde{\Gamma}_B(r, s; u, v)$ a G -graph of type B . Then we can define $m = s - v = u - r$, and since the corresponding b_i in the continued fraction is 2 ($\tilde{\Gamma}_k$ is of type B) we have $q = 2s - v$. Now, since $\tilde{\Gamma}_{k-1}$ is of type A we have

$$r < q - s = (2s - v) - s = s - v = m$$

and then $u = m + r < 2m$, so $\tilde{\Gamma}_k$ is of type $B.1$.

Suppose now that $k < l-1$ so that exists $\tilde{\Gamma}_{k+1} = \tilde{\Gamma}_B(u, v; w, t)$ a qG -graph of type B . Then $w = 2u - r$, and if we call $m' = w - u$, then

$$2m' = 2(w - u) = 2w - 2u = 2w - (w + r) = w - r$$

Therefore $w \geq 2m'$, i.e. a type $B.2$ qG -graph. By induction the rest of the qG -graphs are

also of type $B.2$.

Type $B.1$

In this case $u < 2m$. The description of the G -graphs of type $B.1$ is given by the following proposition:

Proposition 4.16. *The ideal*

$$I_{B.1} = (x^{r+s} + (-1)^r y^{r+s}, x^{m+s} y^{m-r} + (-1)^{m-r} x^{m-r} y^{m+s}, x^u y^m, x^m y^u)$$

defines a G -graph $\Gamma_{B.1}(r, s; u, v)$ of type $B.1$.

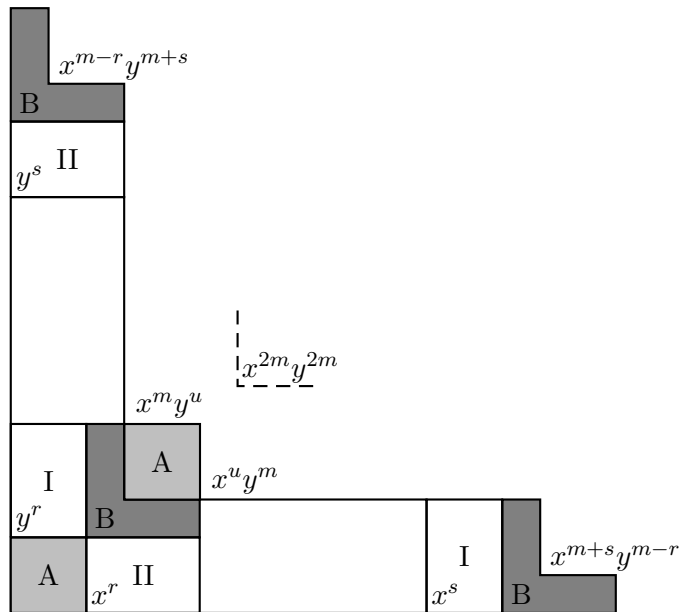

Figure 4.7: G -graph of type $B.1$. The “twin region” is denoted by B

Proof. Since $u < 2m$ we know that $r < u$. Then $x^r y^r \in \Gamma$ is a basis element and we have the following relation:

$$x^{r+s} + (-1)^r y^{r+s} = 0$$

which creates a twin region. Also, using the condition $x^u y^m = x^m y^u = 0$ and multiplying the previous relation by x^m and y^m we get

$$x^{s+u} = y^{s+u} = 0$$

Looking now at the representations ρ_0^+ and ρ_0^- , we see that $x^{m+s} y^{m-r} + (-1)^{m-r} x^{m-r} y^{m+s} =$

0 (since 1 is always basic) and $x^{m+s}y^{m-r} - (-1)^{m-r}x^{m-r}y^{m+s} = 0$ (otherwise $x^m y^m = 0$ and the G -graph would not have enough elements) , which implies

$$x^{m+s}y^{m-r} = x^{m-r}y^{m+s} = 0$$

All these relations are enough to determine a G -graph.

To finish we need to check that in Γ we have the correct number of elements in each representation. As in the type A case, this is true since the representations involved in the overlap are exactly those for the elements we have just added. In Figure 4.7 we show the G -graph and the underlying relation between the representations of G for the type $B.1$ case. \square

Type $B.2$

Now we have that $u \geq 2m$ and $x^u y^m = x^m y^u = 0$.

Proposition 4.17. *The ideal*

$$I_{B.2} = (x^{2m}y^{2m}, x^{s+m}, y^{s+m}, x^u y^m, x^m y^u)$$

defines a G -graph $\Gamma_{B.2}(r, s; u, v)$ of type $B.2$.

Proof. First observe that $x^r y^m$ and $x^m y^r$ are elements of the basis. Indeed, the pairs

$$(x^{r-m}, y^{r-m}), (y^{s+m}, (-1)^{s+m}x^{s+m}), (x^r y^m, -x^m y^r) \in V_{2r-u}$$

The monomials x^{r-m} and y^{r-m} must be in Γ since they belong to the qG -graph. If $x^r y^m = x^m y^r = 0$ then $y^{s+m}, x^{s+m} \in \Gamma$, which is the case of the previous type B G -graph.

Therefore we can assume that

$$x^{s+m} = y^{s+m} = 0$$

From this, together with the rest of assumptions and the G -invariant relation $x^{2m}y^{2m} = 0$, we obtain the result. In the Figure 4.8 we show the resulting G -graph and the relation with the representations in the overlap. \square

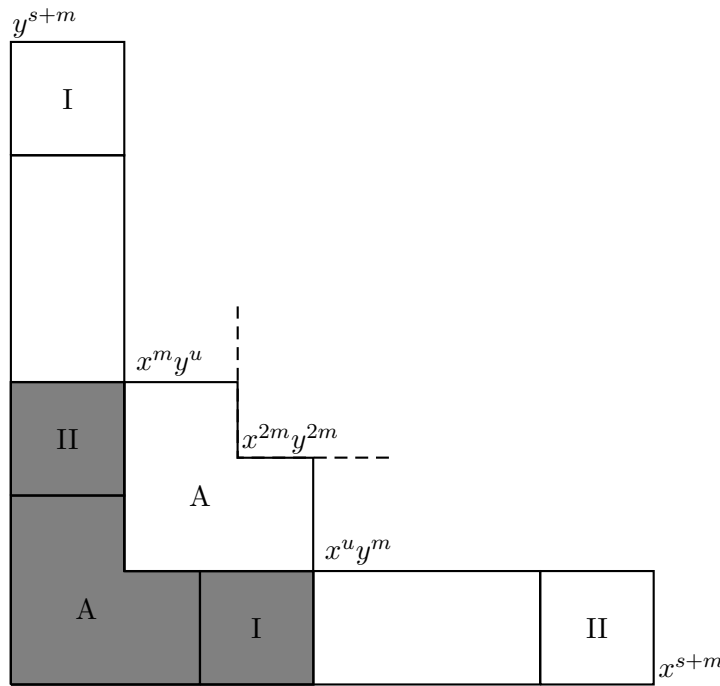
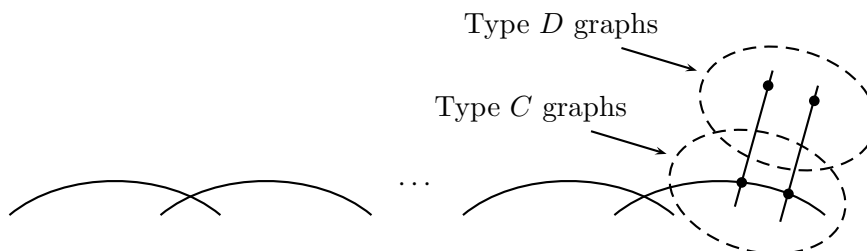

Figure 4.8: G -graph of type $B.2$. The overlap in this case is extended without twin regions.

4.4.3 Remaining G -graphs: types C and D

From any qG -Graph we are able to find uniquely its corresponding G -graph by adding some suitable basis elements. This procedure will give almost all possible G -graphs. Indeed, the involution of the middle rational curve to itself by β gives two isolated fixed points, and therefore two more rational curves in the exceptional locus for the resolution of \mathbb{C}^2/G . This part of the exceptional locus cannot be recovered with qG -graphs, i.e. from the toric information of $A\text{-Hilb}(\mathbb{C}^2)$.

In this section we construct the G -graphs which correspond to the neighbourhood of the two exceptional curves coming from the involution of the middle curve (the discontinuous area in the diagram below).



They will be called *type C* and *type D*, and each of them have two cases, C^+ and C^- (D^+ and D^- respectively).

Let $e_m = (r, s)$ and $e_{m+1} = (q, q)$ be the lattice points giving the last qG -graph Γ_{m-1} , and define

$$m_1 := s - q \quad \text{and} \quad m_2 := q - r$$

Note that if the last qG -graph is of type B then $m_1 = m_2$, and if it is of type A then $m_1 > m_2$. The new G -graphs depend on a choice of basis of the following two 1-dimensional representations of G :

$$\begin{aligned} x^q + (-i)^q y^q, \quad x^s y^{m_2} + (-1)^r i^q x^{m_2} y^s &\in \rho_q^+ \\ x^q - (-i)^q y^q, \quad x^s y^{m_2} - (-1)^r i^q x^{m_2} y^s &\in \rho_q^- \end{aligned}$$

which correspond to the two curves we want to cover (see Section 4.6).

Note that the polynomials $x^q + (-i)^q y^q$ and $x^q - (-i)^q y^q$ cannot be both out of the basis of $\mathbb{C}[x, y]/I$ at the same time. Indeed, if $x^q + (-i)^q y^q, x^q - (-i)^q y^q \in I$ then also $x^q, y^q \in I$, which is a contradiction since they are elements of the last qG -graph.

Remark 4.18. The monomial $x^{s-r} y^{s-r}$ is G -invariant, and therefore is in I . Indeed,

$$\alpha(x^{s-r} y^{s-r}) = \beta(x^{s-r} y^{s-r}) = x^{s-r} y^{s-r}$$

since r and s have the same parity, and $ar \equiv s$ and $as \equiv r \pmod{2n}$. Similarly, the pairs of monomials $x^{s-r+iq} y^{s-r-iq} + (-1)^{iq} x^{s-r-iq} y^{s-r+iq}$ are also G -invariant for every i .

Now we give the description of these G -graphs starting with the type D case first, followed by the type C .

G -graphs of type D

Suppose that $x^q + (-i)^q y^q \in I$. Then $x^s y^{m_2} + (-1)^r i^q x^{m_2} y^s$ must be in the G -graph Γ , and the basis elements are $x^q - (-i)^q y^q$ and $x^s y^{m_2} + (-1)^r i^q x^{m_2} y^s$. Similarly, we can choose $x^q - (-i)^q y^q \in I$, which now implies $x^q + (-i)^q y^q$ and $x^s y^{m_2} - (-1)^r i^q x^{m_2} y^s$ are in the basis. The first case corresponds to type D^+ and the second to type D^- .

The assumption $x^q + (-i)^q y^q = 0$ (or analogously, $x^q - (-i)^q y^q = 0$ for the Case D^-) identifies the monomials x^q with y^q as twin elements in $\mathbb{C}[x, y]/I$, and together with $x^{s-r} y^{s-r} = 0$ characterise completely the shape of the G -graph Γ . This gives the following Proposition:

Proposition 4.19. *The ideal $I_{D^+} = (x^q + (-i)^q y^q, x^{s-r} y^{s-r})$ defines a G -graph of type D^+ , and similarly, the ideal $I_{D^-} = (x^q - (-i)^q y^q, x^{s-r} y^{s-r})$ defines a G -graph of type D^- .*

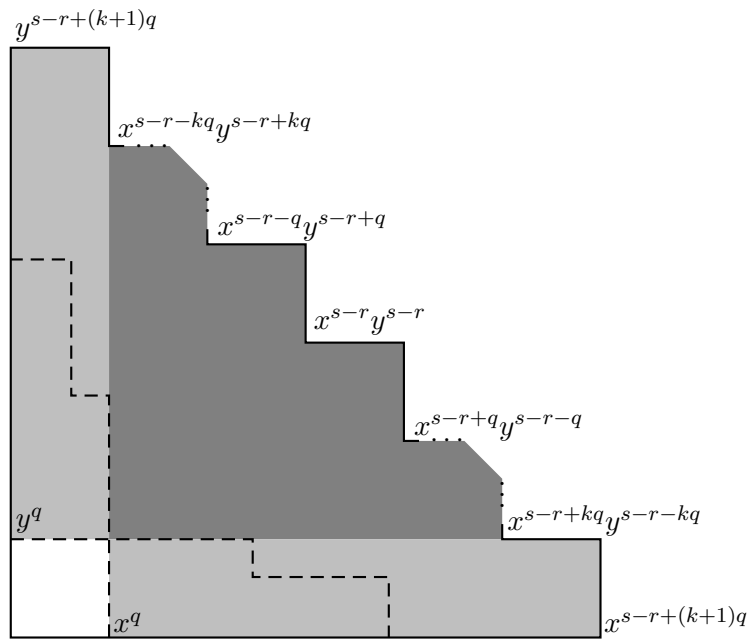

Figure 4.9: G -graph of type D . The monomials x^q and y^q are identified.

Proof. We check that the number of basis elements is correct: by Remark 4.18 we have that $x^{s-r+iq} y^{s-r-iq} + (-1)^{iq} x^{s-r-iq} y^{s-r+iq} \in \rho_0^+$ for all i , i.e. they belong to I . Also, $x^{s-r+iq} y^{s-r-iq} + (-1)^{iq} x^{s-r-iq} y^{s-r+iq} \in \rho_0^-$ belong to I because now $x^{(s-r)/2} y^{(s-r)/2}$ is in the basis of ρ_0^- . Hence $x^{s-r+iq} y^{s-r-iq}, x^{s-r-iq} y^{s-r+iq} \in I$, and the G -graph has a “stair” shape with stairs of height q as shows Figure 4.9 shows.

The condition $x^q + (-1)^q y^q \in I$ gives the identification $y^q = -(-1)^q x^q$, so every monomial $x^i y^j$ in Γ with $i \geq q$ can be written in terms of monomials $x^k y^l$ with $k < q$. So, if we define k, t such that $s - r = kq + t$, we have that that the number of basis elements

after the twin identifications are

$$t(s - r + (k + 1)q) + (q - t)(s - r + kq) = q(s - r + t + qk) = 2q(s - r)$$

But, since the points (r, s) and (q, q) define an A -cluster, we have that $qs - qr = 2n$, and the number above is equal to $4n = |G|$. \square

G -graphs of type C

Now $x^q + (-i)^q y^q$ and $x^q - (-i)^q y^q$ are basis elements for ρ_q^+ and ρ_q^- , i.e. $x^s y^{m_2} \pm (-1)^r i^q x^{m_2} y^s \in I$, which implies that $x^s y^{m_2}, x^{m_2} y^s \in I$.

The following pairs belong to the same 2-dimensional representation (omitting the corresponding signs)

$$(x^r, y^r), (y^s, (-1)^s x^s), (x^q y^{m_1}, (-1)^{m_1} x^{m_1} y^q) \in V_r$$

and all monomials in them must belong to the basis (otherwise the G -graph would have less than $|G|$ elements). Therefore there must be an identification between pairs of the same degree, that is, we take as basic elements (x^r, y^r) and a linear combination of $(y^s, (-1)^s x^s)$ and $(x^q y^{m_1}, (-1)^{m_1} x^{m_1} y^q)$. We have two possibilities:

Case C^+ : $y^{m_1}(x^q + (-i)^q y^q), x^{m_1}(x^q + (-i)^q y^q) \in I$ and the elements in the basis are:

$$(x^r, y^r), (y^{m_1}(x^q - (-i)^q y^q), x^{m_1}(x^q - (-i)^q y^q)).$$

Case C^- : $y^{m_1}(x^q - (-i)^q y^q), x^{m_1}(x^q - (-i)^q y^q) \in I$ and the elements in the basis are:

$$(x^r, y^r), (y^{m_1}(x^q + (-i)^q y^q), x^{m_1}(x^q + (-i)^q y^q)).$$

Note also that the irreducible representation ρ_{2q}^+ contain the elements

$$x^{2q} + (-1)^q y^{2q} \quad \text{and} \quad x^q y^q,$$

and since it is a 1-dimensional representation, we need only one element to be the basis for ρ_{2q}^+ . On the other hand, both of them must belong to Γ , otherwise there will be not

$|G|$ elements in Γ . This implies that we have to take a combination of them as our basis for ρ_{2q}^+ . We will take

$$(x^q + (-i)^q y^q)^2 = x^{2q} + (-1)^q y^{2q} + 2(-i)^q x^q y^q \in I \text{ for type } C^+, \text{ and} \quad (4.1)$$

$$(x^q - (-i)^q y^q)^2 = x^{2q} + (-1)^q y^{2q} - 2(-i)^q x^q y^q \in I \text{ for type } C^- \quad (4.2)$$

Note that in both cases, if the last qG -graph Γ_l is of type B then this last equation is redundant, so it is only needed in the type A case. Indeed, substituting the value of $s = 2q - r$ into the equations for case C^+ we get

$$y^{2q-r} + x^q y^{q-r}, x^{2q-r} + (-1)^q x^{q-r} y^q \in I$$

Now multiplying 4.1 by $(-i)^q y^r$ and 4.2 by x^r , and adding them together we get $x^{2q} + (-1)^q y^{2q} + 2(-i)^q x^q y^q$ as desired.

In the case when the last G -graph Γ_l is of type A , we do need the equation $x^{2q} + (-1)^q y^{2q} \pm 2(-i)^q x^q y^q$ together with the G -invariant $x^{m_1} y^{m_2} + (-1)^{m_2} x^{m_2} y^{m_1}$. In this case $x^{s-r} y^{s-r}$ can be obtained using the rest of identities. In other words,

$$x^{s-r} y^{s-r} \in (x^{2q} + (-1)^q y^{2q} + 2(-i)^q x^q y^q, x^s y^{m_2} - (-i)^q x^{m_2} y^s, x^{m_1} y^{m_2} + (-1)^{m_2} x^{m_2} y^{m_1})$$

Indeed, using the second and third generators of the ideal we have that

$$x^{s-r-q} y^{s-r+q} = (-i)^q x^{2(s-q)} y^{2(q-r)} = -(-1)^{q-r} (-i)^q x^{r-s} y^{r-s}, \text{ and}$$

$$x^{s-r+q} y^{s-r-q} = (-i)^q x^{2(q-r)} y^{2(s-q)} = -(-1)^{q-r} (-i)^q x^{r-s} y^{r-s}$$

Since $s < 2(s-q)$ we can multiply the first generator by $x^{s-r-q} y^{s-r-q}$ getting

$$-(-1)^{q-r} x^{s-r} y^{s-r} - (-1)^r x^{s-r} y^{s-r} + 2x^{s-r} y^{s-r}$$

The only possibility for this to be identically zero is only if q and r are both even at the same time. But this is impossible because it would imply that every boundary lattice point in the lattice L is even, a contradiction. Therefore, the sum above is not identically zero, which implies that $x^{s-r} y^{s-r} = 0$.

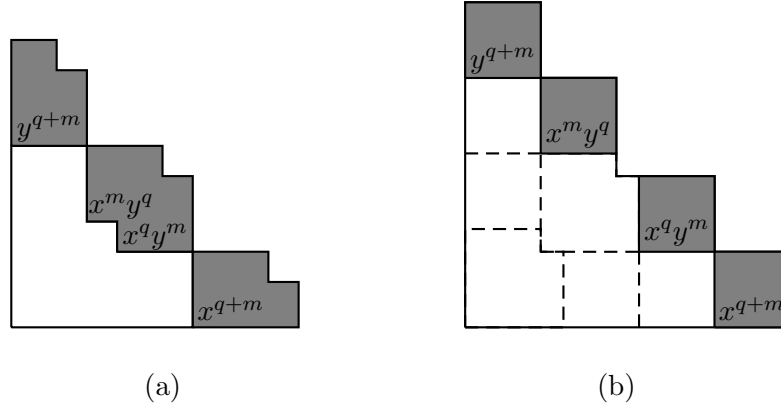

Figure 4.10: G -graph of type C when Γ_l is (a) of type $B.1.$ and (b) of type $B.2.$

Now we have the following proposition

Proposition 4.20. *Let Γ_l be the last qG -graph. Then the ideal*

$$I_{C_A^+} = ((x^q + (-i)^q y^q)^2, x^s y^{m_2} + (-1)^r i^q x^{m_2} y^s, x^{m_1} y^{m_2} + (-1)^{m_2} x^{m_2} y^{m_1})$$

if Γ_l is of type A , or

$$I_{C_B^+} = (y^{m_1} (x^q + (-i)^q y^q), x^{m_1} (x^q + (-i)^q y^q), x^{s-r} y^{s-r}, x^s y^{m_2}, x^{m_2} y^s)$$

if Γ_l is of type B , defines a G -graph of type C^+ (and similarly for C^- changing the corresponding signs).

The shape of the G -cluster is the same in both cases, and as in the type D case, it has a stair shape. In this case, the conditions $x^s y^{m_2}, x^{m_2} y^s \in I$ make the stair smaller. Figure 4.10 we represents the type B situation, i.e. when the last qG -graph is of type B (the type A case is similar).

4.5 Walking along the exceptional divisor

Theorem 4.21. *Let $G = \text{BD}_{2n}(a)$ and let $\Gamma_0, \Gamma_1, \dots, \Gamma_{m-1}, C^+, C^-, D^+, D^-$ be the sequence of G -graphs with $I_{\Gamma_0}, I_{\Gamma_1}, \dots, I_{\Gamma_l}, I_{C^+}, I_{C^-}, I_{D^+}, I_{D^-}$ the corresponding defining ideals. Then,*

1. *For any two consecutive G -graphs, Γ_i and Γ_{i+1} , there exists a family of ideals $J_{(\xi_i, \eta_i)}$ with $(\xi_i : \eta_i) \in \mathbb{P}^1$ such that*

- $J_{(0:1)} = I_{\Gamma_i}$, $J_{(1:0)} = I_{\Gamma_{i+1}}$ and
 - $J_{(\xi_i, \eta_i)}$ defines a G -cluster.
2. There exists a family of ideals $J_{(\gamma_+, \delta_+)}^+$ (respectively $J_{(\gamma_-, \delta_-)}^-$) with $(\gamma_+, \delta_+) \in \mathbb{P}^1$ such that

- $J_{(0:1)}^+ = I_{C^+}$, $J_{(1:0)}^+ = I_{D^+}$ and
- $J_{(\gamma_+, \delta_+)}^+$ defines a G -cluster.

(Similarly for $J_{(\gamma_-, \delta_-)}^-$).

3. There exists a family of ideals $J_{(\tau, \mu)}^C$ with $(\tau, \mu) \in \mathbb{P}^1$ such that

- $J_{(0:1)}^C = I_{C^+}$, $J_{(1:0)}^C = I_{C^-}$, $J_{(1:1)}^C = I_{\Gamma_i}$ and
- $J_{(\tau, \mu)}^C$ defines a G -cluster.

Proof. The proof goes through case by case analysis. For any two consecutive G -graphs Γ_1 and Γ_2 with defining ideals I_{Γ_1} and I_{Γ_2} , we give a family of ideals parametrised by a \mathbb{P}^1 joining the two ideals, and prove that every ideal of this family defines a G -cluster.

- **$\mathbf{A}(\mathbf{r}, \mathbf{s}; \mathbf{u}, \mathbf{v}) \rightarrow \mathbf{A}(\mathbf{u}, \mathbf{v}; \mathbf{t}, \mathbf{w})$:** Suppose that we have two consecutive G -graphs of type A , $\Gamma_1 = \Gamma_A(r, s; u, v)$ and $\Gamma_2 = \Gamma_A(u, v; t, w)$, and let P_1 and P_2 the corresponding clusters in $G\text{-Hilb}(\mathbb{C}^2)$ defined by them. Then we have the conditions $r < u < t \leq w < v < s$, $t = b_i u - r$ and $w = b_i v - s$ from the lattice L , and $u < s - v$, $t < v - w$ from the type A assumption.

We claim that the family of ideals $I_{(a:b)}$ given by the polynomials

$$R_1 := ax^u y^u - b(x^{u+v} + (-1)^u y^{u+v})$$

$$R_2 := x^{r+s} + (-1)^r y^{r+s}$$

$$R_3 := x^{s-v} y^{u-r} + (-1)^{u-r} x^{u-r} y^{s-v}$$

$$R_4 := x^t y^t$$

$$R_5 := x^{v-w} y^{t-u} + (-1)^{t-u} x^{t-u} y^{v-w}$$

define a 1-parameter family of G -clusters parametrised by a \mathbb{P}^1 with coordinates a and b , such that the cluster P_1 is defined by $I_{(1:0)}$ and P_2 is defined by $I_{(0:1)}$.

Indeed, let $P = (0 : 1)$, i.e. $a = 0$ and $R_1 = x^{u+v} + (-1)^u y^{u+v} = 0$. We need to prove that the ideal is generated by R_1 , R_4 and R_5 . Let us start proving that R_3 is a combination of them. First notice that $u+v \leq s-v$. Otherwise $s = b_i v - w < u + 2v$, which can only happen when $b_i = 2$. In that case $u - r = t - u$ and $s - v = v - w$ which implies that the equations R_3 and R_5 are the same. Thus, we can multiply R_1 by $x^{s-v-(u+v)} y^{u-r} + (-1)^r x^{u-r} y^{s-v-(u+v)}$ to get

$$R_3 + (-1)^u (x^{s-v-(u+v)} y^{2u+v-r} + (-1)^{u+r} x^{2u+v-r} y^{s-v-(u+v)}) = 0$$

So, if the inequalities $t \leq 2u + v - r$ and $t \leq s - v - (u + v)$ as satisfied, we can use the equation $x^t y^t = 0$ to conclude that the generator R_3 is redundant. The first inequality is true since $t < t + w < u + v < u + v + (u - r)$. For the second inequality, suppose that is false, i.e. suppose that $t > s - 2v - u$. Then $s = b_i v - w < t + 2v + u$, i.e. $(b_i - 2)v < t + u + w$ since $t + w$ and u are both less than v . Hence $b_i = 2$ or 3 . As before, if $b_i = 2$ the equations R_3 and R_5 are the same, and if $b_i = 3$ then $v < t + u + w$ or equivalently $u + v < t + w$, which is impossible since $t < v - w$ by the type A condition.

For R_2 , note that multiplying R_1 by $(x^{(r+s)-(u+v)} + (-1)^{u+r} y^{(r+s)-(u+v)})$ we get

$$R_2 + (-1)^u (x^{(r+s)-(u+v)} y^{u+v} + (-1)^r x^{u+v} y^{(r+s)-(u+v)}) = 0$$

But $t < v < u + v$ and by the previous case $t < s - v - (u + v) < (r + s) - (u + v)$, so the second term is divisible by $x^t y^t$ and therefore the equation $R_2 = x^{r+s} + (-1)^r y^{r+s}$ is also not needed to define P_1 .

If $P = (0 : 1)$, i.e. $b = 0$, we have that $R_1 = x^u y^u = 0$ and we need to check that in this case the generators R_4 and R_5 are redundant. The inequalities $u < t$ imply that R_4 is divisible by R_1 . For R_5 , note that we always have $u < v - w$ and $u < t - u$ except when $b_i = 2$, in which case $R_5 = R_3$ are the same. Thus, R_5 is also divisible by R_1 .

Now suppose that P is neither P_1 nor P_2 , i.e. $a, b \neq 0$. We now prove that the ideal defines a G -cluster, or in other words, it admits as basis the G -graph $\Gamma_1 = A(r, s; u, v)$:

Since $t < s - v$ (otherwise $s = b_i v - w < t + v$ and $(b_i - 1)v < t + w < v$ which

contradicts $b_i \geq 2$), we have that

$$\begin{aligned} x^{t-(u-r)}R_3 &= x^{(r+s)-(u+v)+t}y^{u-r} + (-1)^{u-r}x^t y^{s-v} = 0 \\ y^{t-(u-r)}R_3 &= x^{s-v}y^t + (-1)^{u-r}x^{u-r}y^{(r+s)-(u+v)+t} = 0, \end{aligned}$$

which implies that

$$x^{(r+s)-(u+v)+t}y^{u-v} = x^{u-v}y^{(r+s)-(u+v)+t} = 0 \quad (4.3)$$

On the other hand we have that

$$x^{u+i}y^u = x^i x^u y^u = x^i R_1 = \frac{b}{a}(x^{u+v+i} + (-1)^u x^i y^{u+v}) \quad (4.4)$$

and similarly for $y^i R_1$. Note that we are interested only for $i \in [1, \dots, (r+s)-(u+v)]$, so that the elements above lie in the boundary of the G -graph we are aiming for. In this case, $u+v+i \leq s$ so that x^{u+v+i} is always in Γ_1 , thus we also need to check that the monomial $x^i y^{u+v}$ can be written in terms of elements in Γ_1 .

If $i = u$ then

$$\begin{aligned} x^{2u}y^u &= \frac{b}{a}(x^{2u+v} + (-1)^u x^u y^{u+v}) \\ &= \frac{b}{a}(x^{2u+v} + (-1)^u b/a'(x^{u+v}y^v + (-1)^u y^{u+2v})) \end{aligned}$$

but $t < v < u+v$, so using R_4 we write $x^{2u}y^u$ (and similarly $x^u y^{2u}$) as a combination of elements in Γ_1 . Also, since $t < u+v$, by equation 4.4 we have that $x^{u+t}y^u = \frac{b}{a}(x^{u+v+t})$, so we are reduced to checking the values of i in the interval (u, t) .

Note that if $u+v \geq (s-v+r) + t - u$, using equation 4.3 we can conclude that the monomials $x^i y^{u+v}$ are either 0 or an element in Γ_1 for all i . So suppose that $u+v < (s-v+r) + t - u$. Then, for any $i \in [1, t-u]$, monomials of the form $x^{2u+i}y^u$ are a combination of elements in Γ_1 if and only if $x^i y^{u+2}$ also are. Again, if $u+2v \geq (s-v+r) + t - u$ all these monomials will be a combination of elements in Γ_1 . Otherwise, iterating the same procedure, we will end up with some $j \in \mathbb{N}$ such that $u+jv \geq (s-v+r) + t - u$ and we are done.

- **A(r,s;u,v)→B1(u,v;t,w)**: In this case the family of G -clusters is parametrised by

the $\mathbb{P}^1_{(b;d)}$, and they are defined by the ideal generated by the following polynomials

$$\begin{aligned} R_1 &:= cx^u y^u - d(x^{u+v} + (-1)^u y^{u+v}) & R_4 &:= x^t y^m \\ R_2 &:= x^{r+s} + (-1)y^{r+s} & R_5 &:= x^m y^t \\ R_3 &:= x^{s-v} y^{u-r} + (-1)^{u-r} x^{u-r} y^{s-v} & R_6 &:= x^{m+v} y^{m-u} + (-1)^{m-u} x^{m-u} y^{m+v} \end{aligned}$$

where the point $P_1 = (1 : 0)$ is defined by a G -graph of type A , and the point $P_2 = (0 : 1)$ by a G -graph of type $B.1$.

Let $d = 0$. We want to prove that the ideal is generated by R_1 , R_2 and R_3 . We have that $R_1 = x^u y^u = 0$ and $u \leq m$ (Otherwise $m = t - u < u$, so $t = b_i u - r < 2u$ or equivalently $(b_i - 2)u < r$. This implies that $b_i = 2$, but this would mean that P_1 is defined by a G -graph of type B , a contradiction). Thus, R_4 and R_5 are divisible by R_1 . For R_6 , note that $u < v < 2v - w = m + v$ and $u \leq m - u$ except when $b_i = 2$ or 3 . As before the case $b_i = 2$ is impossible, and when $b_i = 3$ we have that $R_3 = R_6$.

In the case when $c = 0$ we want to show that R_2 and R_3 redundant. Since $m = t - u < t$, with the same calculation as before we obtain R_2 . Similarly, since $u + v < s - v$ (again unless $b_i = 2$) we can use $R_1 = x^{u+v} + (-1)^u y^{u+v}$ to obtain R_3 .

- **B1(r,s;u,v)→B2(u,v;t,w)**: In this case the family of ideals parametrized by $\mathbb{P}^1_{(e,f)}$ is given by the following generators:

$$\begin{aligned} R_1 &:= ex^u y^m - fy^s & R_5 &:= x^t y^m \\ R_2 &:= ex^m y^u + (-1)^v f x^s & R_6 &:= x^m y^t \\ R_3 &:= x^{r+s} + (-1)y^{r+s} & R_7 &:= x^{2m} y^{2m} \\ R_4 &:= x^{m+s} y^{m-r} + (-1)^{m-r} x^{m-r} y^{m+s} \end{aligned}$$

If $f = 0$ the ideal defines a G -graph of type $B.1$, i.e. the family is generated by R_1 , R_2 , R_3 and R_4 . Indeed, since $x^m y^u = x^u y^m = 0$ and $u < t$ we have that $R_5 = R_6 = 0$. And since $P_1 = (0 : 1)$ is of type $B1$ we know that $u < 2m$ which implies that R_7 also vanishes.

If $e = 0$ then $x^s = y^s = 0$, and consequently $x^{r+s} = y^{r+s} = x^{m+s} y^{m-r} = x^{m-r} y^{m+s} = 0$. Thus the ideal at $P_2 = (1 : 0)$ is defined by R_1 , R_2 , R_4 , R_5 and R_6 as desired.

For the rest of the points $(e : f)$ with $e, f \neq 0$ we have that $x^s = (-1)^v e / f x^m y^u$ and $y^s = e / f x^u y^m$. Therefore $x^s y^i = (-1)^v e / f x^m y^{u+i}$ for $1 \leq i < m$, where $x^m y^{u+i} \in \Gamma_{B.2}$ (and similarly with $x^s y^i$ for $1 \leq i < m$). This two equations, together with R_5 , R_6 and R_7 allow us to take the G -graph corresponding to P_2 the basis for every point in the rational curve parametrised by c and d .

- **$\mathbf{B2}(\mathbf{r}, \mathbf{s}; \mathbf{u}, \mathbf{v}) \rightarrow \mathbf{B2}(\mathbf{u}, \mathbf{v}; \mathbf{t}, \mathbf{w})$** : This case is very similar to the previous one. The difference is that now all the equations except R_7 involve 2-dimensional representations. The family of ideals is given by the following generators:

$$\begin{aligned} R_1 &:= gx^u y^m - hy^s & R_5 &:= x^t y^m \\ R_2 &:= gx^m y^u + (-1)^v hx^s & R_6 &:= x^m y^t \\ R_3 &:= y^{s+m} & R_7 &:= x^{2m} y^{2m} \\ R_4 &:= x^{s+m} \end{aligned}$$

which are parametrised by a \mathbb{P}^1 with coordinates $(g : h)$.

From now on suppose that the last G -graph is $\Gamma_l = \Gamma(r, s; q, q)$. Depending on the type of Γ_l we have a different G -graph of type C , so we will denote by a subindex, A or B , whether Γ_l is of type A or B .

- **$\mathbf{C}_A^+(\mathbf{r}, \mathbf{s}; \mathbf{q}, \mathbf{q}) \rightarrow \mathbf{C}_A^-(\mathbf{r}, \mathbf{s}; \mathbf{q}, \mathbf{q})$** : In this case the family of ideals

$$\begin{aligned} R_1 &:= j_-(x^q + (-i)^q y^q)^2 - j_+(x^q - (-i)^q y^q)^2 & R_4 &:= x^{m_1} y^{m_2} + (-1)^{m_2} x^{m_2} y^{m_1} \\ R_2 &:= x^s y^{m_2} + (-1)^r i^q x^{m_2} y^s & R_5 &:= x^{r+s} + (-1)^r y^{r+s} \\ R_3 &:= x^s y^{m_2} - (-1)^r i^q x^{m_2} y^s \end{aligned}$$

is parametrised by a \mathbb{P}^1 with coordinates (j_-, j_+) . Note that generators R_2 and R_3 together imply that $x^s y^{m_2} = x^{m_2} y^s = 0$, so we obtain a G -graph of type C^+ at $j_+ = 0$, and G -graph of type C^- at $j_- = 0$ (the polynomial R_5 is redundant in both cases).

Expanding the equation R_1 we have that

$$R_1 = (j_- - j_+)(x^{2q} + (-1)^q y^{2q}) + 2(-i)^q (j_- + j_+) x^q y^q$$

Therefore, at the point $Q = (1 : 1)$ the ideal is generated by R_4 , R_5 and $x^q y^q$, i.e. it is defined by the last G -graph $\Gamma_l(r, s; q, q)$ of type A .

- $\mathbf{C}_B^+(\mathbf{r}, \mathbf{s}; \mathbf{q}, \mathbf{q}) \rightarrow \mathbf{C}_B^-(\mathbf{r}, \mathbf{s}; \mathbf{q}, \mathbf{q})$ If the last G -graph is of type $B.1$ then the family is given by

$$\begin{aligned} R_1 &:= k_-(y^s + x^q y^m) - k_+(y^s - x^q y^m) & R_4 &:= x^s y^m + (-1)^r i^q x^m y^s \\ R_2 &:= k_-((-1)^s x^s - x^m y^q) - k_+((-1)^s x^s + x^m y^q) & R_5 &:= x^m y^s - (-1)^r i^q x^m y^s \\ R_3 &:= x^{2m} y^{2m} & R_6 &:= x^{r+s} + (-1)^r y^{r+s} \end{aligned}$$

If the last G -graph is of type $B.2$, we have to replace the equation R_6 involving the 1-dimensional representation $\rho_{r+s}^{(-1)^r}$ by the relations $R'_6 := y^{s+m}$ and $R'_7 := x^{s+m}$, which now involve monomials in the 2-dimensional representation V_{r-m} .

- $\mathbf{C}_A^\pm(\mathbf{r}, \mathbf{s}; \mathbf{q}, \mathbf{q}) \rightarrow \mathbf{D}^\pm(\mathbf{r}, \mathbf{s}; \mathbf{q}, \mathbf{q})$ We have the family in this case, is given by

$$\begin{aligned} R_1 &:= z_\pm(x^q \pm (-i)^q y^q) - w_\pm(x^s y^{m_2} \pm (-1)^r i^q x^{m_2} y^s) \\ R_2 &:= x^{s-r} y^{s-r} \\ R_3 &:= x^{m_1} y^{m_2} + (-1)^{m_2} x^{m_2} y^{m_1} \\ R_4 &:= (x^q \pm (-i)^q y^q)^2 \end{aligned}$$

When $w_\pm = 0$ the ideal is generated by R_1 and R_2 , i.e. it has a type D basis, and when $z_\pm = 0$ we obtain the G -graph of type C_A defined by R_1 , R_3 and R_4 .

- $\mathbf{C}_B^\pm \rightarrow \mathbf{D}^\pm$ This case is similar to the previous case changing the generator R_3 for the two equations belonging to the corresponding 2-dimensional representation.

□

Theorem 4.22. *Let $G = \text{BD}_{2n}(a)$ be small and let $P \in G\text{-Hilb}(\mathbb{C}^2)$ be defined by the ideal I . Then we can always chose a basis for $\mathbb{C}[x, y]/I$ from one of the following list:*

$$\Gamma_A, \Gamma_B, \Gamma_{C^+}, \Gamma_{C^-}, \Gamma_{D^+}, \Gamma_{D^-}$$

Proof. By construction, every point in $G\text{-Hilb}(\mathbb{C}^2)$ away from the ‘‘horns’’ corresponds to a pair of $\langle \alpha \rangle$ -clusters in $\langle \alpha \rangle\text{-Hilb}(\mathbb{C}^2)$. Therefore, we can chose for these $\langle \alpha \rangle$ -clusters

the symmetric $\langle \alpha \rangle$ -graphs $\tilde{\Gamma}(r, s; u, v)$ and $\tilde{\Gamma}(v, u; s, r)$ for some (r, s) and (u, v) boundary lattice points in the Newton polygon for $\frac{1}{2n}(1, a)$, and we can take $\Gamma(r, s; u, v)$ to be the G -graph (of type A or B) for our G -cluster.

For the clusters in the exceptional “horns” E^+ and E^- , we know by Theorem 4.21 that these exceptional curves are covered by the ideals $J_{(\gamma_+, \delta_+)}^+$ and $J_{(\gamma_-, \delta_-)}^-$, which correspond to G -graphs of type C^\pm and D^\pm , and we are done. \square

4.6 Special representations

For a finite small subgroup $G \subset \text{GL}(2, \mathbb{C})$, the McKay correspondence states that there is a one-to-one correspondence between exceptional divisors E_i in the minimal resolution of \mathbb{C}^2/G and the *special* irreducible representations ρ_i of G . In [Ish02] Ishii proves that the minimal resolution is in fact $G\text{-Hilb}(\mathbb{C}^2)$.

Theorem 4.23 ([Ish02], §7.1). *Let $G \subset \text{GL}(2, \mathbb{C})$ be small and denote by I_y the ideal corresponding to $y \in G\text{-Hilb}(\mathbb{C}^2)$ and by m the maximal ideal of $\mathcal{O}_{\mathbb{C}^2}$ corresponding to the origin 0 . If y is in the exceptional locus, then we have an isomorphism*

$$I_y/mI_y \cong \begin{cases} \rho_i \oplus \rho_0 & \text{if } y \in E_i, \text{ and } y \notin E_j \text{ for } j \neq i, \\ \rho_i \oplus \rho_j \oplus \rho_0 & \text{if } y \in E_i \cap E_j, \end{cases}$$

as representations of G , where ρ_i is the special representation associated with the irreducible exceptional curve E_i .

In other words, for any point in the exceptional divisor of $G\text{-Hilb}(\mathbb{C}^2)$, only the trivial and the special representations corresponding to the curves which the point lies on are involved in the ideal defining the G -cluster. In our case, the explicit description of these ideals is the following:

Proposition 4.24. *Let $G = \text{BD}_{2n}(a)$ be small and $y \in G\text{-Hilb}(\mathbb{C}^2)$ be a point in the exceptional locus. Denote by I_y the ideal defining y and by $\Gamma_y = \Gamma(r, s; u, v)$ the corresponding*

G -graph. Then

$$I_y/mI_y \cong \begin{cases} \rho_{r+s}^{(-1)^r} \oplus \rho_{u+v}^{(-1)^u} \oplus \rho_0^+ & \text{if } \Gamma_y \text{ is of type A,} \\ \rho_{r+s}^{(-1)^r} \oplus V_r \oplus \rho_0^+ & \text{if } \Gamma_y \text{ is of type B.1,} \\ V_{2r-u} \oplus V_r \oplus \rho_0^+ & \text{if } \Gamma_y \text{ is of type B.2,} \\ \rho_{2q}^{(-1)^q} \oplus \rho_q^\pm \oplus \rho_0^+ & \text{if } \Gamma_y \text{ is of type } C^\pm \text{ and } \Gamma_{m-1} \text{ is of type A,} \\ V_r \oplus \rho_q^\pm \oplus \rho_0^+ & \text{if } \Gamma_y \text{ is of type } C^\pm \text{ and } \Gamma_{m-1} \text{ is of type B,} \\ \rho_q^\pm \oplus \rho_0^+ & \text{if } \Gamma_y \text{ is of type } D^\pm, \end{cases}$$

where m the maximal ideal of $\mathcal{O}_{\mathbb{C}^2}$ corresponding to the origin 0 .

Proof. Reformulating Propositions 4.12, 4.16, 4.17, 4.20 and 4.19 in the language of Theorem 4.23, we see that the representations involved in the generators of each of the ideals are the ones presented above.

Now by Theorem 4.21 we can find a rational curve E_i connecting any two consecutive G -graphs, which must agree with the exceptional divisor of $G\text{-Hilb}(\mathbb{C}^2)$. \square

As a corollary of both 4.23 and 4.24 we obtain the list of special representations of $G = \text{BD}_{2n}(a)$ in terms of the continued fraction $\frac{2n}{a}$.

Theorem 4.25. *Let $\Gamma_0, \Gamma_1, \dots, \Gamma_{m-1}$ the sequence of qG -graphs given by $e_0 = (0, 2n), e_1 = (1, a), e_2 = (c_1, d_1), \dots, e_{m-1} = (c_{m-2}, d_{m-2}), e_m = (q, q)$, where*

$$\begin{aligned} \Gamma_0, \dots, \Gamma_i & \text{ are of type A} \\ \Gamma_{i+1} & \text{ is of type B.1} \\ \Gamma_{i+2}, \dots, \Gamma_{m-1} & \text{ are of type B.2} \end{aligned}$$

Then, the special representations are

$$\begin{aligned} \rho_{1+a}^-, \rho_{c_1+d_1}^{(-1)^{c_1}}, \rho_{c_2+d_2}^{(-1)^{c_2}} \cdots, \rho_{c_{i+1}+d_{i+1}}^{(-1)^{c_{i+1}}} & \text{ from type A,} \\ V_{c_i} & \text{ from type B.1,} \\ V_{c_{i+1}}, \dots, V_{c_{m-2}} & \text{ form type B.2 and} \\ \rho_q^+, \rho_q^- & \text{ from types C and D} \end{aligned}$$

Corollary 4.8 follows immediately, and we can easily check now the correspondences between G -graphs of type A with 1-dimensional special representations (excluding the “horns” which correspond to type D), and between G -graphs of type B with 2-dimensional special representations.

Chapter 5

Explicit G -Hilb(\mathbb{C}^2) via quiver representations

In this Chapter we describe G -Hilb(\mathbb{C}^2) by calculating explicitly the moduli of stable representations $\mathcal{M}_\theta(Q, R)$ of the bound McKay quiver.

In Section 5.1 we describe the bound McKay quiver (Q, R) for small $\text{BD}_{2n}(a)$ groups, calculating the relations of Q following [BSW08]. Section 5.2 is devoted to the explicit calculation of G -Hilb(\mathbb{C}^2). We give assign to every G -graph Γ an open set in $\mathcal{M}_\theta(Q, R)$. By the classification of G -graphs into the types A , B , C and D given in Section 4, the corresponding open sets give us an affine open cover of $\mathcal{M}_\theta(Q, R)$. In Section 5.3 we illustrate this method by some examples.

5.1 McKay quivers for $\text{BD}_{2n}(a)$ groups

In this section we describe the McKay quivers for the groups $\text{BD}_{2n}(a)$ and give the relations for the bound McKay quiver (Q, R) following [BSW08].

Definition 5.1. We define q to be the smallest integer such that $(a-1)q \equiv 0 \pmod{2n}$ (see also the Proposition-Definition 3.10), and k to be the smallest positive integer such that $(a+1)k \equiv 0 \pmod{2n}$. In other words, k is the smallest such that $x^k y^k$ is $\langle \alpha \rangle$ -invariant.

Remark 5.2. The quantities q and k also appear in the classification of binary dihedral groups given by Brieskorn [Bri68] as follows: $G = \mathbb{D}_{N,q}$ (small) where $(N, q) = 1$, and $k := N - q$. See also Section 3.3.1. Note that $2kq = 2n$ and for the $\text{BD}_{2n}(a)$ groups, k is

odd.

The McKay quiver is the $\mathbb{Z}/2$ orbifold quotient of the McKay quiver for the Abelian subgroup $A = \langle \frac{1}{2n}(1, a) \rangle$. That is, it is obtained from standard parallelogram

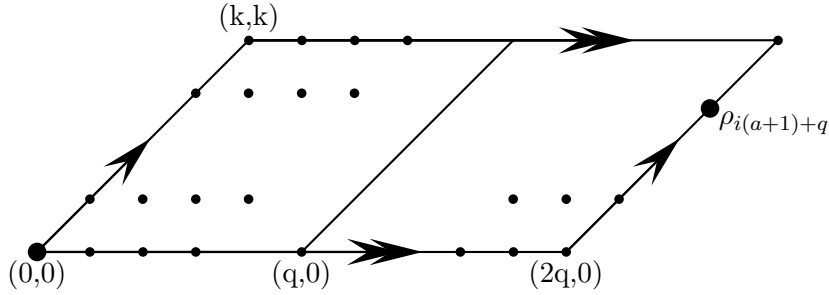

by reflecting in the two diagonal lines (see Figure 5.2 for an example). Away from the fixed locus of the reflection, two rank one representations of A combine to give a rank two representation of G . The fixed points correspond to rank one representations of A that go to themselves under conjugation by β , so they split into ± 1 pairs of rank one representations of G .

Therefore, the McKay quiver of G can be represented by a parallelogram of length q and height k , as shown in Figure 5.1. The quiver is drawn in a cylinder, so that the bottom and top rows are identified, with $\mathbb{Z}/2$ orbifold edges where the 1-dimensional representations are situated. At every row i we denote by a $+$ sign the representation ρ_i^+ and with a $-$ sign the representation ρ_i^- . The vertices in the middle of the parallelogram represent the 2-dimensional representations V_j .

5.1.1 Orbifold McKay quiver

In the same spirit as in Remark 3.19, the McKay quiver of G can be obtained from the McKay quiver of its maximal normal subgroup. Even though the construction can be done in more generality, here we restrict ourselves to the case $G = \text{BD}_{2n}(a)$.

Let $A = \langle \alpha \rangle \trianglelefteq G = \text{BD}_{2n}(a)$ be the maximal cyclic subgroup. The McKay quiver of A , denoted by $\text{McKayQ}(A)$, can be drawn in a torus as follows: Let $M \cong \mathbb{Z}^2$ be the lattice of monomials and $M_{\text{inv}} \cong \mathbb{Z}^2$ the lattice of invariant monomials by A . If we take $M_{\mathbb{R}} = M \otimes_{\mathbb{Z}} \mathbb{R}$ we can consider the torus $T := M_{\mathbb{R}}/M_{\text{inv}}$. The set of vertices in $\text{McKayQ}(A)$

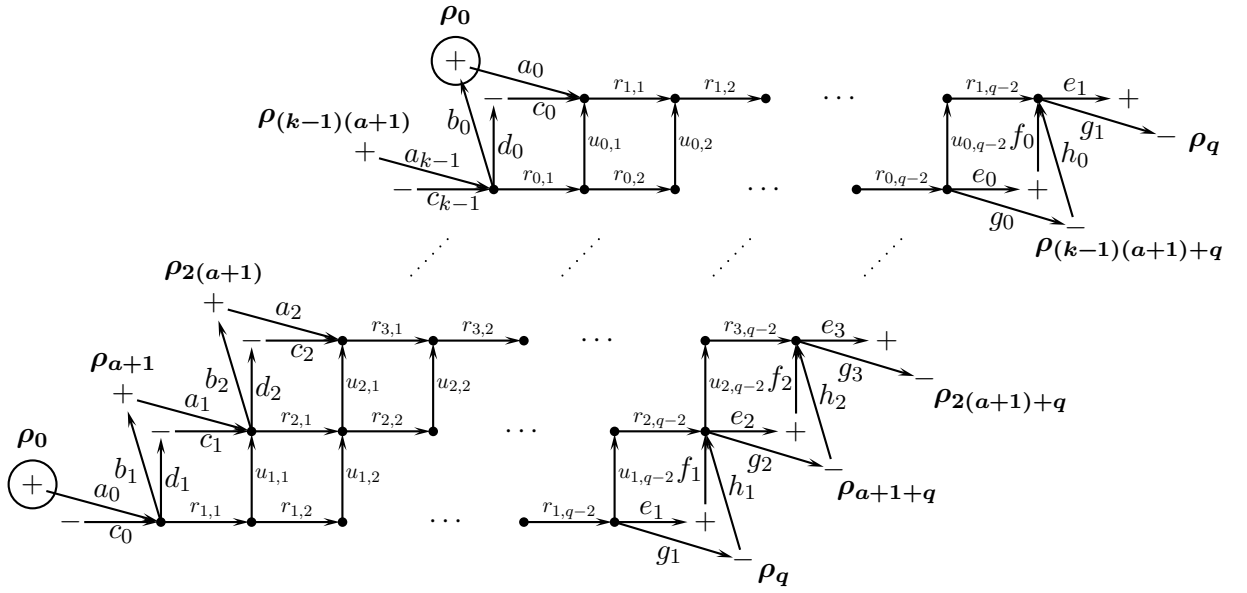
 Figure 5.1: McKay quiver for $BD_{2n}(a)$ groups

is precisely $Q_0 = M \cap T$, and the arrows between each vertex are the natural multiplications by x and y in M .

Using the symmetric continued fraction $\frac{2n}{2n-a}$, we know that $u_r = x^k y^k$ is the monomial in M_{inv} of the form $(xy)^i$ with the smallest exponent $i > 0$. Therefore we can choose $M_{\text{inv}} = \mathbb{Z} \cdot v_r \oplus \mathbb{Z} \cdot v_{r+1}$ where $v_r = (k, k)$ and $v_{r+1} = (s, t)$ are linearly independent vectors, and v_{r+1} corresponds to the monomial $u_{r+1} = x^s y^t \in M_{\text{inv}}$. In this way, if the parallelogram with vertices $0, v_r, v_{r+1}$ and $v_r + v_{r+1}$ does not contain any other vector in M_{inv} , we can take it as a fundamental domain for T .

Claim 5.3. *We can always choose a fundamental domain \mathcal{D} for T to be the parallelogram with vertices $0, (k, k), (2q, 0)$ and $(k + 2q, k)$ where the opposite sides are identified.*

Indeed, observe that $(q + k)(a + 1) = q(a - 1) + k(a + 1) + 2q \equiv 2q \pmod{2n}$, by definition of q and k , so $\rho_{2q} = \rho_{j(a+1)}$ for some $0 < j < k$. Therefore, the monomial $x^{2q+j} y^j$ is A -invariant so we can consider the fundamental domain generated by the linearly independent vectors (k, k) and $(2q+j, j)$. The number of lattice points in the parallelogram is $2kq = 2n$ (see Remark 5.2) so the domain is fundamental. Now by a simple translation we can consider the fundamental region \mathcal{D} as desired.

Example 5.4. Let $G = BD_{30}(19)$ where $q = 5$ and $k = 3$. The continued fraction

$\frac{30}{30-19} = \frac{30}{11} = [3, 4, 3]$ describes the lattice M_{inv} . The two consecutive invariant monomials x^3y^3 and $x^{11}y$ define a fundamental domain of the lattice T , which can be translated into the parallelogram filled with numbers shown in the diagram below.

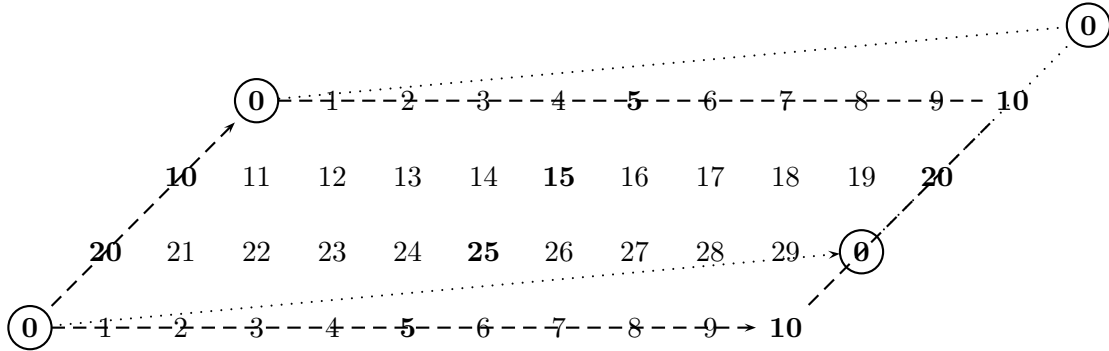

Figure 5.2: McKay quiver for the Abelian group $\frac{1}{30}(1, 19)$.

The diagram represents the lattice M where the bottom left corner represents the monomial 1 and the numbers denote the representation to which they belong to, e.g. the number $\mathbf{0}$ corresponds to monomials in M_{inv} . Opposite sides of the parallelogram are identified. The McKay quiver is completed by adding at every vertex the two arrows corresponding to the multiplication by x and y to the corresponding adjacent vertices.

Now $G/A = \langle \beta \rangle \cong \mathbb{Z}/2$ acts on $\text{Irr } G$ (see Remark 3.19) by conjugation $\beta \cdot \rho_i := \rho_{ai}$, and therefore G/A acts on $\text{McKayQ}(A)$. The McKay quiver for G becomes the $\mathbb{Z}/2$ orbifold quotient of $\text{McKayQ}(A)$: the free orbits are the representations ρ_i and ρ_{ai} with $ai \not\equiv i \pmod{2n}$, and they correspond to the 2-dimensional representations V_i . The fixed points ρ_j with $aj \equiv j \pmod{2n}$ split in the 1-dimensional representations ρ_j^+ and ρ_j^- .

The fixed representations are contained in the left (and identified right) side of \mathcal{D} , and in the line parallel to it passing through the middle of \mathcal{D} (more precisely, $\rho_{i(a+1)}$ and $\rho_{i(a+1)+q}$ for $0 \leq i < k$ respectively). The resulting parallelogram representing $\text{McKayQ}(A)$ has height k and length q (half of the length of $\text{McKayQ}(A)$), and the ± 1 couple of one dimensional representations are placed at the sides of the parallelogram. Note that $\text{McKayQ}(G)$ is now drawn in a cylinder where only the top and bottom sides are identified.

The arrows of $\text{McKayQ}(A)$ going into and out of representations in the fixed locus,

split into two different arrows, while for the rest we have a one-to-one correspondence between arrows in $\text{McKayQ}(A)$ and $\text{McKayQ}(G)$. Hence, we obtain $\text{McKayQ}(G)$ as shown in Figure 5.1.

Example 5.5. In the previous example we see that representations $\rho_0, \rho_{20}, \rho_{10}$ and $\rho_5, \rho_{25}, \rho_{15}$ are fixed by β , while the rest are contained in a free orbit. The $\text{McKayQ}(BD_{30}(19))$ is shown in Figure 5.3.

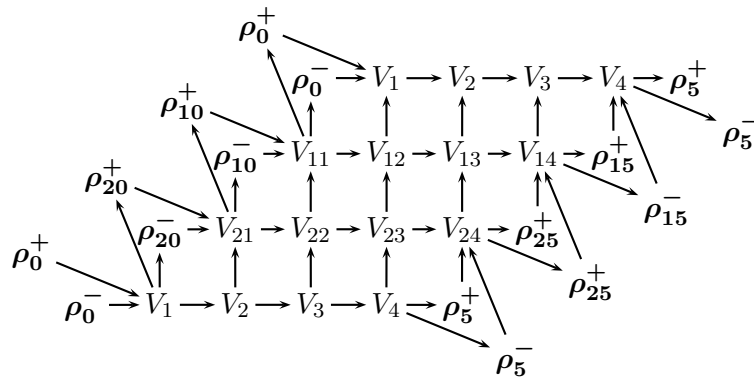

Figure 5.3: McKay quiver for the group $BD_{30}(19)$. Top and bottom rows are identified.

5.1.2 BSW Relations

In this section we describe briefly the method used in [BSW08] to obtain the ideal of relations R in the path algebra $\mathbb{k}Q$ of the McKay quiver Q that make the two algebras $\mathbb{k}Q/R$ and $S * G$ Morita equivalent, and we give the relations in the case $G = BD_{2n}(a)$.

Let $G \subset GL(n, \mathbb{C})$ be finite and small. Let Q be the McKay quiver of G with vertices e_i and corresponding representations ρ_i . Denote by V the natural representation, and consider the 1-dimensional representation $\det_V := \bigwedge^n V$. Note that \det_V is the trivial representation if and only if $G \subset SL(n, \mathbb{C})$.

Tensoring with \det_V induces a permutation τ (often called *twist*) on $\text{Irr } G$, and therefore on the vertices of the McKay quiver as follows:

$$e_i = \tau(e_j) \iff \rho_i = \rho_j \otimes \det_V$$

Since Q is the McKay quiver, we can think of an arrow $a : e_i \rightarrow e_j$ as an element $\psi_a \in \text{Hom}_{\mathbb{C}G}(\rho_i, \rho_j \otimes V)$. Then for any path $p = a_1 a_2 \cdots a_n$ of length n we can consider the following G -module homomorphism

$$\rho_{t(p)} \xrightarrow{\psi_p} \rho_{h(p)} \otimes V^{\otimes n} \xrightarrow{\text{id}_{\rho_{h(p)}} \otimes \gamma} \rho_{h(p)} \otimes \bigwedge^n V = \rho_{h(p)} \otimes \det_V \quad (5.1)$$

The ψ_p is the composition of the maps ψ_{a_i} (and $\otimes \text{id}_V$ at every step), and $\gamma : V^{\otimes n} \rightarrow \bigwedge^n V$ sends $v_1 \otimes \cdots \otimes v_n \mapsto v_1 \wedge \cdots \wedge v_n$. By Schur's Lemma (see for example [JL01]) the composition of maps in 5.1 is zero if $\tau(h(p)) \neq t(p)$, a scalar c_p otherwise. Therefore, we can define the formal expression or *superpotential* as

$$\Phi := \sum_{|p|=n} (c_p \dim h(p)) p$$

where $|p|$ denotes the length of the path p .

The last ingredient before giving the set of relations R is to consider partial derivations in $\mathbb{k}Q$: given any two paths $p, q \in \mathbb{k}Q$ we can define the partial derivative of p with respect to q to be $\partial_q p = r$ if $p = qr$, and 0 otherwise.

Theorem 5.6 ([BSW08]). *The algebra $\mathbb{k}[x_1, \dots, x_n] * G$ is Morita equivalent to the algebra $\mathbb{k}Q / \langle \partial_q \Phi : |q| = n - 2 \rangle$.*

In the case of groups $G = \text{BD}_{2n}(a) \subset \text{GL}(2, \mathbb{C})$ we have $V = V_1$ and $\det_V = \rho_{a+1}^-$. Then,

$$\begin{aligned} \rho_j^\pm \otimes \det_V &= \rho_j^\pm \otimes \rho_{a+1}^+ = \rho_{j+a+1}^\pm \\ V_k \otimes \det_V &= V_k \otimes \rho_{a+1}^+ = V_{k+a+1} \end{aligned}$$

so τ translates $\text{McKayQ}(G)$ one step diagonally up (See Figure 5.1). Hence only paths of length 2 joining two vertices identified by τ appear in Φ . The length 2 paths in the McKay quiver of G are shown in Figure 5.4.

Therefore, The relations R for the bound McKay quiver are given by the ‘‘short’’

relations:

$$\begin{aligned}
 a_i b_{i+1} &= 0 \\
 c_i d_{i+1} &= 0 \\
 f_i e_{i+1} &= 0 \\
 h_i g_{i+1} &= 0,
 \end{aligned}
 \tag{5.2}$$

and the “long” relations:

$$\begin{aligned}
 b_i a_i + d_i c_i &= r_{i,1} u_{i,1} \\
 u_{i,j} r_{i+1,j} &= r_{i,j+1} u_{i,j+1} \\
 e_i f_i + g_i h_i &= u_{i,q-2} r_{i+1,q-2}
 \end{aligned}
 \tag{5.3}$$

where we consider the subindices modulo k .

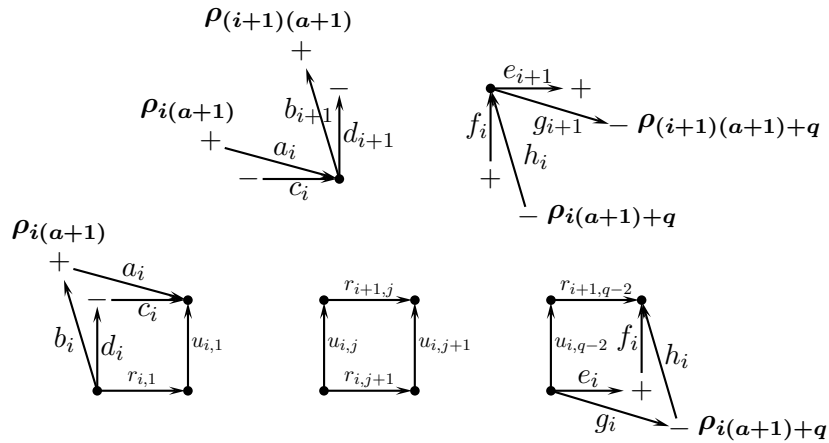

Figure 5.4: Paths of length two in the McKay quiver for $BD_{2n}(a)$ groups.

Remark 5.7. We need to mention at this point that the quiver considered in this thesis has the orientation reversed in comparison to that used in [BSW08]. This is because by our choice of the action of G on the polynomial ring $\mathbb{C}[x, y]$, the semi-invariant $\mathbb{k}[x, y]^G$ -modules are $(\mathbb{k}[x, y] \otimes \rho^*)^G$, which is dual to the one in [BSW08] (we can go from one McKay quiver to the other by replacing V by its dual). In any case, the algebras obtained are isomorphic so the relations are the same.

5.2 Explicit calculation of $G\text{-Hilb}(\mathbb{C}^2)$

Let (Q, R) be the bound Mckay quiver. From now we consider on representations of Q with dimension vector $\mathbf{d} = (\dim \rho_i)_{i \in Q_0}$ and stability condition $\theta = (-\sum_{\rho_i \in \text{Irr } G} \dim \rho_i, 1, \dots, 1)$, i.e our choice of θ is generic (see Remark 2.9).

Given $G = \text{BD}_{2n}(a) \subset \text{GL}(2, \mathbb{C})$, we construct an affine cover of $G\text{-Hilb}(\mathbb{C}^2)$ by calculating explicitly the open sets in $\mathcal{M}_\theta(Q, R)$ corresponding to every Γ_i , for $i = A, B, C$ or D . We start by calculating in detail the easiest example D_4 in $\text{SL}(2, \mathbb{C})$.

5.2.1 First case: $D_4 \subset \text{SL}(2, \mathbb{C})$

Let $G = D_4 = \text{BD}_4(3)$ be the dihedral group of order 8 in $\text{SL}(2, \mathbb{C})$. We start by presenting the character table of the group together with some polynomials in each irreducible representation.

	1	α^2	α	β	$\alpha\beta$	S_ρ
ρ_0^+	1	1	1	1	1	$1, x^2y^2, x^4 + y^4, xy(x^4 - y^4), \dots$
ρ_0^-	1	1	1	-1	-1	$xy, x^4 - y^4, \dots$
ρ_2^+	1	1	-1	1	-1	$x^2 + y^2, xy(x^2 - y^2), \dots$
ρ_2^-	1	1	-1	-1	1	$x^2 + y^2, xy(x^2 - y^2), \dots$
V	2	-2	0	0	0	$(x, y), (y^3, -x^3), (x^2y, -xy^2), \dots$

Since the group is in $\text{SL}(2, \mathbb{C})$, $\det_V = \rho_0^+$ is the trivial representation, so there is no “twist” and the bound McKay quiver (Q, R) is

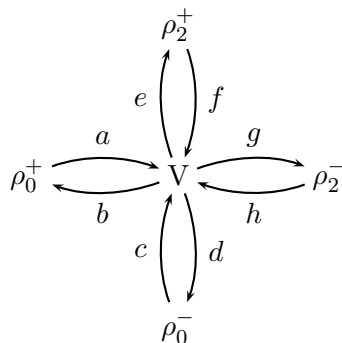

satisfying the following relations R :

$$ab = cd = hg = fe = 0 \tag{5.4}$$

$$ba + dc = gh + ef \tag{5.5}$$

On the other hand, we have an underlying quiver verifying the same relations but labeled with the irreducible maps between the irreducible representations as Cohen-Macaulay $\mathbb{C}[x, y]^G$ -modules S_ρ . Notice that we can fill the right column of the previous table starting from the trivial representation with the element $\mathbf{1}$.

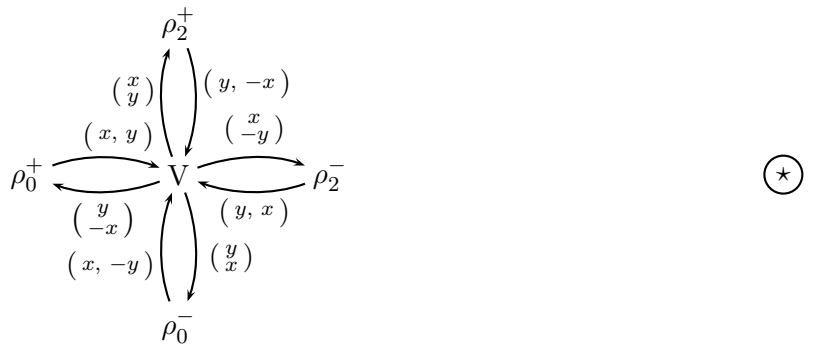

By Chapter 3 (see also [Len02]) we know that $D_4\text{-Hilb}(\mathbb{C}^2)$ is covered by 5 G -graphs of types A , C^+ , C^- , D^+ and D^- , distributed along the exceptional locus as follows:

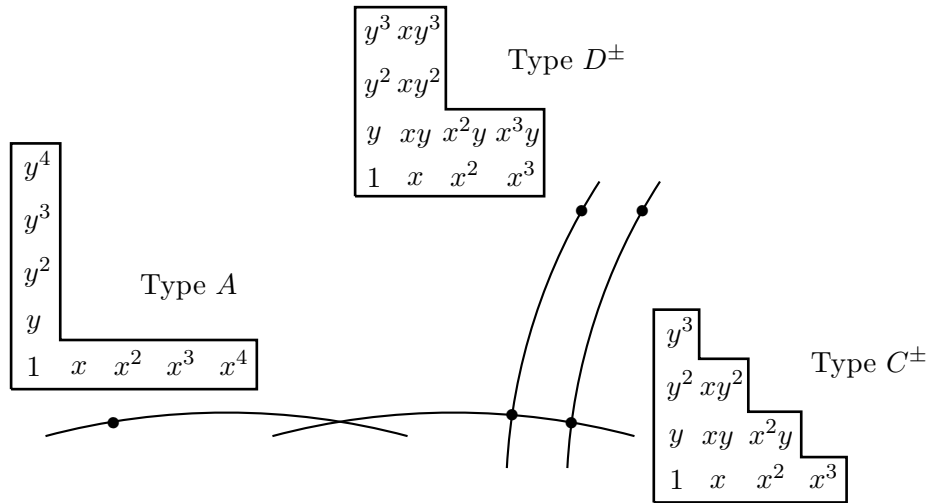

Note that the G -graphs C^+ and C^- are enough to cover the whole of the middle \mathbb{P}^1 .

We are now going to calculate the equations for the open sets of $D_4\text{-Hilb}(\mathbb{C}^2)$ for each of the G -graphs. To do that we first assign a θ -stable representation of the McKay quiver

to every G -graph, and the calculation of the open set in $\mathcal{M}_\theta(Q, R)$ containing this representation will give the equation we are looking for.

In this case, a representation of the McKay quiver consists of four 1-dimensional vector spaces (let us consider \mathbb{C} for such vector space) situated at the corners of the quiver, one 2-dimensional vector space \mathbb{C}^2 for the 2-dimensional irreducible representation V at the middle vertex, and a linear map for every arrow. Thus, we have the following representation space:

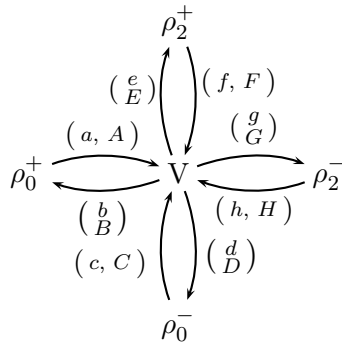

subject to the relations 5.4 and 5.5.

Type A

Consider the open set in $\mathcal{M}_\theta(Q, R)$ given by $a, D, e, F, g \neq 0$. By changing coordinates at the middle vertex, we can choose $A = f = 0$. See Figure 5.5. We claim that the corresponding G -graph is exactly of type A.

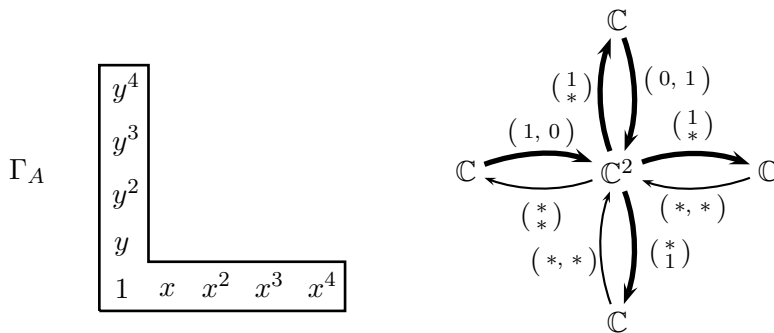

Figure 5.5: D_4 -graph of type A, and the corresponding open set in $\mathcal{M}_\theta(Q, R)$.

Indeed, starting at the trivial vertex with the basis element 1 and following the bold arrows, the open choice we made above enables us to reach every vertex from the vector

space corresponding to ρ_0^+ . That is, we generate the whole module from the trivial vertex, i.e. the representation is θ -stable. Table 5.1 shows every nonzero path from ρ_0^+ to every vertex and the corresponding basis element according to the quiver.

Representation	Nonzero path	Basis Element
ρ_0^+	e_0	1
ρ_0^-	$ae fd$	$-(x^4 - y^4)$
ρ_2^+	ae	$x^2 + y^2$
ρ_2^-	ag	$x^2 - y^2$
V	a	(x, y)
	$ae f$	$(y(x^2 + y^2), -x(x^2 + y^2))$

Table 5.1: Basis elements for the G -graph of type A

We calculate now the equation for this open set in $\mathcal{M}_\theta(Q, R)$: using relation 5.4 of the McKay quiver we have $b = E = 0$, $D = -cd$ and $h = -GH$. Relation 5.5 now implies

$$\begin{pmatrix} 0 \\ B \end{pmatrix} (1, 0) + \begin{pmatrix} d \\ 1 \end{pmatrix} (c, -cd) = \begin{pmatrix} 1 \\ 0 \end{pmatrix} (0, 1) + \begin{pmatrix} 1 \\ G \end{pmatrix} (-GH, H)$$

$$\begin{pmatrix} 0 & 0 \\ B & 0 \end{pmatrix} + \begin{pmatrix} cd & -cd^2 \\ c & -cd \end{pmatrix} = \begin{pmatrix} 0 & 1 \\ 0 & 0 \end{pmatrix} + \begin{pmatrix} -GH & H \\ -G^2H & GH \end{pmatrix}$$

giving the relations $cd = -GH$, $H = -1 - cd^2$ and $B = -c - G^2H$. Therefore, the equation for this affine piece in $\mathcal{M}_\theta(Q, R)$ is the nonsingular hypersurface in $\mathbb{C}_{c,d,G}$:

$$cd = (1 + cd^2)G$$

The resulting representation space is the following:

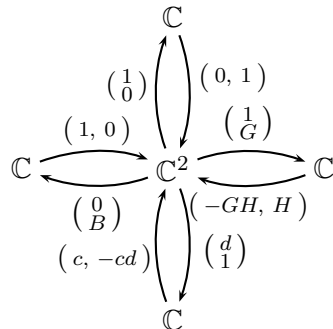

As we have seen, this also corresponds to an open set in $D_4\text{-Hilb}(\mathbb{C}^2)$. We now calculate the ideals (or G -clusters) parametrised by this affine set using paths in the quiver:

$$\begin{aligned} ad &= (1, 0) \begin{pmatrix} d \\ 1 \end{pmatrix} = d && \implies 2xy = -d(x^4 - y^4) \\ aefg &= (1, 0) \begin{pmatrix} 1 \\ 0 \end{pmatrix} (0, 1) \begin{pmatrix} 1 \\ G \end{pmatrix} = G && \implies 2xy(x^2 + y^2) = G(x^2 - y^2) \\ aefb &= (1, 0) \begin{pmatrix} 1 \\ 0 \end{pmatrix} (0, 1) \begin{pmatrix} 0 \\ B \end{pmatrix} = B && \implies (x^2 + y^2)^2 = B \end{aligned}$$

and finally

$$aefdc = (1, 0) \begin{pmatrix} 1 \\ 0 \end{pmatrix} (0, 1) \begin{pmatrix} d \\ 1 \end{pmatrix} (c, -cd) = (c, -cd)$$

which gives

$$(-x(x^4 - y^4), y(x^4 - y^4)) = c(x, y) - cd(y(x^2 + y^2), -x(x^2 + y^2)).$$

Remark 5.8. Note that using this procedure any monomial of degree d not in Γ_A can be obtained as a combination of paths of length d in the quiver (\star) . This combination of paths written in terms of the representation corresponding to this open set gives us the expression of any monomial of degree d not in Γ_A as a combination of elements in Γ_A . This proves that any cluster in contained in this open set has Γ_A as basis.

The G -clusters of the corresponding open set in $D_4\text{-Hilb}(\mathbb{C}^2)$ are therefore given by the ideals $I_{c,d,G}$ generated by the following polynomials:

$$\begin{aligned} R_1 &= 2xy + d(x^4 - y^4) \\ R_2 &= 2xy(x^2 + y^2) - G(x^2 - y^2) \\ R_3 &= x(x^4 - y^4) + cx - cdy(x^2 + y^2) \\ R_4 &= y(x^4 - y^4) - cy - cdx(x^2 + y^2) \\ R_5 &= (x^2 + y^2)^2 - B \end{aligned}$$

where $B = -c + G^2(1 + cd^2)$ and $cd = (1 + cd^2)G$. Note that even though B doesn't appear in the equation of the affine set, the generator R_5 is needed. Indeed, if we remove R_5 the ideal at the origin we would have $\dim \mathcal{O}_{\mathbb{Z}(0,0,0)} = 9$, i.e. not a G -cluster.

Type C^+

The G -graph Γ_{C^+} and the corresponding θ -stable representation space are showed in Figure 5.6, and the choices of basis for each irreducible representation are given in Table 5.2.

Using the relations 5.5 in this case we have that

$$\begin{aligned} \begin{pmatrix} 0 \\ B \end{pmatrix} (1, 0) + \begin{pmatrix} 1 \\ D \end{pmatrix} (-CD, C) &= \begin{pmatrix} 1 \\ 0 \end{pmatrix} (0, 1) + \begin{pmatrix} 1 \\ G \end{pmatrix} (-GH, H) \\ \begin{pmatrix} 0 & 0 \\ B & 0 \end{pmatrix} + \begin{pmatrix} -CD & C \\ -CD^2 & CD \end{pmatrix} &= \begin{pmatrix} 0 & 1 \\ 0 & 0 \end{pmatrix} + \begin{pmatrix} -GH & H \\ -G^2H & GH \end{pmatrix} \end{aligned}$$

giving the relations $CD = GH$, $C = 1 + H$ and $B = CD^2 - G^2H$. Therefore, the equation for this affine piece in $\mathcal{M}_\theta(Q, R)$ is the nonsingular hypersurface in $\mathbb{C}_{D,G,H}$:

$$GH = (1 + H)D$$

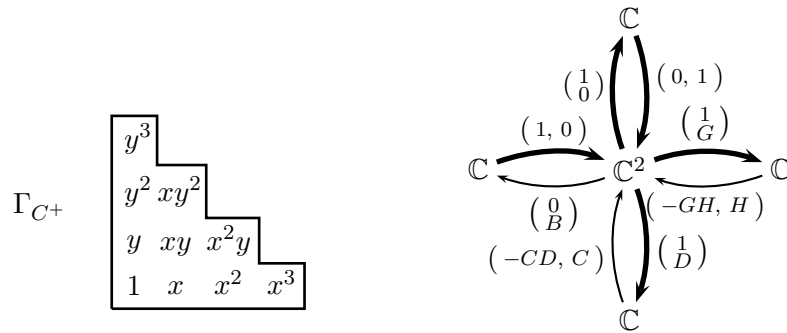

Figure 5.6: D_4 -graph of type C^+ , and the corresponding open set in $\mathcal{M}_\theta(Q, R)$.

For the ideals $I_{(D,G,H)}$ in the corresponding open set in $D_4\text{-Hilb}(\mathbb{C}^2)$ we have

$$\begin{aligned} aefg = (1, 0) \begin{pmatrix} 1 \\ 0 \end{pmatrix} (0, 1) \begin{pmatrix} 1 \\ G \end{pmatrix} = G &\implies 2xy(x^2 + y^2) = G(x^2 - y^2) \\ aefd = (1, 0) \begin{pmatrix} 1 \\ 0 \end{pmatrix} (0, 1) \begin{pmatrix} 1 \\ D \end{pmatrix} = D &\implies -(x^4 - y^4) = 2Dxy \end{aligned}$$

As in the type A case we obtain $(x^2 + y^2)^2 = B$, and to finish, notice that

$$agh = (1, 0) \begin{pmatrix} 1 \\ G \end{pmatrix} (-GH, H) = (-GH, H)$$

which gives $(y(x^2 - y^2), x(x^2 - y^2)) = -GH(x, y) + H(y(x^2 + y^2), -x(x^2 + y^2))$.

The G -clusters of this open set are given by the ideals $I_{D,G,H}$ generated by the following polynomials:

$$\begin{aligned} R_1 &= 2xy(x^2 + y^2) - G(x^2 - y^2) & R_3 &= x(x^2 - y^2) + GHx - Hy(x^2 + y^2) \\ R_2 &= x^4 - y^4 + 2Dxy & R_4 &= y(x^2 - y^2) + GHy + Hx(x^2 + y^2) \\ R_5 &= (x^2 + y^2)^2 - B \end{aligned}$$

where $B = D^2(1 + H) + G^2H$.

Representation	Nonzero path	Basis Element
ρ_0^+	e_0	1
ρ_0^-	ad	$2xy$
ρ_2^+	ae	$x^2 + y^2$
ρ_2^-	ag	$x^2 - y^2$
V	a	(x, y)
	$ae f$	$(y(x^2 + y^2), -x(x^2 + y^2))$

Table 5.2: Type C^+ representations and basis elements

Type C^-

Since this case is similar to Type C^+ we just give the results. See Figure 5.7 for the G -graph Γ_{C^-} and corresponding representation.

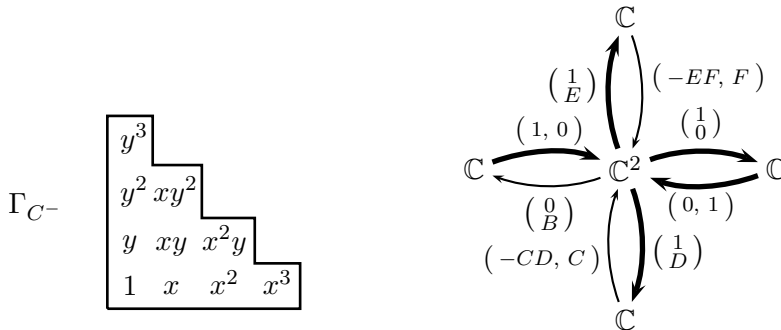

Figure 5.7: D_4 -graph of type C^- , and the corresponding open set in $\mathcal{M}_\theta(Q, R)$.

Relation 5.5 gives us $CD = EF$, $C = 1 + F$ and $B = CD^2 - E^2F$, which implies that

the equation we were looking for is the hypersurface $EF = (F + 1)D$ in $\mathbb{C}_{D,E,F}^3$. In this case the ideals are

$$\begin{aligned}
 I_{D,E,F} = & (2xy(x^2 - y^2) - E(x^2 + y^2), \\
 & x^4 - y^4 - 2Dxy, \\
 & y(x^2 + y^2) + EFx - Fy(x^2 - y^2), \\
 & x(x^2 + y^2) - EFy + Fx(x^2 - y^2), \\
 & (x^2 - y^2)^2 + B)
 \end{aligned}$$

where $B = D^2(1 + F) - E^2F$.

Type D^+

See Figure 5.8 and Table 5.3 for the G -graph Γ_{D^+} and the distribution of basis elements in this case.

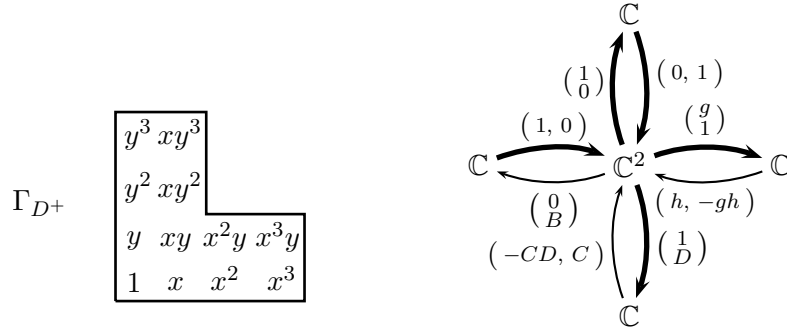

Figure 5.8: D_4 -graph of type D^+ , and the corresponding open set in $\mathcal{M}_\theta(Q, R)$.

Representation	Nonzero path	Basis Element
ρ_0^+	e_0	1
ρ_0^-	ad	$2xy$
ρ_2^+	$aghe$	$x^2 + y^2$
ρ_2^-	ag	$2xy(x^2 + y^2)$
V	a	(x, y)
	aeg	$(y(x^2 + y^2), -x(x^2 + y^2))$

Table 5.3: Type D^+ representations and basis elements

The “long” relation 5.5 gives us $CD = -gh$, $C = 1 - g^2h$ and $B = h + CD^2$ which implies that the equation of the open set in $\mathcal{M}_\theta(Q, R)$ is the hypersurface $gh = (g^2h - 1)D$

in $\mathbb{C}_{D,g,h}^3$, and the corresponding ideals in $D_4\text{-Hilb}(\mathbb{C}^2)$ are

$$\begin{aligned} I_{D,g,h} = & (x^2 - y^2 - 2gxy(x^2 + y^2), \\ & x^4 - y^4 + 2Dxy, \\ & 2xy^2(x^2 + y^2) - hx + ghy(x^2 + y^2), \\ & 2x^2y(x^2 + y^2) - hy - ghx(x^2 + y^2), \\ & (x^2 + y^2)^2 - B) \end{aligned}$$

where $B = h + (1 - g^2h)D^2$.

Type D^-

This case is analogous to the previous one. The G -graph Γ_{D^-} and representations are

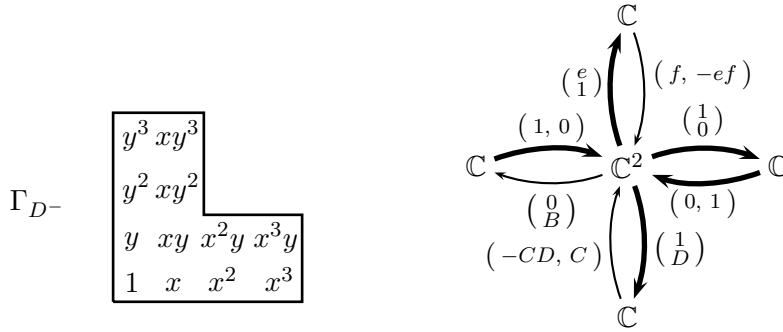

Figure 5.9: D_4 -graph of type D^- , and the corresponding open set in $\mathcal{M}_\theta(Q, R)$.

The open set is given by the hypersurface $ef = (e^2f - 1)D$ in $\mathbb{C}_{e,f,D}^3$, and the ideals are

$$\begin{aligned} I_{D,e,f} = & (x^2 + y^2 - 2exy(x^2 - y^2), \\ & x^4 - y^4 - 2Dxy, \\ & 2xy^2(x^2 - y^2) - fx + efy(x^2 - y^2), \\ & 2x^2y(x^2 - y^2) - fy + efx(x^2 - y^2), \\ & (x^2 - y^2)^2 + B) \end{aligned}$$

where $B = f + (1 - e^2f)D^2$.

5.2.2 $\text{BD}_{2n}(n+1)$ groups

In this section we prove explicitly that the minimal resolution $Y = \text{BD}_{2n}(n+1)\text{-Hilb}(\mathbb{C}^2)$ of the dihedral quotient singularity $\mathbb{C}^2/\text{BD}_{2n}(n+1)$, is a nonsingular surface covered by hypersurfaces in \mathbb{C}^3 .

Let $q = 2$. In this case there is only one “long” relation in 5.3 and all maps between representations are row or column vectors. See Figure 5.10 for the McKay quiver in this case. Note that k is odd by Remark 5.2, so the number of rows is also odd.

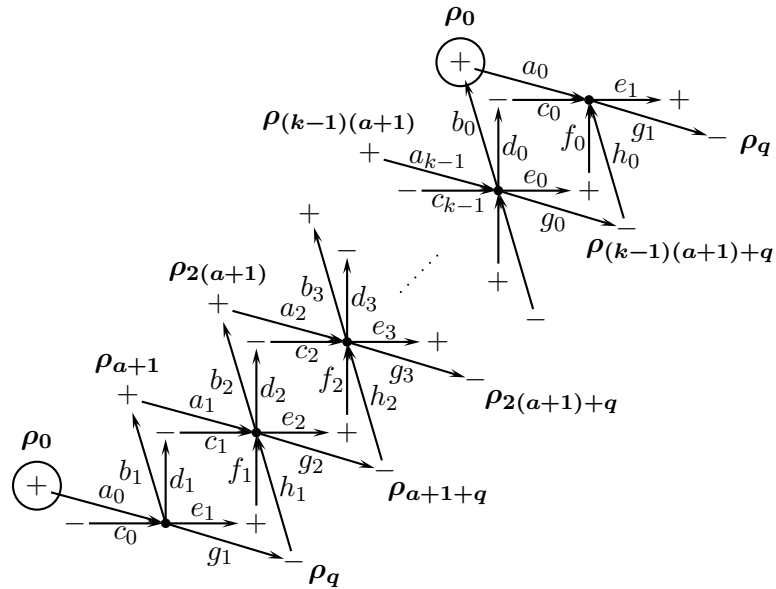

Figure 5.10: McKay quiver for $\text{BD}_{2n}(n+1)$ groups

The relations R for the McKay quiver in this case are

$$\begin{aligned}
 a_i b_i &= 0 \\
 c_i d_i &= 0 \\
 f_i e_{i+1} &= 0 \\
 h_i g_{i+1} &= 0 \\
 b_i a_{i+1} + d_i c_{i+1} &= e_i f_i + h_i g_i
 \end{aligned}$$

Since $u \leq q$, the only possibilities for qG -graphs are $\Gamma(0, 2n; 1, a)$ and $\Gamma(1, a; 2, 2)$,

where the last G -graph can be covered using type C^+ and C^- . Now $\frac{2n}{a} = [b_1, b_2, b_1]$ so $2 = b_1a - 2n = b_1$, and we get $a = n + 1$, $b_1 = 2$ and $b_2 = \frac{n+2}{2}$. Therefore this case corresponds to the binary dihedral groups $\text{BD}_{2n}(n + 1)$.

This family of examples is a generalisation of the previous section. Indeed, if $n = 2$ we obtain the previous case $G = D_4$. Then $k = 1$ and it is the only case where the last G -graph is of type B . Thus we suppose from now on that $n \geq 2$.

Considering representations of this quiver, the key observation for the calculation of $\mathcal{M}_\theta(Q, R)$ in this case is the fact that at every 2-dimensional vector space, i.e. at every vertex in the middle of the quiver, we can always change basis in such way that two of the arrows coming into it are $(1, 0)$ and $(0, 1)$. We make this choice according to the G -graph the quiver (\star) labelled with x 's and y 's. In this case it is the repetition of the following block all around the quiver:

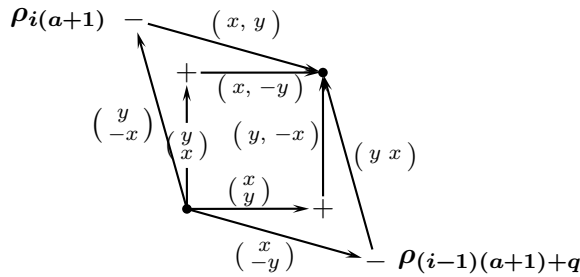

Case $A(0, 2n; 1, n + 1)$

This is the “thin” G -graph where the monomial xy is out of Γ_A , and the monomials x^{2n} and y^{2n} are twins. The choice of $(1,0)$ and $(0,1)$'s according to the G -graph is very symmetric. It repeats itself in blocks of two “segments”, the consecutive rows corresponding to ρ_i with i odd and i even, until it reaches the end (see Figure 5.11).

The way that the representation does not choose the monomial xy as part of the basis is by taking the linear map corresponding to the arrow $d_1 : V_1 \rightarrow \rho_{a+1}^-$ to be given by $\begin{pmatrix} d_1 \\ 1 \end{pmatrix}$. We are allowed to make this choice since by stability the representation ρ_{a+1}^- must be reached from the element 1 in the trivial representation ρ_0^+ , so either $d_1 \neq 0$ or $D_1 \neq 0$. The choice $d_1 \neq 0$ corresponds to the next case C .

Similarly, we choose $\begin{pmatrix} 1 \\ E_1 \end{pmatrix}$ and $\begin{pmatrix} 1 \\ G_1 \end{pmatrix}$ for the arrows e_1 and g_1 so that the basis elements for ρ_q^+ and ρ_q^- are $x^2 + y^2$ and $x^2 - y^2$ as desired. The rest of the choices are done in a similar fashion. Note that $G_1 = 0$ since we are choosing $h_0 = (0, 1)$ and $h_0 g_1 = 0$.

Figure 5.11 shows the representation space for this open set. The vertices in the middle represent the 2-dimensional vector spaces \mathbb{C}^2 . The marked arrows give the choice of basis elements for them.

At ρ_{odd} the relations of the quiver tell us that

$$\begin{pmatrix} 0 \\ 1 \end{pmatrix} (a_i, -a_i b_{i+1}) + \begin{pmatrix} d_i \\ 1 \end{pmatrix} (1, 0) = \begin{pmatrix} 1 \\ E_i \end{pmatrix} (0, 1) + \begin{pmatrix} 1 \\ 0 \end{pmatrix} (-G_{i+1} H_i, H_i)$$

$$\begin{pmatrix} 0 & 0 \\ a_i & -a_i b_{i+1} \end{pmatrix} + \begin{pmatrix} d_i & 0 \\ 1 & 0 \end{pmatrix} = \begin{pmatrix} 0 & 1 \\ 0 & E_i \end{pmatrix} + \begin{pmatrix} -G_{i+1} H_i & H_i \\ 0 & 0 \end{pmatrix}$$

so that $H_i = a_i = -1$, $G_{i+1} = d_i$ and $b_{i+1} = E_i$.

At ρ_{even} we have:

$$\begin{pmatrix} E_i \\ 1 \end{pmatrix} (1, 0) + \begin{pmatrix} 0 \\ 1 \end{pmatrix} (c_{i+1}, -c_{i+1} d_{i+2}) = \begin{pmatrix} 1 \\ 0 \end{pmatrix} (-E_{i+2} F_{i+1}, F_{i+1}) + \begin{pmatrix} 1 \\ d_i \end{pmatrix} (0, 1)$$

$$\begin{pmatrix} E_i & 0 \\ 1 & 0 \end{pmatrix} + \begin{pmatrix} 0 & 0 \\ c_{i+1} & -c_{i+1} d_{i+2} \end{pmatrix} = \begin{pmatrix} -E_{i+2} F_{i+1} & F_{i+1} \\ 0 & 0 \end{pmatrix} + \begin{pmatrix} 0 & 1 \\ 0 & d_i \end{pmatrix}$$

so that $F_{i+1} = c_{i+1} = -1$, $E_{i+2} = E_i$ and $d_{i+2} = d_i$. By induction, everything can be written in terms of the variables d_1 and E_1 except for the segment at the top of the quiver. There we get

$$\begin{pmatrix} 0 \\ B_0 \end{pmatrix} (1, 0) + \begin{pmatrix} d_1 \\ 1 \end{pmatrix} (c_0, -c_0 d_1) = \begin{pmatrix} 1 \\ E_1 \end{pmatrix} (-E_1 F_0, F_0) + \begin{pmatrix} 1 \\ 0 \end{pmatrix} (0, 1)$$

$$\begin{pmatrix} 0 & 0 \\ B_0 & 0 \end{pmatrix} + \begin{pmatrix} c_0 d_1 & -c_0 d_1^2 \\ c_0 & -c_0 d_1 \end{pmatrix} = \begin{pmatrix} -E_1 F_0 & F_0 \\ -E_1^2 F_0 & E_1 F_0 \end{pmatrix} + \begin{pmatrix} 0 & 1 \\ 0 & 0 \end{pmatrix}$$

which gives us the following identities $c_0 d_1 = -E_1 F_0$, $F_0 = -1 - c_0 d_1^2$ and $B_0 = -c_0 - E_1^2 F_0$. Therefore, the equation for the affine piece of $\mathcal{M}_\theta(Q, R)$ in this case is the following

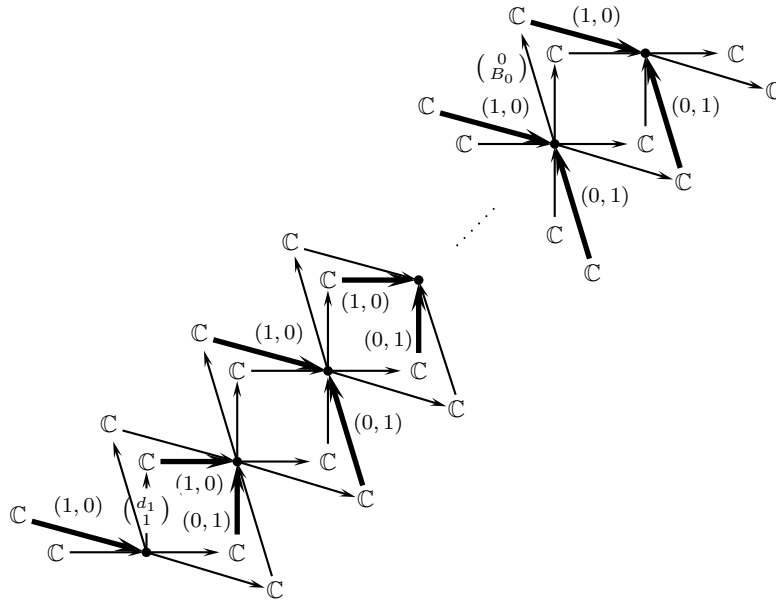

Figure 5.11: Representation corresponding to $BD_{2n}(n+1)$ -graph of type $A(0, 2n; 1, n+1)$.

hypersurface in $\mathbb{C}_{c_0, d_1, E_1}^3$:

$$c_0 d_1 = (1 + c_0 d_1^2) E_1,$$

and the ideals in the corresponding open set of $G\text{-Hilb}(\mathbb{C}^2)$ are given by the following generators

$$\begin{aligned} I_{c_0, d_1, E_1} &= (2xy - d_1(x^2 + y^2)^k(x^2 - y^2), \\ &\quad 2xy(x^2 + y^2)^{k-1}(x^2 - y^2) - E_1(x^2 + y^2), \\ &\quad x(x^2 + y^2)^{2k-1}(x^2 - y^2) - c_0x + c_0d_1y(x^2 + y^2)^{k-1}(x^2 - y^2), \\ &\quad y(x^2 + y^2)^{2k-1}(x^2 - y^2) + c_0y + c_0d_1x(x^2 + y^2)^{k-1}(x^2 - y^2), \\ &\quad (x^2 + y^2)^{2k-2}(x^2 - y^2)^2 - B_0) \end{aligned}$$

with c_0, d_1, E_1 and B_0 satisfying the above relations.

Case C^+

Since $xy \in \Gamma_{C^+}$, we suppose from now on that the linear map corresponding to the arrow $d_1 : V_1 \rightarrow \rho_{a+1}^-$ is given by the column vector $\begin{pmatrix} 1 \\ D_1 \end{pmatrix}$. The last G -graph is of type B if and only if $n = 2$, which is the D_4 already done in the previous section. We can then suppose that the last G -graph is Γ_A .

As we have seen in Sections 4.4.3 and 4.6 the special representation is $\rho_{2(a+1)}^+$, so for the type C^+ case we have that $(x^2 + y^2)^2$ is the basis. Therefore, we choose $e_1 = \begin{pmatrix} 1 \\ E_1 \end{pmatrix}$, $g_1 = \begin{pmatrix} 1 \\ G_1 \end{pmatrix}$, $f_1 = \begin{pmatrix} 0 \\ 1 \end{pmatrix}$ and $b_2 = \begin{pmatrix} b_2 \\ 1 \end{pmatrix}$. The rest of choices are the same as in the type A case except for the last segment, where now $f_0 = (0, 1)$. Hence, by the relation $f_0 e_1 = 0$ we have that $E_1 = 0$. See Figure 5.12. For the first two segments we have

$$\begin{aligned} \begin{pmatrix} 0 \\ 1 \end{pmatrix} (a_1, -a_1 b_2) + \begin{pmatrix} 1 \\ D_1 \end{pmatrix} (1, 0) &= \begin{pmatrix} 1 \\ 0 \end{pmatrix} (0, 1) + \begin{pmatrix} 1 \\ G_1 \end{pmatrix} (-G_2 H_1, H_1), \quad \text{and} \\ \begin{pmatrix} b_2 \\ 1 \end{pmatrix} (1, 0) + \begin{pmatrix} 0 \\ 1 \end{pmatrix} (c_2, -c_2 d_3) &= \begin{pmatrix} 1 \\ 0 \end{pmatrix} (-E_3 F_2, F_2) + \begin{pmatrix} 1 \\ 1 \end{pmatrix} (0, 1) \end{aligned}$$

which imply $c_2 = F_2 = H_1 = -1$, $d_3 = G_2 = 1$ and $E_3 = b_2$, together with $G_1 = a_1 b_2$ and $a_1 + D_1 = G_1$.

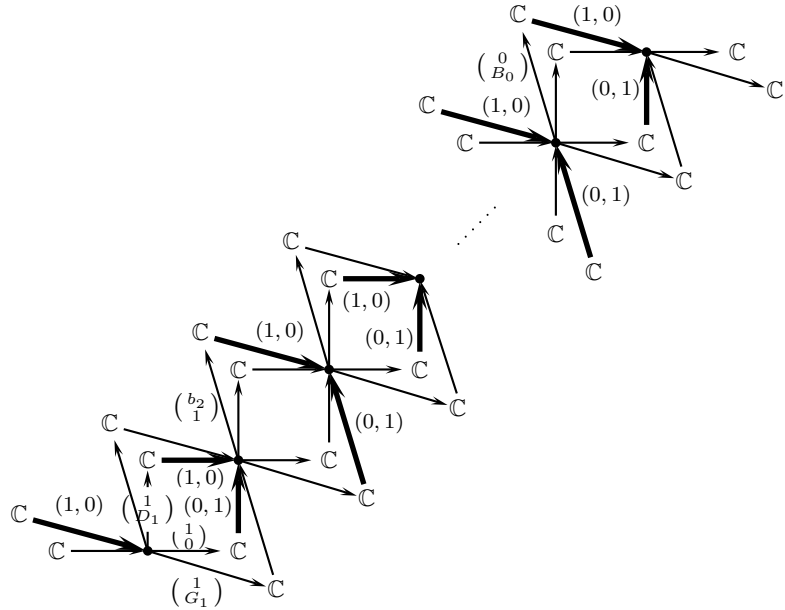

Figure 5.12: Representation corresponding to the $BD_{2n}(n+1)$ -graph of type C^+ .

For any segment corresponding to $\rho_{i(a+1)}$ the relations of the quiver give the same equations as in the type A case, i.e. we obtain $a_i = c_{i+1} = F_{i+1} = H_i = -1$, $E_i = E_{i+1} = b_{i+1}$ and $d_{i+2} = d_i = G_{i+1} = 1$.

Finally, at ρ_0 we have

$$\begin{aligned} \begin{pmatrix} 0 \\ B_0 \end{pmatrix} (1, 0) + \begin{pmatrix} 1 \\ 1 \end{pmatrix} (-C_0 D_1, C_0) &= \begin{pmatrix} 1 \\ b_2 \end{pmatrix} (0, 1) + \begin{pmatrix} 1 \\ 0 \end{pmatrix} (-G_1 H_0, H_0) \\ \begin{pmatrix} 0 & 0 \\ B_0 & 0 \end{pmatrix} + \begin{pmatrix} -C_0 D_1 & C_0 \\ -C_0 D_1 & C_0 \end{pmatrix} &= \begin{pmatrix} 0 & 1 \\ 0 & b_2 \end{pmatrix} + \begin{pmatrix} -G_1 H_0 & H_0 \\ 0 & 0 \end{pmatrix} \end{aligned}$$

which implies that $B_0 = C_0 D_1$, $C_0 = b_2$, $H_0 = C_0 - 1$ and $C_0 D_1 = G_1 H_0$. In other words, the open set of $\mathcal{M}_\theta(Q, R)$ in this case is the hypersurface in $\mathbb{C}_{b_2, D_1, G_1}^3$ given by

$$b_2 D_1 = (b_2 - 1) G_1$$

Case C^-

In this case the basis element for $\rho_{2(a+1)}^+$ is $(x^2 - y^2)^2$, so we choose $h_0 = (0, 1)$, $e_1 = \begin{pmatrix} 1 \\ E_1 \end{pmatrix}$, $g_1 = \begin{pmatrix} 1 \\ 0 \end{pmatrix}$ and $b_2 = \begin{pmatrix} b_2 \\ 1 \end{pmatrix}$, and the rest is as in the C^+ case. The affine open set of $\mathcal{M}_\theta(Q, R)$ is then given by the equation $b_2 D_1 = (b_2 - 1) E_1$, a nonsingular hypersurface in $\mathbb{C}_{b_2, D_1, E_1}^2$.

Case D

In this case the polynomial $x^2 + y^2$ does not belong to Γ_{D^+} (respectively $x^2 - y^2$ for type D^-). Thus, we choose $e_1 = \begin{pmatrix} e_1 \\ 1 \end{pmatrix}$ and $g_1 = \begin{pmatrix} 1 \\ 0 \end{pmatrix}$ in the D^+ case, and $e_1 = \begin{pmatrix} 1 \\ 0 \end{pmatrix}$, $g_1 = \begin{pmatrix} g_1 \\ 1 \end{pmatrix}$ in the D^- case. See Figure 5.13.

For the D^+ case we have that for $2 \leq i \leq k - 1$, the relations at ρ_i are

$$\begin{pmatrix} 0 \\ 1 \end{pmatrix} (1, 0) + \begin{pmatrix} 1 \\ D_i \end{pmatrix} (-C_i D_{i+1}, C_i) = \begin{pmatrix} e_i \\ 1 \end{pmatrix} (f_i, -e_{i+1} f_i) + \begin{pmatrix} 1 \\ 0 \end{pmatrix} (0, 1)$$

which imply that $C_i D_{i+1} = -e_i f_i$, $C_i = 1 - e_i e_{i+1} f_i$, $f_i = 1 - C_i D_i D_{i+1}$ and $C_i D_i = -e_{i+1} f_i$. For the relation at ρ_0 we have:

$$\begin{pmatrix} 0 \\ B_0 \end{pmatrix} (1, 0) + \begin{pmatrix} 1 \\ D_0 \end{pmatrix} (-C_0 D_1, C_0) = \begin{pmatrix} e_{k-1} \\ 1 \end{pmatrix} (f_0, -e_1 f_0) + \begin{pmatrix} 1 \\ 0 \end{pmatrix} (0, 1)$$

which gives $C_0 D_1 = -e_0 f_0$, $C_0 = 1 - e_0 e_1 f_0$, $f_0 = B_0 - C_0 D_0 D_1$ and $C_0 D_0 = -e_1 f_0$.

All relations together imply that $e_0 = \dots = e_{k-1}$, $C_0 = \dots = C_{k-1}$, $D_0 = \dots = D_{k-1}$, $f_0 = \dots = f_{k-1}$, $B_0 = f_0 + C_0 D_1^2$, and the equation for the corresponding affine piece is the hypersurface in $\mathbb{C}_{D_1, e_1, f_0}^3$ given by

$$e_1 f_0 = D_1(e_1^2 f_0 - 1)$$

The case D^- is analogous (see Figure 5.13 for the difference in the labels), giving in this case the hypersurface $g_1 h_0 = D_1(g_1^2 h_0 - 1)$ in $\mathbb{C}_{D_1, g_1, h_0}^3$.

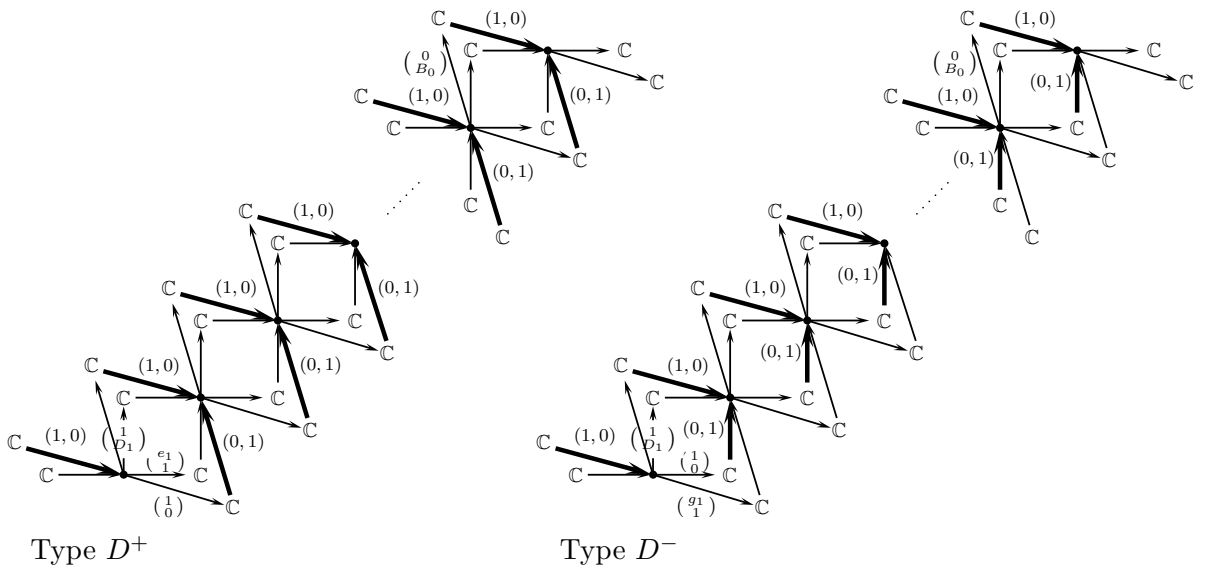

Figure 5.13: Representation corresponding the $BD_{2n}(n+1)$ -graphs of type D^+ and D^- .

5.2.3 The general case: First steps

As we have seen in the previous sections the first step before calculating the equations of the moduli space is to simplify as much as we can the entries in the representation space by change of basis. Mainly, we want to write as many 1's and 0's as we can. By stability we can not have maps which are identically zero, so we can suppose that at least one entry is different than zero (and consider it to be 1 after a suitable change of basis). Different affine open sets are given by different choices for the entries to be nonzero, and these choices are determined by the corresponding G -graph.

Let (Q, R) be the bound McKay quiver 5.1 with relations 5.2 and 5.3. Thus, at any segment between $\rho_{i(a+1)}$ and $\rho_{i(a+1)+q}$ involving the variables $a_i, b_i, c_i, d_i, r_{i,1}, \dots, r_{i,q-2}, u_{i,1}, \dots, u_{i,q-2}, e_1, f_1, g_1$ and h_i with $i \neq 0$, we can make the following simplifications:

Step 1 We can choose either a_i or c_i (or both) to be $(1, 0)$, by changing basis at the head of the arrow.

Step 2 Every horizontal arrow $r_{i,j}$ for $1 \leq j \leq q - 2$ between 2 dimensional vector spaces is of the form $\begin{pmatrix} 1 & 0 \\ r_{i,j} & R_{i,j} \end{pmatrix}$, by changing basis at the head of every arrow. Moreover, at the first row we can achieve $\begin{pmatrix} 1 & 0 \\ 0 & R_{i,j} \end{pmatrix}$ by changing at the tail.

Step 3 The arrow b_i can be chosen to be either $\begin{pmatrix} 1 \\ c_i \end{pmatrix}$ or $\begin{pmatrix} c_i \\ 1 \end{pmatrix}$, by changing basis at the head of the arrow. Similarly for the arrows d_i, e_i and g_i .

Step 4 Every vertical arrow $u_{i,j}$ for $1 \leq j \leq q - 2$ between 2-dimensional vector spaces can be taken to be of the form $\begin{pmatrix} u_{i,j} & U_{i,j} \\ 0 & 1 \end{pmatrix}$, by changing basis at the end of the arrow.

Step 5 We can choose either f_i or h_i to be $(0, 1)$, by changing basis at the head of the arrow.

In addition to these steps, every G -graph has its own specific choices, which depend on the type of the G -graph.

5.2.4 From G -graphs to representations of quivers

In this section we explain how to obtain an open set in $\mathcal{M}_\theta(Q, R)$ of θ -stable representations corresponding to a G -graph Γ_A of type A . We give the types $B.1$ and C^+ as examples in Section 5.3.

Suppose for example that we have a G -graph of type $\Gamma_A(r, s; u, v)$. Then $x^u y^u \notin \Gamma_A$ but $x^i y^i \in \Gamma_A$ for $i < u$. In fact, these monomials belong to the representations $\rho_{i(a+1)}^{(-1)^i}$ situated all of them in the left side of the McKay quiver. Therefore, starting from ρ_0^+ with the element 1 and the map $a_0 = (1, 0)$ we need to reach every representation $\rho_{i(a+1)}^{(-1)^i}$ with $i < u$ with a composition of maps of length i . In other words, we need to choose $d_1 = \begin{pmatrix} 1 \\ D_1 \end{pmatrix}$, $b_2 = \begin{pmatrix} 1 \\ B_2 \end{pmatrix}$, $d_3 = \begin{pmatrix} 1 \\ D_3 \end{pmatrix}$, \dots until $d_{u-1} = \begin{pmatrix} 1 \\ D_{u-1} \end{pmatrix}$ if u is even or $b_{u-1} = \begin{pmatrix} 1 \\ B_{u-1} \end{pmatrix}$ if u is odd.

The fact that $x^u y^u \notin \Gamma_A$ is given by the choice $b_u = \begin{pmatrix} b_u \\ 1 \end{pmatrix}$ if u is even, or $d_u = \begin{pmatrix} d_u \\ 1 \end{pmatrix}$ if u is odd. In this way, the nonzero map from ρ_0^+ to $\rho_{u(a+1)}$ which gives the basis element

\mathbf{m} is a path of length bigger than u , and we have that $x^u t^u = d_u \cdot \mathbf{m}$.

In Figure 5.14 we show the choices of nonzero elements in the representation space and the corresponding basis elements (represented as monomials) in the G -graph that these choices produce (the arrows are chosen according to Steps 1, 2 and 3).

We repeat Steps 1 to 5 from Section 5.2.3 (in order) starting from ρ_{a+1} until we arrive to the last segment, the one corresponding to ρ_0 . There, for Step 1 we choose $a_0 = (1, 0)$ since by stability the whole module need to be generated from ρ_0^+ . Also, notice that the map b_0 can be identically zero since ρ_0^+ is already generated by $\mathbf{1}$.

The steps 2 and 3 at the last segment can be done as the previous ones, but the situation is different for the Step 4. Indeed, making the change of basis now affects the vertical arrows in the next segment, so that they don't have the form $\begin{pmatrix} u_j & U_j \\ 0 & 1 \end{pmatrix}$ any more. Nevertheless, we can make the assumption $V_{0,j} = 1$ for $1 \leq j \leq q - 2$. Thus we have the following extra step:

Step 6 Every vertical arrow $u_{0,j}$ for $1 \leq j \leq q - 2$ between 2-dimensional vector spaces can be taken to be of the form $\begin{pmatrix} u_{i,j} & U_{i,j} \\ v_{i,j} & 1 \end{pmatrix}$, by changing basis at the end of the arrow.

Note that the change of basis needed in the Step 6 does change the matrix of the next vertical map. Indeed, by making for example the map $u_{0,k}$ to be as in Step 6 we change the map $u_{1,k-1}$ to be given by the matrix $\begin{pmatrix} u_{1,k-1} & U_{1,k-1} \\ 0 & V_{0,k} \end{pmatrix}$. But now we can change basis at the head of $u_{1,k-1}$ changing the map $u_{2,k-2} \dots$ and so on. Iterating this procedure we "translate" the variable $V_{0,k}$ around the quiver: if we reach the left side of the quiver, the variable is translated horizontally until it reaches the right side where then it continues vertically... and so on.

The process terminates when the translation arrives vertically to the map $u_{k-1,1}$. There we change basis at the vertex corresponding to the representation $V_{(k-1)(a+1)+1}$, and now the arrows b_0 and d_0 are changed. But b_0 can be identically zero so we don't need to change basis at ρ_0^+ , and for d_0 the change of basis at ρ_0^- does not affect c_0 since the choice of $(1, 0)$ has been made for a_0 . The fact that k and q are coprime imply that we can run this argument with all of the vertical arrows in the last row, including f_0 and g_0 for Step 5.

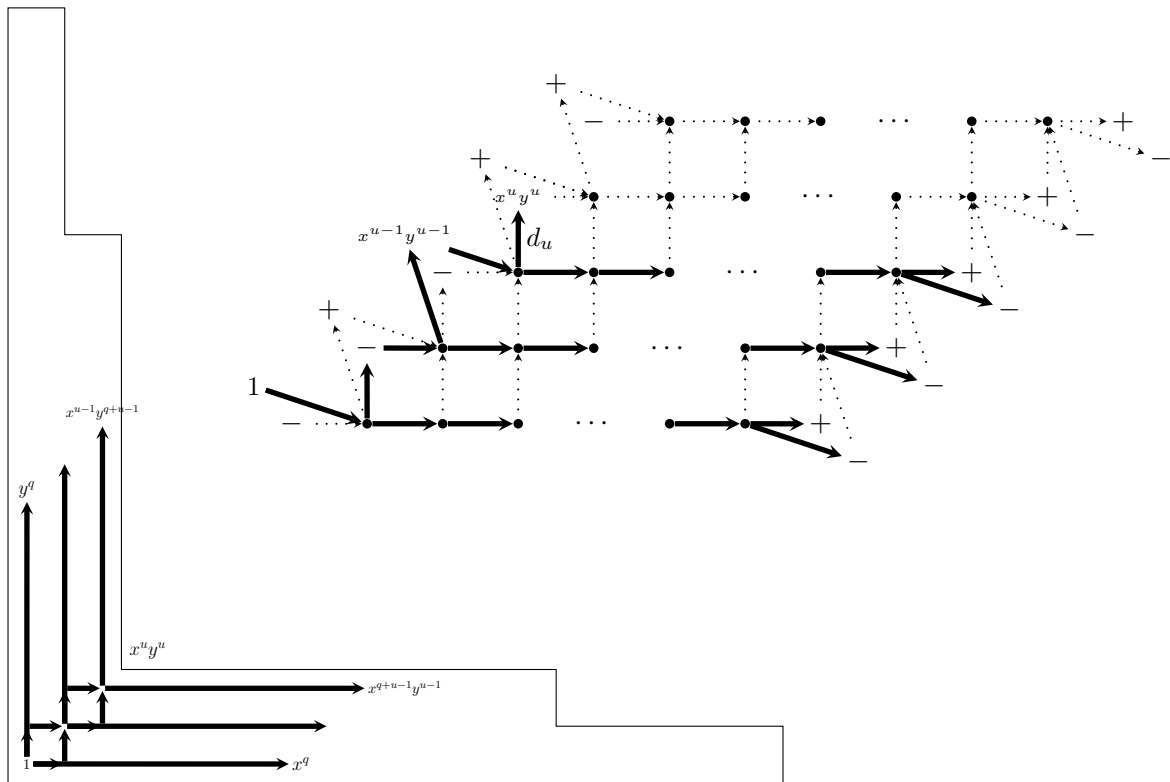

Figure 5.14: Basis elements in the G -graph Γ_A and the corresponding choices in the representation space.

The remaining of the choices are done according to Steps 1-6 in Section 5.2.3. They imply that every 1-dimensional vector space is generated by one elements and the 2-dimensional ones by two, corresponding one-to-one with all basis elements in Γ_A , so we have a θ -stable representation.

Once we fix the nonzero assumptions in the representation according to the G -graph, the use of the relations of the quiver gives the equation of the affine piece in $\mathcal{M}_\theta(Q, R)$ that we were looking for.

5.3 Examples

In this section we present two examples, illustrating the method described in previous sections.

5.3.1 Type $C^+(2, 8; 5, 5)$ in $BD_{30}(11)$

By Proposition 4.20 the ideal defining the G -graph $\Gamma_{C^+}(2, 8; 5, 5)$ is $I = (y^3(x^5 + iy^5), x^3(x^5 + iy^5), x^8y^3, x^3y^8, x^6y^6)$. Since the first two generators belong to the representation V_2 , we have to take as its basis elements (x^2, y^2) and $(y^3(x^5 - iy^5), x^3(x^5 - iy^5))$. This explains why in this case the map $h_1 = (0, 1)$ (see Table 5.3.1), while the case C^- is given by the same choices but taking $f_1 = (0, 1)$ instead.

See Figure 5.15 for choices of nonzero elements corresponding to Γ_{C^+} . The the representations inside a circle are the special representations. In this case, the quiver (\star) consists of the McKay quiver labelled with the following irreducible maps:

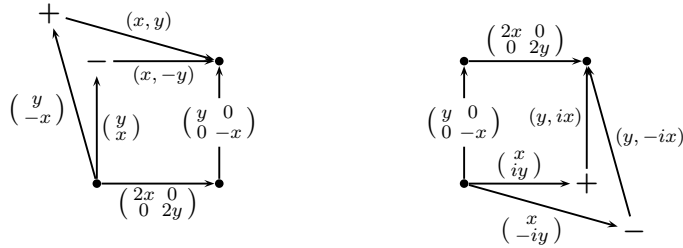

at any pair of 1-dimensional modules S_{ρ_i} , and the matrices $\begin{pmatrix} 2x & 0 \\ 0 & 2y \end{pmatrix}$ and $\begin{pmatrix} y & 0 \\ 0 & -x \end{pmatrix}$ for the remaining horizontal and respectively vertical irreducible maps between the rest of 2-dimensional S_{V_j} . By using this quiver we can give the basis elements for each irreducible representation obtained by the above choice in the representation, which shows that every cluster \mathcal{Z} in this open set of G -Hilb(\mathbb{C}^2) has Γ_{C^+} as basis for $I_{\mathcal{Z}}$.

Writing down the remaining variables in the representation (see notation in Figure 5.1) and using the relations of the quiver, we obtain that the open set corresponding to the G -graph $\Gamma_{C^+}(2, 8; 5, 5)$ is the nonsingular hypersurface in $\mathbb{C}_{D_0, E_1, F_0}^3$ defined by

$$D_0(F_0 + 1) = E_1F_0$$

5.3.2 Type $B1(1, 13; 4, 10)$ in $BD_{42}(13)$

In this case we have that $q = 7$ and $k = 3$. By Proposition 4.16 we have that x^4y^3 and x^3y^4 are out of the basis, and since they belong to the irreducible representation V_1 , we

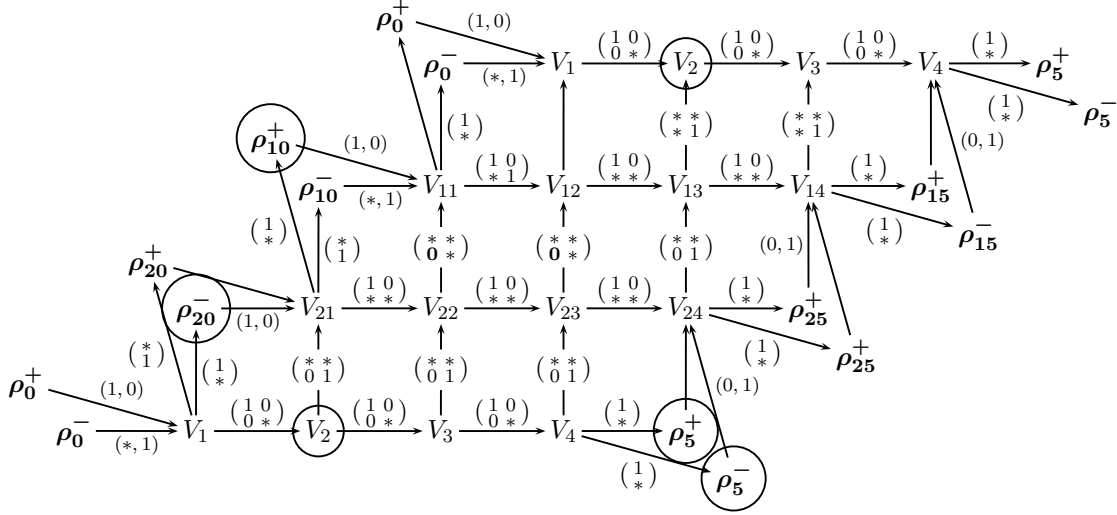

Figure 5.15: Open set in $\mathcal{M}_\theta(Q, R)$ corresponding to the $\text{BD}_{30}(11)$ -graph $\Gamma_{C^+}(2, 8; 5, 5)$.

ρ_0^+	1	ρ_{20}^+	x^4y^4	ρ_{10}^+	x^2y^2
ρ_0^-	x^3y^3	ρ_{20}^-	xy	ρ_{10}^-	$(-)^2$
V_1	$(x, y),$ $(x^4y^3, -x^3y^4)$	V_{21}	$(x^2y, -xy^2),$ $(y^4(-), ix^4(-))$	V_{11}	$(x^3y^2, x^2y^3),$ $(x(-)^2, -y(-)^2)$
V_2	$(x^2, y^2),$ $(y^3(-), -ix^3(-))$	V_{22}	$(x^3y, -xy^3),$ $(xy^4(-), ix^4y(-))$	V_{12}	$(x^4y^2, x^2y^4),$ $(x^2(-)^2, -y^2(-)^2)$
V_3	$(x^3, y^3),$ $(xy^3(-), -ix^3y(-))$	V_{23}	$(x^4y, -xy^4),$ $(x^2y^4(-), ix^4y^2(-))$	V_{13}	$(x^5y^2, x^2y^5),$ $(y^2(-), ix^2(-))$
V_4	$(x^4, y^4),$ $(x^2y^3(-), -ix^3y^2(-))$	V_{24}	$(x^5y, -xy^5),$ $(y(-), -ix(-))$	V_{14}	$(x^6y^2, x^2y^6),$ $(xy^2(-), ix^2y(-))$
ρ_5^+	$(+)$	ρ_{25}^+	$xy(-)$	ρ_{15}^+	$x^2y^2(+)$
ρ_5^-	$(-)$	ρ_{25}^-	$xy(+)$	ρ_{15}^-	$x^2y^2(-)$

Table 5.4: Basis elements of the G -graph $\Gamma_{C^+}(2, 8; 5, 5)$

allow the map c_0 to be zero so that $(x^4y^3, -x^3y^4)$ is not in the basis of V_1 .

The G -graph $\Gamma_{B.1}(1, 13; 4, 10)$ is given by the following diagram:

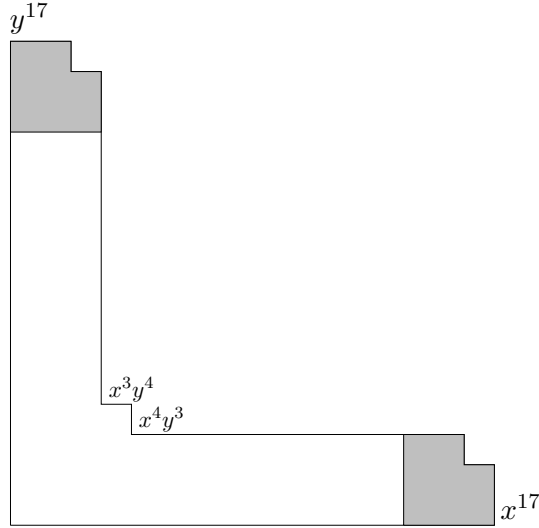

In Table 5.3.2 we write the basis elements for each irreducible representation of $BD_{42}(11)$ given according to our choice of nonzero elements. Since $xy \in \Gamma_{B1}$ is the basis for the special representation ρ_{14}^- , the twin region is created by the monomial $x^{14} - y^{14}$. The basis elements for the representations contained in the twin region are therefore given by $x^{14} + y^{14} \in \rho_{14}^+$ and its multiples. This explains why the maps $u_{1,1}$, $u_{1,2}$ and $u_{2,1}$ are of the form $\begin{pmatrix} * & * \\ 0 & * \end{pmatrix}$.

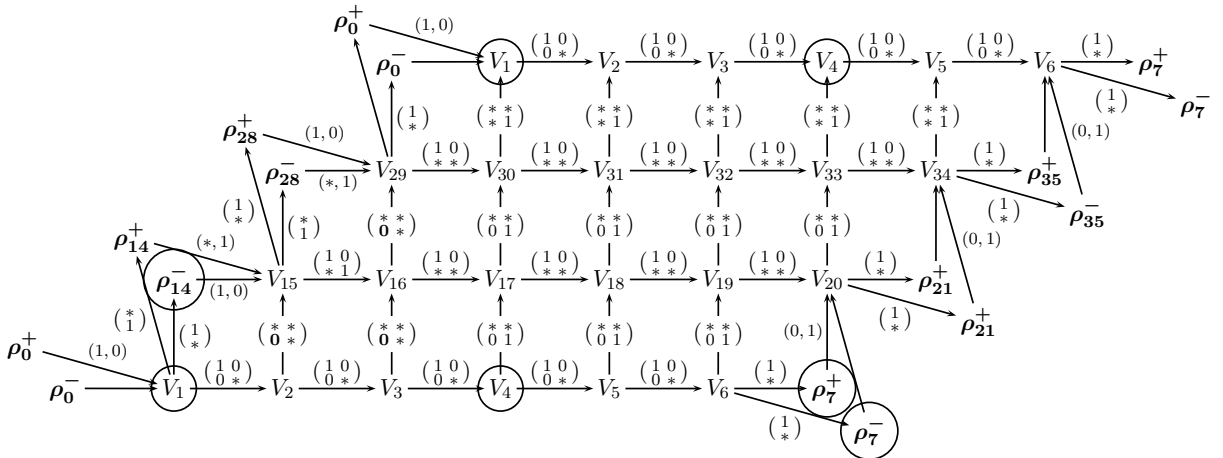

Figure 5.16: Open set in $\mathcal{M}_\theta(Q, R)$ corresponding to the $BD_{42}(13)$ -graph $\Gamma_{B.1}(1, 13; 4, 10)$.

ρ_0^+	1	ρ_{14}^+	$(+)(-) = x^{14} + y^{14}$	ρ_{28}^+	x^2y^2
ρ_0^-	x^3y^3	ρ_{14}^-	xy	ρ_{28}^-	$xy(+)(-)$
V_1	$(x, y),$ $(y^6(+), ix^6(+))$	V_{15}	$(x^2y, -xy^2),$ $(x(+)(-), y(+)(-))$	V_{29}	$(x^3y^2, x^2y^3),$ $(x^2y(+)(-), -xy^2(+)(-))$
V_2	$(x^2, y^2),$ $(xy^6(-), ix^6y(-))$	V_{16}	$(x^3y, -xy^3),$ $(x^2(+)(-), y^2(+)(-))$	V_{30}	$(x^4y^2, x^2y^4),$ $(y^5(+), -ix^y(+))$
V_3	$(x^3, y^3),$ $(x^2y^6(-), -ix^6y^2(-))$	V_{17}	$(x^4y, -xy^4),$ $(y^4(+), ix^4(+))$	V_{31}	$(x^5y^2, x^2y^5),$ $(xy^5(-), -ix^5y(-))$
V_4	$(x^4, y^4),$ $(y^3(+), -ix^3(+))$	V_{18}	$(x^5y, -xy^5),$ $(xy^4(-), ix^4y(-))$	V_{32}	$(x^6y^2, x^2y^6),$ $(x^2y^5(-), ix^5y^2(-))$
V_5	$(x^5, y^5),$ $(xy^3(-), -ix^3y(-))$	V_{19}	$(x^6y, -xy^6),$ $(x^2y^4(-), -ix^4y^2(-))$	V_{33}	$(x^7y^2, x^2y^7),$ $(y^2(+), ix^2(+))$
V_6	$(x^6, y^6),$ $(x^2y^3(-), ix^3y^2(-))$	V_{20}	$(x^7y, -xy^7),$ $(y(+), -ix(+))$	V_{34}	$(x^8y^2, x^2y^8),$ $(xy^2(-), ix^2y(-))$
ρ_7^+	$(+)$	ρ_{21}^+	$xy(-)$	ρ_{35}^+	$x^2y^2(+)$
ρ_7^-	$(-)$	ρ_{21}^-	$xy(+)$	ρ_{35}^-	$x^2y^2(-)$

Table 5.5: Basis elements of the G -graph $\Gamma_{C^+(2, 8; 5, 5)}$, with $(+) = x^7 - iy^7$ and $(-) = x^7 + iy^7$.

Using the relations 5.2 and 5.3 of the quiver, the open set in this case is given by the nonsingular complete intersection in $\mathbb{C}_{C_0, D_0, E_1, F_0}^2$ given by the equations

$$C_0D_1 = E_1F_0$$

$$F_0(C_0E_1F_0 - 1) = 1.$$

Bibliography

- [ASS06] Ibrahim Assem, Daniel Simson, and Andrzej Skowroński. *Elements of the representation theory of associative algebras. Vol. 1*, volume 65 of *London Mathematical Society Student Texts*. Cambridge University Press, Cambridge, 2006. Techniques of representation theory.
- [BKR01] Tom Bridgeland, Alastair King, and Miles Reid. The McKay correspondence as an equivalence of derived categories. *J. Amer. Math. Soc.*, 14(3):535–554 (electronic), 2001.
- [Bri68] Egbert Brieskorn. Rationale Singularitäten komplexer Flächen. *Invent. Math.*, 4:336–358, 1967/1968.
- [BSW08] Raf Bocklandt, Travis Schedler, and Michael Wemyss. Superpotentials and higher order derivations. *arXiv:0802.0162*, 2008.
- [CB] William Crawley-Boevey. Dmv lectures on representations of quivers, preprojective algebras and deformations of quotient singularities. <http://www.amsta.leeds.ac.uk/~pmtwc/dmvlects.pdf>.
- [CMT07a] Alastair Craw, Diane Maclagan, and Rekha R. Thomas. Moduli of McKay quiver representations. I. The coherent component. *Proc. Lond. Math. Soc. (3)*, 95(1):179–198, 2007.
- [CMT07b] Alastair Craw, Diane Maclagan, and Rekha R. Thomas. Moduli of McKay quiver representations. II. Gröbner basis techniques. *J. Algebra*, 316(2):514–535, 2007.
- [CR02] Alastair Craw and Miles Reid. How to calculate A -Hilb \mathbb{C}^3 . In *Geometry of toric varieties*, volume 6 of *Sémin. Congr.*, pages 129–154. Soc. Math. France, Paris, 2002.

- [Cra01] A. Craw. *The McKay correspondence and representations of the McKay quiver*. PhD thesis, Warwck, 2001.
- [Cra07] Alastair Craw. The special Mckay correspondence as an equivalence of derived categories. *arXiv:0704.3627*, 2007.
- [Cra08] Alastair Craw. Quiver representations in toric geometry. *arXiv:0807.2191*, 2008.
- [Dol03] Igor Dolgachev. *Lectures on invariant theory*, volume 296 of *London Mathematical Society Lecture Note Series*. Cambridge University Press, Cambridge, 2003.
- [Dur79] Alan H. Durfee. Fifteen characterizations of rational double points and simple critical points. *Enseign. Math. (2)*, 25(1-2):131–163, 1979.
- [IN96] Yukari Ito and Iku Nakamura. McKay correspondence and Hilbert schemes. *Proc. Japan Acad. Ser. A Math. Sci.*, 72(7):135–138, 1996.
- [IN99] Y. Ito and I. Nakamura. Hilbert schemes and simple singularities. In *New trends in algebraic geometry (Warwick, 1996)*, volume 264 of *London Math. Soc. Lecture Note Ser.*, pages 151–233. Cambridge Univ. Press, Cambridge, 1999.
- [Ish02] Akira Ishii. On the McKay correspondence for a finite small subgroup of $GL(2, \mathbb{C})$. *J. Reine Angew. Math.*, 549:221–233, 2002.
- [Ito02] Yukari Ito. Special McKay correspondence. In *Geometry of toric varieties*, volume 6 of *Sémin. Congr.*, pages 213–225. Soc. Math. France, Paris, 2002.
- [IW08] Osamu Iyama and Michael Wemyss. The classification of special CM modules. *arXiv:0809.1958*, 2008.
- [JL01] Gordon James and Martin Liebeck. *Representations and characters of groups*. Cambridge University Press, New York, second edition, 2001.
- [Kid01] Rie Kidoh. Hilbert schemes and cyclic quotient surface singularities. *Hokkaido Math. J.*, 30(1):91–103, 2001.

- [Kin94] A. D. King. Moduli of representations of finite-dimensional algebras. *Quart. J. Math. Oxford Ser. (2)*, 45(180):515–530, 1994.
- [Len02] Becky Leng. *The McKay correspondence and orbifold Riemann-Roch*. PhD thesis, University of Warwick, 2002.
- [McK80] John McKay. Graphs, singularities, and finite groups. In *The Santa Cruz Conference on Finite Groups (Univ. California, Santa Cruz, Calif., 1979)*, volume 37 of *Proc. Sympos. Pure Math.*, pages 183–186. Amer. Math. Soc., Providence, R.I., 1980.
- [MFK94] D. Mumford, J. Fogarty, and F. Kirwan. *Geometric invariant theory*, volume 34 of *Ergebnisse der Mathematik und ihrer Grenzgebiete (2) [Results in Mathematics and Related Areas (2)]*. Springer-Verlag, Berlin, third edition, 1994.
- [Muk03] Shigeru Mukai. *An introduction to invariants and moduli*, volume 81 of *Cambridge Studies in Advanced Mathematics*. Cambridge University Press, Cambridge, 2003. Translated from the 1998 and 2000 Japanese editions by W. M. Oxbury.
- [Nak01] Iku Nakamura. Hilbert schemes of abelian group orbits. *J. Algebraic Geom.*, 10(4):757–779, 2001.
- [Rei] Miles Reid. Surface cyclic quotient singularities and Hirzebruch–Jung resolutions. <http://www.warwick.ac.uk/~masda/surf/more/cyclic.pdf>.
- [Rei87] Miles Reid. Young person’s guide to canonical singularities. In *Algebraic geometry, Bowdoin, 1985 (Brunswick, Maine, 1985)*, volume 46 of *Proc. Sympos. Pure Math.*, pages 345–414. Amer. Math. Soc., Providence, RI, 1987.
- [Rei02] Miles Reid. La correspondance de McKay. *Astérisque*, 276:53–72, 2002. Séminaire Bourbaki, Vol. 1999/2000.
- [Rie74] Oswald Riemenschneider. Deformationen von Quotientensingularitäten (nach zyklischen Gruppen). *Math. Ann.*, 209:211–248, 1974.
- [Rie77] Oswald Riemenschneider. Die Invarianten der endlichen Untergruppen von $GL(2, \mathbf{C})$. *Math. Z.*, 153(1):37–50, 1977.

-
- [Seb05] Magda Sebestean. *Correspondance de McKay et équivalences dérivés*. PhD thesis, Université Paris 7, 2005.
- [ST54] G. C. Shephard and J. A. Todd. Finite unitary reflection groups. *Canadian J. Math.*, 6:274–304, 1954.
- [Wem07] Michael Wemyss. Reconstruction algebras of type A. *arXiv:0704.3693*, 2007.
- [Wun88] Jürgen Wunram. Reflexive modules on quotient surface singularities. *Math. Ann.*, 279(4):583–598, 1988.
- [Yos90] Yuji Yoshino. *Cohen-Macaulay modules over Cohen-Macaulay rings*, volume 146 of *London Mathematical Society Lecture Note Series*. Cambridge University Press, Cambridge, 1990.