

University of Warwick institutional repository: <http://go.warwick.ac.uk/wrap>

This paper is made available online in accordance with publisher policies. Please scroll down to view the document itself. Please refer to the repository record for this item and our policy information available from the repository home page for further information.

To see the final version of this paper please visit the publisher's website. Access to the published version may require a subscription.

Author(s): I.G. Burns, J.P. Hammond, P.J. White

Article Title: PRECISION PLACEMENT OF FERTILISER FOR OPTIMISING THE EARLY NUTRITION OF VEGETABLE CROPS – A REVIEW OF THE IMPLICATIONS FOR THE YIELD AND QUALITY OF CROPS, AND THEIR NUTRIENT USE EFFICIENCY

Year of publication: 2010

Link to published article:

http://www.actahort.org/books/852/852_21.htm

Publisher statement: The original publication is available at www.actahort.org

Precision Placement of Fertiliser for Optimising the Early Nutrition of Vegetable Crops – A Review of the Implications for the Yield and Quality of Crops, and their Nutrient Use Efficiency

Ian G. Burns and John P. Hammond
Warwick HRI, Wellesbourne
Warwick CV35 9EF, UK

Philip J. White
SCRI, Invergowrie, Dundee
DD2 5DA, Scotland, UK

Keywords: starter fertiliser, band fertiliser, side injection, broadcast fertiliser, nitrogen, phosphorus, potassium

Abstract

The research outlined in this paper highlights the importance of the early nutrition of vegetable crops, and its long-term effects on their subsequent growth and development. Results are also presented to demonstrate how the nutrient supply during the establishment stages of young seedlings and transplants can be enhanced by targeting fertiliser to a zone close to their developing roots. Three different precision fertiliser placement techniques are compared for this purpose: starter, band or side-injected fertiliser. The use of each of these methods consistently produced the same (or greater) yields at lower application rates than those from conventional broadcast applications, increasing the apparent recovery of N, P and K, and the overall efficiency of nutrient use, while reducing the levels of residual nutrients in the soil. Starter fertilisers also advanced the maturity of some crops, and enhanced produce quality by increasing the proportions of the larger and/or more desirable marketable grades. The benefits of the different placement techniques are illustrated with selected examples from research at Warwick HRI using different vegetable crops, including lettuce, onion and carrot.

INTRODUCTION

Vegetable crops require an adequate supply of nutrients throughout growth to avoid reductions in both yield and quality (Burns, 1996). This supply is required to maintain minimum (critical) concentrations of all major nutrients within their tissues for maximum growth. Critical nutrient concentrations tend to decline throughout much of the lifetime of a crop because of the changing proportions of structural and growth-related tissues as the plants age (Greenwood et al., 1986). However, consistently high concentrations are required in young plants to sustain growth rates during the exponential phase before significant structural tissue starts to accumulate, see Fig. 1. Because of the relatively small size of their developing root system at this stage, these plants must maintain high rates of nutrient influx (uptake rates per unit length of root) to fulfil this requirement, see for example Woodhouse et al. (1978). This can only be achieved if the *concentrations* of nutrients in the soil around the roots remain high, even though the plants only need to take up small amounts of nutrient at this stage. In contrast, when the plants are larger their root systems are able to explore the soil more extensively, and the concentration of nutrients around each root becomes less important, provided there are sufficient *amounts* of nutrients in the root zone available for uptake. Thus to be most

effective, fertilisers must be applied so as to optimise the concentration of nutrients around the developing roots to maximise uptake when plants are young, while providing enough nutrients to meet their increasing demand later in growth.

Current fertiliser practices rely heavily on applications of granular fertiliser which are broadcast uniformly over the whole soil surface either as a base or top dressing. These are applied at rates designed to produce the required yield, and focus mainly on sustaining biomass production as the crop approaches maturity. However, there is no guarantee that these applications will maximise uptake when crops are small; it is simply assumed that the same rate will be equally effective at both growth stages.

The objective of this paper is to examine the implications of optimising the early nutrition of vegetable crops and to assess its effect on the yield and quality of produce at maturity. The benefits of using precision placement techniques for targeting the nutrient supply to seedlings and young plants are also discussed, and their effectiveness compared with conventional broadcast fertiliser applications, together with their influence on nutrient use efficiency. Examples of the use of targeted fertiliser applications are drawn largely from previous studies carried out at Warwick HRI. These focus primarily on the use of starter fertilisers, but results for alternative placement methods are also presented.

IMPORTANCE OF EARLY NUTRITION

Failure to maintain high concentrations of nutrients in the soil can make young plants particularly vulnerable to a shortfall in nutrient supply. For instance, Burns (1988, 1990) showed that interruptions or reductions in the N supply for as little as 6 days during the seedling stage of lettuce in hydroponic experiments caused significant reductions in both the weights of adult plants and the yields of produce, as there was little opportunity to recover earlier weight losses by delaying maturity. In contrast, N interruptions of a comparable duration later in growth had a smaller effect. Similar long-term effects of restrictions in early growth from a shortfall in either P or K supply have been reported by Burns (1988) for lettuce plants grown in solution culture and by Grant et al. (2001) for other crops grown in the field.

Costigan (1987a) also studied the early nutrition of lettuce grown at Wellesbourne in mini-plots filled with soils imported from 13 different commercial horticulture sites across the UK. Although granular fertiliser at the recommended rates of N, P and K specific to each soil was incorporated prior to sowing, he found that initial growth varied between soils by more than three-fold. Chemical analysis of the plants and soil solution from each mini-plot revealed that these growth differences were most strongly related to the P supply to these young plants. In a parallel modelling study, Costigan (1987b) predicted that such effects can be caused by a short period of P deficiency resulting from the delay before the roots of young seedlings encounter zones of high P diffusing from fertiliser granules randomly dispersed in the top 75 mm of soil, even when the recommended rate of P fertiliser is applied. The length of this predicted delay varies between crop species due to differences in their seed P reserves and the rate of their early root development, but is less affected by increasing the amount of granular P fertiliser present. This implies that using more targeted applications of nutrients close to a seedling or young plant may be more effective at overcoming these short-term interruptions in the nutrient supply in the early growth stages than simply increasing the rate of broadcast granular fertiliser.

STARTER FERTILISER

Starter fertilisers are normally small amounts of liquid fertiliser introduced into soil 25 to 30 mm below, (or to the side) of seeds or transplants. They are specifically designed to meet the early demand and maintain growth until the normal fertiliser supply becomes available. The beneficial effects of ammonium phosphate used as a starter fertiliser were initially demonstrated in pot experiments by Costigan (1984). These showed that the lowest rate of starter used increased early growth by at least 50% even in well fertilised soil, with the benefits directly related to the P (and to a lesser extent the N) supply to the plants. This study provided the justification for extending the starter fertiliser studies to the field.

Injection Equipment

To facilitate these field studies, Rowse (1993) designed and constructed prototype equipment to inject starter solution beneath a seed row at drilling, see Fig. 2. This was based on a conventional Stanhay seed drill, which was fitted with a knife coulter located in front of the leading wheel at an angle of 30° to the vertical. A narrow tube welded to the trailing edge of the coulter allowed starter solution to be pumped at a selected rate into the soil to the depth of the coulter by adjusting the latter to the required injection depth. All other aspects of the seed drill were unaltered. The equipment was designed to minimise any damage to the soil structure beneath the seed row following injection in order to avoid delaying germination by restricting capillary water movement to the seed. Tests of the equipment showed that pumping a 50:50 mix of ammonium and potassium phosphate solution into the soil at a rate of 18.6 ml m⁻¹ of row could typically deliver a narrow band of N, P and K below the drilling depth at a rate equivalent to 20, 45 and 35 kg ha⁻¹ respectively. Following successful trials with this prototype, a commercial version is now available, details of which can be found at: <http://www.plantsystems.co.uk>

The performance of this prototype equipment was evaluated by measuring the effects of a starter fertiliser injection on the early growth of a range of vegetable crops on separate P and K gradient plots at Wellesbourne (Stone, 1998). This experimental facility had been set up previously by applying between 0 and 3500 kg P ha⁻¹ or 4800 kg K ha⁻¹ to a series of plots on a sandy loam soil in a field with a relatively low PK status, and allowing the fertiliser to equilibrate with the soil for 18 months prior to the start of the experiments. Soil analysis showed that the nutrient status of the plots at the start of the experiments ranged from 25 to 294 µg P g⁻¹ on the P gradients, and from 51 to 735 µg K g⁻¹ on the K gradients. The resulting dry weights of young plants grown without starter increased with P and K status of the soil up to about 70 µg P g⁻¹ and 400 µg K g⁻¹ respectively, as shown for onions and carrots in Fig. 3. However, injecting NPK starter fertiliser enhanced the early growth of the young plants on the lower fertility plots, increasing their dry weights to a level which was indistinguishable from those grown on plots with the highest P or K status.

Effects on Growth and Yield

More detailed trials with the prototype injection equipment have revealed that crop responses can be affected by the composition of the starter solution, particularly when the nutrient status of the soil is low (Stone, 1998). Fig. 4 shows results for carrots grown with different formulations of starter solution on two soils of differing PK status. On the lower PK site, both the early growth and final yield were smaller when either ammonium or potassium phosphate was used individually as a starter, than when a

mixture of the two were used. These differences were not evident on the higher PK soil, partly because additional broadcast PK fertiliser was also applied at the recommended rate to ensure that the status of the soil was maintained. It is interesting to note that early growth with the best starter treatment (50:50 ratio) in the lower fertility soil virtually matched that for carrots grown conventionally without starter (but with the additional PK fertiliser; control treatment) on the higher fertility site (Fig. 4a). However, the similarity in response between these two treatments was not maintained during the latter part of growth, because the PK supply from starter fertiliser alone on the low fertility soil was insufficient to match that from soil and fertiliser combined on the high fertility soil until maturity (Fig. 4b). Such effects can of course be rectified by applying additional PK fertiliser to supplement starter on a low PK soil, as shown in Fig. 5. In this example, applying a NPK starter with broadcast PK fertiliser at half the recommended rate matched the yields at maturity from the recommended rate of broadcast PK alone, and indicates that the overall efficiency of PK use may have been increased by using starter fertiliser (Stone, 1998).

Effects on Crop Quality

In addition to its effects on yield, starter fertiliser can also affect the quality of a crop at harvest. Fig. 6 shows the marketable yields of iceberg quality lettuce (plants with trimmed heads >450 g fresh weight) grown from transplants on a peat soil as part of a commercial trial carried out in northwest England by Stone et al. (1999). There were 2 harvests: at 47 and 57 days after transplanting. Applying broadcast (B) fertiliser alone (at the recommended rate; RR) produced consistently smaller trimmed heads at both harvests than treatments where starter (S) was applied to the soil, either with or without additional broadcast fertiliser (Fig. 6a). Furthermore, at the first harvest there were no plants of iceberg quality from a broadcast application alone, whereas there were substantial yields (>24 t/ha) from ammonium phosphate starter used alone or in combination with a supplementary broadcast dressing (Fig 6b). At the second harvest, the yields of iceberg lettuce from broadcast fertiliser had increased to 26.5 t/ha, but were still greater (at c. 43 t/ha) from starter applications, irrespective of whether or not additional broadcast fertiliser had been applied. Over the two harvests, the yields of iceberg quality lettuce from the two starter treatments were more than 2.5 times greater than from broadcast alone. Results from applying a pre-plant (PP) treatment by soaking the peat blocks of the transplants in nutrient solution instead of applying a starter solution to the soil proved to be intermediate in value. Clearly using starter fertiliser produced combined benefits, not only advancing the maturity date, but also increasing the proportion of crop of the required quality standard.

Experiments with onions have produced similar effects on crop quality. Fig.7 shows that applying ammonium phosphate starter in combination with broadcast applications of NPK at the recommended rate not only increased the total bulb yield by 8% compared with broadcast fertiliser alone, but also increased the proportion of bulbs in the more desirable grade (>55 mm diameter) by 31% (H.R. Rowse, pers. commun.). Once again the responses appear to result from the combined effects of advanced maturity date and a larger whole plant size prior to maturity (Brewster et al., 1991).

Similar results were obtained in another onion experiment in which the effects of ammonium phosphate starter with or without broadcast N fertiliser were compared, in combination with various irrigation treatments (Rahn et al., 1996). Fig. 8 shows that the starter fertiliser increased total bulb yield, with the responses also increasing with the

amount of irrigation applied. The relative effects of both starter and irrigation level were even more pronounced on the yield of larger bulbs (60 to 80 mm diameter). These results emphasise the importance of irrigation in maximising the responses to starter fertiliser, because yields of onions grown without starter on well-irrigated plots were greater than those when starter was used without irrigation. Clearly the full benefits of starter fertiliser will only occur when adequate irrigation is applied. The results may also help to explain why early growth benefits using starter are not always maintained until maturity; the larger size of young plants produced with starter fertiliser increases their use of water and other resources in the soil, making them more susceptible to water (or other) stresses at an earlier stage than the smaller plants produced by conventional fertilisers.

Effects on Nutrient Use Efficiency

The data in Fig. 5 show that yields obtained with NPK starter fertiliser in combination with reduced applications of broadcast P and K fertiliser (at up to half the recommended rate) matched those from broadcast applications when applied alone at the full rate. Furthermore, there were no significant differences in the %P and %K concentrations in whole plants (shoot plus tap root) from these two treatments (D.A. Stone, pers. commun.). It therefore follows that starter fertiliser increases the efficiency with which the crops extract P and K from the soil. This is likely to result from the increased growth from starter fertiliser, which promotes stronger and more rapid root development, allowing these plants to exploit both existing soil P and K, in addition to that from any supplementary dressings.

Similar improvements to the efficiency of N use have been demonstrated in a series of response experiments with lettuce, cabbage and other arable crops (Stone, 2000a, b). Results from one of the bulb onion experiments are shown in Fig. 9. Injections of ammonium phosphate starter applied either alone or in combination with supplementary N (from either broadcast ammonium nitrate or a side-injected eutectic mixture of urea and ammonium nitrate; UAN) produced responses at the salad onion stage which were more than double those from conventional broadcast applications alone (Fig. 9a). Although the relative differences in plant weights declined as they approached maturity, the response curve for the starter treatments consistently remained above that for broadcast fertiliser applications alone, and it is clear that the maximum yield from the latter could not match the best yield obtained with starter fertiliser (Fig. 9b). Comparison of the two fitted response curves also shows that the same yield as that obtained at the optimum rate of broadcast N could be obtained with approximately half the total amount of fertiliser when starter fertiliser was combined with supplementary N. Table 1 compares results from other experiments with onion and lettuce in which similar results were obtained. Corresponding estimates of the mean apparent recoveries of fertiliser N from the combined starter + supplementary applications were both close to 60% for onion and lettuce, compared with values of between 40 and 50% respectively for broadcast fertiliser alone.

Other experiments with lettuce and onion also showed that similar benefits occur when starter fertiliser is supplemented by top rather than base dressings of N fertiliser (Stone, 2000b). In this situation the starter was clearly able to maintain a perfectly adequate supply to the young plants until the N from the top dressing became available. Delaying the application of supplementary N in this way provides an opportunity to adjust the amount applied to take account of local conditions during growth, and may

further improve N use efficiency. Similar increases in N use efficiency were observed in parallel experiments with forage maize and sugar beet.

BANDED BASE DRESSINGS OF N FERTILISER

Nutrient recoveries from conventional broadcast fertiliser applications to many vegetable crops are generally quite low (Greenwood et al., 1974). This is partly because large dressings are needed to overcome the constraints to uptake during the early stages of growth (described above), and partly because the roots of wide-row crops are not always able to fully exploit nutrients applied to the soil in the inter-row areas. One possible way of increasing nutrient recovery is to restrict fertiliser applications to a relatively narrow band spanning each crop row, in order to maximise the available amounts of nutrients during the main period of growth, while maintaining relatively high concentrations in the soil close to the row in an attempt to avoid disadvantaging young plants.

This approach was tested in experiments with cauliflower, leeks and maize by comparing the response to increasing rates of ammonium nitrate fertiliser applied by hand in bands with those from conventional broadcast treatments (C. Patterson, pers. commun.). The banded treatments consisted of equally spaced fertilised and unfertilised bands (each of half the width of the inter-row spacing of the crop), with the seeds drilled in a row along the centre of each fertilised band. Both sets of fertiliser treatments were incorporated into the soil using a power harrow. The resulting total amounts of N fertiliser applied on a whole area basis were thus half those in the corresponding broadcast treatments. Fig. 10 compares the effects of the band and broadcast treatments for cauliflower drilled at a row spacing of 600 mm. The response data (Fig 10a) show that there were no significant differences in yields when the N rate for the respective fertilised areas were compared, confirming that this wide-row crop did not have to rely on that fraction of broadcast N present in the soil well away from the crop row. Soil analysis data also showed that the broadcast treatments consistently left higher mineral N residues at harvest than the corresponding band treatments (Fig. 10b). These results show that targeting the fertiliser in bands in this way not only increased the N use efficiency of the crop, but allowed it to exploit N in the soil more effectively, reducing the risk of environmental pollution from possible nitrate leaching before the next crop. Similar benefits were found in the parallel experiments with leeks and maize. Where heavy applications of N are required to maximise yields of more sensitive crops, it is also possible to apply half of the N in the band and add the remainder as a top dressing subsequently.

SIDE INJECTION

Side placement of fertiliser provides an alternative method of application to banding or starter injection, although the nutrients may need to be placed reasonably close to the crop row to avoid significantly disadvantaging early growth, particularly in low fertility soils. Stone (2000a) tested the effects of placing different rates of a eutectic solution of UAN 30 mm below and either 30 or 60 mm to the side of the drill line of lettuce and onion, using a modified version of the Warwick HRI starter seed drill. Comparisons with corresponding rates of broadcast ammonium nitrate fertiliser for lettuce in Fig 11 show that there was no difference in maximum yield at final harvest between the two application methods. However, yield responses to the lower rates of N were significantly greater for side placed fertiliser, indicating greater N use efficiency in

these treatments. Indeed, these results show that yields could not be bettered by side placing any more than 30 kg N ha⁻¹ into the soil, a rate equivalent to that used in many starter applications. Corresponding results for the parallel onion experiment were less clear-cut, with none of the final bulb yields significantly greater than those for the same rates of broadcast N. There was, however, an indication that side injection of the UAN 60 mm from the drill line produced marginally better yields than at 30 mm, an effect not observed in the lettuce experiment. This suggests that some crops may be more sensitive to injecting large amounts of a relatively mobile form of N close to the seed. This may partly be related to the pattern of root development of the two species, as onion has a root system that initially tends to fan out more than crops such as lettuce which have tap roots.

More recently similar experiments have been carried out to measure the responses of potato, carrot, salad onion, cabbage and lettuce to placed P fertiliser. Triple super phosphate (TSP) granules at half the recommended rate for each crop was side injected to a depth of 75 mm, either 75 mm to both sides (potato) or to one side (other crops) of the planting or drilling line using Chafer placement coulters connected to a Kverneland Accord pneumatic delivery system. Table 2 compares the responses with those from broadcast TSP applied at the full recommended rate. This shows that the placed treatments produced slightly larger yields at maturity, although the differences were not statistically significant. However, as the placed treatments produced essentially equivalent yields with half the normal rate of broadcast P fertiliser, this provides further evidence of the improvements in nutrient use efficiency which such targeted fertiliser applications can bring.

CONCLUSIONS

- 1) Vegetable crops require an adequate supply of nutrients throughout growth to avoid reductions in both yield and quality at maturity. However, the adverse effects from a shortfall in nutrient supply are generally greater when they occur early in growth.
- 2) Conventional broadcast applications of granular fertiliser are not always effective at optimising the early nutrition of many vegetable crops because the nutrients may not become available quickly enough to provide an uninterrupted supply to the roots of developing seedlings in the period immediately after their seed reserves become exhausted. This effect is most noticeable with small seeded species.
- 3) Precision placement techniques (including the injection of small amounts of NPK starter solution either below or close to the side of the crop row) are more effective at providing an uninterrupted supply of nutrients and maximising the early growth of vegetable seedlings and transplants.
- 4) The initial growth benefits from injecting starter solutions are often (but not always) maintained until commercial maturity, and can result in increased total yields and enhanced quality (e.g. a greater proportion of marketable produce in the more desirable larger size grades) provided appropriate supplementary dressings are also applied. In some cases maturity is also advanced.
- 5) The use of injected starter solutions in combination with a supplementary dressing of a conventional fertiliser increases the overall efficiency of nutrient use, and typically reduces the total fertiliser requirement of vegetable crops by up to a half.

- 6) Side placing granular triple super phosphate in a concentrated band at half the recommended rate for a range of vegetable crops produced yields which were indistinguishable from broadcast applications at the full rate.
- 7) An alternative placement technique in which granular fertiliser was applied as a band spanning each crop row allowed reductions in total N applications by up to a half with no significant effects on either early growth or final yield of contrasting vegetable crops. These treatments also reduced residual nutrient levels in the soil at harvest.

ACKNOWLEDGEMENTS

The authors wish to thank past and present colleagues at Warwick HRI, including Peter Costigan, Hugh Rowse, Dave Stone, Carol Patterson and Clive Rahn, on whose work much of this review is based. The technical assistance of Helen Bowen, Rory Hayden and Will Spracklen is also gratefully acknowledged. The research in this paper was funded by the Department of Environment, Food and Rural Affairs (Defra) and the Horticultural Development Council (HDC).

Literature Cited

- Brewster, J.L., Rowse, H.R. and Bosch, A.D. 1991. The effects of sub-seed placement of liquid N and P fertiliser on the growth and development of bulb onions over a range of plant densities using primed and non-primed seed. *J. Hort. Sci.* 66:551-557.
- Burns, I.G. 1988. Effects of interruptions in N, P or K supply on the growth and development of lettuce. *J. Plant Nutr.* 11:1627-1634.
- Burns, I.G. 1990. The effects of continuity of early nitrogen nutrition on growth and development of *Lactuca sativa*. In: M.L. van Beusichem (ed.), *Plant Nutrition – Physiology and Applications*, Proc. Eleventh Intl. Plant Nutr. Colloq. Wageningen, The Netherlands 30 July – 4 Aug. Kluwer Academic Publishers, Dordrecht. p.545-549.
- Burns, I.G. 1996. Nitrogen supply, growth and development. *Acta Hort.* 428:21-30.
- Costigan, P.A. 1984. The effects of placing small amounts of phosphate fertiliser close to the seed on growth and nutrient concentrations of lettuce. *Plant & Soil* 79:191-201.
- Costigan, P.A. 1987a. The importance of seedling nutrient stress in producing site to site variations in yield. *J. Plant Nutr.* 10:1523-1530.
- Costigan, P.A. 1987b. A model to describe the pattern of availability of broadcast phosphorus fertiliser during the growth of a crop. *Plant & Soil* 101:281-285.
- Grant, C.A., Flaten, D.N., Tomasiewicz, D.J., Sheppard, S.C. 2001. The importance of early season phosphorus nutrition. *Canadian J. Plant Sci.* 81:211-224.
- Greenwood, D.J., Cleaver, T.J., Turner, M.K. 1974. Fertiliser requirements of vegetable crops. *Proc. Fertiliser Soc.*, No. 145. 30p.
- Greenwood, D.J., Neeteson, J.J. and Draycott, A. 1986. Quantitative relationships for the dependence of growth rate of arable crops on their nitrogen content, dry weight and aerial environment. *Plant & Soil*, 91:281-301.
- Rahn, C.R., Shepherd, M.A. and Hiron, R.W.P. 1996. The effect of water supply on the response of onions and calabrese to starter solutions. *Acta Hort.* 428:141-150.
- Rowse, H. 1993. Design and testing of commercial prototype equipment for application of starter fertiliser. HDC Final Report FV41a, 18pp.

- Stone D.A. 1998. The effects of “starter” fertiliser injection on the growth and yield of drilled vegetable crops in relation to soil nutrient status. *J. Hort. Sci. & Biotech.* 73:441-451.
- Stone, D.A. 2000a. The effects of starter fertilisers on the growth and nitrogen use efficiency of onion and lettuce. *Soil Use & Mgt.* 16:42-48.
- Stone, D.A. 2000b. Nitrogen requirement of wide-spaced row crops in the presence of starter fertiliser. *Soil Use & Mgt.* 16:285-292.
- Stone, D.A., Tyler, F.T. and Runham, S. 1999. Effect of starter fertilisers on the yield and quality of lettuce grown on peaty soils. *Soil Use & Mgt.* 15:128-132.
- Woodhouse, P.J., Wild, A. and Clement, C.R. 1978. Rate of uptake of potassium by three crop species in relation to growth. *J. Exp. Bot.* 29:885-894.

Tables

Table 1. Total N fertiliser requirements for comparable yields of onion and lettuce from broadcast and combined starter + broadcast fertilizer treatments.

| Crop | Expt | Yield (t ha⁻¹) | Broadcast (kg N ha⁻¹) | Starter + Broadcast (kg N ha⁻¹) |
|-------------|-------------|--------------------------------------|---|---|
| Onion | 1 | 59 | 160 | 85 |
| | 2 | 49 | >160 | 110 |
| Lettuce | 1 | 35 | 170 | 105 |
| | 2 | 24 | 240 | 45 |

Table 2. Comparison of mean yields (\pm SE) of selected vegetable crops from broadcast and side-injected P fertilizer treatments in a low fertility soil at Wellesbourne in 2005.

| Crop | Broadcast at the recommended rate | Placed at 50% of the recommended rate |
|----------------------------|--|--|
| Potato tubers (kg / plot) | 18.3 \pm 0.7 | 18.9 \pm 1.1 |
| Salad onions (g / plant) | 16.3 \pm 1.2 | 18.7 \pm 1.2 |
| Carrot roots (g / plant) | 56.6 \pm 5.5 | 70.0 \pm 6.2 |
| Cabbage hearts (g / plant) | 185 \pm 11 | 178 \pm 11 |
| Lettuce (g / plant) | 533 \pm 43 | 546 \pm 28 |

n = 6 (potato); n = 3 (other crops)

Figures

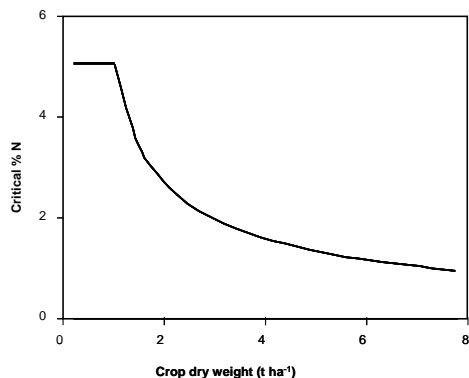

Fig. 1 Changes in plant critical N concentration during growth.

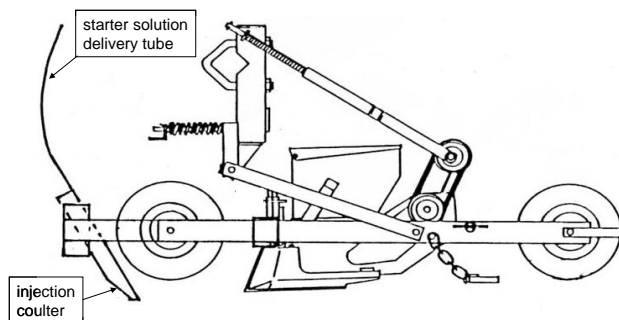

Fig. 2. Stanhay seed drill showing position of commercial prototype injection coultter.

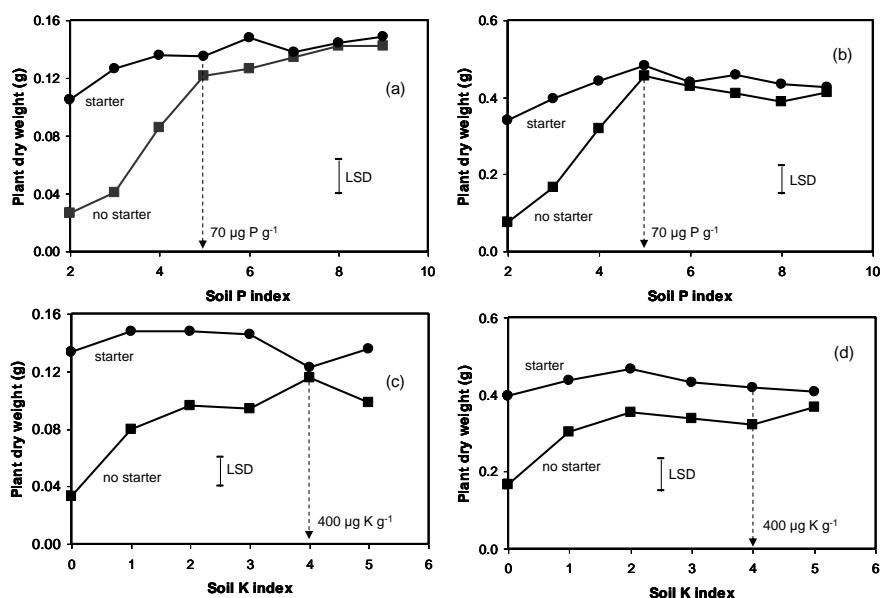

Fig. 3. Responses to NPK starter during early growth of (a) onion; and (b) carrot on soil P gradient plots; and of (c) onion; and (d) carrot on K gradient plots (after Stone, 1998).

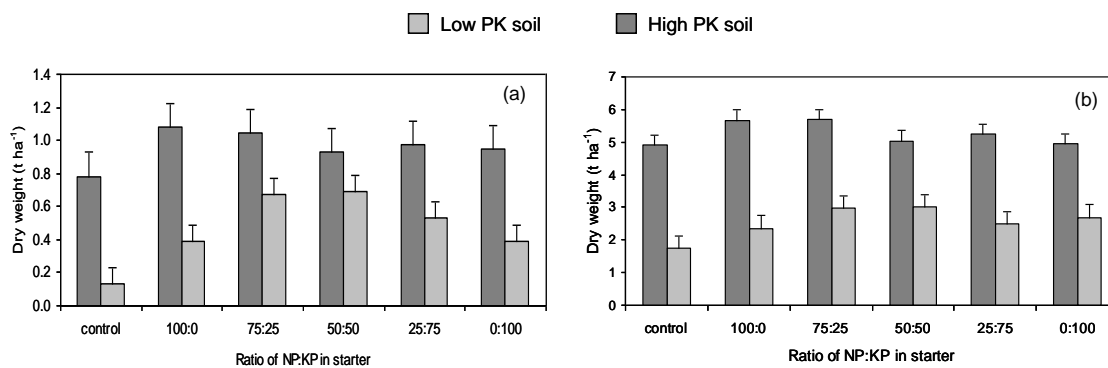

Fig. 4. Responses of carrot roots to starter solution with different ratios of ammonium phosphate to potassium phosphate at: (a) bunching stage; (b) maturity (after Stone, 1998).

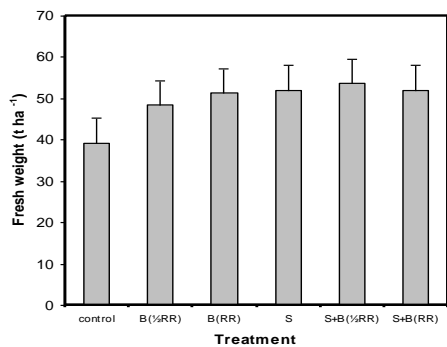

Fig. 5. Responses of carrot roots to broadcast (B) and/or starter (S) PK at half or full recommended rate (RR) (after Stone, 1998).

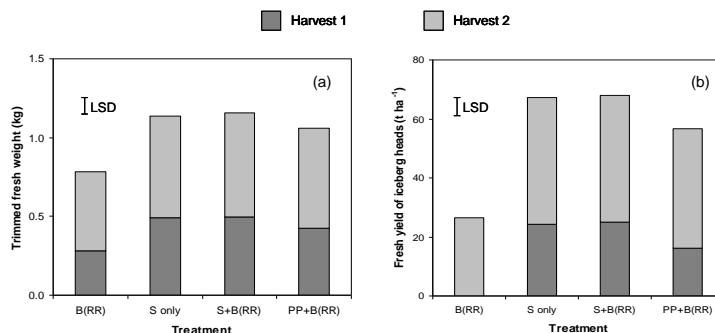

Fig. 6. Responses of block-transplanted lettuce to N broadcast (B) with/without NPK starter (S), or with a NPK solution applied to the peat block (PP) for: (a) total trimmed head weights; (b) yields of iceberg quality lettuce (after Stone et al., 1999).

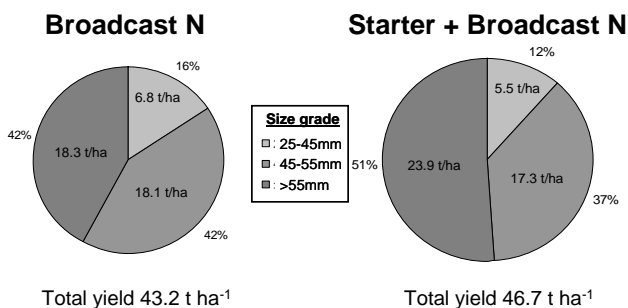

Fig. 7. Total yields and % size grades of bulb onions grown with broadcast N with/without ammonium phosphate starter solution.

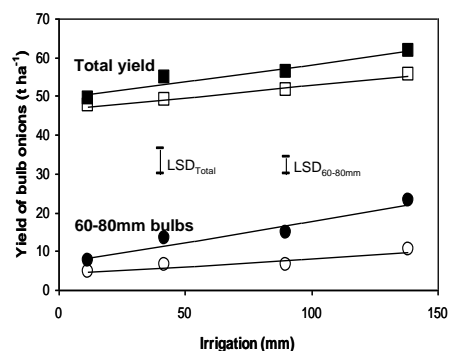

Fig. 8. Yields of bulb onions grown with (■, ●) and without starter (□, ○) (after Rahn et al., 1996).

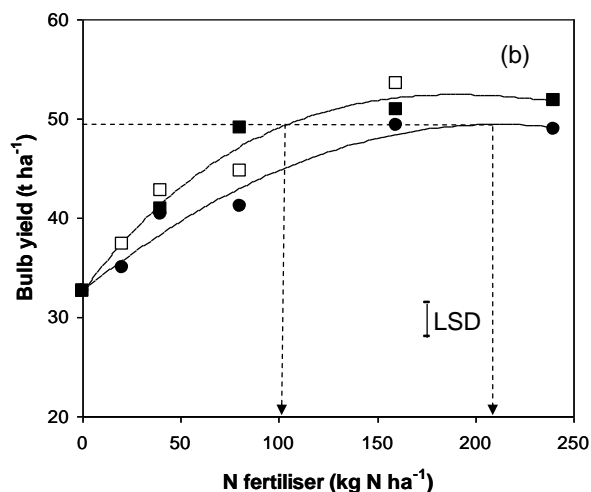
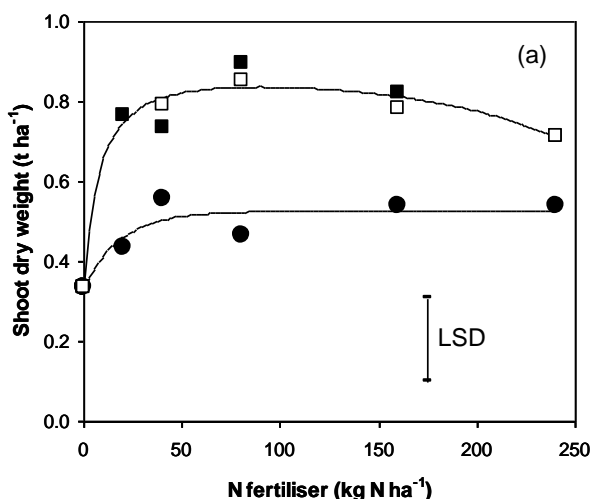

Fig. 9. Responses of onions to broadcast ammonium nitrate (●), and to ammonium phosphate starter supplemented with either broadcast ammonium nitrate (■) or side-injected UAN (□) at: (a) the salad onion stage; or (b) maturity (after Stone, 2000a).

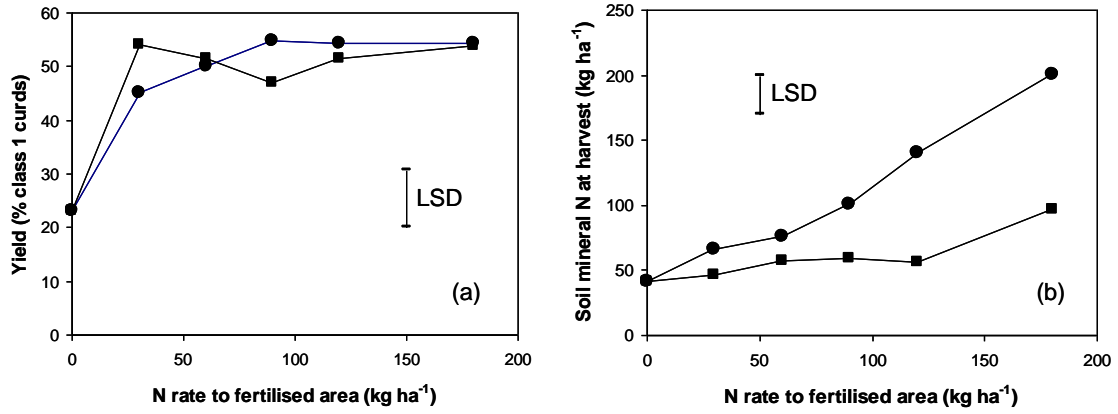

Fig 10. Effects of broadcast (●) and banded (■) ammonium nitrate on: (a) the yield of cauliflower curds; and (b) the soil mineral N remaining at harvest.

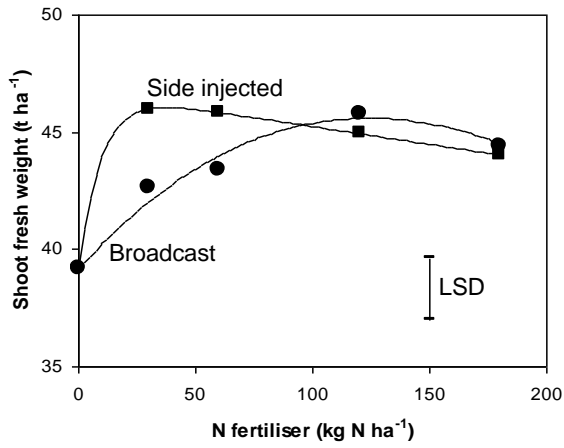

Fig. 11. Response of lettuce to broadcast ammonium nitrate or side-injected UAN fertiliser (after Stone, 2000a).