

NASA TECHNICAL MEMORANDUM

NASA TM X -64792

(NASA-TM-X-64792) A SURVEY OF MASS
ANALYZERS (NASA) 31 D HC \$3.75 CSCI 14E

874-11239

33/14 Unclass
22565

A SURVEY OF MASS ANALYZERS

By W. Walding Moore, Jr.,
and Philip W. Tashbar
Space Sciences Laboratory

November 1973



NASA

*George C. Marshall Space Flight Center
Marshall Space Flight Center, Alabama*

TABLE OF CONTENTS

	Page
INTRODUCTION	1
MAGNETIC ANALYZER	2
TIME-OF-FLIGHT ANALYZER	4
RADIO FREQUENCY ANALYZER (THE BENNETT TUBE)	7
OMEGATRON ANALYZER	9
FARVITRON	12
QUADRUPOLE ANALYZER	14
MONOPOLE ANALYZER	18
THREE-DIMENSIONAL QUADRUPOLE (ION CAGE ANALYZER)	20
REFERENCES	24

PRECEDING PAGE BLANK NOT FILMED

LIST OF ILLUSTRATIONS

Figure	Title	Page
1.	Electron and ion optics for the magnetic analyzer	3
2.	Physical arrangement of the experimental time-of-flight analyzer	5
3a.	Radio frequency spectrometer	8
3b.	Bennett tube (single stage), where a is the ion source; grids c, d, and e are equally spaced; rf potential difference is applied between grids b and c; f is the collecting plate and has a dc stopping potential	8
4.	The cross sections of an omegatron analyzer	10
5.	Diagram of electrodes and of the potential distribution in the Farvitron	13
6a.	Quadrupole analyzer	15
6b.	Stability (a-q) diagram. (Entire shaded area under curve is stable for the quadrupole analyzer. The cross-lined area under curve is stable for the monopole analyzer.)	15
7a.	Zero potential of quadrupole field	18
7b.	Monopole electrodes (end view)	18
8.	Electrode arrangement for a three-dimensional rotational symmetrical quadrupole field	21

DEFINITIONS

Resolving Power — The ability of a mass spectrometer to separate ions of different mass-to-charge ratios (m/e). Two adjacent peaks are "resolved" when the two ionic species are separated. The resolving power is the difficulty of separation. It is defined by the expression $M_1/\Delta M$, where M_1 is the mass of a given ion and ΔM is the difference between the two separate ions M_1 and M_2 . The decision as to how Δ is to be determined for a given M_1 is most frequently an arbitrary one. Peaks are termed resolved when the valley between them is less than a certain percentage of the peaks themselves. The definition depends upon the application.

Sensitivity — Sensitivity can be defined as the amount of the sample required by the instrument to produce useful data [4, 5, 28]. The sensitivity of a mass spectrometer is affected by its ion source, analyzer (ion optics), and detector. The first step for accomplishing maximum sensitivity is to assume that all of the sample reaching the source is ionized completely. The next step is that, for a given mass, the number of ions reaching the detector must be detected (i. e., the detector must distinguish between the noise and the signal).

Direction Focusing — Focusing of ions homogeneous as to mass and velocity, but of a different initial direction [2].

Velocity Focusing — Focusing of ions homogeneous as to mass and direction, but of a different initial velocity [2].

Double Focusing — Focusing of ions homogeneous in mass, but of varying velocities and directions [2].

A SURVEY OF MASS ANALYZERS

INTRODUCTION

Mass spectrometers analyze ionized matter in its gaseous state according to its mass-to-charge ratio (m/e). There are many types of mass spectrometers which have a wide variety of applications. Consequently, no one instrument is suitable in all instances. The nature of the measurement makes the choice of instrument dependent on the following factors [1]:

1. The instrument's influence on the environment being studied,
2. The mass scan range,
3. The useful pressure range of the instrument,
4. The sensitivity of the instrument to the test samples,
5. Speed of response (i.e., the instrument's ability to detect fast reactions),
6. Accuracy and reliability,
7. Consideration of human factors engineering (particularly ease of overall equipment operation), and
8. Fiscal considerations and available peripherals.

There is no attempt in this listing to indicate priorities, since this is always an individual case decision.

A mass spectrometer system that is reduced to its simplest form but still follows closely the components normally found in practical application would consist of [1, 2]:

1. A sample inlet system for introducing the sample into the instrument,
2. An ion source producing ion beams correctly and reproducibly for the sample under investigation,

3. An analyzer section for accepting projected ion beams and subsequently resolving them into various m/e components, and

4. A detection system to measure the resolved ion beam components and render their relative quantities in some observable format.

The principal difference between the various types of mass spectrometers lies in the type of analyzer sections used for separating the ions. In this report, the individual characteristics of different types of analyzers will be examined. To establish a basis for comparison, three fundamental methods for the separation of the ions are defined [1, 3, 4]:

1. Deflection in a magnetic field: The path followed by a beam of positive ions in a magnetic field is a function of the mass-to-charge ratio (m/e) of the individual ions,

2. Time of flight: The time required for electric field-accelerated positive ions of fixed energy to travel between two points is a function of their mass-to-charge ratio (m/e), and

3. Resonance: The resonance frequency of ions in an alternating electric field is dependent on their mass-to-charge ratio (m/e).

MAGNETIC ANALYZER

In the magnetic analyzer (Fig. 1), positive ions are produced in an ion source located, in most cases, outside the main magnetic field. The ionizing electrons for an ion source [1, 5, 6] are monoenergetic and confined to a narrow beam. A small permanent magnet is generally used for focusing the electron beam. The positive ions formed by the electron beam move through a slit at the end of the ionization chamber. An accelerating electrostatic field in conjunction with an ion-repeller electrode assists the extraction of the ions from the source region. This monoenergetic ion beam of rectangular cross section is deflected into an arc of a circle by interaction with a homogeneous magnetic field directed at right angles to the velocity vector of the ions. The angle of deflection, θ , [3, 5, 6,] is usually fixed for a given analyzer (60, 90, 120, or 180 degrees).

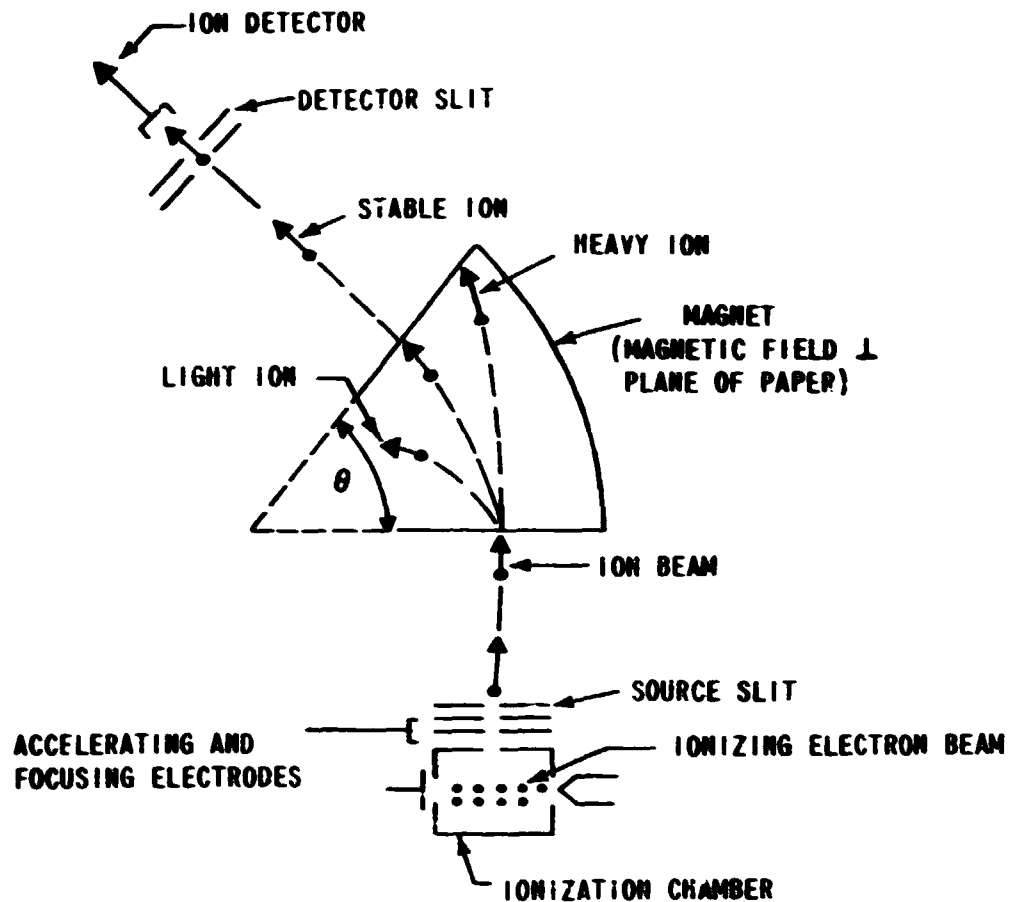

Figure 1. Electron and ion optics for the magnetic analyzer.

The magnetic field separates, and thus classifies, the ions into different m/e ratios. The ion beams which satisfy the conditions of the instrument pass through a collector-defining slit and are registered at the ion collector. To focus ions of a given m/e value on the detector, either the ion-accelerating voltage or the magnetic field strength is varied continuously. Usually, for economic reasons, the accelerating voltage is varied in a fixed magnetic field, and each specific ion of m/e , from light to heavy, is successively brought to a focus on the detector, the signals of which are amplified and recorded. The applied magnetic field must be uniform over a cross section larger than the beam geometry to assure stable path controls and, thus, reproducibility. Varying the accelerating voltage [1, 3, 6, 7] to scan the mass spectrum can reduce the sensitivity for the heavier ions. That is, a reduction of the accelerating voltage results in a smaller fraction of heavy ions being drawn from the ion source than would normally be extracted by varying the strength of the magnetic field.

In the latter case, the extraction efficiency from the ion source would remain constant with the stable accelerating voltage. The sensitivity is also limited by ion throughput of the defining slit. Resolution is limited by alignment errors in the analyzer, the energy spread in the beam entering the analyzer, and instabilities in the control voltages and in the magnetic field. The adjustability of the defining slits makes possible resolution control over a desired mass range. Consequently, the widening of the slits will increase the ion collection (and thus sensitivity) but only at the expense of a reduction in resolution. Mass spectrometers [8] employing magnetic analyzers must be used with sources of ions having a low energy spread, because magnetic analyzers exhibit no energy-focusing properties.

Advantages and disadvantages of the magnetic analyzer include:

1. At the present state of development, it has a greater resolution capability and, therefore, a greater useful mass range [1],
2. Obtains high resolution, but, to a certain extent, at the expense of an increase in size [1],
3. Has approximately the same sensitivity as resonance analyzers, the latter probably being slightly the greater [1],
4. For a given specification, it is easier to operate since it has relatively few control electrodes [1],
5. Is very difficult to calibrate because of limitations on maintaining optimum parameters, such as fringing fields [10],
6. Is superior to the time-of-flight analyzers in measuring accuracy [10], and
7. Ionization must be continuous since the ion beam is restricted to allow individual masses only to reach the detector at a given instant [10, 11].

TIME-OF-FLIGHT ANALYZER

The time-of-flight analyzer (Fig. 2) [9, 10, 11] consists of an ion source which utilizes electron bombardment and a grid system which extracts, accelerates, and projects the ions as a packet through a field-free drift tube

to a detector. The time-of-flight analyzer measures the time required for an ion to traverse a certain specified distance. In this fixed distance of travel [4,5], the time of travel of the ions will vary with their mass. The lighter masses will travel more rapidly and reach the ion collector in a shorter period of time. The rest of the ions follow in increasing order of mass.

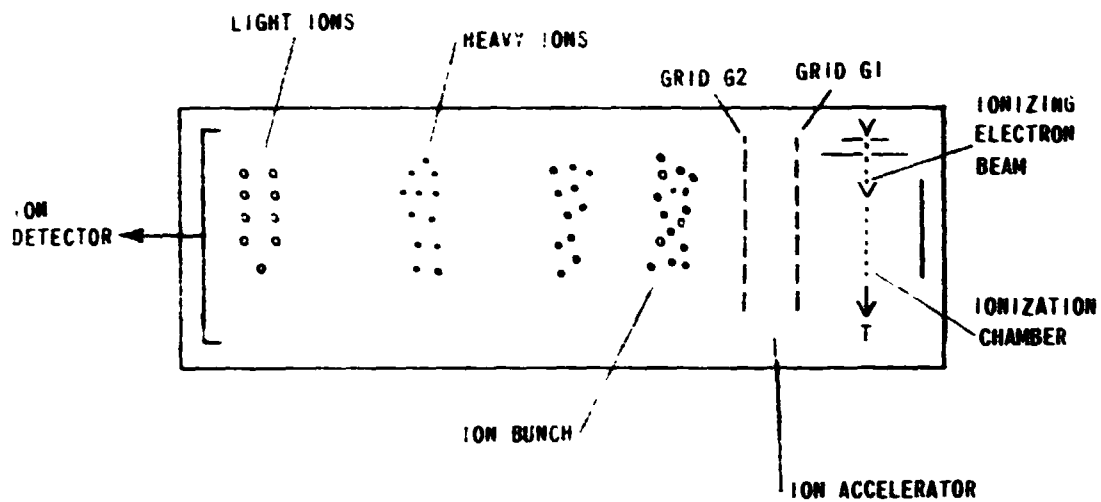

Figure 2. Physical arrangement of the experimental time-of-flight analyzer.

In the time-of-flight analyzer (Fig. 2) [5,9] an electron gun is pulsed. The resultant electron beam passes through the ion source, which is field-free at this time, and thus generates a packet of ions. The electron gun is then turned off, and an electric field is applied across the ion source for a very short time (microseconds). This accelerates the ion packet through a grid (G1). An additional continuous electric field is applied between this grid (G1) and a second grid (G2) which further accelerates the ion packet. The drift tube contains the ion packet and supplies the required distance for m/e separation of the ions according to their distinct mass/velocity relationships. This operation can be repeated as frequently as 50 000 times per second.

The acceleration fields [6,11] used to extract the ions from the ion source and accelerate them toward the ion collector are either applied continuously or are pulsed at the end of the ion formation. All the ions receive essentially the same momentum if, with a single constant accelerating field, the pulse cuts off before any of the ions leave the ion source; all the ions

receive essentially the same energy if the accelerating pulse lasts until all ions have left the ion source. In either case the velocity of the ions in the field-free drift space is a function of their mass-to-charge ratio (m/e) and neither magnetic nor electric fields are employed for mass separation.

The resolving power of the time-of-flight mass spectrometer is dependent upon the source delivering the ions of a given m/e ratio to the ion collector in a sharp pulse, even when the ions vary in initial position and velocity [5] .

Advantages and disadvantages of the time-of-flight analyzer include:

1. Especially suitable for high speed operation (to 50 000 spectra/second) [10, 11] ,
2. Enables one to study how the relative intensities of different ions vary when source conditions change rapidly [1, 11] ,
3. Can record an entire mass spectrum for each accelerating pulse [10,11] .
4. Accuracy depends on the electronic circuits rather than an extremely critical mechanical alignment [10, 11] ,
5. Eliminates critical magnetic fields, thus removing size and shape restrictions which otherwise might keep the evacuated chamber so small as to be sensitive to stray electric fields produced by dirty or corroded inner surfaces [10, 11] ,
6. Extreme sensitivity,
7. Limited resolving power due to practical restrictions of the length of the drift tube. The pulse rate of the ions must be timed so that the leading ion of the second pulse does not overtake the last ion of the first pulse. As frequencies of packet formation increase, this becomes more difficult to maintain [4, 10, 11] ,
8. Has no narrow slits in the ion source and ion detector, which allows one dimension of the ion beam to be much larger than is possible in magnetic analyzers. This allows a more effective utilization of any given electron beam in producing useful ions [11] ,

9. Records all the mass peaks originally formed by the source. This occurs only for those stray ions which emerge from the source at an angle which causes them to miss the ion detector. In contrast, with magnetic analyzers, the fast scanning system ordinarily detects only one mass peak at a time; thus, masses impinge on the vacuum chamber walls and are lost [1, 1],
10. Produces mass spectra slightly more abundant in the heavier ions and slightly less abundant in the lighter ions than in the magnetic analyzer [5],
11. More flexible and accurate due to the replacement of conventional magnets by electronic circuits,
12. Higher transmission factor compared to the magnetic analyzers [10],
13. Produces spurious signals called harmonics, not found at all in the magnetic analyzers [10],
14. The ionizing period covers only a small fraction of a cycle; virtually all the ions which are produced reach the detector [10, 11],
15. Overall sensitivity is essentially the same as that of the magnetic sector [10, 11],
16. Has a nonlinear mass scale; i. e., the separation between adjacent mass peaks decreases with increasing mass, and
17. Has greater sensitivity than the monopole analyzer.

RADIO FREQUENCY ANALYZER (THE BENNETT TUBE)

The Bennett radio frequency analyzer [6] (Fig. 3) is a nonmagnetic analyzer which separates ions of different mass-to-charge ratio by means of electric fields. Ions emerging from the ion source [3, 6, 10] are all accelerated to the same energy by an electrostatic field and are projected into one or more radio frequency stages. Each stage is a series of three equally spaced parallel grids. The control grid is charged with an alternating rf voltage, and the outer grids are at ground potential.

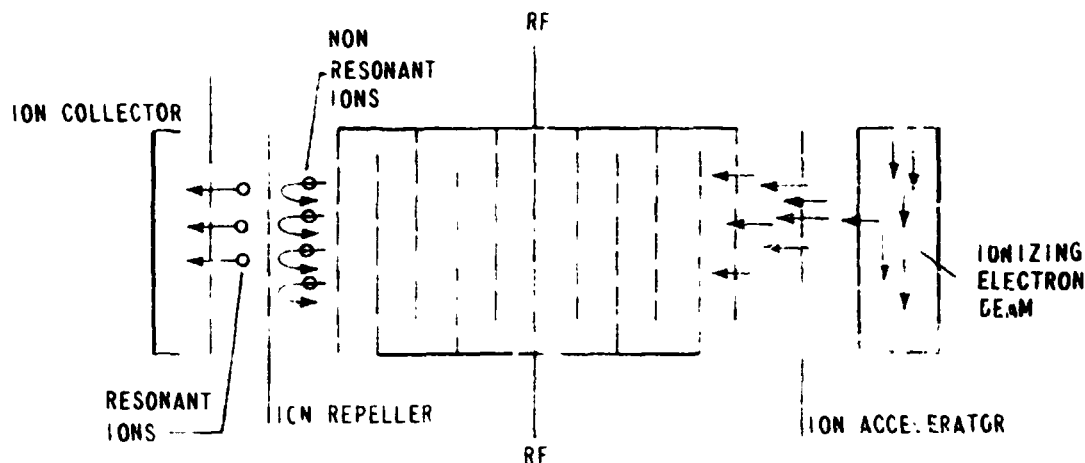

Figure 3a. Radio frequency spectrometer.

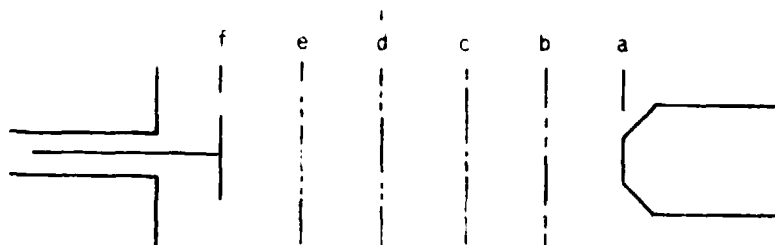

Figure 3b. Bennett tube (single stage), where a is the ion source; grids c, d, and e are equally spaced; rf potential difference is applied between grids b and c; f is the collecting plate and has a dc stopping potential.

During oscillations, to obtain a maximum energy increment, the ions must arrive with the correct velocity to respond to the optimum phase of the rf field. For any given frequency, only ions of a given mass-to-charge ratio will travel from grid to grid in the correct time intervals to benefit from another acceleration. That is, the resonant ion passes through the grids just as the rf grid changes polarity relative to the adjacent grids. Heavier ions fail to reach the grid in time, and lighter ions pass through the grid too soon. The out-of-phase ions lose energy with respect to the ions in phase with the rf field. The accelerated ions will exit the rf stages at a maximum energy value and be detected. The ion beam [6] is accelerated continuously, and the

mass spectrum is scanned by varying the frequency of the accelerating voltage. The resolution of the analyzer can be increased by increasing the number of times energy is imparted to the ion. This is accomplished in multistage rf analyzers which consist of two or more rf sections separated by equipotential drift spaces. Multistage rf analyzers are identified by the number of stages and the frequency and order of rf cycles between successive stages.

Advantages and disadvantages of the radio frequency analyzer include:

1. Simple construction and lightweight [6] ,
2. Mass analysis capability without a magnetic field [3, 6] ,
3. The ion beam cross section is limited only by grid size and the linear mass-to-voltage relationship [6] ,
4. Requires a fair amount of circuitry, and tends to produce ghost signals which can be confusing [3] ,
5. The possible resolution is not very high and decreases with increasing mass [9] ,
6. Can be developed for rapid reproduction of the spectrum because of its high sensitivity [12] ,
7. A disadvantage of all rf analyzers (as compared to the corresponding magnetic analyzers) is the more complicated electronic system [8] , and
8. Using grids as the rf electrodes gives higher current efficiency than the equivalent magnetic analyzer [10] .

OMEGATRON ANALYZER

This instrument (Fig. 4) employs the cyclotron principle to effect mass separation [13]. In other words, ion resonance [6, 14] is used for mass selection. An omegatron differs from a cyclotron only in the manner of application of the ac field. In the omegatron, the field tends to be uniform in space, while in the cyclotron it is concentrated at the junction of two "D's." The electron beam in the omegatron is directed parallel to a magnetic field, ionizing the gas in the central region of the analyzer [8]. Ions are prevented from escaping

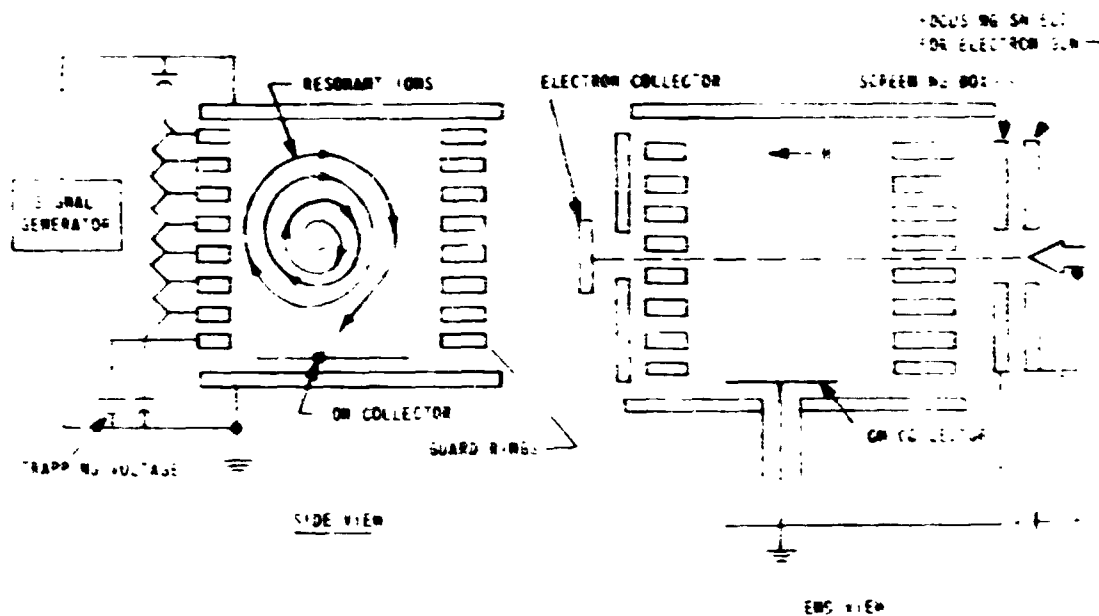

Figure 4. The cross sections of an omegatron analyzer.

axially by a dc field [5, 10, 14]. An rf electric field perpendicular to the magnetic field extracts the ions. When the rf field is in resonance with the cyclotron oscillating frequency of the ions, the ions gain energy with each circulation and spiral outward until they impinge upon the ion collector. In the ideal case, the ion trajectory is an Archimedes spiral with the radius increasing at a constant rate. Nonresonant ions [1, 8, 10] have no continuous buildup of energy and remain in the vicinity of the central axis. Of course, these nonresonant ions will be present in the accelerating phase of the rf field for a limited number of circulations, but they do not reach the ion collector. A small draw-out voltage imposed on the rf electrodes slowly forces the nonresonant ions out of the center where they are caught on the electrodes. The mass spectrum is scanned by varying either the rf frequency or the magnetic field.

There is a guard-ring stack on the omegatron [9, 10, 12] which serves to make the rf field homogeneous and thereby brings the best possible agreement between theoretical and experimental resonant frequency. However, since ions have thermal-velocity components in the direction of the magnetic field, axial drifts are superimposed on the spiral motion already considered. Nonresonant ions benefit from this because they are intercepted by the guard-ring stack which reduces the axial space charge. In turn, to prevent excessive loss of the resonant ions, it is usually necessary to apply a trapping voltage to the guard-ring stack. However, this trapping voltage and the space charge give rise to a radial electric field and, thus, cause the orbital frequency to differ slightly from the cyclotron frequency.

The resolution of the omegatron [1] decreases with increasing ion mass. The resolution can be improved by either increasing the magnetic field or by reducing the rf voltage. This is not always practical, however, because reducing the rf voltage below a certain point creates difficulties of contact potential variation, and increasing the magnetic field becomes very expensive.

In conclusion, r harmonic peaks are produced by the omegatron in its operation because an ion in the omegatron is accelerated continuously rather than at discrete intervals [9, 14]. This is in contrast to the time-of-flight analyzer which produces harmonic peaks.

Advantages and disadvantages of the omegatron analyzer include:

1. Can be built in very small dimensions and is easily degassed [1, 6] ,
2. Is very sensitive [1] due to its volume and the fact that the ion current is not limited by any slits,
3. The pressure [5, 15] is accurately proportional to the reading. Since all resonant ions reach the collector, absolute partial pressures can be calculated from the geometry of the electron beam and the known ionization cross sections of the gases,
4. The resolving power is high and can be adjusted [5, 15] ,
5. Requires a large magnet and is sensitive to small changes of surface potential in the measurement system, which easily give rise to spurious signals [5, 12] ,
6. Has space charge difficulties [10] which interfere with its use with heavier atoms,
7. Has a high transmission ratio (i.e., yield of ions) [15]. The ratio of ions collected at the ion collector after separation to the total number of ions produced is high, and
8. Employs small dc potentials to keep the ions on their long spiral path in the region of the collector, which, like the unavoidable space charge, lead to a deviation of the resonant frequency from the theoretical value and limit the precision of the measurement [2] .

FARVITRON

The Farvitron (Fig. 5) [5, 9] is a type of rf analyzer in which ions execute linear oscillations in an electrostatic potential well maintained between two parallel electrodes [1, 8, 12, 16]. The Farvitron consists of a cylindrically symmetrical electrode system which includes a cathode, an ion cathode electrode, focusing electrodes, and a signal electrode. Located between the ion cathode electrode and the signal electrode is a dc potential well. Ions are produced by an electron beam originating from the cathode and directed axially along the analyzer. The ions formed by the electron beam are accelerated toward the ion cathode electrode and oscillate axially to and fro in the potential well. Around this axis a tubular-shaped ion cloud builds up in which ions of various frequencies and phase angles relative to the field exist. If an rf voltage is now superimposed on the dc potential of the ion cathode electrode, then the electron current is modulated along with the production of ions. Therefore, only a certain group of ions will oscillate in phase, and a continuous energy exchange takes place between the rf field and the ion oscillation [12]. Ions which exchange energy with the rf voltage enter unstable paths and are dispersed quickly, being discharged at the electrodes. The ions in resonance with the rf voltage exchange virtually no energy and, thus, develop an ac voltage of high frequency on the signal electrode. The amplitude of this induced voltage is proportional to the number of ions oscillating in phase. The high-frequency signal thus produced is amplified, demodulated, and recorded by means of a suitable instrument [8].

The oscillation frequency of the ions is governed by the mass-to-charge ratio and is independent of the amplitude. The whole mass spectrum can be scanned by varying the frequency of the rf voltage applied to the ion cathode electrode.

Advantages and disadvantages of the Farvitron include:

1. Has a small, handy gauge head which needs no adjustment [1, 15],
2. Presents fast response, easy amplification of ion currents, and rapid recording possibilities [5, 8],
3. Has a high scanning frequency of the mass spectrum and is, therefore, especially suitable for direct observation of rapidly changing processes,

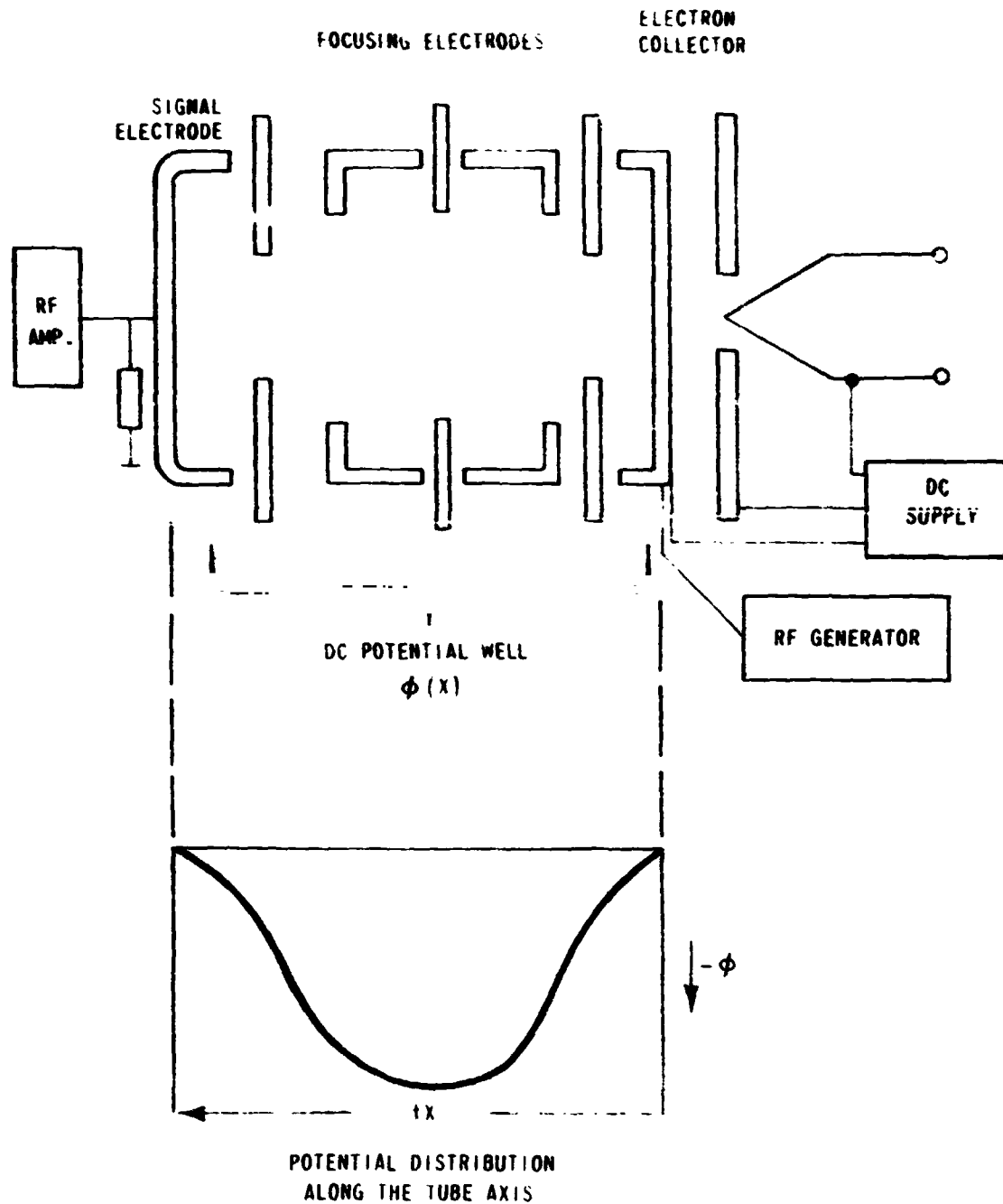

Figure 5. Diagram of electrodes and of the potential distribution in the Farvitron.

4. Uses low rf power,
5. Has no magnetic field [9, 17] ,
6. The neutral particles are ionized within the analyzing section [17] and, therefore, do not have to pass through complex physical structures before analysis,
7. Has low resolution [5, 17] ,
8. Has harmonic peaks [5]. Ghosts caused by higher and lower harmonics of the rf field appear at masses of 1/4 and 4 times that of a given ion (occasionally also at a ninth),
9. Does not allow for quantitative determination of gas composition or for measurement of total pressure because of its measuring principle (15, 17, 18). Gas components, present in small proportion, can be detected only if their share of the total pressure is at least 3 percent,
10. Discriminates in favor of higher masses (lower frequencies) [5] so that the height of the peaks in the mass spectrum obtained gives only a rough indication of partial pressures,
11. Does not allow a quantitative analysis of the gas composition because of space charge limitation [16] , and
12. Has relatively low sensitivity because of high background noise [1] .

QUADRUPOLE ANALYZER

The quadrupole (Fig. 6) uses an rf electric field for mass analysis [8, 9, 12]. A two-dimensional quadrupole field is established between four parallel rod-shaped electrodes. Ideally, the four parallel rods should be hyperbolic in cross section, but in most quadrupoles they have been approximated by rods that are circular in cross section. This is accomplished by making the round rods slightly larger than the instrument radius. Both a dc voltage and an rf voltage are applied to this quadrupole array. The axes of the rods lie along the edges of an imaginary rectangular prism, thus establishing a time-varying potential distribution in the region between the rods. Beyond the four-pole system, ions are injected from an ion source and

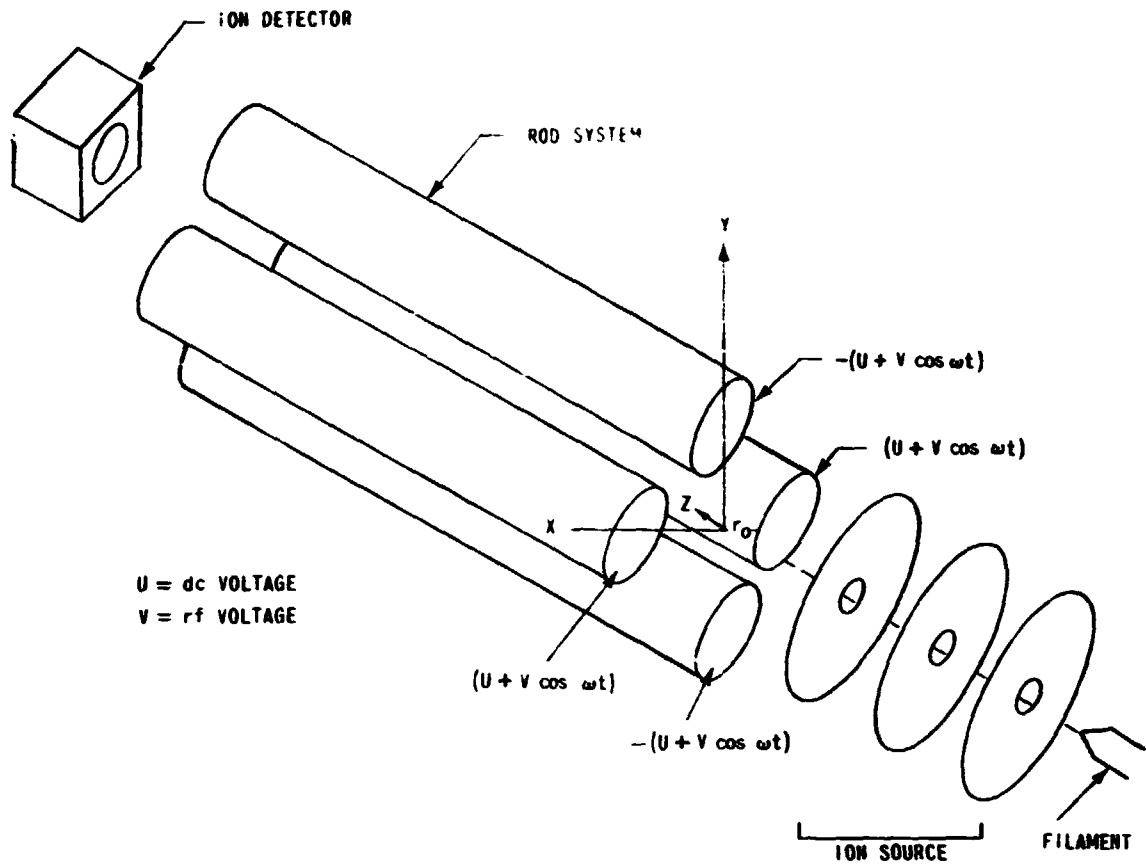

Figure 6a. Quadrupole analyzer.

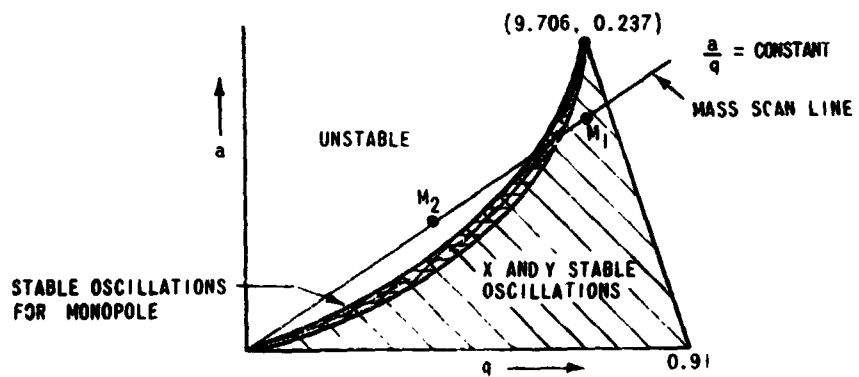

Figure 6b. Stability (a-q) diagram. (Entire shaded area under curve is stable for the quadrupole analyzer. The cross-lined area under curve is stable for the monopole analyzer.)

proceed down the axis of the analyzer section (Z axis) to an ion detector located at the far end [19]. There are no forces acting in the Z direction. The ions continue in the Z direction with the constant velocity at which they were injected into the quadrupole rf field while their x and y amplitudes vary. The ion beam is usually restricted in cross section and angular divergence by circular apertures placed at the entrance to the analyzer [5, 9, 15]. No defining aperture is necessary for the ion detector. Thus, this type of analyzer separates ions of different mass-to-charge ratios by means of a high-frequency electric quadrupole field. For a given field, only the mass-to-charge ratio of an ion determines whether the path is stable or unstable since there is no focusing in the analyzer [20, 21, 12]. The trajectory of ions injected into such a field is described by Mathieu's differential equations, which have well-known properties of solution. These equations are second order linear differential equations with periodic coefficients.

The parameters "a" and "q" of Mathieu's equations [2, 5, 16, 20, 21] play a fundamental role in the theoretical investigation of the quadrupole analyzer. The solutions to Mathieu's equations are best represented on a stability diagram (Fig. 6b). This is a plot of "a" against "q" and shows the regions that are defined by the stable and unstable solutions of the equation. These solutions designate oscillations performed by an ion in the X and Y directions. That is, the ions oscillate between bounded limits, or they grow without limit with time. The stable or resonant ions have a limited amplitude of their oscillations and are bounded to the Z axis in their travel along the analyzed region to the ion detector. All other ions show increasing amplitudes, causing them to impinge on the surrounding electrodes where they are discharged and filtered out. In fact, not only must the ion have a stable trajectory, but this trajectory must have a maximum x (and y) amplitude less than the field radius. Ions having stable trajectories with amplitudes larger than the field radius will, of course, strike the pole pieces before reaching the ion detector.

Nonresonant ions of higher mass are seen to be unstable in the Y direction because they respond too slowly in extracting sufficient energy from the rf field. Nonresonant ions of lower mass are unstable because they respond too fast in extracting the energy.

It has been shown that an increase in the distance of the ions injected into the field axis will cause an increase of the maximum amplitude of the ion trajectory. This maximum amplitude is also increased if the ion possesses appreciable initial kinetic energy in the X (and Y) direction.

The mass spectrum is scanned by varying either the magnitude of the rf voltage or the frequency while maintaining the ratio of the dc and rf voltage constant [1, 8, 12, 14, 20, 21]. Usually the voltage is varied, yielding a linear mass scale. The dc voltage field alone has a focusing effect for the ions in the X direction. Therefore, instability in the X direction must occur from the rf field. At the same time, this dc field has a defocusing effect for the ions in the Y direction. Therefore, stability in the Y direction must result from the interaction of the ion and the rf field. When the rf field is superimposed, the motion of the ion in the X direction is similar to the amplitude of an oscillatory system excited by a frequency close to its resonant frequency. In the Y direction the ion's motion is roughly synchronous with the rf voltage.

As mentioned previously, the ion must be stable in both X and Y directions if it is to reach the ion detector. Whether or not an ion strikes a rod is controlled not only by the stable or unstable nature of its trajectory but also by the initial position and angle of motion of the ion as it enters the quadrupole region.

Advantages and disadvantages of the quadrupole analyzer include:

1. Can be used at high pressures because the stable ions are subjected to focusing forces along their whole path length in the analyzer [22], and, therefore, line-width broadening and intensity reduction suffered by conventional analyzers as a result of gas collisions is reduced in the quadrupole analyzer,
2. Has simple construction, is electrically operated, is lightweight, and has a small volume [21, 22],
3. There is no need for homogeneous ion energies [20, 22]. It can accept a large spread of ion energies entering the analyzer region without loss of resolution,
4. Does not need a magnetic field [19],
5. Has a linear mass scale which is derived from a linear voltage sweep [19],
6. Has a large mass range [15, 21], no adjustment is required, and has a high sensitivity and quantitative indication,
7. The resolution can be increased by lowering the injection energy of the ions [8]; however, the increase of resolution is employed at the expense of transmission. The resolution can also be changed by varying the ratio of dc to rf voltages,

8. Only the resolution and transmission is affected by the initial conditions; the mass spectra are uniquely related to the gas under analysis. This is in contrast to analyzers which depend on the time of flight [8, 21],

9. Offers the possibility of making the separation of masses ineffective when the dc potential is switched off [8]. In this manner, a measurement of total ion-current, and, thereby, total pressure, can be performed, and

10. The main experimental difficulty in the construction of a high-resolution quadrupole stems from the fact that the electrode rods must be uniform in cross section and parallel over their length with a tolerance of only a few microns [9].

MONOPOLE ANALYZER

The monopole analyzer (Fig. 7) is a variation of the quadrupole analyzer [12, 23]. The principles of its operation [5, 23, 24] are essentially the same as those of the quadrupole. In the quadrupole configuration, if one draws equipotential lines in the cross section of the assembly, there is a region defined by the intersection of the two lines which is always at zero potential.

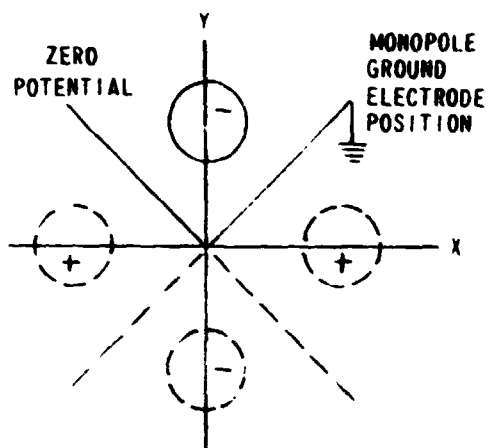

Figure 7a. Zero potential of quadrupole field.

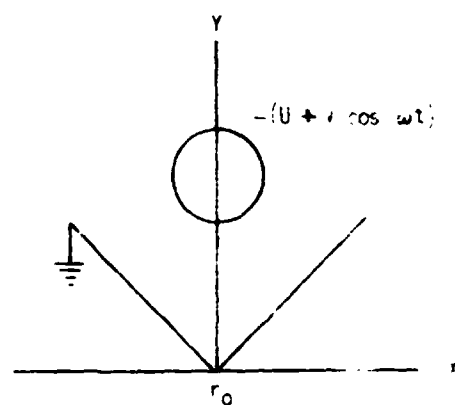

Figure 7b. Monopole electrodes (end view).

The monopole consists of a single rod of circular cross section held parallel to a right-angled electrode. The angled electrode is grounded, while a combined dc and rf potential is applied to the single rod. Mathieu's differential equations for the quadrupole are the same type which describe the field between the grounded angled electrode and the single rod in the monopole. However, there is an important distinction in the solution of the equations of motion in the monopole. In addition to requiring that an ion have trajectories in the stable region of the a - q diagram (Fig. 6b) (being X- and Y-stable), the ion also must not strike the angled electrode. In the case of the monopole, the angled electrode lies along the Z axis, so that the Y direction is of special interest. Now the motion of the ion in the Y direction of the monopole represents a beat, and the high frequency oscillations within the beat are not oscillations about the Z-axis as is the case in the X-direction. Therefore, Y-stable solutions represent a beat of finite amplitude in the Y direction. An ion which is stable in the quadrupole can now only reach the ion detector in the monopole provided $Y > |X|$ and the monopole field length is less than half the length of the total beat [12]. As in the quadrupole, the ions travel with a constant velocity in the Z direction. The field length and the ion velocity in the monopole are chosen so that the X- and Y-stable ions traverse the analyzer during the time that the field length is less than half the beat length of the ions.

The relation between ion mass and beat length is such that ions of greater mass have longer beats and ions of lower mass have shorter beats [5, 12]. The ions of lower mass are X- and Y-stable, but collide with the angled electrode before they can reach the ion detector. Ions of higher mass are unstable in the Y direction [20]. About 50 percent of all ions entering the analyzer enter at the wrong phase of the rf cycle and are lost by being driven into the angled electrode.

The mass spectrum is scanned by varying the frequency of the rf field or the voltage amplitude [5, 12, 23, 24]. However, the ion injection voltage in the monopole is held constant, although it is not necessary that the ratio of applied voltage be maintained constant, as is required in the quadrupole. In addition, as the frequency is varied in the monopole to scan the mass spectrum, all ions that are focused to the detector will experience the same number of rf periods in the analyzing field. Therefore, a constant resolving power over the entire mass range is obtained. The number of rf periods the ions require for a given resolution in the monopole is nearly a factor of three less than the number of periods necessary in the quadrupole [5].

Advantages and disadvantages of the monopole analyzer include:

1. Construction is simpler as only one rod must be aligned rather than the four rods in the quadrupole [5, 12],

2. Requires that the injection energy be kept fairly constant; therefore, it does not share the advantage of the quadrupole in that it is insensitive to a large spread in ion entrance energies [12] ,
3. The resolving power is practically independent of the ratio of applied voltages for the ions reaching the detector, which is not the case for the quadrupole [12, 23] ,
4. Is extremely sensitive to contamination. A similar effect has been observed in the quadrupole [23] ,
5. In the quadrupole, the mass peaks are equally spaced, and their width is proportional to their mass, as is true with most other types of analyzers [12] . Therefore, a light mass will have a narrower peak compared with the peak of a heavier mass. However, in the monopole the mass peaks are equally spaced, but their width is nearly constant regardless of the mass ,
6. Exhibits severe mass discrimination that varies with operating conditions [23] . Also, changing the operating frequency affects the relative amplitudes of the mass peaks. There is also a small mass discrimination in the time of flight between the lightest elements ,
7. Both the time-of-flight and monopole analyzers are nonmagnetic [23] ,
8. Compared to the time-of-flight analyzer, its performance does not deteriorate as rapidly as the energy spread increases in the ion beam being analyzed [23] ,
9. Monopole's sensitivity is a function of the resolution, while the sensitivity of the time-of-flight analyzer is much less dependent on resolution [23] , and
10. Has a linear mass scale [23] .

THREE-DIMENSIONAL QUADRUPOLE (ION CAGE ANALYZER)

The quadrupole field with cylindrical symmetry can be extended to a three-dimensional rotational symmetrical field (Fig. 8) [12, 20] . In the two-dimensional quadrupole, the stable ions were stable with respect to the X and Y directions. Motion was force-free in the Z direction. In the

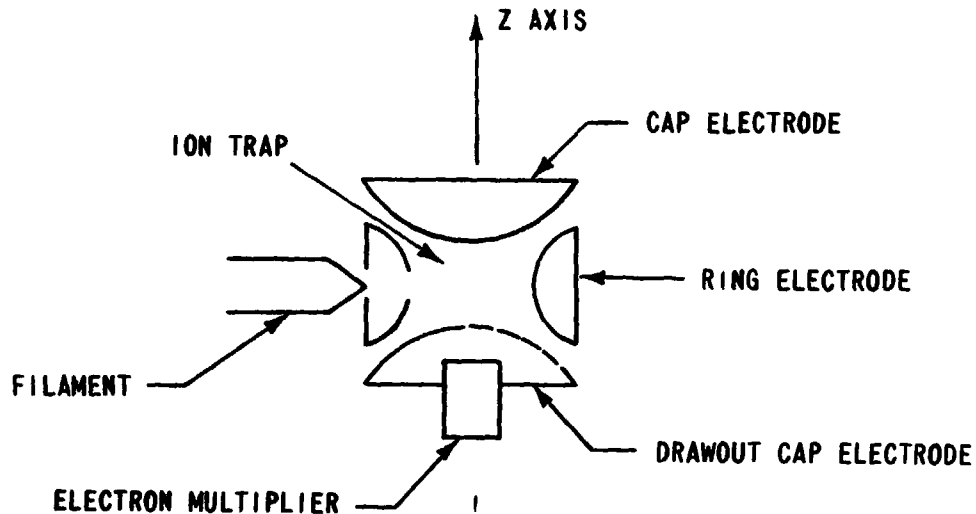

Figure 8. Electrode arrangement for a three-dimensional rotational symmetrical quadrupole field.

three-dimensional quadrupole, the stable ions are stable with respect to all three coordinate axes. The ions are bound quasi-elastically to the origin, about which they describe three-dimensional Lissajous figures. In the absence of interfering effects, the ions can be confined to a region around the origin for an arbitrary length of time (ion cage).

Three electrodes are used to generate the rotationally symmetric quadrupole field, each of which is hyperboloid of revolution [12]. The structure is rotationally symmetrical about the Z axis [20, 25, 26]. The so-called ring and cap electrodes are complementary hyperboloids whose relative dimensions are set by Laplace's equation so that the square of the minimum distance from the center to the ring is equal to twice the minimum distance from the center to the end-caps. That is, the asymptotes are chosen so that the potential satisfies the Laplace equation at all points. The end-caps are maintained at the same potential, and both a dc voltage and an rf voltage are applied between the caps and ring. The equations of motion of the ions again lead to the Mathieu equations with the typical stability behavior of its solutions. For the three-dimensional quadrupole, an r term is used in place of the X or Y direction since they are equivalent and perpendicular to the Z direction.

The motions in the Z and R directions are mutually independent [20, 25, 26]. The Mathieu equations of motion in the R and Z directions have

solutions with bounded trajectories. The question of whether a solution is stable or unstable depends on the position of the working point (a, q) in the stability diagram [12].

In the three-dimensional quadrupole, molecules are ionized inside the analyzer by injecting an electron beam through one of the end-caps [12, 20, 27]. Ions which are oscillating in a stable mode can be detected by a resonance method using the damping of an oscillating circuit. In other words, the existing oscillating ions are excited in their fundamental frequency. The ions absorb energy from the oscillatory circuit and damp the circuit until they collide with the electrodes as a result of their increasing amplitude. Therefore, only some of the existing oscillating ions can fulfill the resonance condition required for detection.

A further development of the above-mentioned resonance method in the three-dimensional quadrupole was the technique of periodically pulsing the stored ions out through one of the end-caps to an electron multiplier [20, 25, 26]. The electron gun can be pulsed off before the ion drainout pulse. This allows the ions of unstable trajectories to be lost and avoids effects of soft x-rays. The magnitude of the rf voltage is scanned, while the ratio of rf to dc voltage remains constant.

Ion containment is dependent on the mass-to-charge ratio along with the proper choice of the working point, so that all ions other than the resonant ions are unstable [20, 25, 26]. That is, considerable resolution can be obtained only if the mass scan line (a line of fixed a/q ratio) intersects a stable area over a very narrow range in the stability diagram.

For small devices, a "stable" ion may not be stored because of collision with the electrodes. This is caused by the stability limits being dependent on the amplitude of the oscillation and not on the initial ion velocity. However, the amplitude of oscillation increases in proportion to the initial ion velocity. In this regard, a small device will discriminate more and more against energetic ions as the mass resolution is increased. At any particular time, only those ions with (a, q) values within a stable region will be stored and measured. In principle, long storage times (of the order of minutes) can be expected; since, as the pressure decreases, the lifetime of the stabilized ions increases.

The resolving power here is approximately equal to the number of resonant field periods experienced by a resonant ion which originated in the X-Y plane [12, 20, 25, 26]. The finite transit times of the resonant ions up to the time of discharge on the electrodes, or the mean time of two collisions

of the ion with neutral gas atoms, results in the limiting of the resolving power. As the resolution is increased, the sensitivity is decreased. Resolution is also limited because of space charge effects.

It may be said that because of the space charge effects, the three-dimensional quadrupole might exhibit all the advantages and disadvantages of the ion accumulation principle [12] .

REFERENCES

1. Leck, J. H.: **Pressure Measurement in Vacuum Systems.** Chapman and Hall, Ltd.
2. Inghram, Mark G. and Hayden, Richard J.: **A Handbook on Mass Spectroscopy.** Nuclear Science Series Report Number 14, National Academy of Sciences - National Research Council, Washington, D. C., 1957.
3. Willard, H. H.; Merritt, L. L. Jr.; and Dean, J. A.: **Instrumental Methods of Analysis, 4th Edition.** D. Van Nostrand Company, Inc., New York, 1965.
4. Hill, H. C.: **Introduction to Mass Spectrometry.** Sadtler Research Laboratories, Inc., Philadelphia, Penn., 1966.
5. Kiser, Robert W.: **Introduction to Mass Spectrometry and Its Applications.** Prentice-Hall, Inc., New Jersey, 1965.
6. Clark, George L.: **The Encyclopedia of Spectroscopy.** Reinhold Publishing Corporation, New York, 1960.
7. Lichtmar, David: **Ultra-High Vacuum Mass Spectrometry.** Research/Development, Technical Publishing Co., Barrington Ill., February 1964.
8. Reed, R. I.: **Mass Spectrometry.** Academic Press, New York, 1965.
9. McDowell, Charles A.: **Mass Spectrometry.** McGraw-Hill Company, Inc., New York, 1963.
10. Jayaram, R.: **Mass Spectrometry, Theory and Applications.** Plenum Press, New York, 1966.
11. Wiley, W. C. and McLaren, I. H.: **Time-of-Flight Mass Spectrometer with Improved Resolution.** Rev. Sci. Instr., vol. 26, no. 12, December 1955.
12. Blauth, Erich W.: **Dynamic Mass Spectrometers.** Elsevier Publishing Company, New York, 1966.

REFERENCES (Continued)

13. Niemann, H. B. and Kennedy, B. C.: Omegatron Mass Spectrometer for Partial Pressure Measurements in Upper Atmosphere. *Rev. Sci. Inst.*, vol. 37, no. 6, June 1966.
14. Brubaker, Wilson M.: Short Course — "Mass Spectrometry Theory and Applications." University of California, Los Angeles, February 6-10, 1967.
15. Diels, K. and Jaeckel, R.: *Leybold Vacuum Handbook*. Second German Edition, Pergamon Press, New York, 1966.
16. Reich, G.: The Farvitron — A New Partial Pressure Indicator without a Magnetic Field. *Proc. 7th Symposium AVS*, pp. 396-400, 1960.
17. Leite, R. J.; Kasper, A. R.; and Mason, C. J.: Development of a Farvitron Mass Spectrometer for Space Applications. Technical Proposal to NASA, submitted by High Altitude Engineering Laboratory, University of Michigan, March 1967.
18. Bachler, W. and Reich, G.: Some Examples of the Use of the Farvitron for Plotting Rapidly Changing Processes. *Proc. 7th Symposium AVS*, pp. 401-406, 1960.
19. Area Leak Detector, Contract No. NAS8-11671.
20. Dawson, P. H. and Whetten, N. R.: Quadrupoles, Monopoles and Ion Traps. *Research/Development*, February 1968, pp. 46-50.
21. Schaefer, E. J. and Nichols, M. H.: Mass Spectrometer for Upper Air Measurement. *ARS Journal*, American Rocket Society, Inc., December 1961.
22. Gunther, Karl-Georg: A Partial Pressure Vacuum Gauge Working According to the Principle of the Electrical Mass Filter. *Vacuum*, vol. 10, no. 4, Pergamon Press, Ltd., 1960, pp. 293-309.
23. Hudson, J. B. and Watters, R. L.: The Monopole - A New Instrument for Measuring Partial Pressures. *IEEE Trans. Instr. and Meas.*, vol. IM-15, no. 3, September 1966.

REFERENCES (Concluded)

24. Dawson, P. H. and Whetten, N. R.: Ion Storage in Three-Dimensional Rotationally Symmetric Quadrupole Fields, I. Theoretical Treatment. G. E. Research and Development Center, Rpt. No. 67-C-287, July 1967.
25. Dawson, P. H. and Whetten, N. R.: Ion Storage in Three-Dimensional Rotationally Symmetric Quadrupole Fields, II. A Sensitive Mass Spectrometer. G. E. Research and Development Center, Report No. 67-C-287, July 1967.
26. Erubaker, Wilson M.: A Study of the Introduction of Ions into the Region of Strong Fields within a Quadrupole Mass Spectrometer. Contract NASw-1298 - 2nd Quarterly Progress Report for the Period November 17, 1965 to February 1966.
27. Gruden, K. R.: Varian Associates, Analytical Instrument Div. Report 52-G-001-37: Sector Instruments versus Cycloidal, March 1967.

APPROVAL

A SURVEY OF MASS ANALYZERS

By W. Walding Moore, Jr. and Philip W. Tashbar

The information in this report has been reviewed for security classification. Review of any information concerning Department of Defense or Atomic Energy Commission programs has been made by the MSFC Security Classification Officer. This report, in its entirety, has been determined to be unclassified.

This document has also been reviewed and approved for technical accuracy.



ROBERT J. NAUMANN
Chief, Physics and Astrophysics Division



CHARLES A. LUNDQUIST
Director, Space Sciences Laboratory