

15. SPACECRAFT SEPARATION SYSTEMS MECHANISMS:
CHARACTERISTICS/PERFORMANCE DURING HIGH-ALTITUDE FLIGHT TEST

FROM NASA Wallops Station, VA.

By Joseph D. Pride
NASA Langley Research Center

SUMMARY

This paper is concerned with the application of various separation mechanisms to meet flight mission goals within the physical and environmental constraints of a single-stage rocket test vehicle. Each separation concept was selected from the numerous choices available on the basis of its unique requirement and the flight test vehicle incorporated several different concepts. Attention to specific requirements and thoroughness in design and testing were essential to success since there is no specific single answer to separation problems.

INTRODUCTION

In the past few years the National Aeronautics and Space Administration (NASA) has conducted several flight test programs to provide data on the performance of decelerator systems in low-density environments at Mach numbers and free-stream dynamic pressures similar to those expected for an entry vehicle approaching the planet Mars.

One such flight test was conducted on October 9, 1970, at NASA Wallops Station, using a single-stage solid propellant rocket vehicle Castor XM-33E2 motor and two recruit TE-M-29-1 motors. This vehicle is shown on launcher in figure 1. The purpose of this flight test was to determine the opening and stability characteristics of a supersonic disk-gap-band parachute decelerator when opened in the wake of a blunt body aeroshell.

The spacecraft is shown closed in figure 2(a), and in the opened position in figures 2(b) and 3. It consisted of a 10° half angle fiberglass nose cone which served as a heat shield and housed the erection system and its nitrogen supply tanks, the nitrogen supply for the spacecraft attitude control system and the control valves and jets. The aeroshell was an erectable structure with a framework of 24 aluminum ribs (fiberglass caps) attached to a central piston mechanism. The framework of ribs was covered with prestretched nomex fabric (0.285 kg/m² (8.4 oz/yd²)) that was coated with a high-temperature resin to reduce its porosity. The rib caps had tongue-and-groove edges so that the nomex fabric was not exposed to the airstream. The ribs were held secure in the folded position at launch and during powered flight.

The flight trajectory and sequence of events are shown in figure 4. At 90 seconds the Castor rocket motor was separated from the spacecraft. At 225 seconds the aeroshell was erected and the nose cone was released. The parachute was ejected by a mortar firing at 240 seconds. Seven seconds after the mortar fired, or at 247 seconds, the aeroshell separated from the payload parachute. The parachute payload continued to descend until at about 4907.3 m (16 000 ft) altitude and at 1099 seconds a command signal was sent for release of the ballast weight from the payload. The payload and parachute splashed in the water at 1655 seconds of flight time and were recovered from the water surface for inspection and retrieval of the data film.

SEPARATION DESIGN GOALS AND OBJECTIVES, CONSTRAINTS, AND DESIGN SOLUTION

The major separation events and the type of mechanism employed in each separation system are shown in figure 5. The purpose of this section is to discuss the selection of separation mechanisms associated with these events. The goal, the special constraints, and the design solution for each event will be discussed separately.

Event II

Goal.- The rocket booster stage must separate at 3.66 m/sec (12 ft/sec) to have sufficient clearance from the spacecraft at aeroshell deployment

Constraint.-

- (1) No damage to overlapping antennas
- (2) Separation system to stay with booster stage
- (3) Shock limited to spacecraft
- (4) Tipoff disturbance within ($\pm 2^\circ$) deadband of attitude control system

Design solution.- Multisegmented, machined, low profile, V-groove band with redundant, self-contained pyrotechnic release devices, and a gas-pressurized bellows device to effect the desired separation velocities.

Event III

Goal.- To erect the aeroshell during the entry leg of the trajectory at the proper pitch and yaw attitude

Constraint.-

- (1) No damage to spacecraft
- (2) Rib release to be immediate and unconstrained after first rib motion
- (3) Allow aeroshell erection in less than 1.0 sec at dynamic pressures up to 191.5 N/m² (4.0 lb/ft²)

Design solution.- A simple 0.32-cm (1/8-in.) diameter aircraft cable with redundant pyrotechnic cable cutters mounted in a groove at the rib ends. The cable assembly included a small calibrated pretension mechanism.

Event IV

Goal.- After aeroshell erection, to eject the nose cone from the vicinity of the spacecraft to avoid possible aerodynamic wake interference.

Constraint.-

- (1) No ejecta nor flame
- (2) Immediate nose-cone release at aeroshell lock into position
- (3) Limited by shock
- (4) Maximum separation velocity
- (5) Minimum tipoff rates at separation
- (6) Remove erection system and spacecraft attitude control assemblies with nose cone
- (7) Aeroshell after separation to provide a smooth aerodynamic blunt cone profile

Design solution.- Incorporated three self-contained pyrotechnic nuts at the base plate of the nose cone and utilized additional piston stroke from the nitrogen-gas erection system. Also a stud retraction mechanism and container were added to the aeroshell to retract and contain the 1.9-cm (3/4-in.) diameter bolts after release of the nose cone.

Events V and VI

Goal.- At the test condition, to eject the parachute to its proper position behind the aeroshell and deploy the 16.76-m (55-ft) diameter disk-gap-band parachute.

Constraint.-

- (1) No ejecta nor flame
- (2) Limited by shock
- (3) Effect shroud line stretchout in less than 1.0 sec

Design solution.- Provided a 38.1-cm (15-in.) diameter mortar tube for the 56.7-kg (125-lb) parachute package with a high pressure pyrotechnic breech and an eroding orifice for the proper pressure characteristics.

Event VII

Goal.- To release the payload parachute from the aeroshell and separate at the proper velocity to allow the payload parachute to decelerate and descend toward the recovery region.

Constraint.-

- (1) No damage to adjacent aeroshell
- (2) Separation system to stay with aeroshell
- (3) Shock limited to payload

Design solution.- Incorporated a multisegmented, machined, low profile, V-groove band with redundant, self-contained pyrotechnic release devices. An expansion limiter was included to prevent the band segments from contacting the aeroshell ribs.

Event VIII

Goal.- To release the ballast weight (352.89 kg (778.0 lb)) at approximately 4572 m (15 000 ft) altitude to allow for payload flotation after water impact.

Constraint.-

- (1) No damage to payload parachute
- (2) Ballast weight to slide over forward camera housing
- (3) Gravity fall separation

Design solution.- Used a small multisegmented machined, low profile, V-groove band with redundant, pyrotechnic release devices. Allowed the bolt pieces and band segments to fly free from the payload.

Event IX

Goal.- For the parachute payload to survive water impact and the payload to float on the surface to allow for recovery operations and retrieval of the parachute payload.

Constraint.-

- (1) Water recovery environment
- (2) Parachute must mechanically detach from the parachute
- (3) Divers, swimming in the water, to effect separation

Design solution.- Incorporated a large, over-center positioned, quick-release pin in the parachute load links.

TYPICAL EXAMPLE: SEPARATION ANALYSIS

1st STAGE SPACECRAFT SEPARATION

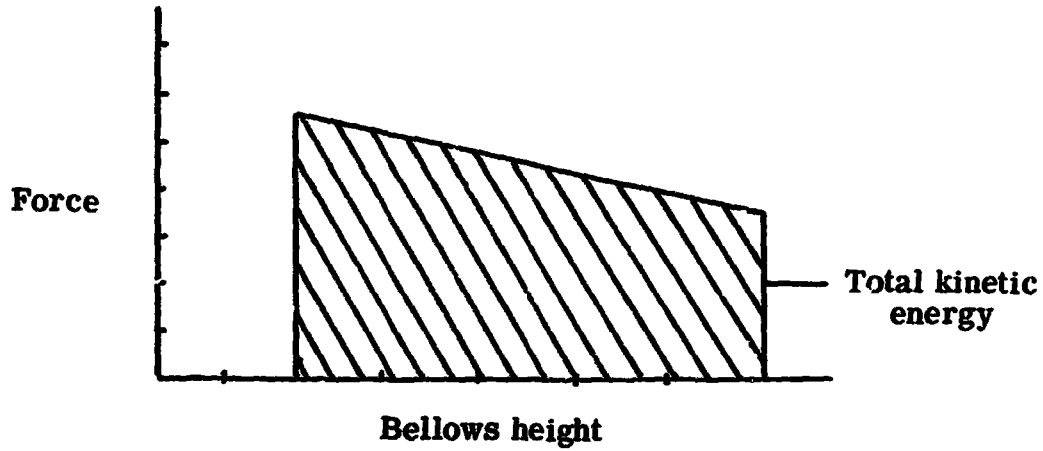
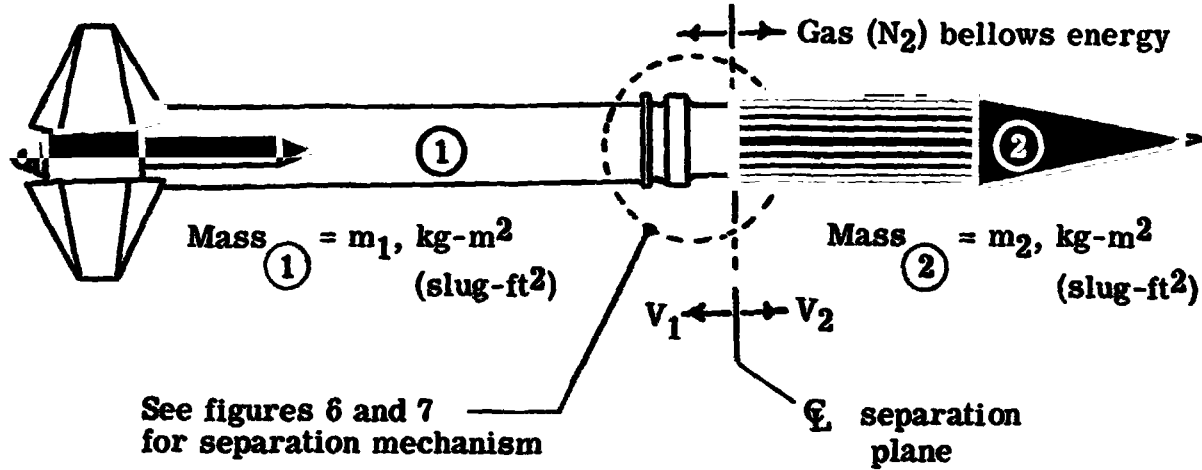

Then:

$$V_R \text{ (Relative velocity)} = V_1 + V_2$$

where:

$$V_1 = \sqrt{\frac{2E_k m_2}{m_1(m_1 + m_2)}}$$

and

$$V_2 = \sqrt{\frac{2E_k m_1}{m_2(m_1 + m_2)}}$$

This typical simplified separation analysis technique, where aerodynamic forces are negligible, can be easily parameterized as shown in figure 8 with the resultant separation velocity plotted versus the bellows pressure which determines the kinetic energy.

GROUND TEST PROGRAM

In preparing the spacecraft for flight, a prototype spacecraft was developed for qualification testing (table I) to assure reliability. A test series was conducted to simulate functional flight separation events and to determine the vibration and shock levels at sensitive locations in the spacecraft. These functional separation tests were usually pyrotechnically initiated and often resulted in high shock reactions. The test data established the flight instrumentation component test levels to determine if the electronic and data retrieval equipment would be adversely affected during these flight separation events. The functional characteristics or relative separation velocities were obtained from the prototype test vehicle to evaluate the theoretical calculations. This verification of the separations provided confidence that the system would perform reliably.

FLIGHT TEST RESULTS

Booster Separation (Event II)

The data from the flight test indicate reasonable agreement with the ground test results as shown in figure 9. After Castor burnout the vehicle roll rate was 40 degrees/sec because of fin asymmetries and thrust misalignments. This was taken to zero by the despin system and held until 90.08 seconds when booster separation occurred without any apparent disturbance. The booster was skin-tracked by the SPANDAR radar and indicated an average separation velocity of approximately 3.66 m/sec (12 ft/sec).

Aeroshell Erection (Event III)

The aeroshell was erected by a ground computer signal when the dynamic pressure was estimated to be 191.52 N/m^2 (4.0 lbf/ft^2) at 224.5 seconds. The restraint cable aeroshell was separated and the structure was locked into the blunt cone configuration in 0.70 second after the initiation signal was sent.

Nose-Cone Separation (Event IV)

When the aeroshell was completely erected, a snap ring in the aeroshell engaged and locked the erection mechanism piston. An electrical switch located in the piston snap ring groove sensed engagement and actuated the three pyrotechnic nuts, which released the nose cone. The desired separation velocity was attained by the remaining 6.35 cm (2.5 in.) of pressure stroke in the erection

piston. The initial relative separation velocity was approximately 3.66 m/sec (12 ft/sec).

Mortar Fire: Parachute Extraction (Events V and VI)

To account for deviations from a nominal trajectory, a ground-based computer predicted when to send the signal that would fire the mortar in order to attain the test condition for the fully deployed parachute. The parachute peak load was recorded at a dynamic pressure of 928.88 N/m^2 (19.4 lb/ft^2) at a Mach number of 2.62. The average deployment velocity from mortar firing to line stretch was 38.40 m/sec (126 ft/sec).

Payload Separation (Event VII)

Seven seconds after the mortar fired, the aeroshell separated from the payload parachute. The four explosive bolts in the V-groove band released and the difference in ballistic coefficients of the two bodies provided a large separation velocity, approximately 121.9 m/sec (400 ft/sec). A forward-facing camera in the payload showed there was no damage to the aeroshell during the flight.

Ballast Separation (Event VIII)

When the payload parachute had fallen to 4907.28-m (16 000-ft) altitude, a ground-based command was sent that fired four explosive bolts in a V-groove band. This released the 352.89-kg (778-lb) ballast weight and allowed it to slide cleanly over the forward camera housing and drop clear of the payload.

Payload Water Impact (Event IX)

The payload and parachute impacted the water at 1655 seconds of flight time. The recovery divers mechanically released the parachute from the floating payload and both were recovered from the water for inspection and retrieval of stored data.

CONCLUSIONS

The SPED II separation designs show no single solution that meets all requirements; instead, each system must be selected to meet the unique conditions of the separation. The goals, constraints, and design solution of each event must be defined and an assessment made of the candidate separation mechanisms. To insure reliable separation characteristics a thorough ground test program must be conducted on prototype hardware, where feasible, and correlated with design and analytical program. The test program showed the adequacy of these designs under simulated conditions. The SPED II flight test results proved that proper separation characteristics could be obtained from a variety of separation mechanisms. These flight test results demonstrate close correlation with ground test results and analytical predictions.

TABLE I.- SPED II GROUND TEST PROGRAM

Prototype qualification and functional tests:

1. Erection system proof pressure
2. Aeroshell functional test - aerodynamic pressure
3. Mortar firings - chute deployment*
4. 1st stage booster/spacecraft separation*
5. Aeroshell vacuum erection*
6. Nose cone separation (vacuum)*
7. Spacecraft/mortar firing (vacuum)*
8. Attitude control system functional (air bearing)
9. Spacecraft vibration and shock tests
10. V-groove band/explosive bolt qualification
11. Helicopter drop-water recovery*

Flight spacecraft - assurance tests:

1. Spacecraft vibration
2. Spacecraft shock
3. Aeroshell quick erection (atmospheric) functional*
4. Antenna patterns
5. Spacecraft vacuum

*Functional/separation tests

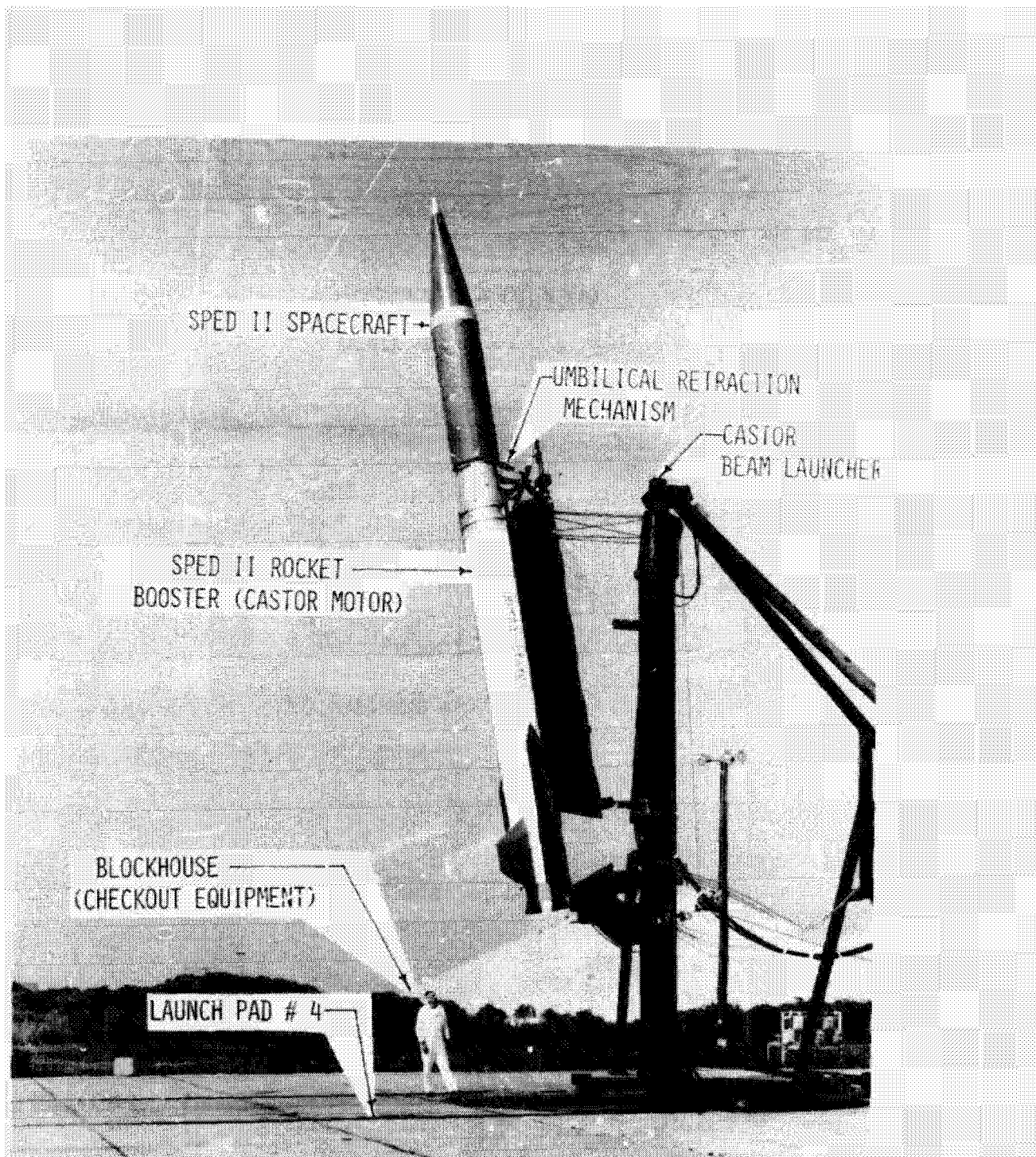
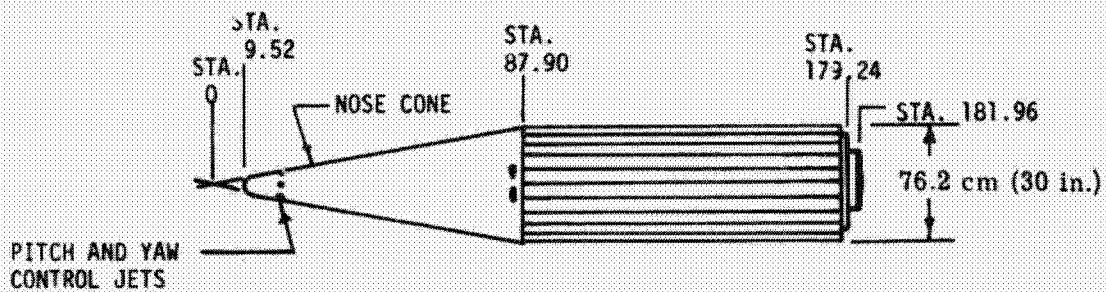
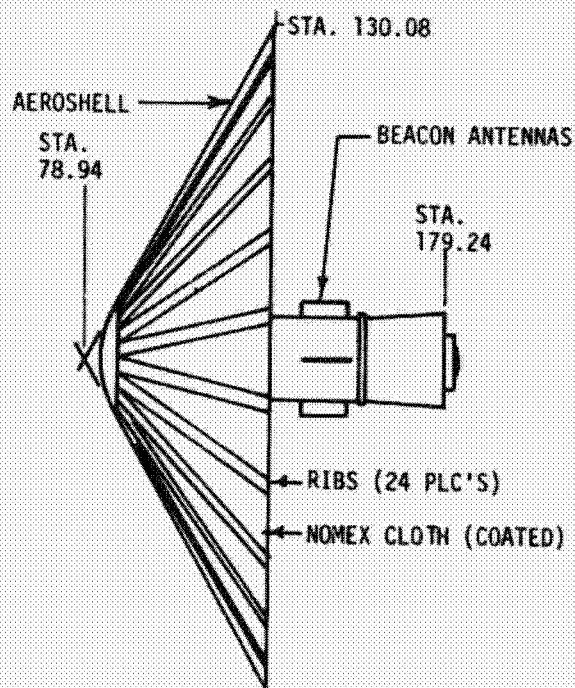

Figure 1.- Vehicle and launch complex.



(a) Folded spacecraft.



(b) Erected aeroshell-payload.

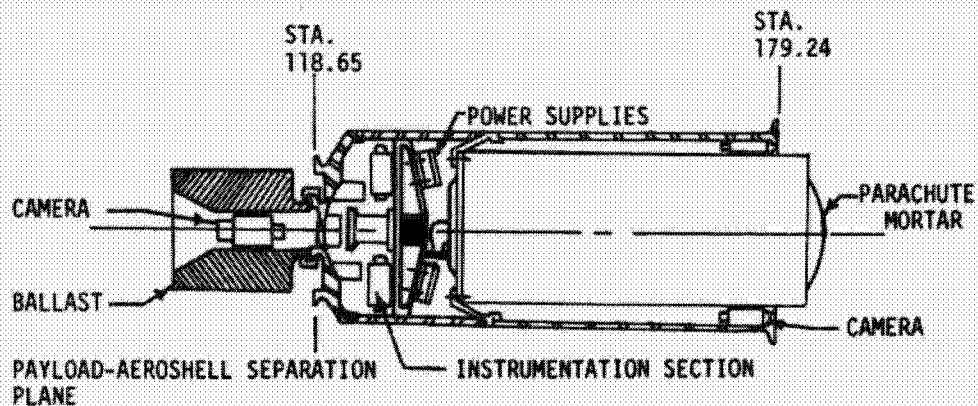

(c) Payload.

Figure 2.- SPED II spacecraft dimensions.

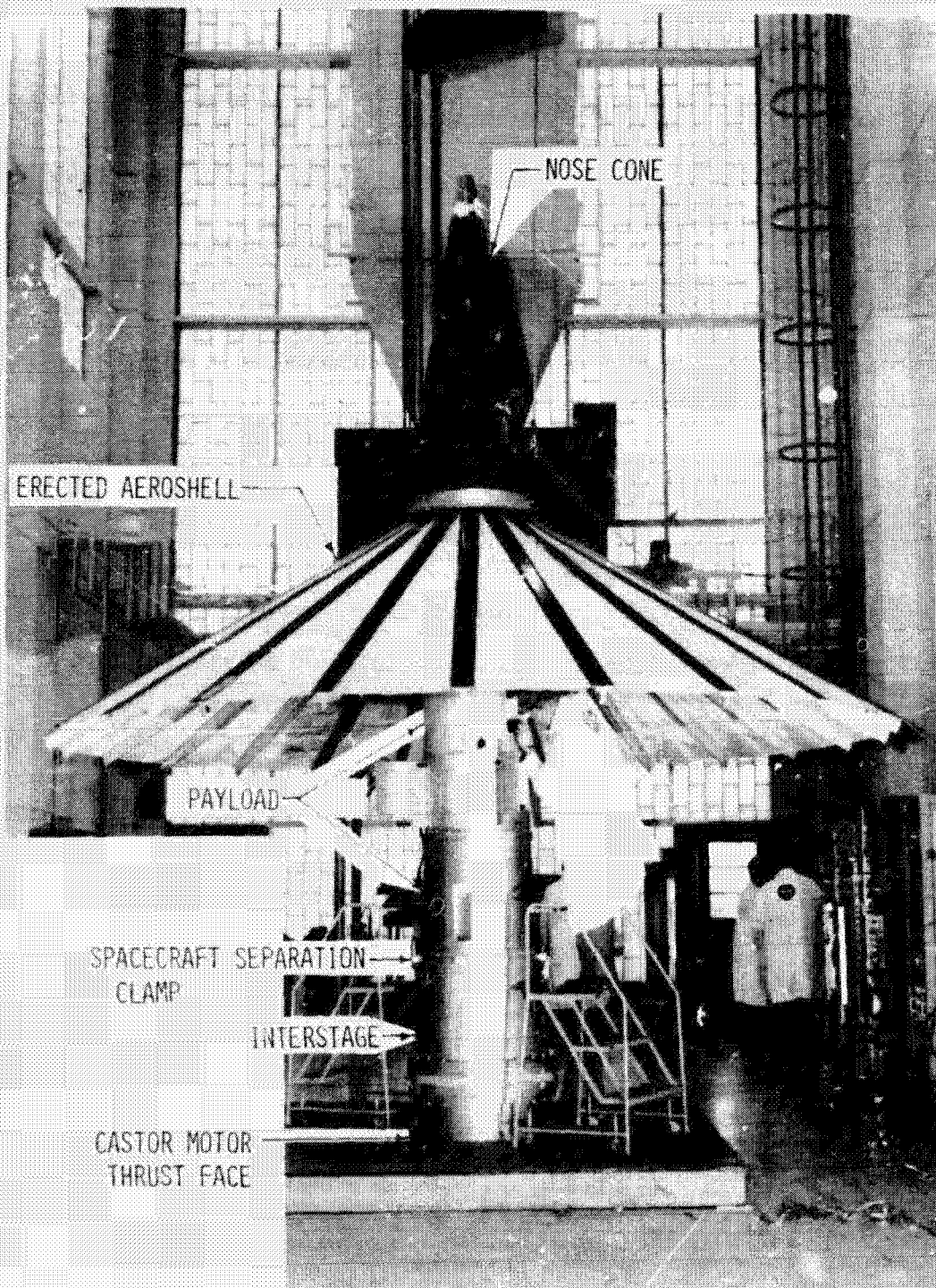

Figure 3.- Erected spacecraft interstage.

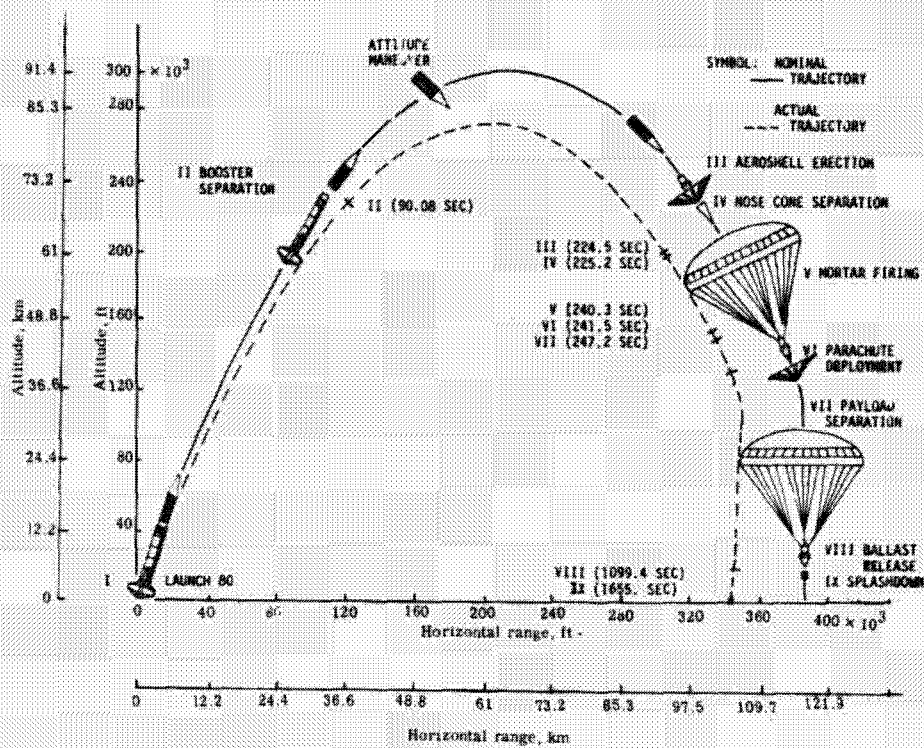

Figure 4.- Illustration of events, nominal and actual trajectory.

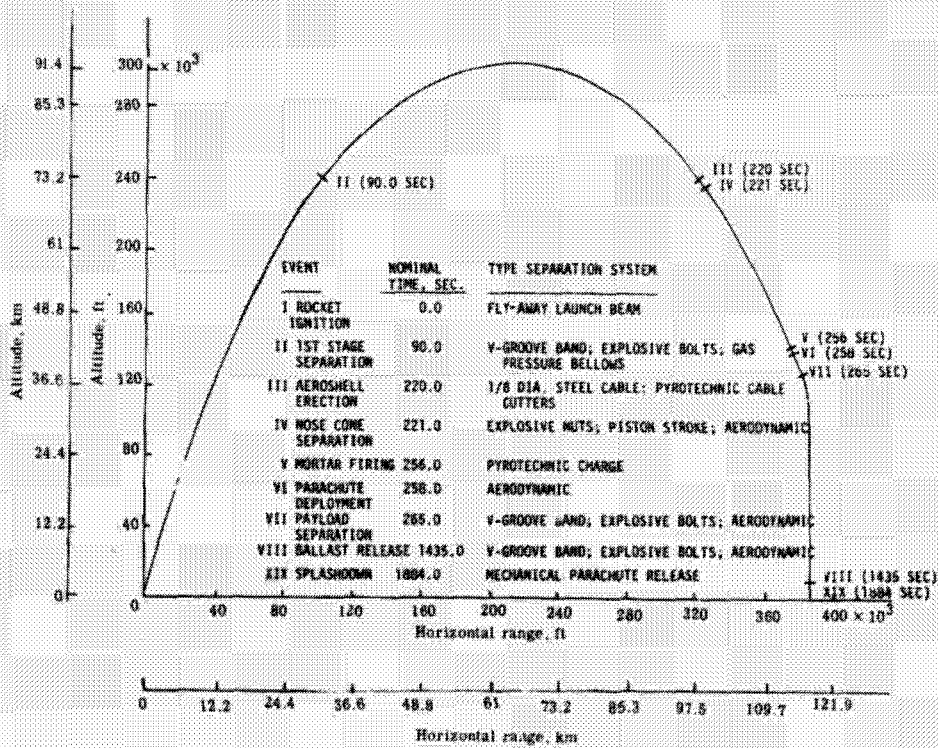

Figure 5.- Nominal trajectory, events, and separation systems.

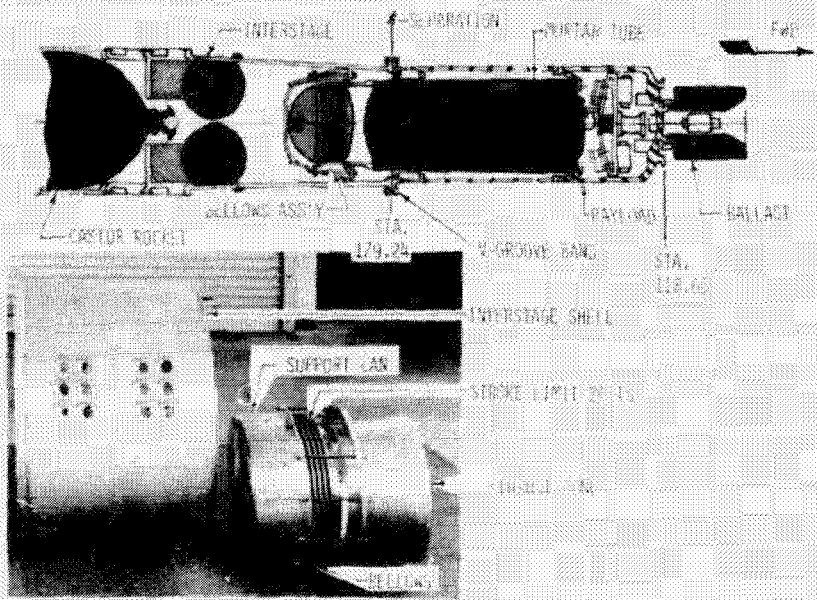

Figure 6.- Rocket booster/spacecraft separation system.

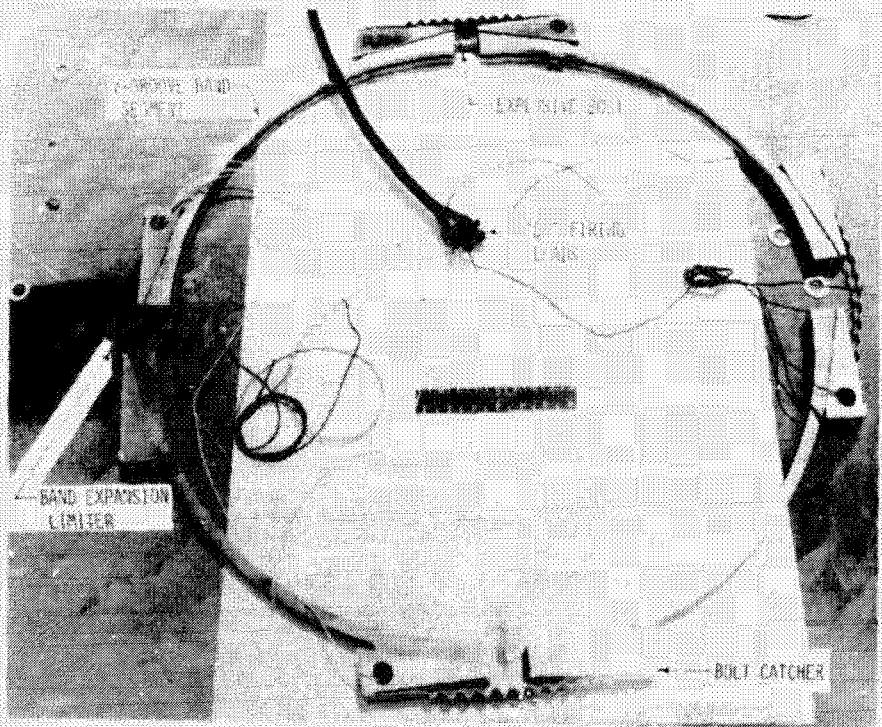

Figure 7.- 1st stage separation, V-groove band assembly.

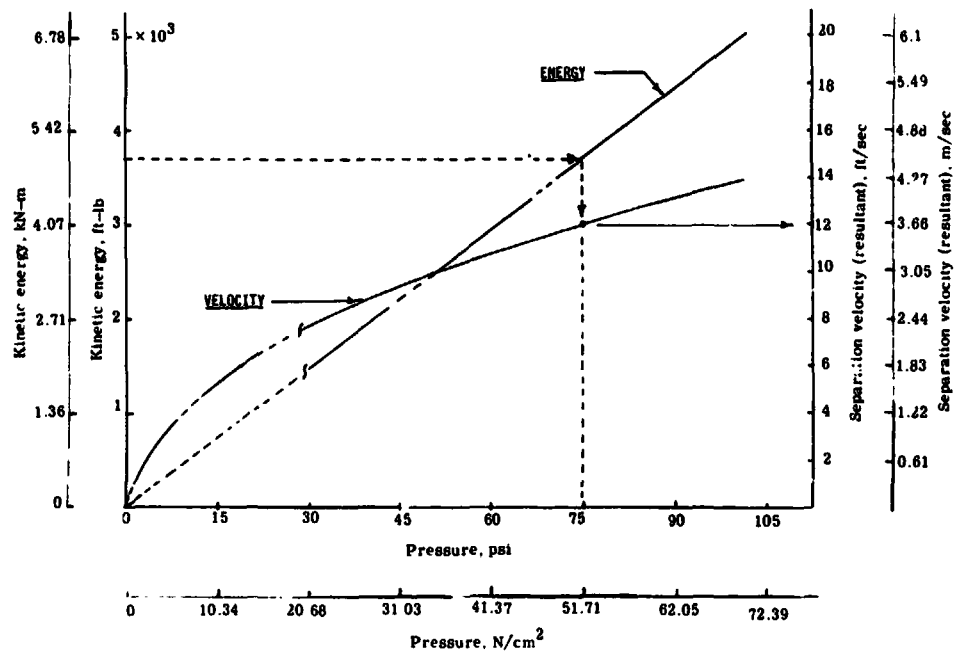

Figure 8.- 1st stage/spacecraft separation.

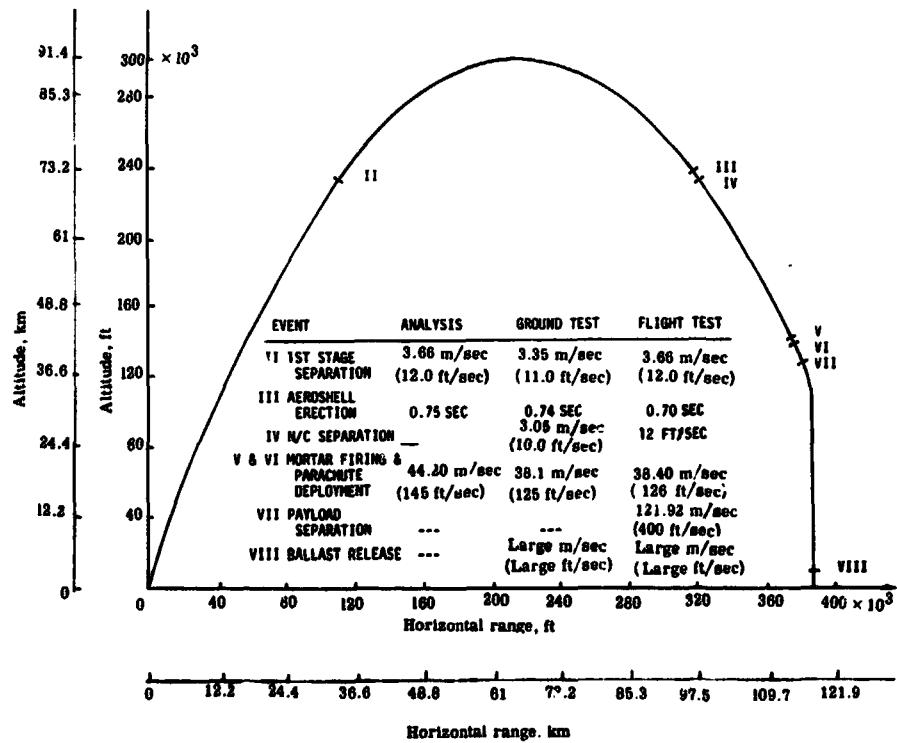

Figure 9.- Flight test results; correlation with analysis and ground test.