

*P
2 mit*

CR-134122

Final Report

NASA-JSC CONTRACT NO.
NAS 9-13026
DRL NO. T-766, LINE
ITEM NO. 2
DRD NO. MA-183T

WASH WATER RECOVERY SYSTEM

73-9497

October 10, 1973

(NASA-CR-134122) WASH WATER RECOVERY
SYSTEM Final Report (Airesearch Mfg.
Co., Los Angeles, Calif.) 105 p HC

N74-11896

93

CSCL 06I

Unclas
22762

G3/05

Prepared for

NASA Johnson Space Center
Houston, Texas 77058

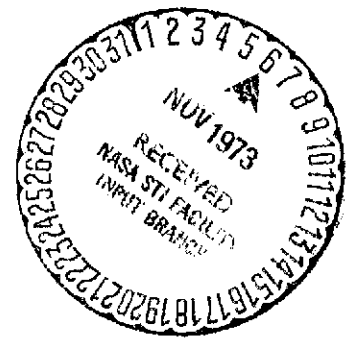

AIRESEARCH MANUFACTURING COMPANY

Reproduced by
NATIONAL TECHNICAL
INFORMATION SERVICE
US Department of Commerce
Springfield, VA. 22151

PRICES SUBJECT TO CHANGE

99

Final Report

NASA-JSC CONTRACT NO.
NAS 9-13026
DRL NO. T-766, LINE
ITEM NO. 2
DRD NO. MA-183T

WASH WATER RECOVERY SYSTEM

73-9497

October 10, 1973

Prepared by G. Deckman

Edited by J. Rousseau
J. Rousseau

Approved by R. L. Johnson
R. L. Johnson

Approved by R. C. Nelson
R. C. Nelson

Prepared for

NASA Johnson Space Center
Houston, Texas 77058



AIRESEARCH MANUFACTURING COMPANY

FOREWORD

This report was prepared by the AiResearch Manufacturing Company of Los Angeles to summarize the results of the program sponsored by the Johnson Space Center of the National Aeronautics and Space Administration under Contract NAS 9-13026. This program involved modification of existing Intermediate Water Recovery System (IWRS) hardware for use with wash water, evaluating wash water flashing and foaming characteristics, determining physical properties of concentrated soap solutions, and performing a long term feasibility study of the Wash Water Recovery System (WWRs). A computer analysis of system performance and detail design of a vortex compressor for a 10 lb/hr system also were completed.

Previous final reports prepared by AiResearch to cover IWRS programs that preceded the current WWRs program are as follows:

Contract NAS 9-8460, Task A--Report 69-5470

Contract NAS 9-8460, Task B -Report 70-7018, Rev. 1

Contract NAS 9-9981--Report 70-7018, Rev. 1

Contract NAS 9-11996--Report 72-8901, Rev. 1

Mr. Frank Collier served as program technical monitor for NASA JSC. At AiResearch, Mr. R. L. Johnson served as Program Engineer. AiResearch personnel who contributed substantially to this program were: O. R. Morton, P. Bond, K. Ikeda, G. Deckman, and J. Rousseau. Microbiological analysis and consulting services were provided by Dr. Ronald Nachum PhD.



CONTENTS

<u>Section</u>		<u>Page</u>
1	INTRODUCTION AND PROGRAM SUMMARY	1-1
	General	1-1
	Background	1-1
	Scope of Current Program	1-1
	Program Summary	1-1
	Recommendations	1-3
2	PRELIMINARY INFORMATION TESTS	2-1
	Experimental Laboratory Demonstration-Flashing/ Foaming Tests	2-1
	Wash Water Properties	2-3
3	SYSTEM FEASIBILITY TESTING	3-1
	General	3-1
	Reliability Criteria	3-1
	Water Analysis Criteria	3-1
	Wash Water Generation and Treatment	3-3
	System Test Setup and Checkout	3-3
	Test Procedure and Results	3-15
	Analysis of Product Water	3-34
4	SYSTEM ANALYSIS AND COMPRESSOR DESIGN	4-1
	System Analysis	4-1
	Vortex Compressor Design	4-1
	Component Problem Statements	4-9
5	CONCLUSIONS AND RECOMMENDATIONS	5-1
	Conclusions	5-1
	Recommendations	5-2



TABLES

<u>Table</u>		<u>Page</u>
2-1	Specific Heat and Thermal Conductivity Measurements for Miranol Jem and Neutrogena Bar Soap Solutions	2-4
3-1	NASA Potable Water Limits for Chemical Analysis	3-2
3-2	Instrumentation Ranges and Types	3-16
3-3	Phase I Operating Modes	3-17
3-4	WRS Performance Summary	3-18
3-5	Summary of Hardware Inspection Results and Evaluations	3-49
3-6	Microbiological Analysis of Product Water Samples	3-50
3-7	NASA Chemical Analysis Results, 3/21/73-5/16/73	3-53
3-8	NASA Chemical Analysis Results, 5/23/73-7/3/73	3-54
4-1	System Performance Predictions	4-2



ILLUSTRATIONS

<u>Figure</u>		<u>Page</u>
2-1	Flashing/Foaming Test Setup	2-2
2-2	Density of Miranol JEM Concentrations	2-5
2-3	Density of Neutrogena Bar Soap Concentrations	2-6
2-4	Density of Neutrogena Rain Bath Body Gel Concentrations at 70°F	2-7
2-5	Viscosity of Miranol JEM Concentrations	2-8
2-6	Viscosity of Neutrogena Bar Soap Concentrations	2-9
2-7	Viscosity of Neutrogena Rain Bath Body Gel Concentrations at 70°F	2-10
2-8	Vapor Pressure of Miranol JEM and Neutrogena Bar Soap Concentrations	2-11
2-9	Vapor Pressure of Neutrogena Rain Bath Body Gel Concentrations	2-12
3-1	Shower Installation	3-4
3-2	Shower Apparatus	3-5
3-3	System Test Setup, Storage Tank Modifications and Feed Water Pretreatment Deaeration Chamber	3-6
3-4	Wash Water Recovery System Test Setup	3-7
3-5	Liquid Loop Flow Rate Calibration Setup	3-8
3-6	Liquid Pump Bypass Setup	3-9
3-7	System Test Setup, Liquid Loop Modifications	3-10
3-8	Nominal System Cycle	3-13
3-9	Typical Wash Water Recovery System Cycle	3-14
3-10	Major Operating Parameters, Days 1-35	3-19
3-11	Major Operating Parameters, Days 36-70	3-20
3-12	Major Operating Parameters, Days 71-102	3-21
3-13	Accumulative Daily Total Weight of Feed Water Input and Product Water Output	3-22
3-14	Post Phase I Examination, Appearance of Separator With Outer Bowl Top Cover Removed	3-27
3-15	Post Phase I Examination, Appearance of Inside Surface of Separator Outer Bowl Top Cover	3-28
3-16	Post Phase I Examination, Appearance of Separator Shaft Assembly and Condenser Liquid Inlet Port	3-29



ILLUSTRATIONS (Continued)

<u>Figure</u>		<u>Page</u>
3-17	Post Phase 1 Examination, Appearance of Separator Inner Bowl	3-30
3-18	Post Phase 1 Examination, Concentrated Soap Solution Remaining in Separator Inner Bowl	3-31
3-19	Post Phase 1 Examination, Soap Residue Remaining in Separator Inner Bowl (Liquid Removed)	3-32
3-20	Post Phase 2 Examination, Appearance of Separator Outer Bowl Cover	3-35
3-21	Post Phase 2 Examination, Concentrated Soap Solution and Urine Remaining in Separator Inner Bowl	3-36
3-22	Post Phase 2 Examination, Appearance of Separator Inner Bowl (Liquid Removed)	3-37
3-23	Post Phase 2 Examination, Appearance of Separator Inner Bowl and Inner Bowl Cover	3-38
3-24	Post Phase 2 Examination, Appearance of Separator Shaft Assembly and Liquid Pitot Tube	3-39
3-25	Post Phase 2 Examination, Appearance of Separator Outer Bowl Housing	3-40
3-26	Post Phase 2 Examination, Appearance of Flash Valve Ports	3-41
3-27	Post Phase 2 Examination, Appearance of Separator and Condenser Ports	3-42
3-28	Post Phase 2 Examination, Appearance of Condenser Components	3-43
3-29	Post Phase 2 Examination, Appearance of Compressor First Stage Wheel and Center Housing	3-44
3-30	Post Phase 2 Examination, Appearance of Compressor Second Stage Wheel and Center Housing	3-45
3-31	Post Phase 2 Examination, Appearance of Compressor Center Housing Ports	3-46
3-32	Post Phase 2 Examination, Interior Appearance of Catalytic Reactor	3-47
3-33	Post Phase 2 Examination, Appearance of Pyrolytic Reactor Catalyst Bed	3-48
4-1	Vortex Compressor Layout	4-5
4-2	Vortex Compressor Optimized Performance	4-6
4-3	Vortex Compressor Assembly	4-7



SECTION 1 INTRODUCTION AND PROGRAM SUMMARY

GENERAL

The Wash Water Recovery System (WWRS) is intended for use in processing shower bath water onboard a spacecraft. The WWRS utilizes flash evaporation, vapor compression, and pyrolytic reaction to process the wash water. The WWRS incorporates completely automatic controls and is instrumented for continuous monitoring during operation.

BACKGROUND

The basic design and development of the flash vaporization/vapor compression concept of water recovery was initially conducted by AiResearch as an Independent Research and Development (IR&D) program beginning in 1967. The program was continued as the Intermediate Water Recovery System (IWRS) under NASA Contracts NAS 9-8460, NAS 9-9981, and NAS 9-11996. These earlier programs dealt with the recovery of potable water from urine and were useful in providing a clearer understanding of system operating peculiarities and identifying further component design requirements.

SCOPE OF CURRENT PROGRAM

The current program consisted of modifying the IWRS to allow recovery of potable water from wash water, evaluating wash water flashing and foaming characteristics, determining physical properties of concentrated wash water, and performing a long term feasibility study on the system. In addition, a computer analysis of the system and a detail design of a 10 lb/hr vortex-type water vapor compressor were completed. The computer analysis also sized remaining system components on the basis of the new vortex compressor design.

PROGRAM SUMMARY

Five washing agents were used in the flashing and foaming tests: (1) Miranol JEM, (2) Neutrogena bar soap, (3) Neutrogena Rain Bath, (4) Cetol, and (5) Chloramine T. These washing agents were tested to determine if foaming problems would occur in system operation and if antifoam agents could be used to make the washing agents acceptable for use in the system.



Miranol Jem and Neutrogena Bar Soap were analyzed to determine density, viscosity, specific heat, thermal conductivity, and vapor pressure. These physical properties were required as inputs for the system performance computer program.

Phase 1 of the feasibility study was conducted to demonstrate the long-term feasibility of processing wash water. This phase covered 83 days of testing with wash water containing 0.3 percent Neutrogena Rain Bath body gel. This test was successfully completed; high quality potable water was processed. After Phase 1, the separator and liquid loop were partially disassembled for visual inspection. Residue deposits were minimal and were found only in static areas of the separator.

Phase 2 of the feasibility study was conducted, after successful completion of Phase 1, to obtain additional information. In this phase, it was decided to evaluate liquid loop performance with a mixed fluid, containing one part urine, by weight, added to 10 parts of the wash water used in Phase 1. The second phase was concluded after 19 days of testing. Evidence of progressive buildup of soap solids in the liquid loop began on the 17th day, with flow stoppage occurring on the 19th day as a result of soap precipitation in reacting with urine brine salts.

The WWRS was completely disassembled and inspected after a total of 102 days of system testing was completed. Generally, the internal surfaces of the separator and condenser were clean. Some soap deposits were found on the inner wall of the separator housing. The condenser liquid loop was plugged with solidified soap gel. Evaluation of the plugging problem showed that, as the liquid loop became concentrated with urine brine, the salts in the brine caused the soap to come out of solution and solidify. The soap continued to solidify until flow stoppage occurred. This solidification of the dissolved soap in wash water will occur when any type of salts are introduced into the solution.



The vortex compressor and pyrolytic reactor were in a relatively cleaner condition than that following the IWRS 30-day urine test. The compressor bearings spun freely; detailed inspection of the bearings showed no signs of wear. The pyrolytic reactor was cut open without disturbing the wire-screen catalyst bed. The wire screens were covered with a thin continuous coating of oxidation. The rhodium plating initially on the screens was not visible. The screens were washed with isopropanol to determine if soap products were present; none were found.

System performance predictions, utilizing a computer program and manual calculations based on optimized performance of the vortex compressor, were made to resize the WWRS plumbing and components for a 10 lb/hr potable water production rate. Component problem statements were derived from the system performance predictions.

RECOMMENDATIONS

The present WWRS, consisting of good-quality engineering development hardware has demonstrated the feasibility of recovering high-quality potable water from shower-generated wash water over a long period (83 days). In line with the successful completion of this feasibility demonstration, it is recommended that NASA continue development of the flash evaporation/vapor compression concept for potable water recovery. Continued developmental efforts will evolve improvements both in hardware designs and system physical arrangements, leading to an optimized WWRS with minimum energy losses and significant advantages over the reverse osmosis and hyperfiltration concepts.



SECTION 2

PRELIMINARY INFORMATION TESTS

EXPERIMENTAL LABORATORY DEMONSTRATION-FLASHING/FOAMING CHARACTERISTICS

Experimental testing was conducted on five washing agents: Miranol Jem, Neutrogena bar soap, Neutrogena Rain Bath, Cetol, and Chloromine T. The test setup, shown in Figure 2-1, included glass tubing and flasks to allow observation of the flashing and foaming characteristics of wash water solutions under test. The major objectives were to determine the following:

- (a) If foaming problems existed that would affect phase separator and pump operation.
- (b) If an antifoam agent was needed.
- (c) If other means of pretreatment were necessary to reduce potential system problems.
- (d) The effect of wash water on system density sensor performance characteristics.

Flashing and foaming tests were conducted on 16 different wash water solutions, containing concentrations of Miranol Jem ranging from 0.25 to 50 percent. Minimal foaming was observed, indicating that foam carryover would not present a problem in separator operation with Miranol Jem. Neutrogena bar soap was tested in three different concentrations: 0.3, 20, and 25 percent. In the 0.3-percent solution, the Neutrogena bar soap had a tendency to become insoluble and agglomerate at temperatures below 100°F. At room temperature (75°F), the 20-percent solution separated into an opaque liquid at the bottom and a yellow liquid at the top. The 25-percent solution formed into a gel when allowed to cool to room temperature. All solutions were homogeneous liquids above 110°F.

Neutrogena bar soap had a tendency to foam more than the Miranol Jem, indicating that an antifoam agent would be required to prevent soap foam carryover into the phase separator.



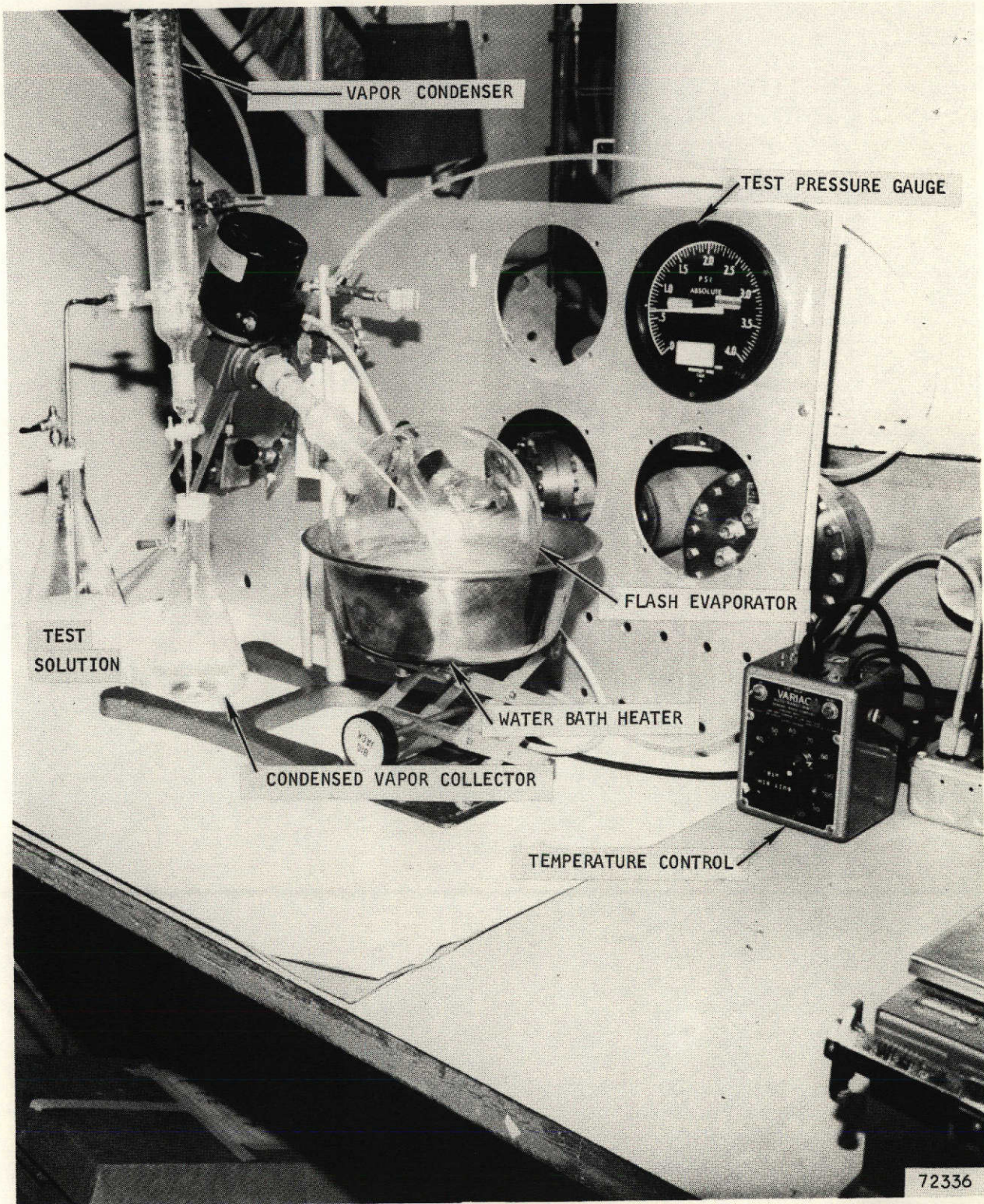

72336

Figure 2-1. Flashing/Foaming Test Setup



Various mixtures of Neutrogena bar soap and Miranol Jem also were tested. In all mixtures from 1:1 to 3:1, excessive foaming occurred. Three types of antifoam agents--phosphoric acid ($H_3 PO_4$) Dow Corning Antifoam "A" Spray, and Dow Corning Antifoam "A" paste--were added to reduce foaming. Of the three, the most effective was the antifoam "A" paste. Phosphoric acid would not control foaming for any of the mixtures. The antifoam spray was unacceptable because the low-boiling aerosol agent in the spray would carry over in the vapor. It is a possibility the aerosol could deteriorate the catalyst, and/or condense out and contaminate the product water. Although the antifoam "A" spray and paste could control foaming, it proved unsatisfactory for another reason. When injected into the wash water storage tank, it floated on top of the wash water solution instead of dissolving. Because of this characteristic, the quantity of antifoam transported to the phase separator could not be controlled.

Additional foaming tests were conducted on Cetol, Cholormine T, and Neutrogena Rain Bath washing agents. Minimal foaming occurred from Cetol and Cholormine T, either individually and in various mixtures, indicating that these washing agents would not require an antifoam agent. Neutrogena Rain Bath foamed extensively in all concentrations and in mixtures with Miranol Jem. Organo-modified silicones were investigated for application as an antifoam agent. Union Carbide Type L-7001 silicone was tried because it acted as an antifoam agent above its $31.5^{\circ}C$ cloud point¹ and remained in solution below $31.5^{\circ}C$. In several tests conducted with Neutrogena Rain Bath in various concentrations, the L-7001 silicone proved to be an effective antifoam. The optimum concentration of antifoam was found to be 0.5 gram per pound of wash water solution. On the basis of these tests, the L-7001 silicone was selected as the antifoam to be used in the long-term system feasibility test.

WASH WATER PROPERTIES

Wash water solutions were developed on three washing agents--Miranol Jem, Neutrogena bar soap, and Neutrogena Rain Bath. Selected concentrations of the three washing agents were analyzed to determine their physical properties.

¹ Cloud point is the point at which the L-7001 Organo-modified silicone/wash water mixture changes phase. At temperatures below the cloud point the L-7001 will remain in solution with the wash water, and at temperatures above the cloud point, the L-7001 will become insoluble and float on top of the wash water.



Test results showed that density and viscosity data on Neutrogena bar soap were not repeatable for concentrations above 10 percent while at temperatures below 105°F. Density, viscosity, and vapor pressure curves for various concentrations of Miranol Jem, Neutrogena bar soap, and Neutrogena Rain Bath are shown in Figures 2-2 through 2-9. Specific heat and thermal conductivity data for Miranol Jem and Neutrogena bar soap at 20 and 50 percent concentrations are presented in Table 2-1.

TABLE 2-1
 SPECIFIC HEAT AND THERMAL CONDUCTIVITY MEASUREMENTS FOR
 MIRANOL JEM AND NEUTROGENA BAR SOAP SOLUTIONS

<u>Sample</u>	<u>Specific Heat, Cp, Btu/lb °F (at 90°F)</u>	<u>Thermal Conductivity, k, Btu/hr ft °F (at 70°F)</u>
Miranol Jem (20%)	0.89	0.33
Miranol Jem (50%)	0.85	0.26
Neutrogena Bar Soap (20%)	0.99	0.23
Neutrogena Bar Soap (50%)	0.97	0.18



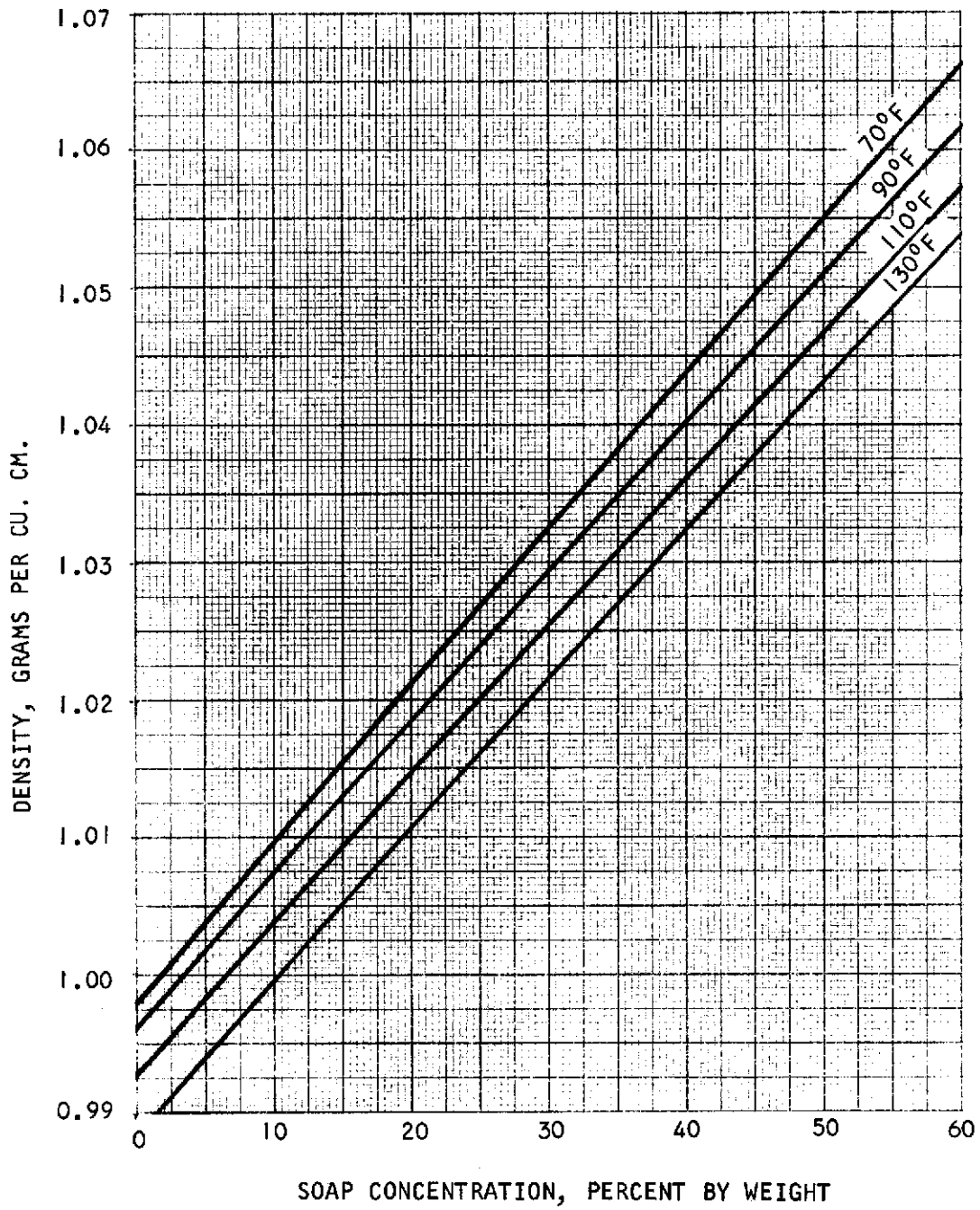

Figure 2-2. Density of Miranol JEM Concentrations



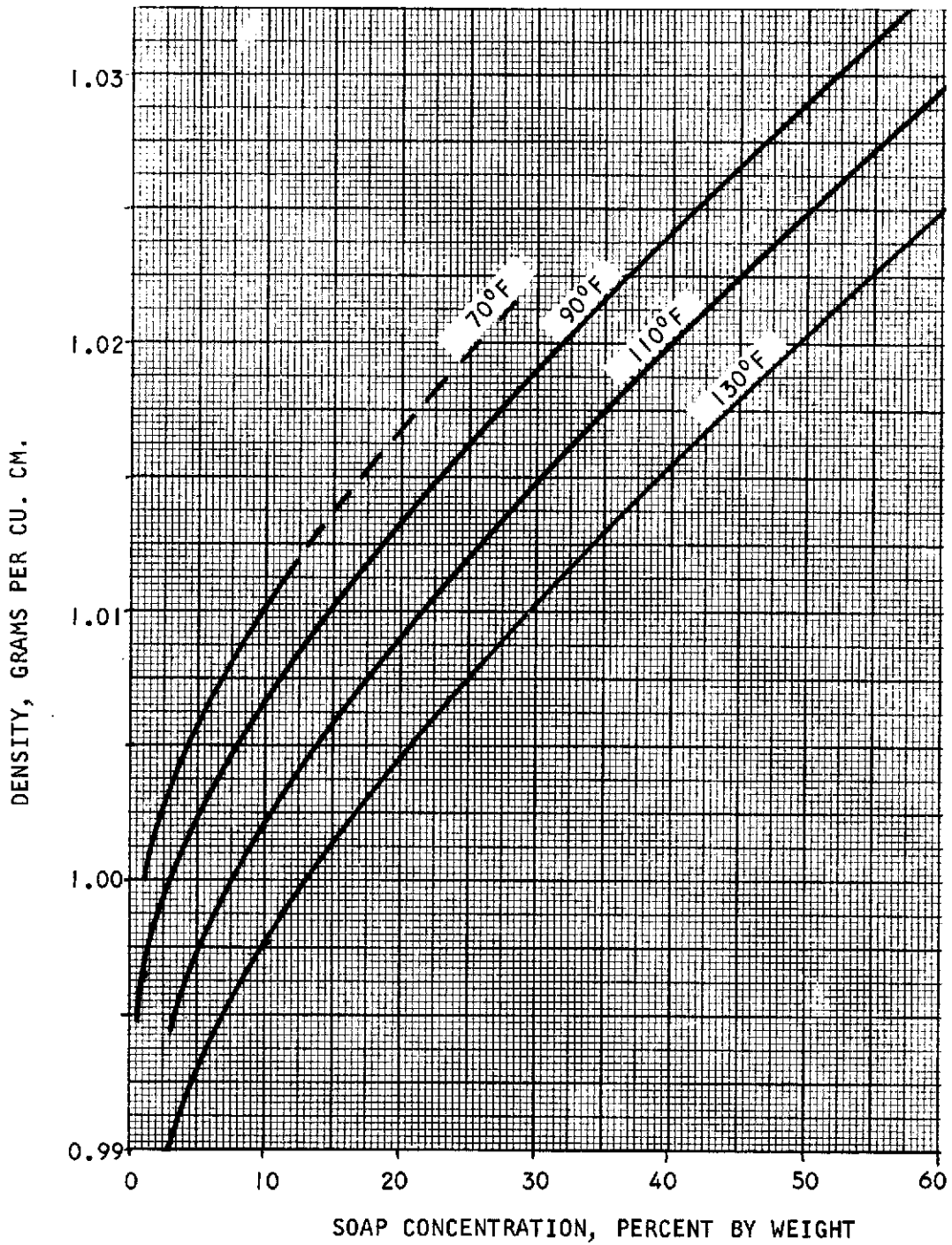

Figure 2-3. Density of Neutrogena Bar Soap Concentrations



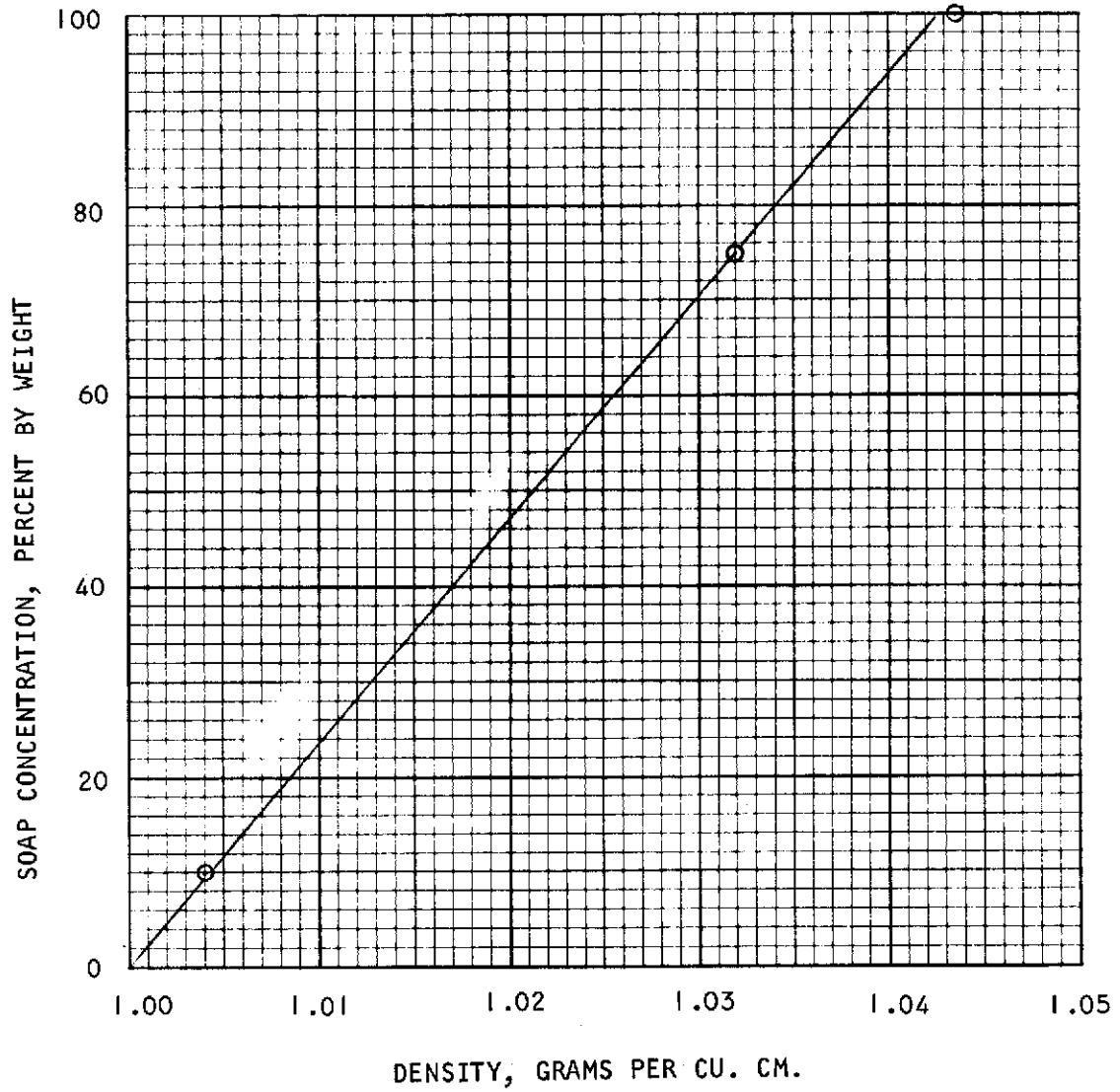

Figure 2-4. Density of Neutrogena Rain Bath Body Gel Concentrations at 70°F



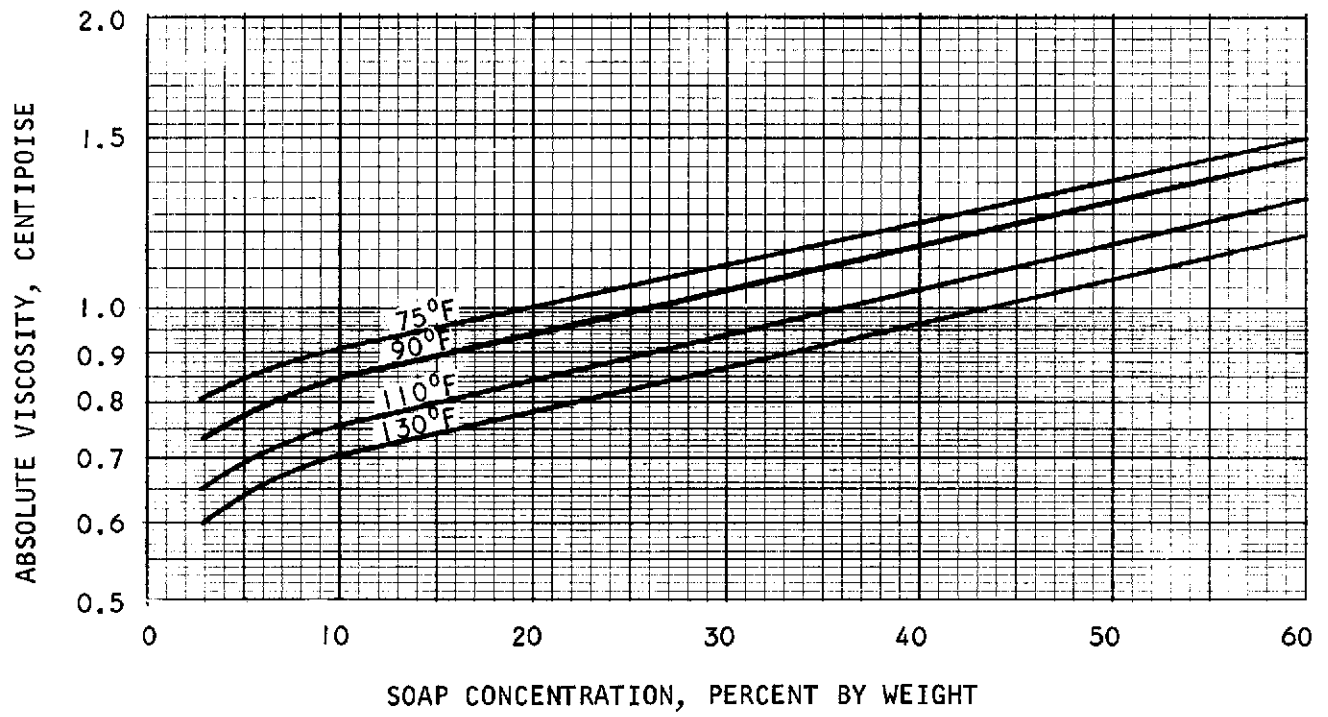

Figure 2-5. Viscosity of Miranol JEM Concentrations



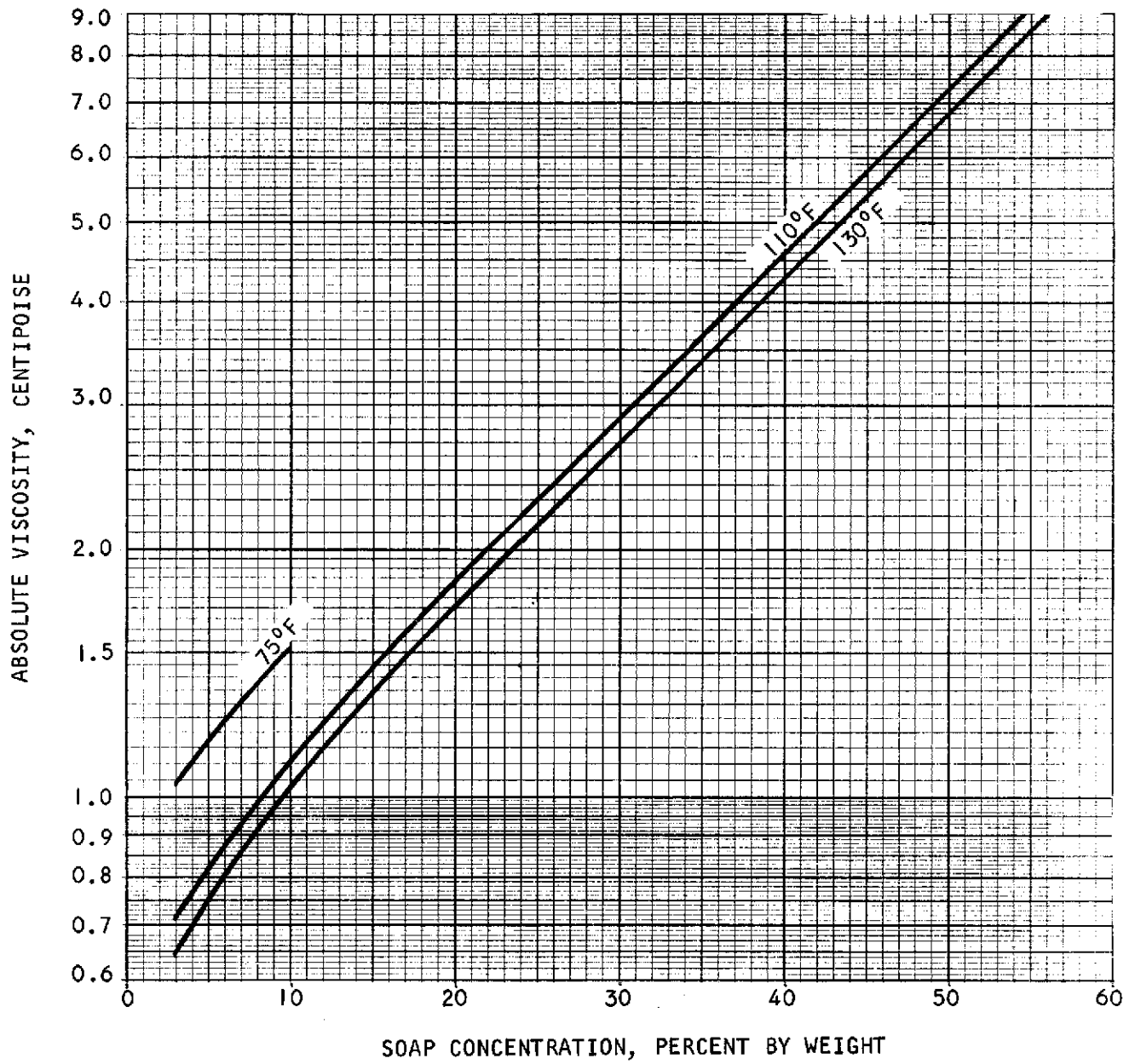

Figure 2-6. Viscosity of Neutrogena Bar Soap Concentrations



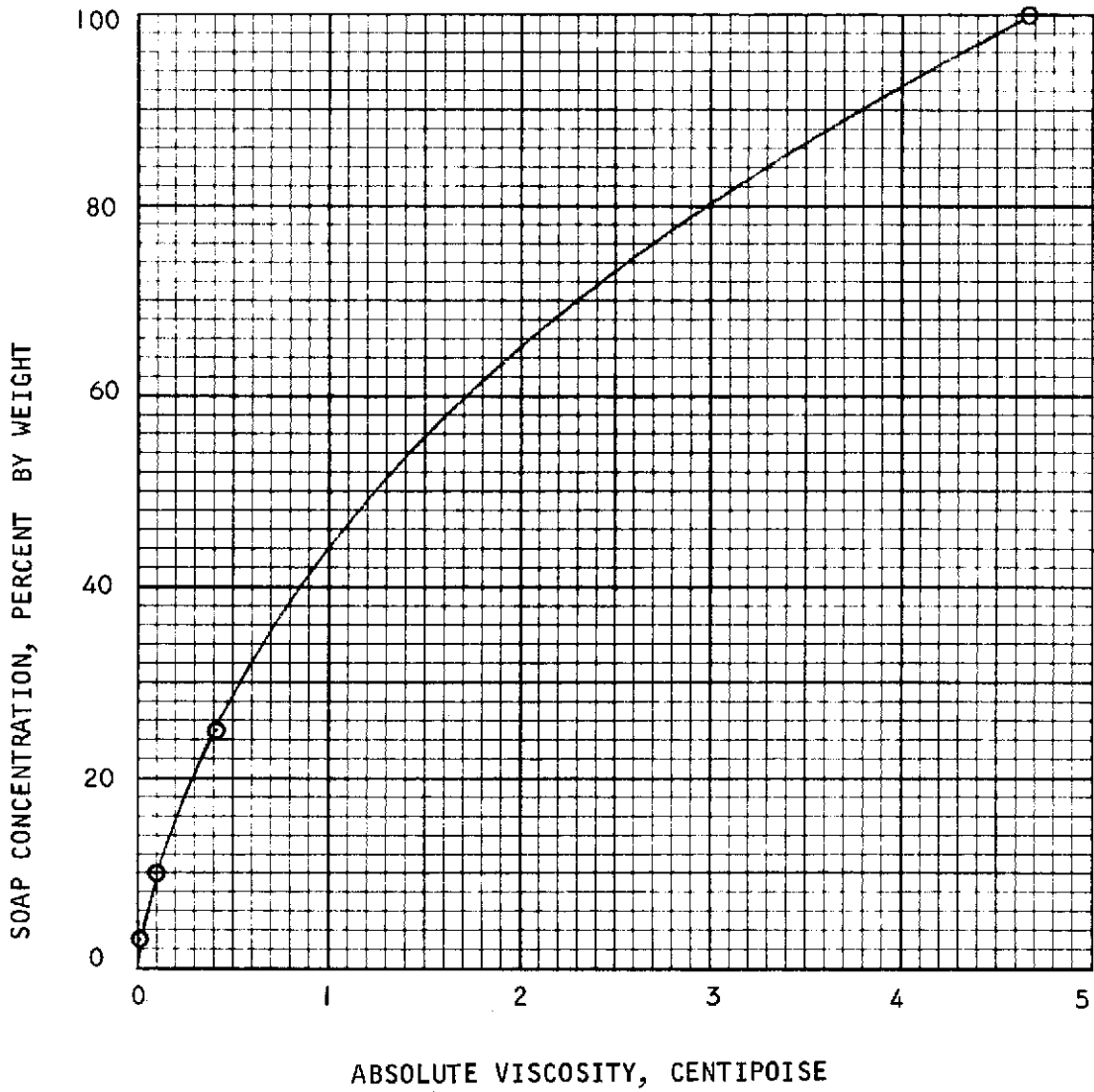

Figure 2-7. Viscosity of Neutrogena Rain Bath Body Gel Concentrations at 70°F



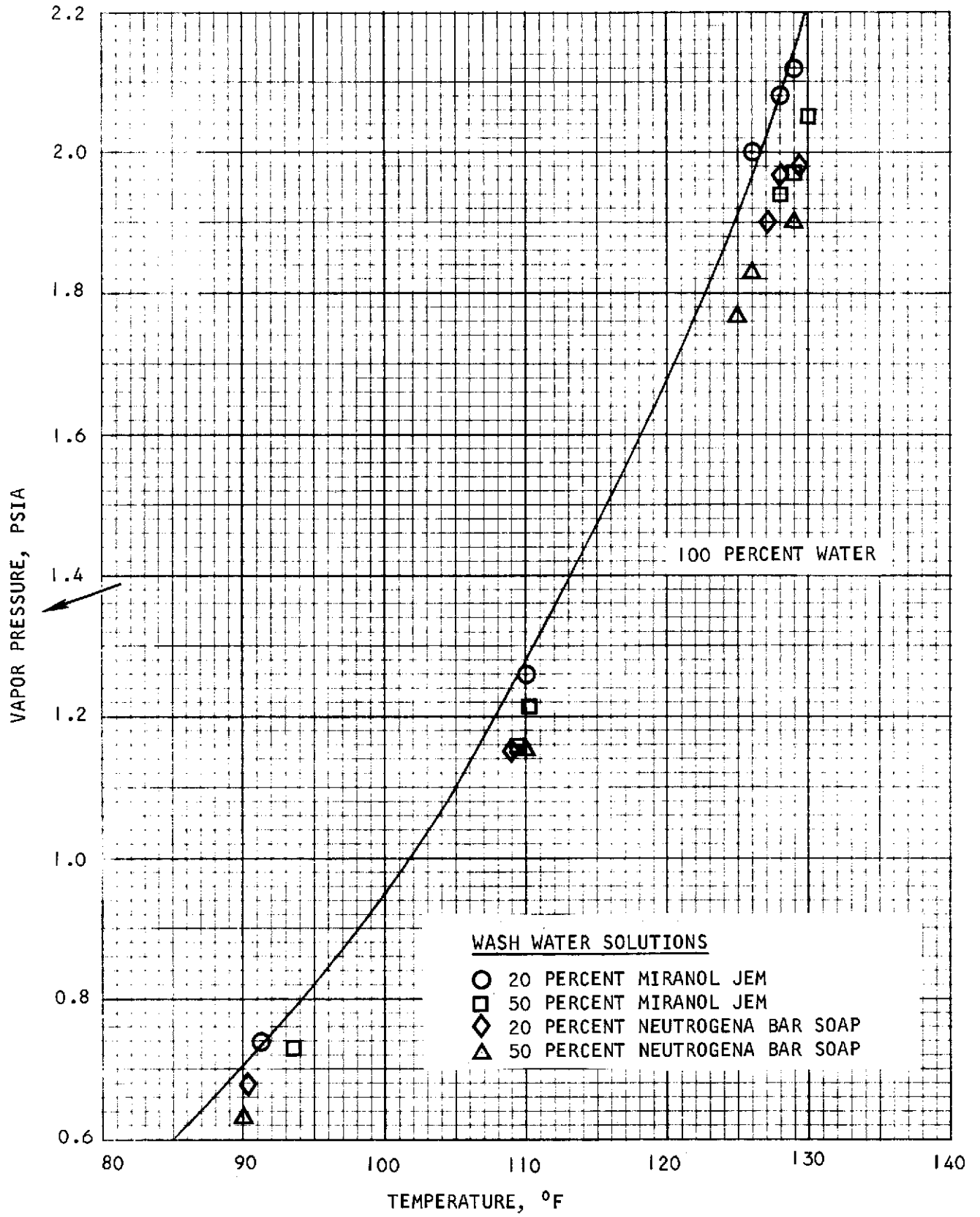

Figure 2-8. Vapor Pressure of Miranol Jem and Neutrogena Bar Soap Concentrations



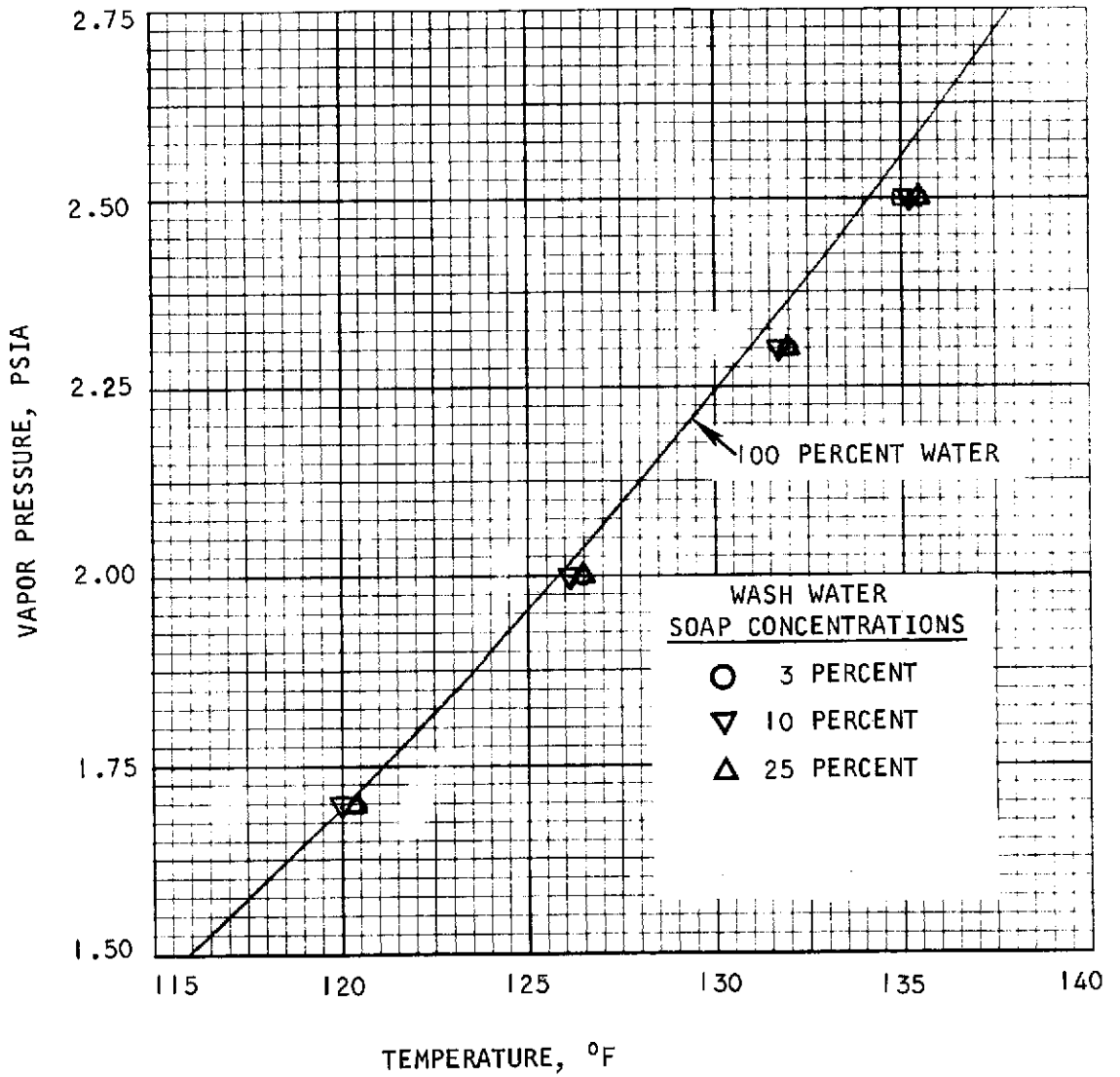

Figure 2-9. Vapor Pressure of Neutrogena Rain Bath Body Gel Concentrations



SECTION 3
SYSTEM FEASIBILITY TESTING

GENERAL

A three-month operational test was conducted on the WWRS to study the feasibility of the basic flash vaporization/vapor compression wash water recovery concept. The test objective was to determine the effects of long-term operation, particularly with respect to liquid loop plugging or flow blockage due to solids buildup.

RELIABILITY CRITERIA

Reliability of the following items was not considered as test criteria for system feasibility testing. Repair or replacement of these items was permissible any time during the test.

1. Bearings in phase separator and vortex compressor
2. Pyrolytic reactor catalyst bed
3. Liquid pump
4. Condenser porous plates
5. Cyclic accumulator
6. Flash valve
7. Instrumentation and controls
8. Support equipment

WATER ANALYSIS CRITERIA

Although production of chemically-pure and microbiologically-free potable water was not considered as test criteria for system feasibility testing, samples of the product water and separator overboard water were taken periodically for submittal to NASA for analysis. Desirable limits established by NASA for chemical content of the product water are shown in Table 3-1.



TABLE 3-1

NASA POTABLE WATER LIMITS FOR CHEMICAL ANALYSIS

<u>Analyzed For</u>	<u>Desirable Limit</u>
pH	6-8
Resistivity (Megohm-cm at 25°C)	Ref. only
Total Solids, ppm	500
Organic Carbon, ppm	100
Inorganic Carbon, ppm	Ref. only
Cadmium as Cd, ppm	0.01
Chromium as Cr ⁺⁶ , ppm	0.05
Copper as Cu, ppm	1.00
Iron as Fe, ppm	0.30
Lead as Pb, ppm	0.05
Magnesium as Mg, ppm	Ref. only
Manganese as Mn, ppm	0.05
Mercury as Hg, ppm	0.005
Nickel as Ni, ppm	0.05
Potassium as K, ppm	Ref. only
Silver as Ag, ppm	0.05
Sodium as Na, ppm	Ref. only
Zinc as Zn, ppm	5.0
Ammonia as N, ppm	3.0
Fluoride as F ⁻ , ppm	20.0
Nitrate as NO ₃ ⁻ , ppm	TBD
Sulfate as SO ₄ ⁻² , ppm	250
Chloride as Cl ⁻ , ppm	450



WASH WATER GENERATION AND TREATMENT

All wash water utilized throughout the feasibility test program was generated through shower baths of test personnel. Eight pounds of deionized water at approximately 105°F and 12 grams of Neutrogena Rain Bath body gel were used in each shower. The shower bath setup is shown in Figures 3-1 and 3-2.

Antifoam treatment was added following each shower bath to control foaming of the wash water in the phase separator. For every pound of wash water, 0.5 grams of Union Carbide organo-modified silicone L-7001 was added. This anti-foam agent is water-soluble below its cloud point of 31.5°C, so that it can be transported from the storage tank to the phase separator. Above the 31.5°C cloud point, it is insoluble, thus acting as an effective antifoam in the operating temperature range.

During early preliminary testing, it was determined that foaming of feed wash water below 31.5°C could be minimized by reducing its pressure for deaeration prior to injecting it into the separator. The feed pretreatment deaeration chamber shown in Figure 3-3 was added to the feed water line for this purpose.

SYSTEM TEST SETUP AND CHECKOUT

The WWRS was assembled in the test setup shown schematically in Figure 3-4. All necessary instrumentation, system control equipment, refurbished separator, and compressor were installed in the test setup. System checkout testing, consisting of density and level sensor evaluation, liquid pump operation, and brine loop flow rate calibration, was then completed.

Modifications and Refurbishment

The existing one lb/hr IWRS, fabricated and tested under Contract NAS 9-11996, was refurbished and modified to provide an operational WWRS. The WWRS test setup included the following major modifications, which are shown in Figures 3-5, 3-6, and 3-7.

1. Addition of a differential pressure (ΔP) transducer to measure condenser liquid loop pressure drop.
2. Addition of a liquid pump and pump bypass circuit.



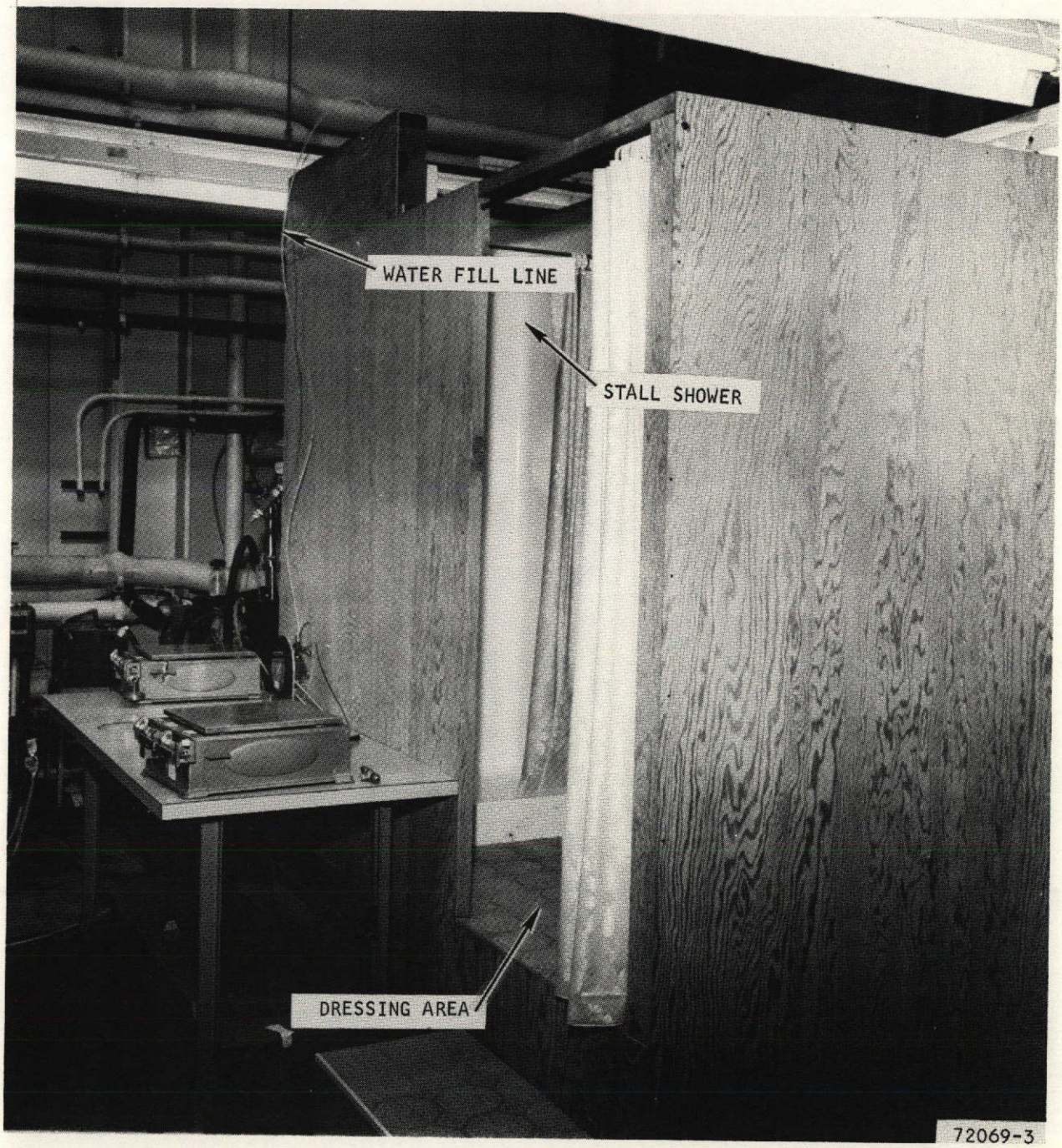

Figure 3-1. Shower Installation



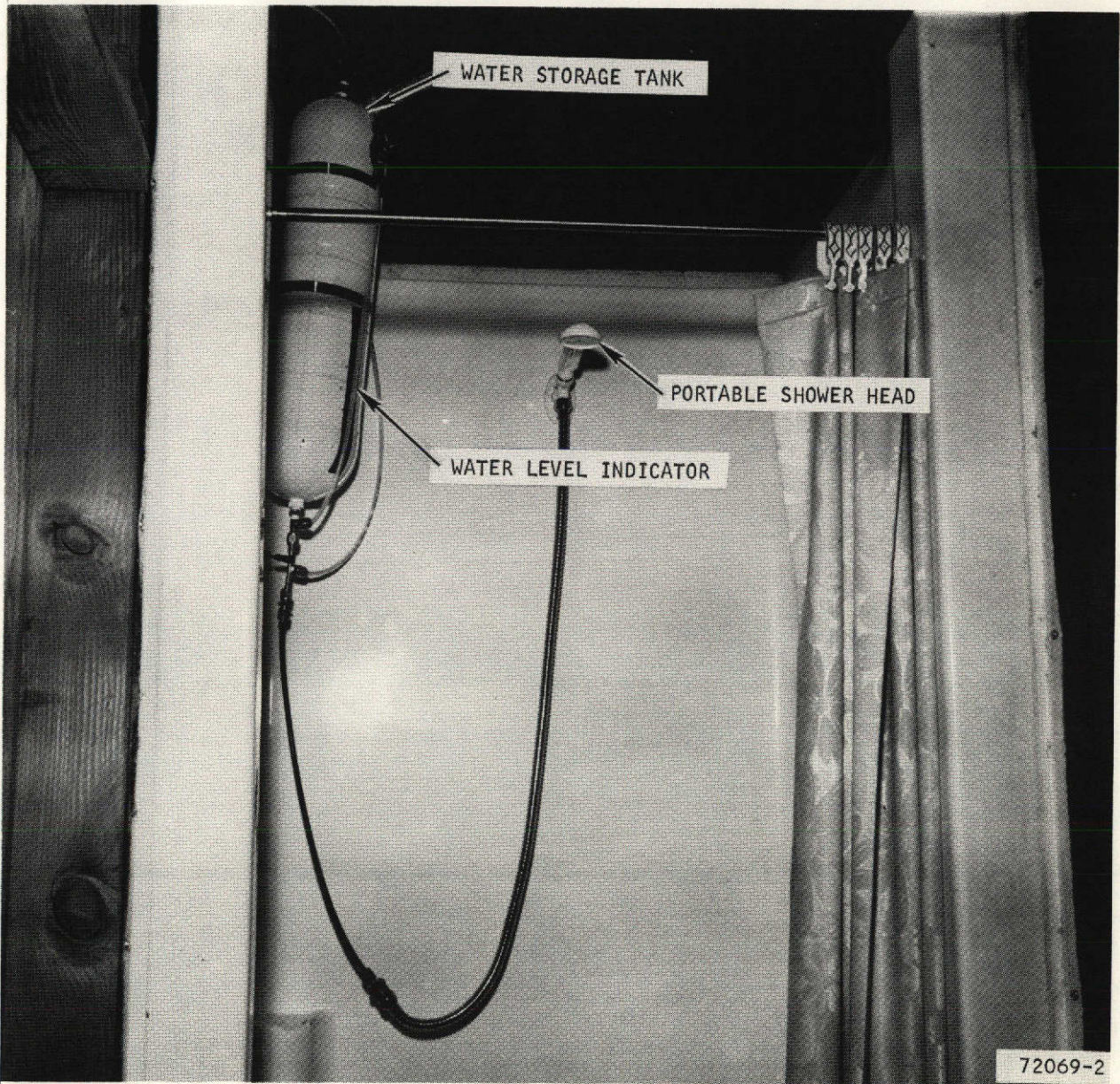

Figure 3-2. Shower Apparatus



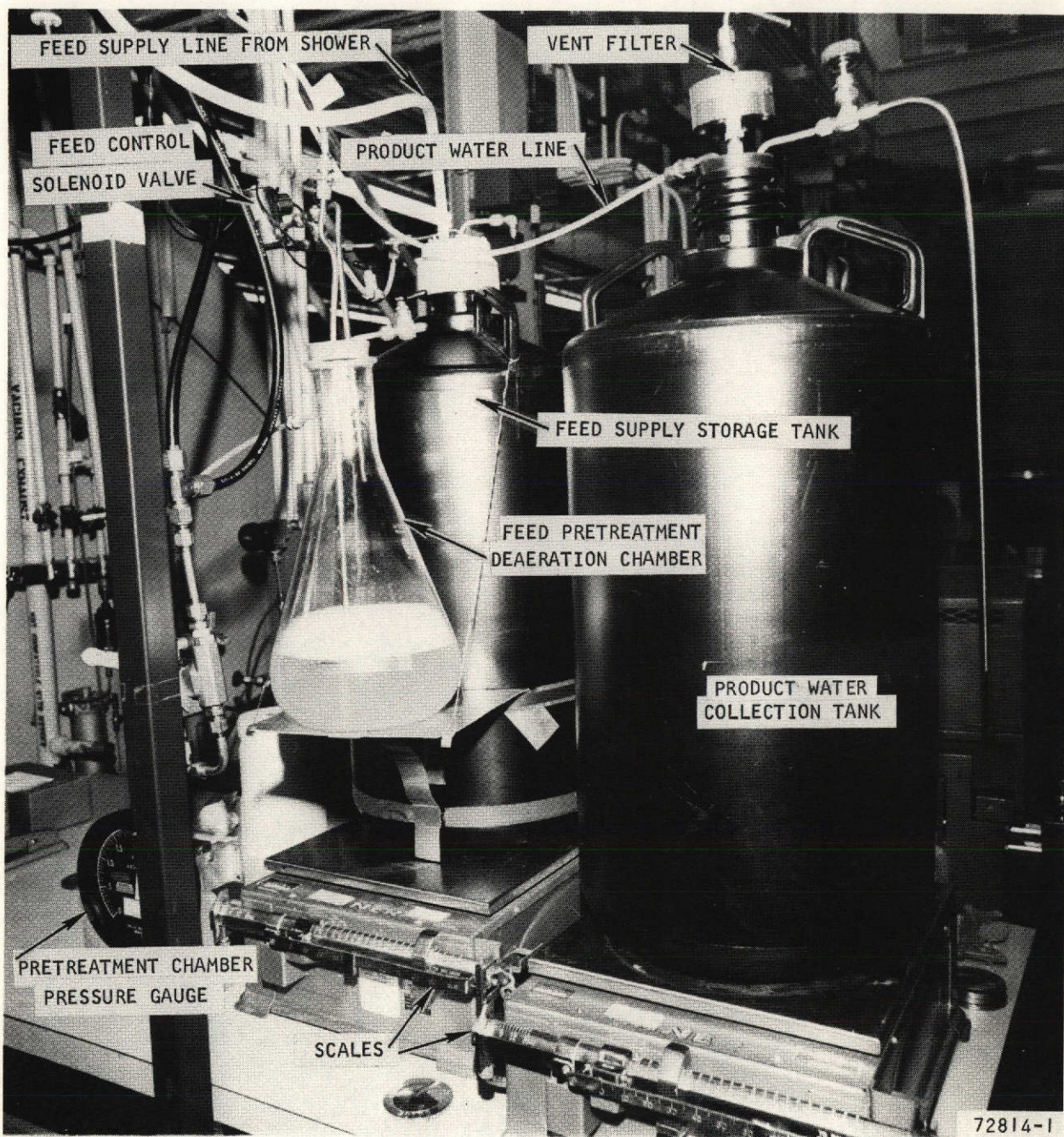

Figure 3-3. System Test Setup, Storage Tank Modifications and Feed Water Pretreatment Deaeration Chamber



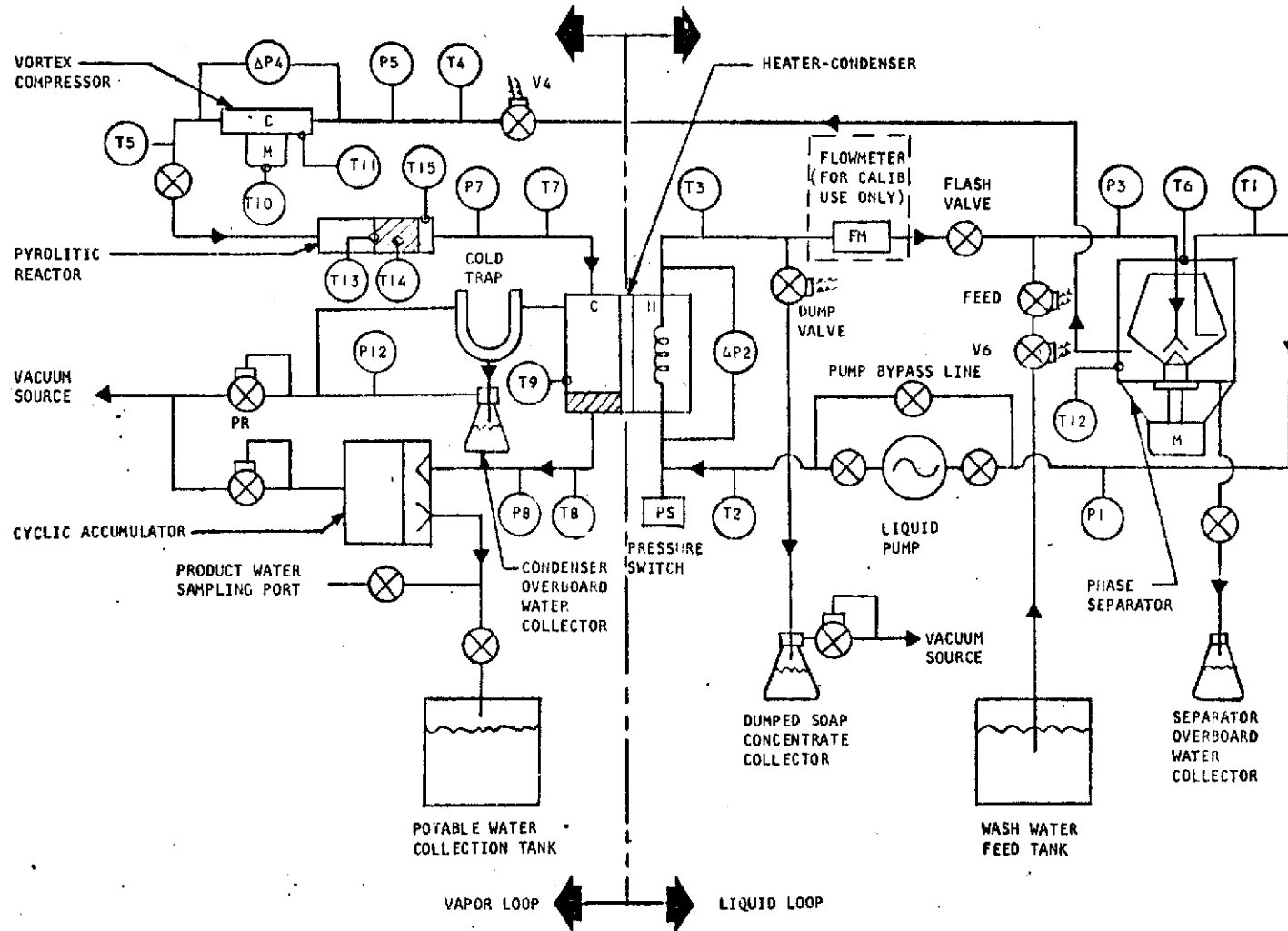

Figure 3-4. Wash Water Recovery System Test Setup

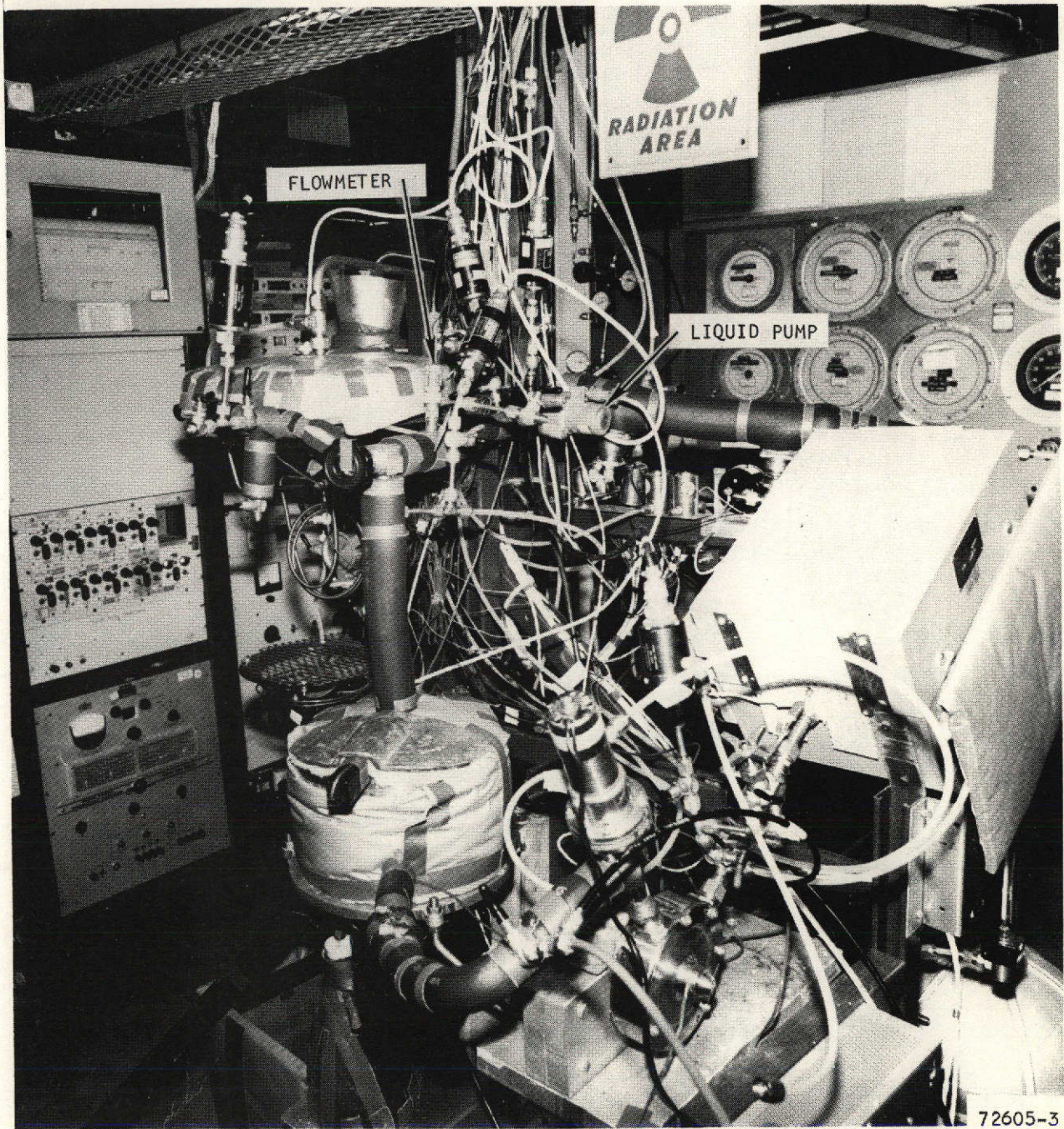
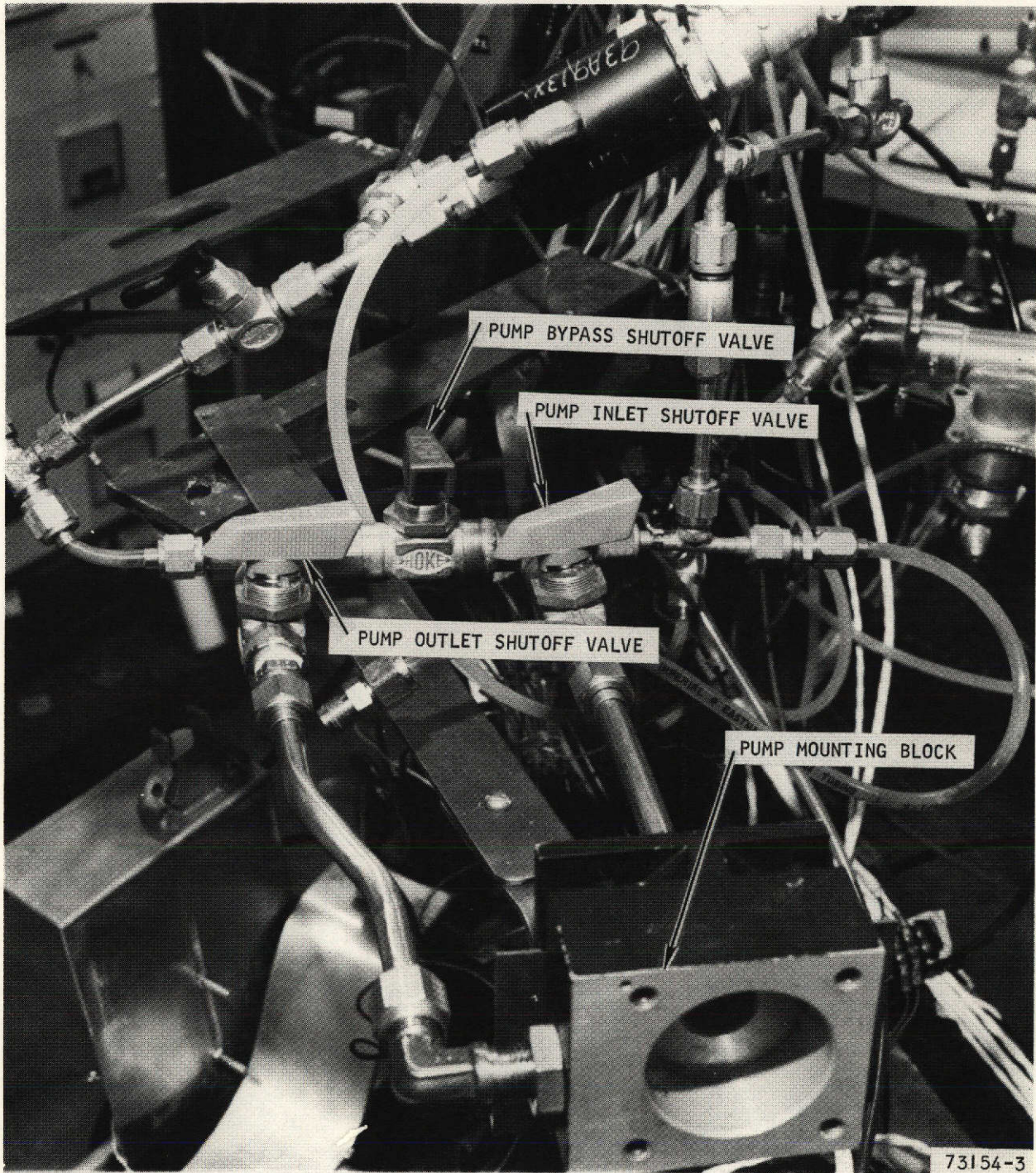

Figure 3-5. Liquid Loop Flow Rate Calibration Setup



AIRESEARCH MANUFACTURING COMPANY
Los Angeles, California



NOTE: This pump bypass setup was added on March 26 to allow replacement of the liquid pump without affecting the separator pressure.

Figure 3-6. Liquid Pump Bypass Setup



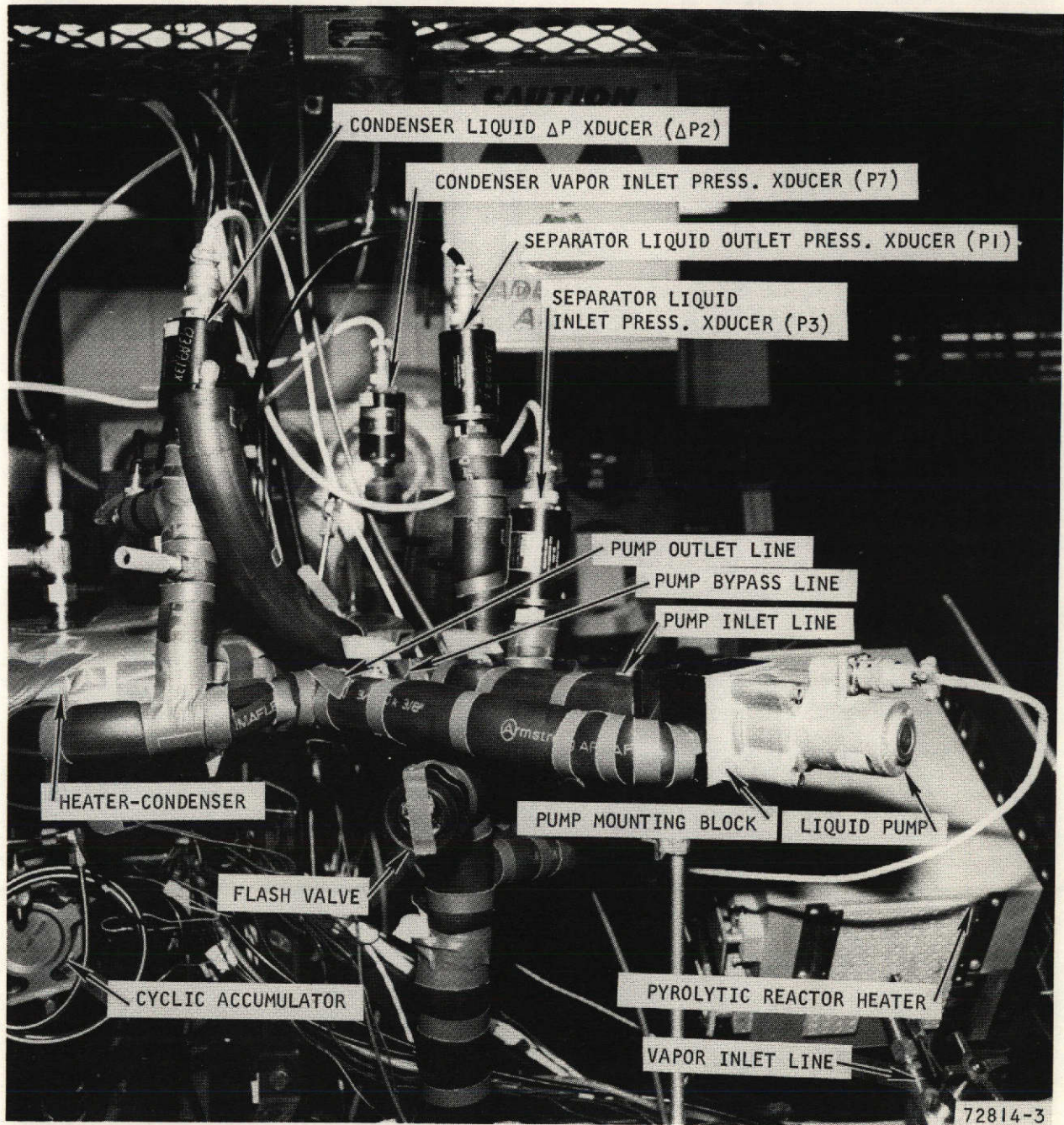

Figure 3-7. System Test Setup, Liquid Loop Modifications



3. Modification of system controls for cycle operation by phase separator level sensing only. Extensive testing on the IWRS sensor sensing the density of soap solution in the phase separator indicated that the unit did not have the sensitivity required for system control.

In addition, the following modifications and refurbishments were made to major system components:

1. Phase Separator

- The existing vapor circuit was modified.
- Slings were added to both bearings.
- A larger lower bearing was installed.
- Means to adjust the magnet face clearance were incorporated.
- A new variable-speed drive motor was installed.

2. Pyrolytic Reactor

- New hardware to existing design was fabricated.
- New rhodium-plated stainless steel screens were installed.

3. Compressor

- All detailed parts were cleaned.
- New bearings were installed in compressor and motor.

4. Condenser

- All detailed parts were cleaned.
- New wicks and refurbished air trap assemblies were installed.

5. Automatic Shutdown System

- A new sequence and inputs were established.

6. Instrumentation

- System instrumentation was modified as necessary.



Description of Nominal System Cycle

The system controls were set to operate the system in accordance with the nominal cycle described below. Initially, the liquid loop, including the separator, was filled with 1800 cc of wash water. The liquid loop wash water evaporated to 720 cc, recovering 1080 cc of product water. The liquid loop was then refilled to 1800 cc. The evaporation cycle was repeated an additional 11 times, and a total of 12,960 cc of product water was recovered. At this point, the total amount of wash water added to the system was 13,680 cc, containing approximately 45 cc of soap. Following the twelfth evaporation cycle, 720 cc of the concentrated solution remained, of which 7.2 percent was soap. After dumping 470 cc of the concentrated solution, the cycle was completed. The system ran automatically, repeating the cycle approximately every 24 hours.

After six system cycles, the soap concentration at dump stabilized at approximately 8.4 percent. This cycle allowed at least 95 percent recovery of the available water in the base wash water solution. The nominal system cycle is shown graphically in Figure 3-8. Continuously recorded test data for a typical system cycle are shown in Figure 3-9.

Automatic Shutdown System

The automatic shutdown system monitored liquid loop pressure and provided a predetermined shutdown sequence if liquid loop pressure was too low. The system contained two main elements: the limit signal sensor and automatic shutdown sequencer, which are described in the following paragraphs.

The automatic shutdown sequencer provided a preset, timed sequence of events necessary to safely shut down the system upon a signal from the limit signal sensor. The sequencer consisted of the following components: a motor driven timer, an electro-mechanical time delay relay, a latching relay, and a rotary stepping switch. When a low pressure signal was received from the limit signal sensor, the latching relay closed and the sequencer operated as follows:



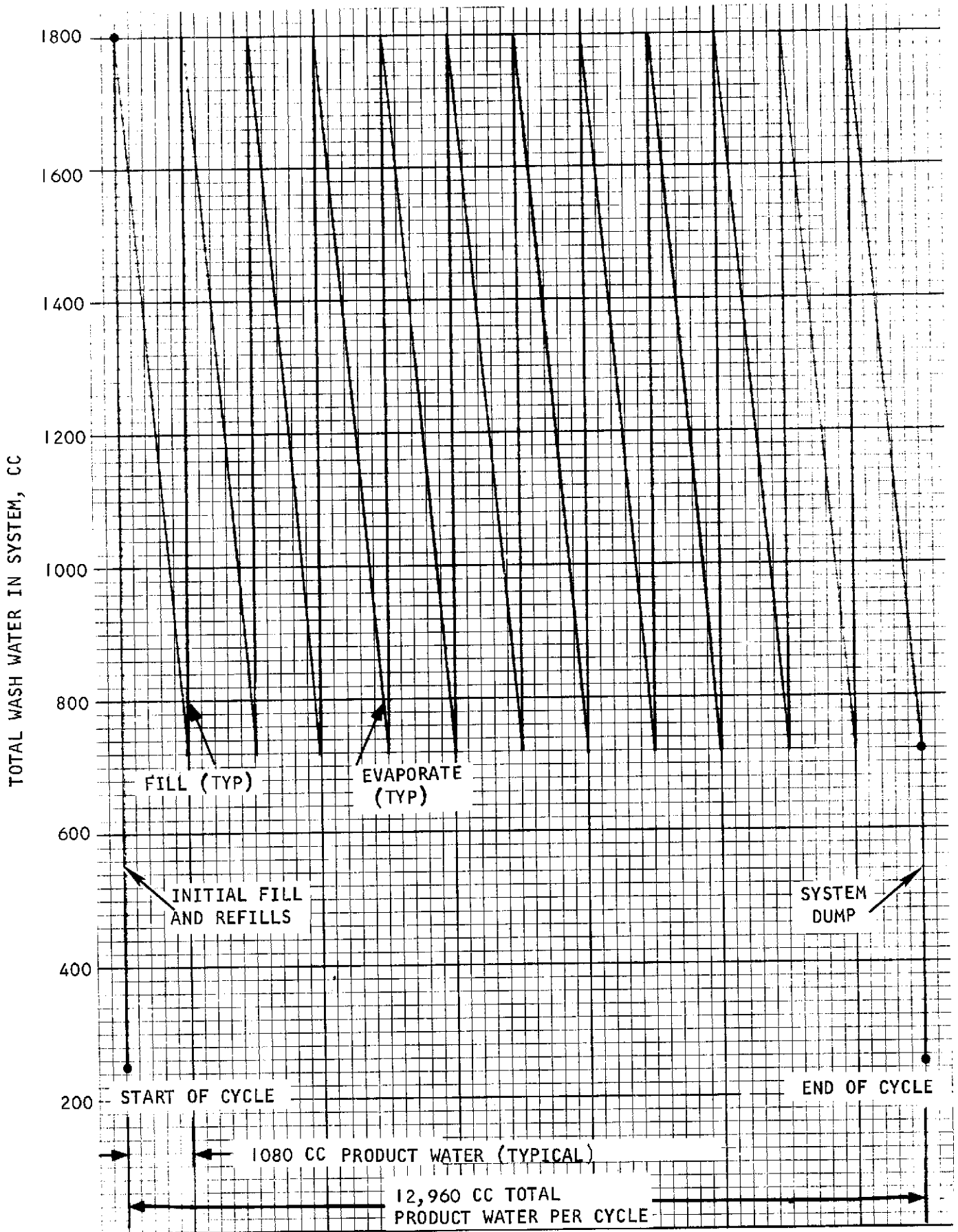

Figure 3-8. Nominal System Cycle



Page intentionally left blank

1. V4 closed; power to compressor was shut off; V6 closed; buzzer sounded.
2. A 25-second hold then occurred.
3. Power to phase separator and liquid pump was shut off to shut down the system.

Instrumentation

System performance monitoring instrumentation consisted of temperature thermocouples, on-line pressure transducers, and pressure gauges, placed in the test setup at the locations shown in Figure 3-4. The instrumentation ranges and types of recording are shown in Table 3-2. In addition a flowmeter was used to calibrate the liquid loop flow rate prior to starting the test. The flow calibration setup, which was used to determine the rate of flow in the liquid loop on the basis of measured condenser pressure drop (ΔP_2), is shown in Figure 3-5.

System Checkout

Prior to initiating the WRS feasibility test, a system checkout was conducted to establish hardware baseline data and to calibrate the controls for the nominal system cycle shown in Figure 3-8. The vapor loop downstream of the pyrolytic reactor was then removed and sterilized in the autoclave. During reassembly after sterilization, each joint reconnect was sterilized with an alcohol flame.

WRS testing was initiated with deionized water. After critical system parameters were stabilized, the feed fluid was switched to wash water on 21 March 1973.

TEST PROCEDURE AND RESULTS

The WRS feasibility test was divided into two phases. In the first phase, the system was operated with shower bath wash water, which was generated and treated as previously described. In the second phase, one part urine by weight was added to 10 parts of the wash water used for Phase I. Between phases, the system was shut down and an interim examination of the phase separator was made to determine the extent of solids buildup.



TABLE 3-2

INSTRUMENTATION RANGES AND TYPES

Code	Instrumentation Parameter	Units	Range	Types of Recording	
				Dynamic	Manual
T1	Separator Brine Outlet Temp	°F	-100 to +250	x	
T2	Condenser Brine Inlet Temp	°F	-100 to +250	x	
T3	Condenser Brine Outlet Temp	°F	-100 to +250	x	
T4	Compressor Vapor Inlet Temp	°F	-100 to +250	x	
T5	Compressor Vapor Outlet Temp	°F	-100 to +250	x	
T6	Separator Top Bearing Temp	°F	-100 to +250	x	
T7	Condenser Vapor Inlet Temp	°F	-100 to +250	x	
T8	Condenser Water Outlet Temp	°F	-100 to +250	x	
T9	Condenser Top Temp	°F	-100 to +250	x	
T10	Compressor Motor Temp	°F	-100 to +25	x	
T11	Compressor Bearing Temp	°F	-100 to +250	x	
T12	Separator Wall Temp	°F	-100 to +250	x	
T13	Reactor Bed Inlet Temp	°F	0 to 1000		x
T14	Reactor Bed Nominal Temp	°F	0 to 1000		x
T15	Reactor Outlet Temp	°F	0 to 1000		x
P1	Separator Brine Outlet Press	psia	0 to 32	x	
ΔP2	Condenser Brine Press Drop	psid	0 to 20	x	
P3	Separator Brine Inlet Press	psia	0 to 2	x	
ΔP4	Compressor Press Rise	psid	0 to 5		x
P5	Compressor Vapor Inlet Press	psia	0 to 5		x
P7	Condenser Vapor Inlet Press	psia	0.5 to 2.5	x	
P8	Condenser Water Outlet Press	psia	0.5 to 2.5	x	
P12	Condenser Overboard Press	psia	0 to 35		x
--	Separator Speed	rpm	600 to 2200	x	
--	Compressor Speed	rpm	0 to 25,000		x
--	Liquid Pump Power	watts	0 to 100		x
--	Compressor Power	watts	0 to 100		x



Phase I Testing

During Phase I testing, the WRS was operated in various modes. These modes and operating conditions are shown in Table 3-3. System operation in Phase I is discussed in the following paragraphs. System performance for all Phase I modes is summarized in Table 3-4. Major operating parameter values and accumulative weight of feed water and product water are plotted on a daily basis in Figures 3-10 through 3-13.

TABLE 3-3
PHASE I OPERATING MODES

<u>Mode</u>	<u>Condenser Vapor Press, psia</u>	<u>Separator Speed, rpm</u>	<u>Liquid Pump Use</u>
BL-1A	2.0	1400	In loop
BL-1B	2.0	1400	Bypassed
VAR-1	2.3	1400	In loop
VAR-2A	1.7	1400	In loop
VAR-2B	1.7	1400-1600	Bypassed
VAR-3A	2.0	1600	In loop
VAR-3B	2.0	1600	Bypassed
VAR-4	2.0	1700	Bypassed
VAR-5	2.0	1800	Bypassed

1. BL-1 Mode Operation

From 21 March to 11 April, the system was operated at baseline conditions-- 2.0 psia condenser vapor pressure and 1400 rpm separator speed-- with the liquid loop pump energized (BL-1A mode). On March 26, the system was stopped to allow the California state safety inspector to measure the Americium 241 source used for level detection. During this period, the test setup was changed to allow removal of the liquid pump without exposing the separator to atmospheric pressure. See photo Figure 3-6 for pump setup. This new test setup caused a slight restriction in the liquid loop reducing the liquid loop flow as noted on Figure 3-10 for the fifth day. From March



31 through April 2 (test days 11, 12 and 13) the liquid pump experienced some bearing problems causing intermittent liquid flow stoppage. No evidence of liquid loop plugging was noted. The WWS processed 556 lb of wash water over a period of 505 hours without shutdown. During this time, 543 lb of product water was recovered and 12.8 lb of wash water concentrate, containing 7.2 percent soap by weight, were dumped by the system. The water production rate was 1.07 lb/hr and system efficiency was 97.7 percent.





TABLE 3-4

WRS PERFORMANCE SUMMARY

Phase 1 Operating Period	Mode	Condenser Vapor Press. (Nominal), psia	Separator Speed (Nominal), rpm	Liquid Pump Use	Feed Water Weight (F), lb	Dump Liquid Weight (D), lb	Dump Liquid Solids Content (avg.), wt. percent	Product Water Weight (F-D), lb	Time In Mode (T), hr	Water Production Rate (Avg.) (F-D)/T, lb/hr	System Efficiency (F-D)/F, percent
3/21 - 4/11	BL-1A	2.0	1400	In loop	556.02	12.81	7.2	543.21	505	1.07	97.7
4/11 - 4/18	BL-1B	2.0	1400	bypassed	125.55	2.93	8.3	122.62	172	0.71	97.5
4/18 - 4/19	BL-1A	2.0	1400	In loop	29.77	1.21	8.6	28.56	25	1.14	96.0
4/19 - 4/25	VAR-1	2.3	1400	In loop	152.63	4.09	7.5	148.54	139	1.07	97.4
4/25 - 4/26	BL-1A	2.0	1400	In loop	28.02	0.63	5.9	27.39	24	1.14	97.8
4/26 - 4/27	VAR-2A	1.7	1400	In loop	30.19	0.69	5.0	29.50	24	1.23	97.7
4/27 - 5/1	VAR-2B	1.7	1400-1600	bypassed	70.33	2.53	7.4	67.80	96	0.71	96.5
5/1 - 5/2	VAR-2A	1.7	1600	In loop	27.30	0.81	9.3	26.49	24	1.10	97.1
5/2 - 5/6	VAR-3A	2.0	1600	In loop	104.76	3.37	6.5	101.39	90	1.12	96.8
5/6 - 5/11	VAR-3B	2.0	1600	bypassed	90.74	2.65	5.2	88.09	126	0.70	97.0
5/11 - 5/16	VAR-4	2.0	1700	bypassed	142.30	3.96	5.9	138.34	124	1.10	97.1
5/16 - 5/21	(*)	2.0	1250-2250	bypassed	46.41	2.37	3.9	44.04	79	0.56	95.0
5/21 - 6/6	VAR-4	2.0	1700	bypassed	337.91	8.18	7.5	329.73	340	0.97	97.6
6/6 - 6/13	VAR-5	2.0	1800	bypassed	182.78	5.20	8.3	177.58	173	1.03	97.0
6/13 - 6/15	(**)	2.0	1400	bypassed	12.10	0.60	3.9	11.50	27	0.43	95.0
					1936.81 Total	51.93 Total		1884.88 Total	1968 Total	0.96 Overall	97.3 Overall
Phase 2 Operating Period											
6/15-7/3	(***)	2.0	1700	bypassed	265.34	11.76	7.1	253.48	430	0.59	95.7

(*) Evaluation and checkout of porous plates in condenser.

(**) System stabilization with wash water prior to adding urine.

(***) 1 part urine added to 10 parts water by weight

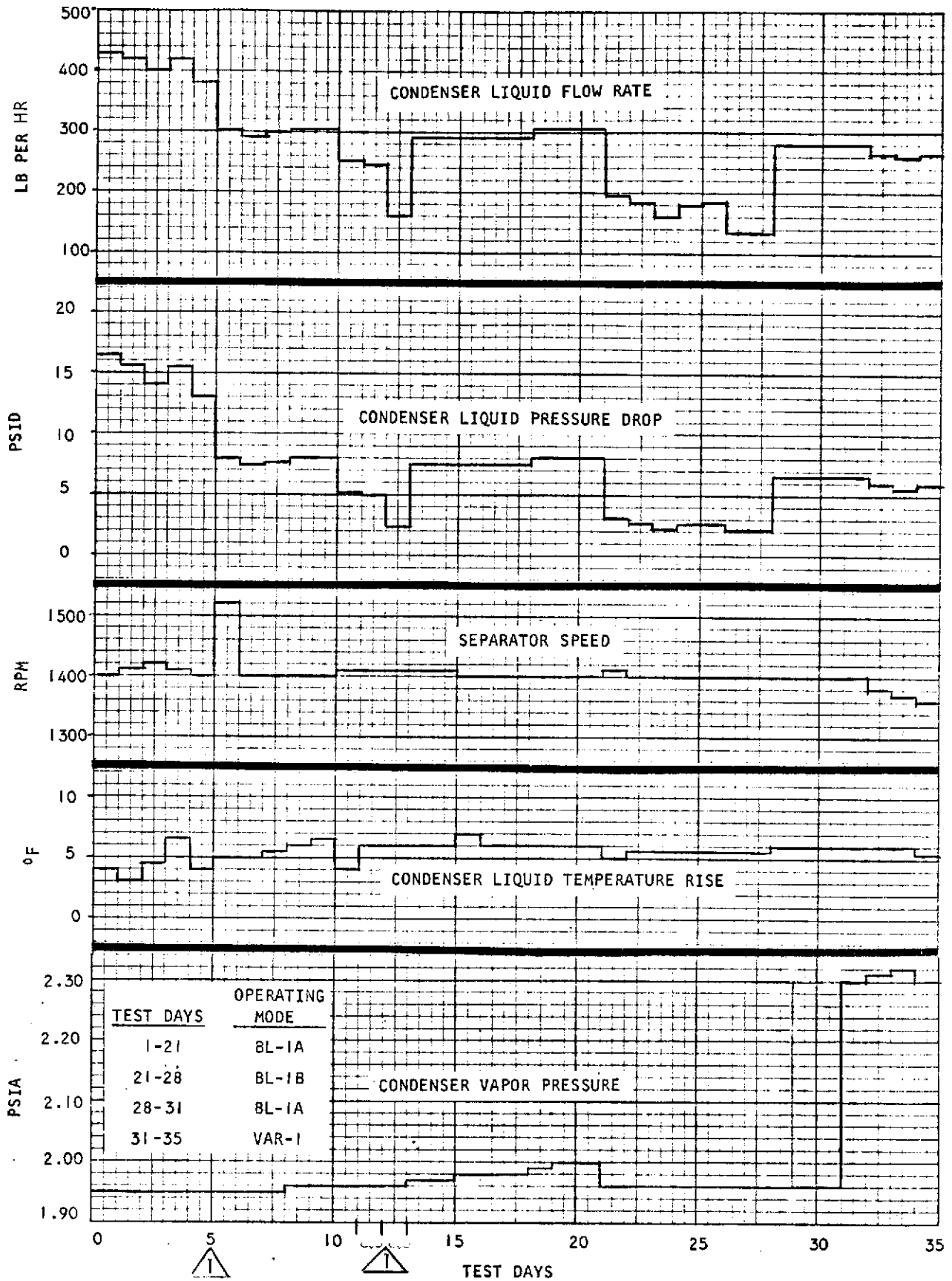

Figure 3-10. Major Operating Parameter Values, Days 1-35

⚠ See page 3-17, 3-18



AIRESEARCH MANUFACTURING COMPANY
Los Angeles, California

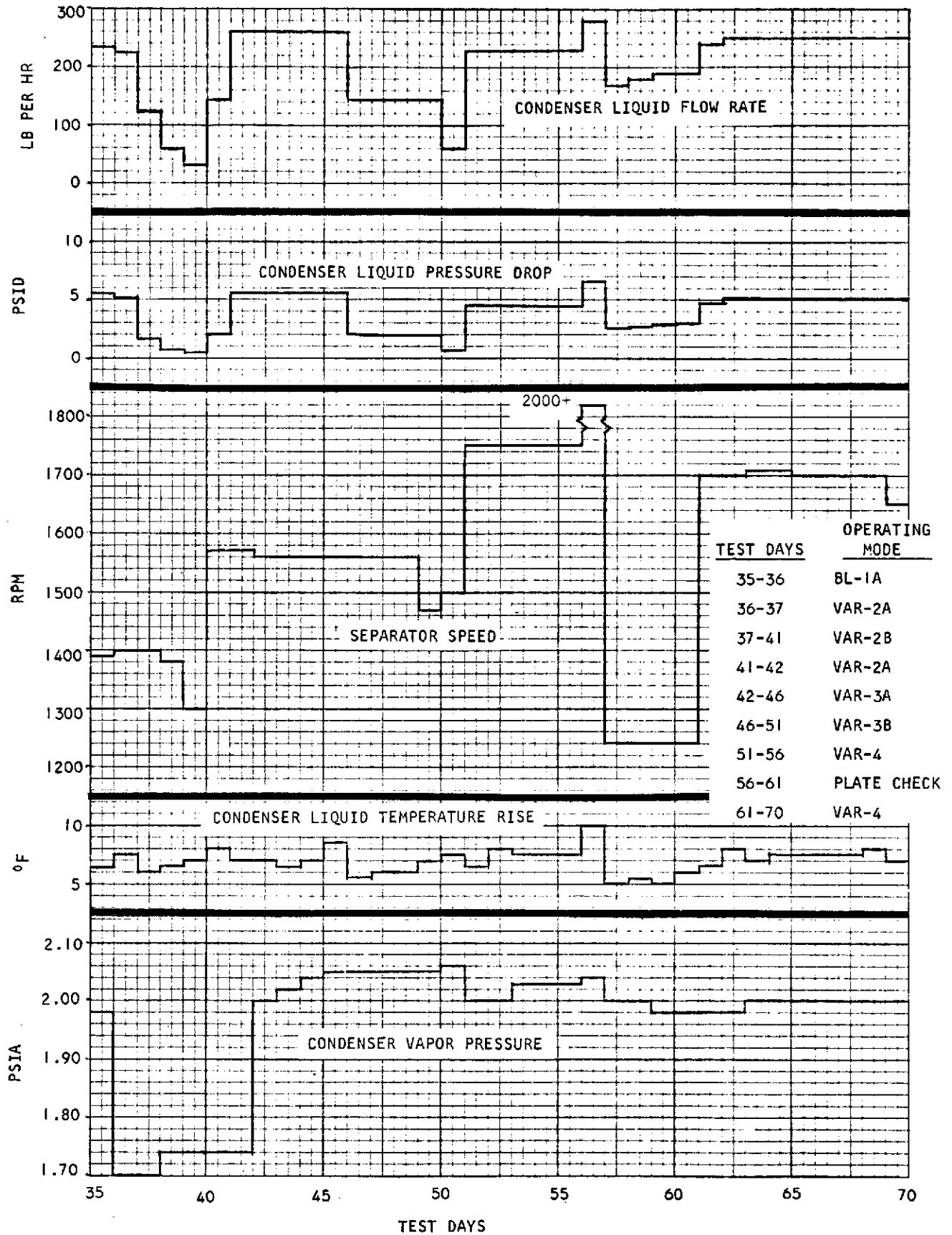

Figure 3-11. Major Operating Parameter Values, Days 36-70



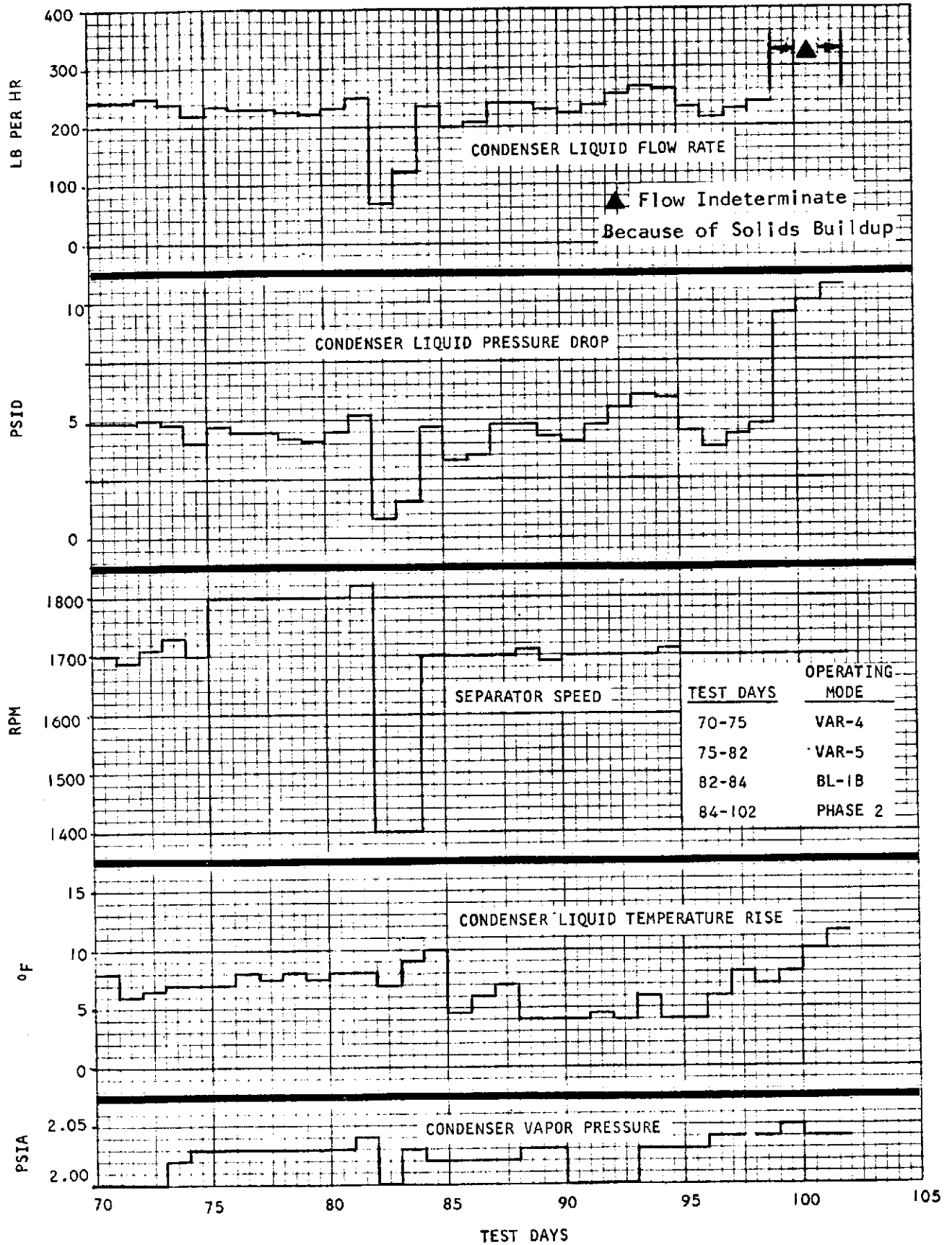

Figure 3-12. Major Operating Parameter Values, Days 71-102



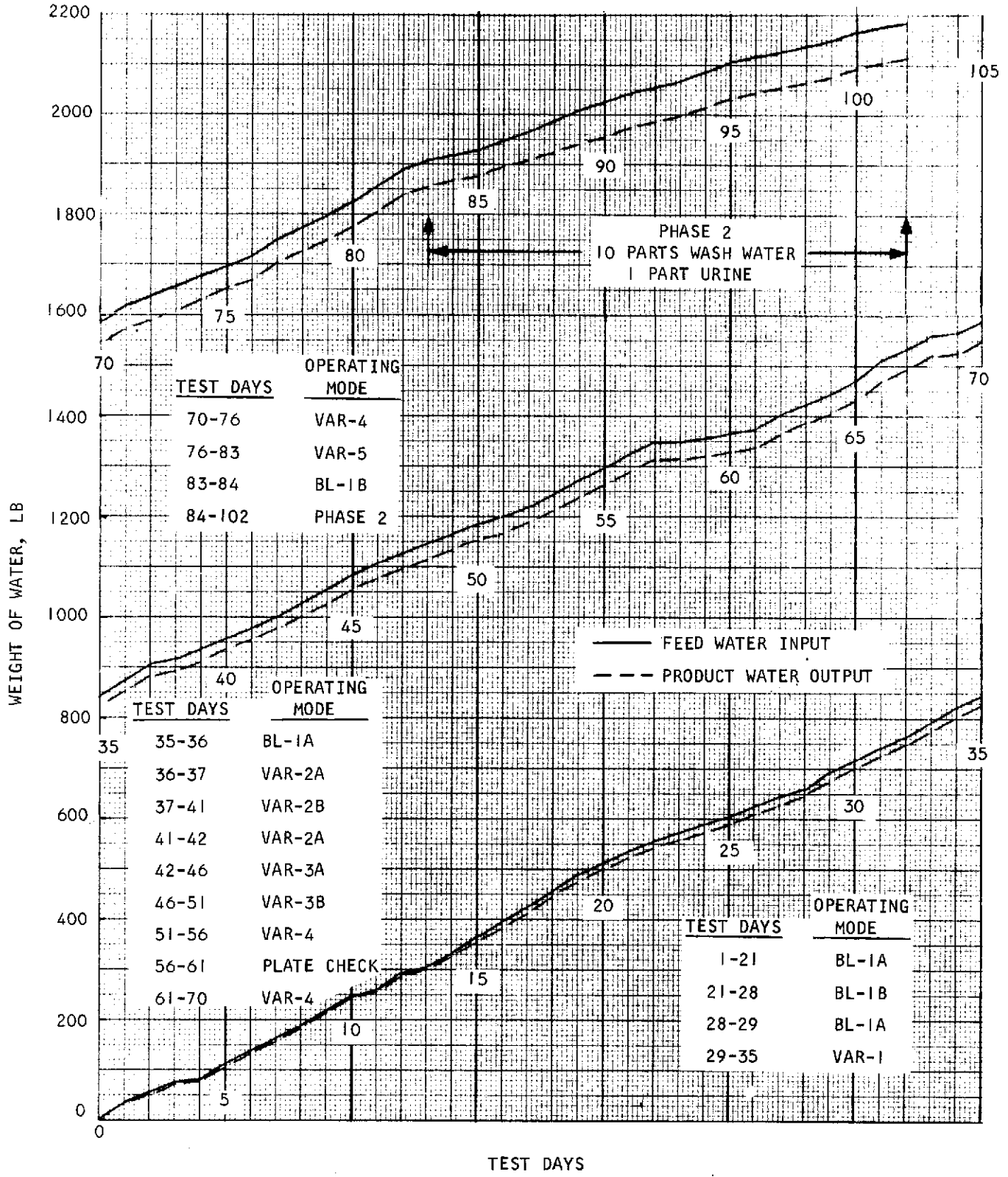

Figure 3-13. Accumulative Daily Total Weight of Feed Water Input and Product Water Output



Operation at baseline conditions, but with the liquid loop pump bypassed (BL-IB mode), was continued without incident from 11 April to 18 April. The WWRS processed 126 lb of wash water over a period of 172 hours. In this period, 123 lb of product water was recovered and 2.9 lb of wash water concentrate, containing 8.3 percent soap by weight, were dumped by the system. The water production rate was 0.71 lb/hr, and system efficiency was 97.5 percent. In comparing system operation with and without the liquid loop pump in use, the primary difference was in the water production rate, which was 34 percent less when the pump was bypassed.

During the next system cycle, covering a 25-hour period from 18 April to 19 April, the pump again was placed in operation (BL-IA mode). The water production rate increased to 1.14 lb/hr, which slightly exceeded the rate achieved initially in the BL-IA mode.

2. VAR-1 Mode Operation

From 19 April to 25 April, the WWRS was operated under a variation from the baseline, wherein condenser vapor pressure was increased to 2.3 psia (VAR-1 mode). Again, the liquid loop pump was operated. System operation remained normal and no plugging of the liquid loop occurred. The WWRS processed 153 lb of wash water in a 139-hour period and recovered 149 lb of product water. A total of 4.1 lb of wash water concentrate, which contained 7.5 percent soap by weight, was dumped. Results showed a water recovery rate and a system efficiency similar to those obtained for the BL-IA mode at the start of the test. For comparison purposes, the BL-IA mode of operation was repeated for one cycle (24 hours). Results were similar to those obtained previously for the BL-IA mode.

3. VAR-2 Mode Operation

Following the BL-IA baseline cycle, condenser vapor pressure was reduced to 1.7 psia, and the system was operated in the VAR-2 mode from 26 April to 2 May. With the liquid loop pump still in operation (VAR-2A mode), the WWRS produced water at a rate of 1.23 lb/hr for a 24 hour period. System efficiency was 97.7 percent. During the next 96 hours, the system was operated in the VAR-2B mode (pump bypassed). Initially, separator speed remained set at 1400



rpm and then was increased to 1570 rpm. Because of the lower liquid loop flow rate without the pump operating, the water production rate dropped to 0.71 lb/hr and system efficiency decreased to 96.5 percent.

During VAR-2B mode operation, a considerable increase in the amount of condenser overboard water was observed, indicating possible performance degradation of the porous plates used in the condenser gas trap assemblies.

When the liquid loop flow rate was increased, by again operating the system in the VAR-2A mode for one cycle, system performance was nearly the same as with that previously obtained in this mode, except for a slight decrease in water production rate (1.10 lb/hr versus 1.23 lb/hr).

4. VAR-3 Mode Operation

On 2 May, condenser vapor pressure was increased from 1.7 psia to 2.0 psia. To operate the WWRS in the VAR-3A mode, the liquid pump remained in operation. System performance during 90 hours of operation in the VAR-3A mode was essentially the same as achieved in the VAR-2A mode, indicating that the condenser vapor pressure change had a negligible effect on performance.

From 6 May to 11 May, the liquid pump was bypassed to operate the WWRS in the VAR-3B mode. As occurred in previous pump-bypassed operation, the water production rate fell to 0.70 lb/hr. System efficiency remained essentially the same.

During the entire VAR-3 mode testing, system operation was normal except that excessive condenser overboard water continued to be observed as in VAR-2B mode operation. No signs of liquid loop plugging were evident.

5. VAR-4 Mode Operation

For the remainder of the WWRS feasibility study (11 May to 15 June), the liquid loop pump was bypassed and a condenser vapor pressure of 2.0 psia was maintained. To increase the water production rate, the phase separator was operated at speeds above 1600 rpm, except for evaluation and checkout periods.

The first increase in separator speed (to 1700 rpm) occurred on 11 May and continued for 124 hours, while operating the WWRS in the VAR-4 mode. During this period, which ended 16 May, the WWRS processed 142 lb of wash



water and recovered 138 lb of product water. A total of 4.0 lb of wash water concentrate, containing 5.9 percent soap by weight, was dumped by the system. The water production rate was 1.10 lb/hr and system efficiency was 97.1 percent.

The occurrence of excessive condenser overboard water continued throughout the period of operation in the VAR-4 mode. On 17 May, supplemental testing was initiated to evaluate the condition of the porous metal plates in the condenser gas trap assemblies. This testing conclusively showed that performance of the plates had degraded. The plates were removed and cleaned. After replacement of the plates in the condenser, a system functional checkout was performed from 18 May to 21 May to ensure proper operation and to stabilize critical operating parameters.

WWRs testing in the VAR-4 mode was resumed on 21 May and continued until 6 June, except for shutdowns between 3 June and 5 June to replace compressor motor bearings. In the ensuing 340-hour operation period, the water production rate decreased by 0.13 lb/hr and system efficiency increased by 0.5 percent. The system functioned normally in all respects, and minimal condenser overboard water was observed.

6. VAR-5 Mode Operation

The separator speed was increased from 1700 rpm to 1800 rpm on 6 June to operate the system in the VAR-5 mode. A slight change from VAR-4 mode performance was observed. The WWRs processed 183 lb of wash water in a 173 hour period ending on 13 June and recovered 178 lb of product water. The dumped wash water concentrate totalled 5.2 lb, the soap content of which was 8.3 percent by weight. The water recovery rate was 1.03 lb/hr and system efficiency was 97.0 percent.

Interim Examination After Phase I Testing

The system was shut down on 13 June to examine vulnerable parts of the liquid loop for evidence of soap deposits or residue. The transparent liquid lines between the phase separator and the condenser inlet were found to be free of deposits. The top cover of the separator was removed and the unit was partially disassembled. Photographs of the condenser liquid inlet port and the exposed internal portions of the separator are shown in Figures 3-14



through 3-19. As can be seen from these photographs, some soap residue was found, but in non-circulatory areas only. Evaluation of the phase separator condition after 83 days of operation indicated no reason that the WWRS could not continue processing wash water for an equal period of time. At this point, it was decided that further testing contemplated for the WWRS should include the addition of urine in the feed water.

Phase 2 Testing

After reassembling the phase separator and reconnecting the condenser, the WWRS was restarted on 13 June and operated with wash water to check out system operation and achieve system stabilization before introducing urine. With NASA concurrence, it was decided to operate the WWRS with the worst case test fluid mixture, consisting of one part urine added to 10 parts wash water, by weight.

The second phase of the three-month feasibility study, in which the feasibility of processing wash water and urine simultaneously was to be determined, began on 15 June. A condenser vapor pressure of 2.0 psia and a separator speed of 1700 rpm (with the liquid pump bypassed) was established and maintained throughout Phase 2.

A review of system performance in Phase 2 showed that the WWRS processed a mixture of 240 lb of wash water and 25 lb of urine in a period of 430 hours. During this period, 253 lb of product water was recovered and 11.8 lb of wash water concentrate and urine brine, containing 7.1 percent soap and brine salts, was dumped by the system. The water production rate was 0.59 lb/hr and system efficiency was 95.7 percent. Daily values of major operating parameters and accumulative weights of feed water input and product water output are shown on Figures 3-12 and 3-13 for Phase 2 operation (test days 84 to 102).

During the last several days of Phase 2 operation, a marked decrease in product water output was observed. In addition, compressor inlet pressure steadily decreased while compressor vapor pressure rise, condenser liquid loop pressure drop and temperature rise kept increasing. Also, the condenser liquid loop pressure drop was approximately equal to the separator liquid pressure rise. Evaluation of these parameter changes pointed toward flow blockage in the condenser liquid loop.



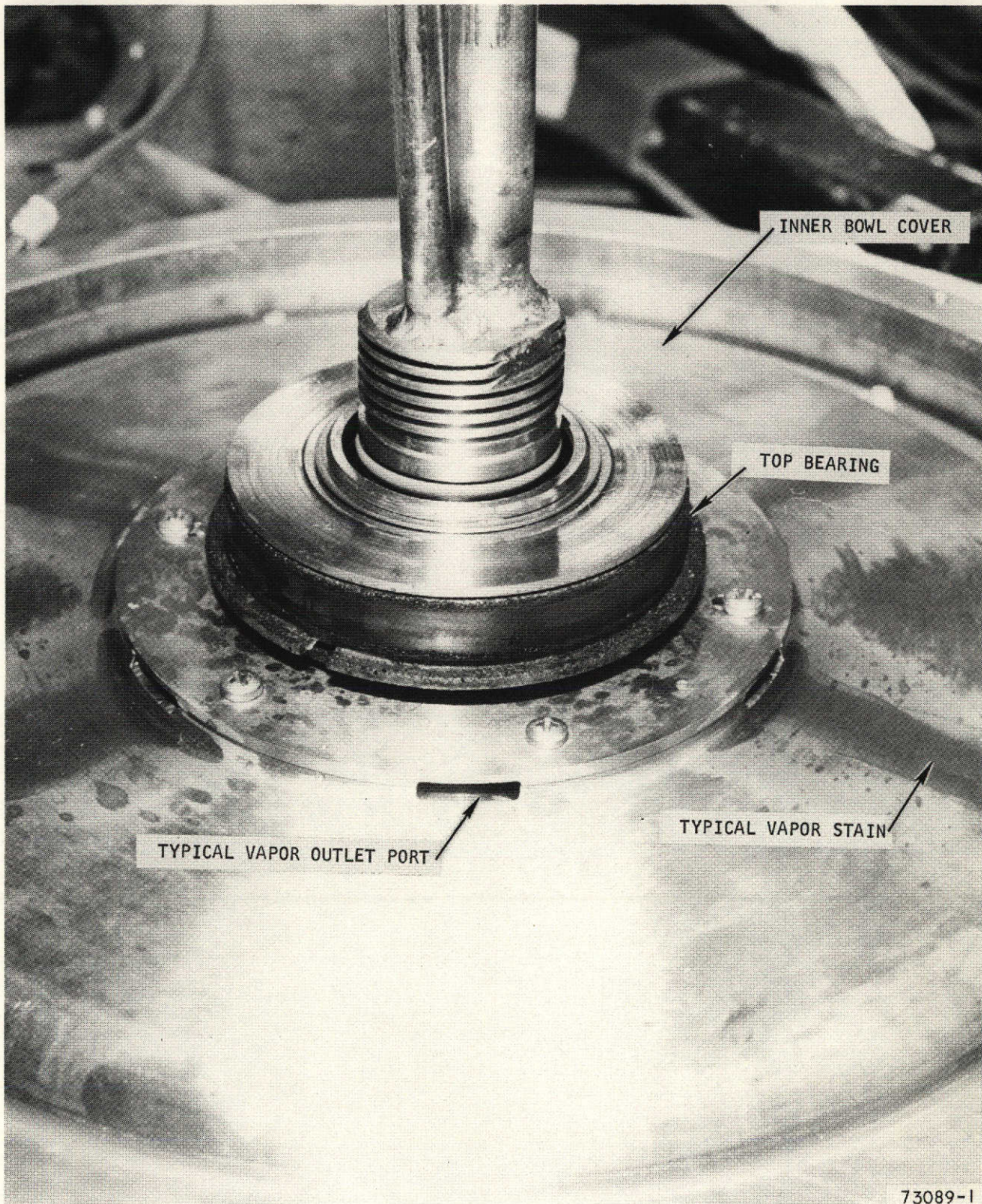
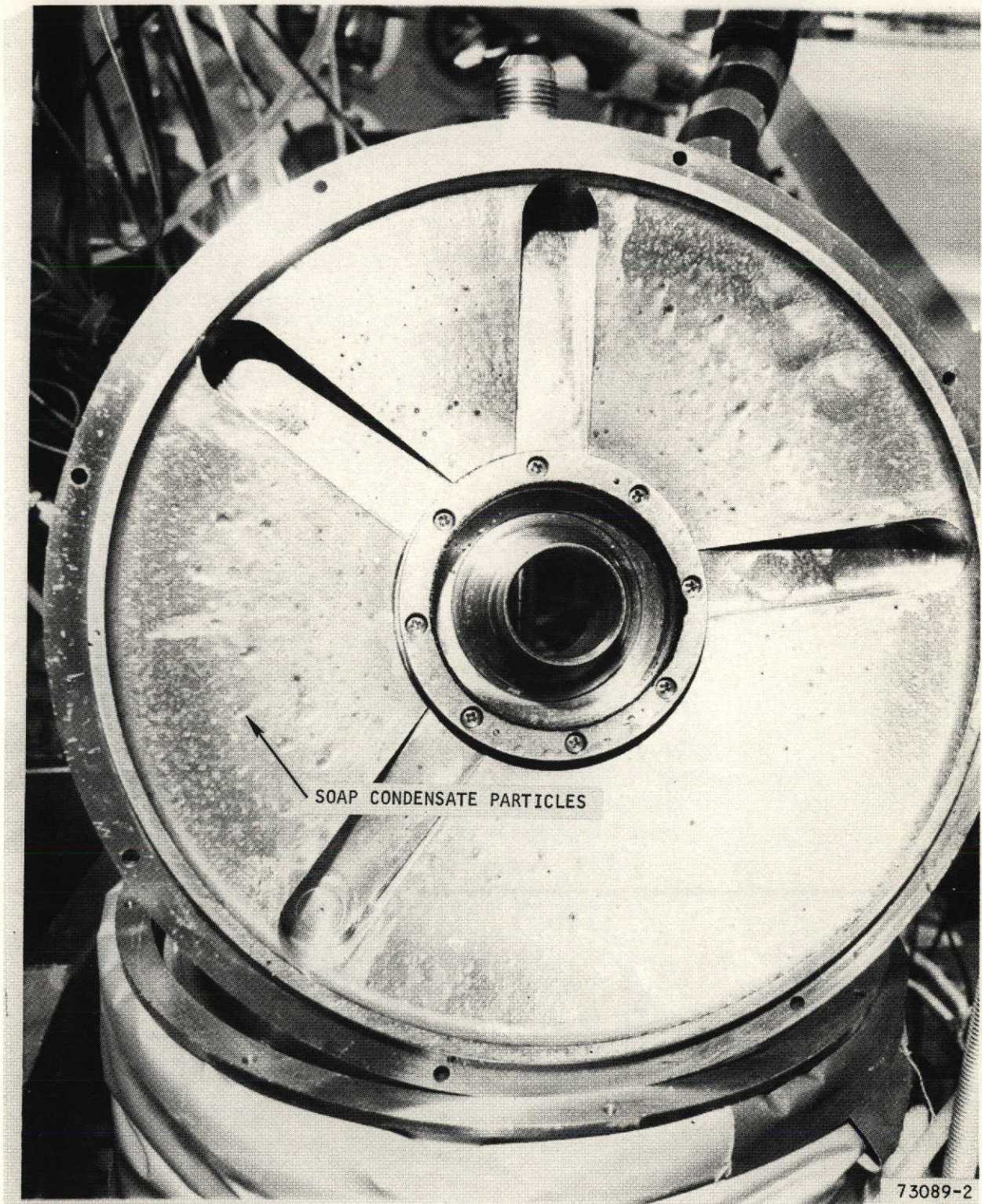

Figure 3-14. Post Phase I Examination, Appearance of Separator With Outer Bowl Top Cover Removed





73089-2

Figure 3-15. Post Phase I Examination, Appearance of Inside Surface of Separator Outer Bowl Top Cover



AIRESEARCH MANUFACTURING COMPANY
Los Angeles, California



Figure 3-16. Post Phase I Examination, Appearance of Separator Shaft Assembly and Condenser Liquid Inlet Port





Figure 3-17. Post Phase I Examination, Appearance of Separator Inner Bowl Cover



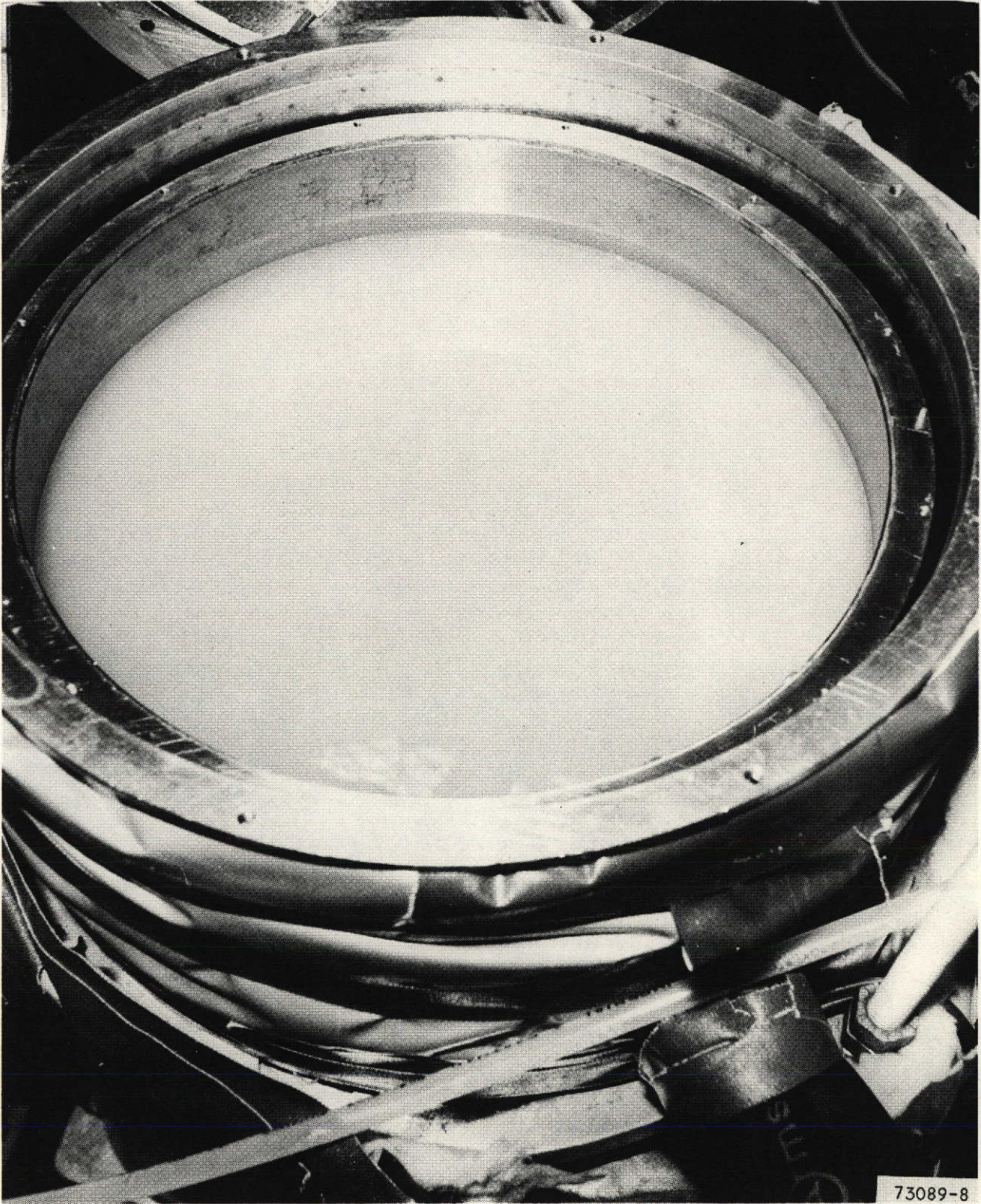

Figure 3-18. Post Phase I Examination, Concentrated Soap Solution Remaining in Separator Inner Bowl



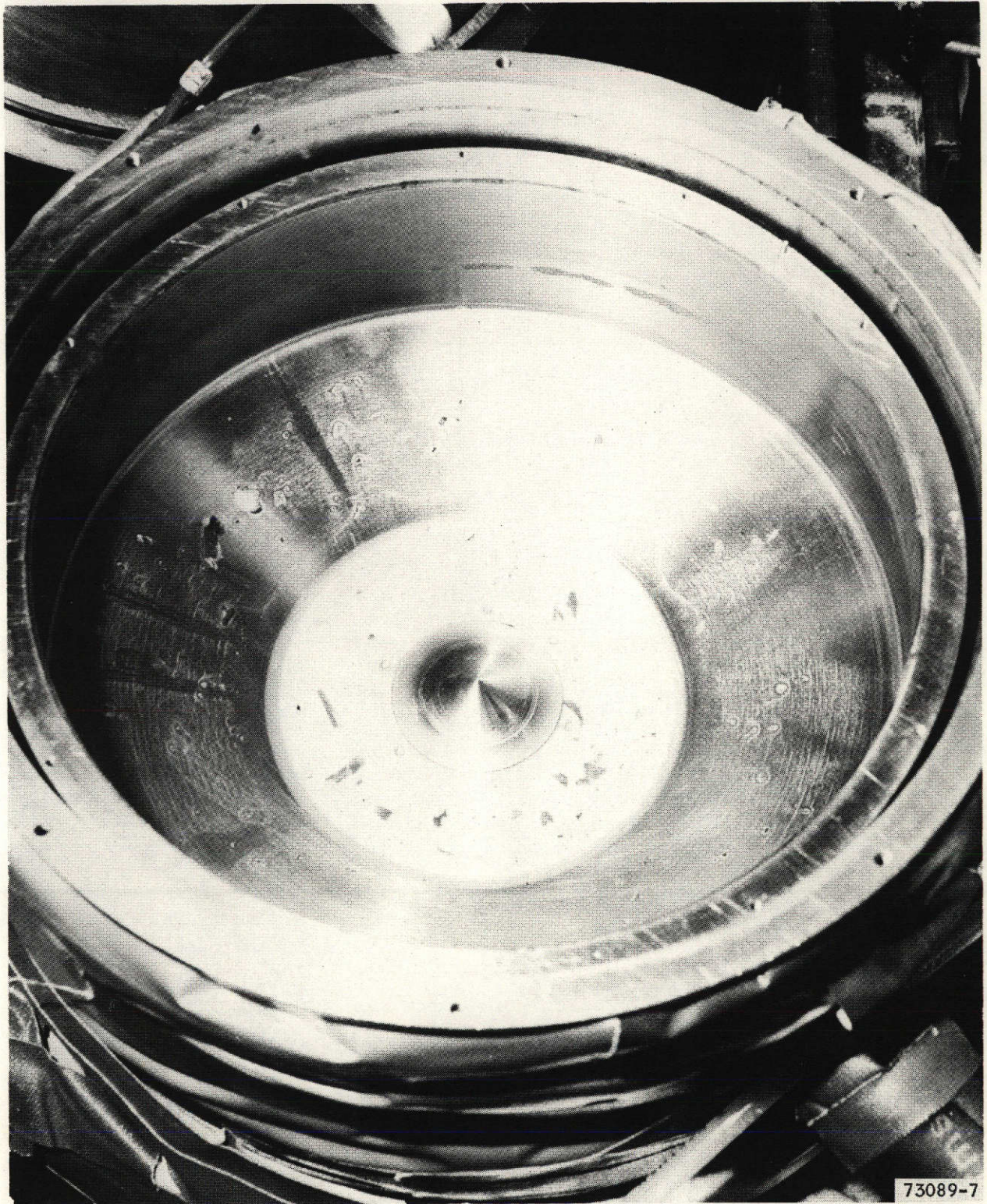

Figure 3-19. Post Phase I Examination, Soap Residue Remaining in Separator Inner Bowl (Liquid Removed)



The flash valve position was varied from 1/2 to 2 turns open to evaluate its effect on flow. Liquid loop flow dropped to zero; completely opening the flash valve did not allow flow to resume. Approximately one lb of feed liquid was manually injected into the separator with no change.

An attempt to dump the liquid loop manually was unsuccessful. This substantiated the assumption that the flow blockage was in the condenser, or at least upstream of the dump valve.

The NASA technical representative was informed of the blockage problem and concurred with the AiResearch recommendations that the test be terminated at this point and that the liquid loop be systematically disassembled to evaluate the nature of blockage and the general condition of the loop.

The second phase was concluded on 3 July, after 19 days of testing with the mixed fluid. A total of 102 days of testing was performed in Phases 1 and 2.

Examination and Analysis After Phase 1 Testing

Before disassembling the liquid loop, the transparent liquid lines were examined and showed heavy deposits in the first 8 inches downstream of the separator outlet interface and between the liquid pump bypass valve and the condenser inlet. A few thick dark liquid deposits were observed between the flash valve inlet and the condenser outlet.

During liquid loop disassembly, the separator outlet tube end was observed to be filled almost completely with a grey gelatinized substance, which also was visible in the flash valve ports. The separator inlet tube was almost entirely free of gel. The same gelatinized substance was found at the condenser liquid inlet and outlet ends. The vapor side of the condenser was free of soap or urine brine deposits. The porous metal plate gas traps were found to be clean. The condenser liquid loop was radiographically inspected, but the plugging did not show up on the film.

The separator was then partially disassembled. The outside of the inner bowl, which was exposed to vapor, showed no evidence of soap or brine carry-over. After disassembly, the inside of the outer bowl was found to be clean, except for light deposits on the walls. The outside surfaces of the inner bowl were very clean, except for minor deposits down near the bearings.



After removal of the liquid, the inside of the inner bowl was found to be coated with the same gelatinized substance found in the lines. The liquid loop pitot pickup was also packed with the gel and heavy deposits were observed at the base of the pitot tube. Further disassembly and inspection of the other liquid loop interfaces revealed the presence of the gel in varying quantities. Photographs of the disassembled hardware are shown in Figures 3-20 through 3-33.

An evaluation of the plugging problems resulted in the conclusion that the urine salts caused the dissolved soap in the wash water to become insoluble in the wash water/urine mixture. As the salt concentration increased, more soap was driven out of the solution until the liquid loop was completely plugged with solidified soap. Other inspection results and evaluations of WWS hardware are summarized in Table 3-5.

ANALYSIS OF PRODUCT WATER

Microbiological Analysis

1. Purpose

The purpose of the microbiological analysis was to analyze product water for the presence of bacterial and fungal contamination. Ten samples for analysis were taken on a weekly basis for comparison with a baseline sample taken prior to adding wash water. Although total aerobic counts were obtained, only a minimal effort was made to identify the isolated microorganisms.

2. Methods

- (a) Sterilization of the System -- The water recovery side of the WWS (from the pyrolytic reactor to the water collection tank) and all glassware and materials used to collect the product water were sterilized in an autoclave.
- (b) Collection of Water Samples -- Water samples were obtained using aseptic techniques and were collected in sterile flasks. Ethanol (70%) was used to wipe off the product water collection port prior



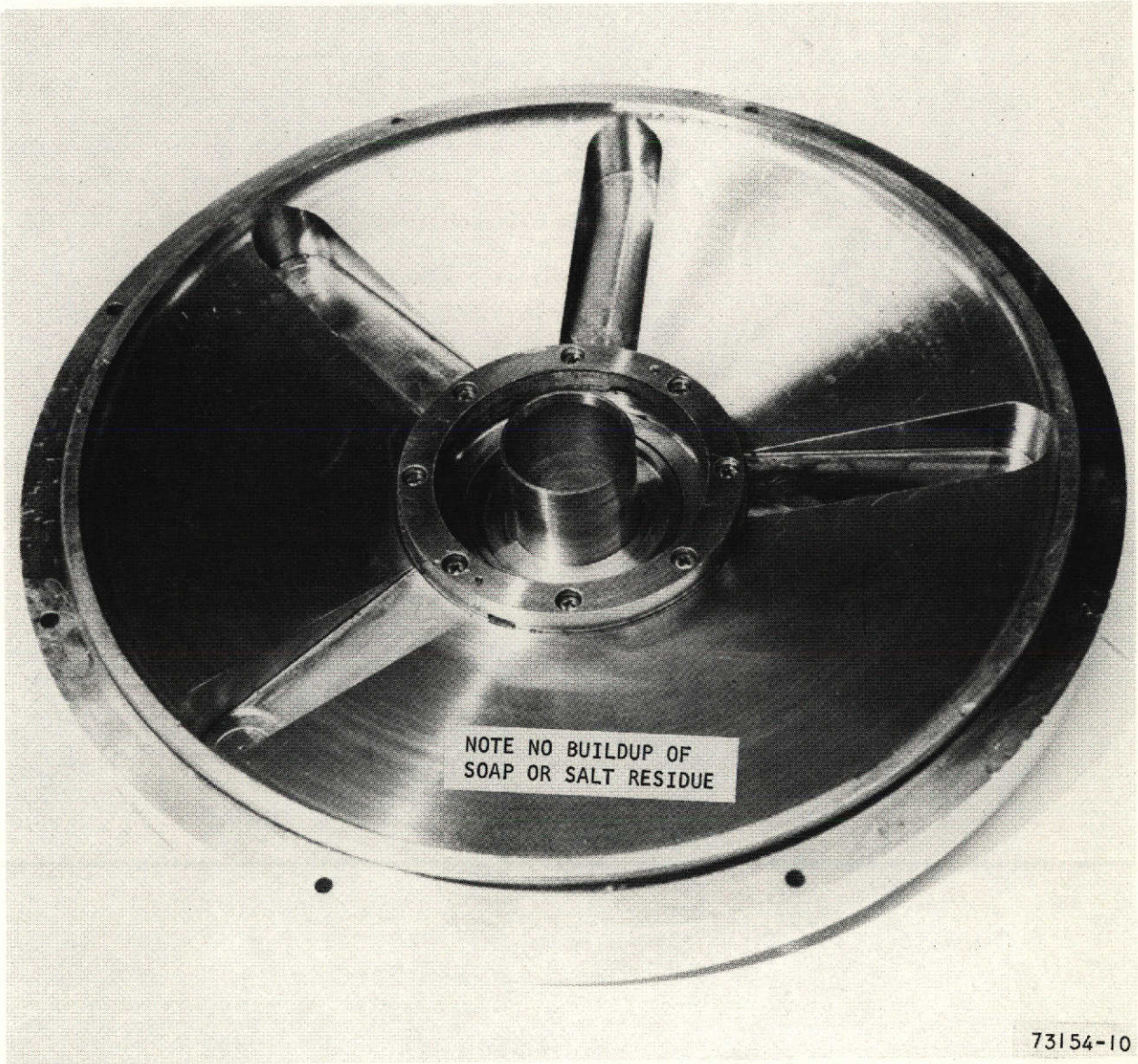

Figure 3-20. Post Phase 2 Examination, Appearance of Separator Outer Bowl Top Cover



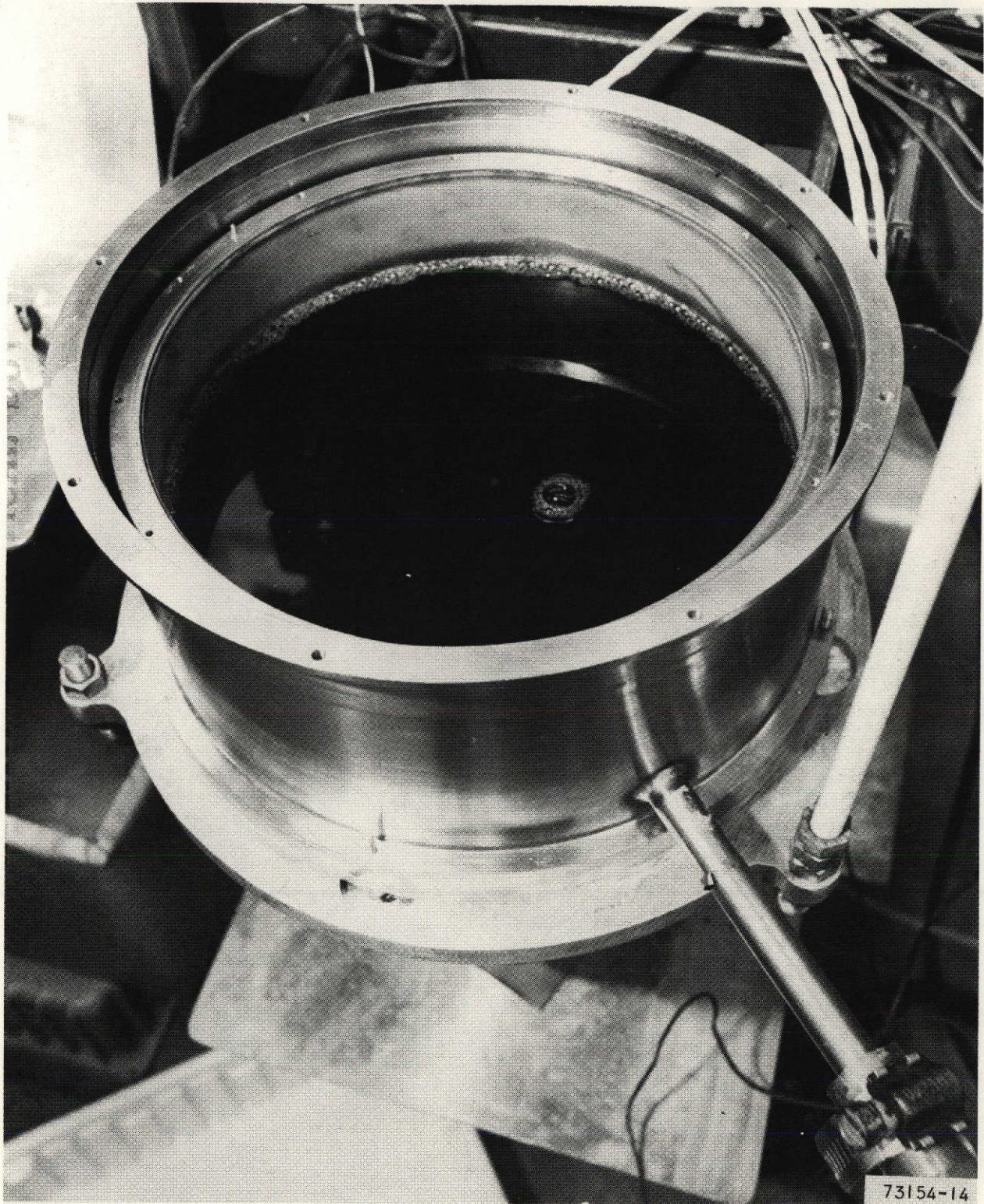

Figure 3-21. Post Phase 2 Examination, Concentrated Soap Solution and Urine Brine Remaining in Separator Inner Bowl



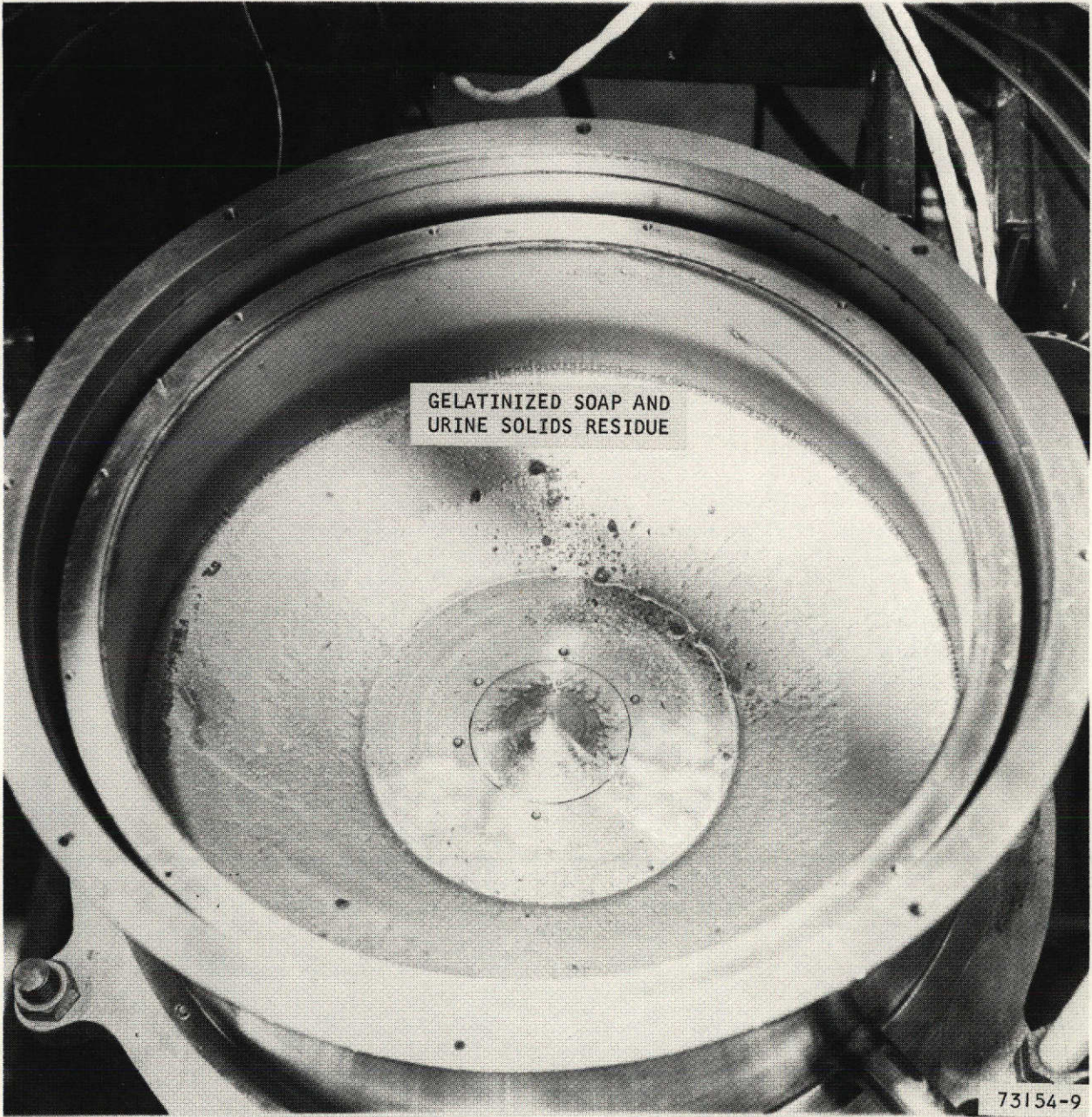

Figure 3-22. Post Phase 2 Examination, Appearance of Separator Inner Bowl (Liquid Removed)



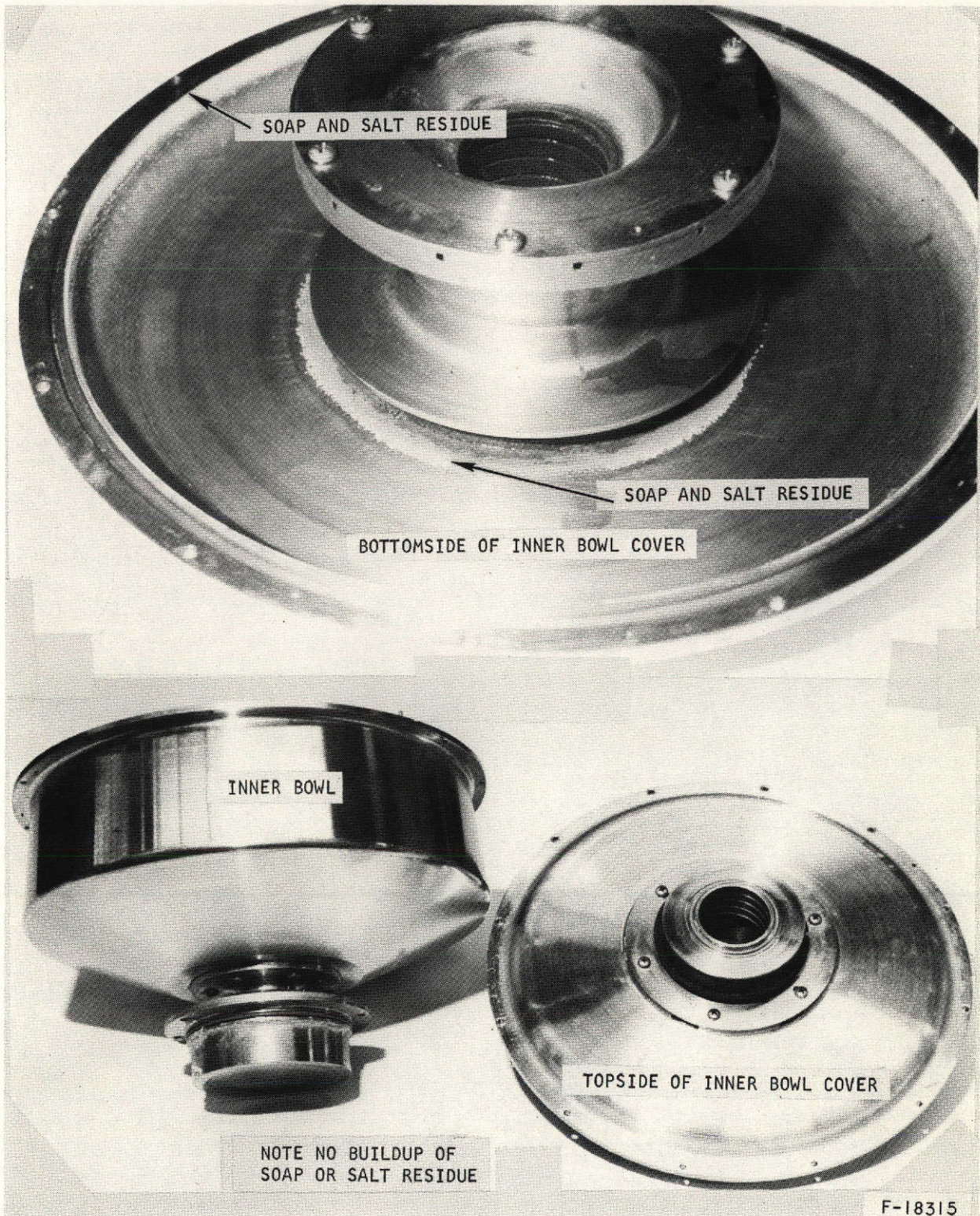

Figure 3-23. Post Phase 2 Examination, Appearance of Separator Inner Bowl and Inner Bowl Cover



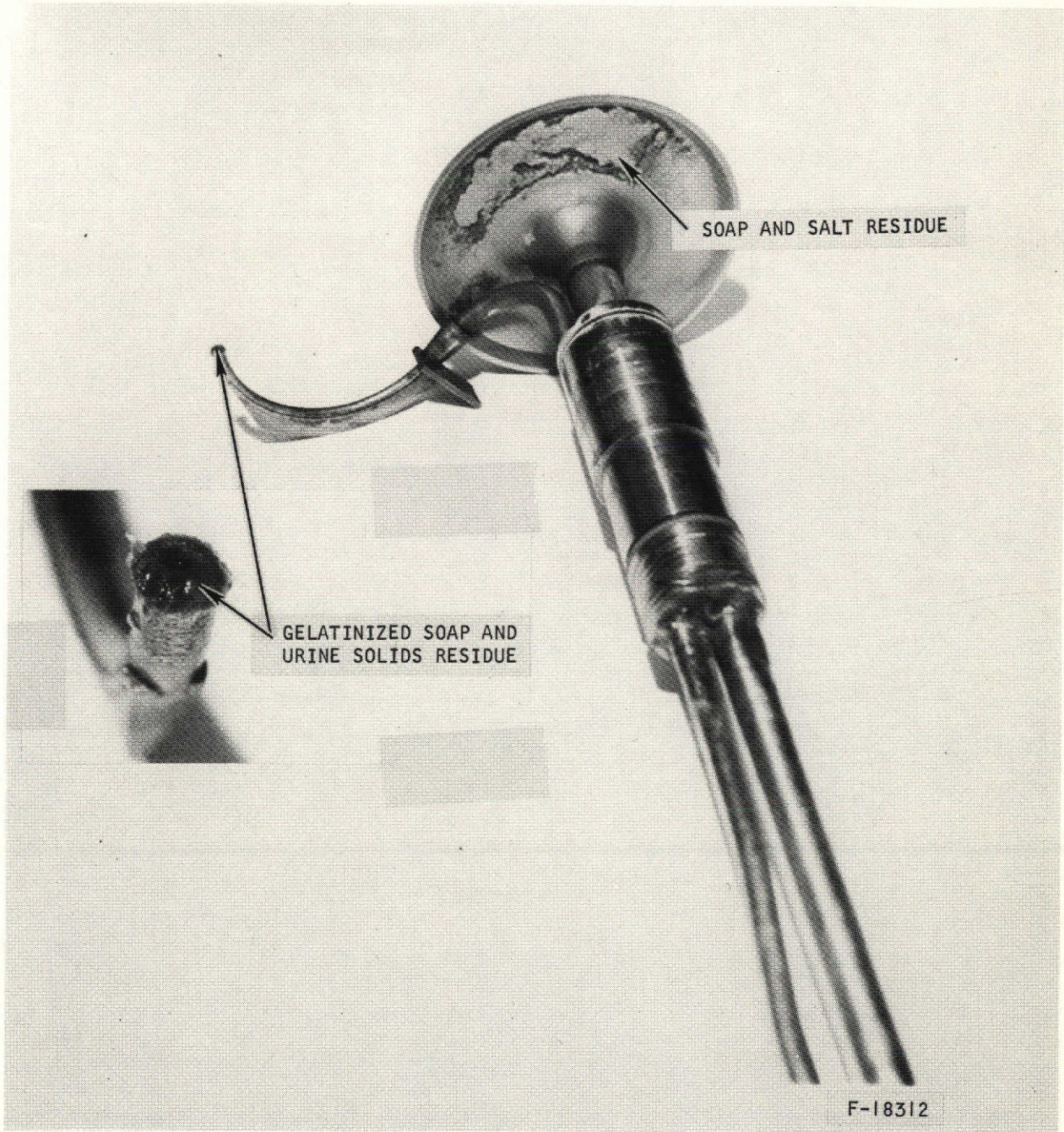

Figure 3-24. Post Phase 2 Examination, Appearance of Separator Shaft Assembly and Liquid Pitot Pickup





Figure 3-25. Post Phase 2 Examination, Appearance of Separator Outer Bowl Housing



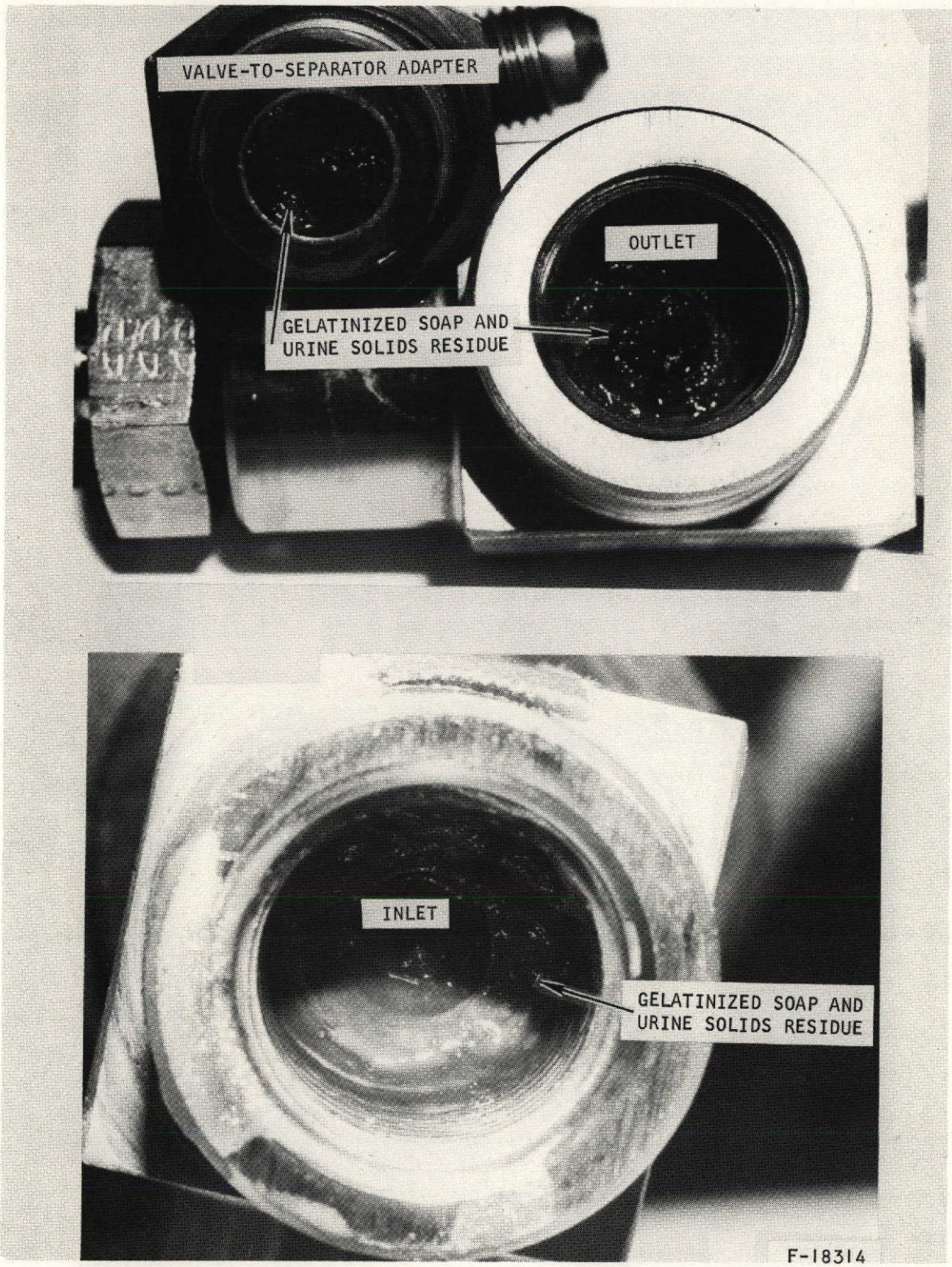

Figure 3-26. Post Phase 2 Examination, Appearance of Flash Valve Ports



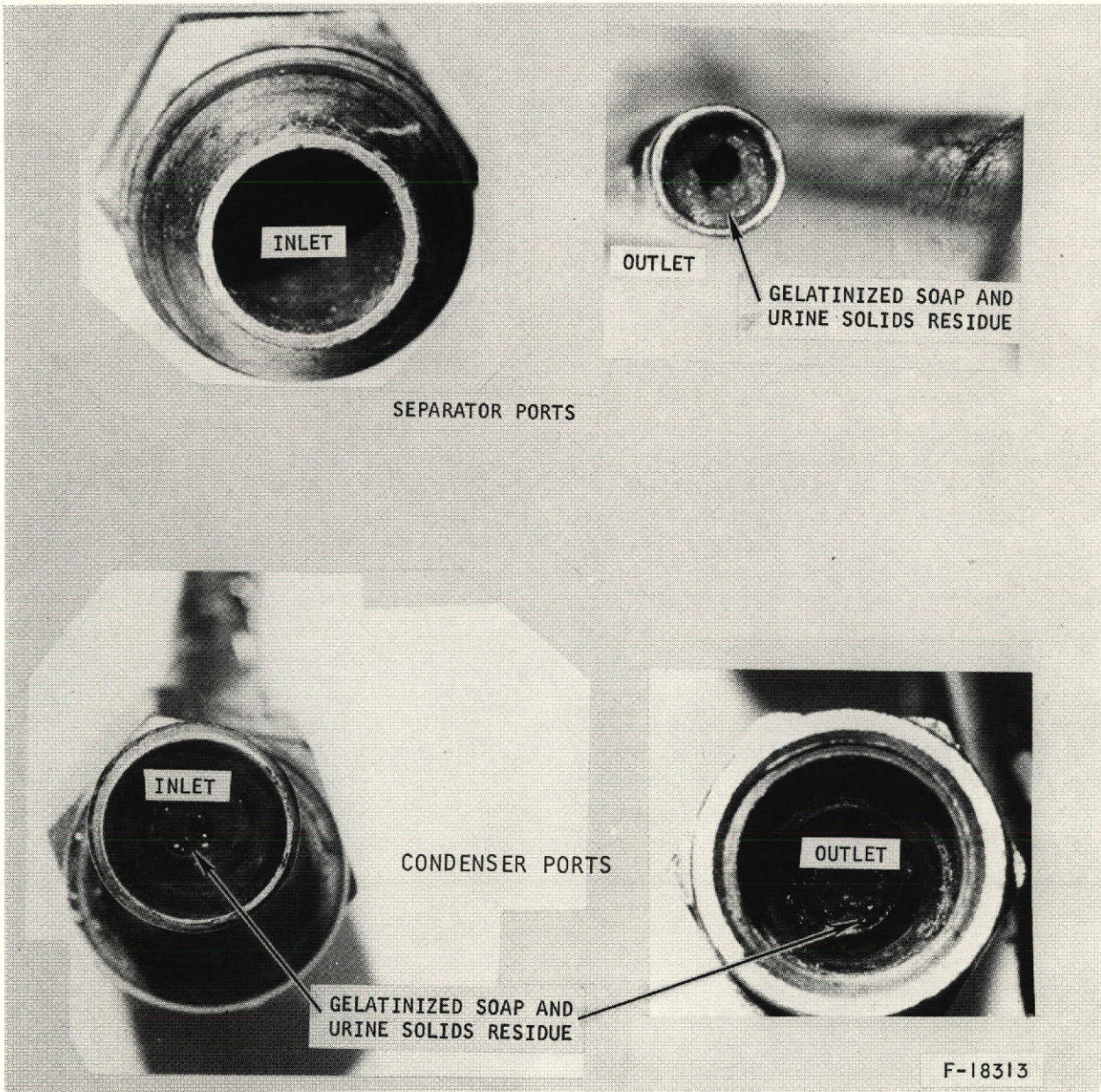

Figure 3-27. Post Phase 2 Examination, Appearance of Separator and Condenser Liquid Ports



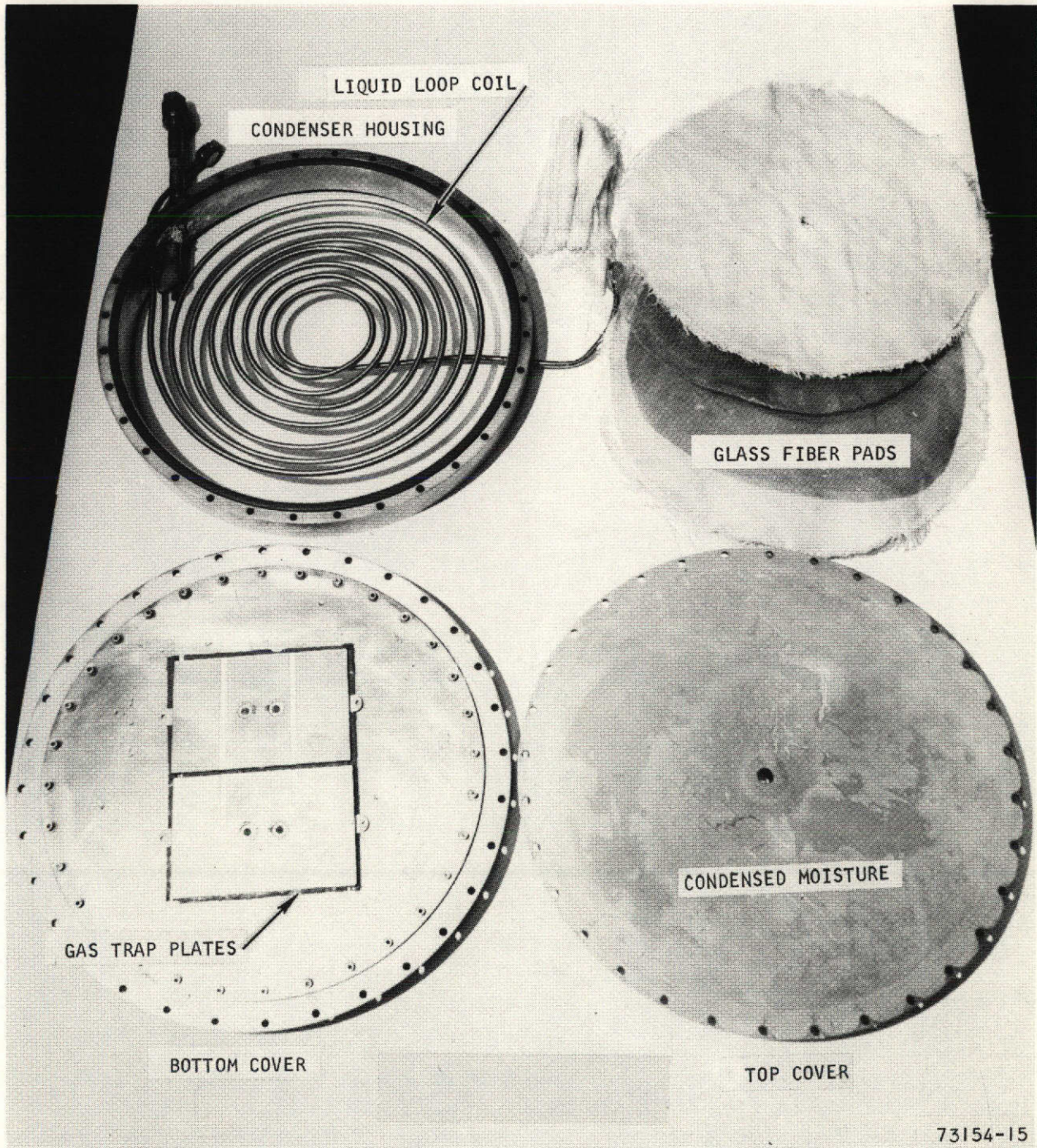

Figure 3-28. Post Phase 2 Examination, Appearance of Condenser Components



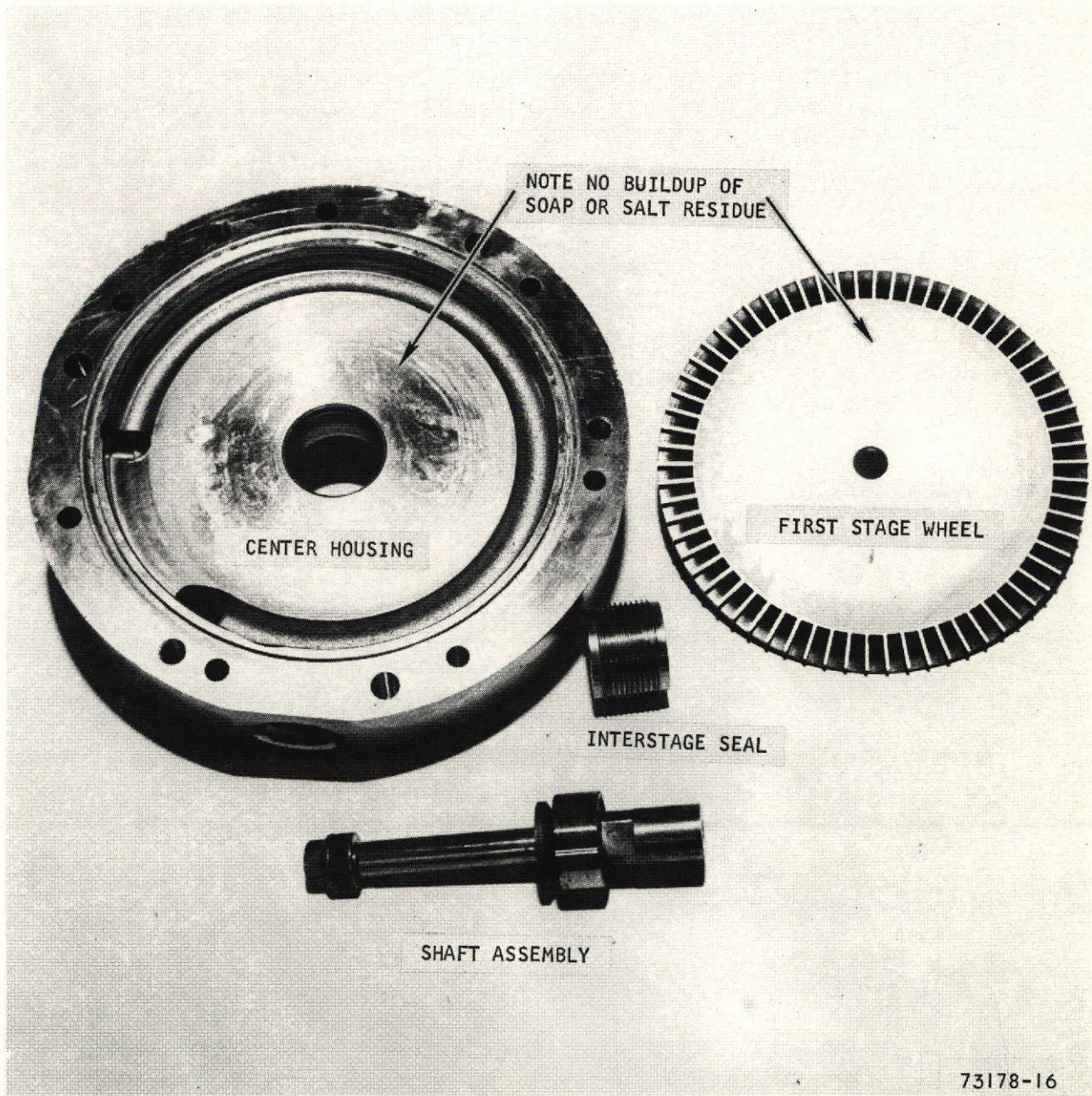

Figure 3-29. Post Phase 2 Examination, Appearance of Compressor First Stage Wheel and Center Housing



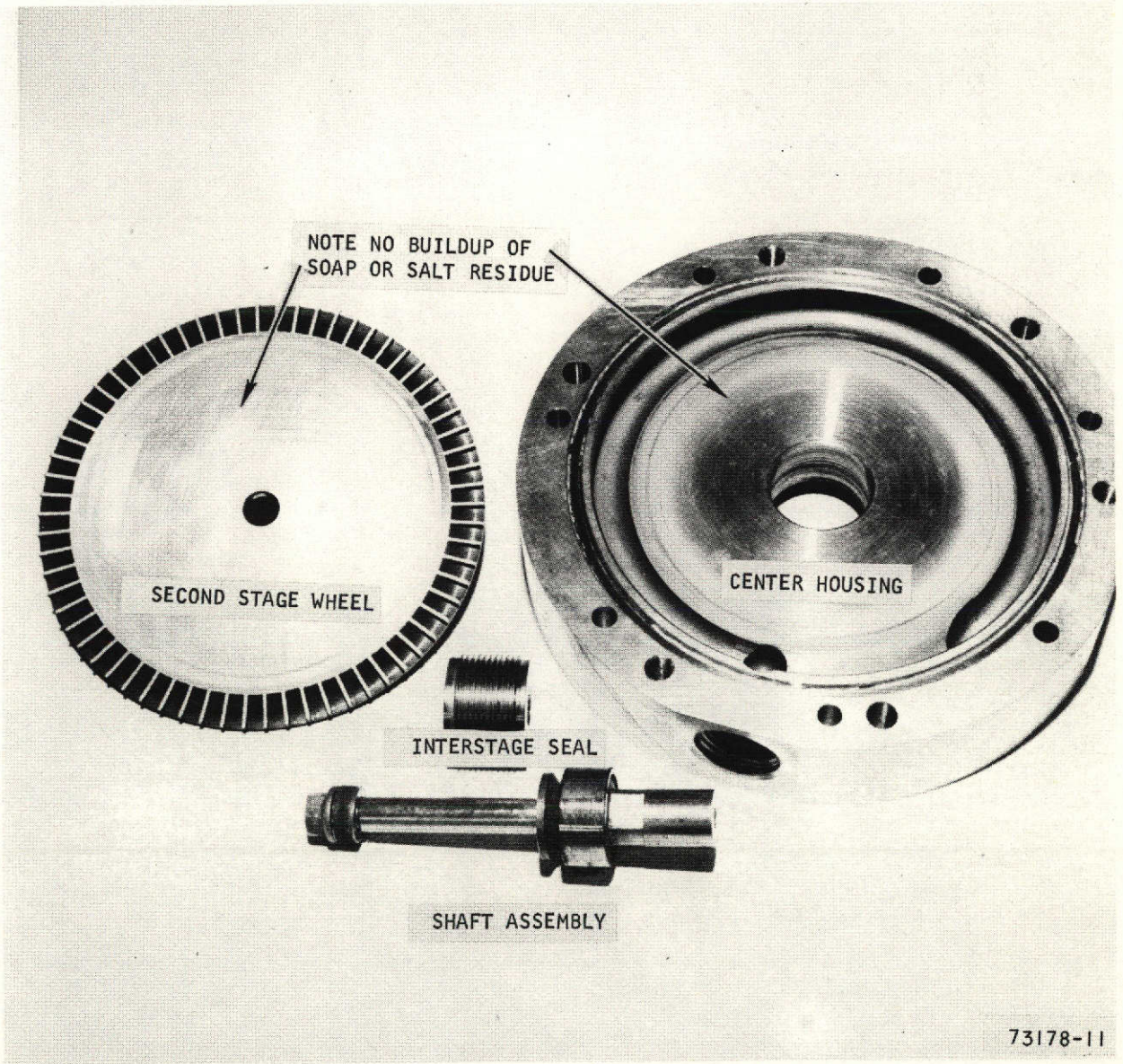

Figure 3-30. Post Phase 2 Examination, Appearance of Compressor Second Stage Wheel and Center Housing



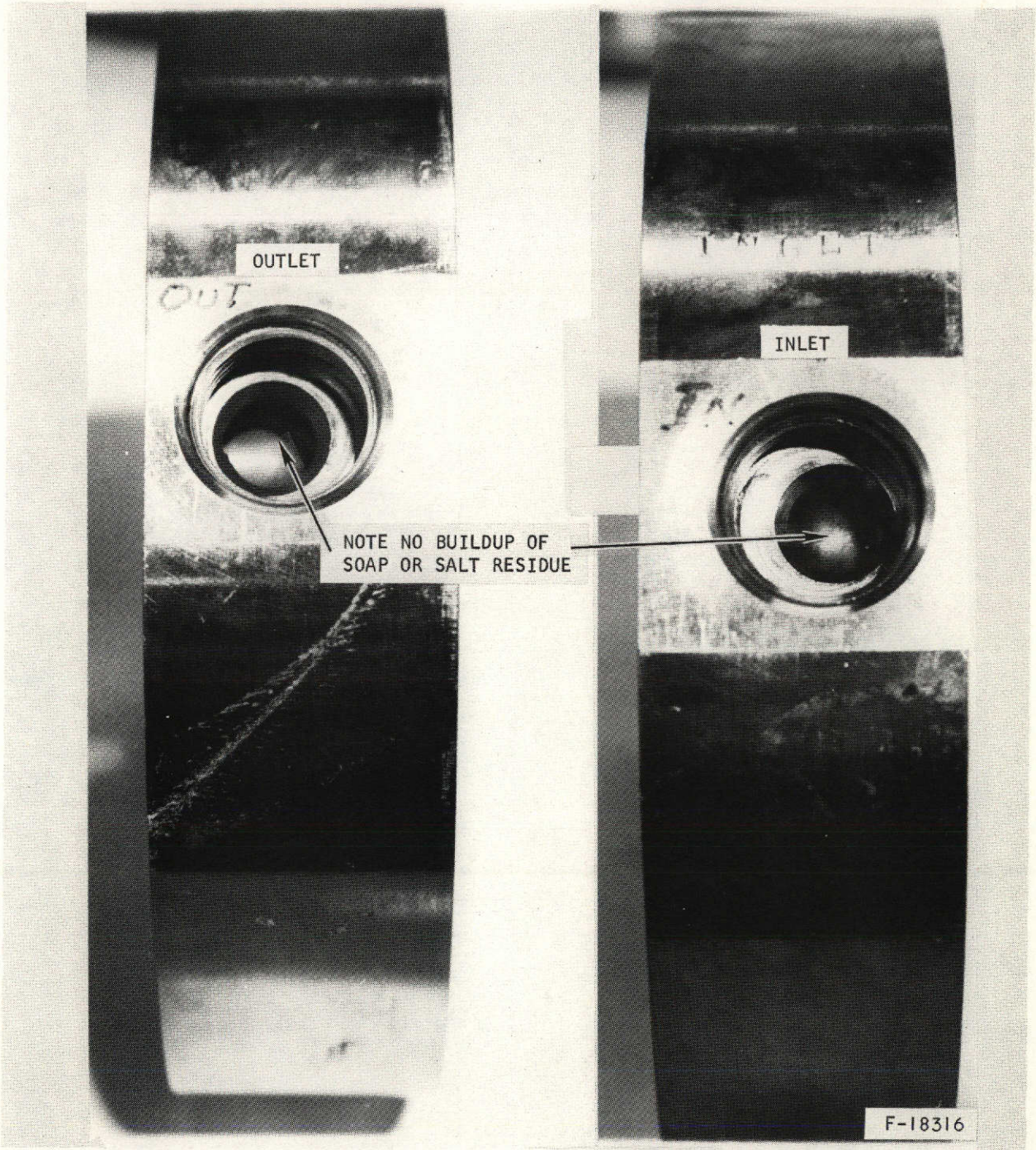

Figure 3-31. Post Phase 2 Examination, Appearance of Compressor Center Housing Ports



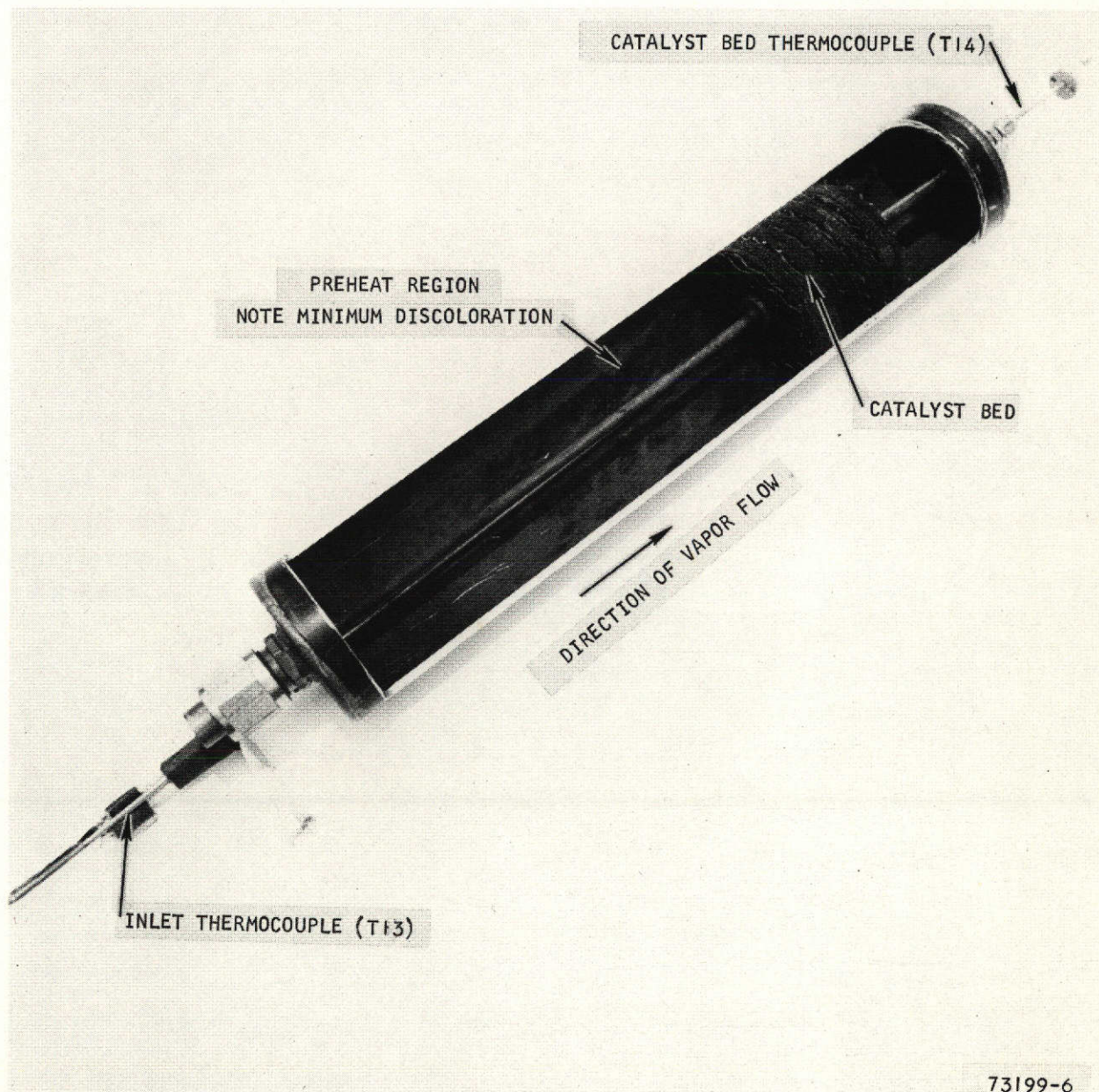

Figure 3-32. Post Phase 2 Examination, Interior Appearance of Pyrolytic Reactor



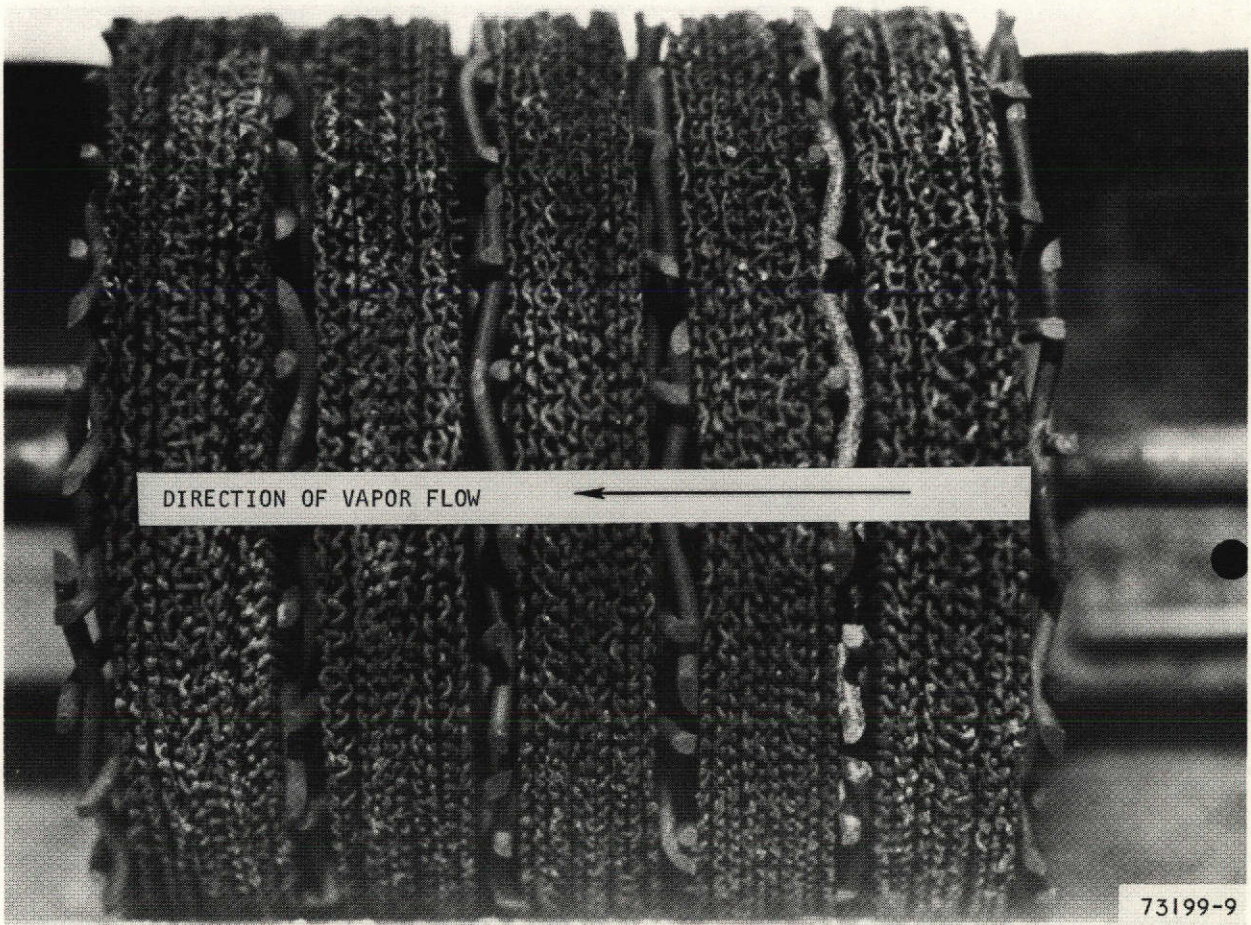

Figure 3-33. Post Phase 2 Examination, Appearance of Pyrolytic Reactor Catalyst Bed





TABLE 3-5

SUMMARY OF HARDWARE INSPECTION RESULTS AND EVALUATIONS

<u>COMPONENT</u>	<u>INSPECTION RESULTS</u>	<u>HARDWARE EVALUATION</u>
Phase Separator	No evidence of liquid carryover. Existing bearing design satisfactory. No wear noted on bearings.	No problems; design acceptable for further upgrading to wash water flight prototype.
Vortex Compressor	Existing bearing design satisfactory. No wear noted on bearings.	No problems; additional component performance testing is needed to further evaluate the computer program performance analysis.
Pyrolytic Reactor	Degradation of rhodium plating found. (Rhodium plating on the catalyst screens was not visible after test). No soap or salt deposits found inside reactor.	Additional study is required to optimize design.
Heater Condenser	No plugging occurred when processing wash water. Degradation of gas trap assemblies found. Plugging of the liquid loop occurred when urine was added to the wash water causing soap solidification.	No problems; some additional evaluation of water removal method is required.
Controls	Liquid level control concept was satisfactory.	No problems; concept is proven.

to draining off the sample. After a water sample was obtained, the collection port was sealed.

- (c) Microbiological -- When possible, one liter water samples were obtained and processed for total aerobic counts by filtering the sample through a sterile 0.45 micron millipore filter. Each filter was placed on tryptic soy agar and incubated aerobically at 35°C for 48 hours before counts were made.

3. Results

Results of the microbiological analyses of product water samples are shown in Table 3-6.

TABLE 3-6
MICROBIOLOGICAL ANALYSIS OF PRODUCT WATER SAMPLES

<u>Sample No.</u>	<u>Figure 3-4 Location</u>	<u>Sample Size, ml</u>	<u>Number of Microorganisms</u>
Baseline	Sampling Port Line	1000	50
1	Sampling Port Line	1000	TNTC (too numerous to count)
2	Sampling Port Line	1000	TNTC
3	Sampling Port Line	1000	53
4	Sampling Port Line	1000	TNTC
5	Sampling Port Line	1000	TNTC
6	Sampling Port Line	1000	TNTC
7	Sampling Port Line	1000	TNTC
8	Pyrolytic Reactor	375	0
9	Pyrolytic Reactor	175	0
10	Pyrolytic Reactor	100	0

As shown in the table, some 50 colonies were obtained from the baseline sample taken subsequent to sterilization. Analysis of samples 1 through 7 generally showed heavy contamination with microorganisms, most of which were identified as pseudomonas sp. Attempts to correct this situation were made by taking the following steps:



- (a) Prior to the time sample 6 was taken, the product water sampling valve and the short line upstream of it were removed and sterilized in the autoclave.
- (b) Prior to obtaining sample 7, the system was shut down and the cyclic accumulator was removed and sterilized in the autoclave. The condenser and lines running downstream to the cyclic accumulator were flushed with boiling water.
- (c) Water samples 8, 9, and 10 were taken just downstream of the pyrolytic reactor.

After steps 1 and 2 were taken, microbiological analysis of the water content of the cyclic accumulator still showed heavy bacterial contamination. After step 3 was taken, sterile water samples were obtained, using low volume samples.

4. Discussion and Conclusions

The purpose of the study was to determine if the WWRS could produce sterile water. The large numbers of microorganisms isolated from product water samples 1, 2, and 4 through 7 were not a reflection of failure in this regard, but rather were indicative of difficulties in sterilizing the product water delivery system. Microorganisms were isolated from lines downstream of the condenser, as well as the cyclic accumulator and sampling port lines. Replacement of the cyclic accumulator with a sterile unit and flushing the condenser with boiling water still resulted in bacteriologically-contaminated product water. The ability of the system to produce sterile water was demonstrated by obtaining product water samples directly downstream of the pyrolytic reactor. The isolation of microorganisms from water obtained through the sample port line was indicative of the difficulties of sterilizing this part of the system and maintaining sterility under adverse experimental conditions.



Chemical Analysis

Throughout the 102 day test period, product water and overboard water samples were taken each week for NASA chemical analysis. Results of these chemical analyses are shown in Tables 3-7 and 3-8. The product water samples were taken from the cyclic accumulator and the overboard samples were taken from the separator. Except for three slightly high pH levels found in the product water samples and six slightly low pH values found in the overboard samples, all water samples taken in Phase 1 testing showed results within the desired limits. Because of laboratory limitations, the minimum measurable amounts of cadmium, lead, and nickel were generally higher than the desired minimum limit. For the Phase 2 water samples, analysis results showed higher pH and ammonia amounts in both product water and overboard water than found in Phase 1. The amounts of solids and organic carbons also were higher, and in the case of overboard water, the desired limits were exceeded in Phase 2.





TABLE 3-7

NASA CHEMICAL ANALYSIS RESULTS, 3/21/73-5/16/73

Sample Number	473-61	473-62	473-63	473-64	473-65	573-45	573-46	573-47	573-48	573-49	573-50	573-58	573-59	573-60	573-61	573-62	573-63	
Date	3/21/73	3/28/73	4/4/73	4/4/73	4/5/73	4/11/73	4/11/73	4/18/73	4/18/73	4/25/73	4/25/73	5/2/73	5/2/73	5/9/73	5/9/73	5/16/73	5/16/73	
Water Sample Source	PRDD.	PRDD.	OVRD.	PRDD.	PRDD.	PRDD.	DVRD.	PRDD.	OVRD.	OVRD.	PRDD.	PRDD.	OVRD.	OVRD.	PRDD.	OVRD.	PRDD.	
Accum. Operating Time, hr	0	170	337	331	356	499	502	669	673	835	835	1003	1000	1176	1176	1330	1341	
Analysis	Desired Limit	ANALYSIS RESULTS - PHASE I																
pH	6-8	6.71	6.72	5.92	6.75	7.45	6.38	6.07	6.11	6.10	5.35	6.10	7.12	6.38	4.89	7.71	5.13	6.47
Resistivity (Megohm-cm at 25 deg C)	Ref. only	0.06	0.02	0.04	0.05	0.05	0.04	0.12	0.035	0.07	0.08	0.045	0.038	0.13	0.078	0.017	0.55	0.024
Total Solids, ppm	500	32.4	100.8	26.3	74.1	58.5	51.6	11.6	62.1	21.4	92	59.8	75.7	11.5	8.2	111.1	16.0	109.8
Organic Carbon, ppm	100	4	21	42	18	15	15	20	17	35	25	19	25	27	31	41	38	36
Inorganic Carbon, ppm	Ref. only	2	1	4	4	5	3	2	3	1	1	2	2	1	1	5	1	2
Cadmium as Cd, ppm	0.01 *	<0.01	<0.01	<0.01	<0.01	<0.01	<0.01	<0.01	<0.01	<0.01	<0.01	<0.01	<0.01	<0.05	<0.05	<0.05	<0.05	<0.05
Chromium as Cr ⁺⁶ , ppm	0.05	<0.005	<0.005	<0.005	<0.005	<0.005	<0.005	<0.005	<0.005	<0.005	0.03	<0.005	<0.005	<0.005	<0.005	<0.005	<0.005	<0.005
Copper as Cu, ppm	1.00	<0.05	<0.05	<0.05	<0.05	<0.05	<0.05	<0.05	<0.05	<0.05	<0.05	<0.05	<0.05	<0.05	<0.05	<0.05	<0.05	<0.05
Iron as Fe, ppm	0.3	<0.1	<0.1	<0.1	<0.1	<0.1	<0.1	<0.1	<0.1	<0.1	<0.1	<0.1	<0.1	<0.1	<0.1	<0.1	<0.1	<0.1
Lead as Pb, ppm	0.05 *	<0.5	<0.5	<0.5	<0.5	<0.5	<0.5	<0.5	<0.5	<0.5	<0.5	<0.5	<0.5	<0.5	<0.5	<0.5	<0.5	<0.5
Magnesium as Mg, ppm	Ref. only	<0.01	<0.01	<0.01	<0.01	<0.01	<0.01	<0.01	<0.01	<0.01	<0.01	0.01	0.01	<0.01	<0.01	<0.01	<0.01	<0.01
Manganese as Mn, ppm	0.05	<0.05	<0.05	<0.05	<0.05	<0.05	<0.05	<0.05	<0.05	<0.05	<0.05	<0.05	<0.05	<0.05	<0.05	<0.05	<0.05	<0.05
Mercury as Hg, ppm	0.005	<0.005	<0.005	<0.005	<0.005	<0.005	<0.005	<0.005	<0.005	<0.005	<0.005	<0.005	<0.005	<0.005	<0.005	<0.005	<0.005	<0.005
Nickel as Ni, ppm	0.05 *	<0.1	<0.1	<0.1	<0.1	<0.1	<0.1	<0.1	<0.1	<0.1	<0.1	<0.1	<0.1	<0.1	<0.1	<0.1	<0.1	<0.1
Potassium as K, ppm	Ref. only	0.25	0.55	0.35	0.50	0.40	0.32	0.26	1.10	0.32	0.27	0.44	0.38	0.19	0.19	0.60	0.25	0.44
Silver as Ag, ppm	0.05	<0.05	<0.05	<0.05	<0.05	<0.05	<0.05	<0.05	<0.05	<0.05	<0.05	<0.05	<0.05	<0.05	<0.05	<0.05	<0.05	<0.05
Sodium as Na, ppm	Ref. only	1.2	8.7	1.0	3.2	2.3	2.6	0.3	3.6	0.9	0.2	2.9	2.3	0.2	0.2	9.3	0.45	5.9
Zinc as Zn, ppm	5.0	<0.01	<0.01	0.07	<0.01	<0.01	<0.01	0.04	<0.01	0.08	0.08	<0.01	<0.01	<0.01	0.03	<0.01	0.03	<0.01
Ammonia as N, ppm	3.0	0.03	0.12	0.25	0.12	0.09	0.12	0.3	0.12	0.25	0.25	0.18	0.12	0.25	0.25	0.25	0.30	0.17
Fluoride as F ⁻ , ppm	20.0	0.17	0.24	<0.05	<0.05	<0.05	0.10	0.06	0.07	<0.05	<0.05	0.05	0.09	0.06	<0.05	0.14	<0.05	<0.05
Nitrate as NO ₃ ⁻ , ppm	T.B.D.	<0.05	<0.05	<0.05	<0.05	<0.05	0.12	0.08	0.07	0.12	0.07	0.08	0.05	0.20	0.18	0.14	0.10	0.19
Sulfate as SO ₄ ⁻² , ppm	250	1.4	3.6	2.8	1.6	1.4	4.0	2.0	5.0	3.5	1.5	6.0	9.5	3.0	2.0	12.0	4.5	8.5
Chloride as Cl ⁻ , ppm	450	0.1	0.3	0.3	<0.05	<0.05	0.08	0.3	0.22	0.34	0.18	0.18	0.8	0.18	0.1	0.5	0.4	1.2

Abbreviations: 1. T.B.D. (To be determined) *Analysis results shown are minimum measurable amounts, which usually were higher than desired limit
 2. PRDD. (Product)
 3. DVRD. (Separator Overboard)



TABLE 3-8

NASA CHEMICAL ANALYSIS RESULTS, 5/23/73-7/3/73

Sample Number	773-1	773-2	773-3	773-4	773-5	773-6	773-7	773-8	773-17	773-18	773-19	773-20	773-21	773-22	
Date	5/23/73	5/23/73	5/30/73	5/30/73	6/6/73	6/6/73	6/13/73	6/13/73	6/20/73	6/20/73	6/27/73	6/27/73	7/3/73	7/3/73	
Water Sample Source	OVBD.	PROD.	OVBD.	PROD.	PROD.	OVBD.	PROD.	OVBD.	PROD.	OVBD.	PROD.	OVBD.	PROD.	OVBD.	
Accum. Operating Time, hr	1501	1501	1669	1668	1817	1817	1983	1983	2142	2142	2313	2311	2456	2455	
Analysis	Desired Limit	ANALYSIS RESULTS - PHASE 1 (CONT.)								ANALYSIS RESULTS - PHASE 2					
pH	6-8	5.80	6.58	7.14	7.38	8.39	4.91	9.19	6.19	9.68	8.99	9.63	8.30	9.65	8.82
Resistivity (Megohm-cm at 25 deg C)	Ref. only	0.07	0.04	0.035	0.035	0.03	0.04	0.03	0.03	<0.01	<0.01	<0.01	<0.01	<0.01	<0.01
Total Solids, ppm	500	39.7	58.1	62.2	64.8	76.7	76.4	119.1	32.5	141.8	138.0	176.3	1246.9	183.2	95.5
Organic Carbon, ppm	100	46	14	49	13	16	91	13	45	22	170	23	3785	23	260
Inorganic Carbon, ppm	Ref. Only	1	5	<1	5	7	<1	9	1	46	170	39	115	37	150
Cadmium as Cd, ppm	0.01 *	<0.05	<0.05	<0.05	<0.05	<0.05	<0.05	<0.05	<0.05	<0.05	<0.05	<0.05	<0.05	<0.05	<0.05
Chromium as Cr ⁺⁶ , ppm	0.05	<0.005	<0.005	<0.005	<0.005	<0.005	<0.005	<0.005	<0.005	<0.005	<0.005	<0.005	<0.005	<0.005	<0.005
Copper as Cu, ppm	1.00	<0.05	<0.05	<0.05	<0.05	<0.05	<0.05	<0.05	<0.05	<0.05	<0.05	<0.05	<0.05	<0.05	<0.05
Iron as Fe, ppm	0.3	<0.1	<0.1	<0.1	<0.1	<0.1	<0.1	<0.1	<0.1	<0.1	<0.1	<0.1	<0.1	<0.1	<0.1
Lead as Pb, ppm	0.05 *	<0.5	<0.5	<0.5	<0.5	<0.5	<0.5	<0.5	<0.5	<0.5	<0.5	<0.5	<0.5	<0.5	<0.5
Magnesium as Mg, ppm	Ref. only	<0.01	<0.01	<0.01	<0.01	<0.01	<0.01	<0.01	<0.01	0.03	<0.01	0.04	0.01	0.03	0.01
Manganese as Mn, ppm	0.05	<0.05	<0.05	<0.05	<0.05	<0.05	<0.05	<0.05	<0.05	<0.05	<0.05	<0.05	<0.05	<0.05	<0.05
Mercury as Hg, ppm	0.005	<0.005	<0.005	<0.005	<0.005	<0.005	<0.005	<0.005	<0.005	<0.005	<0.005	<0.005	<0.005	<0.005	<0.005
Nickel as Ni, ppm	0.05 *	<0.1	<0.1	<0.1	<0.1	<0.1	<0.1	<0.1	<0.1	<0.1	<0.1	<0.1	0.12	<0.1	<0.1
Potassium as K, ppm	Ref. only	0.06	0.24	0.11	0.26	0.32	0.14	0.44	0.19	1.8	1.8	2.15	6.3	2.9	3.0
Silver as Ag, ppm	0.05	<0.05	<0.05	<0.05	<0.05	<0.05	<0.05	<0.05	<0.05	<0.05	<0.05	<0.05	<0.05	<0.05	<0.05
Sodium as Na, ppm	Ref. only	0.75	3.2	1.4	3.5	4.8	1.6	7.4	0.4	12.5	5.5	17.0	35.0	19.0	3.1
Zinc as Zn, ppm	5.0	0.05	<0.01	0.08	<0.01	<0.01	<0.03	<0.01	<0.01	<0.01	0.04	<0.01	0.04	<0.01	0.04
Ammonia as N, ppm	3.0	0.40	0.09	0.40	0.09	0.09	0.40	0.09	0.40	145	145	95	95	120	170
Fluoride as F ⁻ , ppm	20.0	<0.05	<0.05	<0.05	<0.05	<0.05	<0.05	<0.05	<0.05	<0.05	<0.05	0.05	0.05	0.09	0.02
Nitrate as NO ₃ ⁻ , ppm	T.B.D.	<0.05	<0.05	<0.05	<0.05	0.08	<0.05	<0.05	<0.05	<0.05	<0.05	<0.05	0.08	<0.05	<0.05
Sulfate as SO ₄ ⁻² , ppm	250	4.8	4.2	4.7	2.5	2.2	4.8	2.8	4.0	10.1	40	7.7	62	8.2	55
Chloride as Cl ⁻ , ppm	450	0.45	0.2	0.8	0.2	0.3	0.7	0.15	0.15	0.25	5.0	0.55	10	1.1	6.0

Abbreviations: 1. T.B.D. (To be determined)
 2. PROD. (Product)
 3. OVBD. (Separator Overboard)

*Analysis results shown are minimum measurable amounts, which were higher than desired limits.

SECTION 4

SYSTEM ANALYSIS AND COMPRESSOR DESIGN

SYSTEM ANALYSIS

A system analysis was conducted to determine performance requirements for a 10 lb/hr capacity, wash water recovery system. The system was sized for the process capacity of a vortex compressor, operating at near maximum efficiency.

The system analysis was performed, in part, by utilizing computer programs for steady-state operation. Where computer programs were not needed, engineering analysis was accomplished and integrated with the computer analyses.

Computer-derived system performance predictions, based on the optimized vortex compressor performance for a 10 lb/hr water recovery rate, are shown in Table 4-1. Also included in the table are component design requirements, component performance predictions, and fluid line data in the form of pressure losses and heat leak rates. Detailed problem statements for the major components of the system also were generated.

VORTEX COMPRESSOR DESIGN

The vortex compressor, shown in layout form in Figure 4-1, was designed for use in a laboratory demonstration test of the WWRS. A computer program was utilized to optimize the vortex compressor design. Optimized performance curves for the compressor are presented in Figure 4-2. The assembly drawing (Figure 4-3) and detail drawings were prepared in sufficient depth to allow manufacture of the vortex compressor and motor. One set of these drawings was submitted to NASA on 23 February 1973. Normal quality assurance, reliability, and safety functions related to laboratory research hardware were considered in the design, but size, weight, mounting brackets, interface adaptors, and other system integration packaging requirements were not considerations.





TABLE 4-1

SYSTEM PERFORMANCE PREDICTIONS

PAGE 1 OF 3
 08 FEB 73 18:11:52

10 LB WASTE WATER RECOVERY SYSTEM PERFORMANCE

CONFIGURATION DATA

SEPARATOR

ROTATING DRUM WITH PITOT TUBE LIQUID PICKUP

DRUM DIAMETER	▪	12.2000 INCHES	PITOT HEAD COEFFICIENT	▪	.1409
DRUM LENGTH	▪	4.0000 INCHES	PITOT DRAG COEFFICIENT	▪	.1311
PITOT TUBE RADIUS	▪	5.0000 INCHES	MINIMUM SEPARATOR VOLUME	▪	28.7456 CU.IN.
HEAT LEAK TO AMBIENT	▪	1.5000 BTU/HR/F			

COMPRESSOR

SINGLE STAGE VORTEX WITH DOUBLE SIDED WHEEL

HEAT LEAK TO AMBIENT	▪	2.0000 BTU/HR/F			
FLOW(CFM)			PRESS RATIO		POWER(WATTS)
.0000			2.0900		292.0000
25.8500			1.8150		246.0000
51.7000			1.5200		214.0000
72.3000			1.1000		196.0000

RECUPERATOR

CROSS-COUNTER FLOW SHELL TUBE EXCHANGER WITH INLET ON SHELL SIDE

NUMBER OF TUBES	▪	324.0000	FLOW AREA ON SHELL SIDE	▪	.0650 FT-FT
NUMBER OF PASSES	▪	5.0000	FRONTAL AREA SHELL SIDE	▪	.2000 FT-FT
TUBE LENGTH	▪	19.9992 INCHES	BAFFLE FLOW AREA	▪	.1500 FT-FT
TUBE DIAMETER	▪	.1400 INCHES	AXIAL CONDUCTION AREA	▪	.0414 FT-FT
HEAT LEAK TO AMBIENT	▪	.1200 BTU/HR/F	AXIAL COND CONDUCTIVITY	▪	8.6000 BTU/HR/FT/F

CATALYST BED

WIRE MESH CATALYST BED WITH FLOW ALONG AXIS

BED LENGTH	▪	3.0000 INCHES	WIRE DIAMETER	▪	.0160 INCHES
BED DIAMETER	▪	7.1500 INCHES	MESH SIZE	▪	20.0000 WIRES/IN

CONDENSER

SPIRAL TUBE HX-BRINE ON INSIDE-STEAMON OUTSIDE -COUNTER FLOW

TUBE LENGTH	▪	312.5000 INCHES	FOULING FACTOR	▪	.0010
TUBE DIAMETER	▪	.4600 INCHES	HEAT LEAK TO AMBIENT	▪	1.5000 BTU/HR/F

FLUID LINES

	LENGTH(FT)	DIAMETER(IN)	UA(BTU/HR/F)
BRINE LINES			
CONDENSER TO FEED	1.0000	.4600	.2600
FEED TO SEPARATOR	.5000	.4600	.2600
SEPARATOR TO PUMP	.5000	.4600	.2600
PUMP TO CONDENSER	.7000	.4600	.2600
VAPOR LINES			
SEPARATOR TO COMPRESSOR	1.0000	1.4600	.4000
COMPRESSOR TO RECUPERATOR	.7000	1.4600	.4000
RECUPERATOR TO CONDENSER	.5000	1.4600	.3000



TABLE 4-1 (CONTINUED)

PERFORMANCE DATA

OPERATING CONDITIONS					
SEPARATOR LEVEL	=	50.0000 CU. IN	AMBIENT TEMPERATURE	=	70.0000 DEG F
BRINE CONCENTRATION	=	6.0000 PERCENT SOLIDS	FEED TEMPERATURE	=	70.0000 DEG F
FEED CONCENTRATION	=	.3000 PERCENT SOLIDS	VENT PRESSURE	=	2.0000 PSIA
CATALYST TEMPERATURE	=	800.0000			

SYSTEM PERFORMANCE SUMMARY

WATER PROD. RATE	=	10.5344 LB/HR	SEPARATOR POWER	=	4.7050 WATTS
SEPARATOR PRESSURE	=	1.5767 PSIA	COMPRESSOR POWER	=	222.4956 WATTS
COMPRESSOR PRESS RATIO	=	1.6036	CATALYST/RECUP. POWER	=	103.9828 WATTS
BRINE FLOW RATE	=	1669.0554 LB/HR	VAPOR CARRYOVER	=	.3194 LB/HR

SYSTEM STATE POINTS

SYSTEM STATE POINTS	PRESSURE (PSIA)	TEMPERATURE (DEG F)
1 INLET TO FLASH VALUE	2.9831	124.2418
2 OUTLET OF PITOT TUBE	3.6271	117.3668
16 INLET TO PUMP	3.5418	117.3569
17 OUTLET OF PUMP	14.9011	117.6644
3 BRINE INLET TO CONDENSER	14.7817	117.6567
4 BRINE OUTLET FROM CONDENSER	3.5388	124.2598
5 SEPARATOR VAPOR OUTLET	1.5767	117.3665
6 INLET TO COMPRESSOR	1.5765	117.3668
7 OUTLET OF COMPRESSOR	2.5282	215.7589
8 RECUPERATOR INLET	2.5281	203.9833
9 CATALYST BED INLET	2.5254	742.5208
10 CATALYST BED OUTLET	2.4784	600.0000
11 RECUPERATOR OUTLET	2.4748	261.4625
12 CONDENSER VAPOR INLET	2.4747	249.7438

COMPONENT PERFORMANCE DATA

SEPARATOR					
SPEED	=	400.0000 RPM	BRINE OUTLET PRES*	=	3.6271 PSIA
POWER	=	4.7050 WATTS	BRINE TEMPERATURE*	=	117.3668 DEG F
VAPOR PRESSURE	=	1.5767 PSIA	HEAT LEAK	=	71.0502 BTU/HR

COMPONENT PERFORMANCE DATA

COMPRESSOR					
INLET PRESS	=	1.5765 PSIA	POWER	=	222.4956 WATTS
OUTLET PRESS	=	2.5282 PSIA	ADIABATIC EFF.	=	51.8372 PERCENT
PRESS RATIO	=	1.6036	HOUSING TEMP.	=	215.7589 DEG F
VOLUME FLOW	=	44.8371 CFM	HEAT LEAK	=	291.4063 BTU/HR

COMPONENT PERFORMANCE DATA

RECUPERATOR					
INLET TEMP.	=	203.9833 DEG F	INLET PRESS.	=	2.5281 PSIA
OUTLET TEMP.	=	261.4625 DEG F	OUTLET PRESS.	=	2.4748 PSIA
EFFECTIVENESS	=	.9036	SHELL SIDE DEL P	=	.0026 PSID
HEAT LEAK	=	55.2877 BTU/HR	TUBE SIDE DEL P	=	.0036 PSID
POWER	=	103.9828 WATTS			

CATALYST BED					
INLET TEMP.	=	742.5208 DEG F	BED DELTA P	=	.0471 PSID
INLET PRESS.	=	2.5254 PSIA			



TABLE 4-1 (CONTINUED)

COMPONENT PERFORMANCE DATA

PUMP

INLET P = 3,5418 PSIA
 P RISE = 11,3393 PSID
 OUTLET P = 14,9011 PSIA
 BRINE FLOW = 1669,0554 LB/HR
 HEAT LEAK = 488,6806 BTU/HR

PUMP POWER

INLET T = 157,0582 WATTS
 INLET T = 117,6646 DEG F
 VOL FLOW = .4453 CFM
 INLET VAPOR P = 1,5767 PSIA

COMPONENT PERFORMANCE DATA

CONDENSER

BRINE FLOW = 1669,0554 LB/HR
 BRINE DELTA P = 11,2429 PSID
 BRINE DELTA T = 6,6031 DEG F
 BRINE I = 1404,6325 BTU/HR/FT/FT/F
 BRINE INLET T = 117,6557 DEG F
 HEAT LEAK = 71,4850 BTU/HR

VAPOR FLOW

VAPOR FLOW = 10,2150 L9/HR
 VAPOR INLET P = 2,4747 PSIA
 VAPOR DELTA P = .4808 PSID
 VAPOR SATUR T = 125,7341 DEG F
 VAPOR H = 3270,0175 BTU/HR/FT/FT/F

LINE DATA

	PRESSURE DROP(PSID)	HEAT LEAK(BTU/HR)
CONDENSER TO FEED	.1695	14,1076
FEED TO SEPARATOR	.0848	14,1052
SEPARATOR TO PUMP	.0853	12,3154
PUMP TO CONDENSER	.1194	12,3928
SEPARATOR TO COMPRESSOR	.0002	-.0000
COMPRESSOR TO RECUPERATOR	.0001	55,9484
RECUPERATOR TO CONDENSER	.0001	55,6809

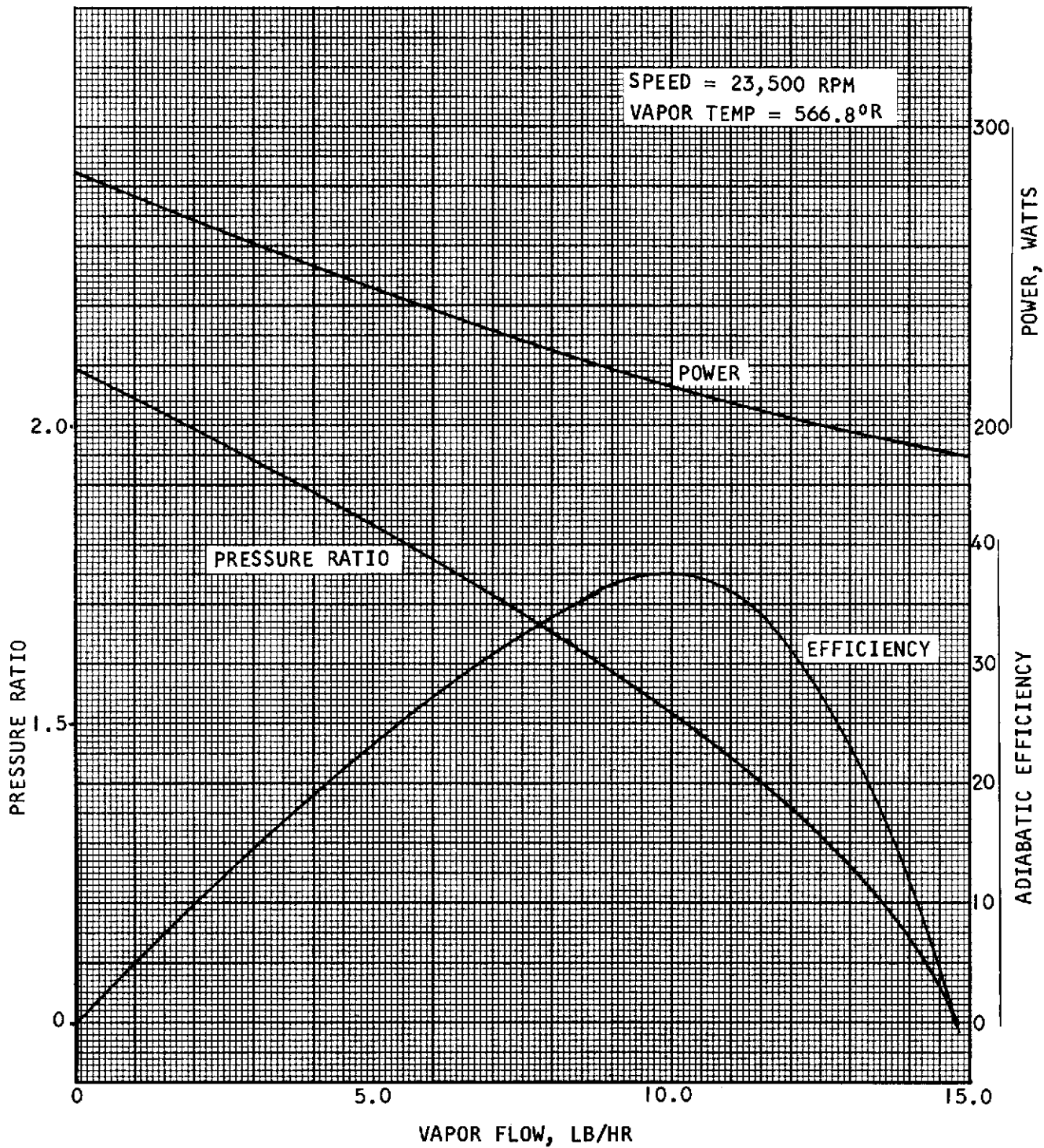

Figure 4-2. Vortex Compressor Optimized Performance

The vapor compressor was designed to perform two functions in the system: (1) provide the head necessary to overcome the pressure drop of the vapor loop and (2) maintain a condenser pressure adequate to assure heater-condenser thermal performance. The vortex compressor is essentially a high-speed rotating machine. It accomplishes compression by imparting a velocity head to the gas and converting that velocity head into a pressure head. In this respect, the vortex compressor is similar to a centrifugal compressor.

The gas passing through a vortex compressor travels around the periphery of the impeller within a horseshoe-shaped stator channel. Within this channel, the gas travels along helical streamlines, the centerline of the helix coinciding with the center of the curved channel. This flow pattern causes the gas to pass through the impeller buckets many times while it is traveling through the compressor. As a result, the vortex compressor can produce discharge heads up to 15 times those produced by a centrifugal compressor operating at equal tip speeds.

The vortex compressor has several additional advantages over a centrifugal type. These include:

- (a) Simple, reliable design (only one rotating assembly)
- (b) Stable, surge-free operation from full-flow to no-flow conditions
- (c) Long life (20,000 hours, as limited by bearing life)
- (d) Freedom from wear and oil contamination (no rubbing or lubricated surfaces are used)
- (e) High operating efficiencies compared to very low specific speed centrifugal compressors

The principal disadvantage of the vortex compressor is its relatively low adiabatic efficiency; however, for an application such as the WWRS, equipment life is significantly more important than efficiency. Furthermore, in a small compressor (of the size necessary for WWRS operation), the mechanical losses incurred can easily offset the losses due to thermodynamic inefficiencies. In this respect, the vortex machine has a minimum of moving parts and is relatively free of losses of mechanical origin.



COMPONENT PROBLEM STATEMENTS

In addition to the system analysis, detailed problem statements were generated for the vortex compressor and the following major components of the 10 lb/hr WWS: phase separator, recuperator-reactor, heater-condenser, and recirculation pump. These problem statements are presented in subsequent paragraphs of this section.

Vortex Compressor Problem Statement

1. Purpose

The vortex compressor provides the vapor pressure rise necessary to assure the temperature differential needed for transfer of heat to the liquid loop by condensation of the vapor.

2. Description

The compressor is a single stage, vortex type, with double-sided wheel, driven by a 3-phase, 400-Hz, 115 volt a-c motor. Compression is accomplished by imparting a velocity head to the vapor and then converting that velocity head into a pressure head. The vapor entering the compressor travels around the periphery of the impeller within a horseshoe-shaped stator channel. Within the channel, the vapor travels along helical streamlines with the centerline of the helix coinciding with the center of the curved channel. This helical flow pattern causes the gas to pass through the impeller buckets many times while it is passing through the compressor.

3. Performance and Design Requirements

Inlet vapor pressure, psia	1.58
Inlet vapor temperature, °F	117
Pressure ratio	1.6
Vapor flow rate, lb/hr	10
Shaft speed, rpm	26,400
Total input power, watts	220 max with 120 volt a-c input
Proof pressure, psig	33



Burst pressure, psig	55
Motor insulation resistance, megohms	50 min between terminals and case with 100 volts dc potential
Motor current leakage, milliamperes	2.0 maximum between terminals and case with 1500 volts rms applied for one minute
Weight, lb	8

Phase Separator Problem Statement

1. Purpose

The phase separator is used in the liquid loop to separate the water vapor from the wash water and to pump the remaining liquid from the separator. The separator also serves as an accumulator-surge tank for the liquid loop.

2. Description

The separator consists of a motor-driven bowl in which is located a stationary pitot tube which is used as a pump. Rotation of the bowl is provided by a brushless 28 volts d-c motor through a magnetic coupling. The unit is statically sealed. The mixture of concentrated wash water and water vapor leaving the flash valve enters the bowl through a stationary delivery tube passing through one end of the bowl. Due to centrifugal force, the liquid is forced against the periphery of the bowl, while the gas is removed through the central withdrawal vapor passage. The pitot tube located near the drum periphery collects the high velocity liquid and pumps it through the recirculating liquid loop. The vapor is drawn from the center of the rotating drum through a demistor. The vapor is then circulated in the cavity between the bowl and the separator housing before being exhausted from the unit. The separator housing is insulated and maintained at a temperature above saturation by the heat from the motor.



3. Performance and Design Requirements

Drum size, in.	12.2 in. dia x 4 in. high
Imersion level for pitot tube pickup, cc	560
Discharge liquid flow rate, lb/hr	1650 to 1700
Liquid and vapor temperatures, °F	40 to 150
Discharge liquid pressure, psia	3.63
Discharge vapor flow rate, lb/hr	10
Discharge vapor pressure, psia	1.58
Vapor passage pressure drop, in. H ₂ O	0.2 max
Bowl speed, rpm	400
Bowl shaft power, watts	4.7 max
Input power, watts	12.5 max with 32 volts d-c input
Motor insulation resistance, megohms	50 minimum between terminals and case with 100 volts dc potential
Motor current leakage, milliamperes	2.0 maximum between terminals and case with 1500 volts rms applied
Weight, lb	15

Recuperator-Reactor Problem Statement

1. Purpose

The recuperator-reactor purifies and sterilizes the vapor after it leaves the vortex compressor. Heating is accomplished within the recuperator section and oxidation of the trace contaminants is performed within catalyst bed of the pyrolytic reactor section. Sterilization of the vapor is effected at the same time due to the high operating temperature of the catalyst bed.



2. Description

The unit consists of a high-effectiveness recuperator and a pyrolytic reactor section containing an electrical heater and a catalyst bed. The recuperator has a tubular multipass cross-counterflow arrangement with multi-passing accomplished on the shell side of the tube. The reactor catalyst is a series of platinum/rhodium wire screens coated with rhodium.

Cool vapor enters the unit and flows through the shell side of the recuperator and into the reactor section. Within this section, the vapor is heated by a 28 volt d-c electrical heater. The vapor next flows through the catalyst bed where catalytic oxidation of the contaminants is accomplished. The hot vapor leaving the catalyst then flows back through the recuperator inside the tubes before leaving the unit. A redundant electrical heater is provided within the unit.

The recuperator and reactor are enclosed by a vacuum-jacketed outer shell. Insulation is installed within the vacuum enclosure to reduce radiant heat loss.

3. Performance and Design Requirements

Vapor flow rate, lb/hr	10
Inlet vapor pressure, psia	2.53
Pressure drop across unit, in. H ₂ O	1.5 max at design flow
Temperature, °F	
Cold side inlet	204
Reactor outlet	800
Hot side outlet	262
Recuperator effectiveness	0.90
Reactor heater power, watts	104 with 32 volts dc input
Heat leak, Btu/hr	55
Proof pressure, psig	33
Burst pressure, psig	55
Weight, lb	20



Heater-Condenser Problem Statement

1. Purpose

The heater-condenser provides the means of transferring the heat from the condensing vapor to the liquid loop.

2. Description

The concentrated wash water liquid flows through a single tube arranged in two concentric cylindrical helixes. Cylindrical wicks are in contact with the coils. The vapor entering the unit flows in the passages formed by the tube and the wicks in a counterflow manner through the two helixes. Vapor condenses outside the tube. The condensate is collected by the wicks and transported to a hydrophilic sintered metal plate. A pressure differential across the plate assures liquid water flow through the plate and out of the unit while presenting a barrier to gas and vapor flow. This pressure differential is imposed upon the plate by a cyclic accumulator. Non-condensable gases are continuously bled from the unit and dumped overboard.

3. Performance and Design Requirements

Inlet liquid temperature, °F	118
Inlet soap concentration, wt %	0.3 to 8.4 (6 at design point)
Liquid loop flow rate, lb/hr	1669
Liquid side pressure drop, psi	11.2 max at design flow
Inlet liquid pressure, psia	14.8
Liquid side temperature rise, °F	6.6 minimum
Inlet vapor temperature, °F	250
Inlet vapor pressure, psia	2.47
Vapor flow rate, lb/hr	10
Noncondensable vent pressure, psia	2.0
Heat transfer rate, Btu/hr	10,200 min
Ambient heat loss, Btu/hr	72 max
Weight, lb	20



Recirculating Pump Problem Statement

1. Purpose

The liquid loop recirculation pump is used to flow wash water through the water recovery system.

2. Description

The liquid loop recirculation pump is located at the outlet of the phase separator and consists of a straight vane-type centrifugal impeller, which is driven by a magnetically-coupled brushless d-c motor. In operation, the pump inlet pressure is maintained approximately 2 psi above the vapor pressure to prevent cavitation.

3. Performance and Design Requirements

Liquid flow rate, lb/hr	1669 at 3.54 psia and 118°F (design flow)
Inlet soap concentration, wt. %	0.3 to 8.4 (6 at design point)
Inlet liquid temperature, °F	100 to 120
Inlet liquid pressure, psia	3.5 to 4.0
Pump pressure rise, psi	11.2 min at design flow
Power consumption, watts	157 max with 32 volts d-c input
Weight, lb	5



SECTION 5

CONCLUSIONS AND RECOMMENDATIONS

CONCLUSIONS

The first phase of the WWRS feasibility test demonstrated that the flash-evaporation/vapor-compression process has the capability of recovering chemically- and microbiologically-acceptable water from shower-generated wash water over an 83-day period. In addition, the system components proved to be highly reliable during 2456 hours of operation, even though they were designed as laboratory test units. The long-term test program also served as a successful demonstration that the WWRS can produce potable water from wash water without encountering such operational problems as soap carryover, plugging, or foaming.

When processing a worst-case mixture of urine and wash water, the soap in the wash water tended to come out of solution and collect in the liquid loop as a gelatinized substance, thus reducing the rate of flow. This problem can conceivably be dealt with by adjusting control settings to dump the concentrated soap solution/urine brine in the liquid loop before the brine salt concentration is sufficient to react with the soap to form a gel. Other possible solutions are to use an additive to prevent the soap from reacting with urine salts or to use a non-soap-type washing agent.

RECOMMENDATIONS

As a result of the system tests conducted, additional study areas have been identified. The following recommendations are designed to improve the efficiency of the WWRS. In general, these recommendations represent a continuation of the current program and involve analysis and testing at the component and system level. The component level design activities and test program are aimed at the development of flight-prototype hardware.



Listed below are AiResearch recommendations pertaining to component improvements:

- a. Catalytic Reactor - Investigate catalyst substrates such as platinum-rhodium wire and gold-plated stainless steel, copper, tantalum, silver, and titanium. Selection criteria would include primarily material stability in the environment of the pyrolysis reactor.
- b. Compressor - Fabricate the 10 lb/hr vortex compressor designed in the current program. Conduct component performance tests to compare with the computer performance prediction program.
- c. Phase Separator - Conduct additional component tests to evaluate soap carryover in various attitudes to finalize design for the flight-prototype unit.

To date, system tests have been conducted with good-quality engineering development hardware. The feasibility of recovering high-quality potable water over a long period and the adequacy of component design approaches have been demonstrated by the present development system. At this time, it is strongly recommended that the flight-prototype hardware described in Section 4 be designed and developed to fully realize the potential of the system.

In a flight-prototype system, the WWRS design can be optimized to minimize energy losses, so that power requirements compare favorably with the reverse osmosis and hyperfiltration processes. To recover potable water from wash water, these processes require power to heat the feed water (up to 165°F), boost feed water pressure (up to 2500 psi), and recirculate non-permeable substances. Also such operational problems as plugging, packing, channeling, and membrane leakage are encountered in the reverse osmosis and hyperfiltration concepts. Because of the intrinsic nature of its design, the flash-evaporation/vapor-compression/vapor pyrolysis concept avoids these significant problems.

