

P
2 mit

NASA TECHNICAL NOTE



NASA TN D-7379

NASA TN D-7379

(NASA-TN-D-7379) : A COMPARISON OF RESULTS FROM TWO SIMULATORS USED FOR STUDIES OF ASTRONAUT MANEUVERING UNITS (NASA) 4847 P
HC \$3.00
N74-12020
CSCL 14B
H1/11
Unclas 23469



A COMPARISON OF RESULTS FROM TWO SIMULATORS USED FOR STUDIES OF ASTRONAUT MANEUVERING UNITS

by *Eric C. Stewart and Robert L. Cannaday*
Langley Research Center
Hampton, Va. 23665

1. Report No. NASA TN D-7379	2. Government Accession No.	3. Recipient's Catalog No.	
4. Title and Subtitle A COMPARISON OF RESULTS FROM TWO SIMULATORS USED FOR STUDIES OF ASTRONAUT MANEUVERING UNITS		5. Report Date December 1973	
		6. Performing Organization Code	
7. Author(s) Eric C. Stewart and Robert L. Cannaday		8. Performing Organization Report No. L-8988	
		10. Work Unit No. 948-70-70-20	
9. Performing Organization Name and Address NASA Langley Research Center Hampton, Va. 23665		11. Contract or Grant No.	
		13. Type of Report and Period Covered Technical Note	
12. Sponsoring Agency Name and Address National Aeronautics and Space Administration Washington, D.C. 20546		14. Sponsoring Agency Code	
		15. Supplementary Notes	
16. Abstract A comparison of the results from a fixed-base, six-degree-of-freedom simulator and a moving-base, three-degree-of-freedom simulator has been made for a close-in, EVA-type maneuvering task in which visual cues of a target spacecraft were used for guidance. The maneuvering unit (the foot-controlled maneuvering unit of Skylab Experiment T020) employed an on-off acceleration command control system operated entirely by the feet. Maneuvers by two test subjects were made for the fixed-base simulator in six and three degrees of freedom and for the moving-base simulator in uncontrolled and controlled, EVA-type visual cue conditions. Comparisons of pilot ratings and 13 different quantitative parameters from the two simulators are made. Different results were obtained from the two simulators, and the effects of limited degrees of freedom and-uncontrolled visual cues are discussed.			
17. Key Words (Suggested by Author(s)) Astronaut maneuvering units Simulators Skylab Experiment T020		18. Distribution Statement Unclassified - Unlimited	
19. Security Classif. (of this report) Unclassified	20. Security Classif. (of this page) Unclassified	21. No. of Pages 45	22. Price* Domestic, \$3.00 Foreign, \$5.50

A COMPARISON OF RESULTS FROM TWO SIMULATORS USED FOR STUDIES OF ASTRONAUT MANEUVERING UNITS

By Eric C. Stewart and Robert L. Cannaday
Langley Research Center

SUMMARY

A comparison of the results from a fixed-base, six-degree-of-freedom simulator and a moving-base, three-degree-of-freedom simulator has been made for a close-in, EVA-type maneuvering task in which visual cues of a target spacecraft were used for guidance. The maneuvering unit (the foot-controlled maneuvering unit of Skylab Experiment T020) employed an on-off acceleration command control system operated entirely by the feet. Maneuvers by two test subjects were made for the fixed-base simulator in six and three degrees of freedom and for the moving-base simulator in uncontrolled and controlled, EVA-type visual cue conditions. Comparisons of pilot ratings and 13 different quantitative parameters from the two simulators are made. Different results were obtained from the two simulators, and the effects of limited degrees of freedom and uncontrolled visual cues are discussed.

INTRODUCTION

Several different types of simulators have been used to study the various astronaut maneuvering units which have been proposed (refs. 1 to 6). Considerable judgment in interpreting the results of these studies is often required because of the possible influences of individual simulation characteristics that are not related to the environment of space. These unique characteristics, hereafter referred to as simulation artifacts, are usually easy to identify but their effects, if any, are not explicitly known. The problem is made much more critical in the case of astronaut-maneuvering-unit simulation by the fact that there has been no significant amount of zero-g flight experience to validate any simulator to date.

A comparison of the results from two simulators of different types has been made to determine whether significantly different results were produced which would indicate that simulation artifacts influenced the data on at least one of the simulators. The two simulators utilized were a fixed-base, six-degree-of-freedom simulator and a moving-base, three-degree-of-freedom simulator. The simulators were developed for research and training in support of Skylab Experiment T020 using the foot-controlled maneuvering

unit (FCMU) (ref. 7). The simulated maneuvering unit, the FCMU, had an on-off acceleration command control system operated entirely by the feet. Identical extravehicular-activity (EVA) maneuvering tasks using close-range visual cues of a target spacecraft for guidance were flown on both simulators with the two subjects wearing normal clothing. The target spacecraft, foot controller characteristics, and control accelerations were made as nearly identical as possible on both simulators. Although the results of the study are directly applicable to the FCMU and experiment T020, they may also be of more general use.

The data taken included pilot ratings, fuel expended, time used, trajectory error, and several selected states at various locations along the trajectory. When the data from the two simulators in their original form were found to be different, the two simulators were modified in an attempt to determine the cause of the differences. The fixed-base simulator was modified so as to limit the motion to the same three degrees of freedom as those allowed on the moving-base simulator, and the visual cues on the moving-base simulator were restricted until they more closely resembled the EVA-type visual cues on the fixed-base simulator. When the results from the two simulators under these conditions were found to be in much better agreement, the effects of the simulator modifications were examined.

SYMBOLS

Values are given in SI Units. Measurements were made in U.S. Customary Units.

d(t)	perpendicular distance from desired trajectory to a point on the actual trajectory at time t, m
h	height of psuedodistribution curve
i	summation index (see table II)
n	number of 5-second time intervals contained in a given run
p,q,r	angular rates of FCMU about principal axes, deg/sec
t	time from start of maneuver, sec
v	velocity of center of mass of FCMU, $\sqrt{\dot{x}^2 + \dot{y}^2 + \dot{z}^2}$, m/sec
X,Y,Z	right-handed coordinate system located in target spacecraft (see fig. 6)

- X_b, Y_b, Z_b right-handed body-axis coordinate system located in FCMU system
(see fig. 1)
- X_p, Y_p, Z_p right-handed principal-axis coordinate system located in FCMU system
(see fig. 1)
- x, y, z coordinates of the center of mass of the FCMU with respect to an axis system located in target spacecraft (see fig. 6), m
- ω angular rate of FCMU, $\sqrt{p^2 + q^2 + r^2}$, deg/sec

A dot over a symbol signifies a derivative with respect to time.

APPARATUS

Foot-Controlled Maneuvering Unit (FCMU)

A sketch of the FCMU is shown in figure 1. This experimental maneuvering unit is scheduled to be flown inside the orbital workshop as a Skylab experiment. The vehicle has eight cold-gas thrusters arranged in two sets of four adjacent to the feet. The thrusters are aligned with the system's principal axes to minimize cross coupling of angular accelerations to undesired axes while applying angular-control inputs. Each thruster is controlled by a mechanically operated valve connected to its adjacent foot pedal so that one distinct foot motion fires one specific thruster. In normal operations the motions of both feet are coordinated to fire a pair of thrusters. Appropriate combinations of foot inputs make it possible to control the vehicle angular acceleration about all three principal axes and the vehicle linear acceleration along the Z-principal axis Z_p . (See fig. 1.) The Z-principal axis was inclined about 20° forward at the feet relative to the conventional body axes aligned parallel to the pilot's backbone. This orientation permitted the pilot to see over his toes in the direction of his translational acceleration.

The pitch thrusters are located below the center of gravity with the result that pitch moments are not pure couples. Thus each pitch acceleration command is accompanied by a small fore-aft acceleration. The net result is that a small linear velocity error is generated whenever a pitch attitude change is made. A complete description of the FCMU and its operational characteristics is included in reference 7.

Fixed-Base Simulator

The fixed-base simulator employed in this study was developed from an Air Force aerial gunnery trainer, type F-151, in a manner similar to that used to study Gemini-

Agema rendezvous and docking (refs. 8 and 9). A sketch of the major components of this simulator is shown in figure 2. The subject was seated on a mockup of the FCMU inside a 6.10-m-diameter projection sphere where he was presented with a visual scene representing an orbiting spacecraft as seen by the operator of the FCMU. (See fig. 3.) The back of the seat was inclined backward 20° from the vertical to provide subject comfort and for ease of pedal operation. The spacecraft image was produced by a 675-line closed-circuit television system which projected a $2\text{ m} \times 2\text{ m}$ black and white picture on the screen using a remotely located camera and a scale model of the simulated target spacecraft.

The model was servo-driven to the desired angular orientation and range relative to the TV camera by the equipment shown in figure 4. Position of the target image in terms of azimuth and elevation relative to the test subject was provided by a servo-driven mirror mounted with two degrees of freedom. Combined angular orientations of the mirror and model drives could simulate a view of the target spacecraft from almost any position and orientation of the simulated vehicle within a range of about 4.5 m to 60 m. In addition, a featureless horizon of the Earth as viewed from a 310-km orbit was simulated by a two-axis horizon projector. This projector consisted of a hemispherical shell servo-driven about a fixed light source. The horizon projector, the projection tube, and mirror are shown in figure 5.

The digital computer used in this study sampled the pilot's inputs at fixed intervals of time and solved the equations of motion for each sample. A computational frequency of 32 iterations per second was used. The computer program was an adaptation of that used for the Gemini-Agena study described in reference 10 and assumed that the controlled vehicle was a rigid body. Thus the effects of pilot limb movement were not considered. The target spacecraft was assumed to be stabilized with respect to the local horizon at an altitude of 310 km with its Z-axis aligned with the local vertical. (See fig. 6.) The orientation and position of the FCMU were calculated with respect to this axis system. Although the program had the capability of including the effects of orbital mechanics, this option was not exercised because of the relatively short maneuver distances and times involved.

The computer also processed and printed at 5-sec intervals the linear and angular positions and velocities of the FCMU with respect to the target, the impulse used by the thrusters, and run time. In addition to the printed data, two 8-channel oscillographic charts supplied continuous time histories of the thruster firings and FCMU linear velocities and angular rates.

Moving-Base Simulator

A photograph of the moving-base vehicle on the simulator floor is shown in figure 7. This mockup was about 2.4 m long and 0.9 m wide and, with a test subject, had a mass of approximately 210 kg. The test subject was lying on his left side so that his sagittal plane was parallel to the floor and 0.94 m above it. Three bearings arranged in an equilateral triangle 0.96 m on a side were used to support the vehicle. The load on the bearings was equalized by shifting movable weights around on the vehicle. Two interconnected air tanks on the back of the vehicle (not visible in photograph) supplied air for both the thrusters and the air bearings so that the vehicle was a completely self-contained unit free of the influence of an umbilical. The thrusters used valves controlled by pneumatic switches activated by the foot pedals.

The simulator floor surface was made from a slow-hardening epoxy resin which was poured on the floor using a technique similar to that described in reference 11. The natural leveling action of the liquid before it hardened provided a flat and level surface approximately 15 m long and 9 m wide at the largest dimensions.

A horizontal photographic grid was hung about 3.5 m over the air-bearing floor (see fig. 7) to provide a means to measure the vehicle's motion. A battery-powered, 16-mm motion-picture camera operating at 16 frames per sec was mounted on the center of gravity of the vehicle so that the optical axis pointed straight up at the grid. A battery-powered searchlight directed toward the grid made it possible to photograph the grid. This arrangement made it possible to determine the vehicle's location and orientation at any time by reading individual motion-picture frames showing portions of the photographic grid. The average velocity of the vehicle was determined by taking differences in position and orientation at 1-sec intervals of time (every 16 frames).

The camera was also used to record the thruster-firing time histories. A pressure-sensitive switch in the pressure line to each thruster turned on a small neon light to indicate that the thruster was firing. A small panel of eight such neon lights (one for each thruster) was attached to the camera so that the lights were in the corner of the camera field of view. The thruster firings were recorded on the same film as the vehicle position and orientation. By summing the time a given thruster fired during a run and multiplying that total by the thrust, the impulse was calculated.

DISCUSSION OF SIMULATION CHARACTERISTICS

Fixed-Base Simulator

The fixed-base simulator was a flexible research and training device. It provided the complete six degrees of freedom for a rigid body and almost unlimited run time.

Since practically any combination of initial position and vehicle characteristics could be quickly and easily set into the program, any desired condition was easily investigated.

The advantages of the fixed-base simulator were partially offset by a few undesirable characteristics. For example, the projected television image was two-dimensional and had limited resolution. Other obvious artifacts of this simulator were the fixed-base limitation and the presence of the earth's gravity vector which was in the plane of the simulated maneuver. The gravity vector could be used to judge attitude from the position of the target or simulated horizon with respect to the local horizontal. The servo-drive systems of the display equipment had some small lags in response and positioning errors. Except for the mechanical deadbands in the rangebed and horizon drives, these deficiencies were usually unnoticed by the test subjects.

Moving-Base Simulator

The moving-base simulator had several advantages; for example, it provided the test subject with full-scale linear and angular motion cues, thruster-firing auditory cues, and three-dimensional visual cues. However, the motion cues should be of a rather low level because of the low linear and angular acceleration levels on the FCMU (approximately 0.06 m/sec^2 and 4 deg/sec^2 , respectively). Another advantage of the moving-base simulator was that the test subject could physically ride on a working mockup of the maneuvering unit.

The moving-base simulator, like the fixed-base simulator, had a number of artifacts which partially offset the advantages. The most prominent artifact was the three-degree-of-freedom limitation which allowed motion in only one plane. For this particular application, motion in the pitch plane was possible while roll, yaw, and lateral translational motions were eliminated. Another consequence of the three-degree-of-freedom limitation was that it was not necessary to coordinate the inputs of both feet to make a control input. Firing one thruster on the moving-base simulator only halved the desired control acceleration and did not produce accelerations around other undesired axes as would have occurred in six degrees of freedom. Another undesirable characteristic was the influence of the bearing surface or floor on the motion of the vehicle. That is, friction between the floor and the bearings and slopes of the floor (see fig. 8) could cause the vehicle to deviate from its true trajectory. Of course, the Earth's gravity vector was present for the moving-base simulator as it was for the fixed-base simulator, but in this case it was perpendicular to the plane of the simulated motion and probably could not be used to judge attitude.

Common Features of Simulators

It should be noted here that the target spacecraft, the FCMU vehicle characteristics, and the test maneuver were made as nearly identical as possible for both simulators. A full-size target spacecraft with similar markings, solar panels, and rocket nozzle was built for the moving-base simulator. The FCMU controller characteristics (force gradients, controller travels, etc.) were also matched as closely as possible. The pitch accelerations, Z_p -translational accelerations, and X_p -translational accelerations due to pitch were measured on the moving-base simulator and then programed into the fixed-base-simulator math model. The roll and yaw accelerations used in the fixed-base simulator were based on estimates for the actual FCMU flight vehicle. Another parameter which may be of importance for a close-range visual task is the eye position with respect to the center of gravity. The eye position on the air-bearing vehicle was found to be approximately 0.85 m above and 0.11 m forward of the center of gravity. These values were programed into the fixed-base-simulator math model. Care was taken in selecting the test maneuver so that the operational limits of both simulators would not be exceeded. That is, the maneuver was made small enough to insure that the air-bearing vehicle would not come too close to the edge of the simulator floor, and the maneuver was terminated far enough away from the target to insure that the minimum range limit on the fixed-base simulator was not exceeded.

SIMULATION MODIFICATIONS

The simulators were modified to make them more nearly alike. These modifications were made in an attempt to determine the cause of the differences in the results obtained for the unmodified, original conditions of the simulators.

Fixed-Base Simulator

The equations of motion of the fixed-base simulator were modified so that the simulated FCMU had the same three degrees of freedom as the moving-base simulator. This modification was accomplished by setting the force in the Y-direction with respect to the target equal to zero, by setting the roll and yaw rates of the simulated vehicle equal to zero, and by orienting the FCMU so that its $X_b Z_b$ -plane was coincident with the target's XZ-plane. Thus, the vehicle could only translate in the X- and Z-directions and rotate about the pitch axis regardless of pilot inputs. A second change was to eliminate the cues available from the horizon projector by simply turning off its light source. This change was made because it was desired to have as nearly identical conditions as possible on the two simulators, and it was not practicable to approximate these horizon cues on the moving-base simulator.

Moving-Base Simulator

The moving-base simulator was modified so as to make the visual cues there more nearly like those on the fixed-base simulator and thus more nearly like EVA visual cues. A felt-covered frame was built around and over the mockup of the target to provide a dark background for the target and to control the lighting as described below. The entire simulation room was made as light tight as practicable and all the overhead lights were turned off. A few additional lights inside the felt-covered frame illuminated the target model, and a battery-powered searchlight on the FCMU mockup illuminated the photographic grid for the movie camera. The felt absorbed most of the light reflected off the target except that which was directed toward the test subject. This spill light only illuminated objects behind the test subject which were out of his field of view. In order to reduce further the pilot's ability to see anything except the target, he was required to wear a pair of goggles with filters with a neutral density of 3.0. This combination of goggles and lighting effectively limited the visual cues to those from the target spacecraft and its reflection in the floor which became more noticeable. The brightness of the target and resolution of the target were not exactly identical to that of the target image in the fixed-base simulator; but the helpful, extraneous visual cues were effectively eliminated. A photograph of the modified operating condition of the moving-base simulator is shown in figure 9.

TEST SUBJECTS

Two test subjects were used in this study. Both subjects were NASA research engineers who had considerable experience with simulation studies of piloted vehicles involving both research pilots and astronauts. Both subjects were, therefore, thoroughly familiar with handling-quality requirements and pilot-rating procedures. In addition to their research experience, subject A was a military pilot prior to his joining the NASA and subject B held a current private pilot's license.

TEST PROCEDURE

Test Maneuver

The test maneuver the subjects were to perform in both simulators was basically a down, then up, and then forward translational motion as shown in figure 10. This maneuver was intended to be representative of an inspection-type EVA maneuver involving attitude changes, position changes, and station-keeping tasks. The runs were started with the FCMU center of mass about 9 m behind and 2 or 3 m above the target's center with the thrust axis pointing toward the target. All runs were started with zero linear velocities and angular rates with respect to the target.

The subject began the maneuver by pitching forward from his starting attitude (position 1 in fig. 10) until his thrust axis was aligned so that a translational input would cause him to translate parallel to the target's Z-axis (position 2). This attitude was a matter of judgment because the subjects had no onboard attitude instruments and because the correct attitude was a function of the amount of translational cross coupling generated in the pitch maneuver itself. That is, the translational velocity generated during the pitch maneuver (result of cross coupling) was a function of the pitch rate – the higher the pitch rate, the greater the resulting translational velocity. Thus in the pitch maneuver between positions 1 and 2 the test subjects had to pitch 5° to 10° farther than would be required without the cross coupling depending on the pitch rate used.

Once the translational velocity was initiated, the subject pitched backward to where he thought his thrust axis was aligned with his velocity vector. Holding this attitude, he translated until his center of gravity was about 4 m below the target spacecraft where he tried to null completely his velocities as if he were station keeping to inspect the bottom of the target (position 3). After the test subject was satisfied he had stopped the vehicle as well as he could, he translated back up to the center line supposedly retracing part of his initial trajectory. When the subject judged his center of gravity was on the center line, he stopped his upward velocity at position 4 and pitched backward to position 5 to start translating toward the target. Some compensation had to be made again for the translational cross coupling of this pitch maneuver.

The subject then translated toward the target to a point where his center of gravity was approximately 4.5 m from the center of the target spacecraft where he again tried to null all his linear and angular velocities at position 6. The subject terminated the run whenever he felt he had the situation stabilized as well as he could without making any large attitude changes to correct any residual linear velocities.

Test Sequence

The different conditions investigated in the two simulators are listed in table I. (Note the abbreviations for each condition as they will be used to identify the quantitative data.) The original, unmodified operating condition of the fixed-base simulator was six degrees of freedom, horizon projector on, FB(6,on), while the original operating condition of the moving-base simulator was overhead lights on and goggles off, MB(on). The modified operating conditions, which were supposed to resemble each other as closely as possible, were three degrees of freedom, horizon projector off for the fixed-base simulator, FB(3,off); and overhead lights off, goggles on for the moving-base simulator, MB(off).

After a thorough training program in which the test subjects tried all six conditions, both subjects flew each condition 10 consecutive times. The two original operating conditions (table I) of each simulator were flown first and the two modified conditions were

flown last. The test subjects were given two formal debriefings, one after the maneuvers covering the first half of the conditions and the other after all the maneuvers. In addition to these formal debriefings when pilot ratings were given using the scheme shown in figure 11, the test subjects offered qualitative comments during and after individual runs.

Quantitative Data

Thirteen different quantitative parameters were chosen to describe the subject's execution of the maneuver. These quantities were divided into three different categories for easier analysis as shown on table II.

A special presentation of the quantitative data was developed because of the scatter in the data from run to run and because of the limited number of runs for each condition. This presentation consists of a triangular-shaped, pseudodistribution curve whose peak was located at an abscissa value equal to the parameter's calculated average as shown in the diagram below. The height of the triangle h was arbitrary. The highest and lowest

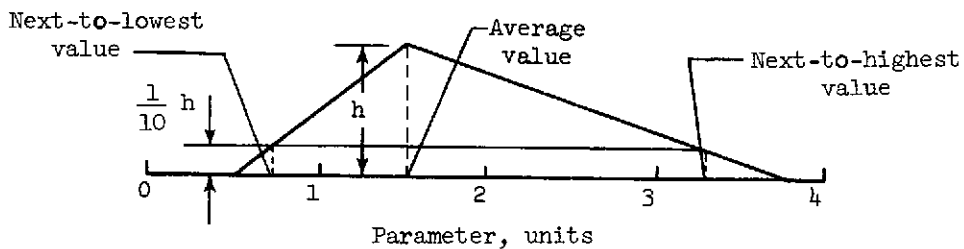

values of each parameter were eliminated from the data to minimize the influence of the occasional pilot mistake. The next-to-the-highest and the next-to-the-lowest values were then used to determine the slope of the sides of the triangle. The ordinate of the next-to-the-highest and the next-to-the-lowest values ($\frac{1}{10} h$) was also arbitrary and was used to compensate for the elimination of the highest and lowest values which tended to make the distribution narrower than it would have been if the two data points had not been removed. The resulting triangle, therefore, reflected the overall distribution of each parameter.

Usually the pseudodistribution curves for two different conditions will be plotted on the same axis for comparison. In the discussions that follow, it will generally be assumed that there is a difference in the results whenever the overlap of the two curves is small and vice versa, see the following diagram. No attempt will be made to determine whether any differences in the results are of practical significance.

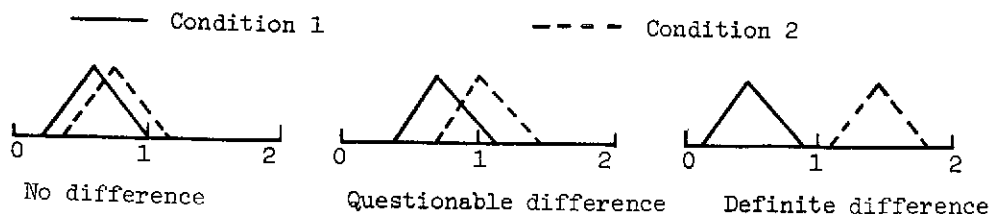

RESULTS AND DISCUSSION

Comparison of Original Operating Conditions of Simulators

Both the qualitative and quantitative data indicated that there were large differences in the tasks on the two simulators as they were originally used.

Qualitative data.- Both test subjects gave identical pilot ratings (see fig. 11), independent of one another, for the two simulators in the original operating conditions - PR 6 for the fixed-base simulator and PR 3 for the moving-base simulator. The differences in pilot rating are large ranging from "very objectionable deficiencies" for the PR 6 to "mildly unpleasant deficiencies" for the PR 3.

The test subjects stated that they were less confident of their ability to satisfactorily perform the maneuver on the fixed-base simulator than on the moving-base simulator. Although they sometimes made what they considered satisfactory runs (probably small deviations of less than about 0.5 m from the intended trajectory and linear velocities less than about 0.03 m/sec while trying to stop) on the fixed-base simulator, they were not consistent. On the moving-base simulator, however, they considered practically every run to be satisfactory.

The test subjects estimated that the workload on the fixed-base simulator was three to four times higher than the workload on the moving-base simulator. Part of this increased workload was due to the added physical workload of making error corrections in roll, yaw, and lateral translation on the fixed-base simulator. The other part of the increased workload, according to the subjects, was an increased mental workload due to difficulty in interpreting the visual presentation. In the fixed-base simulator the subject's task had two distinct parts; determining the vehicle's motion from the visual presentation, and then maneuvering the vehicle to produce the desired motion. On the moving-base simulator the first part of the task was practically automatic because of the abundance of visual cues. The television image, on the other hand, was a two-dimensional presentation of a three-dimensional object, and there were no motion cues or audio cues from the thrusters' firing. The result was that the subjects had to make a continuous mental effort to visualize that they were moving and the spacecraft was stationary rather than vice versa.

The subjects also stated that the drag on the air bearings made them use higher linear and angular rates than they would have if there had been none. During the training sessions on the moving-base simulator, the subjects developed the technique of constantly using high rates when they discovered that using high rates tended to minimize the detectable effects of drag.

Quantitative data.- The quantitative data for the original operating conditions are presented in figures 12 and 13 and generally confirm the qualitative opinions. Substantial

differences are evident in the trajectories of figure 12 and in at least one of the parameters for all three categories of data in figure 13 (performance, cost, and maneuvering rate).

The initial part of the trajectories (fig. 12) are practically the same for both simulators with the FCMU drifting off the desired trajectory about 0.5 m. From position 3 to the end, however, the trajectory for the fixed-base simulator was much worse than that for the moving-base simulator. And it must be remembered that the fixed-base-simulator trajectory does not show the lateral drift from the desired trajectory. This out-of-plane drift averaged about 0.6 m but was sometimes as large as 2.2 m.

The poorer performance on the fixed-base simulator was also reflected in the quantitative pilot performance data of figure 13(a). Both subjects had an average trajectory error of 0.5 m on the moving-base simulator while on the fixed-base simulator their average was about twice as large. The larger width of the pseudodistribution curves for the fixed-base simulator also indicated the subjects' performance of the maneuver was not as consistent as their performance on the moving-base simulator. The second and third performance parameters (null velocity and null angular rate) show very little difference between the two simulators while the fourth and fifth parameters (final velocity and final angular rate) generally show the same 2:1 ratio as the trajectory error. Since each of these parameters was a measure of how well the subjects could stop the vehicle, there seems to be an inconsistency. The cause of this apparent inconsistency could be the difference in visual cues at the null and final positions or a simple accumulation of small errors over the entire run. However, a closer study of the situation is needed.

The higher physical workload on the fixed-base simulator, which was mentioned by the test subjects, is reflected in the larger number of inputs used on it. The larger number of inputs probably contributed to the subjects' using more impulse. (See fig. 13(b).) The increased mental workload on the fixed-base simulator was probably reflected in the think-time data (see fig. 13(b)) which shows the subjects used about three times more time on the fixed-base simulator between the end of their braking maneuver and their acceleration maneuver at position 3 than they used on the moving-base simulator. Part of this increased time was used in trying to determine what their drift velocities were, while on the moving-base simulator the velocities were almost immediately apparent. Increased think times all along the trajectory undoubtedly contributed to the large difference in total time used to complete the maneuver.

The total time used on the fixed-base simulator was also longer because the subjects usually used lower angular and linear rates to perform the maneuver on it. (See fig. 13(c).) This difference may have been partly due to the subjects' lack of confidence and desire not to make errors on the fixed-base simulator, but it was also probably due

to the desire to minimize the effects of drag on the moving-base simulator as mentioned in the previous section.

Comparison of Modified Operating Conditions of Simulators

Qualitative data.- Both subjects again gave identical pilot ratings, independent of one another, for the two modified operating conditions. This time both subjects rated the task as PR 4 on the pilot rating scale for both simulators. It should be noted that both conditions were rated as not being "satisfactory without improvement" while the original operating condition on the moving-base simulator had been "satisfactory without improvement."

Subject A stated that the workload, both mental and physical, was about the same for both simulators while subject B thought the workload was slightly higher on the moving-base simulator. One reason subject B gave for this difference in workload was the fact that there was nothing to rest the head against in the moving-base simulator as there was in the fixed-base simulator. The high back of the seat in the fixed-base simulator provided a fixed reference point which could be used to judge attitude of the vehicle, especially at position 3 on the trajectory. Although the test subjects were unaware of any vestibular cues from the gravity vector in the fixed-base simulator, it is possible they unconsciously made use of these cues to judge attitude. Of course, the gravity vector was perpendicular to the motion on the moving-base simulator and could not, therefore, be used as a pitch-attitude cue.

Both subjects thought that the moving-base simulator was more forgiving of errors than the fixed-base simulator. This difference showed up most often in translational error or cross coupling which accompanied every pitch input on the FCMU. Both subjects thought the cross coupling was much less on the moving-base simulator. Some compensation for this error had to be made on the fixed-base simulator on every run while it was usually unnecessary on the moving-base simulator. There was some evidence that the slope of the air-bearing surface and the drag on the air bearings cancelled some of the cross coupling from the two pitch maneuvers used. (See appendix A.) Aside from this rather indirect evidence of drag and slope, the test subjects were generally not aware of either.

The subjects stated that the graininess of the projection screen provided a nonuniform background against which they could detect very small velocities of the target spacecraft. Another possible aid in nulling angular rates and linear velocities was the surrounding features in the fixed-base simulator such as the seat armrest and the supporting structure for the seat and the television kinescope which were visible to the subjects. On the moving-base simulator there were no such fixed features against which velocities could be judged.

Quantitative data. - The quantitative data, like the qualitative data, for the two simulators were in better agreement for the modified operating conditions than they had been for the original operating conditions. This similarity is very apparent in the two typical trajectories for the modified conditions shown in figure 14. In addition, a comparison of both of these trajectories with the ones in figure 12 shows that the test subjects were able to follow the desired trajectory more closely than they had been able to in the fixed-base-simulator original operating condition and less closely than they had been able to in the moving-base-simulator original condition.

There were slight differences in the quantitative performance data for the two simulators. (See fig. 15(a).) Only the trajectory error out of the five performance parameters showed the same level of performance on both simulators. However, even here the trajectory error should be somewhat higher for the moving-base simulator than is shown because a few runs had to be terminated when the vehicle drifted off the desired trajectory and into the small barriers at the edge of the bearing surface. These terminated runs could not be included in the data presented. The other parameters, which really measured how well the vehicle could be stopped, showed that performance was better on the fixed-base simulator than on the moving-base simulator rather than the other way around as was the case for the original operating conditions. In fact, the null and final angular rates on the fixed-base simulator were about as low as can be obtained on the FCMU considering the minimum length of thruster pulse attainable with these controllers. This improved performance on the fixed-base simulator may have been due to better perception of small rates because of the graininess of the screen mentioned by the test subjects.

Except for the impulse the costs in the modified operating conditions were still generally higher on the fixed-base simulator just as they had been in the original operating conditions. (See fig. 15(b).) The number of inputs used was still higher on the fixed-base simulator even though the three additional axes of control had been eliminated. Evidently other factors were important, possibly damping due to drag on the bearings, motion cues, or maybe the audio cues from the thrusters' firing. There were still substantial differences in the total time used even though there was some narrowing of the difference in the think time used. The difference in total time used was, therefore, probably due mainly to difference in velocities and rates used. (See fig. 15(c).) The differences in the velocities and rates used were still practically as great as for the original operating conditions and indicated that the subjects' confidence level was not the main factor in determining rates used. The drag-reducing technique explained in the section entitled "Comparisons of Original Operating Condition of Simulators" was probably the main factor. The fact that the impulse was approximately the same was probably because of offsetting effects. That is, the increased impulse used on the fixed-base simulator due to a larger number of inputs was offset by the increased impulse used on the moving-base simulator due to the higher maneuvering rates used.

Poor performance and high costs are normally associated with increases in pilot ratings given. Since the performance was poorer on the moving-base simulator in the modified operating condition, this result would imply that the moving-base simulator would be given a higher pilot rating number. The cost data, on the other hand, would imply the opposite, i.e., that the fixed-base simulator would be given a higher pilot rating number. It appears that there were offsetting factors so that the quantitative data may be interpreted as supporting the test subjects' identical pilot ratings for both conditions.

The agreement of the results for the two modified conditions of the simulators confirms the results of reference 12. That study found that after training, comparable results were obtained from a fixed-base simulator and a moving-base simulator with similar visual cues and the same number of degrees of freedom. The Gemini-Agena docking task performed in that report was evaluated in terms of an overall quantitative parameter which included some of the individual parameters used in the present study. If this approach had been used here, the offsetting effects mentioned above would have produced closer agreement than was obtained by the individual comparison methods actually used.

Effects of Simulator Modifications

Since the results from the two modified operating conditions were found to be more nearly alike than the results from the two original conditions, an evaluation was made to ascertain the influence of each of the three modifications. Before these effects could be determined, the question as to whether the order of making the two modifications on the fixed-base simulator was important had to be answered. This question is examined in appendix B, where it is shown that in general the order did not matter.

Qualitative data.- The test subjects said that the order of importance of the modifications was: (1) the degrees-of-freedom change on the fixed-base simulator, (2) the visual-cue change on the moving-base simulator, and (3) the horizon-cue change on the fixed-base simulator. Both subjects agreed that reducing the degrees of freedom reduced the workload of the task and that eliminating the extraneous visual cues on the moving-base simulator increased the workload of the task. On the other hand, subject A stated that removing the horizon cues decreased rather than increased the workload of the task because the horizon tended to "washout" the target spacecraft which provided all his visual cues. Subject B thought that removing the horizon cues increased the workload of the task very slightly or not at all.

Quantitative data.- It was difficult to confirm the order of importance of the modifications with all of the quantitative-data parameters. Exceptions to any general statement could be easily found in several of the parameters. However, samples of the data, which generally showed that the degree-of-freedom change made more difference than the visual-cue change which in turn made more difference than the horizon-cue change, are

presented in figure 16. Samples are shown from each category of data for all three modifications.

The effect of the changes on the parameters were as expected. That is, reducing the degrees of freedom on the fixed-base simulator improved performance, reduced costs, and made little difference in the maneuvering-rate data; eliminating the extraneous visual cues on the moving-base simulator degraded performance, increased costs, and made little difference in the maneuvering-rate data; and removing the horizon cues made no consistent difference (except as noted in appendix B).

It should be mentioned, however, that eliminating the extraneous visual cues did affect the maneuvering-rate data for subject B. (See fig. 17.) This subject became more cautious with EVA-type visual cues as evidenced by the decreased up velocity. On the other hand, he sometimes increased his pitch-up rate because he was frequently in danger of running into the edge of the air-bearing surface and had to hurry his pitch maneuver so he could start translating toward the target and avoid hitting the edge.

All the preceding results are important since they imply that it is necessary to provide a full six degrees of freedom and to eliminate extraneous visual cues for an EVA simulation. That is, a three-degree-of-freedom simulation or a simulation with extraneous visual cues will probably give an optimistic result. Some tentative corrections for the simulation data from simulators with either or both of these deficiencies can be obtained by replotting the data presented in figures 13 and 15 in a format similar to that of figure 16. However, judgment will still be required because the true corrections will probably be dependent on the subject, the vehicle, the maneuver, and the simulator.

CONCLUDING REMARKS

The results from a six-degree-of-freedom fixed-base simulator have been compared with the results from a three-degree-of-freedom moving-base simulator. Different results were obtained from the two simulators even though identical maneuvers were attempted using mockups of the same astronaut maneuvering unit. Qualitatively, the subjects thought the workload on the fixed-base simulator was much higher than the workload on the moving-base simulator. Quantitatively, the performance was worse, the costs were higher, and the maneuvering rates were lower on the fixed-base simulator.

When the simulators were modified to make them more nearly alike in degrees of freedom and visual cues, the overall results were in much better agreement. Qualitatively, the subjects thought the tasks were about equal in workload. Quantitatively, the performance was better, the costs were slightly higher, and the maneuvering rates were lower on the fixed-base simulator. These quantitative results were thought to show offsetting factors which produced identical pilot ratings for the two simulators.

The effects of the modifications to the two simulators were investigated. The subjects thought the degree-of-freedom change on the fixed-base simulator was more important than the visual-cue change on the moving-base simulator in producing the better agreement in the simulator results. The horizon cues were thought to be relatively insignificant. The quantitative data did not confirm or deny these opinions even though individual parameters did lend support. All the results were thought to imply that it was desirable to provide a full six degrees of freedom and to eliminate extraneous visual cues for an EVA simulation. Some tentative corrections for data from simulators with three degrees of freedom and for simulators with extraneous visual cues were suggested.

Langley Research Center,
National Aeronautics and Space Administration,
Hampton, Va., October 5, 1973.

APPENDIX A

PITCH-TRANSLATION CROSS COUPLING

Effect of Slope

The pitch thrusters on the simulated vehicle were located below the center of gravity. Thus, every pitch-attitude change was accompanied by a residual linear velocity V_R directed halfway between the starting and final attitude. (See sketch A1.)

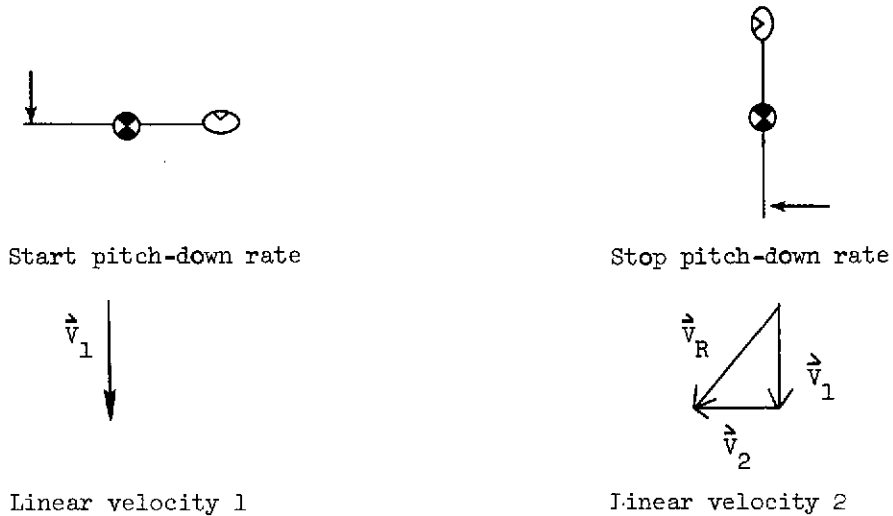

Sketch A1

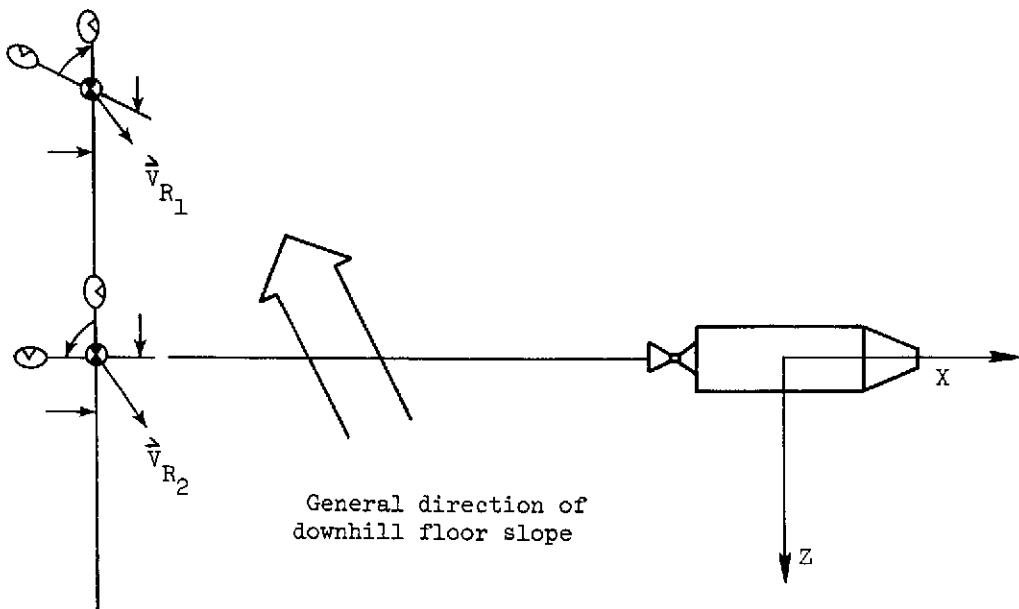

Sketch A2

APPENDIX A – Concluded

The residual velocity was always directed at the half-angle regardless of the direction in which the pitch maneuver was made. The residual velocities due to the two pitch maneuvers in the test maneuver are shown in sketch A2. Both residual velocities were directed in the positive X- and Z-directions. By coincidence the acceleration due to the slope in the floor was in a direction which tended to cancel the cross-coupled translational velocities. That is, the slope of the floor (see fig. 8) was roughly opposite the direction of the residual velocities (sketch A2).

Effect of Drag

The cross-coupled velocity had two components, \vec{V}_1 and \vec{V}_2 . (See sketch A1.) The first component, \vec{V}_1 , was roughly parallel to the final orientation of the translation axis of the vehicle and, therefore, could be corrected easily by the test subject after the final attitude was reached. At that time the second component, \vec{V}_2 , was relatively hard to correct because it was perpendicular to the translational control axis. In fact, the second component was probably the only component which was noticed by the subjects because the large translational velocities used to maneuver the vehicle were parallel to \vec{V}_1 .

This second component of the velocity, \vec{V}_2 , will now be shown to be substantially reduced by the effects of drag. During the pitch maneuver the drag caused the pitch rate to decay slowly so that a smaller thruster pulse was needed to stop the rate than to start it. The smaller this second thruster pulse was, the smaller the second, and most noticeable, component of the residual velocity was (see sketch A3).

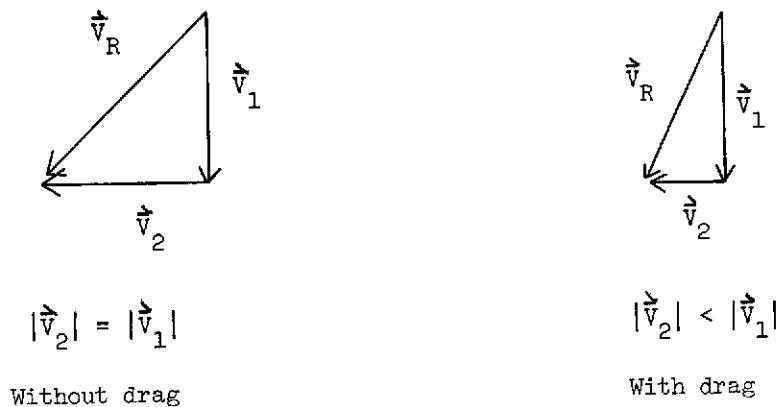

Sketch A3

APPENDIX B

EFFECTS OF THE TWO MODIFICATIONS ON THE FIXED-BASE SIMULATOR

Two different modifications were made on the fixed-base simulator to change it from its original operating condition to its final modified operating condition. Thus, it was not possible to determine from the data for these two conditions what the individual effects of the two modifications were. This difficulty was overcome by taking data at two additional conditions: six degrees of freedom with the horizon projector off and three degrees of freedom with it on. (See table I.) These two additional conditions can be thought of as being the intermediate condition between the original and modified operating conditions for two different sequences of modification. (See sketch B1.)

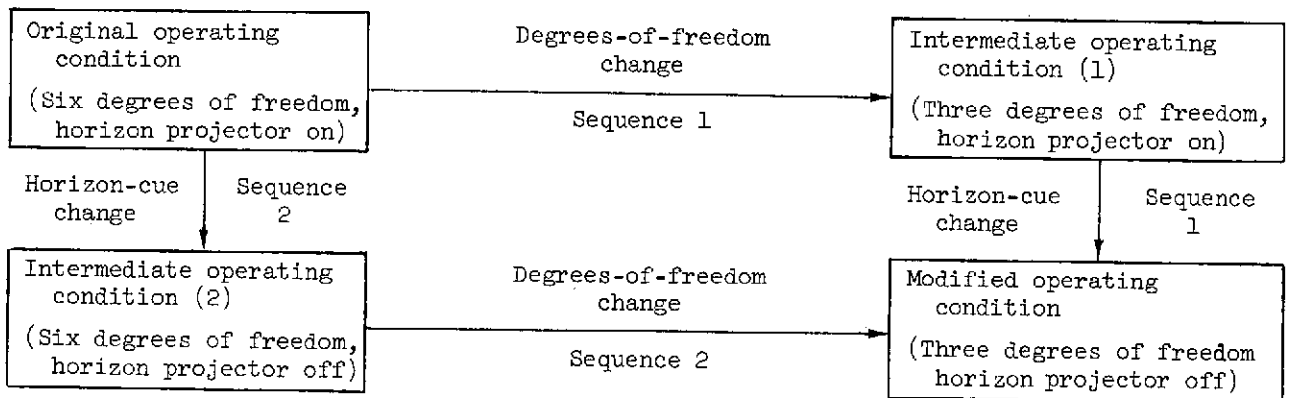

Sketch B1.- Two possible sequences for making modifications to the fixed-base simulator.

For most of the quantitative parameters the differences between the original and modified conditions were due almost entirely to the degree-of-freedom change and not the horizon-cue change no matter which sequence was considered. In fact, turning off the horizon projector made little difference in any of the quantitative parameters except the performance parameters at three degrees of freedom (sequence 1 in sketch B1). The performance was unexpectedly better for both subjects in stopping their linear and angular velocities when the horizon cues were removed. (See, for example, sketch B2.) Evidently the cues from the horizon were confusing the subjects as they tried to stop the vehicle. More experience with the simulator should reduce this confusion and actually make the horizon cues useful to the test subjects. For six degrees of freedom there was no apparent difference due to removing the horizon cues (horizon-cue change sequence 2). This result is surprising since removing the horizon cues in six degrees of freedom reduced both the roll and pitch cues to the subjects and would, therefore, be expected to make more difference than in three degrees of freedom where only pitch cues were removed. More

APPENDIX B - Concluded

data should probably be taken for a velocity nulling task at some distance from the target to confirm these unexpected results.

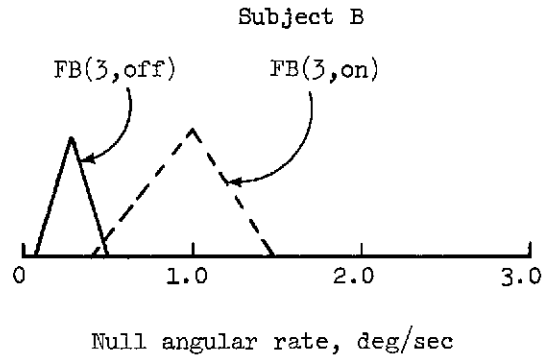

Sketch B2.- Effect of turning horizon projector off at three degrees of freedom.

REFERENCES

1. Thomas, David F., Jr.; Bird, John D.; and Hellbaum, Richard F.: Jet Shoes - An Extravehicular Space Locomotion Device. NASA TN D-3809, 1967.
2. Croston, Ronald C.; and Griffin, James B.: Manned Flight Simulation of the Air Force Modular Maneuvering Unit. J. Spacecraft & Rockets, vol. 4, no. 2, Feb. 1967, pp. 270-272.
3. Wudell, Allwin E.; Hunt, Larry M.; and Tobey, William H.: EVA Maneuvering Unit Comparisons. MCR-68-501, U.S. Air Force, Nov. 1968.
4. Whitsett, C. E., Jr.; and Cramer, P. S.: An Experimental Investigation of Attitude Control Systems for Astronaut Maneuvering Units. AIAA Paper 73-250, Jan. 1973.
5. Flexman, Ralph E.; Seale, Leonard M.; and Henderson, Campbell: Development and Test of the Bell Zero-G Belt. AMRL-TDR-63-23, U.S. Air Force, Mar. 1963.
6. Keller, T. L.; and Breul, H. T.: Hands-Free Precision Control for EVA. Rep. RE-352J, Grumman Aerospace Corp., Dec. 1968.
7. Hewes, Donald E.; and Glover, Kenneth E.: Development of Skylab Experiment T020 Employing a Foot-Controlled Maneuvering Unit. NASA TN D-6674, 1972.
8. Riley, Donald R.; Jaquet, Byron M.; Bardusch, Richard E.; and Deal, Perry L.: A Study of Gemini-Agena Docking Using a Fixed-Base Simulator Employing a Closed-Circuit Television System. NASA TN D-3112, 1965.
9. Riley, Donald R.; Jaquet, Byron M.; and Cobb, Jere B.: Effect of Target Angular Oscillations on Pilot-Controlled Gemini-Agena Docking. NASA TN D-3403, 1966.
10. Wilson, John W.; and Steinmetz, George G. (With appendix A by Roland L. Bowles): Analysis of Numerical Integration Techniques for Real-Time Digital Flight Simulation. NASA TN D-4900, 1968.
11. Catiller, John B.; and Herman, John A.: A Technique for Applying the Finish Surface of Large-Area Platforms Used for Gas-Bearing Zero-G Simulators. AFAPL-TR-67-119, U.S. Air Force, Nov. 1967. (Available from DDC as AD 664 334.)
12. Riley, Donald R.; Jaquet, Byron M.; Pennington, Jack E.; and Brissenden, Roy F.: Comparison of Results of Two Simulations Employing Full-Sized Visual Cues for Pilot-Controlled Gemini-Agena Docking. NASA TN D-3687, 1966.

TABLE I. - DIFFERENT CONDITIONS INVESTIGATED

Type of operating condition	Fixed-base simulator		Moving-base simulator
Original	Six degrees of freedom Horizon projector on Abbreviation: FB(6,on)		Extraneous visual cues Abbreviation: MB(on)
Intermediate	Six degrees of freedom Horizon projector off Abbreviation: FB(6,off)	Three degrees of freedom Horizon projector on Abbreviation: FB(3,on)	
Modified	Three degrees of freedom Horizon projector off Abbreviation: FB(3,off)		EVA visual cues Abbreviation: MB(off)

TABLE II. - DEFINITIONS OF QUANTITATIVE PARAMETERS

Data category	Parameter	Definition
Pilot performance	Trajectory error	"Mean squared" distance from desired trajectory, ^a m
	Null velocity	Linear velocity, v , at position 3 on trajectory, ^b m/sec
	Null angular rate	Angular rate, ω , at position 3 on trajectory, ^b deg/sec
	Final velocity	Linear velocity, v , at end of run (position 6 on trajectory), ^b m/sec
	Final angular rate	Angular rate, ω , at end of run (position 6 on trajectory), ^b deg/sec
Cost	Impulse	Total impulse used in maneuver, N-sec
	Total time	Total time used in maneuver, sec
	Number of inputs	Total number of inputs used in maneuver
	Think time	Time between end of braking maneuver and acceleration maneuver at position 3 on trajectory. ^b This time was probably used to determine whether rates had been properly nulled
Maneuvering rate	Pitch-down rate	Pitch-down rate, q , used between positions 1 and 2 on trajectory, ^b deg/sec
	Pitch-up rate	Pitch-up rate, q , used between positions 4 and 5 on trajectory, ^b deg/sec
	Down velocity	Linear velocity, v , used between positions 2 and 3 on trajectory, ^b m/sec
	Up velocity	Linear velocity, v , used between positions 3 and 4 on trajectory, ^b m/sec

^aThis "mean squared" error was a time-averaged error in which the error was calculated at 5-sec intervals of time; that is, Trajectory error = $\sqrt{\sum_{i=1}^n d^2(t)/n}$, where $t = 5i$.

^bSee figure 10.

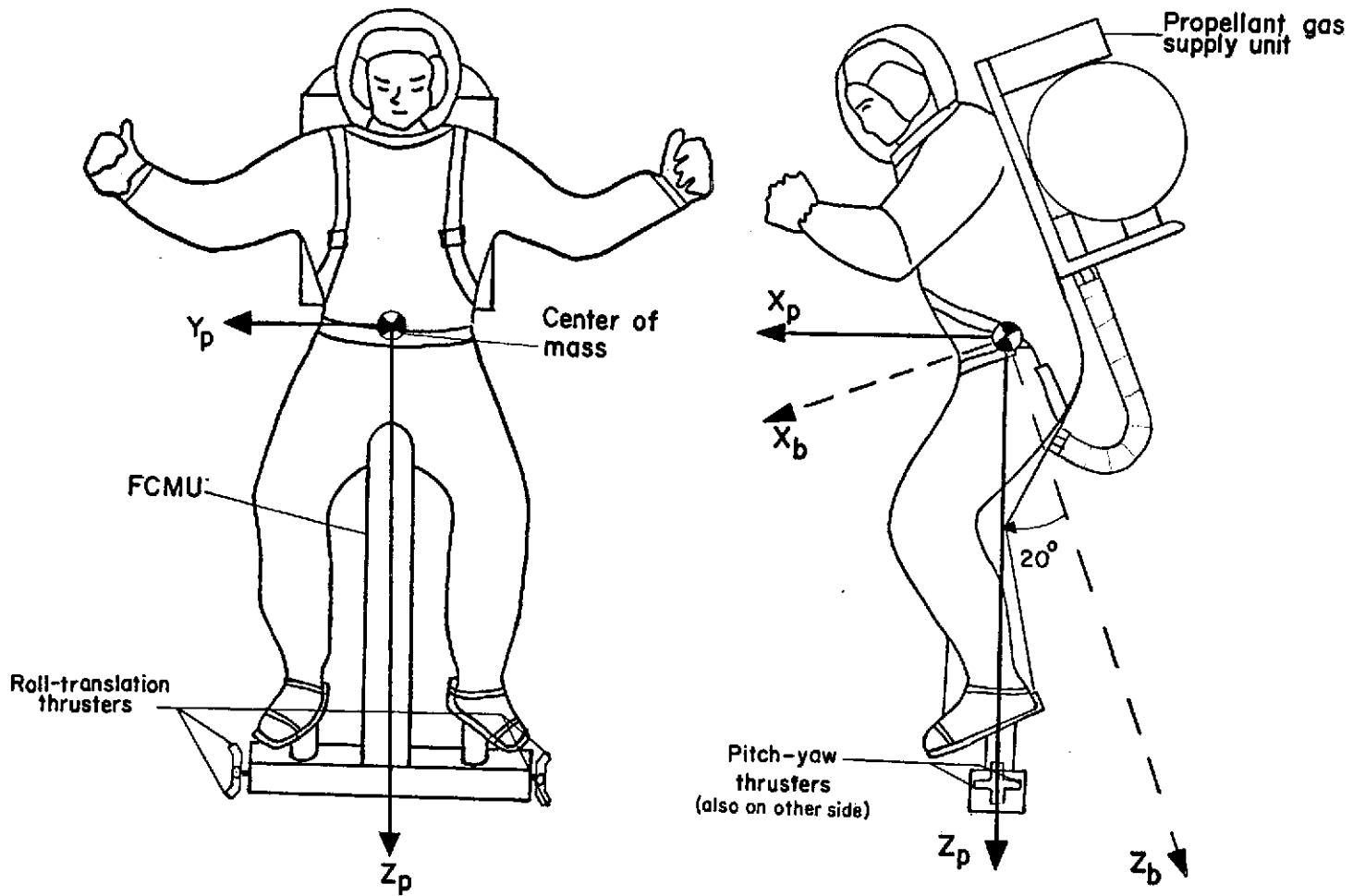

Figure 1.- The FCMU system showing body and principal axes. Arrows indicate positive directions.

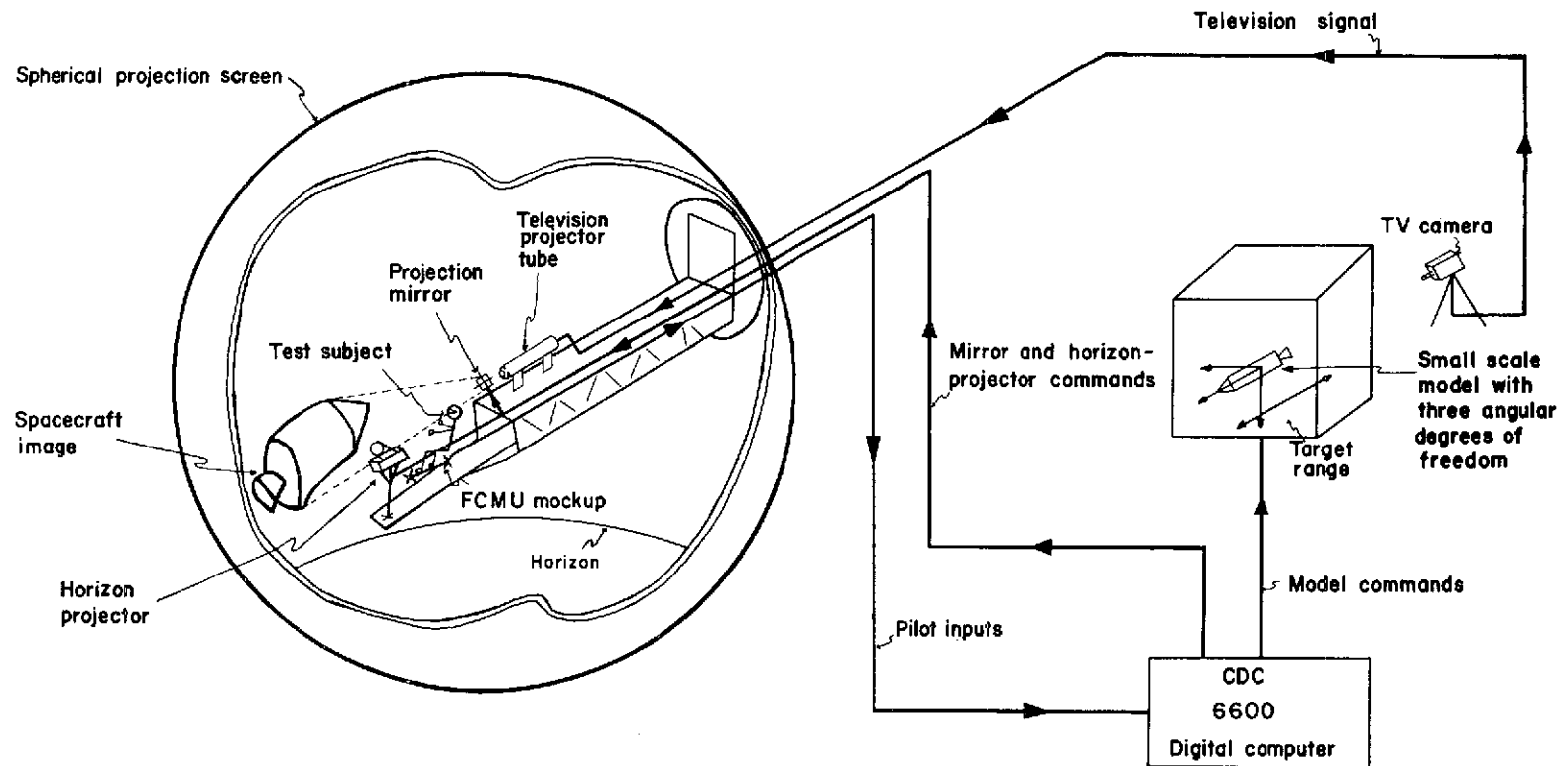
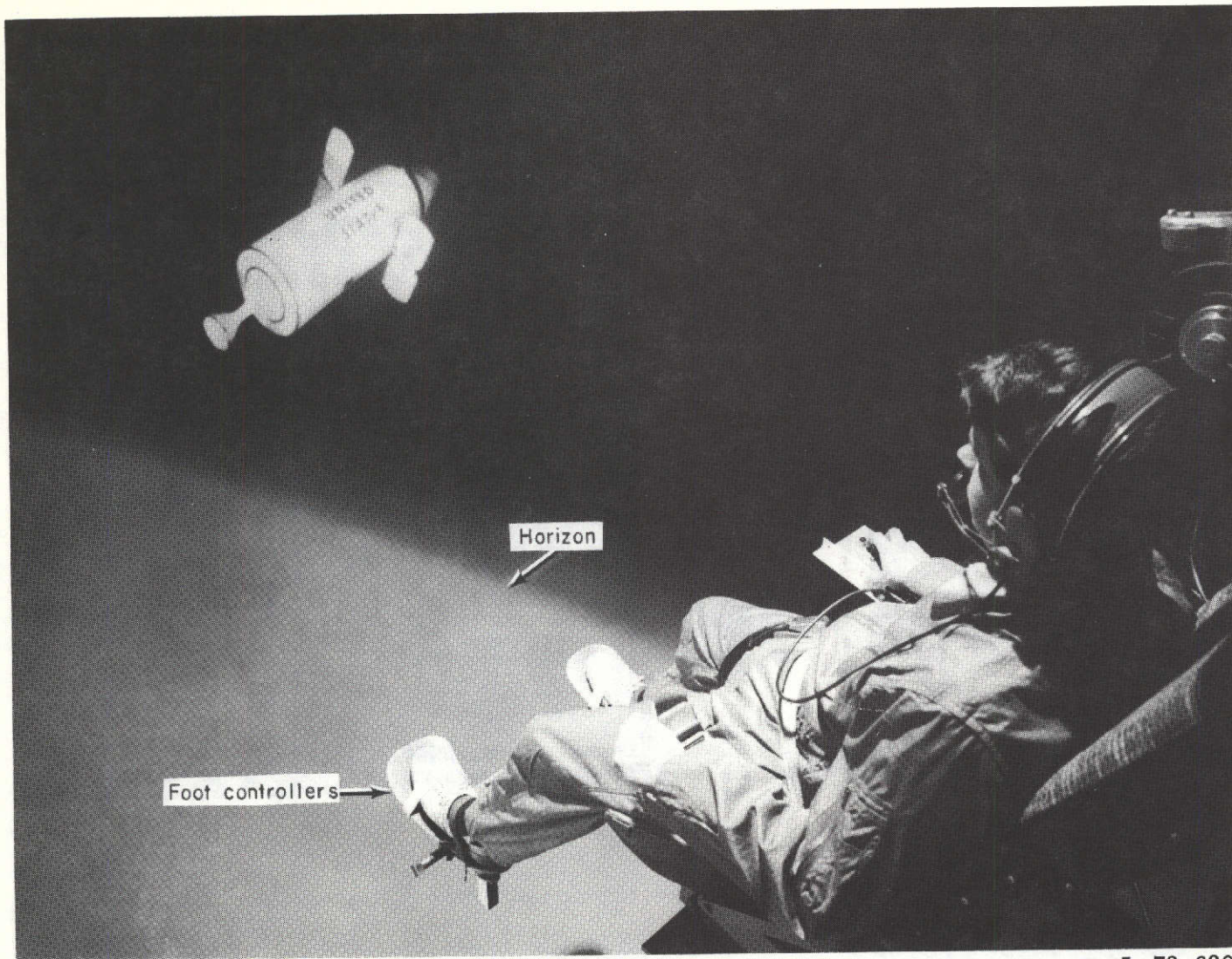
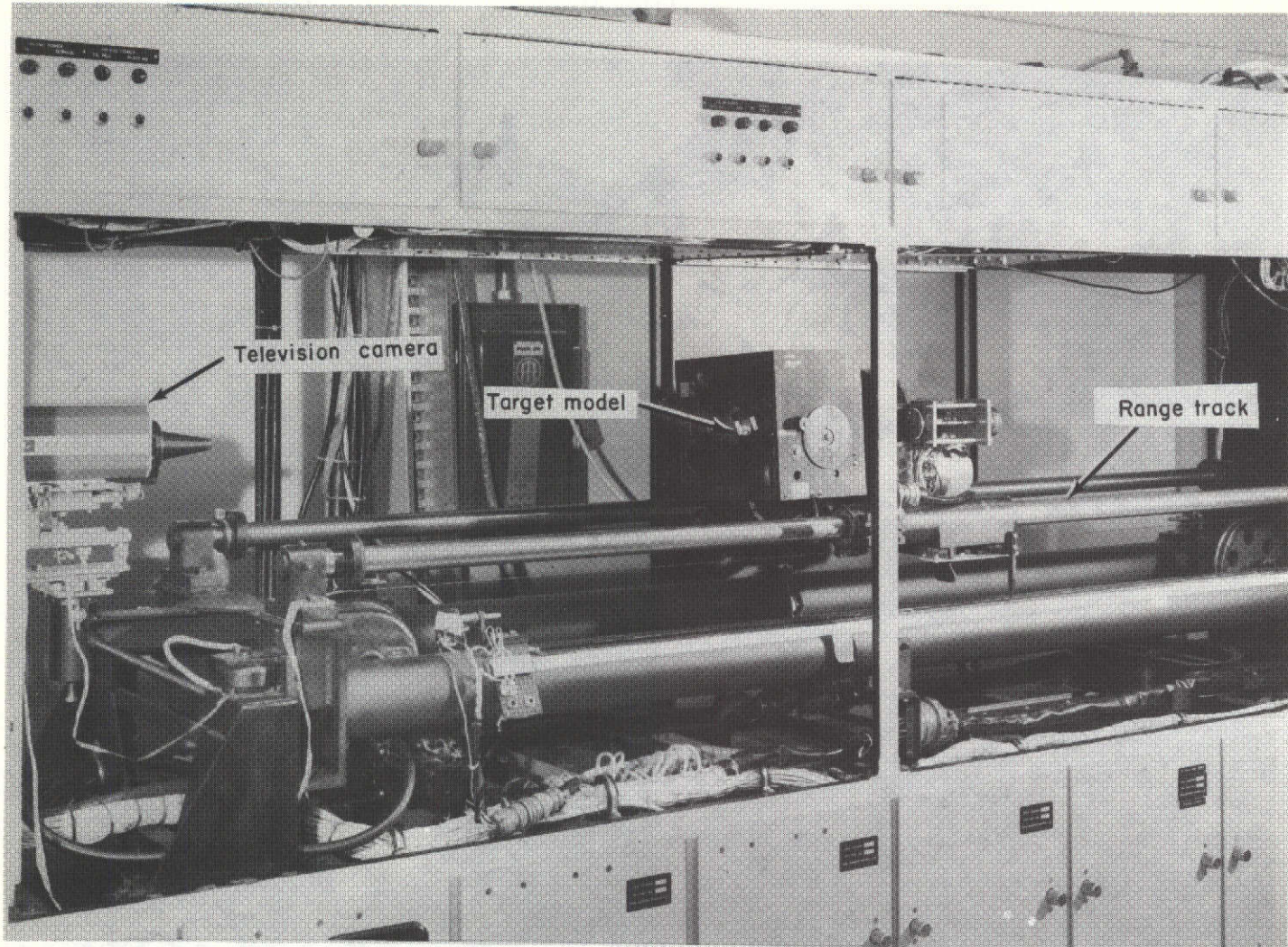

Figure 2.- Components of the fixed-base simulator.



L-73-6893

Figure 3.- Projected television image of target spacecraft in the fixed-base simulator.



L-70-5338.2

Figure 4.- Target-model drive equipment and television camera used in the fixed-base simulator.

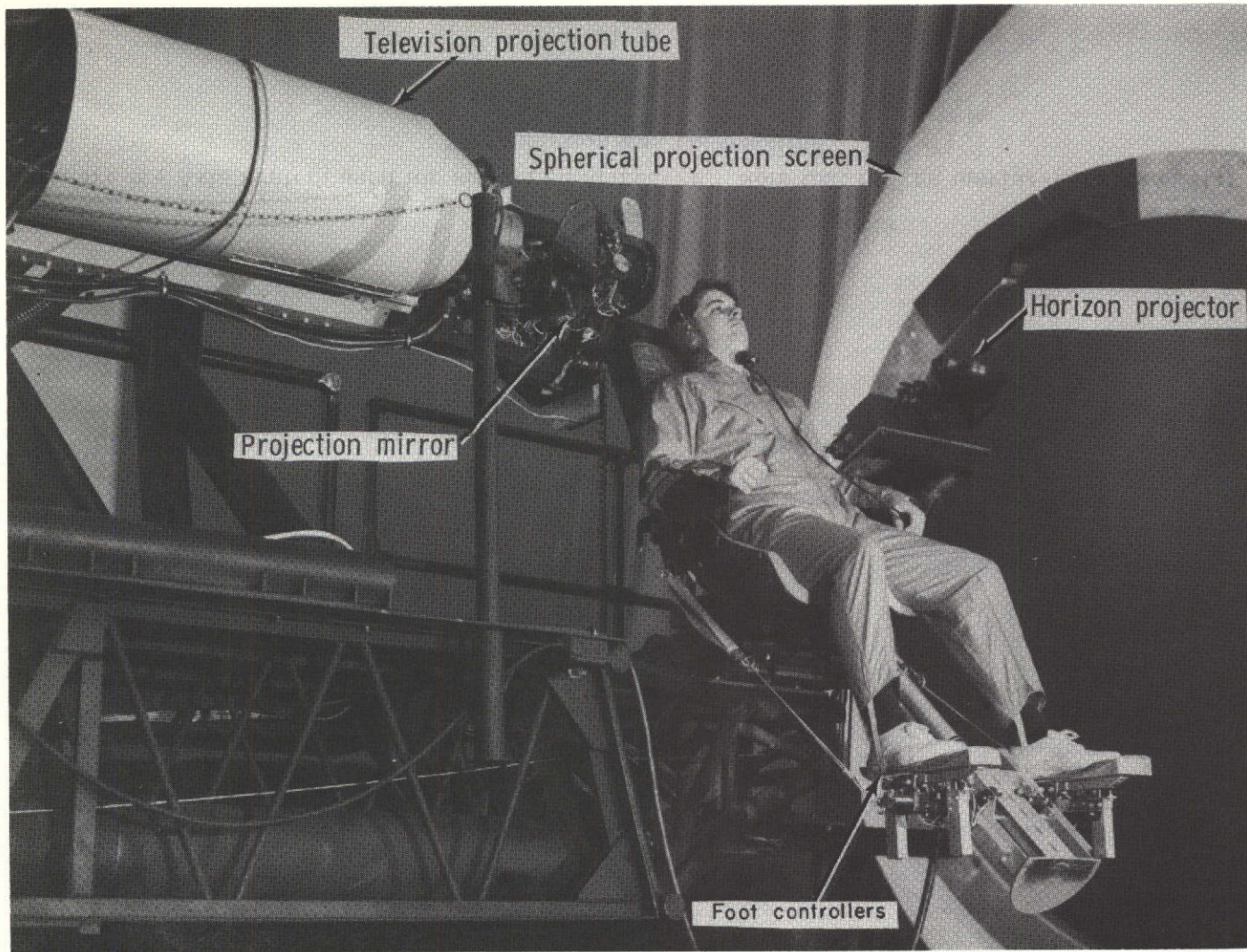

L-70-1855.2

Figure 5.- View of image projection equipment and test subject seated on mockup of FCMU. The spherical projection screen was removed for the photograph.

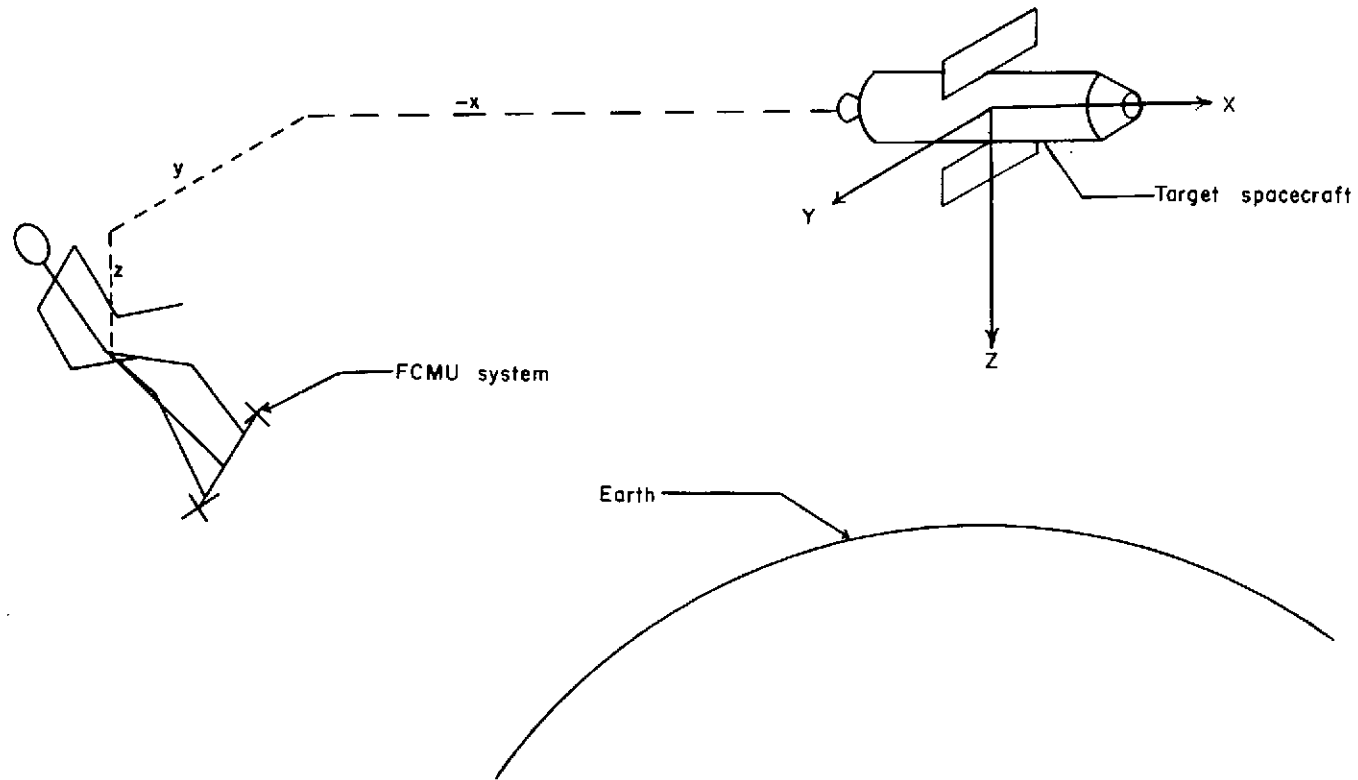
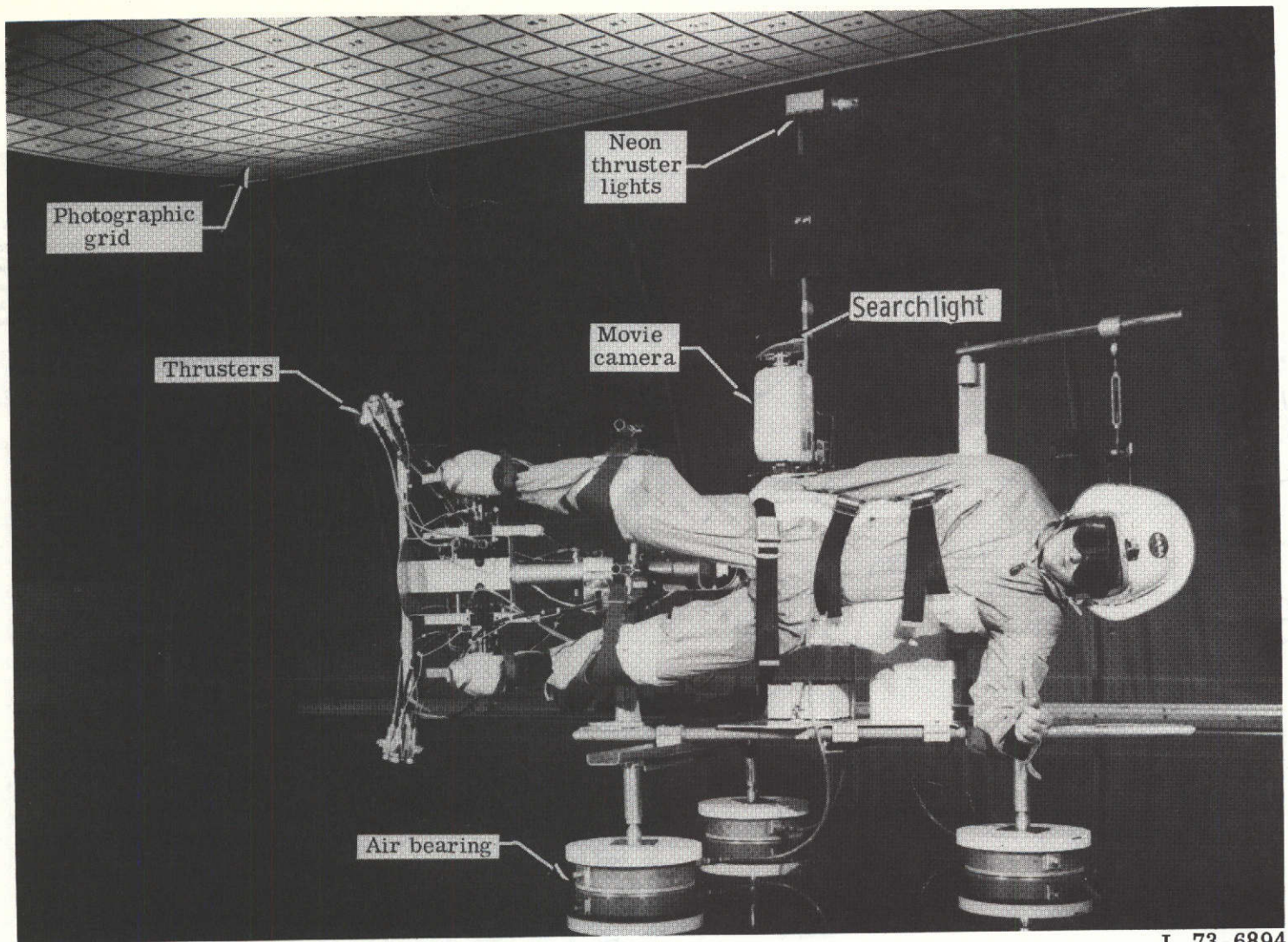

Figure 6. - Axis system used for simulated maneuver. Note that for the moving-base simulator Y-translation was not possible.



L-73-6894

Figure 7.- View of moving-base-simulator equipment.

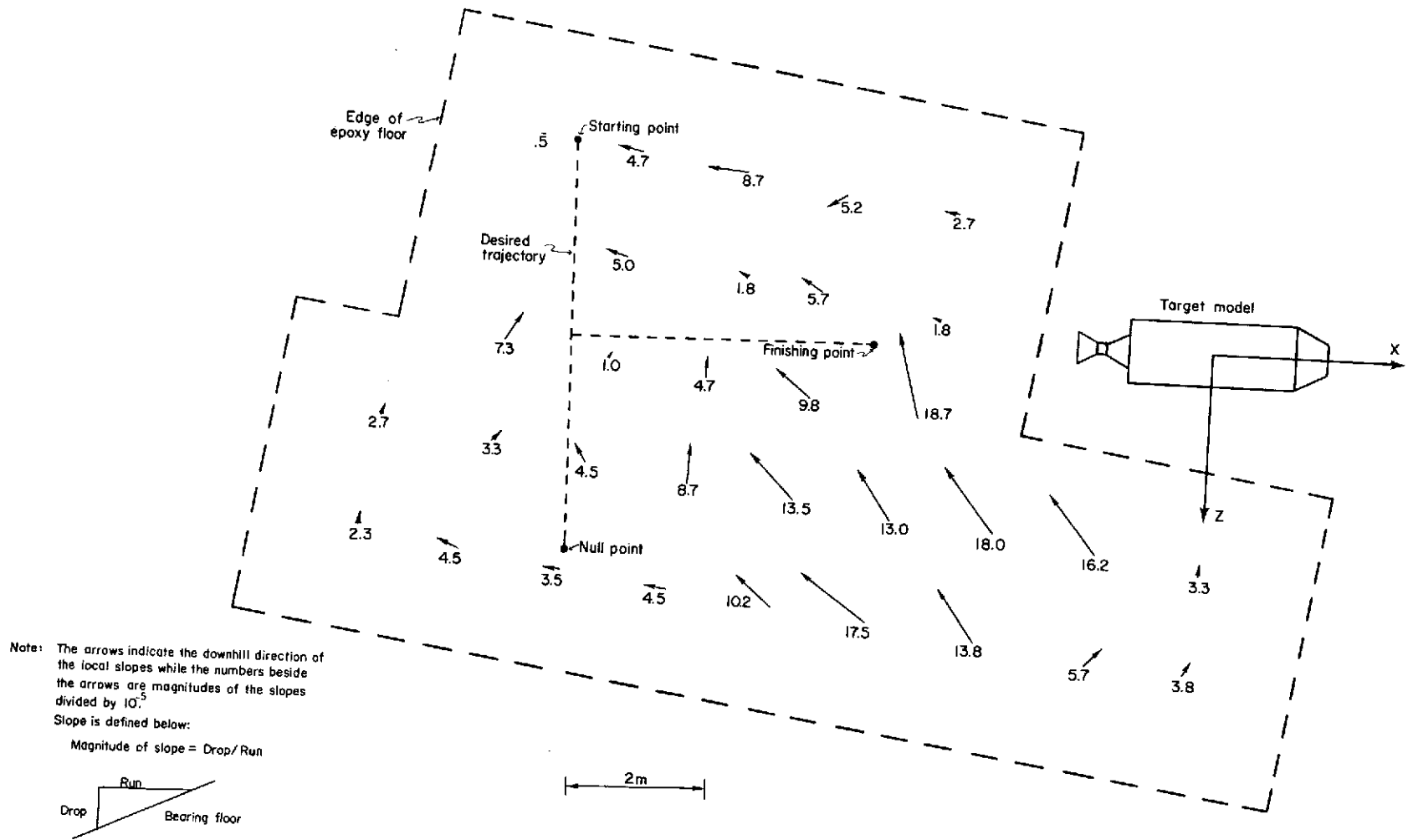
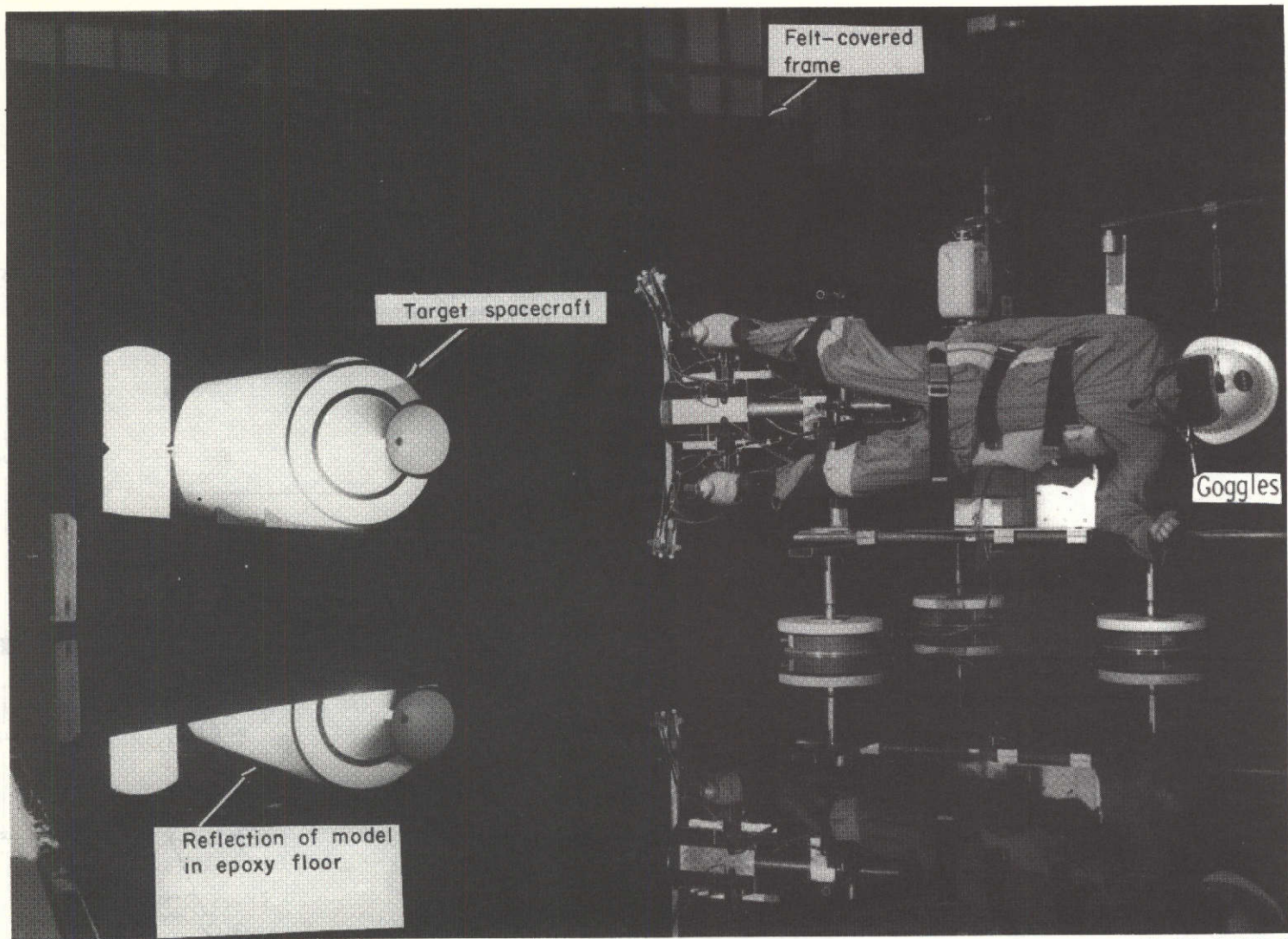

Figure 8.- Local slopes of air-bearing floor.



L-71-6567.1

Figure 9.- View of modified operating condition of moving-base simulator.

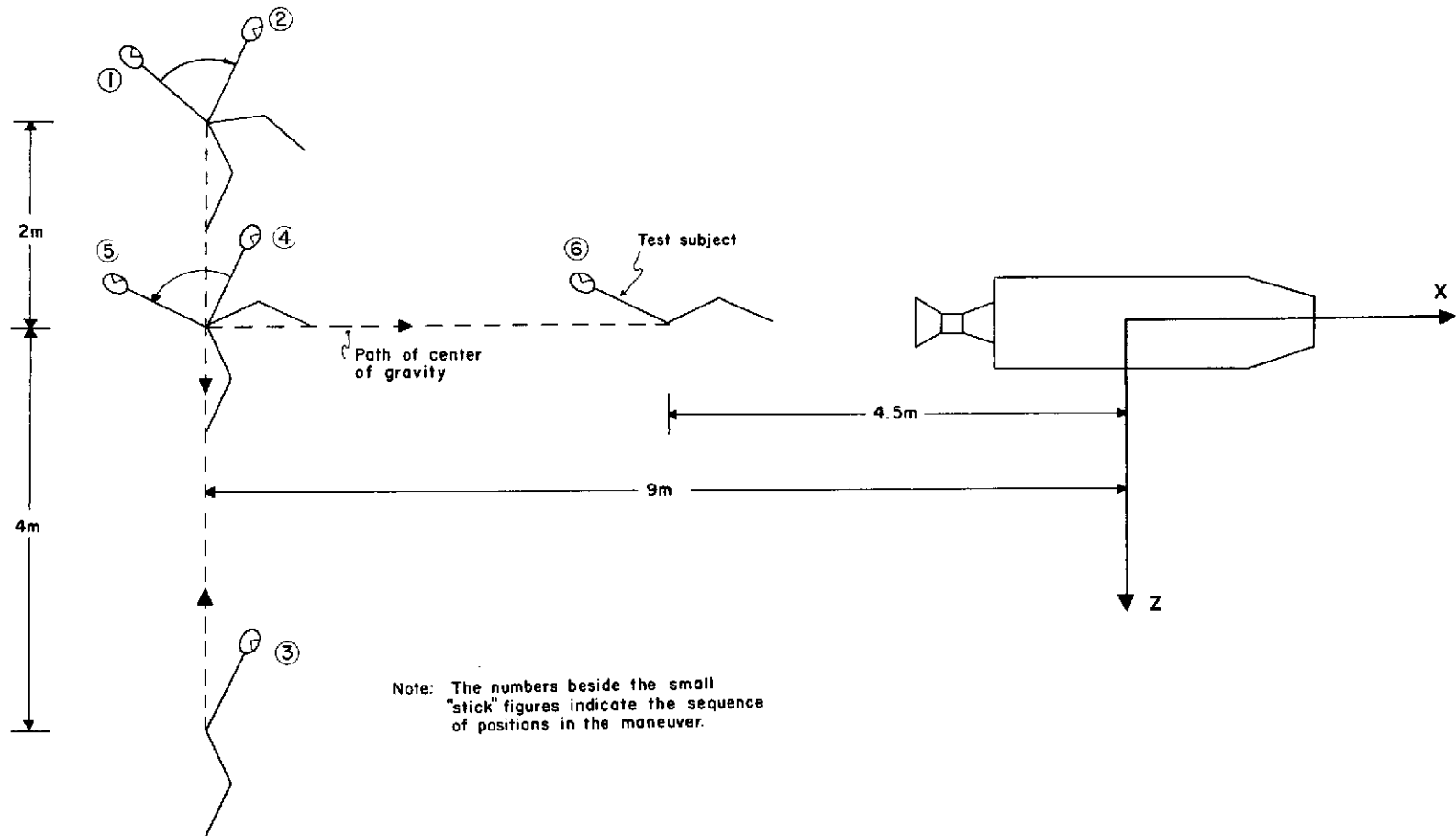

Figure 10.- Desired sequence of positions in simulated maneuver.

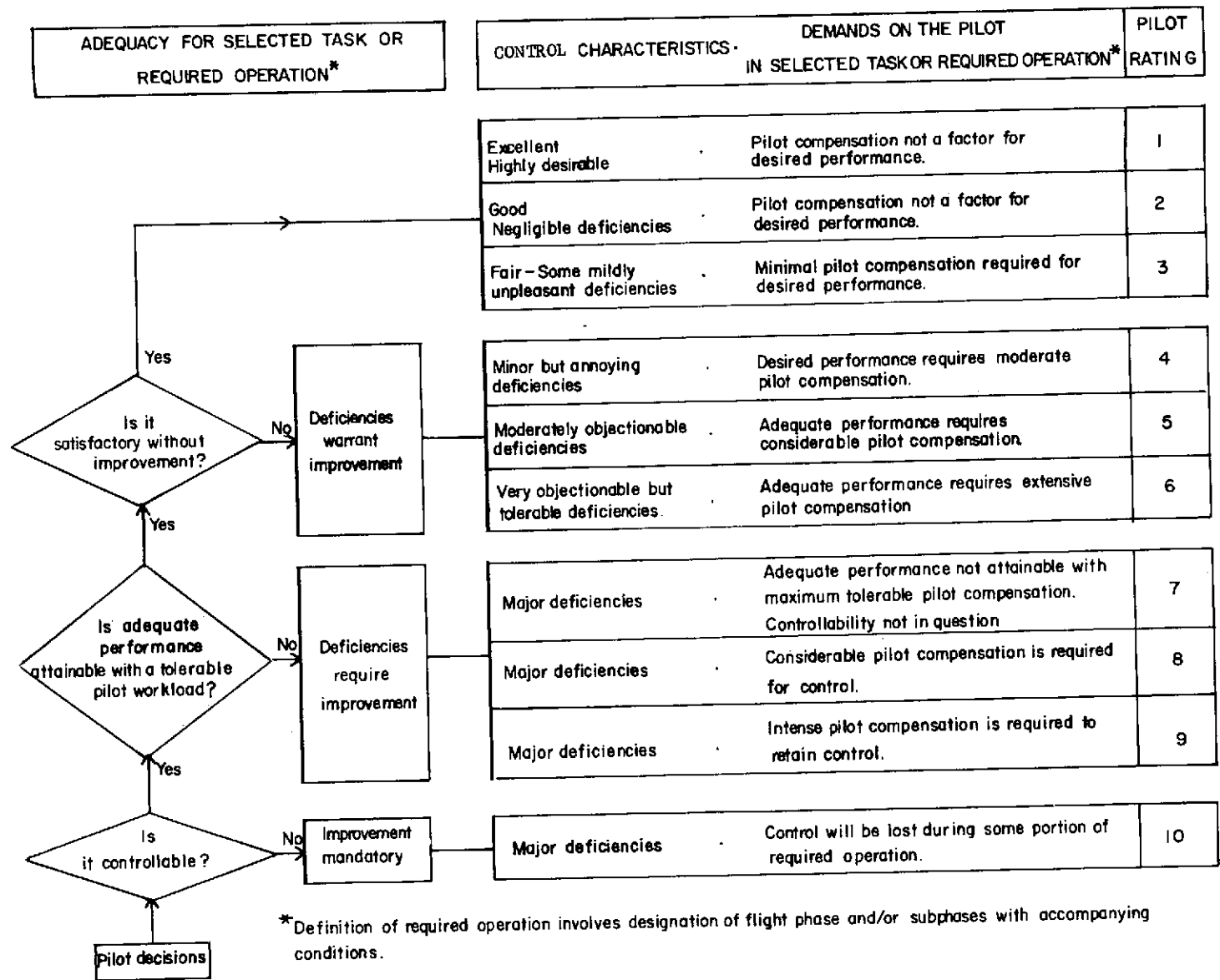
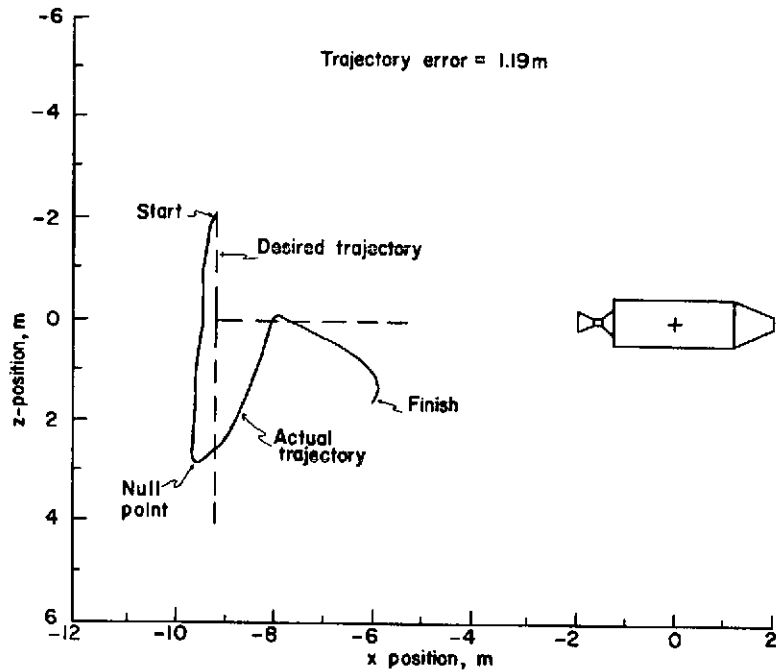
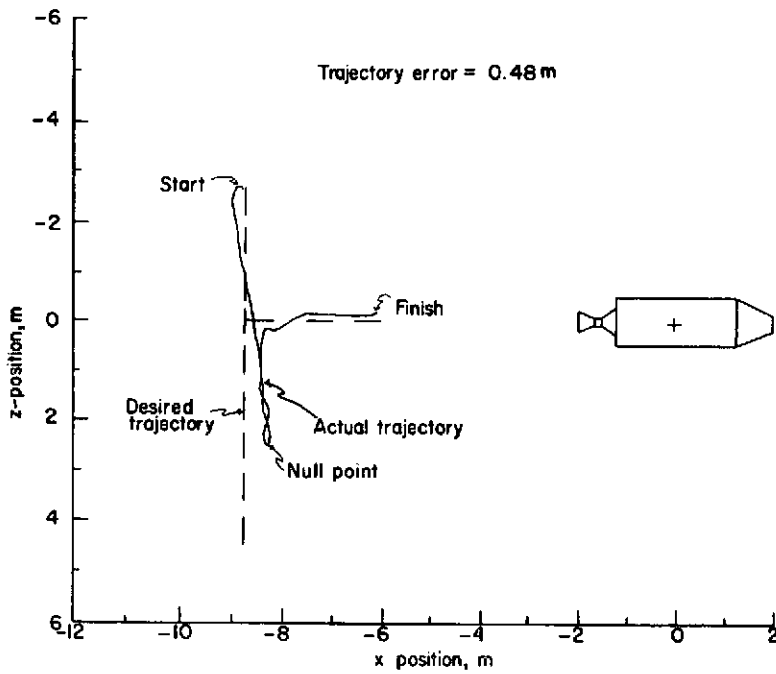

Figure 11.- Pilot rating scale.



(a) Fixed-base simulator.



(b) Moving-base simulator.

Figure 12.- Trajectories for original operating condition of simulators.

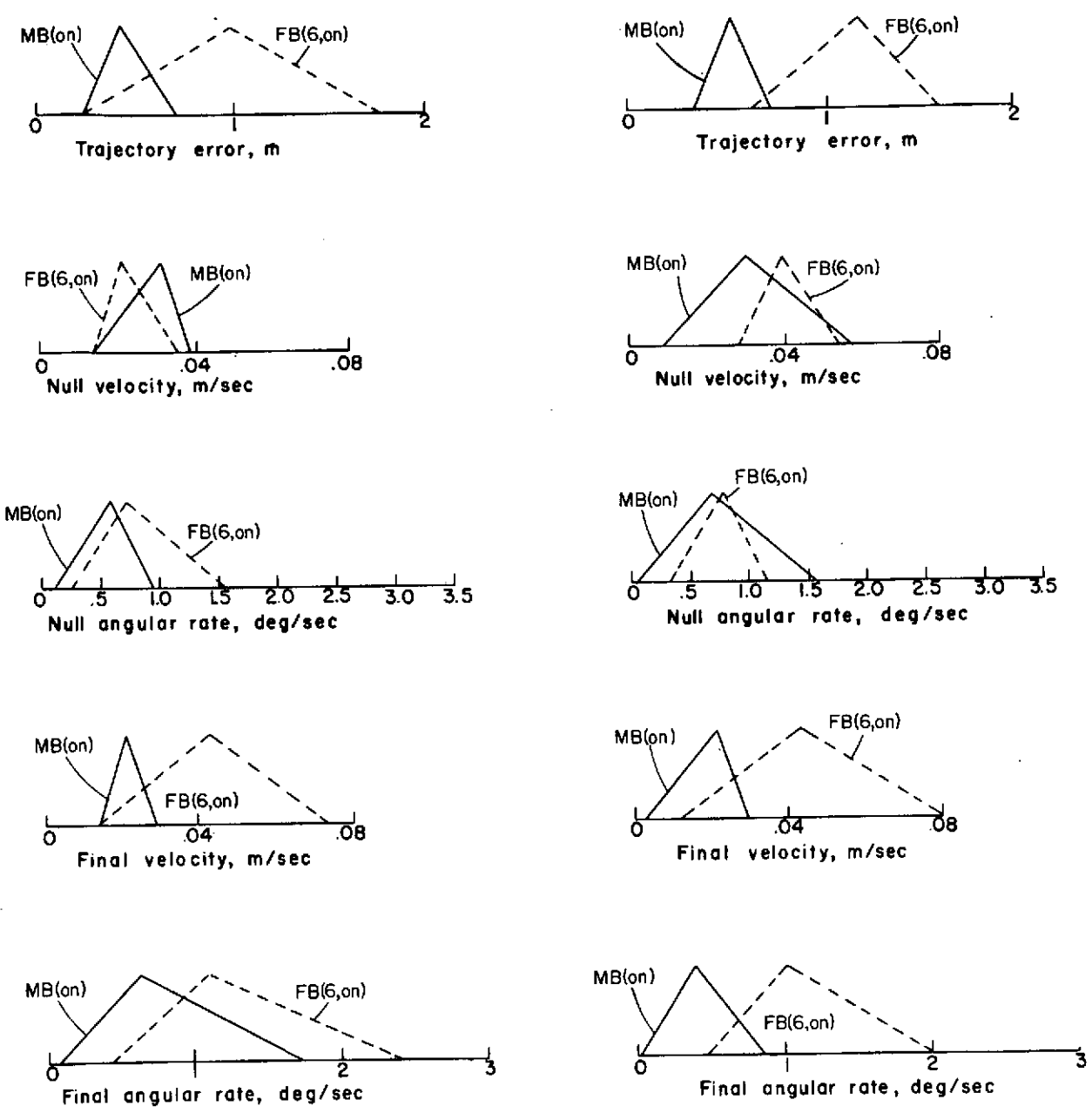

Subject A

Subject B

(a) Pilot performance.

Figure 13.- Data for original operating conditions of simulators.

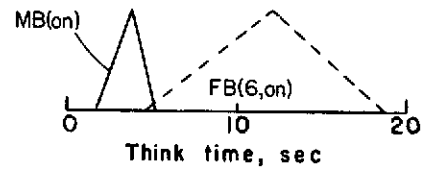
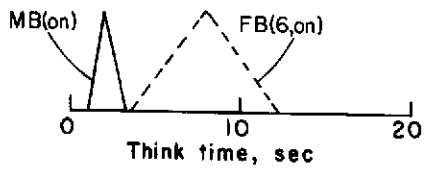
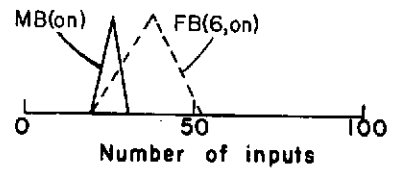
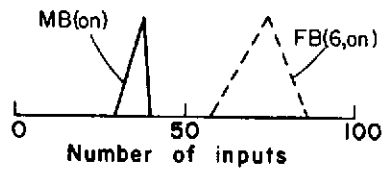
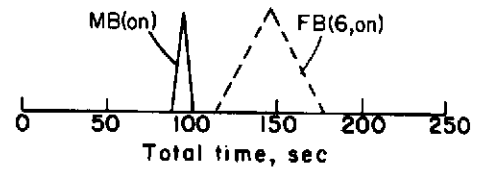
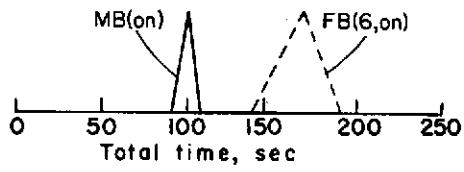
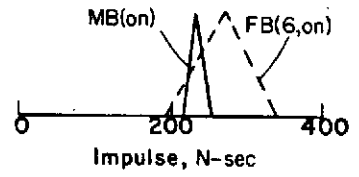
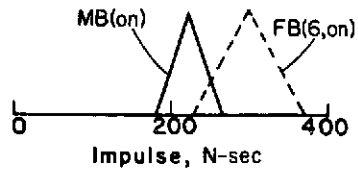

Subject A

Subject B

(b) Cost.

Figure 13.- Continued.

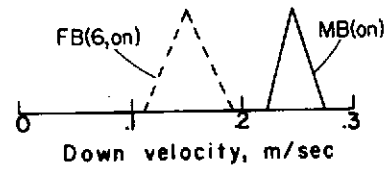
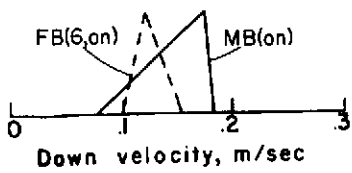
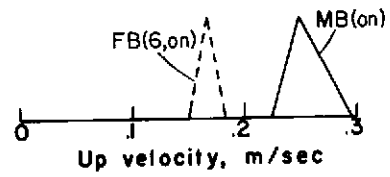
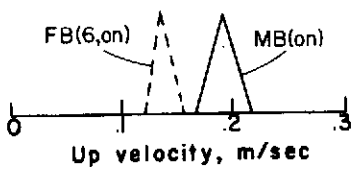
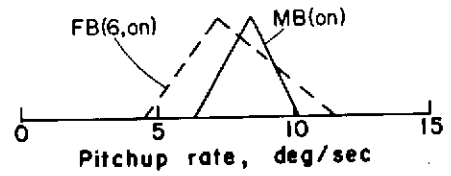
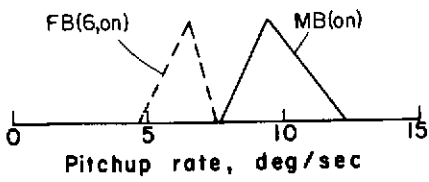
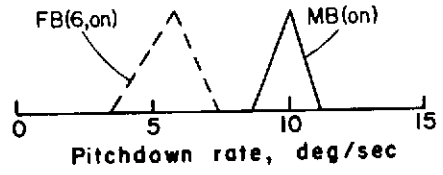
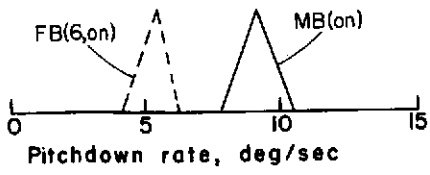

Subject A

Subject B

(c) Maneuvering rate.

Figure 13.- Concluded.

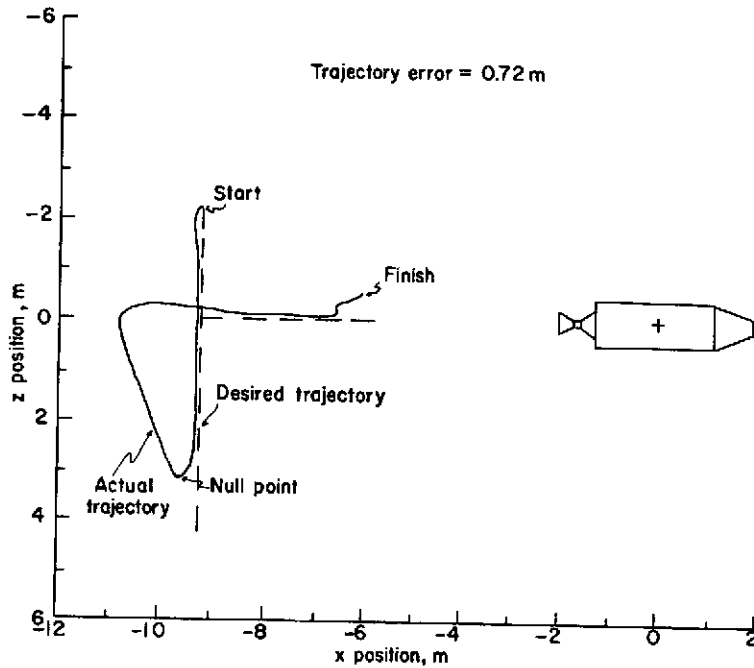

(a) Fixed-base simulator.

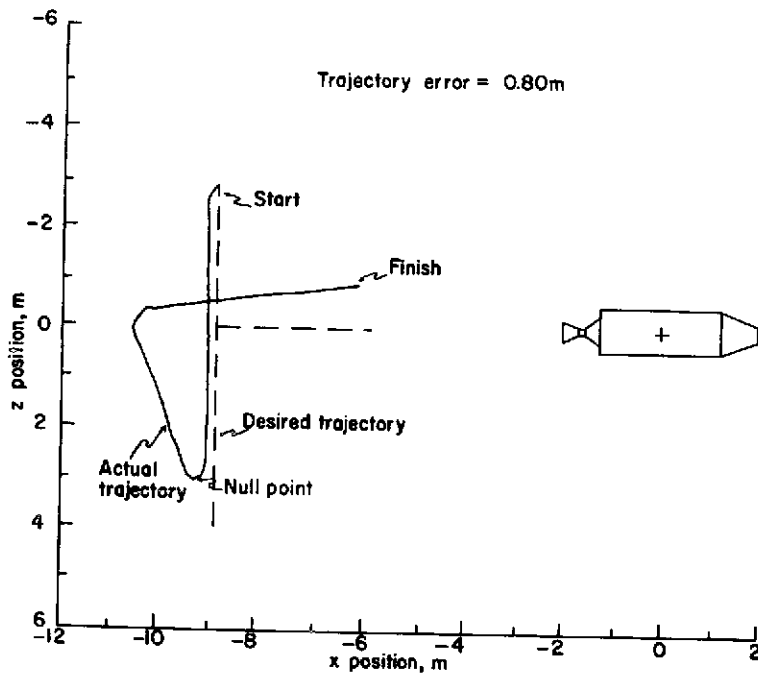

(b) Moving-base simulator.

Figure 14.- Trajectories for modified operating conditions of simulators.

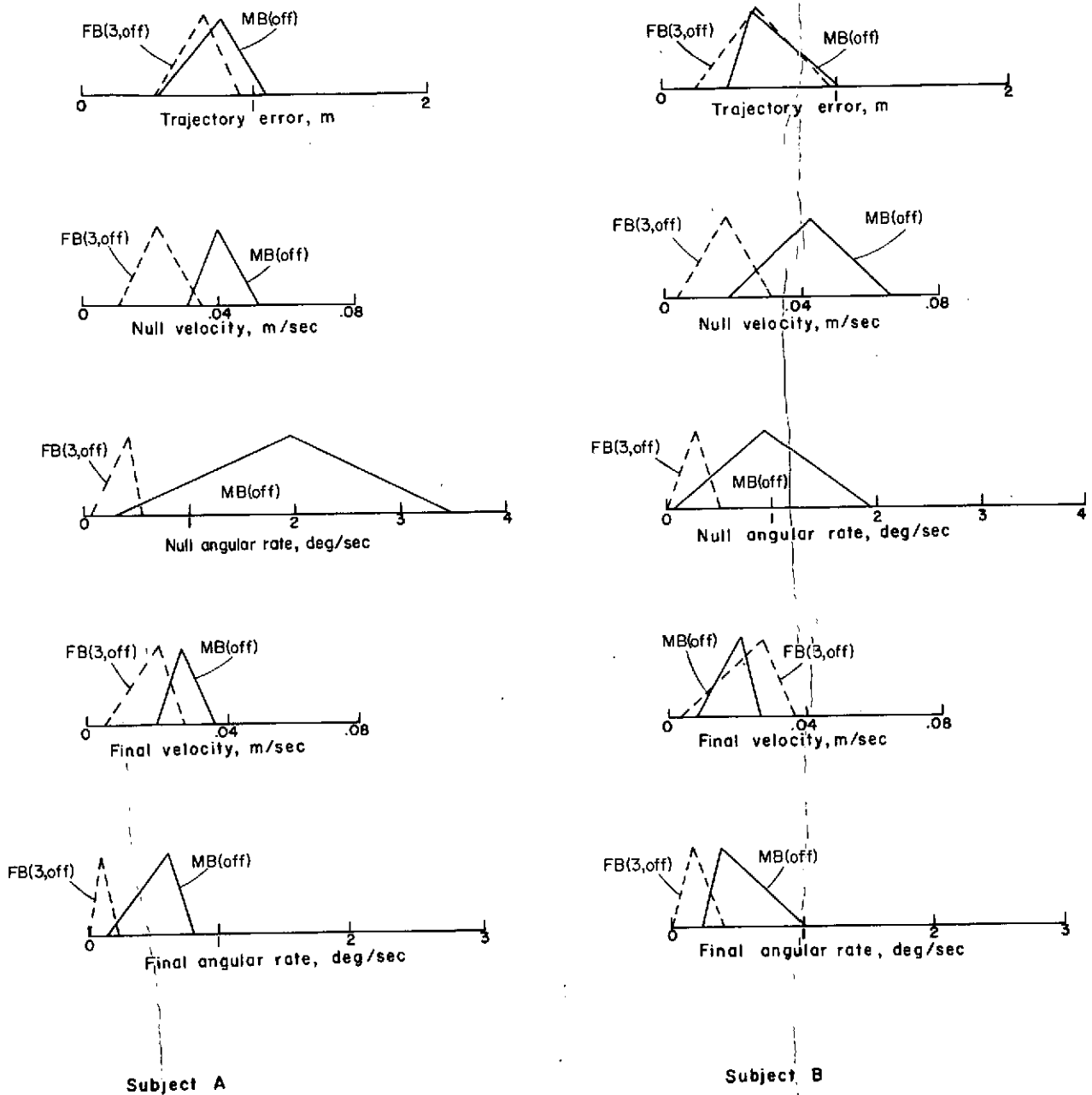

(a) Pilot performance.

Figure 15.- Data for modified operating conditions of simulators.

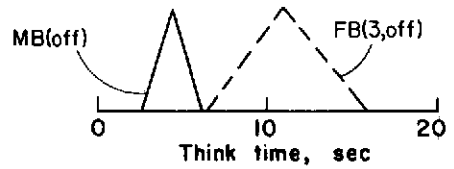
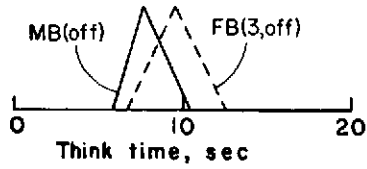
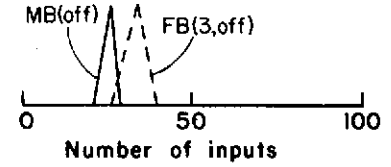
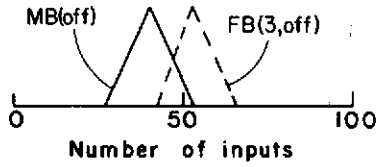
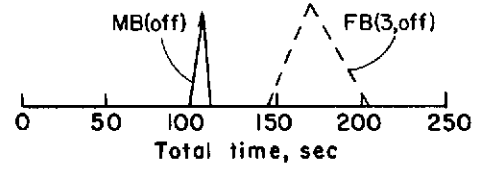
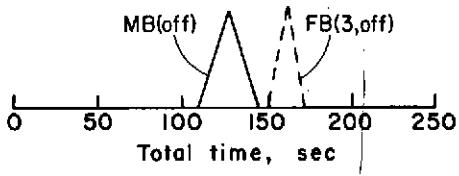
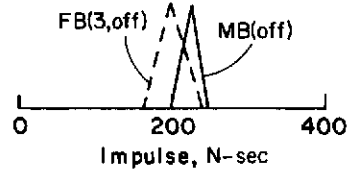
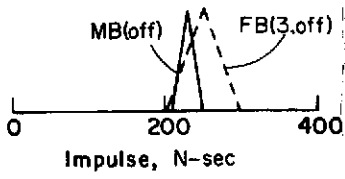

Subject A

Subject B

(b) Cost.

Figure 15.- Continued.

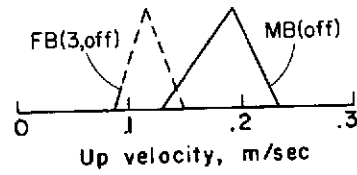
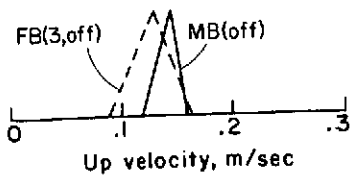
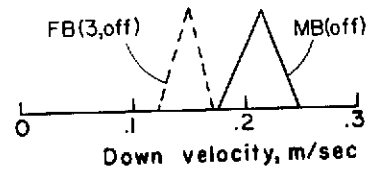
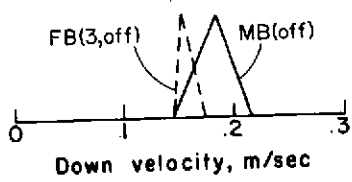
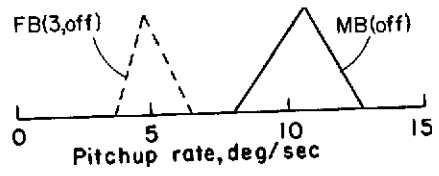
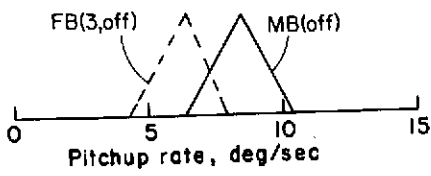
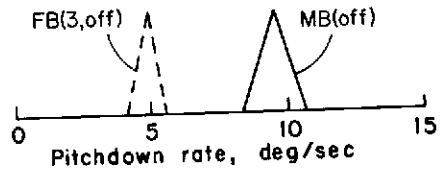
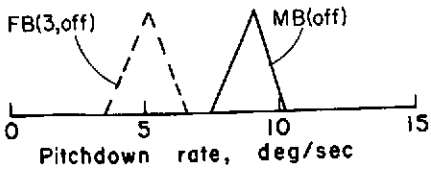

Subject A

Subject B

(c) Maneuvering rate.

Figure 15.- Concluded.

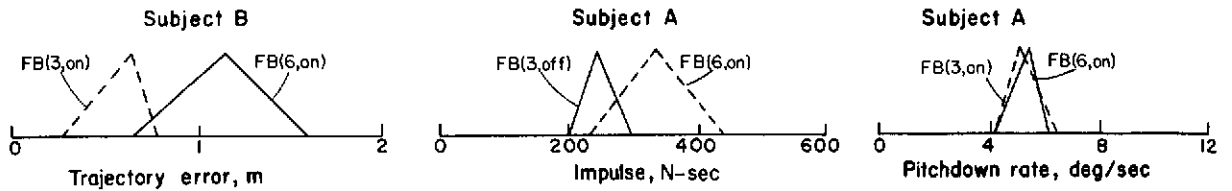

(a) Effects of changing degrees of freedom on the fixed-base simulator.

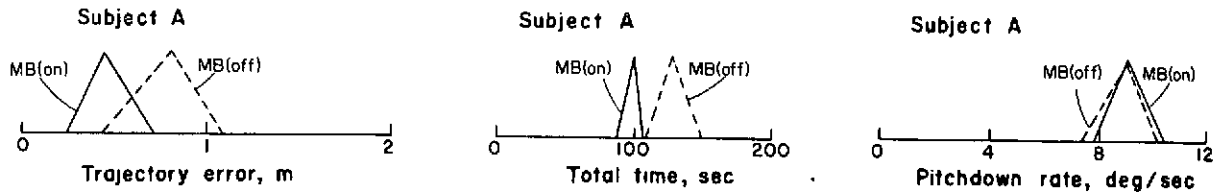

(b) Effects of changing visual cues on the moving-base simulator.

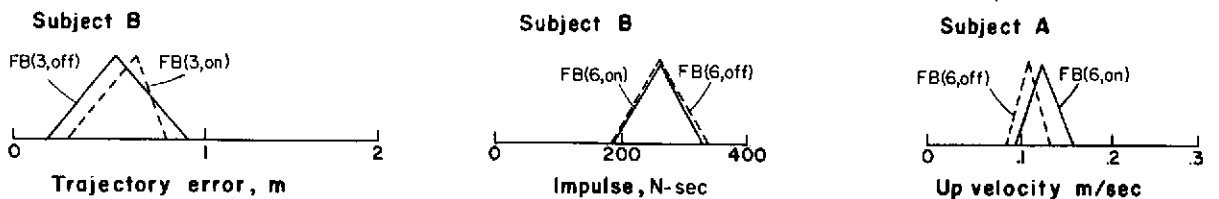

(c) Effects of changing horizon cues on the fixed-base simulator.

Figure 16.- Samples of the quantitative data showing the effects of the three modifications made to the simulators.

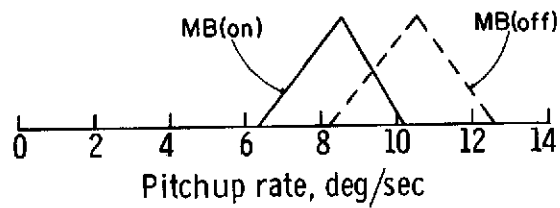
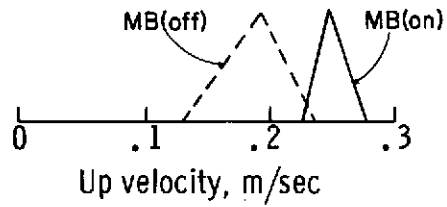

Figure 17.- Quantitative data showing effects of reducing visual cues on the maneuvering-rate data for subject B.