

147

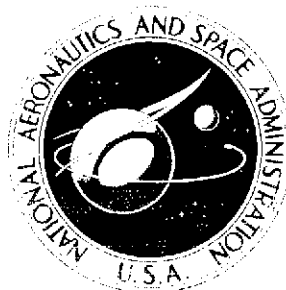

NASA TM X-2913

NASA TECHNICAL
MEMORANDUM

NASA TM X-2913

(NASA-TM-X-2913) COMPUTER PROGRAM FOR
SUPERSONIC KERNEL-FUNCTION FLUTTER
ANALYSIS OF THIN LIFTING SURFACES (NASA)
72 P HC \$3.75 CSCL 20K N74-20565
H1/32 Unclas 34259



COMPUTER PROGRAM FOR SUPERSONIC
KERNEL-FUNCTION FLUTTER ANALYSIS
OF THIN LIFTING SURFACES

by Herbert J. Cunningham
Langley Research Center
Hampton, Va. 23665



1. Report No. NASA TM X-2913	2. Government Accession No.	3. Recipient's Catalog No.	
4. Title and Subtitle COMPUTER PROGRAM FOR SUPERSONIC KERNEL-FUNCTION FLUTTER ANALYSIS OF THIN LIFTING SURFACES		5. Report Date April 1974	
		6. Performing Organization Code	
7. Author(s) Herbert J. Cunningham		8. Performing Organization Report No. L-9126	
		10. Work Unit No. 501-22-04-01	
9. Performing Organization Name and Address NASA Langley Research Center Hampton, Va. 23665		11. Contract or Grant No.	
		13. Type of Report and Period Covered Technical Memorandum	
12. Sponsoring Agency Name and Address National Aeronautics and Space Administration Washington, D.C. 20546		14. Sponsoring Agency Code	
		15. Supplementary Notes	
16. Abstract <p>This report describes a computer program (program D2180) that has been prepared to implement the analysis described in NASA TN D-6012 for calculating the aerodynamic forces on a class of harmonically oscillating planar lifting surfaces in supersonic potential flow. The planforms treated are the delta and modified-delta (arrowhead) planforms with subsonic leading and supersonic trailing edges, and (essentially) pointed tips. The resulting aerodynamic forces are applied in a Galerkin modal flutter analysis. The required input data are the flow and planform parameters including deflection-mode data, modal frequencies, and generalized masses.</p>			
17. Key Words (Suggested by Author(s)) Flutter analysis Aeroelasticity Supersonic kernel function Computer program		18. Distribution Statement Unclassified - Unlimited STAR Category 32	
19. Security Classif. (of this report) Unclassified	20. Security Classif. (of this page) Unclassified	21. No. of Pages 70 72	22. Price* \$3.75

CONTENTS

	Page
SUMMARY	1
INTRODUCTION	1
SYMBOLS	1
PROBLEM DESCRIPTION	4
PROGRAM ORGANIZATION	5
Overlay Structure	5
MAIN Labelled COMMON	5
D2180 Subprogram Descriptions, Flow Charts, and Listings	6
OVERLAY (JMF,0,0); MAIN	7
OVERLAY (JMF,1,0)	8
D2181	8
PART1	9
KERNEL	18
MTXMPY	20
SSSSS	24
GAUSS	24
LCOMP	24
PRT2	25
GLSP	28
OVERLAY (JMF,2,0); D2182	31
Description of External File TAPE9	42
USAGE	42
Program Information and Input Deck Arrangement	42
Input Description	44
Listing of Input Data for Sample Case	47
Discussion of Printed Output	48
Discussion of Punched Output	49
OUTPUT FOR SAMPLE CASE	50
APPENDIX – EVALUATION OF THE SUPERSONIC KERNEL FUNCTION	64
REFERENCES	68

PRECEDING PAGE BLANK NOT FILMED

COMPUTER PROGRAM FOR SUPERSONIC KERNEL-FUNCTION
FLUTTER ANALYSIS OF THIN LIFTING SURFACES

By Herbert J. Cunningham
Langley Research Center

SUMMARY

This report describes a computer program (program D2180) that has been prepared to implement the analysis described in NASA TN D-6012 for calculating the aerodynamic forces on a class of harmonically oscillating planar lifting surfaces in supersonic potential flow. The planforms treated are the delta and modified-delta (arrowhead) planforms with subsonic leading and supersonic trailing edges, and (essentially) pointed tips. The resulting aerodynamic forces are applied in a Galerkin modal flutter analysis. The required input data are the flow and planform parameters including deflection-mode data, modal frequencies, and generalized masses.

INTRODUCTION

References 1 and 2 present the analytical background for, and results from, the flutter analysis of thin lifting surfaces based on a supersonic kernel function procedure. The present report describes the current version of the computer program used to obtain such results, and the user should have access to references 1 and 2 for an adequate understanding of the program. An appendix describes the evaluation of the supersonic kernel function that is used.

SYMBOLS

$a_{nm}^{(j)}$	weighting factor for the term (denoted by subscript n,m) in series for Δp_j
b_0	semichord length at root or plane of symmetry
g	modal-independent damping coefficient
g_i	coefficient of structural, solid-friction damping for mode i
h_i	amplitude of natural mode-shape deflection for mode i

III	transfer matrix
I_c	elements of integrating matrices for chordwise integrations
K	kernel function of integral equation (1)
k	reduced frequency with reference length b_0 , $k = \frac{\omega b_0}{V}$
l_n^*	distribution function in lifting pressure series, $n = 1, 2, \dots$
M	Mach number of stream flow
m_{ij}	generalized mass
$\Delta p, \Delta p_j$	lifting pressure, general, and for mode j , respectively
Q_{ij}, Q_{ij}^*	dimensional and nondimensional generalized aerodynamic forces
q_i, q_j	generalized coordinates of motion for modes i and j
Q_n	integrals ($n = 1$ to 5) (see eqs. (A7) to (A12))
R	region of integration on wing (eq. (1))
$\text{Re}(\), \text{Im}(\)$	real and imaginary parts of ()
s	value of spanwise coordinate at right-hand wing tip
t	time
V	velocity of undisturbed stream flow
w	instantaneous downwash at wing surface, positive with z axis
x	chordwise coordinate
\bar{x}	nondimensional local section chordwise coordinate, referred to local chord
x_c	x coordinate of points at which integrands are evaluated for numerical chordwise integration, where $c = 1, 2, \dots$

x_{le}, x_{te}	local values of chordwise coordinate at leading and trailing edges, respectively
$x_0 = x - \xi$	
y	spanwise coordinate
$y_0 = y - \eta$	
y_σ	y coordinate of span stations at which chordwise integrations are done for subsequent spanwise integration, where $\sigma = 1, 2, \dots$
α	mass of air contained in volume $4\pi b_0^3$, $\alpha \equiv 4\pi\rho b_0^3$
$\beta = \sqrt{M^2 - 1}$	
δ	width of subregion III (see fig. 3 of ref. 1)
η	dummy variable for coordinate y
η_R, η_L	limits of integration (ref. 1)
θ	chordwise coordinate (ref. 1)
ξ	dummy variable for coordinate x
ξ_{le}	local value of ξ on leading edge
ρ	air density
τ	dummy variable of integration
ω	circular frequency of oscillation
ω_B	chosen base or reference frequency
ω_i	natural frequency of mode i

PROBLEM DESCRIPTION

For oscillating and steady thin lifting surfaces in supersonic flow, the linear integral equation that relates the distributions of downwash and lifting pressure on such surfaces is (see eq. (1) of ref. 1 and eq. (6) of ref. 2)

$$-\frac{w(x,y,t)}{V} = \frac{(2b_0)^2}{4\pi\rho V} \iint_R \Delta p(\xi,\eta,t) K(M,k,x_0,y_0) d\xi d\eta \quad (1)$$

where the region of integration R is the area of the wing surface bounded by the forward-facing Mach cone with its apex at x,y . Generally, the downwash $w(x,y,t)$ is known but the lifting pressure distribution $\Delta p(\xi,\eta,t)$ is not known. A finite series is assumed for Δp and each term in the series includes an unknown weighting factor. (See equations (11) to (17) of ref. 1.) Equation (1) is solved by collocation or by a least-squares solution technique.

The surface integrations and the singularity extractions indicated in equation (1) are performed mainly by numerical quadrature, with some aid from closed-form integration. The surface integrals are evaluated and the simultaneous equations are solved for the weighting factors and hence the pressure distribution under the control of subprogram D2181.

Subprogram D2182 uses the results from subprogram D2181 plus the input modal deflection data to compute the generalized aerodynamic force elements (see eqs. (3), (5), and (11) of ref. 2)

$$\left. \begin{aligned} Q_{ij} &= 2b_0 \int_0^s dy \int_{x_{le}}^{x_{te}} h_i(x,y) \frac{\Delta p_j(x,y,t)}{e^{i\omega t}} dx = 4\pi\rho V^2 b_0 Q_{ij}^* \\ Q_{ij}^* &= \int_0^s dy \int_{x_{le}}^{x_{te}} h_i [L_n^* y^m] [\text{III}] \left\{ a_{nm}^{(j)} \right\} dx \end{aligned} \right\} \quad (2)$$

and then, for a sequence of input values of an air density parameter, to solve the flutter stability equations (see eqs. (A9) to (A13) of ref. 2)

$$q_i \left[-\left(\frac{\omega_B}{\omega}\right)^2 (1 + ig_1) \right] + \sum_j q_j \left[\frac{m_{ij}(\omega_B)}{m_{ji}(\omega_1)} \right]^2 + \frac{4\pi\rho b_0}{m_{ii}} \left(\frac{\omega_B}{\omega_1}\right)^2 \frac{Q_{ij}^*}{k^2} = 0 \quad (i = 1, 2, \dots) \quad (3)$$

in searching for the value(s) of air density that correspond to neutrally stable motion(s). The value that corresponds to the lowest dynamic pressure is on a critical boundary, that is, a flutter boundary. Program execution continues for any particular case until a specified number of air density parameters is used. Succeeding cases (other planforms, modes, k-values, M-values, and so forth) are executed until an end of file is reached.

PROGRAM ORGANIZATION

Overlay Structure

This program is organized in overlays to reduce the required field length. The overlay structure is described by the following diagram:

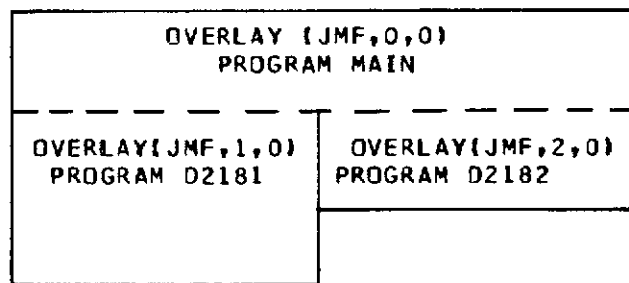

MAIN Labelled COMMON

The following listing contains the FORTRAN variables that appear in labelled COMMON:

COMMON label	FORTTRAN variable	Description
/TRA2182/	XM	Mach number of free stream
	XK	reduced frequency k
	TANLE	tangent of leading-edge sweep angle
	TANLTE	tangent of trailing-edge sweep angle
	S	ratio of wing half span to root-chord length
	NSYM	integer quantity: = 0 for spanwise antisymmetry, ≠ 0 for spanwise symmetry of lift distribution
	IDENT	identification information, up to 80 Hollerith characters
/DEFAULT/	HMLTPLY	two-word array, if nonzero, multiplies real and imaginary parts of downwash input, respectively

D2180 Subprogram Descriptions, Flow Charts, and Listings

Program D2180 is overlaid in order to reduce the maximum required field length. The main overlay 0,0 consists of subprogram MAIN. Primary overlay 1,0 is controlled by subprogram D2181, and primary overlay 2,0 is made up of subprogram D2182. There are no secondary overlays.

This section of the report presents a brief description of each subprogram, its function, flow chart, and listing. A list of the subprograms and their descriptions follows:

<u>Subprogram</u>	<u>Description</u>
MAIN	Reads a NAMELIST input parameter, writes a heading, and directs the access to overlay levels 1,0 and 2,0.
D2181	Writes headings, reads and writes IDENT input, reads and writes NAMELIST input, and calls PART1 and PRT2.
PART1	Computes elements of Π_{nm} matrix (eq. (32) of ref. 1)
KERNEL	Computes \bar{K} (KBAR) (eqs. (3) and (4) of ref. 1)
MTXMPY	Computes matrix III (eqs. (28) to (31) and table I of ref. 1), multiplies as in equation (28) of reference 1 to get Π_{nm} row by row, and writes III matrix on TAPE9.
SSSSS	Stores span stations at which chordwise integrations are to be obtained and also stores the integrating factors for the spanwise integrations to obtain elements of Π_{nm}^* .
GAUSS	For each subregion of surface integration, computes the span stations and spanwise Gaussian quadrature factors.
LCOMP	Computes the l_n^* (eq. (13c), ref. 1)
PRT2	Optionally multiplies the real parts $-(\partial h_1 / \partial x)$ and the imaginary parts $-2h_1$ of the downwash input array by HMLTPLY(1) and HMLTPLY(2), respectively; multiplies the imaginary part also by k; solves equation (32) of reference 1 for the $a_{nm}^{(j)}$ matrix; writes the $a_{nm}^{(j)}$ matrix and the matrix of residuals from the least-squares solution; optionally punches the $a_{nm}^{(j)}$ matrix elements.
GLSP	Solves $N \times M$ system of equations ($N \leq M$) by least squares (for $N < M$), or as a linear system (for $N = M$)
SIMEQ	Solves set of linear simultaneous equations

Subprogram

Description

D2182

Prints heading, reads and writes IDENT input, reads and writes NAMELIST input, reads the III and $a_{nm}^{(j)}$ matrices from TAPE9, and computes the Q_{ij}^* of equation (11b) of reference 2; optionally writes matrices (2), (3), (4), (5), (6), (7), (8), and (8x) of equations (14), (16), and (18) of reference 2; optionally punches Q_{ij}^* matrix and seven associated parameters; writes matrix of h_1 and span stations, $a_{nm}^{(j)}$, m_{ij} , ω_{ij} , g_i ; writes Q_{ij}^* ; solves equation (A13) of reference 2 for eigenvalues and eigenvectors; for each α , it writes α , flutter determinant, eigenvalues, eigenvectors, eigenfrequencies, g values, and stiffness parameters.

OVERLAY (JMF,0,0); MAIN

This is the only subprogram in the 0,0 overlay and its function is to read a single-parameter NAMELIST input IP2180, to write that parameter in a sentence, then to call overlays 1,0 and 2,0 in sequence if $KPROG < 1$, or to call only overlay 2,0 if $KPROG = 1$. The flow chart for subprogram MAIN follows.

MAJOR STEP FLOW CHART

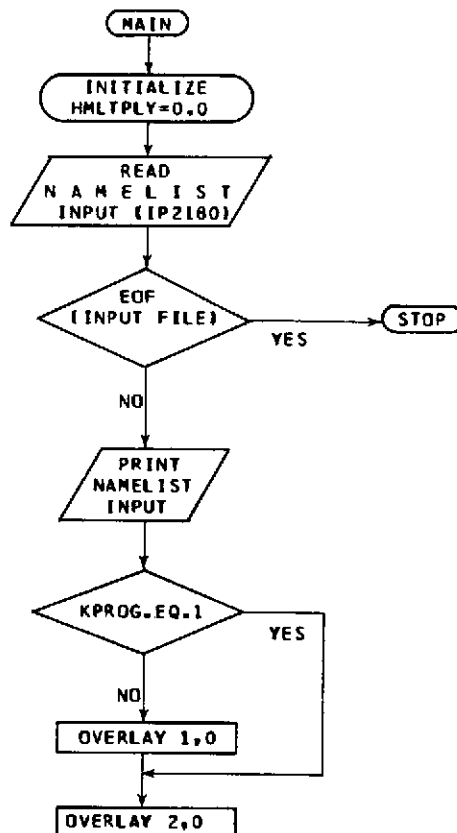

```

*****
* SEQUENCE *
* FOR MUDES *
*****
OVERLAY(JMF,0,0)
PROGRAM MAIN(INPUT=1,OUTPUT=1,PUNCH=2,TAPE9=1,TAPE5=INPUT,
1TAPE6=OUTPUT)
C
C PROGRAM CARD SPECIFIES MINIMUM BUFFERS TO REDUCE FIELD LENGTH
C
DIMENSION IDENT(8), HMLTPLY(2)
COMMON/TRA2182/XM, XK, TANLE, TANLTE, S, NMODE, NSYM, KPROG
NAMELIST /IP2180/KPROG
COMMON/DEFAULT/HMLTPLY
HMLTPLY(1)=0.0$HMLTPLY(2)=0.0
10 READ (5,IP2180)
IF (ENDFILE 5) 20,30
20 STOP 71
30 PRINT 40, KPROG
40 FORMAT (1H1,///51H ***BEGIN PROGRAM D2180, NAMELIST IP2180 IS (KPR
LOG=,11,1H))
IF (KPROG.EQ.1) GO TO 50
CALL OVERLAY (3HJMF,1,0)
50 CONTINUE
CALL OVERLAY (3HJMF,2,0)
GO TO 10
END
A 1 100000
A 1+ 200000
A 1+ 300000
A 2 400000
A 3 500000
A 4 600000
A 5 700000
A 6 800000
A 7 900000
A 8 1000000
A 9 1100000
A 10 1200000
A 11 1300000
A 12 1400000
A 13 1500000
A 14 1600000
A 15 1700000
A 16 1800000
A 17 1900000
A 18 2000000
A 19 2100000
A 20 2200000
A 21- 2300000

```

OVERLAY (JMF,1,0)

D2181.- Subprogram D2181 is the controlling subprogram in overlay 1,0. Its function is to direct the calculation of the weighting factors $a_{nm}^{(j)}$ of the lifting pressure series for each mode j of the downwash as described in reference 1. The subprogram first calls a NAMELIST input, and then calls PART1 and PRT2. Matrices III and a_{nm} are written on TAPE9 for subsequent communication to D2182. The flow chart for subprogram D2181 follows.

MAJOR STEPS IN PROGRAM D2181

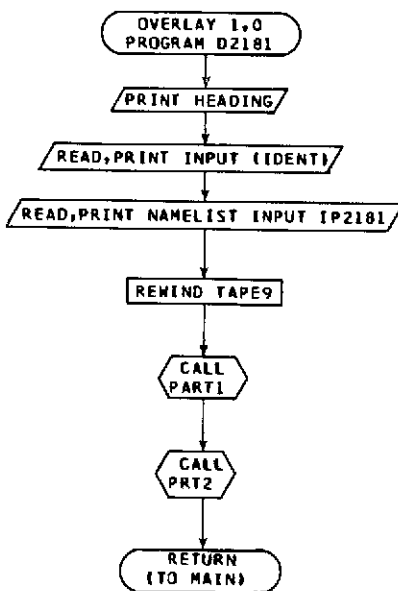

OVERLAY(JMF,1,0)	B	1	2500000
PROGRAM D2181	B	2	2600000
DIMENSION X(48),Y(48),IDENT(8)	B	3	2700000
DIMENSION DHX(48,6),H(48,6),HMLTPLY(2)	B	4	2800000
COMPLEX XMAT2(48,16)	B	5	2900000
DIMENSION WT(96)	B	6	3000000
COMMON/TRK2182/XH,XK,TANLE,TANLTE,S,NMDE,NSYM,KPRUG	B	7	3100000
COMMON/DEFAULT/HMLTPLY	B	8	3200000
COMMON NXY,DEL,X,Y,DHX,H,WT	B	9	3300000
COMMON XA,AB,AC,XN4,XN5,XN6,XN7,XN8,XN9,BETASL,BZY01,XC,Y0,XK0B2,	B	10	3400000
XKMB2,XKAY02,XOTERM,SKAY0,XKY0SQ,XKREAL,XKIMAG,NKK0W,XMAT2,KMPT	B	11	3500000
NAMELIST /IP2181/XK,XM,TANLE,TANLTE,S,NXY,	B	12	3600000
INSYM,DEL,X,Y,DHX,H,NMDE,WT,HMLTPLY	B	13	3700000
WRITE (6,10)	B	14	3800000
WRITE (6,20)	B	15	3900000
10 FORMAT (1H0,///3>X,45HNASA - LANGLEY RESEARCH CENTER - HAMPTON, VA	B	16	4000000
1.///)	B	17	4100000
20 FORMAT (///10X,63HJEAN FOSTER FOR HERB CUNNINGHAM- D2180(INCLUDESD	B	18	4200000
12181 AND D2182)///)	B	19	4300000
WRITE (6,30)	B	20	4400000
30 FORMAT (20X,76HUNSTEADY LIFTING-SURFACE THEORY BY THE SUPERSONIC K	B	21	4500000
ERNEL FUNCTION METHOD AND A/,20X,76H GALERKIN MODAL FLUTTER ANALYSI	B	22	4600000
2S OF ARROWHEAD PLANFORMS WITH SUBSONIC LEADING/20X,35H EDGES AND SU	B	23	4700000
3PERSONIC TRAILING EDGES//,20X,45H***REF. 1 = AIAA JOUR., NOV.1966,	B	24	4800000
4 P.1961-1968/,20X,26H***REF. 2 = NASA TN D-0012 /20X,60H***REF. 3 B	B	25	4900000
D= NASA TN X-2915, THE DESCRIPTION OF THIS PROGRAM	B	26	5000000
C DEFAULT VALUES OF DEL,NSYM, WT ***	B	27	5100000
DEL=0.04\$NSYM=1\$WT=-1.0	B	28	5200000
READ (5,40) IDENT	B	29	5300000
40 FORMAT (6A10)	B	30	5400000
WRITE (6,50) IDENT	B	31	5500000
50 FORMAT (/6A10)	B	32	5600000
READ (5,IP2181)	B	33	5700000
WRITE (6,60)	B	34	5800000
60 FORMAT (//1X,32H ECHO OF NAMELIST IP2181 FOLLOWS)	B	35	5900000
WRITE (6,IP2181)	B	36	6000000
REWIND 4	B	37	6100000
C TAPE9 IS A COMMUNICATION CHANNEL TO OVERLAY 2.0	B	38	6200000
CALL PART1	B	39	6300000
CALL PKT2	B	40	6400000
RETURN	B	41	6500000
END	B	42-	6600000

PART1.- The function of PART1 is to calculate the Π_{nm} matrix of equation (28) of reference 1. By using a number of called subprograms, it first calculates the subdivision of the region of surface integration as shown in figure 3 of reference 1, determines for subregions I, II, and IV whether 6-, 10-, or 16-point Gaussian quadrature is employed, carries out the chordwise and spanwise quadrature to calculate the Π_{nm}^* matrix, and multiplies the latter by the III matrix of equation (28) of reference 1. The flow chart for PART1 follows.

FLOW CHART FOR SUBROUTINE PART I

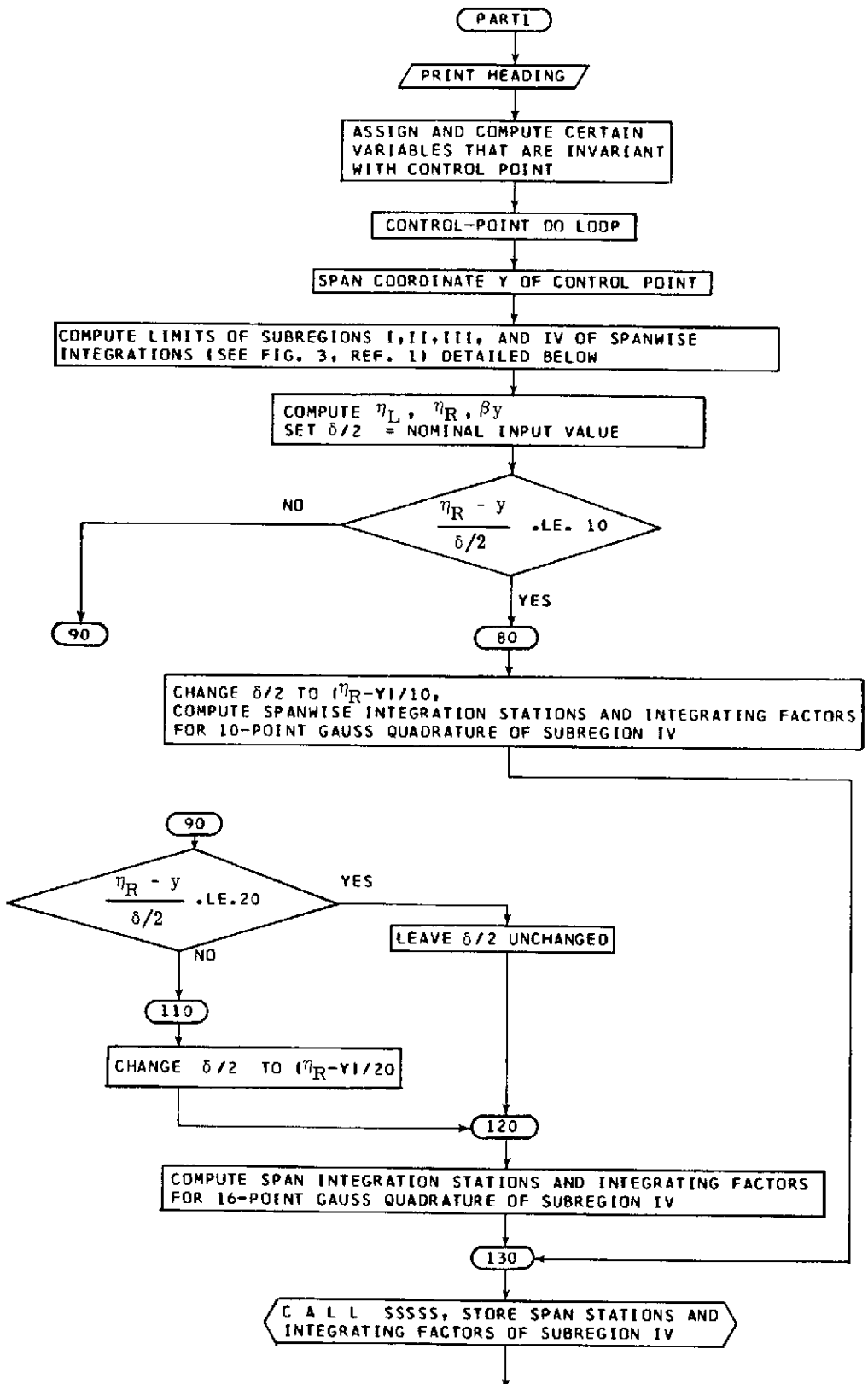

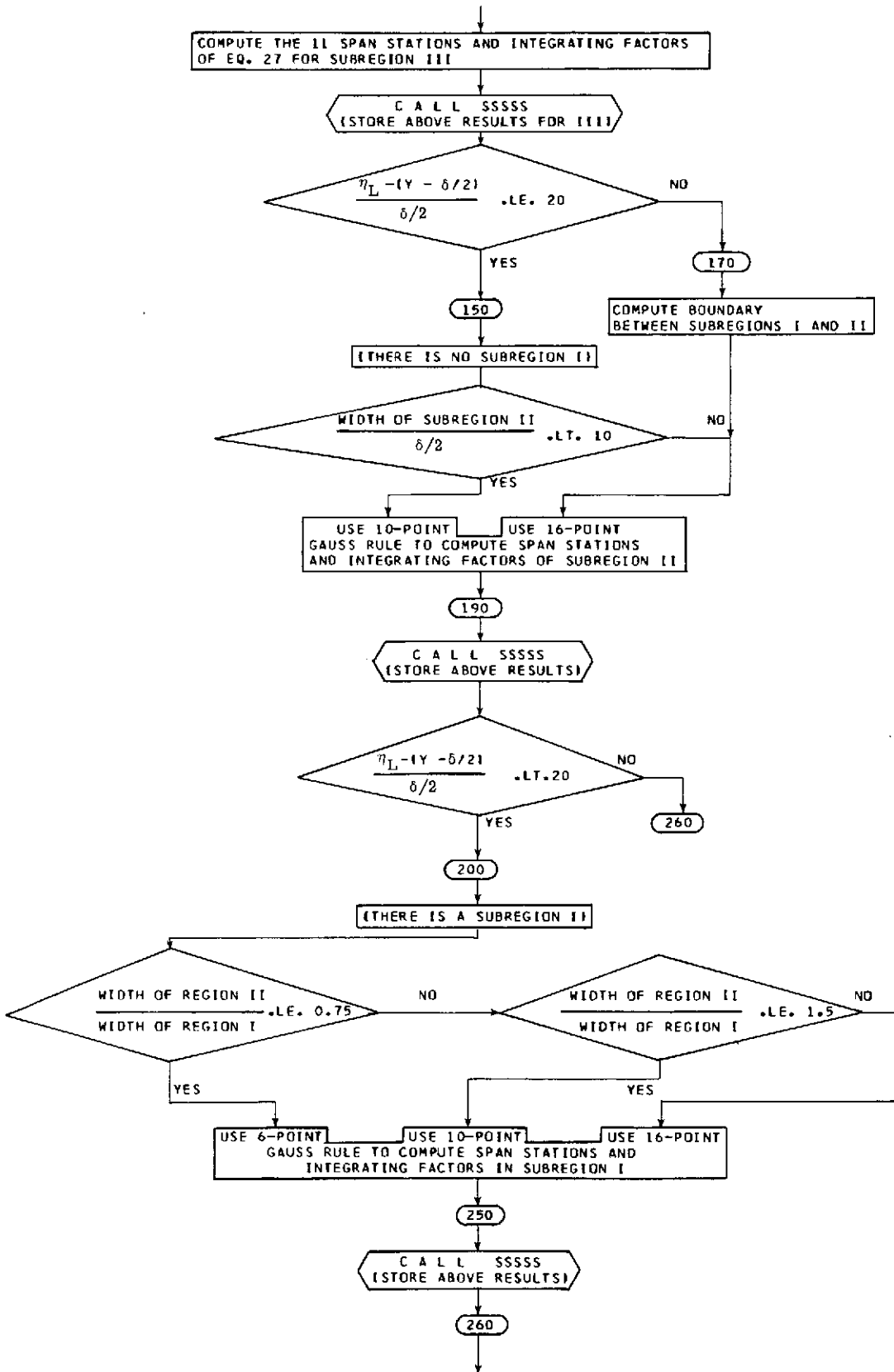

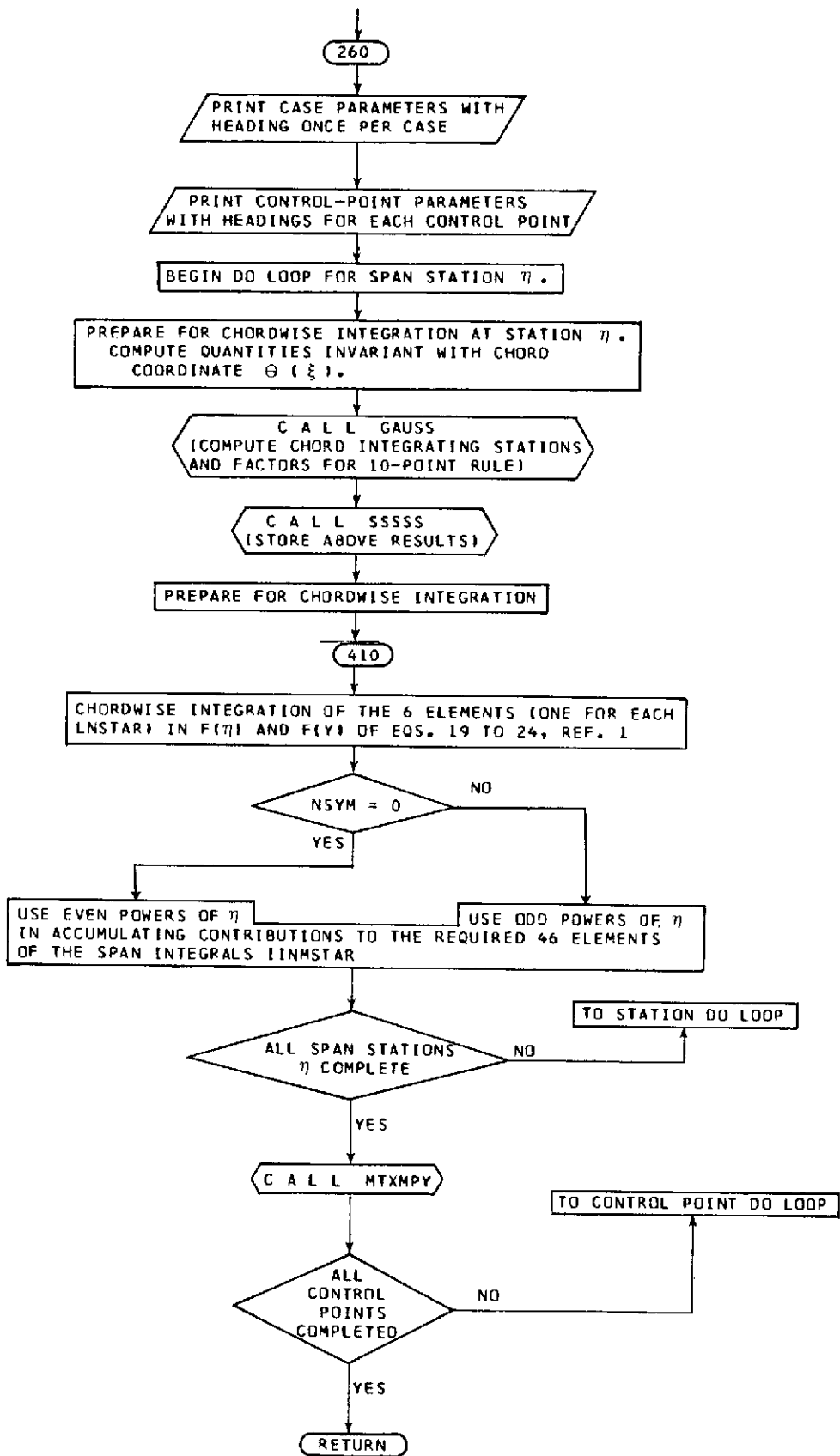

```

SUBROUTINE PART1
  COMPUTE IINM MATRIX OF EQS. 18,28, AND 32 AND OUTPUT IT
  COMPLEX AM2STR(40),XMAT2(48,16)
  DIMENSION IDENT(8)
  DIMENSION X(48),Y(48),RNTAB(11),TABL10(10),TBL6(6),
  ITBL6(16),RTBL6(16),RTBL10(10),RTBL16(16),
  ZETRAN(16),RTRAN(16),ETASTN(6),WGHSTN(6),KOSTI(16),THESTN(16),
  3AL(6),FN5PK(6,3),FN5PI(6,3),FSI(6),FSR(6),FIPK(6),
  4FIP(6),AN(10),FFIR(17,6),FFII(10,6),ANSR(40),ANSI(40),
  5ALMC(6),TABRN(16),THEWGH(16)
  DIMENSION DHX(48,6),H(48,6)
  DIMENSION WT(16)
  COMMON/TRA2162/AM,XK,TANLE,TANLTE,S,NMODE,NSYM,KPRUG
  COMMON NXY,DEL,X,Y,DHX,H,WT
  COMMON AA,AB,AC,AN4,XN5,XN6,XN7,XN8,XN9,BETASQ,BZY01,X0,Y0,XK0b2,
  1XKMB2,AKAYC2,AOTERM,SKAYC,XKYOSQ,XKREAL,XKIMAG,NKK0W,AMAT2,KMPT
  DATA KNTAB/
  1 5.93330950E-02, 4.66287340E-01, 2.57857770E-01, 1.45822960E+00,
  2 7.98243500E+00,-2.24782850E+01, 7.98243600E+00, 1.45822960E+00,
  3 2.57857770E-01, 4.66287340E-01, 5.93330950E-02/
  DATA TBL6/
  1 9.32409514E-01, 6.61209786E-01, 2.38619100E-01,-2.30019180E-01,
  2-6.01209366E-01,-9.32469514E-01/
  DATA TBL10/
  1 9.73906520E-01, 8.65063366E-01, 6.79409500E-01, 4.55395394E-01,
  2 1.48874338E-01,-1.48874338E-01,-4.33395394E-01,-4.33395394E-01,
  3-8.05063366E-01,-9.73906520E-01/
  DATA TBL16/
  1 9.89400934E-01, 9.44575023E-01, 8.65631202E-01, 7.55404408E-01,
  2 6.17876244E-01, 4.58016777E-01, 2.81603550E-01, 9.50125098E-02,
  3-9.50125098E-02,-2.81603550E-01,-4.58016777E-01,-6.17876244E-01,
  4-7.55404408E-01,-8.65631202E-01,-9.44575023E-01,-9.89400934E-01/
  DATA RTBL6/
  1 1.71324492E-01, 3.60761573E-01, 4.67913934E-01, 4.67913934E-01,
  2 3.60761573E-01, 1.71324492E-01/
  DATA RTBL10/
  1 6.66713443E-02, 1.49451349E-01, 2.19086302E-01, 2.69266719E-01,
  2 2.95524224E-01, 2.95524224E-01, 2.69266719E-01, 2.19086302E-01,
  3 1.49451349E-01, 6.66713443E-02/
  DATA RTBL16/
  1 2.71524594E-02, 6.22535239E-02, 9.51585110E-02, 1.24626971E-01,
  2 1.49595988E-01, 1.69156519E-01, 1.82603415E-01, 1.69450610E-01,
  3 1.69450610E-01, 1.82603415E-01, 1.69156519E-01, 1.49595988E-01,
  4 1.24626971E-01, 9.51585116E-02, 6.22535239E-02, 2.71524594E-02/
  WRITE (6,10)
10  FORMAT (1H0,45X,+1H PART I OF 02181 *** GENERATE IINM MATRIX)
  PRINT 20
20  FORMAT (1H0/116H0          K          TANLTE          TANLA
1      S          MACH          DELNUM          NSYMMETRY
2)
  PRINT 30, XK,TANLTE,TANLE,S,XM,DEL,NSYM
30  FORMAT (6E17.0,112)
  PRINT 40
40  FORMAT (1H0,24H          NO. OF C.PTS. (=NXY))
  PRINT 50, NXY
50  FORMAT (I20)
  AA=-.529
  XB=-1.4007
  XC=-2.9
  AN1=-.101
  AN2=-.099
  AN3=-.09480933
  DILLIP=DLL
  XM2=XM**2
  BETA=SQRT(XM2-1.0)
  XK2=XK*2.0
  BTANLE=BETA*TANLE
  BETASQ=BETA**2
  XK0b2=XK2/BETASQ
  XKMB2=XM*XK0b2
  DO 60 L=1,NXY
  DO 60 J=1,10

```

60	AMATZ(L,JI)=(0.,0.)	C 74	14000000
	NXYCNT=1	C 75	14100000
C	BEGIN CONTROL-PGINT DU LOOP *****	C 76	14200000
C	SUBDIVIDE THE REGION OF INTEGRATION INTO SUBREGIONS I,II,III,IV	C 77	14300000
C	AS IN FIG. 3 OF REF. 1. COMPUTE SPAN STATIONS AND SPAN	C 78	14400000
C	INTEGRATING FACTORS.	C 79	14500000
C		C 80	14600000
	DO 780 MJ=1,NXY	C 81	14700000
	DU 70 JN=1,40	C 82	14800000
	ANSR(JN)=0.0	C 83	14900000
70	ANSI(JN)=0.0	C 84	15000000
	IC2=1	C 85	15100000
	YTERM=Y(MJ)	C 86	15200000
	BYMJ=BETA*Y(PJ)	C 87	15300000
	ETAL=(BYMJ-X(MJ))/BTANLE	C 88	15400000
	ETAR=(BYMJ+X(MJ))/BTANLE	C 89	15500000
	DELN2=DEL/2.0	C 90	15600000
	AE=(ETAR-Y(MJ))/DELN2	C 91	15700000
	IF (AE-10.0) 80,80,90	C 92	15800000
80	DEL2=(ETAR-Y(MJ))/10.0	C 93	15900000
C	PREPARE SUBREGION IV ***	C 94	16000000
	ETA5=ETAR	C 95	16100000
	ETA4=Y(MJ)+DEL2	C 96	16200000
	ICOUNT=10	C 97	16300000
	NPTDSK=5	C 98	16400000
	CALL GAUSS (10,ETA4,ETA5,TBL10(1),RTBL10(1),YTERM,1,ETAN(1),RTRAN	C 99	16500000
	1(1))	C 100	16600000
	GU TO 130	C 101	16700000
90	IF (AE-20.0) 100,100,110	C 102	16800000
100	DEL2=DELN2	C 103	16900000
	ETA4=Y(MJ)+DEL2	C 104	17000000
	ETA5=ETAR	C 105	17100000
	GU TO 120	C 106	17200000
110	DEL2=(ETAR-Y(MJ))/20.0	C 107	17300000
	ETA4=Y(MJ)+DEL2	C 108	17400000
	ETA5=ETAR	C 109	17500000
120	ICOUNT=16	C 110	17600000
	NPTDSK=8	C 111	17700000
	CALL GAUSS (16,ETA4,ETA5,TBL16(1),RTBL16(1),YTERM,1,ETAN(1),RTRAN	C 112	17800000
	1(1))	C 113	17900000
130	USR=ETA5-ETA4	C 114	18000000
	CALL SSSSS (IC2,ICOUNT,ETASTN(1),WGHSTN(1),ETAN(1),RTRAN(1))	C 115	18100000
C	PREPARE SUBREGION III ***	C 116	18200000
	IC2=ICOUNT+1	C 117	18300000
	ETA3=Y(MJ)-DEL2	C 118	18400000
	WIDTH=ETA4-ETA3	C 119	18500000
	W=WIDTH/10.0	C 120	18600000
	RG3ST(6)=Y(MJ)	C 121	18700000
	MK=7	C 122	18800000
	JK=5	C 123	18900000
	TABRN(6)=(1.0/DEL2)*RNTAB(6)	C 124	19000000
	DO 140 LK=1,5	C 125	19100000
	NK=JK+1	C 126	19200000
	ML=MK-1	C 127	19300000
	RG3ST(JK)=RG3ST(NK)+W	C 128	19400000
	RG3ST(MK)=RG3ST(ML)-W	C 129	19500000
	TABRN(JK)=(1.0/DEL2)*RNTAB(JK)	C 130	19600000
	TABRN(MK)=(1.0/DEL2)*RNTAB(MK)	C 131	19700000
	JK=JK-1	C 132	19800000
140	MK=MK+1	C 133	19900000
	ICOUNT=ICOUNT+11	C 134	20000000
	CALL SSSSS (IC2,ICOUNT,ETASTN(1),WGHSTN(1),RG3ST(1),TABRN(1))	C 135	20100000
C	PREPARE SUBREGION II ***	C 136	20200000
	IC2=ICOUNT+1	C 137	20300000
	DL=ETA3-ETAL	C 138	20400000
	IF ((DL/DEL2)-20.0) 150,150,170	C 139	20500000
C	THERE IS NO SUBREGION I **	C 140	20600000
150	ETA2=ETAL	C 141	20700000
	J1L=0	C 142	20800000
	U2L=ETA3-ETA2	C 143	20900000
	IF ((U2L/DEL2)-10.0) 160,180,180	C 144	21000000

160	CALL GAUSS (10,ETA2,ETA3,TBL10(1),RTBL10(1),YTERM,1,ETKAN(1),RTRAN	C 145	21100000
	1(1))	C 146	21200000
	ICOUNT=ICOUNT+10	C 147	21300000
	NPTD2L=5	C 148	21400000
	NPTD1L=0	C 149	21500000
	GO TO 190	C 150	21600000
C	BOUNDARY OF SUBREGION I AND II ***	C 151	21700000
170	ETA2=Y(MQ)-19.0*DEL2	C 152	21800000
180	CALL GAUSS (16,ETA2,ETA3,TBL16(1),RTBL16(1),YTERM,1,ETKAN(1),RTRAN	C 153	21900000
	1(1))	C 154	22000000
	NPTD2L=6	C 155	22100000
	NPTD1L=0	C 156	22200000
	ICOUNT=ICOUNT+16	C 157	22300000
190	CALL SSSSS (IC2,ICOUNT,ETASTN(1),WGHSTN(1),ETKAN(1),RTRAN(1))	C 158	22400000
	IC2=ICOUNT+1	C 159	22500000
	IF ((D2L/D1L)-20.0) 26C,26C,200	C 160	22600000
C	PREPARE SUBREGION I ***	C 161	22700000
200	ETA1=ETA1	C 162	22800000
	D1L=ETA3-ETA2	C 163	22900000
	D2L=ETA2-ETA1	C 164	23000000
	IF ((D2L/D1L)-.75) 210,210,220	C 165	23100000
210	CALL GAUSS (6,ETA1,ETA2,TBL6(1),RTBL6(1),YTERM,1,ETKAN(1),RTRAN(1)	C 166	23200000
	1)	C 167	23300000
	ICOUNT=ICOUNT+6	C 168	23400000
	NPTD2L=8	C 169	23500000
	NPTD1L=3	C 170	23600000
	GO TO 250	C 171	23700000
220	IF ((D2L/D1L)-1.5) 230,230,240	C 172	23800000
230	CALL GAUSS (10,ETA1,ETA2,TBL10(1),RTBL10(1),YTERM,1,ETKAN(1),RTRAN	C 173	23900000
	1(1))	C 174	24000000
	ICOUNT=ICOUNT+10	C 175	24100000
	NPTD2L=8	C 176	24200000
	NPTD1L=5	C 177	24300000
	GO TO 250	C 178	24400000
240	CALL GAUSS (16,ETA1,ETA2,TBL16(1),RTBL16(1),YTERM,1,ETKAN(1),RTRAN	C 179	24500000
	1(1))	C 180	24600000
	ICOUNT=ICOUNT+16	C 181	24700000
	NPTD2L=9	C 182	24800000
	NPTD1L=8	C 183	24900000
250	CALL SSSSS (IC2,ICOUNT,ETASTN(1),WGHSTN(1),ETKAN(1),RTRAN(1))	C 184	25000000
260	DSL=D1L+D2L	C 185	25100000
	WRITE (6,270)	C 186	25200000
270	FORMAT (1H0/Y6H X Y DSL	C 187	25300000
	1 D1L D2L DSL)	C 188	25400000
	WRITE (6,280) X(MQ),Y(MQ),DSL,D1L,D2L,DSL	C 189	25500000
280	FORMAT (6E17.8)	C 190	25600000
	WRITE (6,290)	C 191	25700000
290	FORMAT (47H0 PTSD1L PTSD2L PTSOSK)	C 192	25800000
	WRITE (6,300) NPTD1L,NPTD2L,NPTDSR	C 193	25900000
300	FORMAT (19,2117)	C 194	26000000
	WRITE (6,310) DEL2	C 195	26100000
310	FORMAT (41H0 HALF-WIDTH OF CONTROL POINT STRIP E17.8)	C 196	26200000
C		C 197	26300000
C	COMPUTE QUANTITIES INVARIANT WITH CHORDWISE COORDINATE	C 198	26400000
C		C 199	26500000
	THELE=0	C 200	26600000
	THESTN(1)=THELE	C 201	26700000
	DO 760 I=1,ICOUNT	C 202	26800000
	IDCAN=I0-1	C 203	26900000
	AETA=ABS(ETASTN(ID))	C 204	27000000
	YO=Y(MQ)-ETASTN(ID)	C 205	27100000
	AYO=ABS(YO)	C 206	27200000
	PSILE=AETA*TANLE	C 207	27300000
	PSIMC=X(MQ)-BETA*AYO	C 208	27400000
	PSITE=1.0+AETA*TANLTE	C 209	27500000
	PPP=PSITE+PSILE	C 210	27600000
	BBO=PSITE-PSILE	C 211	27700000
	BBO5=.5*BBO	C 212	27800000
	DUM1=(PPP-2.0*PSIMC)/BBO	C 213	27900000
	IF (DUM1) 320,380,330	C 214	28000000
320	NEG=-1	C 215	28100000
	GO TO 340	C 216	28200000

```

330  NEG=1                                C 217  28300000
340  ADUM=ABS(DUM1)                       C 218  28400000
      IF (ABS(ADUM-1.0)-.000001) 250,350,380 C 219  28500000
350  IF (NEG) 360,360,370                 C 220  28600000
360  DUM1=-1.0                             C 221  28700000
      GO TO 360                            C 222  28800000
370  DUM1=1.0                              C 223  28900000
380  SDUM1=ABS(SQRT(1.0-DUM1**2))         C 224  29000000
      THEM1=ATAN2(SDUM1,DUM1)             C 225  29100000
      XKAY0=XK*AY0                        C 226  29200000
      XKAY02=2.0*XKAY0                   C 227  29300000
      XKAY04=4.0*XKAY0                   C 228  29400000
      XKY050=XKAY02**2                   C 229  29500000
      XN4=(XN1/(XA**2+XKY050))*XKAY0     C 230  29600000
      XN5=(XN2/(XB**2+XKY050))*XKAY0     C 231  29700000
      XN6=3.1415926+XKAY02               C 232  29800000
      XN7=3.1415926-XKAY02               C 233  29900000
      XL2=X0**2                           C 234  30000000
      XN8=(XN3/(2.0*(XC2+XN6**2)))*XKAY0 C 235  30100000
      XN9=(XN3/(2.0*(XC2+XN7**2)))*XKAY0 C 236  30200000
      B2Y01=1.0/(BETASQ*AY0)            C 237  30300000
      CALL GAUSS (10,THELE,THEM1,TBL10(1),RTBL10(1),0,0,ETKAN(1),RTRAN(1) C 238  30400000
1) )                                       C 239  30500000
      NPSI=5                               C 240  30600000
      JC2=3                                C 241  30700000
      JCOUNT=12                          C 242  30800000
      CALL SSSSS (JC2,JCOUNT,THESTN(1),THEWGH(1),ETKAN(1),RTRAN(1)) C 243  30900000
      THESTN(2)=THEM1                     C 244  31000000
      IF (Y0) 390,400,390                 C 245  31100000
C      FOR EQS. 22,23 REF. 1 ***          C 246  31200000
390  XS=X(MQ)-PSIMC                       C 247  31300000
      BY=BETASQ*(Y0**2)                   C 248  31400000
      THAT=(XK2*XS*XM2)/BETASQ           C 249  31500000
      COST=COS(THAT)                      C 250  31600000
      SINT=SIN(THAT)                     C 251  31700000
      GO TO 410                            C 252  31800000
400  BY=0                                  C 253  31900000
410  DO 530 IE=2,13                       C 254  32000000
C      IN DO LOOP 1ST TIME FOR XSILE, 2ND TIME FOR XSIMC, 3RD TO C 255  32100000
C      12TH TIME FOR 10-PT. GAUSS QUADRATURE *** C 256  32200000
      NLOW=IE-1                           C 257  32300000
      SINTH=SIN(THETN(NLOW))              C 258  32400000
      PSI=.5*(PPP-(880)*COS(THETN(NLOW))) C 259  32500000
      X0=X(MQ)-PSI                         C 260  32600000
      STHE=THETN(NLOW)                    C 261  32700000
      IF (NLOW-2) 420,430,420             C 262  32800000
420  X0TERM=X0/SQRT(X0**2-BY)              C 263  32900000
      XHERE=X0TERM*COST                   C 264  33000000
      THERE=X0TERM*SINT                   C 265  33100000
C      XSILE TERMS ARE COMPLETE ***      C 266  33200000
      IF (NLOW-1) 430,530,430             C 267  33300000
430  CALL LCUMP (PSI,TANLE,PSILE,AL(1),STHE) C 268  33400000
      IF (NLOW-2) 530,450,440             C 269  33500000
440  CALL KERNEL                           C 270  33600000
      IF (NLOW-3) 530,470,490             C 271  33700000
450  DO 460 JI=1,6                        C 272  33800000
460  ALM(JI)=AL(JI)                        C 273  33900000
C      XSIMC TERMS ARE COMPLETE ***      C 274  34000000
      GO TO 530                            C 275  34100000
470  DO 480 L0W=1,6                       C 276  34200000
      FNSPR(L0W,3)=0                      C 277  34300000
      FNSPI(L0W,3)=0                      C 278  34400000
480  CONTINUE                              C 279  34500000
490  CONTINUE                              C 280  34600000
      DO 520 L0W=1,6                      C 281  34700000
      IF (Y0) 500,510,500                 C 282  34800000
C      ACCUMULATE INTEGRAL OF EQ 23, REF. 1 *** C 283  34900000
500  FNSPK(L0W,3)=FNSPR(L0W,3)+(THEWGH(NLOW))*(XKREAL*AL(L0W)+ALM(L0W) C 284  35000000
1*XHERE)*SINTH                            C 285  35100000
      FNSPI(L0W,3)=FNSPI(L0W,3)+(THEWGH(NLOW))*(XKIMAG*AL(L0W)-ALM(L0W) C 286  35200000
1*THERE)*SINTH                            C 287  35300000
      GO TO 520                            C 288  35400000

```

```

C          ACCUMULATE INTEGRAL OF EQ 24, REF. 1 ***
510  FNSPR(L0W,3)=FNSPR(L0W,3)+(THEWGH(NLOW))*XAKEAL*AL(L0W)*SINTH
      FNSPI(L0W,3)=FNSPI(L0W,3)+(THEWGH(NLOW))*XKIMAG*AL(L0W)*SINTH
520  CONTINUE
530  CONTINUE
      IF (Y0) G+0, 500, 540
C          FOR EQ. 22, REF. 1 ***
540  XT=(X(MJ)-P3(LEJ)**2
      TRY=SQRT(XT-BY)
      WHK=TRY*CUST
      WHI=TRY*SINT
      DU 550 ICAN=1,6
      FSR(ICAN)=- (ALMC(ICAN))*WHR
550  FSI(ICAN)=(ALMC(ICAN))*WHI
      GU TO 560
560  DU 570 IUAN=1,6
      FSR(IUAN)=0
570  FSI(IUAN)=0
580  DU 590 JCN=1,6
      FIPK(JCN)=BB05*FNSPR(JCN,3)+FSR(JCN)
      FIPI(JCN)=BB05*FNSPI(JCN,3)+FSI(JCN)
C          CHURCHWISE INTEGRAL F(ETA) OR F(Y) COMPLETE ****
C          BEGIN MULTIPLICATION BY POWERS OF ETA AS IN EQ. 18, REF. 1
600  IF (NSYM) G2C, 600, 620
      NIN=1
      DU 610 IN=1, 19, 2
      AN(NIN)=(ETASTN(10))**(IN)
610  NIN=NIN+1
      GO TO 670
620  MIN=1
      DU 660 IM=1, 19, 2
      IF (ETASTN(10)) G5C, 630, 650
630  IF (IM-1) G5C, 640, 650
640  AN(MIN)=1.0
      GU TO 660
650  AN(MIN)=(ETASTN(10))**(IM-1)
660  MIN=MIN+1
670  JKN=0
C          COMPUTE 40 TERMS OF IINMSTAR, EQ. 28, REF.1 ****
      DU 750 JCAN=1,6
      IF (JCAN-2) G80, 690, 700
C          10 POWERS OF ETA FOR N=1 AND 3, 8 POWERS FOR N=2 AND 4,
C          6 FOR N=5, 4 FOR N=6. ***
680  NTM=10
      GU TO 740
690  NTM=8
      GU TO 740
700  IF (JCAN-4) G80, 690, 710
710  IF (JCAN-6) 720, 730, 730
720  NTM=6
      GU TO 740
730  NTM=4
740  DU 750 KCAN=1, NTM
      FFIR(KCAN, JCAN)=FIPR(JCAN)*AN(KCAN)
      FFII(KCAN, JCAN)=FIPI(JCAN)*AN(KCAN)
      JKN=JKN+1
      ANSR(JKN)=WGHSTN(10)*FFIR(KCAN, JCAN)+ANSR(JKN)
      ANSI(JKN)=WGHSTN(10)*FFII(KCAN, JCAN)+ANSI(JKN)
750  CONTINUE
760  CONTINUE
      DU 770 JJ=1, JKN
      XM2STR(JJ)=CMPLX(ANSR(JJ), ANSI(JJ))
      KMPT=NXYCNT
C          COMPUTE MATRIX IINM OF EQ. 28, REF. 1 ***
      CALL MTAMPY (XM2STR(1))
780  NXYCNT=NXYCNT+1
C          END OF CONTROL-POINT DO LOOP ***
      NXY2=NXY*2
      RETURN
      END
C 289  35500000
C 290  35600000
C 291  35700000
C 292  35800000
C 293  35900000
C 294  36000000
C 295  36100000
C 296  36200000
C 297  36300000
C 298  36400000
C 299  36500000
C 300  36600000
C 301  36700000
C 302  36800000
C 303  36900000
C 304  37000000
C 305  37100000
C 306  37200000
C 307  37300000
C 308  37400000
C 309  37500000
C 310  37600000
C 311  37700000
C 312  37800000
C 313  37900000
C 314  38000000
C 315  38100000
C 316  38200000
C 317  38300000
C 318  38400000
C 319  38500000
C 320  38600000
C 321  38700000
C 322  38800000
C 323  38900000
C 324  39000000
C 325  39100000
C 326  39200000
C 327  39300000
C 328  39400000
C 329  39500000
C 330  39600000
C 331  39700000
C 332  39800000
C 333  39900000
C 334  40000000
C 335  40100000
C 336  40200000
C 337  40300000
C 338  40400000
C 339  40500000
C 340  40600000
C 341  40700000
C 342  40800000
C 343  40900000
C 344  41000000
C 345  41100000
C 346  41200000
C 347  41300000
C 348  41400000
C 349  41500000
C 350  41600000
C 351  41700000
C 352  41800000
C 353  41900000
C 354  42000000
C 355  42100000
C 356  42200000
C 357  42300000
C 358- 42400000

```

KERNEL.- The function of subprogram KERNEL is to calculate \bar{K} of the super-sonic kernel function of equations (3) to (6) of reference 1. The evaluation of the integral in \bar{K} is based on the approximation of the integrand as in equation (A5) of the appendix. The flow chart for KERNEL follows.

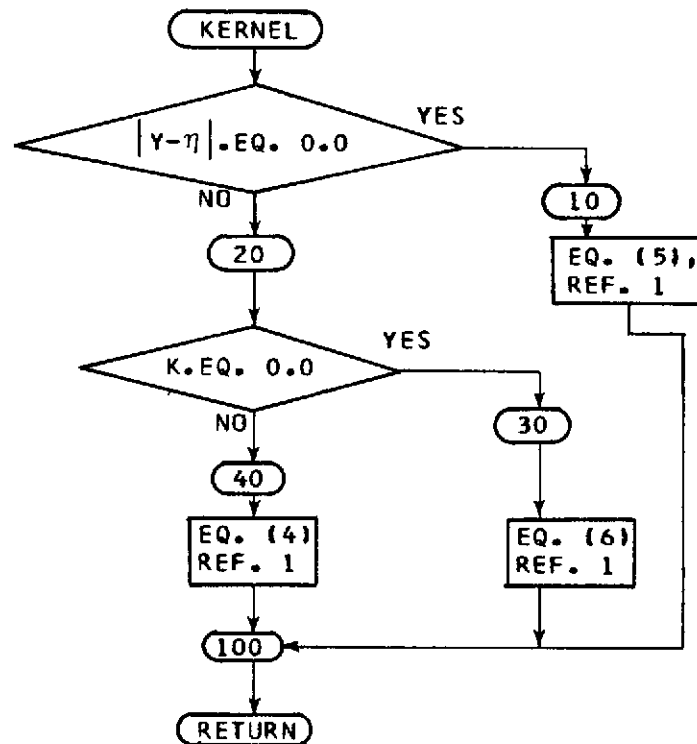

```

SUBROUTINE KERNEL
C
C   COMPUTE THE KBAR OF EQS. 3 AND 4, REF. 1
C   THE ALGORITHM IS DESIGNED TO MINIMIZE CALCULATIONS OF SINES,
C   COSINES, AND EXPONENTIALS. THE INTEGRAND OF THE TAU INTEGRAL
C   IS APPROXIMATED AS IN EQ. 21 OF NASA TR 4-48. CHURCHISE
C   INVARIANT QUANTITIES ARE CALCULATED IN SUBROUTINE PART1 AND
C   PASSED VIA COMMON.
C
DIMENSION WT(76)
DIMENSION X(48),Y(48),IDENT18)
DIMENSION DHX(48,6),H(48,6)
COMPLEX XMATZ(48,16)
COMMON/TRA2102/AM, XK, TANLE, TANLTE, S, NMODE, NSYM, KPR00
COMMON NXY, DEL, X, Y, DHX, H, WT
COMMON AA, AB, AC, AN4, XN5, XN6, XN7, XN8, XN9, BETASQ, B2Y01, X0, Y0, XK0B2,
1XKMB2, XKAY02, X0TERM, SKAY0, XKY0SQ, XKREAL, XKIMAG, NKR00, XMATZ, KMPT
XKAY04=2.0*XKAY02
IF (Y0) 20,10,20
10  UUMBA=(2.0*XK)*X0
   XKREAL=-COS(UUMBA)
   XKIMAG=SIN(UUMBA)
   GO TO 100
20  IF (XK) 40,30,40
30  XKTERM=X0**2-BETASQ*(Y0**2)
   XKREAL=-X0/SQRT(XKTERM)
D  2  42600000
D  3  42700000
D  4  42800000
D  5  42900000
D  6  43000000
D  7  43100000
D  8  43200000
D  9  43300000
D 10  43400000
D 11  43500000
D 12  43600000
D 13  43700000
D 14  43800000
D 15  43900000
D 16  44000000
D 17  44100000
D 18  44200000
D 19  44300000
D 20  44400000
D 21  44500000
D 22  44600000
D 23  44700000
D 24  44800000
D 25  44900000
D 26  45000000
D 27  45100000
  
```

	XKIMAG=0	D 28	45200000
	GU TU 100	D 29	45300000
40	SQR1=SQR((X0**2-BETASQ*(Y0**2))	D 30	45400000
	XUPL=X0+XMSQR1	D 31	45500000
	XJMI=X0-XMSQR1	D 32	45600000
	AXOMI=ABS(XJMI)	D 33	45700000
	TUP=B2Y01*XUPL	D 34	45800000
	ABTLU=B2Y01*AXOMI	D 35	45900000
	AN10=AKUB2*X0	D 36	46000000
	XN11=AKMB2*SQR1	D 37	46100000
	PTUP=(3.1415926)**TUP	D 38	46200000
	PTLU=(3.1415926)*ABTLU	D 39	46300000
	ATU=XA*TUP	D 40	46400000
	ATL=XA*AbTLU	D 41	46500000
	bTU=XB*TUP	D 42	46600000
	bTL=Xb*AbTLU	D 43	46700000
	CTU=XC*TUP	D 44	46800000
	CTL=Xc*AbTLU	D 45	46900000
	EXP1=EXP(ATU)	D 46	47000000
	EXP2=EXP(ATL)	D 47	47100000
	EXP3=EXP(bTU)	D 48	47200000
	EXP4=EXP(bTL)	D 49	47300000
	EXP5=EXP(CTU)	D 50	47400000
	EXP6=EXP(CTL)	D 51	47500000
	CS1=COS(AN10)	D 52	47600000
	CS2=COS(XN11)	D 53	47700000
	SN1=SIN(AN10)	D 54	47800000
	SN2=SIN(XN11)	D 55	47900000
	XN12=CS1*CS2	D 56	48000000
	XN13=SN1*SN2	D 57	48100000
	CS3=XN12-XN13	D 58	48200000
	CS4=XN12+XN13	D 59	48300000
	XN14=SN1*CS2	D 60	48400000
	XN15=SN2*CS1	D 61	48500000
	SN3=XN14+XN15	D 62	48600000
	SN4=XN14-XN15	D 63	48700000
	CS5=COS(PTUP)	D 64	48800000
	CS6=COS(PTLU)	D 65	48900000
	SN5=SIN(PTUP)	D 66	49000000
	SN6=SIN(PTLU)	D 67	49100000
	IF (XJMI) 50,60,60	D 68	49200000
50	SN4=-SN4	D 69	49300000
	SN6=-SN6	D 70	49400000
C		D 71	49500000
C	REAL PART	D 72	49600000
C		D 73	49700000
60	R02=(SN3-SN4)/2.0	D 74	49800000
	R03=((XA*CS3+XKAY02*SN3)*EXP1-(XA*CS4+XKAY02*SN4)*EXP2)*AN4	D 75	49900000
	R04=((Xb*CS5+XKAY02*SN3)*EXP3-(Xb*CS4+XKAY02*SN4)*EXP4)*AN5	D 76	50000000
	XN20=CS5*CS3	D 77	50100000
	XN21=SN5*SN3	D 78	50200000
	CS7=XN20-XN21	D 79	50300000
	CS9=XN20+XN21	D 80	50400000
	XN22=CS6*CS4	D 81	50500000
	XN23=SN6*SN4	D 82	50600000
	CS8=XN22-XN23	D 83	50700000
	CS10=XN22+XN23	D 84	50800000
	XN24=SN5*CS3	D 85	50900000
	XN25=CS5*SN3	D 86	51000000
	SN7=XN24+XN25	D 87	51100000
	SN9=XN24-XN25	D 88	51200000
	XN26=SN6*CS4	D 89	51300000
	XN27=CS6*SN4	D 90	51400000
	SN8=XN26+XN27	D 91	51500000
	SN10=XN26-XN27	D 92	51600000
	R05=((XC*SN7-XN6*CS7)*EXP5+(-XC*SN8+XN6*CS8)*EXP6)*AN6+((XC*SN9-X	D 93	51700000
	LN7*CS5)*EXP5+(-XC*SN10+XN7*CS10)*EXP6)*KN4	D 94	51800000
C		D 95	51900000
C	IMAGINARY PART	D 96	52000000
C		D 97	52100000
	IF (XJMI) 60,70,70	D 98	52200000

```

70  XIQ2=-(-CS3+CS4)/2.0          D 99      52300000
    XIQ3=((-XA*SN3+AKAY02*CS3)*EXP1+(XA*SN4- XKAY02*CS4)*EXP2)*XN4    D 100     52400000
    XIQ4=((-XB*SN3+AKAY02*CS3)*EXP3+(XB*SN4- XKAY02*CS4)*EXP4)*XN5    D 101     52500000
    XIQ5=((XC*CS7+XN6*SN7)*EXP5-(XC*CS8+XN6*SN8)*EXP6)*XN8+((XC*CS9+X  D 102     52600000
    IN7*SN9)*EXP5-(XC*CS10+XN7*SN10)*EXP6)*(-XN9))                    D 103     52700000
    GJ TO 90                      D 104     52800000
80  XIQ2=-(-CS3-CS4+2.0)/2.0      D 105     52900000
    XIQ3=((-XA*SN3+AKAY02*CS3)*EXP1-(XA*SN4- XKAY02*CS4)*EXP2- XKAY04)*X D 106     53000000
    IN4                              D 107     53100000
    XIQ4=((-XB*SN3+AKAY02*CS3)*EXP3-(XB*SN4- XKAY02*CS4)*EXP4- XKAY04)*X D 108     53200000
    IN5                              D 109     53300000
    XIQ5=((XC*CS7+XN6*SN7)*EXP5+(XC*CS8+XN6*SN8)*EXP6-2.0*XC)*XN8+((X  D 110     53400000
    LC*CS9+XN7*SN9)*EXP5+(XC*CS10+XN7*SN10)*EXP6-2.0*XC)*(-XN9))      D 111     53500000
90  KW1=RQ2+KQ3+KQ4+KQ5          D 112     53600000
    XIQ1=XIQ2+XIQ3+XIQ4+XIQ5      D 113     53700000
C   C                              D 114     53800000
C   INTEGRAL IN K BAR FINISHED    D 115     53900000
C   C                              D 116     54000000
    XN31=X0TERM*CS2              D 117     54100000
    XN32=XN31*CS1-XIQ1           D 118     54200000
    XN33=-XN31*SN1+KW1           D 119     54300000
    GS=2.0*AK*XD                 D 120     54400000
    CS11=COS(GS)                  D 121     54500000
    SN11=SIN(GS)                  D 122     54600000
    XKREAL=-XN32*CS11+XN33*SN11 D 123     54700000
    XKIMAG=XN32*SN11-XN33*CS11  D 124     54800000
100 RETURN                        D 125     54900000
    END                            D 126     55000000

```

MTXMPY.- The function of subprogram MTXMPY is to compute the elements of the matrix III of table I of reference 1 and carry out the indicated matrix multiplication of equation (28) of reference 1. The flow chart for subprogram MTXMPY follows.

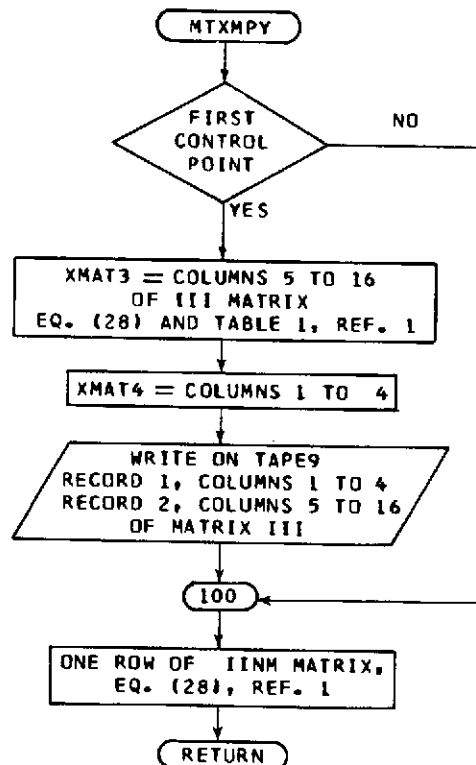

	SUBROUTINE MTXMPY (XM2STR)	E	2	55200000
C	COMPUTE THE III MATRIX OF EQS. 28 TO 31, AND TABLE 1 OF REF. 1-	E	3	55300000
C	AND MULTIPLY AS IN EQ. 28 TO GET IINM MATRIX OF EQS. 18, 28, 32	E	4	55400000
	REAL K4B, K4C, K4D, K4	E	5	55500000
	REAL KE, KF, K2B, K2C, K2D, K2	E	6	55600000
	DIMENSION MT(46)	E	7	55700000
	DIMENSION E(9), F(25), KE(9), KF(15)	E	8	55800000
	DIMENSION X(46), Y(48), IDENT(8)	E	9	55900000
	DIMENSION DHX(48,6), H(48,6)	E	10	56000000
	COMPLEX XMAT3(46,12), XMAT2(48,16), XM2STR(46)	E	11	56100000
	COMPLEX XMAT4(46,4)	E	12	56200000
	COMMON/TRA2182/XM, XK, TANLE, TANLTE, S, NMODE, NSYM, KPROG	E	13	56300000
	COMMON NXY, DEL, X, Y, DHX, H, MT	E	14	56400000
	COMMON XA, XB, XC, XN4, XN5, XN6, XN7, XN8, XN9, BETA5Q, BZY01, X0, Y0, XK0B2,	E	15	56500000
	I, KMB2, XKAY02, XOTERM, SKAY0, XKY0SQ, XKREAL, XKIMAG, NKK0W, XMAT2, KMPT	E	16	56600000
	KZ=2.0*AK	E	17	56700000
C	JUMP TO 1000 FOR OTHER THAN FIRST CONTROL POINT *****	E	18	56800000
	IF (KMPT-1) 10, 10, 100	E	19	56900000
C	COMPUTE ELEMENTS OF III MATRIX, EQS. 29 TO 31 AND TABLE 1, REF. 1	E	20	57000000
10	B11=0.0	E	21	57100000
	B12=0.21132486	E	22	57200000
	B22=0.78867514	E	23	57300000
	B13=0.11270166	E	24	57400000
	B23=0.0	E	25	57500000
	B33=0.88729634	E	26	57600000
	C11=0.75*(1.0/S)*(TANLE+TANLTE)	E	27	57700000
	C12=C11+10.43301270/S)*(TANLE-TANLTE)	E	28	57800000
	C22=2.0*C11-C12	E	29	57900000
	C13=C11+10.58094750/S)*(TANLE-TANLTE)	E	30	58000000
	C23=C11	E	31	58100000
	C33=2.0*C11-C13	E	32	58200000
	CNST=(-1.0/(3.0*S**2))	E	33	58300000
	D11=CNST*C11	E	34	58400000
	D12=CNST*C12	E	35	58500000
	D22=CNST*C22	E	36	58600000
	D13=CNST*C13	E	37	58700000
	D23=CNST*C23	E	38	58800000
	D33=CNST*C33	E	39	58900000
	E(1)=0.0	E	40	59000000
	E(2)=(-6.0*B22-6.0*B12)	E	41	59100000
	E(3)=(-6.0*(C22-6.0*C12)	E	42	59200000
	E(4)=(-6.0*D22-6.0*D12)	E	43	59300000
	E(5)=(-6.0*B12)*(-B22)	E	44	59400000
	E(6)=-6.0*B12*(-C22)-6.0*C12*(-B22)	E	45	59500000
	E(7)=-6.0*B12*(-D22)-6.0*C12*(-C22)-6.0*D12*(-B22)	E	46	59600000
	E(8)=-6.0*C12*(-D22)-6.0*D12*(-C22)	E	47	59700000
	E(9)=-6.0*D12*(-D22)	E	48	59800000
C	F(1) TO F(25) HERE ARE G(1) TO G(25) IN REF. 1 ***	E	49	59900000
	F(1)=-20.0	E	50	60000000
	F(2)=20.0*B23+20.0*B13	E	51	60100000
	F(3)=20.0*C23+20.0*C13	E	52	60200000
	F(4)=20.0*D23+20.0*D13	E	53	60300000
	F(5)=20.0*B13*(-B23)	E	54	60400000
	F(6)=20.0*B13*(-C23)+20.0*C13*(-B23)	E	55	60500000
	F(7)=20.0*B13*(-D23)+20.0*C13*(-C23)+20.0*D13*(-B23)	E	56	60600000
	F(8)=20.0*C13*(-D23)+20.0*D13*(-C23)	E	57	60700000
	F(9)=20.0*D13*(-D23)	E	58	60800000
	F(10)=F(1)	E	59	60900000
	F(11)=F(2)-B33*F(1)	E	60	61000000
	F(12)=F(3)-C33*F(1)	E	61	61100000
	F(13)=F(4)-D33*F(1)	E	62	61200000
	F(14)=F(5)-B33*F(2)	E	63	61300000
	F(15)=F(6)-B33*F(3)-C33*F(2)	E	64	61400000
	F(16)=F(7)-B33*F(4)-C33*F(3)-D33*F(2)	E	65	61500000
	F(17)=F(8)-C33*F(4)-D33*F(3)	E	66	61600000
	F(18)=F(9)-D33*F(4)	E	67	61700000
	F(19)=-B33*F(5)	E	68	61800000
	F(20)=-B33*F(6)-C33*F(5)	E	69	61900000
	F(21)=-B33*F(7)-C33*F(6)-D33*F(5)	E	70	62000000
	F(22)=-B33*F(8)-C33*F(7)-D33*F(6)	E	71	62100000
	F(23)=-B33*F(9)-C33*F(8)-D33*F(7)	E	72	62200000

```

F(124)=-0.33*F(9)-0.33*F(8)
F(125)=-0.33*F(9)
DO 20 J=1,46
DO 20 L=1,12
20 XMAT3(J,L)=(0.,0.)
K2B=2.0*AK*(1-B11)
K2C=2.0*AK*(1-C11)
K2D=2.0*AK*(1-D11)
BSTAR=2.0*B11
CSTAR=2.0*C11
USTAR=2.0*D11
K4B=-4.0*AK*(1-B11)
K4C=-4.0*AK*(1-C11)
K4D=-4.0*AK*(1-D11)
K4=-4.0*AK
C COMPUTE COLUMNS 5 TO 8 OF III MATRIX, TABLE 1 ***
DO 30 J=1,4
XMAT3(J,J)=CMPLX(BSTAR,0.)
L=J+1
XMAT3(L,J)=CMPLX(CSTAR,0.)
L=L+1
XMAT3(L,J)=CMPLX(DSTAR,0.)
L=L+8
XMAT3(L,J)=CMPLX(-2.0,0.)
L=L+8
XMAT3(L,J)=CMPLX(-2.0,K4B)
L=L+1
XMAT3(L,J)=CMPLX(0.,K4C)
L=L+1
XMAT3(L,J)=CMPLX(0.,K4D)
L=L+8
30 XMAT3(L,J)=CMPLX(0.,K4)
DO 40 J=1,9
40 KE(J)=2.0*AK*E(J)
ETAN=E(1)*TANLE**2+E(6)
C COMPUTE COLUMNS 9 TO 12 OF III MATRIX ***
DO 50 J=5,8
L=J-4
XMAT3(L,J)=CMPLX(E(5),0.)
L=L+1
XMAT3(L,J)=CMPLX(ETAN,0.)
L=L+1
XMAT3(L,J)=CMPLX(E(7),0.)
L=L+1
XMAT3(L,J)=CMPLX(E(8),0.)
L=L+1
XMAT3(L,J)=CMPLX(E(9),0.)
L=L+6
XMAT3(L,J)=CMPLX(E(2),0.)
L=L+1
XMAT3(L,J)=CMPLX(E(3),0.)
L=L+1
XMAT3(L,J)=CMPLX(E(4),0.)
L=L+6
XMAT3(L,J)=CMPLX(E(2),KE(5))
L=L+1
XMAT3(L,J)=CMPLX(E(3),KE(6))
L=L+1
XMAT3(L,J)=CMPLX(E(4),KE(7))
L=L+1
XMAT3(L,J)=CMPLX(0.,KE(8))
L=L+1
XMAT3(L,J)=CMPLX(0.,KE(9))
L=L+6
XMAT3(L,J)=CMPLX(3.0*E(1),KE(2))
L=L+1
XMAT3(L,J)=CMPLX(0.,KE(3))
L=L+1
XMAT3(L,J)=CMPLX(0.,KE(4))
L=L+6
50 XMAT3(L,J)=CMPLX(0.,KE(1))
FTAN15=F(15)+F(10)*TANLE**2

```

```

E 73 62300000
E 74 62400000
E 75 62500000
E 76 62600000
E 77 62700000
E 78 62800000
E 79 62900000
E 80 63000000
E 81 63100000
E 82 63200000
E 83 63300000
E 84 63400000
E 85 63500000
E 86 63600000
E 87 63700000
E 88 63800000
E 89 63900000
E 90 64000000
E 91 64100000
E 92 64200000
E 93 64300000
E 94 64400000
E 95 64500000
E 96 64600000
E 97 64700000
E 98 64800000
E 99 64900000
E 100 65000000
E 101 65100000
E 102 65200000
E 103 65300000
E 104 65400000
E 105 65500000
E 106 65600000
E 107 65700000
E 108 65800000
E 109 65900000
E 110 66000000
E 111 66100000
E 112 66200000
E 113 66300000
E 114 66400000
E 115 66500000
E 116 66600000
E 117 66700000
E 118 66800000
E 119 66900000
E 120 67000000
E 121 67100000
E 122 67200000
E 123 67300000
E 124 67400000
E 125 67500000
E 126 67600000
E 127 67700000
E 128 67800000
E 129 67900000
E 130 68000000
E 131 68100000
E 132 68200000
E 133 68300000
E 134 68400000
E 135 68500000
E 136 68600000
E 137 68700000
E 138 68800000
E 139 68900000
E 140 69000000
E 141 69100000
E 142 69200000
E 143 69300000
E 144 69400000

```

	FTAN20=F(20)+F(11)*TANLE**2	E 145	69500000
	FTAN21=F(21)+F(12)*TANLE**2	E 146	69600000
	FTAN22=F(22)+F(13)*TANLE**2	E 147	69700000
	UU 00 J=1.16	E 148	69800000
	JJ=J+9	E 149	69900000
60	KF(J)=2.0*XX*(JJ)	E 150	70000000
C	COMPUTE COLUMNS 13 TO 16 OF III MATRIX ***	E 151	70100000
	DD 70 J=9.12	E 152	70200000
	L=J-8	E 153	70300000
	XMAT3(L,J)=CMPLX(F(19),0.)	E 154	70400000
	L=L+1	E 155	70500000
	XMAT3(L,J)=CMPLX(FTAN20,0.)	E 156	70600000
	L=L+1	E 157	70700000
	XMAT3(L,J)=CMPLX(FTAN21,0.)	E 158	70800000
	L=L+1	E 159	70900000
	XMAT3(L,J)=CMPLX(FTAN22,0.)	E 160	71000000
	L=L+1	E 161	71100000
	XMAT3(L,J)=CMPLX(F(23),0.)	E 162	71200000
	L=L+1	E 163	71300000
	XMAT3(L,J)=CMPLX(F(24),0.)	E 164	71400000
	L=L+1	E 165	71500000
	XMAT3(L,J)=CMPLX(F(25),0.)	E 166	71600000
	L=L+4	E 167	71700000
	XMAT3(L,J)=CMPLX(F(14),0.)	E 168	71800000
	L=L+1	E 169	71900000
	XMAT3(L,J)=CMPLX(FTAN15,0.)	E 170	72000000
	L=L+1	E 171	72100000
	XMAT3(L,J)=CMPLX(F(16),0.)	E 172	72200000
	L=L+1	E 173	72300000
	XMAT3(L,J)=CMPLX(F(17),0.)	E 174	72400000
	L=L+1	E 175	72500000
	XMAT3(L,J)=CMPLX(F(18),0.)	E 176	72600000
	L=L+4	E 177	72700000
	XMAT3(L,J)=CMPLX(F(14),KF(10))	E 178	72800000
	L=L+1	E 179	72900000
	XMAT3(L,J)=CMPLX(F(15),KF(11))	E 180	73000000
	L=L+1	E 181	73100000
	XMAT3(L,J)=CMPLX(F(16),KF(12))	E 182	73200000
	L=L+1	E 183	73300000
	XMAT3(L,J)=CMPLX(F(17),KF(13))	E 184	73400000
	L=L+1	E 185	73500000
	XMAT3(L,J)=CMPLX(F(18),KF(14))	E 186	73600000
	L=L+1	E 187	73700000
	XMAT3(L,J)=CMPLX(0.,KF(15))	E 188	73800000
	L=L+1	E 189	73900000
	XMAT3(L,J)=CMPLX(0.,KF(16))	E 190	74000000
	L=L+4	E 191	74100000
	XMAT3(L,J)=CMPLX((3.0*F(11)),KF(5))	E 192	74200000
	L=L+1	E 193	74300000
	XMAT3(L,J)=CMPLX((3.0*F(12)),KF(6))	E 194	74400000
	L=L+1	E 195	74500000
	XMAT3(L,J)=CMPLX((3.0*F(13)),KF(7))	E 196	74600000
	L=L+1	E 197	74700000
	XMAT3(L,J)=CMPLX(0.,KF(8))	E 198	74800000
	L=L+1	E 199	74900000
	XMAT3(L,J)=CMPLX(0.,KF(9))	E 200	75000000
	L=L+4	E 201	75100000
	XMAT3(L,J)=CMPLX((4.0*F(10)),KF(2))	E 202	75200000
	L=L+1	E 203	75300000
	XMAT3(L,J)=CMPLX(0.,KF(3))	E 204	75400000
	L=L+1	E 205	75500000
	XMAT3(L,J)=CMPLX(0.,KF(4))	E 206	75600000
	L=L+4	E 207	75700000
70	XMAT3(L,J)=CMPLX(0.,KF(1))	E 208	75800000
	AK2=2.*XK	E 209	75900000
	UU 00 KJ=1.4	E 210	76000000
	DD 80 JK=1.46	E 211	76100000
80	XMAT4(JK,KJ)=CMPLX(0.,0.)	E 212	76200000
C	COMPUTE COLUMNS 1 TO 4 OF III MATRIX ***	E 213	76300000
	DD 90 KJ=1.4	E 214	76400000
90	XMAT4(KJ,KJ)=CMPLX(1.,0.)	E 215	76500000
	XMAT4(19,1)=CMPLX(0.,XK2)	E 216	76600000

	XMAT4(20,2)=CMPLX(0.,XK2)	E 217	76700000
	XMAT4(21,3)=CMPLX(0.,XK2)	E 218	76800000
	XMAT4(22,4)=CMPLX(0.,XK2)	E 219	76900000
C	TAPL9 IS A COMMUNICATION CHANNEL TO OVERLAY 2,0	E 220	77000000
	WRITE (9) ((XMAT4(JK,KJ),JK=1,46),KJ=1,4)	E 221	77100000
	WRITE (9) ((XMAT3(JK,KJ),JK=1,46),KJ=1,12)	E 222	77200000
C	MULTIPLY, EQ. 28, REF. 1, RESULT IS THE IINM MATRIX ***	E 223	77300000
100	DO 110 J=1,4	E 224	77400000
	RPT=REAL(XM2STR(J))-K2*AIMAG(XM2STR(J+18))	E 225	77500000
	XIPT=AIMAG(XM2STR(J))+K2*REAL(XM2STR(J+18))	E 226	77600000
110	XMAT2(KMPT,J)=CMPLX(RPT,XIPT)	E 227	77700000
	DO 130 LL=1,12	E 228	77800000
	L=LL+4	E 229	77900000
	DO 120 J=1,40	E 230	78000000
120	XMAT2(KMPT,LJ)=XM2STR(J)*XMAT3(J,LL)+XMAT2(KMPT,L)	E 231	78100000
130	CONTINUE	E 232	78200000
	PRINT 140, KMPT	E 233	78300000
140	FORMAT (1H0,4HRUW ,12,27H OF COEFFICIENT MATRIX IINM)	E 234	78400000
	WRITE (6,150)	E 235	78500000
150	FORMAT (12X,2HRE,17X,4HIMAG,16X,2HRE,17X,4HIMAG,16X,2HRE,17X,4HIMA	E 236	78600000
	IG)	E 237	78700000
	WRITE (6,160) (XMAT2(KMPT,J),J=1,16)	E 238	78800000
160	FORMAT (6(5X,15.8))	E 239	78900000
	RETURN	E 240	79000000
	END	E 241-	79100000

SSSSS.- The function of subprogram SSSSS is to store in sequence the span stations η and the associated spanwise integrating factors for subregions I, II, III, and IV of figure 3 of reference 1. No flow chart is needed.

GAUSS.- The function of subprogram GAUSS is to calculate the span stations η and select spanwise integrating factors for a 6-, 10-, or 16-point Gaussian quadrature in regions I, II, and IV of figure 3 of reference 1. No flow chart is needed.

LCOMP.- The function of subprogram LCOMP is to calculate the values of $l_n^*(\xi, \eta)$ ($n = 0, 1, 2, 3, 4, 5$) of equation (13c) of reference 1. The flow chart for subprogram LCOMP follows.

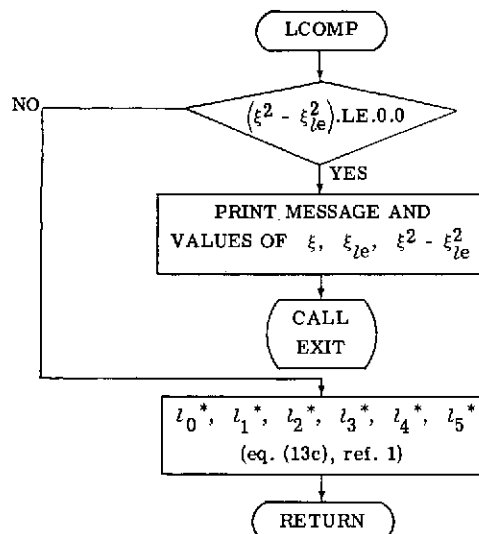

C	SUBROUTINE SSSSS (MC,MCOUNT,STNETA,STNWGH,ETATRA,WGHTRAI)	F	2	79300000
C		F	3	79400000
C	STORAGE OF SPAN STATIONS ETA AND THEIR ASSOCIATED SPANWISE	F	4	79500000
C	INTEGRATING FACTORS	F	5	79600000
C		F	6	79700000
	DIMENSION STNLTA(67),STNWGH(60),ETATRA(16),WGHTRAI(16)	F	7	79800000
	NAY=1	F	8	79900000
	DO 10 I=MC,MCOUNT	F	9	80000000
	STNETA(I)=ETATRA(NAY)	F	10	80100000
	STNWGH(I)=WGHTRAI(NAY)	F	11	80200000
10	NAY=NAY+1	F	12	80300000
	RETURN	F	13	80400000
	END	F	14-	80500000
	SUBROUTINE GAUSS (NGAUSS,A,B,U,R,YGAUSS,NQUEST,STATN,WGHFCT)	G	2	80700000
C		G	3	80800000
C	FOR NGAUSS=0,10, OR 16 COMPUTE SPAN STATIONS (STATN) AND	G	4	80900000
C	SPANWISE GAUSSIAN QUADRATURE FACTORS (WGHFCT) FOR EACH	G	5	81000000
C	SUBREGION, WITH LOWER LIMIT A AND UPPER LIMIT B. ***	G	6	81100000
C		G	7	81200000
	DIMENSION U(16),K(16),STATN(16),WGHFCT(16)	G	8	81300000
	BMA=(B-A)/2.0	G	9	81400000
	BPAT=(B+A)/2.0	G	10	81500000
	DO 30 I=1,NGAUSS	G	11	81600000
	STATN(I)=BMA*U(I)+BPAT	G	12	81700000
	IF (NQUEST) 20,10,20	G	13	81800000
10	VALUE=1.0	G	14	81900000
	GO TO 30	G	15	82000000
20	VALUE=(YGAUSS-STATN(I))*2	G	16	82100000
30	WGHFCT(I)=BMA*R(I)/VALUE	G	17	82200000
	RETURN	G	18	82300000
	END	G	19-	82400000
	SUBROUTINE LCOMP (DPSI,TAN,DPSILE,XLNU,DTHE)	H	2	82600000
C		H	3	82700000
C	COMPUTE THE LNSTAR (N=0 TO 5) OF EQ. 130, REF. 1 ****	H	4	82800000
C		H	5	82900000
	DIMENSION XLNU(6)	H	6	83000000
	ANC=DPSI**2-DPSILE**2	H	7	83100000
	IF (ANC) 10,10,40	H	8	83200000
10	WRITE (6,20)	H	9	83300000
20	FORMAT (20H1EKKK IN LCOMP SQRT)	H	10	83400000
	WRITE (6,30) DPSI,DPSILE,ANC	H	11	83500000
30	FORMAT (10H05H0PSI=E17.8,5X,7H0PSILE=E17.8,5X,4HANC=E17.8)	H	12	83600000
	CALL EXIT	H	13	83700000
40	THIS=SQR(ANC)	H	14	83800000
	DO 80 JJ=1,6	H	15	83900000
	IF (JJ-2) 50,50,70	H	16	84000000
50	XLNU(JJ)=DPSI/THIS	H	17	84100000
	GO TO 80	H	18	84200000
60	XLNU(JJ)=DPSI**2/THIS	H	19	84300000
	GO TO 80	H	20	84400000
70	XLNU(JJ)=(DPSI**(JJ-3))*THIS	H	21	84500000
80	CONTINUE	H	22	84600000
	RETURN	H	23	84700000
	END	H	24-	84800000

PRT2.— The function of subprogram PRT2 is to solve equation (32) of reference 1 for the weighting factors $a_{nm}^{(j)}$. A heading is written. If HMLTPLY(1) and HMLTPLY(2) are both nonzero, the real part of the downwash input $(-\partial h_1/\partial x)$ is multiplied by HMLTPLY(1), and the imaginary part $(-2h_1)$ by HMLTPLY(2). The imaginary part is also multiplied by k . When there are more than 16 control points, the simultaneous equation set is solved by a least-squares subroutine GLSP. The resulting $a_{nm}^{(j)}$ matrix is printed, written on TAPE9 for communication to D2182, and can be optionally punched. The flow chart for PRT2 follows.

SUBROUTINE PRT2

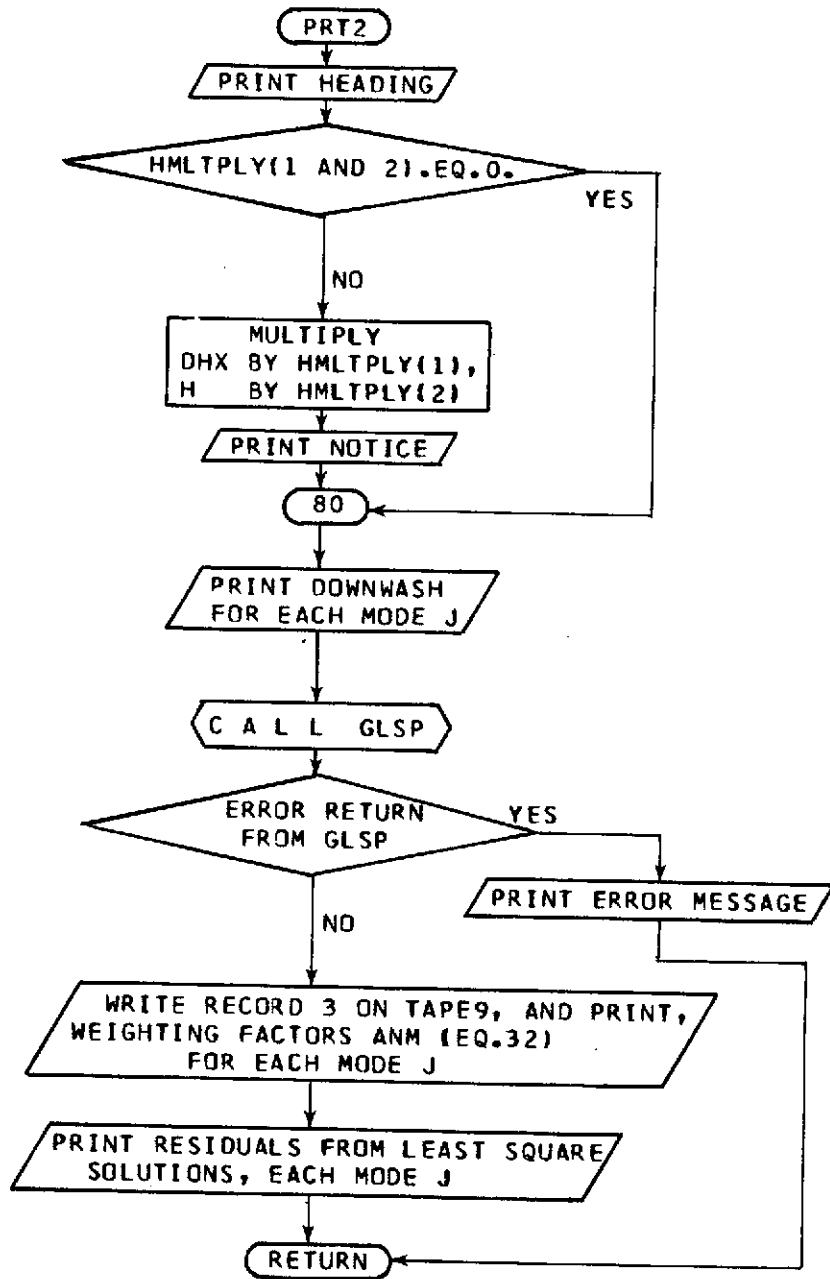

```

SUBROUTINE PRT2
C
C COMPUTE WEIGHTING FACTORS ANM(J) OF EQ 32, REF. 1 AND EQS. 9
C AND 18, REF. 2 FOR A MINIMUM OF 16 AND A MAXIMUM OF 48
C CONTROL POINTS, USING A LEAST-SQUARES SOLUTION.
C WRITE ANM(J) MATRICES AND MATRICES OF LEAST-SQUARES RESIDUALS
C PUNCH ANM MATRICES IF NPUNCH = 1 ***
C
COMMON/DEFAULT/HMLTPLY
COMMON/TRAZ182/XM, XK, TANLE, TANLTE, S, NMODE, NSYM, KPRUG
COMMON NXY, DEL, X, Y, DHX, H, WT
COMMON XA, XB, XC, XN4, XN5, XN6, XN7, XN8, XN9, BETASQ, BZY01, X0, Y0, XKOB2,
1XKM02, XKAY02, XOTERM, SKAY0, XKY0SQ, XKREAL, XKIMAG, NRR0W, XMAT2, KMPT
DIMENSION DCDEF(96,32), BVECT(96,6), WFACT(32,6), U(96,6), SUM(6), WT(9
16), TB(96,32), C(32,32)
DIMENSION DHX(48,6), H(48,6), HR(48,6)
DIMENSION HMLTPLY(2)
DIMENSION X(48), Y(48), IDENT(8)
C ABOVE DIMENSIONS FOR A MAXIMUM OF 48 CONTROL POINTS AND 6 MODES **
COMPLEX XMAT2(48,16)
COMPLEX ANM(16,6)
WRITE (6,10)
10 FORMAT (///37X,58H PART II OF 02181 *** SOLVE SIMULTANEOUS EQUATIO
INS FOR ANM//)
IF (HMLTPLY(1).EQ.0.0.AND.HMLTPLY(2).EQ.0.0) GO TO 40
DO 20 J=1,NMODE
DO 20 I=1,NXY
H(I,J)=HMLTPLY(2)*H(I,J)
DHX(I,J)=HMLTPLY(1)*DHX(I,J)
20 CONTINUE
PRINT 30, HMLTPLY(1),HMLTPLY(2)
30 FORMAT (//,5X,75H*****NOTICE- INPUT DOWNWASH QUANTITIES HAVE BEEN
MULTIPLIED AS FOLLOWS - BY,F6.3,25H FOR THE SLOPES DHX, AND/10X,3
2H BY,F6.3,30H FOR THE DEFLECTIONS H ****,//)
40 NXY2=2*NXY
DO 50 LX=1,NXY
DO 50 J=1,16
ARG1=REAL(XMAT2(LX,J))
ARG2=A[MAG(XMAT2(LX,J))
DCDEF(LX,J)=ARG1
LN=LX+NXY
DCDEF(LN,J)=ARG2
JN=J+16
DCDEF(LX,JN)=-ARG2
50 DCDEF(LN,JN)=ARG1
DO 80 MODE=1,NMODE
DO 80 J=1,NXY
HR(J,MODE)=XK*H(J,MODE)
BVECT(J,MODE)=DHX(J,MODE)
L=NXY+J
BVECT(L,MODE)=HR(J,MODE)
60 WRITE (6,70) MODE
70 FORMAT (//,1X,19HDOWNWASH W/V, MODE(,12,50H), NXY REAL PARTS FIRST
1, IN CONTRCL POINT SEQUENCE//)
80 WRITE (6,90) (BVECT(J,MODE),J=1,NXY2)
90 FORMAT (6(15X,E15.8))
CALL GLSP (DCDEF,NXY2,32,BVECT,NMODE,WFACT,U,SUM,WT,ERRKT,TB,C,96,
132)
IF (ERRKT-1) 140,100,120
100 PRINT 110
110 FORMAT (//1X,70H***** ERROR RETURN FROM LEAST SQUARES ROUTINE, FEWE
1R THAN 16 EQNS. ****//)
GO TO 190
120 PRINT 130
130 FORMAT (//1X,66H***** ERROR RETURN FROM LEAST SQUARES ROUTINE, DETER
MINANT = 0 ****//)
GO TO 190
140 DO 180 MODE=1,NMODE
WRITE (6,150) MODE
150 FORMAT (//,1X,28HWEIGHTING FACTORS ANM, MODE(,12,22H), 16 REAL PAR
ITS FIRST//)
WRITE (6,90) (WFACT(J,MODE),J=1,32)

```

DD 160 JK=1,0	I 74	92200000
DD 160 KJ=1,16	I 75	92300000
RP=WFACT(KJ,JK)	I 76	92400000
KKJ=KJ+10	I 77	92500000
XIP=WFACT(KKJ,JK)	I 78	92600000
160 ANM(KJ,JK)=CMPLX(RP,XIP)	I 79	92700000
C TAPES IS A COMMUNICATION CHANNEL TO OVERLAY 2,0	I 80	92800000
WRITE (9) (ANMIJK,MCDE),JK=1,16)	I 81	92900000
WRITE (6,170) MUDE	I 82	93000000
170 FORMAT (//,1X,29HLEAST SQUARE RESIDUALS, MUDE(,12,5GH), NXY REAL P	I 83	93100000
IAKTS FIRST, IN CONTROL POINT SEQUENCE//)	I 84	93200000
180 WRITE (6,90) (U(J,MUDE),J=1,NXY2)	I 85	93300000
190 RETURN	I 86	93400000
END	I 87-	93500000

^(j)
 a_{nm} GLSP.- The function of subprogram GLSP is to solve for the weighting factors of equation (32) of reference 1 with the aid of subprogram SIMEQ. A weighted least-square-error solution is made if the number of equations M exceeds the number ($N = 16$) of unknowns. The matrix of weights is supplied by the user. For $WT(1) = -1.0$, all weights are made 1.0. After a reduction to a normal form, solution of the simultaneous equations is done by SIMEQ. If the number of equations equals the number of unknowns, SIMEQ is called directly. If the number of equations is less than the number of unknowns, solution is not made. Instead a RETURN is made with $IER = 1$. The listings for subprograms GLSP and SIMEQ follow.

SUBROUTINE GLSP (A,M,N,B,IP,X,U,SUM,WT,IER,TB,WA,MAXM,MAXN)	J 2	93700000
C *** DOCUMENT DATE 08-01-68 SUBROUTINE REVISED 07-09-71 *****	J 3	93800000
C THIS ROUTINE IS ADAPTED FOR USE AT LANGLEY FROM SMHNSUNIAN	J 4	93900000
C ASTROPHYSICAL OBSERVATORY SUBROUTINE GLSP.	J 5	94000000
C A(MAXM,MAXN) = GIVEN RECTANGULAR MATRIX	J 6	94100000
C M = NO. ROWS OF A	J 7	94200000
C N = NO. COLS OF A	J 8	94300000
C B(MAXM,IP) = MATRIX OF RIGHT SIDE	J 9	94400000
C IP = NO. COLS OF B	J 10	94500000
C X(MAXN,IP) = SOLUTION MATRIX	J 11	94600000
C U(MAXM,IP) = RESIDUAL MATRIX	J 12	94700000
C SUM(IP) = SUM OF WEIGHTED SQUARES OF RESIDUALS	J 13	94800000
C WT(MAXM) = WEIGHTS. IF WT(1)=-1.0, ALL WEIGHTS ARE SET = 1.0	J 14	94900000
C IER = ERROR RETURN. = 0, NORMAL. = 1, MULT N. = 2, DET = 0.	J 15	95000000
C TB(MAXN) = TEMP. STORAGE IN SIMEQ	J 16	95100000
C WA(MAXN,MAXN) = MATRIX OF NORMAL EQUATIONS	J 17	95200000
C MAXM = MAXIMUM ROWS OF A	J 18	95300000
C MAXN = MAXIMUM COLS OF A	J 19	95400000
C SIMEQ = ROUTINE TO SOLVE NORMAL EQUATIONS	J 20	95500000
C	J 21	95600000
DIMENSION A(MAXM,MAXN), B(MAXM,IP), X(MAXN,IP), U(MAXM,IP),	J 22	95700000
1 SUM(IP),WT(MAXM),TB(MAXN),WA(MAXN,MAXN)	J 23	95800000
C	J 24	95900000
DET=0.0	J 25	96000000
IER=0	J 26	96100000
C	J 27	96200000
SET ALL WEIGHTS = 1.0 FOR NO WEIGHTING (WT(1) = -1.0)	J 27	96200000
IF (WT(1).GE.0.) GO TO 20	J 28	96300000
DD 10 I=1,M	J 29	96400000
10 WT(I)=1.0	J 30	96500000
20 IF (M-N) 30,40,70	J 31	96600000
C IF M LESS THAN N, NO SOLUTION, IER = 1	J 32	96700000
30 IER=1	J 33	96800000
RETURN	J 34	96900000

```

C      IF M = N, SOLUTION WITH NORMAL EQUATIONS, AX = B
40    DO 60 I=1,M
      DO 50 J=1,N
50    WA(I,J)=A(I,J)
      DO 60 K=1,IP
60    X(I,K)=B(I,K)
      GO TO 100
C      IF M GT N, WA = A(T) * A * WT, X = A(T) * B * WT
C
70    DO 80 K=1,N
      DO 80 J=1,M
      WA(J,K)=0.0
      DO 80 I=1,M
80    WA(J,K)=WA(J,K)+A(I,K)*A(I,J)*WT(I)
C      WEIGHT B
      DO 90 K=1,IP
      DO 90 J=1,N
      X(J,K)=0.0
      DO 90 I=1,M
90    X(J,K)=X(J,K)+A(I,J)*B(I,K)*WT(I)
C      SOLVE EQUATIONS BY SIMEQ
100   CALL SIMEQ (WA,N,X,IP,DET,TB,MAXN,IS)
      IF (DET.NE.0.) GO TO 110
      IER=2
      GO TO 140
C      SOLVE RESIDUALS AND SUM OF SQUARES OF RESIDUES
110   DO 130 K=1,IP
      SUM(K)=0.0
      DO 130 I=1,M
      U(I,K)=-B(I,K)
      DO 120 J=1,N
120   U(I,K)=U(I,K)+(A(I,J)*X(J,K))
130   SUM(K)=SUM(K)+(U(I,K))**2*WT(I)
140   RETURN
      END

```

```

J 35 97000000
J 36 97100000
J 37 97200000
J 38 97300000
J 39 97400000
J 40 97500000
J 41 97600000
J 42 97700000
J 43 97800000
J 44 97900000
J 45 98000000
J 46 98100000
J 47 98200000
J 48 98300000
J 49 98400000
J 50 98500000
J 51 98600000
J 52 98700000
J 53 98800000
J 54 98900000
J 55 99000000
J 56 99100000
J 57 99200000
J 58 99300000
J 59 99400000
J 60 99500000
J 61 99600000
J 62 99700000
J 63 99800000
J 64 99900000
J 65 10000000
J 66 10010000
J 67 10020000
J 68 10030000
J 69- 10040000

```

```

SUBROUTINE SIMEQ (A,N,B,M,DETERM,IPIVOT,NMAX,ISCALE)
C *** DOCUMENT DATE 08-01-68 SUBROUTINE REVISED 08-01-68 *****
C SOLUTION OF SIMULTANEOUS LINEAR EQUATIONS
C
C DIMENSION IPIVOT(N),A(NMAX,N),B(NMAX,M)
C EQUIVALENCE (IKOW,JROW),(ICOLU,JCOLU),(AMAX,T,SWAP)
C
C INITIALIZATION
C
10   ISCALE=0
      R1=10.0**100
      R2=1.0/R1
      DETERM=1.0
      DO 20 J=1,N
20   IPIVOT(J)=0
      DO 300 I=1,N
C
C SEARCH FOR PIVOT ELEMENT
C
      AMAX=0.0
      DO 70 J=1,N
      IF (IPIVOT(J)-1) 30,70,30
30   DO 60 K=1,N
      IF (IPIVOT(K)-1) 40,60,39
40   IF (ABS(AMAX)-ABS(A(J,K))) 50,60,60
50   IRD=J
      ICOLU=K
      AMAX=A(J,K)
60   CONTINUE
70   CONTINUE
      IF (AMAX) 90,80,90
80   DETERM=0.0
      ISCALE=0
      GO TO 370
90   IPIVOT(ICOLU)=IPIVOT(ICOLU)+1

```

```

K 2 100600000
K 3 100700000
K 4 100800000
K 5 100900000
K 6 101000000
K 7 101100000
K 8 101200000
K 9 101300000
K 10 101400000
K 11 101500000
K 12 101600000
K 13 101700000
K 14 101800000
K 15 101900000
K 16 102000000
K 17 102100000
K 18 102200000
K 19 102300000
K 20 102400000
K 21 102500000
K 22 102600000
K 23 102700000
K 24 102800000
K 25 102900000
K 26 103000000
K 27 103100000
K 28 103200000
K 29 103300000
K 30 103400000
K 31 103500000
K 32 103600000
K 33 103700000
K 34 103800000
K 35 103900000
K 36 104000000

```



C		K 37	104100000
C	INTERCHANGE ROWS TO PUT PIVOT ELEMENT ON DIAGONAL	K 38	104200000
C		K 39	104300000
	IF (IROW-ICOLUM) 100,140,100	K 40	104400000
100	DETERM=-DETERM	K 41	104500000
	DO 110 L=1,N	K 42	104600000
	SWAP=A(IR0W,L)	K 43	104700000
	A(IROW,L)=A(ICOLUM,L)	K 44	104800000
110	A(ICOLUM,L)=SWAP	K 45	104900000
	IF (M) 140,140,120	K 46	105000000
120	DO 130 L=1,M	K 47	105100000
	SWAP=B(IR0W,L)	K 48	105200000
	B(IROW,L)=B(ICOLUM,L)	K 49	105300000
130	B(ICOLUM,L)=SWAP	K 50	105400000
140	PIVOT=A(ICOLUM,ICOLUM)	K 51	105500000
	IF (PIVOT) 150,80,150	K 52	105600000
C		K 53	105700000
C	SCALE THE DETERMINANT	K 54	105800000
C		K 55	105900000
150	PIVOTI=PIVOT	K 56	106000000
	IF (ABS(DETERM)-R1) 180,160,160	K 57	106100000
160	DETERM=DETERM/R1	K 58	106200000
	ISCALE=ISCALE+1	K 59	106300000
	IF (ABS(DETERM)-R1) 210,170,170	K 60	106400000
170	DETERM=DETERM/R1	K 61	106500000
	ISCALE=ISCALE+1	K 62	106600000
	GO TO 210	K 63	106700000
180	IF (ABS(DETERM)-R2) 190,190,210	K 64	106800000
190	DETERM=DETERM*R1	K 65	106900000
	ISCALE=ISCALE-1	K 66	107000000
	IF (ABS(DETERM)-R2) 200,200,210	K 67	107100000
200	DETERM=DETERM*R1	K 68	107200000
	ISCALE=ISCALE-1	K 69	107300000
210	IF (ABS(PIVOTI)-R1) 240,220,220	K 70	107400000
220	PIVOTI=PIVOTI/R1	K 71	107500000
	ISCALE=ISCALE+1	K 72	107600000
	IF (ABS(PIVOTI)-R1) 270,230,230	K 73	107700000
230	PIVOTI=PIVOTI/R1	K 74	107800000
	ISCALE=ISCALE+1	K 75	107900000
	GO TO 270	K 76	108000000
240	IF (ABS(PIVOTI)-R2) 250,250,270	K 77	108100000
250	PIVOTI=PIVOTI*R1	K 78	108200000
	ISCALE=ISCALE-1	K 79	108300000
	IF (ABS(PIVOTI)-R2) 260,260,270	K 80	108400000
260	PIVOTI=PIVOTI*R1	K 81	108500000
	ISCALE=ISCALE-1	K 82	108600000
270	DETERM=DETERM*PIVOTI	K 83	108700000
C		K 84	108800000
C	DIVIDE PIVOT ROW BY PIVOT ELEMENT	K 85	108900000
C		K 86	109000000
	DO 290 L=1,N	K 87	109100000
	IF (IPIVOT(L)-1) 280,290,390	K 88	109200000
280	A(ICOLUM,L)=A(ICOLUM,L)/PIVOT	K 89	109300000
290	CONTINUE	K 90	109400000
	IF (M) 320,320,300	K 91	109500000
300	DO 310 L=1,M	K 92	109600000
310	B(ICOLUM,L)=B(ICOLUM,L)/PIVOT	K 93	109700000
C		K 94	109800000
C	REDUCE NON-PIVOT ROWS	K 95	109900000
C		K 96	110000000
320	DO 360 L1=1,N	K 97	110100000
	IF (L1-ICOLUM) 330,380,330	K 98	110200000
330	T=A(L1,ICOLUM)	K 99	110300000
	DO 350 L=1,N	K 100	110400000
	IF (IPIVOT(L)-1) 340,350,390	K 101	110500000
340	A(L1,L)=A(L1,L)-A(ICOLUM,L)*T	K 102	110600000
350	CONTINUE	K 103	110700000
	IF (M) 380,380,360	K 104	110800000
360	DO 370 L=1,M	K 105	110900000
370	B(L1,L)=B(L1,L)-B(ICOLUM,L)*T	K 106	111000000
380	CONTINUE	K 107	111100000
390	RETURN	K 108	111200000
	END	K 109-	111300000

OVERLAY (JMF,2,0); D2182

Subprogram D2182 is the controlling subprogram in overlay 2,0. Its function is to direct the calculation of the generalized aerodynamic forces Q_{ij}^* and, optionally, of the flutter solutions as described in reference 2. A NAMELIST input is read. If it includes previously calculated Q_{ij}^* values, their calculation is bypassed. Otherwise, the III and $a_{nm}^{(j)}$ matrices are obtained from TAPE9. During the calculation of Q_{ij}^* , most of the intermediate matrices can be optionally printed. Finally, flutter solutions are made for up to 25 values of air density, and the output is printed. The flow chart for D2182 follows.

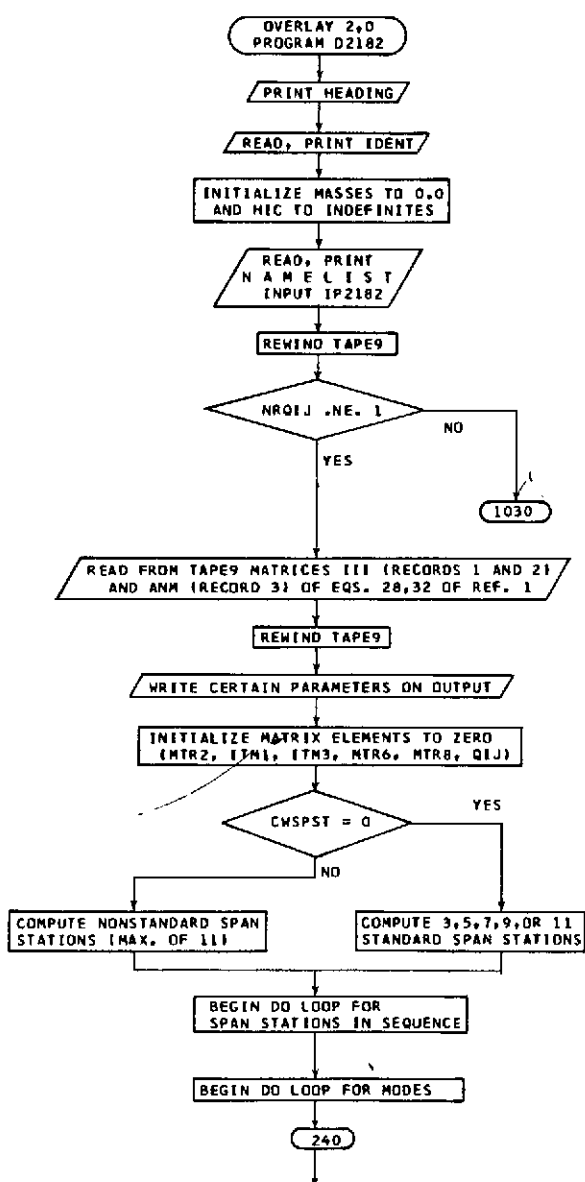
FLOW CHART FOR PROGRAM D2182

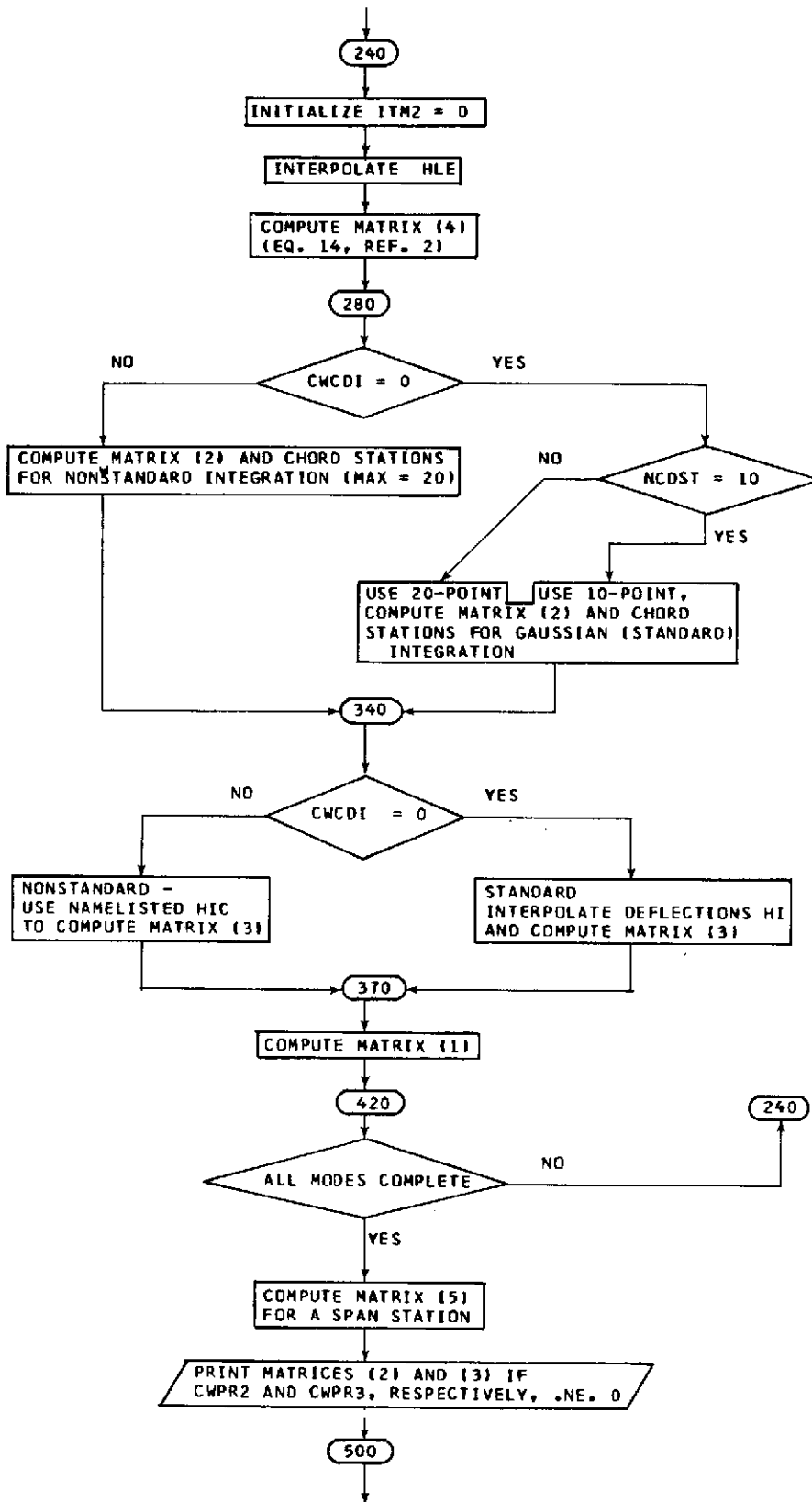



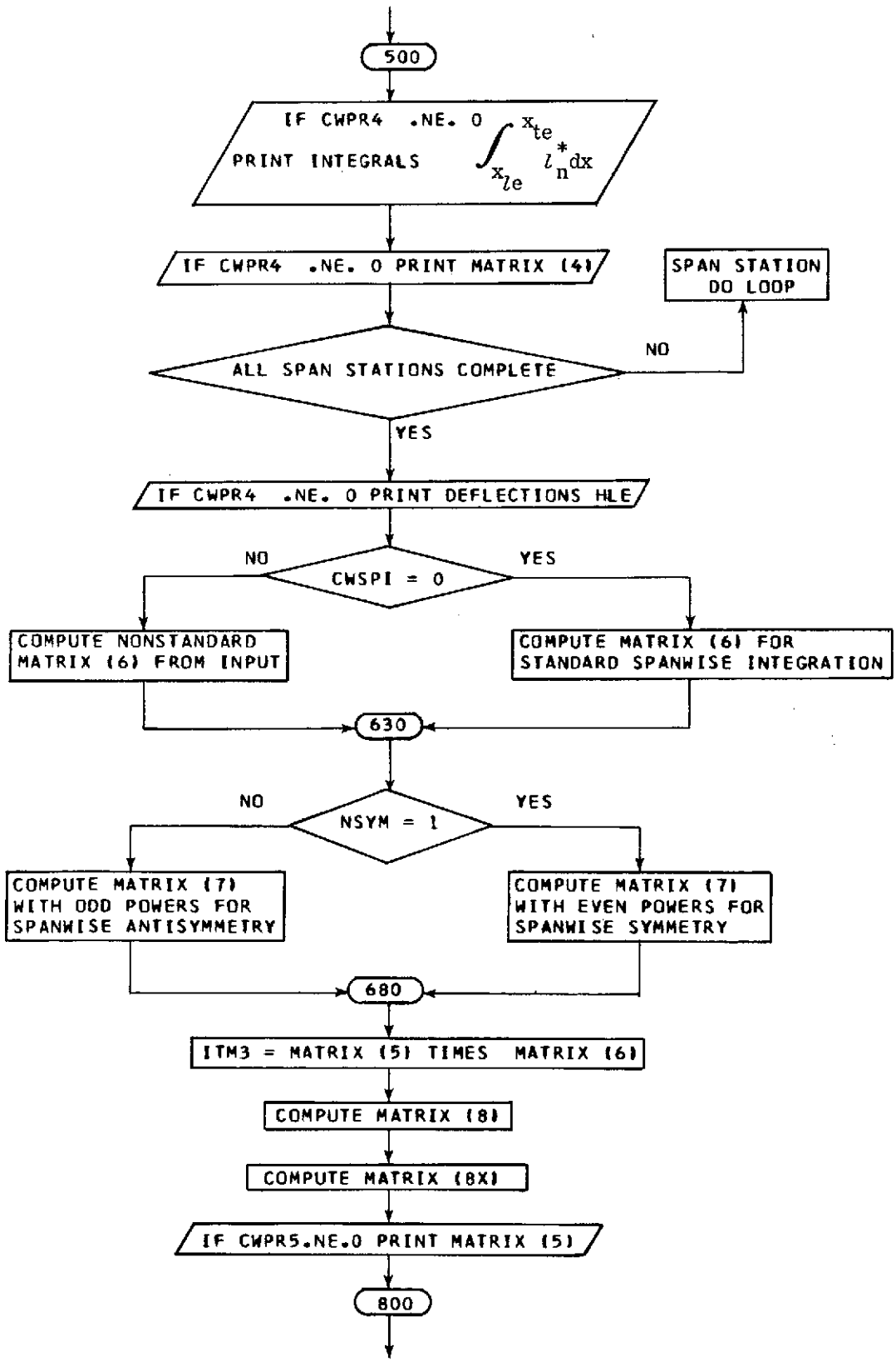

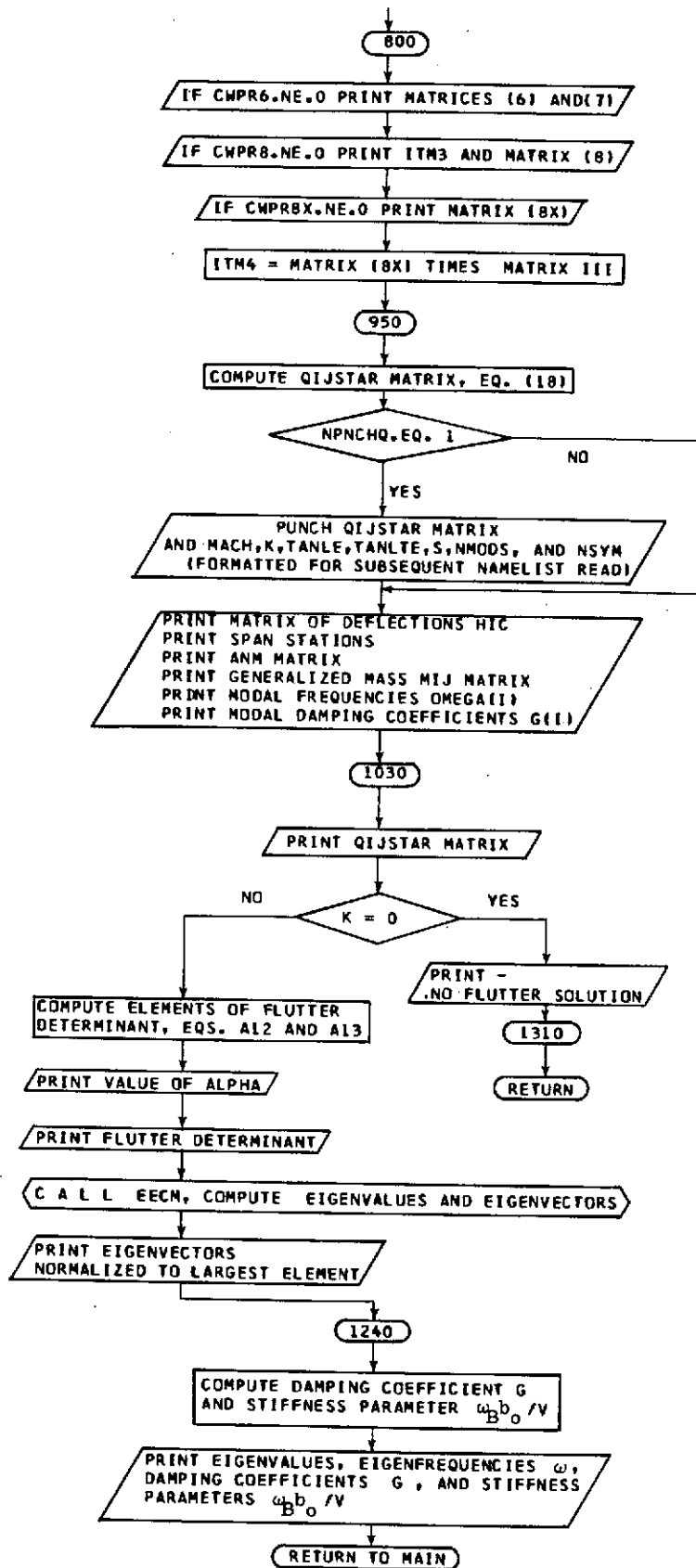

```

OVERLAY(JMF,2,0) L 1 111500000
PROGRAM J21b2 L 2 111600000
DIMENSION XBTB10(10),XBTB20(20),Tb1C10(10),Tb1C20(20),YSP(11), L 3 111700000
1XL(20),XLE(11),XFE(11),MTR1(6,20),MTR2(20),MTR3(20,6),MTR4(6,6), L 4 111800000
2MTR4A(6,11),HLE(11,6),MTR5(6,6,11),MTR6(11),MTR7(11,10), MTR8(6 L 5 111900000
3,6,10),MTR8X(6,4),ITM1(6,20),ITM2(6,6),ITM3(6,6,11),IDENT(8), L 6 112000000
4XCBAR(20),NB(6),YSPS(11),HIC(11,20,6),HTAB(20),NOX(6),CFE(6), L 7 112100000
5TEMP(6),G(6),OMEGA(6),MASS(6,6),ALPHA(25),XLC(20),ATAB(20),SMG(6) L 8 112200000
6,EDMEG(6),ISPS(11),XTR(20),INTHACT(6,2) L 9 112300000
COMPLEX TRKY(46,16),ANM(16,6),GAMMA(6),CAPG(6,6),WJ(6,6),ELG(6) L 10 112400000
1,ITM4(6,6),CFE,AD(6),STOR(6,6),HACT(6,6),VEL(6,6),VECSAV L 11 112500000
REAL MTR1,MTR2,MTR3,MTR4,MTR5,MTR6,MTR7,MTR8,MTR8X,ITM1,ITM2 L 12 112600000
1,ITM3,K,MASS,K6,MACH,ISPS L 13 112700000
COMMON/TRA21b2/AM,XK,TANLE,S,NMUDE,NSYM L 14 112800000
INTEGER CWPST,CWSPI,CWCDI,CWPR2,CWPR3,CWPR4,CWPR5, L 15 112900000
1CWPR6,CWPR7,CWPR8 L 16 113000000
C DATA TABLES FOR INTEGRATION STATIONS AND FACTORS FOR 10 AND L 17 113100000
C 20-POINT GAUSSIAN QUADRATURE FOR QIJ,S *** L 18 113200000
DATA (XBTB10(J),J=1,10)/.12040730E-1,.67400317E-1,.16029522, L 19 113300000
1.28330230,+.2550283,.57443717,.71669770,.85970476,.93253168, L 20 113400000
2.96095326/ L 21 113500000
DATA (XBTB20(J),J=1,20)/.34357004E-2,.18014030E-1,.43802766E-1, L 22 113600000
1.80441514E-1,.12083405,.18697316,.24456650,.31314090,.36010707, L 23 113700000
2.4017007+.23020326,.61289293,.63685374,.70243330,.81302004, L 24 113800000
3.87316595,.91955049,.95611721,.98198590,.99050430/ L 25 113900000
DATA (Tb1C10(J),J=1,10)/.33335672E-1,.74725075E-1,.10954316, L 26 114000000
1.13463330,.14770211,.14776211,.13463336,.10954318,.74725075E-1, L 27 114100000
2.33335072E-1/ L 28 114200000
DATA (Tb1C20(J),J=1,20)/.88770035E-2,.20300715E-1,.31300024E-1, L 29 114300000
1.4103037E-1,.20905060E-1,.59097266E-1,.65044319E-1,.71048055E-1, L 30 114400000
2.74260493E-1,.76376694E-1,.74500493E-1,.71048055E-1, L 31 114500000
3.65044319E-1,.59097266E-1,.59065000E-1,.4103037E-1,.31300024E-1, L 32 114600000
4.20300715E-1,.88770035E-2/ L 33 114700000
NAMELIST /IP21b2/NSPST,NCIDST,MASS,CMEGA,OMEGA,G,NALPHA,ALPHA,YSPS, L 34 114800000
1 ISPS,HIL,CWPST,CWSPI,CWCDI,XTAB,CWPR2,CWPR3, L 35 114900000
2 CWPR4,CWPR5,CWPR6,CWPR7,CWPR8,CWPR9,XLBAR,XLC,NHF L 36 115000000
3,INTUN,NPNCHG,NRQIJ,QIJ,MACH,K,TANLE,TANLTE,S,NMUDS,NSYM L 37 115100000
NMUDS=NMUDE3FALH=XM&K=XK L 38 115200000
PRINT 10 L 39 115300000
10 FORMAT (1H1,///22X,87HPROGRAM J21b2 .. COMPUTE GENERALIZED AERODY L 40 115400000
INAMIC FORCES AND SOLVE FLUTTER DETERMINANTS) L 41 115500000
C DEFAULT VALUES OF CONTROL PARAMETERS FOR QUADRATURE, PRINTING, L 42 115600000
C PUNCHING, AND INPUT *** L 43 115700000
CWCDI=CWPR2=CWPR3=CWPR4=CWPR5=CWPR6=CWPR7=CWPR8=CWPR9=0 L 44 115800000
CWSPI=CWPST=NPNCHG=NRQIJ=0 L 45 115900000
C debug INPUT L 46 116000000
READ (5,20) IDENT L 47 116100000
20 FORMAT (8A10) L 48 116200000
PRINT 30, IDENT L 49 116300000
30 FORMAT (///10X,8A10//) L 50 116400000
DO 40 I1=1,36 L 51 116500000
QIJ(11)=0.0 L 51.1 116600000
40 MASS(I1)=0.0 L 52 116700000
DO 50 I1=1,1320 L 53 116800000
HIL(I1)=1770000000000777777 L 54 116900000
READ (5,IP21b2) L 55 117000000
50 FORMAT (//1A,32H ECHO OF NAMELIST IP21b2 FOLLOWS ) L 56 117100000
WRITE (6,00) L 57 117200000
WRITE (6,IP21b2) L 58 117300000
IF (NRQIJ.EQ.1) GO TO 1030 L 59 117400000
REWIND 9 L 60 117500000
READ (9) (TRKY(JK,KJ),JK=1,46),KJ=1,4) L 61 117600000
READ (9) (TRKY(JK,KJ),JK=1,46),KJ=5,16) L 62 117700000
DO 70 KJ=1,NMUDS L 63 117800000
70 READ (9) (ANM(JK,KJ),JK=1,16) L 64 117900000
REWIND 9 L 65 118000000
WRITE (6,00) MACH,K,TANLE,TANLTE,S,NMUDS,NSYM L 66 118100000
80 FORMAT (//7H MACH=E15.8,5X,2H K=E15.8,5X,6HTANLE=E15.8,5X,7HTANLTE= L 67 118200000
1E15.8,5X,2H S=E15.8//7H NMUDS=12.5X,5HNSYM=12//) L 68 118300000
C L 69 118400000
C*** INITIALIZE MATRIX ELEMENTS TO ZERO L 70 118500000
DO 90 J=1,NCUST L 71 118600000

```

```

90 MTR2(J)=.
  DO 110 NSJ=1,6
    DO 110 NJJ=1,NMUUS
      DO 100 JS=1,NSPST
100  ITM3(NSJ,NJJ,JS)=0.0
110  CCNTINUE
      DO 120 J=1,6
        DO 120 KJ=1,NKCSI
120  ITM1(J,KJ)=0.0
  C
      DO 130 JP=1,NSPST
130  MTR6(JP)=0.0
140  CCNTINUE
      DO 170 MJ=1,6
        DO 160 MK=1,6
          DO 150 ML=1,10
150  MTR8(MJ,MK,ML)=0.0
160  CCNTINUE
170  CCNTINUE
          DO 190 MJ=1,NMUUS
            DO 180 ML=1,NMUUS
              W1J(MJ,ML)=0.0
180  CCNTINUE
190  CCNTINUE
  C  SPANWISE STATIONS ESTABLISHED
  C
  C  IF (CNSPST.EQ.0) GO TO 210
  C
  C  NON-STANDARD SPAN STATIONS
  C
  DO 200 J=1,NSPST
200  YSP(J)=YSPS(J)*S
  GO TO 230
  C
  C  STANDARD SPAN STATIONS (3,5,7,9,OR 11 EQUALLY SPACED)
  C
210  DY=3/FLUAT(NSPST-1)
  YSP(1)=0
  DO 220 J=2,NSPST
220  YSP(J)=YSP(J-1)+DY
230  CCNTINUE
  DO 270 ISPAN=1,NSPST
    DO 420 MJDE=1,NMODS
      DO 240 J=1,6
        DO 240 KJ=1,NMUUS
240  ITM2(J,KJ)=0.0
  C
  C  COMPUTE AND STORE CHOPD INTEGRALS OF LNSTAR - MTR4A
  C
  XLE(ISPAN)=ABS(YSP(ISPAN))*TANLE
  XTE(ISPAN)=1.+ABS(YSP(ISPAN))*TANLLE
  XVAL=XLE(ISPAN)
  DO 250 J=1,NMP
    XTB(J)=XLE(ISPAN)+XTAB(J)*(XTE(ISPAN)-XLE(ISPAN))
250  HTAB(J)=HIC(ISPAN,J,MODE)
  C  INTERPOLATE LE DEFLECTION
  CALL F1LUP (XVAL,HVAL,INTOR,NMP,XTB(1),HTAB(1))
  HLE(ISPAN,MODE)=HVAL
  XLTS0=XTE(ISPAN)**2-XLE(ISPAN)**2
  XLTS1=SQRT(XLTS0)
  XLTS3=XLTS1**3
  XLTS5=XLTS1**5
  XLE2=XLE(ISPAN)**2
  IF (XLE(ISPAN).EQ.0.) GO TO 260
  XTUAL=ABS(XTE(ISPAN)/XLE(ISPAN))
  ACOSH=ALOG(XTUAL+SQRT(XTUAL**2-1.))
  GO TO 270
260  XCUSH=0.0
270  CCNTINUE
  MTR4A1,ISPAN)=XLTSR
  MTR4A2,ISPAN)=.5*XTE(ISPAN)*XLTSR+.5*XLE2*XCUSH
  MTR4A3,ISPAN)=.5*XTE(ISPAN)*XLTSR-.5*XLE2*XCUSH
  MTR4A4,ISPAN)=.33333333*XLTS3

```

```

L 72 118700000
L 73 118800000
L 74 118900000
L 75 119000000
L 76 119100000
L 77 119200000
L 78 119300000
L 79 119400000
L 80 119500000
L 81 119600000
L 82 119700000
L 83 119800000
L 84 119900000
L 85 120000000
L 86 120100000
L 87 120200000
L 88 120300000
L 89 120400000
L 90 120500000
L 91 120600000
L 92 120700000
L 93 120800000
L 94 120900000
L 95 121000000
L 96 121100000
L 97 121200000
L 98 121300000
L 99 121400000
L 100 121500000
L 101 121600000
L 102 121700000
L 103 121800000
L 104 121900000
L 105 122000000
L 106 122100000
L 107 122200000
L 108 122300000
L 109 122400000
L 110 122500000
L 111 122600000
L 112 122700000
L 113 122800000
L 114 122900000
L 115 123000000
L 116 123100000
L 117 123200000
L 118 123300000
L 119 123400000
L 120 123500000
L 121 123600000
L 122 123700000
L 123 123800000
L 124 123900000
L 125 124000000
L 126 124100000
L 127 124200000
L 128 124300000
L 129 124400000
L 130 124500000
L 131 124600000
L 132 124700000
L 133 124800000
L 134 124900000
L 135 125000000
L 136 125100000
L 137 125200000
L 138 125300000
L 139 125400000
L 140 125500000
L 141 125600000
L 142 125700000
L 143 125800000

```

	MTR4A(5,ISPAN)=.25*XTE(ISPAN)*XLTS3+.125*XLE2*XTE(ISPAN)*XLTSK-.12	L 144	125900000
	15*XLE2**2*XCUSH	L 145	126000000
	MTR4A(6,ISPAN)=.2*XLTS5+.33333333*XLE2*XLTS3	L 146	126100000
	DO 280 NN=1,6	L 147	126200000
280	MTR4(NN,MODE)=MTR4A(NN,ISPAN)*HLE(ISPAN,MODE)	L 148	126300000
C		L 149	126400000
C	COMPUTE AND STORE CHORD INTEGRATING MATRIX - MTR2	L 150	126500000
C		L 151	126600000
	IF (CWC01.EQ.0) GO TO 300	L 152	126700000
C		L 153	126800000
C	NON-STANDARD CHORDWISE INTEGRATION	L 154	126900000
C		L 155	127000000
	DO 290 J=1,NCDS	L 156	127100000
	MTR2(J)=XIC(J)*(XTE(ISPAN)-XLE(ISPAN))	L 157	127200000
290	XC(J)=XLE(ISPAN)+XCBAR(J)*(XTE(ISPAN)-XLE(ISPAN))	L 158	127300000
	GO TO 340	L 159	127400000
C		L 160	127500000
C	STANDARD CHORDWISE INTEGRATION (10 OR 20-POINT GAUSS)	L 161	127600000
C		L 162	127700000
300	IF (NCDS.EQ.10) GO TO 320	L 163	127800000
	DO 310 J=1,NCDS	L 164	127900000
	MTR2(J)=T0IC20(J)*(XTE(ISPAN)-XLE(ISPAN))	L 165	128000000
310	XC(J)=XLE(ISPAN)+XBT020(J)*(XTE(ISPAN)-XLE(ISPAN))	L 166	128100000
	GO TO 340	L 167	128200000
320	DO 330 J=1,NCDS	L 168	128300000
	MTR2(J)=T0IC10(J)*(XTE(ISPAN)-XLE(ISPAN))	L 169	128400000
330	XC(J)=XLE(ISPAN)+XBT010(J)*(XTE(ISPAN)-XLE(ISPAN))	L 170	128500000
340	CONTINUE	L 171	128600000
	DO 410 KCHD=1,NCDS	L 172	128700000
C		L 173	128800000
C	COMPUTE AND STORE DEFLECTIONS H-HLE(MODE I) - MTR3	L 174	128900000
C		L 175	129000000
	IF (CWC01.NE.0) GO TO 360	L 176	129100000
C		L 177	129200000
C	STANDARD INTERPOLATION OF DEFLECTIONS	L 178	129300000
C		L 179	129400000
	DO 350 J=1,NHP	L 180	129500000
	XTB(J)=XLE(ISPAN)+XTAB(J)*(XTE(ISPAN)-XLE(ISPAN))	L 181	129600000
350	HTAB(J)=HIC(ISPAN,J,MODE)	L 182	129700000
	HVAL=XC(KCHD)	L 183	129800000
C	INTERPOLATE DEFLECTIONS	L 184	129900000
	CALL FTLOP (HVAL,HVAL,INTOR,NHP,XTB(1),HTAB(1))	L 185	130000000
	MTR3(KCHD,MODE)=HVAL-HLE(ISPAN,MODE)	L 186	130100000
	GO TO 370	L 187	130200000
C		L 188	130300000
C	NON-STANDARD, USE DEFLECTIONS HIC W/O INTERPOLATION	L 189	130400000
C		L 190	130500000
360	MTR3(KCHD,MODE)=HIC(ISPAN,KCHD,MODE)-HLE(ISPAN,MODE)	L 191	130600000
370	CONTINUE	L 192	130700000
	SQRTRAD=SQRT(XC(KCHD)**2-XLE(ISPAN)**2)	L 192.1	130800000
	XCN=1.0	L 192.2	130900000
	DO 400 N=1,6	L 193	131000000
	IF (N.EQ.1) GO TO 380	L 194	131100000
	IF (N.EQ.2) GO TO 390	L 195	131200000
	MTR1(N,KCHD)=XCN*SQRTRAD	L 196	131300000
	XCN=XCN*XC(KCHD)	L 196.1	131400000
	GO TO 400	L 197	131500000
380	IF (SQRTRAD.NE. 0.0) GO TO 382	L 197.1	131600000
	MTR1(N,KCHD)=0.0	L 197.2	131700000
	GO TO 400	L 197.3	131800000
382	MTR1(N,KCHD)=XC(KCHD)/SQRTRAD	L 197.4	131900000
	GO TO 400	L 199	132000000
390	MTR1(N,KCHD)=XC(KCHD)*MTR1(N-1,KCHD)	L 200	132100000
400	CONTINUE	L 201	132200000
410	CONTINUE	L 202	132300000
420	CONTINUE	L 203	132400000
C	END OF MODAL DO LOOP ***	L 204	132500000
C		L 205	132600000
C	MATRIX OPERATION FOR CHORDWISE INTEGRATION	L 206	132700000
C		L 207	132800000
C		L 208	132900000

C	COMPUTE AND STORE CHORD INTEGRALS - MTR5	L 209	133000000
C		L 210	133100000
	DD 430 J=1,0	L 211	133200000
	DD 430 JJ=1,NC DST	L 212	133300000
430	ITM1(J, JJ)=MTR1(J, JJ)*MTR2(JJ)	L 213	133400000
	DD 440 J=1,0	L 214	133500000
	DD 440 JJ=1,NM DUS	L 215	133600000
	DD 440 JJJ=1,NC DST	L 216	133700000
440	ITM2(J, JJJ)=ITM1(J, JJJ)*MTR3(JJJ, JJ)+ITM2(J, JJ)	L 217	133800000
	DD 450 J=1,0	L 218	133900000
	DD 450 JJ=1,NM DUS	L 219	134000000
450	MTR5(JJ, J, I SPAN)=ITM2(J, JJ)+MTR4(J, JJ)	L 220	134100000
	IF (CWP K2.EQ.0) GO TO 480	L 221	134200000
	WRITE (0,460)	L 222	134300000
460	FORMAT (//10X,21HMATRIX MTR1 - BY ROWS)	L 223	134400000
	WRITE (0,1000) ((MTR1(JK, KJ), KJ=1,NC DST), JK=1,0)	L 224	134500000
	WRITE (0,470)	L 225	134600000
470	FORMAT (//10X, 30HMATRIX MTR2, DIAGONAL ELEMENTS)	L 226	134700000
	WRITE (0,1000) (MTR2(JK), JK=1,NC DST)	L 227	134800000
480	IF (CWP K3.EQ.0) GO TO 500	L 228	134900000
	WRITE (0,490)	L 229	135000000
490	FORMAT (//10X,34HDEFLECTIONS H-HLE , MTR3 , BY ROWS)	L 230	135100000
	WRITE (0,1000) ((MTR3(JK, KJ), JK=1,NC DST), KJ=1,NM DUS)	L 231	135200000
500	IF (CWP K4.EQ.0) GO TO 520	L 232	135300000
	WRITE (0,510)	L 233	135400000
510	FORMAT (//10X,33HCHORD INTEGRALS (F LNSTAR - MTR4A/)	L 234	135500000
	WRITE (0,1000) (MTR4A(JK, I SPAN), JK=1,0)	L 235	135600000
520	IF (CWP R4.EQ.0) GO TO 560	L 236	135700000
	WRITE (0,530)	L 237	135800000
530	FORMAT (//10X,21HMATRIX MTR4 - BY ROWS)	L 238	135900000
	WRITE (0,1000) ((MTR4(JK, KJ), KJ=1,NM DUS), JK=1,0)	L 239	136000000
	WRITE (0,540)	L 240	136100000
540	FORMAT (//10X,33HMATRIX ITM1 = MTR1*MTR2 , BY ROWS)	L 241	136200000
	WRITE (0,1000) ((ITM1(JK, KJ), KJ=1,NC DST), JK=1,0)	L 242	136300000
	WRITE (0,550)	L 243	136400000
550	FORMAT (//10X,33HMATRIX ITM2 = ITM1*MTR3 , BY ROWS)	L 244	136500000
	WRITE (0,1000) ((ITM2(JK, KJ), KJ=1,NM DUS), JK=1,0)	L 245	136600000
560	CONTINUE	L 246	136700000
570	CONTINUE	L 247	136800000
C	END OF SPAN-STATION DC LOOP ***	L 248	136900000
	IF (CWP K4.EQ.0) GO TO 590	L 249	137000000
	WRITE (0,580)	L 250	137100000
580	FORMAT (//10X,51HDEFLECTIONS HLE OF MTR4, BY SPAN STA., MODE 1 FIKS	L 251	137200000
	IT)	L 251.1	137300000
	WRITE (0,1000) ((HLE(JK, KJ), JK=1,NSPST), KJ=1,NM DUS)	L 252	137400000
590	CONTINUE	L 253	137500000
C		L 254	137600000
C	COMPUTE AND STORE SPAN INTEGRATING MATRIX - MTR6	L 255	137700000
C		L 256	137800000
	IF (CWP S1.EQ.0) GO TO 610	L 257	137900000
C		L 258	138000000
C	NON-STANDARD SPANWISE INTEGRATION	L 259	138100000
C		L 260	138200000
	DD 600 JS=1,NSPST	L 261	138300000
600	MTR6(JS)=ISPS(JS)*S	L 262	138400000
	GO TO 630	L 263	138500000
C		L 264	138600000
C	STANDARD SPANWISE INTEGRATION	L 265	138700000
C		L 266	138800000
610	QUANT=S/FLUAT(3*(NSPST-1))	L 267	138900000
	MTR6(1)=QUANT	L 268	139000000
	NSM=NSPST-1	L 269	139100000
	DD 620 JS=2,NSM,2	L 270	139200000
	MTR6(JS)=+.0*QUANT	L 271	139300000
620	MTR6(JS+1)=2.0*QUANT	L 272	139400000
	MTR6(NSPST)=QUANT	L 272.1	139500000
C		L 273	139600000
630	CONTINUE	L 274	139700000
	DD 640 JS=1,NSPST	L 275	139800000
640	MTR7(JS,1)=1.0	L 276	139900000
	DD 680 JS=1,NSPST	L 277	140000000
	IF (NSYM.EQ.1) GO TO 660	L 278	140100000

	DU 650 JP=1,10	L 279	140200000
	JSP=2*(JP-1)+1	L 280	140300000
650	MTR7(JS,JP)=YSP(JS)**JSP	L 281	140400000
	GO TO 680	L 282	140500000
660	DU 670 JP=2,10	L 283	140600000
	JSP=2*(JP-2)+2	L 284	140700000
670	MTR7(JS,JP)=YSP(JS)**JSP	L 285	140800000
680	CONTINUE	L 286	140900000
	DU 700 NSJ=1,6	L 287	141000000
	DU 700 NJJ=1,NMUDS	L 288	141100000
	DU 690 JS=1,NSPST	L 289	141200000
690	ITM3(NSJ,NJJ,JS)=MTR5(NJJ,NSJ,JS)*MTR6(JS)	L 290	141300000
700	CONTINUE	L 291	141400000
C		L 292	141500000
C	MATRIX OPERATION FOR SPANWISE INTEGRATION	L 293	141600000
C		L 294	141700000
C		L 295	141800000
C	COMPUTE AND STORE QIJ-STAR MATRIX - MTRB	L 296	141900000
C		L 297	142000000
	DU 740 MJ=1,6	L 298	142100000
	DU 730 MK=1,NMUDS	L 299	142200000
	DU 720 ML=1,10	L 300	142300000
	DU 710 MM=1,NSPST	L 301	142400000
710	MTR8(MJ,MK,ML)=ITM3(MJ,MK,MM)*MTR7(MM,ML)+MTR6(MJ,MK,ML)	L 302	142500000
720	CONTINUE	L 303	142600000
730	CONTINUE	L 304	142700000
740	CONTINUE	L 305	142800000
C		L 306	142900000
C	COMPUTE AND STORE QIJ-STAR REARRANGED - MTR8A	L 307	143000000
C		L 308	143100000
	DU 770 MJ=1,NMUDS	L 309	143200000
	NN=0	L 310	143300000
	DU 760 MK=1,6	L 311	143400000
	IF (MK.EQ.1,OR,MK.EQ.3) NTM=10	L 312	143500000
	IF (MK.EQ.2,OR,MK.EQ.4) NTM=8	L 313	143600000
	IF (MK.EQ.5) NTM=6	L 314	143700000
	IF (MK.EQ.6) NTM=4	L 315	143800000
	DU 750 ML=1,NTM	L 316	143900000
	NN=NN+1	L 317	144000000
750	MTR8A(MJ,NN)=MTR8(MK,MJ,ML)	L 318	144100000
760	CONTINUE	L 319	144200000
770	CONTINUE	L 320	144300000
	IF (CWPKS.EQ.0) GO TO 800	L 321	144400000
	WRITE (6,780)	L 322	144500000
780	FORMAT (//10X,22HCHORD INTEGRALS - MTR5/ 5X, 15HN=0 (IN LNSTAR),	L 323	144600000
	111X, 3HN=1, 17X, 3HN=2, 17X, 3HN=3, 17X, 3HN=4, 17X, 3HN=5)	L 323.1	144700000
	DU 790 MJ=1,NMUDS	L 324	144800000
	PRINT 782, MJ	L324.1	144900000
782	FORMAT (5X, 5HMODE ,I2)	L324.2	145000000
790	WRITE (6,1000) ((MTR5(MJ,JK,KJ),JK=1,6),KJ=1,NSPST)	L 325	145100000
800	IF (CWPKS.EQ.0) GO TO 830	L 326	145200000
	WRITE (6,810)	L 327	145300000
810	FORMAT (//10X,47HSPAN INTEGRATING MATRIX - MTR6 (DIAGONAL TERMS)/)	L 328	145400000
	WRITE (6,1000) (MTR6(JK), JK=1,NSPST)	L 329	145500000
	WRITE (6,820)	L 330	145600000
820	FORMAT (//10X, 23HMATRIX - MTR7 - BY ROWS /)	L 331	145700000
	WRITE (6,1000) ((MTR7(JK,KJ),KJ=1,10),JK=1,NSPST)	L 332	145800000
830	IF (CWPKS.EQ.0) GO TO 880	L 333	145900000
	WRITE (6,840)	L 334	146000000
840	FORMAT (//10X,36HMATRIX ITM3 = MTR5*MTR6 , BY COLUMNS)	L 335	146100000
	DU 850 JK=1,NMUDS	L 336	146200000
850	WRITE (6,1000) ((ITM3(JJ,JK,JM),JJ=1,6),JM=1,NSPST)	L 337	146300000
	WRITE (6,860)	L 338	146400000
860	FORMAT (//10X,50HSPAN INTEGRALS,MTR8,BY ROWS,60 ELEMENTS EACH MODE	L 339	146500000
	1 /)	L 340	146600000
	DU 870 MJ=1,NMUDS	L 341	146700000
870	WRITE (6,1000) ((MTR8(JK,MJ,KJ),KJ=1,10),JK=1,6)	L 342	146800000
880	IF (CWPKS.EQ.0) GO TO 900	L 343	146900000
	WRITE (6,890)	L 344	147000000
890	FORMAT (//10X,62HSPAN INTEGRALS REARRANGED,MTR8A, ROWS OF 46 ELEME	L 345	147100000
	INTS EACH MODE/)	L 346	147200000
	WRITE (6,1000) ((MTR8A(JK,KJ),KJ=1,46),JK=1,NMUDS)	L 347	147300000

900	CONTINUE	L 348	147400000
	DD 920 MJ=1,NMODS	L 349	147500000
	DD 910 ML=1,40	L 350	147600000
910	ITM4(MJ,ML)=0.0	L 351	147700000
920	CONTINUE	L 352	147800000
	DD 940 MJ=1,NMODS	L 353	147900000
	DD 940 ML=1,10	L 354	148000000
	DD 930 MM=1,40	L 355	148100000
930	ITM4(MJ,ML)=MITK0X(MJ,MM)*TREY(MM,ML)+ITM4(MJ,ML)	L 356	148200000
940	CONTINUE	L 357	148300000
C		L 358	148400000
C	MATRIX OPERATION FOR GENERALIZED AERODYNAMIC FORCES	L 359	148500000
	DD 960 MJ=1,NMODS	L 360	148600000
	DD 960 MI=1,NMODS	L 361	148700000
	DD 950 ML=1,10	L 362	148800000
950	QIJ(MJ,MI)=ITM4(MJ,ML)*ANM(ML,MI)+QIJ(MJ,MI)	L 363	148900000
960	CLNTINUE	L 364	149000000
C	QIJ-STAR MATRIX IS COMPLETE	L 365	149100000
	WRITE (0,970)	L 366	149200000
970	FORMAT (//10X,77HINPUT DEFLECTIONS H SUB 1, IN ORDER L.E. TO T.E.,	L 367	149300000
	1 INBOARD FIRST. MODE 1 FIRST//)	L 368	149400000
	DD 990 MJ=1,NMODS	L 369	149500000
	DD 980 MI=1,NSPST	L 370	149600000
980	WRITE (0,1000) (HIC(MI,J,MJ),J=1,NHP)	L 371	149700000
990	CONTINUE	L 372	149800000
1000	FORMAT (0,15X,E15.8)	L 373	149900000
	WRITE (0,1010)	L 374	150000000
1010	FORMAT (//10X,13HSPAN STATIONS//)	L 375	150100000
	WRITE (0,1000) (YSP(J),J=1,NSPST)	L 376	150200000
	WRITE (0,1020)	L 377	150300000
1020	FORMAT (//10X,40HANN MATRIX, BY MODAL COLUMNS OF COMPLEX ELEMENTS/	L 378	150400000
	15X,4HREAL,10X,4HMAG,16X,4HREAL,16X,4HMAG,10X,4HREAL,16X,4HMAG)	L 379	150500000
	WRITE (0,1000) ((ANM(JK,KJ)),JK=1,16),KJ=1,NMODS)	L 380	150600000
1030	CONTINUE	L 381	150700000
	WRITE (0,1040)	L 382	150800000
1040	FORMAT (//10X,10HMIJ MATRIX//)	L 383	150900000
	WRITE (0,1000) ((MASS(JK,KJ)),KJ=1,NMODS),JK=1,NMODS)	L 384	151000000
	WRITE (0,1050)	L 385	151100000
1050	FORMAT (//10X,17HMODAL FREQUENCIES//)	L 386	151200000
	WRITE (0,1000) (UMEGA(J),J=1,NMODS)	L 387	151300000
	WRITE (0,1060)	L 388	151400000
1060	FORMAT (//10X,31HMODAL DAMPING COEFFICIENTS G(1//)	L 389	151500000
	WRITE (0,1000) (G(J),J=1,NMODS)	L 390	151600000
	WRITE (0,1070)	L 391	151700000
1070	FORMAT (//10X,20H QIJ MATRIX, BY COMPLEX ROWS//)	L 392	151800000
	WRITE (0,1000) ((QIJ(JK,KJ)),KJ=1,NMODS),JK=1,NMODS)	L 393	151900000
	IF (NPNCHW.NE.1) GO TO 1102	L 394	152000000
	PUNCH 1080, MACH,K,TANLE,TANLTE,S,NMODS,NSYM	L 395	152100000
1080	FORMAT (1X,5HMACH=E15.8,3H,K=E15.8,7H,TANLE=E15.8,1H,/1X,7HTANLTE=	L 396	152200000
	1E15.8,3H,S=E15.8,7H,NMODS=I2,6H,NSYM=I2,1H,)	L 397	152300000
	DD 1100 MI=1,NMODS	L 398	152400000
	DD 1100 MJ=1,NMODS,2	L 399	152500000
	KQIJ=REAL(QIJ(MJ,MI)) \$ RQIJPI=REAL(QIJ(MJ+1,MI))	L 400	152600000
	AIQIJ=AIMAG(QIJ(MJ,MI)) \$ AIQIJPI=AIMAG(QIJ(MJ+1,MI))	L 401	152700000
	PUNCH 1090, MJ,MI,RQIJ,AIQIJ,RQIJPI,AIQIJPI	L 402	152800000
1090	FORMAT (5H QIJ(,1),1H,1H,1H,2H)=,2(1H,(E15.8,1H,,E15.8,2H),)	L 403	152900000
1100	CONTINUE	L 404	153000000
C		L 405	153100000
C	BEGIN FLUTTER SOLUTION ***	L 406	153200000
C		L 407	153300000
	1102 IF (K.NE.0.) GO TO 1120	L 408	153400000
	PRINT 1110	L 409	153500000
1110	FORMAT (//33H *** K=0, NO FLUTTER SOLUTION ***//)	L 410	153600000
	GO TO 1310	L 411	153700000
1120	DD 1300 NAF=1,NALPHA	L 412	153800000
	DD 1140 MI=1,NMODS	L 413	153900000

KPT=(4*OMEGA/CMEGA(MI))**2/(MASS(MI,MI)*(1.+G(MI)**2))	L 414	154000000
XIPT=-G(MI)*KPT	L 415	154100000
GAMMA(MI)=CMPLX(KPT,XIPT)	L 416	154200000
DU 1130 MJ=1,NMODS	L 417	154300000
1130 CAPG(MI,MJ)=GAMMA(MI)*(MASS(MI,MJ)+ALPHA(NAF)*(QIJ(MI,MJ)/K**2))	L 418	154400000
1140 CONTINUE	L 419	154500000
WRITE (6,1150) ALPHA(NAF)	L 420	154600000
1150 FORMAT (////10X,0HALPHA=E15.8)	L 421	154700000
WRITE (6,1160)	L 422	154800000
1160 FORMAT (//10X,30HFLUTTER DETERMINANT, BY COMPLEX ROWS/)	L 423	154900000
WRITE (6,1000) ((CAPG(JK,KJ),KJ=1,NMODS),JK=1,NMODS)	L 424	155000000
NMAX=6	L 425	155100000
INTHACT(1,1)=INTHACT(2,1)=NMODS	L 426	155200000
CALL EECM (CAPG,EIG,VEC,STOR,HACT,CFE,AD,INTHACT,NMAX)	L 427	155300000
IF (INTHACT(1,1).GE.NMODS) GO TO 1180	L 428	155400000
WRITE (6,1170)	L 429	155500000
1170 FORMAT (/00H ***** NON-CONVERGENCE RETURN FROM SUBROUTINE *****	L 430	155600000
1*****/)	L 431	155700000
GO TO 1300	L 432	155800000
1180 PRINT 1190	L 433	155900000
1190 FORMAT (/0X,90HEIGENVECTORS IN SAME ORDER AS THE EIGENVALUES...EAC	L 434	156000000
1H EIGENVECTOR NORMALIZED TO ITS LARGEST ELEMENT)	L 435	156100000
DU 1230 LVEC=1,NMODS	L 436	156200000
RENORMALIZE EIGENVECTOR, MAKE LARGEST ELEMENT 1.0 + 0.01	L 437	156300000
JSAVE=1	L 438	156400000
DU 1200 J=2,NMODS	L 439	156500000
IF ((VEC(JSAVE,LVEC)*CONJG(VEC(JSAVE,LVEC))).LT.(VEC(J,LVEC)*CONJG	L 440	156600000
1(VEC(J,LVEC)))) JSAVE=J	L 441	156700000
1200 CONTINUE	L 442	156800000
VECSAV=VEC(JSAVE,LVEC)	L 443	156900000
DU 1210 J=1,NMODS	L 444	157000000
VEC(J,LVEC)=VEC(J,LVEC)/VECSAV	L 445	157100000
1210 CONTINUE	L 446	157200000
PRINT 1220, LVEC,(VEC(I,LVEC),I=1,NMODS)	L 447	157300000
1220 FORMAT (14H EIGENVECTOR (,12,1H)/(6E21.8)/)	L 448	157400000
1230 CONTINUE	L 449	157500000
DU 1250 JITE=1,NMODS	L 450	157600000
EIGENR=REAL(EIG(JITE))	L 451	157700000
EIGENI=AIMAG(EIG(JITE))	L 452	157800000
IF (EIGENR.GT.0) GO TO 1240	L 453	157900000
SMG(JITE)=OMEGA(JITE)=KB(JITE)=17770000000000000007777777B	L 454	158000000
GO TO 1250	L 455	158100000
1240 SMG(JITE)=EIGENI/EIGENR	L 456	158200000
OMEGA(JITE)=OMEGA/SQRT(EIGENR)	L 457	158300000
KB(JITE)=K*OMEGA/ECMEG(JITE)	L 458	158400000
1250 CONTINUE	L 459	158500000
WRITE (6,1260)	L 460	158600000
1260 FORMAT (//10X,41HEIGENVALUES. RE(1), IM(1), RE(2), IM(2), ETC./)	L 461	158700000
WRITE (6,1000) (EIG(J),J=1,NMODS)	L 462	158800000
WRITE (6,1270)	L 463	158900000
1270 FORMAT (//10X,10HEIGENFREQUENCIES/)	L 464	159000000
WRITE (6,1000) (OMEGA(J),J=1,NMODS)	L 465	159100000
WRITE (6,1280)	L 466	159200000
1280 FORMAT (//10X,22HDAMPING COEFFICIENTS G/)	L 467	159300000
WRITE (6,1000) (SMG(J),J=1,NMODS)	L 468	159400000
WRITE (6,1290)	L 469	159500000
1290 FORMAT (//10X,20HSTIFFNESS PARAMETERS/)	L 470	159600000
WRITE (6,1000) (KB(J),J=1,NMODS)	L 471	159700000
1300 CONTINUE	L 472	159800000
1310 RETURN	L 473	159900000
END	L 474-	160000000

Description of External File TAPE9

The file TAPE9 is written in Overlay 1,0 and read in Overlay 2,0. As shown on the flow charts, it is handled as follows, for $KPROG = 0$:

(1) Rewound in subprogram D2181.

(2) In subprogram MTXMPY the first four columns of the matrix \mathbf{III} are written as record no. 1, and columns 5 to 16 are written as record no. 2.

(3) In subprogram PRT2 the matrix of $a_{nm}^{(j)}$ is written as record no. 3.

(4) In subprogram D2182, TAPE9 is rewound, the matrix \mathbf{III} is read as the first two records, and the matrix $a_{nm}^{(j)}$ is read as record no. 3. TAPE9 is then rewound.

For $KPROG \neq 0$ TAPE9 is not used.

USAGE

Program Information and Input Deck Arrangement

The program D2180 is written in the FORTRAN IV language for the Control Data 6000 series digital computer under the SCOPE 3.0 operating system. To compile, load, and run requires a field length of 63000 (octal) locations with variables dimensioned as follows: 48 control points, 6 vibration modes, 25 air density values, and 220 points on the half-span wing for modal deflections. An example of a central processor time to compile and run is 166 seconds on a 6400 for a case with 48 control points, 3 modes, 21 density values, and 110 deflection points. The following sketch shows the input deck arrangement

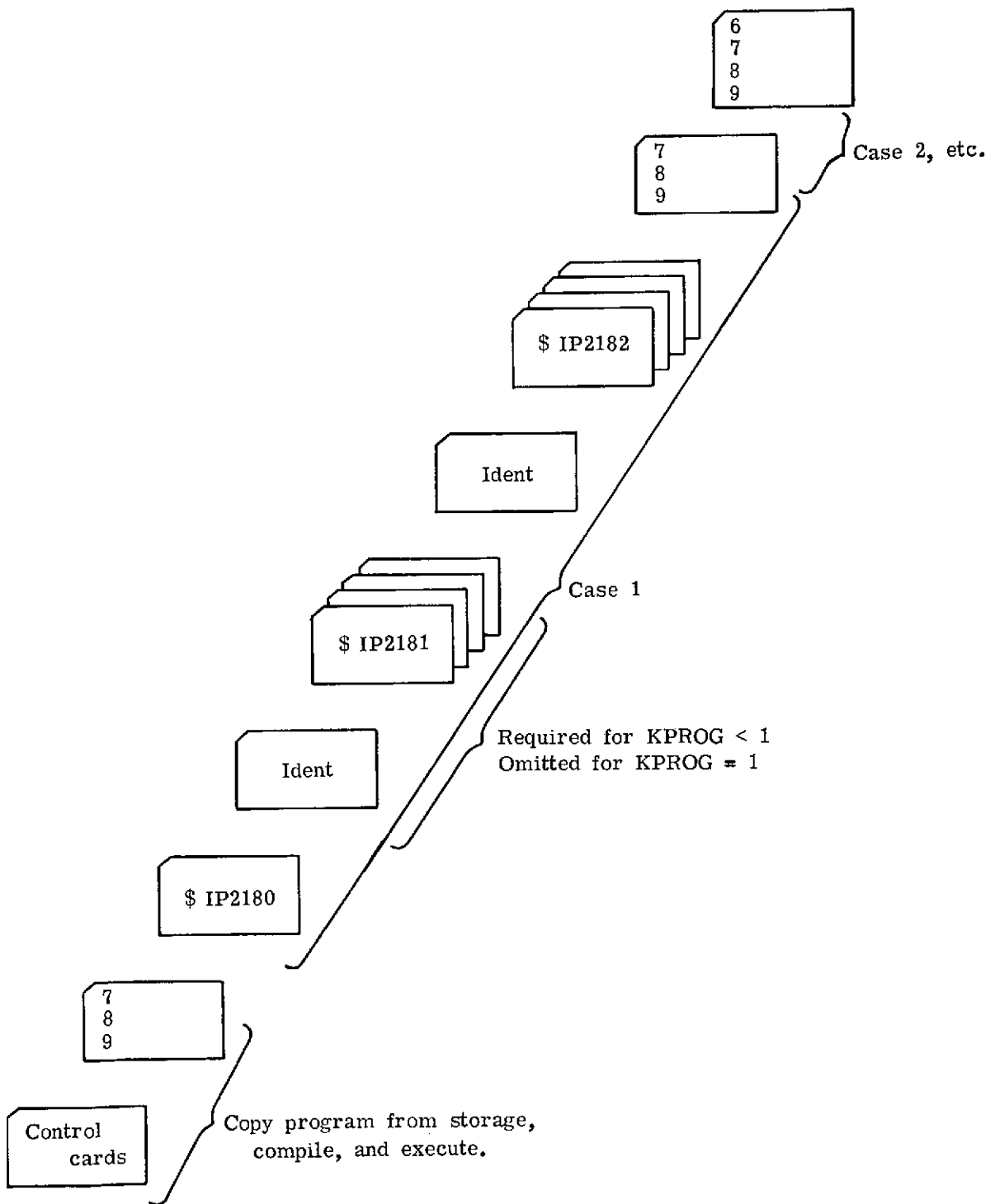

Input Description

The input quantities are loaded by using the FORTRAN IV NAMELIST, with the exception of the IDENT cards that are in 8A10 format. The input symbols are as follows: (Recall that all NAMELIST input begins in columns 2 to 80. Also, see description below of "standard integration" for Q_{ij}^* values).

\$IP2180

KPROG control word: if less than 1, execute both programs D2181 and D2182; if equal to 1, execute only D2182.

\$END

IDENT identification information, one card in 8A10 format

\$IP2181 (equation numbers below refer to the number given in ref. 1).

DEL nominal value of width δ of subregion III. Default value = 0.04.

DHX real part of downwash ratio on left-hand side of equation (18),
 $-\partial h_j / \partial x$, one value per control point

H imaginary part of downwash ratio on left-hand side of equation (18)
(ref. 1) not including k , $-2h$, one value per control point

HMLTPLY optional two-word array that if nonzero multiplies: HMLTPLY(1)
times DHX, HMLTPLY(2) times H. Default values are 0.0.

NMODE number of modes of downwash (maximum of 6)

NSYM control word for spanwise symmetry in lift series A_n^* of equation (13b) of reference 1 and A_n of equation (14) of reference 1:
0 for spanwise antisymmetry (odd powers on η^m), not 0 for spanwise symmetry (even powers on η^m). Default value = 1.

NXY number of downwash control or collocation points, maximum of 48

S ratio of wing semispan to root semichord

TANLE tangent of leading-edge sweep angle, positive for sweepback

TANLTE tangent of trailing-edge sweep angle, positive for sweepback

WT array of weights used in the least-square-error solution of the simultaneous equations (32). WT(1) = -1.0 causes all equal weights.
Default value = -1.0.

XK reduced frequency k

XM Mach number of undisturbed flow

X array of x-coordinates of control points

Y array of y-coordinates of control points

\$END

IDENT identification information, one card in 8A10 format, may differ from preceding IDENT

\$IP2182 (equation numbers below refer to the numbers given in ref. 2)

ALPHA array of values of α in flutter equation (A12), maximum of 25.
ALPHA and MASS must be in consistent units.

CWCDI control word for chordwise integration in equation (11b) of reference 2:
0 for standard, $\neq 0$ for nonstandard, integration. Default value = 0.

CWPR2,CWPR3,CWPR5, } control words for printing matrices (2), (3), (5), (6), (8),
CWPR6, CWPR8,CWPR8X } and (8x), respectively of equations (14), (16), and (18):
 $=0$, do not print; $\neq 0$, print. Default value = 0.

CWPR4 control word for printing matrix (4), its integrals of $L_n^*(x,y_\sigma)$, and
 $h_i(x_{je},y_\sigma)$: $=0$, do not print; $\neq 0$, print. Default value = 0.

CWSPI control word for spanwise integration of equations (11b) and (16): $=0$
for standard integration, $\neq 0$ for nonstandard. Default value = 0.

CWSPST control word for span stations at which chordwise integrations are done:
 $=0$ for standard, $\neq 0$ for nonstandard. Default value = 0.

G modal damping coefficients of structural, solid-friction damping, g_i .
(See eq. (A7).) (Damping force proportional to amplitude, but in
phase with velocity).

HIC three-dimensional array of input values of modal deflections from which
the values of $h_i(x,y)$ of equation (14) are interpolated or used. In
HIC (JSPAN, KCHORD, IMODE) subscripts JSPAN, KCHORD, and
IMODE indicate the index of the span station, the chord station, and
the deflection mode, respectively, of the value of HIC. JSPAN
increases inboard to outboard, KCHORD increases from leading
edge toward trailing edge.

ISPS input array of spanwise-integration factors, which the program multi-
plies by s to produce the I_σ of matrix (6) of equation (16) for non-
standard spanwise quadrature. Omit if CWSPI = 0.

INTOR order of chordwise interpolation (1 if linear, 2 if parabolic) used in
obtaining the deflections h_i of equation (14) from the input data HIC.

MASS a two-dimensional array of generalized mass elements m_{ij} of equa-
tions (A3) and (A13).

NALPHA number of α values in input (see eq. (A12)), maximum of 25.

NCDST number of chord stations used in every chordwise quadrature, $=10$ or
 20 for standard quadrature (with CWCDI = 0); a maximum of 20 for
nonstandard.

NHP number of h (deflection) points input in HIC for each chord, maximum
of 20

NPNCHQ control word for punching matrix of Q_{ij}^* (QIJ) and seven other parameters for subsequent use in NAMELIST input: =1, punch; #1, do not punch. Default value = 0.

NRQIJ control word: =1 when QIJ is included with IP2182 and its calculation is not needed; #1 when QIJ is to be calculated. Default value = 0.

NSPST number of spanwise quadrature stations: 3, 5, 7, 9, or 11 for standard quadrature; a maximum of 11 for nonstandard

OMEGA array of input modal frequencies ω_i

OMEGB base or reference value ω_B (see eq. (3))

QIJ nondimensional generalized-force-matrix elements Q_{ij}^* of equations (11), (18), and (A12)

XCBAR array of nondimensional local chordwise coordinates \bar{x}_c at which $h_i(x_c, y_\sigma)$ of equation (14) of reference 2 are input and used in nonstandard chordwise quadrature. (See eq. (B2).) Same for all chords. Omit for standard quadrature.

XIC array of integrating factors for nonstandard chordwise quadrature, which the program multiplies by the local chord length to produce the $I_c(x_c)$ of matrix (2) (eq. (14)). Omit for standard integration.

XTAB chordwise array of \bar{x} (see eq. (B2)) at which the deflections HIC are input; the same for all span stations

YSPS array of nondimensional span stations y/s for nonstandard spanwise quadrature. (See ISPS and NSPANST.)

\$END

The "standard integration" (for obtaining the generalized aerodynamic forces) referred to with certain of the input variables is that described in reference 2 and is summarized as follows: The chordwise integration (see eq. (13) of ref. 2) is done by Gaussian quadrature, the values of modal deflection h_i being interpolated (linearly or parabolically according to INTOR) at each span station from the deflection data HIC supplied at local chord locations XTAB. The span stations (at which the chordwise integrations are done) are equally spaced for spanwise integration by Simpson's rule for second-degree parabolas. That is, the wing semispan (from $y = 0$ to $y = s$) is divided into an even number of equal-sized parts, and this division results in an odd number of equally spaced span stations.

For nonstandard spanwise integration the user assigns $CWSPI \neq 0$ and inputs the arrays ISPS of spanwise integrating factors and YSPS of span stations. The values of ISPS must be those for a unit semispan; the program multiplies them by s to obtain matrix 6. The values of YSPS are y/s . The array of input deflections HIC must, of course, be at the user-selected span stations YSPS.

For nonstandard chordwise integration, the user assigns $CWCDI \neq 0$ and inputs the arrays $XCBAR$ and XIC . Furthermore, the input deflections HIC are not interpolated, except for the leading-edge values, for use in the chordwise integration and must therefore be supplied for the chordwise locations of the user-specified quadrature scheme. The values of XIC must be those for a unit chord length; the program multiplies them by the local chord length $x_{te} - x_{le}$.

Listing of Input Data for Sample Case

```

$IP2180
KPROG=0,
$END
      HT-7 FLUTTER MODEL, 48 CPTS, 3 MODES, 8/22/73
$IP2181
XM=1.2, XK=.4, NMODE=3, TANLE=1.216, TANLTE=.35255, S=.81, NXY=48,
X(1)=.03,.2,.4,.6,.8,1., X(7)=.1915,.5635,.9355,
X(10)=.369,.541,.7131,.8851,1.0571, X(15)=.3745,.5325,.8486,1.0066,
X(19)=.538,.6821,.8261,.9702,1.1142, X(24)=.5575,.6876,.8176,.9477,1.0778,
X(29)=.707,.8231,.9392,1.0553,1.1713, X(34)=.7405,.8426,.9447,1.0468,1.1488,
X(39)=.8761,.9642,1.0523,1.1404,1.2284, X(44)=.9255,.9976,1.0717,1.1458,1.22,
Y(1)=6*0.0,3*.081,5*.162,4*.243,5*.324,5*.405,5*.486,5*.567,5*.648,5*.729,
HMLTPLY(1)=1.0,HMLTPLY(2)=2.0,
DHX( 1,1)= -.185, -.381, -.503, -.267, -.450, -.678, -.334, -.418,
-.627, -.476, -.473, -.455, -.553, -.619, -.664, -.424,
-.605, -.601, -.569, -.518, -.587, -.636, -.629, -.654,
-.573, -.588, -.657, -.648, -.657, -.604, -.667, -.699,
-.663, -.734, -.695, -.705, -.739, -.733, -.772, -.812,
-.785, -.808, -.841, -.881, -.873, -.816, -.887,-1.049,
DHX( 49,1)= 1.780, 1.830, 1.620, 1.170, 1.170, 1.310, 1.400, 1.370,
1.070, .827, .782, 1.910, 1.440, .698, 1.130, .223,
2.290, .650, .290, .552, 2.600, 1.530, .104, .790,
-.130, 1.740, 2.610, .370, .220, .370, 1.940, 1.730,
.990, .530, .290, .240, .620, .960, .420, .220,
.071, .120, .170, .420, .350, .270, .200, .150,
DHX( 97,1)= .330, .440, .440, .140, .058, .130, .310, .230,
.150, .330, .260, .080, .058, .100, .300, .140,
-.018, .003, -.120, -.190, -.200, -.170, -.160, -.530,
-.500, -.320, -.410, -.770, -.910, -.610, -.680,-1.650,
-2.170,-1.610, -.680,-1.680,-2.760,-1.940,-1.810,-2.350,
-2.990,-2.180,-1.530,-1.790,-1.670,-2.040,-2.170,-1.720,
HI( 1,1)= .2150, .1690, .0720, -.0345, -.0670, -.1890, .1630, -.0090,
-.1690, .0785, -.0040, -.0830, -.1680, -.2710, .0555, -.0310,
-.1755, -.2730, -.0400, -.1170, -.1955, -.2850, -.3760, -.0790,
-.1500, -.2330, -.3145, -.4000, -.2180, -.2900, -.3645, -.4466,
-.5250, -.2900, -.3630, -.4340, -.5080, -.5800, -.4500, -.5200,
-.5900, -.6600, -.7350, -.5550, -.6200, -.6850, -.7450, -.8200,
HI( 49,1)= -.9500, -.6400, -.2875, -.0115, .2150, .4660, -.5850, -.1310,
.3870, -.3380, -.2280, .0080, .3250, .4870, -.3550, -.2610,
.1920, .4300, -.2650, -.2450, -.0055, .3370, .4160, -.2880,
-.2610, -.1820, .1450, .3425, -.2575, -.2460, -.1090, .0770,
.2710, -.3000, -.2570, -.2340, -.1920, -.1080, -.3450, -.3160,
-.3050, -.2975, -.2640, -.4880, -.4590, -.4350, -.4165, -.4055,
HI( 97,1)= -.1130, -.0490, .0460, .1055, .1180, .1400, -.0075, .1320,
.1645, .1075, .1510, .1890, .1980, .2130, .1910, .2275,
.2325, .2320, .3205, .2980, .2690, .2425, .2190, .4200,

```

```

-.3700, .2980, .2500, .1775, .3965, .3060, .2400, .1100,
-.1240, .4095, .2980, .1950, -.0485, -.2950, .2110, .0340,
-.2090, -.4405, -.0000, -.0660, -.3120, -.4740, -.5950, -.7250,
$END
HT-7 FLUTTER MODEL, 48 CPTS, 3 MODES, 8/22/73
$IP2182
INTOR=2, NPNCHQ=1, NSPST=11, NCDST=10,
HIC(1,1,1)=-.218,-.192,-.158,-.110,-.047,.036,.157,.252,.385,.525,.675,
HIC(1,2,1)=-.199,-.163,-.119,-.0557,-.0026,.079,.179,.29,.417,.558,.706,
HIC(1,3,1)=-.109,-.127,-.079,-.0073,.04,.12,.218,.327,.451,.591,.737,
HIC(1,4,1)=-.124,-.083,-.037,.031,.079,.159,.255,.363,.480,.623,.767,
HIC(1,5,1)=-.072,-.034,.0041,.062,.117,.196,.29,.398,.521,.655,.796,
HIC(1,6,1)=-.027,.009,.044,.093,.155,.233,.326,.434,.557,.686,.825,
HIC(1,7,1)=.0040,.044,.0829,.131,.196,.273,.365,.471,.592,.716,.856,
HIC(1,8,1)=.031,.077,.123,.176,.239,.315,.405,.508,.627,.748,.889,
HIC(1,9,1)=.067,.116,.168,.225,.285,.358,.446,.540,.662,.783,.925,
HIC(1,10,1)=.122,.169,.218,.273,.331,.400,.486,.584,.698,.821,.962,
HIC(1,11,1)=.188,.230,.271,.320,.376,.442,.525,.621,.735,.860,1.00,
HIC(1,1,2)=1.0,.721,.545,.455,.388,.35,.328,.328,.385,.504,.639,
HIC(1,2,2)=.622,.587,.429,.355,.309,.288,.284,.30,.364,.488,.621,
HIC(1,3,2)=.64,.464,.338,.288,.265,.257,.258,.275,.345,.475,.605,
HIC(1,4,2)=.459,.355,.282,.261,.259,.261,.254,.257,.328,.459,.591,
HIC(1,5,2)=.288,.249,.228,.233,.245,.254,.246,.245,.316,.447,.576,
HIC(1,6,2)=.138,.151,.136,.149,.165,.182,.202,.234,.309,.436,.558,
HIC(1,7,2)=.012,-.0046,-.008,-.006,-.006,.034,.109,.218,.305,.427,.538,
HIC(1,8,2)=-.101,-.147,-.178,-.193,-.186,-.145,-.013,.192,.302,.419,.519,
HIC(1,9,2)=-.213,-.278,-.325,-.347,-.337,-.283,-.127,.155,.298,.412,.506,
HIC(1,10,2)=-.336,-.387,-.423,-.431,-.404,-.343,-.21,.108,.291,.406,.5,
HIC(1,11,2)=-.460,-.482,-.487,-.468,-.418,-.351,-.271,.058,.284,.4,.497,
HIC(1,1,3)=.122,.035,-.053,-.166,-.335,-.454,-.505,-.498,-.375,-.075,.534,
HIC(1,2,3)=.088,.0077,-.08,-.191,-.328,-.42,-.451,-.41,-.292,.060,.587,
HIC(1,3,3)=.049,-.025,-.108,-.213,-.321,-.385,-.357,-.341,-.211,-.198,.636,
HIC(1,4,3)=-.0016,-.004,-.136,-.227,-.311,-.351,-.347,-.298,-.129,.312,.68,
HIC(1,5,3)=-.040,-.103,-.161,-.235,-.298,-.321,-.306,-.26,-.034,.403,.719,
HIC(1,6,3)=-.084,-.132,-.179,-.236,-.284,-.298,-.274,-.195,.08,.474,.757,
HIC(1,7,3)=-.105,-.140,-.189,-.234,-.269,-.278,-.24,-.088,.209,.535,.798,
HIC(1,8,3)=-.114,-.151,-.194,-.233,-.256,-.256,-.19,.048,.337,.595,.843,
HIC(1,9,3)=-.118,-.154,-.198,-.232,-.243,-.223,-.11,.183,.440,.659,.894,
HIC(1,10,3)=-.127,-.165,-.205,-.232,-.231,-.178,0.0,.295,.53,.727,.946,
HIC(1,11,3)=-.14,-.18,-.213,-.232,-.219,-.126,.124,.388,.60,.798,1.0,
NHP=11,XTAB(1)=0.0,.1,.2,.3,.4,.5,.6,.7,.8,.9,1.0,
MASS(1,1)=.00035704, MASS(2,2)=.0005178, MASS(3,3)=.00026352,
OMEGA(1)=162.5, 391., 725., OMEGB=725., G(1)=3*0.0,
ALPHA(1)=.0004,.0006,.0007,.0008,.0009,.0010,.0011,.0012,.0013,.0014,.0015,
.0016,.0017,.0018,.0019,.0020,.0022,.0024,.0026,.0028,.0030,NALPHA=21,
$END

```

Discussion of Printed Output

The only printing from D2180 is one line that states the value of KPROG. Then follows from D2181 a heading, the contents of the IDENT card, and an echo of the NAME-LIST IP2181. Then comes a heading identifying PART I, and the case data K, TANLTE, TANLA, S, MACH, DELNOM, NSYMMETRY, and number of control points NXY. Then follows, for each control point in sequence,

X	x	
Y	y	
DSL	D1L plus D2L (fig. 3, ref. 1)	
D1L	width of subregion I, if any	
D2L	width of subregion II	
DSR	width of subregion IV	
PTSD1L, PTSD2L, } PTSDSR		one half the number of Gaussian quadrature stations in sub- regions I, II, and IV, respectively

the half-width $\delta/2$ of subregion III (the control-point strip), and a row of the Π_{nm} matrix (16 complex elements).

After the Π_{nm} matrix for the last control point is a heading that identifies the beginning of PRT2. Then, if the input includes a multiplier for the downwash input, a notice is printed regarding that multiplication. The complex downwash elements follow for each downwash mode. Then for each mode comes the 16-element complex $a_{nm}^{(j)}$ matrix and the matrix of residuals from the least-squares solution. (The sequence of subscripts nm in $a_{nm}^{(j)}$ is 00, 02, 04, 06, 10, 12, 14, 16, 20, 22, 24, 26, 30, 32, 34, 36 for spanwise symmetry. For spanwise antisymmetry, m is one unit higher: 01, 03, . . ., etc., . . . 37).

The output from D2182 begins with a heading, followed by the contents of the second IDENT card input, and by an echo of the NAMELIST IP2182 input. Then the input values follow for the case data MACH, K, TANLE, TANLTE, S, NMODS, and NSYM, the matrix of deflections $h_i(x,y)$, the matrix of generalized masses m_{ij} , the modal frequencies ω_i , the modal structural damping coefficients g_i , and the matrix of generalized aerodynamic force elements Q_{ij}^* . Finally, for each value of the air mass parameter α , there is listed α , the flutter determinant, the eigenvector columns $\{q_i\}$, the eigenvalues Ω , the eigenfrequencies ω , the structural damping coefficients g , and the stiffness parameters $b_0\omega_B/V = k\text{Re}(\Omega)$. Where the eigenvalue Ω has a negative real part, ω , g , and $b_0\omega_B/V$ are printed as indefinite quantities.

Discussion of Punched Output

The punched output is obtained when $\text{NPNCHQ} = 1$ and consists of the QIJ matrix and the quantities MACH, K, TANLE, TANLTE, S, NMODS, and NSYM in the format for subsequent NAMELIST/IP2182/ input when flutter solutions are desired for additional air-density parameters ALPHA. For the latter usage, $\text{KPROG} = 1$ and $\text{NRQIJ} = 1$.

OUTPUT FOR SAMPLE CASE

NASA - LANGLEY RESEARCH CENTER - HAMPTON, VA.

JEAN FOSTER FOR HERB CUNNINGHAM- D21801(INCLUDES D2181 AND D2182)

UNSTEADY LIFTING-SURFACE THEORY BY THE SUPERSONIC KERNEL FUNCTION METHOD AND A GALERKIN MODAL FLUTTER ANALYSIS OF ARROWHEAD PLANFORMS WITH SUBSONIC LEADING EDGES AND SUPERSONIC TRAILING EDGES

***REF. 1 = AIAA JOUR., NOV.1966, P.1961-1968

***REF. 2 = NASA TN D-6012

***REF. 3 = NASA TM X-2913, THE DESCRIPTION OF THIS PROGRAM

HT-7 FLUTTER MODEL, 48 CPTS, 3 MODES, 8/22/75

ECHO OF NAMELIST IP2181 FOLLOWS

\$IP2181

XK = 0.4E+00,
XM = 0.12E+01,
TANLE = 0.1216E+01,
TANLTE = 0.35255E+00,
S = 0.81E+00,
NXY = 48,
NSYM = 1,
DEL = 0.4E-01,
X = 0.3E-01, 0.2E+00, 0.4E+00, 0.6E+00, 0.8E+00, 0.1E+01,
0.1915E+00, 0.5635E+00, 0.9355E+00, 0.369E+00, 0.541E+00,
0.7131E+00, 0.8851E+00, 0.10571E+01, 0.3745E+00, 0.5325E+00,
0.8480E+00, 0.10066E+01, 0.538E+00, 0.6821E+00, 0.8261E+00,
0.9702E+00, 0.11142E+01, 0.5575E+00, 0.6676E+00, 0.8176E+00,
0.9477E+00, 0.10778E+01, 0.707E+00, 0.8231E+00, 0.9392E+00,
0.10553E+01, 0.11713E+01, 0.7405E+00, 0.8426E+00, 0.9447E+00,
0.10468E+01, 0.11488E+01, 0.8761E+00, 0.9642E+00, 0.10523E+01,
0.11404E+01, 0.12284E+01, 0.9235E+00, 0.9976E+00, 0.10717E+01,
0.11458E+01, 0.122E+01,
Y = 0.0, 0.0, 0.0, 0.0, 0.0, 0.0, 0.81E-01, 0.81E-01, 0.81E-01,
0.162E+00, 0.162E+00, 0.162E+00, 0.162E+00, 0.162E+00, 0.162E+00,
0.243E+00, 0.243E+00, 0.243E+00, 0.243E+00, 0.324E+00, 0.324E+00,
0.324E+00, 0.324E+00, 0.324E+00, 0.324E+00, 0.405E+00, 0.405E+00,
0.405E+00, 0.405E+00, 0.405E+00, 0.486E+00, 0.486E+00,
0.486E+00, 0.486E+00, 0.567E+00, 0.567E+00, 0.567E+00,
0.648E+00, 0.648E+00, 0.648E+00, 0.648E+00, 0.729E+00,
0.729E+00, 0.729E+00, 0.729E+00, 0.729E+00,
QHX = -0.185E+00, -0.381E+00, -0.503E+00, -0.267E+00, -0.45E+00,
-0.678E+00, -0.334E+00, -0.418E+00, -0.627E+00, -0.476E+00,
-0.473E+00, -0.455E+00, -0.553E+00, -0.619E+00, -0.604E+00,
-0.424E+00, -0.605E+00, -0.601E+00, -0.509E+00, -0.518E+00,
-0.587E+00, -0.636E+00, -0.629E+00, -0.654E+00, -0.573E+00,
-0.583E+00, -0.657E+00, -0.648E+00, -0.657E+00, -0.604E+00,
-0.667E+00, -0.699E+00, -0.663E+00, -0.734E+00, -0.696E+00,
-0.705E+00, -0.739E+00, -0.733E+00, -0.772E+00, -0.812E+00,
-0.785E+00, -0.808E+00, -0.841E+00, -0.881E+00, -0.873E+00,
-0.816E+00, -0.887E+00, -0.1049E+01, 0.178E+01, 0.183E+01,
0.162E+01, 0.117E+01, 0.117E+01, 0.131E+01, 0.14E+01,

PART I OF 02181 *** GENERATE IIMM MATRIX

K TANL TE TANLA S MACH DELNOM NSYMMETRY
 4.0000000E-01 3.5255000E-01 1.2160000E+00 8.1000000E-01 1.2000000E+00 4.0000000E-02 1

NO. OF C.P.TS. (=NXY)
 48

X Y DSL DIL DZL USR
 3.0000000E-02 0. 1.43668608E-02 0. 1.43668608E-02 1.43668608E-02

PTSDLL PTSD2L PTSDSR
 0 5 5

HALF-WIDTH OF CONTROL POINT STRIP 1.59631786E-03

ROW 1 OF COEFFICIENT MATRIX IIMM

RE	IMAG	RE	IMAG	RE	IMAG
4.74004853E+00	1.03679188E-01	-8.76460106E-04	7.29465038E-06	-6.90127313E-08	1.07124020E-09
-1.02001030E-11	1.91804522E-13	4.3719271E+00	9.62853525E-02	-8.29653527E-04	6.90942694E-06
-6.57201494E-06	1.02930759E-09	-9.73970773E-12	1.83163797E-13	3.67640126E+00	8.23672533E-02
-7.39906848E-04	6.17071446E-06	-5.93872373E-08	9.22360544E-10	-8.85359850E-12	1.66524951E-13
-2.73219527E+00	6.32135190E-02	-6.14380432E-04	5.13573241E-06	-5.04648391E-08	7.84296966E-10
-7.60078415E-12	1.43001278E-13				

X Y DSL DIL DZL USR
 2.0000000E-01 0. 9.57790717E-02 0. 9.57790717E-02 9.57790717E-02

PTSDLL PTSD2L PTSDSR
 0 5 5

HALF-WIDTH OF CONTROL POINT STRIP 1.06421191E-02

ROW 2 OF COEFFICIENT MATRIX IIMM

RE	IMAG	RE	IMAG	RE	IMAG
4.76746440E+00	6.86743974E-01	-3.87969774E-02	2.14711711E-03	-1.35192277E-04	1.40166885E-05
-8.86148811E-07	1.11560034E-07	2.20694221E+00	3.67561178E-01	-2.53123758E-02	1.42477625E-03
-9.43559432E-05	9.84505588E-06	-6.36799452E-07	8.04343119E-08	-1.00520425E+00	-6.05331113E-02
-5.04251767E-03	3.64417230E-04	-3.27397959E-05	3.54256769E-06	-2.55113560E-07	3.27819066E-08
-2.48157110E+00	-3.31300079E-01	1.04093482E-02	-5.32759607E-04	2.30910575E-05	-2.23929356E-06
1.00425113E-07	-1.26297046E-08				

X Y DSL DIL DZL USR
 4.0000000E-01 0. 1.92842382E-01 0. 1.92842382E-01 1.92842382E-01

PTSDLL PTSD2L PTSDSR
 0 5 8

HALF-WIDTH OF CONTROL POINT STRIP 2.0000000E-02

ROW 3 OF COEFFICIENT MATRIX IIMM

RE	IMAG	RE	IMAG	RE	IMAG
4.84447070E+00	1.34989417E+00	-1.53320171E-01	1.68377327E-02	-2.10897208E-03	4.39873234E-04
-5.49176682E-05	1.49100733E-05	-5.29641912E-01	1.09921166E-01	-4.96076225E-02	6.08943447E-03
-9.10714940E-04	1.97248072E-04	-2.04197258E-05	6.87044663E-06	-3.19926747E+00	-7.46701082E-01
4.75762074E-02	-6.38747998E-03	3.00364929E-04	-6.33655145E-05	5.39130707E-06	-1.14210452E-06
4.06310602E-01	-2.93899561E-01	5.43360544E-02	-6.20152507E-03	7.7867864E-04	-1.60235851E-04
1.54886565E-05	-4.87864609E-06				

X Y DSL DIL DZL USR
 6.0000000E-01 0. 2.99263572E-01 0. 2.99263572E-01 2.99263572E-01

PTSDLL PTSD2L PTSDSR
 0 8 8

HALF-WIDTH OF CONTROL POINT STRIP 2.0000000E-02

ROW 4 OF COEFFICIENT MATRIX IIMM

RE	IMAG	RE	IMAG	RE	IMAG
4.95201113E+00	1.97315278E+00	-3.38448051E-01	5.50398283E-02	-1.02419055E-02	3.23555583E-03
-5.42830471E-04	2.31969971E-04	-3.60805086E+00	-7.25121470E-01	-3.51690474E-03	4.92928451E-03
-2.01838955E-05	7.55374178E-04	-1.07374118E-04	7.03671205E-05	-1.12352373E+00	-8.35407132E-01
1.40584350E-01	-2.07047544E-02	3.31815905E-03	-9.39446653E-04	1.51661883E-04	-5.36833647E-05
4.59089168E+00	9.69440398E-01	-6.2356790E-03	-3.73870823E-03	1.79795043E-03	-6.49420111E-04
1.41057450E-04	-5.69578480E-05				

X Y DSL DIL DZL USR
 8.0000000E-01 0. 4.04400525E-01 0. 4.04400525E-01 4.04400525E-01

PTSDLL PTSD2L PTSDSR
 0 8 8

HALF-WIDTH OF CONTROL POINT STRIP 2.12842382E-02

ROW 5 OF COEFFICIENT MATRIX IIMM

RE	IMAG	RE	IMAG	RE	IMAG
5.0689426E+00	2.55167493E+00	-5.80907826E-01	1.25079596E-01	-3.05792844E-02	1.30571803E-02
-3.0888566E-03	1.66421589E-03	-6.95580079E+00	-2.07654832E+00	1.70743303E-01	-1.98450203E-02

4.06436978E-04	6.59964653E-04	-3.53137244E-04	2.53319436E-04	5.99001315E+00	7.35065805E-01
1.2025016E-01	-3.01982141E-02	8.0194903E-03	-3.43469930E-03	8.0224663E-04	-3.93955619E-04
-1.24186023E+00	1.04570932E+00	-1.53179126E-01	2.23833921E-02	-1.56370745E-03	3.12195010E-05
1.77194019E-04	-1.36466489E-04				

X	Y	DSL	D1L	D2L	DSR
1.00000000E+00	J.	5.05500656E-01	0.	5.05500656E-01	5.05500656E-01

PTSD1L	PTS02L	PTS03L
0	8	8

HALF-WIDTH OF CONTROL POINT STRIP 2.66052977E-02

ROW 6 OF COEFFICIENT MATRIX I11M

RE	IMAG	RE	IMAG	RE	IMAG
5.16766783E+00	3.09618088E+00	-8.90775585E-01	2.32365561E-01	-6.95388044E-02	3.77732259E-02
-1.06878389E-02	7.51519221E-03	-1.05856866E+01	-3.89439143E+00	5.20834293E-01	-9.06709427E-02
1.44747555E-02	-4.14158903E-03	3.00676713E-04	1.99284872E-04	1.88813716E+01	4.92665916E+00
-2.64629933E-01	2.30348076E-02	6.08011745E-03	-4.42160746E-03	1.72663320E-03	-1.16598689E-03
-3.08003618E+01	-5.31125536E+00	1.26781383E-01	8.03020836E-03	-5.63951917E-03	2.62042586E-03
-4.33140850E-04	1.31554291E-04				

Output for downwash points 7 to 47 not shown

X	Y	DSL	D1L	D2L	DSR
1.22000000E+00	7.29000000E-01	1.10211439E+00	3.19497689E-01	7.83656703E-01	1.59728842E-01

PTSD1L	PTS02L	PTS03L
8	8	5

HALF-WIDTH OF CONTROL POINT STRIP 1.77476492E-02

ROW 48 OF COEFFICIENT MATRIX I11M

RE	IMAG	RE	IMAG	RE	IMAG
5.54418511E+00	3.62648213E+00	4.41739907E+00	1.33422667E+00	2.44403309E+00	7.19471056E-01
3.07875314E-01	4.23957400E-01	-5.54970799E-01	-2.46973966E+00	-2.29791531E+00	-8.29958850E-01
-5.69000000E-01	-5.18000000E-01	-1.04869191E+00	-1.69023457E-01	-8.38903682E-01	1.84892788E+00
-1.71440152E+00	-3.53837521E-01	-1.04869191E+00	-1.69023457E-01	-8.38903682E-01	1.84892788E+00
6.18966921E-01	4.63570668E-01	4.63570668E-01	1.72089808E-01	4.66007649E-01	7.24498117E-02
2.30720796E-01	-4.30966946E-01	-1.35948536E-01	-1.72058246E-01	-1.76162910E-01	-6.03413229E-02
-1.36770996E-01	-2.41181865E-02				

PART II OF D2161 *** SOLVE SIMULTANEOUS EQUATIONS FOR ANM

*****NOTICE- INPUT DOWNWASH QUANTITIES HAVE BEEN MULTIPLIED AS FOLLOWS - BY 1.000 FOR THE SLOPES DHX, AND BY 2.000 FOR THE DEFLECTIONS H *****

DOWNWASH #/V, MODEL 11, NXY REAL PARTS FIRST, IN CONTROL POINT SEQUENCE

-1.85000000E-01	-3.81000000E-01	-5.03000000E-01	-2.67000000E-01	-4.50000000E-01	-6.78000000E-01
-3.34000000E-01	-4.18000000E-01	-6.27000000E-01	-4.70000000E-01	-4.73000000E-01	-4.55000000E-01
-5.53000000E-01	-6.19000000E-01	-6.64000000E-01	-4.24000000E-01	-6.05000000E-01	-6.01000000E-01
-5.69000000E-01	-5.18000000E-01	-5.67000000E-01	-6.36000000E-01	-6.29000000E-01	-6.54000000E-01
-5.73000000E-01	-5.88000000E-01	-6.57000000E-01	-6.48000000E-01	-6.57000000E-01	-6.04000000E-01
-6.87000000E-01	-6.99700000E-01	-6.03000000E-01	-7.34000000E-01	-6.96000000E-01	-7.05000000E-01
-7.39000000E-01	-7.33000000E-01	-7.72000000E-01	-8.12000000E-01	-7.85000000E-01	-8.08000000E-01
-8.41000000E-01	-8.81000000E-01	-8.73000000E-01	-8.16000000E-01	-8.87000000E-01	-1.04900000E+00
1.72000000E-01	1.35200000E-01	5.76000000E-02	-3.60000000E-03	-5.36000000E-02	-1.51200000E-01
1.30400000E-01	-7.20000000E-03	-1.35200000E-01	6.28000000E-02	-3.20000000E-03	-6.64000000E-02
-1.34400000E-01	-2.16800000E-01	4.44000000E-02	-2.46000000E-02	-1.40400000E-01	-2.18400000E-01
-3.20000000E-02	-9.36000000E-02	-1.56400000E-01	-2.28000000E-01	-3.00000000E-01	-6.32000000E-02
-1.20000000E-01	-1.86400000E-01	-2.51600000E-01	-3.20000000E-01	-1.74400000E-01	-2.32000000E-01
-2.91600000E-01	-3.57280000E-01	-4.20000000E-01	-2.32000000E-01	-2.90400000E-01	-3.47200000E-01
-4.06000000E-01	-4.64000000E-01	-3.60000000E-01	-4.16000000E-01	-4.72000000E-01	-5.28000000E-01
-5.88000000E-01	-4.44000000E-01	-4.96000000E-01	-5.46000000E-01	-5.96000000E-01	-6.56000000E-01

UJUNWASH W/V, MODEL 21, NXY REAL PARTS FIRST, IN CONTRL POINT SEQUENCE

1.7800000E+00	1.8300000E+00	1.0200000E+00	1.1700000E+00	1.1700000E+00	1.3100000E+00
1.4030000E+00	1.3770000E+00	1.0700000E+00	8.2700000E-01	7.8200000E-01	1.9100000E+00
1.4400000E+00	6.9800000E-01	1.1300000E+00	2.2000000E-01	2.2930000E+00	6.5000000E-01
2.4030000E-01	5.5200000E-01	2.6000000E+00	1.5000000E+00	1.0400000E-01	7.9000000E-01
-1.3000000E-01	1.7400000E+00	2.0100000E+00	3.7000000E-01	2.2000000E-01	3.7000000E-01
1.9400000E+00	1.7300000E+00	9.9000000E-01	5.3000000E-01	2.9000000E-01	2.4000000E-01
6.2000000E-01	9.6700000E-01	4.2000000E-01	2.2000000E-01	7.1000000E-02	1.2000000E-01
1.7000000E-01	4.2000000E-01	3.9000000E-01	2.7000000E-01	2.0000000E-01	1.5000000E-01
-7.6020000E-01	-5.1200000E-01	-2.3000000E-01	-9.2000000E-03	1.7040000E-01	3.7280000E-01
-4.0600000E-01	-1.7480000E-01	3.0900000E-01	-2.7040000E-01	-1.8240000E-01	6.4000000E-03
2.6000000E-01	3.8960000E-01	-2.0400000E-01	-2.0880000E-01	1.5500000E-01	3.4400000E-01
-2.1200000E-01	-1.9620000E-01	-4.4000000E-03	2.0900000E-01	3.3440000E-01	-2.3040000E-01
-2.0800000E-01	-1.4560000E-01	1.1000000E-01	2.7400000E-01	-1.3600000E-01	-1.9880000E-01
-8.7200000E-02	6.1600000E-02	2.1000000E-01	-2.4000000E-01	-2.0560000E-01	-1.8720000E-01
-1.3500000E-01	-8.6400000E-02	-2.7000000E-01	-2.5280000E-01	-2.4400000E-01	-2.3800000E-01
-2.2720000E-01	-7.9040000E-01	-3.0720000E-01	-3.4600000E-01	-3.3400000E-01	-3.2440000E-01

UJUNWASH W/V, MODEL 31, NXY REAL PARTS FIRST, IN CONTRL POINT SEQUENCE

3.3000000E-01	4.4000000E-01	4.4000000E-01	1.4000000E-01	5.8000000E-02	1.3000000E-01
3.1000000E-01	2.9000000E-01	1.5000000E-01	3.3000000E-01	2.6000000E-01	8.0000000E-02
5.6000000E-02	1.9000000E-01	3.0000000E-01	1.4000000E-01	-1.6000000E-02	3.0000000E-03
-1.2000000E-01	-1.9000000E-01	-2.0000000E-01	-1.7000000E-01	-1.0000000E-01	-5.3000000E-01
-5.0000000E-01	-3.2000000E-01	-4.1000000E-01	-7.7000000E-01	-9.1000000E-01	-6.1000000E-01
-0.8000000E-01	-1.6500000E+00	-2.1700000E+00	-1.6100000E+00	-0.8000000E+00	-1.6000000E+00
-2.7600000E+00	-1.9400000E+00	-1.4100000E+00	-2.3900000E+00	-2.9900000E+00	-2.1800000E+00
-1.5000000E+00	-1.7900000E+00	-1.0700000E+00	-2.0400000E+00	-2.1700000E+00	-1.7200000E+00
-9.0400000E-02	-3.9200000E-02	3.0800000E-02	0.4400000E-02	9.4400000E-02	1.1200000E-01
-6.0000000E-02	1.0560000E-01	1.3100000E-01	8.6000000E-02	1.2880000E-01	1.5120000E-01
1.5840000E-01	1.7040000E-01	1.5280000E-01	1.8200000E-01	1.8000000E-01	1.8560000E-01
2.5640000E-01	2.3840000E-01	2.1520000E-01	1.9400000E-01	1.7520000E-01	3.3600000E-01
3.0000000E-01	3.3840000E-01	2.0400000E-01	1.4200000E-01	3.1720000E-01	2.4480000E-01
1.9200000E-01	8.3000000E-02	-9.9200000E-02	3.2700000E-01	2.3840000E-01	1.5600000E-01
-3.8800000E-02	-2.9600000E-01	1.0880000E-01	2.7200000E-02	-1.6720000E-01	-3.5720000E-01
-4.8030000E-01	-5.2800000E-02	-2.4500000E-01	-3.7920000E-01	-4.7600000E-01	-5.8000000E-01

WEIGHTING FACTORS ANA, MODEL 11, 16 REAL PARTS FIRST

-7.0000000E-02	-2.91381947E-01	8.01254010E-01	-9.80036329E-01	1.70014927E-02	-3.84011078E-01
1.19470531E+00	-7.10973995E-01	1.30479880E-02	-4.57041111E-01	1.42233745E+00	-1.49354605E+00
1.34734102E-02	-2.37714957E-01	0.00304740E-01	4.90027474E-01	3.30060003E-02	-4.78844600E-02
-9.49389402E-02	1.10795670E-01	7.14070992E-03	-4.91078733E-01	-2.04021909E-02	-1.8622790E-01
-1.32089071E-02	-2.92313979E-02	4.55402302E-02	0.18161900E-02	-9.03971909E-04	4.27151488E-04
-3.93292997E-02	5.9720891E-02				

LEAST SQUARE RESIDUALS, MODEL 11, NXY REAL PARTS FIRST, IN CONTRL POINT SEQUENCE

-1.40300197E-02	5.14616231E-03	6.07007000E-02	-1.505014478E-01	1.90900000E-02	3.90122887E-03
-3.54251023E-02	-1.36290675E-02	7.40030149E-02	2.50029329E-02	2.01100000E-02	-1.11233311E-02
2.23092300E-02	-7.60006975E-02	1.30250012E-01	-4.03201613E-02	4.72127804E-02	-1.68964751E-02
2.33997000E-02	-6.93300910E-02	0.915002409E-02	7.85005090E-04	3.22203040E-02	-3.47412007E-02
-1.00100200E-02	-1.20498169E-02	5.07302470E-03	-9.40553550E-03	-3.45000000E-02	-4.38110070E-02
1.93050313E-02	1.93470617E-03	-1.04200241E-03	-2.57230413E-02	-1.09021409E-02	2.38818190E-03
1.21059400E-02	-1.56697204E-02	3.21001424E-02	7.10022647E-02	1.70052774E-02	-3.09795739E-03
-1.08070400E-02	-6.18429785E-03	1.95297000E-02	-9.27400862E-02	-3.07925728E-02	4.20281202E-02
7.93520303E-03	-6.22542081E-03	-7.18327700E-03	-7.70327791E-03	-1.28557507E-02	-7.03206410E-03
2.11295934E-03	2.79230821E-03	7.00000000E-03	-4.22358801E-03	-2.04100419E-03	6.58580606E-03
1.20039420E-03	-2.20284259E-03	5.10570070E-03	1.05771184E-02	7.04521101E-03	7.98236005E-03
-1.07420740E-03	-1.04731788E-03	-4.34007570E-04	3.09172418E-03	-6.59021310E-03	-5.54350711E-03
-0.02420104E-03	-3.02114983E-03	-3.09403801E-03	-2.51790380E-03	2.00190810E-03	9.35712113E-03
-3.35972000E-04	-7.34514273E-04	2.02130045E-04	-1.87000899E-03	2.01225977E-03	7.00903305E-04
3.10600000E-04	-1.28187609E-03	8.00150010E-04	2.40299415E-03	3.00313035E-03	3.71182105E-03
1.91237700E-03	1.37995461E-03	-2.00049723E-03	-3.29009913E-04	-3.02201741E-03	-1.66841625E-03

WEIGHTING FACTORS ANM, MODE(2), 16 REAL PARTS FIRST

2.51777652E-01	-6.58766466E-02	-1.73304300E+00	2.51002594E+00	1.13301660E-01	1.52139513E-01
-2.91740007E+00	2.40659301E+00	4.72000740E-02	2.84120054E+00	-9.50114202E+00	6.70869273E+00
-1.19401905E-02	2.51891131E+00	-3.05147821E+00	2.74302984E+00	-1.14419510E-01	7.91441028E-02
-2.00050191E-01	2.20425241E-02	-5.01290010E-02	2.30104071E-01	-2.53087340E-01	4.34366000E-01
-9.19805032E-03	1.19103841E-01	-0.00519917E-01	7.77326568E-01	4.84439411E-03	-3.22674902E-02
-0.20792000E-01	7.57484029E-01				

LEAST SQUARE RESIDUALS, MODE(2), NXY REAL PARTS FIRST, IN CONTROL POINT SEQUENCE

0.33794240E-02	-2.88536555E-01	-1.99328549E-01	1.10074986E-01	-2.05923052E-01	1.41730206E-02
1.38734800E-01	-4.72469196E-02	3.01303087E-03	1.33504135E-01	3.74127013E-01	-3.40540227E-01
0.01440104E-02	-7.01825572E-02	-2.99100927E-01	4.77018408E-01	-2.04534607E-01	5.27254096E-01
4.22429021E-02	3.94978103E-01	-3.55759102E-01	5.95191354E-01	-5.92450092E-01	-1.90193342E-01
4.59237344E-01	-4.69215114E-01	-4.03580224E-01	1.00003308E+00	3.74022205E-02	7.08144541E-02
-0.82732321E-01	-2.87076108E-02	-4.42294479E-01	8.24465922E-02	-1.20988839E-01	1.95739920E-01
2.42060007E-01	2.96678098E-02	-1.35088400E-01	-6.75187859E-02	1.24050266E-01	1.87857850E-01
1.40152020E-01	1.70454800E-03	1.07454933E-01	3.41937767E-02	-8.94913130E-02	-1.17956891E-01
-8.50780321E-02	4.53138247E-02	1.12730970E-02	-3.05271565E-02	-1.02177879E-02	4.49928203E-03
-6.19700200E-01	1.08005265E-02	1.01049090E-02	-1.07314537E-02	1.00786875E-02	1.23020494E-02
-2.18154133E-01	-2.71014374E-02	6.42294651E-03	-2.29341076E-02	5.81052000E-03	2.13479873E-02
-3.02070521E-02	7.76348682E-03	1.01466230E-02	-2.42871020E-03	1.19020340E-02	2.49363046E-02
-2.24020017E-02	1.56425751E-02	-3.70000000E-02	4.82804024E-03	-8.04097798E-03	-8.07340850E-04
-9.00315000E-03	-1.35382398E-03	-3.40150000E-02	7.38301581E-03	-9.13200000E-03	1.98964190E-04
2.20011324E-02	3.22890939E-02	-6.29090000E-03	3.50800421E-03	7.00000000E-03	8.49210782E-03
5.95790400E-03	2.31815899E-04	0.40000000E-03	3.86104437E-03	-5.78091345E-03	-2.34895018E-02

WEIGHTING FACTORS ANM, MODE(3), 16 REAL PARTS FIRST

5.52030590E-02	-1.53062741E-01	-2.50200110E+00	3.78749023E+00	3.75081091E-02	-5.68603904E-02
4.560921240E-01	-1.19791256E+00	-1.80249003E-02	4.20232532E-01	-5.18003034E+00	8.13001014E+00
-1.47411002E-02	1.93971364E-01	-1.00140013E-01	-5.00987179E+00	-2.43199445E-04	2.41287364E-01
-2.29390000E-01	-2.62266596E-01	-2.81750078E-02	7.20936962E-05	2.00471049E-01	1.03055026E-01
5.07859177E-03	1.53737130E-02	8.99242954E-02	-4.14919773E-01	1.20001116E-03	1.91249909E-03
2.40981000E-02	5.86136587E-01				

LEAST SQUARE RESIDUALS, MODE(3), NXY REAL PARTS FIRST, IN CONTROL POINT SEQUENCE

-8.07875318E-03	-2.08182970E-02	-7.70515770E-02	3.80751301E-02	-4.00083411E-02	-1.58952280E-01
8.32077032E-02	-1.27678251E-02	-1.57420210E-01	-4.19165518E-02	-4.50320906E-02	5.07973503E-02
0.62269194E-02	2.51649766E-01	-1.43270507E-01	5.81568431E-03	1.31705088E-01	1.82684495E-01
9.57276070E-02	1.76277243E-01	1.35678507E-01	9.45973100E-03	-1.99505704E-01	1.19107960E-01
2.12037871E-01	-6.87827617E-02	-2.30077554E-01	-2.12315529E-01	1.38759897E-01	-2.20854845E-01
-4.70027970E-01	1.29376196E-01	2.45017420E-01	-2.95255357E-03	-0.04035231E-01	-1.34336148E-02
0.67260338E-01	-2.15997445E-01	-1.55222053E-02	3.40200010E-01	4.74101002E-01	-3.73290052E-01
-2.42703712E-02	1.64943035E-03	7.73330470E-02	-1.19445648E-01	-2.64187855E-01	1.78009211E-01
-2.33089947E-03	1.48333915E-02	1.35311209E-02	1.04818850E-04	-5.99261632E-04	2.21456780E-03
-7.44843122E-03	-1.13812699E-02	-1.22516228E-02	4.39744259E-03	-1.92268589E-03	-7.45544516E-03
-5.11049201E-03	-3.51034792E-04	1.18952919E-03	-4.31643512E-03	1.01182209E-02	-1.11714225E-02
-1.24100315E-02	4.22957793E-03	1.09044000E-02	1.35948155E-02	1.05831684E-02	-1.22944156E-02
-8.74330430E-03	1.86967563E-02	-7.50417435E-03	-2.32031607E-02	1.37337040E-02	2.0400347E-02
-1.80004527E-02	-4.88018543E-02	5.43122771E-03	-2.04223211E-02	-2.72020951E-03	-3.17303018E-02
0.42340189E-03	1.54578800E-02	-2.73077700E-02	-2.14971406E-02	2.75996399E-02	4.00380165E-02
2.34991057E-03	-8.78343193E-04	1.75417700E-02	1.22042137E-02	-2.00201735E-02	-1.79669131E-02

PROGRAM D2182 ... COMPUTE GENERALIZED AERODYNAMIC FORCES AND SOLVE FLUTTER DETERMINANTS

HT-7 FLUTTER MODEL, 40 CPTS, 3 MODES, 8/22/73

ECHO OF NAMELIST IP2102 FOLLOWS

\$IP21a2

NSPST = 11,
NCDST = 10,
MASS = 0.35704E-03, 0.0, 0.0, 0.0, 0.0, 0.0, 0.0, 0.5178E-03, 0.0,
0.0, 0.0, 0.0, 0.0, 0.0, 0.26352E-03, 0.0, 0.0, 0.0, 0.0,
0.0, 0.0, 0.0, 0.0, 0.0, 0.0, 0.0, 0.0, 0.0, 0.0,
0.0, 0.0, 0.0, 0.0, 0.0, 0.0,
OMEGA = 0.1625E+03, 0.391E+03, 0.725E+03, 1, 1, 1,
OMEGA = 0.725E+03,
G = 0.0, 0.0, 0.0, 1, 1, 1,
NALPHA = 21,
ALPHA = 0.4E-03, 0.6E-03, 0.7E-03, 0.8E-03, 0.9E-03, 0.1E-02,
0.11E-02, 0.12E-02, 0.13E-02, 0.14E-02, 0.15E-02, 0.16E-02,
0.17E-02, 0.18E-02, 0.19E-02, 0.2E-02, 0.22E-02, 0.24E-02,
0.26E-02, 0.28E-02, 0.3E-02, 1, 1, 1, 1,
YSPS = 1, 1, 1, 1, 1, 1, 1, 1, 1, 1, 1,
ISPS = 1, 1, 1, 1, 1, 1, 1, 1, 1, 1, 1,
HIC = -0.218E+00, -0.192E+00, -0.158E+00, -0.11E+00, -0.47E-01, 0.36E-01,
0.157E+00, 0.252E+00, 0.385E+00, 0.525E+00, 0.675E+00,
-0.197E+00, -0.163E+00, -0.119E+00, -0.557E-01, -0.26E-02, 0.79E-01,
0.179E+00, 0.29E+00, 0.417E+00, 0.556E+00, 0.706E+00,
-0.169E+00, -0.127E+00, -0.79E-01, -0.75E-02, 0.4E-01, 0.12E+00,
0.228E+00, 0.327E+00, 0.451E+00, 0.591E+00, 0.737E+00,
-0.124E+00, -0.83E-01, -0.37E-01, 0.31E-01, 0.79E-01, 0.159E+00,
0.255E+00, 0.363E+00, 0.486E+00, 0.623E+00, 0.767E+00,
-0.72E-01, -0.34E-01, 0.41E-02, 0.62E-01, 0.117E+00, 0.196E+00,
0.29E+00, 0.398E+00, 0.521E+00, 0.655E+00, 0.796E+00, -0.27E-01,
0.7E-02, 0.44E-01, 0.93E-01, 0.155E+00, 0.233E+00, 0.328E+00,
0.434E+00, 0.557E+00, 0.686E+00, 0.825E+00, 0.46E-02, 0.44E-01,
0.624E-01, 0.131E+00, 0.196E+00, 0.275E+00, 0.365E+00,
0.471E+00, 0.592E+00, 0.716E+00, 0.856E+00, 0.31E-01, 0.77E-01,
0.123E+00, 0.176E+00, 0.239E+00, 0.315E+00, 0.405E+00,
0.506E+00, 0.627E+00, 0.748E+00, 0.889E+00, 0.67E-01,
0.116E+00, 0.168E+00, 0.225E+00, 0.285E+00, 0.356E+00,
0.446E+00, 0.546E+00, 0.652E+00, 0.763E+00, 0.825E+00,
0.122E+00, 0.169E+00, 0.218E+00, 0.275E+00, 0.331E+00, 0.4E+00,
0.486E+00, 0.584E+00, 0.698E+00, 0.821E+00, 0.962E+00,
0.188E+00, 0.23E+00, 0.271E+00, 0.32E+00, 0.376E+00, 0.442E+00,
0.525E+00, 0.621E+00, 0.735E+00, 0.86E+00, 0.1E+01, 1, 1, 1, 1,
1,
1,
1,
1,
1, 1, 1, 0.1E+01, 0.721E+00, 0.545E+00, 0.455E+00, 0.388E+00,
0.35E+00, 0.328E+00, 0.328E+00, 0.365E+00, 0.504E+00,
0.639E+00, 0.822E+00, 0.567E+00, 0.429E+00, 0.555E+00,
0.505E+00, 0.288E+00, 0.284E+00, 0.3E+00, 0.364E+00, 0.486E+00,
0.621E+00, 0.64E+00, 0.464E+00, 0.336E+00, 0.268E+00,
0.265E+00, 0.257E+00, 0.258E+00, 0.275E+00, 0.345E+00,
0.475E+00, 0.605E+00, 0.455E+00, 0.355E+00, 0.282E+00,
0.261E+00, 0.259E+00, 0.261E+00, 0.254E+00, 0.257E+00,
0.326E+00, 0.459E+00, 0.591E+00, 0.266E+00, 0.249E+00,
0.223E+00, 0.222E+00, 0.245E+00, 0.257E+00, 0.246E+00,
0.245E+00, 0.316E+00, 0.447E+00, 0.576E+00, 0.138E+00,
0.131E+00, 0.136E+00, 0.149E+00, 0.165E+00, 0.182E+00,
0.202E+00, 0.234E+00, 0.309E+00, 0.456E+00, 0.558E+00,

MACH= 1.2000000E+00 K= 4.0000000E-01 TANLE= 1.2160000E+00 TANLTE= 3.5255000E-01 S= 8.1000000E-01
 NMODS= 3 NSYM= 1

INPUT DEFLECTIONS H SUB I, IN CRDR L.E. TO T.E., INBARD FIRST, MODE I FIRST

-2.1800000E-01	-1.9900000E-01	-1.6900000E-01	-1.2400000E-01	-7.2000000E-02	-2.7000000E-02
4.6000000E-03	3.1000000E-02	6.7000000E-02	1.2200000E-01	1.8800000E-01	9.0000000E-03
-1.9200000E-01	-1.6300000E-01	-1.2700000E-01	-8.3000000E-02	-3.4000000E-02	4.4000000E-02
4.4000000E-02	7.7000000E-02	1.1600000E-01	1.6900000E-01	2.3000000E-01	4.1000000E-03
-1.5800000E-01	-1.1900000E-01	-7.9000000E-02	-3.7000000E-02	4.1000000E-03	4.4000000E-02
8.2400000E-02	1.2300000E-01	1.6600000E-01	2.1800000E-01	2.7100000E-01	9.3000000E-02
-1.1000000E-01	-5.5700000E-02	-7.3000000E-03	3.1000000E-02	6.2000000E-02	3.2000000E-01
1.3100000E-01	1.7600000E-01	2.2500000E-01	2.7300000E-01	3.2000000E-01	1.5500000E-01
-4.7000000E-02	-2.6700000E-03	4.0000000E-02	7.9000000E-02	1.1700000E-01	3.7000000E-01
1.9600000E-01	2.7900000E-01	2.6000000E-01	3.3100000E-01	3.7000000E-01	2.3300000E-01
3.6000000E-02	7.9000000E-02	1.2000000E-01	1.5900000E-01	1.9600000E-01	4.4200000E-01
2.7300000E-01	3.1500000E-01	3.9000000E-01	4.0000000E-01	4.4200000E-01	3.2600000E-01
1.3700000E-01	1.7900000E-01	2.1800000E-01	2.5500000E-01	2.9000000E-01	3.2600000E-01
3.6500000E-01	4.0500000E-01	4.4600000E-01	4.8600000E-01	5.2500000E-01	4.3400000E-01
2.5200000E-01	2.9000000E-01	3.2700000E-01	3.6300000E-01	3.9800000E-01	4.3400000E-01
4.7100000E-01	5.0800000E-01	5.4600000E-01	5.8400000E-01	6.2100000E-01	5.5700000E-01
3.8500000E-01	4.1700000E-01	4.9100000E-01	4.8600000E-01	5.2100000E-01	6.8600000E-01
5.9200000E-01	6.2700000E-01	6.6200000E-01	6.9800000E-01	7.3500000E-01	8.2500000E-01
9.2500000E-01	5.5800000E-01	5.9100000E-01	6.2300000E-01	6.5500000E-01	6.8600000E-01
7.1600000E-01	7.4800000E-01	7.8300000E-01	8.2100000E-01	8.6000000E-01	8.2500000E-01
4.7500000E-01	7.0600000E-01	7.3700000E-01	7.6700000E-01	7.9600000E-01	1.3600000E-01
8.9600000E-01	8.8900000E-01	9.2500000E-01	9.6200000E-01	1.0000000E+00	1.3100000E-01
1.0000000E+00	8.2200000E-01	6.4000000E-01	4.5900000E-01	2.8800000E-01	1.3100000E-01
1.2000000E+02	-1.0100000E-01	-2.1300000E-01	-3.3600000E-01	-4.6600000E-01	1.3600000E-01
7.2100000E-01	5.8700000E-01	4.6400000E-01	3.5900000E-01	2.4900000E-01	1.3600000E-01
-4.6000000E-01	-1.4700000E-01	-2.7800000E-01	-3.8700000E-01	-4.8200000E-01	1.3600000E-01
5.4500000E-01	4.2500000E-01	3.5800000E-01	2.8200000E-01	2.2800000E-01	1.4900000E-01
-8.0000000E-03	-1.7800000E-01	-3.2500000E-01	-4.2300000E-01	-4.8700000E-01	1.4900000E-01
4.5900000E-01	3.5500000E-01	2.8800000E-01	2.6100000E-01	2.3300000E-01	1.6500000E-01
-6.0000000E-03	-1.9300000E-01	-3.4700000E-01	-4.3100000E-01	-4.8800000E-01	1.6500000E-01
3.8800000E-01	3.0900000E-01	2.6500000E-01	2.5900000E-01	2.4500000E-01	1.8200000E-01
6.0000000E-03	-1.8600000E-01	-3.3700000E-01	-4.0400000E-01	-4.1800000E-01	1.8200000E-01
3.5000000E-01	2.8800000E-01	2.5700000E-01	2.6100000E-01	2.5400000E-01	2.0200000E-01
3.4000000E-02	-1.4500000E-01	-2.6300000E-01	-3.4300000E-01	-3.5100000E-01	2.0200000E-01
3.2800000E-01	2.8400000E-01	2.5600000E-01	2.4600000E-01	2.4600000E-01	2.3400000E-01
1.0900000E-01	-1.3000000E-02	-1.2700000E-01	-2.1000000E-01	-2.7100000E-01	2.3400000E-01
3.2800000E-01	3.0000000E-01	2.7000000E-01	2.5700000E-01	2.4500000E-01	3.0900000E-01
2.6100000E-01	1.9200000E-01	1.5500000E-01	1.0800000E-01	5.8000000E-02	3.0900000E-01
3.6500000E-01	3.6400000E-01	3.4500000E-01	3.2800000E-01	3.1600000E-01	4.3600000E-01
3.0500000E-01	3.0200000E-01	2.9600000E-01	2.9100000E-01	2.8400000E-01	4.3600000E-01
5.0410000E-01	4.8800000E-01	4.7300000E-01	4.5900000E-01	4.4700000E-01	5.5800000E-01
4.2700000E-01	4.1900000E-01	4.1200000E-01	4.0600000E-01	4.0000000E-01	5.5800000E-01
6.3900000E-01	6.2100000E-01	6.0500000E-01	5.9100000E-01	5.7600000E-01	8.4000000E-02
5.3800000E-01	5.1900000E-01	5.0600000E-01	5.0000000E-01	4.9700000E-01	8.4000000E-02
1.2200000E-01	8.8000000E-02	4.9000000E-02	1.6000000E-03	-4.6000000E-02	-1.3200000E-01
-1.0500000E-01	-7.1400000E-01	-1.1800000E-01	-1.2700000E-01	-1.4000000E-01	-1.3200000E-01
3.0000000E-02	7.7000000E-03	-2.5000000E-02	-6.4000000E-02	-1.0500000E-01	-1.3200000E-01
-1.4600000E-01	-1.5100000E-01	-1.5400000E-01	-1.6500000E-01	-1.8000000E-01	-1.7900000E-01
-3.3000000E-02	-8.7000000E-02	-1.3600000E-01	-1.3600000E-01	-1.6100000E-01	-1.7900000E-01
-1.8700000E-01	-1.9400000E-01	-1.9600000E-01	-2.0500000E-01	-2.1300000E-01	-2.3600000E-01
-1.6600000E-01	-1.9100000E-01	-2.1300000E-01	-2.2700000E-01	-2.3500000E-01	-2.3600000E-01
-2.3400000E-01	-2.3300000E-01	-2.5200000E-01	-2.3200000E-01	-2.3200000E-01	-2.8400000E-01
-3.3500000E-01	-2.7800000E-01	-3.2100000E-01	-3.1100000E-01	-2.9800000E-01	-2.8400000E-01
-2.6900000E-01	-2.5600000E-01	-2.4300000E-01	-2.3100000E-01	-2.1400000E-01	-2.9800000E-01
-4.5400000E-01	-4.2900000E-01	-3.6900000E-01	-3.5100000E-01	-3.2100000E-01	-2.9800000E-01
-2.7800000E-01	-2.5600000E-01	-2.2300000E-01	-1.7800000E-01	-1.2600000E-01	-2.7400000E-01
-3.0500000E-01	-4.5100000E-01	-3.9700000E-01	-3.4700000E-01	-3.0600000E-01	-2.7400000E-01
-2.4000000E-01	-1.9000000E-01	-1.1000000E-01	0.	1.2400000E-01	-1.9500000E-01
-4.9800000E-01	4.1700000E-01	3.4100000E-01	2.9800000E-01	2.6000000E-01	-1.9500000E-01
-8.8600000E-02	4.8000000E-02	1.8300000E-01	2.9500000E-01	3.6800000E-01	8.0000000E-02
-3.7500000E-01	-2.9200000E-01	-2.1100000E-01	-1.2900000E-01	-3.4000000E-02	8.0000000E-02
-2.0900000E-01	3.7000000E-01	4.4600000E-01	5.3000000E-01	6.3000000E-01	4.7400000E-01
-7.5000000E-02	6.6000000E-02	1.9600000E-01	3.1200000E-01	4.0300000E-01	4.7400000E-01
9.3500000E-01	5.9500000E-01	6.9900000E-01	7.2700000E-01	7.9800000E-01	7.5700000E-01
5.3400000E-01	5.8700000E-01	6.5600000E-01	6.8000000E-01	7.1400000E-01	7.5700000E-01
7.5800000E-01	8.4700000E-01	8.9400000E-01	9.4400000E-01	1.0000000E+00	7.5700000E-01

SPAN STATIONS

0.	8.1000000E-02	1.6200000E-01	2.4300000E-01	3.2400000E-01	4.0500000E-01
4.6600000E-01	5.6700000E-01	6.4800000E-01	7.2900000E-01	8.1000000E-01	

ANM MATRIX, BY MODAL COLUMNS OF COMPLEX ELEMENTS

REAL	IMAG	REAL	IMAG	REAL	IMAG
-7.60060033E-02	3.78066663E-02	-2.91301547E-01	-4.78844680E-02	8.81254818E-01	-9.99389482E-02
-4.80030329E-01	1.17799670E-01	1.70014927E-02	7.14078992E-03	-3.84011070E-01	4.91078733E-02
1.19476531E+00	-2.84021909E-03	-7.10553595E-01	-1.28022790E-01	1.30079880E-02	-1.30079880E-02
-4.57041111E-01	-3.92313979E-03	1.42233745E+00	4.55432322E-02	-1.49939405E+00	6.18101900E-02
1.34739180E-02	-9.03971905E-04	-2.37714047E-01	4.27191488E-04	6.50328748E-01	-3.93292997E-02
-4.96827474E-01	5.39720891E-02	2.51707632E-01	-1.14419510E-01	-6.50768406E-02	7.91441028E-02
-1.73364396E+00	-2.75758191E-01	2.51002094E+00	2.20425241E-02	1.13301686E-01	-5.61296018E-02
1.52159513E-01	2.30184671E-01	-2.51748657E+00	-2.53037340E-01	2.70099301E+00	4.34300000E-01
4.72000745E-02	-9.19805632E-03	2.894120094E+00	1.19103841E-01	-9.00119202E+00	-6.65319917E-01
0.70092735E+00	7.7726588E-01	-1.19401505E-02	4.84459411E-03	2.70099301E+00	-3.22874902E-02
-5.63147421E+00	-6.26792886E-01	2.74302984E+00	7.57484039E-01	5.52630590E-02	-2.43199945E-04
-1.53002741E-01	2.41267264E-01	-2.50200110E+00	-2.29390556E-01	3.78740023E+00	-2.83200509E-01
3.75001091E-02	-2.81757078E-02	-5.68003904E-02	7.20930562E-05	4.50921240E-01	2.80471049E-01
-1.19391296E+00	1.03055076E-01	-1.80245603E-02	5.87859177E-03	4.20232532E-01	1.53737130E-02
-5.18003634E+00	8.95242954E-02	8.12001014E+00	-4.14519773E-01	-1.47411062E-02	1.20001110E-03
1.93971304E-01	1.91249909E-02	-1.00140513E-01	2.40981052E-03	-5.50987179E+00	5.88136507E-01

MIX MATRIX

3.57040000E-04	0.	0.	0.	5.17400000E-04	0.
0.	0.	2.63220000E-04			

MODAL FREQUENCIES

1.62500000E+02	3.91700000E+02	7.25000000E+02
----------------	----------------	----------------

MODAL DAMPING COEFFICIENTS (BII)

0.	0.	0.
----	----	----

MIX MATRIX, BY COMPLEX ROWS

-2.92960970E-02	-8.25876865E-03	3.99007005E-02	-1.10105588E-02	-2.69981055E-02	-1.98619433E-03
-1.60347019E-02	1.62523872E-03	3.00007020E-02	-2.46528617E-02	-3.01717331E-03	-3.90140428E-03
6.06116883E-03	-1.20921738E-03	-1.30370177E-02	-1.03557900E-03	8.45197516E-03	-1.20040534E-02

ALPHA = 4.00000000E-04

FLUTTER DETERMINANT, BY COMPLEX ROWS

1.58220274E+01	-1.15198586E+00	5.5735103E+00	-1.53573828E+00	-5.76295463E+00	-2.70830629E-01
-2.99578990E-01	2.69784774E-02	4.04000441E+00	-4.12550250E-01	-8.00440225E-02	-6.47718015E-02
5.75019811E-02	-1.14717799E-02	-1.23070811E-01	-9.82448831E-03	1.08016343E+00	-1.21477055E-01

EIGENVECTORS IN SAME ORDER AS THE EIGENVALUES...LARGEST EIGENVECTOR NORMALIZED TO ITS LARGEST ELEMENT

EIGENVECTOR (1)	0.	-2.50573250E-02	7.56934359E-04	4.19650134E-03	-4.92218400E-04
EIGENVECTOR (2)	0.				
EIGENVECTOR (3)	9.93651128E-02	1.00000000E+00	0.	-4.01480535E-02	-4.58958959E-03
EIGENVECTOR (4)	2.97443124E-02	4.17009477E-02	2.67807249E-02	1.00000000E+00	0.

```

EIGENVALUES, RE(1), IM(1), RE(2), IM(2), ETC.
1.56631401E+01    -1.0646652E+00    4.19996013E+00    -4.92435748E-01    1.06910924E+00    -1.26210907E-01

EIGENFREQUENCIES
1.63166627E+02    3.53922194E+02    6.54707975E+02

DAMPING COEFFICIENTS G
-7.06413900E-02    -1.07825998E-01    -1.15004524E-01

STIFFNESS PARAMETERS
1.58306771E+01    8.19363669E-01    4.17441500E-01

ALPHA= 6.00000000E-04

FLUTTER DETERMINANT, BY COMPLEX ROWS
1.37805784E+01    -1.72662878E+00    8.36028274E+00    -2.30360742E+00    -5.64440194E+00    -4.15245958E-01
-4.49367885E-01    4.04677160E-02    4.34597111E+00    -6.18825367E-01    -9.00660337E-02    -9.71577022E-02
8.62529717E-02    -1.72976689E-02    -1.89616216E-01    -1.47367325E-02    1.12027515E+00    -1.82215583E-01

EIGENVECTORS IN SAME ORDER AS THE EIGENVALUES...EACH EIGENVECTOR NORMALIZED TO ITS LARGEST ELEMENT
EIGENVECTOR( 1)
1.00000000E+00    0.    -5.00000000E-02    -1.17183808E-03    7.66256572E-03    -4.02015384E-04
EIGENVECTOR( 2)
1.00000000E+00    0.    -9.90097200E-01    -1.36976412E-01    7.06066075E-02    1.64087404E-02
EIGENVECTOR( 3)
3.80340505E-01    6.34762253E-02    7.62127555E-02    4.44858034E-02    1.00000000E+00    0.

EIGENVALUES, RE(1), IM(1), RE(2), IM(2), ETC.
1.33143310E+01    -1.62206352E+00    4.79502690E+00    -7.12931495E-01    1.14066678E+00    -1.92674743E-01

EIGENFREQUENCIES
1.98691002E+02    3.31966557E+02    6.78826221E+02

DAMPING COEFFICIENTS G
-1.21826391E-01    -1.48662836E-01    -1.68914135E-01

STIFFNESS PARAMETERS
1.45955232E+00    8.75956793E-01    4.2726011E-01

```

Results for most alpha values are not shown

ALPHA= 9.10000000E-04

FLUTTER DETERMINANT, BY COMPLEX ROWS

1.0717049E+01	-2.58944718E+00	1.2040424E+01	-5.49941113E+00	-8.48660251E+00	-6.22868927E-01
-6.74951627E-01	6.77015747E-02	4.00069080E+00	-9.26238881E-01	-1.35099051E-01	-1.45736553E-01
1.29379456E-01	-2.98115028E-02	-2.78747224E-01	-2.21000967E-02	1.18041272E+00	-2.73323374E-01

EIGENVECTORS IN SAME ORDER AS THE EIGENVALUES...EACH EIGENVECTOR NORMALIZED TO ITS LARGEST ELEMENT

EIGENVECTOR (1)	1.00000000E+00	0.	-1.40670600E-01	-6.66914889E-02	2.04959410E-02	7.07530688E-03
EIGENVECTOR (2)	1.00000000E+00	0.	-2.49475251E-01	6.31611614E-02	3.69475422E-02	-5.89596957E-03
EIGENVECTOR (3)	6.31594281E-01	1.56219854E-01	1.44426006E-01	6.23310572E-02	1.00000000E+00	0.

EIGENVALUES, RE(1), IM(1), RE(2), IM(2), ETC.

8.48434429E+00	-2.99346796E+00	6.99157029E+00	-5.01674207E-01	1.22789395E+00	-2.96142385E-01
----------------	-----------------	----------------	-----------------	----------------	-----------------

EIGENFREQUENCIES

2.46902275E+02	2.74181545E+02	6.25427085E+02
----------------	----------------	----------------

DAMPING COEFFICIENTS G

-3.52624506E-01	-7.1796641E-02	-2.41179122E-01
-----------------	----------------	-----------------

STIFFNESS PARAMETERS

1.16011571E+00	1.75765336E+00	4.43241500E-01
----------------	----------------	----------------

Note change of sign.

ALPHA= 1.00000000E-03

FLUTTER DETERMINANT, BY COMPLEX ROWS

9.69708043E+00	-2.87771464E+00	1.39356046E+01	-3.85934570E+00	-9.40753657E+00	-6.92076597E-01
-7.48946474E-01	6.74461934E+02	4.95786410E+00	-1.03137565E+00	-1.50110056E-01	-1.61929504E-01
1.43754955E-01	-2.86794475E-02	-3.09657024E-01	-2.49612208E-02	1.27049658E+00	-3.03692638E-01

EIGENVECTORS IN SAME ORDER AS THE EIGENVALUES...EACH EIGENVECTOR NORMALIZED TO ITS LARGEST ELEMENT

EIGENVECTOR (1)	1.00000000E+00	0.	-1.14719834E-01	-1.35943599E-01	1.63071173E-02	1.48889205E-02
EIGENVECTOR (2)	1.00000000E+00	0.	-2.47055621E-01	1.61463194E-01	3.27905182E-02	-1.82852619E-02
EIGENVECTOR (3)	7.23047277E-01	2.75768809E-01	1.70968099E-01	1.04556444E-01	1.00000000E+00	0.

EIGENVALUES, RE(1), IM(1), RE(2), IM(2), ETC.

7.41626101E+00	-4.47863857E+00	7.17421649E+00	5.97342589E-01	1.22990360E+00	-3.31486947E-01
----------------	-----------------	----------------	----------------	----------------	-----------------

EIGENFREQUENCIES

2.66222596E+02	2.70582323E+02	6.45906044E+02
----------------	----------------	----------------

DAMPING COEFFICIENTS G

-6.03692762E-01	8.32044030E-02	-2.63105009E-01
-----------------	----------------	-----------------

STIFFNESS PARAMETERS

1.08931399E+00	1.07176255E+00	4.48981710E-01
----------------	----------------	----------------

ALPHA= 3.0000000E-07

FLUTTER DETERMINANT, BY COMPLEX ROWS

-1.37194990E+01	-8.63314292E+00	4.18014137E+01	-1.15160371E+01	-2.62220097E+01	-2.67622979E+00
-2.24052942E+00	2.72338980E-01	7.59752909E+00	-3.09412694E+00	-4.50350168E-01	-4.85788511E-01
4.31264629E-01	-8.69343428E-02	-9.29091079E-01	-7.36056623E-02	1.60137574E+00	-9.11077914E-01

EIGENVECTORS IN SAME ORDER AS THE EIGENVALUES...EACH EIGENVECTOR NORMALIZED TO ITS LARGEST ELEMENT

EIGENVECTOR(1)	1.00000000E+00	0.	9.41646289E-02	-7.66525330E-02	-1.16045695E-02	1.67625904E-02
EIGENVECTOR(2)	1.00000000E+00	0.	2.63790367E-01	2.48078726E-01	-3.41657222E-02	-1.06012119E-01
EIGENVECTOR(3)	1.00000000E+00	0.	3.91647566E-01	9.63148040E-02	1.36496012E-01	-2.95940422E-01

EIGENVALUES. RE(1),IM(1),RE(2),IM(2),ETC.

-7.29962210E+00	-1.94273430E+01	3.90923467E+00	1.76126911E+00	2.26966242E+00	-9.72274906E-01
-----------------	-----------------	----------------	----------------	----------------	-----------------

EIGENFREQUENCIES

11111	3.66684139E+02	4.61233066E+02
-------	----------------	----------------

DAMPING COEFFICIENTS G

11111	4.57547622E-01	-4.26374809E-01
-------	----------------	-----------------

STIFFNESS PARAMETERS

11111	7.90671404E-01	6.02616608E-01
-------	----------------	----------------

12/18/73 LRC ICFs SCHEDULR 6400Z-131K 10/08/73
 13.13.07.UT0000.
 13.13.07. LPC COMPUTER COMPLEX
 13.13.07.JOB,1,3100,00400,2000. A3341
 13.13.07. 6648 R2C2
 13.13.07.USER,CJWINGHAM, HERBERT
 13.13.07.
 13.13.07.LINECNT(10000)
 13.13.11.FETCH(A3341,SPZ12,SOURCE)
 13.13.17.TIME BU ATTACH
 13.13.33.TIME LU ATTACH
 13.13.33.ENV FETLN
 13.13.33.RUN(S,,,SUFILC)
 13.15.11.SETINDP.
 13.15.13.LGU.
 13.30.25. STJP 71
 13.30.25.RFL(10000)
 13.30.26.MEMORY 010000 CM
 13.30.26.RFL C300433 O/S CALLS
 13.30.26.RFL CPU 156.644663 SEC.
 13.30.26.REWINUT(INPUT)
 13.30.27.COPYSOE.
 13.30.29.REWINUT(OUTPUT)
 13.30.30.COPYSOE.
 13.30.32.REWINUT(OUTPUT)
 13.30.33.SPPRINT(OUTPUT,3)
 13.30.34. 0000461 O/S CALLS
 13.30.34.CPU 156.759572 SEC.
 13.30.34.PPU 74.137000 SEC.
 13.30.35.THIS JOB HAS---PUNCH---OUTPUT.
 13.30.35.COST OF THIS JOB WAS \$ 9
 13.30.35.KWH. 2.16 KILOWORD HOURS
 14.14.42.UT0000. 4602 LINES PRINTED. LP24

Langley Research Center,
 National Aeronautics and Space Administration,
 Hampton, Va., December 28, 1973.

APPENDIX

EVALUATION OF THE SUPERSONIC KERNEL FUNCTION

Based on equation (16c) of reference 3, the kernel function can be expressed in a separated form

$$K(M, k, x_0, y_0) = \frac{2\bar{K}(M, k, x_0, y_0)}{(2b)^2 y_0^2 v} \quad (A1)$$

where $x_0 = x - \xi$, $y_0 = y - \eta$, and the reduced kernel \bar{K} is a dimensionless part of K .

For the steady case,

$$\bar{K}(M, 0, x_0, y_0) = \frac{-x_0}{\sqrt{x_0^2 - \beta^2 y_0^2}} \quad (A2)$$

For $y_0 = 0$ (that is, $\eta = y$)

$$\bar{K}(M, k, x_0, 0) = -e^{-12kx_0} \quad (A3)$$

The general expression for $\eta \neq y$ is

$$\begin{aligned} \bar{K} = -e^{-12kx_0} & \left\{ \frac{x_0 e^{-12kx_0/\beta^2}}{\sqrt{x_0^2 - \beta^2 y_0^2}} \cos \left[\frac{2kM}{\beta^2} (x_0^2 - \beta^2 y_0^2)^{1/2} \right] \right. \\ & \left. + ik|y_0| \int_{\tau_l}^{\tau_u} \frac{\tau}{\sqrt{1 + \tau^2}} e^{-12k|y_0|\tau} d\tau \right\} \quad (A4) \end{aligned}$$

where the upper limit $\tau_u = \tau_1 + \tau_2$ and lower limit $\tau_l = \tau_1 - \tau_2$, and

$$\left. \begin{aligned} \tau_1 &= \frac{x_0}{\beta^2 |y_0|} \\ \tau_2 &= \frac{M \sqrt{x_0^2 - \beta^2 y_0^2}}{\beta^2 |y_0|} \end{aligned} \right\} \quad (A5)$$

APPENDIX - Continued

In the integrand in equation (A4) the quantity $\tau/\sqrt{1+\tau^2}$ is closely approximated for positive values of τ as in reference 4

$$\frac{\tau}{\sqrt{1+\tau^2}} \approx 1 + N_1 e^{a\tau} + N_2 e^{b\tau} + N_3 e^{c\tau} \sin \pi\tau \quad (A6)$$

where $N_1 = -0.101$; $N_2 = -0.899$; $N_3 = -0.0932307$; $a = -0.329$; $b = -1.4067$; $c = -2.90$; and only N_3 varies slightly from the corresponding constant in reference 4. With this approximation substituted in equation (A4), the integral can be evaluated in closed form.

The upper limit τ_u is always positive. The lower limit is sometimes positive and sometimes negative. Since the approximation of equation (A6) holds only for positive τ , negative τ_l is accounted for in the following discussion.

Let the integral be defined

$$Q_1 \equiv \int_{\tau_l}^{\tau_u} \frac{\tau}{\sqrt{1+\tau^2}} e^{-12k|y_0|\tau} d\tau \quad (A7)$$

where Q_1 is complex, $Q_1 = \text{Re}(Q_1) + i\text{Im}(Q_1)$. Since there are four terms on the right-hand side of equation (A6),

$$Q_1 \approx Q_2 + Q_3 + Q_4 + Q_5 \quad (A8)$$

and each Q_n is complex as follows:

$$\begin{aligned} Q_2 &\equiv \int_{\tau_l}^{\tau_u} \left(\cos 2k|y_0|\tau - i \sin 2k|y_0|\tau \right) d\tau \\ &= \frac{1}{2k|y_0|} \left[\sin 2k|y_0|\tau_u - \sin 2k|y_0|\tau_l \right. \\ &\quad \left. + i \left(\cos 2k|y_0|\tau_u \mp \cos 2k|y_0|\tau_l - \begin{Bmatrix} 0 \\ 2 \end{Bmatrix} \right) \right] \end{aligned} \quad (A9)$$

where upper of the two signs \mp and the upper of the two quantities $\begin{Bmatrix} 0 \\ 2 \end{Bmatrix}$ are used for positive τ_l , and the lower of the two are used for negative τ_l .

APPENDIX A - Continued

$$\begin{aligned}
 Q_3 &\equiv N_1 \int_{\tau_l}^{\tau_u} e^{a\tau} (\cos 2k|y_0|\tau - i \sin 2k|y_0|\tau) d\tau \\
 &= N_4 \left\{ e^{a\tau_u} (a \cos 2k|y_0|\tau_u + 2k|y_0| \sin 2k|y_0|\tau_u) \right. \\
 &\quad \left. - e^{a|\tau_l|} (a \cos 2k|y_0||\tau_l| + 2k|y_0| \sin 2k|y_0||\tau_l|) \right\} \\
 &\quad + i \left\{ e^{a\tau_u} (-a \sin 2k|y_0|\tau_u + 2k|y_0| \cos 2k|y_0|\tau_u) \right. \\
 &\quad \left. \pm e^{a|\tau_l|} (a \sin 2k|y_0||\tau_l| - 2k|y_0| \cos 2k|y_0||\tau_l|) - \begin{Bmatrix} 0 \\ 4k|y_0| \end{Bmatrix} \right\} \quad (A10)
 \end{aligned}$$

where

$$N_4 \equiv \frac{N_1}{a^2 + (2k|y_0|)^2}$$

$$Q_4 \equiv N_2 \int_{\tau_l}^{\tau_u} e^{b\tau} (\cos 2k|y_0|\tau - i \sin 2k|y_0|\tau) d\tau \quad (A11)$$

is obtained from the right-hand side of equation (A10) by replacing N_1 by N_2 and a by b .

$$\begin{aligned}
 Q_5 &\equiv N_3 \int_{\tau_l}^{\tau_u} e^{c\tau} \sin \pi\tau (\cos 2k|y_0|\tau - i \sin 2k|y_0|\tau) d\tau \\
 &= N_8 \left\{ e^{c\tau_u} [c \sin N_6\tau_u - N_6 \cos N_6\tau_u] - e^{c|\tau_l|} [c \sin N_6|\tau_l| - N_6 \cos N_6|\tau_l|] \right\} \\
 &\quad + N_9 \left\{ e^{c\tau_u} [c \sin N_7\tau_u - N_7 \cos N_7\tau_u] - e^{c|\tau_l|} [c \sin N_7|\tau_l| - N_7 \cos N_7|\tau_l|] \right\} \\
 &\quad + i \left(N_8 \left\{ e^{c\tau_u} [c \cos N_6\tau_u + N_6 \sin N_6\tau_u] \mp e^{c|\tau_l|} [c \cos N_6|\tau_l| + N_6 \sin N_6|\tau_l|] - \begin{Bmatrix} 0 \\ 2c \end{Bmatrix} \right\} \right. \\
 &\quad \left. - N_9 \left\{ e^{c\tau_u} [c \cos N_7\tau_u + N_7 \sin N_7\tau_u] \mp e^{c|\tau_l|} [c \cos N_7|\tau_l| + N_7 \sin N_7|\tau_l|] - \begin{Bmatrix} 0 \\ 2c \end{Bmatrix} \right\} \right) \quad (A12)
 \end{aligned}$$

APPENDIX - Concluded

where

$$N_6 = \pi + 2k|y_0|$$

$$N_7 = \pi - 2k|y_0|$$

$$N_8 = \frac{N_3}{2(c^2 + N_6^2)}$$

$$N_9 = \frac{N_3}{2(c^2 + N_7^2)}$$

and where the upper or lower of two signs and two quantities are used as described with equation (A9).

In the subprogram KERNEL, the number of calculations of sines and cosines has been minimized to only four of each with simple arguments, and the sines and cosines of the sum and difference arguments in Q_5 are obtained as their "multiply-adds."

REFERENCES

1. Cunningham, Herbert J.: Improved Numerical Procedure for Harmonically Deforming Lifting Surfaces From the Supersonic Kernel Function Method. *AIAA J.*, vol. 4, no. 11, Nov. 1966, pp. 1961-1968.
2. Cunningham, Herbert J.: Application of a Supersonic Kernel-Function Procedure to Flutter Analysis of Thin Lifting Surfaces. NASA TN D-6012, 1970.
3. Watkins, Charles E.; and Berman, Julian H.: On the Kernel Function of the Integral Equation Relating Lift and Downwash Distributions of Oscillating Wings in Supersonic Flow. NACA Rep. 1257, 1956. (Supersedes NACA TN 3438.)
4. Watkins, Charles E.; Woolston, Donald S.; and Cunningham, Herbert J.: A Systematic Kernel Function Procedure for Determining Aerodynamic Forces on Oscillating or Steady Finite Wings at Subsonic Speeds. NASA TR R-48, 1959.