

NASA TECHNICAL NOTE



NASA TN D-7596

NASA TN D-7596



(NASA-TN-D-7596) TESTING A SATELLITE
AUTOMATIC NUTATION CONTROL SYSTEM (NASA)
49 p HC \$3.00 CSCL 14B
24

N74-21900

Unclas
38330

H1/11

TESTING A SATELLITE AUTOMATIC NUTATION CONTROL SYSTEM

John A. Hrastar

*Goddard Space Flight Center
Greenbelt, Md. 20771*



1. Report No. D- 7596		2. Government Accession No.		3. Recipient's Catalog No.	
4. Title and Subtitle Testing a Satellite Automatic Nutation Control System				5. Report Date MAY 1974	
				6. Performing Organization Code 730	
7. Author(s) John A. Hrastar				8. Performing Organization Report No. G-7426	
9. Performing Organization Name and Address Goddard Space Flight Center Greenbelt, Maryland 20771				10. Work Unit No. 039-23-01-01	
				11. Contract or Grant No.	
12. Sponsoring Agency Name and Address National Aeronautics and Space Administration Washington, D.C. 20546				13. Type of Report and Period Covered Technical Note	
				14. Sponsoring Agency Code	
15. Supplementary Notes					
16. Abstract Testing of a particular nutation control system for the Synchronous Meteorological Satellite (SMS) is described. The test method and principles involved are applicable to nutation angle control for other satellites with similar requirements. During its ascent to synchronous orbit, a spacecraft like the SMS spins about its minimum-moment-of-inertia axis. An uncontrolled spacecraft in this state is unstable because torques due to fuel motion increase the nutation angle. However, the SMS is equipped with an Automatic Nutation Control (ANC) system which will keep the nutation angle close to zero. Because correct operation of this system is critical to mission success, it was tested on an air-bearing table. The ANC system was mounted on the three-axis air-bearing table which was scaled to the SMS and equipped with appropriate sensors and thrusters. The table was spun up in an altitude chamber and nutation induced so that table motion simulated spacecraft motion. The ANC system was used to reduce the nutation angle. This dynamic test of the ANC system met all its objectives and provided confidence that the ANC system will control the SMS nutation angle.					
17. Key Words (Selected by Author(s)) Nutation control; Air-bearing tests; Simulation			18. Distribution Statement Unclassified—Unlimited CAT. 11		
19. Security Classif. (of this report) Unclassified		20. Security Classif. (of this page) Unclassified		21. No. of Pages 24	22. Price* \$3.00

*For sale by the National Technical Information Service, Springfield, Virginia 22151.

This document makes use of international metric units according to the Systeme International d'Unites (SI). In certain cases, utility requires the retention of other systems of units in addition to the SI units. The conventional units stated in parentheses following the computed SI equivalents are the basis of the measurements and calculations reported.

PRECEDING PAGE BLANK NOT FILMED

CONTENTS

	<i>Page</i>
ABSTRACT	i
NOTATION	iv
INTRODUCTION	1
SYSTEM DESCRIPTION	2
TEST RESULTS	10
CONCLUSIONS	18

NOTATION

\bar{H}	Angular momentum vector
\bar{H}_T	Component of \bar{H} in x-y plane
H_x, H_y, H_z	Magnitude of x,y,z components of \bar{H}
I_x, I_y, I_z	Moments of inertia about the x,y,z axes
I_T	Transverse moment of inertia, $I_T = I_x = I_y$, for SMS
r	Radial location of the nutation sensor
T	Torque due to the axial thrusters
t	Time
Δt	Torque pulse on-time
x, y, z	Spacecraft fixed axes
β	Phase angle due to asymmetry of the torque pulse about the -x axis
θ	Nutation angle
$\Delta\theta$	Change in nutation angle per torque pulse
λ	Nutation frequency, $(\sigma - 1) \omega_z$
σ	Inertia ratio, I_z/I_T
ϕ	Angular location of the nutation sensor
$\bar{\omega}$	Angular rate vector
$\bar{\omega}_T$	Component of $\bar{\omega}$ in x-y plane
$\omega_x, \omega_y, \omega_z$	Magnitude of x,y,z components of $\bar{\omega}$
τ	Time constant

TESTING A SATELLITE AUTOMATIC NUTATION CONTROL SYSTEM

John A. Hrastar

Goddard Space Flight Center

INTRODUCTION

The Synchronous Meteorological Satellite (SMS) spins about its minimum-moment-of-inertia axis during its transfer orbit.* (Transfer orbit is the elliptical trajectory followed by the spacecraft during its ascent from a low earth orbit to synchronous orbit.) The satellite is unstable in this state because the torques due to fuel motion cause the nutation angle to increase. Nutation angle is the angle between the spin axis and the angular momentum vector. If no corrections are made, the nutation angle will increase until the spacecraft is in a flat spin, that is, spinning about the maximum-moment-of-inertia axis, which is perpendicular to the original spin axis.

The SMS has an active nutation control (ANC) system to maintain the nutation angle close to zero. The ANC system uses an accelerometer to sense nutation and an axial thruster to provide the control torque. When the nutation angle exceeds a fixed threshold, the thruster fires to reduce nutation. A single thrust pulse may be sufficient if the nutation angle is small; several pulses may be required if the nutation angle is large.

The ANC system is automatically turned on when the spacecraft enters the transfer orbit, at separation from the third stage. The system operates for the duration of the transfer orbit, which is approximately 6 hours. The rocket motor attached to the spacecraft is fired at the apogee of the transfer orbit, placing the spacecraft in a circular, synchronous orbit. When the motor is separated, the ANC system is automatically disabled. At this time the satellite is spinning in a stable configuration; that is, about the symmetric axis which is now the axis of maximum moment of inertia.

Earlier tests, on an air-bearing table, with models of the SMS fuel tanks demonstrated that the fuel in these tanks would have a major effect on spacecraft nutational stability. If the three spherical tanks are 70 percent full, the divergent time constant τ would be about 30 minutes. If they are only half full, τ could be as low as 12 minutes. Tau is defined by the equation $\theta = \theta_0 \exp(t/\tau)$, where θ_0 is the initial nutation angle and θ is the angle after time t . Thus, a reliable correctly sized ANC system is critical for mission success. For this reason it was decided to test the ANC system dynamically in a closed-loop mode. The test bed was the same spinning, three-axis, air-bearing table used for the fuel tank tests.

* The SMS is being built by WDL Division of Philco-Ford Corporation for NASA Contract NASS-21575. The SMS nutation control system described in this report was designed by Philco-Ford under the technical direction of GSFC.

The objectives of the test were twofold. First, to determine the qualitative aspects: Does it work? Is the design concept sound? Is it phased and sized correctly? Second, to determine quantitative aspects such as how well does it work?. Is the performance close to the design specifications?

The SMS-ANC system breadboard electronics unit was used on the air-bearing table. The table was inertially scaled to the SMS. A nutation sensor, identical to the SMS nutation sensor, and a cold-gas nitrogen propulsion system were also placed on the table to provide the nutation signal and control torque. The table and associated instrumentation were placed in an altitude chamber so that windage torques on the table would be kept to a minimum. The table was spun up and allowed to nutate freely on the air bearing. An active system using a small momentum wheel was used to "pump" nutation, that is, provide a diverging nutation angle. The ANC system was then activated to reduce the nutation angle of the table. A number of runs were made at various spin speeds, torque levels, and nutation angles.

The following sections describe the SMS-ANC system as well as the air-bearing table used for the tests. Quantitative test results are also discussed, comparing the actual performance with the specified (design) performance.

SYSTEM DESCRIPTION

SMS Active Nutation Control System

To reduce the nutation angle in a spinning satellite, the transverse momentum must be reduced. Transverse momentum is the component of the satellite angular momentum vector \bar{H} in the body plane which is perpendicular to the spin axis. This component (\bar{H}_T in Figure 1) rotates around the spacecraft spin (z) axis at the nutation frequency λ . The axial thrusters on SMS are located 0.91 meters out on the -y axis and provide a 22.24-newton (5-pound) force parallel to the z axis in the negative direction. The torque due to the thrusters is along the +x axis. To reduce \bar{H}_T , the thruster should be fired when \bar{H}_T is opposite the torque, that is, when it is along the -x axis. This method of reducing the nutation angle would require an infinitely narrow thrust pulse. In practice the thruster is fired through a sector of \bar{H}_T centered on the -x axis (Figure 2).

A linear accelerometer is used as a nutation sensor. It is placed at a radius r from the z axis with its sensitive axis parallel to the z axis. It measures the acceleration due to the rotation of \bar{H}_T about the z axis. The equation for the nutation sensor output is (for small angles)

$$a = r\omega_z^2 (2 - \sigma)\theta \cos(\phi - \lambda t) \quad (1)$$

thus the sensor output is proportional to nutation angle. The sensor output goes through a filter and then to a threshold detecting circuit. The filter is used to remove dc bias due to misalignments and high-frequency noise. Firing the thruster over a sector of \bar{H}_T motion

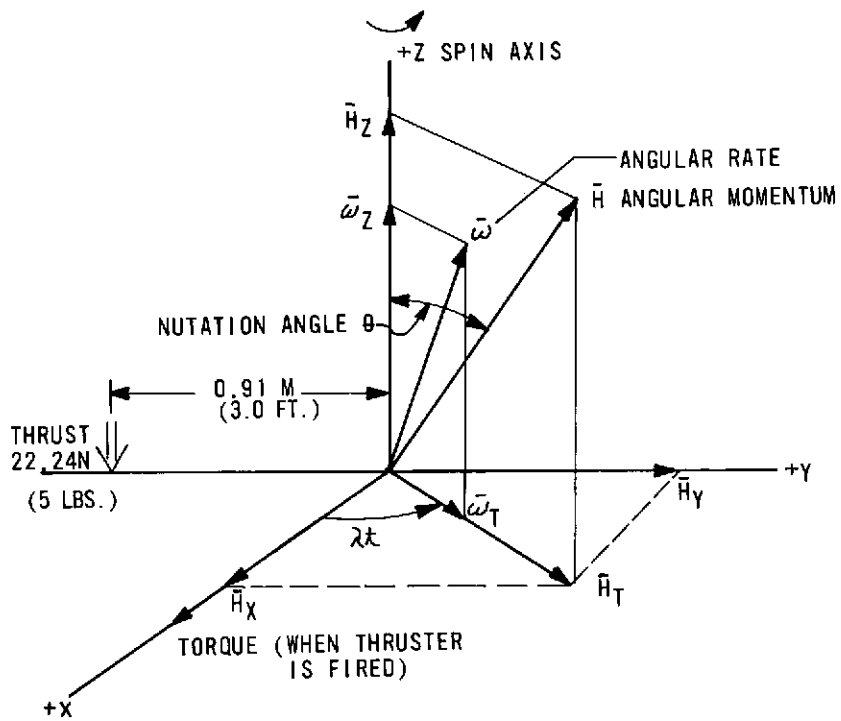

Figure 1. Momentum vector in spacecraft coordinates.

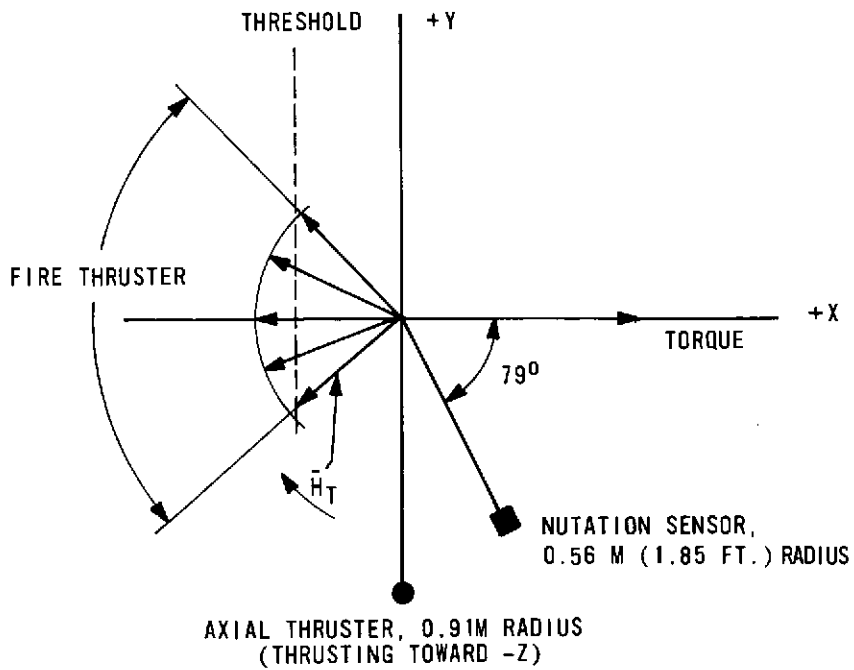

Figure 2. Torque phasing to reduce nutation.

as shown in Figure 2 is the same as centering the pulse on the negative peak of the x component of \bar{H}_T , that is, on H_x . The thruster is fired on a positive threshold of an inverted ANC filter output. Therefore, these two signals, H_x and the filter output, must be in phase if the thruster is to fire correctly in phase.

For σ less than one, λ is negative. If ϕ is chosen to be negative (measured from the x axis), then the nutation sensor output lags H_x by the angle ϕ . If ϕ is set equal to the phase lead of the ANC filter output, then the filter output and H_x will be in phase as required. The value of ϕ for SMS is approximately 79° . Figure 3 shows the phase relationships.

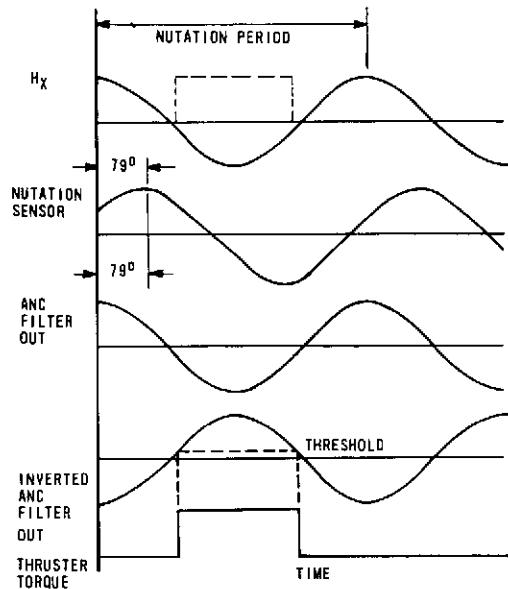

Figure 3. Automatic nutation control system phasing.

Figure 4 is a block diagram of the SMS-ANC system. Following the filter the signal is inverted and conditioned for telemetry as well as threshold detected. The firing logic has four functions:

- Start a thrust pulse when the signal goes above the threshold and stop it when the signal returns through the threshold.
- Provide a minimum pulse width of 200 milliseconds whenever the signal would result in a narrower one.
- Turn off the ANC system if a thruster is on longer than 2 seconds. A command is necessary to restart the ANC system.
- Limit the time between pulses to 1.75 seconds minimum.

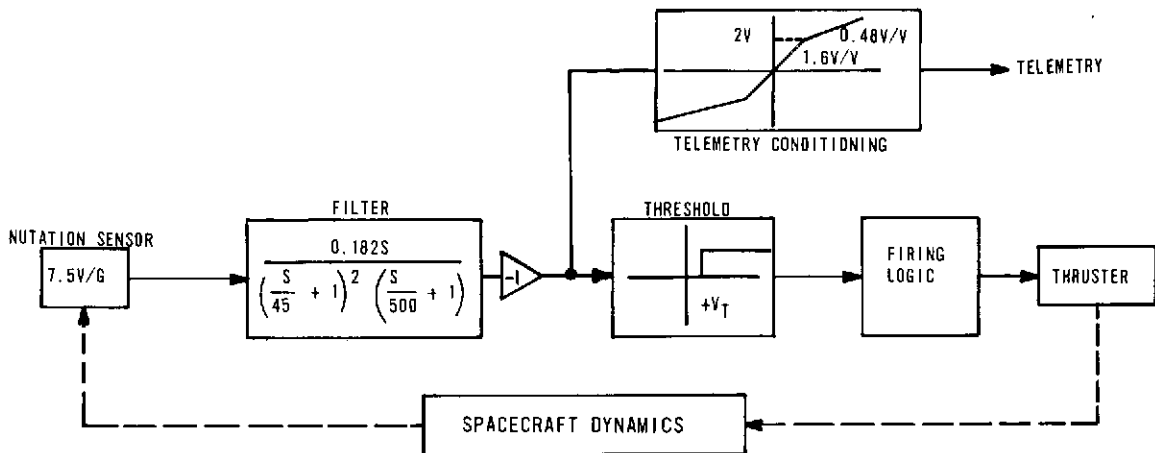

Figure 4. Synchronous meteorological satellite — automatic nutation control, block diagram.

A minimum pulse width is used to ensure the thruster solenoid sufficient time to respond to the thrust command. The time between pulses is limited to a minimum value to prevent spurious pulses due to structural resonance feedback into the nutation sensor. When the structure is excited by the thruster it has time to damp before the next thruster pulse can be fired. The time is selected so the ANC system will fire every other nutation cycle at the nominal frequency of 0.9 Hz. The specified inhibit time is between 1.75 and 1.95 seconds.

Air-Bearing Spin Table

Figure 5 is a photograph of the air-bearing facility. The table is a welded tubular aluminum structure mounted to a 0.254-meter (10-inch) beryllium ball. The ball is mated with a brass cup that mounts on the stand. Dry nitrogen is passed through orifices in the cup to provide the gas bearing between the ball and the cup. Thus the ball and attached table are floated on a virtually friction-free gas film. The table is carefully balanced so that the center of mass is at the center of rotation of the ball. Therefore the table can be used to simulate a torque-free satellite.

In addition to the cup, the stand also holds the mechanism used for spinning the table. When the table is floating, a bell housing concentric with the stand and ball is moved up the stand. The top of the bell, which is parallel to the ground, engages the table, concentric to the ball, righting it to the vertical. When the table is engaged and vertical, the bell is driven about the vertical axis by a motor through a flexible shaft. Thus the motor and bell, in combination, spin up the table on the air bearing. At the desired spin speed, the bell is retracted and the table is free to spin and nutate on the air bearing.

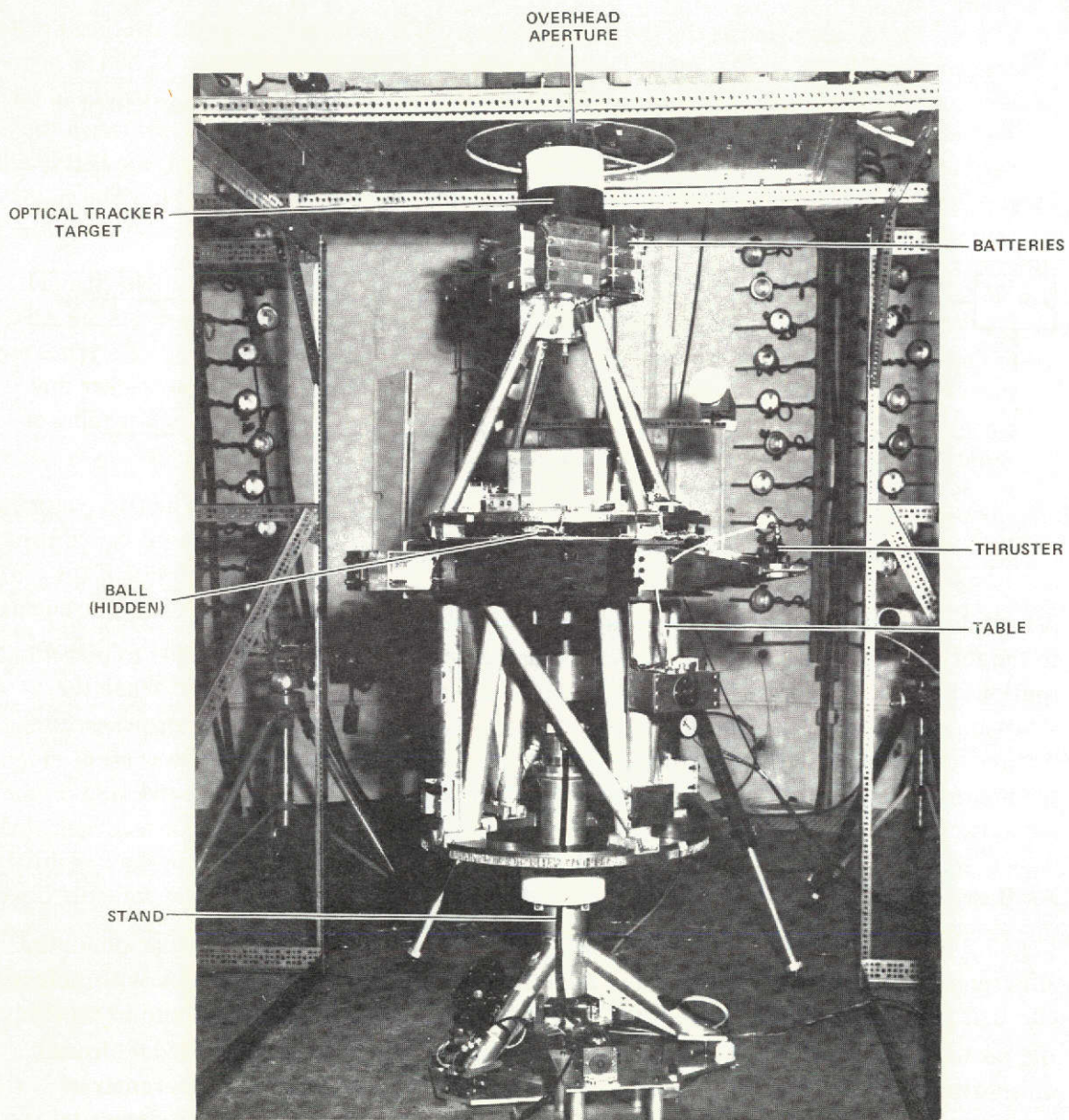

Figure 5. Air-bearing table test facility.

The photograph also shows the overhead mechanism. The large hole in the overhead plate, concentric with the vertical table, limits the nutation angle of the table to 12° . The aperture can be closed with a bar and notched plate mechanism mounted on the overhead plate. This mechanism is used to right the table after a test is complete but does not touch the table during a test. After the table is righted with the overhead mechanism, the bell speed is increased to match the table speed and it is brought up to engage the table. The spin motor is then turned off and motor friction causes the table to spin down.

Instrumentation of the table includes a six-channel telemetry system and a five-channel command system. A linear accelerometer (separate from the nutation sensor of the ANC system) is used to measure nutation angle. A rate gyro measures spin speed. Batteries are included to supply the instrumentation. External to the table is an optical tracker that tracks a black-white interface line on the table (Figure 5). This gives a direct reading of nutation angle.

The table must be correctly scaled if the test is to provide valid results. The two parameters that must be scaled are the inertia ratio σ and the angular acceleration due to the control torque. The inertia ratio must be the same for the table as it is for the satellite if the nutation frequencies are to be the same. For these tests σ was set to be 0.38. The angular acceleration, which is the ratio of the torque to the transverse moment of inertia, must be the same on the table as it is on the satellite so that the response is identical.

Figure 6 is a block diagram of the ANC system tested on the table. Two thrusters were placed on the $\pm y$ axes oriented to give a $+x$ torque. Only one of the two was used. (Figure 7 is a photograph of one thruster and its regulator. The nutation sensor is located on the table as shown in Figure 2.) A bias current supplied to the nutation-sensor feedback coil compensates for the 1-g field. Thrust fire signals are generated at any time the threshold is exceeded. To allow the nutation angle to reach large values, the thruster solenoid drive circuits are controlled by a separate command.

Command channel 3 activates the nutation inducing system. The nutation sensor telemetry signal (sinusoidal at nutation frequency) is fed through the amplifiers to a small momentum wheel. The wheel axis is aligned in the transverse plane so that the sinusoidal torque is *in phase* with the rotating vector \vec{H}_T . When the system is enabled it acts to increase the nutation angle. The telemetry conditioning on the output of the nutation sensor telemetry signal is in addition to the conditioning shown in Figure 4.

Figure 8 shows the nutation sensor, ANC electronics box, and momentum wheel.

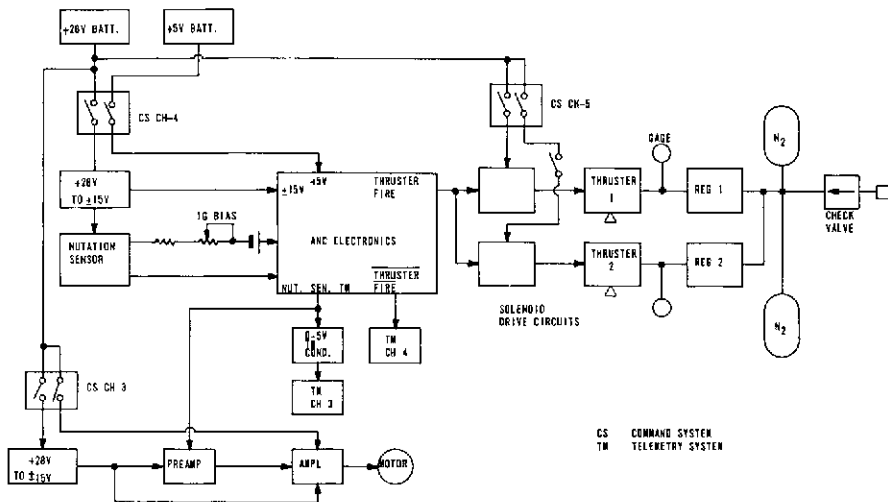

Figure 6. ANC system on the air-bearing table, block diagram.

A typical sequence of operations for a test is as follows:

- Turn on the command receiver.
- Pump down the altitude chamber.
- Command on the instrumentation.
- Float the table.
- Raise the bell to level the table.
- Spin up and release the table.
- Command on the nutation inducing system.
- At the desired nutation angle, enable the thruster and observe the nutation angle reduction.
- After the nutation angle has been reduced, disable the thruster and allow the nutation angle to increase to repeat the test or allow the thruster to remain on and observe the limit cycle operation. Repeat as necessary.
- Capture the table with the movable aperture in the overhead mechanism.
- Raise the bell to engage and despin the table.
- Lower the bell and defloat the table.
- Command off the instrumentation.
- Return the chamber to ambient pressure.

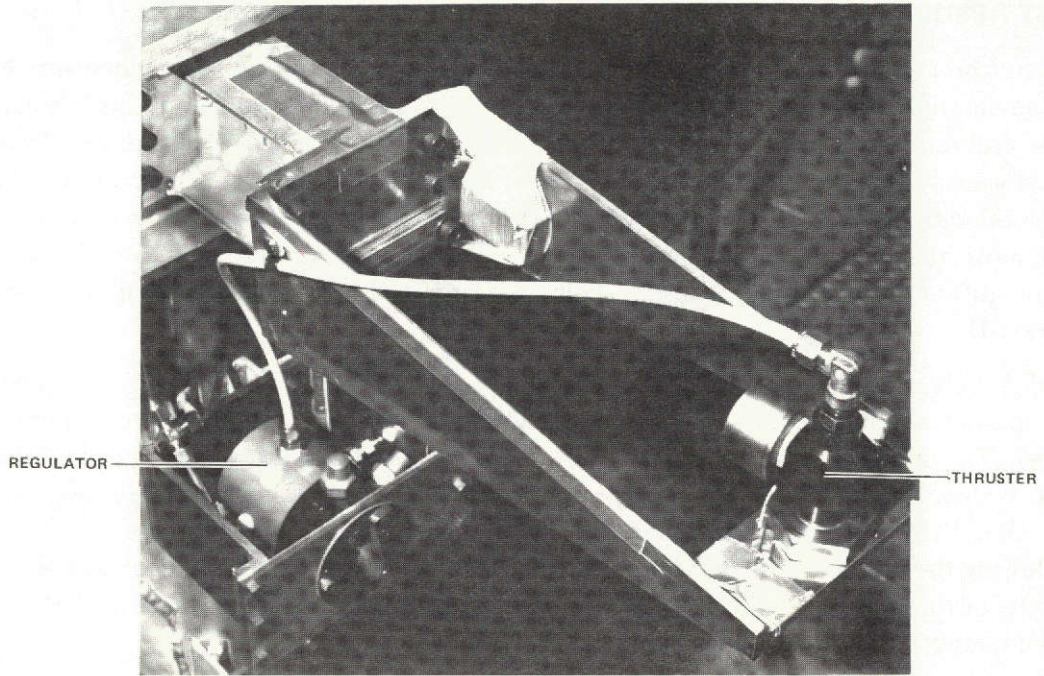

Figure 7. Thruster on the air-bearing table.

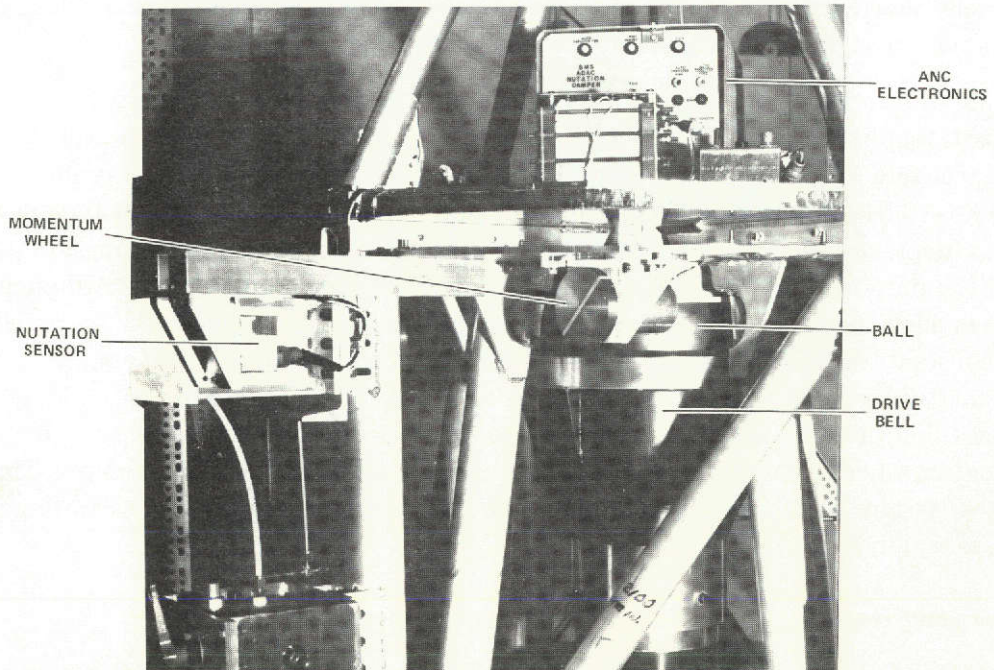

Figure 8. ANC system hardware on the air-bearing table.

TEST RESULTS

The test program consisted of approximately 25 runs; that is, nutation angle increased by the momentum wheel and then reduced by the ANC system. Test runs were made with three different pressures in the nitrogen tanks on the table. This resulted in three different thrust values and three different angular accelerations. The values were chosen to bracket the acceleration values of the SMS. Various spin speeds were used from 95 to 62 rpm, with most runs made near the nominal 90 rpm. The maximum nutation angles allowed for the different runs varied, with 6.5° being the largest. Limit cycle operation was also observed.

Qualitatively, the ANC system was quickly and easily evaluated. The first time the table was spun up and released, a small nutation angle was induced by using the momentum wheel. The momentum wheel was turned off, stopping the nutation angle increase. The ANC system was enabled by command and the nutation angle was quickly reduced to a low value. This initial test confirmed the basic design concept and the system phasing. Following the initial test, many more test runs were made with larger nutation angles. Results of these tests were used to determine the performance characteristics of the ANC system, reported in the following paragraphs.

Divergent Nutation Rate

The natural divergent time constant of the table nutation angle is very large. This is artificially shortened by using the momentum wheel system previously described, so that large nutation angles can be achieved in a reasonable time.

The rate of increase of the table nutation angle with the momentum wheel system is constant; that is, the nutation angle increases linearly with time. The nutation angle divergence rate of the signals in Figures 9 and 10 are approximately $0.0121^\circ/\text{s}$ and $0.0131^\circ/\text{s}$ ($0.0126^\circ/\text{s}$ average). Typically, the nutation angle increase due to fluid devices such as fuel tanks is exponential; the rate of increase is proportional to the angle of nutation. The proportionality constant is the reciprocal time constant, $\dot{\theta} = \theta/\tau$. Although the nutation angle divergence rate for the table is linear rather than exponential, an equivalent time constant can be defined. At 1° with a $0.0126^\circ/\text{s}$ divergence rate, the equivalent time constant is 79 seconds; at 6° , it is 476 seconds. These are both close to the 3-minute time constant that the ANC system is supposed to accept. Except for the initial runs, the momentum wheel system was operating during the time the ANC system was on. Thus the ANC system was always operating when the table nutation angle was attempting to increase rapidly.

Convergence Rate

Figures 9 and 10 clearly show the reduction in nutation angle once the ANC system is enabled. In the run shown in Figure 9, the nutation angle was reduced from 2.28° to 0.11° with seven pulses. The spin speed was approximately 96 rpm. The first few pulses

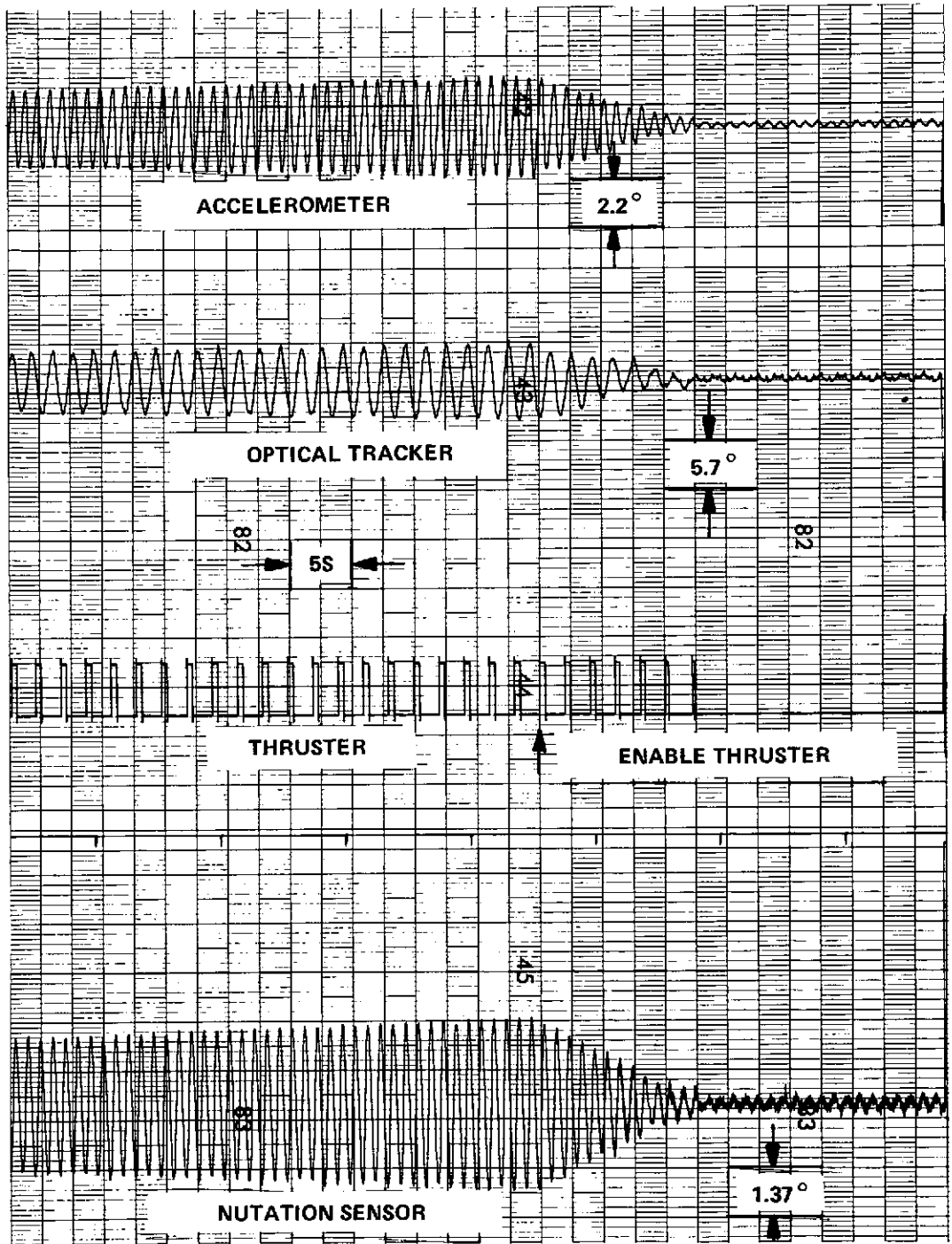

Figure 9. Nutation angle reduction from 2.3° , 95 rpm.

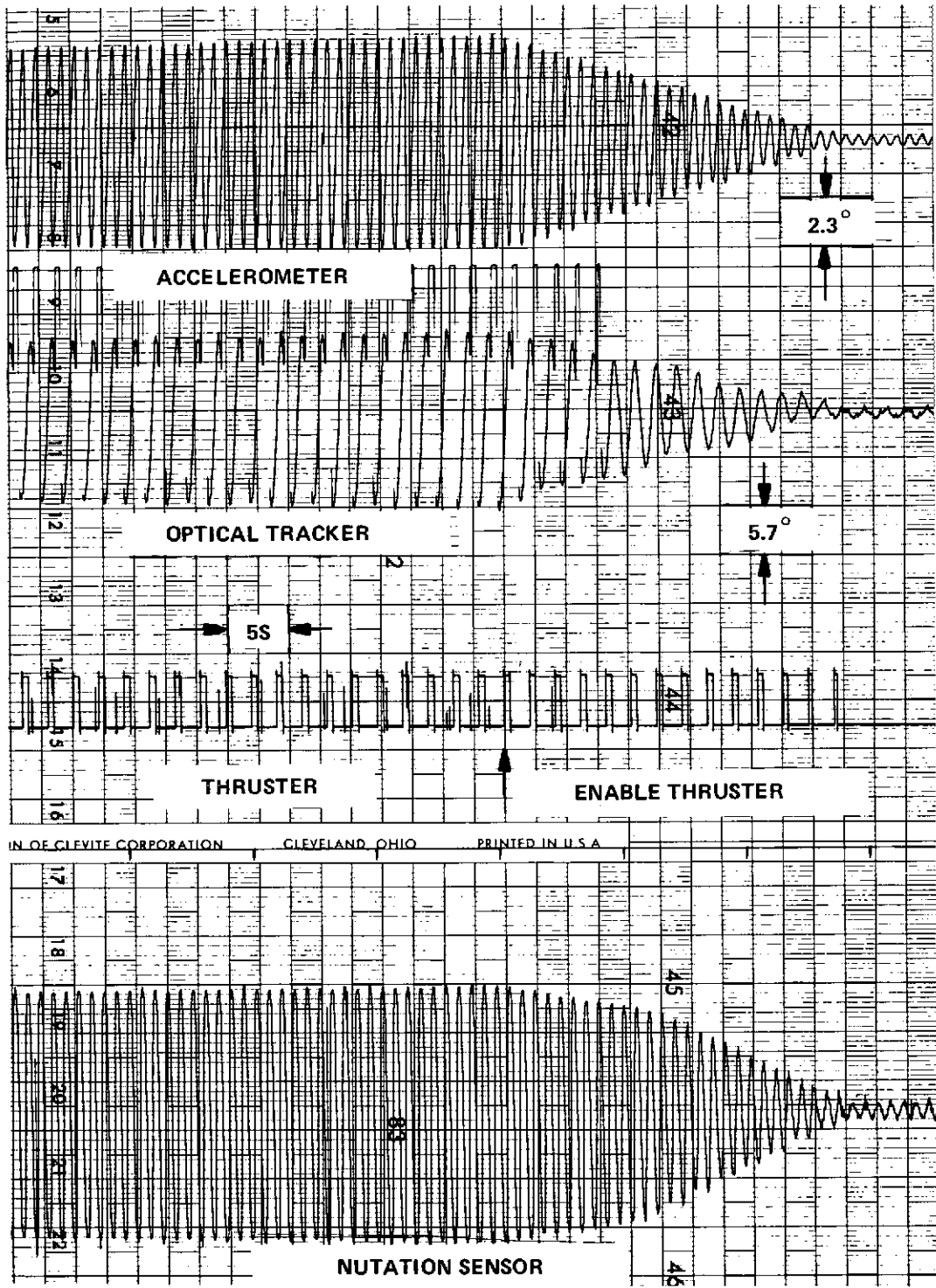

Figure 10. Nutation angle reduction from 5.1° , 93 rpm.

are approximately the same width, one-half a nutation period. During the time of the constant-width pulses, the nutation angle decreases at a constant rate of $0.168^\circ/\text{s}$. Even though the momentum wheel is operating during this time, the convergence rate is almost 14 times the divergence rate. In the run shown in Figure 10, the nutation angle was reduced from 5.13° to 0.22° in approximately 28 seconds with 14 pulses. During the linear portion of the convergence, where the pulses are approximately the same width, the convergence rate is $0.183^\circ/\text{s}$. The spin speed during this run was 93 rpm. The breaks in the telemetry signal conditioning circuit (Figure 4) clearly show up in the envelope of the nutation sensor signal. The pulses riding on the normally sinusoidal optical tracker signal should be ignored. At the larger angles, the table is momentarily out of the field of view of the tracker, which momentarily loses lock. The angular acceleration of the table for the runs shown in Figures 9 and 10 was higher than the SMS angular acceleration. This will be considered in succeeding paragraphs. The final values of the nutation angle in these runs were well below the 0.35° threshold specified for the design.

Nutation Angle Reduction Per Pulse

The change in nutation angle per thruster pulse for a single threshold is

$$\Delta\theta = \left(\frac{2T}{I_T \sigma \lambda \omega_z} \right) \sin \left(\frac{\lambda \Delta t}{2} \right) \cos \beta \quad (2)$$

For a low threshold and $\Delta\theta$ small compared to θ , $\cos \beta$ is approximately one. Beta (β) is the phase angle due to asymmetry of the torque pulse about the $-x$ axis. For the SMS: $T = 20.3 \text{ N m}$, $I_T = 331 \text{ kg m}^2$, $\sigma = 0.38$, $\omega_z = 9.42 \text{ rad/s}$. Assume that $\lambda \Delta t / 2$ is 85° (a large nutation angle, so that Δt is almost half a nutation period). For these parameters $\Delta\theta = 0.33^\circ$. Because of the uncertainty in the value of T , Equation (2) cannot be used to calculate $\Delta\theta$ for the air-bearing table.

The change in θ per pulse was calculated using expanded records, such as those in Figure 11. A number of pulses were used and the results were averaged. For the test runs shown in

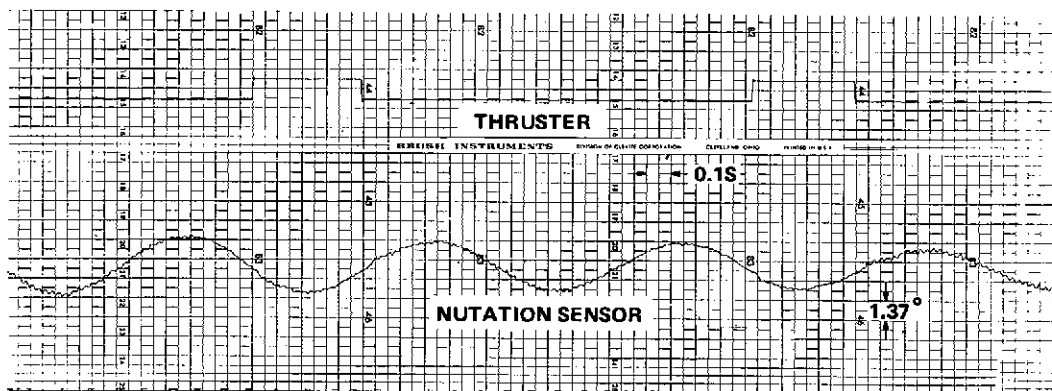

Figure 11. ANC system operation at 95 rpm (expanded version of Figure 9).

Figures 9 and 10, $\Delta\theta$ is $0.36^\circ/\text{pulse}$ and $0.34^\circ/\text{pulse}$. These values are close to the SMS value. They are higher because of the slightly higher table angular acceleration for these particular tests. The nutation frequencies for these two runs were 1 Hz and 0.97 Hz. The thruster was firing every other nutation cycle, that is, at 2-second and 1.94-second intervals. Thus for the linear portion of the runs the convergence rate was $0.18^\circ/\text{s}$. This rate agrees well with the rates measured directly, discussed in the previous section.

Angular Acceleration

The angular acceleration of the SMS due to the axial thrusters in 0.0615 rad/s^2 . The angular acceleration of the table should be the same for a completely valid test. Thrust level was adjusted by using the tank pressure, so the table angular acceleration in the atmosphere was close to the required value. It was not clear precisely how the thrust values would change in the altitude chamber, so it was decided to make runs bracketing the required angular acceleration, instead of trying to achieve it exactly. Three different regulator pressures were used, resulting in three different thrust values, and therefore, in three different angular accelerations. Equation (2) was used with the $\Delta\theta$ measured from a number of pulses to calculate the angular acceleration. Figure 12 plots the angular acceleration against regulator pressure. The figure demonstrates the bracketing.

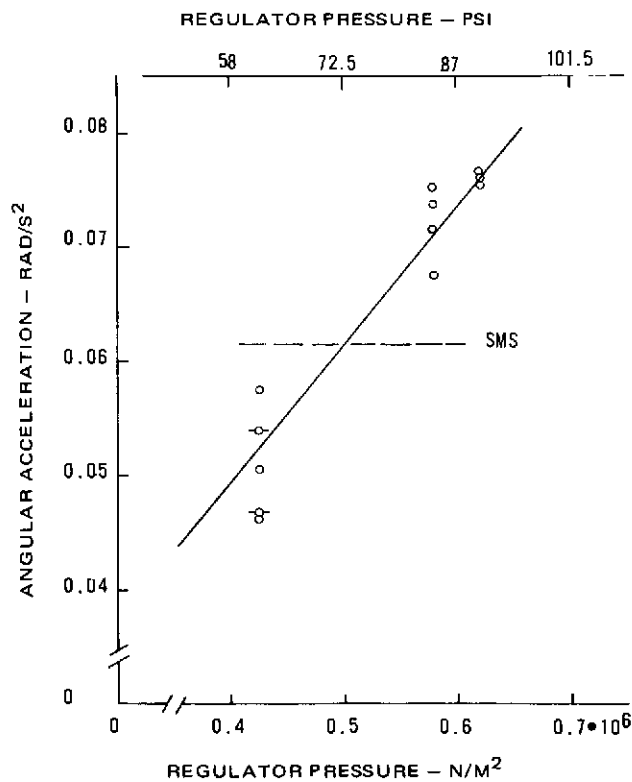

Figure 12. Angular acceleration vs nitrogen regulator pressure.

The ANC system easily reduced the nutation angle in all tests. Even at the low value of angular acceleration, lower than the SMS value, the nutation angle convergence rate was nine times the divergence rate. Applying the factor of nine to the divergence rate of $0.0126^\circ/\text{s}$ means the ANC system should reduce the nutation angle if the divergence rate were almost $0.11^\circ/\text{s}$. The specifications require the SMS-ANC system to handle a 3-minute divergent time constant at a nutation angle up to 12° . The divergence rate at this angle is $0.0667^\circ/\text{s}$. Therefore the SMS-ANC system should meet its specification in this area.

Phasing

Correct phasing of the thrust pulses and momentum component H_x is confirmed by the nutation angle reduction and the correct $\Delta\theta$. Figure 11, which is an expanded version of Figure 9, shows the phasing between the thrust pulse and the ANC system filter output.* The pulses are correctly in phase with the filter signal. The threshold, although difficult to see on the figure, is approximately correct, 136 mV at the 1-Hz nutation frequency. Thrust pulses are on for almost 450 ms out of a possible 500 ms. The reduction in nutation angle due to the thrust pulses can be clearly seen. The correct operation of the timing logic is evident in the thrust pulses, which come on every other nutation cycle instead of every cycle.

Figure 11 also shows some structural ringing, excited when the thruster is fired. Because of the structural differences, the amplitude and frequency of the ringing are expected to be higher in the SMS. The SMS is expected to experience some spurious firings due to resonance but this is not expected to be a major problem.

Limit Cycle

Figure 13 shows the system in limit cycle operation. The thruster fired when the nutation angle reached 0.27° , slightly below the SMS threshold specification of 0.35° . The apparent divergence rate is $0.003^\circ/\text{s}$. At 0.18° this is equivalent to an exponential divergence rate with a 1-minute time constant. Over a 500-second interval, 19 pulses were fired, which is a rate of 137 pulses/hr. For the inertia ratio of 0.38 and spin speed of 90 rpm, this firing rate agrees well with the 120 pulses/hr predicted by computer analysis. Thus the ANC system is able to maintain limit cycle operation for very low time constants.

Low-Speed Operation

The ANC system was designed primarily for operation between 80 and 100 rpm. However, Figure 14 shows that it does operate at 64 rpm, although at reduced efficiency. Figure 15, an expanded version of Figure 14, explains the loss of efficiency. The lower nutation frequency and 1.9-second inhibit allow a thrust pulse at the trailing edge of the following

* An additional inversion in the instrumentation recorder cancels the inversion between the filter and the telemetry conditioning (Figure 4).

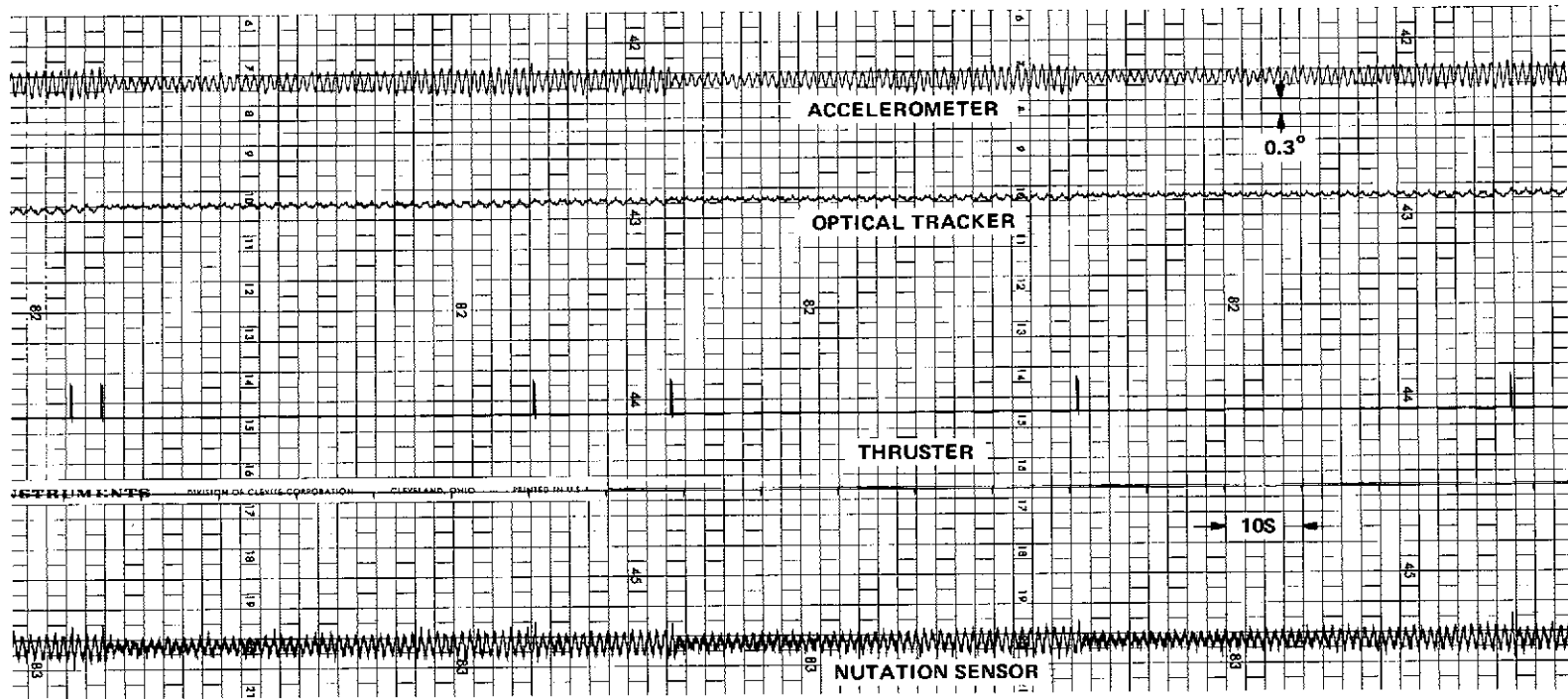

Figure 13. Limit cycle operation of the ANC system.

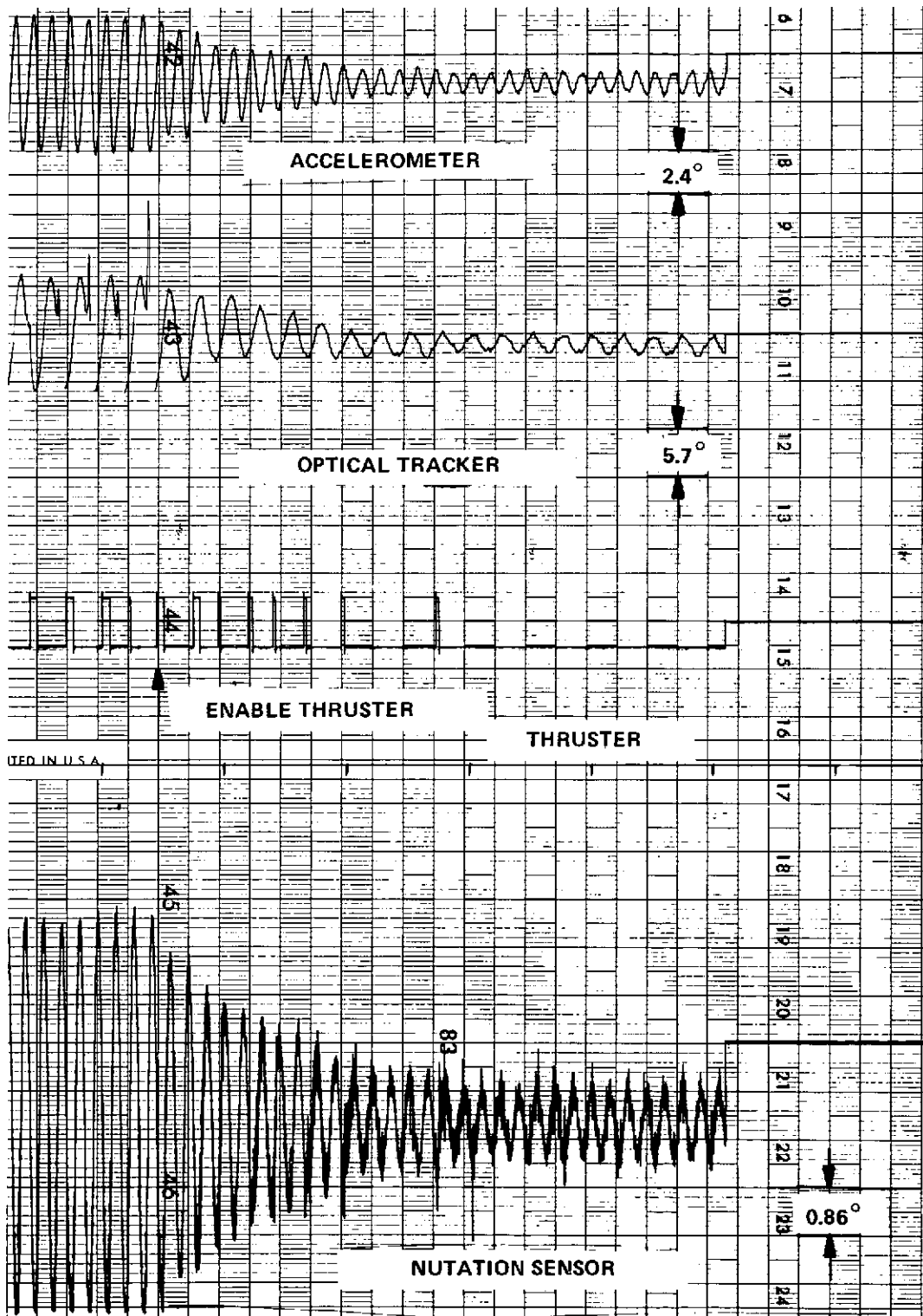

Figure 14. ANC operation at 64 rpm.

cycle rather than skipping this cycle. The 200-millisecond minimum pulse comes on and continues into the positive half cycle. In addition to slightly increasing the nutation angle, this minimum pulse starts another 1.9-second inhibit which prevents a thrust pulse during the following negative half cycle. The inhibit function and the minimum pulse generation as determined by the ANC system logic are clearly demonstrated in Figure 15. Structural ringing is also evident in Figure 15.

In the limit cycle at 62 rpm, the nutation angle was kept within the range of 0.29° to 0.39° .

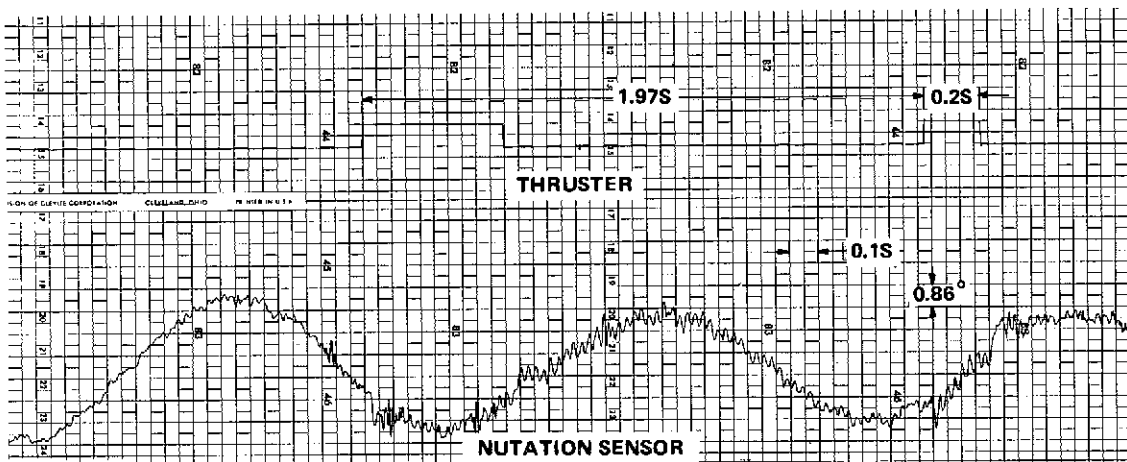

Figure 15. ANC system operation at 64 rpm (expanded version of Figure 14).

CONCLUSIONS

The objectives of the test program were met. With the components of the ANC system located on the table and sized appropriately for the system design, the ANC system always worked well in reducing nutation angle. Thus the design concept, phasing, and sizing of the system have been tested and found acceptable. Quantitatively, factors that could be checked agreed very well with the specifications or design goals, for example: minimum on time, inhibit time, threshold, and $\Delta\theta$.

The ANC system worked successfully against a divergence rate higher than is expected in flight. It should be able to handle a nutation divergence rate with a 3-minute time constant.

Goddard Space Flight Center
 National Aeronautics and Space Administration
 Greenbelt, Maryland November 21, 1973
 039-23-01-01-51