

NASA TECHNICAL NOTE

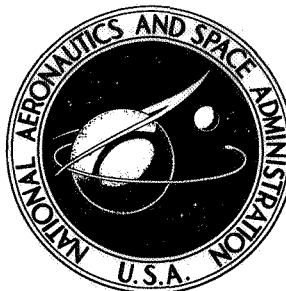

NASA TN D-7731

NASA TN D-7731

**PRELIMINARY PERFORMANCE ESTIMATES OF
AN OBLIQUE, ALL-WING, REMOTELY PILOTED
VEHICLE FOR AIR-TO-AIR COMBAT**

by Walter P. Nelms, Jr., and Rodney O. Bailey

Ames Research Center

Moffett Field, Calif. 94035



NATIONAL AERONAUTICS AND SPACE ADMINISTRATION • WASHINGTON, D. C. • JULY 1974

TABLE OF CONTENTS

	Page
SYMBOLS	v
SUMMARY	1
INTRODUCTION	1
DESCRIPTION OF MISSION	2
DESCRIPTION OF VEHICLE	2
METHOD OF ANALYSIS	4
Synthesis Program	4
Control program	4
Convergence module	4
Optimization module	4
Sensitivity module	4
Geometry module	4
Aerodynamic module	5
Propulsion module	5
Trajectory module	6
Mass properties module	6
Design Philosophy	6
RESULTS	7
Form of the Results	7
Vehicle weight	7
Vehicle volume	7
Vehicle combat performance	8
Sensitivity factors	8
Nominal Configuration	9
Vehicle Parameter Sensitivities	10
General	10
Wing Geometry	11
Aerodynamics	11
Weights	12
Mission Parameter Sensitivities	13
Cruise Mach number and altitude	13
Combat altitude and Mach number	13
Combat radius and maneuvers	14
Sensitivity Factors	14
CONCLUDING REMARKS	15
REFERENCES	17
TABLES	18
FIGURES	21

SYMBOLS

AR		aspect ratio
b		span, m (ft)
C_D	CD	drag coefficient, $\frac{\text{drag}}{qS}$
C_{DL}	CDL	drag-due-to-lift coefficient, $\frac{\text{drag due to lift}}{qS}$
C_{D_0}	CDO	zero-lift drag coefficient, $\frac{\text{zero-lift drag}}{qS}$
$C_{D_{ow}}$	CDOW	weapons drag coefficient, $\frac{\text{weapons drag}}{qS}$
C_L	CL	lift coefficient, $\frac{\text{lift}}{qS}$
	CLA	lift-curve slope, per deg
	CDL/CDL NOM	$\frac{\text{drag-due-to-lift}}{\text{nominal drag-due-to-lift}}$
	CDO/CDO NOM	$\frac{\text{zero-lift drag}}{\text{nominal zero-lift drag}}$
	CLA/CLA NOM	$\frac{\text{lift-curve slope}}{\text{nominal lift-curve slope}}$
	CDOW/CDOW NOM	$\frac{\text{weapons drag}}{\text{nominal weapons drag}}$
c_r		root chord, m (ft)
d		nacelle diameter, m (ft)
D		drag
e		aerodynamic efficiency factor, $\frac{1}{(\pi)(AR)(dCDL/dCL^2)}$
ℓ		nacelle length, m (ft)
L		lift
M		vehicle Mach number
N_Z	NZ	load factor, $\frac{L + T \sin \alpha}{W}$

N_{Z_i}		maximum instantaneous load factor
N_{Z_s}		sustained load factor
$N_{Z_{ult}}$	NZ_{ult}	ultimate load factor
P_S		specific power, $\left(\frac{T \cos \alpha - D}{W}\right) V$, m/sec (ft/sec)
$P_{S_{1g}}$		specific power at 1-g flight condition ($\dot{\theta} = 0$), m/sec (ft/sec)
P_{S_i}		specific power at maximum instantaneous turn rate, m/sec (ft/sec)
q		free-stream dynamic pressure
S		wing planform area, m ² (ft ²)
T		thrust
$\frac{t}{c}$	T/C	maximum thickness-to-chord ratio of wing
$\frac{T}{W}$		thrust-to-weight ratio (launch)
V		vehicle velocity, m/sec (ft/sec)
	VREQD	volume required in wing for fuel and fixed equipment, m ³ (ft ³)
	VWING	total volume of wing, m ³ (ft ³)
W		weight, kg (lb)
W_g	WGTO	gross weight (launch), kg (lb)
	WT/WT NOM	$\frac{\text{wing weight}}{\text{nominal wing weight}}$
$\frac{W}{S}$		wing loading (launch), kN/m ² (lb/ft ²)
α		angle of attack, deg
$\dot{\theta}$		turn rate, deg/sec
$\dot{\theta}_i$		maximum instantaneous turn rate, deg/sec
$\dot{\theta}_s$		sustained turn rate, deg/sec
Λ		sweep of wing midchord line, deg

PRELIMINARY PERFORMANCE ESTIMATES OF AN OBLIQUE, ALL-WING,
REMOTELY PILOTED VEHICLE FOR AIR-TO-AIR COMBAT

Walter P. Nelms, Jr., and Rodney O. Bailey

Ames Research Center

SUMMARY

A computerized aircraft synthesis program has been used to assess the effects of various vehicle and mission parameters on the performance of an oblique, all-wing, remotely piloted vehicle (RPV) for the highly maneuverable, air-to-air combat role. The study mission consists of an outbound cruise, an acceleration phase, a series of subsonic and supersonic turns, and a return cruise. The results are presented in terms of both the required vehicle weight to accomplish this mission and the combat effectiveness as measured by turning and acceleration capability. This report describes the synthesis program, the mission, the vehicle, and results from sensitivity studies.

An optimization process has been used to establish the nominal RPV configuration of the oblique, all-wing concept for the specified mission. In comparison to a previously studied conventional wing-body canard design for the same mission, this oblique, all-wing nominal vehicle is lighter in weight and has higher performance. The nominal configuration is used as a base point for sensitivity studies to determine those parameters, both vehicle and mission oriented, which have the most significant effect on the RPV weight and combat performance. Variations were made in vehicle geometry, aerodynamics, and component and payload weights. Mission parameters varied were cruise altitude and Mach number, combat altitude and Mach number, and combat radius and number of combat maneuvers. Areas requiring further study and areas where possible payoffs can result from advancements in technology are suggested.

INTRODUCTION

Remotely piloted vehicles (RPV) are of considerable interest for military use as a possible complement to manned aircraft for several missions. To date, such vehicles are being considered primarily for reconnaissance and electronic surveillance missions. Studies suggest that RPV's could participate in more advanced roles such as air-to-ground strike and air-to-air combat, with greater efficiency and at lower cost than manned aircraft. A research program at Ames Research Center is directed toward strengthening the technology base required for advanced highly maneuverable aircraft, including RPV's, in the air superiority role. One phase of this research program involves computerized vehicle studies of several RPV configurations for air-to-air combat missions. The main objective of these studies is to identify critical areas where significant performance improvements may result from additional research.

The first configuration considered in these computerized studies was a relatively conventional wing-body-canard design. Reference 1 presents preliminary sensitivity and tradeoff information on

vehicle size, weight, and combat performance for this concept. The results indicate that a relatively high performance RPV can be developed for the air-to-air combat mission with a gross weight considerably less than that of advanced manned aircraft. In an attempt to further improve combat effectiveness, a second configuration has been studied consisting of an oblique wing mounted on an engine nacelle (hereafter called an oblique all-wing RPV). This design should offer several possible advantages, such as higher turn rates due to very low wing loadings and increased aerodynamic efficiency through drag reductions as a result of both wing yaw with Mach number and the absence of large bodies and tails. In addition, this design should have lower structural weights because of load relief since most of the vehicle weight is distributed in the wing. Several other features, such as low observables including low radar cross section and small size and related gross weight, make this concept even more attractive as a highly maneuverable RPV.

In the present study, a computerized aircraft synthesis program (ACSYNT) has been used to assess the effects of various vehicle and mission parameters on the performance of an oblique, all-wing, highly maneuverable RPV for air-to-air combat. The study mission consists of an outbound cruise, an acceleration phase, a series of subsonic and supersonic turns, and a return cruise. The results are presented in terms of both the required vehicle weight to accomplish this mission and the combat effectiveness of the resulting configuration. This report describes the selected mission, vehicle, and synthesis program, together with preliminary results from sensitivity and trade studies.

DESCRIPTION OF MISSION

Many combinations of range and maneuvers are required by an air-to-air combat vehicle. To accomplish the present study, a typical offensive mission (called nominal mission) was chosen (fig. 1). The RPV is ground launched using either a zero-length rocket assist technique or a catapult system. (Another possibility would be to launch from an aircraft.) Following launch, the vehicle accomplishes the specified mission (fig. 1) and returns to its base with 22.7 kg (50 lb) of fuel reserve. The RPV is recovered on the ground with a net or arresting gear and pad. (Details of the launch and recovery systems are not reported here.) It is assumed that two Sidewinder class missiles are carried throughout the mission and are not launched.

The sensitivity of the vehicle weight and combat performance to the cruise altitude, cruise speed, combat radius, combat altitude, combat speed, and number of combat turns is shown later.

DESCRIPTION OF VEHICLE

The RPV configuration studied has an oblique wing (which can be yawed from 0° to 68°) mounted on an engine nacelle (fig. 2). The geometry summary and weight statement for the nominal configuration are also given in figure 2.

This concept represents an attempt to incorporate several technologies for high combat performance into a single vehicle. First, because of the RPV approach itself, there is no acceleration constraint associated with having an onboard pilot. Secondly, the all-wing design not only results in low wing loadings and therefore higher turn rates, but also has reduced drag levels because of the

absence of large bodies and tail surfaces. The yawed wing has a programmed sweep angle with Mach number so that the wing is always at its "optimum" sweep angle (fig. 3). Thus, the configuration has high lift/drag ratios primarily because of low wave drag at high Mach numbers and low induced drag at low Mach numbers. The aspect ratio of the study configuration is sufficiently low to avoid divergence usually anticipated with forward swept wings. Additionally, this flying-wing concept has relatively low structural weights due to load relief since most of the vehicle weight is distributed in the wing. Another important feature of this design is the low visual and radar cross section that results from its small size.

Finally, basic to the success of this all-wing concept is the use of advanced active control technology to provide stabilization and control of the aircraft. The configuration is designed to have essentially neutral stability and, therefore, zero trim drag is assumed in the analysis. The vehicle is envisioned as being electronically stabilized and aerodynamically controlled by use of surfaces along the wing trailing edge and at the wing tips. A detailed description of the control system used on the study vehicle is beyond the scope of this report, but it should be noted that this is an area that requires additional research, particularly for oblique, all-wing configurations.

To capitalize on the concepts just discussed, a nominal configuration has been established as shown schematically in figure 2. The wing, which is of conventional aluminum structure, is sized to contain the fixed equipment and the total fuel supply for the mission. For the nominal configuration, 55 percent of the wing volume is assumed to be available for these two items, and the effect of changes in this percentage value is shown later. The exact weight of the fixed equipment (avionics, electrical systems, sensors, etc.) required for the air-to-air combat mission is difficult to assess at this time; on the basis of current technology, a nominal weight of 227 kg (500 lb) is used. The electro-optical sensor system can be mounted in several locations on the vehicle, but, for the present study, it is mounted in the wing leading edge and rotates in conjunction with the engine nacelle.

The engine nacelle is mounted below and free to rotate in yaw relative to the wing (fig. 2). This angle of wing yaw is programmed as a function of flight speed (fig. 3). The engine used in the present configuration is a study turbojet with afterburner (described in ref. 2). A fixed geometry, normal-shock, air-induction system is used since the upper limit on the speed of this RPV is about Mach 1.6 to 1.8. The weights of the engine, afterburner, engine controls, fuel system, and inlet system are included under "propulsion" in the weight statement. The vehicle payload of 145 kg (320 lb) consists of two infrared seeking missiles of the Sidewinder class mounted on the sides of the nacelle. (Note that the weights of payload attachments and residual fuel and oil are included under "residual load" in the weight statement.)

The effects on weight and performance of varying many of the vehicle characteristics about the nominal configuration are shown later. These characteristics include wing loading, thrust/weight ratio, load factor, wing geometry, fixed equipment weight, and weapon systems weight.

METHOD OF ANALYSIS

Synthesis Program

The computerized synthesis program used in this study on RPV's is the latest version of the Ames program for aircraft synthesis (ACSYNT). Figure 4 is a block diagram of this modularized program. The ACSYNT program provides geometrical, mass, and performance information for a vehicle concept as well as sensitivity information. Each module consists of one or more subroutines which are described below as they apply to the RPV study.

Control program— The control or executive program (fig. 4) controls the sequence and information transfer for all the other modules and handles the input to and output from the entire synthesis program. Inputs include various vehicle definition parameters, mission specification, and several initial assumptions required to start the program. Outputs from the program include computed vehicle characteristics such as component weights and geometry, fuel requirements for the various phases of the mission, aerodynamic and propulsion system characteristics of the configuration, and combat performance parameters. Both data listings and computer graphics presentations are used to display the results.

Convergence module— This module begins with an assumed vehicle gross launch weight. From the discipline modules such as geometry, aerodynamics, propulsion, and trajectory, the aircraft weight is calculated for the input mission. If the calculated launch weight is the same as the assumed weight, the vehicle is said to be converged and the analysis is terminated. If the calculated weight is not in agreement with the assumed value, values of launch weight are updated until a closed vehicle is obtained.

Optimization module— This module iteratively changes the major vehicle design variables (such as wing area, aspect ratio, and thickness/chord ratio) to maximize or minimize a preselected measure of vehicle performance subject to prescribed bounds on the vehicle and mission parameters. In the current study, the "optimum" configuration was obtained by minimizing gross vehicle launch weight with an upper bound on wing volume available for fuel and fixed equipment. The optimization algorithm used is based on Zoutendijk's method of feasible directions; the method and computer program are described in references 3 and 4.

Sensitivity module— Once an optimum vehicle has been defined, it is of value to assess the effect that changing a single design parameter (e.g., aspect ratio) has on the vehicle weight and performance while holding all other design parameters fixed and allowing the vehicle only to change in size and weight. The sensitivity module directs these computations and provides both data listings and computer graphics presentations of sensitivity results.

Geometry module— On the basis of input configuration parameters, some fixed and some assumed, the geometry subroutine defines and sizes the vehicle to be used by the remaining modules of the program. The wing, engine nacelle, and vertical control surface are initially sized in this module. The characteristics of these components are updated at each pass through the program.

The wing is sized on the basis of an input wing loading and shape parameters; an additional constraint of having sufficient volume for fixed equipment and fuel is also applied. A given percentage of the total wing volume is allotted to these two items. For the present RPV configuration, a nominal value of 55 percent is used which was estimated on the basis of a preliminary wing layout. The effects of changes in this percentage value are shown later.

The nacelle geometry is determined in this module from the engine and inlet dimensions and the size of the surrounding structural members. A vertical control surface is not shown in figure 2 since a detailed stability analysis has not been accomplished. However, to account for the possibility of such a surface, the present study includes increments in weight and drag that are functions of the wing size and several other input shape parameters.

Aerodynamic module— This module consists of a procedure to calculate the aerodynamic characteristics of a configuration for a given mission altitude and Mach number schedule. The aerodynamic characteristics of the nacelle-mounted missiles are also estimated. The calculation procedures use both theoretical methods and empirical information. Results from this module have been calibrated with a small amount of existing wind-tunnel data on a similar configuration for a limited angle-of-attack range (ref. 5) and have also been compared with data on other highly maneuvering aircraft configurations.

The friction drag estimates are based on Frankl and Voishel's extension of von Kármán's mixing-length hypothesis to compressible flow (ref. 6). An empirical form factor correction based on a correlation in reference 7 of a large amount of data is added to the skin friction drag. For the wing, the skin friction is based on a reference length that is modified according to the sweep angle (fig. 3).

The wave drag of the oblique wing ($M > 0.9$) is calculated using a procedure similar to that of reference 8 with adjustments based on a correlation with wind-tunnel tests (ref. 5) and with more elaborate prediction methods (ref. 9). This calculation technique gives the wave drag as a function of Mach number, wing thickness, wing sweep, and wing aspect ratio. The wave drag of a vertical control surface (mentioned previously as a possibility) is calculated using a modified empirical procedure (ref. 7) obtained by correlating a large amount of data. A procedure similar to that in reference 10 is used to calculate the wave drag of the nacelle cowl.

The lift is calculated using a linearized technique (ref. 11) that depends on Mach number, wing sweep, an efficiency factor (e), and a correction factor for three-dimensional effects based on the aspect ratio of the wing in the swept position. Drag due to lift at subsonic speeds is a function of the lift coefficient, efficiency factor (e), and aspect ratio of the swept wing (ref. 11). At supersonic speeds, the drag due to lift is calculated with the method described in reference 12.

The drag of the weapons and attachments is calculated using an empirical relationship that is a function of Mach number and missile size. This method is based on a correlation of data obtained in the wind tunnel for similar missiles and methods of attachment.

Propulsion module— The propulsion section of the synthesis program uses an engine similar to the engine of reference 2 — a turbojet with afterburner, with maximum turbine inlet temperature of 1900°F. A four-stage compressor is driven by a single-stage turbine and the compressor pressure

ratio at sea-level static conditions is 5:1. The engine and afterburner are sized on the basis of a specified vehicle thrust/weight ratio. Then the values of thrust, fuel consumption, and air flow are calculated for any altitude, Mach number, and power setting. The following power settings are available: maximum afterburning, intermediate (100 percent rpm), maximum continuous, 90, 70, and 50 percent maximum continuous. The latter power settings are used for throttling during the cruise phase. The basic engine thrust and fuel consumption are corrected for installation losses associated with the inlet and nozzle. The propulsion system characteristics are programmed to allow the use of a wide range of engine sizes, power settings, altitude, and Mach numbers. The engine characteristics are considered to be state of the art, and no performance improvements are used that might be considered advanced propulsion system technology.

Trajectory module— From information generated in the aerodynamic and propulsion modules, this module computes the fuel used in each segment of the specified mission, thus establishing the total fuel requirements. In addition, combat performance parameters for the vehicle are determined at both supersonic and subsonic Mach numbers. These parameters are specific power levels, maximum sustained turn rate, and maximum instantaneous turn rate. An explanation of these performance parameters is given later.

Mass properties module— After the vehicle is sized, the structural weight is calculated by relationships derived from correlations of existing data for the weights of the various vehicle components. The wing weight is a function of load factor, aspect ratio, effective taper ratio, maximum thickness/chord ratio and structural material. For this study, the wing weight is not penalized for divergence (usually a problem with an oblique-wing design) since other studies suggest the aspect ratio is sufficiently low. The weight of the vertical surface is estimated on the basis of its size and a weight per unit area determined for the wing. Empirical relationships that are a function of nacelle size and engine maximum thrust are used to calculate the nacelle and the wing-nacelle pivot weights. Finally, in conjunction with data generated in other modules, the mass properties module compiles a total vehicle weight statement.

Methods similar to those described in references 13 and 14 have been used as a guide in developing the mass properties module. Wherever possible, the results are calibrated against the weights of actual aircraft components or with results from more elaborate prediction methods. However, because of the limited information on the design of oblique, all-wing configurations, it is suggested that a more detailed wing and wing pivot structural analysis be initiated.

Design Philosophy

There are varied opinions as to the philosophy of design for a superior aircraft in air-to-air combat. For example, the designer may choose to provide high acceleration or high Mach number capability as contrasted to a lower speed design with greater maneuverability. Consideration must also be given to other factors such as the weapon system capability and operational environment of a threat aircraft. Because of the differing philosophies, a brief description of the approach used here may be in order before proceeding to the results.

There are several, often conflicting, performance objectives for a low-cost RPV for air superiority. The design philosophy for the combat RPV in this preliminary study is to minimize gross

weight while maintaining a turning performance advantage over future threats, and to accept the acceleration capability of the resulting designs. A level of maximum instantaneous turn rate or maximum load factor capability is provided so that the level of performance is considerably higher than that of any known or planned manned fighter but low enough to keep the structural weight (and therefore vehicle gross weight) and cost at reasonable values.

Also, the sustained turn rate capability at $M = 0.9$ is selected to provide a reasonable increment over that of any advanced aircraft; experience has shown that high-maneuvering engagements tend to occur at high subsonic speeds because both the sustained and maximum instantaneous turn rates usually are a maximum here (ref. 15). Sustained turn rate is an important factor because of its strong effect in determining the vehicle propulsion system size. A relatively modest level of sustained turn rate is chosen for the nominal configuration to keep the resulting thrust/weight ratio, and therefore the engine and vehicle cost, relatively low. However, the acceleration capability of the vehicle is a function of the available thrust and a lower thrust/weight ratio will result in lower acceleration capability. A reduced level of acceleration performance may be acceptable for the present vehicle since defensive breaks followed by high-speed dashes to escape an opponent (for pilot or aircraft safety) may be less critical for an RPV. Therefore, the defensive ability of the RPV under study is given little consideration, with superior offensive capability being the primary objective. Note that if an adversary with a superior acceleration capability is fortunate enough to use this advantage to escape, the mission of the combat RPV — that is, to gain control of the airspace — is still essentially accomplished.

RESULTS

Form of the Results

The majority of the sensitivity results are presented in four forms: the effects on vehicle weights and on vehicle volume of variations in specified parameters, effects of various parameters on vehicle combat performance, and sensitivity factors derived from the weight and performance characteristics.

Vehicle weight— The effect on vehicle weights of varying a specific vehicle or mission parameter is presented in the format of figure 5(a), where wing loading is the parameter illustrated. Structural weight, propulsion system weight, and fuel weight (all in kilograms (lb)) are given along with the vehicle gross weight. A sketch, on the same figure, indicates effects of changes in the parameter on vehicle size and shape. Generally, a sketch is shown in each plot for configurations with the maximum, minimum, and nominal values of the parameter. These sketches have a common scale to allow a quick comparison of vehicle sizes and shapes as a result of changes in configuration and mission parameters. The nominal configuration is usually identified by either filled symbols or tic marks.

Vehicle volume— Because the fuel and fixed equipment are located entirely in the wing, the configuration volume characteristics as affected by changes in a specific vehicle or mission parameter are presented as a second form of the results (e.g., fig. 5(b)). Curves of the volume required for fuel plus fixed equipment and for the total wing volume are shown. In addition, the ratio of the

volume required for fuel plus fixed equipment to the total wing volume is presented. For the present study and on the basis of preliminary wing layouts, an upper limit of 0.55 is placed on this ratio (as indicated by the boundary mark shown in the figure). This implies that excursions of a particular design parameter beyond this limit (with all other parameters held constant) are not considered reasonable configurations, and both the weight and performance plots should be viewed with this in mind.

Vehicle combat performance— Effects on vehicle combat performance of changes in a particular parameter are presented in the format of figure 5(c), where performance is measured, for a given Mach number and altitude, in terms of specific power (P_S) in m/sec (ft/sec) plotted versus turn rate ($\dot{\theta}$) (deg/sec). Three important areas on these performance plots should be described.

First, the P_S level at zero turn rate ($P_{S_{1g}}$) indicates the acceleration or rate-of-climb capability of the vehicle. This is important in the repositioning phase of the engagement before the adversaries are in close contact and a margin in P_S at 1 g can be used to gain a speed or altitude advantage over an opponent. Also, an acceleration advantage can be important (particularly for a manned aircraft) for defensive purposes or escape. Second, the $P_S = 0$ point is the maximum sustained turn rate capability of a vehicle and involves neither a loss nor a gain in vehicle energy. A given number of maneuvers to be performed at $P_S = 0$ is specified in the input mission.

The final important area on the performance plot is the maximum instantaneous turn rate capability of a vehicle, which is usually accomplished at the expense of large losses in vehicle energy (negative specific power). For manned aircraft, the maximum instantaneous turn rate often is limited by pilot tolerance. For the present study of RPV's, the vehicle is allowed to maneuver to its design load factor or lift limit (whichever occurs first) since there is no pilot onboard the aircraft. In several cases, the combat performance presentation includes a second figure (fig. 5(c) concluded) that supplements the plots of P_S versus turn rate. Such a figure usually is included when a parameter appears to have a large effect on both the vehicle weight and combat performance. References 15 through 17 provide a complete discussion of the implications of specific power and turn rate in air-to-air combat.

Sensitivity factors— Results of the trade studies are summarized in terms of sensitivity factors for both the weight and combat performance characteristics. A sensitivity factor is defined as the percentage change in gross weight or performance resulting from a percentage change in the design parameter divided by the percentage change in the design parameter. The sensitivity factors are calculated about the parameter values of the nominal configuration. With a gross weight (W_g) trade as an example, the sensitivity factor is defined as

$$\text{sensitivity factor} = \frac{\text{change in } W_g / \text{nominal value of } W_g}{\text{change in parameter} / \text{nominal value of parameter}}$$

where the parameter may be W/S , T/W , etc. The sensitivity factor may be positive or negative (or 0); if it is positive, the vehicle gross weight or performance increases as the parameter value increases. The magnitude of the effect a given design parameter has on the vehicle weight or performance is indicated by the magnitude of the sensitivity factor.

Nominal Configuration

Following the design philosophy previously described, a nominal configuration to be used in the sensitivity and trade studies is established in this section. An ultimate load factor of 11 is selected which results in a reasonable structural weight and allows sufficient combat performance over that of any planned manned fighter. By use of this value and with the optimizer coupled to the synthesis program, minimum gross weight (W_g) vehicles are obtained for a range of wing volume ratios (volume required for fuel plus fixed equipment ratioed to total wing volume) for the nominal mission. For each value of the volume ratio, the optimizer is allowed to select the optimum combination of wing loading (W/S), thrust/weight ratio (T/W), wing thickness/chord ratio, and wing aspect ratio with all other parameters held constant. These parameters were expected to have a significant effect on vehicle weight and combat performance.

The results of this optimization process are presented in figure 6. Figure 6(a) shows the minimum vehicle weights for a range of wing volume ratios and, as expected, these results indicate that the vehicle gross weight can be decreased if a greater portion of the wing volume is used for fuel and fixed equipment. As previously mentioned, a value of 55 percent for this volume ratio has been selected for the nominal study configuration on the basis of preliminary wing layouts, resulting in a gross weight of 2175 kg (4795 lb) (as indicated by tic marks in fig. 6(a)).

Figure 6(b) shows the value of the previously mentioned vehicle parameters required to provide a minimum gross weight configuration for each of the levels of wing volume ratio. To provide higher wing volume ratios and therefore reduced vehicle gross weights, the vehicle W/S increases and T/W decreases, while only minor changes occur in wing aspect and thickness/chord ratios.

The combat performance at 9144 m (30,000 ft) is presented in figure 6(c) for the optimized vehicles with various values of wing volume ratio including the nominal. As this ratio is reduced, both the P_G level for 1-g flight (zero turn rate) and the sustained turn rate are increased as a result of the decreasing W/S and increasing T/W shown in figure 6(b). The values of maximum instantaneous turn rate (fig. 6(c)) of 22.6 and 16.9 deg/sec at $M = 0.9$ and 1.2, respectively, result from the ultimate load factor of 11 selected for the nominal configuration. The combat results are presented in greater detail in figure 6(c) concluded for both $M = 0.9$ and 1.2. For the configurations considered, the optimized configurations have maximum angles of attack (limited by load factor) up to about 13° . These relatively low angles result primarily from the low wing loadings and the combat altitude of 9144 m (30,000 ft). The acceleration times from $M = 0.9$ to 1.6 vary between about 66 to 78 sec for the various configurations.

As a result of the optimization studies shown in figure 6, a nominal study configuration was selected, and complete vehicle and performance characteristics for this configuration are presented in figure 2 and in table 1. To accomplish the same mission, the resulting gross weight of 2175 kg (4795 lb) for the all-wing design is approximately 272 kg (600 lb) lighter than the wing-body RPV of reference 1. (Both configurations have an ultimate load factor of 11.) In addition, an important result is that the sustained turn rate at $M = 0.9$ of 18.9 deg/sec ($N_{Z_s} = 9.2$) for the present configuration is very high compared to any advanced manned aircraft and is considerably higher than that of the wing-body RPV in reference 1 (12.6 deg/sec). The sustained turn rate at $M = 1.2$ for the present vehicle is also slightly better than that of the configuration in reference 1. These high levels of combat performance for the all-wing design can be attributed primarily to the low value of

optimum launch wing loading of 1.11 kN/m^2 (23.1 psf). The optimum value of T/W at launch of 1.12 (1.29 at the beginning of combat based on sea-level static thrust) is of a modest level compared to some advanced fighters. A wing thickness/chord ratio of 0.096 and a wing aspect ratio of about 6.2 resulted from optimization studies for the nominal configuration shown in figure 2. The weight statement (fig. 2) indicates a fuel fraction of about 36 percent; a breakdown of this fuel usage is shown in table 1. For the combat phase of the mission, the greater fuel consumption occurs during the three supersonic turn maneuvers. Also, the climb and cruise portions of the mission account for over half the total fuel used. Table 1 also shows a total of 4.5 min of combat at maximum power for the nominal study configuration and mission.

Vehicle Parameter Sensitivities

General— This section presents the sensitivity of the weight and combat effectiveness of the nominal configuration to changes in wing loading, thrust/weight ratio, and ultimate load factor. Figure 5(a) shows the effects of a variation in wing loading on the vehicle weights and relative size. The gross weight decreases rapidly with increasing W/S primarily because of an improving wing weight fraction and a decreasing drag level associated with a smaller wing. The sketch shows the relative size of the various configurations considered. The nominal configuration (filled symbols in fig. 5(a)) is not selected as that having the least gross weight because of the volume constraint associated with this all-wing concept (fig. 5(b)). To maintain a volume ratio of 0.55 or less, the wing loading is limited to the nominal value of 1.11 kN/m^2 (23.1 psf) or below. However, wing loadings much below the nominal value result in a significant increase in gross weight (fig. 5(a)). Combat performance as affected by changes in wing loading is shown in figure 5(c). Increasing the wing loading results in a loss in sustained turn rate at $M = 0.9$ but does provide reduced acceleration times (fig. 5(c) concluded). Again, because of the volume constraint, the wing loading is limited to 1.11 kN/m^2 (23.1 psf). Because of this, the maximum angle of attack (limited by load factor) is about 12° for the combat altitude of 9144 m (30,000 ft). Again, note that the turn rate capability of this vehicle is very high compared to that of a manned aircraft and is also superior to the RPV discussed in reference 1.

The effects of variations in vehicle takeoff thrust/weight ratio (T/W) are shown in figure 7. The configuration gross weight increases significantly with higher T/W due to the cascading effects of increases in propulsion system weight and size. At lower T/W , the increased gross weight is associated with greater fuel usage due to longer combat times resulting from the lower T/W . The increasing weight together with the volume constraint (fig. 7(b)) lead to a nominal value of T/W of 1.12 (filled symbols). As noted previously, this value is lower than that proposed for most advanced manned fighters. Figure 7(c) shows that T/W has a very significant effect on the combat performance of the vehicle. An increase in T/W results in higher values of sustained turn rate, increased levels of P_G for 1-g flight, and reductions in acceleration times. However, these improvements in combat performance are accompanied by increases in vehicle gross weight (as indicated before).

Levels of maximum instantaneous turn rate higher than those associated with the nominal configuration can be achieved by increasing the ultimate load factor. The effect of changes in this parameter on vehicle weight and combat effectiveness is shown in figure 8. The vehicle gross weight increases with increasing $N_{Z_{ult}}$ primarily because of higher structural weight fractions (fig. 8(a)).

Figure 8(b) shows that, without changing other vehicle parameters, the load factor cannot be below 11 because of the volume constraint. Since the RPV is allowed to maneuver to its structural limit in the present study, very high levels of maximum instantaneous turn rate can be reached at the higher values of ultimate load factor (fig. 8(c)). This results in reductions in specific power at maximum instantaneous turn rate, but only minor changes in the other combat performance parameters. Even though it is not a realistic configuration volumewise, the vehicle cannot accomplish a sustained turn at $M = 0.9$ for N_Z below about 9.5 since it will always gain energy (fig. 8(c) concluded). That is, the vehicle reaches its structural limit before the P_S is reduced to zero for this Mach number and altitude, again indicating the high maneuvering performance of this configuration. The use of advanced materials can result in sizeable payoffs for vehicles with high ultimate load factors (presented later when reductions in wing weight are considered through the use of composite materials).

Wing geometry— Figure 9 shows the results of variations in wing aspect ratio which indicate that the nominal value of 6.2 gives about the minimum weight vehicle (fig. 9(a)). To meet the volume constraint (fig. 9(b)) for the particular configuration involved, the aspect ratio must be below 6.2 or above 8.2. Configurations with the higher aspect ratio tend to give better supersonic performance and lower acceleration times because of decreased wave drag, but these vehicles have larger wing spans and higher weights, thereby complicating the ground handling problem.

Figure 10 shows the effects of variations in wing maximum thickness/chord ratio. Increasing the t/c of the wing beyond the nominal value of 0.096 (filled symbols in fig. 10(a)) results in higher gross weights primarily because of the increased fuel fractions associated with the higher supersonic drag of the thicker wing. This same increased drag at supersonic speeds results in decreased combat performance for the vehicles with higher values of t/c (fig. 10(c)). Thus the wing thickness/chord ratio for this particular configuration is established by the minimum value required to meet the volume constraint (fig. 10(b)).

Aerodynamics— Figure 11 shows the effects of numerically imposing a ± 10 -percent change in lift-curve slope about the nominal value over the entire mission. The plotted value is lift-curve slope divided by the lift-curve slope of the nominal configuration. Changes in the lift-curve slope have little effect on the weight and performance of the present vehicle primarily because the very low wing loading of this all-wing design results in low operating lift coefficients for the mission being considered. Therefore, a 10-percent change in lift-curve slope does not represent a very significant increment in angle of attack. Also, these C_L values are low on the drag polar, where a change in lift-curve slope results in little change in C_D (very small compared to C_{D_0}), leading to essentially no effect on vehicle weight or performance.

Figure 12 presents the effects of an assumed ± 10 -percent change in zero-lift drag coefficient about the nominal configuration. The vehicle gross weight appears to be very sensitive to changes in this parameter (fig. 12(a)) because of its strong effect on fuel usage during the mission. Increased C_{D_0} significantly reduces the sustained turn rate and specific power for 1-g flight at supersonic speeds (fig. 12(c)).

Figure 13 shows the effects of numerically imposing a ± 10 -percent change in drag-due-to-lift coefficient about the nominal configuration throughout the mission. The effect of this parameter on the vehicle gross weight (fig. 13(a)) is not as significant as a change in C_{D_0} . However, increasing

the drag-due-to-lift coefficient results in a significant loss in sustained turn rate and a reduction in P_S for maximum instantaneous turn rate (fig. 13(c)).

Figure 14 presents the effects of a ± 30 -percent change about the nominal value of the drag of the weapons (consisting of two missiles and their attachments). This spread in the drag level is representative of that noted from wind-tunnel data on similar weapons and mounting methods. The results show an increase in the gross weight of the vehicle with increasing weapon drag (fig. 14(a)), but only minor effects on the combat effectiveness (fig. 14(c)).

As previously indicated, the calculation procedure used here requires as an input an aerodynamic efficiency factor (e). This factor is used to calculate both the lift and the drag-due-to-lift coefficients. A nominal value of 0.85 is used and the effects of changes in this value are shown in figure 15. Reducing this factor results in an increase in gross weight (fig. 15(a)), a loss in sustained turn rate, and a loss in P_S at maximum instantaneous turn rate (fig. 15(c)).

As is typical of most parametric variations on this configuration, those changes in aerodynamic parameters that result in a larger vehicle (size and weight) tend to lessen the volume constraint problem.

Weights— Figure 16 shows the effects of a variation in fixed equipment weight (avionics, electro-optical sensor, electrical systems, etc.) from 45 to 340 kg (100 to 750 lb). The nominal value of 227 kg (500 lb) was selected on the basis of a survey of the weights of various components anticipated as being required to accomplish the RPV combat mission. This value is felt to be conservative on the basis of future projections for miniaturization of this kind of equipment. The vehicle gross weight and size are reduced with reduced fixed equipment weight (fig. 16(a)), but the vehicle combat performance is degraded somewhat at the supersonic Mach number (fig. 16(c)).

For the above variation in fixed equipment weight, the density of packaging the components into the wing was assumed constant at 481 kg/m^3 (30 lb/ft^3). The effects of varying the density of the fixed equipment for a constant weight of 227 kg (500 lb) is shown in figure 17. In this case, increasing the fixed equipment density only affected the volume constraint (fig. 17(b)) since all other parameters were held constant. If the configuration were optimized for the higher values of fixed equipment density, a smaller and therefore lighter weight vehicle would result.

The effects of a change in wing weight from the value associated with the all aluminum structure of the nominal configuration are shown in figure 18. A 20-percent increase and a 40-percent decrease from the nominal wing weight was considered, and should cover almost any material or method of construction. The relatively high reduction of 40 percent was used as a lower value since there are indications that a wing weight savings of as much as 35 percent may be realized through the use of composite materials and improved structural arrangements. As shown in figure 18(a), the gross weight of the configuration is reduced significantly with a decrease in wing weight, but there is a slight loss in combat performance at $M = 1.2$ (fig. 18(c)).

Figure 19 presents the effects of variations in payload weight from 36 to 227 kg (80 to 500 lb). The payload consists of two missiles, one mounted on each side of the nacelle. As previously indicated, the nominal configuration carries two infrared seeking missiles, each weighing 72.5 kg (160 lb) (a total of 145 kg (320 lb)). As the weight of the weapons is varied, their size and

drag are appropriately taken into account. An empirical procedure based on available data is used to estimate the drag level of each missile size. Of course, each weapon system and mounting scheme should be investigated in the wind tunnel to establish the exact aerodynamic penalty. The vehicle gross weight obviously increases with heavier weapons, but its combat performance is only slightly affected (fig. 19(c)).

Mission Parameter Sensitivities

Cruise Mach number and altitude— Figure 20 shows the effects of lowering the cruise Mach number (both out and back) below the nominal value of 0.9. There is only a slight advantage in vehicle weight to cruising at a lower speed. The combat performance is not affected by changing cruise Mach number (fig. 20(c)). The vehicle gross weight seems to be more affected by variations in cruise altitude (out and back) (fig. 21(a)). As the cruise altitude is increased up to 15,240 m (50,000 ft), the gross weight decreases continuously. Improved cruise performance is obtained at higher altitudes because of the very low wing loading of this configuration. A cruise altitude of 13,716 m (45,000 ft) is used for the nominal mission. The combat performance is affected only slightly by cruise altitude (fig. 21(c)).

Combat altitude and Mach number— Figure 22 shows the effects of changes from the nominal combat altitude of 9144 m (30,000 ft) on vehicle weight and combat performance. The minimum gross weights occur for altitudes between about 9144 to 12,192 m (30,000 to 40,000 ft); above or below this, the vehicle weight increases significantly (fig. 22(a)). Combat altitude also has a very significant effect on the combat performance of the RPV (fig. 22(c)). Because of reduced engine performance with increasing altitude, both the specific power for 1-g flight and the sustained turn rate (and the corresponding sustained load factor) decrease steadily with increasing combat altitude for the combat Mach number of 1.2. For $M = 0.9$, these performance characteristics differ slightly in that, for altitudes below about 7925 m (26,000 ft), the vehicle reaches its limiting load factor before P_S is reduced to zero (for maximum power); therefore, the sustained turn rate equals the maximum instantaneous turn rate (fig. 22(c) concluded). The acceleration time greatly increases for combat altitudes above about 10,668 to 12,192 m (35,000 to 40,000 ft) because of the aforementioned loss in engine thrust with increasing altitude (fig. 22(c) concluded). This configuration has sufficient lift to maintain a constant maximum instantaneous load factor of 11 at all altitudes shown for both Mach numbers. To accomplish this, the angle of attack varies from approximately 7 to 30° for the altitude range considered in figure 22(c) concluded. (Note that the analysis is based on linear theory and, at the higher values of lift, the expected nonlinear curves could lead to angles of attack higher than those shown.) Thus it is apparent that, for this oblique, all-wing configuration, the aerodynamic characteristics (as well as the characteristics of the air-induction system) need to be investigated to high angles of attack in the wind tunnel since the prediction methods used for these nonlinear conditions are not well developed.

Figure 23 shows the effects of increasing the supersonic combat Mach number above the nominal mission value of 1.2. Up to approximately 1.5, there is little effect of supersonic combat Mach number on vehicle weight (fig. 23(a)); above this, the gross weight begins to increase. The combat performance for both the $M = 0.9$ and the supersonic legs of the mission is shown in figure 23(c). The major changes occur for the supersonic combat Mach numbers. Therefore, figure 23(c) concluded presents only the variations in combat effectiveness for vehicles designed for

different supersonic combat Mach numbers. For the upper Mach numbers, the vehicle again cannot perform a sustained turn at maximum power without gaining energy because of its high performance.

The effects of decreasing the subsonic combat Mach number below the nominal mission value of 0.9 are presented in figure 24. A decreasing gross weight is noted with decreasing Mach number and there are some significant changes in combat effectiveness. Since figure 24(c) indicates that the major performance changes occur at the subsonic Mach number, figure 24(c) concluded presents only the subsonic combat results. As the Mach number is reduced, there is a loss in P_G for the 1-g flight condition, but an increase in both sustained and maximum instantaneous turn rates (fig. 24(c) concluded).

Combat radius and maneuvers— Figure 25 shows the effects of variations in the combat radius from 185 to 741 km (100 to 400 n.mi.). As the range increases, the vehicle gross weight increases and the vehicle size increases since the total fuel supply is carried internally in the wing. The nominal vehicle weighs 2175 kg (4795 lb) for the 370 km (200 n.mi.) mission; to double this combat radius to 740 km (400 n.mi.), the RPV would weigh approximately three times as much (some 6676 kg (14,719 lb)). The use of external fuel tanks or air launch becomes more attractive for the longer range missions. The changes in combat performance (fig. 25(c)) are associated with the relative weights of the vehicles upon reaching the combat area; that is, for the same takeoff thrust/weight ratio, the vehicle flying the longer range mission uses up more fuel and therefore has a relatively higher T/W (and slightly higher performance) upon reaching the combat zone.

The results in figure 25 are expanded to include the additional effect on RPV gross weight of variations in the number of supersonic and subsonic combat turning maneuvers (fig. 26). The nominal curve (repeated from fig. 25) is for three supersonic ($M = 1.2$) and four subsonic ($M = 0.9$) turns of 360° at $P_G = 0$. For the nominal configuration (tic mark), this results in a total combat time at maximum power of about 4.5 min (including acceleration time from $M = 0.9$ to 1.6). As the number of turns is reduced, the vehicle becomes lighter for any given range (fig. 26). For example, considering curve *D* (one supersonic and one subsonic turn) for the 370 km (200 n.mi.) range, the vehicle weight is about 1665 kg (3670 lb) and the total combat time is on the order of 2.4 min. Thus, the range and turning maneuver requirements can effect the gross weight of the RPV significantly.

Sensitivity Factors

The effects of variations in both vehicle and mission parameters on the RPV weight and combat performance have been presented. The range of the individual parameters was large enough to exhibit the overall, nonlinear sensitivity characteristics. Another method of presenting the results is in terms of sensitivity factors based on local slopes about the nominal configuration. (The sensitivity factor was defined previously.)

The sensitivity factors as determined previously are presented in table 2 for both vehicle and mission parameters (for $M = 0.9$ and 1.2 at 9144 m (30,000 ft)). The gross weight sensitivity factors are given for variations in all vehicle and mission parameters and, where significant changes in combat performance were noted, sensitivity factors that show this are also presented. The first

column in the table lists the parameter (P) being varied and the other columns show the sensitivity factors. The arrows indicate the desired direction of the sensitivity factors, that is, it is desirable to have the gross weight and acceleration times decrease and the three combat performance factors increase. If a sensitivity has a sign that indicates movement in the desired direction, then an increase in the parameter is beneficial and conversely. A brief survey of table 2 shows that the following parameters have a sensitivity factor greater than 1, indicating a significant effect of that parameter on either weight or combat performance:

Gross weight – $W/S, C_{D_0}$
 (W_g)

Acceleration time – $W/S, T/W, (AR)_{wing}, (t/c)_{wing}$
 (Acc)

Specific power at 1-g flight ($\dot{\theta} = 0$) – $W/S, T/W, (AR)_{wing}, (t/c)_{wing},$
 $(P_{S_{1g}})$ combat altitude, combat M

Sustained turn rate ($P_S = 0$) – $T/W, (AR)_{wing}, (t/c)_{wing},$ combat altitude,
 $(\dot{\theta}_s)$ supersonic combat M

Specific power for maximum instantaneous turn rate – $W/S, T/W, N_{Z_{ult}}, (AR)_{wing},$
 $(t/c)_{wing},$ combat altitude, supersonic combat M

The configuration parameters that appear most frequently are changes in vehicle wing loading, thrust/weight ratio, wing aspect ratio, and wing maximum thickness/chord ratio. Combat altitude and Mach number have a particularly significant effect on the combat performance of the vehicle. Again, note that the sensitivity factors indicate only the local effects about the nominal configuration point and that the parametric trade curves presented previously should be consulted for detailed effects.

CONCLUDING REMARKS

A computerized aircraft synthesis program has been used to assess the effects of various vehicle and mission parameters on the performance of an oblique, all-wing, remotely piloted vehicle (RPV) for the highly maneuverable, air-to-air combat role. The results are presented in terms of both the required vehicle weight to accomplish a specified mission and the combat effectiveness as measured by turning and acceleration capability.

By use of an optimization process, a nominal configuration has been established which has a minimum gross weight of 2175 kg (4795 lb) and has sufficient internal wing volume for fuel and equipment to accomplish the study mission. In comparison to a previously studied conventional wing-body canard design for the same mission (as well as compared to advanced manned fighters), this oblique, all-wing concept is lighter in weight and has higher performance. A prime factor attributing to the high maneuvering performance of this concept is its low optimum wing loading of 1.11 kN/m^2 (23.1 lb/ft^2) at launch.

Compared to advanced manned fighters, a relatively modest optimum thrust/weight ratio of 1.12 (at launch) is used which tends to reduce the weight and therefore the cost of the propulsion system, but results in some reduction in acceleration performance. An assessment of the effects of this reduced acceleration capability on the overall RPV combat performance should be made from combat simulation studies.

The principal results of sensitivity studies that use the nominal vehicle as a base point are:

1. The configuration characteristics that effect the vehicle weight and combat performance significantly are wing loading, thrust/weight ratio, wing aspect ratio, and wing maximum thickness/chord ratio. Combat altitude and combat Mach number strongly influence the maneuvering performance of the vehicle. Additional studies are needed to better assess the amount of maneuvering time required of an air-to-air combat RPV. These studies should account for the characteristics of the weapons system and the capabilities of the opponent.

2. Of the aerodynamic characteristics considered in the sensitivity studies, changes in the drag coefficient at zero lift have the greatest effect on the weight of this all-wing concept.

3. Increasing combat altitude resulted in excursions to relatively high angles of attack (up to 30°). Thus, it is apparent that methods of high angle-of-attack aerodynamic analysis need further experimental verification, particularly wind-tunnel tests of the aerodynamic and inlet characteristics over a wide range of angle of attack and Mach number for this type of configuration.

4. Advances in technology that lead to reduced structural weights and lower fixed equipment weights are shown to reduce the RPV gross weight, but tradeoffs against cost and a slight performance degradation should be considered.

5. The results indicate that increased combat performance can be designed into this oblique, all-wing RPV by any of several methods such as increasing thrust/weight ratio, lowering wing loading, increasing limiting load factors, as well as changes in several other vehicle parameters, or a combination of these. However, these improvements in performance generally are at the expense of significant increases in vehicle gross weight and therefore in cost. Thus, studies should be pursued to assess the level of combat performance required in a highly maneuverable RPV.

Ames Research Center
National Aeronautics and Space Administration
Moffett Field, Calif., 94035, February 27, 1974

REFERENCES

1. Nelms, Walter P., Jr.; and Axelson, John A.: Preliminary Performance Estimates of a Highly Maneuverable Remotely Piloted Vehicle. NASA TN D-7551, 1973.
2. Staff of AiResearch Manufacturing Co.: Parametric Engine Performance Data for Remotely-Piloted Vehicle Application. Rept. PE-8215-R, Rev. 2 (A division of Garrett Corp., Phoenix, Arizona), June 1971.
3. Vanderplaats, Garret N.; and Moses, Fred: Structural Optimization by Methods of Feasible Directions. Computers and Structures, vol. 3, July 1973, pp. 739-755.
4. Vanderplaats, Garret N.: CONMIN: A Fortran Program for *Constrained Function Minimization*: User's Manual. NASA TM X-62,282, 1973.
5. Graham, Lawrence A.; Jones, Robert T.; and Boltz, Frederick W.: An Experimental Investigation of an Oblique-Wing and Body Combination at Mach Numbers Between 0.60 and 1.40. NASA TM X-62,207, 1972.
6. Shapiro, Ascher H.: The Dynamics and Thermodynamics of Compressible Fluid Flow, vol. II, Ronald Press Co., 1954.
7. Koelle, Heinz Herman: Handbook of Astronautical Engineering, McGraw-Hill Book Company, Inc., 1961.
8. Jones, R. T.; and Cohen, Doris: Aerodynamics of Wings at High Speeds. In: Aerodynamic Components of Aircraft at High Speeds, Eds.: A. F. Donovan and H. R. Lawrence, vol. VII, Princeton Univ. Press, 1957.
9. Woodward, F. A.; Tinoco, E. N.; and Larsen, J. W.: Analysis and Design of Supersonic Wing-Body Combinations, Including Flow Properties in the Near Field, Part I: Theory and Application. NASA CR-73106, 1967.
10. Waters, Mark H.: Transonic Transport Study-Propulsion Systems. NASA TM X-62,158, 1972.
11. Millikan, Clark B.: Aerodynamics of the Airplane. John Wiley & Sons, Inc., 1941.
12. Jones, R. T.: Reduction of Wave Drag by Antisymmetric Arrangement of Wings and Bodies. AIAA J., vol. 10, no. 2, Feb. 1972, pp. 171-176.
13. Sanders, K. L.: Aircraft Predesign Weight Estimation Handbook, vol. I, Gross, Empty and Structure Weight. Rept. 29244-2, Ryan Aeronautical Co., 1965.
14. Sanders, K. L.: Wing Weight Correlation and Preliminary Estimation Method, with Special Emphasis on Drones and Advanced Structural Materials. ASTM 71-49, Teledyne Ryan Aeronautical Co., Nov. 1967.
15. Fellers, W. E.; and Patierno, J.: Fighter Requirements and Design for Superiority Over Threat Aircraft at Low Cost. AIAA paper 70-516, American Institute of Aeronautics and Astronautics, Atmospheric Flight Mechanics Conference, May 1970.
16. Rutowski, Edward S.: Energy Approach to the General Aircraft Performance Problem. Presented at Annual Summer Meeting, IAS, Los Angeles, July 1953, IAS Preprint 420.
17. Boyd, John R.; and Christie, Thomas P.: Energy-Maneuverability Theory, Rept. APGC-TDR-62-64-35 (Secret). A. F. Systems Command Air Proving Ground Ctr., Eglin AFB, Fla., May 1964.

TABLE 1.- MISSION PERFORMANCE SUMMARY OF THE NOMINAL CONFIGURATION

		Fuel and time	
Mission leg	Power setting	Fuel used, kg (lb)	Time, min
Climb	Intermediate	128.7 (283.7)	5.16
Cruise out	Cruise	157.9 (348.1)	20.35
Acceleration ($M = 0.9$ to 1.6)	Maximum afterburning	88.7 (195.5)	1.18
Supersonic turns ($M = 1.2$)	Maximum afterburning	146.6 (323.3)	2.02
Subsonic turns ($M = 0.9$)	Maximum afterburning	71.4 (157.5)	1.27
Cruise back	Cruise	174.7 (385.2)	23.25
Descent and reserves		22.7 (50.0)	
	Total fuel =	790.7 (1743.3)	
Combat performance			
Supersonic turns ($M = 1.2$)	$P_{S_1g} = 85$ m/sec (279 ft/sec) $\dot{\theta}_s = 8.92$ deg/sec $NZ_s = 5.9$ Sustained turn radius, 2338 m (7669 ft)	$P_{S_i} = -219$ m/sec (-719 ft/sec) $\dot{\theta}_i = 16.93$ deg/sec $NZ_i = 11.0$ Maximum instantaneous turn radius, 1231 m (4040 ft)	
Subsonic turns ($M = 0.9$)	$P_{S_1g} = 148$ m/sec (487 ft/sec) $\dot{\theta}_s = 18.90$ deg/sec $NZ_s = 9.2$ Sustained turn radius, 827 m (2714 ft)	$P_{S_i} = -58$ m/sec (-191 ft/sec) $\dot{\theta}_i = 22.57$ deg/sec $NZ_i = 11.0$ Maximum instantaneous turn radius, 693 m (2273 ft)	

TABLE 2.- SENSITIVITY FACTORS

Vehicle parameters						
Parameter (P) being varied	Weight (W_g)	Acceleration time (Acc)	Combat, M	P_{S1g}	$\dot{\theta}_s$	P_{Si}
	$\frac{\Delta W_g/W_g}{\Delta P/P} \downarrow$	$\frac{\Delta \text{Acc}/\text{Acc}}{\Delta P/P} \downarrow$		$\frac{\Delta P_{S1g}/P_{S1g}}{\Delta P/P} \uparrow$	$\frac{\Delta \dot{\theta}_s/\dot{\theta}_s}{\Delta P/P} \uparrow$	$-\left(\frac{\Delta P_{Si}/P_{Si}}{\Delta P/P}\right) \uparrow$
$\frac{W}{S}$	-1.198	-1.356	0.9 1.2	0 1.410	-0.416 .311	-3.877 -.885
$\frac{T}{W}$.750	-3.955	.9 1.2	.690 3.533	.356 2.160	1.466 1.090
$N_{Z_{ult}}$.447	-.186	.9 1.2	0 .275	0 .117	-7.055 -2.830
Wing AR	-.300	-2.025	.9 1.2	-.330 2.574	.118 1.665	1.556 1.894
Wing $\frac{t}{c}$.286	2.115	.9 1.2	.276 -1.581	.325 -1.474	1.458 -.841
Lift-curve slope	0	---	---	---	---	---
Zero-lift drag coefficient	1.579	---	---	---	---	---
Drag-due-to-lift coefficient	.278	---	---	---	---	---
Weapons drag coefficient	.226	---	---	---	---	---
Aerodynamic efficiency factor	-.295	---	---	---	---	---
Fixed equipment weight	.469	---	---	---	---	---
Fixed equipment density	0	---	---	---	---	---
Wing weight	.678	---	---	---	---	---
Payload weight	.334	---	---	---	---	---
Mission parameters						
Combat altitude	-.261	.777	.9 1.2	-1.335 -1.075	-1.164 -1.121	-7.984 -2.364
Combat Mach number						
• Supersonic	-.188	.198	---	9.140	2.489	2.462
• Subsonic	.203	-.085	---	1.355	-.857	0
Cruise Mach number	.203	---	---	---	---	---
Cruise altitude	-.678	---	---	---	---	---
Combat radius	.547	---	---	---	---	---

Combat - (altitude = 9144 m (30000 ft); maximum power)
 Acceleration from $M = 0.9$ to 1.6
 Three, $P_g = 0$ turns at $M = 1.2$
 Four, $P_g = 0$ turns at $M = 0.9$
 Payload - 2 Sidewinder class missiles 145 kg (320 lbs)

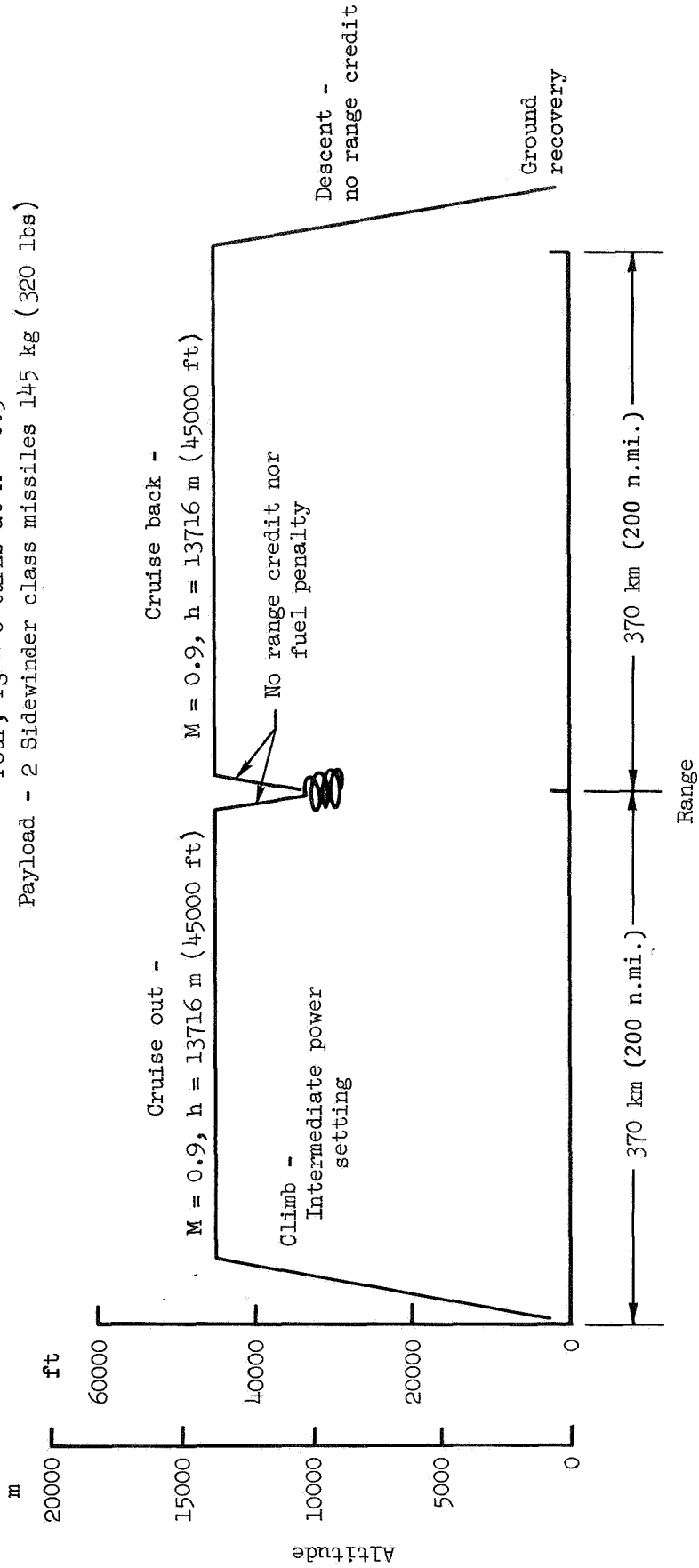
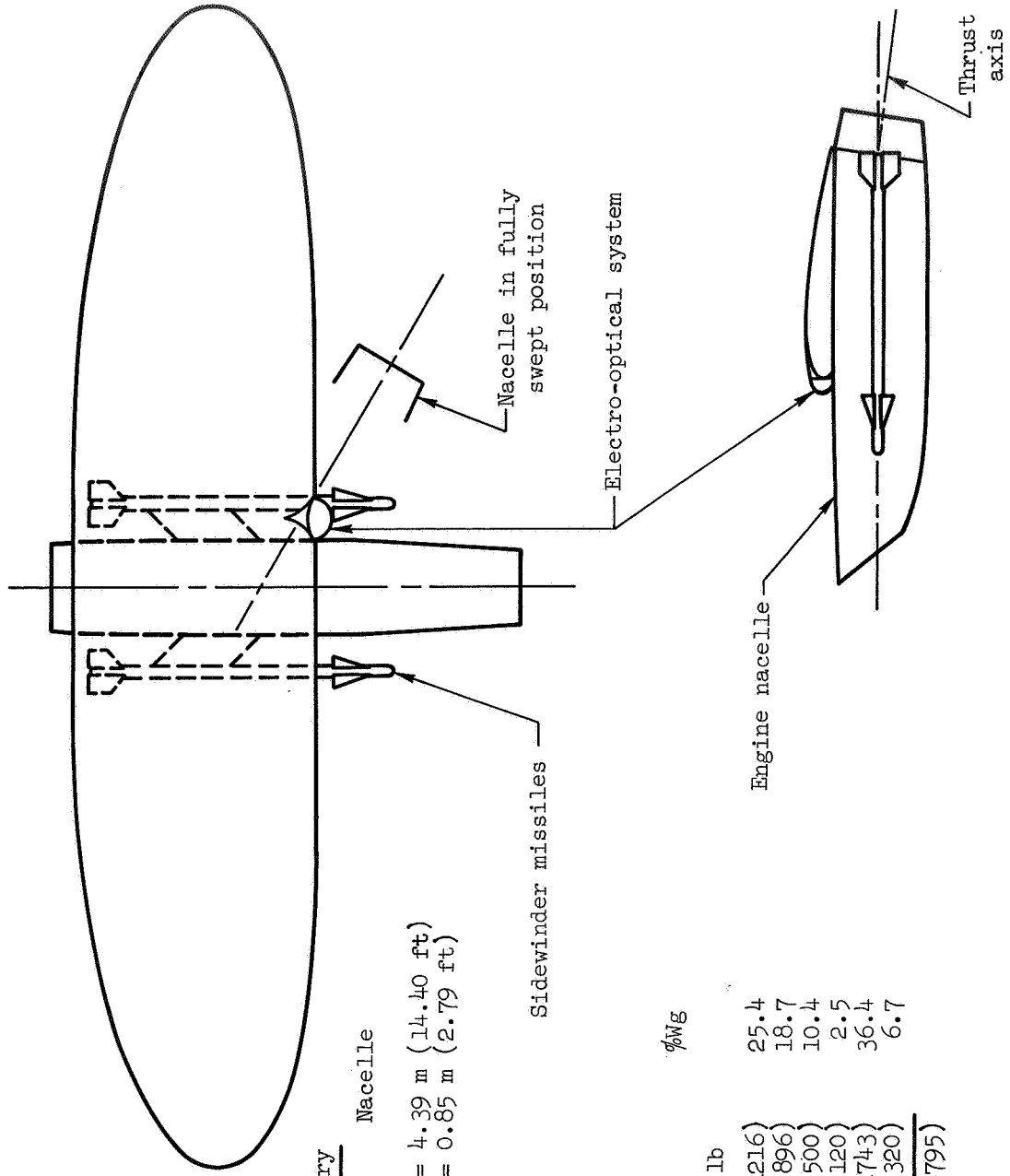

Figure 1.- Nominal mission.



$W/S = 1.11 \text{ kN/m}^2 \text{ (23.14 lb/ft}^2\text{)}$

$T/W = 1.12$

$MZ_{ult} = 11.0$

Geometry summary

Wing

$S = 19.25 \text{ m}^2 \text{ (207.22 ft}^2\text{)}$

$b = 10.91 \text{ m (35.81 ft)}$

$c_r = 2.25 \text{ m (7.37 ft)}$

$AR = 6.19$

$t/c = 0.096$

Nacelle

$l = 4.39 \text{ m (14.40 ft)}$

$d = 0.85 \text{ m (2.79 ft)}$

Sidewinder missiles

Weight statement

	Weight		∅Wg
	kg	lb	
Structure	552	(1216)	25.4
Propulsion	406	(896)	18.7
Fixed equipment	227	(500)	10.4
Residual load	54	(120)	2.5
Fuel	791	(1743)	36.4
Payload	145	(320)	6.7
	<u>Wg = 2175</u>	<u>(4795)</u>	

Figure 2.- Nominal configuration.

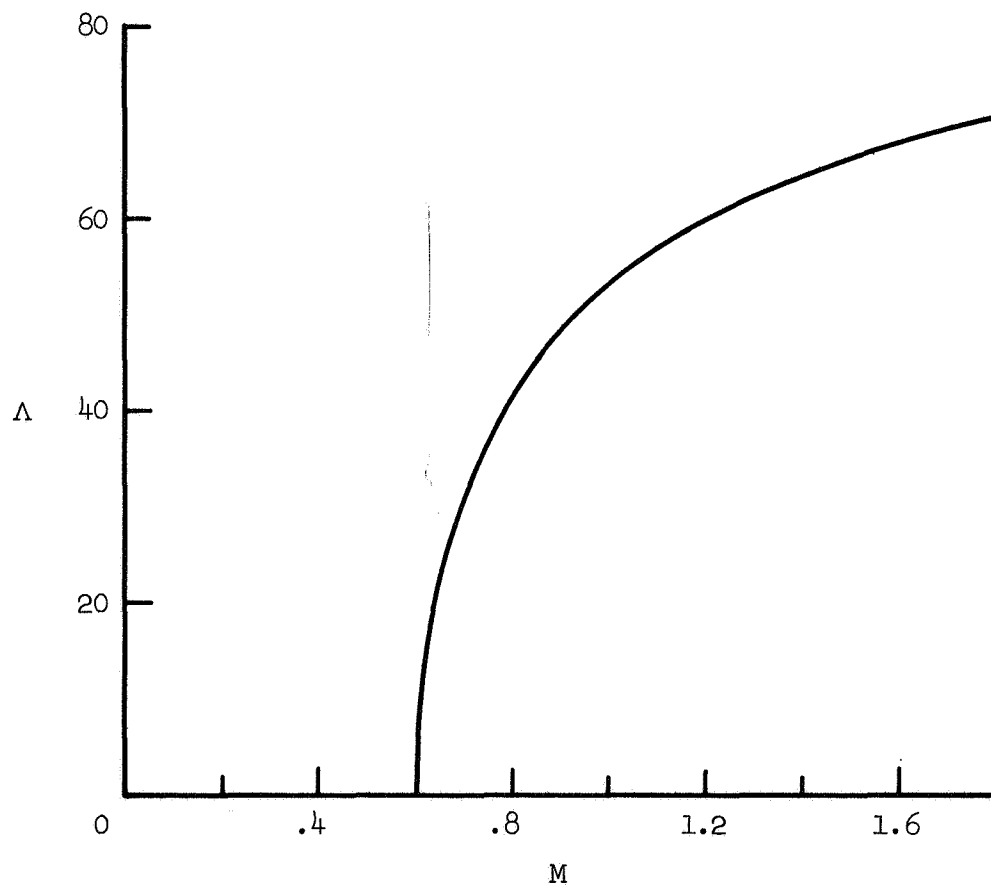

Figure 3.— Wing sweep as a function of Mach number.

Aircraft synthesis programs
(ACSINT)

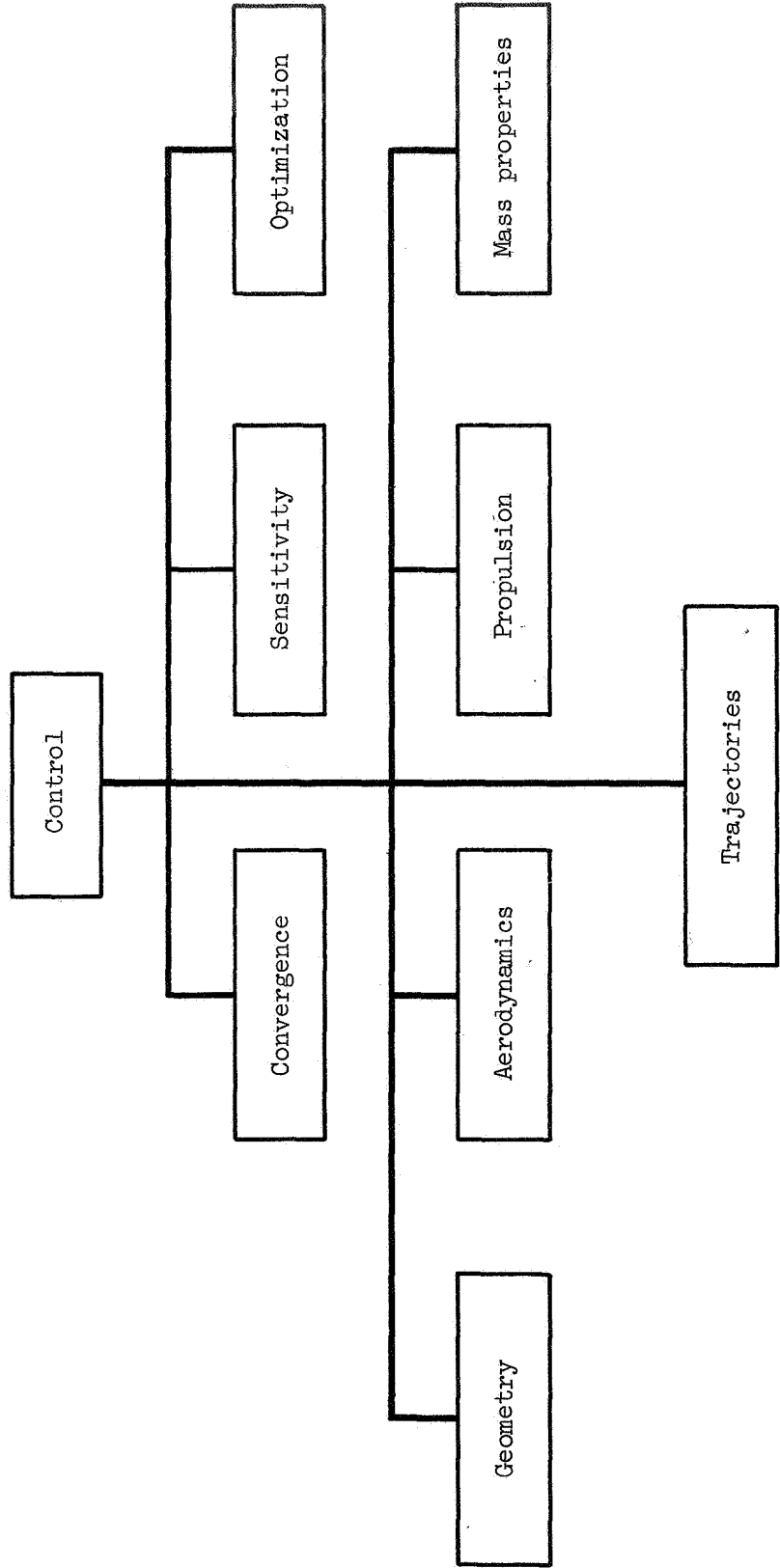
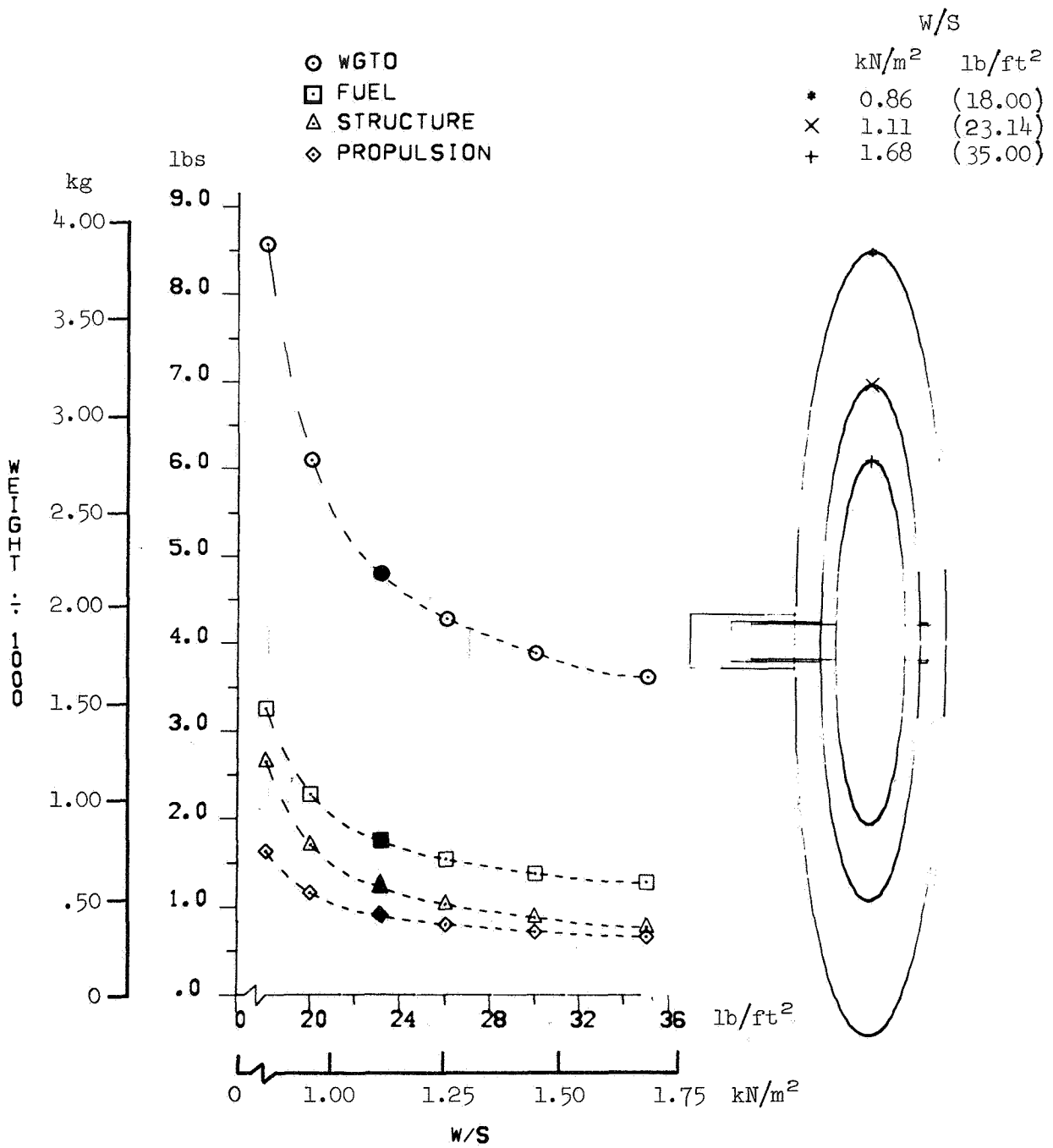
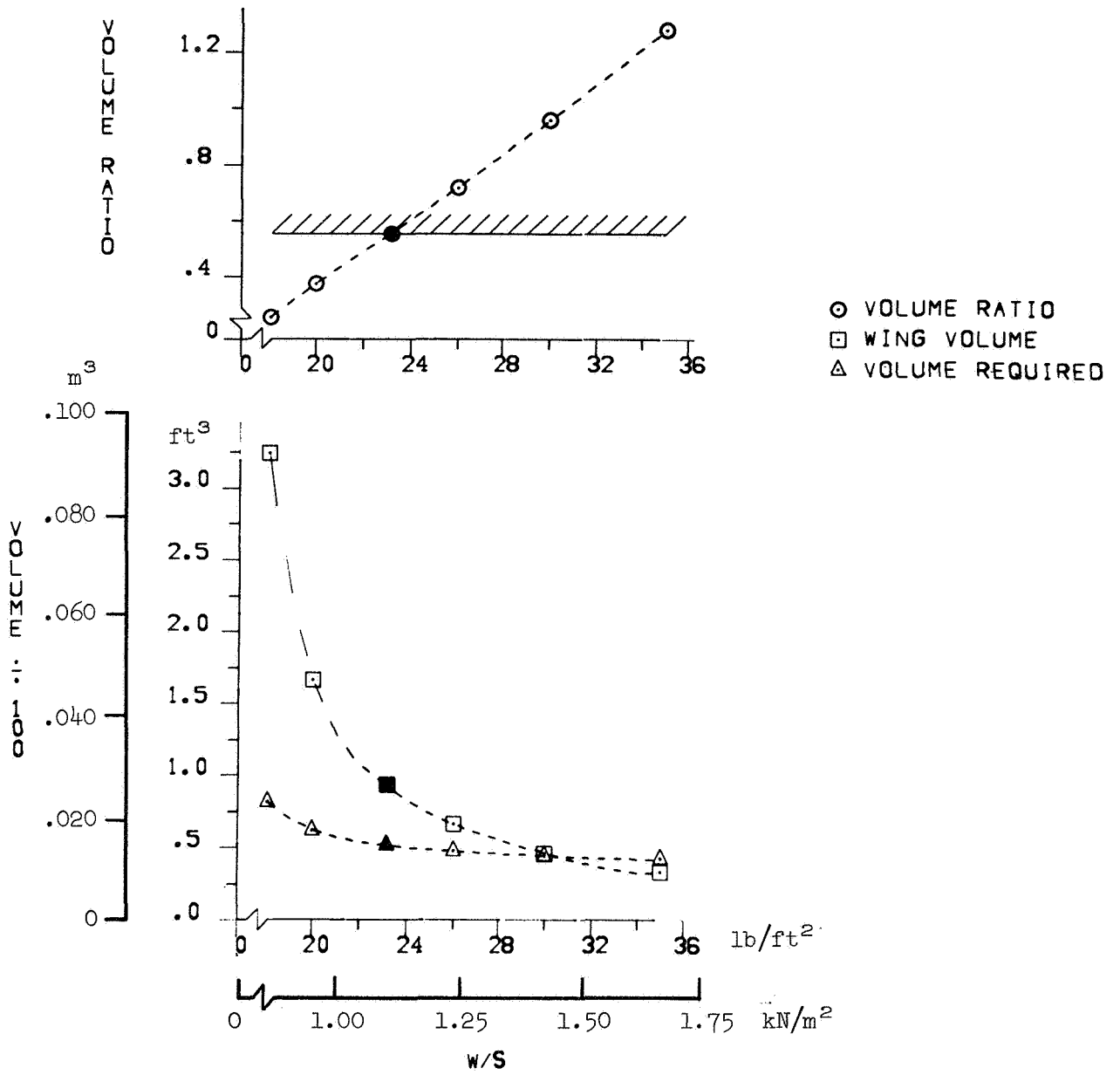

Figure 4.— Block diagram of synthesis program.



(a) Weights.

Figure 5.—Effect of wing loading.



(b) Volume.

Figure 5.— Continued.

	W/S	
	kN/m ²	lb/ft ²
○	0.86	(18.00)
■	1.11	(23.14)
△	1.68	(35.00)

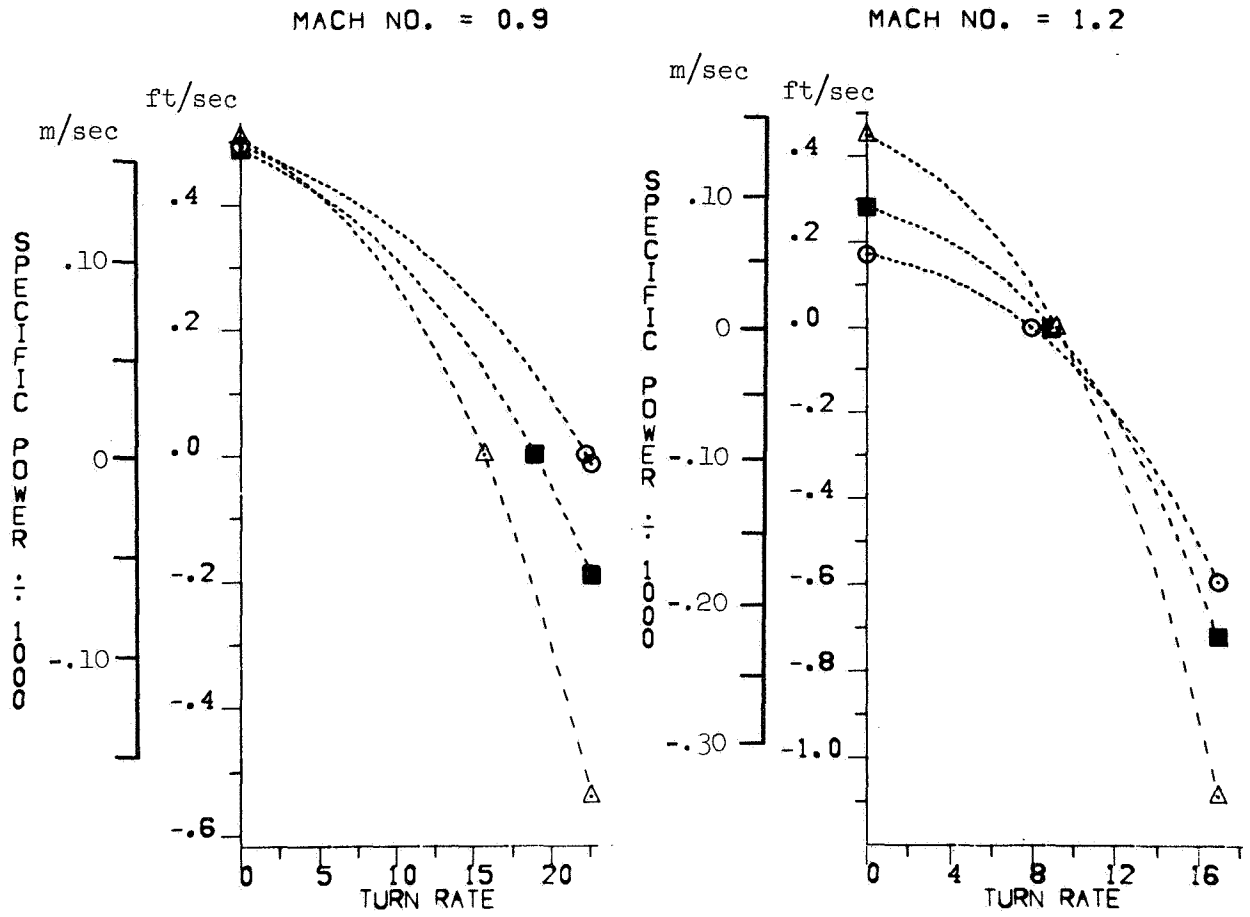

(c) Combat performance.

Figure 5.— Continued.

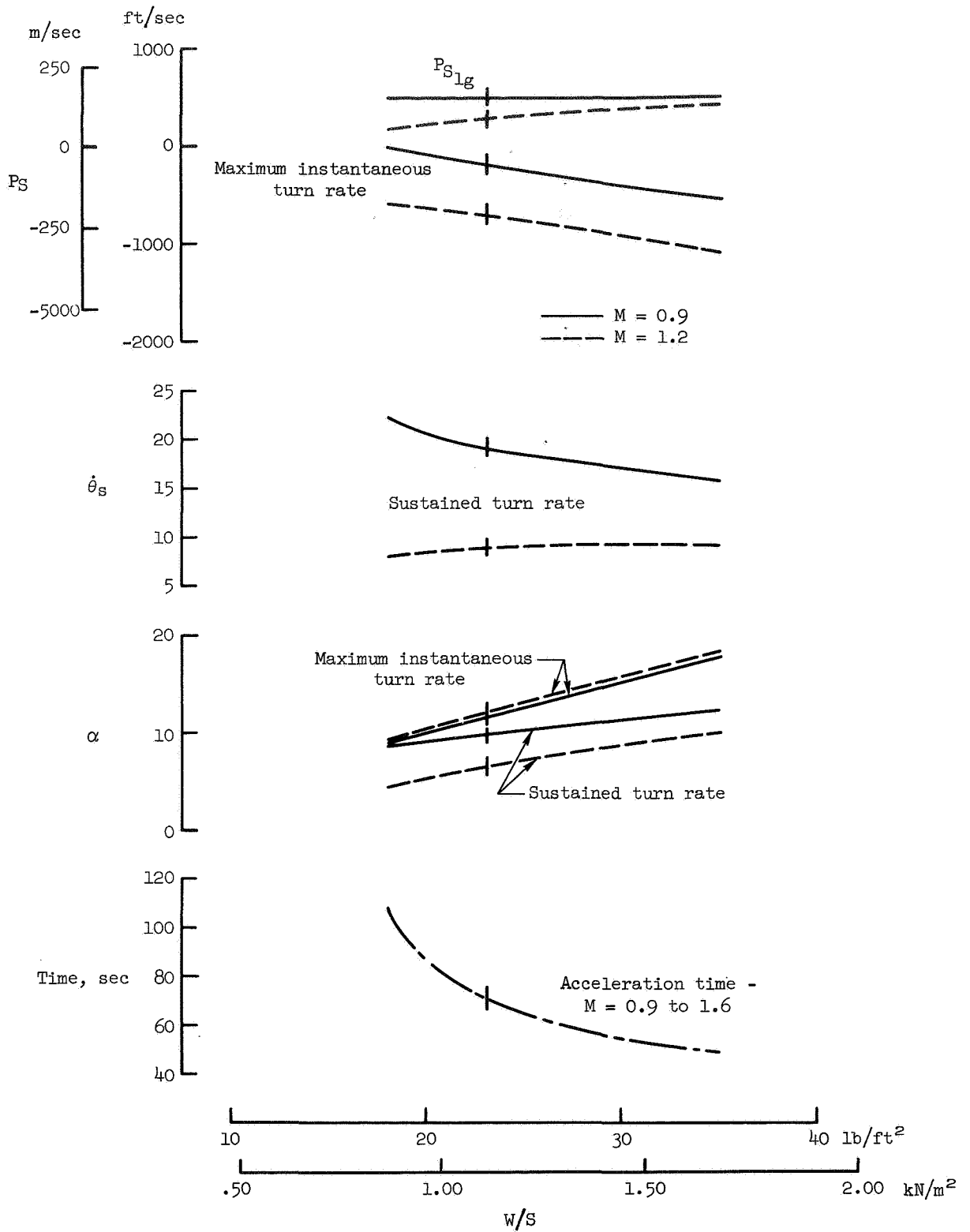

(c) Combat performance (concluded).

Figure 5.— Concluded.

Note: $VREQD/VWING$ is volume required in the wing for fuel plus fixed equipment divided by the total wing volume

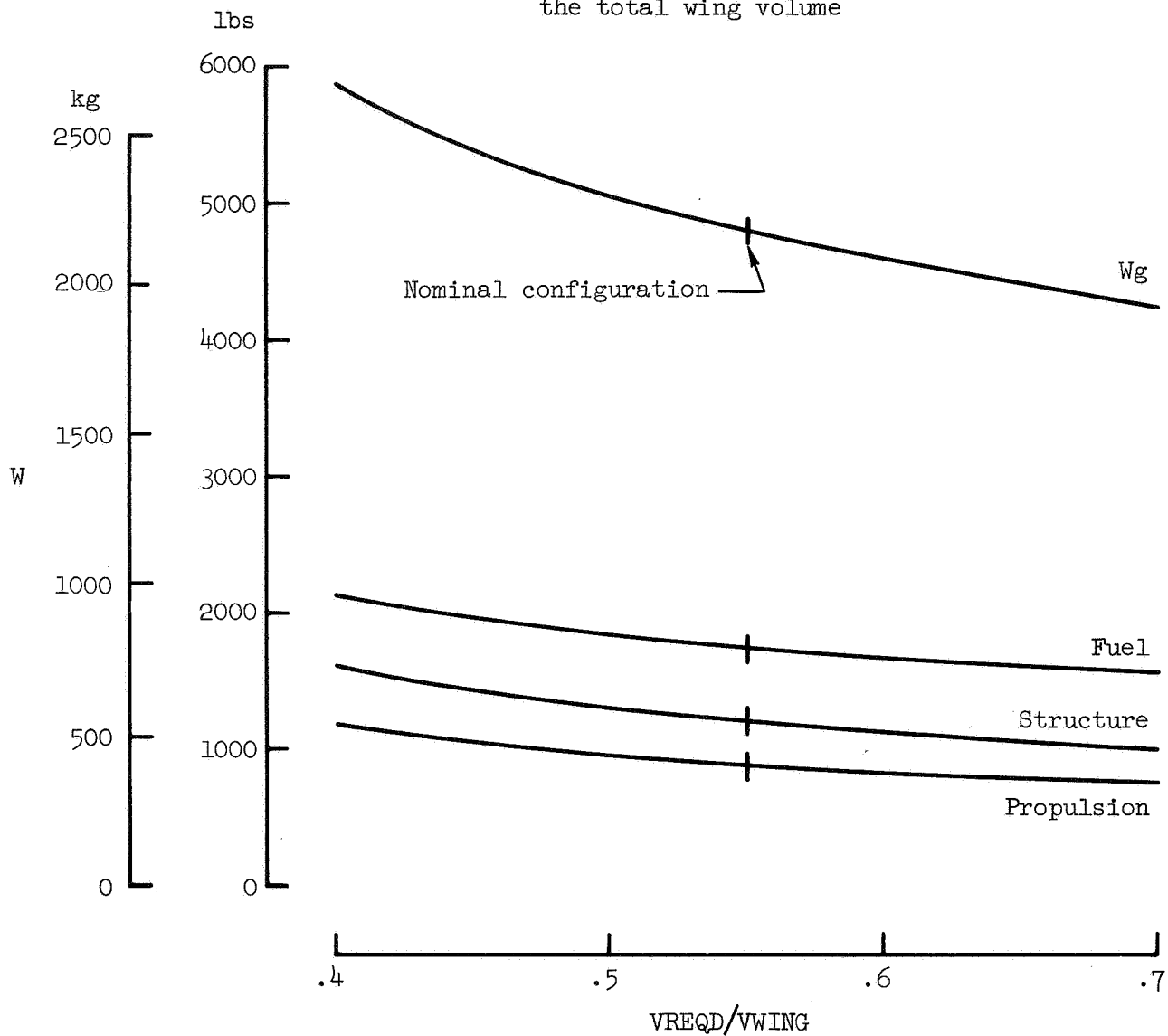

(a) Weights.

Figure 6.— Optimized configurations for various volume ratios.

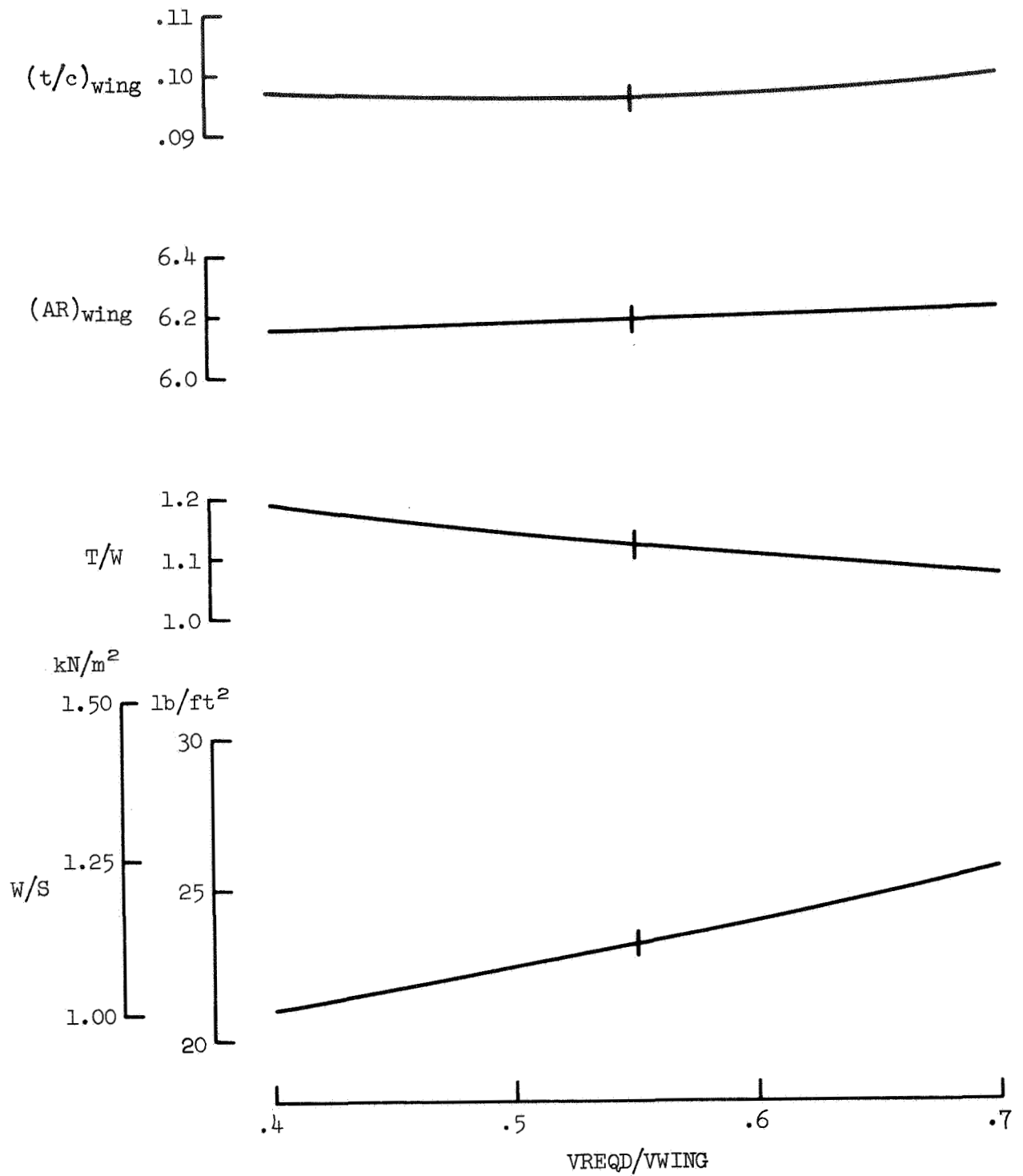

(b) Geometry.

Figure 6.— Continued.

VREQD/VWING

- 0.4
- 0.55
- 0.7

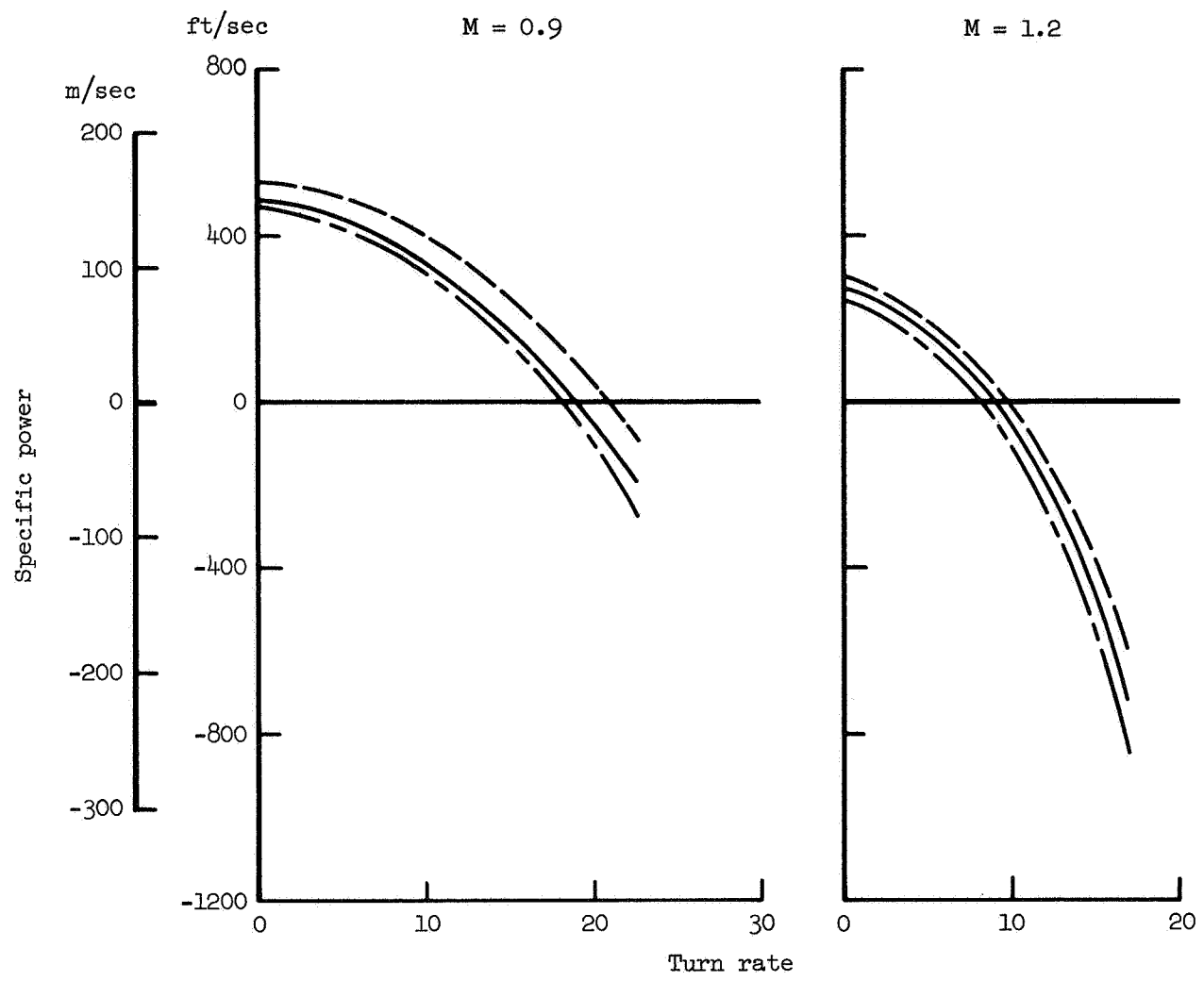

(c) Combat performance.

Figure 6.— Continued.

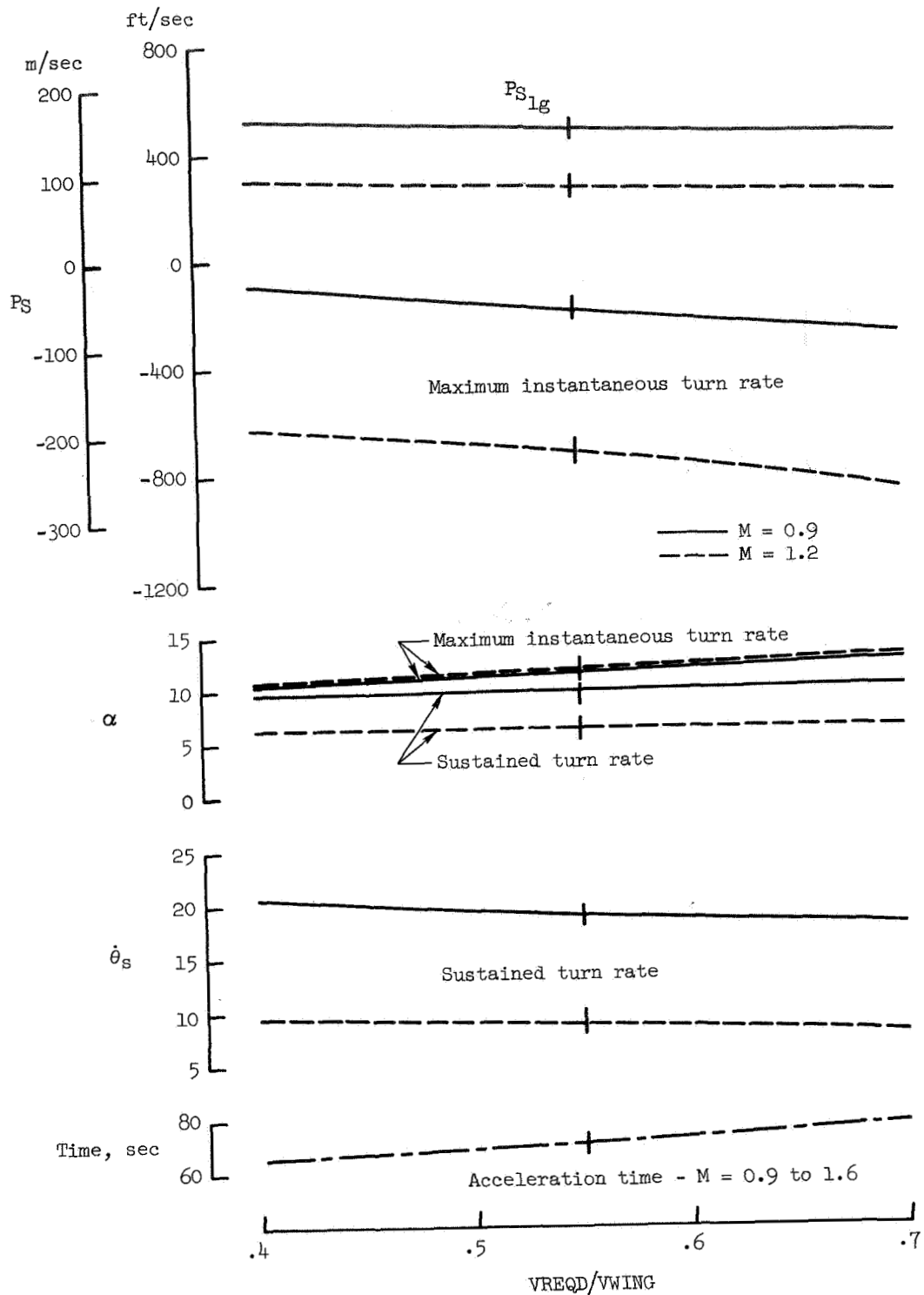

(c) Combat performance (concluded).

Figure 6.- Concluded.

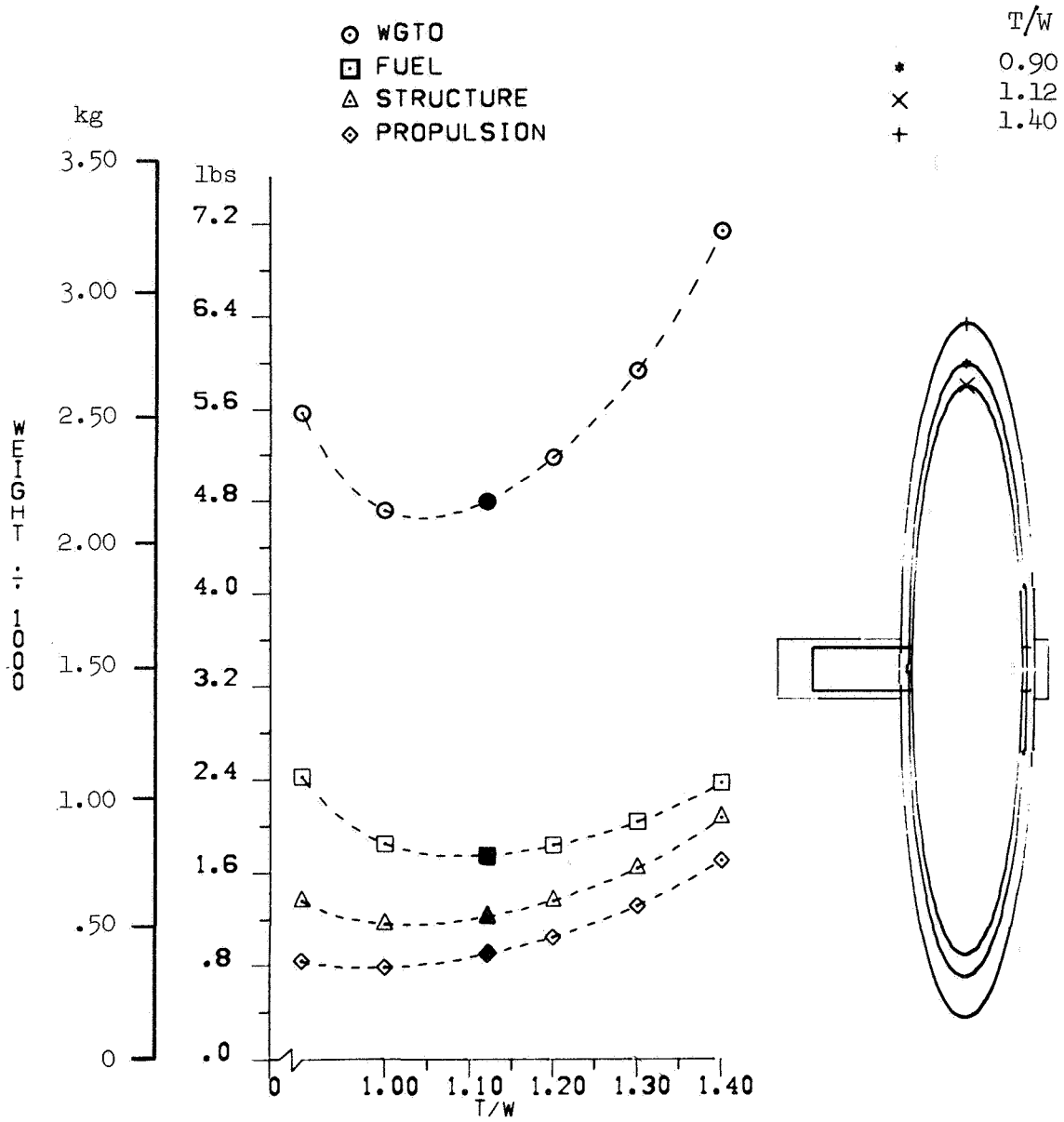

(a) Weights.

Figure 7.— Effect of thrust/weight ratio.

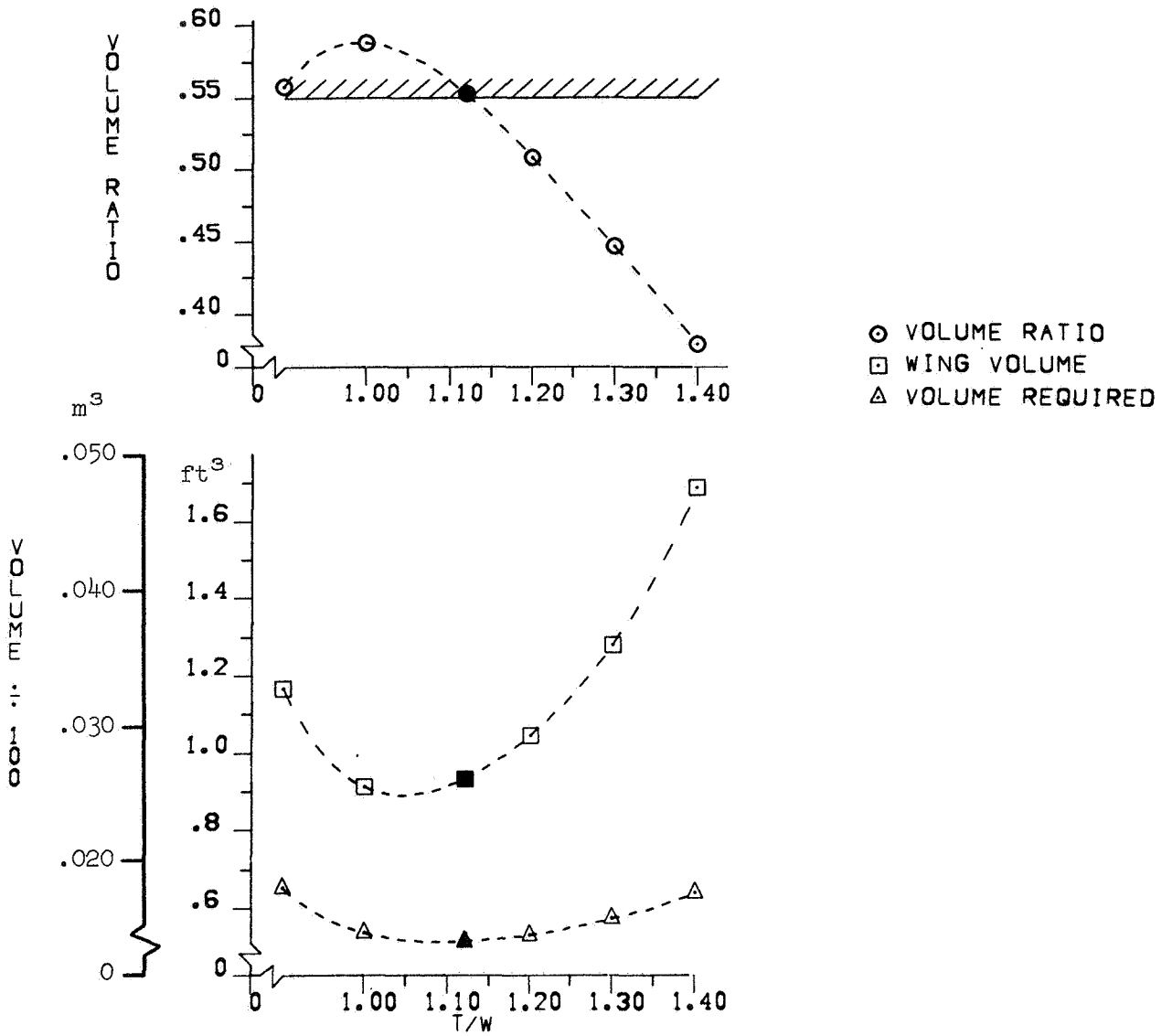

(b) Volume.

Figure 7.— Continued.

	T/W
○	0.90
■	1.12
△	1.40

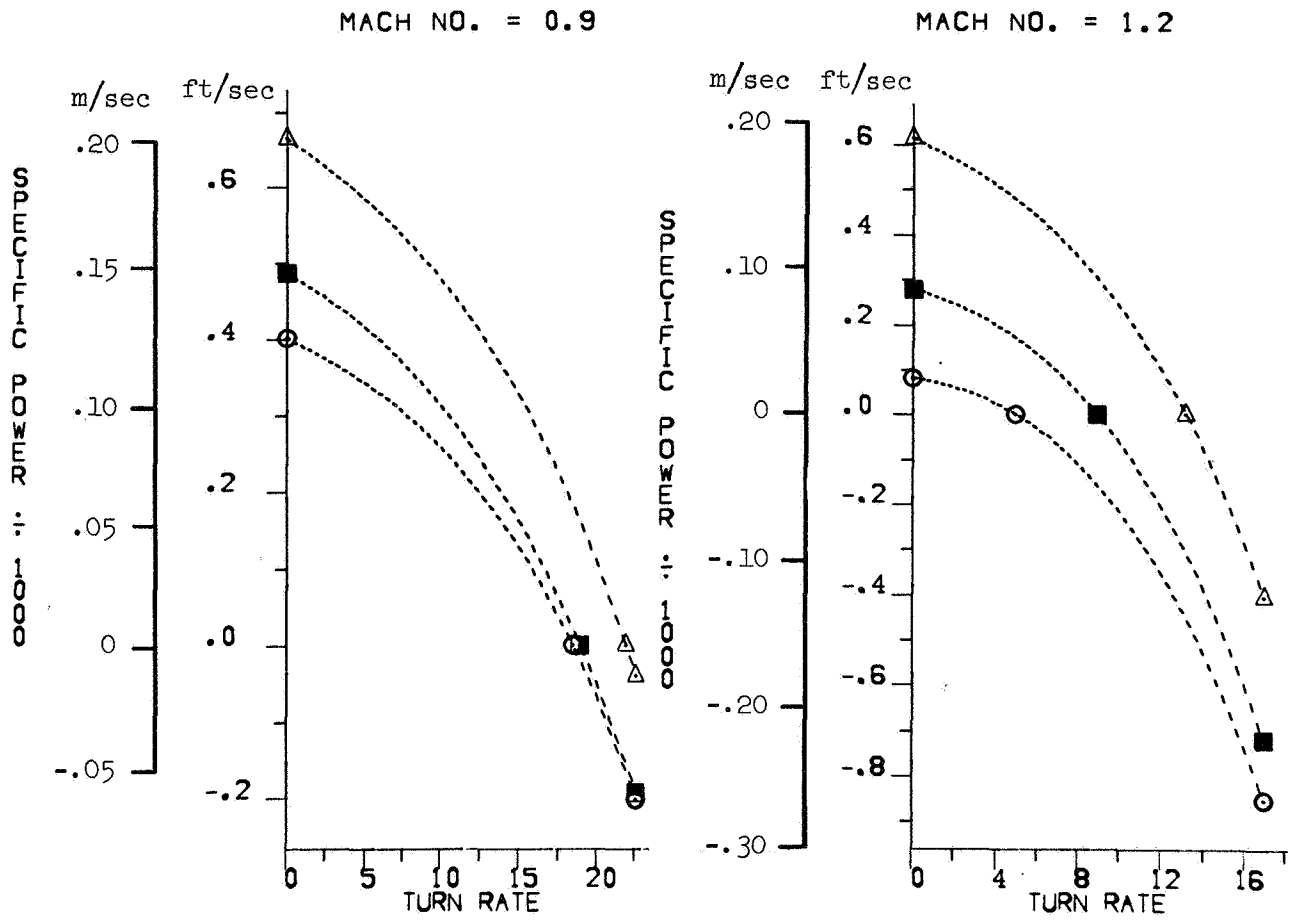

(c) Combat performance.

Figure 7.— Continued.

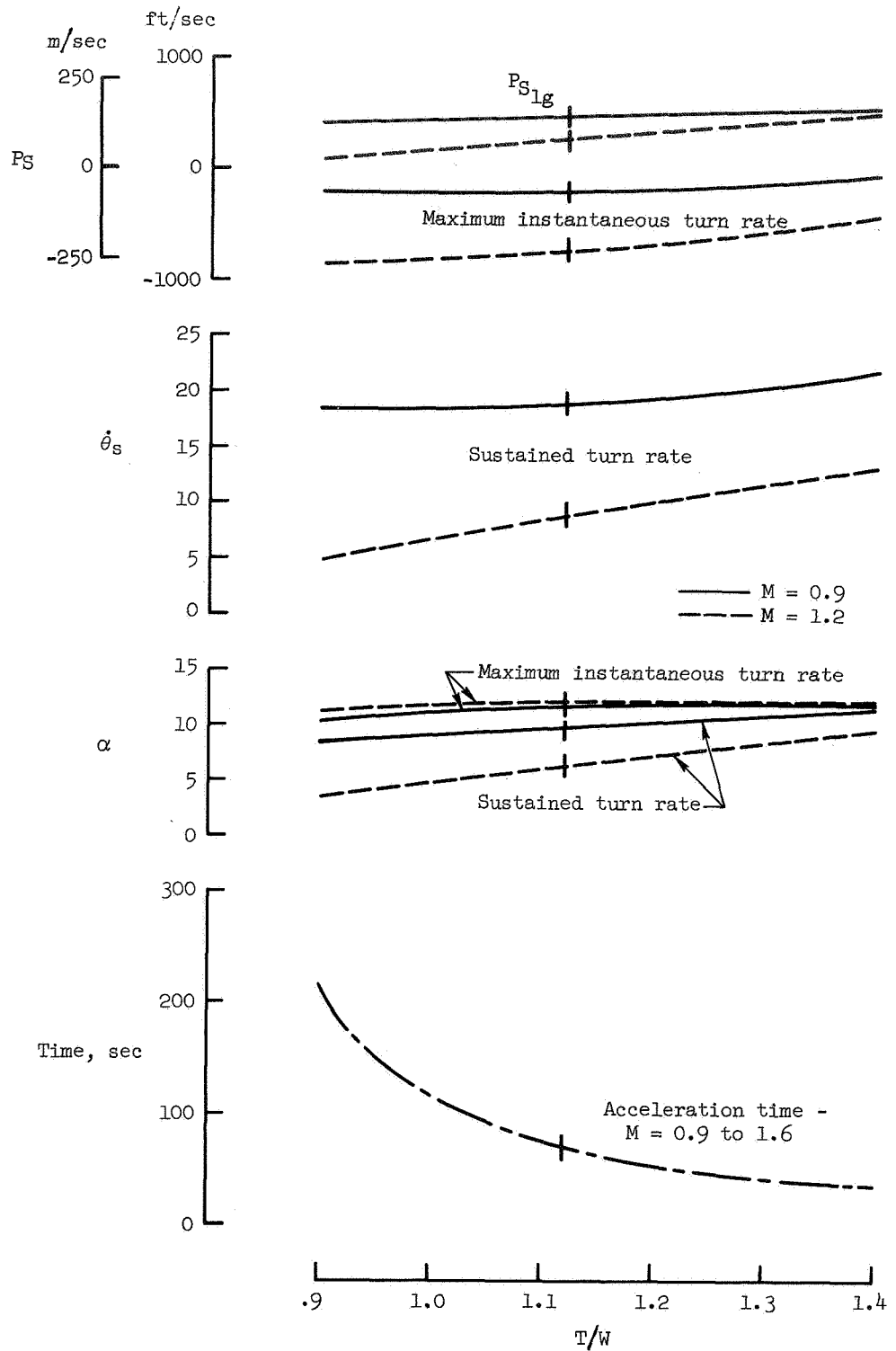

(c) Combat performance (concluded).

Figure 7.— Concluded.

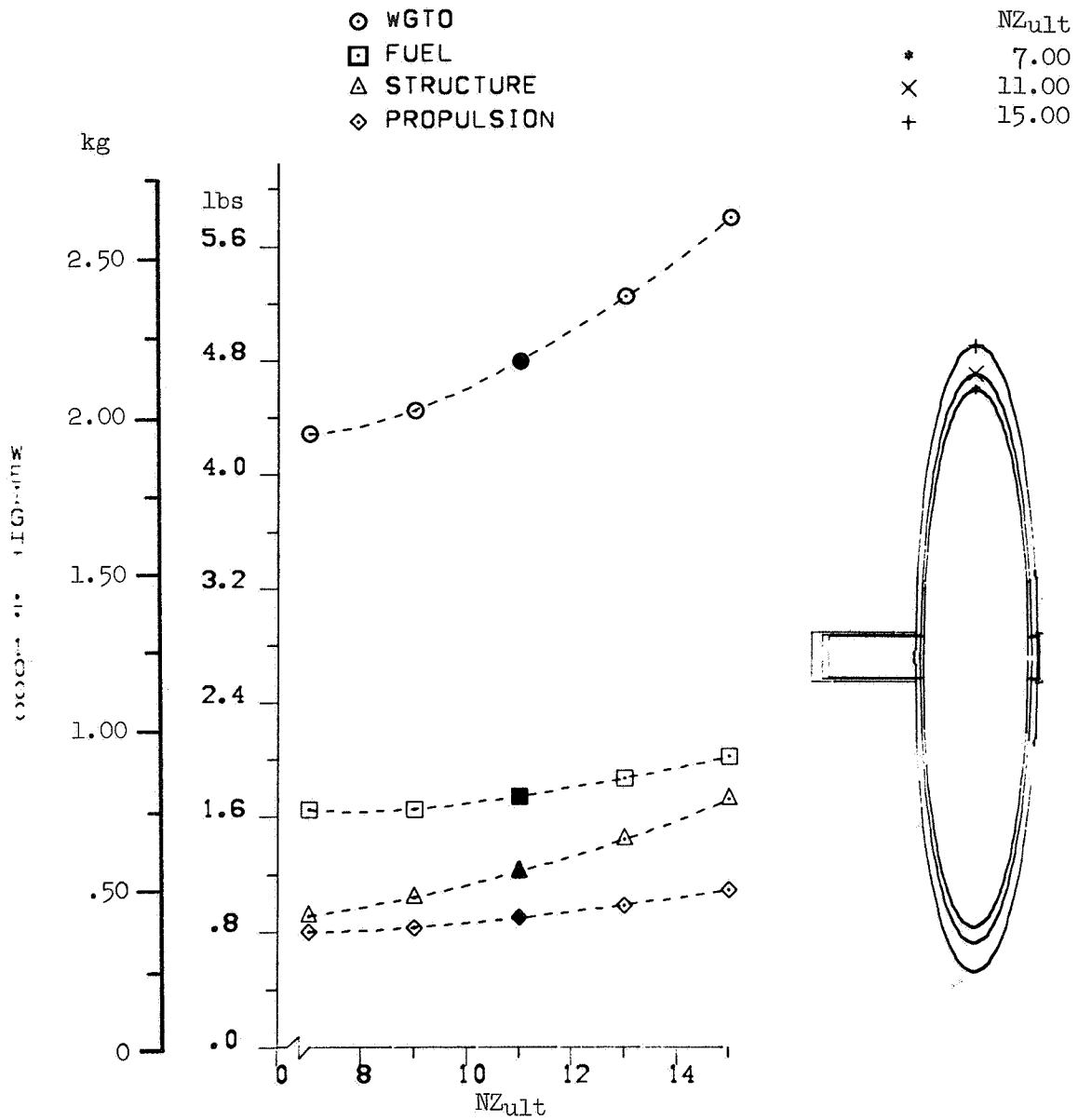

(a) Weights.

Figure 8.— Effect of ultimate load factor.

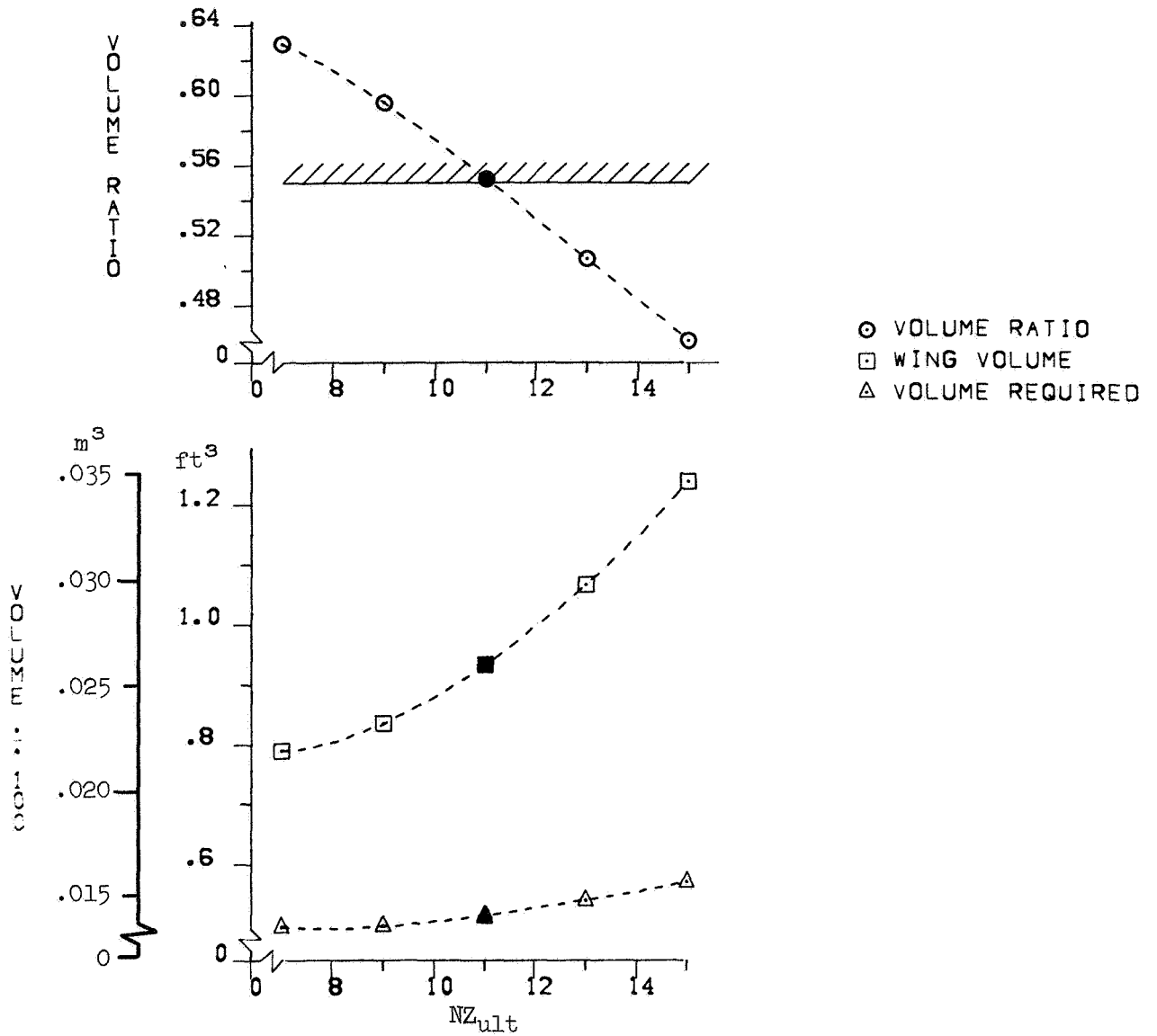

(b) Volume.

Figure 8.— Continued.

- NZ_{ult} 11.00
- 13.00
- △ 15.00

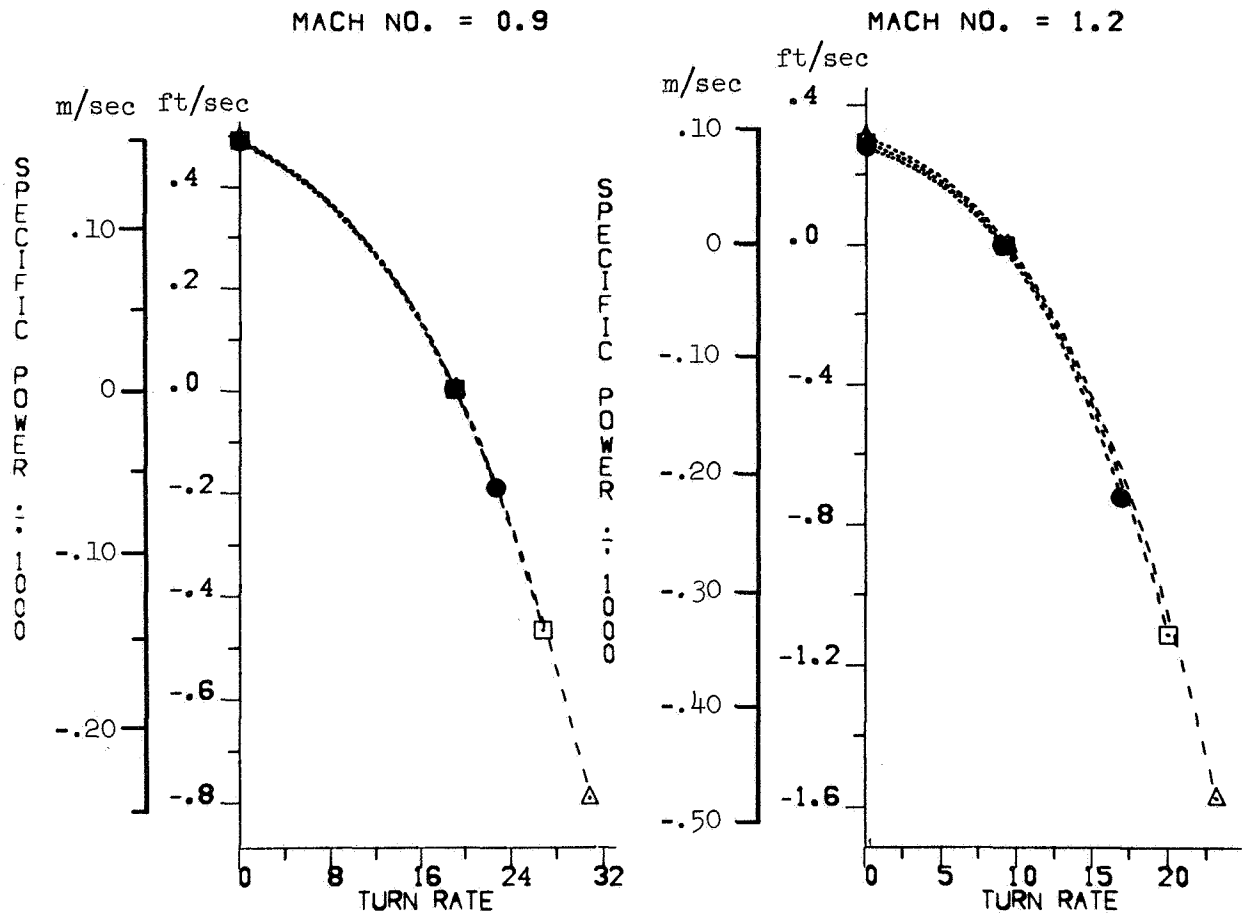

(c) Combat performance.

Figure 8.— Continued.

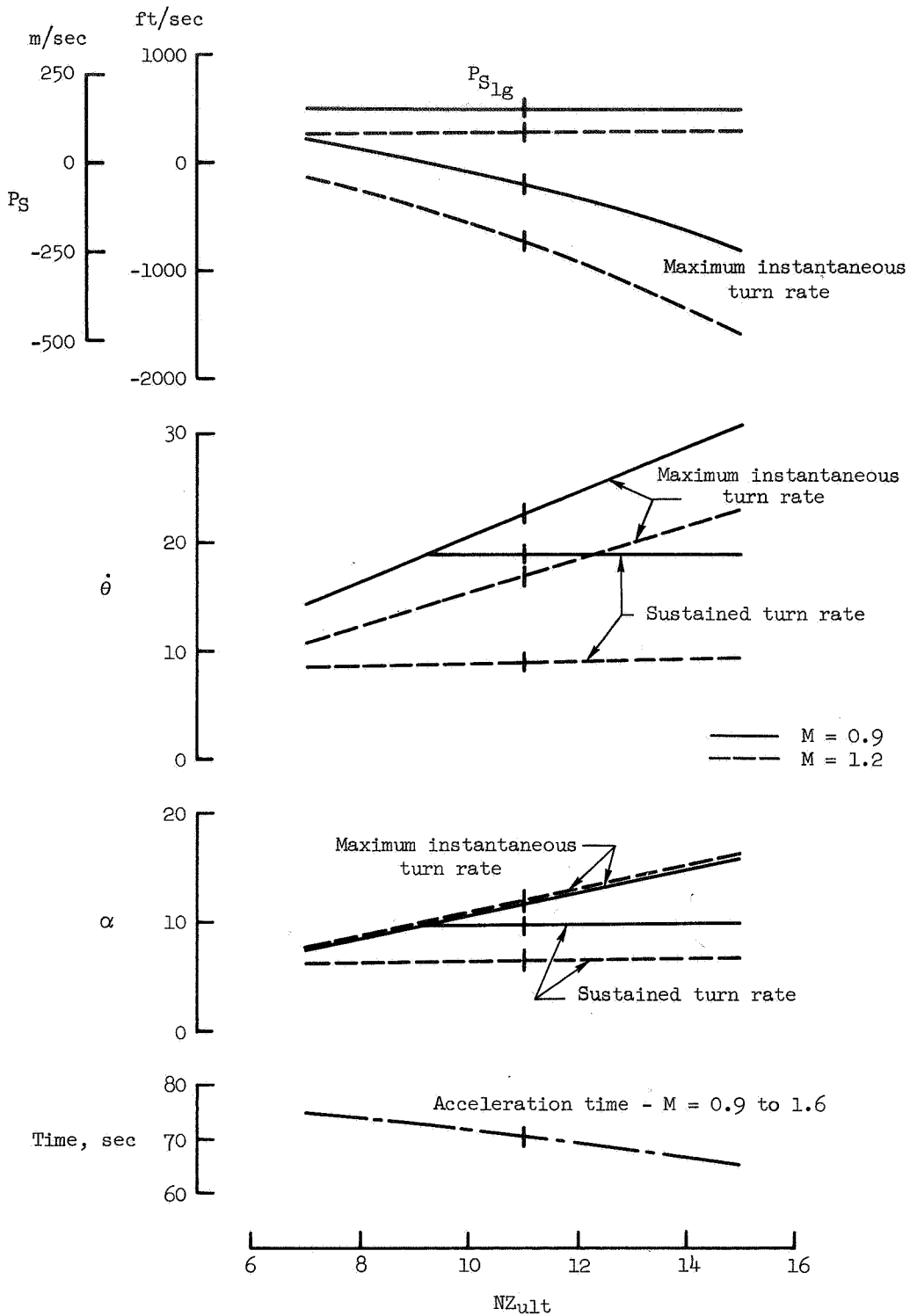

(c) Combat performance (concluded).

Figure 8.— Concluded.

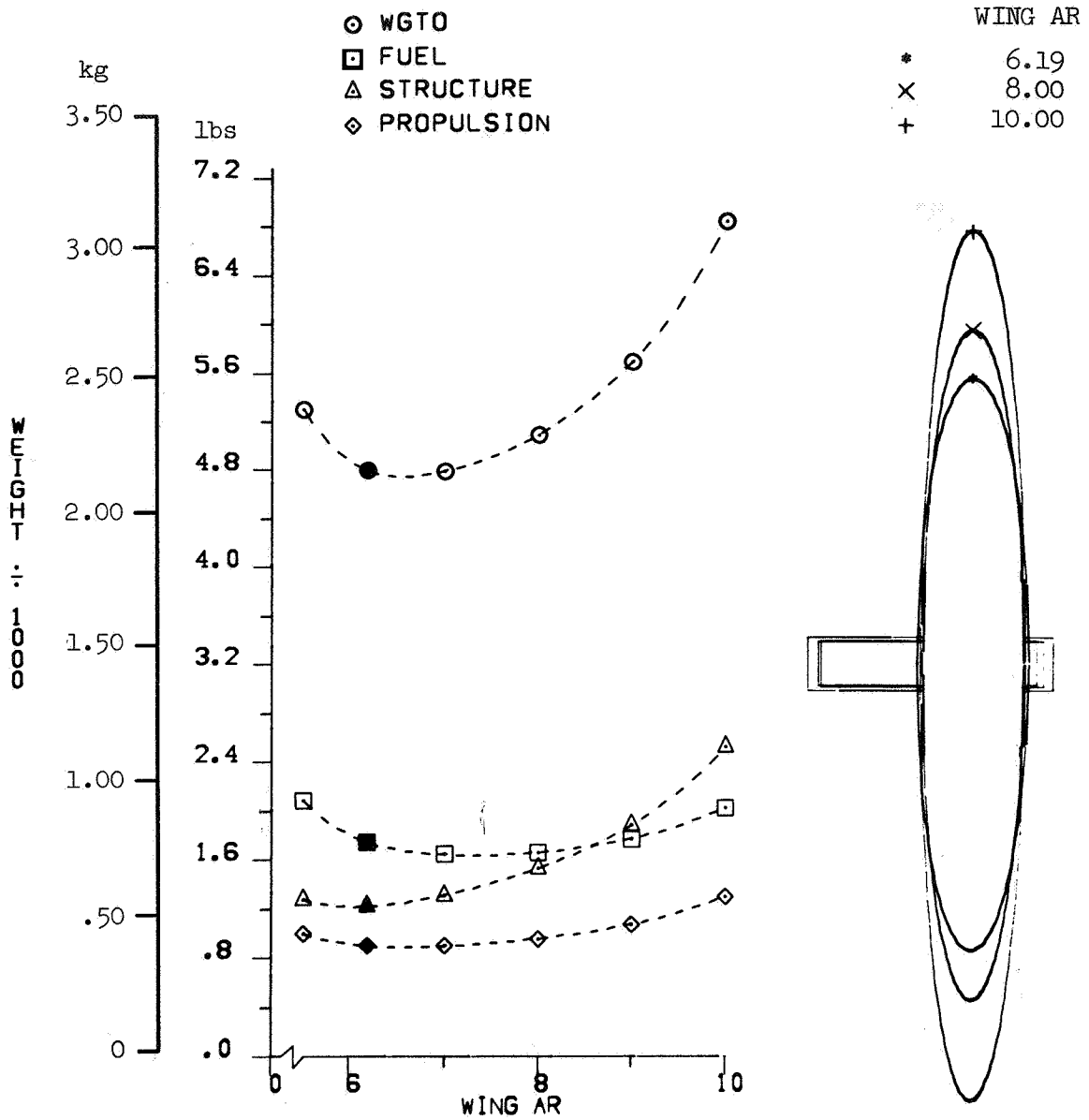

(a) Weights.

Figure 9.— Effect of wing aspect ratio.

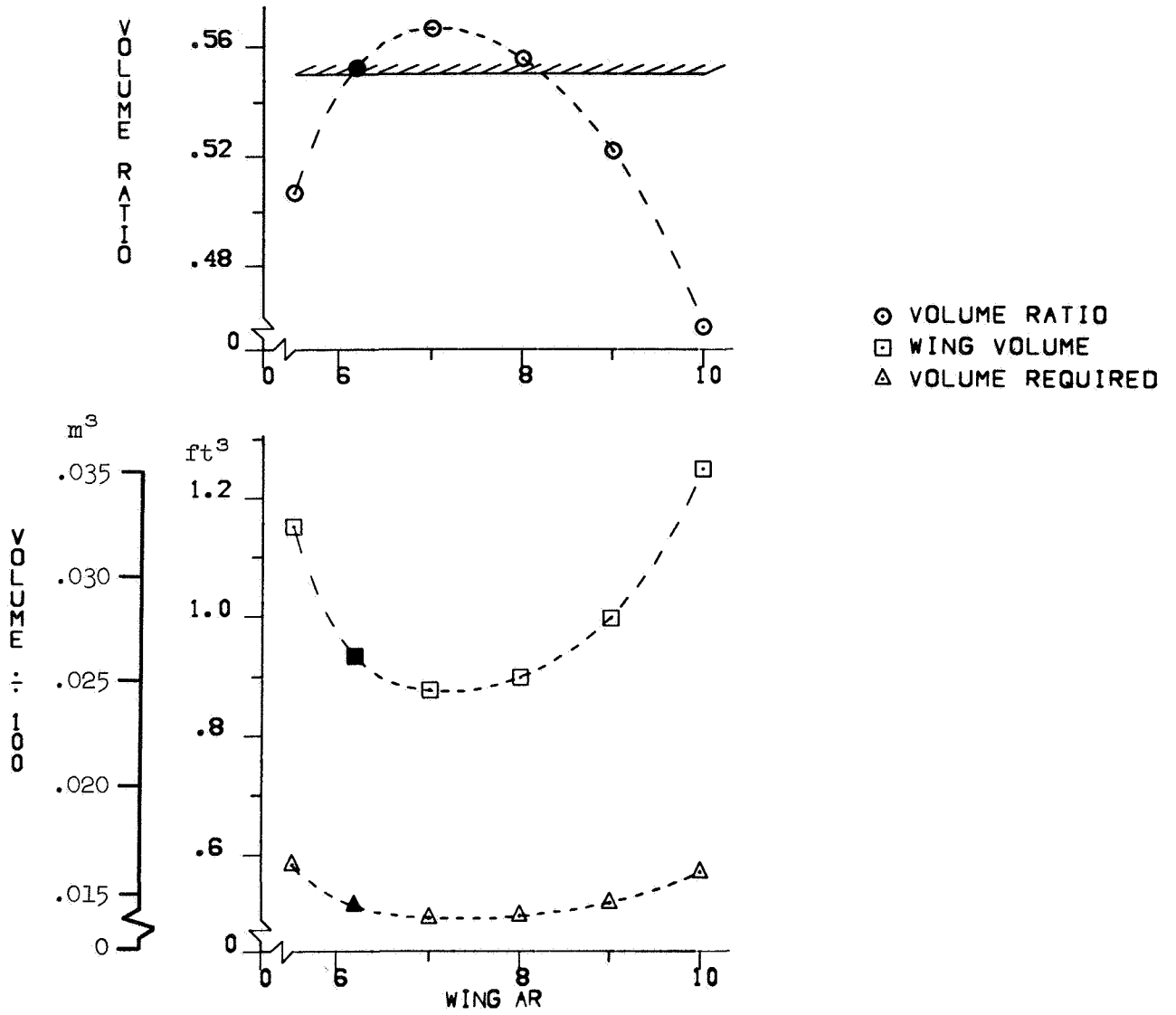

(b) Volume.

Figure 9.— Continued.

WING AR

- 5.50
- 6.19
- △ 9.00

MACH NO. = 0.9

MACH NO. = 1.2

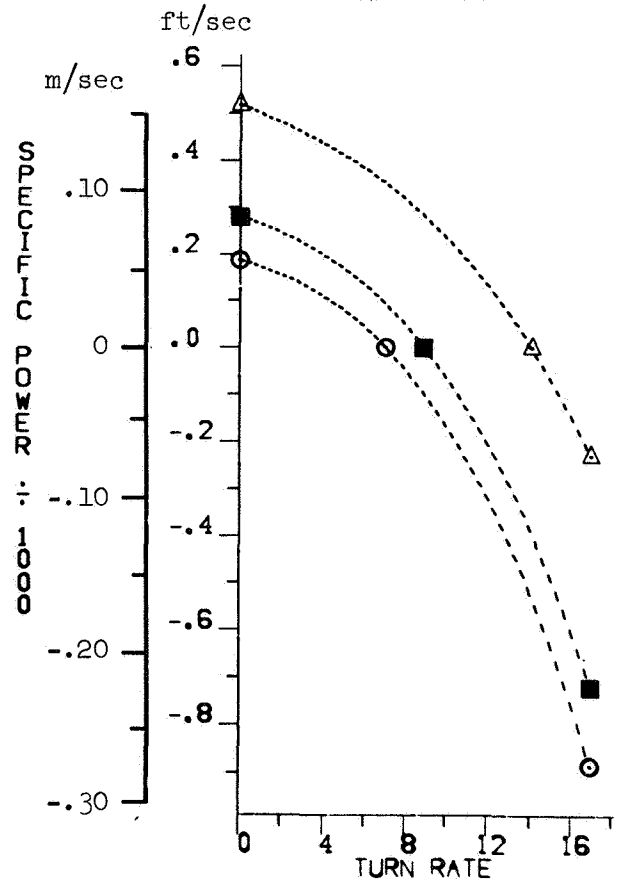
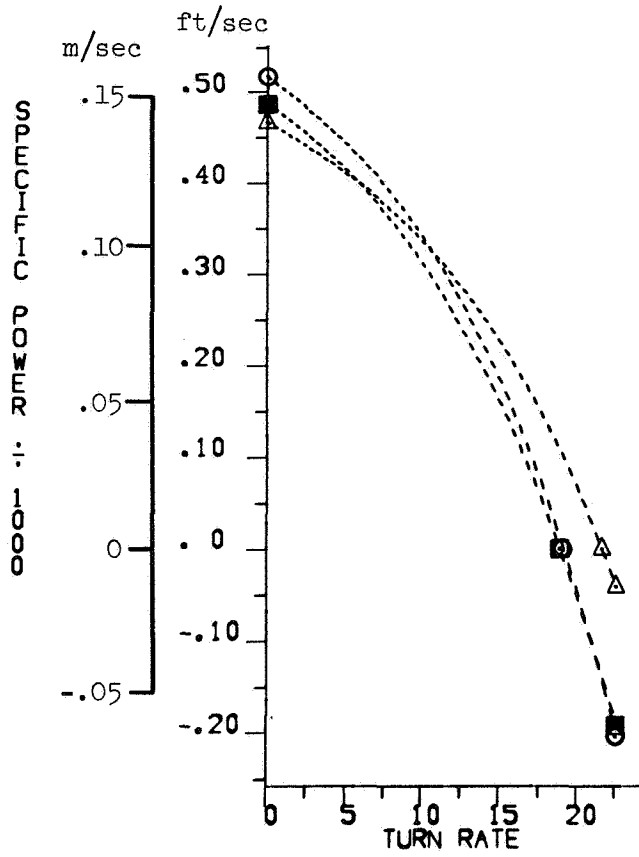

(c) Combat performance.

Figure 9.— Continued.

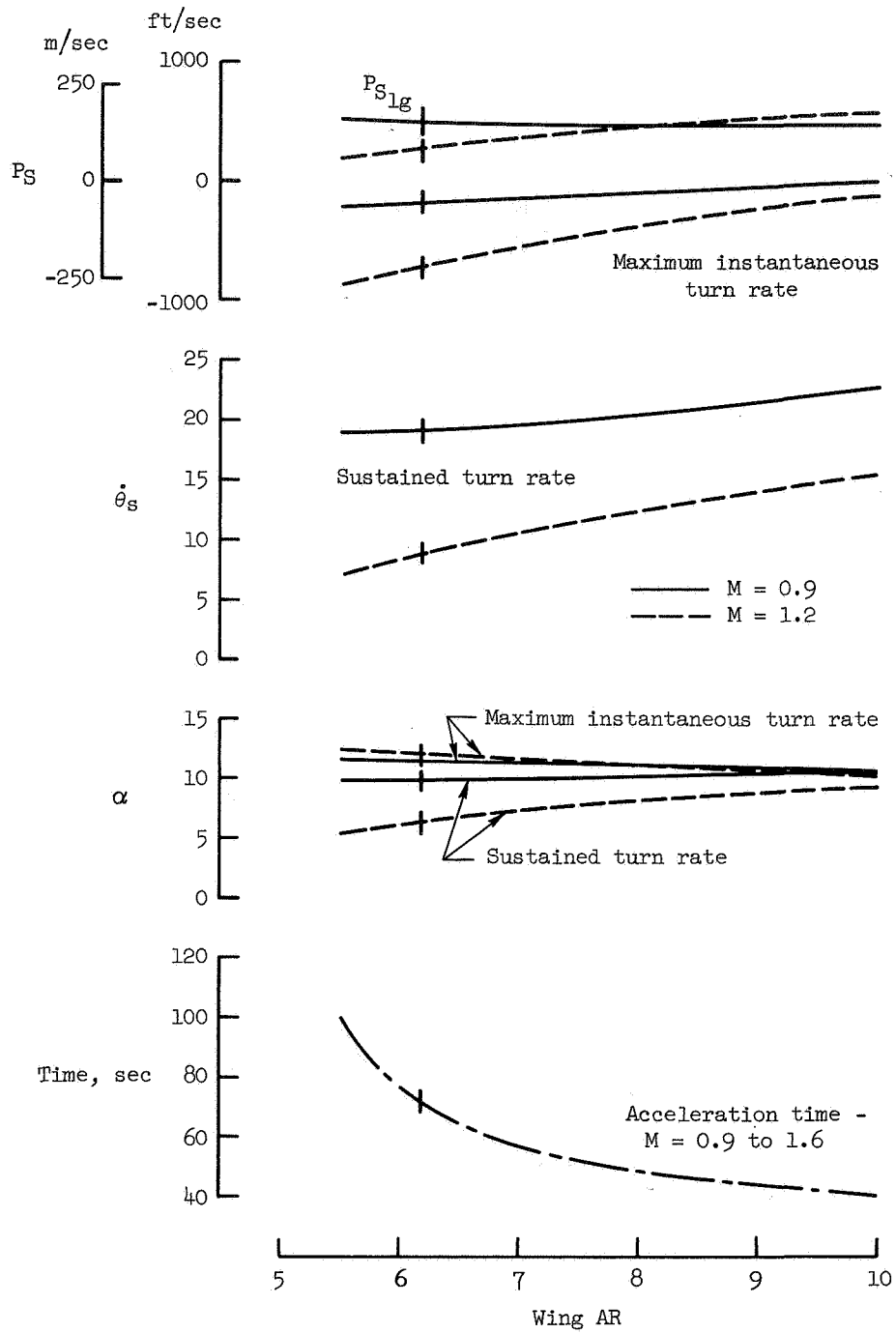

(c) Combat performance (concluded).

Figure 9.— Concluded.

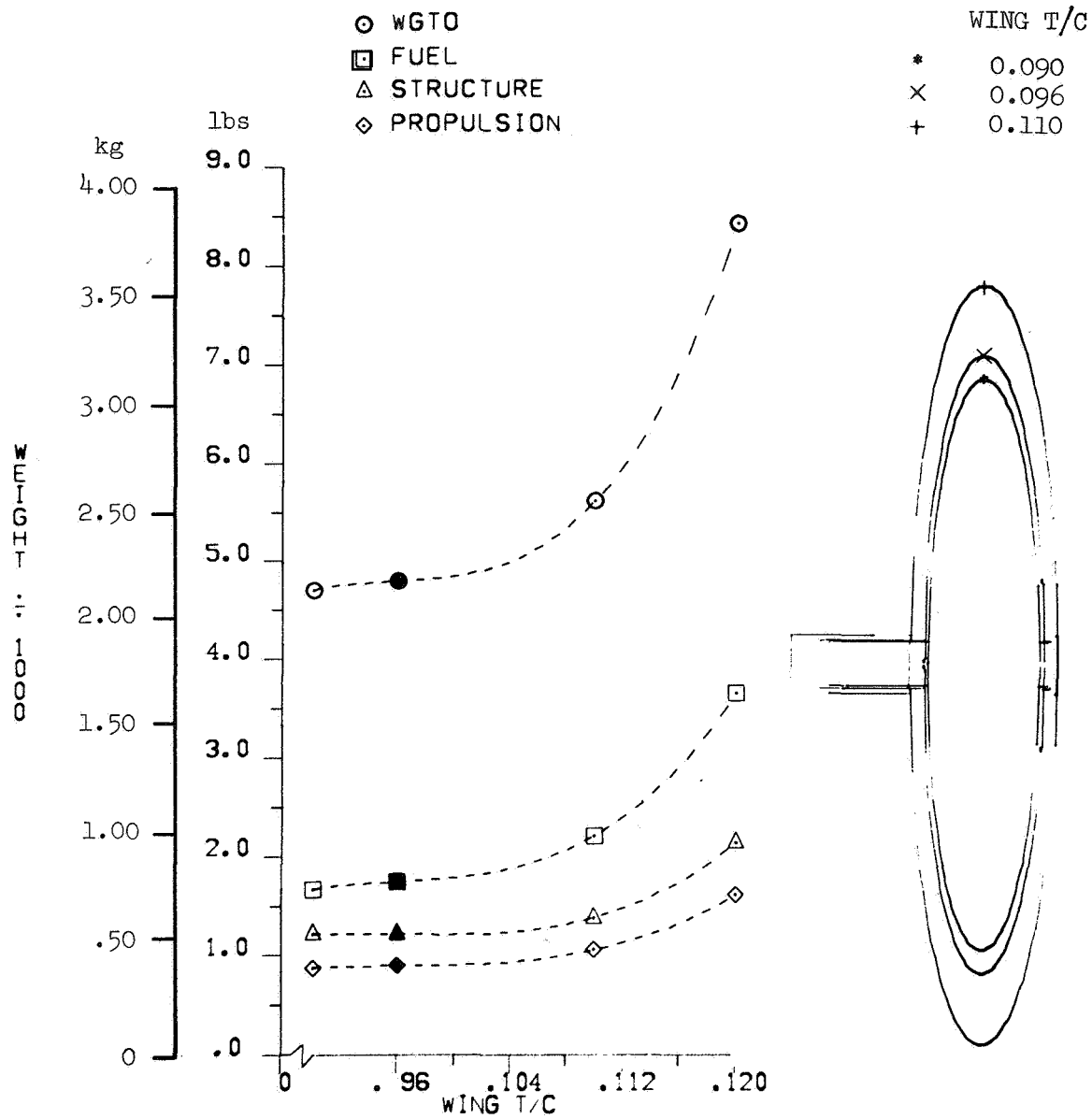

(a) Weights.

Figure 10.— Effect of wing thickness/chord ratio.

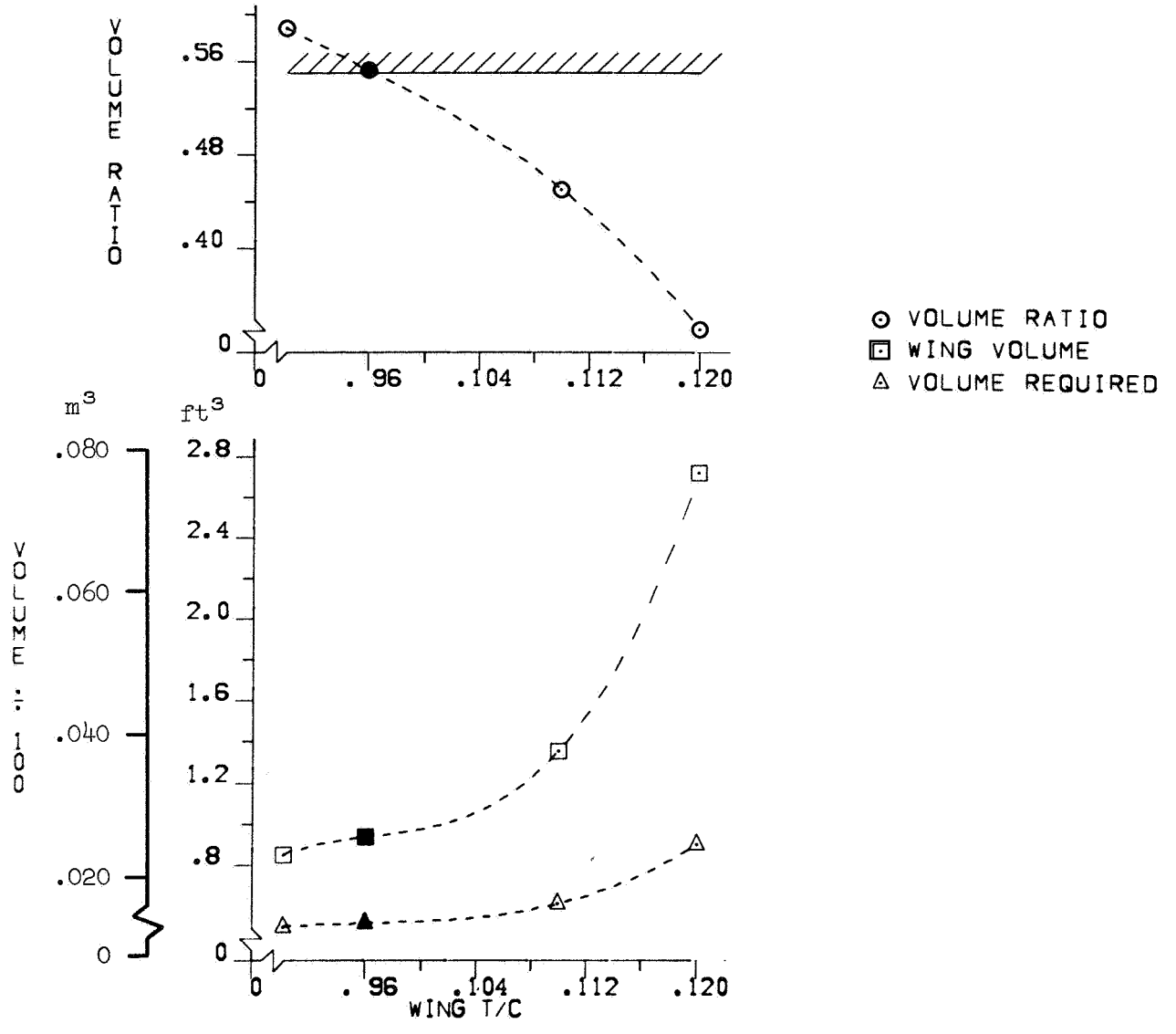

(b) Volume.

Figure 10.— Continued.

WING T/c

- 0.090
- 0.096
- △ 0.110

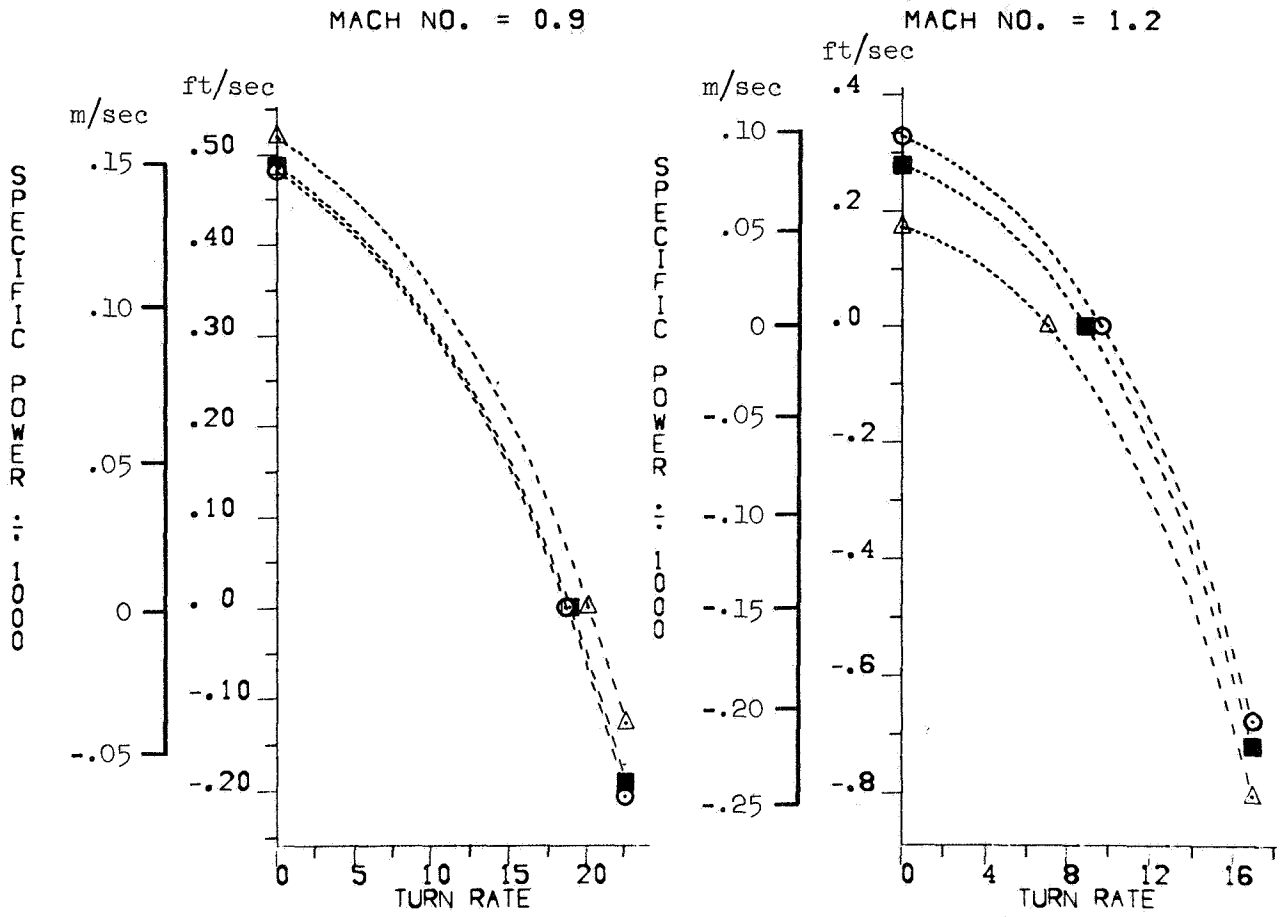

(c) Combat performance.

Figure 10.— Continued.

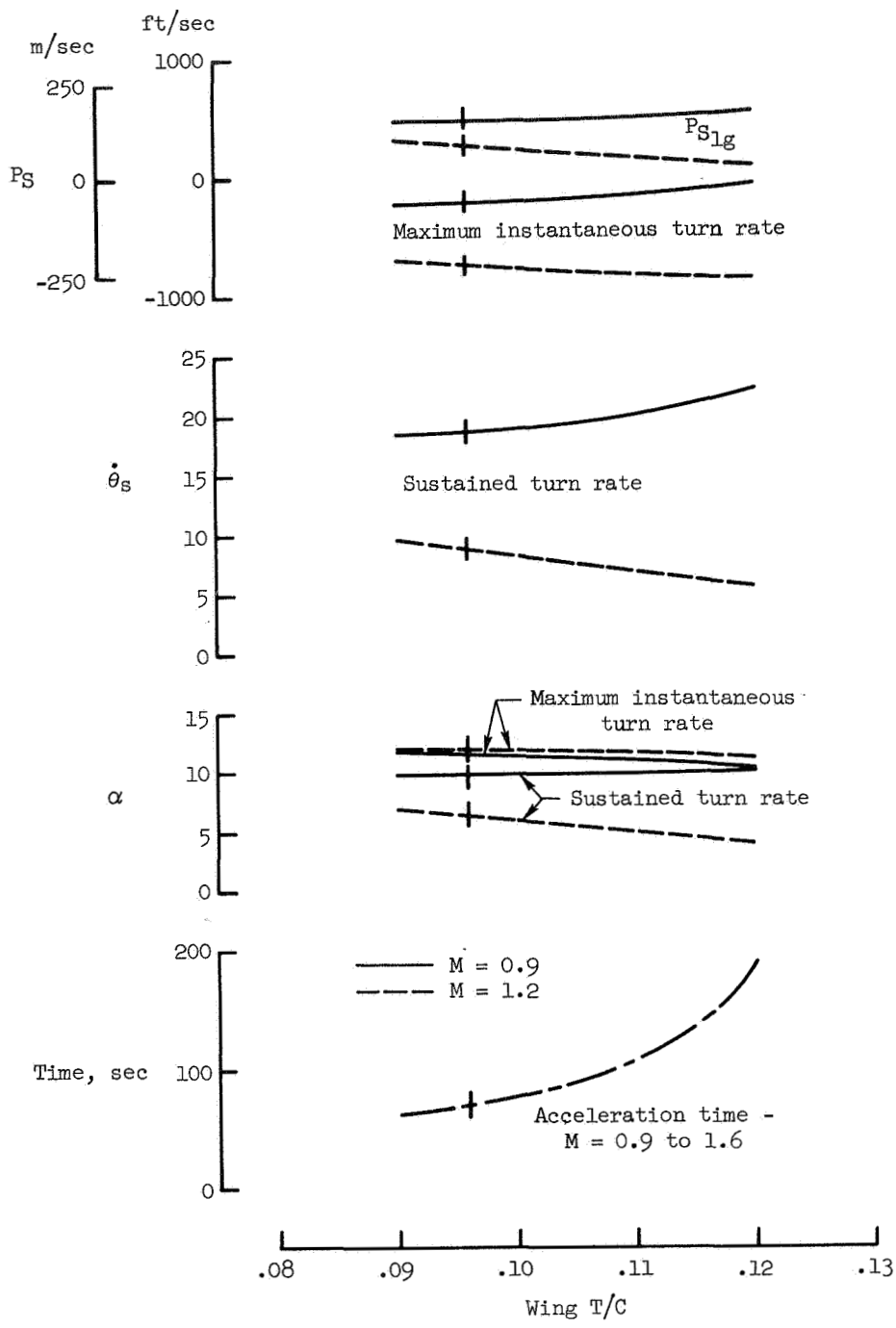

(c) Combat performance (concluded).

Figure 10.— Concluded.

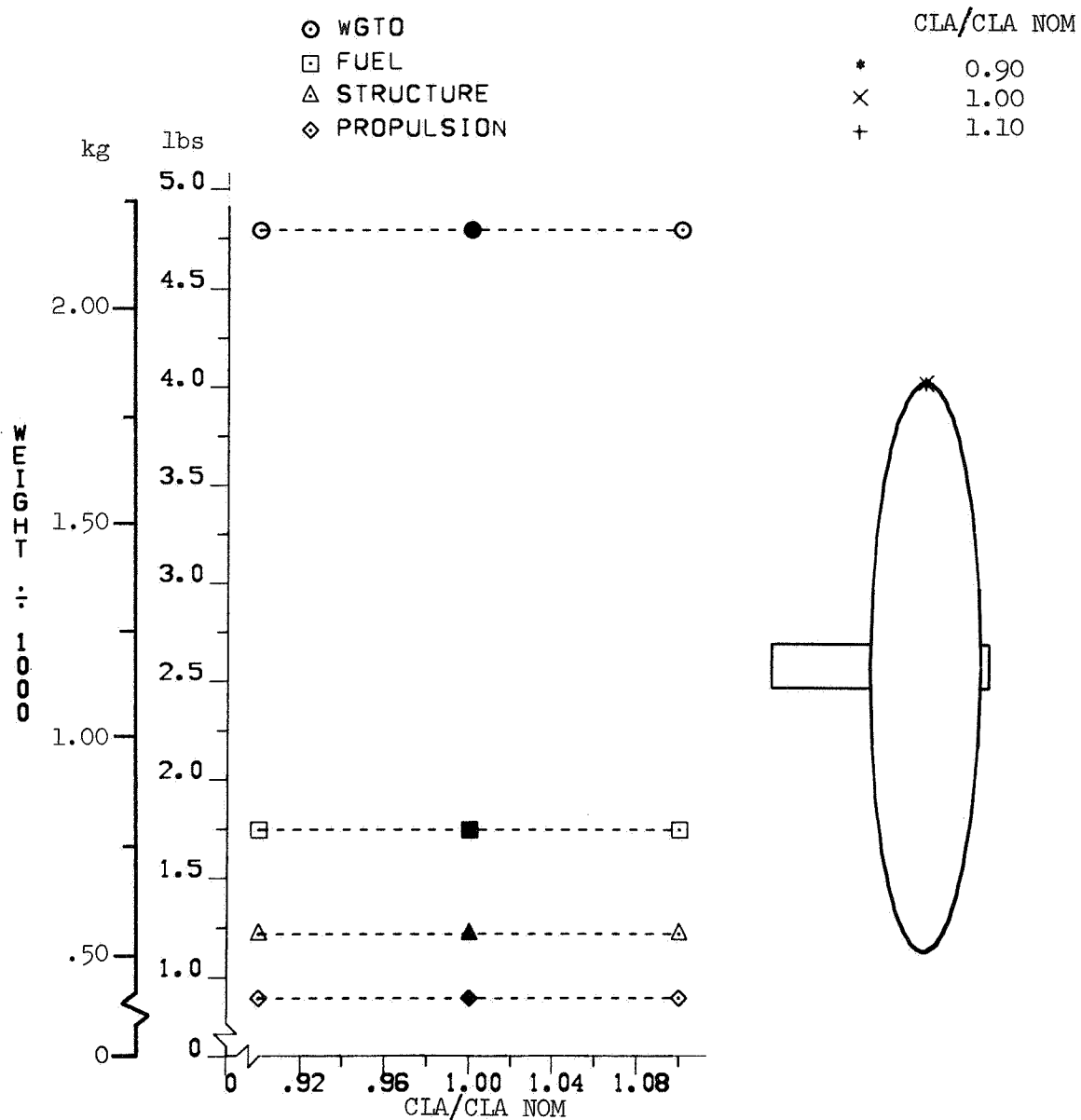

(a) Weights.

Figure 11.— Effect of a change in lift-curve slope.

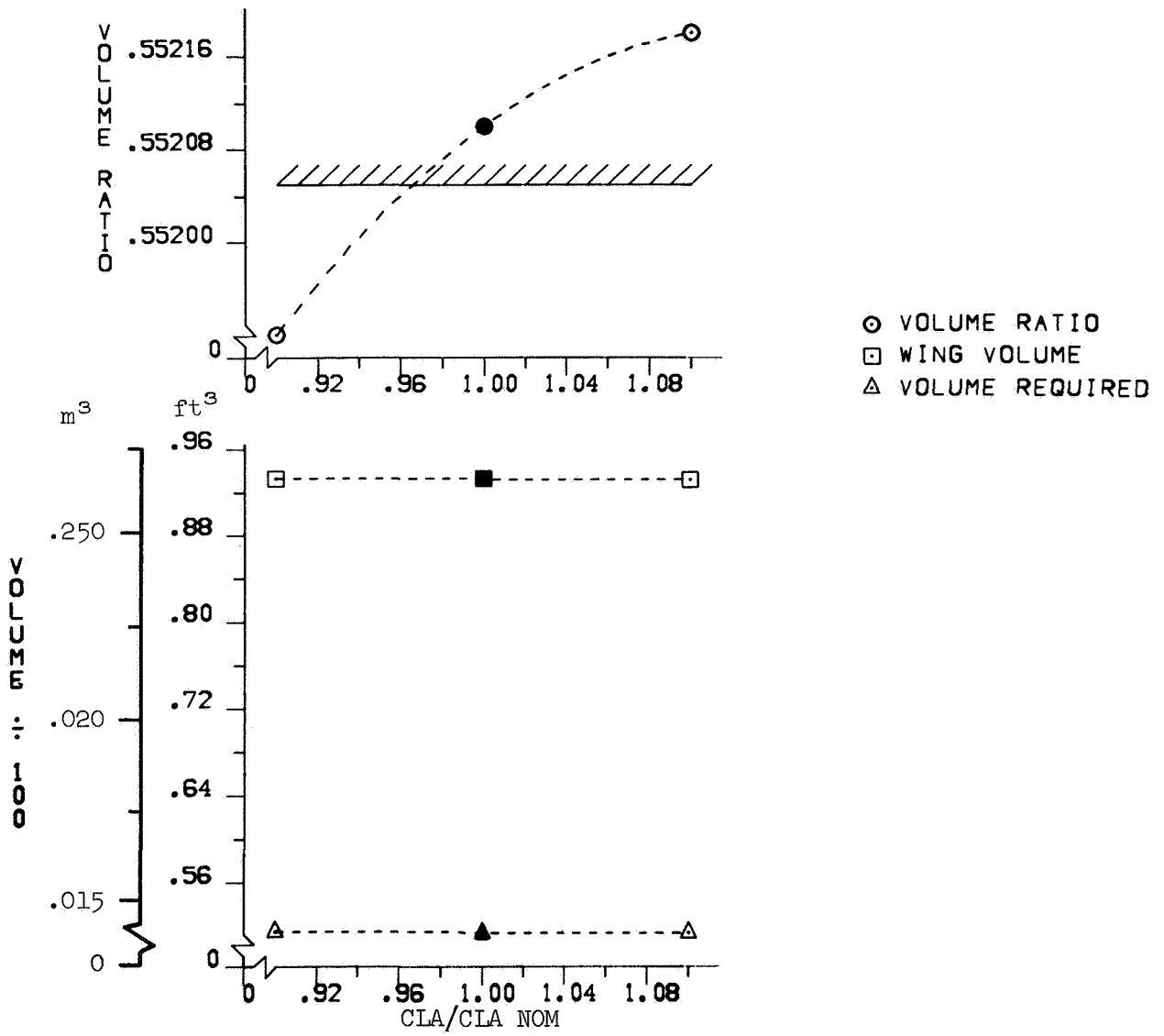

(b) Volume.

Figure 11.— Continued.

CLA/CLA NOM

- ⊙ 0.90
- 1.00
- △ 1.10

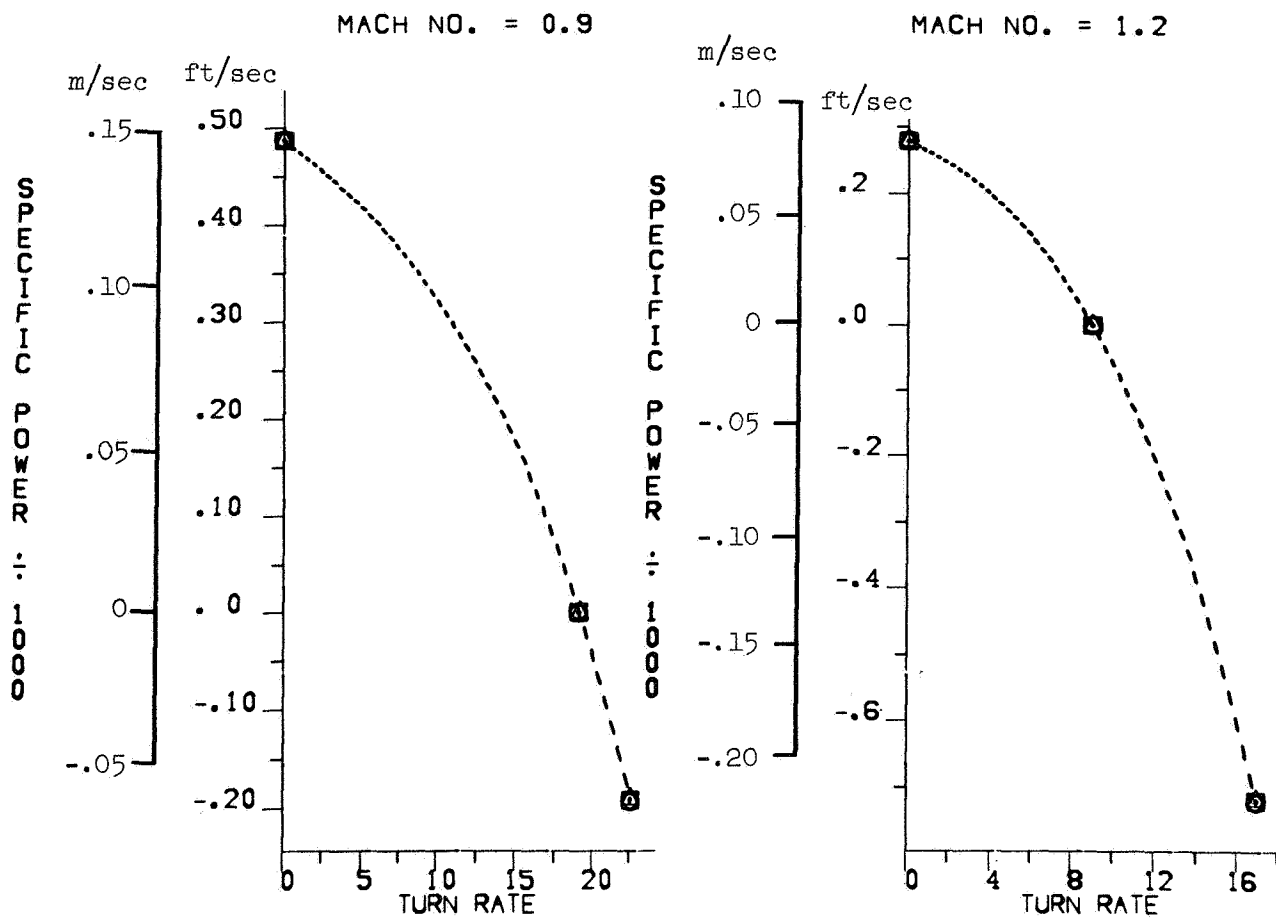

(c) Combat performance.

Figure 11.- Concluded.

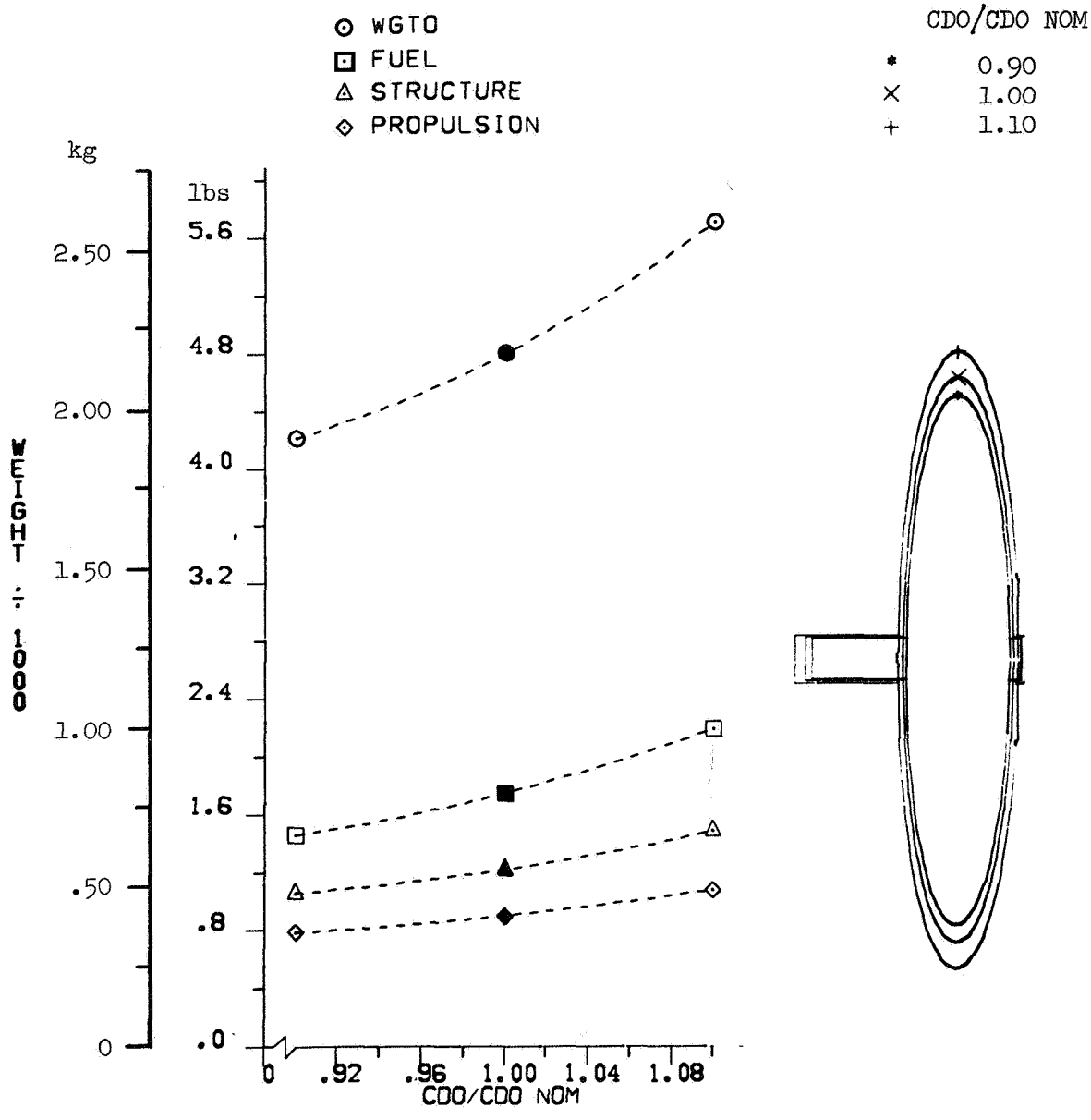

(a) Weights.

Figure 12.— Effect of a change in zero-lift drag coefficient.

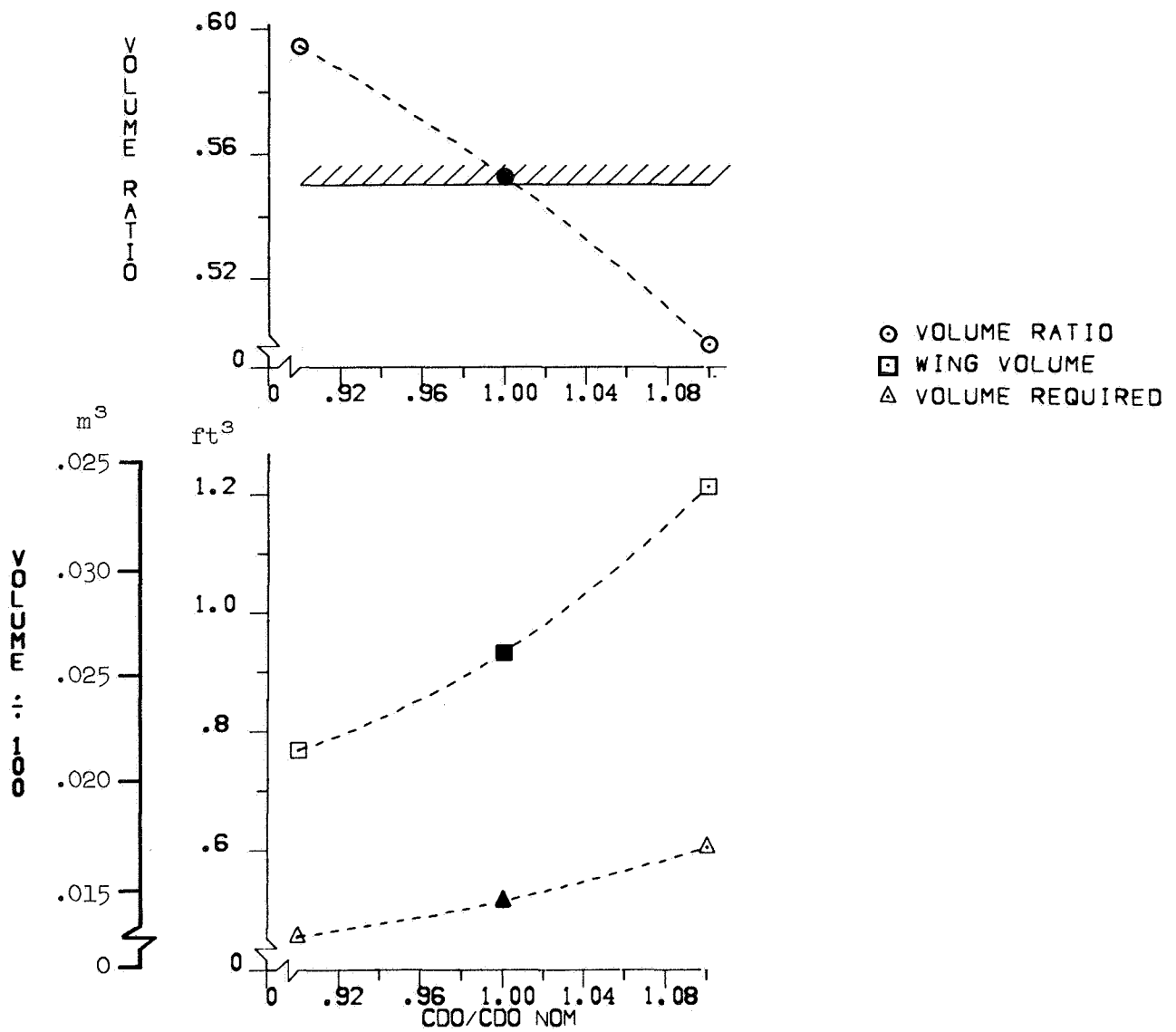

(b) Volume.

Figure 12.— Continued.

CDO/CDO NOM

- 0.90
- 1.00
- △ 1.10

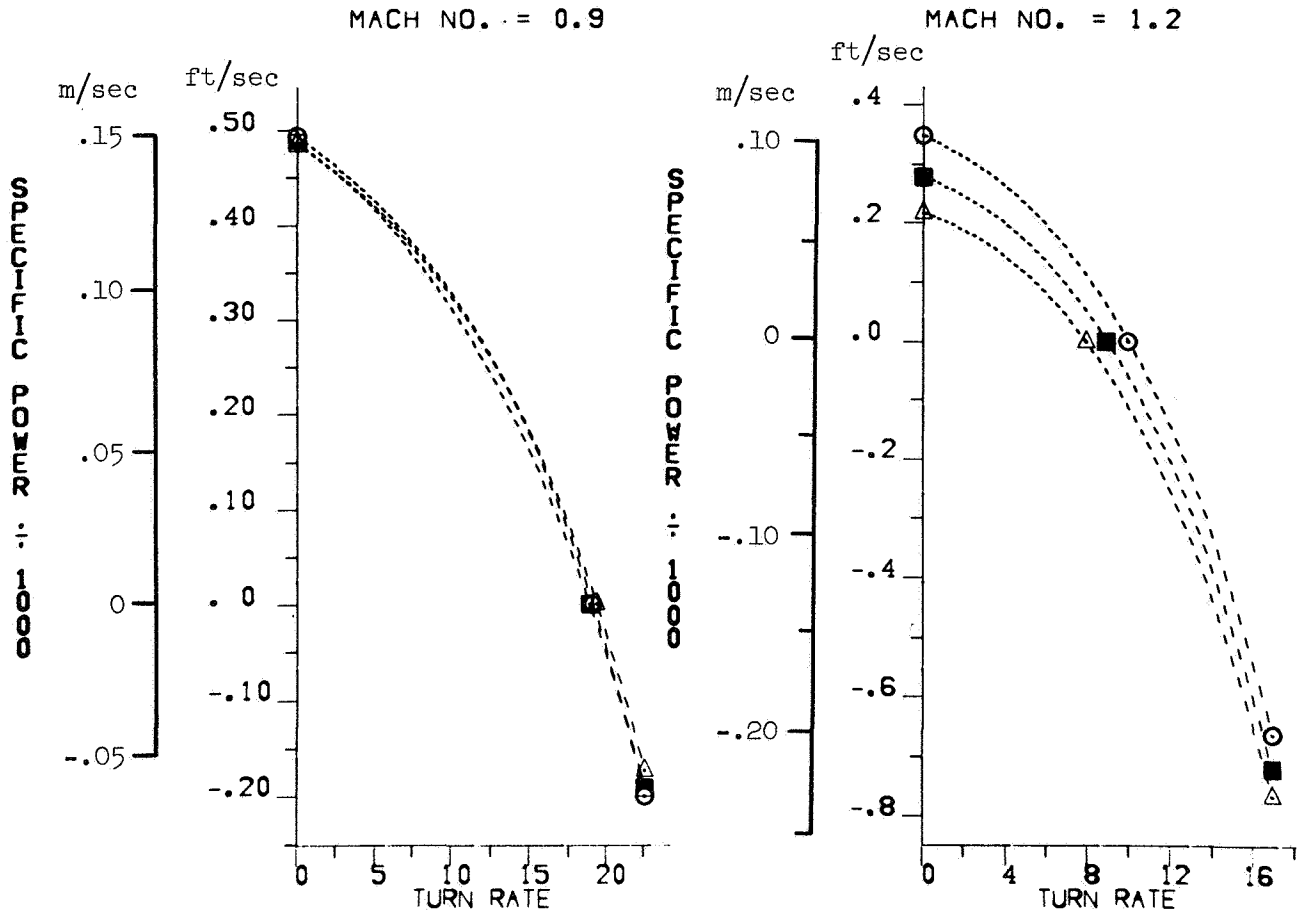

(c) Combat performance.

Figure 12.— Concluded.

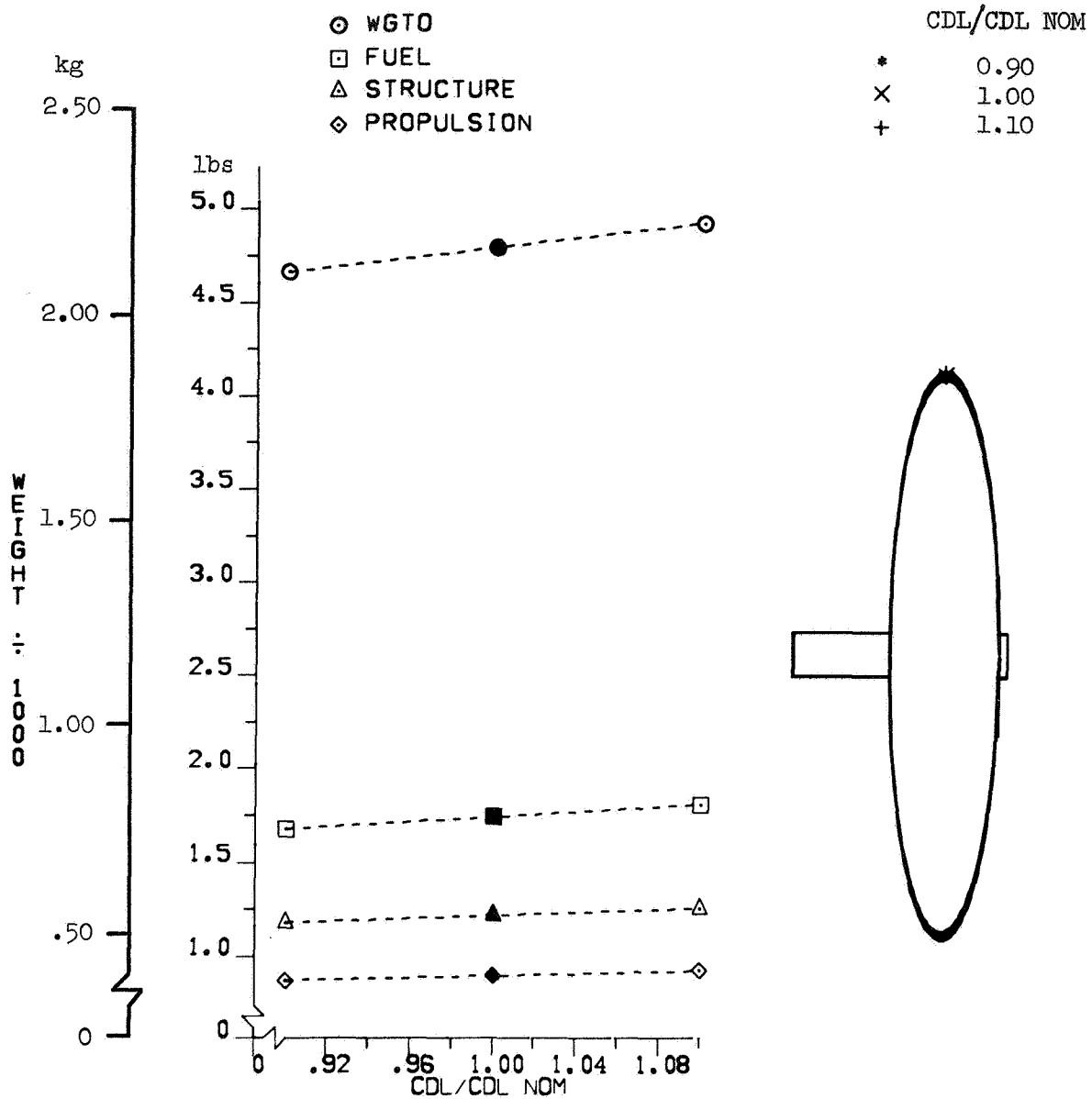

(a) Weights.

Figure 13.— Effect of a change in drag-due-to-lift coefficient.

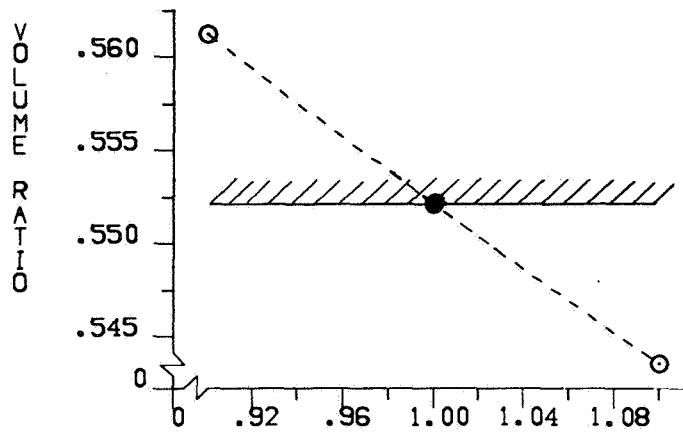

- ⊙ VOLUME RATIO
- WING VOLUME
- △ VOLUME REQUIRED

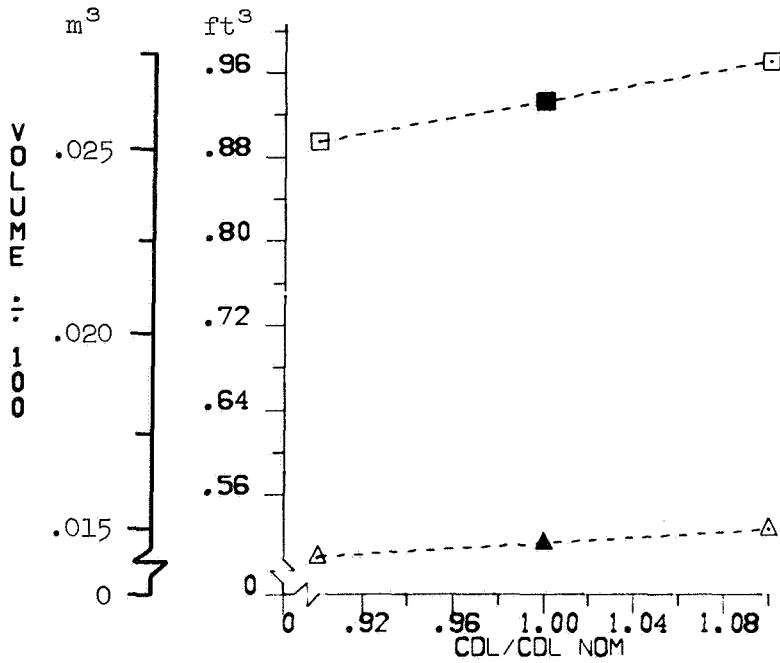

(b) Volume.

Figure 13.— Continued.

CDL/CDL NOM

- ⊙ 0.90
- 1.00
- △ 1.10

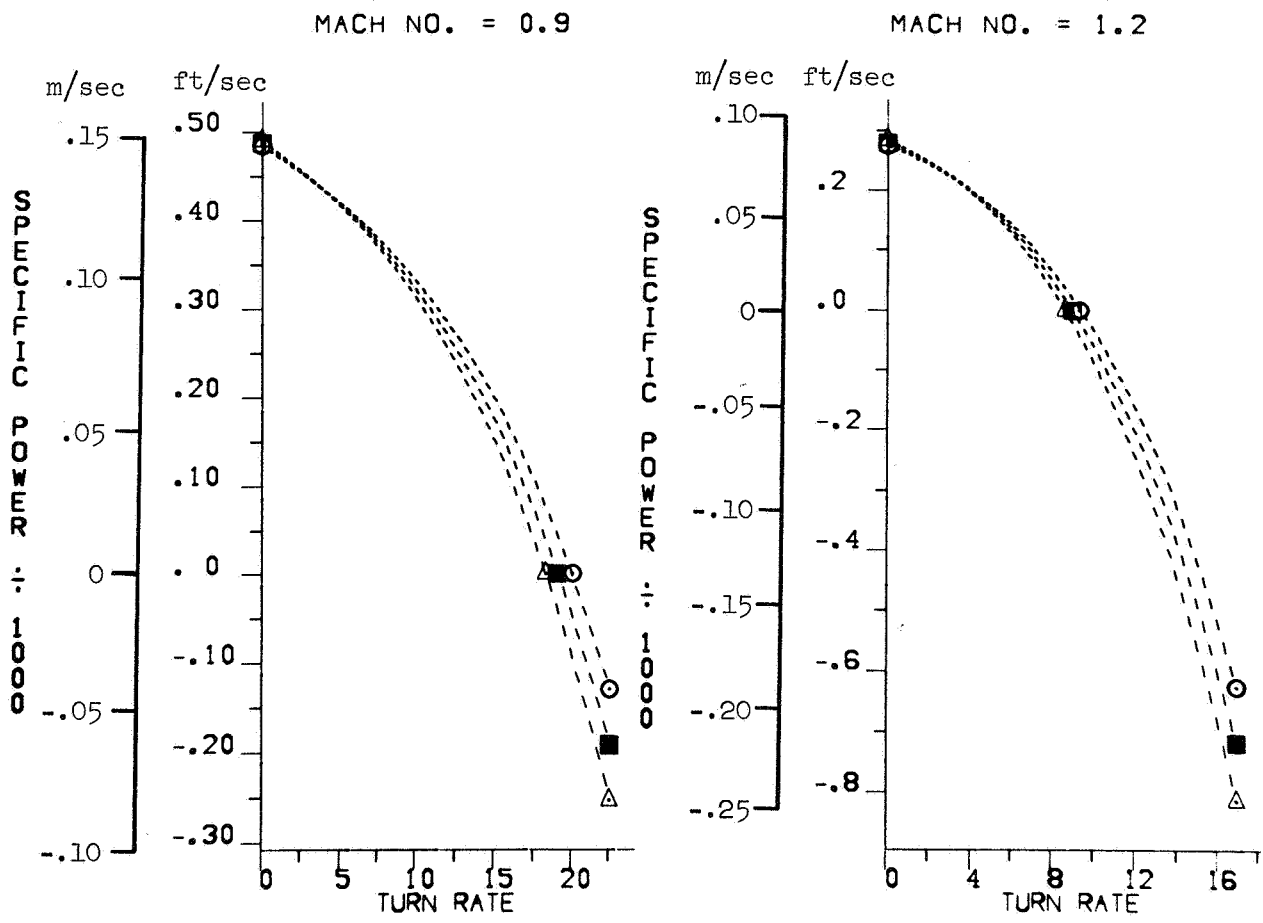

(c) Combat performance.

Figure 13.— Concluded.

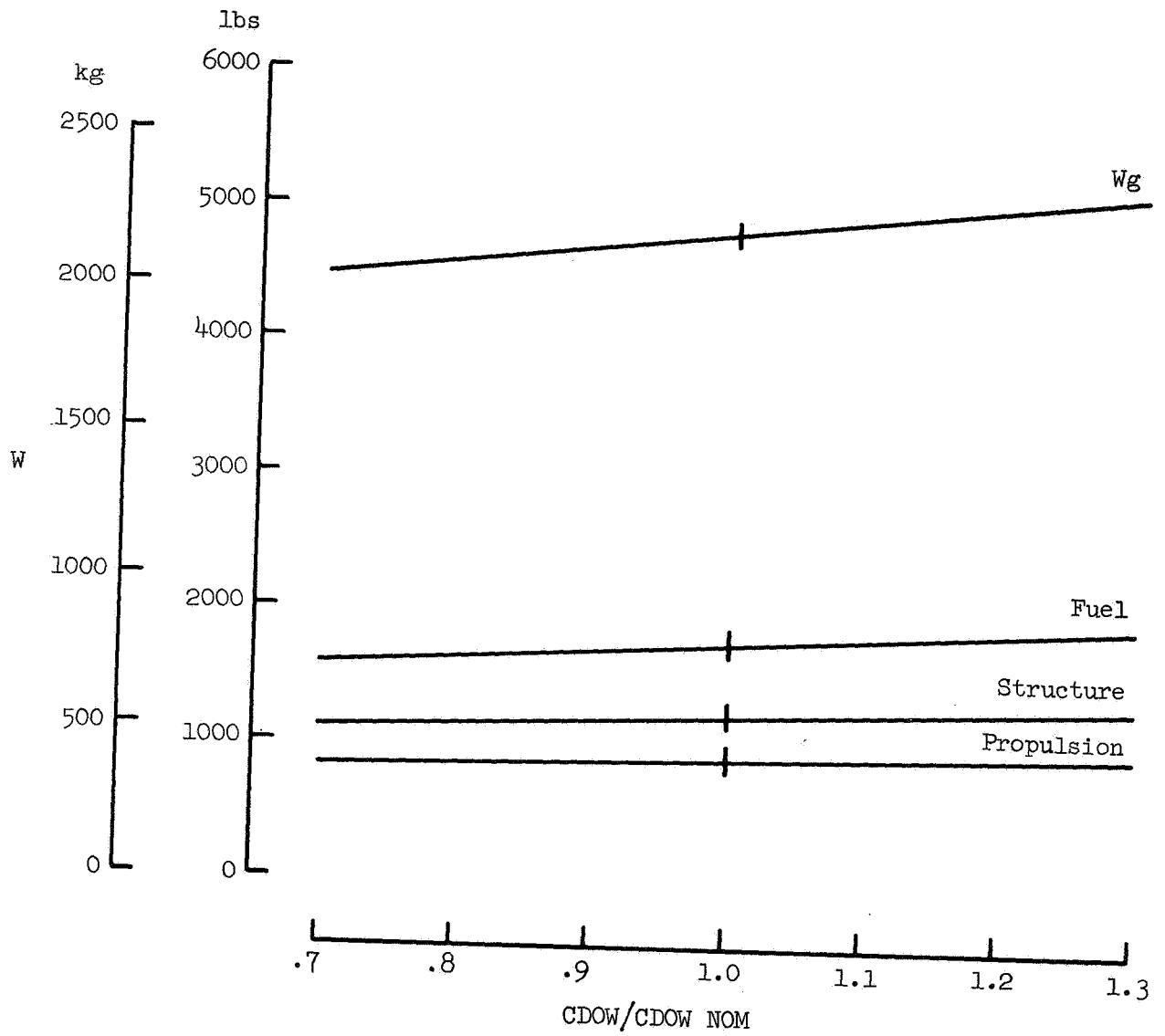

(a) Weights.

Figure 14.— Effect of a change in weapons drag coefficient.

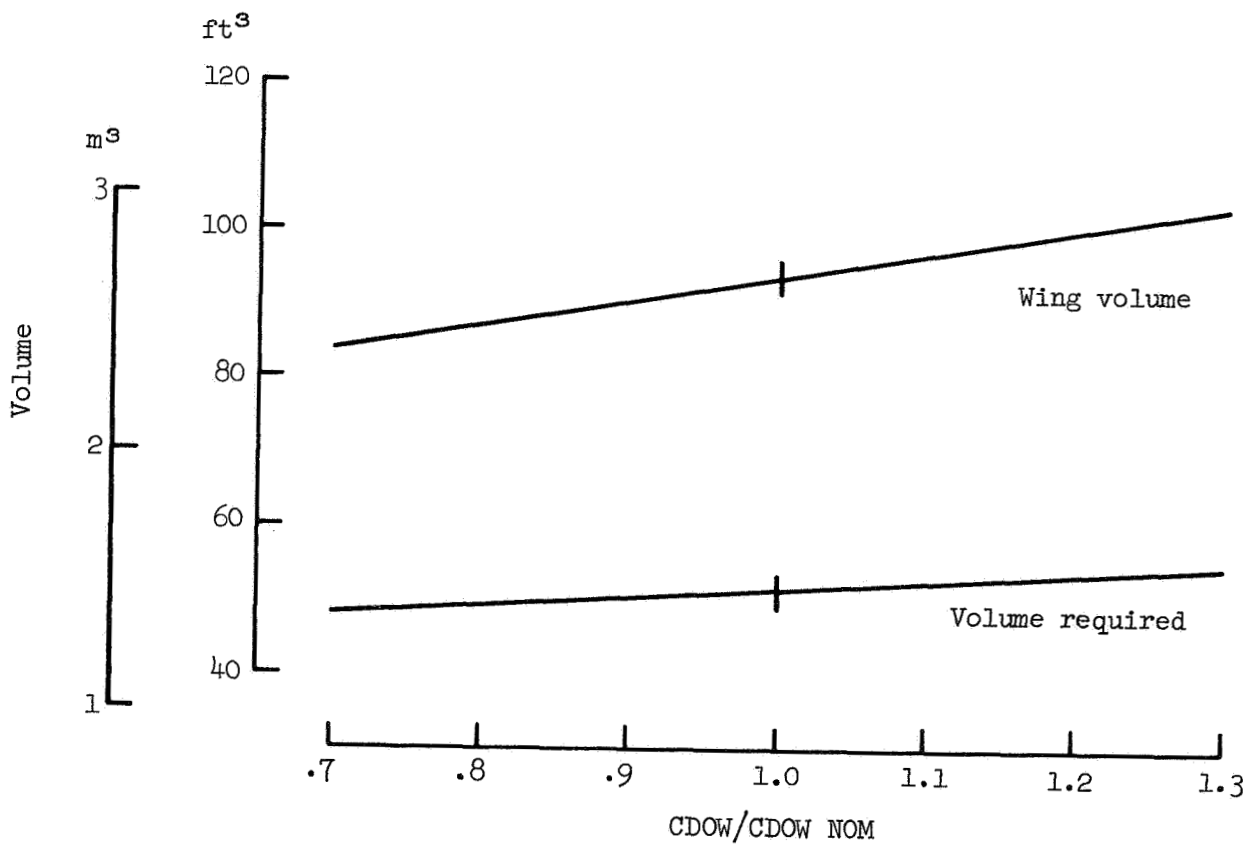
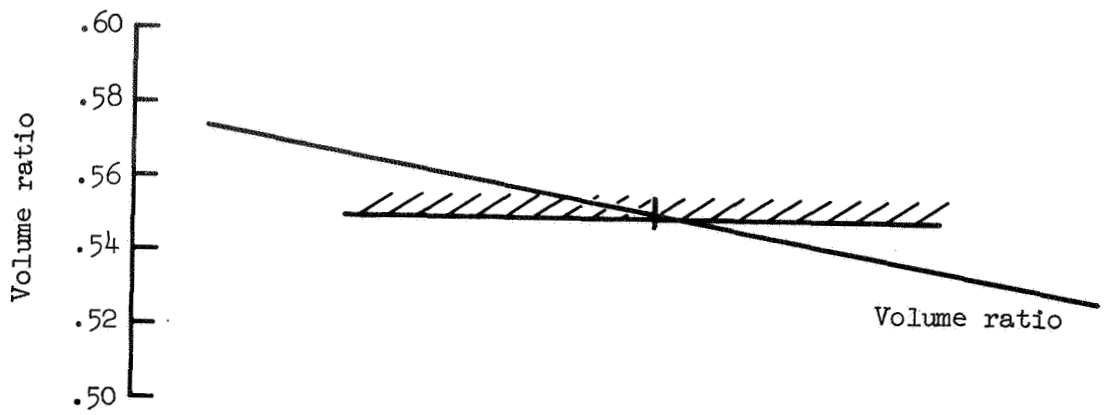

(b) Volume.

Figure 14.— Continued.

CDOW/CDOW NOM

--- 0.7
— 1.0
- - - 1.3

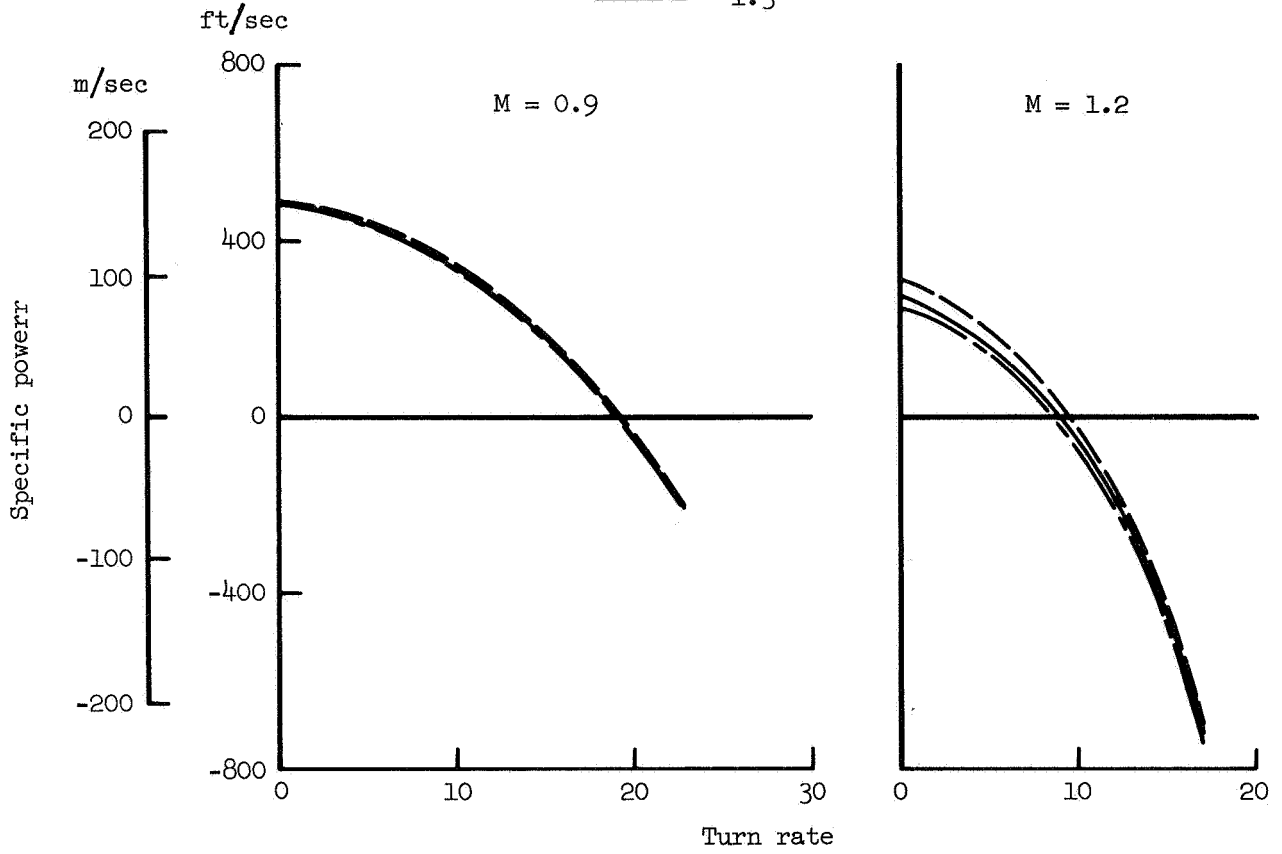

(c) Combat performance.

Figure 14.— Concluded.

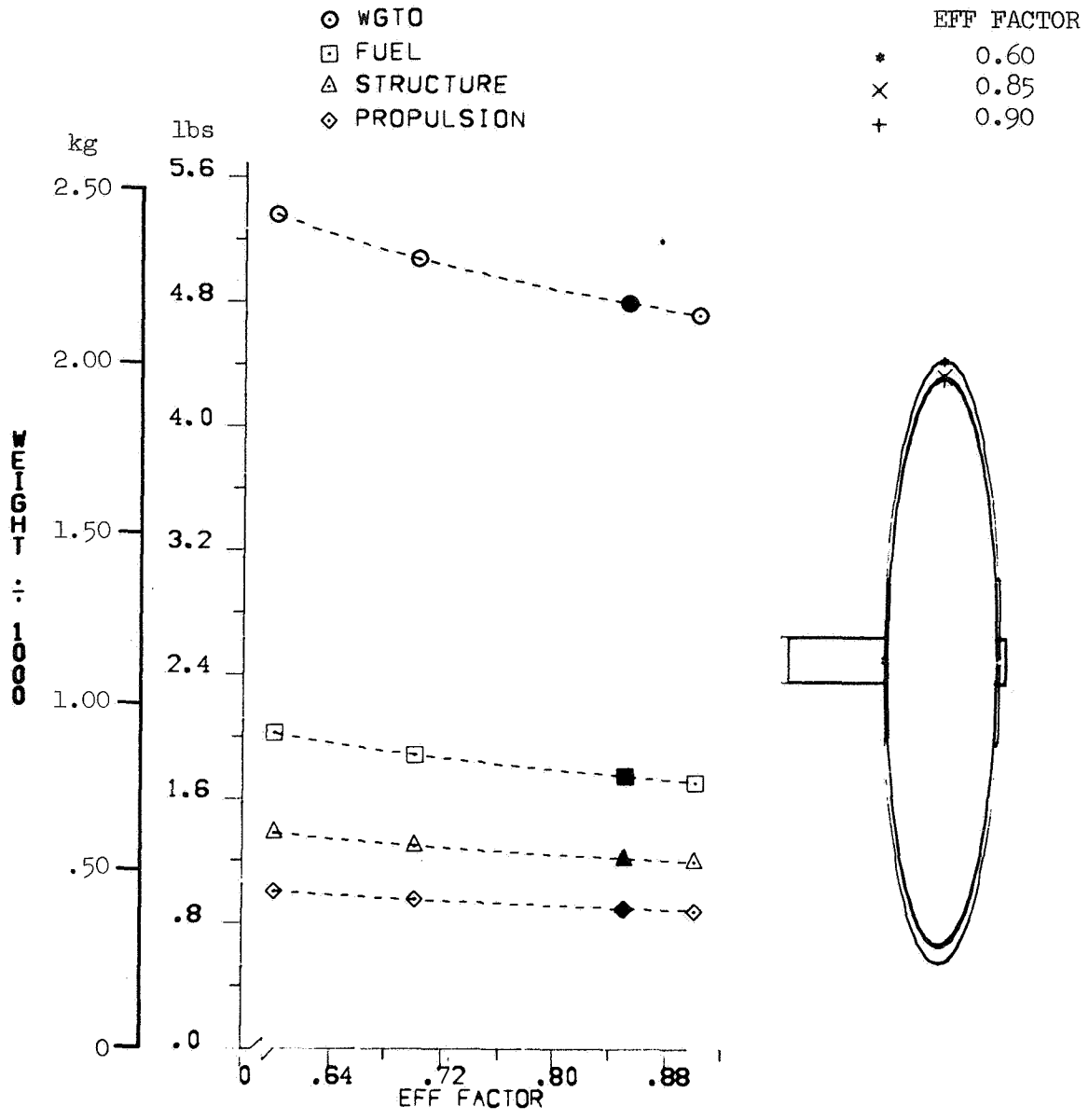

(a) Weights.

Figure 15.— Effect of a change in the aerodynamic efficiency factor.

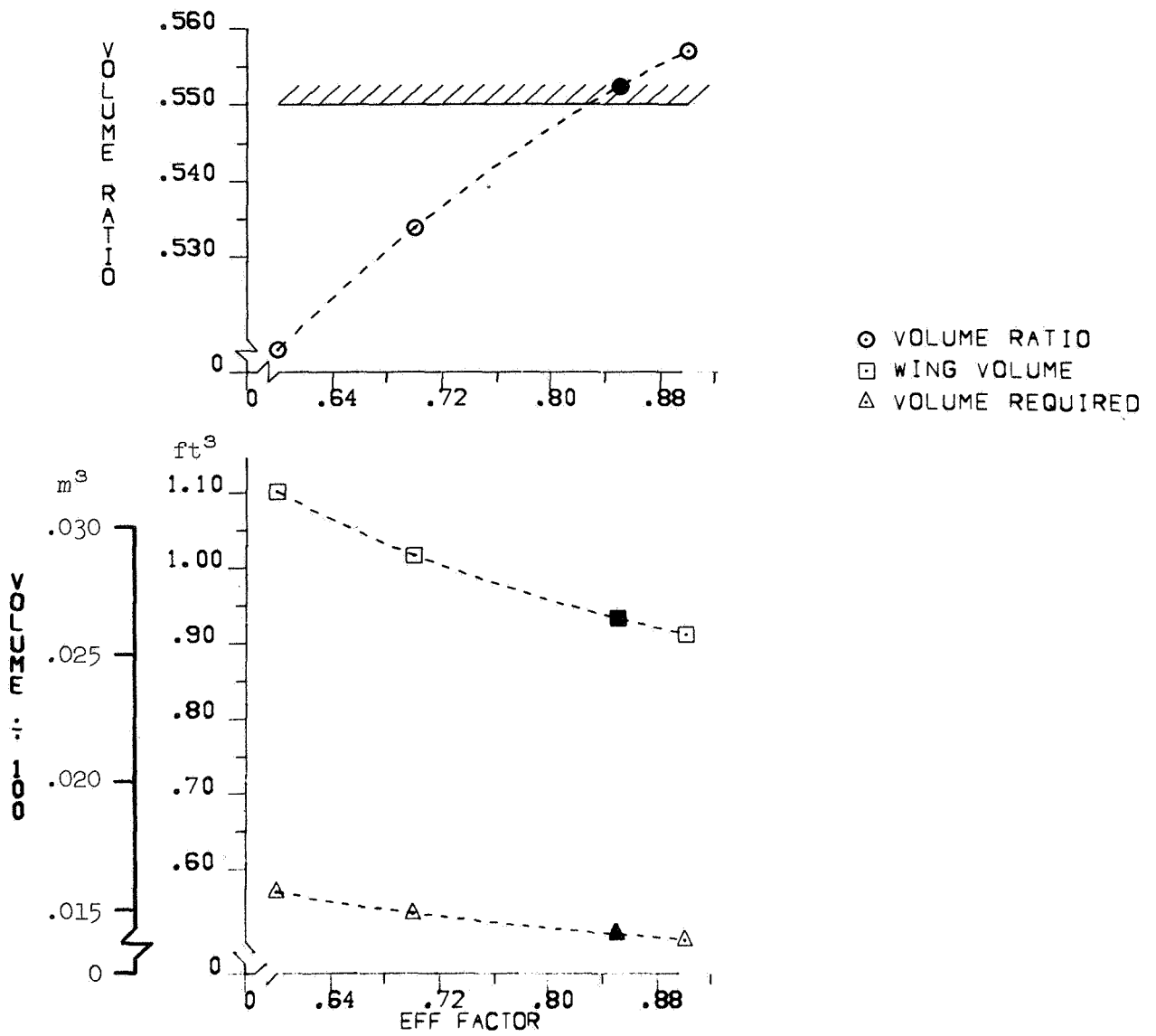

(b) Volume.

Figure 15.- Continued.

EFF FACTOR

- 0.60
- 0.85
- △ 0.90

MACH NO. = 0.9

MACH NO. = 1.2

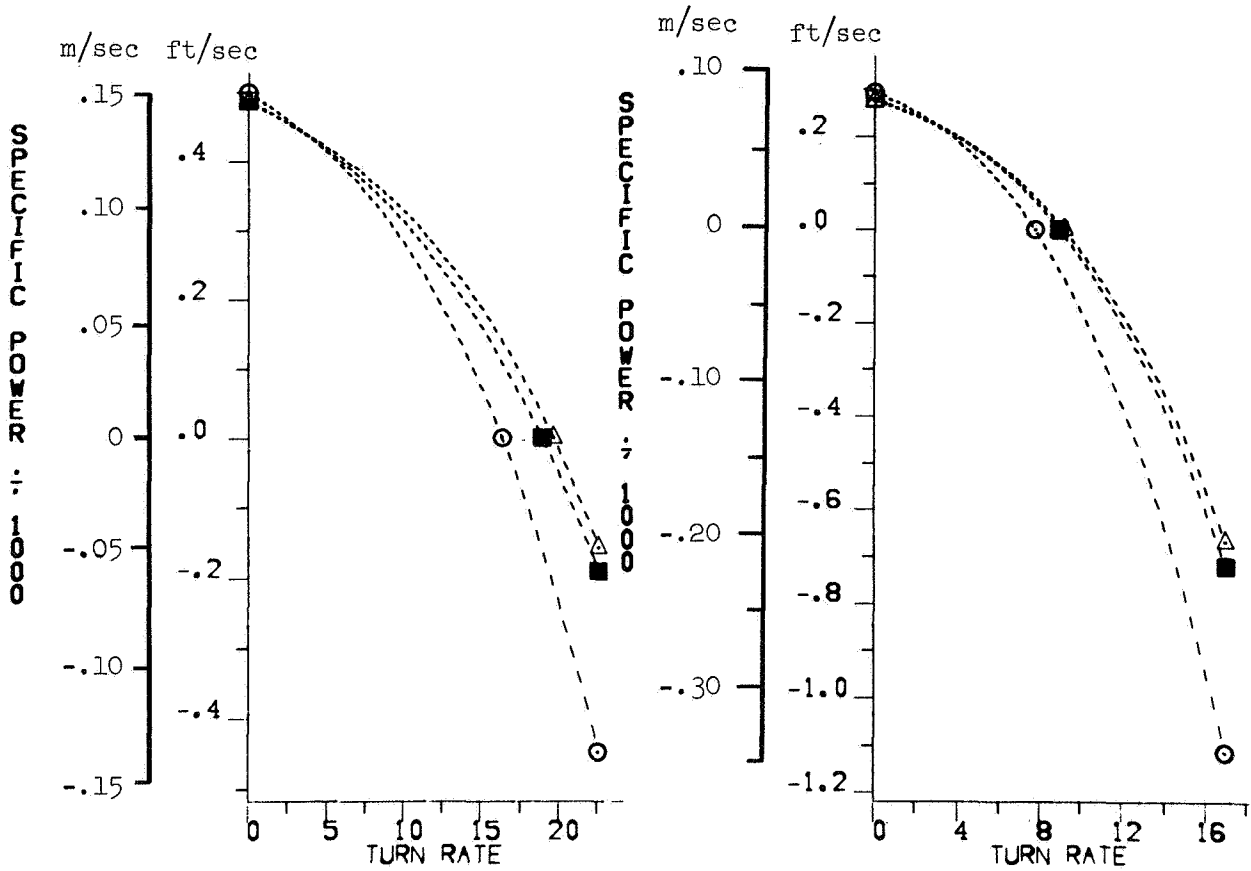

(c) Combat performance.

Figure 15.— Concluded.

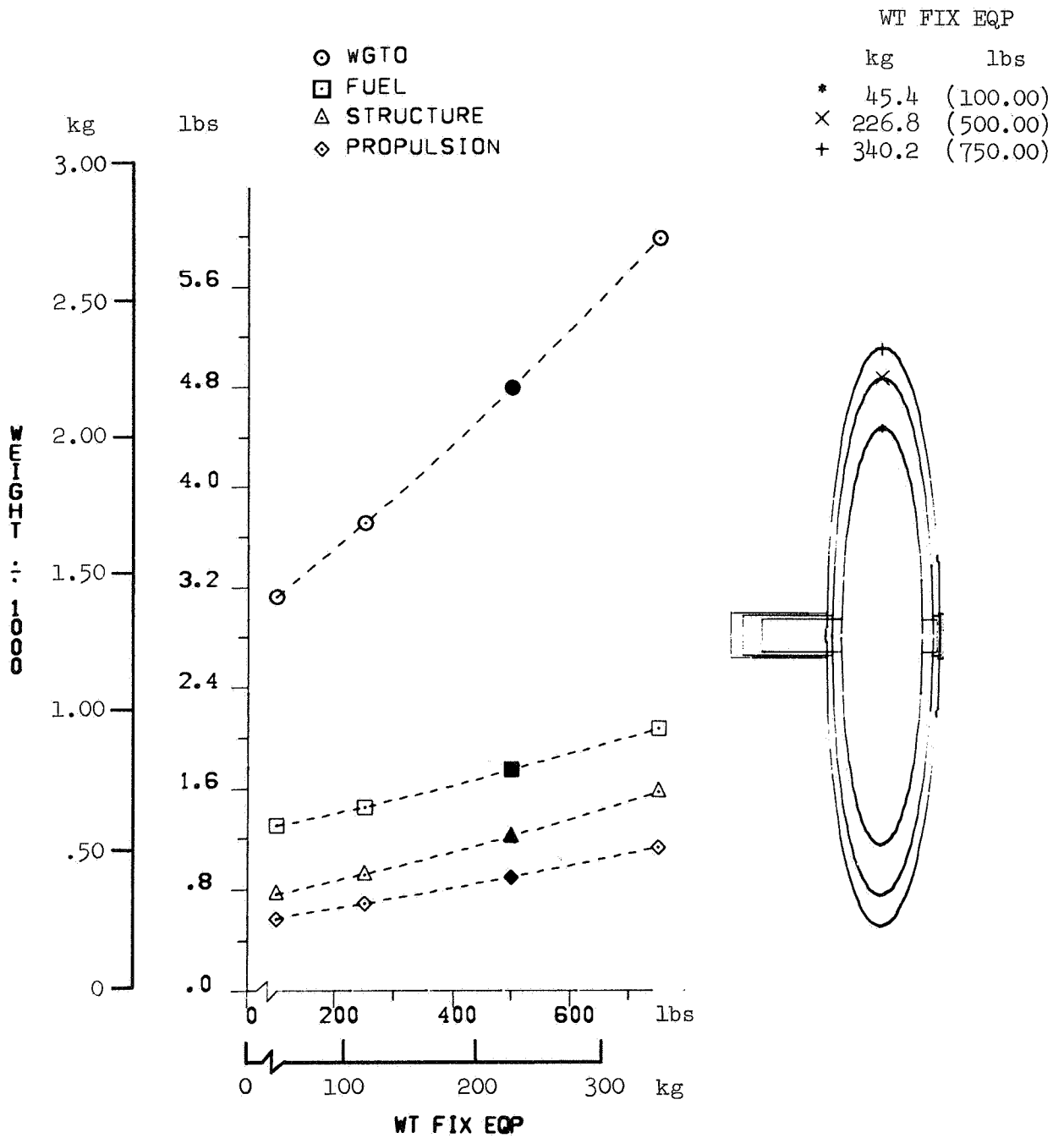

(a) Weights.

Figure 16.— Effect of weight of fixed equipment.

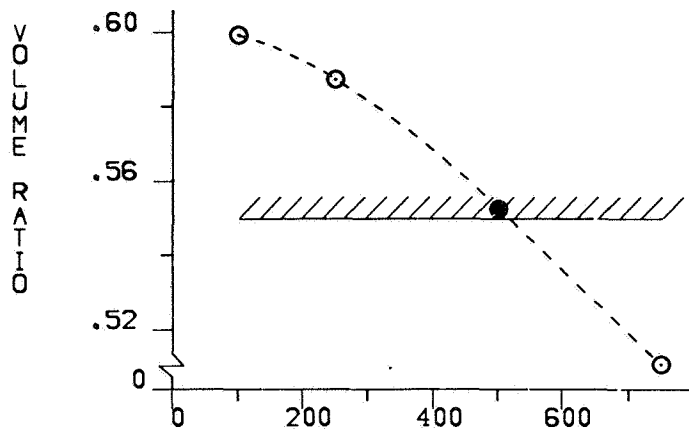

- VOLUME RATIO
- WING VOLUME
- △ VOLUME REQUIRED

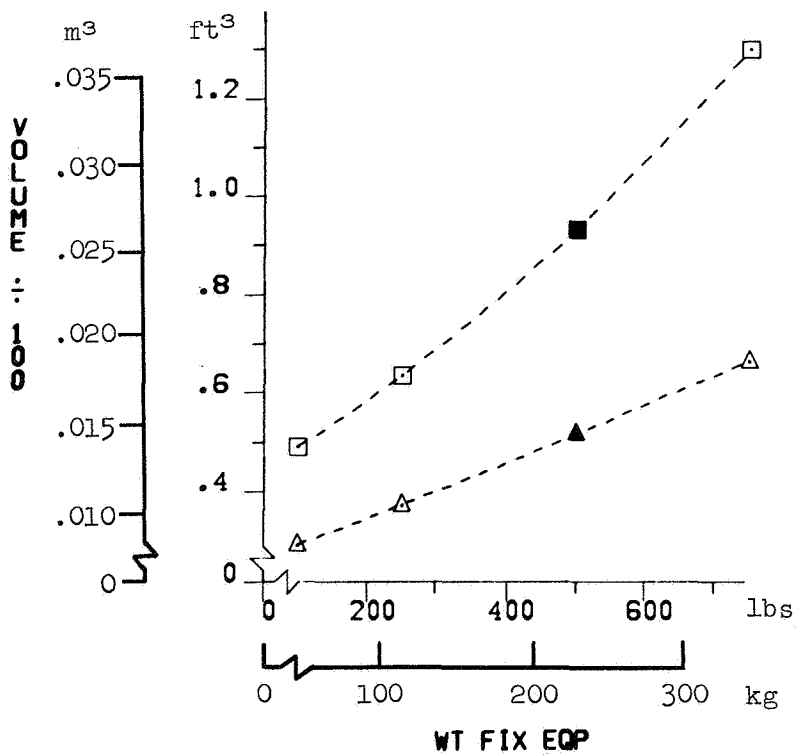

(b) Volume.

Figure 16.— Continued.

WT FIX EQP

kg lbs

⊙ 45.4 (100.00)

■ 226.8 (500.00)

△ 340.2 (750.00)

MACH NO. = 0.9

MACH NO. = 1.2

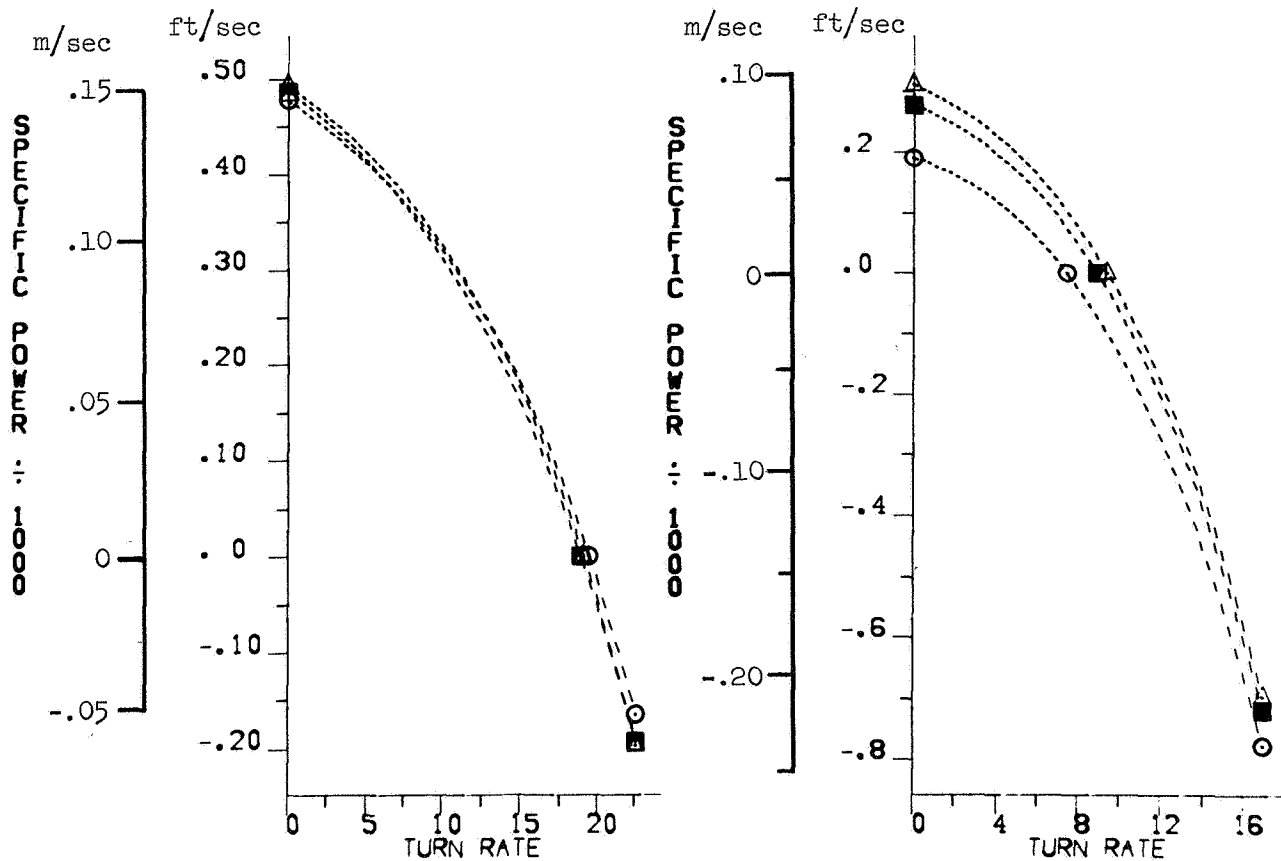

(c) Combat performance.

Figure 16.— Concluded.

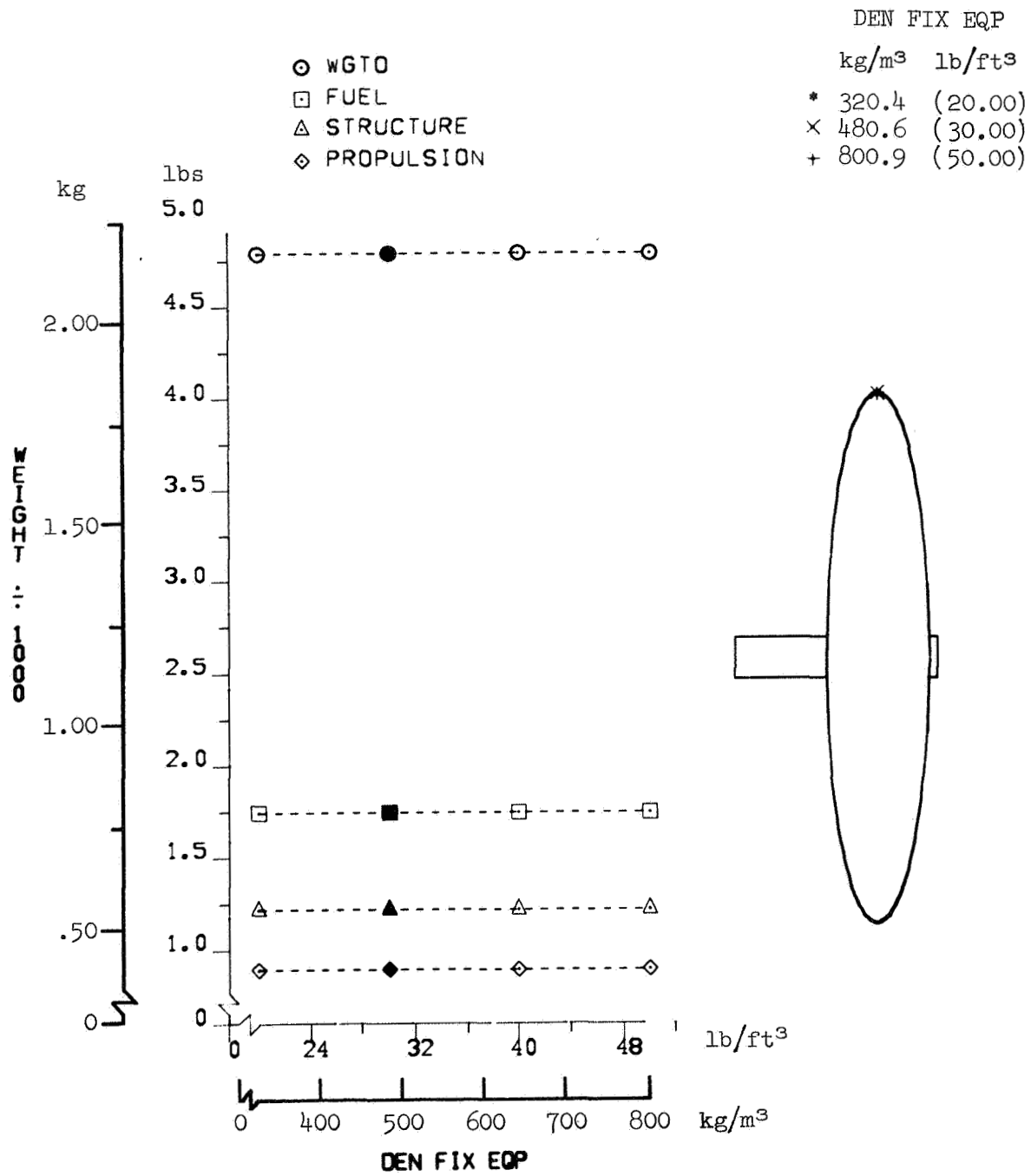

(a) Weights.

Figure 17.— Effect of density of fixed equipment.

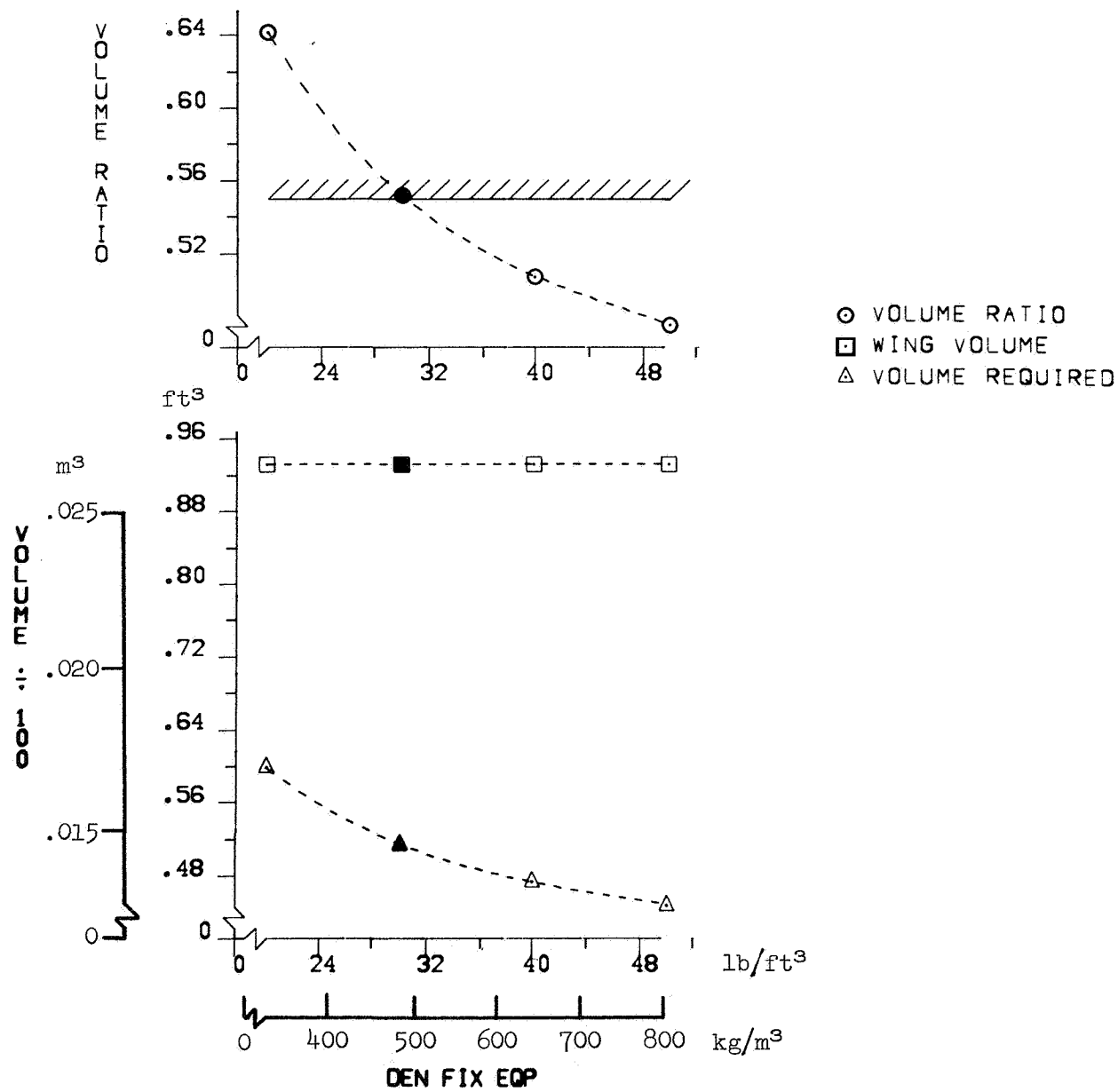

(b) Volume.

Figure 17.— Continued.

DEN FIX EQP
 kg/m³ lb/ft³
 ○ 320.4 (20.00)
 ■ 480.6 (30.00)
 △ 800.9 (50.00)

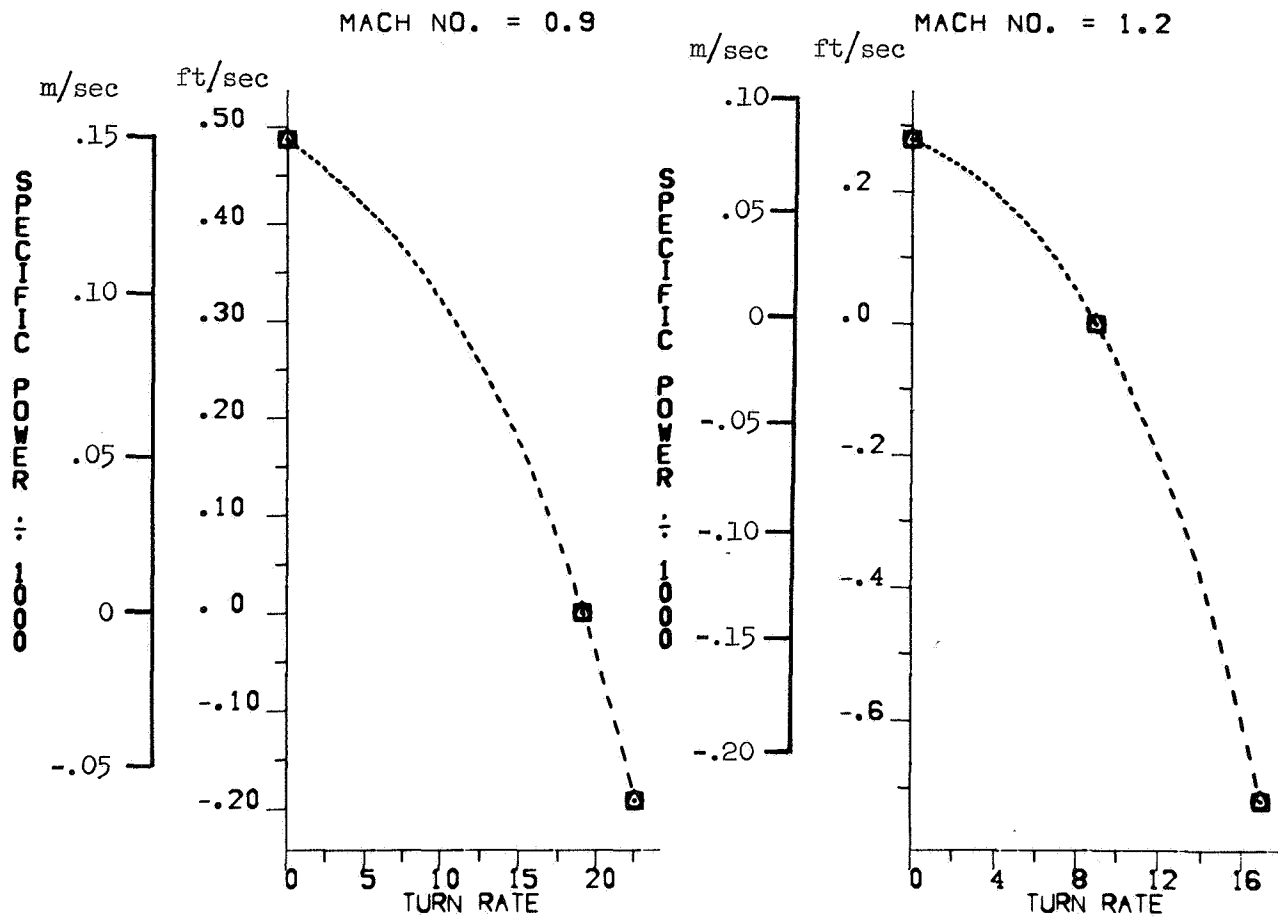

(c) Combat performance.

Figure 17.- Concluded.

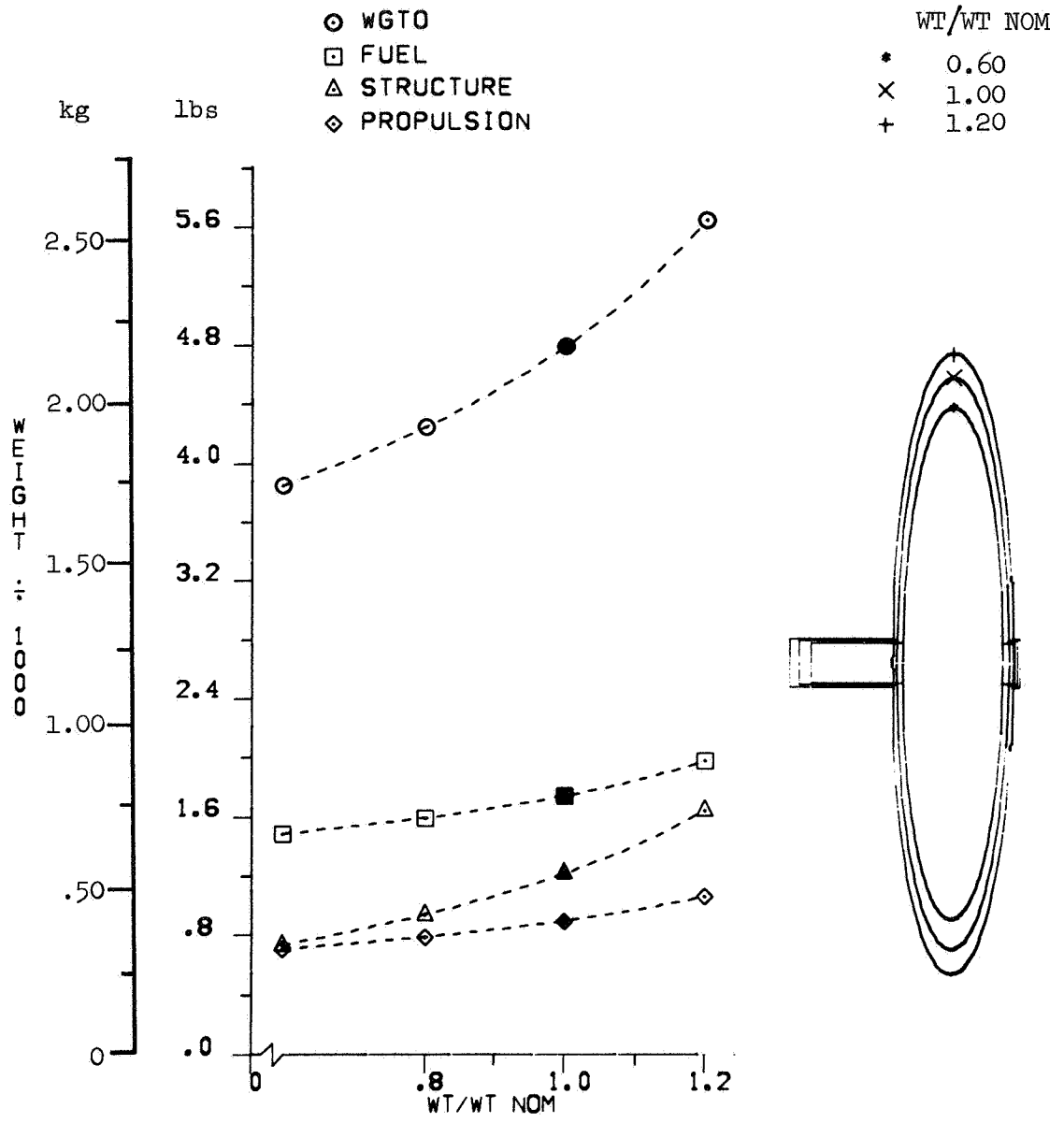

(a) Weights.

Figure 18.— Effect of a change in wing weight.

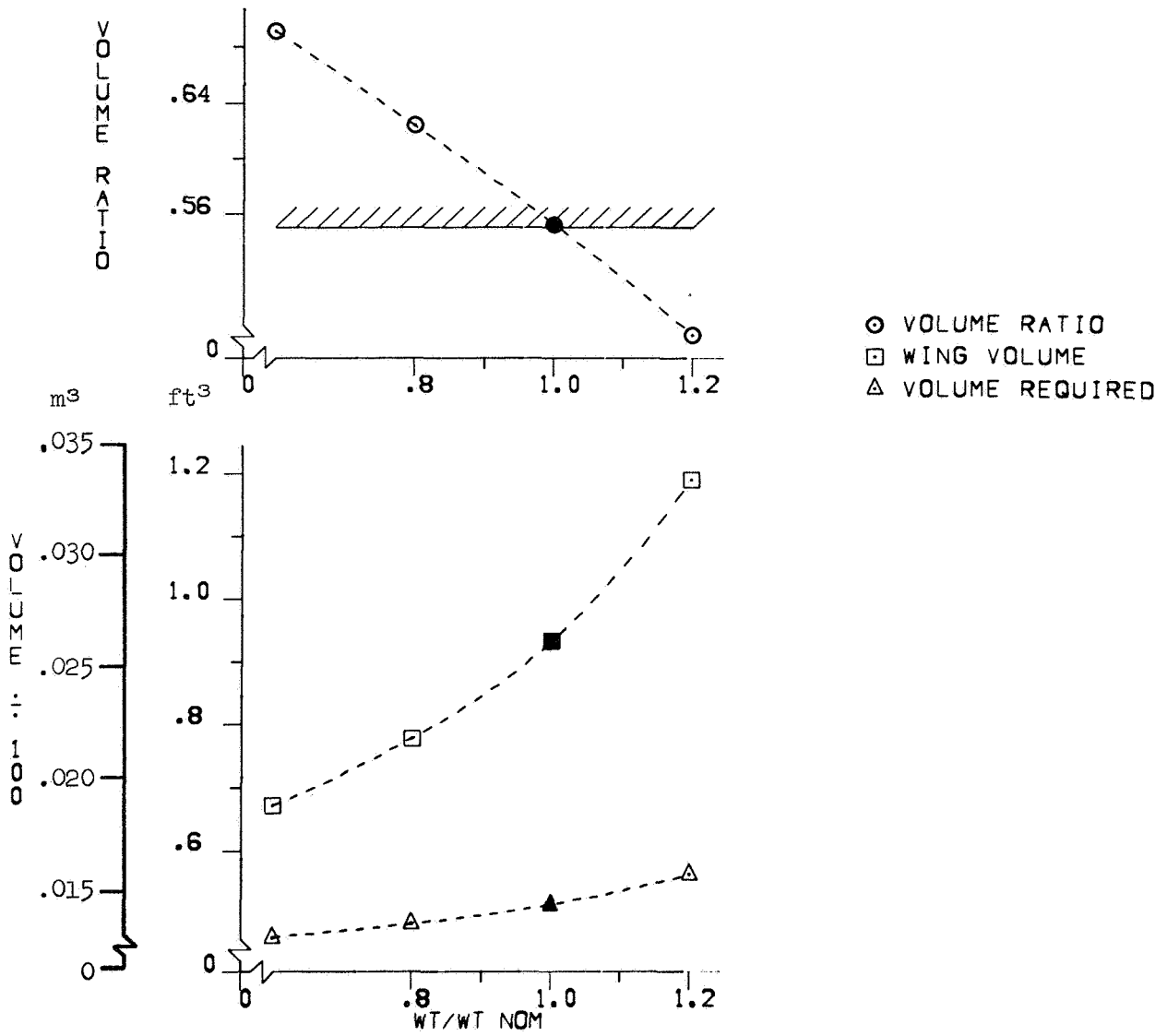

(b) Volume.

Figure 18.— Continued.

WT/WT NOM

- 0.60
- 1.00
- △ 1.20

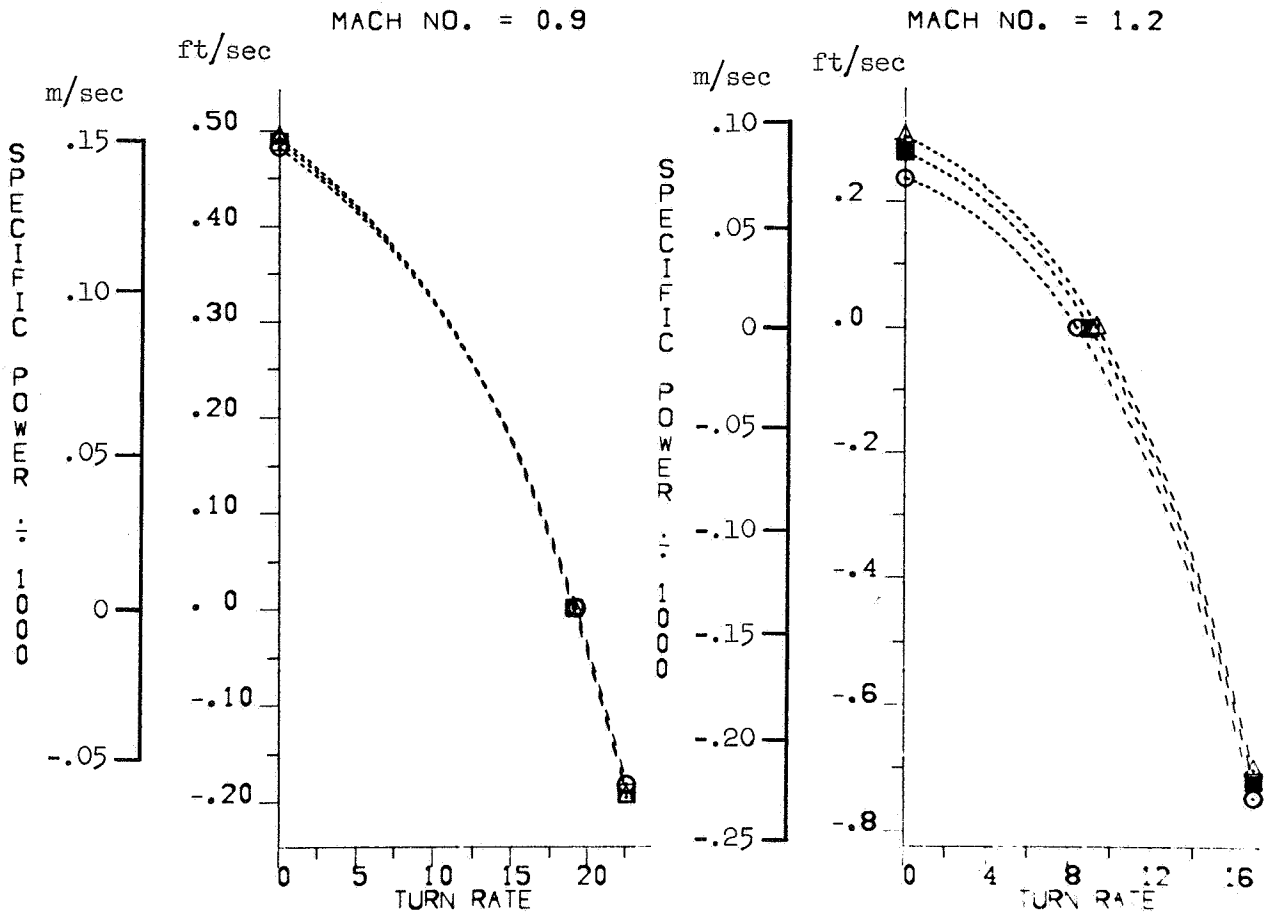

(c) Combat performance.

Figure 18.— Concluded.

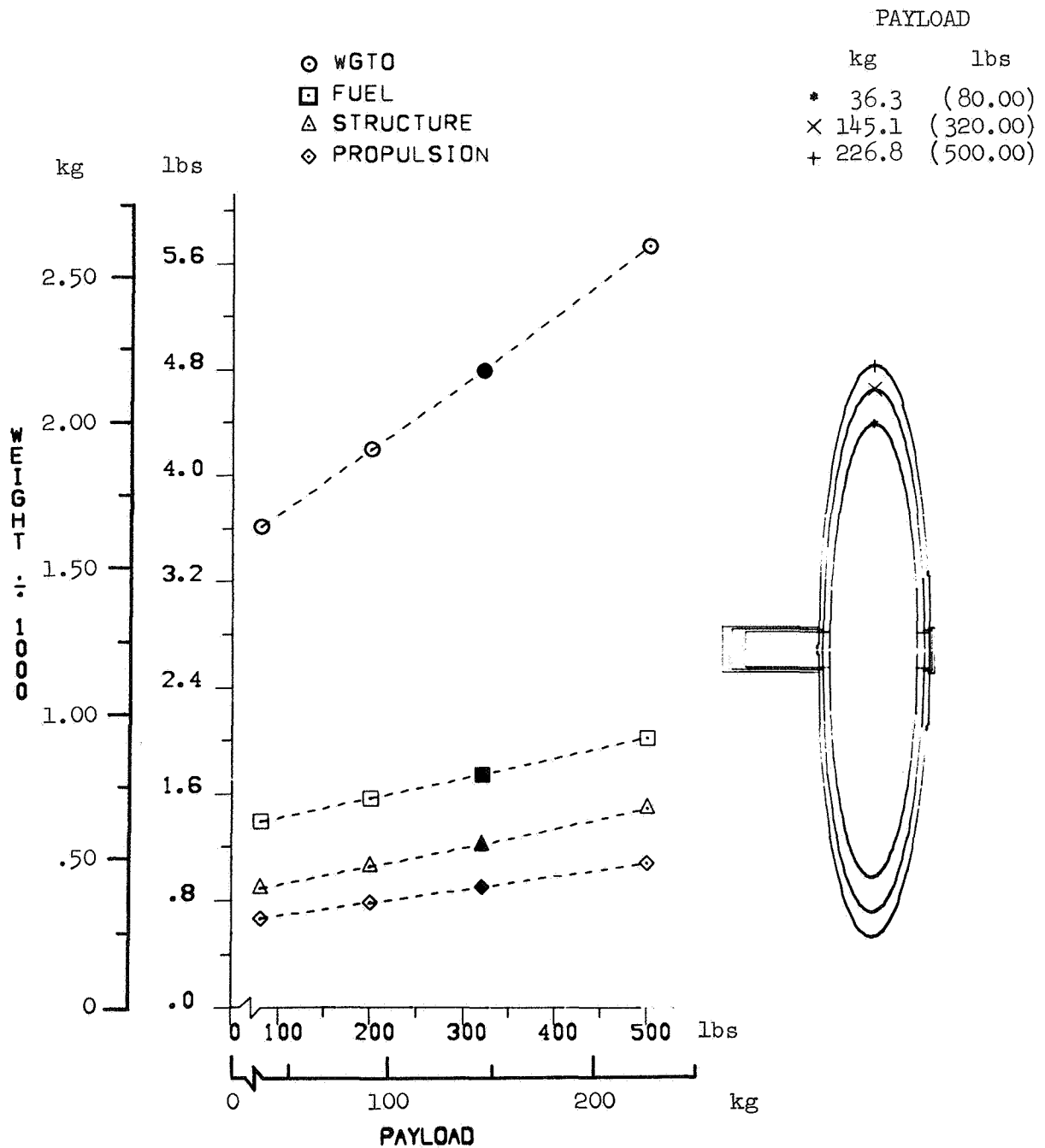

(a) Weights.

Figure 19.— Effect of weight of payload.

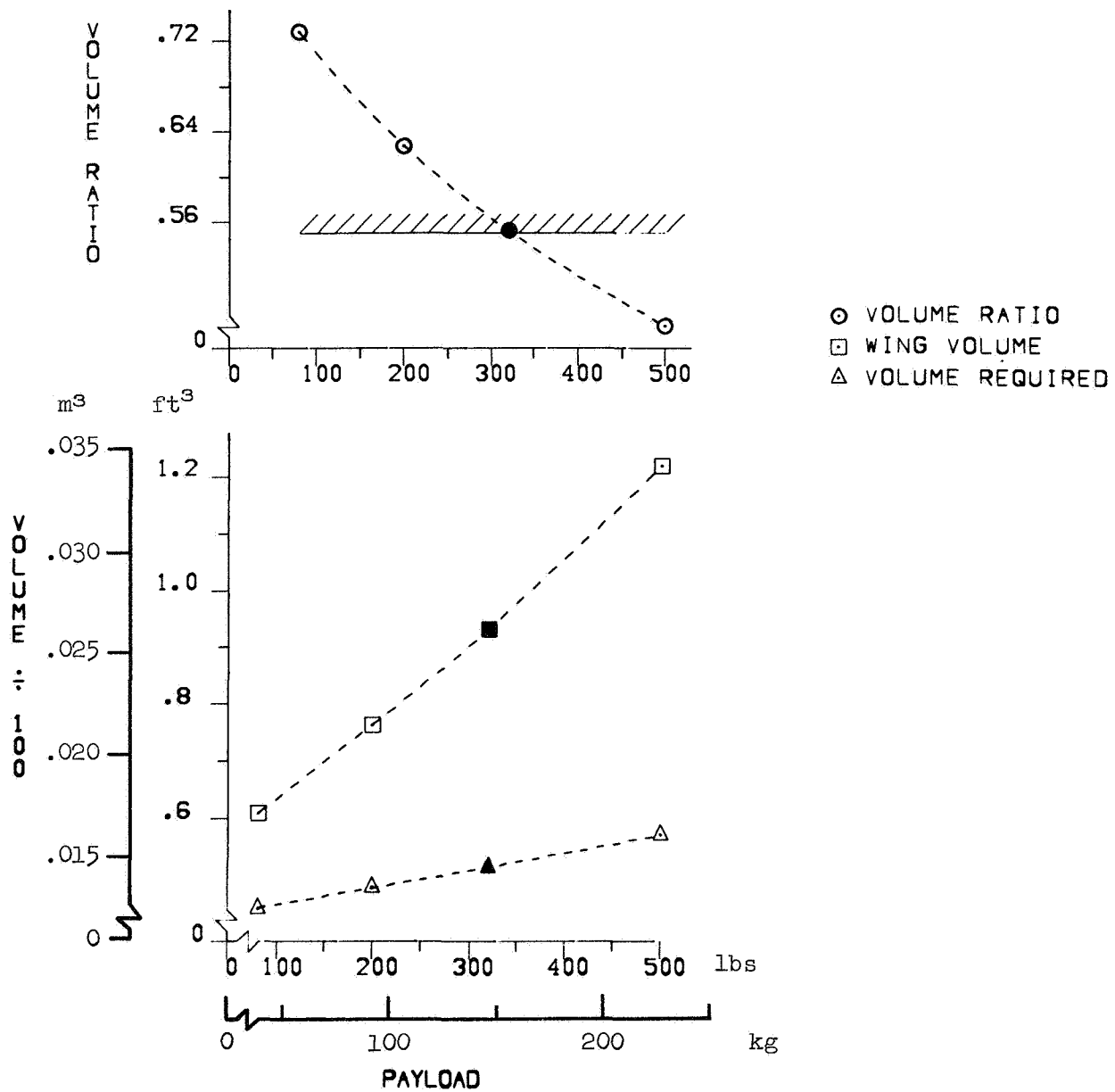

(b) Volume.

Figure 19.— Continued.

PAYLOAD

	kg	lbs
○	36.3	(80.00)
■	145.1	(320.00)
△	226.8	(500.00)

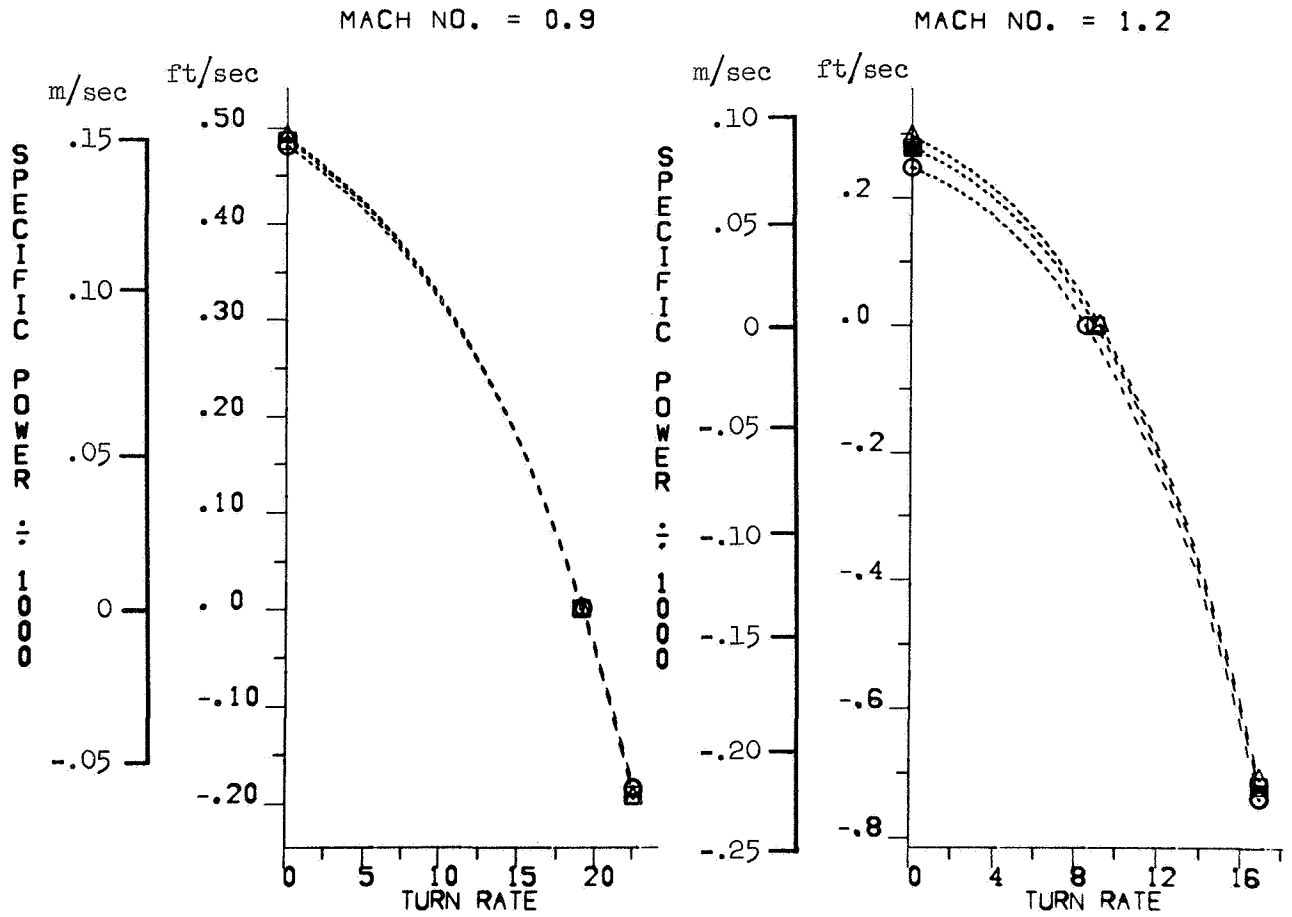

(c) Combat performance.

Figure 19.— Concluded.

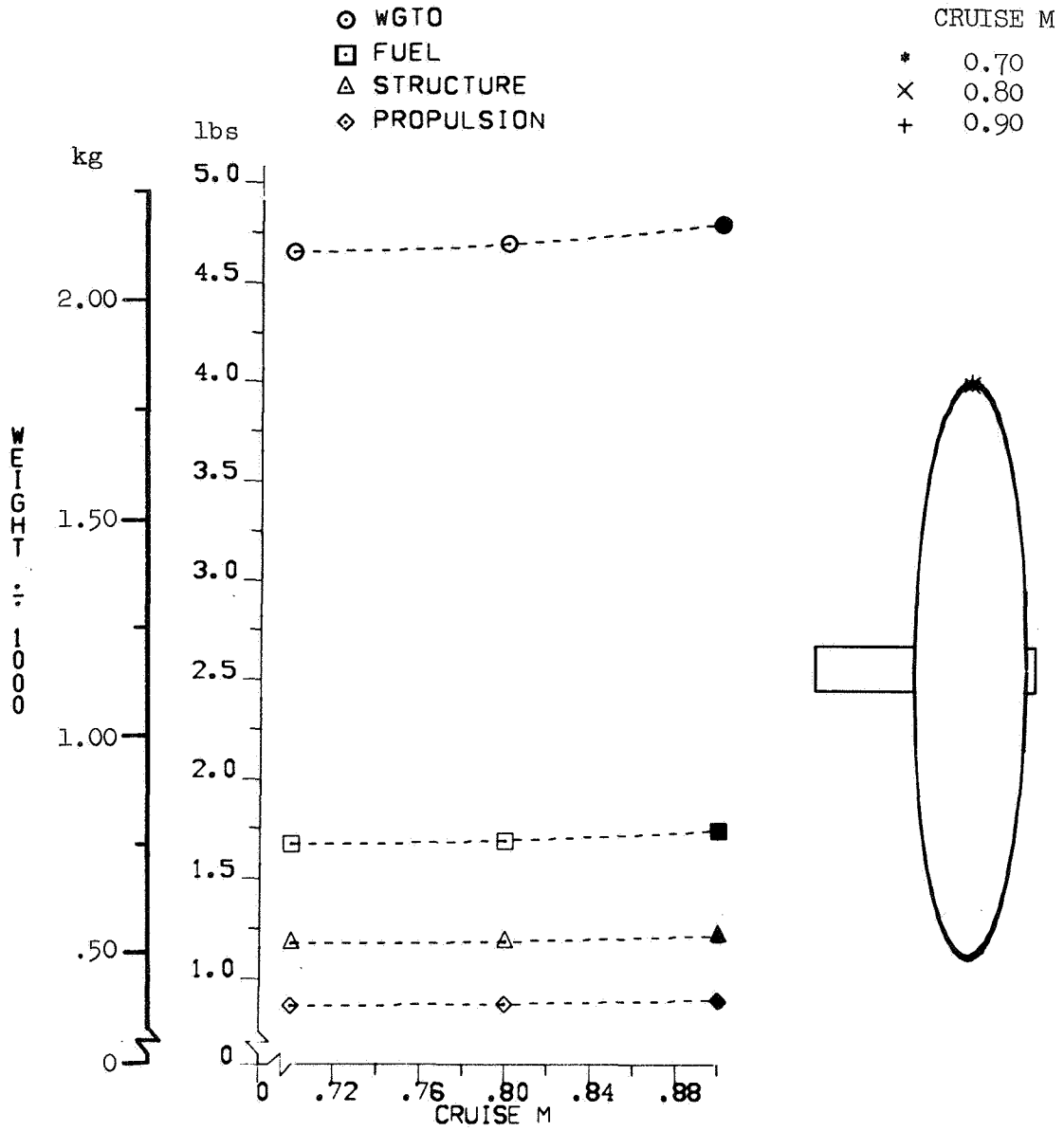

(a) Weights.

Figure 20.— Effect of cruise Mach number.

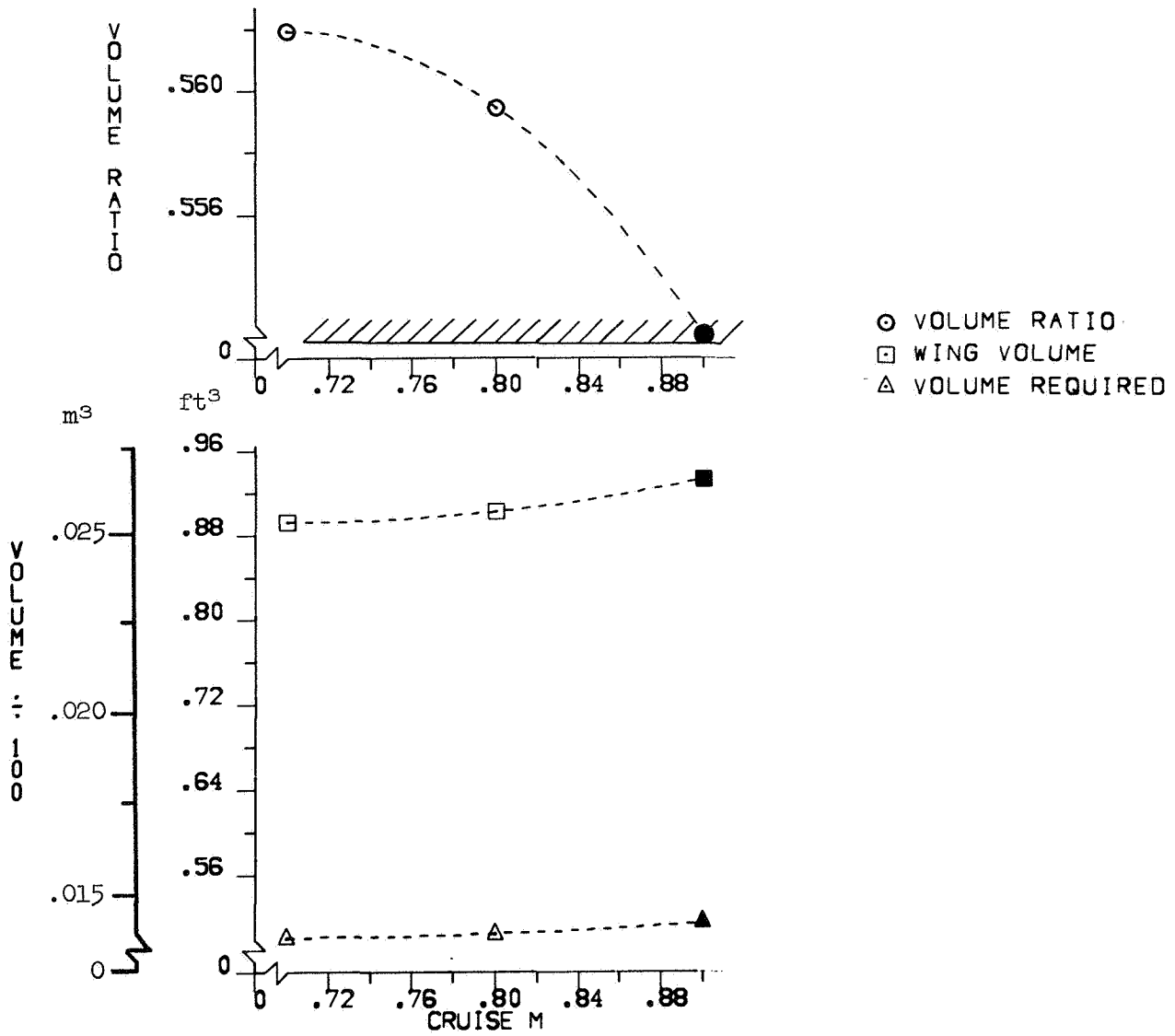

(b) Volume.

Figure 20.— Continued.

CRUISE M

- 0.70
- 0.80
- ▲ 0.90

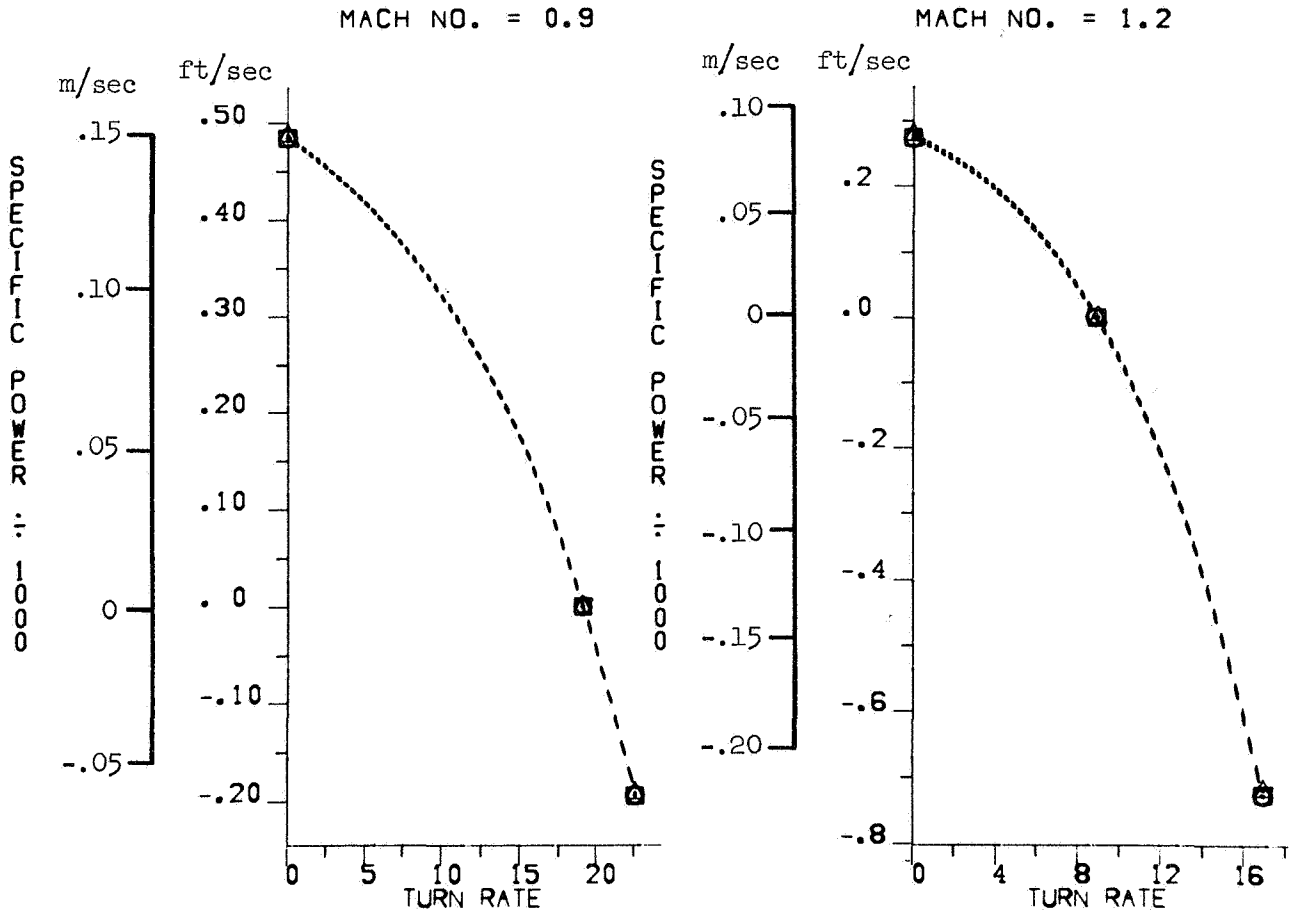

(c) Combat performance.

Figure 20.— Concluded.

CRUISE ALT.

m ft

* 10668 (35000.00)

x 13716 (45000.00)

+ 15240 (50000.00)

- WGT0
- FUEL
- △ STRUCTURE
- ◇ PROPULSION

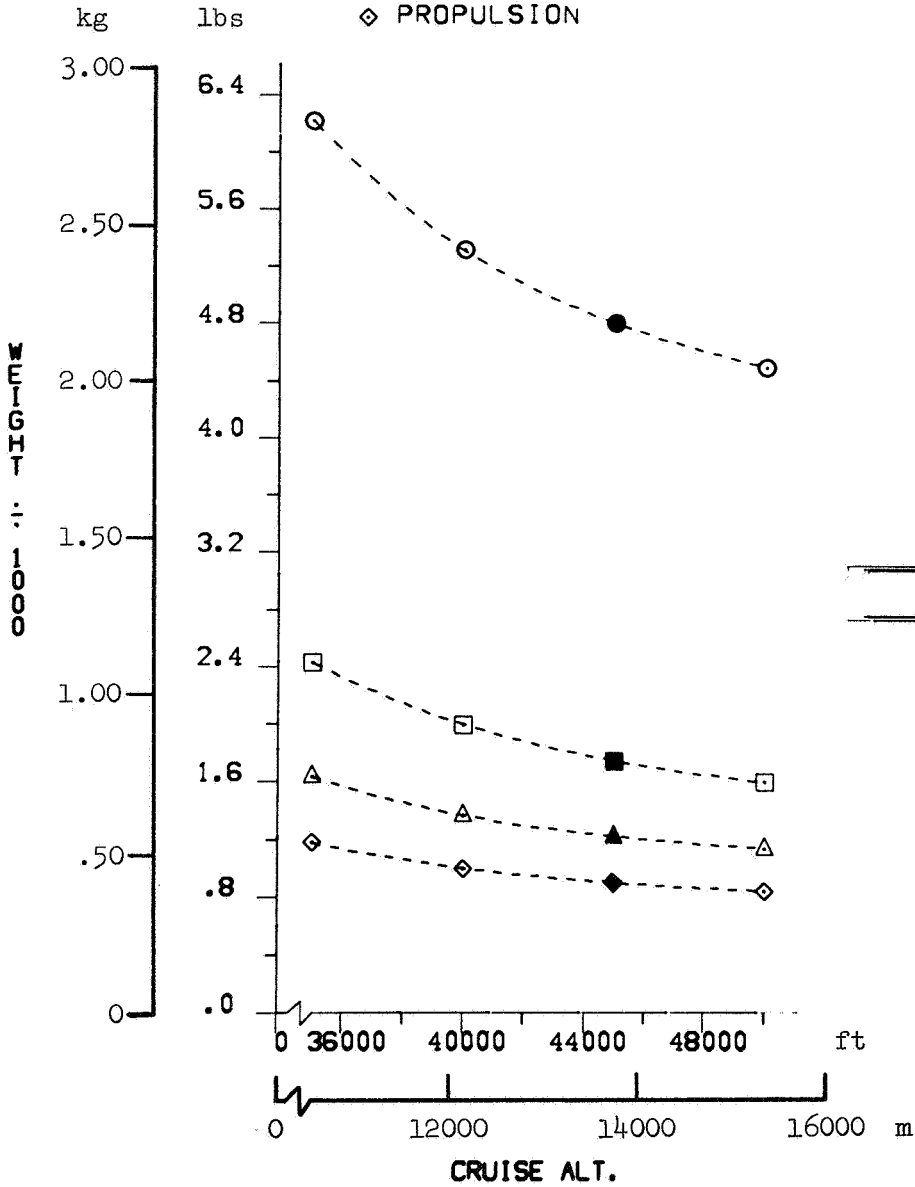

(a) Weights.

Figure 21.— Effect of cruise altitude.

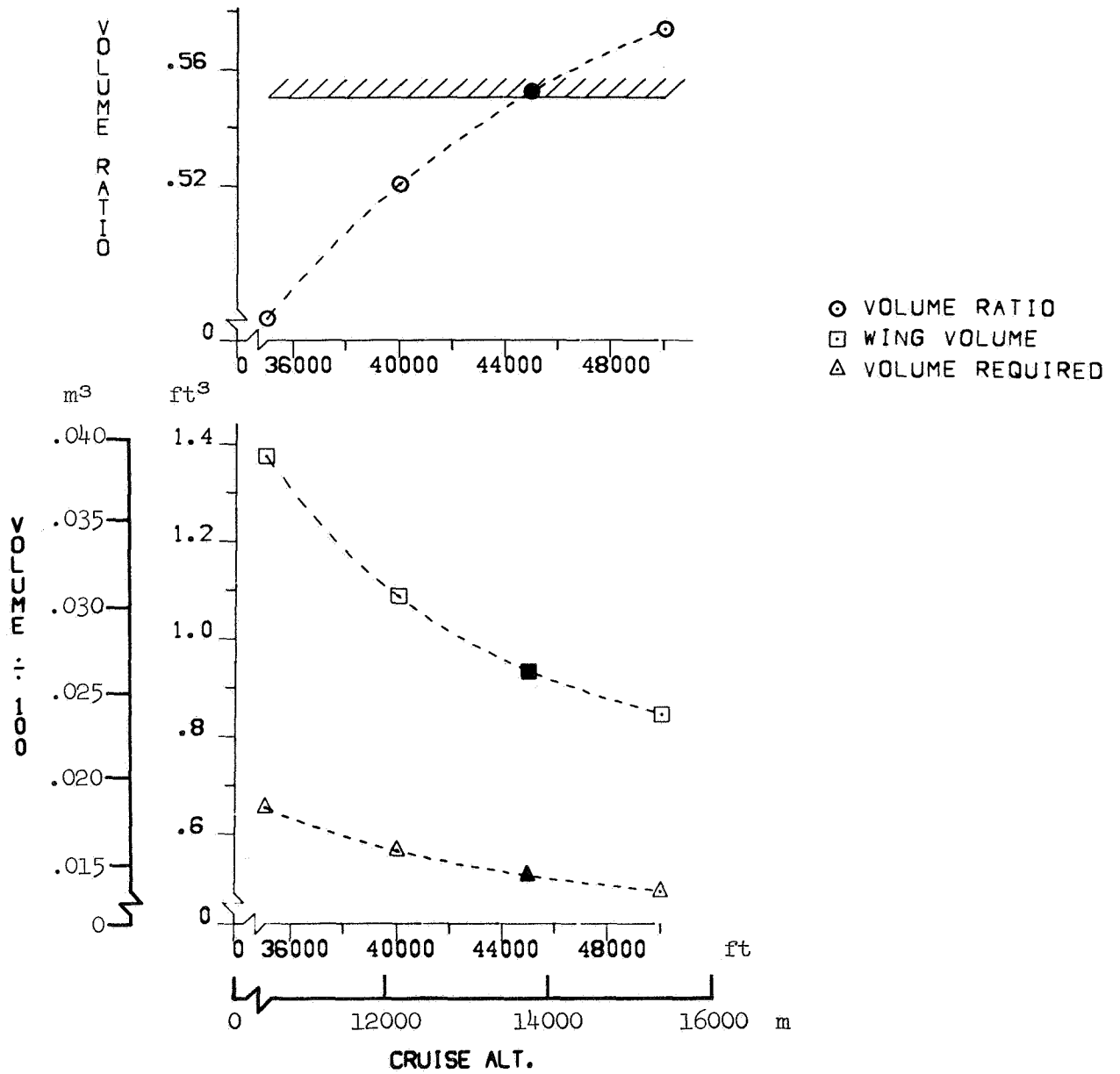

(b) Volume.

Figure 21.— Continued.

CRUISE ALT.

	m	ft
○	10668	(35000.00)
■	13716	(45000.00)
△	15240	(50000.00)

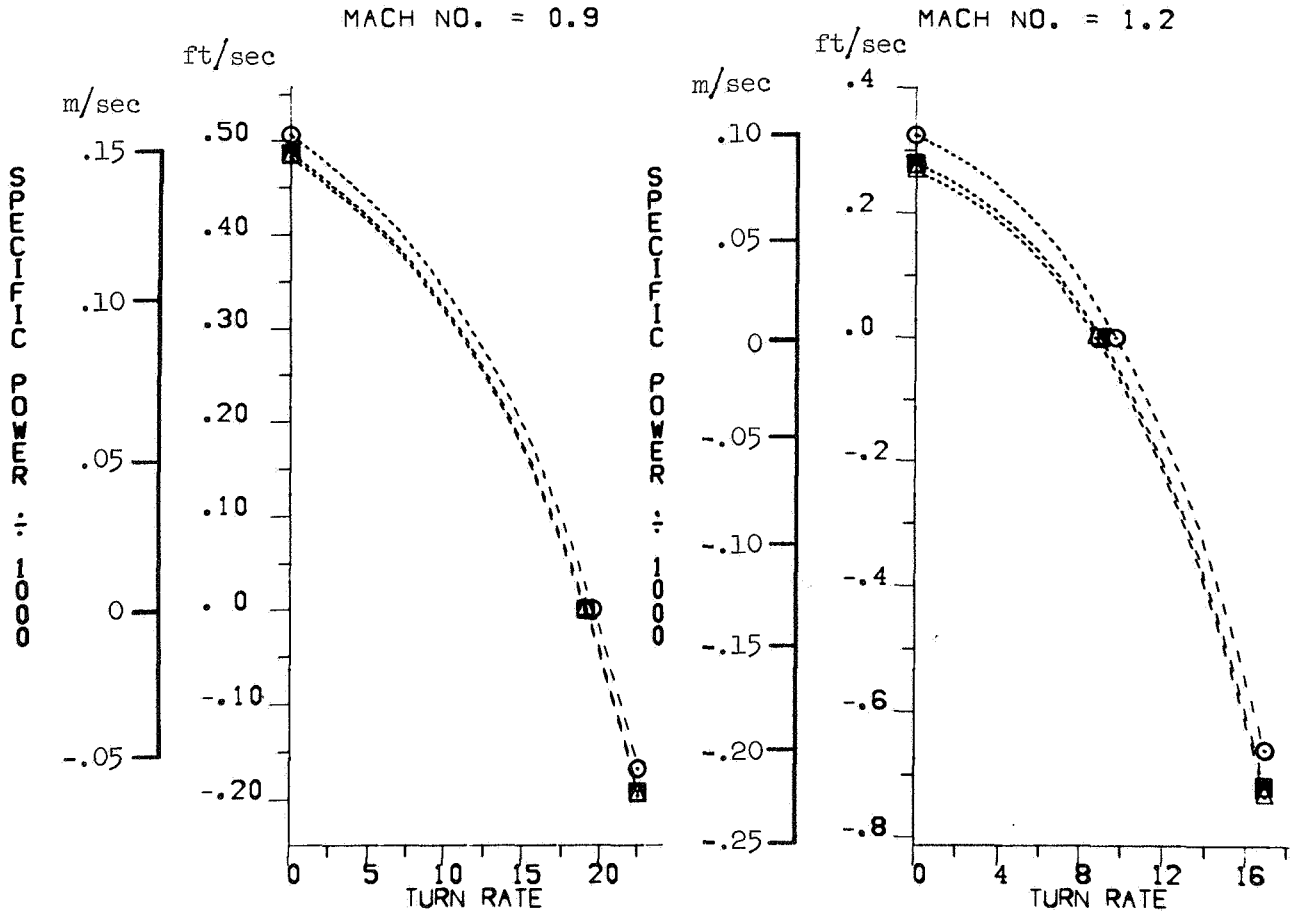

(c) Combat performance.

Figure 21.— Concluded.

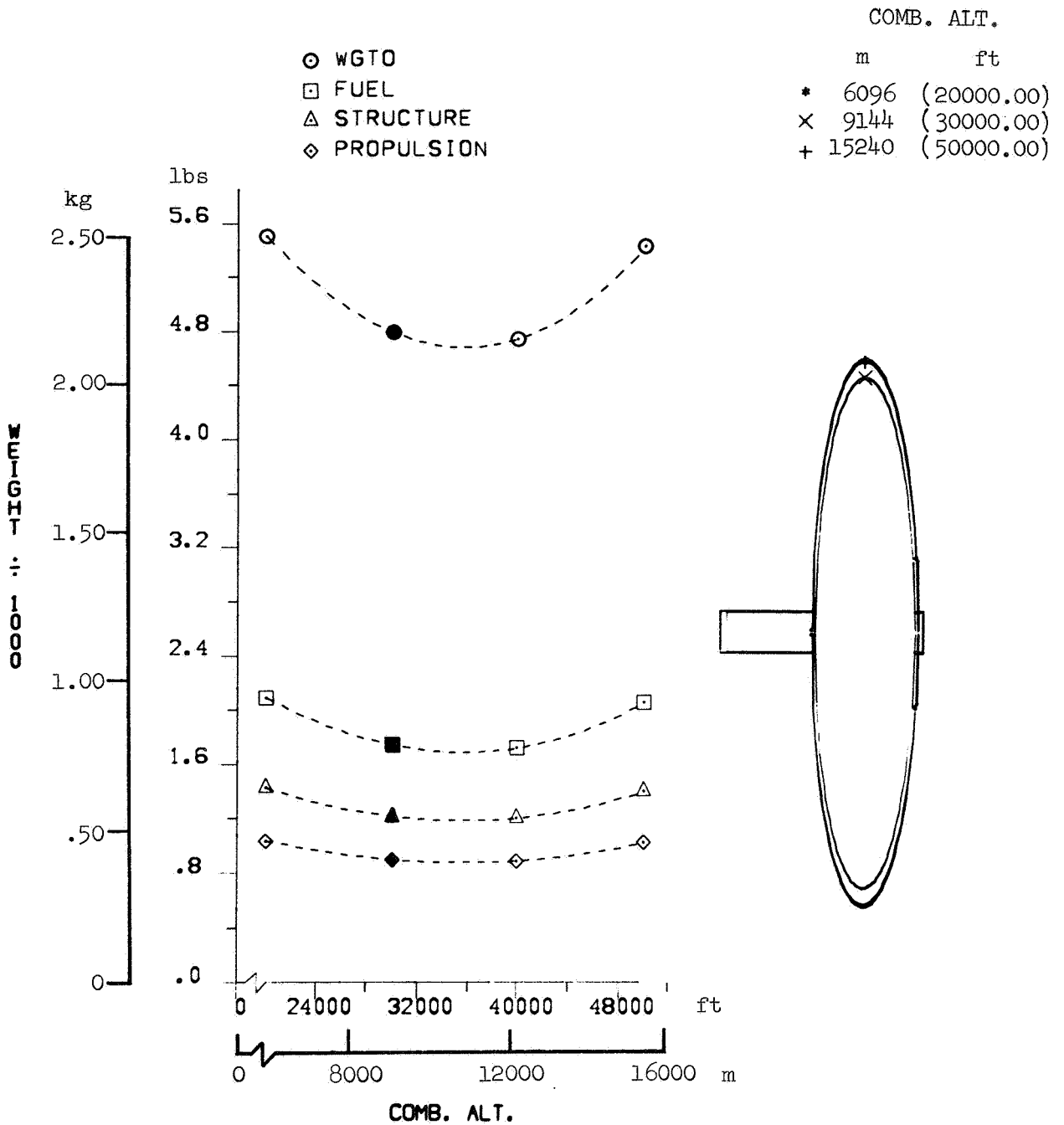

(a) Weights.

Figure 22.— Effect of combat altitude.

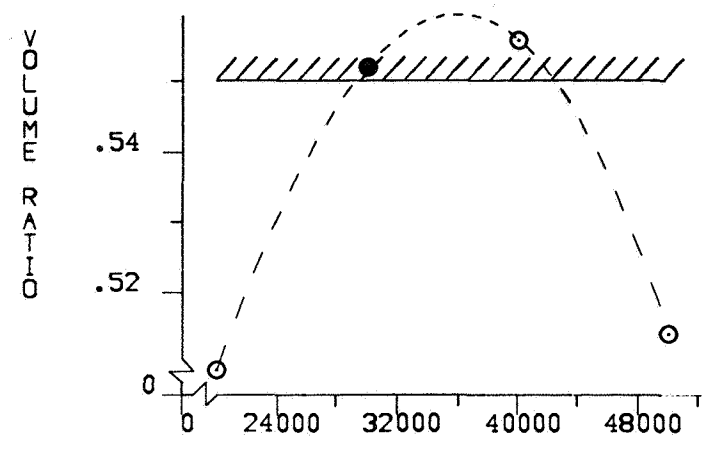

- VOLUME RATIO
- WING VOLUME
- △ VOLUME REQUIRED

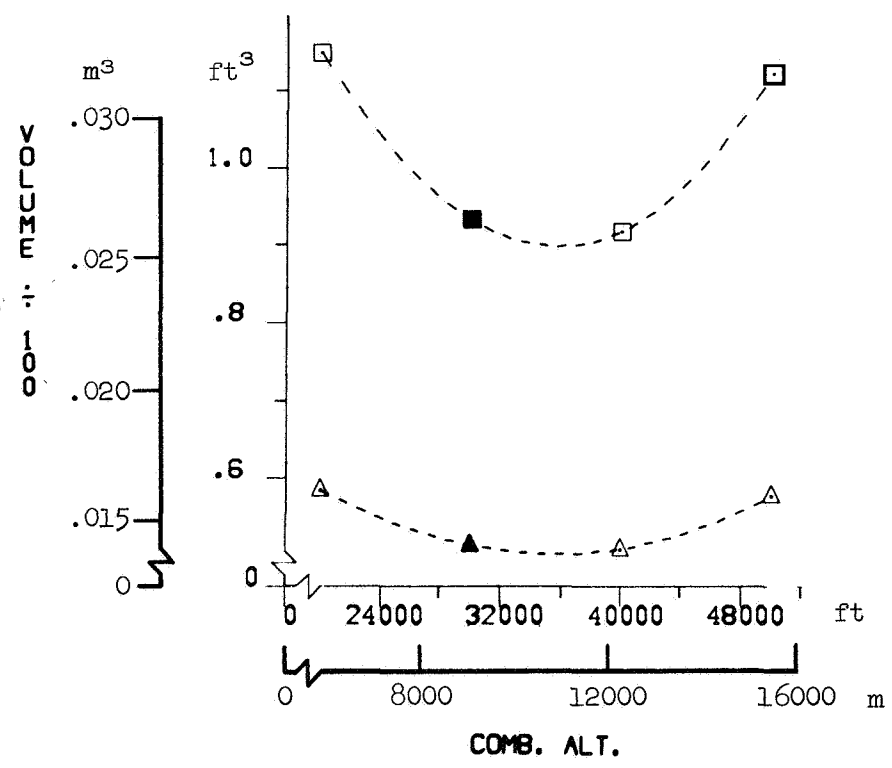

(b) Volume.

Figure 22.— Continued.

COMB. ALT.

m ft

- 9144 (30000.00)
- 12192 (40000.00)
- △ 15240 (50000.00)

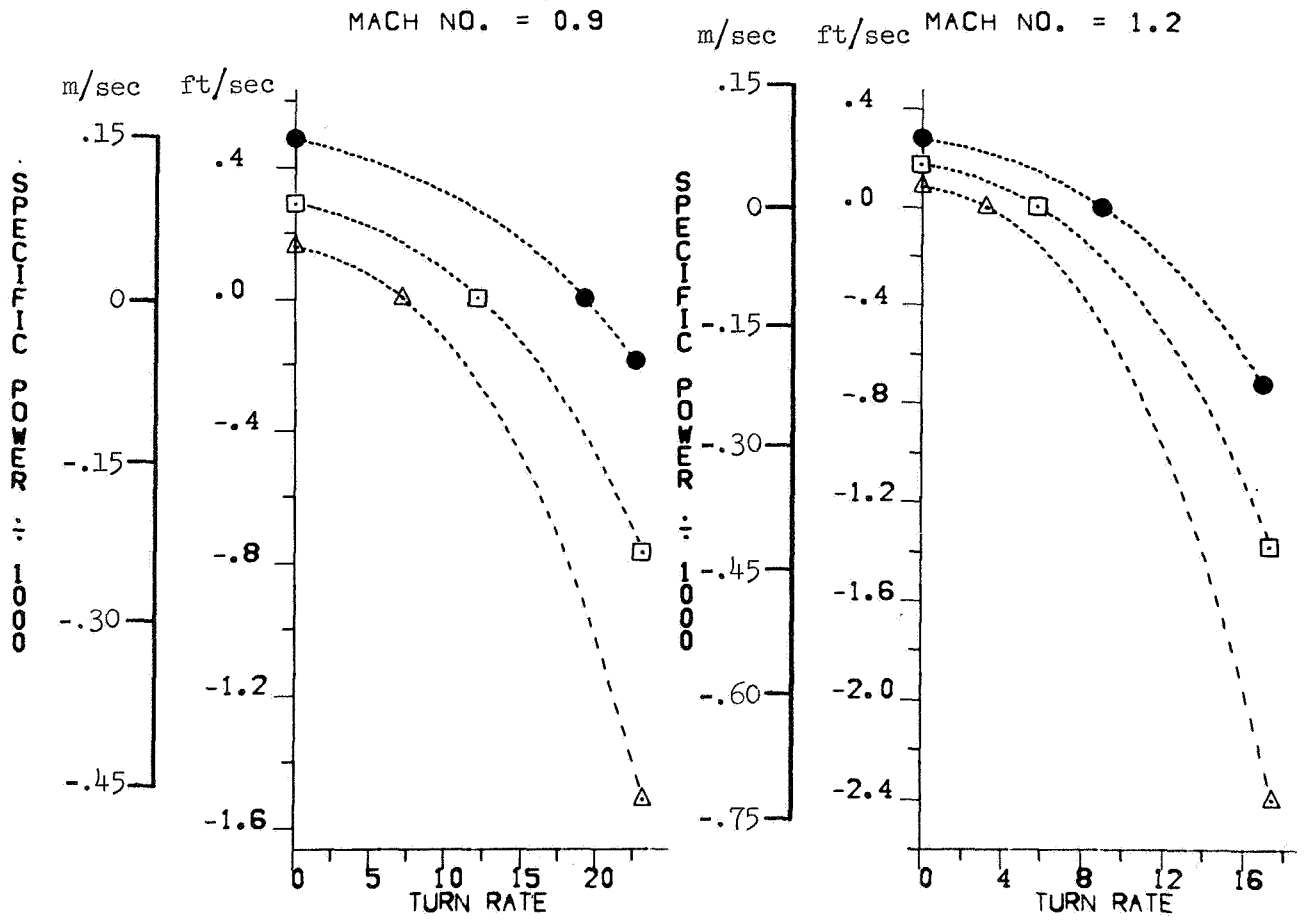

(c) Combat performance.

Figure 22.— Continued.

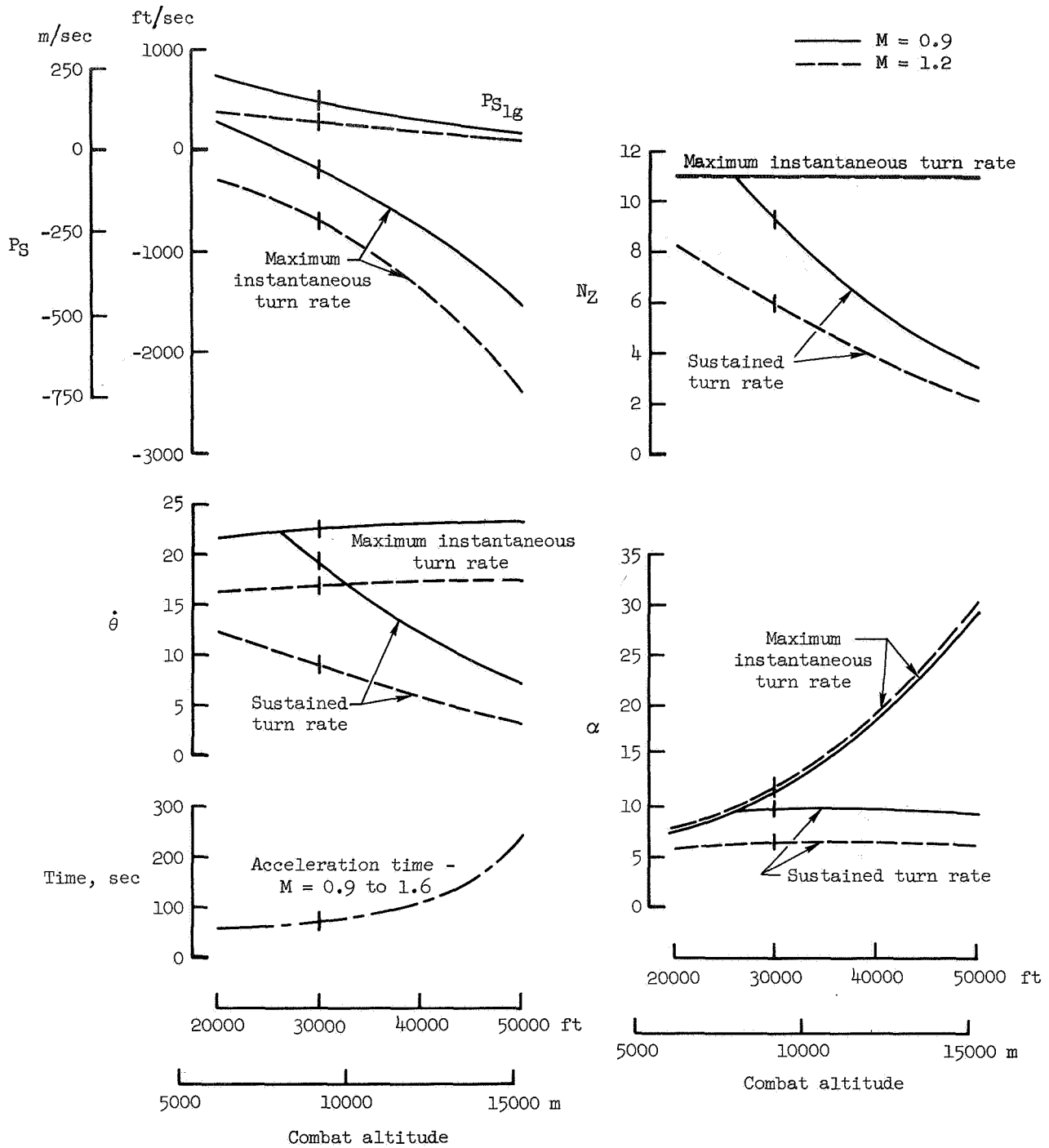

(c) Combat performance (concluded).

Figure 22.— Concluded.

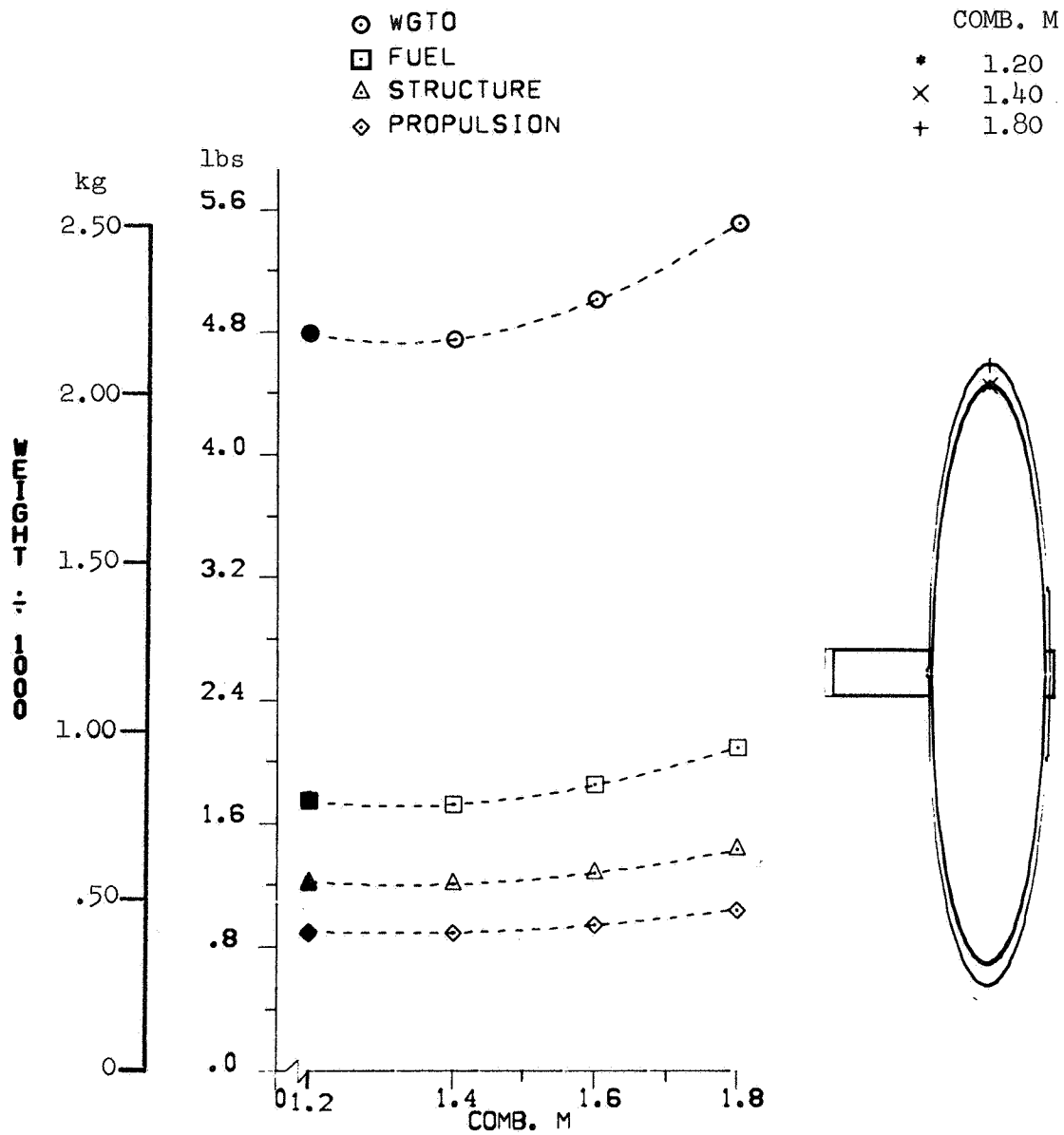

(a) Weights.

Figure 23.— Effect of supersonic combat Mach number.

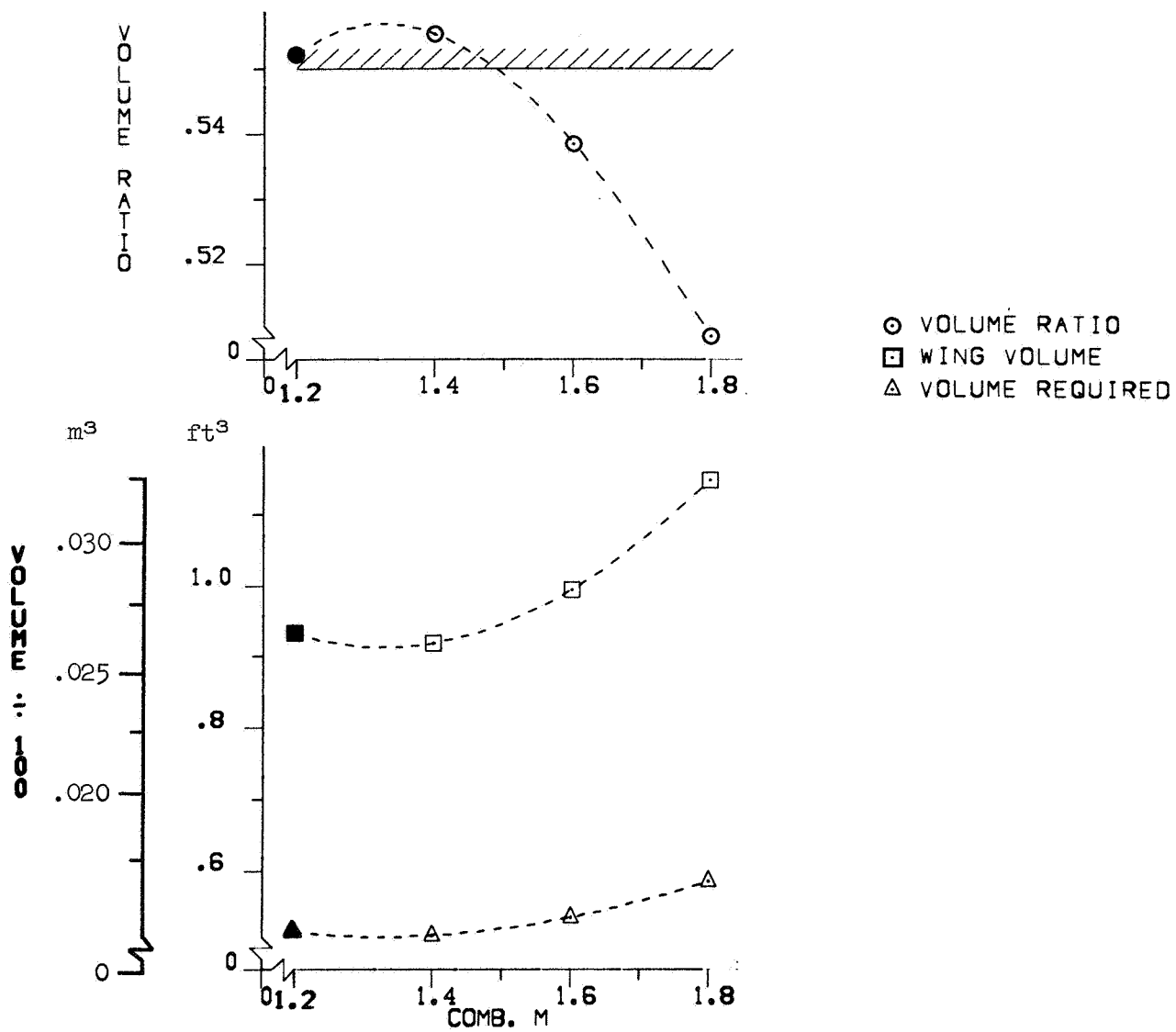

(b) Volume.

Figure 23.— Continued.

COMB. M

- 1.20
- 1.40
- △ 1.80

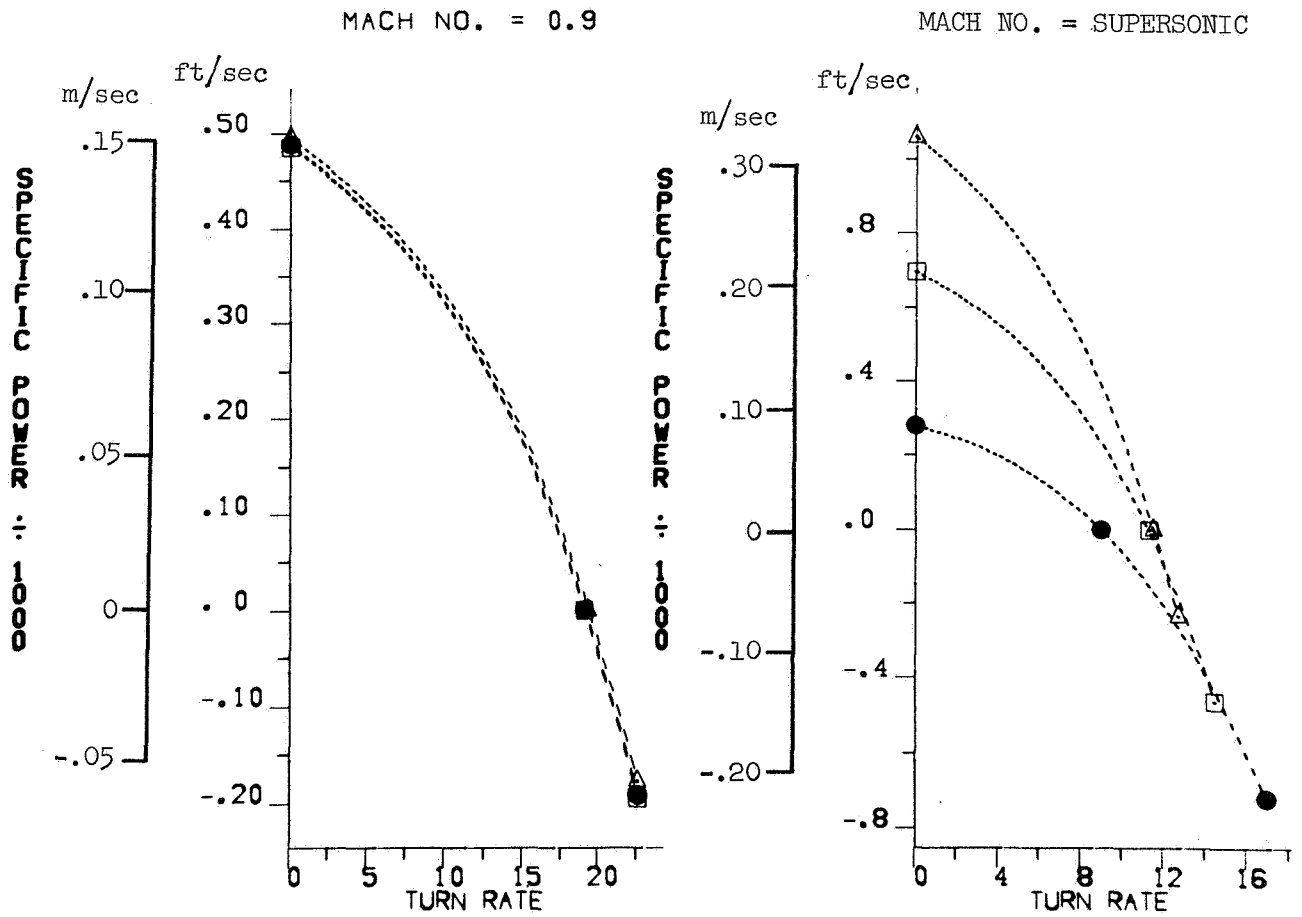

(c) Combat performance.

Figure 23.— Continued.

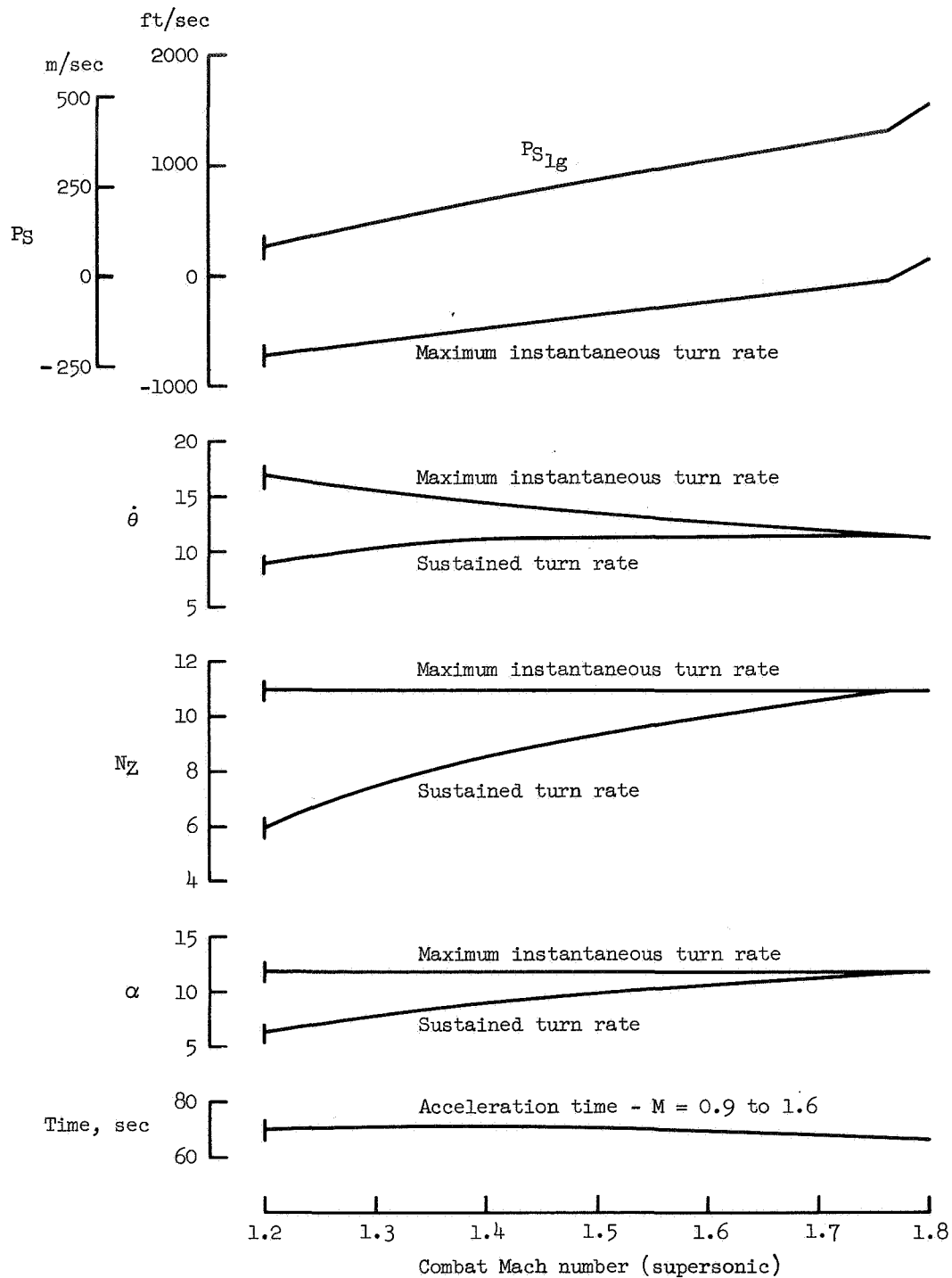

(c) Combat performance (concluded).

Figure 23.— Concluded.

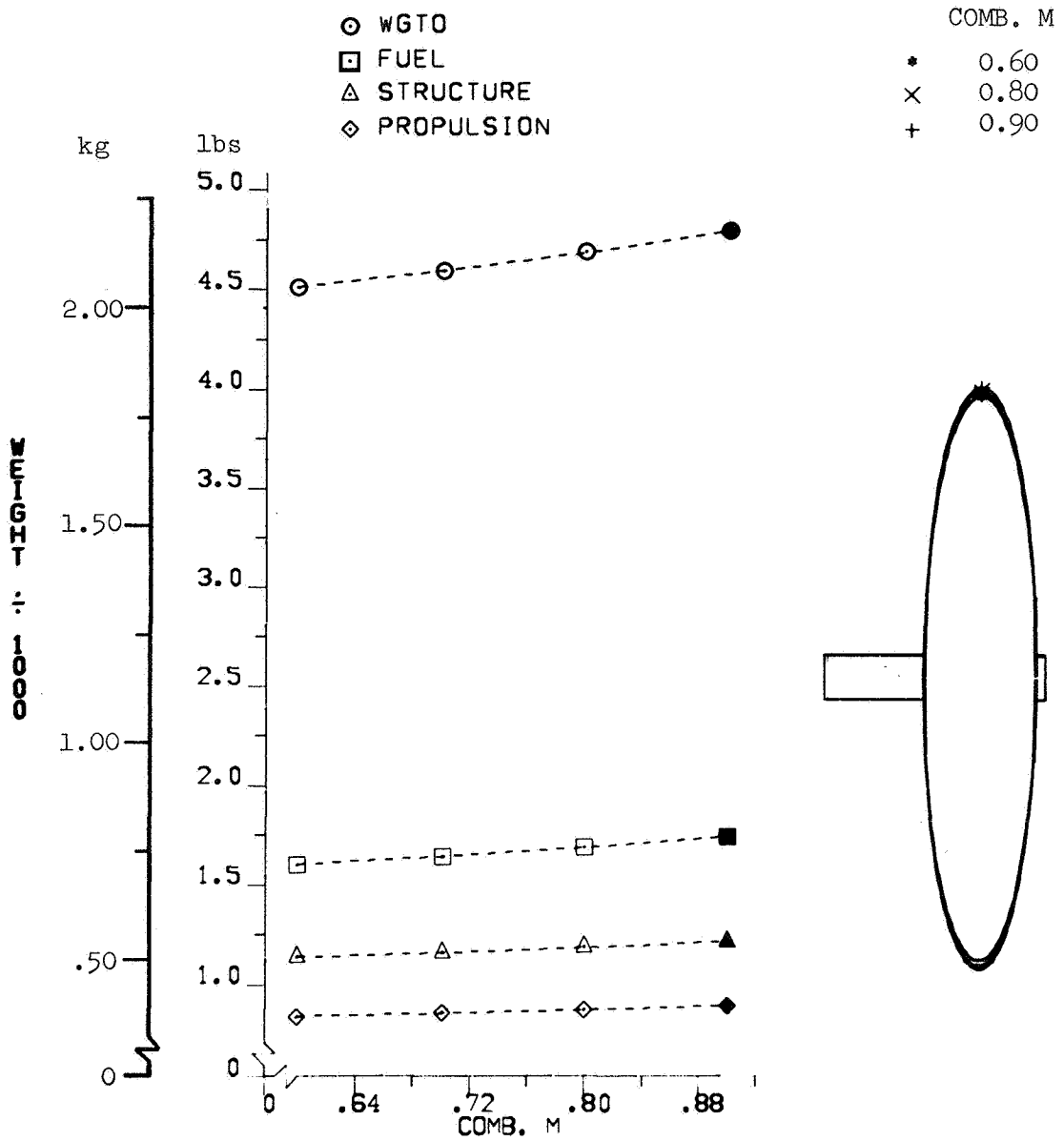

(a) Weights.

Figure 24.— Effect of subsonic combat Mach number.

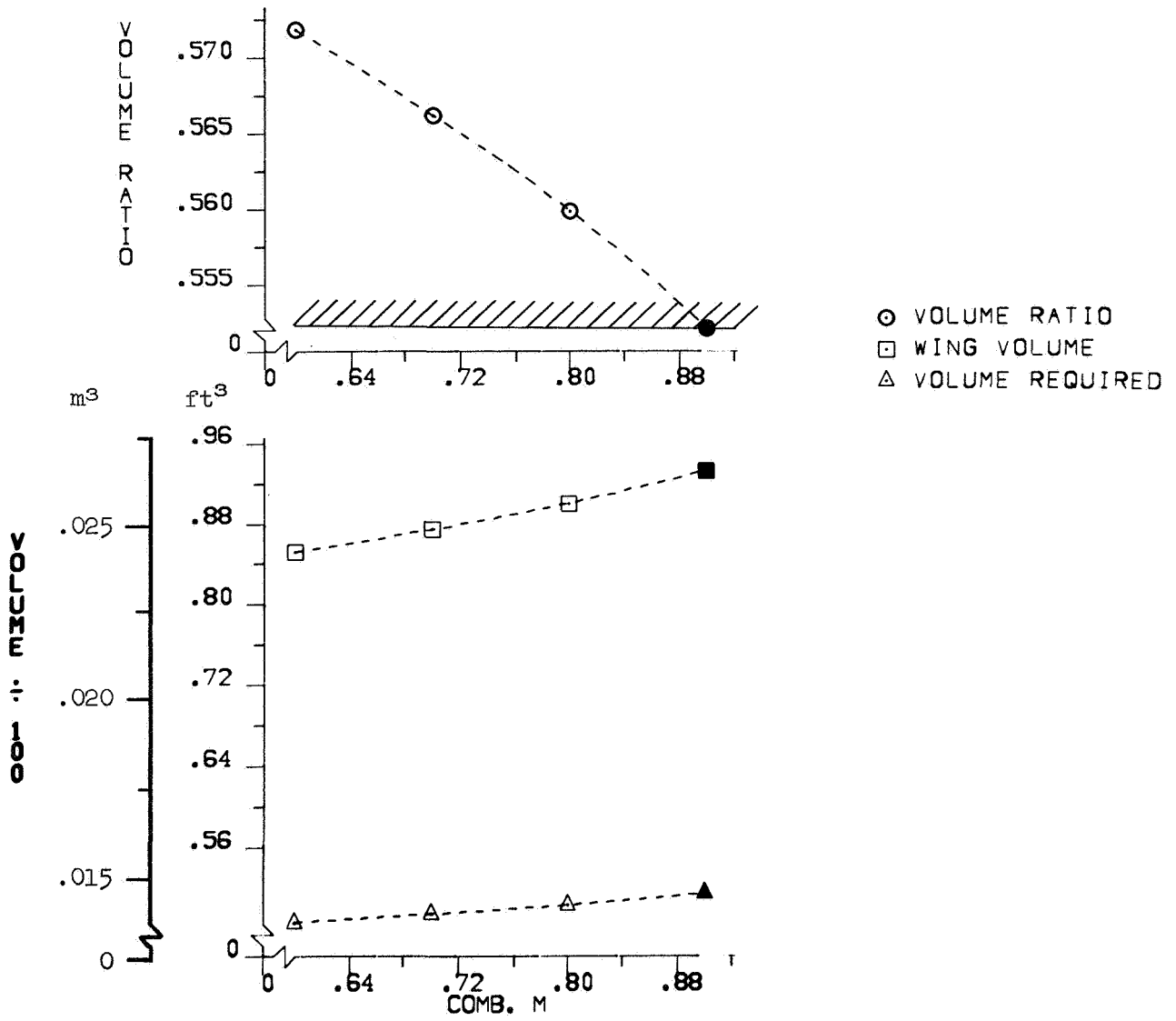

(b) Volume.

Figure 24.— Continued.

COMB. M
 ○ 0.60
 □ 0.80
 ▲ 0.90

MACH NO. = SUBSONIC

MACH NO. = 1.2

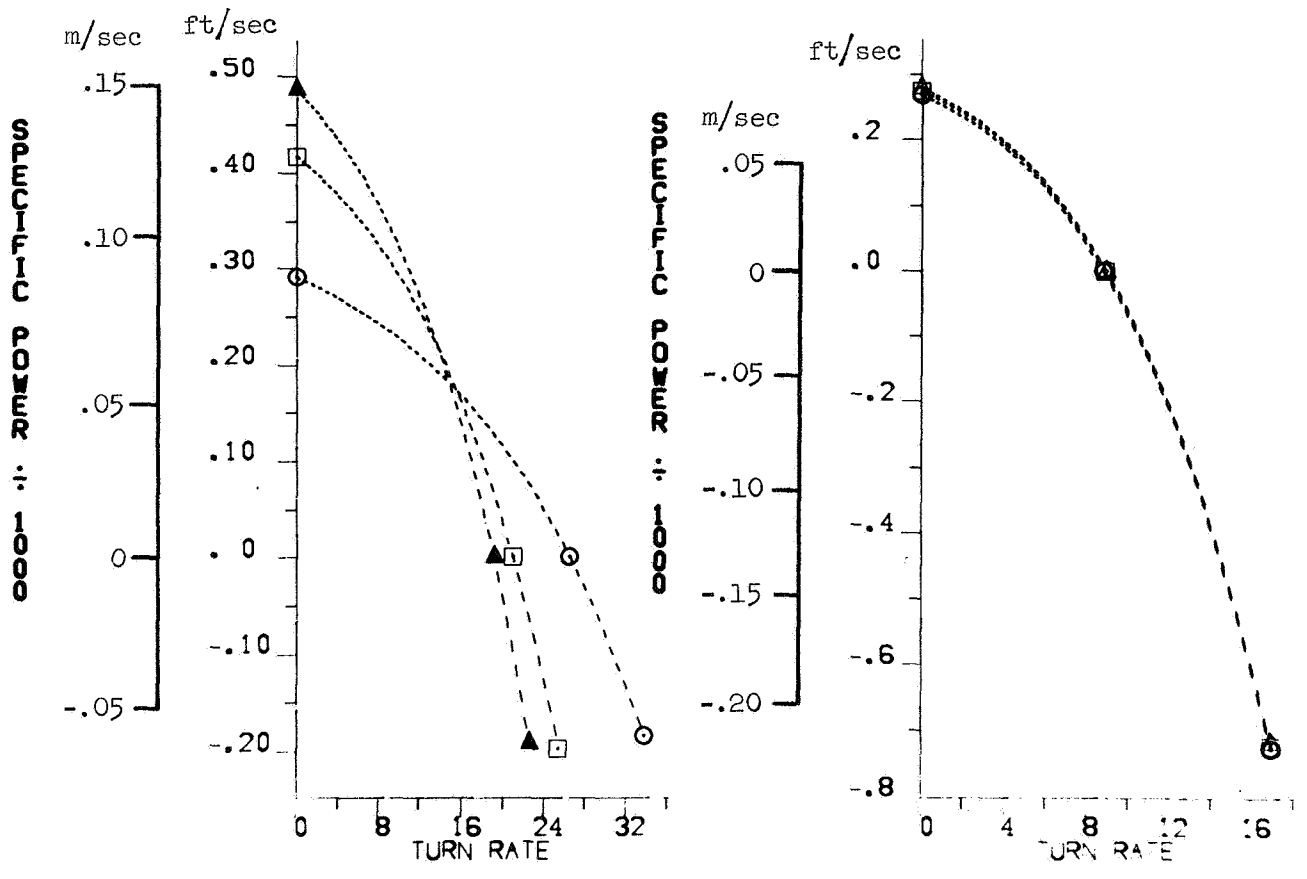

(c) Combat performance.

Figure 24.— Continued.

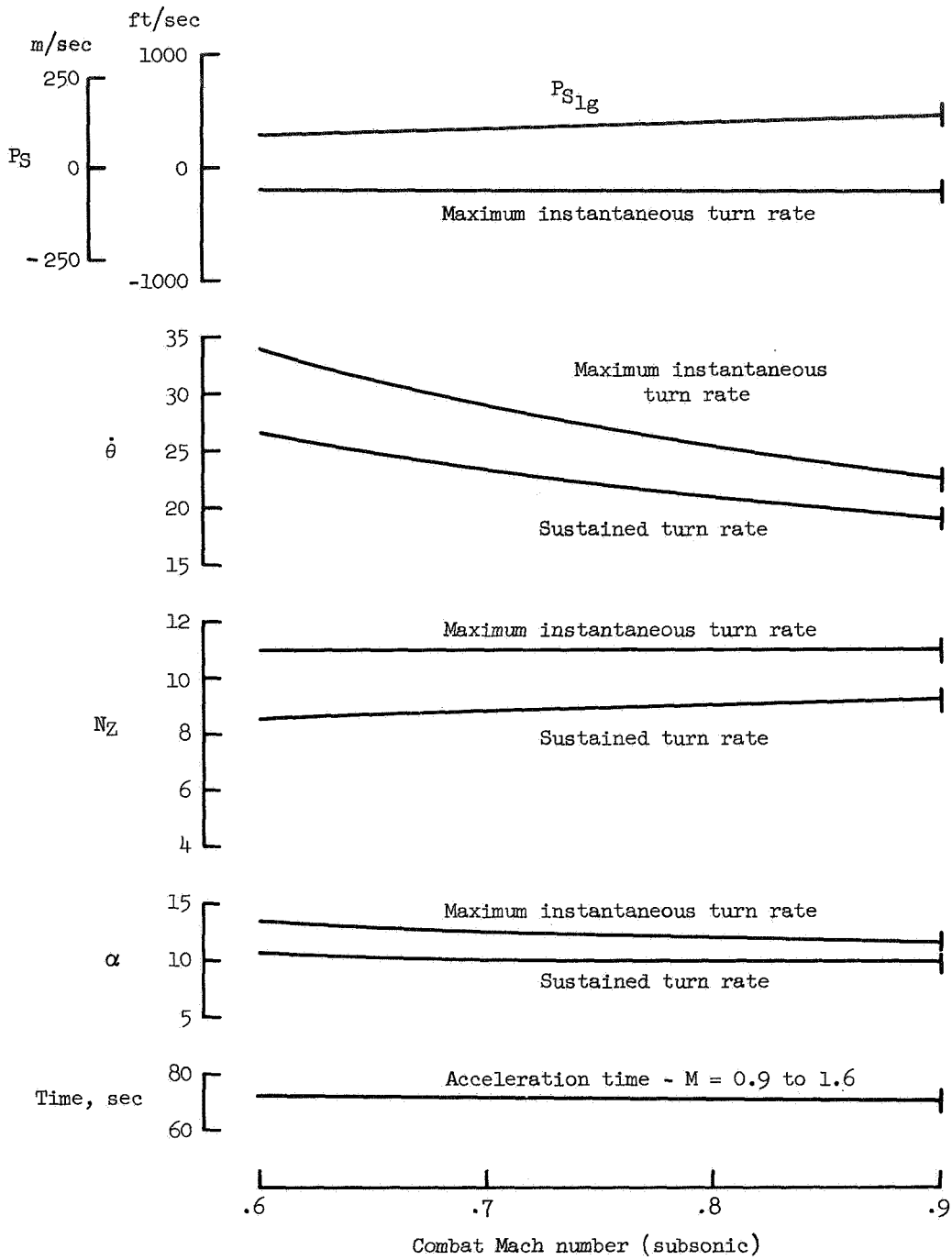

(c) Combat performance (concluded).

Figure 24.- Concluded.

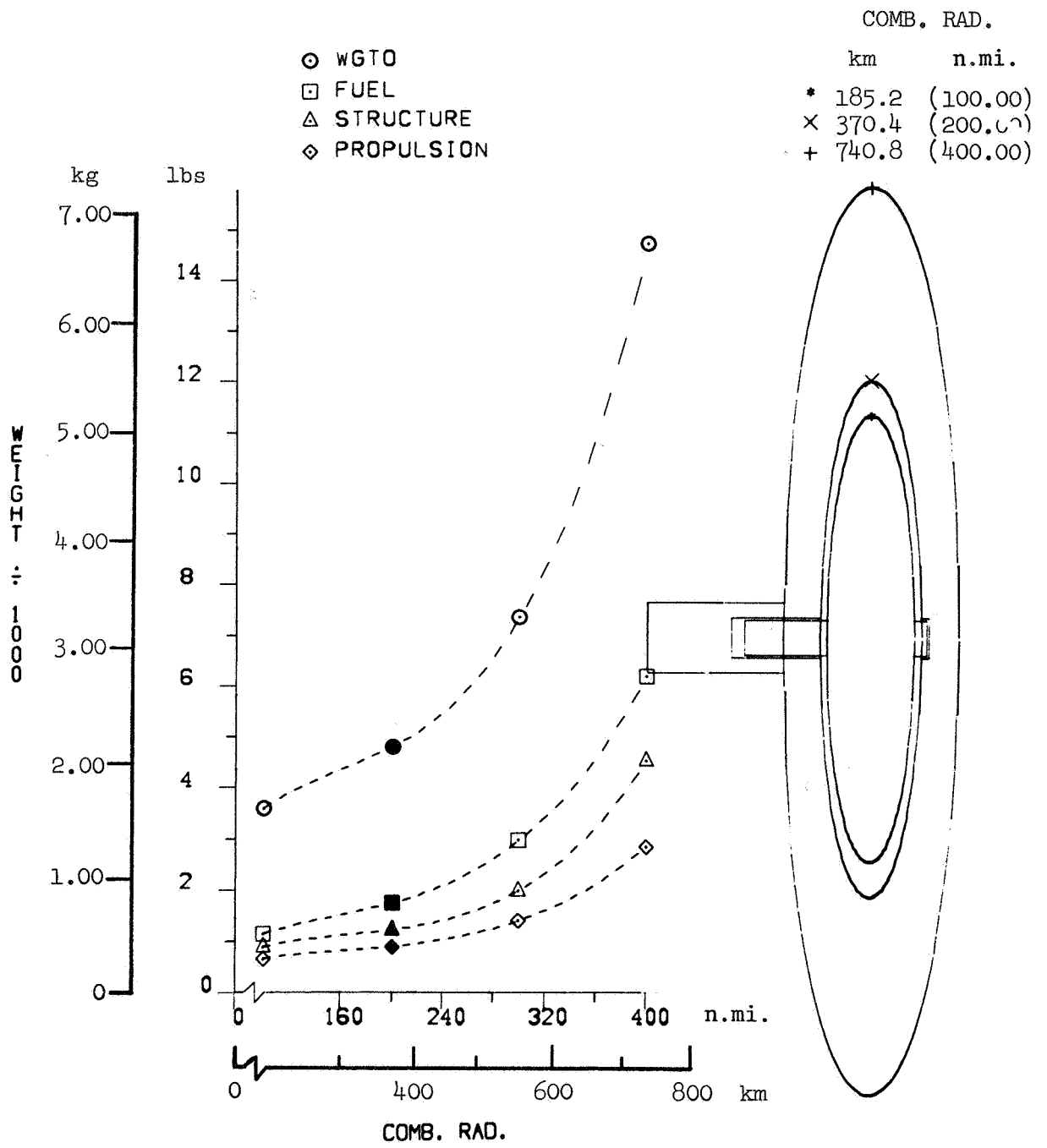

(a) Weights.

Figure 25.— Effect of combat radius.

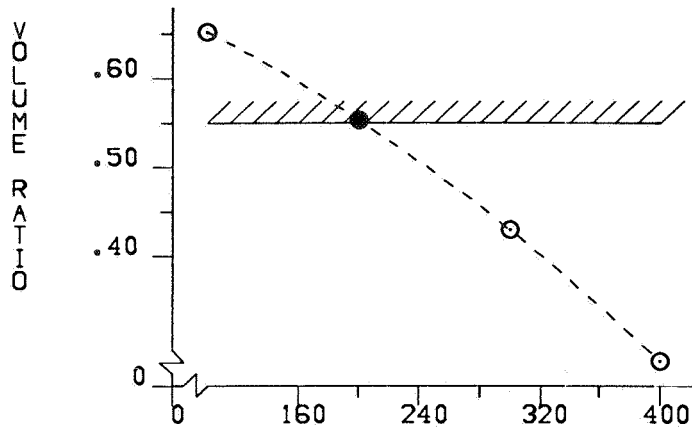

- VOLUME RATIO
- WING VOLUME
- △ VOLUME REQUIRED

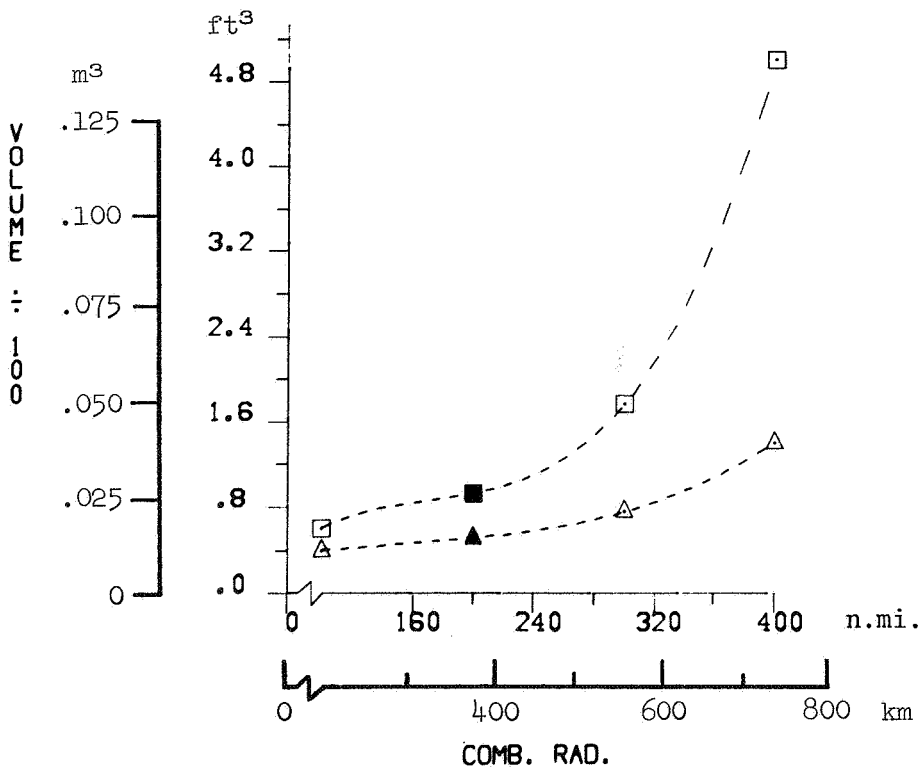

(b) Volume.

Figure 25.— Continued.

COMB. RAD.

km n.m.

- 185.2 (100.00)
- 370.4 (200.00)
- △ 740.8 (400.00)

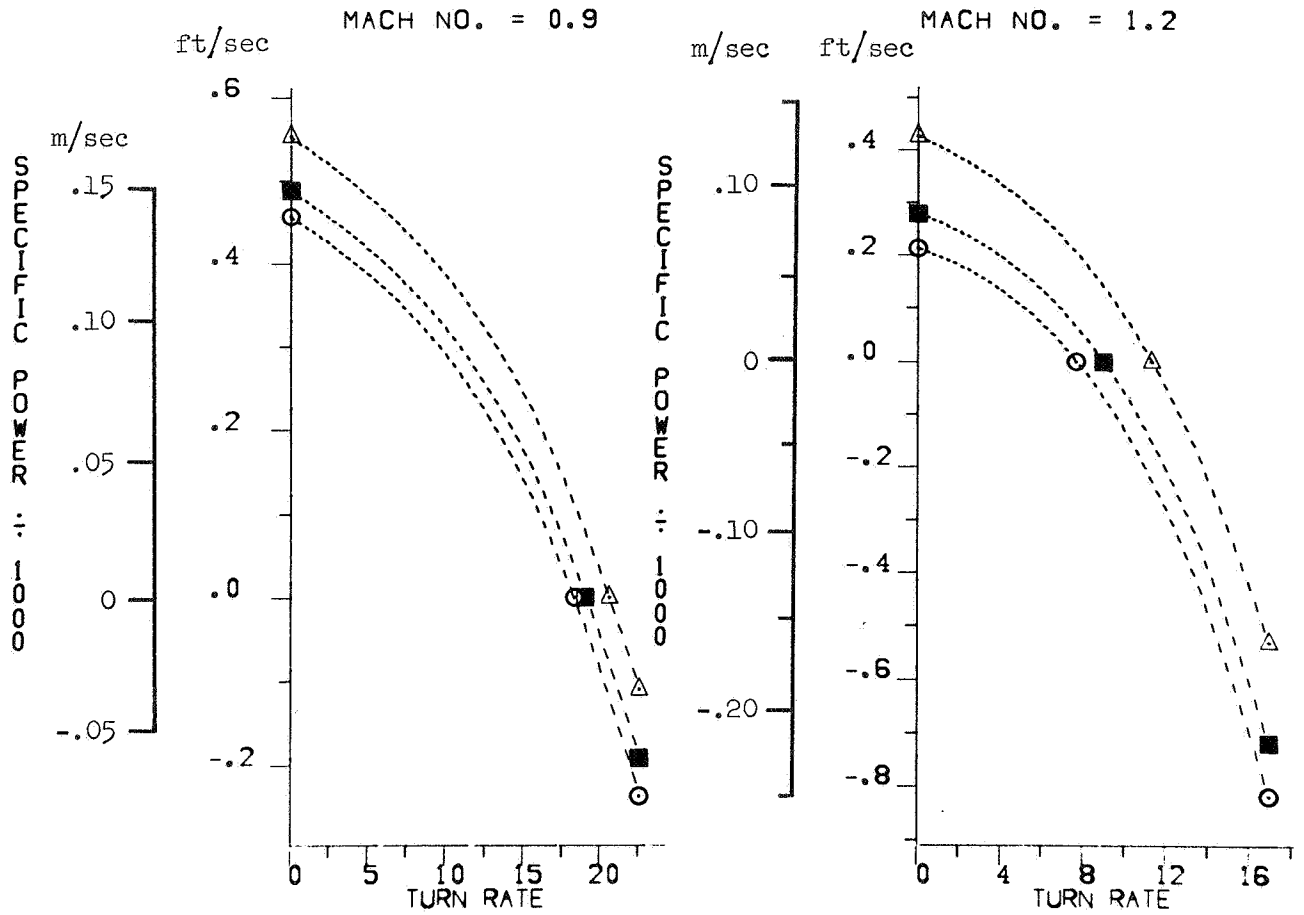

(c) Combat performance.

Figure 25.— Concluded.

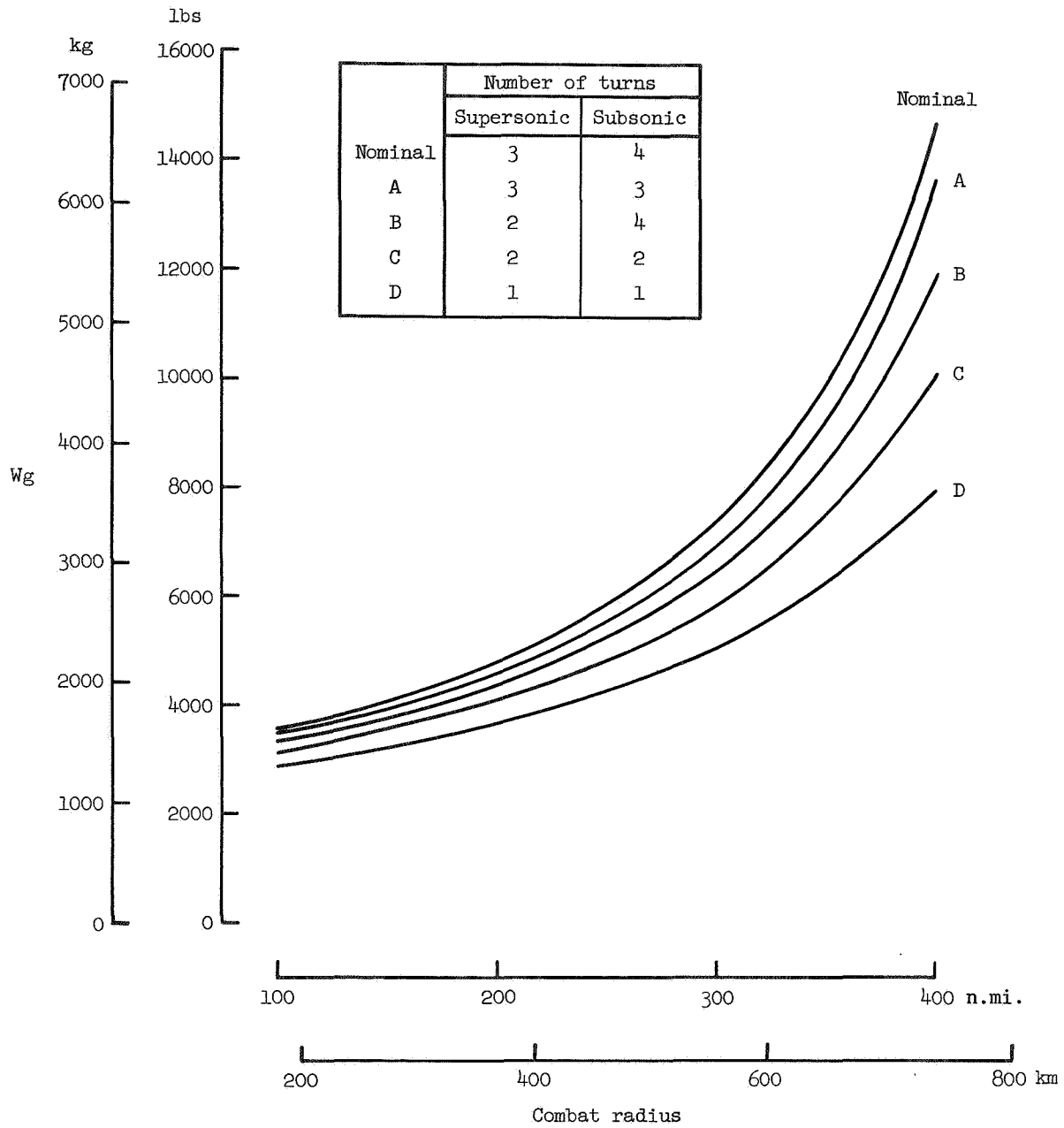

Figure 26.— Effect of number of combat turns and combat radius.

1. Report No. D--7731	2. Government Accession No.	3. Recipient's Catalog No.	
4. Title and Subtitle PRELIMINARY PERFORMANCE ESTIMATES OF AN OBLIQUE, ALL-WING, REMOTELY PILOTED VEHICLE FOR AIR-TO-AIR COMBAT		5. Report Date JULY 1974	6. Performing Organization Code
		8. Performing Organization Report No. A-5338	10. Work Unit No. 791-93-15
7. Author(s) Walter P. Nelms, Jr., and Rodney O. Bailey		11. Contract or Grant No.	
9. Performing Organization Name and Address NASA Ames Research Center Moffett Field, Calif. 94035		13. Type of Report and Period Covered Technical Note	
		14. Sponsoring Agency Code	
12. Sponsoring Agency Name and Address National Aeronautics and Space Administration Washington, D. C. 20546		15. Supplementary Notes	
16. Abstract <p>A computerized aircraft synthesis program has been used to assess the effects of various vehicle and mission parameters on the performance of an oblique, all-wing, remotely piloted vehicle (RPV) for the highly maneuverable, air-to-air combat role. The study mission consists of an outbound cruise, an acceleration phase, a series of subsonic and supersonic turns, and a return cruise. The results are presented in terms of both the required vehicle weight to accomplish this mission and the combat effectiveness as measured by turning and acceleration capability. This report describes the synthesis program, the mission, the vehicle, and results from sensitivity studies.</p> <p>An optimization process has been used to establish the nominal RPV configuration of the oblique, all-wing concept for the specified mission. In comparison to a previously studied conventional wing-body canard design for the same mission, this oblique, all-wing nominal vehicle is lighter in weight and has higher performance. The nominal configuration is used as a base point for sensitivity studies to determine those parameters, both vehicle and mission oriented, which have the most significant effect on the RPV weight and combat performance. Variations were made in vehicle geometry, aerodynamics, and component and payload weights. Mission parameters varied were cruise altitude and Mach number, combat altitude and Mach number, and combat radius and number of combat maneuvers. Areas requiring further study and areas where possible payoffs can result from advancement in technology are suggested.</p>			
17. Key Words (Suggested by Author(s)) Remotely Piloted Vehicles Air Combat Aircraft Highly Maneuverable Aircraft Oblique Wing Aircraft Aircraft Synthesis Aircraft Systems Analysis Aircraft Performance		18. Distribution Statement Unclassified - Unlimited CAT. 02	
19. Security Classif. (of this report) Unclassified	20. Security Classif. (of this page) Unclassified	21. No. of Pages 103	22. Price* \$4.50



POSTMASTER: If Undeliverable (Section 158
Postal Manual) Do Not Return

"The aeronautical and space activities of the United States shall be conducted so as to contribute . . . to the expansion of human knowledge of phenomena in the atmosphere and space. The Administration shall provide for the widest practicable and appropriate dissemination of information concerning its activities and the results thereof."

—NATIONAL AERONAUTICS AND SPACE ACT OF 1958

NASA SCIENTIFIC AND TECHNICAL PUBLICATIONS

TECHNICAL REPORTS: Scientific and technical information considered important, complete, and a lasting contribution to existing knowledge.

TECHNICAL NOTES: Information less broad in scope but nevertheless of importance as a contribution to existing knowledge.

TECHNICAL MEMORANDUMS: Information receiving limited distribution because of preliminary data, security classification, or other reasons. Also includes conference proceedings with either limited or unlimited distribution.

CONTRACTOR REPORTS: Scientific and technical information generated under a NASA contract or grant and considered an important contribution to existing knowledge.

TECHNICAL TRANSLATIONS: Information published in a foreign language considered to merit NASA distribution in English.

SPECIAL PUBLICATIONS: Information derived from or of value to NASA activities. Publications include final reports of major projects, monographs, data compilations, handbooks, sourcebooks, and special bibliographies.

TECHNOLOGY UTILIZATION PUBLICATIONS: Information on technology used by NASA that may be of particular interest in commercial and other non-aerospace applications. Publications include Tech Briefs, Technology Utilization Reports and Technology Surveys.

Details on the availability of these publications may be obtained from:

SCIENTIFIC AND TECHNICAL INFORMATION OFFICE

NATIONAL AERONAUTICS AND SPACE ADMINISTRATION

Washington, D.C. 20546