

(NASA-CR-120219)	TEST REPORT, EARTH	N74-29246
ORBITER TELEOPERATOR VISUAL SYSTEM		
EVALUATION PROGRAM (Essex Corp.)	94 p	
HC \$7.75	CSCCL 05H	Unclas
		G3/30 16667

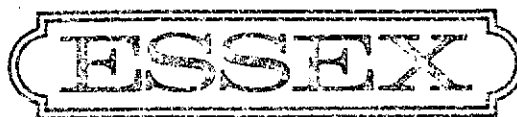

ESSEX CORPORATION • 303 Cameron Street, Alexandria, Virginia 22314 •

TEST REPORT
EARTH ORBITAL TELEOPERATOR VISUAL
SYSTEM EVALUATION PROGRAM

Prepared by:

Mark Kirkpatrick, Ph.D
Nicholas L. Shields, Jr.
Thomas B. Malone, Ph.D

ESSEX CORPORATION
303 Cameron Street
Alexandria, Virginia 22314

ESSEX CORPORATION
Huntsville Operations
11309-B South Memorial Parkway
Huntsville, Alabama 35803

Prepared for:

NATIONAL AERONAUTICS & SPACE ADMINISTRATION
Marshall Space Flight Center
Huntsville, Alabama 35812
(Under Contract NAS8-28298)

Report No. H-4-2

January 1974

TABLE OF CONTENTS

<u>Section</u>	<u>Page</u>
1.0 INTRODUCTION	1
2.0 TELEOPERATOR - VISUAL SYSTEM LABORATORY FURTHER STEREO TV SYSTEM EVALUATION	6
3.0 EFFECTS OF ILLUMINATION INTENSITY ON JUDGMENT OF SOLID TARGET ALIGNMENT	21
4.0 VISUAL SYSTEM LABORATORY UTILIZING TARGET MOTION APPARATUS . .	34
4.1 Teleoperator Visual System Evaluation Laboratory Experiment B ₁ - Motion Detection of a Target Object .	45
4.2 Teleoperator Visual System Evaluation Laboratory Experiment B ₂ - Motion Detection of a Target Object II	66
5.0 OPTICAL RANGE & RANGE RATE ESTIMATION FOR REMOTELY MANNED SYSTEMS	72
6.0 TELEOPERATOR SYSTEM CONTINUING SYSTEM EVALUATION	81
6.1 System Planning I	83
6.2 System Planning II	85
6.3 System Planning III	87
6.4 System Planning IV	88
6.5 System Planning V	89

FIGURES AND TABLES

Figure 1.	General Laboratory Layout	8
Figure 2.	Camera Configurations	10
Figure 3.	Mean Absolute Error Magnitude as a Function of Camera Mode	14
Figure 4.	Mean Absolute Error Magnitude as a Function of Fore/Aft Displacement and Camera Mode	15

TABLE OF CONTENTS, Continued

<u>Section</u>	<u>Page</u>
Figure 5. Mean Absolute Error Magnitude as a Function of Fore/Aft Displacement and Lateral Displacement	17
Figure 6. Probability of Error as a Function of Camera Mode	19
Figure 7. Probability of Error as a Function of Camera Mode and Fore/Aft Displacement	20
Figure 8. Camera-Target-Lighting Geometry	22
Figure 9. Light Source Intensity and Orientation Conditions	25
Figure 10. Mean Non-Alignment Angle Required for Non-Alignment Detection as a Function of Reflected Target Luminance From Source <u>L</u> - Source <u>S</u> Turned Off	30
Figure 11. Mean Non-Alignment Angle Required for Non-Alignment Detection as a Function of Source L Luminance	31
Figure 12. Mean Non-Alignment Angle Required for Non-Alignment Detection as a Function of Source S Angle, Non-Alignment Direction, and Source L Luminance	33
Figure 13. Visual System Laboratory Layout Used for Motion Tests	35
Figure 14. TMG Setup	36
Figure 15. TMG Apparatus	37
Figure 16. Candidate Reticle Formats Used for Motion Detection	46
Figure 17. Subsets of Data Analysis	54
Figure 18. Probability of Motion Detection Error as a Function of Direction and Absolute Rate of Change of Image Diameter - Reticle Condition	56
Figure 19. Probability of Motion Detection Error as a Function of Direction and Absolute Rate of Change of Image Diameter - No Reticle Condition	59
Figure 20. Psychometric Functions for Reticle and No Reticle Conditions	60

TABLE OF CONTENTS, Continued

<u>Section</u>	<u>Page</u>
Figure 21. Range Rate Required for Stated Probability of Motion Detection as a Function of Range	64
Figure 22. Probability of Error as a Function of Frame Rate and Transmission Mode	71
Figure 23. Range and Range Rate Estimation Using a Rate-Aided Cursor Control System	79
Figure 24. System Evaluation Integration Flow Diagram	82
Table 1. Visual System and Target Parameters Selected for Investigation	4
Table 2. Parameters and Levels Investigated in Visual System Tests	5
Table 3. Analysis of Variance of Mean Absolute Error Magnitude	13
Table 4. Analysis of Variance of Probability of Error	18
Table 5. Reflected Luminance Values from the Camera Position for Experimental Conditions (Ft. Lamberts)	23
Table 6. Analysis of Variance of Angle Required for Non-Alignment Detection-Light Source Off-Experiment 12	28
Table 7. Analysis of Variance of Angle Required for Non-Alignment Detection - Variable Intensity and Orientation	29
Table 8. Sample Standard Instructions - Used in Target Motion Experiments	44
Table 9. Displayed Mean Rate of Change of Image Size Used with Reticles	51
Table 10. Displayed Mean Rate of Change of Image Size Used with No Reticle Condition	52
Table 11. Analysis of Variance of Probability of Error - Data Set 1	55

TABLE OF CONTENTS, Continued

<u>Section</u>		<u>Page</u>
Table 12.	Analysis of Variance of Error Probability - Data Set 2	58
Table 13.	Calculated Rates of Change of Image Diameter for Detection Probabilities of .50 and .90	62
Table 14.	Analysis of Variance of Probability of Error - Data Set 3	65
Table 15.	Analysis of Variance of Probability of Error	70

1.0 INTRODUCTION

This present report represents a portion of the work being carried out as part of an overall effort to identify the human performance requirements for remotely manned systems. It relates specifically to the evaluation of the visual system, and reflects the data gathered during investigations carried out at NASA's Marshall Space Flight Center. MSFC facilities located in the Astrionics Laboratory contain the Visual System Evaluation Laboratory, in which the tests reported herein and previously reported studies (Kirkpatrick, Malone and Shields, 1973), were conducted. In the 1973 study, the results of eleven studies, primarily static visual tests, were reported. As a function of some of those experimental results, additional investigations were suggested that would possibly lend support to some of those preliminary tests. Two of the four tests described in this report relate directly to previous findings on detection of non-alignment and on three dimensional distance estimation cues. The other two tests reported here deal with human performance in detecting target motion. It is planned that additional investigations be conducted in the target motion area, such that there is experimental continuity throughout the overall test program. That is, as experimental data are analyzed, these data will impact the planned studies in terms of the levels of the independent variables and the general levels of test complexity, moving from less to more complex.

The findings developed in the Visual System Evaluation Laboratory will also impact test development and conduct in other areas relative to remotely manned systems, such as the manipulator/controller system evaluation plans reported in Shields, Malone, and Kirkpatrick (1974).

Listed below are those tests conducted and analyzed to date and for which there are test reports. The last four tests in this list are reported in detail in this report, and the first eleven are reported in detail in Kirkpatrick, et al, 1973:

- . Visual Acuity
- . Brightness Discrimination
- . Form Discrimination
- . Size Discrimination
- . Pattern Recognition
- . Size Estimation
- . Distance Estimation 1
- . Distance Estimation 2
- . Distance Estimation 3
- . Solid Target Alignment 1
- . Estimation of the Vertical
- . Distance Estimation 4
- . Solid Target Alignment 2
- . Motion Detection 1
- . Motion Detection 2

The general approach followed in developing and conducting the visual system evaluation experiments was to evaluate human performance under varying conditions of existing hardware such as: video sensors, displays, display aids, image processing equipment, worksite lighting and visual aspects of the worksite; and under the varying task conditions or requirements. It was determined that this approach would enable the identification of specific human operator visual capabilities and limitations which in turn would impact the assigned roles and responsibilities of the human operator. The combination of human capabilities and responsibilities, and visual system technology development will then be used to develop preliminary system concept and ongoing modes.

The method employed in determining the most appropriate visual tests for investigation was to reflect that information concerning teleoperator mission requirements, which is contained in the MSFC Earth Orbital Teleoperator Technology Development Plan (1972), and the Teleoperator Mission Analysis (Malone, 1972).

The visual system evaluation program, then, was developed directly from the probable mission requirements.

The information gained from the visual system evaluation program then becomes part of the Human Factors Analysis Requirements which bear directly on any systems requirements. The entire test program is being conducted within the appropriate constraints exerted by the Mission Requirements on one hand, and by the System Requirements on the other.

Table 1 represents those variables under study in the development of human performance criteria and the program of technology development. Table 2 represents the tests under which these variables were manipulated as a function of specific tasks.

The remaining sections of this volume describe the four visual tests completed since the publication of the initial visual system evaluation report (Kirkpatrick, et al, 1972) (Section 2.0, 3.0, and 4.0), applications of results to the analytical assessment of range and range rate determination techniques (5.0), and planning information for future tests in the program.

TABLE 1

VISUAL SYSTEM AND TARGET PARAMETERS
SELECTED FOR INVESTIGATION

<u>PARAMETERS</u>	<u>LEVELS VARIED</u>
Field of view	10° & 25°
Direction of view	Normal, orthogonal, & oblique
Number of cameras	1 camera or 2 cameras
Depth of view	Monoptic or stereoptic
Number of monitors	1 monitor or 2 monitors
Types of monitor face plates	Polarized for stereo or normal glass plate
Operator visual aides	Reticle for motion tests Polarized glasses for stereo
Bandwidth	4.5 MHz & 1 MHz
Signal format	Analog & 4 bit digital
S/N ratio	15 db, 21 db, & 32 db
TV lines/frame	525 lines ~ 435 effective
Target/Background contrast	Variable, by test
Frame rate	30 f/s and 15 f/s
Target brightness	To 100 foot lamberts
Target	Target size, shape, & markings
Limiting resolution	500 lines
Gray scales	NTSC 10 shades

TABLE 2. PARAMETERS AND LEVELS INVESTIGATED IN VISUAL SYSTEM TESTS

PARAMETERS AND LEVELS	VISUAL PERFORMANCE TESTS			
	DEPTH-DISTANCE	TARGET NONALIGNMENT	MOTION DETECTION I	MOTION DETECTION II
FIELD OF VIEW FIXED VARIABLE	X	X		
DIRECTION OF VIEW NORMAL OBLIQUE	X	X	X	X
NUMBER OF CAMERAS/ MONITORS ONE TWO	X	X	X	X
DEPTH OF VIEW 2D 3D	X	X	X	X
OPERATOR AIDES POLARIZED GLASSES RETICLES	X		X	X
BANDWIDTH 4.5 MHz 1.0 MHz	X	X	X	X
SIGNAL FORMAT ANALOG 4 BIT DIGITAL	X	X	X	X
FRAME RATE 30 F/S 15 F/S	X	X	X	X
S/N RATIO 15 db 21 db 32 db				X
CONTRAST FIXED VARIABLE	X	X	X	X
TARGET PARAMETERS SIZE MOTION			X	X
LONGITUDE DISTANCE	X		X	X
LATERAL DISTANCE	X		X	X
MARKINGS		X		

2.0 TELEOPERATOR - VISUAL SYSTEM LABORATORY FURTHER STEREO TV SYSTEM EVALUATION

Results of several human performance experiments using a standard Stereotronics TV System as the visual feedback system in distance estimation tasks have been previously reported (Kirkpatrick, Malone and Shields, 1973). The objective of this experiment was to determine the effects of video system and target position parameters, in combination with the target position relative to the camera line of sight, on the human operator's capability to judge separation distances. To ensure system stability, the data gathered for this experiment was gathered concurrently with data used in the previously reported studies on separation error using varied stereo TV system parameters.

Apparatus

A task board mounted in the horizontal plane was used, along with two back panels mounted perpendicular to one another and to the task board. This formed essentially three connecting sides of a 1.22 m. cube. The task board and back panels were covered with a non-reflective black felt material so that no video image of the task board was apparent. In conjunction with the task board, a grid projector was installed overhead to project a 36x36 inch matrix of one inch squares on the task board. The experimenter used this grid in setting up the target pins between experimental trials, but the projection of the grid was terminated during experimental trials.

The targets used in this experiment were two solid cylinders one inch in diameter and three inches high, both painted to a reflectivity of .7. The targets were illuminated by a light source capable of illuminating the task board at a level of 100 foot candles.

The camera system used in this experiment consisted of an off-the-shelf Stereotronics Stereocaptor fitted to a COHU 2000-100 camera, and another COHU 2000-100 camera, without stereo modification. Convergence and shutter controls were employed on the Stereocaptor for individual adjustment to each subject by the experimenter. A polarized plate fitted on the face of the monitor, and polarized glasses for the subject were employed as necessary elements to this particular stereo TV system. The effect of the Stereocaptor was to divide the camera's field of view into views of the same scene taken from different angles. This split field was then transmitted to the subject's monitor which was equipped with the polarized face plate. The polarized plate was manufactured so that one half of the plate was polarized at 45° to the horizontal, and the other half was polarized at 45° to the horizontal, but 90° to the first half. Figure 1, showing the general laboratory layout, will show this configuration at the subject's monitor.

Experimental Design

The independent variables included the following:

2 TV modes

- 1) monoptic
- 2) stereoptic

Number of cameras for the monoptic mode

- 1) single camera
- 2) dual camera

Camera orientation for dual camera monoptic mode

- 1) 1 forward looking (0°) and the other in plane to the left by 45°
- 2) 1 forward looking (0°) and the other in plane to the left by 90°

4 fore/aft separation distances of the two pins
0, 2, 4, 8 inches

5 lateral separation distances of the two pins
1, 2, 3, 5, and 7 inches

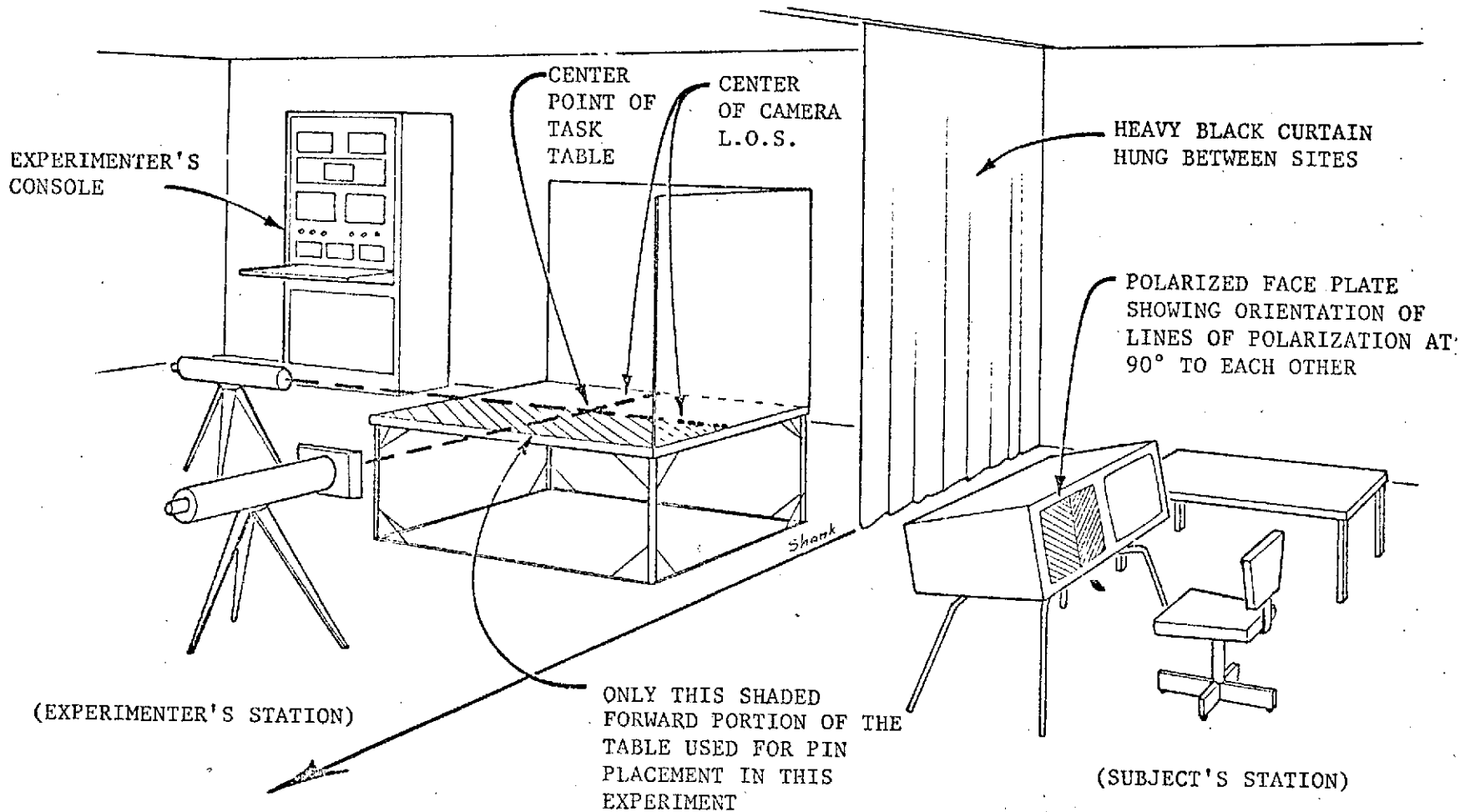

Figure 1. GENERAL LABORATORY LAYOUT

The dependent variables that were recorded were:

- 1) Accuracy of separation judgment
- 2) Level of confidence in judgment

The control variables were set at the following levels:

- 1) Reflectance of pins - .7
- 2) Task Board illumination - 100 ft. candles
- 3) Maximum duration of presentation - 30 sec.
- 4) Position of pin closest to the camera - randomized

Each of the five subjects were screened for 20-20 vision, corrected, both eyes, and for anomalies in depth and distance perception. Each subject was tested on all combinations of conditions. The four fore/aft separations were combined randomly with each of the five lateral separations and presented to the subjects. All trials under one camera condition were completed before proceeding to the next camera condition. Sequence of camera conditions was counterbalanced between subjects. There were 80 trials per subject.

Procedure

The subject was presented with a series of video images of the task board with the pins arranged in different orientations with respect to fore/aft and lateral displacement from each other. The subject was told that the two pins were each one inch in diameter and three inches tall. The subject's task was to judge which of the two pins was closest to him, and the distance, in the fore/aft plane, between the two pins. The basic difference between this test, and those previously reported, was that rather than orienting the pins with respect to the center of the task board, which was also the center of the orthogonal (90° left) camera's field of view, the pins were placed only in the forward one half of the task board, or off the center of the orthogonal camera's line of sight. Using this variation in the experimental set up, the subject viewed the circular pins in the forward plane with one of 4 camera/video configurations as shown in Figure 2:

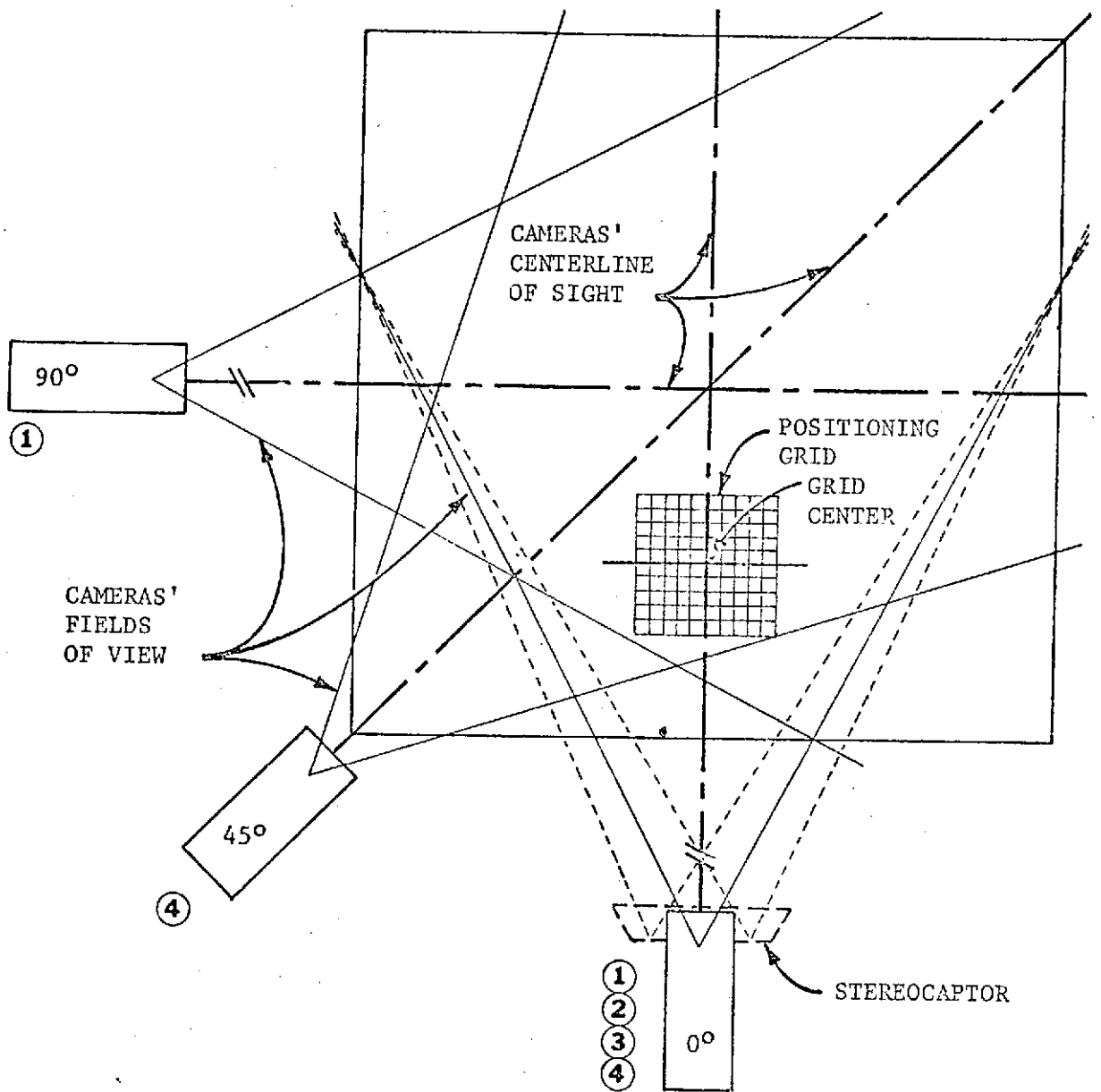

- CAMERA MODE 1 - 0°, 90° - 2 CAMERAS - MONO
- CAMERA MODE 2 - STEREOPTIC MODE - 1 CAMERA
- CAMERA MODE 3 - 0° - 1 CAMERA MONO
- CAMERA MODE 4 - 0°, 45° - 2 CAMERAS - MONO

FIGURE 2 - CAMERA CONFIGURATIONS

- 1) A two camera 2D configuration with one camera at 0 degrees, the axis normal to one backdrop, looking straight across the task board so that the pins appeared on the same vertical video plane when placed anywhere on the board. The second camera was positioned 90 degrees to the left of the first camera, viewing the task board across its horizontal plane. Both cameras were equidistant from the center of the task board. The subject viewed the task through two monitors, with the 90 degree left view in the left monitor and the 0 degree view in the right monitor.
- 2) One 3D stereo camera (Stereotronics Split Field Stereocaptor) positioned at 0 degrees and looking across the horizon of the task board, as in 1 above. The subject viewed the task through a single monitor faced with a polarized plate and the subject used angled polarized glasses to displace the two images to permit stereopsis.
- 3) One 2D camera with axis normal to one backdrop looking across the task board in the plane of the board so that the pins appeared on the same vertical video plane anywhere on the board. The subject viewed the task through a single monitor.
- 4) Two camera, 2D configuration with one camera at 0 degrees (as in 1) and the second camera at 45 degrees to the left of the first. Both cameras looked directly over the horizon of the task board, and both were equidistant from the center of the task board. The subject viewed the task through two monitors, with the left view (45°) in the left monitor and 0 degrees view in the right monitor.

When the subject made his separation judgement, he pressed his response key to terminate his video image. The experimenter then noted which pin the subject perceived as being closest, and how far in inches the pins were reported to be separated from each other in the fore/aft plane.

The experimenter then set up the next trial on the task board and proceeded through the entire sequence of experimental trails for that subject.

Results and Discussion

Two accuracy measures were employed in the current study: probability of error, and error magnitude. Probability of error is the relative frequency with which an observer incorrectly judges which of the two pins is closer. Error magnitude is a measure of the absolute difference between the true pin separation and the separation estimated by the subject. Absolute error magnitude was subjected to an analysis of variance assuming a treatments by subjects design and all factors fixed except subjects. The resulting source table appears in Table 3. The significant sources of variance were found to be camera mode, fore/aft displacement, lateral displacement, and the camera mode by fore/aft displacement interaction.

The camera mode main effect is illustrated in Figure 3. The orthogonal monoptic camera mode (mode 1) may be seen to produce smaller average errors than the other modes. The vertical bar in Figure 3 shows the .10 level Scheffé critical difference (.96 inch). The data show no significant differences between camera modes 2, 3, and 4. These results are in agreement with those of earlier investigations (Kirkpatrick, Malone, and Shields, 1972) in suggesting that orthogonal monoptic viewing produces separation judgment performance superior or equal to stereoptic viewing within the constraints of TV systems and task studies.

The camera mode by fore/aft displacement interaction is illustrated in Figure 4. The significance of this interaction effect is due to differences between the orthogonal monoptic system and the remaining systems. Camera systems 2, 3, and 4 show a rapid increase in mean absolute separation error as true separation increases. Separation judgment error with the orthogonal

TABLE 3.. Analysis of Variance of Mean Absolute Error Magnitude

<u>SOURCE</u>	<u>df</u>	<u>SS</u>	<u>MS</u>	<u>F</u>
Camera Mode (C)	3	93.937	31.312	5.337*
Fore/Aft Displacement (X)	3	431.342	143.781	64.187**
Lateral Displacement (Y)	4	23.011	5.753	4.205*
Subjects (S)	4	46.273	11.568	--
CxX	9	127.131	14.126	3.072*
CxY	12	19.430	1.619	1.273
CxS	12	70.405	5.867	--
XxY	12	12.350	1.029	1.044
XxS	12	26.875	2.240	--
YxS	16	21.888	1.368	--
CxXxY	36	44.683	1.241	1.135
CxXxS	36	165.521	4.598	--
CxYxS	48	61.040	1.272	--
XxYxS	48	47.308	0.986	--
CxXxYxS	144	157.415	1.093	--
TOTAL	399	1348.609		

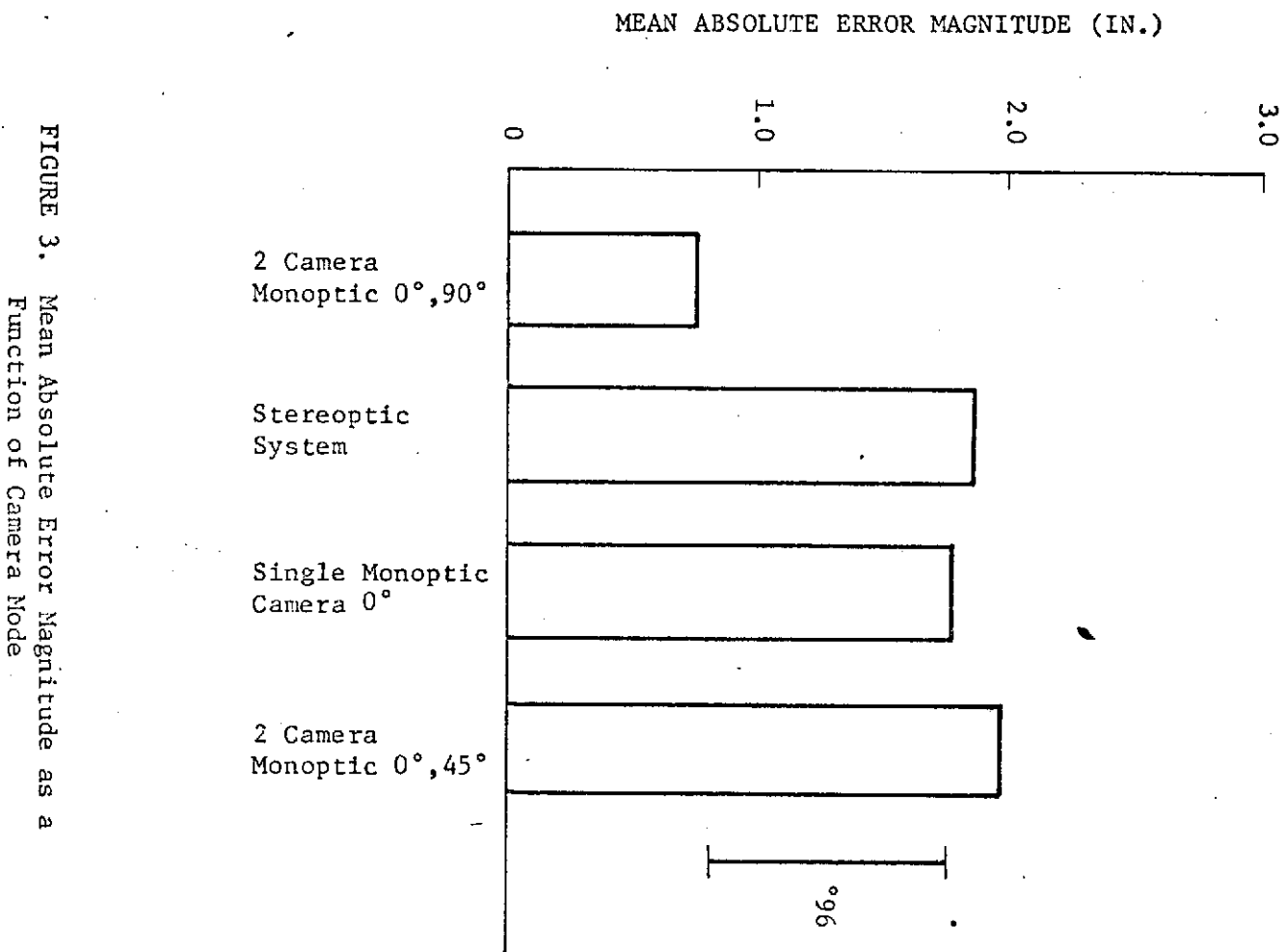

FIGURE 3. Mean Absolute Error Magnitude as a Function of Camera Mode

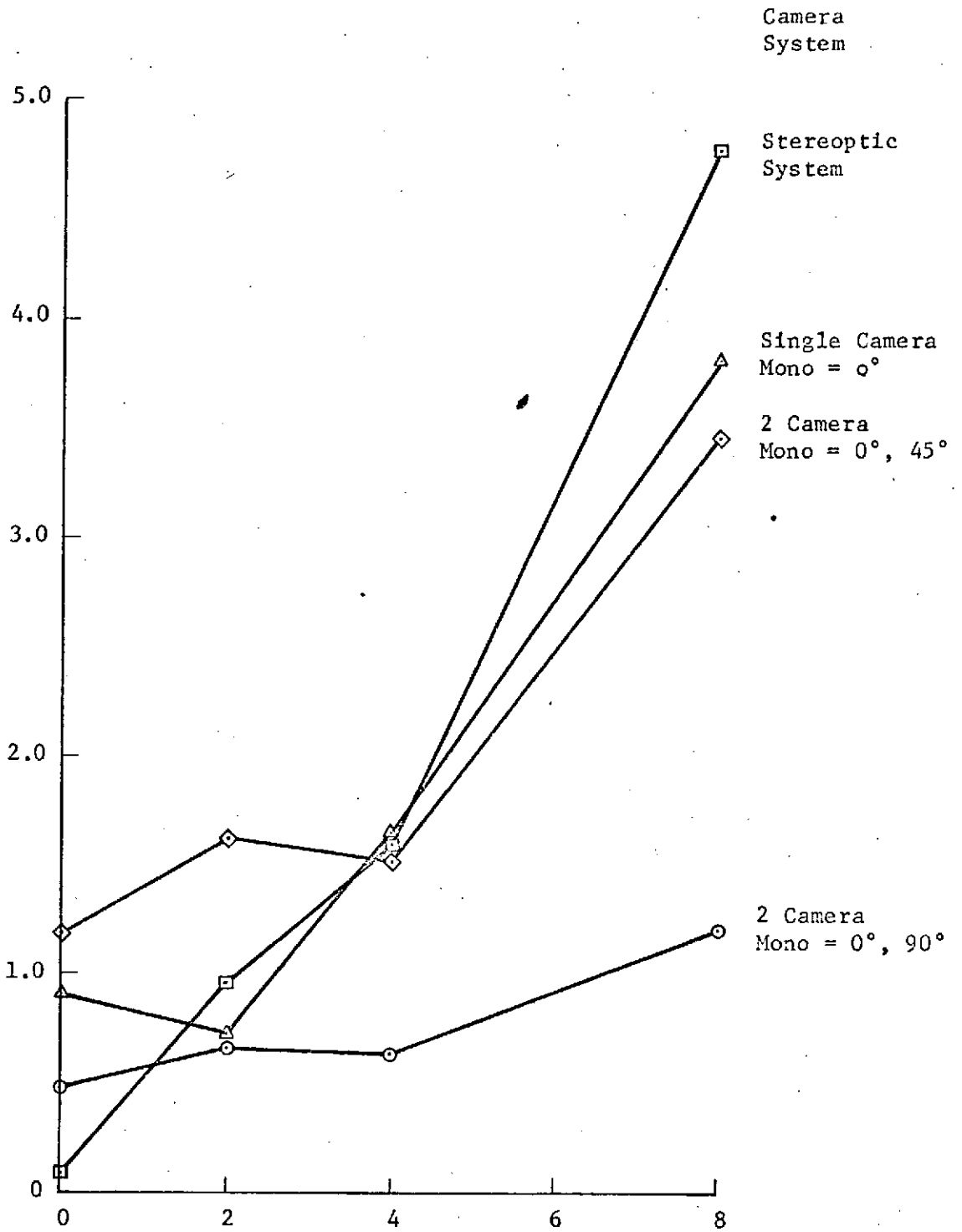

FIGURE 4. Mean Absolute Error Magnitude as a Function of Fore/Aft Displacement and Camera Mode

monoptic system, however, appears to remain nearly independent of true separation out to the limit of separation employed here.

The stereoptic system was found to produce the least estimation error when true separation was zero but to produce the greatest error at the maximum true separation investigated (eight inches). Evidently, the cues available with stereoptic viewing enhance performance in detecting when the pins are, in fact, not separated; however, performance using stereo TV progressively degrades as the target separation is increased.

The main effects of fore/aft and lateral separation are shown in Figure 5. Since the interaction of these variables was found to be non-significant, the data have been smoothed. It appears that lateral displacement effects are marginal compared to those of fore/aft displacement.

A second analysis of variance was performed using probability of error as the dependent measure. The source table appears as Table 4. Camera mode, fore/aft displacement, and the interaction of these variables were found to be significant at the .01 level. The camera mode main effect is shown in Figure 6. In terms of error probability, stereoptic viewing is significantly superior to orthogonal monoptic viewing. The latter system produces more separation judgments having the wrong sign, but the departures of these judgments from true separation are smaller on the average than those resulting from stereoptic viewing.

The interaction of camera mode with fore/aft separation is shown in Figure 7, which shows that much of the superiority of the stereoptic system in terms of error probability is associated with zero true separation. It was noted in connection with mean absolute error that minimum errors were found with stereoptic viewing when true separation was zero. The error probability data show a similar effect. While the stereoptic system produces lower error probability than the other systems tested at zero separation, it becomes comparable to the remaining systems as true separation increases.

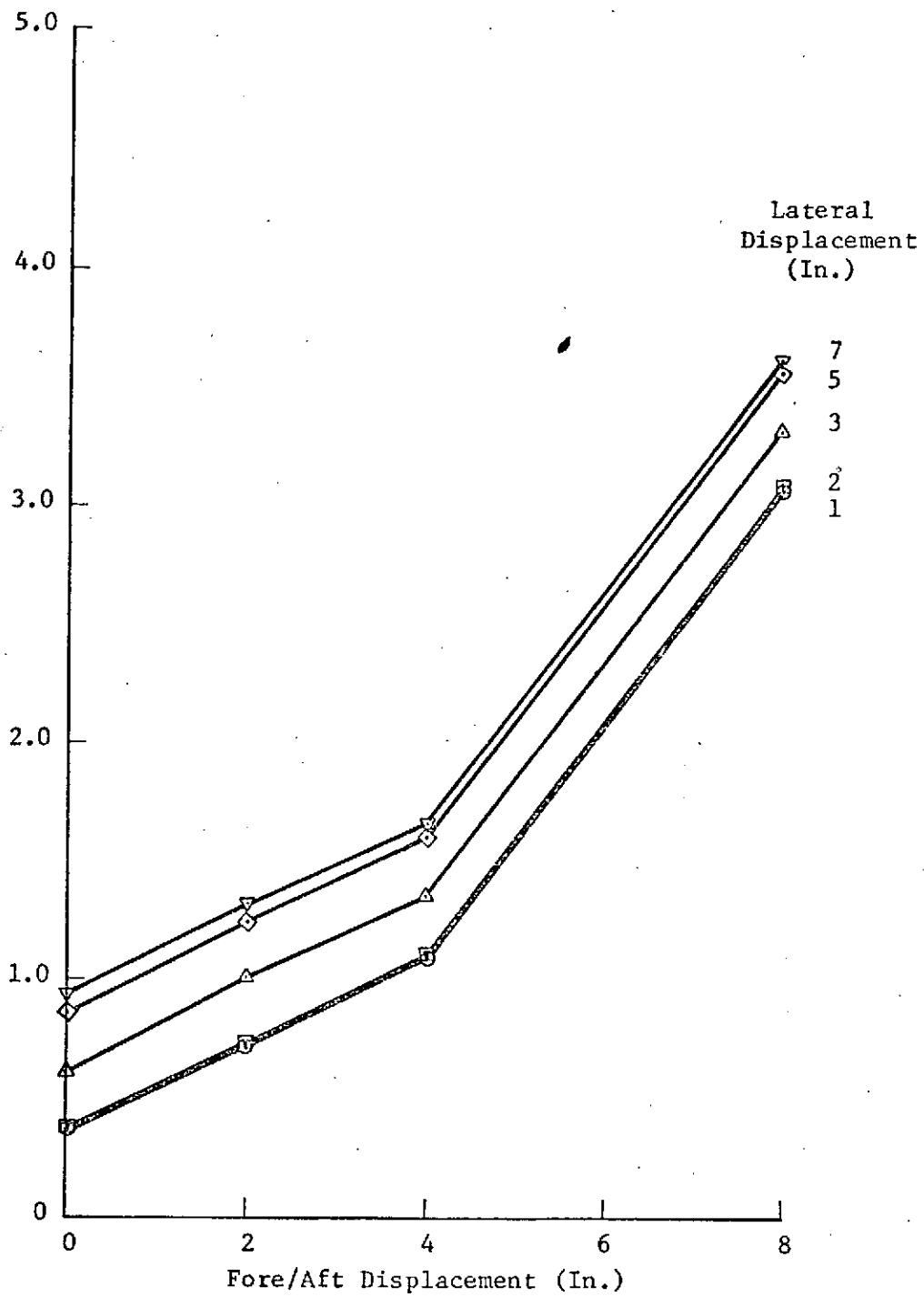

FIGURE 5. Mean Absolute Error Magnitude as a Function of Fore/Aft Displacement and Lateral Displacement

TABLE 4. Analysis of Variance of Probability of Error

<u>SOURCE</u>		<u>df</u>	<u>SS</u>	<u>MS</u>	<u>F</u>
Camera Mode	(C)	3	1.028	.343	6.738**
Fore/Aft Displacement	(X)	3	14.828	4.943	23.629**
Lateral Displacement	(Y)	4	.385	.096	2.611
Subjects	(S)	4	1.210	.303	--
XcX		9	4.483	.498	5.227**
XxY		12	.635	.053	1.109
CxS		12	.610	.051	--
XxY		12	.635	.053	1.000
XxS		12	2.510	.209	--
YxS		16	.590	.037	--
CxXxY		36	2.105	.058	1.174
CxXxS		36	3.430	.095	--
CxYxS		48	2.290	.048	--
XxYxS		48	2.590	.054	--
CxXxYxS		<u>144</u>	<u>7.170</u>	<u>.050</u>	<u>--</u>
	TOTAL	399	44.497		

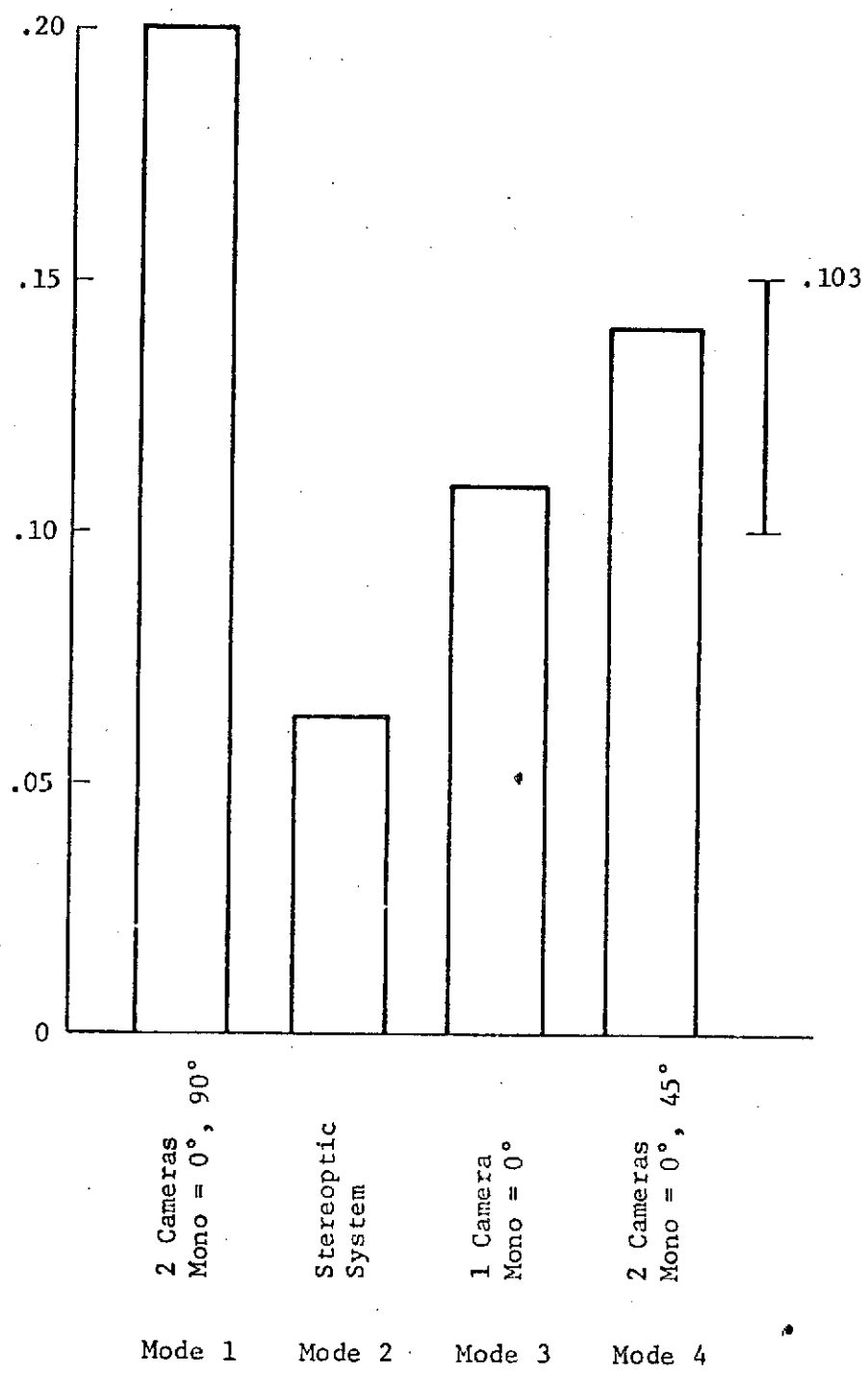

FIGURE 6. Probability of Error as a Function of Camera Mode

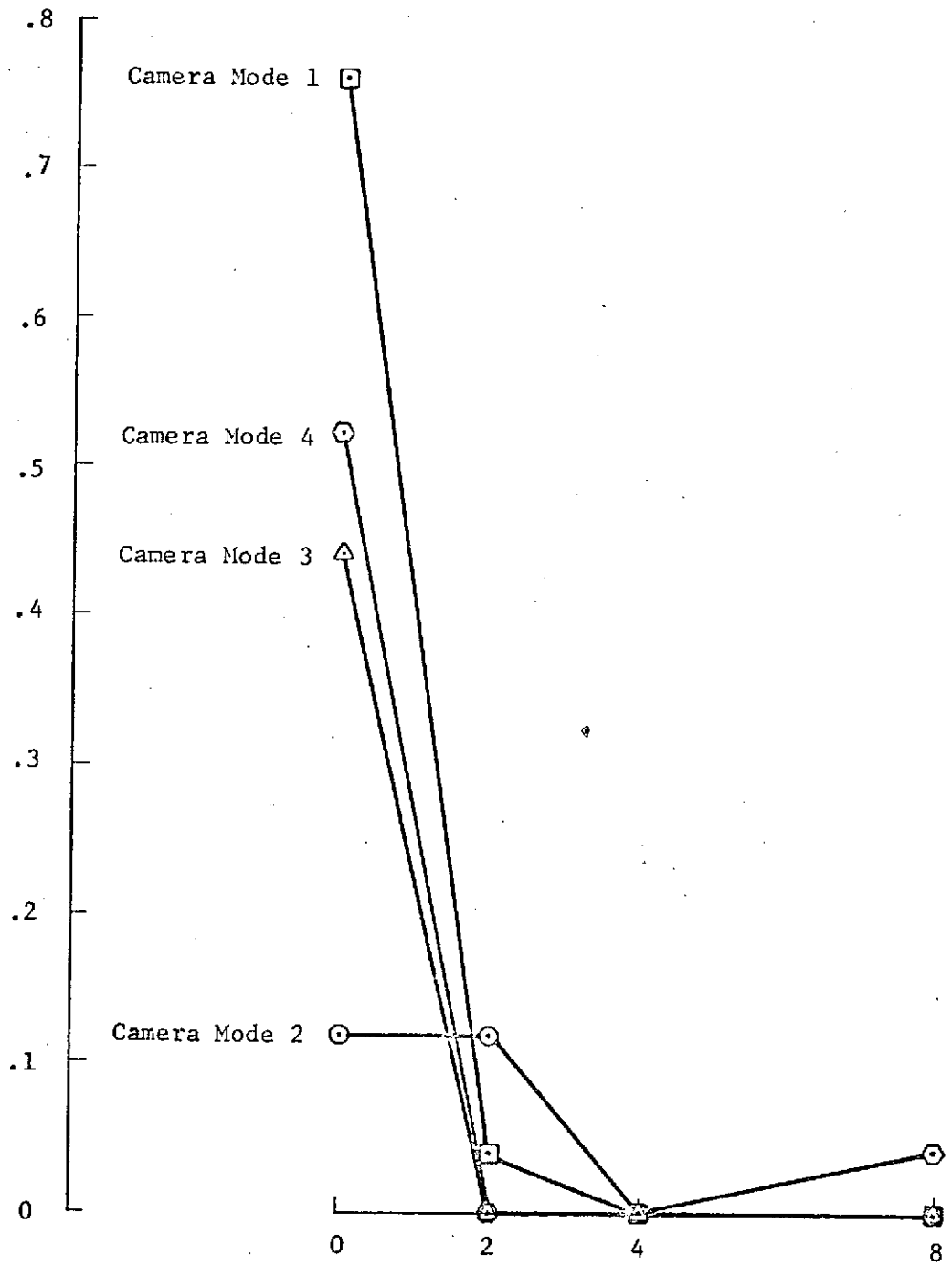

FIGURE 7. Probability of Error as a Function of Camera Mode and Fore/Aft Displacement

3.0 EFFECTS OF ILLUMINATION INTENSITY ON JUDGMENT OF SOLID TARGET ALIGNMENT

When a human observer attempts to judge alignment or non-alignment of a solid target with the viewing axis of a television system, accuracy is strongly dependent on the geometric relationship between the light source, the target, and the camera. For worst case geometry, subjects were unable to detect non-alignment of up to 10° in Experiment 10 reported by Kirkpatrick, Malone, and Shields (1973). These data bear on the RMS operator's ability to judge alignment during final approach to, and docking with, a satellite.

The objective of the current investigation was to study alignment judgment performance as a function of sun-satellite-camera geometry and artificial lighting intensity.

Apparatus

The television system employed has already been described by Kirkpatrick et al. The target was a solid cylinder 10.2 cm (4 in.) in height and 15.2 cm (6 in.) in diameter. The target was affixed to a mount which permitted continuous yaw either left or right. The COHU camera was rigidly positioned so as to align the viewing axis with the longitudinal axis of the center of the target when the target was at the zero yaw position. Two directions of non-alignment were thus possible: left and right.

The experimental apparatus was arranged as shown in Figure 8. The light source denoted S was used to represent the sun although this simulation extended only to orientation with respect to the camera viewing axis. No attempt was made to represent the sun in terms of apparent intensity or spectral composition. A Colortran studio lighting unit was employed. Light

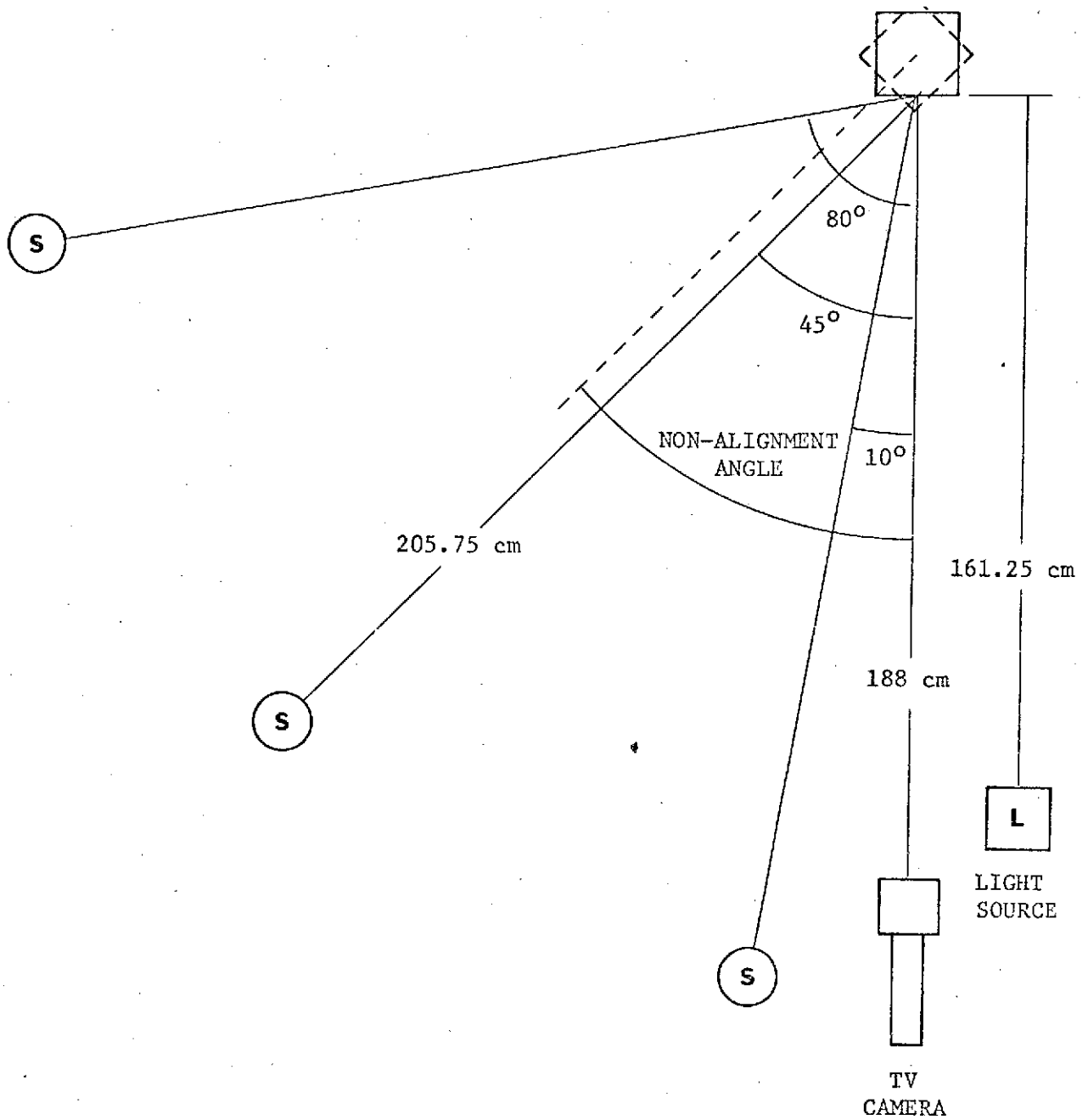

"SUN" ANGLE = 10° , 45° , or 80°
 LIGHT SOURCE S REPRESENTS SUN AT VARIOUS ANGLES TO CAMERA L.O.S.
 LIGHT SOURCE L REPRESENTS ARTIFICIAL LIGHT SOURCE

FIGURE 8 CAMERA-TARGET-LIGHTING GEOMETRY

L was a Kodak slide projector having a standard 300 watt bulb. This source was used to represent artificial lighting and was in proximity to the camera. The projector could be set to one of three intensity values by means of a lens aperture. To specify intensity values under the various experimental conditions, a Tektronix photometer with luminance probe was employed. This instrument was placed along the camera viewing axis and oriented toward the target which was in the zero offset position. The obtained luminance values reflected from the target are shown in Table 5.

TABLE 5
REFLECTED LUMINANCE VALUES FROM THE CAMERA
POSITION FOR EXPERIMENTAL CONDITIONS (FT. LAMBERTS)

Light Source <u>S</u> Orientation	Intensity of Light Source				Level Ft. Lamberts
	Off	1	2	3	
Off	0	24	44	63	
10°	9	33	53	72	
45°	6	30	51	69	
80°	3	27	47	66	

Experimental Design

The independent variables included the following:

2 directions of misalignment

- (1) Toward light source S
- (2) Away from light source S

4 conditions of light source S

- (1) 10 degrees to camera line of sight
- (2) 45 degrees to camera line of sight
- (3) 80 degrees to camera line of sight
- (4) Off

4 intensities of light source L as reflected light measured at the camera lens

- (1) Off
- (2) 23.7 ft. lamberts
- (3) 42.9 ft. lamberts
- (4) 63.0 ft. lamberts

2 target marking conditions

- (1) Uniformly painted surface
- (2) Markings consisting of three 1.9 cm wide black strips running longitudinally from the face edge to the edge of the satellite; the satellite body was painted to a reflectivity of .8 as in 1 above

The misalignment directions were chosen to represent best case (away from S) and worst case (toward S) conditions from experiment 10 (Kirkpatrick et al). The incidence angles of light source S were chosen to investigate the effect of the teleoperator's approach relative to the sun position. Target markings and artificial light source intensity were chosen as two system design parameters which might aid the operator to detect worst case non-alignments. The combinations of light source conditions and the objectives of studying these conditions appear in Figure 9.

	Intensity of Light Source L (Ft. Lamberts)			
	0	24	44	63
Light Source S Condition				
Off	Not Studied	Artificial Light Source Intensity Required for Operations in Earth's Shadow		
10° 45° 80°	Control Condition Without Artificial Lighting	Effect of Artificial Lighting in Compensating for Worst Case Non-Alignment		

FIGURE 9 - LIGHT SOURCE INTENSITY AND ORIENTATION CONDITIONS

The dependent measure employed was non-alignment angle in degrees at detection of non-alignment. The control variables were set at the following levels:

- (1) The camera-to-target distance was maintained at 205.75 cm (81 in.)
- (2) The video transmission characteristics were analog transmission with 4.5 MHz bandwidth and signal-to-noise ratio of 32 db.
- (3) Video levels and camera field of view were held constant during the tests.

Each of five subjects was screened for non-astigmatic vision and 20/20 acuity, both eyes. The matrix of conditions shown in Table 1 was repeated under the four conditions of target marking and non-alignment direction to obtain the sixty cells in the design matrix. Each subject completed two replications of this matrix yielding 120 trials per subject. Light source S levels were presented in counterbalanced blocks, the remaining treatment combinations were presented in random order within blocks.

Procedure

On each trial, a TV image was presented showing the cylindrical target at the aligned position. The subject was required to judge whether the target was aligned or non-aligned and, if non-aligned, in which direction. The initial presentation was always judged to be aligned. Following the subject's response, the TV display was terminated and the target was yawed 2.5 degrees (right or left according to the run schedule). The scene was again presented to the subject for his judgment. This procedure was followed until the target yaw was sufficient for the subject to correctly report the direction. The required yaw angle was then recorded, the apparatus reset, and a new trial was begun.

Results

Two analyses of variance were performed using required yaw angle for detection. One employed data from the condition where light source S was off. The second employed the data from the other three source S conditions. The resulting source tables are shown in Tables 6 and 7. These analyses were performed on cell means taken over the two replications of the experiment.

Table 6 shows two independent variables to be significant - target marking and intensity of source L. The effect of both variables is shown in Figure 10. Since the interaction of these variables was found to be negligible, the data shown have been smoothed by summing main effects. The data presented in Figure 10 are applicable to a case where satellite must be retrieved while in the earth's shadow. The data show that both markings and intensity of artificial illumination influence the operator's ability to detect non-alignment. Under best case conditions in the current experiment, the mean angle required was reduced to about 8 degrees. Further intensity increases might reduce required angles further. While the intensity could easily be incremented in the laboratory, the implications for system power requirements impose constraints on the process. An analysis of power requirements based on range and satellite reflectivity will be required to determine feasibility of further luminance increments.

Table 7 presents the analysis of variance source table for the case where light source S was employed at various angles with respect to the viewing axis of the camera. Source L intensity was found to exert a significant main effect ($\alpha < .01$). The effect is illustrated in Figure 11.

The remaining significant effects in Table 7 result from the interaction of non-alignment direction, source L intensity, and source S angle. The three-way

TABLE 6. ANALYSIS OF VARIANCE OF ANGLE REQUIRED
FOR NON-ALIGNMENT DETECTION - LIGHT SOURCE OFF - EXPERIMENT 12

SOURCE	df	ss	MS	F
Marking (M)	1	50.417	50.417	18.71*
Source L Intensity (I)	2	185.833	185.833	99.43**
Non-Alignment Direction (D)	1	12.604	12.604	4.77
Subjects (S)	4	170.052	42.513	--
MxI	2	1.458	.729	< 1.00
MxD	1	6.667	6.667	5.28
MxS	4	10.781	2.695	--
IxD	2	2.708	1.354	1.28
IxS	8	14.948	1.869	--
DxS	4	10.573	2.643	--
MxIxD	2	2.708	1.354	< 1.00
MxIxS	8	20.156	2.520	--
MxDxS	4	5.052	1.263	--
IxDxS	8	8.490	1.061	--
MxIxDxS	8	16.823	2.103	--
TOTAL	59	519.270	--	--

TABLE 7. ANALYSIS OF VARIANCE
OF ANGLE REQUIRED FOR NON-ALIGNMENT DETECTION -
VARIABLE INTENSITY AND ORIENTATION

SOURCE	df	ss	MS	F
Source S Angle (C)	2	23.606	11.803	<1.00
Marking (M)	1	78.776	78.776	2.97
Source L Intensity (I)	3	1969.739	656.580	46.23**
Non-alignment Direction (D)	1	5975.023	5975.023	139.34**
Subjects (S)	4	354.362	88.591	---
CxM	2	5.560	2.780	<1.00
CxI	6	535.925	89.321	6.91**
CxD	2	430.484	215.242	4.37
CxS	8	195.404	24.425	---
MxI	3	55.547	18.516	1.03
MxD	1	17.606	17.606	6.19
MxS	4	105.925	26.481	---
IxD	3	2133.256	711.085	73.38**
IxS	12	170.430	14.202	---
DxS	4	171.526	42.881	---
CxMxI	6	41.055	6.842	<1.00
CxMxD	2	9.153	4.576	<1.00
CxMxS	8	40.794	5.099	---
CxIxD	6	682.798	113.798	5.72**
CxIxS	24	310.430	12.935	---
CxDxS	8	394.256	49.282	---
MxIxD	3	69.843	23.281	3.28
MxIxS	12	216.263	18.022	---
MxDxS	4	11.366	2.842	---
IxDxS	12	116.288	9.691	---
CxMxIxD	6	62.461	10.410	1.096
CxMxIxS	24	204.518	8.522	---
CxMxDxS	8	47.618	5.952	---
CxIxDxS	24	477.616	19.901	---
MxIxDxS	12	85.299	7.108	---
CxMxIxDxS	24	227.889	9.495	---
<u>TOTAL</u>	239	15220.766	---	---

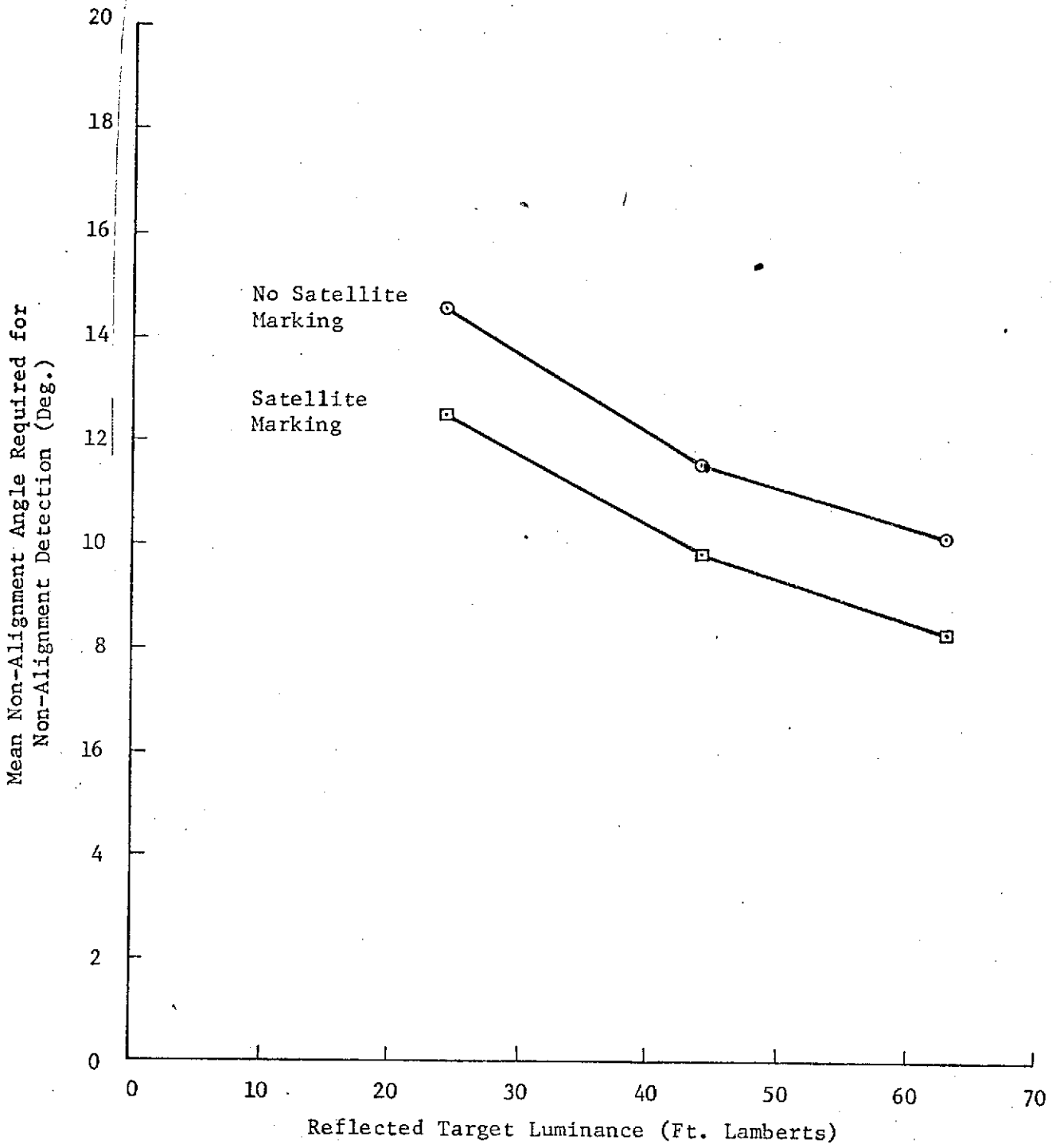

FIGURE 10. Mean Non-Alignment Angle Required for Non-Alignment Detection as a Function of Reflected Target Luminance From Source L - Source S Turned Off

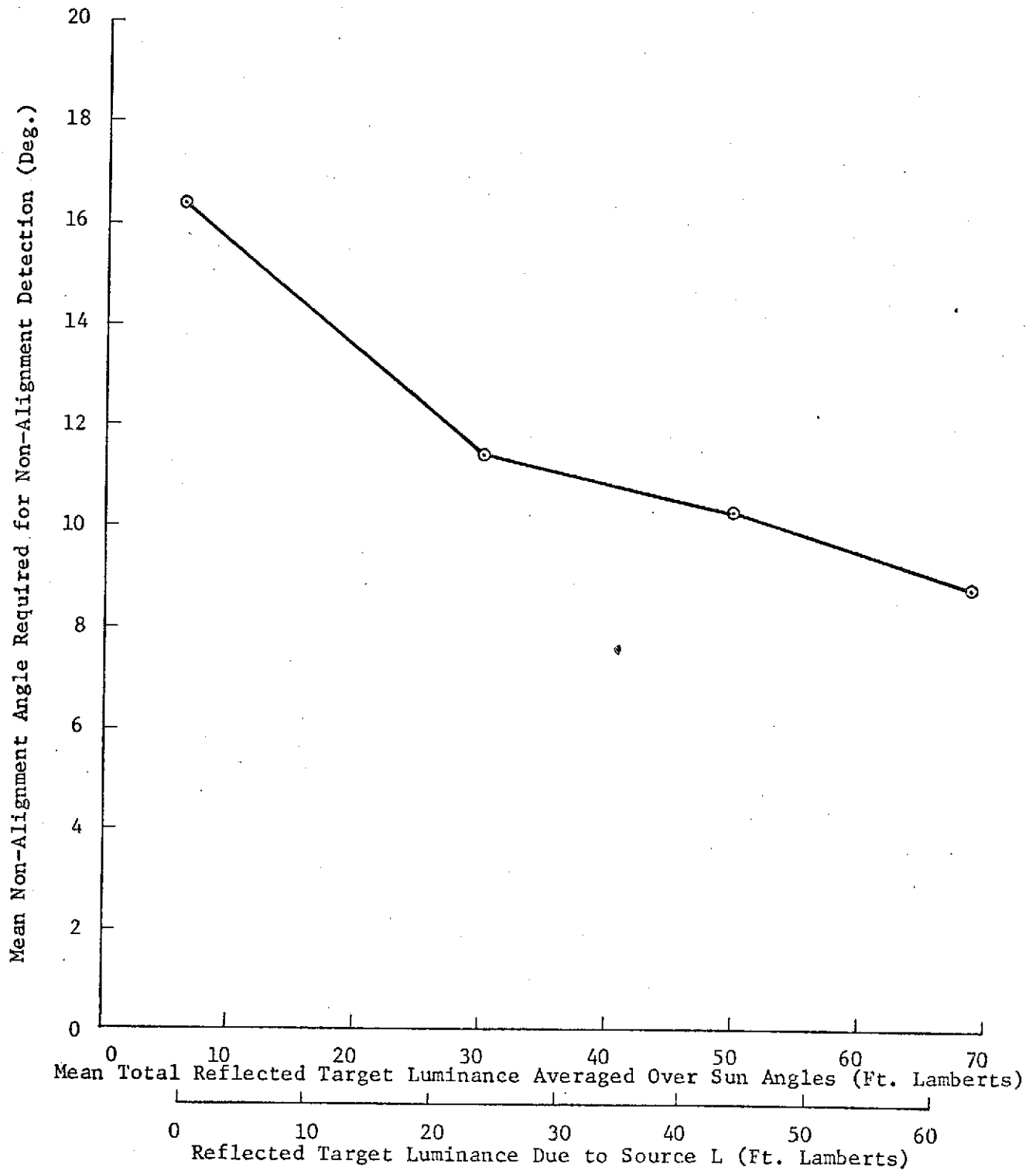

FIGURE 11. Mean Non-Alignment Angle Required for Non-Alignment Detection as a Function of Source L Luminance

interaction which is significant at the .01 level is illustrated in Figure 12. The previously reported finding that non-alignment away from the predominant light source is detected at smaller angles than is non-alignment toward it is evident in the current data. It may be seen that non-alignment detection away from source S is nearly independent of source S angle and source L luminance. When non-alignment is toward source S and no source L illumination is provided, the non-alignment angle required for detection increases drastically as the angle between source S and the camera line of sight increases. As increasing source L luminance is provided, however, the source S angle effect is reduced or eliminated and the level of non-alignment angle required decreases with increasing source L luminance. The data, then, show strong support for the notion that artificial illumination can compensate for non-alignment detection under worst case geometry. In fact, for the highest source L illumination (63 ft. lamberts) the non-alignment direction effect is nearly eliminated.

In the case where source S was employed representing the sunlit case, target marking was not found to exert a significant effect on detection performance nor did it interact with the other independent variables. The facilitative effect of target marking appears to be confined to the case where artificial illumination alone is used.

The current data suggest, then, that artificial illumination can compensate for the non-alignment direction effect noted in a previous study. While limitations on the light intensity will result from power availability, the current data should permit trading off power consumption against operator perceptual performance in detecting RMS-satellite non-alignment during inspection and docking operations.

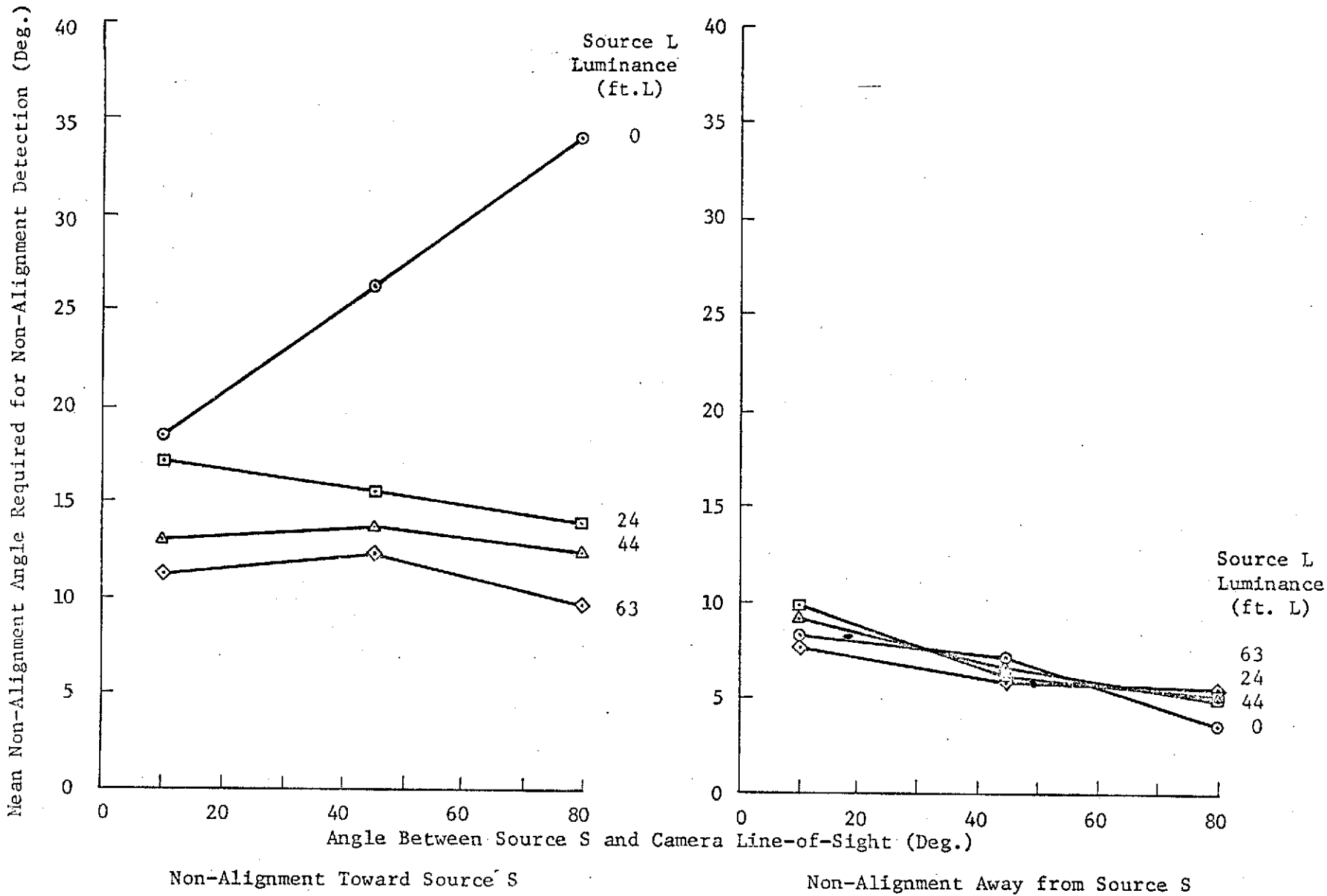

FIGURE 12. Mean Non-Alignment Angle Required for Non-Alignment Detection as a Function of Source S Angle, Non-Alignment Direction, and Source L Luminance

4.0 VISUAL SYSTEM LABORATORY UTILIZING TARGET MOTION APPARATUS

The purpose of this report is to describe the equipment and procedural changes which were made in the visual system laboratory to conduct tests involving motion of visual targets. The laboratory facilities are diagrammed in Figure 13, and reflect the same physical spaces described in Earth Orbital Teleoperator Report #1 (Kirkpatrick, Malone & Shields, 1973).

A. TARGET MOTION GENERATOR

The most significant change in the laboratory was the addition of the target motion generator (TMG) which provided both rotational and translational motion. The TMG is a floor mounted stand which supports a stainless steel hollow tube which can be adjusted to that it is parallel to the floor and normal to a TV viewing axis. The tubular structure (205 cm) is fitted with a drive shaft running through its hollow insides, and a length of gear teeth fitted to its underside. The internal drive supplies rotational motion and the external teeth supply the apparatus with a train for translational motion. Both rotational and translational trains derive their power from separate Motomatic motors with gear ratios of 1 to 100 and a variable speed control from .1 to 100 RPM for rotation and from .02 to 50 cm/sec for translation. The tip of the rotational drive rod was fitted with a threaded end for mounting targets. The TMG motion tube was inserted through a hole at the center of a task board. This task board was covered with non-reflective black felt and was of sufficient size (122 cm x 122 cm) to conceal from the camera, the motors and other apparatus in the background. Other working areas behind, and to the side of the task board were shielded by black felt so that the TV image showed only the target in a totally black field.

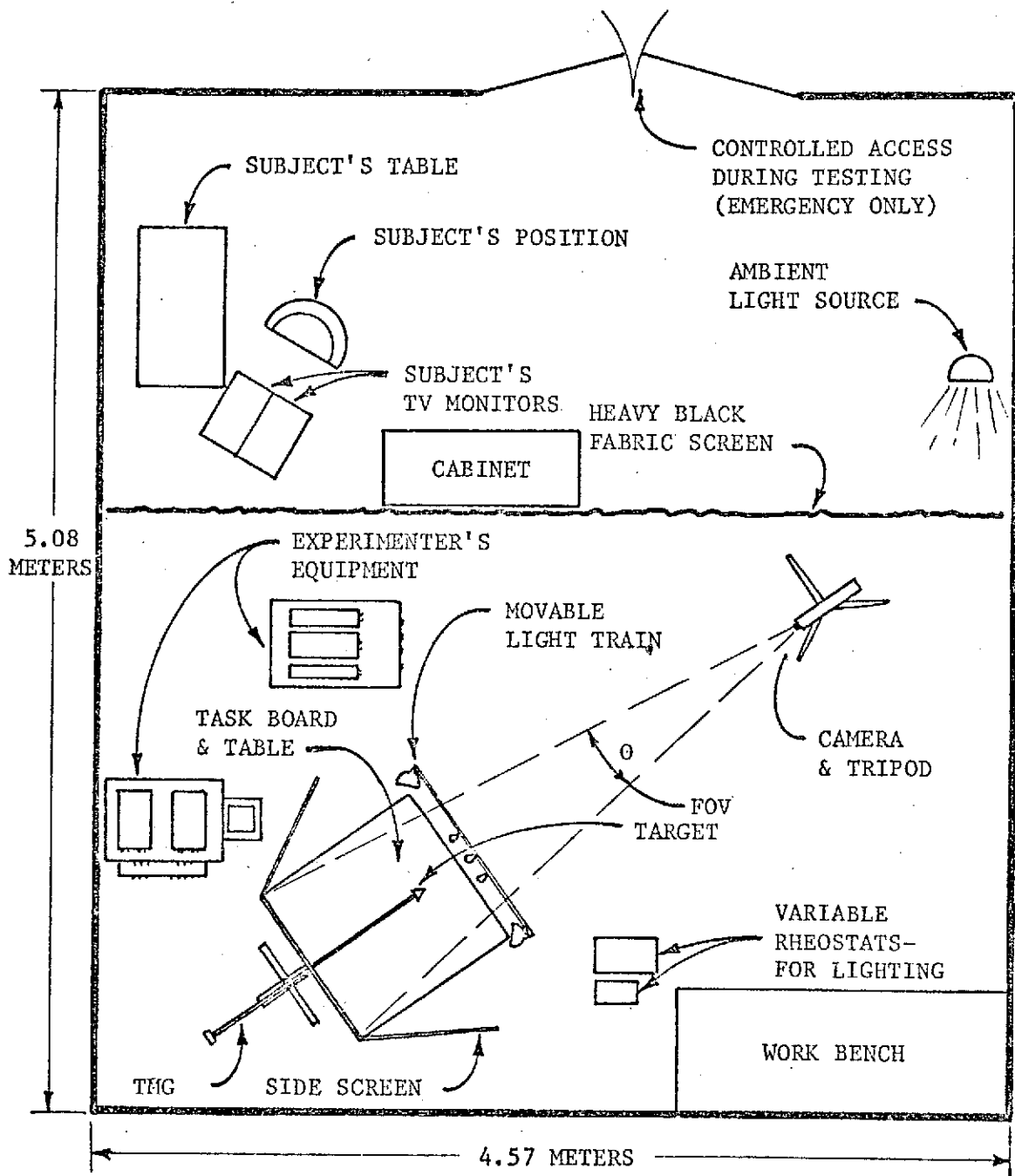

Figure 13. VISUAL SYSTEM LABORATORY LAYOUT USED FOR MOTION TESTS

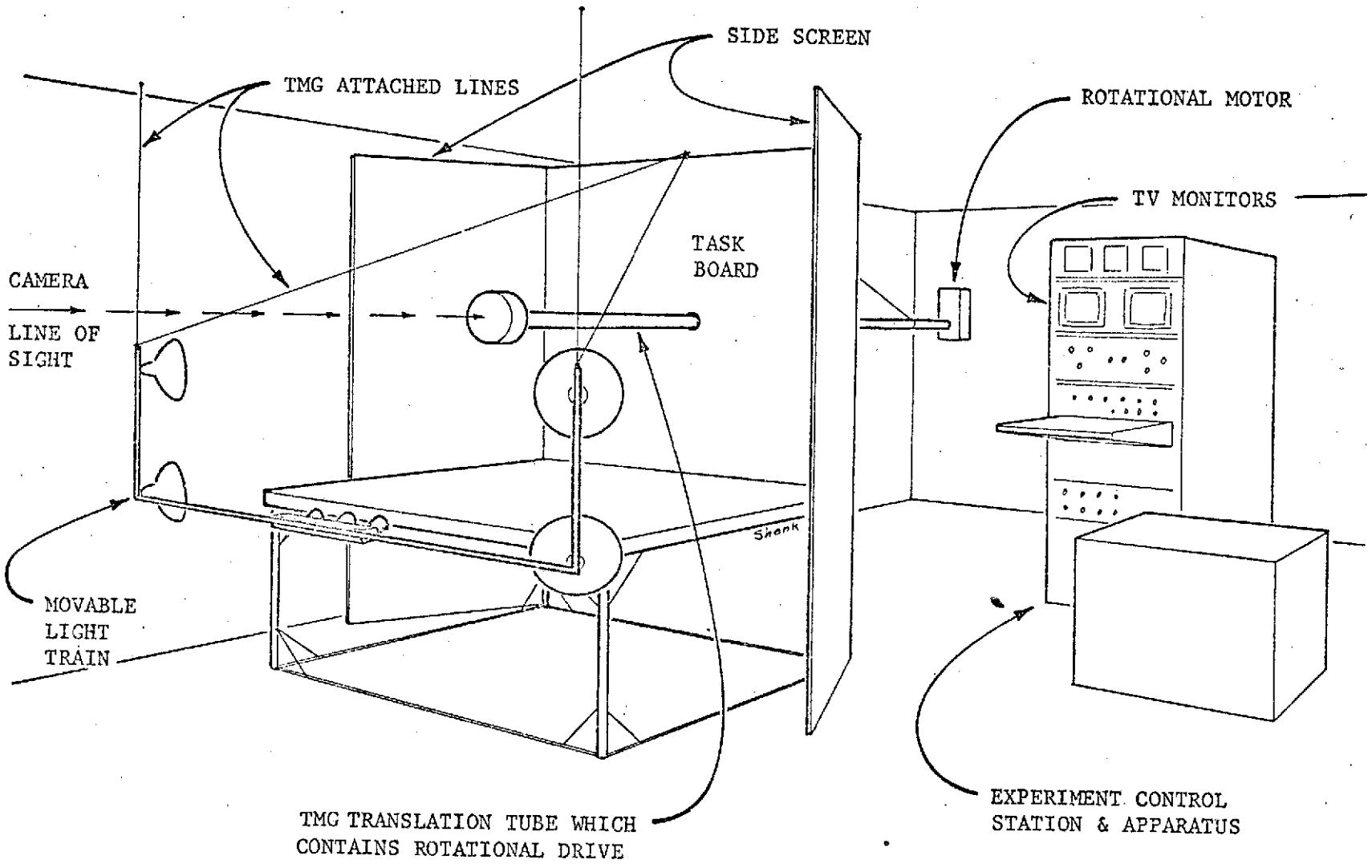

Figure 14. TMG SETUP

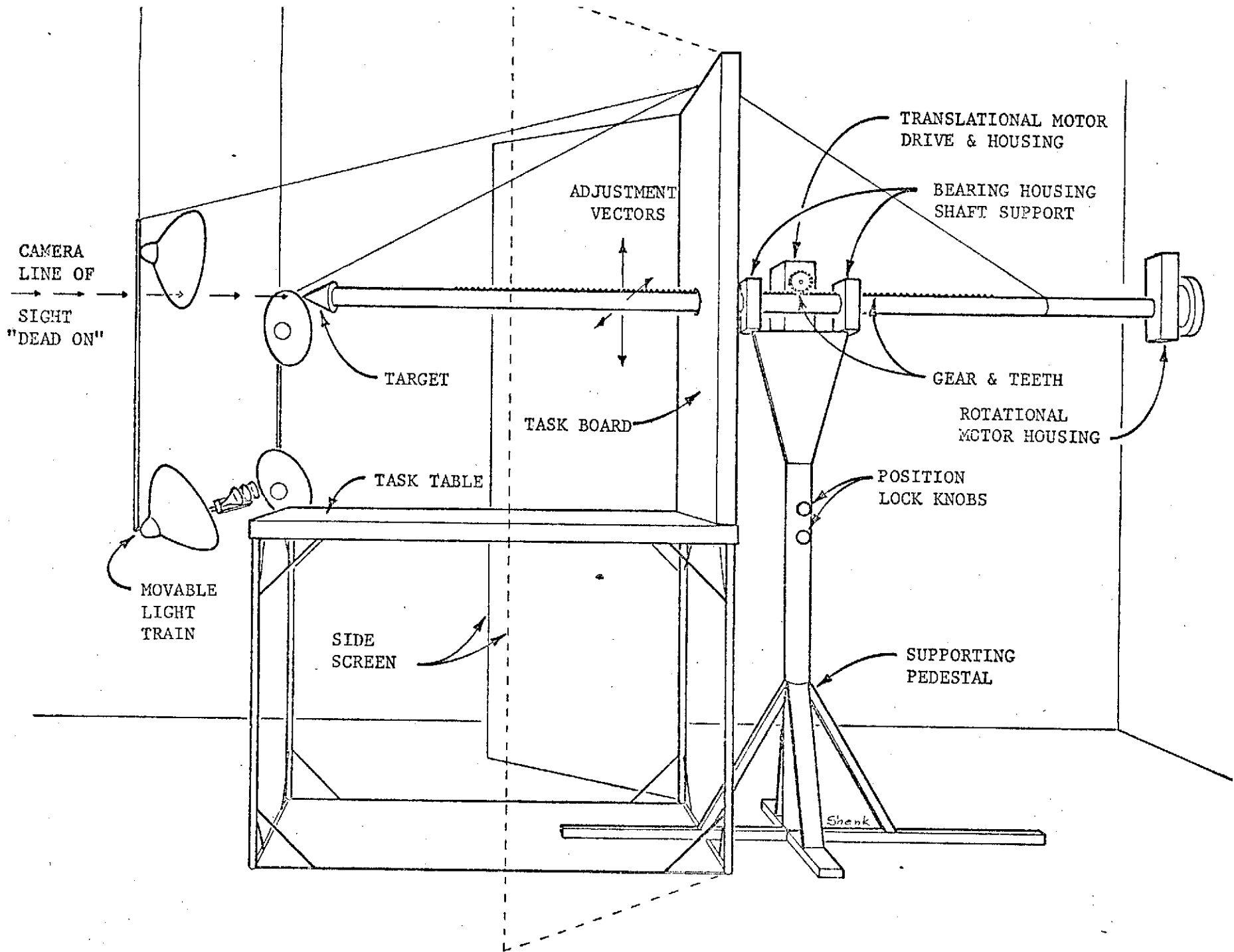

Figure 15. TMG APPARATUS

The operational arrangement for the TMG is shown in Figure 14 and Figure 15. It will be noted that at the leading (camera) edge of the task table, there is a movable light train. This train is a metal tube fitted with 7 light sockets and reflectors. The black string lines from the movable train are attached to the ceiling over the task table and to the TMG shaft behind the task board. This permits the target lighting to fluctuate only ± 1 fl while translating the full extent of target travel.

This technique was employed to eliminate any cues as to target translation due to changes in target brightness. These changes in target brightness would have been very apparent had a stationary lighting system been used. Furthermore, the movable light train better imitates the real world situation of solar light in space.

B. EXPERIMENTER'S CONSOLE & STATION

The experimenter's station consisted of the back portion of the visual system laboratory separated from the subject's station by a heavy black fabric drape. This permitted unaided verbal communication between subject and experimenter while maintaining control over visual feedback. All test equipment - task boards, camera & lights, and controls, were located in this experimenter's area. They are by category:

1. Camera & Light System

- (a) Cohu model 2000 TV camera mounted on a stable tripod
- (b) Associated cabling for the Cohu camera connected to camera control units
- (c) Movable light train with 3-100 watt bulbs & reflectors, 2-60 watt bulbs & reflectors, and 1-150 watt bulb & reflector.
- (d) Two variable rheostats to control power levels to the lighting system.

2. Experimenter's console and controls.

- (a) Camera control units for Cohu 2000 for control of field of view (zoom), target sensitivity, iris open-

ing and focus.

- (b) A Tektronix, Inc., Type RM529 wave form monitor for video system calibration.
- (c) A Computer Lab model HS-615 A/D converter and a Computer Lab Model HS-2615 D/A converter.
- (d) A General Radio Co., type 1390-B S/N 7266 random noise generator to vary signal to noise ratios.
- (e) A Data Disc. video disc memory system for selecting a 15 frame/sec vs a normal 30 frame/sec video frame rate.
- (f) A narrow band pass filter for transmission at 1 MHz.
- (g) Two 7 in (diagonal) Conrac, CNG 8 monitors, for a replication of the subject's view.
- (h) A Hewlett Packard Electronic digital counter, type 5345L, for time control and recording.
- (i) An Electro-Craft Corp. Motomatic, model E-550-M for target rate & direction control.
- (j) A control panel for selection of levels of conditions outlined above - transmission mode, signal to noise, frame rate, etc.
- (k) Associated power supplies and distribution amplifiers and associated cabling to the subject's station.

C. SUBJECT'S CONSOLE & STATION

The subject's station, located in the front section of the laboratory (Figure 13) was set up for maximal control of extraneous variables which might have influenced the experimental results. Two 7 in (diagonally) Conrac monitors, model SNA 9, were located in the subjects station.

Lighting was controlled in the subject's area so that no direct or indirect light was reflected from the subject's monitors. A single 60 watt bulb shielded lamp was pointed into the black curtain to cause ambient illumination at the subject's position to be less than 1 fc in order to afford sufficient light to offset eye strain and fatigue.

General Procedures

The next section can be considered in terms of pre-test, testing, and post-test procedures.

Pre-test

About one and one-half hours prior to testing, all equipment was activated to allow for warm up and stabilization of the system. Sequentially, this involved turning on the lights at the TMG task board, obtaining an ambient light level of 70 f.c., and plugging in the experimenter's console of equipment. After the first major unit, the sync generator, had stabilized, the unit containing the experimenter controls for transmission mode, noise, focus, sensitivity, and zoom was activated followed by the video disc memory system activation. The experimenter's monitor, camera switch, and electronic counter were turned on, the camera was uncapped after the room lights were turned off, and the system was allowed to warm up completely. Target brightness and contrast levels were adjusted by visual inspection so that no background was detectable at the TV monitor. The wave form monitor was then calibrated under the given lightening conditions and the camera sensitivity level adjusted using a control target with .8 reflectivity.

The subject's monitor was then turned on, and the target brightness and contrast levels were adjusted on this monitor so that no background was visible and a target could be obtained under all experimental parameters. Photometric readings were taken from the subject's monitor with a Tectronix 8 degree photometer. This reading was kept constant between subjects so that all contrast and brightness conditions remained the same for each subject.

Testing

All subjects who participated in this test program were volunteers. Each subject met visual acuity test requirements as specified in the Tele-operator Report #1. Both males and females participated as subjects. The breakdown of subjects according to sex and corrected vision will be specified in each test report for the different experiments.

At the beginning of each testing session, the lamp in the subject's station supplying ambient lighting was adjusted towards the black curtain to the left of the subject. The subject was seated in front of one 7 inch (diagonally) Conrac video monitor (model SNA 9) and the monitor was adjusted so that the subject was at a distance of 21 inches from a point at the bridge of his nose to the monitor face. The monitor was offset 15 degrees below the horizontal line of sight, which is the normal viewing angle.

A standard set of instructions for the specific experiment (Table 8) was read at this time and the subject was asked if there were any questions concerning his understanding of these instructions. The experimenter did not have unnecessary conversations with the subject and interruptions were not allowed during the testing session. No entrance was permitted and no telephone calls were allowed with the exception of potential emergency messages which could have been permitted had the need occurred.

After it was determined that the instructions were understood by the subject, the experimenter went behind the dividing curtain to his console to begin the predesigned test sequence. The experimenter set up the run sequence parameters for the first trial as indicated on the data sheets for transmission mode, noise condition, range, frame rate, etc. He also set the Motomatic control (drive control) for direction and rate of the TMG shaft. At this time, the subject was asked if he was "ready" and on hearing

the affirmative response, the experimenter activated the Motomatic control and pressed the circuit button which activated the digital clock and allowed transmission of the target image to the subject's monitor. After two seconds were indicated on the digital clock, the circuit button was pressed again, thus removing the target image from the subject's monitor and resetting the digital clock to zero.

With the removal of the target image from his monitor, the subject gave his verbal response as determined by the instructions. The experimenter recorded the response on the data sheets and proceeded to set up the next trial, repeating the above sequence.

No verbal communication was carried on with the subject unless the subject indicated that there was transmission difficulty on his monitor or the experimenter felt that the response instructions had been misinterpreted by the subject. In either case, the difficulty was corrected and/or the instructions reexplained as the situation required. The misrun trial was repeated later in the testing sequence and the testing was immediately continued without undue delay.

All trials were run with rest periods approximately every 45 minutes until the experiment was completed for the subject. After each rest interval, the subject was reseated, the position of the monitor rechecked and the trials continued until the testing sequence was completed. Only one subject at a time was performing the test.

Post-test

After the entire testing sequence was completed, the experimenter checked the subject's monitor for any possible fluctuations in target transmission conditions thus making sure that the original conditions had been maintained throughout the experiment. After a completed testing day, the equipment was

completely shut down making sure that power to all units was terminated.

The testing sequence proceeded in an identical manner for all subjects to insure that each subject received the same experimental conditions and treatment.

TABLE 8
SAMPLE STANDARD INSTRUCTIONS - USED IN
TARGET MOTION EXPERIMENTS

After Seating Subject and Adjusting Chair, Monitor & Distance

We will present a 2 second view of a "satellite" to you. We want you to look at this view for the 2 seconds and try and determine any forward or aft motion. That is, we want you to determine if you seem to be moving toward or away from the satellite, or if there is no fore/aft motion as far as you can determine. We will present you with the view and at the end of the 2 second interval the view will be removed automatically. You do not have to use the response key.

(Any questions so far?)

If you determine you are moving away from the satellite, the distance between you & the satellite will be increasing. (Right?) So you will respond by saying "Plus" for the increase. If you determine you are moving toward the satellite the distance between you & the satellite will be decreasing (Right?) so you will respond by saying "Minus" for the decrease. On the other hand, if you feel there is no change in the range or distance, or if you are unable to detect any change in distance please respond by saying "None" for this situation.

(Are there any questions?)

All of your TV views should be free of distortion or video problems. If a problem develops, like flopover, please tell us immediately so it can be corrected. If there are no further questions, we will begin.

(Check positions again)

4.1 Teleoperator Visual System Evaluation Laboratory Experiment B₂ - Motion Detection of a Target Object

The objective of this experiment was to determine the effects of alternative visual display aid conditions on the human operator's ability to detect fore/aft motion of a target object.

Apparatus

The task area, task board and target motion generator used in this experiment are described in the Target Motion Generator section of this report. Additionally, a round target (15.2 cm diameter) was affixed to the end of the TMG. This target was painted to a reflectivity of .7. The target in this case was a thin aluminum disc mounted on the TMG and on axis with the camera such that a true three dimensional target was not necessary.

A single Cohu Model 2000 mono TV system was employed in this experiment, and the subject's view was displayed on a single Conrac monitor. The monitor face could be outfitted with either of two reticles shown in Fig. 1. These reticles were acetate overlays affixed directly to, and centered on, the monitor face.

Independent Variables and Experimental Design

The independent variables studied were:

- . Target motion direction
- . Initial range
- . Range rate
- . Reticle conditions

To establish initial range conditions, the apparatus was adjusted to present a displayed image size equal to that of a BRM satellite at ranges

CANDIDATE
RETICLE 1

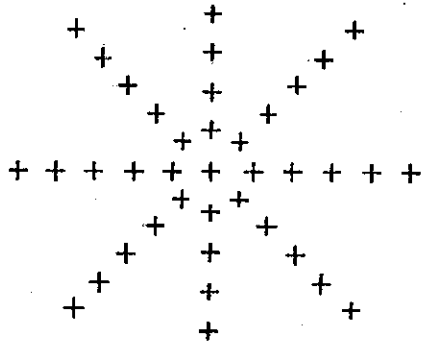

CANDIDATE
RETICLE 2

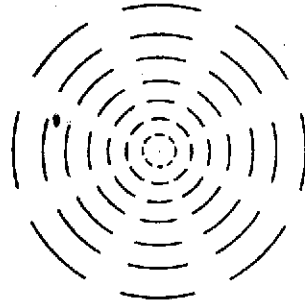

The third viewing condition was an
unaided, without reticle, condition.

FIGURE 16. Candidate Reticle Formats Used for Motion Detection

of 20 or 30 feet. This established a simulated target dimension of 3 feet (the diameter of the BRM). Image size on the monitor is given by:

$$I = \frac{M}{2 \text{ TAN } (\alpha/2)} \cdot \frac{T}{R} \quad (1)$$

Where I = displayed image size } same units
M = monitor dimension }
T = target dimension } same units
R = camera to target range }
 α = angular F.O.V. dimension

For a particular TV system at a fixed optical zoom setting:

$$\frac{M}{2 \text{ TAN } (\alpha/2)} \quad (2)$$

is fixed and may be replaced by a constant K, so that

$$I = \frac{KT}{R} \quad (3)$$

The rate of change of image size is given by the first derivative with respect to time of eq. (3)

$$\dot{I} = \frac{dI}{dt} = \frac{R \cdot \frac{dKT}{dt} - KT \cdot \frac{dR}{dt}}{R^2} \quad (4)$$

$$\dot{I} = \frac{-KTR}{R^2} \quad \text{for } R \text{ a constant} \quad (5)$$

The real world conditions simulated were the following:

- Target - end view of a BRM satellite (3 ft target dimension)
- Angular field of view - 20° (diagonal)
- Monitor dimension - 7.75 in (diagonal)
- Initial range - 20 or 30 ft
- Viewing time - 2 sec

To simulate these conditions, the image size rate of change profiles for the stated conditions and various values of \dot{R} were calculated by means of eq. (5). Range, target size, field of view, and TMG rates were chosen to produce the desired profiles during the 2 sec. viewing time period. To characterize each level of image size rate of change, the mean rate during the viewing time period was employed since regarding \dot{I} as a constant results in only a small percent error. That is, the relationship between image size and time does not depart appreciably from linearity over the time interval employed. The mean rate of change of image size over a time period Δt is given by:

$$\bar{\dot{I}} = \frac{-KTR\dot{R}}{R_0(R_0 + \dot{R}\Delta t)} \quad (6)$$

Where R_0 = initial range

The independent variables manipulated in the experiment included the following:

- . Reticle condition - no reticle, cross hatch reticle, concentric ring reticles as illustrated in Fig. 1.
- . Image size rate - under each reticle condition, five positive image rates, five negative image rates, and one condition of no change were selected as shown in Tables 8 and 9.
- . Initial range - simulated 20 or 30 ft.

The dependent variable measured was probability of error in judging the displayed rate to be positive, negative, or zero.

The control variables were set at the following levels:

- . Target lighting - 100 foot candles
± 1 fc over the entire train of travel for the TMG
- . Transmission parameters - 4.5 MHz
direct transmission with 32 db signal to noise ratio

- . Target parameters
 - shape - circular
 - size - 15.24 cm diameter
 - reflectivity - .7
- . Subject's viewing time of target - 2.0 seconds
- . TV system parameters - peak white sensitivity at .8 reflectivity

Each of five subjects was screened for normal vision using the standard orthorator visual tests. Each subject received all combinations of conditions. The presentation of rates, ranges, and directions of travel were randomized. The 2 reticle conditions and one no-aid condition were run in blocks of 22 trials, which were counterbalanced among subjects, so that 22 trials under one aid condition were run before changing to another aid condition. There were two replications for all trials for each subject. This yielded 132 trials for each of 5 subjects (5 rates x 2 directions x 2 initial ranges x 3 aid conditions x 2 replications + 12 combinations where rate and direction were zero). Total trials run for this experiment were 660 trials.

Procedure

Prior to any experimental run, all equipment in the Visual System Laboratory was calibrated by the experimenter. This assured a constant set of conditions between subjects. The experimenter then selected the appropriate display aid and fitted it to the monitor face (see Fig. 16).

At the time of an experimental run the subject was seated in front of the test TV monitor and its position was adjusted so that it was 21 inches from the bridge of the subject's nose and 15° below the horizontal plane. A set of prepared instructions was read to the subject and he was asked if he understood the task requirements. When the subject fully understood

his role in the experiment, the experimenter left the subject's area and went into the task area to prepare for the first set of trials.

The experimenter set the TMG translation arm to its center position, as indicated by scribes on the arm and power gear. The experimenter then manipulated the camera's zoom control to set the initial range condition to simulate either 20 or 30 feet according to the experimental plan data sheet. From the data sheet, the experimenter also selected the conditions for other independent variables, the direction and rate of translation. These were controlled by a multi-rotational knob which indicated motor speed settings which would produce the appropriate average changes in displayed image size as a function of direction of travel, the details of which are outlined in Tables 9 and 10. If the data sheet indicated an increase in range condition was to be the trial, he set the TMG translation arm forward of the center position on the arm before starting the trial. This allowed any "chatter" in the arm, due to an abrupt start, to be nulled out prior to the time the TV image was displayed to the subject. When the scribes on the arm and power gear travelled to the center position the experimenter would call out "ready" and press the subject's TV image control switch which instantly gave a TV image on the monitor in the subject's station and activated a digital timer in the experimenter's station. The subject was allowed a 2.0 second view of the scene, at which point the experimenter would activate the control switch and terminate the subject's TV image. The experimenter recorded the subject's response and set up the conditions for the next trial.

Results

Since the independent variable, image size rate of change, was nested in reticle condition, the total data matrix could not be subjected to a

TABLE 9. Displayed Mean Rate of Change of Image Size Used With Reticles

<u>INITIAL TARGET RANGE (FT)</u>	<u>MEAN RATE OF CHANGE OF IMAGE SIZE FOR THE 2 SECOND VIEWING INTERVAL (IN/SEC)</u>	<u>CORRESPONDING SIMULATED RANGE RATE (FT/SEC)</u>
20	-.021	+.129
20	-.016	+.098
20	-.011	+.067
20	-.006	+.037
20	-.001	+.006
20	0.000	0.000
20	+.001	-.006
20	+.006	-.036
20	+.011	-.066
20	+.016	-.096
20	+.021	-.126
30	-.021	+.292
30	-.016	+.222
30	-.011	+.152
30	-.006	+.082
30	-.001	+.014
30	0.000	0.000
30	+.001	-.014
30	+.006	-.082
30	+.011	-.149
30	+.016	-.215
30	+.021	-.281

TABLE 10. Displayed Mean Rate of Change of Image Size Used With No Reticle Condition

<u>INITIAL TARGET RANGE (FT)</u>	<u>MEAN RATE OF CHANGE OF IMAGE SIZE FOR THE 2 SECOND VIEWING INTERVAL(IN/SEC)</u>	<u>CORRESPONDING SIMULATED RANGE RATE (FT/SEC)</u>
20	-.070	+.444
20	-.055	+.345
20	-.040	+.249
20	-.025	+.154
20	-.010	+.061
20	0.000	0.000
20	+.010	-.061
20	+.025	-.149
20	+.040	-.237
20	+.055	-.323
20	+.070	-.407
30	-.070	+1.021
30	-.055	+.790
30	-.040	+.567
30	-.025	+.349
30	-.010	+.138
30	0.000	0.000
30	+.010	-.135
30	+.025	-.334
30	+.040	-.527
30	+.055	-.715
30	+.070	-.898

single analysis of variance. Additionally, it was desired to decompose image size rate into two independent variables - direction and absolute magnitude - to determine if direction per se influenced performance. This required that the zero rate data be analyzed separately. Accordingly, three analyses of variance were performed on subsets of the data as depicted in Fig. 17.

The results of the analysis of variance of data set 1 are shown in Table 11. As was expected, the effect of rate of change of image size is significant at the .01 level. No other main effects were found to be significant but the interactions of direction by rate and the four-way interaction of reticle, range, direction, and rate are both significant at the .05 level. The interaction of direction and rate is shown in Fig. 18. The interaction is due to the fact that the error rate is reduced for an image rate of +.001 in/sec relative to +.006. The four way interaction was found to be due to the fact that this effect does not occur for the cross-hatch reticle and 20 ft range condition. It is found, however, for the remaining reticle-range combinations. It seems likely that the cause of this effect is the line spacing of the reticles. For very low rates, detection of motion would be enhanced if the target edge were to cross a reticle line. Since the proximity of a target edge to a line is influenced by the image size/reticle geometry configuration, local maxima and minima might well be found for various range/reticle combinations.

The finding of no significant main effect of range or direction suggests that rate of change of image size is a sufficient metric to use in predicting motion detection performance. For the levels of independent variables studied here, the data may be generalized via calculation of image size rate of change since performance appears relatively insensitive to

RETICLE CONDITION

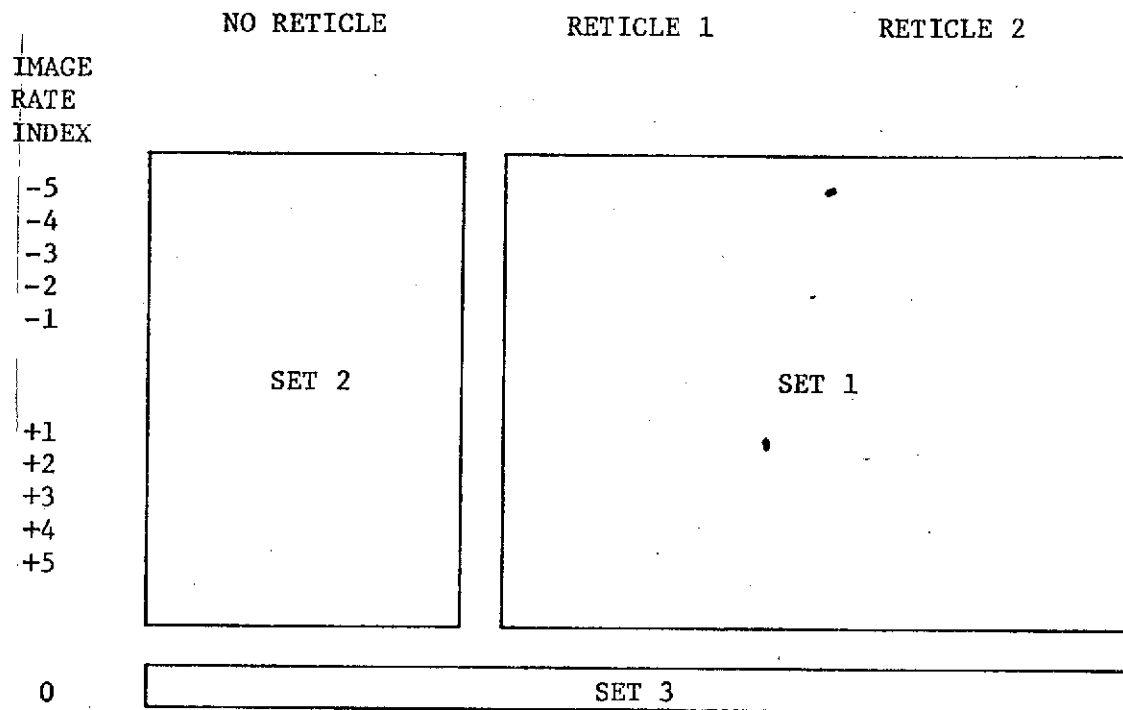

<u>DATA SET</u>	<u>CONSTANT PARAMETERS</u>	<u>INDEPENDENT VARIABLES (EXCLUDING SUBJECTS)</u>
1		Reticle Types Image Size Direction of Change Image Size Change Rate Initial Range
2	No Reticle	Image Size Direction of Change Image Size Change Rate Initial Range
3	No Change in Image Size	Reticle Types vs. No Reticle Initial Range

FIGURE 17. Subsets of Data Analyzed

TABLE 11. Analysis of Variance of Probability of Error - Data Set 1

<u>SOURCE</u>		<u>df</u>	<u>SS</u>	<u>MS</u>	<u>F</u>
Reticle	(A)	1	.5000	.5000	7.62
Range	(R)	1	.5000	.5000	5.92
Direction	(D)	1	.2450	.2450	<1.00
Rate	(V)	4	10.0825	2.5206	44.53**
Subjects	(S)	4	.2825	.0706	--
AxR		1	.0000	.0000	<1.00
AxD		1	.0450	.0450	<1.00
AxV		4	.2125	.0531	<1.00
AxS		4	.2625	.0656	--
RxD		1	.1250	.1250	1.29
RxV		4	.0625	.0156	<1.00
RxS		4	.3375	.0844	--
DxV		4	.9425	.2356	3.37*
DxS		4	6.9425	1.7356	--
VxS		16	.9050	.0566	--
AxRxD		1	.0050	.0050	<1.00
AxRxV		4	.2125	.0531	<1.00
AxRxS		4	.6375	.1594	--
AxDxV		4	.5425	.1356	1.56
AxDxS		4	.8925	.2231	--
AxVxS		16	1.6500	.1031	--
RxDxV		4	.2125	.0531	<1.00
RxDxS		4	.3875	.0969	--
RxVxS		16	1.3500	.0844	--
DxVxS		16	1.1200	.0700	--
AxRxDxV		4	.7325	.1831	4.02*
AxRxDxS		4	.1575	.0394	--
AxRxVxS		16	1.2570	.0786	--
AxDxVxS		16	1.3950	.0872	--
RxDxVxS		16	1.2750	.0797	--
AxRxDxVxS		16	.7300	.0456	--
TOTAL		199	34.0020		

* $\alpha = .05$

** $\alpha = .01$

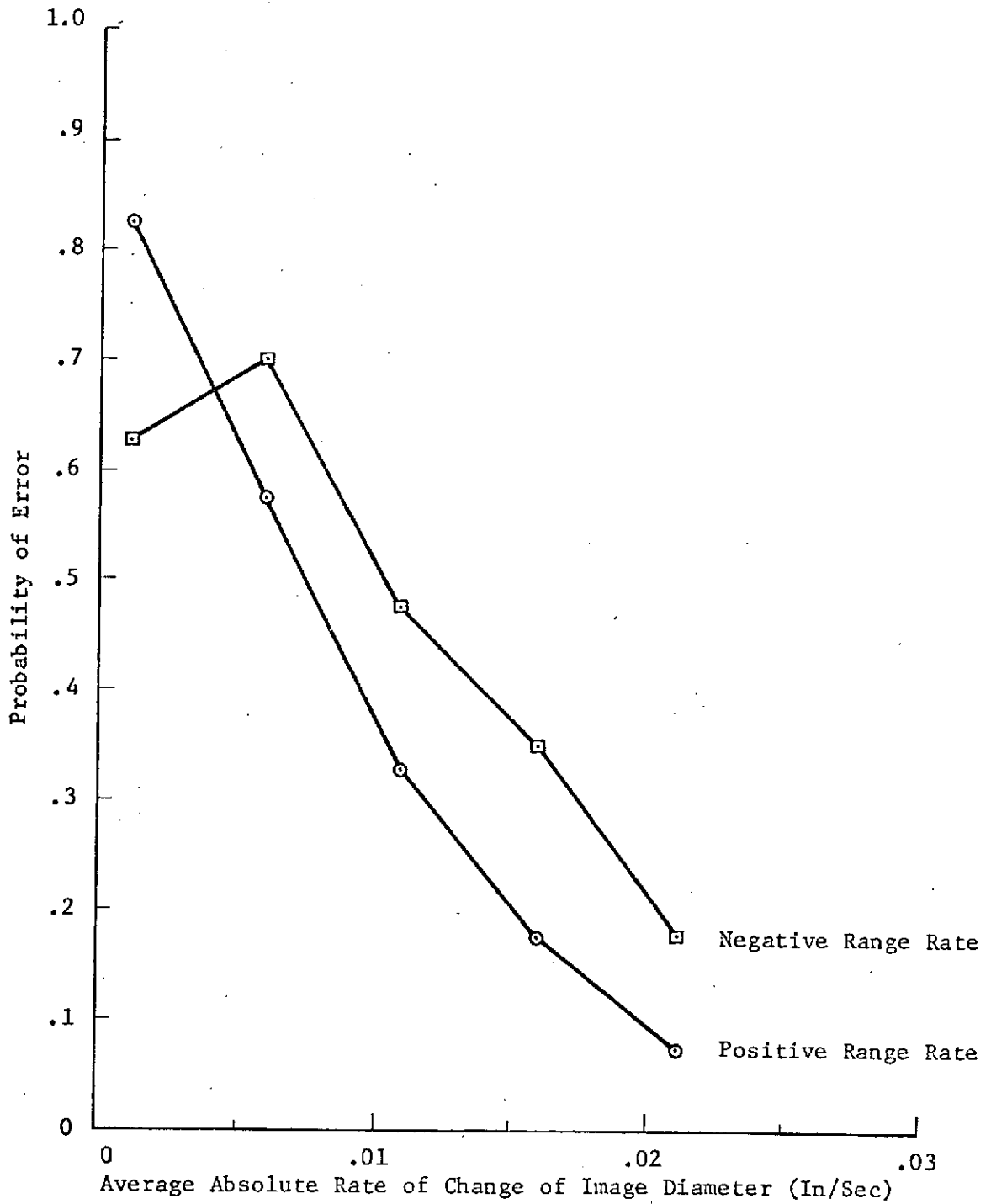

FIGURE 18. Probability of Motion Detection Error as a Function of Direction and Absolute Rate of Change of Image Diameter - Reticle Condition

direction of change or range value other than through the effects of these variables on image rate.

The results of the analysis of variance of data set 2 are shown in Table 12. The data show trends similar to those under the reticle conditions. The main effect of image rate and the direction by rate interaction are found to be significant. These effects are depicted in Fig. 19. With no reticle available, it may be seen that positive range rates are more readily detected than are negative rates for the lower rates employed in the study.

To generalize the data, it is necessary to obtain a psychometric function relating probability of detection to rate of change of image size. Since no significant effect of reticle type is shown in Table 11, the data from the two reticles were pooled. Contrasted to this, the main effect of image rate with no reticle was tabulated. Absolute image rate was employed to simplify the analysis. While certain effects of direction of motion have been located, they are of small magnitude in the case of a reticle being used. For the no reticle condition, averaging data over direction will produce predictions of performance which overshoot performance for low negative range rates and which underestimate performance for low positive rates. Since the operator must deal with both directions of motion during RMS docking operations, the general level of performance predicted should be valid. The reticle and no reticle detection functions are shown in Fig. 20. Since it is generally accepted that such psychometric functions assume a sigmoid form approximating the normal integral, theoretical functions having this form were fitted to the data. The probability of detection is given by:

TABLE 12. Analysis of Variance of Error Probability - Data Set 2

<u>SOURCE</u>		<u>df</u>	<u>SS</u>	<u>MS</u>	<u>F</u>
Range	(R)	1	.0100	.0100	<1.00
Direction	(D)	1	.3600	.3600	3.27
Rate	(V)	4	6.4600	1.6150	20.84**
Subjects	(S)	4	.2100	.0525	--
RxD		1	.0100	.0100	<1.000
RxV		4	.2400	.0600	<1.000
RxS		4	.1400	.0350	--
DxV		4	.6400	.1600	4.57*
DxS		4	.4400	.1100	--
VxS		16	1.2400	.0775	--
RxDxV		4	.0400	.0100	<1.000
RxDxS		4	.3900	.0975	--
RxVxS		16	1.1100	.0694	--
DxVxS		16	.5600	.0350	--
RxDxVxS		16	.8100	.0506	--
TOTAL		99	12.66		

* $\alpha < .05$

** $\alpha < .01$

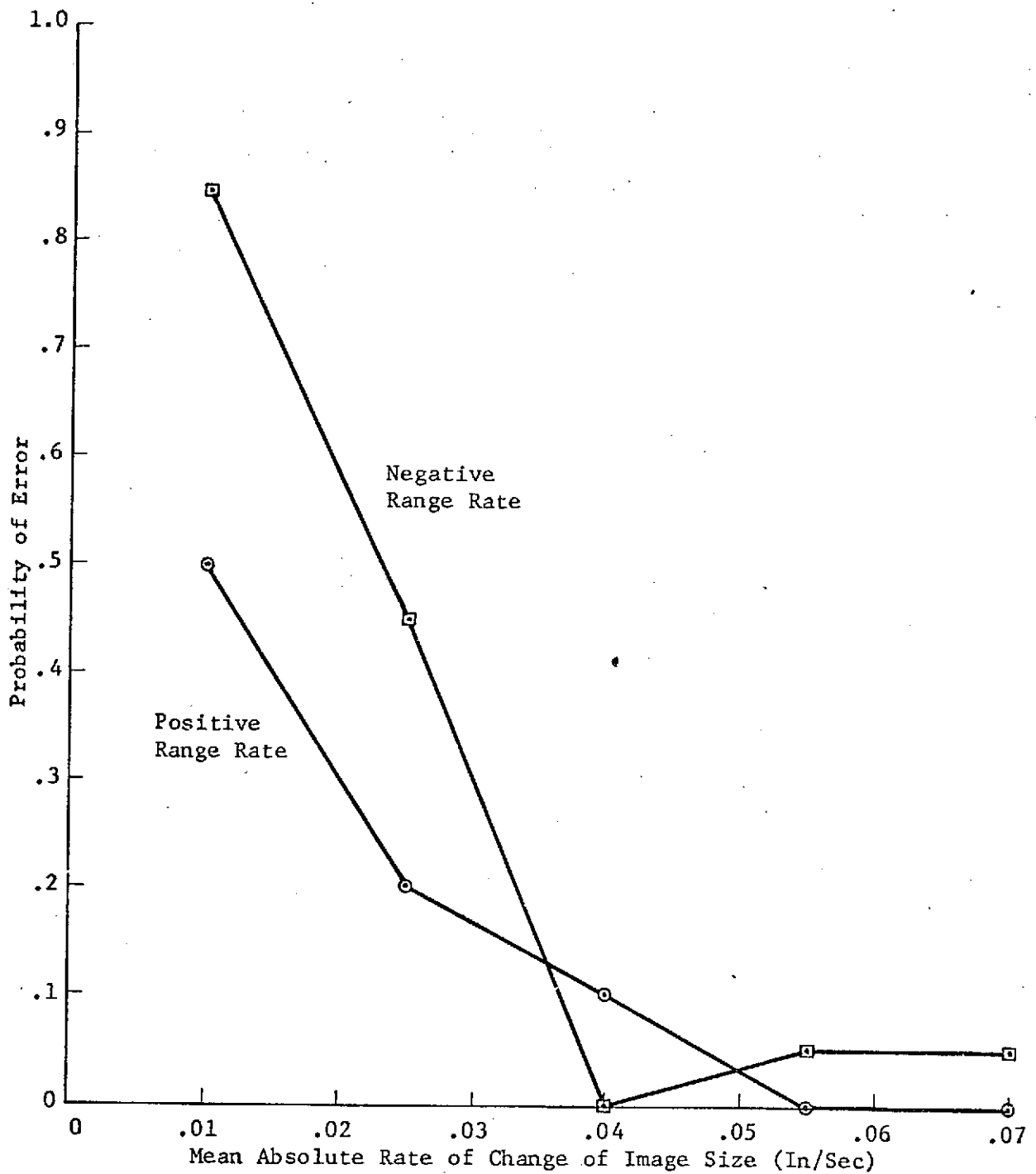

FIGURE 19. Probability of Motion Detection Error as a Function of Direction and Absolute Rate of Change of Image Diameter - No Reticle Condition

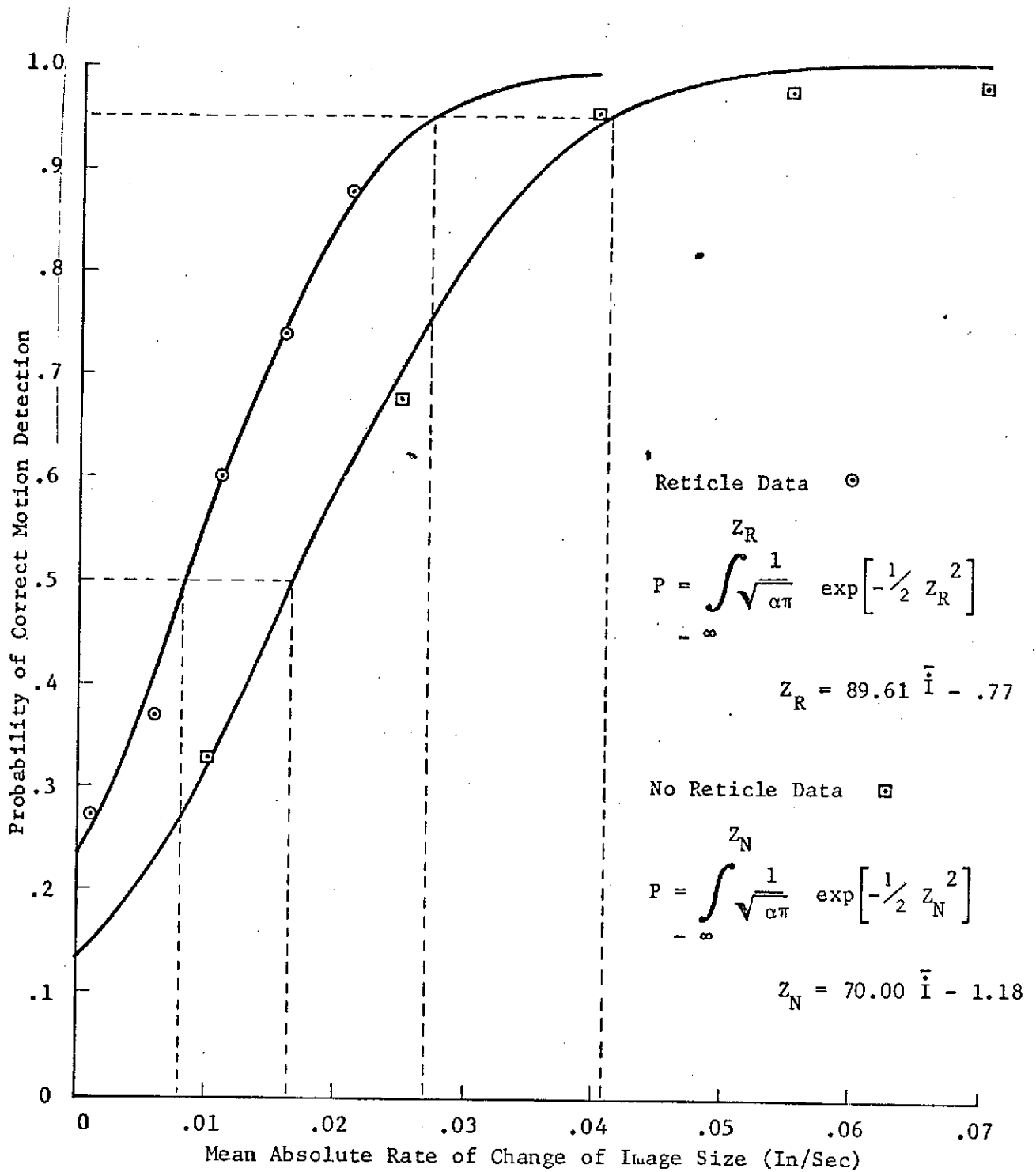

FIGURE 20. Psychometric Functions for Reticle and No Reticle Conditions

$$P = \int_{-\infty}^Z \frac{1}{\sqrt{2\pi}} \exp \left[-\frac{1}{2} Z^2 \right] \quad (7)$$

Where Z is a standard normal deviate. The relation between Z and \bar{I} for reticle and non-reticle conditions was estimated from the data by the method of least squares with the result for reticle and non-reticle conditions respectively:

$$\begin{aligned} Z_R &= 89.61 \bar{I} - .77 \\ Z_N &= 70.00 \bar{I} - 1.18 \end{aligned} \quad (8)$$

The image rates required for .50 and .95 detection probabilities are shown in Fig.20 and the exact values calculated from the fitted functions are shown in Table 13.

Using equation (5) to generalize the results, for probability of range rate detection and use of a reticle:

$$|\bar{I}_D| = \frac{KT|\dot{R}|}{R^2} \quad (9)$$

$$|\dot{R}_D| = |\bar{I}| \cdot R^2 \cdot \left[\frac{2 \text{TAN } \alpha/2}{M \cdot T} \right] \quad (10)$$

To illustrate the use of eq. (10) consider the original test conditions where:

$$\frac{T \cdot M}{2 \text{TAN } (\alpha/2)} = 65.928 \text{ in} \cdot \text{ft}$$

TABLE 13. Calculated Rates of Change of Image Diameter for Detection
 Probabilities of .50 and .90

<u>RETICLE CONDITION</u>	<u>DETECTION PROBABILITY</u>	<u>ABSOLUTE VALUE OF $\frac{\dot{I}}{I}$</u>
Reticle	.50	.0086
Reticle	.95	.0270
No Reticle	.50	.0169
No Reticle	.95	.0404

Then the detectable range rate $|\dot{R}_D|$ for .50 and .95 detection probability is given by:

$$|\dot{R}_{.50}| = .0086 \cdot .0152 \cdot R^2 \quad (11)$$

$$|\dot{R}_{.95}| = .0270 \cdot .0152 \cdot R^2$$

These functions are shown in Figure 21. In general, eq. (10) may be used to determine system parameter levels required for detection of a specified range rate using critical \bar{I} values for the desired detection probability according to eq. (7). It should be noted that the results presented were derived under stated conditions of resolution, signal-to-noise ratio, contrast, etc. and that generalizing the results to other levels of these variables is not warranted without further experimentation.

The analysis of variance table for data set 3 using zero motion rates is shown as Table 14. None of the independent variables was found to exert a significant effect on error probability. The general level of error rate for the zero motion rate case was found to be .433. This is considerably higher than the value obtained as the y-intercept of the functions in Fig. 5 which are in the range of .12 to .24. Interpreting the y-intercept as the guessing parameter for rate detection is not supported by the zero motion rate data. Evidently, a more complex decision process is operative - one which would require considerably more complex experiments to elucidate it.

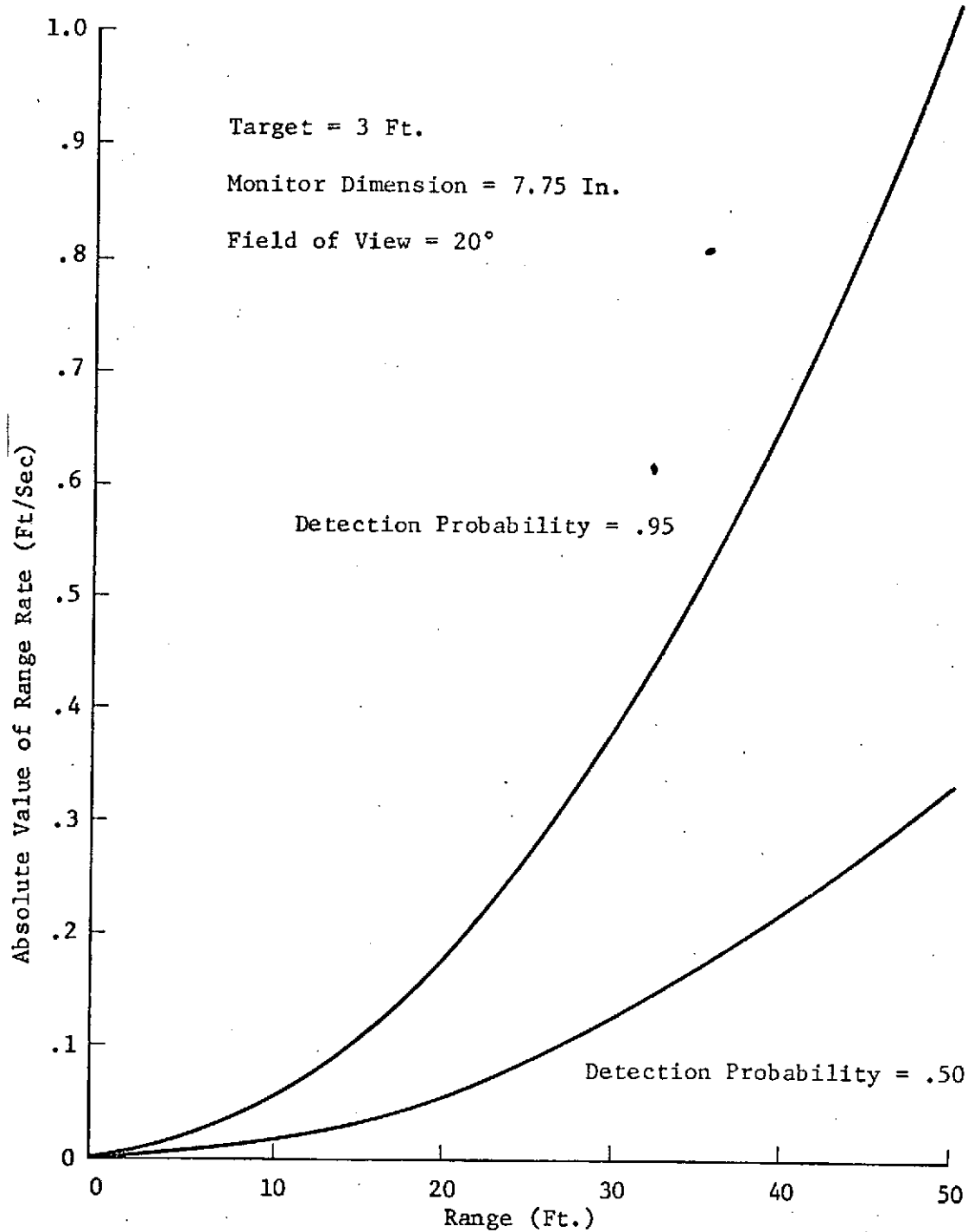

FIGURE 21. Range Rate Required for Stated Probability of Motion Detection as a Function of Range

TABLE 14. Analysis of Variance of Probability of Error - Data Set 3

<u>SOURCE</u>		<u>df</u>	<u>SS</u>	<u>MS</u>	<u>F</u>
Reticle	(A)	2	.267	.134	1.457
Range	(R)	1	.034	.034	1.030
Subjects	(S)	4	.867	.217	---
AxR		2	.266	.133	<1.000
AxS		8	.733	.092	---
RxS		4	.133	.033	---
AxRxS		<u>8</u>	<u>2.067</u>	.258	---
TOTAL		29	4.367		

4.2 Teleoperator Visual System Evaluation Laboratory Experiment B₂ Motion Detection of a Target Object II

The objective of this experiment was to determine the effects of TV transmission parameters on the human operator's ability to detect fore/aft motion of a target object. Tests B₁ and B₂ together represent a study of effects of display aids and transmission parameters on motion detection.

Apparatus

The general apparatus employed in Test B₂ is identical to that employed in B₁. In addition, the disc recorder, the narrow band pass filter, and the noise generator described in the preceding general apparatus section were also utilized. Based on performance results from B₁, a fixed reticle of the concentric circle type (Test B₁, reticle 2) was used for all testing. All system parameters and procedures were the same as for B₁ with the addition of variable TV parameters.

Independent Variables and Experimental Design

The independent variables studied were:

- . Target motion direction
- . Initial range
- . Average absolute rate of change of image size
- . Frame rate
- . Signal-to-noise ratio
- . Transmission mode

Since target motion direction and initial range were found to exert no reliable effect on target motion detection in Test B₁, they were varied

randomly in the current study and were not included in the data analysis. Rate of change of image size was varied at five levels - .001, .008, .015, .021, and .028 in/sec. These values are somewhat larger than those used in Test B₁. Since transmission parameter effects were expected, it was considered necessary to increase image rates somewhat to obtain similar average performance levels between Tests B₁ and B₂.

The remaining independent variables were studied at the following levels:

- . Frame rate 15 or 30 frames/sec
- . Signal-to-noise ratio 15, 21, or 32 db
- . Transmission mode Analog - 4.5 MHz
 Analog - 1.0 MHz - narrow band pass
 Digital - .4 bit

B₂ - Results and Discussion

As discussed previously, the independent variables initial range and motion direction were included as randomized variables in Test B₂. Accordingly, trials associated with variation in these variables were treated as replications. The data analysis was performed on probability of error under all cells of the collapsed design matrix consisting of combinations of:

- . Absolute rate of change of image diameter
- . Frame rate
- . Signal-to-noise ratio
- . Transmission mode
- . Subjects

The analysis of variance source table is shown in Table 15. Image rate was found to influence error probability at the .01 level. This effect is, of course, simply a replication of experiment B₁ and is of little importance to the current investigation which is concerned with effects of transmission parameters on performance. Neither frame rate, signal-to-noise ratio, nor transmission mode was found to have a significant effect on error probability. The only significant effect among the sources of variation associated with transmission parameters is the interaction of frame rate and transmission mode ($p < .05$). This effect is illustrated in Figure 22, where it may be seen that frame rate influenced performance only under reduced horizontal resolution in the analog mode. Under digital or 4.5 MHz analog transmission, no frame rate effect is noted.

In general, the lack of effects of transmission parameters on motion detection are surprising. The data do not show any significant effects of

signal-to-noise ratio even for ratios as low as 15 db. In previous tests using static targets (Kirkpatrick et. al., 1972), signal-to-noise ratio variation from 15 to 30 db exerted marked effects on the tasks studied. Motion detection, however, appears to be relatively insensitive to signal-to-noise ratio within the range of this variable studied. Similarly, the effects of frame rate and transmission parameters appear minimal and are limited to fairly low resolution levels. Human observers appear to be less sensitive to range rates. The B_1 data suggest that a range rate of 10 ft/sec at an initial range of 20 ft is sufficient for detection in 95% of cases when a reticle is employed. Further, this sensitivity was found to be relatively unaffected by fairly wide variation in image quality.

TABLE 15. Analysis of Variance of Probability of Error

<u>SOURCE</u>		<u>df</u>	<u>SS</u>	<u>MS</u>	<u>F</u>
Frame Rate	(F)	1	.2427	.2427	3.242
Image Size Rate	(V)	4	27.8219	6.9555	46.466**
Signal-to-Noise Ratio	(Sn)	2	.3418	.1709	1.774
Transmission Mode	(T)	2	.0830	.0415	1.000
Subjects	(S)	5	.9782	.1956	---
FxV		4	.3567	.0892	1.000
FxSn		2	.2854	.1427	1.000
FxT		2	.4043	.2022	6.397*
FxS		5	.3743	.0749	---
VxSn		8	1.4025	.1753	1.475
VxT		8	.3883	.0485	1.000
VxS		20	2.9937	.1497	---
SnxT		4	.1080	.0270	1.000
SnxS		10	.9634	.0963	---
TxS		10	1.2664	.1266	---
FxVxSn		8	.7241	.0905	1.094
FxVxT		8	1.4130	.1766	1.364
FxVxS		20	2.2132	.1107	---
FxSnxT		4	.6112	.1528	1.806
FxSnxS		10	1.8286	.1829	---
FxTxS		10	.3160	.0316	---
VxSnxT		16	1.4616	.0914	1.049
VxSnxS		40	3.9932	.0998	---
VxTxS		40	4.7554	.1189	---
SnxTxS		20	1.6323	.0816	---
FxVxSnxT		16	1.9062	.1191	1.128
FxVxSnxS		40	3.3105	.0828	---
FxVxTxS		40	5.1786	.1295	---
FxSnxTxS		20	1.6925	.0846	---
VxSnxTxS		80	6.9650	.0871	---
FxVxSnxTxS		80	8.4520	.1057	---
TOTAL		539	84.4637	---	---

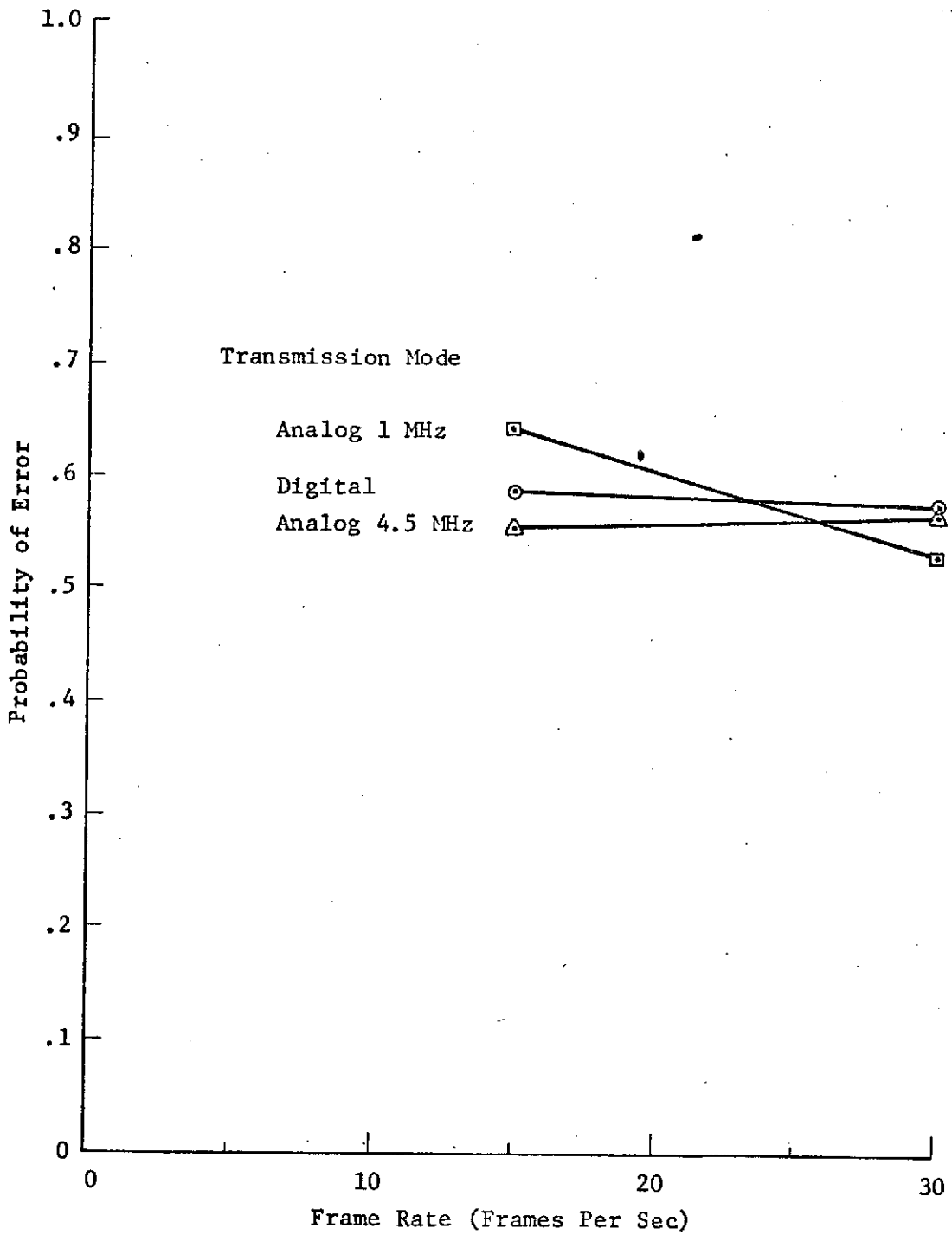

FIGURE 22. Probability of Error as a Function of Frame Rate and Transmission Mode

5.0 OPTICAL RANGE & RANGE RATE ESTIMATION FOR REMOTELY MANNED SYSTEMS

This section deals with remotely manned systems for satellite deployment, retrieval and servicing on orbit. It is assumed that the operator of such a system will receive visual feedback by means of television and that range and range rate data will be required for adequate satellite approach and grappling.

In current approaches to vehicle docking, radar ranging has been a primary technique (i.e., Apollo). While these approaches have relied on radar for measuring long ranges and direct vision for short ranges on the order of a few feet, remotely manned systems require that accurate ranging during final approach be obtained via sensors. Since a television system of some type must be provided for general viewing, it is reasonable to inquire if the specific task of range and range rate measurement can be performed using this sensor display system. It is not suggested that this mode, if feasible, totally supplant specific ranging systems (i.e., radar, laser, etc.). The notion is that ranging via optical methods can serve as an alternative ranging philosophy and can allow flexibility in the design of remotely manned systems.

NASA is currently exploring RMS visual system technology through both in-house and contracted efforts. These studies center on effects of design parameters on viewing system performance where the operator is considered a part of the man-machine system. At the current point in these investigations a number of approaches to optical ranging may be put forth. These vary in the degree to which perceptual judgment is required of the operator. The available approaches include:

Direct estimation - monoptic television

Direct estimation - stereoptic television

Aided estimation - reticles and computer aiding

Direct Estimation

Direct estimation relies on the operator to judge distance based on perceptual cues, knowledge of the target, and knowledge of the television system. In the case of monoptic systems, parallax cues are absent. General vision research suggests that removal of such cues alone might not preclude correct distance estimation since observers can utilize many other types of information such as texture and superposition. Unfortunately, these cues too are largely lacking in the satellite approach phase of an RMS mission. Probably apparent size and, in some circumstances, apparent brightness are the primary if not the only cues transmitted by monoptic television during satellite approach.

Kirkpatrick, Malone, and Shields (1973) have reported size estimation errors from 10 to 40 percent when observers attempt to judge relative target size via television. Direct range estimates would not be expected to be more accurate than this. Even this accuracy level was obtained with a fixed field of view which was familiar to the observer. Since RMS visual systems are expected to incorporate zoom optics, the problem is complicated by a changing relationship between target and image size.

Utilizing a stereo camera pair, it is possible to provide the observer with stereoptic cues. In a conceptual design study of visual systems, Tewell et al (1973) have suggested a fresnel display technique for stereoptic television which is optimum given the current state-of-the-art. The system provides usable stereoptic acuity to a range of 3 meters and could be extended to 12 meters although this would require an exaggerated camera separation and

would require that the observer learn the relationship between true range and apparent range through the system. Observer performance in estimating range with the above system has not been quantified at this time although this will be carried out in the near future.

Aided Estimation with Monoptic Television

Several range estimation methods may be put forth which take advantage of known optical relationships characteristic of television systems. The primary function of interest is that for image size:

$$I = \frac{M T}{2 R \text{TAN } (\alpha/2)} \quad (12)$$

where I = image size (inches)

M = monitor dimension (inches)

T = target size
same units

R = range

α = angular field of view

In equation (12) the monitor dimension (M) is a constant for a particular display system. Target size (T) is a property of the satellite in question. This could be any convenient dimension of the satellite such as body diameter, length of an appendage, etc. The operator presumably would have access to a payload data book and could use any convenient dimension known to him. For a fixed and known field of view (α), calculation of range would follow immediately from measurement of image size. This measurement may be performed by reference to a displayed reticle which could be a transparent overlay placed on the screen or could be an electronic crosshair or a computed generated image. Tests of accuracy of such an approach are currently underway in the Teleoperator Visual

System Laboratory. These tests will include static concentric ring reticles such as concentric circles. Such reticles have already been found to permit detection of range rates on the order of .5 ft. per second for a Bio Research Module at 20 ft. in range.

An adjustable reticle is currently being designed and fabricated for the Visual System Laboratory. It employs two electronically generated peak white vertical crosshairs. The two crosshairs may be adjusted in position on the screen by the operator. Aided range estimation in the real world with this system would require that the operator select a target dimension for use in ranging and manually enter the true dimension in a small computer. A different dimension could be chosen and entered if the first dimension selected exceeds the field of view as range is reduced. Monitor size would be a fixed parameter for a particular display system. Since field of view is variable assuming zoom optics, a zoom encoding method would be required using a feedback potentiometer or similar device in the zoom mechanism. This feedback signal would be fed to the computer. The crosshair generating voltage would also be sampled by the computer. The observer's task would then be to adjust the crosshairs to coincide with the satellite outer edge or matched to whatever target dimension is being used. With appropriate voltage scaling, this would provide all inputs necessary to compute range by means of eq. (12). To minimize compute usage, the operator could command range computation based on current values after he has adjusted the crosshairs. Should the range be changing at the time of measurement, the crosshairs could be set near the present image size and the "compute" command given as the image fills the crosshairs.

The accuracy of such a method would depend on monitor distortion and transmission parameters such as signal-to-noise ratio and horizontal resolution. The

television system should be calibrated just prior to a mission by means of a calibration target mounted on a manipulator arm, on the shuttle, or any convenient place which can be viewed by the video system. Tests of the effects of signal-to-noise ratio and resolution on the operator's ability to perform the required crosshair estimation are currently being planned for the Visual Laboratory. This investigation will yield quantitative error data so as to permit comparison with other types of ranging systems.

With certain modifications, the above system might also be adapted to estimation of range rate. The rate of change of image size on the monitor is given by differentiating eq. (12), letting:

$$K = \frac{M}{2 \text{TAN} (\alpha/2)} \quad (13)$$

so that by eq. (12):

$$I = \frac{KT}{R} \quad (14)$$

The first derivacive of I is:

$$\dot{I} = dI/dt = \frac{R \cdot dKT/dt - KT \cdot dR/dt}{R^2} \quad (15)$$

Simplifying, and since $dR/dt = R$:

$$\dot{I} = \frac{-KTR}{R^2} \quad (16)$$

Eq. (16) suggests that \dot{R} is amenable to estimation by quantities available from the TV display. The crosshair controller, however, should be modified to become rate-proportional rather than position proportional as in the preceeding

discussion. Letting the displayed width between cursors be denoted as W and the control displacement be D , the relationship should be rate proportional:

$$\dot{W} = CD \quad C \text{ a constant} \quad (17)$$

Human factors and control considerations suggest that stability might be enhanced if the system were rate-aided rather than purely rate proportional. That is, one integration of the control displacement might be fed forward into the cursor drive. A small finger operated control stick might be used or, possibly, a thumb controller mounted on the right hand joystick would be suitable since maneuvering the vehicle and visual system use must be integrated. The operator's task would be to match the cursors to the desired target dimension so that at the point in time when the computer samples inputs:

$$W = I \quad \text{and} \quad \dot{W} = \dot{I} \quad (18)$$

Assuming this to be the case, by eq. (14)

$$R = \frac{KT}{W} \quad (19)$$

where R = estimated range

K, T are system and satellite parameters as discussed

W = cursor separation.

Range rate may then be estimated by:

$$\dot{R} = \frac{-R^2 \cdot \dot{W}}{KT} \quad (20)$$

Assuming that sufficient performance by the operator is obtained so that \dot{W} is a close approximation to \dot{I} . A simplified expression for \dot{R} is available since by eq. (19):

$$WR = KT \tag{21}$$

Substituting in eq. (20):

$$\dot{R} = \frac{-R^2 \cdot \dot{W}}{WR} = \frac{-RW}{W} \tag{22}$$

A suitable approach assuming rate aiding is shown in Figure 23.

Such a rate estimation system has not yet been constructed for laboratory testing. Planning for hardware development and testing suggests that such a system could be in testing in the Visual Laboratory by early CY 74 and could support later selection of an RMS ranging technique. Testing should quantify system accuracy and should provide an optimum value for the aiding ratio $\frac{A_2}{A_3}$.

Aided Estimation With Stereoptic Television

It was suggested previously that range judgment performance may be enhanced by using a stereo camera pair with a Fresnel display technique (Tewell et al., 1973). These authors have also proposed a stereo reticle method for range estimation. This involves a position controlled cursor pair-one cursor per monitor. The operator adjusts the cursor separation until the cursors appear as one vertical line at the same range as the object in question. A calculation using cursor separation and optics parameters gives a range estimate in much the same fashion as was discussed in connection with monoptic television. It appears that

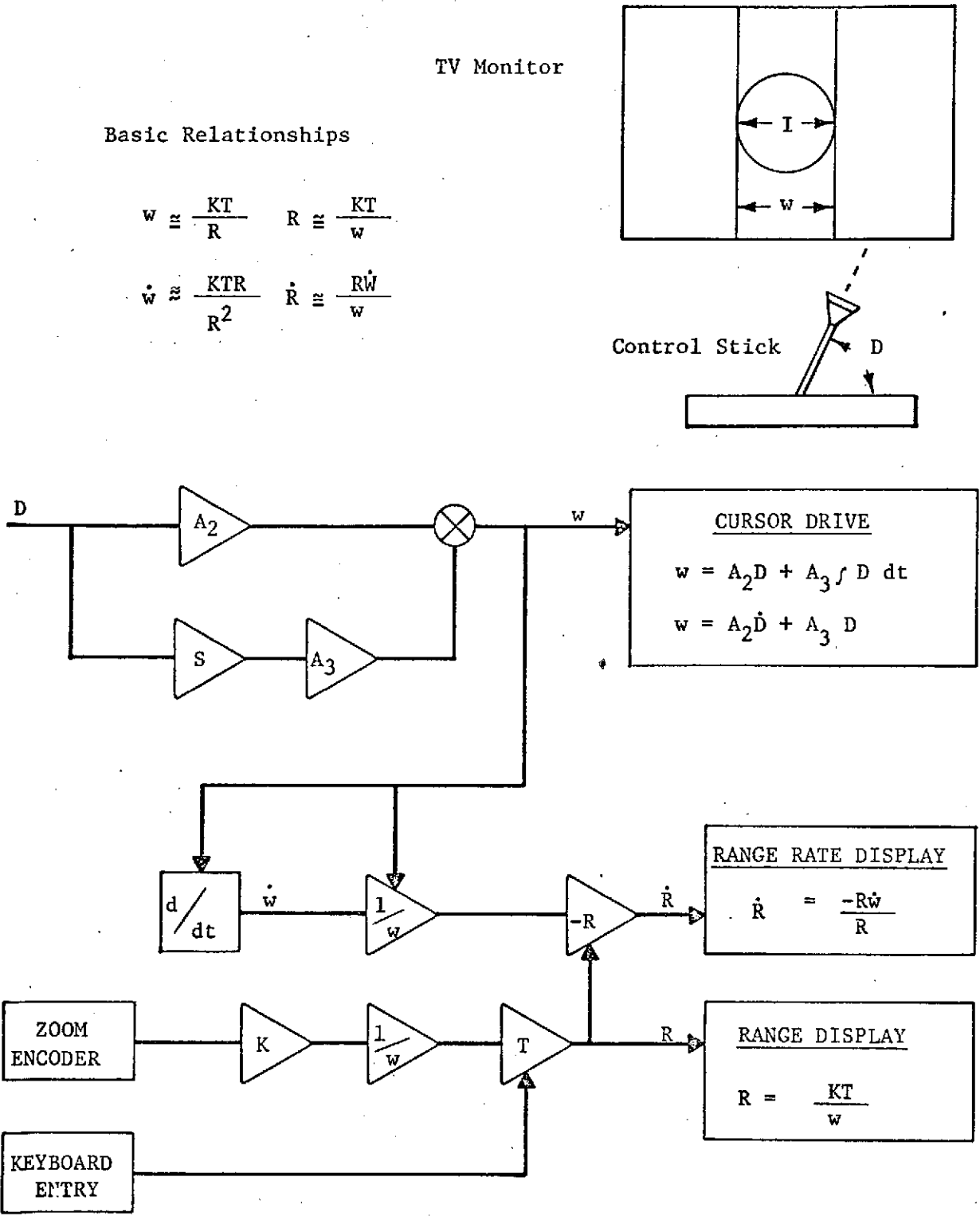

FIGURE 23. Range and Range Rate Estimation
Using a Rate-Aided Cursor Control System

limitations on depth resolution inherent in the stereoptic design may limit the method to final approach ranges. If the camera separation were increased to yield greater depth resolution, however, the reticle method might aid in overcoming direct judgment error due to depth distortion.

The aided stereo and aided mono approaches are not incompatible. For general satellite viewing, the stereoptic system could be used in a monoptic mode. The use of controlled cursors for range estimation are a common feature of both approaches and could be used for range estimation via convergence with the stereo system for very short range work or alternatively to estimate range and range rate via image size as suggested above. Pure range estimation would require pure position control so that allowing two control modes - pure position and rate aided might be warranted to increase the flexibility of the system.

If a more complex display system than simple cursors is selected - i.e. computer generated imagery, active range rate estimation by the operator might not be required. While controlling cursor width so as to match target image size is not a difficult task in itself, when added to the existing translation and altitude control tasks, excessive workload might result. During final approach, range and range rate would be required by the operator only to permit him to match the nominal range-range rate profile planned for the mission. Assuming computer generated imagery, the computer could calculate nominal range as a function of time and display an appropriately sized image on the video display. This would provide the operator with nominal image size data to compare with the observed image size.

6.0 TELEOPERATOR SYSTEM
CONTINUING SYSTEM EVALUATION

As a result of the experimental investigations and findings accumulated in previous research programs, and those findings described in this report, it is apparent that specific problems in the development of the teleoperator visual system parameters must be subjected to further investigation. The purpose of this section is to outline such a series of studies which will further develop, and add to, information already at hand concerning visual system development. The background for each of the proposed areas of investigation is reflected in Figure 24, which describes the many variations of input information necessary to ensure that the proposed test program reflects real world, or operational, concerns.

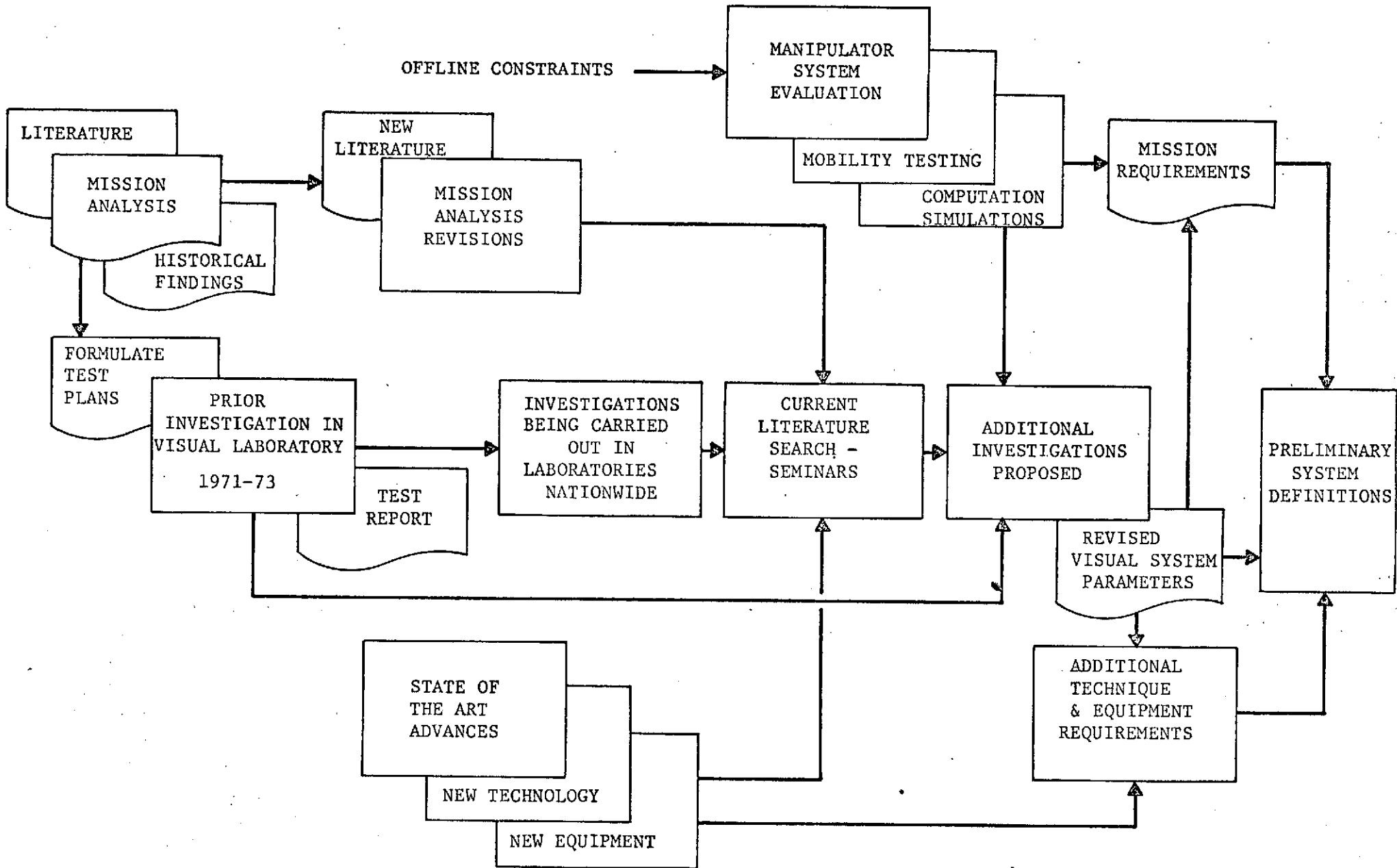

FIGURE 24. System Evaluation Integration Flow Diagram

6.1 System Planning I

Objective: To determine the effects of video system parameters and target parameters on the human operator's ability to detect or visually acquire small targets.

Problem: During the rendezvous portion of a teleoperator mission the operator must visually acquire, and hold in the TV camera's field of view, the target object to which he controls the teleoperator. Depending upon initial range and the TV system's resolving power, he must first discriminate his target object from other objects in the environment (stars, jetsom, planets) and from possible miscues as a function of system noise. Additionally, the operator must control the teleoperator in six degrees of freedom such that the target object remains in the field of view of the cameras aboard the teleoperator. This is akin to a tracking task, but differs in light of the fact that perceived target motion may be a function of a continuing shift in the alignment of the camera's field of view as the teleoperator moves toward rendezvous.

Rationale: It is felt that the first half of this problem, that of visually acquiring or detecting a small target, should be investigated in a static, or non-moving field of view, situation prior to combining this problem with a moving field of view tracking problem. Selected target shapes, target contrasts, target sizes, variable system noise levels, system resolving power and background complexities should be manipulated to yield data on target detection using TV feedback. With this data and

the resulting conclusions, further investigations should be made which involve manipulating shifts, and rates of shifts in the field-of-view of the teleoperator's cameras.

6.2 System Planning II

Objective: To determine the effects of a fresnel lens stereoptic television transmission system on the human operator's ability to judge three dimensional relationships in a target scene.

Problem: Initial investigations have shown that one type of stereoptic TV system does not enable the operator to perform distance estimation tasks as well as with an orthogonal, two camera monoptic system. In complex TV scenes which involve an array of variously configured equipment - such as in a satellite servicing task - it may be necessary to have a TV system which enables the operator to accurately judge depth and distance.

Rationale: It should not be concluded from past research findings that stereoptic TV systems, per se, are not as effective in giving the operator adequate visual feedback as are various monoptic configurations. It is more probable that performance is a function of the specific task parameters, the stereoptic TV system configuration, operator training with the system and other similar variables. The rationale for developing further experiments involving tasks performed with stereoptic TV lies in the fact that preliminary findings from laboratories utilizing a Fresnel Lens Stereo TV System indicate that operator performance is enhanced with the fresnel system where that was not necessarily the case using a split image optical system stereo configuration.

It is envisioned that such a fresnel system should be utilized to carry out distance estimation tasks similar to those already performed so that a preliminary comparison can be made based on performance results. Additionally, tests for finer depth and distance discriminations should be

designed if the preliminary results using the fresnel system are supported by subsequent research. Variables to be manipulated in such research might include relative target sizes, target contrasts, varied working envelopes, varied lighting conditions and varied solid target shapes.

6.3 System Planning III

Objective: To determine the effects of color TV system parameters on the human operator's ability to discriminate among alternative target objects.

Problem: In complex servicing tasks the human operator may be required to discriminate among several similar objects prior to servicing a component or performing removal/replacement tasks. It will be necessary to code various serviceable components, and one way in which to do this is by color coding. While there are other equally obvious methods of coding, (contrast, shape, numerical) information dealing with color discrimination via TV systems is not yet fully available in the research literature. The nature of the problem must also be viewed as one in which data on discrimination is developed so that it can be applied usefully to contexts other than servicing tasks.

Rationale: Although color TV systems have inherent problems such as resolution and power consumption, it is conceivable that human performance for specific tasks is sufficiently enhanced to justify some system development or system utilization for teleoperators. The initial investigation should deal with color systems operating under the best system conditions. This will permit the accumulation of base line data which can then be compared with other types of candidate TV systems without confounding the results with transmission variables. The investigation of variable transmission modes should be taken up under a separate investigation.

6.4 System Planning IV

Objective: To determine the effects of variable transmission parameters in a color TV system upon the human operator's ability to perform discrimination and/or recognition tasks.

Problem: In situations where the transmission parameters are not of the "best case" variety, it may still be necessary for the operator to perform essential mission tasks. With the results of prior experiments at hand, concerning the effects of transmission degradation on operator performance, and with the results developed under System Planning III, it now will be possible to measure human performance for similar tasks using variable transmission parameters with a color TV system. The collection and analysis of this information should yield data which will help to further develop the teleoperator's visual system design criteria.

Rationale: Prior testing has shown that human performance is adversely effected when transmission parameters in a black & white TV system are allowed to degrade below certain levels. This is a partial function of the signal to noise ratio, the transmission bandwidth, the signal format and the frame rate. It is the intention of this particular investigation to identify the effects of variable color TV system parameters upon human performance, in much the same way that these variables were studied for their effect under black & white TV transmission. The relationship between performance and total TV system variables can then be derived and used as input in developing TV system design criteria.

6.5 System Planning V

Objective: To determine the effects of ongoing motion in the camera's field of view on the operator's ability to judge relative positions and distances among targets.

Problem: To date, the task of judging position and distance has been performed in a static scene. That is, the targets did not move in relationship to one another, and there was no apparatus - such as a probe, or manipulator arm - operating in the field. When performing manipulator tasks, the scene will be in a dynamic rather than a static state, and information is needed to assess the impact of dynamic apparatus in the TV field of view on the operator's ability to judge position and distance. This would call for the operator's control over some dynamic equipment in the scene, in much the same way he will be controlling the manipulator arm in the scene. The operator's control over such equipment would then serve as an additional channel for feedback to him.

Rationale: This investigation represents one of the initial steps in the effort to define the functional interactions of the teleoperator system in terms of three of its basic subsystems - manipulator, TV feedback, and man-in-control. The intent is to move from specific and rigidly controlled tasks which yield useful base line data, to more general and more complex tasks where the levels of interaction of the various subsystems can be studied. While the experiments will continue to be rigidly controlled, the increase in the number of variables being considered will tend to reflect more and more the operational environment as contrasted with a strictly laboratory environment.