

CORRELATION OF HIPPOCAMPAL THETA RHYTHM TO
CHANGES IN HYPOTHALAMIC TEMPERATURE¹

M. A. Saleh, J. M. Horowitz, and A. C. Hsieh

Departments of Human and Animal Physiology
University of California, Davis
Davis, California 95616

RUNNING HEAD: THE THETA RHYTHM AND HYPOTHALAMIC TEMPERATURE

Mailing Address: Dr. Arnold Hsieh
Department of Human Physiology
School of Medicine
University of California
Davis, California 95616

¹This study was supported in part by NASA Research Grants NGR-05-004-099, NGL-05-004-031, by a Public Health Service Grant NIMH06686, and by a UCD Faculty research grant D-529.

(NASA-CR-139526) CORRELATION OF THE
HIPPOCAMPAL THETA RHYTHM TO CHANGES IN
HYPOTHALAMIC TEMPERATURE Final Technical
Report (California Univ.) 26 p HC \$4.50

N74-30462

CSSL 06C G3/04

Unclas
45570

ABSTRACT

Warming and cooling the preoptic anterior hypothalamic area in awake, loosely restrained rabbits was found to evoke theta rhythm. This is consistent with previous studies indicating that theta rhythm is a nonspecific response evoked by stimulation of several sensory modalities. Several studies have correlated theta rhythm with alertness. A neural pathway involving the hypothalamus, the hippocampus, the septal area, and the reticular formation is proposed. Thus, a role of this pathway may be to alert the animal to changes in its body temperature.

The hippocampus shows a rhythmic slow wave activity of 4-7 Hz termed the theta rhythm. The theta rhythm was associated with rhythmic bursts of pyramidal cells (13). There is presently no general agreement on the relationship between hippocampal theta activity and behavior (10,15,33). However, Green and Arduini (14) have shown that theta rhythm is a non-specific response that can be evoked by the following stimuli: auditory, olfactory, optic, tactile, and direct brain stem stimulation. Horowitz, Saleh, and Karem (17) have shown that changes in cutaneous temperature alone could elicit theta rhythm.

The hippocampus and the septal area have very extensive fiber connections with the principal thermoregulatory areas of the brain, namely, the hypothalamus and the midbrain (26,28). Although there is a good deal of evidence that limbic structures are involved in many of the functions associated with the hypothalamus (6,16), the possible role of the hippocampus in temperature regulation has not been studied. Specifically, it has not been determined whether thermal stimulation of the body core thermoreceptors in the hypothalamus could evoke theta rhythm.

The present study was undertaken to study the possibility of eliciting hippocampal theta rhythm by heating and cooling the hypothalamus in unanesthetized rabbits and in this way determine if the hippocampus may be involved in temperature regulation.

METHODS

Six New Zealand white rabbits (2-3 kg) were used. The animal was tranquilized with chlorpromazine and anesthetized with sodium pentobarbital. Atropine sulfate was injected to reduce secretion. The rabbit was then placed in a stereotaxic head holder, the skull was exposed and burr holes were drilled in the skull in the stereotaxically determined locations (32). One pair of electrodes was stereotaxically lowered to the hippocampus with the tip of one electrode above and the tip of the other below the pyramidal cell layer (stereotaxic coordinates: A11.0, V10.0 and V13.0, S3.5 and S4.0). The correct positioning of the electrodes was assured by recording characteristic evoked potentials. In order to do this another pair of electrodes was slowly lowered through another burr hole toward the dorsal fornix (stereotaxic coordinates: A16.5, S1.0 and S2.0, V7.0) while repetitive shocks (6V- 1 msec.) were applied across them. At the same time, potentials from each of the two hippocampal electrodes with respect to a reference clip were amplified with Grass P511 preamplifiers and displayed on a 565 Tektronix oscilloscope. When the stimulating electrodes reached the fornix and excited action potentials over it, inverted waveforms were usually observed across the hippocampus. When necessary the vertical position of the hippocampal electrodes was adjusted to obtain characteristic waveforms (Fig. 1), and then the hippocampal electrodes were cemented in place. A water perfused thermode (Fig. 2) was lowered through a burr hole to the preoptic/anterior hypothalamic area (stereotaxic coordinates; A18, S3.5, V13.0). A 21 gauge stainless steel reentry tube, with a sliver soldered end, was implanted into the preoptic/anterior hypothalamic area for the insertion of the copper-constantan thermocouple wire for recording the hypothalamic

temperature (stereotaxic coordinates; A16.0, S2.0, V13.0). This tube was implanted at an angle to avoid destruction of the hypothalamic tissue. Four cortical screw electrodes were anchored to the skull above the motor cortex and the occipital cortex. All the electrodes were connected to a 9 pin Cannon connector (MD1-9SL1), and the connector, the screws, and the thermode were cemented to the skull.

Five days were allowed for recovery. The rabbit was placed in an acoustically and electrically shielded environmental chamber. All the leads to the recorder and tubing to the thermode were threaded through the top of the cage.

To control the hypothalamic temperature, water was continuously circulated at a constant flow, first through a metal coil (outside the environmental chamber) and then through the thermode. The metal coil was placed in a temperature controlled water bath (Blue M Micro-control). The water temperature was adjusted so that although the water was circulating, the hypothalamic temperature maintained the pre-experimental value. To heat the hypothalamus the metal coil was placed in a warmer water bath (Thelco), to cool the hypothalamus the coil was placed in a cooler water bath. The hypothalamic temperature was measured using a copper-constantan thermocouple inserted into the implanted guide tube, and the reference junction was maintained at 0° C using an Omega Ice Point Cell. The voltage changes across the two junctions were recorded on a Beckman R411 pen writer. Leads from the Cannon connector were attached to the pen writer to record from the hippocampal electrodes and the cortical electrodes. When the experiments were terminated, rabbits were deeply anesthetized with sodium pentobarbital and the brains were perfused with 10% formalin through the carotid artery. The brains were removed from

the skulls and sectioned to determine the locations of thermodes and the electrodes. X-ray radiographs were taken to show the exact location of the implanted electrodes and thermodes in the live anesthetized rabbit. To make sure that the hypothalamus was still intact in the rabbits after implantation, the rectal temperature was monitored during heating and cooling the hypothalamus.

RESULTS

Fig. 1 shows the evoked potential recorded from two electrodes one above and one below the pyramidal cell layer of the hippocampus as a result of fornix stimulation. These inverted waveforms indicate that the electrodes were precisely placed to record activity across the pyramidal cell layer. Differential recording between these two electrodes in an awake animal showed that a variety of stimuli can evoke theta rhythm (4-7 Hz) as it has been previously reported (14,17). Fig. 3 shows theta rhythm evoked by sound, light, and changes in cutaneous temperature.

Changes in the hypothalamic temperature of $\pm 1^{\circ}\text{C}$ from normal was enough to evoke theta rhythm in awake, loosely restrained rabbits. Fig. 4 shows theta waves evoked by heating and cooling the hypothalamus. It shows that during the continual increase or decrease in the hypothalamic temperature of the rabbit, the hippocampal electrical activity shifts from the desynchronized, high frequency wave form to the slower, more regular theta rhythm. In all the trials, heating or cooling the hypothalamus caused a significant increase in the theta activity. Table 1 shows data from six rabbits.

The rate of heating and cooling the hypothalamus seemed an important factor since slow temperature changes (less than $.5^{\circ}\text{C}/\text{min}$) did not evoke theta rhythm. Higher rates of temperature change ($1-5^{\circ}\text{C}/\text{min}$) were found to evoke theta rhythm in all animals in all trials.

In one rabbit, the hypothalamic temperature was maintained 2°C above or below normal for about 30 minutes. Then the hypothalamus was heated or cooled ($1^{\circ}\text{C}/\text{min}$) starting from that level and the hippocampal activity was recorded. Table 2 shows the results from that rabbit compared with results using normal hypothalamic temperature. The displacement of the

hypothalamic temperature from normal value, according to the results from this one rabbit, did not seem to affect the theta rhythm evoked by heating and cooling the hypothalamus.

In all rabbits, the locations of thermode and the electrodes were found to be in the anterior hypothalamus/preoptic area and straddling the hippocampal pyramidal cell layer respectively. Fig. 5 shows 2 x-ray radiographs of the rabbit head with the thermode and electrodes in the correct locations.

The hypothalamus thermoregulatory functions were found to be intact despite the implantation of the thermode and the thermocouple tube as it appears from Fig. 6 which shows changes in the rectal temperature during cooling the hypothalamus.

DISCUSSION

The hippocampal theta rhythm can be elicited by heating and cooling the skin of the rabbit within normal thermal reception limits (17). From Fig. 4 it appears that theta rhythm can also be elicited by the thermal stimulation of body core thermoreceptors in the preoptic anterior hypothalamic area.

There is still much debate concerning the nature of the behavioral correlate of theta rhythm. Theta rhythm has been related to learning (1,10), to memory storage (20), to motor activity (12,33), and to arousal (14). Recent studies have failed to show a clear relation between phases of learning or memory storage and the different electrical patterns of the hippocampus (2). Moreover, relating theta rhythm to voluntary motor action contrasts sharply with the observations that skeletal muscle paralysis (14) or normal sleep (9,23) do not abolish theta activity. Klemm (19) observed that phasic muscle movements were always associated with hippocampal theta rhythm but the latter often outlasted the cessation of movement by several seconds or more.

A state of the brain which is optimum for learning, memory storage, or voluntary motor action could be that of general alertness. Jung and Kornmüller (18) were the first to note the slow wave, theta rhythm in the rabbit hippocampus after sensory stimulation (2). Green and Arduini (20) observed that theta rhythm was associated with activation of the reticular formation and they postulated that it reflected the arousal reaction of the hippocampus. They also noted that the hippocampal theta rhythm was accompanied by neocortical desynchronization and that this inverse relationship, although not always present, was maintained during rest or sleep. Since neocortical desynchronization is generally accepted

an an index of arousal they considered it further evidence for correlating theta rhythm with arousal. Anchel and Lindsley (3) electrically stimulated different pathways and examined EEG records for the presence of the hippocampal theta activity and for the hippocampal desynchronized activity. They found that induction of theta activity in the hippocampus, in awake and behaving cats, by stimulation of the medial hypothalamus theta system produced orienting and searching behavior. Blockade of the lateral hypothalamic desynchronizing system had a similar effect upon behavior. In contrast stimulation of the lateral hypothalamic system or cryogenic blocking of the medial hypothalamic system produced an arrest of ongoing behavior and caused an attentive fixation of gaze. Reviewing the literature on the hippocampal electrical activity, Bennet (5) stated that "the available evidence best supports a view relating the occurrence of theta to orienting or attention."

From data in Fig. 4 and Table 1, it is concluded that warming and cooling the hypothalamus in awake loosely restrained rabbits evoked theta rhythm which may indicate a hippocampal alertness response to changes in internal body temperature. This might be the first step for the initiation of thermoregulatory mechanisms leading to heat production or heat loss.

The observation that very slow temperature changes (less than 0.5 C/min) did not evoke theta rhythm might indicate the presence of a rate sensitive thermoreception mechanism in the preoptic anterior hypothalamic area. However, an alternative explanation could be the presence of a thermal threshold that has to be reached in order to elicit theta rhythm, and since changes in the hypothalamic temperature lasted only for a minute, slow rates of heating or cooling did not produce temperature changes enough to reach the threshold, therefore did not elicit theta rhythm.

When the hypothalamic temperature was maintained at 2°C above or 2°C below normal for about 30 minutes, the hippocampal electrical activity returned back gradually to the desynchronized state. Then, when the hypothalamus was heated or cooled (1-3° C/min) starting from that level, theta was evoked in the same manner as in rabbits with normal hypothalamic temperature (Table 2). This preliminary experiment on one rabbit might indicate that theta system is responsive to dynamic temperature changes rather than to steady temperature.

A circuit involving the hippocampus, the hypothalamus, the septal area, and the brain stem reticular formation is shown in Fig. 7. The role of this circuit may be to alert the animal to changes in his body temperature. Alertness to changes in body temperature may lead to the initiation of thermoregulatory responses. An evidence in support of the existence of such a circuit comes from the observation that the hippocampal theta rhythm can be evoked by changes in cutaneous temperature (17) and changes in hypothalamic temperature (Fig. 4). Further evidence comes from the extensive anatomical connections between these structures. Signals from peripheral and spinal cord thermoreceptors ascend in the lateral spinothalamic tract. Many second order neurons of the lateral spinothalamic tract terminate in the reticular substance of the bulbar and mesencephalic areas or send collaterals into these areas (31). It is likely that some of the descending fibers in the midbrain tegmentum carry signals from the hypothalamus thermoreceptors to the reticular formation (26). Signals from the brain stem reticular formation ascend to the septal area through two fiber systems, the dorsal longitudinal fasciculus of Schütz and the medial forebrain bundle (24). There are well known functional connections between septum and hippocampus through

the precommissural fornix (21). It has been suggested that the pacemaker for the hippocampal theta rhythm is located in the medial septal area (4,30). Septal units were found to discharge in strong correlation with the hippocampal theta rhythm (21,23,25). Lesions in this area were found to disrupt theta rhythm (8,11). It has also been demonstrated in anatomical and electrophysiological studies that the hippocampus projects to the preoptic anterior, lateral, and posterior hypothalamus and mammillary bodies via the dorsal fornix and precommissural or postcommissural fornix systems (7,22,27,29). Hippocampal influence could reach the neocortex through the postcommissural fornix, by way of the mammillary nuclei, mammillothalamic tract, anterior thalamic nuclei, to the cingulate cortex to the neocortex (2). Projections from the neocortex and cingulate cortex to the entorhinal area could close the corticohippocampal loop. Since these areas receive afferents from the major sensory systems, the perforant path, from the entorhinal cortex may be an indirect link between the various sensory systems and the hippocampus (2).

Thermal stimulation of central or peripheral thermoreceptors may send signals over this pathway as evident from the appearance of hippocampal theta rhythm during changes in the hypothalamic or cutaneous temperature. This would alert the animal to changes in his body temperature, and possibly activate the hypothalamus and the cortex to initiate and coordinate physiological and behavioral thermoregulatory responses.

REFERENCES

1. Adey, W., C. Dunlop, and C. Hendrix. Hippocampal slow waves; distribution and phase relations in the course of approach learning. Arch. Neurol. (Chicago), (1960), 3, 74-90.
2. Altman, J., R. Brunner and S. Bayer. The hippocampus and behavioral maturation. Behavioral Biology (1973), 8, 55-596.
3. Anchel, H. and D. Lindsley. Differentiation of two reticulo hypothalamic systems regulating hippocampal activity. EEG Clin. Neurophysiol. (1972), 32, 209-226.
4. Ball, G., and J. Gray. Septal self-stimulation and hippocampal activity: separate processes. Physiol. Behav. (1971), 6, 547-550.
5. Bennet, T.L. Hippocampal theta activity and behavior - A review. ✓ Commun. Behav. Biol. (1971), 6, 37-48.
6. Covian, M. Studies on the neurovegetative and behavioral functions of the brain septal area. Prog. Brain Res. (1967), 27, 189-217.
7. Cragg, B., and L. Hamlyn. Histologic connections and electrical and autonomic responses evoked by stimulation of the dorsal fornix in the rabbit. Exp. Neurol (1965), 1, 187-213.
8. Donovick, P. Effects of localized septal lesions on hippocampal EEG activity and behavior in rats. J. Comp. Physiol. Psychol., (1968), 66, 569-578.
9. Grastyan, E. and G. Karmos. A study of possible "dreaming" mechanism in the rat. Acta Physiol. Acad. Sci. Hung. (1961), 20, 41-50.
10. Grastyan, E., I. Madarasz, and H. Donhoffer. Hippocampal electrical activity during the development of conditioned reflexes. Electroenceph. Clin. Neurophysiol. (1959), 11, 409-430.

11. Gray, J. Medial septal lesions, hippocampal theta rhythm and control of vibrissal movement in the freely moving rats. EEG Clin. Neurophysiol. (1971), 30, 189-197.
12. Gray, J., L. Quintao, and M. Araujo-Silva. The partial reinforcement extinction effect in rats with medial septal lesion. Physiol. Behav. (1972), 8, 491-496.
13. Green, J.D. The hippocampus. Physiol. Rev. (1964), 44, 561-608.
14. Green, J. and A. Arduini. Hippocampal electrical activity in arousal. J. Neurophysiol. (1954), 17, 533-557.
15. Harper, R.M. Frequency changes in hippocampal electrical activity during movement and tonic immobility. Physiol. Behav. (1971), 7, 55-58.
16. Hayward, J. and W. Smith. Influence of limbic system on neurohypophysis. Arch. Neurol. (1963), 9, 171-177.
17. Horowitz, J., M. Saleh and R. Kareem. Correlation of the hippocampal theta rhythm with changes in cutaneous temperature. In press.
18. Jung, R. und A.E. Kornmüller. Eine Methodik der Abteilung Lokalisierter Potentialschwankungen aus Subcorticalen Hirngebieten. Arch. Psychiat. Nervenkr., (1938), 109, 1-30.
19. Klemm, W.R. EEG and multiple-unit activity on limbic and motor system during movement and immobility. Physiol. Behav. (1971), 7, 337-343.
20. Landfield, P., J. McGaugh, and R. Tusa. Theta rhythm: A temporal correlate of memory storage processes in the rat. Science (1972), 175, 87-88.
21. Macadar, O, J. Roig, J. Monti, and R. Budelli. The functional relationship between septal and hippocampal unit activity and hippocampal theta rhythm. Physiol. Behav. (1970), 5, 1443-1449.

22. Miller, J. and G. Mogenson. Projections of the septum to the lateral hypothalamus. *Exp. Neurol.* (1972), 34, 229-243.
23. Morales, F., J. Roig, J. Monti, J. Macadar and R. Budelli. Septal unit activity and hippocampal EEG during the sleep-wakefulness cycle of the rat. *Physiol. Behav.* (1971), 6, 563-567.
24. Nauta, H. Hippocampal projections and related neural pathways to the midbrain in the cat. *Brain* (1958), 81: 319-340.
25. Petshe, H., C.H. Stumpf, and G. Gogolak. The significance of the rabbit's septum as a relay station between the midbrain and the hippocampus. I. The control of hippocampal arousal activity by the septum cells. *EEG Clin. Neurophysiol.* (1962), 14, 202-211.
26. Raisman, G. Neural connexions of the hypothalamus. *Br. Med. Bull.* (1966), 22, 197-208.
27. Raisman, G. The connexion of the septum. *Brain*, (1966), 89, 317-348.
28. Raisman, G. Some aspects of the neural connections of the hypothalamus. In: *The Hypothalamus*. Academic Press, (1970), 1-16.
29. Raisman, G., W. Cowan, and T. Powell. An experimental analysis of the efferent projection of the hippocampus. *Brain*, (1966), 89, 83-108.
30. Stumpf, C.H. Drug action on the electrical activity of the hippocampus. *Int. Rev. Neurobiol.* (1965), 8, 77-138.
31. Truex, R., and M. Carpenter. *Human Neuroanatomy*. Sixth edition, The Williams & Wilkins Company, Baltimore.
32. Urgan, I., and P. Richard. *A stereotaxic atlas of the New Zealand rabbit's brain*. Charles Thomas, Springfield, Ill.
33. Vanderwolf, C. Limbic diencephalic mechanisms of voluntary movement. *Psychol. Rev.* (1971), 78, 83-113.

FIGURE LEGENDS

- Figure 1. Evoked potential recorded across the hippocampal pyramidal cell layer following fornix stimulation.
- Figure 2. A water perfused thermode for heating and cooling the hypothalamus.
- Figure 3. EEG records from electrodes on each side of area CA₃ of the hippocampus (lower trace) and across two cortical electrodes (upper trace) in the unanesthetized rabbit. Theta waves are present following warming the ear skin, the onset of a tone or a light.
- Figure 4. EEG records from electrodes on each side of area CA₃ of the hippocampus (labeled H) and across two cortical electrodes (labeled C) in unanesthetized rabbit. Theta waves are present following warming or cooling the hypothalamus at a rate of 2°C/min for one minute.
- Figure 5. X-ray radiographs of the rabbit's head, side view (a) and front view (b), showing the locations of the implanted thermode and electrodes.
- Figure 6. The change in rectal temperature during maintaining the hypothalamic temperature at 35°C for 2 hours.
- Figure 7. A pathway for alerting an animal to changes in its body temperature. (See text.)

Fig. 3-1

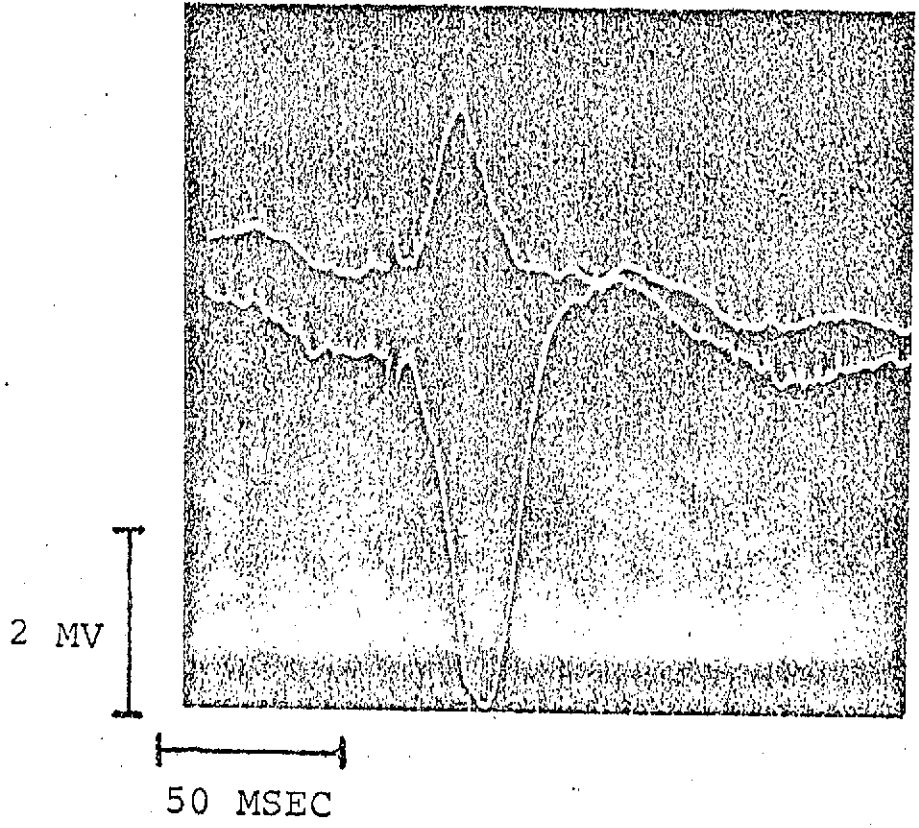
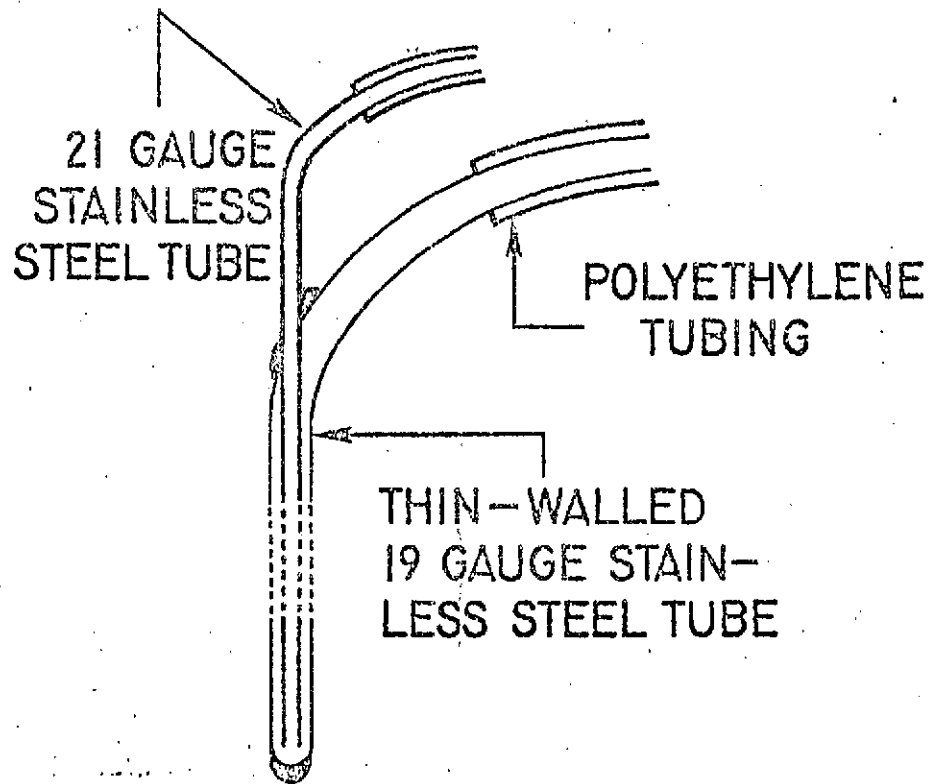

Fig. 3-2



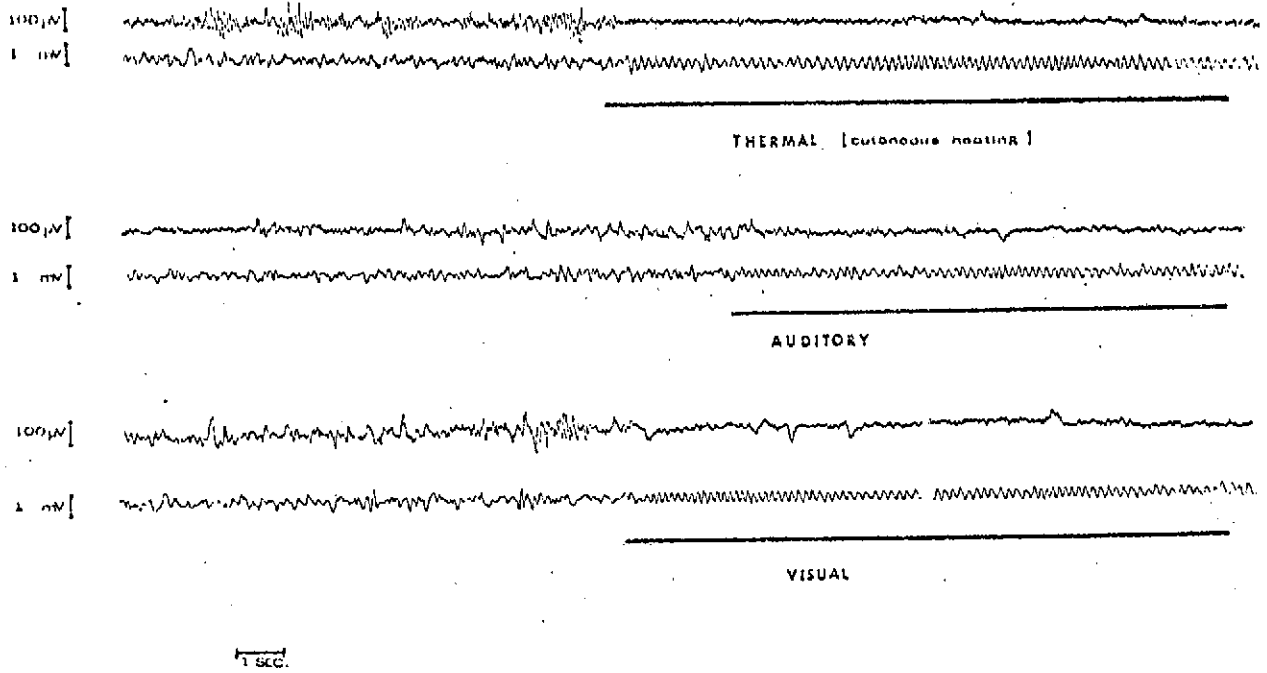
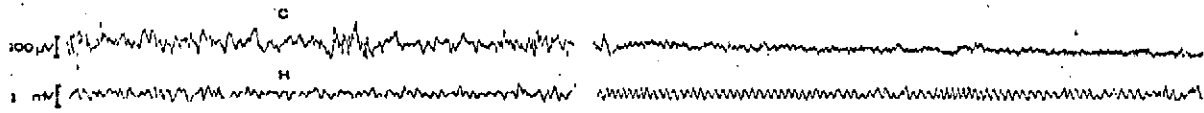
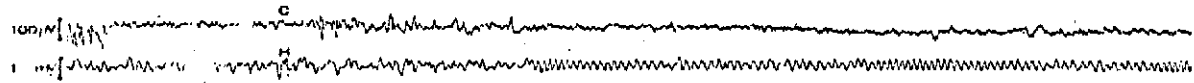

Fig. 3-4



HEATING



COOLING

1 sec.

Fig. 3-5 a

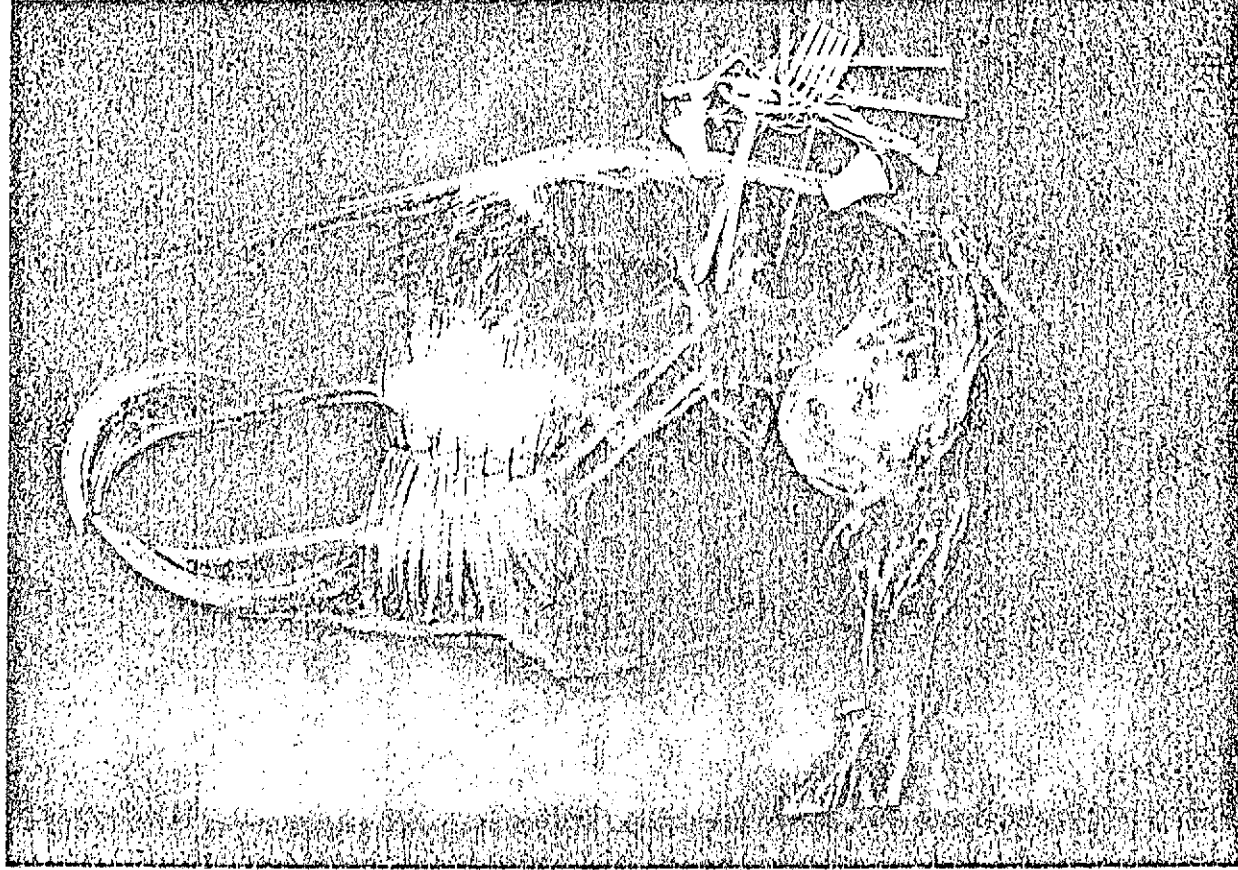

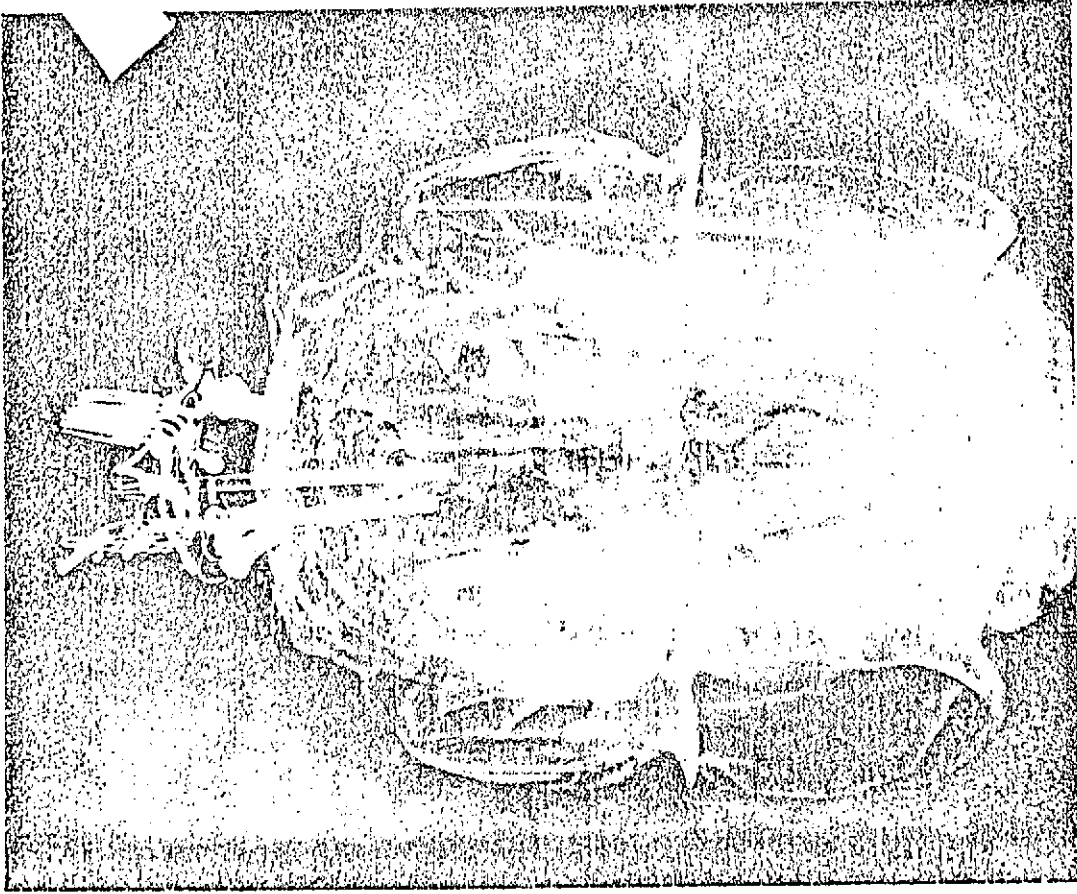
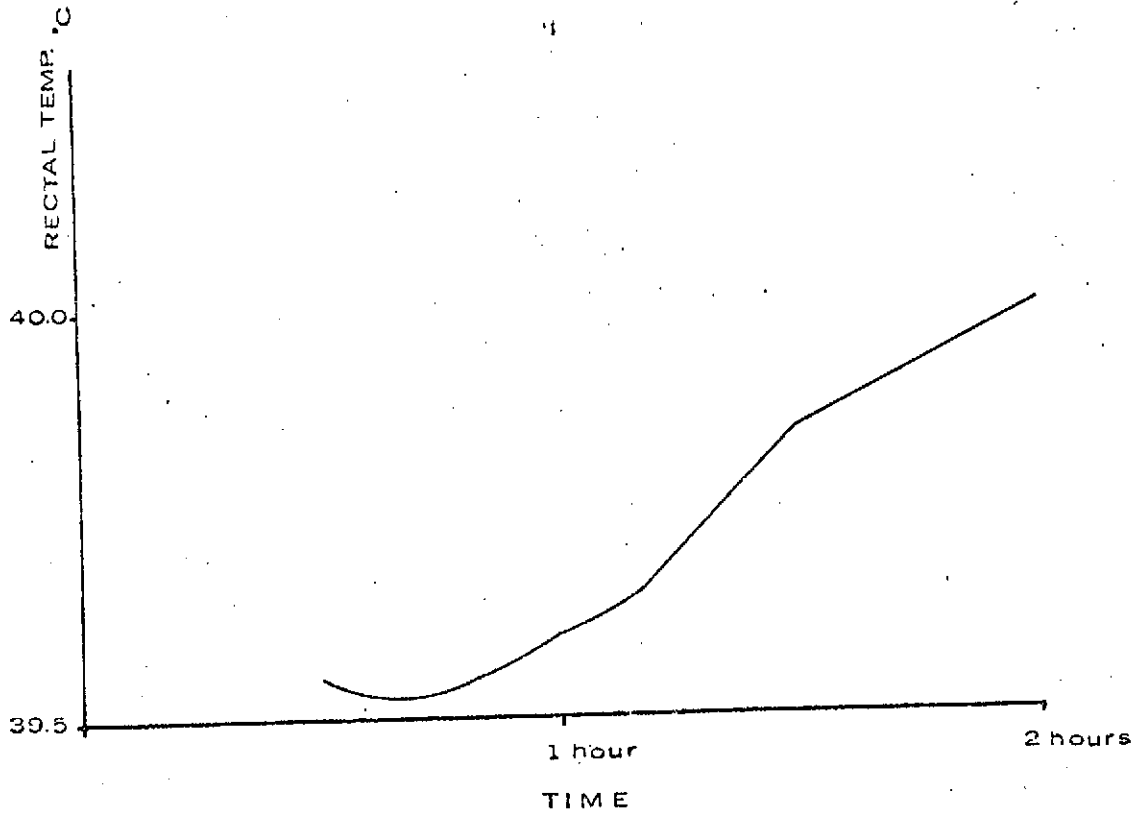

FIG. 3-6



228

Fig. 3-7

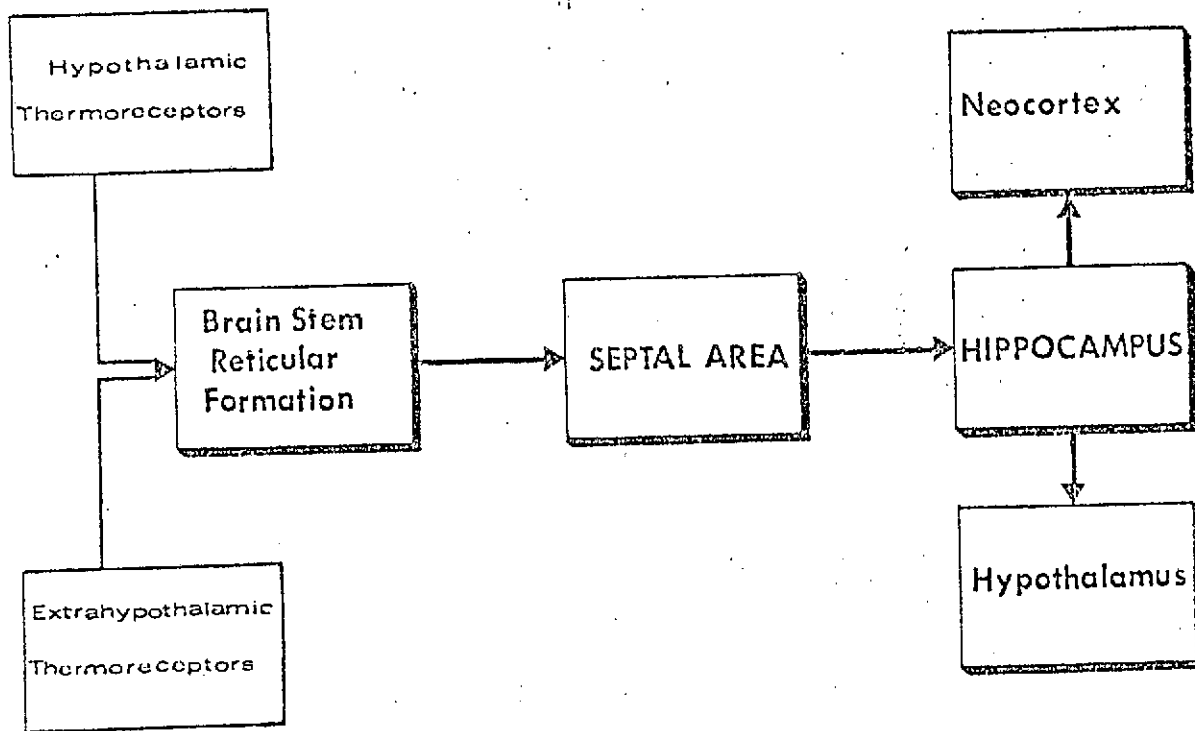

TABLE 1

THETA ACTIVITY BEFORE AND AFTER A CHANGE IN HYPOTHALAMIC
TEMPERATURE

RABBIT NUMBER	HEATING			COOLING		
	No. Trials Averaged	Theta in Interval A	Theta in Interval B	No. Trials Averaged	Theta in Interval A	Theta in Interval B
1	3	20	35	3	33	38
2	3	3	23	3	6	20
3	2	33	44	3	18	31
4	3	43	56	4	35	47
5	4	21	27	3	30	57
6	3	25	31	3	35	53

Notes:

1. When the hypothalamic temperature began to change the time was noted at T_1 on the records. The 60 second interval just prior to T_1 , denoted interval A, was scanned to determine what portion of that interval had a theta rhythm. That is, for each second of the interval if 4 or more peaks were present at a 4-7 Hz rhythm, that one second interval was scored as having theta activity.
2. A 60 second interval just after time T_1 , denoted interval b, was scanned to determine what portion of that interval had a theta rhythm.

TABLE 2

THETA ACTIVITY BEFORE AND AFTER A CHANGE IN HYPOTHALAMIC
TEMPERATURE IN A RABBIT WITH HYPOTHALAMIC TEMPERATURE 2°C
HIGHER OR LOWER THAN NORMAL.

Hypothal- amic Temp.	HEATING			COOLING		
	Trial Number	Theta in Interval A	Theta in Interval B	Trial Number	Theta in Interval A	Theta in Interval B
2°C above normal	1	14	37	1	15	47
	2	23	36	2	24	28
	3	26	52			
2°C below normal	1	7	22	1	41	51
	2	33	51	2	16	24
Normal	1	33	52	1	11	38
	2	44	55	2	24	26
				3	18	29

Notes:

1. When the hypothalamic temperature began to change, the time was noted as T_1 on the records. The 60 second interval just prior to T_1 , denoted interval A, was scanned to determine what portion of that interval had a theta rhythm. That is, for each second of the interval if 4 or more peaks were present at a 4-7 Hz rhythm, that one second interval was scored as having theta activity.
2. A 60 second interval just after time T_1 , denoted interval B, was scanned to determine what portion of that interval had theta rhythm.