

X-711-74-244  
PREPRINT

NASA TM X-70746

# A HIGH VOLTAGE POWER SUPPLY FOR THE AE-C AND D LOW ENERGY ELECTRON EXPERIMENT

(NASA-TM-X-70746) - A HIGH VOLTAGE POWER  
SUPPLY FOR THE AE-C AND D LOW ENERGY  
ELECTRON EXPERIMENT (NASA) 27 p HC  
\$4.50

N74-32677

CSCL 09E

Unclas

G3/09

48008

JOSEPH A. GILLIS

JULY 1974



— GODDARD SPACE FLIGHT CENTER —  
GREENBELT, MARYLAND

A HIGH VOLTAGE POWER SUPPLY FOR THE AE-C AND D  
LOW ENERGY ELECTRON EXPERIMENT

Joseph A. Gillis

July 1974

GODDARD SPACE FLIGHT CENTER  
Greenbelt, Maryland

A HIGH VOLTAGE POWER SUPPLY FOR THE AE-C  
AND D LOW ENERGY ELECTRON EXPERIMENT

Joseph A. Gillis

FOREWORD

The purpose of this document is to describe the mechanical and electrical design, and operation, of a high voltage power supply for space flight use. The supply was used to generate the spiraltron high voltage for the Low Energy Electron Experiment on AE-C and D. Two versions of the supply were designed and built, one referred to as the low power version (AE-C) and the other as the high power version (AE-D). The former was used on AE-C, while one of each version is used on AE-D. Performance is discussed under all operating conditions.

PRECEDING PAGE BLANK NOT FILMED

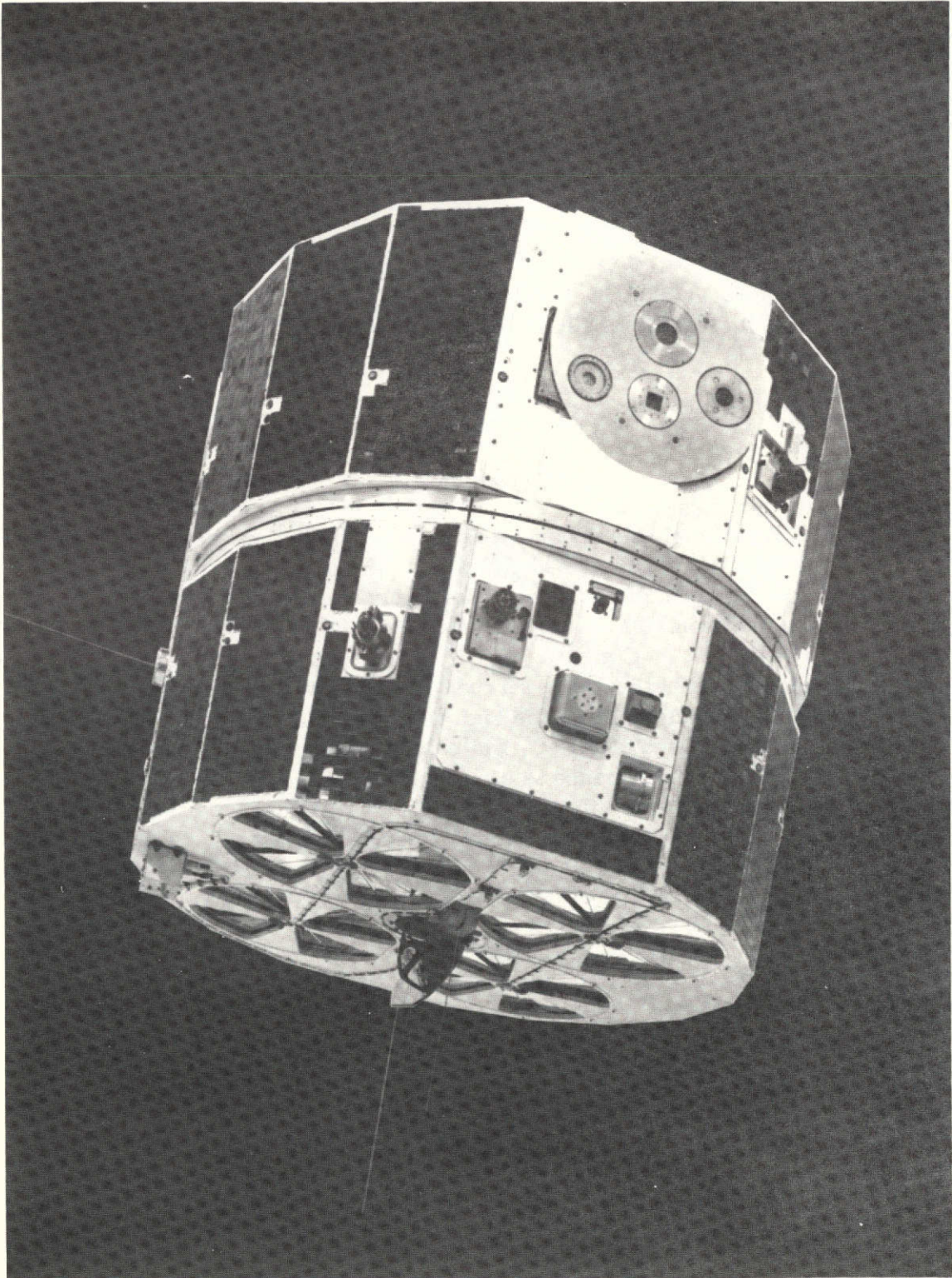

Frontispiece. AE-C Spacecraft

## CONTENTS

	<u>Page</u>
FOREWORD . . . . .	iii
INTRODUCTION . . . . .	1
ELECTRICAL DESIGN . . . . .	1
Design Specifications . . . . .	1
Circuit Description . . . . .	2
MECHANICAL DESIGN AND LAYOUT . . . . .	6
PERFORMANCE DATA . . . . .	14
APPENDIX A — HIGH VOLTAGE MATERIALS AND COMPONENTS . . . . .	A-1
APPENDIX B — MAGNETIC COMPONENT DESIGN . . . . .	B-1

## ILLUSTRATIONS

<u>Figure</u>	<u>Page</u>
Frontispiece — AE-C Spacecraft . . . . .	iv
1 Complete Schematic, AE-C Design . . . . .	3
2 Modification to Schematic Used for the High Power (AE-D) unit . . . . .	6
3 General Mechanical Layout, Top View . . . . .	8
4 Regulated Output Line Connection . . . . .	9
5(a-d) Finished Unit, AE-C SN02 . . . . .	10-13
6 Q4 Collector Current and Emitter to Collector Volts . . . . .	14
7 Q5 Emitter Current and Collector to Ground Voltage . . . . .	15

ILLUSTRATIONS (continued)

<u>Figure</u>		<u>Page</u>
8	Monitor Voltage Output Change . . . . .	16
9	Q8 Collector Current . . . . .	16
10	Q5 Emitter Current and Collector to Ground Voltage . . . . .	17
11	Output Voltage Curves . . . . .	18
12	Monitor Output Voltage Curves . . . . .	19

TABLE

<u>Table</u>		<u>Page</u>
1	TBD Values for All Units and Spare Boxes . . . . .	7

# A HIGH VOLTAGE POWER SUPPLY FOR THE AE-C AND D LOW ENERGY ELECTRON EXPERIMENT

## INTRODUCTION

High voltage power supplies have been a major part of spacecraft experiment electrical systems since the first satellite left the launching pad, and a very large amount of experience has been gained. However, due to the very nature of high voltage in a space environment, this particular area remains today one of the biggest and most persistent problem areas.

In a sense, each job is like delving into the field for the first time all over again. No particular overall design approach at this time seems to have a decided advantage. Hardware must basically be tailored electrically and mechanically to conform to particular project requirements. However, certain basic principals have emerged from experience as being sound engineering practice, and therefore desirable for incorporation in any design.

The electrical design used for the high voltage power supply discussed herein is fairly conventional and will be gone into only insofar as necessary to understand the basic operation. The mechanical design is discussed in the hope that the techniques used may be useful in the design of future high voltage power supplies for space use.

## ELECTRICAL DESIGN

### Design Specifications

**Input Voltage:** -24.5 volts  $\pm$ 0.5 volts normally, with possible excursions to -26.5 volts for indefinite periods and -50 volts for 10 milliseconds.

**Turn-on Transient:** 0.5 amperes for not more than 15 milliseconds.

**Input Current Limit:** The input current will be positively limited to less than three times the quiescent value.

**Reverse Polarity:** The supply shall be protected against reverse polarity at the input.

**Short Circuit Protection:** No damage shall result from temporary or permanent short circuit to common.

Isolation: DC isolation from the input bus is required on the high voltage output.

Electrostatic Shielding: The high voltage transformer coupling the input to output shall be isolated with an electrostatic shield that shall be connected to chassis ground.

Outputs:

	<u>Voltage</u>	<u>Load</u>	<u>Regulation</u>
(a) Command to select one of the following: 3700 v, 3950 v, or 4200 v		0 to 30 $\mu$ amp (low power version) 0 to 100 $\mu$ amp (high power version)	$\pm 1\%$
(b) -22.5 v (low power version only)		7 to 15 mamp	$\pm 1\%$

High Voltage Output Ripple: 10 millivolts peak to peak maximum

Output Voltage Monitor: The high voltage output shall have an analog output in the range of 0 to 5 volts with an output impedance of not greater than 25k ohms.

Temperature: The supply shall perform within specifications over the temperature range of  $-20^{\circ}\text{C}$  to  $+50^{\circ}\text{C}$ .

### Circuit Description

The complete schematic of the high voltage power supply designed for AE-C is shown in Figure 1. The circuit has an input filter L1, C1 and C2 followed by an input regulator which consists of Q1-Q3, R1-R7, CR1-CR3, and C3. The output of this regulator supplies the -22.5 volt output. Q2 and R1 limit the regulator output current to about 40 milliamperes.

The high voltage generation is essentially divided into three stages; T1, T2 and a Cockroft-Walton multiplier stage. Transformer T1 is driven by a class C Hartley Oscillator which uses the -22.5 volt output of the regulator. Winding 5-6 of T1 produces a sinusoidal voltage of about 100 volts peak. This voltage is applied to the primary of T2 and Q5 via the full wave bridge formed by CR4-CR7. Q5 acts as a linear series regulator which is the controlling factor in maintaining the output voltage within the 1% requirement. The maximum output of T2



varies approximately from 440 volts to 480 volts peak depending on the output load. This is multiplied by ten by the Cockroft-Walton multiplier to give a maximum output of about 4600 volts with Q5 full on at room temperature and nominal load. R11, R12, C17 and C18 form a two stage output filter to maintain output ripple below the 10 millivolt peak to peak requirement. R11 and R12 were typically around 330 kohms each. The filter therefore gives an effective attenuation of around 95db at the oscillator frequency of 20kHz. R13 is also around 330 kohms and is used to limit current surges during arcing or accidental shorts.

The divider network for sensing the output voltage consists of R14 through R16. R14 is four metal oxide high voltage resistors in series of 470 megohms each. R15 plus R16 is about 2.2 megohms. This causes approximately 4 volts to appear at the feedback point. A1 acts as a unity gain buffer and presents a low impedance source for the monitor output and divider chain R23-R28. Zener Diode CR24 forms the reference voltage which is divided down by R29-R33. The output voltage level is controlled by appropriate commands to Q6 and Q7. The output of A2 drives Q5 in such a manner as to maintain the output within the required tolerance.

Temperature compensation is accomplished by making R29 a diode, usually a 1N4247. In some units this tends to overcompensate and a sensistor was used in series for R30. R31 and R32 are adjusted to trim the output voltage. The use of a series regulator between two transformers has been used extensively with success by the Power Conversion and Control Section at the Goddard Flight Space Center. It effectively gives isolation between input and output while controlling the voltage at a low level. It has the disadvantage, however, of having a rather complex control loop which includes T2, the Cockroft-Walton multiplier, and the RC filters. This tends to give extensive phase shifting down to low frequencies. The feedback loop must be compensated to substantially reduce AC gain. To this end compensating network R35 and C23 are used between the Q5 collector and base, and A2 uses a 0.47 $\mu$ f capacitor for either C27 or C28. To further ensure stable closed loop operation, the DC gain of A2 is reduced somewhat from its open loop value by use of R34, from pin 8 to ground, the value of which was typically one megohm.

The circuit for AE-D is identical to that for AE-C except the Hartley oscillator is beefed up by using a complementary connection as shown by Q4 and Q8 in Figure 2. This was necessary in order to supply the increased output current (100 microamperes @ 4200 volts) called for in this unit. For the same reason, C6 is 3600 pf to keep higher currents circulating in the tuned circuit. In addition, R1 is adjusted to limit the input regulator current to approximately 47 milliamperes. All TBD values for each unit are shown in Table 1.

PRECEDING PAGE BLANK NOT FILMED

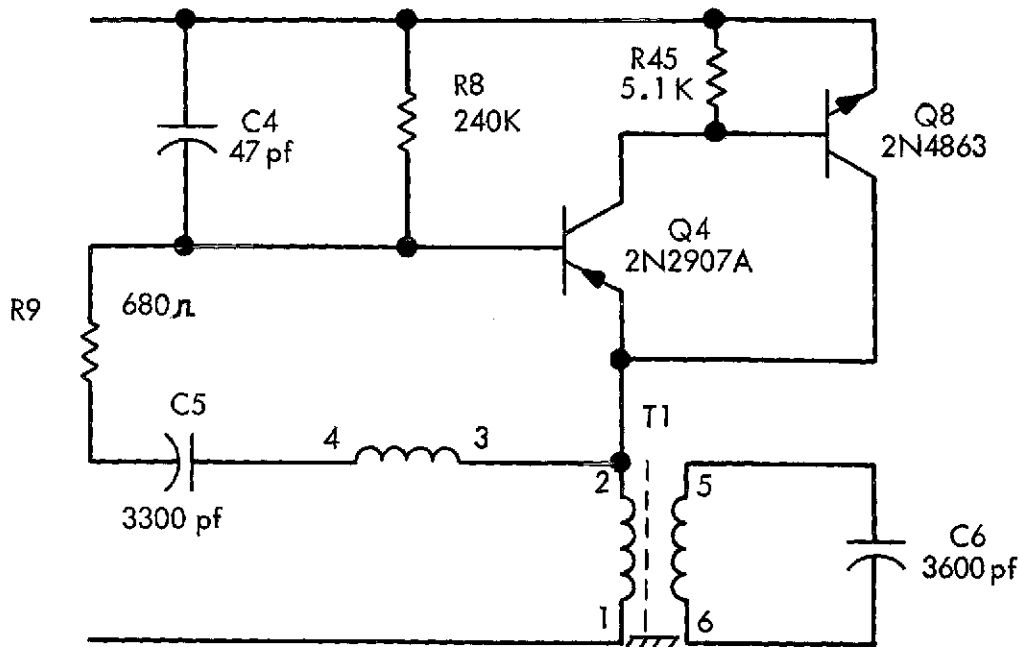

Figure 2. Modification to Schematic Used for High Power (AE-D) Unit

## MECHANICAL DESIGN AND LAYOUT

As previously mentioned, the layout and packaging techniques are very critical in high voltage power supplies. There are two fundamental approaches in packaging technique; potted and unpotted. It was early decided to use the potted method for two reasons;

1. Past experience of the Power Conversion and Control Section in this area, and
2. It tends to make more economical use of the space available and gives mechanical ruggedness.

In addition, if properly done and with a little luck, the power supply can be operated at any pressure level between atmospheric and hard vacuum. All high voltage points in the circuit of 100 volts or more are enclosed and shielded in four boxes. The boxes are fixed by mounting screws to a ground plane which is part of the printed circuit board. This ground plane is connected to chassis ground.

A top view of the layout is shown in Figure 3. The schematic of Figure 1 shows which parts go in which box. Box No. 1 contains that circuitry which produces

Table 1

TBD Values for All Units and Spare Boxes

	R4	R5	R6	R7	R9	R11	R12	R13	R14	R15	R16	R23	R24
AE-C SNO 1	76.8K	2.8K	34.8K	short	3.3K	300K	300K	300K	<sup>4</sup> 470M	2.2M	short	1.58K	short
SNO 2	73.2K	4.22K	34.8K	short	3K	300K	270K	270K	<sup>4</sup> 470M	2.0M	short	1400Ω	short
Spare Boxes						270K	300K	300K	<sup>4</sup> 470M	2.2M	short		
SNO 3	73.2K	4.42K	34.8K	short	3K	330K	360K	330K	<sup>4</sup> 470M	2.2M	short	short	1.58K
AE-D SNO 1	73.2K	3.24K	34.8K	short	680Ω	330K	360K	390K	<sup>4</sup> 470M	2.2M	short	short	1.58K
SNO 2	75K	976Ω	34.8K	short	680Ω	360K	330K	330K	<sup>4</sup> 470M	2.2M	short	short	1.54K
Spare Boxes						360K	360K	300K	<sup>4</sup> 470M	2.2M	short		

	R25	R26	R27	R29	R30	R31	R32	R34	R35	R36	R43	R44	R45*	C27	C28	R1
AE-C SNO 1	1.5K	short	1.4K	IN 3600	9310 Ω	short	short	680K	100K	56K	open	short	open	0.47 μf	open	15 Ω
SNO 2	1.27K	short	1.18K	IN 4247	13K	100Ω	short	680K	100K	51K	open	open	open	open	0.47 μf	15 Ω
Spare Boxes																
SNO 3	1.47K	short	1.4K	500Ω sensistor	14K	102Ω	short	1 MEG	100K	51K	open	open	open	open	0.47 μf	15 Ω
AE-D SNO 1	short	1.47K	1.5K	IN 4247	500Ω sensistor	11.3K	short	1 MEG	51K	18K	open	open	5.1K	open	0.47 μf	13 Ω
SNO 2	short	1.47K	1.5K	14.7K	137 Ω	short	short	1 MEG	51K	18K	open	short	5.1K	0.47 μf	open	13 Ω
Spare Boxes																

\*R45 is from Q5 collector to base on AE-C SNO1-03, and from O8 emitter to base on AE-D SNO1-02.

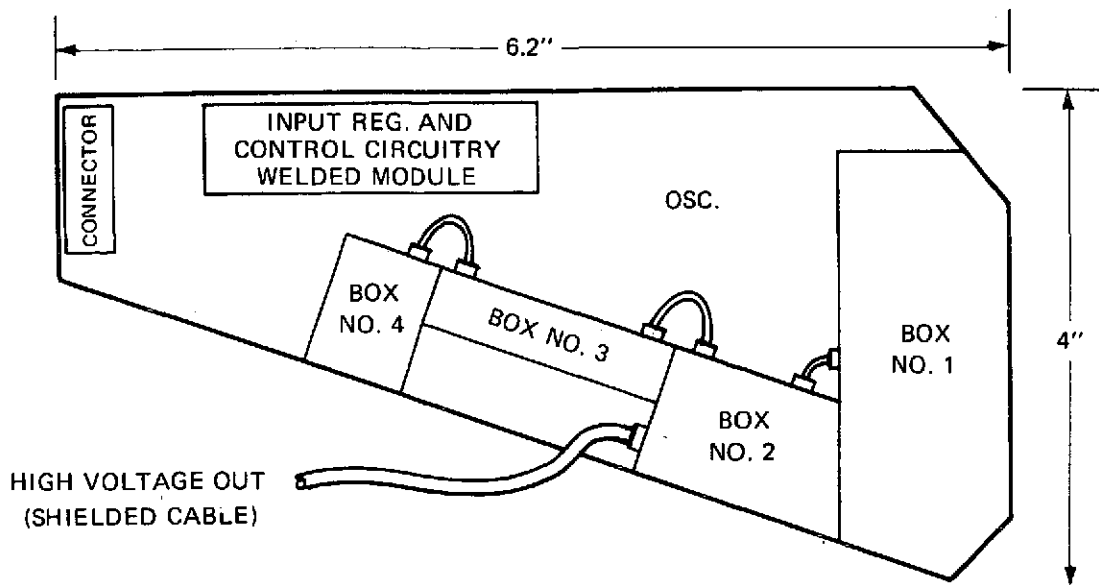

Figure 3. General Mechanical Layout, Top View

the most noise, i. e., the high voltage transformers and multiplier stack. This effectively shields it from the rest of the circuitry.

All the boxes were custom made from General Electric Lexan polycarbon of 40 mils thickness. The boxes were sandblasted, copper plated and gold flashed. All wire connections pass through the sides of the boxes by means of Lexan dowel, with 1/8 inch dowel used for the low voltage lines and 1/4 inch dowel used for all high voltage lines. The holes for the doweling are drilled after the boxes have been plated. The entire board shown in Figure 3 mounts in an aluminum frame which is about 1.8 inches high.

The regulated voltage is brought out of box No. 2 and the frame by means of high voltage shielded cable. The coaxial shield extends into box No. 2, and then back out via a feedthrough to connect to chassis ground. This is shown in Figure 4.

Bringing the high voltage line out in this manner eliminates any high voltage electric fields between the power supply and the load. The shield may or may not be connected to chassis ground at the load end. The high voltage return is brought out through the connector.

High voltage connections between box No. 1 and 2, and between 2 and 3 used the center conductor and insulation from the coaxial cable used for the high voltage output. This provided a very small and flexible conductor with an insulation of very high dielectric strength.

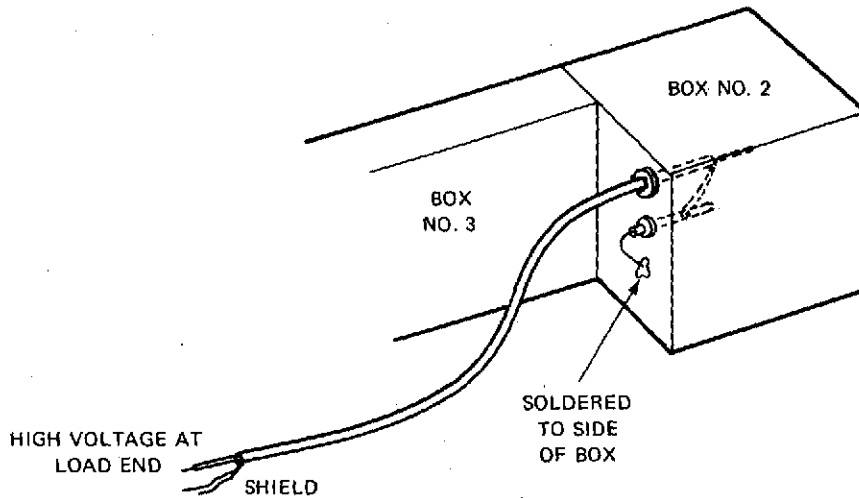

Figure 4. Regulated Output Line Connection

After all the components were mounted in the boxes, and the boxes wired together, they were meticulously cleaned in preparation for potting. The potting material used was Dow Corning 93500. This is a silicon and has some advantages and disadvantages. One disadvantage is that it is difficult at times to get this material to adhere properly to different surfaces. To try and avoid this problem, a very careful job of priming all surfaces, using Dow Corning primer, must be done. This is particularly true of all electronic component surfaces around and between high voltage points and ground. When the potting pulls away from a surface, a void is formed which could develop a partial vacuum as out-gassing occurs in space. One of the main advantages of the 93500 material is its transparency. It is possible to visually inspect the results after potting to ensure there are no problem areas, or to correct any which show up if possible.

Once the boxes are potted, it is generally difficult to perform any circuit repairs should they become necessary. For this reason a complete set of spare boxes was made for each design. In the event of a failure in any one box, the complete set of boxes could be replaced.

After the boxes are mounted and the circuit completely tested, tops are fitted to the boxes by means of methylene chloride which, in effect, melts the polycarbon together. Small holes are drilled in the tops for venting.

Figure 5a-d shows various views of the AE-C finished unit, SN02. In Figure 5a the transparency of the potting material can be readily seen.

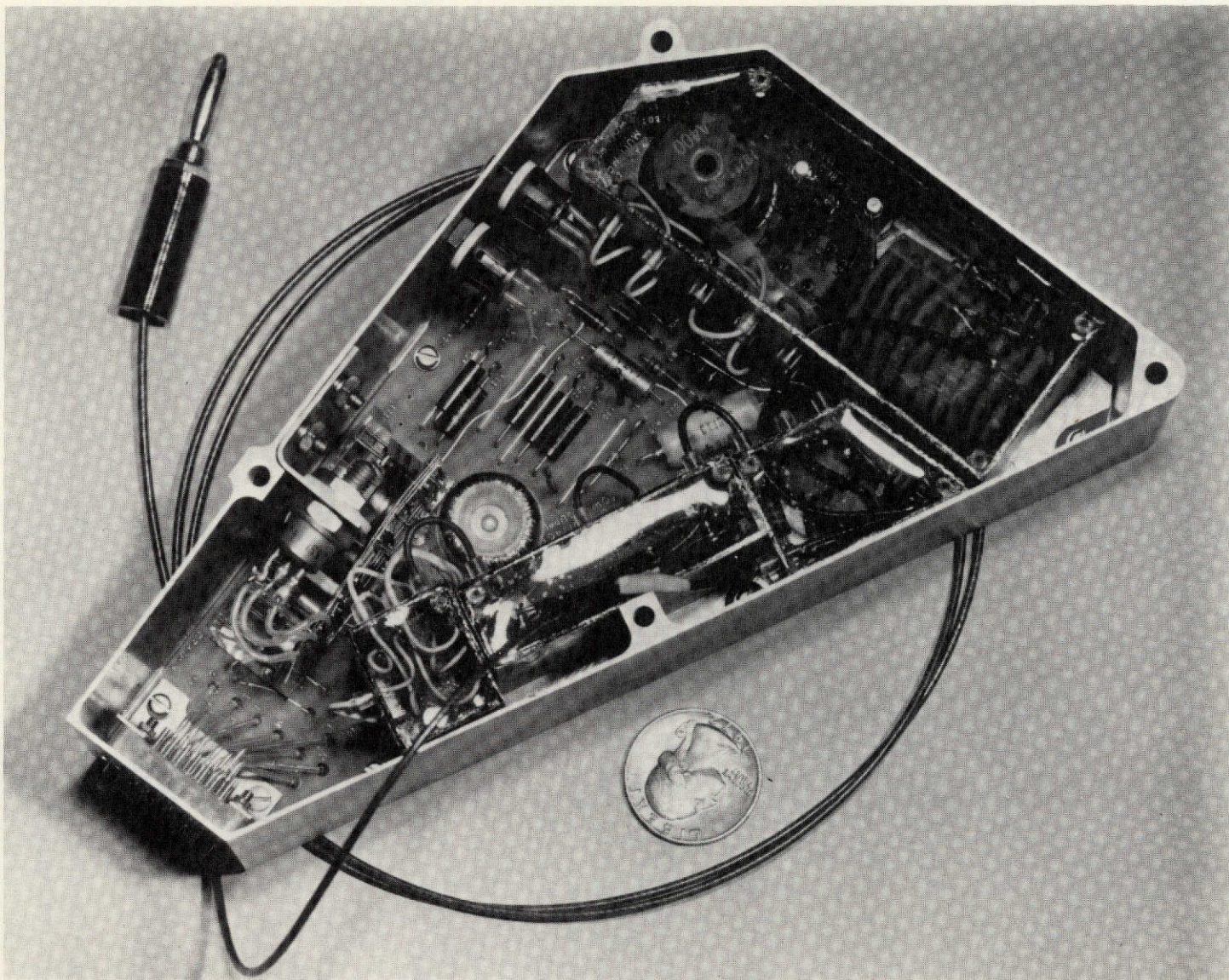

Figure 5a. Finished Unit, AE-C SN02

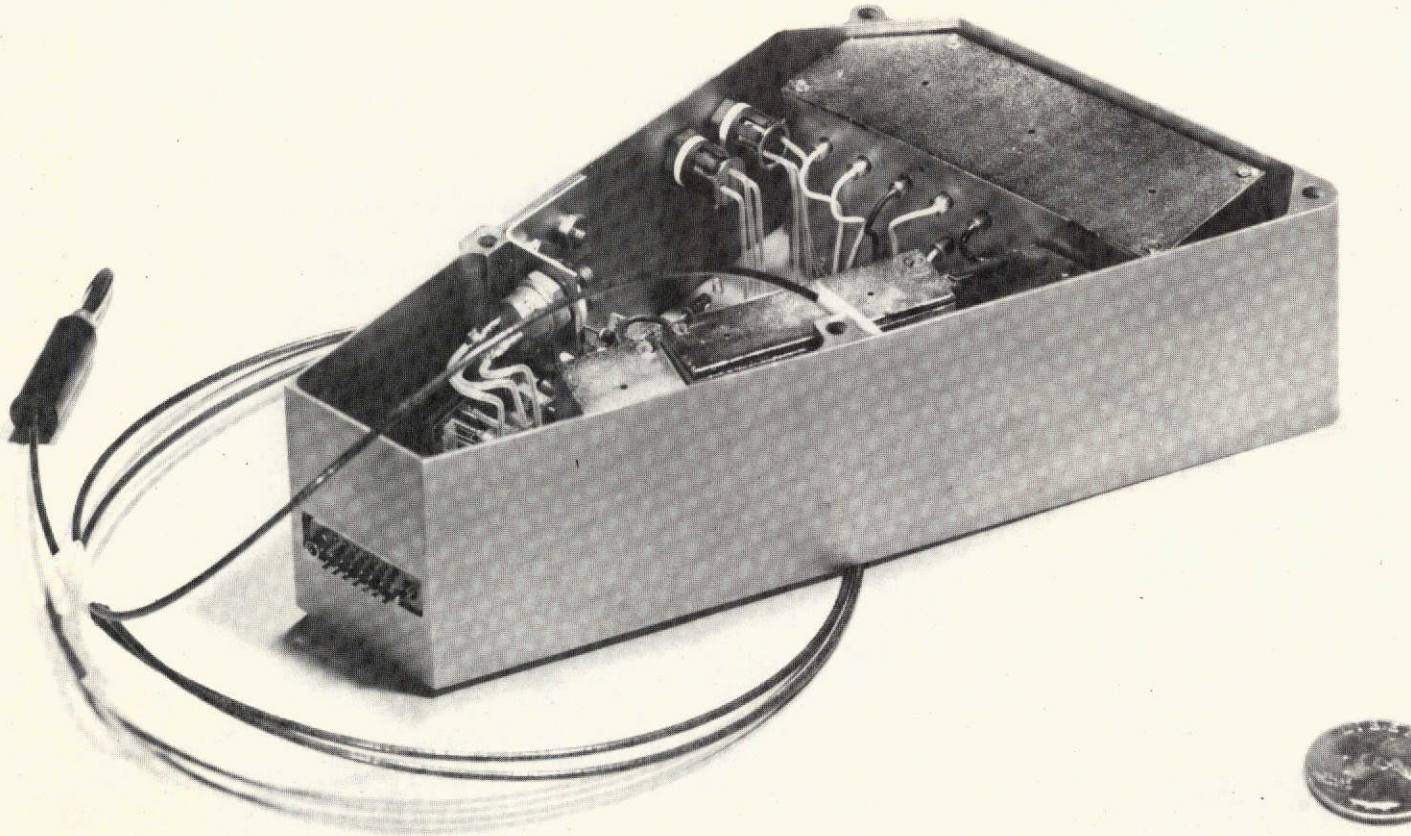

Figure 5b. Finished Unit, AE-C SN02

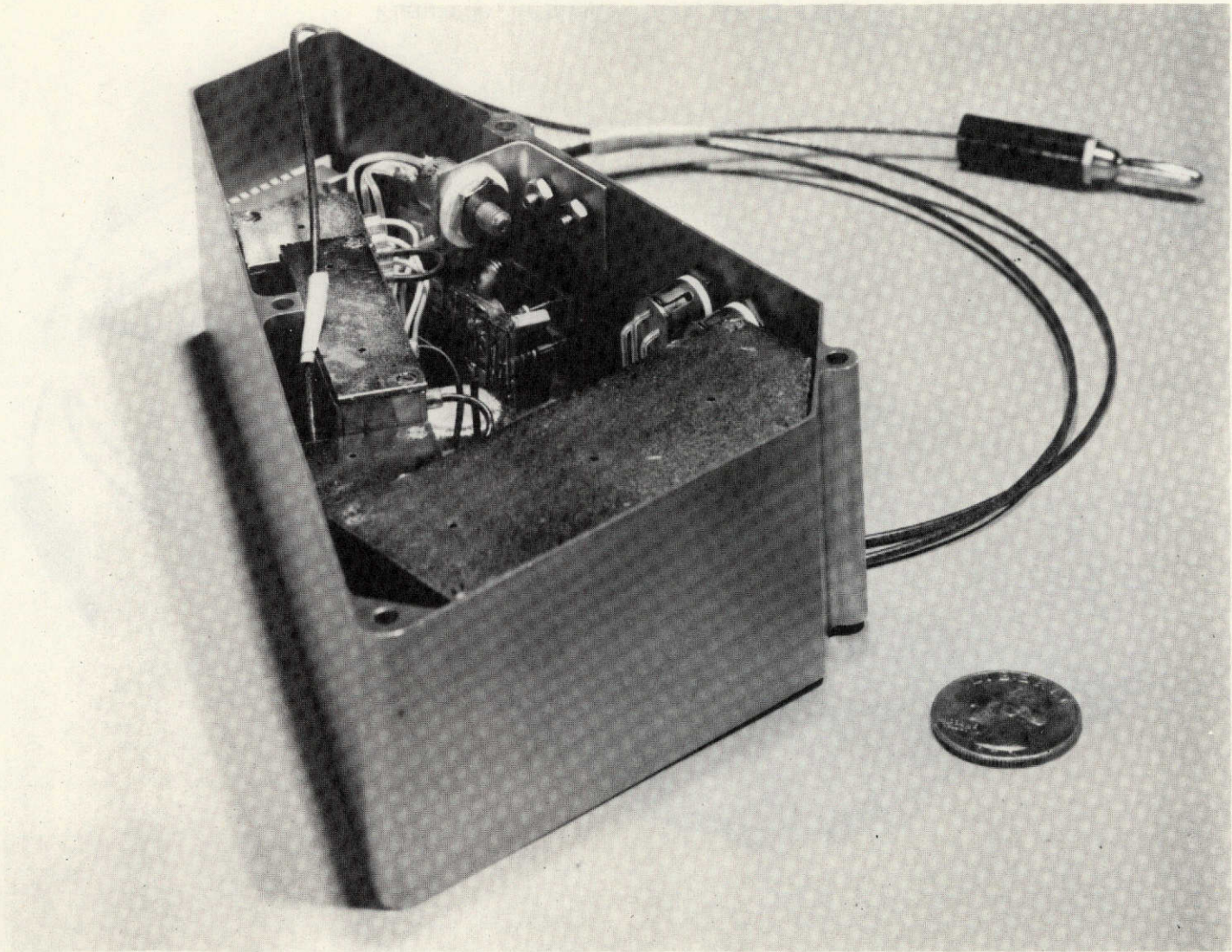

Figure 5c. Finished Unit, AE-C SN02



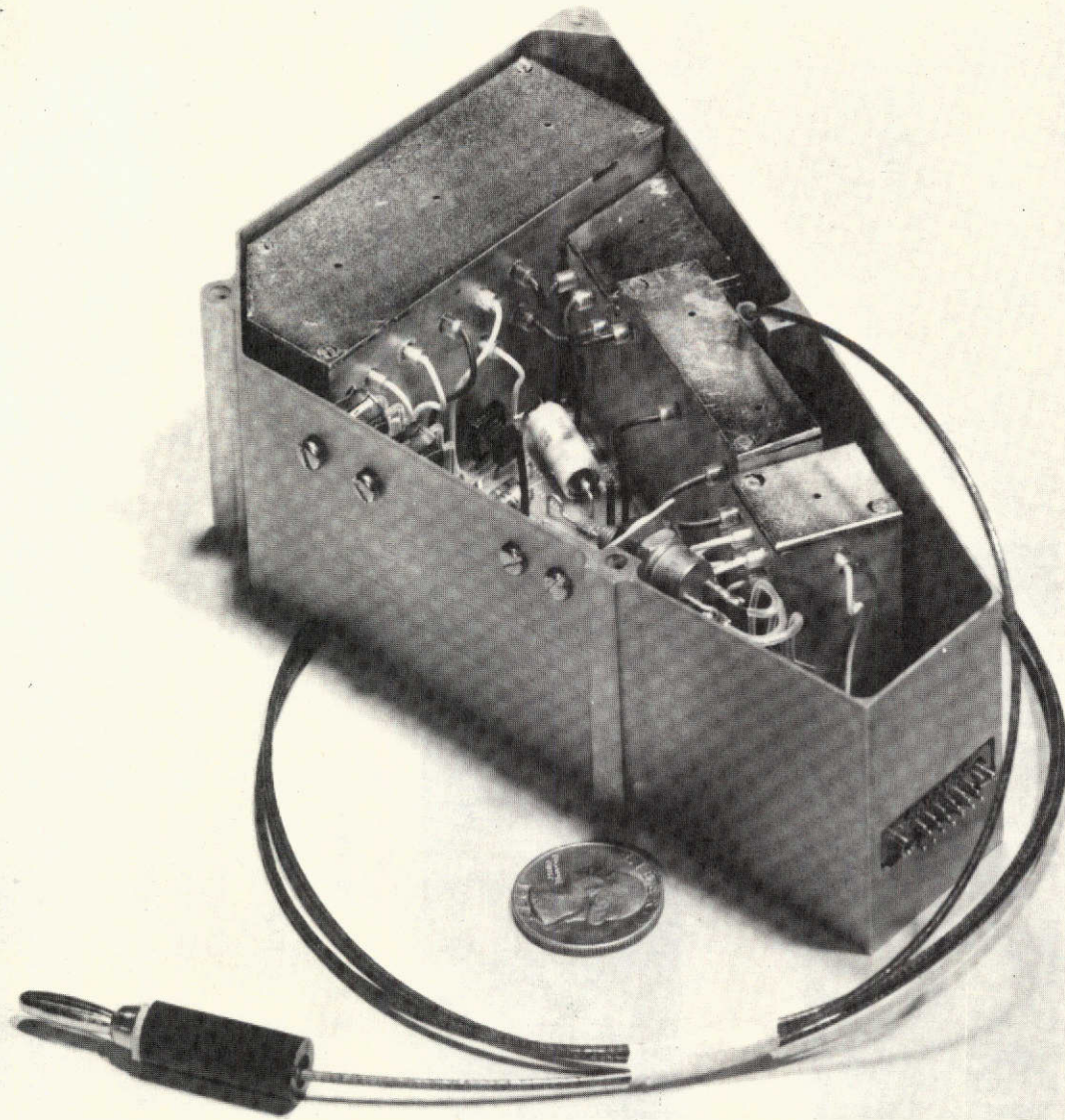

Figure 5d. Finished Unit, AE-C SN02

## PERFORMANCE DATA

Figures 6 and 7 show some typical waveforms taken on the AE-C low power version SN02. Figure 6 (a) and (b) show Q4 collector current at nominal (16 microamperes) and maximum (30 microamperes) load, and Q4 emitter to collector volts at maximum load.

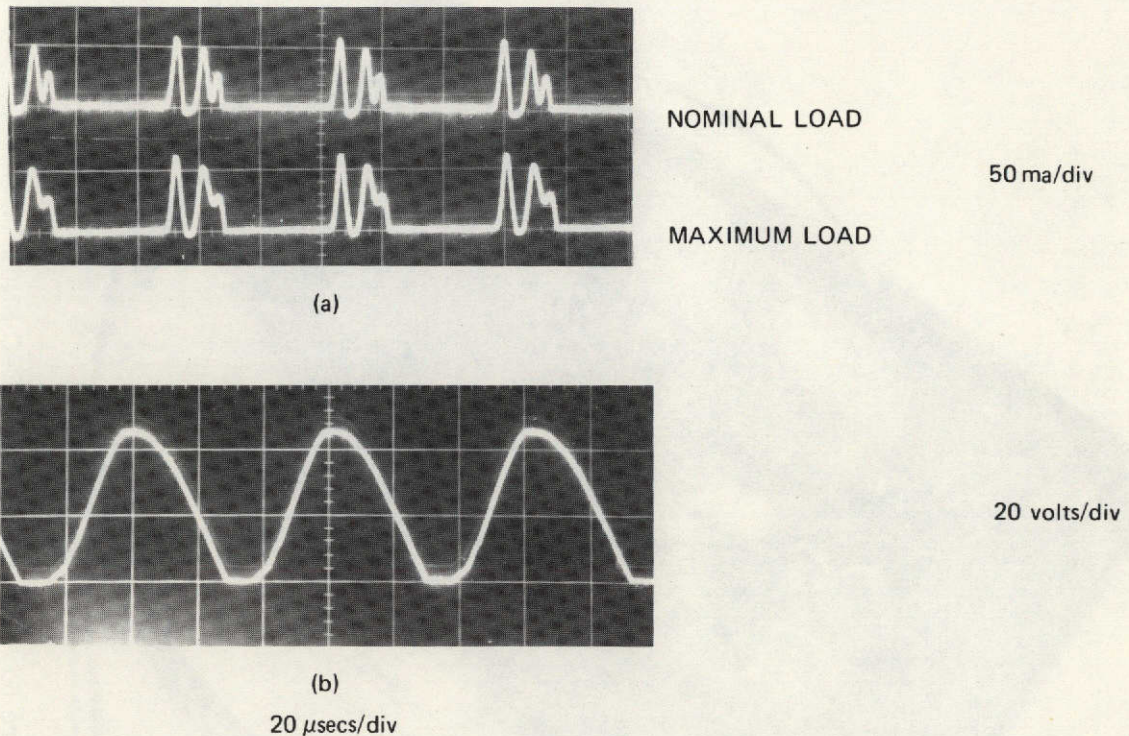
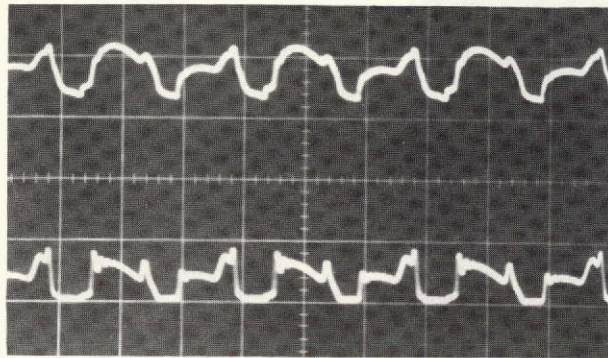

Figure 6. (a) Q4 Collector Current and (b) Q4 Emitter to Collector Volts

Figure 7 shows Q5 emitter current and collector to ground voltage for maximum load at the three output levels.

Figure 8 shows the monitor voltage output as the high voltage is switched up and down through its three levels. The monitor voltage is approximately  $1 \times 10^{-3}$  times the output voltage.

Figures 9 and 10 show typical waveforms for the AE-D high power version SN01. Figure 9 shows Q8 collector current at nominal (50 microamperes) and maximum (100 microamperes) load at 3950 volts output.



0 volts

3700 volts out

10 volts/div

10 ma/div

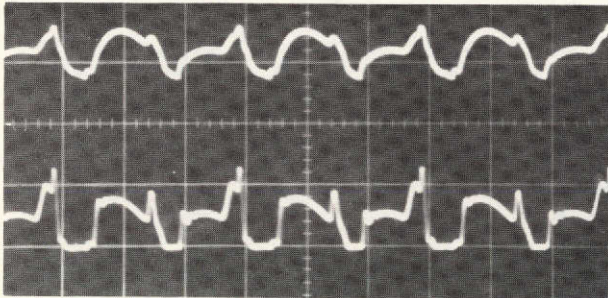

0 volts

3950 volts out

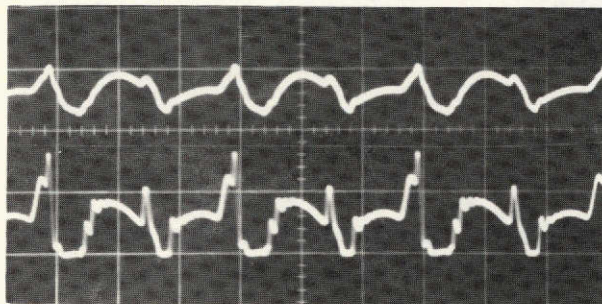

0 volts

4200 volts out

20  $\mu$ secs/div

Figure 7. Q5 Emitter Current (Bottom Trace in Each Photo) and Collector to Ground Voltage for Maximum Load at the Three Output Levels

REPRODUCIBILITY OF THE  
ORIGINAL PAGE IS POOR

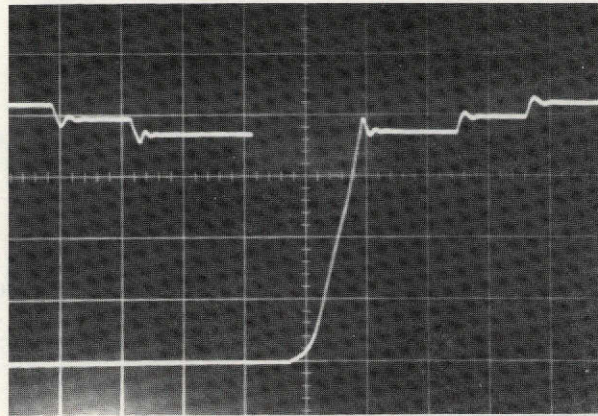

1 sec/div

Figure 8. Monitor Voltage Output Change as High Voltage is Switched Up and Down Through Its Levels

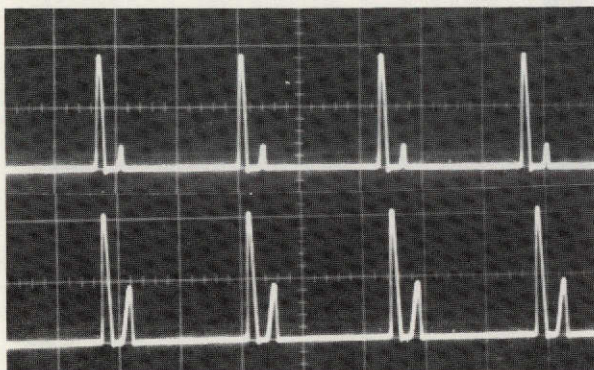

NOMINAL LOAD

200 ma/div

MAXIMUM LOAD

20  $\mu$ secs/div

Figure 9. Q8 Collector Current at Nominal and Maximum Load

Figure 10 (a) and (b) show Q5 emitter current and collector to ground voltage for maximum load at the three high voltage output levels.

Circuit efficiency for the two designs at maximum load and 3950 volts out was:

AE-C: 70.4%

AE-D: 51.7%

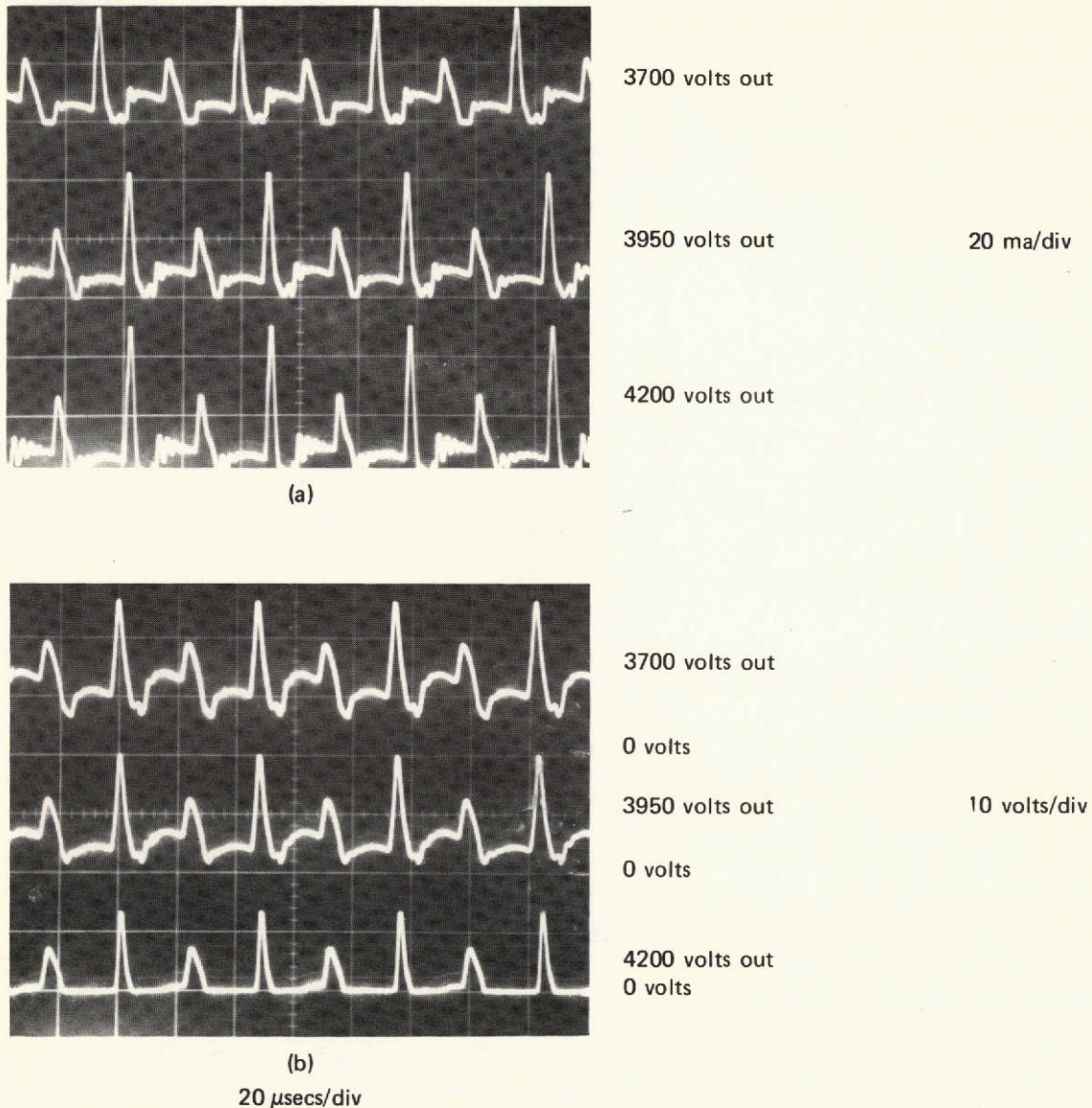

Figure 10. (a) Q5 Emitter Current and (b) Q5 Collector to Ground Voltage at the Three High Voltage Output Levels

The higher efficiency was realized in the former case because a substantial amount of its power output was at 22.5 volts. Input current at maximum load and 3950 volts out was around 21 milliamperes for the low power unit and 28 milliamperes for the high power unit.

Figure 11 shows the output voltage regulation for the AE-C unit, SN02. These curves are typical of all the units. The curves show the output as a function of

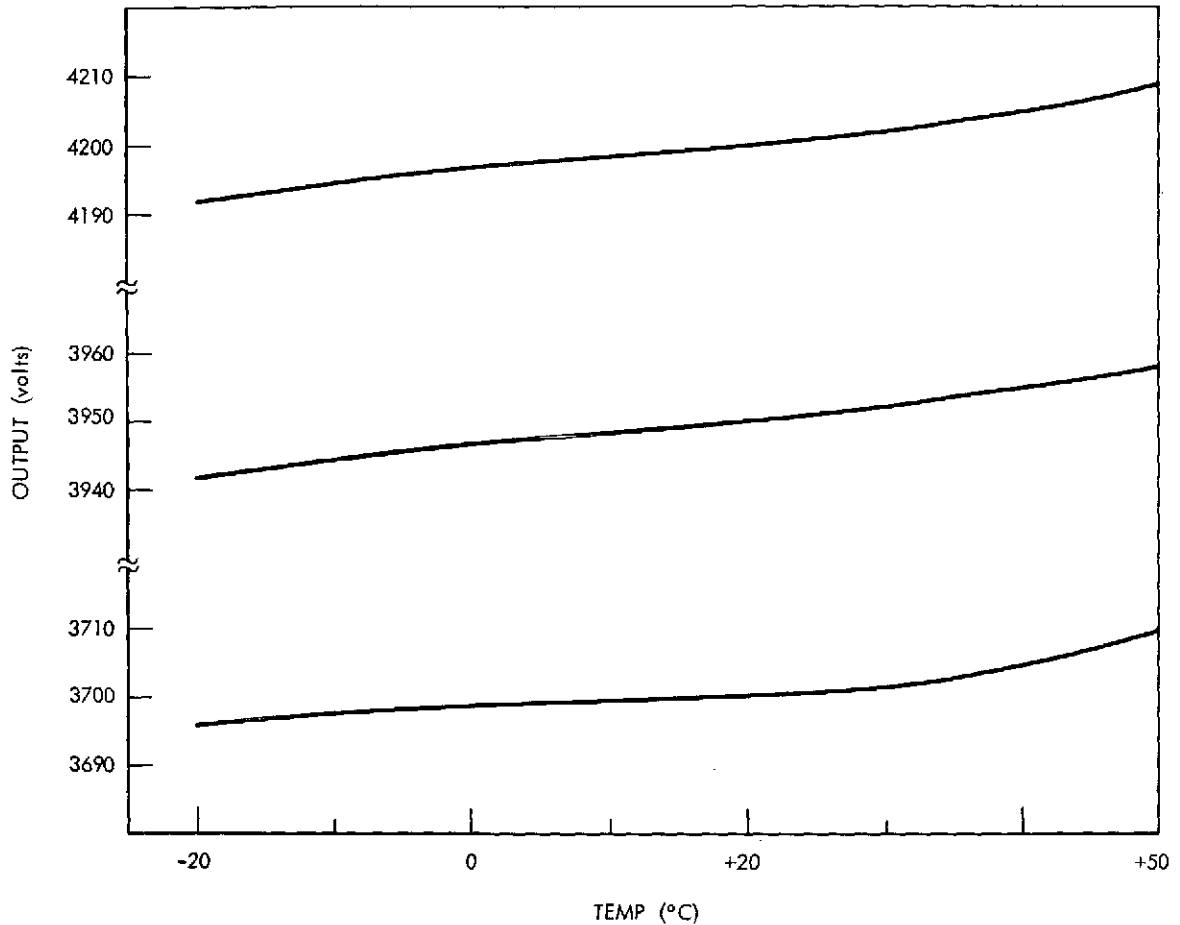

Figure 11. Output Voltage as a Function of Temperature

temperature. There was negligible change in output with load from no load to full load. Regulation on all units was better than 0.5% under all conditions. This was achieved using no high stability (temperaturewise) parts other than the reference zeners CR3 and CR24. However, each unit had to be individually temperature compensated.

Figure 12 shows the monitor output on the AE-C SN02 unit as a function of temperature and high voltage output. These curves would vary from unit to unit, depending on particular temperature coefficients.

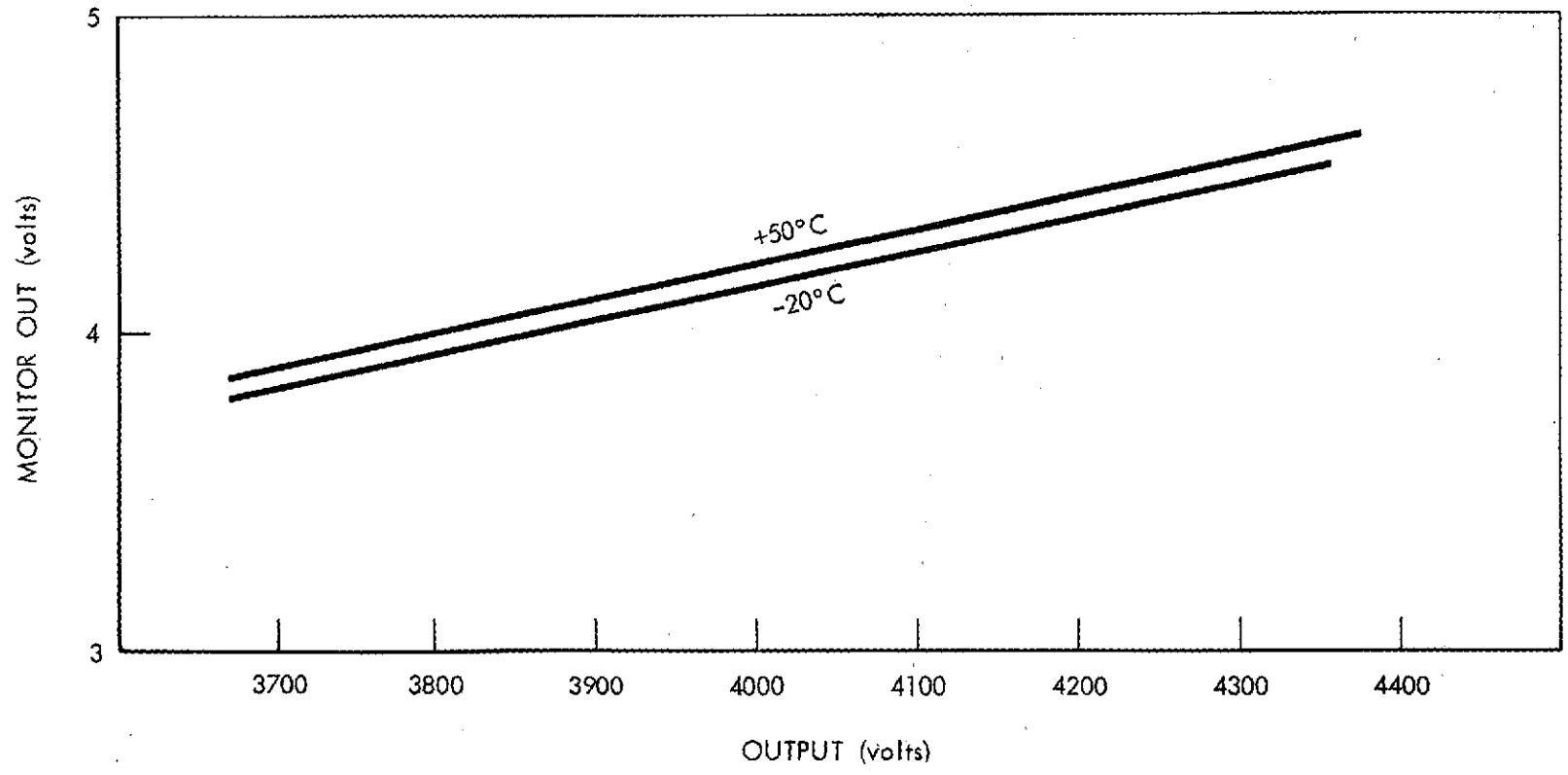

Figure 12. Monitor Output Voltage as a Function of Temperature and High Voltage Output

## APPENDIX A

### HIGH VOLTAGE MATERIALS AND COMPONENTS

- Potting Material:** Dow Corning 93500 silicone. Used in all four boxes only.
- Capacitors:** Centralab Electronics general purpose ceramic high voltage disc capacitors, type CJ encapsulated with Hysol XDK-R123. The multiplier stack uses 8200 pf @ 2 kv and the RC filter uses 1000 pf @ 6 kv. All units screened in house.
- Resistors:**
- (a) Feedback Divider - Victoreen metal oxide high voltage resistors. 470 megohm mox 1125 and 2.2 megohm mox 400.
  - (b) RC Filter - Allen Bradley carbon 5% 1/2 watt. All units screened in house.
- High Voltage Wire:** Tensolite Insulated Wire Co. coaxial 24 gauge shielded conductor. This cable has a double layer of Kapton H film between the inner conductor and the shield, and a single layer around the outside of the shield. This wire has been tested to 10,000 volts in hard and partial vacuum, and can be safely rated at 5000 volts.
- Shield Boxes:** Custom made with 40 mil General Electric Lexan polycarbon. After construction the boxes are copper plated and gold flashed.
- Diodes:** Semtech Corp. silicon rectifiers "Metoxilite Ministac." F25 rated at 2500 volts. Used in multiplier stack. These devices were screened in house. In the future, all high voltage diodes will be ordered to GSFC Specification 73-15077 "Screening Specification For Low Power, High Voltage Rectifiers."



APPENDIX B  
MAGNETIC COMPONENT DESIGN

L1: Magnetics Powder Permalloy 55117-A2  
N<sub>1-2</sub> - 335 turns      AWG 34

AE-C

T1: Ferroxcube 1811PA400-3B7 Pot Core  
N<sub>1-2</sub> - 80 turns      AWG 34  
N<sub>3-4</sub> - 15 turns      AWG 34  
N<sub>5-6</sub> - 375 turns      AWG 36  
N<sub>7</sub> - ground lead      AWG 34

Winding N<sub>5-6</sub> is put on the bobbin first. A conductive shield is placed over this winding and terminal N<sub>7</sub> soldered to it. Then remainder of turns are put on bobbin.

T2: Ferroxcube 2213L00-3B7 Pot Core  
N<sub>1-2</sub> - 206 turns      AWG 34  
N<sub>3-4</sub> - 880 turns      AWG 38

Winding N<sub>3-4</sub> is put on the bobbin first. Insulation tape is put on every 200 turns or so, and then over the entire winding. The last 2 or 3 turns on each end uses AWG 34 wire for strength. Winding N<sub>1-2</sub> is then put on the bobbin with insulating tape over.

AE-D

T1: Ferroxcube 1811PA400-3B7 Pot Core  
N<sub>1-2</sub> - 40 turns      AWG 33  
N<sub>3-4</sub> - 8 turns      AWG 34  
N<sub>5-6</sub> - 190 turns      AWG 34  
N<sub>7</sub> - ground lead      AWG 34

T2: Ferroxcube 2213L00-3B7 Pot Core  
N<sub>1-2</sub> - 200 turns      AWG 34  
N<sub>3-4</sub> - 900 turns      AWG 38

Both these cores are wound in the same fashion as for AE-C.

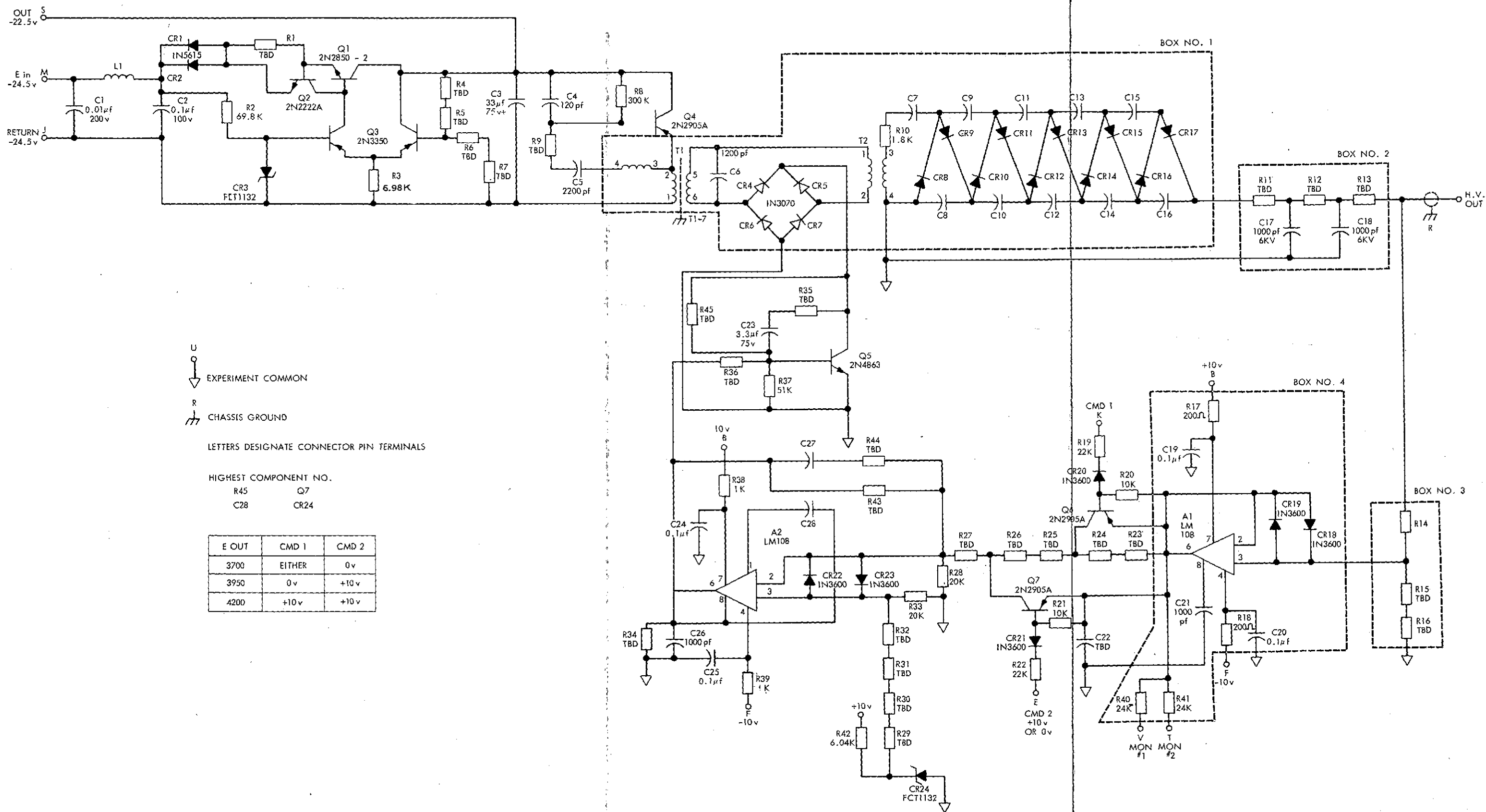

Figure 1. Complete Schematic, AE-C Design

FOLDOUT FRAME

FOLDOUT FRAME