

NASA CONTRACTOR
REPORT



NASA CR-2419

NASA CR-2419

CASE FILE
COPY

VAMP: A COMPUTER PROGRAM
FOR CALCULATING VOLUME,
AREA, AND MASS PROPERTIES
OF AEROSPACE VEHICLES

by P. J. Norton and C. R. Glatt

Prepared by
AEROPHYSICS RESEARCH CORPORATION
Hampton, Va. 23666
for Langley Research Center



NATIONAL AERONAUTICS AND SPACE ADMINISTRATION • WASHINGTON, D. C. • SEPTEMBER 1974

1. Report No. NASA CR-2419		2. Government Accession No.		3. Recipient's Catalog No.	
4. Title and Subtitle VAMP - A Computer Program for Calculating Volume, Area, and Mass Properties of Aerospace Vehicles.				5. Report Date September 1974	
				6. Performing Organization Code	
7. Author(s) P. J. Norton and C. R. Glatt				8. Performing Organization Report No. LTN-10	
				10. Work Unit No.	
9. Performing Organization Name and Address Aerophysics Research Corporation P.O. Box 7007 Hampton, Virginia 23666				11. Contract or Grant No. NAS 1-12008	
				13. Type of Report and Period Covered Contractor Report	
12. Sponsoring Agency Name and Address National Aeronautics and Space Administration Washington D. C. 20546				14. Sponsoring Agency Code	
15. Supplementary Notes Topical Report					
16. Abstract A computerized procedure has been developed for analyzing the geometric and mass properties of aerospace vehicles. The procedure evaluates the properties of elemental surface areas with specified thickness. These properties are accumulated and combined with arbitrarily specified mass elements to form a complete evaluation. Picture-like images of the geometric description can be generated.					
17. Key Words (Suggested by Author(s)) Design, Weight, Mass Properties, Graphics, ODIN				18. Distribution Statement Unclassified - unlimited STAR Category 31	
19. Security Classif. (of this report) Unclassified		20. Security Classif. (of this page) Unclassified		21. No. of Pages 128	22. Price* \$4.75

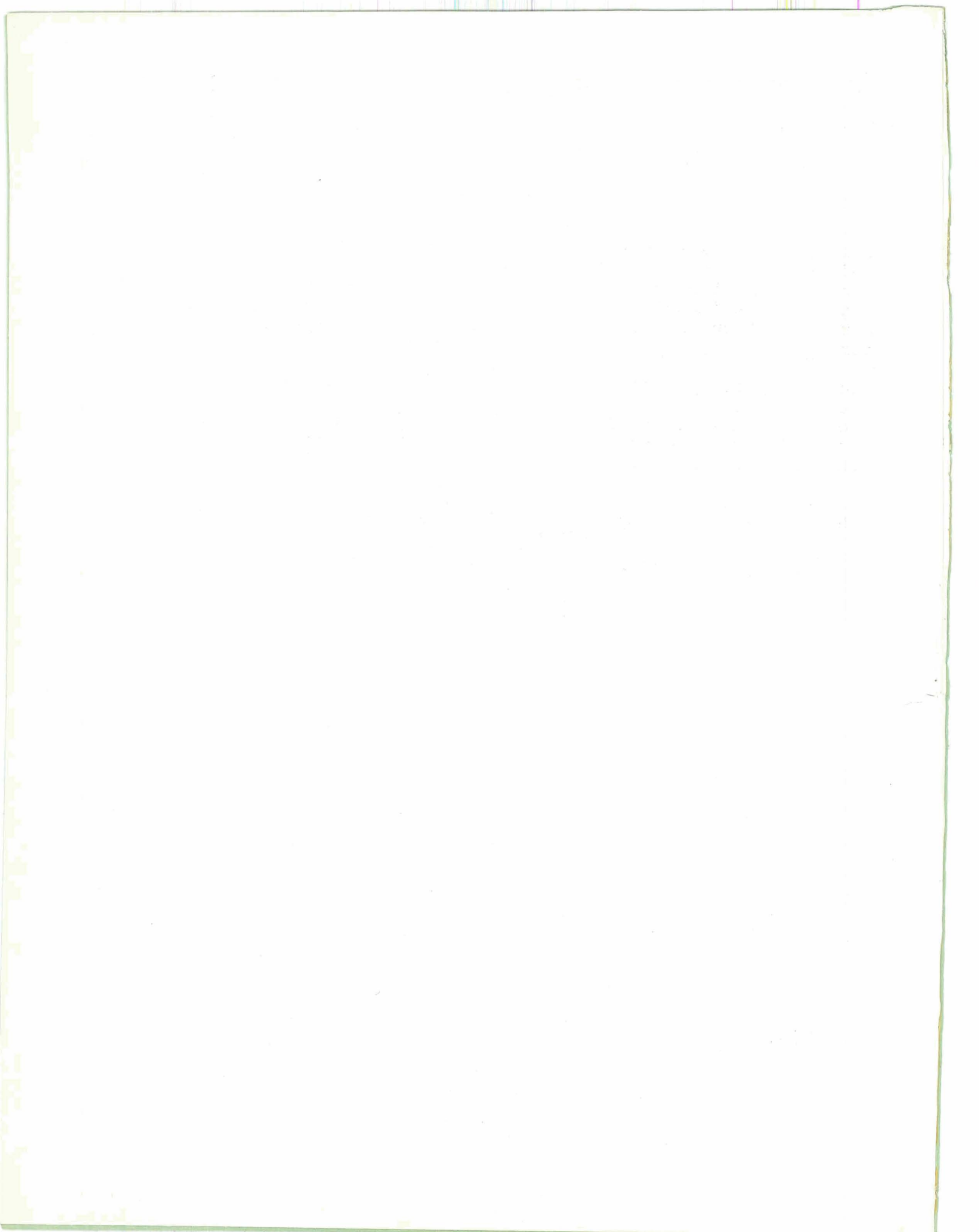

PREFACE

This report was prepared for Contract NAS 1-12008, Expansion and Extension of the ODIN/RLV Computer Program - Task 2, Evaluate and Improve the Existing ODIN Program Library. The contract was funded by the National Aeronautics and Space Administration, Langley Research Center, Space Systems Division.

The ODIN procedure is a design analysis technique which allows the use of existing computer codes as part of a larger simulation. Communication of information among computer codes is accomplished by means of a data base repository accessible and managed by the ODIN executive computer code, DIALOG.

The objective of the contract task was the improvement of the VAMP program and incorporation into the ODIN library. The original development on the VAMP computer code was performed by LTV Aerospace Corporation under contract to NASA.



CONTENTS

	Page
SUMMARY.....	1
INTRODUCTION.....	2
VOLUME, AREA AND MASS PROPERTIES ANALYSIS.....	4
Surface Model.....	5
Mass Properties of a Triangular Surface Element.....	7
Transformation Matrix for Triangle Elements.....	9
Mass Properties of the Surface.....	12
Area Calculations.....	13
Volume Calculations.....	13
Black Box Contributions to the Mass Properties.....	14
Configuration Plotting.....	16
PROGRAM USAGE.....	21
Control Cards.....	21
General Input Procedure.....	24
Title Card.....	24
\$SHAPE Input Set.....	24
\$BLKBOX Input Set.....	27
Plotting Information.....	27
Input Flow Logic.....	27
Configuration Shape Data.....	32
Input Specifications for the \$SHAPE Input Set.....	32
Auxiliary Geometry Input.....	41
Auxiliary Density/Thickness Input.....	45
Auxiliary Surface Weight Input.....	45
Black Box Data.....	47
Input Specification for the \$BLKBOX Input Set.....	47
Plotting Data.....	50
Orthographic Projections.....	50
Plan, Elevation and Rear Views (Stacked).....	52
Perspective View.....	52
Stereo Frames Suitable for Viewing in a Stereoscope.....	54
Use of VAMP within ODIN.....	54
PROGRAM OUTPUT.....	56
Configuration Data Output.....	56
Black Box Data Output.....	57
Configuration Plot Data Output.....	58
ODIN Output.....	59
CONCLUSIONS.....	66
REFERENCES.....	67
SAMPLE PROBLEM.....	69

LIST OF FIGURES

Figure Number		Page
1	TYPICAL THREE-VIEW FROM VAMP.....	18
2	TYPICAL ORTHOGRAPHIC PROJECTION WITH HIDDEN LINES INCLUDED.....	20
3	ILLUSTRATION OF VAMP DECK SETUP.....	22
4	ILLUSTRATIONS OF CONTROL CARDS REQUIRED FOR VAMP.....	23
5A	\$SHAPE INPUT LIST.....	25
5B	\$SHAPE INPUT LIST (Continued).....	26
6	\$BLKBOX INPUT LIST.....	28
7A	INPUT FLOW LOGIC.....	29
7B	INPUT FLOW LOGIC (Continued).....	30
8	INPUT GEOMETRY OPTIONS.....	33
9	INPUT REQUIREMENTS FOR WING GEOMETRY...	38
10	ILLUSTRATION OF DIGITIZER INPUT DATA...	44
11	AUXILIARY INPUT SETUP FOR DENSITY/ THICKNESS.....	46
12	ODIN DATA BASE OUTPUT FOR SEGMENT 1 - FUSELAGE.....	60
13	ODIN DATA BASE OUTPUT FOR SEGMENT 2 - WING.....	61
14	ODIN DATA BASE OUTPUT FOR ONE (1) BLACK BOX.....	63

LIST OF SYMBOLS

A	Area
A_p	Projected Area
B	Base of triangular element
BX	X-projection of the base of the triangular element
BY	Y-projection of the base of the triangular element
BZ	Z-projection of the base of the triangular element
C	Offset of the vertex of a triangular surface element
CV	Center of volume
D	One side of a triangular surface element
DC	Matrix of direction cosines of a triangular surface element
DX	X-projection of the D-side of a triangular surface element
DY	Y-projection of the D-side of a triangular surface element
DZ	Z-projection of the D-side of a triangular surface element
H	Thickness of a triangular surface element
i	Element index in a section plane
J	Element index of sections
I_{xx}	Moment of inertia (x-axis)
I_{yy}	Moment of inertia (y-axis)
I_{zz}	Moment of inertia (z-axis)
I_{xy}	Product of inertia (x-y plane)
I_{yz}	Product of inertia (y-z plane)
I_{zx}	Product of inertia (z-x plane)
PMI	Inertia matrix centered at a triangular element c.g.
PMIP	Inertia matrix centered at the reference system axes.
V	Enclosed volume of elements.
X	Measure of distance in the X direction
XO	X coordinate of the Jth section
XBR	Y coordinate of the base of the triangular element.

XPX	Component of unit vector in the DC matrix
XPY	Component of unit vector in the DC matrix
XPZ	Component of unit vector in the DC matrix
x	Local (triangle) x-axis
Y	Measure of distance in the Y direction
YO	Y coordinate of (I, J) element
YBR	Y coordinate of the base of the triangular element
YPX	Component of unit vector in the DC matrix
YPY	Component of unit vector in the DC matrix
YPZ	Component of unit vector in the DC matrix
y	Local (triangle) y-axis
Z	System reference axis
ZO	Z-coordinate of (I, J) element
ZBR	Z-coordinate of the base of the triangular element
ZPX	Component of unit vector in the DC matrix
ZPY	Component of unit vector in the DC matrix
ZPZ	Component of unit vector in the DC matrix
Z	Local (triangle) y-axis

VAMP: A COMPUTER PROGRAM FOR CALCULATING VOLUME,
AREA, AND MASS PROPERTIES OF AEROSPACE VEHICLES.

by

P. J. Norton - LTV Aerospace Corporation

and

C. R. Glatt - Aerophysics Research Corporation

SUMMARY

This document describes a method and computer program for the calculation of the mass properties, c.g. location, enclosed volume, wetted area and planform area of any closed structure that has a plane of symmetry. The vehicle is described to the computer program by ordered sets of X, Y, Z coordinates of points on its surface. The X, Y, Z coordinates are converted to quadrilateral elements for analysis. The mass properties of each quadrilateral may be computed from a thickness and density input for each quadrilateral or from a weight per unit area input at each point or from a combination of both. The weight per unit area can be a composite of the real wall including skin, insulation, ribs, stringers, standoffs, brackets, etc.

The mass properties of the quadrilateral elements are accumulated for each section of the vehicle and for the total vehicle. The computed mass property totals may contain not only the contribution from the distributed mass on the vehicle surface wall, but additional masses may be added as "black boxes" by specifying each one's c.g. location and mass properties. The added black boxes may be inside or outside the surface and do not have to be symmetrical with respect to X-Z plane.

Program VAMP (Volume, Area and Mass Properties) can produce picture-like images of the vehicle or individual sections from the quadrilateral element data. This facilitates checking the input and visualizing new/or modified configurations. Orthographic, perspective and stereo views may be obtained.

The VAMP program has been integrated into the ODIN (Optimal Design Integration) Library of programs so that any selected mass properties data can be stored in a common data base for use by other programs. Alternately, VAMP may accept data from the common data base as input to the program.

INTRODUCTION

The estimation of the mass properties of a vehicle is one of the most important considerations in the design process and yet one of the most inexact engineering endeavors. While the calculation of aerodynamic, propulsion and mission performance are based on widely recognized mathematical prediction techniques, the estimation of weight must be based largely on historical data. The art of weight estimation has evolved through the years by the diligent collection and correlation of component weights of previously built vehicles. New design weights are predicted on the basis of the component weights of past designs. Little information is usually available on the other properties such as volume, area, center of gravity and inertia of the components. Even for "weights only" calculation, historical methods lack validity in predicting advanced state-of-the-art design data. Further, the influence of small design perturbations eludes such gross prediction methods.

During the later design phases when detail structured analyses are available for some components, the weights engineer must still revert to empirical analysis methods for subsystem and secondary structure weights such as wing leading edges, canopies, fairings, etc.

Existing programs such as references 1 through 6 lean heavily on the historical approach for weight estimating. To obtain more reliable information, the designer must turn to structural analysis and subsystem design programs such as references 7 through 13. The detailed geometry descriptions required for these classes of analyses are usually not known until the later design phases. At this later phase the design is usually frozen and little geometric perturbation is allowed. Further, small perturbation analysis using these programs is very expensive in terms of manpower and computer resources.

Although the precise weight and other properties of the vehicle components are illusive, or at best a very complex calculation, mathematical equations for combining the components mass properties into total vehicle mass properties are quite concise. Mass property evaluations for the total vehicle as well as perturbations due to added or deleted masses are easily determined once the mass properties of all the components are known (or assigned).

The program VAMP (for Volume Area and Mass Properties) is designed to bridge the gap between the historical weight approach and the detailed structural analysis approach. VAMP computes the volume, area and mass properties based on a surface model and a surface unit distribution of mass. Any number of surface models or sections may be described. The program maintains an accounting of the properties of each component and can accumulate the properties of all vehicle sections. The accumulated section properties can be combined with the properties of arbitrary specified masses (black boxes).

The original development on the VAMP computer code was performed by Mr. Patrick Norton under contract to NASA. Robert T. Wingate served as contract monitor. Mr. Phillip J. Klich, also of NASA, made significant contributions to the development and final checkout of the VAMP computer program. VAMP was later modified for use in the ODIN system and has since been used extensively in design analysis studies at NASA/Langley Research Center.

The significant contribution of the VAMP program development to the general problem of computer aided design is twofold. First, the program offers a unified approach to the accounting of the vehicle component mass properties. The fact that a component weight is not well known does not exclude it from being analyzed in a mass properties evaluation. Furthermore, detailed mass properties of some vehicle components may be determined elsewhere and still be included in the VAMP analysis. Second, the distributed mass surface model incorporated in VAMP allows a very convenient means of producing vehicle geometric perturbations early in the design process with some degree of confidence in the relative affect of the perturbation. As more detailed information on the design becomes available, the component input to VAMP may be gradually replaced without distruction of the overall continuity of the weights analysis.

VOLUME, AREA AND MASS PROPERTIES ANALYSIS

The mathematical modeling of the VAMP program permits the calculation of the mass properties, c.g. locations, enclosed volume, wetted area and planform area of any closed structure that has a plane of symmetry, e.g. fuselage, stiffened fuel tank, etc. The vehicle is described in a symmetrical manner and consists of sets of X, Y, Z coordinates on its surface. The surface coordinates are converted to quadrilateral elements but since the four corners of the quadrilaterals are not necessarily coplanar, each quadrilateral is analyzed as two triangles. The mass properties are computed from a thickness and density input for each quadrilateral, from a weight per unit area input at each point, or from a combination of both. The weight per unit area can be a composite of the real wall including skin, insulation, ribs, stringers, standoffs, brackets, etc.

The elemental mass properties are accumulated for each section and for the total vehicle. The computed mass property totals containing the contribution from the distributed mass in the vehicle surface wall may be combined with additional masses specifying each one's c.g. location and mass properties about its c.g. The added black boxes may be inside or outside the surface and do not have to be symmetrical.

The properties of the vehicle computed by the program are:

1. Weight
2. Coordinates of the c.g.
3. Three mass moments of inertia plus I_{XZ} about both the reference axes and axes through the c.g. parallel to the reference axes.
4. Surface area.
5. Enclosed volume.
6. Coordinates of the c.v.
7. Projected area.

These properties are output for each segment along with cumulative totals and complete vehicle values.

Surface Model

The numerical model of the surface shape to be analyzed is described by quadrilateral elements. Each quadrilateral element consists of a grouping of four surface points. An organized set of quadrilateral elements form a segment of the configuration. A number of segments may be used to provide a complete description of the configuration.

The configuration is usually (but not necessarily) positioned with its nose at the coordinate system origin and with the length of the body stretching in a positive X-direction. The coordinate system used for this program is the right hand Cartesian system as illustrated below:

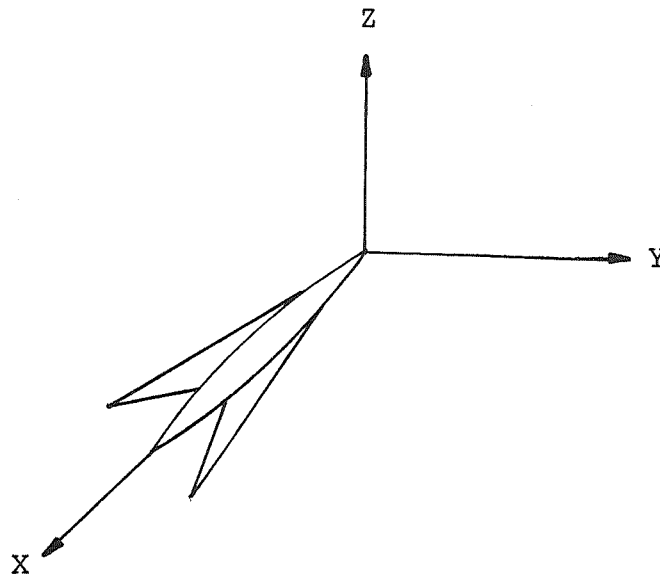

The configuration is assumed symmetrical about the X-Z plane, and the analysis accounts for the plane of symmetry.

The configuration may consist of an arbitrary number of wing and body sections. The body sections are described in the positive half plane perpendicular to the plane of symmetry. The wings are described as airfoil sections parallel to the plane of symmetry. Canards and horizontal stabilizers are described similar to wings. Fins cannot be described as airfoil sections but they may be described as body sections.

Points along the X-axis are referred to as station coordinates. A Y-Z plane is a station plane. The Y-Z coordinates in the station plane form a station contour.

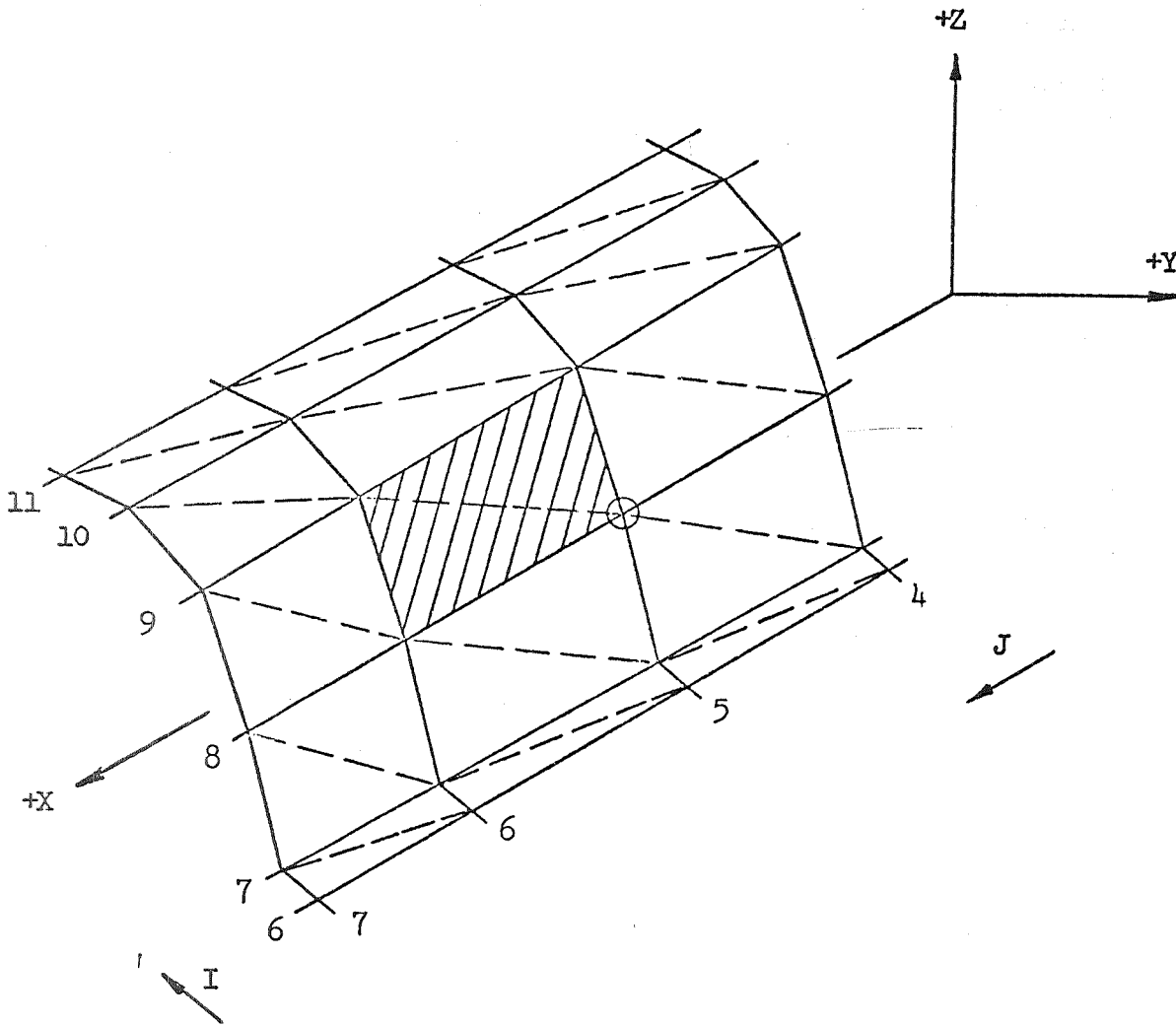

A portion of the mathematical surface model is presented in the illustration above. The X,Y,Z coordinates of the points where the solid grid lines cross are described to the program. Each point (I,J) is associated with a station number J and a contour point I. Thus, the circled point is 8,5 and it has coordinates $X_5; Y_{8,5}; Z_{8,5}$. The model

groups the surface points into quadrilateral elements which also have unique I,J identification. The crosshatched one is 8,5 corresponding to its lowest numbered corner. The dashed diagonals illustrate the division of each quadrilateral into two triangles for analysis.

Airfoil sections are described in a similar manner as the body sections above. In the case of airfoil section, the parts are described in X-Z planes parallel to the plane of symmetry.

The objective in the analysis is to calculate the properties of each quadrilateral (two triangles) elements and transform the results back to the reference coordinate system, then accumulate the properties from all elements of the surface.

Mass Properties of a Triangular Surface Element. - The triangular surface element illustrated below with its base a station J and apex at J+1 is assumed to be of uniform thickness and homogeneous.

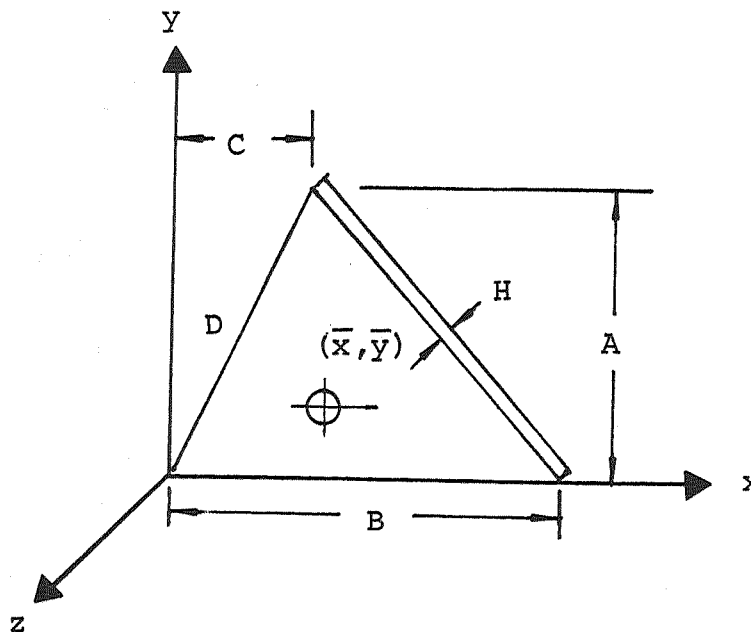

As viewed from the outside of the vehicle, the local x,y,z coordinate system has its origin at (I,J). The x-y plane is coincidental with the plane of the triangle. \bar{A} is the height of the triangle. \bar{B} is the base of the triangle.

C is the offset of the apex from the y-axis. H is the thickness which is assumed to be small compared to A, B and C.

The area, S of this elemental triangle is:

$$S = AB/2 \quad (1)$$

The first moments of inertia for the same triangle are:

$$S_x = \rho HS(B+C)/Z \quad (2)$$

$$S_y = \rho HSA/2 \quad (3)$$

$$S_z = 0 \quad (4)$$

The second moments of inertia for the elemental triangle are:

$$I_{xx} = \rho HA^2S/6 \quad (5)$$

$$I_{yy} = \rho H(B^2+BC+C^2)S/6 \quad (6)$$

$$I_{zz} = I_{xx} + I_{yy} \quad (7)$$

Where ρ is the density of the thin triangle. Finally, the products of inertia are:

$$I_{xy} = \rho H(B+2C)AS/12 \quad (8)$$

$$I_{yz} = 0 \quad (9)$$

$$I_{xz} = 0 \quad (10)$$

The coordinates of the centroid (center of gravity) of the triangular element are:

$$\bar{x} = (B+C)/3 \quad (11)$$

$$\bar{y} = A/3 \quad (12)$$

The transformation of the inertias and products of inertia to the centroid yield:

$$\bar{I}_{xx} = SA^2/18 \quad (13)$$

$$\bar{I}_{yy} = X(B^2 - BC + C^2)/18 \quad (14)$$

$$\bar{I}_{xy} = SA(ZC - B)/36 \quad (15)$$

$$\bar{I}_{zz} = \bar{I}_{xx} + \bar{I}_{yy} \quad (16)$$

Transformation Matrix for Triangle Elements. - The mass properties above are given for a simple triangular element in the local x, y, z coordinate system. The elemental mass properties must be transformed to the reference coordinate system X, Y, Z for cummulation with other elements. The transformation from the primary X, Y, Z coordinate system to the local system is given by:

$$\begin{bmatrix} x \\ y \\ z \end{bmatrix} = [DC] \begin{bmatrix} X - XO \\ Y - YO \\ Z - ZO \end{bmatrix} \quad (17)$$

Where XO, YO, ZO are the coordinates of the prime system origin with respect to same arbitrary reference point and DC is a matrix of direction cosines. The elements of DC are:

$$[DC] = \begin{bmatrix} XPX & XPY & XPZ \\ YPX & YPY & YPZ \\ ZPX & ZPY & ZPZ \end{bmatrix} \quad (18)$$

For a unit vector in the x direction, XPX is the projection of x on X , XPY is the projector of x on Y , etc. The vertices of the triangular element in local x, y, z coordinates may be considered as vectices B and D , drawn from the origin $(0,0,0)$. The components of B and D are developed as follows. That is, BX is the X component of B and DY is the Y component of D , etc. Therefore:

If: $XO = X(J)$ (19)

$YO = Y(I,J)$ (20)

$ZO = Z(I,J)$ (21)

Then: $BX = 0.0$ (B lies in YZ Plane) (22)

$BY = Y(I+1,J) - YO$ (23)

$BZ = Z(I+1,J) - ZO$ (24)

$DX = X(J+1) - XO$ (25)

$DY = Y(I+1,J+1) - YO$ (26)

$DZ = Z(I-1,J-1) - ZO$ (27)

The cross product of B with D is a vector $\overline{S2}$ in the z direction. Its magnitude is twice the surface area of the triangle. Let SX,SY and SZ be the components of S2. Since BX = 0, the cross product yields:

$SX = BY*DZ - DY*BZ$ (28)

$SY = BZ*DX$ (29)

$SZ = -DX*BY$ (30)

Let B, D, S2 represent the magnitude of their respective vectors. Then $\overline{B}/B =$ unit vector in x direction and $\overline{S2}/S2 =$ unit vector in z direction.

It follows:

$\overline{S2}/S2$ cross $\overline{B}/B =$ unit vector in y direction (31)

The components of each unit vector are a row in the matrix DC. Therefore:

$XPX = BX/B = 0.0$ (32)

$XPY = BY/B$ (33)

$XPZ = BZ/B$ (34)

$ZPX = SX/S2$ (35)

$ZPY = SY/S2$ (36)

$ZPZ = SZ/S2$ (37)

$YPX = ZPX*XPZ - XPY*ZPZ = DX/A$ (38)

$$YPY = XPZ * ZPX \quad (39)$$

$$YPZ = ZPX * XPY \quad (40)$$

The preceding steps considered a triangle with its base on J and apex on J+1. The other half of each quadrilateral has its base on J+1 and vertex on J. The vertices are identified as follows:

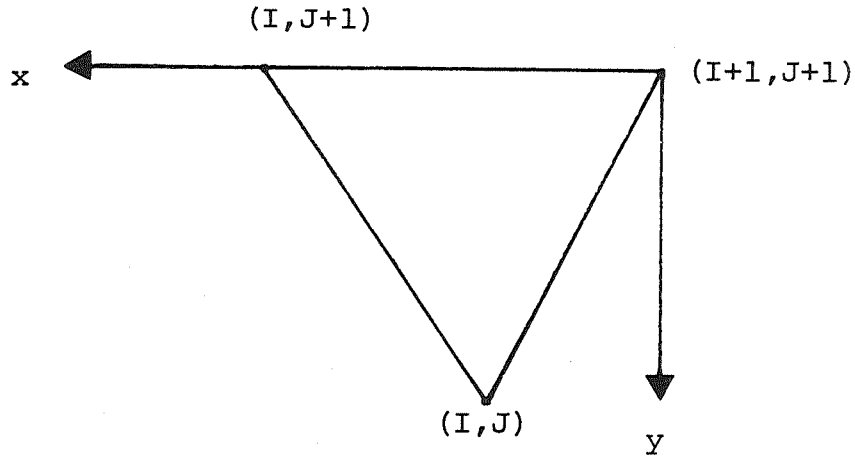

The analysis for the inverted triangle is similar to the upright triangle. The only difference is in equations (13) through (21). For the inverted triangle,

$$XO = X(J+1) \quad (41)$$

$$YO = Y(I+1, J+1) \quad (42)$$

$$ZO = Z(I+1, J+1) \quad (43)$$

$$BX = 0.0 \quad (44)$$

$$BY = Y(I, J+1) - YO \quad (45)$$

$$BZ = Z(I, J+1) - ZO \quad (46)$$

$$DX = X(J) - XO \quad (47)$$

$$DY = Y(I, J) - YO \quad (48)$$

$$DZ = Z(I, J) - ZO \quad (49)$$

The above analysis is similar for airfoil type sections described in the x-z plane.

Mass Properties of the Surface. - The c.g. and mass properties expressions for a triangle are given in the previous section. The triangular element parameters A and B have been developed above and are always positive. Now $C^2 = D^2 - A^2$ but C can be negative. However, C and its sign are given directly by the dot product of D with the unit vector in the x direction.

$$C = DY*XPY+DZ*XPZ \quad (50)$$

The resulting c.g. coordinates are in the x, y, z system and the inertias are about axes through the c.g., parallel to the prime system. They are transformed to the system reference axes as follows:

$$\begin{bmatrix} XBR \\ YBR \\ ZBR \end{bmatrix} = \begin{bmatrix} XO \\ YO \\ ZO \end{bmatrix} + [DC]^{-1} * \begin{bmatrix} \bar{X} \\ \bar{Y} \\ \bar{Z} \end{bmatrix} \quad (51)$$

This is readily expanded since the inverse of DC is identical to its transpose. The products and moments of inertia parallel to the prime axes are assembled in PMIP:

$$PMIP = \begin{bmatrix} I_{XX} & -I_{XY} & -I_{XZ} \\ I_{XY} & -I_{YY} & -I_{YX} \\ I_{XZ} & -I_{YZ} & -I_{ZZ} \end{bmatrix} \quad (52)$$

The minus signs on the products of inertia are a consequence of the coordinate system definition. This places the matrix PMIP in tensor form. It can be shown that the inertias are rotated parallel to the system axes by:

$$[PMI] = [DC]^T * [PMIP] * [DC] \quad (53)$$

PMI contains the inertias about axes parallel to the system reference axes, but centered on the triangle's c.g. Translation to the system origin makes use of the parallel axis theorem along with XBR, YBR, ZBR computed above, and is included with the summation procedure described in the next paragraph. The products of inertia contained in PMI are the negative of their engineering definition, like they are in PMIP.

In the VAMP analysis, all values in PMI are twice the true value since $S_2 =$ twice the area of the triangle, S_2 has been retained through all the computations. But each triangle has a symmetrical counterpart on the other side of $Y = 0$ whose contribution to the total is either equal or equal-and-opposite. In the latter case, the resultant is zero; i.e., $I_{XY} = I_{YZ} = 0.0$.

Area Calculations. - The surface area and projected area result from the summation of the elemental areas from the above analyses. The surface area is:

$$A = 1/2 \sum S_{2_i} \quad (54)$$

S_2 is twice the elemental area and the projected area (on the y-z plane) is:

$$A_p = 1/2 \sum SY_i \quad (55)$$

Volume Calculations. - The elemental volume of a surface element is the projection of the elemental area on the x-y plane multiplied by the average distance to the c.g. of the element. The total volume is:

$$V = \sum \bar{x}_i \cdot ZPX_i \cdot A_i \quad (56)$$

The sign of the direction cosine accounts for whether the elemental volume is added or subtracted.

The center of volume is simply:

$$CV = \frac{1}{V} \sum \bar{X}_i^2 ZPX_i A_i$$

The above calculations are approximate because of the assumption that the c.g. of the element is an adequate approximation for the entire elemental surface. The assumption is reasonable for small elements but may not be valid for a gross panelling of the configuration.

Black Box Contributions to the Mass Properties

The surface model described above is suitable for describing shell structures such as tanks, skins, etc. However, the addition of mass not conforming the above model may be necessary in the complete description of the vehicle mass properties. In the VAMP analysis, additional mass sources may be added by specifying each ones center of gravity (c.g.) location and mass properties. These mass sources called "black boxes" may lie inside or outside the surface and do not have to be symmetrical with respect to the x-z plane. The VAMP program combines the detailed shape inputs and the black box data to produce the overall mass properties of the vehicle.

Black box masses are described to the program in the following manner:

1. Location of its c.g. in system reference coordinates.
2. Total weight.
3. Moments and products of inertia about local axes through its c.g.
4. Orientation of local axes relative to the system reference axes or relative to some intermediate axes.

The minimum required for a black box input is the specification of items 1 and 2. If items 3 and 4 are omitted, the moments and products of inertia are assumed to be zero and the orientation of the local axis is assumed to be coincidental with the system reference axes. The contribution of each black box is added to the cumulative totals produced by the analysis. Since the size and shape is not being specified, there is no addition to surface area or volume. Since the black boxes do not have to be symmetrical with respect to the x-z plane, $I_{XY} \neq I_{YZ} \neq 0.0$, and there can be a non-zero first moment with respect to Y.

The moments and products of inertia of each black box are input directly to PMIP (see equation 52). The program takes care of filling the upper half and adding the minus

signs. Rotation of the inertias uses equation 53. DC is obtained from input data as follows. Consider the local x,y plane:

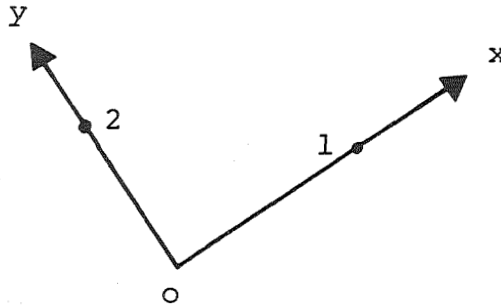

Point 0 is the origin. Points 1 and 2 are arbitrary points on the $+x$ and $+y$ axes respectively. Coordinates of these three points, measured in the system to which the inertias are being rotated, are inputs. It is a simple matter to construct unit vectors in the x and y directions and their components yield the first two rows in DC, equation 18. The third row is the cross product of these two unit vectors.

In order to construct DC, it is not necessary that point 0 be the c.g.. The coordinates x, y must be parallel to the axes to which the PMIP inputs are referenced, but rotation is performed independently of translation. After the rotation of equation 53, the inertias in PMI are still centered on the c.g. of the black box. Only the rotation takes place and the contents of PMI are moved to PMIP. Thus, it is possible to make several rotations, if needed, to reach alignment with the system reference axes. The input to the program can be developed from any convenient points on the black box and intermediate structure whose coordinates are known. The input does not always have to be in the same units as the system X,Y,Z data.

Configuration Plotting

The plotting capability in the VAMP program is based upon reference 16. The following types of plotting capability are contained in the program:

1. Three-views.
2. Orthographic, from an arbitrary viewing angle.
3. Perspective, from an arbitrary viewing angle.
4. Stereoscopic, from an arbitrary viewing angle.

The program interfaces through the CDC 6600 to the following types of equipment:

1. On-line cathode ray tube.
2. CALCOMP plotter.
3. Gerber plotter.
4. Stereoscope.

The numerical model of the aircraft configuration may include any combination of components available in the basic VAMP program. The wing is made up of airfoil sections, the body is defined by either circular or arbitrary sections. The fins must be defined similar to the fuselage, but stabilizers and canards can be defined similar to the wings. The vehicle geometric specification is converted into a set of quadrilateral panel elements in a manner similar to that described above. However, quadrilateral elements are analyzed directly rather than as two triangles.

Orthographic projections are created by rotating each point on the body surface to the desired viewing angle and then transforming the points into a coordinate system in the plane of the paper. The rotations of the body and its coordinate system to give a desired viewing angle are specified by angles of roll, pitch and yaw (ϕ , θ , ψ) using the convention below:

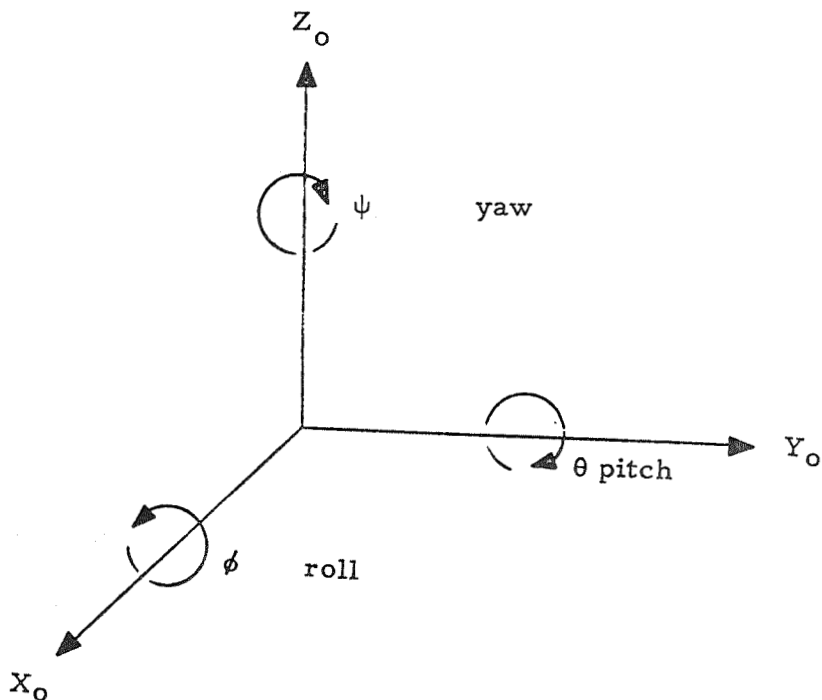

The code computes the "average" unit normal vector to each panel. The resulting set of vectors may be used to provide the capability of deleting most elements on the surface of the configuration which would not be seen by a viewer. By this device a user may remove many confusing panel elements. No provision is made for deleting components hidden by other components or for deleting portions of an element at the present time.

When three-views are requested, the plan, front and side views are provided in a compact and pleasing to the eye arrangement. An option is provided for the orthographic projections of these three-views to be spaced one above the other. A typical three-view obtained in this manner has been presented in figure 1.

The perspective views represent the projection of a given three-dimensional array. The two-dimensional view is constructed relative to a viewing point and a focal point specified by coordinate points in the data coordinate system. Data are scaled to the viewer page size automatically by the specification of the viewing field diameter and the viewing field distance. The coordinates of the viewing point determine the position from which the data array will be viewed and the coordinate values

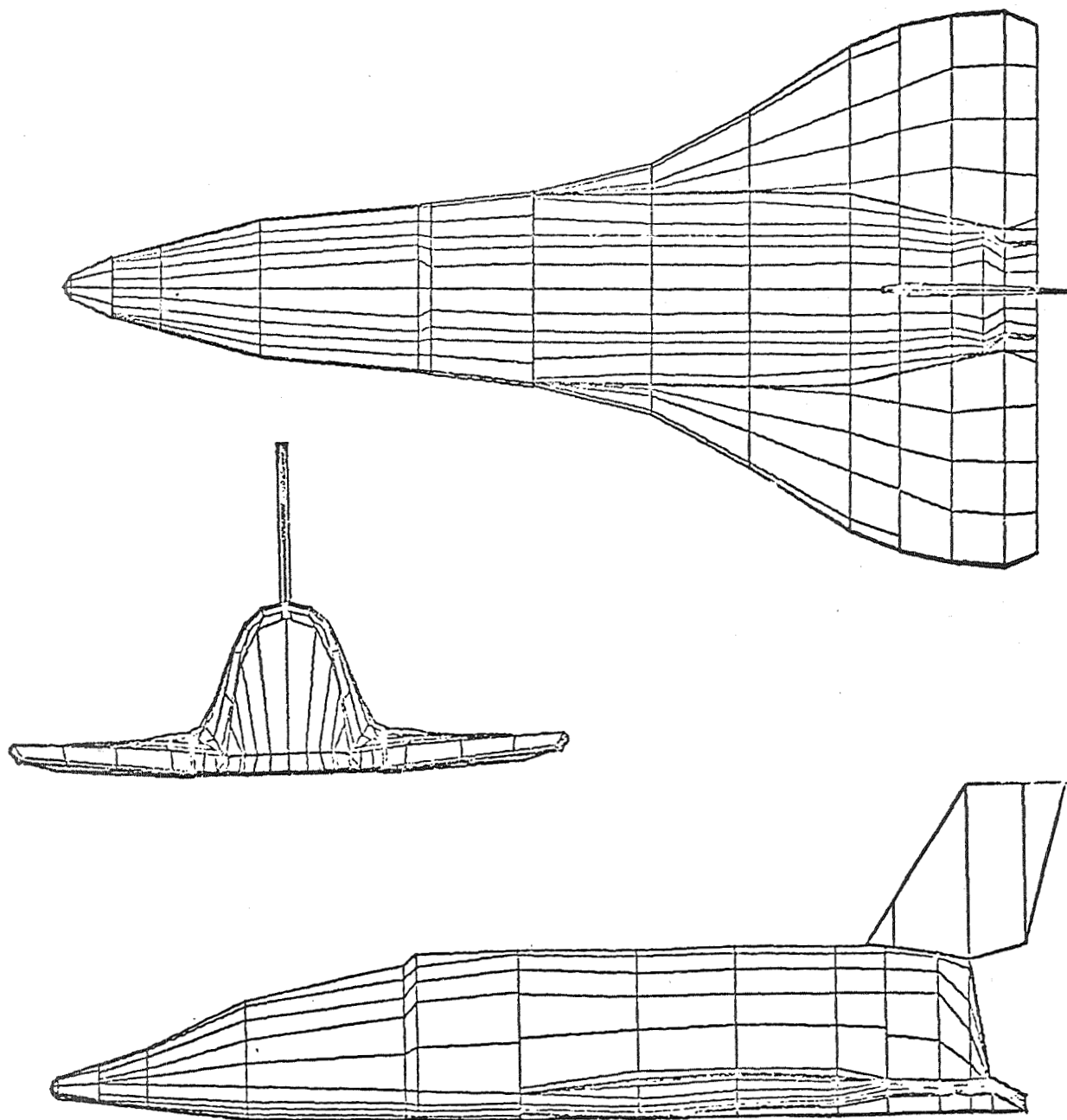

FIGURE 1 TYPICAL THREE-VIEW FROM VAMP.

of the focal point control the direction and focus. The size of the projection on the viewing plane reflects the distance between the viewing point and the focal point. Data which are within the cone of the viewing plane but not in the immediate range of the focal point may be distorted. Perspective may be eliminated by specifying a large viewing field distance. A typical detailed orthographic projection of a shuttle type vehicle is presented in figure 2.

The above explanation of the perspective plots also applies to the stereo views. The use of the stereo option causes the program to be executed twice in setting up two plots for the left and right frames. These frames are suitable for viewing in a stereoscope.

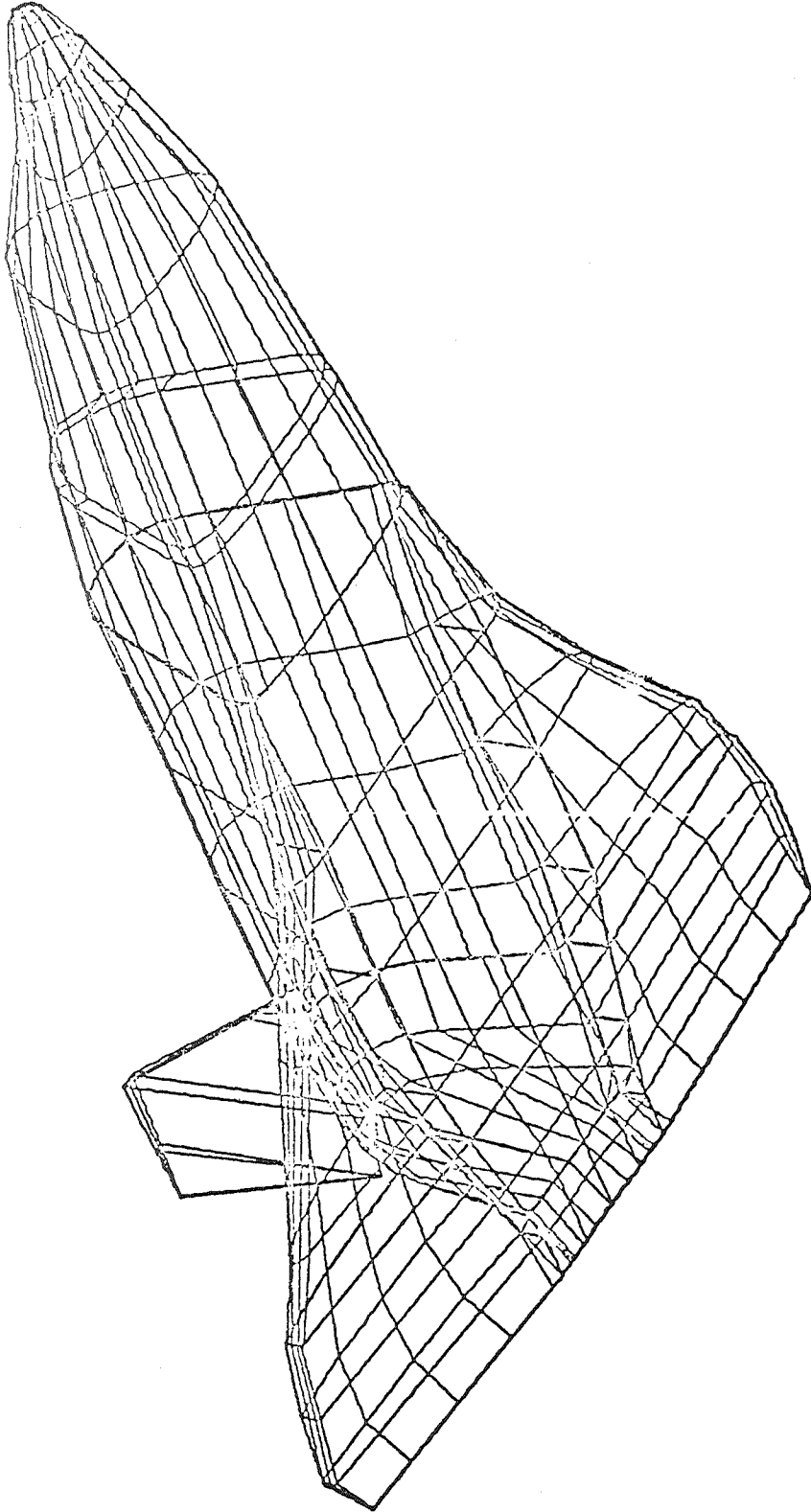

FIGURE 2 TYPICAL ORTHOGRAPHIC PROJECTION WITH HIDDEN LINES INCLUDED.

PROGRAM USAGE

The VAMP input data is organized by cases as illustrated in figure 3. Each case consists of a title card, configuration shape data, black box input data and plot data. Either or both configuration shape data and black box data may be specified. Plot data is optional and its use depends on the values of certain input parameters. If both configuration and black box data are specified, the black box data follows the shape data. Plot data is always at the end of the input list.

Control Cards

The program case data is preceded by the control cards required to retrieve the VAMP program from permanent storage and execute the program. Figure 4 illustrates the control cards to use VAMP at Langley Research Center (LRC). Figure 4A illustrates execution from a stored machine language program. Figure 4B illustrates a compile, load and execute run from stored source code assuming program modifications are required. Figure 4C illustrates the use of VAMP within the ODIN system. In the ODIN system VAMP is stored in absolute binary form.

The dashes on the JOB, USER and REQUEST cards indicate other information which the user must supply in accordance with LRC computer complex accounting procedures. Further, the wedge number (program storage location) is subject to change. The latest wedge number is available from Langley (LRC). The user must supply the estimated run time in CPU seconds, field length for the job and O/S call count on the JOB card. Typical values for a single case are tabulated below:

	<u>CPU</u>	<u>FIELD LENGTH</u>	<u>O/S CALLS</u>
EXECUTE ABSOLUTE BINARY PROGRAM	20	42000	500
COMPILE, LOAD AND EXECUTE	40	51000	800
EXECUTE WITHIN ODIN SYSTEM	60	56000	1000

The tabulated values for CPU and O/S calls estimated in the above tables will vary with the complexity of the configuration data, the number of cases and the number of plots. A

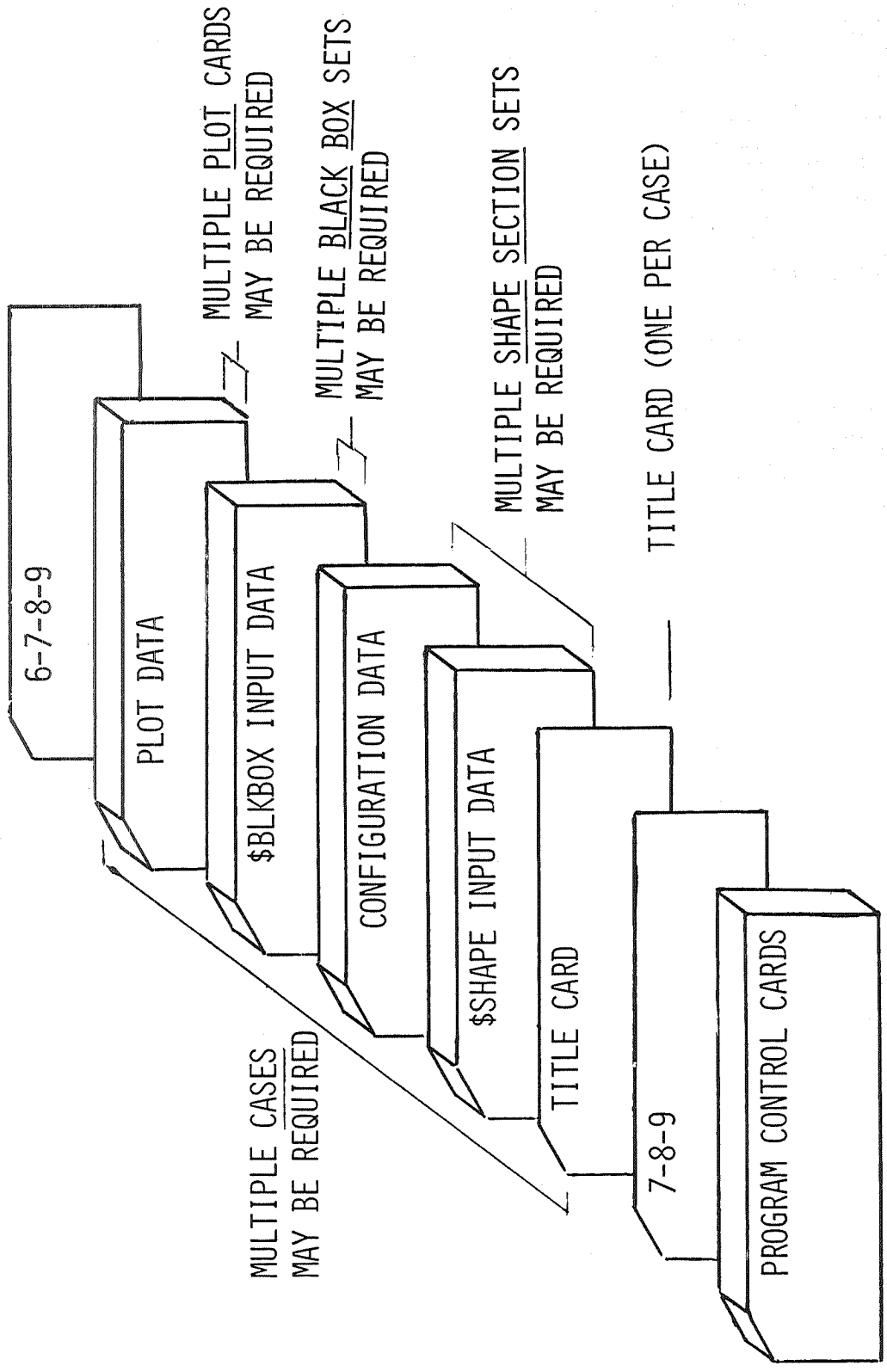

FIGURE 3 ILLUSTRATION OF VAMP DECK SETUP.

```

JOB,1,20,41000,500. - - - -
USER. - - -
FETCH,A3683,SPR____,BINARY,,OVAMP2.
OVAMP2.
REQUEST,TAPE98,HI. CALTP,RIL, - - - }
REWIND,CALTPE,TAPE99.                } REQUIRED ONLY IF
COPYBF,CALTPE,TAPE99.                } PLOTS ARE REQUESTED
UNLOAD,TAPE99.
7-8-9
(VAMP CASE DATA)
6-7-8-9

```

FIGURE 4A EXECUTION OF STORED PROGRAM

```

JOB,1,40,51000,800. - - - -
USER. - - -
FETCH,A3683,SPR____,SOURCE.
RUN,S,,,SCFILE.
LGO.
REQUEST,TAPE98,HI. CALTP,RIL, - - - }
REWIND,CALTPE,TAPE99.                } REQUIRED ONLY IF
COPYBF,CALTPE,TAPE99.                } PLOTS ARE REQUESTED
UNLOAD,TAPE99.
7-8-9
(MODS TO SOURCE PROGRAM, IF ANY)
7-8-9
(VAMP CASE DATA)
6-7-8-9

```

FIGURE 4B COMPILE, LOAD AND EXECUTE

```

'EXECUTE VAMP'
(VAMP CASE DATA)
7-8-9
'EXECUTE PLOTSV'                       }
7-8-9                                   } REQUIRED ONLY IF
                                           } PLOTS ARE REQUESTED

```

FIGURE 4C EXECUTE VAMP WITHIN ODIN SIMULATION

FIGURE 4 ILLUSTRATIONS OF CONTROL CARDS REQUIRED FOR VAMP.

good rule to follow is to allow ample CPU and O/S calls on the first run, then use the results to estimate these parameters of future runs.

General Input Procedure

A typical VAMP input deck will consist of four types of input:

1. Title card in free-field format.
2. Surface model data (\$SHAPE) in NAMELIST format.
3. Black box input data (\$BLKBOX) in NAMELIST format.
4. Plotting information in fixed field format.

These input sets may be combined in various ways depending upon the input parameters in \$SHAPE and \$BLKBOX input sets. All input information, including NAMELIST, must be placed in the first 72 columns of the input cards. Columns 73 through 80 are reserved for comments and identifiers. The purpose of this section is to summarize the input data requirements and describe the input data flow logic.

Title Card - The title card is a single card with any desired information in columns 1 through 72. The contents of this card are printed at the top of each page of output and on all plots.

\$SHAPE Input Set - The \$SHAPE input data description in figure 5 contains the corner-point geometry of the component external surfaces, the elemental surface thicknesses, the surface weight distribution, etc. The configuration is described by ordered sets of points on the surface for each component. Each component is subdivided into sections for input purposes. Any number of components may be described to the program. All of this surface model data can be supplied in the \$SHAPE input list or some may be supplied by Harris type input (reference 16) or digitizer input as described later. A minimum of two \$SHAPE input sets is required for each segment. If any of the auxiliary data options, KXYZ, KRHOH or KSWT are invoked they must be set in the first \$SHAPE set and the appropriate supplemental formatted data cards must be placed between the first and second \$SHAPE set. The second \$SHAPE set normally terminates the input for one component of the configuration. However, additional \$SHAPE sets may be required if the user decides to rearrange the section data (KEEP option).

<u>NAME</u>	<u>DEFAULT VALUE</u>	<u>DESCRIPTION</u>
CNVMS	32.175 (A)	Factor to convert weight to mass.
H(40,25)	1000*0. (D)	Surface element thickness.
KEEP(30)	30*0 (C)	Sequence of contain points to be used in constructing a component.
KPLT	0 (A)	Compute/plot central indicator. KPLT = 0; computes mass properties and plots. KPLT = -1; computes mass properties only. KPLT = +1; plots only.
KRHOH	0 (A)	Density input option if KRHOH = 1, RHO and H are input in 10F7.0 format after \$SHAPE input list.
KSWT	0 (A)	Surface weight input option if KSWT = 1, elemental surface weights are input in 10F7.0 format after \$SHAPE input list.
KWNG	0	Wing input option (10F7.0 format) KWNG = 0; no wings. KWNG = 1; define upper and lower surface. KWNG = 2; define upper surface and mean camber. KWNG = 3; define both surfaces.
KXYZ	0 (A,E,)	Corner point geometry input option. KWYZ = 0; data expected in \$SHAPE list. KXYZ = 1; data expected in 10F7.0 format. KWYZ = 2; data for circular cross section. KXYZ = 3; digitizer input.
KYZRO	0 (B)	Contour closure option. KYZRO = 0; program closes contour to x-y plane. KYZRO = 1; program sets last y,z value to the first y,z values. KYZRO = 2; leaves the input unchanged.
LABEL(6)	0 (B)	Label of 6 words for each segment.
NOSE	0 (B)	Indicator identifying a singular station at the nose (constant y,z - values).
NPTS	0 (A)	Number of points on each station contour (2<NPTS<45).

FIGURE 5A \$SHAPE INPUT LIST.

<u>NAME</u>	<u>DEFAULT VALUE</u>		<u>DESCRIPTION</u>
NSEG	0	(A)	Number of segments or components for the configuration.
NSTA	0	(A)	Number of stations in the current segment or component (2>NSTA>25).
RFLNTH	100.	(A)	Reference length for the vehicle or configuration.
RHO (40,25)	1000*0	(D)	Elemental density.
SCLX	1.0	(A)	X-scale factor for geometric input.
SCLY	1.0	(A)	Y-scale factor for geometric input.
SCLZ	1.0	(A)	Z-scale factor for geometric input.
SURFWT (40,25)	1000*0	(D)	Elemental units weights for the surface components.
X(40)	40*0	(D)	X-position of body station planes.
Y(40,25)	1000*0	(D)	Y-position of body station planes.
Z(40,25)	1000*0	(D)	Z-position of body stations.
XOF	0.	(A)	X-offset from system reference.
YOF	0.	(A)	Y-offset from system reference.
ZOF	0.	(A)	Z-offset of system reference.
XWNG (40,25)	1000*0	(D)	X-position of wing station planes.
YWNG(40)	40*0	(D)	Y-position of wing sections.
ZWNG(40,25)	1000*0	(D)	Z-position of wing section.

- A. Reset before each new case.
- B. Reset before each segment.
- C. There is a second \$SHAPE set required for every segment. KEEP may be input in this second set. If KEEP is non-zero, the program returns and requests another "second set." KEEP is reset to zero prior to reading each second set.
- D. Values can be indefinite depending on the loader option set. Indefinite means the initial value will be the value in the computer after the program is loaded or after a change in overlays during execution.
- E. The Y,Z arrays generated when KXYZ = 2, can be retained for the next segment by changing to KXYZ = 0 in the next segment.

FIGURE 5B \$SHAPE INPUT LIST (CONTINUED).

The arrangement of the \$SHAPE data is illustrated below:

\$SHAPE- - - -\$

Optional formatted data

\$SHAPE- - - -\$

Optional rearrangement of sections

\$SHAPE- - - -\$

\$BLKBOX Input Set. - The \$BLKBOX input contains the information necessary to describe auxiliary masses which cannot be described by geometric input data. Any number of black boxes may be described to the program and they may be symmetrical or nonsymmetrical with respect to the configuration center plane. Figure 6 briefly describes the input parameters in the \$BLKBOX input.

Plotting Information. - Four CALCOMP plot options are available in VAMP.

1. Orthographics projection.
2. Three views.
3. Prospectives.
4. Stereo frames.

Each of the above options may be invoked by a single formatted input to be described later. The components plotted are those specified in the \$SHAPE input sets above.

Input Flow Logic

Figure 7 shows the input flow logic for the program. After initializing the data, VAMP reads a title card, then proceeds to read in the surface model (figure 7B). The first \$SHAPE data set determines the flow path within the VAMP program for the component. If the number of components (NSEG) is less than one, program flow returns (figure 7A) assuming there is no external geometric configuration data. If one or more segments are to be input, the auxiliary data option parameter (KXYZ) is tested. Three auxiliary data options can be invoked depending upon the value of KXYZ.

1. Read Harris-type input (KXYZ = 1).
2. Compute circular cross section (KXYZ = 2).

<u>NAME</u>	<u>DEFAULT VALUE</u>	<u>DESCRIPTION</u>
BXPLN(3,3)	9*0. (C)	Coordinates of three points.
CNVMS	32.174 (A)	Factor to convert weight to mass.
IXX	0. (B)	Black box inertia about load x-axis.
IYY	0. (B)	Black box inertia about load y-axis.
IZZ	0. (B)	Black box inertia about load z-axis.
LABEL(6)	0. (B)	Alphanumerical label up to 6 words.
NBX	0. (C)	Controls transformation of black box to reference axis. NBX = 0; no (more) black boxes. NBX = 1; transform inertias (PMIP) to reference system and accumulate. NBX = 2; If black box has symmetrical counterpart. NBX = -1; Rotate inertia but not translated.
PMIP(3,3)	9*0. (B)	Black box moments and products of inertia.
WTM	0. (B)	Black box weight or mass
XO	0. (A,D)	X-position of black box c.g.
YO	0. (A,D)	Y-position of black box c.g.
ZO	0. (A,D)	Z-position of black box c.g.
XOF	0. (A)	X-offset from the system reference axis.
YOF	0. (A)	Y-offset from the system reference axis.
ZOF	0. (A)	Z-offset from the system reference axis.

- A. Reset before each new case. Thus, the value is carried forward from the vehicle wall computations.
- B. Reset before each new black box.
- C. Reset before each \$BLKBOX set is read. NBX must appear in every \$BLKBOX set except the last one.
- D. Only the second and third columns of BXPLN are reset to zero. The first column contains XO,YO,ZO which retain their input values. They are not changed by the offsets (XOF, etc.)

FIGURE 6 \$BLKBOX INPUT LIST.

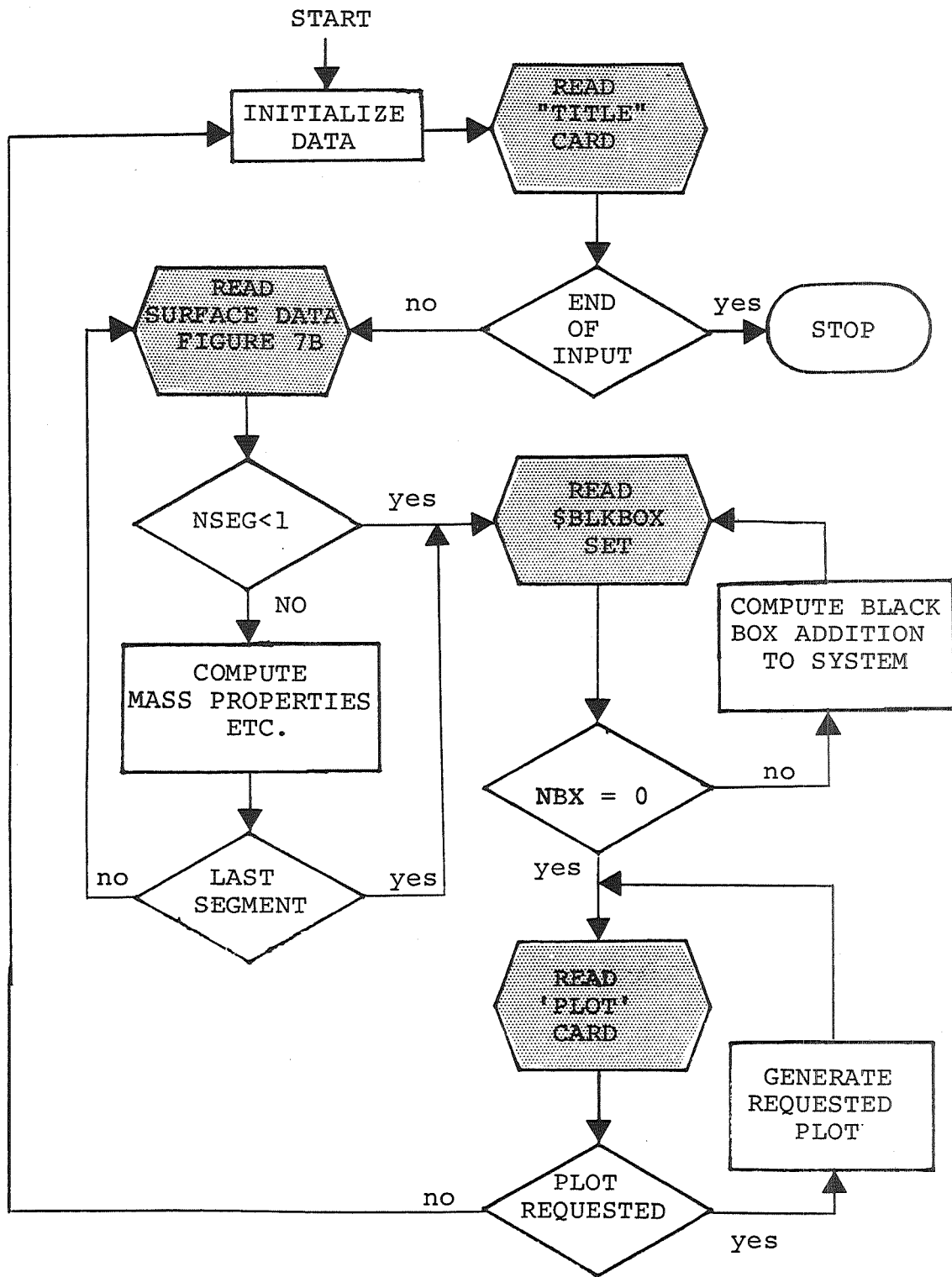

FIGURE 7A INPUT FLOW LOGIC.

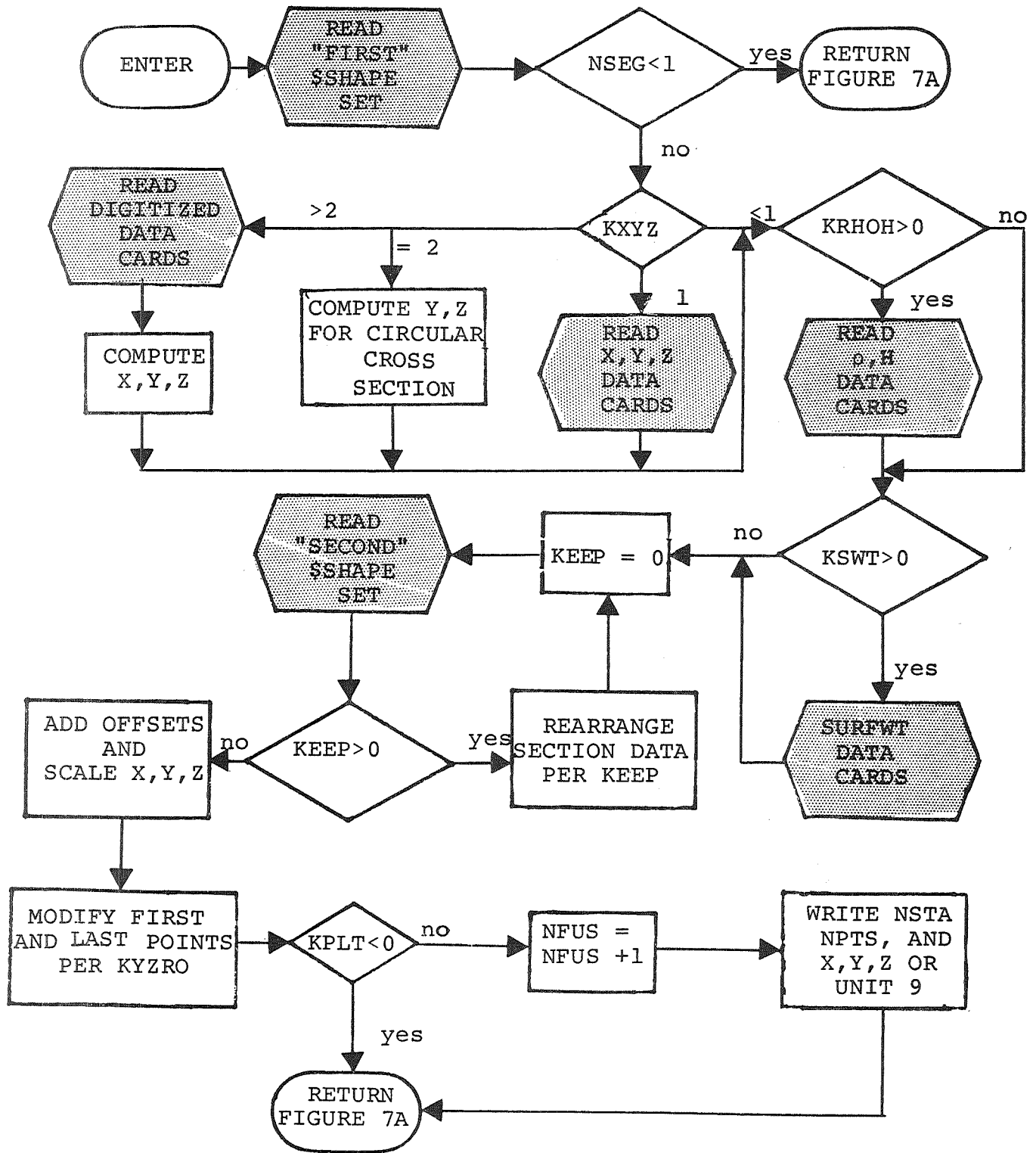

FIGURE 7B INPUT FLOW LOGIC.

3. Digitalized data cards (KXYZ = 3).

The first and third options require additional input which automatically overrides the \$SHAPE input geometry. Density and thickness may also be read in the auxiliary data format depending on the value of KRHOH. Surface weight data may be read by the auxiliary data format by use of the input parameter KSWT. The stacking of the auxiliary data described above can be determined from the input flow logic (figure 7B). In general, the sequence is:

1. Auxiliary geometry data. (KXYZ>0)
2. Auxiliary density/thickness data. (KRHOH>0)
3. Auxiliary surface weight data. (KSWT>0)

If any of the auxiliary data options are not invoked, the data subset is simply omitted.

After all auxiliary data is read into the program, a second \$SHAPE input set is read by the program. The second set provides the user the opportunity to rearrange the sections of the current vehicle component. This is done through the use of the KEEP option. If the KEEP option is invoked, the sections are rearranged according to the sequence provided in the KEEP array, then another \$SHAPE set is read by the program. After all KEEP options are satisfied, the program proceeds to add offsets and scale the corner-point geometry. Then the data is modified by the closure option, KYZRO. If the KPLT option is invoked, the data for the current section is written on an auxiliary file for later use by the plot subprogram.

After completion of the above sequence, the program proceeds to check for \$BLKBOX data. Any number of black boxes may be added through multiple \$BLKBOX data sets. After all black box data is read and accumulated with the rest of the vehicle mass property data, the program proceeds to the plot option. If plot cards are present, the program plots the information contained on the auxiliary plot file. After all the plot request cards are satisfied, the program proceeds back to the initialization of the data and a new case. If no case data is present, the program stops.

Configuration Shape Data

The surface of the configuration being analyzed is described to the program by ordered sets of corner-point geometry. Components can be sectioned for input purposes by one of the methods illustrated in figure 8. Body stations (Y-Z plane) or wing stations (X-Z plane) may be described depending upon the value of the KWNG parameter. In either case, the program assumes symmetry about the X-Y plane so that only one-half of the configuration geometry need to be input. For the body stations the right half (facing aft) is input. The right wing airfoil sections are described to the program.

The mass properties of the surface are supplied to the program in elemental form. The weights may be input directly as elemental surface weight contributions or they may be input as density and thickness specifications of each surface panel. Elemental mass properties may be specified in NAMELIST format or by formatted input cards similar to geometric data. Fixed offsets and geometric scale factors may also be supplied for each component.

Input Specifications for the \$SHAPE Input Set. - The normal mode of input is through the \$SHAPE input list which includes the input parameters for many of the program options. All geometric and mass properties data may be specified through this mode of input. No auxiliary data read is essential to the operation of the program.

The use of NAMELIST input was chosen for the following reasons:

1. It is a simple name oriented input easily understood by most computer users.
2. The format is standard and does not require relearning from program to program.
3. It is easily modified by the engineer or programmer when adding input variables to the program.

When a NAMELIST read is encountered in the program, the entire input file is scanned up to an end-of-file or a record with a dollar in column 2 followed immediately by the NAMELIST name requested by the programs. Succeeding data items are read until a second dollar is encountered signifying the end of the NAMELIST. Any data on the input file before the requested NAMELIST is found will be ignored. All data between the opening and closing dollar is interpreted by the NAMELIST input routine. The data item within the NAMELIST statement may be in any of three forms:

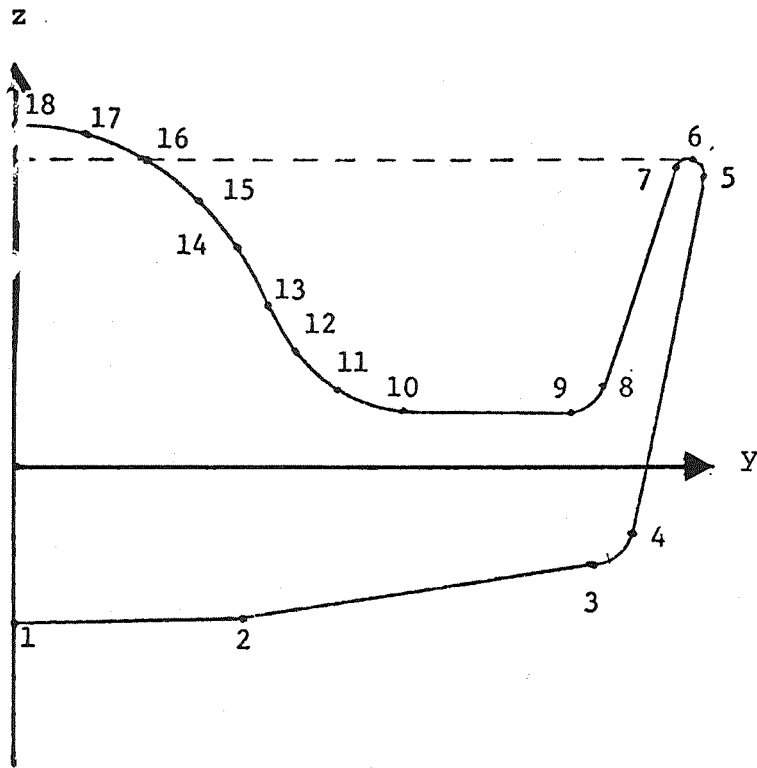

X-BODY STATION (KWNG = 0)

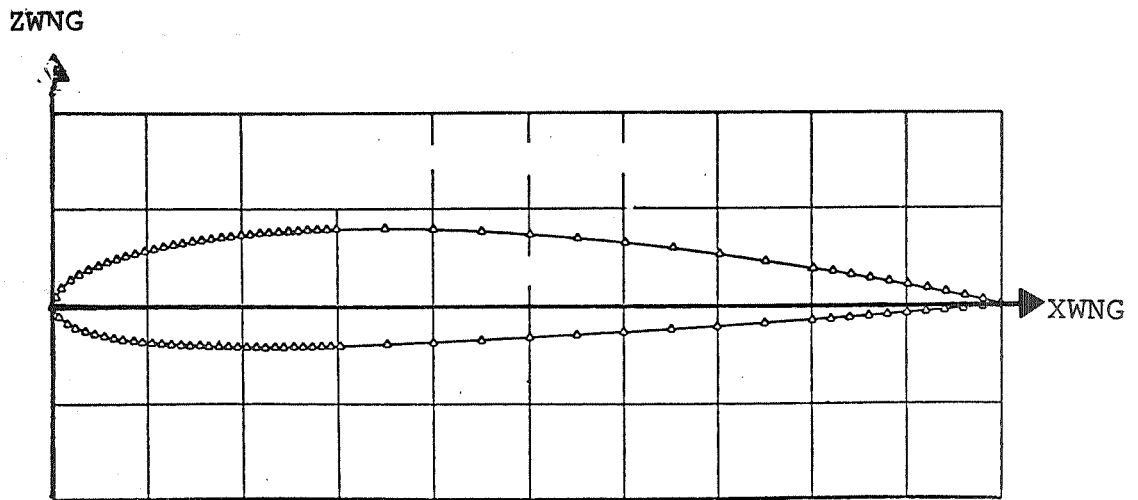

YWNG-WING STATION (KWNG > 0)

FIGURE 8 INPUT GEOMETRY OPTIONS.

$$V = C,$$

$$A = D_1, \dots, D_j,$$

$$A(n) = D_1, \dots, D_m,$$

V is a variable name; C is a constant; A is an array name and n is an integer constant subscript, D_1, \dots, D_m , are simple constants or repeated constants of the form $k*C$, where k is the repetition factor. Data items and constants must be separated by commas. The number of constants, including repetitions given for an unscripted array must equal the number of elements in that array. For a subscripted array name, the number of constants need not be equal but may not exceed the number of array elements needed to fill the array. More than one card may be used for input data and arrays may be split between cards. All except the last record must end with a constant followed by a comma and no sequence numbers may appear. The first column of each record is ignored. The set of data items may consist of any subset of the variable names associated with the NAMELIST name and the name need not be any particular order. More details on the use of NAMELIST are available in any FORTRAN users guide, but the above description should be sufficient for the operation of the VAMP program.

The following paragraphs provide detailed descriptions of each variable name in the \$SHAPE input list in alphabetical order. The descriptive material represents an expansion of the abbreviated description given in figure 5.

CNVMS: Factor to convert weight units into mass units. This input parameter affects only the moment and product of inertia calculations. The total weight remains in input units. The weight elements entered into an inertia calculation are divided by CNVMS for conversion to mass. The initialization of CNVMS is preset to 32.174lb/slug.

H(40,25): Thickness of the quadrilateral surface elements. H(I,J) is the thickness of an element defined by four points starting at the geometric point (I,J) and extending one point beyond in each direction. It will require change only if units of mass other than English units are used. Any quadrilateral that has $H < 0.0$ is deleted from the surface area and mass properties calculations, but the volume contribution is accumulated for all elements. However, there must be at least one non-zero thickness between every station if mass properties are to be computed.

KEEP(point): An array of integers defining a new sequence of previously defined contour points at all stations of a component or segment. Consider a component defined by a first \$SHAPE set or auxiliary geometric input cards which has eleven contour points per station. Assume that it is desired to delete point 8 from the contour, add a new contour point between 2 and 3, and duplicate contour point 5 in order to input a step change in the surface weight at the position of contour point 5. The second \$SHAPE set for the component would contain:

NPTS = 12, KEEP = 1,2,2,3,4,5,5,6,7,9,10,11,

The program would construct new section data at all stations such that each new station contour would contain the data from the original contours taken from the contour locations specified by KEEP. The new station 3 may be replaced through use of another \$SHAPE input set.

New contour data and subsequent corrections must correspond to the revised point numbering. The operation of KEEP is bypassed if there is no KEEP input (KEEP(1) = 0) and will be ignored if it is input with the first \$SHAPE set. Caution: The program does not rearrange RHO, H or SURFWT. It is left to the user to ensure that these inputs correspond to the final numbering system including changes to NSTA.

KPLT: Integer which controls the mass calculation and configuration plotting.

If KPLT = 0, the program computes the mass properties and plots the configuration.

If KPLT =+1, the program plots the vehicle but skips the mass properties calculating.

If KPLT =-1, the program computes the mass properties, but skips plotting.

KPLT does not have to be given the same value for all segments but can be varied to skip plotting or mass calculations of some segments, etc. The program automatically accounts for the number of segments that are to be plotted. The plotted segments do not have to be continuous.

KRHOH: Integer which controls the auxiliary reading of elemental density or thickness. If KRHOH < 1, this option is skipped. Otherwise, RHO and H input for the current segment are expected on formatted cards. The card format is

10F7.0 (10 numbers per card; each number can be 7 columns wide). H refers to surface elements between the grid points. Therefore, the cards contain in order:

1. NPTS-1 values of RHO for the quadrilaterals between stations 1 and 2.
2. NPTS-1 values of H for the same quadrilaterals.
3. NSTA-1 repetitions of 1 and 2 for the quadrilaterals between subsequent stations.

Values for H cannot occupy the same cards as RHO and vice versa. (See Auxiliary Density/Thickness Input.)

KSWT: Integer which controls the auxiliary reading of surface element weights. If $KWST < 1$, this option is skipped. Otherwise, surface weight distribution (SURFWT) for the current segment is expected on formatted cards. The format is 10F7.0 (10 numbers per card; each number can be up to 1 column wide). The formatted cards contain in order:

1. NPTS values of SURFWT for the first station contour.
2. NSTA repetitions of 1 for subsequent station.

Values of two stations cannot occupy the same card.

KWNG: An integer which controls the specification of wing geometry. It is used in conjunction with the KXYZ option described below:

If $KWNG = 0$, the geometry in input in body station coordinates in accordance with the KXYZ options.

If $KWNG = 1$, the upper and lower surface geometry are specified in pairs from the leading edge. The program converts the input data for the pair to a single station.

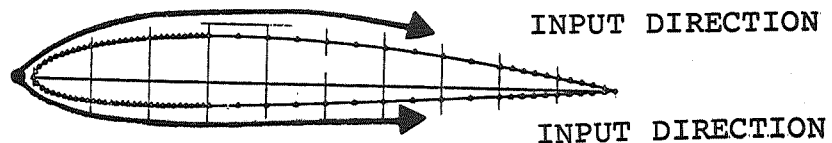

If $KWNG = 2$, The upper surface and the mean line are specified with respect to the leading edge in pairs. The program computes the

the lower surface geometry and replaces the mean line input then converts to a single station.

If KWNG = 3, the upper and lower surface are specified in a single sequence of contour points.

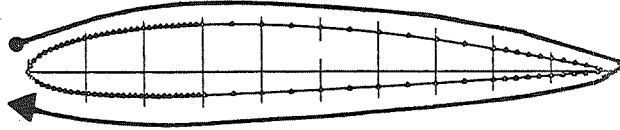

Figure 9 summarizes the wing input options available by cornering input values of KWNG and KXYZ.

KXYZ: Integer which controls the auxiliary reading of surface geometry data for both wing and body stations. The following discussion pertains to input of body station contour. A discussion of wing station contours is given under the heading KNWG.

If $KXYZ < 1$, All geometry data is expected in the \$SHAPE input. There are three auxiliary data read options invoked by $KXYZ = 1, 2$ or 3 respectively.

If $KXYZ = 1$, contour inputs for the current segment are expected on formatted cards. The format is 10F7.0 (10 numbers per card; up to 7 columns per number is allowed). The formatted cards contain in order:

1. NSTA values of X for the complete component.
2. NPTS values of Y for the first station contour.
3. NPTS values of Z for the first station contour.
4. NSTA repetitions of 2 and 3 for subsequent stations.

Values for different names cannot occupy the same card.

If $KXYZ = 2$, the program generates contour points for a circular cross section from input values of radius and vertical offset.

The contour points are spread in even angular increments between the lower center plane and the upper center plane of the body. The number of generated points is specified by the user (NPTS). Let $I =$ point number on contour and $J =$ station number. The radius of each circular section is input to the

<u>KWING</u>	<u>KXYZ</u>	<u>INPUT DESCRIPTIONS</u>
1	0	Input upper and lower surface (one station for each) from leading edge in \$SHAPE $ZWNG = F(XWNG)$. XWNG must be even increments.
2	0	
3	0	
} \$SHAPE INPUT		
1	1	Input wing ordinates in percent chord. Input leading edge coordinates and chord length. Input camber line in percent chord. Input upper surface thicknesses in percent chord. Input lower surface in percent chord.
2	1	
1	2	
2	2	
} 10F7.0 FORMAT (FOLLOWING \$SHAPE INPUT)		

FIGURE 9 INPUT REQUIREMENTS FOR WING GEOMETRY.

first row of Y and the centerline offset from the X axis is input to the first row of Z. Note that this is row, not column. The input values are replaced at execution time by the appropriate contour point data.

If $KXYZ \geq 3$, contour points for the current segment are expected on formatted cards prepared by a digitizer which provides coordinates of points (DCP) directly from drawings.

The digitizer senses discrete positions of a "reader" placed on a drawing. Thus, the digitizer cards contain coordinates of points around the station contours in units corresponding to the digitizer scale. Additional data is needed to transform the card input into true units and correct for the angular position of the Y,Z axes relative to the digitizer axes. The cards must contain in order:

1. True distance between two points and the DCP of the points on the y and z axes. Format (F8.3,4F4.0).
2. True X coordinate of the first station contour, DCP of the $Y = Z = 0$ point on the drawing, DCP of an arbitrary point on the +Y axis, DCP of selected points along the contour. Format (F8.3,16F4.0).
3. If $NPTS > 6$, the DCP of the remaining points follows on successive cards. Format (18F4.0).
4. NSTA repetitions of 2 and 3 for subsequent stations.

Values for different stations cannot occupy the same card. Values can start in column 1. Note that each DCP is two 4-digit values. (See Digitizer Data Specifications)

KYZRO: Integer controlling the closure of a section contour. Normally, the contour is expected to meet its symmetrical counterpart on the Z axis but the input data may not have $Y = 0.0$ exactly at these two points. If $KYZRO = 0$, the program sets the first and last value of Y at each station = 0.0. If the cross section is a closed contour that does not cross the Z axis, $KYZRO = 1$, will set the last contour point equal to the first contour point. $KYZRO = 2$ leaves the input unchanged. The $KYZRO$ control is evoked after the input is scaled. (See figure 5)

LABEL (word): An alphanumeric label input for each segment (and each black box). It can be up to 60 characters long, input with a hollerith character count, nH. A long hollerith string cannot be continued on a second card, but can be input in multiple of 10 character e.g.:

LABEL(1) = 20H THIS IS A SAMPLE BLA,

LABEL(3) = 12H CK BOX LABEL,

Note that blank spaces are included in the hollerith count.

NOSE: An integer which identifies the first station as a singular station (i.e. all contour points have the same value).

NPTS: The number of points defined around each station contour in the current segment: $2 \leq NPTS \leq 45$.

NSEG: The number of components or segments in a complete case. It must be supplied in the first \$SHAPE set of a case. If NSEG = 0, the program skips to processing black boxes.

NSTA: The number of station planes in the current segment: $2 \leq NSTA \leq 25$.

RFLNTH: The reference length of the vehicle. It is used to compute the percent location of the center of gravity c.g. and center of volume c.v. The origin for the reference length and percent calculation is taken to be the X-coordinate of the first station in the first segment. If the preset value --100.0--is used, the percentages become axial distance from this origin.

RHO (40,25): Density of the quadrilateral surface elements. RHO(I,J.) is the density of an element defined by four points starting at the geometric point (I,J.) and extending one point beyond in each direction.

SCLX: Scale factor applied to all the X-coordinates for the current component. It can be used for units conversion as well as for changing the vehicle size. SCLX operates on the input data after the last \$SHAPE set for a segment has been read. (See figure 7B)

SCLY and SCLZ: Scale factors applied to all Y and Z coordinates respectively.

SURFWT (40,25): Weight per unit area distribution of the surface of the configuration. SURFWT is input at every grid point. Its contribution to each surface is obtained by linear interpolation to determine the mean surface unit weight at the centroid of the surface element.

X(25): The axial coordinates of the station planes within a segment.

Y(40,25): The horizontal coordinates of grid points around each body station contour. Each column in this array contains the Y coordinates for all points at one station. Up to 40 contour points per station may be used. Up to 25 stations per component may be specified.

Z(40,25): Similar to Y (above). Z is the vertical coordinate of grid points and can be negative.

XOF: Offset from the system references axes to the origin of the X-values that are input. XOF is added to every value of X after scaling (see SCLX). The result replaces the X array.

YOF and ZOF: Similar to XOF (above). They are added to the Y and Z inputs, respectively.

XWNG(40,25): Chordwise coordinates of the grid points around each wing-station contour. Each column in this array contains the X-coordinates for all points at one station. Up to 40 contour points per station may be used. Up to 25 stations per component may be specified. A station may consist of a complete wing section or only one-half (upper surface) and a camber line may be included (see KWNG input).

YWNG(40): Spanwise positions of the wing contours.

ZWNG(40,25): Vertical coordinates of the grid points around each wing-station contour corresponding to the XWNG input above.

Auxiliary Geometry Input. - The program provides for auxiliary geometry input following the first \$SHAPE input set for each component. This geometry input is basically compatible with the geometry input scheme of reference 16 (Harris input). Only two of the Harris input options are available in VAMP, the fuselage input and wing input. All data is placed in the input cards in 10F7.0 format (10 values per card and 7 column per input value). Each new subset of data (coordinate points) must begin with a new card.

Fuselage Data Cards: If the fuselage is circular and cambered, no auxiliary data cards need be supplied. The radius and camber data are supplied in the \$SHAPE input set.

If the fuselage is of arbitrary shape, the y coordinates for a half section are given (NPTS values) as Y(I,J.) where J is the station number. Following these are the corresponding

Z ordinates (NPTS values) for the half section as Z (I.J.) where J is the station number. Each station will have a set of Y and Z cards and the convention of ordering the ordinates from bottom to top is observed.

For each fuselage segment a new \$SHAPE data set is required. If the auxiliary Harris input is specified, a set of cards as described above must be provided. The segment descriptions should be given in order of increasing X.

Wing Data Cards: The first wing data card (or cards) contain the percent-chord locations at which the ordinates of all the wing airfoils are to be specified. There will be exactly NPTS percent-chord locations given. (See KWNG Input)

The next wing data cards (there will be NSTA cards) each contain four numbers which give the origin and chord length of each of the wing airfoils that is to be specified. The cards representing the most inboard airfoil are given first, followed by the cards for successive airfoils. The information is arranged on each card as follows:

<u>Columns</u>	<u>Description</u>
1-7	x-ordinate of the airfoil leading edge
8-14	y-ordinate of the airfoil leading edge
15-21	z-ordinate of the airfoil leading edge
22-28	the airfoil streamwise chord length

If a cambered wing has been specified, (KXYZ = 1), the next set of wing data cards is the mean camber line cards. The first card contains up to 10 ΔZ values, referenced to the Z-ordinate of the airfoil leading edge, at each of the specified percent of chord locations for the first airfoil. If more than 10 values are to be specified for each airfoil, there will be NPTS values, the remaining values are continued on successive cards. The remaining airfoils are described in the same manner, data for each airfoil starting on a new card, and the cards arranged in the order which begins with the most inboard airfoil and proceeds to the outboard.

Next are the wing airfoil ordinate cards. The first card contains up to 10 half-thickness (KWNG = 2) ordinates of the first airfoil expressed as a percent of the chord length. If more than 10 ordinates are to be specified for each airfoil (there will be NPTS values) the remaining ordinates are

continued on successive cards. The remaining airfoils are each described in the same manner, and the cards are arranged in the order which begins with the most inboard airfoil and proceeds to the outboard.

If KWNG = 1, the above set of data cards contain the upper surface data in percent chord location followed by another subset of data containing the lower surface data in percent chord locations. (See figure 9)

Digitizer Data Specification: Fuselage data may be specified to the VAMP program through use of data digitizer output. The digitizer data option is invoked by specifying KXYZ = 3 in the \$SHAPE input set for the current section. A data digitizer is a device which converts graphical information into digital data. It measures the relative distance among points on a configuration drawing, formats the data and records it on an output recorder. When coupled with a key-punch machine, the digitizer provides coordinate data on punched cards in F4.0 format. The data recorded is suitable for computer processing. The VAMP program accepts digitized data (KXYZ = 3) and converts it for use in computing mass properties of surface elements.

The data digitizer is usually supplied with a coordinate digitizing table upon which the user places the drawing of the configuration under study. The following procedure is employed in generating digitized geometry input data for the VAMP program.

1. Turn on the power switch. If an absolute zero is not provided on the data digitizer, move the cursor to a convenient point in the lower left portion of the digitizer table. Reset the x and y to zero.
2. Turn on the keypunch machine, set autofeed to on and feed two cards down. Depress foot pedal to test digitizer. Remove the test card from the keypunch machine.
3. Generate a calibration card. This is done by hand punching a number representing a convenient measure in F8.0 format on the first card as illustrated in figure 10. Then digitize two points representing that length (measure) on the drawing.
4. On a new card, hand punch the x-value of the first station in F8.3 format. Now proceed to digitize

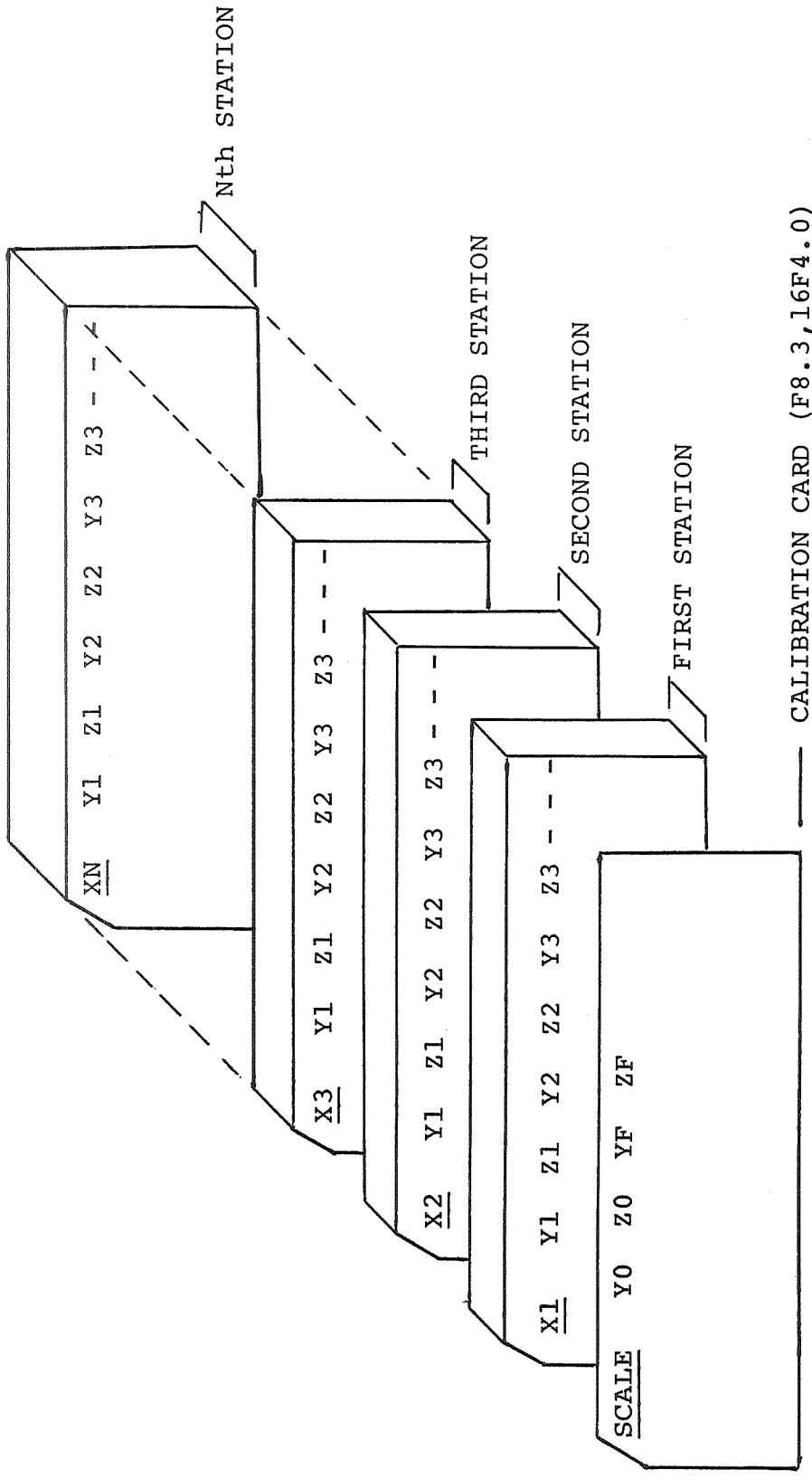

NOTE: Underlined values (the first number of each set) are punched directly on the card by hand. All others are digitized data.

FIGURE 10 ILLUSTRATION OF DIGITIZER INPUT DATA.

the contour points in a counter clockwise manner as illustrated in figure 8. If more than eight points are needed, the data will be punched on additional cards.

5. Repeat number 4 above for each station.

Figure 10 provides an illustration of a data deck digitized from a fuselage station. Digitizer data specification can not be used for wing stations.

Auxiliary Density/Thickness Input. - The elemental density and thickness are usually provided to the program through the \$SHAPE input list under the variable names RHO and H respectively, but can be read into the program on formatted (10F7.0) input cards following the first \$SHAPE input as illustrated in figure 11. The auxiliary read option is invoked by the parameter:

KRHOH = 1,

set in the first \$SHAPE input list. When the option is invoked, input cards must be provided with the following information in 10F7.0 format (10 values per card, 7 columns per value):

1. Values of RHO for the surface elements between station 1 and 2.
2. Values of H for the surface elements between station 1 and station 2.
3. Repetition of 1 and 2 for all subsequent stations for the current component.

Each new set of RHO or H must start a new card. (figure 11)

Further, if the auxiliary geometry option described above is invoked simultaneously with the auxiliary density/thicknesses input option, the auxiliary density/thickness data set follows the auxiliary geometry.

Auxiliary Surface Weight Input. - The elemental surface weight distribution is usually provided to the program through the \$SHAPE input list under the variable name SURFWT but it can be read into the program on formatted (10F7.0) input cards following the first \$SHAPE input set similar to the auxiliary density thickness option (figure 11). The option is invoked by the parameter:

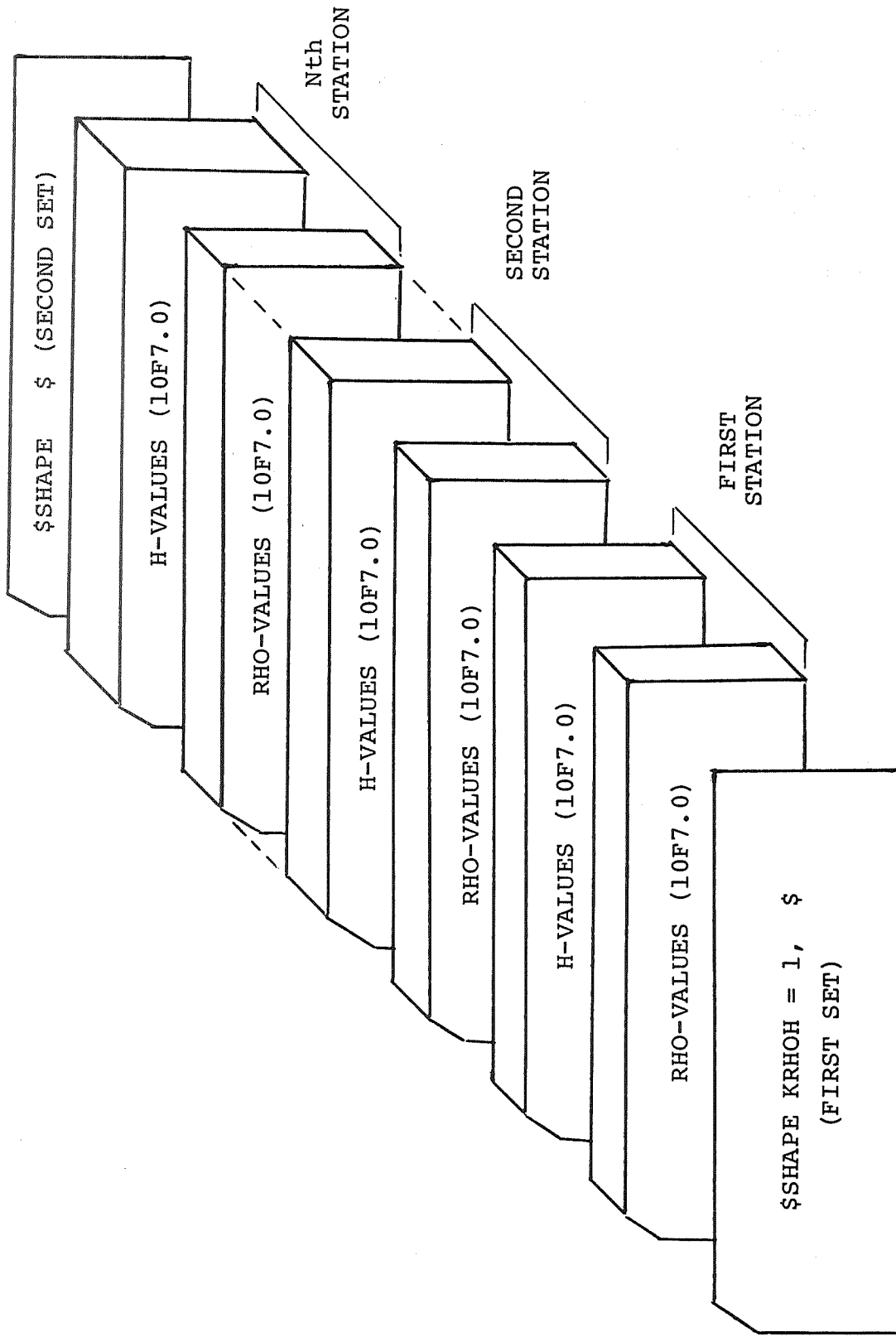

FIGURE 11 AUXILIARY INPUT SETUP FOR DENSITY/THICKNESS.

KSWT = 1,

set in the first \$SHAPE input list. When the option is in effect, the following information must be provided ten values per card and seven columns per value (10F7.0 format):

1. Values of SURFWT for each point on the geometric contour for the first station.
2. Repetition of 1. for all stations of the current component.

SURFWT values for each new station must start on a new card.

Any auxiliary geometry and/or auxiliary density/thickness data precede the auxiliary surface weight data in the deck setup. The sequence for the three auxiliary data sets is:

1. Geometry (KXYZ > 0).
2. Density/thickness (KRHOH > 0).
3. Surface weight distribution (KSWT > 0)

Any or all of the above data sets may be omitted assuming the appropriate option parameters are set to zero.

Black Box Data

The configuration shape data described above provides input to the program for analyzing shell structures such as fuselage, wings, tank, etc. However, the analysis of masses not conforming to the surface model or having an unknown shape may also be specified by inputting the center of gravity (c.g.) and mass properties.

The mass sources called black boxes may be described by the c.g. and weight only (point mass). However, the inertias may be taken into account by specifying the moment of inertia of the elemented mass about the local axis through its own c.g. The orientation of the local axis may be specified relation to the system reference or some intermediate reference system.

Input Specification for the \$BLKBOX Input Set. - The following discussion provides a description of the inputs required to evaluate mass sources by the black box method. The input format is standard FORTRAN namelist as described above (see Configuration Shape Data).

The program searches for a \$BLKBOX input set after reading and analyzing all configuration shape data. The format of the data is:

\$BLKBOX - - - - -\$

\$BLKBOX - - - - -\$

The dashes indicate (name=value) sets which will be described below:

BXPLN(3,3): Black box orientation array. This array contains the coordinates of three points.

In matrix notation,

$$\text{BXPLN} = \begin{bmatrix} X_0 & X_1 & X_2 \\ Y_0 & Y_1 & Y_2 \\ Z_0 & Z_1 & Z_2 \end{bmatrix}$$

The first column of BXPLN contains the X,Y,Z of the local c.g. Second column contains the coordinates of a point on the local +x axis. Third column contains the coordinates of the local +y axis. Thus, BXPLN defines the position and orientation of the black box. BXPLN is used to rotate and translate the inertias to the reference axes. If NBX (see below) is negative, only the rotation is performed and the resultant inertias are saved (see PMIP) and combined with the next black box input. Once NBX is set positive, complete transformation of the accumulated data is performed.

CNVMS: Factor to convert weight units into mass units. This input parameter affects only the moment and product of inertia calculations. The total weight remains in input units. The weight elements entered into an inertia calculation are divided by CNVMS for conversion to mass. The initialization of CNVMS is preset to 32.174lb/slug.

IXX: Mass moment of inertia of a black box about a local x axis through its c.g. It must be in consistent inertia units. It is not affected by the value of CNVMS.

IYY and IZZ: Mass moments of inertia for the local y and z axes respectively.

LABEL(6): An alphanumeric label input for each segment (and each black box). It can be up to 60 characters long, input with a hollerith character count, nH. A long hollerith string cannot be continued on a second card, but can be input in multiple of 10 character c.g.

LABEL(1) = 20H THIS IS A SAMPLE BLC,

LABEL(3) 12H CK BOX LABEL,

Note that blank spaces are included in the hollerith count.

NBX: Control integer for black box input. If NBX = 0, program proceeds to plotting data or to the next case. NBX = 1 is used to specify non-symmetrical transformation of the inertias in PMIP to system reference axes and add to system total. NBX = 2 is used to specify a symmetrical transformation.

$$I_{XY} = I_{YZ} = 0.0$$

The weight and remaining inertias are doubled, translated to system reference axes, and added to system total. If NBX is negative, the program rotates the inertias but does not translate to the reference axes.

As long as NBX remains negative, the accumulation of inertia properties in PMIP continues. When NBX becomes positive, the current contents of PMIP are transformed to the system reference axes according to whether NBX is 1 or 2.

PMIP(3,3): This array contains the black box's products and moments of inertia about an axis through the local c.g.

In matrix notation,

$$\text{PMIP} = \begin{bmatrix} I_{XX} & & \\ I_{XY} & I_{YY} & \\ I_{XZ} & I_{YZ} & I_{ZZ} \end{bmatrix}$$

The array is actually symmetrical about the major diagonal but only the lower terms are input. The program fills the upper half. The diagonal terms can be input with the names IXX, IYY and IZZ. If the NBX = negative

feature is being used, this array is input only with the first \$BLKBOX set in the group of black boxes being accumulated. Input must be in consistent inertia units.

WTM: Weight of a black box. If $NBX = 2$, this is the weight of the black box contribution to the black box set. The mass contribution of WTM to the inertia transformation is determined by conversion using CNVMS.

XO: This is the X coordinate of a black box c.g. This input will place a value in the X_0 position in BXPLN. When NBX is positive, XO must be the black box c.g. measured parallel to the absolute system reference axes.

YO and ZO: Similar to XO (above). These are Y_0 and Z_0 coordinates. Their values are placed in the first column of BXPLN. If $NBX = 1$, YO can be negative.

XOF: X-offset from the system reference to the origin of the XO-values that are input, XOF is added to every value of XO.

YOF and ZOF: Similar to XOF (above). They are added to Y and Z inputs respectively.

Plotting Data

The program provides optional plotting for all configuration geometry on a component by component basis. The integer KPLT (set in \$SHAPE) controls the storage of plot data for each component. Once the VAMP analysis is complete, any number of plots may be generated from the stored geometry for later plotting on the CALCOMP plotter (see figure 4).

Four plot options are available, each requiring a single card input. The four plot type options and required input for each are described below. The program continues to read cards and produce plot information until after completing a request that included a one (1) in column 72.

The title card is printed on every plot. The contents of the plot request card are printed on all plots except those produced by the VU3 option.

Orthographic Projections. - An orthographic projection request card contains the following data punched in the indicated columns:

<u>Column</u>	<u>Fortran Name</u>	<u>Description</u>
1	HORZ	"X," "Y" or "Z" for horizontal axis.
3	VERT	"X," "Y" or "Z" for vertical axis.
5-7	TEST1	The word "OUT" for the deletion of hidden lines, otherwise, leave blank.
8-12	PHI	Roll angle, degrees.
13-17	THETA	Pitch angle, degrees.
18-22	PSI	Yaw angle, degrees.
48-52	PLOTSZ	PLOTSZ determines the size of the plot. A scale factor is computed using PLOTSZ and the maximum dimension of the configuration.
53-55	TYPE	The word "ORT."
72	KODE	1 if this is the last plot.

The orthographic projections are created by rotating each point on the body surface to the desired viewing angle and then transforming the points into a coordinate system in the plane of the paper. The body coordinate system is coincident with the fixed system in the plane of the paper when all of the rotation angles are zero; for example, the configuration X axis and Y axis would coincide with the paper for plots in the X,Y paper plane. This would produce a top or plan view with the nose to the left. The Y,Z view is from the rear and the X,Y view (elevation) is from the Y = negative side, nose to left. The rotations of the body and its coordinate system to give a desired viewing angle are specified by angles of roll, pitch and yaw (θ, ϕ, ψ) which are positive by the right hand rule. HORZ and VERT specify the starting position from which the view is rotated, according to the input angles.

An attempt is made to center the given configuration within the specified field. If the desired plot size is greater than 28 inches, centering is attempted within 28 inches so care must be taken in choosing the view, i.e., PLOTSZ may exceed 28 as long as the resultant vertical dimensions of the plot do not exceed 28 inches since the paper is 29.5 inches wide (but up to 120 feet long).

Minimum values are adjusted so that body axis lines with no rotation angles coincide with grid lines on the plotter paper. Therefore, the plotter pen should be positioned one inch from the side of the plotting space and on the intersection of heavy grid lines at the start of plotting if plotting is to be done on grid paper. The initial pen position is not input to the program but specified on the CALCOMP plotting instruction card submitted to the computing center after the program VAMP run is completed.

Plan, Elevation and Rear Views (Stacked). - A three-view plot request card contains the following data punched in the indicated columns:

<u>Columns</u>	<u>Fortran Name</u>	<u>Description</u>
5-7	TEST1	The word "OUT" for the deletion of hidden lines, otherwise, leave blank.
8-12	PHI	Y-position on the paper of plan view, inches.
13-17	THETA	Y-position on the paper of the side view, inches.
18-22	PSI	Y-position on the paper of the rear view, inches.
48-52	PLOTSZ	PLOTSZ determines the size of the plot. See Orthographic projections.
53-55	TYPE	The word "VU3."
72	KODE	If 1, this is the last plot.

This option produces the X,Y, X,Z and Y,Z orthographic projections with no rotation angles. The views are stacked across the paper. No attempt is made to center the views or keep them from overlapping each other. The final origin point of the X,Y,Z arrays is used as the origin of the two axes that are being plotted for each view. The "Y-position" defines the location of the horizontal axis being plotted for the particular view.

Perspective View. - A perspective view request card contains the following data punched in the indicated columns:

<u>Columns</u>	<u>Fortran Name</u>	<u>Description</u>
8-12	PHI	x of the viewpoint (location of viewer) in the data coordinate system.
13-17	THETA	y of the viewpoint in the data coordinate system.
18-22	PSI	z of the viewpoint in the data coordinate system.
23-27	XF	x of the focalpoint (determines direction and focus) in the data coordinate system.
28-32	YF	y of the focalpoint in the data coordinate system.
33-37	ZF	z of the focal point in the data coordinate system.
38-42	DIST	The distance from the eye to the viewing plane.
43-47	FMAG	The viewing plane magnification factor. It controls the size of the projected image.
48-52	PLOTSZ	The diameter in inches of the viewing plane. DIST and PLOTSZ together determine a cone which is the field of vision.
53-55	TYPE	The word "PER."
72	KODE	If 1, this is the last plot.

Perspective views are obtained by projecting straight lines from points on the object to the viewer; the viewer being a single point in space. The points where these lines intercept the view plane form the image. If the view plane is between the viewer and object, the image is smaller than the object because the projected lines are converging. Thus, the basic scale of the plot is controlled by the ratio of DIST to the viewer's distance from the object. In this program, the view plane cannot be placed behind the object. It can be placed within the object, in which case, a cutaway view is obtained of what remains behind the plane. The focal point is the point towards which the viewer is looking; also called center

of view. The view plane is normal to the line from the viewer to the focus. PLOTSZ is the diameter of a circular "hole" located at DIST, through which the object is viewed. Perspective line intercepts outside this circle are not plotted. Thus, PLOTSZ is the maximum size of the actual plot, but it can be smaller. FMAG magnifies the view of the object (FMAG can be less than 1.0). It affects the dimensions normal to the viewer-focus line. The magnified view is still seen through the PLOTSZ hole. If DIST and PLOTSZ are such that the entire object cannot be seen, even less will be seen as FMAG increases. Each plot will be inside a PLOTSZ circle. Data which are within the cone of the viewing plane, but not in the immediate range of the focal point, may be distorted.

Stereo Frames Suitable for Viewing in a Steroscope. - The input is identical to that for the perspective views except that the word "STE" is used in columns 53-55. DIST, FMAG and PLOTSZ must be selected to produce a plot that will fit the intended stereo viewer. The stereo plots are two perspective views with the viewpoint shifted. These two plots are centered 9.8 inches apart.

Use of VAMP within ODIN

The Optimal Design Integration (ODIN) system is a library of independent computer programs representing the analytical capabilities in a wide variety of technological disciplines. The VAMP computer program is but a single member of the ODIN library. The sequence of execution of the individual programs is controlled by the executive program, DIALOG (reference 15) which also maintains a name-oriented data base of design information. Each piece of information is stored by name. The data base forms a communication link among the programs in the library. When used within the ODIN system, VAMP receives data from the data base before execution and provides information for updating the data base. The actual transfer of information to and from the data base is performed by DIALOG through pre- and post-processing of the data so VAMP is "unaware" that it is part of an analysis involving many programs. The general procedure for using ODIN is described in reference 15, but there are no special input requirements for using VAMP within the ODIN system. A single control directive,

```
'EXECUTE VAMP'
```

is required for the execution of the program. The delimiter (') is a 4-8 punch. The data which follows this directive is the normal input data described above. However, any data values may come from the data base by specifying the data base name on the input card (in lieu of the actual value).

```

$SHAPE
'
'
'
SCLX = 'SCALE,'
SCLY = 'SCALE,'
SCALX = 'SCALE,'
'
'
$END

```

In the above illustration the name SCALE is a data base name which may represent a scale factor for the entire configuration. The executive program, DIALOG replaces the name and the associated delimiter 'SCALE' with the data base value for SCALE. Upon execution of VAMP, the input component is photometrically scaled by the current scale factor in the data base. A procedure is also available for transferring data base arrays (see reference 15).

The illustration above applies to namelist input, but the procedure for extracting data base information is equally applicable to formatted input. The field width is specified to the position of the delimiters (') as illustrated below:

2579	3.426	'DEN'	7.29	- - -
------	-------	-------	------	-------

DEN is assumed to be the name of a data base variable. The value of DEN will be placed (by DIALOG) on the input card in the most significant (E or F) format left justified in the specified field. If the data base variables were an integer the value would be right justified in the field (I format).

PROGRAM OUTPUT

The output from the VAMP program is divided into five groups.

- Input deck listing
- Configuration data output
- Black box data output
- ODIN output
- Configuration plot data output

The first three groups are printed in the listed order on the normal output elements. The ODIN output is a subset of the configuration and black box data saved or a special output file for potential storage in the ODIN data base. Configuration plot data are stored as a plot vector file (a physical tape) for later plotting on a CALCOMP device. A sample case illustrating all data output is presented in Appendix A.

Configuration Data Output

The program computes the volume, areas and mass properties of shell structures on a section-by-section basis for each component and on a segment-by-segment (component) basis for the entire configuration. It accumulates the results of previous (sections or segments) with the current section (or segment) as the calculation proceeds. One page of output presents the mass properties of the current section and the cumulative results of all previous sections.

Intermediate results for each component are summarized by a page of output presenting the mass properties of the current segment and the cumulative results for all previous segments. The last such summary provides mass properties for the entire configuration. The mass properties output for each segment is preceded by a printout of program controls and corner-point geometry. The first page contains the current values of all the program option controls, the X coordinates of the segment, the cross section areas of all station planes and the net half widths of all station contours. A new page is started with the corner-point geometry of the segment. If mass property calculations were requested (KPLT<0), H, RHO and SURFWT are then printed for the segment. The geometry and unit mass data is printed in station order

(J) down the page and around the contour (I) order across the page. The format provides for 11 points to be printed across the page. Since the program can accept up to 45 points per contour, the additional points follow in separate groups. The (I,J) indices for each value's position in its respective array are clearly indicated so that the proper subscripts can be readily determined if changes in the input are needed.

Black Box Data Output

The black box data output is similar in structure to the configuration data output. The elemental properties of the black boxes are rotated and/or transformed to the system references one at a time until all black box input is satisfied. The program prints the individual properties and the accumulated properties as the calculation proceeds. The accumulated properties include all configuration data as well as the properties of previous black boxes. The accumulated properties for the last black box represents the mass properties for the entire vehicle.

The black box output contains values printed in columns. The columns are identified at the top of each page. The columns include X,Y,Z coordinates, weight and the six moments and products of inertia. Each line starts with an alphabetic description. The second output line starts with the word INPUT and presents part of the input supplied for the current black box. The X,Y,Z columns are the coordinates of its c.g. (the first column of BXPLN). The inertias in this line are the input values, relative to the local prime axes. The third line starts with:

ROT-TRANS/REF.AX

This line contains the mass properties of the black box about the system reference axes. If no rotation of the inertias was required, the letters ROT are deleted. If NBX = 2, the current black box has a symmetrical counterpart and Y = 0.0 on this line along with the appropriate doubling or zeroing of the weight and inertias. After transforming the black box to the reference axes, program VAMP adds it to the cumulative system which includes all segments of the vehicle and all preceding black boxes. The resultant mass properties about the reference axes, are printed on the line that starts with SYSTEM/REF.AXES and continues with no entries in the X,Y,Z columns. The fifth (and last) line

leads off with SYSTEM/C.G. and contains the c.g. coordinates of the accumulated system, total weight and inertias about axes through the system c.g., parallel to the reference axes.

If NBX is negative, only the first and second lines are printed (LABEL and INPUT) but the program expects more input to complete the current black box. With each succeeding \$BLKBOX set, the INPUT line reflects the rotation specified by the preceding set. ROT is still deleted if the final \$BLKBOX set does not specify rotation. The five line format is repeated for all black boxes in the case.

Configuration Plot Data Output

Plotted output from the VAMP program depends on the occurrence of the following four events:

1. The setting of $KPLT \geq 0$ for at least one of the configuration components.
2. The presence of at least one plot request card following last black box data input set.
3. The transfer of the plot vector file CALTPE to a physical tape as illustrated in figure 4.
4. The submittal of a CALCOMP plotting instruction card.

Any of the four types of plots described earlier may be generated. Figures 1 and 2 illustrate CALCOMP output for the program. Appendix A also contains a sequence of CALCOMP output examples for the sample case.

In addition to the plotted data, the program provides some printed information also.

The program prints the minimum, maximum and difference between maximum and minimum values of X,Y and Z respectively. There are the values used to scale the plots. The program also lists the plot request cards. Each card is listed twice. First is the card image which shows what was punched on the card. The second listing is the computer's interpretation of the card. This interpretation is designed to indicate the correct columns for the data. Thus, it shows input rounded off to a whole number, but all decimal places are retained internally. It also shows the signs which have been known to be punched in the wrong column and lost.

If plotting trouble is encountered, the last request card listed is the one the program is trying to satisfy. Remember that the last plot request card must have a 1 in column 72 unless it is also the last card in the input deck. If there are no plot request cards and no following case data (i.e. end of input file), the program will make a normal stop after printing the maximum/minimum values.

The actual plots are made on a CALCOMP plotter. Each plot provides an image of the title card. With the exception of plots produced by the VU3 option, each plot also contains the image of the plot request card. Thirty inch plot paper should be requested.

ODIN Output

The ODIN data base output consists of the volume, area and mass properties of each segment on an individual and cumulative basis. The information is placed on a special file in a namelist like format for use by the DIALOG (reference 15) executive program. Any subset of the information in this file may be placed in the data base by DIALOG for use by other programs. A special name generating capability is employed in VAMP to provide unique descriptions (names) for the various segment, component and black box properties.

A set of array information is generated for each segment as follows:

SEGTOT0n	}	Individual Segment Information
SEGXYZ0n		
SEGSBT0n		
CUMTOT0n	}	Cumulative Information
CUMXYZ0n		
CUMSBT0n		

The character position, n, varies as the segment number changes. There are as many of the above sets as there are segments in the mass properties analysis. Figures 12 and 13 associate the elements of the above arrays with the actual output from VAMP. The reader unfamiliar with the illustrated output is referred to Appendix A for complete familiarization.

CSGT 001 HARRIS TYPE INPUT OCT 11, 1972

SEGMENT 1 --- FUSELAGE

NET RESULTS FOR THIS SEGMENT.
 SINCE PRECEDING OUTPUT, KSYM HAS DONE ITS THING AND, IF THIS IS A WING SEGMENT, OFFSETS HAVE BEEN ADDED.

SURF AREA= 3.89105E+04 PJCTD AREA= 1.54583E+04 WALL VOL= 1.94553E+04 ENCL VOL= 3.41970E+05 C.V. AT X= 2.07308E+02
 SEGTOT01 (11) INERTIAS ABOUT REF. AXES (12) (13) (14)

IXX= 1.42336E+06 IYY= 1.32563E+08 IZZ= 1.33202E+08 PIXY= 0. PIXZ= 1.45162E+06 PIYZ= 0.
 SEGTOT01 (5) WEIGHT OF WALL= 1.04985E+05 C.G. AT X,Y,Z= 1.83774E+02 0. (8) -1.96559E+00 (9) (10)
 SEGTOT01 (1) INERTIAS ABOUT C.G. SEGXYZ01 (1) (2) (3)

IXX= 1.41075E+06 IYY= 2.23481E+07 IZZ= 2.29958E+07 PIXY= 0. PIXZ= 2.72926E+05 PIYZ= 0.
 SEGSBT01 (5) (6) (7) (8) (9) (10)

CUMULATIVE RESULTS FOR THIS AND PRECEDING SEGMENTS

SURF AREA= 3.89105E+04 PJCTD AREA= 1.54583E+04 WALL VOL= 1.94553E+04 ENCL VOL= 3.41970E+05 C.V. AT X= 2.07308E+02
 CUMTOT01 (11) INERTIAS ABOUT REF. AXES (12) (13) (14)

IXX= 1.42336E+06 IYY= 1.32563E+08 IZZ= 1.33202E+08 PIXY= 0. PIXZ= 1.45162E+06 PIYZ= 0.
 CUMTOT01 (5) WEIGHT OF WALL= 1.04985E+05 C.G. AT X,Y,Z= 1.83774E+02 0. (8) -1.96559E+00 (9) (10)
 CUMTOT01 (1) INERTIAS ABOUT C.G. CUMXYZ01 (1) (2) (3)

IXX= 1.41075E+06 IYY= 2.23481E+07 IZZ= 2.29958E+07 PIXY= 0. PIXZ= 2.72926E+05 PIYZ= 0.
 CUMSBT01 (5) REF. LENGTH= 320.000, C.G. AT 57.43 PERCENT, C.V. AT 64.78 PERCENT (6) (7) (8) (9) (10)

NOTE: ODIN array names and element numbers are identified below relevant output.

FIGURE 12 ODIN DATA BASE OUTPUT FOR SEGMENT 1 ----FUSELAGE.

CSGT 001 HARRIS TYPE INPUT OCT 11, 1972

SEGMENT 2 ---- WING

NET RESULTS FOR THIS SEGMENT.
 SINCE PRECEDING OUTPUT, KSYM HAS DONE ITS THING AND, IF THIS IS A WING SEGMENT, OFFSETS HAVE BEEN ADDED.

SURF AREA= 9.24311E+03 PJCTD AREA= 4.48385E+03 WALL VOL= 0. ENCL VOL= 0. C.V. AT X= 0.
 (11) (12) (13) (14)

SEGTOT02 INERTIAS ABOUT REF. AXES

I XX= 2.02393E+06 IYY= 6.90545E+07 IZZ= 7.08675E+C7 PIXY= 0. PIXZ= 2.64033E+06 PIYZ= 0.
 SEGTOT02(5) (6) (7) (8) (9) (10)
 WEIGHT OF WALL= 2.71544E+04 C.G. AT X,Y,Z= 2.84956E+02 0. -1.09676E+01
 SEGTOT02 (1) (2) (3)

I XX= 1.92241E+06 IYY= 4.21611E+05 IZZ= 2.33655E+06 PIXY= 0. PIXZ= 2.64234E+03 PIYZ= 0.
 SEGSBT02(5) (6) (7) (8) (9) (10)

CUMULATIVE RESULTS FOR THIS AND PRECEDING SEGMENTS

SURF AREA= 4.81536E+04 PJCTD AREA= 1.99421E+04 WALL VOL= 1.94553E+04 ENCL VOL= 3.41970E+05 C.V. AT X= 2.07308E+02
 CUMTOT02 (11) (12) (13) (14)

INERTIAS ABOUT REF. AXES

I XX= 3.44729E+06 IYY= 2.01617E+08 IZZ= 2.04070E+C8 PIXY= 0. PIXZ= 4.09195E+06 PIYZ= 0.
 CUMTOT02(5) (6) (7) (8) (9) (10)
 WEIGHT OF WALL= 1.32140E+05 C.G. AT X,Y,Z= 2.04566E+02 0. -3.81548E+00
 CUMTOT02 (1) (2) (3)

I XX= 3.38750E+06 IYY= 2.96890E+07 IZZ= 3.22013E+07 PIXY= 0. PIXZ= 8.86330E+05 PIYZ= 0.
 CUMSBT02(5) (6) (7) (8) (9) (10)

REF. LENGTH= 320.000, C.G. AT 63.93 PERCENT, C.V. AT 64.78 PERCENT

NOTE: ODIN array names and element numbers are identified below relevant output.

FIGURE 13 ODIN DATA BASE OUTPUT FOR SEGMENT 2 ----WING.

Figure 12 is the normal output for SEGMENT 1---FUSELAGE. Generally the upper half of the page is segment data and the lower half is cumulative (all previous segment calculations) data. Since figure 12 is the first segment, the lower half data is identical with the upper half data. The generated ODIN data base array names appear on the left in bold type and the element numbers of the generated names which are associated with the data elements appear directly beneath the corresponding data elements. For example, the c.g. location of segment 1 (SEGXYZ01) is:

$$X_{cg} = 1.838 = \text{SEGXYZ01}(1)$$

$$Y_{cg} = 0. = \text{SEGXYZ01}(2)$$

$$Z_{cg} = 1.966 = \text{SEGXYZ01}(3)$$

The corresponding cumulative c.g. location CUMXYZ01 is illustrated in the lower half of figure 12. Similar examples may be observed for surface areas, inertias, etc.

Figure 13 illustrates the correspondence between VAMP data and ODIN data base elements for the second segment. Here the upper half is the calculated properties for the wing segment. The lower half is the accumulated properties for the wing and fuselage (segments 1 and 2). The ODIN data base names are similar to those in figure 12 differing only in the last character positions.

n = 2 for the wing

n = 1 for the fuselage

The analyst may quickly determine from the segment number printed what ODIN data base name will be generated. Once determined the information may be defined in the ODIN data base for use by other programs. Up to 99 segment names may be generated (i.e. SEGXYZ099).

In addition to analyzing configuration segments, VAMP generates mass properties (individual and cumulative) for elemental point masses (black boxes). Figure 14 illustrates ODIN data base output for one black box.

The first set of print statements represents the cumulation of all properties for all segments. This data is identical

CSGT 001 HARRIS TYPE INPUT OCT 11, 1972

	X	Y	Z	HEIGHT	IXX	IYY	IZZ	PIXY	PIXZ	PIYZ
TOTALS FOR BODY WITHOUT BLACK BOXES (REF)										
SYSTEM/REF.AXES										
SYSTEM/ C.G.	204.566	0.000	-3.815	1.3214E+05	3.4473E+06	2.0162E+08	2.0407E+08	0.	4.0919E+06	0.
CUMXYZ00	(1)	(2)	CUMTOT01	(1)	(5)	(6)	(7)	(8)	(9)	(10)
INPUT	160.000	0.000	10.000	1.3214E+05	3.3875E+06	2.9689E+07	3.2201E+07	0.	8.8633E+05	0.
-TRANS/REF.AXES	160.000	0.000	10.000	1.0000E+04	0.	0.	0.	0.	0.	0.
SYSTEM/REF.AXES				1.0000E+04	3.1081E+04	7.9878E+06	7.9567E+06	0.	-4.9730E+05	0.
SYSTEM/ C.G.	201.431	0.000	-2.844	1.4214E+05	3.4784E+06	2.0961E+08	2.1208E+08	0.	3.5946E+06	0.
Input line is black box only input data; no ODIN output				1.4214E+05	3.4427E+06	3.0318E+07	3.2775E+07	0.	1.0642E+06	0.
BBXYZ10	(1)	(2)	(3)							
(line 2 cont'd)										
CUMXYZ10	(1)	(2)	CUMTOT10	(1)	(5)	(6)	(7)	(8)	(9)	(10)
				BBXSBT10	(5)	(6)	(7)	(8)	(9)	(10)
				CUMTOT10	(5)	(6)	(7)	(8)	(9)	(10)
				(3) CUMSBT10	(5)	(6)	(7)	(8)	(9)	(10)

NOTE: ODIN array names and element numbers are identified below relevant output.

FIGURE 14 ODIN DATA BASE OUTPUT FOR ONE (1) BLACK BOX.

to the data accumulation for the last segment (see figure 12). The ODIN data base output names for this cumulation will always be:

CUMTOT00

CUMXYZ00

with 00 as the last two character positions. Therefore, even though the number of segments may change from run to run, the vehicle totals (without black box) will always bear the above names.

The second set of data, in figure 14, is for the black box, both individually and cumulative. The correspondence of the ODIN names and data elements with the black box data is indicated below. The individual black box properties have root names.

BBXYZn0

BBXSBTn0

The black box number is identified by n. For example, the third black box would be:

BBXYZ30

BBXSBT30

The cumulative properties of the black boxes have root names of:

CUMTOTn0

CUMXYZn0

CUMSBTn0

The root names are identical to the root names for the segment cumulative properties. The differences lies in the last two character positions:

CUMXYZ05 = Cumulative c.g. properties for the fifth segment.

CUMXYZ50 = Cumulative properties of all segments plus five black boxes.

Up to 99 black box names may be generated. The last character position will always be zero (0) such test the 99th ODIN name would be:

CUMXYZ990

The ODIN data base output scheme described above is adequate for extracting most any combination of vehicle properties. Intermediate or section data is not available directly but can be obtained simply by grouping sections into smaller segments. The new segments would consist of portions of an original segment. For example, the fuselage may be split into multiple segments by input. By judicious selection of segments, the analyst may obtain the properties desired for storing in the ODIN data base.

CONCLUDING REMARKS

Program VAMP is designed to bridge the gap between the historical approach to estimating weight and the detailed structural design approach. It computes the mass properties, center of gravity location, enclosed volume, wetted area and planform area of any closed structure that has a plane of symmetry. The configuration is described to the program by ordered sets of coordinates on its surface. The surface is approximated by quadrilateral surface elements among the points. The mass properties of the configuration are computed from properties input at each point. The computed mass property totals contain the contribution from the distributed mass in the vehicle surface wall. Additional masses may be added by specifying each center of gravity location and mass properties. Picture-like images of the configuration under study may be obtained from the surface geometry.

The program can be interfaced with other technology modules within the ODIN system. VAMP itself is not a sizing or structural synthesis program; other modules in the ODIN program library carry out these functions. As a contributor to the overall design analysis, VAMP provides a means for assembling shape and mass properties data from other sources and for combining the information to produce the total mass properties of a vehicle design.

The significant contribution of the program to the general problem of computer aided design is twofold. First, the program offers a unified approach to the accounting of the vehicle component mass properties. The fact that a component weight is not well known does not exclude it from being analyzed in a mass properties evaluation. Furthermore, detailed mass properties of some vehicle components may be determined elsewhere and still be included in the VAMP analysis. Second, the distributed mass surface model incorporated in VAMP allows a very convenient means of producing vehicle geometric perturbations early in the design process with some degree of confidence in the resulting affect of the perturbation.

REFERENCES

1. Gregory, T.J., Peterson, R.J. and Wyss, J.A.: Performance Trade-Offs and Research Problems for Hypersonic Transports. AIAA Journal of Aircraft, July-August 1965.
2. Peterson, R.H., Gregory, T.J. and Smith C.L.: Some Comparisons of Turboramjet-Powered Hypersonic Aircraft for Cruise and Boost Missions. Journal of Aircraft, September-October, 1966.
3. Adams, J.D.: Vehicle Synthesis of High Speed Aircraft. VSAC, Volume I, USAF AFFDL-TR-71-40, 1971.
4. Oman, B.: Vehicle Synthesis for High Speed Aircraft. VSAC, Volume II, USAF AFFDL-TR-41-40, 1971.
5. Lee, V.A., Ball, H.G., Wadsworth, E.A., Moran, W.J. and McLead, J.D.: Computerized Aircraft Synthesis. AIAA Journal of Aircraft, September-October 1967.
6. Herbst, W.B. and Ross, H.: Application of Computer Aided Design Programs for the Management of Fighter Development Projects. AIAA Paper 70-364, presented at the AIAA Fighter Aircraft Conference, March 1970.
7. Koenig, Robert W. and Fishback, Laurence H.: GENENG - A Program for Calculating Design and Off-Design Performance for Turbojet and Turbofan Engines, NASA TN-D-6552, 1972.
8. Fishback, Laurence H. and Koenig, Robert W.: GENENG II - A Program for Calculating Design and Off-Design Performance for Two-and-Three Spool Turbofans with as Many as Three Nozzles, NASA TN-D-6553, 1972.
9. Giles, Gary L., Blackburn, Charles L. and Dixon, Sidney C.: Automated Procedure for Sizing Aerospace Vehicles Structures. Journal of Aircraft, Volume 9, No. 12, December 1972.
10. Sobieszczanski, J. and Soendorf, D.: A Mixed Optimization Method for Automated Design of Fuselage Structures. Journal of Aircraft, Volume 9, No. 12, December 1972, pp 805-811.

11. Giles, Gary L.: A Procedure for Automating Aircraft Wing Structural Design, Journal of Structures Division, American Society of Civil Engineers. January 1971, pp. 99-113.
12. Stroud, W. Jefferson, Dexter, Cornelia B. and Stein, Manual: Automated Preliminary Design of Simplified Wing Structures to Satisfy Strength and Flutter Requirements. NASA TN-D-6534, 1971.
13. Dwyer, Walter J., Emerton, Robert K. and Ojalvo, Irving V.: An Automated Procedure for the Optimization of Practical Structures. Volume I, Theretical Development and User's Information. AFFDL-TR-70-118, USAF, April 1971.
14. Hague, D.S. and Glatt, C.R.: Optimal Design Integration of Military Flight Vehicles - ODIN/MFV. AFFDL-TR-73-132, 1973.
15. Glatt, C.R., Hague, D.S. and Watson, D.A.: DIALOG: An Executive Computer Program for Linking Independent Programs. NASA CR-2296, July 1973.
16. Craidon, C.B.: Description of a Digital Computer Program for Airplane Configuration Plots, NASA TM X-2074, September 1970.

APPENDIX A

SAMPLE PROBLEM

The configuration being analyzed with the sample problem is a wing body configuration representing an advanced transportation concept. Both the wing and the body are described to the program through use of the auxiliary geometric data input option (KXYZ > 0). The wing geometry is described to the program using the camber and thickness distribution option (KWNG = 2, KWYZ = 2). The surface weight option is employed for specifying the unit weight distribution for both the fuselage and wing surfaces. Surface weight distribution is described to the program through the \$SHAPE input set (KSWT = 0).

One black box is input representing the weight of 10000 pounds located 160 feet aft of the nose and ten feet above the fuselage reference line. Five plots are requested. The first one is a three-view and the other four are orthographic projections representing different views and using different hidden line options. The data presented is a sequential listing of the data output from the computer. The ODIN output is appended by copying the special output file to the printer at the end of the job. The geometric pictures were obtained by submitting the plot vector tape file to the CALCOMP plotter. These pictures are presented at the end of the section.

PROGRAM VAMP --- LIST OF ALL CARDS INPUT TO THIS RUN

```

CSGT 001 HARRIS TYPE INPUT OCT 11, 1972
$SHAPE NSEG=2,NSTA=22,NPIS=21,KWNG=0,KXVZ=1,RFLNTH=320.,NOSE=1,
RHO=1000*2.0,H=1000*0.5,SURFWT=1000*0.0,
LABEL= 9H FUSELAGE,
SURFWT (1,1)=21*3.12,
SURFWT (1,2)=21*3.12,
SURFWT (1,3)=9*3.12,12*2.36,
SURFWT (1,4)=8*3.12,13*2.17,
SURFWT (1,5)=8*5.12,2.17,12*1.80,
SURFWT (1,6)=7*2.95,3*2.17,11*1.80,
SURFWT (1,7)=7*2.95,5*2.17,11*1.80,
SURFWT (1,8)=7*2.95,3*2.17,11*1.80,
SURFWT (1,9)=7*2.95,3*2.17,3*1.80,8*1.40,
SURFWT (1,10)=7*2.30,3*2.17,3*1.80,8*1.40,
SURFWT (1,11)=7*2.30,3*2.17,3*1.80,8*1.40,
SURFWT (1,12)=7*2.30,3*2.17,3*1.80,8*1.40,
SURFWT (1,13)=7*2.30,3*2.17,3*1.80,8*1.40,
SURFWT (1,14)=7*2.30,3*2.17,3*1.80,8*1.40,
SURFWT (1,15)=7*2.30,3*2.17,3*1.80,8*1.40,
SURFWT (1,16)=7*2.30,3*2.17,3*1.80,8*1.40,
SURFWT (1,17)=7*2.30,3*2.17,3*1.80,8*1.40,
SURFWT (1,18)=7*2.30,3*2.17,3*1.80,8*1.40,
SURFWT (1,19)=7*2.30,3*2.17,3*1.80,8*1.40,
SURFWT (1,20)=7*2.30,3*2.17,3*1.80,8*1.40,
SURFWT (1,21)=5*2.17,3*0.0,13*1.10,
SURFWT (1,22)=5*2.17,3*0.0,13*1.10,
$END OF SFT FORMATTED CARDS TO FOLLOW
0.000 8.000 16.000 24.000 32.000 40.000 48.000 56.000 64.000 72.000
80.000 93.333106.667120.000133.333146.667160.000173.333186.667200.000
265.400320.000
0.000 0.000 0.000 0.000 0.000 0.000 0.000 0.000 0.000 0.000
0.000 0.000 0.000 0.000 0.000 0.000 0.000 0.000 0.000 0.000
-0.000 -0.000 -0.000 -0.000 -0.000 -0.000 -0.000 -0.000 -0.000 -0.000
-U.000 0.000 0.000 0.000 0.000 0.000 0.000 0.000 0.000 0.000
0.000
0.000 .385 .769 1.154 1.539 1.924 2.308 2.693 3.078 3.462
3.847 3.462 3.078 2.693 2.308 1.924 1.539 1.154 .769 .385
0.000
-1.924 -1.914 -1.885 -1.835 -1.765 -1.666 -1.539 -1.374 -1.154 -.838
-.000 .838 1.154 1.374 1.539 1.666 1.763 1.835 1.885 1.914
1.924
0.000
6.241 5.617 4.993 4.365 3.745 3.121 2.497 1.872 1.248 .624

```

PROGRAM VAMP --- LIST OF ALL CARDS INPUT TO THIS RUN

0.000	-3.105	-3.058	-2.977	-2.860	-2.703	-2.497	-2.229	-1.872	-1.360	* Y	3
-0.000	1.360	1.872	2.229	2.497	2.703	2.860	2.977	3.058	3.105	* Z	3
3.121										* Z	3
0.000	.831	1.662	2.494	3.325	4.156	4.987	5.818	6.649	7.481	* Y	4
8.312	7.481	6.649	5.818	4.987	4.156	3.325	2.494	1.662	.831	* Y	4
0.000	-4.135	-4.072	-3.964	-3.809	-3.599	-3.325	-2.968	-2.494	-1.812	* Z	4
-0.000	1.812	2.494	2.968	3.325	3.599	3.809	3.964	4.072	4.135	* Z	4
4.156										* Z	4
0.000	1.019	2.038	3.057	4.076	5.096	6.115	7.134	8.153	9.172	* Y	5
10.191	9.172	8.153	7.134	6.115	5.096	4.076	3.057	2.038	1.019	* Y	5
0.000	-5.070	-4.993	-4.861	-4.670	-4.413	-4.076	-3.639	-3.057	-2.221	* Y	5
-0.000	2.221	3.057	3.639	4.076	4.413	4.670	4.861	4.993	5.070	* Z	5
5.070										* Z	5
0.000	1.193	2.386	3.579	4.772	5.965	7.158	8.351	9.544	10.738	* Y	6
11.931	10.738	9.544	8.351	7.158	5.965	4.772	3.579	2.386	1.193	* Y	6
0.000	-5.935	-5.845	-5.691	-5.467	-5.166	-4.772	-4.260	-3.579	-2.600	* Z	6
-0.000	2.600	3.579	4.260	4.772	5.166	5.467	5.691	5.845	5.935	* Z	6
5.965										* Z	6
0.000	1.356	2.711	4.067	5.423	6.778	8.134	9.450	10.845	12.201	* Y	7
13.556	12.201	10.845	9.490	8.134	6.778	5.423	4.067	2.711	1.356	* Y	7
0.000	-6.778	-6.641	-6.466	-6.212	-5.870	-5.423	-4.841	-4.067	-2.955	* Z	7
-0.000	2.955	4.067	4.841	5.423	5.870	6.212	6.466	6.641	6.778	* Z	7
6.778										* Z	7
0.000	1.508	3.017	4.525	6.033	7.542	9.050	10.559	12.067	13.575	* Y	8
15.084	13.575	12.067	10.559	9.050	7.542	6.033	4.525	3.017	1.508	* Y	8
0.000	-7.542	-7.389	-7.194	-6.912	-6.531	-6.033	-5.386	-4.525	-3.287	* Z	8
-0.000	3.287	4.525	5.386	6.033	6.531	6.912	7.194	7.389	7.542	* Z	8
7.542										* Z	8
0.000	1.652	3.304	4.957	6.609	8.261	9.913	11.565	13.218	14.870	* Y	9
16.522	14.870	13.218	11.565	9.913	8.261	6.609	4.957	3.304	1.652	* Y	9
0.000	-8.261	-8.220	-8.094	-7.880	-7.571	-7.154	-6.609	-5.900	-4.957	* Z	9
-0.000	3.601	4.957	5.900	6.609	7.154	7.571	7.880	8.094	8.220	* Z	9
8.261										* Z	9
0.000	1.788	3.576	5.363	7.151	8.939	10.727	12.515	14.302	16.090	* Y	10
17.878	16.090	14.302	12.515	10.727	8.939	7.151	5.363	3.576	1.788	* Y	10
0.000	-8.939	-8.894	-8.758	-8.527	-8.193	-7.741	-7.151	-6.384	-5.363	* Z	10

PROGRAM VAMP --- LIST OF ALL CARDS INPUT TO THIS RUN

-0.000	3.896	5.363	6.384	7.151	7.741	8.193	8.527	8.758	8.894	* Z	10
8.939										* Z	10
0.000	1.916	3.831	5.747	7.663	9.578	11.494	13.410	15.325	17.241	* Y	11
19.157	17.241	15.325	13.410	11.494	9.578	7.663	5.747	3.831	1.916	* Y	11
0.000										* Y	11
-9.578	-9.530	-9.385	-9.137	-8.779	-8.295	-7.663	-6.840	-5.747	-4.175	* Z	11
-0.000	4.175	5.747	6.840	7.663	8.295	8.779	9.137	9.385	9.530	* Z	11
9.578										* Z	11
0.000	2.113	4.225	6.338	8.450	10.563	12.675	14.788	16.900	19.013	* Y	12
21.126	19.013	16.900	14.788	12.675	10.563	8.450	6.338	4.225	2.113	* Y	12
0.000										* Y	12
-10.563	-10.510	-10.349	-10.076	-9.681	-9.148	-8.450	-7.543	-6.338	-4.604	* Z	12
-0.000	4.604	6.338	7.543	8.450	9.148	9.681	10.076	10.349	10.510	* Z	12
10.563										* Z	12
0.000	2.290	4.581	6.871	9.161	11.451	13.742	16.032	18.322	20.613	* Y	13
22.903	20.613	18.322	16.032	13.742	11.451	9.161	6.871	4.581	2.290	* Y	13
0.000										* Y	13
-11.451	-11.394	-11.220	-10.924	-10.455	-9.917	-9.161	-8.178	-6.871	-4.992	* Z	13
-0.000	4.992	6.871	8.178	9.161	9.917	10.455	10.924	11.220	11.394	* Z	13
11.451										* Z	13
0.000	2.450	4.900	7.350	9.800	12.250	14.700	17.150	19.600	22.049	* Y	14
24.499	22.049	19.600	17.150	14.700	12.250	9.800	7.350	4.900	2.450	* Y	14
0.000										* Y	14
-12.250	-12.188	-12.002	-11.685	-11.227	-10.609	-9.800	-8.748	-7.350	-5.340	* Z	14
-0.000	5.340	7.350	8.748	9.800	10.609	11.227	11.685	12.002	12.188	* Z	14
12.250										* Z	14
0.000	2.592	5.185	7.777	10.370	12.962	15.554	18.147	20.739	23.331	* Y	15
25.924	23.331	20.739	18.147	15.554	12.962	10.370	7.777	5.185	2.592	* Y	15
0.000										* Y	15
-12.962	-12.897	-12.700	-12.365	-11.880	-11.225	-10.370	-9.257	-7.777	-5.650	* Z	15
-0.000	5.650	7.777	9.257	10.370	11.225	11.880	12.365	12.700	12.897	* Z	15
12.962										* Z	15
0.000	2.732	5.464	8.195	10.927	13.659	16.391	19.122	21.854	24.586	* Y	16
27.318	24.586	21.854	19.122	16.391	13.659	10.927	8.195	5.464	2.732	* Y	16
0.000										* Y	16
-13.659	-13.590	-13.383	-13.030	-12.518	-11.829	-10.927	-9.754	-8.195	-5.954	* Z	16
-0.000	5.954	8.195	9.754	10.927	11.829	12.518	13.030	13.383	13.590	* Z	16
13.659										* Z	16
0.000	2.859	5.718	8.577	11.435	14.294	17.153	20.012	22.871	25.730	* Y	17
28.589	25.730	22.871	20.012	17.153	14.294	11.435	8.577	5.718	2.859	* Y	17
0.000										* Y	17
-14.294	-14.223	-14.005	-13.656	-13.101	-12.379	-11.435	-10.208	-8.577	-6.231	* Z	17
-0.000	6.231	8.577	10.208	11.435	12.379	13.101	13.636	14.005	14.223	* Z	17
14.294										* Z	17

PROGRAM VAMP --- LIST OF ALL CARDS INPUT TO THIS RUN

```

0.000 2.958 5.915 8.873 11.830 14.788 17.745 20.703 23.660 26.618
29.575 26.618 23.660 20.703 17.745 14.788 11.830 8.873 5.915 2.958
0.000
-14.788 -14.714 -14.489 -14.107 -13.553 -12.807 -11.830 -10.561 -8.873 -6.446
14.788 8.873 10.561 11.830 12.807 13.553 14.107 14.489 14.714
0.000 3.029 6.057 9.086 12.115 15.144 18.172 21.201 24.230 27.258
30.287 27.258 24.230 21.201 18.172 15.144 12.115 9.086 6.057 3.029
0.000
-15.144 -15.068 -14.838 -14.446 -13.879 -13.115 -12.115 -10.815 -9.086 -6.601
15.144 6.601 9.086 10.815 12.115 13.115 13.879 14.446 14.838 15.068
0.000 3.074 6.147 9.221 12.255 15.368 18.442 21.516 24.585 27.663
30.737 27.663 24.589 21.516 18.442 15.368 12.255 9.221 6.147 3.074
0.000
-15.368 -15.291 -15.058 -14.660 -14.085 -13.309 -12.295 -10.975 -9.221 -6.699
15.368 6.699 9.221 10.975 12.295 13.309 14.085 14.660 15.058 15.291
30.737 27.663 24.589 21.516 18.442 15.368 12.295 9.221 6.147 3.074
0.000
-15.368 -15.368 -15.368 -15.368 -15.368 -15.368 -15.368 -15.368 -15.368 -15.368
15.368 6.147 12.295 18.442 24.589 30.737 30.737 30.737 30.737 30.737
30.737 27.663 24.589 21.516 18.442 15.368 12.295 9.221 6.147 3.074
0.000
-15.368 -15.368 -15.368 -15.368 -15.368 -15.368 -15.368 -15.368 -15.368 -15.368
15.368 6.699 9.221 10.975 12.295 13.309 14.085 14.660 15.058 15.291
0.000
0.000 6.147 12.295 18.442 24.589 30.737 30.737 30.737 30.737 30.737
30.737 27.663 24.589 21.516 18.442 15.368 12.295 9.221 6.147 3.074
0.000
-15.368 -15.368 -15.368 -15.368 -15.368 -15.368 -15.368 -15.368 -15.368 -15.368
15.368 6.699 9.221 10.975 12.295 13.309 14.085 14.660 15.058 15.291
0.000
$SHAPE $END INPUT FOR FUSELAGE
START INPUT FOR WING
$SHAPE NSTA=2,NPTS=17,KWNG=2,KXYZ=2,
RHO=1000*2.0,H=1000*0.5,SURFWT=1000*0.0,
LABEL= 5H WING,
SURFWT(1,1)=6*3.12,6*1.6,5*1.1,6*3.12,5*2.30,5*1.90,
SURFWT(1,2)=6*3.12,6*1.6,5*1.1,6*3.12,5*2.30,5*1.90,
$END OF SET FORMATTED CARDS TO FOLLOW
0.0 1.25 2.5 5.0 7.5 10.0 15.0 20.0 30.0 40.0
50.0 60.0 70.0 80.0 90.0 95.0 100.0
229. 30.5 -10.34 91.0
299.6 70.75 -11.42 20.4
0.0 1.209 1.635 2.178 2.542 2.827 3.245 3.529 3.885 4.0
3.885 3.547 2.987 2.213 1.245 .685

```

PROGRAM VAMP --- LIST OF ALL CARDS INPUT TO THIS RUN

```

0.0 1.813 2.453 3.267 3.813 4.240 4.867 5.293 5.827 6.0
5.827 5.320 4.480 3.320 1.867 1.027 .012
$SHAPE $END INPUTS FOR WING
$BLKBOX NBX=1, WTM=10000., XC=160., Y0=0., Z0=10., $END
.$BLKBOX NBX=0, $END
    OUT10.0 2.0 6.0
X Z OUT -45. 10. -150.
X Z   -45. 10. -150.
X Z   -60. 20. -160.
X Z OUT -60. 20. -160.

```

```

4.96VU3
4.96ORTHOGGRAPHIC
4.96ORTHOGGRAPHIC
4.96ORTHOGGRAPHIC
4.96ORTHOGGRAPHIC

```

```

* WAFORD 2.
* WAFORD 2
*
*
*
*
*
*

```

CSGT 001 HARRIS TYPE INPUT OCT 11, 1972

DATA FOR SEGMENT NUMBER 1 --- FUSELAGE

CONTROLS ARE SET AS FOLLOWS

NSEG= 2 NSTA= 22 NPIS= 21 NOSE= 1
 KPLT= 0 KWNG= 0 KSYM= 0 KYZRO= 0
 OFFSETS= 0.000 0.000 0.000 0.000
 KXYZ= 1 KRHOH= 0 KSWT= 0
 SCALE FACTORS= 1.00000 1.00000 1.00000

X COORD OF STATION PLANES

0.000	8.000	16.000	24.000	32.000	40.000	48.000	56.000	64.000	72.000
80.000	93.333	106.667	120.000	133.333	146.667	160.000	173.333	186.667	200.000
265.400	320.000								

XSEC AREA OF STATION PLANES

0.000	22.974	60.469	107.244	161.216	220.944	285.271	353.151	423.735	496.123
569.645	692.755	814.225	931.700	1043.192	1158.378	1268.679	1357.791	1423.912	1466.474
1677.969	1677.969								

YMAX -Y(1) OF STATION PLANES

0.000	3.847	6.241	8.312	10.191	11.931	13.556	15.084	16.522	17.878
19.157	21.126	22.903	24.499	25.924	27.318	28.589	29.575	30.287	30.737
30.737	30.737								

CSGT 001 HARRIS TYPE INPUT OCT 11, 1972

DATA FOR SEGMENT NUMBER 1 --- FUSELAGE

J/	1	2	3	4	5	6	7	8	9	10	11
1	0.000	0.000	0.000	0.000	0.000	0.000	0.000	0.000	0.000	0.000	0.000
2	0.000	.385	.769	1.154	1.539	1.924	2.308	2.693	3.078	3.462	3.847
3	0.000	.624	1.248	1.872	2.497	3.121	3.745	4.369	4.993	5.617	6.241
4	0.000	.831	1.662	2.494	3.325	4.156	4.987	5.818	6.649	7.481	8.312
5	0.000	1.019	2.038	3.057	4.076	5.096	6.115	7.134	8.153	9.172	10.191
6	0.000	1.193	2.386	3.579	4.772	5.965	7.158	8.351	9.544	10.738	11.931
7	0.000	1.356	2.711	4.067	5.423	6.778	8.134	9.490	10.845	12.201	13.556
8	0.000	1.508	3.017	4.525	6.033	7.542	9.050	10.559	12.067	13.575	15.084
9	0.000	1.652	3.304	4.957	6.609	8.261	9.913	11.565	13.218	14.870	16.522
10	0.000	1.788	3.576	5.151	6.803	8.453	10.105	11.757	13.409	15.061	16.713
11	0.000	1.916	3.831	5.477	7.063	8.648	10.234	11.800	13.366	14.932	16.498
12	0.000	2.113	4.225	6.338	8.450	10.563	12.675	14.788	16.900	19.013	21.126
13	0.000	2.290	4.581	6.871	9.161	11.451	13.742	16.032	18.322	20.613	22.903
14	0.000	2.450	4.900	7.350	9.800	12.250	14.700	17.150	19.600	22.049	24.499
15	0.000	2.592	5.185	7.777	10.370	12.962	15.554	18.147	20.739	23.331	25.924
16	0.000	2.732	5.464	8.195	10.927	13.591	16.391	19.122	21.854	24.586	27.318
17	0.000	2.859	5.718	8.577	11.435	14.294	17.153	20.012	22.871	25.730	28.589
18	0.000	2.958	5.915	8.873	11.830	14.788	17.745	20.703	23.660	26.618	29.575
19	0.000	3.029	6.057	9.086	12.115	15.144	18.172	21.201	24.230	27.258	30.287
20	0.000	3.074	6.147	9.221	12.295	15.368	18.442	21.516	24.585	27.653	30.737
21	0.000	6.147	12.295	18.442	24.589	30.737	30.737	30.737	30.737	30.737	30.737
22	0.000	6.147	12.295	18.442	24.589	30.737	30.737	30.737	30.737	30.737	30.737

CSGT 001 HARRIS TYPE INPUT CCT 11, 1972

DATA FOR SEGMENT NUMBER 1 ---- FUSELAGE

J/	11	12	13	14	15	16	17	18	19	20	21
1	0.000	0.000	0.000	0.000	0.000	0.000	0.000	0.000	0.000	0.000	0.000
2	3.847	3.462	3.078	2.693	2.308	1.924	1.539	1.154	.769	.385	0.000
3	6.241	5.617	4.993	4.369	3.745	3.121	2.497	1.872	1.248	.624	0.000
4	8.312	7.481	6.649	5.818	4.987	4.156	3.325	2.494	1.662	.831	0.000
5	10.191	9.172	8.153	7.134	6.115	5.096	4.076	3.057	2.038	1.019	0.000
6	11.931	10.738	9.544	8.351	7.158	5.965	4.772	3.579	2.386	1.193	0.000
7	13.556	12.201	10.845	9.490	8.134	6.778	5.423	4.067	2.711	1.356	0.000
8	15.084	13.575	12.067	10.559	9.050	7.542	6.033	4.525	3.017	1.508	0.000
9	16.522	14.870	13.218	11.565	9.913	8.261	6.609	4.957	3.304	1.652	0.000
10	17.878	16.090	14.302	12.515	10.727	8.939	7.151	5.363	3.576	1.788	0.000
11	19.157	17.241	15.325	13.410	11.494	9.578	7.663	5.747	3.831	1.916	0.000
12	21.126	19.013	16.900	14.788	12.675	10.562	8.450	6.338	4.225	2.113	0.000
13	22.903	20.613	18.322	16.032	13.742	11.451	9.161	6.871	4.581	2.290	0.000
14	24.499	22.049	19.600	17.150	14.700	12.250	9.800	7.350	4.900	2.450	0.000
15	25.924	23.331	20.739	18.147	15.554	12.962	10.370	7.777	5.185	2.592	0.000
16	27.318	24.586	21.854	19.122	16.391	13.659	10.927	8.195	5.464	2.752	0.000
17	28.589	25.730	22.871	20.012	17.153	14.294	11.435	8.577	5.718	2.859	0.000
18	29.575	26.618	23.660	20.703	17.745	14.788	11.830	8.873	5.915	2.958	0.000
19	30.287	27.258	24.230	21.201	18.172	15.144	12.115	9.086	6.057	3.029	0.000
20	30.737	27.663	24.585	21.516	18.442	15.368	12.295	9.221	6.147	3.074	0.000
21	30.737	27.663,	24.589	21.516	18.442	15.368	12.295	9.221	6.147	3.074	0.000
22	30.737	27.663,	24.589	21.516	18.442	15.368	12.295	9.221	6.147	3.074	0.000

CSGT 001 HARRIS TYPE INPUT OCT 11, 1972

DATA FOR SEGMENT NUMBER 1 --- FUSELAGE

JJ	1	2	3	4	5	6	7	8	9	10	11
1	0.000	0.000	0.000	0.000	0.000	0.000	0.000	0.000	0.000	0.000	0.000
2	-1.924	-1.914	-1.885	-1.835	-1.763	-1.666	-1.539	-1.374	-1.154	0.000	0.000
3	-3.121	-3.105	-3.058	-2.977	-2.860	-2.703	-2.497	-2.229	-1.872	-0.838	0.000
4	-4.156	-4.135	-4.072	-3.964	-3.809	-3.599	-3.325	-2.968	-2.494	-1.360	0.000
5	-5.096	-5.070	-4.993	-4.861	-4.670	-4.413	-4.076	-3.639	-3.057	-1.812	0.000
6	-5.965	-5.935	-5.845	-5.691	-5.467	-5.166	-4.772	-4.260	-3.579	-2.221	0.000
7	-6.778	-6.744	-6.641	-6.466	-6.212	-5.870	-5.423	-4.841	-4.067	-2.955	0.000
8	-7.542	-7.504	-7.389	-7.194	-6.912	-6.531	-6.033	-5.386	-4.525	-3.287	0.000
9	-8.261	-8.220	-8.054	-7.880	-7.571	-7.154	-6.609	-5.900	-4.957	-3.601	0.000
10	-8.939	-8.894	-8.758	-8.527	-8.193	-7.741	-7.151	-6.384	-5.363	-3.896	0.000
11	-9.578	-9.530	-9.385	-9.137	-8.779	-8.295	-7.663	-6.840	-5.747	-4.175	0.000
12	-10.563	-10.510	-10.345	-10.076	-9.681	-9.148	-8.450	-7.543	-6.338	-4.604	0.000
13	-11.451	-11.394	-11.220	-10.924	-10.495	-9.917	-9.161	-8.178	-6.871	-4.992	0.000
14	-12.250	-12.188	-12.002	-11.685	-11.227	-10.609	-9.800	-8.748	-7.350	-5.340	0.000
15	-12.962	-12.897	-12.700	-12.365	-11.880	-11.225	-10.370	-9.257	-7.777	-5.650	0.000
16	-13.659	-13.590	-13.385	-13.030	-12.518	-11.829	-10.927	-9.754	-8.195	-5.954	0.000
17	-14.294	-14.223	-14.005	-13.636	-13.101	-12.379	-11.435	-10.208	-8.577	-6.231	0.000
18	-14.738	-14.714	-14.489	-14.107	-13.553	-12.807	-11.830	-10.561	-8.873	-6.446	0.000
19	-15.144	-15.068	-14.828	-14.446	-13.879	-13.115	-12.115	-10.815	-9.086	-6.601	0.000
20	-15.368	-15.291	-15.058	-14.660	-14.085	-13.309	-12.295	-10.975	-9.221	-6.699	0.000
21	-15.368	-15.368	-15.368	-15.368	-15.368	-15.368	-12.295	-9.221	-6.147	-3.074	0.000
22	-15.368	-15.368	-15.368	-15.368	-15.368	-15.368	-12.295	-9.221	-6.147	-3.074	0.000

CSGT 001 HARRIS TYPE INPUT OCT 11, 1972

DATA FOR SEGMENT NUMBER 1 ---- FUSELAGE

J/	11	12	13	14	15	16	17	18	19	20	21
1	0.000	0.000	0.000	0.000	0.000	0.000	0.000	0.000	0.000	0.000	0.000
2	0.000	0.838	1.154	1.574	1.539	1.666	1.763	1.835	1.885	1.914	1.924
3	0.000	1.360	1.872	2.229	2.497	2.703	2.860	2.977	3.058	3.106	3.121
4	0.000	1.812	2.454	2.968	3.225	3.599	3.809	3.964	4.072	4.135	4.156
5	0.000	2.221	3.057	3.639	4.076	4.413	4.670	4.861	4.993	5.070	5.096
6	0.000	2.600	3.579	4.260	4.772	5.166	5.467	5.691	5.845	5.925	5.965
7	0.000	2.955	4.067	4.841	5.423	5.870	6.212	6.466	6.641	6.744	6.778
8	0.000	3.287	4.525	5.386	6.033	6.531	6.912	7.194	7.389	7.504	7.542
9	0.000	3.601	4.957	5.900	6.609	7.154	7.571	7.880	8.094	8.220	8.261
10	0.000	3.896	5.363	6.384	7.151	7.741	8.193	8.527	8.758	8.894	8.939
11	0.000	4.175	5.747	6.840	7.663	8.295	8.779	9.137	9.385	9.530	9.578
12	0.000	4.604	6.358	7.543	8.450	9.148	9.681	10.076	10.349	10.510	10.563
13	0.000	4.992	6.871	8.178	9.161	9.917	10.495	10.924	11.220	11.394	11.451
14	0.000	5.340	7.350	8.748	9.800	10.609	11.227	11.685	12.002	12.188	12.250
15	0.000	5.650	7.777	9.257	10.370	11.225	11.880	12.365	12.700	12.897	12.962
16	0.000	5.954	8.195	9.754	10.927	11.829	12.518	13.030	13.383	13.540	13.659
17	0.000	6.231	8.577	10.208	11.435	12.379	13.101	13.636	14.005	14.223	14.294
18	0.000	6.446	8.875	10.561	11.830	12.807	13.553	14.107	14.489	14.714	14.788
19	0.000	6.601	9.086	10.815	12.115	13.115	13.879	14.446	14.838	15.068	15.144
20	0.000	6.699	9.221	10.975	12.295	13.309	14.085	14.660	15.058	15.291	15.368
21	0.000	6.699	9.221	10.975	12.295	13.309	14.085	14.660	15.058	15.291	15.368
22	0.000	6.699	9.221	10.975	12.295	13.309	14.085	14.660	15.058	15.291	15.368

CSGT 001 HARRIS TYPE INPUT OCT. 11, 1972

DATA FOR SEGMENT NUMBER 1 --- FUSELAGE

J/	H (QUAD) AROUND EACH STATION CONTOUR (J)	1	2	3	4	5	6	7	8	9	10	11
1	1	.50000	.50000	.50000	.50000	.50000	.50000	.50000	.50000	.50000	.50000	.50000
2	1	.50000	.50000	.50000	.50000	.50000	.50000	.50000	.50000	.50000	.50000	.50000
3	1	.50000	.50000	.50000	.50000	.50000	.50000	.50000	.50000	.50000	.50000	.50000
4	1	.50000	.50000	.50000	.50000	.50000	.50000	.50000	.50000	.50000	.50000	.50000
5	1	.50000	.50000	.50000	.50000	.50000	.50000	.50000	.50000	.50000	.50000	.50000
6	1	.50000	.50000	.50000	.50000	.50000	.50000	.50000	.50000	.50000	.50000	.50000
7	1	.50000	.50000	.50000	.50000	.50000	.50000	.50000	.50000	.50000	.50000	.50000
8	1	.50000	.50000	.50000	.50000	.50000	.50000	.50000	.50000	.50000	.50000	.50000
9	1	.50000	.50000	.50000	.50000	.50000	.50000	.50000	.50000	.50000	.50000	.50000
10	1	.50000	.50000	.50000	.50000	.50000	.50000	.50000	.50000	.50000	.50000	.50000
11	1	.50000	.50000	.50000	.50000	.50000	.50000	.50000	.50000	.50000	.50000	.50000
12	1	.50000	.50000	.50000	.50000	.50000	.50000	.50000	.50000	.50000	.50000	.50000
13	1	.50000	.50000	.50000	.50000	.50000	.50000	.50000	.50000	.50000	.50000	.50000
14	1	.50000	.50000	.50000	.50000	.50000	.50000	.50000	.50000	.50000	.50000	.50000
15	1	.50000	.50000	.50000	.50000	.50000	.50000	.50000	.50000	.50000	.50000	.50000
16	1	.50000	.50000	.50000	.50000	.50000	.50000	.50000	.50000	.50000	.50000	.50000
17	1	.50000	.50000	.50000	.50000	.50000	.50000	.50000	.50000	.50000	.50000	.50000
18	1	.50000	.50000	.50000	.50000	.50000	.50000	.50000	.50000	.50000	.50000	.50000
19	1	.50000	.50000	.50000	.50000	.50000	.50000	.50000	.50000	.50000	.50000	.50000
20	1	.50000	.50000	.50000	.50000	.50000	.50000	.50000	.50000	.50000	.50000	.50000
21	1	.50000	.50000	.50000	.50000	.50000	.50000	.50000	.50000	.50000	.50000	.50000

CSGT 001 HARRIS TYPE INPUT OCT 11, 1972

DATA FOR SEGMENT NUMBER 1 FUSELAGE

J/	H (QUAD) AROUND EACH STATION CONTOUR (J)	11	12	13	14	15	16	17	18	19	20
1	1	.50000	.50000	.50000	.50000	.50000	.50000	.50000	.50000	.50000	.50000
2	2	.50000	.50000	.50000	.50000	.50000	.50000	.50000	.50000	.50000	.50000
3	3	.50000	.50000	.50000	.50000	.50000	.50000	.50000	.50000	.50000	.50000
4	4	.50000	.50000	.50000	.50000	.50000	.50000	.50000	.50000	.50000	.50000
5	5	.50000	.50000	.50000	.50000	.50000	.50000	.50000	.50000	.50000	.50000
6	6	.50000	.50000	.50000	.50000	.50000	.50000	.50000	.50000	.50000	.50000
7	7	.50000	.50000	.50000	.50000	.50000	.50000	.50000	.50000	.50000	.50000
8	8	.50000	.50000	.50000	.50000	.50000	.50000	.50000	.50000	.50000	.50000
9	9	.50000	.50000	.50000	.50000	.50000	.50000	.50000	.50000	.50000	.50000
10	10	.50000	.50000	.50000	.50000	.50000	.50000	.50000	.50000	.50000	.50000
11	11	.50000	.50000	.50000	.50000	.50000	.50000	.50000	.50000	.50000	.50000
12	12	.50000	.50000	.50000	.50000	.50000	.50000	.50000	.50000	.50000	.50000
13	13	.50000	.50000	.50000	.50000	.50000	.50000	.50000	.50000	.50000	.50000
14	14	.50000	.50000	.50000	.50000	.50000	.50000	.50000	.50000	.50000	.50000
15	15	.50000	.50000	.50000	.50000	.50000	.50000	.50000	.50000	.50000	.50000
16	16	.50000	.50000	.50000	.50000	.50000	.50000	.50000	.50000	.50000	.50000
17	17	.50000	.50000	.50000	.50000	.50000	.50000	.50000	.50000	.50000	.50000
18	18	.50000	.50000	.50000	.50000	.50000	.50000	.50000	.50000	.50000	.50000
19	19	.50000	.50000	.50000	.50000	.50000	.50000	.50000	.50000	.50000	.50000
20	20	.50000	.50000	.50000	.50000	.50000	.50000	.50000	.50000	.50000	.50000
21	21	.50000	.50000	.50000	.50000	.50000	.50000	.50000	.50000	.50000	.50000

CSGT 001 HARRIS TYPE INPUT OCT 11, 1972
 DATA FOR SEGMENT NUMBER 1 ---- FUSELAGE

J/	11	12	13	14	15	16	17	18	19	20
1	2.00000	2.00000	2.00000	2.00000	2.00000	2.00000	2.00000	2.00000	2.00000	2.00000
2	2.00000	2.00000	2.00000	2.00000	2.00000	2.00000	2.00000	2.00000	2.00000	2.00000
3	2.00000	2.00000	2.00000	2.00000	2.00000	2.00000	2.00000	2.00000	2.00000	2.00000
4	2.00000	2.00000	2.00000	2.00000	2.00000	2.00000	2.00000	2.00000	2.00000	2.00000
5	2.00000	2.00000	2.00000	2.00000	2.00000	2.00000	2.00000	2.00000	2.00000	2.00000
6	2.00000	2.00000	2.00000	2.00000	2.00000	2.00000	2.00000	2.00000	2.00000	2.00000
7	2.00000	2.00000	2.00000	2.00000	2.00000	2.00000	2.00000	2.00000	2.00000	2.00000
8	2.00000	2.00000	2.00000	2.00000	2.00000	2.00000	2.00000	2.00000	2.00000	2.00000
9	2.00000	2.00000	2.00000	2.00000	2.00000	2.00000	2.00000	2.00000	2.00000	2.00000
10	2.00000	2.00000	2.00000	2.00000	2.00000	2.00000	2.00000	2.00000	2.00000	2.00000
11	2.00000	2.00000	2.00000	2.00000	2.00000	2.00000	2.00000	2.00000	2.00000	2.00000
12	2.00000	2.00000	2.00000	2.00000	2.00000	2.00000	2.00000	2.00000	2.00000	2.00000
13	2.00000	2.00000	2.00000	2.00000	2.00000	2.00000	2.00000	2.00000	2.00000	2.00000
14	2.00000	2.00000	2.00000	2.00000	2.00000	2.00000	2.00000	2.00000	2.00000	2.00000
15	2.00000	2.00000	2.00000	2.00000	2.00000	2.00000	2.00000	2.00000	2.00000	2.00000
16	2.00000	2.00000	2.00000	2.00000	2.00000	2.00000	2.00000	2.00000	2.00000	2.00000
17	2.00000	2.00000	2.00000	2.00000	2.00000	2.00000	2.00000	2.00000	2.00000	2.00000
18	2.00000	2.00000	2.00000	2.00000	2.00000	2.00000	2.00000	2.00000	2.00000	2.00000
19	2.00000	2.00000	2.00000	2.00000	2.00000	2.00000	2.00000	2.00000	2.00000	2.00000
20	2.00000	2.00000	2.00000	2.00000	2.00000	2.00000	2.00000	2.00000	2.00000	2.00000
21	2.00000	2.00000	2.00000	2.00000	2.00000	2.00000	2.00000	2.00000	2.00000	2.00000

CSGT 001 HARRIS TYPE INPUT OCT 11, 1972

DATA FOR SEGMENT NUMBER 1 --- FUSELAGE

J/	11	12	13	14	15	16	17	18	19	20	21
1	3.12000	3.12000	3.12000	3.12000	3.12000	3.12000	3.12000	3.12000	3.12000	3.12000	3.12000
2	3.12000	3.12000	3.12000	3.12000	3.12000	3.12000	3.12000	3.12000	3.12000	3.12000	3.12000
3	2.36000	2.36000	2.36000	2.36000	2.36000	2.36000	2.36000	2.36000	2.36000	2.36000	2.36000
4	2.17000	2.17000	2.17000	2.17000	2.17000	2.17000	2.17000	2.17000	2.17000	2.17000	2.17000
5	1.80000	1.80000	1.80000	1.80000	1.80000	1.80000	1.80000	1.80000	1.80000	1.80000	1.80000
6	1.80000	1.80000	1.80000	1.80000	1.80000	1.80000	1.80000	1.80000	1.80000	1.80000	1.80000
7	1.80000	1.80000	1.80000	1.80000	1.80000	1.80000	1.80000	1.80000	1.80000	1.80000	1.80000
8	1.80000	1.80000	1.80000	1.80000	1.80000	1.80000	1.80000	1.80000	1.80000	1.80000	1.80000
9	1.80000	1.80000	1.80000	1.80000	1.80000	1.80000	1.80000	1.80000	1.80000	1.80000	1.80000
10	1.80000	1.80000	1.80000	1.80000	1.80000	1.80000	1.80000	1.80000	1.80000	1.80000	1.80000
11	1.80000	1.80000	1.80000	1.80000	1.80000	1.80000	1.80000	1.80000	1.80000	1.80000	1.80000
12	1.80000	1.80000	1.80000	1.80000	1.80000	1.80000	1.80000	1.80000	1.80000	1.80000	1.80000
13	1.80000	1.80000	1.80000	1.80000	1.80000	1.80000	1.80000	1.80000	1.80000	1.80000	1.80000
14	1.80000	1.80000	1.80000	1.80000	1.80000	1.80000	1.80000	1.80000	1.80000	1.80000	1.80000
15	1.80000	1.80000	1.80000	1.80000	1.80000	1.80000	1.80000	1.80000	1.80000	1.80000	1.80000
16	1.80000	1.80000	1.80000	1.80000	1.80000	1.80000	1.80000	1.80000	1.80000	1.80000	1.80000
17	1.80000	1.80000	1.80000	1.80000	1.80000	1.80000	1.80000	1.80000	1.80000	1.80000	1.80000
18	1.80000	1.80000	1.80000	1.80000	1.80000	1.80000	1.80000	1.80000	1.80000	1.80000	1.80000
19	1.80000	1.80000	1.80000	1.80000	1.80000	1.80000	1.80000	1.80000	1.80000	1.80000	1.80000
20	1.80000	1.80000	1.80000	1.80000	1.80000	1.80000	1.80000	1.80000	1.80000	1.80000	1.80000
21	1.10000	1.10000	1.10000	1.10000	1.10000	1.10000	1.10000	1.10000	1.10000	1.10000	1.10000
22	1.10000	1.10000	1.10000	1.10000	1.10000	1.10000	1.10000	1.10000	1.10000	1.10000	1.10000

CSGT 001 HARRIS TYPE INPUT OCT 11, 1972

SEGMENT 1 , --- FUSELAGE

FOR SUB-SEGMENT BETWEEN STATION 1, X= 0.000 AREA= 0.000 AND STATION 2, X= 8.000 AREA= 22.974
 SURF AREA= 7.77783E+01 PJCTD AREA= 3.07760E+01 WALL VOL= 3.88891E+01 ENCL VOL= 6.12646E+01 C.V. AT X= 6.00000E+00

INERTIAS ABOUT REF. AXES

IXX= 4.13849E+01 IYY= 3.29263E+02 IZZ= 3.45545E+02 PIXY= -8.74240E+01 PIXZ= -1.24379E-12 PIYZ= -2.03176E-13
 WEIGHT OF WALL= 3.20446E+02 C.G. AT X,Y,Z= 5.33333E+00 1.46295E+00 1.20624E-14

INERTIAS ABOUT C.G.

IXX= 2.00688E+01 IYY= 4.59617E+01 IZZ= 4.49324E+01 PIXY= -9.71377E+00 PIXZ= -6.03051E-13 PIYZ= -2.74192E-14

CUMULATIVE RESULTS FOR SEGMENT

SURF AREA= 7.77783E+01 PJCTD AREA= 3.07760E+01 WALL VOL= 3.88891E+01 ENCL VOL= 6.12646E+01 C.V. AT X= 6.00000E+00

INERTIAS ABOUT REF. AXES

IXX= 4.13849E+01 IYY= 3.29263E+02 IZZ= 3.45545E+02 PIXY= -8.74240E+01 PIXZ= -1.24379E-12 PIYZ= -2.03176E-13
 WEIGHT OF WALL= 3.20446E+02 C.G. AT X,Y,Z= 5.33333E+00 1.46295E+00 1.20624E-14

INERTIAS ABOUT C.G.

IXX= 2.00688E+01 IYY= 4.59617E+01 IZZ= 4.49324E+01 PIXY= -9.71377E+00 PIXZ= -6.03051E-13 PIYZ= -2.74192E-14

CSGT 001 HARRIS TYPE INPUT OCT 11, 1972

SEGMENT 1 --- FUSELAGE

FOR SUB-SEGMENT BETWEEN STATION 2, X= 8.000 AREA= 22.574 AND STATION 3, X= 16.000 AREA= 60.469
SURF AREA= 1.98176E+02 PJCTD AREA= 8.07040E+01 WALL VOL= 9.90881E+01 ENCL VOL= 3.21907E+02 C.V. AT X= 1.26212E+01

INERTIAS ABOUT REF. AXES

IXX= 3.52688E+02 IYY= 3.80973E+03 IZZ= 3.97642E+03 PIXY= -8.62888E+02 PIXZ= 2.64942E+01 PIYZ= 4.29953E+00
HEIGHT OF WALL= 7.64924E+02 C.G. AT X,Y,Z= 1.22916E+01 2.88166E+00 -8.56083E-02

INERTIAS ABOUT C.G.

IXX= 1.55091E+02 IYY= 2.17601E+02 IZZ= 1.87042E+02 PIXY= -2.07863E+01 PIXZ= 1.47707E+00 PIYZ= -1.56551E+00

CUMULATIVE RESULTS FOR SEGMENT

SURF AREA= 2.75954E+02 PJCTD AREA= 1.11480E+02 WALL VOL= 1.37977E+02 ENCL VOL= 3.83171E+02 C.V. AT X= 1.15626E+01

INERTIAS ABOUT REF. AXES

IXX= 3.94073E+02 IYY= 4.13899E+03 IZZ= 4.32577E+03 PIXY= -9.50312E+02 PIXZ= 2.64942E+01 PIYZ= 4.29953E+00
HEIGHT OF WALL= 1.08537E+03 C.G. AT X,Y,Z= 1.02372E+01 2.46280E+00 -6.03331E-02

INERTIAS ABOUT C.G.

IXX= 1.89339E+02 IYY= 6.03470E+02 IZZ= 5.85958E+02 PIXY= -9.97927E+01 PIXZ= 5.65835E+00 PIYZ= -7.12999E-01

CSGT 001 HARRIS TYPE INPUT OCT 11, 1972

SEGMENT 1 --- FUSELAGE

FOR SUB-SEGMENT BETWEEN STATION 3, X= 16.000 AREA= 60.469 AND STATION 4, X= 24.000 AREA= 107.244

SURF AREA= 2.84534E+02 PJCTD AREA= 1.16424E+02 WALL VOL= 1.42267E+02 ENCL VOL= 6.61976E+02 C.V. AT X= 2.03769E+01

INERTIAS ABOUT REF. AXES

IXX= 9.27897E+02 IYY= 1.32271E+04 IZZ= 1.36512E+C4 PIXY= -2.59696E+03 PIXZ= 1.69343E+02 PIYZ= 2.31844E+01

WEIGHT OF WALL= 1.01175E+03 C.G. AT X,Y,Z= 2.01821E+01 4.05458E+00 -2.63651E-01

INERTIAS ABOUT C.G.

IXX= 4.08749E+02 IYY= 4.16374E+C2 IZZ= 3.25715E+02 PIXY= -2.37280E+01 PIXZ= 2.01710E+00 PIYZ= -1.04313E+01

CUMULATIVE RESULTS FOR SEGMENT

SURF AREA= 5.60489E+02 PJCTC AREA= 2.27904E+02 WALL VOL= 2.80244E+02 ENCL VOL= 1.04515E+03 C.V. AT X= 1.71454E+01

INERTIAS ABOUT REF. AXES

IXX= 1.32197E+03 IYY= 1.73661E+04 IZZ= 1.79772E+04 PIXY= -3.54727E+03 PIXZ= 1.55837E+02 PIYZ= 2.74839E+01

WEIGHT OF WALL= 2.09712E+03 C.G. AT X,Y,Z= 1.50351E+01 3.23075E+00 -1.58423E-01

INERTIAS ABOUT C.G.

IXX= 6.39998E+02 IYY= 2.63013E+03 IZZ= 2.56252E+03 PIXY= -3.81156E+02 PIXZ= 4.05831E+01 PIYZ= -5.87708E+00

CSGT 001 HARRIS TYPE INPUT OCT 11, 1972

SEGMENT 1 --- FUSELAGE

FOR SUB-SEGMENT BETWEEN STATION 4, X= 24.000 AREA= 107.244 AND STATION 5, X= 32.000 AREA= 161.216
SURF AREA= 3.60851E+02 PJCTD AREA= 1.48024E+02 WALL VOL= 1.80428E+02 ENCL VOL= 1.06693E+03 C.V. AT X= 2.82699E+01

INERTIAS ABOUT REF. AXES

IXX= 1.75739E+03 IYY= 3.04500E+04 IZZ= 3.12285E+04 PIXY= -5.39461E+03 PIXZ= 4.89571E+02 PIVZ= 5.91149E+01

HEIGHT OF WALL= 1.21060E+03 C.G. AT X,Y,Z= 2.81238E+01 5.07381E+00 -4.58623E-01

INERTIAS ABOUT C.G.

IXX= 7.80838E+02 IYY= 6.81420E+02 IZZ= 4.99613E+02 PIXY= -2.54951E+01 PIXZ= 4.25609E+00 PIVZ= -2.84407E+01

CUMULATIVE RESULTS FOR SEGMENT

SURF AREA= 9.21340E+02 PJCTD AREA= 3.75928E+02 WALL VOL= 4.60670E+02 ENCL VOL= 2.11168E+03 C.V. AT X= 2.27640E+01

INERTIAS ABOUT REF. AXES

IXX= 3.07936E+03 IYY= 4.78161E+04 IZZ= 4.92061E+04 PIXY= -8.94188E+03 PIXZ= 6.85408E+02 PIVZ= 8.65988E+01

HEIGHT OF WALL= 3.30771E+03 C.G. AT X,Y,Z= 1.98255E+01 3.90529E+00 -2.68294E-01

INERTIAS ABOUT C.G.

IXX= 1.50402E+03 IYY= 7.40048E+03 IZZ= 7.22995E+03 PIXY= -9.82126E+02 PIXZ= 1.38573E+02 PIVZ= -2.11188E+01

CSGT 001 HARRIS TYPE INPUT OCT 11, 1972

SEGMENT 1 --- FUSELAGE

FOR SUB-SEGMENT BETWEEN STATION 5, X= 32.000 AREA= 161.216 AND STATION 6, X= 40.000 AREA= 220.944
 SURF AREA= 4.30695E+02 PJCTD AREA= 1.76976E+02 WALL VOL= 2.15347E+02 ENCL VOL= 1.52238E+03 C.V. AT X= 3.52092E+01

INERTIAS ABOUT REF. AXES

IXX= 2.05722E+03 IYY= 5.70756E+04 IZZ= 5.83380E+04 PIXY= -9.41848E+03 PIXZ= 9.57130E+02 PIYZ= 1.08890E+02

WEIGHT OF WALL= 1.38336E+03 C.G. AT X,Y,Z= 3.61053E+01 6.04896E+00 -6.15077E-01

INERTIAS ABOUT C.G.

IXX= 1.26774E+03 IYY= 1.00999E+03 IZZ= 7.15414E+02 PIXY= -2.81596E+01 PIXZ= 4.29190E+00 PIYZ= -5.10806E+01

CUMULATIVE RESULTS FOR SEGMENT

SURF AREA= 1.35203E+03 PJCTD AREA= 5.52904E+02 WALL VOL= 6.76017E+02 ENCL VOL= 3.63405E+03 C.V. AT X= 2.83965E+01

INERTIAS ABOUT REF. AXES

IXX= 5.93659E+03 IYY= 1.04892E+05 IZZ= 1.07544E+05 PIXY= -1.83604E+04 PIXZ= 1.64254E+03 PIYZ= 1.95489E+02

WEIGHT OF WALL= 4.69107E+03 C.G. AT X,Y,Z= 2.46262E+01 4.53744E+00 -3.70557E-01

INERTIAS ABOUT C.G.

IXX= 2.91472E+03 IYY= 1.64491E+04 IZZ= 1.61197E+04 PIXY= -2.06830E+03 PIXZ= 3.12021E+02 PIYZ= -4.96622E+01

CSGT 001 HARRIS TYPE INPUT OCT 11, 1972

SEGMENT 1 --- FUSELAGE

FOR SUB-SEGMENT BETWEEN STATION 6, X= 40.000 AREA= 220.944 AND STATION 7, X= 48.000 AREA= 285.271
 SURF AREA= 4.95583E+02 PJCTD AREA= 2.03896E+02 WALL VOL= 2.47792E+02 ENCL VOL= 2.01939E+03 C.V. AT X= 4.41699E+01

INERTIAS ABOUT REF. AXES

IXX= 4.33191E+03 IYY= 9.67405E+04 IZZ= 9.86759E+04 PIXY= -1.51348E+04 PIXZ= 1.41018E+03 PIYZ= 1.48615E+02

WEIGHT OF WALL= 1.57700E+03 C.G. AT X,Y,Z= 4.40901E+01 6.58960E+00 -6.51018E-01

INERTIAS ABOUT C.G.

IXX= 1.91655E+03 IYY= 1.43850E+03 IZZ= 1.00008E+03 PIXY= -2.98613E+01 PIXZ= 3.29079E+00 PIYZ= -7.44189E+01

CUMULATIVE RESULTS FOR SEGMENT

SURF AREA= 1.84762E+03 PJCTD AREA= 7.56800E+02 WALL VOL= 9.23809E+02 ENCL VOL= 5.65344E+03 C.V. AT X= 3.40307E+01

INERTIAS ABOUT REF. AXES

IXX= 1.02685E+04 IYY= 2.01632E+05 IZZ= 2.06222E+05 PIXY= -3.34552E+C4 PIXZ= 3.05272E+03 PIYZ= 3.44104E+02

WEIGHT OF WALL= 6.26807E+03 C.G. AT X,Y,Z= 2.95232E+01 5.15438E+00 -4.41119E-01

INERTIAS ABOUT C.G.

IXX= 5.05473E+03 IYY= 3.17875E+04 IZZ= 3.12373E+C4 PIXY= -3.84898E+03 PIXZ= 5.15558E+02 PIYZ= -9.88529E+01

CSGT OUI HARRIS TYPE INPUT OCT 11, 1972

SEGMENT 1 --- FUSELAGE

FOR SUB-SEGMENT BETWEEN STATION 7, X= 48.000 AREA= 285.271 AND STATION 8, X= 56.000 AREA= 353.151
 SURF AREA= 5.56304E+02 PJCTD AREA= 2.29120E+02 WALL VOL= 2.78152E+02 ENCL VOL= 2.54886E+03 C.V. AT X= 5.21420E+01

INERTIAS ABOUT REF. AXES

IXX= 6.13101E+03 IYY= 1.51199E+05 IZZ= 1.93936E+05 PIXY= -2.25204E+04 PIXZ= 2.09899E+03 PIYZ= 2.10322E+02
 HEIGHT OF WALL= 1.77020E+03 C.G. AT X,Y,Z= 5.20761E+01 7.86889E+00 -7.31322E-01

INERTIAS ABOUT C.G.

IXX= 2.71210E+03 IYY= 1.56050E+03 IZZ= 1.33783E+03 PIXY= -3.16575E+01 PIXZ= 3.59387E+00 PIYZ= -1.05494E+02

CUMULATIVE RESULTS FOR SEGMENT

SURF AREA= 2.40392E+03 PJCTD AREA= 9.85920E+02 WALL VOL= 1.20196E+03 ENCL VOL= 8.20231E+03 C.V. AT X= 3.96588E+01

INERTIAS ABOUT REF. AXES

IXX= 1.63995E+04 IYY= 3.52831E+05 IZZ= 3.60156E+05 PIXY= -5.60155E+04 PIXZ= 5.15170E+03 PIYZ= 5.54426E+02
 HEIGHT OF WALL= 8.03627E+03 C.G. AT X,Y,Z= 3.44898E+01 5.74777E+00 -5.05028E-01

INERTIAS ABOUT C.G.

IXX= 8.08193E+03 IYY= 5.55736E+04 IZZ= 5.47086E+04 PIXY= -6.48782E+03 PIXZ= 7.99950E+02 PIYZ= -1.70799E+02

CSGT 001 HARRIS TYPE INPUT OCT 11, 1972

SEGMENT 1 --- FUSELAGE

FOR SUB-SEGMENT BETWEEN STATION 8, X= 56.000 AREA= 353.151 AND STATION 9, X= 64.000 AREA= 423.735
 SURF AREA= 6.13370E+02 PJCTD AREA= 2.52848E+02 WALL VOL= 3.06689E+02 ENCL VOL= 3.10326E+03 C.V. AT X= 6.01213E+01

INERTIAS ABOUT REF. AXES

IXX= 8.09337E+03 IYY= 2.16733E+05 IZZ= 2.20399E+05 PIXY= -3.10914E+04 PIXZ= 3.48475E+03 PIYZ= 3.34791E+02

WEIGHT OF WALL= 1.91072E+03 C.G. AT X,Y,Z= 6.00573E+01 8.70771E+00 -9.74669E-01

INERTIAS ABOUT C.G.

IXX= 3.53417E+03 IYY= 2.47367E+03 IZZ= 1.69357E+03 PIXY= -3.41383E+01 PIXZ= 8.46340E+00 PIYZ= -1.69236E+02

CUMULATIVE RESULTS FOR SEGMENT

SURF AREA= 3.01729E+03 PJCTD AREA= 1.23877E+03 WALL VOL= 1.50865E+03 ENCL VOL= 1.13056E+04 C.V. AT X= 4.52755E+01

INERTIAS ABOUT REF. AXES

IXX= 2.44931E+04 IYY= 5.65564E+05 IZZ= 5.80556E+05 PIXY= -8.71069E+04 PIXZ= 8.63646E+03 PIYZ= 8.89217E+02

WEIGHT OF WALL= 9.94899E+03 C.G. AT X,Y,Z= 3.94001E+01 6.31623E+00 -5.95223E-01

INERTIAS ABOUT C.G.

IXX= 1.20471E+04 IYY= 8.94234E+04 IZZ= 8.81881E+04 PIXY= -1.01531E+04 PIXZ= 1.38456E+03 PIYZ= -2.73335E+02

CSGT 001 HARRIS TYPE INPUT OCT 11, 1972

SEGMENT } --- FUSELAGE

FOR SUB-SEGMENT BETWEEN STATION 5, X= 64.000 AREA= 423.735 AND STATION 10, X= 72.000 AREA= 496.123
 SURF AREA= 6.67075E+02 PJCTD AREA= 2.75200E+02 WALL VOL= 3.33538E+02 ENCL VOL= 3.67563E+03 C.V. AT X= 6.81050E+01

INERTIAS ABOUT REF. AXES

IXX= 1.00827E+04 IYY= 2.87601E+05 IZZ= 2.92372E+05 PIXY= -4.04381E+04 PIXZ= 4.33068E+03 PIVZ= 4.12328E+02
 WEIGHT OF WALL= 1.97777E+03 C.G. AT X,Y,Z= 6.80449E+01 9.65913E+00 -1.03590E+00

INERTIAS ABOUT C.G.

IXX= 4.28154E+03 IYY= 2.91780E+03 IZZ= 2.01918E+03 PIXY= -3.59815E+01 PIXZ= -2.25192E+00 PIVZ= -2.02743E+02

CUMULATIVE RESULTS FOR SEGMENT

SURF AREA= 3.68437E+03 PJCTD AREA= 1.51397E+03 WALL VOL= 1.84218E+03 ENCL VOL= 1.49812E+04 C.V. AT X= 5.08767E+01

INERTIAS ABOUT REF. AXES

IXX= 3.45758E+04 IYY= 8.57165E+05 IZZ= 8.72927E+05 PIXY= -1.27545E+05 PIXZ= 1.29671E+04 PIVZ= 1.30154E+03
 WEIGHT OF WALL= 1.19268E+04 C.G. AT X,Y,Z= 4.41502E+01 6.87057E+00 -6.68298E-01

INERTIAS ABOUT C.G.

IXX= 1.69116E+04 IYY= 1.34425E+05 IZZ= 1.32855E+05 PIXY= -1.50993E+04 PIXZ= 2.02958E+03 PIVZ= -4.00539E+02

CSGT 001 HARRIS TYPE INPLT OCT 11, 1972

SEGMENT 1 ---- FUSELAGE

FOR SUB-SEGMENT BETWEEN STATION 10, X= 72.000 AREA= 496.123 AND STATION 11, X= 80.000 AREA= 569.645
 SURF AREA= 7.17675E+02 PJCTD AREA= 2.96280E+02 WALL VOL= 3.58838E+02 ENCL VOL= 4.25968E+03 C.V. AT X= 7.50921E+01

INERTIAS ABOUT REF. AXES

IXX= 1.23117E+04 IYY= 3.74262E+05 IZZ= 3.80241E+05 PIXY= -5.13344E+04 PIXZ= 4.31106E+03 PIYZ= 4.10055E+02

WEIGHT OF WALL= 2.06245E+03 C.G. AT X,Y,Z= 7.60508E+01 1.05232E+01 -8.83829E-01

INERTIAS ABOUT C.G.

IXX= 5.16297E+03 IYY= 3.45774E+03 IZZ= 2.38866E+03 PIXY= -3.26936E+01 PIXZ= 2.32249E+00 PIYZ= -1.86151E+02

CUMULATIVE RESULTS FOR SEGMENT

SURF AREA= 4.40204E+03 PJCTD AREA= 1.81025E+03 WALL VOL= 2.20102E+03 ENCL VOL= 1.92409E+04 C.V. AT X= 5.64591E+01

INERTIAS ABOUT REF. AXES

IXX= 4.68875E+04 IYY= 1.23143E+06 IZZ= 1.25317E+06 PIXY= -1.78879E+05 PIXZ= 1.72782E+04 PIYZ= 1.71160E+03

WEIGHT OF WALL= 1.39892E+04 C.G. AT X,Y,Z= 4.88533E+01 7.40905E+00 -7.00074E-01

INERTIAS ABOUT C.G.

IXX= 2.28063E+04 IYY= 1.93503E+05 IZZ= 1.91589E+05 PIXY= -2.15002E+04 PIXZ= 2.40767E+03 PIYZ= -5.43665E+02

CSGT 001 HARRIS TYPE INPUT OCT 11, 1972

SEGMENT 1, --- FUSELAGE

FOR SUB-SEGMENT BETWEEN STATION 11, X= 80.000 AREA= 569.645 AND STATION 12, X= 93.333 AREA= 692.755
 SURF AREA= 1.29994E+03 PJCTD AREA= 5.37093E+02 WALL VOL= 6.49968E+02 ENCL VOL= 8.40242E+03 C.V. AT X= 8.68836E+01

INERTIAS ABOUT REF. AXES

IXX= 2.64138E+04 IYY= 8.83020E+05 IZZ= 8.95845E+C5 PIXY= -1.15522E+05 PIXZ= 9.70387E+03 PIVZ= 8.79898E+02
 WEIGHT OF WALL= 3.73592E+03 C.G. AT X,Y,Z= 8.67831E+01 1.14492E+01 -9.61871E-01

INERTIAS ABOUT C.G.

IXX= 1.10853E+04 IYY= 8.40569E+03 IZZ= 6.11677E+C3 PIXY= -1.49501E+02 PIXZ= 1.11670E+01 PIVZ= -3.98851E+02

CUMULATIVE RESULTS FOR SEGMENT

SURF AREA= 5.70198E+03 PJCTD AREA= 2.34734E+03 WALL VOL= 2.85099E+03 ENCL VOL= 2.76433E+04 C.V. AT X= 6.57069E+01

INERTIAS ABOUT REF. AXES

IXX= 7.33012E+04 IYY= 2.11445E+06 IZZ= 2.14901E+06 PIXY= -2.94402E+05 PIXZ= 2.69821E+04 PIVZ= 2.59150E+03
 WEIGHT OF WALL= 1.77251E+04 C.G. AT X,Y,Z= 5.68478E+01 8.26063E+00 -7.55253E-01

INERTIAS ABOUT C.G.

IXX= 3.53937E+04 IYY= 3.33757E+05 IZZ= 3.31045E+C5 PIXY= -3.56931E+04 PIXZ= 3.32883E+03 PIVZ= -8.45587E+02

CSGT 001 HARRIS TYPE INPUT OCT 11, 1972

SEGMENT 1 --- FUSELAGE

FOR SUB-SEGMENT BETWEEN STATION 12, X= 93.323 AREA= 692.755 AND STATION 13, X= 106.667 AREA= 814.225
 SURF AREA= 1.41970E+03 PJCTD AREA= 5.87083E+02 WALL VOL= 7.09848E+02 ENCL VOL= 1.00361E+04 C.V. AT X= 1.00179E+02

INERTIAS ABOUT REF. AXES

IXX= 3.44276E+04 IYY= 1.28131E+06 IZZ= 1.29802E+06 PIXY= -1.58917E+05 PIXZ= 1.33560E+04 PIYZ= 1.14727E+03
 WEIGHT OF WALL= 4.07997E+03 C.G. AT X,Y,Z= 1.00098E+02 1.25080E+01 -1.05135E+00

INERTIAS ABOUT C.G.

IXX= 1.44480E+04 IYY= 1.05975E+04 IZZ= 7.60580E+03 PIXY= -1.48632E+02 PIXZ= 1.08262E+01 PIYZ= -5.20314E+02

CUMULATIVE RESULTS FOR SEGMENT

SURF AREA= 7.12167E+03 PJCTD AREA= 2.93442E+03 WALL VOL= 3.56084E+03 ENCL VOL= 3.76794E+04 C.V. AT X= 7.48888E+01

INERTIAS ABOUT REF. AXES

IXX= 1.07729E+05 IYY= 3.39576E+06 IZZ= 3.44743E+06 PIXY= -4.53319E+05 PIXZ= 4.03380E+04 PIYZ= 3.73877E+03
 WEIGHT OF WALL= 2.18051E+04 C.G. AT X,Y,Z= 6.49403E+01 9.05536E+00 -8.10656E-01

INERTIAS ABOUT C.G.

IXX= 5.17104E+04 IYY= 5.37184E+05 IZZ= 5.33331E+05 PIXY= -5.47778E+04 PIXZ= 4.65974E+03 PIYZ= -1.23626E+03

CSGT 001 HARRIS TYPE INPUT OCT 11, 1972

SEGMENT 1 --- FUSELAGE

FOR SUB-SEGMENT BETWEEN STATION 13, X= 106.667 AREA= 814.225 AND STATION 14, X= 120.000 AREA= 931.700
 SURF AREA= 1.52723E+03 PJCTC AREA= 6.32011E+02 WALL VOL= 7.63613E+02 ENCL VOL= 1.16304E+04 C.V. AT X= 1.13483E+02

INERTIAS ABOUT REF. AXES

IXX= 4.28981E+04 IYY= 1.76775E+06 IZZ= 1.78856E+06 PIXY= -2.08412E+05 PIXZ= 1.75237E+04 PIYZ= 1.43005E+03
 WEIGHT OF WALL= 4.38887E+03 C.G. AT X,Y,Z= 1.13416E+02 1.34616E+01 -1.13200E+00

INERTIAS ABOUT C.G.

IXX= 1.80036E+04 IYY= 1.28896E+04 IZZ= 9.15377E+03 PIXY= -1.44813E+02 PIXZ= 1.02673E+01 PIYZ= -6.48655E+02

CUMULATIVE RESULTS FOR SEGMENT

SURF AREA= 8.64890E+03 PJCTD AREA= 3.56663E+03 WALL VOL= 4.32445E+03 ENCL VOL= 4.93099E+04 C.V. AT X= 8.39918E+01

INERTIAS ABOUT REF. AXES

IXX= 1.50627E+05 IYY= 5.16351E+06 IZZ= 5.23555E+06 PIXY= -6.61731E+05 PIXZ= 5.78617E+04 PIYZ= 5.16882E+03
 WEIGHT OF WALL= 2.61940E+04 C.G. AT X,Y,Z= 7.30626E+01 9.79364E+00 -8.64499E-01

INERTIAS ABOUT C.G.

IXX= 7.19304E+04 IYY= 8.16930E+05 IZZ= 8.11534E+05 PIXY= -7.91776E+04 PIXZ= 6.43892E+03 PIYZ= -1.72413E+03

CSGT 001 HARRIS TYPE INPUT OCT 11, 1972

SEGMENT 1 --- FUSELAGE

FOR SUB-SEGMENT BETWEEN STATION 14, X= 120.000 AREA= 931.700 AND STATION 15, X= 133.333 AREA= 1043.192
 SURF AREA= 1.62352E+03 PJCTD AREA= 6.72290E+02 WALL VOL= 8.11759E+02 ENCL VOL= 1.31586E+04 C.V. AT X= 1.26792E+02

INERTIAS ABOUT REF. AXES

IXX= 5.15737E+04 IYY= 2.34459E+06 IZZ= 2.36960E+06 PIXY= -2.63227E+05 PIXZ= 2.21418E+04 PIYZ= 1.7190E+03
 WEIGHT OF WALL= 4.66548E+03 C.G. AT X,Y,Z= 1.26737E+02 1.43155E+01 -1.20429E+00

INERTIAS ABOUT C.G.

IXX= 2.16465E+04 IYY= 1.52200E+04 IZZ= 1.07213E+04 PIXY= -1.38793E+02 PIXZ= 9.50440E+00 PIYZ= -7.80134E+02

CUMULATIVE RESULTS FOR SEGMENT

SURF AREA= 1.02724E+04 PJCTD AREA= 4.23872E+03 WALL VOL= 5.13621E+03 ENCL VOL= 6.24685E+04 C.V. AT X= 9.30074E+01

INERTIAS ABOUT REF. AXES

IXX= 2.02201E+05 IYY= 7.50810E+06 IZZ= 7.60515E+06 PIXY= -9.24958E+05 PIXZ= 8.00035E+04 PIYZ= 6.88861E+03
 WEIGHT OF WALL= 3.08595E+04 C.G. AT X,Y,Z= 8.11774E+01 1.04773E+01 -9.15870E-01

INERTIAS ABOUT C.G.

IXX= 9.61078E+04 IYY= 1.18677E+06 IZZ= 1.17938E+06 PIXY= -1.09190E+05 PIXZ= 8.69325E+03 PIYZ= -2.31515E+03

CSGT 001 HARRIS TYPE INPUT OCT 11, 1972

SEGMENT 1 ---- FUSELAGE

FOR SUB-SEGMENT BETWEEN STATION 15, X= 133.333 AREA= 1043.192 AND STATION 16, X= 146.667 AREA= 1158.378
 SURF AREA= 1.71421E+03 PJCTD AREA= 7.09929E+02 WALL VCL= 8.57106E+02 ENCL VOL= 1.46712E+04 C.V. AT X= 1.40116E+02

INERTIAS ABOUT REF. AXES

IXX= 6.07032E+04 IYY= 3.02164E+06 IZZ= 3.05108E+C6 PIXY= -3.24280E+05 PIXZ= 2.72788E+04 PIYZ= 2.02426E+03
 WEIGHT OF WALL= 4.92607E+03 C.G. AT X,Y,Z= 1.40066E+02 1.51147E+C1 -1.27157E+00

INERTIAS ABOUT C.G.

IXX= 2.54778E+04 IYY= 1.76551E+04 IZZ= 1.23583E+C4 PIXY= -1.44082E+02 PIXZ= 9.70263E+00 PIYZ= -9.18367E+02

CUMULATIVE RESULTS FOR SEGMENT

SURF AREA= 1.19866E+04 PJCTD AREA= 4.94865E+03 WALL VOL= 5.99332E+03 ENCL VOL= 7.71396E+04 C.V. AT X= 1.01967E+02

INERTIAS ABOUT REF. AXES

IXX= 2.62904E+05 IYY= 1.05297E+07 IZZ= 1.06583E+07 PIXY= -1.24924E+06 PIXZ= 1.07282E+05 PIYZ= 8.91287E+03
 WEIGHT OF WALL= 3.57855E+04 C.G. AT X,Y,Z= 8.92837E+01 1.11156E+01 -9.64834E-01

INERTIAS ABOUT C.G.

IXX= 1.24444E+05 IYY= 1.666231E+06 IZZ= 1.65244E+C6 PIXY= -1.45391E+05 PIXZ= 1.14686E+04 PIYZ= -3.01573E+03

CSGT 001 HARRIS TYPE INPUT OCT 11, 1972

SEGMENT 1 FUSELAGE

FOR SUB-SEGMENT BETWEEN STATION 16, X= 146.667 AREA= 1158.378 AND STATION 17, X= 160.000 AREA= 1268.679
SURF AREA= 1.79916E+03 PJCTD AREA= 7.65408E+02 WALL VOL= 8.95581E+02 ENCL VOL= 1.61744E+04 C.V. AT X= 1.53435E+02

INERTIAS ABOUT REF. AXES

IXX= 7.02295E+04 IYY= 3.80142E+06 IZZ= 3.83547E+06 PIXY= -3.91287E+05 PIXZ= 3.29228E+04 PIYZ= 2.34229E+03

WEIGHT OF WALL= 5.17012E+03 C.G. AT X,Y,Z= 1.53392E+02 1.58607E+01 -1.33530E+00

INERTIAS ABOUT C.G.

IXX= 2.94778E+04 IYY= 2.01854E+04 IZZ= 1.40524E+04 PIXY= -1.39251E+02 PIXZ= 9.06076E+00 PIYZ= -1.06271E+03

CUMULATIVE RESULTS FOR SEGMENT

SURF AREA= 1.37858E+04 PJCTC AREA= 5.69406E+03 WALL VOL= 6.89290E+03 ENCL VOL= 9.33140E+04 C.V. AT X= 1.10888E+02

INERTIAS ABOUT REF. AXES

IXX= 3.33133E+05 IYY= 1.43312E+07 IZZ= 1.44917E+07 PIXY= -1.64053E+06 PIXZ= 1.40205E+05 PIYZ= 1.12552E+04

WEIGHT OF WALL= 4.09557E+04 C.G. AT X,Y,Z= 5.73766E+01 1.17157E+01 -1.01160E+00

INERTIAS ABOUT C.G.

IXX= 1.57111E+05 IYY= 2.25957E+06 IZZ= 2.24672E+06 PIXY= -1.88314E+05 PIXZ= 1.48123E+04 PIYZ= -3.83120E+03

CSGT 00L HARRIS TYPE INPUT OCT 11, 1972

SEGMENT 1 . --- FUSELAGE

FOR SUB-SEGMENT BETWEEN STATION 17, X= 160.000 AREA= 1268.679 AND STATION 18, X= 173.333 AREA= 1357.791
 SURF AREA= 1.87035E+03 PJCTD AREA= 7.75501E+02 WALL VOL= 9.35173E+02 ENCL VOL= 1.75060E+04 C.V. AT X= 1.66742E+02

INERTIAS ABOUT REF. AXES

IXX= 7.89892E+04 IYY= 4.66554E+06 IZZ= 4.70381E+06 PIXY= -4.59757E+05 PIXZ= 3.87018E+04 PIVZ= 2.63533E+03
 WEIGHT OF WALL= 5.37455E+03 C.G. AT X,Y,Z= 1.66712E+02 1.65050E+01 -1.38547E+00

INERTIAS ABOUT C.G.

IXX= 3.31608E+04 IYY= 2.25093E+04 IZZ= 1.56001E+04 PIXY= -1.15204E+02 PIXZ= 6.84950E+00 PIVZ= -1.19558E+03

CUMULATIVE RESULTS FOR SEGMENT

SURF AREA= 1.56561E+04 PJCTD AREA= 6.46956E+03 WALL VOL= 7.82807E+03 ENCL VOL= 1.10820E+05 C.V. AT X= 1.19711E+02

INERTIAS ABOUT REF. AXES

IXX= 4.12422E+05 IYY= 1.89967E+07 IZZ= 1.91955E+07 PIXY= -2.10028E+06 PIXZ= 1.78907E+05 PIVZ= 1.38905E+04
 WEIGHT OF WALL= 4.63302E+04 C.G. AT X,Y,Z= 1.05420E+02 1.22712E+01 -1.05544E+00

INERTIAS ABOUT C.G.

IXX= 1.93680E+05 IYY= 2.99200E+06 IZZ= 2.97561E+06 PIXY= -2.37465E+05 PIXZ= 1.86881E+04 PIVZ= -4.75954E+03

CSGT 001 HARRIS TYPE INPUT OCT 11, 1972

SEGMENT 1 --- FUSELAGE

FOR SUB-SEGMENT BETWEEN STATION 18, X= 173.333 AREA= 1357.791 AND STATION 19, X= 186.667 AREA= 1423.912
SURF AREA= 1.92399E+03 PJCTD AREA= 7.98200E+02 WALL VOL= 9.61996E+02 ENCL VOL= 1.85439E+04 C.V. AT X= 1.80053E+02

INERTIAS ABOUT REF. AXES

IXX= 8.60425E+04 IYY= 5.59428E+06 IZZ= 5.63556E+06 PIXY= -5.25491E+05 PIXZ= 4.42514E+04 PIYZ= 2.87147E+03

WEIGHT OF WALL= 5.52859E+C3 C.G. AT X,Y,Z= 1.80034E+02 1.69835E+01 -1.43027E+00

INERTIAS ABOUT C.G.

IXX= 3.61273E+04 IYY= 2.43769E+04 IZZ= 1.68415E+04 PIXY= -8.90684E+01 PIXZ= 4.48129E+00 PIYZ= -1.30254E+03

CUMULATIVE RESULTS FOR SEGMENT

SURF AREA= 1.75801E+04 PJCTC AREA= 7.26776E+03 WALL VOL= 8.79007E+03 ENCL VOL= 1.29364E+05 C.V. AT X= 1.28361E+02

INERTIAS ABOUT REF. AXES

IXX= 9.98165E+05 IYY= 2.45910E+07 IZZ= 2.48315E+07 PIXY= -2.62577E+06 PIXZ= 2.23158E+05 PIYZ= 1.67620E+04

WEIGHT OF WALL= 5.18588E+04 C.G. AT X,Y,Z= 1.13374E+02 1.27736E+01 -1.05540E+00

INERTIAS ABOUT C.G.

IXX= 2.33238E+05 IYY= 3.87107E+06 IZZ= 3.85053E+06 PIXY= -2.91531E+05 PIXZ= 2.29861E+04 PIYZ= -5.79093E+03

CJGT 001 HARRIS TYPE INPUT CCT 11, 1972

SEGMENT 1 --- FUSELAGE

FOR SUB-SEGMENT BETWEEN STATION 19, X= 186.667 AREA= 1423.512 AND STATION 20, X= 200.000 AREA= 1466.474
SURF AREA= 1.96043E+03 PJCTD AREA= 8.13633E+02 WALL VOL= 9.80217E+02 ENCL VOL= 1.92681E+04 C.V. AT X= 1.93366E+02

INERTIAS ABOUT REF. AXES

IXX= 9.10878E+04 IYY= 6.57205E+06 IZZ= 6.61616E+06 PIXY= -5.86103E+05 PIXZ= 4.93663E+04 PIYZ= 3.04036E+03
WEIGHT OF WALL= 5.63320E+03 C.G. AT X,Y,Z= 1.93358E+02 1.73108E+01 -1.45814E+00

INERTIAS ABOUT C.G.

IXX= 3.82491E+04 IYY= 2.57090E+04 IZZ= 1.77273E+04 PIXY= -6.20943E+01 PIXZ= 2.09027E+00 PIYZ= -1.37907E+03

CUMULATIVE RESULTS FOR SEGMENT

SURF AREA= 1.95406E+04 PJCTD AREA= 8.08140E+03 WALL VOL= 9.77028E+03 ENCL VOL= 1.48632E+05 C.V. AT X= 1.36788E+02

INERTIAS ABOUT REF. AXES

IXX= 5.89253E+05 IYY= 3.11630E+07 IZZ= 3.14477E+07 PIXY= -3.21188E+06 PIXZ= 2.72524E+05 PIYZ= 1.98023E+04
WEIGHT OF WALL= 5.74920E+04 C.G. AT X,Y,Z= 1.21211E+02 1.22182E+01 -1.13094E+00

INERTIAS ABOUT C.G.

IXX= 2.74759E+05 IYY= 4.90713E+06 IZZ= 4.88134E+06 PIXY= -3.48905E+05 PIXZ= 2.75703E+04 PIYZ= -6.91007E+03

CSGT 001 HARRIS TYPE INPUT OCT 11, 1972

SEGMENT 1 --- FUSELAGE

FOR SUB-SEGMENT BETWEEN STATION 20, X= 200.000 AREA= 1466.474 AND STATION 21, X= 265.400 AREA= 1677.969
 SURF AREA= 1.02926E+04 PJCTD AREA= 4.02040E+03 WALL VOL= 5.14631E+03 ENCL VOL= 1.01721E+05 C.V. AT X= 2.33441E+02

INERTIAS ABOUT REF. AXES

IXX= 4.55222E+05 IYY= 4.51686E+07 IZZ= 4.53714E+07 PIXY= -3.37901E+06 PIXZ= 4.77918E+05 PIYZ= 3.22767E+04
 HEIGHT OF WALL= 2.64911E+04 C.G. AT X,Y,Z= 2.33128E+02 1.75791E+01 -2.42971E+00

INERTIAS ABOUT C.G.

IXX= 1.95921E+05 IYY= 4.14652E+05 IZZ= 3.67913E+05 PIXY= -5.49456E+03 PIXZ= 1.15334E+04 PIYZ= -2.89111E+03

CUMULATIVE RESULTS FOR SEGMENT

SURF AREA= 2.98332E+04 PJCTC AREA= 1.21018E+04 WALL VOL= 1.49166E+04 ENCL VOL= 2.50353E+05 C.V. AT X= 1.76059E+02

INERTIAS ABOUT REF. AXES

IXX= 1.04447E+06 IYY= 7.63316E+07 IZZ= 7.68194E+07 PIXY= -6.59168E+06 PIXZ= 7.50442E+05 PIYZ= 5.20790E+04
 HEIGHT OF WALL= 8.39830E+04 C.G. AT X,Y,Z= 1.56514E+02 1.45937E+01 -1.54062E+00

INERTIAS ABOUT C.G.

IXX= 4.82349E+05 IYY= 1.23827E+07 IZZ= 1.23204E+07 PIXY= -6.29495E+05 PIXZ= 1.21033E+05 PIYZ= -6.60875E+03

CSGT 001 HARRIS TYPE INPUT OCT 11, 1972

SEGMENT 1 --- FUSELAGE

FOR SUB-SEGMENT BETWEEN STATION 21, X= 265.400 AREA= 1677.969 AND STATION 22, X= 320.000 AREA= 1677.969
SURF AREA= 9.07733E+03 PJCTD AREA= 3.35648E+03 WALL VOL= 4.53866E+03 ENCL VOL= 9.16171E+04 C.V. AT X= 2.92700E+02

INERTIAS ABOUT REF. AXES

IXX= 3.78885E+05 IYY= 5.62312E+07 IZZ= 5.63825E+07 PIXY= -3.37109E+06 PIXZ= 7.01177E+05 PIYZ= 4.45806E+04
WEIGHT OF WALL= 2.10824E+04 C.G. AT X₀,Y₀,Z₀= 2.92779E+02 1.76363E+01 -3.66497E+00

INERTIAS ABOUT C.G.

IXX= 1.67078E+05 IYY= 2.66997E+05 IZZ= 2.24411E+05 PIXY= -4.60553E+02 PIXZ= 7.33755E+02 PIYZ= 2.38752E+03

CUMULATIVE RESULTS FOR SEGMENT

SURF AREA= 3.89205E+04 PJCTD AREA= 1.54583E+04 WALL VOL= 1.94553E+04 ENCL VOL= 3.41970E+05 C.V. AT X= 2.07308E+02

INERTIAS ABOUT REF. AXES

IXX= 1.42336E+06 IYY= 1.32563E+08 IZZ= 1.33202E+08 PIXY= -9.96277E+06 PIXZ= 1.45162E+06 PIYZ= 9.66597E+04
WEIGHT OF WALL= 1.04985E+05 C.G. AT X₀,Y₀,Z₀= 1.83774E+02 1.52024E+01 -1.96559E+00

INERTIAS ABOUT C.G.

IXX= 6.56618E+05 IYY= 2.23481E+07 IZZ= 2.22457E+07 PIXY= -8.46452E+05 PIXZ= 2.72926E+05 PIYZ= -8.46082E+02

CSGT 001 HARRIS TYPE INPUT OCT 11, 1972

SEGMENT 1 --- FUSELAGE

NET RESULTS FOR THIS SEGMENT.

SINCE PRECEDING OUTPUT, KSYM HAS DONE ITS THING AND, IF THIS IS A WING SEGMENT, OFFSETS HAVE BEEN ADDED.

SURF AREA= 3.89105E+04 PJCID AREA= 1.54583E+04 WALL VOL= 1.94553E+04 ENCL VOL= 3.41970E+05 C.V. AT X= 2.07308E+02

INERTIAS ABOUT REF. AXES

IXX= 1.42336E+06 IYY= 1.32563E+08 IZZ= 1.33202E+08 PIXY= 0. PIXZ= 1.45162E+06 PIYZ= 0.

WEIGHT OF WALL= 1.04985E+05 C.G. AT X,Y,Z= 1.83774E+02 0. -1.96559E+00

INERTIAS ABOUT C.G.

IXY= 1.41675E+06 IYY= 2.23481E+07 IZZ= 2.29958E+07 PIXY= 0. PIXZ= 2.72926E+05 PIYZ= 0.

CUMULATIVE RESULTS FOR THIS AND PRECEDING SEGMENTS

SURF AREA= 3.89105E+04 PJCID AREA= 1.54583E+04 WALL VOL= 1.94553E+04 ENCL VOL= 3.41970E+05 C.V. AT X= 2.07308E+02

INERTIAS ABOUT REF. AXES

IXX= 1.42336E+06 IYY= 1.32563E+08 IZZ= 1.33202E+08 PIXY= 0. PIXZ= 1.45162E+06 PIYZ= 0.

WEIGHT OF WALL= 1.04985E+05 C.G. AT X,Y,Z= 1.83774E+02 0. -1.96559E+00

INERTIAS ABOUT C.G.

IXX= 1.41075E+06 IYY= 2.23481E+07 IZZ= 2.29958E+07 PIXY= 0. PIXZ= 2.72926E+05 PIYZ= 0.

REF. LENGTH= 320.000, C.G. AT 57.43 PERCENT, C.V. AT 64.78 PERCENT

CSGT.001 HARRIS TYPE INPUT OCT 11, 1972

DATA FOR SEGMENT NUMBER 2 --- WING

CONTROLS ARE SET AS FOLLOWS

NSEG= 2 NSTA= 2 NPTS= 33 NOSE= 0
KPLT= 0 KWNG= 2 KSVH= 0 KYZRO= 1
OFFSETS= 0.000 0.000 0.000 0.000
KXYZ= 2 KRHOH= 0 KSWT= 0
SCALE FACTORS= 1.00000 1.00000 1.00000

YWG COORD OF STATION PLANES

30.500 70.750

XSEC AREA OF STATION PLANES

952.657 71.809

XWNG CHORD OF STATION PLANES

91.000 20.400

CSGT 001 HARRIS TYPE INPUT OCT 11, 1972

DATA FOR SEGMENT NUMBER 2 ---- WING

Z/WING COORD AROUND EACH STATION C/CONTOUR (J)		1		2		3		4		5		6		7		8		9		10		11	
J/	I=	1	2	3	4	5	6	7	8	9	10	11	12	13	14	15	16	17	18	19	20	21	
1		-10.340	-9.240	-8.852	-8.358	-8.027	-7.767	-7.387	-7.129	-6.802	-6.700	-6.805											
2		-11.420	-11.050	-10.920	-10.754	-10.642	-10.555	-10.427	-10.340	-10.231	-10.196	-10.231											
Z/WING COORD AROUND EACH STATION CONTOUR (J)		11		12		13		14		15		16		17		18		19		20		21	
J/	I=	11	12	13	14	15	16	17	18	19	20	21	22	23	24	25	26	27	28	29	30	31	
1		-6.805	-7.112	-7.622	-8.326	-8.207	-8.717	-10.267	-10.963	-11.473	-12.354	-13.058											
2		-10.231	-10.335	-10.506	-10.744	-11.039	-11.210	-11.418	-11.630	-11.801	-12.097	-12.334											
Z/WING COORD AROUND EACH STATION CONTOUR (J)		21		22		23		24		25		26		27		28		29		30		31	
J/	I=	21	22	23	24	25	26	27	28	29	30	31	32	33	34	35	36	37	38	39	40	41	
1		-13.058	-13.568	-13.875	-13.980	-13.875	-13.551	-13.253	-12.913	-12.653	-12.322	-11.828											
2		-12.334	-12.505	-12.609	-12.644	-12.605	-12.500	-12.413	-12.285	-12.198	-12.086	-11.920											
Z/WING COORD AROUND EACH STATION CONTOUR (J)		31		32		33		34		35		36		37		38		39		40		41	
J/	I=	31	32	33	34	35	36	37	38	39	40	41	42	43	44	45	46	47	48	49	50	51	
1		-11.828	-11.440	-10.340																			
2		-11.920	-11.790	-11.420																			
X/WING COORD AROUND EACH STATION CONTOUR (J)		1		2		3		4		5		6		7		8		9		10		11	
J/	I=	1	2	3	4	5	6	7	8	9	10	11	12	13	14	15	16	17	18	19	20	21	
1		229.000	230.137	231.275	233.550	235.825	238.100	242.650	247.200	256.300	265.400	274.500											
2		299.600	299.855	306.110	300.620	301.130	301.640	302.660	303.680	305.720	307.760	309.800											
X/WING COORD AROUND EACH STATION CONTOUR (J)		11		12		13		14		15		16		17		18		19		20		21	
J/	I=	11	12	13	14	15	16	17	18	19	20	21	22	23	24	25	26	27	28	29	30	31	
1		274.500	283.600	292.700	301.800	310.900	315.450	320.000	315.450	310.900	301.800	292.700											
2		309.800	311.840	313.880	315.920	317.960	318.980	320.000	318.980	317.960	315.920	313.880											
X/WING COORD AROUND EACH STATION CONTOUR (J)		21		22		23		24		25		26		27		28		29		30		31	
J/	I=	21	22	23	24	25	26	27	28	29	30	31	32	33	34	35	36	37	38	39	40	41	
1		292.700	283.600	274.500	265.400	256.300	247.200	242.650	238.100	235.825	233.550	231.275											
2		313.880	311.840	305.800	307.760	305.720	303.680	302.660	301.640	301.130	300.620	300.110											
X/WING COORD AROUND EACH STATION CONTOUR (J)		31		32		33		34		35		36		37		38		39		40		41	
J/	I=	31	32	33	34	35	36	37	38	39	40	41	42	43	44	45	46	47	48	49	50	51	
1		231.275	230.137	229.000																			
2		300.110	299.855	299.600																			

CSGT 001 HARRIS TYPE INPUT OCT 11, 1972

DATA FOR SEGMENT NUMBER 2 --- WING

J/	I=	21	22	23	24	25	26	27	28	29	30	31
		SURFHT (PT) AROUND EACH STATION CONTOUR (J)										
1		1.90000	1.90000	2.30000	2.30000	2.30000	2.30000	2.30000	3.12000	3.12000	3.12000	3.12000
2		1.90000	1.90000	2.30000	2.30000	2.30000	2.30000	2.30000	3.12000	3.12000	3.12000	3.12000

J/	I=	31	32	33
		SURFHT (PT) AROUND EACH STATION CONTOUR (J)		
1		3.12000	3.12000	3.12000
2		3.12000	3.12000	3.12000

CSGT 001 HARRIS TYPE INPUT OCT 11, 1972

SEGMENT 2 --- WING

FOR SUB-SEGMENT BETWEEN STATION 1, YWNG= 30.500 AREA= 952.657 AND STATION 2, YWNG= 70.750 AREA= 71.809
SURF AREA= 9.24311E+03 PJCTD AREA= 4.48385E+03 WALL VOL= 4.62155E+03 ENCL VOL= 1.73255E+04 C.V. AT X= 4.37612E+01

INERTIAS ABOUT WING AXES

IXX= 2.02393E+06 IYY= 6.90545E+07 IZZ= 7.08679E+07 PIXY= -1.12625E+07 PIXZ= 2.64033E+06 PIYZ= 4.31985E+05
WEIGHT OF WALL= 2.71544E+04 C.G. AT X,Y,Z= 2.84956E+02 4.64320E+01 -1.076E+01

INERTIAS ABOUT C.G.

IXX= 1.02842E+05 IYY= 4.21611E+05 IZZ= 5.16976E+05 PIXY= -9.57290E+04 PIXZ= 2.64234E+03 PIYZ= 2.18866E+03

CUMULATIVE RESULTS FOR WING

SURF AREA= 9.24311E+03 PJCTD AREA= 4.48385E+03 WALL VOL= 4.62155E+03 ENCL VOL= 1.73255E+04 C.V. AT X= 4.37612E+01

INERTIAS ABOUT WING AXES

IXX= 2.02393E+06 IYY= 6.90545E+07 IZZ= 7.08679E+07 PIXY= -1.12625E+07 PIXZ= 2.64033E+06 PIYZ= 4.31985E+05
WEIGHT OF WALL= 2.71544E+04 C.G. AT X,Y,Z= 2.84956E+02 4.64320E+01 -1.09676E+01

INERTIAS ABOUT C.G.

IXX= 1.02842E+05 IYY= 4.21611E+05 IZZ= 5.16976E+05 PIXY= -9.57290E+04 PIXZ= 2.64234E+03 PIYZ= 2.18866E+03

CSGT 001 HARRIS TYPE INPUT OCT 11, 1972

SEGMENT 2 --- WING

NET RESULTS FOR THIS SEGMENT.
SINCE PRECEDING OUTPUT, KSYM HAS DONE ITS THING AND, IF THIS IS A WING SEGMENT, OFFSETS HAVE BEEN ADDED.

SURF AREA= 9.24311E+03 PJCTD AREA= 4.48385E+03 WALL VOL= 0. ENCL VOL= 0. C.V. AT X= 0.

INERTIAS ABOUT REF. AXES

IXX= 2.02393E+06 IYY= 6.90545E+07 IZZ= 7.08675E+07 PIXY= 0. PIXZ= 2.64033E+06 PIYZ= 0.

WEIGHT OF WALL= 2.71544E+04 C.G. AT X,Y,Z= 2.84956E+02 0. -1.09676E+01

INERTIAS ABOUT C.G.

IXX= 1.92241E+06 IYY= 4.21611E+05 IZZ= 2.33655E+06 PIXY= 0. PIXZ= 2.64234E+03 PIYZ= 0.

CUMULATIVE RESULTS FOR THIS AND PRECEDING SEGMENTS

SURF AREA= 4.81536E+04 PJCTD AREA= 1.99421E+04 WALL VOL= 1.94553E+04 ENCL VOL= 3.41970E+03 C.V. AT X= 2.07308E+02

INERTIAS ABOUT REF. AXES

IXX= 3.44729E+06 IYY= 2.01617E+08 IZZ= 2.04070E+08 PIXY= 0. PIXZ= 4.09195E+06 PIYZ= 0.

WEIGHT OF WALL= 1.32140E+05 C.G. AT X,Y,Z= 2.04566E+02 0. -3.81548E+00

INERTIAS ABOUT C.G.

IXX= 3.38750E+06 IYY= 2.96890E+07 IZZ= 3.22013E+07 PIXY= 0. PIXZ= 8.86330E+05 PIYZ= 0.

REF. LENGTH= 320.000, C.G. AT 63.93 PERCENT, C.V. AT 64.78 PERCENT

CSGT 001 HARRIS TYPE INPUT OCT 11, 1972

	X	Y	Z	WEIGHT	IXX	IYY	IZZ	PIXY	PIYX	PIYZ
TOTALS FOR BODY WITHOUT BLACK BOXES (REF)										
SYSTEM/REF-AXES	204.566	0.000	-3.815	1.3214E+05	3.4473E+06	2.0142E+08	2.0407E+08	0.	4.0919E+06	0.
SYSTEM/ C.G.				1.3214E+05	3.3875E+06	2.9689E+07	3.2201E+07	0.	8.8633E+05	0.
INPUT	160.000	0.000	10.000	1.0000E+04	0.	0.	0.	0.	0.	0.
-TRNS/REF-AX	160.000	0.000	10.000	1.0000E+04	3.1081E+04	7.9878E+06	7.9567E+06	0.	-4.9730E+05	0.
SYSTEM/REF-AXES				1.4214E+C5	3.4784E+06	2.0961E+08	2.1203E+C8	0.	3.5946E+06	0.
SYSTEM/ C.G.	201.431	0.000	-2.844	1.4214E+05	3.4427E+06	3.0318E+07	3.2775E+07	0.	1.0642E+06	0.

CSGT 001 HARRIS TYPE INPUT OCT 11, 1972

RANGE OF DATA TO BE PLOTTED IN FORM MIN,MAX,DIFF AND ORDER X Y Z
 0.000 320.000 320.000 -70.750 70.750 141.500 -15.368 15.368 30.736

LISTING OF PLOT REQUEST CARDS

```

OUT10.0 2.0 6.0
OUT 10 2 6 -0 -0 -0 4.96VU3 -0
      5VU3
X Z OUT -45. 10. -150.
X Z OUT -45 10 -150 -0 -0 -0 4.96ORTHOGRAPHIC -0
      5ORT
X Z -45. 10. -150.
X Z -45 10 -150 -0 -0 -0 4.96ORTHOGRAPHIC -0
      5ORT
X Z -60. 20. -160.
X Z -60 20 -160 -0 -0 -0 4.96ORTHOGRAPHIC -0
      5CRT
X Z OUT -60. 20. -160.
X Z OUT -60 20 -160 -0 -0 -0 4.96ORTHOGRAPHIC -0
      5ORT
$VAMP SEGTOT 0 1= 1.049854313319E+05, 1.929354734267E+07, 0.
      1.025628220585E+08, 1.332019812066E+08, 0.
      3.891051491565E+04, 1.545827502100E+04, 1.945525745782E+04, 3.419697109915E+05, 7.089316953960E+07,
      -2.063586579636E+05, 1.423360297667E+06,
      1.451619445020E+06, 0.
$VAMP SEGXYZ 0 1= 1.837735683638E+02, 0.
      -1.965593276569E+00,
      2.100239154173E+04, 6.149045656756E+06, 3.704048928167E+05, -7.697306068597E+04, 1.410753310950E+06,
      2.234806257851E+07, 2.299982911331E+07, 0.
      9.077327299871E+03, 3.356480400000E+03, 4.538663649936E+03, 9.161713409940E+04, 2.681633515089E+07,
      1.049854313319E+05, 1.929354734267E+07, 0.
      1.325628220585E+08, 1.332019812066E+08, 0.
      -2.063586579636E+05, 1.423360297667E+06,
      1.451619445020E+06, 0.
$VAMP CUMXYZ 0 1= 1.837735683638E+02, 0.
      3.891051491565E+04, 1.545827502100E+04, 1.945525745782E+04, 3.419697109915E+05, 7.089316953960E+07,
      -1.965593276569E+00,
      1.837735683638E+02, 0.
      2.100239154173E+04, 6.149045656756E+06, 3.704048928167E+05, -7.697306068597E+04, 1.410753310950E+06,
      2.234806257851E+07, 2.299982911331E+07, 0.
      9.077327299871E+03, 3.356480400000E+03, 4.538663649936E+03, 9.161713409940E+04, 2.681633515089E+07,
    
```

```

$VAMP 0 2= 2.715438435476E+04, 7.737793435594E+06, 0.000000000000E+00, 2.023354064383E+067
6.90544753345CE+07, 7.086789023191E+07, 0.000000000000E+00, 2.640325952488E+06, 0.000000000000E+00
9.243107800653E+03, 4.483850000000E+03, 0.000000000000E+00, 0.000000000000E+00, 0.000000000000E+00
$VAMP 0 2= 2.849555835442E+02, 0.000000000000E+00, -1.096757536423E+01, 0.000000000000E+00
$VAMP 0 2= 2.0438435476E+04, 7.737793435594E+06, 1.260831274225E+06, -2.978177568801E+05, 1.922413000997E+06,
4.216107977943E+05, 2.336566758183E+06, 0.000000000000E+00, 2.642335232019E+03, 0.000000000000E+00
9.243107800653E+03, 4.483850000000E+03, 4.621553900326E+03, 1.732553758119E+04, 7.581862616043E+05, 0.000000000000E+00
$VAMP 0 2= 1.321398156866E+05, 2.703134078167E+07, 0.000000000000E+00, -5.041764148438E+05, 3.447294362050E+06,
2.016172973934E+08, 2.0406587143385E+08, 0.000000000000E+00, 4.091945357508E+06, 0.000000000000E+00
4.81536227163CE+04, 1.994212502100E+04, 1.945525745782E+04, 3.419657109915E+05, 7.089316953960E+07,
0.000000000000E+00, -3.815476903944E+00, 0.000000000000E+00
$VAMP 0 2= 2.045662061901E+02, 0.000000000000E+00, -3.815476903944E+00, 0.000000000000E+00
$VAMP 0 2= 2.715438435476E+04, 7.737793435594E+06, 1.260831274225E+06, -2.978177568801E+05, 3.387504672663E+06,
2.968895446426E+07, 3.220131815874E+07, 0.000000000000E+00, 8.863304153765E+05, 0.000000000000E+00
9.243107800653E+03, 4.483850000000E+03, 4.621553900326E+03, 1.732553758119E+04, 7.581862616043E+05, 0.000000000000E+00
$VAMP 0 0= 1.321398156866E+05, 2.703134078167E+07, 0.000000000000E+00, -5.041764148438E+05, 3.447294362050E+06,
2.016172973934E+08, 2.0406587143385E+08, 0.000000000000E+00, 4.091945357508E+06, 0.000000000000E+00
4.81536227163CE+04, 1.994212502100E+04, 1.945525745782E+04, 3.419657109915E+05, 7.089316953960E+07,
0.000000000000E+00, -3.815476903944E+00, 0.000000000000E+00
$VAMP 0 0= 2.715438435476E+04, 7.737793435594E+06, 1.260831274225E+06, -2.978177568801E+05, 3.387504672663E+06,
2.968895446426E+07, 3.220131815874E+07, 0.000000000000E+00, 8.863304153765E+05, 0.000000000000E+00
9.243107800653E+03, 4.483850000000E+03, 4.621553900326E+03, 1.732553758119E+04, 7.581862616043E+05, 0.000000000000E+00
$VAMP 0 0= 2.045662061901E+02, 0.000000000000E+00, -3.815476903944E+00, 0.000000000000E+00
$VAMP 1 0= 1.000000000000E+06, 1.600000000000E+06, 0.000000000000E+00, 1.000000000000E+05, 3.108099707839E+04,
7.987816249145E+06, 7.95673525267E+06, 0.000000000000E+00, -4.972959532542E+05, 0.000000000000E+00
9.243107800653E+03, 4.483850000000E+03, 4.621553900326E+03, 1.732553758119E+04, 7.581862616043E+05, 0.000000000000E+00
$VAMP 1 0= 1.600000000000E+02, 0.000000000000E+00, 1.000000000000E+00, 0.000000000000E+00
$VAMP 1 0= 1.421398156866E+05, 2.863134078167E+07, 0.000000000000E+00, -4.041764148438E+05, 3.478375359129E+06,
2.096051156426E+08, 2.12026666566E+08, 0.000000000000E+00, 3.594649444254E+06, 0.000000000000E+00
4.81536227163CE+04, 1.994212502100E+04, 1.945525745782E+04, 3.419657109915E+05, 7.089316953960E+07,
0.000000000000E+00, 1.000000000000E+06, 1.600000000000E+06, 0.000000000000E+00, 1.000000000000E+05, 3.442654563048E+05,
5.031798849350E+07, 3.277520233759E+07, 0.000000000000E+00, 1.064233891003E+06, 0.000000000000E+00

```

7.649107800653E+03, 4.483850000000E+03, 4.62153700326E+03, 1.75253375 0119E+04, 7.581662810043E+03

\$
\$VAHP
\$

CUMYZ 1 0= 2.014308281136E+02, 0. -2.84351300788E+00,

CSGT 001 HARRIS TYPE INPUT OC

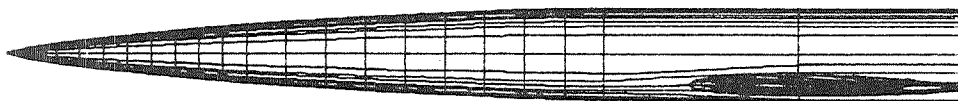
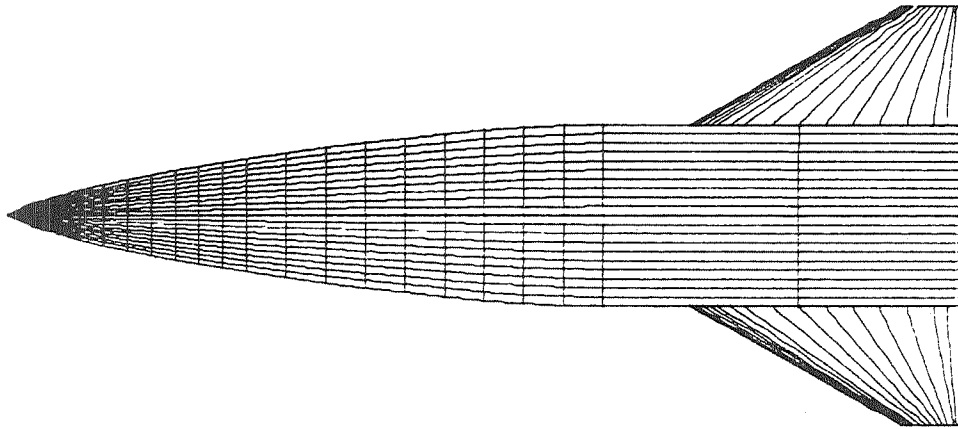

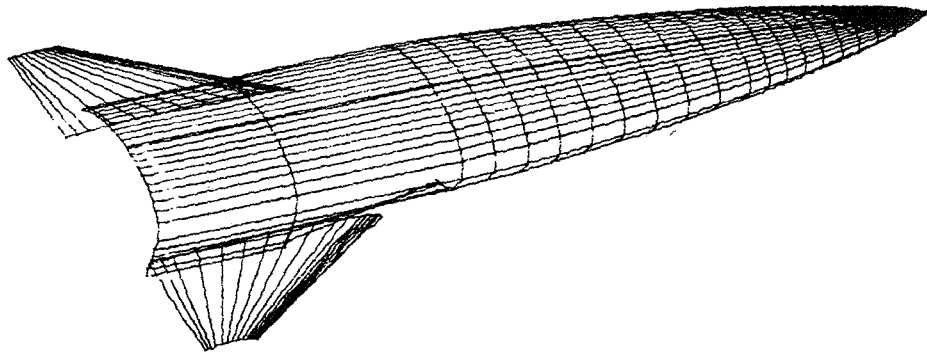

CSGT 001 HARRIS TYPE INPUT OCT 11, 1972

X Z OUT -45. 10. -150.

4.960RTHO

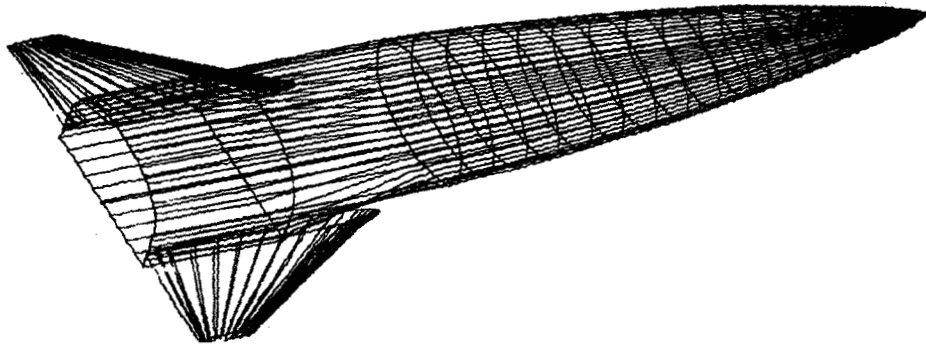

CSGT 001 HARRIS TYPE INPUT OCT 11, 1972

X Z -45. 10. -150.

4.960RTHO

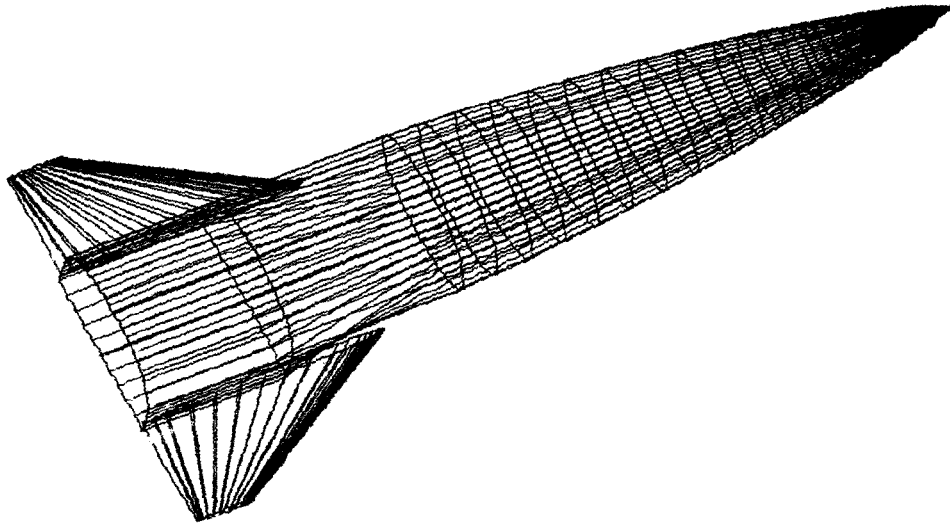

CSGT 001 HARRIS TYPE INPUT OCT 11. 1972

X 2 -60- 20- -160-

4.960RTHO

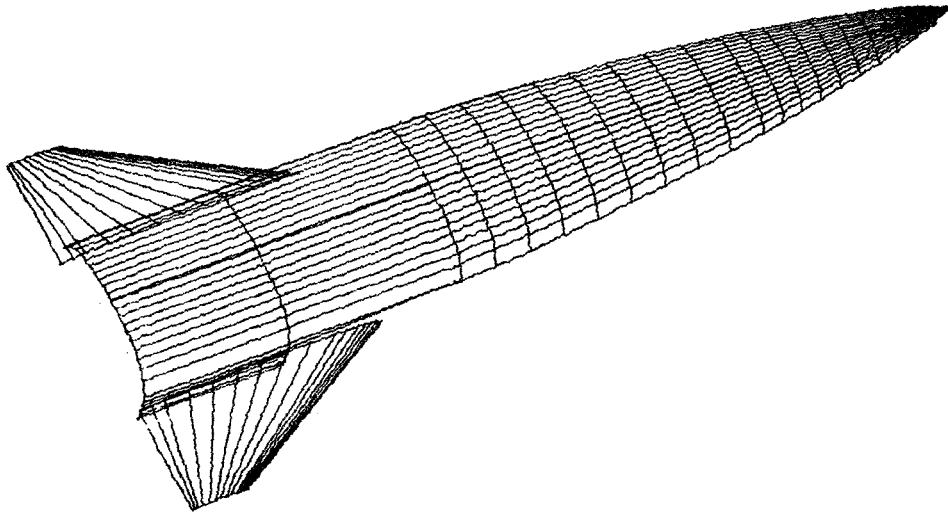

CSGT 001 HARRIS TYPE INPUT OCT 11. 1972

X 2 OUT -60. 20. -160.

4.960RHO

NATIONAL AERONAUTICS AND SPACE ADMINISTRATION
WASHINGTON, D.C. 20546

OFFICIAL BUSINESS
PENALTY FOR PRIVATE USE \$300

**SPECIAL FOURTH-CLASS RATE
BOOK.**

POSTAGE AND FEES PAID
NATIONAL AERONAUTICS AND
SPACE ADMINISTRATION
451



POSTMASTER: If Undeliverable (Section 158
Postal Manual) Do Not Return

"The aeronautical and space activities of the United States shall be conducted so as to contribute . . . to the expansion of human knowledge of phenomena in the atmosphere and space. The Administration shall provide for the widest practicable and appropriate dissemination of information concerning its activities and the results thereof."

—NATIONAL AERONAUTICS AND SPACE ACT OF 1958

NASA SCIENTIFIC AND TECHNICAL PUBLICATIONS

TECHNICAL REPORTS: Scientific and technical information considered important, complete, and a lasting contribution to existing knowledge.

TECHNICAL NOTES: Information less broad in scope but nevertheless of importance as a contribution to existing knowledge.

TECHNICAL MEMORANDUMS: Information receiving limited distribution because of preliminary data, security classification, or other reasons. Also includes conference proceedings with either limited or unlimited distribution.

CONTRACTOR REPORTS: Scientific and technical information generated under a NASA contract or grant and considered an important contribution to existing knowledge.

TECHNICAL TRANSLATIONS: Information published in a foreign language considered to merit NASA distribution in English.

SPECIAL PUBLICATIONS: Information derived from or of value to NASA activities. Publications include final reports of major projects, monographs, data compilations, handbooks, sourcebooks, and special bibliographies.

TECHNOLOGY UTILIZATION PUBLICATIONS: Information on technology used by NASA that may be of particular interest in commercial and other non-aerospace applications. Publications include Tech Briefs, Technology Utilization Reports and Technology Surveys.

Details on the availability of these publications may be obtained from:

**SCIENTIFIC AND TECHNICAL INFORMATION OFFICE
NATIONAL AERONAUTICS AND SPACE ADMINISTRATION
Washington, D.C. 20546**