

(NASA-CR-140766) DIRECTION FINDING  
MEASUREMENTS OF AURORAL KILOMETRIC  
RADIATION (Iowa Univ.) 37 p HC \$3.75

N75-11889

CSSL 03B

Unclas

G3/93 53894

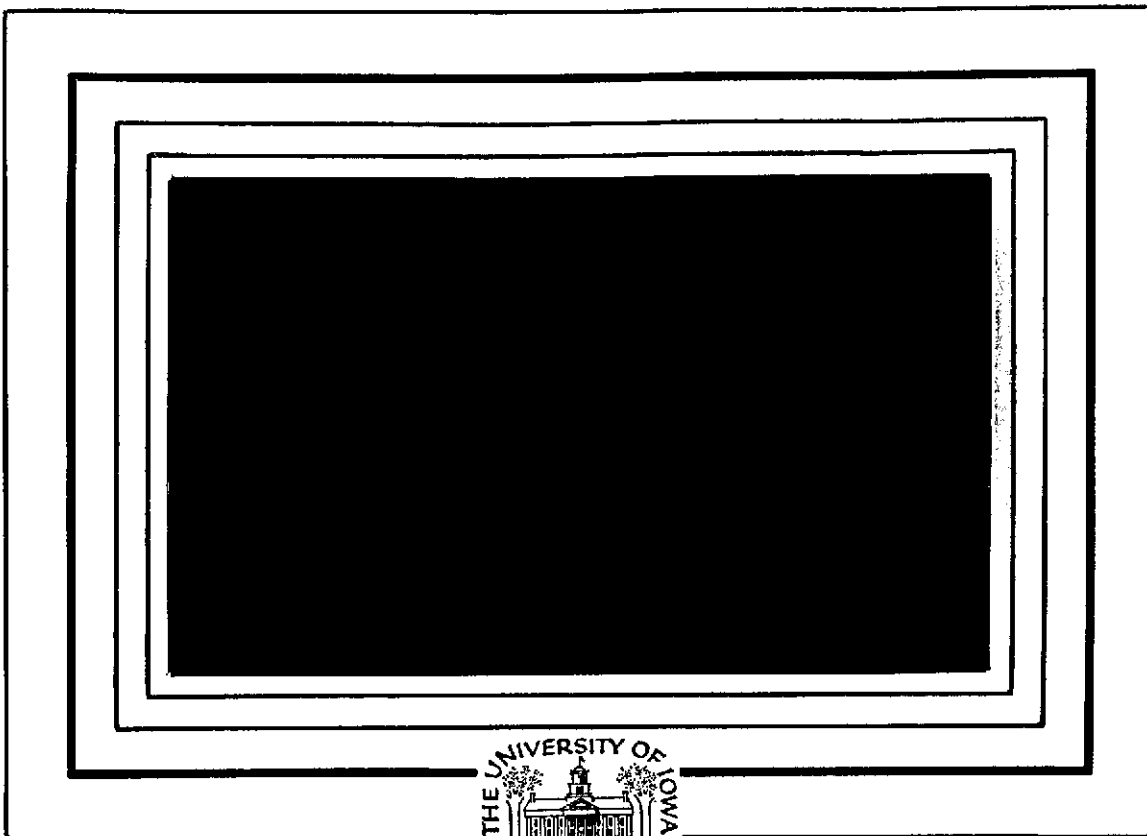

"Reproduction in whole or in part is permitted for any purpose of the United States Government.

Research was supported in part by the Office of Naval Research under contract N00014-68-A-0196-0009."

Department of Physics and Astronomy  
**THE UNIVERSITY OF IOWA**

Iowa City, Iowa 52242



Direction Finding Measurements of  
Auroral Kilometric Radiation

by

William S. Kurth  
Mark M. Baumbach  
and  
Donald A. Gurnett

October, 1974

Department of Physics and Astronomy  
The University of Iowa  
Iowa City, Iowa 52242

This work was supported in part by the National Aeronautics and Space Administration under contracts NAS1-11257, NAS1-13129, and NAS5-11431 and Grant NGL-16-001-043 and by the Office of Naval Research under Grant N00014-68-A-0196-0009.

REPORT DOCUMENTATION PAGE		READ INSTRUCTIONS BEFORE COMPLETING FORM
1. REPORT NUMBER U. of Iowa/74-35	2. GOVT ACCESSION NO.	3. RECIPIENT'S CATALOG NUMBER
4. TITLE (and Subtitle) DIRECTION FINDING MEASUREMENTS OF AURORAL KILOMETRIC RADIATION	5. TYPE OF REPORT & PERIOD COVERED Progress October 1974	
	6. PERFORMING ORG. REPORT NUMBER	
7. AUTHOR(s) W. S. Kurth, M. M. Baumback, and D. A. Gurnett	8. CONTRACT OR GRANT NUMBER(s) N00014-68-A-0196-0009	
9. PERFORMING ORGANIZATION NAME AND ADDRESS Department of Physics and Astronomy The University of Iowa Iowa City, Iowa 52242	10. PROGRAM ELEMENT, PROJECT, TASK AREA & WORK UNIT NUMBERS	
11. CONTROLLING OFFICE NAME AND ADDRESS Office of Naval Research Arlington, Virginia 22217	12. REPORT DATE October, 1974	
	13. NUMBER OF PAGES 35	
14. MONITORING AGENCY NAME & ADDRESS (if different from Controlling Office)	15. SECURITY CLASS. (of this Report) UNCLASSIFIED	
	15a. DECLASSIFICATION/DOWNGRADING SCHEDULE	
16. DISTRIBUTION STATEMENT (of this Report)  Approved for public release; distribution is unlimited.		
17. DISTRIBUTION STATEMENT (of the abstract entered in Block 20, if different from Report)		
18. SUPPLEMENTARY NOTES  To be published in <u>J. Geophys. Res.</u>		
19. KEY WORDS (Continue on reverse side if necessary and identify by block number)  Auroral Kilometric Radiation Direction Finding		
20. ABSTRACT (Continue on reverse side if necessary and identify by block number)  [See Following Page.]		

## ABSTRACT

Direction finding measurements with plasma wave experiments on the HAWKEYE-1 and IMP-8 satellites are used to locate the source region of auroral kilometric radiation. This radiation has peak intensities between about 100 kHz and 300 kHz and is emitted in intense sporadic bursts lasting for from half an hour to several hours. At peak intensity the total power emitted in this frequency range exceeds  $10^9$  watts. The occurrence of this radiation is known to be closely associated with bright auroral arcs which occur in the local evening auroral regions.

HAWKEYE-1 provides direction finding measurements of kilometric radiation from observations at high latitudes (5 to  $20 R_e$ ) over the northern polar regions and IMP-8 provides similar observations at large radial distances (23 to  $46 R_e$ ) near the equatorial plane. Results from both satellites place the source of the intense auroral kilometric radiation in the late local evening at about 22.0 hours local time and at a distance of about  $0.75 R_e$  from the polar axis of the earth. These direction finding measurements, together with earlier results from the IMP-6 satellite, strongly indicate that the intense kilometric radiation associated with auroral arcs is generated by energetic auroral electrons at low altitudes in the evening auroral zone. The observed source location is in good quantitative agreement with the source position expected from simple propagation and ray path considerations.

PRECEDING PAGE BLANK NOT FILMED

## I. INTRODUCTION

Satellite measurements of low frequency radio emissions have shown that the earth is a very intense emitter of electromagnetic radiation with peak intensities in the frequency range from about 100 kHz to 300 kHz [Dunckel et al., 1970; Brown, 1973; Gurnett, 1974]. This radiation is generated at frequencies above the local plasma frequency in the ionosphere and can propagate freely away from the earth. Since the wavelength of this radiation is in the kilometric range it is called kilometric radiation. Kilometric radio emissions are observed to occur in sporadic "storms" lasting for periods from half an hour to several hours. At peak intensity the total power emitted by the earth in this frequency range is very large, on the order of  $10^9$  watts. The occurrence of these sporadic bursts of kilometric radiation is closely correlated with the occurrence of discrete auroral arcs detected optically by the low altitude, polar orbiting, DAPP reconnaissance satellite. Figure 1, from Gurnett [1974], shows an example of the close association observed between kilometric radio emissions and auroral arcs. The photographs in this illustration are from the DAPP satellite and show the distribution and occurrence of aurora over the northern polar region for a series of dawn-dusk (left to right) passes through the local midnight region. The north magnetic pole is located in the top center of each photograph. The top panel shows

the intensity of kilometric radiation at 178 kHz detected by the IMP-6 satellite far from the earth during this same period. The occurrence of intense kilometric noise bursts during orbits 1094 and 1096 is clearly related to the occurrence of the bright auroral arcs in the DAPP photographs for these orbits. This correlation strongly implies that the radiation is generated by the electrons which produce these auroral arcs. Measurements of the angular distribution of the kilometric radiation [Gurnett, 1974] also indicate that the noise is generated at low altitudes of 1.0 to 1.5  $R_e$  along auroral field lines in the local evening region. To distinguish the intense, aurora related, kilometric radio emissions from other weaker and less prominent radiation from the earth at kilometer wavelengths we will refer to this noise as auroral kilometric radiation.

Although both the angular distribution of the intense auroral kilometric radiation and the correlation of this radiation with auroral arcs indicate that the noise is generated in the local evening auroral region, no direct measurements have been made confirming that the radiation comes from this region. In fact, some evidence to the contrary has been presented. Stone et al. [1974], using preliminary radio direction finding measurements from the IMP-6 and RAE-2 satellites, have identified a spatially compact source on the day side of the earth with a sporadic time structure which seems to correspond in all basic respects to the intense auroral kilometric radiation. The day side location of the source is not, however, consistent with several of the

known characteristics of this noise. The purpose of this paper is to establish the region of generation of the auroral kilometric radiation discussed by Gurnett [1974].

## II. DIRECTION FINDING MEASUREMENTS WITH HAWKEYE-1

### A. Instrumentation Description

The HAWKEYE-1 spacecraft was launched on June 3, 1974, into a highly eccentric polar orbit with initial perigee and apogee geocentric radial distances of 6,847 km and 130,856 km, respectively, orbit inclination of 89.79 degrees, and period of 49.94 hours. The initial argument of perigee is 274.6 degrees so that the apogee is located almost directly over the north pole as shown in Figure 2. The spacecraft is spin stabilized and has a rotation period of about 11.00 seconds. As indicated in Figure 2, the spin axis is oriented parallel to the orbital plane and approximately perpendicular to the spacecraft-earth line when the spacecraft is at apogee.

The plasma wave experiment on HAWKEYE-1 uses an electric dipole antenna with a tip-to-tip length of 42.45 meters for electric field measurements. The electric antenna is extended perpendicular to the spin axis as shown in Figure 2. Electric field spectrum measurements are made in 16 frequency channels extending from 1.78 Hz to 178 kHz and magnetic field spectrum measurements are made in 8 frequency channels extending from 1.78 Hz to 5.62 kHz. Wide-band measurements can also be obtained from either the electric or magnetic antennas. The wide-band receiver can have a bandwidth of either 10 kHz or 45 kHz depending on the mode of operation.



### B. Method of Analysis

The intensity of the auroral kilometric radiation detected by HAWKEYE-1 shows a pronounced modulation caused by the rotation of the electric antenna. The angular position of the null in the spin modulation can be used to determine the direction of propagation projected into the plane of rotation of the antenna. Since the electric field of an electromagnetic wave in free space is always perpendicular to the direction of propagation the null in the spin modulation occurs when the antenna axis is parallel to the direction of propagation. The deepest nulls, and the best accuracy for direction finding, occurs when the propagation vector lies exactly in the spin plane of the antenna. When the propagation vector lies out of the spin plane the null depth decreases and the directional determination becomes increasingly subject to errors caused by polarization effects as the angle between the propagation vector and the spin plane increases. For the HAWKEYE-1 orbit the angular position of the earth is relatively close to the spin plane of the antenna over the entire high altitude portions of the orbit so that deep nulls and good accuracy for direction finding measurements of kilometric radiation are possible over most of the orbit.

The antenna orientation angle used in the HAWKEYE-1 direction finding analysis is the angle,  $\delta_y$ , between the projection of the spacecraft-earth line into the spin plane and the antenna (y) axis, measured in the right-hand sense with respect to the spin vector as shown in Figure 2. This angle is determined by measuring the angle,  $\phi_y$ , between

the projection of the spacecraft-sun line in the spin plane and the y-axis of the spacecraft using the spacecraft optical aspect system and by computing the angle,  $\phi_E$ , between the spacecraft-sun and spacecraft-earth vectors projected into the spin plane. In addition to the strictly geometric determination of the antenna orientation the angle  $\delta_y$  must also be corrected for the phase shift caused by the non-zero time constant of the receiver. For the HAWKEYE-1 experiment the phase shift due to the receiver time constant is quite small, about  $1.63^\circ$  for the nominal spin period.

Because the sampling rate for each frequency channel is comparable to the spin rate (one sample every 11.52 seconds), many rotations are required to determine the null direction. Since the noise intensity often fluctuates considerably on a time scale comparable to the spin period it is necessary to sort the intensity measurements according to the angle at which the measurement is made and then average the intensities over a long time interval to reduce the errors caused by fluctuations in the noise intensity. Averaging intervals of one hour or more are usually required to reduce the statistical fluctuations to an acceptable level. During the averaging process the field strengths are periodically normalized by dividing by a short term average over a time interval corresponding to one complete cycle of the angle sampled through  $360^\circ$ .

Figure 3 shows the normalized electric field strengths obtained for a one-hour averaging interval during a period for which intense auroral kilometric radiation was being detected by HAWKEYE-1 at a radial

distance of about  $18.9 R_e$ . The normalized field strengths in this example are sorted into eighteen  $10^\circ$  intervals in the angle  $\delta_y$ , from  $-90^\circ$  to  $+90^\circ$ . Because of the symmetry of the dipole antenna pattern angles in the range  $90^\circ < \delta_y \leq 270^\circ$  are shifted into the range  $-90^\circ < \delta_y \leq 90^\circ$  by subtracting  $180^\circ$ . The  $1.63^\circ$  phase shift correction due to the receiver time constant has already been taken into account in computing  $\delta_y$ .

A clearly defined null is evident in the normalized field strengths when the antenna axis is pointed toward the earth. A precise determination of the null direction,  $\delta$ , is obtained by finding the best fit of the measured normalized field strengths,  $E/E_0$ , to a theoretical expression for the modulation envelope given by

$$\left(\frac{E}{E_0}\right)^2 = \left(1 - \frac{m}{2}\right) - \frac{m}{2} \cos [2(\delta_y - \delta)], \quad (1)$$

where  $m$  is the modulation factor. Standard techniques of Fourier analysis are used to obtain the best fit values for  $m$  and  $\delta$ . For the case shown in Figure 3 the best fit is obtained when the null angle is  $\delta = 3.41^\circ \pm 1.38^\circ$ . The statistical uncertainty of  $\pm 1.38^\circ$  is evaluated from the mean square error in the best fit.

Other sources of systematic error may be present which could add to the uncertainty in the null angle. Four sources of systematic error have been considered: (1) errors in the receiver phase shift correction, (2) errors in the optical aspect determination of  $\phi_y$ ,

(3) errors in the earth-sun angle,  $\phi_E$ , due to either orbital errors and/or errors in the spin axis determination, and (4) errors caused by misalignment of the electric antenna axis with respect to the y-axis of the spacecraft. Of these errors the uncertainty of the alignment of electric antenna axis is considered to be the dominant error for the HAWKEYE direction finding measurements. Investigations of the misalignment of the flight spare electric antenna and calculations by the antenna manufacturer indicate that the misalignment of the electric antenna axis relative to the y-axis of the spacecraft should not exceed  $2^\circ$ .

### C. Results

Auroral kilometric radiation events lasting for one hour or more can provide sufficiently accurate measurements of the null-earth angle to be useful for analysis. Normally several such events occur in each orbit. Since auroral kilometric radiation usually has the maximum intensity in the 178 kHz frequency channel of HAWKEYE-1 this channel is used for all measurements presented in this paper. To insure that the low level continuum radiation discussed by Frankel [1973] does not influence the direction finding results for the auroral kilometric radiation only events which have a power flux continuously exceeding  $10^{-18}$  watts  $m^{-2}$  at 178 kHz are used. Since the direction finding technique only provides a one-dimensional determination of the source position many orbits with spin axis orientations at various local times must be used to obtain a two-dimensional determination of the average source position. Figure 4 summarizes a series of direction finding

measurements of kilometric radiation at 178 kHz obtained from two orbits which have their orbit planes, hence spin axis directions, approximately at right angles (using sun referenced coordinates). The null directions measured for the various events observed on these two orbits are shown as straight lines drawn outward from the spacecraft at the point along the orbit where the measurement was obtained. These lines are shown as viewed from a direction parallel to the spin axis (edgewise to the orbital plane).

Considerable variability is evident in the null directions determined during these two orbits. This variability is due to actual fluctuations in the position of the centroid of the source since the statistical errors in determining the null direction are typically much less than the scatter in the observed null directions. For orbit 5 the average source position is very close to the orbital plane with a slight tendency for the average position to lie to the left of the orbital plane, toward local evening, as viewed from B. For orbit 42 the average source position is shifted very distinctly to the right of the orbital plane, again toward local night, as viewed from A. Projecting the average source positions obtained from these two orbits into the equatorial plane the average source position would be located on the night side of the earth at about 2 hours local time and about  $1.2 R_e$  from the polar axis.

To provide a better determination of the average source location direction finding measurements of auroral kilometric radiation at 178 kHz have been made for a series of orbits spaced at approximately

even intervals in local time. The results of this analysis are illustrated in Figure 5, which shows the projection of the average null position into the geographic equatorial plane for each orbit (or pair of orbits) analyzed. Pairs of orbits are used in some cases because too few events sometimes occurred on a single orbit to provide a meaningful analysis. The average null position consists of a straight line in this diagram because the null determination is one dimensional and the source could in principle lie anywhere along this line and still be consistent with the null angle observed at the spacecraft. Actually it is known that the source must be located close to the earth since the modulation factor is usually close to one (typically  $m$  is greater than 0.9 for radial distances greater than  $10 R_e$ ), however the modulation factor has not been used in this analysis. The width of the shaded region shown for each orbit gives the r.m.s. spread (plus and minus the standard deviation) in the distribution of the null positions observed during that orbit.

The average location of the auroral kilometric radiation source projected into the equatorial plane can be qualitatively estimated from the intersections of the average null lines for each orbit, taking into account the fact that lines which intersect at nearly right angles provide a better position determination than lines which intersect at a shallow angle. Almost all of the intersections occur on the night-side of the earth. The average position of all intersections, without regard to the angle at which the intersection occurs, is in the late local evening at a local time of 22.7 hours and at a distance of  $0.65 R_e$

from the polar axis. The approximate range of variation in the source position from this average position can be seen from the shaded regions in Figure 5. Evidently considerable variability, on the order of  $1.0 R_e$  exists in the instantaneous source position relative to the average position.

### III. DIRECTION FINDING MEASUREMENTS WITH IMP-8

#### A. Instrumentation Description

The IMP-8 spacecraft was launched on October 26, 1973, into a low eccentricity orbit with initial perigee and apogee geocentric radial distances of 147,434 km and 295,054 km, respectively, orbit inclination of 28.6 degrees, and period of 11.98 days. The spacecraft is spin stabilized with a nominal rotation period of 2.59 seconds. The spin axis is oriented perpendicular to the ecliptic plane.

The University of Iowa plasma wave experiment on IMP-8 uses an electric dipole antenna with a tip-to-tip length of 121.8 meters for electric field measurements and a tri-axial search coil magnetometer for magnetic field measurements. The electric dipole is extended outward, perpendicular to the spacecraft spin axis, by centrifugal force. Electric field spectrum measurements are made in 15 frequency channels extending from 40 Hz to 178 kHz and magnetic field spectrum measurements are made in 7 frequency channels extending from 40 Hz to 1.78 kHz.

#### B. Method of Analysis

The method of analyzing the IMP-8 data to provide direction finding measurements is essentially identical to the method used for HAWKEYE-1, except that the null angle measured is in the ecliptic plane.



Long averaging periods, of an hour or more, must also be used on the IMP-8 data to reduce statistical fluctuations to an acceptable level. Since IMP-8 is at larger distances from the earth than HAWKEYE, greater accuracy is needed in the directional determination. However, much more data is currently available from IMP-8 and since the orbital period of IMP-8 is much longer than HAWKEYE it is possible to use very long averaging periods (on the order of 12 hours or more) to provide smaller statistical errors in the null direction.

The largest sources of systematic error in the IMP-8 direction finding measurements are thought to be the uncertainty in the phase shift correction caused by the receiver time constant and the antenna misalignment. Because of the higher spin rate of IMP-8 the phase shift due to the receiver time constant is relatively large, approximately  $7.16^\circ$ . The uncertainty in this phase shift is estimated to be about  $\pm 2.0^\circ$ . Since comparable errors may also exist in the antenna alignment and overall accuracies of  $\pm 1^\circ$  are needed, it is absolutely essential that some method be used in flight to calibrate the overall systematic error in the direction determination. The method used is to require that the average null-earth angle for measurements obtained on opposite sides of the earth (correcting for radial distance variations) be zero. This averaging condition has been applied to a large number of direction finding measurements of auroral kilometric radiation and the best estimate of the phase shift correction is  $11.96^\circ$ . This phase shift correction includes the phase shift due to the receiver time constant and is used for all IMP-8 direction finding measurements presented

in this paper. As will be pointed out, however, the position of the source can be determined independent of this phase shift correction.

### C. Results

Figures 6 and 7 show two IMP-8 direction finding measurements of auroral kilometric radiation at 178 kHz obtained from positions near the equatorial plane on approximately opposite sides of the earth (local times of 2.76 hours and 16.85 hours, respectively). In both cases the measurements were made during an exceptionally long and steady auroral kilometric radiation event lasting for over 12 hours and at times when the angular position of the earth was very close to the spin plane of the antenna, thereby assuring a deep null in the spin modulation and a very small statistical error in the null direction. The null directions at 2.76 hours and 16.85 hours local time are  $\delta = 1.0^\circ \pm 0.4^\circ$  and  $\delta = -1.1^\circ \pm 0.4^\circ$ , respectively. The positive direction for measuring the earth-antenna angle,  $\delta_y$ , for IMP-8 are shown in the sketches in Figures 6 and 7 as viewed looking down from the north ecliptic pole. The measured null directions are seen to be consistent with a source located in the local evening region.

Other similar measurements, all using averaging intervals of several hours and restricted to events with large modulation factors ( $m > 0.875$ ) to assure small statistical errors, have been made at a variety of local times. Figure 8 shows the null directions obtained from these events as a function of local time. A very clear trend is evident in these data with the null-earth angles negative in the local afternoon and positive in the local morning, consistent with a

source located on the night side of the earth. The local time position of the source and the approximate offset from the polar axis can be determined completely independent of the constant phase shift correction to  $\delta$ . Since  $\delta$  is always small for the IMP-8 orbit the local time and distance of the source from the polar axis are completely determined by the phase and amplitude of the best sine wave fit to  $\delta$  as a function of local time, appropriately correcting  $\delta$  for radial distance effects. This sine wave analysis technique has been applied to the data in Figure 8 and gives an average source position, projected into the equatorial plane, of  $21.25 \pm 0.41$  hours local time at a distance of  $0.835 \pm 0.09 R_e$  from the polar axis.

The null directions shown in Figure 8 are plotted as projections in the geographic equatorial plane in Figure 9 to provide a qualitative indication of the scatter and distribution of null directions observed by IMP-8. The arrows on each line indicate the direction from the spacecraft to the source. Considerable variability from the average source position is also evident in the IMP-8 direction finding measurements. Both qualitatively and quantitatively the IMP-8 direction finding measurements of auroral kilometric radiation are seen to be in close agreement with the HAWKEYE-1 results.

## IV. DISCUSSION

Evidence has been presented showing that the intense bursts of auroral kilometric radiation detected by HAWKEYE-1 and IMP-8 originate from the local evening side of the earth. At a frequency of 178 kHz the average position of the source, projected into the equatorial plane, is at a local time of about 22.0 hours and at a distance of about  $0.75 R_e$  from the polar axis. These results strongly support the previous evidence presented by Gurnett [1974] indicating that the auroral kilometric radiation is produced at relatively low altitudes (of 1.0 to 1.5  $R_e$  for 178 kHz) in the local evening auroral zone.

Simple geometric considerations and reasonable estimates of the altitude at which the auroral kilometric radiation is generated appear to be in good agreement with the observed offset of the average source position from the polar axis. As discussed by Gurnett [1974] the radiation must be generated at an altitude above the propagation cutoff surface for the mode of propagation in which the radiation is generated. Since wave-particle interactions cannot occur at frequencies substantially above the local plasma frequency or gyrofrequency and since these frequencies are relatively close together in the region of the ionosphere where this noise is generated the radiation must be generated rather close to the propagation cutoff surface. For a frequency of 178 kHz the propagation cutoff surface and hence the generation region

are located at an altitude of about  $1.0 R_e$  [Gurnett, 1974]. If we follow a representative auroral field line at  $70^\circ$  invariant altitude up to an altitude of  $1.0 R_e$  and assume that the source is located at this point the source position projected into the equatorial plane would be  $0.96 R_e$  from the polar axis (see Figure 10). These estimates of the source location are in good quantitative agreement with the observed distance of the source from the polar axis.

The observed time and space averaged local time position of the centroid of the emitting region in the late local evening is consistent with the location expected from the known association between auroral kilometric radiation and auroral arcs. It is well known that the most intense auroral electron precipitation and the brightest auroral arcs occur in the local evening [Akasofu, 1968; Snyder et al., 1974]. The observed source position is also consistent with the angular distribution of the kilometric radiation which shows a broad maximum centered on about 22.0 hours local time [Gurnett, 1974]. Spatial variation in the brightness distribution of the source on a time scale comparable to or longer than the averaging interval, such as the westward traveling surge and other spatial evolutions which occur during substorms, may account for the variability in position seen between events studied.

## ACKNOWLEDGMENTS

This work was supported in part by the National Aeronautics and Space Administration under Contracts NAS1-11257, NAS1-13129, and NAS5-11431 and Grant NGL-16-001-043 and by the Office of Naval Research under Grant N00014-68-A-0196-0009.

## REFERENCES

- Akasofu, S.-I., Polar and Magnetospheric Substorms, Reidel, Dordrecht, The Netherlands, 223, 1968.
- Brown, L. W., The galactic radio spectrum between 130 kHz and 2600 kHz, Astrophys. J., 180, 359, 1973.
- Dunckel, N., B. Ficklin, L. Rorden, and R. A. Helliwell, Low-frequency noise observed in the distant magnetosphere with OGO 1, J. Geophys. Res., 75, 1854, 1970.
- Frankel, M. S., LF radio noise from the Earth's magnetosphere, Radio Science, 8, 991, 1973.
- Gurnett, D. A., The earth as a radio source: terrestrial kilometric radiation, J. Geophys. Res., (accepted for publication), 1974.
- Snyder, A. L., S.-I. Akasofu, T. N. Davis, Auroral substorms observed from above the north polar region by a satellite, J. Geophys. Res., 79, 1393, 1974.

Stone, R. G., M. L. Kaiser, and R. Johnson, Radio emission from the magnetosphere, Abstract, EOS Trans. AGU, 55, 398, 1974.



## FIGURE CAPTIONS

- Figure 1 Simultaneous observations of auroral kilometric radiation far from the earth by IMP-6 and low altitude auroral photographs obtained on a series of polar passes with the DAPP satellite. The intense bursts of 178 kHz noise during orbits 1094 and 1096 are seen to be closely associated with discrete auroral arcs in the local evening and midnight regions of the auroral zone.
- Figure 2 The HAWKEYE-1 orbit and spin axis orientation relative to the orbit plane. The angle  $\delta_y$  is the angle between the antenna axis and the projection of the satellite-earth direction into the spin plane of the antenna. The angle  $\delta_y$  at which a null occurs determines a meridian plane through the spin axis on which the source must be located.
- Figure 3 The average normalized electric field amplitude parallel to the antenna axis of auroral kilometric radiation at 178 kHz detected by HAWKEYE-1 as a function of the antenna orientation. A distinct null is evident when the antenna is pointed near the earth. The precise angle at which the null occurs is determined by Fourier analysis.

- Figure 4 Two representative orbits showing the null directions for auroral kilometric radiation at 178 kHz observed at various points along the orbit. Orbit 42 shows a clear tendency for the radiation to originate from the night side of the earth.
- Figure 5 An equatorial plane projection of the average null directions of auroral kilometric radiation at 178 kHz for a series of HAWKEYE-1 orbits at various local times. The shaded region for each orbit gives the r.m.s. spread (plus or minus the standard deviation) in the distribution of null positions for all events analyzed during that orbit. The average source position is located in the late local evening at a local time (LT) of 22.7 hours and at a distance of  $0.65 R_e$  from the polar axis.
- Figure 6 The average normalized electric field strength as a function of the antenna orientation for a period during which intense auroral kilometric radiation at 178 kHz was being detected by IMP-8 at a local time of about 2.76 hours. The averaging period in this case is made very long, 14 hours, to reduce the statistical error in the null determination to only  $\pm 0.4^\circ$ . The null position in this case is slightly to the left of the earth's polar axis and on the night side of the earth as viewed from the spacecraft.

Figure 7 Another null determination using IMP-8 similar to the case in Figure 6, except at a local time of about 16.85 hours. The null position in this case is slightly to the right of the earth's polar axis, again on the night side of the earth, as viewed from the spacecraft.

Figure 8 A series of null directions for auroral kilometric radiation at 178 kHz obtained by IMP-8 as a function of local time. The null angle in all cases is larger in the local morning than in the local evening. This dependence places the source on the night side of the earth independent of any systematic errors which may be present in determining the null direction.

Figure 9 An equatorial plane projection of the null directions given in Figure 8. The arrows indicate the direction from the spacecraft to the source. These null direction measurements place the average source position in the late local evening at a local time of 21.25 hours and at a distance of  $0.835 R_e$  from the polar axis.

Figure 10 A qualitative sketch of the ray paths of auroral kilometric radiation emitted on an auroral field line at  $70^\circ$  invariant latitude.

D-674-43

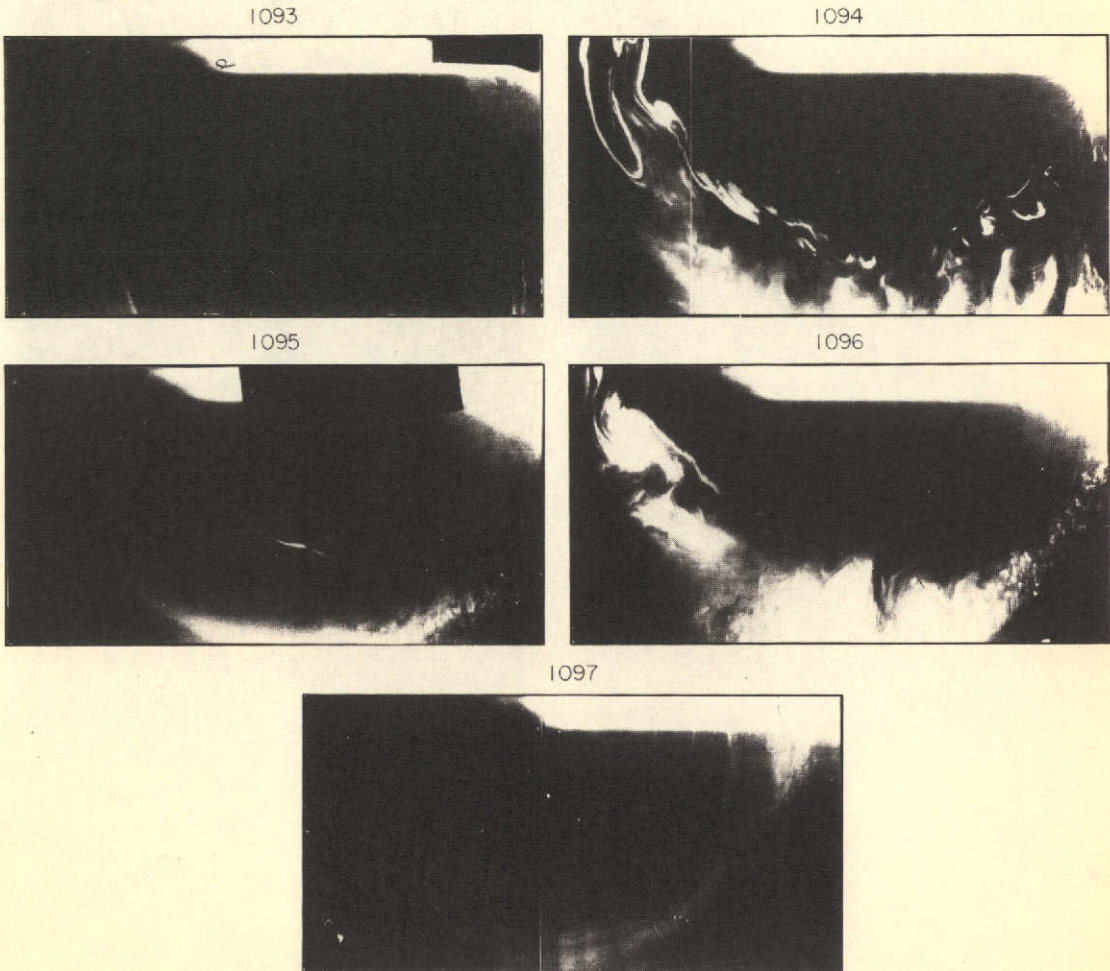
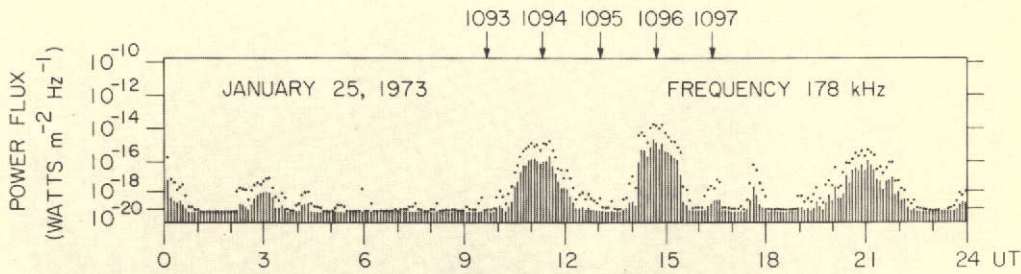

FIGURE 1

REPRODUCIBILITY OF THE ORIGINAL PAGE IS POOR

C-674-769

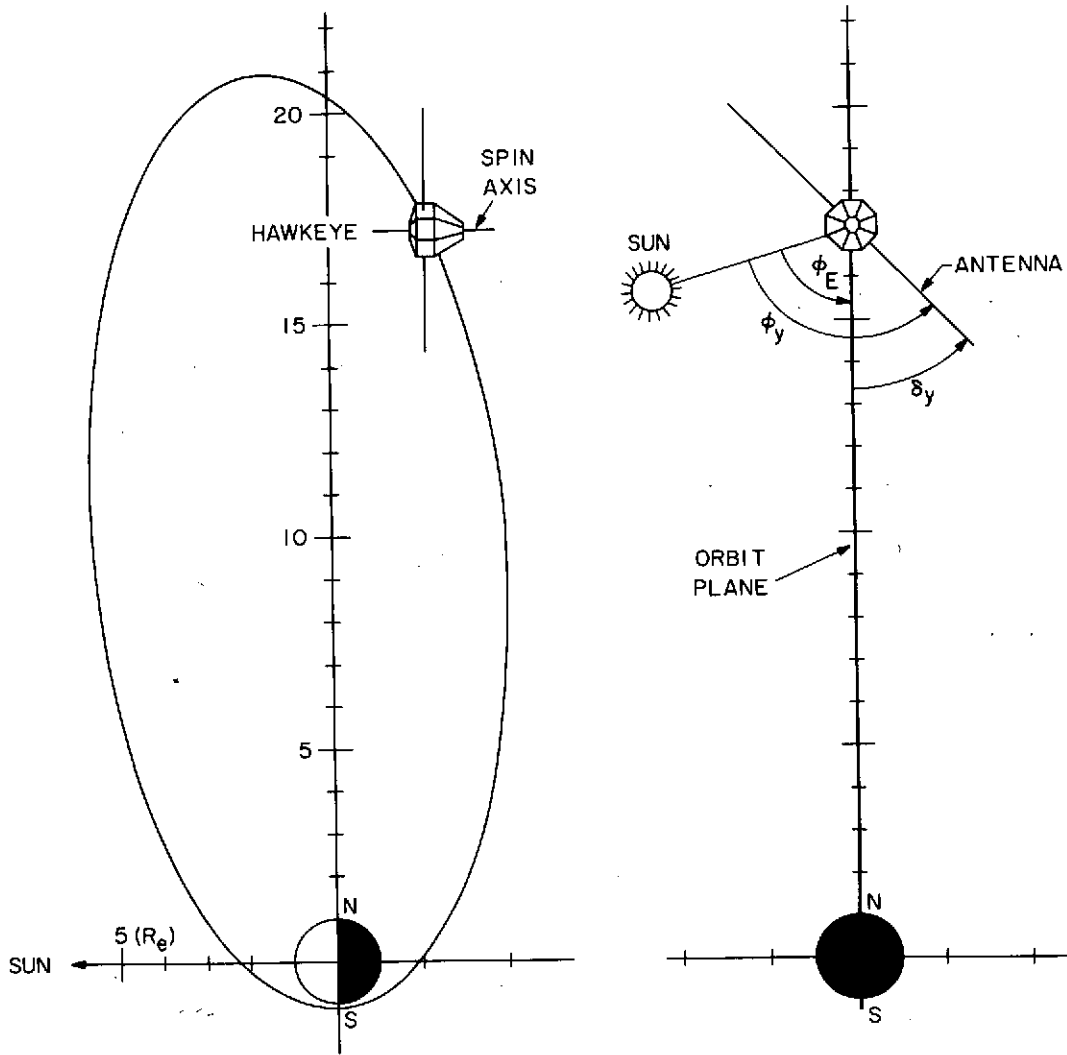

Figure 2

B-G74-768

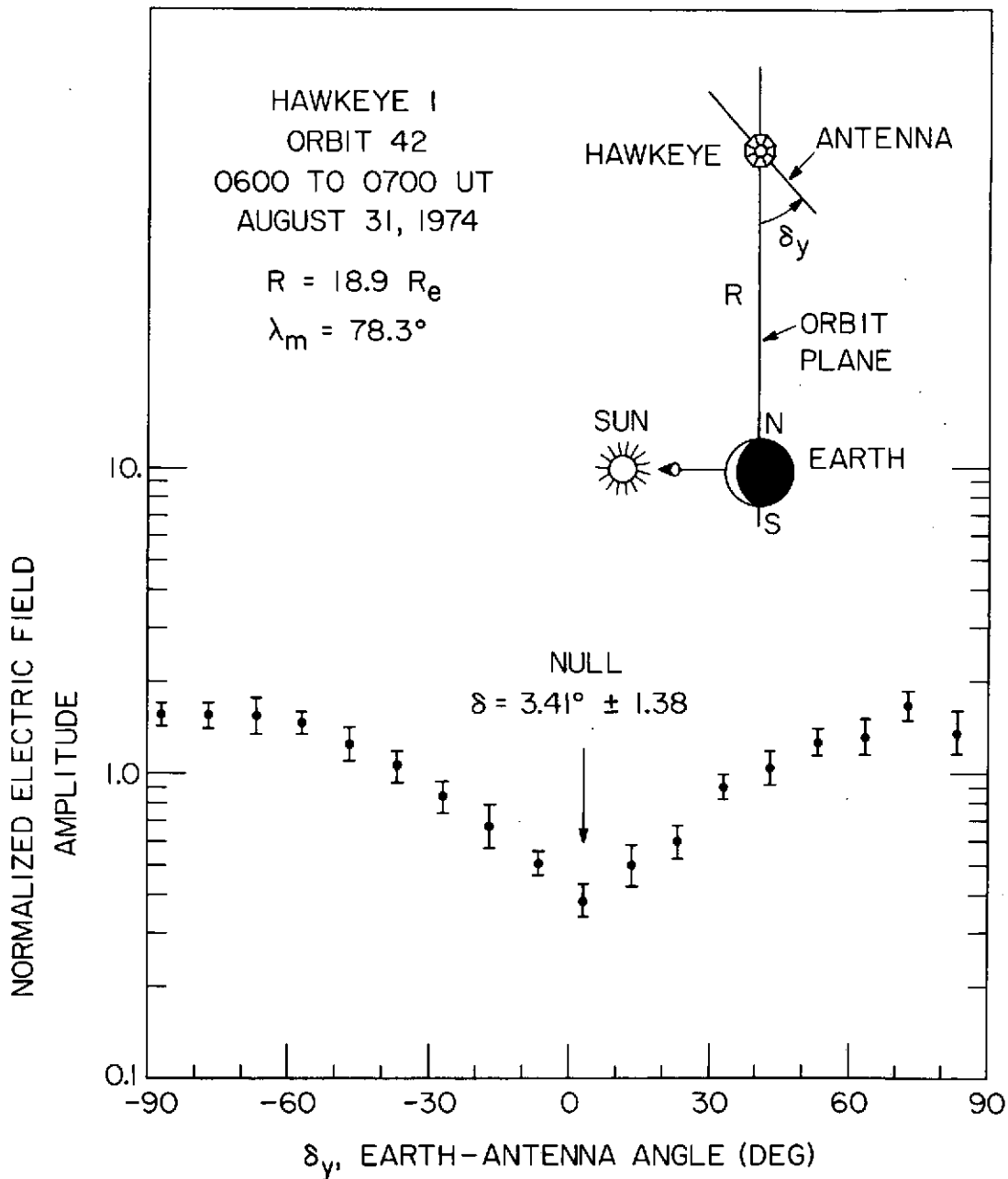

Figure 3

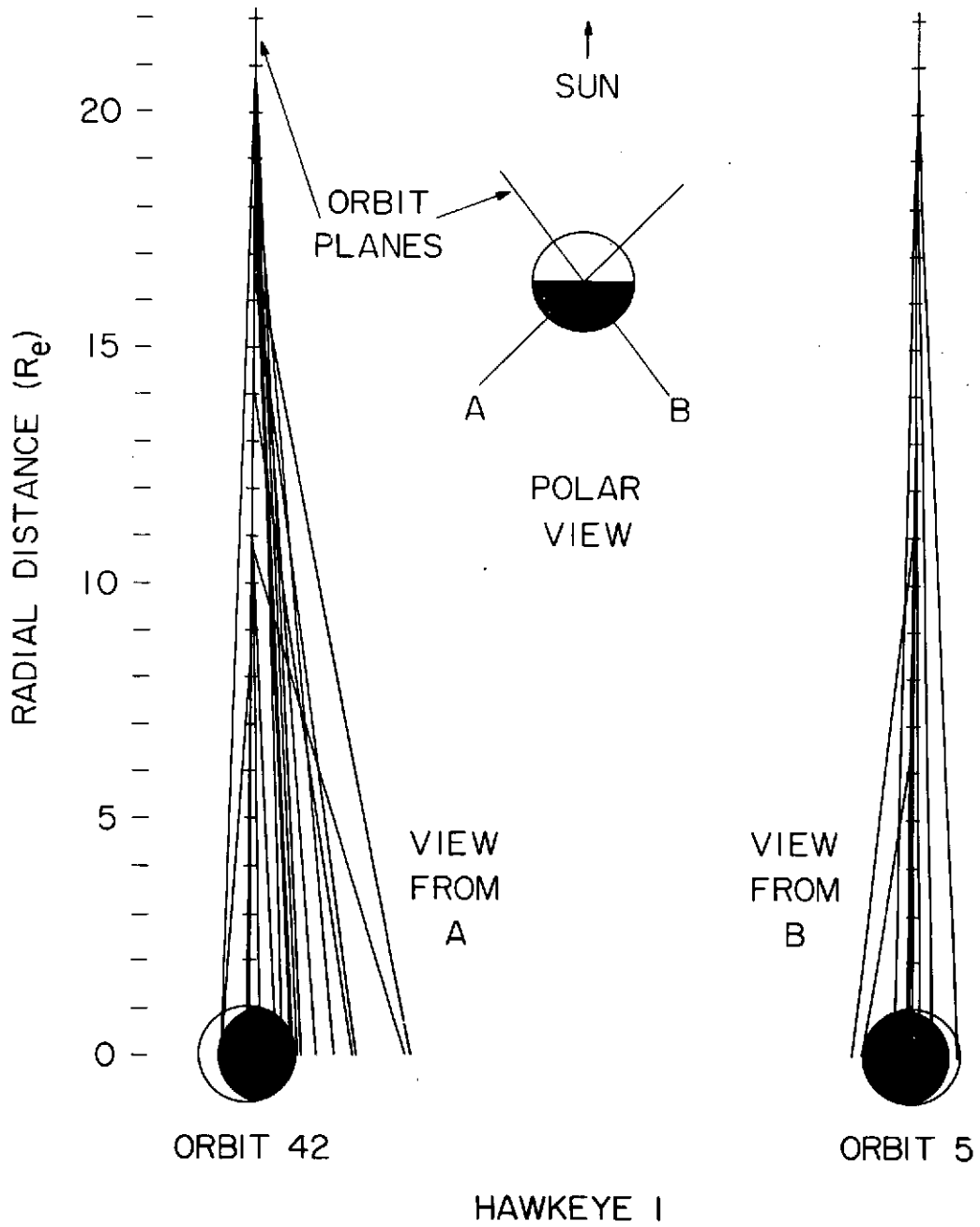

Figure 4

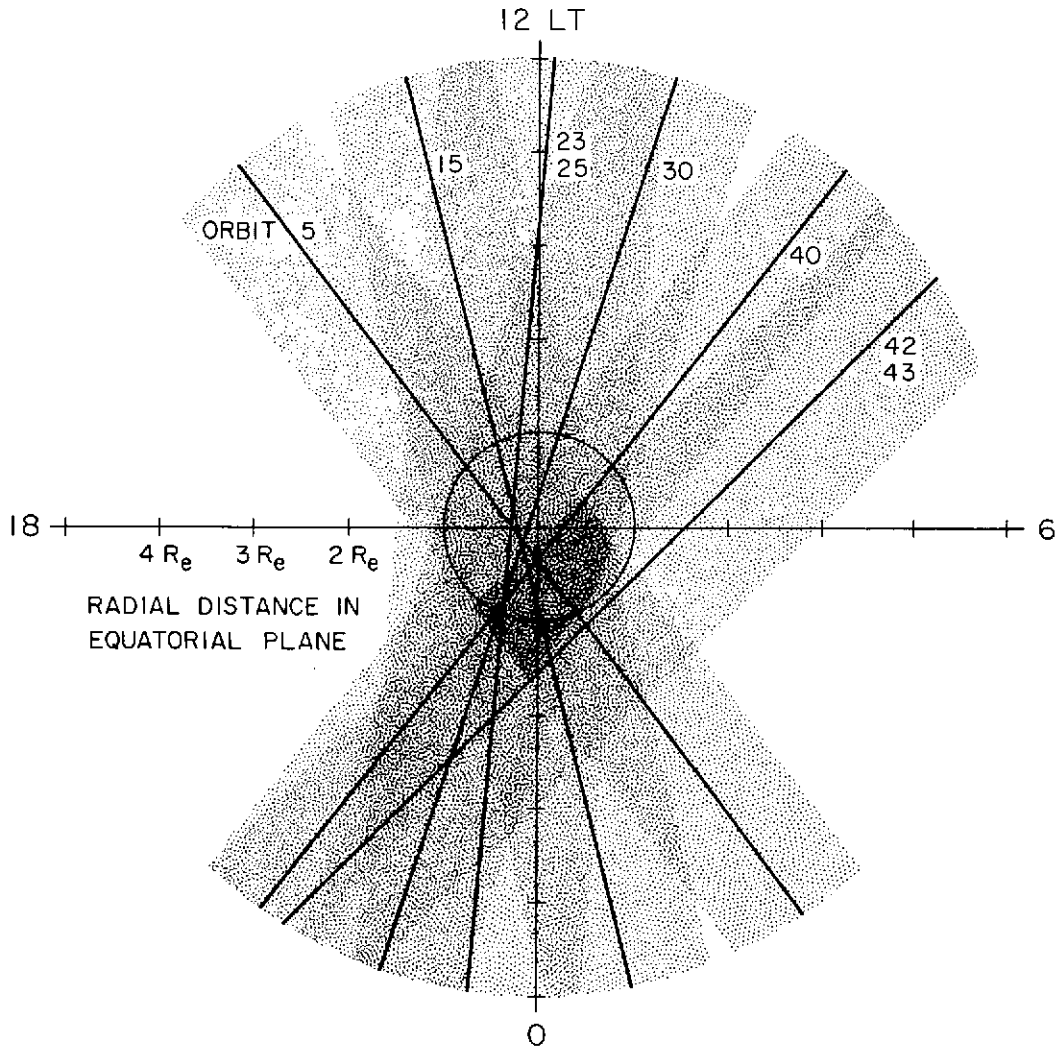

FIGURE 5



B-G74-777

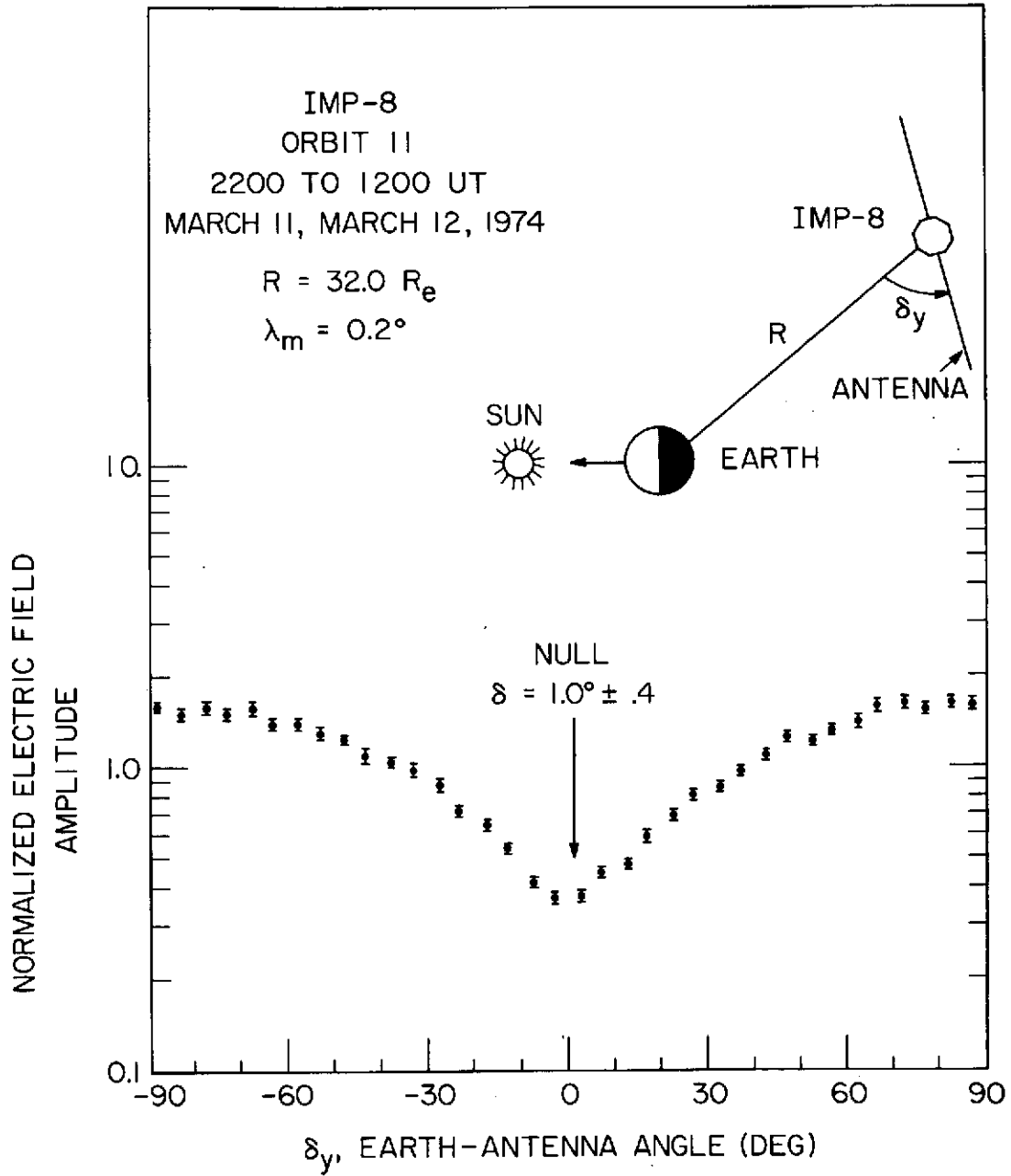

Figure 6

B-G74-778

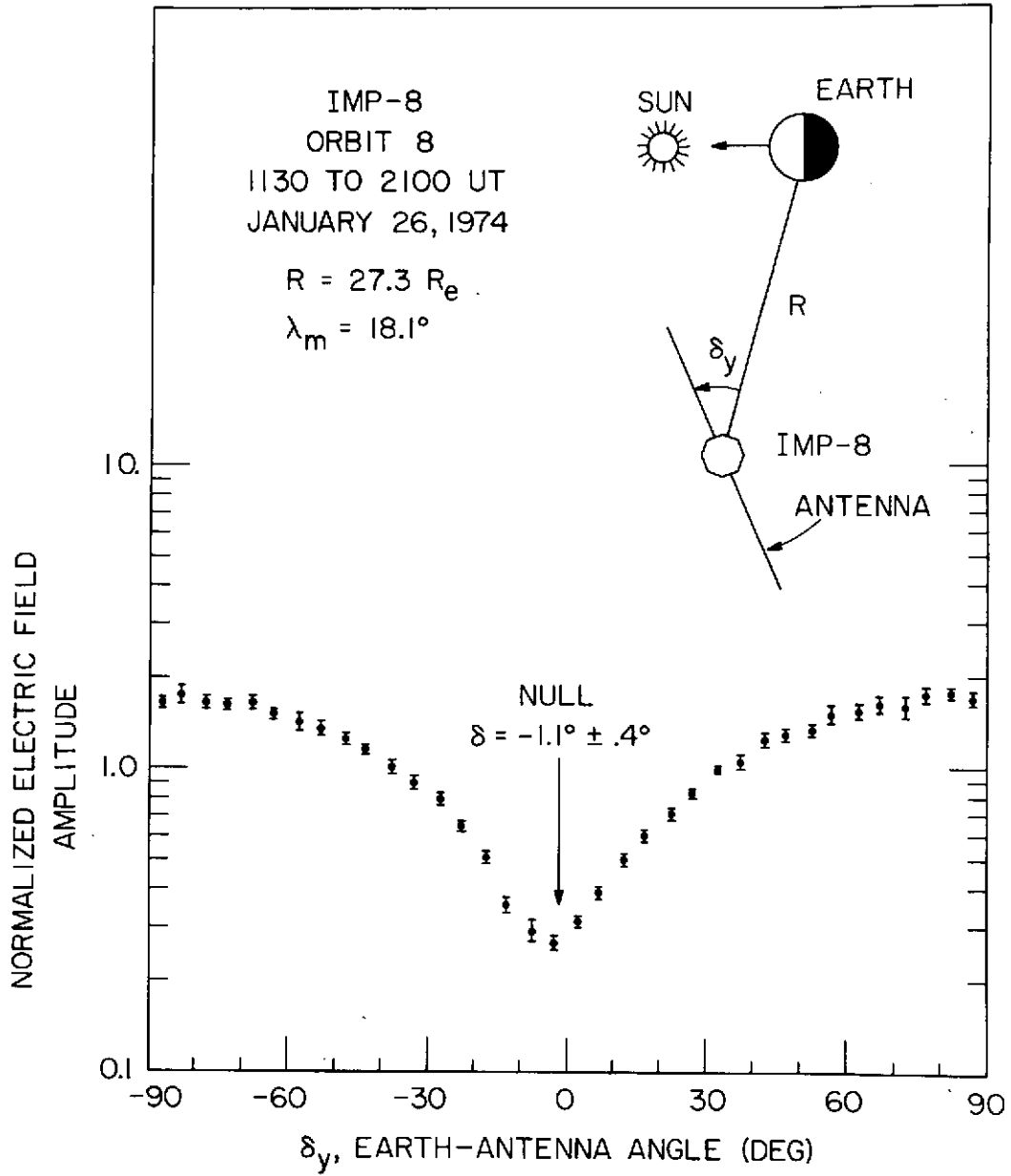

Figure 7

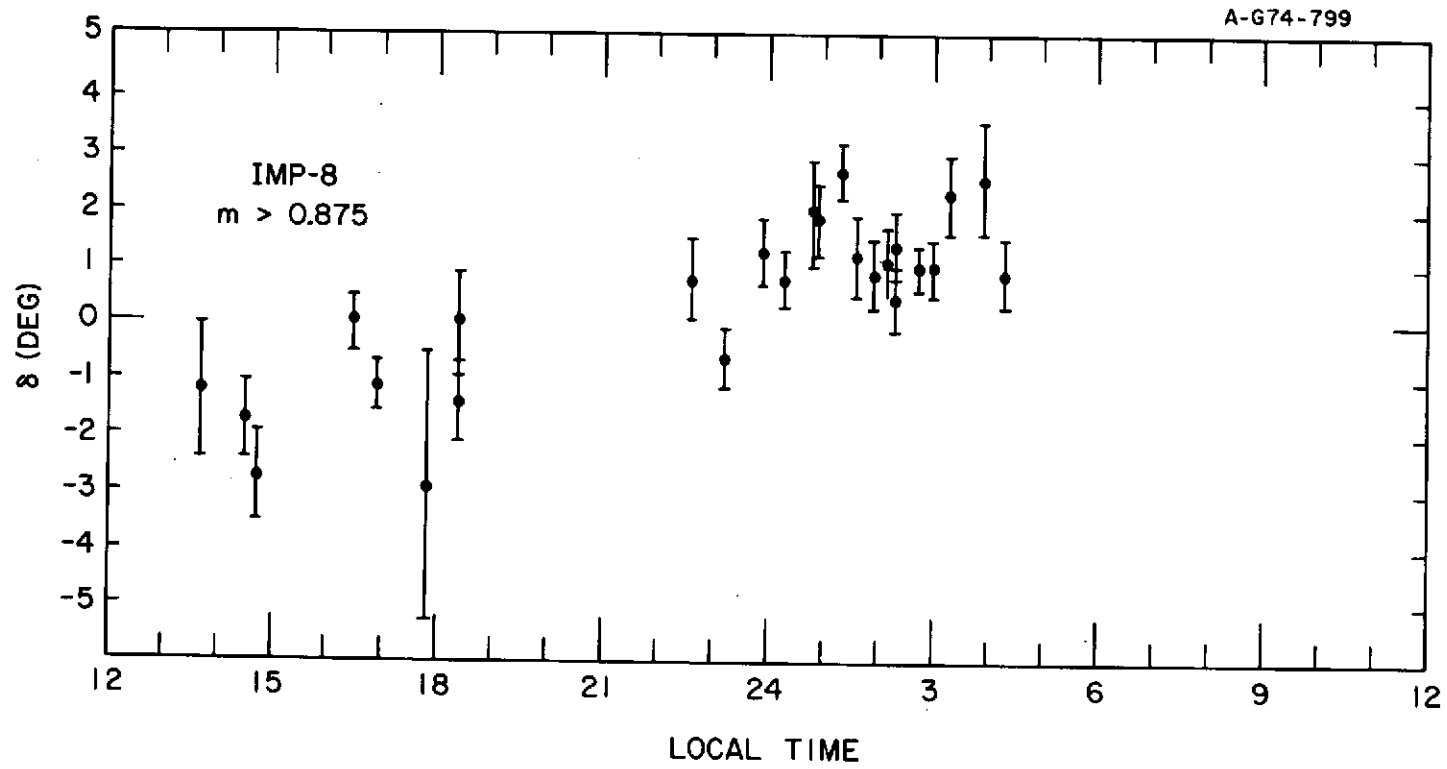

Figure 8

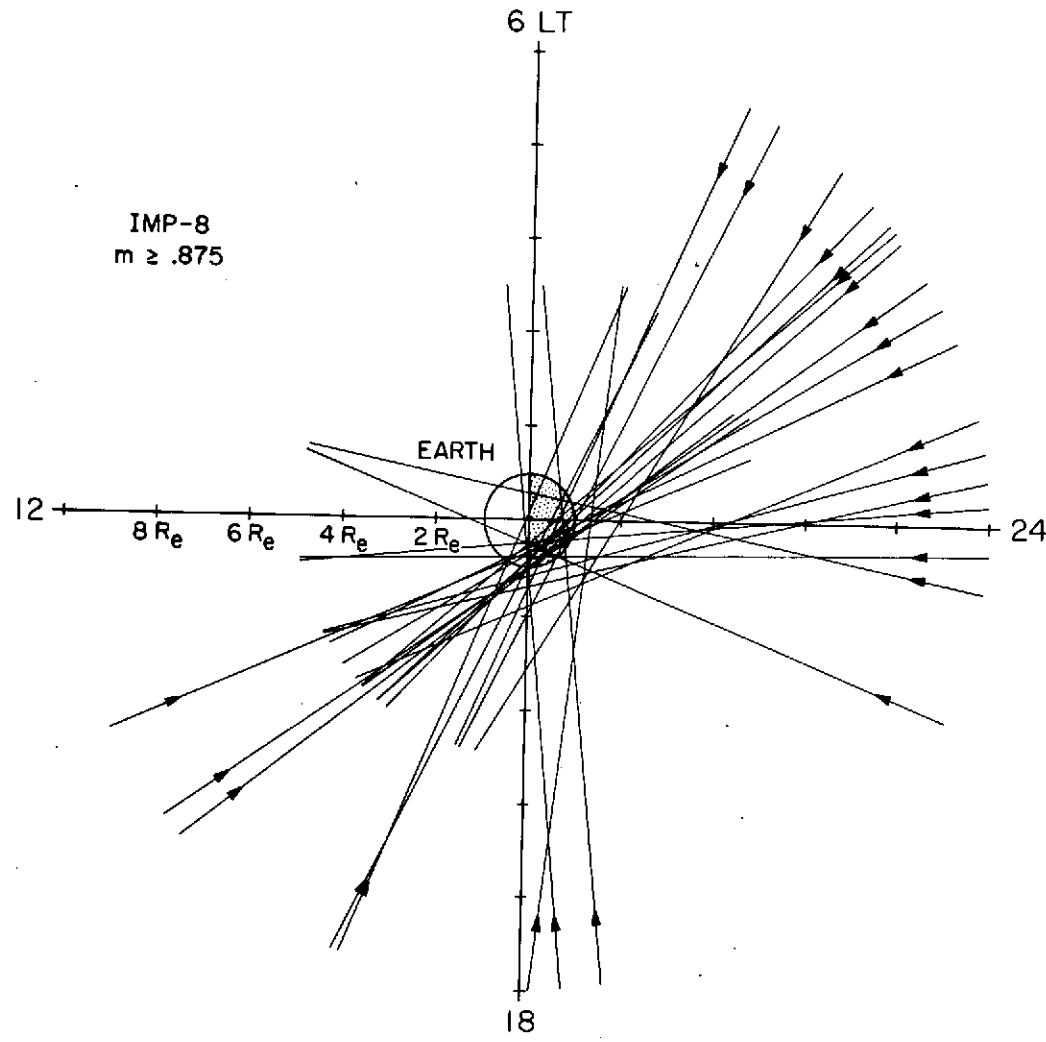

Figure 9

A-674-51

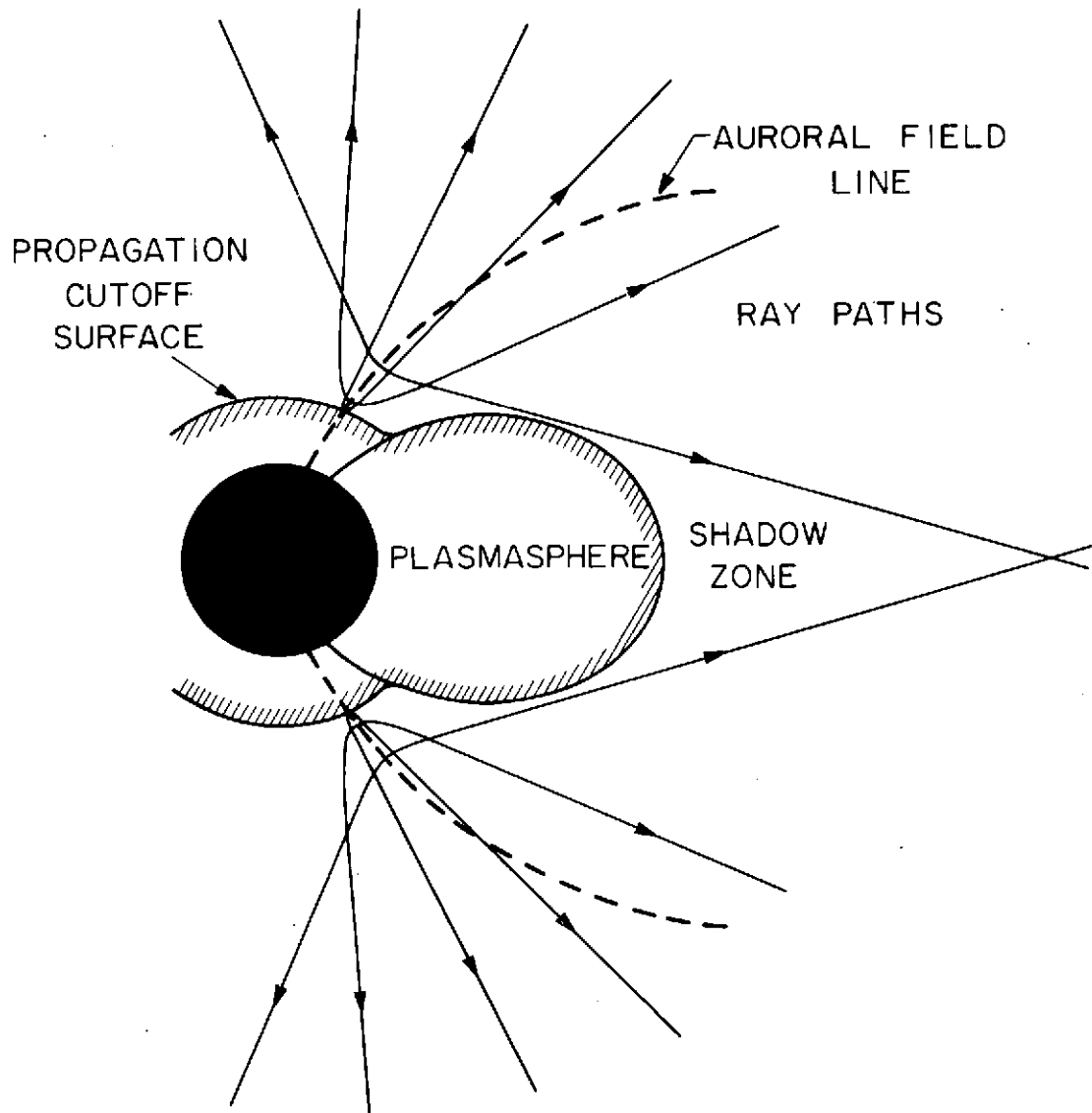

Figure 10