

NASA CR 120986
BOEING D3-8686

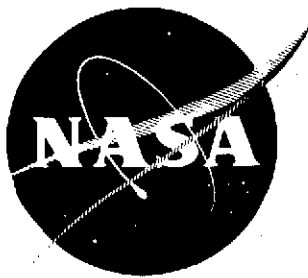

ACOUSTIC ATTENUATION DESIGN REQUIREMENTS ESTABLISHED THROUGH EPNL PARAMETRIC TRADES

BY
HENRY F. VELDMAN

1972

THE **BOEING** COMPANY
WICHITA DIVISION - WICHITA, KANSAS. 67210

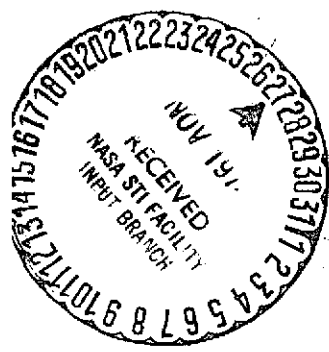

PREPARED FOR

NATIONAL AERONAUTICS AND SPACE ADMINISTRATION

NASA-LEWIS RESEARCH CENTER
CONTRACT NAS 3-14321
H. BLOOMER, PROJECT MANAGER

(NASA-CR-120986) ACOUSTIC ATTENUATION DESIGN REQUIREMENTS ESTABLISHED THROUGH EPNL PARAMETRIC TRADES (Boeing Co., Wichita, Kans.) 248 p HC \$7.50 CSCL 20A N75-11985
Unclas
G3/07 53883

IG730168

NOTICE

This report was prepared as an account of Government-sponsored work. Neither the United States, nor the National Aeronautics and Space Administration (NASA), nor any person acting on behalf of NASA:

- A.) Makes any warranty or representation, expressed or implied, with respect to the accuracy, completeness, or usefulness of the information contained in this report, or that the use of any information, apparatus, method, or process disclosed in this report may not infringe privately-owned rights; or
- B.) Assumes any liabilities with respect to the use of, or for damages resulting from the use of, any information, apparatus, method or process disclosed in this report.

As used above, "person acting on behalf of NASA" includes any employee or contractor of NASA, or employee of such contractor, to the extent that such employee or contractor of NASA or employee of such contractor prepares, disseminates, or provides access to any information pursuant to his employment or contract with NASA, or his employment with such contractor.

Requests for copies of this report should be referred to

National Aeronautics and Space Administration
Scientific and Technical Information Facility
P.O. Box 33
College Park, Md. 20740

NASA CR 120986
BOEING D3-8686

TOPICAL REPORT

ACOUSTIC ATTENUATION DESIGN
REQUIREMENT ESTABLISHED THROUGH
EPNL PARAMETRIC TRADES

BY
HENRY F. VELDMAN

THE BOEING COMPANY
3801 SOUTH OLIVER
WICHITA, KANSAS 67210

PREPARED FOR
NATIONAL AERONAUTICS AND SPACE ADMINISTRATION
1972

CONTRACT NASA 3-14321

NASA-LEWIS RESEARCH CENTER
CLEVELAND, OHIO
H. BLOOMER, PROJECT MANAGER
V/STOL AND NOISE DIVISION

FOREWORD

The work described herein was done by The Boeing Company, Wichita Division, under NASA contract NAS 3-14321 with Mr. H. Bloomer, V/STOL and Noise Division, NASA-Lewis Research Center, as Project Manager.

ABSTRACT

A method is presented to establish acoustic attenuation design requirements through parametric trade studies using the subjective noise unit of effective perceived noise level (EPNL). Results obtained from these studies are then used with an optimization procedure to provide an acoustic lining configuration that is balanced with respect to engine performance losses and lining attenuation characteristics.

TABLE OF CONTENTS

	PAGE
1.0 INTRODUCTION	1
2.0 TECHNICAL APPROACH	3
3.0 ACOUSTIC TRADE STUDY	5
4.0 SELECTION OF DESIGN ATTENUATION SPECTRA	7
5.0 RESULTS	9
6.0 APPLICATIONS AND LIMITATIONS	11
7.0 CONCLUSIONS AND RECOMMENDATIONS	13
8.0 REFERENCES	15
FIGURES	17
TABLES	31
APPENDIX 1, EPNL Program Description	55
APPENDIX 2, EPNL Program Flow Chart	61
APPENDIX 3, EPNL Program Listing	99
APPENDIX 4, PHI Program Description	137
APPENDIX 5, PHI Program Flow Chart	141
APPENDIX 6, PHI Program Listing	157
APPENDIX 7, EPNL Acoustic Trade Study Results	175

LIST OF FIGURES

NUMBER	TITLE	PAGE
1	Power Insertion Loss Characteristics	19
2	Inlet Attenuation Versus Fan Duct Attenuation for 5 EPNdB Reduction	20
3	Inlet Attenuation Versus Fan Duct Attenuation for 10 EPNdB Reduction	21
4	Inlet Mode Attenuation ($M = -.4$) Over 1 Octave Band	22
5	Exhaust Mode Attenuation ($M = .4$) Over 1 Octave Band	23
6	Relation Between Treated Area, Flow Area, and Attenuation	24
7	Attenuation Trade Study Results	25
8	Inlet Lining Attenuation Requirement – Approach	26
9	Fan Duct Lining Attenuation Requirement – Approach	27
10	Inlet Lining Attenuation Requirement – Takeoff	28
11	Fan Duct Lining Attenuation Requirement – Takeoff	29

LIST OF TABLES

NUMBER	TITLE	PAGE
1	Schematic of Acoustic Trade Study and Absorber Evaluation	33
2	Fan Noise Spectrum	34
3	Forward Fan Noise Spectrum	35
4	Aft Fan Noise Spectrum	36
5	Approach and Takeoff Flight Conditions	37
6	EPNL Trade Study Run Identification	38
7	Input Data Identification	39
8	Fan and Secondary Jet Noise Spectrum	40
9	Primary Jet Noise Spectrum	41
10	Turbomachinery Noise Spectrum	42
11	Modified Data Identification	43
12	Fan and Secondary Jet Noise Spectrum	44
13	Primary Jet Noise Spectrum	45
14	Secondary Jet Noise Spectrum	46
15	Turbomachinery Noise Spectrum	47
16	EPNL Program Input (Control Cards)	48
17	EPNL Program Input (Fan, Primary and Secondary Jet Noise Spectrum)	49
18	EPNL Program Input (Fan, Total Jet, and Turbomachinery Noise Spectrum)	50
19a.	EPNL Program Output	51
19b.	EPNL Program Output	52
19c.	EPNL Program Output	53

SUMMARY

An analysis plan was developed for design of acoustically treated nacelles for suppression of fan generated noise from high bypass turbofan engines. The plan was followed in developing two conceptual nacelle designs. The first was a flight nacelle for the NASA/General Electric quiet engine typical of a 707/DC-8 class airplane installation. The quiet engine nacelle design was modified to a design for the NASA Lewis quiet fan. Measured noise data from the NASA quiet fan were used for acoustic design of both conceptual nacelles. This plan included a trade study to select lining attenuation requirements which would provide a 10 EPNdB reduction in flyover noise.

The procedure developed includes a systematic variation of the far field acoustic spectra for each component of the engine noise source and the corresponding change in PNL/EPNL associated with the acoustic spectra variations. Results obtained from these studies are used together with an optimization procedure to minimize the amount of acoustic treatment for a balanced acoustic design that includes engine performance considerations. The design attenuation spectra established in this manner were used to determine the lining characteristics best suited to satisfy the acoustic design objective.

1.0 INTRODUCTION

The FAA noise standards set forth in FAR Part 36 have led to the implementation of various designs to reduce the noise being radiated from high bypass turbofan engines. One method of achieving the noise reduction goal is through the design and installation of acoustic liners in the inlet and fan exhaust duct of turbofan engines. This document summarizes one phase of a systematic acoustic lining procedure that has been developed to ensure a reasonable lining design configuration both with respect to acoustic performance and minimum engine performance degradation. This design procedure was developed for and used to establish the attenuation objectives for conceptual nacelle design of the NASA-Lewis QF-2 fan.

The acoustic attenuation design requirements or objectives can be established by a series of PNL/EPNL parametric trade studies. Either test data or estimated values of the engine acoustic signature together with airplane flight path information are used to compute a baseline (untreated) EPNL value for a specific engine configuration. Through the use of a systematic incremental reduction in the various noise components of the engine and computing the associated EPNL value, a matrix of noise reduction values can be established. This matrix will define the various combinations of acoustic attenuations that are required for each noise source to achieve a specific noise reduction goal. A weighting function was used to minimize the total area of acoustic treatment in the engine while meeting the desired EPNL objective. The weighting function related attenuation to the treated area required to obtain that attenuation. By minimizing the sums of these products, the total treated area can be optimized.

The procedure identifies attenuation requirements for inlet and fan duct linings prior to the actual detail design and provides confidence that the acoustic attenuation objective can be obtained. In addition, effects of component noise floors are considered and the effect of the acoustic treatment on engine operational losses are held to a minimum. This procedure allows the engineer flexibility in selecting the attenuated acoustic spectrum. This capability is desirable to respond to geometric and/or manufacturing constraints.

2.0 TECHNICAL APPROACH

The basic elements used to provide an acoustic lining configuration that is balanced with respect to engine performance losses and lining attenuation characteristics are outlined in Table I. The steps identified in the flow chart are used to perform a systematic variation of the far field acoustic signature. Each cycle provides one value in the EPNL matrix. Details of the individual analysis elements are outlined in the following paragraphs.

The analysis begins with the identification of the baseline spectra for each component of the noise source (Step 1). In this document, the total noise source is assumed to be a composite of the: (1) fan noise, (2) primary jet noise, (3) secondary jet noise, and (4) turbomachinery noise.

A reduction in Sound Pressure Level (SPL) of an acoustic spectrum is usually referred to as applying attenuation to a baseline component spectra (Step 2). Each component attenuation spectra should be representative of the expected reduction derived from either tests or analysis. The total attenuated noise spectrum of the engine is the power sum of each of the individual attenuated noise components.

The significance of a balanced acoustic design for a particular noise source is closely linked to the "noise floor" concept. Consider two noise components, the fan and jet noise of a turbofan engine. If, at a given frequency, the fan noise has been attenuated to a level below that of the jet noise, then subsequent reduction in the fan noise level will not result in a discernable lower overall noise level. In this case, the noise floor has been established by the jet noise level.

The next step in evaluating the acoustic performance is to extrapolate the attenuated spectra to the requested condition (Step 3). The form at which the input data is available may consist of a set of 1/3 octave data that is either measured or predicted on a polar radius around the noise source or at a sideline distance. The output can be calculated at any one of the above conditions or flight conditions simulating approach, takeoff, or level fly by.

The airplane flight characteristics and atmospheric environment are used to determine the projected SPL spectra by accounting for factors such as the propagation time and distance, the atmospheric attenuation corrections, directivity index and doppler shift.

The atmospheric attenuation corrections are the standard atmospheric absorption as a function of distance, relative humidity, and temperature (Reference 1) and the extra ground attenuation as a function of elevation angle and distance (Reference 2).

The propagation distance is accounted for by the spherical divergence which takes the form of:

$$\Delta\text{dB} = 20 \log_{10} (\text{Distance ratio between input and output condition})$$

The corrections due to the doppler shift effect are taken from Reference 3.

Differences in the number of engines between the input and projected condition are corrected by using the relation

$$\Delta\text{dB} = 10 \log_{10} (\text{number of engines})$$

PRECEDING PAGE BLANK NOT FILMED

The relative jet velocity correction due to the forward airplane speed, outlined in Reference 4, defines a frequency shift as

$$\text{Frequency shift} = \frac{\text{Primary jet velocity} - \text{forward airplane speed}}{\text{Primary jet velocity under static condition}}$$

The change in the sound pressure level (SPL) due to the relative jet velocity is expressed as

$$\Delta \text{dB} = 80 \log_{10} (\text{Frequency shift})$$

The conversion from projected SPL values to subjective units is performed in Step 4. Each 1/3 octave SPL value is converted to the respective NOY unit. The details of this procedure can be found in Reference 5.

The Perceived Noise Level (PNL) is calculated at each angle by using the relation (Reference 6).

$$\text{PNL} = 40 + 33.3 \log_{10} \left(\text{NOY}_{\text{max}} + .15 \left(\sum \text{NOY} - \text{NOY}_{\text{max}} \right) \right)$$

When spectral irregularities are present, the PNL value is adjusted to account for a tone correction by applying the technique set forth in Reference 7.

The Effective Perceived Noise Level (EPNL) is calculated by integrating the time history of the tone corrected PNL as outlined in Reference 7.

3.0 ACOUSTIC TRADE STUDY

The noise abatement system for this program considered the placement of lining material in the inlet and the fan duct. In the analyses, the total fan noise spectrum (Table 2) is treated as being a composite of two independent noise sources. The inlet radiated noise controls the forward quadrant (Table 3), the fan duct radiated noise dominates the aft quadrant (Table 4).

The spectral Power Insertion Loss (PIL) characteristics of tuned single layer acoustic linings tend to have a bell shaped curve about the tuned frequency. The PIL curve shape used for this acoustic trade study, generated from flow duct data, is shown in Figure 1. Segmented acoustic lining configurations were considered for the inlet and fan duct. In one segment, the attenuation was tuned to the fan fundamental frequency and the second segment was tuned to the second fan harmonic. For convenience, the acoustic lining segments in the inlet are referred to as inlet fundamental and inlet harmonic while the lining segments in the fan duct are referred to as fan fundamental and fan harmonic. When the PIL curves of the fundamental and harmonic overlap each other, algebraic addition was used to obtain the resultant PIL.

The attenuated forward and aft fan noise spectrum was combined with jet noise and turbomachinery noise components to form a composite polar spectrum. This spectrum and the appropriate flight parameters were used to obtain an EPNL value.

The EPNL trade studies were conducted for typical takeoff and approach conditions with the observer located at 3.5 n.m. from brake release and 1.0 n.m. from touchdown respectively, as defined in FAR Part 36 (Reference 7). The takeoff and approach were simulated using the flight conditions listed in Table 5. If the value of PNLT at the 10 dB down point is 90 PNdB or less, Reference 7 allows the option of using a time interval between the initial and the final time value for which PNLT equals 90 PNdB. This option was not used because it can give rise to discontinuities when the maximum PNLT value approaches a value equal to or less than 90 PNdB.

The EPNL trade study calculations were accomplished by varying the four lining segment characteristics: (1) inlet fundamental, (2) inlet harmonic, (3) fan fundamental, and (4) fan harmonic, independently at successive values of 0, 5, 10, 20, and 30 dB for the peak value of attenuation. In addition, for the takeoff simulation, primary jet noise attenuations were simulated by applying a uniform attenuation factor to the jet SPL spectrum in increments of 0, 2.5, 5, 7.5, and 10 dB. The approach condition was evaluated with and without the turbomachinery noise component. Table 6 identifies the 8 EPNL trades presented in this document. Runs 1A and 2A represent the baseline engine as simulated for approach and takeoff conditions. Runs 10A and 11A have the primary jet and turbine noise components removed which would be representative of the noise levels measured on a fan test configuration.

The data was plotted in terms of Δ EPNL versus inlet fundamental attenuation for constant fan fundamental attenuations. These data reflect combinations of inlet and fan harmonic acoustic treatment. For improved visibility, a cross plotting of the data was accomplished for constant Δ EPNL levels of 5 and 10 EPNdB. Each graph depicts the variation of inlet fundamental attenuation versus fan fundamental attenuation for different values of inlet harmonic attenuations (Figures 2 and 3). In each case, the fan harmonic attenuation has a constant preassigned value. Whenever a graph appears blank, this merely indicates that the Δ EPNL level cannot be achieved for the attenuation conditions stated. Asterisks appearing within the tabulated data sets indicate that

the attenuation value is outside the range of 0 to 30 dB. The "with tone" notation in the graph heading indicates that the standard tone correction was used as identified in FAR Part 36.

4.0 SELECTION OF DESIGN ATTENUATION SPECTRA

The EPNL trade study provides a data bank of Δ EPNL values for combinations of inlet and fan duct attenuation levels tuned to the fundamental and harmonic blade passage frequency of the fan. In view of the large amount of data that can be generated to evaluate various combinations of attenuation levels to satisfy specific design goals, a systematic method was developed to evaluate the EPNL trade study results. This method uses weighting functions that are applied to the individual attenuation levels, such that the summation of these functions are proportional to the total acoustic treatment area.

A four-dimensional interpolation using the Δ EPNL data bank was performed to identify each attenuation spectra which gave a 10 EPNdB reduction at takeoff and approach. The results of the interpolation showed that a great number of different spectra satisfied the acoustic design criteria. The selection of the optimum spectra, based on minimum treated area was accomplished by using a lining optimization procedure described in Reference 8, which is based on maximizing the attenuation of a "pink" noise source. This source has a constant SPL for one octave bandwidth and is zero elsewhere. Figures 4 and 5 show results of this optimization procedure for inlet and exhaust Mach numbers of .4 as a function of Hf/c , where H is the duct height between the lined walls, f is the frequency, and c is the speed of sound. The results presented are attenuation level for a one octave attenuation bandwidth versus the ratio of the lining length, L , to duct height, H . The ratio of duct length to height is proportional to the ratio of treated area to flow area in an annular duct with all surfaces lined.

The curves of Figures 4 and 5 were approximated by an equation of the following form:

$$\phi \left(\frac{\text{Treated Area}}{\text{Flow Area}} \right) = C \Delta \text{dB}^{5/3}$$

Figure 6 compares the theoretical and empirical curves for $Hf/c = 1.0$ when the inlet and exhaust Mach numbers are .4. The constant C depends on the value of Hf/c and the flow condition in the duct (i.e., Mach number and direction of flow relative to the noise source). The value of the constant increases with Hf/c . For example, at an exhaust Mach number of .4, the constant increases by a factor of 1.75 as Hf/c is doubled. At an inlet Mach number of .4, the constant increases a factor of 1.6 as Hf/c is doubled. The following table compares relative values of the proportionality constant as a function of Hf/c and duct flow condition.

<u>Hf/c</u>	<u>Inlet Mach No. = 0.4</u>	<u>Exhaust Mach No. = 0.4</u>
1	0.455	1.0*
2	0.73	1.75

*Reference Value

The relative values of the constants listed above are proportional to the theoretical treated area required to obtain a given level of suppression, assuming equivalent flow areas in the inlet and exhaust ducts. The results for $Hf/c = 1$ show the increased efficiency of inlet linings compared to fan duct linings, which is theoretically predicted assuming no velocity gradients in the ducts. This

magnitude of increased efficiency had not been observed in flow duct tests of linings conducted prior to this study. Consequently, the effectiveness of inlet and fan duct linings were assumed equal for this study. Subsequently, it was discovered that if inlet linings are designed considering velocity gradients, the lining effectiveness approaches the theoretical levels, (Reference 9).

The weighting function used to minimize treated area while achieving a given level of suppression was

$$\phi \left(\frac{\text{Treated Area}}{\text{Flow Area}} \right) = \left(\Delta \text{dB}_{\text{fundamental}}^{5/3} + 1.6 \Delta \text{dB}_{\text{harmonic}}^{5/3} \right) \text{ inlet} \\ + \left(\Delta \text{dB}_{\text{fundamental}}^{5/3} + 1.75 \Delta \text{dB}_{\text{harmonic}}^{5/3} \right) \text{ fan duct.}$$

The optimum lining configuration determined by the ϕ function satisfied the design objective while minimizing the amount of treated area in the inlet and fan duct. Figure 7 shows the EPNL reduction versus the optimum value of the weighting function ϕ . Each point on the curve represents the inlet and fan duct attenuation spectra for minimum treated area. The results show that the 10 EPNdB reduction goal can be achieved at the approach condition. However, the goal cannot be achieved at takeoff without core jet suppression since the noise floor level is established by the primary jet.

The attenuation requirements for the approach condition were selected as those which gave a 10 EPNdB reduction with the minimum value of the weighting function, ϕ . Figures 8 and 9 show the attenuation requirements at approach for the inlet and fan duct, respectively. Takeoff attenuation requirements were reduced to 7.5 EPNdB due to the presence of the noise floor controlled by the primary jet. The requirements, based on minimum ϕ , are shown in Figures 10 and 11 for the inlet and fan duct, respectively.

5.0 RESULTS

The airplane flyover noise prediction computer program (EPNL program) was developed to accept individual noise component spectra. Each spectra defining the 1/3 octave SPL variation with frequency and position. The acoustic characteristic of a turbofan engine was defined by four noise components.

- a. Noise due to the low pressure compressor rotation, usually referred to as "Fan Noise" or simply "Fan."
- b. Primary exhaust jet noise; Jet prim or Jet 1
- c. Secondary exhaust jet noise; Jet sec or Jet 2
- d. Turbo machinery noise; Turb

The array defining the turbomachinery noise includes all other internally generated noise.

The computer program internally separates the fan into forward and aft radiated noise components (fan fwd and fan aft). Equal power distribution is assumed at 90° with a rapidly decreasing influence of the forward fan component in the aft quadrant and vice versa.

At this stage all the noise components are stored individually. Changes in the spectra due to noise suppression techniques or due to different flight characteristics can be accounted for on a per component basis. After all components have been adjusted to match the simulated configuration they are added together for flyover simulation calculations.

The acoustic data for the QF-2 fan was made available in the form of the combined fan and secondary jet spectra at a polar distance of 100 feet. The primary jet noise spectra was obtained at a 250 feet polar distance. Turbomachinery noise was only defined in a frequency region from 1,250 to 10,000 Hz and for angles from 100° to 130°. The above information and the data source are identified in Table 7. The 1/3 octave spectra are listed in Tables 8 through 10.

All the data was subsequently standardized to a 200 feet polar arc distance at 59°F and 70% relative humidity. Furthermore, a polar spectrum defining the secondary jet noise was generated to accomplish the separation of the QF-2 fan and secondary jet noise. The modified data and the type is identified in Table 11. The 1/3 octave spectra are listed in Tables 12 through 15.

The EPNL computer program was modified to include the option allowing either fan or combined fan and secondary jet noise as basic component input.

A sample of the EPNL program output is shown in Tables 16 through 21 for a typical approach condition. The details and explanation of the input code and data format is described in Appendix I (EPNL program description). Table 17 lists the input spectra of the QF-2 fan and secondary jet noise (Fan Jet 2), the primary jet noise (Jet Prim), and the secondary jet noise (Jet Sec). The fan noise spectrum, which is calculated by subtracting the secondary jet noise from the QF-2 noise data, is tabulated in Table 18 (Fan Base). The total jet noise (Jet Tot) is the sum of the primary and secondary jet noise. The turbomachinery noise (Turb Base) was extrapolated to include all angles (10° through 170°) and all frequencies (50 to 10,000 Hz) with an arbitrary lower noise limit of 10 dB.

A sample of the trade study output is listed in Table 19. Each line represents the results of a particular combination of inlet and/or fan duct attenuation. The notation at the head of Table 19 is as follows:

Two columns each under "inlet" and "fan duct" indicate the fundamental and harmonic peak attenuation value in dB. The number under "jet" is an identifier applicable to the jet noise used. The next column contains the EPNL value. Next listed are airplane altitude at overhead, airplane velocity, relative humidity, and temperature. The sideline and offset values are relative to the FAR Part 36 measuring stations. The climb gradient is listed as "Gamma", while "Alpha" is the airplane angle of attack relative to the flight path.

The "duration" is the length of time of the flyover which is used in the EPNL calculation. The "DEPNL" value is the change in EPNdB relative to the condition for no attenuation in the inlet or the fan duct.

Appendix 7 contains the reduced data from the EPNL and PHI computer programs. The results presented are for a 5 and 10 EPNdB noise reduction. The run identification numbers are listed in Table 6.

6.0 APPLICATIONS AND LIMITATIONS

The technique outlined in this document can be applied to any turbofan engine installation whether mounted on a test stand or on an airplane. A sufficiently detailed noise source description on a narrow band or 1/3 octave band basis is desirable to conduct comprehensive EPNL trade studies. If the SPL spectra is only available at a few angles and/or in octave band form, an EPNL trade study should be limited to establishing preliminary design attenuation objectives.

The basic limitations in the computer program are the following:

1. A single airplane configuration can be analyzed during a flyover. This implies a constant power setting, climb gradient, angle of attack, and airplane velocity. Although this may seem like a severe limitation, in actual flight the above parameters do not change very drastically except in a cutback procedure during takeoff.
2. The attenuation is applied in equal amounts at all angles. Angular dependency is neglected because sufficient data were not available to justify the use of a directivity correction. However, inclusion of directivity patterns can easily be incorporated.

7.0 CONCLUSIONS AND RECOMMENDATIONS

A trade study based on EPNL level together with a program to minimize the acoustic treatment required to achieve the attenuation goal is an economic and effective method to estimate lining attenuation requirements for a balanced design with respect to engine and acoustic performance. In addition, the portion of the acoustic spectra where the attenuation goal can be achieved are identified without spending an excessive amount of computer time and/or engineering manhours.

A common method of reducing aircraft noise is through the use of acoustic lining materials and different nozzle configurations: however, there are other techniques which may satisfy a particular requirement. The cutback procedure was introduced to lower the noise level in populated areas around the flight path. A proposed two-segmented approach profile can be examined for the same reason. Changes in airplane configuration, such as different flap settings, have also been suggested as possible candidates for an improved acoustic flyover performance. In view of these considerations, a desirable extension of the present EPNL program would be a modification to account for changes in power setting, engine spool down time, climb gradient, angle of attack, and airplane velocity.

PRECEDING PAGE BLANK NOT FILMED

8.0 REFERENCES

1. Society of Automotive Engineers Aerospace Recommended Practice (ARP) 866, "Standard Values of Atmospheric Absorption as a Function of Temperature and Humidity for Use in Evaluating Aircraft Flyover Noise," SAE Committee A-21, August 31, 1964.
2. Society of Automotive Engineers Aerospace Information Report (AIR) 923, "Method for Calculating the Attenuation of Aircraft Ground to Ground Noise Propagation During Takeoff and Landing," SAE Committee A-21, August 15, 1966.
3. Technical Note D6-17095 TN, "Doppler Effect Correction for Motions of Source, Observer and Fluid," The Boeing Company, R. A. Mangiarotty, November 21, 1966.
4. "Method of Flight Vehicle Noise Prediction," WADC T.R. 58-354, Part II.
5. R. A. Pinker, "Mathematical Formulation of the Noy Tables," Journal of Sound Vibration (1968), Volume 8, pp. 488-493.
6. Society of Automotive Engineers Aerospace Recommended Practice (ARP), 865, "Definitions and Procedures for Computing the Perceived Noise Level of Aircraft Noise," SAE Committee A-21, October 15, 1964.
7. Federal Aviation Administration, DOT. Federal Aviation Regulations, Part 36 – Noise Standards: Aircraft Type Certification.
8. Anderson, A. O.; and Fischer, F. W.: Optimization of Duct Linings for Sound Attenuation, D6-29356 TN, The Boeing Company, January 20, 1968.
9. Eversman, Walter: Effect of Boundary Layer on the Transmission and Attenuation of Sound in an Acoustically Treated Circular Duct, J. Acoust. Soc. Am., Vol. 49, No. 5 (Part 1), May 1971, pp. 1372 - 1380.

PRECEDING PAGE BLANK NOT FILMED

FIGURES

PRECEDING PAGE BLANK NOT FILMED

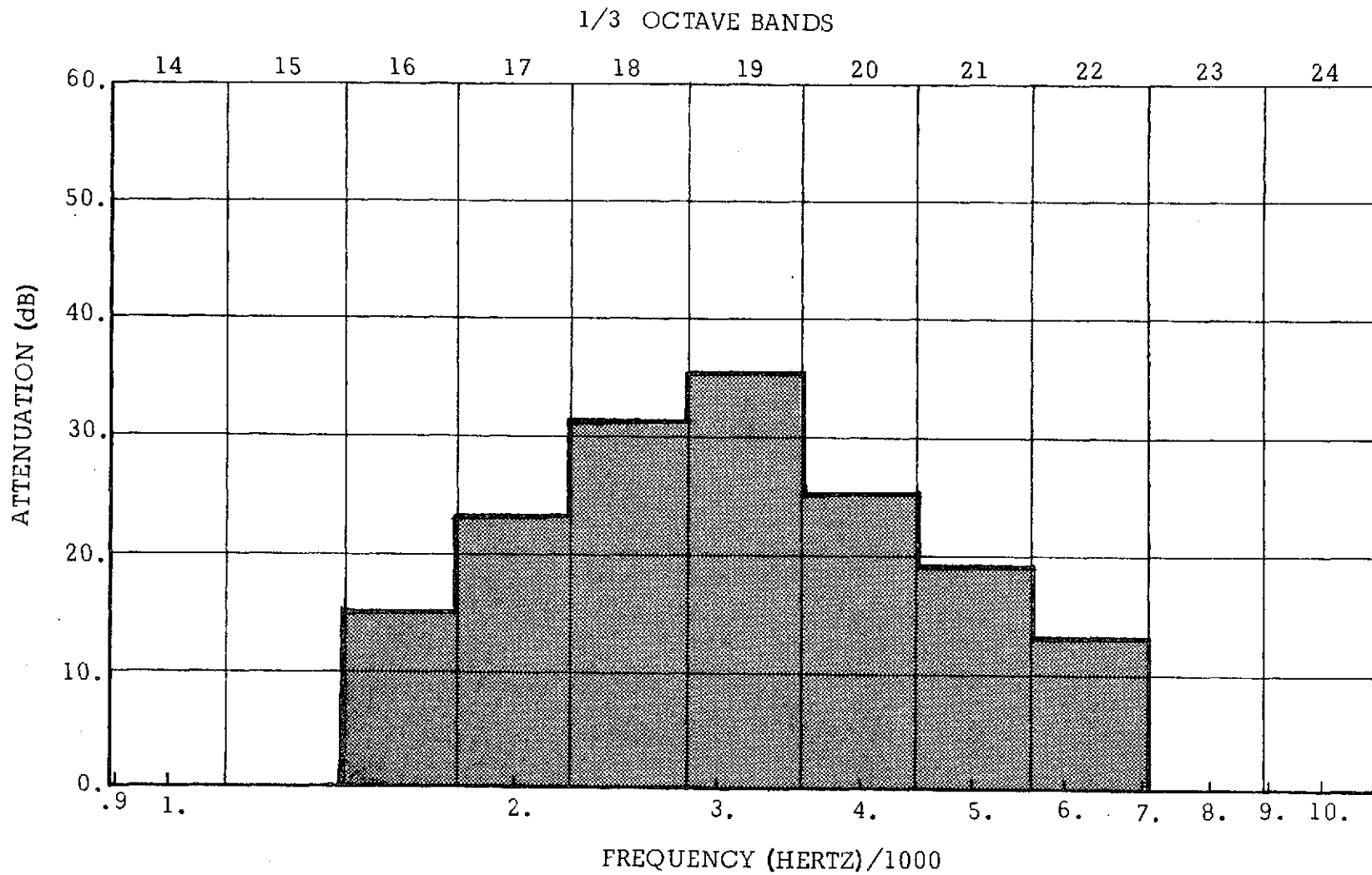
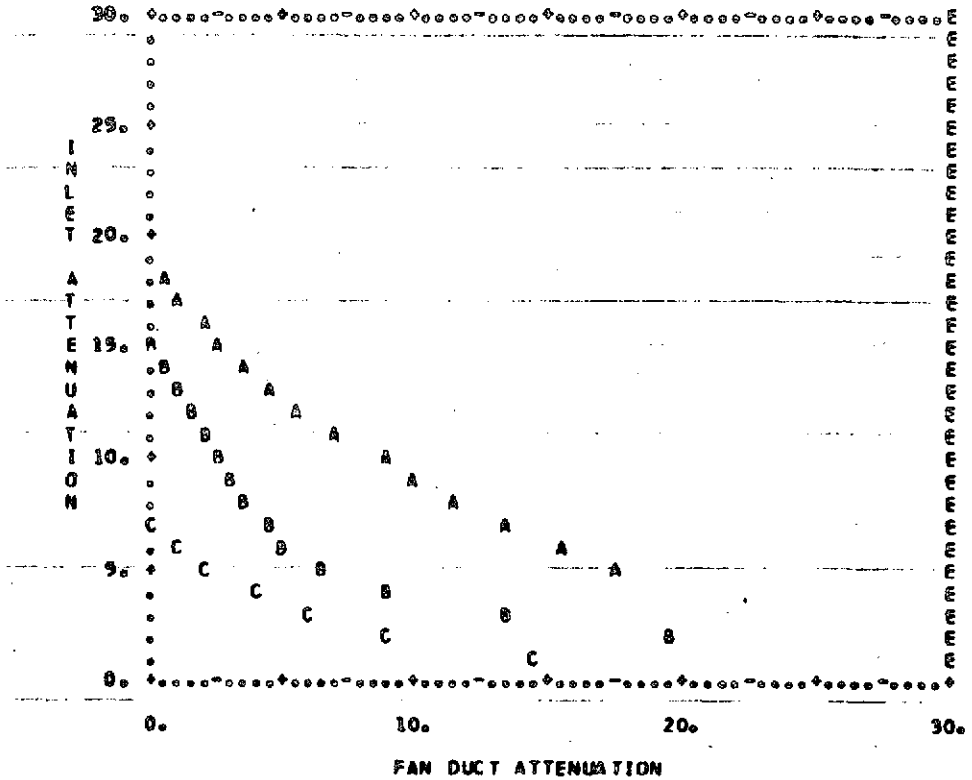

Figure 1. Power Insertion Loss Characteristics

DELTA EPNL = 5.0 FAN HARMONIC = 20.0
 INLET HARMONIC (A = 0, B = 5, C = 10, D = 20, E = 30)
 APP. WITH TONE, 0. JET ATT. WITH TURB. EPNL = 101.80, RUN 1 A



FAN HARMONIC = 20.0		DELTA EPNL = 5.0				
INLET HARMONIC =		A	B	C	D	F
		0	5	10	20	30
INLET FUND.	FAN FUND.	FAN FUND.	FAN FUND.	FAN FUND.	FAN FUND.	FAN FUND.
1.00	*****	*****	14.53	*****	*****	
2.00	*****	19.33	9.04	*****	*****	
3.00	*****	13.40	6.00	*****	*****	
4.00	*****	8.97	3.79	*****	*****	
5.00	17.65	6.37	1.96	*****	*****	
6.00	15.55	5.21	0.96	*****	*****	
7.00	13.58	4.38	0.06	*****	*****	
8.00	11.72	3.66	*****	*****	*****	
9.00	9.98	2.98	*****	*****	*****	
10.00	8.94	2.32	*****	*****	*****	
11.00	7.20	1.88	*****	*****	*****	
12.00	5.67	1.45	*****	*****	*****	
13.00	4.50	1.02	*****	*****	*****	
14.00	3.57	0.61	*****	*****	*****	
15.00	2.69	0.20	*****	*****	*****	
16.00	1.84	*****	*****	*****	*****	
17.00	1.04	*****	*****	*****	*****	
18.00	0.28	*****	*****	*****	*****	
19.00	*****	*****	*****	*****	*****	
20.00	*****	*****	*****	*****	*****	
21.00	*****	*****	*****	*****	*****	
22.00	*****	*****	*****	*****	*****	
23.00	*****	*****	*****	*****	*****	
24.00	*****	*****	*****	*****	*****	
25.00	*****	*****	*****	*****	*****	
26.00	*****	*****	*****	*****	*****	
27.00	*****	*****	*****	*****	*****	
28.00	*****	*****	*****	*****	*****	
29.00	*****	*****	*****	*****	*****	
30.00	*****	*****	*****	*****	*****	

Figure 2. Inlet Attenuation Versus Fan Duct Attenuation for 5 EPNdB Reduction

DELTA EPNL = 10.0 FAN HARMONIC = 20.0
 INLET HARMONIC (A = 0, B = 5, C = 10, D = 20, E = 30)
 APP, WITH TONE, 0. JET ATT, WITH TURB, EPNL = 101.80, RUN 1 A

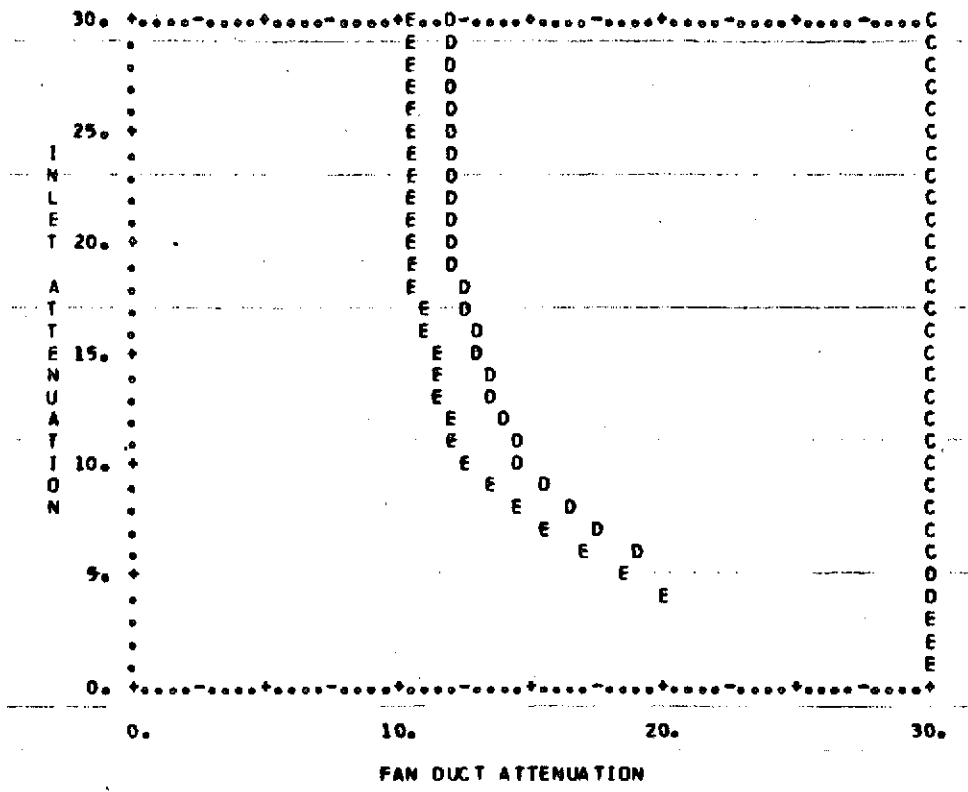

FAN HARMONIC = 20.0		DELTA EPNL = 10.0				
INLET HARMONIC =		A	B	C	D	E
		0	5	10	20	30
INLET FUND.	FAN FUND.	FAN FUND.	FAN FUND.	FAN FUND.	FAN FUND.	FAN FUND.
1.00	*****	*****	*****	*****	*****	*****
2.00	*****	*****	*****	*****	*****	*****
3.00	*****	*****	*****	*****	*****	*****
4.00	*****	*****	*****	*****	*****	20.02
5.00	*****	*****	*****	*****	*****	18.63
6.00	*****	*****	*****	*****	18.84	16.99
7.00	*****	*****	*****	*****	17.64	15.57
8.00	*****	*****	*****	*****	16.55	14.35
9.00	*****	*****	*****	*****	15.54	13.28
10.00	*****	*****	*****	*****	14.60	12.34
11.00	*****	*****	*****	*****	14.30	12.12
12.00	*****	*****	*****	*****	14.00	11.91
13.00	*****	*****	*****	*****	13.71	11.70
14.00	*****	*****	*****	*****	13.43	11.50
15.00	*****	*****	*****	*****	13.16	11.30
16.00	*****	*****	*****	*****	12.89	11.11
17.00	*****	*****	*****	*****	12.64	10.93
18.00	*****	*****	*****	*****	12.39	10.75
19.00	*****	*****	*****	*****	12.15	10.57
20.00	*****	*****	*****	*****	11.91	10.40
21.00	*****	*****	*****	*****	11.91	10.40
22.00	*****	*****	*****	*****	11.91	10.40
23.00	*****	*****	*****	*****	11.91	10.40
24.00	*****	*****	*****	*****	11.91	10.40
25.00	*****	*****	*****	*****	11.91	10.40
26.00	*****	*****	*****	*****	11.91	10.40
27.00	*****	*****	*****	*****	11.91	10.40
28.00	*****	*****	*****	*****	11.91	10.40
29.00	*****	*****	*****	*****	11.91	10.40
30.00	*****	*****	*****	*****	11.91	10.40

Figure 3. Inlet Attenuation Versus Fan Duct Attenuation for 10 EPNdB Reduction

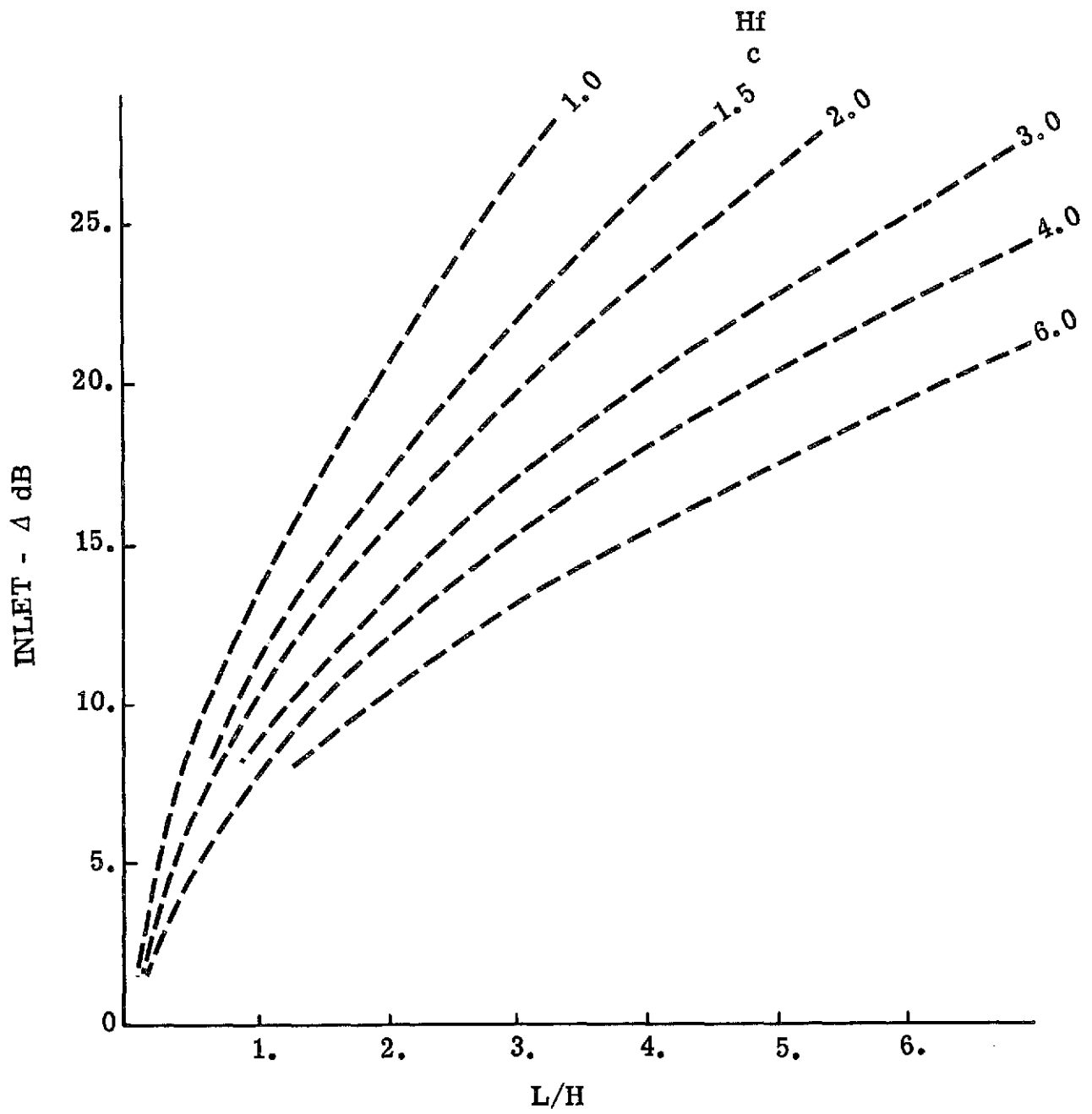

Figure 4. Inlet Mode Attenuation ($M = .4$) over 1 Octave - Band

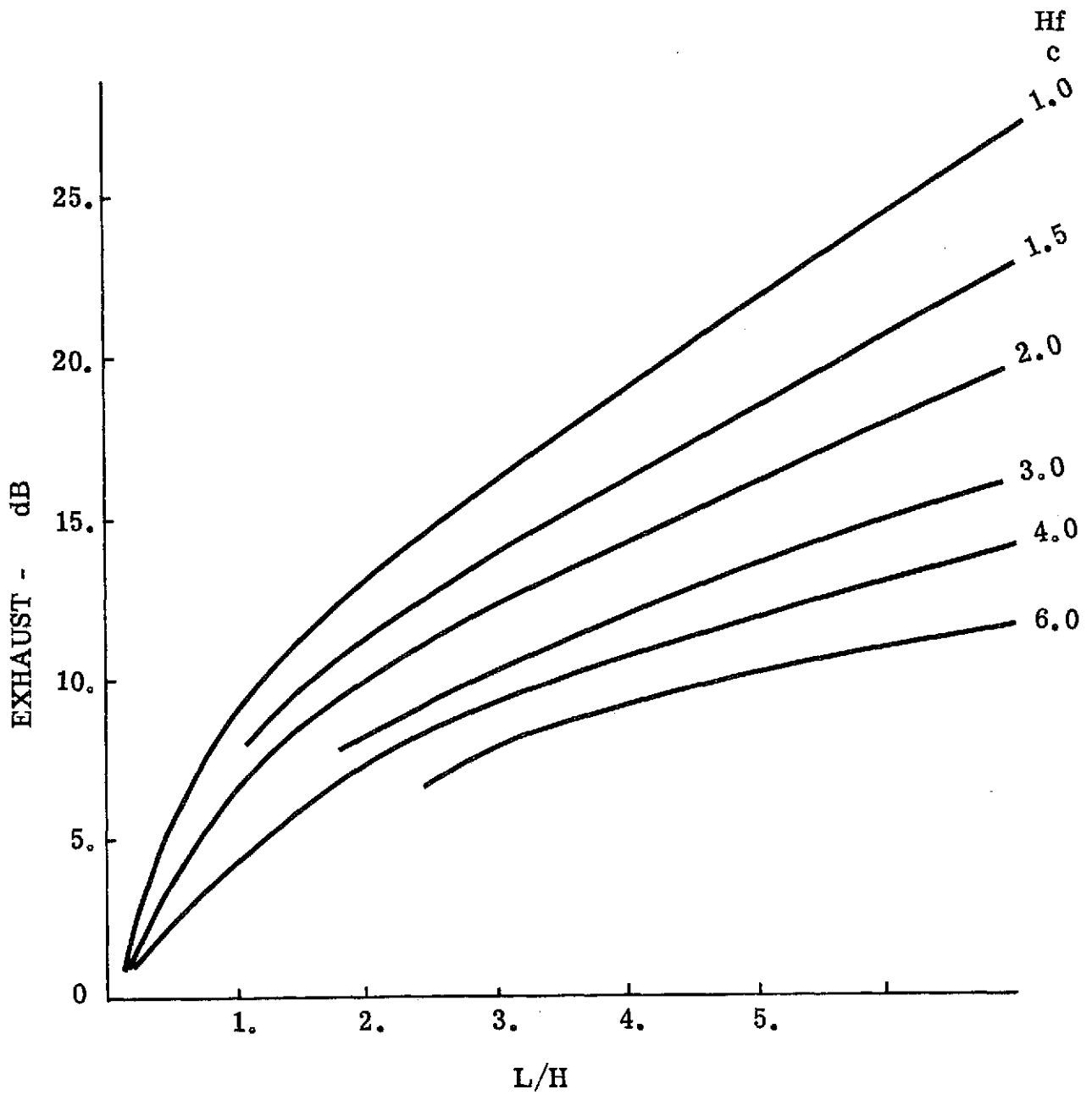

Figure 5. Exhaust Mode Attenuation ($M = .4$) over 1 Octave - Band

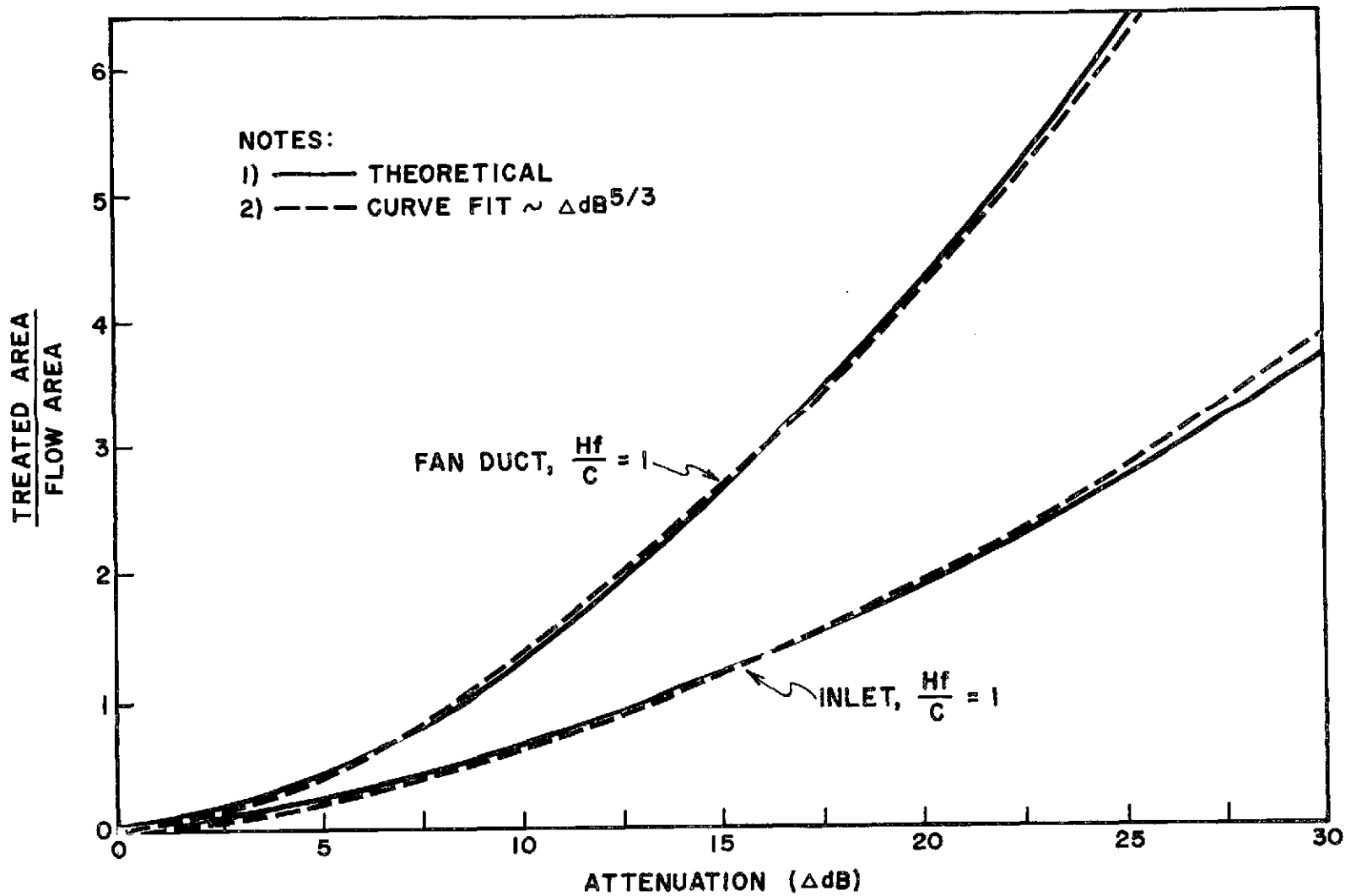

Figure 6. Relation Between Treated Area, Flow Area, and Attenuation

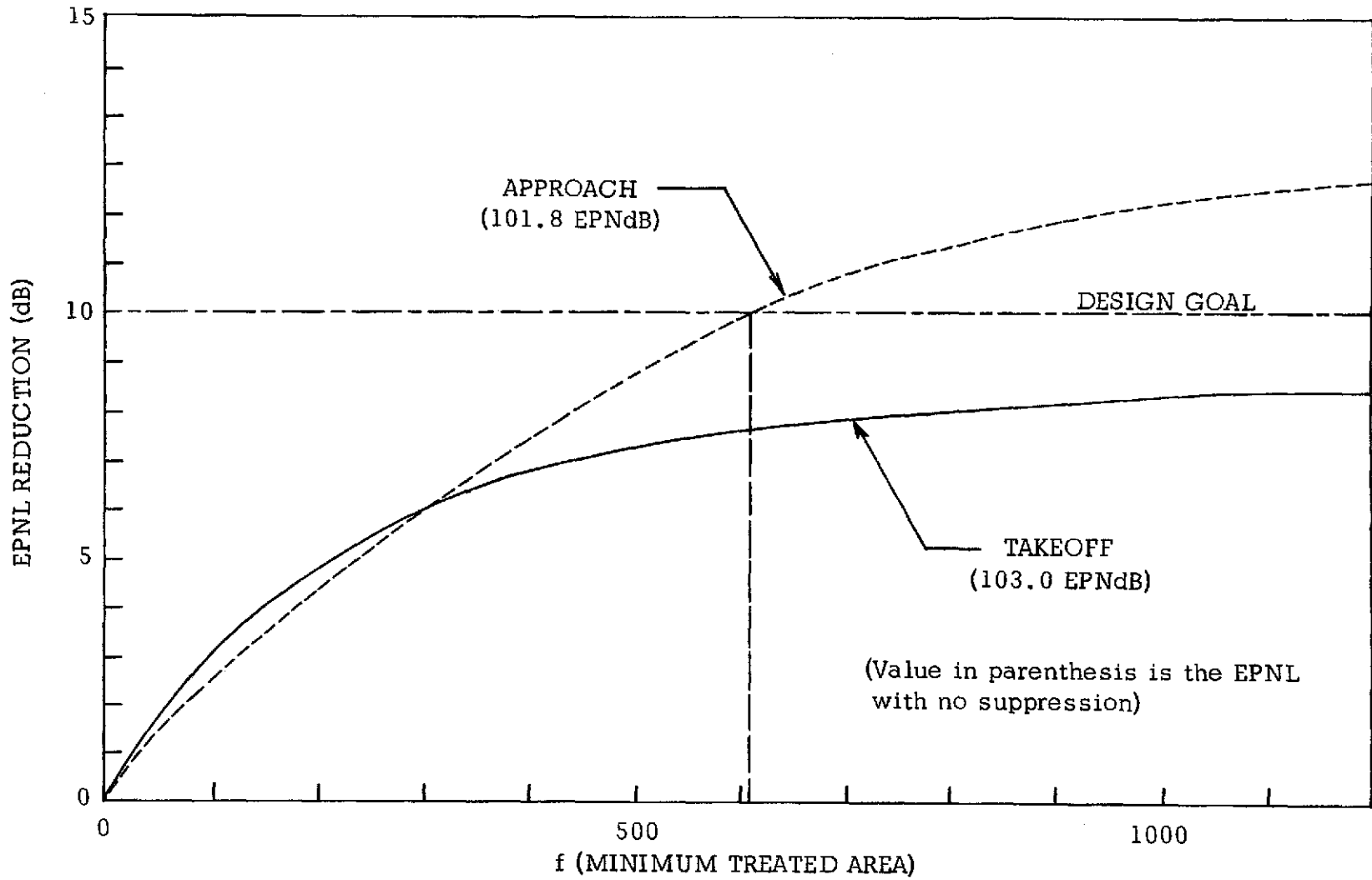

Figure 7. Attenuation Trade Study Results

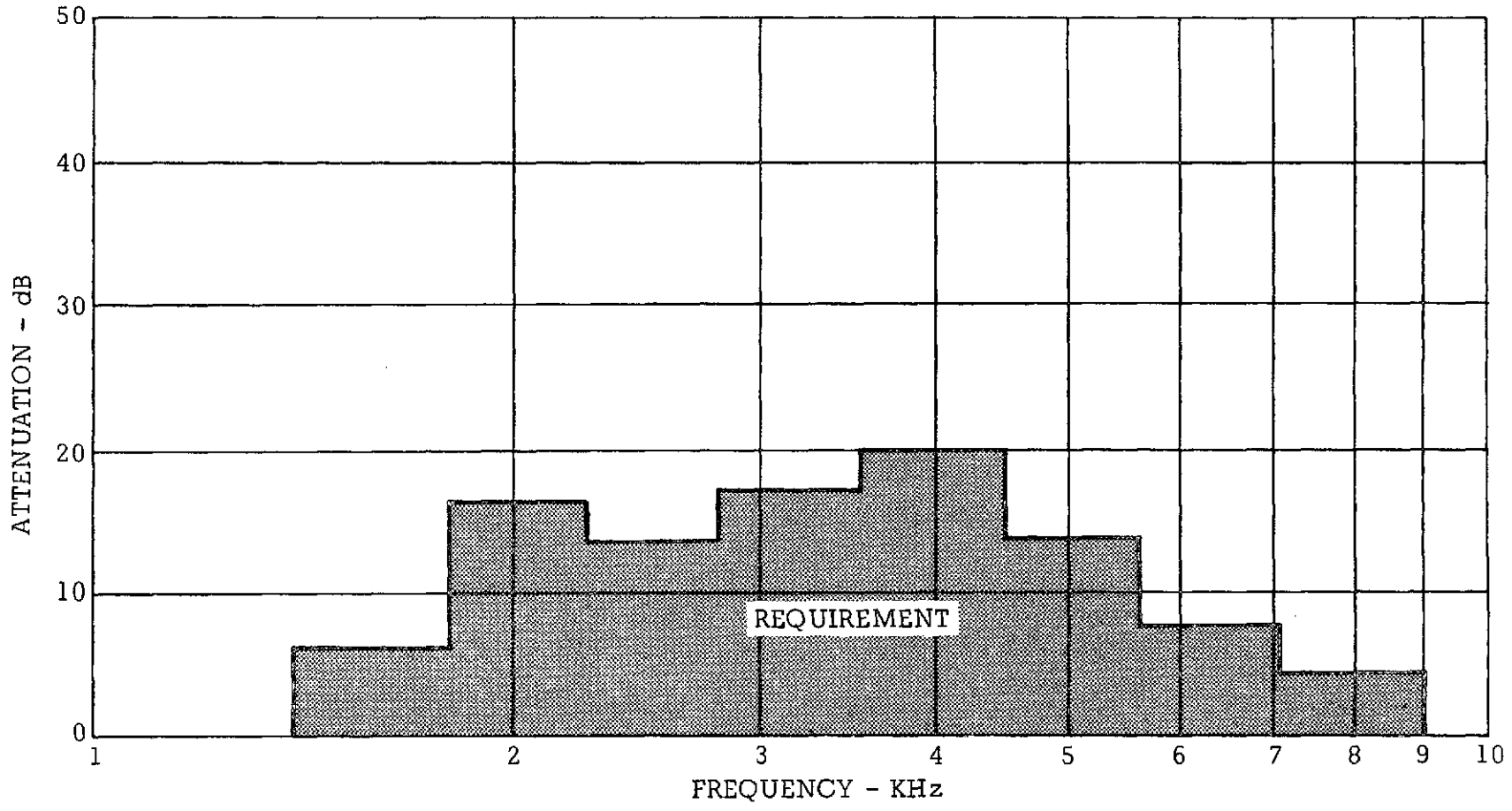

Figure 8. Inlet Lining Attenuation Requirement - Approach

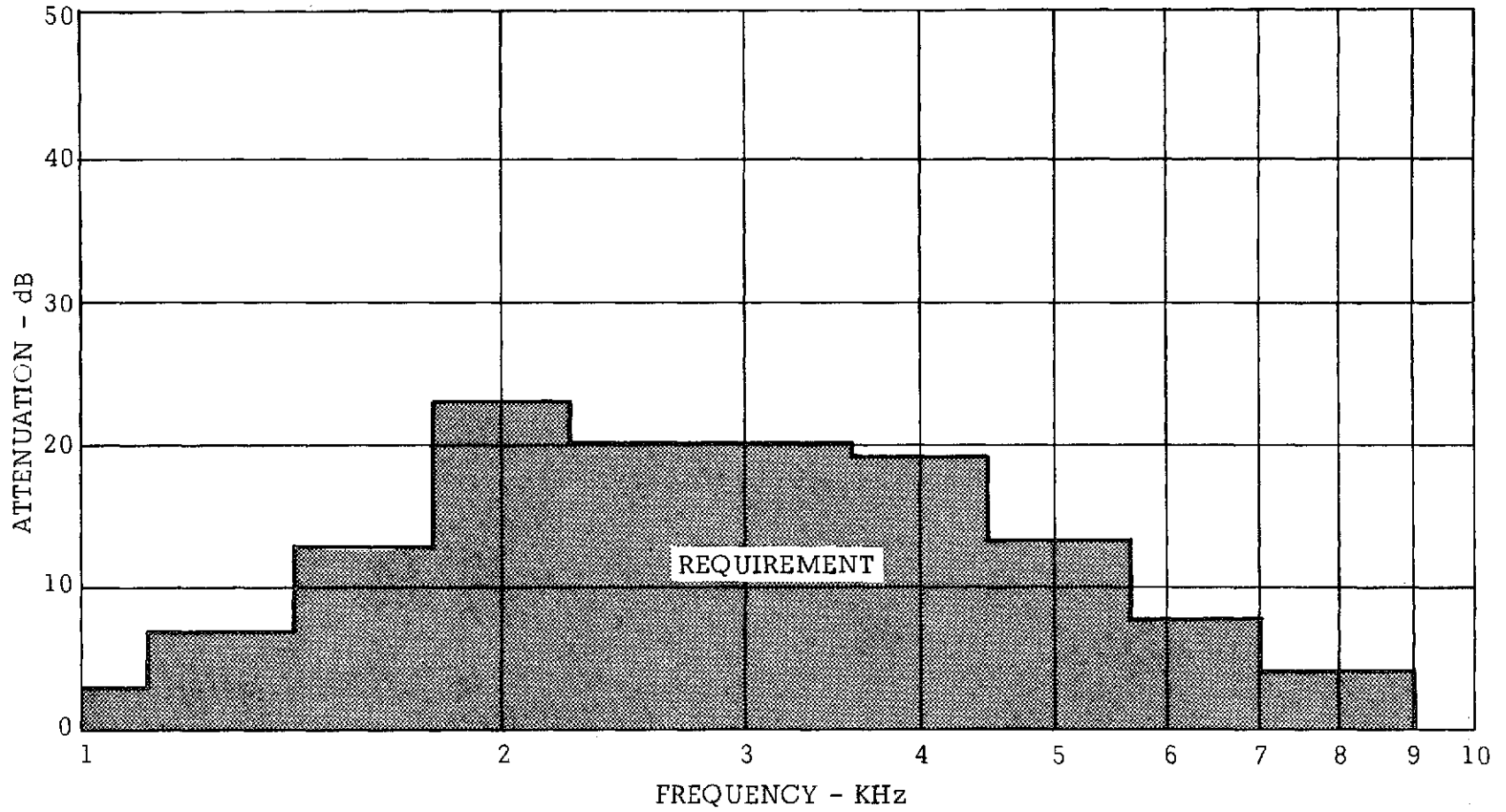

Figure 9. Fan Duct Lining Attenuation Requirement - Approach

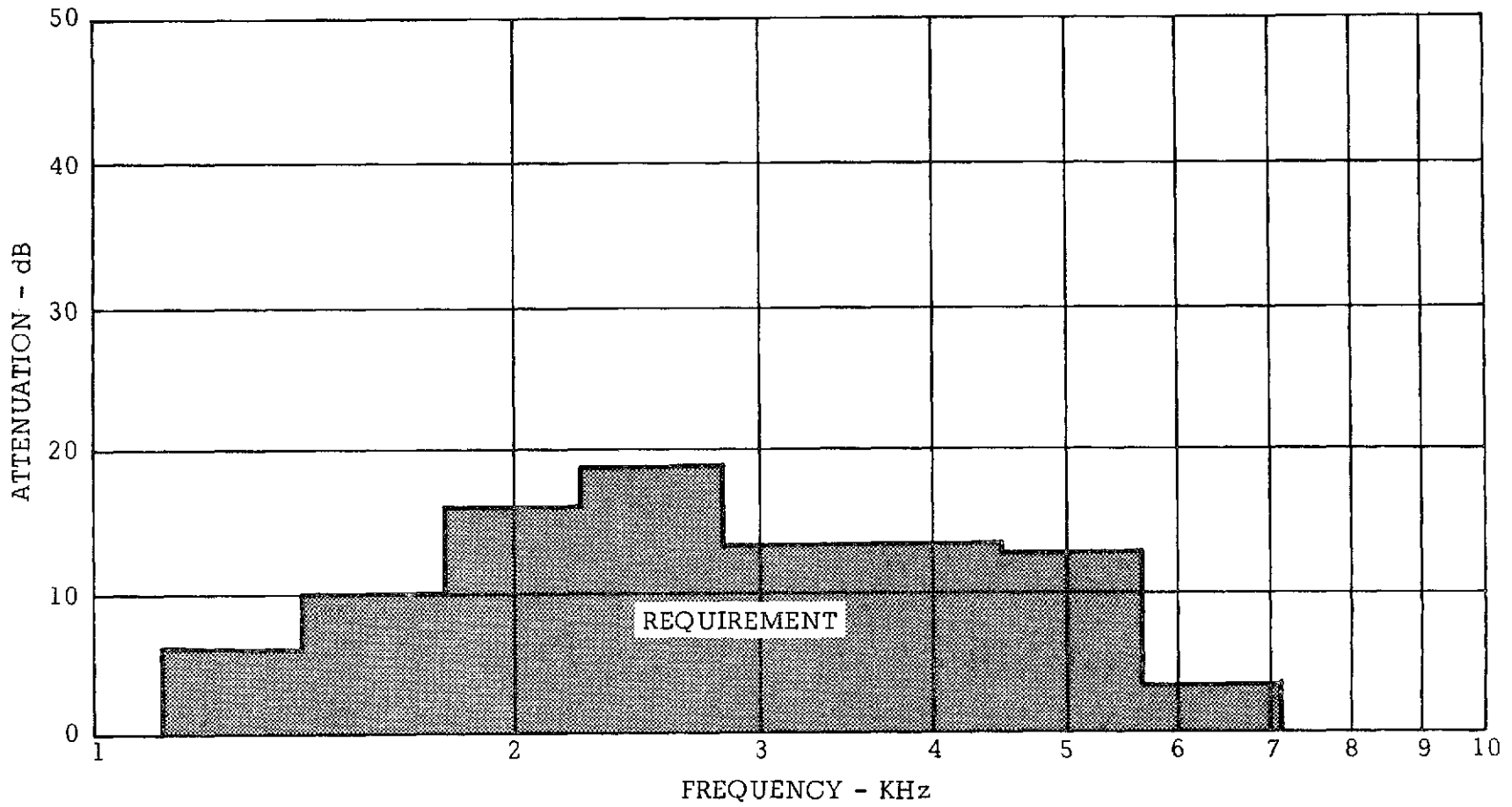

Figure 10. Inlet Lining Attenuation Requirement - Takeoff

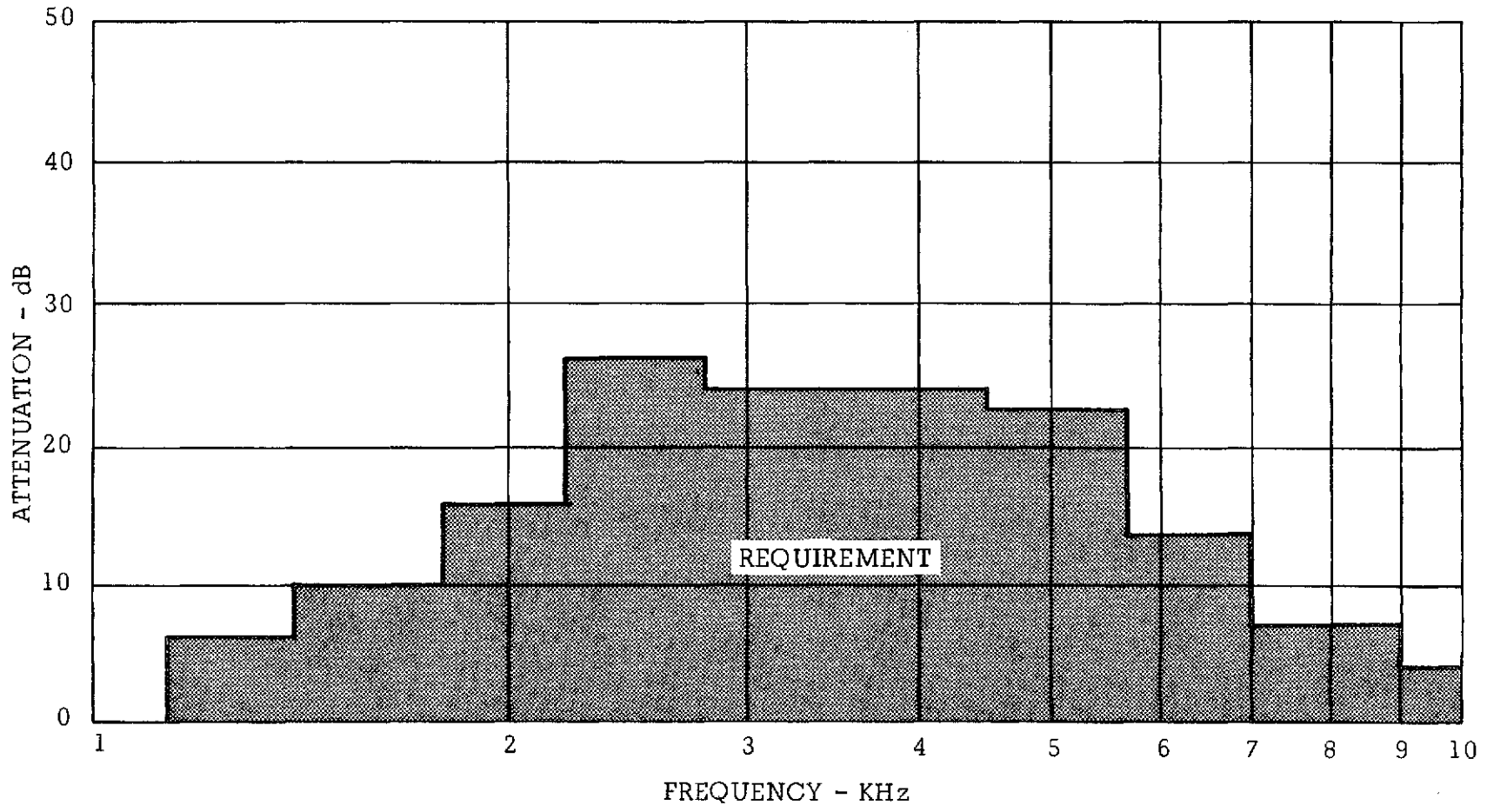

Figure 11. Fan Duct Lining Attenuation Requirement - Takeoff

TABLES

PRECEDING PAGE BLANK NOT FILMED

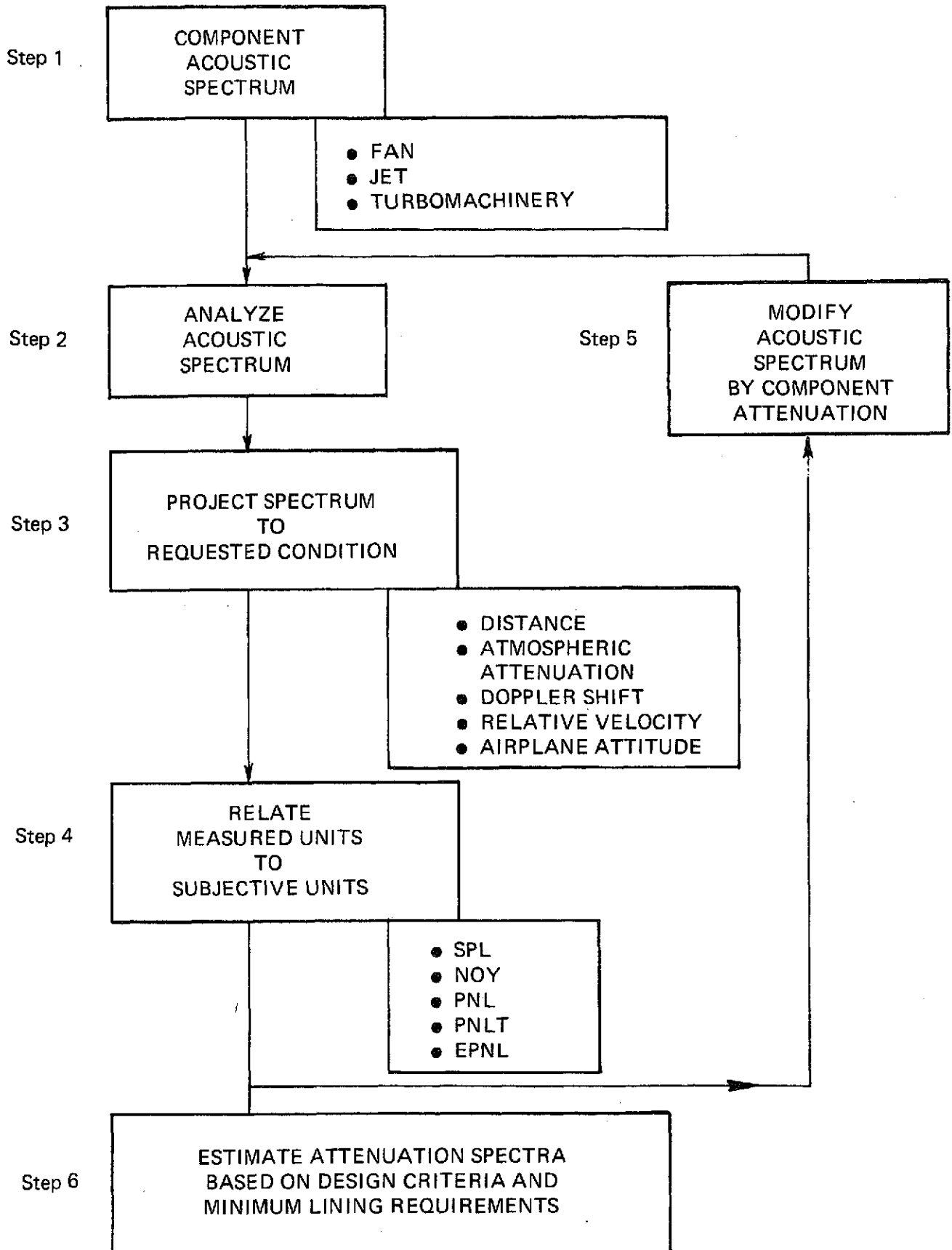

TABLE 1
SCHEMATIC OF ACOUSTIC TRADE STUDY AND ABSORBER EVALUATION

TABLE 2
FAN NOISE SPECTRUM

		FAN																
BAND	ANGLE	10.	20.	30.	40.	50.	60.	70.	80.	90.	100.	110.	120.	130.	140.	150.	160.	170.
	FREQ.																	
17	50.	48.6	62.6	50.6	46.6	55.6	46.6	47.6	47.6	49.6	51.6	51.6	53.6	54.6	56.6	58.6	58.6	58.6
18	63.	48.6	62.6	50.6	46.6	55.6	46.6	47.6	47.6	49.6	51.6	51.6	53.6	54.6	56.6	58.6	58.6	58.6
19	80.	48.6	62.6	50.6	46.6	55.6	46.6	47.6	47.6	49.6	51.6	51.6	53.6	54.6	56.6	58.6	58.6	58.6
20	100.	48.6	62.6	50.6	46.6	55.6	46.6	47.6	47.6	49.6	51.6	51.6	53.6	54.6	56.6	58.6	58.6	58.6
21	125.	62.5	68.1	66.5	68.2	66.9	67.5	63.5	65.2	65.5	65.5	67.5	64.9	65.9	64.1	66.1	66.1	66.1
22	160.	66.8	70.5	70.1	66.1	69.1	64.8	65.8	67.1	66.6	65.1	65.1	64.8	62.5	63.6	71.0	71.0	71.0
23	200.	69.5	78.6	71.5	66.4	74.2	65.2	64.9	63.6	62.5	64.5	66.2	66.5	69.2	69.5	66.9	62.1	62.1
24	250.	68.6	76.9	68.3	63.7	72.1	64.3	64.1	64.1	66.1	66.8	69.3	68.8	69.8	68.9	66.8	63.5	63.5
25	315.	69.8	75.6	70.7	68.8	73.5	65.6	65.5	65.5	65.2	65.9	68.4	67.9	68.9	69.6	66.5	59.1	59.1
26	400.	72.9	74.8	70.8	69.9	72.6	65.7	65.6	65.6	67.5	68.6	69.6	69.4	70.4	70.1	67.9	63.8	63.8
27	500.	74.0	77.5	73.0	75.3	68.9	66.8	66.8	67.4	68.7	70.8	71.0	71.0	71.7	71.5	68.6	65.5	65.5
28	630.	75.0	80.8	76.0	74.0	75.9	69.7	68.9	70.9	71.9	72.9	71.8	73.9	72.7	70.3	67.8	67.8	
29	800.	76.0	83.9	77.0	77.0	79.0	72.0	70.0	72.0	74.0	74.0	73.9	75.9	74.9	70.5	68.2	68.2	
30	1000.	79.0	85.0	80.0	78.0	80.0	74.0	73.0	73.0	76.0	77.0	78.0	77.0	79.0	79.0	73.8	71.7	71.7
31	1250.	80.0	85.0	82.0	80.0	81.0	74.0	74.0	75.0	78.0	79.0	80.0	79.0	80.0	80.0	75.9	73.9	73.9
32	1600.	84.0	89.0	86.0	83.0	85.0	78.0	76.0	77.0	80.0	82.0	82.0	82.0	83.0	82.0	79.0	75.9	75.9
33	2000.	89.0	94.0	90.0	88.0	90.0	84.0	81.0	81.0	83.0	85.0	86.0	86.0	87.0	86.0	82.0	79.0	79.0
34	2500.	81.0	88.0	86.0	86.0	85.0	77.0	77.0	78.0	80.0	83.0	83.0	83.0	84.0	83.0	79.0	74.0	74.0
35	3150.	82.0	87.0	86.0	85.0	86.0	79.0	76.0	77.0	81.0	83.0	84.0	84.0	84.0	83.0	77.0	74.0	74.0
36	4000.	83.0	89.0	86.0	85.0	88.0	81.0	77.0	77.0	81.0	82.0	84.0	84.0	84.0	83.0	78.0	75.0	75.0
37	5000.	83.0	88.0	85.0	83.0	87.0	79.0	74.0	75.0	78.0	80.0	81.0	82.0	83.0	82.0	77.0	73.0	73.0
38	6300.	82.0	86.0	84.0	81.0	86.0	78.0	73.0	74.0	77.0	79.0	80.0	81.0	83.0	82.0	77.0	73.0	73.0
39	8000.	79.0	84.0	82.0	81.0	84.0	76.0	71.0	70.0	74.0	76.0	78.0	79.0	81.0	80.0	75.0	71.0	71.0
40	10000.	75.0	80.0	79.0	77.0	80.0	72.0	69.0	67.0	68.0	71.0	74.0	74.0	76.0	75.0	70.0	67.0	67.0

APPROACH

		FAN																
BAND	ANGLE	10.	20.	30.	40.	50.	60.	70.	80.	90.	100.	110.	120.	130.	140.	150.	160.	170.
	FREQ.																	
17	50.	60.6	65.6	58.6	58.6	64.6	59.6	59.6	59.6	62.6	63.6	65.6	67.6	69.6	72.6	74.6	74.6	74.6
18	63.	60.6	65.6	58.6	58.6	64.6	59.6	59.6	59.6	62.6	63.6	65.6	67.6	69.6	72.6	74.6	74.6	74.6
19	80.	60.6	65.6	59.6	58.6	64.6	59.6	59.6	59.6	62.6	63.6	65.6	67.6	69.6	72.6	74.6	74.6	74.6
20	100.	60.6	65.6	58.6	58.6	64.6	59.6	59.6	59.6	62.6	63.6	65.6	67.6	69.6	72.6	74.6	74.6	74.6
21	125.	74.5	72.1	76.2	74.5	78.5	73.5	75.5	78.6	75.9	79.5	79.5	81.5	80.9	80.1	82.1	82.1	82.1
22	160.	77.4	82.4	78.1	78.1	81.4	77.9	79.1	80.3	61.6	78.9	79.1	78.8	77.5	69.6	71.6	71.6	71.6
23	200.	79.2	82.3	78.4	78.4	81.9	76.9	76.9	76.9	77.5	76.5	78.5	80.5	84.2	85.5	85.5	82.9	82.9
24	250.	78.3	83.3	77.4	76.3	79.8	76.1	76.1	77.3	78.4	81.3	82.1	82.8	83.4	84.9	85.1	79.5	79.5
25	315.	80.7	83.5	80.8	79.8	84.7	79.7	78.6	78.6	78.9	80.4	81.2	81.9	83.9	84.2	84.5	75.1	75.1
26	400.	84.9	85.8	82.9	81.9	83.7	79.8	78.7	79.8	79.3	81.6	82.6	83.4	84.3	84.8	82.1	77.8	79.8
27	500.	81.9	84.3	80.9	81.9	85.9	80.9	79.8	78.8	79.5	80.7	81.6	82.5	83.4	83.9	81.5	76.9	76.9
28	630.	83.9	85.7	81.9	81.9	84.9	79.9	79.9	79.9	79.4	81.8	82.8	82.6	83.6	83.1	82.4	79.1	79.1
29	800.	83.0	88.0	83.0	83.0	85.0	80.0	79.0	79.0	81.8	82.9	83.9	83.8	84.8	83.4	81.6	76.5	76.5
30	1000.	85.0	89.0	86.0	86.0	90.0	84.0	82.0	83.0	83.9	85.0	85.9	84.9	85.9	84.6	82.1	79.4	79.4
31	1250.	86.0	90.0	87.0	87.0	90.0	84.0	83.0	84.0	86.0	87.0	87.0	87.0	87.9	85.8	82.4	79.9	79.9
32	1600.	87.0	91.0	88.0	89.0	91.0	85.0	85.0	86.0	88.0	89.0	90.0	89.0	91.0	86.9	83.6	81.4	81.4
33	2000.	88.0	93.0	91.0	89.0	92.0	87.0	87.0	87.0	90.0	92.0	92.0	92.0	94.0	89.0	85.8	82.7	82.7
34	2500.	91.0	98.0	97.0	97.0	100.0	94.0	92.0	91.0	93.0	95.0	96.0	95.0	96.0	91.0	87.9	84.9	84.9
35	3150.	90.0	96.0	95.0	94.0	98.0	92.0	91.0	90.0	92.0	94.0	94.0	94.0	95.0	90.0	86.9	83.9	83.9
36	4000.	88.0	93.0	90.0	90.0	93.0	88.0	87.0	88.0	91.0	93.0	93.0	92.0	93.0	88.0	83.9	81.9	81.9
37	5000.	88.0	94.0	92.0	91.0	94.0	89.0	88.0	89.0	91.0	92.0	93.0	93.0	93.0	90.0	85.0	81.9	81.9
38	6300.	88.0	92.0	91.0	90.0	93.0	87.0	86.0	88.0	89.0	91.0	92.0	93.0	93.0	90.0	85.0	81.9	81.9
39	8000.	84.0	89.0	88.0	88.0	90.0	84.0	83.0	84.0	86.0	89.0	90.0	91.0	91.0	88.0	83.0	79.9	79.9
40	10000.	80.0	86.0	84.0	84.0	88.0	80.0	79.0	80.0	82.0	85.0	86.0	87.0	87.0	84.0	79.9	75.9	75.9

TAKEOFF

TABLE 3
FORWARD FAN NOISE SPECTRUM

BAND	ANGLE FREQ.	FAN								FWD								
		10.	20.	30.	40.	50.	60.	70.	80.	90.	100.	110.	120.	130.	140.	150.	160.	170.
17	50.	48.6	62.6	50.6	46.6	55.6	46.5	47.2	47.0	46.6	42.7	41.0	32.0	28.2	25.0	22.2	17.0	12.4
18	63.	48.6	62.6	50.6	46.6	55.6	46.5	47.2	47.0	46.6	42.7	41.0	32.0	28.2	25.0	22.2	17.0	12.4
19	80.	48.6	62.6	50.6	46.6	55.6	46.5	47.2	47.0	46.6	42.7	41.0	32.0	28.2	25.0	22.2	17.0	12.4
20	100.	48.6	62.6	50.6	46.6	55.6	46.5	47.2	47.0	46.6	42.7	41.0	32.0	28.2	25.0	22.2	17.0	12.4
21	125.	62.5	68.1	66.5	68.2	66.9	62.5	63.1	64.5	62.5	56.6	57.0	43.3	39.5	32.5	29.8	24.6	20.0
22	160.	66.8	70.5	70.1	66.1	69.1	63.7	65.4	66.5	61.4	56.2	54.5	43.2	36.1	22.0	34.6	29.5	24.8
23	200.	69.5	78.6	71.5	66.4	74.2	65.1	64.5	63.0	59.5	55.6	55.6	44.9	42.8	37.9	30.5	20.6	15.9
24	250.	63.6	74.9	68.3	69.7	72.0	64.2	63.7	63.5	63.1	57.9	58.7	47.2	43.4	37.3	30.5	22.0	17.3
25	315.	69.8	75.6	70.7	68.8	73.5	65.6	65.1	64.9	62.2	57.0	57.8	46.3	42.6	38.0	30.2	17.6	12.9
26	400.	72.9	74.8	70.8	69.9	72.5	65.7	65.2	65.0	64.7	59.7	59.1	47.8	44.0	38.5	31.9	22.3	18.0
27	500.	74.0	77.5	73.9	73.0	75.8	69.9	68.4	66.2	64.8	59.8	60.3	49.4	45.3	39.9	32.3	24.0	19.3
28	630.	75.0	78.5	76.0	74.0	75.9	69.9	68.5	68.3	67.9	63.0	62.4	50.2	47.5	41.1	33.9	26.2	21.6
29	800.	76.0	83.9	77.0	77.0	79.0	71.9	69.6	69.4	69.0	65.1	63.4	52.3	49.6	43.3	34.1	26.6	22.0
30	1000.	79.0	85.0	80.0	78.0	80.0	74.0	72.4	73.0	73.0	69.1	67.4	55.4	52.6	47.4	37.9	30.2	23.6
31	1250.	80.0	85.0	82.0	80.0	81.0	74.0	73.6	74.4	75.0	70.1	69.4	57.4	53.6	48.4	39.5	32.3	28.1
32	1600.	84.0	89.0	86.0	83.0	85.0	78.0	75.6	76.4	77.0	73.1	71.4	60.4	56.6	50.4	42.6	34.4	29.7
33	2000.	89.0	94.0	90.0	88.0	90.0	84.0	80.6	80.4	80.0	76.1	75.4	64.4	60.6	54.4	45.7	37.5	32.8
34	2500.	83.0	88.0	86.0	84.0	85.0	77.0	75.6	76.4	77.0	74.1	72.4	61.4	57.6	51.4	42.6	32.5	27.8
35	3150.	82.0	87.0	86.0	85.0	86.0	79.0	75.6	76.4	78.0	74.1	73.4	62.4	57.6	50.4	40.7	32.4	27.8
36	4000.	83.0	89.0	86.0	85.0	88.0	81.0	78.6	78.4	78.0	73.1	73.4	62.4	57.6	51.4	41.6	33.4	29.2
37	5000.	84.0	89.0	85.0	83.0	87.0	79.0	73.6	74.4	75.0	71.1	70.4	60.4	56.6	50.4	40.7	31.4	26.8
38	6300.	82.0	86.0	84.0	83.0	86.0	79.0	72.6	73.4	74.0	70.1	69.4	59.4	56.6	50.4	40.7	31.5	26.8
39	8000.	79.0	84.0	82.0	81.0	84.0	76.0	70.6	69.4	71.0	67.1	67.4	57.4	54.6	48.4	38.6	29.4	24.9
40	10000.	75.0	80.0	79.0	77.0	80.0	72.0	65.6	66.4	65.0	62.1	63.4	52.4	49.6	43.4	33.7	25.4	20.8

APPROACH

BAND	ANGLE FREQ.	FAN								FWD								
		10.	20.	30.	40.	50.	60.	70.	80.	90.	100.	110.	120.	130.	140.	150.	160.	170.
17	50.	60.6	65.6	58.6	58.6	64.6	59.5	59.2	59.0	59.6	54.7	55.0	46.0	43.2	41.0	38.2	33.0	28.4
18	63.	60.6	65.6	58.6	58.6	64.6	59.5	59.2	59.0	59.6	54.7	55.0	46.0	43.2	41.0	38.2	33.0	28.4
19	80.	60.6	65.6	58.6	58.6	64.6	59.5	59.2	59.0	59.6	54.7	55.0	46.0	43.2	41.0	38.2	33.0	28.4
20	100.	60.6	65.6	58.6	58.6	64.6	59.5	59.2	59.0	61.6	56.7	55.0	46.0	43.2	41.0	38.2	33.0	28.4
21	125.	74.5	72.1	76.1	74.5	78.5	73.5	75.1	78.0	72.9	70.6	69.0	59.9	54.5	48.5	45.8	40.6	36.3
22	160.	77.4	82.4	78.1	78.1	81.4	77.7	78.7	79.7	58.6	70.0	68.5	57.2	51.1	38.0	35.2	30.0	25.8
23	200.	79.2	82.9	78.4	78.4	81.9	76.9	75.5	76.3	74.5	67.6	68.0	58.9	57.8	53.9	49.2	41.4	36.7
24	250.	78.3	83.3	77.4	76.3	79.4	76.0	75.7	76.7	75.4	72.4	71.5	61.2	57.0	53.3	49.7	39.0	33.3
25	315.	80.7	83.5	80.8	73.8	84.7	79.7	71.2	78.0	75.9	71.5	70.6	60.3	57.6	52.5	48.2	33.6	28.9
26	400.	84.9	85.8	82.9	81.0	83.7	79.8	74.3	79.2	76.3	72.8	72.0	61.8	57.9	53.2	45.7	38.3	33.7
27	500.	81.9	84.8	80.9	81.9	85.9	80.8	72.4	78.2	76.5	71.8	71.0	60.9	57.0	52.3	45.1	35.4	30.7
28	630.	83.9	85.9	81.9	81.9	84.9	79.9	74.5	79.3	76.7	72.9	72.2	61.0	57.2	51.5	45.0	37.5	33.3
29	800.	83.0	88.0	83.0	83.0	85.9	80.9	74.5	79.3	78.9	74.0	73.3	62.2	58.4	51.8	45.2	35.0	30.4
30	1000.	85.0	84.0	86.0	86.0	90.0	83.9	81.6	82.4	80.9	76.1	75.4	63.3	59.5	53.0	45.7	37.9	33.6
31	1250.	86.0	90.0	87.0	87.0	90.0	84.0	82.6	83.0	83.0	78.1	76.4	65.3	61.6	54.2	46.0	38.4	33.7
32	1600.	87.0	91.0	88.0	88.0	91.0	86.0	84.6	85.4	85.0	80.1	79.4	67.4	64.6	55.3	47.3	39.9	35.2
33	2000.	88.0	93.0	91.0	89.0	92.0	86.0	86.4	87.0	83.1	81.4	70.4	67.6	67.6	57.3	44.5	41.2	36.5
34	2500.	91.0	98.0	97.0	97.0	103.0	94.0	93.6	90.4	90.0	86.1	85.4	73.6	69.6	59.4	51.6	43.3	38.7
35	3150.	90.0	96.0	95.0	94.0	92.0	90.6	89.4	89.0	85.1	83.4	72.4	68.6	58.4	50.6	42.3	38.1	
36	4000.	88.0	93.0	90.0	90.0	93.0	88.0	86.6	87.4	89.0	84.1	82.4	70.4	66.6	56.4	47.6	40.3	35.7
37	5000.	88.0	94.0	92.0	91.0	94.0	89.0	87.6	88.0	88.0	83.1	82.4	71.4	66.6	58.4	48.6	40.4	35.7
38	6300.	88.0	92.0	91.0	90.0	93.0	87.0	85.6	87.4	86.0	82.1	81.4	71.4	66.6	58.4	48.6	40.4	36.1
39	8000.	84.0	89.0	88.0	88.0	90.0	84.0	82.4	83.4	83.0	80.1	79.4	69.4	64.6	50.4	44.6	38.4	33.8
40	10000.	80.0	86.0	84.0	84.0	86.0	80.0	78.6	79.4	79.0	76.1	75.4	65.4	60.6	57.4	42.6	34.3	29.7

TAKEOFF

TABLE 4
AFT FAN NOISE SPECTRUM

BAND	ANGLE FREQ.	FAN								AFT								APPROACH
		10.	20.	30.	40.	50.	60.	70.	80.	90.	100.	110.	120.	130.	140.	150.	160.	
17	50.	2.4	21.0	14.2	15.0	29.2	25.0	37.0	38.7	46.5	51.0	51.2	53.5	54.6	56.6	58.6	58.6	58.6
18	63.	2.4	21.0	14.2	15.0	29.2	25.0	37.0	38.7	46.5	51.0	51.2	53.5	54.6	56.6	58.6	58.6	58.6
19	80.	2.4	21.0	14.2	15.0	29.2	25.0	37.0	38.7	46.5	51.0	51.2	53.5	54.6	56.6	58.6	58.6	58.6
20	100.	2.4	21.0	14.2	15.0	29.2	25.0	37.0	38.7	46.5	51.0	51.2	53.5	54.6	56.6	58.6	58.6	58.6
21	125.	16.4	26.6	30.1	36.6	40.5	40.9	53.0	56.3	62.5	64.9	67.1	64.9	65.9	64.1	66.1	66.1	66.1
22	160.	20.6	29.0	33.7	34.5	42.7	43.7	55.2	58.2	63.6	64.5	64.7	64.8	62.5	53.6	71.0	71.0	71.0
23	200.	23.7	37.1	35.2	34.8	47.8	43.6	54.4	54.7	59.5	63.9	65.8	66.5	69.1	69.5	66.9	62.1	62.1
24	250.	22.4	33.3	31.9	37.1	45.7	42.7	53.5	55.2	63.0	66.2	68.9	68.7	69.8	68.9	66.8	63.9	63.9
25	315.	23.0	34.1	34.3	37.2	47.1	44.0	54.9	56.6	62.1	65.3	68.0	67.9	68.9	69.6	66.5	59.1	59.1
26	400.	26.8	33.2	34.4	38.3	46.2	44.1	55.1	56.8	64.6	68.0	69.2	69.4	70.4	70.1	67.9	63.8	63.8
27	500.	27.8	36.0	37.6	41.4	49.5	47.3	56.3	57.9	64.7	68.1	70.4	71.0	71.7	71.5	68.6	65.5	65.5
28	630.	29.2	39.3	39.5	42.4	49.5	48.3	59.4	60.0	67.9	71.3	72.5	71.8	73.9	72.7	70.3	67.8	67.8
29	800.	29.9	42.4	40.7	45.4	52.6	50.4	59.4	61.1	68.9	73.4	73.6	73.9	75.9	74.9	70.5	68.2	68.2
30	1000.	32.8	43.5	43.7	46.4	53.6	52.4	62.4	64.1	73.0	76.4	77.6	76.9	79.0	79.0	73.8	71.7	71.7
31	1250.	33.8	43.4	45.7	48.4	54.6	52.4	63.4	66.1	75.0	78.4	79.6	79.0	80.0	80.0	75.9	73.9	73.9
32	1600.	37.8	47.5	49.7	51.4	58.6	56.4	65.4	68.1	77.0	81.4	81.6	82.0	83.0	82.0	79.0	75.9	75.9
33	2000.	42.8	52.5	53.7	56.4	63.6	62.4	70.4	72.1	80.0	84.4	85.6	86.0	87.0	86.0	82.0	79.0	79.0
34	2500.	36.8	46.5	49.6	52.4	58.6	55.4	65.4	68.1	77.0	82.4	82.6	83.0	84.0	83.0	79.0	74.0	74.0
35	3150.	35.8	45.4	49.6	53.4	59.6	57.4	65.4	68.1	78.0	82.4	83.6	84.0	84.0	82.0	77.0	74.0	74.0
36	4000.	37.2	47.5	49.7	53.4	61.6	59.4	66.4	68.1	78.0	81.4	83.6	84.0	84.0	83.0	78.0	75.0	75.0
37	5000.	36.8	46.5	49.6	51.4	60.6	57.4	63.4	66.1	75.0	79.4	80.6	82.0	83.0	82.0	77.0	73.0	73.0
38	6300.	35.9	44.5	47.6	51.4	59.6	56.4	62.4	65.1	74.0	78.4	79.6	81.0	83.0	82.0	77.0	73.0	73.0
39	8000.	32.4	42.5	45.7	49.4	57.4	54.4	60.4	61.1	71.0	75.4	77.6	79.0	81.0	80.0	75.0	71.0	71.0
40	10000.	28.4	38.5	42.6	45.4	53.6	50.4	55.4	58.1	65.0	70.4	73.6	74.0	76.0	75.0	70.0	67.0	67.0

BAND	ANGLE FREQ.	FAN								AFT								TAKEOFF
		10.	20.	30.	40.	50.	60.	70.	80.	90.	100.	110.	120.	130.	140.	150.	160.	
17	50.	14.5	24.0	22.2	27.0	38.2	38.0	49.0	50.7	59.5	63.0	65.2	67.5	69.6	72.6	74.6	74.6	74.6
18	63.	14.5	24.0	22.2	27.0	38.2	38.0	49.0	50.7	59.5	63.0	65.2	67.5	69.6	72.6	74.6	74.6	74.6
19	80.	14.5	24.0	22.2	27.0	38.2	38.0	49.0	50.7	59.5	63.0	65.2	67.5	69.6	72.6	74.6	74.6	74.6
20	100.	14.5	24.0	22.2	27.0	38.2	38.0	49.0	50.7	61.5	63.0	65.2	67.5	69.6	72.6	74.6	74.6	74.6
21	125.	28.4	30.6	39.8	42.9	52.2	51.9	65.0	69.7	72.9	78.9	79.1	81.5	80.9	80.1	82.1	82.1	82.1
22	160.	31.2	40.9	41.7	48.5	55.0	55.2	64.5	71.4	58.5	78.5	78.7	78.8	77.5	59.6	71.6	71.6	71.6
23	200.	33.0	41.4	42.0	46.8	55.5	55.3	66.4	68.0	74.5	75.9	78.1	80.5	84.1	85.5	85.5	82.9	82.9
24	250.	32.1	41.7	41.1	44.7	53.4	54.4	65.5	68.4	75.4	80.7	81.7	82.7	83.4	94.9	85.1	79.5	79.5
25	315.	34.5	42.0	44.4	48.2	58.3	58.1	68.0	69.7	75.9	79.8	80.8	81.9	83.9	84.1	84.5	75.1	75.1
26	400.	38.7	44.3	46.5	50.3	57.3	58.2	66.2	70.9	76.2	81.0	82.2	83.4	84.3	84.8	82.1	79.8	79.8
27	500.	35.7	43.3	44.6	50.3	59.5	59.3	69.3	69.9	76.5	80.1	81.2	82.5	83.3	83.9	81.5	76.9	76.9
28	630.	37.8	44.3	45.6	50.3	58.5	58.3	68.3	71.0	76.6	81.2	82.4	82.6	83.5	83.1	82.4	79.1	79.1
29	800.	37.2	46.4	46.6	51.4	59.6	59.3	69.4	71.0	78.8	82.3	83.5	83.8	84.7	83.4	81.6	76.5	76.5
30	1000.	38.9	47.4	49.6	54.4	63.6	62.4	71.4	74.1	80.9	84.4	85.5	84.9	85.9	84.6	82.1	79.4	79.4
31	1250.	39.8	48.5	50.7	55.4	63.6	62.4	72.4	75.1	82.9	86.4	86.6	86.9	87.9	85.8	87.4	79.9	79.9
32	1600.	40.8	49.4	51.6	56.4	64.6	64.4	74.4	77.1	85.0	88.4	89.6	88.9	91.0	86.9	83.6	81.4	81.4
33	2000.	41.8	51.5	54.6	57.4	65.6	65.4	76.4	78.1	87.0	91.4	91.6	92.0	94.0	88.9	85.8	82.7	82.7
34	2500.	44.8	56.5	60.6	65.4	73.6	72.4	81.4	82.1	90.0	94.4	95.6	95.0	96.0	91.0	87.9	84.9	84.9
35	3150.	43.8	54.5	58.7	62.4	71.6	73.4	80.4	81.1	89.0	93.4	93.6	94.0	95.0	90.0	86.9	83.9	83.9
36	4000.	41.8	51.5	53.7	58.4	66.6	66.4	76.4	79.1	88.0	92.4	92.6	92.0	93.0	88.0	83.9	81.9	81.9
37	5000.	41.9	52.5	54.6	59.4	67.6	67.4	77.4	80.1	88.0	91.4	92.6	93.0	93.0	90.0	85.0	81.9	81.9
38	6300.	42.7	50.5	54.7	58.4	66.6	65.4	75.4	79.1	86.0	90.4	91.6	93.0	93.0	90.0	85.0	81.9	81.9
39	8000.	37.8	47.5	51.7	56.4	63.6	62.4	72.4	75.1	83.0	88.4	89.6	91.0	91.0	88.0	81.0	79.9	79.9
40	10000.	32.9	44.5	47.7	52.4	59.6	58.4	68.4	71.1	79.0	84.4	85.6	87.0	87.0	84.0	79.9	75.9	75.9

**TABLE 5
APPROACH AND TAKEOFF FLIGHT CONDITIONS**

<u>CONDITION</u>	<u>ROTOR SPEED (%)</u>	<u>FAA REF. POINT (N. MILE)</u>	<u>VELOCITY (FT/SEC.)</u>	<u>ALTITUDE (FT.)</u>	<u>CLIMB GRADIENT</u>	<u>ANGLE OF ATTACK</u>
Approach	60	1	254	370	-3.0 ^o	3.7 ^o
Takeoff	90	3.5	317.44	1000	4.57 ^o	7.6 ^o

TABLE 6
EPNL TRADE STUDY RUN IDENTIFICATION

<u>RUN</u>	<u>CONDITION</u>	<u>TURBINE NOISE</u>	<u>PRIMARY JET ATTENUATION (dB)</u>	<u>EPN LEVEL WITHOUT LININGS (EPNdB)</u>
1A	Approach	Yes	0	101.80
2A	Takeoff	No	0	103.02
5A	Takeoff	No	10	101.83
10A	Takeoff	No		101.70
11A	Approach	No		101.66
12A	Takeoff	No	2.5	102.56
13A	Takeoff	No	5.0	102.22
14A	Takeoff	No	7.5	101.98

**TABLE 7
INPUT DATA IDENTIFICATION**

<u>DATA</u>	<u>TYPE</u>	<u>ORIGIN</u>
Fan + Jet 2	100-ft. Polar	NASA-Lewis
Jet	250-ft. Polar	General Electric
Turbomachinery	370-ft. Sideline	General Electric

TABLE 8
FAN AND SECONDARY JET NOISE SPECTRUM (100-FT. POLAR)

BAND	ANGLE DEG.	FAN + JET2																
		10.	20.	30.	40.	50.	60.	70.	80.	90.	100.	110.	120.	130.	140.	150.	160.	170.
17	50.	72.0	86.0	74.0	70.0	74.0	70.0	71.0	71.0	73.0	75.0	75.0	77.0	78.0	80.0	82.0	82.0	82.0
18	63.	72.0	86.0	74.0	70.0	79.0	73.0	71.0	71.0	73.0	75.0	75.0	77.0	78.0	80.0	82.0	82.0	82.0
19	80.	72.0	86.0	74.0	70.0	79.0	70.0	71.0	71.0	73.0	75.0	75.0	77.0	78.0	80.0	82.0	82.0	82.0
20	100.	72.0	86.0	74.0	70.0	79.0	70.0	71.0	71.0	73.0	75.0	75.0	77.0	78.0	80.0	82.0	82.0	82.0
21	125.	73.0	82.0	76.0	76.0	79.0	72.0	73.0	74.0	75.0	76.0	77.0	77.0	78.0	80.0	80.0	80.0	80.0
22	160.	75.0	84.0	78.0	74.0	79.0	73.0	74.0	75.0	75.0	75.0	75.0	76.0	76.0	78.0	78.0	78.0	78.0
23	200.	77.0	87.0	79.0	74.0	82.0	73.0	73.0	72.0	72.0	74.0	75.0	76.0	76.0	79.0	79.0	78.0	78.0
24	250.	76.0	84.0	76.0	76.0	80.0	72.0	72.0	72.0	74.0	75.0	77.0	77.0	78.0	78.0	77.0	75.0	75.0
25	315.	77.0	84.0	78.0	76.0	81.0	73.0	73.0	73.0	73.0	74.0	76.0	76.0	77.0	78.0	77.0	75.0	75.0
26	400.	80.0	83.0	78.0	77.0	80.0	73.0	73.0	73.0	75.0	76.0	77.0	77.0	78.0	77.0	75.0	75.0	75.0
27	500.	81.0	85.0	81.0	80.0	83.0	76.0	76.0	74.0	75.0	76.0	78.0	78.0	79.0	79.0	77.0	75.0	75.0
28	630.	82.0	88.0	83.0	81.0	83.0	77.0	76.0	76.0	78.0	79.0	80.0	79.0	81.0	80.0	78.0	76.0	76.0
29	800.	83.0	91.0	84.0	84.0	86.0	79.0	77.0	77.0	79.0	81.0	81.0	81.0	83.0	82.0	78.0	76.0	76.0
30	1000.	86.0	92.0	87.0	85.0	87.0	81.0	80.0	80.0	83.0	84.0	85.0	84.0	86.0	86.0	81.0	79.0	79.0
31	1250.	87.0	92.0	89.0	87.0	88.0	81.0	81.0	82.0	85.0	86.0	87.0	86.0	87.0	87.0	83.0	81.0	81.0
32	1600.	91.0	96.0	93.0	90.0	92.0	85.0	83.0	83.0	87.0	89.0	89.0	90.0	90.0	90.0	86.0	83.0	83.0
33	2000.	96.0	101.0	97.0	95.0	97.0	91.0	88.0	88.0	90.0	92.0	93.0	93.0	94.0	93.0	89.0	86.0	86.0
34	2500.	90.0	95.0	93.0	91.0	92.0	84.0	83.0	84.0	87.0	90.0	90.0	91.0	91.0	90.0	86.0	81.0	81.0
35	3150.	90.0	95.0	94.0	93.0	94.0	87.0	84.0	85.0	87.0	91.0	92.0	92.0	92.0	90.0	85.0	82.0	82.0
36	4000.	91.0	97.0	94.0	93.0	96.0	89.0	85.0	85.0	89.0	90.0	92.0	92.0	92.0	91.0	86.0	83.0	83.0
37	5000.	91.0	96.0	93.0	91.0	95.0	87.0	82.0	83.0	86.0	88.0	89.0	89.0	91.0	90.0	85.0	81.0	81.0
38	6300.	90.0	94.0	92.0	91.0	94.0	85.0	81.0	82.0	85.0	87.0	88.0	89.0	91.0	90.0	85.0	81.0	81.0
39	8000.	88.0	93.0	91.0	90.0	93.0	85.0	80.0	82.0	83.0	85.0	87.0	88.0	90.0	89.0	84.0	80.0	80.0
40	10000.	85.0	90.0	89.0	87.0	90.0	82.0	76.0	77.0	78.0	81.0	84.0	84.0	86.0	85.0	80.0	77.0	77.0

APPROACH

BAND	ANGLE DEG.	FAN + JET2																
		10.	20.	30.	40.	50.	60.	70.	80.	90.	100.	110.	120.	130.	140.	150.	160.	170.
17	50.	84.0	89.0	82.0	82.0	86.0	83.0	83.0	83.0	86.0	87.0	89.0	91.0	93.0	96.0	98.0	98.0	98.0
18	63.	84.0	89.0	82.0	82.0	88.0	83.0	83.0	83.0	86.0	87.0	89.0	91.0	93.0	96.0	98.0	98.0	98.0
19	80.	84.0	89.0	82.0	82.0	88.0	83.0	83.0	83.0	86.0	87.0	89.0	91.0	93.0	96.0	98.0	98.0	98.0
20	100.	84.0	89.0	82.0	82.0	88.0	83.0	83.0	83.0	86.0	87.0	89.0	91.0	93.0	96.0	98.0	98.0	98.0
21	125.	85.0	88.0	85.0	84.0	89.0	84.0	85.0	87.0	88.0	89.0	90.0	92.0	93.0	94.0	96.0	96.0	96.0
22	160.	86.0	91.0	86.0	86.0	90.0	86.0	87.0	88.0	89.0	89.0	90.0	91.0	93.0	93.0	95.0	95.0	95.0
23	200.	87.0	91.0	86.0	86.0	90.0	85.0	85.0	85.0	86.0	86.0	86.0	86.0	86.0	86.0	86.0	86.0	86.0
24	250.	86.0	91.0	85.0	84.0	88.0	84.0	84.0	85.0	87.0	89.0	90.0	91.0	92.0	94.0	95.0	93.0	93.0
25	315.	89.0	91.0	88.0	87.0	92.0	87.0	86.0	86.0	87.0	88.0	89.0	90.0	92.0	93.0	92.0	91.0	91.0
26	400.	92.0	93.0	90.0	89.0	91.0	87.0	86.0	87.0	87.0	89.0	90.0	91.0	92.0	93.0	92.0	91.0	91.0
27	500.	89.0	92.0	88.0	89.0	93.0	88.0	87.0	86.0	87.0	88.0	89.0	90.0	91.0	92.0	91.0	89.0	89.0
28	630.	91.0	93.0	89.0	89.0	92.0	87.0	86.0	87.0	87.0	89.0	90.0	90.0	91.0	91.0	91.0	89.0	89.0
29	800.	90.0	95.0	90.0	90.0	93.0	88.0	87.0	87.0	89.0	90.0	91.0	91.0	92.0	91.0	90.0	87.0	87.0
30	1000.	92.0	96.0	93.0	93.0	97.0	91.0	89.0	90.0	91.0	92.0	93.0	92.0	93.0	92.0	90.0	88.0	88.0
31	1250.	93.0	97.0	96.0	96.0	97.0	91.0	90.0	91.0	93.0	94.0	94.0	94.0	94.0	93.0	90.0	88.0	88.0
32	1600.	94.0	98.0	95.0	95.0	98.0	93.0	92.0	93.0	95.0	96.0	97.0	96.0	96.0	94.0	91.0	89.0	89.0
33	2000.	95.0	100.0	96.0	96.0	99.0	94.0	93.0	94.0	96.0	97.0	98.0	97.0	97.0	95.0	93.0	90.0	90.0
34	2500.	98.0	104.0	104.0	104.0	107.0	101.0	101.0	101.0	103.0	103.0	103.0	103.0	103.0	103.0	98.0	95.0	92.0
35	3150.	96.0	104.0	103.0	102.0	106.0	101.0	101.0	101.0	103.0	103.0	103.0	103.0	103.0	103.0	98.0	95.0	92.0
36	4000.	96.0	101.0	98.0	98.0	101.0	96.0	96.0	96.0	97.0	97.0	97.0	97.0	97.0	97.0	96.0	92.0	90.0
37	5000.	96.0	102.0	100.0	99.0	102.0	97.0	96.0	97.0	99.0	100.0	101.0	101.0	101.0	101.0	98.0	93.0	90.0
38	6300.	96.0	100.0	99.0	98.0	101.0	95.0	94.0	96.0	97.0	99.0	100.0	101.0	101.0	101.0	98.0	93.0	90.0
39	8000.	93.0	98.0	97.0	96.0	99.0	93.0	92.0	93.0	95.0	96.0	99.0	100.0	100.0	97.0	92.0	89.0	89.0
40	10000.	90.0	96.0	94.0	94.0	95.0	90.0	89.0	90.0	92.0	95.0	96.0	97.0	97.0	94.0	84.0	86.0	86.0

TAKEOFF

TABLE 9
PRIMARY JET NOISE SPECTRUM (250 FT. POLAR)

BAND	ANGLE FREQ.	JET					PRIM											APPROACH
		10.	20.	30.	40.	50.	60.	70.	80.	90.	100.	110.	120.	130.	140.	150.	160.	
17	50.	53.2	52.1	52.9	53.6	54.6	55.2	55.9	57.2	58.9	60.8	63.0	65.9	69.2	73.2	77.9	75.6	75.6
18	63.	54.8	53.5	53.8	54.4	54.9	56.0	56.8	58.1	59.5	61.5	63.5	66.4	69.4	73.1	76.7	74.8	74.8
19	80.	56.0	54.5	54.7	55.3	55.9	56.6	57.5	58.7	60.2	61.9	64.0	66.7	69.4	72.7	75.3	73.4	73.4
20	100.	56.4	54.7	55.0	55.4	56.2	57.0	57.8	58.9	60.4	62.1	64.2	66.6	69.1	72.1	73.9	71.7	71.7
21	125.	56.9	55.0	54.9	55.5	56.2	57.0	57.8	58.9	60.3	62.0	63.8	66.2	68.5	71.2	72.0	70.1	70.1
22	160.	56.8	54.7	54.7	55.3	56.0	56.9	57.6	58.6	60.0	61.6	63.3	65.5	67.7	69.9	70.1	68.3	68.3
23	200.	56.5	54.3	54.4	54.8	55.5	56.3	57.1	58.1	59.3	60.9	62.6	64.6	66.6	68.5	68.2	66.4	66.4
24	250.	56.2	53.8	53.7	54.2	54.7	55.5	56.4	57.3	58.6	60.1	61.6	63.4	65.3	66.8	66.0	64.3	64.3
25	315.	55.7	53.0	52.9	53.3	53.8	54.6	55.5	56.4	57.5	59.1	60.5	62.2	63.9	64.9	63.9	62.2	62.2
26	400.	55.0	52.2	52.0	52.2	52.9	53.6	54.5	55.4	56.4	57.8	59.1	60.9	62.4	62.9	61.8	60.3	60.3
27	500.	54.2	51.2	50.8	51.1	51.8	52.5	53.3	54.3	55.3	56.5	57.8	59.5	60.8	60.8	59.5	58.3	58.3
28	630.	53.3	50.1	49.8	50.0	50.6	51.3	52.1	53.0	54.0	55.1	56.5	57.9	59.2	58.8	57.4	56.3	56.3
29	800.	52.4	49.1	48.5	48.8	49.4	50.0	50.8	51.7	52.7	53.8	55.0	56.4	57.4	56.8	55.3	54.4	54.4
30	1000.	51.5	48.0	47.3	47.5	48.1	48.7	49.5	50.4	51.2	52.3	53.5	54.8	55.7	54.8	53.2	52.5	52.5
31	1250.	50.5	46.7	46.0	46.2	46.7	47.3	48.1	48.0	49.8	51.0	52.1	53.3	53.9	53.0	51.2	50.6	50.6
32	1600.	49.4	45.4	44.7	44.9	45.2	46.1	46.8	47.6	48.4	49.5	50.8	51.9	52.0	51.2	49.2	48.9	48.9
33	2000.	48.2	44.1	43.4	43.4	43.9	44.7	45.5	46.2	47.0	48.1	49.3	50.3	50.3	49.4	47.4	47.2	47.2
34	2500.	46.8	42.7	42.0	41.9	42.5	43.3	44.1	44.8	45.7	46.8	47.9	49.0	49.6	47.7	45.6	45.4	45.4
35	3150.	45.4	41.3	40.6	40.7	41.2	41.9	42.8	43.5	44.4	45.4	46.7	47.7	47.0	46.1	44.0	43.8	43.8
36	4000.	44.0	39.8	39.4	39.4	40.0	40.8	41.5	42.2	43.2	44.2	45.4	46.5	45.6	44.6	42.5	42.2	42.2
37	5000.	42.7	38.5	38.1	38.1	38.7	39.3	40.2	41.0	42.0	42.9	44.1	45.1	44.1	43.1	41.0	40.7	40.7
38	6300.	41.5	37.3	36.9	36.9	37.5	38.2	39.0	39.8	40.8	41.7	42.9	43.9	42.7	41.7	39.6	39.3	39.3
39	8000.	40.4	36.2	35.7	35.7	36.2	37.0	37.7	38.6	39.5	40.6	41.6	42.7	41.3	40.3	38.3	38.0	38.0
40	10000.	39.2	35.1	34.6	34.6	35.1	35.8	36.5	37.3	38.3	39.2	40.4	41.5	40.0	39.0	36.9	36.7	36.7

BAND	ANGLE FREQ.	JET					PRIM											TAKEOFF
		10.	20.	30.	40.	50.	60.	70.	80.	90.	100.	110.	120.	130.	140.	150.	160.	
17	50.	77.7	76.6	77.3	78.1	79.1	79.6	80.3	81.6	83.3	85.2	87.4	90.3	93.7	97.7	102.3	100.1	100.1
18	63.	80.3	79.0	79.3	79.9	80.5	81.6	82.3	83.6	85.0	87.0	89.0	92.0	95.0	98.6	102.2	100.3	100.3
19	80.	82.6	81.1	81.3	81.9	82.5	83.2	84.1	85.3	86.8	88.5	90.6	93.3	96.0	99.3	101.9	100.0	100.0
20	100.	84.0	82.3	82.6	83.0	83.8	84.6	85.4	86.6	88.1	89.8	91.8	94.2	96.7	99.7	101.5	93.3	93.3
21	125.	85.5	83.6	83.5	84.1	84.8	85.5	86.4	87.5	88.9	90.6	92.4	94.7	97.1	99.8	100.6	98.7	98.7
22	160.	86.2	84.1	84.2	84.7	85.4	86.2	86.9	88.1	89.5	91.1	92.8	94.9	97.1	99.3	99.6	97.7	97.7
23	200.	86.8	84.6	84.6	85.0	85.8	86.5	87.4	88.3	89.5	91.1	92.9	94.8	96.9	98.7	98.4	96.7	96.7
24	250.	87.2	84.8	84.7	85.1	85.7	86.5	87.4	88.2	89.5	91.0	92.6	94.4	96.3	97.7	97.0	95.3	95.3
25	315.	87.7	84.6	84.4	84.9	85.4	86.2	87.1	87.9	89.1	90.6	92.1	93.8	95.5	96.5	95.4	91.8	91.8
26	400.	87.1	84.2	84.1	84.3	85.0	85.7	86.5	87.5	88.5	89.9	91.1	93.0	94.5	95.0	93.9	92.3	92.3
27	500.	86.7	83.7	83.3	83.6	84.3	85.0	85.8	86.8	87.8	89.0	90.3	92.0	93.3	93.3	92.0	90.8	90.8
28	630.	86.1	82.9	82.6	82.8	83.3	84.1	84.9	85.8	86.8	87.9	89.3	90.7	91.9	91.6	90.2	89.1	89.1
29	800.	85.4	82.0	81.5	81.8	82.3	83.0	83.8	84.7	85.6	86.6	88.0	89.4	90.3	89.8	88.3	87.3	87.3
30	1000.	84.6	81.0	80.4	80.6	81.1	81.8	82.6	83.4	84.3	85.3	86.6	87.9	88.7	87.9	86.3	85.5	85.5
31	1250.	83.6	79.3	79.1	79.3	79.8	80.4	81.2	82.0	82.9	84.0	85.2	86.4	87.0	86.1	84.3	83.7	83.7
32	1600.	82.4	78.4	77.8	77.9	78.3	79.1	79.8	80.6	81.4	82.5	83.8	84.9	85.1	84.2	82.3	81.9	81.9
33	2000.	81.1	77.0	76.3	76.3	76.8	77.6	78.4	79.1	79.9	81.0	82.2	83.2	83.2	82.3	80.3	80.1	80.1
34	2500.	79.6	75.4	74.6	74.6	75.2	76.0	76.4	77.6	78.4	79.5	80.6	81.7	81.4	80.4	78.4	78.1	78.1
35	3150.	78.3	73.8	73.2	73.2	73.7	74.4	75.1	75.9	76.9	77.9	79.2	80.2	79.6	78.6	76.5	76.3	76.3
36	4000.	76.3	72.2	71.7	71.7	72.3	72.9	73.4	74.5	75.5	76.5	77.7	78.9	77.9	76.9	74.8	74.6	74.6
37	5000.	74.8	70.7	70.2	70.2	70.8	71.4	72.1	73.1	74.1	75.0	76.2	77.2	76.2	75.2	73.1	72.9	72.9
38	6300.	73.5	69.4	68.9	68.9	69.5	70.2	71.0	71.8	72.8	73.7	74.9	75.9	74.7	73.7	71.6	71.4	71.4
39	8000.	72.3	68.2	67.6	67.6	68.2	69.0	69.7	70.5	71.5	72.5	73.6	74.7	73.3	72.3	70.2	70.0	70.0
40	10000.	71.2	67.1	66.4	66.4	67.1	67.8	68.5	69.3	70.3	71.2	72.4	73.5	72.0	71.0	68.9	68.7	68.7

BAND	ANGLE FREQ.	TURB							BASE							APPROACH		
		10.	20.	30.	40.	50.	60.	70.	80.	90.	100.	110.	120.	130.	140.		150.	160.
17	50.	0.0	0.0	0.0	0.0	0.0	0.0	0.0	0.0	0.0	10.0	10.0	10.0	10.0	0.0	0.0	0.0	0.0
18	64.	0.0	0.0	0.0	0.0	0.0	0.0	0.0	0.0	0.0	10.0	10.0	10.0	10.0	0.0	0.0	0.0	0.0
19	80.	0.0	0.0	0.0	0.0	0.0	0.0	0.0	0.0	0.0	10.0	10.0	10.0	10.0	0.0	0.0	0.0	0.0
20	100.	0.0	0.0	0.0	0.0	0.0	0.0	0.0	0.0	0.0	10.0	10.0	10.0	10.0	0.0	0.0	0.0	0.0
21	125.	0.0	0.0	0.0	0.0	0.0	0.0	0.0	0.0	0.0	10.0	10.0	10.0	10.0	0.0	0.0	0.0	0.0
22	160.	0.0	0.0	0.0	0.0	0.0	0.0	0.0	0.0	0.0	10.0	10.0	10.0	10.0	0.0	0.0	0.0	0.0
23	200.	0.0	0.0	0.0	0.0	0.0	0.0	0.0	0.0	0.0	10.0	10.0	10.0	10.0	0.0	0.0	0.0	0.0
24	250.	0.0	0.0	0.0	0.0	0.0	0.0	0.0	0.0	0.0	10.0	10.0	10.0	10.0	0.0	0.0	0.0	0.0
25	315.	0.0	0.0	0.0	0.0	0.0	0.0	0.0	0.0	0.0	10.0	10.0	10.0	10.0	0.0	0.0	0.0	0.0
26	400.	0.0	0.0	0.0	0.0	0.0	0.0	0.0	0.0	0.0	10.0	10.0	10.0	10.0	0.0	0.0	0.0	0.0
27	500.	0.0	0.0	0.0	0.0	0.0	0.0	0.0	0.0	0.0	10.0	10.0	10.0	10.0	0.0	0.0	0.0	0.0
28	640.	0.0	0.0	0.0	0.0	0.0	0.0	0.0	0.0	0.0	10.0	10.0	10.0	10.0	0.0	0.0	0.0	0.0
29	800.	0.0	0.0	0.0	0.0	0.0	0.0	0.0	0.0	0.0	10.0	10.0	10.0	10.0	0.0	0.0	0.0	0.0
30	1000.	0.0	0.0	0.0	0.0	0.0	0.0	0.0	0.0	0.0	10.0	10.0	10.0	10.0	0.0	0.0	0.0	0.0
31	1250.	0.0	0.0	0.0	0.0	0.0	0.0	0.0	0.0	0.0	40.0	41.0	41.6	10.0	0.0	0.0	0.0	0.0
32	1600.	0.0	0.0	0.0	0.0	0.0	0.0	0.0	0.0	0.0	43.0	43.0	44.8	40.0	0.0	0.0	0.0	0.0
33	2000.	0.0	0.0	0.0	0.0	0.0	0.0	0.0	0.0	0.0	46.0	46.7	47.7	43.5	0.0	0.0	0.0	0.0
34	2500.	0.0	0.0	0.0	0.0	0.0	0.0	0.0	0.0	0.0	48.0	49.5	50.8	47.7	0.0	0.0	0.0	0.0
35	3150.	0.0	0.0	0.0	0.0	0.0	0.0	0.0	0.0	0.0	52.1	52.8	53.7	50.0	0.0	0.0	0.0	0.0
36	4000.	0.0	0.0	0.0	0.0	0.0	0.0	0.0	0.0	0.0	58.0	55.5	54.3	55.1	0.0	0.0	0.0	0.0
37	5000.	0.0	0.0	0.0	0.0	0.0	0.0	0.0	0.0	0.0	62.5	60.5	64.2	60.2	0.0	0.0	0.0	0.0
38	6300.	0.0	0.0	0.0	0.0	0.0	0.0	0.0	0.0	0.0	67.5	65.5	69.0	65.4	0.0	0.0	0.0	0.0
39	8000.	0.0	0.0	0.0	0.0	0.0	0.0	0.0	0.0	0.0	68.1	70.0	69.0	65.2	0.0	0.0	0.0	0.0
40	10000.	0.0	0.0	0.0	0.0	0.0	0.0	0.0	0.0	0.0	68.5	68.0	68.7	60.0	0.0	0.0	0.0	0.0

TABLE 10
TURBOMACHINERY NOISE SPECTRUM (370 FT. SIDELINE)

TABLE 11
MODIFIED DATA IDENTIFICATION

<u>DATA</u>	<u>TYPE</u>
Fan + Jet 2	200-ft. Polar
Jet 1	200-ft. Polar
Jet 2	200-ft. Polar
Turbomachinery	200-ft. Polar

TABLE 12
FAN AND SECONDARY JET NOISE SPECTRUM (200-FT. POLAR)

BAND	ANGLE FREQ.	FAN JET2																
		10.	20.	30.	40.	50.	60.	70.	80.	90.	100.	110.	120.	130.	140.	150.	160.	170.
17	50.	65.0	79.0	67.0	63.0	72.0	63.0	64.0	64.0	66.0	68.0	68.0	70.0	71.0	73.0	75.0	75.0	75.0
18	63.	65.0	79.0	67.0	63.0	72.0	63.0	64.0	64.0	66.0	68.0	68.0	70.0	71.0	73.0	75.0	75.0	75.0
19	80.	65.0	79.0	67.0	63.0	72.0	64.0	64.0	64.0	66.0	68.0	68.0	70.0	71.0	73.0	75.0	75.0	75.0
20	100.	65.0	79.0	67.0	63.0	72.0	63.0	64.0	64.0	66.0	68.0	68.0	70.0	71.0	73.0	75.0	75.0	75.0
21	125.	66.0	75.0	69.0	69.0	72.0	65.0	66.0	67.0	68.0	69.0	70.0	70.0	71.0	71.0	73.0	73.0	73.0
22	160.	68.0	77.0	71.0	67.0	72.0	66.0	67.0	67.0	68.0	68.0	68.0	69.0	69.0	70.0	70.0	71.0	71.0
23	200.	70.0	80.0	72.0	67.0	75.0	66.0	66.0	65.0	65.0	67.0	68.0	69.0	71.0	72.0	72.0	71.0	71.0
24	250.	69.0	77.0	69.0	69.0	73.0	65.0	65.0	65.0	67.0	68.0	70.0	70.0	71.0	71.0	71.0	70.0	70.0
25	315.	70.0	77.0	71.0	69.0	74.0	66.0	66.0	66.0	66.0	67.0	69.0	69.0	70.0	71.0	70.0	68.0	68.0
26	400.	73.0	76.0	71.0	70.0	73.0	66.0	66.0	66.0	66.0	69.0	70.0	70.0	71.0	71.0	70.0	68.0	68.0
27	500.	74.0	76.0	74.0	73.0	76.0	69.0	67.0	67.0	67.0	69.0	71.0	71.0	72.0	72.0	70.0	68.0	68.0
28	630.	75.0	81.0	76.0	74.0	76.0	70.0	69.0	69.0	71.0	72.0	73.0	72.0	74.0	73.0	71.0	69.0	69.0
29	800.	76.0	84.0	77.0	77.0	79.0	72.0	70.0	70.0	72.0	74.0	74.0	74.0	76.0	75.0	71.0	69.0	69.0
30	1000.	79.0	85.0	80.0	78.0	80.0	74.0	73.0	73.0	76.0	77.0	78.0	77.0	79.0	79.0	74.0	72.0	72.0
31	1250.	80.0	85.0	82.0	80.0	81.0	74.0	74.0	75.0	78.0	79.0	80.0	79.0	80.0	80.0	76.0	74.0	74.0
32	1600.	84.0	89.0	86.0	83.0	85.0	78.0	78.0	77.0	80.0	82.0	82.0	82.0	83.0	82.0	79.0	76.0	76.0
33	2000.	84.0	94.0	90.0	88.0	90.0	84.0	81.0	81.0	83.0	85.0	86.0	86.0	87.0	86.0	82.0	79.0	79.0
34	2500.	83.0	86.0	86.0	84.0	85.0	77.0	76.0	77.0	80.0	83.0	83.0	83.0	84.0	83.0	79.0	76.0	74.0
35	3150.	82.0	87.0	86.0	85.0	86.0	79.0	76.0	77.0	81.0	83.0	84.0	84.0	84.0	82.0	77.0	74.0	74.0
36	4000.	83.0	89.0	86.0	85.0	88.0	81.0	77.0	77.0	81.0	82.0	84.0	84.0	84.0	83.0	78.0	75.0	75.0
37	5000.	83.0	88.0	85.0	83.0	87.0	79.0	74.0	75.0	78.0	80.0	81.0	82.0	83.0	82.0	77.0	73.0	73.0
38	6300.	82.0	86.0	84.0	83.0	86.0	74.0	73.0	74.0	77.0	79.0	80.0	81.0	83.0	82.0	77.0	73.0	73.0
39	8000.	79.0	84.0	82.0	81.0	84.0	76.0	71.0	70.0	74.0	76.0	78.0	79.0	81.0	80.0	75.0	71.0	71.0
40	10000.	75.0	80.0	77.0	77.0	80.0	72.0	66.0	67.0	68.0	71.0	74.0	74.0	76.0	75.0	70.0	67.0	67.0

APPROACH

BAND	ANGLE FREQ.	FAN JET2																
		10.	20.	30.	40.	50.	60.	70.	80.	90.	100.	110.	120.	130.	140.	150.	160.	170.
17	50.	77.0	82.0	75.0	75.0	81.0	76.0	75.0	76.0	79.0	80.0	82.0	84.0	86.0	89.0	91.0	91.0	91.0
18	63.	77.0	82.0	75.0	75.0	81.0	76.0	76.0	76.0	79.0	80.0	82.0	84.0	86.0	89.0	91.0	91.0	91.0
19	80.	77.0	82.0	75.0	75.0	81.0	76.0	76.0	76.0	79.0	80.0	82.0	84.0	86.0	89.0	91.0	91.0	91.0
20	100.	77.0	82.0	75.0	75.0	81.0	76.0	76.0	76.0	79.0	81.0	80.0	82.0	84.0	86.0	89.0	91.0	91.0
21	125.	78.0	81.0	78.0	77.0	82.0	77.0	76.0	80.0	81.0	82.0	83.0	85.0	86.0	87.0	89.0	89.0	89.0
22	160.	79.0	84.0	79.0	79.0	83.0	79.0	79.0	81.0	82.0	81.0	82.0	83.0	84.0	86.0	89.0	88.0	88.0
23	200.	80.0	84.0	79.0	79.0	83.0	78.0	78.0	80.0	80.0	81.0	81.0	83.0	85.0	88.0	89.0	88.0	88.0
24	250.	79.0	84.0	78.0	77.0	81.0	77.0	78.0	80.0	82.0	83.0	84.0	85.0	87.0	86.0	86.0	86.0	86.0
25	315.	81.0	84.0	81.0	80.0	85.0	80.0	79.0	79.0	80.0	82.0	83.0	84.0	85.0	86.0	85.0	84.0	84.0
26	400.	85.0	86.0	83.0	82.0	84.0	80.0	79.0	80.0	80.0	82.0	83.0	84.0	85.0	86.0	85.0	84.0	84.0
27	500.	82.0	85.0	81.0	82.0	86.0	81.0	80.0	79.0	80.0	81.0	82.0	83.0	84.0	85.0	84.0	82.0	82.0
28	630.	84.0	86.0	82.0	82.0	85.0	82.0	78.0	80.0	80.0	82.0	83.0	84.0	84.0	84.0	84.0	82.0	82.0
29	800.	83.0	88.0	83.0	83.0	86.0	81.0	80.0	80.0	82.0	83.0	84.0	85.0	85.0	84.0	83.0	80.0	80.0
30	1000.	85.0	89.0	86.0	86.0	90.0	84.0	82.0	83.0	84.0	86.0	86.0	86.0	86.0	85.0	83.0	81.0	81.0
31	1250.	86.0	90.0	87.0	87.0	90.0	84.0	83.0	83.0	86.0	87.0	87.0	87.0	88.0	86.0	83.0	81.0	81.0
32	1600.	87.0	91.0	88.0	88.0	91.0	86.0	85.0	86.0	88.0	89.0	90.0	90.0	91.0	89.0	84.0	82.0	82.0
33	2000.	88.0	93.0	91.0	92.0	92.0	87.0	87.0	87.0	90.0	92.0	92.0	92.0	94.0	94.0	89.0	83.0	83.0
34	2500.	91.0	98.0	97.0	97.0	100.0	94.0	92.0	91.0	93.0	95.0	96.0	95.0	96.0	91.0	88.0	85.0	85.0
35	3150.	90.0	96.0	95.0	94.0	98.0	92.0	91.0	90.0	92.0	94.0	94.0	94.0	94.0	90.0	87.0	84.0	84.0
36	4000.	86.0	93.0	91.0	90.0	93.0	84.0	83.0	82.0	91.0	93.0	93.0	92.0	93.0	88.0	84.0	82.0	82.0
37	5000.	86.0	94.0	92.0	91.0	94.0	84.0	83.0	82.0	91.0	92.0	93.0	93.0	93.0	90.0	85.0	82.0	82.0
38	6300.	88.0	92.0	91.0	90.0	93.0	87.0	85.0	84.0	91.0	92.0	93.0	93.0	93.0	90.0	85.0	82.0	82.0
39	8000.	84.0	89.0	86.0	84.0	90.0	85.0	83.0	82.0	89.0	90.0	91.0	91.0	91.0	88.0	83.0	80.0	80.0
40	10000.	80.0	86.0	84.0	84.0	86.0	80.0	79.0	80.0	82.0	85.0	86.0	87.0	87.0	84.0	79.0	76.0	76.0

TAKEOFF

BAND	ANGLE DEG.	JET					PRIM											
		10.	20.	30.	40.	50.	60.	70.	80.	90.	100.	110.	120.	130.	140.	150.	160.	170.
17	50.	55.0	54.0	55.0	56.0	57.0	57.0	58.0	59.0	61.0	63.0	65.0	68.0	71.0	75.0	80.0	78.0	78.0
18	63.	57.0	55.0	56.0	56.0	57.0	58.0	59.0	60.0	61.0	63.0	65.0	68.0	71.0	75.0	79.0	77.0	77.0
19	80.	58.0	57.0	57.0	57.0	58.0	59.0	60.0	61.0	62.0	64.0	66.0	69.0	71.0	75.0	77.0	75.0	75.0
20	100.	58.0	57.0	57.0	57.0	58.0	59.0	60.0	61.0	62.0	64.0	66.0	69.0	71.0	74.0	76.0	74.0	74.0
21	125.	59.0	57.0	57.0	58.0	58.0	59.0	60.0	61.0	62.0	64.0	66.0	68.0	71.0	73.0	74.0	72.0	72.0
22	160.	59.0	57.0	57.0	57.0	58.0	59.0	60.0	61.0	62.0	64.0	65.0	68.0	70.0	72.0	72.0	70.0	70.0
23	200.	59.0	56.0	56.0	57.0	58.0	58.0	59.0	60.0	61.0	63.0	65.0	67.0	69.0	71.0	70.0	68.0	68.0
24	250.	58.0	56.0	56.0	56.0	57.0	58.0	59.0	60.0	61.0	62.0	64.0	65.0	67.0	69.0	68.0	66.0	66.0
25	315.	58.0	55.0	55.0	55.0	56.0	57.0	58.0	59.0	60.0	61.0	63.0	64.0	66.0	67.0	66.0	64.0	64.0
26	400.	57.0	54.0	54.0	54.0	55.0	56.0	57.0	58.0	59.0	60.0	61.0	63.0	64.0	65.0	64.0	62.0	62.0
27	500.	56.0	53.0	53.0	53.0	54.0	55.0	56.0	57.0	58.0	59.0	60.0	62.0	63.0	63.0	62.0	60.0	60.0
28	630.	55.0	52.0	52.0	52.0	53.0	54.0	55.0	56.0	57.0	58.0	59.0	60.0	61.0	60.0	58.0	56.0	56.0
29	800.	55.0	51.0	51.0	51.0	52.0	53.0	54.0	55.0	56.0	57.0	58.0	59.0	60.0	59.0	57.0	55.0	55.0
30	1000.	54.0	50.0	49.0	50.0	50.0	51.0	52.0	53.0	54.0	55.0	56.0	57.0	58.0	57.0	55.0	53.0	53.0
31	1250.	53.0	49.0	48.0	48.0	49.0	50.0	50.0	51.0	52.0	53.0	54.0	55.0	56.0	55.0	53.0	51.0	51.0
32	1600.	52.0	48.0	47.0	47.0	47.0	48.0	49.0	50.0	51.0	52.0	53.0	54.0	54.0	53.0	51.0	51.0	51.0
33	2000.	51.0	46.0	46.0	46.0	46.0	47.0	48.0	49.0	50.0	51.0	52.0	53.0	53.0	52.0	50.0	50.0	50.0
34	2500.	49.0	45.0	44.0	44.0	44.0	45.0	46.0	47.0	48.0	49.0	50.0	51.0	51.0	50.0	48.0	48.0	48.0
35	3150.	48.0	44.0	43.0	43.0	44.0	44.0	45.0	46.0	47.0	48.0	49.0	50.0	49.0	48.0	46.0	46.0	46.0
36	4000.	47.0	42.0	42.0	42.0	43.0	43.0	44.0	45.0	46.0	47.0	48.0	49.0	48.0	47.0	45.0	45.0	45.0
37	5000.	45.0	41.0	41.0	41.0	41.0	42.0	43.0	44.0	45.0	46.0	47.0	48.0	47.0	46.0	44.0	44.0	44.0
38	6300.	44.0	40.0	40.0	40.0	40.0	41.0	42.0	43.0	44.0	45.0	46.0	47.0	46.0	45.0	42.0	42.0	42.0
39	8000.	44.0	39.0	39.0	39.0	39.0	40.0	41.0	42.0	43.0	44.0	45.0	46.0	46.0	45.0	41.0	41.0	41.0
40	10000.	43.0	39.0	38.0	38.0	39.0	39.0	40.0	41.0	42.0	43.0	44.0	45.0	44.0	43.0	40.0	40.0	40.0

APPROACH

TABLE 13
PRIMARY JET NOISE SPECTRUM (200-FT. POLAR)

BAND	ANGLE DEG.	JET					PRIM											
		10.	20.	30.	40.	50.	60.	70.	80.	90.	100.	110.	120.	130.	140.	150.	160.	170.
17	50.	80.0	79.0	79.0	80.0	81.0	82.0	82.0	84.0	85.0	87.0	89.0	92.0	96.0	100.0	104.0	102.0	102.0
18	63.	82.0	81.0	81.0	82.0	82.0	84.0	84.0	86.0	87.0	89.0	91.0	94.0	97.0	101.0	104.0	102.0	102.0
19	80.	85.0	83.0	83.0	84.0	85.0	85.0	87.0	87.0	89.0	91.0	93.0	95.0	98.0	101.0	104.0	102.0	102.0
20	100.	86.0	84.0	85.0	85.0	86.0	87.0	87.0	89.0	90.0	92.0	94.0	96.0	99.0	102.0	104.0	95.0	95.0
21	125.	88.0	86.0	86.0	86.0	87.0	88.0	89.0	90.0	91.0	93.0	94.0	97.0	99.0	102.0	103.0	101.0	101.0
22	160.	84.0	86.0	86.0	87.0	87.0	88.0	89.0	90.0	92.0	93.0	95.0	97.0	99.0	101.0	102.0	100.0	100.0
23	200.	89.0	87.0	87.0	87.0	88.0	89.0	89.0	90.0	92.0	93.0	95.0	97.0	99.0	101.0	100.0	99.0	99.0
24	250.	89.0	87.0	87.0	87.0	88.0	89.0	89.0	90.0	92.0	93.0	95.0	96.0	98.0	100.0	99.0	97.0	97.0
25	315.	89.0	87.0	87.0	87.0	88.0	89.0	89.0	90.0	91.0	93.0	94.0	96.0	98.0	99.0	97.0	96.0	96.0
26	400.	89.0	86.0	86.0	86.0	87.0	88.0	89.0	90.0	91.0	92.0	93.0	95.0	97.0	97.0	96.0	94.0	94.0
27	500.	89.0	86.0	85.0	86.0	86.0	87.0	88.0	89.0	90.0	91.0	92.0	94.0	95.0	95.0	94.0	93.0	93.0
28	630.	84.0	85.0	85.0	85.0	85.0	86.0	87.0	88.0	89.0	90.0	91.0	93.0	94.0	94.0	94.0	92.0	91.0
29	800.	84.0	84.0	84.0	84.0	84.0	85.0	86.0	87.0	88.0	89.0	90.0	92.0	92.0	92.0	90.0	89.0	89.0
30	1000.	87.0	83.0	83.0	83.0	83.0	84.0	85.0	86.0	86.0	87.0	89.0	90.0	91.0	90.0	88.0	88.0	88.0
31	1250.	86.0	82.0	81.0	82.0	82.0	83.0	84.0	85.0	86.0	87.0	89.0	89.0	89.0	88.0	87.0	86.0	86.0
32	1600.	85.0	81.0	80.0	80.0	81.0	82.0	83.0	84.0	85.0	86.0	87.0	89.0	89.0	88.0	87.0	86.0	86.0
33	2000.	83.0	79.0	79.0	79.0	79.0	80.0	81.0	82.0	83.0	84.0	85.0	86.0	86.0	86.0	85.0	83.0	82.0
34	2500.	82.0	78.0	78.0	78.0	78.0	79.0	80.0	81.0	82.0	83.0	84.0	85.0	86.0	86.0	85.0	83.0	82.0
35	3150.	80.0	76.0	76.0	76.0	76.0	77.0	78.0	79.0	80.0	81.0	82.0	83.0	84.0	84.0	83.0	81.0	80.0
36	4000.	79.0	75.0	74.0	74.0	75.0	76.0	77.0	78.0	79.0	80.0	81.0	82.0	83.0	83.0	82.0	80.0	80.0
37	5000.	77.0	73.0	73.0	73.0	73.0	74.0	75.0	76.0	77.0	78.0	79.0	80.0	80.0	79.0	78.0	76.0	76.0
38	6300.	76.0	72.0	72.0	72.0	72.0	73.0	74.0	75.0	76.0	77.0	78.0	79.0	79.0	78.0	77.0	75.0	75.0
39	8000.	75.0	71.0	71.0	71.0	71.0	72.0	73.0	74.0	75.0	76.0	77.0	78.0	78.0	77.0	75.0	73.0	73.0
40	10000.	74.0	71.0	70.0	70.0	71.0	71.0	72.0	73.0	74.0	75.0	76.0	77.0	77.0	76.0	75.0	72.0	72.0

TAKEOFF

TABLE 14
SECONDARY JET NOISE SPECTRUM (200-FT. POLAR)

BAND	ANGLE FREQ.	JET SEC																
		10.	20.	30.	40.	50.	60.	70.	80.	90.	100.	110.	120.	130.	140.	150.	160.	170.
17	50.	64.9	78.9	66.9	62.9	71.9	62.9	63.9	63.9	65.9	67.9	67.9	69.9	70.9	72.9	74.9	74.9	76.9
18	63.	64.9	78.9	66.9	62.9	71.9	62.9	63.9	63.9	65.9	67.9	67.9	69.9	70.9	72.9	74.9	74.9	76.9
19	80.	64.9	78.9	66.9	62.9	71.9	62.9	63.9	63.9	65.9	67.9	67.9	69.9	70.9	72.9	74.9	74.9	76.9
20	100.	64.9	78.9	66.9	62.9	71.9	62.9	63.9	63.9	65.9	67.9	67.9	69.9	70.9	72.9	74.9	74.9	76.9
21	125.	63.4	77.4	65.4	61.4	70.4	61.4	62.4	62.4	64.4	66.4	66.4	68.4	69.4	71.4	73.4	73.4	75.4
22	160.	61.9	75.9	63.9	59.9	68.9	59.9	60.9	60.9	62.9	64.9	64.9	66.9	67.9	69.9	71.9	71.9	73.9
23	200.	60.4	74.4	62.4	58.4	67.4	58.4	59.4	59.4	61.4	63.4	63.4	65.4	66.4	68.4	70.4	70.4	72.4
24	250.	58.9	72.9	60.9	56.9	65.9	56.9	57.9	57.9	59.9	61.9	61.9	63.9	64.9	66.9	68.9	68.9	70.9
25	315.	57.4	71.4	59.4	55.4	64.4	55.4	56.4	56.4	58.4	60.4	60.4	62.4	63.4	65.4	67.4	67.4	69.4
26	400.	55.9	69.9	57.9	53.9	62.9	53.9	54.9	54.9	56.9	58.9	58.9	60.9	61.9	63.9	65.9	65.9	67.9
27	500.	54.4	68.4	56.4	52.4	61.4	52.4	53.4	53.4	55.4	57.4	57.4	59.4	60.4	62.4	64.4	64.4	66.4
28	630.	52.9	66.9	54.9	50.9	59.9	50.9	51.9	51.9	53.9	55.9	55.9	57.9	58.9	60.9	62.9	62.9	64.9
29	800.	51.4	65.4	53.4	49.4	58.4	49.4	50.4	50.4	52.4	54.4	54.4	56.4	57.4	59.4	61.4	61.4	63.4
30	1000.	49.9	63.9	51.9	47.9	56.9	47.9	48.9	48.9	50.9	52.9	52.9	54.9	55.9	57.9	59.9	59.9	61.9
31	1250.	48.4	62.4	50.4	46.4	55.4	46.4	47.4	47.4	49.4	51.4	51.4	53.4	54.4	56.4	58.4	58.4	60.4
32	1600.	46.9	60.9	48.9	44.9	53.9	44.9	45.9	45.9	47.9	49.9	49.9	51.9	52.9	54.9	56.9	56.9	58.9
33	2000.	45.4	59.4	47.4	43.4	52.4	43.4	44.4	44.4	46.4	48.4	48.4	50.4	51.4	53.4	55.4	55.4	57.4
34	2500.	43.9	57.9	45.9	41.9	50.9	41.9	42.9	42.9	44.9	46.9	46.9	48.9	49.9	51.9	53.9	53.9	55.9
35	3150.	42.4	56.4	44.4	40.4	49.4	40.4	41.4	41.4	43.4	45.4	45.4	47.4	48.4	50.4	52.4	52.4	54.4
36	4000.	40.9	54.9	42.9	38.9	47.9	38.9	39.9	39.9	41.9	43.9	43.9	45.9	46.9	48.9	50.9	50.9	52.9
37	5000.	39.4	53.4	41.4	37.4	46.4	37.4	38.4	38.4	40.4	42.4	42.4	44.4	45.4	47.4	49.4	49.4	51.4
38	6300.	37.9	51.9	39.9	35.9	44.9	35.9	36.9	36.9	38.9	40.9	40.9	42.9	43.9	45.9	47.9	47.9	49.9
39	8000.	36.4	50.4	38.4	34.4	43.4	34.4	35.4	35.4	37.4	39.4	39.4	41.4	42.4	44.4	46.4	46.4	48.4
40	10000.	34.9	48.9	36.9	32.9	41.9	32.9	33.9	33.9	35.9	37.9	37.9	39.9	40.9	42.9	44.9	44.9	46.9

APPROACH

TAKEOFF

TABLE 15
TURBOMACHINERY NOISE SPECTRUM (200-FT. POLAR)

BAND	ANGLE FREQ.	TURB																APPROACH	
		10.	20.	30.	40.	50.	60.	70.	80.	90.	100.	110.	120.	130.	140.	150.	160.		170.
17	50.	10.0	10.0	10.0	10.0	10.0	10.0	10.0	10.0	10.0	10.0	10.0	10.0	10.0	10.0	10.0	10.0	10.0	10.0
18	63.	10.0	10.0	10.0	10.0	10.0	10.0	10.0	10.0	10.0	10.0	10.0	10.0	10.0	10.0	10.0	10.0	10.0	10.0
19	80.	10.0	10.0	10.0	10.0	10.0	10.0	10.0	10.0	10.0	10.0	10.0	10.0	10.0	10.0	10.0	10.0	10.0	10.0
20	100.	10.0	10.0	10.0	10.0	10.0	10.0	10.0	10.0	10.0	10.0	10.0	10.0	10.0	10.0	10.0	10.0	10.0	10.0
21	125.	10.0	10.0	10.0	10.0	10.0	10.0	10.0	10.0	10.0	10.0	10.0	10.0	10.0	10.0	10.0	10.0	10.0	10.0
22	163.	10.0	10.0	10.0	10.0	10.0	10.0	10.0	10.0	10.0	10.0	10.0	10.0	10.0	10.0	10.0	10.0	10.0	10.0
23	200.	10.0	10.0	10.0	10.0	10.0	10.0	10.0	10.0	10.0	10.0	10.0	10.0	10.0	10.0	10.0	10.0	10.0	10.0
24	250.	10.0	10.0	10.0	10.0	10.0	10.0	10.0	10.0	10.0	10.0	10.0	10.0	10.0	10.0	10.0	10.0	10.0	10.0
25	315.	10.0	10.0	10.0	10.0	10.0	10.0	10.0	10.0	10.0	10.0	10.0	15.0	15.0	15.0	10.0	10.0	10.0	10.0
26	400.	10.0	10.0	10.0	10.0	10.0	10.0	10.0	10.0	10.0	14.0	20.0	20.0	20.0	20.0	14.0	10.0	10.0	10.0
27	500.	10.0	10.0	10.0	10.0	10.0	10.0	10.0	10.0	14.0	18.0	25.0	25.0	25.0	25.0	18.0	14.0	10.0	10.0
28	630.	10.0	10.0	10.0	10.0	10.0	10.0	10.0	13.0	17.0	22.0	30.0	30.0	30.0	30.0	22.0	17.0	13.0	10.0
29	800.	10.0	10.0	10.0	10.0	10.0	12.0	16.0	21.0	26.0	35.0	35.0	35.0	35.0	35.0	26.0	21.0	16.0	12.0
30	1000.	10.0	10.0	10.0	10.0	12.0	15.0	19.0	24.0	30.0	40.0	40.0	40.0	40.0	40.0	30.0	24.0	19.0	15.0
31	1250.	10.0	10.0	10.0	11.0	14.0	18.0	23.0	28.0	34.0	46.0	48.0	50.0	50.0	48.0	34.0	28.0	23.0	18.0
32	1600.	10.0	10.0	10.0	12.0	16.0	20.0	26.0	31.0	38.0	50.0	50.0	53.0	50.0	38.0	31.0	26.0	20.0	16.0
33	2000.	10.0	10.0	10.0	13.0	18.0	23.0	29.0	35.0	42.0	53.0	54.0	56.0	54.0	42.0	35.0	29.0	23.0	18.0
34	2500.	10.0	10.0	10.0	14.0	20.0	25.0	32.0	38.0	46.0	55.0	57.0	60.0	54.0	46.0	38.0	32.0	25.0	20.0
35	3150.	10.0	10.0	10.0	15.0	21.0	28.0	35.0	42.0	50.0	59.0	61.0	63.0	61.0	50.0	42.0	35.0	28.0	21.0
36	4000.	10.0	10.0	10.0	16.0	23.0	30.0	38.0	45.0	54.0	66.0	64.0	69.0	67.0	54.0	45.0	38.0	30.0	23.0
37	5000.	10.0	10.0	10.0	17.0	25.0	33.0	41.0	49.0	58.0	70.0	69.0	74.0	72.0	58.0	49.0	41.0	33.0	25.0
38	6300.	10.0	10.0	10.0	18.0	27.0	35.0	44.0	53.0	62.0	76.0	75.0	80.0	78.0	62.0	53.0	44.0	35.0	27.0
39	8000.	10.0	10.0	10.0	19.0	28.0	37.0	47.0	56.0	66.0	78.0	81.0	81.0	80.0	66.0	56.0	47.0	37.0	28.0
40	10000.	10.0	10.0	10.0	20.0	30.0	40.0	50.0	60.0	70.0	80.0	80.0	83.0	77.0	70.0	60.0	50.0	40.0	30.0

BREAKDOWN OF CONTROL CARD

1	1 = ONE READER CARD	1
2	1 = SECOND READER CARD	1
3	0 = FIXED NOISE SOURCE	0
4	0 = STANDARD (NON POLAR ANGLE) INPUT	0
5	NOT USED	0
6	0 = SIDELINE INPUT = 1 POLAR INPUT	1
7	4 = STANDARD (FORMAT 17) SPL INPUT	4
8	NOT USED	0
9	0 = USE TONE CORRECTION	0
10	NOT USED	0
11	1 = PUNCHED OUTPUT	1
12-15	NOT USED	0101
16	1 = GENERAL CRT. TERMS INTERNALLY	1
17	NOT USED	0
18	1 = READ DISTANCE JET + SUPP. CARD	1
19	1 = SHORT FORM OUTPUT	1
20	1 = STANDARD (LONG FORM) OUTPUT	0
21	1 = JET CORE INPUT	1
22	1 = DEVELOPER FOOTPRINT	0
23	1 = TIME PRINT (GCOM SUR)	0
24	1 = DETERMINE DOPPLER EFFECTS	1
25	1 = FAN NOISE INPUT	1
26	1 = INLET JET SHEET	1
27	1 = TURBINE NOISE INPUT	1
28	0 = USE GRIDDED ATTENUATION	0
29	1 = USE JET, INLET, FWD DUCT ATTEN.	1
30	1 = GRID GEN. FOR DEVELOPING L-POL CNTRS	0
31-32	NO OF INPUT CASES	1
33-34	NO OF POLAR ANGLES	17
35-36	24 = 1/3 OCTAVE DATA	24
37-38		0
39-40	NO OF FLIGHT PROFILE SECTIONS	0
41-42	NO OF P.P.M. INPUTS	0
43-44		0
45-46	NO OF MODES SURFED	0
47-48	NO OF GRID POINTS	0
49-50	NO OF ATTENUATIONS	1
51	NO OF ENGINES	4.0

CONTROL CARD AND DATA INPUT

110001400010101101101001111010 11774 0 0 0 0 0 1 4.

SPL24=SPL-FAN+JET 2 SPLJE=SPL JET 1 SPLREF=SPL JET 2
 CONVERTED FROM 100 F (0 200 FT) APP 2/1971

ALTITUDE	VELOCITY	HUMIDITY	TEMP	SIDELINE	OFFSET	POWER	OVRTIM	NJ
200.00	0.0	70.00	59.00	0.0	0.0	0.0	0.0	17
370.00	754.00	70.00	59.00	0.0	0.0			

TABLE 16
 EPNL PROGRAM INPUT (CONTROL CARDS)

FAN													JETZ											
ANGLE	1	2	3	4	5	6	7	8	9	10	11	12	13	14	15	16	17	18	19	20	21	22	23	24
10.00	65	65	65	65	66	68	70	69	70	73	74	75	76	79	80	84	85	82	82	83	82	79	75	
20.00	75	75	75	75	77	80	77	77	76	78	81	84	85	85	88	94	88	87	89	88	86	84	80	
30.00	67	67	67	67	69	71	72	69	71	71	74	76	77	80	82	86	90	86	86	85	84	82	79	
40.00	63	63	63	63	66	67	67	69	69	70	73	74	77	78	80	83	88	84	85	85	83	81	77	
50.00	70	70	72	72	72	72	75	73	74	73	76	76	79	80	81	85	90	85	86	86	87	86	80	
60.00	67	65	65	65	65	66	65	65	66	66	67	70	72	74	74	78	84	77	75	81	75	78	72	
70.00	64	64	64	64	66	67	64	65	66	66	67	69	70	73	74	76	81	76	76	77	74	73	71	66
80.00	64	64	64	64	67	68	65	65	66	66	67	69	70	73	75	77	81	77	77	77	75	74	70	67
89.90	66	66	66	66	68	68	65	66	66	68	68	71	72	76	78	80	83	80	81	78	77	74	68	
100.00	68	68	68	68	69	68	67	68	67	69	69	72	74	77	79	82	85	83	83	82	80	79	76	71
110.00	68	68	68	68	70	68	68	69	70	69	70	71	73	74	78	80	82	83	84	84	81	80	78	74
120.00	70	70	70	70	71	69	69	70	69	70	71	73	74	77	79	82	84	84	84	82	81	79	74	
130.00	71	71	71	71	71	69	71	71	70	71	72	74	76	79	80	83	87	84	84	84	83	83	81	76
140.00	71	71	73	73	71	70	72	71	71	71	72	73	75	79	80	82	86	83	82	83	82	80	75	
150.00	75	75	75	75	73	71	72	71	70	70	70	71	71	74	76	79	82	76	77	78	77	77	75	70
160.00	75	75	75	75	73	71	71	70	68	68	68	69	69	72	74	76	79	74	74	75	73	73	71	67
170.00	75	75	75	75	73	71	71	70	68	68	68	69	69	72	74	76	79	74	74	75	73	73	71	67

JET											PRIM													
ANGLE	1	2	3	4	5	6	7	8	9	10	11	12	13	14	15	16	17	18	19	20	21	22	23	24
10.00	55	57	58	58	59	59	58	58	58	57	56	55	55	54	53	52	51	49	48	47	45	44	44	43
20.00	54	55	57	57	57	57	56	56	55	54	53	52	51	50	49	48	46	45	44	42	41	40	39	39
30.00	55	56	57	57	57	57	56	56	55	54	53	52	51	49	48	47	46	44	43	42	41	40	39	38
40.00	56	58	57	57	58	57	57	56	55	54	53	52	51	50	49	47	46	44	43	42	41	40	39	38
50.00	57	57	58	58	58	58	57	56	55	54	53	52	50	49	47	46	45	44	43	41	40	39	39	
60.00	57	58	58	58	58	58	58	57	56	55	54	53	52	51	50	48	47	46	44	43	42	41	40	39
70.00	58	59	60	60	60	59	59	58	58	57	56	54	53	52	50	49	48	46	45	44	43	42	41	40
80.00	59	60	61	61	61	61	60	59	58	57	56	54	53	51	50	49	47	46	45	44	43	42	41	
89.90	61	61	62	62	62	62	61	61	60	58	57	56	55	53	52	51	49	48	47	46	45	44	43	42
100.00	63	63	64	64	64	64	63	62	61	60	59	57	56	54	53	52	50	49	48	47	46	45	44	43
110.00	65	65	66	66	66	65	65	64	63	61	60	59	57	56	54	53	52	50	49	48	47	46	45	44
120.00	68	68	69	69	68	68	67	65	64	63	62	60	59	57	56	54	53	51	50	49	48	47	46	45
130.00	71	71	71	71	71	70	69	67	66	64	63	61	60	58	56	54	53	51	49	48	47	46	44	44
140.00	75	75	75	74	73	72	71	69	67	65	63	61	59	57	55	53	52	50	49	47	46	45	43	43
150.00	80	79	77	76	74	72	70	68	66	64	62	60	57	55	53	51	50	48	46	45	44	42	41	40
160.00	78	77	75	74	72	70	68	66	64	62	60	58	57	55	53	51	50	48	46	45	43	42	41	40
170.00	78	77	75	74	72	70	68	66	64	62	60	58	57	55	53	51	50	48	46	45	43	42	41	40

JET											SEC														
ANGLE	1	2	3	4	5	6	7	8	9	10	11	12	13	14	15	16	17	18	19	20	21	22	23	24	
10.00	65	65	65	65	63	62	60	59	57	55	54	53	51	50	48	47	45	44	42	41	39	38	36	35	
20.00	74	74	74	74	72	70	74	73	71	70	68	67	65	64	62	61	59	58	56	55	53	52	50	49	
30.00	67	67	67	67	65	64	62	61	59	58	56	55	53	52	50	49	47	46	44	43	41	40	38	37	
40.00	67	67	67	67	65	64	62	61	59	58	56	55	53	52	50	49	47	46	44	43	41	40	38	37	
50.00	72	72	72	72	70	69	67	66	64	63	61	60	58	57	55	54	52	51	49	48	46	45	43	42	
60.00	63	63	63	63	61	60	58	57	55	54	52	51	49	48	46	45	43	42	40	39	37	36	34	33	
70.00	64	64	64	64	62	61	59	58	56	55	53	52	50	49	47	46	44	43	41	40	38	37	35	34	
80.00	64	64	64	64	62	61	59	58	56	55	53	52	50	49	47	46	44	43	41	40	38	37	35	34	
89.90	66	66	66	66	64	63	61	60	58	57	55	54	52	51	49	48	46	45	43	42	40	39	37	36	
100.00	68	68	68	68	66	65	63	62	60	59	57	56	54	53	51	50	48	47	45	44	42	41	39	38	
110.00	68	68	68	68	66	65	63	62	60	59	57	56	54	53	51	50	48	47	45	44	42	41	39	38	
120.00	70	70	70	70	68	67	65	64	62	61	59	58	56	55	53	52	50	49	47	46	44	43	41	40	
130.00	71	71	71	71	69	68	66	65	63	62	60	59	57	56	54	53	51	50	48	47	45	44	42	41	
140.00	75	75	75	75	73	72	70	69	67	66	64	63	61	60	58	57	55	54	52	51	49	48	46	45	
150.00	78	78	78	78	76	74	72	70	69	67	66	64	63	61	60	58	57	55	54	52	51	49	48	46	45
160.00	78	78	78	78	76	74	72	70	69	67	66	64	63	61	60	58	57	55	54	52	51	49	48	46	45
170.00	78	78	78	78	76	74	72	70	69	67	66	64	63	61	60	58	57	55	54	52	51	49	48	46	45

TABLE 17
EPNL PROGRAM INPUT
(FAN, PRIMARY AND SECONDARY JET NOISE SPECTRUM)

ANGLE	FAN											BASE												
	1	2	3	4	5	6	7	8	9	10	11	12	13	14	15	16	17	18	19	20	21	22	23	24
10.00	64	69	74	79	84	89	94	99	104	109	114	119	124	129	134	139	144	149	154	159	164	169	174	179
20.00	67	72	77	82	87	92	97	102	107	112	117	122	127	132	137	142	147	152	157	162	167	172	177	182
30.00	71	76	81	86	91	96	101	106	111	116	121	126	131	136	141	146	151	156	161	166	171	176	181	186
40.00	75	80	85	90	95	100	105	110	115	120	125	130	135	140	145	150	155	160	165	170	175	180	185	190
50.00	79	84	89	94	99	104	109	114	119	124	129	134	139	144	149	154	159	164	169	174	179	184	189	194
60.00	83	88	93	98	103	108	113	118	123	128	133	138	143	148	153	158	163	168	173	178	183	188	193	198
70.00	87	92	97	102	107	112	117	122	127	132	137	142	147	152	157	162	167	172	177	182	187	192	197	202
80.00	91	96	101	106	111	116	121	126	131	136	141	146	151	156	161	166	171	176	181	186	191	196	201	206
90.00	95	100	105	110	115	120	125	130	135	140	145	150	155	160	165	170	175	180	185	190	195	200	205	210
100.00	99	104	109	114	119	124	129	134	139	144	149	154	159	164	169	174	179	184	189	194	199	204	209	214
110.00	103	108	113	118	123	128	133	138	143	148	153	158	163	168	173	178	183	188	193	198	203	208	213	218
120.00	107	112	117	122	127	132	137	142	147	152	157	162	167	172	177	182	187	192	197	202	207	212	217	222
130.00	111	116	121	126	131	136	141	146	151	156	161	166	171	176	181	186	191	196	201	206	211	216	221	226
140.00	115	120	125	130	135	140	145	150	155	160	165	170	175	180	185	190	195	200	205	210	215	220	225	230
150.00	119	124	129	134	139	144	149	154	159	164	169	174	179	184	189	194	199	204	209	214	219	224	229	234
160.00	123	128	133	138	143	148	153	158	163	168	173	178	183	188	193	198	203	208	213	218	223	228	233	238
170.00	127	132	137	142	147	152	157	162	167	172	177	182	187	192	197	202	207	212	217	222	227	232	237	242

ANGLE	JET											TOT												
	1	2	3	4	5	6	7	8	9	10	11	12	13	14	15	16	17	18	19	20	21	22	23	24
10.00	65	66	67	68	69	70	71	72	73	74	75	76	77	78	79	80	81	82	83	84	85	86	87	88
20.00	67	68	69	70	71	72	73	74	75	76	77	78	79	80	81	82	83	84	85	86	87	88	89	90
30.00	69	70	71	72	73	74	75	76	77	78	79	80	81	82	83	84	85	86	87	88	89	90	91	92
40.00	71	72	73	74	75	76	77	78	79	80	81	82	83	84	85	86	87	88	89	90	91	92	93	94
50.00	73	74	75	76	77	78	79	80	81	82	83	84	85	86	87	88	89	90	91	92	93	94	95	96
60.00	75	76	77	78	79	80	81	82	83	84	85	86	87	88	89	90	91	92	93	94	95	96	97	98
70.00	77	78	79	80	81	82	83	84	85	86	87	88	89	90	91	92	93	94	95	96	97	98	99	100
80.00	79	80	81	82	83	84	85	86	87	88	89	90	91	92	93	94	95	96	97	98	99	100	101	102
90.00	81	82	83	84	85	86	87	88	89	90	91	92	93	94	95	96	97	98	99	100	101	102	103	104
100.00	83	84	85	86	87	88	89	90	91	92	93	94	95	96	97	98	99	100	101	102	103	104	105	106
110.00	85	86	87	88	89	90	91	92	93	94	95	96	97	98	99	100	101	102	103	104	105	106	107	108
120.00	87	88	89	90	91	92	93	94	95	96	97	98	99	100	101	102	103	104	105	106	107	108	109	110
130.00	89	90	91	92	93	94	95	96	97	98	99	100	101	102	103	104	105	106	107	108	109	110	111	112
140.00	91	92	93	94	95	96	97	98	99	100	101	102	103	104	105	106	107	108	109	110	111	112	113	114
150.00	93	94	95	96	97	98	99	100	101	102	103	104	105	106	107	108	109	110	111	112	113	114	115	116
160.00	95	96	97	98	99	100	101	102	103	104	105	106	107	108	109	110	111	112	113	114	115	116	117	118
170.00	97	98	99	100	101	102	103	104	105	106	107	108	109	110	111	112	113	114	115	116	117	118	119	120

DELTA JET PRIMARY = 0.0

ANGLE	TURB											BASE												
	1	2	3	4	5	6	7	8	9	10	11	12	13	14	15	16	17	18	19	20	21	22	23	24
10.00	10	10	10	10	10	10	10	10	10	10	10	10	10	10	10	10	10	10	10	10	10	10	10	10
20.00	10	10	10	10	10	10	10	10	10	10	10	10	10	10	10	10	10	10	10	10	10	10	10	10
30.00	10	10	10	10	10	10	10	10	10	10	10	10	10	10	10	10	10	10	10	10	10	10	10	10
40.00	10	10	10	10	10	10	10	10	10	10	10	10	10	10	10	10	10	10	10	10	10	10	10	10
50.00	10	10	10	10	10	10	10	10	10	10	10	10	10	10	10	10	10	10	10	10	10	10	10	10
60.00	10	10	10	10	10	10	10	10	10	10	10	10	10	10	10	10	10	10	10	10	10	10	10	10
70.00	10	10	10	10	10	10	10	10	10	10	10	10	10	10	10	10	10	10	10	10	10	10	10	10
80.00	10	10	10	10	10	10	10	10	10	10	10	10	10	10	10	10	10	10	10	10	10	10	10	10
90.00	10	10	10	10	10	10	10	10	10	10	10	10	10	10	10	10	10	10	10	10	10	10	10	10
100.00	10	10	10	10	10	10	10	10	10	10	10	10	10	10	10	10	10	10	10	10	10	10	10	10
110.00	10	10	10	10	10	10	10	10	10	10	10	10	10	10	10	10	10	10	10	10	10	10	10	10
120.00	10	10	10	10	10	10	10	10	10	10	10	10	10	10	10	10	10	10	10	10	10	10	10	10
130.00	10	10	10	10	10	10	10	10	10	10	10	10	10	10	10	10	10	10	10	10	10	10	10	10
140.00	10	10	10	10	10	10	10	10	10	10	10	10	10	10	10	10	10	10	10	10	10	10	10	10
150.00	10	10	10	10	10	10	10	10	10	10	10	10	10	10	10	10	10	10	10	10	10	10	10	10
160.00	10	10	10	10	10	10	10	10	10	10	10	10	10	10	10	10	10	10	10	10	10	10	10	10
170.00	10	10	10	10	10	10	10	10	10	10	10	10	10	10	10	10	10	10	10	10	10	10	10	10

TABLE 18
EPNL PROGRAM INPUT
(FAN, TOTAL JET, AND TURBOMACHINERY NOISE SPECTRUM)

INLET	FANOUT	JET	EPNL	ALTITUDE	VEL	REL INM	TEMP	SIDLINE	OFFSET	GAMMA	ALPHA	DURATION	D EPNL	
1.0	0.0	0.0	20.0	4.465	98.13	370.00	254.00	70.00	59.00	0.0	0. -3.00	3.70	5.73	2.67
5.0	0.0	0.0	20.0	4.465	98.23	370.00	254.00	70.00	59.00	0.0	0. -3.00	3.70	5.53	3.57
10.0	0.0	0.0	20.0	4.465	97.58	370.00	254.00	70.00	59.00	0.0	0. -3.00	3.70	5.58	3.92
20.0	0.0	0.0	20.0	4.465	96.58	370.00	254.00	70.00	59.00	0.0	0. -3.00	3.70	5.26	5.21
30.0	0.0	0.0	20.0	4.465	96.50	370.00	254.00	70.00	59.00	0.0	0. -3.00	3.70	5.61	5.30
0.0	0.0	5.0	20.0	4.465	98.82	370.00	254.00	70.00	59.00	0.0	0. -3.00	3.70	5.43	3.18
5.0	0.0	5.0	20.0	4.465	97.59	370.00	254.00	70.00	59.00	0.0	0. -3.00	3.70	5.17	4.21
10.0	0.0	5.0	20.0	4.465	97.17	370.00	254.00	70.00	59.00	0.0	0. -3.00	3.70	5.20	4.63
20.0	0.0	5.0	20.0	4.465	95.58	370.00	254.00	70.00	59.00	0.0	0. -3.00	3.70	5.39	6.12
30.0	0.0	5.0	20.0	4.465	95.59	370.00	254.00	70.00	59.00	0.0	0. -3.00	3.70	5.65	6.21
0.0	0.0	10.0	20.0	4.465	98.78	370.00	254.00	70.00	59.00	0.0	0. -3.00	3.70	5.16	3.52
5.0	0.0	10.0	20.0	4.465	97.19	370.00	254.00	70.00	59.00	0.0	0. -3.00	3.70	4.94	4.61
10.0	0.0	10.0	20.0	4.465	96.70	370.00	254.00	70.00	59.00	0.0	0. -3.00	3.70	4.96	5.10
20.0	0.0	10.0	20.0	4.465	94.88	370.00	254.00	70.00	59.00	0.0	0. -3.00	3.70	5.28	6.92
30.0	0.0	10.0	20.0	4.465	94.77	370.00	254.00	70.00	59.00	0.0	0. -3.00	3.70	5.56	7.03
0.0	0.0	20.0	20.0	4.465	97.93	370.00	254.00	70.00	59.00	0.0	0. -3.00	3.70	4.81	3.87
5.0	0.0	20.0	20.0	4.465	95.58	370.00	254.00	70.00	59.00	0.0	0. -3.00	3.70	4.48	5.12
10.0	0.0	20.0	20.0	4.465	96.11	370.00	254.00	70.00	59.00	0.0	0. -3.00	3.70	4.47	5.69
20.0	0.0	20.0	20.0	4.465	93.89	370.00	254.00	70.00	59.00	0.0	0. -3.00	3.70	4.68	7.91
30.0	0.0	20.0	20.0	4.465	93.48	370.00	254.00	70.00	59.00	0.0	0. -3.00	3.70	4.93	8.12
0.0	0.0	30.0	20.0	4.465	98.00	370.00	254.00	70.00	59.00	0.0	0. -3.00	3.70	4.82	3.80
5.0	0.0	30.0	20.0	4.465	96.76	370.00	254.00	70.00	59.00	0.0	0. -3.00	3.70	4.47	5.04
10.0	0.0	30.0	20.0	4.465	96.17	370.00	254.00	70.00	59.00	0.0	0. -3.00	3.70	4.45	5.63
20.0	0.0	30.0	20.0	4.465	94.11	370.00	254.00	70.00	59.00	0.0	0. -3.00	3.70	4.59	7.69
30.0	0.0	30.0	20.0	4.465	92.71	370.00	254.00	70.00	59.00	0.0	0. -3.00	3.70	4.86	7.89
0.0	5.0	0.0	20.0	4.465	98.73	370.00	254.00	70.00	59.00	0.0	0. -3.00	3.70	6.32	3.07
5.0	5.0	0.0	20.0	4.465	97.58	370.00	254.00	70.00	59.00	0.0	0. -3.00	3.70	6.10	4.12
10.0	5.0	0.0	20.0	4.465	97.19	370.00	254.00	70.00	59.00	0.0	0. -3.00	3.70	5.88	4.61
20.0	5.0	0.0	20.0	4.465	96.47	370.00	254.00	70.00	59.00	0.0	0. -3.00	3.70	5.72	5.32
30.0	5.0	0.0	20.0	4.465	96.53	370.00	254.00	70.00	59.00	0.0	0. -3.00	3.70	5.77	5.27
0.0	5.0	5.0	20.0	4.465	98.14	370.00	254.00	70.00	59.00	0.0	0. -3.00	3.70	5.97	3.66
5.0	5.0	5.0	20.0	4.465	96.46	370.00	254.00	70.00	59.00	0.0	0. -3.00	3.70	5.70	4.86
10.0	5.0	5.0	20.0	4.465	96.35	370.00	254.00	70.00	59.00	0.0	0. -3.00	3.70	5.44	5.45
20.0	5.0	5.0	20.0	4.465	95.56	370.00	254.00	70.00	59.00	0.0	0. -3.00	3.70	5.75	6.24
30.0	5.0	5.0	20.0	4.465	95.62	370.00	254.00	70.00	59.00	0.0	0. -3.00	3.70	5.80	6.18
0.0	5.0	10.0	20.0	4.465	97.79	370.00	254.00	70.00	59.00	0.0	0. -3.00	3.70	5.73	4.01
5.0	5.0	10.0	20.0	4.465	96.64	370.00	254.00	70.00	59.00	0.0	0. -3.00	3.70	5.45	5.37
10.0	5.0	10.0	20.0	4.465	95.77	370.00	254.00	70.00	59.00	0.0	0. -3.00	3.70	5.19	6.03
20.0	5.0	10.0	20.0	4.465	94.84	370.00	254.00	70.00	59.00	0.0	0. -3.00	3.70	6.02	6.96
30.0	5.0	10.0	20.0	4.465	94.83	370.00	254.00	70.00	59.00	0.0	0. -3.00	3.70	5.81	6.97
0.0	5.0	20.0	20.0	4.465	97.33	370.00	254.00	70.00	59.00	0.0	0. -3.00	3.70	5.29	4.42
5.0	5.0	20.0	20.0	4.465	95.85	370.00	254.00	70.00	59.00	0.0	0. -3.00	3.70	4.94	5.95
10.0	5.0	20.0	20.0	4.465	95.84	370.00	254.00	70.00	59.00	0.0	0. -3.00	3.70	4.65	6.76
20.0	5.0	20.0	20.0	4.465	93.81	370.00	254.00	70.00	59.00	0.0	0. -3.00	3.70	5.38	7.99
30.0	5.0	20.0	20.0	4.465	93.74	370.00	254.00	70.00	59.00	0.0	0. -3.00	3.70	5.18	8.06
0.0	5.0	30.0	20.0	4.465	97.45	370.00	254.00	70.00	59.00	0.0	0. -3.00	3.70	5.29	4.35
5.0	5.0	30.0	20.0	4.465	95.93	370.00	254.00	70.00	59.00	0.0	0. -3.00	3.70	4.91	5.87
10.0	5.0	30.0	20.0	4.465	95.11	370.00	254.00	70.00	59.00	0.0	0. -3.00	3.70	4.61	6.69
20.0	5.0	30.0	20.0	4.465	94.00	370.00	254.00	70.00	59.00	0.0	0. -3.00	3.70	5.29	7.80
30.0	5.0	30.0	20.0	4.465	92.93	370.00	254.00	70.00	59.00	0.0	0. -3.00	3.70	5.10	7.87
0.0	10.0	0.0	20.0	4.465	98.37	370.00	254.00	70.00	59.00	0.0	0. -3.00	3.70	6.58	3.43
5.0	10.0	0.0	20.0	4.465	97.09	370.00	254.00	70.00	59.00	0.0	0. -3.00	3.70	6.42	4.71
10.0	10.0	0.0	20.0	4.465	96.39	370.00	254.00	70.00	59.00	0.0	0. -3.00	3.70	5.73	5.41
20.0	10.0	0.0	20.0	4.465	95.95	370.00	254.00	70.00	59.00	0.0	0. -3.00	3.70	5.05	5.85
30.0	10.0	0.0	20.0	4.465	95.91	370.00	254.00	70.00	59.00	0.0	0. -3.00	3.70	5.06	5.89
0.0	10.0	5.0	20.0	4.465	97.73	370.00	254.00	70.00	59.00	0.0	0. -3.00	3.70	6.21	4.07
5.0	10.0	5.0	20.0	4.465	96.35	370.00	254.00	70.00	59.00	0.0	0. -3.00	3.70	6.32	5.45
10.0	10.0	5.0	20.0	4.465	95.45	370.00	254.00	70.00	59.00	0.0	0. -3.00	3.70	5.79	6.35
20.0	10.0	5.0	20.0	4.465	94.85	370.00	254.00	70.00	59.00	0.0	0. -3.00	3.70	4.96	6.95
30.0	10.0	5.0	20.0	4.465	94.82	370.00	254.00	70.00	59.00	0.0	0. -3.00	3.70	4.99	6.98
0.0	10.0	10.0	20.0	4.465	97.35	370.00	254.00	70.00	59.00	0.0	0. -3.00	3.70	5.97	4.45
5.0	10.0	10.0	20.0	4.465	95.75	370.00	254.00	70.00	59.00	0.0	0. -3.00	3.70	6.06	6.05
10.0	10.0	10.0	20.0	4.465	94.73	370.00	254.00	70.00	59.00	0.0	0. -3.00	3.70	5.57	7.07
20.0	10.0	10.0	20.0	4.465	93.99	370.00	254.00	70.00	59.00	0.0	0. -3.00	3.70	5.27	7.81
30.0	10.0	10.0	20.0	4.465	93.96	370.00	254.00	70.00	59.00	0.0	0. -3.00	3.70	5.37	7.84
0.0	10.0	20.0	20.0	4.465	96.89	370.00	254.00	70.00	59.00	0.0	0. -3.00	3.70	5.49	4.91

TABLE 19a.
EPNL PROGRAM OUTPUT

**APPENDIX 1
EPNL PROGRAM DESCRIPTION**

PRECEDING PAGE BLANK NOT FILMED

PROGRAM DESCRIPTION

The object of this computer program is to use aircraft sound data to estimate the time pattern at other hypothetical observer locations and convert the projected sound into subjective units. The time history of an aircraft flyby is simulated using either stationary ground runup data, flyover data measured at other than requested conditions, or predicted data. Acceptable input consists of one-third octave band sound pressure levels (SPL) as a function of: (1) directivity angle at a constant polar radius, or (2) directivity angle at a constant sideline distance. Since these input spectra may be derived by other prediction methods, or may be actual test measurements, this computer program will be useful in all phases of aircraft development from preliminary design to final test. Output consists of SPL spectra for both the input and projected conditions with the results presented in terms of perceived noise level (PNL), tone corrected PNL (TCPNL), peak TCPNL, effective perceived noise level (EPNL, as defined by the FAA), and overall sound pressure level (OASPL).

The simulation technique consists of applying various corrections to the input SPL spectra to obtain the projected SPL spectra. Corrections due to the following effects are determined by this program: (1) spherical divergence, (2) atmospheric absorption, (3) extra ground attenuation, and (4) number of engines. Also, the program has the options to determine: (1) doppler shift effects and (2) tone corrected PNL and effective perceived noise level.

State-of-the-art techniques of sound calculation are incorporated in such a way that if the calculation procedures change and become standardized, this program can be easily modified. The basic idea is to control the correction effects by selection of the calculation techniques used. A program user controls the selection of computation by means of an input control card which selects the sequence of calculation subroutines. The subroutines are in a general form such that the conditions supplied by input determine the value of the corrections to be applied. Variations in noise characteristics might be achieved for example by considering doppler shift effects and extra ground attenuation for one simulation and neglecting these effects for another simulation.

Input Data

The input data can consist of three basic types of noise spectra: (1) SPL measurements on a polar arc around a stationary engine, (2) SPL measurements on a sideline parallel to the stationary engine, and (3) SPL measurements at a given location during an aircraft flyby. All data inputting is handled by the main program.

In discussing the input data, a set consists of the SPL measurements for one operating condition, and a case consists of one to four sets of data. A computer run consists of an unlimited number of cases and is terminated by an end-of-file card. This section of the report describes the data input cards in the sequence necessary for proper program execution. Unless specified in the writeup, the cards are needed only when indicated on the control card. A description of each storage array, where the numbers in parenthesis denote the dimensions of the array, is presented in the section on the main program.

Control Card

The first of each case must be a control card. Columns (1-30) are 30 one-digit indicators which

control the sequence of program execution and are stored in (MF(30)) in order. Columns (31–50) are 10 two-digit indicators which also control the sequence of execution and are stored in (MN(10)) in order. Column (51) is an indicator for the number of engines to be considered. In the following description of the indicators in Columns (1–50), blank values are considered as zeros and indicate no special action is to be taken.

<u>Column</u>	<u>Description</u>
(3)	(MF(3)) – For a value less than 0, the program expects the SPL input as a function of time. A value of 1 indicates one-quarter second input and a value of 2 indicates one-half second input.
(4)	(MF(4)) – For a value of 4, the program expects polar angle input using a format (F10., 12F5./10X, 12F5.).
(6) _{IN}	(MF(6)) – For any nonzero value, the program expects the SPL input as a function of a constant polar distance. For a zero value and also a zero value in (MF(3)), the program expects the SPL input as a function of a constant sideline distance.
(9)	(MF(9)) – For a zero value determine the pure tone correction.
(10)	(MF(10)) – For a value of 1, apply engine shielding effect.
(11)	(MF(11)) – For a value of 1, generate card output for EPNL trade study.
(16)	(MF(16)) – Generate the attenuation trades internally.
(17)	(MF(17)) – For a value of 1, omit the relative jet velocity correction.
(18)	(MF(18)) – For a value of 1, read a card which indicates the uniform jet suppression value.
(19)	(MF(19)) – For a value of 1, use the short form printout.
(20)	(MF(20)) – For a value of 1, use the long form printout.
(21)	(MF(21)) – For a value of 1, the SPLJE array is interpreted as the primary jet noise spectrum.
(22)	(MF(22)) – For a value of 1, develop a footprint output.
(24)	(MF(24)) – For a value of 1, determine the doppler shift effect.
(25)	(MF(25)) – For a value of 1, the SPL24 array is interpreted as the fan noise and secondary jet noise spectrum.
(26)	(MF(26)) – For a value of 1, omit any jet noise correction for irregularities.
(27)	(MF(27)) – For a value of 1, input the turbine noise spectrum.

- (28) (MF(28)) – For any nonzero value, the program suppresses the correction calculation for extra ground attenuation. A value of 1 suppresses the correction for the predicted data. A value of 2 suppresses the correction for both input and predicted data.
- (29) (MF(29)) – For a value of 1, the program expects component noise spectrum. It also expects data cards specifying the peak attenuation which is applied to an attenuation spectrum.
- (30) (MF(30)) – For a value of 1, the program expects a card describing a new condition (such as velocity, altitude, etc.).
- (1) (MN(1)) – Number of input cases.
- (2) (MN(2)) – Number of polar angles.
- (3) (MN(3)) – Number of 1/3 octave bands (24).
- (5) (MN(5)) – Number of flight profile sections.
- (6) (MN(6)) – Number of R.P.M. inputs.
- (8) (MN(8)) – Number of modes summed.
- (9) (MN(9)) – Number of grid line points.
- (10) (MN(10)) – Number of attenuations.

Input Condition Card

This card is automatically read (FORMAT 9F8.0) and is the first card of a series of data sets (number of sets indicated by (MN(1))). The numbers in each field are stored in sequence in (H(3,4); V(3,4); HREL (3,4); TEMP (3,4); X(3,4); Y (3,4); GAMM (2); ALP 2; VMJET). Field one is the polar distance (field two = 0) or altitude of the aircraft in feet; field two is the aircraft speed in feet per second; field three is the atmospheric relative humidity in percent; field four is the atmospheric temperature in °F; field five is the sideline distance in feet; field six is the parallel offset distance in feet; field seven is the climb gradient in degrees; field eight is the angle of attack in degrees; field nine is the jet velocity at the aircraft speed in feet per second.

Prediction Condition Card

This card is automatically read (FORMAT 9F8.0) and must follow the input condition card. The information on this card (corresponding field for field with the first nine fields of the input condition card) describes the conditions of the projected data.

Spectral Data Cards

These cards are read according to the format (F10.3, 12F5.2/10X, 12F5.2). Information on these cards is stored in SPL24, SPLJE, SPLREF, and SPLTU. Each spectral set is preceded by a data card containing an identifier, the jet velocity at zero airplane velocity (if applicable), and a title descriptor (FORMAT 2F10., 13A4). After the array SPLJE is read in, the card describing the attenuation spectra are to be read in where CAT is the maximum value in the array ATEN.

Output

The output from this program consists of printed, plotted, and/or punched parameters. All printing, plotting, and punching of the output data are controlled by the program user by control card indicators.

Printed Output

At the start of a case, the title, control indicators, and the conditions describing the input and predicted spectra are printed. The input SPL data and the predicted SPL, PNL, OASPL, and EPNL values are automatically printed. IF $MF(19) = 1$ and $MF(20) = 0$, a special short form printout is used showing the essential flight and environmental parameters, the peak attenuation values, the time duration factor, the relative change in EPNL, and a counter indicating the number of runs made.

Punched Output

The punched output consists of one card for each run ($MF(11) = 1$). The card contains the peak attenuations, the jet noise identifier, the EPNL level, the change in EPNL, and a counter indicating the number of runs made.

Main Control Program

The main control program has general control over input, order of solution, and output throughout the computer run. This is done by calling into operation specialized subroutines in a controlled logical order.

APPENDIX 2
EPNL PROGRAM FLOW CHART

MAIN PROGRAM

EPNL 304014 01 - 17
EFFECTIVE PERCEIVED NOISE LEVEL
220 FORMAT 11X, F6.2, 1X, 24F4.01

DO 000 J=1,24

800 FL0C24(J)=AL0C10(FREQ24(J))

10 READ (5,25,END=99901)
1 MF,MM,ENGINE

4B

C INITIALIZATION

NJ = 1
FJAST1 = .TRUE.

C NJ IS THE NO. OF ANGLES, MM IS THE NO. OF FREQ. BANDS

NJ=1
NI=MM(2)
NK=MM(3)
NSPAIN=MF(18)
NLPAIN=MF(20)
MM=1
NB=1
NID=1
B3=0.0
NCF=2

IF (MF(25) .EQ. 1)
NCF=4

DELJET = 0.0

DO 502 NC=1,4

ATEM(NC)=0.
CAT INCI=0.

DO 502 NB=1,24

502 ATER (NB, NC)=100.

READ (5,1001) TITLE
WRITE (P00F,511) MF (JCM), JCM=1,101
WRITE (P00F,512) MF (JCM), JCM=11,201
WRITE (P00F,513) MF (JCM), JCM=21,301
WRITE (P00F,514) MM (JCM), JCM=1,101...ENGINE
WRITE (P00F,351)
1 MF,MM,ENGINE,TITLE

J=1

READ (5,1011) J1, Y11, J1, HREL (1, J1), TEMP (1, J1), X11, J1, Y11, J1,
1 GAMM (1), ALP1, VMJET
2 H12, J1, Y12, J1, HREL (2, J1), TEMP (2, J1), X12, J1, Y12, J1, GAMM (2), ALP2
3 VMJET

ALPH (1) = ALP1 + GAMM (1)
C (1) = 48.82 + SBAT (TEMP (1, 1)) + 459.671
SLD = SBAT (H12, 1) ** 2 * X12, 1 ** 2
SLD1 = SBAT (H11, 1) ** 2 * X11, 1 ** 2

WRITE (P00F,361)
1 H11, J1, Y11, J1, HREL (1, J1), TEMP (1, J1), X11, J1, Y11, J1,
2 SLD1, GAMM (1), ALP1, VMJET
3 H12, J1, Y12, J1, HREL (2, J1), TEMP (2, J1), X12, J1, Y12, J1,
4 SLD, GAMM (2), ALP2, VMJET

1A

2A

PRECEDING PAGE BLANK NOT FILMED

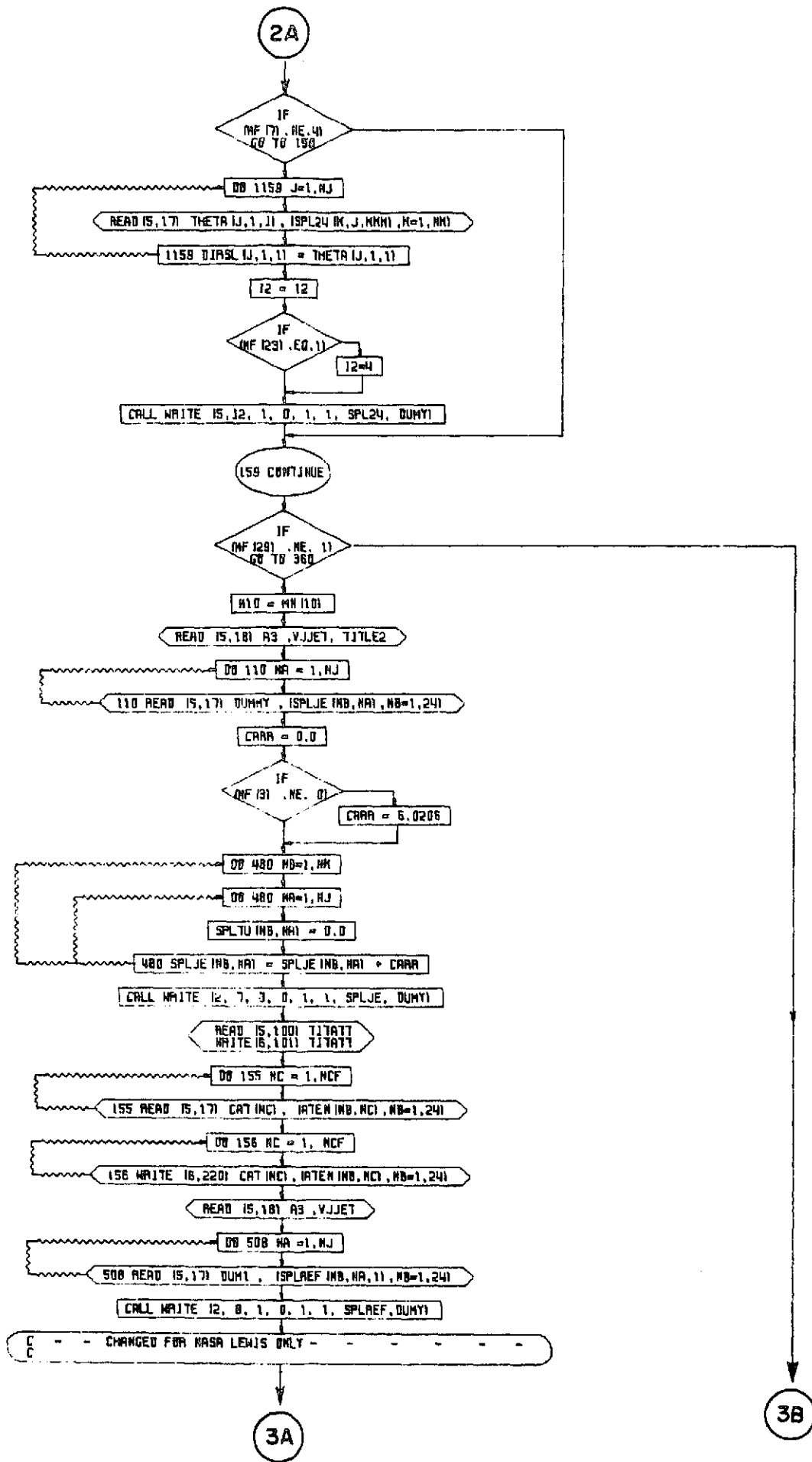

3A

IF (MF 118) .GT. 0

READ 15,17) DELJET

IF (MF 125) .EQ. 0
GO TO 352

DO 108 NA =1, N3

DO 109 NB =1, 24

IF (MF 123) .GT. 0
GO TO 107

IF (SPL24 (NB, NA, KKK) .GT.
SPLREF (NB, NA, 1))
GO TO 108

WRITE 16,41) NA, NB, SPL24 (NB, NA, KKK), SPLREF (NB, NA, 1)

SPLREF (NB, NA, 1) = SPL24 (NB, NA, KKK) - 1.0

108 CONTINUE

107 IF (MF 123) .EQ. 0

SPL24 (NB, NA, 1) = 1.0, = ALOG10 (1.0, = (SPL24 (NB, NA, KKK) * 1) - 1.0, = (SPLREF (NB, NA, 1) * 1.1))

IF (MF 121) .EQ. 1

SPLJE (NB, NA) = 1.0, = ALOG10 (1.0, = (SPLJE (NB, NA) - DELJET) * 1.1) + 1.0, = (SPLREF (NB, NA, 1) * 1.1))

109 SPLREF (NB, NA, 1) = 0.0

GO TO 350

C - - - - - TO HERE - - - - -

352 CALL JSPIET

350 CALL WRITE 15, 1, 1, 0, 1, 1, SPL24, DUMY)
CALL WRITE 12, 9, 0, 0, 1, 1, SPLJE, DUMY)

WRITE 16,42) DELJET

IF (MF 127) .EQ. 0
GO TO 360

READ 15,18) A4, VTJET

DO 112 NA =1, N3

112 READ 15,17) DUMYTT, ISPLTU (NB, NA), NB=1,24)

CALL WRITE 13, 1, 1, 0, 1, 1, SPLTU, DUMY)

360 CONTINUE

4A

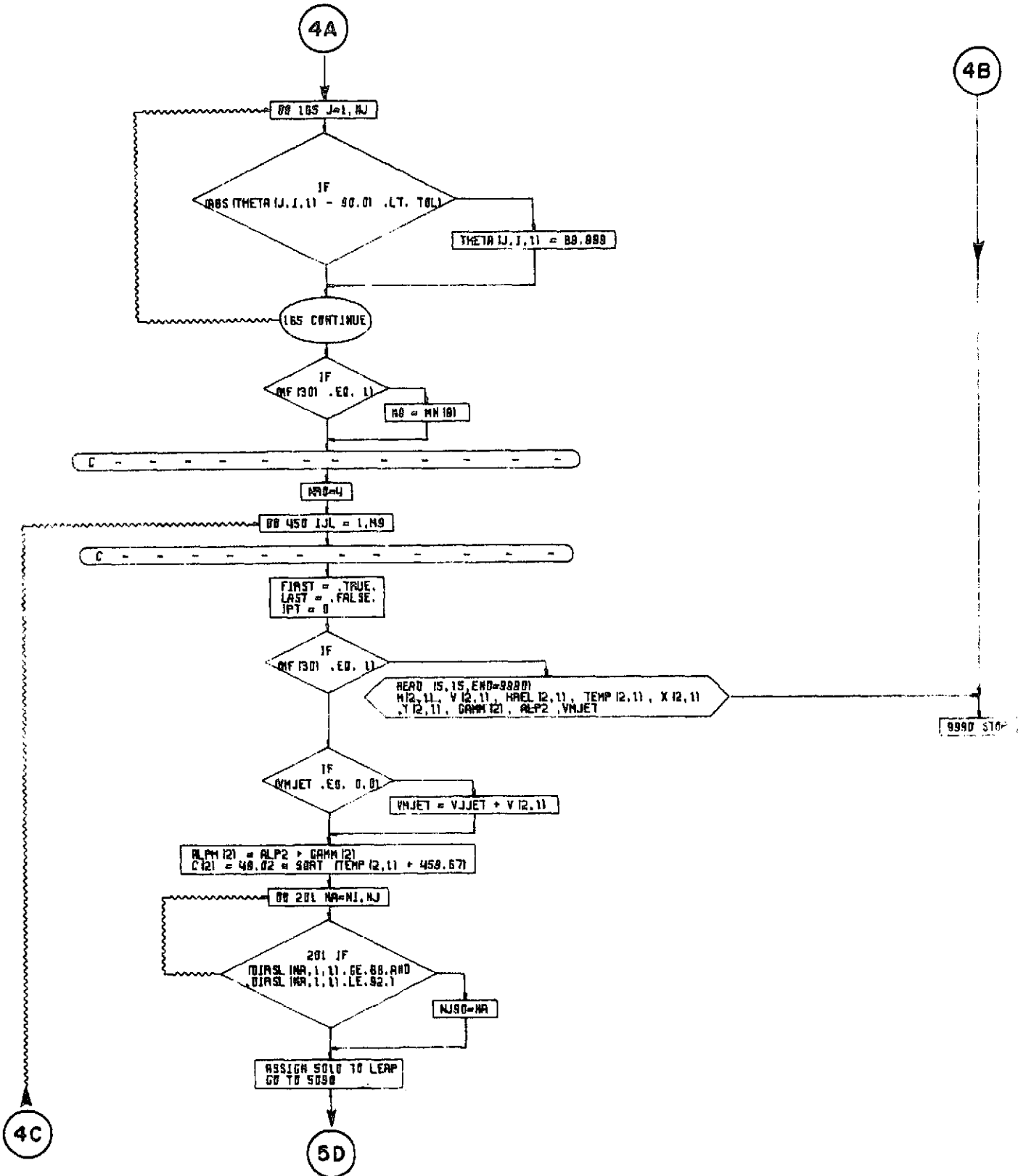

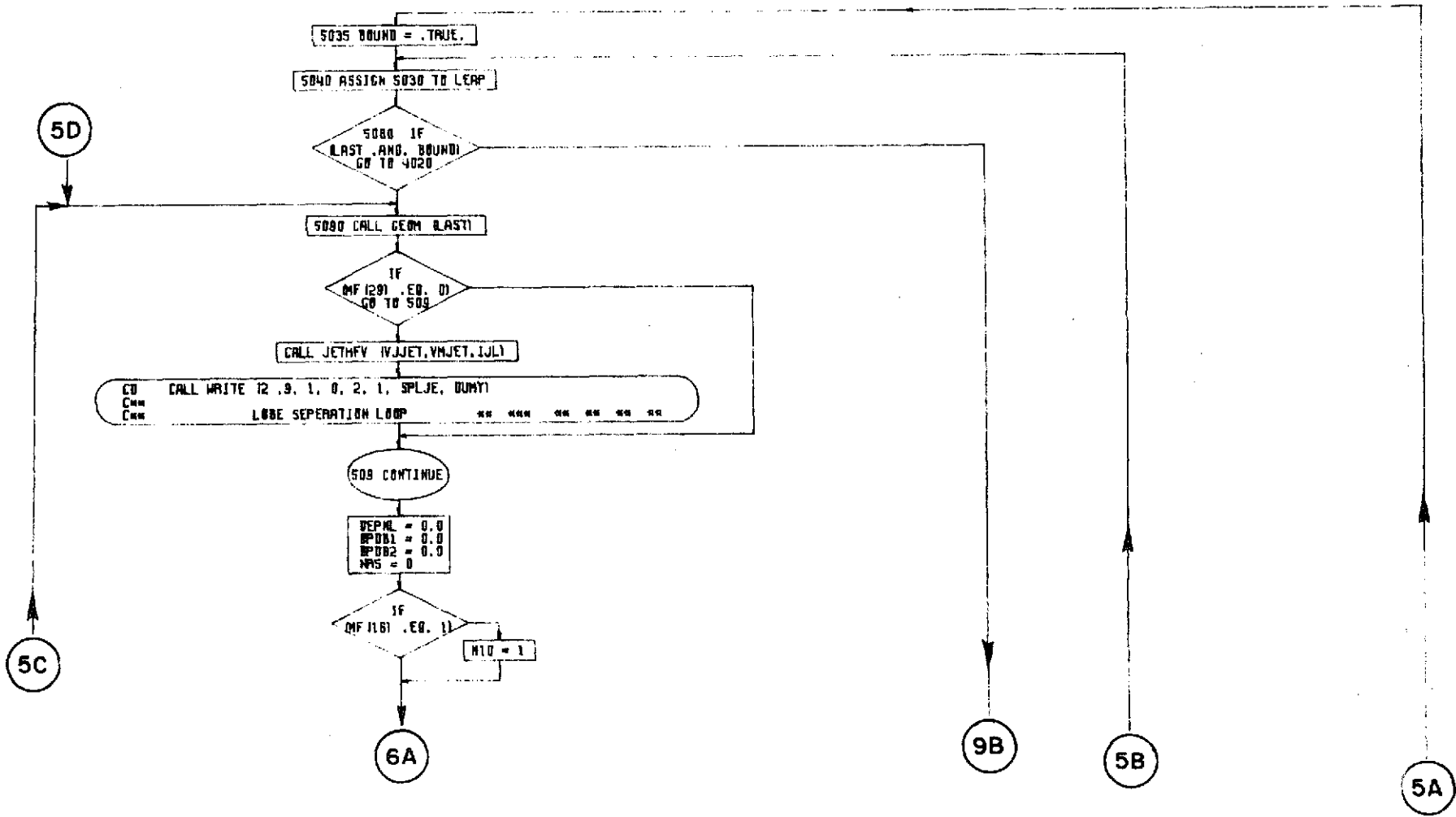

(6A)

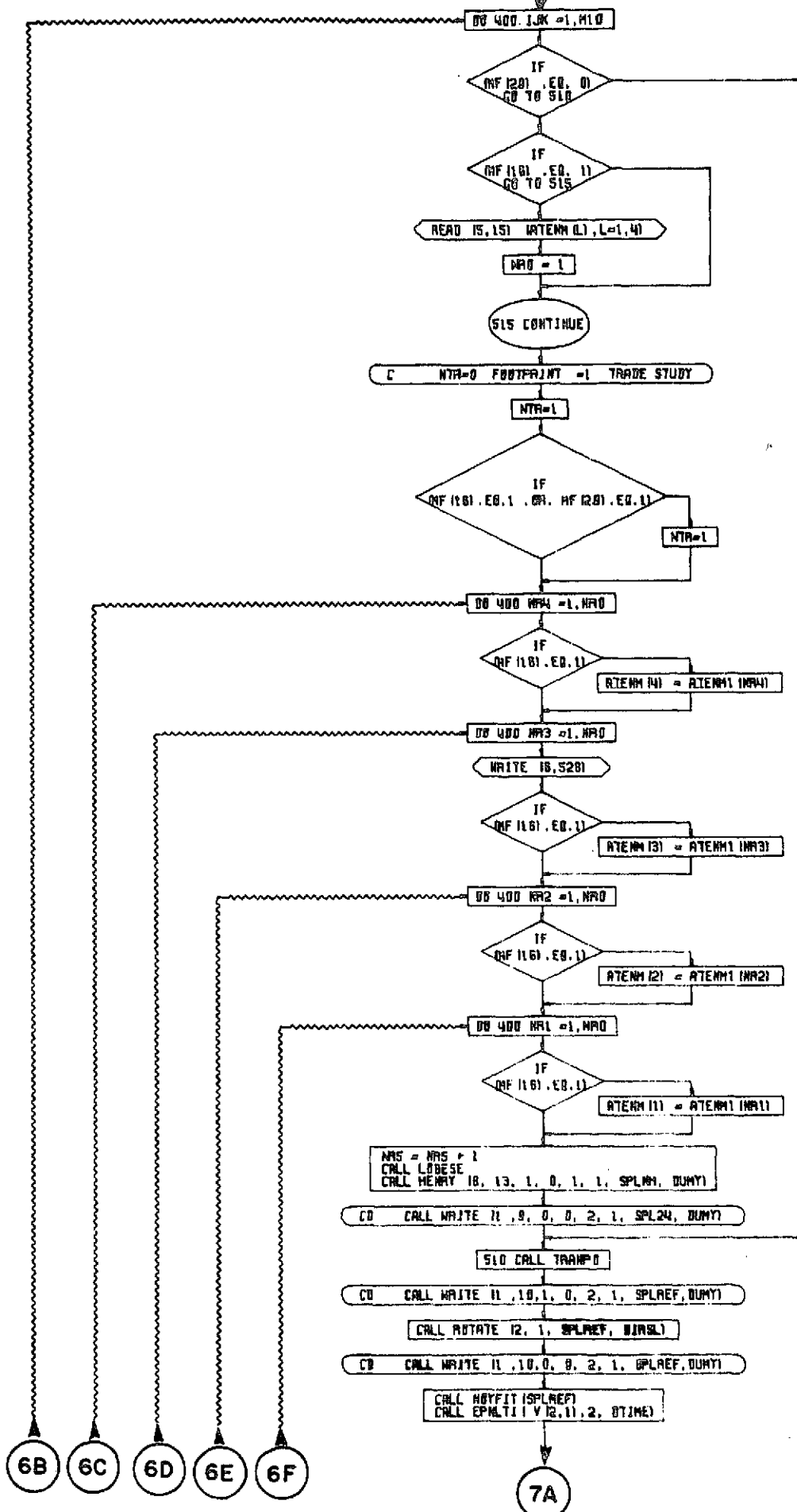

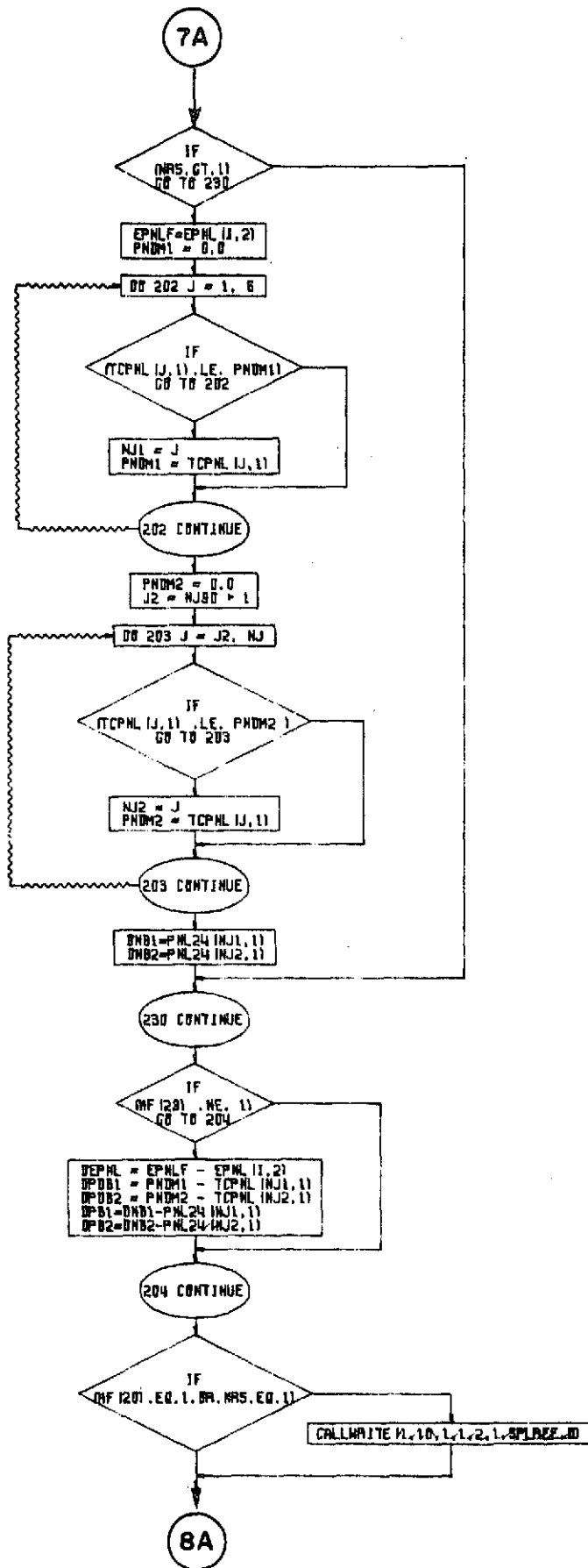

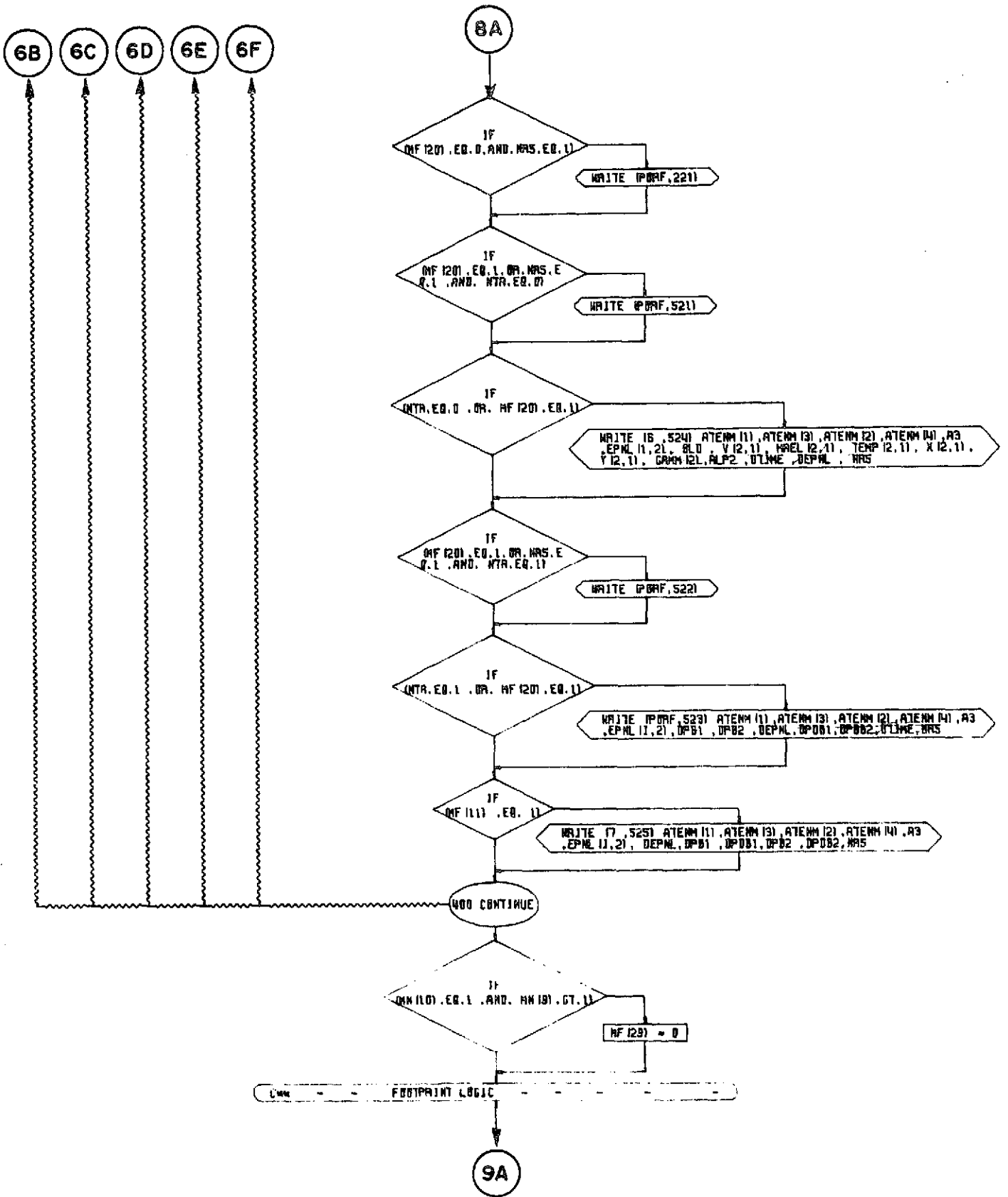

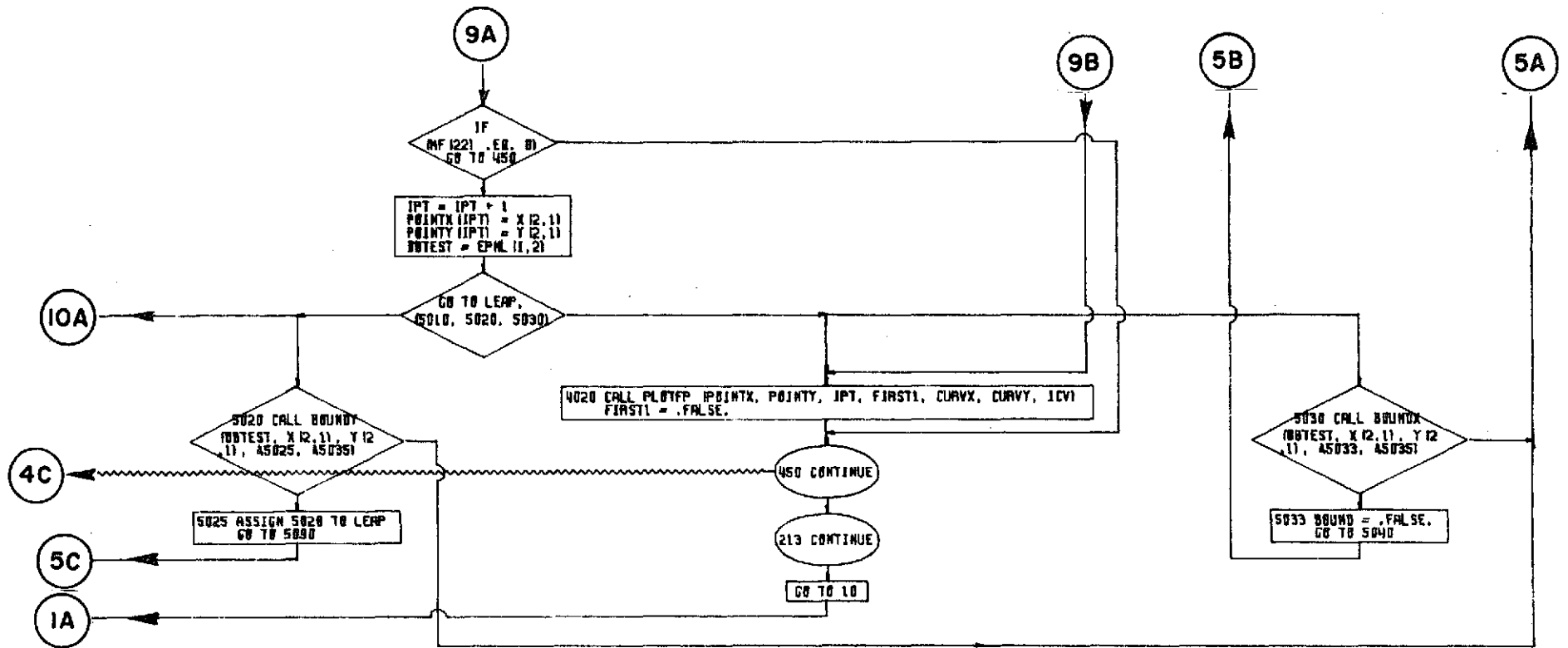

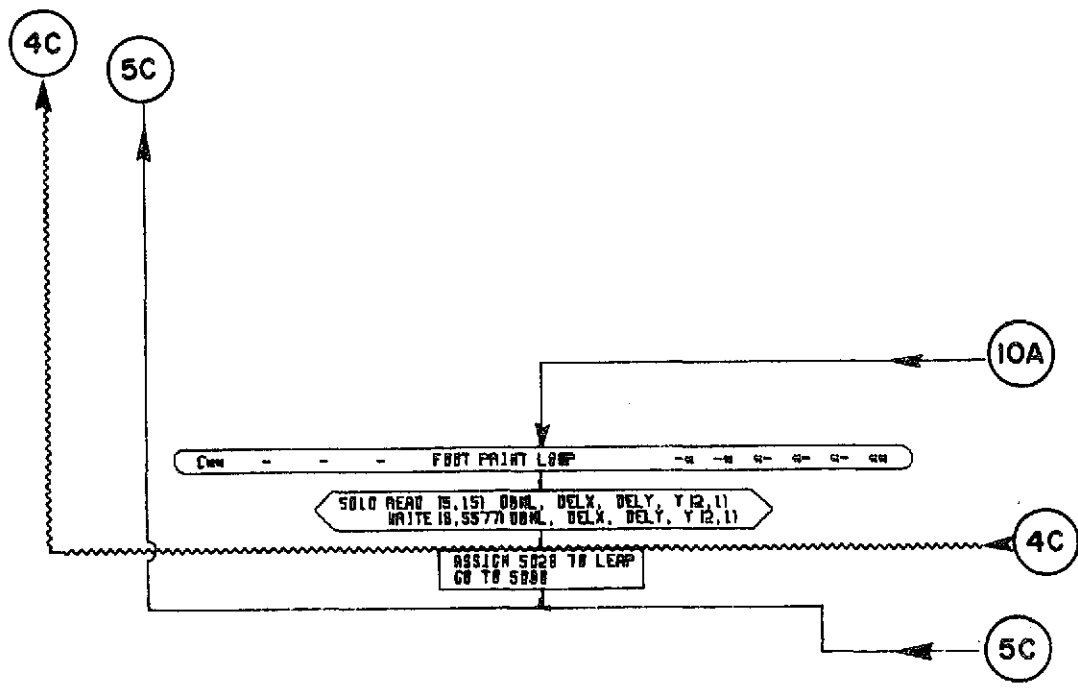

SUBROUTINE WRITE IJJ, JJ, K, L, M, N, SPL24, TITLE 1

ZON914 23 - 23

```

JJ      TITLE 1 SUBSCRIPT
JJ      TITLE 2 SUBSCRIPT
K       = 1  SKIP PAGE
L       = 0  SPL ARRAY ONLY
L       = 1  COMPLETE OUTPUT
M       = 1  INPUT CONDITIONS
M       = 2  TRANSLATED CONDITIONS
N       VALUE OF THE THIRD SUBSCRIPT ON ALL 3-D ARRAYS
SPL24   SPL ARRAY
TITLE   USED IN EPNL 2
    
```

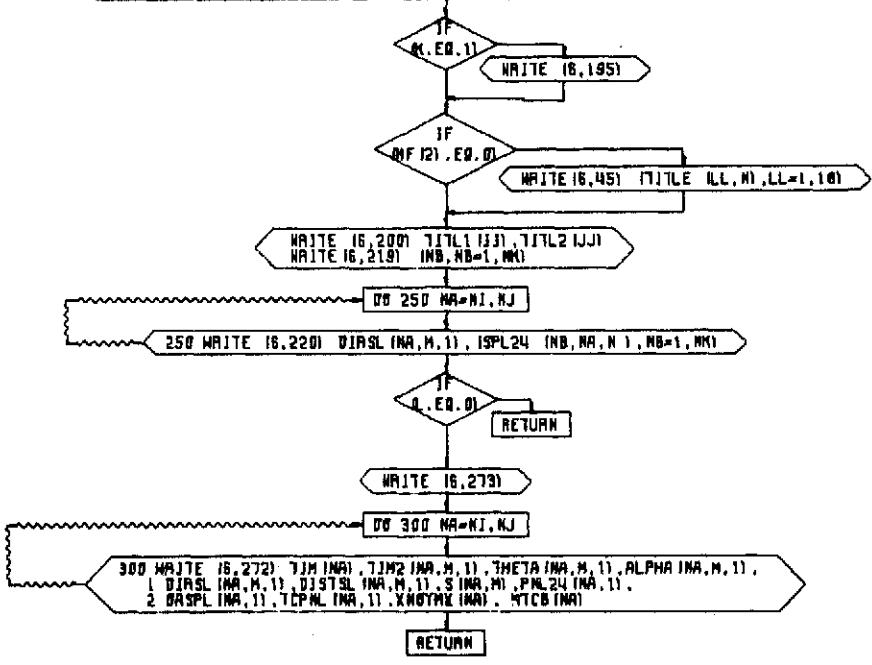

SUBROUTINE JSHIFT

ZDMS14 24 - K7

KKK = 1
 NN = 10
 NNB = 15
 NN2 = NNB + 1

IF (MF (28) .EQ. 1)
 GO TO 400

CALL JET9NB (SPLJE)
 CALL JET9NB (SPLRB)

400 DO 500 NB = 1, 24

DO 500 NA = N1, N2

SPLREF (NB, NA, 1) = SPLJE (NB, NA) - SPLREF (NB, NA, 1)

IF (SPLJE (NB, NA) .GE. SPL24 (NB, NA, KKK))
 SPLJE (NB, NA) = SPL24 (NB, NA, KKK) - 1.0

500 CONTINUE

IF (MF (26) .EQ. 1)
 RETURN

90 485 NA = N1, N2

SAV1 = SPLJE (NB, NA)

DO 510 NB = 1, KKB

SPLJE (NB, NA) = SPL24 (NB, NA, KKK) - SHARK (NB)

IF (SPL24 (NB, NA, KKK) .LE. SPLJE (NB, NA))
 SPLJE (NB, NA) = SPL24 (NB, NA, KKK) - 4.0

510 SPLJE (NB, NA) = 10. * AL0610 (10. * (SPL24 (NB, NA, KKK) * .1) - 10. * (SPLJE (NB, NA) * .1))

SAV1 = SPLJE (NB, NA) - SAV1

DO 485 NB = NB2, 24

SPLJE (NB, NA) = SPLJE (NB, NA) + SAV1

IF (SPLJE (NB, NA) .LE. SPL24 (NB, NA, KKK))
 GO TO 485

SAV1 = SPL24 (NB, NA, KKK) * .05 - (SPLJE (NB, NA) - SAV1)
 SPLJE (NB, NA) = SPL24 (NB, NA, KKK) * .05

485 CONTINUE

RETURN

SUBROUTINE JETSMO ISPLJEI

C * * * * * ZDM914 25 - KT * * * * *
C * * * * *

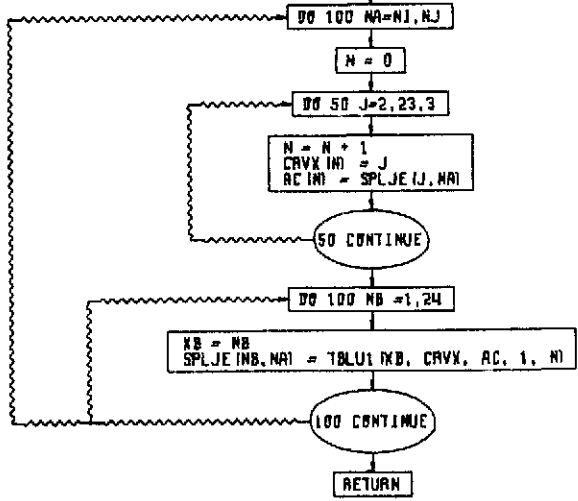

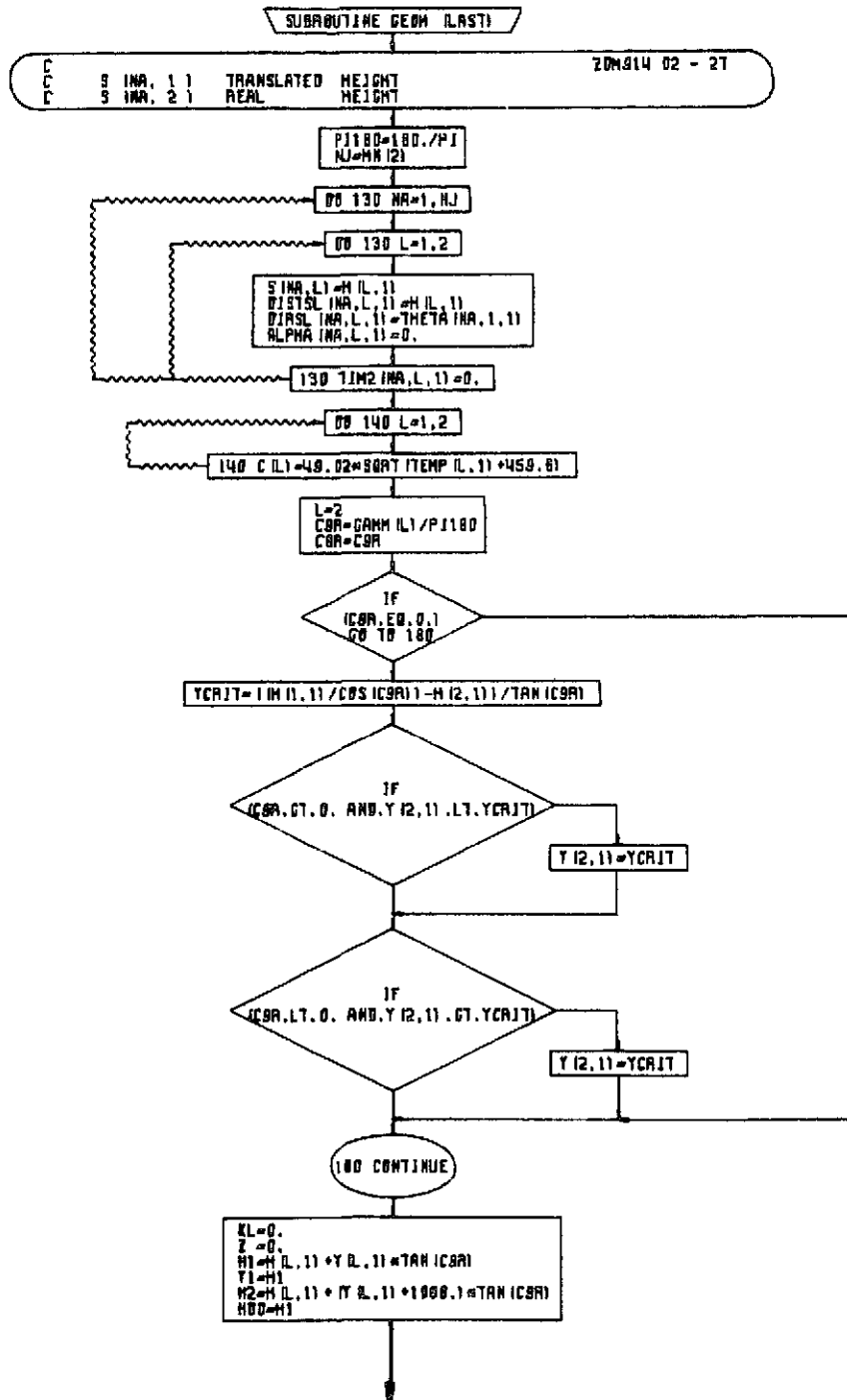

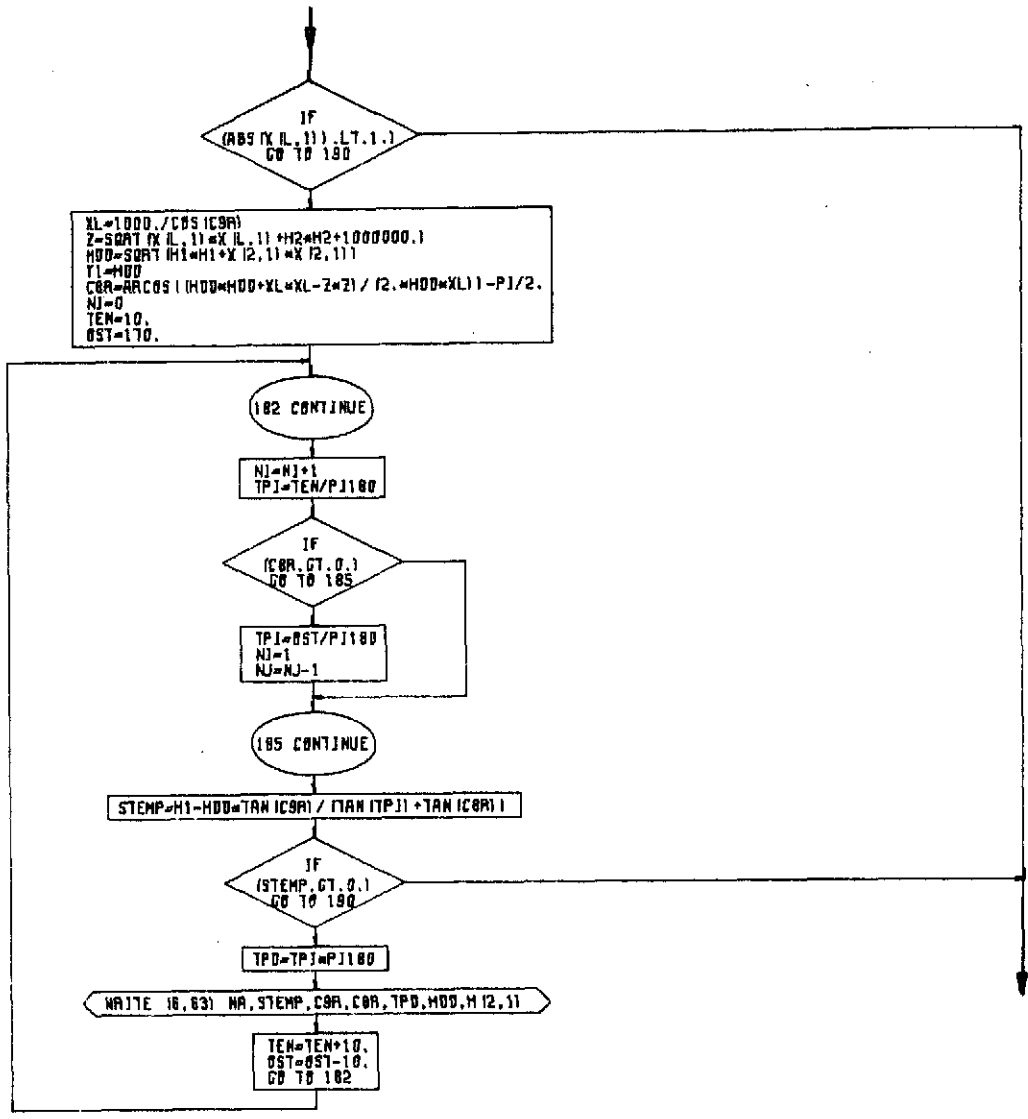

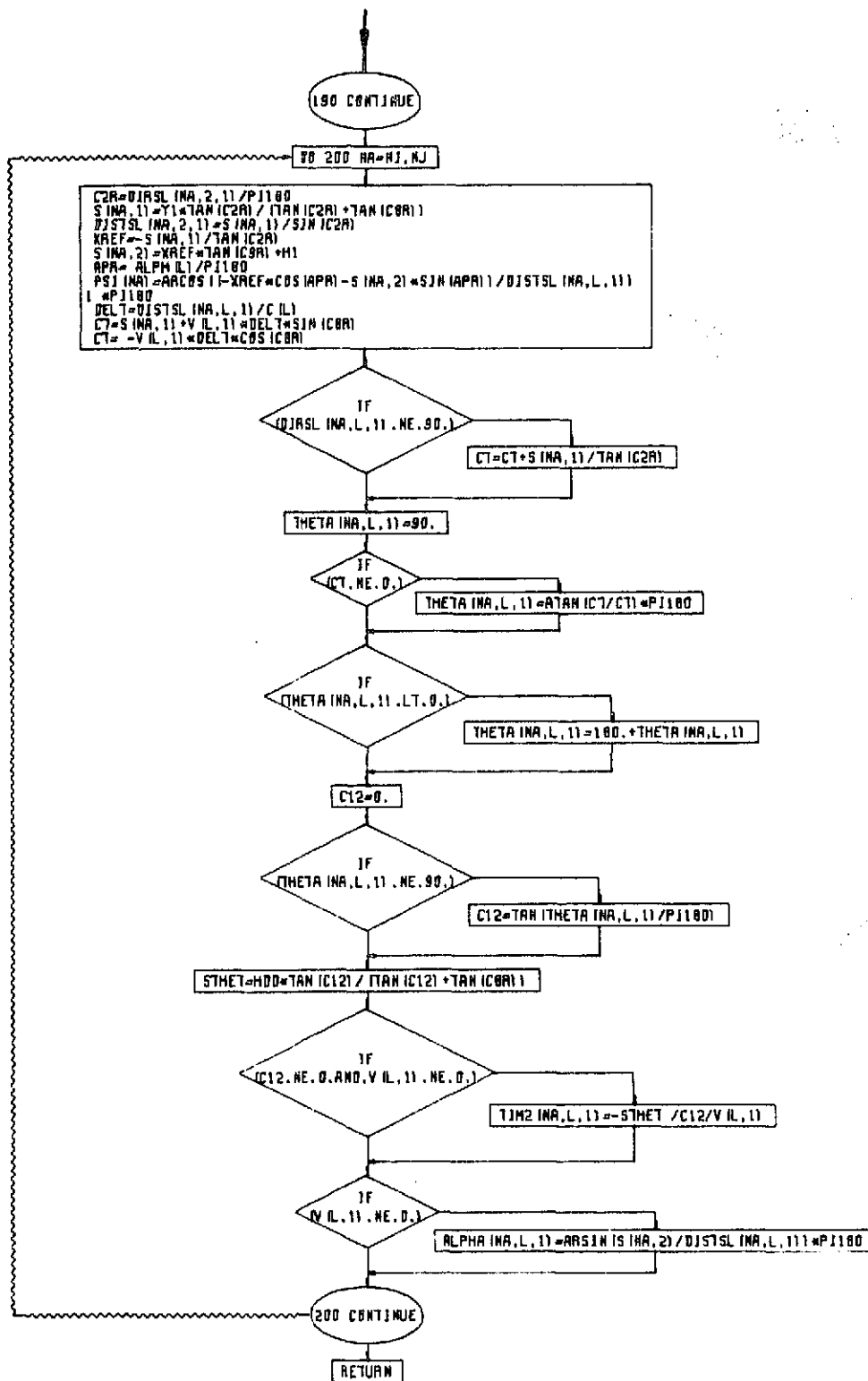

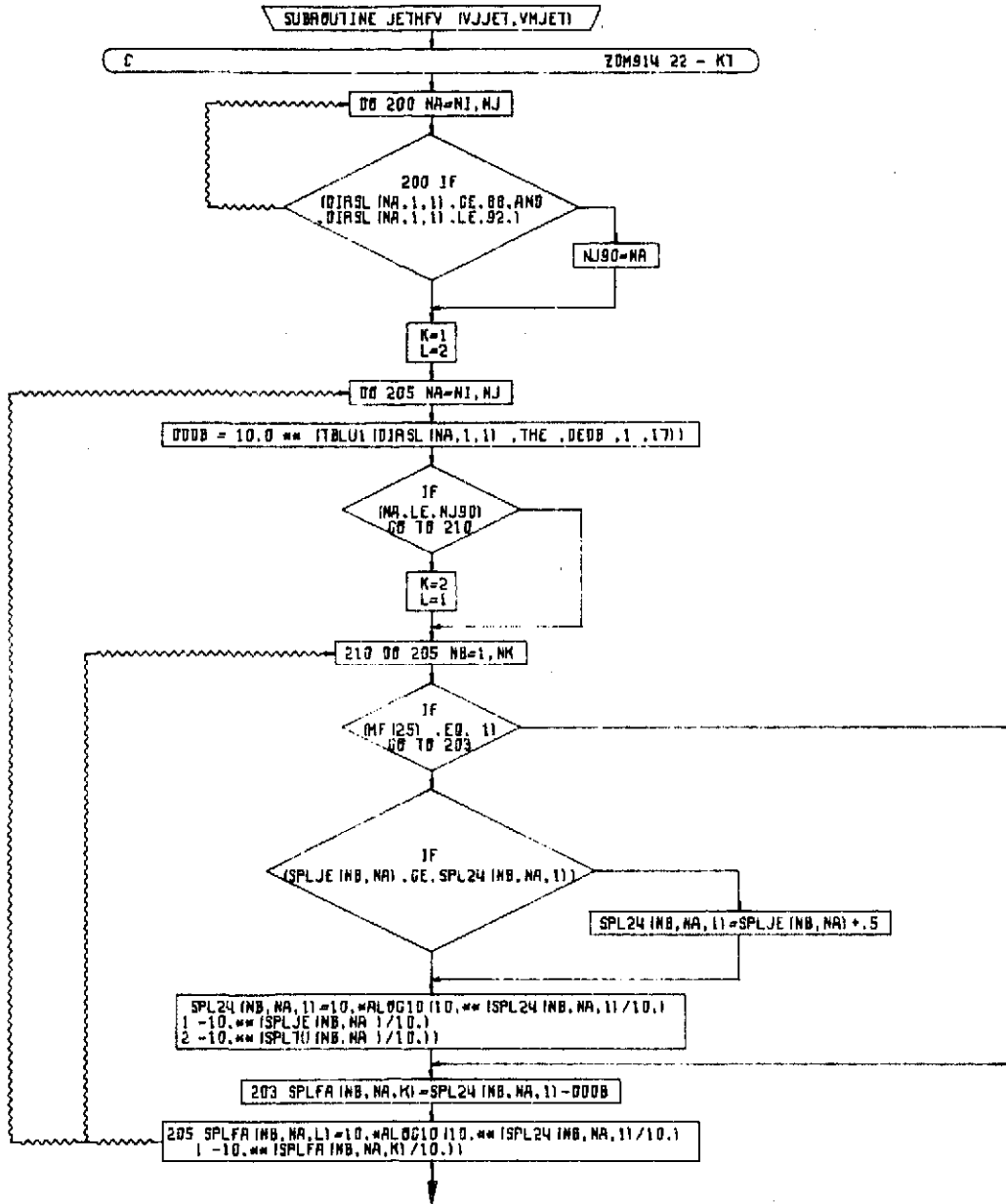

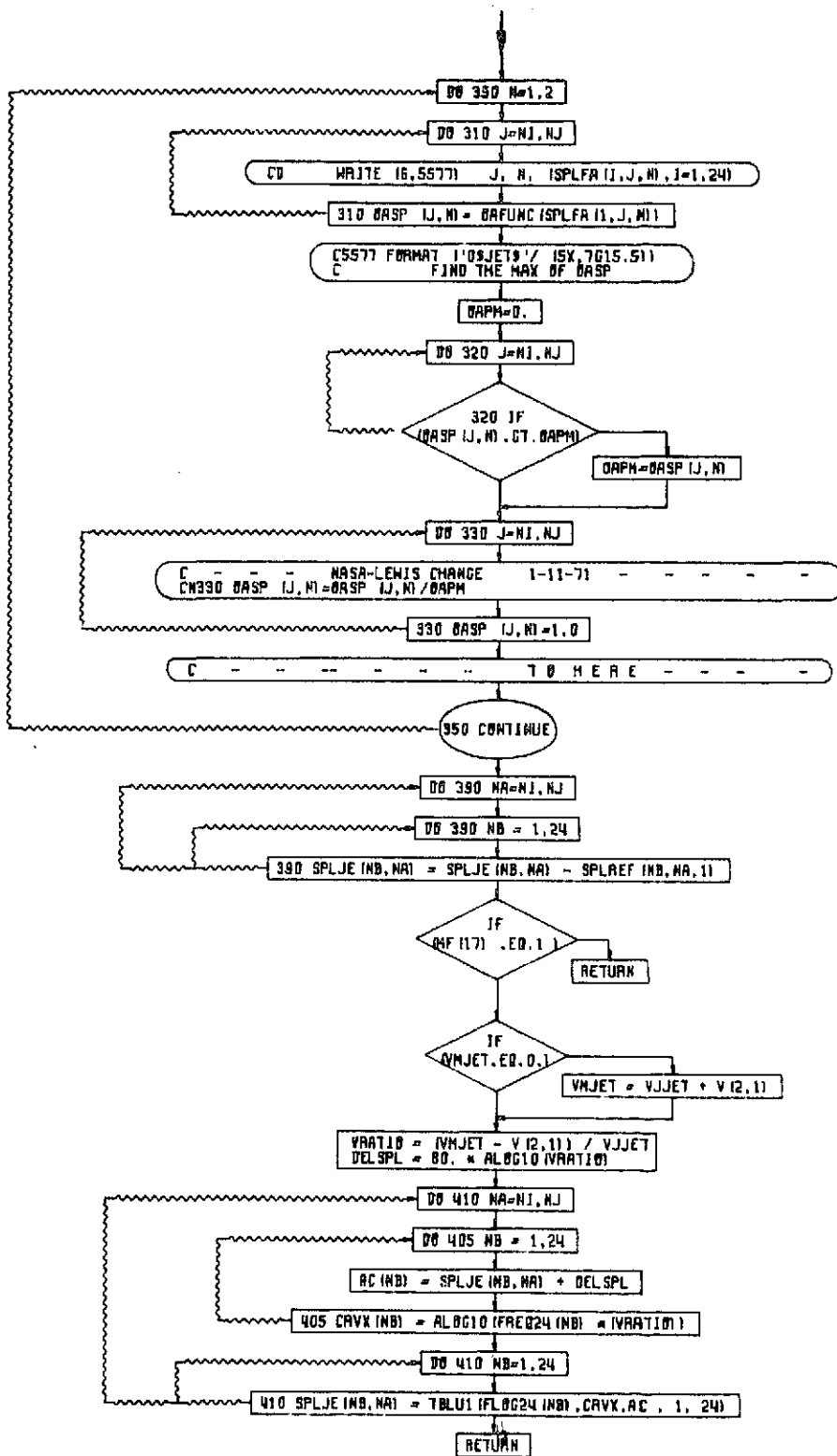

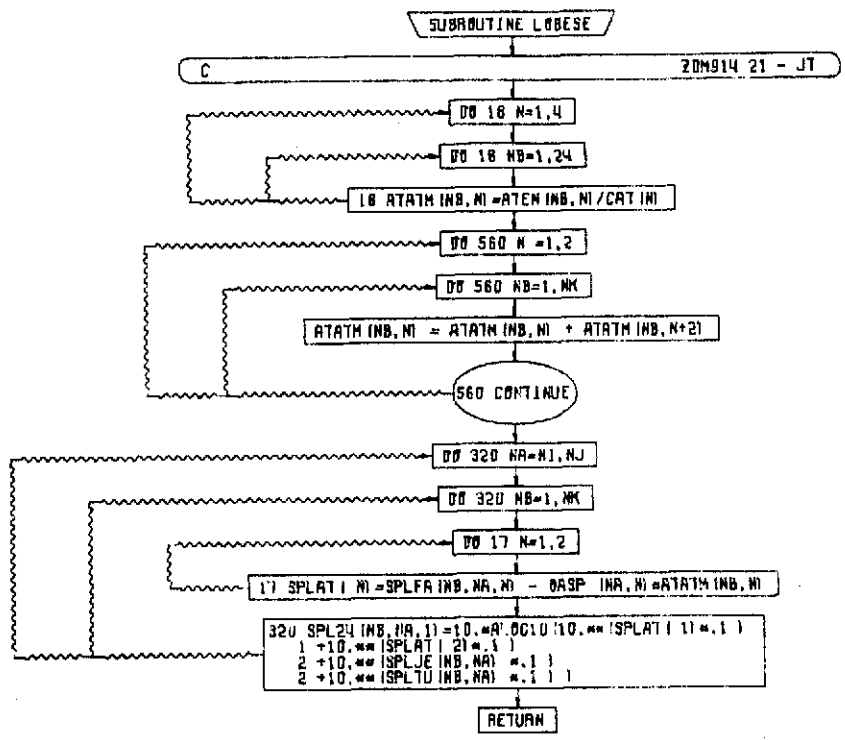

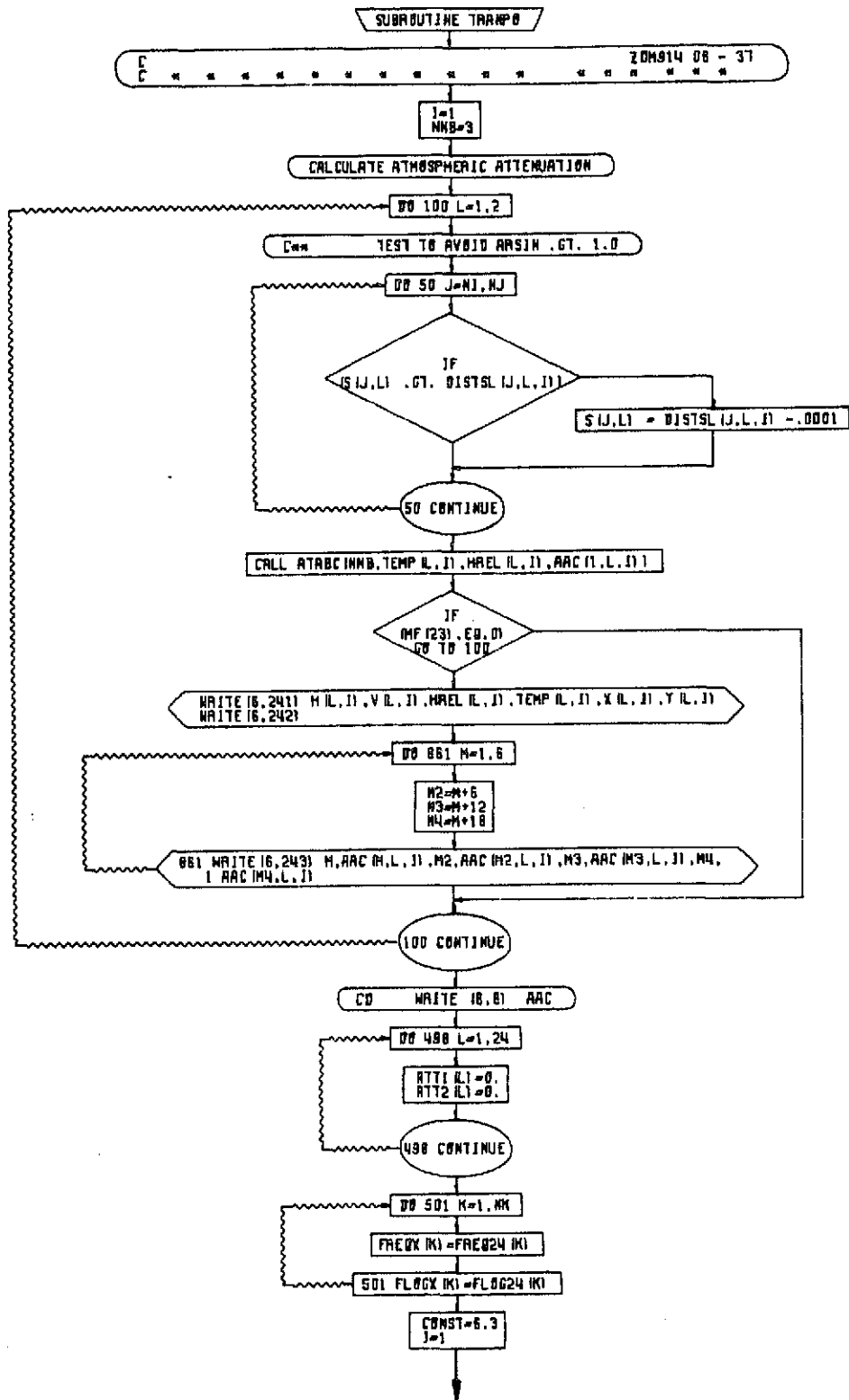

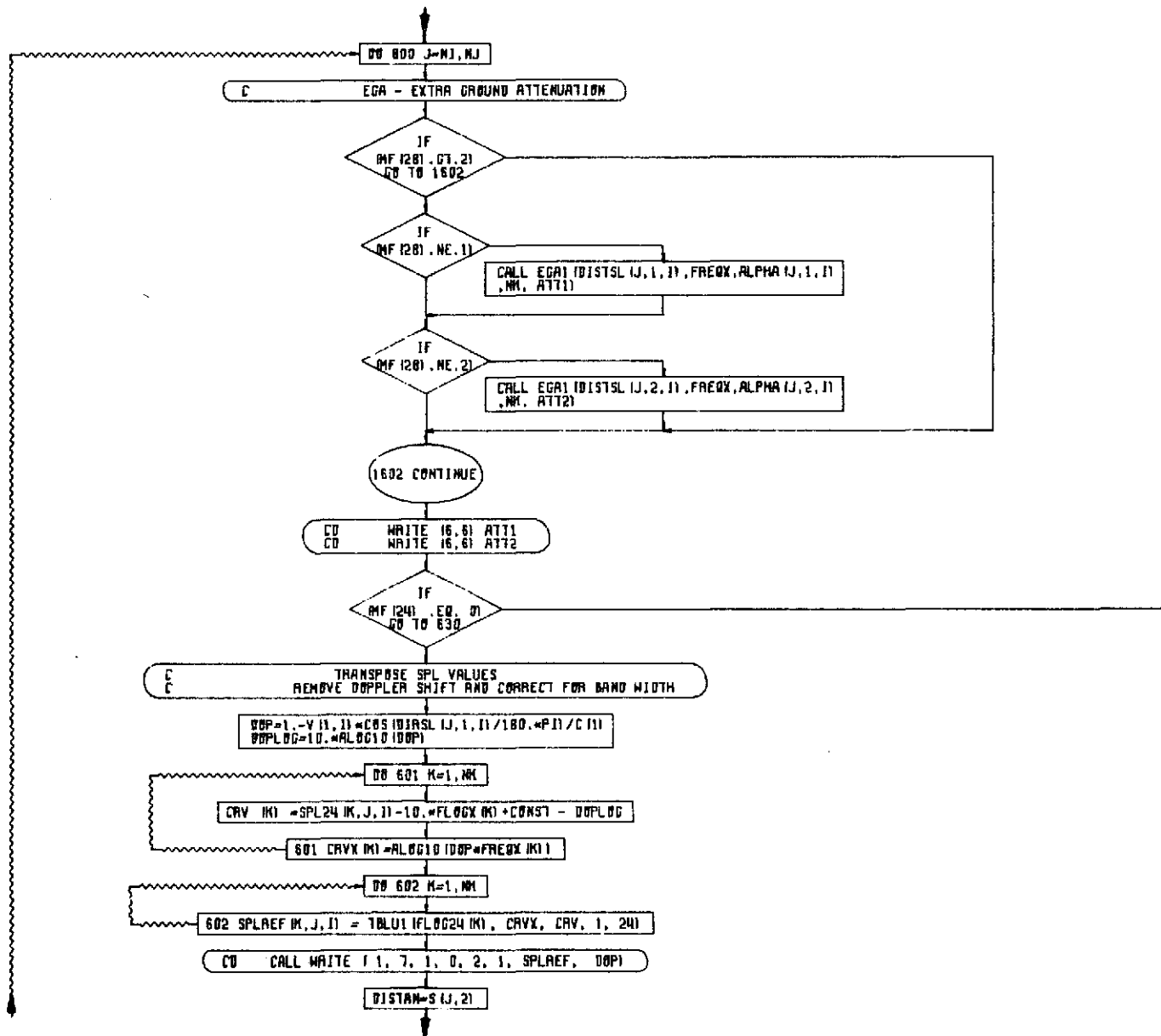

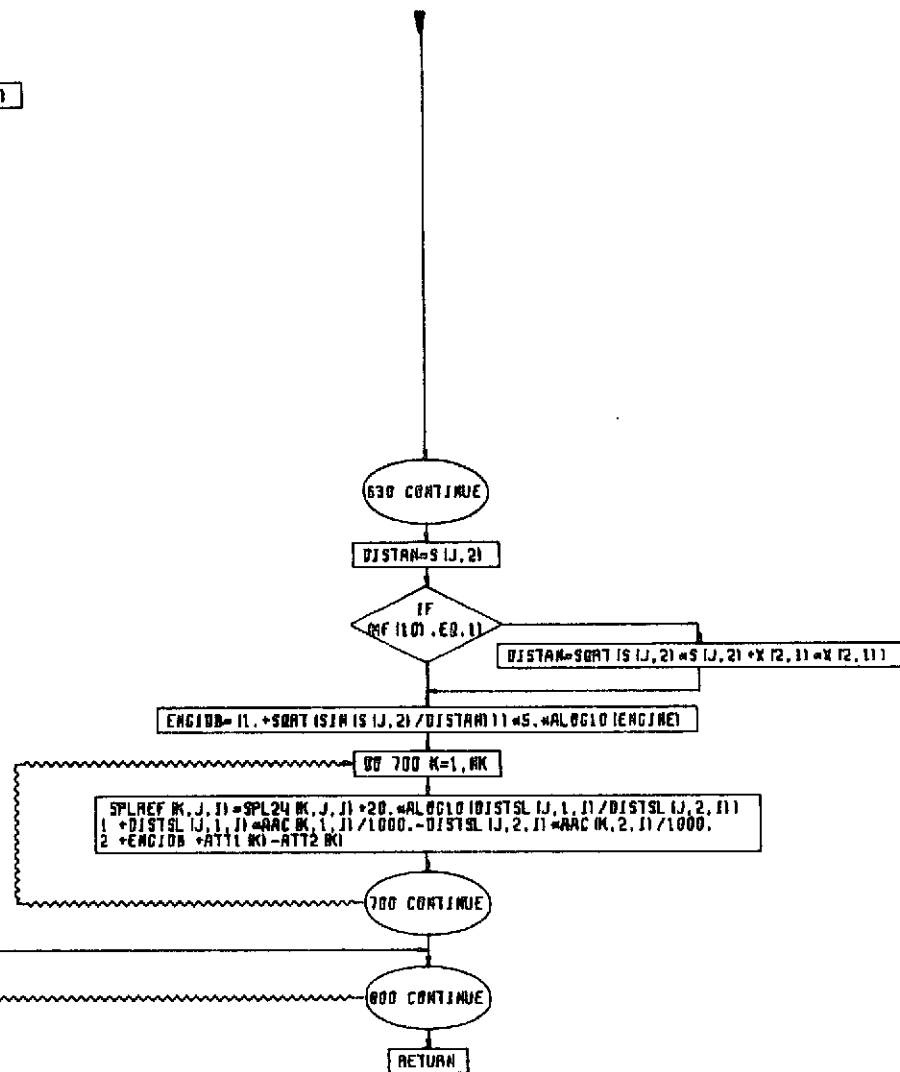
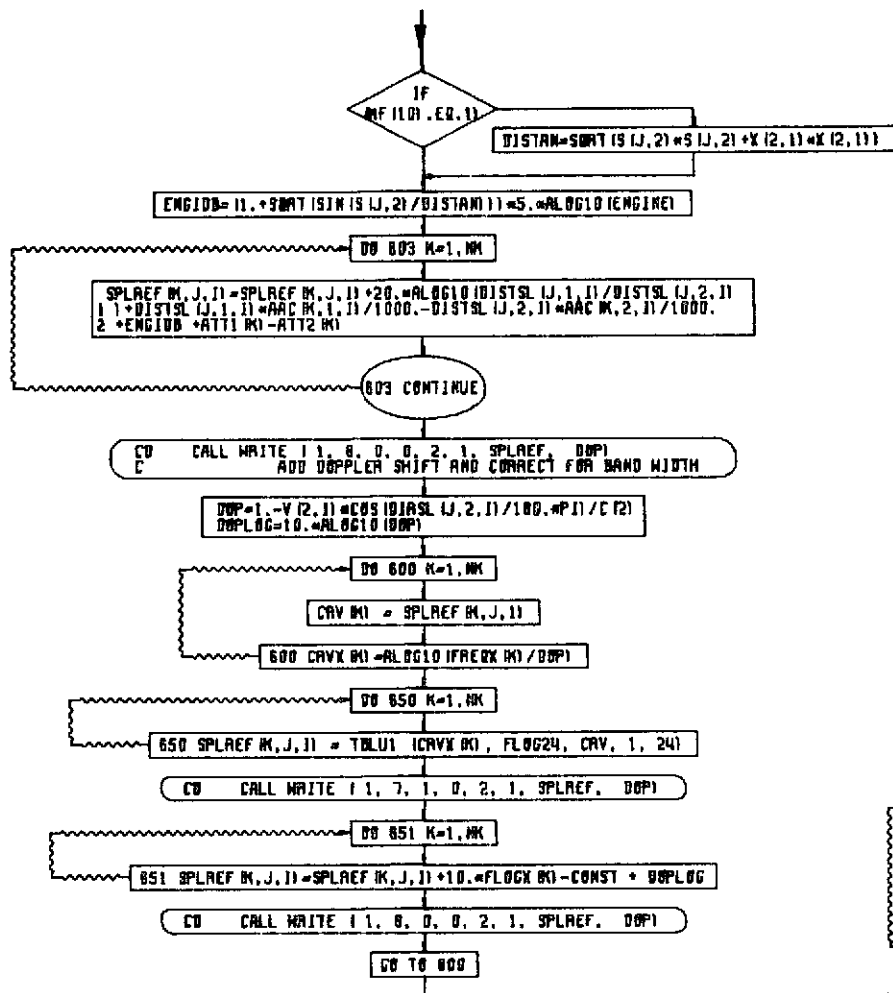

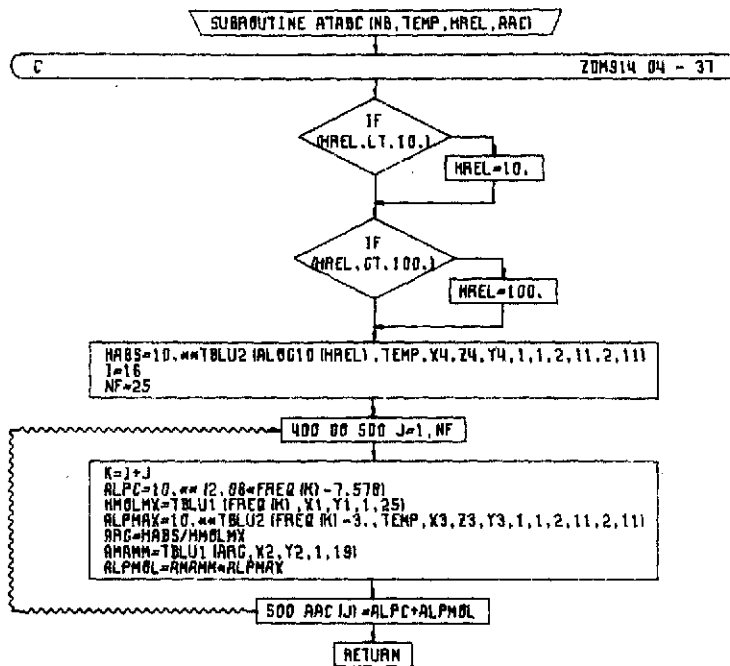

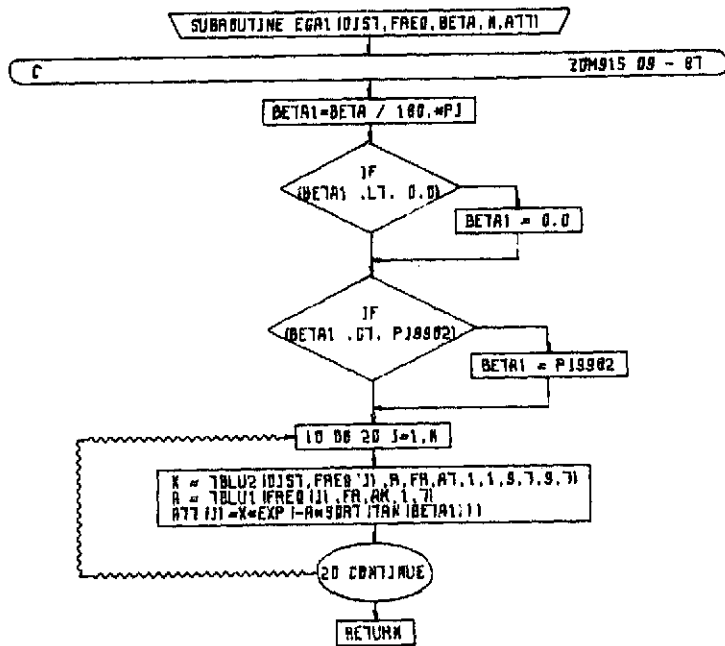

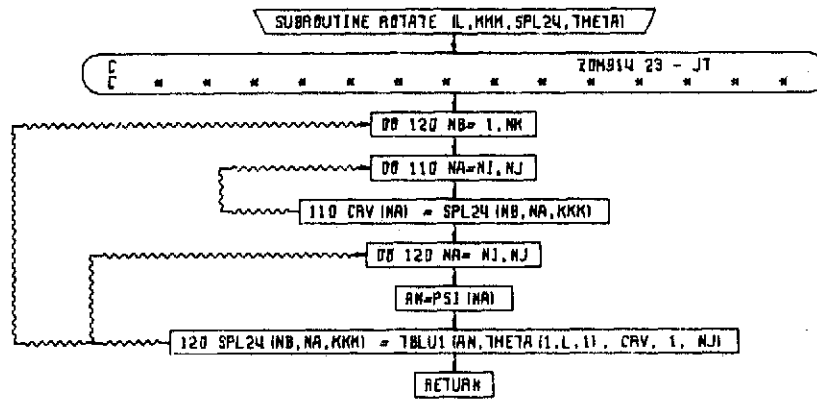

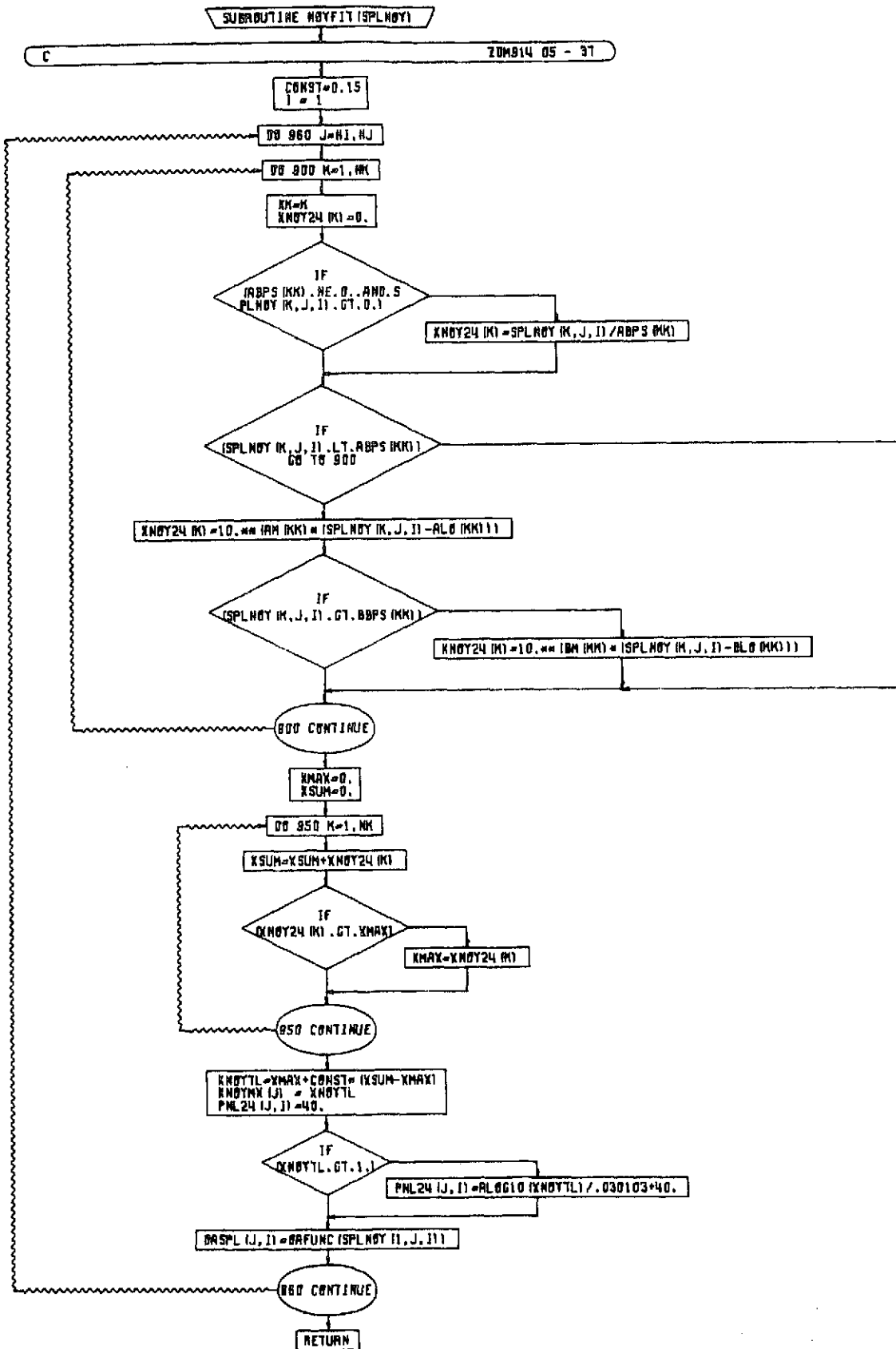

FUNCTION FNTONE (SPZ, NTCB)

C
E 20M914 08 - 08

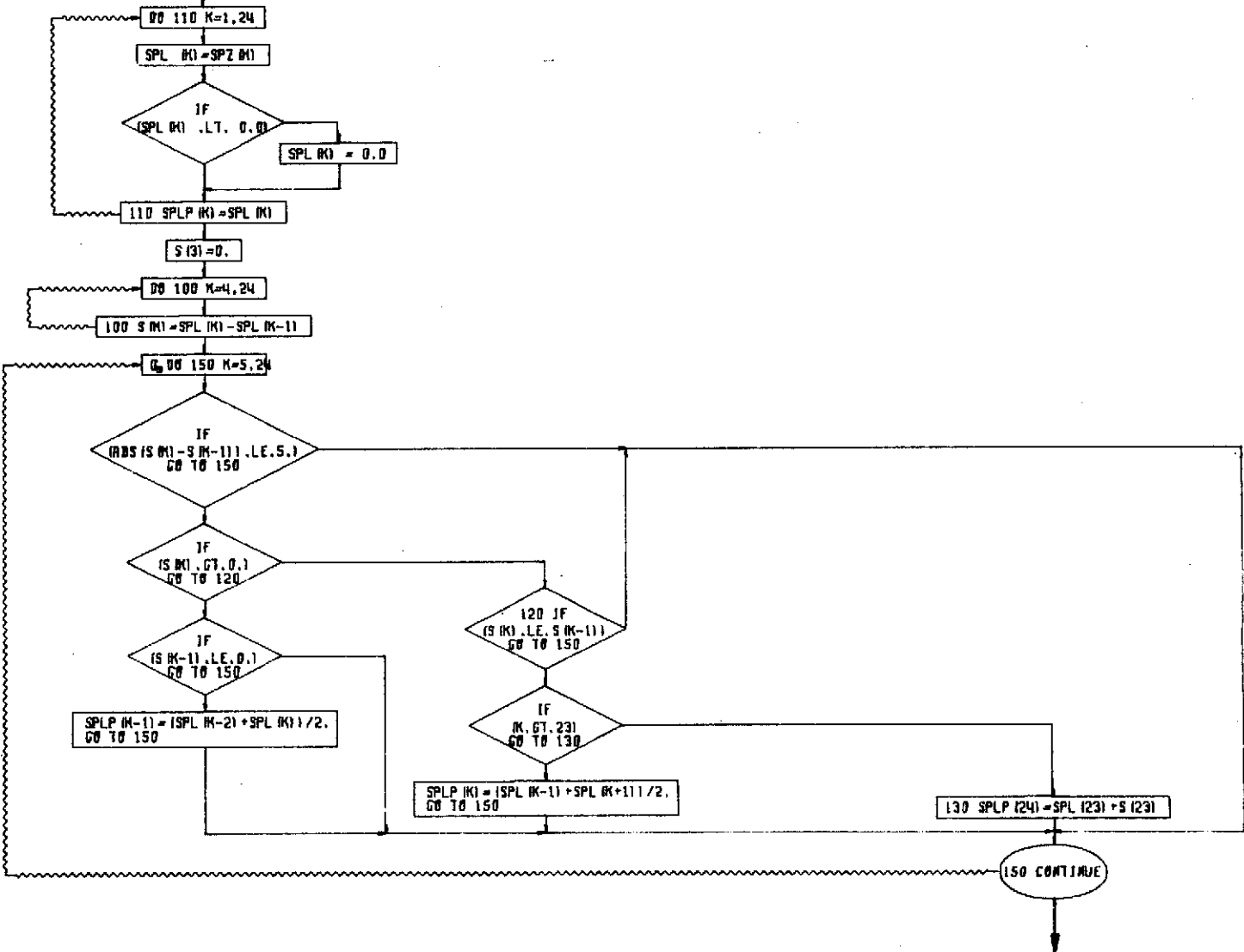

68

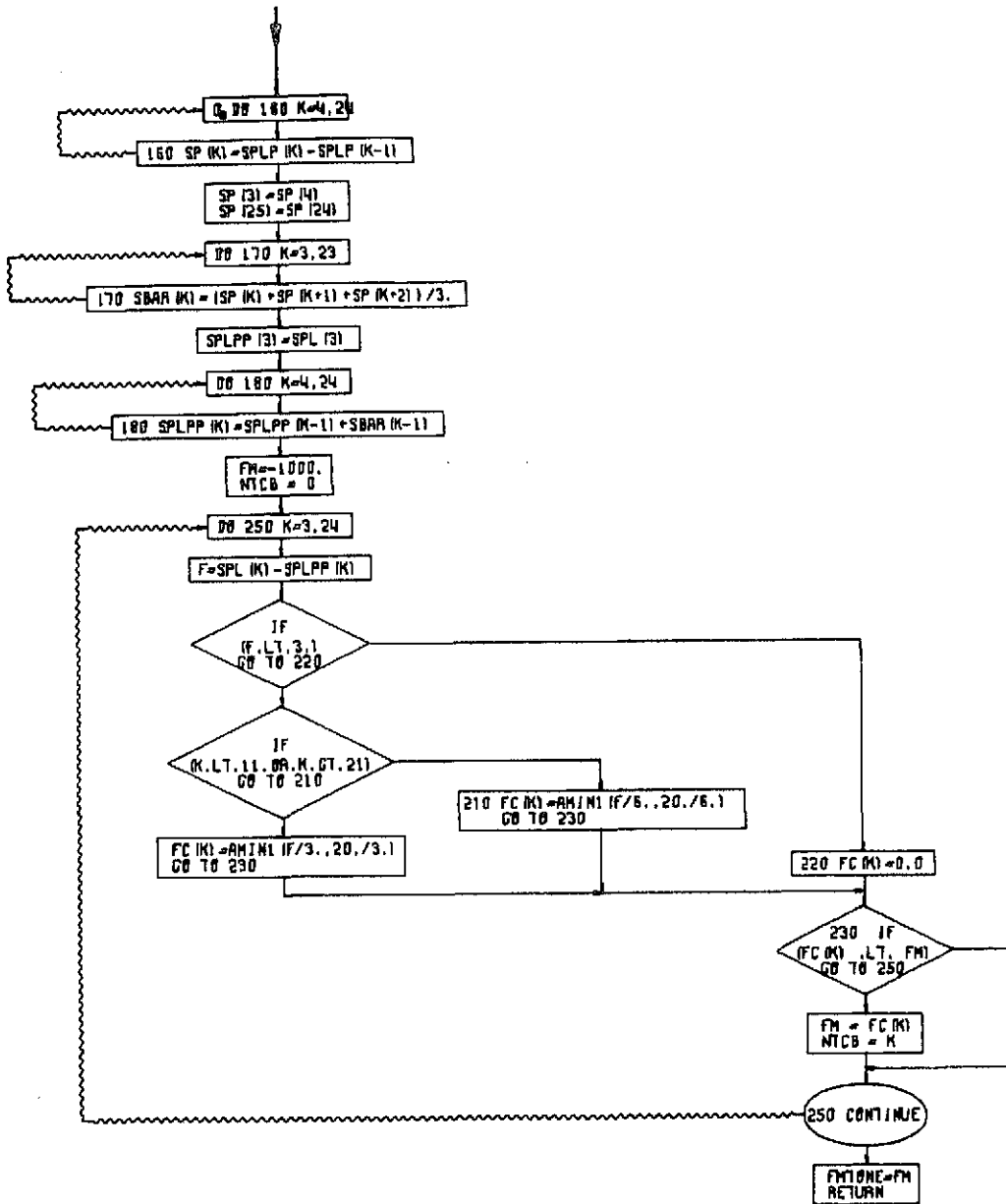

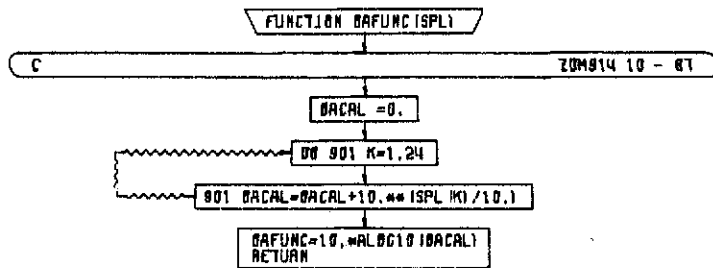

SUBROUTINE EPMLTJ ISPLEPH ,VEL.L ,DTIMEI

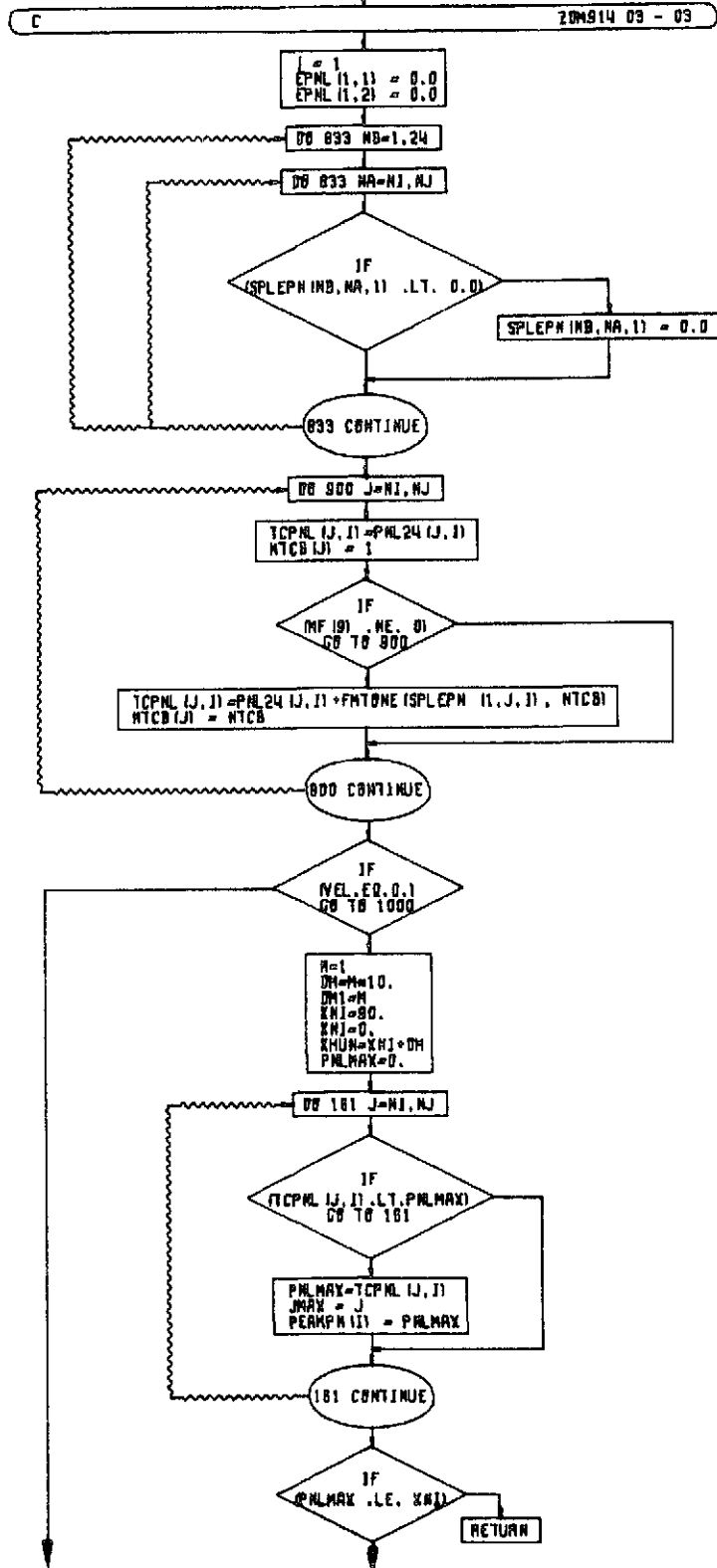

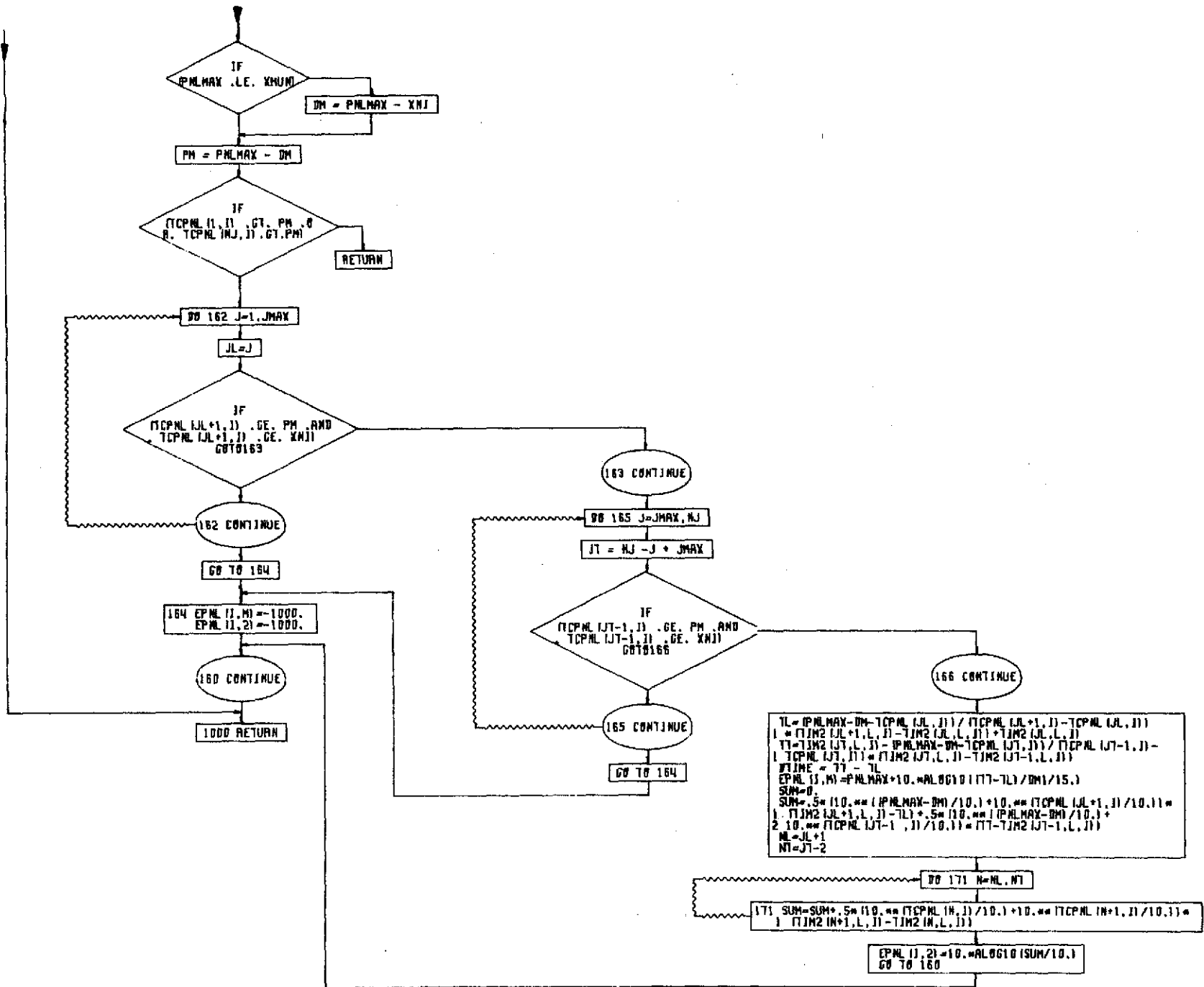

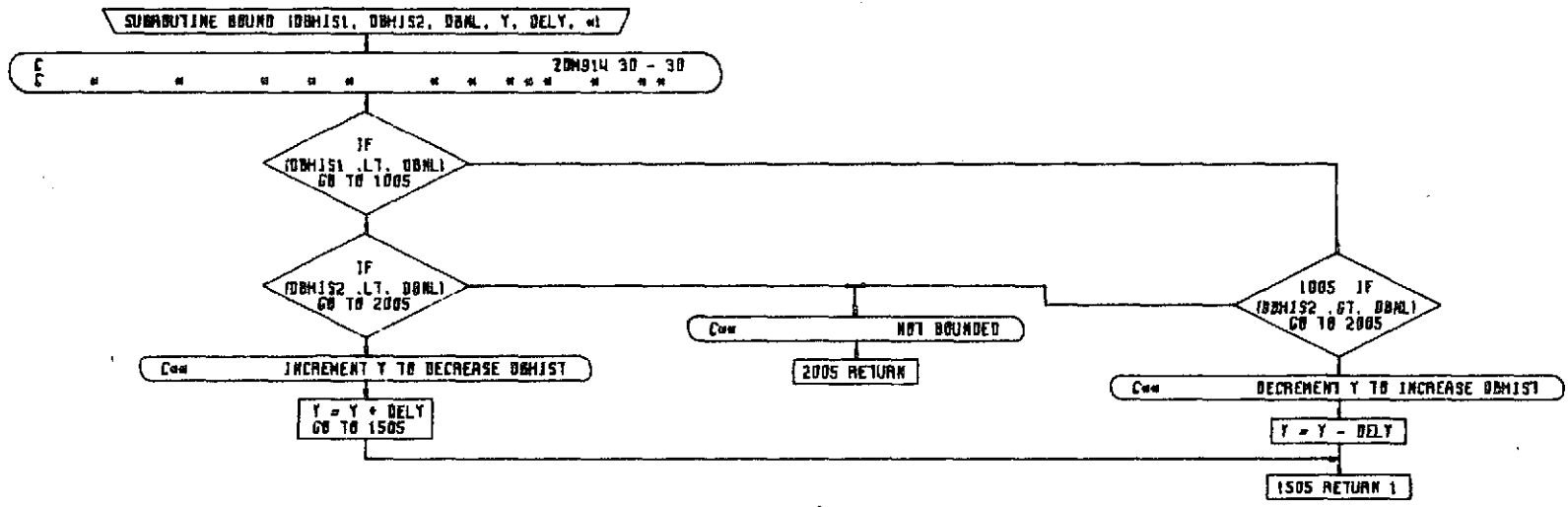

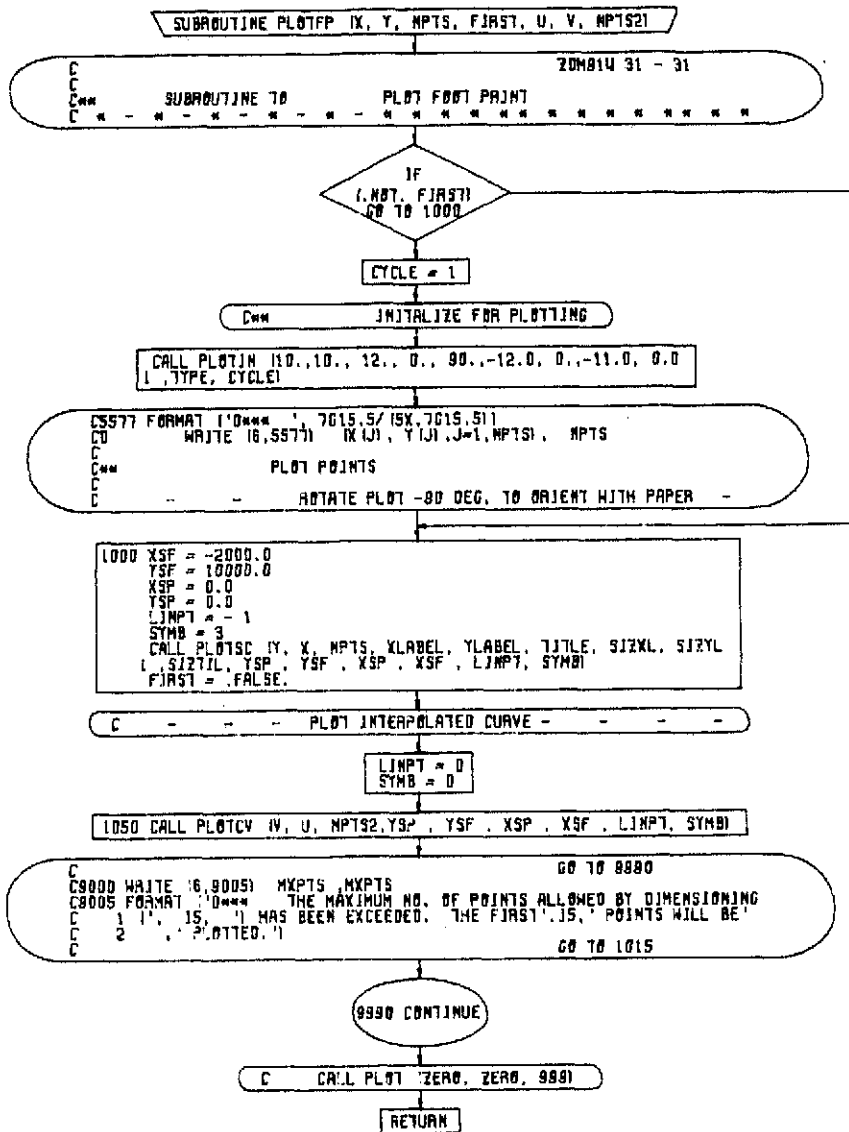

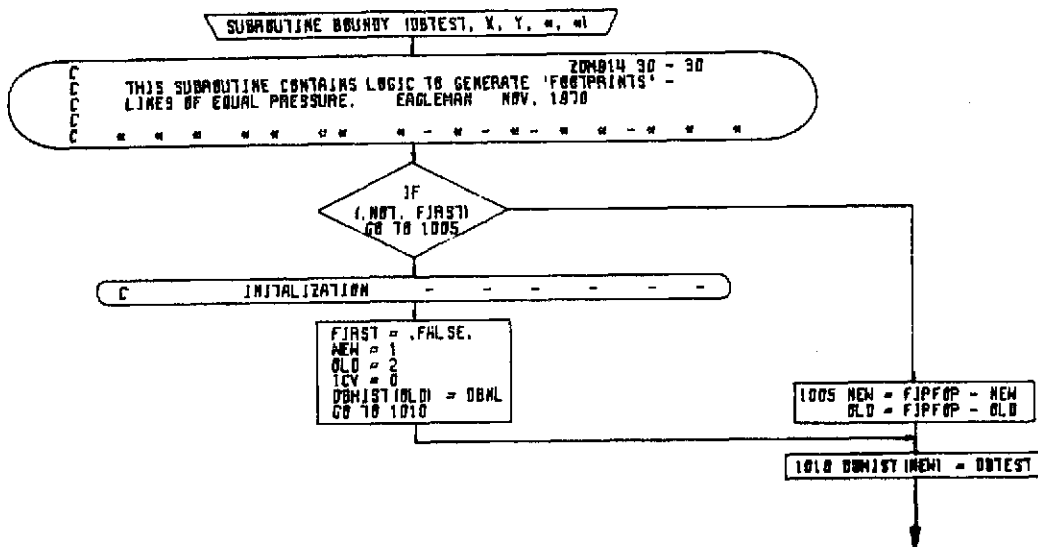

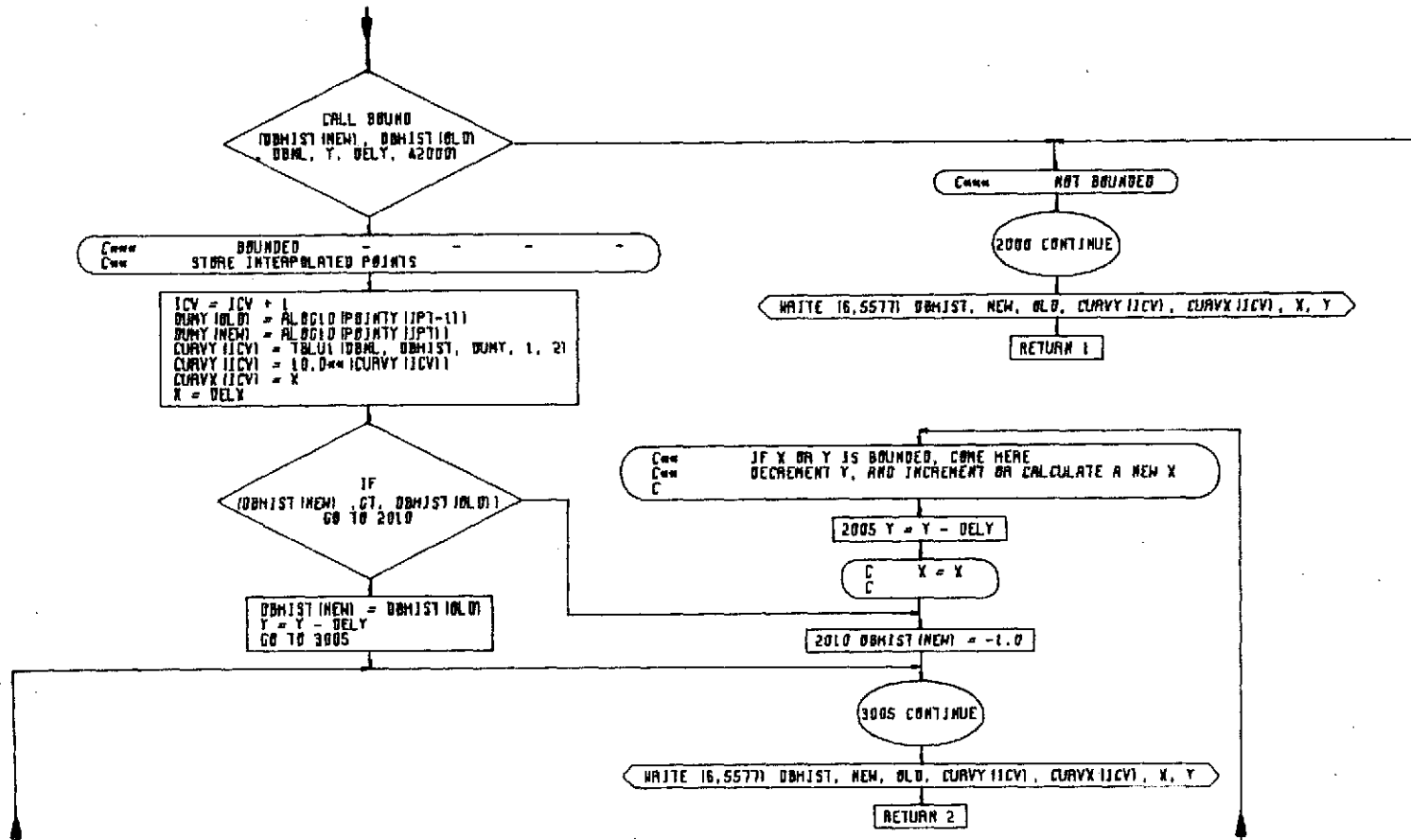

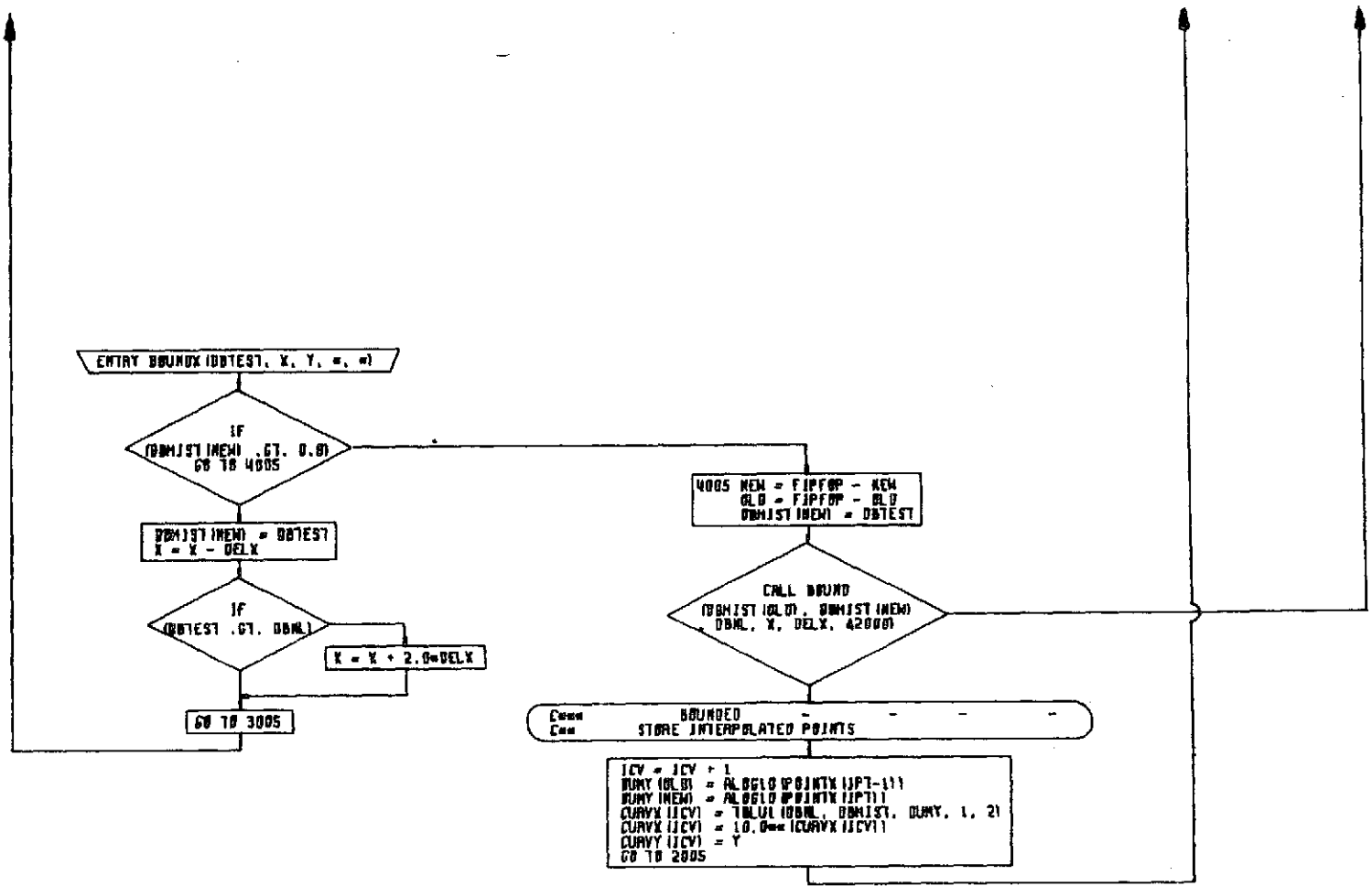

APPENDIX 3
EPNL PROGRAM LISTING

C-2

C
C
C
C

EPNL

ZDM914 01 - 1T

(EFFECTIVE PERCIEVED NOISE LEVEL)

LOGICAL *4 FIRST, LAST ,FIRST1 ,BOUND
INTEGER *4 PAPER/06/, PORF/06/
REAL *4 TOL/1.0E-04/

```
1          ,BLANK/'  ' / ,TITLE2(13)
2  ,BAST(3)/*1  BASELINE' /, INPT(5)/*INPUT)          /*/
3  ,ATTT(3)/*0 ATTENUATED' /, CALT(5)/*CALCULATED)      /*/
4  ,DELT(3)/*0   DELTA' /, CALST(5)/*CALCULATED - SHRANK)' /
5          , TURB(5)/*TURBINE)                          /*/
6  ,ATENM1(5)/0.0 ,5.0 ,10.0 ,20.0 ,30.0/
COMMON / AREA1 / SPL24(24,70,2), SPLRFF(24,70,1)
COMMON/AREA2/TITLE(40)
COMMON / AREA3 / FREQ24(24),FLOG24(24),FREQ8(8),FLOG8(8),BWN(24)
COMMON / AREA4 / MF(30),MN(10),ENGINE ,NI,NJ,NK,NII,CRV(400),MKT
COMMON / AREA5 / PNL24(70,1),XNOY24(24),EPNL(4,2),PEAKPN (4),
1          OASPL(70,1),TCPNL(70,1) ,XNOYMX(70), MTCB(70)
COMMON/AREA6/THRUST(4),THRUSI (6),OVHTIM(4),TIM(70),TIM2(70,3,1)
COMMON /FOOTPT/ ICV, CURVX(100), CURVY(100), IPT, POINTX(250)
1          ,POINTY(250), DBNL, DELX, DELY
COMMON/GEOM1/H(3,4),V(3,4),HREL(3,4),TEMP(3,4),X(3,4),Y(3,4), PI
1          ,GAMM(2),ALPH(2), S(70,2), W(70,2) ,C(2)
COMMON/GEOM2/THETA(70,3,1),ALPHA(70,3,1),DIRSL(70,3,1),
1  DISTSL(70,3,1),AAC(25,2,4)
COMMON/CCNOY/ABPS(24),BBPS(24),ALD(24),BLO(24),AM(24),BM(24)
COMMON /HFVJF/ SPLFA(24,70,2),SPLJE(24,70), DAPS(70,2)
1          ,SPLTU(24,70)
COMMON /HFVJT/ CAT(4) ,ATEN(24,4) ,ATATM(24,4) ,ATENM(4)
```

C
C

DIMENSION CRVX(50),HH(32),XX1(32),FREQP(8),FREQC(8),NBAND(24)

```
5  FORMAT(7F10.4/F8.4,I2)
15  FORMAT(9F8.0)
16  FORMAT (9F7.0)
17  FORMAT( F10.3, 12F5.2 / 10X,12F5.2)
18  FORMAT(2F10.0, 13A4)
20  FORMAT (18A4)
25  FORMAT(30I1,10I2,F5.0 ,2F8.0)
31  FORMAT(2X,18F4.0)
35  FORMAT(1H1, 28H CONTROL CARD AND DATA INPUT //
1  2X,30I1,10I2,F5.0 // 2X,18A4 / 2X,18A4 /
2  2X, 7A4,F4.1, 4A4, F4.1, 3A4, F4.1, A4//)
36  FORMAT(//// 96H          ALTITUDE VELOCITY HUMIDITY          TEMP SID
1ELINE  OFFSET          POWER          OVHTIM          NJ /
2  7X,3F10.2,I10 / 7X,6F10.2 )
41  FORMAT (2X,2I5, 3F10.2)
42  FORMAT (// 15X, 'DELTA JET PRIMARY =' , F4.1)
100  FORMAT (18A4)
101  FORMAT (1H1,36A4)
```

PRECEDING PAGE BLANK NOT FILMED

```

105 FORMAT      (7A4,F4.1, 4A4, F4.1, 3A4, F4.1, A4)
199 FORMAT (5X,18A4)
200 FORMAT (1H1,55X,22H S P L           I N P U T/)
2000 FORMAT(1H1,55X,36H S P L           T R A N S L A T E D /)
210 FORMAT(1H , 3X,15H POWER LEVEL = ,F10.2, 2H ,6X,11H ALTITUDE = ,
1 F10.2,6X,11H SIDELINE = ,F10.2 )
219 FJRMAT (1X,5H ANGLE,24(1X,I3  ))
220 FORMAT (3X,27F4.0)
221 FORMAT(1H1)
272 FORMAT (1X, 5F8.2 ,2F10.2, 4F8.2, 14)
273 FORMAT (1X,/ ' TIME TIME THETA ELEVA DIRSL DIST°
1 ,T52, °HEIGHT PNL OASPL TCPNL XNOYMX TCBAND°/)
280 FORMAT ( /1X,16H MAXIMUM TCPNL = , F10.2,
1 1X,19H APPROXIMATE EPNL = , F10.2,
2 1X,19H INTEGRATION EPNL = , F10.2)
511 FORMAT ('1BREAKDOWN OF CONTROL CARD E P N L 1',///,
1 ° 1 --- 1 = ONE HEADER CARD ----- °, 11, / °
2 ° 2 --- 1 = SECOND HEADER CARD ----- °, 11, / °
3 ° 3 --- 0 = FIXED NOISE SOURCE ----- °, 11, / °
4 ° 4 --- 0 = STANDARD (NON POLAR ANGLE) INPUT - °, 11, / °
5 ° 5 --- NOT USED ----- °, 11, / °
6 ° 6 --- 0 = SIDELINE INPUT = 1 POLAR INPUT --- °, 11, / °
7 ° 7 --- 4 = STANDARD (FORMAT 17) SPL INPUT --- °, 11, / °
8 ° 8 --- NOT USED ----- °, 11, / °
9 ° 9 --- 0 = USE TONE CORRECTION ----- °, 11, / °
X ° 10 --- 1 = APPLY SHIELDING EFFECT ----- °, 11, / /)
512 FORMAT (
1 ° 11 --- 1 = PUNCHED OUTPUT ----- °, 11, / °
5 ° 12-15 ----- NOT USED ----- °, 411, / °
6 ° 16 --- 1 = GENERATE ATT. TRADES INTERNALLY --- °, 11, / °
7 ° 17 --- 1 = OMIT REL. JET VEL. CORRECTION ---- °, 11, / °
8 ° 18 --- 1 = READ UNIFORM JET - SUPP. CARD ---- °, 11, / °
9 ° 19 --- 1 = SHORT FORM OUTPUT ----- °, 11, / °
X ° 20 --- 1 = STANDARD (LONG FORM) OUTPUT ---- °, 11, / /)
513 FORMAT (
1 ° 21 --- 1 = JET CORE INPUT ----- °, 11, / °
2 ° 22 --- 1 = DEVELOP FOOTPRINT ----- °, 11, / °
3 ° 23 --- 1 = TIME PRINT (GEOM SUB) ----- °, 11, / °
4 ° 24 --- 1 = DETERMINE DOPPLER EFFECTS ---- °, 11, / °
5 ° 25 --- 1 = FAN NOISE INPUT ----- °, 11, / °
6 ° 26 --- -1 = OMIT JET SHIFT ----- °, 11, / °
7 ° 27 --- 1 = TURBINE NOISE INPUT ----- °, 11, / °
8 ° 28 --- 0 = USE GROUND ATENUATION ----- °, 11, / °
9 ° 29 --- 1 = USE JET, INLET, FWD DUCT ATTEN. --- °, 11, / °
A ° 30 --- 1 = GRID GEN. FOR DEVELOPING EPNL CNTRS °, 11, / /)
514 FORMAT (° 31-32 --- NO OF INPUT CASES ----- °, 12, / °
1 ° 33-34 --- NO OF POLAR ANGLES ----- °, 12, / °
2 ° 35-36 --- 24 = 1/3 OCTAVE DATA ----- °, 12, / °
3 ° 37-38 --- ----- °, 12, / °
4 ° 39-40 --- NO OF FLIGHT PROFILE SECTIONS ----- °, 12, / °
5 ° 41-42 --- NO OF R.P.M. INPUTS ----- °, 12, / °

```

```

6 * 43-44 --- -----, I2, /,
7 * 45-46 --- NO OF MODES SUMMED -----, I2, /,
8 * 47-48 --- NO OF GRIDPOINTS -----, I2, /,
9 * 49-50 --- NO OF ATTENUATIONS -----, I2, /,
A * 51 --- NO OF ENGINES -----, F5.1)
522 FORMAT (// ' INLET FANDUCT JET FPNL SLANT D VEL'
1 ' REL HUM TEMP SIDLINE OFFSET GAMMA ALPHA DURATION',
2 ' D EPNL SEQ'/)
523 FORMAT (1X, 4F5.1, F8.3, 5F8.2, 2X, F8.1, F8.0, F6.2, F7.2
1 ,2F9.2, I4)
524 FORMAT (2A4, ' JET DATA (' , 5A4, 5X, 13A4//' ANGLE', 24(1X,I3)/
1 (3X,25F4.0))
525 FORMAT (1X, 4F5.1, F8.3, 2F8.2, 30X, I5)
526 FORMAT ('O')
C*** PREFERRED FULL OCTAVE
DATA FREQ
1 / 63., 125., 250., 500., 1000., 2000., 4000., 8000. /
C*** COMMON FULL OCTAVE
DATA FREQ
1 / 53., 106., 212., 424., 848., 1696., 3392., 6784. /
C
C ** ** ** ** ** ** ** ** ** ** ** ** ** ** ** * * * * *
C
DO 900 I=1,24
900 FLOG24(I)=ALOG10(FREQ24(I))
C
10 READ (5,25,END=5990)
1 MF,MN,ENGINE ,THRUST(1) ,OVHTIM(1)
C - - - - - INITIALZIATION - - - - -
C FIRST1 = .TRUE.
C NJ IS THE NO. OF ANGLES, NK IS THE NO. OF FREQ. BANDS
NI=1
NJ =MN(2)
NK =MN(3)
NSPRIN = MF(19)
NLPRIN = MF(20)
KKK = 1
M9 = 1
M10 = 1
A3 = 0.0
NCF=2
IF (MF(25) .EQ. 1) NCF=4
DELJET = 0.0
DO 582 NC=1,4
ATENM(NC)=0.
CAT(NC)=1.
DO 582 NB=1,24
582 ATEN (NB,NC)=0.0
C
READ(5,100) (TITLE(L),L=1,36)
WRITE (PORF,511) (MF(JGW), JGW=1,10)

```

```

WRITE (PORF,512)      (MF(JGW), JGW=11,20)
WRITE (PORF,513)      (MF(JGW), JGW=21,30)
WRITE (PORF,514)      (MN(JGW), JGW= 1,10) ,ENGINE
WRITE (PORF,35)
1      MF,MN,ENGINE,(TITLE(L),L=1,25)
2      ,ATENM(1),(TITLE(L),L=27,30), ATENM(2), (TITLE(L),L=32,34)
3      ,A3, TITLE(36)
I = 1
READ(5,15)H(1,I),V(1,I),HREL(1,I),TEMP(1,I),X(1,I),Y(1,I),
1      GAMM(1),ALPI ,VMJET
2      ,H(2,I),V(2,I),HREL(2,I),TEMP(2,I),X(2,I),Y(2,I) ,GAMM(2) ,ALP2
3      ,VMJET
ALPH(1) = ALPI * GAMM(1)
C(1) = 49.02 * SQRT(TEMP(1,I) + 459.67)
WRITE (PORF,36)
1      H(1,I),V(1,I),HREL(1,I),TEMP(1,I),X(1,I),Y(1,I),
2      THRUST(I),OVHTIM(I),NJ
3      ,H(2,I),V(2,I),HREL(2,I),TEMP(2,I),X(2,I),Y(2,I)
IF(MF(7).NE.4) GO TO 159
DO 1159 J=1,NJ
READ(5,17) THETA(J,1,I),(SPL24(K,J,KKK),K=1,NK)
1159 DIRSL(J,1,I) = THETA(J,1,I)
CALL WRITE (5,12, 1, 0, 1, 1, SPL24, DUMY)
159 CONTINUE
IF (MF(29) .NE. 1) GO TO 360
M10 = MN(10)
READ (5,18) A3 ,VJJET, TITLE2
DO 110 NA = 1,NJ
110 READ (5,17) DUMMY , (SPLJE(NB,NA),NB=1,24)
CARR = C.0
IF (MF(3) .NE. 0) CARR = 6.0206
DO 480 NB=1,NK
DO 480 NA=1,NJ
SPLTU(NB,NA) = C.0
480 SPLJE(NB,NA) = SPLJE(NB,NA) + CARR
CALL WRITE (2, 7, 0, 0, 1, 1, SPLJE, DUMY)
DO 155 NC = 1,NCF
155 READ (5,17) CAT(NC), (ATEN(NB,NC),NB=1,24)
READ (5,18) A3 ,VJJET
DO 508 NA =1,NJ
508 READ (5,17) DUM1 , (SPLREF(NB,NA,1),NB=1,24)
CALL WRITE (2, 8, 1, 0, 1, 1, SPLREF,DUMY)
C - - CHANGED FOR NASA LEWIS ONLY - - - - -
C
IF (MF(18) .GT. 0) READ (5,17) DELJET
IF (MF(25) .EQ. 0) GO TO 352
DO 109 NA =1,NJ
DO 109 NB =1,24
IF (SPL24(NB,NA,KKK) .GT. SPLREF(NB,NA,1)) GO TO 108
WRITE (6,41) NA,NB, SPL24(NB,NA,KKK),SPLREF(NB,NA,1)

```

```

    SPLREF(NB,NA,1) = SPL24(NB,NA,KKK) -1.0
108 CONTINUE
    SPL24(NB,NA,1) = 10. * ALOG10(10.**((SPL24 (NB,NA,KKK)*.1)
1      -10.**(SPLREF(NB,NA,1) *.1))
        IF (MF(21) .EQ. 1)
1SPLJE(NB,NA) = 10. * ALOG10(
2      10.**((SPLJE(NB,NA) - DELJET)      *.1)
3      +10.**(SPLREF(NB,NA,1) *.1))
109 SPLREF(NB,NA,1) = 0.0
                                           GO TO 350
C  - - - - - T O H E R E - - - - -
352 CALL JSHIFT
350 CALL WRITE (5, 1, 1, 0, 1, 1, SPL24 , DUMY)
    CALL WRITE (2, 9, 0, 0, 1, 1, SPLJE , DUMY)
    WRITE (6,42) DELJET
    IF (MF(27) .EQ. 0) GO TO 360
    READ (5,18) A4 ,VTJET
    DO 112 NA =1,NJ
112 READ (5,17) THETA(NA,1,1), (SPLTU(NB,NA),NB=1,24)
    CALL WRITE (3, 1, 1, 0, 1, 1, SPLTU , DUMY)
360 CONTINUE
    DO 165 J=1,NJ
    IF (ABS(THETA(J,1,1) - 90.0) .LT. TCL) THETA(J,1,1) = 89.999
165 CONTINUE
    IF (MF(30) .EQ. 1) M9 = MN(9)
    IF (MF(20) .EQ. 1) GO TO 166
    WRITE (6,221)
    WRITE (6,522)
166 CONTINUE
C  - - - - -
    NRO=5
    DO 450 IJL = 1,M9
C  - - - - -
    FIRST = .TRUE.
    LAST = .FALSE.
    IPT = 0
    IF (MF(30) .EQ. 1) READ (5,15,END=9990)
1      H(2,1), V(2,1), HREL(2,1), TEMP(2,1), X(2,1)
2      ,Y(2,1), GAMM(2), ALP2 ,VMJET
    IF (VMJET .EQ. 0.0) VMJET = VJJET + V(2,1)
    ALPH(2) = ALP2 + GAMM(2)
    C(2) = 49.02 * SQRT (TEMP(2,1) + 459.67)
    ASSIGN 5010 TO LEAP
                                           GO TO 5090
C** - - - - - FOOT PRINT LOOP - * - * - * - * - **
5010 READ (5,15) DBNL, DELX, DELY, Y(2,1)
5577 FORMAT ('0$$$M$$ ', 8G15.7)
    WRITE(6,5577)DBNL, DELX, DELY, Y(2,1)
    ASSIGN 5020 TO LEAP
                                           GO TO 5090
5020 CALL BOUNDY (DBTEST, X(2,1), Y(2,1), +5025, +5035)

```

```

5025 ASSIGN 5020 TO LEAP
5030 CALL BOUNDX (DBTEST, X(2,1), Y(2,1), +5033, +5035)
5033 BOUND = .FALSE.
5035 BOUND = .TRUE.
5040 ASSIGN 5030 TO LEAP
5080 IF (LAST .AND. BOUND)
5090 CALL GEOM (LAST)
      IF (MF(29) .EQ. 0)
      CALL JETPV (VJJET, VMJET)
CD CALL WRITE (2, 9, 1, 0, 2, 1, SPLJE, DUMY)
C**
C**          LOBE SEPERATION LOOP          **  ***  **  **  **  **
509 CONTINUE
NR5 = 0
  IF (MF(16) .EQ. 1) M10 = 1
  DO 400 IJK = 1, M10
  IF (MF(29) .EQ. 0)
  IF (MF(16) .EQ. 1)
  READ (5, 15) (ATENM(L), L=1, 4)
  NRO = 1
515 CONTINUE
  DO 400 NR4 = 1, NRO
  ATENM(4) = ATENM1(NR4)
  DO 400 NR3 = 1, NRO
  WRITE (6, 526)
  ATENM(3) = ATENM1(NR3)
  DO 400 NR2 = 1, NRO
  ATENM(2) = ATENM1(NR2)
  DO 400 NR1 = 1, NRO
  ATENM(1) = ATENM1(NR1)
  NR5 = NR5 + 1
  CALL LOBESE
CD CALL WRITE (1, 9, 0, 0, 2, 1, SPL24, DUMY)
510 CALL TRANPO
CD CALL WRITE (1, 10, 1, 0, 2, 1, SPLREF, DUMY)
  CALL ROTATE(2, 1, SPLREF, DIRSL)
CD CALL WRITE (1, 10, 0, 0, 2, 1, SPLREF, DUMY)
  CALL NOYFIT(SPLREF)
  CALL EPNLTI(SPLREF, V(2,1), 2, DTIME)
  IF (NR5 .EQ. 1) EPNLF = EPNL(I, 2)
DEPNL = 0.0
  IF (MF(29) .EQ. 1) DEPNL = EPNLF - EPNL(I, 2)
  IF (MF(20) .EQ. 1) CALL WRITE (1, 10, 1, 1, 2, 1, SPLREF, 0)
  IF (NLPRIN .EQ. 1) WRITE (PORF, 522)
  SLD = SQRT(H(2,1)**2 + X(2,1)**2)
  WRITE (PORF, 523) ATENM(1), ATENM(3), ATENM(2), ATENM(4), A3
1  , EPNL(I, 2), SLD , V(2,1), HREL(2,1), TEMP(2,1), X(2,1),
2  Y(2,1), GAMM(2), ALP2, DTIME, DEPNL, NR5
  IF (MF(11) .EQ. 1)

```



```

1      WRITE (7 ,525) ATENM(1),ATENM(3),ATENM(2),ATENM(4),A3
2      ,EPNL(I,2), DEPNL ,NR5
CF     WRITE (PAPER,523) ATENM(1), ATENM(2), A3,
CF 1   EPNL(I,2), H(2,1), V(2,1), HREL(2,1), TEMP(2,1), X(2,1),
CF 2   Y(2,1), GAMM(2), ALP2 ,DTIME ,DEPNL
400 CONTINUE
      IF (MN(10).EQ.1 .AND. MN(9).GT.1) MF(29) = 0
C**   - - FOOTPRINT LOGIC - - - - -
      IF (MF(22) .EQ. 0) GO TO 450
      IPT = IPT + 1
      POINTX(IPT) = X(2,1)
      POINTY(IPT) = Y(2,1)
      DBTEST = EPNL(I,2)
                                GO TO LEAP,(5010, 5020, 5030)

C
4020 CONTINUE
C4020 CALL PLOTFP (POINTX, POINTY, IPT, FIRST1, CURVX, CURVY, ICV)
      FIRST1 = .FALSE.
450 CONTINUE
213 CONTINUE
GO TO 1C
9990 STOP
END

```

SUBROUTINE WRITE (II,JJ,K,L,M,N,SPL24 ,TITLE)

ZDM914 23 - 23

C
C
C
C
C
C
C
C
C
C
C

```
II          YITLE 1 SUBSCRIPT
JJ          YITLE 2 SUBSCRIPT
K           = 1   SKIP PAGE
L           = 0   SPL ARRAY ONLY
M           = 1   COMPLETE OUTPUT
            = 2   TRANSLATED CONDITIONS
N           VALUE OF THE THIRD SUBSCRIPT ON ALL 3-D ARRAYS
SPL24      SPL ARRAY
TITLE      USED IN EPNL 2
COMMON / AREA4 / MF(30),MN(10),ENGINE ,NI,NJ,NK,NII,CRV(400),MKT
COMMON / AREA5 / PNL24(70,1),XNOY24(24),EPNL(4,21),PEAKPN (4),
1           OASPL(70,1),TCPNL(70,1) ,XNOYMX(70), MTCB(70)
COMMON/AREA6/THRUST(4),THRUSTI (6),OVHTIM(4),TIM(70),TIM2(70,3,1)
COMMON/GEOM1/H(3,4),V(3,4),HREL(3,4),TEMP(3,4),X(3,4),Y(3,4), PI
1           ,GAMM(2) ,ALPH(2), S(70,2), W(70,2) ,C(2)
COMMON/GEOM2/THETA(70,3,1),ALPHA(70,3,1),DIRSL(70,3,1),
1           DISTSL(70,3,1),AAC(25,2,4)
COMMON /HFVJE/ SPLFA(24,70,2) ,SPLJE(24,70), OAPS(70,2)
1           ,SPLTU(24,70)
DIMENSION   SPL24(24,17,1)
DIMENSION   TITL1(8),TITL2(13), TITLE(18,3)
DATA  TITL1  /'ENG','JET ','TURB','      ','FAN ','JET2',
1      ' ',' /
2      ,TITL2  /'BASE','ATT.','CORR','      ','FWD ','AFT ','PRIM'
3      , 'SEC ', 'TOT ', 'TRAN','(DA)','JET2','      '/
45 FORMAT ( 1X,18A4)
195 FORMAT ('1')
200 FORMAT (/55X,A4,10X,A4/)
219 FORMAT (5X'ANGLE'2X,(24(1X,12,1X) ) /)
220 FORMAT (5X,F6.2,1X,24F4.0)
272 FORMAT (1X,5F8.2,2F10.2,4F8.2,14)
273 FORMAT ( /5X      ' TIME      TIME      THETA      FLEVA      DIRSL      DIST'
1 4X'HEIGHT      PNL      OASPL      TCPNL      NOYMAX      NB'//)
C - - - - -
IF (K.EQ.1) WRITE (6,195)
IF (MF(2).EQ.0) WRITE(6,45) (TITLE (LL,N),LL=1,18)
WRITE (6,200) TITL1(II),TITL2(JJ)
WRITE(6,219) (NB,NB=1,NK)
DO 250 NA=NI,NJ
250 WRITE (6,220) DIRSL(NA,M,1),(SPL24 (NB,NA,N ),NB=1,NK)
IF (L.EQ.0) RETURN
WRITE (6,273)
DO 300 NA=NI,NJ
300 WRITE (6,272) TIM(NA),TIM2(NA,M,1),THETA(NA,M,1),ALPHA(NA,M,1),
1 DIRSL(NA,M,1),DISTSL(NA,M,1),S(NA,M),PNL24(NA,1),
2 OASPL(NA,1),TCPNL(NA,1),XNOYMX(NA), MTCB(NA)
RETURN
END
```

SUBROUTINE GEOM (LAST)

ZDM914 02 - 2T

```

C
LOGICAL *4 LAST
REAL * 4 BIG/1.0E+50/
COMMON / AREA4 / MF(30),MN(10),ENGINE ,NI,NJ,NK,NII,CRV(400),MKT
COMMON/AREA6/THRUST(4),THRUST (6),OVHTIM(4),TIM(70),TIM2(70,3,1)
COMMON/GEOM1/H(3,4),V(3,4),HREL(3,4),TEMP(3,4),X(3,4),Y(3,4), PI
1   ,GAMM(2), ALPH(2), S(70,2), W(70,2) ,C(2)
COMMON/GEOM2/THETA(70,3,1),ALPHA(70,3,1),DIRSL(70,3,1),
1   DISTSL(70,3,1),AAC(25,2,4)
COMMON / GEOM7 / PSI(70)
DIMENSION CRVX(50) ,P(3,4)
C
C   S (NA, 1 ) TRANSLATED HEIGHT
C   S (NA, 2 ) REAL HEIGHT
63  FORMAT (///10X'*** X(2,1) TOO LARGE S('I3,',1) IS NEG',2X,F15.5
1   // 10X,EF12.5///)
PI180=180./PI
NJ=MN(2)
DO 130 NA=1,NJ
DO 130 L=1,2
S(NA,L)=H(L,1)
DISTSL(NA,L,1)=H(L,1)
DIRSL(NA,L,1)=THETA(NA,1,1)
ALPHA(NA,L,1)=0.
130 TIM2(NA,L,1)=0.
DO 140 L=1,2
140 C(L)=49.02*SQR(TEMP(L,1)+459.6)
L=2
C9R=GAMM(L)/PI180
C8R=C9R
IF (C9R.EQ.0.) GO TO 180
YCRIT=((H(1,1)/COS(C9R))-H(2,1))/TAN(C9R)
IF (C9R.GT.0. AND.Y(2,1).LT.YCRIT) Y(2,1)=YCRIT
IF (C9R.LT.0. AND.Y(2,1).GT.YCRIT) Y(2,1)=YCRIT
180 CONTINUE
XL=0.
Z=0.
H1=H(L,1)+Y(L,1)*TAN(C9R)
Y1=H1
H2=H(L,1)+(Y(L,1)+1000.)*TAN(C9R)
HDD=H1
IF (ABS(X(L,1)).LT.1.) GO TO 190
XL=1000./COS(C9R)
Z=SQR(X(L,1)*X(L,1)+H2*H2+1000000.)
HDD=SQR(H1*H1+X(2,1)*X(2,1))
Y1=HDD
C8R=ARCOS((HDD*HDD+XL*XL-Z*Z)/(2.*HDD*XL))-PI/2.
NI=0
TEN=10.
OST=170.
182 CONTINUE

```

```

NI=NI+1
TPI=TEN/PI180
IF(C8R.GT.C.) GO TO 185
TPI=OST/PI180
NI=1
NJ=NJ-1
185 CONTINUE
STEMP=H1-HDD*TAN(C9R)/(TAN(TPI)+TAN(C8R))
IF(STEMP.GT.0.) GO TO 190
TPD=TPI*PI180
WRITE (6,63) NA,STEMP,C9R,C8R,TPD,HDD,H(2,1)
TEN=TEN+10.
OST=OST-10.
GO TO 182
190 CONTINUE
DO 200 NA=NI,NJ
C2R=DIRSL(NA,2,1)/PI180
S(NA,1)=V1*TAN(C2R)/(TAN(C2R)+TAN(C8R))
DISTSL(NA,2,1)=S(NA,1)/SIN(C2R)
XREF=-S(NA,1)/TAN(C2R)
S(NA,2)=XREF*TAN(C9R)+H1
APR=ALPH(L)/PI180
PSI(NA)=ARCOS((-XREF*COS(APR)-S(NA,2)*SIN(APR))/DISTSL(NA,L,1))
I *PI180
DELT=DISTSL(NA,L,1)/C(L)
C7=S(NA,1)+V(L,1)*DELT*SIN(C8R)
CT=-V(L,1)*DELT*COS(C8R)
IF(DIRSL(NA,L,1).NE.90.) CT=CT+S(NA,1)/TAN(C2R)
THETA(NA,L,1)=90.
IF(CT.NE.0.) THETA(NA,L,1)=ATAN(C7/CT)*PI180
IF(THETA(NA,L,1).LT.0.) THETA(NA,L,1)=180.+THETA(NA,L,1)
C12=0.
IF(THETA(NA,L,1).NE.90.) C12=TAN(THETA(NA,L,1)/PI180)
STHET=HCD*TAN(C12)/(TAN(C12)+TAN(C8R))
IF(C12.NE.0.AND.V(L,1).NE.0.) TIM2(NA,L,1)=-STHET/C12/V(L,1)
IF(V(L,1).NE.0.)ALPHA(NA,L,1)=ARSIN(S(NA,2)/DISTSL(NA,L,1))*PI180
200 CONTINUE
RETURN
END

```

SUBROUTINE TRANPO

ZDM914 06 - 3T

C

```

COMMON / AREA1 / SPL24(24,70,2),SPLREF(24,70,1)
COMMON / AREA3 / FREQ24(24),FLOG24(24),FREQ8(8),FLOG8(8),8WN(24)
COMMON / AREA4 / MF(30),MN(10),ENGINE ,NI,NJ,NK,NII,CRV(400),MKT
COMMON/GEOM1/H(3,4),V(3,4),HREL(3,4),TEMP(3,4),X(3,4),Y(3,4), PI
1 ,GAMM(2), ALPH(2), S(70,2), W(70,2) ,C(2)
COMMON/GEOM2/THETA(70,3,1),ALPHA(70,3,1),DIRSL(70,3,1),
1 DISTSL(70,3,1),AAC(25,2,4)
DIMENSION CRVX(50),FREQX(24),FLOGX(24)
DIMENSION ATT1(24),ATT2(24)
241 FORMAT(/, 3X,4HH = ,F12.2,4HV = ,F12.2,7HHREL = ,F12.2,7HTEMP = ,
1 F12.2,4HX = ,F12.2,4HY = ,F12.2)
242 FORMAT(3X,21HABSORPTION CORRECTORS 1
243 FORMAT(3X,4(I3,1H=,G15.6,3X))

```

C

```

* * * * *

```

I=1

NNB=3

CALCULATE ATMOSPHERIC ATTENUATION

DO 100 L=1,2

C** TEST TO AVOID ARSIN .GT. 1.0

DO 50 J=NI,NJ

IF (S(J,L) .GT. DISTSL(J,L,I)) S(J,L) = DISTSL(J,L,I) -.0001

50 CONTINUE

CALL ATABC(NNB,TEMP(L,I),HREL(L,I),AAC(1,L,I))

IF(MF(23).EQ.0) GO TO 100

WRITE(6,241) H(L,I),V(L,I),HREL(L,I),TEMP(L,I),X(L,I),Y(L,I)

WRITE(6,242)

DO 861 M=1,6

M2=M+6

M3=M+12

M4=M+18

861 WRITE(6,243) M,AAC(M,L,I),M2,AAC(M2,L,I),M3,AAC(M3,L,I),M4,

1 AAC(M4,L,I)

100 CONTINUE

6 FORMAT (/12F9.3)

CO WRITE (6,6) AAC

DO 498 L=1,24

ATT1(L)=C.

ATT2(L)=C.

498 CONTINUE

DO 501 K=1,NK

FREQX(K)=FREQ24(K)

501 FLOGX(K)=FLOG24(K)

CONST=6.2

I=1

DO 800 J=NI,NJ

C

EGA - EXTRA GROUND ATTENUATION

IF(MF(26).GT.2) GO TO 1602

IF(MF(28).NE.1) CALL EGA1(DISTSL(J,1,I),FREQX,ALPHA(J,1,I)

1 ,NK, ATT1)

```

        IF (MF(28).NE.2) CALL EGA1(DISTSL(J,2,I),FREQX,ALPHA(J,2,I)
1      ,NK, ATT2)
1602 CONTINUE
CD      WRITE (6,6) ATT1
CD      WRITE (6,6) ATT2
        IF (MF(24).EQ. 0)                GO TO 630
C
C          TRANSPOSE SPL VALUES
C          REMOVE DOPPLER SHIFT AND CORRECT FOR BAND WIDTH
DOP=1.-V(1,I)*COS(DIRSL(J,1,I)/180.*PI)/C(1)
DOPLOG=10.*ALOG10(DOP)
DO 601 K=1,NK
CRV (K) =SPL24(K,J,I)-10.*FLOGX(K)+CONST - DOPLOG
601 CRVX(K)=ALOG10(DOP*FREQX(K))
DO 602 K=1,NK
602 SPLREF(K,J,I) = TBLU1(FLOG24(K), CRVX, CRV, 1, 24)
CD      CALL WRITE ( 1, 7, 1, 0, 2, 1, SPLREF, DOP)
DISTRAN=S(J,2)
IF (MF(10).EQ.1) DISTRAN=SQRT(S(J,2)*S(J,2)+X(2,1)*X(2,1))
ENGICB=(1.+SQRT(SIN(S(J,2)/DISTRAN)))*5.*ALOG10(ENGINE)
DO 603 K=1,NK
SPLREF(K,J,I)=SPLREF(K,J,I)+20.*ALOG10(DISTSL(J,1,I)/DISTSL(J,2,I)
1  )+DISTSL(J,1,I)*AAC(K,1,I)/1000.-DISTSL(J,2,I)*AAC(K,2,I)/1000.
2  +ENGICB +ATT1(K)-ATT2(K)
603 CONTINUE
CD      CALL WRITE ( 1, 8, 0, 0, 2, 1, SPLREF, DOP)
C          ADD DOPPLER SHIFT AND CORRECT FOR BAND WIDTH
DOP=1.-V(2,I)*COS(DIRSL(J,2,I)/180.*PI)/C(2)
DOPLOG=10.*ALOG10(DOP)
DO 600 K=1,NK
CRV(K) = SPLREF(K,J,I)
600 CRVX(K)=ALOG10(FREQX(K)/DOP)
DO 650 K=1,NK
650 SPLREF(K,J,I) = TBLU1 (CRVX(K), FLOG24, CRV, 1, 24)
CD      CALL WRITE ( 1, 7, 1, 0, 2, 1, SPLREF, DOP)
DO 651 K=1,NK
651 SPLREF(K,J,I)=SPLREF(K,J,I)+10.*FLOGX(K)-CONST + DOPLOG
CD      CALL WRITE ( 1, 8, 0, 0, 2, 1, SPLREF, DOP)
                                                GO TO 800
630 CONTINUE
DISTRAN=S(J,2)
IF (MF(10).EQ.1) DISTRAN=SQRT(S(J,2)*S(J,2)+X(2,1)*X(2,1))
ENGICB=(1.+SQRT(SIN(S(J,2)/DISTRAN)))*5.*ALOG10(ENGINE)
DO 700 K=1,NK
SPLREF(K,J,I)=SPL24(K,J,I)+20.*ALOG10(DISTSL(J,1,I)/DISTSL(J,2,I))
1  +DISTSL(J,1,I)*AAC(K,1,I)/1000.-DISTSL(J,2,I)*AAC(K,2,I)/1000.
2  +ENGICB +ATT1(K)-ATT2(K)
700 CONTINUE
800 CONTINUE
RETURN
END

```

SUBROUTINE ROTATE (L, KKK, SPL24, THETA)

ZDM914 23 - JT

C

```
REAL *4 SPL24(24,70,2), THETA(70,3,1)
COMMON / AREA4 / MF(30), MN(10), ENGINE, NI, NJ, NK, NII, CRV(400), MKT
COMMON / GEOM1 / H(3,4), V(3,4), HREL(3,4), TEMP(3,4), X(3,4),
1 Y(3,4), PI, GAMM(2), ALPH(2), S(70,2), W(70,2), C(2)
COMMON / GEOM7 / PSI(70)
```

C

```
* * * * *
DO 120 NB= 1, NK
DO 110 NA= NI, NJ
110 CRV(NA) = SPL24(NB, NA, KKK)
DO 120 NA= NI, NJ
AN=PSI(NA)
120 SPL24(NB, NA, KKK) = TBLU1(AN, THETA(1, L, 1), CRV, 1, NJ)
RETURN
END
```

SUBROUTINE NOYFIT(SPLNOY)

ZDM914 05 - 3T

C

COMMON / AREA4 / NF(30),MN(10),ENGINE ,NI,NJ,NK,NII,CRV(400),MKT

COMMON / AREA5 / PNL24(70,1),XNOY24(24),EPNL(4,2),PEAKPN (4),

1 OASPL(70,1),TCPNL(70,1), XNOYMX(70), MTCB(70)

COMMON/CONNOY/ABPS(24),BBPS(24),ALO(24),BLO(24),AM(24),BM(24)

DIMENSION SPLNOY(24,70,1)

CONST=0.15

I = 1

DO 960 J=NI,NJ

DO 900 K=1,NK

KK=K

XNOY24(K)=0.

IF(ABPS(KK).NE.C..AND.SPLNOY(K,J,I).GT.0.)

1 XNOY24(K)=SPLNOY(K,J,I)/ABPS(KK)

IF(SPLNOY(K,J,I).LT.ABPS(KK)) GO TO 900

XNOY24(K)=10.**((AM(KK)*SPLNOY(K,J,I)-ALO(KK)))

IF(SPLNOY(K,J,I).GT.BBPS(KK))

1 XNOY24(K)=10.**((BM(KK)*SPLNOY(K,J,I)-BLO(KK)))

900 CONTINUE

XMAX=0.

XSUM=0.

DO 950 K=1,NK

XSUM=XSUM+XNOY24(K)

IF(XNOY24(K).GT.XMAX) XMAX=XNOY24(K)

950 CONTINUE

XNOYTL=XMAX+CONST*(XSUM-XMAX)

XNOYMX(J) = XNOYTL

PNL24(J,I)=40.

IF(XNOYTL.GT.1.) PNL24(J,I)=ALOG10(XNOYTL)/.030103+40.

OASPL(J,I)=OAFUNC(SPLNOY(I,J,I))

960 CONTINUE

RETURN

END

SUBROUTINE EPNLTI(SPLEPN ,VEL,L ,DTIME)

ZDM914 03 - 03

```
C
COMMON / AREA1 / SPL24(24,70,2), SPLREF(24,70,1)
COMMON / AREA3 / FREQ24(24), FLOG24(24), FREQ8(8), FLOG8(8), BWN(24)
COMMON / AREA4 / MF(30), MN(10), ENGINE ,NI, NJ, NK, NII, CRV(400), MKT
COMMON / AREA5 / PNL24(70,1), XNDY24(24), EPNL(4,2), PEAKPN (4),
1      OASPL(70,1), TCPNL(70,1) , XNDYMX(70), MTCB(70)
COMMON/AREA6/THRUST(4), THRUSI (6), OVHTIM(4), TIM(70), TIM2(70,3,1)
COMMON/GEOM1/H(3,4), V(3,4), HREL(3,4), TEMP(3,4), X(3,4), Y(3,4), PI
1      , GAMM(2) , ALPH(2) , S(70,2) , W(70,2) , C(2)
COMMON/GEOM2/THETA(70,3,1), ALPHA(70,3,1), DIRSL(70,3,1),
1  DISTSL(70,3,1), AAC(25,2,4)
DIMENSION SPLEPN (24,60,1)
I = 1
EPNL(1,1) = 0.0
EPNL(1,2) = 0.0
      DO 833 NB=1,24
DO 833 NA=NI,NJ
      IF(SPLEPN(NB,NA,1) .LT. 0.0) SPLEPN(NB,NA,1) = 0.0
833 CONTINUE
DO 900 J=NI,NJ
TCPNL(J,I)=PNL24(J,I)
MTCB(J) = 1
      IF (MF(9) .NE. 0) GO TO 900
TCPNL(J,I)=PNL24(J,I)+FMTONE(SPLEPN (1,J,I), NTCB)
MTCB(J) = NTCB
900 CONTINUE
IF(VEL.EQ.0.) GO TO 1000
M=1
DM=M*10.
DM1=M
XNI=90.
XNI=0.
XHUN=XNI+DM
PNLMAX=C.
DO 161 J=NI,NJ
IF(TCPNL(J,I).LT.PNLMAX) GO TO 161
PNLMAX=TCPNL(J,I)
JMAX = J
PEAKPN(I) = PNLMAX
161 CONTINUE
      IF (PNLMAX .LE. XNI) RETURN
      IF (PNLMAX .LE. XHUN) DM = PNLMAX - XNI
PM = PNLMAX - DM
      IF (TCPNL(1,I) .GT. PM .OR. TCPNL(NJ,I).GT.PM) RETURN
DO 162 J=1,JMAX
JL=J
IF(TCPNL(JL+1,I) .GE. PM .AND. TCPNL(JL+1,I) .GE. XNI) GOTO163
162 CONTINUE
GO TO 164
163 CONTINUE
```

```

DO 165 J=JMAX,NJ
JT = NJ -J + JMAX
IF(TCPNL(JT-1,I) .GE. PM .AND. TCPNL(JT-1,I) .GE. XNI) GOTO166
165 CONTINUE
GO TO 164
166 CONTINUE
TL=(PNLMAX-DM-TCPNL(JL,I))/(TCPNL(JL+1,I)-TCPNL(JL,I))
1 *(TIM2(JL+1,L,I)-TIM2(JL,L,I))+TIM2(JL,L,I)
TT=TIM2(JT,L,I)-(PNLMAX-DM-TCPNL(JT,I))/(TCPNL(JT-1,I)-
1 TCPNL(JT,I))*(TIM2(JT,L,I)-TIM2(JT-1,L,I))
DTIME = TT - TL
EPNL(I,M)=PNLMAX*10.*ALOG10((TT-TL)/DM1/15.)
SUM=C.
SUM=.5*(10.**((PNLMAX-DM)/10.))+10.**(TCPNL(JL+1,I)/10.)*
1 (TIM2(JL+1,L,I)-TL)+.5*(10.**((PNLMAX-DM)/10.))+
2 10.**(TCPNL(JT-1,I)/10.)*(TT-TIM2(JT-1,L,I))
NL=JL+1
NT=JT-2
DO 171 N=NL,NT
171 SUM=SUM+.5*(10.**(TCPNL(N,I)/10.))+10.**(TCPNL(N+1,I)/10.)*
1 (TIM2(N+1,L,I)-TIM2(N,L,I))
EPNL(I,2)=10.*ALOG10(SUM/10.)
GO TO 16C
164 EPNL(I,M)=-1000.
EPNL(I,2)=-1000.
160 CONTINUE
1000 RETURN
END

```

SUBROUTINE JSHIFT

ZDM914 24 - KT

```

COMMON / AREA1 / SPL24(24,70,2), SPLREF(24,70,1)
COMMON / AREA4 / MF(30), MN(10), ENGINE ,NI,NJ,NK,NII,CRV(400),MKT
COMMON / HFVJE / SPLFA(24,70,2), SPLJE(24,70), CASP(70,2)
1   , SPLTU(24,70)
REAL *4 ACC(25), CRVX(25) , SPLRO(24,70)
1   , SHRANK(24) /17., 16.8, 16.5, 16., 15.0, 14.5, 14.0, 13.5,12.5,
2   12., 11.5, 11., 10., 9., 8., 6., 4., 1., 0., .5, 1.5, 3., 5.,
3   7./
EQUIVALENCE (SPLREF(1,1,1), SPLRO(1,1))
C * * * * *
KKK = 1
NI = 19
MN8 = 15
NQ2 = MN8 + 1
IF (MF(26) .EQ. 1) GO TO 400
CALL JETSMO (SPLJE)
CALL JETSMO (SPLRO)
400 DO 508 NB = 1,24
DO 508 NA=NI,NJ
SPLREF (NB,NA,1) = SPLJE (NB,NA) - SPLREF (NB,NA,1)
IF (SPLJE (NB,NA) .GE. SPL24 (NB,NA,KKK)) SPLJE (NB,NA) =
1   SPL24 (NB,NA,KKK) - 1.0
508 CONTINUE
IF (MF(26) .EQ. 1) RETURN
DO 485 NA=NI,NJ
SAV1 = SPLJE (MN8,NA)
DO 518 NB =1,MN8
SPLJE (NB,NA) = SPL24 (NI,NA,KKK) - SHRANK (NB)
IF (SPL24 (NB,NA,KKK) .LE. SPLJE (NB,NA))
1   SPLJE (NB,NA) = SPL24 (NB,NA,KKK) - 4.0
518 SPLJE (NB,NA) = 10. * ALOG10 (10. ** (SPL24 (NB,NA,KKK) * .1)
1   -10. ** (SPLJE (NB,NA) * .1))
SAV1 = SPLJE (MN8,NA) - SAV1
DO 485 NB = NQ2,24
SPLJE (NB,NA) = SPLJE (NB,NA) + SAV1
IF (SPLJE (NB,NA) .LE. SPL24 (NB,NA,KKK)) GO TO 485
SAV1 = SPL24 (NB,NA,KKK) - .05 - (SPLJE (NB,NA) - SAV1)
SPLJE (NB,NA) = SPL24 (NB,NA,KKK) - .05
485 CONTINUE
RETURN
END

```

SUBROUTINE JETSMO (SPLJE)

ZDM914 25 - KT

C

COMMON / AREA4 / MF(30),MN(10),ENGINE,NI,NJJ(1),NK,NII,CRV(400)

1,MKT

REAL *4 AC(25), CRVX(25), SPLJE(24,70)

EQUIVALENCE (NJ,NJJ(1))

C

* * * * *

DO 100 NA=NI,NJ

N = 0

DO 50 J=2,23,3

N = N + 1

CRVX(N) = J

AC(N) = SPLJE(J,NA)

50 CONTINUE

DO 100 NB = 1,24

XB = NB

SPLJE(NB,NA) = YBLU1(XB, CRVX, AC, 1, N)

100 CONTINUE

RETURN

END

SUBROUTINE JETHFV (VJJET,VMJET)

ZDM914 22 - KT

C

```

REAL *4 AC(25), CRVX(25)
COMMON / AREA1 / SPL24(24,70,2), SPLREF(24,70,1)
COMMON / AREA3 / FREQ24(24), FLOG24(24), FREQ8(8), FLOG8(8), BWN(24)
COMMON / AREA4 / MF(30), MN(10), ENGINE ,NI,NJ,NK,NII,CRV(400),MKT
COMMON / GEOM1 / H(3,4), V(3,4), HREL(3,4), TEMP(3,4), X(3,4)
1 ,Y(3,4), PI, GAMM(2), ALPH(2), S(70,2), W(70,2), C(2)
COMMON / GEOM2 / THETA(70,3,1), ALPHA(70,3,1), DIRSL(70,3,1),
1 DISTSL(70,3,1), AAC(25,2,4)
COMMON / HFVJE / SPLFA(24,70,2), SPLJE(24,70), OASP(70,2)
1 , SPLTU(24,70)
DIMENSION DE DB(17) , THE(17)
DATA DE DB / -4., -3.52288, -3., -2.52288, -2., -1.52288, -.39794,
1 -.22185, .47712, -.22185, -.39794, -1.52288, -2.0, -2.52288
2 , -3., -3.52288, -4./
3 , THE / 10., 20., 30., 40., 50., 60., 70., 80., 90., 100.,
4 110., 120., 130., 140., 150., 160., 170./
DO 200 NA=NI,NJ
200 IF (DIRSL(NA,1,1).GE.88.AND.DIRSL(NA,1,1).LE.92.) NJ90=NA
K=1
L=2
DO 205 NA=NI,NJ
DDDB = 10.0 ** (TBLU1(DIRSL(NA,1,1) ,THE ,DEDB ,1 ,17))
IF (NA.LE.NJ90) GO TO 210
K=2
L=1
210 DO 205 NB=1,NK
IF (MF(25) .EQ. 1) GO TO 203
IF (SPLJE(NB,NA).GE.SPL24(NB,NA,1)) SPL24(NB,NA,1)=SPLJE(NB,NA)+.5
SPL24(NB,NA,1)=10.*ALOG10(10.**((SPL24(NB,NA,1)/10.)
1 -10.**((SPLJE(NB,NA )/10.)
2 -10.**((SPLTU(NB,NA )/10.))
203 SPLFA(NB,NA,K)=SPL24(NB,NA,1)-DDDB
205 SPLFA(NB,NA,L)=10.*ALOG10(10.**((SPL24(NB,NA,1)/10.)
1 -10.**((SPLFA(NB,NA,K)/10.))
DO 350 N=1,2
DO 310 J=NI,NJ
CC WRITE (6,5577) J, N, (SPLFA(I,J,N),I=1,24)
310 OASP (J,N)= OAFUNC(SPLFA(1,J,N))
C5577 FORMAT ('O$JETS' / (5X,7G15.5))
C FIND THE MAX OF OASP
OAPM=0.
DO 320 J=NI,NJ
320 IF (OASP(J,N).GT.OAPM) OAPM=OASP(J,N)
DO 330 J=NI,NJ
C - - - NASA-LEWIS CHANGE 1-11-71 - - - - -
CN330 OASP (J,N)=OASP (J,N)/OAPM
330 OASP (J,N)=1.0
C - - - - - T O H E R E - - - - -
350 CONTINUE

```

```

DO 390 NA=NI,NJ
  DO 390 NB = 1,24
390 SPLJE(NB,NA) = SPLJE(NB,NA) - SPLREF(NB,NA,1)
  IF (MF(17) .EQ.1 ) RETURN
  IF (VMJET.EQ.0.) VMJET = VJJET + V(2,1)
  VRATIO = (VMJET - V(2,1)) / VJJET
  DELSPL = 80. * ALOG10(VRATIO)
DO 410 NA=NI,NJ
  DO 405 NB = 1,24
  AC(NB) = SPLJE(NB,NA) + DELSPL
405 CRVX(NB) = ALOG10(FREQ24(NB) *(VRATIO))
  DO 410 NB=1,24
410 SPLJE(NB,NA) = TBLU1(FLOG24(NB),CRVX,AC , 1, 24)
  RETURN
  END

```

SUBROUTINE LOBESE

ZDM914 21 - JT

C

```

COMMON / AREA1 / SPL24(24,70,2), SPLREF(24,70,1)
COMMON / AREA4 / MF(30), MN(10), ENGINE ,NI,NJ,NK,NII,CRV(400),MKT
COMMON / HFVJE / SPLFA(24,70,2), SPLJE(24,70), OASP(70,2)
1   , SPLTU(24,70)
COMMON / HFVJT / CAT(4), ATEN(24,4), ATATM(24,4), ATENM(4)
DIMENSION      SPLAT(2)
DO 18 N=1,4
DO 18 NB=1,24
18 ATATM(NB,N)=ATEN(NB,N)/CAT(N)
DO 560 N =1,2
DO 560 NB=1,NK
ATATM(NB,N) = ATATM(NB,N) + ATATM(NB,N+2)
560 CONTINUE
DO 320 NA=NI,NJ
DO 320 NB=1,NK
DO 17 N=1,2
17 SPLAT( N)=SPLFA(NB,NA,N) - OASP (NA,N)*ATATM(NB,N)
320 SPL24(NB,NA,1)=10.*ALOG10(10.**(SPLAT( 1)*.1 )
1   +10.**(SPLAT( 2)*.1 )
2   +10.**(SPLJE(NB,NA) *.1 )
2   +10.**(SPLTU(NB,NA) *.1 )
RETURN
END

```

FUNCTION FMTONE(SPZ, NTCB)

ZDM914 08 - 08

```
C
DIMENSION SPL(25),S(25),SPLP(25),SP(25),SBAR(25),SPLPP(25),FC(25)
1   ,SPZ(1)
EQUIVALENCE (SP,S,SPLPP) , (SPLP, SBAR,FC)
C
DO 110 K=1,24
SPL (K)=SPZ(K)
IF (SPL(K) .LT. 0.0) SPL(K) = 0.0
110 SPLP(K)=SPL(K)
S(3)=0.
DO 100 K=4,24
100 S(K)=SPL(K)-SPL(K-1)

DO 150 K=5,24
IF(ABS(S(K)-S(K-1)).LE.5.) GO TO 150
IF(S(K).GT.0.) GO TO 120
IF(S(K-1).LE.0.) GO TO 150
SPLP(K-1)=(SPL(K-2)+SPL(K))/2.
GO TO 150
120 IF(S(K).LE.S(K-1)) GO TO 150
IF(K.GT.23) GO TO 130
SPLP(K)=(SPL(K-1)+SPL(K+1))/2.
GO TO 150
130 SPLP(24)=SPL(23)+S(23)
150 CONTINUE

DO 160 K=4,24
160 SP(K)=SPLP(K)-SPLP(K-1)
SP(3)=SP(4)
SP(25)=SP(24)
DO 170 K=3,23
170 SBAR(K)=(SP(K)+SP(K+1)+SP(K+2))/3.
SPLPP(3)=SPL(3)
DO 180 K=4,24
180 SPLPP(K)=SPLPP(K-1)+SBAR(K-1)
FM=-1000.
NTCB = C
DO 250 K=3,24
F=SPL(K)-SPLPP(K)
IF(F.LT.3.) GO TO 220
IF(K.LT.11.OR.K.GT.21) GO TO 210
FC(K)=AMIN1(F/3.,20./3.)
GO TO 220
210 FC(K)=AMIN1(F/6.,20./6.)
GO TO 220
220 FC(K)=0.0
230 IF (FC(K) .LT. FM) GO TO 250
FM = FC(K)
NTCB = K
250 CONTINUE
```

FMTONE=FM
RETURN
END

SUBROUTINE ATABC(NB,TEMP,HREL,AAC)

ZDM914 04 - 3T

C

```
DIMENSION AAC(1),PFREQ(8),CFREQ(8),TFREQ(25),FREQ(41),X1(25),
1      Y1(25),X2(19),Y2(19),X3(2),Y3(2,11),Z3(11),X4(2),
2      Y4(2,11),Z4(11)
EQUIVALENCE (FREQ(1),PFREQ(1)),(FREQ(9),CFREQ(1)),
1      (FREQ(17),TFREQ(1),X1(1)),(Z3(1),Z4(1))
DATA PFREQ/1.799341,2.09691,2.39794,2.69897,3.,3.30103,3.60206,
1      3.773786/
DATA CFREQ/1.724276,2.025306,2.326336,2.628389,2.929419,3.230449,
1      3.531479,3.702431/
DATA TFREQ/1.69897,1.799341,1.90309,2.,2.09691,2.20412,2.30103,
1      2.39794,2.498311,2.60206,2.69897,2.799341,2.90309,3.,
2      3.09691,3.20412,3.30103,3.39794,3.498311,3.60206,
3      3.650308,3.748963,3.851258,3.951338,4.049218/
DATA Y1/.22,.25,.28,.32,.36,.41,.45,.51,.56,.63,.7,.79,.89,1.01,
1      1.14,1.27,1.41,1.57,1.75,1.98,2.10,2.36,2.67,2.98,3.26/
DATA X2/0.,.5,.65,.75,.9,1.,1.12,1.25,1.5,2.,2.5,3.,3.5,4.,4.5,5.,
1      6.,6.5,8./
DATA Y2/C.,.69,.9,.96,1.,1.,.95,.865,.75,.57,.45,.37,.31,.27,.24,
1      .225,.21,.2.,2./
DATA X3/-.522879,.954243/
DATA Y3/.0086,1.498311,.079181,1.556303,.136721,1.618048,.198657,
1      1.672098,.247973,1.724276,.292256,1.770852,.342423,
2      1.812913,.380211,1.869232,.431364,1.908485,.477121,
3      1.954243,.525045,1.995635/
DATA Z3/C.,10.,20.,30.,40.,50.,60.,70.,80.,90.,100./
DATA X4/1.,2./
DATA Y4/-.958607,.021189,-.744727,.230449,-.545155,.431364,
1      -.346787,.633468,-.180454,.80618,-.017729,.963788,.113943,
2      1.10721,.255273,1.255273,.406540,1.389166,.531479,
3      1.518514,.662758,1.643453/
IF(HREL.LT.10.) HREL=10.
IF(HREL.GT.100.) HREL=100.
HABS=10.**TBLU2(ALOG10(HREL),TEMP,X4,Z4,Y4,1,1,2,11,2,11)
I=16
NF=25
400 DO 500 J=1,NF
      K=I+J
      ALPC=10.**((2.06*FREQ(K)-7.578)
      HMOLMX=TBLU1(FREQ(K),X1,Y1,1,25)
      ALPMAX=10.**TBLU2(FREQ(K)-3.,TEMP,X3,Z3,Y3,1,1,2,11,2,11)
      ARG=FABS/HMOLMX
      AMAMM=TBLU1(ARG,X2,Y2,1,19)
      ALPMOL=AMAMM*ALPMAX
500 AAC(J)=ALPC+ALPMOL
      RETURN
      END
```

SUBROUTINE EGAI(DIST,FREQ,BETA,N,ATT)

ZDM915 09 - 8T

DIMENSION FREQ(N),ATT(N),AK(7),AT(63),FR(7),R(9)

DATA AK / 2.7, 2.27, 2.19, 1.93, 1.63, 2.11, 2.11/

DATA AT/

1	.5	.1	.1	.1	.1.5	.2	.4	.4.5	.5	.
2	1.	.1.5	.2	.2	.2.5	.3	.6	.7	.7	.
3	1.	.1.5	.2	.2.5	.3	.4	.7.5	.9	.9	.
4	1.	.1.5	.2	.3	.4	.5	.10	.11	.11	.
5	1.	.1.5	.2	.3.5	.5	.6	.11	.13	.14	.
6	1.	.2	.3	.4.5	.6	.7	.13	.15	.15	.
7	1.	.2	.3	.4.5	.6	.7	.13	.15	.15	/

DATA FR /53., 106., 212., 425., 850., 1700., 3400./

DATA R /100., 200., 400., 600., 800., 1000., 2000., 3000.,

1 4000./

DATA PI/3.14159265/

DATA PI9902/1.55508836/

BETA1=BETA / 180.*PI

IF (BETA1 .LT. 0.0) BETA1 = 0.0

IF (BETA1 .GT. PI9902) BETA1 = PI9902

10 DO 20 I=1,N

X = TBLU2(DIST,FREQ(I),R,FR,AT,1,1,9,7,9,7)

A = TBLU1(FREQ(I),FR,AK,1,7)

ATT(I)=X*EXP(-A*SQRT(TAN(BETA1)))

20 CONTINUE

RETURN

END

```
FUNCTION OAFUNC(SPL)
```

ZDM914 10 - BT

C

```
DIMENSION SPL(24)
```

```
OACAL = 0.
```

```
DO 901 K=1,24
```

```
901 OACAL=OACAL+10.**(SPL(K)/10.)
```

```
OAFUNC=10.*ALOG10(OACAL)
```

```
RETURN
```

```
END
```

BLOCK DATA

ZDM914 13 - 8T

C

```

COMMON / AREA1 / SPL24(24,70,2), SPLREF(24,70,1)
COMMON / AREA2 / TITLE(40)
COMMON / AREA3 / FREQ24(24), FLOG24(24), FREQ8(8), FLOG8(8), BWN(24)
COMMON / AREA4 / MF(30), MN(10), ENGINE ,NI, NJ, NK, NII, CRV(400), MKT
COMMON / AREA5 / PNL24(70), XNOY24(24), EPNL(8), PEAKPN(4),
1   DASPL(70,1), TCPNL(70,1), XNOYMX(70), MTCB(70)
COMMON / AREA6 / THRUST(4), THRUSTI (6), DVHTIM(4), TIM(70), TIM2(70,3,1)
COMMON / GEOM1 / H(3,4), V(3,4), HREL(3,4), TEMP(3,4), X(3,4), Y(3,4), PI
1   , GAMM(2), ALPH(2), S(70,2), W(70,2), C(2)
COMMON / GEOM2 / THETA(14), THETA2(196), ALPHA(210), DIRSL(210),
1   DISTSL(210), AAC(200)
COMMON / CONNOY / ABPS(24), BBPS(24), ALO(24), BLO(24), AM(24), BM(24)
COMMON / HFVJE / SPLFA(24,70,2), SPLJE(24,70), GASP(70,2)
1   , SPLTU(24,70)
DATA PI / 3.1415926536 / , SPLTU/1680*0.0/
2   , AAC/ 200*0.0/, TITLE/40*0./
4   , PEAKPN/4*0.0/
5   , EPNL /8*0.0/
6   , TIM /70*0.0/
8   , TCPNL /70*0.0/
DATA THETA/30., 40., 50., 60., 70., 80., 90., 100., 110., 120., 130., 140.,
1   150., 160./
DATA BWN /1.0, 2.0, 3.0, 4.0, 5.0, 6.0, 7.0, 8.0, 9.0, 10.0, 11.0, 12.0,
1 13.0, 14.0, 15.0, 16.0, 17.0, 18.0, 19.0, 20.0, 21.0, 22.0, 23.0, 24.0/
DATA FREQ24
1 / 50., 63., 80., 100., 125., 160., 200., 250., 315., 400.,
2 500., 630., 800., 1000., 1250., 1600., 2000., 2500., 3150., 4000.,
3 5000., 6300., 8000., 10000. /
DATA ABPS/
1 64. ,60. ,56. ,53. ,51. ,48. ,46. ,44. ,42. ,40. ,
2 40. ,40. ,40. ,40. ,38. ,34. ,32. ,30. ,29. ,29. ,
3 30. ,31. ,37. ,41. /
DATA BBPS/
1 91. ,85.9 ,87.3 ,79.9 ,79.8 ,76. ,74. ,74.9 ,94.6 ,1000.,
2 1000. ,1000. ,1000. ,1000. ,1000. ,1000. ,1000. ,1000. ,1000. ,1000.,
3 1000. ,1000. ,44.3 ,50.7 /
DATA ALO /
1 64. ,60. ,56. ,53. ,51. ,48. ,46. ,44. ,42. ,40. ,
2 40. ,40. ,40. ,40. ,38. ,34. ,32. ,30. ,29. ,29. ,
3 30. ,31. ,37. ,41. /
DATA BLO /
1 52. ,51. ,49. ,47. ,46. ,45. ,43. ,42. ,41. ,40. ,
2 40. ,40. ,40. ,40. ,38. ,34. ,32. ,30. ,29. ,29. ,
3 30. ,31. ,34. ,37. /
DATA AM /
1 .043478 ,.04057 ,.036831 ,.036831 ,.035336 ,
2 .033333 ,.033333 ,.032051 ,.030675 ,.030103 ,
3 .030103 ,.030103 ,.030103 ,.030103 ,.030103 ,
4 .02996 ,.02996 ,.02996 ,.02996 ,.02996 ,

```

5 .C2996 ..C2996 ..042285 ..042285/
DATA BM/15*.030103,9*.02996/
END

C FUNCTION TBLUI(XX,X,Y,MDX,NLX)

ZDM914 14 - 14

DIMENSION X(1),Y(1)

NO X = MDX-1

CALL SEARCH(X,XX,NO X,NLX,I,DELTA 1,A 1)

TBLUI = Y(I) + (Y(I+1)-Y(I))*DELTA 1/A 1

RETURN

END

```

FUNCTION TBLU2(XX,YY,X,Y,F2,MDX,MDY,NLX,NLY,NFX,NFY)
DIMENSION F2(NFX,NFY),X(1),Y(1)
NO X = MDX-1
NO Y = MDY-1
CALL SEARCH(X,XX,NO X,NLX,I,DELTA 1,A 1)
CALL SEARCH(Y,YY,NO Y,NLY,J,DELTA 2,A 2)
DFX1 = (F2(I+1,J)-F2(I,J))*DELTA 1/A1
DFX2 = (F2(I+1,J+1)-F2(I,J+1))*DELTA 1/A1
TBLU2 = F2(I,J) + DFX1 + (F2(I,J+1)-F2(I,J)+DFX2-DFX1)*DELTA 2/A 2
RETURN
END

```



```

SUBROUTINE SEARCH(X,XX,NOX,NLX,I,DELTA,A)
DIMENSION X(1)
1 NO X = NO X + 1
IF(XX.LT.X(NO X)) GO TO 5
IF(NO X.GE.NLX)GO TO 5
GO TO 1
5 DELTA = XX - X(NO X)
I = NO X
IF(NO X.NE.1) GO TO 10
A = X(NO X + 1) - X(NO X)
RETURN
10 IF(XX.LT.X(NLX)) GO TO 20
DELTA = XX - X(NO X-1)
A = X(NO X) - X(NO X-1)
I = NO X - 1
RETURN
20 DELTA = XX - X(NO X - 1)
A = X(NO X) - X(NO X-1)
I = (NO X-1)
RETURN
END

```



```

C
3005 CONTINUE
      WRITE(6,5577) DBHIST, NEW, OLD, CURVY(ICV), CURVX(ICV), X, Y
      RETURN 2
C
C
      ENTRY BOUNDX(DBTEST, X, Y, *, *)
C
      IF (DBHIST(NEW) .GT. 0.0)                                GO TO 4005
      DBHIST(NEW) = DBTEST
      X = X - DELX
      IF (DBTEST .GT. DBNL)      X = X + 2.0*DELX
                                                                GO TO 3005
4005 NEW = FIPFOP - NEW
      OLD = FIPFOP - OLD
      DBHIST(NEW) = DBTEST
      CALL BOUND (DBHIST(OLD), DBHIST(NEW), DBNL, X, DELX, +2000)
C***          BOUNDED          -          -          -          -
C**          STORE INTERPOLATED POINTS
      ICV = ICV + 1
      DUMY(OLD) = ALOG10(POINTX(IPT-1))
      DUMY(NEW) = ALOG10(POINTX(IPT))
      CURVX(ICV) = TBLU1(DBNL, DBHIST, DUMY, 1, 2)
      CURVX(ICV) = 10.0**(CURVX(ICV))
      CURVY(ICV) = Y
                                                                GO TO 2005
      END

```

```

SUBROUTINE BOUND (DBHIS1, DBHIS2, DBNL, Y, DELY, *)
C
C
C      *      *      *      *      *      *      *      *      *      *      *
C      IF (DBHIS1 .LT. DBNL)                                GO TO 1005
C      IF (DBHIS2 .LT. DBNL)                                GO TO 2005
C**      INCREMENT Y TO DECREASE DBHIST
Y = Y + DELY
C
C      1005 IF (DBHIS2 .GT. DBNL)                                GO TO 1505
C**      DECREMENT Y TO INCREASE DBHIST
Y = Y - DELY
C      1505 RETURN 1
C**      NOT BOUNDED
C      2005 RETURN
C**      BOUNDED
END

```

```

SUBROUTINE PLOTFP (X, Y, NPTS, FIRST, U, V, NPTS2)
C
C
C**          SUBROUTINE TO          PLOT FOOT PRINT
LOGICAL *4  FIRST
INTEGER *4  MXPTS/1000/, XLABEL(1)/'  ',SIZXL/0/  ,CYCLE
1           ,YLABEL(1)/'  '  /, SIZYL/00/
2           ,TITLE(4)/'EPNL TEST DATA  '/, SIZTIL/14/ ,TYPE/'REC'/
3           ,SYMB
REAL *4     X(1)  , Y(1), U(1),      ZERO/0.0/ ,V(1)
C * - * - * - * - * - * * * * * * * * * * * * * * * *
IF (.NOT. FIRST) GO TO 1000
CYCLE = 1

C
C**          INITIALIZE FOR PLOTTING
CALL PLCTIN (10.,10., 12., 0., 90.,-12.0, 0.,-11.0, 0.0
1           ,TYPE, CYCLE)

C
C5577 FORMAT ('0***  ', 7G15.5/(5X,7G15.5))
CD      WRITE (6,5577) (X(J), Y(J),J=1,NPTS), NPTS
C
C**          PLOT POINTS
C
C          - - - - - ROTATE PLOT -90 DEG. TO ORIENT WITH PAPER -
1000 XSF = -2000.0
      YSF = 10000.0
      XSP = 0.0
      YSP = 0.0
      LINPT = - 1
      SYMB = 2
      CALL PLOTSC (Y, X, NPTS, XLABEL, YLABEL, TITLE, SIZXL, SIZYL
1           ,SIZTIL, YSP , YSF , XSP , XSF , LINPT, SYMB)
      FIRST = .FALSE.
C          - - - - - PLOT INTERPOLATED CURVE - - - - -
      LINPT = 0
      SYMB = 0
1050 CALL PLOTCV (V, U, NPTS2,YSP , YSF , XSP , XSF , LINPT, SYMB)
C
C9000 WRITE (6,9005) MXPTS ,MXPTS
C9005 FORMAT ('0***          THE MAXIMUM NO. OF POINTS ALLOWED BY DIMENSIONING
C 1 (' , I5, ') HAS BEEN EXCEEDED. THE FIRST',I5,' POINTS WILL BE'
C 2      , ' PLOTTED.')
C
C
C          GO TO 1015
9990 CONTINUE
C CALL PLOT (ZERO, ZERO, 999)
RETURN
END

```

APPENDIX 4
PHI PROGRAM DESCRIPTION

PRECEDING PAGE BLANK NOT FILMED

PHI PROGRAM

This computer program evaluates the relative effectiveness of the inlet and fan duct lining and the fundamental and harmonic attenuation.

The main program accepts the punched output from the Aircraft Noise Time History Prediction Program (EPNL program).

Program Input

1. Title card columns (1-72)

2. K1, K10 (215)

K1 indicates the number of attenuations used with values as indicated by DATA statement ATENM2. If $K1 = 4$, then the data statement is rearranged by replacing $ATENM2(4) = ATENM2(5)$.

$K10 = 0$ at all times.

3. LON1, LON2, LON3, LON4, MTH, NST, NIN, IPHI (815)

LON1 = 1 Write input

LON2 = 1 Write revised input

LON3 = 1 Plot attenuation

LON4 = Plot phi study

IPHI = 1 Long printout for design information

= 0 Short printout for documentation

NST = Start of phi calculation (integer between initial and final peak attenuation value)

NTH = Final value of NST

NIN = Increment to be used in going from NST to NTH

4. C1, C2, C3, C4, C5 (5F 10.1)

Constants used in the elevation of the phi function.

5. ATT2 (40X, F6.0)

The change in EPNL as effected by the attenuation.

6. CORREC (F10.2)

The difference between the first EPNL calculated and the reference EPNL value.

The program is set up to accept inputs for attenuations of 0, 5, 10, 20, and 30 dB (ATENM2). The revised input (ATENM1) can be changed to allow a detailed description of the attenuation, for instance 0., 2.5, 5, 7.5, 10 dB.

APPENDIX 5
PHI PROGRAM FLOW CHART

MAIN PROGRAM

PROGRAM TO EVALUATE THE RELATIVE EFFECTIVENESS OF INLET AND
PRODUCT LINING MATERIALS

REFERENCE DOCUMENT D3-8686

LON1=1 WRITE INPUT
 LON2=1 WRITE REVISED INPUT
 LON3=1 PLOT ATTENUATIONS
 LON4=1 PLOT PHJ STUDY
 IPHI = 0 SHORT PRINT OUT FOR DOCUMENTATION
 IPHI = 1 LONG PRINT OUT TO GET DESIGN FACTORS

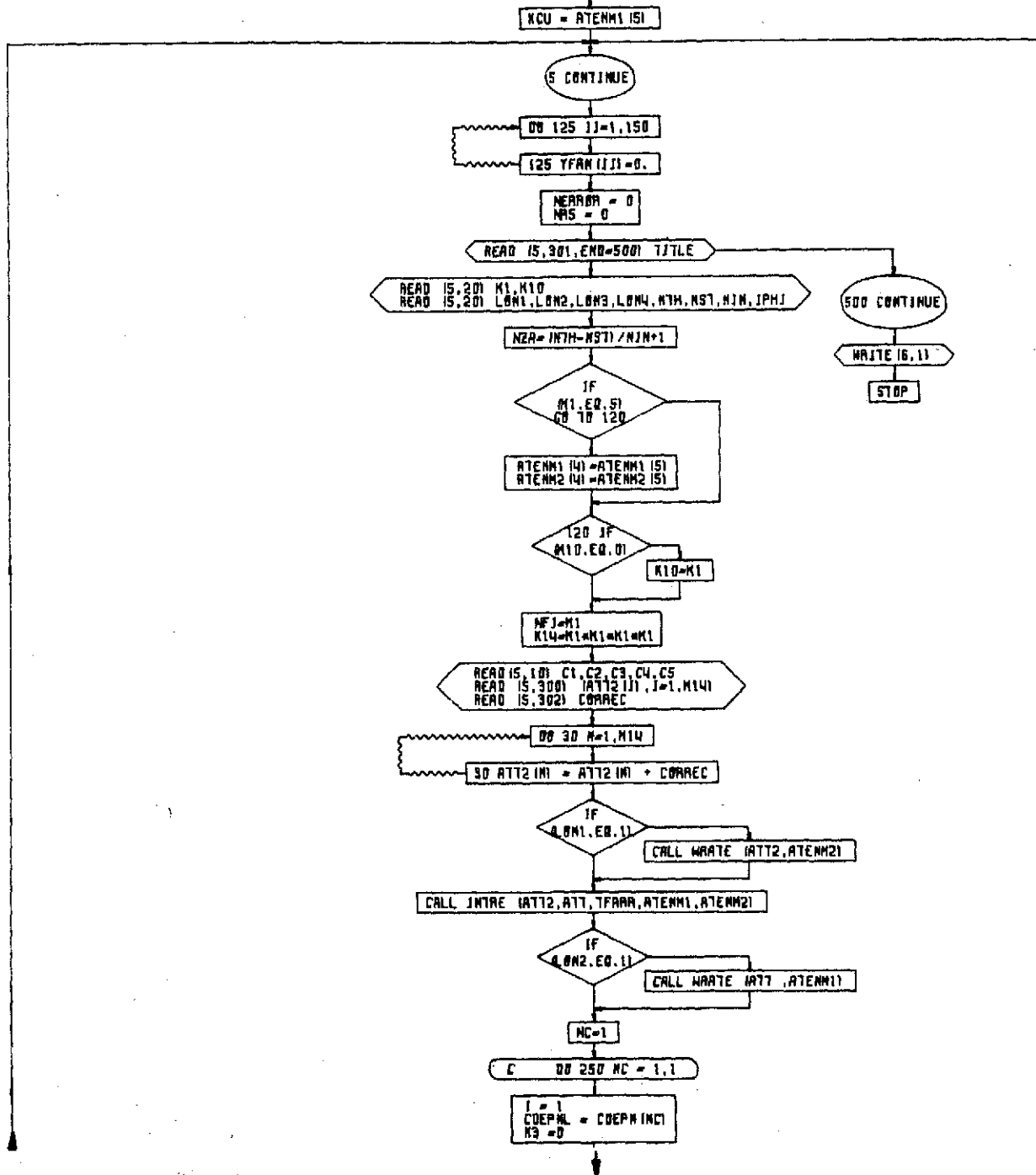

PRECEDING PAGE BLANK NOT FILMED

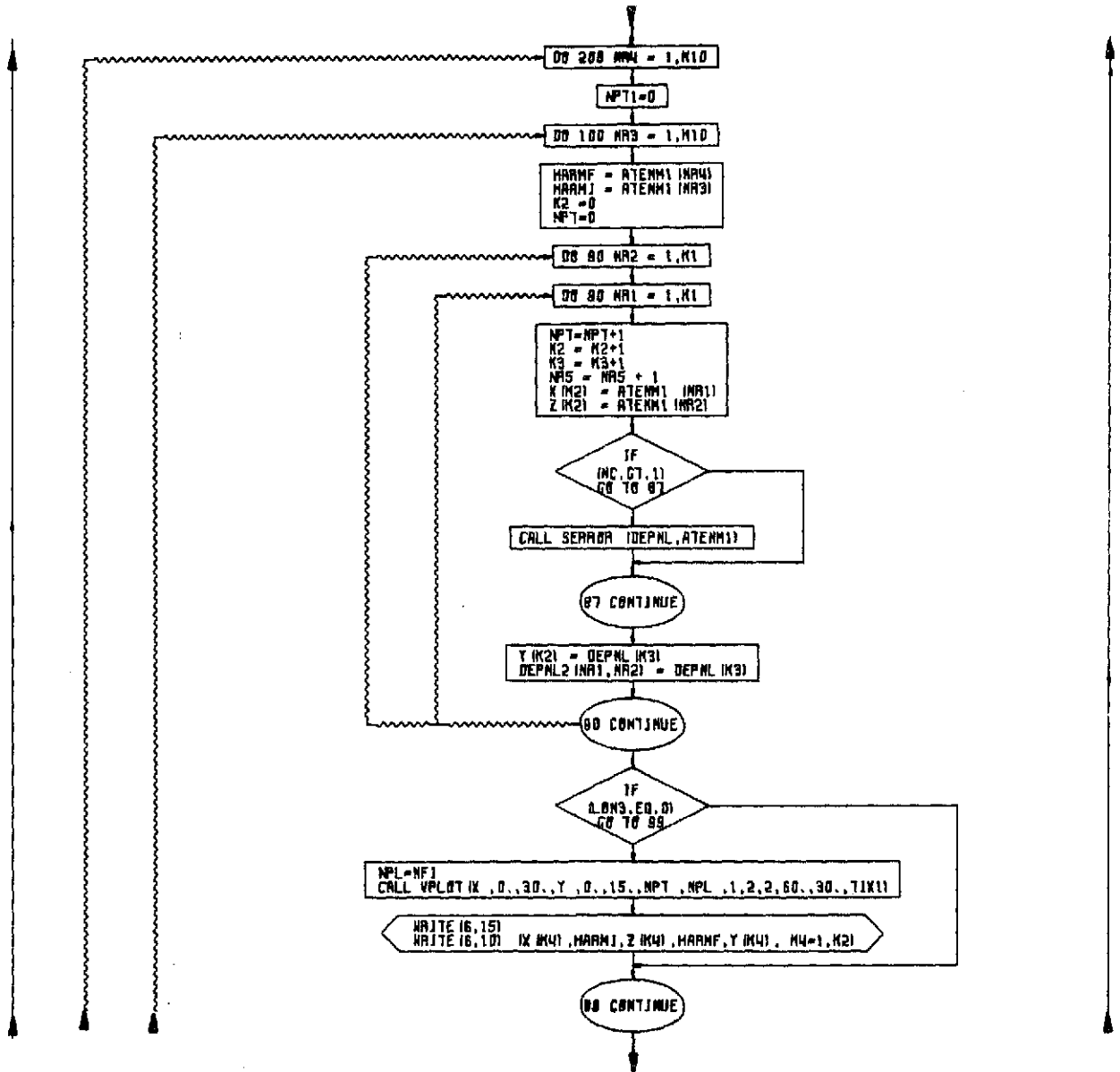

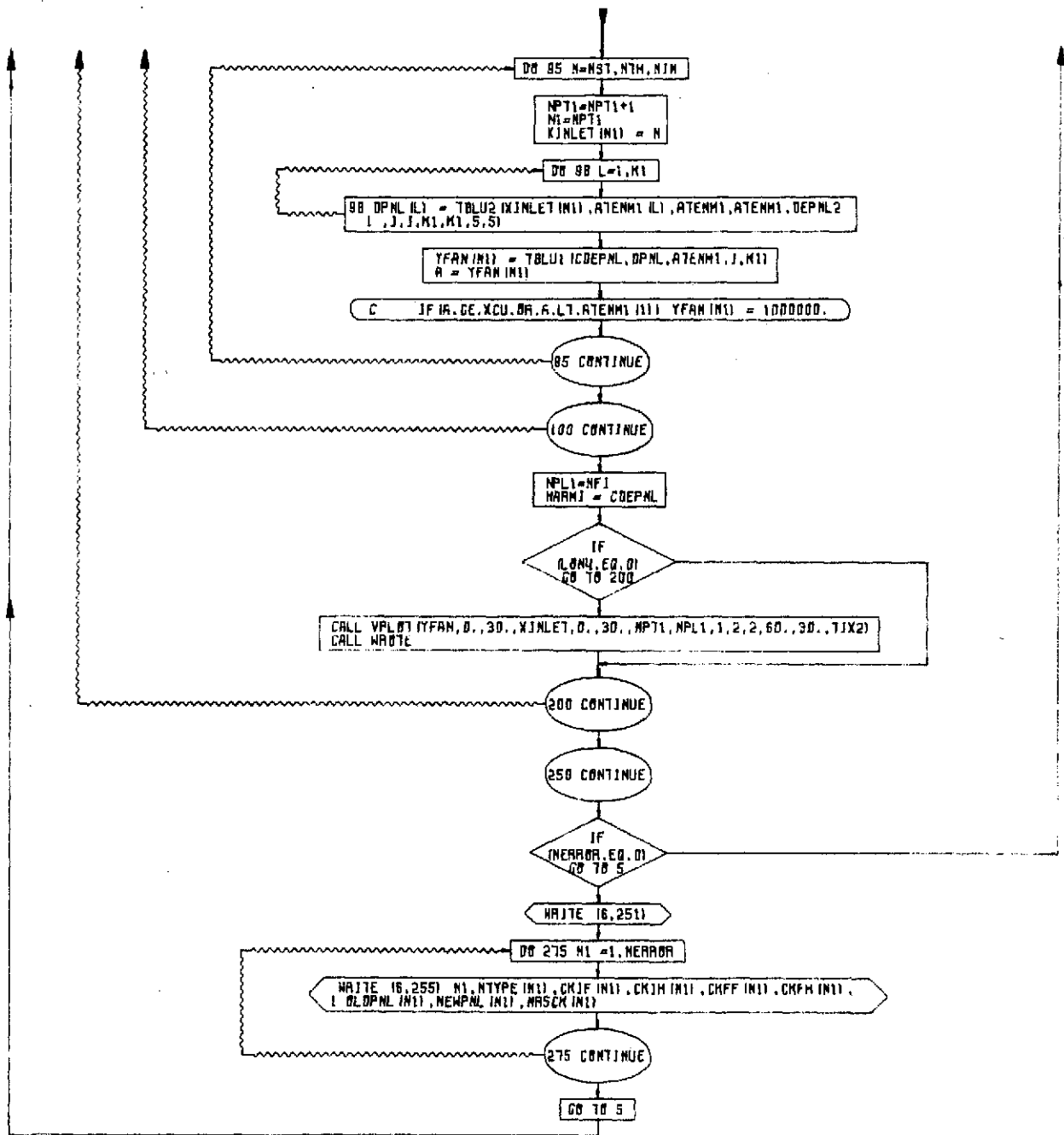

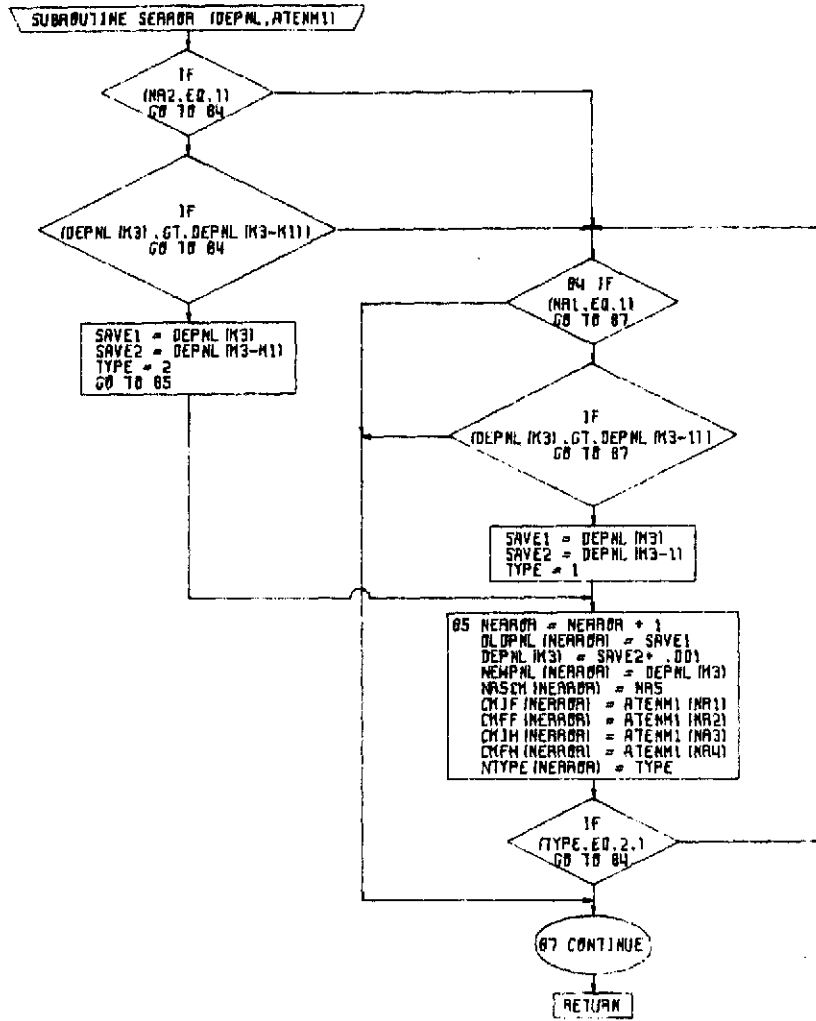

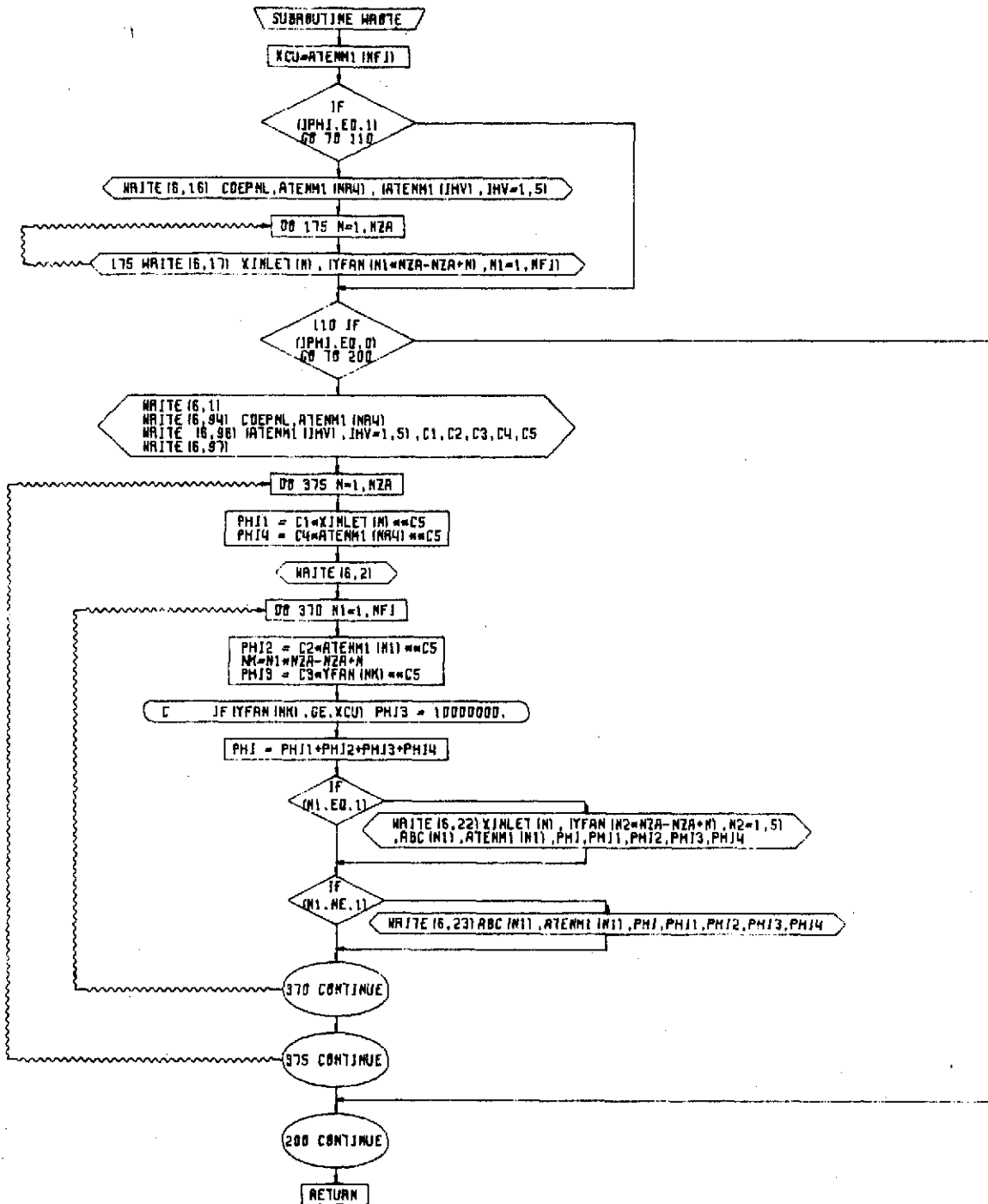

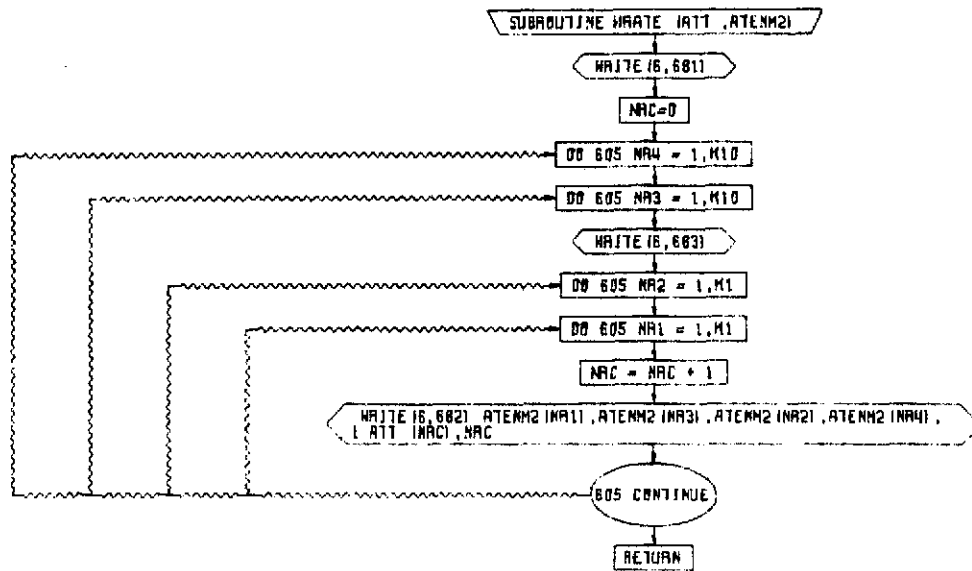

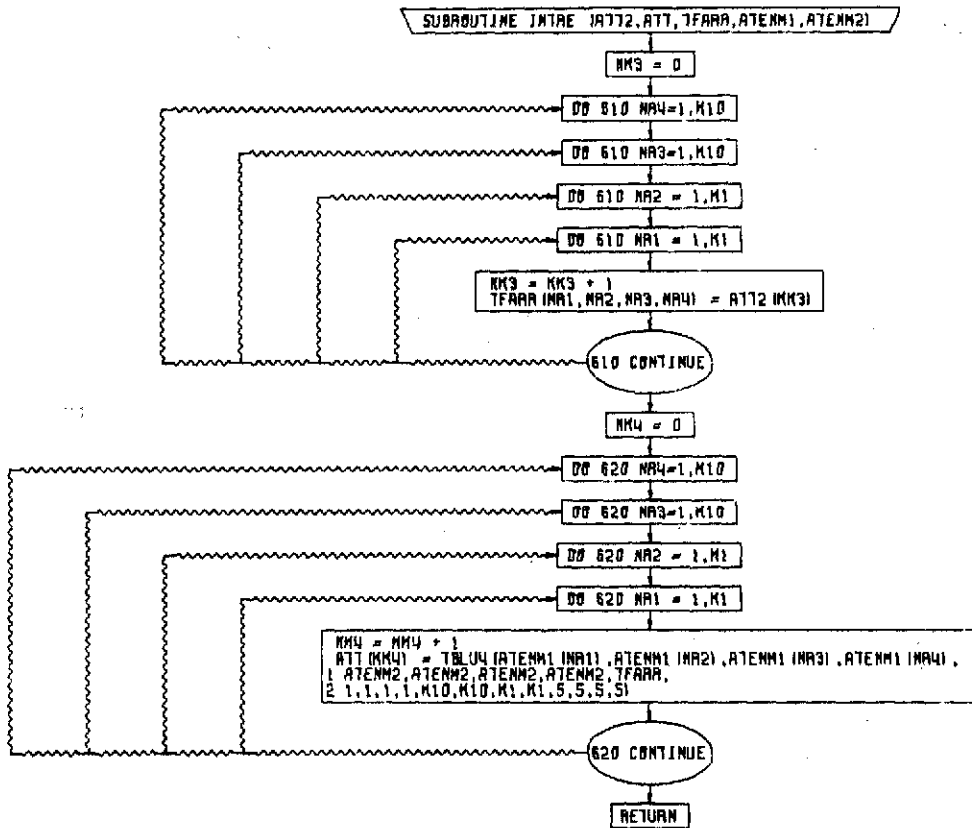

FUNCTION TBLU1 (X, Y, MDX, MLX)

```
NO X = MDX-1
CALL SEARCH IX, XX, NO X, MLX, J, DELTA 1, A 11
TBLU1 = Y(I) + (Y(I+1)-Y(I)) * DELTA 1/A 1
RETURN
```

FUNCTION TBLU2 (X, Y, F2, MDX, MDY, MLX, MLY, NFX, NFY)

```
NO X = MDX-1
NO Y = MDY-1
CALL SEARCH IX, XX, NO X, MLX, J, DELTA 1, A 11
CALL SEARCH IY, YY, NO Y, MLY, J, DELTA 2, A 21
DFX1 = (F2(I+1, J) - F2(I, J)) * DELTA 1/A 1
DFX2 = (F2(I+1, J+1) - F2(I, J+1)) * DELTA 1/A 1
TBLU2 = F2(I, J) + DFX1 + (F2(I, J+1) - F2(I, J) + DFX2 - DFX1) * DELTA 2/A 2
RETURN
```

FUNCTION TBLU4 (X, Y, Z, W, X, Y, Z, W, V, MDX, MDY, MDZ, MDW,
MLX, MLY, MLZ, MLW, NFX, NFY, NFZ, NFW)

```
NO X = MDX - 1
NO Y = MDY - 1
NO Z = MDZ - 1
NO W = MDW - 1
CALL SEARCH IX, XX, NO X, MLX, J, DELTA 1, A 11
CALL SEARCH IY, YY, NO Y, MLY, J, DELTA 2, A 21
CALL SEARCH IZ, ZZ, NO Z, MLZ, K, DELTA 3, A 31
CALL SEARCH IW, WW, NO W, MLW, L, DELTA 4, A 41
DA1 = DELTA 1/A 1
DA2 = DELTA 2/A 2
DA3 = DELTA 3/A 3
DA4 = DELTA 4/A 4
VPX1 = VPX (DA1, V(I, J, M, L), V(I+1, J, M, L))
VPX2 = VPX (DA1, V(I, J+1, M, L), V(I+1, J+1, M, L))
VPX3 = VPX (DA1, V(I, J, M+1, L), V(I+1, J, M+1, L))
VPX4 = VPX (DA1, V(I, J+1, M+1, L), V(I+1, J+1, M+1, L))
VPX5 = VPX (DA1, V(I, J, M, L+1), V(I+1, J, M, L+1))
VPX6 = VPX (DA1, V(I, J+1, M, L+1), V(I+1, J+1, M, L+1))
VPX7 = VPX (DA1, V(I, J, M+1, L+1), V(I+1, J, M+1, L+1))
VPX8 = VPX (DA1, V(I, J+1, M+1, L+1), V(I+1, J+1, M+1, L+1))
VPXY1 = VPX (DA2, VPX1, VPX2)
VPXY2 = VPX (DA2, VPX3, VPX4)
VPXY3 = VPX (DA2, VPX5, VPX6)
VPXY4 = VPX (DA2, VPX7, VPX8)
VPXY11 = VPX (DA3, VPXY1, VPXY2)
VPXY12 = VPX (DA3, VPXY3, VPXY4)
TBLU4 = VPX (DA4, VPXY11, VPXY12)
RETURN
```

FUNCTION VPX (A, B, C)

```
VPX = B + A * (C-B)
RETURN
```

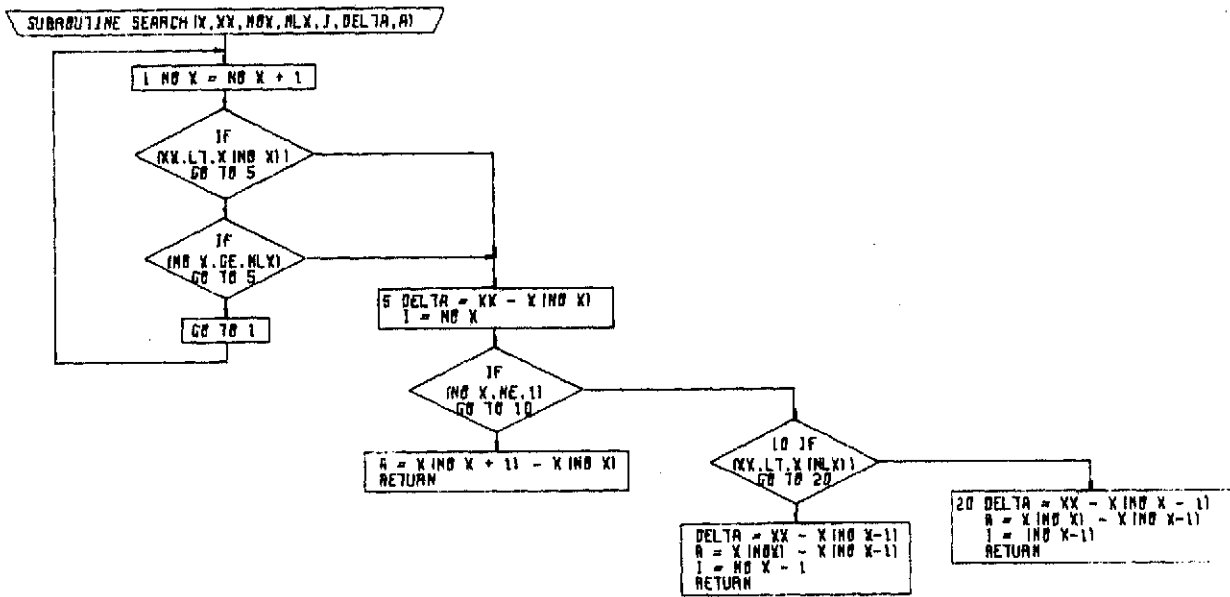

SUBROUTINE VPLOT IXS,XI,XA,YS,YJ,YA,APT,NPL,NC,LX,LY,XAN,YAN,TIX)

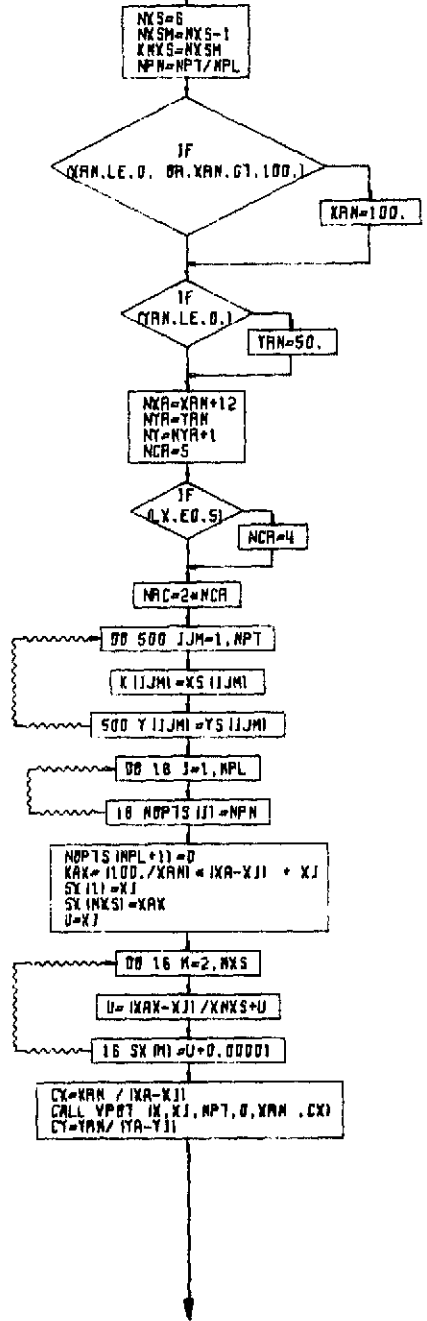

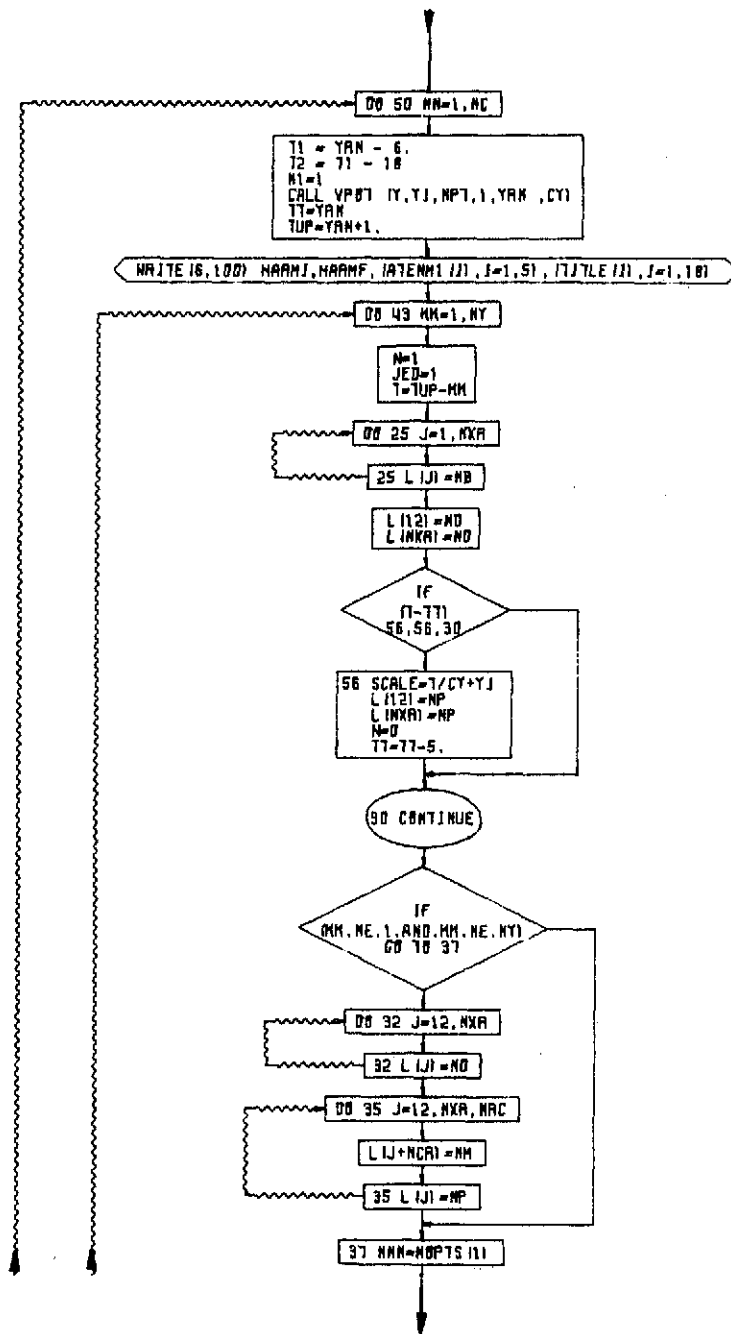

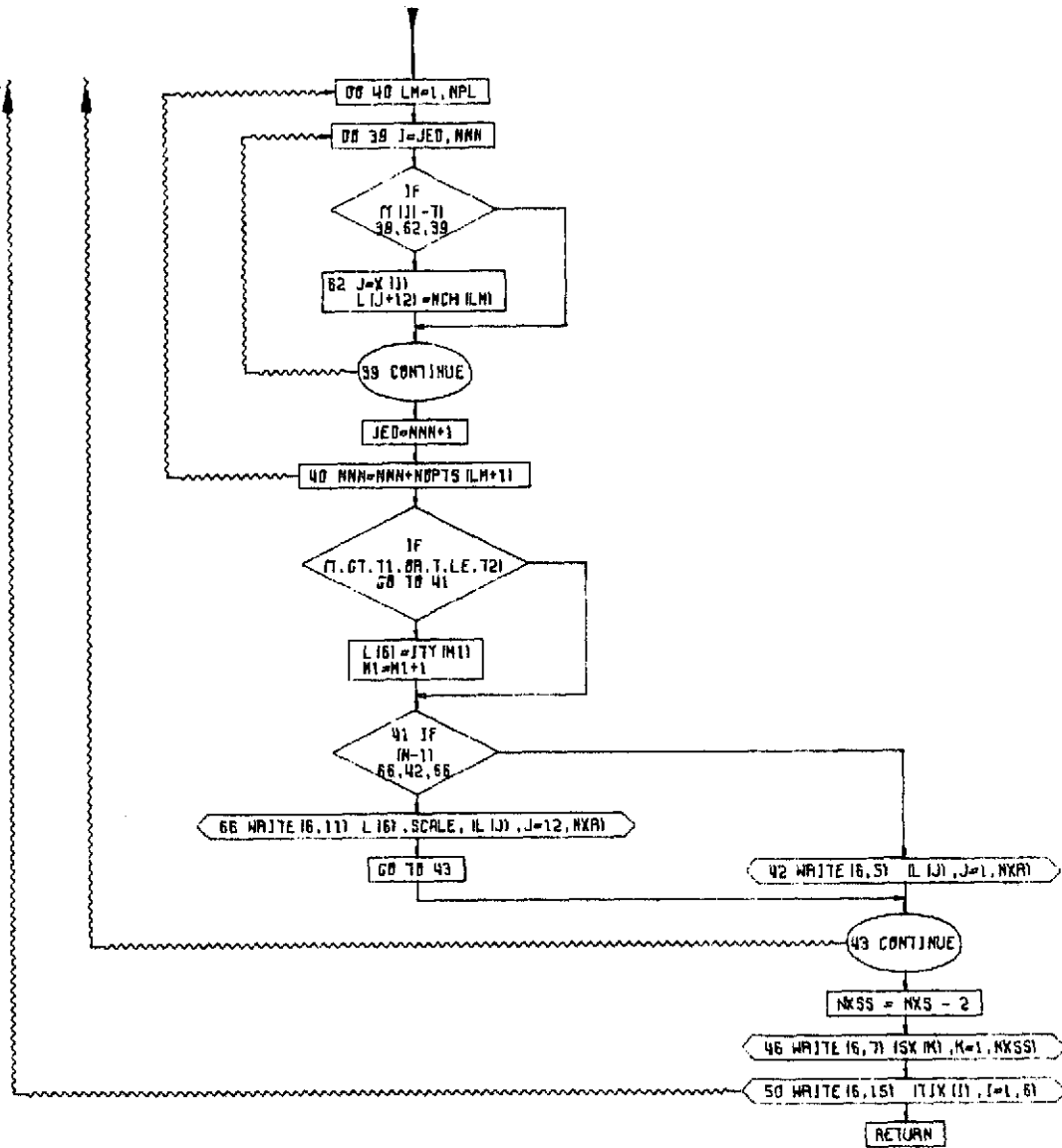

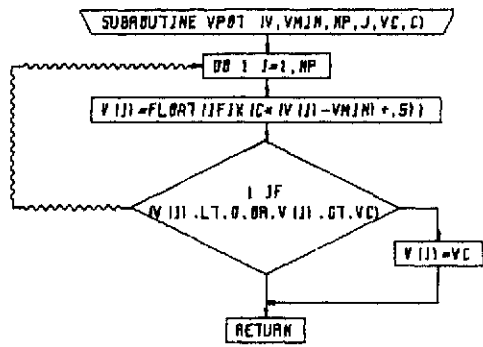

APPENDIX 6
PHI PROGRAM LISTING

PRECEDING PAGE BLANK NOT FILMED

C
C
C
C
C
C
C
C
C
C
C
C
C
C
C
C

PROGRAM TO EVALUATE THE RELATIVE EFFECTIVENESS OF INLET AND FAN DUCT LINING MATERIALS

REFERENCE DOCUMENT D3-8686

LON1=1 WRITE INPUT
LON2=1 WRITE REVISED INPUT
LON3=1 PLGT ATTENUATIONS
LON4=1 PLOT PHI STUDY
 IPHI = 0 SHORT PRINT OUT FOR DOCUMENTATION
 IPHI = 1 LONG PRINT OUT TO GET DESIGN FACTORS

REAL NEWPNL
DIMENSION X(25), Y(25), Z(25)
DIMENSION ATT(625), DEPNL(625)
DIMENSION DEPNL2(5,5)
DIMENSION TIX1(6), TIX2(6)
DIMENSION ATENM2(5), ATT2(625), TFARR(5,5,5,5)
COMMON / COMM1 / OLDPNL(625), NEWPNL(625), NR5CK(625), NTYPE(625)
1 ,CKIF(625), CKFF(625), CKIH(625), CMFH(625)
COMMON / COMM2 / K1,K2,K3,K4,NR1,NR2,NR3,NR4,NR5,NERROR,K10,K14
COMMON / COMM3 / IFLAG,IPHI,NTH,NFI,NST,NIN,NZA,NZR
COMMON/COMM4/DPNL(5),XINLET(150),YFAN(150)
COMMON/COMM5/ C1,C2,C3,C4,C5,CDEPNL
COMMON / COMM6 / ATENM1(5),ABC(5)
COMMON / COMM7 / LON1,LON2,LON3,LON4,LON5,LON6,LON7,LON8
DIMENSION CDEPN(6)
DATA CDEPN /10.,5*0./
DATA ATENM2 /0.,5.,10.,20.,30./
DATA ATENM1 /0.,5.,10.,20.,30./
EQUIVALENCE (ATT(1),DEPNL(1))
DATA ABC/'A','B','C','D','E'/
DATA TIX1 /'INLE','T AT','TENU','ATIO','N ',' '//
DATA TIX2 /'FAN ','DUCT',' ATT','ENUA','TION',' '//
COMMON / RFOPLD / HARM1,HARMF,TITLE(36)
1 FORMAT('1')
10 FORMAT(4F10.1,F10.2)
15 FORMAT(/10X,'INLET'15X'FAN DUCT'6X'D-EPNL'/5X'FUND.'5X'HARM.'
1 5X'FUND.'5X'HARM.'//)
20 FORMAT (10I5)
251 FORMAT('1 DATA CORRECTIONS'///
1 TYPE = 1 INCREASED INLET FUND. ATT. GAVE DECREASED DELTA EPNL'//
2 TYPE = 2 INCREASED FAN FUND. ATT. GAVE DECREASED DELTA EPNL'//
3//3X' NO. '3X' TYPE'3X'INLET'3X'INLET'3X' FAN '3X' FAN '3X' OLD '
43X' NEW '3X' DATA'//19X'FUND.'3X'HARM.'3X'FUND.'3X'HARM.'3X'DEPNL '
53X'DEPNL'3X' CARD'//)
255 FORMAT(2X,I3,8X,I1,1X,4(3X,F5.2),2(2X,F6.3),5X,I3)
300 FORMAT(4CX,F6.0)

```

301 FORMAT(1PA4)
302 FORMAT(F10.0)
XCU = ATENM1(5)
5 CONTINUE
DO 125 I=1,150
125 YFAN(I)=0.
NERROR = 0
NR5 = C
READ (5,301,END=500) TITLE
READ (5,20) K1,K10
READ (5,20) LON1,LON2,LON3,LON4,NTH,NST,NIN,IPHI
NZA=(NTH-NST)/NIN+1
IF (K1.EQ.5) GO TO 120
ATENM1(4)=ATENM1(5)
ATENM2(4)=ATENM2(5)
120 IF (K10.EQ.0) K10=K1
NFI=K1
K14=K1*K1*K1*K1
READ(5,10) C1,C2,C3,C4,C5
READ (5,300) (ATT2(I),I=1,K14)
READ (5,302) CORREC
DO 30 N=1,K14
30 ATT2(N) = ATT2(N) + CORREC
IF (LON1.EQ.1) CALL WRATE (ATT2,ATENM2)
CALL INTRE (ATT2,ATT,TFARR,ATENM1,ATENM2)
IF (LON2.EQ.1) CALL WRATE (ATT,ATENM1)
NC=1
C DO 250 NC = 1,1
I = 1
CDEPNL = CDEPN(NC)
K3 = 0
DO 200 NR4 = 1,K10
NPT1=0
DO 100 NR3 = 1,K10
HARMF = ATENM1(NR4)
HARMI = ATENM1(NR3)
K2 = C
NPT=C
DO 90 NR2 = 1,K1
DO 90 NR1 = 1,K1
NPT=NPT+1
K2 = K2+1
K3 = K3+1
NR5 = NR5 + I
X(K2) = ATENM1 (NR1)
Z(K2) = ATENM1(NR2)
IF(NC.GT.1) GO TO 87
CALL SERROR (DEPNL,ATENM1)
87 CONTINUE
Y(K2) = DEPNL(K2)
DEPNL2(NR1,NR2) = DEPNL(K3)

```

```

90 CONTINUE
  IF (LON3.EQ.0) GO TO 99
  NPL=NFI
  CALL VPLOT(X ,0.,30.,Y ,0.,15.,NPT ,NPL ,1,2,2,60.,30.,TIX1)
  WRITE(6,15)
  WRITE(6,10) (X(K4),HARMI,Z(K4),HARMF,Y(K4), K4=1,K2)
99 CONTINUE
  DO 95 N=NST,NTH,NIN
  NPT1=NPT1+1
  N1=NPT1
  XINLET(N1) = N
  DO 98 L=1,K1
98 DPNL(L) = TBLU2(XINLET(N1),ATENM1(L),ATENM1,ATENM1,DEPNL2
  1 ,I,I,K1,K1,5,5)
  YFAN(N1) = TBLU1(CDEPNL,DPNL,ATENM1,I,K1)
  A = YFAN(N1)
C IF(A.GE.XCU.OR.A.LT.ATENM1(1)) YFAN(N1) = 1000000.
95 CONTINUE
100 CONTINUE
  NPL1=NFI
  HARMI = CDEPNL
  IF (LON4.EQ.0) GO TO 200
  CALL VPLOT(YFAN,0.,30.,XINLET,0.,30.,NPT1,NPL1,1,2,2,60.,30.,TIX2)
  CALL WROTE
200 CONTINUE
250 CONTINUE
  IF(NERROR.EQ.0) GO TO 5
  WRITE (6,251)
  DO 275 N1 =1,NERROR
  WRITE (6,255) N1,NTYPE(N1),CKIF(N1),CKIH(N1),CKFF(N1),CKFH(N1),
  1 OLDPNL(N1),NEWPNL(N1),NR5CK(N1)
275 CONTINUE
  GO TO 5
500 CONTINUE
  WRITE(6,1)
  STOP
  END

```

```

SUBROUTINE SERROR (DEPNL,ATENM1)
REAL
NEWPNL
COMMON / COMM1 / OLDPNL(625), NEWPNL(625), NR5CK(625), NTYPE(625)
1 COMMON / COMM2 / K1,K2,K3,K4,NR1,NR2,NR3,NR4,NR5,NERROR,K10,K14
COMMON / COMM7 / LON1,LON2,LON3,LON4,LON5,LON6,LON7,LON8
DIMENSION DEPNL(625),ATENM1(5)
IF(NR2.EQ.1) GO TO 84
IF(DEPNL(K3).GT.DEPNL(K3-K1)) GO TO 84
SAVE1 = DEPNL(K3)
SAVE2 = DEPNL(K3-K1)
TYPE = 2
GO TO 85
84 IF(NR1.EQ.1) GO TO 87
IF(DEPNL(K3).GT.DEPNL(K3-1)) GO TO 87
SAVE1 = DEPNL(K3)
SAVE2 = DEPNL(K3-1)
TYPE = 1
85 NERROR = NERROR + 1
OLDPNL(NERROR) = SAVE1
DEPNL(K3) = SAVE2 + .001
NEWPNL(NERROR) = DEPNL(K3)
NR5CK(NERROR) = NR5
CKIF(NERROR) = ATENM1(NR1)
CKFF(NERROR) = ATENM1(NR2)
CKIH(NERROR) = ATENM1(NR3)
CKFH(NERROR) = ATENM1(NR4)
NTYPE(NERROR) = TYPE
IF(TYPE.EQ.2.) GO TO 84
87 CONTINUE
RETURN
END

```

```

SUBROUTINE WRITE
COMMON / COMM2 / K1,K2,K3,K4,NR1,NR2,NR3,NR4,NR5,NERROR,K10,K14
COMMON / COMM3 / IFLAG,IPHI,NTH,NFI,NST,NIN,NZA,NZR
COMMON/COMM4/DPNL(5),XINLET(150),YFAN(150)
COMMON/COMM5/ C1,C2,C3,C4,C5,CDEPNL
COMMON / COMM6 / ATENM1(5),ABC(5)
COMMON / COMM7 / LON1,LON2,LON3,LON4,LON5,LON6,LON7,LON8
1 FORMAT('1')
2 FORMAT (/)
16 FORMAT(//10X'DELTA EPNL = 'F5.1,10X'FAN HARMONIC = 'F5.1
1 / 26X'A'10X'B'9X' C'9X' D'9X' E'/
1 4X'INLET HARMONIC = '5X,5(F4.1,7X)/
1 /10X'INLET'2X,5(8X'FAN')/10X'FUND.'3X,
2 5(6X'FUND.')/)
17 FORMAT(9X,F6.2,3X,5(5X,F6.2))
22 FORMAT(5X,F5.2,6X,5(3X,F5.2),12X,A1,1X,F5.2,5(2X,F7.2))
23 FORMAT(68X,A1,1X,F5.2,5(2X,F7.2))
94 FORMAT(5X'DELTA EPNL = 'F4.1,10X'FAN HARMONIC = 'F4.1/)
96 FORMAT(21X'A'7X'B'7X'C'7X'D'7X'E'16X'FUNCTION PHI'/3X'INLET HARMON
1IC = ' 2X,5(F4.1,4X),12X, 'C1 = 'F5.3,3X'C2 = 'F5.3,3X
3 'C3 = 'F5.3,3X'C4 = 'F5.3/70X'EXPONENT C5 = 'F5.3/5X'INLET'5X,
4 5(5X'FAN'),15X'INLET'2X' PHI '2X'PHI(IF)'2X'PHI(IH)'2X'PHI(FF)'
5 2X'PHI(FH)')
97 FORMAT(15X'FUND.'6X,5(3X,'FUND.'),14X'HARM.' )
XCU=ATENM1(NFI)
IF(IPHI.EQ.1) GO TO 110
WRITE(6,16) CDEPNL,ATENM1(NR4),(ATENM1(IHV),IHV=1,5)
DO 175 N=1,NZA
175 WRITE(6,17) XINLET(N),(YFAN(N1*NZA-NZA+N),N1=1,NFI)
110 IF(IPHI.EQ.0) GO TO 200
WRITE(6,1)
WRITE(6,94) CDEPNL,ATENM1(NR4)
WRITE (6,96)(ATENM1(IHV),IHV=1,5),C1,C2,C3,C4,C5
WRITE(6,97)
DO 375 N=1,NZA
PHI1 = C1*XINLET(N)**C5
PHI4 = C4*ATENM1(NR4)**C5
WRITE(6,2)
DO 370 N1=1,NFI
PHI2 = C2*ATENM1(N1)**C5
NK=N1*NZA-NZA+N
PHI3 = C3*YFAN(NK)**C5
C IF(YFAN(NK).GE.XCU) PHI3 = 10000000.
PHI = PHI1+PHI2+PHI3+PHI4
IF(N1.EQ.1) WRITE(6,22)XINLET(N),(YFAN(N2*NZA-NZA+N),N2=1,5)
1 ,ABC(N1),ATENM1(N1),PHI,PHI1,PHI2,PHI3,PHI4
IF(N1.NE.1) WRITE(6,23)ABC(N1),ATENM1(N1),PHI,PHI1,PHI2,PHI3,PHI4
370 CONTINUE
375 CONTINUE
200 CONTINUE
RETURN

```

```

SUBROUTINE WRATE (ATT ,ATENM2)
DIMENSION      ATT(1),ATENM2(1)
COMMON / COMM2 / K1,K2,K3,K4,NR1,NR2,NR3,NR4,NR5,NERROR,K10,K14
681 FORMAT('1'20X,'INLET'15X'FANDUCT'6X'D-EPNL'14X'DATA'/
1          17X'FUND.'5X'HARM.'
2          5X'FUND.'5X'HARM.'22X'CARD')
682 FORMAT(11X,4F10.1,F10.2,12X,I5)
683 FORMAT(/)
WRITE(6,681)
NRC=0
DO 605 NR4 = 1,K10
DO 605 NR3 = 1,K10
WRITE(6,683)
DO 605 NR2 = 1,K1
DO 605 NR1 = 1,K1
NRC = NRC + 1
WRITE(6,682) ATENM2(NR1),ATENM2(NR3),ATENM2(NR2),ATENM2(NR4),
1           ATT (NRC),NRC
605 CONTINUE
RETURN
END

```

PRECEDING PAGE BLANK NOT FILMED

```

SUBROUTINE INTRE (ATT2,ATT,TFARR,ATENM1,ATENM2)
COMMON / COMM2 / K1,K2,K3,K4, NR1, NR2, NR3, NR4, NR5, NERROR, K10, K14
DIMENSION      TFARR(5,5,5,5)
DIMENSION      ATT2(1),ATT (1),ATENM1(1),ATENM2(1)
KK3 = 0
DO 610 NR4=1,K10
DO 610 NR3=1,K10
DO 610 NR2 = 1,K1
DO 610 NR1 = 1,K1
KK3 = KK2 + 1
TFARR(NR1, NR2, NR3, NR4) = ATT2(KK3)
510 CONTINUE
KK4 = 0
DO 620 NR4=1,K10
DO 620 NR3=1,K10
DO 620 NR2 = 1,K1
DO 620 NR1 = 1,K1
KK4 = KK4 + 1
ATT(KK4) = TBLU4(ATENM1(NR1),ATENM1(NR2),ATENM1(NR3),ATENM1(NR4),
1          ATENM2,ATENM2,ATENM2,ATENM2,TFARR,
2          1,1,1,1,K10,K10,K1,K1,5,5,5,5)
520 CONTINUE
RETURN
END

```

```
FUNCTION TBLUI(XX,X,Y,MDX,NLX)
DIMENSION X(1),Y(1)
NO X = MDX-1
CALL SEARCH(X,XX,NO X,NLX,I,DELTA 1,A 1)
TBLUI = Y(I) + (Y(I+1)-Y(I))*DELTA 1/A 1
RETURN
END
```

```

FUNCTION TBLU2(XX,YY,X,Y,F2,MDX,MDY,NLX,NLY,NFX,NFY)
DIMENSION F2(NFX,NFY),X(1),Y(1)
NO X = MDX-1
NO Y = MDY-1
CALL SEARCH(X,XX,NO X,NLX,I,DELTA 1,A 1)
CALL SEARCH(Y,YY,NO Y,NLY,J,DELTA 2,A 2)
DFX1 = (F2(I+1,J)-F2(I,J))*DELTA 1/A1
DFX2 = (F2(I+1,J+1)-F2(I,J+1))*DELTA 1/A1
TBLU2 = F2(I,J) + DFX1 + (F2(I,J+1)-F2(I,J)+DFX2-DFX1)*DELTA 2/A 2
RETURN
END

```



```

FUNCTION TBLU4(XX,YY,ZZ,WW,X,Y,Z,w,v,MDX,MDY,MDZ,MDW,
1          NLX,NLY,NLZ,NLW,NFX,NFY,NFZ,NFW)
DIMENSION V(NFX,NFY,NFZ,NFW),X(1),Y(1),Z(1),W(1)
NO X = MDX - 1
NO Y = MDY - 1
NO Z = MDZ - 1
NO W = MDW - 1
CALL SEARCH(X,XX,NO X,NLX,I,DELTA 1,A 1)
CALL SEARCH(Y,YY,NO Y,NLY,J,DELTA 2,A 2)
CALL SEARCH(Z,ZZ,NO Z,NLZ,K,DELTA 3,A 3)
CALL SEARCH(W,WW,NO W,NLW,L,DELTA 4,A 4)
DA1 = DELTA 1/A 1
DA2 = DELTA 2/A 2
DA3 = DELTA 3/A 3
DA4 = DELTA 4/A 4
VPX1 = VPX(DA1,V(I,J ,K ,L ),V(I+1,J ,K ,L ))
VPX2 = VPX(DA1,V(I,J+1,K ,L ),V(I+1,J+1,K ,L ))
VPX3 = VPX(DA1,V(I,J ,K+1,L ),V(I+1,J ,K+1,L ))
VPX4 = VPX(DA1,V(I,J+1,K+1,L ),V(I+1,J+1,K+1,L ))
VPX5 = VPX(DA1,V(I,J ,K ,L+1),V(I+1,J ,K ,L+1))
VPX6 = VPX(DA1,V(I,J+1,K ,L+1),V(I+1,J+1,K ,L+1))
VPX7 = VPX(DA1,V(I,J ,K+1,L+1),V(I+1,J ,K+1,L+1))
VPX8 = VPX(DA1,V(I,J+1,K+1,L+1),V(I+1,J+1,K+1,L+1))
VPXY1 = VPX(DA2,VPX1,VPX2)
VPXY2 = VPX(DA2,VPX3,VPX4)
VPXY3 = VPX(DA2,VPX5,VPX6)
VPXY4 = VPX(DA2,VPX7,VPX8)
VPXYW1 = VPX(DA3,VPXY1,VPXY2)
VPXYW2 = VPX(DA3,VPXY3,VPXY4)
TBLU4 = VPX(DA4,VPXYW1,VPXYW2)
RETURN
END

```

```
FUNCTION VPX(A,B,C)
VPX = B + A*(C-B)
RETURN
END
```

```

SUBROUTINE SEARCH(X,XX,NOX,NLX,I,DELTA,A)
DIMENSION X(1)
1 NO X = NO X + 1
IF(XX.LT.X(NO X)) GO TO 5
IF(NO X.GE.NLX)GO TO 5
GO TO 1
5 DELTA = XX - X(NO X)
I = NO X
IF(NO X.NE.1) GO TO 10
A = X(NO X + 1) - X(NO X)
RETURN
10 IF(XX.LT.X(NLX)) GO TO 20
DELTA = XX - X(NO X-1)
A = X(NO X) - X(NO X-1)
I = NO X - 1
RETURN
20 DELTA = XX - X(NO X - 1)
A = X(NO X) - X(NO X-1)
I = (NO X-1)
RETURN
END

```

```

SUBROUTINE VPLOT (XS,XI,XA,YS,YI,YA,NPT,NPL,NC,LX,LY,XRN,YRN,TIX)
DIMENSION XS(1),YS(1),NOPTS(30),SX(20),X(200),Y(200)
DIMENSION ITY(18),TIX(6),L(120),NCH(27)
COMMON / RFOPLO / HARM1,HARMF,TITLE(36)
COMMON / COMM6 / ATENM1(5),ABC(5)
DATA ND/' ','/ ',NP/'+' / ,NM/'-' / ,NB/' ' /
DATA NCH/'A','B','C','D','E','F','G','H','I','J',
1 'K','L','M','N','O','P','Q','R','S','T','U',
2 'V','W','X','Y','Z',' ' /
DATA ITY /'I','N','L','E','T',' ','A','T','T','E','N','U',
1 'A','T','I','O','N',' ' /
3 FORMAT('1'18A4/18A4)
100 FORMAT('1 DELTA EPNL = 'F5.1,10X'FAN HARMONIC = 'F5.1/7X
1 'INLET HARMONIC (A = 'F4.1 'B = 'F4.1 ' C = 'F4.1
1 ' D = 'F4.1 ' E = 'F4.1
1 /7X,18A4/)
5 FORMAT(120A1)
7 FORMAT(/F13.0,10F20.0)
11 FORMAT(5X,A1,1X,F3.0,1X,109A1)
15 FORMAT(/30X,6A4)
NXS=6
NXSM=NXS-1
XNXS=XXSM
NPN=NPT/NPL
IF (XRN.LE.0. OR.XRN.GT.100.) XRN=100.
IF (YRN.LE.0.) YRN=50.
NXR=XRN+12
NYR=YRN
NY=NYR+1
NCR=5
IF (LX.EQ.5)NCR=4
NRC=2*NCR
DO 500 IJM=1,NPT
X(IJM)=XS(IJM)
500 Y(IJM)=YS(IJM)
DO 18 I=1,NPL
18 NOPTS(I)=NPN
NOPTS(NPL+1)=0
XAX=(100./XRN)*(XA-XI) + XI
SX(1)=XI
SX(NXS)=XAX
U=XI
DO 16 K=2,NXS
U=(XAX-XI)/XNXS+U
16 SX(K)=U+C.C0001
CX=XRN / (XA-XI)
CALL VPLOT (X,XI,NPT,0,XRN ,CX)
CY=YRN/(YA-YI)
DO 50 NN=1,NC
T1 = YRN - 6.
T2 = T1 - 18

```

```

M1=1
CALL      VPOT  (Y,YI,NPT,1,YRN ,CY)
TT=YRN
TUP=YRN+1.
WRITE(6,100) HARM1,HARMF,(ATENM1(I),I=1,5),(TITLE(I),I=1,18)
CO 43  KK=1,NY
N=1
JED=1
T=TUP-KK
DO 25  J=1,NXR
25 L(J)=NB
   L(12)=NC
   L(NXR)=NC
   IF(T-TT) 56,56,30
56 SCALE=T/CY+YI
   L(12)=NP
   L(NXR)=NP
   N=0
   TT=TT-5.
30 CONTINUE
   IF (KK.NE.1.AND.KK.NE.NY) GO TO 37
   DO 32  J=12,NXR
32 L(J)=ND
   DO 35  J=12,NXR,NRC
   L(J+NCR)=NM
35 L(J)=NP
37 NNN=NOPTS(1)
   DO 40  LM=1,NPL
   DO 39  I=JED,NNN
   IF(Y(I)-T) 39,62,39
62 J=X(I)
   L(J+12)=NCH(LM)
39 CONTINUE
   JED=NNN+1
40 NNN=NNN+NOPTS(LM+1)
   IF (T.GT.T1.OR.T.LE.T2) GO TO 41
   L(6)=ITY(M1)
   M1=M1+1
41 IF(N-1) 66,42,66
66 WRITE(6,11) L(6),SCALE,(L(J),J=12,NXR)
   GO TO 43
42 WRITE(6,5) (L(J),J=1,NXR)
43 CONTINUE
   NXSS = NXS - 2
46 WRITE(6,7) (SX(K),K=1,NXSS)
50 WRITE(6,15) (TIX(I),I=1,6)
   RETURN
   END

```

```
      SUBROUTINE VPOT (V,VMIN,NP,J,VC,C)
      DIMENSION      V(1)
      DO 1 I=1,NP
      V(I)=FLCAT(IFIX(C*(V(I)-VMIN)+.5))
1 IF (V(I).LT.0.OR.V(I).GT.VC) V(I)=VC
      RETURN
      END
```

APPENDIX 7
EPNL ACOUSTIC TRADE STUDY RESULTS

DELTA EPNL = 5.0 FAN HARMONIC = 0.0
 INLET HARMONIC (A = 0, B = 5, C = 10, D = 20, E = 30)
 APP. WITH TONE, 0. JET ATT. WITH TONE, EPNL = 101.90, RUN 1 A

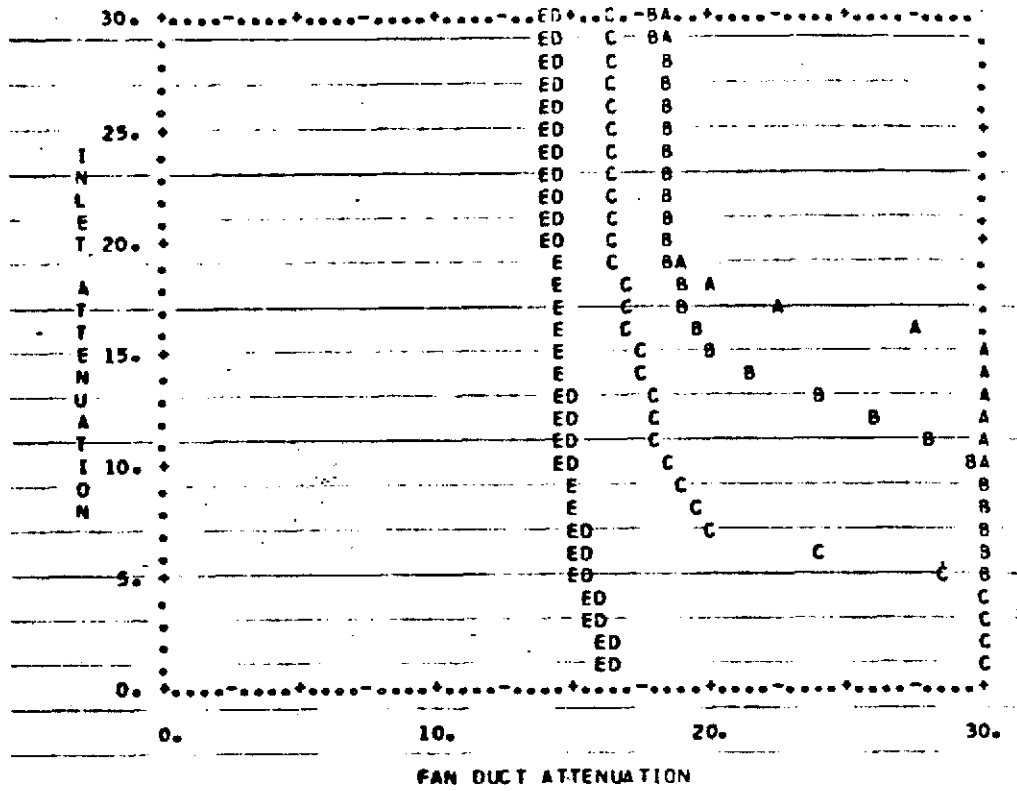

FAN HARMONIC = 0.0		DELTA-EPNL ← 5.0				
INLET HARMONIC =		A	B	C	D	E
		0	5	10	20	30
INLET FUND.	FAN FUND.	FAN FUND.	FAN FUND.	FAN FUND.	FAN FUND.	FAN FUND.
1.00	*****	*****	*****	*****	15.57	15.99
2.00	*****	*****	*****	*****	15.32	15.79
3.00	*****	*****	*****	*****	16.07	15.59
4.00	*****	*****	*****	*****	15.84	15.39
5.00	*****	*****	*****	28.44	15.61	15.19
6.00	*****	*****	*****	23.88	15.47	15.08
7.00	*****	*****	*****	19.98	15.34	14.97
8.00	*****	*****	*****	19.43	15.20	14.87
9.00	*****	*****	*****	18.92	15.06	14.77
10.00	*****	29.75	18.43	14.92	14.67	14.67
11.00	*****	27.89	18.20	14.88	14.62	14.62
12.00	*****	25.90	17.98	14.84	14.57	14.57
13.00	*****	23.79	17.77	14.79	14.53	14.53
14.00	*****	21.53	17.56	14.75	14.48	14.48
15.00	*****	19.88	17.35	14.71	14.44	14.44
16.00	27.35	19.55	17.15	14.67	14.39	14.39
17.00	22.69	19.22	16.96	14.62	14.35	14.35
18.00	19.75	18.90	16.77	14.58	14.31	14.31
19.00	19.21	18.59	16.59	14.54	14.27	14.27
20.00	18.70	18.29	16.41	14.50	14.22	14.22
21.00	18.66	18.28	16.40	14.50	14.22	14.22
22.00	18.62	18.28	16.40	14.50	14.22	14.22
23.00	18.58	18.28	16.40	14.50	14.22	14.22
24.00	18.54	18.27	16.40	14.50	14.22	14.22
25.00	18.50	18.27	16.40	14.50	14.22	14.22
26.00	18.46	18.26	16.40	14.49	14.22	14.22
27.00	18.42	18.26	16.40	14.49	14.22	14.22
28.00	18.39	18.25	16.40	14.49	14.22	14.22
29.00	18.34	18.25	16.40	14.49	14.22	14.22
30.00	18.30	18.24	16.40	14.49	14.22	14.22

DELTA EPNL = 5.0 FAN HARMONIC = 5.0
 INLET HARMONIC (A = 0, B = 5, C = 10, D = 20, E = 30)
 APP. WITH TONE, 0. JET ATT. WITH TURN, EPNL = 101.80, RUN 1 A

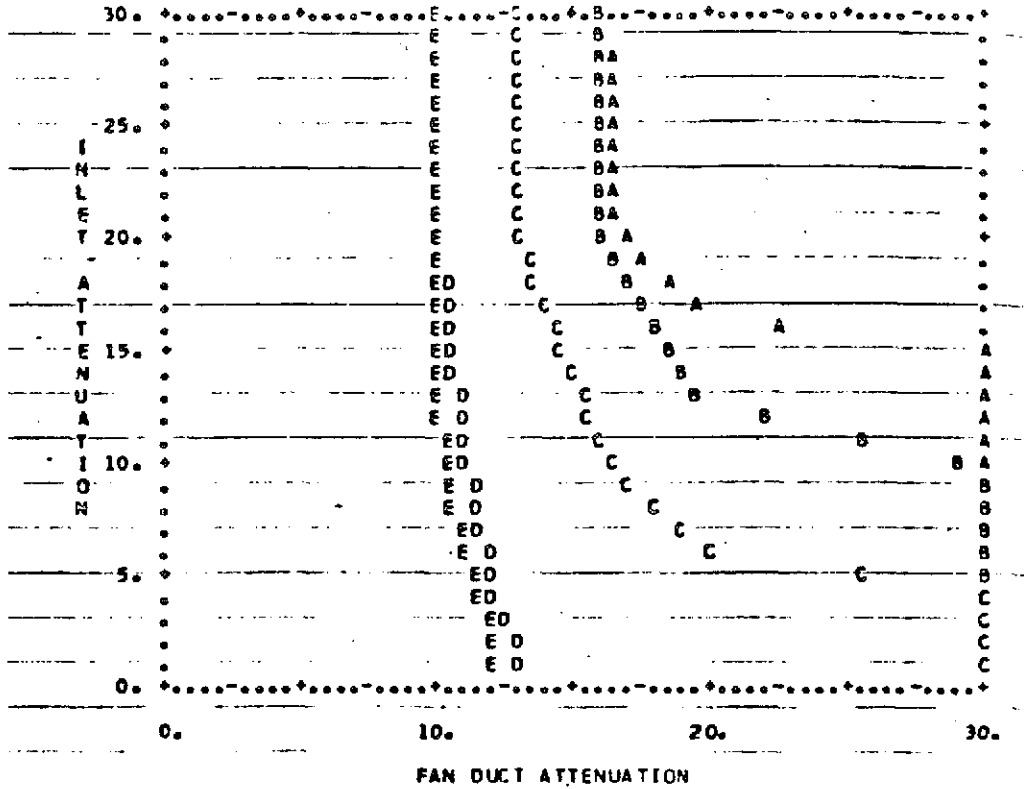

INLET FUND.	FAN HARMONIC = 5.0		DELTA EPNL = 5.0		
	A	B	C	D	E
	INLET HARMONIC = 0		10	20	30
	FAN FUND.	FAN FUND.	FAN FUND.	FAN FUND.	FAN FUND.
1.00	*****	*****	*****	13.22	12.20
2.00	*****	*****	*****	12.97	12.00
3.00	*****	*****	*****	12.53	11.81
4.00	*****	*****	*****	12.21	11.63
5.00	*****	*****	25.71	11.91	11.46
6.00	*****	*****	19.83	11.76	11.21
7.00	*****	*****	18.86	11.51	10.99
8.00	*****	*****	17.96	11.46	10.74
9.00	*****	*****	17.11	11.32	10.51
10.00	*****	29.09	16.32	11.18	10.29
11.00	*****	25.53	15.96	11.07	10.25
12.00	*****	21.81	15.60	10.96	10.23
13.00	*****	19.71	15.27	10.85	10.21
14.00	*****	19.17	14.94	10.74	10.19
15.00	30.59	18.65	14.62	10.63	10.17
16.00	22.32	18.14	14.31	10.52	10.15
17.00	19.33	17.64	14.02	10.41	10.13
18.00	18.44	17.15	13.73	10.31	10.12
19.00	17.59	16.68	13.45	10.20	10.10
20.00	16.77	16.21	13.18	10.09	10.09
21.00	16.71	16.20	13.18	10.09	10.09
22.00	16.64	16.19	13.18	10.09	10.07
23.00	16.58	16.17	13.18	10.08	10.07
24.00	16.52	16.16	13.18	10.07	10.06
25.00	16.45	16.15	13.17	10.07	10.06
26.00	16.39	16.14	13.17	10.06	10.06
27.00	16.33	16.12	13.17	10.06	10.05
28.00	16.26	16.11	13.17	10.05	10.05
29.00	16.20	16.10	13.17	10.05	10.04
30.00	16.13	16.09	13.17	10.05	10.04

DELTA EPNL = 5.0 FAN HARMONIC = 10.0
 INLET HARMONIC (A = 0, B = 5, C = 10, D = 20, E = 30)
 APP. WITH TONE, 0. JET ATT. WITH TURB. EPNL = 101.80, RUN 1 A

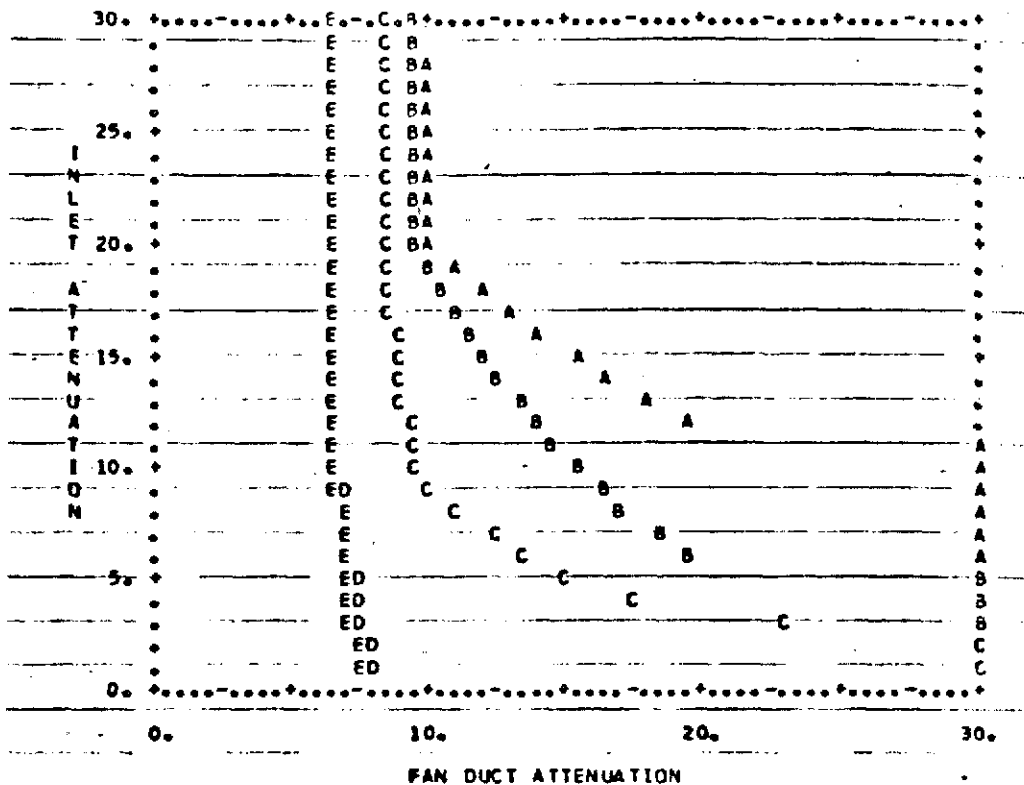

INLET HARMONIC	FAN HARMONIC = 10.0			DELTA-EPNL = 5.0		
	A	B	C	D	E	
	0	5	10	20	30	
INLET FUND.	FAN FUND.	FAN FUND.	FAN FUND.	FAN FUND.	FAN FUND.	
1.00	*****	*****	*****	7.92	7.32	
2.00	*****	*****	*****	7.76	7.25	
3.00	*****	*****	23.08	7.60	7.19	
4.00	*****	*****	17.49	7.45	7.13	
5.00	*****	*****	14.95	7.30	7.07	
6.00	*****	19.33	13.58	7.19	6.97	
7.00	*****	18.26	12.31	7.07	6.9	
8.00	*****	17.24	11.14	6.95	6.83	
9.00	*****	16.26	10.05	6.83	6.66	
10.00	*****	15.32	9.59	6.71	6.56	
11.00	*****	14.63	9.46	6.69	6.54	
12.00	19.29	13.96	9.33	6.67	6.51	
13.00	17.92	13.30	9.20	6.65	6.49	
14.00	16.61	12.66	9.08	6.63	6.47	
15.00	15.36	12.04	8.95	6.61	6.45	
16.00	14.17	11.43	8.83	6.59	6.43	
17.00	13.04	10.84	8.72	6.57	6.41	
18.00	11.96	10.26	8.60	6.55	6.39	
19.00	10.92	9.86	8.49	6.53	6.38	
20.00	9.97	9.61	8.38	6.51	6.36	
21.00	9.94	9.61	8.37	6.51	6.36	
22.00	9.92	9.61	8.36	6.51	6.36	
23.00	9.89	9.61	8.34	6.50	6.35	
24.00	9.87	9.61	8.33	6.50	6.35	
25.00	9.84	9.61	8.32	6.50	6.35	
26.00	9.81	9.61	8.31	6.50	6.35	
27.00	9.79	9.61	8.30	6.50	6.35	
28.00	9.76	9.61	8.28	6.50	6.35	
29.00	9.74	9.61	8.27	6.49	6.35	
30.00	9.71	9.61	8.26	6.49	6.35	

DELTA EPNL = 5.0 FAN HARMONIC = 20.0
 INLET HARMONIC (A = 0, B = 5, C = 10, D = 20, E = 30)
 APP, WITH TONE, 0. JET ATT, WITH TURB, EPNL = 101.80, RUN 1 A

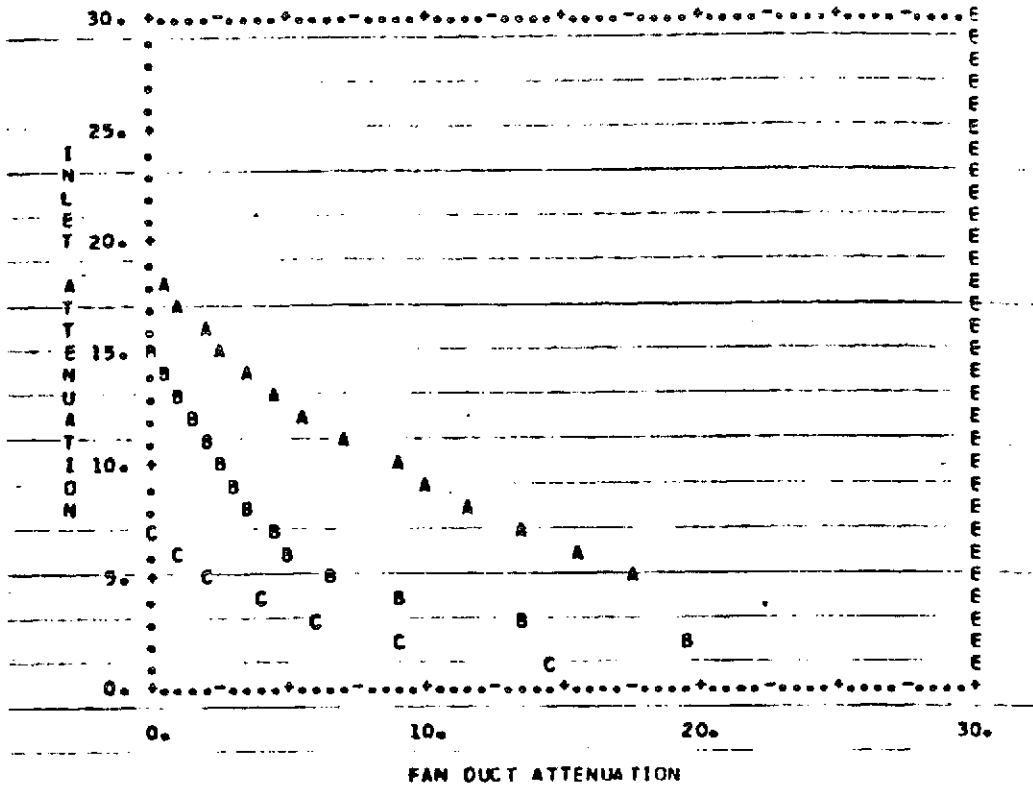

INLET HARMONIC =	FAN HARMONIC = 20.0		DELTA EPNL = 5.0		
	A	B	C	D	E
	0	5	10	20	30
	INLET	FAN	FAN	FAN	FAN
	FUND.	FUND.	FUND.	FUND.	FUND.
1.00	*****	*****	14.53	*****	*****
2.00	*****	19.33	9.04	*****	*****
3.00	*****	13.40	6.00	*****	*****
4.00	*****	8.97	3.79	*****	*****
5.00	17.65	6.37	1.96	*****	*****
6.00	15.55	5.21	0.96	*****	*****
7.00	13.58	4.38	0.05	*****	*****
8.00	11.72	3.66	*****	*****	*****
9.00	9.98	2.98	*****	*****	*****
10.00	8.94	2.32	*****	*****	*****
11.00	7.20	1.88	*****	*****	*****
12.00	5.67	1.45	*****	*****	*****
13.00	4.50	1.02	*****	*****	*****
14.00	3.57	0.61	*****	*****	*****
15.00	2.69	0.20	*****	*****	*****
16.00	1.84	*****	*****	*****	*****
17.00	1.04	*****	*****	*****	*****
18.00	0.28	*****	*****	*****	*****
19.00	*****	*****	*****	*****	*****
20.00	*****	*****	*****	*****	*****
21.00	*****	*****	*****	*****	*****
22.00	*****	*****	*****	*****	*****
23.00	*****	*****	*****	*****	*****
24.00	*****	*****	*****	*****	*****
25.00	*****	*****	*****	*****	*****
26.00	*****	*****	*****	*****	*****
27.00	*****	*****	*****	*****	*****
28.00	*****	*****	*****	*****	*****
29.00	*****	*****	*****	*****	*****
30.00	*****	*****	*****	*****	*****

DELTA EPNL = 5.0 FAN HARMONIC = 30.0
 INLET HARMONIC (A = 0, B = 5, C = 10, D = 20, E = 30)
 APP. WITH TUNE, 0. JET ATT. WITH TIRR, EPNL = 101.80, RUN 1 A

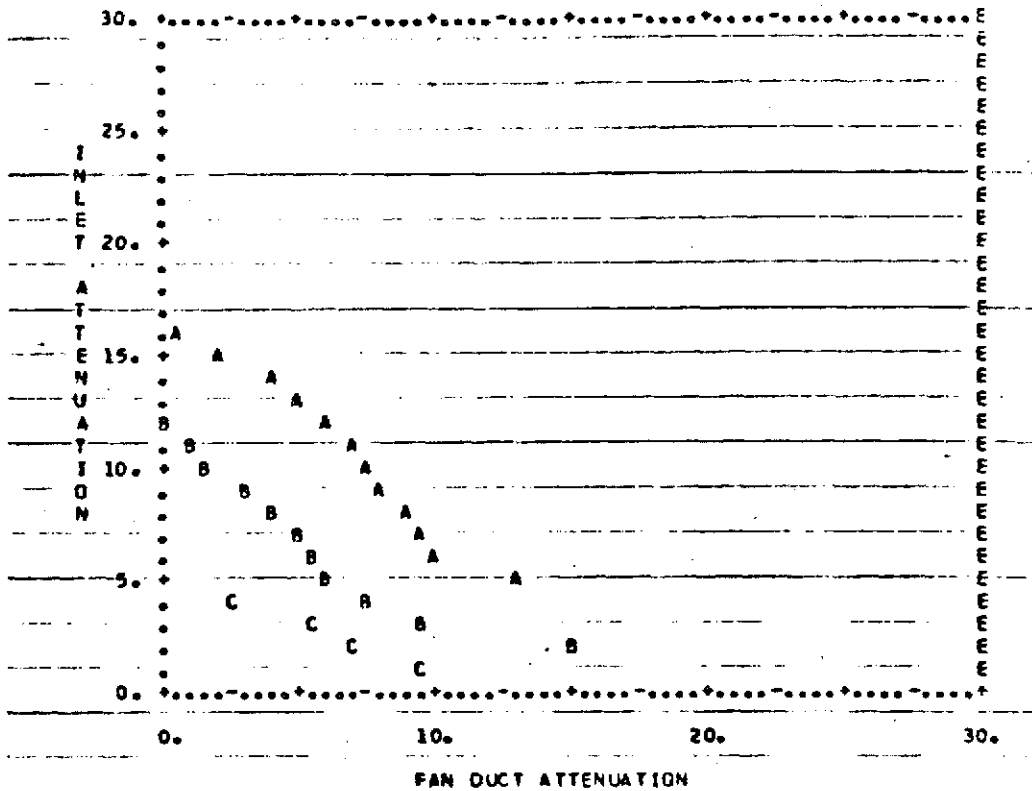

FAN HARMONIC → 30.0		DELTA EPNL → 5.0				
INLET HARMONIC =		A	B	C	D	E
		0	5	10	20	30
INLET FUND.	FAN FUND.	FAN FUND.	FAN FUND.	FAN FUND.	FAN FUND.	FAN FUND.
1.00	*****	*****	9.55	*****	*****	
2.00	*****	15.20	7.21	*****	*****	
3.00	*****	9.26	5.44	*****	*****	
4.00	*****	7.58	2.71	*****	*****	
5.00	13.24	6.21	*****	*****	*****	
6.00	10.11	5.59	*****	*****	*****	
7.00	9.38	5.02	*****	*****	*****	
8.00	8.78	3.90	*****	*****	*****	
9.00	8.22	2.80	*****	*****	*****	
10.00	7.69	1.73	*****	*****	*****	
11.00	6.75	0.86	*****	*****	*****	
12.00	5.91	0.00	*****	*****	*****	
13.00	5.15	*****	*****	*****	*****	
14.00	3.77	*****	*****	*****	*****	
15.00	2.22	*****	*****	*****	*****	
16.00	0.69	*****	*****	*****	*****	
17.00	*****	*****	*****	*****	*****	
18.00	*****	*****	*****	*****	*****	
19.00	*****	*****	*****	*****	*****	
20.00	*****	*****	*****	*****	*****	
21.00	*****	*****	*****	*****	*****	
22.00	*****	*****	*****	*****	*****	
23.00	*****	*****	*****	*****	*****	
24.00	*****	*****	*****	*****	*****	
25.00	*****	*****	*****	*****	*****	
26.00	*****	*****	*****	*****	*****	
27.00	*****	*****	*****	*****	*****	
28.00	*****	*****	*****	*****	*****	
29.00	*****	*****	*****	*****	*****	
30.00	*****	*****	*****	*****	*****	

DELTA EPNL = 10.0 FAN HARMONIC = 0.0
 INLET HARMONIC (A = 0, B = 5, C = 10, D = 20, E = 30)
 APP. WITH TONE, 0. JET ATT. WITH TURB. EPNL = 101.80, RUN 1 A

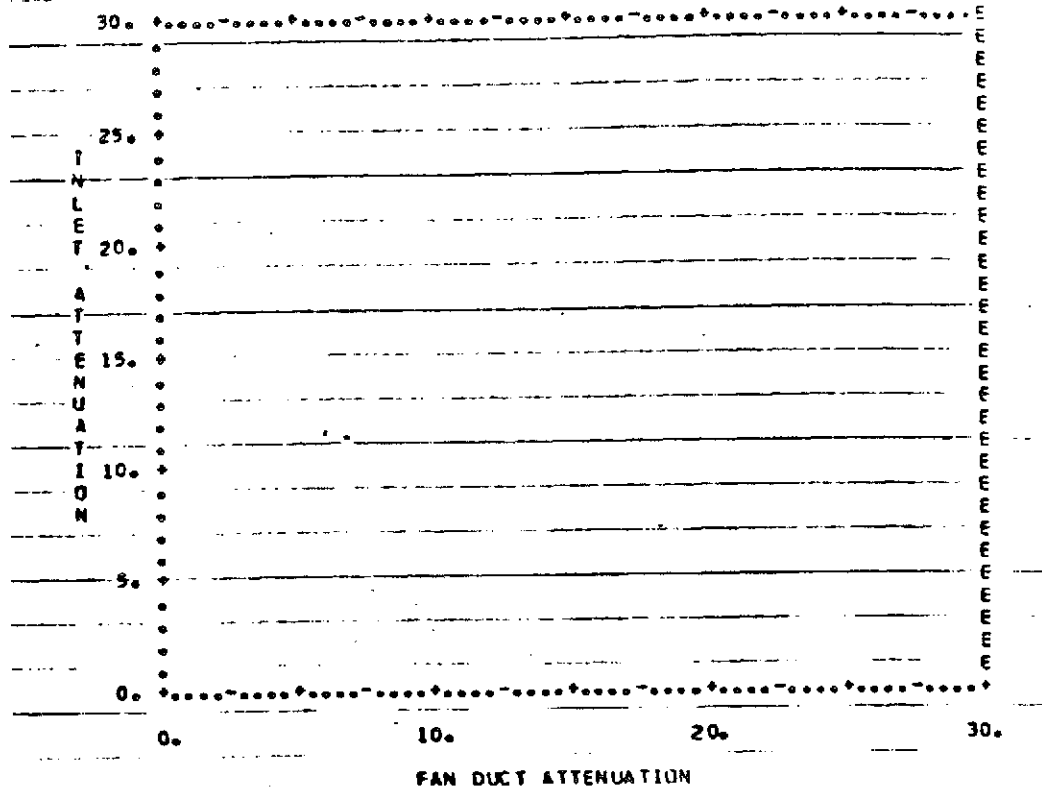

INLET FUND.	FAN HARMONIC = 0.0		DELTA EPNL = 10.0			
	A	B	C	D	E	
	0	5	10	20	30	
	FAN FUND.	FAN FUND.	FAN FUND.	FAN FUND.	FAN FUND.	
1.00	*****	*****	*****	*****	*****	
2.00	*****	*****	*****	*****	*****	
3.00	*****	*****	*****	*****	*****	
4.00	*****	*****	*****	*****	*****	
5.00	*****	*****	*****	*****	*****	
6.00	*****	*****	*****	*****	*****	
7.00	*****	*****	*****	*****	*****	
8.00	*****	*****	*****	*****	*****	
9.00	*****	*****	*****	*****	*****	
10.00	*****	*****	*****	*****	*****	
11.00	*****	*****	*****	*****	*****	
12.00	*****	*****	*****	*****	*****	
13.00	*****	*****	*****	*****	*****	
14.00	*****	*****	*****	*****	*****	
15.00	*****	*****	*****	*****	*****	
16.00	*****	*****	*****	*****	*****	
17.00	*****	*****	*****	*****	*****	
18.00	*****	*****	*****	*****	*****	
19.00	*****	*****	*****	*****	*****	
20.00	*****	*****	*****	*****	*****	
21.00	*****	*****	*****	*****	*****	
22.00	*****	*****	*****	*****	*****	
23.00	*****	*****	*****	*****	*****	
24.00	*****	*****	*****	*****	*****	
25.00	*****	*****	*****	*****	*****	
26.00	*****	*****	*****	*****	*****	
27.00	*****	*****	*****	*****	*****	
28.00	*****	*****	*****	*****	*****	
29.00	*****	*****	*****	*****	*****	
30.00	*****	*****	*****	*****	*****	

DELTA EPNL = 10.0 FAN HARMONIC = 5.0
 INLET HARMONIC (A = 0, B = 5, C = 10, D = 20, E = 30)
 APP. WITH TONE, 0. JET ATT. WITH TURE, EPNL = 101.80, RUN 1 A

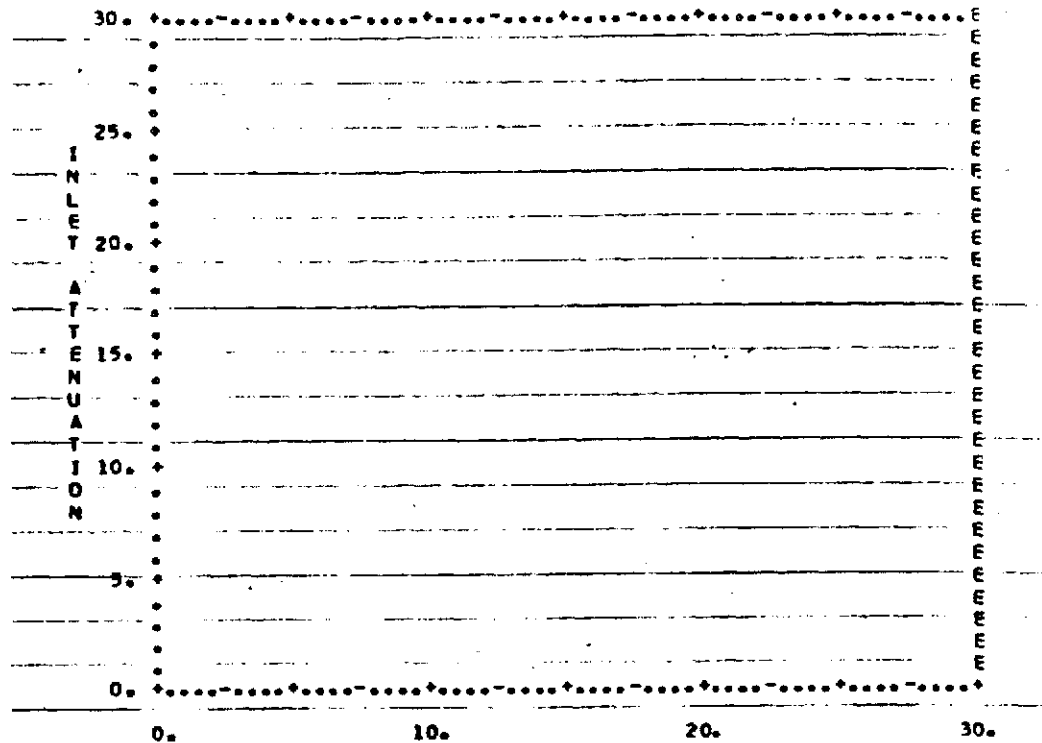

FAN DUCT ATTENUATION

INLET HARMONIC	FAN HARMONIC = 5.0		DELTA EPNL = 10.0		
	A	B	C	D	E
	0	5	10	20	30
	INLET FUND.	FAN FUND.	FAN FUND.	FAN FUND.	FAN FUND.
1.00	*****	*****	*****	*****	*****
2.00	*****	*****	*****	*****	*****
3.00	*****	*****	*****	*****	*****
4.00	*****	*****	*****	*****	*****
5.00	*****	*****	*****	*****	*****
6.00	*****	*****	*****	*****	*****
7.00	*****	*****	*****	*****	*****
8.00	*****	*****	*****	*****	*****
9.00	*****	*****	*****	*****	*****
10.00	*****	*****	*****	*****	*****
11.00	*****	*****	*****	*****	*****
12.00	*****	*****	*****	*****	*****
13.00	*****	*****	*****	*****	*****
14.00	*****	*****	*****	*****	*****
15.00	*****	*****	*****	*****	*****
16.00	*****	*****	*****	*****	*****
17.00	*****	*****	*****	*****	*****
18.00	*****	*****	*****	*****	*****
19.00	*****	*****	*****	*****	*****
20.00	*****	*****	*****	*****	*****
21.00	*****	*****	*****	*****	*****
22.00	*****	*****	*****	*****	*****
23.00	*****	*****	*****	*****	*****
24.00	*****	*****	*****	*****	*****
25.00	*****	*****	*****	*****	*****
26.00	*****	*****	*****	*****	*****
27.00	*****	*****	*****	*****	*****
28.00	*****	*****	*****	*****	*****
29.00	*****	*****	*****	*****	*****
30.00	*****	*****	*****	*****	*****

DELTA EPNL = 10.0 FAN HARMONIC = 10.0
 INLET HARMONIC (A = 0, B = 5, C = 10, D = 20, E = 30)
 APP, WITH TONE, 0. JET ATT, WITH TURB, EPNL = 101.80, RUN 1 A

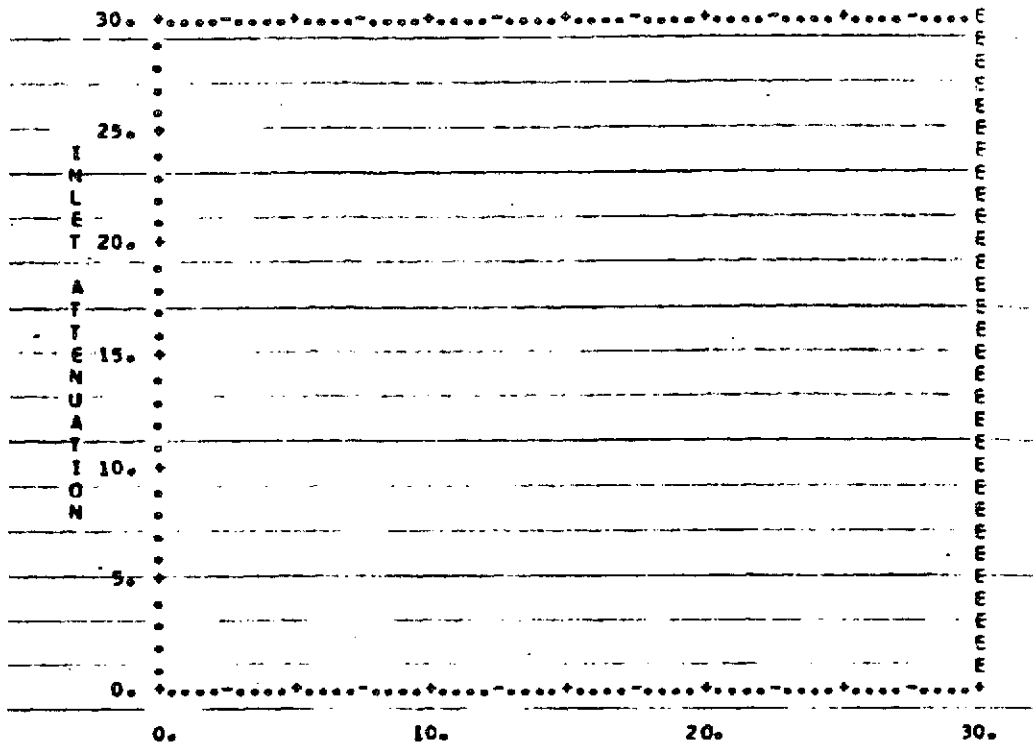

FAN DUCT ATTENUATION

INLET HARMONIC	FAN HARMONIC = 10.0		DELTA EPNL = 10.0		
	A	B	C	D	E
	0	5	10	20	30
	FAN FUND.	FAN FUND.	FAN FUND.	FAN FUND.	FAN FUND.
1.00	*****	*****	*****	*****	*****
2.00	*****	*****	*****	*****	*****
3.00	*****	*****	*****	*****	*****
4.00	*****	*****	*****	*****	*****
5.00	*****	*****	*****	*****	*****
6.00	*****	*****	*****	*****	*****
7.00	*****	*****	*****	*****	*****
8.00	*****	*****	*****	*****	*****
9.00	*****	*****	*****	*****	*****
10.00	*****	*****	*****	*****	*****
11.00	*****	*****	*****	*****	*****
12.00	*****	*****	*****	*****	*****
13.00	*****	*****	*****	*****	*****
14.00	*****	*****	*****	*****	*****
15.00	*****	*****	*****	*****	*****
16.00	*****	*****	*****	*****	*****
17.00	*****	*****	*****	*****	*****
18.00	*****	*****	*****	*****	*****
19.00	*****	*****	*****	*****	*****
20.00	*****	*****	*****	*****	*****
21.00	*****	*****	*****	*****	*****
22.00	*****	*****	*****	*****	*****
23.00	*****	*****	*****	*****	*****
24.00	*****	*****	*****	*****	*****
25.00	*****	*****	*****	*****	*****
26.00	*****	*****	*****	*****	*****
27.00	*****	*****	*****	*****	*****
28.00	*****	*****	*****	*****	*****
29.00	*****	*****	*****	*****	*****
30.00	*****	*****	*****	*****	*****

DELTA EPNL = 10.0 FAN HARMONIC = 20.0
 INLET HARMONIC (A = 0, B = 5, C = 10, D = 20, E = 30)
 APP. WITH TONE, O. JET ATT. WITH TURB. EPNL = 101.80, RUN 1 A

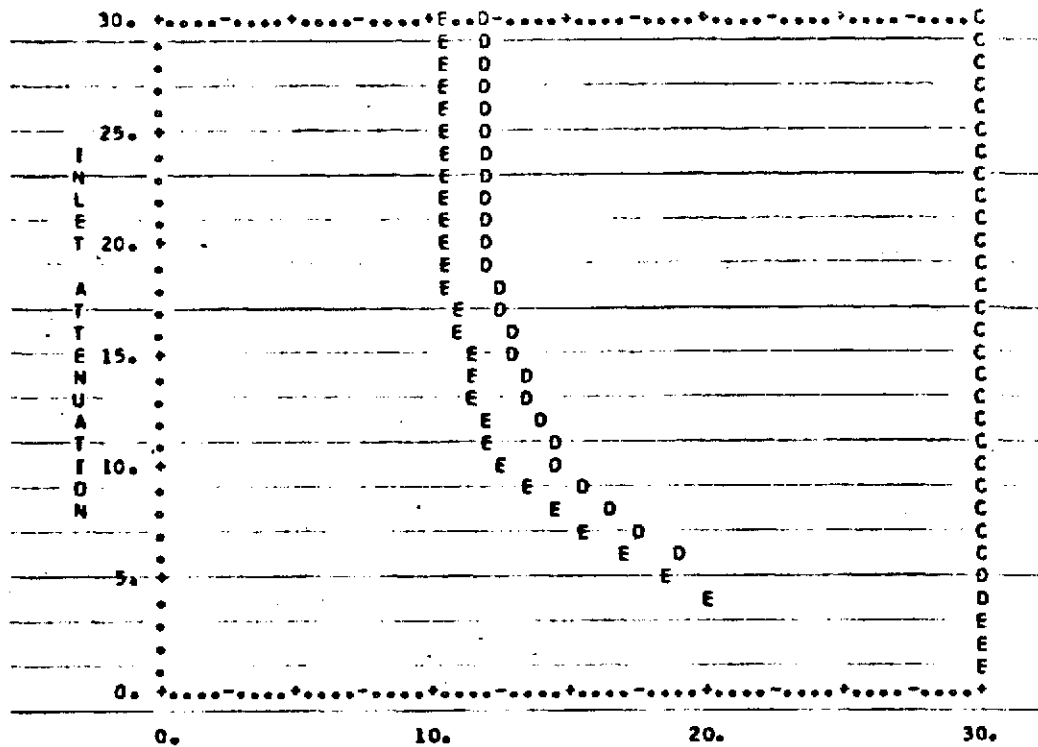

FAN DUCT ATTENUATION

INLET HARMONIC =	FAN HARMONIC = 20.0		DELTA EPNL = 10.0		E
	A	B	C	D	
	0	5	10	20	30
INLET FUND.	FAN FUND.	FAN FUND.	FAN FUND.	FAN FUND.	FAN FUND.
1.00	*****	*****	*****	*****	*****
2.00	*****	*****	*****	*****	*****
3.00	*****	*****	*****	*****	*****
4.00	*****	*****	*****	*****	20.02
5.00	*****	*****	*****	*****	18.63
6.00	*****	*****	*****	18.84	16.99
7.00	*****	*****	*****	17.64	15.57
8.00	*****	*****	*****	16.55	14.35
9.00	*****	*****	*****	15.54	13.28
10.00	*****	*****	*****	14.60	12.34
11.00	*****	*****	*****	14.30	12.12
12.00	*****	*****	*****	14.00	11.91
13.00	*****	*****	*****	13.71	11.70
14.00	*****	*****	*****	13.43	11.50
15.00	*****	*****	*****	13.16	11.30
16.00	*****	*****	*****	12.89	11.11
17.00	*****	*****	*****	12.64	10.93
18.00	*****	*****	*****	12.39	10.75
19.00	*****	*****	*****	12.15	10.57
20.00	*****	*****	*****	11.91	10.40
21.00	*****	*****	*****	11.91	10.40
22.00	*****	*****	*****	11.91	10.40
23.00	*****	*****	*****	11.91	10.40
24.00	*****	*****	*****	11.91	10.40
25.00	*****	*****	*****	11.91	10.40
26.00	*****	*****	*****	11.91	10.40
27.00	*****	*****	*****	11.91	10.40
28.00	*****	*****	*****	11.91	10.40
29.00	*****	*****	*****	11.91	10.40
30.00	*****	*****	*****	11.91	10.40

DELTA EPNL = 10.0 FAN HARMONIC = 30.0
 INLET HARMONIC IA = 0, B = 5, C = 10, D = 20, E = 30
 APP, WITH TONE, 0. JET ATT, WITH TURB, EPNL = 101.80, RUN 1 A

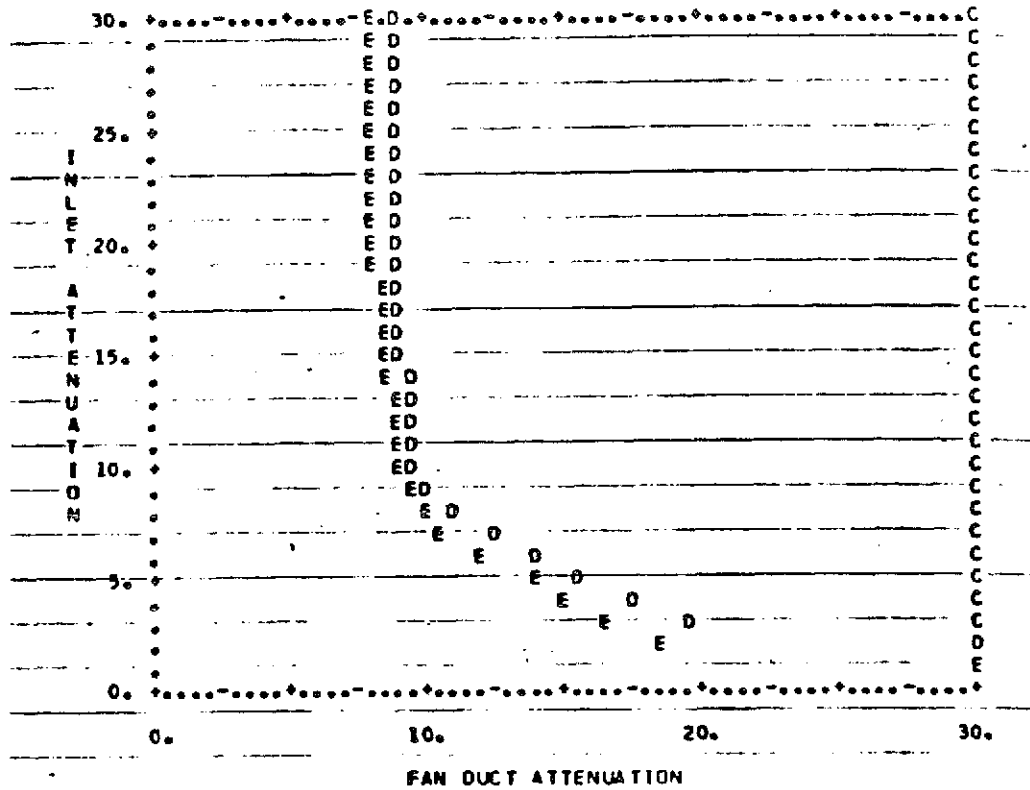

FAN HARMONIC = 30.0		DELTA EPNL = 10.0				
INLET HARMONIC =		A	B	C	D	E
		0	5	10	20	30
INLET FUND.	FAN FUND.	FAN FUND.	FAN FUND.	FAN FUND.	FAN FUND.	FAN FUND.
1.00	*****	*****	*****	*****	*****	*****
2.00	*****	*****	*****	*****	*****	18.64
3.00	*****	*****	*****	*****	19.71	16.74
4.00	*****	*****	*****	*****	17.49	15.14
5.00	*****	*****	*****	*****	15.49	13.77
6.00	*****	*****	*****	*****	13.95	12.1
7.00	*****	*****	*****	*****	12.38	10.00
8.00	*****	*****	*****	*****	11.06	9.31
9.00	*****	*****	*****	*****	9.95	9.42
10.00	*****	*****	*****	*****	9.61	9.06
11.00	*****	*****	*****	*****	9.53	8.96
12.00	*****	*****	*****	*****	9.45	8.86
13.00	*****	*****	*****	*****	9.37	8.77
14.00	*****	*****	*****	*****	9.29	8.67
15.00	*****	*****	*****	*****	9.22	8.59
16.00	*****	*****	*****	*****	9.14	8.48
17.00	*****	*****	*****	*****	9.07	8.39
18.00	*****	*****	*****	*****	8.99	8.30
19.00	*****	*****	*****	*****	8.92	8.21
20.00	*****	*****	*****	*****	8.84	8.11
21.00	*****	*****	*****	*****	8.84	8.11
22.00	*****	*****	*****	*****	8.84	8.11
23.00	*****	*****	*****	*****	8.84	8.11
24.00	*****	*****	*****	*****	8.84	8.11
25.00	*****	*****	*****	*****	8.84	8.11
26.00	*****	*****	*****	*****	8.84	8.11
27.00	*****	*****	*****	*****	8.84	8.11
28.00	*****	*****	*****	*****	8.84	8.11
29.00	*****	*****	*****	*****	8.84	8.11
30.00	*****	*****	*****	*****	8.84	8.11

DELTA EPNL = 5.0 FAN HARMONIC = 0.0
 INLET HARMONIC 1A = 0, B = 5, C = 10, D = 20, E = 30
 T/O, WITH TONE, 0. JET ATT, NO TURB, EPNL = 103.02, RUN 2 A

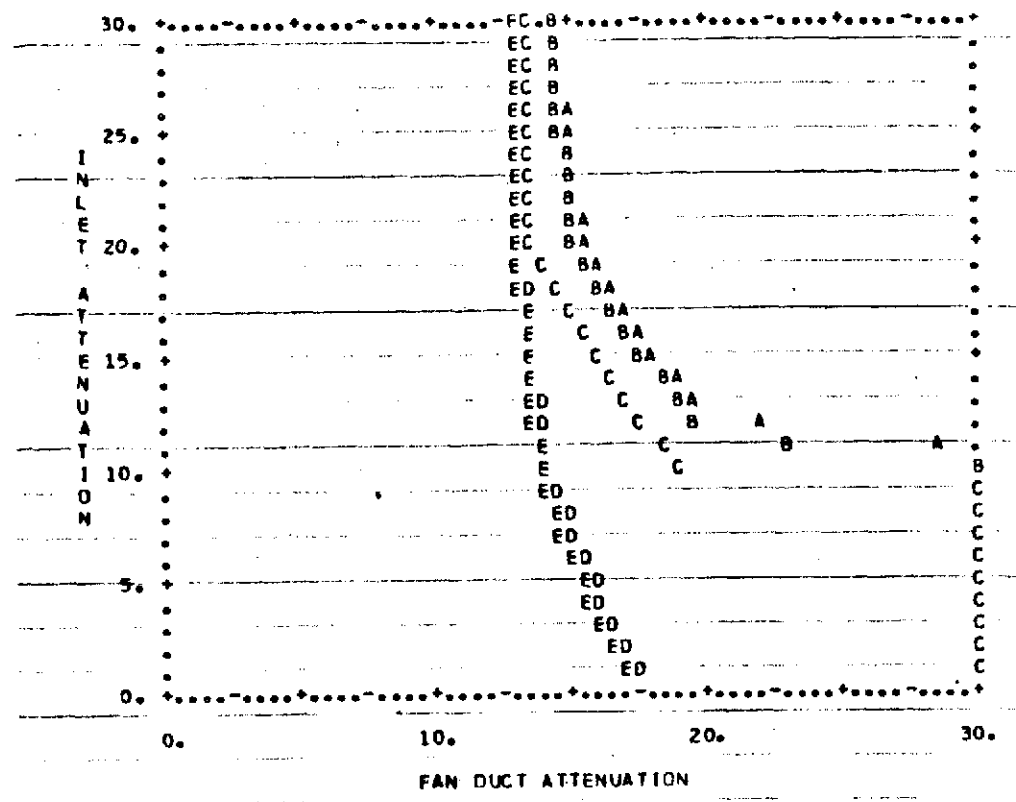

FAN HARMONIC = 0.0		DELTA EPNL = 5.0				
INLET HARMONIC =		A	B	C	D	E
		0	5	10	20	30
	INLET FUND.	FAN FUND.	FAN FUND.	FAN FUND.	FAN FUND.	FAN FUND.
	1.00	*****	*****	*****	17.38	16.88
	2.00	*****	*****	*****	16.95	16.45
	3.00	*****	*****	*****	16.54	16.05
	4.00	*****	*****	*****	16.15	15.68
	5.00	*****	*****	*****	15.77	15.32
	6.00	*****	*****	*****	15.43	15.02
	7.00	*****	*****	*****	15.10	14.73
	8.00	*****	*****	*****	14.77	14.44
	9.00	*****	*****	*****	14.44	14.15
	10.00	*****	*****	18.98	14.12	13.88
	11.00	28.57	22.91	18.34	14.01	13.75
	12.00	21.81	19.54	17.73	13.91	13.69
	13.00	19.49	18.88	17.14	13.80	13.60
	14.00	18.82	18.25	16.57	13.70	13.51
	15.00	18.19	17.65	16.03	13.60	13.43
	16.00	17.58	17.07	15.50	13.50	13.34
	17.00	17.00	16.51	15.00	13.41	13.25
	18.00	16.45	15.98	14.51	13.31	13.17
	19.00	15.92	15.47	14.04	13.22	13.09
	20.00	15.42	14.98	13.58	13.12	13.00
	21.00	15.31	14.92	13.57	13.12	13.00
	22.00	15.21	14.87	13.55	13.11	13.00
	23.00	15.10	14.81	13.53	13.11	13.00
	24.00	15.00	14.76	13.51	13.10	12.99
	25.00	14.90	14.71	13.49	13.10	12.99
	26.00	14.80	14.65	13.47	13.09	12.99
	27.00	14.70	14.60	13.45	13.08	12.99
	28.00	14.60	14.55	13.43	13.08	12.98
	29.00	14.50	14.49	13.41	13.07	12.98
	30.00	14.40	14.44	13.39	13.07	12.97

DELTA EPNL = 5.0 FAN HARMONIC = 5.0
 INLET HARMONIC (A = 0, B = 5, C = 10, D = 20, E = 30)
 T/O, WITH TONE, 0, JET ATT, NO TURB, EPNL = 103.02, RUN 2 A

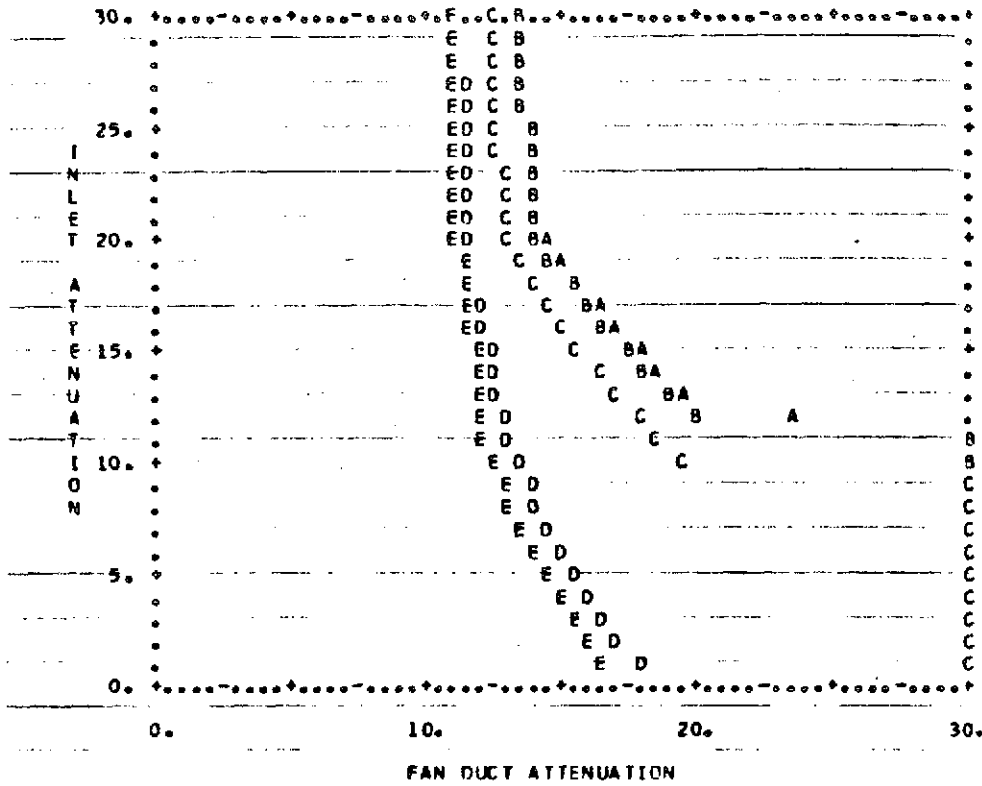

FAN HARMONIC = 5.0		DELTA EPNL = 5.0				
INLET HARMONIC =		A	B	C	D	E
INLET FUND.		FAN FUND.	FAN FUND.	FAN FUND.	FAN FUND.	FAN FUND.
1.00	*****	*****	*****	*****	17.87	16.59
2.00	*****	*****	*****	*****	17.20	16.04
3.00	*****	*****	*****	*****	16.59	15.52
4.00	*****	*****	*****	*****	15.99	15.03
5.00	*****	*****	*****	*****	15.44	14.57
6.00	*****	*****	*****	*****	14.99	14.00
7.00	*****	*****	*****	*****	14.56	13.65
8.00	*****	*****	*****	*****	14.15	13.21
9.00	*****	*****	*****	*****	13.76	12.79
10.00	*****	*****	*****	19.57	13.39	12.38
11.00	30.72	*****	*****	18.66	13.17	12.25
12.00	23.74	19.89	*****	17.82	12.95	12.12
13.00	19.59	19.02	*****	17.04	12.74	11.99
14.00	18.73	18.21	*****	16.31	12.53	11.87
15.00	17.91	17.44	*****	15.64	12.32	11.75
16.00	17.13	16.71	*****	15.01	12.12	11.64
17.00	16.38	16.02	*****	14.41	11.91	11.52
18.00	15.66	15.37	*****	13.86	11.72	11.41
19.00	14.97	14.75	*****	13.34	11.52	11.30
20.00	14.30	14.16	*****	12.84	11.33	11.20
21.00	14.19	14.08	*****	12.81	11.32	11.19
22.00	14.09	14.00	*****	12.79	11.31	11.19
23.00	13.98	13.93	*****	12.76	11.29	11.18
24.00	13.88	13.85	*****	12.73	11.28	11.18
25.00	13.78	13.78	*****	12.70	11.27	11.17
26.00	13.68	13.70	*****	12.67	11.26	11.17
27.00	13.59	13.63	*****	12.65	11.25	11.16
28.00	13.50	13.55	*****	12.62	11.24	11.16
29.00	13.40	13.48	*****	12.59	11.23	11.15
30.00	13.32	13.41	*****	12.56	11.22	11.15

DELTA EPNL = 5.0 FAN HARMONIC = 10.0
 INLET HARMONIC (A = 0, B = 5, C = 10, D = 20, E = 30)
 T/O, WITH TONE, G. JET ATT, NO TURB, EPNL = 103.02, RUN 2 A

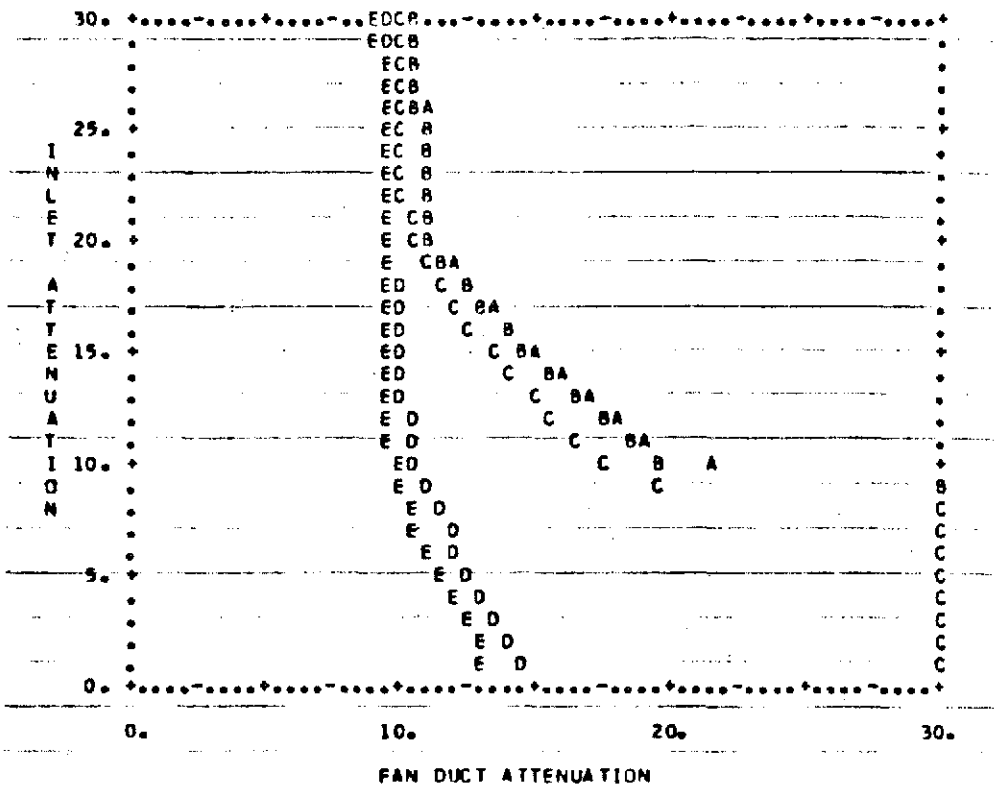

INLET HARMONIC =	DELTA EPNL = 5.0				
	A = 0	B = 5	C = 10	D = 20	E = 30
INLET FUND.	FAN FUND.	FAN FUND.	FAN FUND.	FAN FUND.	FAN FUND.
1.00	*****	*****	*****	14.73	13.23
2.00	*****	*****	*****	14.13	12.77
3.00	*****	*****	*****	13.59	12.37
4.00	*****	*****	*****	13.09	11.99
5.00	*****	*****	*****	12.62	11.66
6.00	*****	*****	*****	12.19	11.19
7.00	*****	*****	*****	11.78	10.73
8.00	*****	*****	*****	11.39	10.29
9.00	*****	*****	19.62	11.02	9.94
10.00	21.33	19.59	17.35	10.67	9.77
11.00	18.96	18.43	16.44	10.51	9.72
12.00	17.84	17.36	15.58	10.35	9.67
13.00	16.81	16.37	14.78	10.20	9.62
14.00	15.84	15.45	14.03	10.06	9.57
15.00	14.95	14.59	13.32	9.96	9.52
16.00	14.11	13.80	12.66	9.89	9.47
17.00	13.33	13.06	12.02	9.83	9.43
18.00	12.59	12.36	11.43	9.77	9.38
19.00	11.90	11.71	10.86	9.70	9.33
20.00	11.25	11.09	10.33	9.64	9.29
21.00	11.17	11.04	10.28	9.64	9.28
22.00	11.09	10.98	10.24	9.64	9.28
23.00	11.01	10.92	10.20	9.63	9.27
24.00	10.93	10.86	10.15	9.63	9.27
25.00	10.85	10.81	10.11	9.63	9.26
26.00	10.77	10.75	10.07	9.63	9.26
27.00	10.69	10.69	10.02	9.62	9.25
28.00	10.61	10.64	9.99	9.62	9.25
29.00	10.54	10.58	9.97	9.62	9.25
30.00	10.46	10.52	9.95	9.62	9.24

DELTA EPNL = 5.0 FAN HARMONIC = 20.0
 INLET HARMONIC (A = 0, B = 5, C = 10, D = 20, E = 30)
 T/D, WITH TONE, 0. JET ATT, NO TURB, EPNL = 103.02, RUN 2 A

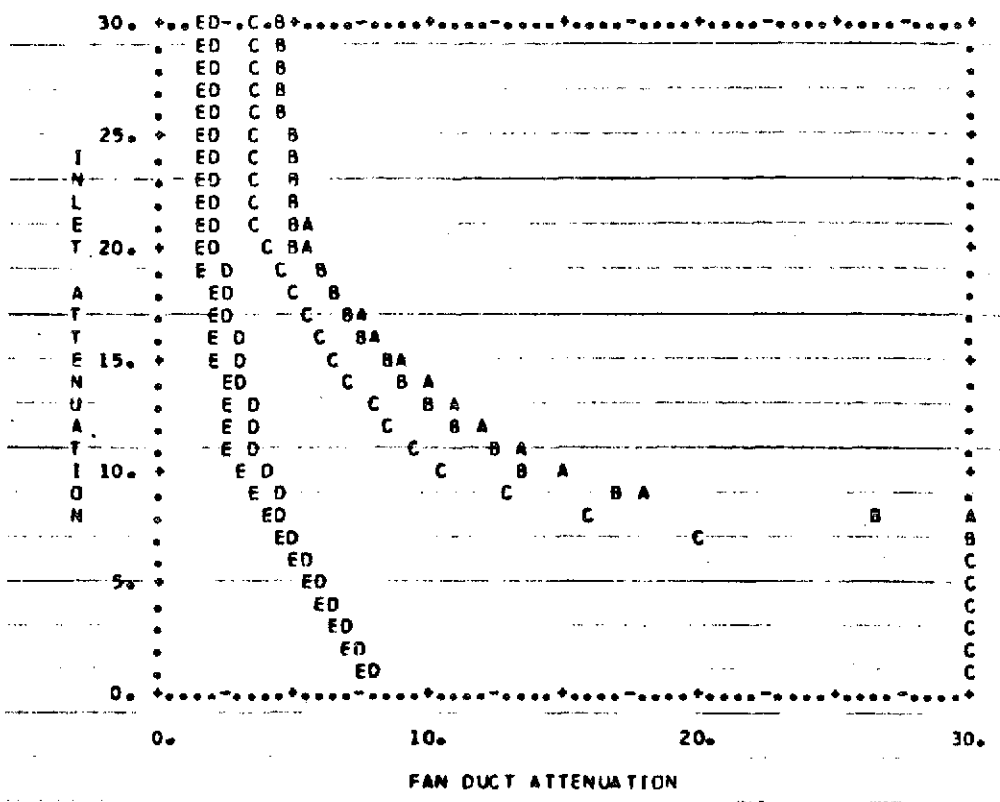

FAN HARMONIC = 20.0		DELTA EPNL = 5.0				
INLET HARMONIC =		A	B	C	D	E
		0	5	10	20	30
INLET FUND.	FAN FUND.	FAN FUND.	FAN FUND.	FAN FUND.	FAN FUND.	FAN FUND.
1.00	*****	*****	*****	*****	8.04	7.41
2.00	*****	*****	*****	*****	7.49	6.89
3.00	*****	*****	*****	*****	6.93	6.38
4.00	*****	*****	*****	*****	6.37	5.87
5.00	*****	*****	*****	*****	5.80	5.37
6.00	*****	*****	*****	*****	5.42	4.97
7.00	*****	*****	*****	19.84	5.04	4.47
8.00	30.56	26.67	15.96	4.55	3.96	
9.00	17.85	16.94	12.84	4.25	3.42	
10.00	14.80	13.59	10.26	3.85	2.86	
11.00	13.35	12.30	9.39	3.67	2.70	
12.00	12.04	11.14	8.61	3.49	2.55	
13.00	10.86	10.08	7.88	3.32	2.41	
14.00	9.81	9.24	7.20	3.15	2.28	
15.00	8.95	8.46	6.56	2.97	2.16	
16.00	8.14	7.72	5.96	2.80	2.04	
17.00	7.39	7.03	5.40	2.63	1.93	
18.00	6.67	6.38	4.86	2.46	1.83	
19.00	6.00	5.76	4.30	2.29	1.74	
20.00	5.36	5.17	3.77	2.12	1.65	
21.00	5.26	5.10	3.73	2.11	1.64	
22.00	5.15	5.03	3.70	2.10	1.64	
23.00	5.05	4.96	3.66	2.09	1.63	
24.00	4.95	4.89	3.63	2.08	1.62	
25.00	4.84	4.81	3.59	2.06	1.61	
26.00	4.74	4.74	3.56	2.05	1.61	
27.00	4.63	4.66	3.53	2.04	1.60	
28.00	4.53	4.59	3.49	2.03	1.59	
29.00	4.43	4.52	3.46	2.01	1.58	
30.00	4.33	4.44	3.43	2.00	1.58	

DELTA EPNL = 5.0 FAN HARMONIC = 30.0
 INLET HARMONIC (A = 0, B = 5, C = 10, D = 20, E = 30)
 T/O, WITH TONE, O. JET AYT, NO TURB, EPNL = 103.02, RUN 2 A

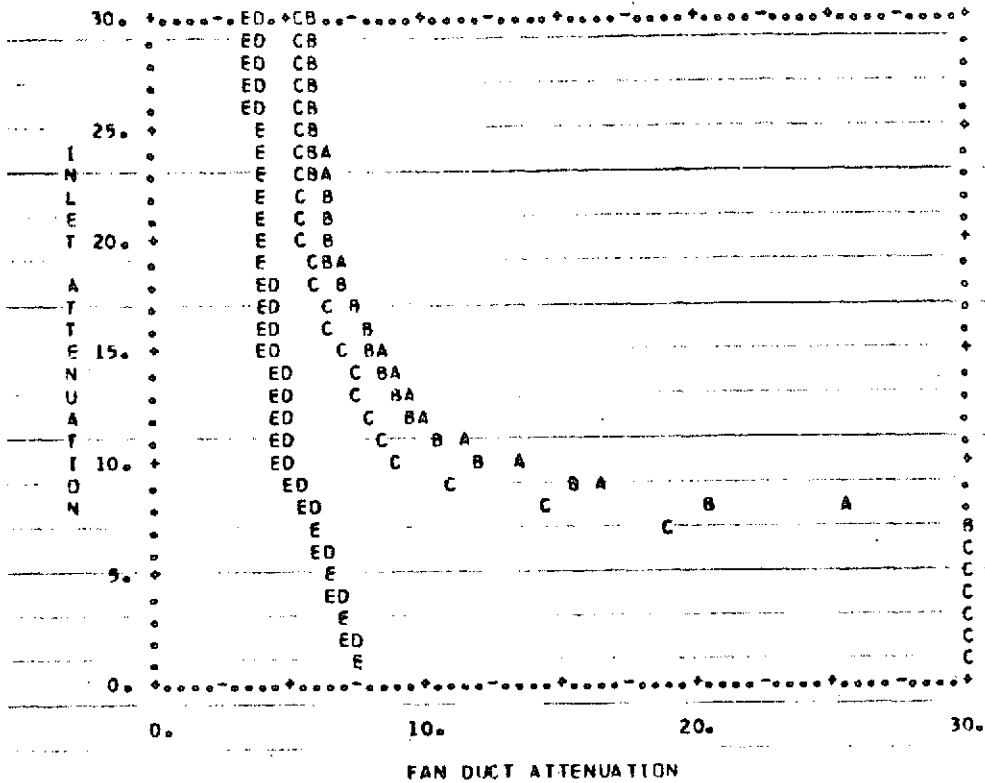

INLET FUND.	DELTA EPNL = 5.0				
	A	B	C	D	E
1.00	*****	*****	*****	7.56	7.47
2.00	*****	*****	*****	7.27	7.22
3.00	*****	*****	*****	7.01	6.96
4.00	*****	*****	*****	6.76	6.70
5.00	*****	*****	*****	6.54	6.43
6.00	*****	*****	*****	6.28	6.10
7.00	*****	*****	18.77	6.02	5.76
8.00	25.45	20.48	14.44	5.76	5.42
9.00	16.75	15.72	10.98	5.50	5.08
10.00	13.33	12.04	9.04	5.25	4.56
11.00	11.71	10.67	8.52	5.16	4.48
12.00	10.25	9.72	8.05	5.08	4.41
13.00	9.50	9.15	7.63	4.99	4.33
14.00	8.95	8.64	7.25	4.85	4.25
15.00	8.46	8.18	6.91	4.70	4.19
16.00	8.01	7.75	6.60	4.56	4.11
17.00	7.61	7.36	6.32	4.43	4.04
18.00	7.24	7.00	6.06	4.29	3.96
19.00	6.91	6.66	5.82	4.16	3.89
20.00	6.60	6.35	5.59	4.02	3.81
21.00	6.32	6.30	5.57	4.01	3.80
22.00	6.45	6.26	5.55	3.99	3.79
23.00	6.37	6.21	5.53	3.97	3.77
24.00	6.29	6.16	5.51	3.96	3.76
25.00	6.21	6.11	5.49	3.94	3.75
26.00	6.13	6.06	5.47	3.93	3.74
27.00	6.05	6.01	5.45	3.91	3.73
28.00	5.97	5.96	5.43	3.90	3.72
29.00	5.89	5.91	5.40	3.88	3.70
30.00	5.81	5.86	5.38	3.86	3.69

DELTA EPNL = 10.0 FAN HARMONIC = 0.0
 INLET HARMONIC (A = 0, B = 5, C = 10, D = 20, E = 30)
 T/O, WITH TONE, 0, JET ATT, NO TURB, EPNL = 103.02, RUN 2 A

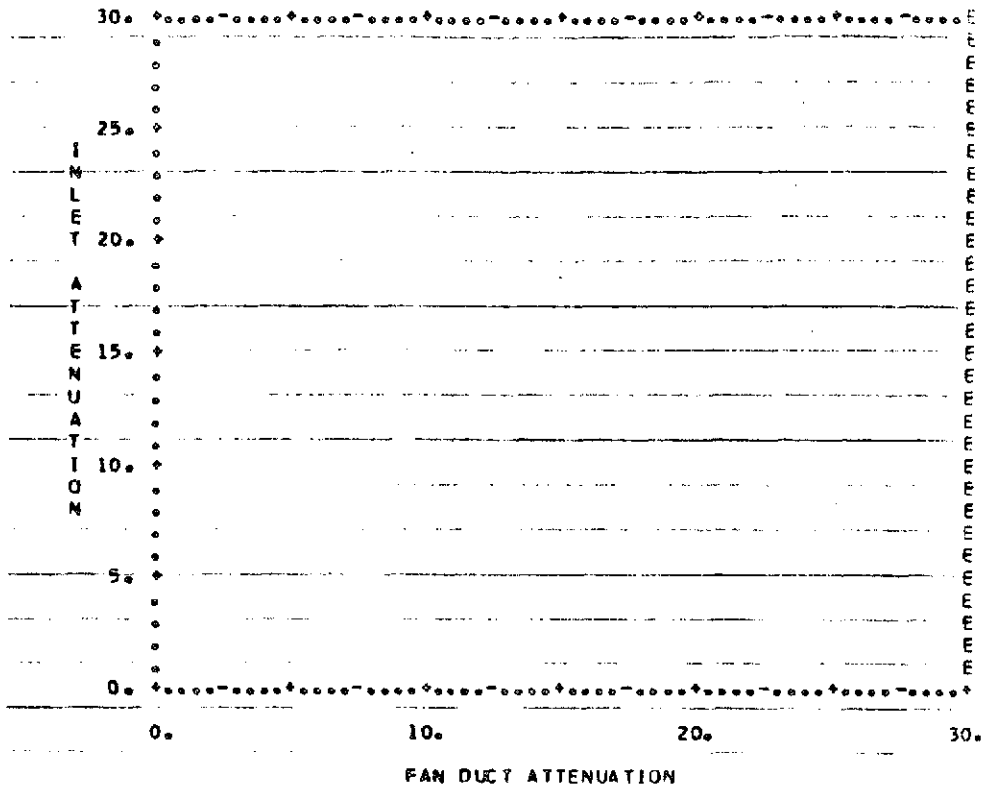

FAN HARMONIC = 0.0		DELTA EPNL = 10.0				
INLET HARMONIC = 0		A	B	C	D	E
		0	5	10	20	30
	INLET FUND.	FAN FUND.	FAN FUND.	FAN FUND.	FAN FUND.	FAN FUND.
	1.00	*****	*****	*****	*****	*****
	2.00	*****	*****	*****	*****	*****
	3.00	*****	*****	*****	*****	*****
	4.00	*****	*****	*****	*****	*****
	5.00	*****	*****	*****	*****	*****
	6.00	*****	*****	*****	*****	*****
	7.00	*****	*****	*****	*****	*****
	8.00	*****	*****	*****	*****	*****
	9.00	*****	*****	*****	*****	*****
	10.00	*****	*****	*****	*****	*****
	11.00	*****	*****	*****	*****	*****
	12.00	*****	*****	*****	*****	*****
	13.00	*****	*****	*****	*****	*****
	14.00	*****	*****	*****	*****	*****
	15.00	*****	*****	*****	*****	*****
	16.00	*****	*****	*****	*****	*****
	17.00	*****	*****	*****	*****	*****
	18.00	*****	*****	*****	*****	*****
	19.00	*****	*****	*****	*****	*****
	20.00	*****	*****	*****	*****	*****
	21.00	*****	*****	*****	*****	*****
	22.00	*****	*****	*****	*****	*****
	23.00	*****	*****	*****	*****	*****
	24.00	*****	*****	*****	*****	*****
	25.00	*****	*****	*****	*****	*****
	26.00	*****	*****	*****	*****	*****
	27.00	*****	*****	*****	*****	*****
	28.00	*****	*****	*****	*****	*****
	29.00	*****	*****	*****	*****	*****
	30.00	*****	*****	*****	*****	*****

DELTA EPNL = 10.0 FAN HARMONIC = 5.0
 INLET HARMONIC (A = 0, B = 5, C = 10, D = 20, E = 30)
 T/O. WITH TONE, 0. JET ATT, NO TURB, EPNL = 103.02, RUN 2 A

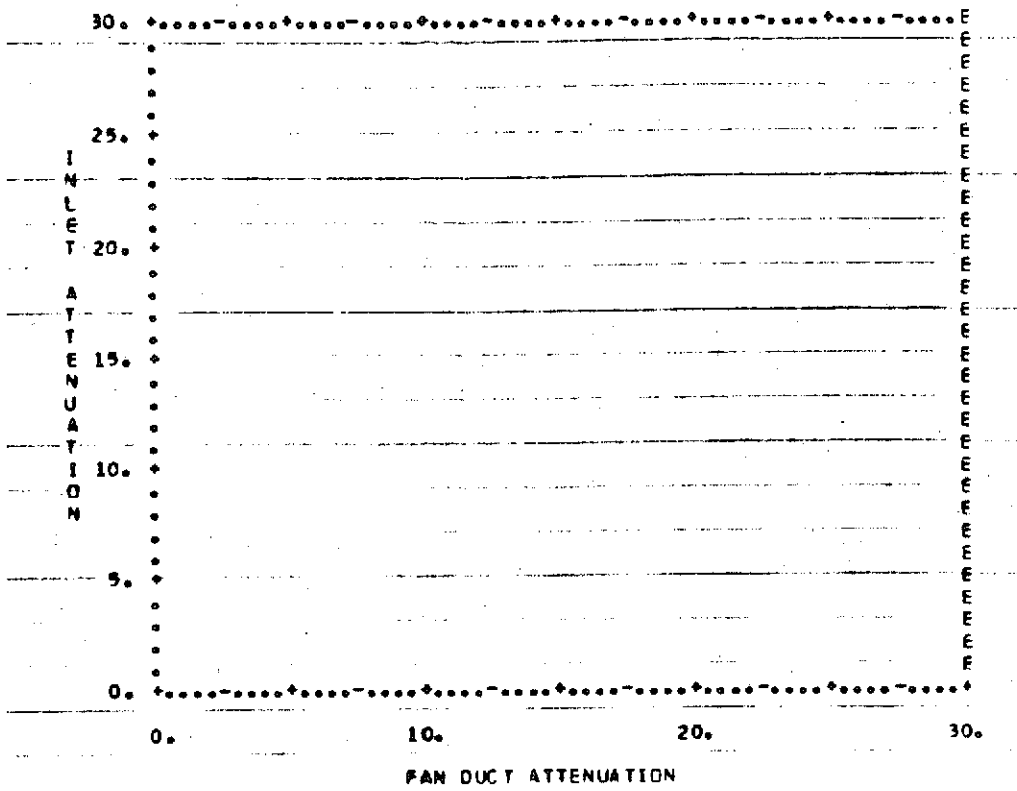

INLET HARMONIC =	FAN HARMONIC = 5.0					DELTA EPNL = 10.0				
	A	B	C	D	E	A	B	C	D	E
	0	5	10	20	30	0	5	10	20	30
	FAN FUND.	FAN FUND.	FAN FUND.	FAN FUND.	FAN FUND.	FAN FUND.	FAN FUND.	FAN FUND.	FAN FUND.	FAN FUND.
1.00	*****	*****	*****	*****	*****	*****	*****	*****	*****	*****
2.00	*****	*****	*****	*****	*****	*****	*****	*****	*****	*****
3.00	*****	*****	*****	*****	*****	*****	*****	*****	*****	*****
4.00	*****	*****	*****	*****	*****	*****	*****	*****	*****	*****
5.00	*****	*****	*****	*****	*****	*****	*****	*****	*****	*****
6.00	*****	*****	*****	*****	*****	*****	*****	*****	*****	*****
7.00	*****	*****	*****	*****	*****	*****	*****	*****	*****	*****
8.00	*****	*****	*****	*****	*****	*****	*****	*****	*****	*****
9.00	*****	*****	*****	*****	*****	*****	*****	*****	*****	*****
10.00	*****	*****	*****	*****	*****	*****	*****	*****	*****	*****
11.00	*****	*****	*****	*****	*****	*****	*****	*****	*****	*****
12.00	*****	*****	*****	*****	*****	*****	*****	*****	*****	*****
13.00	*****	*****	*****	*****	*****	*****	*****	*****	*****	*****
14.00	*****	*****	*****	*****	*****	*****	*****	*****	*****	*****
15.00	*****	*****	*****	*****	*****	*****	*****	*****	*****	*****
16.00	*****	*****	*****	*****	*****	*****	*****	*****	*****	*****
17.00	*****	*****	*****	*****	*****	*****	*****	*****	*****	*****
18.00	*****	*****	*****	*****	*****	*****	*****	*****	*****	*****
19.00	*****	*****	*****	*****	*****	*****	*****	*****	*****	*****
20.00	*****	*****	*****	*****	*****	*****	*****	*****	*****	*****
21.00	*****	*****	*****	*****	*****	*****	*****	*****	*****	*****
22.00	*****	*****	*****	*****	*****	*****	*****	*****	*****	*****
23.00	*****	*****	*****	*****	*****	*****	*****	*****	*****	*****
24.00	*****	*****	*****	*****	*****	*****	*****	*****	*****	*****
25.00	*****	*****	*****	*****	*****	*****	*****	*****	*****	*****
26.00	*****	*****	*****	*****	*****	*****	*****	*****	*****	*****
27.00	*****	*****	*****	*****	*****	*****	*****	*****	*****	*****
28.00	*****	*****	*****	*****	*****	*****	*****	*****	*****	*****
29.00	*****	*****	*****	*****	*****	*****	*****	*****	*****	*****
30.00	*****	*****	*****	*****	*****	*****	*****	*****	*****	*****

DELTA EPNL = 10.0 FAN HARMONIC = 10.0
 INLET HARMONIC (A = 0, B = 5, C = 10, D = 20, E = 30)
 T/O, WITH TONE, 0. JET ATT, NO TURB, EPNL = 103.02, RUN 2 A

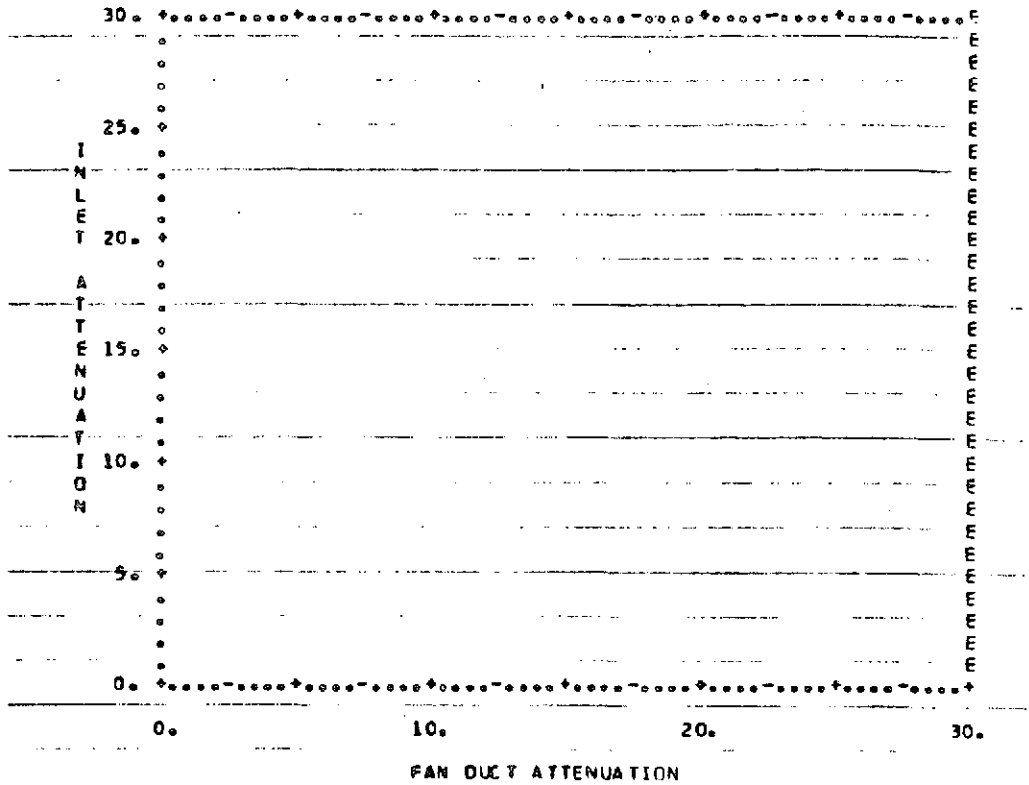

FAN HARMONIC = 10.0		DELTA EPNL = 10.0				
INLET HARMONIC =		A	B	C	D	E
		0	5	10	20	30
	INLET FUND.	FAN FUND.	FAN FUND.	FAN FUND.	FAN FUND.	FAN FUND.
	1.00	*****	*****	*****	*****	*****
	2.00	*****	*****	*****	*****	*****
	3.00	*****	*****	*****	*****	*****
	4.00	*****	*****	*****	*****	*****
	5.00	*****	*****	*****	*****	*****
	6.00	*****	*****	*****	*****	*****
	7.00	*****	*****	*****	*****	*****
	8.00	*****	*****	*****	*****	*****
	9.00	*****	*****	*****	*****	*****
	10.00	*****	*****	*****	*****	*****
	11.00	*****	*****	*****	*****	*****
	12.00	*****	*****	*****	*****	*****
	13.00	*****	*****	*****	*****	*****
	14.00	*****	*****	*****	*****	*****
	15.00	*****	*****	*****	*****	*****
	16.00	*****	*****	*****	*****	*****
	17.00	*****	*****	*****	*****	*****
	18.00	*****	*****	*****	*****	*****
	19.00	*****	*****	*****	*****	*****
	20.00	*****	*****	*****	*****	*****
	21.00	*****	*****	*****	*****	*****
	22.00	*****	*****	*****	*****	*****
	23.00	*****	*****	*****	*****	*****
	24.00	*****	*****	*****	*****	*****
	25.00	*****	*****	*****	*****	*****
	26.00	*****	*****	*****	*****	*****
	27.00	*****	*****	*****	*****	*****
	28.00	*****	*****	*****	*****	*****
	29.00	*****	*****	*****	*****	*****
	30.00	*****	*****	*****	*****	*****

DELTA EPNL = 10.0 FAN HARMONIC = 20.0
 INLET HARMONIC (A = 0, B = 5, C = 10, D = 20, E = 30)
 T/O. WITH TONE, 0. JET ATT. NO TURB, EPNL = 103.02, RUN 2 A

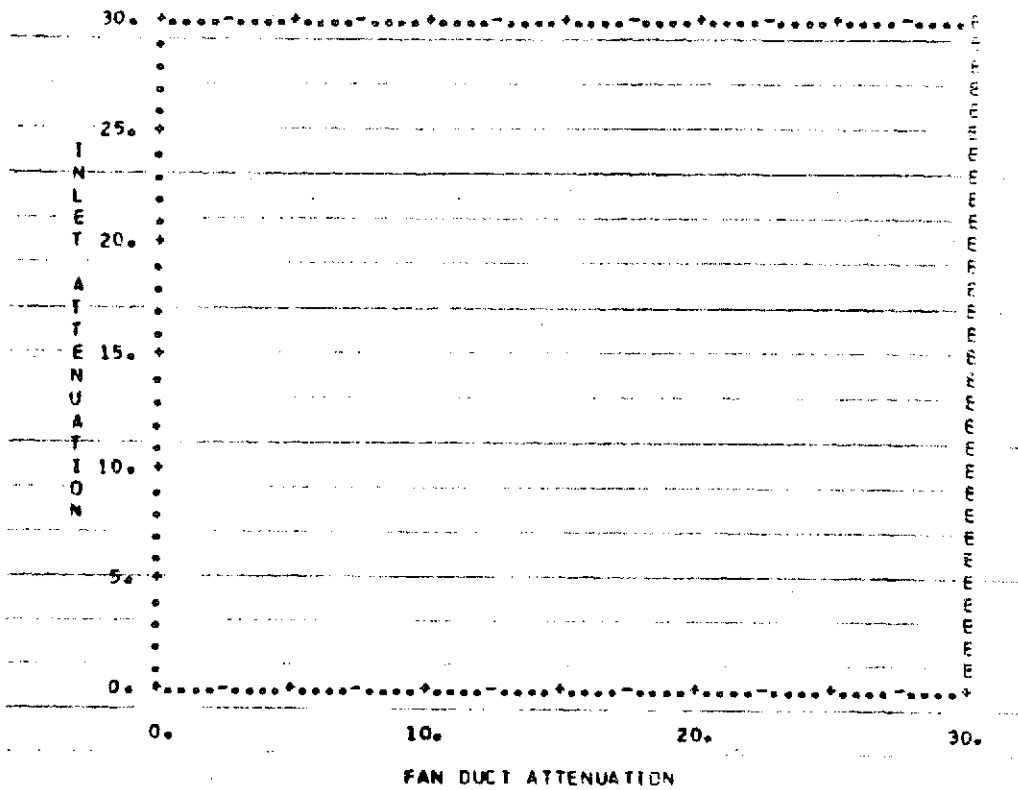

INLET HARMONIC *	FAN HARMONIC = 20.0				
	A	B	C	D	E
INLET FUND.	FAN FUND.	FAN FUND.	FAN FUND.	FAN FUND.	FAN FUND.
1.00	*****	*****	*****	*****	*****
2.00	*****	*****	*****	*****	*****
3.00	*****	*****	*****	*****	*****
4.00	*****	*****	*****	*****	*****
5.00	*****	*****	*****	*****	*****
6.00	*****	*****	*****	*****	*****
7.00	*****	*****	*****	*****	*****
8.00	*****	*****	*****	*****	*****
9.00	*****	*****	*****	*****	*****
10.00	*****	*****	*****	*****	*****
11.00	*****	*****	*****	*****	*****
12.00	*****	*****	*****	*****	*****
13.00	*****	*****	*****	*****	*****
14.00	*****	*****	*****	*****	*****
15.00	*****	*****	*****	*****	*****
16.00	*****	*****	*****	*****	*****
17.00	*****	*****	*****	*****	*****
18.00	*****	*****	*****	*****	*****
19.00	*****	*****	*****	*****	*****
20.00	*****	*****	*****	*****	*****
21.00	*****	*****	*****	*****	*****
22.00	*****	*****	*****	*****	*****
23.00	*****	*****	*****	*****	*****
24.00	*****	*****	*****	*****	*****
25.00	*****	*****	*****	*****	*****
26.00	*****	*****	*****	*****	*****
27.00	*****	*****	*****	*****	*****
28.00	*****	*****	*****	*****	*****
29.00	*****	*****	*****	*****	*****
30.00	*****	*****	*****	*****	*****

DELTA EPNL = 10.0 FAN HARMONIC = 30.0
 INLET HARMONIC (A = 0, B = 5, C = 10, D = 20, E = 30)
 T/O, WITH TONE, 0, JET ATT, NO TURB, EPNL = 103.02, RUN 2 A

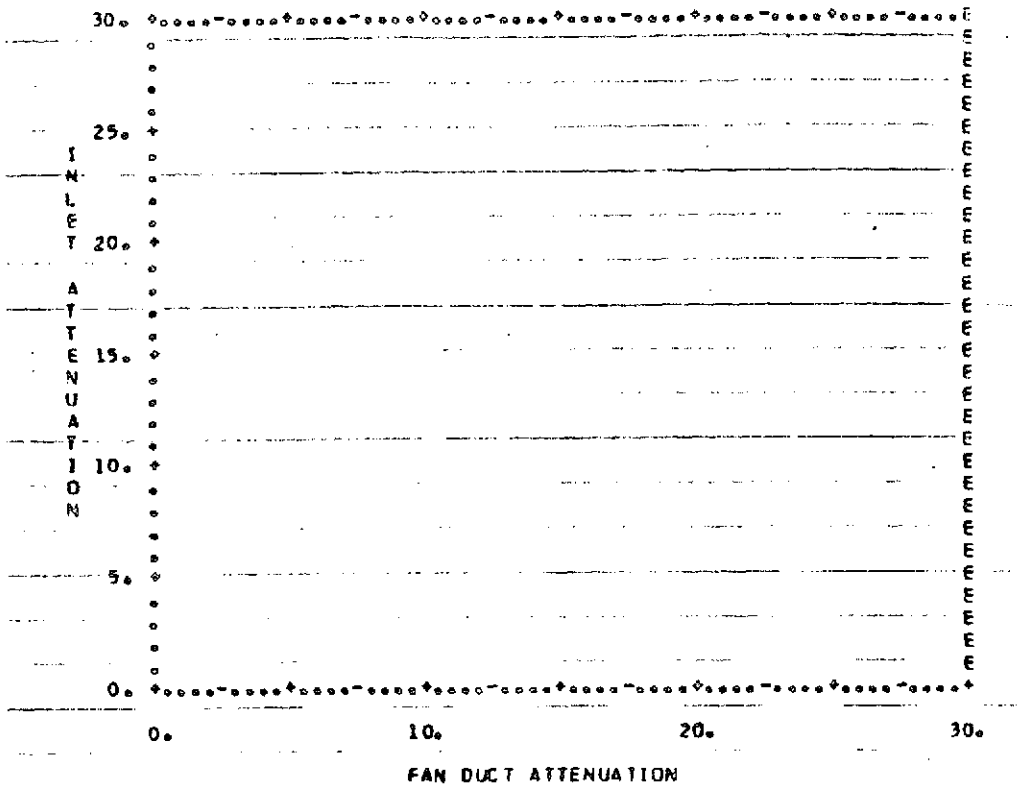

INLET FUND.	DELTA EPNL = 10.0				
	A	B	C	D	E
	INLET HARMONIC =				
	0	5	10	20	30
	FAN FUND.	FAN FUND.	FAN FUND.	FAN FUND.	FAN FUND.
1.00	*****	*****	*****	*****	*****
2.00	*****	*****	*****	*****	*****
3.00	*****	*****	*****	*****	*****
4.00	*****	*****	*****	*****	*****
5.00	*****	*****	*****	*****	*****
6.00	*****	*****	*****	*****	*****
7.00	*****	*****	*****	*****	*****
8.00	*****	*****	*****	*****	*****
9.00	*****	*****	*****	*****	*****
10.00	*****	*****	*****	*****	*****
11.00	*****	*****	*****	*****	*****
12.00	*****	*****	*****	*****	*****
13.00	*****	*****	*****	*****	*****
14.00	*****	*****	*****	*****	*****
15.00	*****	*****	*****	*****	*****
16.00	*****	*****	*****	*****	*****
17.00	*****	*****	*****	*****	*****
18.00	*****	*****	*****	*****	*****
19.00	*****	*****	*****	*****	*****
20.00	*****	*****	*****	*****	*****
21.00	*****	*****	*****	*****	*****
22.00	*****	*****	*****	*****	*****
23.00	*****	*****	*****	*****	*****
24.00	*****	*****	*****	*****	*****
25.00	*****	*****	*****	*****	*****
26.00	*****	*****	*****	*****	*****
27.00	*****	*****	*****	*****	*****
28.00	*****	*****	*****	*****	*****
29.00	*****	*****	*****	*****	*****
30.00	*****	*****	*****	*****	*****

DELTA EFNL = 5.0 FAN HARMONIC = 0.0
 INLET HARMONIC (A = 0, B = 5, C = 10, D = 20, E = 30)
 T/C, WITH TCNE, 10. JET ATT, NO TURB, EFNL = 101.83, RUN 5A

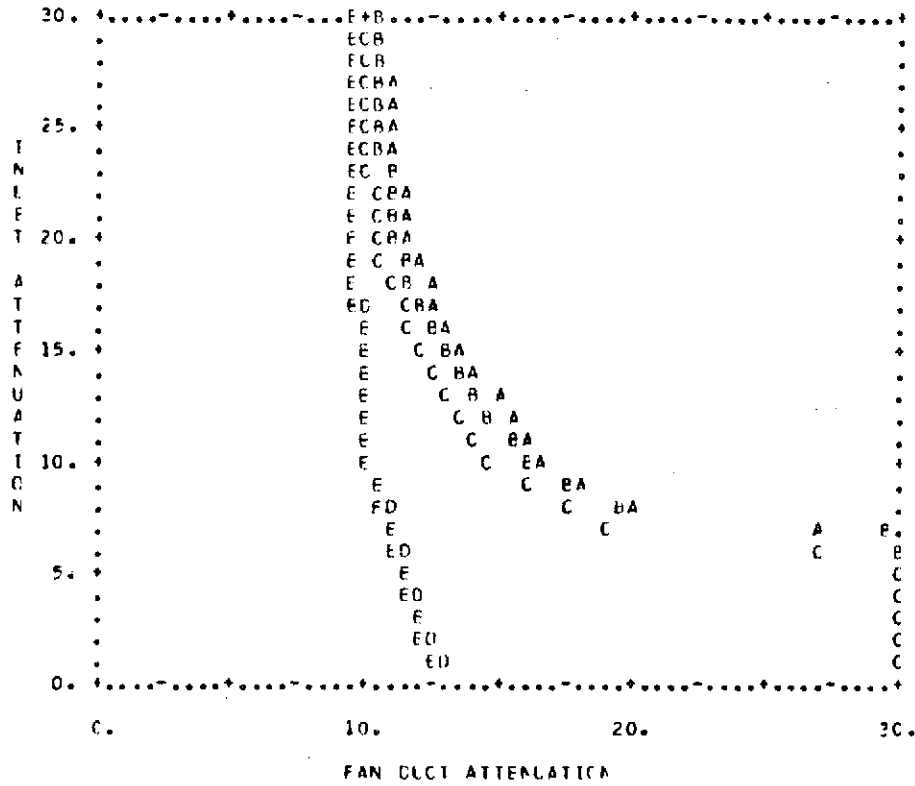

INLET FUND.	FAN HARMONIC = 0.0		DELTA EFNL = 5.0		
	A	B	C	D	E
	C	5	10	20	30
FAN FUND.	FAN FUND.	FAN FUND.	FAN FUND.	FAN FUND.	FAN FUND.
1.00	*****	*****	*****	12.85	12.42
2.00	*****	*****	*****	12.53	12.14
3.00	*****	*****	*****	12.23	11.88
4.00	*****	*****	*****	11.95	11.65
5.00	*****	*****	*****	11.68	11.43
6.00	*****	*****	26.59	11.37	11.13
7.00	27.21	25.54	19.03	11.08	10.84
8.00	19.90	19.54	17.29	10.79	10.58
9.00	18.14	17.63	15.77	10.51	10.32
10.00	16.65	16.03	14.43	10.24	10.08
11.00	15.59	15.35	13.27	10.17	10.04
12.00	15.36	14.72	13.36	10.11	9.99
13.00	14.77	14.13	12.89	10.05	9.94
14.00	14.22	13.59	12.46	9.99	9.89
15.00	13.69	13.08	12.05	9.93	9.84
16.00	13.20	12.60	11.68	9.87	9.79
17.00	12.73	12.15	11.33	9.81	9.74
18.00	12.29	11.73	11.00	9.75	9.69
19.00	11.86	11.33	10.69	9.69	9.65
20.00	11.46	10.96	10.41	9.63	9.60
21.00	11.35	10.91	10.34	9.63	9.59
22.00	11.25	10.85	10.27	9.62	9.59
23.00	11.15	10.80	10.20	9.61	9.58
24.00	11.06	10.75	10.13	9.61	9.58
25.00	10.96	10.70	10.05	9.60	9.57
26.00	10.87	10.65	9.98	9.60	9.57
27.00	10.78	10.60	9.90	9.59	9.56
28.00	10.70	10.55	9.83	9.59	9.56
29.00	10.62	10.50	9.76	9.58	9.55
30.00	10.54	10.45	9.69	9.57	9.55

DELTA EPNL = 5.0 FAN HARMONIC = 5.0
 INLET HARMONIC (A = 0, B = 5, C = 10, D = 20, E = 30)
 1/3, WITH TCNE, 10. JET ATT, NO TURB, EPNL = 101.83, RUN 5A

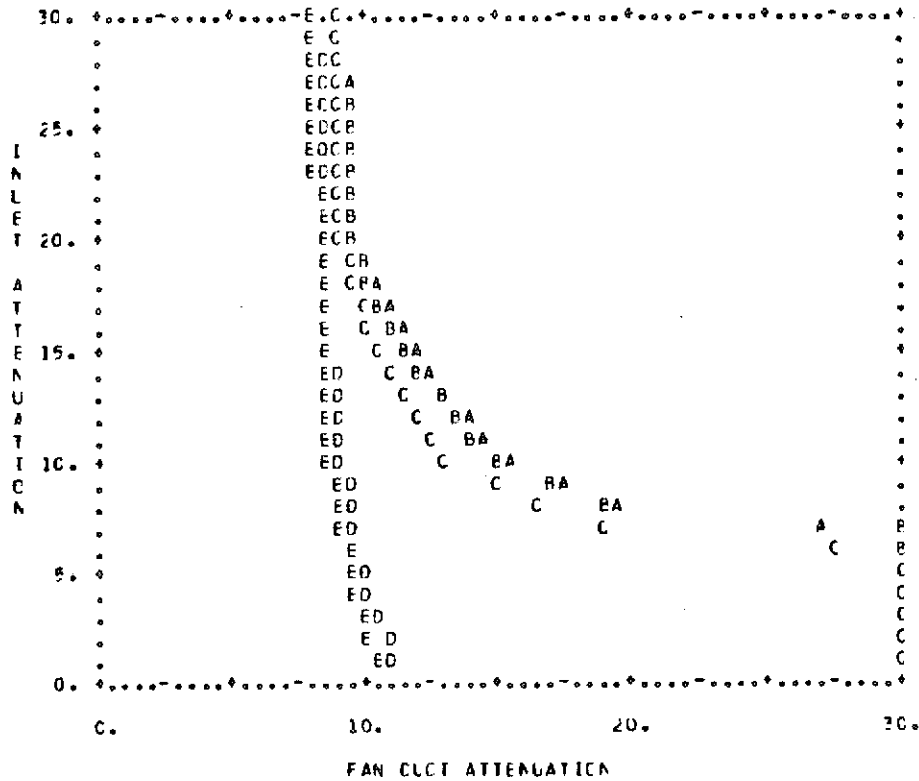

FAN HARMONIC = 5.0		DELTA EPNL = 5.0				
INLET HARMONIC =		A	B	C	D	E
		C	5	10	20	30
INLET FUND.	FAN FUND.	FAN FUND.	FAN FUND.	FAN FUND.	FAN FUND.	FAN FUND.
1.00	*****	*****	*****	*****	11.23	10.28
2.00	*****	*****	*****	*****	10.85	10.02
3.00	*****	*****	*****	*****	10.49	9.87
4.00	*****	*****	*****	*****	10.16	9.73
5.00	*****	*****	*****	*****	9.90	9.59
6.00	*****	*****	*****	27.66	9.75	9.39
7.00	27.18	30.00	18.84	9.59	9.19	
8.00	19.26	19.23	16.72	9.43	9.00	
9.00	17.26	16.95	14.84	9.28	8.82	
10.00	15.46	15.00	13.18	9.13	8.65	
11.00	14.68	14.19	12.53	9.03	8.61	
12.00	13.93	13.46	11.96	8.94	8.57	
13.00	13.24	12.80	11.44	8.85	8.53	
14.00	12.59	12.19	10.97	8.76	8.49	
15.00	11.99	11.64	10.54	8.68	8.45	
16.00	11.43	11.13	10.15	8.60	8.41	
17.00	10.90	10.66	9.84	8.52	8.37	
18.00	10.40	10.22	9.56	8.44	8.33	
19.00	9.96	9.87	9.32	8.36	8.29	
20.00	9.66	9.58	9.07	8.29	8.26	
21.00	9.61	9.53	9.05	8.29	8.25	
22.00	9.56	9.48	9.02	8.28	8.25	
23.00	9.51	9.43	9.00	8.28	8.25	
24.00	9.46	9.38	8.98	8.27	8.24	
25.00	9.41	9.33	8.96	8.27	8.24	
26.00	9.35	9.28	8.94	8.26	8.24	
27.00	9.30	9.23	8.92	8.26	8.23	
28.00	9.25	9.18	8.89	8.25	8.23	
29.00	9.20	9.13	8.87	8.25	8.23	
30.00	9.14	9.08	8.85	8.24	8.22	

DELTA EPAL = 5.0 FAN HARMONIC = 10.0
 INLET HARMONIC (A = C, B = 5, C = 10, D = 20, E = 30)
 T/O, WITH TCNE, 10. JET ATT, NO TURB, EPAL = 101.83, RUN 5A

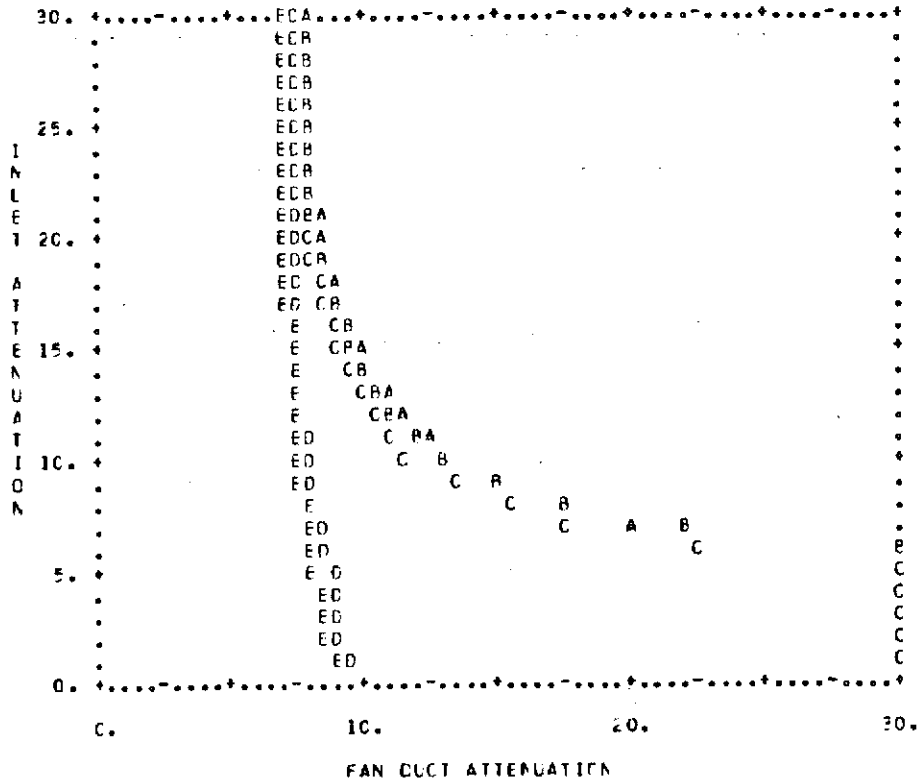

INLET FUND.	FAN HARMONIC = 10.0		DELTA EPAL = 5.0		
	A	B	C	D	E
	C	5	10	20	30
1.00	*****	*****	*****	9.37	8.91
2.00	*****	*****	*****	9.23	8.74
3.00	*****	*****	*****	9.10	8.56
4.00	*****	*****	*****	8.97	8.38
5.00	*****	*****	*****	8.85	8.20
6.00	*****	*****	22.47	8.65	8.07
7.00	19.93	22.17	17.63	8.45	7.95
8.00	17.40	17.44	15.26	8.25	7.84
9.00	15.19	14.96	13.31	8.05	7.73
10.00	13.22	12.84	11.67	7.86	7.63
11.00	12.34	11.99	10.93	7.80	7.57
12.00	11.55	11.24	10.29	7.73	7.51
13.00	10.84	10.57	9.83	7.68	7.45
14.00	10.20	9.98	9.45	7.62	7.40
15.00	9.77	9.63	9.17	7.56	7.34
16.00	9.44	9.29	8.87	7.50	7.29
17.00	9.14	8.96	8.57	7.45	7.24
18.00	8.86	8.64	8.29	7.40	7.19
19.00	8.59	8.34	8.02	7.34	7.14
20.00	8.34	8.04	7.75	7.29	7.09
21.00	8.28	8.01	7.73	7.29	7.09
22.00	8.23	7.98	7.70	7.29	7.09
23.00	8.17	7.95	7.66	7.29	7.08
24.00	8.11	7.91	7.65	7.29	7.08
25.00	8.05	7.88	7.63	7.29	7.08
26.00	8.00	7.85	7.61	7.29	7.08
27.00	7.94	7.82	7.58	7.29	7.08
28.00	7.88	7.79	7.56	7.29	7.08
29.00	7.82	7.76	7.53	7.29	7.08
30.00	7.76	7.73	7.51	7.29	7.08

DELTA EPAL = 5.0 FAN HARMONIC = 20.0
 INLET HARMONIC (A = 0, B = 5, C = 10, D = 20, E = 30)
 1/D, WITH 1CNE, 10. JET ATT, NO TURB, EPAL = 101.83, RUN 5A

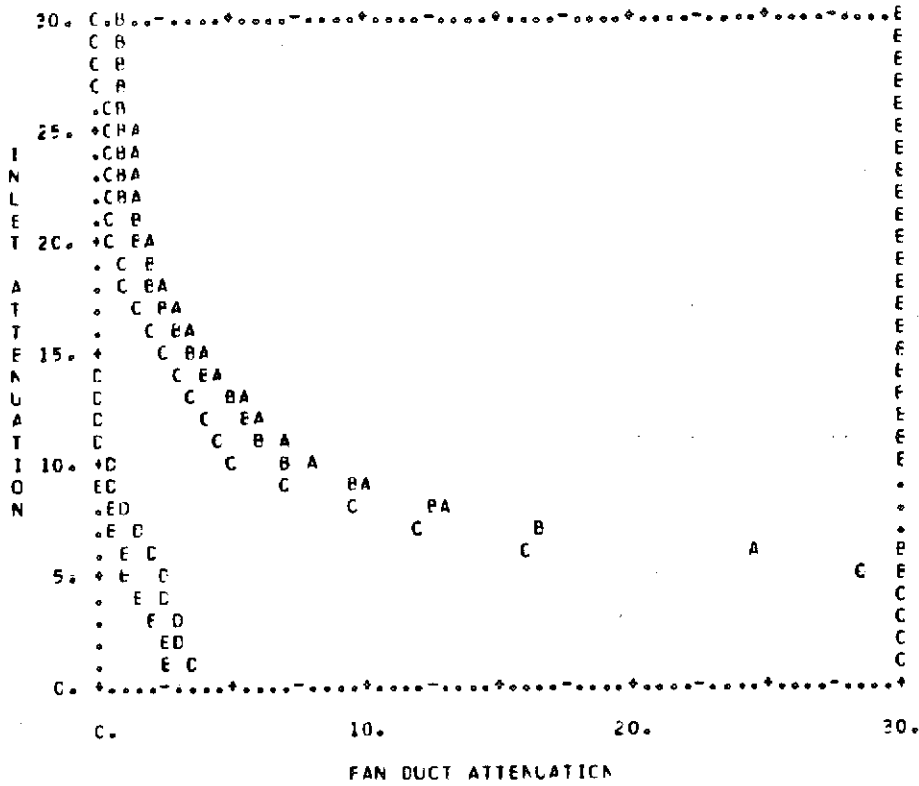

INLET HARMONIC =	FAN HARMONIC = 20.0		DELTA EPAL = 5.0		E
	A	B	C	D	
	C	5	10	20	30
INLET FLND.	FAN FUNC.	FAN FUNC.	FAN FUNC.	FAN FLND.	FAN FUNC.
1.00	*****	*****	*****	3.54	2.74
2.00	*****	*****	*****	3.21	2.31
3.00	*****	*****	*****	2.90	1.92
4.00	*****	*****	*****	2.60	1.56
5.00	*****	*****	28.46	2.32	1.24
6.00	24.41	*****	15.97	1.67	0.93
7.00	19.39	16.60	12.10	1.45	0.63
8.00	12.97	12.64	9.29	1.05	0.33
9.00	10.11	9.51	7.15	0.66	0.02
10.00	7.67	7.12	5.24	0.29	*****
11.00	6.88	6.24	4.56	0.22	*****
12.00	6.01	5.46	3.97	0.15	*****
13.00	5.25	4.80	3.42	0.08	*****
14.00	4.63	4.23	2.91	0.01	*****
15.00	4.09	3.69	2.44	*****	*****
16.00	3.57	3.17	1.99	*****	*****
17.00	3.08	2.68	1.56	*****	*****
18.00	2.62	2.21	1.13	*****	*****
19.00	2.18	1.76	0.82	*****	*****
20.00	1.76	1.33	0.47	*****	*****
21.00	1.66	1.27	0.43	*****	*****
22.00	1.56	1.22	0.40	*****	*****
23.00	1.46	1.16	0.36	*****	*****
24.00	1.37	1.11	0.33	*****	*****
25.00	1.27	1.06	0.29	*****	*****
26.00	1.18	1.00	0.25	*****	*****
27.00	1.09	0.95	0.22	*****	*****
28.00	0.99	0.90	0.18	*****	*****
29.00	0.90	0.85	0.14	*****	*****
30.00	0.81	0.80	0.11	*****	*****

DELTA EPNL = 5.0 FAN HARMONIC = 30.0
 INLET HARMONIC (A = 0, B = 5, C = 10, D = 20, E = 30)
 1/3, WITH ICNE, 10. JET ATT, NO TURE, EPNL = 101.82, RUN 5A

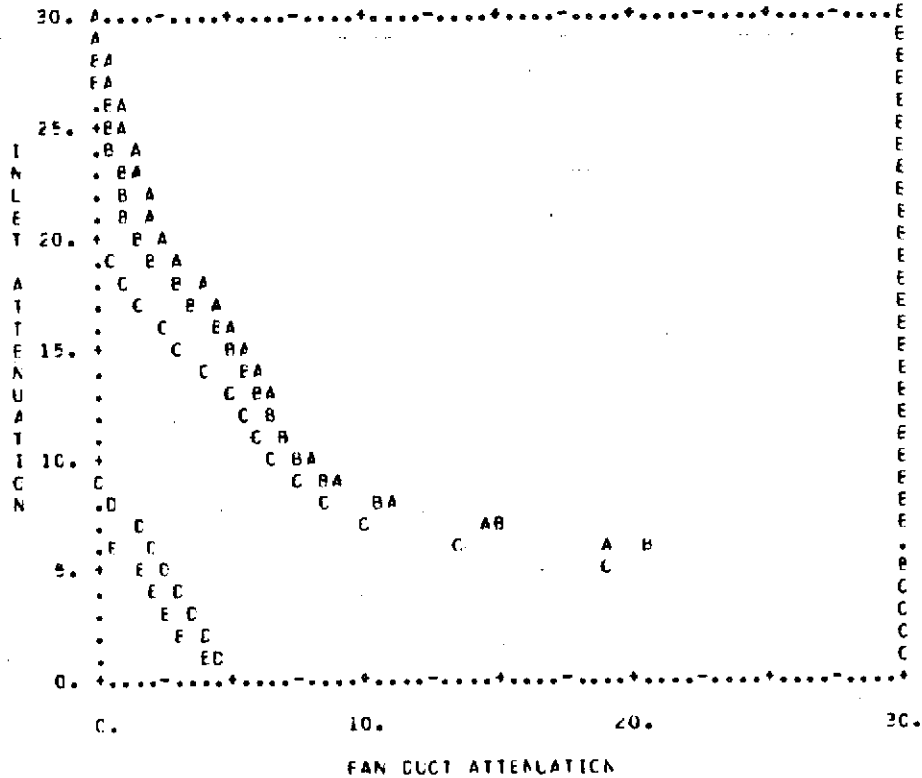

INLET HARMONIC =	DELTA EPNL = 5.0				
	A	B	C	D	E
	0	5	10	20	30
FAN FUND.	FAN FUND.	FAN FUND.	FAN FUND.	FAN FUND.	FAN FUND.
1.00	*****	*****	*****	4.52	3.79
2.00	*****	*****	*****	4.00	3.09
3.00	*****	*****	*****	3.51	2.45
4.00	*****	*****	*****	3.04	1.85
5.00	*****	*****	18.57	2.61	1.30
6.00	19.22	20.30	13.72	1.95	0.55
7.00	14.67	14.76	10.00	1.33	*****
8.00	10.92	10.59	8.63	0.73	*****
9.00	9.01	8.70	7.43	0.16	*****
10.00	7.77	7.34	6.35	*****	*****
11.00	7.21	6.81	5.86	*****	*****
12.00	6.71	6.32	5.42	*****	*****
13.00	6.27	5.89	5.03	*****	*****
14.00	5.87	5.49	4.13	*****	*****
15.00	5.51	5.13	3.24	*****	*****
16.00	5.18	4.46	2.42	*****	*****
17.00	4.69	3.64	1.66	*****	*****
18.00	3.92	2.85	0.96	*****	*****
19.00	3.16	2.09	0.30	*****	*****
20.00	2.43	1.35	*****	*****	*****
21.00	2.18	1.18	*****	*****	*****
22.00	1.93	1.02	*****	*****	*****
23.00	1.68	0.86	*****	*****	*****
24.00	1.43	0.70	*****	*****	*****
25.00	1.19	0.54	*****	*****	*****
26.00	0.94	0.38	*****	*****	*****
27.00	0.70	0.22	*****	*****	*****
28.00	0.47	0.06	*****	*****	*****
29.00	0.23	*****	*****	*****	*****
30.00	0.00	*****	*****	*****	*****

DELTA EFNL = 10.0 FAN HARMONIC = 0.0
 INLET HARMONIC (A = 0, B = 5, C = 10, D = 20, E = 30)
 1/0, WITH TCNE, 10. JET ATT, NO TURE, EPNL = 101.83, RUN 5A

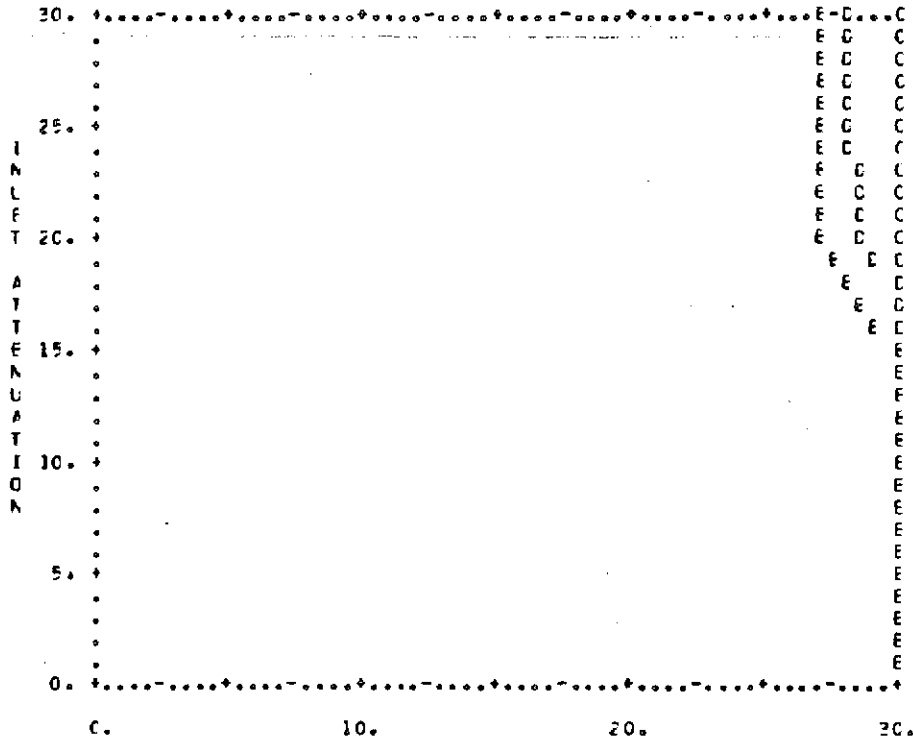

FAN CLCT ATTENUATION

INLET FUND.	FAN HARMONIC = 0.0		DELTA EFNL = 10.0		
	A C	B 5	C 10	D 20	E 30
1.00	*****	*****	*****	*****	*****
2.00	*****	*****	*****	*****	*****
3.00	*****	*****	*****	*****	*****
4.00	*****	*****	*****	*****	*****
5.00	*****	*****	*****	*****	*****
6.00	*****	*****	*****	*****	*****
7.00	*****	*****	*****	*****	*****
8.00	*****	*****	*****	*****	*****
9.00	*****	*****	*****	*****	*****
10.00	*****	*****	*****	*****	*****
11.00	*****	*****	*****	*****	*****
12.00	*****	*****	*****	*****	*****
13.00	*****	*****	*****	*****	*****
14.00	*****	*****	*****	*****	30.45
15.00	*****	*****	*****	*****	29.84
16.00	*****	*****	*****	*****	29.23
17.00	*****	*****	*****	30.61	28.65
18.00	*****	*****	*****	29.60	28.10
19.00	*****	*****	*****	29.03	27.56
20.00	*****	*****	*****	28.31	27.06
21.00	*****	*****	*****	28.29	27.08
22.00	*****	*****	*****	28.28	27.08
23.00	*****	*****	*****	28.26	27.08
24.00	*****	*****	*****	28.24	27.08
25.00	*****	*****	*****	28.23	27.08
26.00	*****	*****	*****	28.21	27.08
27.00	*****	*****	*****	28.20	27.08
28.00	*****	*****	*****	28.18	27.08
29.00	*****	*****	*****	28.16	27.08
30.00	*****	*****	*****	28.15	27.08

DELTA EPNL = 10.0 FAN HARMONIC = 5.0
 INLET HARMONIC (A = C, B = 5, C = 10, D = 20, E = 30)
 1/3, WITH TCNE, 10. JET ATT, NO TLRE, EPNL = 101.83, RUN 5A

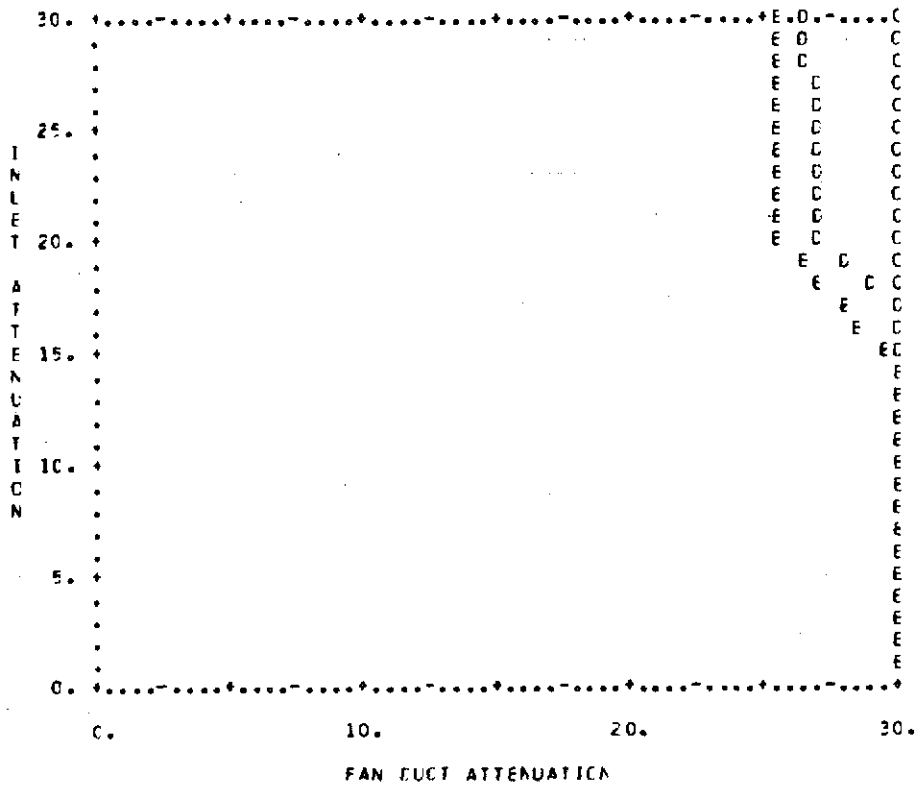

INLET HARMONIC =	FAN HARMONIC = 5.0		DELTA EPNL = 10.0		
	A	B	C	D	E
C	5	10	20	30	
FAN FUND.	FAN FUND.	FAN FUND.	FAN FUND.	FAN FUND.	FAN FUND.
1.00	*****	*****	*****	*****	*****
2.00	*****	*****	*****	*****	*****
3.00	*****	*****	*****	*****	*****
4.00	*****	*****	*****	*****	*****
5.00	*****	*****	*****	*****	*****
6.00	*****	*****	*****	*****	*****
7.00	*****	*****	*****	*****	*****
8.00	*****	*****	*****	*****	*****
9.00	*****	*****	*****	*****	*****
10.00	*****	*****	*****	*****	*****
11.00	*****	*****	*****	*****	*****
12.00	*****	*****	*****	*****	*****
13.00	*****	*****	*****	*****	*****
14.00	*****	*****	*****	*****	30.48
15.00	*****	*****	*****	*****	29.56
16.00	*****	*****	*****	*****	28.68
17.00	*****	*****	*****	30.19	27.84
18.00	*****	*****	*****	29.10	27.04
19.00	*****	*****	*****	28.07	26.27
20.00	*****	*****	*****	27.09	25.53
21.00	*****	*****	*****	27.05	25.53
22.00	*****	*****	*****	27.00	25.52
23.00	*****	*****	*****	26.95	25.52
24.00	*****	*****	*****	26.91	25.52
25.00	*****	*****	*****	26.86	25.52
26.00	*****	*****	*****	26.82	25.52
27.00	*****	*****	30.90	26.77	25.52
28.00	*****	*****	30.56	26.73	25.52
29.00	*****	*****	30.23	26.68	25.52
30.00	*****	*****	29.90	26.64	25.52

DELTA EFNL = 10.0 FAN HARMONIC = 10.0
 INLET HARMONIC (A = 0, B = 5, C = 10, D = 20, E = 30)
 T/D, WITH TCNE, 10. JET ATT, NC TURB, EPNL = 101.83, RUN 5)

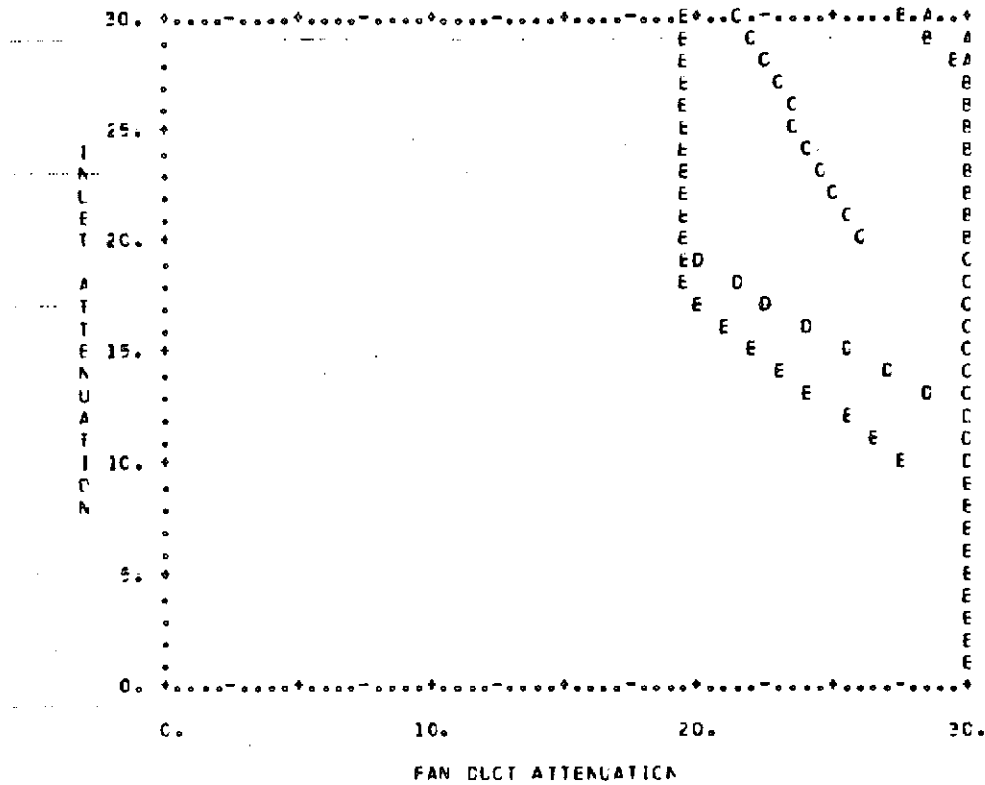

FAN HARMONIC = 10.0		DELTA EFNL = 10.0				
INLET HARMONIC =		A	B	C	D	E
		0	5	10	20	30
INLET	FAN	FAN	FAN	FAN	FAN	FAN
FUND.	FUND.	FUND.	FUND.	FUND.	FUND.	FUND.
1.00	*****	*****	*****	*****	*****	*****
2.00	*****	*****	*****	*****	*****	*****
3.00	*****	*****	*****	*****	*****	*****
4.00	*****	*****	*****	*****	*****	*****
5.00	*****	*****	*****	*****	*****	*****
6.00	*****	*****	*****	*****	*****	*****
7.00	*****	*****	*****	*****	*****	*****
8.00	*****	*****	*****	*****	*****	*****
9.00	*****	*****	*****	*****	*****	30.65
10.00	*****	*****	*****	*****	*****	27.71
11.00	*****	*****	*****	*****	*****	26.52
12.00	*****	*****	*****	*****	30.22	25.36
13.00	*****	*****	*****	*****	28.58	24.23
14.00	*****	*****	*****	*****	27.00	23.13
15.00	*****	*****	*****	*****	25.48	22.05
16.00	*****	*****	*****	*****	24.03	20.99
17.00	*****	*****	*****	*****	22.62	19.99
18.00	*****	*****	*****	*****	21.27	19.74
19.00	*****	*****	*****	30.48	19.99	19.49
20.00	*****	*****	*****	26.06	19.71	19.26
21.00	*****	*****	*****	25.57	19.69	19.26
22.00	*****	*****	*****	25.10	19.68	19.25
23.00	*****	*****	*****	24.63	19.66	19.25
24.00	*****	*****	*****	24.18	19.64	19.25
25.00	*****	*****	*****	23.73	19.62	19.25
26.00	*****	*****	*****	23.30	19.61	19.25
27.00	*****	*****	30.17	22.87	19.59	19.25
28.00	*****	*****	29.26	22.45	19.57	19.25
29.00	29.77	*****	28.38	22.05	19.55	19.25
30.00	28.26	*****	27.53	21.65	19.54	19.25

C-3

DELTA EPNL = 10.0 FAN HARMONIC = 20.0
 INLET HARMONIC (A = 0, B = 5, C = 10, D = 20, E = 30)
 7/0, WITH TCNE, 10. JET ATT, NO TURB, EPAL = 101.83, RUN 5A

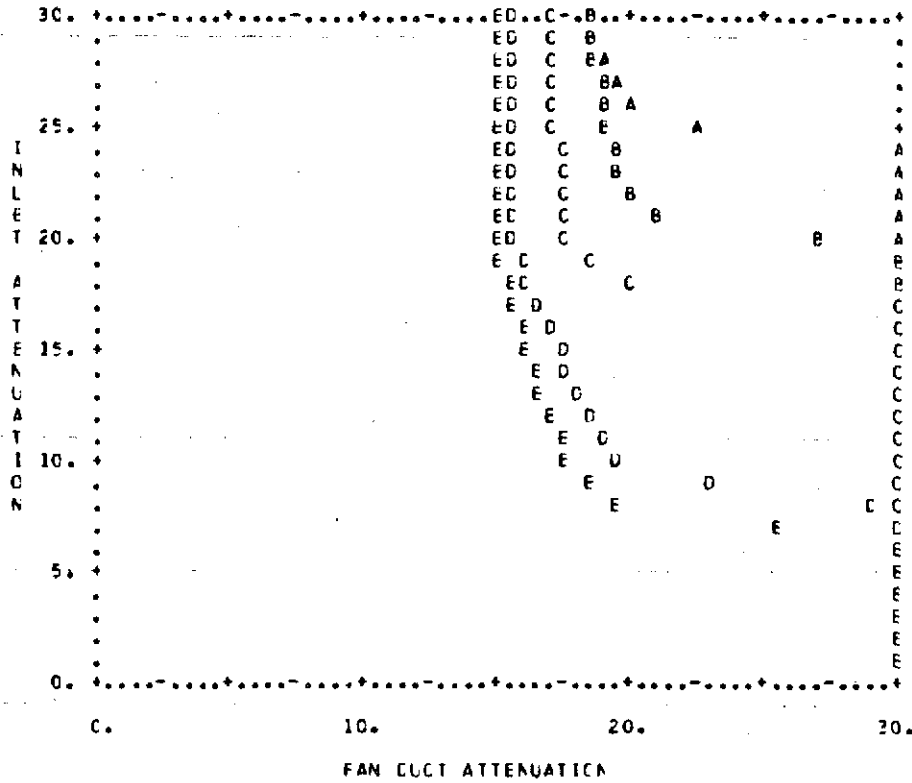

INLET HARMONIC =	DELTA EPAL = 10.0				
	A	B	C	D	F
	C	5	10	20	30
INLET FUND.	FAN FUND.	FAN FUND.	FAN FUND.	FAN FUND.	FAN FUND.
1.00	*****	*****	*****	*****	*****
2.00	*****	*****	*****	*****	*****
3.00	*****	*****	*****	*****	*****
4.00	*****	*****	*****	*****	*****
5.00	*****	*****	*****	*****	*****
6.00	*****	*****	*****	*****	*****
7.00	*****	*****	*****	*****	25.45
8.00	*****	*****	*****	29.23	19.54
9.00	*****	*****	*****	22.88	18.51
10.00	*****	*****	*****	19.50	17.58
11.00	*****	*****	*****	19.01	17.26
12.00	*****	*****	*****	18.55	16.96
13.00	*****	*****	*****	18.11	16.66
14.00	*****	*****	*****	17.69	16.36
15.00	*****	*****	*****	17.29	16.11
16.00	*****	*****	*****	16.91	15.85
17.00	*****	*****	*****	16.55	15.59
18.00	*****	*****	19.89	16.20	15.35
19.00	*****	*****	18.72	15.87	15.11
20.00	*****	27.00	17.66	15.55	14.88
21.00	*****	21.10	17.57	15.54	14.86
22.00	*****	19.84	17.47	15.52	14.88
23.00	*****	19.63	17.38	15.51	14.88
24.00	*****	19.43	17.29	15.50	14.88
25.00	22.65	19.23	17.20	15.46	14.87
26.00	19.75	19.04	17.11	15.47	14.87
27.00	19.39	18.85	17.02	15.46	14.87
28.00	19.05	18.67	16.93	15.44	14.87
29.00	18.72	18.49	16.84	15.43	14.87
30.00	18.40	18.32	16.75	15.42	14.87

DELTA EPNL = 10.0 FAN HARMONIC = 30.0
 INLET HARMONIC (A = 0, B = 5, C = 10, D = 20, E = 30)
 T/C, WITH TCNE, 10. JET ATT, NO TLRE, EPNL = 101.83, RUN 5A

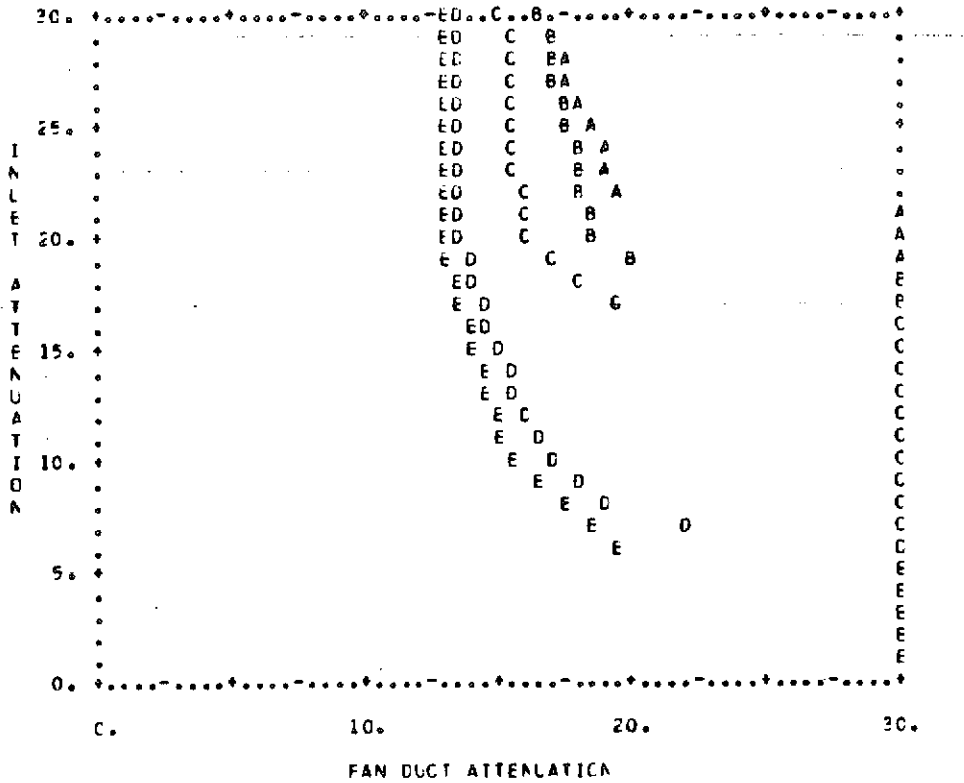

FAN HARMONIC = 30.0		DELTA EPNL = 10.0				
INLET HARMONIC *		A	B	C	D	E
	C	5	10	20	30	
INLET FUND.	FAN FUND.	FAN FUND.	FAN FUND.	FAN FUND.	FAN FUND.	FAN FUND.
1.00	*****	*****	*****	*****	*****	*****
2.00	*****	*****	*****	*****	*****	*****
3.00	*****	*****	*****	*****	*****	*****
4.00	*****	*****	*****	*****	*****	*****
5.00	*****	*****	*****	*****	*****	*****
6.00	*****	*****	*****	*****	*****	19.54
7.00	*****	*****	*****	*****	22.03	18.36
8.00	*****	*****	*****	*****	18.98	17.28
9.00	*****	*****	*****	*****	17.87	16.34
10.00	*****	*****	*****	*****	16.87	15.51
11.00	*****	*****	*****	*****	16.44	15.20
12.00	*****	*****	*****	*****	16.05	14.90
13.00	*****	*****	*****	*****	15.68	14.62
14.00	*****	*****	*****	*****	15.33	14.35
15.00	*****	*****	*****	*****	15.01	14.08
16.00	*****	*****	*****	*****	14.71	13.83
17.00	*****	*****	*****	15.50	14.42	13.59
18.00	*****	*****	*****	18.19	14.15	13.36
19.00	*****	19.79	*****	16.49	13.90	13.13
20.00	*****	18.56	*****	15.91	13.66	12.92
21.00	*****	18.35	*****	15.83	13.64	12.91
22.00	19.65	18.15	*****	15.76	13.61	12.91
23.00	19.21	17.96	*****	15.68	13.58	12.91
24.00	18.75	17.77	*****	15.61	13.56	12.90
25.00	18.39	17.59	*****	15.54	13.53	12.90
26.00	18.02	17.41	*****	15.47	13.50	12.89
27.00	17.67	17.24	*****	15.40	13.48	12.89
28.00	17.34	17.06	*****	15.33	13.45	12.89
29.00	17.03	16.90	*****	15.26	13.42	12.88
30.00	16.73	16.73	*****	15.20	13.40	12.88

DELTA EPNL = 5.0 FAN HARMONIC = 0.0
 INLET HARMONIC (A = 0, B = 5, C = 10, D = 20, E = 30)
 T/D, WITH TONE, 0, JET ATT, NO TURB, EPNL = 101.70, RUN 10A NO JET1

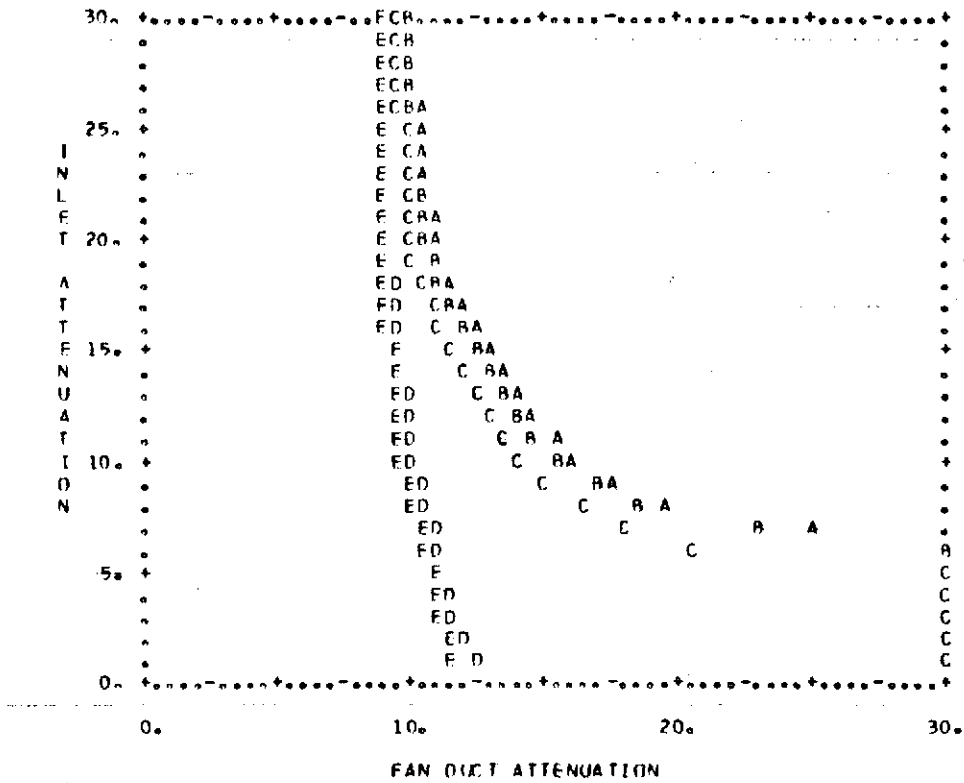

FAN HARMONIC = 0.0		DELTA EPNL = 5.0				
INLET HARMONIC =		A	B	C	D	E
		0	5	10	20	30
INLET	FAN	FAN	FAN	FAN	FAN	FAN
FUND.	FUND.	FUND.	FUND.	FUND.	FUND.	FUND.
1.00	*****	*****	*****	*****	12.31	11.66
2.00	*****	*****	*****	*****	12.02	11.41
3.00	*****	*****	*****	*****	11.74	11.19
4.00	*****	*****	*****	*****	11.47	10.99
5.00	*****	*****	*****	*****	11.21	10.81
6.00	*****	*****	*****	*****	10.94	10.54
7.00	24.94	22.83	18.23	10.76	10.76	10.28
8.00	19.27	18.63	16.57	10.57	10.57	10.03
9.00	17.59	16.91	15.12	10.38	9.78	9.78
10.00	16.10	15.42	13.85	10.21	9.53	9.53
11.00	15.38	14.71	13.27	10.10	9.49	9.49
12.00	14.72	14.07	12.75	9.99	9.44	9.44
13.00	14.11	13.48	12.28	9.87	9.39	9.39
14.00	13.54	12.93	11.85	9.74	9.34	9.34
15.00	13.01	12.43	11.46	9.62	9.29	9.29
16.00	12.52	11.97	11.09	9.51	9.24	9.24
17.00	12.07	11.53	10.76	9.40	9.20	9.20
18.00	11.64	11.13	10.45	9.29	9.15	9.15
19.00	11.24	10.76	10.17	9.19	9.11	9.11
20.00	10.86	10.41	9.87	9.09	9.06	9.06
21.00	10.75	10.35	9.85	9.08	9.06	9.06
22.00	10.65	10.29	9.82	9.08	9.05	9.05
23.00	10.56	10.24	9.80	9.07	9.05	9.05
24.00	10.46	10.19	9.78	9.07	9.04	9.04
25.00	10.37	10.13	9.75	9.06	9.04	9.04
26.00	10.28	10.08	9.73	9.06	9.03	9.03
27.00	10.19	10.03	9.70	9.05	9.03	9.03
28.00	10.11	9.97	9.68	9.05	9.02	9.02
29.00	10.03	9.90	9.65	9.04	9.02	9.02
30.00	9.94	9.84	9.63	9.04	9.01	9.01

DELTA EPNL = 5.0 FAN HARMONIC = 5.0
 INLET HARMONIC (A = 0, B = 5, C = 10, D = 20, E = 30)
 T/O, WITH TONE, 0. JET ATT, NO TURB, EPNL = 101.70, RUN 10A NO JET1

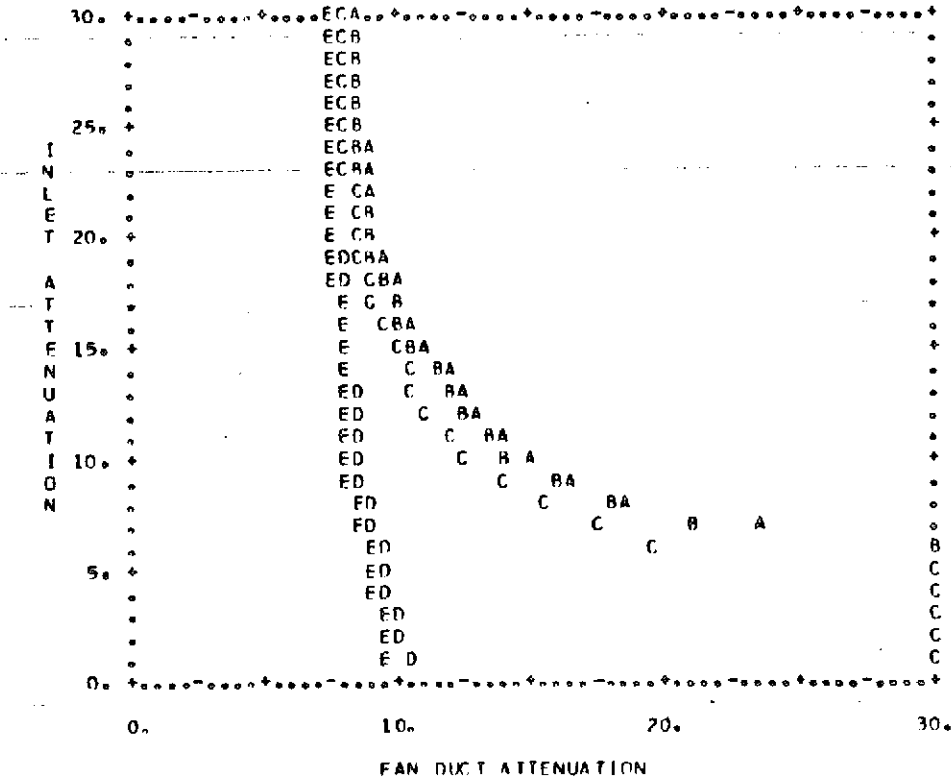

FAN HARMONIC = 5.0		DELTA EPNL = 5.0				
INLET HARMONIC =		A	B	C	D	E
		0	5	10	20	30
INLET FUND.	FAN FUND.	FAN FUND.	FAN FUND.	FAN FUND.	FAN FUND.	FAN FUND.
1.00	*****	*****	*****	*****	10.46	9.69
2.00	*****	*****	*****	*****	10.12	9.52
3.00	*****	*****	*****	*****	9.86	9.36
4.00	*****	*****	*****	*****	9.65	9.20
5.00	*****	*****	*****	*****	9.45	9.05
6.00	*****	*****	*****	19.56	9.27	8.83
7.00	23.71	21.05	17.30	9.09	8.63	8.63
8.00	18.52	17.83	15.41	8.91	8.43	8.43
9.00	16.53	15.82	13.79	8.72	8.24	8.24
10.00	14.78	14.09	12.40	8.54	8.05	8.05
11.00	13.93	13.28	11.78	8.44	8.01	8.01
12.00	13.16	12.55	11.22	8.34	7.97	7.97
13.00	12.47	11.89	10.72	8.25	7.93	7.93
14.00	11.83	11.28	10.26	8.16	7.89	7.89
15.00	11.24	10.73	9.87	8.08	7.85	7.85
16.00	10.70	10.23	9.53	7.99	7.81	7.81
17.00	10.21	9.81	9.21	7.91	7.77	7.77
18.00	9.80	9.46	8.89	7.84	7.73	7.73
19.00	9.47	9.13	8.59	7.76	7.70	7.70
20.00	9.15	8.81	8.30	7.69	7.66	7.66
21.00	9.06	8.75	8.28	7.69	7.66	7.66
22.00	8.97	8.70	8.25	7.69	7.65	7.65
23.00	8.89	8.64	8.23	7.69	7.65	7.65
24.00	8.80	8.58	8.21	7.68	7.64	7.64
25.00	8.71	8.52	8.18	7.68	7.64	7.64
26.00	8.63	8.47	8.16	7.68	7.63	7.63
27.00	8.54	8.41	8.14	7.68	7.63	7.63
28.00	8.45	8.35	8.12	7.68	7.63	7.63
29.00	8.37	8.29	8.09	7.67	7.62	7.62
30.00	8.28	8.24	8.07	7.67	7.62	7.62

DELTA EPNL = 5.0 FAN HARMONIC = 10.0
 INLET HARMONIC (A = 0, B = 5, C = 10, D = 20, E = 30)
 T/O, WITH TONE, O, JET ATT, NO TURB, EPNL = 101.70, RUN 10A NO JET1

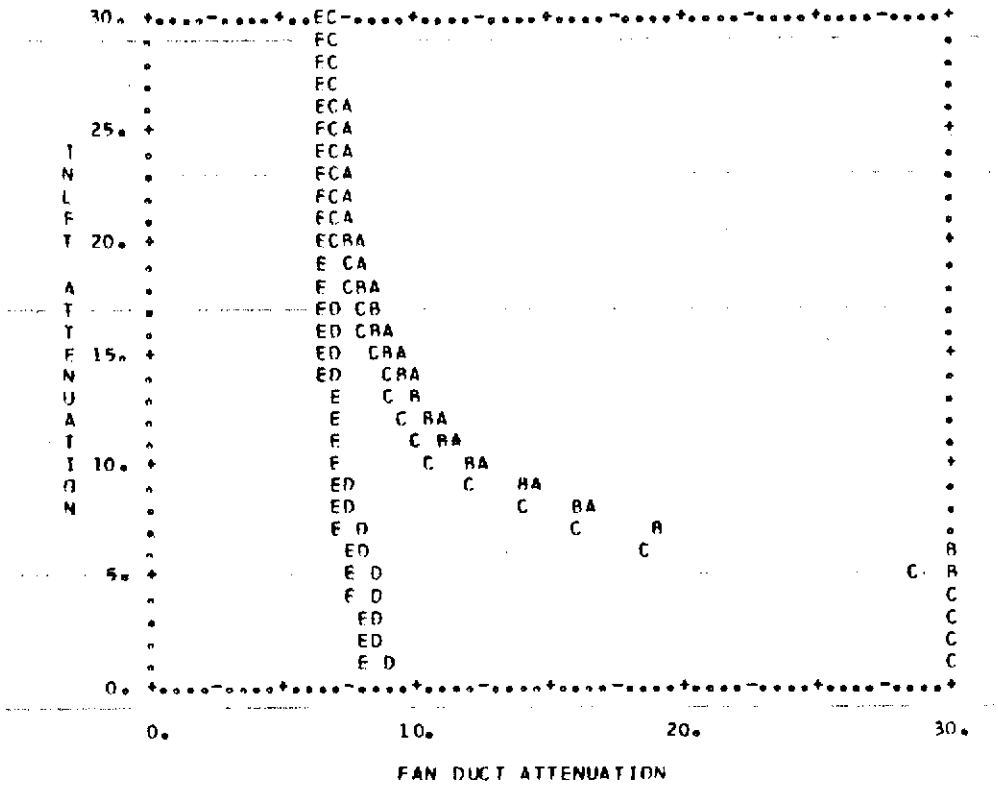

FAN HARMONIC = 10.0		DELTA EPNL = 5.0				
INLET HARMONIC =		A	B	C	D	F
		0	5	10	20	30
INLET FUND.	FAN FUND.	FAN FUND.	FAN FUND.	FAN FUND.	FAN FUND.	FAN FUND.
1.00	*****	*****	*****	*****	8.89	8.22
2.00	*****	*****	*****	*****	9.73	8.03
3.00	*****	*****	*****	*****	8.57	7.84
4.00	*****	*****	*****	*****	9.42	7.64
5.00	*****	*****	*****	28.75	8.27	7.45
6.00	*****	*****	*****	18.68	8.04	7.34
7.00	19.72	18.76	18.98	15.98	7.81	7.23
8.00	16.68	16.12	13.82	7.58	7.13	
9.00	14.50	13.92	12.05	7.36	7.03	
10.00	12.59	12.07	10.58	7.15	6.94	
11.00	11.70	11.22	9.94	7.09	6.89	
12.00	10.92	10.47	9.54	7.03	6.83	
13.00	10.24	9.87	9.17	6.97	6.78	
14.00	9.75	9.44	8.81	6.91	6.73	
15.00	9.37	9.03	8.47	6.86	6.68	
16.00	9.02	8.65	8.14	6.81	6.64	
17.00	8.68	8.27	7.83	6.75	6.59	
18.00	8.37	7.92	7.54	6.70	6.55	
19.00	8.08	7.58	7.26	6.65	6.50	
20.00	7.80	7.25	6.99	6.61	6.46	
21.00	7.72	7.22	6.96	6.60	6.46	
22.00	7.63	7.19	6.94	6.60	6.46	
23.00	7.55	7.16	6.91	6.60	6.45	
24.00	7.47	7.13	6.89	6.59	6.45	
25.00	7.38	7.10	6.87	6.59	6.45	
26.00	7.30	7.07	6.84	6.59	6.44	
27.00	7.22	7.04	6.82	6.58	6.44	
28.00	7.13	7.01	6.80	6.58	6.44	
29.00	7.05	6.98	6.77	6.57	6.44	
30.00	6.97	6.95	6.75	6.57	6.43	

DELTA EPNL = 5.0 FAN HARMONIC = 20.0
 INLET HARMONIC (A = 0, B = 5, C = 10, D = 20, E = 30)
 Y/O, WITH TONE, 0. JET ATT, NO TURR, EPNL = 101.70, RUN 10A NO JET1

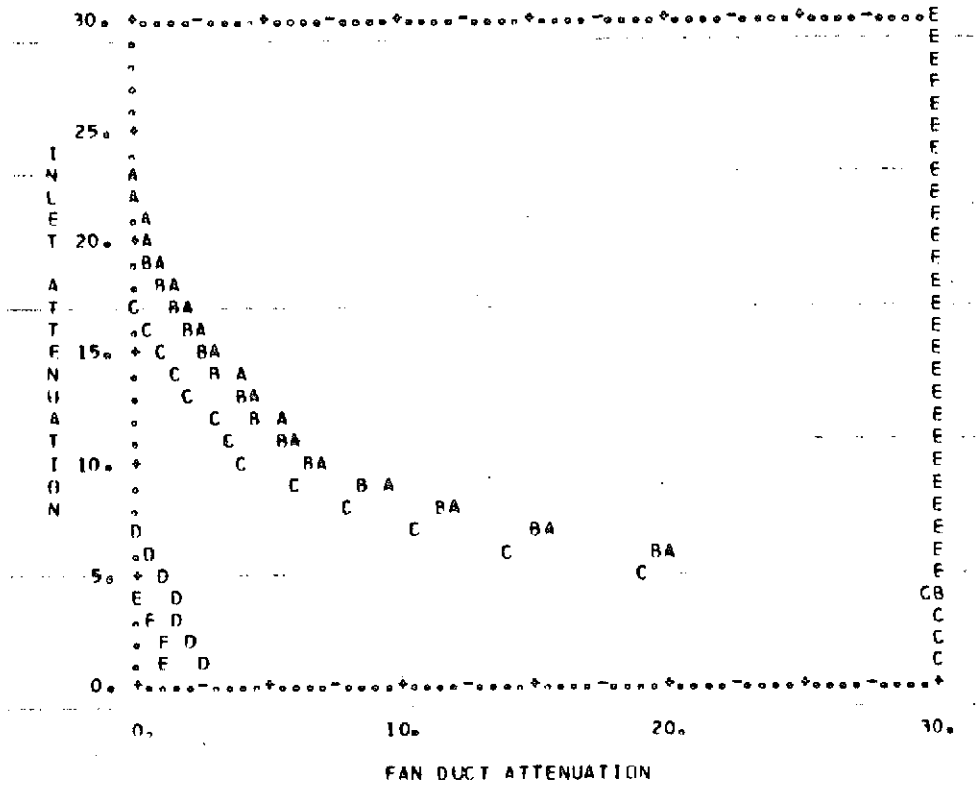

FAN HARMONIC = 20.0		DELTA EPNL = 5.0				
INLET HARMONIC =		A	B	C	D	E
		0	5	10	20	30
INLET FUND.	FAN FUND.	FAN FUND.	FAN FUND.	FAN FUND.	FAN FUND.	FAN FUND.
1.00	*****	*****	*****	*****	2.30	1.15
2.00	*****	*****	*****	*****	1.99	0.76
3.00	*****	*****	*****	*****	1.68	0.39
4.00	*****	*****	*****	29.65	1.37	0.05
5.00	*****	*****	*****	19.06	1.06	*****
6.00	19.78	19.29	14.02	0.61	*****	*****
7.00	15.58	14.79	10.42	0.19	*****	*****
8.00	12.14	11.25	7.97	*****	*****	*****
9.00	9.35	8.57	5.97	*****	*****	*****
10.00	7.12	6.39	4.12	*****	*****	*****
11.00	6.13	5.44	3.44	*****	*****	*****
12.00	5.28	4.63	2.81	*****	*****	*****
13.00	4.55	3.90	2.21	*****	*****	*****
14.00	3.88	3.21	1.65	*****	*****	*****
15.00	3.24	2.56	1.12	*****	*****	*****
16.00	2.63	1.94	0.63	*****	*****	*****
17.00	2.05	1.35	0.15	*****	*****	*****
18.00	1.50	0.79	*****	*****	*****	*****
19.00	0.97	0.26	*****	*****	*****	*****
20.00	0.47	*****	*****	*****	*****	*****
21.00	0.34	*****	*****	*****	*****	*****
22.00	0.21	*****	*****	*****	*****	*****
23.00	0.08	*****	*****	*****	*****	*****
24.00	*****	*****	*****	*****	*****	*****
25.00	*****	*****	*****	*****	*****	*****
26.00	*****	*****	*****	*****	*****	*****
27.00	*****	*****	*****	*****	*****	*****
28.00	*****	*****	*****	*****	*****	*****
29.00	*****	*****	*****	*****	*****	*****
30.00	*****	*****	*****	*****	*****	*****

DELTA EPNL = 5.0 FAN HARMONIC = 30.0
 INLET HARMONIC 1A = 0, B = 5, C = 10, D = 20, E = 30
 T/D, WITH TUNE, 0. JET ATT, NO TURB, EPNL = 101.70, RUN 10A NO JET1

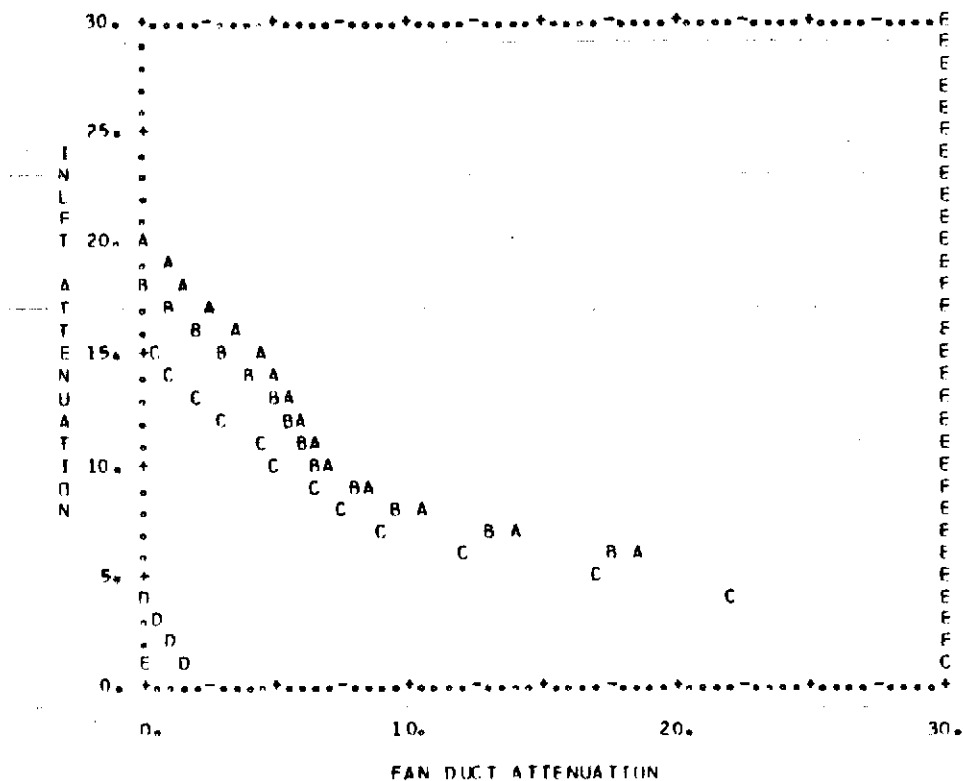

FAN HARMONIC = 30.0		DELTA EPNL = 5.0				
INLET HARMONIC =		A	B	C	D	E
		0	5	10	20	30
INLET FUND.	FAN FUND.	FAN FUND.	FAN FUND.	FAN FUND.	FAN FUND.	FAN FUND.
1.00	*****	*****	*****	*****	1.60	0.10
2.00	*****	*****	*****	*****	1.10	*****
3.00	*****	*****	*****	*****	0.64	*****
4.00	*****	*****	*****	22.09	0.20	*****
5.00	*****	*****	*****	17.18	*****	*****
6.00	18.42	17.46	11.88	*****	*****	*****
7.00	14.01	13.05	9.09	*****	*****	*****
8.00	10.34	9.66	7.59	*****	*****	*****
9.00	8.51	8.08	6.30	*****	*****	*****
10.00	7.25	6.72	5.18	*****	*****	*****
11.00	6.63	6.10	4.25	*****	*****	*****
12.00	6.08	5.55	3.16	*****	*****	*****
13.00	5.59	5.06	2.16	*****	*****	*****
14.00	5.14	4.03	1.24	*****	*****	*****
15.00	4.32	2.98	0.40	*****	*****	*****
16.00	3.35	1.99	*****	*****	*****	*****
17.00	2.44	1.07	*****	*****	*****	*****
18.00	1.58	0.20	*****	*****	*****	*****
19.00	0.77	*****	*****	*****	*****	*****
20.00	0.00	*****	*****	*****	*****	*****
21.00	*****	*****	*****	*****	*****	*****
22.00	*****	*****	*****	*****	*****	*****
23.00	*****	*****	*****	*****	*****	*****
24.00	*****	*****	*****	*****	*****	*****
25.00	*****	*****	*****	*****	*****	*****
26.00	*****	*****	*****	*****	*****	*****
27.00	*****	*****	*****	*****	*****	*****
28.00	*****	*****	*****	*****	*****	*****
29.00	*****	*****	*****	*****	*****	*****
30.00	*****	*****	*****	*****	*****	*****

DELTA EPNL = 10.0 FAN HARMONIC = 0.0
 INLET HARMONIC (A = 0, B = 5, C = 10, D = 20, E = 30)
 T/D, WITH TONE, 0, JET ATT, NO TURB, EPNL = 101.70, RUN 10A NO JET1

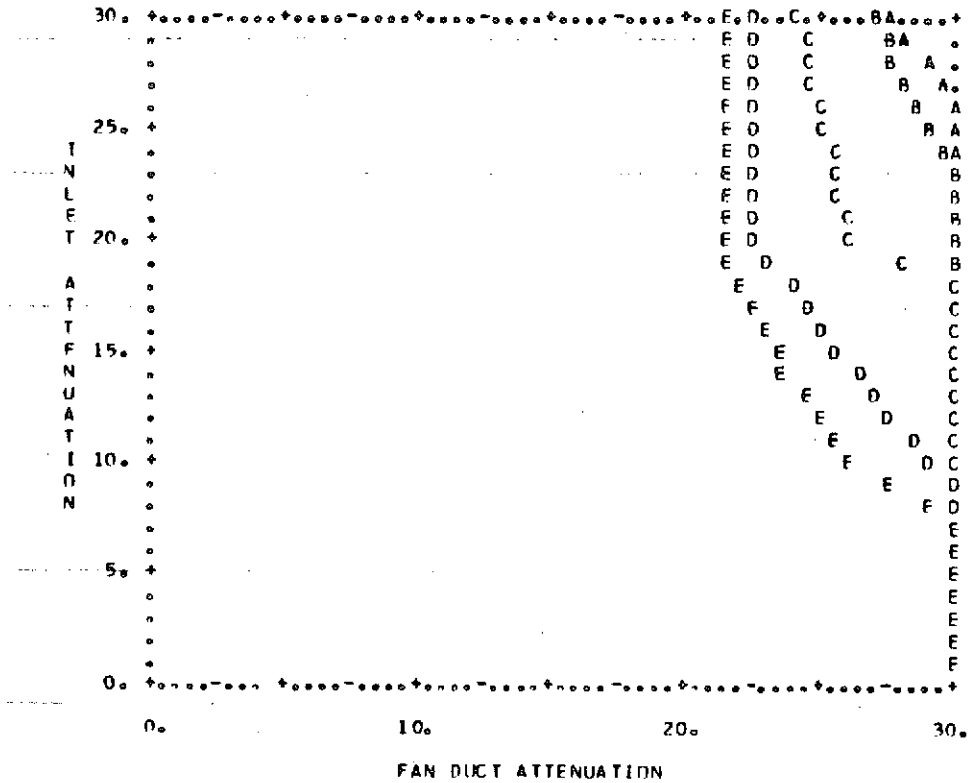

FAN HARMONIC = 0.0		DELTA EPNL = 10.0				
INLET HARMONIC =		A	B	C	D	E
		0	5	10	20	30
INLET	FAN	FAN	FAN	FAN	FAN	FAN
FUND.	FUND.	FUND.	FUND.	FUND.	FUND.	FUND.
1.00	*****	*****	*****	*****	*****	*****
2.00	*****	*****	*****	*****	*****	*****
3.00	*****	*****	*****	*****	*****	*****
4.00	*****	*****	*****	*****	*****	*****
5.00	*****	*****	*****	*****	*****	*****
6.00	*****	*****	*****	*****	*****	*****
7.00	*****	*****	*****	*****	*****	30.94
8.00	*****	*****	*****	*****	*****	29.18
9.00	*****	*****	*****	*****	*****	27.59
10.00	*****	*****	*****	29.25	*****	26.14
11.00	*****	*****	*****	27.44	*****	25.45
12.00	*****	*****	*****	27.67	*****	24.82
13.00	*****	*****	*****	26.94	*****	24.25
14.00	*****	*****	*****	26.25	*****	23.74
15.00	*****	*****	*****	25.59	*****	23.26
16.00	*****	*****	*****	24.96	*****	22.83
17.00	*****	*****	*****	24.36	*****	22.43
18.00	*****	*****	30.54	23.78	*****	22.06
19.00	*****	*****	28.72	23.23	*****	21.72
20.00	*****	*****	26.11	22.70	*****	21.40
21.00	*****	*****	25.90	22.67	*****	21.40
22.00	*****	30.58	25.68	22.64	*****	21.40
23.00	*****	30.07	25.47	22.61	*****	21.40
24.00	*****	29.57	25.27	22.58	*****	21.40
25.00	*****	29.09	25.07	22.55	*****	21.40
26.00	30.55	28.62	24.87	22.52	*****	21.40
27.00	29.73	28.17	24.67	22.49	*****	21.40
28.00	28.94	27.73	24.48	22.47	*****	21.40
29.00	28.18	27.30	24.29	22.44	*****	21.40
30.00	27.45	26.89	24.10	22.41	*****	21.40

DELTA EPNL = 10.0 FAN HARMONIC = 5.0
 INLET HARMONIC (A = 0, B = 5, C = 10, D = 20, E = 30)
 T/O, WITH TONE, O. JET ATT, NO TURB, EPNL = 101.70, RUN 10A NO JET1

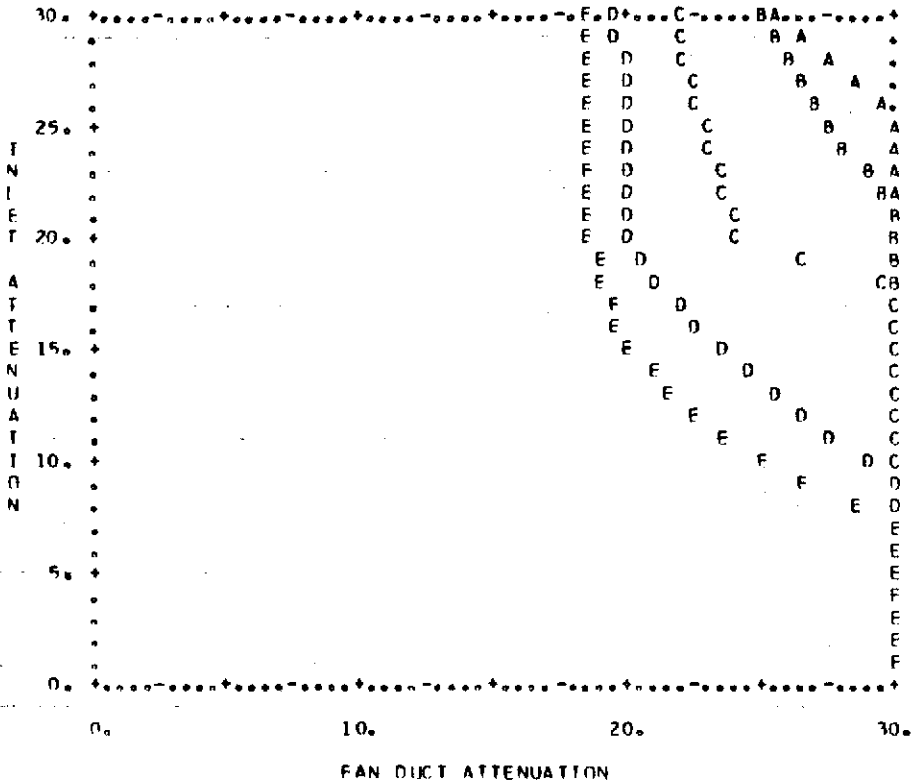

FAN HARMONIC = 5.0		DELTA EPNL = 10.0				
INLET HARMONIC =		A	B	C	D	E
		0	5	10	20	30
	INLET FUND.	FAN FUND.	FAN FUND.	FAN FUND.	FAN FUND.	FAN FUND.
	1.00	*****	*****	*****	*****	*****
	2.00	*****	*****	*****	*****	*****
	3.00	*****	*****	*****	*****	*****
	4.00	*****	*****	*****	*****	*****
	5.00	*****	*****	*****	*****	*****
	6.00	*****	*****	*****	*****	*****
	7.00	*****	*****	*****	*****	30.97
	8.00	*****	*****	*****	*****	28.73
	9.00	*****	*****	*****	*****	26.71
	10.00	*****	*****	*****	24.80	24.88
	11.00	*****	*****	*****	27.58	23.72
	12.00	*****	*****	*****	26.46	22.67
	13.00	*****	*****	*****	25.41	21.71
	14.00	*****	*****	*****	24.44	20.82
	15.00	*****	*****	*****	23.54	20.00
	16.00	*****	*****	*****	22.69	19.71
	17.00	*****	*****	*****	21.90	19.43
	18.00	*****	*****	29.49	21.16	19.16
	19.00	*****	*****	26.66	20.46	18.91
	20.00	*****	30.88	24.13	19.92	18.67
	21.00	*****	30.16	23.87	19.40	18.67
	22.00	*****	29.47	23.61	19.88	18.67
	23.00	*****	28.82	23.36	19.86	18.66
	24.00	*****	28.18	23.12	19.84	18.66
	25.00	30.64	27.58	22.88	19.82	18.66
	26.00	29.47	26.99	22.65	19.80	18.66
	27.00	28.37	26.44	22.42	19.79	18.66
	28.00	27.35	25.90	22.20	19.77	18.66
	29.00	26.40	25.38	21.98	19.75	18.66
	30.00	25.50	24.88	21.76	19.73	18.66

DELTA EPNL = 10.0 FAN HARMONIC = 10.0
 INLET HARMONIC (A = 0, B = 5, C = 10, D = 20, E = 30)
 T/O, WITH TONE, O. JET ATT, NO TURB, EPNL = 101.70, RUN 10A NO JET 1

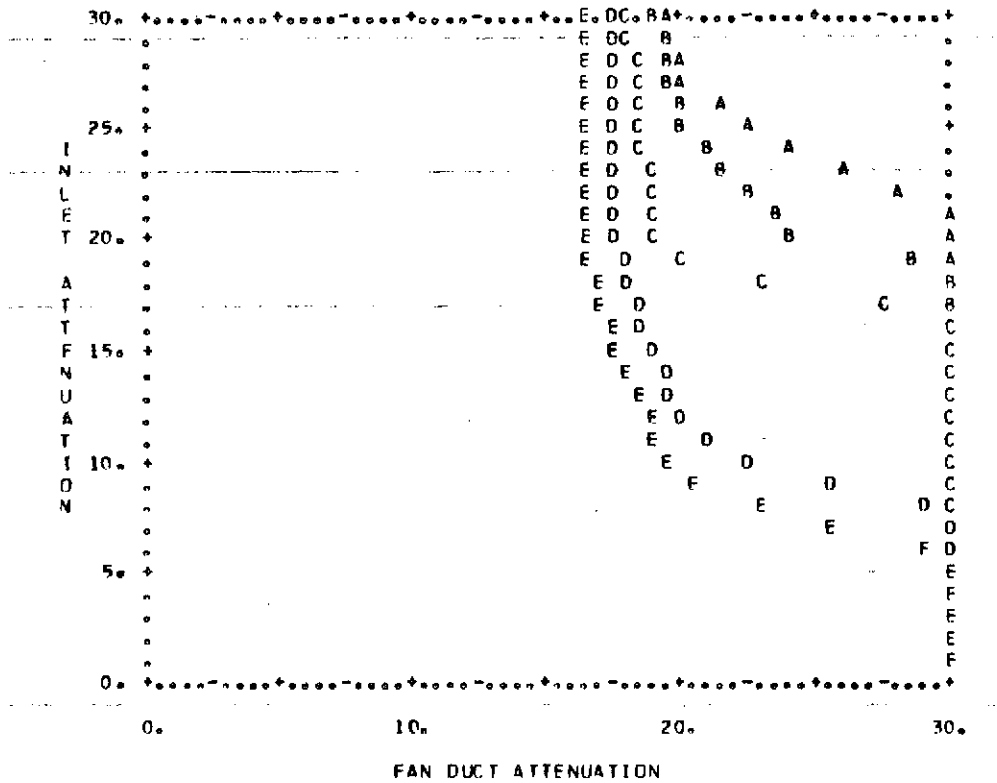

FAN HARMONIC = 10.0		DELTA EPNL = 10.0				
INLET HARMONIC =		A	B	C	D	E
		0	5	10	20	30
	INLET FUND.	FAN FUND.	FAN FUND.	FAN FUND.	FAN FUND.	FAN FUND.
	1.00	*****	*****	*****	*****	*****
	2.00	*****	*****	*****	*****	*****
	3.00	*****	*****	*****	*****	*****
	4.00	*****	*****	*****	*****	*****
	5.00	*****	*****	*****	*****	*****
	6.00	*****	*****	*****	*****	28.89
	7.00	*****	*****	*****	*****	25.66
	8.00	*****	*****	*****	28.92	22.92
	9.00	*****	*****	*****	25.55	20.56
	10.00	*****	*****	*****	22.60	19.55
	11.00	*****	*****	*****	21.72	19.14
	12.00	*****	*****	*****	19.97	18.76
	13.00	*****	*****	*****	19.63	18.40
	14.00	*****	*****	*****	19.30	18.06
	15.00	*****	*****	*****	18.98	17.73
	16.00	*****	*****	*****	18.68	17.43
	17.00	*****	*****	27.25	18.40	17.14
	18.00	*****	*****	23.07	18.12	16.86
	19.00	*****	28.66	19.84	17.86	16.60
	20.00	*****	24.21	19.03	17.60	16.35
	21.00	30.21	23.29	18.94	17.58	16.35
	22.00	27.93	22.42	18.85	17.56	16.35
	23.00	25.95	21.59	18.76	17.53	16.35
	24.00	24.22	20.81	18.67	17.51	16.35
	25.00	22.68	20.06	18.58	17.49	16.35
	26.00	21.32	19.85	18.50	17.47	16.35
	27.00	20.09	19.68	18.41	17.44	16.35
	28.00	19.78	19.52	18.33	17.42	16.35
	29.00	19.55	19.36	18.24	17.40	16.35
	30.00	19.33	19.21	18.16	17.38	16.34

DELTA EPNL = 10.0 FAN HARMONIC = 20.0
 INLET HARMONIC (A = 0, B = 5, C = 10, D = 20, E = 30)
 T/D, WITH TONE, 0. JET ATT, NO TURB, EPNL = 101.70, RUN 10A NO JET 1

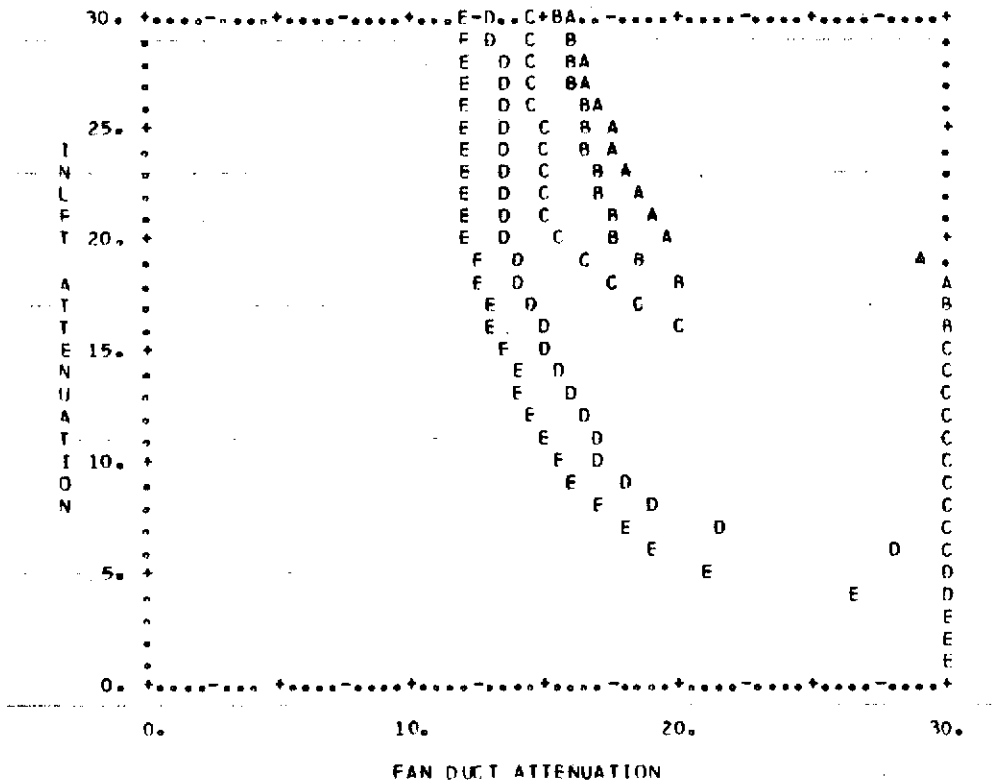

FAN HARMONIC = 20.0		DELTA EPNL = 10.0				
INLET HARMONIC =		A	B	C	D	E
		0	5	10	20	30
INLET FUND.	FAN FUND.	FAN FUND.	FAN FUND.	FAN FUND.	FAN FUND.	FAN FUND.
1.00	*****	*****	*****	*****	*****	*****
2.00	*****	*****	*****	*****	*****	*****
3.00	*****	*****	*****	*****	*****	*****
4.00	*****	*****	*****	*****	*****	26.42
5.00	*****	*****	*****	*****	*****	20.85
6.00	*****	*****	*****	24.13	*****	18.96
7.00	*****	*****	*****	21.70	*****	17.91
8.00	*****	*****	*****	19.20	*****	16.98
9.00	*****	*****	*****	18.17	*****	16.16
10.00	*****	*****	*****	17.24	*****	15.42
11.00	*****	*****	*****	16.76	*****	14.96
12.00	*****	*****	*****	16.31	*****	14.53
13.00	*****	*****	*****	15.89	*****	14.13
14.00	*****	*****	*****	15.49	*****	13.76
15.00	*****	*****	*****	15.12	*****	13.42
16.00	*****	*****	*****	14.76	*****	13.10
17.00	*****	*****	*****	14.43	*****	12.80
18.00	*****	19.92	17.33	14.12	*****	12.52
19.00	29.16	18.65	16.27	13.82	*****	12.26
20.00	19.31	17.50	15.32	13.54	*****	12.01
21.00	18.88	17.29	15.21	13.50	*****	12.01
22.00	18.47	17.08	15.10	13.47	*****	12.01
23.00	18.08	16.89	14.99	13.43	*****	12.01
24.00	17.71	16.69	14.89	13.40	*****	12.01
25.00	17.36	16.51	14.78	13.36	*****	12.01
26.00	17.02	16.33	14.68	13.33	*****	12.01
27.00	16.70	16.15	14.58	13.29	*****	12.01
28.00	16.39	15.98	14.47	13.26	*****	12.01
29.00	16.09	15.82	14.38	13.23	*****	12.01
30.00	15.80	15.66	14.28	13.19	*****	12.01

DELTA EPNL = 10.0 FAN HARMONIC = 30.0
 INLET HARMONIC (A = 0, B = 5, C = 10, D = 20, E = 30)
 T/O. WITH TONE, 0. JET ATT, NO TURB, EPNL = 101.70, RUN 10A NO JET1

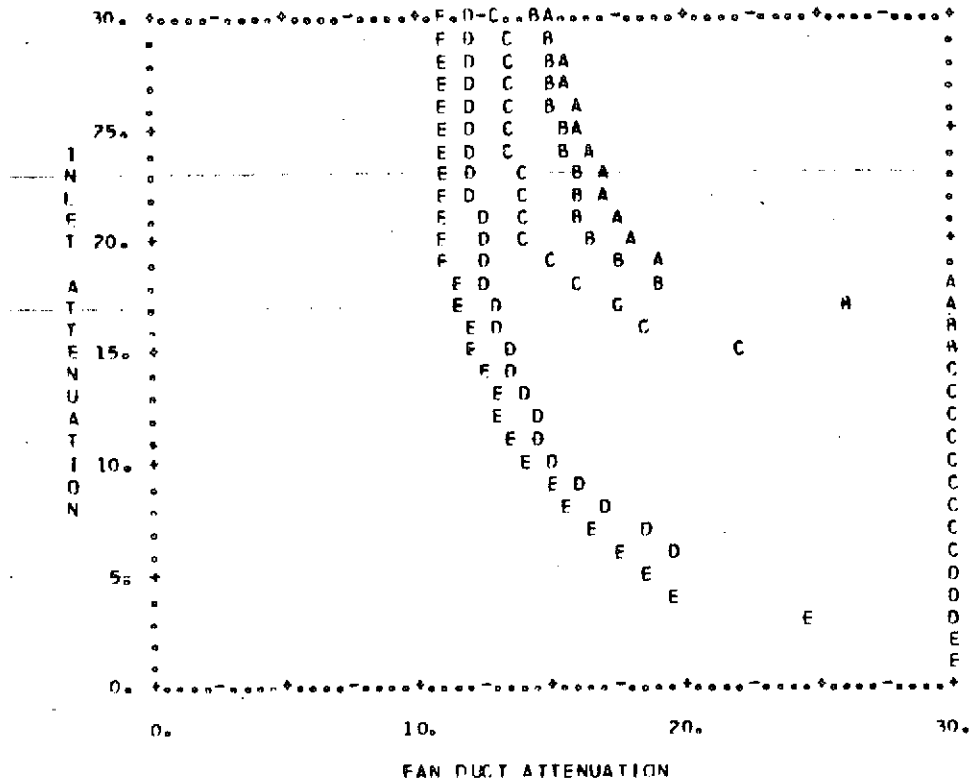

FAN HARMONIC = 30.0		DELTA EPNL = 10.0				
INLET HARMONIC =		A	B	C	D	E
		0	5	10	20	30
	INLET FUND.	FAN FUND.	FAN FUND.	FAN FUND.	FAN FUND.	FAN FUND.
	1.00	*****	*****	*****	*****	*****
	2.00	*****	*****	*****	*****	*****
	3.00	*****	*****	*****	*****	24.65
	4.00	*****	*****	*****	*****	19.49
	5.00	*****	*****	*****	*****	18.46
	6.00	*****	*****	*****	19.72	17.35
	7.00	*****	*****	*****	19.35	16.38
	8.00	*****	*****	*****	17.14	15.52
	9.00	*****	*****	*****	16.06	14.76
	10.00	*****	*****	*****	15.11	14.08
	11.00	*****	*****	*****	14.71	13.61
	12.00	*****	*****	*****	14.35	13.19
	13.00	*****	*****	*****	14.01	12.80
	14.00	*****	*****	*****	13.71	12.45
	15.00	*****	*****	21.84	13.43	12.13
	16.00	*****	*****	18.61	13.17	11.83
	17.00	*****	25.76	17.28	12.93	11.56
	18.00	*****	18.85	16.11	12.70	11.31
	19.00	19.18	17.53	15.08	12.49	11.07
	20.00	17.95	16.36	14.15	12.30	10.85
	21.00	17.56	16.15	14.05	12.27	10.85
	22.00	17.19	15.95	13.94	12.23	10.85
	23.00	16.84	15.76	13.84	12.20	10.85
	24.00	16.50	15.58	13.74	12.17	10.85
	25.00	16.18	15.40	13.64	12.14	10.85
	26.00	15.88	15.23	13.55	12.11	10.85
	27.00	15.59	15.07	13.45	12.07	10.85
	28.00	15.31	14.92	13.36	12.04	10.85
	29.00	15.04	14.77	13.27	12.01	10.85
	30.00	14.79	14.62	13.19	11.98	10.85

DELTA EPNL = 5.0 FAN HARMONIC = G.0
 INLET HARMONIC 1A = C, B = 5, C = 10, D = 20, E = 30
 APP. WITH TCNE, 3. JET ATT., NO TLRE, EPNL = 101.66, RUN 11A NO JET1

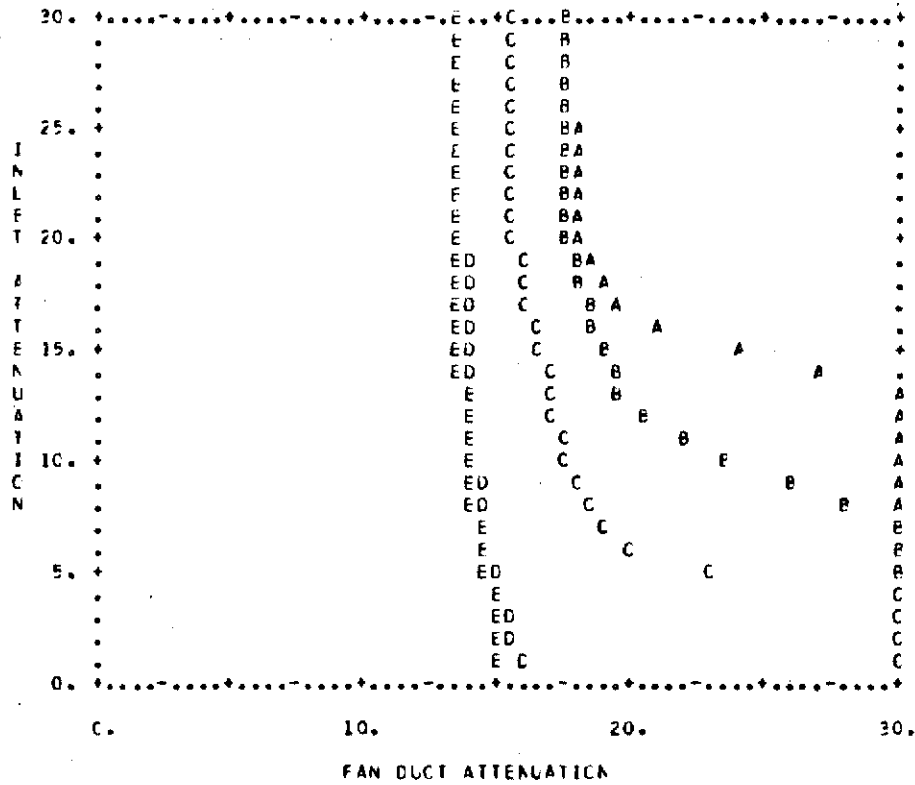

FAN HARMONIC = C.0		DELTA EPNL = 5.0				
INLET HARMONIC =		A	B	C	D	E
		C	5	10	20	30
INLET	FAN	FAN	FAN	FAN	FAN	FAN
FUND.	FUND.	FUND.	FUND.	FUND.	FUND.	FUND.
1.00	*****	*****	*****	*****	15.81	15.23
2.00	*****	*****	*****	*****	15.56	15.07
3.00	*****	*****	*****	*****	15.33	14.91
4.00	*****	*****	30.76	*****	15.10	14.75
5.00	*****	*****	22.57	*****	14.88	14.60
6.00	*****	*****	15.63	*****	14.73	14.45
7.00	*****	20.83	15.24	*****	14.59	14.31
8.00	*****	28.20	18.69	*****	14.44	14.17
9.00	*****	25.77	18.17	*****	14.29	14.03
10.00	*****	23.52	17.68	*****	14.15	13.89
11.00	*****	21.93	17.45	*****	14.11	13.85
12.00	*****	20.30	17.23	*****	14.05	13.81
13.00	30.00	19.72	17.02	*****	14.02	13.77
14.00	26.89	19.38	16.81	*****	13.98	13.73
15.00	23.81	19.06	16.61	*****	13.94	13.70
16.00	20.78	18.74	16.42	*****	13.90	13.66
17.00	19.58	18.42	16.22	*****	13.86	13.62
18.00	19.04	18.12	16.04	*****	13.83	13.59
19.00	18.52	17.82	15.86	*****	13.79	13.55
20.00	18.02	17.53	15.68	*****	13.75	13.52
21.00	17.97	17.52	15.68	*****	13.75	13.51
22.00	17.93	17.52	15.68	*****	13.75	13.51
23.00	17.88	17.51	15.68	*****	13.74	13.51
24.00	17.83	17.51	15.68	*****	13.74	13.51
25.00	17.78	17.50	15.68	*****	13.74	13.51
26.00	17.73	17.49	15.68	*****	13.74	13.51
27.00	17.68	17.49	15.68	*****	13.74	13.50
28.00	17.63	17.48	15.68	*****	13.74	13.50
29.00	17.59	17.48	15.68	*****	13.73	13.50
30.00	17.54	17.47	15.68	*****	13.73	13.50

DELTA EFNL = 5.0 FAN HARMONIC = 5.0
 INLET HARMONIC (A = C, H = 5, C = 10, D = 20, E = 30)
 APP. WITH TENE, 3. JET ATT., NO TLRB, EFNL = 101.66, RUN 11A NC JET1

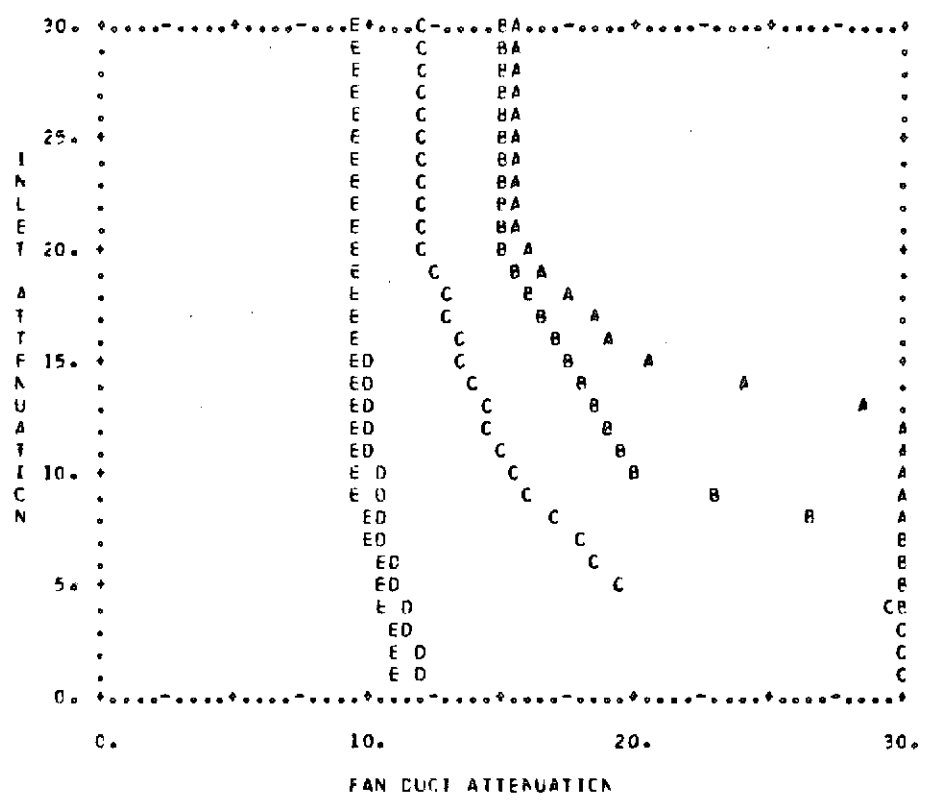

FAN HARMONIC = 5.0		DELTA EFNL = 5.0				
INLET HARMONIC =		A	B	C	D	E
		C	5	10	20	30
INLET FUND.	FAN FUND.	FAN FUND.	FAN FUND.	FAN FUND.	FAN FUND.	FAN FUND.
1.00	*****	*****	*****	12.22	11.19	
2.00	*****	*****	*****	11.89	11.02	
3.00	*****	*****	*****	11.58	10.87	
4.00	*****	*****	29.67	11.29	10.71	
5.00	*****	*****	19.73	11.01	10.57	
6.00	*****	*****	18.71	10.86	10.32	
7.00	*****	*****	30.90	17.76	10.08	
8.00	*****	26.58	16.88	10.56	9.88	
9.00	*****	22.79	16.06	10.42	9.71	
10.00	*****	19.87	15.29	10.29	9.54	
11.00	*****	19.37	14.93	10.18	9.53	
12.00	*****	18.87	14.58	10.07	9.52	
13.00	28.32	18.38	14.25	9.97	9.50	
14.00	24.22	17.90	13.93	9.89	9.49	
15.00	20.26	17.43	13.62	9.80	9.48	
16.00	19.14	16.97	13.32	9.72	9.47	
17.00	18.25	16.51	13.03	9.64	9.46	
18.00	17.39	16.06	12.75	9.57	9.44	
19.00	16.56	15.61	12.48	9.49	9.43	
20.00	15.76	15.18	12.22	9.42	9.42	
21.00	15.72	15.18	12.22	9.42	9.42	
22.00	15.68	15.18	12.22	9.42	9.41	
23.00	15.64	15.17	12.22	9.42	9.41	
24.00	15.60	15.17	12.22	9.42	9.41	
25.00	15.56	15.17	12.22	9.42	9.41	
26.00	15.52	15.17	12.22	9.42	9.40	
27.00	15.48	15.17	12.22	9.42	9.40	
28.00	15.44	15.17	12.22	9.42	9.40	
29.00	15.40	15.17	12.22	9.42	9.39	
30.00	15.36	15.17	12.22	9.42	9.39	

DELTA EPNL = 5.0 FAN HARMONIC = 10.0
 INLET HARMONIC (A = 0, B = 5, C = 10, D = 20, E = 30)
 APP. WITH TCNE, 3. JET AFT., NO TURE, EPNL = 101.66, RUA 11A AC JET1

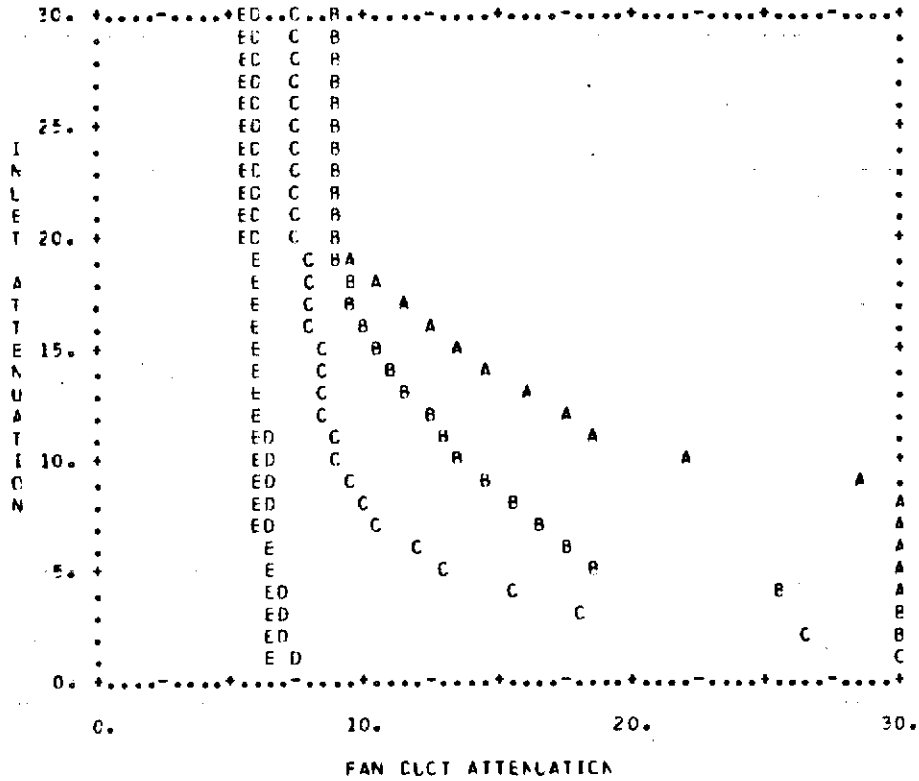

FAN HARMONIC = 10.0		DELTA EPNL = 5.0				
INLET HARMONIC =		A	B	C	D	E
		C	5	10	20	30
INLET	FAN	FAN	FAN	FAN	FAN	FAN
FUND.	FUND.	FUND.	FUND.	FUND.	FUND.	FUND.
1.00	*****	*****	*****	7.31	6.70	
2.00	*****	*****	26.45	7.14	6.62	
3.00	*****	*****	18.06	6.98	6.55	
4.00	*****	25.45	15.50	6.83	6.48	
5.00	*****	18.55	13.20	6.68	6.42	
6.00	*****	17.45	11.91	6.60	6.31	
7.00	*****	16.41	10.72	6.52	6.21	
8.00	*****	15.43	9.82	6.45	6.10	
9.00	28.65	14.51	9.36	6.37	5.99	
10.00	21.67	13.63	8.93	6.30	5.89	
11.00	18.72	12.97	8.79	6.25	5.87	
12.00	17.28	12.33	8.66	6.21	5.86	
13.00	15.93	11.69	8.53	6.16	5.84	
14.00	14.66	11.07	8.40	6.12	5.83	
15.00	13.47	10.46	8.27	6.07	5.81	
16.00	12.34	9.93	8.15	6.02	5.80	
17.00	11.28	9.66	8.03	5.98	5.76	
18.00	10.27	9.39	7.91	5.93	5.77	
19.00	9.67	9.14	7.80	5.89	5.76	
20.00	9.24	8.90	7.69	5.84	5.74	
21.00	9.22	8.90	7.67	5.84	5.74	
22.00	9.15	8.90	7.66	5.84	5.74	
23.00	9.16	8.90	7.65	5.84	5.74	
24.00	9.13	8.90	7.63	5.83	5.74	
25.00	9.11	8.90	7.62	5.83	5.73	
26.00	9.08	8.90	7.61	5.83	5.73	
27.00	9.05	8.90	7.59	5.83	5.73	
28.00	9.02	8.90	7.58	5.83	5.73	
29.00	9.00	8.90	7.57	5.82	5.73	
30.00	8.97	8.90	7.55	5.82	5.73	

DELTA EFNL = 5.0 FAN HARMONIC = 20.0
 INLET HARMONIC (A = 0, B = 5, C = 10, D = 20, E = 30)
 APP. WITH TCNE, 3. JET ATT., NO TURB. EPNL = 101.66, RUN 11A AC JET1

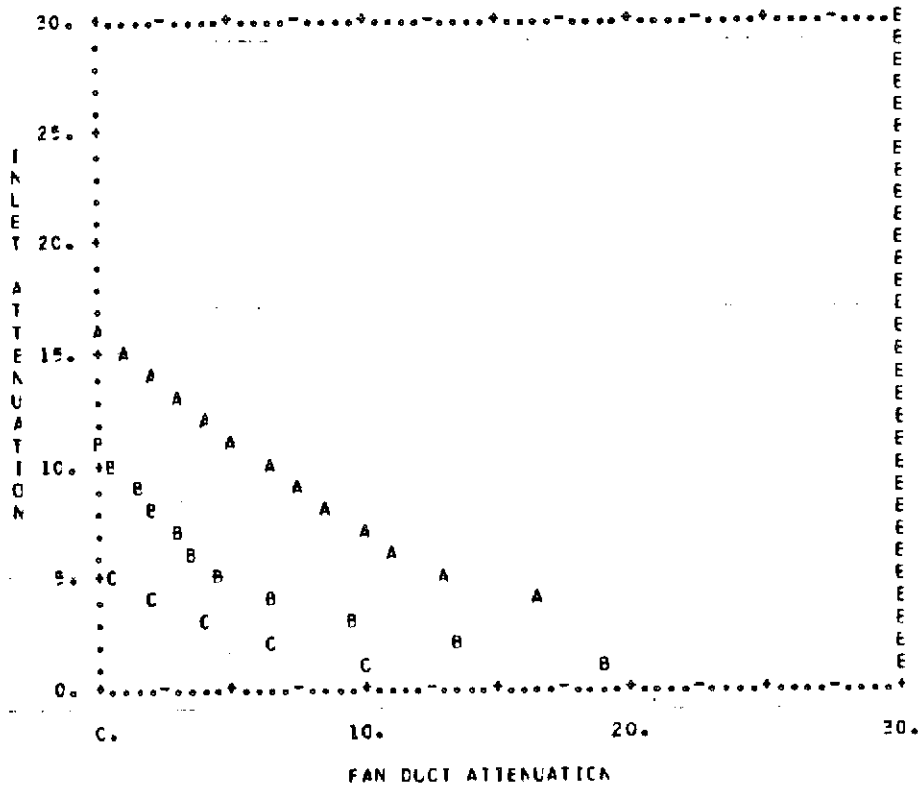

INLET HARMONIC	DELTA EFNL = 5.0				
	FAN HARMONIC = 20.0 A	B	C	D	E
	C	5	10	20	30
INLET FUND.	FAN FUND.	FAN FUND.	FAN FUND.	FAN FUND.	FAN FUND.
1.00	*****	18.80	9.85	*****	*****
2.00	*****	13.69	6.57	*****	*****
3.00	*****	9.44	4.08	*****	*****
4.00	15.68	6.74	2.08	*****	*****
5.00	12.84	4.50	0.26	*****	*****
6.00	11.21	3.63	*****	*****	*****
7.00	9.77	2.80	*****	*****	*****
8.00	8.69	2.01	*****	*****	*****
9.00	7.68	1.27	*****	*****	*****
10.00	6.73	0.56	*****	*****	*****
11.00	5.16	0.10	*****	*****	*****
12.00	4.00	*****	*****	*****	*****
13.00	2.95	*****	*****	*****	*****
14.00	1.98	*****	*****	*****	*****
15.00	1.06	*****	*****	*****	*****
16.00	0.21	*****	*****	*****	*****
17.00	*****	*****	*****	*****	*****
18.00	*****	*****	*****	*****	*****
19.00	*****	*****	*****	*****	*****
20.00	*****	*****	*****	*****	*****
21.00	*****	*****	*****	*****	*****
22.00	*****	*****	*****	*****	*****
23.00	*****	*****	*****	*****	*****
24.00	*****	*****	*****	*****	*****
25.00	*****	*****	*****	*****	*****
26.00	*****	*****	*****	*****	*****
27.00	*****	*****	*****	*****	*****
28.00	*****	*****	*****	*****	*****
29.00	*****	*****	*****	*****	*****
30.00	*****	*****	*****	*****	*****

DELTA EPNL = 5.0 FAN HARMONIC = 30.0
 INLET HARMONIC (A = 0, B = 5, C = 10, D = 20, E = 30)
 APP. WITH TCNE, 3. JET ATT., NO TURB, EPNL = 101.66, RUN 11A NC JET1

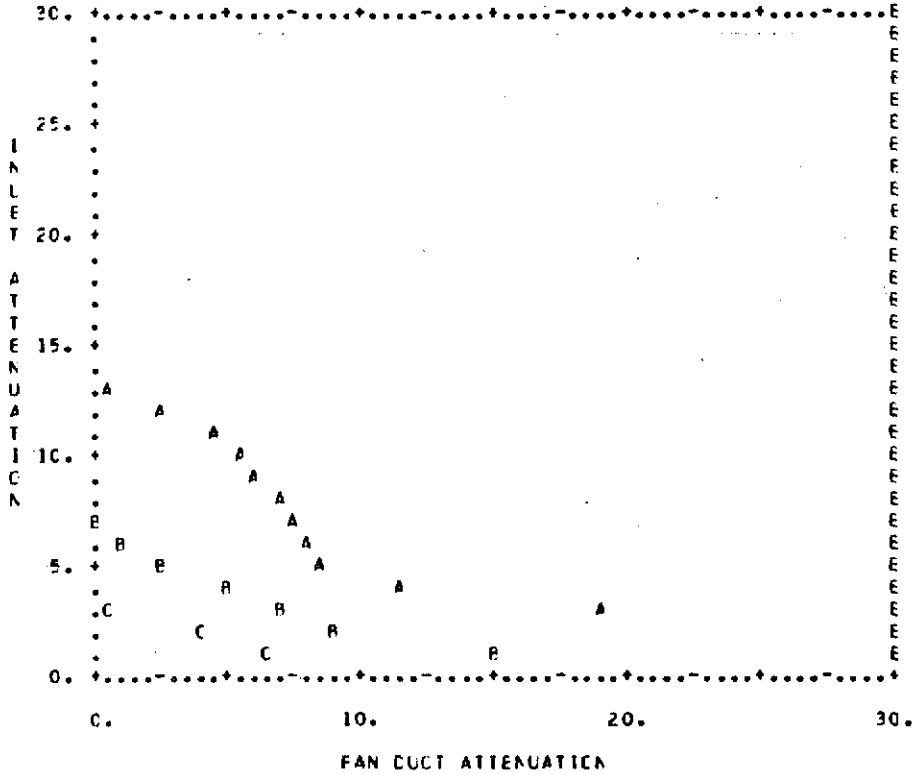

FAN HARMONIC = 30.0		DELTA EPNL = 5.0				
INLET HARMONIC =		A	B	C	D	E
		0	5	10	20	30
INLET FUND.	FAN FUND.	FAN FUND.	FAN FUND.	FAN FUND.	FAN FUND.	FAN FUND.
1.00	*****	15.08	6.65	*****	*****	
2.00	*****	9.05	3.78	*****	*****	
3.00	19.02	6.91	0.20	*****	*****	
4.00	11.39	5.18	*****	*****	*****	
5.00	8.75	2.50	*****	*****	*****	
6.00	8.02	1.20	*****	*****	*****	
7.00	7.37	0.02	*****	*****	*****	
8.00	6.75	*****	*****	*****	*****	
9.00	6.18	*****	*****	*****	*****	
10.00	5.64	*****	*****	*****	*****	
11.00	4.30	*****	*****	*****	*****	
12.00	2.46	*****	*****	*****	*****	
13.00	0.68	*****	*****	*****	*****	
14.00	*****	*****	*****	*****	*****	
15.00	*****	*****	*****	*****	*****	
16.00	*****	*****	*****	*****	*****	
17.00	*****	*****	*****	*****	*****	
18.00	*****	*****	*****	*****	*****	
19.00	*****	*****	*****	*****	*****	
20.00	*****	*****	*****	*****	*****	
21.00	*****	*****	*****	*****	*****	
22.00	*****	*****	*****	*****	*****	
23.00	*****	*****	*****	*****	*****	
24.00	*****	*****	*****	*****	*****	
25.00	*****	*****	*****	*****	*****	
26.00	*****	*****	*****	*****	*****	
27.00	*****	*****	*****	*****	*****	
28.00	*****	*****	*****	*****	*****	
29.00	*****	*****	*****	*****	*****	
30.00	*****	*****	*****	*****	*****	

DELTA EPNL = 10.0 FAN HARMONIC = 0.0
 INLET HARMONIC (A = 0, B = 5, C = 10, D = 20, E = 30)
 APP. WITH TCNE, 3. JET ATT., NO TURB, EPNL = 101.66, RUN 11A NC JET1

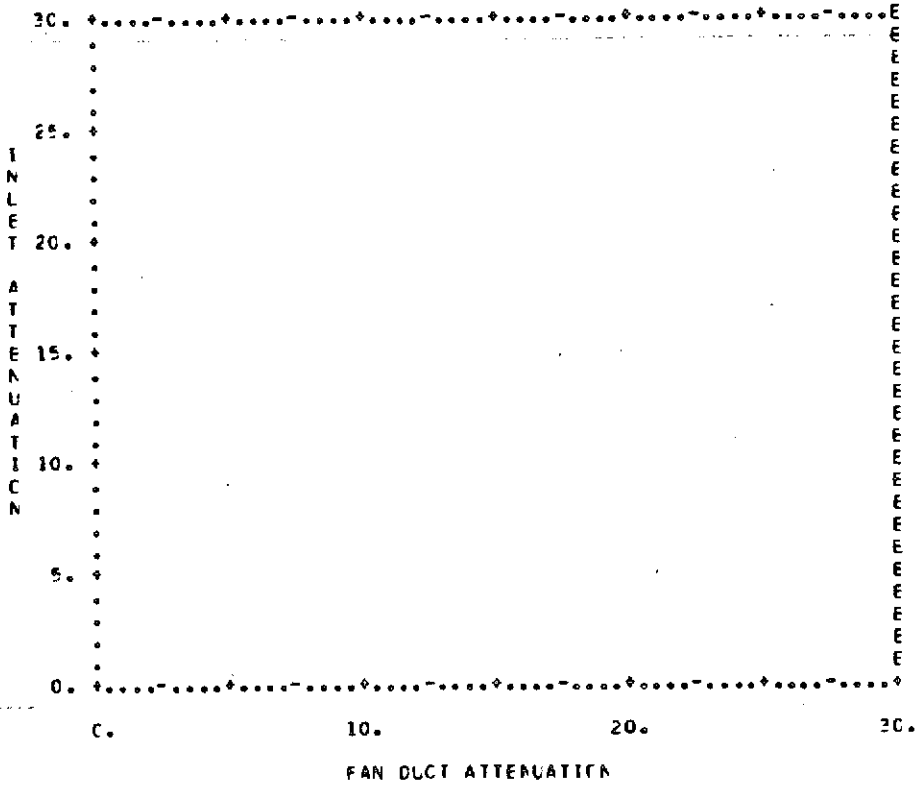

FAN HARMONIC = 0.0		DELTA EPNL = 10.0				
INLET HARMONIC =		A	B	C	D	E
		0	5	10	20	30
INLET	FAN	FAN	FAN	FAN	FAN	FAN
FUND.	FUND.	FUND.	FUND.	FUND.	FUND.	FUND.
1.00	*****	*****	*****	*****	*****	*****
2.00	*****	*****	*****	*****	*****	*****
3.00	*****	*****	*****	*****	*****	*****
4.00	*****	*****	*****	*****	*****	*****
5.00	*****	*****	*****	*****	*****	*****
6.00	*****	*****	*****	*****	*****	*****
7.00	*****	*****	*****	*****	*****	*****
8.00	*****	*****	*****	*****	*****	*****
9.00	*****	*****	*****	*****	*****	*****
10.00	*****	*****	*****	*****	*****	*****
11.00	*****	*****	*****	*****	*****	*****
12.00	*****	*****	*****	*****	*****	*****
13.00	*****	*****	*****	*****	*****	*****
14.00	*****	*****	*****	*****	*****	*****
15.00	*****	*****	*****	*****	*****	*****
16.00	*****	*****	*****	*****	*****	*****
17.00	*****	*****	*****	*****	*****	*****
18.00	*****	*****	*****	*****	*****	*****
19.00	*****	*****	*****	*****	*****	*****
20.00	*****	*****	*****	*****	*****	*****
21.00	*****	*****	*****	*****	*****	*****
22.00	*****	*****	*****	*****	*****	*****
23.00	*****	*****	*****	*****	*****	*****
24.00	*****	*****	*****	*****	*****	*****
25.00	*****	*****	*****	*****	*****	*****
26.00	*****	*****	*****	*****	*****	*****
27.00	*****	*****	*****	*****	*****	*****
28.00	*****	*****	*****	*****	*****	*****
29.00	*****	*****	*****	*****	*****	*****
30.00	*****	*****	*****	*****	*****	*****

DELTA EPNL = 10.0 FAN HARMONIC = 5.0
 INLET HARMONIC (A = 0, B = 5, C = 10, D = 20, E = 30)
 APP. WITH TCNE, 3. JET ATT., NO TURB, EPNL = 101.66, RUN 11A NC JET1

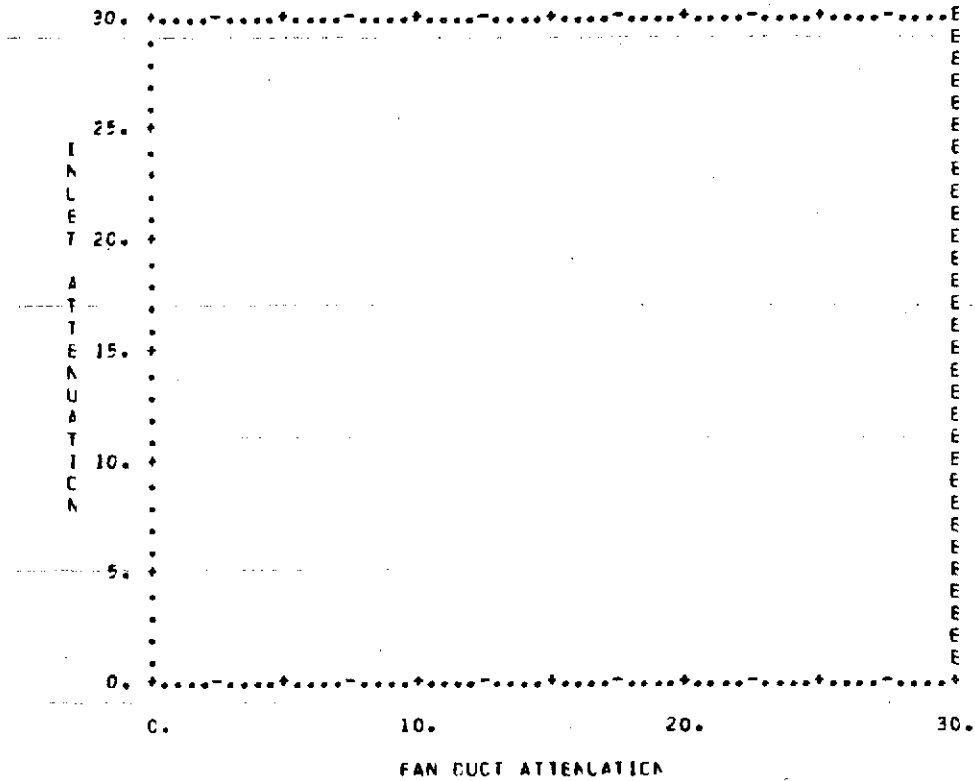

INLET HARMONIC =	FAN HARMONIC = 5.0		DELTA EPNL = 10.0			
	A	B	C	D	E	
	0	5	10	20	30	
	INLET FUND.	FAN FUND.	FAN FUND.	FAN FUND.	FAN FUND.	
1.00	*****	*****	*****	*****	*****	
2.00	*****	*****	*****	*****	*****	
3.00	*****	*****	*****	*****	*****	
4.00	*****	*****	*****	*****	*****	
5.00	*****	*****	*****	*****	*****	
6.00	*****	*****	*****	*****	*****	
7.00	*****	*****	*****	*****	*****	
8.00	*****	*****	*****	*****	*****	
9.00	*****	*****	*****	*****	*****	
10.00	*****	*****	*****	*****	*****	
11.00	*****	*****	*****	*****	*****	
12.00	*****	*****	*****	*****	*****	
13.00	*****	*****	*****	*****	*****	
14.00	*****	*****	*****	*****	*****	
15.00	*****	*****	*****	*****	*****	
16.00	*****	*****	*****	*****	*****	
17.00	*****	*****	*****	*****	*****	
18.00	*****	*****	*****	*****	*****	
19.00	*****	*****	*****	*****	*****	
20.00	*****	*****	*****	*****	*****	
21.00	*****	*****	*****	*****	*****	
22.00	*****	*****	*****	*****	*****	
23.00	*****	*****	*****	*****	*****	
24.00	*****	*****	*****	*****	*****	
25.00	*****	*****	*****	*****	*****	
26.00	*****	*****	*****	*****	*****	
27.00	*****	*****	*****	*****	*****	
28.00	*****	*****	*****	*****	*****	
29.00	*****	*****	*****	*****	*****	
30.00	*****	*****	*****	*****	*****	

DELTA EFNL = 10.0 FAN HARMONIC = 10.0
 INLET HARMONIC 1A = 0, B = 5, C = 10, D = 20, E = 30
 APP, WITH TCNE, 3. JET ATT., NO TURB, EPNL = 101.66, RUN 11A AC JET1

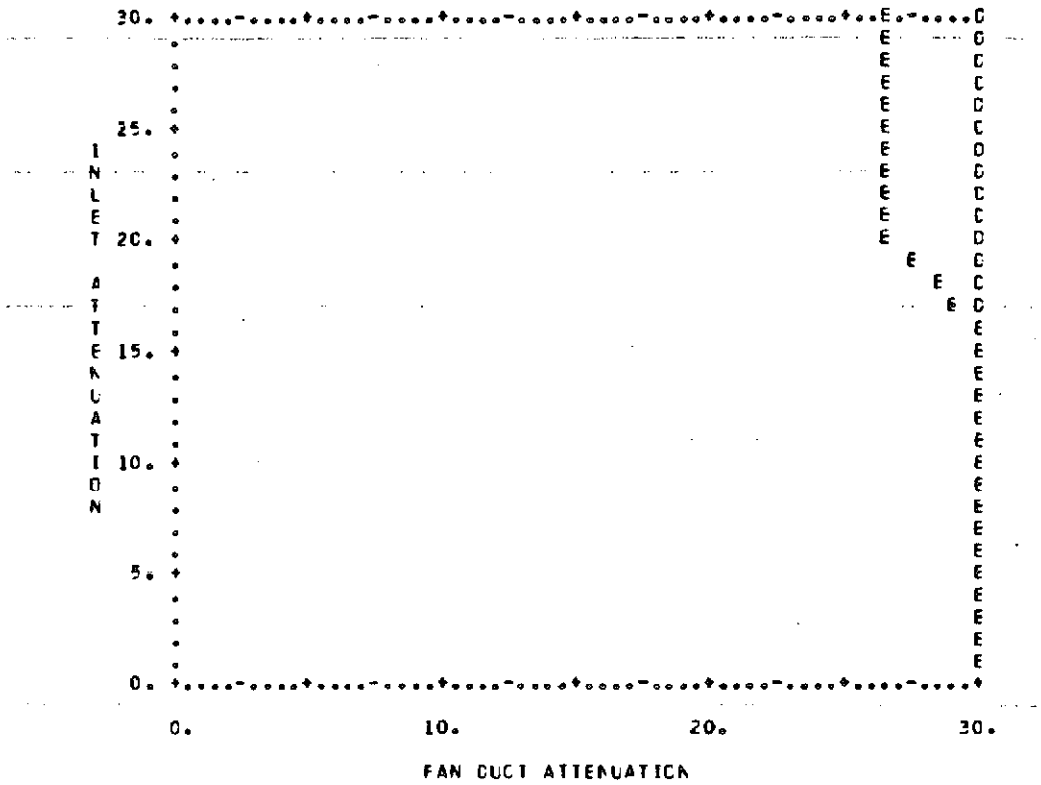

FAN HARMONIC = 10.0		DELTA EFNL = 10.0				
INLET HARMONIC =		A	B	C	D	E
		0	5	10	20	30
INLET	FAN	FAN	FAN	FAN	FAN	FAN
FUND.	FUND.	FUND.	FUND.	FUND.	FUND.	FUND.
1.00	*****	*****	*****	*****	*****	*****
2.00	*****	*****	*****	*****	*****	*****
3.00	*****	*****	*****	*****	*****	*****
4.00	*****	*****	*****	*****	*****	*****
5.00	*****	*****	*****	*****	*****	*****
6.00	*****	*****	*****	*****	*****	*****
7.00	*****	*****	*****	*****	*****	*****
8.00	*****	*****	*****	*****	*****	*****
9.00	*****	*****	*****	*****	*****	*****
10.00	*****	*****	*****	*****	*****	*****
11.00	*****	*****	*****	*****	*****	*****
12.00	*****	*****	*****	*****	*****	*****
13.00	*****	*****	*****	*****	*****	*****
14.00	*****	*****	*****	*****	*****	*****
15.00	*****	*****	*****	*****	*****	*****
16.00	*****	*****	*****	*****	*****	30.07
17.00	*****	*****	*****	*****	*****	29.16
18.00	*****	*****	*****	*****	*****	28.29
19.00	*****	*****	*****	*****	*****	27.46
20.00	*****	*****	*****	*****	*****	26.67
21.00	*****	*****	*****	*****	*****	26.67
22.00	*****	*****	*****	*****	*****	26.66
23.00	*****	*****	*****	*****	*****	26.66
24.00	*****	*****	*****	*****	*****	26.66
25.00	*****	*****	*****	*****	*****	26.66
26.00	*****	*****	*****	*****	*****	26.66
27.00	*****	*****	*****	*****	*****	26.66
28.00	*****	*****	*****	*****	*****	26.65
29.00	*****	*****	*****	*****	*****	26.65
30.00	*****	*****	*****	*****	*****	26.65

DELTA EPNL = 10.0 FAN HARMONIC = 20.0
 INLET HARMONIC (A = 0, B = 5, C = 10, D = 20, E = 30)
 APP, WITH TCNE, 3. JET ATT., NO TURB, EPNL = 101.66, RUN 11A NO JET1

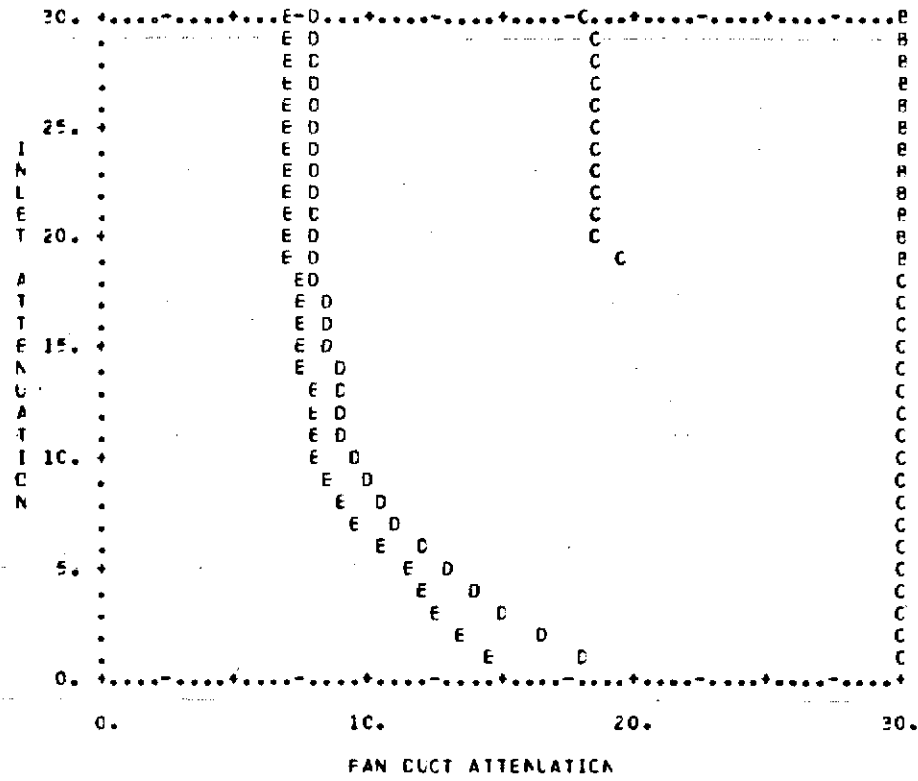

FAN HARMONIC = 20.0		DELTA EPNL = 10.0				
INLET HARMONIC =		A	B	C	D	E
		0	5	10	20	30
INLET	FAN	FAN	FAN	FAN	FAN	FAN
FUND.	FUND.	FUND.	FUND.	FUND.	FUND.	FUND.
1.00	*****	*****	*****	*****	17.84	14.46
2.00	*****	*****	*****	*****	16.36	13.53
3.00	*****	*****	*****	*****	15.05	12.71
4.00	*****	*****	*****	*****	13.89	11.57
5.00	*****	*****	*****	*****	12.84	11.31
6.00	*****	*****	*****	*****	11.97	10.43
7.00	*****	*****	*****	*****	11.19	9.74
8.00	*****	*****	*****	*****	10.49	9.18
9.00	*****	*****	*****	*****	9.88	8.67
10.00	*****	*****	*****	*****	9.39	8.19
11.00	*****	*****	*****	*****	8.93	7.80
12.00	*****	*****	*****	*****	8.50	7.46
13.00	*****	*****	*****	*****	8.11	7.15
14.00	*****	*****	*****	*****	7.76	6.87
15.00	*****	*****	*****	*****	7.44	6.61
16.00	*****	*****	*****	*****	7.15	6.37
17.00	*****	*****	*****	*****	6.89	6.14
18.00	*****	*****	*****	*****	6.66	5.92
19.00	*****	*****	*****	19.45	6.46	5.71
20.00	*****	*****	*****	18.68	6.27	5.51
21.00	*****	*****	*****	18.63	6.10	5.32
22.00	*****	*****	*****	18.59	5.94	5.14
23.00	*****	*****	*****	18.54	5.79	4.97
24.00	*****	*****	*****	18.49	5.65	4.81
25.00	*****	*****	*****	18.44	5.52	4.66
26.00	*****	*****	*****	18.39	5.40	4.52
27.00	*****	*****	*****	18.35	5.28	4.38
28.00	*****	*****	*****	18.30	5.17	4.25
29.00	*****	*****	*****	18.25	5.06	4.12
30.00	*****	*****	*****	18.21	4.96	4.00

DELTA EPNL = 10.0 FAN HARMONIC = 30.0
 INLET HARMONIC (A = 0, B = 5, C = 10, D = 20, E = 30)
 APP. WITH TCNE, 3. JET ATT., NO TLRE, EPNL = 101.66, RUN 11A AC JET1

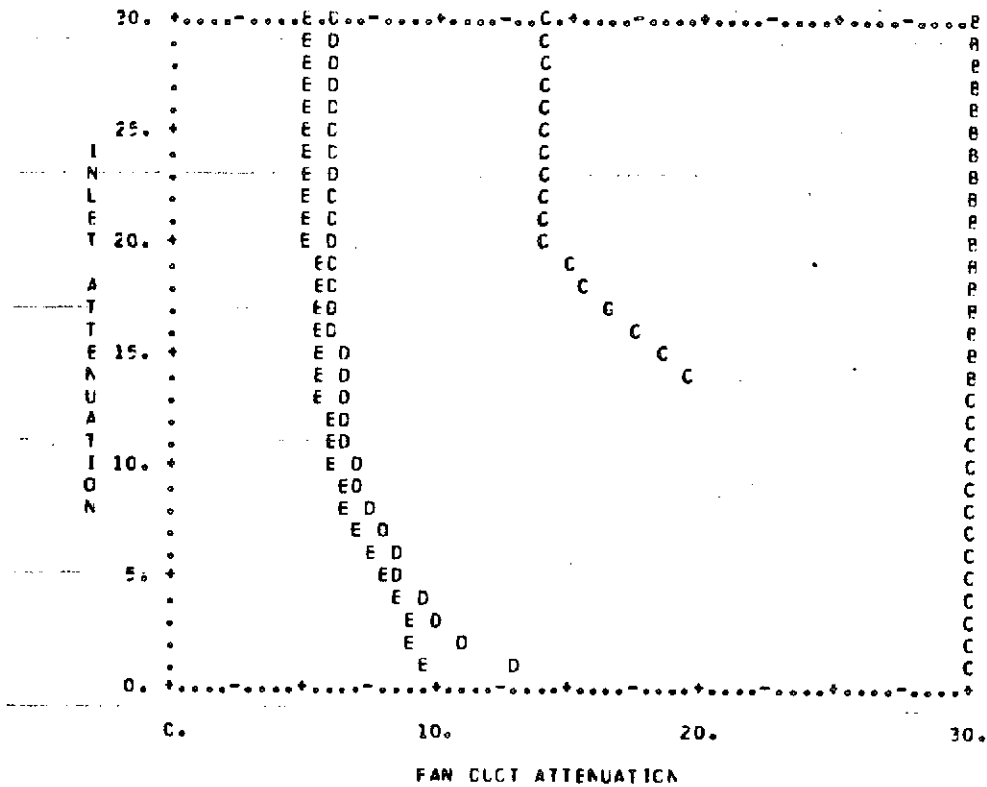

INLET HARMONIC =	DELTA EPNL = 10.0				
	A 0	B 5	C 10	D 20	E 30
1.00	*****	*****	*****	12.79	9.55
2.00	*****	*****	*****	11.10	9.15
3.00	*****	*****	*****	9.84	8.78
4.00	*****	*****	*****	9.25	8.42
5.00	*****	*****	*****	8.71	8.09
6.00	*****	*****	*****	8.28	7.58
7.00	*****	*****	*****	7.88	7.12
8.00	*****	*****	*****	7.51	6.70
9.00	*****	*****	*****	7.17	6.32
10.00	*****	*****	*****	6.85	5.97
11.00	*****	*****	*****	6.73	5.88
12.00	*****	*****	*****	6.63	5.80
13.00	*****	*****	*****	6.52	5.72
14.00	*****	*****	15.46	6.42	5.64
15.00	*****	*****	18.46	6.32	5.56
16.00	*****	*****	17.50	6.22	5.49
17.00	*****	*****	16.59	6.13	5.42
18.00	*****	*****	15.71	6.04	5.35
19.00	*****	*****	14.86	5.95	5.28
20.00	*****	*****	14.06	5.86	5.21
21.00	*****	*****	14.05	5.86	5.21
22.00	*****	*****	14.03	5.86	5.21
23.00	*****	*****	14.00	5.86	5.21
24.00	*****	*****	13.97	5.86	5.21
25.00	*****	*****	13.95	5.86	5.21
26.00	*****	*****	13.92	5.86	5.21
27.00	*****	*****	13.90	5.86	5.21
28.00	*****	*****	13.87	5.86	5.21
29.00	*****	*****	13.85	5.86	5.21
30.00	*****	*****	13.82	5.86	5.21

DELTA EPNL = 5.0 FAN HARMONIC = 0.0
 INLET HARMONIC {A = 0, B = 5, C = 10, D = 20, E = 30}
 1/0, WITH TONF, 2.5 JET ATT, NO TURB, EPNL = 102.56, RUN 12A

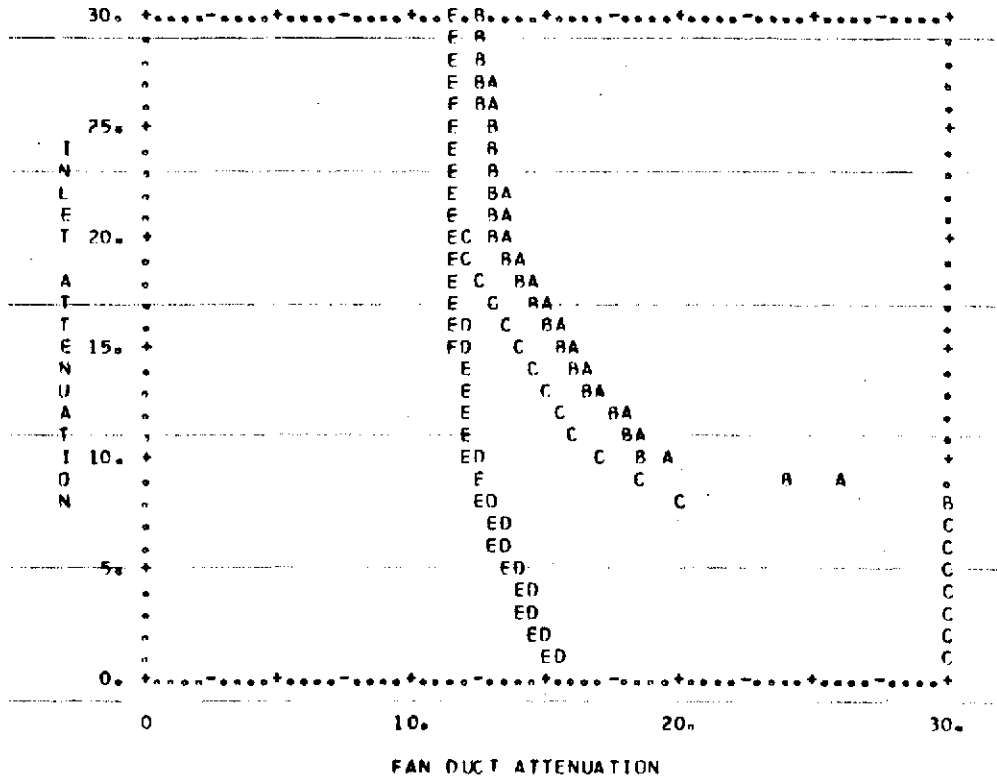

FAN HARMONIC = 0.0		DELTA EPNL = 5.0				
INLET HARMONIC =		A	B	C	D	F
		0	5	10	20	30
	INLET FUND.	FAN FUND.	FAN FUND.	FAN FUND.	FAN FUND.	FAN FUND.
	1.00	*****	*****	*****	15.37	14.90
	2.00	*****	*****	*****	14.98	14.52
	3.00	*****	*****	*****	14.61	14.18
	4.00	*****	*****	*****	14.26	13.85
	5.00	*****	*****	*****	13.93	13.55
	6.00	*****	*****	*****	13.59	13.23
	7.00	*****	*****	*****	13.26	12.91
	8.00	*****	*****	*****	12.92	12.61
	9.00	26.03	23.78	18.28	12.62	12.32
	10.00	19.37	18.74	16.82	12.31	12.04
	11.00	18.62	18.02	16.20	12.21	11.97
	12.00	17.91	17.34	15.61	12.12	11.90
	13.00	17.25	16.69	15.05	12.02	11.82
	14.00	16.62	16.09	14.51	11.93	11.75
	15.00	16.03	15.51	14.00	11.84	11.68
	16.00	15.47	14.97	13.51	11.75	11.62
	17.00	14.93	14.45	13.05	11.66	11.55
	18.00	14.43	13.96	12.60	11.58	11.48
	19.00	13.95	13.50	12.18	11.50	11.42
	20.00	13.49	13.05	11.77	11.42	11.36
	21.00	13.39	12.99	11.75	11.41	11.35
	22.00	13.29	12.94	11.73	11.41	11.34
	23.00	13.19	12.88	11.70	11.40	11.34
	24.00	13.10	12.83	11.68	11.39	11.33
	25.00	13.00	12.78	11.66	11.39	11.33
	26.00	12.91	12.72	11.64	11.38	11.32
	27.00	12.81	12.67	11.62	11.38	11.31
	28.00	12.72	12.61	11.59	11.37	11.31
	29.00	12.63	12.56	11.57	11.36	11.30
	30.00	12.54	12.51	11.55	11.36	11.30

DELTA EPNL = 5.0 FAN HARMONIC = 5.0
 INLET HARMONIC (A = 0, B = 5, C = 10, D = 20, E = 30)
 T/D, WITH TONE, 2.5 JFT ATT, NO TURB, EPNL = 102.56, RUN 12A

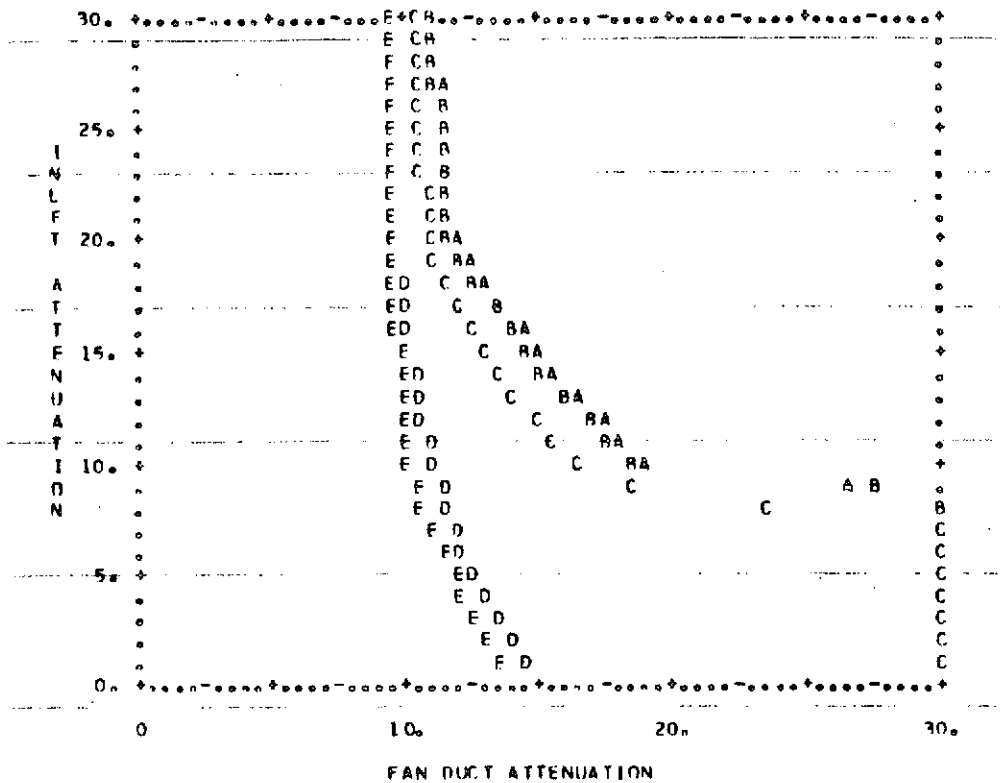

FAN HARMONIC = 5.0		DELTA EPNL = 5.0				
INLET HARMONIC =		A	R	C	D	E
		0	5	10	20	30
INLET FUND.	FAN FUND.	FAN FUND.	FAN FUND.	FAN FUND.	FAN FUND.	FAN FUND.
1.00	*****	*****	*****	*****	14.48	13.37
2.00	*****	*****	*****	*****	13.93	12.92
3.00	*****	*****	*****	*****	13.42	12.50
4.00	*****	*****	*****	*****	12.95	12.12
5.00	*****	*****	*****	*****	12.51	11.76
6.00	*****	*****	*****	*****	12.17	11.38
7.00	*****	*****	*****	*****	11.85	11.02
8.00	*****	*****	*****	*****	11.55	10.67
9.00	26.51	27.56	18.28	11.26	10.33	
10.00	19.09	18.54	16.37	10.99	10.00	
11.00	18.16	17.61	15.58	10.80	9.95	
12.00	17.28	16.76	14.87	10.62	9.91	
13.00	16.46	15.97	14.27	10.44	9.86	
14.00	15.68	15.24	13.62	10.26	9.82	
15.00	14.94	14.55	13.06	10.09	9.77	
16.00	14.25	13.91	12.55	9.96	9.73	
17.00	13.59	13.31	12.08	9.86	9.69	
18.00	12.97	12.75	11.64	9.78	9.64	
19.00	12.38	12.22	11.22	9.69	9.60	
20.00	11.81	11.72	10.84	9.60	9.56	
21.00	11.73	11.64	10.81	9.60	9.56	
22.00	11.64	11.57	10.77	9.60	9.56	
23.00	11.56	11.50	10.74	9.59	9.55	
24.00	11.48	11.42	10.70	9.59	9.55	
25.00	11.40	11.35	10.67	9.58	9.55	
26.00	11.33	11.28	10.63	9.58	9.55	
27.00	11.25	11.21	10.60	9.57	9.54	
28.00	11.18	11.14	10.56	9.57	9.54	
29.00	11.11	11.07	10.53	9.56	9.54	
30.00	11.04	11.00	10.49	9.56	9.54	

DELTA EPNL = 5.0 FAN HARMONIC = 10.0
 INLET HARMONIC (A = 0, B = 5, C = 10, D = 20, E = 30)
 T/O, WITH TONF, 2.5 JET ATT, NO TURB, EPNL = 102.56, RUN 12A

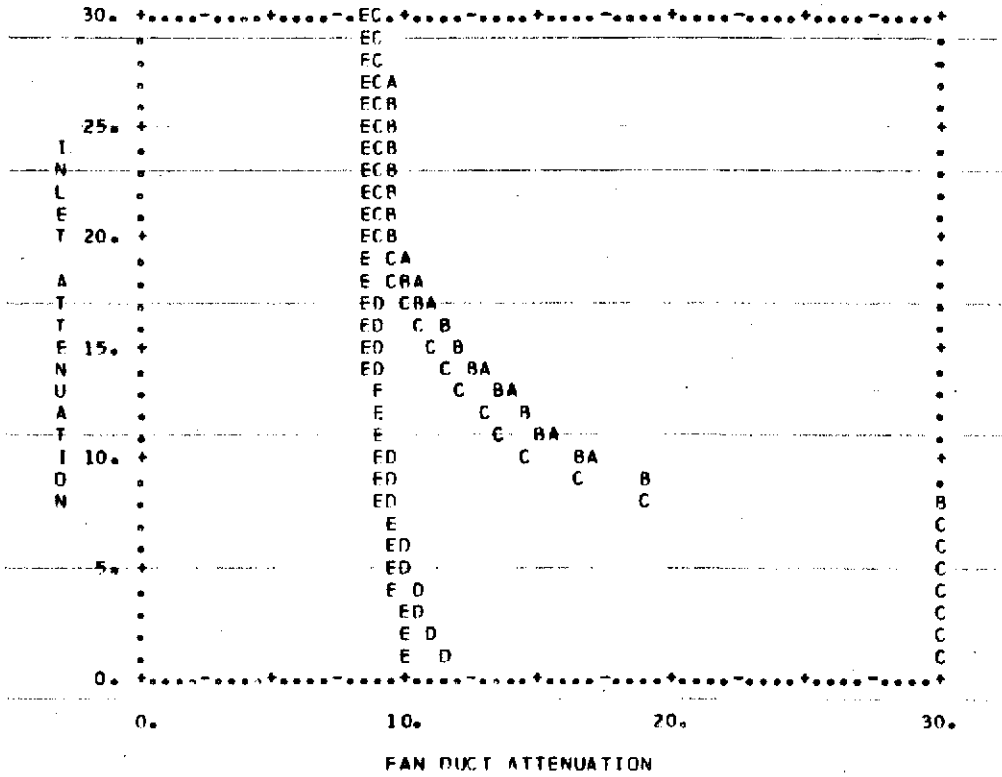

FAN HARMONIC = 10.0		DELTA EPNL = 5.0				
INLET HARMONIC =		A	B	C	D	E
		0	5	10	20	30
INLET FUND.	FAN FUND.	FAN FUND.	FAN FUND.	FAN FUND.	FAN FUND.	FAN FUND.
1.00	*****	*****	*****	*****	11.57	10.19
2.00	*****	*****	*****	*****	11.13	9.96
3.00	*****	*****	*****	*****	10.74	9.85
4.00	*****	*****	*****	*****	10.38	9.74
5.00	*****	*****	*****	*****	10.06	9.62
6.00	*****	*****	*****	*****	9.86	9.49
7.00	*****	*****	*****	*****	9.70	9.37
8.00	29.81	*****	19.17	9.55	9.55	9.24
9.00	19.07	18.82	16.73	9.40	9.40	9.13
10.00	16.79	16.28	14.64	9.26	9.26	9.01
11.00	15.68	15.25	13.72	9.19	9.19	8.94
12.00	14.68	14.31	12.90	9.12	9.12	8.86
13.00	13.77	13.45	12.16	9.05	9.05	8.79
14.00	12.95	12.66	11.50	8.99	8.99	8.72
15.00	12.19	11.94	10.89	8.92	8.92	8.65
16.00	11.50	11.27	10.33	8.86	8.86	8.58
17.00	10.86	10.65	9.90	8.80	8.80	8.52
18.00	10.27	10.07	9.63	8.73	8.73	8.45
19.00	9.86	9.74	9.37	8.67	8.67	8.39
20.00	9.59	9.45	9.12	8.62	8.62	8.33
21.00	9.55	9.42	9.09	8.61	8.61	8.32
22.00	9.51	9.39	9.07	8.61	8.61	8.32
23.00	9.46	9.36	9.05	8.61	8.61	8.32
24.00	9.42	9.33	9.03	8.61	8.61	8.32
25.00	9.38	9.30	9.00	8.60	8.60	8.32
26.00	9.33	9.27	8.98	8.60	8.60	8.31
27.00	9.29	9.24	8.96	8.60	8.60	8.31
28.00	9.24	9.21	8.93	8.60	8.60	8.31
29.00	9.20	9.18	8.91	8.59	8.59	8.31
30.00	9.15	9.15	8.89	8.59	8.59	8.30

DELTA EPNL = 5.0 FAN HARMONIC = 20.0
 INLET HARMONIC (A = 0, B = 5, C = 10, D = 20, E = 30)
 T/O, WITH TONE, 2.5 JET ATT, NO TURB, EPNL = 102.56, RUN 12A

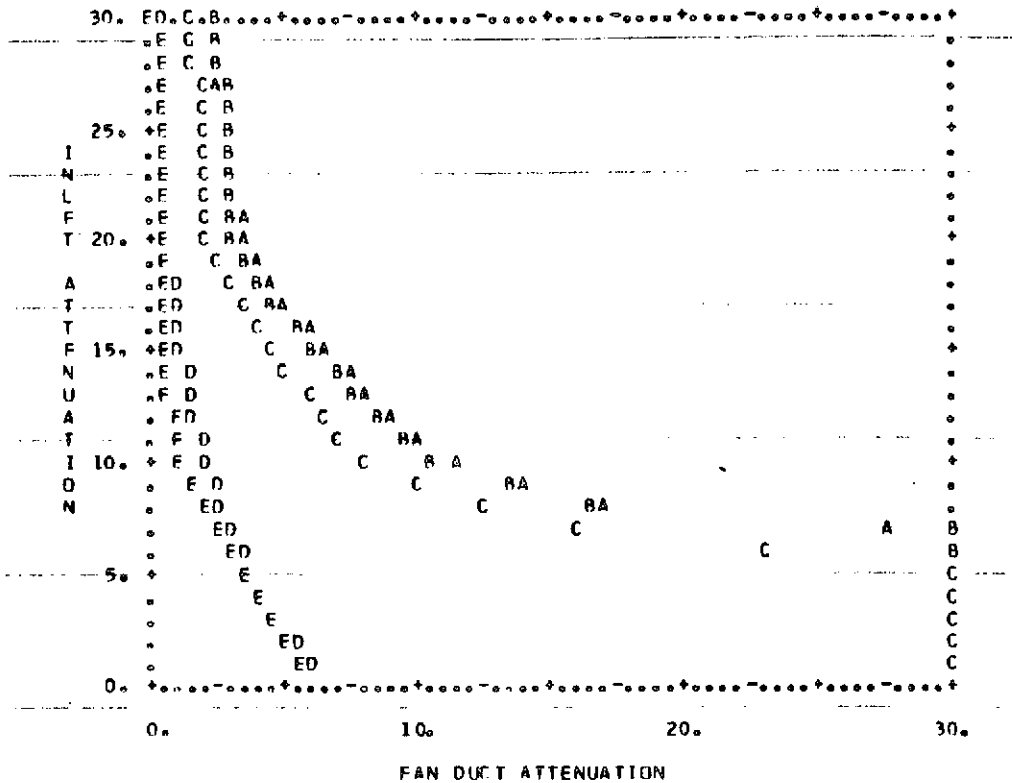

FAN HARMONIC = 20.0		DELTA EPNL = 5.0				
INLET HARMONIC =		A	B	C	D	E
		0	5	10	20	30
INLET FUND.	FAN FUND.	FAN FUND.	FAN FUND.	FAN FUND.	FAN FUND.	FAN FUND.
1.00	*****	*****	*****	*****	5.86	5.40
2.00	*****	*****	*****	*****	5.27	4.90
3.00	*****	*****	*****	*****	4.70	4.34
4.00	*****	*****	*****	*****	4.17	3.83
5.00	*****	*****	*****	*****	3.69	3.35
6.00	*****	*****	*****	22.80	3.35	2.87
7.00	27.44	*****	*****	15.85	3.01	2.38
8.00	17.09	16.69	12.44	2.66	1.90	
9.00	14.02	13.25	9.75	2.31	1.41	
10.00	11.37	10.40	7.93	1.95	0.91	
11.00	10.14	9.36	7.17	1.80	0.84	
12.00	9.11	8.43	6.46	1.65	0.77	
13.00	8.18	7.57	5.78	1.50	0.70	
14.00	7.31	6.77	5.13	1.36	0.64	
15.00	6.51	6.03	4.51	1.21	0.58	
16.00	5.76	5.34	3.94	1.07	0.52	
17.00	5.07	4.72	3.40	0.93	0.47	
18.00	4.49	4.15	2.91	0.79	0.42	
19.00	3.96	3.62	2.45	0.65	0.37	
20.00	3.46	3.11	2.03	0.52	0.32	
21.00	3.35	3.06	1.99	0.51	0.32	
22.00	3.24	3.01	1.95	0.49	0.31	
23.00	3.13	2.97	1.92	0.48	0.30	
24.00	3.02	2.92	1.88	0.46	0.29	
25.00	2.91	2.87	1.85	0.45	0.28	
26.00	2.80	2.83	1.81	0.44	0.28	
27.00	2.69	2.78	1.77	0.42	0.27	
28.00	2.58	2.74	1.74	0.41	0.26	
29.00	2.47	2.69	1.70	0.39	0.25	
30.00	2.36	2.64	1.67	0.38	0.25	

DELTA EPNL = 5.0 FAN HARMONIC = 30.0
 INLET HARMONIC (A = 0, B = 5, C = 10, D = 20, E = 30)
 T/O. WITH TONF, 2.5 JET ATT, NO TURB, EPNL = 102.56, RUN 12A

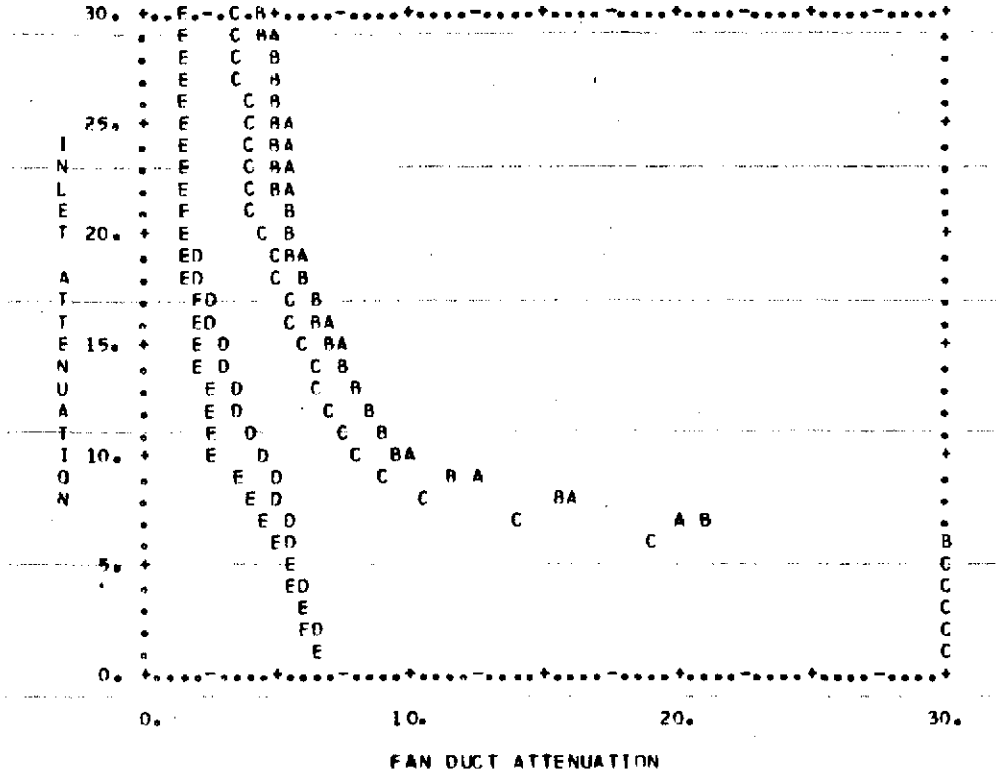

FAN HARMONIC = 30.0		DELTA EPNL = 5.0				
INLET HARMONIC =		A	B	C	D	E
		0	5	10	20	30
INI FT	FAN	FAN	FAN	FAN	FAN	FAN
FUND.	FUND.	FUND.	FUND.	FUND.	FUND.	FUND.
1.00	*****	*****	*****	*****	6.64	6.51
2.00	*****	*****	*****	*****	6.38	6.23
3.00	*****	*****	*****	*****	6.14	5.95
4.00	*****	*****	*****	*****	5.91	5.68
5.00	*****	*****	*****	*****	5.69	5.42
6.00	*****	*****	*****	19.15	5.51	5.16
7.00	19.95	21.20	14.20	5.33	4.72	4.72
8.00	15.87	15.43	10.12	5.15	4.04	4.04
9.00	12.40	11.62	8.89	4.95	3.39	3.39
10.00	9.76	9.33	7.79	4.36	2.75	2.75
11.00	9.16	8.79	7.36	4.00	2.60	2.60
12.00	8.63	8.29	6.98	3.67	2.47	2.47
13.00	8.14	7.83	6.62	3.36	2.33	2.33
14.00	7.69	7.40	6.29	3.07	2.19	2.19
15.00	7.28	6.99	5.99	2.80	2.06	2.06
16.00	6.91	6.62	5.70	2.55	1.93	1.93
17.00	6.56	6.27	5.44	2.32	1.80	1.80
18.00	6.24	5.94	5.20	2.09	1.68	1.68
19.00	5.94	5.63	4.91	1.89	1.55	1.55
20.00	5.66	5.34	4.31	1.69	1.43	1.43
21.00	5.58	5.29	4.23	1.68	1.41	1.41
22.00	5.50	5.24	4.14	1.67	1.40	1.40
23.00	5.42	5.19	4.06	1.66	1.38	1.38
24.00	5.34	5.13	3.97	1.65	1.37	1.37
25.00	5.25	5.08	3.88	1.65	1.35	1.35
26.00	5.17	5.03	3.78	1.64	1.34	1.34
27.00	5.09	4.96	3.67	1.63	1.33	1.33
28.00	5.01	4.83	3.57	1.62	1.31	1.31
29.00	4.80	4.70	3.45	1.61	1.30	1.30
30.00	4.59	4.58	3.33	1.60	1.28	1.28

DELTA EPNL = 10.0 FAN HARMONIC = 0.0
 INLET HARMONIC (A = 0, B = 5, C = 10, D = 20, E = 30)
 T/D, WITH TONE, 2.5 JET ATT, NO TURB, EPNL = 102.56, RUN 12A

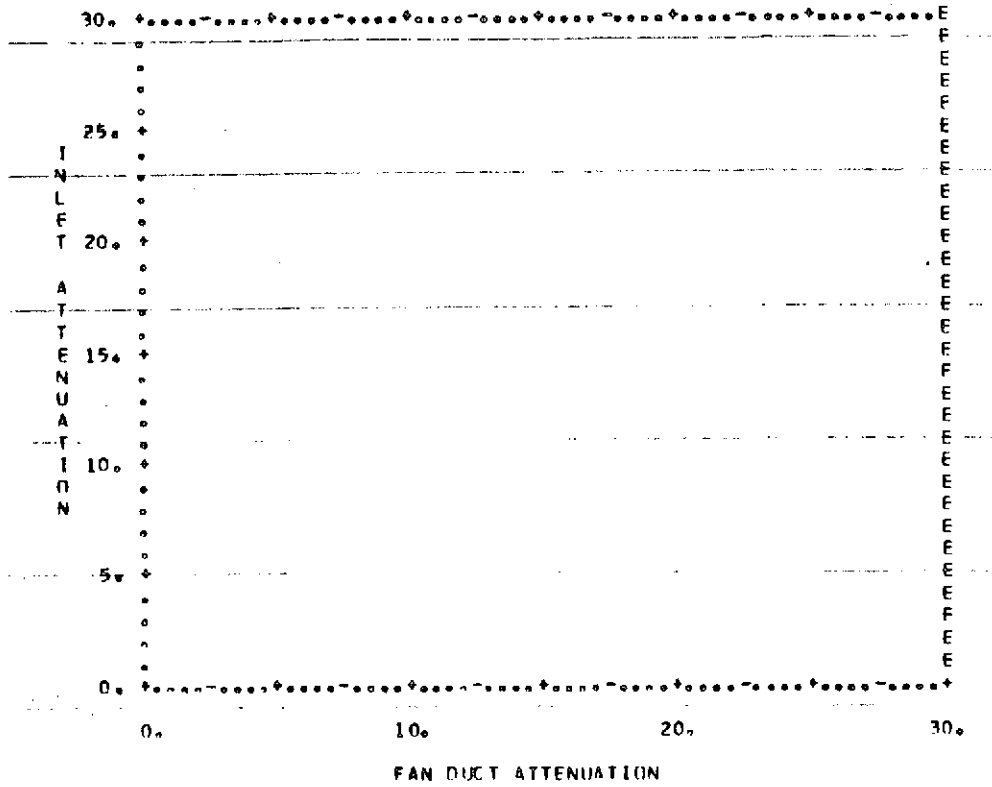

FAN HARMONIC = 0.0		DELTA EPNL = 10.0				
INLET HARMONIC =		A	B	C	D	E
		0	5	10	20	30
INLET	FAN	FAN	FAN	FAN	FAN	FAN
FUND.	FUND.	FUND.	FUND.	FUND.	FUND.	FUND.
1.00	*****	*****	*****	*****	*****	*****
2.00	*****	*****	*****	*****	*****	*****
3.00	*****	*****	*****	*****	*****	*****
4.00	*****	*****	*****	*****	*****	*****
5.00	*****	*****	*****	*****	*****	*****
6.00	*****	*****	*****	*****	*****	*****
7.00	*****	*****	*****	*****	*****	*****
8.00	*****	*****	*****	*****	*****	*****
9.00	*****	*****	*****	*****	*****	*****
10.00	*****	*****	*****	*****	*****	*****
11.00	*****	*****	*****	*****	*****	*****
12.00	*****	*****	*****	*****	*****	*****
13.00	*****	*****	*****	*****	*****	*****
14.00	*****	*****	*****	*****	*****	*****
15.00	*****	*****	*****	*****	*****	*****
16.00	*****	*****	*****	*****	*****	*****
17.00	*****	*****	*****	*****	*****	*****
18.00	*****	*****	*****	*****	*****	*****
19.00	*****	*****	*****	*****	*****	*****
20.00	*****	*****	*****	*****	*****	*****
21.00	*****	*****	*****	*****	*****	*****
22.00	*****	*****	*****	*****	*****	*****
23.00	*****	*****	*****	*****	*****	*****
24.00	*****	*****	*****	*****	*****	*****
25.00	*****	*****	*****	*****	*****	*****
26.00	*****	*****	*****	*****	*****	*****
27.00	*****	*****	*****	*****	*****	*****
28.00	*****	*****	*****	*****	*****	*****
29.00	*****	*****	*****	*****	*****	*****
30.00	*****	*****	*****	*****	*****	*****

DELTA EPNL = 10.0 FAN HARMONIC = 5.0
 INLET HARMONIC (A = 0, B = 5, C = 10, D = 20, E = 30)
 T/O, WITH TONE, 2.5 JET ATT, NO TURB, EPNL = 102.56, RUN 12A

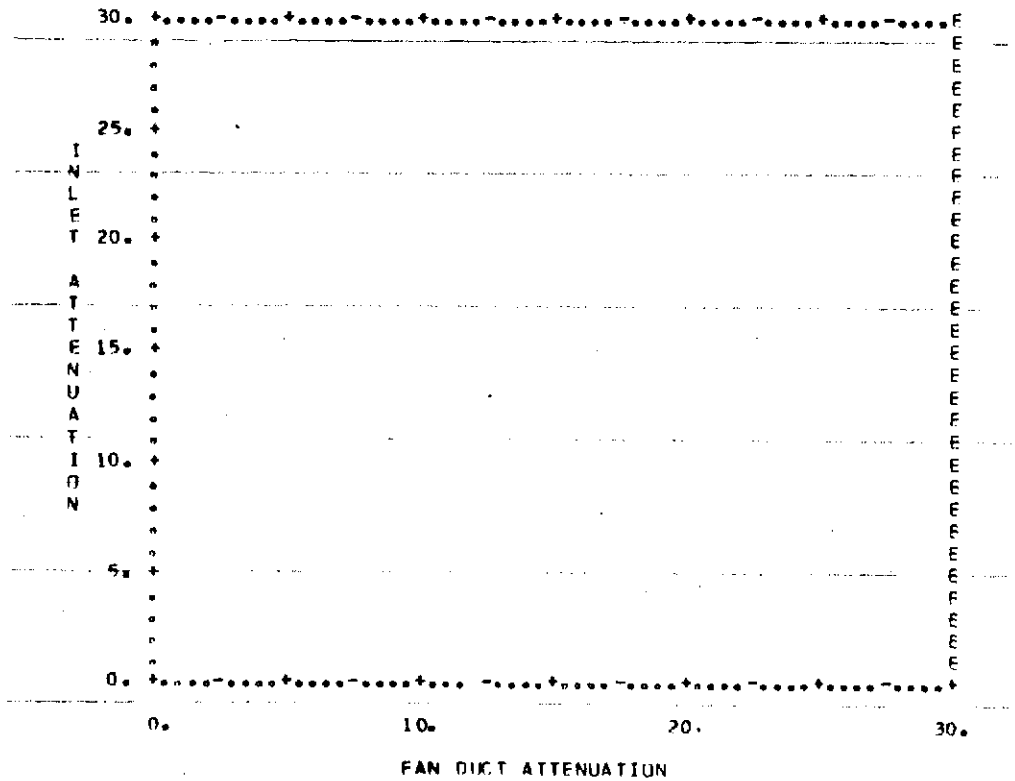

FAN HARMONIC = 5.0		DELTA EPNL = 10.0				
INLET HARMONIC =		A	B	C	D	E
		0	5	10	20	30
INLET	FAN	FAN	FAN	FAN	FAN	FAN
FUND.	FUND.	FUND.	FUND.	FUND.	FUND.	FUND.
1.00	*****	*****	*****	*****	*****	*****
2.00	*****	*****	*****	*****	*****	*****
3.00	*****	*****	*****	*****	*****	*****
4.00	*****	*****	*****	*****	*****	*****
5.00	*****	*****	*****	*****	*****	*****
6.00	*****	*****	*****	*****	*****	*****
7.00	*****	*****	*****	*****	*****	*****
8.00	*****	*****	*****	*****	*****	*****
9.00	*****	*****	*****	*****	*****	*****
10.00	*****	*****	*****	*****	*****	*****
11.00	*****	*****	*****	*****	*****	*****
12.00	*****	*****	*****	*****	*****	*****
13.00	*****	*****	*****	*****	*****	*****
14.00	*****	*****	*****	*****	*****	*****
15.00	*****	*****	*****	*****	*****	*****
16.00	*****	*****	*****	*****	*****	*****
17.00	*****	*****	*****	*****	*****	*****
18.00	*****	*****	*****	*****	*****	*****
19.00	*****	*****	*****	*****	*****	*****
20.00	*****	*****	*****	*****	*****	*****
21.00	*****	*****	*****	*****	*****	*****
22.00	*****	*****	*****	*****	*****	*****
23.00	*****	*****	*****	*****	*****	*****
24.00	*****	*****	*****	*****	*****	*****
25.00	*****	*****	*****	*****	*****	*****
26.00	*****	*****	*****	*****	*****	*****
27.00	*****	*****	*****	*****	*****	*****
28.00	*****	*****	*****	*****	*****	*****
29.00	*****	*****	*****	*****	*****	*****
30.00	*****	*****	*****	*****	*****	*****

DELTA EPNL = 10.0 FAN HARMONIC = 10.0
 INLET HARMONIC (A = 0, B = 5, C = 10, D = 20, E = 30)
 T/O, WITH TONE, 2.5 JET ATT, NO TURB, EPNL = 102.56, RUN 12A

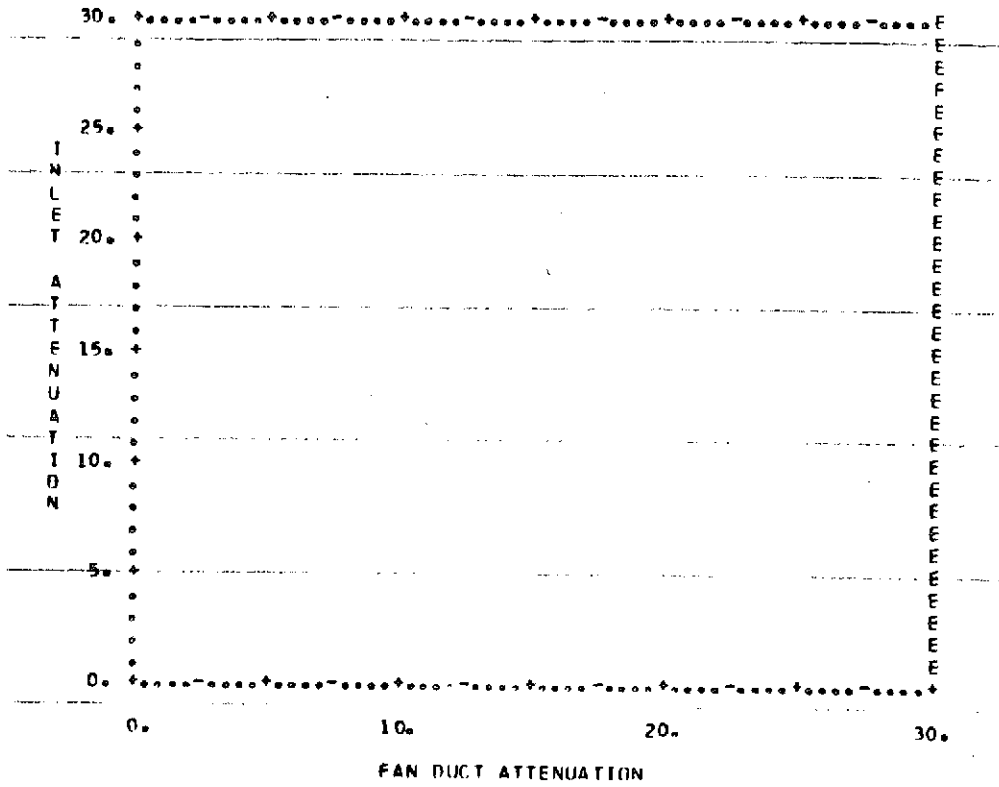

FAN HARMONIC = 10.0		DELTA EPNL = 10.0				
INLET HARMONIC =		A	B	C	D	F
		0	5	10	20	30
INLET	FUND.	FAN	FAN	FAN	FAN	FAN
	FUND.	FUND.	FUND.	FUND.	FUND.	FUND.
1.00	*****	*****	*****	*****	*****	*****
2.00	*****	*****	*****	*****	*****	*****
3.00	*****	*****	*****	*****	*****	*****
4.00	*****	*****	*****	*****	*****	*****
5.00	*****	*****	*****	*****	*****	*****
6.00	*****	*****	*****	*****	*****	*****
7.00	*****	*****	*****	*****	*****	*****
8.00	*****	*****	*****	*****	*****	*****
9.00	*****	*****	*****	*****	*****	*****
10.00	*****	*****	*****	*****	*****	*****
11.00	*****	*****	*****	*****	*****	*****
12.00	*****	*****	*****	*****	*****	*****
13.00	*****	*****	*****	*****	*****	*****
14.00	*****	*****	*****	*****	*****	*****
15.00	*****	*****	*****	*****	*****	*****
16.00	*****	*****	*****	*****	*****	*****
17.00	*****	*****	*****	*****	*****	*****
18.00	*****	*****	*****	*****	*****	*****
19.00	*****	*****	*****	*****	*****	*****
20.00	*****	*****	*****	*****	*****	*****
21.00	*****	*****	*****	*****	*****	*****
22.00	*****	*****	*****	*****	*****	*****
23.00	*****	*****	*****	*****	*****	*****
24.00	*****	*****	*****	*****	*****	*****
25.00	*****	*****	*****	*****	*****	*****
26.00	*****	*****	*****	*****	*****	*****
27.00	*****	*****	*****	*****	*****	*****
28.00	*****	*****	*****	*****	*****	*****
29.00	*****	*****	*****	*****	*****	*****
30.00	*****	*****	*****	*****	*****	*****

DELTA EPNL = 10.0 FAN HARMONIC = 20.0
 INLET HARMONIC (A = 0, B = 5, C = 10, D = 20, E = 30)
 T/O, WITH TONE, 2.5 JET ATT, NO TURB, EPNL = 102.56, RUN 12A

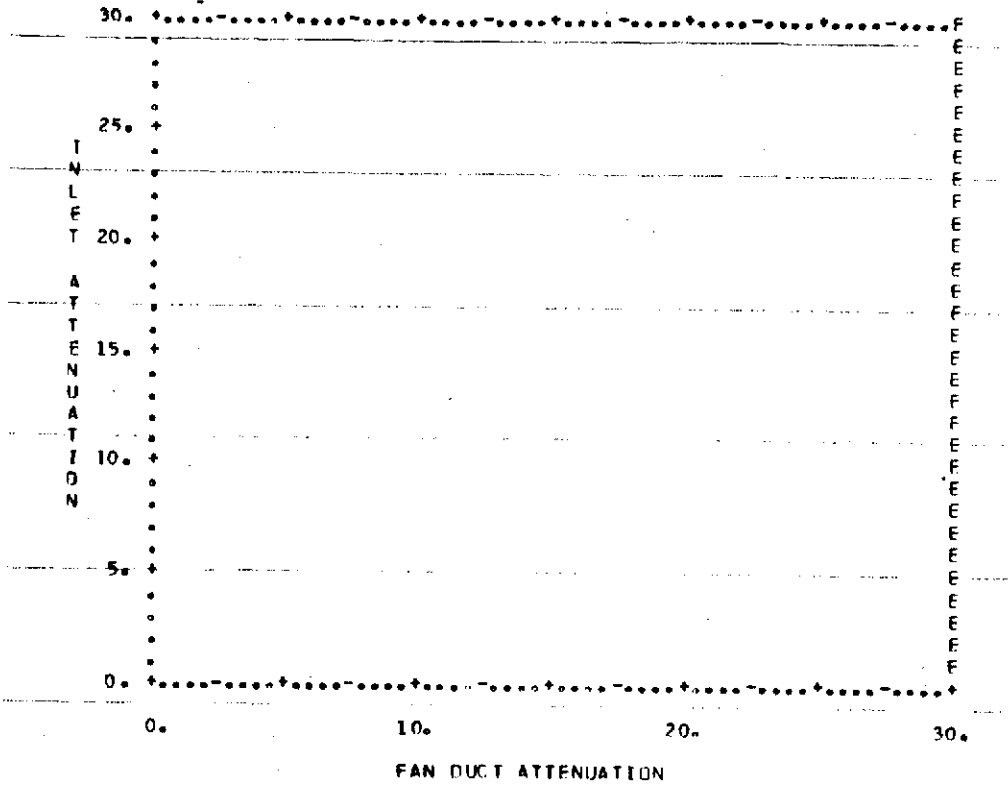

FAN HARMONIC = 20.0		DELTA EPNL = 10.0				
INLET HARMONIC =		A	B	C	D	E
		0	5	10	20	30
INLET FUND.	FAN FUND.	FAN FUND.	FAN FUND.	FAN FUND.	FAN FUND.	FAN FUND.
1.00	*****	*****	*****	*****	*****	*****
2.00	*****	*****	*****	*****	*****	*****
3.00	*****	*****	*****	*****	*****	*****
4.00	*****	*****	*****	*****	*****	*****
5.00	*****	*****	*****	*****	*****	*****
6.00	*****	*****	*****	*****	*****	*****
7.00	*****	*****	*****	*****	*****	*****
8.00	*****	*****	*****	*****	*****	*****
9.00	*****	*****	*****	*****	*****	*****
10.00	*****	*****	*****	*****	*****	*****
11.00	*****	*****	*****	*****	*****	*****
12.00	*****	*****	*****	*****	*****	*****
13.00	*****	*****	*****	*****	*****	*****
14.00	*****	*****	*****	*****	*****	*****
15.00	*****	*****	*****	*****	*****	*****
16.00	*****	*****	*****	*****	*****	*****
17.00	*****	*****	*****	*****	*****	*****
18.00	*****	*****	*****	*****	*****	*****
19.00	*****	*****	*****	*****	*****	*****
20.00	*****	*****	*****	*****	*****	*****
21.00	*****	*****	*****	*****	*****	*****
22.00	*****	*****	*****	*****	*****	*****
23.00	*****	*****	*****	*****	*****	*****
24.00	*****	*****	*****	*****	*****	*****
25.00	*****	*****	*****	*****	*****	*****
26.00	*****	*****	*****	*****	*****	*****
27.00	*****	*****	*****	*****	*****	*****
28.00	*****	*****	*****	*****	*****	*****
29.00	*****	*****	*****	*****	*****	*****
30.00	*****	*****	*****	*****	*****	*****

DELTA EPNL = 10.0 FAN HARMONIC = 30.0
 INLET HARMONIC (A = 0, B = 5, C = 10, D = 20, E = 30)
 T/0, WITH TONE, 2.5 JET ATT, NO TURB, EPNL = 102.56, RUN 12A

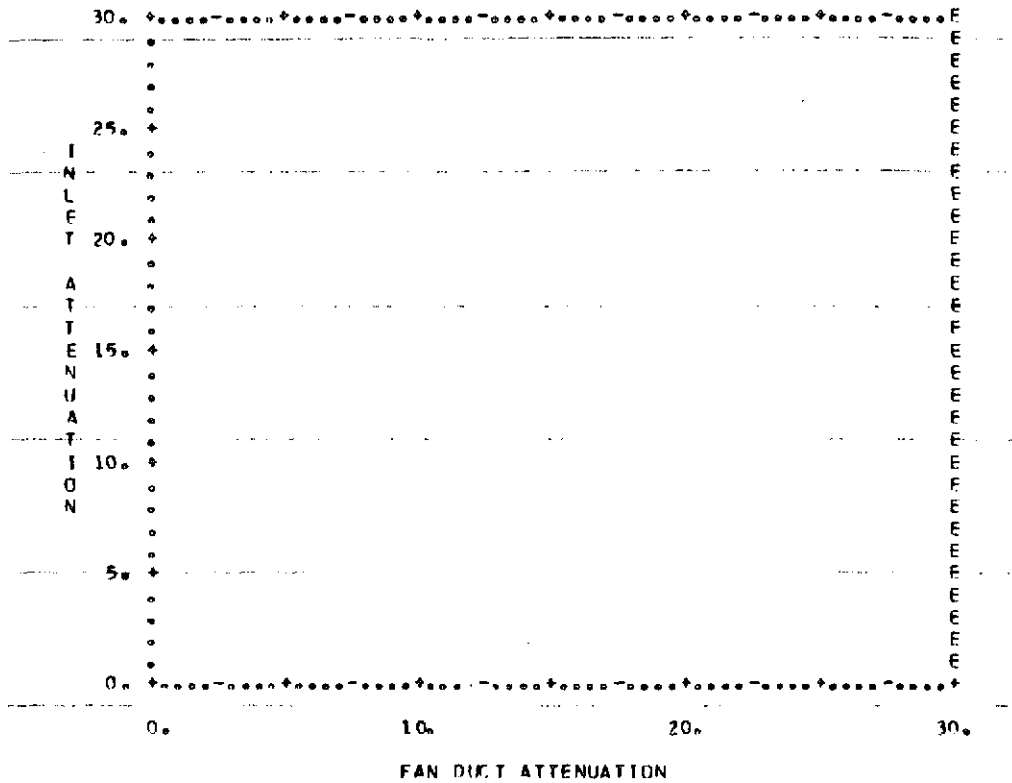

FAN HARMONIC = 30.0		DELTA EPNL = 10.0				
INLET HARMONIC =		A	B	C	D	E
		0	5	10	20	30
INLET FUND.	FAN FUND.	FAN FUND.	FAN FUND.	FAN FUND.	FAN FUND.	FAN FUND.
1.00	*****	*****	*****	*****	*****	*****
2.00	*****	*****	*****	*****	*****	*****
3.00	*****	*****	*****	*****	*****	*****
4.00	*****	*****	*****	*****	*****	*****
5.00	*****	*****	*****	*****	*****	*****
6.00	*****	*****	*****	*****	*****	*****
7.00	*****	*****	*****	*****	*****	*****
8.00	*****	*****	*****	*****	*****	*****
9.00	*****	*****	*****	*****	*****	*****
10.00	*****	*****	*****	*****	*****	*****
11.00	*****	*****	*****	*****	*****	*****
12.00	*****	*****	*****	*****	*****	*****
13.00	*****	*****	*****	*****	*****	*****
14.00	*****	*****	*****	*****	*****	*****
15.00	*****	*****	*****	*****	*****	*****
16.00	*****	*****	*****	*****	*****	*****
17.00	*****	*****	*****	*****	*****	*****
18.00	*****	*****	*****	*****	*****	*****
19.00	*****	*****	*****	*****	*****	*****
20.00	*****	*****	*****	*****	*****	*****
21.00	*****	*****	*****	*****	*****	*****
22.00	*****	*****	*****	*****	*****	*****
23.00	*****	*****	*****	*****	*****	*****
24.00	*****	*****	*****	*****	*****	*****
25.00	*****	*****	*****	*****	*****	*****
26.00	*****	*****	*****	*****	*****	*****
27.00	*****	*****	*****	*****	*****	*****
28.00	*****	*****	*****	*****	*****	*****
29.00	*****	*****	*****	*****	*****	*****
30.00	*****	*****	*****	*****	*****	*****

DELTA EFNL = 5.0 FAN HARMONIC = 0.0
 INLET HARMONIC (A = 0, B = 5, C = 10, D = 20, E = 30)
 T/C, WITH TCNE, 5. JET ATT, NO TURB, EPNL = 102.22, RUN-13A

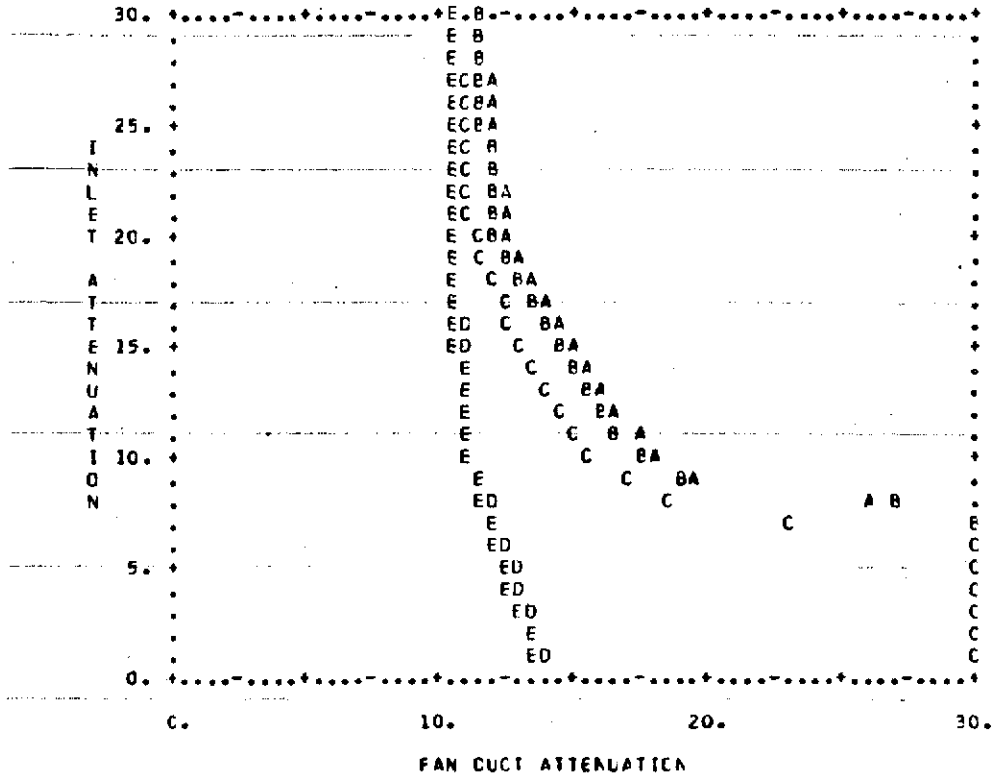

FAN HARMONIC = 0.0		DELTA EFNL = 5.0				
INLET HARMONIC =		A	B	C	D	E
		0	5	10	20	30
INLET FLND.	FAN FUND.	FAN FUND.	FAN FUND.	FAN FLND.	FAN FLND.	FAN FUND.
1.00	*****	*****	*****	*****	14.06	13.64
2.00	*****	*****	*****	*****	13.71	13.28
3.00	*****	*****	*****	*****	13.38	12.95
4.00	*****	*****	*****	*****	13.07	12.65
5.00	*****	*****	*****	*****	12.77	12.37
6.00	*****	*****	*****	*****	12.45	12.08
7.00	*****	*****	*****	22.86	12.14	11.80
8.00	26.22	27.18	18.48	11.83	11.53	11.53
9.00	19.55	19.03	16.90	11.53	11.28	11.28
10.00	19.02	17.33	15.51	11.24	11.04	11.04
11.00	17.31	16.63	14.95	11.16	10.97	10.97
12.00	16.64	15.98	14.44	11.08	10.91	10.91
13.00	16.01	15.37	13.95	11.01	10.85	10.85
14.00	15.41	14.80	13.50	10.93	10.79	10.79
15.00	14.85	14.26	13.08	10.86	10.73	10.73
16.00	14.33	13.76	12.68	10.79	10.68	10.68
17.00	13.83	13.28	12.30	10.72	10.62	10.62
18.00	13.35	12.82	11.95	10.66	10.56	10.56
19.00	12.90	12.39	11.62	10.59	10.51	10.51
20.00	12.47	11.99	11.30	10.52	10.45	10.45
21.00	12.37	11.93	11.23	10.52	10.45	10.45
22.00	12.26	11.87	11.16	10.51	10.45	10.45
23.00	12.16	11.82	11.09	10.51	10.44	10.44
24.00	12.06	11.76	11.02	10.50	10.44	10.44
25.00	11.96	11.71	10.94	10.49	10.44	10.44
26.00	11.87	11.65	10.87	10.49	10.44	10.44
27.00	11.77	11.60	10.80	10.48	10.43	10.43
28.00	11.68	11.54	10.72	10.48	10.43	10.43
29.00	11.59	11.49	10.65	10.47	10.43	10.43
30.00	11.50	11.44	10.58	10.46	10.42	10.42

DELTA EPNL = 5.0 FAN HARMONIC = 5.0
 INLET HARMONIC (A = 0, B = 5, C = 10, D = 20, E = 30)
 T/O, WITH TCNE,5. JET ATT, NO TURB, EPNL = 102.22, RUN-13A

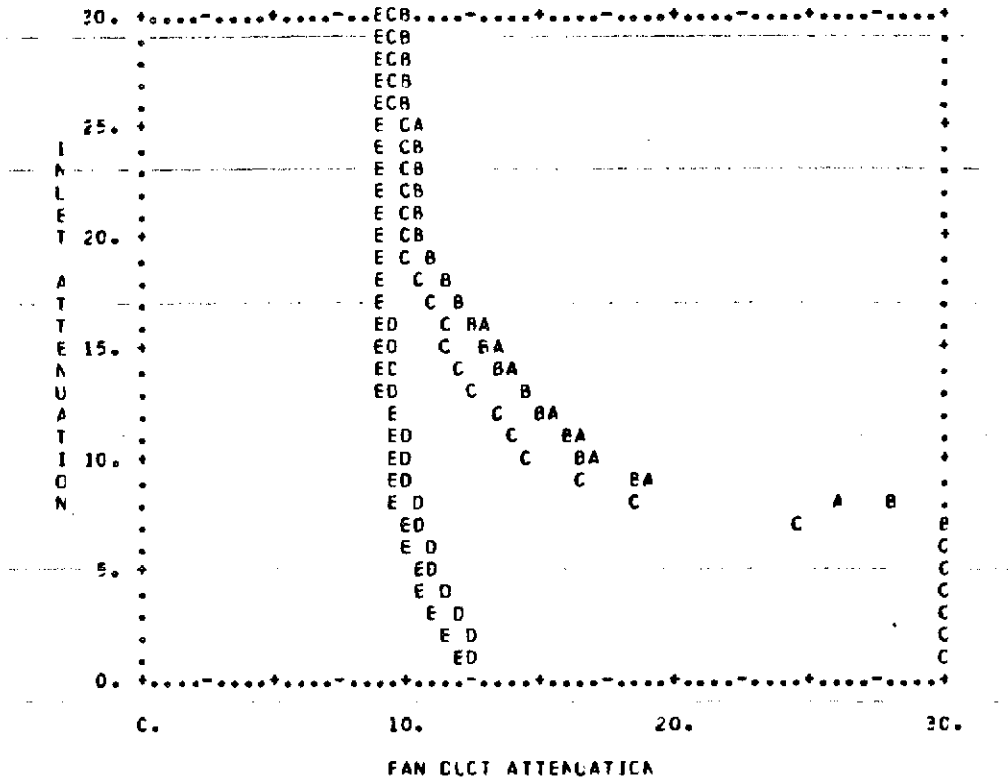

FAN HARMONIC = 5.0		DELTA EPNL = 5.0				
INLET HARMONIC =		A	B	C	D	E
		0	5	10	20	30
INLET FUND.	FAN FUND.	FAN FUND.	FAN FUND.	FAN FUND.	FAN FUND.	FAN FUND.
1.00	*****	*****	*****	*****	12.73	11.78
2.00	*****	*****	*****	*****	12.27	11.39
3.00	*****	*****	*****	*****	11.85	11.04
4.00	*****	*****	*****	*****	11.47	10.72
5.00	*****	*****	*****	*****	11.11	10.42
6.00	*****	*****	*****	*****	10.83	10.11
7.00	*****	*****	*****	24.39	10.57	9.88
8.00	26.15	27.86	18.30	10.31	9.70	9.70
9.00	19.03	18.73	16.32	10.07	9.53	9.53
10.00	17.16	16.65	14.56	9.90	9.37	9.37
11.00	16.30	15.79	13.90	9.80	9.33	9.33
12.00	15.45	15.01	13.29	9.70	9.29	9.29
13.00	14.74	14.29	12.73	9.60	9.25	9.25
14.00	14.04	13.63	12.21	9.51	9.21	9.21
15.00	13.38	13.02	11.74	9.42	9.16	9.16
16.00	12.76	12.45	11.30	9.33	9.12	9.12
17.00	12.18	11.92	10.89	9.25	9.08	9.08
18.00	11.63	11.43	10.51	9.16	9.04	9.04
19.00	11.11	10.97	10.16	9.08	9.00	9.00
20.00	10.62	10.53	9.87	9.00	8.96	8.96
21.00	10.54	10.47	9.85	9.00	8.96	8.96
22.00	10.47	10.40	9.82	8.99	8.96	8.96
23.00	10.39	10.33	9.80	8.99	8.95	8.95
24.00	10.32	10.27	9.78	8.98	8.95	8.95
25.00	10.25	10.20	9.76	8.97	8.94	8.94
26.00	10.18	10.14	9.73	8.97	8.94	8.94
27.00	10.12	10.08	9.71	8.96	8.93	8.93
28.00	10.05	10.01	9.69	8.96	8.93	8.93
29.00	9.99	9.97	9.67	8.95	8.93	8.93
30.00	9.95	9.92	9.65	8.94	8.92	8.92

DELTA EPNL = 5.0 FAN HARMONIC = 10.0
 INLET HARMONIC (A = 0, B = 5, C = 10, D = 20, E = 30)
 1/0, WITH ICNE.5. JET ATT, NO TURE, EPNL = 102.22, RUN-13A

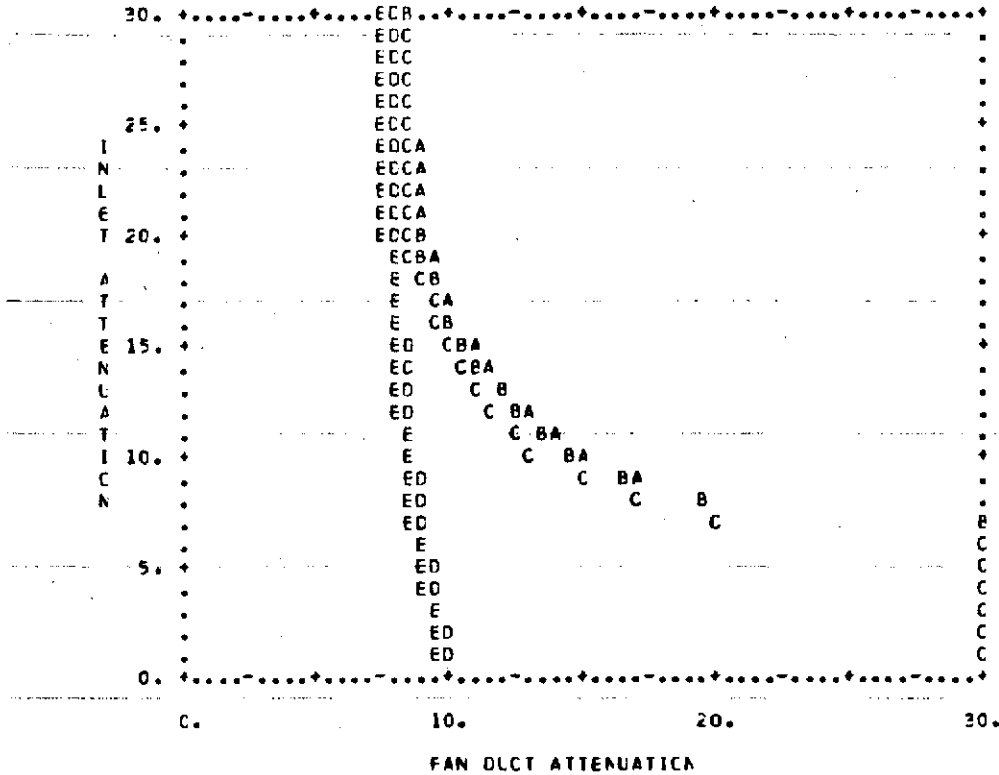

FAN HARMONIC = 10.0		DELTA EPNL = 5.0				
INLET HARMONIC =		A	B	C	D	E
		0	5	10	20	30
INLET	FAN	FAN	FAN	FAN	FAN	FAN
FUND.	FUND.	FUND.	FUND.	FUND.	FUND.	FUND.
1.00	*****	*****	*****	9.99	9.64	
2.00	*****	*****	*****	9.84	9.46	
3.00	*****	*****	*****	9.69	9.28	
4.00	*****	*****	*****	9.54	9.10	
5.00	*****	*****	*****	9.40	8.92	
6.00	*****	*****	*****	9.24	8.79	
7.00	*****	*****	19.82	9.08	8.68	
8.00	19.29	19.39	17.19	8.92	8.56	
9.00	16.95	16.69	14.99	8.75	8.45	
10.00	14.84	14.37	13.14	8.59	8.35	
11.00	13.87	13.45	12.30	8.52	8.28	
12.00	12.99	12.62	11.56	8.46	8.21	
13.00	12.20	11.87	10.89	8.39	8.15	
14.00	11.48	11.19	10.30	8.33	8.08	
15.00	10.82	10.56	9.86	8.27	8.02	
16.00	10.22	9.99	9.56	8.21	7.96	
17.00	9.82	9.68	9.27	8.15	7.90	
18.00	9.53	9.37	9.00	8.10	7.85	
19.00	9.25	9.07	8.73	8.04	7.79	
20.00	9.00	8.78	8.47	7.99	7.73	
21.00	8.95	8.75	8.44	7.98	7.73	
22.00	8.90	8.71	8.42	7.98	7.73	
23.00	8.85	8.68	8.39	7.98	7.73	
24.00	8.80	8.65	8.37	7.97	7.72	
25.00	8.74	8.62	8.34	7.97	7.72	
26.00	8.65	8.58	8.32	7.97	7.72	
27.00	8.64	8.55	8.30	7.96	7.72	
28.00	8.55	8.52	8.27	7.96	7.72	
29.00	8.54	8.49	8.25	7.96	7.72	
30.00	8.48	8.46	8.23	7.96	7.72	

DELTA EPAL = 5.0 FAN HARMONIC = 20.0
 INLET HARMONIC (A = 0, B = 5, C = 10, D = 20, E = 30)
 T/O, WITH TCNE, 5. JET ATT, NO TURB, EPAL = 102.22, RUA-13A

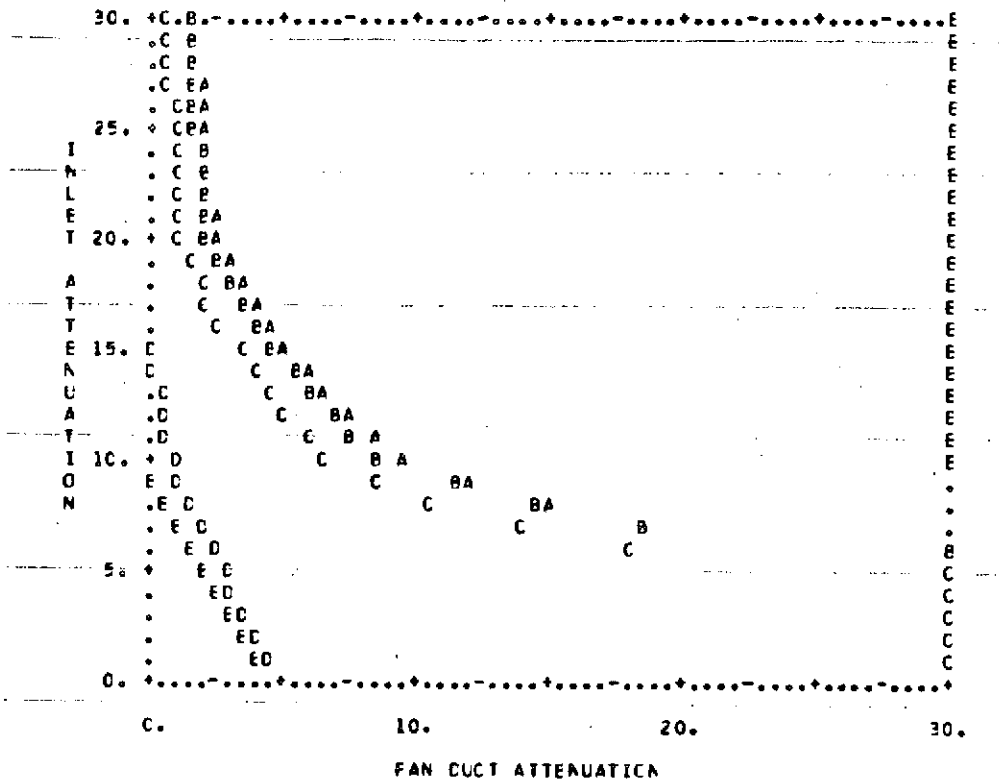

INLET HARMONIC =	DELTA EPAL = 5.0				
	A	B	C	D	E
FAN HARMONIC =	5	10	20	30	
INLET FREQ.	FAN FUND.	FAN FUND.	FAN FUND.	FAN FUND.	FAN FUND.
1.00	*****	*****	*****	4.64	3.93
2.00	*****	*****	*****	4.15	3.40
3.00	*****	*****	*****	3.67	2.91
4.00	*****	*****	*****	3.22	2.47
5.00	*****	*****	*****	2.79	2.06
6.00	*****	*****	10.13	2.37	1.58
7.00	18.27	18.64	13.83	1.97	1.10
8.00	14.85	14.60	10.38	1.57	0.62
9.00	11.58	11.31	8.26	1.19	0.14
10.00	9.57	8.72	6.54	0.82	*****
11.00	8.48	7.75	5.83	0.67	*****
12.00	7.49	6.87	5.15	0.52	*****
13.00	6.60	6.06	4.48	0.38	*****
14.00	5.80	5.33	3.84	0.23	*****
15.00	5.06	4.67	3.26	0.09	*****
16.00	4.44	4.06	2.72	*****	*****
17.00	3.87	3.49	2.23	*****	*****
18.00	3.34	2.96	1.77	*****	*****
19.00	2.84	2.45	1.35	*****	*****
20.00	2.37	1.96	0.96	*****	*****
21.00	2.29	1.92	0.93	*****	*****
22.00	2.20	1.87	0.90	*****	*****
23.00	2.12	1.82	0.87	*****	*****
24.00	2.03	1.78	0.83	*****	*****
25.00	1.94	1.73	0.80	*****	*****
26.00	1.85	1.68	0.77	*****	*****
27.00	1.76	1.63	0.73	*****	*****
28.00	1.67	1.58	0.70	*****	*****
29.00	1.58	1.53	0.67	*****	*****
30.00	1.48	1.48	0.63	*****	*****

DELTA EFNL = 5.0 FAN HARMONIC = 30.0
 INLET HARMONIC (A = 0, B = 5, C = 10, D = 20, E = 30)
 1/3, WITH TCNE,5. JET ATT, NO TURB, EPAL = 102.22, RUN-13A.

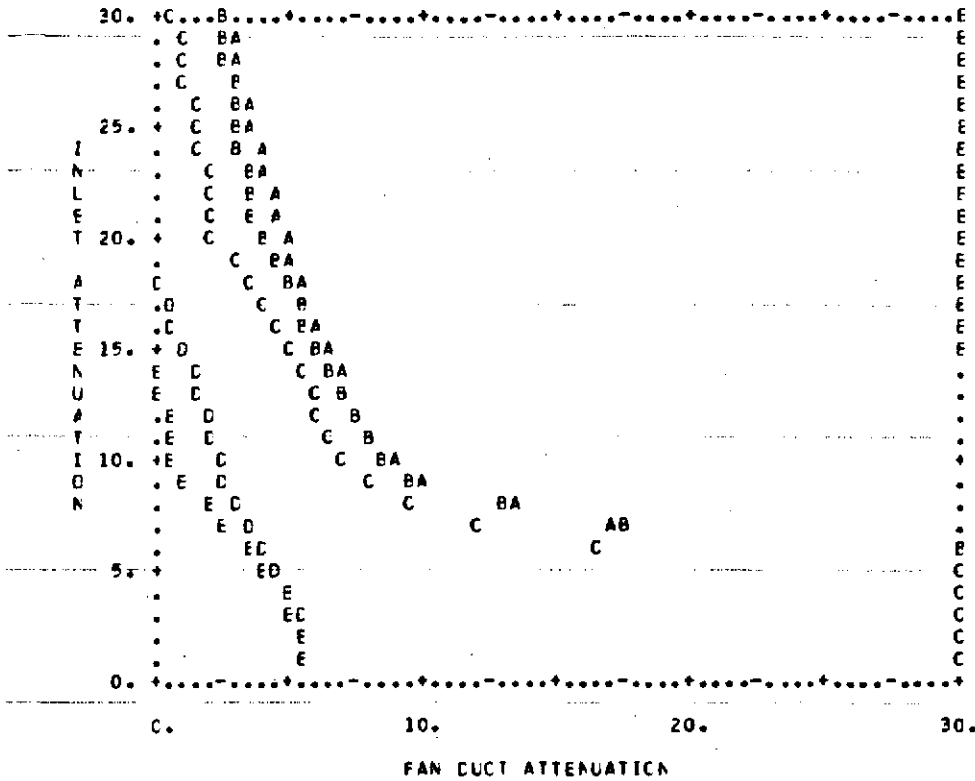

INLET HARMONIC	FAN HARMONIC = 30.0				
	A	B	C	D	E
	0	5	10	20	30
INLET FUND.	FAN FUND.	FAN FUND.	FAN FUND.	FAN FUND.	FAN FUND.
1.00	*****	*****	*****	5.74	5.66
2.00	*****	*****	*****	5.51	5.41
3.00	*****	*****	*****	5.28	5.17
4.00	*****	*****	*****	5.07	4.81
5.00	*****	*****	*****	4.63	4.15
6.00	*****	*****	16.25	4.13	3.31
7.00	17.14	17.28	11.89	3.65	2.54
8.00	13.25	12.86	9.36	3.18	1.81
9.00	9.95	9.69	8.11	2.73	1.14
10.00	8.78	8.35	6.57	2.30	0.51
11.00	8.20	7.82	6.52	2.05	0.39
12.00	7.68	7.33	6.11	1.80	0.27
13.00	7.22	6.89	5.75	1.54	0.14
14.00	6.80	6.47	5.43	1.27	0.03
15.00	6.42	6.09	5.14	1.00	*****
16.00	6.07	5.74	4.67	0.72	*****
17.00	5.75	5.41	4.03	0.44	*****
18.00	5.45	5.10	3.40	0.15	*****
19.00	5.18	4.52	2.80	*****	*****
20.00	4.80	3.82	2.22	*****	*****
21.00	4.56	3.67	2.08	*****	*****
22.00	4.33	3.53	1.94	*****	*****
23.00	4.10	3.38	1.80	*****	*****
24.00	3.87	3.24	1.65	*****	*****
25.00	3.64	3.09	1.49	*****	*****
26.00	3.42	2.95	1.32	*****	*****
27.00	3.19	2.80	1.15	*****	*****
28.00	2.97	2.66	0.96	*****	*****
29.00	2.75	2.51	0.77	*****	*****
30.00	2.53	2.37	0.56	*****	*****

DELTA EPNL = 10.0 FAN HARMONIC = 0.0
 INLET HARMONIC (A = 0, B = 5, C = 10, D = 20, E = 30)
 T/O, WITH TCNE,5. JET ATT, NO TURB, EPNL = 102.22, RUN-13A

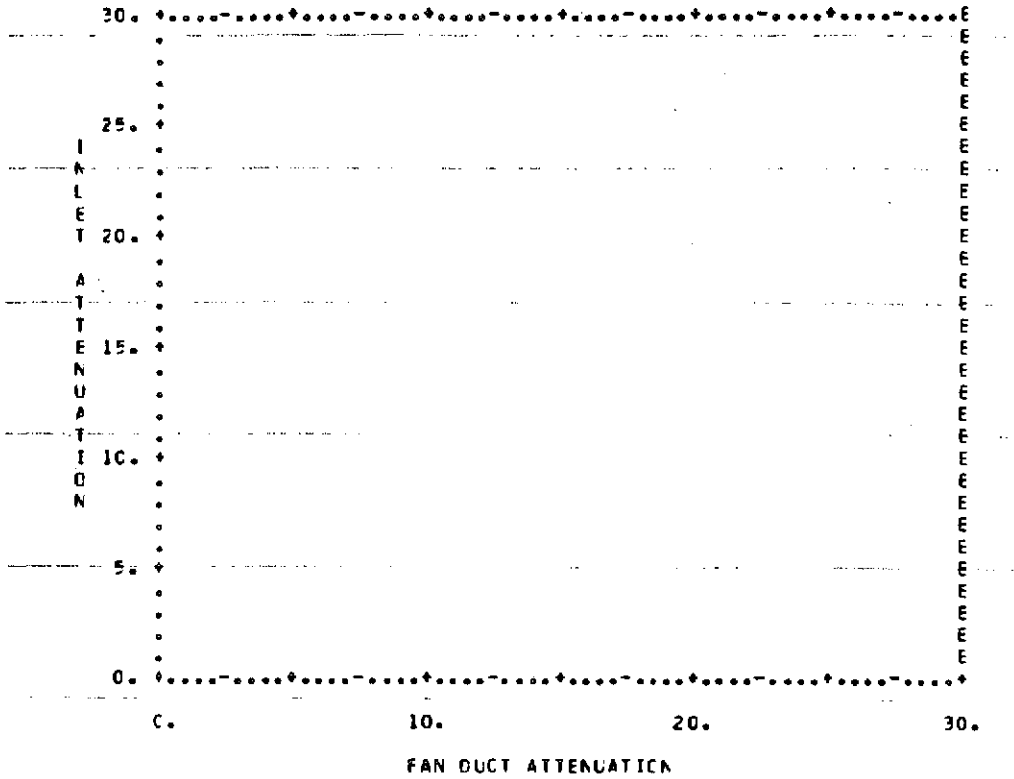

FAN HARMONIC = 0.0		DELTA EPNL = 10.0				
INLET HARMONIC =		A	B	C	D	E
		0	5	10	20	30
INLET FUND.	FAN FUND.	FAN FUND.	FAN FUND.	FAN FLNC.	FAN FUND.	FAN FUND.
1.00	*****	*****	*****	*****	*****	*****
2.00	*****	*****	*****	*****	*****	*****
3.00	*****	*****	*****	*****	*****	*****
4.00	*****	*****	*****	*****	*****	*****
5.00	*****	*****	*****	*****	*****	*****
6.00	*****	*****	*****	*****	*****	*****
7.00	*****	*****	*****	*****	*****	*****
8.00	*****	*****	*****	*****	*****	*****
9.00	*****	*****	*****	*****	*****	*****
10.00	*****	*****	*****	*****	*****	*****
11.00	*****	*****	*****	*****	*****	*****
12.00	*****	*****	*****	*****	*****	*****
13.00	*****	*****	*****	*****	*****	*****
14.00	*****	*****	*****	*****	*****	*****
15.00	*****	*****	*****	*****	*****	*****
16.00	*****	*****	*****	*****	*****	*****
17.00	*****	*****	*****	*****	*****	*****
18.00	*****	*****	*****	*****	*****	*****
19.00	*****	*****	*****	*****	*****	*****
20.00	*****	*****	*****	*****	*****	*****
21.00	*****	*****	*****	*****	*****	*****
22.00	*****	*****	*****	*****	*****	*****
23.00	*****	*****	*****	*****	*****	*****
24.00	*****	*****	*****	*****	*****	*****
25.00	*****	*****	*****	*****	*****	*****
26.00	*****	*****	*****	*****	*****	*****
27.00	*****	*****	*****	*****	*****	*****
28.00	*****	*****	*****	*****	*****	*****
29.00	*****	*****	*****	*****	*****	*****
30.00	*****	*****	*****	*****	*****	*****

DELTA EPNL = 10.0 FAN HARMONIC = 5.0
 INLET HARMONIC (A = 0, B = 5, C = 10, D = 20, E = 30)
 T/C, WITH TONE, 5. JET ATT, NO TURB, EPAL = 102.22, RUN-13A

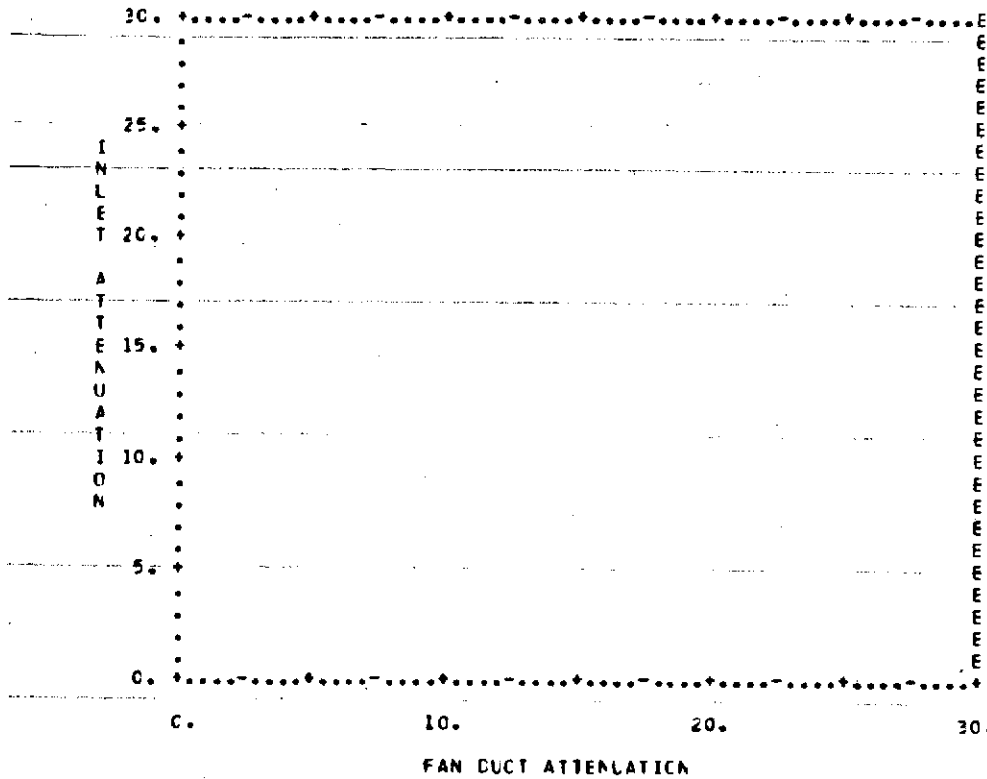

INLET FUND.	FAN HARMONIC = 5.0		DELTA EPNL = 10.0		
	A C	B 5	C 10	D 20	E 30
	FAN FUND.	FAN FUND.	FAN FUND.	FAN FUND.	FAN FUND.
1.00	*****	*****	*****	*****	*****
2.00	*****	*****	*****	*****	*****
3.00	*****	*****	*****	*****	*****
4.00	*****	*****	*****	*****	*****
5.00	*****	*****	*****	*****	*****
6.00	*****	*****	*****	*****	*****
7.00	*****	*****	*****	*****	*****
8.00	*****	*****	*****	*****	*****
9.00	*****	*****	*****	*****	*****
10.00	*****	*****	*****	*****	*****
11.00	*****	*****	*****	*****	*****
12.00	*****	*****	*****	*****	*****
13.00	*****	*****	*****	*****	*****
14.00	*****	*****	*****	*****	*****
15.00	*****	*****	*****	*****	*****
16.00	*****	*****	*****	*****	*****
17.00	*****	*****	*****	*****	*****
18.00	*****	*****	*****	*****	*****
19.00	*****	*****	*****	*****	*****
20.00	*****	*****	*****	*****	*****
21.00	*****	*****	*****	*****	*****
22.00	*****	*****	*****	*****	*****
23.00	*****	*****	*****	*****	*****
24.00	*****	*****	*****	*****	*****
25.00	*****	*****	*****	*****	*****
26.00	*****	*****	*****	*****	*****
27.00	*****	*****	*****	*****	*****
28.00	*****	*****	*****	*****	*****
29.00	*****	*****	*****	*****	*****
30.00	*****	*****	*****	*****	*****

DELTA EFNL = 10.0 FAN HARMONIC = 10.0
 INLET HARMONIC (A = 0, B = 5, C = 10, D = 20, E = 30)
 1/C; WITH ICNE,5. JET ATT, NO TURB, EPAL = 102.22, RUN-13A

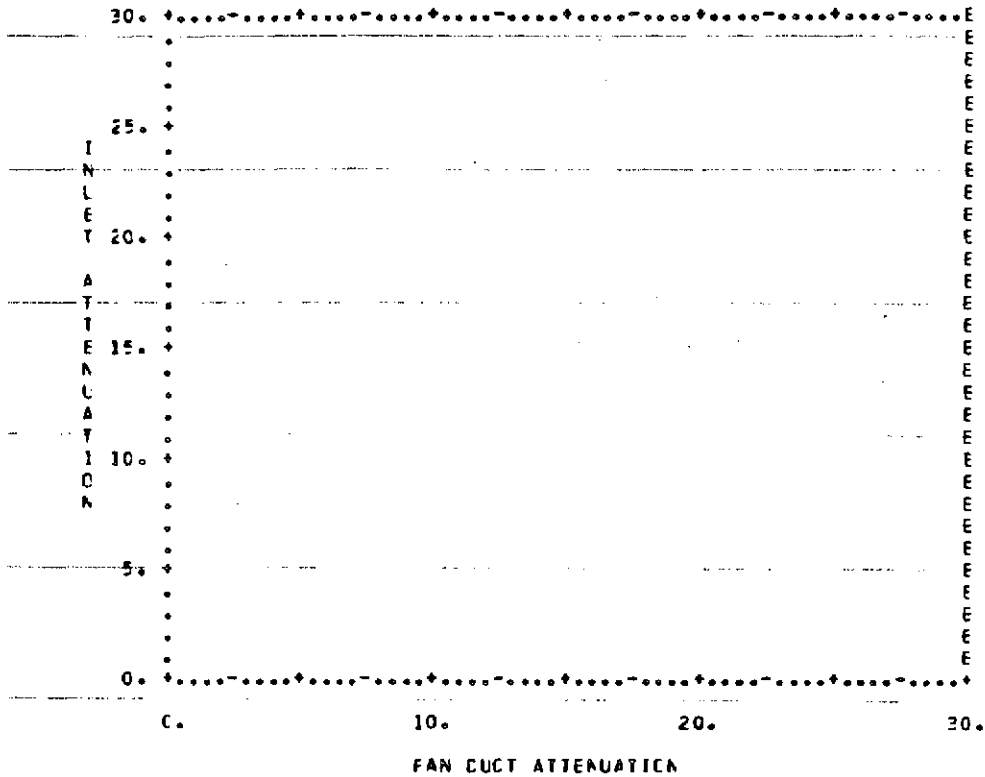

FAN HARMONIC = 10.0		DELTA EFNL = 10.0				
INLET HARMONIC =		A	B	C	D	E
		C	5	10	20	30
INLET FUND.	FAN FUND.	FAN FUND.	FAN FUND.	FAN FUND.	FAN FUND.	FAN FUND.
1.00	*****	*****	*****	*****	*****	*****
2.00	*****	*****	*****	*****	*****	*****
3.00	*****	*****	*****	*****	*****	*****
4.00	*****	*****	*****	*****	*****	*****
5.00	*****	*****	*****	*****	*****	*****
6.00	*****	*****	*****	*****	*****	*****
7.00	*****	*****	*****	*****	*****	*****
8.00	*****	*****	*****	*****	*****	*****
9.00	*****	*****	*****	*****	*****	*****
10.00	*****	*****	*****	*****	*****	*****
11.00	*****	*****	*****	*****	*****	*****
12.00	*****	*****	*****	*****	*****	*****
13.00	*****	*****	*****	*****	*****	*****
14.00	*****	*****	*****	*****	*****	*****
15.00	*****	*****	*****	*****	*****	*****
16.00	*****	*****	*****	*****	*****	*****
17.00	*****	*****	*****	*****	*****	*****
18.00	*****	*****	*****	*****	*****	*****
19.00	*****	*****	*****	*****	*****	*****
20.00	*****	*****	*****	*****	*****	*****
21.00	*****	*****	*****	*****	*****	*****
22.00	*****	*****	*****	*****	*****	*****
23.00	*****	*****	*****	*****	*****	*****
24.00	*****	*****	*****	*****	*****	*****
25.00	*****	*****	*****	*****	*****	*****
26.00	*****	*****	*****	*****	*****	*****
27.00	*****	*****	*****	*****	*****	*****
28.00	*****	*****	*****	*****	*****	*****
29.00	*****	*****	*****	*****	*****	*****
30.00	*****	*****	*****	*****	*****	*****

DELTA EPNL = 10.0 FAN HARMONIC = 20.0
 INLET HARMONIC (A = 0, B = 5, C = 10, D = 20, E = 30)
 T/O, WITH TCNE,5. JET ATT, NO TURB, EPNL = 102.22, RUN-13A

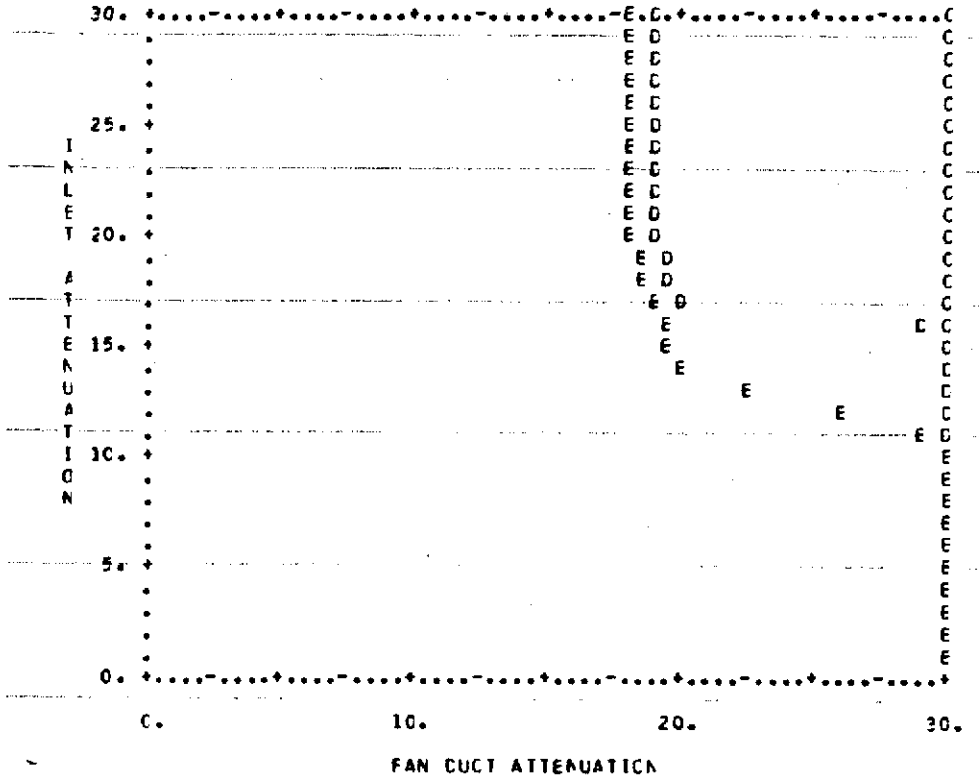

INLET HARMONIC =	FAN HARMONIC = 20.0		DELTA EPNL = 10.0		
	A C	B 5	C 10	D 20	E 30
	INLET FUND.	FAN FUND.	FAN FUND.	FAN FUND.	FAN FUND.
1.00	*****	*****	*****	*****	*****
2.00	*****	*****	*****	*****	*****
3.00	*****	*****	*****	*****	*****
4.00	*****	*****	*****	*****	*****
5.00	*****	*****	*****	*****	*****
6.00	*****	*****	*****	*****	*****
7.00	*****	*****	*****	*****	*****
8.00	*****	*****	*****	*****	*****
9.00	*****	*****	*****	*****	*****
10.00	*****	*****	*****	*****	*****
11.00	*****	*****	*****	*****	29.18
12.00	*****	*****	*****	*****	26.16
13.00	*****	*****	*****	*****	22.42
14.00	*****	*****	*****	*****	19.86
15.00	*****	*****	*****	*****	19.57
16.00	*****	*****	*****	20.93	19.28
17.00	*****	*****	*****	20.00	19.00
18.00	*****	*****	*****	19.62	18.72
19.00	*****	*****	*****	19.25	18.46
20.00	*****	*****	*****	18.90	18.20
21.00	*****	*****	*****	18.89	18.20
22.00	*****	*****	*****	18.88	18.20
23.00	*****	*****	*****	18.88	18.20
24.00	*****	*****	*****	18.87	18.20
25.00	*****	*****	*****	18.86	18.20
26.00	*****	*****	*****	18.85	18.20
27.00	*****	*****	*****	18.85	18.20
28.00	*****	*****	*****	18.84	18.20
29.00	*****	*****	*****	18.83	18.19
30.00	*****	*****	*****	18.82	18.19

DELTA EFNL = 10.0 FAN HARMONIC = 30.0
 INLET HARMONIC (A = 0, B = 5, C = 10, D = 20, E = 30)
 T/O, WITH TCNE, S. JET ATT, NO TURB, EPNL = 102.22, RUN-13A

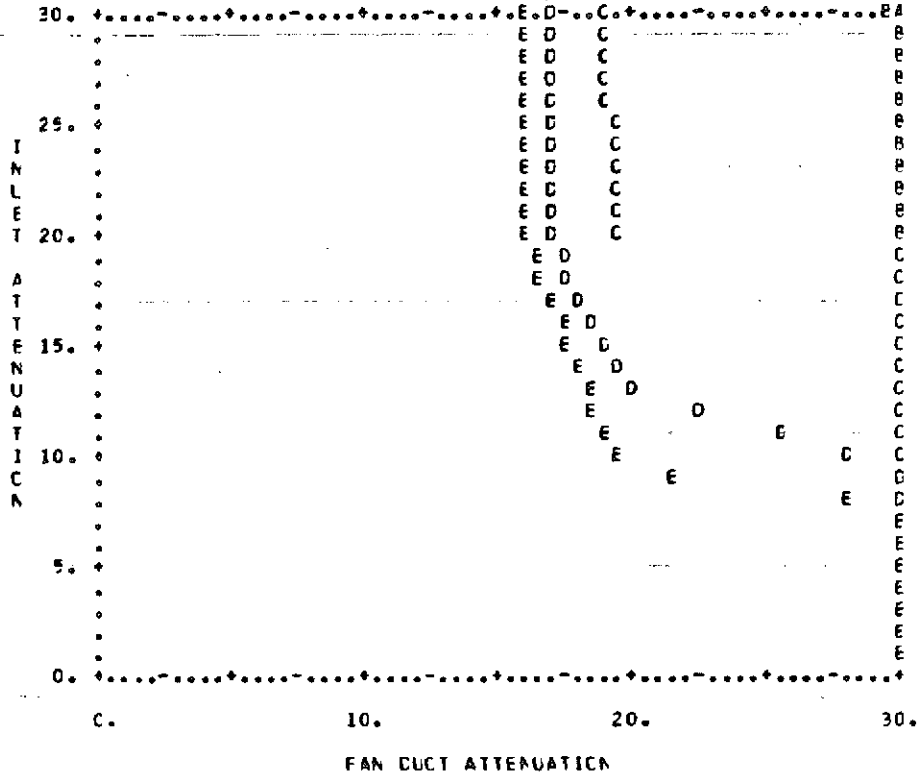

FAN HARMONIC = 30.0 DELTA EFNL = 10.0

INLET HARMONIC =	A	B	C	D	E
	0	5	10	20	30
	INLET	FAN	FAN	FAN	FAN
	FUND.	FUND.	FUND.	FUND.	FUND.
1.00	*****	*****	*****	*****	*****
2.00	*****	*****	*****	*****	*****
3.00	*****	*****	*****	*****	*****
4.00	*****	*****	*****	*****	*****
5.00	*****	*****	*****	*****	*****
6.00	*****	*****	*****	*****	*****
7.00	*****	*****	*****	*****	*****
8.00	*****	*****	*****	*****	27.77
9.00	*****	*****	*****	*****	21.47
10.00	*****	*****	*****	27.95	19.26
11.00	*****	*****	*****	25.42	18.92
12.00	*****	*****	*****	22.53	18.59
13.00	*****	*****	*****	19.89	18.26
14.00	*****	*****	*****	19.40	17.94
15.00	*****	*****	*****	18.94	17.62
16.00	*****	*****	*****	18.50	17.31
17.00	*****	*****	*****	18.07	17.01
18.00	*****	*****	*****	17.66	16.71
19.00	*****	*****	*****	17.27	16.42
20.00	*****	*****	19.63	16.88	16.13
21.00	*****	*****	19.56	16.88	16.13
22.00	*****	*****	19.50	16.88	16.13
23.00	*****	*****	19.43	16.88	16.13
24.00	*****	*****	19.37	16.88	16.13
25.00	*****	*****	19.30	16.88	16.13
26.00	*****	*****	19.24	16.88	16.13
27.00	*****	*****	19.18	16.88	16.13
28.00	*****	*****	19.11	16.88	16.13
29.00	*****	*****	19.05	16.88	16.13
30.00	*****	29.52	18.99	16.88	16.13

DELTA EPNL = 5.0 FAN HARMONIC = 0.0
 INLET HARMONIC (A = 0, B = 5, C = 10, D = 20, E = 30)
 T/D, WITH TONE, 7.5 JET ATT, NO TURB, EPNL = 101.98, RUN-14A

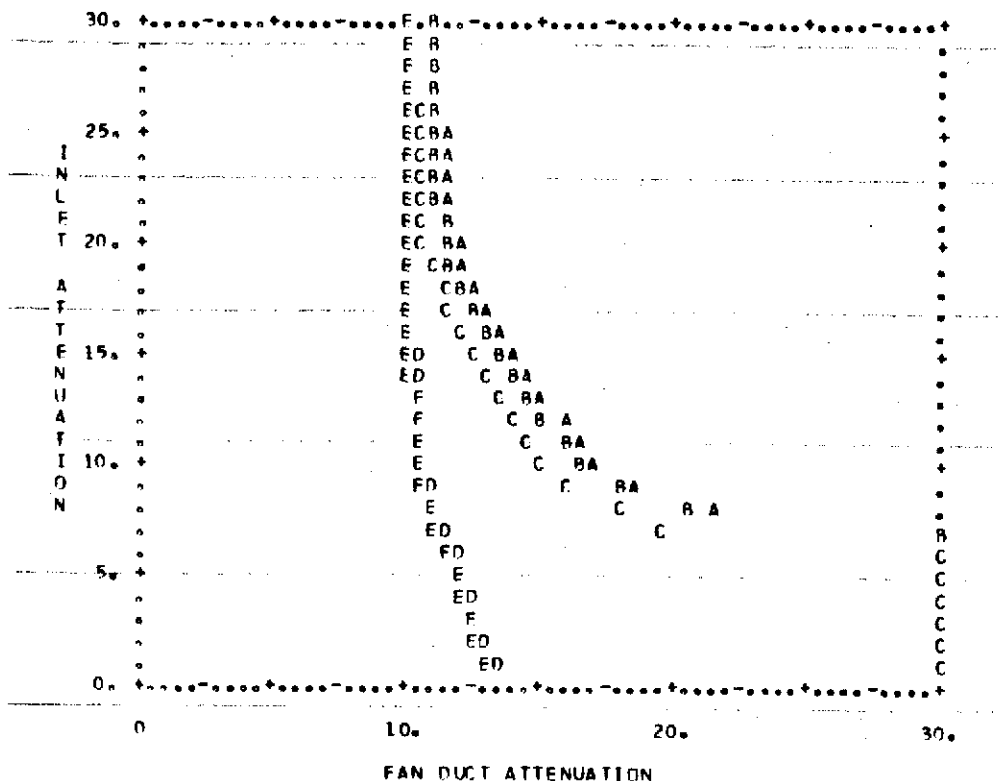

INLET HARMONIC	DELTA EPNL = 5.0				
	A = 0	B = 5	C = 10	D = 20	E = 30
1.00	*****	*****	*****	13.31	12.88
2.00	*****	*****	*****	12.98	12.57
3.00	*****	*****	*****	12.66	12.28
4.00	*****	*****	*****	12.37	12.01
5.00	*****	*****	*****	12.09	11.76
6.00	*****	*****	*****	11.79	11.47
7.00	30.30	*****	19.55	11.48	11.19
8.00	21.59	20.43	17.79	11.19	10.92
9.00	18.68	18.13	16.24	10.91	10.68
10.00	17.17	16.49	14.88	10.63	10.44
11.00	16.46	15.81	14.31	10.56	10.39
12.00	15.80	15.18	13.79	10.49	10.34
13.00	15.19	14.59	13.31	10.43	10.29
14.00	14.61	14.04	12.86	10.36	10.24
15.00	14.07	13.52	12.45	10.30	10.18
16.00	13.57	13.04	12.06	10.23	10.14
17.00	13.09	12.58	11.70	10.17	10.09
18.00	12.64	12.15	11.36	10.11	10.04
19.00	12.21	11.74	11.04	10.06	9.99
20.00	11.81	11.36	10.74	10.00	9.94
21.00	11.41	11.00	10.47	9.94	9.94
22.00	11.01	10.64	10.20	9.98	9.93
23.00	10.61	10.28	9.93	9.97	9.92
24.00	10.21	9.92	9.67	9.97	9.92
25.00	9.81	9.56	9.41	9.96	9.91
26.00	9.41	9.20	9.15	9.95	9.91
27.00	9.01	8.84	8.89	9.94	9.90
28.00	8.61	8.45	8.51	9.93	9.90
29.00	8.21	8.09	8.15	9.92	9.89
30.00	7.81	7.74	7.80	9.91	9.88

DELTA EPNL = 5.0 FAN HARMONIC = 5.0
 INLET HARMONIC (A = 0, B = 5, C = 10, D = 20, E = 30)
 T/D, WITH TONE, 7.5 JET ATT, NO TURB, EPNL = 101.98, RUN-14A

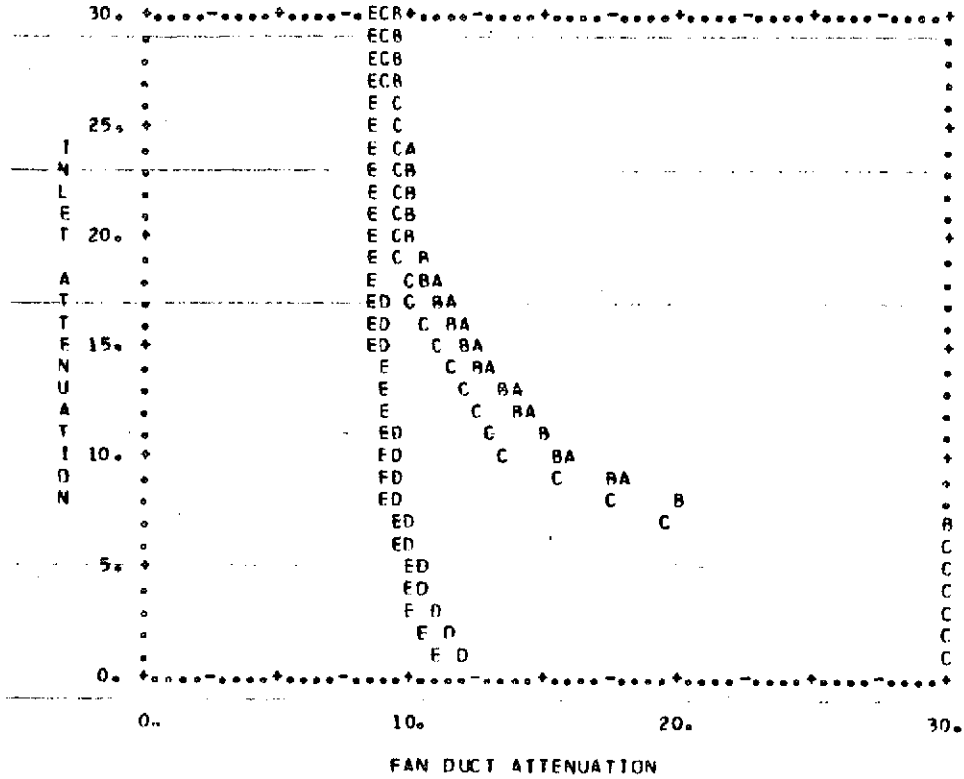

FAN HARMONIC = 5.0		DELTA EPNL = 5.0				
INLET HARMONIC =		A	B	C	D	E
		0	5	10	20	30
INLET FUND.	FAN FUND.	FAN FUND.	FAN FUND.	FAN FUND.	FAN FUND.	FAN FUND.
1.00	*****	*****	*****	*****	11.77	10.81
2.00	*****	*****	*****	*****	11.37	10.49
3.00	*****	*****	*****	*****	10.99	10.19
4.00	*****	*****	*****	*****	10.64	9.95
5.00	*****	*****	*****	*****	10.32	9.79
6.00	*****	*****	*****	*****	10.07	9.60
7.00	*****	*****	*****	19.48	9.89	9.41
8.00	19.93	19.89	17.33	9.74	9.24	9.24
9.00	17.90	17.58	15.43	9.58	9.08	9.08
10.00	16.08	15.60	13.74	9.43	8.93	8.93
11.00	15.25	14.78	13.08	9.33	8.89	8.89
12.00	14.48	14.03	12.48	9.24	8.85	8.85
13.00	13.76	13.35	11.94	9.15	8.81	8.81
14.00	13.10	12.73	11.45	9.06	8.77	8.77
15.00	12.48	12.15	11.01	8.97	8.73	8.73
16.00	11.90	11.62	10.60	8.89	8.69	8.69
17.00	11.36	11.13	10.22	8.80	8.65	8.65
18.00	10.85	10.68	9.90	8.73	8.61	8.61
19.00	10.37	10.26	9.65	8.65	8.58	8.58
20.00	9.95	9.90	9.40	8.57	8.54	8.54
21.00	9.90	9.85	9.37	8.57	8.53	8.53
22.00	9.86	9.80	9.35	8.56	8.53	8.53
23.00	9.81	9.76	9.33	8.56	8.53	8.53
24.00	9.76	9.71	9.30	8.55	8.52	8.52
25.00	9.71	9.66	9.28	8.55	8.52	8.52
26.00	9.66	9.61	9.26	8.54	8.51	8.51
27.00	9.61	9.56	9.23	8.53	8.51	8.51
28.00	9.56	9.51	9.21	8.53	8.50	8.50
29.00	9.51	9.46	9.19	8.52	8.50	8.50
30.00	9.46	9.41	9.17	8.52	8.50	8.50

DELTA EPNL = 5.0 FAN HARMONIC = 10.0
 INLET HARMONIC (A = 0, B = 5, C = 10, D = 20, E = 30)
 T/O, WITH TUNE, 7.5 JET ATT, NO TURB, EPNL = 101.98, RUN-14A

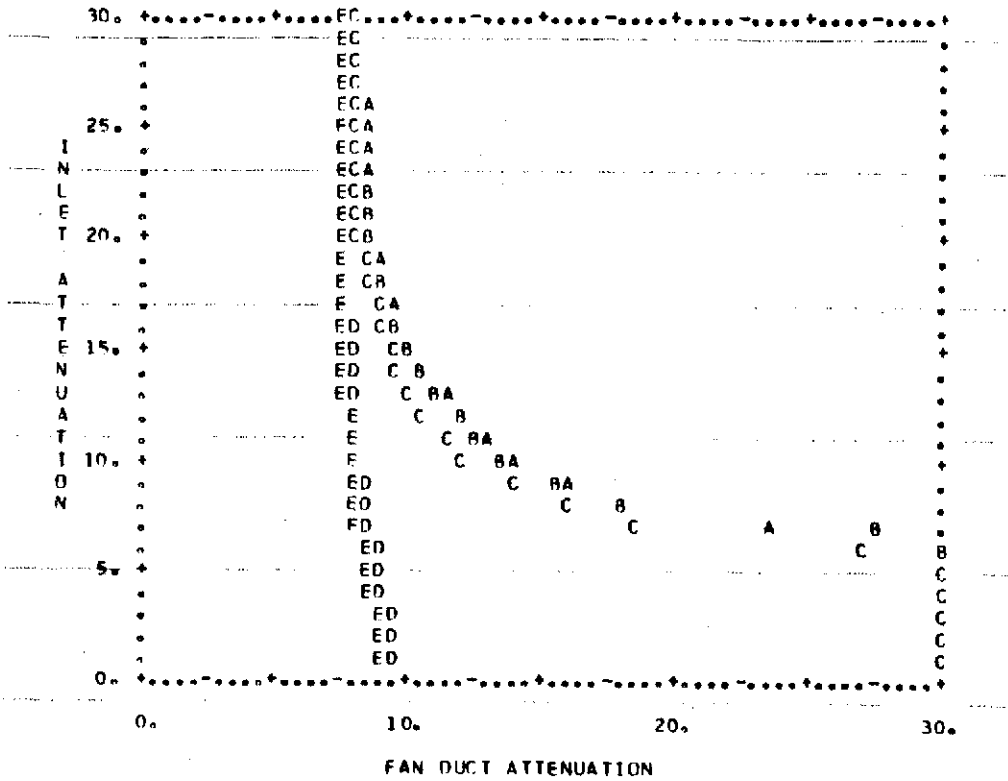

FAN HARMONIC = 10.0		DELTA EPNL = 5.0				
INLET HARMONIC =		A	B	C	D	E
	0	5	10	20	30	
INLET FUND.	FAN FUND.	FAN FUND.	FAN FUND.	FAN FUND.	FAN FUND.	FAN FUND.
1.00	*****	*****	*****	*****	9.59	9.19
2.00	*****	*****	*****	*****	9.43	9.01
3.00	*****	*****	*****	*****	9.28	8.82
4.00	*****	*****	*****	*****	9.14	8.64
5.00	*****	*****	*****	*****	9.00	8.45
6.00	*****	*****	*****	*****	8.83	8.33
7.00	23.50	27.36	18.40	8.66	8.22	
8.00	18.10	18.12	15.94	8.48	8.12	
9.00	15.84	15.58	13.90	8.31	8.01	
10.00	13.83	13.41	12.19	8.14	7.91	
11.00	12.91	12.54	11.41	8.08	7.85	
12.00	12.09	11.76	10.73	8.01	7.79	
13.00	11.35	11.06	10.13	7.96	7.73	
14.00	10.69	10.43	9.75	7.90	7.67	
15.00	10.09	9.91	9.43	7.84	7.61	
16.00	9.72	9.57	9.13	7.79	7.55	
17.00	9.42	9.25	8.84	7.73	7.50	
18.00	9.13	8.93	8.56	7.68	7.45	
19.00	8.86	8.63	8.29	7.63	7.39	
20.00	8.60	8.33	8.03	7.57	7.34	
21.00	8.55	8.30	8.00	7.57	7.34	
22.00	8.49	8.27	7.98	7.57	7.34	
23.00	8.43	8.24	7.96	7.56	7.34	
24.00	8.38	8.20	7.94	7.56	7.34	
25.00	8.32	8.17	7.92	7.55	7.34	
26.00	8.27	8.14	7.89	7.55	7.34	
27.00	8.21	8.11	7.87	7.54	7.33	
28.00	8.15	8.08	7.85	7.54	7.33	
29.00	8.09	8.05	7.83	7.54	7.33	
30.00	8.04	8.02	7.81	7.53	7.33	

DELTA EPNL = 5.0 FAN HARMONIC = 20.0
 INLET HARMONIC (A = 0, B = 5, C = 10, D = 20, E = 30)
 T/O, WITH TONE, 7.5 JET ATT, NO TURB, EPNL = 101.98, RUN-14A

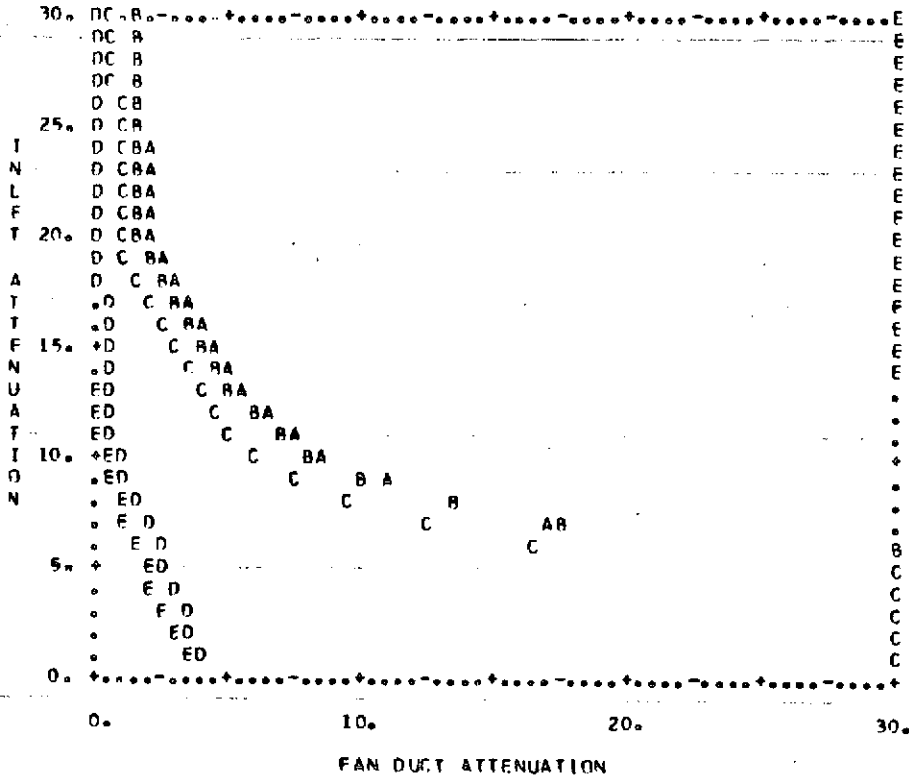

FAN HARMONIC = 20.0		DELTA EPNL = 5.0				
INLET HARMONIC =		A	B	C	D	F
		0	5	10	20	30
	INLET FUND.	FAN FUND.	FAN FUND.	FAN FUND.	FAN FUND.	FAN FUND.
	1.00	*****	*****	*****	4.00	3.29
	2.00	*****	*****	*****	3.65	2.86
	3.00	*****	*****	*****	3.32	2.47
	4.00	*****	*****	*****	2.99	2.11
	5.00	*****	*****	*****	2.68	1.77
	6.00	*****	*****	16.72	2.27	1.47
	7.00	17.07	17.51	17.60	1.88	1.18
	8.00	13.63	13.46	9.53	1.51	0.89
	9.00	10.79	10.17	7.51	1.15	0.60
	10.00	8.49	7.76	5.77	0.80	0.31
	11.00	7.45	6.81	5.03	0.73	0.27
	12.00	6.51	5.96	4.41	0.66	0.14
	13.00	5.67	5.19	3.84	0.58	0.06
	14.00	4.92	4.57	3.32	0.51	*****
	15.00	4.38	4.03	2.84	0.44	*****
	16.00	3.86	3.52	2.39	0.37	*****
	17.00	3.38	3.03	1.98	0.30	*****
	18.00	2.93	2.57	1.60	0.24	*****
	19.00	2.51	2.14	1.25	0.17	*****
	20.00	2.11	1.73	0.92	0.10	*****
	21.00	2.03	1.69	0.89	0.10	*****
	22.00	1.96	1.65	0.87	0.10	*****
	23.00	1.88	1.61	0.84	0.10	*****
	24.00	1.81	1.57	0.82	0.10	*****
	25.00	1.73	1.53	0.79	0.10	*****
	26.00	1.66	1.49	0.76	0.10	*****
	27.00	1.58	1.45	0.74	0.10	*****
	28.00	1.50	1.41	0.71	0.10	*****
	29.00	1.42	1.37	0.68	0.10	*****
	30.00	1.34	1.33	0.65	0.10	*****

DELTA EPNL = 5.0 FAN HARMONIC = 30.0
 INLET HARMONIC (A = 0, B = 5, C = 10, D = 20, E = 30)
 T/O. WITH TONE, 7.5 JET ATT, NO TURB, EPNL = 101.98, RUN-14A

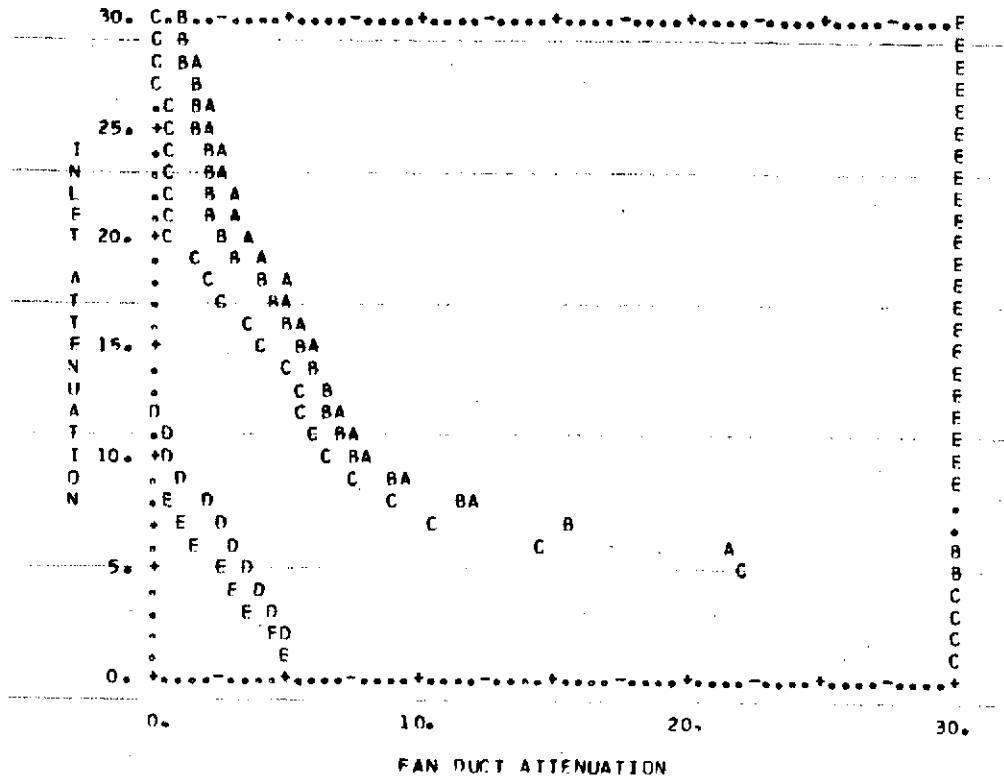

INLET HARMONIC	DELTA EPNL = 5.0				
	A 0	B 5	C 10	D 20	F 30
1.00	*****	*****	*****	5.21	5.02
2.00	*****	*****	*****	5.01	4.32
3.00	*****	*****	*****	4.45	3.64
4.00	*****	*****	*****	3.92	3.01
5.00	*****	*****	22.00	3.43	2.43
6.00	21.46	*****	14.63	2.85	1.75
7.00	15.60	15.66	10.66	2.29	1.06
8.00	11.84	11.43	8.89	1.75	0.37
9.00	9.41	9.09	7.64	1.23	*****
10.00	8.17	7.73	6.51	0.72	*****
11.00	7.60	7.20	6.04	0.45	*****
12.00	7.09	6.72	5.63	0.17	*****
13.00	6.64	6.28	5.26	*****	*****
14.00	6.23	5.87	4.83	*****	*****
15.00	5.86	5.50	4.06	*****	*****
16.00	5.53	5.16	3.32	*****	*****
17.00	5.22	4.60	2.63	*****	*****
18.00	4.85	3.83	1.97	*****	*****
19.00	4.13	3.09	1.34	*****	*****
20.00	3.42	2.37	0.74	*****	*****
21.00	3.17	2.22	0.67	*****	*****
22.00	2.92	2.06	0.59	*****	*****
23.00	2.68	1.91	0.52	*****	*****
24.00	2.44	1.76	0.44	*****	*****
25.00	2.19	1.60	0.37	*****	*****
26.00	1.95	1.45	0.29	*****	*****
27.00	1.72	1.29	0.22	*****	*****
28.00	1.48	1.14	0.15	*****	*****
29.00	1.25	0.99	0.07	*****	*****
30.00	1.01	0.83	0.00	*****	*****

DELTA EPNL = 10.0 FAN HARMONIC = 0.0
 INLET HARMONIC (A = 0, B = 5, C = 10, D = 20, E = 30)
 T/0, WITH TONE, 7.5 JET ATT, NO TURB, EPNL = 101.98, RUN-14A

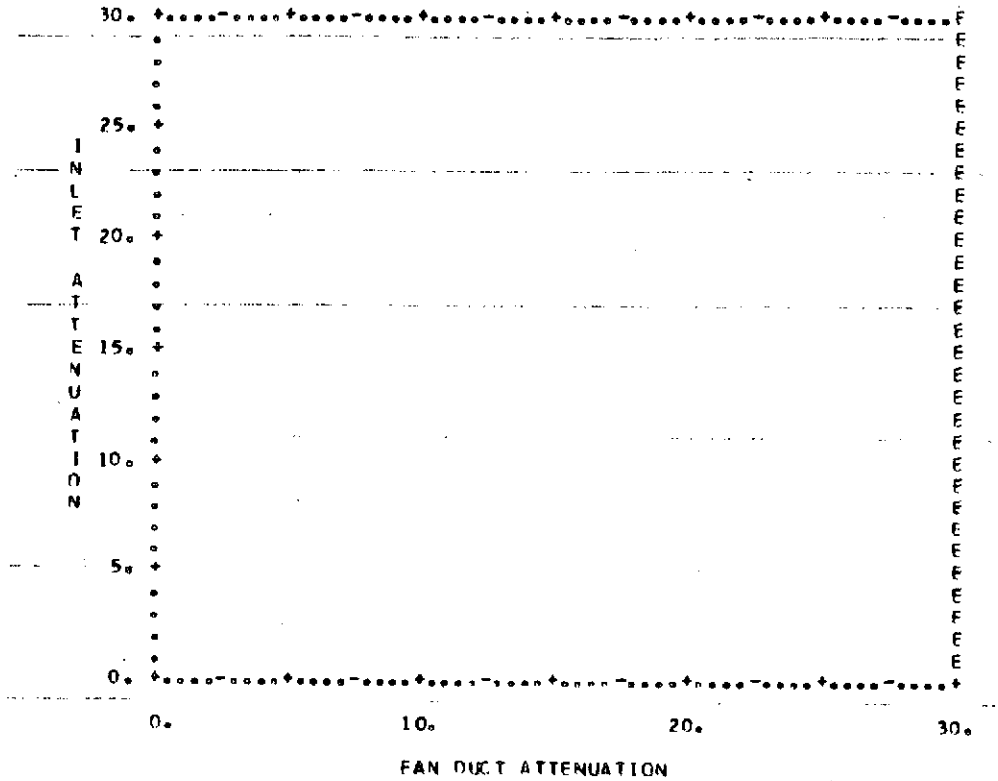

FAN HARMONIC = 0.0		DELTA EPNL = 10.0				
INLET HARMONIC =		A	B	C	D	E
		0	5	10	20	30
	INLET FUND.	FAN FUND.	FAN FUND.	FAN FUND.	FAN FUND.	FAN FUND.
	1.00	*****	*****	*****	*****	*****
	2.00	*****	*****	*****	*****	*****
	3.00	*****	*****	*****	*****	*****
	4.00	*****	*****	*****	*****	*****
	5.00	*****	*****	*****	*****	*****
	6.00	*****	*****	*****	*****	*****
	7.00	*****	*****	*****	*****	*****
	8.00	*****	*****	*****	*****	*****
	9.00	*****	*****	*****	*****	*****
	10.00	*****	*****	*****	*****	*****
	11.00	*****	*****	*****	*****	*****
	12.00	*****	*****	*****	*****	*****
	13.00	*****	*****	*****	*****	*****
	14.00	*****	*****	*****	*****	*****
	15.00	*****	*****	*****	*****	*****
	16.00	*****	*****	*****	*****	*****
	17.00	*****	*****	*****	*****	*****
	18.00	*****	*****	*****	*****	*****
	19.00	*****	*****	*****	*****	*****
	20.00	*****	*****	*****	*****	*****
	21.00	*****	*****	*****	*****	*****
	22.00	*****	*****	*****	*****	*****
	23.00	*****	*****	*****	*****	*****
	24.00	*****	*****	*****	*****	*****
	25.00	*****	*****	*****	*****	*****
	26.00	*****	*****	*****	*****	*****
	27.00	*****	*****	*****	*****	*****
	28.00	*****	*****	*****	*****	*****
	29.00	*****	*****	*****	*****	*****
	30.00	*****	*****	*****	*****	*****

DELTA EPNL = 10.0 FAN HARMONIC = 5.0
 INLET HARMONIC (A = 0, B = 5, C = 10, D = 20, E = 30)
 T/O, WITH TONE, 7.5 JET ATT, NO TURB, EPNL = 101.98, RUN-14A

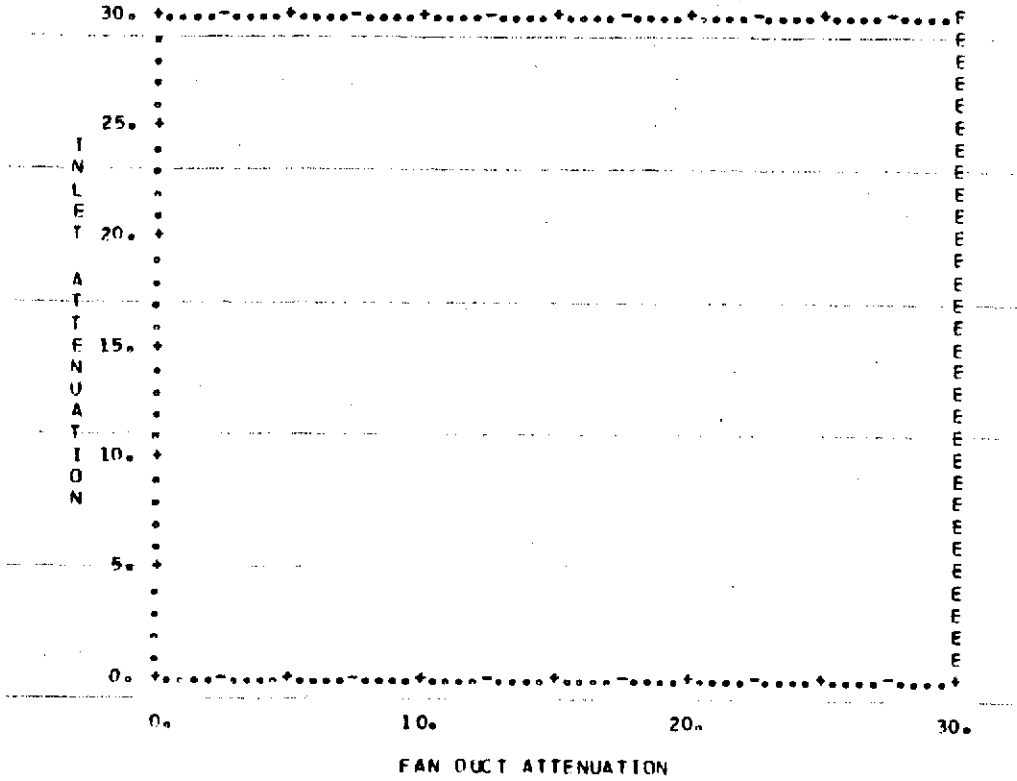

FAN HARMONIC = 5.0		DELTA EPNL = 10.0				
INLET HARMONIC =		A	B	C	D	E
		0	5	10	20	30
	INLET FUND.	FAN FUND.	FAN FUND.	FAN FUND.	FAN FUND.	FAN FUND.
	1.00	*****	*****	*****	*****	*****
	2.00	*****	*****	*****	*****	*****
	3.00	*****	*****	*****	*****	*****
	4.00	*****	*****	*****	*****	*****
	5.00	*****	*****	*****	*****	*****
	6.00	*****	*****	*****	*****	*****
	7.00	*****	*****	*****	*****	*****
	8.00	*****	*****	*****	*****	*****
	9.00	*****	*****	*****	*****	*****
	10.00	*****	*****	*****	*****	*****
	11.00	*****	*****	*****	*****	*****
	12.00	*****	*****	*****	*****	*****
	13.00	*****	*****	*****	*****	*****
	14.00	*****	*****	*****	*****	*****
	15.00	*****	*****	*****	*****	*****
	16.00	*****	*****	*****	*****	*****
	17.00	*****	*****	*****	*****	*****
	18.00	*****	*****	*****	*****	*****
	19.00	*****	*****	*****	*****	*****
	20.00	*****	*****	*****	*****	*****
	21.00	*****	*****	*****	*****	*****
	22.00	*****	*****	*****	*****	*****
	23.00	*****	*****	*****	*****	*****
	24.00	*****	*****	*****	*****	*****
	25.00	*****	*****	*****	*****	*****
	26.00	*****	*****	*****	*****	*****
	27.00	*****	*****	*****	*****	*****
	28.00	*****	*****	*****	*****	*****
	29.00	*****	*****	*****	*****	*****
	30.00	*****	*****	*****	*****	*****

DELTA EPNL = 10.0 FAN HARMONIC = 10.0
 INLET HARMONIC (A = 0, B = 5, C = 10, D = 20, E = 30)
 T/O, WITH TONE, 7.5 JET ATT, NO TURB, EPNL = 101.98, RIJN-14A

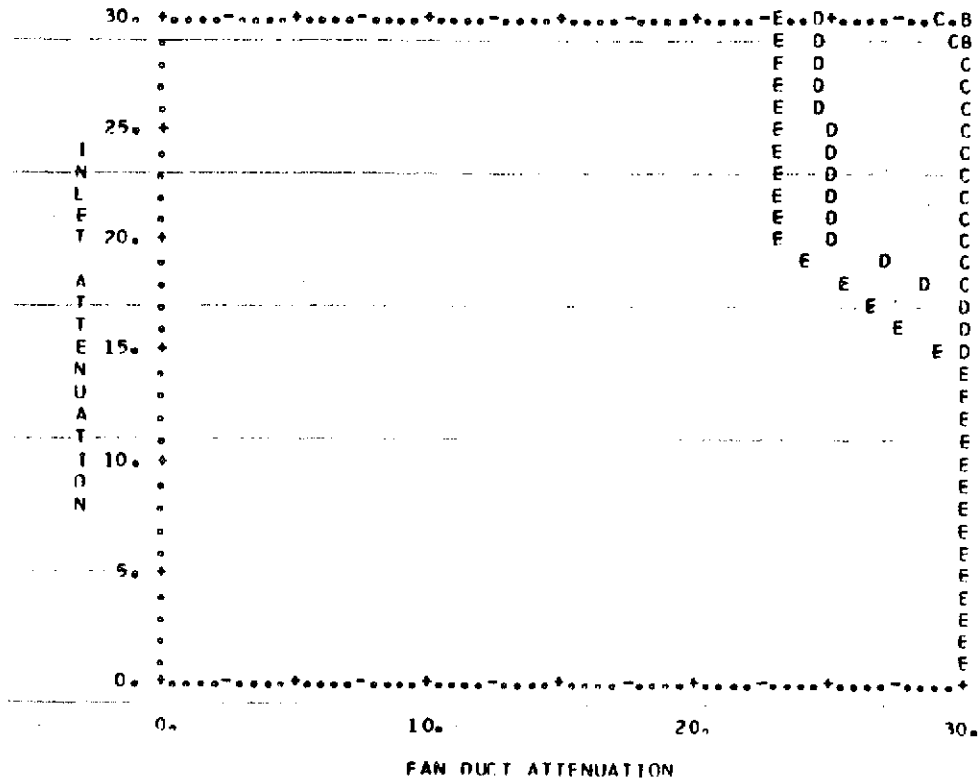

FAN HARMONIC = 10.0		DELTA EPNL = 10.0				
INLET HARMONIC =		A	B	C	D	F
		0	5	10	20	30
	INLET FUND.	FAN FUND.	FAN FUND.	FAN FUND.	FAN FUND.	FAN FUND.
	1.00	*****	*****	*****	*****	*****
	2.00	*****	*****	*****	*****	*****
	3.00	*****	*****	*****	*****	*****
	4.00	*****	*****	*****	*****	*****
	5.00	*****	*****	*****	*****	*****
	6.00	*****	*****	*****	*****	*****
	7.00	*****	*****	*****	*****	*****
	8.00	*****	*****	*****	*****	*****
	9.00	*****	*****	*****	*****	*****
	10.00	*****	*****	*****	*****	*****
	11.00	*****	*****	*****	*****	*****
	12.00	*****	*****	*****	*****	*****
	13.00	*****	*****	*****	*****	*****
	14.00	*****	*****	*****	*****	30.20
	15.00	*****	*****	*****	*****	28.94
	16.00	*****	*****	*****	*****	27.69
	17.00	*****	*****	*****	30.02	26.46
	18.00	*****	*****	*****	28.37	25.25
	19.00	*****	*****	*****	26.78	24.06
	20.00	*****	*****	*****	25.22	22.88
	21.00	*****	*****	*****	25.14	22.88
	22.00	*****	*****	*****	25.06	22.87
	23.00	*****	*****	*****	24.98	22.87
	24.00	*****	*****	*****	24.90	22.87
	25.00	*****	*****	*****	24.81	22.87
	26.00	*****	*****	30.86	24.73	22.87
	27.00	*****	*****	30.36	24.65	22.87
	28.00	*****	*****	29.88	24.57	22.87
	29.00	*****	*****	29.40	24.49	22.86
	30.00	*****	*****	28.92	24.41	22.86

DELTA EPNL = 10.0 FAN HARMONIC = 20.0
 INLET HARMONIC (A = 0, B = 5, C = 10, D = 20, E = 30)
 T/0, WITH TONE, 7.5 JET ATT, NO TURB, EPNL = 101.98, RUN-14A

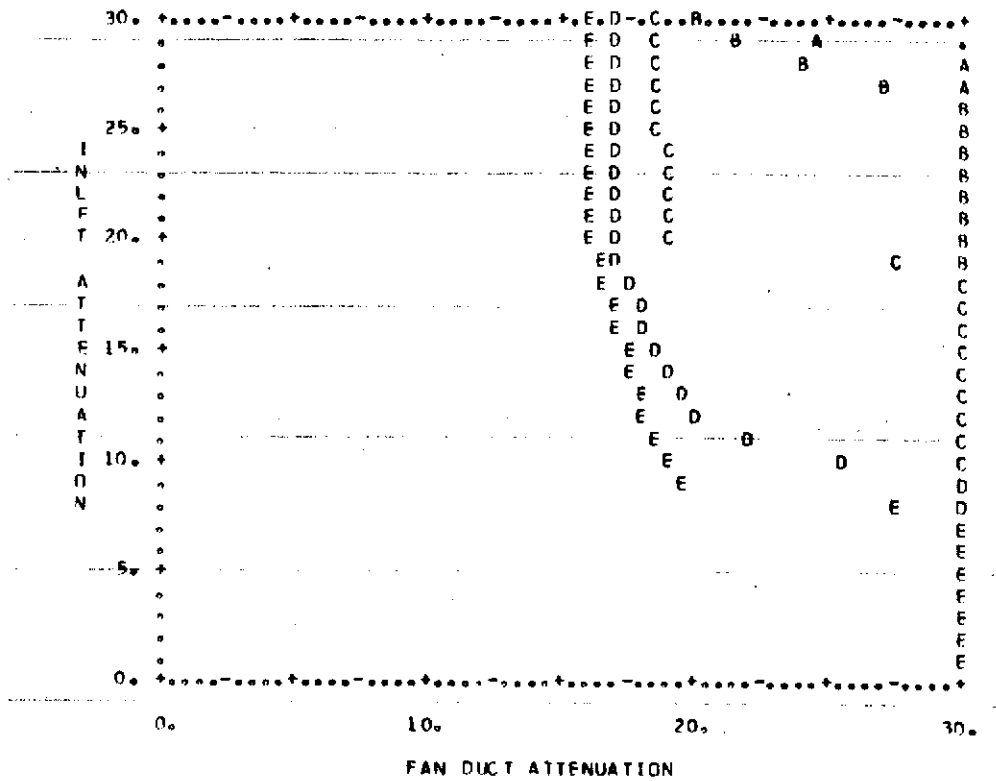

FAN HARMONIC = 20.0		DELTA EPNL = 10.0				
INLET HARMONIC =		A	B	C	D	E
		0	5	10	20	30
INLET FUND.	FAN FUND.	FAN FUND.	FAN FUND.	FAN FUND.	FAN FUND.	FAN FUND.
1.00	*****	*****	*****	*****	*****	*****
2.00	*****	*****	*****	*****	*****	*****
3.00	*****	*****	*****	*****	*****	*****
4.00	*****	*****	*****	*****	*****	*****
5.00	*****	*****	*****	*****	*****	*****
6.00	*****	*****	*****	*****	*****	*****
7.00	*****	*****	*****	*****	*****	*****
8.00	*****	*****	*****	*****	*****	27.32
9.00	*****	*****	*****	*****	*****	19.66
10.00	*****	*****	*****	*****	25.71	18.76
11.00	*****	*****	*****	*****	21.92	18.45
12.00	*****	*****	*****	*****	19.78	18.15
13.00	*****	*****	*****	*****	19.37	17.86
14.00	*****	*****	*****	*****	18.98	17.58
15.00	*****	*****	*****	*****	18.60	17.31
16.00	*****	*****	*****	*****	18.23	17.04
17.00	*****	*****	*****	*****	17.88	16.79
18.00	*****	*****	*****	*****	17.53	16.54
19.00	*****	*****	*****	27.44	17.20	16.30
20.00	*****	*****	*****	19.12	16.88	16.06
21.00	*****	*****	*****	19.04	16.88	16.06
22.00	*****	*****	*****	19.95	16.87	16.06
23.00	*****	*****	*****	18.87	16.87	16.06
24.00	*****	*****	*****	18.78	16.87	16.06
25.00	*****	*****	*****	18.70	16.87	16.06
26.00	*****	*****	*****	18.62	16.87	16.05
27.00	*****	27.16	*****	18.54	16.86	16.05
28.00	30.40	23.98	*****	18.45	16.86	16.05
29.00	24.32	21.33	*****	18.37	16.86	16.05
30.00	19.96	19.93	*****	18.29	16.86	16.05

DELTA EPNL = 10.0 FAN HARMONIC = 30.0
 INLET HARMONIC (A = 0, B = 5, C = 10, D = 20, E = 30)
 T/D, WITH TUNE, 7.5 JET ATT, NO TURB, EPNL = 101.98, RUN-14A

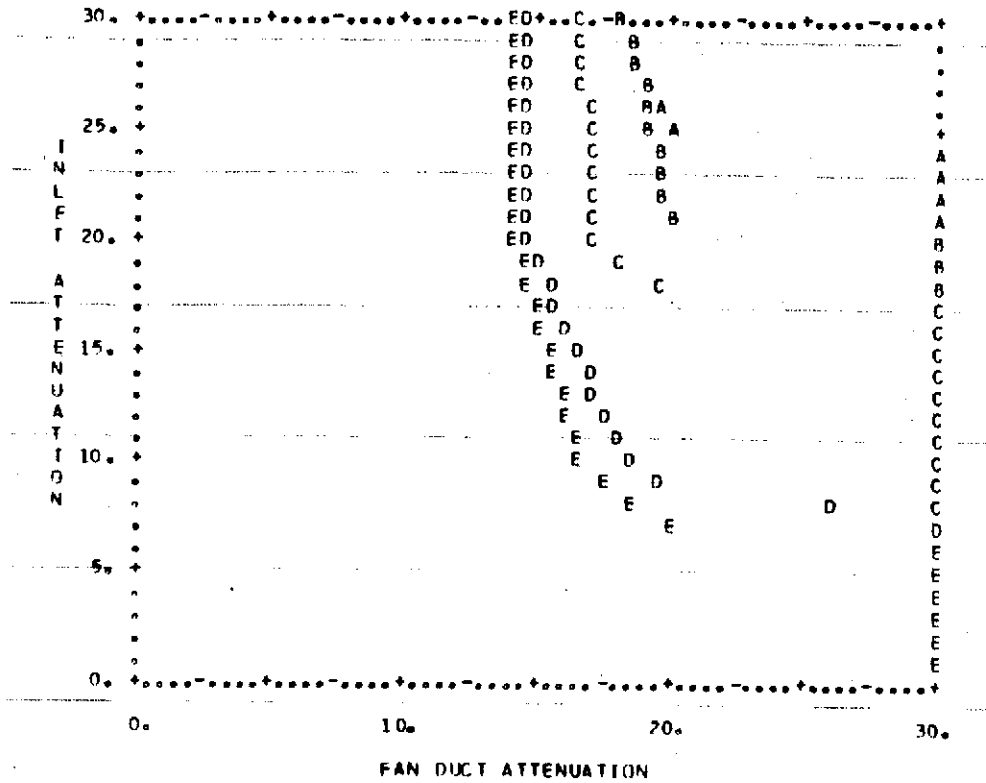

FAN HARMONIC = 30.0		DELTA EPNL = 10.0				
INLET HARMONIC =		A	B	C	D	E
	0	5	10	20	30	
	INLET FUND.	FAN FUND.	FAN FUND.	FAN FUND.	FAN FUND.	FAN FUND.
1.00	*****	*****	*****	*****	*****	*****
2.00	*****	*****	*****	*****	*****	*****
3.00	*****	*****	*****	*****	*****	*****
4.00	*****	*****	*****	*****	*****	*****
5.00	*****	*****	*****	*****	*****	*****
6.00	*****	*****	*****	*****	*****	*****
7.00	*****	*****	*****	*****	*****	19.81
8.00	*****	*****	*****	*****	25.96	18.65
9.00	*****	*****	*****	*****	19.56	17.64
10.00	*****	*****	*****	*****	18.58	16.74
11.00	*****	*****	*****	*****	18.09	16.45
12.00	*****	*****	*****	*****	17.63	16.16
13.00	*****	*****	*****	*****	17.19	15.88
14.00	*****	*****	*****	*****	16.78	15.61
15.00	*****	*****	*****	*****	16.40	15.34
16.00	*****	*****	*****	*****	16.03	15.09
17.00	*****	*****	*****	*****	15.69	14.84
18.00	*****	*****	*****	19.43	15.36	14.59
19.00	*****	*****	*****	18.20	15.05	14.36
20.00	*****	*****	*****	17.08	14.75	14.13
21.00	*****	*****	19.95	17.03	14.74	14.13
22.00	*****	*****	19.74	16.97	14.73	14.13
23.00	*****	*****	19.53	16.92	14.72	14.13
24.00	*****	*****	19.33	16.87	14.71	14.13
25.00	19.80	19.14	16.82	14.70	14.13	14.13
26.00	19.43	18.95	16.76	14.69	14.13	14.13
27.00	19.08	18.76	16.71	14.68	14.13	14.13
28.00	18.75	18.58	16.66	14.66	14.13	14.13
29.00	18.43	18.40	16.62	14.65	14.13	14.13
30.00	18.13	18.23	16.57	14.64	14.12	14.12