

75N14767

NASA TECHNICAL NOTE



NASA TN D-7836

NASA TN D-7836

**AERODYNAMIC PERFORMANCE OF
0.5-METER-DIAMETER, 337-METER-PER-SECOND
TIP SPEED, 1.5-PRESSURE-RATIO,
SINGLE-STAGE FAN DESIGNED FOR
LOW NOISE AIRCRAFT ENGINES**

Thomas F. Gelder and George W. Lewis, Jr.

Lewis Research Center

Cleveland, Ohio 44135

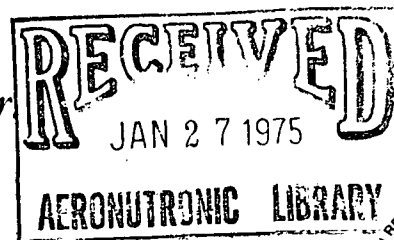

1. Report No. NASA TN D-7836		2. Government Accession No.		3. Recipient's Catalog No.	
4. Title and Subtitle AERODYNAMIC PERFORMANCE OF 0.5-METER-DIAMETER, 337-METER-PER-SECOND TIP SPEED, 1.5-PRESSURE-RATIO, SINGLE-STAGE FAN DESIGNED FOR LOW NOISE AIRCRAFT ENGINES				5. Report Date December 1974	
				6. Performing Organization Code	
7. Author(s) Thomas F. Gelder and George W. Lewis, Jr.				8. Performing Organization Report No. E-7779	
9. Performing Organization Name and Address Lewis Research Center National Aeronautics and Space Administration Cleveland, Ohio 44135				10. Work Unit No. 501-24	
				11. Contract or Grant No.	
12. Sponsoring Agency Name and Address National Aeronautics and Space Administration Washington, D. C. 20546				13. Type of Report and Period Covered Technical Note	
				14. Sponsoring Agency Code	
15. Supplementary Notes					
16. Abstract Overall and blade-element aerodynamic performance of a 0.271-scale model of QF-1 are presented, examined, and then compared and evaluated with that from similar low noise fan stage designs from NASA's low noise aircraft engine programs. The tests cover a wide range of speeds and weight flows along with variations in stator setting angle and stator axial spacing from the rotor. At design speed with stator at design setting angle and a fixed distance between stage measuring stations, there were no significant effects of increasing the axial spacing between rotor and stator from 1.0 to 3.5 rotor chords on stage overall pressure ratio, efficiency, or stall margin.					
17. Key Words (Suggested by Author(s)) Low speed fan aerodynamics Low noise fan aerodynamics			18. Distribution Statement Unclassified - unlimited STAR Category 01		
19. Security Classif. (of this report) Unclassified		20. Security Classif. (of this page) Unclassified		21. No. of Pages 182	22. Price* \$7.00

* For sale by the National Technical Information Service, Springfield, Virginia 22151

CONTENTS

	Page
SUMMARY	1
INTRODUCTION	1
APPARATUS AND PROCEDURE	3
Test Stage Design	3
Aerodynamic design	3
Mechanical design	4
Compressor Test Facility	4
Instrumentation	5
Test Procedure	6
Calculation Procedure	6
RESULTS AND DISCUSSION	8
Stage Overall Performance	8
Baseline configuration	8
Reset stator configuration	9
Close stator spacing configurations	9
Exit pylon configurations	10
Comparison of stage 15-9 with QF-1	10
Rotor Performance	10
Effects of measuring station	10
Effects of weight flow	13
Stator Performance	14
Effects of measuring station	14
Effects of weight flow	14
Losses, Loadings, and Deviation Angle Variations with Incidence Angle	15
Rotor	15
Stator	16
Blade Element Loadings Near Stage Stall	17
Effects of speed, flow, and configuration	17
Effects of axial velocity ratio across stator	18
Correlation of stator modified loading parameter near stall	18
Comparisons with Other Designs	19
Overall performance	19
Blade loadings near stage stall	21
Flow capacity	21

	Page
SUMMARY OF RESULTS	22
APPENDIXES	
A - SYMBOLS	24
B - EQUATIONS	27
C - ABBREVIATIONS AND UNITS USED IN TABLES	30
REFERENCES	33

AERODYNAMIC PERFORMANCE OF 0.5-METER-DIAMETER, 337-METER-
PER-SECOND TIP SPEED, 1.5-PRESSURE-RATIO, SINGLE-STAGE
FAN DESIGNED FOR LOW NOISE AIRCRAFT ENGINES

by Thomas F. Gelder and George W. Lewis, Jr.

Lewis Research Center

SUMMARY

Overall and blade-element aerodynamic performance of a 0.271-scale model of QF-1 are presented, examined, and then compared and evaluated with that from similar low noise fan stage designs from NASA's low noise aircraft engine programs. The QF-1 fan was designed and previously tested outdoors by NASA in one of these programs. The emphasis of the previous full-scale tests was on acoustics; only a limited amount of aerodynamic data were obtained. The present tests were in a conventional aerodynamic test facility. They covered a wide range of speeds and weight flows along with variations in stator setting angle and stator axial spacing from the rotor.

Stage overall performance on a calculated operating line passing through the design point was 1.475 total pressure ratio (1.499 design) and 0.835 efficiency (0.848 design). Resetting the stator increased stage efficiency to 0.845. At design speed with stator at design setting angle and a fixed distance between stage measuring stations, there were no significant effects of increasing the axial spacing between the rotor and stator from 1.0 to 3.5 rotor chords on stage overall pressure ratio, efficiency, or stall margin.

Stage stall occurred when blade row loading limits were encountered. The stator hub elements initiated stall at 90 and 100 percent of design speed and were near stall, if not initiating it, when the stage stalled at all lower speeds for all configurations tested. A modified loading parameter that correlated this stator hub near stall operating conditions for all speeds and configurations tested was the sum of the conventional diffusion factor and a fraction (0.44 for this stator) of the axial velocity ratio.

INTRODUCTION

In support of NASA's low noise aircraft engine programs (ref. 1), several fan stages

were designed, built, and tested (refs. 2 to 6). All of these fan designs embodied some unconventional geometric and aerodynamic features. They were generally low tip speed, single stage, without inlet guide vanes, with large axial spacing between blade rows (at least two rotor chords), and with about twice the number of stator blades as rotor blades. Also, attaining the desired fan pressure ratio of 1.5 with the low tip speed generally resulted in relatively high rotor and stator blade loadings and stator inlet Mach numbers as well as large negative relative air angles at the rotor hub exit. The detailed aerodynamic performance of these unconventional designs needs documentation and understanding so that the noise related features can be properly assessed.

The first fan designed (ref. 2) and tested (ref. 3) in these low noise engine programs was called QF-1. It was 1.824 meters in diameter with a tip speed of 337 meters per second and a design total pressure ratio of 1.5. All tests were done in an outdoor facility instrumented primarily for noise performance. Some overall aerodynamic performance was obtained on QF-1 and reported in reference 3. Those tests were at less than design speed, with only three exhaust nozzle sizes (throttle settings), with only fixed instrumentation, and with a fixed stator location and setting angle. A single large support pylon (maximum thickness 20 percent of chord) downstream of the stators was also involved. To obtain detailed aerodynamic performance of the QF-1 fan design without the previous limitations, a 0.271-scale model was built and tested in a conventional indoor compressor test facility at the NASA Lewis Research Center. The 0.5-meter-diameter model was designated stage 15-9 (rotor 15-stator 9).

Overall and blade-element performance for stage 15-9 were obtained over the stable operating flow range at constant rotative speeds of 70, 90, and 100 percent of design speed, and at the near-stall condition only for 50, 60, and 80 percent speeds. Three axial spacings between rotor and stator were investigated: 1.0, 1.5, and 3.5 rotor chords (the latter is the QF-1 configuration). Two stator 9 setting angles were evaluated and the exit pylon(s) were simulated for some of the tests. Some overall total pressure ratio and weight flow results with rotor 15 tested without stators are also included.

The purposes of this report are: (1) to provide detailed aerodynamic performance for the QF-1 design over a wide range of operation including axial movement of the stators and resetting them, (2) to examine the effects of stator spacing, stator reset, high stator blade number, high blade loadings, large negative relative air angles at the rotor hub exit, and other low noise features, on the aerodynamic performance of the fan, and then (3) to compare and evaluate some of the aforementioned results with those from other low speed designs from NASA's low noise aircraft engine programs.

For detailed reference, overall performance data from all the tests are tabulated as are all blade-element data for configurations with the stator at 3.5-rotor-chord spacing. Some of these data have also been selected for illustrative plots.

The symbols and equations are defined in appendixes A and B. The abbreviations and units used for the tabular data are defined in appendix C.

APPARATUS AND PROCEDURE

Test Stage Design

The aerodynamic and mechanical designs of the full-scale version of stage 15-9 (QF-1) were described in reference 2. Further details of the aerodynamic design are included in this report for convenient reference.

Aerodynamic design. - Several computer programs have been developed to aid in the design of compressors and fans. The programs used in the design of this fan stage were a streamline analysis program, a blade geometry program, and a blade coordinates program. These programs are presented in detail in references 7 to 9.

The streamline analysis program (ref. 7) calculates the velocity vector diagrams at several axial locations, including planes approximating the blade leading and trailing edges. This program accounts for both streamline curvatures and entropy gradients. Weight flow, rotor speed, flow path geometry, and radial distributions of total pressure and temperature are the inputs to this program.

The calculated velocity vectors and total pressure and temperature distributions from the streamline analysis program are then used in the blade geometry program (ref. 8). This program calculates the blade geometry which will satisfy the vector diagrams. Losses are calculated within this program. They are based on a calculated shock loss (as related to the particular blade shape) and a profile loss.

After the blade geometry is defined for both the rotor and the stator, the blade coordinate program presented in reference 9 is used to compute the blade elements on conical surfaces approximating the stream surfaces passing through the blade. The program then stacks these blade elements on a radial line about their center of gravity and computes the Cartesian blade coordinates for fabrication.

The overall design parameters for stage 15-9 are listed in table I, and the flow path is shown in figure 1. This stage was designed for an overall pressure ratio of 1.499 and an efficiency of 0.848 at a weight flow of 29.16 kilograms per second (201.8 kg/sec/m^2 of annulus area). The design tip speed was 337 meters per second. The stage was designed with a tip solidity of 1.344 for the rotor and 1.406 for the stator. There were 53 rotor blades with an aspect ratio of 3.0 and 112 stator blades with an aspect ratio of 5.1. (Blade aspect ratio is defined as the ratio of average span to aerodynamic chord at midspan.) The rotor inlet hub-to-tip ratio was 0.5.

The blade-element design parameters for rotor 15 are presented in table II. This rotor was designed for a radially constant total pressure ratio of 1.541. The stator blade-element design parameters are given in table III. The blade geometry is presented in table IV for rotor 15 and in table V for stator 9. Both rotor and stator used multiple circular arc blade shapes. Percent span in this report is generally with refer-

ence to the blade tip and values are those for design streamlines at the rotor trailing edge.

Mechanical design. - Rotor 15 blades are pin mounted at the base and have no vibration dampers. Rotor 15 is shown in figure 2. Rotor blades were machined from maraging 200 steel. Rotor tip clearance measured statically was about 0.07 centimeter. Stator 9 and its mounting rings are shown in figure 3. Stator blades were machined from 17-4 stainless steel. The mounting rings were slotted by electrical discharge machining to conform to the blade sections at each end. A second set of mounting rings were subsequently utilized as part of the test program. These alternate rings were slotted for setting angles (angle between aerodynamic chord and the meridional plane) 3.7° closed from the design values to reduce stator incidence angles. This alternate stator configuration is hereinafter referred to as the reset stator.

The stator assembly was tested in three different axial locations as shown in figure 1. The straight section between rotor and stator was varied in length by spacer rings on each side of the stator assembly. Flow path contours adjacent to the stator edges were the same at all stator locations. The baseline configuration was with the stator leading edge 3.5-rotor-chord lengths (13.56 cm) downstream of the rotor trailing edge. The stage was also tested with the stator at alternate locations of 1.0 and 1.5 rotor chords downstream of the rotor.

A large pylon with its leading edge about six stator chords (11.5 cm) downstream of the stator trailing edge (fig. 1) supported the QF-1 stage in the full-scale outdoor facility (ref. 2). The pylon was simulated for a few of the scale model tests in order to evaluate its effects, if any, on aerodynamic performance of the stage. The pylon, as depicted in figure 1, was a symmetrical airfoil section with maximum thickness to chord ratio of 0.20. Pylon chord length was approximately 43 centimeters. Four smaller, equally spaced pylons are also depicted in figure 1. This alternate pylon configuration resulted in 15 percent more total blockage to the flow area compared with the single pylon. A few tests were made with the four pylons. Unlike QF-1 design (ref. 2) the flow path for stage 15-9 was not enlarged to account for pylon blockage.

Compressor Test Facility

The compressor test facility is the same as that described in reference 7. A schematic view of the facility is shown in figure 4. The drive system consists of an electric motor with a variable frequency speed control. The drive motor is coupled to a 5.521-to-1 ratio speed-increaser gearbox that drives the test rotor. Atmospheric air enters from a line on the roof of the building and flows through the orifice and into the plenum chamber just upstream of the test rotor. The air then passes through the compressor

stage and the collector valve and exhausts to either a low- or high-vacuum receiver, as required.

Instrumentation

The compressor weight flow was determined from measurements with a calibrated thin-plate orifice. The air temperature at the orifice was determined from an average of two Chromel-Alumel thermocouples. Pressures across the orifice were measured by calibrated transducers.

Radial surveys of the flow were made at three axial locations: upstream of the rotor, between the rotor and the stator, and downstream of the stator (see fig. 1). There are two survey planes available between the rotor and stator when the stators are at 3.5-rotor-chord spacing, station 2a near the rotor exit and station 2b near the stator inlet.

Two combination probes (fig. 5(a)) and two 8° wedge probes (fig. 5(b)) were used at each axial measuring station. The probes were located approximately 90° apart, with the two like probes located opposite each other (fig. 6). The combination probes at station 3 were circumferentially traversed 3.2° (1 stator blade gap) counterclockwise from the nominal values shown in figure 6. The wedge probes were used to determine static pressure; and the combination probes were used to determine total pressure, total temperature, and flow angle. Each probe had associated null-balancing equipment that automatically aligned the probe to the direction of flow. Iron-constantan thermocouples were used in the combination probes to determine stream temperatures. Calibrated transducers were used to measure all pressures.

Static pressure taps were also installed on both the outer and inner walls of the compressor casing. These pressure taps were at the same axial location as the probes but were offset in the circumferential direction (see fig. 6). The rotative speed of the test rotor was determined by an electronic speed counter. The test data were recorded by a central data recording system.

The estimated errors of the data, based on inherent accuracies of the instrumentation and recording system are as follows:

Weight flow, kg/sec	±0.3
Rotative speed, rpm	±30
Flow angle, deg	±1
Temperature, K	±0.6
Rotor-inlet total pressure, N/cm^2	±0.01
Rotor-outlet total pressure, N/cm^2	±0.07
Stator-outlet total pressure, N/cm^2	±0.07
Rotor-inlet static pressure, N/cm^2	±0.04
Rotor-outlet static pressure, N/cm^2	±0.04
Stator-outlet static pressure, N/cm^2	±0.04

A further indication of the consistency of the data can be observed by comparing the integrated weight flows at each measuring station with the orifice weight flow in table VI.

Test Procedure

For each stage configuration, survey data were taken over a range of weight flows (obtained by adjusting back pressure on the stage) from maximum flow to the near-stall conditions at 70, 90, and 100 percent of design speed. At 50, 60, and 80 percent of design speed, surveys at all stations were made at the near-stall weight flow only. Data were recorded at nine radial positions for each speed and weight flow. At each radial position the two combination probes behind the stator were circumferentially traversed to nine different locations across the stator gap (3.2°). The wedge probes were set at midgap because preliminary studies showed that the static pressure across the stator gap was constant. Values of pressure, temperature, and flow angle were recorded at each circumferential position. At the last circumferential position, values of pressure, temperature, and flow angle were also recorded for stations 1 and 2. All probes were then traversed to the next radial position and the circumferential-traverse procedure repeated.

At each of the six rotative speeds, the back pressure on the stage was increased (by closing the sleeve valve in the collector) until a stalled condition was evident. Stall was detected by a sudden drop in stage-outlet total pressure which was measured by a probe located at midpassage and recorded on an X-Y plotter. Stall was also confirmed by large increases in blade stresses on both rotor and stator, along with a sudden increase in noise level.

The actual weight flow at stall was not generally recorded in this test program, and for this report references to stall or near stall flow will be actually the lowest possible flow where survey data were obtained for a given configuration. From some exploratory tests at 90 and 100 percent speed it was observed that actual weight flow at stage stall was about 1 kilogram per second higher with survey probes in the stream than without. However, at these same speeds, inserting the survey probes tended to lower the flow through the orifice about 1 kilogram per second. The net result is that the near stall flows presented herein for 90 and 100 percent speed are believed to be representative of actual flows at stage stall unaffected by survey probes. At speeds below 90 percent, the presence of the survey probes did not affect the actual stall flow or orifice flow.

Calculation Procedure

All data shown in this report have been corrected to standard conditions (i. e., total

pressure of 10.13 N/cm^2 and total temperature of 288.2 K at the rotor inlet (station 1). Hereinafter, references to weight flow or equivalent weight flow, or to speed or equivalent rotative speed, are to corrected values of these variables. Also, unless noted, all weight flows are the orifice measured values. The blade-element data have been translated from the measuring stations along design streamlines to conditions at the blade edges. The translation procedure described in reference 8 was used.

Due to the physical construction of the 8° wedge probe (fig. 5(b)), static pressure could not be measured at the 5, 10, and 95 percent span from tip locations. Thus, a linear interpolation between the outer-wall static pressure and the value of static pressure at 15 percent span from tip was used to obtain static pressure at 5 and 10 percent span. At 95 percent span, an interpolation between the static pressures at 90 percent span and the inner wall was used to obtain the static pressure.

At each radial survey position, nine circumferential values of pressure, temperature, and flow angle were measured downstream of the stator (station 3). The nine values of total temperature were mass averaged to obtain stator-outlet total temperature. The nine values of total pressure were converted to their enthalpy equivalent, $\left\{ \left[P_{2a} \text{ (or } 2b) / P_1 \right]^{(\gamma-1)/\gamma} - 1 \right\}$, and then mass averaged. Compressor adiabatic (temperature rise) efficiency is basically defined as the ratio of ideal- to actual-enthalpy (work) input in order to achieve the actual total pressure ratio developed by the compressor. That is why enthalpy equivalents of total pressure are used to mass average the pressures for subsequent efficiency calculations. (Efficiency differences between mass averaging pressures directly instead of their enthalpy equivalents are generally insignificant for a single-stage compressor.) The flow angle presented for each radial position is calculated based on mass-averaged axial and tangential velocities. All the blade-element data presented at the stator outlet are based on these averaged values of pressure, temperature, and flow angle.

To obtain the overall performance, the radial values of total temperature were mass averaged and the values of total pressure were converted to their enthalpy equivalent and then mass averaged as before.

Performance comparisons to design values as well as comparisons to other fans are often made along an operating line passing through the design point (refs. 4 to 6). Such an operating line can be calculated for a fixed area fan exhaust nozzle (or exhaust throttle setting). The ratio of nozzle static pressure to total pressure is set equal to the reciprocal of the measured fan total pressure ratio at design speed, and the temperature is also determined from tests. Only one nozzle exhaust area will satisfy the aforementioned requirements. Once determined at design speed, the fixed area can be utilized to locate the operating line intersection with other constant speed lines of interest. Along such an operating line the fan performs much like it would in a complete engine system (with a fixed bypass ratio), responding to fuel flow changes by changes in speed. Such

an operating line passing through the design point will be calculated and utilized for evaluating performance in this report.

RESULTS AND DISCUSSION

The test results as affected by speed, weight flow, stator setting angle, axial spacing of stators, exit pylons, and measuring station location are presented and discussed in this section. Stage overall performance is presented first. Rotor and stator performance are next, both overall and blade element. Then, blade-element loadings near stage stall are examined and correlated for the various configurations tested. Finally, some performance comparisons with other low noise fan stage designs from NASA's low noise aircraft engine programs are made.

Overall performance parameters for all configurations are listed in table VI. Blade-element tabulations for the rotor and stator in the baseline configuration are given in tables VII to XXVII (rotor) and XXVIII to XLVIII (stator). The baseline configuration is the same as QF-1 and is defined as that with the stator at design setting angle and 3.5 rotor chords downstream of the rotor trailing edge as shown in figure 1.

Stage Overall Performance

Baseline configuration. - An overall performance map for stage 15-9 is presented in figure 7. At design speed and on the calculated operating line (explained in the section Calculation Procedure) passing through the design point, the baseline stage pressure ratio, efficiency, and percent design weight flow were 1.475, 0.835, and 98.0, respectively; these compare favorably with design values of 1.499, 0.848, and 100.0. However, the near-stall line is not much removed from the operating line shown. The calculated stall margin (defined in appendix B) from the operating line is only about 4 percent which is inadequate for applications of interest.

Further insight into the stall characteristics of the stage are possible with the rotor 15 (installed without stator 9) results shown in figure 8. These rotor-alone data are from an earlier series of tests in a similar test facility. Temperature data were not available, but rotor exit air angles were measured along with total pressure ratio and weight flow. The near-stall line for rotor alone (fig. 8) is substantially improved both in pressure and in flow over that for the stage, particularly at the higher speeds. This favorable shift in near-stall line indicates stage stall was stator controlled, at least at 90 and 100 percent of design speed. At the lower speed, the stator or rotor or both may be critical, that is, stall first. Thus provisions were made to reset the stator for some of the subsequent tests.

Rotor overall total pressure ratio at design speed starts to decrease with flow reductions below about 93 percent of design (fig. 8). And, as demonstrated by Bullock, Wilcox, and Moses (ref. 10), a pressure-flow characteristic at constant speed that has a positive slope is a necessary condition for flow instability and surge. Thus stall margin that is dependent on a positive slope characteristic may not be realized in a practical engine installation. Factors which caused this undesirable characteristic at the lower flows are discussed in the section Effects of weight flow.

The maximum flow values at 100 and 90 percent speed in figure 8 indicate that flow capacity for stage 15-9 was controlled by the rotor because the values from the rotor alone tests agreed with those from the stage tests.

Reset stator configuration. - The amount of stator reset was selected by comparing the measured absolute air angles (at station 2a) with rotor alone at near-stall weight flow to those with the stage at near stall weight flow. The rotor-alone angle at design speed and 90 percent span from the tip was about 3° higher than the stage baseline configuration. To compensate for this higher possible rotor exit air angle, another set of stator blade mounting rings (fig. 3) were provided which realigned the chord line of the stators 3.7° in the closed or incidence reducing direction.

The overall performance for stage 15-9 with the reset stator at 3.5-rotor-chord axial spacing is shown in figure 9. Results from the baseline configuration and the calculated operating line are included for comparison. At design speed and on the operating line, the reset stator configuration exhibits stage pressure ratio, efficiency, and percent design weight flow of 1.482, 0.845, and 98.6, respectively. This represents a slight improvement in operating line performance compared with the baseline configuration. The near-stall flow at design speed with the reset stator has been substantially reduced to about 87 percent of design compared with about 95 percent for the baseline configuration. However, stators cannot energize the flow and the positive slope of the rotor characteristic previously discussed (fig. 8) precludes a useable improvement in stall margin with the reset stator.

Close stator spacing configurations. - Overall performance for stage 15-9 with the stators moved axially closer to the rotor than the 3.5 rotor chords of the baseline configuration is presented in figure 10(a) for stators at design setting angle and in figure 10(b) for reset stators. These alternate (closer) stator locations are 1.0 and 1.5 rotor chords from the rotor trailing edge. Compared with the 3.5-rotor-chord spacing configurations, there are insignificant effects on stage pressure ratio, efficiency, or stall margin in moving the stators to 1.0 or 1.5 rotor chord spacings at either design or reset stator setting angles. These comparisons are based on the performance measured at instrumentation planes (or stations) 1 and 3 which do not change with stator location as illustrated in figure 11. Thus for the fixed distance between stage measuring stations 1 and 3, the longer portion of ducting with the higher and swirling rotor exit velocities (fig. 11(a)) did not result in an overall performance decrement relative to the

longer portion of ducting with the lower and axial stator exit velocities (fig. 11(b)) as might be expected.

Exit pylon configurations. - Overall performance with exit pylons downstream of the stators is presented in figure 12. The axial spacing of stators was 3.5 rotor chords and only the near stall and wide open throttle flows were tested. The exit pylons did not restrict the maximum flow capacity of the stage. Exit pylons did reduce the near stall flow of the stage and result in a maximum stall margin from the operating line of 13 percent at design speed for the reset stator configuration with 1 exit pylon. But as previously discussed, this stall margin improvement is unusable because of the slope of the pressure-flow characteristic which is rotor controlled.

Comparison of stage 15-9 with QF-1. - For convenient reference, the QF-1 overall total pressure ratio data from reference 3 (three exit nozzle configurations) is presented in figure 13. Also, some additional pressure and efficiency (temperature) data (unpublished NASA data) from QF-2 (like QF-1 except for reblading to change direction of rotation) is included. With QF-1 and QF-2, the maximum speed tested was 90 percent of design. The peak total pressure at constant speed comparison between stage 15-9 and QF-1 and QF-2 is favorable. Flow comparisons are not conclusive because of the scatter in the full-scale data. The peak efficiencies shown for QF-2 at 70 and 90 percent design speed are 6 and 5 percent lower, respectively, than those for stage 15-9 (80 percent speed data not available for stage 15-9). The differences in efficiency are not attributed to a scale effect but rather to the difficulties in obtaining accurate temperature measurements with the instrumentation and conditions at the outdoor full-scale facility as indicated in reference 3.

Rotor Performance

Effects of measuring station. - The overall performance at design speed for rotor 15 with the stators at 3.5-rotor-chord axial spacing is shown in figure 14 as a function of weight flow and location of measuring station 2. With the wide spacing available between blade rows in the baseline configuration, two measuring stations were provided between the rotor and stator (see fig. 1). Either station 2a (near rotor trailing edge) or station 2b (near stator leading edge) were instrumented for a given series of tests. Overall total pressure and efficiency (fig. 14) are consistently a little lower from station 2b compared to that from station 2a. There was no significant change in total temperature between these two stations. Based on station 2b and a flow 98.5 percent of design (on a calculated operating line passing through the design point (fig. 14)), rotor total pressure ratio and efficiency were 1.510 and 0.895. Comparable values based on station 2a were 1.520 and 0.910. Rotor design values were 1.541 and 0.909 (table I). Also shown in

figure 14 is the effect of resetting the stator which was to lower the minimum, near-stall flow but otherwise not change rotor overall performance.

Radial distributions of rotor pressure ratio, temperature ratio, and efficiency as affected by measuring station are shown in figure 15. The stator is at 3.5-rotor-chord axial spacing and at design setting angle for figure 15(a) and reset 3.7° closed for figure 15(b). For the design stator angle the two reading numbers have nearly identical weight flow to design ratios thus differences should be only due to the different measuring stations used. For the reset stator, reading numbers with the closest available flows for the different measuring stations are shown. Total pressure ratio trends are similar for both stator setting angles. The pressure is less at station 2b than at station 2a mainly in both end wall regions but also at midspan. For the equal flow data in figure 15(a), total temperature differences between stations 2a and 2b may be insignificant. But, for unknown reasons, the 50 percent span value is consistently slightly lower at station 2b for all available data when plotted as a function of weight flow. The effect of measuring station on the radial distribution of efficiency for the design setting angle (fig. 15(a)) is similar to that just described for total pressure.

Further evidence of a small but systematic drop in midspan total pressure (ratioed to rotor inlet) between stations 2a and 2b is presented in figure 16. Here, the 30, 50, and 70 percent span rotor outlet total pressure ratios were averaged for each flow condition and accompanying measuring station (2a or 2b). These midspan average rotor outlet total pressure ratios were then divided by stator outlet free stream total pressure ratios averaged over the same spanwise region. The average rotor outlet ratios to average stator outlet (free stream) ratios are then plotted as a function of percent design flow. The spanwise averaging was done to indicate the spanwise extent involved and also to minimize possible streamline inconsistencies between stations. The stator outlet free stream total pressure ratio (average of three highest total pressures from station 3 circumferential surveys across stator wake) was selected for reference because in some experimental evaluations (e. g., refs. 11 and 12) this is utilized as the rotor exit total pressure. The average drop in the midspan total pressure ratio between stations 2a and 2b in figure 16 is about 0.01. With the standard rotor inlet pressure of 10.13 N/cm² (14.69 psi), this represents an absolute drop in average midspan total pressure of about 0.10 N/cm² (0.15 psi). Also, the total pressure measured at station 2b agreed (within probe accuracy) with the stator outlet free stream value previously described; those measured at station 2a were consistently higher. Percent of design flow or stator reset did not appear to alter these results.

Radial distributions of rotor total loss coefficient $\bar{\omega}'$, diffusion factor D , and deviation angle δ^0 , as affected by measuring station are shown in figure 17. The same reading numbers used for the pressure, temperature, and efficiency comparisons (fig. 15(a)) are used for the figure 17 parameters. Comparing the rotor results from station 2b to those from station 2a reveals the following trends: (1) losses $\bar{\omega}'$ are much

higher near both end walls but are about the same at midspan because both temperature and pressure are a little lower there (see fig. 15(a)), (2) loadings in terms of D factor tend to be a little higher near the tip and a little lower near the hub, and (3) deviation angles are 1° to 2° higher across most of the span.

With rotor loss coefficient differing only in the end wall regions between stations 2a and 2b such differences could be attributed to increased losses in the inner and outer wall boundary layers in the annulus length between the two stations. With such a developing annulus wall flow loss model, charging these losses to the rotor or to the stator may not be appropriate. Perhaps a separate annulus wall loss term should be identified for the wide axial spacing of stator configurations. Correlation of such data is not evident, however. For as previously discussed (fig. 11), there is no difference in overall total pressure ratio between stations 3 and 1 in moving the stator from 3.5- to 1.0-rotor-chord axial spacing although the annulus lengths and flow velocities are changed.

Another problem with the annulus wall flow loss model is that the midspan differences in total pressure ratio between stations 2a and 2b (figs. 15 and 16) are not accounted for. Perhaps mixing of the rotor wake with the free stream is not completed by measuring station 2a which is about 0.5 rotor chord downstream of the rotor trailing edge (fig. 1). The 0.5-rotor-chord location for rotor exit instrumentation has in the past been justified by the work of Lieblein and Roudebush (ref. 13). They showed that practically all the loss in total pressure arising from the mixing of the wake is incurred within 0.5-chord length distance behind the blade. However, those results were based on very low speed ($M < 0.25$), two-dimensional cascade sections which could differ substantially from those for the relative high speed ($M \approx 0.65$ at midspan), highly loaded sections ($D \approx 0.5$) of rotor 15. If pressure losses arising from the mixing of the rotor wake continue downstream of station 2a (0.5 rotor chord), then total pressures measured at station 2b (2.5 rotor chords) would be lower than those at station 2a and such additional losses should be charged to the rotor.

Instrumentation utilized in the present study were not sufficient to give a detailed description of the flow between the rotor and stator. Such a picture is required in order to properly charge losses, for example, to the rotor, the stator, or the intermediate annulus walls. Further study and analysis is required so that design systems can be refined to properly account for the various components in wide blade row spacing configurations.

Rotor blade-element performance in this report will be based on measuring station 2a (and station 1) unless noted. These measuring stations are nearest the blade edges of interest and are also those previously used to measure the performance of rotors tested in the same facility (e. g., refs. 7 and 8). However, when rotor 15 overall performance is later compared with that from contractor designs, measuring station 2b (and station 1) will be utilized. This is because the rotor data from the contractor designs are based on stator exit free stream pressure being the rotor exit pressure and,

as previously shown (fig. 16), station 2b pressure equals the stator exit free stream value (at least over the midspan region from 30 to 70 percent span) while station 2a pressure is consistently a little higher.

Effects of weight flow. - With the rotor at design speed, the stator at 3.5-rotor-chord spacing, and for different flows, radial distributions of pressure ratio, temperature ratio, and efficiency are shown in figure 18; total loss coefficient, diffusion factor, and deviation angle are shown in figure 19; and pressure ratios across the rotor, the stator, and the stage are shown in figure 20. Throttling the flow from 100.0 to 94.8 percent of design significantly increased total temperature (energy addition) and total pressure over the outer two-thirds span (fig. 18). Concurrently, rotor losses are decreasing (fig. 19), and efficiencies are increasing (fig. 18) in this same region of the blade. At flows less than about 95 percent of design, rotor total pressure decreases with further decreases in flow over the entire span (fig. 20). The largest decreases in total pressure occur over the outer two-thirds span where rapidly increasing losses and decreasing energy addition (see table XVIII, reading number 683) combine to yield the undesirable positive slope pressure-flow characteristic for the rotor and thus for the stage as shown.

In the hub region from about 80 to 100 percent span, rotor total pressure decreases slightly but consistently as the flow is throttled from about 100.0 to 88.6 percent of design (fig. 20(e)). This is a consequence of the negative relative air angles (turning past the axial direction) in the low noise design of rotor 15 (see tables II and IV). Rotor losses in this hub region are less than design for all flows shown (fig. 19). Coupled with the nearly constant and near design energy addition, the hub region efficiencies are as much as three points above design at 85 percent span (fig. 18). Thus the unconventional air turning past axial in the hub region resulted in very good performance with little sensitivity to changes in flow.

For comparisons with design, the weight flow on the calculated operating line passing through the design point is useful. This flow is about 98.2 percent of design (see fig. 7) which is that for reading number 539 (figs. 18 and 19). At this flow, the radial distribution of energy addition is less than design except near the hub, and the losses are greater than design between 15 and 50 percent span from the tip. The resultant efficiency is as much as four points below design at the 30 percent span location. The diffusion factor is generally less than design across the entire span and is about 0.46 compared with 0.479 (design) at the 30 percent span high loss location. Deviation angles exceeded design over the outer half span with a maximum difference of about 3° at 5 percent span. This caused the energy addition to be less than design.

Stator Performance

Effects of measuring station. - Radial distributions of stator total loss coefficient $\bar{\omega}$, diffusion factor D , and deviation angle δ^0 , as effected by measuring station are shown in figure 21. The same reading numbers used in the rotor comparison (figs. 15(a) and 17) are used for the stator comparison in figure 21. Stator losses $\bar{\omega}$ are lower near both end walls from station 2b data compared with station 2a, particularly near the tip. There is also lower stator loss at midspan. These effects are the result of the same differences in total pressure across the span of the rotor between stations 2a and 2b as previously shown in figure 15(a). Stator loadings in terms of D factor are generally a little less from station 2b than from station 2a with about a 5 percent reduction at 90 percent span from the tip. Deviation angles at the stator exit are independent of station 2 measurements.

Because most of the data for stage 15-9 was obtained with measuring station 2a instrumented rather than station 2b (see table VI), most of the tabulated blade-element data for the stator (tables XXVIII to XLVIII) are based on station 2a (and station 3). However, station 2b, which is much closer to the stator leading edge, would be a preferable stator inlet reference. Otherwise the annulus wall losses between stations 2a and 2b, or possible rotor wake mixing losses beyond station 2a are charged to the stator. This doesn't seem appropriate for stator blade-element evaluation. Fortunately, except for stator loss coefficient, the other stator blade-element parameters (D factor, axial velocity ratio, deviation angle, etc.) are not significantly different whether based on station 2a or 2b. To examine stator blade-element performance, the available station 2b data (tables XXIX and XLVI to XLVIII) at design speed are utilized for the subsequent plots and discussion.

Effects of weight flow. - The radial distribution of stator loss coefficient, diffusion factor, and deviation angle as affected by changes in weight flow are shown in figure 22. The rotor is at design speed and the stator at 3.5-rotor-chord spacing. With the stator at design setting angle, throttling the flow from 99.8 to 95.4 percent of design reduced stator loss in the midspan region of the blade but increased losses at either end. A near-operating line (calculated) flow of 98.5 percent of design was obtained by reading number 601 (fig. 22). At this flow, losses were near design values across the span but loadings (D factors) were not attained. Deviation angles exceed design values across the span with the largest differences, about 7^0 , at 5 percent span.

Also shown in figure 22 is the performance of the reset stator operating at one of the same (nearly) weight flows as the design setting angle configuration. On this basis, resetting the stator reduced losses across the entire span except at 5 percent from tip. Loss reductions of about 50 percent are apparent at 15 to 50 percent span from tip. The reduced losses at midspan are the result of the reduced incidence angles due to reset. As listed in table XL, reading number 709, the incidence angle to the suction surface at

50 percent span for the reset stator is -6.0° . The comparable value in table XXIX, reading number 602, for the design stator setting is -0.6° . At the same weight flow of about 95 percent of design, resetting the stator resulted in small diffusion factor changes with reductions at the blade ends and increases in the midspan region.

Losses, Loadings, and Deviation Angle Variations with Incidence Angle

Rotor. - Total loss coefficient \bar{w}' , diffusion factor D , and deviation angle δ° are presented in figure 23(a) to (e) for spanwise locations of 10, 30, 50, 70, and 90 percent span from tip, respectively. The stator is at 3.5-rotor-chord axial spacing, the intra-blade row instrumentation is at station 2a, and both stator setting angles are utilized to maximize the incidence angle range. Speeds of 70, 90, and 100 percent of design are shown as are the design point values for each parameter. The incidence angles corresponding to the flow on the calculated operating line at design speed are also indicated by vertical arrows.

Rotor losses across the span appear to be near minimums at the lowest incidence angles. This agrees with peak overall efficiency for the rotor occurring near maximum flow (fig. 14). At design speed and at operating line incidence angles in figure 23, rotor loss is also near minimum values. These minimum losses are close to-, or even less than-design values across the span. However, at design speed, the low loss range of incidence is quite narrow and losses increase sharply, especially in the 30 to 70 percent span region as soon as the reset stator allows operation at weight flows less than about 95 percent of design. These are the flows and elemental locations where the rotor pressure-flow characteristic turns positive as previously discussed. The range of low loss incidence angles increases as speed is reduced.

Resetting the stator had no effect on rotor blade-element losses which supports the overall performance comparison previously noted (fig. 14).

Rotor loadings (D factor) are independent of stator setting angle and are near design values at design incidence except near the hub (fig. 23(e)). The maximum rotor D factor at design speed and 10 percent span from the tip is about 0.475. However, at design speed as shown by figure 8, the stage stalled before the rotor alone stalled. Thus the stator initiated stage stall at design speed. Therefore the rotor D factor of 0.475 is not its maximum possible value. According to figure 8, at 70 percent design speed, the rotor and stator may be equally critical in initiating stage stall. Thus the maximum rotor D factor of about 0.56 at 10 percent span from the tip (fig. 23(a)) is believed near its maximum possible value. (A subsequent section entitled Blade Element Loadings Near Stage Stall contains further discussion.)

Rotor deviation angle data of figure 23 vary a few degrees from the design values at design incidence and speed. Rotor deviation angles with the reset stator are generally 1° or 2° less than with the design stator. There is a general increase in deviation angle as speed is reduced.

Stator. - Total loss coefficient $\bar{\omega}$, diffusion factor D , and deviation angle δ° are presented in figure 24(a) to (e) for spanwise locations of 10, 30, 50, 70, and 90 percent span from tip, respectively. The stator is at 3.5-rotor-chord axial spacing, the intra-blade row instrumentation is at station 2b, and both stator setting angles are presented. Only design speed data were taken for these configurations with instrumentation at station 2b. Additional stator blade-element data based on station 2a measurements are listed in tables XXVIII and XXX to XLV. Plots of these station 2a data are not presented herein but were made and utilized to guide the fairing of the curves through and slightly beyond the station 2b data of figure 24.

Based on all the stator 9 data, losses generally decreased smoothly with decreased incidence angle until an abrupt increase occurred at lowest incidence. Resetting the stator 3.7° closed from design values shifted the blade operation to lower incidence angles across the span and allowed lowest loss operation at 2° to 3° more negative incidence. The concept of a maximum suction surface Mach number for a blade element above which losses abruptly rise could explain the observed loss behavior due to reset. Further analysis to calculate the velocities on the blade surfaces is needed to substantiate this concept.

As shown in figure 24, losses across the span at the same incidence angle are about equal for either setting angle. For operating line incidence angles, denoted by the vertical arrows for both setting angles, stator losses across the span are at or near their minimum values which are equal to or even less than design values for both setting angles. Losses are a little lower with the reset stator over the inner half span. These lower stator losses with reset account for the improved overall stage performance previously shown (fig. 9). Operating line incidence angles range from about -4° near the tip to -2° near the hub for the stator at design setting angle, and 1° to 4° more negative for the reset stator. Design incidence was 0° across the span.

For operating line incidence angles, stator diffusion factors D near the tip and hub are about the same for either setting angle. However, in the midspan region, the D factor is about 0.05 higher with reset while the accompanying losses are equal to or less than those with the design setting angle. (The blade surface velocity analysis previously suggested might also clarify this apparent contradiction of lower losses with higher D factors for these stator 9 data.) Stator D factors are highest near the hub and in that region (fig. 24(e)) they increase rapidly with increasing incidence. The maximum D factor attained (fig. 24(e)) was about 0.49 for the reset stator and about 0.45 for the stator at design setting angle. The design value of 0.51 at 90 percent span from the tip was never attained. Because the stator at design setting angle stalls before the rotor at de-

sign speed (fig. 8), the D factor of 0.45 represents the maximum allowable loading for stator 9. The 3.7° stator reset raises this limit to 0.49. (These stator loading limits are further discussed and correlated in a subsequent section.)

Stator deviation angles across the span (fig. 24) generally show a shift due to reset. Absolute values of deviation angle for the design setting angle are about 4° higher than design across most of the span. With the reset stator, the spanwise average flow direction at the stator exit is about 9° from the axial direction. This combines the 3.7° of reset and the deviation angle above design.

Blade Element Loadings Near Stage Stall

Effects of speed, flow, and configuration. - The combination of high inlet Mach number and high diffusion factor at either the rotor tip or the stator hub generally makes one or the other or both blade sections the critical element that initiates stage stall. As previously shown (fig. 8), the stator initiated stage stall at 90 and 100 percent speed while at lower speeds, the stator or rotor or both may be critical, that is, stall first.

For a closer look at the critical blade element and its critical loading (D factor) level with the stator at 3.5-rotor-chord axial spacing, figures 25 to 28 are presented. Diffusion factors as a function of flow over the range from choke to near stall are shown for the stator hub, 90 percent span, (fig. 25) and rotor tip, 10 percent span, (fig. 26) for the configurations without exit pylon(s). Corresponding figures with exit pylons are shown in figures 27 and 28. Each figure (figs. 25 to 28) shows the stator at design setting angle in part (a) and reset 3.7° closed in part (b). Rotor-alone critical flows from figure 8 are also indicated for convenient reference. Stator hub diffusion factor (fig. 25) increases as flow is reduced until a maximum level is reached at the near-stall flow that is the same for all speeds for a given stator setting angle. This implies the stator hub elements were near stall when the stage was near stall for all speeds tested. The critical D factor is about 0.47 with design setting angle and about 0.51 with reset, both based on measuring station 2a (and station 3) which was utilized for most of the tests. Based on measuring station 2b (preferred for the stator), the critical stator hub D factors are about 5 percent lower at 0.445 and 0.485 for design-, and reset-setting angle, respectively. At the same time, the rotor tip diffusion factors (fig. 26) appear to approach a maximum level only at speeds below 90 percent of design. There, the near-stall flows for the stage approach those indicated for the rotor alone. The rotor tip maximum D factor is about 0.56 (based on station 2a and station 1, preferred for the rotor) and is independent of the stator setting angle. Because the stator hub elements have been shown to be near stall at the lower speeds, it is not certain if the maximum attained rotor tip D factor of about 0.56 is a near-stall limit for the rotor. Blade-element data from rotor alone tests are not available to clarify this point.

With exit pylon(s), the stator hub critical D factor (fig. 27) is a little lower than without pylons for both setting angles. Although the data with pylons was limited to only a few speeds and flows, the difference in critical D factor between 1 and 4 exit pylons appears insignificant (fig. 27(a)). This is not surprising because of the similar total blockage to the exit flow. Rotor D factors are not significantly changed by the addition of pylons downstream of the stator (fig. 28).

Although not presented in this report, configurations with the close axial spacing of stators (1.0 or 1.5 rotor chord) gave essentially the same results as shown in figures 25 and 26 for the 3.5-rotor-chord spacing.

In summary, it is concluded that the stator hub elements initiated stage stall at 90 and 100 percent speed and were near stall, if not in fact initiating it, when the stage stalled at all the lower speeds for all configurations of stage 15-9 tested.

Effects of axial velocity ratio across stator. - A study of the stator hub critical loading levels for all configurations tested revealed small but systematic effects of axial velocity ratio as shown in figure 29. As axial velocity ratio across the stator is increased, the critical diffusion factor decreases linearly. The lower velocity ratios are with the reset stator. The reset stator increased outlet static pressure relative to the design setting angle and resulted in a lower stator exit velocity and thus a lower exit to inlet velocity ratio. The higher velocity ratios are with the exit pylons. They tend to block the flow, raise the stator exit velocity, and thus raise the velocity ratio. The reasons for the apparent dependence of stator critical D factor on axial velocity are not presently known. However, this relation can be used to define a modified loading parameter which effectively correlates all the stator near-stall data for all the various configurations of stage 15-9 as demonstrated next.

Correlation of stator modified loading parameter near stall. - The modified loading parameter, $D + 0.44(V_{z3}/V_{z2})$, at 90 percent span from the tip (from fig. 29) is shown as a function of flow in figure 30. Part (a) of the figure is for all the data utilizing measuring stations 2a and 3 and part (b) is for the remaining data utilizing stations 2b and 3. A single value of the critical stator modified loading parameter of 0.932 (based on stations 2a and 3) or the corresponding 0.917 (based on stations 2b and 3) applies for all configurations and all speeds within an overall data spread of about ± 2.5 percent. The configurations with the closely spaced stators (1.0 and 1.5 rotor chords) although not shown here, yielded the same correlation.

Typical stator design practice is an axial velocity ratio of about 1.0. With the stator critical modified loading parameter of 0.917, a critical D factor of about 0.48 results. This compares unfavorably with other stator designs as discussed in the next section.

Comparisons with Other Designs

Overall performance. - Stage 15-9 performance comparisons with other low noise fan stage designs from NASA's low noise aircraft engine programs are made in this section. They all have similar tip speeds, pressure ratios, wide axial spacing of stators, (at least two rotor blade chords) and stator to rotor blade number ratios greater than 2.0. These fans have been tested and reported under NASA contracts (refs. 4 to 6). Overall performance of all these fans at design speed and on operating lines passing through their design points are summarized in the following table:

Design tip speed, m/sec	Pressure ratio				Temperature ratio		Efficiency				Percent design weight flow		Stall margin, percent	Source
	Stage		Rotor		Actual	Design	Stage		Rotor		Actual	Design		
	Actual	Design	Actual	Design			Actual	Design	Actual	Design				
337	1.475	1.499	^a 1.510	1.541	1.140	1.145	0.835	0.848	^a 0.895	0.909	98.6	100.0	4.0	Stage 15-9, baseline (table I)
337	1.482	-----	^a 1.515	-----	1.141	-----	.845	-----	^a .895	-----	98.6	-----	10.0	Rotor 15, stator 9, reset
354	^b 1.520	^b 1.500	^b 1.545	-----	^b 1.144	-----	^b .883	^b .865	^b .920	-----	101.3	100.0	12.4	Ref. 5, GE fan A
354	^b 1.520	^b 1.500	^b 1.550	-----	^b 1.146	-----	^b .869	^b .870	^b .916	-----	101.7	100.0	19.5	Ref. 6, GE fan B
305	^d 1.474	^c 1.500	^d 1.508	^c 1.540	^d 1.133	^c 1.141	^d .883	^c .873	^d .936	^c .933	^d 97.5	100.0	^d 15.0	Ref. 4, PWA fan

^aBased on measuring station 2b.

^bBypass duct performance (nominal bypass ratio of 5.0).

^cDesign with original stator.

^dActual performance with redesigned stator.

The following is a comparison of some of the blade geometry features:

Design tip speed, m/sec	Blade type	Blade shape	Blade number	Blade aspect ratio	Chord length at mid-span, cm	Thickness to chord ratio ^a		Solidity ^a	Source
						Maximum	Leading and trailing edge		
337	Rotor	(b)	53	3.0	3.80	0.038	0.010	1.40	Rotor 15 } baseline stage Stator 9 }
337	Stator	(b)	112	5.1	1.84	.062	.015	2.22	
354	Rotor	(b)	40	2.3	19.48	.029	.006	1.50	Ref. 14, GE fan A
354	Stator	(c)	90	3.9	7.74	.041	.010	1.75	Ref. 14, GE bypass duct behind fan A
354	Rotor	(b)	26	1.7	26.38	.023	.006	1.34	Ref. 14, GE fan B
354	Stator	(c)	60	2.6	11.65	.043	.010	1.75	Ref. 14, GE bypass duct behind fan B
305	Rotor	(b)	24	1.7	12.70	.034	.003	1.41	Ref. 4, PWA fan
305	Stator	(b)	64	3.7	4.65	.042	.004	2.00	Ref. 4, PWA original stator
305	Stator	(b)	50	2.5	6.60	.043	.004	2.14	Ref. 4, PWA redesigned stator

^a10 Percent span from tip for rotor blades; 90 percent span from tip for stator blades.

^bMultiple circular arc in rotor tip and stator hub regions.

^cNACA 65-series thickness distribution on circular arc meanline.

In general the contract stages were 3 to 5 points more efficient than stage 15-9, with the rotors responsible for all but about 1 point of the stage differences. The nearly double leading and trailing edge thickness to chord ratios of rotor 15 compared with the contract designs could result in relatively higher rotor losses. This could particularly apply over the outer half-span where the inlet relative Mach numbers are slightly supersonic (see table II). From 15 to 50 percent span from the tip, rotor 15 losses were as much as 50 percent higher than design (fig. 19) and higher, for example, than comparable values measured on the 305-meter-per-second stage in the 20 to 80 percent span region (ref. 4). These higher rotor 15 losses also caused the positive slope pressure-flow characteristic previously discussed. Such a characteristic was not exhibited by the contract rotors. Another general difference in the rotor designs considered is blade aspect ratio, which differs mainly because of different blade numbers. For rotor 15 the aspect ratio was 3.0 compared with maximum values near 2.0 for the other rotors. In many other ways, all rotor designs considered appear similar. None have part span dampers (fan A (refs. 5 and 14) utilized tip dampers). Blade shapes and solidities were similar, as were maximum thickness to chord ratios, and mean line incidence angles over the outer half-span.

The efficiency decrements across the various stator designs in the previous performance table range from 3.7 points (354 m/sec, fan A, ref. 5) to 6.0 points (337 m/sec, stator 9, without reset). The lowest stator decrements are associated with the 354-meter-per-second stages (fans A and B) both of which utilized NACA 65-series thickness distributions on a circular arc meanline (see previous geometry table). Stator maximum thickness to chord ratios were about a third less than stator 9, and their inlet Mach numbers were about 10 percent less in the hub region. The stators for both 354-meter-per-second stages (ref. 14 for geometry details) had edge thickness to chord ratios on the order of two thirds those for stator 9. The stators in the 305-meter-per-second stage (ref. 4) were multiple circular arc designs with inlet Mach numbers similar to stator 9; however, their maximum and leading edge thickness to chord ratios were about one-third and two-thirds less, respectively, than stator 9. The chordwise distribution of turning (camber) was also different for stator 9 compared with all the contract designs. Stator 9 had about 30 percent more suction surface front turning (camber ahead of an assumed normal shock intersection with the suction surface) than the stators of the 354-meter-per-second stages. Compared with the stators in the 305-meter-per-second stage, stator 9 had nearly double their front turning over the inner half-span. The higher front turning along with a thicker leading edge for stator 9 compared to the contract designs probably resulted in much higher maximum velocities on the suction surface. Diffusing this velocity to a trailing edge value that is about the same for all designs would result in higher suction surface velocity gradients for stator 9 than for the other designs at comparable inlet conditions. This would be true even if the stator 9 chord length were comparable to the other designs; instead, it is much shorter. In

terms of aspect ratio, stator 9 has 5.1 whereas the maximum value for the contract stages is 3.9. Although all stages considered satisfied the low noise stator vane to rotor blade number ratio greater than 2, the 53 blades in rotor 15 was by far the highest number used. Thus the higher velocity gradients (loadings) on the stator suction surface could result in relatively higher losses for stator 9. Also, stator stall could occur at a relatively higher flow as discussed next.

Blade loadings/near stage stall. - As previously shown for stator 9 (fig. 25(a)), the stall critical loading occurs at the stator hub at design speed and is described by a D factor of about 0.445 (based on station 2b). Similar stator critical loading levels have also been measured (unpublished NASA data) with a different stator design tested with the same rotor 15. Compared with stator 9 design, this different stator had thinner edges, different incidence angles, and a lower aspect ratio of 2.7 (60 blades instead of 112). These stator hub critical D factors near 0.445 compare unfavorably with the results from the 305-meter-per-second stage (ref. 4). There, two different stator designs with aspect ratios of 2.5 and 3.7 had stator hub critical D factors of about 0.6 at axial velocity ratios across the stator near unity. Thus stator aspect ratio is not believed to be the main reason for the large difference in loading capability just noted. Neither is the higher maximum suction surface Mach numbers near the hub resulting from more front turning on stator 9 relative to the reference 4 stator designs. After all, the stator 9 critical diffusion factor remained constant down to 50 percent speed where any Mach number (shock) effects should be negligible.

The possible effects of scale and wall flow differences have not been evaluated. The larger scale and smaller hub to tip ratio of the reference 4 stage compared to stage 15-9, resulted in a stator blade span at midchord of about 16.6 centimeters compared to about 9.4 centimeters, respectively. The different test facilities also resulted in different wall boundary layer conditions entering the fan and the stator which in turn probably influenced the critical value of D factor in the stator hub region. Definitive reasons for the significant differences in near stall level of diffusion factor for these stators (ref. 4 and stator 9) with comparable inlet Mach numbers, incidence angles, and similar axial spacings between rotor and stator are not presently known. Such differences, however, greatly influence the stall margin and thus perhaps the usefulness of a stator critical fan stage.

Stator hub diffusion factors near stage stall for the other low noise designs (refs. 5 and 6) are not available, nor is it known whether the stator hub was the stall critical region for those designs.

Flow capacity. - As previously shown by figure 8, the maximum flow capacity for stage 15-9 at design speed was controlled by the rotor blading. Maximum flow was similarly rotor controlled in the contractor low noise designs (e.g., ref. 4). Design values of minimum area ratio (actual flow area to a choked flow area at local conditions) are often used to gage flow capacity. The radially mass-flow-averaged values of mini-

imum area ratio for rotor 15 (table IV, last column) and the other contractor designs, each calculated for their design point follow:

Design tip speed, m/sec	Area ratio	Source
337	1.030	Stage 15-9, baseline
354	1.050	Ref. 14, GE fan A
354	1.045	Ref. 14, GE fan B
395	1.050	Ref. 4, PWA fan

Choked flow was attained during tests with fans A, B, and stage 15-9 at percent design flows of approximately 103.0, 104.0, and 100.5, respectively. Thus it appears that the design point average minimum area ratio for rotor 15 was too small and the margin should have been greater than 1.030, perhaps about 1.050 in order to increase its choked flow value. Such an increase would probably increase the total range of flow and also the stall margin on the usable, negative slope part of the pressure-flow characteristic at design speed. Also, as shown by the blade-element data for both rotor and stator (figs. 23 and 24), the present choking limit of stage 15-9 lies in the region of minimum loss from hub to tip. Thus a larger design point value of average minimum area ratio for rotor 15 could produce a well matched rotor and stator with a higher stage efficiency occurring nearer the original design flow than that tested. Also, from before, thinner rotor leading (and trailing) edge could reduce losses over most of the span thereby improving efficiency and eliminating the positive slope pressure-flow characteristic at the lower flows now limiting the stall margin. With these revisions to rotor 15, stage efficiency and usable stall margin comparisons with the other contractor low noise designs might then be more favorable than previously noted.

SUMMARY OF RESULTS

Aerodynamic tests with a 0.5-meter-diameter, 337-meter-per-second tip speed, 1.5-pressure-ratio, single-stage fan with 53 rotor blades and 112 stator blades designed for low noise (0.271 scale model of NASA QF-1) were conducted over a wide range of speed and flow. Axial spacing between blade rows, stator setting angle, and exit pylon simulation were also varied. The following principal results were obtained:

1. At design speed with stator at design setting angle and a fixed distance between stage measuring stations, there were no significant effects of increasing the axial

spacing between the rotor and stator from 1.0 to 3.5 rotor chords on stage overall pressure ratio, efficiency, or stall margin.

2. On a calculated operating line passing through the design point, total pressure ratio, and efficiency for the stage were 1.475 and 0.835 with the stator at design setting angle compared to design values of 1.499 and 0.848. There was a six-point loss in efficiency across the stator as predicted in design. By resetting the stator 3.7° closed, the stage efficiency became 0.845 with no change in rotor performance. Compared to similar low noise fan stage designs from NASA's low noise aircraft engine programs, the stage was three to five points less efficient, perhaps because of thicker rotor and stator edges, a smaller rotor flow area margin, and more front camber on the stator.

3. Stall margin from a calculated operating line passing through the design point was only 4 percent with the stator at design setting angle. Stall margins greater than 4 percent were attained with the reset stator but they depended on a positive slope pressure-flow characteristic at design speed caused by high rotor losses making the higher stall margins unusable in a practical application.

4. Stage stall occurred when blade row loading limits were encountered. The stator hub elements initiated stall at 90 and 100 percent of design speed and were near stall, if not initiating it, when the stage stalled at all the lower speeds for all configurations tested.

5. A modified loading parameter that correlated this stator hub near-stall operating conditions for all speeds and configurations tested was the sum of the conventional diffusion factor and a fraction (0.44 for this stator) of the axial velocity ratio.

Lewis Research Center,
National Aeronautics and Space Administration,
Cleveland, Ohio, August 14, 1974,
501-24.

APPENDIX A

SYMBOLS

A_{an}	annulus area at rotor leading edge, 0.144 m^2
A_f	frontal area at rotor leading edge, 0.192 m^2
C_p	specific heat at constant pressure, $1004 \text{ J}/(\text{kg})(\text{K})$
c	aerodynamic chord, cm
D	diffusion factor
i_{mc}	mean incidence angle, angle between inlet air direction and line tangent to blade mean camber line at leading edge, deg
i_{ss}	suction-surface incidence angle, angle between inlet air direction and line tangent to blade suction surface at leading edge, deg
M	Mach number
N	rotative speed, rpm
N_D	design rotative speed, 13 020 rpm
P	total pressure, N/cm^2
p	static pressure, N/cm^2
r	radius, cm
SM	stall margin
T	total temperature, K
U	wheel speed, m/sec
V	air velocity, m/sec
W	weight flow, kg/sec
W_D	design weight flow, 29.16 kg/sec
Z	axial distance referenced from rotor blade hub leading edge, cm
α_c	cone angle, deg
α_s	slope of streamline, deg
β	air angle, angle between air velocity and axial direction, deg
β'_c	relative meridional air angle based on cone angle, $\arctan(\tan \beta'_m \cos \alpha_c / \cos \alpha_s)$, deg

γ	ratio of specific heats (1.40)
δ	ratio of rotor inlet total pressure to standard pressure of 10.13 N/cm ²
δ°	deviation angle, angle between exit air direction and tangent to blade mean camber line at trailing edge, deg
η	efficiency
θ	ratio of rotor inlet total temperature to standard temperature of 288.2 K
κ_{mc}	angle between blade mean camber line and meridional plane, deg
κ_{ss}	angle between blade suction-surface at leading edge and meridional plane, deg
σ	solidity, ratio of chord to spacing
$\bar{\omega}$	total loss coefficient
$\bar{\omega}_p$	profile loss coefficient
$\bar{\omega}_s$	shock loss coefficient

Subscripts:

ad	adiabatic (temperature rise)
id	ideal
LE	blade leading edge
m	meridional direction
mom	momentum rise
p	polytropic
R	rotor
ref	reference
stall	
TE	blade trailing edge
tip	tip
z	axial direction
θ	tangential direction
1	instrumentation plane upstream of rotor (see fig. 1)
2a	instrumentation plane nearest rotor trailing edge (see fig. 1)
2b	instrumentation plane nearest stator leading edge (see fig. 1)

3 instrumentation plane downstream of stator (see fig. 1)

Superscript:

' relative to blade

APPENDIX B

EQUATIONS

Suction-surface incidence angle

$$i_{ss} = (\beta'_c)_{LE} - \kappa_{ss} \quad (B1)$$

Mean incidence angle

$$i_{mc} = (\beta'_c)_{LE} - (\kappa_{mc})_{LE} \quad (B2)$$

Deviation angle

$$\delta^o = (\beta'_c)_{TE} - (\kappa_{mc})_{TE} \quad (B3)$$

Diffusion factor

$$D = 1 - \frac{V'_{TE}}{V'_{LE}} + \left| \frac{(rV_\theta)_{TE} - (rV_\theta)_{LE}}{(r_{TE} + r_{LE})\sigma(V'_{LE})} \right| \quad (B4)$$

Total loss coefficient

$$\bar{\omega} = \frac{(P'_{id})_{TE} - P'_{TE}}{P'_{LE} - p_{LE}} \quad (B5)$$

Profile loss coefficient

$$\bar{\omega}_p = \bar{\omega} - \bar{\omega}_s \quad (B6)$$

Total loss parameter

$$\frac{\bar{\omega} \cos(\beta'_m)_{TE}}{2\sigma} \quad (B7)$$

Profile loss parameter

$$\frac{\bar{\omega}_p \cos(\beta'_m)_{TE}}{2\sigma} \quad (B8)$$

Adiabatic (temperature-rise) efficiency

$$\eta_{ad} = \frac{\left(\frac{P_{TE}}{P_{LE}}\right)^{(\gamma-1)/\gamma} - 1}{\frac{T_{TE}}{T_{LE}} - 1} \quad (B9)$$

Momentum-rise efficiency

$$\eta_{mom} = \frac{\left(\frac{P_{TE}}{P_{LE}}\right)^{(\gamma-1)/\gamma} - 1}{\frac{(UV_\theta)_{TE} - (UV_\theta)_{LE}}{T_{LE} C_p}} \quad (B10)$$

Equivalent weight flow

$$\frac{W\sqrt{\theta}}{\delta} \quad (B11)$$

Equivalent rotative speed

$$\frac{N}{\sqrt{\theta}} \quad (B12)$$

Weight flow per unit annulus area

$$\frac{\left(\frac{W\sqrt{\theta}}{\delta}\right)}{A_{an}} \quad (B13)$$

Weight flow per unit frontal area

$$\frac{\left(\frac{W\sqrt{\theta}}{\delta}\right)}{A_f} \quad (\text{B14})$$

Head-rise coefficient

$$\frac{C_p T_{LE}}{U_{tip}^2} \left[\left(\frac{P_{TE}}{P_{LE}} \right)^{(\gamma-1)/\gamma} - 1 \right] \quad (\text{B15})$$

Flow coefficient

$$\left(\frac{V_z}{U_{tip}} \right)_{LE} \quad (\text{B16})$$

Stall margin

$$SM = \left[\frac{\left(\frac{P_{TE}}{P_{LE}} \right)_{stall} \times \left(\frac{W\sqrt{\theta}}{\delta} \right)_{ref}}{\left(\frac{P_{TE}}{P_{LE}} \right)_{ref} \times \left(\frac{W\sqrt{\theta}}{\delta} \right)_{stall}} - 1 \right] \times 100 \quad (\text{B17})$$

Polytropic efficiency

$$\eta_p = \frac{\ln \left(\frac{P_{TE}}{P_{LE}} \right)^{(\gamma-1)/\gamma}}{\ln \frac{T_{TE}}{T_{LE}}} \quad (\text{B18})$$

APPENDIX C

ABBREVIATIONS AND UNITS USED IN TABLES

ABS	absolute
AERO CHORD	aerodynamic chord, cm
AREA RATIO	ratio of actual flow area to critical area (where local Mach number is 1)
BETAM	meridional air angle, deg
CONE ANGLE	angle between axial direction and conical surface representing blade element, deg
DELTA INC	difference between mean camber blade angle and suction-surface blade angle at leading edge, deg
DEV	deviation angle (defined by eq. (B3)), deg
D-FACT	diffusion factor (defined by eq. (B4))
EFF	adiabatic efficiency (defined by eq. (B9))
IN	inlet (leading edge of blade)
INCIDENCE	incidence angle (suction surface defined by eq. (B1) and mean defined by eq. (B2)), deg
KIC	angle between blade mean camber line at leading edge and meridional plane, deg
KOC	angle between blade mean camber line at trailing edge and meridional plane, deg
KTC	angle between blade mean camber line at transition point and meridional plane, deg
LOSS COEFF	loss coefficient (total defined by eq. (B5) and profile defined by eq. (B6))
LOSS PARAM	loss parameter (total defined by eq. (B7) and profile defined by eq. (B8))
MERID	meridional
MERID VEL R	meridional velocity ratio
OUT	outlet (trailing edge of blade)
PERCENT SPAN	percent of blade span from tip at rotor trailing edge for design streamlines

PHISS	suction-surface camber ahead of assumed shock location, deg
PRESS	pressure, N/cm^2
PROF	profile
RADII	radius, cm
REL	relative to blade
RI	inlet radius (leading edge of blade), cm
RO	outlet radius (trailing edge of blade), cm
RP	radial position
RPM	equivalent rotative speed, rpm
SETTING ANGLE	angle between aerodynamic chord and meridional plane, deg
SOLIDITY	ratio of aerodynamic chord to blade spacing
SPEED	speed, m/sec
SS	suction surface
STREAMLINE SLOPE	slope of streamline, deg
TANG	tangential
TEMP	temperature, K
TI	thickness of blade at leading edge, cm
TM	thickness of blade at maximum thickness, cm
TO	thickness of blade at trailing edge, cm
TOT	total
TOTAL CAMBER	difference between inlet and outlet blade mean camber lines, deg
VEL	velocity, m/sec
WT FLOW	equivalent weight flow, kg/sec
X FACTOR	ratio of suction-surface camber ahead of assumed shock location of a multiple-circular-arc blade section to that of a double-circular-arc blade section
ZIC	axial distance to blade leading edge from rotor hub leading edge, cm
ZMC	axial distance to blade maximum thickness point from rotor hub leading edge, cm

ZOC axial distance to blade trailing edge from rotor hub leading edge, cm
ZTC axial distance to transition point from rotor hub leading edge, cm

REFERENCES

1. Kramer, James J.; Hartmann, Melvin J.; Leonard, Bruce R.; Klapproth, Jack F.; and Sofrin, Thomas G.: Fan Noise and Performance. Section II of Aircraft Engine Noise Reduction. NASA SP-311, 1972, pp. 7-61.
2. Leonard, Bruce R.; Schmiedlin, Ralph F.; Stakolich, Edward G.; and Neumann, Harvey E.: Acoustic and Aerodynamic Performance of a 6-Foot-Diameter Fan for Turbofan Engines. I - Design of Facility and QF-1 Fan. NASA TN D-5877, 1970.
3. Goldstein, Arthur W.; Lucas, James G.; and Balombin, Joseph R.: Acoustic and Aerodynamic Performance of a 6-Foot-Diameter Fan for Turbofan Engines. 2 - Performance of QF-1 Fan in Nacelle Without Acoustic Suppression. NASA TN D-6080, 1970.
4. Keenan, M. J.; and Burdsall, E. A.: High Loading, Low Speed Fan Study. Part 5: Final Report. PWA-4517, Pratt & Whitney Aircraft (NASA CR-121148), 1973.
5. Giffin, R. G.; Parker, D. E.; and Dunbar, L. W.: Experimental Quiet Engine Program Aerodynamic Performance of Fan A. General Electric Company (NASA CR-120858), 1971.
6. Giffin, R. G.; Parker, D. E.; and Dunbar, L. W.: Experimental Quiet Engine Program Aerodynamic Performance of Fan B. General Electric Company (NASA CR-72993), 1972.
7. Urasek, Donald C.; and Janetzke, David C.: Performance of Tandem-Bladed Transonic Compressor Rotor with Tip Speed of 1375 Feet per Second. NASA TM X-2484, 1972.
8. Ball, Calvin L.; Janetzke, David C.; and Reid, Lonnie: Performance of 1380-Foot-Per-Second-Tip-Speed Axial-Flow Compressor Rotor with Blade Tip Solidity of 1.5. NASA TM X-2379, 1972.
9. Crouse, James E.; Janetzke, David C.; and Schwirian, Richard E.: A Computer Program for Composing Compressor Blading from Simulated Circular-Arc Elements on Conical Surfaces. NASA TN D-5437, 1969.
10. Bullock, Robert O.; Wilcox, Ward W.; and Moses, Jason J.: Experimental and Theoretical Studies of Surging in Continuous-Flow Compressor. NACA TN 1213, 1947.
11. Harley, K. G.; and Burdsall, E. A.: High-Loading Low-Speed Fan Study. Part 2: Data and Performance Unslotted Blades and Vanes. PWA-3653, Pratt & Whitney Aircraft (NASA CR-72667), 1970.

12. Tesch, W. A.; and Doyle, V. L.: Inlet Flow Distortion Testing Evaluation of Range and Distortion Tolerance for High Mach Number Transonic Fan Stages, Volume 1, Task II Stage Data and Performance Report. GE-R70-AEG-426-vol. -1, General Electric Company (NASA CR-72786-vol. 1), 1971.
13. Lieblein, Seymour; and Roudebush, William H.: Low-Speed Wake Characteristics of Two-Dimensional Cascade and Isolated Airfoil Sections. NACA TN 3771, 1956.
14. Experimental Quite Engine Program. Volume 1, Phase 1: Engine Design Report. General Electric Co. (NASA CR-72967), 1970.

TABLE I. - DESIGN OVERALL PARAMETERS
FOR STAGE 15-9

ROTOR TOTAL PRESSURE RATIO.....	1.541
STAGE TOTAL PRESSURE RATIO	1.499
ROTOR TOTAL TEMPERATURE RATIO.....	1.145
STAGE TOTAL TEMPERATURE RATIO	1.145
ROTOR ADIABATIC EFFICIENCY.....	0.909
STAGE ADIABATIC EFFICIENCY	0.848
ROTOR POLYTROPIC EFFICIENCY.....	0.915
STAGE POLYTROPIC EFFICIENCY	0.856
ROTOR HEAD RISE COEFFICIENT.....	0.334
STAGE HEAD RISE COEFFICIENT	0.312
FLOW COEFFICIENT.....	0.581
WT FLOW PER UNIT FRONTAL AREA	151.534
WT FLOW PER UNIT ANNULUS AREA.....	201.797
WT FLOW	29.161
RPM.....	13020.000
TIP SPEED	337.451

TABLE II. - DESIGN BLADE-ELEMENT PARAMETERS FOR ROTOR 15

RP	RADII		ABS BETAM		REL BETAM		TOTAL TEMP		TOTAL PRESS	
	IN	OUT	IN	OUT	IN	OUT	IN	RATIO	IN	RATIO
TIP	24.750	23.962	0.	40.8	63.6	45.6	288.2	1.169	10.13	1.541
1	24.132	23.424	0.	38.9	61.6	44.9	288.2	1.158	10.13	1.541
2	23.510	22.886	-0.	37.6	59.8	44.1	288.2	1.149	10.13	1.541
3	22.884	22.347	-0.	36.9	58.3	43.0	288.2	1.143	10.13	1.541
4	21.021	20.732	-0.	38.2	54.7	37.6	288.2	1.139	10.13	1.541
5	18.560	18.579	-0.	41.5	50.9	27.1	288.2	1.141	10.13	1.541
6	16.075	16.425	-0.	45.3	47.2	11.7	288.2	1.144	10.13	1.541
7	14.192	14.810	-0.	48.6	44.0	-3.0	288.2	1.148	10.13	1.541
8	13.573	14.272	-0.	49.9	42.7	-8.3	288.2	1.149	10.13	1.541
9	12.960	13.734	-0.	51.3	41.5	-13.8	288.2	1.151	10.13	1.541
HUB	12.352	13.195	0.	52.6	40.1	-19.2	288.2	1.152	10.13	1.541

RP	ABS VEL		REL VEL		MERID VEL		TANG VEL		WHEEL SPEED	
	IN	OUT	IN	OUT	IN	OUT	IN	OUT	IN	OUT
TIP	167.3	229.2	376.6	247.7	167.3	173.4	0.	149.8	337.5	326.7
1	177.8	227.4	374.0	249.9	177.8	176.9	0.	142.9	329.0	319.4
2	186.3	226.5	370.7	249.8	186.3	179.4	-0.	138.2	320.5	312.0
3	192.7	226.3	366.7	247.4	192.7	180.9	-0.	135.9	312.0	304.7
4	203.0	230.9	351.2	229.1	203.0	181.5	-0.	142.7	286.6	282.7
5	205.7	242.4	326.1	203.9	205.7	181.6	-0.	160.6	253.1	253.3
6	203.2	261.7	298.9	188.0	203.2	184.2	-0.	185.9	219.2	224.0
7	200.7	282.0	278.8	186.6	200.7	186.3	-0.	211.7	193.5	201.9
8	200.2	290.1	272.7	188.7	200.2	186.8	-0.	221.9	185.1	194.6
9	200.0	298.8	266.9	192.5	200.0	187.0	-0.	233.1	176.7	187.3
HUB	200.1	308.3	261.5	198.1	200.1	187.1	0.	245.0	168.4	179.9

RP	ABS MACH NO		REL MACH NO		MERID MACH NO		STREAMLINE SLOPE		MERID PEAK SS	
	IN	OUT	IN	OUT	IN	OUT	IN	OUT	VEL R	MACH NO
TIP	0.504	0.649	1.135	0.701	0.504	0.491	-19.40	-14.51	1.037	1.448
1	0.537	0.646	1.130	0.710	0.537	0.503	-16.77	-12.48	0.995	1.455
2	0.565	0.646	1.124	0.713	0.565	0.512	-14.29	-10.63	0.963	1.455
3	0.585	0.648	1.114	0.708	0.585	0.518	-11.97	-8.97	0.939	1.448
4	0.619	0.663	1.071	0.658	0.619	0.521	-5.98	-4.78	0.894	1.451
5	0.628	0.699	0.995	0.588	0.628	0.523	0.30	-0.20	0.883	1.475
6	0.620	0.759	0.911	0.546	0.620	0.534	5.93	4.15	0.906	1.405
7	0.611	0.825	0.849	0.546	0.611	0.545	10.16	7.57	0.928	1.324
8	0.610	0.851	0.831	0.554	0.610	0.548	11.61	8.79	0.933	1.292
9	0.609	0.880	0.813	0.567	0.609	0.551	13.07	10.05	0.935	1.258
HUB	0.609	0.911	0.797	0.586	0.609	0.553	14.55	11.34	0.935	1.222

RP	PERCENT SPAN	INCIDENCE		DEV	D-FACT	EFF	LOSS COEFF		LOSS PARAM	
		MEAN	SS				TOT	PROF	TOT	PROF
TIP	0.	3.3	-0.0	7.0	0.488	0.778	0.189	0.154	0.049	0.040
1	5.00	3.4	-0.0	6.4	0.469	0.834	0.136	0.100	0.035	0.026
2	10.00	3.5	0.0	5.9	0.458	0.883	0.093	0.059	0.024	0.015
3	15.00	3.6	-0.0	5.7	0.453	0.919	0.063	0.031	0.016	0.008
4	30.00	4.2	-0.0	5.8	0.479	0.944	0.046	0.018	0.012	0.005
5	50.00	5.5	0.0	6.4	0.517	0.936	0.058	0.035	0.015	0.009
6	70.00	7.8	-0.0	7.4	0.529	0.914	0.090	0.081	0.022	0.020
7	85.00	10.3	0.0	8.1	0.504	0.890	0.131	0.129	0.029	0.029
8	90.00	11.6	0.0	8.2	0.486	0.882	0.148	0.147	0.031	0.031
9	95.00	13.1	0.0	8.3	0.462	0.873	0.166	0.165	0.033	0.033
HUB	100.00	14.9	-0.0	8.5	0.430	0.864	0.185	0.185	0.034	0.034

TABLE III. - DESIGN BLADE-ELEMENT PARAMETERS FOR STATOR 9

RP	RADI I		ABS BETAM		REL BETAM		TOTAL TEMP		TOTAL PRESS	
	IN	OUT	IN	OUT	IN	OUT	IN	RATIO	IN	RATIO
TIP	23.414	23.409	37.5	0.	37.5	0.	336.9	1.000	15.61	0.952
1	22.948	22.945	35.3	0.	35.3	0.	333.6	1.000	15.61	0.961
2	22.478	22.475	33.8	-0.	33.8	-0.	331.1	1.000	15.61	0.969
3	22.004	21.999	32.9	-0.	32.9	-0.	329.4	1.000	15.61	0.975
4	20.577	20.575	33.4	-0.	33.4	-0.	328.3	1.000	15.61	0.983
5	18.682	18.718	36.1	-0.	36.1	-0.	328.7	1.000	15.61	0.986
6	16.786	16.916	40.2	-0.	40.2	-0.	329.6	1.000	15.61	0.983
7	15.343	15.622	45.4	-0.	45.4	-0.	330.7	1.000	15.61	0.979
8	14.848	15.165	47.2	-0.	47.2	-0.	331.1	1.000	15.61	0.951
9	14.344	14.683	49.0	-0.	49.0	-0.	331.6	1.000	15.61	0.899
HUB	13.833	14.181	50.8	-0.	50.8	-0.	332.0	1.000	15.61	0.821

RP	ABS VEL		REL VEL		MERID VEL		TANG VEL		WHEEL SPEED	
	IN	OUT	IN	OUT	IN	OUT	IN	OUT	IN	OUT
TIP	252.0	187.1	252.0	187.1	199.9	187.1	153.4	0.	0.	0.
1	252.2	190.9	252.2	190.9	205.7	190.9	145.9	0.	0.	0.
2	253.0	193.8	253.0	193.8	210.3	193.8	140.7	-0.	0.	0.
3	254.3	195.9	254.3	195.9	213.6	195.9	138.0	-0.	0.	0.
4	261.2	198.7	261.2	198.7	218.1	198.7	143.8	-0.	0.	0.
5	271.2	199.1	271.2	199.1	219.2	199.1	159.7	-0.	0.	0.
6	281.8	198.5	281.8	198.5	215.1	198.5	181.9	-0.	0.	0.
7	287.2	195.2	287.2	195.2	201.8	195.2	204.4	-0.	0.	0.
8	289.9	188.7	289.9	188.7	196.9	188.7	212.7	-0.	0.	0.
9	293.5	177.7	293.5	177.7	192.5	177.7	221.5	-0.	0.	0.
HUB	297.8	162.0	297.8	162.0	188.3	162.0	230.7	-0.	0.	0.

RP	ABS MACH NO		REL MACH NO		MERID MACH NO		STREAMLINE SLOPE		MERID PEAK SS	
	IN	OUT	IN	OUT	IN	OUT	IN	OUT	VEL R	MACH NO
TIP	0.719	0.522	0.719	0.522	0.571	0.522	-0.01	0.00	0.936	1.261
1	0.724	0.536	0.724	0.536	0.591	0.536	0.01	0.01	0.928	1.212
2	0.730	0.547	0.730	0.547	0.606	0.547	0.02	0.01	0.922	1.181
3	0.736	0.555	0.736	0.555	0.618	0.555	0.03	0.00	0.917	1.165
4	0.760	0.564	0.760	0.564	0.634	0.564	0.27	0.18	0.911	1.196
5	0.792	0.565	0.792	0.565	0.640	0.565	1.39	1.25	0.908	1.274
6	0.825	0.563	0.825	0.563	0.630	0.563	3.69	3.59	0.923	1.377
7	0.842	0.551	0.842	0.551	0.592	0.551	6.87	7.40	0.967	1.469
8	0.850	0.532	0.850	0.532	0.578	0.532	7.91	9.04	0.958	1.506
9	0.862	0.499	0.862	0.499	0.565	0.499	8.84	10.85	0.923	1.546
HUB	0.876	0.453	0.876	0.453	0.554	0.453	9.67	12.83	0.860	1.589

RP	PERCENT		INCIDENCE		DEV	D-FACT	EFF	LOSS COEFF		LOSS PARAM	
	SPAN		MEAN	SS				TOT	PROF	TOT	PROF
TIP	0.		13.7	0.0	5.3	0.474	0.	0.165	0.165	0.059	0.059
1	5.00		14.1	0.0	4.8	0.445	0.	0.131	0.131	0.046	0.046
2	10.00		14.3	0.0	4.5	0.424	0.	0.103	0.103	0.035	0.035
3	15.00		14.3	0.0	4.3	0.411	0.	0.082	0.082	0.027	0.027
4	30.00		13.1	-0.0	4.5	0.412	0.	0.053	0.053	0.017	0.017
5	50.00		11.2	0.0	5.1	0.433	0.	0.040	0.040	0.011	0.011
6	70.00		9.4	0.0	5.9	0.460	0.	0.048	0.045	0.012	0.011
7	85.00		8.1	0.0	6.8	0.485	0.	0.056	0.046	0.013	0.011
8	90.00		7.6	0.0	7.1	0.513	0.	0.130	0.116	0.029	0.026
9	95.00		7.2	0.0	7.4	0.557	0.	0.264	0.245	0.057	0.053
HUB	100.00		6.8	-0.0	7.6	0.616	0.	0.455	0.428	0.095	0.090

TABLE IV. - BLADE GEOMETRY FOR ROTOR 15

RP	PERCENT RADII		BLADE ANGLES			DELTA	CONE	
	SPAN	RI	RO	KIC	KTC	KOC	INC	ANGLE
TIP	0.	24.750	23.962	60.18	56.04	37.62	3.32	-20.375
1	5.	24.132	23.424	58.16	53.63	37.89	3.37	-17.428
2	10.	23.510	22.886	56.33	51.57	37.68	3.46	-14.752
3	15.	22.884	22.347	54.69	49.88	37.00	3.58	-12.262
4	30.	21.021	20.732	50.52	45.02	31.80	4.17	-5.998
5	50.	18.560	18.579	45.41	38.87	20.63	5.49	0.349
6	70.	16.075	16.425	39.39	32.45	4.28	7.78	5.833
7	85.	14.192	14.810	33.67	27.61	-11.12	10.32	9.632
8	90.	13.573	14.272	31.22	26.10	-16.53	11.60	10.738
9	95.	12.960	13.734	28.47	24.63	-22.01	13.13	11.756
HUB	100.	12.352	13.195	25.42	23.22	-27.59	14.88	12.727

RP	BLADE THICKNESSES			AXIAL DIMENSIONS			
	Ti	Tm	To	ZIC	ZMC	ZTC	ZOC
TIP	0.036	0.143	0.032	0.711	1.655	1.926	2.831
1	0.036	0.145	0.031	0.666	1.683	1.914	2.920
2	0.037	0.147	0.032	0.620	1.700	1.886	2.990
3	0.038	0.151	0.032	0.573	1.706	1.841	3.042
4	0.042	0.167	0.034	0.448	1.673	1.674	3.196
5	0.050	0.199	0.038	0.313	1.624	1.408	3.407
6	0.062	0.246	0.045	0.203	1.625	1.114	3.638
7	0.074	0.295	0.052	0.082	1.631	0.825	3.723
8	0.079	0.315	0.055	0.048	1.637	0.731	3.734
9	0.084	0.337	0.058	0.022	1.648	0.641	3.738
HUB	0.090	0.360	0.061	0.000	1.664	0.554	3.734

RP	AERO	SETTING	TOTAL	X			AREA
	CHORD	ANGLE	CAMBER	SOLIDITY	FACTOR	PHISS	RATIO
TIP	3.880	53.99	22.56	1.344	0.500	8.34	1.005
1	3.863	51.91	20.27	1.370	0.578	8.62	1.014
2	3.851	50.05	18.65	1.400	0.638	8.76	1.021
3	3.838	48.36	17.69	1.431	0.681	8.78	1.024
4	3.812	42.94	18.72	1.540	0.780	9.66	1.036
5	3.802	34.59	24.78	1.727	0.858	11.38	1.046
6	3.820	23.56	35.11	1.983	0.920	13.11	1.047
7	3.858	13.29	44.80	2.244	0.963	13.64	1.029
8	3.871	9.62	47.75	2.346	0.976	13.54	1.015
9	3.887	5.85	50.48	2.456	0.989	13.30	0.996
HUB	3.906	1.98	53.02	2.579	1.000	12.92	0.972

TABLE V. - BLADE GEOMETRY FOR STATOR 9

RP	PERCENT RADII		BLADE ANGLES			DELTA	CONE	
	SPAN	RI	RO	KIC	KTC	KOC	INC	ANGLE
TIP	0.	23.414	23.409	23.77	14.42	-5.26	13.73	-0.162
1	5.	22.948	22.945	21.22	14.42	-4.82	14.11	-0.100
2	10.	22.478	22.475	19.49	14.48	-4.49	14.30	-0.125
3	15.	22.004	21.999	18.58	14.59	-4.29	14.30	-0.180
4	30.	20.577	20.575	20.32	15.70	-4.50	13.09	-0.060
5	50.	18.682	18.718	24.88	17.85	-5.14	11.19	1.156
6	70.	16.786	16.916	30.81	20.69	-5.94	9.39	4.176
7	85.	15.343	15.622	37.14	23.74	-6.78	8.06	9.026
8	90.	14.848	15.165	39.39	24.91	-7.08	7.64	10.248
9	95.	14.344	14.683	41.60	26.13	-7.35	7.22	10.973
HJB	100.	13.833	14.181	43.80	27.41	-7.62	6.83	11.305

RP	BLADE THICKNESSES			AXIAL DIMENSIONS			
	TI	TM	TO	ZIC	ZMC	ZTC	ZOC
TIP	0.037	0.184	0.028	17.366	18.159	17.771	19.162
1	0.036	0.181	0.028	17.365	18.161	17.740	19.163
2	0.035	0.177	0.028	17.366	18.163	17.718	19.164
3	0.035	0.173	0.028	17.367	18.165	17.705	19.166
4	0.032	0.162	0.028	17.369	18.164	17.709	19.165
5	0.030	0.147	0.028	17.375	18.161	17.731	19.164
6	0.028	0.132	0.028	17.382	18.154	17.750	19.159
7	0.028	0.122	0.028	17.393	18.146	17.767	19.155
8	0.028	0.118	0.028	17.399	18.145	17.773	19.154
9	0.028	0.115	0.028	17.407	18.145	17.777	19.155
HJB	0.028	0.110	0.028	17.416	18.146	17.781	19.157

RP	AERO	SETTING	TOTAL	X		AREA	
	CHORD	ANGLE	CAMBER	SOLIDITY	FACTOR	PHISS	RATIO
TIP	1.846	7.98	29.03	1.406	1.300	19.35	1.123
1	1.845	7.61	26.04	1.434	1.300	17.05	1.095
2	1.845	7.41	23.98	1.463	1.300	15.39	1.074
3	1.845	7.36	22.87	1.495	1.300	14.36	1.061
4	1.844	8.02	24.82	1.597	1.300	14.11	1.052
5	1.843	9.48	30.02	1.757	1.300	15.13	1.054
6	1.846	11.46	36.75	1.953	1.300	16.87	1.078
7	1.863	13.62	43.93	2.145	1.300	19.13	1.124
8	1.869	14.43	46.47	2.220	1.300	19.88	1.140
9	1.873	15.24	48.96	2.301	1.300	20.55	1.157
HJB	1.875	16.07	51.42	2.386	1.300	21.15	1.173

TABLE VI. - OVERALL PERFORMANCE OF STAGE 15-9

(a) Stator at design setting angle; 3.5-rotor-chord axial spacing; effects of speed and flow

Parameter	100 Percent design speed; rotor exit instrumentation at station								
	2a					2b			
	Reading number								
	558	538	560	539	543	551	600	601	602
ROTOR TOTAL PRESSURE RATIO	1.471	1.480	1.510	1.513	1.525	1.547	1.453	1.481	1.535
STAGE TOTAL PRESSURE RATIO	1.397	1.432	1.460	1.463	1.481	1.484	1.409	1.448	1.485
ROTOR TOTAL TEMPERATURE RATIO	1.132	1.134	1.137	1.139	1.140	1.146	1.129	1.133	1.145
STAGE TOTAL TEMPERATURE RATIO	1.131	1.133	1.137	1.138	1.140	1.146	1.130	1.134	1.146
ROTOR TEMP. RISE EFFICIENCY	0.885	0.886	0.910	0.907	0.915	0.908	0.875	0.890	0.895
STAGE TEMP. RISE EFFICIENCY	0.763	0.812	0.831	0.830	0.846	0.821	0.790	0.833	0.821
ROTOR MOMENTUM RISE EFFICIENCY	0.862	0.883	0.882	0.898	0.904	0.905	0.853	0.887	0.896
ROTOR HEAD RISE COEFFICIENT	0.295	0.300	0.316	0.318	0.324	0.337	0.287	0.304	0.330
STAGE HEAD RISE COEFFICIENT	0.253	0.274	0.288	0.290	0.300	0.303	0.262	0.285	0.303
FLOW COEFFICIENT	0.525	0.518	0.516	0.510	0.511	0.494	0.523	0.516	0.495
WT FLOW PER UNIT FRONTAL AREA	152.07	151.49	149.65	148.87	148.15	143.67	151.33	149.23	144.55
WT FLOW PER UNIT ANNULUS AREA	202.50	201.73	199.28	198.24	197.29	191.31	201.52	198.72	192.49
WT FLOW AT ORIFICE	29.26	29.15	28.89	28.65	28.51	27.65	29.12	28.72	27.92
WT FLOW AT ROTOR INLET	29.54	29.25	29.24	28.94	28.99	28.19	29.38	29.09	28.22
WT FLOW AT ROTOR OUTLET	29.67	29.76	29.19	29.45	29.51	28.86	29.00	28.64	28.20
WT FLOW AT STATOR OUTLET	30.25	29.87	29.22	29.20	29.61	28.81	30.10	29.27	29.10
ROTATIVE SPEED	13053.3	13041.9	13065.6	13057.2	13051.8	13025.9	13004.5	12982.2	13039.2
PERCENT OF DESIGN SPEED	100.3	100.2	100.4	100.3	100.2	100.0	99.9	99.7	100.1
PERCENT DESIGN WT FLOW AT ORIFICE	100.3	100.0	98.8	98.2	97.8	94.8	99.8	98.5	95.4

Parameter	Percent design speed (rotor exit instrumentation at station 2a)							
	90						80	
	Reading number							
	564	565	566	567	568	580	545	572
ROTOR TOTAL PRESSURE RATIO	1.367	1.379	1.402	1.415	1.421	1.405	1.398	1.300
STAGE TOTAL PRESSURE RATIO	1.320	1.346	1.367	1.377	1.378	1.355	1.334	1.243
ROTOR TOTAL TEMPERATURE RATIO	1.102	1.103	1.108	1.113	1.116	1.116	1.121	1.099
STAGE TOTAL TEMPERATURE RATIO	1.102	1.104	1.108	1.112	1.116	1.115	1.120	1.098
ROTOR TEMP. RISE EFFICIENCY	0.917	0.929	0.936	0.926	0.912	0.881	0.827	0.788
STAGE TEMP. RISE EFFICIENCY	0.806	0.851	0.862	0.852	0.830	0.787	0.715	0.657
ROTOR MOMENTUM RISE EFFICIENCY	0.893	0.899	0.906	0.897	0.887	0.856	0.817	0.767
ROTOR HEAD RISE COEFFICIENT	0.292	0.300	0.316	0.324	0.329	0.322	0.315	0.308
STAGE HEAD RISE COEFFICIENT	0.259	0.276	0.291	0.298	0.299	0.287	0.269	0.253
FLOW COEFFICIENT	0.539	0.534	0.514	0.492	0.467	0.437	0.409	0.355
WT FLOW PER UNIT FRONTAL AREA	143.78	142.68	138.42	133.89	128.38	120.89	114.37	91.46
WT FLOW PER UNIT ANNULUS AREA	191.47	190.01	184.32	178.30	170.96	160.98	152.30	121.80
WT FLOW AT ORIFICE	27.67	27.46	26.64	25.77	24.71	23.26	22.01	17.60
WT FLOW AT ROTOR INLET	27.86	27.69	26.91	26.02	24.97	23.49	22.23	17.66
WT FLOW AT ROTOR OUTLET	27.99	27.79	27.11	26.25	25.31	23.97	22.94	17.93
WT FLOW AT STATOR OUTLET	28.47	27.95	27.09	26.32	25.43	23.91	22.82	18.25
ROTATIVE SPEED	11727.0	11747.4	11748.6	11766.6	11764.5	11676.5	11716.6	10446.3
PERCENT OF DESIGN SPEED	90.1	90.2	90.2	90.4	90.4	89.7	90.0	80.2
PERCENT DESIGN WT FLOW AT ORIFICE	94.9	94.2	91.4	88.4	84.7	79.8	75.5	60.4

Parameter	Percent design speed (rotor exit instrumentation at station 2a)							
	70						60	50
	Reading number							
	573	574	575	576	550	577	578	579
ROTOR TOTAL PRESSURE RATIO	1.194	1.210	1.229	1.231	1.225	1.227	1.162	1.101
STAGE TOTAL PRESSURE RATIO	1.177	1.195	1.211	1.204	1.185	1.183	1.133	1.090
ROTOR TOTAL TEMPERATURE RATIO	1.055	1.060	1.066	1.071	1.075	1.076	1.055	1.034
STAGE TOTAL TEMPERATURE RATIO	1.056	1.060	1.066	1.071	1.074	1.076	1.055	1.032
ROTOR TEMP. RISE EFFICIENCY	0.937	0.941	0.922	0.862	0.800	0.792	0.791	0.821
STAGE TEMP. RISE EFFICIENCY	0.855	0.867	0.851	0.770	0.673	0.650	0.659	0.771
ROTOR MOMENTUM RISE EFFICIENCY	0.926	0.923	0.909	0.856	0.806	0.776	0.784	0.787
ROTOR HEAD RISE COEFFICIENT	0.270	0.290	0.314	0.316	0.312	0.312	0.310	0.285
STAGE HEAD RISE COEFFICIENT	0.248	0.270	0.290	0.281	0.259	0.254	0.256	0.255
FLOW COEFFICIENT	0.561	0.518	0.457	0.398	0.353	0.343	0.336	0.362
WT FLOW PER UNIT FRONTAL AREA	121.12	113.40	101.50	89.49	79.84	77.80	65.67	55.05
WT FLOW PER UNIT ANNULUS AREA	161.29	151.01	135.16	119.18	106.32	103.60	87.45	73.30
WT FLOW AT ORIFICE	23.31	21.82	19.53	17.22	15.36	14.97	12.64	10.59
WT FLOW AT ROTOR INLET	23.48	21.98	19.72	17.37	15.41	15.05	12.73	10.51
WT FLOW AT ROTOR OUTLET	23.46	22.02	19.88	17.76	16.00	15.26	12.98	11.13
WT FLOW AT STATOR OUTLET	23.38	21.90	19.72	17.60	15.83	15.51	13.13	11.00
ROTATIVE SPEED	9107.2	9123.1	9132.3	9127.5	9083.2	9124.0	7808.1	6497.0
PERCENT OF DESIGN SPEED	69.9	70.1	70.1	70.1	69.8	70.1	60.0	49.9
PERCENT DESIGN WT FLOW AT ORIFICE	79.9	74.8	67.0	59.0	52.7	51.3	43.3	36.3

TABLE VI. - Continued. OVERALL PERFORMANCE OF STAGE 15-9

(b) Stator at design setting angle; rotor exit instrumentation at station 2a; effects of exit pylon(s) and axial spacing of stators (3.5-rotor-chord axial spacing unless noted otherwise)

Parameter	Number of exit pylons										
	1					4					1-Rotor-chord axial spacing
	Percent design speed										
	100		90			100		90		100	
Reading number											
	613	614	615	616	621	622	619	620	627	628	
ROTOR TOTAL PRESSURE RATIO	1.546	1.476	1.378	1.395	1.466	1.525	1.366	1.400	1.457	1.506	
STAGE TOTAL PRESSURE RATIO	1.465	1.382	1.324	1.322	1.386	1.445	1.317	1.331	1.379	1.451	
ROTOR TOTAL TEMPERATURE RATIO	1.147	1.132	1.103	1.121	1.130	1.147	1.101	1.122	1.129	1.136	
STAGE TOTAL TEMPERATURE RATIO	1.140	1.130	1.102	1.119	1.130	1.147	1.103	1.121	1.127	1.135	
ROTOR TEMP. RISE EFFICIENCY	0.903	0.893	0.929	0.827	0.890	0.872	0.920	0.850	0.881	0.911	
STAGE TEMP. RISE EFFICIENCY	0.820	0.746	0.821	0.696	0.751	0.755	0.795	0.705	0.758	0.834	
ROTOR MOMENTUM RISE EFFICIENCY	0.845	0.849	0.877	0.780	0.869	0.844	0.836	0.804	0.842	0.881	
ROTOR HEAD RISE COEFFICIENT	0.335	0.299	0.301	0.313	0.293	0.325	0.291	0.315	0.288	0.315	
STAGE HEAD RISE COEFFICIENT	0.291	0.246	0.262	0.260	0.248	0.281	0.255	0.266	0.244	0.285	
FLOW COEFFICIENT	0.475	0.522	0.534	0.397	0.522	0.441	0.538	0.402	0.522	0.512	
WT FLOW PER UNIT FRONTAL AREA	140.26	151.27	142.32	111.10	151.73	133.62	143.77	112.68	151.35	148.54	
WT FLOW PER UNIT ANNULUS AREA	186.78	201.45	189.53	147.94	202.05	177.94	191.46	150.95	201.55	197.80	
WT FLOW AT ORIFICE	26.99	29.11	27.39	21.38	29.20	25.71	27.67	21.68	29.13	28.58	
WT FLOW AT ROTOR INLET	27.45	29.37	27.64	21.66	29.40	25.92	27.83	21.93	29.38	29.03	
WT FLOW AT ROTOR OUTLET	27.85	29.58	27.87	21.99	29.45	26.17	27.81	22.04	29.58	29.17	
WT FLOW AT STATOR OUTLET	29.15	30.93	28.81	22.61	31.12	27.80	29.31	23.15	29.40	28.77	
ROTATIVE SPEED	13066.0	13015.5	11720.6	11720.7	13036.1	13040.9	11750.5	11752.9	13023.1	13029.4	
PERCENT OF DESIGN SPEED	100.4	100.0	90.0	90.0	100.1	100.2	90.2	90.3	100.0	100.1	
PERCENT DESIGN WT FLOW AT ORIFICE	92.6	99.8	93.9	73.3	100.1	88.2	94.9	74.3	99.9	98.0	

Parameter	Percent design speed (1-rotor-chord axial spacing)										
	100		90				80		70		
	Reading number										
	629	632	644	633	634	635	636	637	638	639	640
ROTOR TOTAL PRESSURE RATIO	1.504	1.544	1.539	1.412	1.412	1.393	1.356	1.308	1.189	1.215	1.230
STAGE TOTAL PRESSURE RATIO	1.445	1.467	1.470	1.355	1.367	1.354	1.289	1.264	1.169	1.197	1.208
ROTOR TOTAL TEMPERATURE RATIO	1.137	1.145	1.143	1.117	1.112	1.106	1.100	1.092	1.054	1.061	1.068
STAGE TOTAL TEMPERATURE RATIO	1.135	1.144	1.142	1.116	1.111	1.105	1.099	1.092	1.055	1.061	1.067
ROTOR TEMP. RISE EFFICIENCY	0.905	0.913	0.914	0.886	0.924	0.936	0.913	0.863	0.933	0.856	0.897
STAGE TEMP. RISE EFFICIENCY	0.805	0.805	0.822	0.781	0.838	0.858	0.759	0.796	0.837	0.859	0.828
ROTOR MOMENTUM RISE EFFICIENCY	0.876	0.876	0.886	0.856	0.891	0.898	0.864	0.846	0.900	0.915	0.900
ROTOR HEAD RISE COEFFICIENT	0.313	0.336	0.332	0.325	0.327	0.311	0.284	0.318	0.263	0.268	0.316
STAGE HEAD RISE COEFFICIENT	0.281	0.294	0.295	0.285	0.295	0.282	0.235	0.276	0.237	0.274	0.287
FLOW COEFFICIENT	0.518	0.479	0.496	0.433	0.474	0.517	0.537	0.402	0.557	0.498	0.432
WT FLOW PER UNIT FRONTAL AREA	150.75	140.93	145.15	120.15	129.12	139.24	143.47	101.71	120.81	109.38	96.66
WT FLOW PER UNIT ANNULUS AREA	200.75	187.68	193.30	160.00	171.94	185.42	191.06	135.44	160.87	145.66	128.72
WT FLOW AT ORIFICE	29.01	27.12	27.93	23.12	24.85	26.80	27.61	19.57	23.25	21.05	18.60
WT FLOW AT ROTOR INLET	29.27	27.57	28.35	23.38	25.14	27.04	27.81	19.76	23.36	21.18	18.71
WT FLOW AT ROTOR OUTLET	29.45	28.05	28.75	23.94	25.60	27.41	28.04	20.33	23.61	21.51	19.04
WT FLOW AT STATOR OUTLET	29.14	27.64	28.31	23.44	25.19	26.97	27.76	19.69	23.20	21.11	18.64
ROTATIVE SPEED	13043.7	13011.3	13039.2	11711.5	11688.1	11744.8	11744.8	10401.9	9115.6	9100.4	9127.0
PERCENT OF DESIGN SPEED	100.2	99.9	100.1	89.9	89.8	90.2	90.2	79.9	70.0	69.9	70.1
PERCENT DESIGN WT FLOW AT ORIFICE	99.5	93.0	95.8	79.3	85.2	91.9	94.7	67.1	79.7	72.2	63.8

Parameter	Axial spacing, rotor chords													
	1					1.5								
	Percent design speed													
	70		60			50		100		90		70		50
Reading number														
	641	642	643	649	651	655	656	658	659	660	661			
ROTOR TOTAL PRESSURE RATIO	1.229	1.163	1.112	1.469	1.536	1.548	1.412	1.228	1.225	1.189	1.110			
STAGE TOTAL PRESSURE RATIO	1.192	1.135	1.092	1.396	1.472	1.469	1.354	1.150	1.206	1.169	1.091			
ROTOR TOTAL TEMPERATURE RATIO	1.073	1.054	1.037	1.131	1.142	1.146	1.118	1.074	1.064	1.054	1.037			
STAGE TOTAL TEMPERATURE RATIO	1.072	1.054	1.038	1.130	1.141	1.145	1.117	1.073	1.064	1.055	1.037			
ROTOR TEMP. RISE EFFICIENCY	0.836	0.820	0.819	0.887	0.919	0.911	0.880	0.822	0.927	0.837	0.812			
STAGE TEMP. RISE EFFICIENCY	0.712	0.682	0.680	0.772	0.831	0.801	0.776	0.692	0.857	0.833	0.674			
ROTOR MOMENTUM RISE EFFICIENCY	0.825	0.811	0.811	0.850	0.874	0.866	0.849	0.805	0.904	0.900	0.810			
ROTOR HEAD RISE COEFFICIENT	0.315	0.313	0.311	0.293	0.330	0.338	0.326	0.313	0.307	0.262	0.311			
STAGE HEAD RISE COEFFICIENT	0.267	0.261	0.259	0.252	0.295	0.295	0.285	0.263	0.284	0.235	0.258			
FLOW COEFFICIENT	0.370	0.346	0.337	0.521	0.504	0.477	0.431	0.361	0.471	0.360	0.335			
WT FLOW PER UNIT FRONTAL AREA	83.66	67.84	59.65	151.90	147.15	140.66	119.76	81.95	104.48	121.59	55.01			
WT FLOW PER UNIT ANNULUS AREA	111.41	90.34	74.11	232.29	195.06	187.32	159.48	109.13	159.14	161.92	73.25			
WT FLOW AT ORIFICE	16.10	13.06	10.71	29.23	28.32	27.07	23.05	15.77	20.11	23.40	10.59			
WT FLOW AT ROTOR INLET	16.20	13.11	10.75	29.40	28.69	27.47	23.25	15.88	20.25	23.52	10.63			
WT FLOW AT ROTOR OUTLET	16.73	13.63	11.23	29.53	29.09	27.88	23.81	16.35	20.52	23.71	11.05			
WT FLOW AT STATOR OUTLET	16.10	13.03	10.66	29.41	28.78	27.58	23.36	15.78	20.20	23.32	10.59			
ROTATIVE SPEED	9118.8	7799.3	6518.6	13073.6	13052.5	13021.0	11697.3	9132.2	9138.7	9135.5	6486.5			
PERCENT OF DESIGN SPEED	70.0	59.9	50.1	100.4	100.2	100.0	89.8	70.1	70.2	70.2	49.8			
PERCENT DESIGN WT FLOW AT ORIFICE	55.2	44.8	36.7	100.2	97.1	92.8	79.0	54.1	69.0	80.2	36.3			

TABLE VII. - BLADE-ELEMENT DATA AT BLADE EDGES FOR

ROTOR 15 (100 PERCENT DESIGN SPEED; INTRABLADE

ROW INSTRUMENTATION AT STATION 2a)

(a) Reading number 558

RP	RADII		ABS BETAM		IREL BETAM		TOTAL TEMP		TOTAL PRESS	
	IN	OUT	IN	OUT	IN	OUT	IN	RATIO	IN	RATIO
1	24.133	23.424	-0.1	31.4	60.8	48.5	288.7	1.123	10.06	1.401
2	23.510	22.885	-0.1	31.4	58.8	46.8	288.5	1.122	10.13	1.409
3	22.883	22.347	-0.2	31.5	57.4	45.1	288.3	1.122	10.13	1.420
4	21.026	20.731	-0.5	34.2	54.0	39.0	288.1	1.125	10.14	1.447
5	18.560	18.578	-0.8	38.0	50.2	27.5	288.0	1.131	10.14	1.470
6	16.076	16.426	-0.4	41.4	46.3	12.0	288.0	1.137	10.14	1.505
7	14.194	14.811	-0.5	45.3	43.7	-3.8	288.0	1.149	10.14	1.567
8	13.574	14.272	-0.5	46.8	42.6	-8.6	287.9	1.152	10.14	1.573
9	12.959	13.734	-0.8	48.9	41.8	-13.3	287.7	1.151	10.11	1.551

RP	ABS VEL		REL VEL		MERID VEL		TANG VEL		WHEEL SPEED	
	IN	OUT	IN	OUT	IN	OUT	IN	OUT	IN	OUT
1	184.6	215.6	378.6	277.9	184.6	184.0	-0.3	112.3	330.2	320.5
2	194.8	218.9	376.2	272.9	194.8	186.9	-0.4	114.0	321.4	312.9
3	200.5	221.9	372.3	267.9	200.5	189.1	-0.6	116.0	313.1	305.7
4	210.0	230.1	357.4	244.8	210.0	190.3	-1.9	129.3	287.3	283.3
5	213.6	247.6	333.7	220.1	213.6	195.3	-2.9	152.3	253.5	253.8
6	211.2	273.2	305.6	209.6	211.2	205.0	-1.4	180.7	219.5	224.3
7	205.3	305.2	283.9	215.1	205.3	214.6	-1.9	217.0	194.2	202.7
8	203.7	311.9	276.8	215.7	203.7	213.3	-1.8	227.5	185.7	195.3
9	200.8	312.8	269.5	211.1	200.8	205.5	-3.0	235.8	176.8	187.3

RP	ABS MACH NO		REL MACH NO		MERID MACH NO		MERID PEAK SS	
	IN	OUT	IN	OUT	IN	OUT	VEL R	MACH NO
1	0.558	0.620	1.146	0.799	0.558	0.529	0.997	1.439
2	0.592	0.631	1.143	0.786	0.592	0.539	0.959	1.434
3	0.611	0.640	1.134	0.773	0.611	0.546	0.943	1.432
4	0.642	0.665	1.093	0.708	0.642	0.550	0.906	1.442
5	0.654	0.719	1.022	0.639	0.654	0.567	0.914	1.463
6	0.646	0.800	0.935	0.614	0.646	0.600	0.971	1.414
7	0.627	0.903	0.867	0.636	0.627	0.635	1.045	1.343
8	0.621	0.925	0.845	0.640	0.621	0.632	1.047	1.311
9	0.612	0.928	0.822	0.626	0.612	0.610	1.023	1.282

RP	PERCENT	INCIDENCE		DEV	D-FACT	EFF	LOSS COEFF		LOSS PARAM	
	SPAN	MEAN	SS				TOT	PROF	TOT	PROF
1	5.00	2.6	-0.8	10.0	0.373	0.824	0.114	0.080	0.028	0.019
2	10.00	2.4	-1.0	8.6	0.382	0.844	0.101	0.068	0.025	0.017
3	15.00	2.7	-0.9	7.8	0.389	0.862	0.091	0.059	0.022	0.014
4	30.00	3.5	-0.7	7.1	0.433	0.888	0.081	0.052	0.020	0.013
5	50.00	4.8	-0.7	6.8	0.475	0.890	0.090	0.065	0.023	0.017
6	70.00	6.9	-0.9	7.7	0.466	0.905	0.093	0.081	0.023	0.020
7	85.00	10.1	-0.3	7.3	0.418	0.920	0.095	0.092	0.021	0.020
8	90.00	11.5	-0.1	8.0	0.402	0.912	0.109	0.108	0.023	0.023
9	95.00	13.5	0.4	8.8	0.402	0.883	0.151	0.150	0.030	0.030

TABLE VII. - Continued. BLADE-ELEMENT DATA AT BLADE EDGES

FOR ROTOR 15 (100 PERCENT DESIGN SPEED; INTRABLADE

ROW INSTRUMENTATION AT STATION 2a)

(b) Reading number 538

RP	RADII		ABS BETAM		REL BETAM		TOTAL TEMP		TOTAL PRESS	
	IN	OUT	IN	OUT	IN	OUT	IN	RATIO	IN	RATIO
1	24.133	23.424	0.1	31.6	61.2	48.9	288.8	1.126	10.04	1.408
2	23.510	22.885	-0.1	31.0	59.2	47.1	288.6	1.125	10.11	1.419
3	22.883	22.347	-0.2	31.4	57.8	45.1	288.5	1.126	10.13	1.434
4	21.026	20.731	-0.3	34.1	54.3	39.1	288.1	1.128	10.14	1.458
5	18.560	18.578	-1.0	38.0	50.6	27.4	287.9	1.133	10.14	1.484
6	16.076	16.426	-0.6	41.4	46.8	12.0	287.8	1.138	10.15	1.519
7	14.194	14.811	-0.3	45.2	44.3	-2.6	287.9	1.148	10.14	1.557
8	13.574	14.272	-0.8	47.1	43.4	-7.9	287.9	1.150	10.14	1.564
9	12.959	13.734	-0.4	49.3	41.9	-13.0	288.0	1.151	10.13	1.550

RP	ABS VEL		REL VEL		MERID VEL		TANG VEL		WHEEL SPEED	
	IN	OUT	IN	OUT	IN	OUT	IN	OUT	IN	OUT
1	180.5	213.2	375.2	276.0	180.5	181.6	0.4	111.7	329.3	319.6
2	191.4	217.3	374.1	273.5	191.4	186.2	-0.5	112.0	320.9	312.4
3	197.4	221.7	370.3	268.0	197.4	189.2	-0.8	115.4	312.6	305.2
4	207.2	229.8	355.1	244.9	207.2	190.2	-0.9	129.0	287.4	283.4
5	211.2	247.7	332.9	220.0	211.2	195.2	-3.7	152.5	253.6	253.9
6	207.8	272.9	303.8	209.2	207.8	204.6	-2.1	180.6	219.5	224.3
7	199.7	299.1	279.3	210.9	199.7	210.7	-1.0	212.3	194.2	202.6
8	198.9	305.7	273.6	210.2	198.9	208.2	-2.7	223.8	185.2	194.8
9	198.8	308.4	267.1	206.4	198.8	201.2	-1.5	233.7	176.9	187.5

RP	ABS MACH NO		REL MACH NO		MERID MACH NO		MERID PEAK SS	
	IN	OUT	IN	OUT	IN	OUT	VEL R	MACH NO
1	0.545	0.611	1.134	0.792	0.545	0.521	1.006	1.444
2	0.581	0.625	1.135	0.786	0.581	0.535	0.973	1.441
3	0.600	0.638	1.126	0.772	0.600	0.545	0.959	1.440
4	0.633	0.663	1.085	0.707	0.633	0.549	0.918	1.446
5	0.646	0.719	1.019	0.638	0.646	0.566	0.924	1.477
6	0.635	0.799	0.929	0.612	0.635	0.599	0.985	1.420
7	0.609	0.882	0.851	0.622	0.609	0.622	1.055	1.338
8	0.606	0.904	0.833	0.622	0.606	0.616	1.047	1.314
9	0.606	0.913	0.813	0.611	0.606	0.595	1.012	1.271

RP	PERCENT	INCIDENCE		DEV	D-FACT	EFF	LOSS COEFF		LOSS PARAM	
	SPAN	MEAN	SS				TOT	PROF	TOT	PROF
1	5.00	3.0	-0.4	10.3	0.371	0.816	0.123	0.089	0.030	0.021
2	10.00	2.8	-0.6	9.0	0.375	0.840	0.107	0.074	0.026	0.018
3	15.00	3.1	-0.5	7.8	0.385	0.862	0.095	0.062	0.023	0.015
4	30.00	3.8	-0.4	7.2	0.428	0.887	0.084	0.055	0.021	0.014
5	50.00	5.2	-0.3	6.8	0.475	0.896	0.088	0.062	0.023	0.016
6	70.00	7.5	-0.3	7.7	0.464	0.917	0.083	0.071	0.020	0.017
7	85.00	10.7	0.4	8.5	0.419	0.912	0.106	0.103	0.023	0.023
8	90.00	12.2	0.6	8.6	0.412	0.909	0.114	0.113	0.024	0.024
9	95.00	13.6	0.4	9.1	0.412	0.883	0.153	0.153	0.030	0.030

TABLE VII. - Continued. BLADE-ELEMENT DATA AT BLADE EDGES

FOR ROTOR 15 (100 PERCENT DESIGN SPEED; INTRABLADE

ROW INSTRUMENTATION AT STATION 2a)

(c) Reading number 560

RP	RADII		ABS BETAM		REL BETAM		TOTAL TEMP		TOTAL PRESS	
	IN	OUT	IN	OUT	IN	OUT	IN	RATIO	IN	RATIO
1	24.133	23.424	-0.0	34.2	60.9	47.8	288.7	1.132	10.06	1.460
2	23.510	22.885	-0.2	33.8	58.9	45.8	288.5	1.133	10.13	1.471
3	22.883	22.347	-0.1	34.3	57.4	44.0	288.4	1.132	10.13	1.483
4	21.026	20.731	-0.5	36.9	54.1	38.0	288.1	1.134	10.14	1.494
5	18.560	18.578	-0.8	40.4	50.4	26.4	288.0	1.137	10.15	1.517
6	16.076	16.426	-0.6	43.9	47.2	11.7	287.9	1.140	10.14	1.536
7	14.194	14.811	-0.6	48.2	45.6	-3.3	288.0	1.147	10.14	1.554
8	13.574	14.272	-0.9	50.0	44.7	-8.8	287.8	1.148	10.14	1.562
9	12.959	13.734	-1.0	52.0	43.7	-14.5	288.1	1.149	10.11	1.563

RP	ABS VEL		REL VEL		MERID VEL		TANG VEL		WHEEL SPEED	
	IN	OUT	IN	OUT	IN	OUT	IN	OUT	IN	OUT
1	183.6	217.3	377.7	267.6	183.6	179.7	-0.1	122.1	330.0	320.3
2	194.4	221.8	376.0	264.3	194.4	184.4	-0.7	123.3	321.2	312.6
3	199.8	224.2	371.1	257.4	199.8	185.3	-0.4	126.3	312.3	305.0
4	209.1	231.4	356.9	234.8	209.1	185.0	-1.7	138.9	287.5	283.5
5	212.4	247.9	333.3	210.9	212.4	188.9	-2.9	160.6	254.1	254.3
6	206.3	267.3	303.5	196.5	206.3	192.4	-2.2	185.5	220.4	225.2
7	192.8	286.9	275.3	191.5	192.7	191.2	-2.0	213.9	194.6	203.0
8	190.6	293.5	268.3	191.0	190.6	188.7	-3.0	224.7	185.9	195.4
9	188.9	298.5	261.3	189.8	188.8	183.7	-3.4	235.3	177.3	187.9

RP	ABS MACH NO		REL MACH NO		MERID MACH NO		MERID PEAK SS	
	IN	OUT	IN	OUT	IN	OUT	VEL R	MACH NO
1	0.555	0.622	1.143	0.766	0.555	0.515	0.979	1.440
2	0.591	0.636	1.142	0.758	0.591	0.529	0.948	1.435
3	0.608	0.644	1.130	0.739	0.608	0.532	0.927	1.429
4	0.639	0.666	1.091	0.676	0.639	0.533	0.885	1.444
5	0.650	0.718	1.021	0.611	0.650	0.547	0.889	1.470
6	0.630	0.779	0.927	0.573	0.630	0.561	0.933	1.429
7	0.586	0.842	0.837	0.562	0.586	0.561	0.992	1.350
8	0.579	0.863	0.815	0.562	0.579	0.555	0.990	1.323
9	0.573	0.880	0.793	0.559	0.573	0.542	0.973	1.288

RP	PERCENT		INCIDENCE		DEV	D-FACT	EFF	LOSS COEFF		LOSS PARAM	
	SPAN	MEAN	SS	TOT				PROF	TOT	PROF	
1	5.00	2.7	-0.7	9.3	0.408	0.864	0.095	0.061	0.023	0.015	
2	10.00	2.5	-1.0	7.6	0.413	0.879	0.085	0.052	0.021	0.013	
3	15.00	2.7	-0.9	6.7	0.424	0.901	0.071	0.040	0.018	0.010	
4	30.00	3.6	-0.6	6.2	0.469	0.904	0.074	0.045	0.019	0.011	
5	50.00	5.0	-0.5	5.8	0.509	0.924	0.065	0.040	0.017	0.010	
6	70.00	7.8	0.0	7.4	0.510	0.934	0.067	0.055	0.017	0.014	
7	85.00	11.9	1.6	7.9	0.483	0.915	0.104	0.101	0.023	0.023	
8	90.00	13.6	2.0	7.8	0.474	0.917	0.107	0.106	0.023	0.022	
9	95.00	15.4	2.3	7.6	0.465	0.916	0.112	0.112	0.022	0.022	

TABLE VII. - Continued. BLADE-ELEMENT DATA AT BLADE EDGES

FOR ROTOR 15 (100 PERCENT DESIGN SPEED; INTRABLADE

ROW INSTRUMENTATION AT STATION 2a)

(d) Reading number 539

RP	RADII		ABS BETAM		REL BETAM		TOTAL TEMP		TOTAL PRESS	
	IN	OUT	IN	OUT	IN	OUT	IN	RATIO	IN	RATIO
1	24.133	23.424	-0.1	34.3	61.5	48.3	288.9	1.136	10.03	1.457
2	23.510	22.885	0.5	33.2	59.2	46.1	288.6	1.135	10.11	1.477
3	22.883	22.347	-0.2	33.6	57.9	44.0	288.4	1.135	10.13	1.494
4	21.026	20.731	-0.2	36.6	54.3	38.1	288.1	1.136	10.14	1.500
5	18.560	18.578	-1.1	39.6	50.8	26.8	288.0	1.137	10.15	1.520
6	16.076	16.426	-1.0	43.3	47.9	12.3	287.9	1.140	10.15	1.534
7	14.194	14.811	-1.2	47.2	46.5	-2.1	287.9	1.146	10.14	1.552
8	13.574	14.272	-0.3	49.4	45.0	-8.3	288.0	1.148	10.14	1.566
9	12.959	13.734	-1.0	51.4	44.0	-13.7	288.0	1.149	10.12	1.563

RP	ABS VEL		REL VEL		MERID VEL		TANG VEL		WHEEL SPEED	
	IN	OUT	IN	OUT	IN	OUT	IN	OUT	IN	OUT
1	179.8	215.1	376.3	267.1	179.8	177.7	-0.3	121.2	330.3	320.6
2	190.7	220.7	372.2	266.2	190.7	184.6	1.6	121.0	321.3	312.7
3	196.7	224.7	369.7	260.3	196.7	187.2	-0.5	124.3	312.5	305.1
4	206.7	231.0	354.6	235.7	206.7	185.4	-0.8	137.8	287.3	283.3
5	210.2	247.5	332.6	213.6	210.2	190.8	-4.1	157.7	253.7	253.9
6	201.6	266.0	301.0	198.3	201.6	193.7	-3.6	182.3	219.9	224.6
7	188.2	286.1	273.2	194.7	188.2	194.5	-3.9	209.7	194.2	202.7
8	187.0	294.3	264.3	193.6	187.0	191.6	-1.0	223.3	185.7	195.3
9	186.9	298.4	259.7	191.6	186.8	186.2	-3.2	233.2	177.3	187.8

RP	ABS MACH NO		REL MACH NO		MERID MACH NO		MERIC PEAK SS VEL R MACH NO
	IN	OUT	IN	OUT	IN	OUT	
1	0.543	0.614	1.137	0.763	0.543	0.507	0.988 1.454
2	0.578	0.632	1.129	0.762	0.578	0.529	0.968 1.436
3	0.598	0.645	1.124	0.747	0.598	0.537	0.952 1.440
4	0.631	0.665	1.083	0.678	0.631	0.533	0.897 1.446
5	0.643	0.717	1.017	0.618	0.643	0.552	0.908 1.483
6	0.615	0.775	0.918	0.578	0.615	0.565	0.961 1.438
7	0.571	0.839	0.829	0.571	0.571	0.571	1.034 1.363
8	0.567	0.866	0.801	0.570	0.567	0.564	1.025 1.307
9	0.567	0.879	0.788	0.565	0.567	0.549	0.997 1.286

RP	PERCENT		INCIDENCE		DEV	D-FACT	EFF	LOSS COEFF		LOSS PARAM	
	SPAN	MEAN	SS	SS				TOT	PROF	TOT	PROF
1	5.00	3.2	-0.2	9.8	0.406	0.835	0.118	0.082	0.029	0.020	
2	10.00	2.8	-0.7	7.9	0.398	0.874	0.091	0.059	0.023	0.015	
3	15.00	3.1	-0.4	6.7	0.412	0.899	0.074	0.042	0.019	0.011	
4	30.00	3.8	-0.3	6.3	0.461	0.900	0.078	0.049	0.020	0.013	
5	50.00	5.4	-0.1	6.1	0.499	0.927	0.063	0.037	0.016	0.009	
6	70.00	8.6	0.8	8.0	0.499	0.931	0.071	0.058	0.017	0.014	
7	85.00	12.8	2.5	9.1	0.465	0.918	0.101	0.098	0.022	0.022	
8	90.00	13.8	2.2	8.2	0.453	0.922	0.103	0.102	0.022	0.022	
9	95.00	15.7	2.5	8.4	0.453	0.914	0.118	0.118	0.023	0.023	

TABLE VII. - Continued. BLADE-ELEMENT DATA AT BLADE EDGES
 FOR ROTOR 15 (100 PERCENT DESIGN SPEED; INTRABLADE
 ROW INSTRUMENTATION AT STATION 2a)

(e) Reading number 543

RP	RADII		ABS BETAM		REL BETAM		TOTAL TEMP		TOTAL PRESS	
	IN	OUT	IN	OUT	IN	OUT	IN	RATIO	IN	RATIO
1	24.133	23.424	0.3	36.2	61.6	46.1	289.0	1.145	10.04	1.532
2	23.510	22.885	0.1	34.2	59.1	45.7	288.7	1.139	10.12	1.501
3	22.883	22.347	0.1	35.2	57.5	42.9	288.5	1.137	10.13	1.516
4	21.026	20.731	-0.4	37.0	54.3	38.0	288.0	1.137	10.15	1.514
5	18.560	18.578	-0.9	39.9	50.7	27.1	288.0	1.138	10.14	1.516
6	16.076	16.426	-0.8	43.2	47.7	12.6	287.9	1.140	10.15	1.531
7	14.194	14.811	-1.0	47.3	46.2	-2.0	287.9	1.146	10.14	1.550
8	13.574	14.272	-0.4	49.4	44.9	-7.9	287.8	1.148	10.14	1.558
9	12.959	13.734	-0.9	51.2	43.9	-13.6	287.9	1.150	10.12	1.574

RP	ABS VEL		REL VEL		MERID VEL		TANG VEL		WHEEL SPEED	
	IN	OUT	IN	OUT	IN	OUT	IN	OUT	IN	OUT
1	177.6	223.8	373.6	260.6	177.6	180.6	0.9	132.1	329.6	319.9
2	192.0	222.1	374.2	263.0	192.0	183.7	0.3	124.7	321.4	312.9
3	198.7	228.5	370.0	254.8	198.7	186.6	0.4	131.8	312.6	305.3
4	207.7	231.3	356.0	234.4	207.7	184.6	-1.4	139.3	287.7	283.6
5	210.0	245.3	331.8	211.4	209.9	188.1	-3.4	157.4	253.6	253.8
6	202.4	264.6	300.9	197.6	202.4	192.8	-3.0	181.2	219.7	224.5
7	189.3	284.7	273.3	193.1	189.3	193.0	-3.2	209.3	193.9	202.4
8	187.8	291.7	265.1	191.6	187.8	189.7	-1.4	221.6	185.6	195.1
9	187.3	299.2	259.8	192.9	187.2	187.4	-2.9	233.2	177.2	187.8

RP	ABS MACH NO		REL MACH NO		MERID MACH NO		MERID PEAK SS	
	IN	OUT	IN	OUT	IN	OUT	VEL R	MACH NO
1	0.536	0.638	1.127	0.743	0.536	0.515	1.017	1.452
2	0.583	0.635	1.135	0.752	0.583	0.525	0.957	1.438
3	0.605	0.656	1.126	0.732	0.605	0.536	0.939	1.430
4	0.635	0.665	1.088	0.674	0.635	0.531	0.889	1.448
5	0.642	0.709	1.015	0.611	0.642	0.544	0.896	1.480
6	0.618	0.771	0.918	0.576	0.617	0.562	0.952	1.432
7	0.575	0.835	0.830	0.566	0.575	0.566	1.020	1.356
8	0.570	0.857	0.804	0.563	0.570	0.558	1.010	1.309
9	0.568	0.882	0.788	0.568	0.568	0.552	1.001	1.284

RP	PERCENT		INCIDENCE		DEV	D-FACT	EFF	LOSS COEFF		LOSS PARAM	
	SPAN	MEAN	SS	SS				TOT	PROF	TOT	PROF
1	5.00	3.4	0.0	7.6	0.429	0.894	0.082	0.047	0.021	0.012	
2	10.00	2.7	-0.7	7.5	0.414	0.886	0.084	0.051	0.021	0.013	
3	15.00	2.8	-0.8	5.6	0.434	0.923	0.057	0.026	0.015	0.007	
4	30.00	3.8	-0.4	6.2	0.469	0.916	0.066	0.036	0.017	0.009	
5	50.00	5.3	-0.2	6.5	0.503	0.917	0.072	0.046	0.019	0.012	
6	70.00	8.3	0.6	8.3	0.499	0.926	0.075	0.063	0.018	0.016	
7	85.00	12.5	2.2	9.1	0.470	0.912	0.108	0.106	0.024	0.024	
8	90.00	13.7	2.1	8.6	0.461	0.912	0.116	0.115	0.024	0.024	
9	95.00	15.6	2.4	8.5	0.448	0.925	0.103	0.103	0.020	0.020	

TABLE VII. - Concluded. BLADE-ELEMENT DATA AT BLADE EDGES

FOR ROTOR 15 (100 PERCENT DESIGN SPEED; INTRABLADE

ROW INSTRUMENTATION AT STATION 2a)

(f) Reading number 551

RP	RADII		ABS BETAM		REL BETAM		TOTAL TEMP		TOTAL PRESS	
	IN	OUT	IN	OUT	IN	OUT	IN	RATIO	IN	RATIO
1	24.133	23.424	0.5	39.2	62.7	45.9	289.1	1.159	10.06	1.569
2	23.510	22.885	0.6	37.9	60.7	44.3	288.9	1.154	10.11	1.571
3	22.883	22.347	0.1	38.2	59.1	42.6	288.4	1.151	10.13	1.568
4	21.026	20.731	-0.8	39.7	55.5	37.5	288.0	1.146	10.14	1.547
5	18.560	18.578	-1.2	41.3	51.7	27.0	287.9	1.140	10.15	1.532
6	16.076	16.426	-1.0	44.2	48.7	13.0	287.8	1.139	10.14	1.525
7	14.194	14.811	-0.6	48.5	47.0	-2.5	287.9	1.146	10.14	1.545
8	13.574	14.272	-0.5	50.1	45.9	-8.3	287.8	1.150	10.14	1.560
9	12.959	13.734	-0.7	51.8	44.6	-13.7	288.0	1.150	10.13	1.562

RP	ABS VEL		REL VEL		MERID VEL		TANG VEL		WHEEL SPEED	
	IN	OUT	IN	OUT	IN	OUT	IN	OUT	IN	OUT
1	169.3	223.1	368.7	248.3	169.2	172.9	1.5	141.1	329.1	319.4
2	178.9	225.4	365.4	248.4	178.9	177.8	1.9	138.6	320.5	312.0
3	186.6	227.4	363.8	242.8	186.6	178.6	0.2	140.7	312.5	305.2
4	198.8	230.4	351.3	223.2	198.8	177.2	-2.7	147.2	287.0	283.0
5	203.7	243.5	328.4	205.3	203.6	183.0	-4.1	160.6	253.5	253.7
6	195.7	259.7	296.4	191.2	195.7	186.3	-3.5	180.9	219.2	224.0
7	182.4	280.6	267.2	186.2	182.4	186.1	-1.8	210.1	193.6	202.0
8	180.9	288.8	259.9	187.2	180.9	185.2	-1.4	221.6	185.1	194.7
9	181.1	294.3	254.5	187.2	181.1	181.9	-2.3	231.3	176.5	187.1

RP	ABS MACH NO		REL MACH NO		MERID MACH NO		MERID PEAK SS VEL R MACH NO	
	IN	OUT	IN	OUT	IN	OUT		
1	0.509	0.632	1.110	0.703	0.509	0.490	1.021	1.476
2	0.540	0.641	1.104	0.706	0.540	0.505	0.994	1.469
3	0.565	0.648	1.102	0.692	0.565	0.509	0.957	1.469
4	0.605	0.659	1.070	0.639	0.605	0.507	0.891	1.480
5	0.622	0.703	1.002	0.592	0.621	0.528	0.898	1.508
6	0.596	0.755	0.902	0.556	0.595	0.542	0.952	1.436
7	0.552	0.821	0.809	0.545	0.552	0.544	1.020	1.345
8	0.548	0.847	0.787	0.549	0.548	0.543	1.024	1.308
9	0.548	0.865	0.770	0.550	0.548	0.535	1.005	1.275

RP	PERCENT	INCIDENCE		DEV	D-FACT	EFF	LOSS COEFF		LOSS PARAM	
	SPAN	MEAN	SS				TOT	PROF	TOT	PROF
1	5.00	4.4	1.1	7.3	0.463	0.866	0.113	0.077	0.029	0.020
2	10.00	4.3	0.8	6.1	0.452	0.896	0.087	0.052	0.022	0.013
3	15.00	4.4	0.8	5.3	0.466	0.908	0.076	0.042	0.020	0.011
4	30.00	5.0	0.9	5.6	0.502	0.910	0.076	0.044	0.020	0.011
5	50.00	6.3	0.8	6.3	0.520	0.926	0.067	0.038	0.017	0.010
6	70.00	9.3	1.5	8.7	0.513	0.919	0.085	0.073	0.021	0.018
7	85.00	13.3	3.0	8.6	0.483	0.906	0.121	0.119	0.027	0.027
8	90.00	14.8	3.2	8.3	0.467	0.906	0.129	0.129	0.027	0.027
9	95.00	16.3	3.2	8.4	0.457	0.907	0.132	0.132	0.026	0.026

TABLE VIII. - BLADE-ELEMENT DATA AT BLADE EDGES FOR
 ROTOR 15 (100 PERCENT DESIGN SPEED; INTRABLADE
 ROW INSTRUMENTATION AT STATION 2b)

(a) Reading number 600

RP	RADII		ABS BETAM		REL BETAM		TOTAL TEMP		TOTAL PRESS	
	IN	OUT	IN	OUT	IN	OUT	IN	RATIO	IN	RATIO
1	24.133	23.424	-0.3	32.6	60.9	50.2	288.9	1.121	10.06	1.340
2	23.510	22.885	-0.3	31.7	59.0	47.3	288.6	1.120	10.14	1.387
3	22.883	22.347	-0.4	31.5	57.7	45.9	288.4	1.119	10.13	1.401
4	21.026	20.731	-0.8	33.9	54.3	40.2	288.1	1.122	10.14	1.432
5	18.560	18.578	-1.1	37.6	50.5	28.9	288.0	1.127	10.14	1.464
6	16.076	16.426	-0.8	41.3	46.6	13.3	287.8	1.133	10.14	1.498
7	14.194	14.811	-0.4	45.0	43.9	-2.3	287.9	1.145	10.14	1.550
8	13.574	14.272	-0.8	46.3	43.0	-7.3	287.9	1.150	10.14	1.546
9	12.959	13.734	-0.9	48.9	42.1	-12.4	287.8	1.150	10.11	1.494

RP	ABS VEL		REL VEL		MERID VEL		TANG VEL		WHEEL SPEED	
	IN	OUT	IN	OUT	IN	OUT	IN	OUT	IN	OUT
1	183.4	205.7	377.0	270.8	183.4	173.3	-0.8	110.8	328.6	319.0
2	193.3	215.6	375.2	270.3	193.3	183.4	-1.2	113.3	320.4	311.9
3	197.8	217.1	370.1	266.0	197.8	185.2	-1.3	113.3	311.5	304.2
4	208.3	224.1	356.4	243.6	208.2	186.1	-3.0	124.9	286.2	282.2
5	211.9	241.4	332.9	218.3	211.9	191.2	-4.0	147.5	252.7	253.0
6	209.3	266.6	304.6	205.7	209.3	200.2	-2.8	176.0	218.5	223.3
7	203.1	297.5	281.6	210.6	203.1	210.4	-1.6	210.3	193.5	202.0
8	201.1	306.5	275.2	213.3	201.1	211.6	-2.7	221.7	185.1	194.6
9	198.5	306.5	267.6	206.2	198.5	201.4	-3.0	231.1	176.4	186.9

RP	ABS MACH NO		REL MACH NO		MERID MACH NO		MERID PEAK SS	
	IN	OUT	IN	OUT	IN	OUT	VEL R	MACH NO
1	0.555	0.590	1.140	0.776	0.555	0.497	0.945	1.437
2	0.587	0.621	1.139	0.778	0.587	0.528	0.949	1.437
3	0.602	0.626	1.126	0.767	0.602	0.534	0.936	1.436
4	0.636	0.647	1.089	0.704	0.636	0.537	0.894	1.447
5	0.649	0.701	1.019	0.634	0.649	0.555	0.902	1.471
6	0.640	0.780	0.932	0.602	0.640	0.586	0.957	1.418
7	0.620	0.878	0.859	0.621	0.620	0.621	1.036	1.337
8	0.613	0.907	0.839	0.631	0.613	0.626	1.052	1.314
9	0.605	0.907	0.815	0.610	0.605	0.596	1.015	1.279

RP	PERCENT SPAN	INCIDENCE		DEV	D-FACT	EFF	LOSS COEFF		LOSS PARAM	
		MEAN	SS				TOT	PROF	TOT	PROF
1	5.00	2.6	-0.7	11.7	0.388	0.721	0.177	0.144	0.041	0.034
2	10.00	2.6	-0.9	9.1	0.387	0.813	0.120	0.087	0.029	0.021
3	15.00	3.0	-0.6	8.6	0.388	0.852	0.096	0.064	0.023	0.016
4	30.00	3.7	-0.4	8.3	0.432	0.886	0.080	0.051	0.020	0.013
5	50.00	5.1	-0.4	8.3	0.476	0.906	0.076	0.051	0.019	0.013
6	70.00	7.2	-0.6	9.0	0.474	0.920	0.077	0.065	0.019	0.016
7	85.00	10.2	-0.1	8.9	0.423	0.918	0.096	0.093	0.021	0.021
8	90.00	11.9	0.3	9.3	0.403	0.885	0.142	0.141	0.030	0.030
9	95.00	13.8	0.7	9.7	0.412	0.811	0.241	0.241	0.048	0.048

TABLE VIII. - Continued. BLADE-ELEMENT DATA AT BLADE EDGES

FOR ROTOR 15 (100 PERCENT DESIGN SPEED; INTRABLADE

ROW INSTRUMENTATION AT STATION 2b)

(b) Reading number 601

RP	RADII		ABS BETAM		REL BETAM		TOTAL TEMP		TOTAL PRESS	
	IN	OUT	IN	OUT	IN	OUT	IN	RATIO	IN	RATIO
1	24.133	23.424	-0.1	34.9	61.0	51.3	288.9	1.130	10.05	1.380
2	23.510	22.885	-0.3	33.2	59.0	47.3	288.6	1.128	10.13	1.437
3	22.883	22.347	-0.3	33.2	57.6	45.4	288.2	1.127	10.13	1.455
4	21.026	20.731	-0.9	35.7	54.3	39.7	288.1	1.129	10.14	1.469
5	18.560	18.578	-1.2	39.1	50.6	28.8	288.0	1.131	10.14	1.496
6	16.076	16.426	-0.9	42.8	47.5	14.0	287.9	1.135	10.14	1.515
7	14.194	14.811	-0.5	46.2	45.3	-0.3	288.0	1.145	10.14	1.535
8	13.574	14.272	-0.9	47.5	44.6	-6.2	288.1	1.148	10.14	1.554
9	12.959	13.734	-0.8	50.2	43.6	-11.1	287.9	1.148	10.12	1.492

RP	ABS VEL		REL VEL		MERID VEL		TANG VEL		WHEEL SPEED	
	IN	OUT	IN	OUT	IN	OUT	IN	OUT	IN	OUT
1	182.3	199.7	375.8	261.9	182.3	163.9	-0.5	114.2	328.1	318.5
2	192.8	213.9	374.2	264.0	192.8	178.9	-0.9	117.2	319.8	311.3
3	197.8	217.6	369.5	259.2	197.8	182.0	-0.9	119.3	311.2	303.9
4	207.9	224.4	356.3	236.8	207.9	182.3	-3.3	130.8	286.1	282.1
5	210.7	239.1	332.1	211.5	210.7	185.5	-4.4	150.8	252.4	252.6
6	202.8	258.3	300.0	195.5	202.8	189.6	-3.2	175.3	218.0	222.7
7	193.0	280.2	274.1	193.9	193.0	193.9	-1.8	202.2	192.9	201.3
8	190.7	292.8	267.6	199.0	190.7	197.9	-3.1	215.8	184.8	194.3
9	188.2	290.4	259.7	189.3	188.2	185.8	-2.8	223.2	176.2	186.7

RP	ABS MACH NO.		REL MACH NO.		MERID MACH NO.		MERID PEAK SS	
	IN	OUT	IN	OUT	IN	OUT	VEL R	MACH NO
1	0.551	0.569	1.136	0.746	0.551	0.467	0.899	1.437
2	0.585	0.613	1.136	0.757	0.585	0.513	0.928	1.434
3	0.602	0.625	1.124	0.745	0.602	0.523	0.920	1.433
4	0.635	0.646	1.088	0.682	0.635	0.525	0.877	1.449
5	0.645	0.692	1.016	0.612	0.645	0.536	0.880	1.476
6	0.619	0.752	0.915	0.569	0.619	0.552	0.935	1.420
7	0.587	0.820	0.833	0.567	0.587	0.567	1.005	1.336
8	0.579	0.860	0.813	0.585	0.579	0.582	1.038	1.314
9	0.571	0.853	0.788	0.556	0.571	0.546	0.987	1.275

RP	PERCENT		INCIDENCE		DEV	D-FACT	EFF	LOSS COEFF		LOSS PARAM	
	SPAN	MEAN	SS	TOT				PROF	TOT	PROF	
1	5.00	2.7	-0.6	12.7	0.413	0.742	0.175	0.142	0.040	0.032	
2	10.00	2.6	-0.8	9.2	0.406	0.850	0.103	0.070	0.025	0.017	
3	15.00	2.9	-0.7	8.1	0.411	0.889	0.077	0.046	0.019	0.011	
4	30.00	3.8	-0.4	7.8	0.457	0.899	0.075	0.045	0.019	0.011	
5	50.00	5.2	-0.3	8.1	0.498	0.927	0.061	0.035	0.016	0.009	
6	70.00	8.1	0.3	9.7	0.500	0.931	0.069	0.058	0.017	0.014	
7	85.00	11.6	1.3	10.8	0.462	0.897	0.126	0.124	0.028	0.028	
8	90.00	13.4	1.8	10.4	0.435	0.905	0.123	0.122	0.026	0.026	
9	95.00	15.2	2.1	11.0	0.453	0.816	0.245	0.245	0.049	0.049	

TABLE VIII. - Concluded. BLADE-ELEMENT DATA AT BLADE EDGES

FOR ROTOR 15 (100 PERCENT DESIGN SPEED; INTRABLADE

ROW INSTRUMENTATION AT STATION 2b)

(c) Reading number 602

RP	RADII		ABS BETAM		REL BETAM		TOTAL TEMP		TOTAL PRESS	
	IN	OUT	IN	OUT	IN	OUT	IN	RATIO	IN	RATIO
1	24.133	23.424	0.1	42.5	63.1	49.1	288.7	1.159	10.06	1.512
2	23.510	22.885	0.2	39.9	61.0	45.2	288.4	1.154	10.13	1.556
3	22.883	22.347	-0.1	39.5	59.6	43.8	288.7	1.151	10.14	1.559
4	21.026	20.731	-0.9	40.8	56.1	38.4	288.2	1.146	10.14	1.544
5	18.560	18.578	-1.1	40.8	51.4	28.7	287.9	1.137	10.14	1.518
6	16.076	16.426	-0.6	43.6	48.1	14.3	287.9	1.138	10.14	1.523
7	14.194	14.811	-0.4	46.9	45.9	-0.9	287.9	1.145	10.14	1.554
8	13.574	14.272	-0.5	48.3	45.1	-6.0	287.9	1.149	10.14	1.547
9	12.959	13.734	-0.6	50.9	44.2	-11.9	288.0	1.151	10.11	1.514

RP	ABS VEL		REL VEL		MERID VEL		TANG VEL		WHEEL SPEED	
	IN	OUT	IN	OUT	IN	OUT	IN	OUT	IN	OUT
1	166.1	208.8	367.8	235.2	166.1	154.0	0.3	140.9	328.4	318.8
2	177.3	220.1	365.3	239.7	177.3	168.7	0.6	141.3	320.0	311.5
3	182.9	221.5	361.9	236.6	182.9	170.8	-0.2	141.1	312.1	304.8
4	194.9	225.9	349.6	218.3	194.9	171.0	-3.0	147.6	287.3	283.2
5	206.3	237.9	330.3	205.5	206.3	180.2	-4.1	155.3	253.9	254.1
6	199.3	256.8	298.4	191.8	199.3	185.9	-2.2	177.2	219.9	224.7
7	188.9	280.9	271.5	191.8	188.9	191.8	-1.3	205.2	193.8	202.2
8	186.6	288.8	264.5	193.1	186.6	192.1	-1.7	215.6	185.7	195.3
9	184.2	292.2	257.0	188.4	184.2	184.4	-1.9	226.6	177.3	187.9

RP	ABS MACH NO		REL MACH NO		MERID MACH NO		MERID PEAK SS	
	IN	OUT	IN	OUT	IN	OUT	VEL R	MACH NO
1	0.500	0.589	1.106	0.663	0.500	0.434	0.927	1.490
2	0.535	0.625	1.103	0.681	0.535	0.479	0.952	1.479
3	0.553	0.630	1.095	0.673	0.553	0.486	0.934	1.482
4	0.593	0.645	1.063	0.624	0.593	0.489	0.877	1.495
5	0.630	0.686	1.009	0.593	0.630	0.520	0.873	1.499
6	0.607	0.746	0.909	0.557	0.607	0.540	0.933	1.429
7	0.573	0.822	0.824	0.561	0.573	0.561	1.015	1.340
8	0.566	0.847	0.802	0.566	0.566	0.563	1.029	1.313
9	0.558	0.857	0.779	0.553	0.558	0.541	1.001	1.277

RP	PERCENT		INCIDENCE		DEV	D-FACT	EFF	LOSS COEFF		LOSS PARAM	
	SPAN	MEAN	SS	SS				TOT	PROF	TOT	PROF
1	5.00	4.9	1.5	10.6	0.498	0.786	0.180	0.142	0.043	0.034	
2	10.00	4.6	1.1	7.1	0.480	0.877	0.102	0.066	0.026	0.017	
3	15.00	4.9	1.3	6.5	0.481	0.894	0.088	0.053	0.022	0.013	
4	30.00	5.6	1.4	6.6	0.515	0.905	0.081	0.047	0.021	0.012	
5	50.00	5.9	0.5	8.1	0.518	0.923	0.067	0.039	0.017	0.010	
6	70.00	8.7	0.9	10.0	0.510	0.923	0.079	0.068	0.019	0.017	
7	85.00	12.3	2.0	10.2	0.467	0.923	0.096	0.094	0.021	0.021	
8	90.00	14.0	2.4	10.5	0.449	0.889	0.147	0.146	0.031	0.031	
9	95.00	15.9	2.8	10.2	0.453	0.832	0.233	0.233	0.046	0.046	

TABLE IX. - BLADE-ELEMENT DATA AT BLADE EDGES FOR

ROTOR 15 (90 PERCENT DESIGN SPEED; INTRABLADE

ROW INSTRUMENTATION AT STATION 2a)

(a) Reading number 564

RP	RADII		ABS BETAM		REL BETAM		TOTAL TEMP		TOTAL PRESS	
	IN	OUT	IN	OUT	IN	OUT	IN	RATIO	IN	RATIO
1	24.133	23.424	-0.4	27.9	60.5	48.2	288.7	1.089	10.07	1.295
2	23.510	22.885	-0.6	27.6	58.6	46.6	288.4	1.090	10.14	1.299
3	22.883	22.347	-0.6	28.1	57.3	44.8	288.2	1.091	10.13	1.312
4	21.026	20.731	-0.8	30.8	53.8	38.7	288.1	1.096	10.14	1.346
5	18.560	18.578	-0.9	34.7	49.7	27.3	288.0	1.102	10.14	1.376
6	16.076	16.426	-0.5	38.8	45.8	12.6	288.0	1.109	10.14	1.404
7	14.194	14.811	-0.6	43.4	43.2	-2.0	288.0	1.117	10.14	1.429
8	13.574	14.272	-0.4	45.7	42.1	-7.9	288.0	1.120	10.14	1.446
9	12.959	13.734	-1.0	47.2	41.4	-12.5	288.0	1.124	10.11	1.454

RP	ABS VEL		REL VEL		MERID VEL		TANG VEL		WHEEL SPEED	
	IN	OUT	IN	OUT	IN	OUT	IN	OUT	IN	OUT
1	167.9	197.4	341.3	261.6	167.9	174.4	-1.0	92.5	296.1	287.5
2	177.3	200.2	340.0	258.5	177.3	177.4	-1.8	92.8	288.4	289.7
3	181.7	203.4	336.0	253.0	181.7	179.4	-1.9	95.8	280.7	274.1
4	191.5	212.3	324.0	233.9	191.5	182.5	-2.8	108.6	258.6	255.0
5	195.4	229.6	302.4	212.3	195.4	188.7	-2.9	130.8	227.9	228.1
6	193.5	251.8	277.8	201.0	193.5	196.1	-1.7	158.0	197.5	201.8
7	187.6	274.6	257.3	199.5	187.6	199.4	-1.9	188.8	174.2	181.8
8	186.2	283.4	250.8	199.9	186.2	198.0	-1.2	202.8	166.8	175.4
9	184.2	289.4	245.7	201.4	184.2	196.6	-3.3	212.4	159.3	168.8

RP	ABS MACH NO		REL MACH NO		MERID MACH NO		MERID PEAK SS	
	IN	OUT	IN	OUT	IN	OUT	VEL R	MACH NO
1	0.505	0.573	1.027	0.760	0.505	0.506	1.039	1.356
2	0.536	0.582	1.027	0.751	0.535	0.516	1.001	1.355
3	0.550	0.592	1.017	0.736	0.550	0.522	0.987	1.360
4	0.581	0.619	0.984	0.681	0.581	0.532	0.953	1.370
5	0.594	0.671	0.920	0.621	0.594	0.552	0.966	1.327
6	0.588	0.741	0.844	0.591	0.588	0.577	1.014	1.263
7	0.569	0.813	0.780	0.590	0.569	0.590	1.063	1.196
8	0.565	0.841	0.761	0.593	0.565	0.588	1.063	1.166
9	0.558	0.860	0.744	0.598	0.558	0.584	1.067	1.151

RP	PERCENT	INCIDENCE		DEV	D-FACT	EFF	LOSS COEFF		LOSS PARAM	
	SPAN	MEAN	SS				TOT	PROF	TOT	PROF
1	5.00	2.3	-1.1	9.6	0.332	0.859	0.079	0.066	0.019	0.016
2	10.00	2.2	-1.3	8.5	0.338	0.859	0.080	0.067	0.020	0.017
3	15.00	2.5	-1.0	7.5	0.348	0.884	0.068	0.055	0.017	0.014
4	30.00	3.3	-0.9	6.9	0.389	0.927	0.047	0.036	0.012	0.009
5	50.00	4.3	-1.2	6.6	0.426	0.941	0.045	0.041	0.012	0.010
6	70.00	6.5	-1.3	8.3	0.423	0.937	0.058	0.058	0.014	0.014
7	85.00	9.6	-0.8	9.1	0.393	0.920	0.089	0.089	0.020	0.020
8	90.00	10.9	-0.7	8.7	0.381	0.924	0.090	0.090	0.019	0.019
9	95.00	13.1	-0.0	9.6	0.364	0.913	0.110	0.110	0.022	0.022

TABLE IX. - Continued. BLADE-ELEMENT DATA AT BLADE EDGES

FOR ROTOR 15 (90 PERCENT DESIGN SPEED; INTRABLADE

ROW INSTRUMENTATION AT STATION 2a)

(b) Reading number 565

RP	RADII		ABS BETAM		REL BETAM		TOTAL TEMP		TOTAL PRESS	
	IN	OUT	IN	OUT	IN	OUT	IN	RATIO	IN	RATIO
1	24.133	23.424	-0.6	29.1	60.8	47.5	288.8	1.094	10.06	1.325
2	23.510	22.885	-0.4	29.0	58.6	46.1	288.4	1.095	10.13	1.323
3	22.883	22.347	-0.6	29.5	57.4	44.1	288.1	1.095	10.13	1.339
4	21.026	20.731	-0.9	31.8	53.9	38.4	288.1	1.098	10.14	1.361
5	18.560	18.578	-0.9	35.7	50.0	27.3	288.0	1.103	10.14	1.385
6	16.076	16.426	-0.5	39.8	46.3	13.1	288.0	1.108	10.14	1.403
7	14.194	14.811	-0.7	44.6	44.0	-1.9	288.0	1.117	10.14	1.435
8	13.574	14.272	-0.6	46.6	42.9	-7.6	288.0	1.120	10.14	1.447
9	12.959	13.734	-1.0	48.3	42.1	-12.7	288.0	1.123	10.11	1.456

RP	ABS VEL		REL VEL		MERID VEL		TANG VEL		WHEEL SPEED	
	IN	OUT	IN	OUT	IN	OUT	IN	OUT	IN	OUT
1	166.6	199.7	341.5	258.6	166.6	174.6	-1.6	97.0	296.5	287.8
2	177.3	202.0	340.6	255.0	177.3	176.7	-1.3	97.9	289.5	281.8
3	181.6	205.6	336.7	249.3	181.5	178.9	-2.0	101.3	281.5	274.9
4	190.9	212.3	324.0	230.5	190.9	180.5	-3.1	111.8	258.7	255.1
5	194.5	228.1	302.4	208.6	194.5	185.3	-3.1	133.0	228.5	228.7
6	190.5	246.6	275.8	194.7	190.4	189.6	-1.8	157.7	197.7	202.0
7	182.9	268.3	254.4	191.1	182.9	191.0	-2.2	188.5	174.6	182.2
8	181.5	276.4	247.9	191.6	181.5	189.9	-1.9	200.8	167.0	175.6
9	179.5	283.2	242.0	193.0	179.5	188.3	-3.0	211.5	159.4	169.0

RP	ABS MACH NO		REL MACH NO		MERID MACH NO		MERID PEAK SS	
	IN	OUT	IN	OUT	IN	OUT	VEL R	MACH NO
1	0.501	0.579	1.027	0.750	0.501	0.506	1.048	1.366
2	0.535	0.586	1.029	0.740	0.535	0.513	0.997	1.357
3	0.549	0.598	1.019	0.725	0.549	0.520	0.985	1.364
4	0.580	0.618	0.984	0.671	0.579	0.525	0.946	1.373
5	0.591	0.666	0.920	0.609	0.591	0.541	0.953	1.334
6	0.578	0.724	0.837	0.571	0.578	0.557	0.995	1.266
7	0.554	0.792	0.770	0.564	0.554	0.564	1.045	1.203
8	0.549	0.817	0.750	0.567	0.549	0.562	1.047	1.172
9	0.543	0.839	0.732	0.572	0.543	0.558	1.049	1.150

RP	PERCENT	INCIDENCE		DEV	D-FACT	EFF	LOSS COEFF		LOSS PARAM	
	SPAN	MEAN	SS				TOT	PROF	TOT	PROF
1	5.00	2.6	-0.8	9.0	0.347	0.894	0.063	0.049	0.015	0.012
2	10.00	2.3	-1.2	8.0	0.354	0.879	0.072	0.059	0.018	0.015
3	15.00	2.7	-0.9	6.8	0.366	0.914	0.052	0.039	0.013	0.010
4	30.00	3.4	-0.8	6.6	0.403	0.942	0.039	0.027	0.010	0.007
5	50.00	4.6	-0.9	6.7	0.441	0.945	0.043	0.038	0.011	0.010
6	70.00	6.9	-0.8	8.8	0.441	0.941	0.054	0.054	0.013	0.013
7	85.00	10.4	0.1	9.2	0.419	0.929	0.080	0.080	0.018	0.018
8	90.00	11.8	0.2	9.0	0.406	0.926	0.089	0.089	0.019	0.019
9	95.00	13.8	0.7	9.4	0.388	0.919	0.104	0.104	0.021	0.021

TABLE IX. - Continued. BLADE-ELEMENT DATA AT BLADE EDGES

FOR ROTOR 15 (90 PERCENT DESIGN SPEED; INTRABLADE

ROW INSTRUMENTATION AT STATION 2a)

(c) Reading number 566

RP	RADII		ABS BETAM		REL BETAM		TOTAL TEMP		TOTAL PRESS	
	IN	OUT	IN	OUT	IN	OUT	IN	RATIO	IN	RATIO
1	24.133	23.424	-0.5	32.5	61.5	46.0	288.7	1.106	10.08	1.387
2	23.510	22.885	-0.4	32.0	59.5	44.9	288.4	1.105	10.13	1.383
3	22.883	22.347	-0.7	32.5	58.2	43.3	288.2	1.104	10.13	1.384
4	21.026	20.731	-1.1	34.7	54.9	37.9	288.1	1.105	10.14	1.393
5	18.560	18.578	-1.0	38.1	51.1	27.6	288.0	1.106	10.14	1.397
6	16.076	16.426	-0.5	41.8	47.7	13.4	288.0	1.110	10.14	1.408
7	14.194	14.811	-0.8	46.4	45.7	-1.9	288.0	1.117	10.14	1.431
8	13.574	14.272	-0.2	48.4	44.5	-8.4	288.1	1.122	10.13	1.454
9	12.959	13.734	-0.7	50.0	43.7	-13.2	288.0	1.123	10.11	1.454

RP	ABS VEL		REL VEL		MERID VEL		TANG VEL		WHEEL SPEED	
	IN	OUT	IN	OUT	IN	OUT	IN	OUT	IN	OUT
1	162.1	204.3	339.7	248.2	162.1	172.4	-1.4	109.7	297.0	288.3
2	171.4	204.9	337.4	245.2	171.4	173.7	-1.3	108.6	289.4	281.7
3	176.1	206.4	333.8	239.1	176.1	174.0	-2.0	111.0	281.6	275.0
4	184.3	210.7	320.2	219.6	184.3	173.3	-3.5	119.9	258.3	254.7
5	186.8	222.6	297.7	197.6	186.8	175.2	-3.2	137.4	228.6	228.8
6	181.4	239.2	269.5	183.2	181.4	178.2	-1.6	159.5	197.7	232.0
7	172.3	259.5	246.9	179.0	172.3	178.9	-2.3	188.0	174.5	182.1
8	171.0	270.2	239.5	181.2	171.0	179.3	-0.7	202.1	167.0	175.6
9	169.3	274.8	234.0	181.6	169.3	176.8	-2.1	210.4	159.5	169.0

RP	ABS MACH NO		REL MACH NO		MERID MACH NO		MERID PEAK SS	
	IN	OUT	IN	OUT	IN	OUT	VEL R	MACH NO
1	0.487	0.590	1.021	0.717	0.487	0.498	1.063	1.387
2	0.517	0.592	1.017	0.709	0.517	0.502	1.014	1.383
3	0.532	0.597	1.008	0.692	0.532	0.504	0.988	1.389
4	0.558	0.611	0.970	0.637	0.558	0.502	0.941	1.386
5	0.567	0.648	0.903	0.575	0.566	0.510	0.938	1.345
6	0.549	0.699	0.816	0.536	0.549	0.521	0.982	1.272
7	0.520	0.763	0.745	0.526	0.520	0.526	1.038	1.207
8	0.516	0.796	0.722	0.534	0.516	0.528	1.049	1.166
9	0.510	0.811	0.706	0.536	0.510	0.522	1.045	1.145

RP	PERCENT SPAN		INCIDENCE		DEV	D-FACT	EFF	LOSS COEFF		LOSS PARAM	
	SPAN	MEAN	SS	SS				TOT	PROF	TOT	PROF
1	5.00	3.2	-0.1	7.5	0.387	0.924	0.051	0.035	0.013	0.009	
2	10.00	3.1	-0.4	6.7	0.388	0.923	0.052	0.037	0.013	0.009	
3	15.00	3.4	-0.1	6.0	0.401	0.936	0.043	0.028	0.011	0.007	
4	30.00	4.3	0.2	6.0	0.438	0.947	0.038	0.026	0.010	0.007	
5	50.00	5.7	0.2	6.9	0.473	0.947	0.043	0.038	0.011	0.010	
6	70.00	8.3	0.5	9.1	0.473	0.934	0.065	0.064	0.016	0.016	
7	85.00	12.1	1.8	9.2	0.450	0.922	0.094	0.094	0.021	0.021	
8	90.00	13.3	1.7	8.2	0.428	0.929	0.092	0.092	0.019	0.019	
9	95.00	15.3	2.2	8.9	0.414	0.920	0.110	0.110	0.022	0.022	

TABLE IX. - Continued. BLADE-ELEMENT DATA AT BLADE EDGES

FOR ROTOR 15 (90 PERCENT DESIGN SPEED; INTRABLADE

ROW INSTRUMENTATION AT STATION 2a)

(d) Reading number 567

RP	RADII		ABS BETAM		REL BETAM		TOTAL TEMP		TOTAL PRESS	
	IN	OUT	IN	OUT	IN	OUT	IN	RATIO	IN	RATIO
1	24.133	23.424	-0.4	35.1	62.7	45.8	288.8	1.114	10.07	1.418
2	23.510	22.885	-0.5	34.6	60.7	44.5	288.4	1.113	10.13	1.412
3	22.883	22.347	-0.8	35.1	59.4	43.1	288.3	1.112	10.14	1.410
4	21.026	20.731	-1.4	37.1	56.2	37.8	288.1	1.110	10.14	1.412
5	18.560	18.578	-1.2	40.3	52.4	27.8	288.0	1.109	10.14	1.401
6	16.076	16.426	-0.6	43.7	49.2	14.1	287.9	1.111	10.13	1.404
7	14.194	14.811	-0.4	48.3	47.0	-2.9	288.0	1.119	10.14	1.438
8	13.574	14.272	-0.5	49.7	45.9	-8.8	288.0	1.122	10.14	1.457
9	12.959	13.734	-0.7	51.1	44.9	-13.7	288.0	1.123	10.12	1.458

RP	ABS VEL		REL VEL		MERID VEL		TANG VEL		WHEEL SPEED	
	IN	OUT	IN	OUT	IN	OUT	IN	OUT	IN	OUT
1	153.7	203.7	335.4	238.7	153.7	166.5	-1.0	117.2	297.0	288.3
2	163.3	204.6	333.4	236.1	163.2	168.4	-1.4	116.2	289.3	281.6
3	168.3	205.3	330.3	230.2	168.2	168.0	-2.3	117.9	281.9	275.3
4	176.0	208.8	316.4	210.8	176.0	166.6	-4.2	125.9	258.7	255.1
5	178.6	217.8	292.9	188.0	178.6	166.2	-3.8	140.8	228.4	228.6
6	172.9	232.3	264.4	173.1	172.9	167.9	-1.8	160.6	198.3	202.6
7	164.4	255.9	241.0	170.4	164.4	170.2	-1.2	191.2	175.0	182.7
8	163.5	265.9	235.1	173.9	163.5	171.8	-1.4	202.9	167.6	176.2
9	162.4	271.1	229.3	175.3	162.4	170.3	-1.9	210.9	159.9	169.5

RP	ABS MACH NO		REL MACH NO		MERID MACH NO		MERID PEAK SS	
	IN	OUT	IN	OUT	IN	OUT	VEL R	MACH NO
1	0.461	0.586	1.005	0.686	0.461	0.479	1.083	1.426
2	0.491	0.589	1.003	0.680	0.491	0.485	1.032	1.422
3	0.507	0.592	0.995	0.664	0.507	0.484	0.999	1.423
4	0.532	0.603	0.956	0.609	0.532	0.481	0.946	1.410
5	0.540	0.632	0.886	0.545	0.540	0.482	0.931	1.359
6	0.522	0.677	0.798	0.504	0.522	0.489	0.971	1.284
7	0.495	0.750	0.726	0.499	0.495	0.499	1.035	1.206
8	0.492	0.782	0.707	0.511	0.492	0.505	1.051	1.177
9	0.489	0.799	0.690	0.516	0.489	0.502	1.048	1.148

RP	PERCENT	INCIDENCE		DEV	D-FACT	EFF	LOSS COEFF		LOSS PARAM	
	SPAN	MEAN	SS				TOT	PROF	TOT	PROF
1	5.00	4.5	1.1	7.2	0.415	0.920	0.058	0.039	0.015	0.010
2	10.00	4.3	0.8	6.3	0.416	0.919	0.058	0.041	0.015	0.010
3	15.00	4.7	1.1	5.8	0.429	0.924	0.055	0.038	0.014	0.010
4	30.00	5.7	1.5	5.9	0.466	0.938	0.047	0.035	0.012	0.009
5	50.00	7.0	1.5	7.2	0.501	0.926	0.063	0.058	0.016	0.015
6	70.00	9.8	2.0	9.8	0.502	0.918	0.084	0.083	0.020	0.020
7	85.00	13.4	3.0	8.3	0.475	0.918	0.104	0.104	0.023	0.023
8	90.00	14.8	3.2	7.7	0.450	0.932	0.092	0.092	0.019	0.019
9	95.00	16.6	3.4	8.4	0.430	0.927	0.103	0.103	0.020	0.020

TABLE IX. - Continued. BLADE-ELEMENT DATA AT BLADE EDGES

FOR ROTOR 15 (90 PERCENT DESIGN SPEED; INTRABLADE

ROW INSTRUMENTATION AT STATION 2a)

(e) Reading number 568

RP	RADII		ABS BETAM		REL BETAM		TOTAL TEMP		TOTAL PRESS	
	IN	OUT	IN	OUT	IN	OUT	IN	RATIO	IN	RATIO
1	24.133	23.424	-0.3	37.5	63.8	45.6	288.9	1.120	10.09	1.440
2	23.510	22.885	-0.4	37.0	62.1	44.4	288.4	1.119	10.13	1.431
3	22.883	22.347	-0.6	37.8	60.7	42.9	288.3	1.118	10.13	1.427
4	21.026	20.731	-1.3	39.4	57.7	38.1	288.1	1.115	10.13	1.420
5	18.560	18.578	-1.2	42.2	54.0	28.6	288.0	1.111	10.14	1.402
6	16.076	16.426	-0.6	45.8	50.7	14.0	287.9	1.112	10.14	1.401
7	14.194	14.811	-0.5	49.4	48.5	-3.3	288.0	1.120	10.14	1.439
8	13.574	14.272	-0.5	50.6	47.2	-9.2	287.9	1.122	10.13	1.457
9	12.959	13.734	-0.8	52.0	46.3	-14.1	288.0	1.122	10.11	1.458

RP	ABS VEL		REL VEL		MERID VEL		TANG VEL		WHEEL SPEED	
	IN	OUT	IN	OUT	IN	OUT	IN	OUT	IN	OUT
1	146.4	203.4	331.9	230.7	146.4	161.4	-0.7	123.7	297.2	288.5
2	154.2	203.6	329.0	227.9	154.2	162.7	-1.0	122.4	289.6	282.0
3	158.7	204.1	324.6	220.2	158.7	161.3	-1.7	125.1	281.5	274.9
4	166.3	205.9	311.3	202.5	166.3	159.2	-3.9	130.6	259.2	255.6
5	168.9	212.9	287.2	179.6	168.8	157.7	-3.5	143.1	228.8	229.1
6	163.4	227.2	258.1	163.2	163.4	158.3	-1.6	163.0	198.1	202.5
7	156.2	252.7	235.6	164.6	156.2	164.3	-1.5	192.0	174.9	182.5
8	155.6	262.2	229.2	168.6	155.6	166.5	-1.2	202.6	167.1	175.7
9	154.6	267.3	223.7	169.8	154.6	164.7	-2.0	210.5	159.7	169.2

RP	ABS MACH NO		REL MACH NO		MERID MACH NO		MERID PEAK SS	
	IN	OUT	IN	OUT	IN	OUT	VEL R	MACH NO
1	0.438	0.583	0.993	0.661	0.438	0.463	1.103	1.453
2	0.462	0.584	0.987	0.654	0.462	0.467	1.055	1.449
3	0.477	0.586	0.975	0.633	0.477	0.463	1.017	1.440
4	0.501	0.593	0.938	0.583	0.501	0.459	0.958	1.431
5	0.509	0.616	0.866	0.519	0.509	0.456	0.934	1.374
6	0.492	0.660	0.777	0.474	0.492	0.460	0.969	1.290
7	0.469	0.739	0.708	0.482	0.469	0.481	1.052	1.212
8	0.467	0.770	0.689	0.495	0.467	0.489	1.070	1.176
9	0.464	0.786	0.672	0.500	0.464	0.485	1.065	1.149

RP	PERCENT	INCIDENCE		DEV	D-FACT	EFF	LOSS COEFF		LOSS PARAM	
	SPAN	MEAN	SS				TOT	PROF	TOT	PROF
1	5.00	5.6	2.2	7.0	0.440	0.911	0.069	0.048	0.018	0.012
2	10.00	5.7	2.2	6.3	0.439	0.907	0.072	0.052	0.018	0.013
3	15.00	6.0	2.4	5.6	0.457	0.909	0.071	0.053	0.018	0.014
4	30.00	7.2	3.0	6.3	0.489	0.915	0.070	0.056	0.018	0.014
5	50.00	8.6	3.1	8.0	0.523	0.911	0.079	0.075	0.020	0.019
6	70.00	11.3	3.6	9.7	0.530	0.900	0.107	0.107	0.026	0.026
7	85.00	14.9	4.5	7.8	0.488	0.913	0.115	0.115	0.026	0.026
8	90.00	16.1	4.5	7.4	0.459	0.932	0.096	0.096	0.020	0.020
9	95.00	18.0	4.8	8.0	0.440	0.934	0.098	0.098	0.019	0.019

TABLE IX. - Continued. BLADE-ELEMENT DATA AT BLADE EDGES

FOR ROTOR 15 (90 PERCENT DESIGN SPEED; INTRABLADE

ROW INSTRUMENTATION AT STATION 2a)

(f) Reading number 580

RP	RADII		ABS BETAM		REL BETAM		TOTAL TEMP		TOTAL PRESS	
	IN	OUT	IN	OUT	IN	OUT	IN	RATIO	IN	RATIO
1	24.133	23.424	-0.6	38.1	65.3	46.4	288.9	1.120	10.08	1.424
2	23.510	22.885	-0.5	37.8	63.6	45.0	288.6	1.120	10.13	1.419
3	22.883	22.347	-1.0	38.7	62.4	44.0	288.0	1.117	10.13	1.405
4	21.026	20.731	-2.0	41.5	59.8	39.7	288.1	1.114	10.13	1.388
5	18.560	18.578	-1.4	45.5	56.3	28.9	288.0	1.113	10.14	1.383
6	16.076	16.426	-0.7	47.2	52.7	13.7	288.1	1.112	10.14	1.394
7	14.194	14.811	-0.7	49.9	50.0	-3.3	288.0	1.118	10.14	1.430
8	13.574	14.272	-0.9	50.8	48.9	-9.2	288.1	1.121	10.13	1.454
9	12.959	13.734	-0.8	52.1	47.7	-14.2	288.0	1.121	10.12	1.457

RP	ABS VEL		REL VEL		MERID VEL		TANG VEL		WHEEL SPEED	
	IN	OUT	IN	OUT	IN	OUT	IN	OUT	IN	OUT
1	136.4	198.8	326.9	226.9	136.3	156.4	-1.3	122.8	295.8	287.1
2	143.9	199.9	323.3	223.4	143.9	157.9	-1.3	122.6	288.1	280.5
3	147.3	198.0	318.4	214.8	147.3	154.5	-2.6	123.9	279.7	273.1
4	152.9	197.1	303.4	191.7	152.8	147.6	-5.4	130.7	256.7	253.1
5	153.5	206.1	276.7	164.8	153.4	144.3	-3.7	147.1	226.5	226.7
6	151.2	223.2	249.4	156.1	151.2	151.6	-1.7	163.9	196.7	200.9
7	147.0	248.4	228.6	160.2	147.0	159.9	-1.7	190.0	173.3	180.9
8	146.7	259.4	223.1	166.1	146.7	164.0	-2.2	201.0	165.9	174.4
9	146.3	265.3	217.4	168.2	146.3	163.1	-2.1	209.3	158.6	168.1

RP	ABS MACH NO		REL MACH NO		MERID MACH NO		MERID PEAK SS	
	IN	OUT	IN	OUT	IN	OUT	VEL R	MACH NO
1	0.407	0.569	0.975	0.649	0.407	0.448	1.147	1.478
2	0.430	0.573	0.967	0.640	0.430	0.453	1.097	1.469
3	0.442	0.568	0.954	0.616	0.441	0.443	1.049	1.464
4	0.459	0.566	0.910	0.551	0.458	0.424	0.966	1.452
5	0.461	0.594	0.830	0.475	0.461	0.416	0.941	1.383
6	0.453	0.648	0.748	0.453	0.453	0.440	1.003	1.293
7	0.440	0.726	0.685	0.468	0.440	0.467	1.088	1.208
8	0.439	0.761	0.668	0.487	0.439	0.481	1.118	1.179
9	0.438	0.780	0.651	0.495	0.438	0.480	1.115	1.145

RP	PERCENT		INCIDENCE		DEV	D-FACT	EFF	LOSS COEFF		LOSS PARAM	
	SPAN	MEAN	SS	SS				TOT	PROF	TOT	PROF
1	5.00	7.1	3.7	7.9	0.442	0.884	0.092	0.070	0.023	0.018	
2	10.00	7.2	3.7	6.9	0.444	0.879	0.097	0.077	0.024	0.019	
3	15.00	7.7	4.1	6.7	0.463	0.870	0.104	0.085	0.026	0.021	
4	30.00	9.2	5.1	7.8	0.513	0.865	0.113	0.100	0.028	0.025	
5	50.00	10.9	5.4	8.2	0.562	0.861	0.133	0.130	0.034	0.033	
6	70.00	13.3	5.5	9.4	0.543	0.888	0.127	0.127	0.031	0.031	
7	85.00	16.4	6.0	7.9	0.490	0.909	0.125	0.125	0.028	0.028	
8	90.00	17.8	6.2	7.4	0.454	0.934	0.096	0.096	0.020	0.020	
9	95.00	19.4	6.2	7.9	0.430	0.938	0.095	0.095	0.019	0.019	

TABLE IX. - Concluded. BLADE-ELEMENT DATA AT BLADE EDGES

FOR ROTOR 15 (90 PERCENT DESIGN SPEED; INTRABLADE

ROW INSTRUMENTATION AT STATION 2a)

(g) Reading number 545

RP	RADII		ABS BETAM		REL BETAM		TOTAL TEMP		TOTAL PRESS	
	IN	OUT	IN	OUT	IN	OUT	IN	RATIO	IN	RATIO
1	24.133	23.424	-0.6	46.4	67.9	48.3	289.0	1.134	10.07	1.389
2	23.510	22.885	-0.5	43.1	65.8	46.2	288.5	1.130	10.12	1.391
3	22.883	22.347	-0.9	41.8	64.5	44.5	288.3	1.127	10.14	1.394
4	21.026	20.731	-1.8	43.2	61.7	39.9	288.1	1.120	10.14	1.382
5	18.560	18.578	-1.8	46.8	58.2	29.3	288.1	1.117	10.14	1.378
6	16.076	16.426	-1.0	47.0	54.0	14.0	287.9	1.114	10.14	1.396
7	14.194	14.811	-0.4	49.6	50.9	-2.4	287.9	1.121	10.14	1.429
8	13.574	14.272	-0.2	50.5	49.6	-8.5	287.8	1.123	10.14	1.455
9	12.959	13.734	-0.2	51.5	48.3	-13.5	287.9	1.124	10.12	1.464

RP	ABS VEL		REL VEL		MERID VEL		TANG VEL		WHEEL SPEED	
	IN	OUT	IN	OUT	IN	OUT	IN	OUT	IN	OUT
1	121.0	192.1	321.8	199.2	121.0	132.4	-1.3	139.2	296.8	288.1
2	130.1	194.2	317.2	204.9	130.1	141.8	-1.0	132.7	288.3	280.6
3	134.7	195.8	313.1	204.6	134.7	145.8	-2.0	130.6	280.6	274.0
4	141.6	196.5	298.3	186.7	141.5	143.2	-4.5	134.6	258.0	254.4
5	144.3	205.2	273.7	161.1	144.2	140.5	-4.5	149.6	228.1	228.3
6	144.9	223.5	246.6	157.1	144.9	152.4	-2.5	163.4	197.0	201.3
7	142.4	247.5	225.8	160.5	142.3	160.3	-1.1	188.6	174.1	181.7
8	142.0	258.7	219.3	166.4	142.0	164.6	-0.6	199.6	166.5	175.1
9	141.9	266.0	213.3	170.5	141.9	165.8	-0.5	208.0	158.7	168.2

RP	ABS MACH NO		REL MACH NO		MERID MACH NO		MERID PEAK SS	
	IN	OUT	IN	OUT	IN	OUT	VEL R	MACH NO
1	0.360	0.545	0.956	0.565	0.360	0.375	1.094	1.532
2	0.388	0.553	0.946	0.583	0.388	0.404	1.090	1.508
3	0.402	0.559	0.935	0.584	0.402	0.416	1.083	1.500
4	0.423	0.563	0.892	0.535	0.423	0.410	1.012	1.482
5	0.432	0.590	0.819	0.463	0.432	0.404	0.974	1.417
6	0.434	0.648	0.739	0.455	0.434	0.442	1.052	1.310
7	0.426	0.722	0.676	0.468	0.426	0.468	1.126	1.214
8	0.425	0.758	0.657	0.488	0.425	0.482	1.159	1.175
9	0.425	0.782	0.638	0.501	0.425	0.487	1.168	1.136

RP	PERCENT SPAN	INCIDENCE		DEV	D-FACT	EFF	LOSS COEFF		LOSS PARAM	
		MEAN	SS				TOT	PROF	TOT	PROF
1	5.00	9.7	6.3	9.8	0.538	0.732	0.234	0.206	0.057	0.050
2	10.00	9.4	6.0	8.1	0.503	0.760	0.209	0.186	0.052	0.046
3	15.00	9.8	6.2	7.2	0.493	0.787	0.185	0.164	0.046	0.041
4	30.00	11.2	7.0	8.1	0.524	0.808	0.172	0.157	0.043	0.039
5	50.00	12.8	7.3	8.6	0.574	0.819	0.182	0.177	0.046	0.045
6	70.00	14.6	6.9	9.7	0.535	0.875	0.146	0.146	0.036	0.036
7	85.00	17.3	7.0	8.7	0.480	0.888	0.160	0.160	0.036	0.036
8	90.00	18.5	6.9	8.1	0.441	0.922	0.119	0.119	0.025	0.025
9	95.00	20.0	6.8	8.6	0.405	0.930	0.113	0.113	0.022	0.022

TABLE X. - BLADE-ELEMENT DATA AT BLADE EDGES FOR
 ROTOR 15 (80 PERCENT DESIGN SPEED; INTRABLADE
 ROW INSTRUMENTATION AT STATION 2a;
 READING NUMBER 572)

RP	RADII		ABS BETAM		REL BETAM		TOTAL TEMP		TOTAL PRESS	
	IN	OUT	IN	OUT	IN	OUT	IN	RATIO	IN	RATIO
1	24.133	23.424	-0.5	52.8	70.7	52.2	288.6	1.111	10.09	1.283
2	23.510	22.885	-0.6	47.8	68.9	48.7	288.3	1.106	10.13	1.289
3	22.883	22.347	-0.6	45.8	67.9	46.5	288.3	1.102	10.13	1.294
4	21.026	20.731	-1.1	49.9	65.4	42.1	288.1	1.098	10.14	1.280
5	18.560	18.578	-1.8	53.3	62.2	30.3	288.0	1.096	10.13	1.278
6	16.076	16.426	-1.7	51.2	57.9	12.3	288.0	1.094	10.14	1.306
7	14.194	14.811	-0.8	50.9	54.2	-3.1	288.0	1.096	10.14	1.337
8	13.574	14.272	-0.5	51.9	52.7	-9.4	287.9	1.097	10.13	1.352
9	12.959	13.734	-0.6	52.8	51.3	-14.8	288.1	1.098	10.13	1.363

RP	ABS VEL		REL VEL		MERID VEL		TANG VEL		WHEEL SPEED	
	IN	OUT	IN	OUT	IN	OUT	IN	OUT	IN	OUT
1	92.7	162.7	280.7	160.4	92.7	98.4	-0.9	129.6	264.1	256.3
2	99.7	166.4	277.0	169.5	99.7	111.9	-1.0	123.2	257.4	250.6
3	102.2	168.6	271.8	170.9	102.2	117.5	-1.1	120.8	250.8	244.9
4	106.4	168.3	255.4	146.3	106.4	108.5	-2.1	128.7	230.2	226.9
5	108.6	176.4	233.1	122.0	108.5	105.3	-3.4	141.6	202.9	203.1
6	112.3	196.0	211.3	125.7	112.3	122.8	-3.3	152.7	175.7	179.5
7	113.0	218.3	193.4	137.9	113.0	137.7	-1.7	169.5	155.2	162.0
8	113.7	227.6	187.6	142.5	113.7	140.6	-1.0	179.0	148.2	155.9
9	114.4	235.6	183.2	147.2	114.4	142.4	-1.3	187.8	141.8	150.2

RP	ABS MACH NO		REL MACH NO		MERID MACH NO		MERID PEAK SS	
	IN	OUT	IN	OUT	IN	OUT	VEL R	MACH NO
1	0.274	0.463	0.831	0.456	0.274	0.280	1.061	1.410
2	0.296	0.475	0.821	0.484	0.296	0.319	1.122	1.396
3	0.303	0.483	0.806	0.489	0.303	0.336	1.150	1.386
4	0.316	0.483	0.758	0.420	0.316	0.311	1.020	1.355
5	0.322	0.508	0.692	0.351	0.322	0.303	0.970	1.294
6	0.334	0.568	0.628	0.365	0.334	0.356	1.094	1.199
7	0.336	0.638	0.575	0.403	0.336	0.402	1.218	1.099
8	0.338	0.667	0.558	0.417	0.338	0.412	1.237	1.058
9	0.340	0.692	0.544	0.432	0.340	0.418	1.244	1.027

RP	PERCENT SPAN		INCIDENCE		DEV	D-FACT	EFF	LOSS COEFF		LOSS PARAM	
	SPAN	MEAN	SS	SS				TOT	PROF	TOT	PROF
1	5.00	12.5	9.1	13.6	0.596	0.662	0.306	0.301	0.068	0.067	
2	10.00	12.5	9.1	10.6	0.546	0.707	0.261	0.257	0.061	0.061	
3	15.00	13.2	9.6	9.2	0.526	0.747	0.225	0.222	0.054	0.053	
4	30.00	14.9	10.7	10.3	0.592	0.743	0.245	0.244	0.059	0.059	
5	50.00	16.8	11.3	9.7	0.657	0.754	0.270	0.270	0.067	0.067	
6	70.00	18.5	10.7	8.0	0.593	0.842	0.201	0.201	0.050	0.050	
7	85.00	20.6	10.3	8.0	0.488	0.902	0.150	0.150	0.033	0.033	
8	90.00	21.6	10.0	7.2	0.450	0.927	0.119	0.119	0.025	0.025	
9	95.00	23.0	9.9	7.3	0.412	0.944	0.097	0.097	0.019	0.019	

TABLE XI. - BLADE-ELEMENT DATA AT BLADE EDGES FOR

ROTOR 15 (70 PERCENT DESIGN SPEED; INTRABLADE

ROW INSTRUMENTATION AT STATION 2a)

(a) Reading number 573

RP	RAD II		ABS BETAM		REL BETAM		TOTAL TEMP		TOTAL PRESS	
	IN	OUT	IN	OUT	IN	OUT	IN	RATIO	IN	RATIO
1	24.133	23.424	0.4	20.5	60.0	47.7	288.5	1.043	10.08	1.141
2	23.510	22.885	0.0	20.5	57.8	46.4	288.3	1.043	10.14	1.142
3	22.883	22.347	-0.1	21.3	56.6	44.9	288.3	1.044	10.13	1.148
4	21.026	20.731	-0.4	24.4	53.0	39.3	288.1	1.048	10.14	1.170
5	18.560	18.578	-0.9	29.5	49.1	28.2	288.1	1.055	10.14	1.196
6	16.076	16.426	-0.9	34.7	45.4	13.8	288.0	1.063	10.14	1.224
7	14.194	14.811	-0.6	40.5	42.4	-1.2	288.0	1.072	10.14	1.255
8	13.574	14.272	-0.8	42.8	41.5	-7.0	288.0	1.074	10.13	1.268
9	12.959	13.734	-0.6	44.8	40.3	-12.3	288.1	1.077	10.12	1.275

RP	ABS VEL		REL VEL		MERID VEL		TANG VEL		WHEEL SPEED	
	IN	OUT	IN	OUT	IN	OUT	IN	OUT	IN	OUT
1	132.4	161.6	264.7	225.1	132.4	151.4	0.8	56.7	230.0	223.3
2	141.0	163.8	264.9	222.4	141.0	153.4	0.1	57.5	224.4	218.4
3	144.3	165.4	262.2	217.6	144.3	154.1	-0.2	60.0	218.7	213.6
4	151.9	170.5	252.4	200.8	151.9	155.3	-1.1	70.5	200.6	197.8
5	155.4	184.5	237.3	182.2	155.3	160.6	-2.4	90.9	176.9	177.1
6	153.6	202.9	218.6	171.8	153.6	166.8	-2.4	115.5	153.3	156.6
7	149.4	222.8	202.5	169.5	149.4	169.5	-1.4	144.6	135.2	141.1
8	148.6	231.2	198.6	171.1	148.6	169.8	-2.1	157.0	129.6	136.2
9	147.5	238.2	193.4	173.1	147.5	169.1	-1.6	167.8	123.4	130.8

RP	ABS MACH NO		REL MACH NO		MERID MACH NO		MERID PEAK SS	
	IN	OUT	IN	OUT	IN	OUT	VEL R	MACH NO
1	0.395	0.475	0.789	0.662	0.395	0.445	1.143	1.050
2	0.422	0.482	0.792	0.654	0.422	0.451	1.088	1.047
3	0.432	0.487	0.785	0.640	0.432	0.453	1.068	1.046
4	0.455	0.502	0.757	0.591	0.455	0.457	1.023	1.034
5	0.466	0.543	0.712	0.537	0.466	0.473	1.034	1.012
6	0.461	0.599	0.656	0.507	0.461	0.492	1.086	0.971
7	0.448	0.660	0.607	0.502	0.448	0.502	1.134	0.915
8	0.446	0.686	0.595	0.507	0.445	0.504	1.142	0.902
9	0.442	0.708	0.580	0.514	0.442	0.502	1.146	0.874

RP	PERCENT SPAN		INCIDENCE		DEV	D-FACT	EFF	LOSS COEFF		LOSS PARAM	
	SPAN	MEAN	SS	TOT				PROF	TOT	PROF	
1	5.00	1.7	-1.6	9.2	0.226	0.894	0.045	0.045	0.011	0.011	
2	10.00	1.5	-2.0	8.2	0.237	0.893	0.045	0.045	0.011	0.011	
3	15.00	1.9	-1.7	7.6	0.250	0.913	0.038	0.038	0.009	0.009	
4	30.00	2.5	-1.7	7.5	0.296	0.953	0.024	0.024	0.006	0.006	
5	50.00	3.7	-1.8	7.6	0.346	0.951	0.031	0.031	0.008	0.008	
6	70.00	6.0	-1.8	9.5	0.352	0.944	0.047	0.047	0.011	0.011	
7	85.00	8.8	-1.5	9.9	0.327	0.934	0.070	0.070	0.016	0.016	
8	90.00	10.4	-1.2	9.6	0.314	0.943	0.065	0.065	0.014	0.014	
9	95.00	12.0	-1.2	9.8	0.288	0.935	0.080	0.080	0.016	0.016	

TABLE XI. - Continued. BLADE-ELEMENT DATA AT BLADE EDGES

FOR ROTOR 15 (70 PERCENT DESIGN SPEED; INTRABLADE

ROW INSTRUMENTATION AT STATION 2a)

(b) Reading number 574

RP	RADII		ABS BETAM		REL BETAM		TOTAL TEMP		TOTAL PRESS	
	IN	OUT	IN	OUT	IN	OUT	IN	RATIO	IN	RATIO
1	24.133	23.424	0.2	26.4	61.6	46.9	288.4	1.053	10.09	1.183
2	23.510	22.885	-0.2	26.1	59.9	45.9	288.2	1.053	10.13	1.180
3	22.883	22.347	-0.2	26.6	58.6	44.6	288.2	1.053	10.14	1.182
4	21.026	20.731	-0.7	29.1	55.2	39.5	288.2	1.055	10.14	1.195
5	18.560	18.578	-1.1	33.5	51.6	29.1	288.0	1.058	10.14	1.208
6	16.076	16.426	-0.7	38.1	47.8	14.8	288.0	1.064	10.13	1.226
7	14.194	14.811	-0.9	43.1	45.2	-0.3	288.0	1.071	10.14	1.251
8	13.574	14.272	-0.7	45.4	44.0	-6.8	288.0	1.073	10.13	1.264
9	12.959	13.734	-1.0	47.0	43.1	-12.1	287.9	1.074	10.12	1.273

RP	ABS VEL		REL VEL		MERID VEL		TANG VEL		WHEEL SPEED	
	IN	OUT	IN	OUT	IN	OUT	IN	OUT	IN	OUT
1	124.4	159.8	261.8	209.6	124.4	143.2	0.4	71.0	230.8	224.0
2	130.5	159.7	260.0	206.2	130.5	143.4	-0.5	70.3	224.4	218.4
3	133.5	160.5	256.4	201.4	133.5	143.4	-0.5	71.9	218.4	213.3
4	140.7	164.3	246.7	186.0	140.7	143.6	-1.8	79.8	200.9	198.1
5	142.7	174.8	229.8	166.7	142.7	145.7	-2.7	96.6	177.4	177.6
6	140.7	190.2	209.5	154.7	140.7	149.6	-1.7	117.4	153.6	156.9
7	136.8	208.3	194.2	152.1	136.7	152.1	-2.2	142.4	135.7	141.6
8	136.1	217.2	189.3	153.7	136.1	152.6	-1.7	154.5	129.8	136.4
9	134.9	224.4	184.7	156.6	134.9	153.1	-2.4	164.0	123.7	131.1

RP	ABS MACH NO		REL MACH NO		MERID MACH NO		MERID PEAK SS	
	IN	OUT	IN	OUT	IN	OUT	VEL R	MACH NO
1	0.370	0.467	0.780	0.613	0.370	0.419	1.151	1.082
2	0.389	0.467	0.776	0.603	0.389	0.420	1.099	1.080
3	0.398	0.470	0.765	0.589	0.398	0.420	1.074	1.074
4	0.421	0.481	0.738	0.544	0.421	0.420	1.021	1.064
5	0.427	0.513	0.688	0.489	0.427	0.427	1.021	1.036
6	0.421	0.559	0.627	0.454	0.421	0.439	1.063	0.980
7	0.409	0.614	0.580	0.448	0.409	0.448	1.112	0.930
8	0.407	0.641	0.565	0.454	0.407	0.451	1.121	0.904
9	0.403	0.664	0.552	0.463	0.403	0.453	1.135	0.884

RP	PERCENT	INCIDENCE		DEV	D-FACT	EFF	LOSS COEFF		LOSS PARAM	
	SPAN	MEAN	SS				TOT	PROF	TOT	PROF
1	5.00	3.4	0.0	8.4	0.297	0.924	0.040	0.040	0.010	0.010
2	10.00	3.5	0.0	7.8	0.303	0.911	0.047	0.047	0.012	0.012
3	15.00	3.9	0.3	7.3	0.312	0.927	0.039	0.039	0.010	0.010
4	30.00	4.7	0.6	7.6	0.353	0.954	0.027	0.027	0.007	0.007
5	50.00	6.2	0.7	8.4	0.400	0.951	0.034	0.034	0.009	0.009
6	70.00	8.4	0.7	10.5	0.407	0.936	0.058	0.058	0.014	0.014
7	85.00	11.6	1.3	10.8	0.386	0.934	0.075	0.075	0.017	0.017
8	90.00	12.9	1.3	9.8	0.368	0.946	0.067	0.067	0.014	0.014
9	95.00	14.7	1.6	9.9	0.341	0.960	0.053	0.053	0.010	0.010

TABLE XI. - Continued. BLADE-ELEMENT DATA AT BLADE EDGES

FOR ROTOR 15 (70 PERCENT DESIGN SPEED; INTRABLADE

ROW INSTRUMENTATION AT STATION 2a)

(c) Reading number 575

RP	RAD II		ABS BETAM		REL BETAM		TOTAL TEMP		TOTAL PRESS	
	IN	OUT	IN	OUT	IN	OUT	IN	RATIO	IN	RATIO
1	24.133	23.424	0.0	34.0	64.7	47.0	288.6	1.066	10.10	1.222
2	23.510	22.885	0.2	33.2	62.8	45.9	288.3	1.065	10.13	1.220
3	22.883	22.347	-0.1	33.6	61.6	44.5	288.1	1.063	10.13	1.219
4	21.026	20.731	-0.5	36.2	58.5	39.7	288.2	1.063	10.13	1.220
5	18.560	18.578	-1.3	39.8	55.2	29.5	288.1	1.064	10.14	1.225
6	16.076	16.426	-0.8	43.4	51.6	15.1	288.0	1.066	10.14	1.230
7	14.194	14.811	-0.7	47.5	48.9	-1.0	288.0	1.072	10.14	1.251
8	13.574	14.272	-0.5	48.9	47.6	-7.6	288.0	1.074	10.13	1.265
9	12.959	13.734	-1.0	50.2	46.5	-12.5	287.9	1.074	10.13	1.264

RP	ABS VEL		REL VEL		MERID VEL		TANG VEL		WHEEL SPEED	
	IN	OUT	IN	OUT	IN	OUT	IN	OUT	IN	OUT
1	109.1	154.4	255.1	187.8	109.1	128.0	0.0	86.4	230.5	223.8
2	115.3	155.0	252.4	186.4	115.3	129.6	0.3	85.0	224.9	218.9
3	118.0	155.5	248.4	181.7	118.0	129.5	-0.1	86.0	218.4	213.3
4	123.8	156.9	236.8	164.8	123.8	126.7	-1.1	92.6	200.7	197.9
5	125.7	165.8	220.1	146.4	125.6	127.5	-2.9	106.1	177.9	178.1
6	123.5	178.1	198.6	134.1	123.5	129.5	-1.7	122.3	153.8	157.2
7	119.9	195.6	182.5	132.2	119.9	132.2	-1.5	144.2	136.0	141.9
8	119.7	205.1	177.4	135.9	119.7	134.7	-1.0	154.6	129.9	136.6
9	119.3	209.5	173.4	137.5	119.3	134.2	-2.1	160.9	123.8	131.2

RP	ABS MACH NO		REL MACH NO		MERID MACH NO		MERID PEAK SS	
	IN	OUT	IN	OUT	IN	OUT	VEL R	MACH NO
1	0.324	0.448	0.757	0.545	0.324	0.371	1.173	1.135
2	0.343	0.450	0.750	0.541	0.343	0.377	1.124	1.121
3	0.351	0.452	0.739	0.528	0.351	0.377	1.098	1.114
4	0.369	0.456	0.705	0.479	0.369	0.369	1.024	1.095
5	0.375	0.483	0.656	0.427	0.374	0.372	1.015	1.068
6	0.368	0.521	0.592	0.392	0.368	0.379	1.049	1.000
7	0.357	0.573	0.543	0.388	0.357	0.388	1.103	0.938
8	0.356	0.602	0.528	0.399	0.356	0.396	1.125	0.908
9	0.355	0.617	0.516	0.405	0.355	0.395	1.125	0.888

RP	PERCENT SPAN		INCIDENCE		DEV	D-FACT	EFF	LOSS COEFF		LOSS PARAM	
	SPAN	MEAN	SS	SS				TOT	PROF	TOT	PROF
1	5.00	6.4	3.1	8.5	0.386	0.896	0.070	0.070	0.017	0.017	
2	10.00	6.4	3.0	7.8	0.380	0.904	0.064	0.064	0.016	0.016	
3	15.00	6.9	3.3	7.2	0.388	0.923	0.052	0.052	0.013	0.013	
4	30.00	8.0	3.8	7.9	0.432	0.927	0.053	0.053	0.013	0.013	
5	50.00	9.8	4.3	8.8	0.478	0.926	0.062	0.062	0.016	0.016	
6	70.00	12.2	4.4	10.8	0.484	0.920	0.083	0.083	0.020	0.020	
7	85.00	15.3	5.0	10.2	0.457	0.925	0.097	0.097	0.022	0.022	
8	90.00	16.4	4.8	9.0	0.426	0.944	0.078	0.078	0.016	0.016	
9	95.00	18.2	5.1	9.6	0.404	0.939	0.088	0.088	0.018	0.018	

TABLE XI. - Continued. BLADE-ELEMENT DATA AT BLADE EDGES
 FOR ROTOR 15 (70 PERCENT DESIGN SPEED; INTRABLADE
 ROW INSTRUMENTATION AT STATION 2a)

(d) Reading number 576

RP	RADII		ABS BETAM		REL BETAM		TOTAL TEMP		TOTAL PRESS	
	IN	OUT	IN	OUT	IN	OUT	IN	RATIO	IN	RATIO
1	24.133	23.424	-0.0	40.4	67.9	48.3	288.5	1.074	10.11	1.228
2	23.510	22.885	-0.1	39.0	66.1	47.1	288.2	1.071	10.13	1.224
3	22.883	22.347	-0.2	39.2	65.0	46.0	288.3	1.070	10.13	1.223
4	21.026	20.731	-0.7	42.1	62.3	41.4	288.2	1.069	10.13	1.219
5	18.560	18.578	-1.3	46.3	59.2	30.3	288.0	1.069	10.14	1.219
6	16.076	16.426	-0.4	48.4	55.1	13.6	288.0	1.071	10.14	1.232
7	14.194	14.811	-0.5	50.1	52.1	-3.1	287.9	1.074	10.13	1.261
8	13.574	14.272	-0.8	50.8	51.0	-8.2	288.1	1.075	10.13	1.266
9	12.959	13.734	-1.1	52.1	49.4	-14.1	288.1	1.074	10.13	1.267

RP	ABS VEL		REL VEL		MERID VEL		TANG VEL		WHEEL SPEED	
	IN	OUT	IN	OUT	IN	OUT	IN	OUT	IN	OUT
1	93.9	149.2	249.5	171.0	93.9	113.7	-0.1	96.6	231.1	224.3
2	99.6	149.0	245.7	170.3	99.6	115.9	-0.1	93.7	224.5	218.5
3	102.3	149.1	242.1	166.3	102.3	115.5	-0.4	94.2	219.0	213.8
4	106.4	150.1	229.1	148.3	106.4	111.3	-1.3	100.7	201.5	198.7
5	107.3	157.5	209.3	126.1	107.3	108.8	-2.4	113.8	177.3	177.5
6	107.9	172.9	188.4	118.2	107.9	114.9	-0.7	129.2	153.7	157.1
7	106.4	193.5	173.3	124.2	106.4	124.0	-1.0	148.5	135.8	141.7
8	106.7	200.1	169.4	127.7	106.7	126.4	-1.5	155.1	130.1	136.8
9	107.1	205.3	164.5	130.1	107.0	126.2	-2.0	162.0	122.8	130.2

RP	ABS MACH NO		REL MACH NO		MERID MACH NO		MERID PEAK SS	
	IN	OUT	IN	OUT	IN	OUT	VEL R	MACH NO
1	0.278	0.431	0.738	0.493	0.278	0.328	1.210	1.183
2	0.295	0.431	0.728	0.492	0.295	0.335	1.163	1.169
3	0.303	0.431	0.718	0.481	0.303	0.334	1.129	1.163
4	0.316	0.435	0.680	0.429	0.316	0.322	1.046	1.144
5	0.319	0.457	0.622	0.366	0.319	0.316	1.014	1.096
6	0.320	0.503	0.560	0.344	0.320	0.335	1.065	1.013
7	0.316	0.566	0.515	0.364	0.316	0.363	1.165	0.946
8	0.317	0.586	0.503	0.374	0.317	0.370	1.184	0.923
9	0.318	0.603	0.488	0.382	0.318	0.371	1.179	0.888

RP	PERCENT		INCIDENCE		DEV	D-FACT	EFF	LOSS COEFF		LOSS PARAM	
	SPAN	MEAN	SS	TOT				PROF	TOT	PROF	
1	5.00	9.7	6.3	9.8	0.454	0.820	0.138	0.138	0.033	0.033	
2	10.00	9.7	6.2	9.0	0.441	0.835	0.126	0.126	0.031	0.031	
3	15.00	10.3	6.7	8.7	0.448	0.843	0.121	0.121	0.029	0.029	
4	30.00	11.8	7.6	9.5	0.496	0.844	0.130	0.130	0.032	0.032	
5	50.00	13.8	8.3	9.7	0.559	0.841	0.155	0.155	0.039	0.039	
6	70.00	15.7	7.9	9.3	0.548	0.867	0.160	0.160	0.039	0.039	
7	85.00	18.5	8.2	8.0	0.480	0.930	0.102	0.102	0.023	0.023	
8	90.00	19.8	8.2	8.3	0.448	0.935	0.100	0.100	0.021	0.021	
9	95.00	21.1	7.9	7.9	0.418	0.945	0.089	0.089	0.018	0.018	

TABLE XI. - Continued. BLADE-ELEMENT DATA AT BLADE EDGES

FOR ROTOR 15 (70 PERCENT DESIGN SPEED; INTRABLADE

ROW INSTRUMENTATION AT STATION 2a)

(e) Reading number 550

RP	RADII		ABS BETAM		REL BETAM		TOTAL TEMP		TOTAL PRESS	
	IN	OUT	IN	OUT	IN	OUT	IN	RATIO	IN	RATIO
1	24.133	23.424	-0.1	51.6	71.1	51.9	288.6	1.084	10.10	1.214
2	23.510	22.885	0.3	46.2	69.1	48.9	288.3	1.080	10.12	1.217
3	22.883	22.347	0.2	44.0	68.0	46.8	288.4	1.076	10.13	1.219
4	21.026	20.731	-0.2	47.8	65.3	42.3	288.2	1.074	10.13	1.212
5	18.560	18.578	-0.7	51.4	62.1	31.1	288.0	1.073	10.13	1.208
6	16.076	16.426	-1.0	50.3	58.0	13.1	288.0	1.072	10.14	1.228
7	14.194	14.811	-0.3	50.1	54.3	-3.1	287.9	1.074	10.14	1.261
8	13.574	14.272	-0.4	50.8	53.0	-8.2	287.8	1.074	10.13	1.264
9	12.959	13.734	-0.8	51.5	51.9	-12.7	287.9	1.073	10.13	1.263

RP	ABS VEL		REL VEL		MERID VEL		TANG VEL		WHEEL SPEED	
	IN	OUT	IN	OUT	IN	OUT	IN	OUT	IN	OUT
1	78.7	141.2	242.4	142.2	78.7	87.8	-0.1	110.6	229.2	222.5
2	85.0	143.7	238.8	151.2	85.0	99.4	0.5	103.8	223.7	217.7
3	87.8	145.4	234.1	152.6	87.8	104.5	0.4	101.1	217.4	212.3
4	92.2	146.1	220.7	132.7	92.2	98.2	-0.3	108.2	200.2	197.4
5	94.1	152.6	201.0	111.2	94.1	95.2	-1.2	119.2	176.5	176.6
6	96.8	170.5	182.6	111.9	96.8	109.0	-1.7	131.1	153.1	156.4
7	97.5	192.8	167.2	123.8	97.5	123.6	-0.5	148.0	135.3	141.2
8	97.6	198.3	162.3	126.7	97.6	125.4	-0.6	153.6	129.0	135.6
9	97.7	202.8	158.2	129.3	97.7	126.1	-1.3	158.8	123.1	130.5

RP	ABS MACH NO		REL MACH NO		MERID MACH NO		MERID PEAK SS	
	IN	OUT	IN	OUT	IN	OUT	VEL R	MACH NO
1	0.232	0.405	0.716	0.407	0.232	0.252	1.116	1.224
2	0.251	0.413	0.706	0.435	0.251	0.286	1.169	1.207
3	0.260	0.419	0.692	0.440	0.260	0.301	1.190	1.192
4	0.273	0.422	0.653	0.383	0.273	0.283	1.065	1.166
5	0.279	0.441	0.596	0.322	0.279	0.276	1.012	1.110
6	0.287	0.496	0.541	0.325	0.287	0.317	1.126	1.034
7	0.289	0.564	0.496	0.362	0.289	0.361	1.267	0.950
8	0.289	0.581	0.481	0.371	0.289	0.368	1.285	0.918
9	0.290	0.596	0.469	0.380	0.290	0.370	1.291	0.893

RP	PERCENT	INCIDENCE		DEV	D-FACT	EFF	LOSS COEFF		LOSS PARAM	
	SPAN	MEAN	SS				TOT	PROF	TOT	PROF
1	5.00	12.8	9.5	13.3	0.578	0.676	0.291	0.291	0.065	0.065
2	10.00	12.8	9.3	10.8	0.519	0.721	0.245	0.245	0.058	0.058
3	15.00	13.3	9.7	9.5	0.497	0.763	0.208	0.208	0.050	0.050
4	30.00	14.8	10.6	10.4	0.557	0.764	0.222	0.222	0.053	0.053
5	50.00	16.7	11.2	10.5	0.620	0.765	0.256	0.256	0.064	0.064
6	70.00	18.6	10.8	8.8	0.573	0.841	0.205	0.205	0.050	0.050
7	85.00	20.7	10.4	8.0	0.462	0.918	0.129	0.129	0.029	0.029
8	90.00	21.9	10.3	8.4	0.427	0.935	0.108	0.108	0.023	0.023
9	95.00	23.5	10.4	9.4	0.395	0.942	0.099	0.099	0.020	0.020

TABLE XI. - Concluded. BLADE-ELEMENT DATA AT BLADE EDGES

FOR ROTOR 15 (70 PERCENT DESIGN SPEED; INTRABLADE

ROW INSTRUMENTATION AT STATION 2a)

(f) Reading number 577

RP	RADII		ABS BETAM		REL BETAM		TOTAL TEMP		TOTAL PRESS	
	IN	OUT	IN	OUT	IN	OUT	IN	RATIO	IN	RATIO
1	24.133	23.424	-0.1	54.4	71.4	52.6	288.7	1.085	10.11	1.215
2	23.510	22.885	0.0	50.1	69.7	49.4	288.4	1.083	10.13	1.217
3	22.883	22.347	-0.1	47.1	68.8	47.1	288.0	1.079	10.13	1.220
4	21.026	20.731	-0.4	50.6	66.2	42.5	288.2	1.076	10.13	1.212
5	18.560	18.578	-1.1	54.2	63.0	30.8	288.1	1.074	10.14	1.209
6	16.076	16.426	-1.2	52.1	58.7	11.4	288.1	1.073	10.13	1.233
7	14.194	14.811	-0.7	51.6	55.0	-4.5	288.0	1.075	10.13	1.262
8	13.574	14.272	-0.9	51.9	53.6	-9.5	287.9	1.074	10.14	1.268
9	12.959	13.734	-1.2	52.6	52.3	-13.9	288.2	1.074	10.13	1.266

RP	ABS VEL		REL VEL		MERID VEL		TANG VEL		WHEEL SPEED	
	IN	OUT	IN	OUT	IN	OUT	IN	OUT	IN	OUT
1	77.5	142.0	243.2	136.2	77.5	82.7	-0.1	115.4	230.4	223.6
2	83.1	144.3	239.6	142.3	83.1	92.6	0.0	110.7	224.8	218.8
3	84.9	145.5	234.6	145.6	84.9	99.0	-0.2	106.6	218.5	213.4
4	88.9	146.6	220.6	126.1	88.9	93.1	-0.7	113.2	201.2	198.4
5	91.3	153.1	201.0	104.2	91.2	89.5	-1.7	124.2	177.4	177.5
6	94.8	172.0	182.3	107.9	94.7	105.7	-2.0	135.6	153.7	157.0
7	95.8	193.0	167.1	120.4	95.8	120.0	-1.3	151.1	135.7	141.6
8	96.7	199.2	162.7	124.8	96.7	123.1	-1.5	156.7	129.5	136.2
9	97.4	203.5	159.1	127.3	-97.3	123.5	-2.0	161.8	123.8	131.2

RP	ABS MACH NO		REL MACH NO		MERID MACH NO		MERID PEAK SS	
	IN	OUT	IN	OUT	IN	OUT	VEL R	MACH NO
1	0.229	0.407	0.718	0.390	0.229	0.237	1.067	1.236
2	0.245	0.414	0.708	0.409	0.245	0.266	1.114	1.224
3	0.251	0.419	0.694	0.419	0.251	0.285	1.167	1.214
4	0.263	0.423	0.653	0.364	0.263	0.268	1.047	1.186
5	0.270	0.443	0.595	0.301	0.270	0.259	0.981	1.128
6	0.281	0.500	0.540	0.314	0.281	0.307	1.116	1.046
7	0.284	0.564	0.495	0.352	0.284	0.351	1.253	0.961
8	0.287	0.584	0.482	0.366	0.287	0.361	1.273	0.930
9	0.289	0.597	0.471	0.374	0.288	0.363	1.269	0.904

RP	PERCENT	INCIDENCE		DEV	D-FACT	EFF	LOSS COEFF		LOSS PARAM	
	SPAN	MEAN	SS				TOT	PROF	TOT	PROF
1	5.00	13.2	9.8	14.1	0.611	0.672	0.295	0.295	0.065	0.065
2	10.00	13.4	9.9	11.3	0.569	0.696	0.275	0.275	0.064	0.064
3	15.00	14.1	10.5	9.8	0.537	0.740	0.233	0.233	0.055	0.055
4	30.00	15.7	11.5	10.6	0.595	0.744	0.247	0.247	0.059	0.059
5	50.00	17.6	12.1	10.1	0.663	0.756	0.269	0.269	0.067	0.067
6	70.00	19.3	11.5	7.1	0.601	0.842	0.209	0.209	0.052	0.052
7	85.00	21.4	11.1	6.6	0.487	0.920	0.127	0.127	0.028	0.028
8	90.00	22.4	10.8	7.1	0.446	0.946	0.089	0.089	0.019	0.019
9	95.00	23.9	10.8	8.2	0.415	0.944	0.096	0.096	0.019	0.019

TABLE XII. - BLADE-ELEMENT DATA AT BLADE EDGES FOR

ROTOR 15 (60 PERCENT DESIGN SPEED; INTRABLADE

ROW INSTRUMENTATION AT STATION 2a;

READING NUMBER 578)

RP	RADII		ABS BETAM		REL BETAM		TOTAL TEMP		TOTAL PRESS	
	IN	OUT	IN	OUT	IN	OUT	IN	RATIO	IN	RATIO
1	24.133	23.424	0.1	54.8	71.9	53.0	288.7	1.062	10.12	1.156
2	23.510	22.885	0.0	50.8	70.1	50.0	288.2	1.061	10.13	1.156
3	22.883	22.347	0.1	46.8	69.2	47.5	288.2	1.058	10.13	1.158
4	21.026	20.731	-0.3	49.9	66.7	42.4	288.2	1.055	10.13	1.154
5	18.560	18.578	-0.8	53.7	63.4	30.6	288.1	1.055	10.13	1.153
6	16.076	16.426	-1.0	51.3	59.2	13.9	288.0	1.053	10.13	1.163
7	14.194	14.811	-0.7	51.0	55.6	-1.7	288.1	1.053	10.13	1.178
8	13.574	14.272	-0.9	51.5	54.1	-8.1	288.0	1.054	10.13	1.189
9	12.959	13.734	-1.3	52.3	52.7	-12.9	287.9	1.054	10.13	1.188

RP	ABS VEL		REL VEL		MERID VEL		TANG VEL		WHEEL SPEED	
	IN	OUT	IN	OUT	IN	OUT	IN	OUT	IN	OUT
1	64.6	121.0	207.5	115.9	64.6	69.8	0.1	98.9	197.2	191.4
2	69.5	122.5	204.6	120.6	69.5	77.4	0.1	95.0	192.5	187.4
3	71.0	123.7	199.9	125.5	71.0	84.7	0.2	90.1	187.0	182.7
4	74.4	125.3	187.8	109.3	74.4	80.7	-0.4	95.9	172.0	169.6
5	76.5	131.1	170.6	90.2	76.5	77.7	-1.1	105.7	151.4	151.6
6	79.1	143.7	154.6	92.6	79.1	89.9	-1.4	112.2	131.5	134.4
7	80.3	159.8	142.1	100.6	80.3	100.5	-1.0	124.2	116.2	121.3
8	81.2	168.3	138.6	105.9	81.2	104.9	-1.3	131.7	111.0	116.7
9	82.2	172.4	135.5	108.2	82.1	105.5	-1.9	136.4	105.8	112.2

RP	ABS MACH NO		REL MACH NO		MERID MACH NO		MERID PEAK SS	
	IN	OUT	IN	OUT	IN	OUT	VEL R	MACH NO
1	0.190	0.349	0.611	0.334	0.190	0.201	1.080	1.062
2	0.205	0.354	0.604	0.348	0.205	0.224	1.114	1.052
3	0.210	0.358	0.590	0.363	0.210	0.245	1.192	1.041
4	0.220	0.363	0.554	0.317	0.220	0.234	1.084	1.015
5	0.226	0.381	0.504	0.262	0.226	0.225	1.016	0.963
6	0.234	0.419	0.457	0.270	0.234	0.262	1.137	0.894
7	0.237	0.468	0.420	0.294	0.237	0.294	1.252	0.823
8	0.240	0.494	0.410	0.311	0.240	0.307	1.291	0.798
9	0.243	0.506	0.401	0.318	0.243	0.310	1.284	0.775

RP	PERCENT SPAN	INCIDENCE		DEV	D-FACT	EFF	LOSS COEFF		LOSS PARAM	
		MEAN	SS				TOT	PROF	TOT	PROF
1	5.00	13.6	10.3	14.5	0.612	0.679	0.284	0.284	0.062	0.062
2	10.00	13.8	10.3	11.9	0.574	0.692	0.276	0.276	0.063	0.063
3	15.00	14.5	10.9	10.2	0.528	0.744	0.227	0.227	0.054	0.054
4	30.00	16.1	12.0	10.6	0.583	0.756	0.233	0.233	0.056	0.056
5	50.00	18.0	12.5	10.0	0.652	0.756	0.274	0.274	0.068	0.068
6	70.00	19.9	12.1	9.6	0.588	0.836	0.214	0.214	0.052	0.052
7	85.00	21.9	11.6	9.5	0.493	0.903	0.150	0.150	0.033	0.033
8	90.00	23.0	11.4	8.4	0.445	0.937	0.103	0.103	0.022	0.022
9	95.00	24.4	11.2	9.1	0.415	0.939	0.104	0.104	0.021	0.021

TABLE XIII. - BLADE-ELEMENT DATA AT BLADE EDGES FOR

ROTOR 15 (50 PERCENT DESIGN SPEED; INTRABLADE

ROW INSTRUMENTATION AT STATION 2a;

READING NUMBER 579)

RP	RADI I		ABS BETAM		REL BETAM		TOTAL TEMP		TOTAL PRESS	
	IN	OUT	IN	OUT	IN	OUT	IN	RATIO	IN	RATIO
1	24.133	23.424	37.7	55.5	78.9	53.2	290.9	1.030	10.09	1.110
2	23.510	22.885	48.5	57.7	79.2	51.7	292.2	1.024	10.06	1.106
3	22.883	22.347	29.0	54.6	71.3	49.6	291.2	1.025	10.08	1.101
4	21.026	20.731	4.6	50.2	63.6	44.1	288.8	1.029	10.08	1.086
5	18.560	18.578	-1.1	46.5	60.1	31.6	287.3	1.034	10.15	1.093
6	16.076	16.426	-1.2	46.6	56.5	15.7	286.9	1.036	10.17	1.100
7	14.194	14.811	-1.3	47.3	53.1	-1.0	286.7	1.039	10.18	1.113
8	13.574	14.272	-1.3	48.0	51.8	-6.9	286.6	1.040	10.18	1.121
9	12.959	13.734	-1.7	49.7	50.7	-12.7	287.0	1.042	10.17	1.124

RP	ABS VEL		REL VEL		MERID VEL		TANG VEL		WHEEL SPEED	
	IN	OUT	IN	OUT	IN	OUT	IN	OUT	IN	OUT
1	35.2	100.7	145.3	95.3	27.9	57.0	21.5	83.0	164.2	159.3
2	37.9	102.5	134.1	88.2	25.1	54.7	28.4	86.6	160.1	155.8
3	50.7	101.5	138.2	90.7	44.4	58.8	24.6	82.7	155.4	151.8
4	68.2	101.2	153.0	90.2	68.0	64.8	5.5	77.8	142.6	140.6
5	73.7	110.3	147.6	89.1	73.6	75.9	-1.4	80.0	126.5	126.7
6	73.5	121.8	133.2	86.9	73.5	83.7	-1.5	88.5	109.5	111.9
7	73.6	139.2	122.7	94.3	73.6	94.3	-1.7	102.3	96.5	100.7
8	73.9	146.6	119.6	98.8	73.9	98.1	-1.7	108.9	92.3	97.1
9	74.2	151.8	117.0	100.7	74.1	98.3	-2.2	115.8	88.3	93.6

RP	ABS MACH NO		REL MACH NO		MERID MACH NO		MERID PEAK SS	
	IN	OUT	IN	OUT	IN	OUT	VEL R	MACH NO
1	0.103	0.293	0.426	0.277	0.082	0.166	2.044	0.845
2	0.111	0.298	0.392	0.257	0.073	0.159	2.181	0.809
3	0.149	0.295	0.405	0.264	0.130	0.171	1.326	0.743
4	0.201	0.295	0.451	0.263	0.200	0.189	0.953	0.779
5	0.218	0.322	0.436	0.260	0.218	0.222	1.030	0.783
6	0.218	0.357	0.394	0.255	0.218	0.245	1.138	0.733
7	0.218	0.409	0.363	0.277	0.218	0.277	1.281	0.680
8	0.219	0.431	0.354	0.291	0.219	0.289	1.328	0.661
9	0.219	0.447	0.346	0.296	0.219	0.289	1.325	0.645

RP	PERCENT	INCIDENCE		DEV	D-FACT	EFF	LOSS COEFF		LOSS PARAM	
	SPAN	MEAN	SS				TOT	PROF	TOT	PROF
1	5.00	20.7	17.4	14.7	0.495	1.001	-0.001	-0.001	-0.000	-0.000
2	10.00	22.9	19.4	13.5	0.493	1.209	-0.172	-0.172	-0.038	-0.038
3	15.00	16.6	13.0	12.3	0.487	1.094	-0.076	-0.076	-0.017	-0.017
4	30.00	13.1	8.9	12.3	0.563	0.810	0.145	0.145	0.034	0.034
5	50.00	14.7	9.2	11.0	0.556	0.756	0.227	0.227	0.056	0.056
6	70.00	17.1	9.3	11.3	0.520	0.762	0.283	0.283	0.069	0.069
7	85.00	19.5	9.2	10.1	0.424	0.789	0.321	0.321	0.071	0.071
8	90.00	20.7	9.1	9.7	0.376	0.821	0.291	0.291	0.061	0.061
9	95.00	22.3	9.2	9.4	0.350	0.810	0.334	0.334	0.066	0.066

TABLE XIV. - BLADE-ELEMENT DATA AT BLADE EDGES FOR

ROTOR 15 (100 PERCENT DESIGN SPEED; 1 EXIT PYLON;

INTRABLADE ROW INSTRUMENTATION

AT STATION 2a)

(a) Reading number 613

RP	RADII		ABS BETAM		REL BETAM		TOTAL TEMP		TOTAL PRESS	
	IN	OUT	IN	OUT	IN	OUT	IN	RATIO	IN	RATIO
1	24.133	23.424	0.4	40.6	63.3	44.9	288.9	1.155	10.06	1.582
2	23.510	22.885	0.7	39.8	61.0	43.4	288.8	1.152	10.12	1.572
3	22.883	22.347	0.3	40.2	59.6	41.4	288.6	1.151	10.13	1.567
4	21.026	20.731	-0.9	42.4	56.7	35.3	288.0	1.147	10.14	1.551
5	18.560	18.578	-1.1	44.8	53.2	24.9	287.9	1.142	10.14	1.526
6	16.076	16.426	-0.9	47.3	50.3	10.5	287.8	1.140	10.15	1.513
7	14.194	14.811	-0.9	51.1	48.2	-6.6	287.8	1.147	10.14	1.547
8	13.574	14.272	-0.7	52.1	47.0	-11.5	287.9	1.150	10.14	1.561
9	12.959	13.734	-1.2	53.5	46.1	-15.8	287.9	1.149	10.12	1.555

RP	ABS VEL		REL VEL		MERID VEL		TANG VEL		WHEEL SPEED	
	IN	OUT	IN	OUT	IN	OUT	IN	OUT	IN	OUT
1	164.9	227.3	367.3	243.5	164.9	172.5	1.2	147.9	329.4	319.8
2	176.8	229.2	365.1	242.3	176.8	176.2	2.2	146.7	321.6	313.1
3	182.8	231.7	361.6	235.8	182.8	176.9	0.8	149.7	312.8	305.5
4	190.6	236.9	347.5	214.1	190.5	174.8	-3.1	159.9	287.6	283.5
5	192.4	245.7	321.2	192.2	192.3	174.4	-3.6	173.1	253.7	253.9
6	185.5	261.1	290.2	180.0	185.5	177.0	-3.0	192.0	220.1	224.9
7	176.4	287.5	264.7	181.6	176.4	180.4	-2.8	223.9	194.5	203.0
8	175.4	294.5	257.3	184.5	175.4	180.8	-2.1	232.5	186.1	195.7
9	174.1	296.1	251.1	183.2	174.1	176.3	-3.5	237.9	177.4	188.1

RP	ABS MACH NO		REL MACH NO		MERID MACH NO		MERID PEAK SS	
	IN	OUT	IN	OUT	IN	OUT	VEL R	MACH NO
1	0.496	0.646	1.104	0.692	0.496	0.490	1.046	1.495
2	0.534	0.653	1.102	0.690	0.534	0.502	0.997	1.480
3	0.553	0.661	1.094	0.673	0.553	0.505	0.968	1.480
4	0.579	0.679	1.055	0.614	0.579	0.501	0.917	1.513
5	0.585	0.709	0.976	0.555	0.585	0.503	0.907	1.523
6	0.563	0.759	0.880	0.523	0.563	0.515	0.954	1.448
7	0.533	0.843	0.800	0.533	0.533	0.529	1.023	1.363
8	0.530	0.866	0.777	0.543	0.530	0.532	1.031	1.322
9	0.526	0.871	0.758	0.539	0.526	0.519	1.013	1.293

RP	PERCENT SPAN	INCIDENCE		DEV	D-FACT	EFF	LOSS COEFF		LOSS PARAM	
		MEAN	SS				TOT	PROF	TOT	PROF
1	5.00	5.1	1.7	6.3	0.481	0.900	0.084	0.046	0.022	0.012
2	10.00	4.7	1.2	5.2	0.476	0.906	0.078	0.042	0.020	0.011
3	15.00	4.9	1.3	4.1	0.490	0.906	0.079	0.044	0.021	0.011
4	30.00	6.2	2.1	3.4	0.535	0.908	0.080	0.044	0.021	0.012
5	50.00	7.8	2.3	4.2	0.561	0.903	0.091	0.063	0.024	0.017
6	70.00	10.9	3.1	6.2	0.551	0.894	0.114	0.104	0.028	0.026
7	85.00	14.6	4.3	4.5	0.509	0.900	0.131	0.129	0.029	0.029
8	90.00	15.9	4.3	5.1	0.482	0.907	-0.129	0.128	0.027	0.027
9	95.00	17.8	4.7	6.3	0.472	0.901	0.143	0.143	0.028	0.028

TABLE XIV. - Concluded. BLADE-ELEMENT DATA AT BLADE

EDGES FOR ROTOR 15 (100 PERCENT DESIGN SPEED; 1 EXIT

PYLON; INTRABLADE ROW INSTRUMENTATION

AT STATION 2a)

(b) Reading number 614

RP	RADII		ABS BETAM		REL BETAM		TOTAL TEMP		TOTAL PRESS	
	IN	OUT	IN	OUT	IN	OUT	IN	RATIO	IN	RATIO
1	24.133	23.424	0.1	32.3	61.1	48.3	288.8	1.123	10.05	1.410
2	23.510	22.885	0.3	32.1	58.8	46.5	288.5	1.122	10.13	1.410
3	22.883	22.347	0.0	32.5	57.5	44.5	288.3	1.123	10.13	1.427
4	21.026	20.731	-0.4	35.2	54.1	37.5	288.1	1.127	10.14	1.455
5	18.560	18.578	-0.6	39.0	50.3	25.6	288.0	1.131	10.14	1.480
6	16.076	16.426	-0.5	42.1	46.6	10.2	287.9	1.137	10.15	1.515
7	14.194	14.811	-0.4	45.7	43.8	-4.4	287.9	1.145	10.14	1.549
8	13.574	14.272	-0.5	47.5	42.8	-9.5	287.9	1.148	10.14	1.561
9	12.959	13.734	-0.7	49.7	42.0	-13.8	287.9	1.149	10.11	1.538

RP	ABS VEL		REL VEL		MERID VEL		TANG VEL		WHEEL SPEED	
	IN	OUT	IN	OUT	IN	OUT	IN	OUT	IN	OUT
1	181.8	215.6	375.8	273.8	181.8	182.2	0.3	115.2	329.2	319.5
2	192.8	218.4	372.7	269.1	192.8	185.1	0.9	116.0	319.8	311.3
3	198.8	223.4	370.6	264.2	198.8	188.3	0.0	120.1	312.7	305.4
4	208.5	234.3	355.4	241.4	208.5	191.4	-1.6	135.2	286.3	282.3
5	211.8	252.6	331.5	217.7	211.8	196.3	-2.2	158.9	252.7	253.0
6	209.1	278.7	304.3	209.9	209.1	206.7	-1.9	187.0	219.2	224.0
7	202.9	304.6	281.1	213.2	202.9	212.5	-1.3	218.2	193.2	231.6
8	201.4	311.3	274.6	213.2	201.4	210.3	-1.7	229.5	185.0	194.5
9	199.0	310.6	267.9	207.1	199.0	201.1	-2.6	236.8	176.9	187.5

RP	ABS MACH NO		REL MACH NO		MERID MACH NO		MERID PEAK SS	
	IN	OUT	IN	OUT	IN	OUT	VEL R	MACH NO
1	0.550	0.620	1.136	0.787	0.550	0.524	1.002	1.440
2	0.585	0.629	1.131	0.775	0.585	0.533	0.960	1.426
3	0.605	0.645	1.128	0.762	0.605	0.543	0.947	1.432
4	0.637	0.678	1.086	0.698	0.637	0.554	0.918	1.440
5	0.648	0.735	1.014	0.633	0.648	0.571	0.927	1.464
6	0.639	0.818	0.931	0.616	0.639	0.607	0.988	1.416
7	0.619	0.903	0.857	0.632	0.619	0.630	1.048	1.332
8	0.614	0.924	0.837	0.633	0.614	0.624	1.044	1.304
9	0.606	0.921	0.816	0.614	0.606	0.597	1.011	1.279

RP	PERCENT	INCIDENCE		DEV	D-FACT	EFF	LOSS COEFF		LOSS PARAM	
	SPAN	MEAN	SS				TOT	PROF	TOT	PROF
1	5.00	2.8	-0.5	9.7	0.381	0.839	0.106	0.072	0.026	0.018
2	10.00	2.5	-1.0	8.4	0.387	0.849	0.100	0.068	0.024	0.017
3	15.00	2.8	-0.8	7.2	0.399	0.871	0.086	0.055	0.021	0.014
4	30.00	3.6	-0.6	5.7	0.445	0.890	0.080	0.052	0.021	0.013
5	50.00	4.9	-0.6	5.0	0.484	0.903	0.081	0.057	0.021	0.015
6	70.00	7.2	-0.6	5.9	0.468	0.923	0.076	0.064	0.019	0.016
7	85.00	10.2	-0.1	6.7	0.419	0.920	0.094	0.091	0.021	0.020
8	90.00	11.7	0.1	7.1	0.407	0.916	0.103	0.102	0.022	0.021
9	95.00	13.7	0.6	8.3	0.414	0.876	0.159	0.159	0.031	0.031

TABLE XV. - BLADE-ELEMENT DATA AT BLADE EDGES FOR

ROTOR 15 (90 PERCENT DESIGN SPEED; 1 EXIT PYLON;

INTRABLADE ROW INSTRUMENTATION

AT STATION 2a)

(a) Reading number 615

RP	RADII		ABS BETAM		REL BETAM		TOTAL TEMP		TOTAL PRESS	
	IN	OUT	IN	OUT	IN	OUT	IN	RATIO	IN	RATIO
1	24.133	23.424	-0.1	29.9	61.1	47.3	288.7	1.094	10.05	1.327
2	23.510	22.885	-0.2	29.5	58.7	45.5	288.5	1.095	10.13	1.325
3	22.883	22.347	-0.4	29.9	57.4	43.4	288.3	1.095	10.14	1.340
4	21.026	20.731	-0.7	32.5	53.9	37.0	288.1	1.098	10.14	1.364
5	18.560	18.578	-0.6	36.4	49.9	25.7	288.0	1.103	10.14	1.382
6	16.076	16.426	-0.4	40.3	46.2	11.2	287.9	1.108	10.14	1.404
7	14.194	14.811	-0.4	44.5	43.5	-3.6	288.0	1.116	10.14	1.429
8	13.574	14.272	-0.5	46.4	42.5	-8.9	288.0	1.120	10.14	1.442
9	12.959	13.734	-0.7	48.6	41.6	-14.0	288.0	1.123	10.12	1.447

RP	ABS VEL		REL VEL		MERID VEL		TANG VEL		WHEEL SPEED	
	IN	OUT	IN	OUT	IN	OUT	IN	OUT	IN	OUT
1	163.7	199.9	338.6	255.5	163.7	173.3	-0.4	99.6	296.0	287.3
2	175.5	203.5	338.0	252.9	175.5	177.2	-0.6	100.1	288.2	280.6
3	180.6	207.9	335.1	248.2	180.6	180.2	-1.4	103.7	281.0	274.4
4	189.9	217.1	322.5	229.4	189.9	183.1	-2.4	116.5	258.2	254.6
5	193.7	232.3	300.4	207.5	193.6	186.9	-1.9	137.9	227.7	227.9
6	191.0	253.2	275.8	196.9	191.0	193.2	-1.3	163.6	197.5	201.8
7	185.0	277.3	255.0	198.2	185.0	197.8	-1.2	194.4	174.3	181.9
8	183.6	284.1	248.9	198.2	183.6	195.8	-1.5	205.9	166.6	175.2
9	181.7	287.9	243.0	196.2	181.6	190.3	-2.3	216.1	159.0	168.5

RP	ABS MACH NO		REL MACH NO		MERID MACH NO		MERID PEAK SS	
	IN	OUT	IN	OUT	IN	OUT	VEL R	MACH NO
1	0.492	0.580	1.018	0.741	0.492	0.503	1.059	1.373
2	0.530	0.591	1.020	0.734	0.530	0.514	1.009	1.357
3	0.546	0.605	1.014	0.722	0.546	0.524	0.998	1.364
4	0.576	0.633	0.979	0.669	0.576	0.534	0.964	1.367
5	0.589	0.680	0.913	0.607	0.589	0.547	0.965	1.321
6	0.580	0.745	0.838	0.580	0.580	0.569	1.011	1.262
7	0.561	0.822	0.773	0.588	0.561	0.586	1.069	1.193
8	0.556	0.844	0.754	0.589	0.556	0.581	1.066	1.166
9	0.550	0.855	0.736	0.583	0.550	0.565	1.048	1.142

RP	PERCENT	INCIDENCE		DEV	D-FACT	EFF	LOSS COEFF		LOSS PARAM	
	SPAN	MEAN	SS				TOT	PROF	TOT	PROF
1	5.00	2.9	-0.5	8.7	0.352	0.894	0.064	0.050	0.016	0.012
2	10.00	2.3	-1.1	7.4	0.357	0.882	0.071	0.059	0.018	0.015
3	15.00	2.7	-0.9	6.1	0.368	0.914	0.053	0.040	0.014	0.010
4	30.00	3.4	-0.8	5.2	0.408	0.947	0.035	0.025	0.009	0.006
5	50.00	4.4	-1.0	5.1	0.444	0.945	0.043	0.039	0.011	0.010
6	70.00	6.8	-1.0	6.9	0.438	0.944	0.052	0.052	0.013	0.013
7	85.00	9.9	-0.5	7.5	0.397	0.922	0.087	0.087	0.019	0.019
8	90.00	11.3	-0.3	7.7	0.386	0.923	0.093	0.093	0.020	0.020
9	95.00	13.3	0.2	8.1	0.381	0.908	0.117	0.117	0.023	0.023

TABLE XV. - Concluded. BLADE-ELEMENT DATA AT BLADE EDGES

FOR ROTOR 15 (90 PERCENT DESIGN SPEED; 1 EXIT PYLON;

INTRABLADE ROW INSTRUMENTATION

AT STATION 2a)

(b) Reading number 616

RP	RADII		ABS BETAM		REL BETAM		TOTAL TEMP		TOTAL PRESS	
	IN	OUT	IN	OUT	IN	OUT	IN	RATIO	IN	RATIO
1	24.133	23.424	-0.3	43.7	68.0	48.5	288.7	1.127	10.08	1.393
2	23.510	22.885	-0.4	42.5	66.1	46.2	288.4	1.125	10.13	1.394
3	22.883	22.347	-0.6	42.9	65.0	44.7	288.2	1.122	10.14	1.389
4	21.026	20.731	-1.6	47.1	62.5	39.3	288.1	1.120	10.14	1.371
5	18.560	18.578	-1.6	50.5	59.2	27.3	288.0	1.119	10.14	1.373
6	16.076	16.426	-1.0	50.5	55.0	10.2	288.0	1.116	10.14	1.397
7	14.194	14.811	-0.5	51.8	51.8	-6.3	288.0	1.121	10.14	1.436
8	13.574	14.272	-0.5	52.5	50.5	-11.7	288.0	1.122	10.13	1.458
9	12.959	13.734	-0.6	53.5	49.4	-15.7	288.1	1.122	10.13	1.454

RP	ABS VEL		REL VEL		MERID VEL		TANG VEL		WHEEL SPEED	
	IN	OUT	IN	OUT	IN	OUT	IN	OUT	IN	OUT
1	120.0	191.0	320.7	208.4	120.0	138.0	-0.5	132.0	296.9	288.2
2	128.2	194.4	316.4	207.2	128.2	143.4	-0.8	131.3	288.5	283.9
3	131.5	195.0	311.0	200.7	131.5	142.8	-1.3	132.8	280.5	273.9
4	136.2	197.3	295.0	173.6	136.2	134.4	-3.8	144.4	258.0	254.3
5	138.5	207.6	270.1	148.5	138.5	132.0	-3.8	160.2	228.1	228.3
6	140.0	227.3	243.8	147.0	139.9	144.7	-2.5	175.4	197.2	201.5
7	138.1	252.9	223.3	157.2	138.1	156.3	-1.3	198.9	174.2	181.7
8	138.2	262.5	217.2	163.4	138.2	160.0	-1.2	208.1	166.4	175.0
9	137.7	265.3	211.5	164.1	137.6	158.0	-1.5	213.1	159.1	168.6

RP	ABS MACH NO		REL MACH NO		MERID MACH NO		MERID PEAK SS	
	IN	OUT	IN	OUT	IN	OUT	VEL R	MACH NO
1	0.357	0.544	0.954	0.593	0.357	0.393	1.156	1.532
2	0.382	0.555	0.943	0.591	0.382	0.409	1.119	1.514
3	0.392	0.558	0.928	0.574	0.392	0.408	1.086	1.504
4	0.407	0.565	0.881	0.497	0.407	0.385	0.987	1.489
5	0.414	0.597	0.807	0.427	0.414	0.380	0.953	1.423
6	0.419	0.660	0.729	0.426	0.419	0.420	1.034	1.317
7	0.413	0.740	0.668	0.460	0.413	0.457	1.131	1.219
8	0.413	0.770	0.649	0.480	0.413	0.470	1.158	1.182
9	0.411	0.779	0.632	0.482	0.411	0.464	1.148	1.149

RP	PERCENT		INCIDENCE		DEV	D-FACT	EFF	LOSS COEFF		LOSS PARAM	
	SPAN		MEAN	SS				TOT	PROF	TOT	PROF
1	5.00		9.8	6.4	10.0	0.499	0.780	0.186	0.159	0.045	0.038
2	10.00		9.7	6.3	8.1	0.492	0.797	0.172	0.148	0.042	0.037
3	15.00		10.3	6.7	7.4	0.503	0.806	0.165	0.144	0.041	0.036
4	30.00		12.0	7.8	7.4	0.574	0.786	0.195	0.180	0.049	0.045
5	50.00		13.8	8.3	6.7	0.626	0.799	0.208	0.204	0.054	0.052
6	70.00		15.6	7.8	5.9	0.583	0.865	0.163	0.163	0.040	0.040
7	85.00		18.2	7.8	4.9	0.500	0.900	0.146	0.146	0.032	0.032
8	90.00		19.4	7.8	4.9	0.458	0.930	0.109	0.109	0.023	0.023
9	95.00		21.1	7.9	6.3	0.436	0.922	0.128	0.128	0.025	0.025

TABLE XVI. - BLADE-ELEMENT DATA AT BLADE EDGES FOR

ROTOR 15 (100 PERCENT DESIGN SPEED; 4 EXIT PYLONS;

INTRABLADE ROW INSTRUMENTATION

AT STATION 2a)

(a) Reading number 621

RP	RADII		ABS BETAM		REL BETAM		TOTAL TEMP		TOTAL PRESS	
	IN	OUT	IN	OUT	IN	OUT	IN	RATIO	IN	RATIO
1	24.133	23.424	1.2	31.8	60.8	48.4	288.9	1.119	10.04	1.396
2	23.510	22.885	1.2	31.5	58.6	46.8	288.6	1.119	10.12	1.396
3	22.883	22.347	1.0	31.8	57.2	45.0	288.3	1.119	10.13	1.410
4	21.026	20.731	0.6	34.6	53.8	38.4	288.1	1.123	10.14	1.442
5	18.560	18.578	0.6	38.7	49.9	26.8	288.0	1.128	10.14	1.464
6	16.076	16.426	0.8	42.1	45.9	10.6	287.9	1.137	10.15	1.508
7	14.194	14.811	1.1	45.5	43.0	-3.8	288.0	1.146	10.15	1.551
8	13.574	14.272	0.8	47.4	42.0	-9.4	287.9	1.149	10.14	1.567
9	12.959	13.734	0.7	49.6	41.0	-14.2	288.0	1.151	10.13	1.555

RP	ABS VEL		REL VEL		MERID VEL		TANG VEL		WHEEL SPEED	
	IN	OUT	IN	OUT	IN	OUT	IN	OUT	IN	OUT
1	181.7	215.0	372.2	275.1	181.6	182.7	3.9	113.4	328.7	319.1
2	193.0	217.8	370.3	271.4	192.9	185.7	4.2	113.8	320.2	311.7
3	198.9	221.0	366.7	265.7	198.9	187.9	3.6	116.4	311.6	304.3
4	207.9	231.8	352.3	243.3	207.9	190.8	2.3	131.6	286.7	282.7
5	212.1	249.3	329.1	218.1	212.1	194.7	2.2	155.7	253.8	254.1
6	209.7	277.0	301.5	209.0	209.7	205.4	3.1	185.8	219.6	224.4
7	204.2	304.1	279.1	213.5	204.1	213.0	4.0	217.0	194.3	202.7
8	202.8	312.2	272.8	214.2	202.8	211.3	2.9	229.8	185.5	195.0
9	201.0	314.9	266.3	210.8	201.0	204.3	2.6	239.7	177.2	187.8

RP	ABS MACH NO		REL MACH NO		MERID MACH NO		MERID PEAK SS	
	IN	OUT	IN	OUT	IN	OUT	VEL R	MACH NO
1	0.549	0.619	1.125	0.792	0.549	0.526	1.006	1.422
2	0.586	0.628	1.124	0.783	0.586	0.535	0.962	1.412
3	0.606	0.638	1.116	0.768	0.606	0.543	0.944	1.411
4	0.635	0.671	1.076	0.704	0.635	0.552	0.918	1.425
5	0.649	0.725	1.007	0.635	0.649	0.566	0.918	1.448
6	0.642	0.813	0.922	0.613	0.641	0.603	0.980	1.382
7	0.623	0.900	0.852	0.632	0.623	0.631	1.044	1.300
8	0.619	0.927	0.832	0.636	0.619	0.627	1.042	1.274
9	0.613	0.935	0.812	0.626	0.613	0.607	1.016	1.243

RP	PERCENT	INCIDENCE		DEV	D-FACT	EFF	LOSS COEFF		LOSS PARAM	
	SPAN	MEAN	SS				TOT	PROF	TOT	PROF
1	5.00	2.5	-0.8	9.8	0.366	0.842	0.102	0.072	0.025	0.017
2	10.00	2.2	-1.2	8.7	0.371	0.842	0.103	0.074	0.025	0.018
3	15.00	2.4	-1.1	7.7	0.381	0.868	0.087	0.060	0.021	0.015
4	30.00	3.3	-0.9	6.5	0.428	0.894	0.077	0.052	0.020	0.013
5	50.00	4.5	-1.0	6.2	0.472	0.897	0.085	0.064	0.022	0.017
6	70.00	6.5	-1.2	6.3	0.461	0.908	0.092	0.084	0.023	0.021
7	85.00	9.4	-1.0	7.3	0.409	0.917	0.099	0.097	0.022	0.022
8	90.00	10.9	-0.7	7.2	0.397	0.917	0.104	0.104	0.022	0.022
9	95.00	12.7	-0.5	7.8	0.395	0.888	0.147	0.147	0.029	0.029

TABLE XVI. - Concluded. BLADE-ELEMENT DATA AT BLADE EDGES

FOR ROTOR 15 (100 PERCENT DESIGN SPEED; 4 EXIT PYLONS;

INTRABLADE ROW INSTRUMENTATION

AT STATION 2a)

(b) Reading number 622

RP	RADI I		ABS BETAM		REL BETAM		TOTAL TEMP		TOTAL PRESS	
	IN	OUT	IN	OUT	IN	OUT	IN	RATIO	IN	RATIO
1	24.133	23.424	1.6	41.7	64.3	45.8	289.2	1.155	10.06	1.560
2	23.510	22.885	1.9	40.9	62.3	44.3	288.9	1.152	10.13	1.555
3	22.883	22.347	1.5	41.2	61.0	42.7	288.5	1.151	10.13	1.543
4	21.026	20.731	0.2	43.8	59.4	37.6	288.0	1.147	10.14	1.521
5	18.560	18.578	0.1	47.2	55.4	27.4	287.8	1.142	10.14	1.495
6	16.076	16.426	0.5	50.2	51.6	11.6	287.9	1.141	10.15	1.494
7	14.194	14.811	0.7	52.3	49.0	-6.1	287.9	1.147	10.14	1.540
8	13.574	14.272	0.6	53.0	47.7	-11.5	287.9	1.150	10.14	1.561
9	12.959	13.734	0.5	54.0	46.5	-16.1	287.8	1.150	10.13	1.565

RP	ABS VEL		REL VEL		MERID VEL		TANG VEL		WHEEL SPEED	
	IN	OUT	IN	OUT	IN	OUT	IN	OUT	IN	OUT
1	156.3	223.3	360.7	239.0	156.2	166.7	4.3	148.5	329.4	319.8
2	165.9	224.7	356.6	237.1	165.8	169.8	5.5	147.1	321.2	312.6
3	170.2	224.8	351.4	230.2	170.2	169.1	4.4	148.2	311.8	304.5
4	169.4	226.7	332.8	206.5	169.4	163.6	0.6	157.0	287.1	283.0
5	174.4	233.3	307.3	178.6	174.4	158.5	0.4	171.3	253.3	253.6
6	172.7	249.4	278.1	163.1	172.7	159.8	1.5	191.5	219.5	224.2
7	167.4	279.3	255.0	171.9	167.4	170.9	1.9	220.9	194.2	202.7
8	166.9	288.6	248.1	177.4	166.9	173.8	1.8	230.3	185.5	195.1
9	166.7	293.8	242.2	179.9	166.7	172.9	1.3	237.6	177.1	187.7

RP	ABS MACH NO		REL MACH NO		MERID MACH NO		MERID PEAK SS	
	IN	OUT	IN	OUT	IN	OUT	VEL R	MACH NO
1	0.468	0.633	1.081	0.678	0.468	0.473	1.067	1.515
2	0.499	0.639	1.072	0.674	0.499	0.483	1.024	1.505
3	0.513	0.640	1.059	0.656	0.513	0.481	0.994	1.508
4	0.511	0.648	1.004	0.590	0.511	0.467	0.966	1.584
5	0.527	0.670	0.928	0.513	0.527	0.455	0.908	1.518
6	0.521	0.721	0.840	0.472	0.521	0.462	0.925	1.420
7	0.505	0.816	0.769	0.502	0.505	0.499	1.021	1.329
8	0.503	0.846	0.748	0.520	0.503	0.510	1.042	1.290
9	0.502	0.863	0.730	0.529	0.502	0.508	1.037	1.255

RP	PERCENT		INCIDENCE		DEV	D-FACT	EFF	LOSS COEFF		LOSS PARAM	
	SPAN	MEAN	SS	SS				TOT	PROF	TOT	PROF
1	5.00	6.1	2.7	7.2	0.481	0.873	0.108	0.070	0.028	0.018	
2	10.00	5.9	2.4	6.1	0.475	0.882	0.101	0.065	0.026	0.017	
3	15.00	6.3	2.7	5.4	0.486	0.874	0.109	0.074	0.028	0.019	
4	30.00	8.9	4.7	5.8	0.531	0.866	0.123	0.081	0.032	0.021	
5	50.00	10.0	4.5	6.8	0.580	0.857	0.143	0.121	0.037	0.031	
6	70.00	12.2	4.5	7.3	0.588	0.862	0.160	0.154	0.040	0.038	
7	85.00	15.3	5.0	5.1	0.522	0.892	0.151	0.150	0.033	0.033	
8	90.00	16.6	5.0	5.1	0.486	0.907	0.138	0.138	0.029	0.029	
9	95.00	18.2	5.1	6.0	0.462	0.909	0.141	0.141	0.028	0.028	

TABLE XVII. - BLADE-ELEMENT DATA AT BLADE EDGES FOR

ROTOR 15 (90 PERCENT DESIGN SPEED; 4 EXIT PYLONS;

INTRABLADE ROW INSTRUMENTATION

AT STATION 2a)

(a) Reading number 619

RP	RADII		ABS BETAM		REL BETAM		TOTAL TEMP		TOTAL PRESS	
	IN	OUT	IN	OUT	IN	OUT	IN	RATIO	IN	RATIO
1	24.133	23.424	1.0	27.6	60.7	48.5	288.8	1.089	10.04	1.293
2	23.510	22.885	1.0	28.4	58.3	46.5	288.5	1.089	10.13	1.299
3	22.883	22.347	0.7	28.7	56.9	44.7	288.3	1.090	10.14	1.308
4	21.026	20.731	0.4	31.5	53.4	38.1	288.1	1.094	10.14	1.343
5	18.560	18.578	0.6	35.9	49.2	26.3	288.0	1.101	10.14	1.375
6	16.076	16.426	0.9	39.8	45.2	11.2	287.9	1.108	10.14	1.404
7	14.194	14.811	1.0	44.1	42.3	-3.4	288.0	1.116	10.14	1.431
8	13.574	14.272	1.1	45.8	41.2	-8.7	288.0	1.121	10.14	1.450
9	12.959	13.734	0.9	48.0	40.3	-13.8	288.0	1.124	10.12	1.454

RP	ABS VEL		REL VEL		MERID VEL		TANG VEL		WHEEL SPEED	
	IN	OUT	IN	OUT	IN	OUT	IN	OUT	IN	OUT
1	165.1	196.5	337.3	262.9	165.0	174.0	2.8	91.2	297.0	288.2
2	176.9	200.7	336.3	256.4	176.9	176.6	3.1	95.5	289.2	281.5
3	181.6	203.6	332.8	251.1	161.6	178.5	2.2	97.9	281.1	274.6
4	190.7	213.9	320.0	231.6	190.7	182.2	1.5	111.9	258.4	254.8
5	195.4	232.0	299.1	209.5	195.4	187.9	2.2	136.1	228.6	228.8
6	193.7	255.1	274.6	199.7	193.6	195.9	3.1	163.3	197.8	202.1
7	188.4	279.4	254.7	201.2	188.4	200.8	3.4	194.3	174.8	182.4
8	187.1	287.9	248.4	203.0	187.0	200.7	3.6	206.4	167.1	175.7
9	185.3	292.2	242.7	201.3	185.2	195.5	2.8	217.2	159.7	169.2

RP	ABS MACH NO		REL MACH NO		MERID MACH NO		MERID PEAK SS	
	IN	OUT	IN	OUT	IN	OUT	VEL R	MACH NO
1	0.496	0.571	1.014	0.763	0.496	0.505	1.055	1.358
2	0.534	0.584	1.016	0.746	0.534	0.514	0.998	1.340
3	0.549	0.593	1.007	0.731	0.549	0.520	0.983	1.346
4	0.579	0.624	0.972	0.676	0.579	0.532	0.956	1.340
5	0.594	0.679	0.910	0.613	0.594	0.550	0.962	1.296
6	0.589	0.751	0.835	0.588	0.589	0.577	1.012	1.229
7	0.572	0.829	0.773	0.597	0.572	0.596	1.066	1.161
8	0.567	0.856	0.753	0.604	0.567	0.597	1.073	1.132
9	0.561	0.869	0.736	0.599	0.561	0.581	1.055	1.109

RP	PERCENT SPAN	INCIDENCE		DEV	D-FACT	EFF	LOSS COEFF		LOSS PARAM	
		MEAN	SS				TOT	PROF	TOT	PROF
1	5.00	2.5	-0.9	10.0	0.314	0.861	0.079	0.067	0.019	0.016
2	10.00	1.9	-1.6	8.3	0.334	0.870	0.075	0.064	0.018	0.016
3	15.00	2.2	-1.4	7.4	0.345	0.884	0.068	0.058	0.017	0.014
4	30.00	2.9	-1.3	6.2	0.387	0.934	0.043	0.035	0.011	0.009
5	50.00	3.8	-1.7	5.6	0.429	0.940	0.046	0.043	0.012	0.011
6	70.00	5.8	-2.0	6.9	0.421	0.939	0.057	0.057	0.014	0.014
7	85.00	8.7	-1.7	7.7	0.381	0.926	0.083	0.083	0.019	0.019
8	90.00	10.0	-1.6	7.9	0.361	0.928	0.087	0.087	0.018	0.018
9	95.00	11.9	-1.2	8.3	0.356	0.911	0.115	0.115	0.023	0.023

TABLE XVII. - Concluded. BLADE-ELEMENT DATA AT BLADE EDGES
FOR ROTOR 15 (90 PERCENT DESIGN SPEED; 4 EXIT PYLONS;

INTRABLADE ROW INSTRUMENTATION

AT STATION 2a)

(b) Reading number 620

RP	RADII		ABS BETAM		REL BETAM		TOTAL TEMP		TOTAL PRESS	
	IN	OUT	IN	OUT	IN	OUT	IN	RATIO	IN	RATIO
1	24.133	23.424	0.6	46.1	67.8	47.7	288.9	1.132	10.09	1.401
2	23.510	22.885	0.6	44.3	65.9	45.8	288.5	1.130	10.13	1.402
3	22.883	22.347	0.5	43.8	64.8	44.3	288.2	1.127	10.13	1.398
4	21.026	20.731	-0.0	46.3	61.8	39.7	288.1	1.120	10.14	1.382
5	18.560	18.578	0.0	49.9	58.3	28.5	288.0	1.118	10.13	1.376
6	16.076	16.426	0.7	49.6	54.0	12.2	287.9	1.115	10.14	1.399
7	14.194	14.811	0.8	52.1	50.9	-5.6	288.0	1.121	10.14	1.431
8	13.574	14.272	1.1	52.8	49.5	-11.8	288.0	1.123	10.14	1.462
9	12.959	13.734	0.9	53.7	48.2	-16.1	288.0	1.123	10.12	1.461

RP	ABS VEL		REL VEL		MERID VEL		TANG VEL		WHEEL SPEED	
	IN	OUT	IN	OUT	IN	OUT	IN	OUT	IN	OUT
1	120.8	194.3	319.1	200.1	120.7	134.8	1.2	139.9	296.6	287.9
2	128.6	196.2	315.4	201.6	128.5	140.5	1.3	137.0	289.3	281.6
3	132.0	196.7	309.8	198.6	132.0	142.0	1.1	136.0	281.4	274.8
4	138.6	196.9	293.6	176.7	138.6	136.0	-0.1	142.3	258.8	255.2
5	141.1	205.2	268.5	150.5	141.1	132.3	0.1	156.9	228.4	228.7
6	142.6	224.5	242.6	148.9	142.6	145.5	1.8	171.0	198.1	202.4
7	140.2	250.0	222.3	154.3	140.2	153.6	2.1	197.3	174.7	182.2
8	140.5	262.2	216.3	161.8	140.5	158.4	2.7	208.9	167.2	175.8
9	140.6	266.4	211.1	164.2	140.6	157.8	2.1	214.6	159.6	169.1

RP	ABS MACH NO		REL MACH NO		MERID MACH NO		MERID PEAK SS	
	IN	OUT	IN	OUT	IN	OUT	VEL R	MACH NO
1	0.359	0.552	0.949	0.569	0.359	0.383	1.116	1.515
2	0.383	0.559	0.940	0.574	0.383	0.400	1.093	1.504
3	0.394	0.561	0.924	0.567	0.394	0.405	1.076	1.492
4	0.414	0.564	0.878	0.506	0.414	0.390	0.982	1.462
5	0.422	0.590	0.803	0.433	0.422	0.380	0.938	1.392
6	0.427	0.651	0.726	0.432	0.427	0.422	1.020	1.288
7	0.419	0.730	0.665	0.451	0.419	0.449	1.096	1.194
8	0.420	0.769	0.647	0.475	0.420	0.464	1.127	1.156
9	0.420	0.783	0.631	0.483	0.420	0.464	1.122	1.123

RP	PERCENT		INCIDENCE		DEV	D-FACT	EFF	LOSS COEFF		LOSS PARAM	
	SPAN	MEAN	SS	SS				TOT	PROF	TOT	PROF
1	5.00	9.5	6.2	9.1	0.529	0.767	0.203	0.179	0.050	0.044	
2	10.00	9.6	6.1	7.7	0.512	0.779	0.194	0.172	0.048	0.043	
3	15.00	10.1	6.5	7.0	0.509	0.794	0.182	0.163	0.046	0.041	
4	30.00	11.3	7.1	7.8	0.554	0.805	0.179	0.167	0.045	0.042	
5	50.00	12.9	7.4	7.8	0.609	0.810	0.197	0.195	0.050	0.050	
6	70.00	14.6	6.8	7.9	0.564	0.874	0.153	0.153	0.038	0.038	
7	85.00	17.3	7.0	5.6	0.506	0.894	0.155	0.155	0.034	0.034	
8	90.00	18.4	6.8	4.8	0.461	0.932	0.107	0.107	0.022	0.022	
9	95.00	19.9	6.8	6.0	0.433	0.929	0.116	0.116	0.023	0.023	

TABLE XVIII. - BLADE-ELEMENT DATA AT BLADE EDGES FOR
 ROTOR 15 (100 PERCENT DESIGN SPEED; STATOR RESET;

INTRABLADE ROW INSTRUMENTATION

AT STATION 2a)

(a) Reading number 678

RP	RADI I		ABS BETAM		REL BETAM		TOTAL TEMP		TOTAL PRESS	
	IN	OUT	IN	OUT	IN	OUT	IN	RATIO	IN	RATIO
1	24.133	23.424	1.2	34.0	61.4	47.5	288.6	1.134	9.99	1.475
2	23.510	22.885	1.5	33.6	58.5	45.5	288.5	1.132	10.13	1.472
3	22.883	22.347	1.0	34.0	57.2	43.4	288.3	1.132	10.14	1.484
4	21.026	20.731	0.1	36.6	53.9	36.7	288.2	1.133	10.14	1.497
5	18.560	18.578	0.2	39.8	50.0	24.8	288.0	1.136	10.14	1.508
6	16.076	16.426	-0.7	42.3	46.8	9.8	288.0	1.138	10.15	1.532
7	14.194	14.811	-0.9	45.6	44.3	-3.9	288.0	1.145	10.15	1.553
8	13.574	14.272	-0.3	47.5	43.0	-8.8	288.0	1.148	10.15	1.561
9	12.959	13.734	-1.1	49.2	42.3	-13.1	288.0	1.150	10.14	1.563

RP	ABS VEL		REL VEL		MERID VEL		TANG VEL		WHEEL SPEED	
	IN	OUT	IN	OUT	IN	OUT	IN	OUT	IN	OUT
1	177.8	218.8	371.6	268.6	177.8	181.4	3.8	122.3	330.1	320.5
2	194.0	223.4	371.0	265.3	193.9	186.0	5.1	123.7	321.4	312.9
3	199.7	227.8	368.2	259.8	199.7	188.9	3.5	127.3	313.0	305.6
4	209.4	237.4	355.5	237.9	209.4	190.7	0.4	141.4	287.7	283.6
5	212.7	255.5	330.7	216.4	212.7	196.4	0.8	163.4	253.9	254.2
6	209.6	280.8	305.8	210.8	209.5	207.7	-2.7	189.0	220.1	224.9
7	202.3	303.6	282.6	212.9	202.3	212.5	-3.3	216.9	194.0	202.5
8	200.7	308.8	274.3	211.1	200.7	208.6	-1.1	227.8	185.9	195.5
9	199.2	311.1	269.3	208.7	199.1	203.2	-3.8	235.5	177.5	188.1

RP	ABS MACH NO		REL MACH NO		MERID MACH NO		MERID PEAK SS	
	IN	OUT	IN	OUT	IN	OUT	VEL-R	MACH NO
1	0.537	0.627	1.122	0.769	0.537	0.520	1.020	1.442
2	0.589	0.642	1.127	0.762	0.589	0.534	0.959	1.410
3	0.608	0.655	1.121	0.748	0.608	0.544	0.946	1.415
4	0.640	0.686	1.087	0.687	0.640	0.551	0.911	1.433
5	0.651	0.743	1.012	0.629	0.651	0.571	0.923	1.452
6	0.641	0.825	0.935	0.619	0.641	0.610	0.991	1.428
7	0.617	0.899	0.862	0.631	0.617	0.629	1.050	1.353
8	0.612	0.916	0.836	0.626	0.612	0.618	1.039	1.307
9	0.607	0.923	0.820	0.619	0.607	0.603	1.020	1.293

RP	PERCENT		INCIDENCE		DEV	D-FACT	EFF	LOSS COEFF		LOSS PARAM	
	SPAN		MEAN	SS				TOT	PROF	TOT	PROF
1	5.00		3.2	-0.2	9.0	0.392	0.879	0.087	0.054	0.021	0.013
2	10.00		2.1	-1.4	7.3	0.397	0.882	0.084	0.056	0.021	0.014
3	15.00		2.4	-1.1	6.0	0.410	0.903	0.070	0.042	0.018	0.011
4	30.00		3.4	-0.8	4.9	0.459	0.917	0.064	0.036	0.017	0.009
5	50.00		4.6	-0.9	4.2	0.488	0.918	0.070	0.048	0.019	0.013
6	70.00		7.4	-0.4	5.5	0.471	0.937	0.063	0.050	0.016	0.012
7	85.00		10.7	0.3	7.3	0.424	0.928	0.083	0.080	0.019	0.018
8	90.00		11.8	0.2	7.8	0.413	0.918	0.101	0.100	0.021	0.021
9	95.00		14.0	0.9	8.9	0.411	0.909	0.117	0.116	0.023	0.023

TABLE XVIII. - Continued. BLADE-ELEMENT DATA AT BLADE EDGES
FOR ROTOR 15 (100 PERCENT DESIGN SPEED; STATOR RESET;

INTRABLADE ROW INSTRUMENTATION

AT STATION 2a)

(b) Reading number 680

RP	RADII		ABS BETAM		REL BETAM		TOTAL TEMP		TOTAL PRESS	
	IN	OUT	IN	OUT	IN	OUT	IN	RATIO	IN	RATIO
1	24.133	23.424	1.0	34.9	61.4	47.1	288.7	1.139	10.00	1.493
2	23.510	22.885	1.2	34.2	58.6	45.2	288.5	1.137	10.12	1.493
3	22.883	22.347	1.1	34.8	57.1	43.0	288.4	1.136	10.13	1.503
4	21.026	20.731	0.7	37.4	53.8	36.4	288.1	1.137	10.14	1.512
5	18.560	18.578	-0.3	40.3	50.3	24.5	288.0	1.137	10.15	1.523
6	16.076	16.426	-0.7	43.0	47.0	10.2	288.0	1.138	10.15	1.531
7	14.194	14.811	0.4	46.4	44.1	-4.2	287.9	1.146	10.15	1.561
8	13.574	14.272	-1.2	48.2	43.9	-9.0	287.9	1.147	10.14	1.565
9	12.959	13.734	-0.4	50.1	42.3	-13.5	287.9	1.149	10.15	1.556

RP	ABS VEL		REL VEL		MERID VEL		TANG VEL		WHEEL SPEED	
	IN	OUT	IN	OUT	IN	OUT	IN	OUT	IN	OUT
1	178.7	220.2	372.7	265.4	178.7	180.7	3.0	126.0	330.1	320.4
2	193.9	224.8	372.5	263.7	193.8	185.8	4.0	126.5	322.2	313.6
3	200.5	229.0	368.9	257.2	200.4	188.0	3.7	130.6	313.4	306.1
4	209.1	238.1	354.0	235.1	209.1	189.2	2.5	144.6	288.2	284.1
5	212.1	255.8	331.9	214.3	212.1	195.0	-1.2	165.5	254.1	254.3
6	207.7	277.0	304.7	205.8	207.7	202.6	-2.5	188.9	220.4	225.2
7	199.3	301.5	277.7	208.4	199.3	207.8	1.3	218.4	194.6	203.1
8	197.4	305.5	274.1	206.2	197.4	203.7	-4.2	227.7	186.0	195.5
9	196.6	306.2	265.7	201.9	196.6	196.3	-1.4	234.9	177.4	188.0

RP	ABS MACH NO		REL MACH NO		MERID MACH NO		MERID PEAK SS	
	IN	OUT	IN	OUT	IN	OUT	VEL R	MACH NO
1	0.540	0.629	1.126	0.759	0.540	0.516	1.011	1.442
2	0.589	0.644	1.131	0.756	0.589	0.533	0.959	1.419
3	0.610	0.658	1.123	0.739	0.610	0.540	0.938	1.413
4	0.639	0.687	1.082	0.678	0.639	0.546	0.905	1.427
5	0.649	0.743	1.016	0.623	0.649	0.567	0.920	1.464
6	0.635	0.812	0.931	0.603	0.635	0.594	0.975	1.430
7	0.607	0.892	0.846	0.616	0.607	0.615	1.043	1.324
8	0.601	0.905	0.834	0.611	0.601	0.603	1.032	1.331
9	0.598	0.906	0.809	0.597	0.598	0.581	0.999	1.274

RP	PERCENT SPAN	INCIDENCE		DEV	D-FACT	EFF	LOSS COEFF		LOSS PARAM	
		MEAN	SS				TOT	PROF	TOT	PROF
1	5.00	3.1	-0.3	8.6	0.406	0.875	0.092	0.060	0.023	0.015
2	10.00	2.3	-1.2	7.1	0.408	0.886	0.084	0.053	0.021	0.013
3	15.00	2.4	-1.2	5.7	0.422	0.910	0.067	0.038	0.017	0.010
4	30.00	3.3	-0.9	4.6	0.465	0.917	0.065	0.039	0.017	0.010
5	50.00	4.9	-0.6	3.9	0.500	0.934	0.057	0.033	0.015	0.009
6	70.00	7.6	-0.1	5.9	0.485	0.937	0.063	0.050	0.016	0.012
7	85.00	10.5	0.2	6.9	0.427	0.932	0.081	0.080	0.018	0.018
8	90.00	12.8	1.2	7.6	0.432	0.926	0.091	0.090	0.019	0.019
9	95.00	14.0	0.8	8.6	0.427	0.903	0.126	0.126	0.025	0.025

TABLE XVIII. - Continued. BLADE-ELEMENT DATA AT BLADE EDGES

FOR ROTOR 15 (100 PERCENT DESIGN SPEED; STATOR RESET;

INTRABLADE ROW INSTRUMENTATION

AT STATION 2a)

(c) Reading number 684

RP	RADII		ABS BETAM		REL BETAM		TOTAL TEMP		TOTAL PRESS	
	IN	OUT	IN	OUT	IN	OUT	IN	RATIO	IN	RATIO
1	24.133	23.424	0.4	40.9	63.8	45.1	289.0	1.159	10.03	1.586
2	23.510	22.885	1.1	39.7	61.4	43.6	288.8	1.153	10.13	1.575
3	22.883	22.347	0.8	40.1	60.1	42.3	288.5	1.152	10.12	1.560
4	21.026	20.731	-0.7	42.1	57.5	36.5	288.0	1.148	10.14	1.545
5	18.560	18.578	-0.8	44.4	53.6	25.9	287.9	1.141	10.14	1.524
6	16.076	16.426	-0.3	44.7	48.0	10.4	287.9	1.139	10.15	1.527
7	14.194	14.811	-0.5	49.0	46.8	-4.5	287.9	1.145	10.15	1.537
8	13.574	14.272	0.3	51.0	45.4	-10.4	287.9	1.148	10.14	1.554
9	12.959	13.734	0.1	52.4	44.3	-14.8	288.0	1.149	10.13	1.554

RP	ABS VEL		REL VEL		MERID VEL		TANG VEL		WHEEL SPEED	
	IN	OUT	IN	OUT	IN	OUT	IN	OUT	IN	OUT
1	161.7	226.4	366.2	242.3	161.7	171.1	1.0	148.3	329.6	319.9
2	173.1	227.7	361.6	242.0	173.1	175.2	3.4	145.4	320.9	312.3
3	178.0	227.7	357.3	235.5	177.9	174.2	2.4	146.5	312.3	305.0
4	184.3	232.0	342.9	214.2	184.3	172.1	-2.1	155.5	287.0	283.0
5	188.7	242.7	318.4	192.8	188.7	173.4	-2.7	169.8	253.7	253.9
6	198.5	269.2	296.8	194.6	198.5	191.4	-0.9	189.3	219.7	224.5
7	183.2	287.6	267.8	189.4	183.1	188.8	-1.5	217.0	193.8	202.3
8	181.9	294.9	259.2	188.5	181.9	185.4	0.9	229.3	185.6	195.2
9	180.8	297.0	252.8	187.3	180.8	181.1	0.4	235.4	177.1	187.7

RP	ABS MACH NO		REL MACH NO		MERID MACH NO		MERID PEAK SS	
	IN	OUT	IN	OUT	IN	OUT	VEL R	MACH NO
1	0.485	0.642	1.100	0.687	0.485	0.485	1.058	1.508
2	0.522	0.648	1.090	0.689	0.522	0.499	1.013	1.485
3	0.538	0.649	1.079	0.671	0.537	0.496	0.979	1.489
4	0.558	0.664	1.039	0.613	0.558	0.493	0.934	1.530
5	0.573	0.700	0.966	0.556	0.573	0.500	0.919	1.522
6	0.605	0.786	0.904	0.568	0.605	0.559	0.964	1.419
7	0.555	0.845	0.811	0.556	0.555	0.555	1.031	1.344
8	0.551	0.868	0.785	0.555	0.551	0.546	1.019	1.293
9	0.547	0.875	0.765	0.552	0.547	0.533	1.002	1.258

RP	PERCENT		INCIDENCE		DEV	D-FACT	EFF	LOSS COEFF		LOSS PARAM	
	SPAN	MEAN	SS	SS				TOT	PROF	TOT	PROF
1	5.00	5.6	2.2	6.5	0.483	0.888	0.096	0.056	0.025	0.014	
2	10.00	5.0	1.6	5.5	0.469	0.903	0.082	0.047	0.021	0.012	
3	15.00	5.4	1.8	5.0	0.480	0.894	0.090	0.056	0.023	0.014	
4	30.00	7.0	2.8	4.7	0.523	0.894	0.094	0.057	0.024	0.015	
5	50.00	8.2	2.7	5.3	0.551	0.906	0.089	0.062	0.023	0.016	
6	70.00	8.6	0.9	6.1	0.508	0.924	0.079	0.069	0.019	0.017	
7	85.00	13.2	2.9	6.7	0.478	0.901	0.125	0.124	0.028	0.028	
8	90.00	14.3	2.7	6.1	0.465	0.909	0.123	0.123	0.026	0.026	
9	95.00	16.0	2.9	7.3	0.454	0.902	0.140	0.140	0.028	0.028	

TABLE XVIII. - Concluded. BLADE-ELEMENT DATA AT BLADE EDGES

FOR ROTOR 15 (100 PERCENT DESIGN SPEED; STATOR RESET;

INTRABLADE ROW INSTRUMENTATION

AT STATION 2a)

(d) Reading number 683

RP	RADII		ABS BETAM		REL BETAM		TOTAL TEMP		TOTAL PRESS	
	IN	OUT	IN	OUT	IN	OUT	IN	RATIO	IN	RATIO
1	24.133	23.424	0.6	41.4	64.8	45.6	289.1	1.156	10.30	1.558
2	23.510	22.885	1.0	40.4	62.3	44.0	288.8	1.152	10.06	1.552
3	22.883	22.347	0.9	40.8	61.0	42.8	288.6	1.150	10.15	1.542
4	21.026	20.731	-0.4	43.2	58.4	37.3	287.9	1.147	10.09	1.519
5	18.560	18.578	-1.0	46.3	55.4	26.4	287.9	1.142	10.13	1.500
6	16.076	16.426	-0.7	49.5	52.5	10.7	287.9	1.143	10.13	1.495
7	14.194	14.811	-0.4	51.0	49.6	-5.7	287.8	1.147	10.10	1.534
8	13.574	14.272	-0.4	51.7	48.4	-10.6	287.9	1.149	10.14	1.554
9	12.959	13.734	-0.5	52.6	47.3	-14.5	287.9	1.150	10.12	1.563

RP	ABS VEL		REL VEL		MERID VEL		TANG VEL		WHEEL SPEED	
	IN	OUT	IN	OUT	IN	OUT	IN	OUT	IN	OUT
1	154.3	223.6	361.9	239.8	154.3	167.6	1.7	148.0	329.1	319.4
2	166.7	225.2	358.2	238.5	166.6	171.5	3.0	145.9	320.1	311.6
3	171.4	225.5	353.9	232.6	171.4	170.8	2.8	147.2	312.4	305.1
4	176.9	228.3	338.2	209.2	176.9	166.5	-1.3	156.2	286.9	282.9
5	177.3	238.1	311.9	183.6	177.2	164.4	-3.0	172.3	253.6	253.8
6	170.3	254.3	279.9	168.0	170.3	165.1	-2.2	193.4	219.9	224.7
7	165.8	283.3	256.1	179.2	165.8	178.3	-1.3	220.2	193.8	202.3
8	165.5	291.2	249.1	183.7	165.5	180.5	-1.1	228.5	185.1	194.6
9	165.0	295.2	243.2	185.4	165.0	179.4	-1.4	234.4	177.3	187.9

RP	ABS MACH NO		REL MACH NO		MERID MACH NO		MERID PEAK SS	
	IN	OUT	IN	OUT	IN	OUT	VEL R	MACH NO
1	0.462	0.634	1.084	0.680	0.462	0.476	1.087	1.531
2	0.501	0.641	1.078	0.679	0.501	0.488	1.029	1.508
3	0.517	0.642	1.067	0.663	0.516	0.486	0.997	1.512
4	0.535	0.653	1.022	0.598	0.535	0.476	0.941	1.556
5	0.536	0.685	0.943	0.528	0.536	0.473	0.928	1.540
6	0.514	0.736	0.844	0.487	0.514	0.478	0.969	1.454
7	0.500	0.830	0.772	0.525	0.500	0.522	1.075	1.352
8	0.499	0.855	0.750	0.539	0.499	0.530	1.091	1.310
9	0.497	0.868	0.733	0.545	0.497	0.528	1.087	1.278

RP	PERCENT SPAN	INCIDENCE		DEV	D-FACT	EFF	LOSS COEFF		LOSS PARAM	
		MEAN	SS				TOT	PROF	TOT	PROF
1	5.00	6.5	3.2	7.1	0.483	0.868	0.113	0.071	0.029	0.018
2	10.00	5.9	2.4	5.9	0.475	0.883	0.099	0.062	0.026	0.016
3	15.00	6.3	2.7	5.4	0.484	0.877	0.105	0.069	0.027	0.018
4	30.00	7.9	3.8	5.4	0.532	0.864	0.121	0.082	0.031	0.021
5	50.00	10.0	4.5	5.7	0.574	0.867	0.130	0.102	0.034	0.027
6	70.00	13.1	5.3	6.4	0.578	0.852	0.172	0.163	0.043	0.040
7	85.00	16.0	5.7	5.4	0.497	0.887	0.156	0.155	0.035	0.034
8	90.00	17.2	5.6	6.0	0.464	0.902	0.143	0.143	0.030	0.030
9	95.00	18.9	5.8	7.6	0.441	0.910	0.138	0.138	0.027	0.027

TABLE XIX. - BLADE-ELEMENT DATA AT BLADE EDGES FOR

ROTOR 15 (100 PERCENT DESIGN SPEED; STATOR RESET;

INTRABLADE ROW INSTRUMENTATION

AT STATION 2b)

(a) Reading number 704

RP	RADII		ABS BETAM		REL BETAM		TOTAL TEMP		TOTAL PRESS	
	IN	OUT	IN	OUT	IN	OUT	IN	RATIO	IN	RATIO
1	24.133	23.424	0.5	36.4	61.3	48.6	288.7	1.140	10.03	1.450
2	23.510	22.885	0.4	35.2	59.0	45.3	288.5	1.137	10.12	1.487
3	22.883	22.347	0.5	35.5	57.5	43.5	288.4	1.135	10.13	1.496
4	21.026	20.731	0.2	38.0	54.0	37.0	288.2	1.136	10.14	1.499
5	18.560	18.578	-0.1	41.6	50.4	25.4	288.0	1.135	10.15	1.507
6	16.076	16.426	0.2	44.5	47.1	10.8	287.9	1.137	10.15	1.515
7	14.194	14.811	0.7	47.7	44.6	-4.0	287.9	1.146	10.15	1.546
8	13.574	14.272	0.6	49.3	43.7	-8.5	287.9	1.149	10.14	1.537
9	12.959	13.734	0.1	52.7	42.9	-12.1	287.9	1.146	10.14	1.455

RP	ABS VEL		REL VEL		MERID VEL		TANG VEL		WHEEL SPEED	
	IN	OUT	IN	OUT	IN	OUT	IN	OUT	IN	OUT
1	179.3	211.9	373.3	257.9	179.3	170.5	1.5	125.8	329.0	319.3
2	191.9	222.3	372.3	258.3	191.9	181.6	1.5	128.2	320.5	312.0
3	197.5	225.2	367.6	252.7	197.5	183.4	1.6	130.6	311.7	304.4
4	207.2	235.2	352.9	230.1	207.2	183.7	0.6	143.7	286.3	282.3
5	209.4	248.3	328.8	205.5	209.4	185.5	-0.4	165.0	253.0	253.3
6	203.0	267.3	298.2	194.1	203.0	190.7	0.7	187.3	219.1	223.8
7	193.3	291.1	271.6	196.4	193.3	195.9	2.5	215.2	193.3	201.7
8	191.3	294.3	264.5	194.2	191.3	192.0	2.0	223.0	184.7	194.2
9	189.5	280.7	258.7	174.0	189.5	170.1	0.2	223.2	176.3	186.9

RP	ABS MACH NO		REL MACH NO		MERID MACH NO		MERID PEAK SS	
	IN	OUT	IN	OUT	IN	OUT	VEL R	MACH NO
1	0.542	0.604	1.128	0.735	0.542	0.486	0.951	1.442
2	0.582	0.637	1.130	0.740	0.582	0.520	0.946	1.429
3	0.601	0.646	1.118	0.725	0.601	0.526	0.929	1.424
4	0.633	0.671	1.078	0.662	0.633	0.529	0.886	1.433
5	0.640	0.720	1.005	0.596	0.640	0.538	0.886	1.467
6	0.619	0.780	0.910	0.567	0.619	0.557	0.939	1.399
7	0.588	0.856	0.826	0.578	0.588	0.576	1.014	1.336
8	0.581	0.866	0.803	0.571	0.581	0.565	1.004	1.276
9	0.575	0.821	0.785	0.509	0.575	0.498	0.898	1.253

RP	PERCENT SPAN		INCIDENCE		DEV	D-FACT	EFF	LOSS COEFF		LOSS PARAM	
	SPAN	MEAN	SS	TOT				PROF	TOT	PROF	
1	5.00	3.1	-0.3	10.1	0.429	0.803	0.145	0.112	0.035	0.027	
2	10.00	2.6	-0.9	7.2	0.426	0.877	0.090	0.059	0.023	0.015	
3	15.00	2.8	-0.8	6.1	0.434	0.903	0.072	0.042	0.018	0.011	
4	30.00	3.5	-0.6	5.2	0.479	0.903	0.076	0.050	0.020	0.013	
5	50.00	5.0	-0.5	4.8	0.521	0.920	0.070	0.046	0.018	0.012	
6	70.00	7.7	-0.1	6.5	0.508	0.917	0.084	0.076	0.021	0.019	
7	85.00	11.0	0.7	7.2	0.455	0.908	0.115	0.114	0.026	0.025	
8	90.00	12.6	1.0	8.1	0.449	0.878	0.160	0.160	0.034	0.034	
9	95.00	14.6	1.4	10.0	0.508	0.775	0.296	0.296	0.059	0.059	

TABLE XIX. - Continued. BLADE-ELEMENT DATA AT BLADE EDGES

FOR ROTOR 15 (100 PERCENT DESIGN SPEED; STATOR RESET;

INTRABLADE ROW INSTRUMENTATION

AT STATION 2b)

(b) Reading number 709

RP	RADII		ABS BETAM		REL BETAM		TOTAL TEMP		TOTAL PRESS	
	IN	OUT	IN	OUT	IN	OUT	IN	RATIO	IN	RATIO
1	24.133	23.424	1.2	42.5	63.6	47.4	289.0	1.164	10.04	1.548
2	23.510	22.885	1.2	41.0	61.4	44.6	288.8	1.157	10.12	1.564
3	22.883	22.347	1.2	40.9	59.9	42.8	288.7	1.153	10.14	1.568
4	21.026	20.731	0.1	42.3	56.7	36.9	288.0	1.148	10.14	1.548
5	18.560	18.578	0.0	41.7	50.5	25.9	287.9	1.136	10.15	1.510
6	16.076	16.426	0.1	44.6	47.3	11.0	287.8	1.138	10.14	1.523
7	14.194	14.811	0.8	48.0	44.9	-3.6	287.8	1.148	10.14	1.547
8	13.574	14.272	0.4	49.4	44.0	-8.3	287.9	1.150	10.14	1.545
9	12.959	13.734	-0.3	53.4	43.3	-11.2	287.8	1.147	10.12	1.436

RP	ABS VEL		REL VEL		MERID VEL		TANG VEL		WHEEL SPEED	
	IN	OUT	IN	OUT	IN	OUT	IN	OUT	IN	OUT
1	161.9	216.5	364.0	235.6	161.9	159.6	3.3	146.3	329.3	319.7
2	173.0	222.9	360.9	236.2	173.0	168.3	3.6	146.2	320.4	311.9
3	178.7	225.2	356.7	232.2	178.7	170.3	3.8	147.4	312.5	305.2
4	187.9	230.2	342.7	213.2	187.9	170.4	0.3	154.8	286.9	282.9
5	208.2	246.8	327.7	204.9	208.2	184.4	0.1	164.0	253.2	253.4
6	202.1	267.1	298.2	193.8	202.1	190.3	0.2	187.4	219.5	224.3
7	192.2	289.2	271.4	194.0	192.2	193.6	2.6	214.8	194.2	202.6
8	190.3	293.7	264.7	193.3	190.3	191.3	1.5	222.8	185.5	195.1
9	188.8	274.7	259.6	167.1	188.8	163.9	-1.0	220.4	177.2	187.8

RP	ABS MACH NO		REL MACH NO		MERID MACH NO		MERID PEAK SS	
	IN	OUT	IN	OUT	IN	OUT	VEL R	MACH NO
1	0.486	0.611	1.093	0.664	0.486	0.450	0.986	1.497
2	0.521	0.632	1.088	0.670	0.521	0.477	0.973	1.483
3	0.540	0.640	1.077	0.660	0.540	0.484	0.953	1.481
4	0.570	0.659	1.040	0.610	0.570	0.487	0.907	1.505
5	0.636	0.715	1.002	0.593	0.636	0.534	0.885	1.470
6	0.617	0.780	0.910	0.566	0.617	0.555	0.941	1.407
7	0.584	0.849	0.825	0.570	0.584	0.569	1.007	1.313
8	0.578	0.863	0.804	0.568	0.578	0.562	1.005	1.286
9	0.573	0.801	0.788	0.487	0.573	0.478	0.868	1.270

RP	PERCENT	INCIDENCE		DEV	D-FACT	EFF	LOSS COEFF		LOSS PARAM	
	SPAN	MEAN	SS				TOT	PROF	TOT	PROF
1	5.00	5.4	2.0	8.8	0.494	0.812	0.165	0.127	0.041	0.031
2	10.00	5.0	1.5	6.4	0.485	0.867	0.115	0.080	0.029	0.020
3	15.00	5.2	1.6	5.5	0.488	0.894	0.091	0.058	0.023	0.015
4	30.00	6.2	2.1	5.1	0.523	0.900	0.088	0.056	0.023	0.014
5	50.00	5.1	-0.4	5.2	0.520	0.919	0.071	0.047	0.018	0.012
6	70.00	7.9	0.2	6.7	0.510	0.922	0.080	0.071	0.020	0.018
7	85.00	11.3	1.0	7.6	0.463	0.899	0.126	0.125	0.028	0.028
8	90.00	12.9	1.3	8.3	0.453	0.880	0.159	0.158	0.033	0.033
9	95.00	15.0	1.9	10.8	0.535	0.740	0.340	0.340	0.068	0.068

TABLE XIX. - Concluded. BLADE-ELEMENT DATA AT BLADE EDGES

FOR ROTOR 15 (100 PERCENT DESIGN SPEED; STATOR RESET;

INTRABLADE ROW INSTRUMENTATION

AT STATION 2b)

(c) Reading number 707

RP	RADII		ABS BETAM		REL BETAM		TOTAL TEMP		TOTAL PRESS	
	IN	OUT	IN	OUT	IN	OUT	IN	RATIO	IN	RATIO
1	24.133	23.424	1.6	44.0	64.4	49.0	289.5	1.160	10.01	1.508
2	23.510	22.885	1.4	42.4	62.7	46.0	289.1	1.156	10.15	1.527
3	22.883	22.347	1.4	42.1	61.3	44.2	288.7	1.153	10.19	1.528
4	21.026	20.731	0.1	44.4	58.8	38.5	288.0	1.148	10.12	1.508
5	18.560	18.578	-0.3	47.4	55.9	27.5	287.8	1.143	10.15	1.489
6	16.076	16.426	-0.2	49.2	52.6	11.4	287.7	1.143	10.14	1.494
7	14.194	14.811	0.1	50.2	49.7	-3.8	287.7	1.148	10.14	1.538
8	13.574	14.272	0.1	51.5	48.6	-8.7	287.7	1.149	10.13	1.536
9	12.959	13.734	-0.0	54.5	47.4	-11.6	287.8	1.148	10.12	1.448

RP	ABS VEL		REL VEL		MERID VEL		TANG VEL		WHEEL SPEED	
	IN	OUT	IN	OUT	IN	OUT	IN	OUT	IN	OUT
1	155.7	210.1	360.6	230.6	155.7	151.2	4.3	145.9	329.6	319.9
2	164.1	217.3	357.1	230.8	164.0	160.4	4.0	146.7	321.2	312.7
3	168.5	219.2	351.3	226.8	168.5	162.7	4.0	146.9	312.3	304.9
4	173.9	223.8	335.9	204.1	173.9	159.8	0.3	156.6	287.6	283.6
5	172.3	233.3	307.5	178.0	172.3	157.9	-1.0	171.7	253.7	253.9
6	168.3	252.1	276.8	168.1	168.3	164.7	-0.6	190.8	219.3	224.1
7	164.2	278.3	253.9	178.4	164.2	178.0	0.2	213.9	193.8	202.2
8	163.1	283.4	246.6	178.5	163.1	176.4	0.2	221.8	185.1	194.7
9	162.3	269.0	239.8	159.3	162.3	156.1	-0.0	219.1	176.5	187.1

RP	ABS MACH NO		REL MACH NO		MERID MACH NO		MERID PEAK SS	
	IN	OUT	IN	OUT	IN	OUT	VEL R	MACH NO
1	0.466	0.592	1.080	0.649	0.466	0.426	0.972	1.517
2	0.493	0.615	1.073	0.653	0.493	0.454	0.978	1.517
3	0.507	0.622	1.058	0.644	0.507	0.462	0.966	1.518
4	0.525	0.638	1.014	0.582	0.525	0.456	0.919	1.566
5	0.520	0.670	0.928	0.511	0.520	0.453	0.916	1.534
6	0.507	0.729	0.835	0.486	0.507	0.477	0.979	1.439
7	0.495	0.813	0.765	0.521	0.495	0.520	1.084	1.341
8	0.491	0.829	0.743	0.522	0.491	0.516	1.082	1.303
9	0.488	0.782	0.722	0.463	0.488	0.454	0.962	1.263

RP	PERCENT	INCIDENCE		DEV	D-FACT	EFF	LOSS COEFF		LOSS PARAM	
	SPAN	MEAN	SS				TOT	PROF	TOT	PROF
1	5.00	6.2	2.8	10.5	0.502	0.778	0.192	0.153	0.046	0.037
2	10.00	6.3	2.8	7.8	0.494	0.824	0.152	0.113	0.038	0.028
3	15.00	6.6	3.0	6.9	0.495	0.844	0.136	0.099	0.034	0.025
4	30.00	8.3	4.1	6.6	0.542	0.840	0.145	0.106	0.037	0.027
5	50.00	10.5	5.0	6.9	0.584	0.841	0.159	0.135	0.041	0.035
6	70.00	13.2	5.4	7.1	0.569	0.847	0.181	0.174	0.045	0.043
7	85.00	16.1	5.8	7.4	0.489	0.883	0.165	0.164	0.037	0.037
8	90.00	17.5	5.9	7.8	0.473	0.874	0.188	0.188	0.040	0.040
9	95.00	19.1	6.0	10.5	0.527	0.756	0.368	0.368	0.073	0.073

TABLE XX. - BLADE-ELEMENT DATA AT BLADE EDGES FOR
 ROTOR 15 (90 PERCENT DESIGN SPEED; STATOR RESET;
 INTRABLADE ROW INSTRUMENTATION
 AT STATION 2a)

(a) Reading number 686

RP	RADII		ABS BETAM		REL BETAM		TOTAL TEMP		TOTAL PRESS	
	IN	OUT	IN	OUT	IN	OUT	IN	RATIO	IN	RATIO
1	24.133	23.424	0.0	31.6	61.3	45.9	288.7	1.105	10.05	1.376
2	23.510	22.885	-0.1	31.1	59.0	44.4	288.4	1.103	10.13	1.375
3	22.883	22.347	-0.5	31.0	57.8	43.0	288.3	1.102	10.14	1.374
4	21.026	20.731	-0.7	33.4	54.4	36.9	288.1	1.103	10.14	1.385
5	18.560	18.578	-0.9	37.0	50.7	26.0	288.0	1.105	10.14	1.393
6	16.076	16.426	-0.4	40.6	47.0	11.8	288.0	1.110	10.14	1.403
7	14.194	14.811	-0.3	44.7	44.5	-2.8	287.9	1.117	10.14	1.430
8	13.574	14.272	-0.2	46.6	43.4	-8.1	288.0	1.120	10.14	1.442
9	12.959	13.734	-0.5	48.3	42.5	-12.5	288.0	1.122	10.12	1.450

RP	ABS VEL		REL VEL		MERID VEL		TANG VEL		WHEEL SPEED	
	IN	OUT	IN	OUT	IN	OUT	IN	OUT	IN	OUT
1	162.6	205.2	338.2	251.1	162.6	174.8	0.1	107.6	296.6	287.9
2	173.9	208.0	338.0	249.3	173.9	178.1	-0.5	107.4	289.4	281.7
3	178.5	209.2	334.6	245.2	178.5	179.4	-1.7	107.6	281.4	274.8
4	187.2	216.6	321.1	226.2	187.2	180.9	-2.4	119.1	258.5	254.9
5	189.5	230.6	299.1	204.8	189.5	184.1	-2.9	138.9	228.5	228.7
6	185.3	249.6	271.9	193.5	185.3	189.4	-1.3	162.5	197.8	232.1
7	178.4	272.9	250.3	194.3	178.4	194.0	-0.8	191.9	174.8	182.4
8	177.3	279.0	243.9	193.5	177.3	191.6	-0.5	202.8	167.0	175.6
9	175.6	282.2	238.2	192.3	175.6	187.8	-1.6	210.6	159.4	168.9

RP	ABS MACH NO		REL MACH NO		MERID MACH NO		MERID PEAK SS	
	IN	OUT	IN	OUT	IN	OUT	VEL R	MACH NO
1	0.489	0.593	1.016	0.725	0.489	0.505	1.075	1.378
2	0.525	0.602	1.020	0.722	0.525	0.516	1.024	1.369
3	0.539	0.606	1.011	0.711	0.539	0.520	1.005	1.376
4	0.568	0.630	0.974	0.658	0.568	0.526	0.967	1.375
5	0.575	0.674	0.908	0.598	0.575	0.538	0.972	1.339
6	0.562	0.733	0.824	0.568	0.562	0.556	1.022	1.267
7	0.539	0.807	0.757	0.575	0.539	0.574	1.088	1.195
8	0.536	0.826	0.737	0.573	0.536	0.567	1.081	1.162
9	0.531	0.836	0.720	0.570	0.531	0.556	1.069	1.139

RP	PERCENT		INCIDENCE		DEV	D-FACT	EFF	LOSS COEFF		LOSS PARAM	
	SPAN	MEAN	SS	TOT				PROF	TOT	PROF	
1	5.00	3.0	-0.4	7.3	0.372	0.909	0.061	0.046	0.015	0.012	
2	10.00	2.7	-0.8	6.3	0.375	0.921	0.052	0.038	0.013	0.010	
3	15.00	3.0	-0.5	5.7	0.380	0.927	0.048	0.034	0.012	0.009	
4	30.00	3.8	-0.3	5.0	0.418	0.947	0.038	0.027	0.010	0.007	
5	50.00	5.3	-0.2	5.4	0.452	0.947	0.042	0.038	0.011	0.010	
6	70.00	7.7	-0.1	7.5	0.442	0.928	0.070	0.069	0.017	0.017	
7	85.00	10.9	0.6	8.3	0.399	0.919	0.094	0.094	0.021	0.021	
8	90.00	12.2	0.6	8.5	0.389	0.916	0.105	0.105	0.022	0.022	
9	95.00	14.2	1.1	9.6	0.379	0.918	0.108	0.108	0.021	0.021	

TABLE XX. - Continued. BLADE-ELEMENT DATA AT BLADE EDGES

FOR ROTOR 15 (90 PERCENT DESIGN SPEED; STATOR RESET;

INTRABLADE ROW INSTRUMENTATION

AT STATION 2a)

(b) Reading number 687

RP	RADII		ABS BETAM		REL BETAM		TOTAL TEMP		TOTAL PRESS	
	IN	OUT	IN	OUT	IN	OUT	IN	RATIO	IN	RATIO
1	24.133	23.424	0.1	37.3	63.4	45.4	288.5	1.119	10.06	1.432
2	23.510	22.885	0.0	36.2	61.4	44.0	288.3	1.116	10.13	1.427
3	22.883	22.347	-0.3	36.8	60.1	42.4	288.3	1.116	10.14	1.422
4	21.026	20.731	-0.7	38.2	56.8	36.7	288.1	1.113	10.14	1.421
5	18.560	18.578	-1.1	40.9	53.3	26.4	288.1	1.110	10.14	1.408
6	16.076	16.426	-0.8	43.9	50.0	12.7	288.0	1.109	10.14	1.399
7	14.194	14.811	0.3	48.2	47.2	-3.7	288.1	1.117	10.14	1.424
8	13.574	14.272	-0.2	49.6	46.4	-9.3	288.0	1.120	10.14	1.445
9	12.959	13.734	0.4	50.9	44.9	-13.7	287.9	1.120	10.12	1.449

RP	ABS VEL		REL VEL		MERID VEL		TANG VEL		WHEEL SPEED	
	IN	OUT	IN	OUT	IN	OUT	IN	OUT	IN	OUT
1	147.9	203.4	330.8	230.5	147.9	161.8	0.2	123.2	296.1	287.4
2	157.2	204.8	328.4	230.0	157.2	165.4	0.1	120.9	288.5	283.8
3	162.3	206.3	325.2	223.5	162.3	165.1	-0.9	123.7	281.0	274.4
4	170.4	211.6	311.3	207.5	170.4	166.4	-2.2	130.8	258.3	254.7
5	172.4	221.9	288.5	187.2	172.3	167.7	-3.3	145.2	228.1	228.3
6	167.6	235.4	260.5	173.9	167.5	169.7	-2.3	163.2	197.2	201.5
7	160.3	258.8	236.1	172.8	160.3	172.5	0.9	192.9	174.3	181.9
8	159.1	267.2	230.7	175.5	159.1	173.2	-0.5	203.4	166.5	175.1
9	158.1	270.3	223.2	175.5	158.1	170.5	1.1	209.7	158.6	168.1

RP	ABS MACH NO		REL MACH NO		MERID MACH NO		MERID PEAK SS	
	IN	OUT	IN	OUT	IN	OUT	VEL R	MACH NO
1	0.443	0.584	0.990	0.662	0.443	0.464	1.094	1.436
2	0.472	0.589	0.986	0.662	0.472	0.476	1.052	1.426
3	0.488	0.594	0.978	0.643	0.488	0.475	1.017	1.422
4	0.514	0.611	0.939	0.599	0.514	0.481	0.977	1.404
5	0.520	0.644	0.871	0.544	0.520	0.487	0.973	1.362
6	0.505	0.687	0.785	0.508	0.505	0.495	1.013	1.284
7	0.482	0.760	0.710	0.508	0.482	0.507	1.076	1.186
8	0.478	0.787	0.693	0.517	0.478	0.510	1.088	1.164
9	0.475	0.797	0.671	0.518	0.475	0.503	1.079	1.116

RP	PERCENT		INCIDENCE		DEV	D-FACT	EFF	LOSS COEFF		LOSS PARAM	
	SPAN	MEAN	SS	TOT				PROF	TOT	PROF	
1	5.00	5.2	1.8	6.9	0.437	0.911	0.068	0.050	0.017	0.013	
2	10.00	5.0	1.6	5.9	0.429	0.922	0.059	0.042	0.015	0.011	
3	15.00	5.3	1.8	5.1	0.445	0.912	0.068	0.052	0.018	0.014	
4	30.00	6.3	2.1	4.8	0.471	0.932	0.055	0.044	0.014	0.011	
5	50.00	7.9	2.4	5.7	0.500	0.936	0.056	0.052	0.015	0.014	
6	70.00	10.6	2.8	8.4	0.494	0.923	0.079	0.079	0.019	0.019	
7	85.00	13.6	3.3	7.5	0.453	0.908	0.119	0.119	0.027	0.027	
8	90.00	15.2	3.6	7.3	0.432	0.924	0.104	0.104	0.022	0.022	
9	95.00	16.6	3.4	8.4	0.409	0.930	0.103	0.103	0.020	0.020	

TABLE XX. - Continued. BLADE-ELEMENT DATA AT BLADE EDGES
FOR ROTOR 15 (90 PERCENT DESIGN SPEED; STATOR RESET;

INTRABLADE ROW INSTRUMENTATION

AT STATION 2a)

(c) Reading number 688

RP	RADII		ABS BETAM		REL BETAM		TOTAL TEMP		TOTAL PRESS	
	IN	OUT	IN	OUT	IN	OUT	IN	RATIO	IN	RATIO
1	24.133	23.424	0.2	40.3	66.7	46.4	288.7	1.125	10.07	1.430
2	23.510	22.885	0.0	39.5	64.4	44.6	288.4	1.123	10.14	1.426
3	22.883	22.347	0.0	40.0	63.3	43.8	288.2	1.121	10.14	1.411
4	21.026	20.731	-0.6	43.0	60.6	39.5	288.1	1.117	10.13	1.386
5	18.560	18.578	-0.9	47.0	57.5	27.8	288.1	1.117	10.14	1.382
6	16.076	16.426	-0.7	48.0	53.9	11.7	288.0	1.114	10.15	1.400
7	14.194	14.811	-0.1	50.3	50.9	-4.6	288.0	1.119	10.14	1.425
8	13.574	14.272	0.7	51.1	49.3	-10.2	288.0	1.122	10.14	1.453
9	12.959	13.734	0.1	51.9	48.3	-14.0	288.0	1.122	10.13	1.452

RP	ABS VEL		REL VEL		MERID VEL		TANG VEL		WHEEL SPEED	
	IN	OUT	IN	OUT	IN	OUT	IN	OUT	IN	OUT
1	127.9	199.0	322.8	220.1	127.9	151.8	0.5	128.7	296.9	288.1
2	138.1	201.1	320.1	217.9	138.1	155.1	0.0	128.1	288.8	281.2
3	141.7	199.4	314.9	211.6	141.7	152.8	0.0	128.2	281.2	274.6
4	146.2	198.0	298.0	187.7	146.2	144.8	-1.5	135.1	258.1	254.5
5	146.4	209.0	272.7	161.2	146.4	142.5	-2.2	152.9	227.9	228.1
6	145.2	228.7	246.5	156.1	145.1	152.9	-1.9	170.1	197.3	201.6
7	142.2	253.5	225.3	162.5	142.2	161.9	-0.3	195.0	174.4	182.0
8	141.8	263.9	217.7	168.3	141.8	165.7	1.8	205.4	167.0	175.6
9	141.5	266.5	212.9	169.4	141.5	164.4	0.2	209.7	159.3	168.8

RP	ABS MACH NO		REL MACH NO		MERID MACH NO		MERID PEAK SS	
	IN	OUT	IN	OUT	IN	OUT	VEL R	MACH NO
1	0.381	0.568	0.961	0.629	0.381	0.433	1.187	1.500
2	0.413	0.576	0.956	0.624	0.413	0.444	1.123	1.482
3	0.424	0.571	0.942	0.606	0.424	0.438	1.078	1.471
4	0.438	0.568	0.892	0.539	0.438	0.416	0.991	1.450
5	0.438	0.602	0.817	0.464	0.438	0.410	0.974	1.394
6	0.435	0.665	0.738	0.454	0.435	0.444	1.053	1.307
7	0.425	0.742	0.674	0.476	0.425	0.474	1.139	1.209
8	0.424	0.775	0.651	0.494	0.424	0.487	1.168	1.159
9	0.423	0.783	0.637	0.498	0.423	0.483	1.161	1.135

RP	PERCENT SPAN		INCIDENCE		DEV	D-FACT	EFF	LOSS COEFF		LOSS PARAM	
	SPAN	MEAN	SS	SS				TOT	PROF	TOT	PROF
1	5.00	8.4	5.1	7.9	0.461	0.860	0.116	0.093	0.029	0.023	
2	10.00	8.1	4.6	6.5	0.460	0.868	0.109	0.089	0.028	0.023	
3	15.00	8.5	5.0	6.5	0.468	0.857	0.119	0.101	0.030	0.025	
4	30.00	10.1	5.9	7.7	0.518	0.833	0.147	0.135	0.037	0.034	
5	50.00	12.1	6.6	7.2	0.574	0.827	0.175	0.171	0.045	0.044	
6	70.00	14.5	6.8	7.3	0.544	0.885	0.135	0.135	0.033	0.033	
7	85.00	17.2	6.9	6.6	0.476	0.892	0.154	0.154	0.034	0.034	
8	90.00	18.2	6.6	6.4	0.431	0.920	0.124	0.124	0.026	0.026	
9	95.00	20.0	6.9	8.1	0.411	0.920	0.129	0.129	0.026	0.026	

TABLE XX. - Concluded. BLADE-ELEMENT DATA AT BLADE EDGES

FOR ROTOR 15 (90 PERCENT DESIGN SPEED; STATOR RESET;

INTRABLADE ROW INSTRUMENTATION

AT STATION 2a)

(d) Reading number 689

RP	RADI		ABS BETAM		REL BETAM		TOTAL TEMP		TOTAL PRESS	
	IN	OUT	IN	OUT	IN	OUT	IN	RATIO	IN	RATIO
1	24.133	23.424	0.4	45.3	67.8	48.2	288.8	1.132	10.05	1.400
2	23.510	22.885	0.3	43.4	65.9	46.0	288.4	1.129	10.16	1.401
3	22.883	22.347	-0.0	43.2	64.8	44.5	288.3	1.126	10.16	1.399
4	21.026	20.731	-0.5	45.8	62.1	39.8	288.1	1.122	10.16	1.378
5	18.560	18.578	-1.3	48.6	59.2	28.3	288.0	1.118	10.12	1.375
6	16.076	16.426	-1.2	48.7	55.3	11.8	288.0	1.117	10.13	1.400
7	14.194	14.811	-0.3	50.8	52.0	-5.0	288.0	1.121	10.13	1.427
8	13.574	14.272	-0.1	51.5	50.7	-10.5	288.0	1.123	10.13	1.456
9	12.959	13.734	-0.0	52.2	49.5	-14.4	288.0	1.124	10.11	1.461

RP	ABS VEL		REL VEL		MERID VEL		TANG VEL		WHEEL SPEED	
	IN	OUT	IN	OUT	IN	OUT	IN	OUT	IN	OUT
1	121.2	192.6	320.1	203.1	121.2	135.5	0.8	136.9	297.0	288.3
2	128.7	195.3	315.7	204.5	128.7	141.9	0.7	134.1	289.0	281.4
3	132.7	196.4	311.6	200.8	132.7	143.2	-0.1	134.4	281.8	275.2
4	137.6	196.6	294.2	178.3	137.6	137.0	-1.3	141.1	258.8	255.1
5	138.1	206.6	269.5	155.1	138.1	136.5	-3.0	155.1	228.4	228.6
6	139.2	227.9	244.6	153.5	139.2	150.3	-2.8	171.3	198.3	202.7
7	137.1	253.3	222.8	160.6	137.1	160.0	-0.8	196.4	174.8	182.4
8	137.0	263.8	216.3	167.1	137.0	164.3	-0.1	206.4	167.2	175.9
9	136.6	267.6	210.2	169.5	136.6	164.1	-0.1	211.4	159.7	169.2

RP	ABS MACH NO		REL MACH NO		MERID MACH NO		MERID PEAK SS	
	IN	OUT	IN	OUT	IN	OUT	VEL R	MACH NO
1	0.360	0.547	0.952	0.577	0.360	0.385	1.118	1.520
2	0.384	0.556	0.941	0.583	0.384	0.404	1.103	1.506
3	0.396	0.561	0.930	0.573	0.396	0.409	1.079	1.501
4	0.411	0.563	0.879	0.510	0.411	0.392	0.996	1.473
5	0.413	0.594	0.806	0.446	0.413	0.393	0.989	1.421
6	0.416	0.661	0.732	0.445	0.416	0.436	1.080	1.330
7	0.410	0.741	0.666	0.470	0.410	0.468	1.167	1.221
8	0.409	0.774	0.646	0.491	0.409	0.482	1.200	1.181
9	0.408	0.787	0.628	0.498	0.408	0.482	1.202	1.143

RP	PERCENT		INCIDENCE		DEV	D-FACT	EFF	LOSS COEFF		LOSS PARAM	
	SPAN	MEAN	SS	SS				TOT	PROF	TOT	PROF
1	5.00	9.5	6.2	9.6	0.518	0.768	0.202	0.176	0.049	0.043	
2	10.00	9.6	6.1	7.9	0.501	0.783	0.189	0.167	0.047	0.041	
3	15.00	10.1	6.5	7.2	0.504	0.796	0.178	0.158	0.044	0.039	
4	30.00	11.6	7.4	7.9	0.550	0.787	0.197	0.184	0.049	0.046	
5	50.00	13.8	8.3	7.7	0.595	0.805	0.203	0.198	0.052	0.051	
6	70.00	15.9	8.2	7.5	0.554	0.865	0.164	0.164	0.040	0.040	
7	85.00	18.4	8.1	6.2	0.480	0.882	0.174	0.174	0.039	0.039	
8	90.00	19.6	8.0	6.1	0.436	0.920	0.126	0.126	0.026	0.026	
9	95.00	21.1	8.0	7.7	0.405	0.925	0.126	0.126	0.025	0.025	

TABLE XXI. - BLADE-ELEMENT DATA AT BLADE EDGES FOR

ROTOR 15 (80 PERCENT DESIGN SPEED; STATOR RESET;

INTRABLADE ROW INSTRUMENTATION AT

STATION 2a; READING NUMBER 692)

RP	RADII		ABS BETAM		REL BETAM		TOTAL TEMP		TOTAL PRESS	
	IN	OUT	IN	OUT	IN	OUT	IN	RATIO	IN	RATIO
1	24.133	23.424	0.7	52.1	70.9	51.2	288.8	1.112	10.08	1.293
2	23.510	22.885	0.5	48.8	68.9	48.2	288.4	1.107	10.13	1.295
3	22.883	22.347	0.4	46.6	67.8	46.0	288.2	1.103	10.14	1.299
4	21.026	20.731	0.2	48.9	65.3	41.1	288.1	1.099	10.14	1.287
5	18.560	18.578	-0.6	52.6	62.3	29.6	288.0	1.096	10.14	1.279
6	16.076	16.426	-0.8	51.3	58.0	11.5	288.0	1.094	10.14	1.304
7	14.194	14.811	0.2	51.4	54.3	-4.6	287.9	1.096	10.14	1.333
8	13.574	14.272	-0.1	51.8	53.3	-9.9	288.0	1.097	10.14	1.351
9	12.959	13.734	-0.0	52.3	52.0	-13.6	288.0	1.098	10.13	1.352

RP	ABS VEL		REL VEL		MERID VEL		TANG VEL		WHEEL SPEED	
	IN	OUT	IN	OUT	IN	OUT	IN	OUT	IN	OUT
1	91.1	165.0	278.4	161.9	91.1	101.4	1.1	130.1	264.1	256.4
2	98.8	168.1	274.5	166.2	98.8	110.8	0.9	126.4	257.1	250.2
3	101.7	170.3	269.7	168.2	101.7	117.0	0.8	123.7	250.5	244.7
4	106.0	171.2	253.2	149.4	106.0	112.5	0.4	129.0	230.4	227.2
5	107.7	178.7	231.2	125.0	107.6	108.7	-1.2	141.9	203.5	203.7
6	110.9	198.6	209.5	126.7	110.9	124.2	-1.5	155.0	176.3	180.2
7	111.3	221.8	190.8	138.9	111.3	138.4	0.4	173.3	155.3	162.1
8	111.2	230.6	185.9	144.6	111.2	142.5	-0.2	181.3	148.8	156.5
9	111.1	234.4	180.6	147.4	111.1	143.3	-0.0	185.6	142.3	150.8

RP	ABS MACH NO		REL MACH NO		MERID MACH NO		MERID PEAK SS VEL R MACH NO
	IN	OUT	IN	OUT	IN	OUT	
1	0.269	0.469	0.823	0.461	0.269	0.289	1.114 1.403
2	0.293	0.480	0.813	0.475	0.293	0.316	1.122 1.383
3	0.301	0.488	0.800	0.482	0.301	0.335	1.150 1.374
4	0.315	0.491	0.752	0.429	0.315	0.323	1.062 1.340
5	0.320	0.515	0.687	0.360	0.320	0.313	1.009 1.284
6	0.330	0.576	0.623	0.368	0.330	0.360	1.119 1.192
7	0.331	0.648	0.567	0.406	0.331	0.405	1.244 1.086
8	0.330	0.676	0.552	0.424	0.330	0.418	1.281 1.059
9	0.330	0.688	0.537	0.433	0.330	0.421	1.289 1.025

RP	PERCENT SPAN	INCIDENCE		DEV	D-FACT	EFF	LOSS COEFF		LOSS PARAM	
		MEAN	SS				TOT	PROF	TOT	PROF
1	5.00	12.7	9.3	12.7	0.585	0.683	0.292	0.288	0.067	0.066
2	10.00	12.5	9.1	10.0	0.556	0.717	0.258	0.255	0.061	0.061
3	15.00	13.1	9.6	8.6	0.534	0.755	0.223	0.221	0.054	0.054
4	30.00	14.7	10.6	9.3	0.574	0.756	0.237	0.237	0.058	0.058
5	50.00	16.8	11.4	9.0	0.639	0.758	0.267	0.267	0.067	0.067
6	70.00	18.7	10.9	7.1	0.586	0.837	0.211	0.211	0.052	0.052
7	85.00	20.7	10.4	6.5	0.478	0.888	0.176	0.176	0.039	0.039
8	90.00	22.1	10.5	6.7	0.435	0.921	0.132	0.132	0.028	0.028
9	95.00	23.7	10.6	8.4	0.399	0.919	0.143	0.143	0.028	0.028

TABLE XXII. - BLADE-ELEMENT DATA AT BLADE EDGES FOR

ROTOR 15 (70 PERCENT DESIGN SPEED; STATOR RESET;

INTRABLADE ROW INSTRUMENTATION

AT STATION 2a)

(a) Reading number 693

RP	RADII		ABS BETAM		REL BETAM		TOTAL TEMP		TOTAL PRESS	
	IN	OUT	IN	OUT	IN	OUT	IN	RATIO	IN	RATIO
1	24.133	23.424	0.9	21.2	60.1	47.1	288.6	1.043	10.07	1.146
2	23.510	22.885	0.5	20.4	57.7	45.9	288.3	1.044	10.13	1.145
3	22.883	22.347	0.0	20.6	56.5	44.7	288.2	1.045	10.13	1.147
4	21.026	20.731	-0.3	23.6	53.0	38.7	288.2	1.048	10.14	1.168
5	18.560	18.578	-0.3	28.7	49.0	27.6	288.1	1.055	10.14	1.194
6	16.076	16.426	-0.4	34.2	45.1	12.8	288.0	1.063	10.14	1.223
7	14.194	14.811	0.1	39.4	42.0	-1.5	288.0	1.071	10.14	1.252
8	13.574	14.272	0.1	41.7	40.8	-7.0	288.0	1.074	10.14	1.264
9	12.959	13.734	-0.0	43.6	39.8	-11.4	288.0	1.076	10.12	1.271

RP	ABS VEL		REL VEL		MERID VEL		TANG VEL		WHEEL SPEED	
	IN	OUT	IN	OUT	IN	OUT	IN	OUT	IN	OUT
1	131.6	164.2	264.0	225.1	131.6	153.1	2.2	59.3	231.0	224.2
2	140.9	166.0	264.0	223.7	140.9	155.6	1.3	57.9	224.5	218.5
3	144.6	167.0	262.3	220.0	144.6	156.2	0.0	58.8	218.8	213.6
4	151.8	174.4	252.0	204.6	151.8	159.8	-0.7	69.8	200.4	197.6
5	155.2	189.0	236.3	187.2	155.2	165.8	-0.9	90.6	177.3	177.5
6	153.9	209.1	217.9	177.4	153.9	173.0	-1.0	117.4	153.3	156.6
7	150.3	230.7	202.5	178.4	150.3	178.3	0.1	146.4	135.7	141.7
8	149.7	237.2	197.9	178.3	149.7	177.0	0.2	158.0	129.6	136.2
9	148.6	241.2	193.4	178.2	148.6	174.7	-0.0	166.4	123.8	131.2

RP	ABS MACH NO		REL MACH NO		MERID MACH NO		MERID PEAK SS	
	IN	OUT	IN	OUT	IN	OUT	VEL R	MACH NO
1	0.392	0.483	0.787	0.662	0.392	0.450	1.163	1.050
2	0.421	0.489	0.789	0.658	0.421	0.458	1.105	1.040
3	0.433	0.491	0.785	0.647	0.433	0.460	1.080	1.044
4	0.455	0.514	0.756	0.603	0.455	0.471	1.053	1.030
5	0.466	0.557	0.710	0.552	0.466	0.489	1.069	1.004
6	0.462	0.619	0.654	0.525	0.462	0.512	1.125	0.961
7	0.451	0.685	0.607	0.530	0.451	0.530	1.186	0.907
8	0.449	0.706	0.593	0.530	0.449	0.526	1.182	0.885
9	0.445	0.718	0.580	0.531	0.445	0.520	1.176	0.865

RP	PERCENT		INCIDENCE		DEV	D-FACT	EFF	LOSS COEFF		LOSS PARAM	
	SPAN	MEAN	SS	SS				TOT	PROF	TOT	PROF
1	5.00	1.9	-1.5	8.6	0.225	0.927	0.031	0.031	0.008	0.008	
2	10.00	1.4	-2.1	7.8	0.228	0.903	0.042	0.042	0.010	0.010	
3	15.00	1.8	-1.8	7.4	0.239	0.898	0.045	0.045	0.011	0.011	
4	30.00	2.4	-1.7	6.8	0.278	0.946	0.027	0.027	0.007	0.007	
5	50.00	3.5	-1.9	7.0	0.320	0.950	0.031	0.031	0.008	0.008	
6	70.00	5.7	-2.1	8.4	0.324	0.940	0.050	0.050	0.012	0.012	
7	85.00	8.4	-1.9	9.6	0.283	0.932	0.072	0.072	0.016	0.016	
8	90.00	9.7	-1.9	9.6	0.273	0.933	0.076	0.076	0.016	0.016	
9	95.00	11.5	-1.6	10.7	0.259	0.936	0.078	0.078	0.015	0.015	

TABLE XXII. - Continued. BLADE-ELEMENT DATA AT BLADE EDGES

FOR ROTOR 15 (70 PERCENT DESIGN SPEED; STATOR RESET;

INTRABLADE ROW INSTRUMENTATION

AT STATION 2a)

(b) Reading number 694

RP	RADII		ABS BETAM		REL BETAM		TOTAL TEMP		TOTAL PRESS	
	IN	OUT	IN	OUT	IN	OUT	IN	RATIO	IN	RATIO
1	24.133	23.424	0.6	29.3	63.2	46.8	288.5	1.059	10.08	1.203
2	23.510	22.885	0.4	29.0	60.8	45.5	288.4	1.058	10.13	1.199
3	22.883	22.347	0.5	29.0	59.5	44.3	288.2	1.057	10.14	1.199
4	21.026	20.731	0.1	31.1	56.2	38.8	288.1	1.058	10.14	1.208
5	18.560	18.578	-0.4	35.4	52.7	28.3	288.1	1.061	10.14	1.215
6	16.076	16.426	-0.2	39.5	49.0	13.9	288.0	1.065	10.14	1.229
7	14.194	14.811	0.0	44.0	46.3	-1.0	288.0	1.070	10.14	1.247
8	13.574	14.272	0.5	46.0	45.0	-7.1	288.0	1.072	10.13	1.262
9	12.959	13.734	0.0	47.6	44.1	-11.9	288.0	1.074	10.12	1.268

RP	ABS VEL		REL VEL		MERID VEL		TANG VEL		WHEEL SPEED	
	IN	OUT	IN	OUT	IN	OUT	IN	OUT	IN	OUT
1	115.5	157.5	256.6	200.9	115.5	137.4	1.3	77.0	230.4	223.6
2	124.6	158.9	255.8	198.0	124.6	138.9	0.8	77.1	224.2	218.2
3	127.9	159.4	252.3	194.8	127.9	139.4	1.2	77.4	218.6	213.5
4	134.1	164.4	241.4	180.6	134.1	140.8	0.1	85.0	200.9	198.0
5	135.9	174.2	224.1	161.5	135.9	142.1	-0.9	100.8	177.3	177.5
6	133.6	189.6	203.8	150.7	133.6	146.3	-0.5	120.7	153.4	156.7
7	129.4	207.5	187.3	149.3	129.4	149.3	0.1	144.1	135.6	141.5
8	128.6	215.5	181.9	150.8	128.6	149.6	1.1	155.1	129.7	136.4
9	127.9	220.1	177.9	151.8	127.9	148.6	0.0	162.4	123.7	131.1

RP	ABS MACH NO		REL MACH NO		MERID MACH NO		MERID PEAK SS	
	IN	OUT	IN	OUT	IN	OUT	VEL R	MACH NO
1	0.343	0.459	0.762	0.585	0.343	0.400	1.190	1.100
2	0.371	0.463	0.762	0.578	0.371	0.405	1.115	1.087
3	0.381	0.465	0.752	0.569	0.381	0.407	1.090	1.080
4	0.400	0.481	0.721	0.528	0.400	0.411	1.050	1.064
5	0.406	0.510	0.669	0.473	0.406	0.416	1.046	1.033
6	0.399	0.557	0.609	0.442	0.399	0.429	1.095	0.976
7	0.386	0.611	0.559	0.440	0.386	0.440	1.154	0.916
8	0.384	0.636	0.542	0.445	0.384	0.442	1.163	0.885
9	0.381	0.650	0.530	0.449	0.381	0.439	1.162	0.867

RP	PERCENT		INCIDENCE		DEV	D-FACT	EFF	LOSS COEFF		LOSS PARAM	
	SPAN	MEAN	SS	SS				TOT	PROF	TOT	PROF
1	5.00	5.0	1.6	8.3	0.323	0.916	0.050	0.050	0.013	0.013	
2	10.00	4.5	1.0	7.3	0.331	0.920	0.047	0.047	0.012	0.012	
3	15.00	4.8	1.2	7.0	0.332	0.929	0.042	0.042	0.011	0.011	
4	30.00	5.7	1.6	6.9	0.365	0.953	0.031	0.031	0.008	0.008	
5	50.00	7.3	1.8	7.7	0.411	0.947	0.041	0.041	0.010	0.010	
6	70.00	9.6	1.9	9.5	0.412	0.935	0.063	0.063	0.015	0.015	
7	85.00	12.7	2.4	10.1	0.378	0.932	0.081	0.081	0.018	0.018	
8	90.00	13.9	2.3	9.5	0.356	0.950	0.065	0.065	0.014	0.014	
9	95.00	15.7	2.6	10.2	0.338	0.954	0.063	0.063	0.013	0.013	

TABLE XXII. - Continued. BLADE-ELEMENT DATA AT BLADE EDGES

FOR ROTOR 15 (70 PERCENT DESIGN SPEED; STATOR RESET;

INTRABLADE ROW INSTRUMENTATION

AT STATION 2a)

(c) Reading number 695

RP	RADII		ABS BETAM		REL BETAM		TOTAL TEMP		TOTAL PRESS	
	IN	OUT	IN	OUT	IN	OUT	IN	RATIO	IN	RATIO
1	24.133	23.424	0.8	38.3	66.9	47.7	288.6	1.072	10.09	1.233
2	23.510	22.885	0.8	37.7	64.9	46.2	288.3	1.070	10.13	1.230
3	22.883	22.347	0.5	37.6	63.8	45.0	288.2	1.068	10.13	1.227
4	21.026	20.731	0.2	39.5	60.8	40.0	288.2	1.067	10.13	1.224
5	18.560	18.578	-0.4	43.3	57.6	29.3	288.0	1.067	10.14	1.222
6	16.076	16.426	0.2	46.1	54.0	13.7	288.0	1.069	10.14	1.230
7	14.194	14.811	-0.1	49.1	51.2	-3.0	288.0	1.073	10.13	1.253
8	13.574	14.272	0.2	50.0	49.9	-8.6	288.0	1.074	10.13	1.264
9	12.959	13.734	-0.1	50.8	48.7	-12.6	288.0	1.073	10.13	1.263

RP	ABS VEL		REL VEL		MERID VEL		TANG VEL		WHEEL SPEED	
	IN	OUT	IN	OUT	IN	OUT	IN	OUT	IN	OUT
1	97.6	151.0	249.0	176.1	97.6	118.6	1.4	93.6	230.5	223.7
2	104.6	152.3	246.4	174.0	104.6	120.6	1.5	93.1	224.6	218.6
3	107.3	152.2	242.6	170.5	107.3	120.6	1.0	92.9	218.6	213.5
4	111.9	154.4	229.6	155.6	111.9	119.2	0.3	98.1	200.9	198.1
5	113.0	162.2	211.0	135.4	113.0	118.1	-0.9	111.2	177.3	177.5
6	111.7	176.6	189.8	126.0	111.7	122.4	0.5	127.3	153.9	157.3
7	109.4	196.7	174.6	129.1	109.4	128.9	-0.2	148.6	135.9	141.8
8	109.0	204.1	169.3	132.6	109.0	131.1	0.4	156.5	129.9	136.5
9	108.7	206.8	164.8	133.8	108.7	130.6	-0.2	160.3	123.7	131.1

RP	ABS MACH NO		REL MACH NO		MERID MACH NO		MERID PEAK SS	
	IN	OUT	IN	OUT	IN	OUT	VEL R	MACH NO
1	0.289	0.436	0.737	0.509	0.289	0.343	1.215	1.157
2	0.310	0.441	0.731	0.504	0.310	0.349	1.153	1.143
3	0.318	0.441	0.720	0.494	0.318	0.349	1.124	1.137
4	0.332	0.448	0.682	0.451	0.332	0.346	1.066	1.114
5	0.336	0.472	0.627	0.394	0.336	0.344	1.045	1.072
6	0.332	0.515	0.564	0.368	0.332	0.357	1.096	0.999
7	0.325	0.577	0.519	0.378	0.325	0.378	1.179	0.937
8	0.324	0.600	0.503	0.390	0.324	0.385	1.203	0.905
9	0.323	0.608	0.489	0.394	0.323	0.384	1.202	0.879

RP	PERCENT		INCIDENCE		DEV	D-FACT	EFF	LOSS COEFF		LOSS PARAM	
	SPAN	MEAN	SS	TOT				PROF	TOT	PROF	
1	5.00	8.7	5.3	9.1	0.426	0.851	0.113	0.113	0.028	0.028	
2	10.00	8.5	5.1	8.0	0.425	0.871	0.096	0.096	0.024	0.024	
3	15.00	9.0	5.5	7.7	0.428	0.882	0.088	0.088	0.022	0.022	
4	30.00	10.3	6.2	8.1	0.460	0.881	0.097	0.097	0.024	0.024	
5	50.00	12.2	6.7	8.7	0.512	0.882	0.110	0.110	0.028	0.028	
6	70.00	14.6	6.8	9.4	0.507	0.888	0.130	0.130	0.032	0.032	
7	85.00	17.6	7.3	8.1	0.455	0.916	0.119	0.119	0.027	0.027	
8	90.00	18.8	7.2	7.9	0.418	0.942	0.089	0.089	0.019	0.019	
9	95.00	20.4	7.3	9.5	0.392	0.945	0.086	0.086	0.017	0.017	

TABLE XXII. - Concluded. BLADE-ELEMENT DATA AT BLADE EDGES
FOR ROTOR 15 (70 PERCENT DESIGN SPEED; STATOR RESET;

INTRABLADE ROW INSTRUMENTATION

AT STATION 2a)

(d) Reading number 696

RP	RADII		ABS BETAM		REL BETAM		TOTAL TEMP		TOTAL PRESS	
	IN	OUT	IN	OUT	IN	OUT	IN	RATIO	IN	RATIO
1	24.133	23.424	0.7	52.3	71.2	51.8	288.7	1.085	10.10	1.219
2	23.510	22.885	0.8	48.9	69.4	48.6	288.4	1.082	10.13	1.222
3	22.883	22.347	0.6	46.2	68.4	46.4	288.3	1.078	10.13	1.225
4	21.026	20.731	0.4	48.6	65.9	41.7	288.1	1.075	10.13	1.214
5	18.560	18.578	-0.1	52.9	62.8	30.5	288.0	1.073	10.14	1.208
6	16.076	16.426	-0.5	51.8	58.7	11.9	288.0	1.072	10.13	1.226
7	14.194	14.811	0.0	51.8	55.1	-5.6	288.0	1.075	10.13	1.257
8	13.574	14.272	-0.1	51.9	54.0	-10.1	288.0	1.075	10.13	1.267
9	12.959	13.734	-0.0	52.2	52.6	-13.5	288.0	1.074	10.13	1.264

RP	ABS VEL		REL VEL		MERID VEL		TANG VEL		WHEEL SPEED	
	IN	OUT	IN	OUT	IN	OUT	IN	OUT	IN	OUT
1	78.0	142.7	242.7	141.4	78.0	87.3	1.0	112.9	230.8	224.1
2	83.9	145.8	238.5	144.8	83.9	95.8	1.2	109.9	224.4	218.5
3	86.3	147.6	234.5	148.1	86.3	102.2	1.0	106.6	219.0	213.8
4	89.8	148.0	219.7	131.2	89.8	97.9	0.6	111.0	201.2	198.4
5	91.3	154.3	200.0	108.0	91.3	93.0	-0.2	123.2	177.8	178.0
6	94.1	171.8	181.1	108.6	94.1	106.3	-0.8	134.9	154.0	157.3
7	94.7	195.3	165.6	121.4	94.7	120.8	0.0	153.5	135.9	141.8
8	94.8	202.2	161.1	126.9	94.8	124.9	-0.1	159.1	130.1	136.8
9	94.8	204.6	156.1	129.0	94.8	125.5	-0.0	161.6	124.0	131.5

RP	ABS MACH NO		REL MACH NO		MERID MACH NO		MERID PEAK SS	
	IN	OUT	IN	OUT	IN	OUT	VEL R	MACH NO
1	0.230	0.409	0.716	0.405	0.230	0.250	1.119	1.229
2	0.248	0.419	0.705	0.416	0.248	0.275	1.142	1.211
3	0.255	0.425	0.693	0.427	0.255	0.294	1.183	1.204
4	0.266	0.427	0.650	0.379	0.266	0.283	1.090	1.174
5	0.270	0.447	0.592	0.312	0.270	0.269	1.019	1.120
6	0.279	0.500	0.537	0.316	0.279	0.309	1.129	1.040
7	0.281	0.572	0.491	0.355	0.281	0.354	1.275	0.954
8	0.281	0.593	0.477	0.372	0.281	0.366	1.318	0.926
9	0.281	0.601	0.463	0.379	0.281	0.368	1.324	0.893

RP	PERCENT SPAN	INCIDENCE		DEV	D-FACT	EFF	LOSS COEFF		LOSS PARAM	
		MEAN	SS				TOT	PROF	TOT	PROF
1	5.00	13.0	9.7	13.3	0.583	0.682	0.287	0.287	0.065	0.065
2	10.00	13.0	9.6	10.4	0.554	0.723	0.249	0.249	0.059	0.059
3	15.00	13.7	10.1	9.1	0.524	0.760	0.214	0.214	0.052	0.052
4	30.00	15.4	11.2	9.9	0.565	0.760	0.231	0.231	0.056	0.056
5	50.00	17.4	11.9	9.9	0.639	0.761	0.264	0.264	0.066	0.066
6	70.00	19.3	11.5	7.6	0.591	0.828	0.227	0.227	0.056	0.056
7	85.00	21.5	11.2	5.6	0.478	0.905	0.153	0.153	0.034	0.034
8	90.00	22.8	11.2	6.5	0.428	0.937	0.108	0.108	0.023	0.023
9	95.00	24.3	11.2	8.6	0.390	0.935	0.116	0.116	0.023	0.023

TABLE XXIII. - BLADE-ELEMENT DATA AT BLADE EDGES FOR

ROTOR 15 (60 PERCENT DESIGN SPEED; STATOR RESET;

INTRABLADE ROW INSTRUMENTATION AT

STATION 2a; READING NUMBER 699)

RP	RADII		ABS BETAM		REL BETAM		TOTAL TEMP		TOTAL PRESS	
	IN	OUT	IN	OUT	IN	OUT	IN	RATIO	IN	RATIO
1	24.133	23.424	0.5	55.4	72.0	52.6	288.6	1.063	10.11	1.159
2	23.510	22.885	0.4	50.5	70.3	49.3	288.4	1.062	10.13	1.161
3	22.883	22.347	0.3	47.0	69.3	46.6	288.1	1.059	10.13	1.163
4	21.026	20.731	0.1	50.0	66.9	41.4	288.2	1.056	10.13	1.157
5	18.560	18.578	-0.4	54.5	63.9	30.2	288.0	1.054	10.13	1.151
6	16.076	16.426	-0.5	53.0	59.8	12.2	288.1	1.053	10.13	1.161
7	14.194	14.811	0.2	51.8	56.1	-2.9	288.0	1.053	10.13	1.174
8	13.574	14.272	-0.0	51.9	54.9	-8.7	287.9	1.053	10.13	1.184
9	12.959	13.734	-0.4	52.6	53.8	-13.5	288.0	1.054	10.13	1.187

RP	ABS VEL		REL VEL		MERID VEL		TANG VEL		WHEEL SPEED	
	IN	OUT	IN	OUT	IN	OUT	IN	OUT	IN	OUT
1	64.1	122.4	207.0	114.3	64.1	69.5	0.5	100.8	197.4	191.6
2	69.1	124.4	204.6	121.3	69.1	79.1	0.4	96.0	193.0	187.9
3	70.5	125.9	199.8	125.0	70.5	85.9	0.3	92.1	187.3	182.9
4	73.6	127.5	187.2	109.2	73.6	81.9	0.1	97.7	172.3	169.9
5	74.6	131.9	169.6	88.5	74.6	76.6	-0.6	107.4	151.8	151.9
6	77.3	145.1	153.4	89.3	77.3	87.3	-0.7	115.9	131.9	134.7
7	78.1	160.8	139.9	99.5	78.1	99.4	0.2	126.4	116.3	121.4
8	78.2	168.4	135.8	105.1	78.2	103.9	-0.1	132.6	111.0	116.7
9	78.1	173.3	132.1	108.3	78.1	105.3	-0.5	137.6	106.0	112.3

RP	ABS MACH NO		REL MACH NO		MERID MACH NO		MERID PEAK SS	
	IN	OUT	IN	OUT	IN	OUT	VEL R	MACH NO
1	0.189	0.353	0.610	0.330	0.189	0.200	1.084	1.062
2	0.204	0.359	0.604	0.350	0.204	0.228	1.145	1.055
3	0.208	0.364	0.590	0.362	0.208	0.249	1.219	1.043
4	0.217	0.370	0.553	0.316	0.217	0.237	1.113	1.016
5	0.220	0.383	0.501	0.257	0.220	0.222	1.027	0.966
6	0.228	0.423	0.453	0.260	0.228	0.255	1.130	0.895
7	0.231	0.471	0.414	0.291	0.231	0.291	1.272	0.818
8	0.231	0.494	0.401	0.308	0.231	0.305	1.329	0.793
9	0.231	0.509	0.390	0.318	0.231	0.309	1.349	0.769

RP	PERCENT	INCIDENCE		DEV	D-FACT	EFF	LOSS COEFF		LOSS PARAM	
	SPAN	MEAN	SS				TOT	PROF	TOT	PROF
1	5.00	13.7	10.4	14.0	0.622	0.683	0.286	0.286	0.063	0.063
2	10.00	13.9	10.4	11.1	0.572	0.705	0.267	0.267	0.062	0.062
3	15.00	14.6	11.1	9.3	0.533	0.752	0.223	0.223	0.054	0.054
4	30.00	16.3	12.2	9.5	0.585	0.763	0.229	0.229	0.056	0.056
5	50.00	18.5	13.0	9.5	0.662	0.763	0.265	0.265	0.066	0.066
6	70.00	20.4	12.6	7.9	0.611	0.827	0.229	0.229	0.056	0.056
7	85.00	22.4	12.1	8.3	0.494	0.886	0.181	0.181	0.040	0.040
8	90.00	23.7	12.1	7.9	0.440	0.929	0.120	0.120	0.025	0.025
9	95.00	25.4	12.3	8.6	0.399	0.938	0.111	0.111	0.022	0.022

TABLE XXIV. - BLADE-ELEMENT DATA AT BLADE EDGES FOR

ROTOR 15 (50 PERCENT DESIGN SPEED; STATOR RESET;

INTRABLADE ROW INSTRUMENTATION AT

STATION 2a; READING NUMBER 700)

RP	RADII		ABS BETAM		REL BETAM		TOTAL TEMP		TOTAL PRESS	
	IN	OUT	IN	OUT	IN	OUT	IN	RATIO	IN	RATIO
1	24.133	23.424	0.3	53.5	72.3	52.4	288.6	1.043	10.12	1.110
2	23.510	22.885	0.2	49.7	70.5	49.3	288.3	1.042	10.13	1.111
3	22.883	22.347	0.2	46.8	69.6	47.0	288.2	1.040	10.13	1.112
4	21.026	20.731	0.2	48.8	67.1	41.8	288.1	1.038	10.13	1.108
5	18.560	18.578	0.1	53.9	64.1	31.1	288.1	1.037	10.13	1.104
6	16.076	16.426	-0.3	53.3	60.1	11.7	288.1	1.037	10.13	1.112
7	14.194	14.811	0.1	52.2	56.3	-4.1	288.1	1.038	10.13	1.124
8	13.574	14.272	-0.1	52.2	55.1	-9.3	287.9	1.038	10.13	1.129
9	12.959	13.734	-0.4	52.5	54.0	-13.2	288.1	1.038	10.13	1.130

RP	ABS VEL		REL VEL		MERID VEL		TANG VEL		WHEEL SPEED	
	IN	OUT	IN	OUT	IN	OUT	IN	OUT	IN	OUT
1	52.8	101.9	173.4	99.4	52.8	60.7	0.3	81.9	165.4	160.6
2	56.9	103.5	170.5	102.5	56.9	66.9	0.2	78.9	160.9	156.6
3	58.4	104.6	167.1	105.0	58.4	71.6	0.2	76.3	156.8	153.1
4	60.9	105.8	156.1	93.5	60.9	69.7	0.2	79.6	144.3	142.3
5	61.7	109.5	141.4	75.4	61.7	64.6	0.1	88.4	127.3	127.4
6	63.6	121.6	127.5	74.3	63.6	72.7	-0.3	97.5	110.2	112.6
7	64.8	136.2	116.8	83.6	64.8	83.4	0.1	107.6	97.4	101.6
8	64.9	141.6	113.4	88.0	64.9	86.8	-0.1	111.8	92.9	97.7
9	64.8	144.9	110.4	90.7	64.8	88.3	-0.5	114.9	88.8	94.1

RP	ABS MACH NO		REL MACH NO		MERID MACH NO		MERID PEAK SS	
	IN	OUT	IN	OUT	IN	OUT	VEL R	MACH NO
1	0.155	0.295	0.511	0.288	0.155	0.176	1.149	0.894
2	0.168	0.301	0.502	0.298	0.168	0.194	1.175	0.882
3	0.172	0.304	0.493	0.305	0.172	0.208	1.226	0.875
4	0.179	0.308	0.460	0.272	0.179	0.203	1.145	0.849
5	0.182	0.319	0.417	0.220	0.182	0.188	1.046	0.807
6	0.188	0.355	0.376	0.217	0.188	0.212	1.143	0.748
7	0.191	0.399	0.345	0.245	0.191	0.244	1.287	0.685
8	0.191	0.416	0.335	0.258	0.191	0.255	1.338	0.663
9	0.191	0.426	0.326	0.266	0.191	0.259	1.361	0.645

RP	PERCENT	INCIDENCE		DEV	D-FACT	EFF	LOSS COEFF		LOSS PARAM	
	SPAN	MEAN	SS				TOT	PROF	TOT	PROF
1	5.00	14.1	10.7	13.9	0.596	0.699	0.262	0.262	0.058	0.058
2	10.00	14.1	10.7	11.1	0.561	0.731	0.233	0.233	0.054	0.054
3	15.00	14.8	11.3	9.7	0.529	0.765	0.204	0.204	0.049	0.049
4	30.00	16.5	12.4	10.0	0.565	0.777	0.209	0.209	0.051	0.051
5	50.00	18.7	13.2	10.5	0.647	0.767	0.257	0.257	0.064	0.064
6	70.00	20.7	12.9	7.4	0.613	0.828	0.232	0.232	0.057	0.057
7	85.00	22.7	12.4	7.0	0.494	0.901	0.160	0.160	0.035	0.035
8	90.00	24.0	12.4	7.3	0.440	0.935	0.110	0.110	0.023	0.023
9	95.00	25.7	12.6	8.8	0.397	0.941	0.105	0.105	0.021	0.021

TABLE XXV. - BLADE-ELEMENT DATA AT BLADE EDGES FOR

ROTOR 15 (100 PERCENT DESIGN SPEED; STATOR RESET;

1 EXIT PYLON; INTRABLADE ROW INSTRUMENTATION

AT STATION 2b)

(a) Reading number 713

RP	RADII		ABS BETAM		REL BETAM		TOTAL TEMP		TOTAL PRESS	
	IN	OUT	IN	OUT	IN	OUT	IN	RATIO	IN	RATIO
1	24.133	23.424	0.3	43.2	62.9	47.3	289.0	1.163	10.05	1.552
2	23.510	22.885	0.5	41.7	60.6	44.3	288.8	1.158	10.12	1.575
3	22.883	22.347	0.4	41.5	59.3	42.3	288.6	1.154	10.13	1.574
4	21.026	20.731	-0.8	43.7	56.5	35.6	288.1	1.150	10.14	1.557
5	18.560	18.578	-0.8	45.8	52.8	24.5	287.9	1.144	10.14	1.535
6	16.076	16.426	-0.5	47.4	49.5	9.9	287.8	1.142	10.14	1.531
7	14.194	14.811	-0.6	50.2	47.6	-4.7	287.8	1.148	10.15	1.546
8	13.574	14.272	0.1	51.3	46.3	-9.4	287.8	1.151	10.14	1.546
9	12.959	13.734	-0.6	54.2	45.7	-11.9	287.9	1.148	10.13	1.453

RP	ABS VEL		REL VEL		MERID VEL		TANG VEL		WHEEL SPEED	
	IN	OUT	IN	OUT	IN	OUT	IN	OUT	IN	OUT
1	168.0	217.1	369.3	233.2	168.0	158.2	1.0	148.7	329.8	320.1
2	180.1	224.9	367.3	234.3	180.1	167.9	1.6	149.7	321.8	313.2
3	184.7	227.3	362.3	230.2	164.7	170.2	1.3	150.6	312.9	305.6
4	192.5	234.8	348.6	208.9	192.5	169.8	-2.8	162.2	287.8	283.8
5	195.2	245.8	322.5	188.3	195.2	171.4	-2.8	176.2	254.0	254.2
6	188.8	262.8	290.7	180.6	188.8	177.9	-1.5	193.5	219.6	224.4
7	179.0	283.5	265.6	182.3	179.0	181.7	-1.9	217.7	194.2	202.7
8	177.1	288.5	256.4	182.9	177.1	180.5	0.3	225.1	185.8	195.3
9	175.1	273.0	250.5	163.0	175.1	159.5	-1.7	221.6	177.4	188.0

RP	ABS MACH NO		REL MACH NO		MERID MACH NO		MERID PEAK SS	
	IN	OUT	IN	OUT	IN	OUT	VEL R	MACH NO
1	0.505	0.613	1.111	0.658	0.505	0.446	0.941	1.486
2	0.544	0.638	1.110	0.665	0.544	0.476	0.932	1.472
3	0.559	0.647	1.097	0.655	0.559	0.484	0.922	1.473
4	0.585	0.672	1.059	0.598	0.585	0.486	0.882	1.506
5	0.594	0.709	0.981	0.543	0.594	0.494	0.878	1.516
6	0.573	0.764	0.883	0.525	0.573	0.517	0.942	1.430
7	0.542	0.830	0.804	0.534	0.542	0.532	1.015	1.353
8	0.535	0.846	0.775	0.536	0.535	0.529	1.019	1.300
9	0.529	0.795	0.757	0.475	0.529	0.465	0.911	1.279

RP	PERCENT		INCIDENCE		DEV	D-FACT	EFF	LOSS COEFF		LOSS PARAM	
	SPAN	MEAN	SS	TOT				PROF	TOT	PROF	
1	5.00	4.7	1.3	8.8	0.512	0.823	0.152	0.114	0.038	0.028	
2	10.00	4.3	0.8	6.1	0.504	0.875	0.106	0.071	0.027	0.018	
3	15.00	4.6	1.0	5.0	0.507	0.900	0.085	0.051	0.022	0.013	
4	30.00	6.0	1.8	3.7	0.553	0.900	0.087	0.052	0.023	0.014	
5	50.00	7.4	1.9	3.8	0.577	0.906	0.088	0.060	0.023	0.016	
6	70.00	10.1	2.3	5.5	0.550	0.911	0.097	0.088	0.024	0.022	
7	85.00	14.0	3.7	6.4	0.502	0.896	0.135	0.134	0.030	0.030	
8	90.00	15.2	3.6	7.2	0.478	0.881	0.167	0.167	0.035	0.035	
9	95.00	17.3	4.2	10.2	0.536	0.760	0.338	0.338	0.067	0.067	

TABLE XXV. - Concluded. BLADE-ELEMENT DATA AT BLADE EDGES

FOR ROTOR 15 (100 PERCENT DESIGN SPEED; STATOR RESET;

1 EXIT PYLON; INTRABLADE ROW INSTRUMENTATION

AT STATION 2b)

(b) Reading number 712

RP.	RADII		ABS BETAM		REL BETAM		TOTAL TEMP		TOTAL PRESS	
	IN	OUT	IN	OUT	IN	OUT	IN	RATIO	IN	RATIO
1	24.133	23.424	0.7	46.7	66.0	49.4	289.4	1.164	10.06	1.520
2	23.510	22.885	0.9	45.0	63.7	46.0	289.1	1.160	10.13	1.540
3	22.883	22.347	0.6	44.6	62.4	44.2	288.7	1.157	10.13	1.537
4	21.026	20.731	-1.2	47.0	60.1	38.2	288.0	1.151	10.14	1.509
5	18.560	18.578	-1.3	49.9	57.1	26.4	287.8	1.147	10.15	1.491
6	16.076	16.426	-0.5	50.9	53.5	9.9	287.8	1.146	10.13	1.501
7	14.194	14.811	-0.3	51.3	50.4	-5.2	287.7	1.150	10.14	1.543
8	13.574	14.272	-0.2	52.3	49.4	-10.1	287.7	1.152	10.14	1.550
9	12.959	13.734	-0.2	54.8	48.4	-12.9	287.8	1.150	10.12	1.468

RP	ABS VEL		REL VEL		MERID VEL		TANG VEL		WHEEL SPEED	
	IN	OUT	IN	OUT	IN	OUT	IN	OUT	IN	OUT
1	146.0	209.0	358.3	220.3	146.0	143.4	1.8	152.1	329.0	319.4
2	157.3	217.1	355.0	221.0	157.3	153.5	2.5	153.4	320.8	312.3
3	162.3	218.9	350.5	217.3	162.3	155.9	1.8	153.7	312.4	305.1
4	167.0	223.3	335.0	193.8	167.0	152.3	-3.4	163.3	287.0	283.0
5	166.7	234.0	306.5	168.1	166.7	150.6	-3.7	179.1	253.6	253.8
6	163.5	253.3	275.0	162.3	163.5	159.9	-1.4	196.5	219.7	224.5
7	160.5	279.4	252.0	175.5	160.5	174.8	-0.7	218.0	193.5	202.0
8	159.2	285.8	244.8	177.5	159.2	174.7	-0.4	226.2	185.5	195.1
9	157.6	273.5	237.4	161.6	157.6	157.5	-0.5	223.6	177.1	187.6

RP	ABS MACH NO		REL MACH NO		MERID MACH NO		MERID PEAK SS	
	IN	OUT	IN	OUT	IN	OUT	VEL R	MACH NO
1	0.436	0.587	1.071	0.619	0.436	0.403	0.982	1.564
2	0.472	0.613	1.065	0.624	0.472	0.434	0.976	1.549
3	0.488	0.620	1.053	0.616	0.488	0.442	0.960	1.551
4	0.503	0.636	1.009	0.552	0.503	0.434	0.912	1.608
5	0.502	0.671	0.924	0.482	0.502	0.432	0.904	1.562
6	0.492	0.732	0.828	0.469	0.492	0.462	0.978	1.454
7	0.483	0.816	0.758	0.512	0.483	0.510	1.089	1.349
8	0.479	0.836	0.736	0.519	0.479	0.511	1.097	1.313
9	0.474	0.796	0.714	0.470	0.474	0.458	1.000	1.273

RP	PERCENT		INCIDENCE		DEV	D-FACT	EFF	LOSS COEFF		LOSS PARAM	
	SPAN	MEAN	SS	SS				TOT	PROF	TOT	PROF
1	5.00	7.7	4.4	10.9	0.536	0.774	0.202	0.156	0.048	0.037	
2	10.00	7.3	3.9	7.8	0.527	0.820	0.160	0.118	0.040	0.029	
3	15.00	7.7	4.1	6.8	0.530	0.834	0.149	0.107	0.037	0.027	
4	30.00	9.6	5.4	6.3	0.582	0.826	0.160	0.114	0.041	0.029	
5	50.00	11.7	6.2	5.7	0.624	0.825	0.180	0.152	0.047	0.039	
6	70.00	14.1	6.4	5.6	0.593	0.845	0.188	0.180	0.047	0.045	
7	85.00	16.8	6.5	5.9	0.501	0.880	0.172	0.172	0.038	0.038	
8	90.00	18.3	6.7	6.5	0.477	0.879	0.185	0.185	0.039	0.039	
9	95.00	20.1	7.0	9.2	0.517	0.773	0.355	0.355	0.071	0.071	

TABLE XXVI. - BLADE-ELEMENT DATA AT BLADE EDGES FOR
 ROTOR 15 (70 PERCENT DESIGN SPEED; STATOR RESET;
 1 EXIT PYLON; INTRABLADE ROW INSTRUMENTATION
 AT STATION 2b; READING NUMBER 721)

RP	RADI		ABS BETAM		REL BETAM		TOTAL TEMP		TOTAL PRESS	
	IN	OUT	IN	OUT	IN	OUT	IN	RATIO	IN	RATIO
1	24.133	23.424	12.5	58.1	71.6	56.8	292.4	1.068	10.04	1.216
2	23.510	22.885	8.9	54.2	68.3	51.8	291.5	1.069	10.08	1.220
3	22.883	22.347	0.3	49.1	67.0	48.7	288.3	1.077	10.14	1.221
4	21.026	20.731	-0.0	48.6	64.5	41.8	287.5	1.074	10.14	1.219
5	18.560	18.578	-0.8	51.4	61.4	29.2	287.4	1.073	10.14	1.217
6	16.076	16.426	-0.7	50.4	57.5	11.3	287.4	1.072	10.14	1.232
7	14.194	14.811	0.7	50.7	53.7	-3.6	287.5	1.073	10.14	1.250
8	13.574	14.272	-0.1	52.3	53.0	-9.3	287.5	1.074	10.14	1.254
9	12.959	13.734	-0.5	54.4	52.0	-12.9	287.5	1.075	10.14	1.230

RP	ABS VEL		REL VEL		MERID VEL		TANG VEL		WHEEL SPEED	
	IN	OUT	IN	OUT	IN	OUT	IN	OUT	IN	OUT
1	73.4	135.4	226.9	130.7	71.6	71.6	15.9	115.0	231.2	224.4
2	85.4	141.1	228.4	133.5	84.4	82.5	13.1	114.5	225.4	219.4
3	93.2	142.9	238.1	141.6	93.2	93.5	0.5	108.0	219.6	214.4
4	96.3	148.0	223.4	131.5	96.3	98.0	-0.1	111.0	201.5	198.7
5	97.6	157.4	204.1	112.5	97.5	98.2	-1.4	123.0	177.8	178.0
6	98.9	175.3	184.1	113.9	98.9	111.7	-1.3	135.1	154.1	157.4
7	99.0	193.2	167.2	122.5	99.0	122.3	1.1	149.5	135.9	141.8
8	98.4	198.4	163.4	123.0	98.4	121.4	-0.2	156.9	130.3	137.0
9	97.8	193.6	158.8	115.6	97.8	112.7	-0.9	157.4	124.2	131.6

RP	ABS MACH NO		REL MACH NO		MERID MACH NO		MERID PEAK SS	
	IN	OUT	IN	OUT	IN	OUT	VEL R	MACH NO
1	0.215	0.388	0.665	0.375	0.210	0.205	0.999	1.149
2	0.251	0.405	0.672	0.383	0.248	0.237	0.978	1.129
3	0.276	0.411	0.705	0.408	0.276	0.269	1.004	1.190
4	0.286	0.428	0.663	0.380	0.286	0.283	1.017	1.163
5	0.289	0.456	0.605	0.326	0.289	0.285	1.006	1.115
6	0.294	0.511	0.547	0.332	0.293	0.326	1.129	1.036
7	0.294	0.566	0.496	0.359	0.294	0.358	1.236	0.940
8	0.292	0.582	0.485	0.361	0.292	0.356	1.234	0.925
9	0.290	0.567	0.471	0.338	0.290	0.330	1.152	0.899

RP	PERCENT		INCIDENCE		DEV	D-FACT	EFF	LOSS COEFF		LOSS PARAM	
	SPAN	MEAN	SS	TOT				PROF	TOT	PROF	
1	5.00	13.4	10.0	18.3	0.580	0.848	0.128	0.128	0.026	0.026	
2	10.00	11.9	8.5	13.7	0.571	0.846	0.130	0.130	0.029	0.029	
3	15.00	12.3	8.7	11.4	0.561	0.765	0.201	0.201	0.046	0.046	
4	30.00	13.9	9.8	10.0	0.572	0.783	0.201	0.201	0.049	0.049	
5	50.00	16.0	10.5	8.6	0.625	0.794	0.218	0.218	0.055	0.055	
6	70.00	18.1	10.4	7.0	0.570	0.852	0.189	0.189	0.047	0.047	
7	85.00	20.1	9.8	7.5	0.469	0.900	0.155	0.155	0.034	0.034	
8	90.00	21.8	10.2	7.3	0.457	0.905	0.155	0.155	0.033	0.033	
9	95.00	23.6	10.5	9.2	0.481	0.813	0.322	0.322	0.064	0.064	

TABLE XXVII. - BLADE-ELEMENT DATA AT BLADE EDGES FOR
 ROTOR 15 (50 PERCENT DESIGN SPEED; STATOR RESET;
 1 EXIT PYLON; INTRABLADE ROW INSTRUMENTATION
 AT STATION 2b; READING NUMBER 723)

RP	RADII		ABS BETAM		REL BETAM		TOTAL TEMP		TOTAL PRESS	
	IN	OUT	IN	OUT	IN	OUT	IN	RATIO	IN	RATIO
1	24.133	23.424	78.0	66.7	82.8	61.8	295.7	1.012	10.25	1.089
2	23.510	22.885	69.7	62.7	82.0	55.0	293.6	1.017	10.11	1.107
3	22.883	22.347	46.1	59.9	74.6	51.2	291.7	1.022	10.05	1.110
4	21.026	20.731	12.4	52.5	63.4	42.3	288.8	1.027	10.07	1.106
5	18.560	18.578	1.5	48.8	59.6	29.8	286.7	1.032	10.13	1.104
6	16.076	16.426	-0.4	49.0	56.2	13.0	285.8	1.036	10.15	1.107
7	14.194	14.811	-0.9	51.8	53.4	-3.8	285.6	1.039	10.17	1.112
8	13.574	14.272	-1.2	53.7	52.4	-9.5	285.4	1.040	10.17	1.109
9	12.959	13.734	-1.3	56.7	51.8	-13.3	285.5	1.041	10.16	1.096

RP	ABS VEL		REL VEL		MERID VEL		TANG VEL		WHEEL SPEED	
	IN	OUT	IN	OUT	IN	OUT	IN	OUT	IN	OUT
1	62.6	96.6	104.5	80.9	13.1	38.2	61.2	88.7	164.9	160.0
2	46.9	101.4	117.9	81.0	16.3	46.4	44.0	90.1	160.8	156.5
3	48.4	102.6	126.2	82.2	33.6	51.4	34.9	88.8	156.5	152.9
4	66.4	105.4	145.0	86.7	64.9	64.2	14.3	83.6	144.0	141.9
5	73.2	112.4	144.7	85.3	73.2	74.1	1.9	84.5	126.7	126.9
6	73.9	123.9	132.8	83.5	73.9	81.4	-0.5	93.5	109.8	112.2
7	73.0	136.0	122.3	84.4	72.9	84.2	-1.1	106.8	97.1	101.3
8	72.3	137.5	118.5	82.5	72.3	81.4	-1.5	110.9	92.5	97.2
9	70.7	132.5	114.4	74.7	70.7	72.7	-1.7	110.8	88.3	93.6

RP	ABS MACH NO		REL MACH NO		MERID MACH NO		MERID PEAK SS	
	IN	OUT	IN	OUT	IN	OUT	VEL R	MACH NO
1	0.182	0.281	0.304	0.235	0.038	0.111	2.926	0.648
2	0.137	0.295	0.344	0.236	0.048	0.135	2.846	0.747
3	0.142	0.299	0.369	0.239	0.098	0.150	1.533	0.721
4	0.196	0.308	0.427	0.254	0.191	0.188	0.989	0.735
5	0.217	0.329	0.428	0.250	0.217	0.217	1.012	0.762
6	0.219	0.364	0.394	0.245	0.219	0.239	1.101	0.728
7	0.216	0.400	0.363	0.248	0.216	0.248	1.154	0.683
8	0.214	0.405	0.352	0.243	0.214	0.240	1.126	0.664
9	0.210	0.389	0.339	0.219	0.210	0.214	1.028	0.646

RP	PERCENT SPAN	INCIDENCE		DEV	D-FACT	EFF	LOSS COEFF		LOSS PARAM	
		MEAN	SS				TOT	PROF	TOT	PROF
1	5.00	24.6	21.3	23.4	0.314	2.065	-0.711	-0.711	-0.123	-0.123
2	10.00	25.7	22.2	16.9	0.447	1.736	-0.552	-0.552	-0.113	-0.113
3	15.00	19.9	16.3	13.9	0.494	1.364	-0.310	-0.310	-0.068	-0.068
4	30.00	12.9	8.7	10.4	0.555	1.082	-0.064	-0.064	-0.015	-0.015
5	50.00	14.2	8.7	9.1	0.576	0.902	0.089	0.089	0.022	0.022
6	70.00	16.8	9.0	8.7	0.552	0.827	0.205	0.205	0.050	0.050
7	85.00	19.8	9.4	7.4	0.511	0.786	0.323	0.323	0.072	0.072
8	90.00	21.3	9.7	7.1	0.511	0.750	0.408	0.408	0.086	0.086
9	95.00	23.5	10.4	8.7	0.553	0.650	0.618	0.618	0.122	0.122

TABLE XXVIII. - BLADE-ELEMENT DATA AT BLADE EDGES FOR

STATOR 9 (100 PERCENT DESIGN SPEED; INTRABLADE ROW

INSTRUMENTATION AT STATION 2a)

(a) Reading number 558

RP	RADII		ABS BETAM		REL BETAM		TOTAL TEMP		TOTAL PRESS	
	IN	OUT	IN	OUT	IN	OUT	IN	RATIO	IN	RATIO
1	22.949	22.944	27.8	7.5	27.8	7.5	324.2	0.997	14.10	0.925
2	22.479	22.474	27.5	3.9	27.5	3.9	323.7	0.999	14.27	0.970
3	22.004	21.999	27.4	3.1	27.4	3.1	323.5	0.999	14.38	0.973
4	20.577	20.574	29.3	5.4	29.3	5.4	324.2	1.000	14.67	0.960
5	18.682	18.717	32.2	5.8	32.2	5.8	325.7	1.000	14.91	0.952
6	16.787	16.916	35.9	2.6	35.9	2.6	327.4	1.000	15.26	0.946
7	15.342	15.624	41.9	1.5	41.9	1.5	330.9	0.999	15.89	0.926
8	14.849	15.164	44.5	1.8	44.5	1.8	331.6	1.001	15.95	0.940
9	14.343	14.684	47.8	3.7	47.8	3.7	331.2	0.999	15.69	0.904

RP	ABS VEL		REL VEL		MERID VEL		TANG VEL		WHEEL SPEED	
	IN	OUT	IN	OUT	IN	OUT	IN	OUT	IN	OUT
1	245.5	206.5	245.5	206.5	217.1	204.8	114.7	26.9	0.	0.
2	251.1	228.7	251.1	228.7	222.6	228.2	116.1	15.7	0.	0.
3	255.9	231.1	255.9	231.1	227.1	230.8	117.8	12.6	0.	0.
4	266.4	228.7	266.4	228.7	232.4	227.7	130.3	21.4	0.	0.
5	284.4	230.2	284.4	230.2	240.8	229.0	151.4	23.4	0.	0.
6	301.7	234.6	301.7	234.6	244.5	234.4	176.8	10.8	0.	0.
7	313.9	244.1	313.9	244.1	233.8	244.1	209.5	6.4	0.	0.
8	311.9	248.9	311.9	248.9	222.4	248.7	218.7	7.7	0.	0.
9	304.7	232.1	304.7	232.1	204.6	231.6	225.8	14.9	0.	0.

RP	ABS MACH NO		REL MACH NO		MERID MACH NO		MERID PEAK SS	
	IN	OUT	IN	OUT	IN	OUT	VEL R	MACH NO
1	0.714	0.593	0.714	0.593	0.631	0.588	0.943	1.014
2	0.733	0.662	0.733	0.662	0.650	0.660	1.025	1.029
3	0.748	0.669	0.748	0.669	0.664	0.668	1.016	1.045
4	0.782	0.661	0.782	0.661	0.682	0.658	0.980	1.122
5	0.840	0.664	0.840	0.664	0.711	0.660	0.951	1.241
6	0.896	0.676	0.896	0.676	0.726	0.675	0.959	1.363
7	0.933	0.702	0.933	0.702	0.695	0.702	1.044	2.568
8	0.925	0.716	0.925	0.716	0.659	0.715	1.119	0.015
9	0.900	0.664	0.900	0.664	0.605	0.663	1.132	2.745

RP	PERCENT		INCIDENCE		DEV	D-FACT	EFF	LOSS COEFF		LOSS PARAM.	
	SPAN	MEAN	SS	TOT				PROF	TOT	PROF	
1	5.00	6.6	-7.5	12.3	0.283	0.	0.261	0.261	0.090	0.090	
2	10.00	8.0	-6.3	8.4	0.226	0.	0.100	0.100	0.034	0.034	
3	15.00	8.8	-5.5	7.4	0.234	0.	0.087	0.087	0.029	0.029	
4	30.00	9.0	-4.1	9.9	0.269	0.	0.120	0.120	0.037	0.037	
5	50.00	7.3	-3.9	11.0	0.319	0.	0.130	0.130	0.037	0.037	
6	70.00	5.0	-4.3	8.6	0.363	0.	0.132	0.126	0.034	0.032	
7	85.00	4.6	-3.5	8.3	0.372	0.	0.172	-0.213	0.040	-0.050	
8	90.00	4.9	-2.7	8.8	0.353	0.	0.142	0.142	0.032	0.032	
9	95.00	6.0	-1.2	11.0	0.387	0.	0.234	-0.249	0.051	-0.054	

TABLE XXVIII. - Continued. BLADE-ELEMENT DATA AT BLADE

EDGES FOR STATOR 9 (100 PERCENT DESIGN SPEED;

INTRABLADE ROW INSTRUMENTATION

AT STATION 2a)

(b) Reading number 538

RP	RADII		ABS BETAM		REL BETAM		TOTAL TEMP		TOTAL PRESS	
	IN	OUT	IN	OUT	IN	OUT	IN	RATIO	IN	RATIO
1	22.949	22.944	28.1	7.9	28.1	7.9	325.2	0.996	14.14	0.932
2	22.479	22.474	27.2	4.8	27.2	4.8	324.7	0.999	14.35	0.968
3	22.004	21.999	27.3	3.5	27.3	3.5	324.8	0.998	14.53	0.974
4	20.577	20.574	29.3	3.1	29.3	3.1	325.1	1.000	14.79	0.979
5	18.682	18.717	32.2	3.8	32.2	3.8	326.3	0.998	15.05	0.968
6	16.787	16.916	35.9	0.8	35.9	0.8	327.6	1.000	15.41	0.973
7	15.342	15.624	41.8	1.0	41.8	1.0	330.5	1.001	15.80	0.970
8	14.849	15.164	44.8	2.4	44.8	2.4	331.1	1.001	15.87	0.961
9	14.343	14.684	48.1	4.1	48.1	4.1	331.5	0.998	15.71	0.916

RP	ABS VEL		REL VEL		MERID VEL		TANG VEL		WHEEL SPEED	
	IN	OUT	IN	OUT	IN	OUT	IN	OUT	IN	OUT
1	242.1	184.9	242.1	184.9	213.5	183.1	114.0	25.5	0.	0.
2	249.1	207.4	249.1	207.4	221.5	206.7	114.0	17.2	0.	0.
3	255.6	213.6	255.6	213.6	227.2	213.2	117.2	12.9	0.	0.
4	265.9	218.1	265.9	218.1	232.0	217.8	130.0	11.7	0.	0.
5	284.4	217.9	284.4	217.9	240.6	217.4	151.6	14.4	0.	0.
6	301.2	225.8	301.2	225.8	243.9	225.7	176.7	3.3	0.	0.
7	307.4	233.7	307.4	233.7	229.1	233.7	205.0	4.1	0.	0.
8	305.5	232.6	305.5	232.6	216.9	232.4	215.2	9.8	0.	0.
9	300.5	213.0	300.5	213.0	200.5	212.5	223.8	15.3	0.	0.

RP	ABS MACH NO		REL MACH NO		MERID MACH NO		MERID PEAK SS	
	IN	OUT	IN	OUT	IN	OUT	VEL R	MACH NO
1	0.702	0.526	0.702	0.526	0.619	0.521	0.857	1.003
2	0.725	0.595	0.725	0.595	0.645	0.592	0.933	1.012
3	0.746	0.614	0.746	0.614	0.663	0.613	0.939	1.039
4	0.779	0.627	0.779	0.627	0.680	0.626	0.939	1.117
5	0.839	0.625	0.839	0.625	0.710	0.624	0.903	1.240
6	0.894	0.648	0.894	0.648	0.724	0.648	0.926	1.361
7	0.911	0.669	0.911	0.669	0.679	0.669	1.020	1.480
8	0.904	0.665	0.904	0.665	0.642	0.664	1.071	1.524
9	0.886	0.605	0.886	0.605	0.591	0.604	1.060	1.562

RP	PERCENT	INCIDENCE		DEV	D-FACT	EFF	LOSS COEFF		LOSS PARAM	
	SPAN	MEAN	SS				TOT	PROF	TOT	PROF
1	5.00	6.9	-7.2	12.7	0.364	0.	0.244	0.244	0.084	0.084
2	10.00	7.8	-6.5	9.2	0.300	0.	0.109	0.109	0.037	0.037
3	15.00	8.7	-5.6	7.8	0.301	0.	0.084	0.084	0.028	0.028
4	30.00	8.9	-4.2	7.6	0.319	0.	0.065	0.065	0.020	0.020
5	50.00	7.3	-3.9	8.9	0.371	0.	0.086	0.085	0.024	0.024
6	70.00	5.1	-4.3	6.8	0.397	0.	0.067	0.061	0.017	0.016
7	85.00	4.5	-3.5	7.8	0.391	0.	0.073	0.057	0.017	0.013
8	90.00	5.2	-2.5	9.5	0.388	0.	0.095	0.074	0.021	0.017
9	95.00	6.4	-0.9	11.5	0.440	0.	0.211	0.187	0.046	0.040

TABLE XXVIII. - Continued. BLADE-ELEMENT DATA AT BLADE

EDGES FOR STATOR 9 (100 PERCENT DESIGN SPEED);

INTRABLADE ROW INSTRUMENTATION

AT STATION 2a)

(c) Reading number 560

RP	RADI		ABS BETAM		REL BETAM		TOTAL TEMP		TOTAL PRESS	
	IN	OUT	IN	OUT	IN	OUT	IN	RATIO	IN	RATIO
1	22.949	22.944	30.6	7.8	30.6	7.8	326.8	0.999	14.68	0.929
2	22.479	22.474	29.8	5.3	29.8	5.3	326.7	1.000	14.89	0.966
3	22.004	21.999	30.1	3.9	30.1	3.9	326.6	1.000	15.03	0.973
4	20.577	20.574	32.0	3.1	32.0	3.1	326.8	0.999	15.15	0.977
5	18.682	18.717	34.7	3.0	34.7	3.0	327.4	1.000	15.39	0.970
6	16.787	16.916	38.9	1.0	38.9	1.0	328.2	1.000	15.58	0.975
7	15.342	15.624	45.1	1.8	45.1	1.8	330.2	1.000	15.76	0.969
8	14.849	15.164	47.8	3.6	47.8	3.6	330.5	1.001	15.84	0.951
9	14.343	14.684	50.9	4.3	50.9	4.3	330.9	0.999	15.80	0.919

RP	ABS VEL		REL VEL		MERID VEL		TANG VEL		WHEEL SPEED	
	IN	OUT	IN	OUT	IN	OUT	IN	OUT	IN	OUT
1	245.2	177.2	245.2	177.2	211.1	175.6	124.6	24.0	0.	0.
2	252.4	200.5	252.4	200.5	219.0	199.6	125.5	18.5	0.	0.
3	255.9	206.5	255.9	206.5	221.4	206.0	128.3	14.2	0.	0.
4	264.2	207.0	264.2	207.0	224.0	206.7	140.0	11.1	0.	0.
5	280.2	207.4	280.2	207.4	230.3	207.1	159.7	10.8	0.	0.
6	289.3	208.8	289.3	208.8	225.3	208.8	181.5	3.7	0.	0.
7	291.5	211.3	291.5	211.3	205.7	211.2	206.5	6.7	0.	0.
8	291.5	207.0	291.5	207.0	195.8	206.6	216.0	12.9	0.	0.
9	290.3	193.6	290.3	193.6	183.2	193.1	225.3	14.6	0.	0.

RP	ABS MACH NO		REL MACH NO		MERID MACH NO		MERID PEAK SS	
	IN	OUT	IN	OUT	IN	OUT	VEL R	MACH NO
1	0.710	0.501	0.710	0.501	0.611	0.497	0.832	1.074
2	0.733	0.571	0.733	0.571	0.636	0.569	0.912	1.088
3	0.745	0.590	0.745	0.590	0.644	0.588	0.930	1.108
4	0.771	0.591	0.771	0.591	0.654	0.590	0.923	1.177
5	0.823	0.591	0.823	0.591	0.676	0.591	0.900	1.288
6	0.853	0.595	0.853	0.595	0.664	0.595	0.926	1.383
7	0.857	0.601	0.857	0.601	0.605	0.600	1.027	1.489
8	0.857	0.587	0.857	0.587	0.575	0.586	1.055	1.535
9	0.852	0.547	0.852	0.547	0.538	0.545	1.054	1.584

RP	PERCENT		INCIDENCE		DEV	D-FACT	EFF	LOSS COEFF		LOSS PARAM	
	SPAN	MEAN	SS	TOT				PROF	TOT	PROF	
1	5.00	9.3	-4.8	12.6	0.420	0.	0.247	0.247	0.085	0.085	
2	10.00	10.3	-4.0	9.8	0.351	0.	0.115	0.115	0.039	0.039	
3	15.00	11.5	-2.8	8.2	0.342	0.	0.089	0.089	0.030	0.030	
4	30.00	11.7	-1.4	7.6	0.369	0.	0.069	0.069	0.022	0.022	
5	50.00	9.9	-1.3	8.1	0.411	0.	0.084	0.084	0.024	0.024	
6	70.00	8.0	-1.4	6.9	0.435	0.	0.066	0.062	0.017	0.016	
7	85.00	7.8	-0.2	8.6	0.433	0.	0.081	0.068	0.019	0.016	
8	90.00	8.2	0.6	10.6	0.445	0.	0.129	0.111	0.029	0.025	
9	95.00	9.1	1.9	11.7	0.489	0.	0.214	0.190	0.046	0.041	

TABLE XXVIII. - Continued. BLADE-ELEMENT DATA AT BLADE

EDGES FOR STATOR 9 (100 PERCENT DESIGN SPEED;

INTRABLADE ROW INSTRUMENTATION

AT STATION 2a)

(d) Reading number 539

RP	RADI I		ABS BETAM		REL BETAM		TOTAL TEMP		TOTAL PRESS	
	IN	OUT	IN	OUT	IN	OUT	IN	RATIO	IN	RATIO
1	22.949	22.944	30.7	7.7	30.7	7.7	328.2	0.998	14.62	0.942
2	22.479	22.474	29.3	5.4	29.3	5.4	327.5	1.000	14.94	0.966
3	22.004	21.999	29.4	3.8	29.4	3.8	327.3	1.000	15.14	0.969
4	20.577	20.574	31.7	3.1	31.7	3.1	327.4	0.999	15.22	0.977
5	18.682	18.717	33.9	3.1	33.9	3.1	327.4	1.000	15.42	0.969
6	16.787	16.916	38.1	1.2	38.1	1.2	328.1	0.999	15.57	0.974
7	15.342	15.624	44.0	1.9	44.0	1.9	329.8	1.001	15.75	0.968
8	14.849	15.164	47.2	3.7	47.2	3.7	330.7	0.999	15.89	0.945
9	14.343	14.684	50.3	4.5	50.3	4.5	330.9	0.999	15.83	0.919

RP	ABS VEL		REL VEL		MERID VEL		TANG VEL		WHEEL SPEED	
	IN	OUT	IN	OUT	IN	OUT	IN	OUT	IN	OUT
1	242.2	178.1	242.2	178.1	208.2	176.5	123.7	23.9	0.	0.
2	251.5	199.0	251.5	199.0	219.2	198.1	123.2	18.9	0.	0.
3	257.2	205.2	257.2	205.2	224.1	204.7	126.2	13.7	0.	0.
4	264.1	207.2	264.1	207.2	224.6	206.9	138.8	11.1	0.	0.
5	281.0	206.1	281.0	206.1	233.2	205.8	156.9	11.0	0.	0.
6	288.8	207.6	288.8	207.6	227.2	207.6	178.4	4.2	0.	0.
7	291.6	210.8	291.6	210.8	209.8	210.6	202.5	7.1	0.	0.
8	292.7	206.0	292.7	206.0	198.9	205.6	214.7	13.4	0.	0.
9	290.4	194.3	290.4	194.3	185.7	193.7	223.3	15.3	0.	0.

RP	ABS MACH NO		REL MACH NO		MERID MACH NO		MERID PEAK SS	
	IN	OUT	IN	OUT	IN	OUT	VEL R	MACH NO
1	0.699	0.503	0.699	0.503	0.601	0.499	0.848	1.061
2	0.729	0.566	0.729	0.566	0.636	0.563	0.904	1.069
3	0.748	0.585	0.748	0.585	0.652	0.583	0.913	1.095
4	0.770	0.591	0.770	0.591	0.655	0.590	0.921	1.169
5	0.826	0.587	0.826	0.587	0.685	0.587	0.883	1.269
6	0.851	0.592	0.851	0.592	0.669	0.592	0.914	1.360
7	0.858	0.599	0.858	0.599	0.617	0.599	1.004	1.457
8	0.860	0.584	0.860	0.584	0.585	0.583	1.033	1.522
9	0.852	0.549	0.852	0.549	0.545	0.547	1.043	1.566

RP	PERCENT		INCIDENCE		DEV	D-FACT	EFF	LOSS COEFF		LOSS PARAM	
	SPAN	MEAN	SS	TOT				PROF	TOT	PROF	
1	5.00	9.5	-4.6	12.5	0.408	0.	0.207	0.207	0.071	0.071	
2	10.00	9.8	-4.5	9.9	0.350	0.	0.114	0.114	0.039	0.039	
3	15.00	10.8	-3.5	8.1	0.349	0.	0.099	0.099	0.033	0.033	
4	30.00	11.4	-1.7	7.6	0.367	0.	0.069	0.069	0.022	0.022	
5	50.00	9.0	-2.1	8.2	0.414	0.	0.087	0.086	0.025	0.025	
6	70.00	7.3	-2.1	7.1	0.435	0.	0.069	0.066	0.018	0.017	
7	85.00	6.7	-1.4	8.7	0.432	0.	0.083	0.073	0.019	0.017	
8	90.00	7.6	-0.0	10.8	0.449	0.	0.145	0.128	0.032	0.029	
9	95.00	8.5	1.2	11.9	0.485	0.	0.214	0.192	0.046	0.042	

TABLE XXVIII. - Continued. BLADE-ELEMENT DATA AT BLADE

EDGES FOR STATOR 9 (100 PERCENT DESIGN SPEED;

INTRABLADE ROW INSTRUMENTATION

AT STATION 2a)

(e) Reading number 543

RP	RADII		ABS BETAM		REL BETAM		TOTAL TEMP		TOTAL PRESS	
	IN	OUT	IN	OUT	IN	OUT	IN	RATIO	IN	RATIO
1	22.949	22.944	32.4	7.1	32.4	7.1	330.9	1.002	15.38	0.929
2	22.479	22.474	30.2	5.1	30.2	5.1	328.7	1.001	15.18	0.960
3	22.004	21.999	30.9	3.5	30.9	3.5	328.0	1.000	15.35	0.962
4	20.577	20.574	32.1	2.9	32.1	2.9	327.6	0.999	15.37	0.972
5	18.682	18.717	34.4	2.8	34.4	2.8	327.6	1.000	15.37	0.973
6	16.787	16.916	38.1	2.0	38.1	2.0	328.0	1.000	15.53	1.017
7	15.342	15.624	44.2	1.7	44.2	1.7	330.0	1.001	15.72	0.970
8	14.849	15.164	47.2	3.5	47.2	3.5	330.5	1.000	15.80	0.949
9	14.343	14.684	50.1	4.3	50.1	4.3	331.0	0.998	15.92	0.914

RP	ABS VEL		REL VEL		MERID VEL		TANG VEL		WHEEL SPEED	
	IN	OUT	IN	OUT	IN	OUT	IN	OUT	IN	OUT
1	251.5	183.8	251.5	183.8	212.3	182.4	134.8	22.6	0.	0.
2	252.2	198.6	252.2	198.6	217.9	197.8	127.0	17.6	0.	0.
3	260.4	204.7	260.4	204.7	223.4	204.3	133.8	12.6	0.	0.
4	263.8	205.1	263.8	205.1	223.4	204.8	140.3	10.5	0.	0.
5	277.4	204.7	277.4	204.7	229.0	204.4	156.6	10.0	0.	0.
6	287.2	216.1	287.2	216.1	225.9	215.9	177.3	7.5	0.	0.
7	290.0	210.0	290.0	210.0	208.1	209.9	202.0	6.4	0.	0.
8	290.1	204.9	290.1	204.9	197.0	204.5	213.0	12.4	0.	0.
9	291.2	194.1	291.2	194.1	186.9	193.6	223.3	14.5	0.	0.

RP	ABS MACH NO		REL MACH NO		MERID MACH NO		MERID PEAK SS VEL R MACH NO	
	IN	OUT	IN	OUT	IN	OUT		
1	0.725	0.517	0.725	0.517	0.612	0.513	0.859	1.143
2	0.730	0.563	0.730	0.563	0.631	0.561	0.908	1.093
3	0.757	0.583	0.757	0.583	0.650	0.581	0.914	1.149
4	0.769	0.584	0.769	0.584	0.651	0.584	0.917	1.178
5	0.814	0.583	0.814	0.583	0.672	0.582	0.893	1.262
6	0.846	0.617	0.846	0.617	0.665	0.617	0.956	1.351
7	0.852	0.597	0.852	0.597	0.612	0.597	1.009	1.453
8	0.852	0.581	0.852	0.581	0.579	0.580	1.038	1.509
9	0.855	0.549	0.855	0.549	0.549	0.547	1.036	1.565

RP	PERCENT SPAN	INCIDENCE		DEV	D-FACT	EFF	LOSS COEFF		LOSS PARAM	
		MEAN	SS				TOT	PROF	TOT	PROF
1	5.00	11.2	-2.9	11.9	0.425	0.	0.239	0.239	0.083	0.083
2	10.00	10.7	-3.6	9.6	0.361	0.	0.135	0.135	0.046	0.046
3	15.00	12.3	-2.0	7.8	0.370	0.	0.119	0.119	0.040	0.040
4	30.00	11.8	-1.3	7.4	0.377	0.	0.085	0.085	0.027	0.027
5	50.00	9.5	-1.7	8.0	0.412	0.	0.075	0.075	0.021	0.021
6	70.00	7.3	-2.1	7.9	0.398	0.	-0.046	-0.049	-0.012	-0.012
7	85.00	6.9	-1.2	8.5	0.432	0.	0.079	0.070	0.018	0.016
8	90.00	7.7	0.0	10.5	0.447	0.	0.136	0.122	0.031	0.027
9	95.00	8.3	1.1	11.6	0.487	0.	0.226	0.204	0.049	0.044

TABLE XXVIII. - Concluded. BLADE-ELEMENT DATA AT BLADE

EDGES FOR STATOR 9 (100 PERCENT DESIGN SPEED;

INTRABLADE ROW INSTRUMENTATION

AT STATION 2a)

(f) Reading number 551

RP	RADII		ABS BETAM		REL BETAM		TOTAL TEMP		TOTAL PRESS	
	IN	OUT	IN	OUT	IN	OUT	IN	RATIO	IN	RATIO
1	22.949	22.944	35.5	6.1	35.5	6.1	334.9	0.998	15.78	0.936
2	22.479	22.474	33.9	4.5	33.9	4.5	333.3	0.998	15.89	0.950
3	22.004	21.999	34.0	4.1	34.0	4.1	332.0	1.000	15.88	0.951
4	20.577	20.574	34.9	3.9	34.9	3.9	330.1	1.000	15.69	0.963
5	18.682	18.717	35.8	3.1	35.8	3.1	328.2	1.001	15.54	0.971
6	16.787	16.916	39.2	1.3	39.2	1.3	328.0	1.000	15.47	0.975
7	15.342	15.624	45.4	2.1	45.4	2.1	329.9	0.999	15.68	0.965
8	14.849	15.164	48.0	3.9	48.0	3.9	330.9	0.997	15.82	0.938
9	14.343	14.684	50.7	4.1	50.7	4.1	331.1	0.997	15.82	0.928

RP	ABS VEL		REL VEL		MERID VEL		TANG VEL		WHEEL SPEED	
	IN	OUT	IN	OUT	IN	OUT	IN	OUT	IN	OUT
1	247.9	186.7	247.9	186.7	201.8	185.7	144.0	19.7	0.	0.
2	252.7	195.9	252.7	195.9	209.6	195.3	141.1	15.3	0.	0.
3	255.5	195.5	255.5	195.5	211.8	195.0	142.9	14.1	0.	0.
4	259.1	195.1	259.1	195.1	212.4	194.7	148.4	13.1	0.	0.
5	272.7	198.6	272.7	198.6	221.1	198.3	159.7	10.8	0.	0.
6	279.9	198.4	279.9	198.4	216.8	198.3	177.0	4.4	0.	0.
7	284.8	202.6	284.8	202.6	200.0	202.5	202.8	7.6	0.	0.
8	286.9	196.6	286.9	196.6	192.1	196.1	213.0	13.2	0.	0.
9	286.4	192.3	286.4	192.3	181.5	191.8	221.5	13.9	0.	0.

RP	ABS MACH NO		REL MACH NO		MERID MACH NO		MERID PEAK SS	
	IN	OUT	IN	OUT	IN	OUT	VEL R	MACH NO
1	0.709	0.523	0.709	0.523	0.577	0.520	0.920	1.192
2	0.726	0.552	0.726	0.552	0.602	0.550	0.932	1.178
3	0.737	0.551	0.737	0.551	0.611	0.550	0.920	1.194
4	0.750	0.552	0.750	0.552	0.615	0.551	0.917	1.220
5	0.797	0.564	0.797	0.564	0.646	0.563	0.897	1.277
6	0.821	0.564	0.821	0.564	0.636	0.564	0.915	1.343
7	0.835	0.575	0.835	0.575	0.586	0.574	1.012	1.459
8	0.841	0.556	0.841	0.556	0.563	0.555	1.021	1.510
9	0.839	0.543	0.839	0.543	0.531	0.542	1.056	1.553

RP	PERCENT		INCIDENCE		DEV	D-FACT	EFF	LOSS COEFF		LOSS PARAM	
	SPAN	MEAN	SS	TOT				PROF	TOT	PROF	
1	5.00	14.3	0.2	10.9	0.422	0.	0.225	0.225	0.078	0.078	
2	10.00	14.4	0.1	9.0	0.395	0.	0.169	0.169	0.058	0.058	
3	15.00	15.4	1.1	8.4	0.404	0.	0.162	0.162	0.054	0.054	
4	30.00	14.6	1.5	8.4	0.410	0.	0.118	0.118	0.037	0.037	
5	50.00	11.0	-0.2	8.3	0.427	0.	0.085	0.085	0.024	0.024	
6	70.00	8.4	-1.0	7.2	0.449	0.	0.069	0.067	0.018	0.017	
7	85.00	8.1	0.1	8.9	0.447	0.	0.096	0.087	0.022	0.020	
8	90.00	8.4	0.7	10.9	0.470	0.	0.167	0.153	0.037	0.034	
9	95.00	8.9	1.7	11.5	0.484	0.	0.196	0.178	0.043	0.039	

TABLE XXIX. - BLADE-ELEMENT DATA AT BLADE EDGES FOR
 STATOR 9 (100 PERCENT DESIGN SPEED; INTRABLADE ROW
 INSTRUMENTATION AT STATION 2b)

(a) Reading number 600

RP	RADI		ABS BETAM		REL BETAM		TOTAL TEMP		TOTAL PRESS	
	IN	OUT	IN	OUT	IN	OUT	IN	RATIO	IN	RATIO
1	22.949	22.944	29.2	6.9	29.2	6.9	323.9	0.999	13.48	0.967
2	22.479	22.474	27.9	3.6	27.9	3.6	323.3	1.000	14.06	0.982
3	22.004	21.999	27.5	2.4	27.5	2.4	322.6	1.001	14.19	0.986
4	20.577	20.574	29.1	3.4	29.1	3.4	323.3	1.001	14.52	0.977
5	18.682	18.717	32.1	4.7	32.1	4.7	324.6	1.002	14.85	0.967
6	16.787	16.916	36.0	1.6	36.0	1.6	326.1	1.003	15.20	0.966
7	15.342	15.624	41.6	0.9	41.6	0.9	329.8	1.000	15.72	0.954
8	14.849	15.164	44.0	1.6	44.0	1.6	331.0	0.998	15.68	0.958
9	14.343	14.684	47.8	4.0	47.8	4.0	331.0	0.997	15.11	0.941

RP	ABS VEL		REL VEL		MERID VEL		TANG VEL		WHEEL SPEED	
	IN	OUT	IN	OUT	IN	OUT	IN	OUT	IN	OUT
1	231.7	197.6	231.7	197.6	202.3	196.2	113.1	23.7	0.	0.
2	246.4	220.0	246.4	220.0	217.7	219.6	115.4	13.7	0.	0.
3	249.5	223.0	249.5	223.0	221.4	222.8	115.1	9.5	0.	0.
4	258.4	223.7	258.4	223.7	225.7	223.3	125.9	13.3	0.	0.
5	276.2	225.2	276.2	225.2	234.0	224.4	146.6	18.5	0.	0.
6	293.1	231.0	293.1	231.0	237.2	230.9	172.3	6.5	0.	0.
7	306.0	240.4	306.0	240.4	228.9	240.4	203.1	3.6	0.	0.
8	306.9	241.6	306.9	241.6	220.9	241.5	213.0	6.6	0.	0.
9	298.8	224.1	298.8	224.1	200.9	223.6	221.2	15.8	0.	0.

RP	ABS MACH NO		REL MACH NO		MERID MACH NO		MERID PEAK SS	
	IN	OUT	IN	OUT	IN	OUT	VEL R	MACH NO
1	0.671	0.565	0.671	0.565	0.585	0.561	0.970	0.984
2	0.718	0.634	0.718	0.634	0.634	0.633	1.009	1.018
3	0.729	0.644	0.729	0.644	0.647	0.644	1.007	1.019
4	0.757	0.646	0.757	0.646	0.661	0.645	0.989	1.082
5	0.814	0.648	0.814	0.648	0.689	0.646	0.959	1.199
6	0.869	0.665	0.869	0.665	0.703	0.664	0.974	1.325
7	0.907	0.691	0.907	0.691	0.679	0.691	1.050	2.476
8	0.908	0.694	0.908	0.694	0.654	0.694	1.093	2.572
9	0.881	0.640	0.881	0.640	0.592	0.639	1.113	2.680

RP	PERCENT	INCIDENCE		DEV	D-FACT	EFF	LOSS COEFF		LOSS PARAM	
	SPAN	MEAN	SS				TOT	PROF	TOT	PROF
1	5.00	8.0	-6.1	11.7	0.282	0.	0.128	0.128	0.044	0.044
2	10.00	8.4	-5.9	8.1	0.248	0.	0.061	0.061	0.021	0.021
3	15.00	8.9	-5.4	6.7	0.248	0.	0.048	0.048	0.016	0.016
4	30.00	8.8	-4.3	7.9	0.271	0.	0.074	0.074	0.023	0.023
5	50.00	7.2	-4.0	9.8	0.317	0.	0.094	0.094	0.027	0.027
6	70.00	5.2	-4.2	7.5	0.356	0.	0.089	0.086	0.023	0.022
7	85.00	4.3	-3.8	7.6	0.365	0.	0.110	-0.231	0.026	-0.054
8	90.00	4.4	-3.2	8.6	0.362	0.	0.100	-0.289	0.023	-0.065
9	95.00	6.0	-1.3	11.4	0.397	0.	0.148	-0.303	0.032	-0.066

TABLE XXIX. - Continued. BLADE-ELEMENT DATA AT BLADE

EDGES FOR STATOR 9 (100 PERCENT DESIGN SPEED;

INTRABLADE ROW INSTRUMENTATION

AT STATION 2b)

(b) Reading number 601

RP	RADII		ABS BETAM		REL BETAM		TOTAL TEMP		TOTAL PRESS	
	IN	OUT	IN	OUT	IN	OUT	IN	RATIO	IN	RATIO
1	22.949	22.944	31.5	7.7	31.5	7.7	326.4	0.998	13.87	0.972
2	22.479	22.474	29.5	4.9	29.5	4.9	325.7	1.000	14.56	0.976
3	22.004	21.999	29.2	3.4	29.2	3.4	324.9	1.001	14.74	0.980
4	20.577	20.574	30.9	2.5	30.9	2.5	325.4	1.000	14.90	0.984
5	18.682	18.717	33.7	2.5	33.7	2.5	325.8	1.003	15.17	0.983
6	16.787	16.916	37.7	0.4	37.7	0.4	326.8	1.001	15.36	0.981
7	15.342	15.624	43.0	1.3	43.0	1.3	329.8	0.998	15.56	0.971
8	14.849	15.164	45.2	3.1	45.2	3.1	330.8	0.996	15.75	0.946
9	14.343	14.684	49.0	4.1	49.0	4.1	330.6	0.997	15.09	0.954

RP	ABS VEL		REL VEL		MERID VEL		TANG VEL		WHEEL SPEED	
	IN	OUT	IN	OUT	IN	OUT	IN	OUT	IN	OUT
1	222.8	177.7	222.8	177.7	189.9	176.1	116.6	23.9	0.	0.
2	242.7	201.1	242.7	201.1	211.3	200.4	119.3	17.1	0.	0.
3	248.1	206.9	248.1	206.9	216.6	206.5	121.1	12.2	0.	0.
4	256.4	209.0	256.4	209.0	219.9	208.8	131.8	9.0	0.	0.
5	270.4	211.2	270.4	211.2	225.0	211.0	150.0	9.0	0.	0.
6	280.2	210.7	280.2	210.7	221.6	210.7	171.6	1.3	0.	0.
7	286.3	214.1	286.3	214.1	209.4	214.1	195.2	4.7	0.	0.
8	292.4	210.4	292.4	210.4	206.1	210.1	207.4	11.3	0.	0.
9	283.2	197.7	283.2	197.7	185.7	197.2	213.8	14.3	0.	0.

RP	ABS MACH NO		REL MACH NO		MERID MACH NO		MERID PEAK SS	
	IN	OUT	IN	OUT	IN	OUT	VEL R	MACH NO
1	0.640	0.504	0.640	0.504	0.545	0.499	0.928	0.989
2	0.703	0.574	0.703	0.574	0.612	0.572	0.948	1.034
3	0.722	0.592	0.722	0.592	0.630	0.591	0.954	1.053
4	0.748	0.598	0.748	0.598	0.641	0.598	0.949	1.115
5	0.793	0.603	0.793	0.603	0.660	0.603	0.938	1.212
6	0.824	0.602	0.824	0.602	0.652	0.602	0.951	1.306
7	0.840	0.610	0.840	0.610	0.614	0.610	1.022	1.399
8	0.859	0.599	0.859	0.599	0.606	0.598	1.020	1.462
9	0.829	0.560	0.829	0.560	0.544	0.558	1.062	1.487

RP	PERCENT	INCIDENCE		DEV	D-FACT	EFF	LOSS COEFF		LOSS PARAM	
	SPAN	MEAN	SS				TOT	PROF	TOT	PROF
1	5.00	10.3	-3.8	12.6	0.347	0.	0.115	0.115	0.040	0.040
2	10.00	10.0	-4.3	9.4	0.315	0.	0.086	0.086	0.029	0.029
3	15.00	10.6	-3.7	7.7	0.313	0.	0.067	0.067	0.022	0.022
4	30.00	10.6	-2.5	7.0	0.335	0.	0.052	0.052	0.016	0.016
5	50.00	8.8	-2.4	7.6	0.367	0.	0.050	0.050	0.014	0.014
6	70.00	6.9	-2.5	6.3	0.403	0.	0.052	0.051	0.013	0.013
7	85.00	5.7	-2.4	8.0	0.406	0.	0.079	0.074	0.018	0.017
8	90.00	5.6	-2.0	10.1	0.430	0.	0.140	0.130	0.032	0.029
9	95.00	7.2	0.0	11.5	0.453	0.	0.126	0.116	0.027	0.025

TABLE XXIX. - Concluded. BLADE-ELEMENT DATA AT BLADE

EDGES FOR STATOR 9 (100 PERCENT DESIGN SPEED;

INTRABLADE ROW INSTRUMENTATION

AT STATION 2b)

(c) Reading number 602

RP	RADI		ABS BETAM		REL BETAM		TOTAL TEMP		TOTAL PRESS	
	IN	OUT	IN	OUT	IN	OUT	IN	RATIO	IN	RATIO
1	22.949	22.944	39.0	5.6	39.0	5.6	334.8	0.999	15.20	0.973
2	22.479	22.474	36.1	4.4	36.1	4.4	332.7	1.000	15.77	0.959
3	22.004	21.999	35.5	3.5	35.5	3.5	332.3	0.998	15.80	0.958
4	20.577	20.574	36.1	3.9	36.1	3.9	330.2	1.001	15.66	0.967
5	18.682	18.717	35.5	2.7	35.5	2.7	327.4	1.004	15.40	0.983
6	16.787	16.916	38.7	0.7	38.7	0.7	327.7	1.000	15.44	0.978
7	15.342	15.624	43.8	1.6	43.8	1.6	329.7	0.999	15.76	0.956
8	14.849	15.164	46.0	3.3	46.0	3.3	330.9	0.995	15.68	0.946
9	14.343	14.684	49.7	4.3	49.7	4.3	331.5	0.995	15.31	0.946

RP	ABS VEL		REL VEL		MERID VEL		TANG VEL		WHEEL SPEED	
	IN	OUT	IN	OUT	IN	OUT	IN	OUT	IN	OUT
1	228.5	186.5	228.5	186.5	177.5	185.6	143.9	18.3	0.	0.
2	244.4	196.2	244.4	196.2	197.5	195.6	143.8	15.0	0.	0.
3	246.9	195.9	246.9	195.9	201.1	195.5	143.2	12.0	0.	0.
4	252.2	195.4	252.2	195.4	203.7	194.9	148.7	13.2	0.	0.
5	266.3	204.0	266.3	204.0	216.9	203.8	154.5	9.7	0.	0.
6	277.2	204.2	277.2	204.2	216.3	204.2	173.4	2.5	0.	0.
7	286.4	207.4	286.4	207.4	206.8	207.3	198.1	6.0	0.	0.
8	287.9	202.6	287.9	202.6	199.8	202.3	207.2	11.8	0.	0.
9	284.6	193.0	284.6	193.0	184.2	192.5	217.0	14.5	0.	0.

RP	ABS MACH NO		REL MACH NO		MERID MACH NO		MERID PEAK SS	
	IN	OUT	IN	OUT	IN	OUT	VEL R	MACH NO
1	0.649	0.523	0.649	0.523	0.504	0.520	1.046	1.168
2	0.700	0.553	0.700	0.553	0.566	0.551	0.990	1.187
3	0.709	0.553	0.709	0.553	0.577	0.552	0.972	1.184
4	0.728	0.552	0.728	0.552	0.568	0.551	0.957	1.214
5	0.777	0.580	0.777	0.580	0.633	0.579	0.939	1.235
6	0.813	0.581	0.813	0.581	0.634	0.581	0.944	1.315
7	0.841	0.590	0.841	0.590	0.607	0.589	1.002	1.422
8	0.844	0.575	0.844	0.575	0.586	0.574	1.013	1.461
9	0.832	0.546	0.832	0.546	0.539	0.544	1.045	1.512

RP	PERCENT		INCIDENCE		DEV	D-FACT	EFF	LOSS COEFF		LOSS PARAM	
	SPAN	MEAN	SS	TOT				PROF	TOT	PROF	
1	5.00	17.8	3.7	10.4	0.375	0.	0.108	0.108	0.038	0.038	
2	10.00	16.6	2.3	8.9	0.377	0.	0.146	0.146	0.050	0.050	
3	15.00	16.9	2.6	7.8	0.384	0.	0.147	0.147	0.049	0.049	
4	30.00	15.8	2.7	8.4	0.394	0.	0.111	0.111	0.035	0.035	
5	50.00	10.6	-0.6	7.9	0.389	0.	0.052	0.052	0.015	0.015	
6	70.00	7.9	-1.5	6.6	0.421	0.	0.063	0.063	0.016	0.016	
7	85.00	6.5	-1.6	8.4	0.431	0.	0.119	0.112	0.028	0.026	
8	90.00	6.5	-1.2	10.4	0.447	0.	0.144	0.135	0.032	0.030	
9	95.00	7.9	0.7	11.7	0.474	0.	0.148	0.135	0.032	0.029	

TABLE XXX. - BLADE-ELEMENT DATA AT BLADE EDGES FOR

STATOR 9 (90 PERCENT DESIGN SPEED; INTRABLADE ROW

INSTRUMENTATION AT STATION 2a)

(a) Reading number 564

RP	RAD II		ABS BETAM		REL BETAM		TOTAL TEMP		TOTAL PRESS	
	IN	OUT	IN	OUT	IN	OUT	IN	RATIO	IN	RATIO
1	22.949	22.944	24.8	6.0	24.8	6.0	314.5	0.999	13.04	0.936
2	22.479	22.474	24.3	2.5	24.3	2.5	314.4	1.000	13.17	0.978
3	22.004	21.999	24.5	1.6	24.5	1.6	314.5	1.000	13.29	0.983
4	20.577	20.574	26.4	2.5	26.4	2.5	315.7	1.000	13.65	0.974
5	18.682	18.717	29.4	3.7	29.4	3.7	317.3	0.999	13.96	0.963
6	16.787	16.916	33.7	1.6	33.7	1.6	319.3	1.001	14.24	0.961
7	15.342	15.624	40.1	0.8	40.1	0.8	321.7	1.001	14.49	0.964
8	14.849	15.164	43.3	1.2	43.3	1.2	322.6	1.002	14.66	0.969
9	14.343	14.684	45.9	3.3	45.9	3.3	323.7	1.000	14.70	0.932

RP	ABS VEL		REL VEL		MERID VEL		TANG VEL		WHEEL SPEED	
	IN	OUT	IN	OUT	IN	OUT	IN	OUT	IN	OUT
1	224.8	191.8	224.8	191.8	204.0	190.7	94.4	20.2	0.	0.
2	229.8	212.7	229.8	212.7	209.5	212.5	94.5	9.4	0.	0.
3	234.4	216.9	234.4	216.9	213.3	216.8	97.3	6.0	0.	0.
4	246.3	219.0	246.3	219.0	220.7	218.8	109.4	9.6	0.	0.
5	264.9	221.0	264.9	221.0	230.7	220.5	130.1	14.1	0.	0.
6	278.6	226.3	278.6	226.3	231.9	226.2	154.6	6.5	0.	0.
7	283.1	236.7	283.1	236.7	216.5	236.7	182.3	3.3	0.	0.
8	284.2	241.5	284.2	241.5	206.8	241.5	194.9	5.2	0.	0.
9	283.1	229.9	283.1	229.9	197.0	229.5	203.4	13.3	0.	0.

RP	ABS MACH NO		REL MACH NO		MERID MACH NO		MERID PEAK SS	
	IN	OUT	IN	OUT	IN	OUT	VEL R	MACH NO
1	0.659	0.556	0.659	0.556	0.598	0.553	0.935	0.866
2	0.675	0.621	0.675	0.621	0.616	0.621	1.014	0.871
3	0.690	0.634	0.690	0.634	0.628	0.634	1.016	0.893
4	0.727	0.640	0.727	0.640	0.652	0.639	0.991	0.969
5	0.786	0.644	0.786	0.644	0.685	0.643	0.956	1.087
6	0.830	0.658	0.830	0.658	0.690	0.658	0.976	1.201
7	0.841	0.688	0.841	0.688	0.644	0.688	1.093	1.318
8	0.844	0.702	0.844	0.702	0.614	0.702	1.168	1.382
9	0.839	0.665	0.839	0.665	0.583	0.664	1.165	1.416

RP	PERCENT	INCIDENCE		DEV	D-FACT	EFF	LOSS COEFF		LOSS PARAM	
	SPAN	MEAN	SS				TOT	PROF	TOT	PROF
1	5.00	3.6	-10.5	10.9	0.262	0.	0.252	0.252	0.087	0.087
2	10.00	4.8	-9.5	7.0	0.201	0.	0.082	0.082	0.028	0.028
3	15.00	5.9	-8.4	5.9	0.205	0.	0.064	0.064	0.021	0.021
4	30.00	6.1	-7.0	7.0	0.238	0.	0.089	0.089	0.028	0.028
5	50.00	4.5	-6.6	8.8	0.290	0.	0.109	0.109	0.031	0.031
6	70.00	2.9	-6.5	7.6	0.323	0.	0.107	0.107	0.027	0.027
7	85.00	2.8	-5.3	7.6	0.310	0.	0.096	0.095	0.022	0.022
8	90.00	3.7	-3.9	8.3	0.299	0.	0.083	0.079	0.019	0.018
9	95.00	4.1	-3.1	10.7	0.332	0.	0.185	0.179	0.040	0.039

TABLE XXX. - Continued. BLADE-ELEMENT DATA AT BLADE EDGES

FOR STATOR 9 (90 PERCENT DESIGN SPEED; INTRABLADE ROW

INSTRUMENTATION AT STATION 2a)

(b) Reading number 565

RP	RADII		ABS BETAM		REL BETAM		TOTAL TEMP		TOTAL PRESS	
	IN	OUT	IN	OUT	IN	OUT	IN	RATIO	IN	RATIO
1	22.949	22.944	25.9	6.9	25.9	6.9	315.8	1.000	13.33	0.937
2	22.479	22.474	25.6	3.9	25.6	3.9	315.8	1.000	13.40	0.979
3	22.004	21.999	25.8	2.8	25.8	2.8	315.5	1.000	13.56	0.982
4	20.577	20.574	27.3	2.3	27.3	2.3	316.3	1.000	13.81	0.982
5	18.682	18.717	30.4	2.7	30.4	2.7	317.8	0.999	14.05	0.979
6	16.787	16.916	34.8	0.3	34.8	0.3	319.0	1.002	14.22	0.986
7	15.342	15.624	41.4	0.8	41.4	0.8	321.7	1.001	14.54	0.977
8	14.849	15.164	44.3	1.8	44.3	1.8	322.6	1.001	14.67	0.972
9	14.343	14.684	47.0	3.7	47.0	3.7	323.5	1.000	14.72	0.931

RP	ABS VEL		REL VEL		MERID VEL		TANG VEL		WHEEL SPEED	
	IN	OUT	IN	OUT	IN	OUT	IN	OUT	IN	OUT
1	227.0	177.9	227.0	177.9	204.2	176.6	99.0	21.4	0.	0.
2	231.0	199.0	231.0	199.0	208.4	198.5	99.7	13.6	0.	0.
3	236.1	203.9	236.1	203.9	212.5	203.7	102.9	9.8	0.	0.
4	245.1	206.9	245.1	206.9	217.7	206.7	112.6	8.3	0.	0.
5	261.4	210.0	261.4	210.0	225.4	209.8	132.3	10.1	0.	0.
6	270.6	215.4	270.6	215.4	222.3	215.4	154.4	1.0	0.	0.
7	275.3	222.7	275.3	222.7	206.6	222.7	181.9	3.0	0.	0.
8	276.5	224.5	276.5	224.5	198.1	224.3	193.0	7.2	0.	0.
9	276.8	211.1	276.8	211.1	188.7	210.7	202.5	13.7	0.	0.

RP	ABS MACH NO		REL MACH NO		MERID MACH NO		MERID PEAK SS	
	IN	OUT	IN	OUT	IN	OUT	VEL R	MACH NO
1	0.665	0.512	0.665	0.512	0.598	0.509	0.865	0.898
2	0.678	0.577	0.678	0.577	0.611	0.576	0.953	0.905
3	0.694	0.593	0.694	0.593	0.625	0.592	0.958	0.931
4	0.723	0.601	0.723	0.601	0.642	0.601	0.950	0.988
5	0.774	0.609	0.774	0.609	0.668	0.609	0.931	1.096
6	0.803	0.624	0.803	0.624	0.660	0.624	0.969	1.192
7	0.815	0.644	0.815	0.644	0.612	0.644	1.078	1.312
8	0.818	0.649	0.818	0.649	0.586	0.648	1.133	1.365
9	0.817	0.607	0.817	0.607	0.557	0.606	1.117	1.411

RP	PERCENT SPAN	INCIDENCE		DEV	D-FACT	EFF	LOSS COEFF		LOSS PARAM	
		MEAN	SS				TOT	PROF	TOT	PROF
1	5.00	4.6	-9.5	11.7	0.335	0.	0.245	0.245	0.085	0.085
2	10.00	6.1	-8.2	8.4	0.266	0.	0.081	0.081	0.028	0.028
3	15.00	7.3	-7.0	7.0	0.268	0.	0.066	0.066	0.022	0.022
4	30.00	7.0	-6.1	6.8	0.289	0.	0.061	0.061	0.019	0.019
5	50.00	5.5	-5.7	7.9	0.329	0.	0.064	0.064	0.018	0.018
6	70.00	4.0	-5.4	6.2	0.349	0.	0.042	0.042	0.011	0.011
7	85.00	4.1	-4.0	7.6	0.341	0.	0.065	0.064	0.015	0.015
8	90.00	4.7	-3.0	8.9	0.338	0.	0.078	0.076	0.018	0.017
9	95.00	5.2	-2.0	11.1	0.383	0.	0.194	0.189	0.042	0.041

TABLE XXX. - Continued. BLADE-ELEMENT DATA AT BLADE EDGES

FOR STATOR 9 (90 PERCENT DESIGN SPEED; INTRABLADE ROW

INSTRUMENTATION AT STATION 2a)

(c) Reading number 566

RP	RADIO		ABS BETAM		REL BETAM		TOTAL TEMP		TOTAL PRESS	
	IN	OUT	IN	OUT	IN	OUT	IN	RATIO	IN	RATIO
1	22.949	22.944	29.1	6.9	29.1	6.9	319.3	1.000	13.98	0.939
2	22.479	22.474	28.4	4.3	28.4	4.3	318.8	1.000	14.01	0.976
3	22.004	21.999	28.7	3.2	28.7	3.2	318.2	1.000	14.03	0.983
4	20.577	20.574	30.2	2.9	30.2	2.9	318.3	0.999	14.12	0.980
5	18.682	18.717	33.0	2.7	33.0	2.7	318.5	1.000	14.16	0.982
6	16.787	16.916	37.1	1.0	37.1	1.0	319.6	1.000	14.28	0.980
7	15.342	15.624	43.3	1.4	43.3	1.4	321.6	1.000	14.51	0.977
8	14.849	15.164	46.2	2.9	46.2	2.9	323.1	0.999	14.74	0.963
9	14.343	14.684	48.7	4.3	48.7	4.3	323.3	0.999	14.70	0.936

RP	ABS VEL		REL VEL		MERID VEL		TANG VEL		WHEEL SPEED	
	IN	OUT	IN	OUT	IN	OUT	IN	OUT	IN	OUT
1	230.3	173.4	230.3	173.4	201.3	172.2	112.0	20.8	0.	0.
2	232.3	191.9	232.3	191.9	204.3	191.4	110.6	14.3	0.	0.
3	234.5	194.4	234.5	194.4	205.7	194.1	112.7	10.7	0.	0.
4	239.9	193.9	239.9	193.9	207.3	193.6	120.8	9.7	0.	0.
5	250.8	195.8	250.8	195.8	210.3	195.6	136.6	9.4	0.	0.
6	258.8	197.5	258.8	197.5	206.4	197.5	156.1	3.5	0.	0.
7	264.6	204.3	264.6	204.3	192.5	204.2	181.5	5.0	0.	0.
8	269.3	205.7	269.3	205.7	186.5	205.5	194.3	10.5	0.	0.
9	268.3	194.5	268.3	194.5	177.2	194.0	201.5	14.4	0.	0.

RP	ABS MACH NO		REL MACH NO		MERID MACH NO		MERID PEAK SS	
	IN	OUT	IN	OUT	IN	OUT	VEL R	MACH NO
1	0.671	0.496	0.671	0.496	0.587	0.492	0.856	0.982
2	0.678	0.552	0.678	0.552	0.597	0.551	0.936	0.974
3	0.686	0.561	0.686	0.561	0.602	0.560	0.944	0.989
4	0.703	0.559	0.703	0.559	0.608	0.558	0.934	1.031
5	0.738	0.565	0.738	0.565	0.619	0.564	0.930	1.111
6	0.763	0.569	0.763	0.569	0.609	0.569	0.957	1.192
7	0.779	0.587	0.779	0.587	0.567	0.587	1.061	1.306
8	0.793	0.591	0.793	0.591	0.549	0.590	1.101	1.376
9	0.789	0.556	0.789	0.556	0.521	0.555	1.095	1.407

RP	PERCENT	INCIDENCE		DEV	D-FACT	EFF	LOSS COEFF		LOSS PARAM	
	SPAN	MEAN	SS				TOT	PROF	TOT	PROF
1	5.00	7.9	-6.2	11.7	0.385	0.	0.233	0.233	0.081	0.081
2	10.00	8.9	-5.4	8.8	0.316	0.	0.089	0.089	0.030	0.030
3	15.00	10.1	-4.2	7.4	0.316	0.	0.064	0.064	0.021	0.021
4	30.00	9.9	-3.2	7.4	0.337	0.	0.070	0.070	0.022	0.022
5	50.00	8.1	-3.1	7.9	0.363	0.	0.060	0.060	0.017	0.017
6	70.00	6.3	-3.1	7.0	0.387	0.	0.061	0.061	0.016	0.016
7	85.00	6.0	-2.0	8.2	0.382	0.	0.070	0.070	0.016	0.016
8	90.00	6.6	-1.1	10.0	0.388	0.	0.110	0.108	0.025	0.024
9	95.00	6.9	-0.3	11.6	0.425	0.	0.190	0.187	0.041	0.041

TABLE XXX. - Continued. BLADE-ELEMENT DATA AT BLADE EDGES

FOR STATOR 9 (90 PERCENT DESIGN SPEED; INTRABLADE ROW

INSTRUMENTATION AT STATION 2a)

(d) Reading number 567

RP	RADII		ABS BETAM		REL BETAM		TOTAL TEMP		TOTAL PRESS	
	IN	OUT	IN	OUT	IN	OUT	IN	RATIO	IN	RATIO
1	22.949	22.944	31.7	6.8	31.7	6.8	321.7	1.000	14.28	0.943
2	22.479	22.474	31.0	4.6	31.0	4.6	320.8	1.001	14.30	0.975
3	22.004	21.999	31.2	3.6	31.2	3.6	320.5	0.999	14.30	0.979
4	20.577	20.574	32.7	3.1	32.7	3.1	319.9	1.000	14.31	0.980
5	18.682	18.717	35.3	3.0	35.3	3.0	319.4	1.001	14.21	0.984
6	16.787	16.916	39.2	1.5	39.2	1.5	319.9	0.999	14.23	0.979
7	15.342	15.624	45.3	2.0	45.3	2.0	322.3	0.999	14.57	0.974
8	14.849	15.164	47.5	3.5	47.5	3.5	323.1	0.998	14.78	0.955
9	14.343	14.684	49.8	4.5	49.8	4.5	323.3	0.999	14.75	0.935

RP	ABS VEL		REL VEL		MERID VEL		TANG VEL		WHEEL SPEED	
	IN	OUT	IN	OUT	IN	OUT	IN	OUT	IN	OUT
1	227.6	169.8	227.6	169.8	193.6	168.6	119.7	20.0	0.	0.
2	230.0	185.5	230.0	185.5	197.2	184.9	118.3	14.9	0.	0.
3	231.0	187.2	231.0	187.2	197.5	186.9	119.8	11.7	0.	0.
4	235.0	186.1	235.0	186.1	197.8	185.8	126.9	10.0	0.	0.
5	242.2	185.6	242.2	185.6	197.7	185.4	140.0	9.7	0.	0.
6	248.8	184.3	248.8	184.3	192.9	184.3	157.1	4.9	0.	0.
7	259.5	194.7	259.5	194.7	182.5	194.6	184.6	6.8	0.	0.
8	264.4	193.5	264.4	193.5	178.5	193.1	195.0	11.9	0.	0.
9	264.4	184.7	264.4	184.7	170.7	184.1	201.9	14.6	0.	0.

RP	ABS MACH NO		REL MACH NO		MERID MACH NO		MERID PEAK SS	
	IN	OUT	IN	OUT	IN	OUT	VEL R	MACH NO
1	0.660	0.483	0.660	0.483	0.561	0.480	0.871	1.024
2	0.669	0.531	0.669	0.531	0.573	0.529	0.938	1.018
3	0.672	0.537	0.672	0.537	0.575	0.536	0.946	1.027
4	0.686	0.534	0.686	0.534	0.577	0.533	0.939	1.063
5	0.709	0.532	0.709	0.532	0.579	0.532	0.938	1.123
6	0.730	0.529	0.730	0.529	0.566	0.528	0.955	1.192
7	0.762	0.558	0.762	0.558	0.536	0.557	1.066	1.329
8	0.777	0.554	0.777	0.554	0.524	0.553	1.082	1.384
9	0.777	0.527	0.777	0.527	0.501	0.525	1.079	1.415

RP	PERCENT SPAN	INCIDENCE		DEV	D-FACT	EFF	LOSS COEFF		LOSS PARAM	
		MEAN	SS				TOT	PROF	TOT	PROF
1	5.00	10.5	-3.6	11.6	0.407	0.	0.225	0.225	0.078	0.078
2	10.00	11.5	-2.8	9.1	0.347	0.	0.098	0.098	0.033	0.033
3	15.00	12.7	-1.6	7.9	0.346	0.	0.080	0.080	0.027	0.027
4	30.00	12.4	-0.7	7.6	0.364	0.	0.075	0.075	0.023	0.023
5	50.00	10.4	-0.8	8.1	0.387	0.	0.056	0.056	0.016	0.016
6	70.00	8.3	-1.1	7.5	0.415	0.	0.072	0.072	0.018	0.018
7	85.00	8.0	-0.0	8.8	0.408	0.	0.081	0.081	0.019	0.019
8	90.00	8.0	0.3	10.6	0.422	0.	0.138	0.136	0.031	0.031
9	95.00	8.0	0.8	11.9	0.453	0.	0.198	0.195	0.043	0.042

TABLE XXX. - Continued. BLADE-ELEMENT DATA AT BLADE EDGES

FOR STATOR 9 (90 PERCENT DESIGN SPEED; INTRABLADE ROW

INSTRUMENTATION AT STATION 2a)

(e) Reading number 568

RP	RADII		ABS BETAM		REL BETAM		TOTAL TEMP		TOTAL PRESS	
	IN	OUT	IN	OUT	IN	OUT	IN	RATIO	IN	RATIO
1	22.949	22.944	34.0	6.1	34.0	6.1	323.6	1.001	14.52	0.945
2	22.479	22.474	33.3	4.5	33.3	4.5	322.7	1.001	14.50	0.970
3	22.004	21.999	34.0	3.7	34.0	3.7	322.2	1.000	14.46	0.973
4	20.577	20.574	35.0	3.4	35.0	3.4	321.2	0.999	14.39	0.976
5	18.682	18.717	37.4	3.0	37.4	3.0	320.0	1.001	14.22	0.981
6	16.787	16.916	41.4	2.0	41.4	2.0	320.3	0.999	14.20	0.976
7	15.342	15.624	46.5	2.4	46.5	2.4	322.5	0.998	14.59	0.969
8	14.849	15.164	48.4	3.9	48.4	3.9	323.0	0.997	14.77	0.949
9	14.343	14.684	50.7	4.5	50.7	4.5	323.2	0.999	14.75	0.936

RP	ABS VEL		REL VEL		MERID VEL		TANG VEL		WHEEL SPEED	
	IN	OUT	IN	OUT	IN	OUT	IN	OUT	IN	OUT
1	225.6	168.5	225.6	168.5	187.0	167.6	126.3	18.0	0.	0.
2	226.9	180.1	226.9	180.1	189.6	179.5	124.6	14.3	0.	0.
3	227.4	180.1	227.4	180.1	188.6	179.7	127.0	11.7	0.	0.
4	229.4	177.2	229.4	177.2	188.0	176.9	131.6	10.6	0.	0.
5	234.3	175.7	234.3	175.7	186.1	175.4	142.3	9.2	0.	0.
6	241.0	174.1	241.0	174.1	180.7	173.9	159.5	6.1	0.	0.
7	255.5	186.0	255.5	186.0	175.9	185.8	185.3	7.9	0.	0.
8	260.4	183.6	260.4	183.6	172.8	183.2	194.8	12.4	0.	0.
9	260.6	177.7	260.6	177.7	165.1	177.1	201.6	14.0	0.	0.

RP	ABS MACH NO		REL MACH NO		MERID MACH NO		MERID PEAK SS	
	IN	OUT	IN	OUT	IN	OUT	VEL R	MACH NO
1	0.652	0.478	0.652	0.478	0.540	0.475	0.896	1.062
2	0.657	0.513	0.657	0.513	0.549	0.511	0.946	1.052
3	0.659	0.514	0.659	0.514	0.547	0.513	0.953	1.067
4	0.666	0.506	0.666	0.506	0.546	0.505	0.941	1.085
5	0.683	0.502	0.683	0.502	0.543	0.501	0.943	1.130
6	0.704	0.497	0.704	0.497	0.528	0.497	0.962	1.204
7	0.749	0.531	0.749	0.531	0.515	0.531	1.056	1.336
8	0.764	0.524	0.764	0.524	0.507	0.523	1.060	1.384
9	0.764	0.506	0.764	0.506	0.484	0.504	1.073	1.416

RP	PERCENT	INCIDENCE		DEV	D-FACT	EFF	LOSS COEFF		LOSS PARAM	
	SPAN	MEAN	SS				TOT	PROF	TOT	PROF
1	5.00	12.8	-1.3	11.0	0.420	0.	0.224	0.224	0.077	0.077
2	10.00	13.8	-0.5	9.0	0.373	0.	0.121	0.121	0.041	0.041
3	15.00	15.4	1.1	8.0	0.378	0.	0.108	0.108	0.036	0.036
4	30.00	14.7	1.6	7.9	0.393	0.	0.095	0.095	0.030	0.030
5	50.00	12.5	1.3	8.1	0.412	0.	0.072	0.072	0.020	0.020
6	70.00	10.6	1.2	7.9	0.440	0.	0.086	0.086	0.022	0.022
7	85.00	9.2	1.1	9.2	0.433	0.	0.100	0.100	0.023	0.023
8	90.00	8.8	1.2	10.9	0.451	0.	0.160	0.159	0.036	0.036
9	95.00	8.9	1.7	11.9	0.473	0.	0.200	0.198	0.043	0.043

TABLE XXX. - Continued. BLADE-ELEMENT DATA AT BLADE EDGES

FOR STATOR 9 (90 PERCENT DESIGN SPEED; INTRABLADE ROW

INSTRUMENTATION AT STATION 2a)

(f) Reading number 580

RP	RADII		ABS BETAM		REL BETAM		TOTAL TEMP		TOTAL PRESS	
	IN	OUT	IN	OUT	IN	OUT	IN	RATIO	IN	RATIO
1	22.949	22.944	34.8	6.0	34.8	6.0	323.6	1.001	14.36	0.945
2	22.479	22.474	34.2	4.4	34.2	4.4	323.1	1.000	14.37	0.960
3	22.004	21.999	35.0	3.6	35.0	3.6	321.7	1.002	14.24	0.970
4	20.577	20.574	37.3	3.6	37.3	3.6	320.9	1.000	14.07	0.974
5	18.682	18.717	40.9	3.1	40.9	3.1	320.4	0.999	14.02	0.969
6	16.787	16.916	42.9	2.6	42.9	2.6	320.4	0.999	14.14	0.968
7	15.342	15.624	47.0	2.5	47.0	2.5	322.1	0.999	14.50	0.970
8	14.849	15.164	48.6	3.8	48.6	3.8	322.9	0.997	14.74	0.944
9	14.343	14.684	50.8	4.6	50.8	4.6	322.9	0.999	14.75	0.933

RP	ABS VEL		REL VEL		MERID VEL		TANG VEL		WHEEL SPEED	
	IN	OUT	IN	OUT	IN	OUT	IN	OUT	IN	OUT
1	219.8	162.0	219.8	162.0	180.6	161.1	125.3	16.9	0.	0.
2	221.9	170.3	221.9	170.3	183.5	169.8	124.8	13.2	0.	0.
3	219.5	170.0	219.5	170.0	179.8	169.6	125.8	10.8	0.	0.
4	217.2	164.7	217.2	164.7	172.8	164.3	131.7	10.5	0.	0.
5	223.4	160.3	223.4	160.3	168.8	160.1	146.3	8.6	0.	0.
6	235.5	164.8	235.5	164.8	172.4	164.6	160.4	7.4	0.	0.
7	250.8	181.3	250.8	181.3	171.0	181.1	183.5	8.0	0.	0.
8	257.5	178.2	257.5	178.2	170.2	177.8	193.2	11.9	0.	0.
9	258.6	173.6	258.6	173.6	163.5	173.1	200.4	13.8	0.	0.

RP	ABS MACH NO		REL MACH NO		MERID MACH NO		MERID PEAK SS	
	IN	OUT	IN	OUT	IN	OUT	VEL R	MACH NO
1	0.633	0.458	0.633	0.458	0.520	0.456	0.892	1.048
2	0.641	0.484	0.641	0.484	0.530	0.482	0.926	1.046
3	0.634	0.483	0.634	0.483	0.520	0.482	0.943	1.050
4	0.628	0.469	0.628	0.469	0.500	0.468	0.951	1.073
5	0.648	0.456	0.648	0.456	0.490	0.456	0.949	1.150
6	0.686	0.470	0.686	0.470	0.503	0.469	0.955	1.208
7	0.734	0.518	0.734	0.518	0.500	0.517	1.059	1.322
8	0.754	0.508	0.754	0.508	0.499	0.507	1.045	1.373
9	0.758	0.494	0.758	0.494	0.479	0.492	1.059	1.407

RP	PERCENT		INCIDENCE		DEV	D-FACT	EFF	LOSS COEFF		LOSS PARAM	
	SPAN	MEAN	SS	SS				TOT	PROF	TOT	PROF
1	5.00	13.5	-0.6	10.8	0.435	0.	0.233	0.233	0.081	0.081	
2	10.00	14.7	0.4	8.9	0.404	0.	0.164	0.164	0.056	0.056	
3	15.00	16.4	2.1	7.9	0.401	0.	0.126	0.126	0.042	0.042	
4	30.00	17.0	3.9	8.1	0.417	0.	0.110	0.110	0.034	0.034	
5	50.00	16.0	4.8	8.2	0.457	0.	0.127	0.127	0.036	0.036	
6	70.00	12.1	2.7	8.5	0.466	0.	0.120	0.120	0.031	0.031	
7	85.00	9.7	1.7	9.3	0.439	0.	0.101	0.101	0.023	0.023	
8	90.00	9.1	1.4	10.9	0.465	0.	0.177	0.176	0.040	0.040	
9	95.00	9.0	1.8	11.9	0.483	0.	0.210	0.208	0.046	0.045	

TABLE XXX. - Concluded. BLADE-ELEMENT DATA AT BLADE EDGES

FOR STATOR 9 (90 PERCENT DESIGN SPEED; INTRABLADE ROW

INSTRUMENTATION AT STATION 2a)

(g) Reading number 545

RP	RADII		ABS BETAM		REL BETAM		TOTAL TEMP		TOTAL PRESS	
	IN	OUT	IN	OUT	IN	OUT	IN	RATIO	IN	RATIO
1	22.949	22.944	43.2	4.4	43.2	4.4	327.9	0.997	13.99	0.938
2	22.479	22.474	39.6	3.5	39.6	3.5	326.0	0.998	14.08	0.941
3	22.004	21.999	38.1	3.2	38.1	3.2	324.8	0.999	14.13	0.941
4	20.577	20.574	39.0	3.3	39.0	3.3	322.6	1.000	14.01	0.955
5	18.682	18.717	42.2	2.7	42.2	2.7	321.8	0.998	13.97	0.960
6	16.787	16.916	42.7	2.8	42.7	2.8	320.8	0.999	14.16	0.967
7	15.342	15.624	46.7	2.2	46.7	2.2	322.7	0.998	14.49	0.969
8	14.849	15.164	48.3	3.5	48.3	3.5	323.1	0.998	14.75	0.944
9	14.343	14.684	50.2	4.4	50.2	4.4	323.5	0.998	14.83	0.932

RP	ABS VEL		REL VEL		MERID VEL		TANG VEL		WHEEL SPEED	
	IN	OUT	IN	OUT	IN	OUT	IN	OUT	IN	OUT
1	207.4	149.7	207.4	9.7	151.1	149.3	142.1	11.4	0.	0.
2	211.9	155.5	211.9	35.5	163.2	155.2	135.1	9.4	0.	0.
3	214.7	156.7	214.7	156.7	168.9	156.5	132.6	8.8	0.	0.
4	215.2	158.6	215.2	158.6	167.2	158.4	135.6	9.1	0.	0.
5	221.4	156.2	221.4	156.2	163.9	156.0	148.8	7.5	0.	0.
6	235.9	164.8	235.9	164.8	173.4	164.6	159.9	8.0	0.	0.
7	250.1	180.1	250.1	180.1	171.5	180.0	182.0	6.8	0.	0.
8	257.0	178.2	257.0	178.2	170.9	177.9	191.9	10.8	0.	0.
9	259.5	175.0	259.5	175.0	166.2	174.5	199.2	13.4	0.	0.

RP	ABS MACH NO		REL MACH NO		MERID MACH NO		MERID PEAK SS	
	IN	OUT	IN	OUT	IN	OUT	VEL R	MACH NO
1	0.591	0.420	0.591	0.420	0.431	0.419	0.988	1.152
2	0.607	0.438	0.607	0.438	0.467	0.437	0.951	1.152
3	0.617	0.442	0.617	0.442	0.485	0.442	0.927	1.086
4	0.620	0.449	0.620	0.449	0.482	0.449	0.947	1.096
5	0.640	0.443	0.640	0.443	0.474	0.443	0.952	1.165
6	0.687	0.469	0.687	0.469	0.505	0.469	0.949	1.204
7	0.731	0.514	0.731	0.514	0.501	0.513	1.050	1.309
8	0.752	0.508	0.752	0.508	0.501	0.507	1.041	1.361
9	0.760	0.498	0.760	0.498	0.487	0.496	1.050	1.394

RP	PERCENT		INCIDENCE		DEV	D-FACT	EFF	LOSS COEFF		LOSS PARAM	
	SPAN	MEAN	SS	TOT				PROF	TOT	PROF	
1	5.00	22.0	7.9	9.2	0.498	0.	0.294	0.294	0.102	0.102	
2	10.00	20.1	5.8	8.0	0.469	0.	0.267	0.267	0.091	0.091	
3	15.00	19.6	5.3	7.5	0.463	0.	0.261	0.261	0.087	0.087	
4	30.00	18.7	5.6	7.8	0.447	0.	0.196	0.196	0.061	0.061	
5	50.00	17.3	6.2	7.9	0.476	0.	0.165	0.165	0.047	0.047	
6	70.00	11.9	2.5	8.7	0.465	0.	0.122	0.122	0.031	0.031	
7	85.00	9.4	1.4	8.9	0.441	0.	0.105	0.105	0.024	0.024	
8	90.00	8.7	1.1	10.5	0.463	0.	0.178	0.177	0.040	0.040	
9	95.00	8.4	1.2	11.8	0.479	0.	0.215	0.213	0.046	0.046	

TABLE XXXI. - BLADE-ELEMENT DATA AT BLADE EDGES FOR

STATOR 9 (80 PERCENT DESIGN SPEED; INTRABLADE ROW

INSTRUMENTATION AT STATION 2a;

READING NUMBER 572)

RP	RADI		ABS BETAM		REL BETAM		TOTAL TEMP		TOTAL PRESS	
	IN	OUT	IN	OUT	IN	OUT	IN	RATIO	IN	RATIO
1	22.949	22.944	50.0	2.3	50.0	2.3	320.7	0.995	12.95	0.945
2	22.479	22.474	44.6	1.6	44.6	1.6	319.0	0.998	13.06	0.936
3	22.004	21.999	42.4	2.1	42.4	2.1	317.8	1.000	13.11	0.933
4	20.577	20.574	46.1	3.2	46.1	3.2	316.4	1.000	12.97	0.953
5	18.682	18.717	49.3	2.5	49.3	2.5	315.8	0.999	12.96	0.962
6	16.787	16.916	47.3	2.5	47.3	2.5	315.1	1.001	13.24	0.980
7	15.342	15.624	48.1	1.4	48.1	1.4	315.6	0.997	13.56	0.961
8	14.849	15.164	49.7	3.1	49.7	3.1	315.9	0.996	13.71	0.946
9	14.343	14.684	51.5	4.7	51.5	4.7	316.4	0.998	13.80	0.939

RP	ABS VEL		REL VEL		MERID VEL		TANG VEL		WHEEL SPEED	
	IN	OUT	IN	OUT	IN	OUT	IN	OUT	IN	OUT
1	172.7	115.2	172.7	115.2	111.0	115.1	132.3	4.6	0.	0.
2	178.7	115.0	178.7	115.0	127.3	115.0	125.4	3.2	0.	0.
3	182.0	115.5	182.0	115.5	134.4	115.4	122.7	4.3	0.	0.
4	180.0	122.7	180.0	122.7	124.8	122.5	129.7	6.8	0.	0.
5	185.7	127.1	185.7	127.1	121.1	126.9	140.8	5.6	0.	0.
6	203.5	149.9	203.5	149.9	138.2	149.7	149.5	6.5	0.	0.
7	219.9	155.0	219.9	155.0	146.9	154.9	163.6	3.9	0.	0.
8	225.7	153.8	225.7	153.8	146.0	153.6	172.1	8.3	0.	0.
9	229.9	154.5	229.9	154.5	143.2	154.0	179.8	12.7	0.	0.

RP	ABS MACH NO		REL MACH NO		MERID MACH NO		MERID PEAK SS	
	IN	OUT	IN	OUT	IN	OUT	VEL R	MACH NO
1	0.493	0.325	0.493	0.325	0.317	0.325	1.037	1.004
2	0.512	0.325	0.512	0.325	0.365	0.325	0.903	1.020
3	0.523	0.327	0.523	0.327	0.386	0.326	0.859	0.999
4	0.518	0.348	0.518	0.348	0.359	0.348	0.982	1.044
5	0.536	0.361	0.536	0.361	0.349	0.361	1.048	1.111
6	0.592	0.429	0.592	0.429	0.402	0.428	1.084	1.131
7	0.642	0.444	0.642	0.444	0.429	0.444	1.055	1.182
8	0.660	0.441	0.660	0.441	0.427	0.440	1.052	1.226
9	0.673	0.442	0.673	0.442	0.420	0.441	1.075	1.266

RP	PERCENT		INCIDENCE		DEV	D-FACT	EFF	LOSS COEFF		LOSS PARAM	
	SPAN	MEAN	SS	TOT				PROF	TOT	PROF	
1	5.00	28.8	14.7	7.1	0.591	0.	0.363	0.363	0.126	0.126	
2	10.00	25.1	10.8	6.1	0.590	0.	0.389	0.389	0.133	0.133	
3	15.00	23.8	9.5	6.4	0.583	0.	0.391	0.391	0.131	0.131	
4	30.00	25.8	12.7	7.7	0.532	0.	0.279	0.279	0.087	0.087	
5	50.00	24.4	13.2	7.7	0.523	0.	0.215	0.215	0.061	0.061	
6	70.00	16.4	7.0	8.4	0.443	0.	0.097	0.097	0.025	0.025	
7	85.00	10.8	2.7	8.2	0.463	0.	0.160	0.160	0.037	0.037	
8	90.00	10.1	2.5	10.2	0.480	0.	0.214	0.214	0.048	0.048	
9	95.00	9.7	2.5	12.1	0.484	0.	0.233	0.233	0.051	0.051	

TABLE XXXII. - BLADE-ELEMENT DATA AT BLADE EDGES FOR
 STATOR 9 (70 PERCENT DESIGN SPEED; INTRABLADE ROW
 INSTRUMENTATION AT STATION 2a)

(a) Reading number 573

RP	RADI		ABS BETAM		REL BETAM		TOTAL TEMP		TOTAL PRESS	
	IN	OUT	IN	OUT	IN	OUT	IN	RATIO	IN	RATIO
1	22.949	22.944	18.4	2.4	18.4	2.4	300.9	1.000	11.50	0.963
2	22.479	22.474	18.2	0.1	18.2	0.1	300.8	1.000	11.58	0.989
3	22.004	21.999	18.8	-0.8	18.8	-0.8	301.0	1.000	11.64	0.992
4	20.577	20.574	21.2	-0.9	21.2	-0.9	302.0	1.000	11.86	0.990
5	18.682	18.717	25.4	-1.1	25.4	-1.1	304.0	1.000	12.12	0.987
6	16.787	16.916	30.4	-1.3	30.4	-1.3	306.1	1.000	12.41	0.987
7	15.342	15.624	37.4	-1.1	37.4	-1.1	308.7	0.998	12.72	0.977
8	14.849	15.164	40.3	0.3	40.3	0.3	309.4	1.000	12.85	0.980
9	14.343	14.684	43.2	2.3	43.2	2.3	310.2	1.001	12.91	0.963

RP	ABS VEL		REL VEL		MERID VEL		TANG VEL		WHEEL SPEED	
	IN	OUT	IN	OUT	IN	OUT	IN	OUT	IN	OUT
1	183.5	155.0	183.5	155.0	174.2	154.8	57.9	6.4	0.	0.
2	187.1	170.6	187.1	170.6	177.8	170.6	58.5	0.3	0.	0.
3	189.5	174.0	189.5	174.0	179.4	174.0	61.0	-2.3	0.	0.
4	196.3	179.4	196.3	179.4	183.0	179.3	71.0	-2.7	0.	0.
5	210.9	185.4	210.9	185.4	190.5	185.3	90.3	-3.4	0.	0.
6	223.2	193.4	223.2	193.4	192.5	193.3	113.1	-4.4	0.	0.
7	230.1	202.0	230.1	202.0	182.9	202.0	139.6	-3.8	0.	0.
8	233.1	208.1	233.1	208.1	177.7	208.1	150.9	1.0	0.	0.
9	234.5	203.9	234.5	203.9	170.8	203.7	160.6	8.3	0.	0.

RP	ABS MACH NO		REL MACH NO		MERID MACH NO		MERID PEAK SS	
	IN	OUT	IN	OUT	IN	OUT	VEL R	MACH NO
1	0.543	0.455	0.543	0.455	0.515	0.454	0.889	0.553
2	0.555	0.503	0.555	0.503	0.527	0.503	0.960	0.555
3	0.562	0.513	0.562	0.513	0.532	0.513	0.970	0.580
4	0.582	0.529	0.582	0.529	0.543	0.529	0.980	0.657
5	0.627	0.546	0.627	0.546	0.566	0.546	0.973	0.774
6	0.664	0.569	0.664	0.569	0.572	0.569	1.005	0.885
7	0.683	0.594	0.683	0.594	0.543	0.594	1.104	1.007
8	0.692	0.612	0.692	0.612	0.527	0.612	1.171	1.064
9	0.695	0.598	0.695	0.598	0.507	0.597	1.193	1.111

RP	PERCENT		INCIDENCE		DEV	D-FACT	EFF	LOSS COEFF		LOSS PARAM	
	SPAN	MEAN	SS	TOT				PROF	TOT	PROF	
1	5.00	-2.8	-16.9	7.2	0.254	0.	0.202	0.202	0.070	0.070	
2	10.00	-1.3	-15.6	4.6	0.195	0.	0.061	0.061	0.021	0.021	
3	15.00	0.2	-14.1	3.5	0.193	0.	0.041	0.041	0.014	0.014	
4	30.00	0.9	-12.2	3.6	0.204	0.	0.047	0.047	0.015	0.015	
5	50.00	0.5	-10.7	4.1	0.247	0.	0.054	0.054	0.015	0.015	
6	70.00	-0.4	-9.8	4.6	0.268	0.	0.051	0.051	0.013	0.013	
7	85.00	0.1	-8.0	5.7	0.266	0.	0.086	0.086	0.020	0.020	
8	90.00	0.8	-6.9	7.4	0.251	0.	0.073	0.073	0.016	0.016	
9	95.00	1.5	-5.8	9.7	0.270	0.	0.134	0.134	0.029	0.029	

TABLE XXXII. - Continued. BLADE-ELEMENT DATA AT BLADE

EDGES FOR STATOR 9 (70 PERCENT DESIGN SPEED;

INTRABLADE ROW INSTRUMENTATION

AT STATION 2a)

(b) Reading number 574

RP	RADII		ABS BETAM		REL BETAM		TOTAL TEMP		TOTAL PRESS	
	IN	OUT	IN	OUT	IN	OUT	IN	RATIO	IN	RATIO
1	22.949	22.944	23.8	4.2	23.8	4.2	303.8	1.000	11.94	0.966
2	22.479	22.474	23.4	1.9	23.4	1.9	303.5	1.000	11.95	0.989
3	22.004	21.999	23.8	1.1	23.8	1.1	303.5	0.999	11.98	0.992
4	20.577	20.574	25.6	0.6	25.6	0.6	304.0	1.000	12.11	0.991
5	18.682	18.717	29.3	0.9	29.3	0.9	304.9	1.000	12.25	0.990
6	16.787	16.916	34.0	0.1	34.0	0.1	306.5	1.001	12.42	0.993
7	15.342	15.624	40.1	0.4	40.1	0.4	308.4	1.000	12.68	0.983
8	14.849	15.164	43.0	1.3	43.0	1.3	309.1	1.000	12.81	0.982
9	14.343	14.684	45.5	3.4	45.5	3.4	309.3	1.002	12.87	0.960

RP	ABS VEL		REL VEL		MERID VEL		TANG VEL		WHEEL SPEED	
	IN	OUT	IN	OUT	IN	OUT	IN	OUT	IN	OUT
1	179.3	143.6	179.3	143.6	164.0	143.3	72.4	10.6	0.	0.
2	180.0	156.8	180.0	156.8	165.2	156.7	71.6	5.2	0.	0.
3	181.2	158.9	181.2	158.9	165.8	158.9	73.1	2.9	0.	0.
4	186.1	161.7	186.1	161.7	167.9	161.7	80.4	1.6	0.	0.
5	196.1	165.7	196.1	165.7	171.0	165.7	96.1	2.6	0.	0.
6	205.7	172.7	205.7	172.7	170.6	172.7	114.9	0.3	0.	0.
7	213.5	180.0	213.5	180.0	163.3	180.0	137.5	1.3	0.	0.
8	217.8	185.0	217.8	185.0	159.3	184.9	148.5	4.2	0.	0.
9	220.4	178.2	220.4	178.2	154.6	177.9	157.1	10.5	0.	0.

RP	ABS MACH NO		REL MACH NO		MERID MACH NO		MERID PEAK SS	
	IN	OUT	IN	OUT	IN	OUT	VEL R	MACH NO
1	0.527	0.418	0.527	0.418	0.482	0.417	0.873	0.673
2	0.530	0.458	0.530	0.458	0.486	0.458	0.949	0.666
3	0.534	0.465	0.534	0.465	0.488	0.465	0.958	0.675
4	0.548	0.473	0.548	0.473	0.494	0.473	0.963	0.715
5	0.579	0.484	0.579	0.484	0.505	0.484	0.969	0.798
6	0.607	0.504	0.607	0.504	0.504	0.504	1.012	0.885
7	0.630	0.525	0.630	0.525	0.482	0.525	1.102	0.987
8	0.643	0.540	0.643	0.540	0.470	0.540	1.161	1.046
9	0.651	0.519	0.651	0.519	0.457	0.518	1.151	1.089

RP	PERCENT	INCIDENCE		DEV	D-FACT	EFF	LOSS COEFF		LOSS PARAM	
	SPAN	MEAN	SS				TOT	PROF	TOT	PROF
1	5.00	2.6	-11.5	9.1	0.319	0.	0.198	0.198	0.069	0.069
2	10.00	3.9	-10.4	6.4	0.255	0.	0.064	0.064	0.022	0.022
3	15.00	5.2	-9.1	5.3	0.253	0.	0.045	0.045	0.015	0.015
4	30.00	5.3	-7.8	5.1	0.264	0.	0.050	0.050	0.016	0.016
5	50.00	4.5	-6.7	6.0	0.290	0.	0.051	0.051	0.014	0.014
6	70.00	3.1	-6.3	6.0	0.303	0.	0.034	0.034	0.009	0.009
7	85.00	2.8	-5.3	7.2	0.304	0.	0.073	0.073	0.017	0.017
8	90.00	3.4	-4.2	8.4	0.298	0.	0.073	0.073	0.016	0.016
9	95.00	3.7	-3.6	10.7	0.334	0.	0.160	0.160	0.035	0.035

TABLE XXXII. - Continued. BLADE-ELEMENT DATA AT BLADE

EDGES FOR STATOR 9 (70 PERCENT DESIGN SPFD);

INTRABLADE ROW INSTRUMENTATION

AT STATION 2a)

(c) Reading number 575

RP	RADI I		ABS BETAM		REL BETAM		TOTAL TEMP		TOTAL PRESS	
	IN	OUT	IN	OUT	IN	OUT	IN	RATIO	IN	RATIO
1	22.949	22.944	31.2	6.1	31.2	6.1	307.6	1.001	12.34	0.966
2	22.479	22.474	30.2	4.0	30.2	4.0	307.0	1.001	12.36	0.984
3	22.004	21.999	30.4	2.8	30.4	2.8	306.3	1.000	12.36	0.989
4	20.577	20.574	32.4	2.3	32.4	2.3	306.3	1.000	12.36	0.991
5	18.682	18.717	35.5	2.5	35.5	2.5	306.6	1.000	12.41	0.988
6	16.787	16.916	39.3	1.3	39.3	1.3	307.1	0.999	12.47	0.986
7	15.342	15.624	44.6	1.9	44.6	1.9	308.6	1.000	12.69	0.987
8	14.849	15.164	46.7	3.3	46.7	3.3	309.2	1.000	12.82	0.978
9	14.343	14.684	48.6	4.6	48.6	4.6	309.1	1.000	12.79	0.964

RP	ABS VEL		REL VEL		MERID VEL		TANG VEL		WHEEL SPEED	
	IN	OUT	IN	OUT	IN	OUT	IN	OUT	IN	OUT
1	170.3	128.1	170.3	128.1	145.6	127.4	88.2	13.7	0.	0.
2	171.7	140.3	171.7	140.3	148.3	139.9	86.5	9.8	0.	0.
3	172.5	142.2	172.5	142.2	148.8	142.0	87.3	7.0	0.	0.
4	173.9	142.0	173.9	142.0	146.7	141.9	93.3	5.7	0.	0.
5	181.7	142.9	181.7	142.9	148.0	142.8	105.5	6.3	0.	0.
6	189.1	145.1	189.1	145.1	146.3	145.1	119.7	3.2	0.	0.
7	198.3	156.2	198.3	156.2	141.3	156.1	139.2	5.1	0.	0.
8	204.3	158.2	204.3	158.2	140.2	157.9	148.6	9.2	0.	0.
9	205.2	150.4	205.2	150.4	135.6	149.9	154.0	12.1	0.	0.

RP	ABS MACH NO		REL MACH NO		MERID MACH NO		MERID PEAK SS	
	IN	OUT	IN	OUT	IN	OUT	VEL R	MACH NO
1	0.496	0.369	0.496	0.369	0.424	0.367	0.875	0.761
2	0.501	0.406	0.501	0.406	0.433	0.405	0.943	0.751
3	0.504	0.412	0.504	0.412	0.435	0.412	0.955	0.756
4	0.508	0.412	0.508	0.412	0.429	0.411	0.967	0.784
5	0.532	0.414	0.532	0.414	0.433	0.414	0.965	0.846
6	0.554	0.421	0.554	0.421	0.429	0.420	0.992	0.907
7	0.582	0.452	0.582	0.452	0.415	0.452	1.104	1.000
8	0.600	0.458	0.600	0.458	0.412	0.457	1.126	1.051
9	0.603	0.435	0.603	0.435	0.398	0.433	1.105	1.074

RP	PERCENT		INCIDENCE		DEV	D-FACT	EFF	LOSS COEFF		LOSS PARAM	
	SPAN	MEAN	SS	SS				TOT	PROF	TOT	PROF
1	5.00	10.0	-4.1	11.0	0.400	0.	0.217	0.217	0.075	0.075	
2	10.00	10.8	-3.5	8.5	0.336	0.	0.100	0.100	0.034	0.034	
3	15.00	11.8	-2.5	7.1	0.331	0.	0.071	0.071	0.024	0.024	
4	30.00	12.1	-1.0	6.8	0.341	0.	0.058	0.058	0.018	0.018	
5	50.00	10.6	-0.6	7.7	0.369	0.	0.071	0.071	0.020	0.020	
6	70.00	8.5	-0.9	7.2	0.389	0.	0.073	0.073	0.019	0.019	
7	85.00	7.3	-0.8	8.6	0.369	0.	0.065	0.065	0.015	0.015	
8	90.00	7.1	-0.6	10.4	0.378	0.	0.100	0.100	0.022	0.022	
9	95.00	6.9	-0.4	12.0	0.415	0.	0.164	0.164	0.035	0.035	

TABLE XXXII. - Continued. BLADE-ELEMENT DATA AT BLADE

EDGES FOR STATOR 9 (70 PERCENT DESIGN SPEED;

INTRABLADE ROW INSTRUMENTATION

AT STATION 2a)

(d) Reading number 576

RP	RADII		ABS BETAM		REL BETAM		TOTAL TEMP		TOTAL PRESS	
	IN	OUT	IN	OUT	IN	OUT	IN	RATIO	IN	RATIO
1	22.949	22.944	37.4	5.2	37.4	5.2	309.8	1.001	12.42	0.963
2	22.479	22.474	35.9	4.2	35.9	4.2	308.8	1.002	12.40	0.971
3	22.004	21.999	35.9	4.1	35.9	4.1	308.6	1.000	12.39	0.977
4	20.577	20.574	38.4	3.5	38.4	3.5	308.1	1.000	12.35	0.985
5	18.682	18.717	42.1	2.9	42.1	2.9	307.9	0.999	12.36	0.981
6	16.787	16.916	44.4	2.6	44.4	2.6	308.4	0.999	12.49	0.983
7	15.342	15.624	47.3	2.2	47.3	2.2	309.1	0.999	12.78	0.978
8	14.849	15.164	48.6	3.9	48.6	3.9	309.6	0.998	12.83	0.966
9	14.343	14.684	50.6	4.8	50.6	4.8	309.4	1.000	12.83	0.960

RP	ABS VEL		REL VEL		MERID VEL		TANG VEL		WHEEL SPEED	
	IN	OUT	IN	OUT	IN	OUT	IN	OUT	IN	OUT
1	162.2	114.7	162.2	114.7	128.7	114.2	98.6	10.4	0.	0.
2	162.8	120.1	162.8	120.1	131.9	119.8	95.4	8.8	0.	0.
3	163.0	123.5	163.0	123.5	132.0	123.2	95.6	8.7	0.	0.
4	163.5	126.0	163.5	126.0	128.1	125.8	101.5	7.7	0.	0.
5	168.8	122.8	168.8	122.8	125.3	122.6	113.2	6.2	0.	0.
6	180.7	131.2	180.7	131.2	129.1	131.0	126.4	6.0	0.	0.
7	195.1	143.6	195.1	143.6	132.3	143.5	143.4	5.6	0.	0.
8	198.8	140.3	198.8	140.3	131.5	140.0	149.1	9.5	0.	0.
9	200.7	137.1	200.7	137.1	127.4	136.7	155.1	11.5	0.	0.

RP	ABS MACH NO		REL MACH NO		MERID MACH NO		MERID PEAK SS	
	IN	OUT	IN	OUT	IN	OUT	VEL R	MACH NO
1	0.470	0.328	0.470	0.328	0.373	0.327	0.887	0.820
2	0.472	0.345	0.472	0.345	0.383	0.344	0.908	0.798
3	0.473	0.355	0.473	0.355	0.383	0.354	0.934	0.798
4	0.475	0.363	0.475	0.363	0.372	0.362	0.981	0.828
5	0.491	0.353	0.491	0.353	0.365	0.353	0.978	0.892
6	0.527	0.378	0.527	0.378	0.377	0.378	1.015	0.955
7	0.571	0.415	0.571	0.415	0.387	0.414	1.085	1.035
8	0.582	0.405	0.582	0.405	0.385	0.404	1.065	1.059
9	0.589	0.395	0.589	0.395	0.374	0.394	1.073	1.088

RP	PERCENT		INCIDENCE		DEV	D-FACT	EFF	LOSS COEFF		LOSS PARAM	
	SPAN	MEAN	SS	SS				TOT	PROF	TOT	PROF
1	5.00	16.2	2.1	10.0	0.482	0.	0.265	0.265	0.092	0.092	
2	10.00	16.4	2.1	8.7	0.444	0.	0.203	0.203	0.069	0.069	
3	15.00	17.4	3.1	8.4	0.420	0.	0.160	0.160	0.053	0.053	
4	30.00	18.1	5.0	8.0	0.409	0.	0.105	0.105	0.033	0.033	
5	50.00	17.2	6.0	8.0	0.453	0.	0.126	0.126	0.036	0.036	
6	70.00	13.6	4.2	8.6	0.444	0.	0.097	0.097	0.025	0.025	
7	85.00	10.0	2.0	9.0	0.427	0.	0.113	0.113	0.026	0.026	
8	90.00	9.0	1.4	10.9	0.450	0.	0.166	0.166	0.037	0.037	
9	95.00	8.8	1.6	12.2	0.470	0.	0.190	0.190	0.041	0.041	

TABLE XXXII. - Continued. BLADE-ELEMENT DATA AT BLADE

EDGES FOR STATOR 9 (70 PERCENT DESIGN SPEED;

INTRABLADE ROW INSTRUMENTATION

AT STATION 2a)

(e) Reading number 550

RP	RADII		ABS BETAM		REL BETAM		TOTAL TEMP		TOTAL PRESS	
	IN	OUT	IN	OUT	IN	OUT	IN	RATIO	IN	RATIO
1	22.949	22.944	48.8	2.4	48.8	2.4	312.9	0.996	12.26	0.958
2	22.479	22.474	43.2	2.0	43.2	2.0	311.4	0.998	12.32	0.953
3	22.004	21.999	40.8	2.7	40.8	2.7	310.4	1.001	12.35	0.952
4	20.577	20.574	44.1	3.5	44.1	3.5	309.5	1.000	12.28	0.966
5	18.682	18.717	47.3	2.8	47.3	2.8	308.9	1.000	12.25	0.974
6	16.787	16.916	46.4	2.7	46.4	2.7	308.7	1.000	12.45	0.984
7	15.342	15.624	47.3	2.1	47.3	2.1	309.4	0.997	12.78	0.966
8	14.849	15.164	48.5	3.7	48.5	3.7	309.1	0.997	12.81	0.956
9	14.343	14.684	50.0	5.0	50.0	5.0	309.0	1.000	12.80	0.955

RP	ABS VEL		REL VEL		MERID VEL		TANG VEL		WHEEL SPEED	
	IN	OUT	IN	OUT	IN	OUT	IN	OUT	IN	OUT
1	150.0	100.3	150.0	100.3	98.8	100.2	112.9	4.2	0.	0.
2	154.4	100.8	154.4	100.8	112.6	100.7	105.7	3.5	0.	0.
3	157.1	101.8	157.1	101.8	118.9	101.7	102.6	4.7	0.	0.
4	156.7	108.7	156.7	108.7	112.6	108.5	109.0	6.6	0.	0.
5	161.2	112.2	161.2	112.2	109.2	112.1	118.5	5.5	0.	0.
6	177.2	129.8	177.2	129.8	122.2	129.7	128.3	6.2	0.	0.
7	194.4	136.1	194.4	136.1	131.8	136.0	142.8	5.0	0.	0.
8	197.0	132.9	197.0	132.9	130.4	132.7	147.7	8.5	0.	0.
9	198.4	133.5	198.4	133.5	127.4	133.0	152.0	11.7	0.	0.

RP	ABS MACH NO		REL MACH NO		MERID MACH NO		MERID PEAK SS	
	IN	OUT	IN	OUT	IN	OUT	VEL R	MACH NO
1	0.431	0.286	0.431	0.286	0.284	0.286	1.014	0.928
2	0.445	0.288	0.445	0.288	0.324	0.287	0.895	0.864
3	0.454	0.290	0.454	0.290	0.344	0.290	0.855	0.842
4	0.453	0.311	0.453	0.311	0.326	0.311	0.963	0.880
5	0.467	0.322	0.467	0.322	0.317	0.321	1.026	0.935
6	0.516	0.374	0.516	0.374	0.356	0.373	1.061	0.971
7	0.569	0.392	0.569	0.392	0.386	0.392	1.032	1.031
8	0.577	0.383	0.577	0.383	0.382	0.382	1.017	1.049
9	0.582	0.384	0.582	0.384	0.374	0.383	1.044	1.064

RP	PERCENT	INCIDENCE		DEV	D-FACT	EFF	LOSS COEFF		LOSS PARAM	
	SPAN	MEAN	SS				TOT	PROF	TOT	PROF
1	5.00	27.6	13.5	7.2	0.584	0.	0.353	0.353	0.123	0.123
2	10.00	23.7	9.4	6.5	0.573	0.	0.370	0.370	0.126	0.126
3	15.00	22.2	7.9	7.0	0.560	0.	0.365	0.365	0.122	0.122
4	30.00	23.8	10.7	8.0	0.511	0.	0.258	0.258	0.081	0.081
5	50.00	22.5	11.3	7.9	0.503	0.	0.187	0.187	0.053	0.053
6	70.00	15.6	6.2	8.7	0.443	0.	0.098	0.098	0.025	0.025
7	85.00	10.0	1.9	8.9	0.464	0.	0.174	0.174	0.041	0.041
8	90.00	9.0	1.3	10.8	0.482	0.	0.219	0.219	0.049	0.049
9	95.00	8.3	1.0	12.4	0.479	0.	0.217	0.217	0.047	0.047

TABLE XXXII. - Concluded. BLADE-ELEMENT DATA AT BLADE

EDGES FOR STATOR 9 (70 PERCENT DESIGN SPEED;

INTRABLADE ROW INSTRUMENTATION

AT STATION 2a)

(f) Reading number 577

RP	RADII		ABS BETAM		REL BETAM		TOTAL TEMP		TOTAL PRESS	
	IN	OUT	IN	OUT	IN	OUT	IN	RATIO	IN	RATIO
1	22.949	22.944	51.7	1.8	51.7	1.8	313.3	0.997	12.28	0.954
2	22.479	22.474	47.1	1.3	47.1	1.3	312.4	0.998	12.33	0.949
3	22.004	21.999	43.9	1.9	43.9	1.9	310.7	1.001	12.36	0.947
4	20.577	20.574	47.0	3.2	47.0	3.2	310.1	1.000	12.29	0.961
5	18.682	18.717	50.3	2.5	50.3	2.5	309.3	1.000	12.26	0.971
6	16.787	16.916	48.2	2.6	48.2	2.6	309.2	1.000	12.50	0.980
7	15.342	15.624	48.8	2.0	48.8	2.0	309.5	0.998	12.79	0.964
8	14.849	15.164	49.7	3.7	49.7	3.7	309.2	0.998	12.85	0.957
9	14.343	14.684	51.2	5.0	51.2	5.0	309.4	1.000	12.82	0.956

RP	ABS VEL		REL VEL		MERID VEL		TANG VEL		WHEEL SPEED	
	IN	OUT	IN	OUT	IN	OUT	IN	OUT	IN	OUT
1	150.0	98.6	150.0	98.6	93.0	98.6	117.8	3.1	0.	0.
2	153.8	97.2	153.8	97.2	104.7	97.2	112.7	2.1	0.	0.
3	156.2	97.1	156.2	97.1	112.6	97.1	108.3	3.2	0.	0.
4	156.1	104.3	156.1	104.3	106.5	104.1	114.1	5.7	0.	0.
5	160.5	110.2	160.5	110.2	102.5	110.1	123.5	4.8	0.	0.
6	177.9	129.4	177.9	129.4	118.5	129.3	132.7	5.9	0.	0.
7	194.0	136.0	194.0	136.0	127.9	135.9	145.9	4.8	0.	0.
8	197.6	135.0	197.6	135.0	127.9	134.8	150.6	8.7	0.	0.
9	198.9	134.4	198.9	134.4	124.7	133.9	154.9	11.8	0.	0.

RP	ABS MACH NO		REL MACH NO		MERID MACH NO		MERID PEAK SS	
	IN	OUT	IN	OUT	IN	OUT	VEL R	MACH NO
1	0.431	0.281	0.431	0.281	0.267	0.280	1.060	0.976
2	0.443	0.277	0.443	0.277	0.301	0.277	0.928	0.923
3	0.451	0.277	0.451	0.277	0.325	0.277	0.862	0.886
4	0.451	0.298	0.451	0.298	0.308	0.298	0.977	0.923
5	0.465	0.316	0.465	0.316	0.297	0.315	1.074	0.982
6	0.518	0.372	0.518	0.372	0.345	0.372	1.091	1.009
7	0.568	0.392	0.568	0.392	0.374	0.392	1.063	1.058
8	0.579	0.389	0.579	0.389	0.375	0.388	1.053	1.074
9	0.583	0.387	0.583	0.387	0.366	0.385	1.073	1.089

RP	PERCENT SPAN		INCIDENCE		DEV	D-FACT	EFF	LOSS COEFF		LOSS PARAM	
	SPAN	MEAN	SS	TOT				PROF	TOT	PROF	
1	5.00	30.5	16.4	6.6	0.609	0.	0.382	0.382	0.133	0.133	
2	10.00	27.6	13.3	5.7	0.614	0.	0.408	0.408	0.140	0.140	
3	15.00	25.3	11.0	6.2	0.603	0.	0.410	0.410	0.137	0.137	
4	30.00	26.6	13.6	7.7	0.549	0.	0.303	0.303	0.095	0.095	
5	50.00	25.4	14.3	7.7	0.524	0.	0.214	0.214	0.061	0.061	
6	70.00	17.4	8.0	8.6	0.454	0.	0.122	0.122	0.031	0.031	
7	85.00	11.5	3.4	8.8	0.467	0.	0.181	0.181	0.042	0.042	
8	90.00	10.1	2.4	10.8	0.476	0.	0.214	0.214	0.048	0.048	
9	95.00	9.4	2.2	12.4	0.479	0.	0.213	0.213	0.046	0.046	

TABLE XXXIII. - BLADE-ELEMENT DATA AT BLADE EDGES FOR
 STATOR 9 (60 PERCENT DESIGN SPEED; INTRABLADE ROW
 INSTRUMENTATION AT STATION 2a;
 READING NUMBER 578)

RP	RADII		ABS BETAM		REL BETAM		TOTAL TEMP		TOTAL PRESS	
	IN	OUT	IN	OUT	IN	OUT	IN	RATIO	IN	RATIO
1	22.949	22.944	52.2	1.3	52.2	1.3	306.6	0.998	11.69	0.966
2	22.479	22.474	47.9	0.8	47.9	0.8	305.9	0.999	11.72	0.963
3	22.004	21.999	43.7	1.4	43.7	1.4	304.8	1.000	11.74	0.961
4	20.577	20.574	46.4	3.0	46.4	3.0	304.2	1.000	11.70	0.971
5	18.682	18.717	49.8	2.3	49.8	2.3	303.8	0.999	11.68	0.978
6	16.787	16.916	47.5	2.7	47.5	2.7	303.1	1.001	11.78	0.989
7	15.342	15.624	48.2	2.5	48.2	2.5	303.4	0.999	11.94	0.981
8	14.849	15.164	49.2	4.3	49.2	4.3	303.6	0.999	12.05	0.970
9	14.343	14.684	50.7	5.6	50.7	5.6	303.4	1.000	12.03	0.969

RP	ABS VEL		REL VEL		MERID VEL		TANG VEL		WHEEL SPEED	
	IN	OUT	IN	OUT	IN	OUT	IN	OUT	IN	OUT
1	127.7	83.6	127.7	83.6	78.3	83.6	100.9	1.9	0.	0.
2	130.2	83.4	130.2	83.4	87.3	83.4	96.7	1.2	0.	0.
3	132.6	83.0	132.6	83.0	95.9	83.0	91.5	2.0	0.	0.
4	133.5	89.7	133.5	89.7	92.1	89.6	96.6	4.7	0.	0.
5	137.5	94.6	137.5	94.6	88.7	94.5	105.1	3.8	0.	0.
6	148.8	109.7	148.8	109.7	100.5	109.5	109.8	5.1	0.	0.
7	160.8	115.6	160.8	115.6	107.1	115.5	119.9	5.1	0.	0.
8	167.1	115.6	167.1	115.6	109.1	115.2	126.6	8.6	0.	0.
9	168.7	115.6	168.7	115.6	106.8	115.0	130.6	11.3	0.	0.

RP	ABS MACH NO		REL MACH NO		MERID MACH NO		MERID PEAK SS VEL R MACH NO	
	IN	OUT	IN	OUT	IN	OUT		
1	0.369	0.240	0.369	0.240	0.226	0.240	1.069	0.843
2	0.377	0.239	0.377	0.239	0.252	0.239	0.956	0.797
3	0.384	0.239	0.384	0.239	0.278	0.238	0.865	0.752
4	0.388	0.258	0.388	0.258	0.267	0.258	0.973	0.785
5	0.400	0.273	0.400	0.273	0.258	0.273	1.065	0.836
6	0.434	0.317	0.434	0.317	0.293	0.317	1.090	0.834
7	0.471	0.335	0.471	0.335	0.313	0.335	1.079	0.868
8	0.490	0.335	0.490	0.335	0.320	0.334	1.056	0.902
9	0.495	0.335	0.495	0.335	0.313	0.333	1.077	0.918

RP	PERCENT SPAN	INCIDENCE		DEV	D-FACT	EFF	LOSS COEFF		LOSS PARAM	
		MEAN	SS				TOT	PROF	TOT	PROF
1	5.00	31.0	16.9	6.1	0.615	0.	0.380	0.380	0.133	0.133
2	10.00	28.4	14.1	5.3	0.610	0.	0.392	0.392	0.134	0.134
3	15.00	25.1	10.8	5.7	0.600	0.	0.399	0.399	0.134	0.134
4	30.00	26.1	13.0	7.5	0.544	0.	0.292	0.292	0.091	0.091
5	50.00	25.0	13.8	7.5	0.522	0.	0.211	0.211	0.060	0.060
6	70.00	16.7	7.3	8.6	0.442	0.	0.094	0.094	0.024	0.024
7	85.00	10.9	2.9	9.3	0.446	0.	0.133	0.133	0.031	0.031
8	90.00	9.7	2.0	11.3	0.465	0.	0.196	0.196	0.044	0.044
9	95.00	9.0	1.7	12.9	0.466	0.	0.199	0.199	0.043	0.043

TABLE XXXIV. - BLADE-ELEMENT DATA AT BLADE EDGES FOR

STATOR 9 (50 PERCENT DESIGN SPEED; INTRABLADE ROW

INSTRUMENTATION AT STATION 2a;

READING NUMBER 579)

RP	RADI I		ABS BETAM		REL BETAM		TOTAL TEMP		TOTAL PRESS	
	IN	OUT	IN	OUT	IN	OUT	IN	RATIO	IN	RATIO
1	22.949	22.944	53.0	2.6	53.0	2.6	299.6	0.999	11.20	0.979
2	22.479	22.474	55.1	3.2	55.1	3.2	299.2	0.997	11.13	0.981
3	22.004	21.999	51.7	3.1	51.7	3.1	298.7	0.997	11.10	0.986
4	20.577	20.574	46.8	3.1	46.8	3.1	297.4	0.998	10.95	1.002
5	18.682	18.717	42.6	2.6	42.6	2.6	297.1	0.999	11.09	0.999
6	16.787	16.916	42.8	2.2	42.8	2.2	297.2	0.999	11.18	0.997
7	15.342	15.624	44.5	3.1	44.5	3.1	298.0	0.998	11.33	0.984
8	14.849	15.164	45.7	4.0	45.7	4.0	298.2	0.998	11.41	0.972
9	14.343	14.684	48.0	3.1	48.0	3.1	299.0	0.997	11.43	0.964

RP	ABS VEL		REL VEL		MERID VEL		TANG VEL		WHEEL SPEED	
	IN	OUT	IN	OUT	IN	OUT	IN	OUT	IN	OUT
1	106.0	69.1	106.0	69.1	63.8	69.0	84.7	3.1	0.	0.
2	107.5	69.4	107.5	69.4	61.5	69.3	88.2	3.8	0.	0.
3	107.0	72.3	107.0	72.3	66.3	72.2	84.0	3.9	0.	0.
4	107.6	77.0	107.6	77.0	73.7	76.9	78.4	4.1	0.	0.
5	117.6	85.1	117.6	85.1	86.6	85.0	79.6	3.9	0.	0.
6	127.4	91.2	127.4	91.2	93.5	91.1	86.6	3.5	0.	0.
7	141.0	93.4	141.0	93.4	100.5	93.3	98.8	5.0	0.	0.
8	146.3	89.6	146.3	89.6	102.2	89.4	104.7	6.3	0.	0.
9	149.1	85.2	149.1	85.2	99.7	85.0	110.8	4.6	0.	0.

RP	ABS MACH NO		REL MACH NO		MERID MACH NO		MERID PEAK SS VEL R MACH NO	
	IN	OUT	IN	OUT	IN	OUT		
1	0.308	0.200	0.308	0.200	0.186	0.200	1.083	0.715
2	0.313	0.201	0.313	0.201	0.179	0.201	1.128	0.751
3	0.312	0.210	0.312	0.210	0.193	0.210	1.088	0.764
4	0.314	0.224	0.314	0.224	0.215	0.224	1.043	0.641
5	0.344	0.248	0.344	0.248	0.254	0.248	0.981	0.631
6	0.374	0.266	0.374	0.266	0.274	0.266	0.974	0.657
7	0.414	0.272	0.414	0.272	0.295	0.272	0.928	0.711
8	0.430	0.261	0.430	0.261	0.301	0.260	0.875	0.740
9	0.438	0.248	0.438	0.248	0.293	0.247	0.853	0.772

RP	PERCENT		INCIDENCE		DEV	D-FACT	EFF	LOSS COEFF		LOSS PARAM	
	SPAN		MEAN	SS				TOT	PROF	TOT	PROF
1	5.00		31.8	17.7	7.4	0.616	0.	0.336	0.336	0.117	0.117
2	10.00		35.6	21.3	7.6	0.623	0.	0.289	0.289	0.099	0.099
3	15.00		33.1	18.8	7.4	0.575	0.	0.214	0.214	0.071	0.071
4	30.00		26.5	13.4	7.6	0.501	0.	-0.033	-0.033	-0.010	-0.010
5	50.00		17.7	6.5	7.7	0.460	0.	0.018	0.018	0.005	0.005
6	70.00		12.0	2.6	8.1	0.451	0.	0.037	0.037	0.009	0.009
7	85.00		7.2	-0.9	9.8	0.491	0.	0.147	0.147	0.034	0.034
8	90.00		6.1	-1.5	11.1	0.537	0.	0.235	0.235	0.053	0.053
9	95.00		6.3	-1.0	10.5	0.581	0.	0.287	0.287	0.062	0.062

TABLE XXXV. - BLADE-ELEMENT DATA AT BLADE EDGES FOR
 STATOR 9 (100 PERCENT DESIGN SPEED; 1 EXIT PYLON;
 INTRABLADE ROW INSTRUMENTATION AT STATION 2a)

(a) Reading number 613

RP	RADII		ABS BETAM		REL BETAM		TOTAL TEMP		TOTAL PRESS	
	IN	OUT	IN	OUT	IN	OUT	IN	RATIO	IN	RATIO
1	22.949	22.944	36.8	7.0	36.8	7.0	333.9	1.000	15.91	0.922
2	22.479	22.474	35.7	5.5	35.7	5.5	332.8	1.000	15.91	0.945
3	22.004	21.999	35.9	4.5	35.9	4.5	332.3	0.999	15.88	0.948
4	20.577	20.574	37.6	4.3	37.6	4.3	330.4	1.000	15.73	0.948
5	18.682	18.717	39.5	3.3	39.5	3.3	328.8	1.002	15.47	0.962
6	16.787	16.916	42.6	2.2	42.6	2.2	328.3	0.965	15.35	0.967
7	15.342	15.624	48.2	2.7	48.2	2.7	330.3	1.000	15.69	0.947
8	14.849	15.164	50.1	3.7	50.1	3.7	330.9	0.999	15.83	0.923
9	14.343	14.684	52.4	3.4	52.4	3.4	330.9	0.998	15.73	0.894

RP	ABS VEL		REL VEL		MERID VEL		TANG VEL		WHEEL SPEED	
	IN	OUT	IN	OUT	IN	OUT	IN	OUT	IN	OUT
1	251.8	186.9	251.8	186.9	201.6	185.5	151.0	22.8	0.	0.
2	255.8	198.4	255.8	198.4	207.6	197.5	149.3	18.9	0.	0.
3	258.9	199.6	258.9	199.6	209.7	199.0	152.0	15.6	0.	0.
4	264.0	203.3	264.0	203.3	209.2	202.8	161.1	15.2	0.	0.
5	270.5	207.9	270.5	207.9	208.7	207.6	172.2	12.1	0.	0.
6	277.4	205.1	277.4	205.1	204.0	204.9	187.9	7.9	0.	0.
7	289.7	212.6	289.7	212.6	193.0	212.4	216.1	10.0	0.	0.
8	291.4	209.0	291.4	209.0	187.0	208.6	223.4	13.4	0.	0.
9	287.6	193.7	287.6	193.7	175.6	193.4	227.8	11.6	0.	0.

RP	ABS MACH NO		REL MACH NO		MERID MACH NO		MERID PEAK SS	
	IN	OUT	IN	OUT	IN	OUT	VEL R	MACH NO
1	0.723	0.524	0.723	0.524	0.578	0.520	0.920	1.247
2	0.736	0.559	0.736	0.559	0.598	0.557	0.951	1.240
3	0.747	0.564	0.747	0.564	0.605	0.562	0.949	1.260
4	0.766	0.576	0.766	0.576	0.607	0.575	0.969	1.315
5	0.789	0.591	0.789	0.591	0.609	0.590	0.995	1.363
6	0.813	0.595	0.813	0.595	0.598	0.594	1.004	1.423
7	0.851	0.605	0.851	0.605	0.567	0.604	1.100	1.570
8	0.856	0.593	0.856	0.593	0.549	0.592	1.115	1.600
9	0.843	0.548	0.843	0.548	0.515	0.547	1.101	1.611

RP	PERCENT		INCIDENCE		DEV	D-FACT	EFF	LOSS COEFF		LOSS PARAM	
	SPAN	MEAN	SS	SS				TOT	PROF	TOT	PROF
1	5.00	15.6	1.5	11.8	0.435	0.	0.264	0.264	0.091	0.091	
2	10.00	16.2	1.9	9.9	0.399	0.	0.182	0.182	0.062	0.062	
3	15.00	17.4	3.1	8.8	0.405	0.	0.168	0.168	0.056	0.056	
4	30.00	17.3	4.2	8.8	0.403	0.	0.163	0.163	0.051	0.051	
5	50.00	14.6	3.5	8.5	0.399	0.	0.112	0.111	0.032	0.031	
6	70.00	11.8	2.4	8.1	0.426	0.	0.092	0.088	0.024	0.022	
7	85.00	10.9	2.9	9.5	0.430	0.	0.141	0.119	0.033	0.028	
8	90.00	10.5	2.9	10.7	0.443	0.	0.202	0.176	0.045	0.039	
9	95.00	10.6	3.4	10.8	0.488	0.	0.286	0.259	0.062	0.056	

TABLE XXXV. - Concluded. BLADE-ELEMENT DATA AT BLADE EDGES

FOR STATOR 9 (100 PERCENT DESIGN SPEED; 1 EXIT PYLON;

INTRABLADE ROW INSTRUMENTATION AT STATION 2a)

(b) Reading number 614

RP	RADII		ABS BETAM		REL BETAM		TOTAL TEMP		TOTAL PRESS	
	IN	OUT	IN	OUT	IN	OUT	IN	RATIO	IN	RATIO
1	22.949	22.944	28.7	7.1	28.7	7.1	324.3	0.998	14.17	0.918
2	22.479	22.474	28.2	4.7	28.2	4.7	323.6	0.999	14.28	0.965
3	22.004	21.999	28.4	4.6	28.4	4.6	323.7	0.999	14.46	0.959
4	20.577	20.574	30.2	5.8	30.2	5.8	324.7	0.998	14.76	0.946
5	18.682	18.717	33.1	4.8	33.1	4.8	325.8	0.997	15.01	0.936
6	16.787	16.916	36.5	2.5	36.5	2.5	327.3	1.000	15.38	0.930
7	15.342	15.624	42.3	1.2	42.3	1.2	329.6	0.996	15.71	0.919
8	14.849	15.164	45.2	1.8	45.2	1.8	330.6	0.997	15.84	0.918
9	14.343	14.684	48.5	3.0	48.5	3.0	330.9	0.997	15.56	0.895

RP	ABS VEL		REL VEL		MERID VEL		TANG VEL		WHEEL SPEED	
	IN	OUT	IN	OUT	IN	OUT	IN	OUT	IN	OUT
1	244.7	208.4	244.7	208.4	214.6	206.8	117.6	25.7	0.	0.
2	249.8	230.1	249.8	230.1	220.1	229.3	118.1	18.8	0.	0.
3	256.9	232.4	256.9	232.4	226.1	231.6	122.0	18.8	0.	0.
4	270.9	246.9	270.9	246.9	234.2	245.7	136.2	24.8	0.	0.
5	289.5	252.3	289.5	252.3	242.6	251.4	158.0	21.0	0.	0.
6	307.5	257.8	307.5	257.8	247.1	257.5	183.0	11.4	0.	0.
7	312.7	263.5	312.7	263.5	231.2	263.5	210.6	5.5	0.	0.
8	310.8	264.3	310.8	264.3	218.9	264.2	220.6	8.5	0.	0.
9	302.5	248.2	302.5	248.2	200.3	247.9	226.7	13.0	0.	0.

RP	ABS MACH NO		REL MACH NO		MERID MACH NO		MERID PEAK SS	
	IN	OUT	IN	OUT	IN	OUT	VEL R	MACH NO
1	0.711	0.598	0.711	0.598	0.624	0.594	0.964	1.031
2	0.728	0.666	0.728	0.666	0.642	0.664	1.042	1.041
3	0.751	0.673	0.751	0.673	0.661	0.671	1.025	1.074
4	0.796	0.719	0.796	0.719	0.688	0.715	1.049	1.166
5	0.857	0.735	0.857	0.735	0.718	0.733	1.036	1.292
6	0.916	0.750	0.916	0.750	0.737	0.749	1.042	1.414
7	0.931	0.767	0.931	0.767	0.688	0.767	1.140	2.598
8	0.922	0.768	0.922	0.768	0.650	0.768	1.207	2.704
9	0.893	0.716	0.893	0.716	0.591	0.715	1.238	2.774

RP	PERCENT	INCIDENCE		DEV	D-FACT	EFF	LOSS COEFF		LOSS PARAM	
	SPAN	MEAN	SS				TOT	PROF	TOT	PROF
1	5.00	7.5	-6.6	11.9	0.279	0.	0.288	0.288	0.100	0.100
2	10.00	8.7	-5.6	9.2	0.215	0.	0.119	0.119	0.041	0.041
3	15.00	9.8	-4.5	8.9	0.230	0.	0.132	0.132	0.044	0.044
4	30.00	9.9	-3.2	10.3	0.217	0.	0.158	0.158	0.049	0.049
5	50.00	8.2	-3.0	9.9	0.263	0.	0.169	0.168	0.048	0.048
6	70.00	5.7	-3.7	8.5	0.304	0.	0.168	0.158	0.043	0.040
7	85.00	5.0	-3.0	8.0	0.309	0.	0.189	-0.211	0.044	-0.049
8	90.00	5.6	-2.0	8.9	0.301	0.	0.193	-0.263	0.044	-0.059
9	95.00	6.8	-0.5	10.3	0.331	0.	0.259	-0.241	0.056	-0.052

TABLE XXXVI. - BLADE-ELEMENT DATA AT BLADE EDGES FOR
 STATOR 9 (90 PERCENT DESIGN SPEED; 1 EXIT PYLON;
 INTRABLADE ROW INSTRUMENTATION AT STATION 2a)

(a) Reading number 615

RP	RADII		ABS BETAM		REL BETAM		TOTAL TEMP		TOTAL PRESS	
	IN	OUT	IN	OUT	IN	OUT	IN	RATIO	IN	RATIO
1	22.949	22.944	26.7	6.8	26.7	6.8	315.9	0.998	13.33	0.930
2	22.479	22.474	26.0	3.4	26.0	3.4	315.9	0.998	13.43	0.973
3	22.004	21.999	26.2	2.6	26.2	2.6	315.8	0.997	13.58	0.974
4	20.577	20.574	27.9	3.3	27.9	3.3	316.3	0.997	13.83	0.965
5	18.682	18.717	31.0	3.3	31.0	3.3	317.6	0.998	14.02	0.963
6	16.787	16.916	35.2	1.7	35.2	1.7	319.0	1.001	14.24	0.962
7	15.342	15.624	41.2	1.0	41.2	1.0	321.5	0.997	14.49	0.958
8	14.849	15.164	44.1	1.8	44.1	1.8	322.5	0.997	14.62	0.949
9	14.343	14.684	47.4	3.3	47.4	3.3	323.3	0.998	14.65	0.916

RP	ABS VEL		REL VEL		MERID VEL		TANG VEL		WHEEL SPEED	
	IN	OUT	IN	OUT	IN	OUT	IN	OUT	IN	OUT
1	226.7	183.6	226.7	183.6	202.6	182.3	101.7	21.7	0.	0.
2	232.6	204.2	232.6	204.2	209.1	203.9	101.9	12.0	0.	0.
3	238.9	208.6	238.9	208.6	214.4	208.3	105.3	9.6	0.	0.
4	250.9	221.9	250.9	221.9	221.8	221.6	117.4	12.8	0.	0.
5	266.1	232.4	266.1	232.4	228.0	232.0	137.1	13.3	0.	0.
6	278.1	239.0	278.1	239.0	227.4	238.9	160.1	7.0	0.	0.
7	285.0	247.7	285.0	247.7	214.5	247.7	187.6	4.1	0.	0.
8	284.4	248.0	284.4	248.0	204.3	247.9	197.9	7.9	0.	0.
9	281.2	236.9	281.2	236.9	190.5	236.5	206.9	13.8	0.	0.

RP	ABS MACH NO		REL MACH NO		MERID MACH NO		MERID PEAK SS	
	IN	OUT	IN	OUT	IN	OUT	VEL R	MACH NO
1	0.664	0.530	0.664	0.530	0.593	0.526	0.900	0.915
2	0.683	0.594	0.683	0.594	0.614	0.593	0.975	0.922
3	0.703	0.608	0.703	0.608	0.631	0.607	0.972	0.951
4	0.741	0.649	0.741	0.649	0.655	0.648	0.999	1.028
5	0.790	0.681	0.790	0.681	0.677	0.680	1.017	1.136
6	0.828	0.699	0.828	0.699	0.677	0.699	1.050	1.240
7	0.848	0.726	0.848	0.726	0.638	0.726	1.155	1.360
8	0.845	0.725	0.845	0.725	0.607	0.725	1.214	1.406
9	0.833	0.688	0.833	0.688	0.564	0.687	1.241	1.446

RP	PERCENT	INCIDENCE		DEV	D-FACT	EFF	LOSS COEFF		LOSS PARAM	
	SPAN	MEAN	SS				TOT	PROF	TOT	PROF
1	5.00	5.4	-8.7	11.6	0.313	0.	0.274	0.274	0.095	0.095
2	10.00	6.5	-7.8	7.9	0.254	0.	0.100	0.100	0.034	0.034
3	15.00	7.6	-6.7	6.9	0.261	0.	0.093	0.093	0.031	0.031
4	30.00	7.6	-5.5	7.8	0.246	0.	0.113	0.113	0.035	0.035
5	50.00	6.1	-5.1	8.4	0.259	0.	0.109	0.109	0.031	0.031
6	70.00	4.3	-5.1	7.6	0.281	0.	0.104	0.104	0.027	0.027
7	85.00	3.9	-4.2	7.7	0.279	0.	0.111	0.108	0.026	0.025
8	90.00	4.5	-3.1	8.9	0.277	0.	0.137	0.131	0.031	0.030
9	95.00	5.6	-1.6	10.7	0.305	0.	0.230	0.222	0.050	0.048

TABLE XXXVI. - Concluded. BLADE -ELEMENT DATA AT BLADE

EDGES FOR STATOR 9 (90 PERCENT DESIGN SPEED; 1 EXIT

PYLON; INTRABLADE ROW INSTRUMENTATION

AT STATION 2a)

(b) Reading number 616

RP	RADII		ABS BETAM		REL BETAM		TOTAL TEMP		TOTAL PRESS	
	IN	OUT	IN	OUT	IN	OUT	IN	RATIO	IN	RATIO
1	22.949	22.944	40.5	6.0	40.5	6.0	325.5	0.998	14.05	0.936
2	22.479	22.474	39.0	4.9	39.0	4.9	324.4	1.000	14.12	0.936
3	22.004	21.999	39.3	4.5	39.3	4.5	323.3	1.001	14.08	0.941
4	20.577	20.574	43.0	4.2	43.0	4.2	322.7	0.999	13.90	0.952
5	18.682	18.717	46.1	3.4	46.1	3.4	322.2	0.998	13.92	0.954
6	16.787	16.916	46.3	3.0	46.3	3.0	321.3	0.999	14.16	0.961
7	15.342	15.624	49.0	2.8	49.0	2.8	322.9	0.999	14.55	0.956
8	14.849	15.164	50.4	3.6	50.4	3.6	323.3	0.999	14.78	0.928
9	14.343	14.684	52.2	3.3	52.2	3.3	323.3	0.997	14.72	0.907

RP	ABS VEL		REL VEL		MERID VEL		TANG VEL		WHEEL SPEED	
	IN	OUT	IN	OUT	IN	OUT	IN	OUT	IN	OUT
1	207.6	144.3	207.6	144.3	157.9	143.5	134.8	15.1	0.	0.
2	212.5	149.2	212.5	149.2	165.3	148.7	133.6	12.7	0.	0.
3	213.2	152.1	213.2	152.1	165.1	151.6	134.9	12.0	0.	0.
4	213.5	156.4	213.5	156.4	156.2	156.0	145.5	11.4	0.	0.
5	221.1	158.7	221.1	158.7	153.3	158.4	159.3	9.3	0.	0.
6	237.2	171.4	237.2	171.4	163.8	171.2	171.6	8.8	0.	0.
7	254.3	185.7	254.3	185.7	166.7	185.5	192.0	9.0	0.	0.
8	259.8	183.0	259.8	183.0	165.8	182.6	200.1	11.3	0.	0.
9	258.2	173.2	258.2	173.2	158.3	173.0	204.1	10.0	0.	0.

RP	ABS MACH NO		REL MACH NO		MERID MACH NO		MERID PEAK SS	
	IN	OUT	IN	OUT	IN	OUT	VEL R	MACH NO
1	0.594	0.406	0.594	0.406	0.452	0.404	0.909	1.099
2	0.610	0.421	0.610	0.421	0.474	0.419	0.900	1.095
3	0.613	0.429	0.613	0.429	0.475	0.428	0.918	1.104
4	0.615	0.443	0.615	0.443	0.450	0.442	0.998	1.170
5	0.639	0.450	0.639	0.450	0.443	0.449	1.033	1.250
6	0.691	0.489	0.691	0.489	0.477	0.488	1.045	1.298
7	0.744	0.530	0.744	0.530	0.488	0.530	1.113	1.393
8	0.762	0.522	0.762	0.522	0.486	0.521	1.102	1.432
9	0.756	0.493	0.756	0.493	0.463	0.492	1.093	1.442

RP	PERCENT		INCIDENCE		DEV	D-FACT	EFF	LOSS COEFF		LOSS PARAM	
	SPAN	MEAN	SS	TOT				PROF	TOT	PROF	
1	5.00	19.3	5.2	10.8	0.506	0.	0.301	0.301	0.105	0.105	
2	10.00	19.5	5.2	9.4	0.493	0.	0.287	0.287	0.098	0.098	
3	15.00	20.7	6.4	8.8	0.480	0.	0.263	0.263	0.088	0.088	
4	30.00	22.6	9.6	8.7	0.464	0.	0.215	0.215	0.067	0.067	
5	50.00	21.2	10.0	8.5	0.475	0.	0.189	0.189	0.054	0.054	
6	70.00	15.5	6.1	8.9	0.452	0.	0.142	0.142	0.036	0.036	
7	85.00	11.7	3.7	9.6	0.436	0.	0.142	0.141	0.033	0.033	
8	90.00	10.8	3.1	10.6	0.457	0.	0.226	0.223	0.051	0.050	
9	95.00	10.4	3.2	10.7	0.490	0.	0.293	0.290	0.064	0.063	

TABLE XXXVII. - BLADE-ELEMENT DATA AT BLADE EDGES FOR
 STATOR 9 (100 PERCENT DESIGN SPEED; 4 EXIT PYLONS;
 INTRABLADE ROW INSTRUMENTATION AT STATION 2a)

(a) Reading number 621

RP	RADII		ABS BETAM		REL BETAM		TOTAL TEMP		TOTAL PRESS	
	IN	OUT	IN	OUT	IN	OUT	IN	RATIO	IN	RATIO
1	22.949	22.944	28.3	6.9	28.3	6.9	323.2	0.999	14.02	0.926
2	22.479	22.474	27.7	3.7	27.7	3.7	323.0	1.000	14.14	0.975
3	22.004	21.999	27.7	2.8	27.7	2.8	322.5	1.001	14.29	0.975
4	20.577	20.574	29.6	5.2	29.6	5.2	323.6	1.002	14.62	0.958
5	18.682	18.717	32.8	5.2	32.8	5.2	324.9	1.000	14.86	0.948
6	16.787	16.916	36.6	2.1	36.6	2.1	327.4	1.000	15.30	0.938
7	15.342	15.624	42.1	0.7	42.1	0.7	330.0	0.999	15.74	0.923
8	14.849	15.164	45.1	1.4	45.1	1.4	331.0	0.999	15.89	0.924
9	14.343	14.684	48.5	3.2	48.5	3.2	331.6	0.998	15.74	0.887

RP	ABS VEL		REL VEL		MERID VEL		TANG VEL		WHEEL SPEED	
	IN	OUT	IN	OUT	IN	OUT	IN	OUT	IN	OUT
1	244.4	207.1	244.4	207.1	215.3	205.6	115.7	24.8	0.	0.
2	249.5	229.0	249.5	229.0	220.9	228.5	115.8	14.7	0.	0.
3	254.5	232.7	254.5	232.7	225.4	232.4	118.2	11.5	0.	0.
4	268.3	247.5	268.3	247.5	233.2	246.5	132.6	22.5	0.	0.
5	285.6	255.4	285.6	255.4	239.9	254.4	154.9	22.9	0.	0.
6	305.2	260.1	305.2	260.1	245.1	259.9	181.8	9.7	0.	0.
7	312.5	266.6	312.5	266.6	231.8	266.5	209.5	3.5	0.	0.
8	311.8	267.7	311.8	267.7	220.1	267.7	220.9	6.5	0.	0.
9	306.6	254.9	306.6	254.9	203.2	254.6	229.5	14.2	0.	0.

RP	ABS MACH NO		REL MACH NO		MERID MACH NO		MERID PEAK SS VEL R MACH NO
	IN	OUT	IN	OUT	IN	OUT	
1	0.712	0.595	0.712	0.595	0.627	0.591	0.955 1.021
2	0.728	0.663	0.728	0.663	0.645	0.662	1.034 1.027
3	0.745	0.675	0.745	0.675	0.660	0.674	1.031 1.048
4	0.789	0.721	0.789	0.721	0.686	0.718	1.057 1.141
5	0.845	0.745	0.845	0.745	0.710	0.742	1.060 1.267
6	0.908	0.757	0.908	0.757	0.730	0.757	1.060 1.403
7	0.929	0.775	0.929	0.775	0.689	0.775	1.150 2.576
8	0.925	0.777	0.925	0.777	0.653	0.777	1.216 2.704
9	0.906	0.736	0.906	0.736	0.601	0.735	1.252 2.809

RP	PERCENT SPAN	INCIDENCE		DEV	D-FACT	EFF	LOSS COEFF		LOSS PARAM	
		MEAN	SS				TOT	PROF	TOT	PROF
1	5.00	7.0	-7.1	11.7	0.282	0.	0.259	0.259	0.090	0.090
2	10.00	8.2	-6.1	8.2	0.221	0.	0.085	0.085	0.029	0.029
3	15.00	9.1	-5.2	7.1	0.226	0.	0.081	0.081	0.027	0.027
4	30.00	9.3	-3.8	9.7	0.206	0.	0.125	0.125	0.039	0.039
5	50.00	8.0	-3.2	10.3	0.237	0.	0.139	0.138	0.039	0.039
6	70.00	5.7	-3.6	8.1	0.292	0.	0.151	0.142	0.039	0.036
7	85.00	4.8	-3.2	7.5	0.299	0.	0.181	-0.209	0.042	-0.049
8	90.00	5.5	-2.1	8.5	0.294	0.	0.179	-0.277	0.040	-0.062
9	95.00	6.7	-0.5	10.5	0.319	0.	0.275	-0.242	0.060	-0.053

TABLE XXXVII. - Concluded. BLADE-ELEMENT DATA AT BLADE

EDGES FOR STATOR 9 (100 PERCENT DESIGN SPEED; 4 EXIT

PYLONS; INTRABLADE ROW INSTRUMENTATION

AT STATION 2a)

(b) Reading number 622

RP	RADII		ABS BETAM		REL BETAM		TOTAL TEMP		TOTAL PRESS	
	IN	OUT	IN	OUT	IN	OUT	IN	RATIO	IN	RATIO
1	22.949	22.944	38.0	6.2	38.0	6.2	334.1	1.000	15.70	0.926
2	22.479	22.474	37.0	4.8	37.0	4.8	332.9	1.001	15.74	0.940
3	22.004	21.999	37.1	4.1	37.1	4.1	332.1	1.000	15.64	0.947
4	20.577	20.574	39.2	3.7	39.2	3.7	330.3	1.001	15.42	0.953
5	18.682	18.717	42.3	2.9	42.3	2.9	328.7	1.002	15.16	0.962
6	16.787	16.916	45.8	2.0	45.8	2.0	328.4	1.001	15.15	0.966
7	15.342	15.624	49.5	2.9	49.5	2.9	330.3	0.999	15.62	0.946
8	14.849	15.164	50.9	4.0	50.9	4.0	330.9	0.998	15.83	0.917
9	14.343	14.684	52.9	3.5	52.9	3.5	331.1	0.997	15.85	0.891

RP	ABS VEL		REL VEL		MERID VEL		TANG VEL		WHEEL SPEED	
	IN	OUT	IN	OUT	IN	OUT	IN	OUT	IN	OUT
1	246.1	181.7	246.1	181.7	193.9	180.6	151.6	19.8	0.	0.
2	249.1	190.5	249.1	190.5	199.0	189.8	149.8	15.9	0.	0.
3	249.4	192.1	249.4	192.1	198.9	191.6	150.5	13.7	0.	0.
4	250.1	195.9	250.1	195.9	193.7	195.5	158.2	12.7	0.	0.
5	252.9	194.1	252.9	194.1	186.9	193.9	170.3	9.9	0.	0.
6	261.3	195.8	261.3	195.8	182.0	195.6	187.4	6.7	0.	0.
7	280.6	204.7	280.6	204.7	182.4	204.5	213.3	10.2	0.	0.
8	285.1	201.7	285.1	201.7	179.7	201.2	221.4	14.0	0.	0.
9	285.3	191.9	285.3	191.9	172.3	191.6	227.5	11.6	0.	0.

RP	ABS MACH NO		REL MACH NO		MERID MACH NO		MERID PEAK SS	
	IN	OUT	IN	OUT	IN	OUT	VEL R	MACH NO
1	0.704	0.509	0.704	0.509	0.555	0.506	0.932	1.244
2	0.715	0.535	0.715	0.535	0.571	0.533	0.954	1.234
3	0.717	0.541	0.717	0.541	0.572	0.540	0.964	1.238
4	0.721	0.554	0.721	0.554	0.559	0.553	1.009	1.279
5	0.732	0.550	0.732	0.550	0.541	0.549	1.038	1.335
6	0.760	0.555	0.760	0.555	0.529	0.555	1.075	1.414
7	0.821	0.581	0.821	0.581	0.533	0.580	1.121	1.549
8	0.835	0.571	0.835	0.571	0.526	0.570	1.120	1.586
9	0.835	0.542	0.835	0.542	0.504	0.541	1.112	1.611

RP	PERCENT SPAN	INCIDENCE		DEV	D-FACT	EFF	LOSS COEFF		LOSS PARAM	
		MEAN	SS				TOT	PROF	TOT	PROF
1	5.00	16.8	2.7	11.1	0.449	0.	0.264	0.264	0.091	0.091
2	10.00	17.5	3.2	9.3	0.419	0.	0.206	0.206	0.070	0.070
3	15.00	18.5	4.2	8.4	0.413	0.	0.183	0.183	0.061	0.061
4	30.00	18.9	5.8	8.2	0.399	0.	0.162	0.162	0.051	0.051
5	50.00	17.5	6.3	8.1	0.413	0.	0.126	0.126	0.036	0.036
6	70.00	15.0	5.6	7.9	0.427	0.	0.108	0.105	0.028	0.027
7	85.00	12.2	4.1	9.6	0.437	0.	0.152	0.136	0.035	0.032
8	90.00	11.4	3.7	11.1	0.454	0.	0.226	0.203	0.051	0.046
9	95.00	11.1	3.9	10.8	0.490	0.	0.296	0.270	0.064	0.059

TABLE XXXVIII. - BLADE-ELEMENT DATA AT BLADE EDGES FOR

STATOR 9 (90 PERCENT DESIGN SPEED; 4 EXIT PYLONS;

INTRABLADE ROW INSTRUMENTATION

AT STATION 2a)

(a) Reading number 619

RP	RADII		ABS BETAM		REL BETAM		TOTAL TEMP		TOTAL PRESS	
	IN	OUT	IN	OUT	IN	OUT	IN	RATIO	IN	RATIO
1	22.949	22.944	24.6	5.4	24.6	5.4	314.4	1.000	12.99	0.942
2	22.479	22.474	25.0	2.0	25.0	2.0	314.2	1.001	13.16	0.980
3	22.004	21.999	25.1	1.0	25.1	1.0	314.3	1.000	13.27	0.985
4	20.577	20.574	27.1	1.7	27.1	1.7	315.2	1.002	13.62	0.976
5	18.682	18.717	30.5	2.9	30.5	2.9	317.2	1.001	13.95	0.963
6	16.787	16.916	34.6	1.1	34.6	1.1	319.1	1.003	14.24	0.960
7	15.342	15.624	40.7	0.1	40.7	0.1	321.5	1.002	14.51	0.959
8	14.849	15.164	43.4	0.7	43.4	0.7	322.8	1.000	14.70	0.949
9	14.343	14.684	46.8	2.8	46.8	2.8	323.7	0.999	14.71	0.912

RP	ABS VEL		REL VEL		MERID VEL		TANG VEL		WHEEL SPEED	
	IN	OUT	IN	OUT	IN	OUT	IN	OUT	IN	OUT
1	223.8	191.6	223.8	191.6	203.5	190.8	93.1	17.9	0.	0.
2	229.8	209.4	229.8	209.4	208.3	209.3	97.2	7.4	0.	0.
3	234.2	214.5	234.2	214.5	212.1	214.5	99.5	3.7	0.	0.
4	247.6	231.9	247.6	231.9	220.4	231.8	112.7	6.9	0.	0.
5	266.5	243.5	266.5	243.5	229.6	243.2	135.4	12.2	0.	0.
6	281.3	249.8	281.3	249.8	231.5	249.7	159.8	4.8	0.	0.
7	287.7	259.3	287.7	259.3	218.1	259.3	187.6	0.3	0.	0.
8	288.6	259.4	288.6	259.4	209.6	259.4	198.4	3.1	0.	0.
9	285.5	248.7	285.5	248.7	195.6	248.4	208.0	12.0	0.	0.

RP	ABS MACH NO		REL MACH NO		MERID MACH NO		MERID PEAK SS	
	IN	OUT	IN	OUT	IN	OUT	VEL R	MACH NO
1	0.656	0.556	0.656	0.556	0.597	0.553	0.938	0.856
2	0.676	0.611	0.676	0.611	0.612	0.610	1.005	0.890
3	0.690	0.627	0.690	0.627	0.624	0.627	1.011	0.908
4	0.732	0.681	0.732	0.681	0.652	0.680	1.051	0.994
5	0.792	0.716	0.792	0.716	0.682	0.715	1.059	1.125
6	0.839	0.733	0.839	0.733	0.690	0.733	1.079	1.241
7	0.857	0.761	0.857	0.761	0.650	0.761	1.189	1.360
8	0.858	0.761	0.858	0.761	0.623	0.761	1.238	1.409
9	0.846	0.725	0.846	0.725	0.580	0.724	1.270	1.453

RP	PERCENT		INCIDENCE		DEV	D-FACT	EFF	LOSS COEFF		LOSS PARAM	
	SPAN	MEAN	SS	SS				TOT	PROF	TOT	PROF
1	5.00	3.4	-10.8	10.2	0.261	0.	0.229	0.229	0.080	0.080	
2	10.00	5.5	-8.8	6.5	0.222	0.	0.078	0.078	0.026	0.026	
3	15.00	6.5	-7.8	5.3	0.221	0.	0.056	0.056	0.019	0.019	
4	30.00	6.8	-6.3	6.2	0.197	0.	0.081	0.081	0.025	0.025	
5	50.00	5.7	-5.5	8.0	0.218	0.	0.109	0.109	0.031	0.031	
6	70.00	3.8	-5.6	7.0	0.253	0.	0.109	0.109	0.028	0.028	
7	85.00	3.4	-4.7	6.8	0.249	0.	0.108	0.104	0.025	0.024	
8	90.00	3.9	-3.8	7.8	0.252	0.	0.134	0.127	0.030	0.029	
9	95.00	5.0	-2.2	10.1	0.276	0.	0.234	0.225	0.051	0.049	

TABLE XXXVIII. - Concluded. BLADE-ELEMENT DATA AT BLADE
EDGES FOR STATOR 9 (90 PERCENT DESIGN SPEED; 4 EXIT

PYLONS; INTRABLADE ROW INSTRUMENTATION

AT STATION 2a)

(b) Reading number 620

RP	RADI I		ABS BETAM		REL BETAM		TOTAL TEMP		TOTAL PRESS	
	IN	OUT	IN	OUT	IN	OUT	IN	RATIO	IN	RATIO
1	22.949	22.944	42.8	5.1	42.8	5.1	327.0	0.998	14.14	0.933
2	22.479	22.474	40.8	4.0	40.8	4.0	326.0	0.999	14.20	0.938
3	22.004	21.999	40.1	3.7	40.1	3.7	324.7	1.000	14.17	0.940
4	20.577	20.574	42.2	3.2	42.2	3.2	322.7	1.001	14.01	0.953
5	18.682	18.717	45.4	2.7	45.4	2.7	322.0	0.999	13.95	0.962
6	16.787	16.916	45.4	2.5	45.4	2.5	321.1	0.999	14.18	0.963
7	15.342	15.624	49.3	2.8	49.3	2.8	322.7	0.999	14.51	0.965
8	14.849	15.164	50.8	4.1	50.8	4.1	323.5	0.999	14.82	0.933
9	14.343	14.684	52.4	3.8	52.4	3.8	323.4	0.999	14.79	0.916

RP	ABS VEL		REL VEL		MERID VEL		TANG VEL		WHEEL SPEED	
	IN	OUT	IN	OUT	IN	OUT	IN	OUT	IN	OUT
1	210.0	148.1	210.0	148.1	154.0	147.6	142.8	13.2	0.	0.
2	213.5	154.5	213.5	154.5	161.7	154.1	139.5	10.9	0.	0.
3	214.6	156.0	214.6	156.0	164.2	155.6	138.1	10.0	0.	0.
4	213.6	161.3	213.6	161.3	158.3	161.0	143.4	9.1	0.	0.
5	219.0	163.6	219.0	163.6	153.6	163.4	156.1	7.7	0.	0.
6	235.0	171.3	235.0	171.3	164.9	171.1	167.3	7.4	0.	0.
7	251.2	185.9	251.2	185.9	163.8	185.7	190.5	9.2	0.	0.
8	259.3	185.2	259.3	185.2	164.0	184.7	200.8	13.4	0.	0.
9	259.2	178.2	259.2	178.2	158.0	177.8	205.5	11.9	0.	0.

RP	ABS MACH NO		REL MACH NO		MERID MACH NO		MERID PEAK SS	
	IN	OUT	IN	OUT	IN	OUT	VEL R	MACH NO
1	0.600	0.416	0.600	0.416	0.440	0.414	0.958	1.161
2	0.612	0.435	0.612	0.435	0.463	0.434	0.953	1.136
3	0.616	0.440	0.616	0.440	0.471	0.439	0.948	1.127
4	0.615	0.457	0.615	0.457	0.456	0.456	1.017	1.153
5	0.633	0.465	0.633	0.465	0.444	0.464	1.064	1.223
6	0.684	0.488	0.684	0.488	0.480	0.488	1.038	1.263
7	0.734	0.531	0.734	0.531	0.479	0.530	1.134	1.382
8	0.760	0.528	0.760	0.528	0.480	0.527	1.126	1.439
9	0.759	0.507	0.759	0.507	0.463	0.506	1.125	1.454

RP	PERCENT		INCIDENCE		DEV	D-FACT	EFF	LOSS COEFF		LOSS PARAM	
	SPAN	MEAN	SS	SS				TOT	PROF	TOT	PROF
1	5.00	21.6	7.5	9.9	0.510	0.	0.311	0.311	0.108	0.108	
2	10.00	21.3	7.0	8.5	0.482	0.	0.279	0.279	0.095	0.095	
3	15.00	21.5	7.2	8.0	0.473	0.	0.263	0.263	0.088	0.088	
4	30.00	21.9	8.8	7.7	0.442	0.	0.208	0.208	0.065	0.065	
5	50.00	20.6	9.4	7.8	0.446	0.	0.161	0.161	0.046	0.046	
6	70.00	14.6	5.2	8.4	0.445	0.	0.136	0.136	0.035	0.035	
7	85.00	12.0	3.9	9.6	0.426	0.	0.117	0.117	0.027	0.027	
8	90.00	11.2	3.5	11.2	0.447	0.	0.210	0.206	0.047	0.046	
9	95.00	10.7	3.4	11.2	0.473	0.	0.264	0.260	0.057	0.056	

TABLE XXXIX. - BLADE-ELEMENT DATA AT BLADE EDGES FOR
 STATOR 9 (100 PERCENT DESIGN SPEED; STATOR RESET;
 INTRABLADE ROW INSTRUMENTATION

AT STATION 2a)

(a) Reading number 678

RP	RADII		ABS BETAM		REL BETAM		TOTAL TEMP		TOTAL PRESS	
	IN	OUT	IN	OUT	IN	OUT	IN	RATIO	IN	RATIO
1	22.949	22.944	30.3	11.4	30.3	11.4	327.2	0.999	14.73	0.932
2	22.479	22.474	29.6	7.8	29.6	7.8	326.7	1.000	14.92	0.970
3	22.004	21.999	29.7	7.1	29.7	7.1	326.4	0.999	15.04	0.969
4	20.577	20.574	31.4	9.8	31.4	9.8	326.6	0.999	15.19	0.951
5	18.682	18.717	33.8	10.2	33.8	10.2	327.1	1.001	15.30	0.947
6	16.787	16.916	36.6	7.0	36.6	7.0	327.8	0.999	15.55	0.926
7	15.342	15.624	42.2	5.7	42.2	5.7	329.6	1.002	15.77	0.930
8	14.849	15.164	45.2	5.9	45.2	5.9	330.5	1.002	15.84	0.949
9	14.343	14.684	48.1	8.1	48.1	8.1	331.1	0.997	15.86	0.888

RP	ABS VEL		REL VEL		MERID VEL		TANG VEL		WHEEL SPEED	
	IN	OUT	IN	OUT	IN	OUT	IN	OUT	IN	OUT
1	247.3	216.6	247.3	216.6	213.4	212.3	124.9	42.8	0.	0.
2	254.7	234.3	254.7	234.3	221.4	232.1	125.9	31.8	0.	0.
3	261.1	235.0	261.1	235.0	226.8	233.2	129.3	29.1	0.	0.
4	273.1	226.1	273.1	226.1	233.0	222.8	142.5	38.4	0.	0.
5	292.1	227.1	292.1	227.1	242.7	223.5	162.5	40.2	0.	0.
6	310.0	224.1	310.0	224.1	248.8	222.4	184.9	27.2	0.	0.
7	311.9	233.3	311.9	233.3	231.2	232.2	209.4	23.4	0.	0.
8	308.3	240.6	308.3	240.6	217.1	239.4	218.9	24.6	0.	0.
9	303.0	220.4	303.0	220.4	202.4	218.2	225.5	31.0	0.	0.

RP	ABS MACH NO		REL MACH NO		MERID MACH NO		MERID PEAK SS	
	IN	OUT	IN	OUT	IN	OUT	VEL R	MACH NO
1	0.716	0.620	0.716	0.620	0.618	0.608	0.995	0.987
2	0.741	0.676	0.741	0.676	0.644	0.669	1.048	0.999
3	0.762	0.678	0.762	0.678	0.662	0.673	1.028	1.025
4	0.801	0.650	0.801	0.650	0.683	0.641	0.956	1.106
5	0.864	0.652	0.864	0.652	0.718	0.642	0.921	1.214
6	0.924	0.643	0.924	0.643	0.742	0.638	0.894	1.313
7	0.928	0.668	0.928	0.668	0.688	0.665	1.004	2.297
8	0.914	0.690	0.914	0.690	0.644	0.687	1.102	2.410
9	0.895	0.629	0.895	0.629	0.598	0.622	1.078	2.485

RP	PERCENT	INCIDENCE		DEV	D-FACT	EFF	LOSS COEFF		LOSS PARAM	
	SPAN	MEAN	SS				TOT	PROF	TOT	PROF
1	5.00	5.4	-8.7	12.5	0.240	0.	0.235	0.235	0.080	0.080
2	10.00	6.4	-7.9	8.6	0.207	0.	0.098	0.098	0.033	0.033
3	15.00	7.4	-6.9	7.7	0.228	0.	0.097	0.097	0.032	0.032
4	30.00	7.4	-5.7	10.6	0.291	0.	0.143	0.143	0.044	0.044
5	50.00	5.2	-6.0	11.6	0.341	0.	0.139	0.139	0.039	0.039
6	70.00	2.1	-7.3	9.2	0.407	0.	0.174	0.170	0.044	0.043
7	85.00	1.2	-6.9	8.8	0.389	0.	0.164	-0.092	0.038	-0.021
8	90.00	2.0	-5.7	9.2	0.360	0.	0.123	-0.185	0.027	-0.042
9	95.00	2.6	-4.6	11.7	0.410	0.	0.276	-0.070	0.059	-0.015

TABLE XXXIX. - Continued. BLADE-ELEMENT DATA AT BLADE

EDGES FOR STATOR 9 (100 PERCENT DESIGN SPEED; STATOR

RESET; INTRABLADE ROW INSTRUMENTATION

AT STATION 2a)

(b) Reading number 680

RP	RADII		ABS BETAM		REL BETAM		TOTAL TEMP		TOTAL PRESS	
	IN	OUT	IN	OUT	IN	OUT	IN	RATIO	IN	RATIO
1	22.949	22.944	31.2	12.5	31.2	12.5	328.7	0.997	14.94	0.934
2	22.479	22.474	30.2	9.0	30.2	9.0	328.0	0.999	15.12	0.970
3	22.004	21.999	30.5	7.4	30.5	7.4	327.5	0.999	15.23	0.980
4	20.577	20.574	32.3	7.6	32.3	7.6	327.5	0.998	15.33	0.973
5	18.682	18.717	34.4	7.9	34.4	7.9	327.4	1.001	15.46	0.970
6	16.787	16.916	37.5	4.7	37.5	4.7	327.8	1.000	15.54	0.974
7	15.342	15.624	43.1	5.5	43.1	5.5	329.8	1.002	15.84	0.974
8	14.849	15.164	45.9	7.1	45.9	7.1	330.3	1.001	15.88	0.955
9	14.343	14.684	49.0	8.6	49.0	8.6	330.8	0.997	15.79	0.893

RP	ABS VEL		REL VEL		MERID VEL		TANG VEL		WHEEL SPEED	
	IN	OUT	IN	OUT	IN	OUT	IN	OUT	IN	OUT
1	248.2	192.1	248.2	192.1	212.4	187.5	128.6	41.7	0.	0.
2	255.8	212.6	255.8	212.6	221.0	209.9	128.8	33.3	0.	0.
3	261.7	217.7	261.7	217.7	225.5	215.9	132.7	28.0	0.	0.
4	272.7	212.2	272.7	212.2	230.5	210.3	145.6	28.1	0.	0.
5	291.3	212.7	291.3	212.7	240.3	210.6	164.6	29.3	0.	0.
6	303.3	215.2	303.3	215.2	240.5	214.5	184.8	17.5	0.	0.
7	308.6	223.8	308.6	223.8	225.4	222.8	210.9	21.4	0.	0.
8	304.6	218.5	304.6	218.5	211.8	216.8	218.8	27.2	0.	0.
9	298.1	191.5	298.1	191.5	195.6	189.3	225.0	28.6	0.	0.

RP	ABS MACH NO		REL MACH NO		MERID MACH NO		MERID PEAK SS	
	IN	OUT	IN	OUT	IN	OUT	VEL R	MACH NO
1	0.717	0.545	0.717	0.545	0.614	0.532	0.883	1.010
2	0.742	0.607	0.742	0.607	0.642	0.599	0.950	1.017
3	0.762	0.623	0.762	0.623	0.657	0.618	0.957	1.047
4	0.798	0.607	0.798	0.607	0.675	0.601	0.912	1.126
5	0.860	0.607	0.860	0.607	0.710	0.601	0.877	1.228
6	0.901	0.615	0.901	0.615	0.715	0.613	0.892	1.308
7	0.916	0.639	0.916	0.639	0.669	0.636	0.989	1.414
8	0.901	0.622	0.901	0.622	0.627	0.617	1.023	1.443
9	0.879	0.541	0.879	0.541	0.577	0.535	0.968	1.464

RP	PERCENT		INCIDENCE		DEV	D-FACT	EFF	LOSS COEFF		LOSS PARAM	
	SPAN	MEAN	SS	TOT				PROF	TOT	PROF	
1	5.00	6.3	-7.8	13.6	0.348	0.	0.228	0.228	0.078	0.078	
2	10.00	7.0	-7.3	9.8	0.297	0.	0.097	0.097	0.033	0.033	
3	15.00	8.2	-6.1	8.0	0.302	0.	0.064	0.064	0.021	0.021	
4	30.00	8.3	-4.8	8.4	0.357	0.	0.079	0.079	0.024	0.024	
5	50.00	5.8	-5.4	9.4	0.402	0.	0.078	0.078	0.022	0.022	
6	70.00	3.0	-6.4	6.9	0.431	0.	0.063	0.060	0.016	0.015	
7	85.00	2.1	-6.0	8.5	0.416	0.	0.061	0.051	0.014	0.012	
8	90.00	2.7	-5.0	10.5	0.422	0.	0.109	0.097	0.024	0.022	
9	95.00	3.5	-3.7	12.3	0.499	0.	0.271	0.259	0.058	0.056	

TABLE XXXIX. - Continued. BLADE-ELEMENT DATA AT BLADE
EDGES FOR STATOR 9 (100 PERCENT DESIGN SPEED; STATOR
RESET; INTRABLADE ROW INSTRUMENTATION

AT STATION 2a)

(c) Reading number 684

RP	RADII		ABS BETAM		REL BETAM		TOTAL TEMP		TOTAL PRESS	
	IN	OUT	IN	OUT	IN	OUT	IN	RATIO	IN	RATIO
1	22.949	22.944	37.2	12.2	37.2	12.2	334.8	0.999	15.91	0.933
2	22.479	22.474	35.7	10.2	35.7	10.2	333.1	1.001	15.96	0.960
3	22.004	21.999	35.9	8.6	35.9	8.6	332.2	1.000	15.80	0.976
4	20.577	20.574	37.3	8.5	37.3	8.5	330.6	1.000	15.66	0.976
5	18.682	18.717	39.2	7.7	39.2	7.7	328.6	1.000	15.45	0.978
6	16.787	16.916	39.6	6.0	39.6	6.0	327.9	1.001	15.50	0.982
7	15.342	15.624	45.9	6.6	45.9	6.6	329.6	0.999	15.61	0.976
8	14.849	15.164	48.9	9.0	48.9	9.0	330.4	0.997	15.76	0.936
9	14.343	14.684	51.3	9.8	51.3	9.8	330.9	0.996	15.74	0.896

RP	ABS VEL		REL VEL		MERID VEL		TANG VEL		WHEEL SPEED	
	IN	OUT	IN	OUT	IN	OUT	IN	OUT	IN	OUT
1	250.5	181.7	250.5	181.7	199.6	177.6	151.4	38.4	0.	0.
2	253.9	195.6	253.9	195.6	206.3	192.5	148.0	34.7	0.	0.
3	254.0	197.0	254.0	197.0	205.8	194.7	148.8	29.6	0.	0.
4	258.3	189.3	258.3	189.3	205.4	187.3	156.7	27.9	0.	0.
5	267.4	186.1	267.4	186.1	207.3	184.4	168.8	25.0	0.	0.
6	290.5	202.1	290.5	202.1	223.8	201.0	185.2	21.1	0.	0.
7	291.6	200.0	291.6	200.0	202.9	198.7	209.5	23.1	0.	0.
8	292.4	188.1	292.4	188.1	192.0	185.8	220.4	29.5	0.	0.
9	288.8	168.7	288.8	168.7	180.6	166.2	225.4	28.8	0.	0.

RP	ABS MACH NO		REL MACH NO		MERID MACH NO		MERID PEAK SS	
	IN	OUT	IN	OUT	IN	OUT	VEL R	MACH NO
1	0.717	0.508	0.717	0.508	0.572	0.497	0.890	1.156
2	0.730	0.551	0.730	0.551	0.593	0.542	0.933	1.136
3	0.731	0.555	0.731	0.555	0.593	0.549	0.946	1.140
4	0.747	0.534	0.747	0.534	0.594	0.528	0.912	1.182
5	0.779	0.526	0.779	0.526	0.604	0.521	0.889	1.238
6	0.857	0.575	0.857	0.575	0.660	0.572	0.898	1.305
7	0.858	0.567	0.858	0.567	0.597	0.563	0.979	1.406
8	0.860	0.531	0.860	0.531	0.565	0.525	0.967	1.464
9	0.847	0.474	0.847	0.474	0.530	0.467	0.921	1.478

RP	PERCENT	INCIDENCE		DEV	D-FACT	EFF	LOSS COEFF		LOSS PARAM	
	SPAN	MEAN	SS				TOT	PROF	TOT	PROF
1	5.00	12.3	-1.9	13.3	0.432	0.	0.232	0.232	0.079	0.079
2	10.00	12.5	-1.8	11.0	0.382	0.	0.136	0.136	0.046	0.046
3	15.00	13.6	-0.7	9.2	0.382	0.	0.082	0.082	0.027	0.027
4	30.00	13.3	0.2	9.3	0.423	0.	0.078	0.078	0.024	0.024
5	50.00	10.6	-0.6	9.2	0.457	0.	0.066	0.066	0.018	0.018
6	70.00	5.1	-4.3	8.2	0.448	0.	0.047	0.046	0.012	0.012
7	85.00	4.9	-3.1	9.7	0.461	0.	0.064	0.058	0.015	0.013
8	90.00	5.7	-2.0	12.4	0.502	0.	0.166	0.156	0.037	0.035
9	95.00	5.8	-1.4	13.5	0.562	0.	0.278	0.267	0.059	0.057

TABLE XXXIX. - Concluded. BLADE-ELEMENT DATA AT BLADE

EDGES FOR STATOR 9 (100 PERCENT DESIGN SPEED; STATOR

RESET; INTRABLADE ROW INSTRUMENTATION

AT STATION 2a)

(d) Reading number 683

RP	RADII		ABS BETAM		REL BETAM		TOTAL TEMP		TOTAL PRESS	
	IN	OUT	IN	OUT	IN	OUT	IN	RATIO	IN	RATIO
1	22.949	22.944	37.8	12.1	37.8	12.1	334.1	1.000	16.05	0.913
2	22.479	22.474	36.4	10.2	36.4	10.2	332.6	1.001	15.62	0.962
3	22.004	21.999	36.6	8.8	36.6	8.8	332.0	1.000	15.65	0.965
4	20.577	20.574	38.5	8.7	38.5	8.7	330.2	1.000	15.33	0.975
5	18.682	18.717	41.3	8.1	41.3	8.1	328.7	1.000	15.20	0.972
6	16.787	16.916	45.1	7.3	45.1	7.3	329.0	1.000	15.14	0.985
7	15.342	15.624	48.1	7.3	48.1	7.3	330.0	0.997	15.50	0.961
8	14.849	15.164	49.6	9.5	49.6	9.5	330.7	0.995	15.75	0.926
9	14.343	14.684	51.4	9.8	51.4	9.8	331.0	0.996	15.81	0.889

RP	ABS VEL		REL VEL		MERID VEL		TANG VEL		WHEEL SPEED	
	IN	OUT	IN	OUT	IN	OUT	IN	OUT	IN	OUT
1	246.7	177.8	246.7	177.8	195.1	173.8	151.0	37.3	0.	0.
2	250.2	190.4	250.2	190.4	201.3	187.3	148.6	33.7	0.	0.
3	250.6	192.2	250.6	192.2	201.2	189.9	149.5	29.5	0.	0.
4	252.6	184.2	252.6	184.2	197.6	182.1	157.4	27.8	0.	0.
5	259.5	178.3	259.5	178.3	194.9	176.5	171.3	25.3	0.	0.
6	267.2	183.4	267.2	183.4	188.7	181.9	189.3	23.2	0.	0.
7	285.6	186.0	285.6	186.0	190.7	184.5	212.6	23.6	0.	0.
8	288.3	177.4	288.3	177.4	186.9	175.0	219.6	29.2	0.	0.
9	287.1	160.7	287.1	160.7	178.9	158.3	224.5	27.5	0.	0.

RP	ABS MACH NO		REL MACH NO		MERID MACH NO		MERID PEAK SS	
	IN	OUT	IN	OUT	IN	OUT	VEL R	MACH NO
1	0.706	0.497	0.706	0.497	0.558	0.486	0.891	1.152
2	0.719	0.535	0.719	0.535	0.578	0.527	0.931	1.137
3	0.721	0.541	0.721	0.541	0.579	0.535	0.944	1.142
4	0.729	0.519	0.729	0.519	0.571	0.513	0.922	1.184
5	0.753	0.503	0.753	0.503	0.566	0.498	0.906	1.252
6	0.778	0.518	0.778	0.518	0.549	0.513	0.964	1.329
7	0.837	0.526	0.837	0.526	0.559	0.521	0.968	1.434
8	0.846	0.500	0.846	0.500	0.548	0.493	0.937	1.460
9	0.841	0.450	0.841	0.450	0.524	0.444	0.885	1.472

RP	PERCENT		INCIDENCE		DEV	D-FACT	EFF	LOSS COEFF		LOSS PARAM	
	SPAN	MEAN	SS	SS				TOT	PROF	TOT	PROF
1	5.00	12.8	-1.3	13.2	0.440	0.	0.308	0.308	0.105	0.105	
2	10.00	13.2	-1.1	11.0	0.396	0.	0.130	0.130	0.044	0.044	
3	15.00	14.3	0.0	9.4	0.393	0.	0.119	0.119	0.039	0.039	
4	30.00	14.5	1.4	9.5	0.431	0.	0.084	0.084	0.026	0.026	
5	50.00	12.7	1.5	9.6	0.473	0.	0.090	0.090	0.025	0.025	
6	70.00	10.6	1.2	9.5	0.472	0.	0.045	0.044	0.011	0.011	
7	85.00	7.1	-1.0	10.3	0.501	0.	0.106	0.099	0.025	0.023	
8	90.00	6.3	-1.3	12.8	0.531	0.	0.199	0.190	0.044	0.042	
9	95.00	6.0	-1.3	13.5	0.587	0.	0.299	0.289	0.064	0.062	

TABLE XL. - BLADE-ELEMENT DATA AT BLADE EDGES FOR

STATOR 9 (100 PERCENT DESIGN SPEED; STATOR

RESET; INTRABLADE ROW INSTRUMENTATION

AT STATION 2b)

(a) Reading number 704

RP	RADII		ABS BETAM		REL BETAM		TOTAL TEMP		TOTAL PRESS	
	IN	OUT	IN	OUT	IN	OUT	IN	RATIO	IN	RATIO
1	22.949	22.944	33.1	12.6	33.1	12.6	328.9	0.986	14.54	0.961
2	22.479	22.474	31.1	9.4	31.1	9.4	328.0	1.000	15.05	0.977
3	22.004	21.999	30.6	7.6	30.6	7.6	327.4	1.000	15.16	0.985
4	20.577	20.574	31.4	7.7	31.4	7.7	327.3	0.999	15.20	0.983
5	18.682	18.717	33.7	7.4	33.7	7.4	326.9	1.004	15.29	0.989
6	16.787	16.916	37.6	5.0	37.6	5.0	327.5	1.001	15.37	0.983
7	15.342	15.624	44.2	5.7	44.2	5.7	330.0	0.998	15.68	0.972
8	14.849	15.164	47.4	7.6	47.4	7.6	330.8	0.996	15.59	0.958
9	14.343	14.684	52.5	9.2	52.5	9.2	329.9	0.998	14.75	0.955

RP	ABS VEL		REL VEL		MERID VEL		TANG VEL		WHEEL SPEED	
	IN	OUT	IN	OUT	IN	OUT	IN	OUT	IN	OUT
1	234.9	186.8	234.9	186.8	196.7	182.2	128.4	40.9	0.	0.
2	253.1	209.3	253.1	209.3	216.8	206.5	130.6	34.4	0.	0.
3	260.5	214.2	260.5	214.2	224.2	212.3	132.6	28.4	0.	0.
4	277.4	209.1	277.4	209.1	236.7	207.2	144.7	28.2	0.	0.
5	295.8	212.1	295.8	212.1	246.2	210.3	164.1	27.4	0.	0.
6	300.1	212.3	300.1	212.3	237.6	211.5	183.3	18.4	0.	0.
7	298.0	217.7	298.0	217.7	213.6	216.6	207.8	21.6	0.	0.
8	291.0	211.1	291.0	211.1	196.9	209.3	214.3	28.0	0.	0.
9	269.4	188.6	269.4	188.6	164.1	186.2	213.7	30.2	0.	0.

RP	ABS MACH NO		REL MACH NO		MERID MACH NO		MERID PEAK SS	
	IN	OUT	IN	OUT	IN	OUT	VEL R	MACH NO
1	0.675	0.532	0.675	0.532	0.565	0.519	0.927	0.995
2	0.734	0.597	0.734	0.597	0.629	0.589	0.952	1.026
3	0.758	0.612	0.758	0.612	0.653	0.607	0.947	1.046
4	0.814	0.597	0.814	0.597	0.694	0.592	0.875	1.124
5	0.877	0.605	0.877	0.605	0.730	0.600	0.854	1.229
6	0.891	0.606	0.891	0.606	0.705	0.604	0.890	1.296
7	0.879	0.621	0.879	0.621	0.630	0.618	1.014	1.390
8	0.855	0.601	0.855	0.601	0.578	0.596	1.063	1.412
9	0.784	0.533	0.784	0.533	0.477	0.526	1.135	1.401

RP	PERCENT	INCIDENCE		DEV	D-FACT	EFF	LOSS COEFF		LOSS PARAM	
	SPAN	MEAN	SS				TOT	PROF	TOT	PROF
1	5.00	8.2	-5.9	13.8	0.335	0.	0.149	0.149	0.051	0.051
2	10.00	7.9	-6.4	10.2	0.303	0.	0.077	0.077	0.026	0.026
3	15.00	8.3	-6.0	8.2	0.312	0.	0.046	0.046	0.015	0.015
4	30.00	7.4	-5.7	8.5	0.378	0.	0.049	0.049	0.015	0.015
5	50.00	5.1	-6.1	8.9	0.414	0.	0.029	0.029	0.008	0.008
6	70.00	3.1	-6.3	7.2	0.432	0.	0.041	0.039	0.011	0.010
7	85.00	3.2	-4.8	8.8	0.414	0.	0.070	0.064	0.016	0.015
8	90.00	4.2	-3.5	11.0	0.417	0.	0.110	0.103	0.024	0.023
9	95.00	7.0	-0.2	12.9	0.446	0.	0.136	0.133	0.029	0.029

TABLE XL. - Continued. BLADE-ELEMENT DATA AT BLADE EDGES

FOR STATOR 9 (100 PERCENT DESIGN SPEED; STATOR

RESET; INTRABLADE ROW INSTRUMENTATION

AT STATION 2b)

(b) Reading number 709

RP	RADII		ABS BETAM		REL BETAM		TOTAL TEMP		TOTAL PRESS	
	IN	OUT	IN	OUT	IN	OUT	IN	RATIO	IN	RATIO
1	22.949	22.944	39.2	12.5	39.2	12.5	336.3	0.997	15.54	0.959
2	22.479	22.474	36.9	10.6	36.9	10.6	334.3	1.000	15.83	0.974
3	22.004	21.999	36.1	8.9	36.1	8.9	333.0	0.999	15.89	0.978
4	20.577	20.574	36.0	8.6	36.0	8.6	330.6	1.001	15.70	0.982
5	18.682	18.717	33.8	7.3	33.8	7.3	327.1	1.005	15.32	0.990
6	16.787	16.916	37.7	5.3	37.7	5.3	327.7	1.001	15.45	0.983
7	15.342	15.624	44.5	5.9	44.5	5.9	330.2	0.998	15.68	0.975
8	14.849	15.164	47.5	7.8	47.5	7.8	331.1	0.996	15.66	0.955
9	14.343	14.684	53.1	9.3	53.1	9.3	330.2	0.998	14.54	0.972

RP	ABS VEL		REL VEL		MERID VEL		TANG VEL		WHEEL SPEED	
	IN	OUT	IN	OUT	IN	OUT	IN	OUT	IN	OUT
1	236.1	181.5	236.1	181.5	182.9	177.2	149.4	39.3	0.	0.
2	248.0	196.8	248.0	196.8	198.3	193.4	148.8	36.3	0.	0.
3	253.7	199.5	253.7	199.5	204.9	197.1	149.7	31.0	0.	0.
4	265.2	192.8	265.2	192.8	214.5	190.7	156.0	28.8	0.	0.
5	293.3	209.0	293.3	209.0	243.7	207.3	163.1	26.4	0.	0.
6	299.7	210.0	299.7	210.0	237.0	209.1	183.4	19.4	0.	0.
7	295.7	214.2	295.7	214.2	210.8	213.0	207.3	22.1	0.	0.
8	290.4	207.2	290.4	207.2	196.1	205.3	214.2	28.2	0.	0.
9	263.8	185.3	263.8	185.3	158.3	182.8	211.1	30.1	0.	0.

RP	ABS MACH NO		REL MACH NO		MERID MACH NO		MERID PEAK SS	
	IN	OUT	IN	OUT	IN	OUT	VEL R	MACH NO
1	0.671	0.507	0.671	0.507	0.519	0.495	0.969	1.127
2	0.710	0.553	0.710	0.553	0.568	0.544	0.975	1.134
3	0.730	0.563	0.730	0.563	0.589	0.556	0.962	1.144
4	0.770	0.544	0.770	0.544	0.622	0.538	0.889	1.184
5	0.868	0.595	0.868	0.595	0.721	0.590	0.850	1.220
6	0.889	0.599	0.889	0.599	0.703	0.596	0.882	1.296
7	0.871	0.610	0.871	0.610	0.621	0.607	1.011	1.386
8	0.852	0.589	0.852	0.589	0.575	0.583	1.047	1.410
9	0.765	0.523	0.765	0.523	0.459	0.516	1.155	1.385

RP	PERCENT SPAN	INCIDENCE		DEV	D-FACT	EFF	LOSS COEFF		LOSS PARAM	
		MEAN	SS				TOT	PROF	TOT	PROF
1	5.00	14.3	0.2	13.6	0.394	0.	0.158	0.158	0.054	0.054
2	10.00	13.7	-0.6	11.4	0.362	0.	0.092	0.092	0.031	0.031
3	15.00	13.9	-0.4	9.5	0.370	0.	0.072	0.072	0.024	0.024
4	30.00	12.0	-1.1	9.4	0.423	0.	0.056	0.056	0.017	0.017
5	50.00	5.2	-6.0	8.7	0.420	0.	0.025	0.025	0.007	0.007
6	70.00	3.2	-6.2	7.5	0.439	0.	0.043	0.041	0.011	0.010
7	85.00	3.5	-4.5	9.0	0.420	0.	0.064	0.059	0.015	0.014
8	90.00	4.2	-3.4	11.2	0.429	0.	0.118	0.112	0.026	0.025
9	95.00	7.7	0.4	13.0	0.444	0.	0.088	0.086	0.019	0.019

TABLE XL. - Concluded. BLADE-ELEMENT DATA AT BLADE EDGES

FOR STATOR 9 (100 PERCENT DESIGN SPEED; STATOR

RESET; INTRABLADE ROW INSTRUMENTATION

AT STATION 2b)

(c) Reading number 707

RP	RADI I		ABS BETAM		REL BETAM		TOTAL TEMP		TOTAL PRESS	
	IN	OUT	IN	OUT	IN	OUT	IN	RATIO	IN	RATIO
1	22.949	22.944	40.8	12.7	40.8	12.7	335.8	0.998	15.09	0.964
2	22.479	22.474	38.5	10.7	38.5	10.7	334.2	0.999	15.50	0.961
3	22.004	21.999	37.5	9.4	37.5	9.4	332.7	0.999	15.57	0.964
4	20.577	20.574	38.5	9.1	38.5	9.1	330.7	1.000	15.26	0.977
5	18.682	18.717	40.6	8.2	40.6	8.2	329.0	1.000	15.12	0.971
6	16.787	16.916	43.3	7.5	43.3	7.5	329.0	1.000	15.15	0.976
7	15.342	15.624	47.0	7.7	47.0	7.7	330.3	0.996	15.59	0.953
8	14.849	15.164	49.7	9.5	49.7	9.5	330.7	0.996	15.57	0.941
9	14.343	14.684	54.3	9.9	54.3	9.9	330.3	0.997	14.65	0.963

RP	ABS VEL		REL VEL		MERID VEL		TANG VEL		WHEEL SPEED	
	IN	OUT	IN	OUT	IN	OUT	IN	OUT	IN	OUT
1	227.9	176.4	227.9	176.4	172.6	172.1	148.9	38.6	0.	0.
2	240.0	187.7	240.0	187.7	187.9	184.4	149.3	34.9	0.	0.
3	245.0	189.1	245.0	189.1	194.4	186.6	149.2	30.9	0.	0.
4	253.6	182.6	253.6	182.6	198.5	180.4	157.8	28.8	0.	0.
5	262.2	175.5	262.2	175.5	199.0	173.6	170.7	25.1	0.	0.
6	272.1	180.2	272.1	180.2	198.0	178.7	186.7	23.6	0.	0.
7	282.3	187.1	282.3	187.1	192.5	185.4	206.5	25.2	0.	0.
8	279.4	182.3	279.4	182.3	180.6	179.8	213.2	30.1	0.	0.
9	258.4	165.8	258.4	165.8	151.0	163.4	209.8	28.4	0.	0.

RP	ABS MACH NO		REL MACH NO		MERID MACH NO		MERID PEAK SS	
	IN	OUT	IN	OUT	IN	OUT	VEL R	MACH NO
1	0.646	0.492	0.646	0.492	0.489	0.480	0.997	1.120
2	0.685	0.526	0.685	0.526	0.536	0.517	0.982	1.131
3	0.702	0.532	0.702	0.532	0.557	0.525	0.960	1.134
4	0.732	0.514	0.732	0.514	0.573	0.508	0.909	1.187
5	0.762	0.494	0.762	0.494	0.578	0.489	0.873	1.248
6	0.794	0.508	0.794	0.508	0.578	0.504	0.902	1.309
7	0.826	0.529	0.826	0.529	0.563	0.524	0.963	1.384
8	0.816	0.514	0.816	0.514	0.527	0.507	0.995	1.412
9	0.748	0.466	0.748	0.466	0.437	0.459	1.082	1.383

RP	PERCENT		INCIDENCE		DEV	D-FACT	EFF	LOSS COEFF		LOSS PARAM	
	SPAN	MEAN	SS	SS				TOT	PROF	TOT	PROF
1	5.00	15.9	1.8	13.8	0.395	0.	0.148	0.148	0.050	0.050	
2	10.00	15.3	1.0	11.5	0.381	0.	0.147	0.147	0.049	0.049	
3	15.00	15.2	0.9	10.0	0.390	0.	0.127	0.127	0.042	0.042	
4	30.00	14.5	1.4	9.9	0.439	0.	0.077	0.077	0.024	0.024	
5	50.00	12.0	0.9	9.7	0.489	0.	0.090	0.090	0.025	0.025	
6	70.00	8.8	-0.6	9.8	0.490	0.	0.070	0.069	0.018	0.018	
7	85.00	6.0	-2.0	10.8	0.485	0.	0.130	0.126	0.030	0.029	
8	90.00	6.5	-1.2	12.8	0.493	0.	0.168	0.163	0.037	0.036	
9	95.00	8.8	1.6	13.5	0.508	0.	0.120	0.119	0.026	0.025	

TABLE XLI. - BLADE -ELEMENT DATA AT BLADE EDGES FOR

STATOR 9 (90 PERCENT DESIGN SPEED; STATOR RESET;

INTRABLADE ROW INSTRUMENTATION

AT STATION 2a)

(a) Reading number 686

RP	RADII		ABS BETAM		REL BETAM		TOTAL TEMP		TOTAL PRESS	
	IN	OUT	IN	OUT	IN	OUT	IN	RATIO	IN	RATIO
1	22.949	22.944	28.3	10.6	28.3	10.6	319.0	0.999	13.83	0.944
2	22.479	22.474	27.5	6.2	27.5	6.2	318.2	1.000	13.93	0.978
3	22.004	21.999	27.1	4.6	27.1	4.6	317.9	0.999	13.93	0.986
4	20.577	20.574	28.8	5.2	28.8	5.2	317.8	0.999	14.04	0.980
5	18.682	18.717	31.7	5.3	31.7	5.3	318.3	1.000	14.13	0.981
6	16.787	16.916	35.6	3.8	35.6	3.8	319.5	1.000	14.24	0.984
7	15.342	15.624	41.4	4.5	41.4	4.5	321.7	1.001	14.50	0.981
8	14.849	15.164	44.3	5.7	44.3	5.7	322.6	1.001	14.62	0.973
9	14.343	14.684	47.0	7.9	47.0	7.9	323.2	0.998	14.67	0.912

RP	ABS VEL		REL VEL		MERID VEL		TANG VEL		WHEEL SPEED	
	IN	OUT	IN	OUT	IN	OUT	IN	OUT	IN	OUT
1	232.1	186.6	232.1	186.6	204.5	183.5	109.9	34.3	0.	0.
2	237.1	203.6	237.1	203.6	210.4	202.4	109.3	22.1	0.	0.
3	239.6	205.5	239.6	205.5	213.2	204.8	109.3	16.5	0.	0.
4	249.1	202.4	249.1	202.4	218.3	201.6	120.0	18.3	0.	0.
5	262.8	204.2	262.8	204.2	223.5	203.4	138.2	19.0	0.	0.
6	273.0	207.4	273.0	207.4	221.9	206.9	159.0	13.7	0.	0.
7	280.1	216.1	280.1	216.1	210.1	215.4	185.3	17.0	0.	0.
8	279.1	216.7	279.1	216.7	199.8	215.7	194.9	21.5	0.	0.
9	275.8	194.9	275.8	194.9	188.2	193.0	201.7	26.7	0.	0.

RP	ABS MACH NO		REL MACH NO		MERID MACH NO		MERID PEAK SS	
	IN	OUT	IN	OUT	IN	OUT	VEL R	MACH NO
1	0.677	0.536	0.677	0.536	0.597	0.527	0.897	0.883
2	0.694	0.589	0.694	0.589	0.616	0.585	0.962	0.881
3	0.703	0.595	0.703	0.595	0.625	0.594	0.961	0.881
4	0.734	0.586	0.734	0.586	0.643	0.584	0.923	0.944
5	0.778	0.591	0.778	0.591	0.662	0.588	0.910	1.037
6	0.810	0.599	0.810	0.599	0.659	0.598	0.932	1.123
7	0.831	0.624	0.831	0.624	0.623	0.622	1.026	1.235
8	0.827	0.625	0.827	0.625	0.592	0.622	1.079	1.278
9	0.815	0.558	0.815	0.558	0.556	0.553	1.026	1.302

RP	PERCENT		INCIDENCE		DEV	D-FACT	EFF	LOSS COEFF		LOSS PARAM	
	SPAN	MEAN	SS	TOT				PROF	TOT	PROF	
1	5.00	3.3	-10.8	11.7	0.310	0.	0.213	0.213	0.073	0.073	
2	10.00	4.3	-10.0	7.0	0.267	0.	0.080	0.080	0.027	0.027	
3	15.00	4.9	-9.4	5.2	0.272	0.	0.051	0.051	0.017	0.017	
4	30.00	4.8	-8.3	6.0	0.315	0.	0.065	0.065	0.020	0.020	
5	50.00	3.1	-8.1	6.8	0.352	0.	0.058	0.058	0.016	0.016	
6	70.00	1.1	-8.3	6.0	0.376	0.	0.046	0.046	0.012	0.012	
7	85.00	0.4	-7.6	7.6	0.367	0.	0.053	0.053	0.012	0.012	
8	90.00	1.0	-6.6	9.1	0.362	0.	0.075	0.074	0.017	0.017	
9	95.00	1.5	-5.7	11.5	0.429	0.	0.248	0.247	0.053	0.053	

TABLE XLI. - Continued. BLADE-ELEMENT DATA AT BLADE EDGES

FOR STATOR 9 (90 PERCENT DESIGN SPEED; STATOR RESET

INTRABLADE ROW INSTRUMENTATION

AT STATION 2a)

(b) Reading number 687

RP	RADII		ABS BETAM		REL BETAM		TOTAL TEMP		TOTAL PRESS	
	IN	OUT	IN	OUT	IN	OUT	IN	RATIO	IN	RATIO
1	22.949	22.944	33.9	11.9	33.9	11.9	322.8	1.000	14.40	0.951
2	22.479	22.474	32.5	9.1	32.5	9.1	321.7	1.001	14.45	0.977
3	22.004	21.999	33.0	7.5	33.0	7.5	321.8	0.998	14.42	0.985
4	20.577	20.574	33.7	7.4	33.7	7.4	320.7	0.999	14.40	0.981
5	18.682	18.717	35.9	7.0	35.9	7.0	319.7	1.001	14.28	0.984
6	16.787	16.916	39.3	5.9	39.3	5.9	319.4	1.001	14.19	0.984
7	15.342	15.624	45.2	6.3	45.2	6.3	321.8	1.000	14.45	0.986
8	14.849	15.164	47.4	8.0	47.4	8.0	322.6	0.998	14.66	0.959
9	14.343	14.684	49.6	9.4	49.6	9.4	322.6	0.998	14.67	0.917

RP	ABS VEL		REL VEL		MERID VEL		TANG VEL		WHEEL SPEED	
	IN	OUT	IN	OUT	IN	OUT	IN	OUT	IN	OUT
1	225.7	169.6	225.7	169.6	187.5	165.9	125.8	35.1	0.	0.
2	229.0	184.9	229.0	184.9	193.2	182.5	123.1	29.1	0.	0.
3	230.8	186.6	230.8	186.6	193.6	185.0	125.6	24.3	0.	0.
4	237.5	181.4	237.5	181.4	197.6	179.9	131.8	23.5	0.	0.
5	246.5	181.4	246.5	181.4	199.7	180.0	144.4	22.1	0.	0.
6	252.2	180.9	252.2	180.9	195.2	180.0	159.7	18.5	0.	0.
7	262.6	191.4	262.6	191.4	185.1	190.2	186.2	21.0	0.	0.
8	265.8	186.7	265.8	186.7	180.0	184.9	195.5	25.9	0.	0.
9	263.7	167.6	263.7	167.6	170.9	165.4	200.8	27.4	0.	0.

RP	ABS MACH NO		REL MACH NO		MERID MACH NO		MERID PEAK SS	
	IN	OUT	IN	OUT	IN	OUT	VEL R	MACH NO
1	0.653	0.482	0.653	0.482	0.542	0.471	0.885	0.979
2	0.665	0.528	0.665	0.528	0.560	0.521	0.945	0.963
3	0.670	0.534	0.670	0.534	0.562	0.530	0.956	0.979
4	0.693	0.519	0.693	0.519	0.576	0.515	0.910	1.010
5	0.723	0.519	0.723	0.519	0.586	0.516	0.901	1.068
6	0.742	0.518	0.742	0.518	0.574	0.515	0.922	1.121
7	0.773	0.548	0.773	0.548	0.545	0.545	1.028	1.246
8	0.782	0.534	0.782	0.534	0.530	0.528	1.027	1.290
9	0.775	0.476	0.775	0.476	0.503	0.470	0.967	1.308

RP	PERCENT SPAN		INCIDENCE		DEV	D-FACT.	EFF	LOSS COEFF		LOSS PARAM	
	SPAN	MEAN	SS	SS				TOT	PROF	TOT	PROF
1	5.00	8.9	-5.2	13.1	0.389	0.	0.198	0.198	0.068	0.068	
2	10.00	9.3	-5.0	9.9	0.333	0.	0.091	0.091	0.031	0.031	
3	15.00	10.7	-3.6	8.1	0.338	0.	0.056	0.056	0.019	0.019	
4	30.00	9.7	-3.4	8.2	0.379	0.	0.069	0.069	0.021	0.021	
5	50.00	7.3	-3.9	8.4	0.405	0.	0.056	0.056	0.016	0.016	
6	70.00	4.8	-4.6	8.1	0.425	0.	0.051	0.051	0.013	0.013	
7	85.00	4.2	-3.9	9.4	0.416	0.	0.043	0.043	0.010	0.010	
8	90.00	4.1	-3.5	11.3	0.439	0.	0.124	0.124	0.028	0.028	
9	95.00	4.1	-3.1	13.0	0.505	0.	0.253	0.253	0.054	0.054	

TABLE XLI. - Continued. BLADE-ELEMENT DATA AT BLADE EDGES

FOR STATOR 9 (90 PERCENT DESIGN SPEED; STATOR RESET

INTRABLADE ROW INSTRUMENTATION

AT STATION 2a)

(c) Reading number 688

RP	RADII		ABS BETAM		REL BETAM		TOTAL TEMP		TOTAL PRESS	
	IN	OUT	IN	OUT	IN	OUT	IN	RATIO	IN	RATIO
1	22.949	22.944	36.9	11.3	36.9	11.3	324.8	1.000	14.39	0.947
2	22.479	22.474	35.9	10.1	35.9	10.1	323.9	1.000	14.46	0.961
3	22.004	21.999	36.2	8.9	36.2	8.9	322.9	1.001	14.31	0.975
4	20.577	20.574	38.8	8.4	38.8	8.4	321.8	1.000	14.04	0.982
5	18.682	18.717	42.4	8.0	42.4	8.0	321.9	0.997	14.01	0.974
6	16.787	16.916	43.7	7.2	43.7	7.2	320.8	1.001	14.20	0.982
7	15.342	15.624	47.4	6.6	47.4	6.6	322.4	0.998	14.45	0.977
8	14.849	15.164	49.0	8.6	49.0	8.6	323.3	0.997	14.73	0.946
9	14.343	14.684	50.6	9.3	50.6	9.3	323.3	0.997	14.71	0.917

RP	ABS VEL		REL VEL		MERID VEL		TANG VEL		WHEEL SPEED	
	IN	OUT	IN	OUT	IN	OUT	IN	OUT	IN	OUT
1	218.6	157.1	218.6	157.1	174.8	154.0	131.4	30.7	0.	0.
2	222.2	166.6	222.2	166.6	179.9	164.0	130.4	29.1	0.	0.
3	220.2	167.9	220.2	167.9	177.6	165.9	130.2	25.9	0.	0.
4	217.2	159.8	217.2	159.8	169.3	158.0	136.1	23.4	0.	0.
5	225.5	154.2	225.5	154.2	166.5	152.7	152.0	21.6	0.	0.
6	240.8	166.5	240.8	166.5	174.0	165.2	166.4	20.8	0.	0.
7	255.8	175.2	255.8	175.2	173.1	174.1	188.3	20.0	0.	0.
8	261.8	170.3	261.8	170.3	171.9	168.4	197.4	25.5	0.	0.
9	259.8	154.8	259.8	154.8	164.8	152.7	200.8	25.1	0.	0.

RP	ABS MACH NO		REL MACH NO		MERID MACH NO		MERID PEAK SS	
	IN	OUT	IN	OUT	IN	OUT	VEL R	MACH NO
1	0.629	0.443	0.629	0.443	0.503	0.435	0.881	1.008
2	0.641	0.472	0.641	0.472	0.519	0.465	0.912	1.003
3	0.636	0.476	0.636	0.476	0.513	0.471	0.934	0.999
4	0.627	0.453	0.627	0.453	0.489	0.448	0.933	1.024
5	0.653	0.438	0.653	0.438	0.482	0.433	0.917	1.109
6	0.703	0.474	0.703	0.474	0.508	0.470	0.950	1.168
7	0.750	0.499	0.750	0.499	0.507	0.496	1.005	1.266
8	0.768	0.484	0.768	0.484	0.504	0.479	0.979	1.308
9	0.761	0.438	0.761	0.438	0.483	0.432	0.927	1.311

RP	PERCENT		INCIDENCE		DEV	D-FACT	EFF	LOSS COEFF		LOSS PARAM	
	SPAN	MEAN	MEAN	SS				TOT	PROF	TOT	PROF
1	5.00	12.0	-2.1	12.4	0.442	0.	0.226	0.226	0.077	0.077	
2	10.00	12.7	-1.6	10.9	0.406	0.	0.162	0.162	0.055	0.055	
3	15.00	14.0	-0.3	9.5	0.396	0.	0.104	0.104	0.034	0.034	
4	30.00	14.8	1.7	9.2	0.427	0.	0.075	0.075	0.023	0.023	
5	50.00	13.8	2.6	9.5	0.481	0.	0.106	0.106	0.030	0.030	
6	70.00	9.2	-0.2	9.4	0.462	0.	0.064	0.064	0.016	0.016	
7	85.00	6.4	-1.7	9.6	0.467	0.	0.075	0.075	0.017	0.017	
8	90.00	5.7	-2.0	11.9	0.495	0.	0.168	0.168	0.037	0.037	
9	95.00	5.1	-2.1	13.0	0.549	0.	0.261	0.261	0.056	0.056	

TABLE XLI. - Concluded. BLADE-ELEMENT DATA AT BLADE EDGES
FOR STATOR 9 (90 PERCENT DESIGN SPEED; STATOR RESET

INTRABLADE ROW INSTRUMENTATION

AT STATION 2a)

(d) Reading number 689

RP	RADII		ABS BETAM		REL BETAM		TOTAL TEMP		TOTAL PRESS	
	IN	OUT	IN	OUT	IN	OUT	IN	RATIO	IN	RATIO
1	22.949	22.944	42.1	11.1	42.1	11.1	326.8	0.998	14.08	0.946
2	22.479	22.474	39.9	9.9	39.9	9.9	325.6	0.999	14.23	0.945
3	22.004	21.999	39.5	9.2	39.5	9.2	324.7	0.999	14.21	0.950
4	20.577	20.574	41.7	8.9	41.7	8.9	323.2	0.999	14.00	0.966
5	18.682	18.717	44.1	8.5	44.1	8.5	322.1	0.998	13.92	0.970
6	16.787	16.916	44.5	7.3	44.5	7.3	321.5	1.001	14.17	0.986
7	15.342	15.624	48.0	6.6	48.0	6.6	322.9	0.997	14.45	0.973
8	14.849	15.164	49.3	8.8	49.3	8.8	323.5	0.996	14.74	0.941
9	14.343	14.684	50.9	9.4	50.9	9.4	323.6	0.996	14.78	0.912

RP	ABS VEL		REL VEL		MERID VEL		TANG VEL		WHEEL SPEED	
	IN	OUT	IN	OUT	IN	OUT	IN	OUT	IN	OUT
1	208.5	145.5	208.5	145.5	154.8	142.8	139.7	28.1	0.	0.
2	213.0	151.5	213.0	151.5	163.4	149.2	136.6	26.0	0.	0.
3	214.6	153.2	214.6	153.2	165.6	151.3	136.5	24.4	0.	0.
4	213.6	152.5	213.6	152.5	159.5	150.6	142.1	23.7	0.	0.
5	221.5	148.9	221.5	148.9	158.9	147.3	154.3	22.1	0.	0.
6	239.3	167.0	239.3	167.0	170.7	165.6	167.6	21.3	0.	0.
7	255.3	173.0	255.3	173.0	171.0	171.9	189.6	19.9	0.	0.
8	261.5	168.0	261.5	168.0	170.4	166.0	198.4	25.8	0.	0.
9	260.8	153.9	260.8	153.9	164.5	151.8	202.4	25.2	0.	0.

RP	ABS MACH NO		REL MACH NO		MERID MACH NO		MERID PEAK SS VEL R MACH NO
	IN	OUT	IN	OUT	IN	OUT	
1	0.596	0.409	0.596	0.409	0.442	0.401	0.922 1.059
2	0.610	0.426	0.610	0.426	0.468	0.420	0.913 1.037
3	0.616	0.432	0.616	0.432	0.476	0.427	0.913 1.037
4	0.615	0.431	0.615	0.431	0.459	0.426	0.944 1.064
5	0.640	0.422	0.640	0.422	0.459	0.417	0.927 1.126
6	0.697	0.475	0.697	0.475	0.498	0.471	0.970 1.176
7	0.747	0.492	0.747	0.492	0.500	0.489	1.005 1.276
8	0.767	0.477	0.767	0.477	0.500	0.472	0.974 1.317
9	0.764	0.436	0.764	0.436	0.482	0.430	0.923 1.324

RP	PERCENT SPAN	INCIDENCE		DEV	D-FACT	EFF	LOSS COEFF		LOSS PARAM	
		MEAN	SS				TOT	PROF	TOT	PROF
1	5.00	17.1	3.0	12.2	0.489	0.	0.254	0.254	0.087	0.087
2	10.00	16.7	2.4	10.7	0.466	0.	0.248	0.248	0.084	0.084
3	15.00	17.2	2.9	9.8	0.461	0.	0.220	0.220	0.073	0.073
4	30.00	17.7	4.6	9.7	0.460	0.	0.150	0.150	0.047	0.047
5	50.00	15.6	4.4	10.0	0.497	0.	0.124	0.124	0.035	0.035
6	70.00	9.9	0.6	9.5	0.458	0.	0.052	0.052	0.013	0.013
7	85.00	7.0	-1.1	9.6	0.475	0.	0.087	0.087	0.020	0.020
8	90.00	6.1	-1.6	12.2	0.504	0.	0.182	0.181	0.040	0.040
9	95.00	5.4	-1.8	13.1	0.555	0.	0.275	0.274	0.059	0.059

TABLE XLII. - BLADE-ELEMENT DATA AT BLADE EDGES FOR
 STATOR 9 (80 PERCENT DESIGN SPEED; STATOR RESET;
 INTRABLADE ROW INSTRUMENTATION AT
 STATION 2a; READING NUMBER 692)

RP	RADII		ABS BETAM		REL BETAM		TOTAL TEMP		TOTAL PRESS	
	IN	OUT	IN	OUT	IN	OUT	IN	RATIO	IN	RATIO
1	22.949	22.944	49.2	9.9	49.2	9.9	321.1	0.996	13.04	0.949
2	22.479	22.474	45.6	9.2	45.6	9.2	319.3	0.999	13.12	0.945
3	22.004	21.999	43.2	9.4	43.2	9.4	317.9	1.001	13.17	0.945
4	20.577	20.574	45.1	9.5	45.1	9.5	316.6	1.000	13.04	0.966
5	18.682	18.717	48.5	8.3	48.5	8.3	315.7	1.000	12.97	0.978
6	16.787	16.916	47.3	6.8	47.3	6.8	315.1	1.001	13.21	0.991
7	15.342	15.624	48.6	7.3	48.6	7.3	315.7	0.997	13.51	0.966
8	14.849	15.164	49.7	9.8	49.7	9.8	316.0	0.997	13.69	0.947
9	14.343	14.684	50.9	10.9	50.9	10.9	316.2	0.998	13.70	0.934

RP	ABS VEL		REL VEL		MERID VEL		TANG VEL		WHEEL SPEED	
	IN	OUT	IN	OUT	IN	OUT	IN	OUT	IN	OUT
1	175.4	114.9	175.4	114.9	114.6	113.2	132.8	19.7	0.	0.
2	180.2	115.7	180.2	115.7	126.1	114.2	128.7	18.6	0.	0.
3	183.5	118.2	183.5	118.2	133.7	116.6	125.7	19.3	0.	0.
4	183.5	126.2	183.5	126.2	129.6	124.5	129.9	20.9	0.	0.
5	188.5	129.6	188.5	129.6	125.1	128.2	141.1	18.7	0.	0.
6	206.2	147.7	206.2	147.7	139.7	146.7	151.7	17.5	0.	0.
7	223.1	148.1	223.1	148.1	147.6	146.9	167.3	18.7	0.	0.
8	228.6	145.8	228.6	145.8	147.9	143.6	174.3	24.9	0.	0.
9	228.8	138.7	228.8	138.7	144.2	136.2	177.7	26.2	0.	0.

RP	ABS MACH NO		REL MACH NO		MERID MACH NO		MERID PEAK SS	
	IN	OUT	IN	OUT	IN	OUT	VEL R	MACH NO
1	0.501	0.324	0.501	0.324	0.327	0.319	0.988	1.017
2	0.516	0.327	0.516	0.327	0.361	0.322	0.906	0.979
3	0.528	0.334	0.528	0.334	0.384	0.330	0.872	0.955
4	0.529	0.358	0.529	0.358	0.373	0.353	0.960	0.976
5	0.545	0.369	0.545	0.369	0.361	0.365	1.025	1.040
6	0.600	0.422	0.600	0.422	0.407	0.419	1.050	1.071
7	0.653	0.424	0.653	0.424	0.432	0.420	0.995	1.128
8	0.670	0.417	0.670	0.417	0.433	0.411	0.971	1.157
9	0.670	0.395	0.670	0.395	0.422	0.388	0.944	1.162

RP	PERCENT	INCIDENCE		DEV	D-FACT	EFF	LOSS COEFF		LOSS PARAM	
	SPAN	MEAN	SS				TOT	PROF	TOT	PROF
1	5.00	24.3	10.2	11.0	0.570	0.	0.324	0.324	0.111	0.111
2	10.00	22.4	8.1	10.0	0.567	0.	0.334	0.334	0.113	0.113
3	15.00	20.9	6.6	10.0	0.550	0.	0.321	0.321	0.106	0.106
4	30.00	21.0	8.0	10.3	0.498	0.	0.194	0.194	0.060	0.060
5	50.00	19.9	8.7	9.7	0.497	0.	0.120	0.120	0.034	0.034
6	70.00	12.8	3.4	9.1	0.449	0.	0.043	0.043	0.011	0.011
7	85.00	7.6	-0.5	10.3	0.490	0.	0.137	0.137	0.032	0.032
8	90.00	6.4	-1.2	13.2	0.507	0.	0.203	0.203	0.045	0.045
9	95.00	5.5	-1.8	14.5	0.536	0.	0.255	0.255	0.055	0.055

TABLE XLIII. - BLADE-ELEMENT DATA AT BLADE EDGES FOR
 STATOR 9 (70 PERCENT DESIGN SPEED; STATOR RESET;
 INTRABLADE ROW INSTRUMENTATION

AT STATION 2a)

(a) Reading number 693

RP	RADII		ABS BETAM		REL BETAM		TOTAL TEMP		TOTAL PRESS	
	IN	OUT	IN	OUT	IN	OUT	IN	RATIO	IN	RATIO
1	22.949	22.944	18.9	5.4	18.9	5.4	301.0	1.000	11.54	0.964
2	22.479	22.474	18.1	3.1	18.1	3.1	300.9	1.000	11.60	0.986
3	22.004	21.999	18.2	2.3	18.2	2.3	301.1	1.000	11.63	0.991
4	20.577	20.574	20.4	2.2	20.4	2.2	301.9	1.000	11.84	0.989
5	18.682	18.717	24.5	2.2	24.5	2.2	303.8	1.000	12.11	0.985
6	16.787	16.916	29.8	3.2	29.8	3.2	306.1	1.001	12.40	0.985
7	15.342	15.624	36.2	3.6	36.2	3.6	308.5	0.999	12.70	0.972
8	14.849	15.164	39.3	4.3	39.3	4.3	309.3	1.001	12.81	0.980
9	14.343	14.684	42.1	5.9	42.1	5.9	309.8	1.001	12.87	0.957

RP	ABS VEL		REL VEL		MERID VEL		TANG VEL		WHEEL SPEED	
	IN	OUT	IN	OUT	IN	OUT	IN	OUT	IN	OUT
1	186.4	168.1	186.4	168.1	176.4	167.4	60.5	15.7	0.	0.
2	190.0	180.2	190.0	180.2	180.6	179.9	58.9	9.7	0.	0.
3	191.7	183.0	191.7	183.0	182.2	182.8	59.7	7.2	0.	0.
4	201.7	186.5	201.7	186.5	189.0	186.3	70.3	7.1	0.	0.
5	217.3	192.2	217.3	192.2	197.8	192.1	90.1	7.5	0.	0.
6	231.2	200.3	231.2	200.3	200.6	200.0	114.9	11.0	0.	0.
7	239.3	207.9	239.3	207.9	193.1	207.4	141.3	13.0	0.	0.
8	239.7	214.0	239.7	214.0	185.5	213.4	151.8	16.1	0.	0.
9	237.8	206.8	237.8	206.8	176.5	205.7	159.3	21.3	0.	0.

RP	ABS MACH NO		REL MACH NO		MERID MACH NO		MERID PEAK SS	
	IN	OUT	IN	OUT	IN	OUT	VEL R	MACH NO
1	0.552	0.495	0.552	0.495	0.522	0.493	0.949	0.552
2	0.563	0.533	0.563	0.533	0.536	0.532	0.996	0.563
3	0.569	0.541	0.569	0.541	0.540	0.541	1.004	0.569
4	0.599	0.551	0.599	0.551	0.562	0.551	0.986	0.599
5	0.648	0.568	0.648	0.568	0.589	0.567	0.971	0.648
6	0.690	0.590	0.690	0.590	0.599	0.590	0.997	0.805
7	0.714	0.612	0.714	0.612	0.576	0.611	1.074	0.930
8	0.714	0.631	0.714	0.631	0.552	0.629	1.151	0.981
9	0.707	0.607	0.707	0.607	0.525	0.604	1.165	1.012

RP	PERCENT		INCIDENCE		DEV	D-FACT	EFF	LOSS COEFF		LOSS PARAM	
	SPAN	MEAN	SS	TOT				PROF	TOT	PROF	
1	5.00	-6.0	-20.1	6.5	0.182	0.	0.194	0.194	0.067	0.067	
2	10.00	-5.1	-19.4	3.9	0.140	0.	0.073	0.073	0.025	0.025	
3	15.00	-4.1	-18.4	2.9	0.137	0.	0.043	0.043	0.014	0.014	
4	30.00	-3.6	-16.7	3.0	0.174	0.	0.052	0.052	0.016	0.016	
5	50.00	-4.1	-15.3	3.7	0.224	0.	0.062	0.062	0.018	0.018	
6	70.00	-4.7	-14.1	5.4	0.248	0.	0.057	0.057	0.014	0.014	
7	85.00	-4.8	-12.9	6.7	0.255	0.	0.096	0.096	0.022	0.022	
8	90.00	-4.0	-11.6	7.7	0.233	0.	0.071	0.071	0.016	0.016	
9	95.00	-3.4	-10.6	9.6	0.254	0.	0.151	0.151	0.033	0.033	

TABLE XLIII. - Continued. BLADE-ELEMENT DATA AT BLADE

EDGES FOR STATOR 9 (70 PERCENT DESIGN SPEED; STATOR

RESET; INTRABLADE ROW INSTRUMENTATION

AT STATION 2a)

(b) Reading number 694

RP	RADI		ABS BETAM		REL BETAM		TOTAL TEMP		TOTAL PRESS	
	IN	OUT	IN	OUT	IN	OUT	IN	RATIO	IN	RATIO
1	22.949	22.944	26.6	8.6	26.6	8.6	305.6	1.000	12.12	0.969
2	22.479	22.474	26.2	5.2	26.2	5.2	305.0	1.000	12.14	0.990
3	22.004	21.999	26.0	3.8	26.0	3.8	304.7	1.000	12.15	0.993
4	20.577	20.574	27.5	3.6	27.5	3.6	304.9	1.000	12.24	0.990
5	18.682	18.717	31.1	3.5	31.1	3.5	305.5	1.000	12.32	0.990
6	16.787	16.916	35.3	2.9	35.3	2.9	306.7	1.000	12.46	0.992
7	15.342	15.624	41.0	3.9	41.0	3.9	308.1	1.001	12.64	0.990
8	14.849	15.164	43.7	5.1	43.7	5.1	308.9	1.001	12.79	0.987
9	14.343	14.684	46.0	7.4	46.0	7.4	309.3	1.000	12.84	0.947

RP	ABS VEL		REL VEL		MERID VEL		TANG VEL		WHEEL SPEED	
	IN	OUT	IN	OUT	IN	OUT	IN	OUT	IN	OUT
1	175.6	140.3	175.6	140.3	157.0	138.8	78.6	21.0	0.	0.
2	177.9	152.5	177.9	152.5	159.6	151.9	78.5	13.7	0.	0.
3	179.0	154.3	179.0	154.3	160.8	153.9	78.6	10.2	0.	0.
4	185.3	154.4	185.3	154.4	164.3	154.1	85.6	9.8	0.	0.
5	194.2	157.1	194.2	157.1	166.3	156.8	100.3	9.6	0.	0.
6	204.2	162.6	204.2	162.6	166.5	162.4	118.1	8.2	0.	0.
7	212.2	170.4	212.2	170.4	160.2	170.0	139.1	11.6	0.	0.
8	215.8	175.0	215.8	175.0	156.1	174.3	149.0	15.6	0.	0.
9	216.1	158.9	216.1	158.9	150.1	157.5	155.5	20.5	0.	0.

RP	ABS MACH NO		REL MACH NO		MERID MACH NO		MERID PEAK SS	
	IN	OUT	IN	OUT	IN	OUT	VEL R	MACH NO
1	0.514	0.407	0.514	0.407	0.460	0.403	0.884	0.638
2	0.522	0.444	0.522	0.444	0.468	0.442	0.952	0.637
3	0.525	0.450	0.525	0.450	0.472	0.449	0.957	0.636
4	0.545	0.450	0.545	0.450	0.483	0.449	0.938	0.674
5	0.572	0.458	0.572	0.458	0.490	0.457	0.943	0.749
6	0.602	0.474	0.602	0.474	0.491	0.473	0.975	0.829
7	0.626	0.496	0.626	0.496	0.473	0.495	1.061	0.921
8	0.637	0.509	0.637	0.509	0.461	0.507	1.117	0.971
9	0.638	0.460	0.638	0.460	0.443	0.456	1.050	0.999

RP	PERCENT SPAN	INCIDENCE		DEV	D-FACT	EFF	LOSS COEFF		LOSS PARAM	
		MEAN	SS				TOT	PROF	TOT	PROF
1	5.00	1.7	-12.4	9.7	0.315	0.	0.186	0.186	0.064	0.064
2	10.00	3.0	-11.3	5.9	0.267	0.	0.062	0.062	0.021	0.021
3	15.00	3.8	-10.5	4.4	0.266	0.	0.039	0.039	0.013	0.013
4	30.00	3.5	-9.6	4.4	0.295	0.	0.053	0.053	0.017	0.017
5	50.00	2.5	-8.7	4.9	0.324	0.	0.049	0.049	0.014	0.014
6	70.00	0.8	-8.6	5.1	0.341	0.	0.035	0.035	0.009	0.009
7	85.00	-0.0	-8.1	7.0	0.336	0.	0.044	0.044	0.010	0.010
8	90.00	0.4	-7.2	8.5	0.327	0.	0.056	0.056	0.013	0.013
9	95.00	0.5	-6.7	11.1	0.399	0.	0.220	0.220	0.047	0.047

TABLE XLIII. - Continued. BLADE-ELEMENT DATA AT BLADE
 EDGES FOR STATOR 9 (70 PERCENT DESIGN SPEED; STATOR
 RESET; INTRABLADE ROW INSTRUMENTATION

AT STATION 2a)

(c) Reading number 695

RP	RADII		ABS BETAM		REL BETAM		TOTAL TEMP		TOTAL PRESS	
	IN	OUT	IN	OUT	IN	OUT	IN	RATIO	IN	RATIO
1	22.949	22.944	35.4	11.3	35.4	11.3	309.5	1.000	12.44	0.969
2	22.479	22.474	34.6	9.4	34.6	9.4	308.5	1.002	12.46	0.981
3	22.004	21.999	34.4	7.5	34.4	7.5	307.9	1.002	12.43	0.989
4	20.577	20.574	35.7	6.8	35.7	6.8	307.6	0.999	12.40	0.991
5	18.682	18.717	39.0	6.7	39.0	6.7	307.3	1.000	12.39	0.992
6	16.787	16.916	42.1	6.2	42.1	6.2	307.8	1.000	12.47	0.990
7	15.342	15.624	46.2	6.1	46.2	6.1	308.9	0.999	12.70	0.987
8	14.849	15.164	47.8	8.2	47.8	8.2	309.2	0.999	12.81	0.970
9	14.343	14.684	49.3	9.3	49.3	9.3	309.0	1.000	12.79	0.948

RP	ABS VEL		REL VEL		MERID VEL		TANG VEL		WHEEL SPEED	
	IN	OUT	IN	OUT	IN	OUT	IN	OUT	IN	OUT
1	164.9	120.9	164.9	120.9	134.5	118.5	95.5	23.7	0.	0.
2	167.0	129.6	167.0	129.6	137.5	127.8	94.8	21.1	0.	0.
3	167.1	133.0	167.1	133.0	138.0	131.9	94.3	17.4	0.	0.
4	169.5	131.4	169.5	131.4	137.6	130.5	98.9	15.6	0.	0.
5	175.7	131.7	175.7	131.7	136.5	130.8	110.6	15.3	0.	0.
6	185.8	134.5	185.8	134.5	137.9	133.7	124.6	14.5	0.	0.
7	198.8	144.8	198.8	144.8	137.6	143.9	143.5	15.5	0.	0.
8	203.0	141.5	203.0	141.5	136.4	140.0	150.4	20.1	0.	0.
9	202.4	127.5	202.4	127.5	131.9	125.8	153.5	20.7	0.	0.

RP	ABS MACH NO		REL MACH NO		MERID MACH NO		MERID PEAK SS	
	IN	OUT	IN	OUT	IN	OUT	VEL R	MACH NO
1	0.478	0.347	0.478	0.347	0.390	0.340	0.881	0.742
2	0.485	0.373	0.485	0.373	0.400	0.368	0.930	0.737
3	0.486	0.383	0.486	0.383	0.401	0.380	0.956	0.733
4	0.494	0.379	0.494	0.379	0.401	0.377	0.948	0.754
5	0.513	0.380	0.513	0.380	0.399	0.378	0.958	0.812
6	0.544	0.388	0.544	0.388	0.404	0.386	0.970	0.874
7	0.583	0.418	0.583	0.418	0.404	0.416	1.046	0.961
8	0.596	0.408	0.596	0.408	0.401	0.404	1.026	0.992
9	0.594	0.367	0.594	0.367	0.387	0.362	0.954	0.998

RP	PERCENT		INCIDENCE		DEV	D-FACT	EFF	LOSS COEFF		LOSS PARAM	
	SPAN	MEAN	SS	TOT				PROF	TOT	PROF	
1	5.00	10.5	-3.7	12.4	0.419	0.	0.214	0.214	0.073	0.073	
2	10.00	11.4	-2.9	10.2	0.375	0.	0.129	0.129	0.043	0.043	
3	15.00	12.1	-2.2	8.1	0.358	0.	0.073	0.073	0.024	0.024	
4	30.00	11.7	-1.4	7.6	0.378	0.	0.056	0.056	0.017	0.017	
5	50.00	10.4	-0.8	8.1	0.404	0.	0.046	0.046	0.013	0.013	
6	70.00	7.6	-1.8	8.4	0.427	0.	0.057	0.057	0.015	0.015	
7	85.00	5.2	-2.9	9.2	0.420	0.	0.065	0.065	0.015	0.015	
8	90.00	4.5	-3.1	11.5	0.446	0.	0.139	0.139	0.031	0.031	
9	95.00	3.8	-3.4	13.0	0.510	0.	0.243	0.243	0.052	0.052	

TABLE XLIII. - Concluded. BLADE-ELEMENT DATA AT BLADE

EDGES FOR STATOR 9 (70 PERCENT DESIGN SPEED; STATOR

RESET; INTRABLADE ROW INSTRUMENTATION

AT STATION 2a)

(d) Reading number 696

RP	RADII		ABS BETAM		REL BETAM		TOTAL TEMP		TOTAL PRESS	
	IN	OUT	IN	OUT	IN	OUT	IN	RATIO	IN	RATIO
1	22.949	22.944	49.5	9.8	49.5	9.8	313.4	0.996	12.31	0.961
2	22.479	22.474	45.9	9.1	45.9	9.1	311.9	0.999	12.38	0.958
3	22.004	21.999	43.0	9.2	43.0	9.2	310.8	1.001	12.41	0.959
4	20.577	20.574	44.9	9.5	44.9	9.5	309.7	1.001	12.31	0.976
5	18.682	18.717	49.0	8.1	49.0	8.1	309.1	1.000	12.25	0.984
6	16.787	16.916	48.0	7.1	48.0	7.1	308.8	1.001	12.42	0.993
7	15.342	15.624	49.0	7.6	49.0	7.6	309.5	0.997	12.74	0.968
8	14.849	15.164	49.7	10.1	49.7	10.1	309.6	0.997	12.84	0.954
9	14.343	14.684	50.7	11.1	50.7	11.1	309.3	0.999	12.80	0.945

RP	ABS VEL		REL VEL		MERID VEL		TANG VEL		WHEEL SPEED	
	IN	OUT	IN	OUT	IN	OUT	IN	OUT	IN	OUT
1	151.5	99.7	151.5	99.7	98.3	98.2	115.2	17.0	0.	0.
2	155.9	100.9	155.9	100.9	108.5	99.6	111.9	16.0	0.	0.
3	158.8	103.5	158.8	103.5	116.2	102.2	108.3	16.6	0.	0.
4	158.4	110.1	158.4	110.1	112.2	108.6	111.8	18.1	0.	0.
5	162.3	112.4	162.3	112.4	106.6	111.3	122.5	15.9	0.	0.
6	177.8	127.7	177.8	127.7	119.1	126.7	132.0	15.8	0.	0.
7	196.3	129.5	196.3	129.5	128.7	128.3	148.2	17.0	0.	0.
8	200.6	126.4	200.6	126.4	129.8	124.4	152.9	22.1	0.	0.
9	200.0	119.1	200.0	119.1	126.7	116.9	154.7	22.9	0.	0.

RP	ABS MACH NO		REL MACH NO		MERID MACH NO		MERID PEAK SS	
	IN	OUT	IN	OUT	IN	OUT	VEL R	MACH NO
1	0.435	0.284	0.435	0.284	0.282	0.280	1.000	0.888
2	0.449	0.287	0.449	0.287	0.313	0.284	0.918	0.856
3	0.459	0.295	0.459	0.295	0.336	0.291	0.879	0.826
4	0.458	0.315	0.458	0.315	0.325	0.311	0.968	0.844
5	0.471	0.322	0.471	0.322	0.309	0.319	1.044	0.907
6	0.518	0.367	0.518	0.367	0.347	0.364	1.064	0.936
7	0.575	0.373	0.575	0.373	0.377	0.369	0.997	1.002
8	0.588	0.364	0.588	0.364	0.381	0.358	0.959	1.016
9	0.586	0.342	0.586	0.342	0.371	0.336	0.923	1.012

RP	PERCENT	INCIDENCE		DEV	D-FACT	EFF	LOSS COEFF		LOSS PARAM	
	SPAN	MEAN	SS				TOT	PROF	TOT	PROF
1	5.00	24.6	10.5	11.0	0.568	0.	0.317	0.317	0.109	0.109
2	10.00	22.7	8.4	9.9	0.563	0.	0.326	0.326	0.110	0.110
3	15.00	20.7	6.4	9.8	0.541	0.	0.308	0.308	0.102	0.102
4	30.00	20.9	7.8	10.3	0.490	0.	0.182	0.182	0.056	0.056
5	50.00	20.4	9.2	9.6	0.494	0.	0.112	0.112	0.032	0.032
6	70.00	13.4	4.0	9.3	0.448	0.	0.040	0.040	0.010	0.010
7	85.00	8.0	-0.0	10.6	0.494	0.	0.159	0.159	0.037	0.037
8	90.00	6.4	-1.2	13.4	0.514	0.	0.219	0.219	0.049	0.049
9	95.00	5.2	-2.0	14.7	0.545	0.	0.263	0.263	0.056	0.056

TABLE XLIV. - BLADE-ELEMENT DATA AT BLADE EDGES FOR
 STATOR 9 (60 PERCENT DESIGN SPEED; STATOR RESET;
 INTRABLADE ROW INSTRUMENTATION AT
 STATION 2a; READING NUMBER 699)

RP	RADII		ABS BETAM		REL BETAM		TOTAL TEMP		TOTAL PRESS	
	IN	OUT	IN	OUT	IN	OUT	IN	RATIO	IN	RATIO
1	22.949	22.944	52.9	9.5	52.9	9.5	306.8	0.997	11.73	0.970
2	22.479	22.474	47.6	8.7	47.6	8.7	306.3	0.998	11.76	0.968
3	22.004	21.999	43.9	9.0	43.9	9.0	305.0	1.000	11.78	0.967
4	20.577	20.574	46.5	9.6	46.5	9.6	304.3	1.000	11.73	0.980
5	18.682	18.717	50.7	8.3	50.7	8.3	303.5	1.001	11.67	0.987
6	16.787	16.916	49.3	7.6	49.3	7.6	303.2	1.001	11.77	0.994
7	15.342	15.624	49.1	8.3	49.1	8.3	303.2	1.000	11.89	0.985
8	14.849	15.164	49.7	10.7	49.7	10.7	303.2	0.999	11.99	0.973
9	14.343	14.684	51.0	11.4	51.0	11.4	303.5	0.999	12.03	0.960

RP	ABS VEL		REL VEL		MERID VEL		TANG VEL		WHEEL SPEED	
	IN	OUT	IN	OUT	IN	OUT	IN	OUT	IN	OUT
1	129.0	84.5	129.0	84.5	77.9	83.3	102.9	14.0	0.	0.
2	132.3	84.9	132.3	84.9	89.2	83.9	97.7	12.9	0.	0.
3	135.0	86.1	135.0	86.1	97.3	85.0	93.5	13.5	0.	0.
4	135.8	93.0	135.8	93.0	93.5	91.7	98.5	15.5	0.	0.
5	138.0	94.7	138.0	94.7	87.4	93.7	106.8	13.7	0.	0.
6	149.6	106.7	149.6	106.7	97.5	105.7	113.4	14.2	0.	0.
7	161.5	109.6	161.5	109.6	105.8	108.5	122.0	15.7	0.	0.
8	167.1	107.9	167.1	107.9	108.1	106.0	127.5	20.0	0.	0.
9	169.5	100.5	169.5	100.5	106.6	98.5	131.7	19.9	0.	0.

RP	ABS MACH NO		REL MACH NO		MERID MACH NO		MERID PEAK SS	
	IN	OUT	IN	OUT	IN	OUT	VEL R	MACH NO
1	0.373	0.242	0.373	0.242	0.225	0.239	1.069	0.807
2	0.383	0.244	0.383	0.244	0.258	0.241	0.940	0.753
3	0.391	0.247	0.391	0.247	0.282	0.244	0.874	0.717
4	0.394	0.268	0.394	0.268	0.271	0.264	0.981	0.748
5	0.402	0.273	0.402	0.273	0.254	0.270	1.072	0.799
6	0.437	0.308	0.437	0.308	0.285	0.306	1.084	0.809
7	0.473	0.317	0.473	0.317	0.310	0.314	1.026	0.826
8	0.490	0.312	0.490	0.312	0.317	0.307	0.981	0.848
9	0.497	0.290	0.497	0.290	0.313	0.284	0.924	0.863

RP	PERCENT SPAN	INCIDENCE		DEV	D-FACT	EFF	LOSS COEFF		LOSS PARAM	
		MEAN	SS				TOT	PROF	TOT	PROF
1	5.00	27.9	13.8	10.6	0.586	0.	0.328	0.328	0.113	0.113
2	10.00	24.4	10.1	9.5	0.578	0.	0.336	0.336	0.114	0.114
3	15.00	21.6	7.3	9.6	0.560	0.	0.329	0.329	0.109	0.109
4	30.00	22.5	9.4	10.4	0.506	0.	0.201	0.201	0.062	0.062
5	50.00	22.1	10.9	9.7	0.506	0.	0.123	0.123	0.035	0.035
6	70.00	14.8	5.4	9.9	0.456	0.	0.053	0.053	0.013	0.013
7	85.00	8.1	0.0	11.3	0.473	0.	0.107	0.107	0.025	0.025
8	90.00	6.4	-1.2	14.0	0.497	0.	0.180	0.180	0.040	0.040
9	95.00	5.5	-1.7	15.1	0.548	0.	0.258	0.258	0.055	0.055

TABLE XLV. - BLADE-ELEMENT DATA AT BLADE EDGES FOR

STATOR 9 (50 PERCENT DESIGN SPEED; STATOR RESET;

INTRABLADE ROW INSTRUMENTATION AT

STATION 2a; READING NUMBER 700)

RP	RADII		ABS BETAM		REL BETAM		TOTAL TEMP		TOTAL PRESS	
	IN	OUT	IN	OUT	IN	OUT	IN	RATIO	IN	RATIO
1	22.949	22.944	50.9	9.8	50.9	9.8	301.1	0.998	11.23	0.979
2	22.479	22.474	46.9	9.0	46.9	9.0	300.3	1.000	11.25	0.978
3	22.004	21.999	43.8	9.3	43.8	9.3	299.7	1.000	11.26	0.979
4	20.577	20.574	45.3	9.9	45.3	9.9	299.1	1.000	11.23	0.987
5	18.682	18.717	50.1	8.4	50.1	8.4	298.8	1.001	11.18	0.992
6	16.787	16.916	49.7	8.0	49.7	8.0	298.8	1.000	11.27	0.994
7	15.342	15.624	49.5	8.5	49.5	8.5	298.9	1.000	11.39	0.986
8	14.849	15.164	49.9	10.7	49.9	10.7	298.7	1.000	11.44	0.979
9	14.343	14.684	50.9	11.6	50.9	11.6	298.9	0.999	11.44	0.970

RP	ABS VEL		REL VEL		MERID VEL		TANG VEL		WHEEL SPEED	
	IN	OUT	IN	OUT	IN	OUT	IN	OUT	IN	OUT
1	107.7	71.0	107.7	71.0	67.9	70.0	83.6	12.1	0.	0.
2	110.1	72.2	110.1	72.2	75.2	71.3	80.4	11.3	0.	0.
3	112.0	73.7	112.0	73.7	80.8	72.7	77.5	11.9	0.	0.
4	112.8	78.6	112.8	78.6	79.3	77.4	80.2	13.5	0.	0.
5	114.7	79.5	114.7	79.5	73.6	78.6	87.9	11.6	0.	0.
6	125.2	88.7	125.2	88.7	81.1	87.8	95.4	12.3	0.	0.
7	136.7	92.1	136.7	92.1	88.7	91.1	103.9	13.7	0.	0.
8	140.4	90.2	140.4	90.2	90.4	88.7	107.5	16.7	0.	0.
9	141.8	83.0	141.8	83.0	89.5	81.3	110.0	16.7	0.	0.

RP	ABS MACH NO		REL MACH NO		MERID MACH NO		MERID PEAK SS	
	IN	OUT	IN	OUT	IN	OUT	VEL R	MACH NO
1	0.313	0.205	0.313	0.205	0.197	0.202	1.031	0.654
2	0.320	0.209	0.320	0.209	0.219	0.206	0.948	0.622
3	0.326	0.213	0.326	0.213	0.235	0.211	0.900	0.596
4	0.329	0.228	0.329	0.228	0.231	0.224	0.976	0.610
5	0.335	0.230	0.335	0.230	0.215	0.228	1.068	0.658
6	0.366	0.258	0.366	0.258	0.237	0.255	1.083	0.683
7	0.401	0.268	0.401	0.268	0.260	0.265	1.026	0.705
8	0.412	0.262	0.412	0.262	0.265	0.258	0.981	0.716
9	0.416	0.241	0.416	0.241	0.263	0.236	0.908	0.721

RP	PERCENT SPAN	INCIDENCE		DEV	D-FACT	EFF	LOSS COEFF		LOSS PARAM	
		MEAN	SS				TOT	PROF	TOT	PROF
1	5.00	26.0	11.9	11.0	0.571	0.	0.319	0.319	0.109	0.109
2	10.00	23.7	9.4	9.8	0.559	0.	0.314	0.314	0.106	0.106
3	15.00	21.5	7.2	9.9	0.538	0.	0.296	0.296	0.098	0.098
4	30.00	21.3	8.2	10.7	0.489	0.	0.181	0.181	0.056	0.056
5	50.00	21.5	10.3	9.9	0.496	0.	0.109	0.109	0.031	0.031
6	70.00	15.1	5.7	10.2	0.461	0.	0.069	0.069	0.017	0.017
7	85.00	8.5	0.5	11.6	0.478	0.	0.132	0.132	0.030	0.030
8	90.00	6.7	-1.0	14.0	0.501	0.	0.191	0.191	0.042	0.042
9	95.00	5.4	-1.8	15.2	0.555	0.	0.268	0.268	0.057	0.057

TABLE XLVI. - BLADE-ELEMENT DATA AT BLADE EDGES FOR

STATOR 9 (100 PERCENT DESIGN SPEED; STATOR RESET;

1 EXIT PYLON; INTRABLADE ROW INSTRUMENTATION

AT STATION 2b)

(a) Reading number 713

RP	RADIO		ABS BETAM		REL BETAM		TOTAL TEMP		TOTAL PRESS	
	IN	OUT	IN	OUT	IN	OUT	IN	RATIO	IN	RATIO
1	22.949	22.944	40.0	10.4	40.0	10.4	336.1	0.997	15.60	0.955
2	22.479	22.474	37.6	9.3	37.6	9.3	334.6	0.997	15.94	0.962
3	22.004	21.999	36.7	7.8	36.7	7.8	333.0	0.998	15.95	0.967
4	20.577	20.574	37.4	6.9	37.4	6.9	331.2	0.999	15.79	0.969
5	18.682	18.717	38.5	6.2	38.5	6.2	329.2	1.002	15.57	0.981
6	16.787	16.916	41.1	5.2	41.1	5.2	328.7	1.000	15.53	0.972
7	15.342	15.624	46.9	6.7	46.9	6.7	330.4	0.997	15.69	0.959
8	14.849	15.164	49.5	8.9	49.5	8.9	331.1	0.996	15.68	0.947
9	14.343	14.684	54.0	11.1	54.0	11.1	330.6	0.997	14.72	0.948

RP	ABS VEL		REL VEL		MERID VEL		TANG VEL		WHEEL SPEED	
	IN	OUT	IN	OUT	IN	OUT	IN	OUT	IN	OUT
1	236.4	178.6	236.4	178.6	181.2	175.7	151.8	32.4	0.	0.
2	249.7	192.9	249.7	192.9	197.8	190.4	152.4	31.0	0.	0.
3	255.6	195.1	255.6	195.1	204.9	193.3	152.9	26.6	0.	0.
4	269.0	200.9	269.0	200.9	213.7	199.5	163.4	24.1	0.	0.
5	281.5	210.6	281.5	210.6	220.3	209.4	175.3	22.8	0.	0.
6	288.0	212.6	288.0	212.6	217.1	211.7	189.3	19.3	0.	0.
7	287.8	217.2	287.8	217.2	196.6	215.7	210.2	25.5	0.	0.
8	284.5	213.5	284.5	213.5	184.7	210.9	216.4	33.1	0.	0.
9	262.2	188.2	262.2	188.2	154.1	184.7	212.1	36.3	0.	0.

RP	ABS MACH NO		REL MACH NO		MERID MACH NO		MERID PEAK SS	
	IN	OUT	IN	OUT	IN	OUT	VEL R	MACH NO
1	0.672	0.499	0.672	0.499	0.515	0.491	0.970	1.145
2	0.715	0.542	0.715	0.542	0.567	0.535	0.962	1.160
3	0.736	0.550	0.736	0.550	0.590	0.545	0.944	1.169
4	0.781	0.568	0.781	0.568	0.620	0.564	0.933	1.237
5	0.825	0.599	0.825	0.599	0.646	0.595	0.950	1.292
6	0.848	0.606	0.848	0.606	0.639	0.604	0.976	1.333
7	0.844	0.619	0.844	0.619	0.577	0.615	1.097	0.015
8	0.832	0.608	0.832	0.608	0.540	0.600	1.142	2.479
9	0.760	0.532	0.760	0.532	0.447	0.522	1.198	2.466

RP	PERCENT		INCIDENCE		DEV	D-FACT	EFF	LOSS COEFF		LOSS PARAM	
	SPAN	MEAN	SS	SS				TOT	PROF	TOT	PROF
1	5.00	15.0	0.9	11.6	0.420	0.	0.171	0.171	0.059	0.059	
2	10.00	14.4	0.1	10.1	0.394	0.	0.132	0.132	0.045	0.045	
3	15.00	14.5	0.2	8.4	0.402	0.	0.110	0.110	0.036	0.036	
4	30.00	13.4	0.3	7.7	0.415	0.	0.093	0.093	0.029	0.029	
5	50.00	9.9	-1.3	7.6	0.406	0.	0.052	0.051	0.015	0.014	
6	70.00	6.6	-2.8	7.4	0.412	0.	0.074	0.072	0.019	0.018	
7	85.00	5.9	-2.1	9.8	0.393	0.	0.109	0.109	0.025	0.025	
8	90.00	6.2	-1.4	12.3	0.393	0.	0.145	-0.200	0.032	-0.045	
9	95.00	8.5	1.3	14.8	0.426	0.	0.163	-0.182	0.035	-0.039	

TABLE XLVI. - Concluded. BLADE-ELEMENT DATA AT BLADE
 EDGES FOR STATOR 9 (100 PERCENT DESIGN SPEED; STATOR
 RESET; 1 EXIT PYLON; INTRABLADE ROW
 INSTRUMENTATION AT STATION 2b)

(b) Reading number 712

RP	RADII		ABS BETAM		REL BETAM		TOTAL TEMP		TOTAL PRESS	
	IN	OUT	IN	OUT	IN	OUT	IN	RATIO	IN	RATIO
1	22.949	22.944	43.6	9.8	43.6	9.8	336.9	0.995	15.29	0.953
2	22.479	22.474	41.1	9.2	41.1	9.2	335.4	0.997	15.60	0.946
3	22.004	21.999	40.1	8.3	40.1	8.3	334.0	0.997	15.57	0.950
4	20.577	20.574	41.2	7.5	41.2	7.5	331.4	1.000	15.30	0.957
5	18.682	18.717	43.4	6.9	43.4	6.9	329.9	0.999	15.13	0.959
6	16.787	16.916	45.2	6.3	45.2	6.3	329.7	0.998	15.21	0.964
7	15.342	15.624	48.1	6.8	48.1	6.8	330.9	0.996	15.65	0.957
8	14.849	15.164	50.6	8.9	50.6	8.9	331.4	0.996	15.72	0.943
9	14.343	14.684	54.6	10.6	54.6	10.6	331.0	0.996	14.86	0.941

RP	ABS VEL		REL VEL		MERID VEL		TANG VEL		WHEEL SPEED	
	IN	OUT	IN	OUT	IN	OUT	IN	OUT	IN	OUT
1	225.1	170.2	225.1	170.2	163.0	167.7	155.2	29.0	0.	0.
2	237.7	177.7	237.7	177.7	179.2	175.4	156.2	28.5	0.	0.
3	242.3	180.3	242.3	180.3	165.3	178.4	156.1	25.9	0.	0.
4	249.7	182.4	249.7	182.4	187.8	180.9	164.5	23.9	0.	0.
5	259.2	181.7	259.2	181.7	188.3	180.4	178.1	22.0	0.	0.
6	271.2	188.8	271.2	188.8	191.2	187.7	192.3	20.9	0.	0.
7	282.6	204.2	282.6	204.2	188.7	202.8	210.4	24.2	0.	0.
8	281.4	203.9	281.4	203.9	178.7	201.4	217.4	31.5	0.	0.
9	262.7	182.6	262.7	182.6	152.2	179.5	214.1	33.7	0.	0.

RP	ABS MACH NO		REL MACH NO		MERID MACH NO		MERID PEAK SS	
	IN	OUT	IN	OUT	IN	OUT	VEL R	MACH NO
1	0.636	0.474	0.636	0.474	0.461	0.467	1.029	1.165
2	0.676	0.497	0.676	0.497	0.510	0.490	0.979	1.177
3	0.692	0.505	0.692	0.505	0.529	0.500	0.963	1.179
4	0.719	0.513	0.719	0.513	0.541	0.509	0.963	1.232
5	0.751	0.512	0.751	0.512	0.546	0.508	0.958	1.301
6	0.790	0.534	0.790	0.534	0.557	0.531	0.982	1.352
7	0.826	0.580	0.826	0.580	0.552	0.576	1.075	1.416
8	0.822	0.578	0.822	0.578	0.522	0.571	1.127	1.446
9	0.761	0.515	0.761	0.515	0.441	0.506	1.180	1.415

RP	PERCENT SPAN	INCIDENCE		DEV	D-FACT	EFF	LOSS COEFF		LOSS PARAM	
		MEAN	SS				TOT	PROF	TOT	PROF
1	5.00	18.7	4.6	10.9	0.440	0.	0.198	0.198	0.068	0.068
2	10.00	17.9	3.6	10.0	0.436	0.	0.204	0.204	0.069	0.069
3	15.00	17.8	3.5	8.8	0.436	0.	0.182	0.182	0.060	0.060
4	30.00	17.2	4.1	8.3	0.446	0.	0.146	0.146	0.045	0.045
5	50.00	14.8	3.6	8.4	0.470	0.	0.132	0.132	0.037	0.037
6	70.00	10.6	1.2	8.6	0.465	0.	0.105	0.104	0.027	0.027
7	85.00	7.1	-0.9	9.8	0.429	0.	0.120	0.115	0.028	0.027
8	90.00	7.3	-0.3	12.2	0.422	0.	0.160	0.153	0.036	0.034
9	95.00	9.1	1.9	14.3	0.452	0.	0.186	0.183	0.040	0.039

TABLE XLVII. - BLADE-ELEMENT DATA AT BLADE EDGES FOR
 STATOR 9 (70 PERCENT DESIGN SPEED; STATOR RESET;
 1 EXIT PYLON; INTRABLADE ROW INSTRUMENTATION
 AT STATION 2b; READING NUMBER 721)

RP	RADI		ABS BETAM		REL BETAM		TOTAL TEMP		TOTAL PRESS	
	IN	OUT	IN	OUT	IN	OUT	IN	RATIO	IN	RATIO
1	22.949	22.944	55.8	7.9	55.8	7.9	312.3	0.996	12.21	0.970
2	22.479	22.474	51.2	8.3	51.2	8.3	311.7	0.995	12.30	0.965
3	22.004	21.999	45.5	8.2	45.5	8.2	310.5	0.998	12.38	0.969
4	20.577	20.574	43.8	7.6	43.8	7.6	308.9	1.000	12.36	0.978
5	18.682	18.717	45.9	6.5	45.9	6.5	308.3	0.999	12.34	0.980
6	16.787	16.916	45.4	5.9	45.4	5.9	308.1	1.000	12.50	0.986
7	15.342	15.624	47.7	6.2	47.7	6.2	308.5	0.999	12.69	0.983
8	14.849	15.164	50.4	8.7	50.4	8.7	308.7	1.000	12.71	0.977
9	14.343	14.684	53.8	10.7	53.8	10.7	309.0	0.998	12.46	0.971

RP	ABS VEL		REL VEL		MERID VEL		TANG VEL		WHEEL SPEED	
	IN	OUT	IN	OUT	IN	OUT	IN	OUT	IN	OUT
1	141.9	98.1	141.9	98.1	79.7	97.2	117.4	13.4	0.	0.
2	149.5	101.1	149.5	101.1	93.7	100.0	116.5	14.6	0.	0.
3	153.8	107.4	153.8	107.4	107.8	106.3	109.7	15.3	0.	0.
4	161.7	116.5	161.7	116.5	116.8	115.5	111.8	15.4	0.	0.
5	170.5	120.4	170.5	120.4	118.7	119.7	122.4	13.5	0.	0.
6	185.8	132.6	185.8	132.6	130.5	131.9	132.2	13.6	0.	0.
7	195.2	142.9	195.2	142.9	131.4	142.1	144.4	15.5	0.	0.
8	195.9	144.0	195.9	144.0	125.0	142.4	150.8	21.8	0.	0.
9	186.8	133.3	186.8	133.3	110.3	131.0	150.7	24.8	0.	0.

RP	ABS MACH NO		REL MACH NO		MERID MACH NO		MERID PEAK SS	
	IN	OUT	IN	OUT	IN	OUT	VEL R	MACH NO
1	0.407	0.280	0.407	0.280	0.229	0.277	1.218	0.929
2	0.430	0.289	0.430	0.289	0.270	0.286	1.068	0.904
3	0.444	0.307	0.444	0.307	0.311	0.304	0.986	0.839
4	0.469	0.334	0.469	0.334	0.339	0.331	0.988	0.845
5	0.496	0.346	0.496	0.346	0.345	0.344	1.008	0.902
6	0.543	0.382	0.543	0.382	0.382	0.380	1.011	0.933
7	0.572	0.413	0.572	0.413	0.385	0.411	1.081	0.972
8	0.574	0.416	0.574	0.416	0.366	0.411	1.139	1.006
9	0.546	0.384	0.546	0.384	0.322	0.378	1.187	1.000

RP	PERCENT	INCIDENCE		DEV	D-FACT	EFF	LOSS COEFF		LOSS PARAM	
	SPAN	MEAN	SS				TOT	PROF	TOT	PROF
1	5.00	30.9	16.8	9.0	0.564	0.	0.282	0.282	0.097	0.097
2	10.00	28.0	13.7	9.1	0.557	0.	0.295	0.295	0.100	0.100
3	15.00	23.2	8.9	8.8	0.507	0.	0.242	0.242	0.080	0.080
4	30.00	19.7	6.6	8.4	0.466	0.	0.157	0.157	0.049	0.049
5	50.00	17.3	6.1	7.9	0.475	0.	0.130	0.130	0.037	0.037
6	70.00	10.9	1.5	8.1	0.449	0.	0.080	0.080	0.020	0.020
7	85.00	6.7	-1.4	9.3	0.420	0.	0.085	0.085	0.020	0.020
8	90.00	7.1	-0.6	12.1	0.411	0.	0.113	0.113	0.025	0.025
9	95.00	8.3	1.1	14.4	0.430	0.	0.159	0.159	0.034	0.034

TABLE XLVIII. - BLADE-ELEMENT DATA AT BLADE EDGES FOR

STATOR 9 (50 PERCENT DESIGN SPEED; STATOR RESET;

1 EXIT PYLON; INTRABLADE ROW INSTRUMENTATION

AT STATION 2b; READING NUMBER 723)

RP	RADII		ABS BETAM		REL BETAM		TOTAL TEMP		TOTAL PRESS	
	IN	OUT	IN	OUT	IN	OUT	IN	RATIO	IN	RATIO
1	22.949	22.944	64.9	7.6	64.9	7.6	299.2	0.996	11.16	0.977
2	22.479	22.474	60.3	8.8	60.3	8.8	298.6	0.995	11.19	0.974
3	22.004	21.999	56.9	8.4	56.9	8.4	298.2	0.995	11.16	0.978
4	20.577	20.574	48.1	7.0	48.1	7.0	296.6	0.997	11.15	0.986
5	18.682	18.717	43.4	6.2	43.4	6.2	295.9	0.999	11.18	0.990
6	16.787	16.916	44.1	5.9	44.1	5.9	296.0	1.000	11.24	0.991
7	15.342	15.624	48.8	7.1	48.8	7.1	296.7	0.998	11.30	0.981
8	14.849	15.164	51.8	8.7	51.8	8.7	296.8	0.998	11.27	0.981
9	14.343	14.684	56.0	9.6	56.0	9.6	297.1	0.998	11.14	0.979

RP	ABS VEL		REL VEL		MERID VEL		TANG VEL		WHEEL SPEED	
	IN	OUT	IN	OUT	IN	OUT	IN	OUT	IN	OUT
1	100.0	64.2	100.0	64.2	42.4	63.6	90.6	8.5	0.	0.
2	105.7	64.7	105.7	64.7	52.4	63.9	91.8	9.9	0.	0.
3	107.7	67.2	107.7	67.2	58.8	66.5	90.2	9.8	0.	0.
4	113.3	77.8	113.3	77.8	75.7	77.2	84.3	9.5	0.	0.
5	122.3	88.6	122.3	88.6	88.8	88.1	84.0	9.6	0.	0.
6	131.4	96.3	131.4	96.3	94.3	95.8	91.5	9.9	0.	0.
7	137.0	96.5	137.0	96.5	90.3	95.7	103.1	12.0	0.	0.
8	135.7	94.5	135.7	94.5	84.0	93.4	106.6	14.2	0.	0.
9	128.0	84.7	128.0	84.7	71.6	85.5	106.1	14.2	0.	0.

RP	ABS MACH NO		REL MACH NO		MERID MACH NO		MERID PEAK SS	
	IN	OUT	IN	OUT	IN	OUT	VEL R	MACH NO
1	0.291	0.186	0.291	0.186	0.123	0.185	1.500	0.776
2	0.308	0.188	0.308	0.188	0.153	0.186	1.220	0.758
3	0.314	0.195	0.314	0.195	0.172	0.193	1.131	0.727
4	0.332	0.227	0.332	0.227	0.222	0.225	1.020	0.648
5	0.359	0.259	0.359	0.259	0.261	0.257	0.991	0.622
6	0.387	0.282	0.387	0.282	0.278	0.280	1.016	0.648
7	0.403	0.282	0.403	0.282	0.266	0.280	1.061	0.700
8	0.399	0.276	0.399	0.276	0.247	0.273	1.113	0.718
9	0.376	0.247	0.376	0.247	0.210	0.244	1.166	0.717

RP	PERCENT		INCIDENCE		DEV	D-FACT	EFF	LOSS COEFF		LOSS PARAM	
	SPAN	MEAN	SS	TOT				PROF	TOT	PROF	
1	5.00	40.0	25.9	8.7	0.644	0.	0.411	0.411	0.142	0.142	
2	10.00	37.1	22.8	9.6	0.653	0.	0.407	0.407	0.138	0.138	
3	15.00	34.6	20.3	9.0	0.625	0.	0.334	0.334	0.111	0.111	
4	30.00	24.0	10.9	7.8	0.520	0.	0.188	0.188	0.059	0.059	
5	50.00	14.8	3.6	7.6	0.449	0.	0.113	0.113	0.032	0.032	
6	70.00	9.6	0.2	8.1	0.425	0.	0.092	0.092	0.023	0.023	
7	85.00	7.8	-0.2	10.2	0.449	0.	0.175	0.175	0.040	0.040	
8	90.00	8.5	0.9	12.0	0.454	0.	0.188	0.188	0.042	0.042	
9	95.00	10.5	3.3	13.3	0.492	0.	0.225	0.225	0.048	0.048	

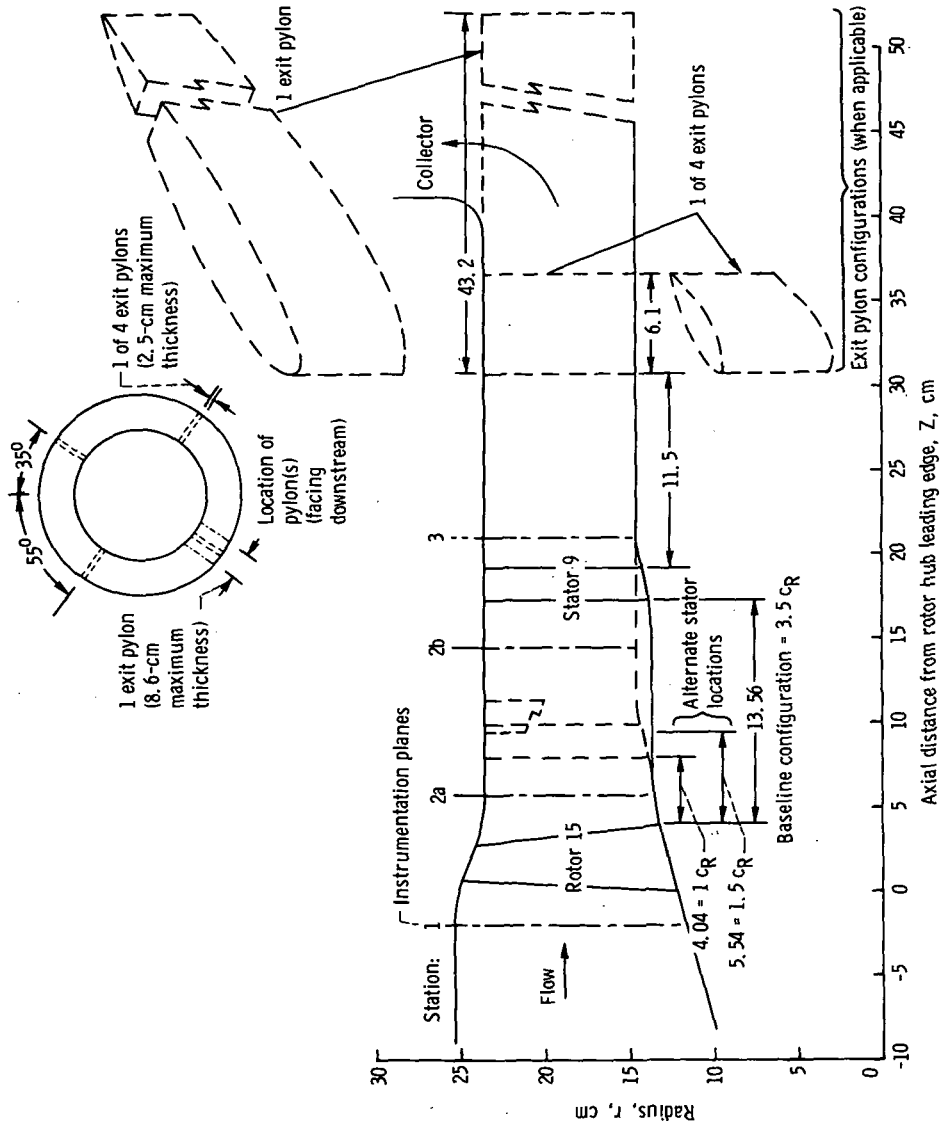

Figure 1. - Flow path for stage 15-9 showing axial location of instrumentation, stator, locations, and exit pylons. (All dimensions in cm unless indicated otherwise.)

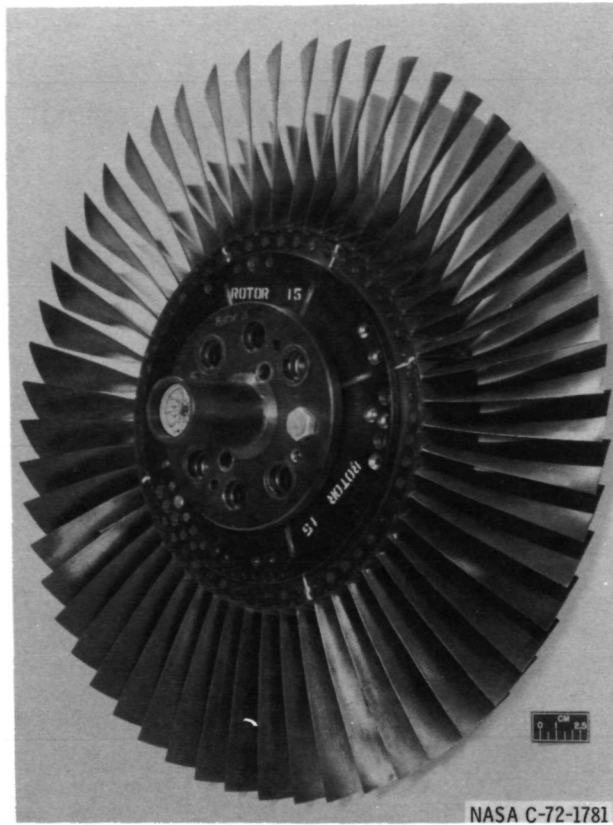

Figure 2. - Rotor 15.

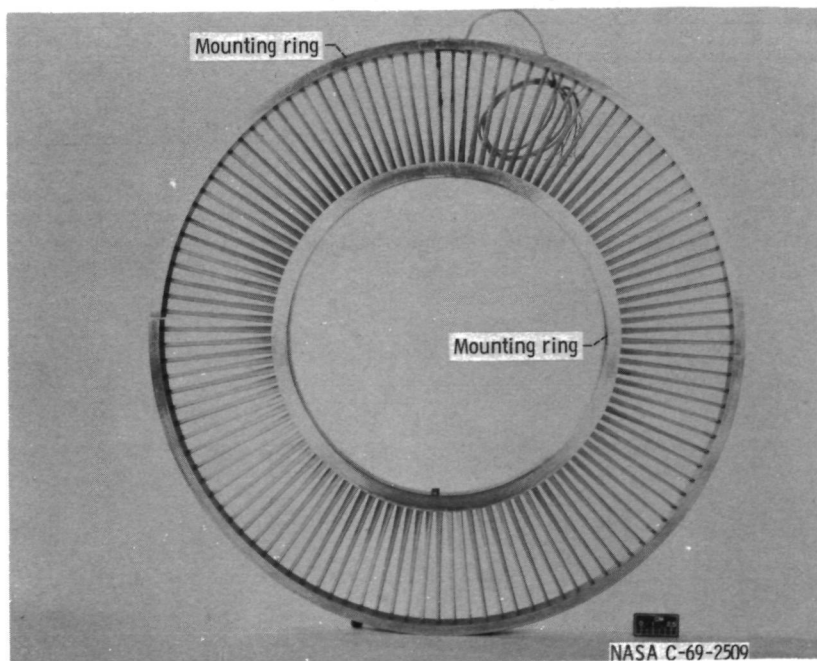
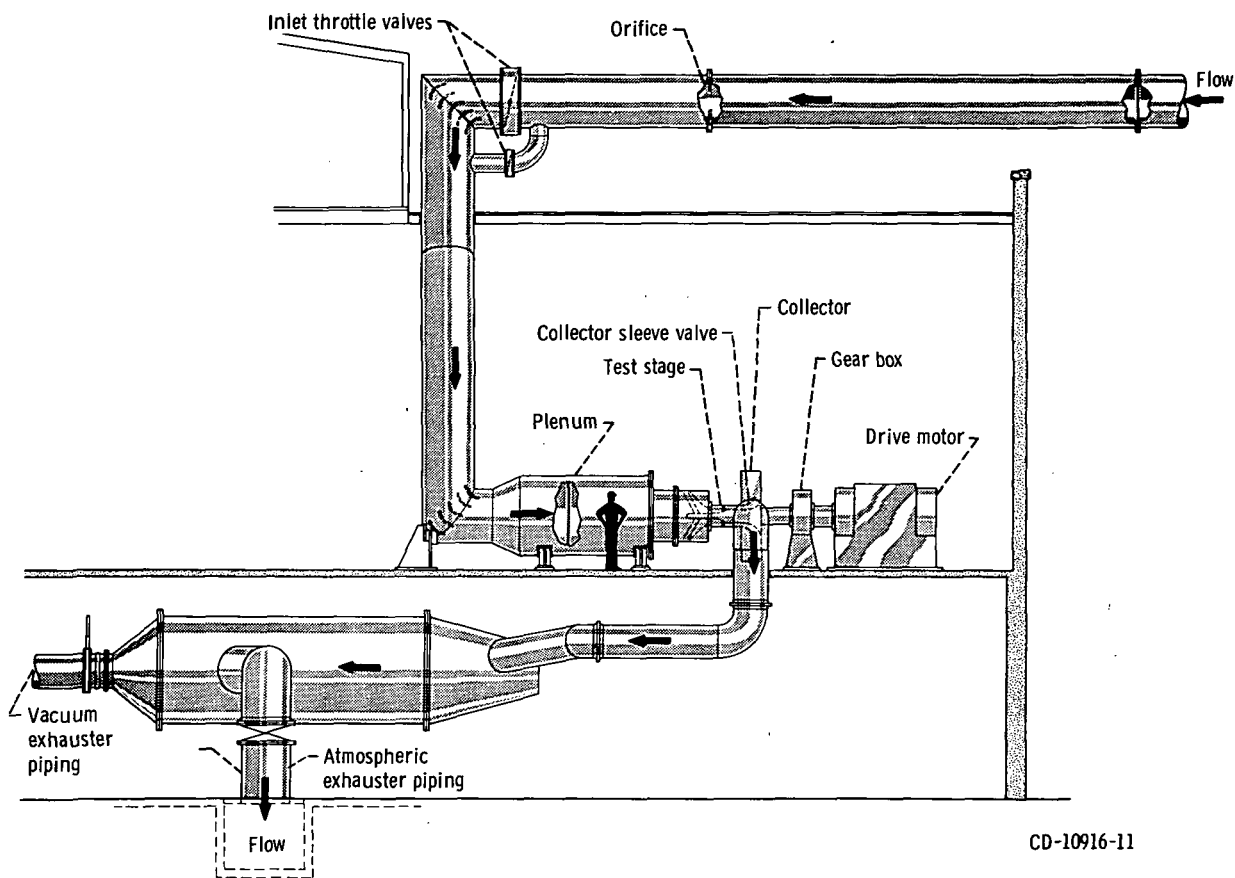
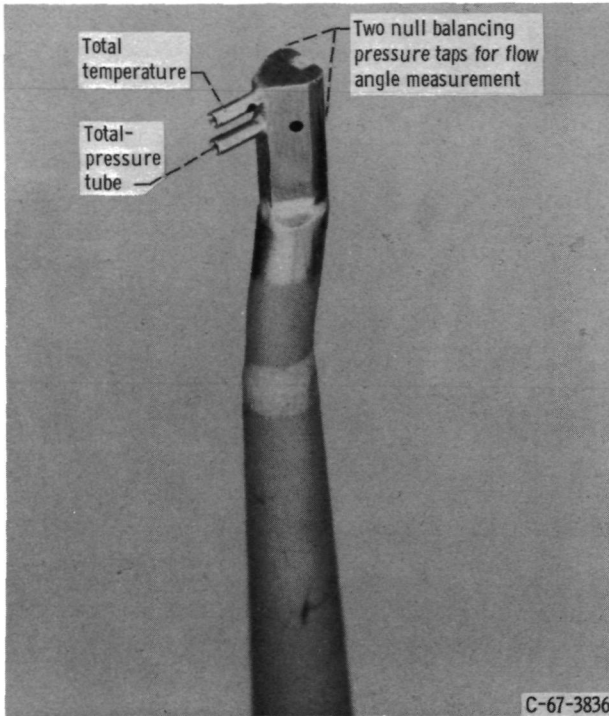

Figure 3. - Stator 9 (looking downstream).



CD-10916-11

Figure 4. - Compressor test facility.



(a) Combination total pressure, total temperature, and flow angle probe (double barrel probe).

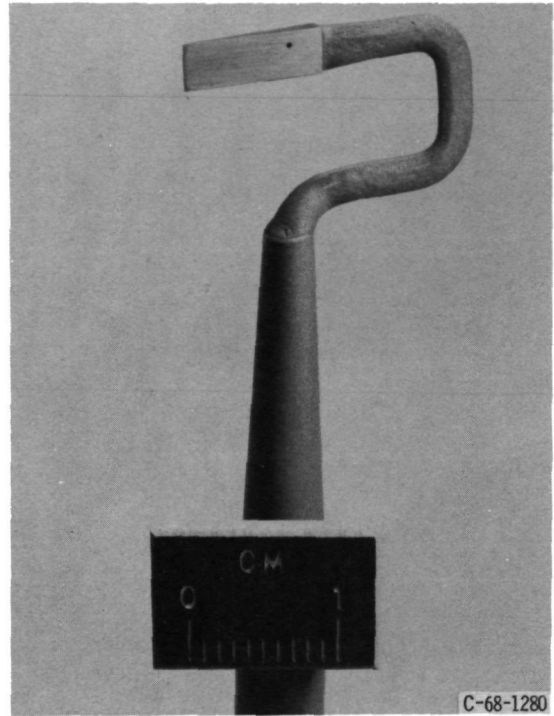

(b) Static pressure probe (8° wedge).

Figure 5. - Sensing probes.

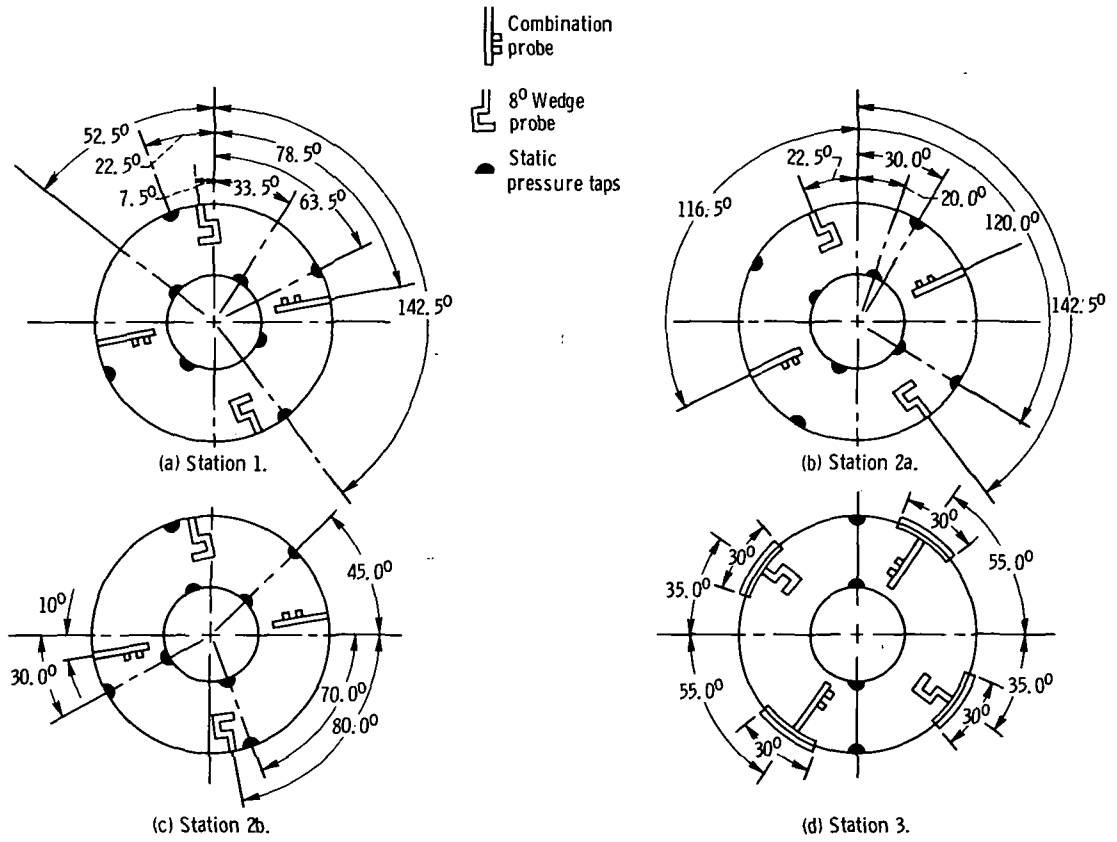

Figure 6. - Circumferential location of instrumentation at measuring stations (facing downstream).

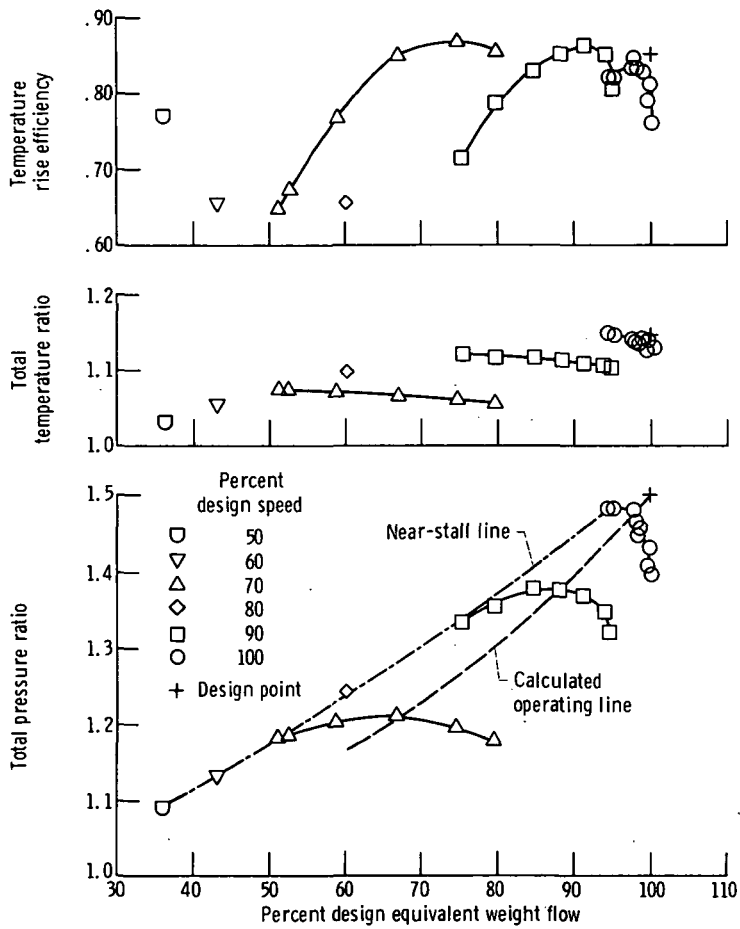

Figure 7. - Overall performance for stage 15-9; baseline configuration: stator at design setting angle and at 3.5-rotor-chord axial spacing.

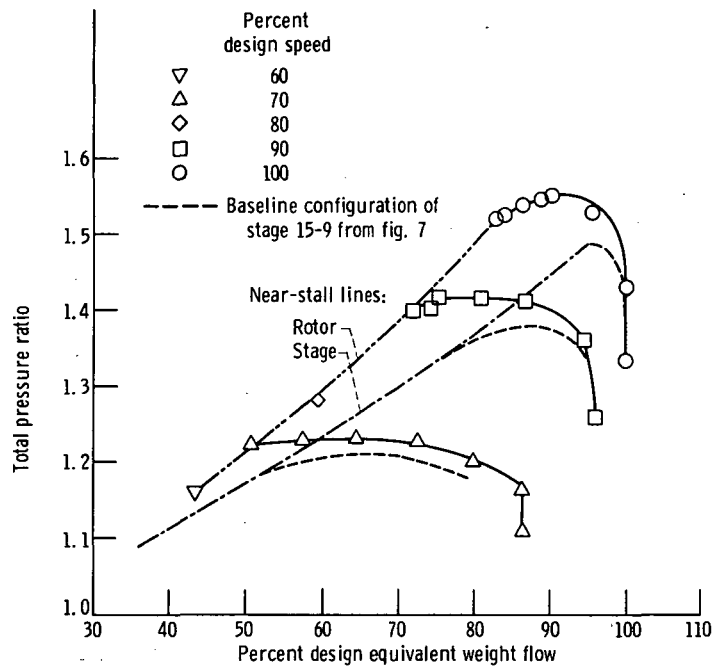

Figure 8. - Overall total pressure ratio for rotor 15 compared with stage 15-9; baseline configuration.

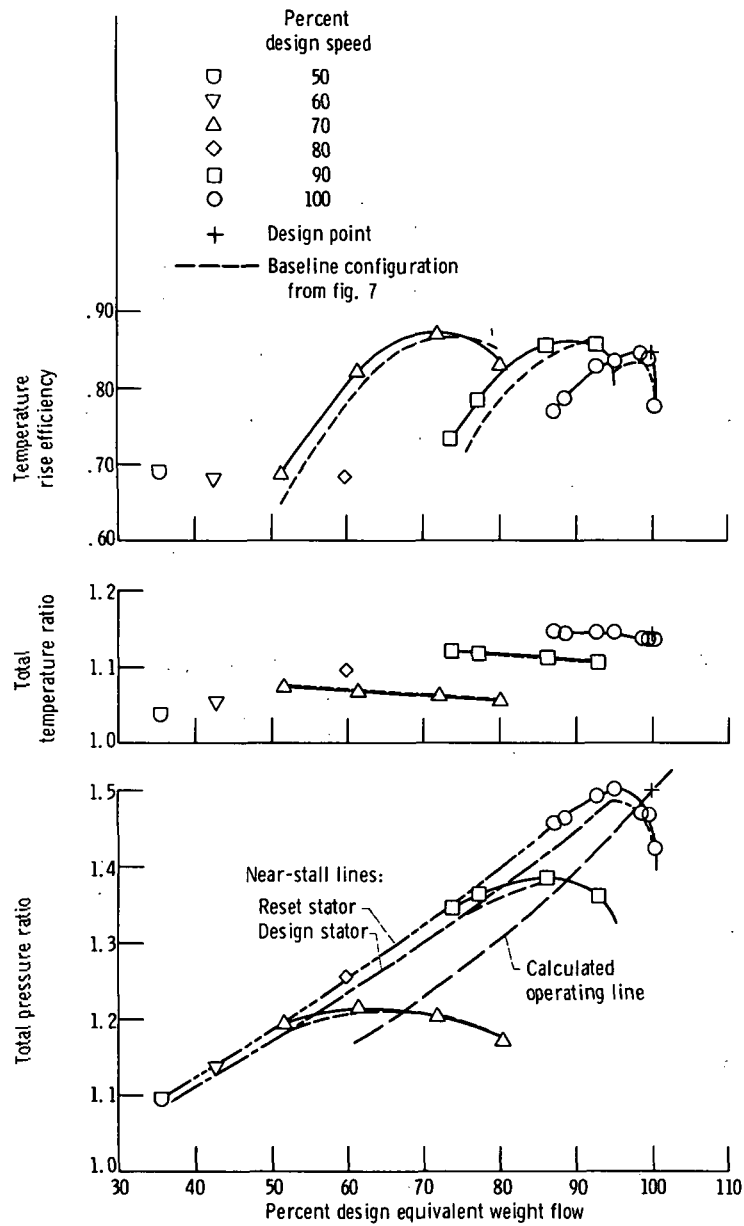

Figure 9. - Overall performance for stage 15-9 with reset stator (setting angle closed 3.7° from design) 3.5-rotor-chord axial spacing.

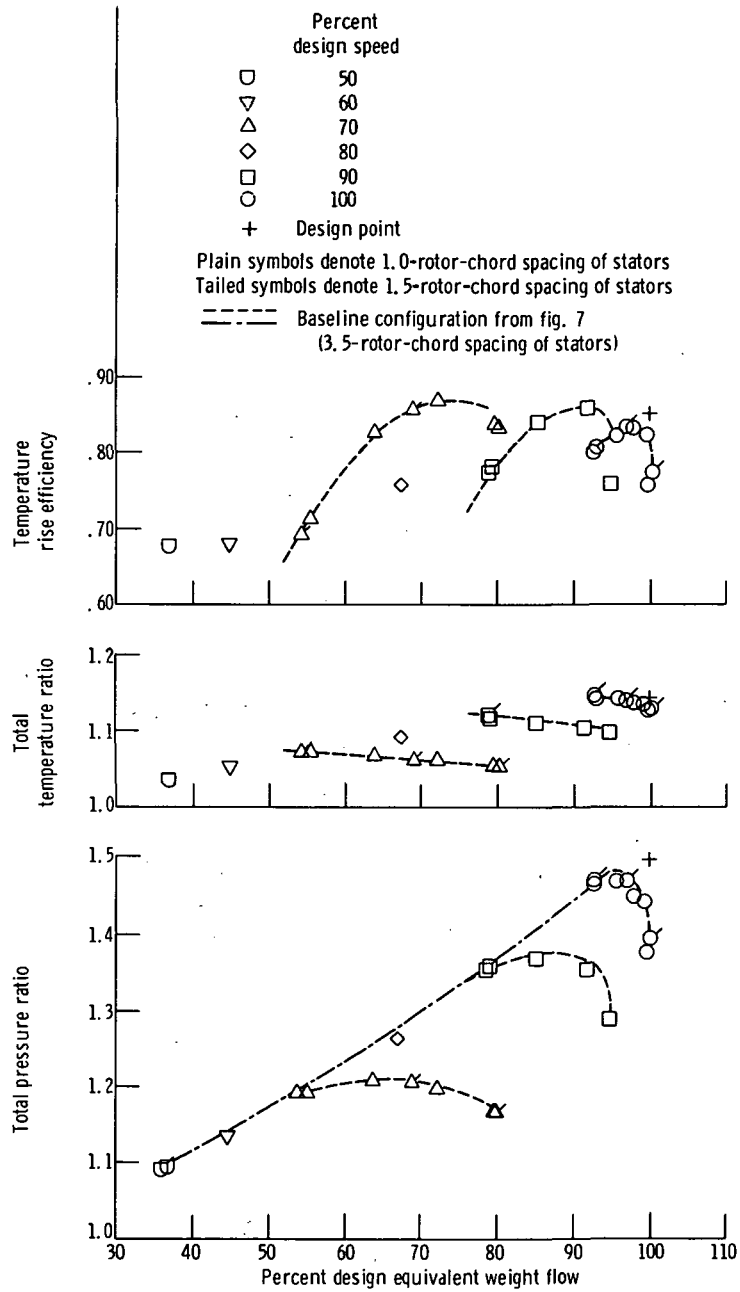
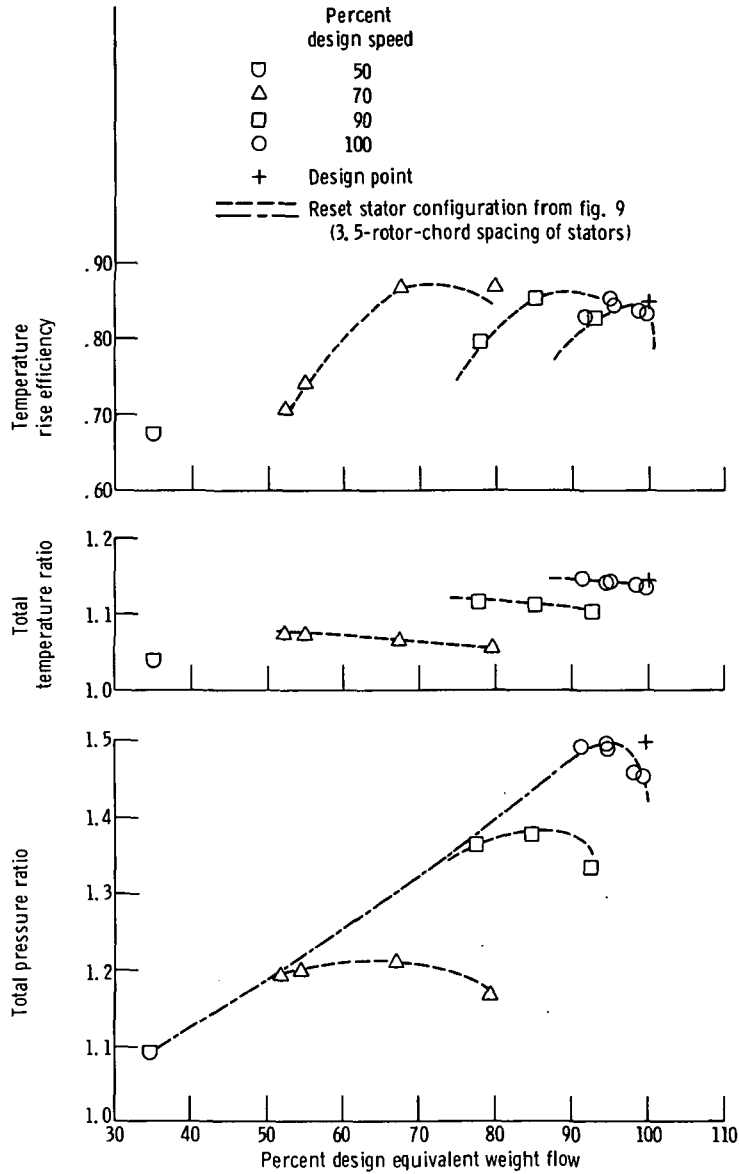
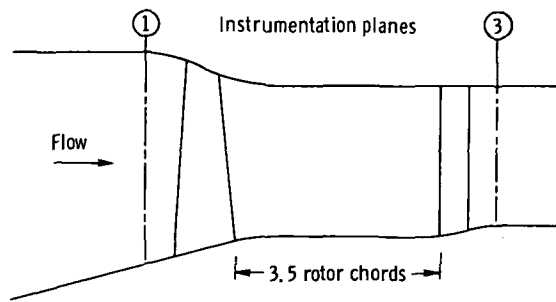

Figure 10. - Overall performance for stage 15-9 with close axial spacing of stators.



(b) Reset stator (setting angle closed 3.7° from design); 1.0-rotor-chord axial spacing of stators.

Figure 10. - Concluded.



(a) Baseline configuration.

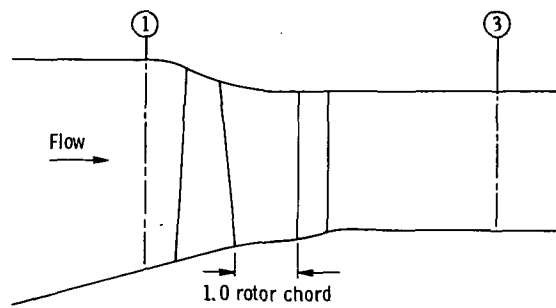

(b) Typical alternate configuration; close axial spacing of stators.

Figure 11. - Configurations utilized to evaluate effects of axial spacing of stators on overall performance for stage 15-9.

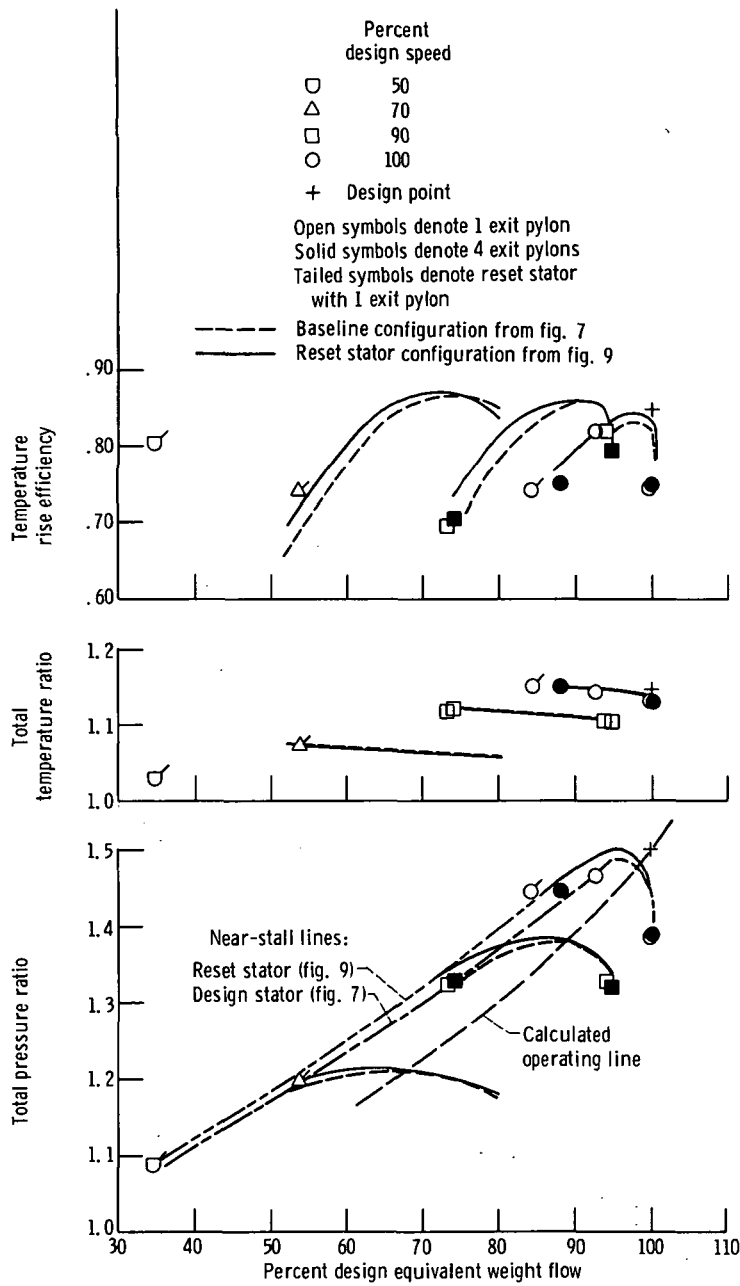

Figure 12. - Overall performance for stage 15-9 with exit pylon(s) in place; 3.5-rotor-chord axial spacing of stators.

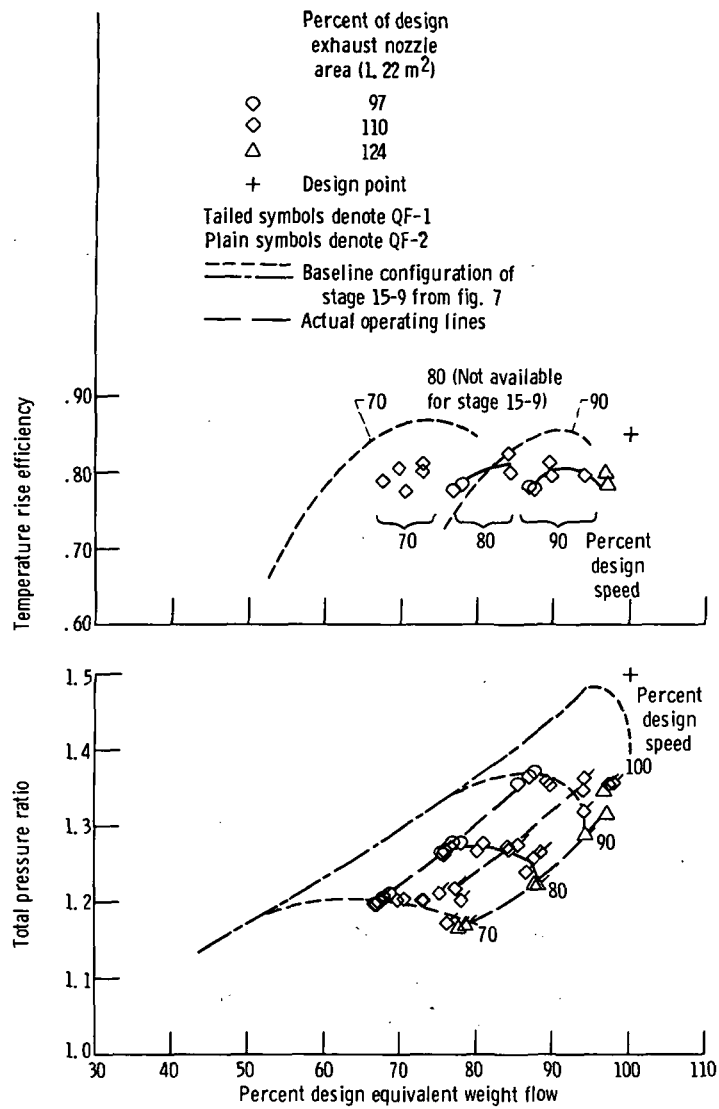

Figure 13. - Overall performance of QF-1 and QF-2 (1.824 m rotor tip diameter) compared with 0.271 scale model stage 15-9; baseline configuration.

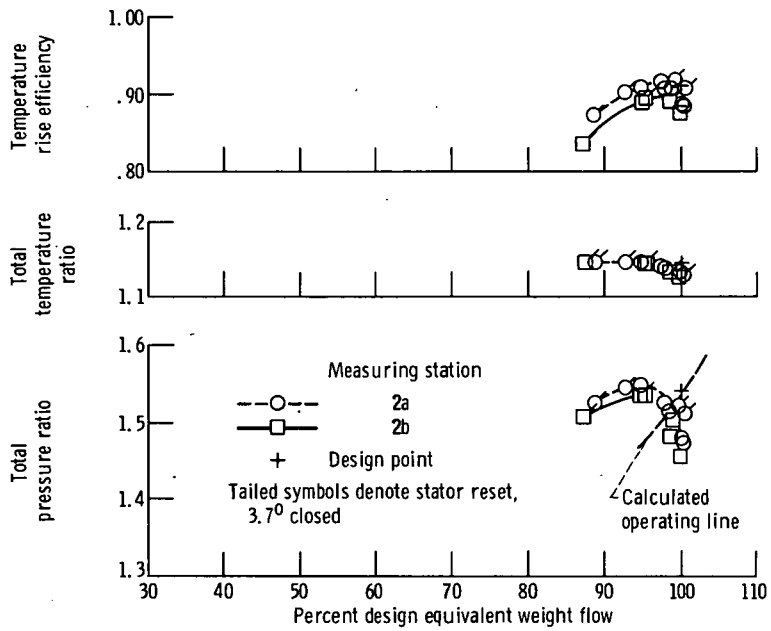

Figure 14. - Effects of measuring station and stator reset on overall performance for rotor 15 at design speed; 3.5-rotor-chord axial spacing of stators.

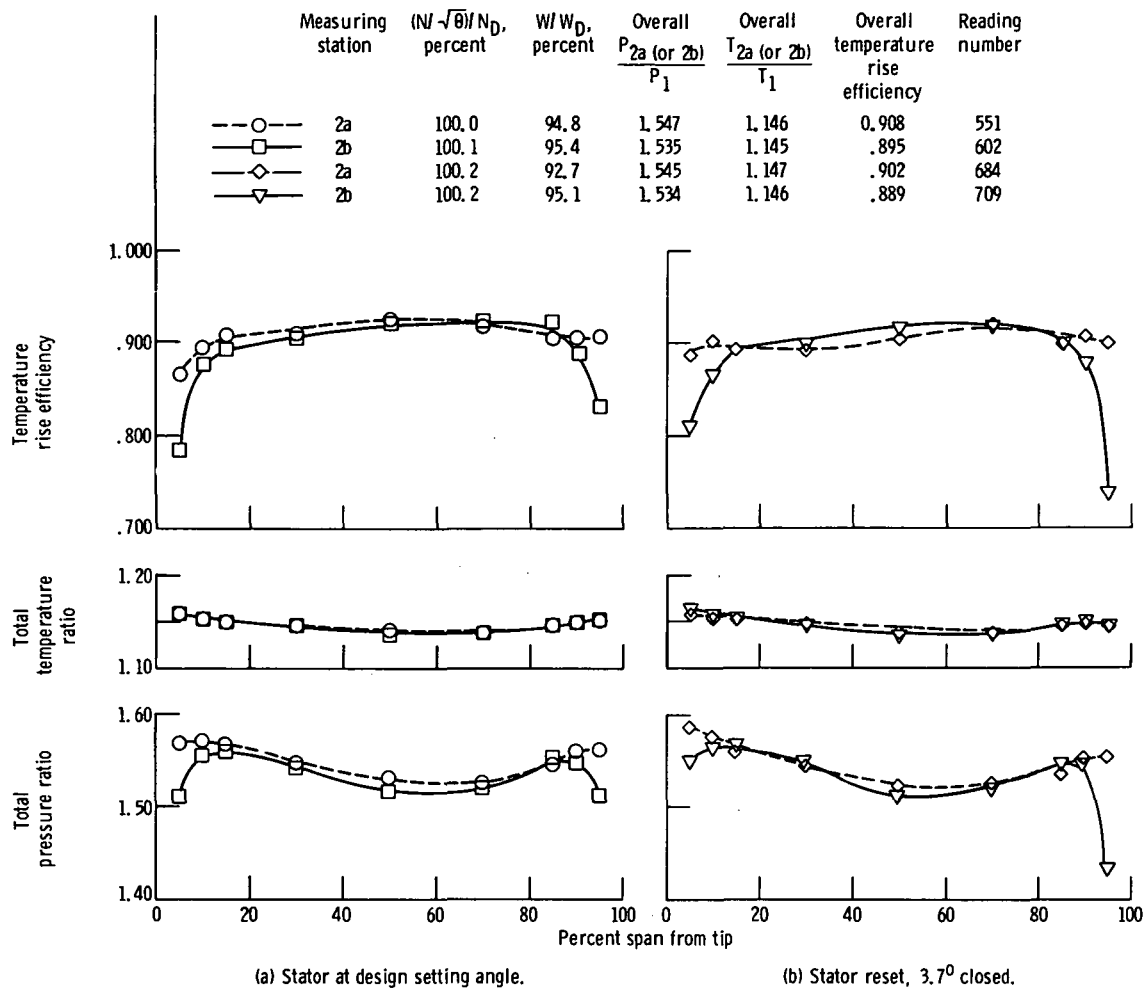

Figure 15. - Effects of measuring station on radial distribution of rotor performance; 3.5-rotor-chord axial spacing of stator.

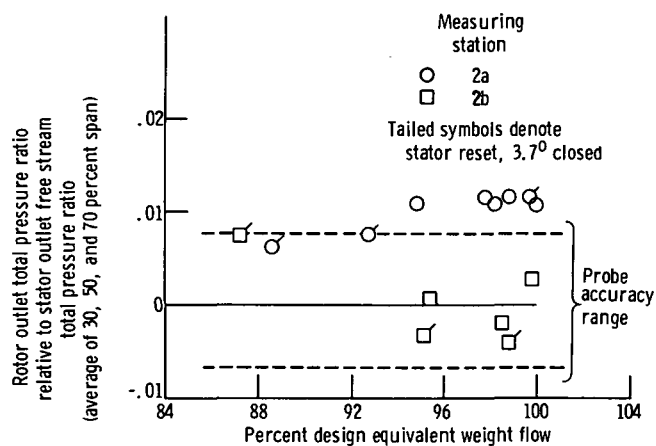

Figure 16. - Effects of measuring station on midspan average values of rotor outlet total pressure ratio relative to stator outlet free stream total pressure ratio. Design speed; stator at 3.5-rotor-chord axial spacing.

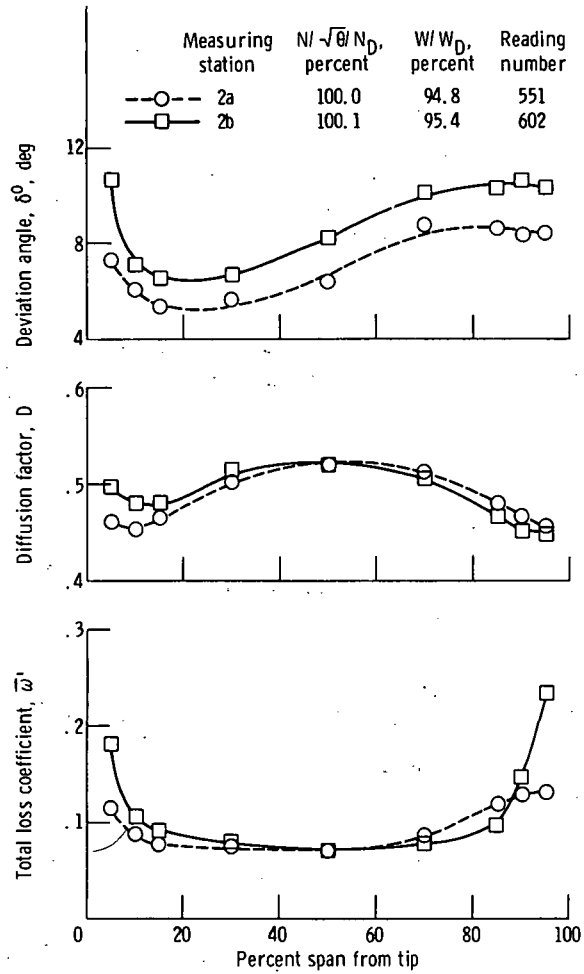

Figure 17. - Effects of measuring station on radial distribution of rotor performance. Design speed; stator at 3.5-rotor-chord axial spacing; design setting angle.

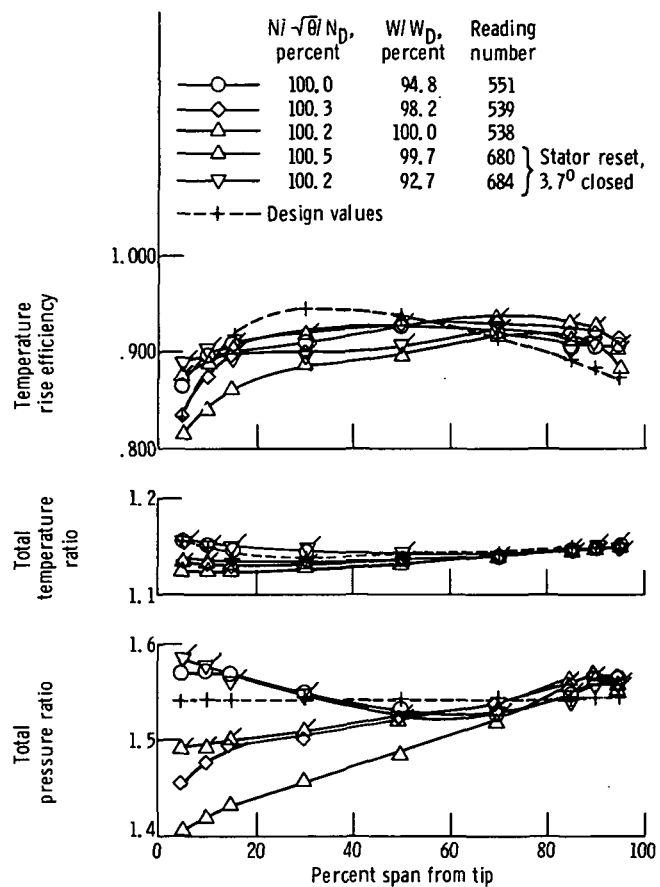

Figure 18. - Effects of weight flow on radial distribution of rotor performance (from measuring stations 2a and 1). Design speed; stator at 3.5-rotor-chord axial spacing.

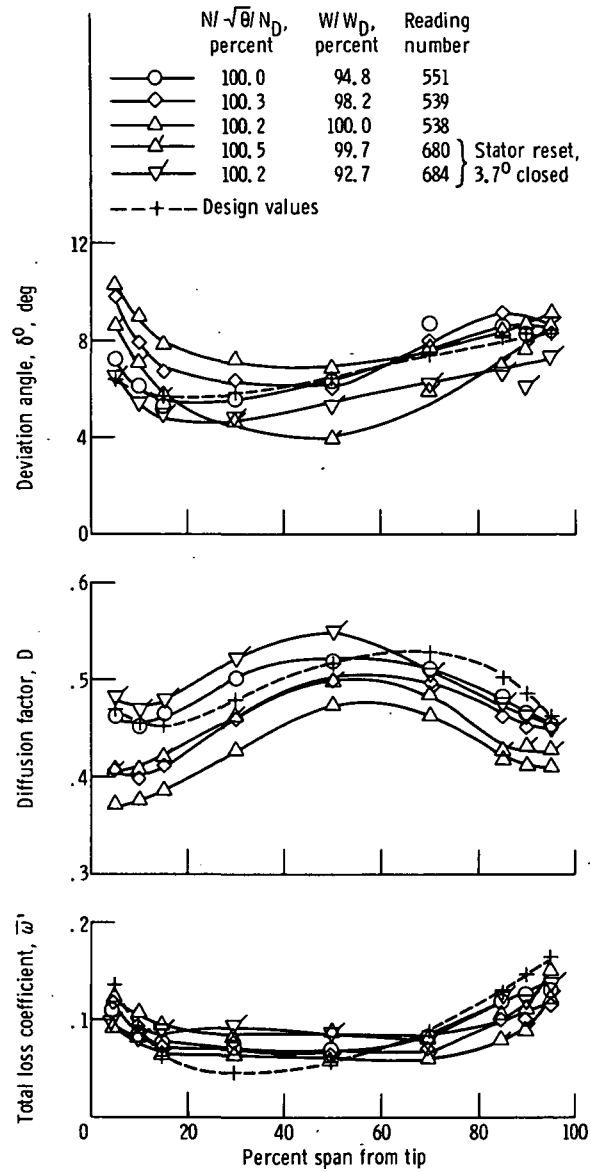
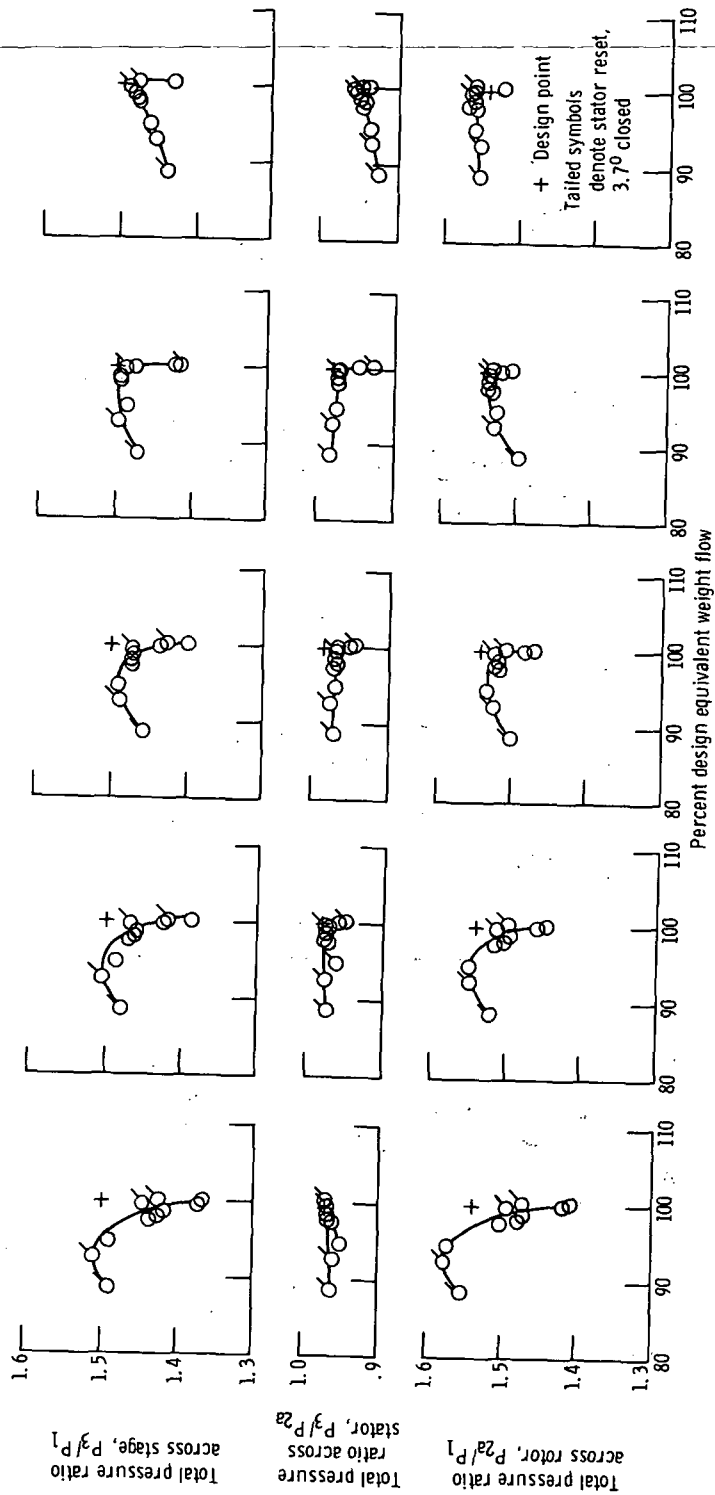

Figure 19. - Effects of weight flow on radial distribution of rotor performance (from measuring stations 2a and 1). Design speed; stator at 3.5-rotor-chord axial spacing.



(a) 10 Percent span from tip. (b) 30 Percent span from tip. (c) 50 Percent span from tip. (d) 70 Percent span from tip. (e) 90 Percent span from tip. Figure 20. - Effects of weight flow on elemental total pressure ratios across rotor, stator, and stage. Design speed; stator at 3, 5-rotor-chord axial spacing.

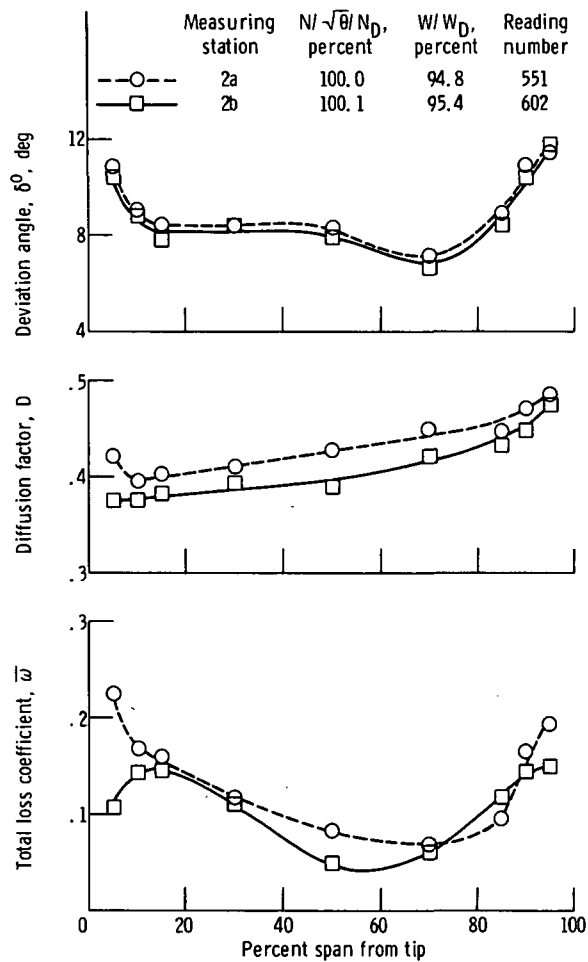

Figure 21. - Effects of measuring station on radial distribution of stator performance. Design speed; stator at 3.5-rotor-chord axial spacing; design setting angle.

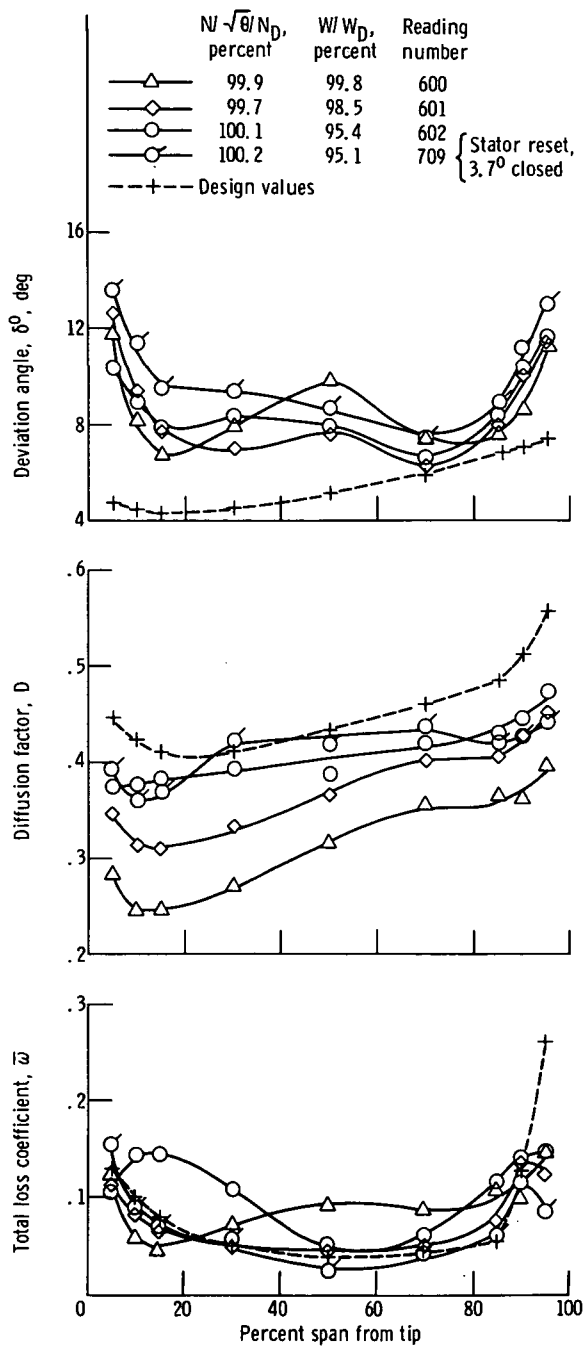

Figure 22. - Effects of weight flow on radial distribution of stator performance (from measuring stations 3 and 2b). Design speed; stator at 3.5-rotor-chord axial spacing.

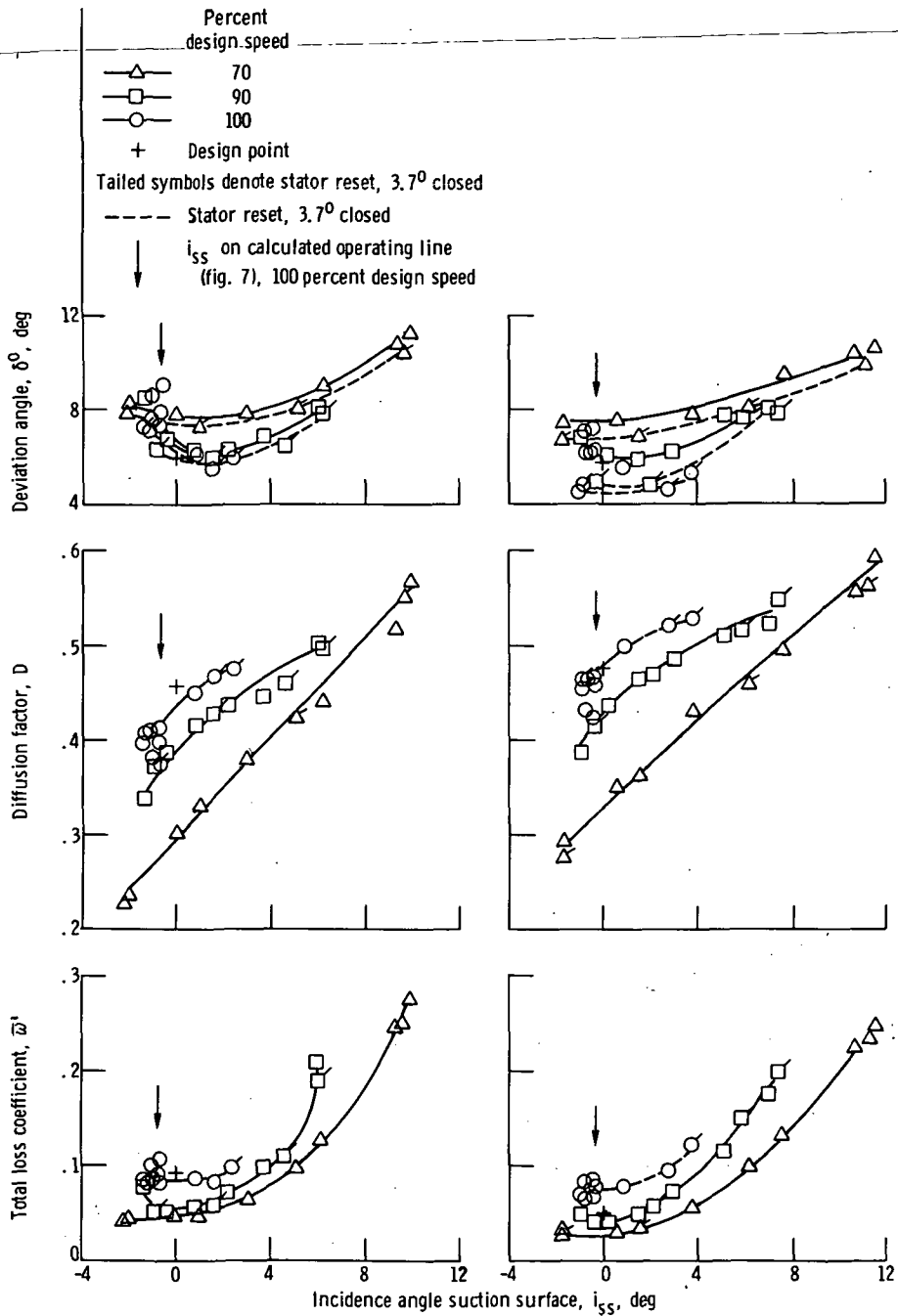
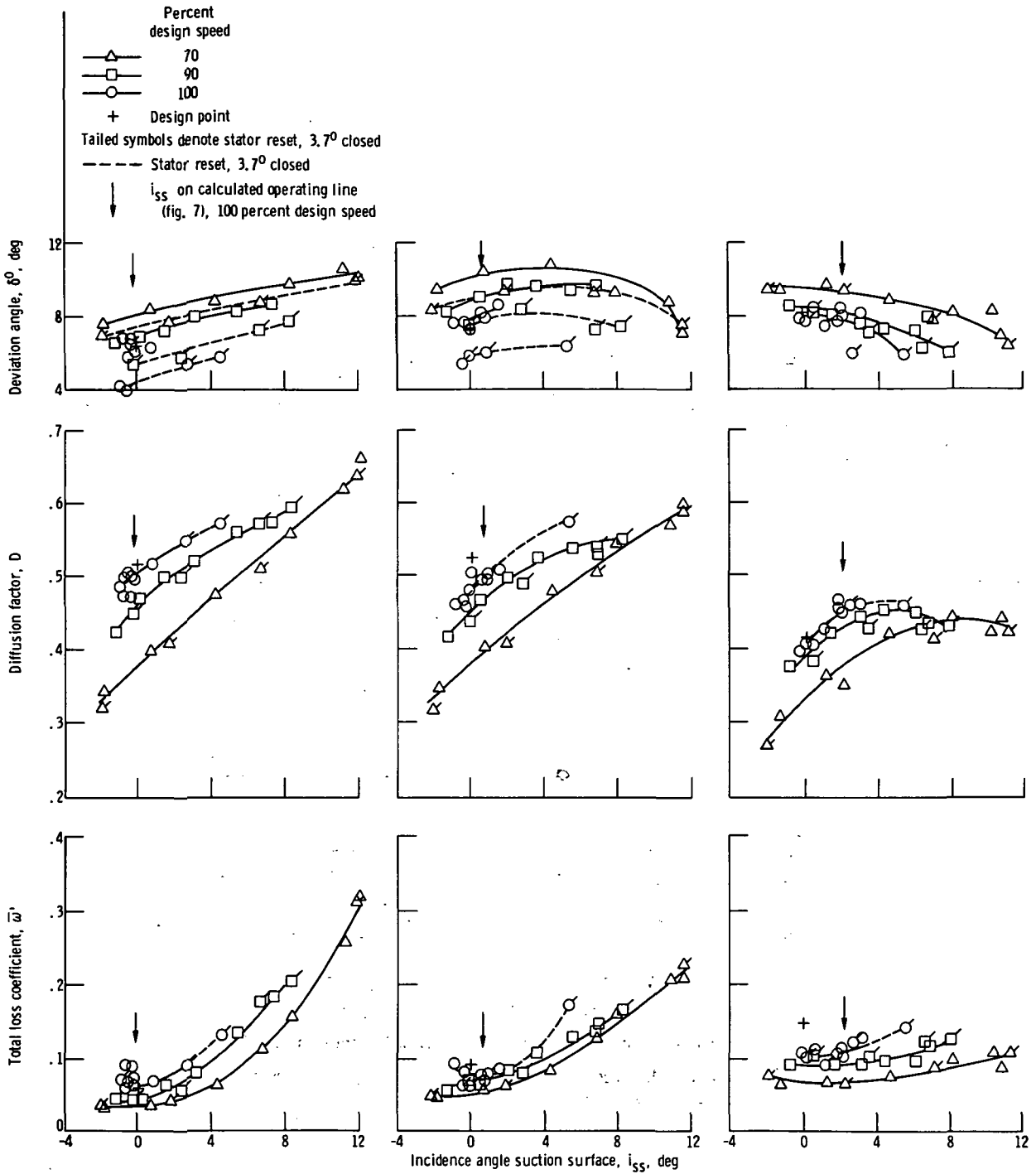

Figure 23. - Blade-element performance for rotor 15 (from measuring stations 2a and 1). Stator at 3.5-rotor-chord axial spacing.



(c) 50 Percent span from tip.

(d) 70 Percent span from tip.

(e) 90 Percent span from tip.

Figure 23. - Concluded.

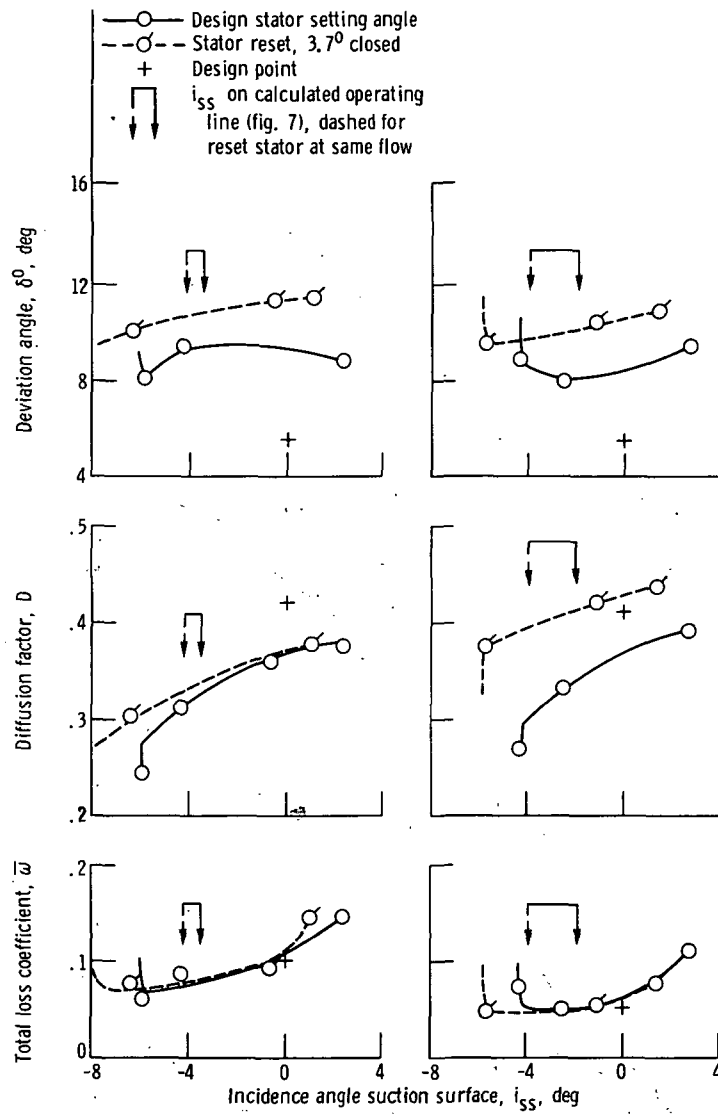

(a) 10 Percent span from tip. (b) 30 Percent span from tip.

Figure 24. - Blade-element performance for stator 9 (from measuring stations 3 and 2b). Design speed; stator at 3.5-rotor-chord axial spacing.

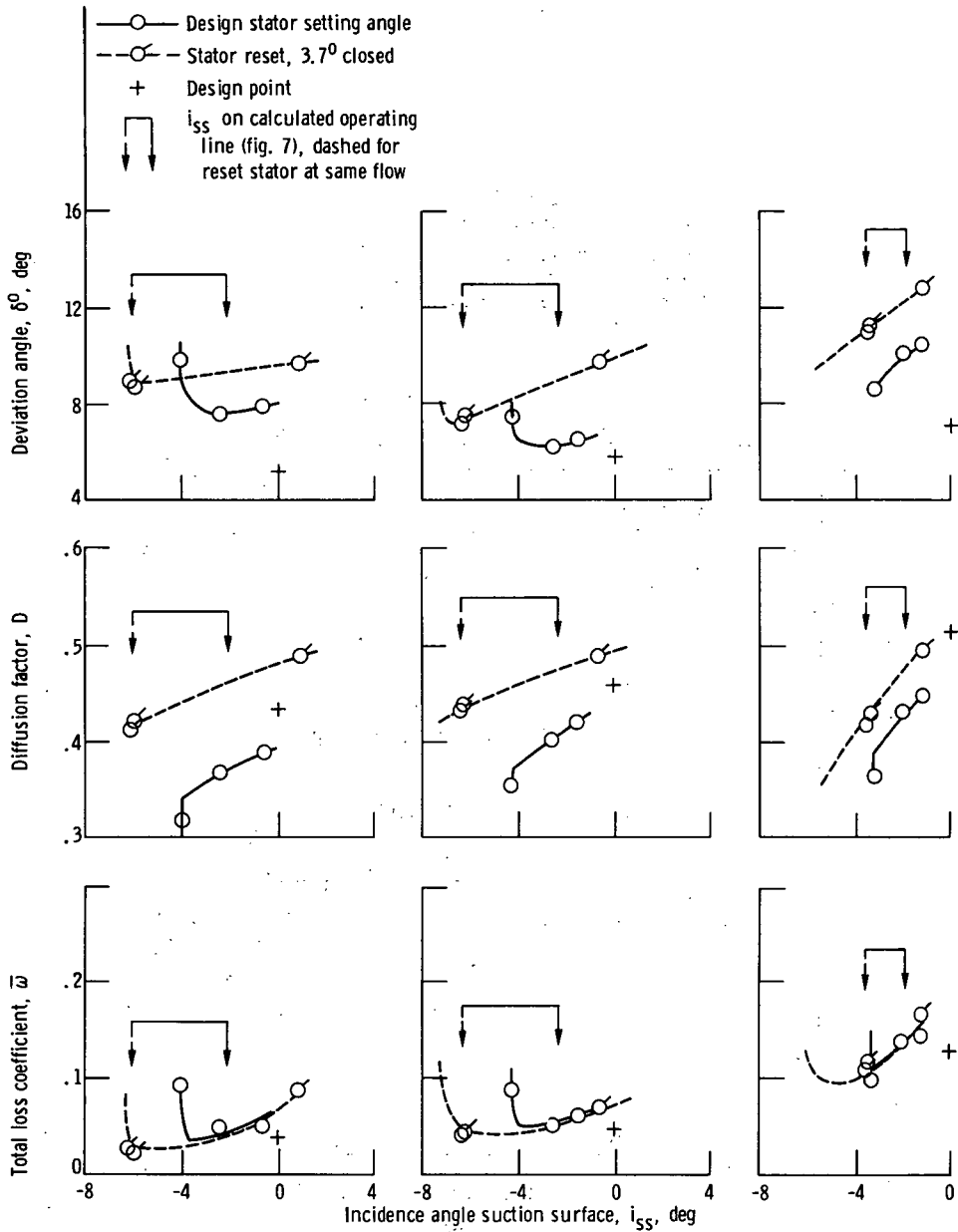

(c) 50 Percent span from tip.

(d) 70 Percent span from tip.

(e) 90 Percent span from tip.

Figure 24. - Concluded.

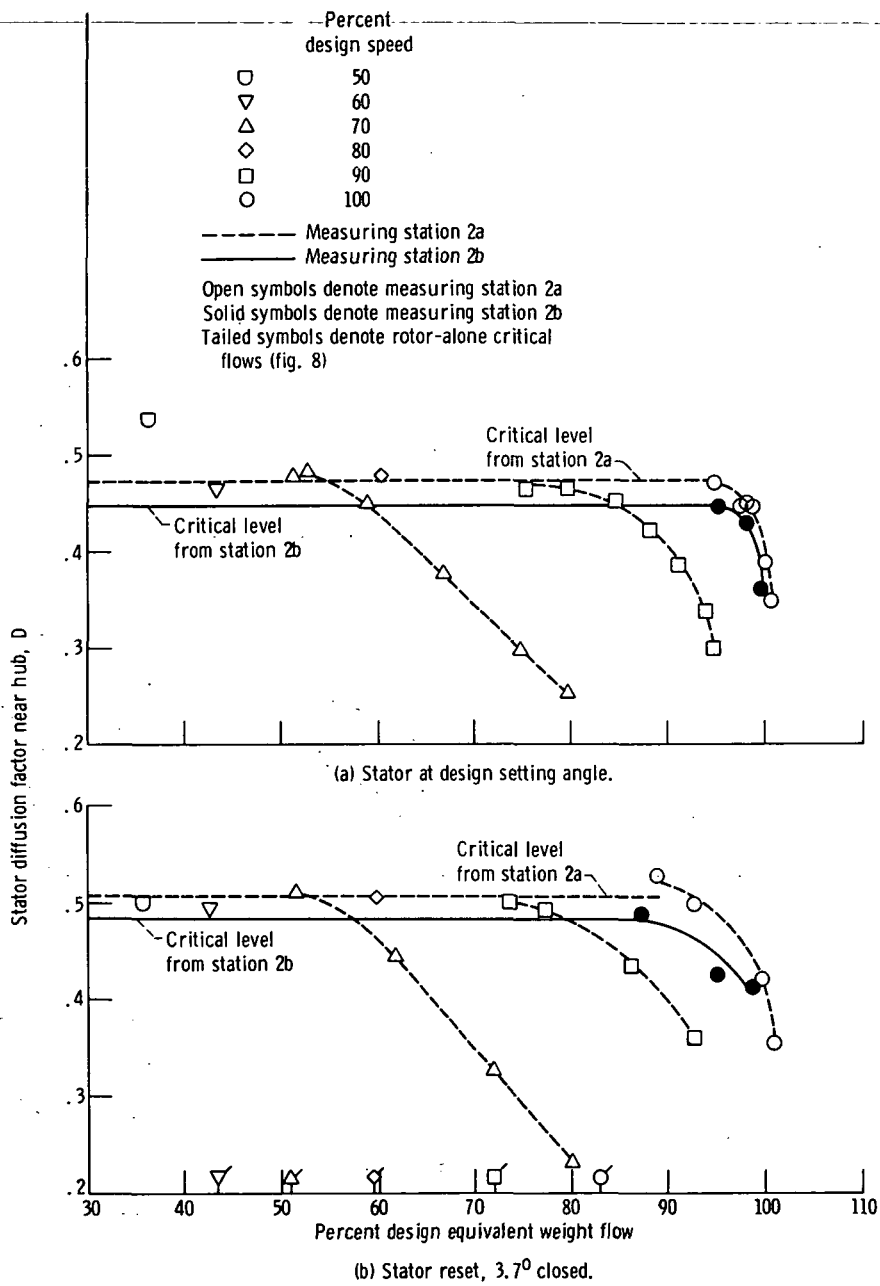

Figure 25. - Stator 9 loadings at 90 percent span from tip. Stator at 3.5-rotor-chord axial spacing.

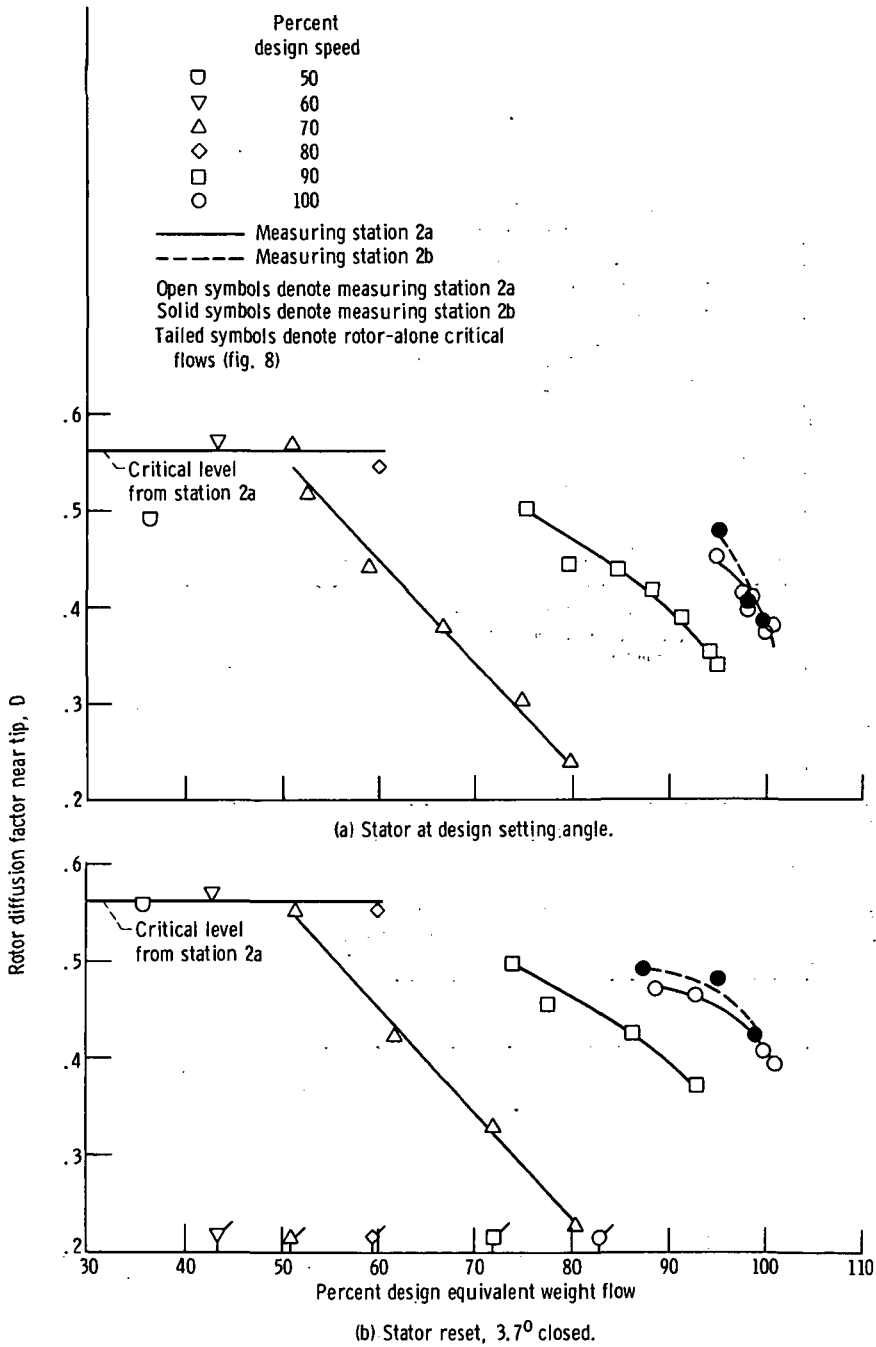

Figure 26. - Rotor 15 loadings at 10 percent span from tip. Stator at 3.5-rotor-chord axial spacing.

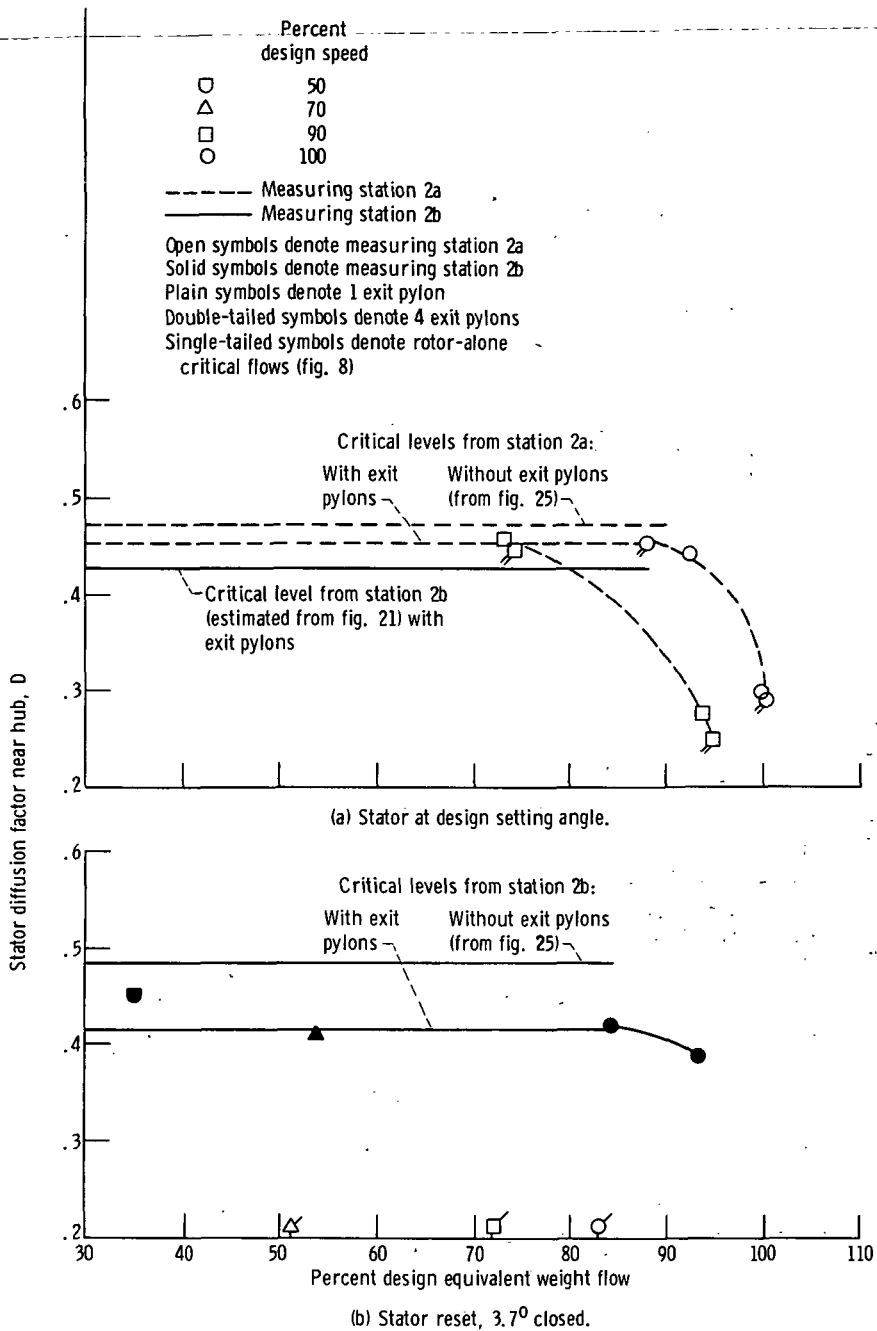

Figure 27. - Stator 9 loadings at 90 percent span from tip, with exit pylon(s). Stator at 3.5-rotor-chord axial spacing.

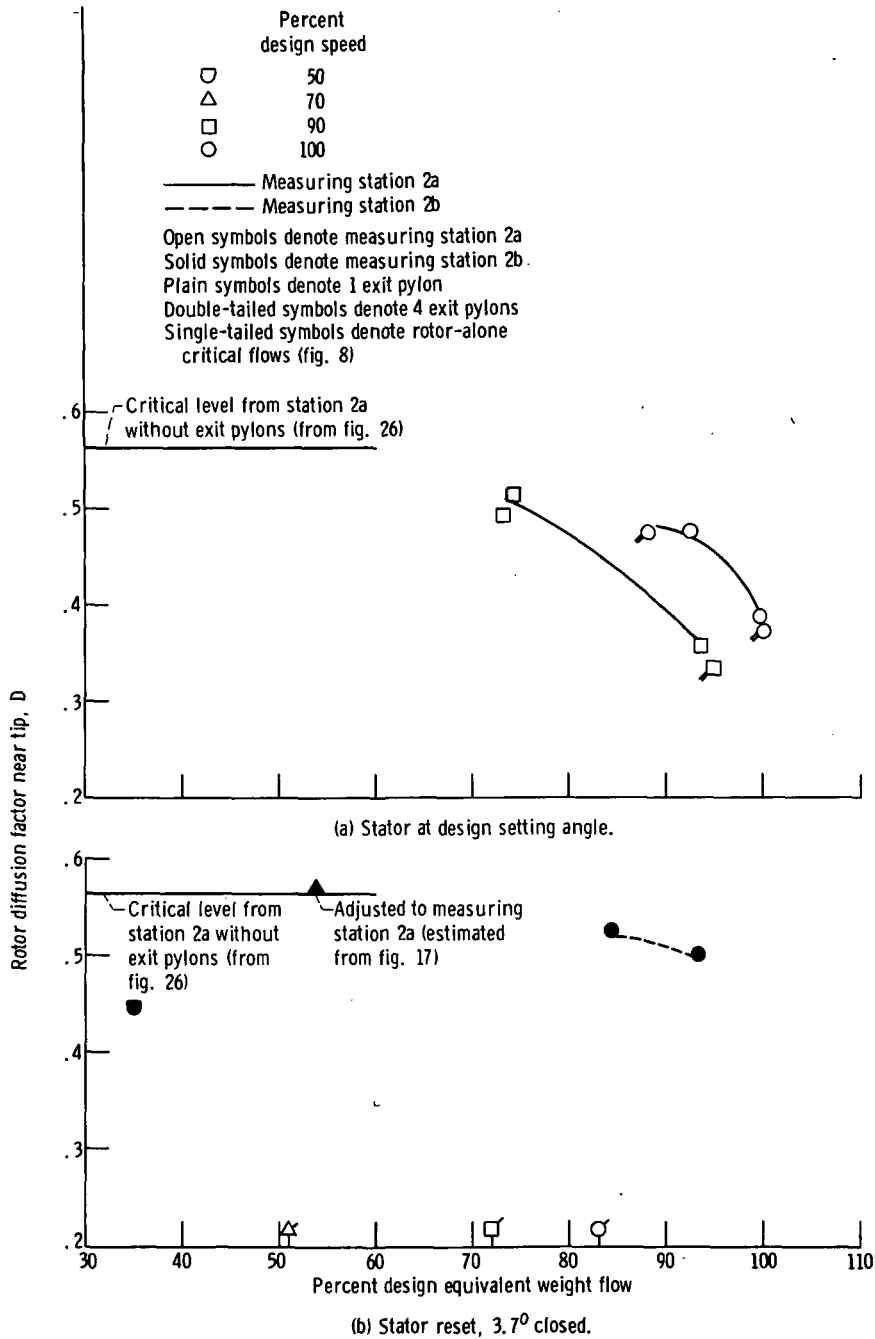

Figure 28. - Rotor 15 loadings at 10 percent span from tip with exit pylon(s). Stator at 3.5-rotor-chord axial spacing.

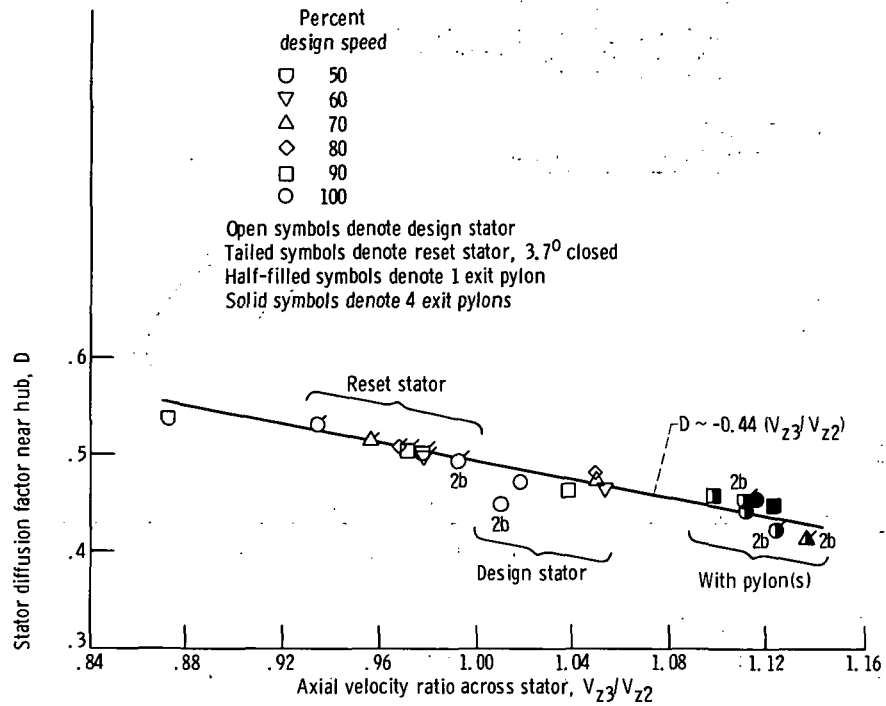

Figure 29. - Stator 9 loading-axial velocity ratio relation near stall; 90 percent span from tip; all configurations with stator at 3.5-rotor-chord axial spacing. (Measuring station 2a unless indicated otherwise.)

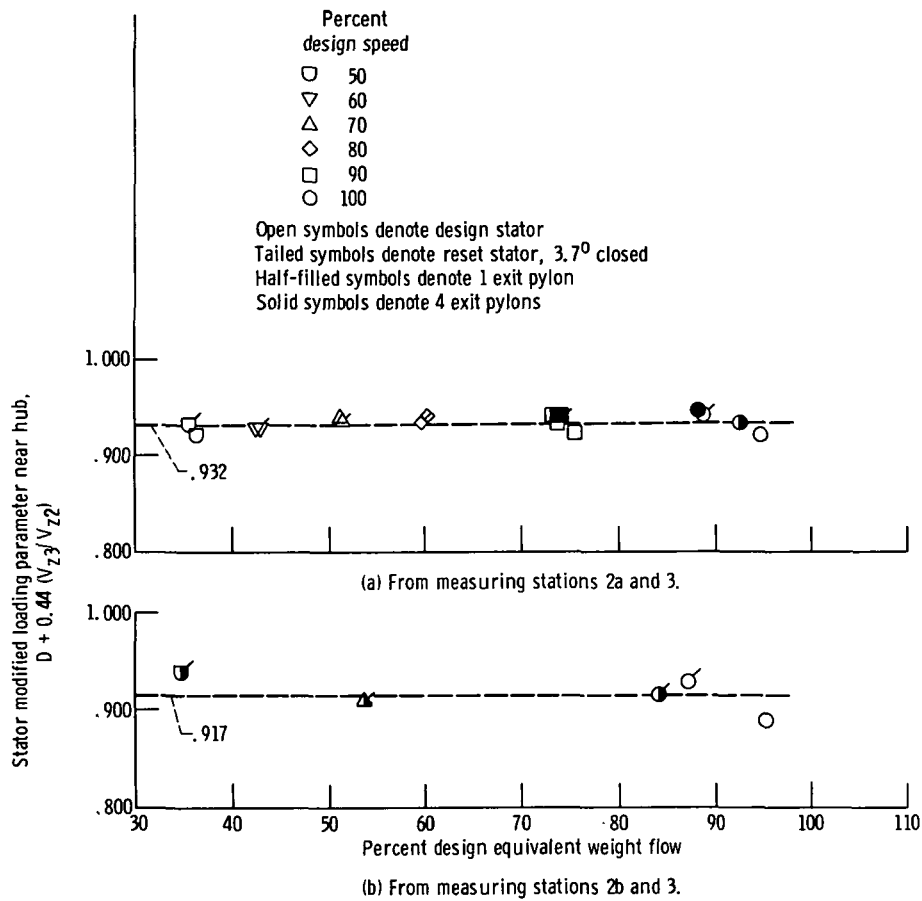

Figure 30. - Correlation of stator 9 modified loading parameter near stall; 90 percent span from tip; all configurations with stator at 3.5-rotor-chord axial spacing.



2 001 C1 U 01 741206 500120ES
HILCO FORD CORP
AERONUTRONIC DIV
AEROSPACE & COMMUNICATIONS OPERATION
ATTN: TECHNICAL INFO SERVICES
10000 & FORD ROADS
BEACH CA 92668

POSTMASTER: If Undeliverable (Section 158
Postal Manual) Do Not Return

"The aeronautical and space activities of the United States shall be conducted so as to contribute . . . to the expansion of human knowledge of phenomena in the atmosphere and space. The Administration shall provide for the widest practicable and appropriate dissemination of information concerning its activities and the results thereof."

—NATIONAL AERONAUTICS AND SPACE ACT OF 1958

NASA SCIENTIFIC AND TECHNICAL PUBLICATIONS

TECHNICAL REPORTS: Scientific and technical information considered important, complete, and a lasting contribution to existing knowledge.

TECHNICAL NOTES: Information less broad in scope but nevertheless of importance as a contribution to existing knowledge.

TECHNICAL MEMORANDUMS: Information receiving limited distribution because of preliminary data, security classification, or other reasons. Also includes conference proceedings with either limited or unlimited distribution.

CONTRACTOR REPORTS: Scientific and technical information generated under a NASA contract or grant and considered an important contribution to existing knowledge.

TECHNICAL TRANSLATIONS: Information published in a foreign language considered to merit NASA distribution in English.

SPECIAL PUBLICATIONS: Information derived from or of value to NASA activities. Publications include final reports of major projects, monographs, data compilations, handbooks, sourcebooks, and special bibliographies.

TECHNOLOGY UTILIZATION PUBLICATIONS: Information on technology used by NASA that may be of particular interest in commercial and other non-aerospace applications. Publications include Tech Briefs, Technology Utilization Reports and Technology Surveys.

Details on the availability of these publications may be obtained from:

SCIENTIFIC AND TECHNICAL INFORMATION OFFICE

NATIONAL AERONAUTICS AND SPACE ADMINISTRATION

Washington, D.C. 20546