

NASA CR-132490

**ANALYTICAL AND EXPERIMENTAL INVESTIGATION OF A
1/8-SCALE DYNAMIC MODEL OF THE
SHUTTLE ORBITER**

Volume IIIA — Supporting Data

by

P. W. Mason, H. G. Harris, J. Zalesak, and M. Bernstein

May 1974

Final Report — Prepared Under Contract No. NAS 1-10635-12

by

Grumman Aerospace Corporation
Bethpage, New York 11714

Langley Research Center
Hampton, Virginia 23665

NATIONAL AERONAUTICS AND SPACE ADMINISTRATION

**ANALYTICAL AND EXPERIMENTAL INVESTIGATION OF A
1/8-SCALE DYNAMIC MODEL OF THE
SHUTTLE ORBITER**

Volume IIIA – Supporting Data

Prepared under Contract NAS 1-10635-12

for the

Langley Research Center
National Aeronautics and Space Administration
Hampton, Virginia 23365

by

P. W. Mason, H. G. Harris, J. Zalesak, and M. Bernstein

Grumman Aerospace Corporation
Bethpage, New York 11714

May 1974

Appendix A1
DESIGN DRAWINGS FOR 1/8-SCALE ORBITER MODEL

APPENDIX A1

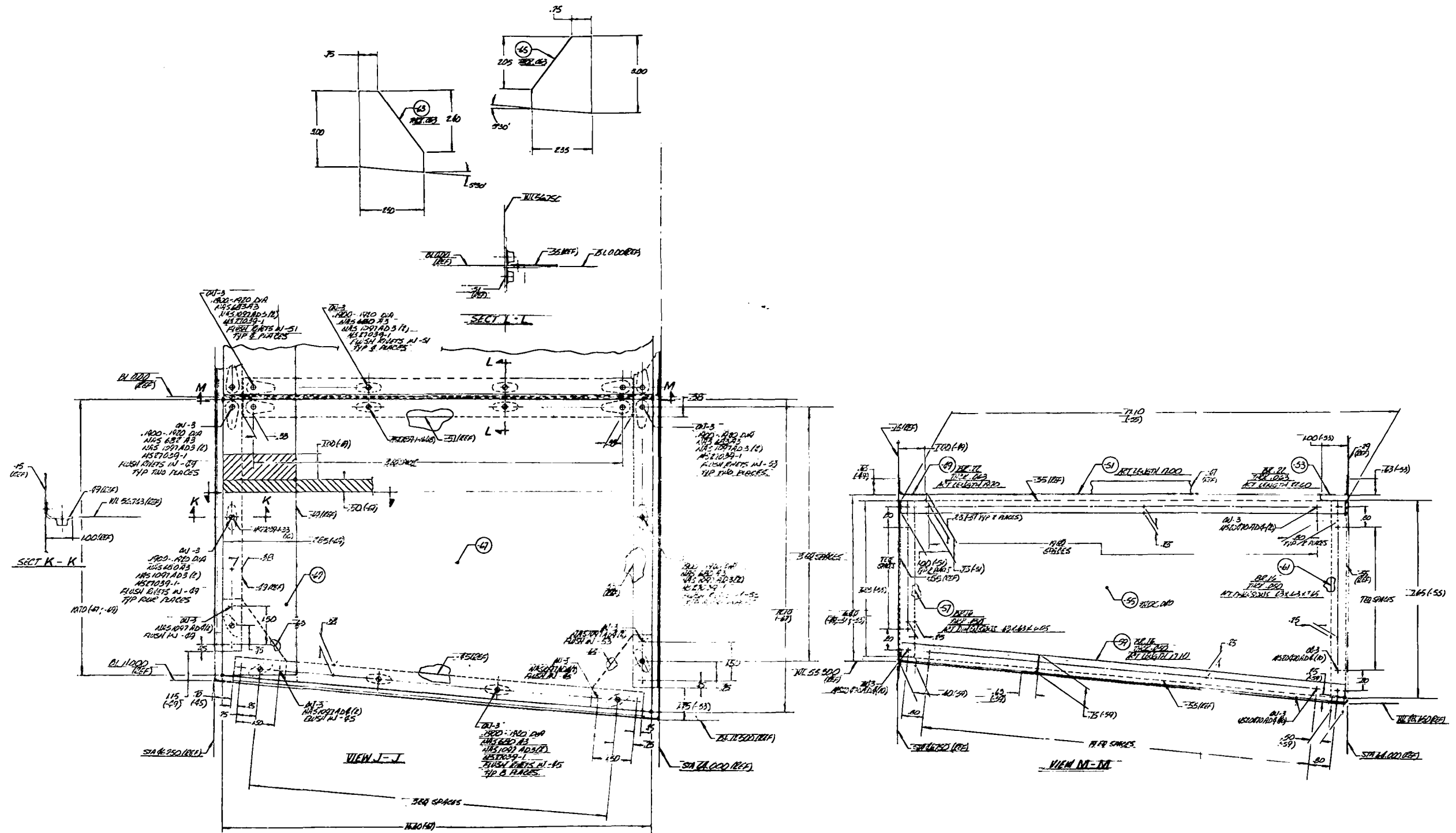

Orbiter Forward Section Ass'y and Installation
 (Sta 46.750 to 64.000) (Sheet 1 of 3)

A0383-525 (A)

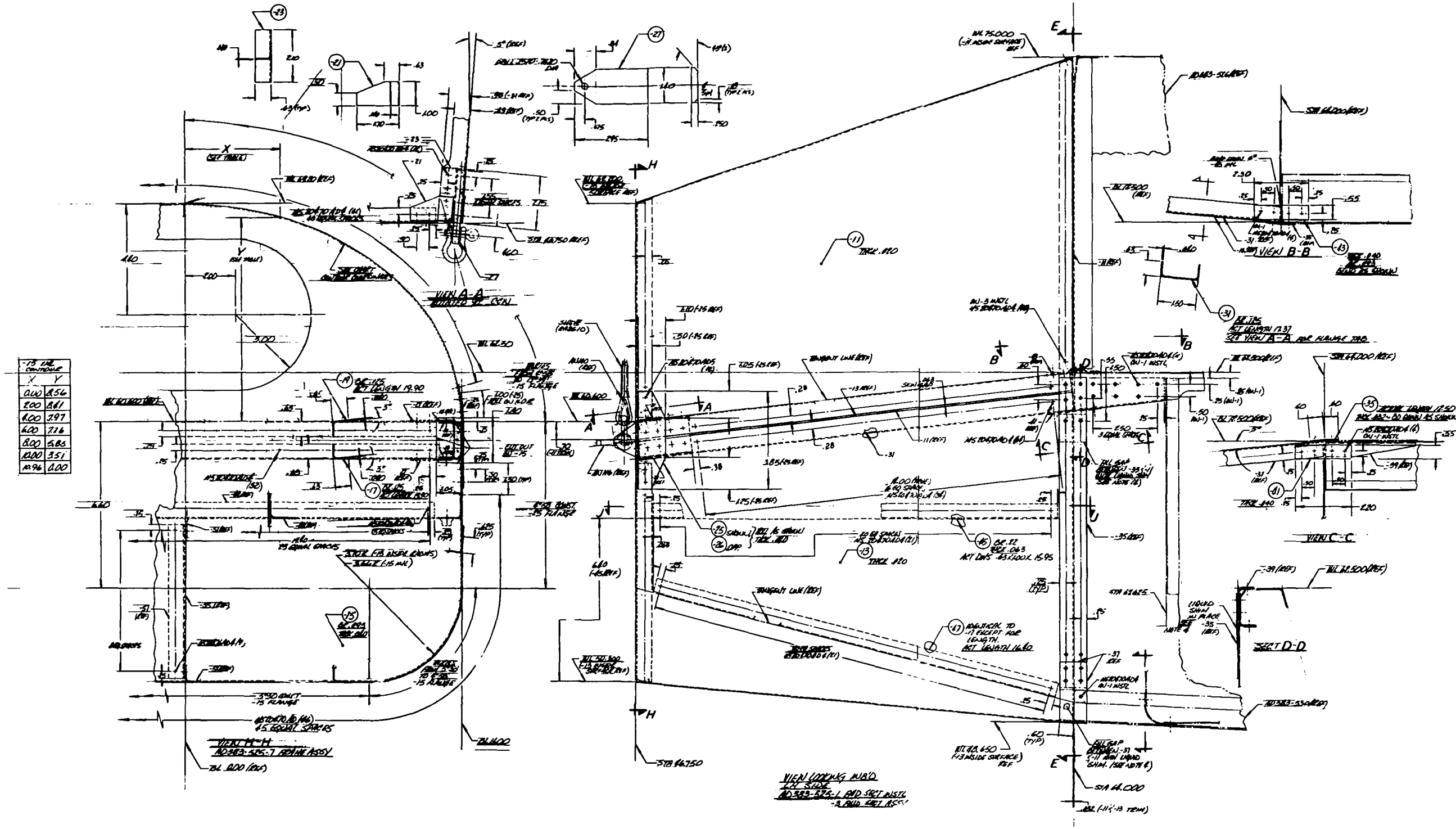

Orbiter Forward Section Ass'y and Installation
 (Sta 46.750 to 64.000) (Sheet 2 of 3)

A0383-525 (A)

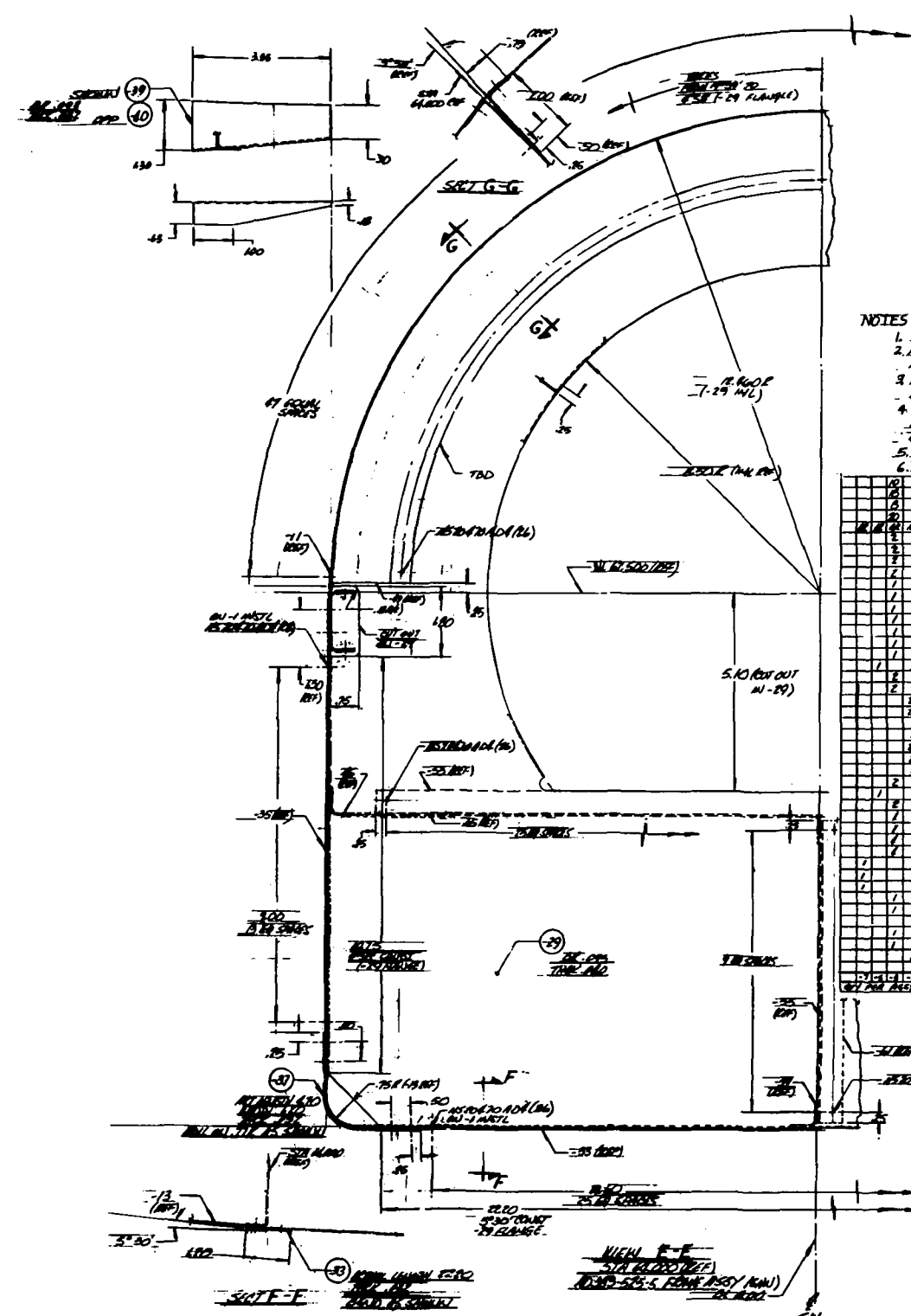

REV	DATE	DESCRIPTION	BY	CHKD
1	11/17/67	ISSUED FOR CONSTRUCTION	WJ	WJ
2	11/21/67	REVISED TO SHOW CHANGES	WJ	WJ
3	11/21/67	REVISED TO SHOW CHANGES	WJ	WJ

- NOTES:
1. NO MATERIAL SUBSTITUTION OR LOWER TENSILE FOR PARTS NOTED
 2. FINISH - 11 THRU - 65 WITH ALUMINE 1800 PPS
 3. ALL PARTS SHALL BE CLASS II
 4. DIMENSIONS AND WEIGHT (WEIGHTS) SHALL BE FIELD OF DIMENSIONS OF SCHEMATIC FROM AREA REST STR LINE, UNLESS OTHERWISE SHOWN
 5. LINDSAY SHALL BE 1/4" OF EQUIVALENT
 6. FINISH - 67 - 69 WITH TWO COATS OF ZINC CHROMATE PRIMER

NO	DESCRIPTION	QTY	UNIT	REMARKS
1	ALUMINUM PLATE	1	PLATE	
2	ALUMINUM PLATE	1	PLATE	
3	ALUMINUM PLATE	1	PLATE	
4	ALUMINUM PLATE	1	PLATE	
5	ALUMINUM PLATE	1	PLATE	
6	ALUMINUM PLATE	1	PLATE	
7	ALUMINUM PLATE	1	PLATE	
8	ALUMINUM PLATE	1	PLATE	
9	ALUMINUM PLATE	1	PLATE	
10	ALUMINUM PLATE	1	PLATE	
11	ALUMINUM PLATE	1	PLATE	
12	ALUMINUM PLATE	1	PLATE	
13	ALUMINUM PLATE	1	PLATE	
14	ALUMINUM PLATE	1	PLATE	
15	ALUMINUM PLATE	1	PLATE	
16	ALUMINUM PLATE	1	PLATE	
17	ALUMINUM PLATE	1	PLATE	
18	ALUMINUM PLATE	1	PLATE	
19	ALUMINUM PLATE	1	PLATE	
20	ALUMINUM PLATE	1	PLATE	
21	ALUMINUM PLATE	1	PLATE	
22	ALUMINUM PLATE	1	PLATE	
23	ALUMINUM PLATE	1	PLATE	
24	ALUMINUM PLATE	1	PLATE	
25	ALUMINUM PLATE	1	PLATE	
26	ALUMINUM PLATE	1	PLATE	
27	ALUMINUM PLATE	1	PLATE	
28	ALUMINUM PLATE	1	PLATE	
29	ALUMINUM PLATE	1	PLATE	
30	ALUMINUM PLATE	1	PLATE	
31	ALUMINUM PLATE	1	PLATE	
32	ALUMINUM PLATE	1	PLATE	
33	ALUMINUM PLATE	1	PLATE	
34	ALUMINUM PLATE	1	PLATE	
35	ALUMINUM PLATE	1	PLATE	
36	ALUMINUM PLATE	1	PLATE	
37	ALUMINUM PLATE	1	PLATE	
38	ALUMINUM PLATE	1	PLATE	
39	ALUMINUM PLATE	1	PLATE	
40	ALUMINUM PLATE	1	PLATE	
41	ALUMINUM PLATE	1	PLATE	
42	ALUMINUM PLATE	1	PLATE	
43	ALUMINUM PLATE	1	PLATE	
44	ALUMINUM PLATE	1	PLATE	
45	ALUMINUM PLATE	1	PLATE	
46	ALUMINUM PLATE	1	PLATE	
47	ALUMINUM PLATE	1	PLATE	
48	ALUMINUM PLATE	1	PLATE	
49	ALUMINUM PLATE	1	PLATE	
50	ALUMINUM PLATE	1	PLATE	
51	ALUMINUM PLATE	1	PLATE	
52	ALUMINUM PLATE	1	PLATE	
53	ALUMINUM PLATE	1	PLATE	
54	ALUMINUM PLATE	1	PLATE	
55	ALUMINUM PLATE	1	PLATE	
56	ALUMINUM PLATE	1	PLATE	
57	ALUMINUM PLATE	1	PLATE	
58	ALUMINUM PLATE	1	PLATE	
59	ALUMINUM PLATE	1	PLATE	
60	ALUMINUM PLATE	1	PLATE	
61	ALUMINUM PLATE	1	PLATE	
62	ALUMINUM PLATE	1	PLATE	
63	ALUMINUM PLATE	1	PLATE	
64	ALUMINUM PLATE	1	PLATE	
65	ALUMINUM PLATE	1	PLATE	
66	ALUMINUM PLATE	1	PLATE	
67	ALUMINUM PLATE	1	PLATE	
68	ALUMINUM PLATE	1	PLATE	
69	ALUMINUM PLATE	1	PLATE	
70	ALUMINUM PLATE	1	PLATE	
71	ALUMINUM PLATE	1	PLATE	
72	ALUMINUM PLATE	1	PLATE	
73	ALUMINUM PLATE	1	PLATE	
74	ALUMINUM PLATE	1	PLATE	
75	ALUMINUM PLATE	1	PLATE	
76	ALUMINUM PLATE	1	PLATE	
77	ALUMINUM PLATE	1	PLATE	
78	ALUMINUM PLATE	1	PLATE	
79	ALUMINUM PLATE	1	PLATE	
80	ALUMINUM PLATE	1	PLATE	
81	ALUMINUM PLATE	1	PLATE	
82	ALUMINUM PLATE	1	PLATE	
83	ALUMINUM PLATE	1	PLATE	
84	ALUMINUM PLATE	1	PLATE	
85	ALUMINUM PLATE	1	PLATE	
86	ALUMINUM PLATE	1	PLATE	
87	ALUMINUM PLATE	1	PLATE	
88	ALUMINUM PLATE	1	PLATE	
89	ALUMINUM PLATE	1	PLATE	
90	ALUMINUM PLATE	1	PLATE	
91	ALUMINUM PLATE	1	PLATE	
92	ALUMINUM PLATE	1	PLATE	
93	ALUMINUM PLATE	1	PLATE	
94	ALUMINUM PLATE	1	PLATE	
95	ALUMINUM PLATE	1	PLATE	
96	ALUMINUM PLATE	1	PLATE	
97	ALUMINUM PLATE	1	PLATE	
98	ALUMINUM PLATE	1	PLATE	
99	ALUMINUM PLATE	1	PLATE	
100	ALUMINUM PLATE	1	PLATE	

REV	DATE	DESCRIPTION	BY	CHKD
1	11/17/67	ISSUED FOR CONSTRUCTION	WJ	WJ
2	11/21/67	REVISED TO SHOW CHANGES	WJ	WJ
3	11/21/67	REVISED TO SHOW CHANGES	WJ	WJ

Orbiter Forward Section Ass'y and Installation
(Sta 46.750 to 64.000) (Sheet 3 of 3)

A0383-525 (A)

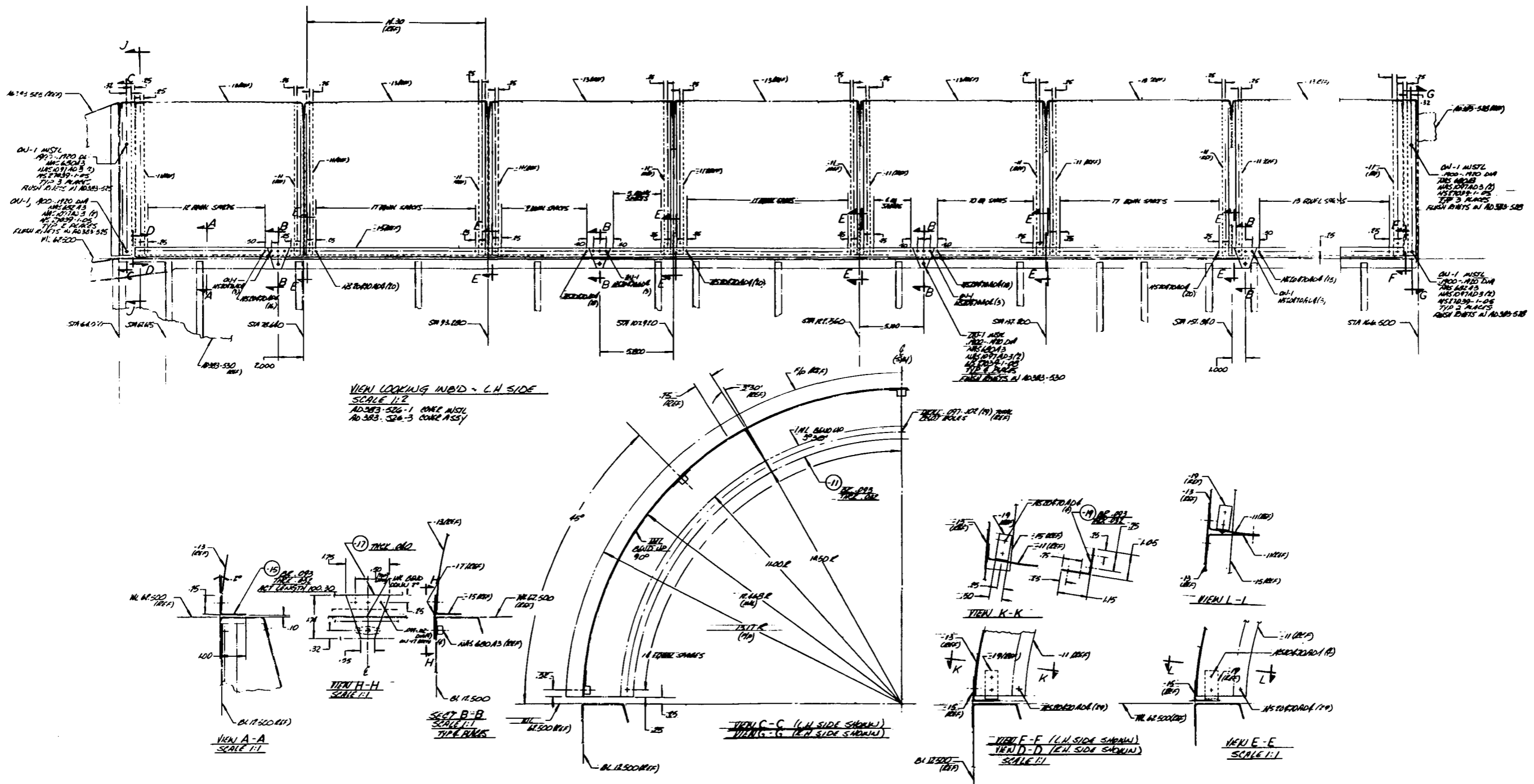

Orbiter Payload Bay Cover Ass'y and Installation
 (Sta 64.000 to 166.500) (Sheet 1 of 2)

AD383-526 (N/C)

SECTION		REV	DATE	BY	APP'D

NOTES:
 1. DESIGN - IS - 17 WITH MODINE 1700 PER MIL-G-5581 CLASS B.
 2. THESE ASSIGNED TOLERANCES ARE SPECIFIED AND MUST BE SUBSTITUTED...
 3. DIMT DIMENSIONS NOT DIMENSIONED ON FIELD OF DIMS MAY BE SCAL'D FROM NEAREST SEA LINE, WATER LINE OR OUTLINE. SPANIAL...
 4. DIMS - 11 DIMS TO BE ADD. ON SHI SIBUM WITHIN 1. P.S.

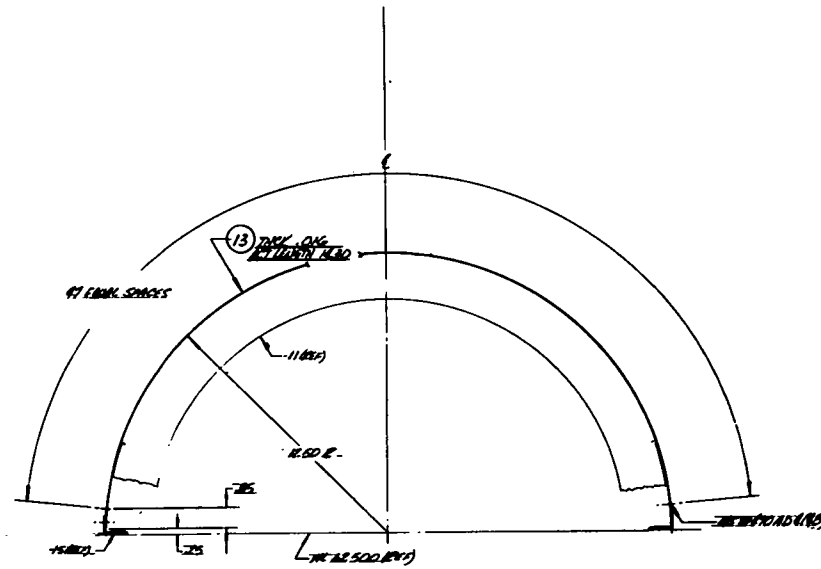

VIEW J - J (TOP A. PLACES)
SCALE 1:1

REV	DATE	DESCRIPTION	APP'D	CHK'D	BY	DATE
1		REVISED TO ADD. ON SHI SIBUM WITHIN 1. P.S.				
2		REVISED TO ADD. ON SHI SIBUM WITHIN 1. P.S.				
3		REVISED TO ADD. ON SHI SIBUM WITHIN 1. P.S.				
4		REVISED TO ADD. ON SHI SIBUM WITHIN 1. P.S.				
5		REVISED TO ADD. ON SHI SIBUM WITHIN 1. P.S.				

AD383-526	1
AD383-525	1
AD383-524	1
AD383-523	1
AD383-522	1
AD383-521	1
AD383-520	1
AD383-519	1
AD383-518	1
AD383-517	1
AD383-516	1
AD383-515	1
AD383-514	1
AD383-513	1
AD383-512	1
AD383-511	1
AD383-510	1
AD383-509	1
AD383-508	1
AD383-507	1
AD383-506	1
AD383-505	1
AD383-504	1
AD383-503	1
AD383-502	1
AD383-501	1

AD383-526	1
AD383-525	1
AD383-524	1
AD383-523	1
AD383-522	1
AD383-521	1
AD383-520	1
AD383-519	1
AD383-518	1
AD383-517	1
AD383-516	1
AD383-515	1
AD383-514	1
AD383-513	1
AD383-512	1
AD383-511	1
AD383-510	1
AD383-509	1
AD383-508	1
AD383-507	1
AD383-506	1
AD383-505	1
AD383-504	1
AD383-503	1
AD383-502	1
AD383-501	1

Orbiter Payload Bay Cover Ass'y and Installation
 (Sta 64.000 to 166.500) (Sheet 2 of 2)

AD383-526 (N/C)

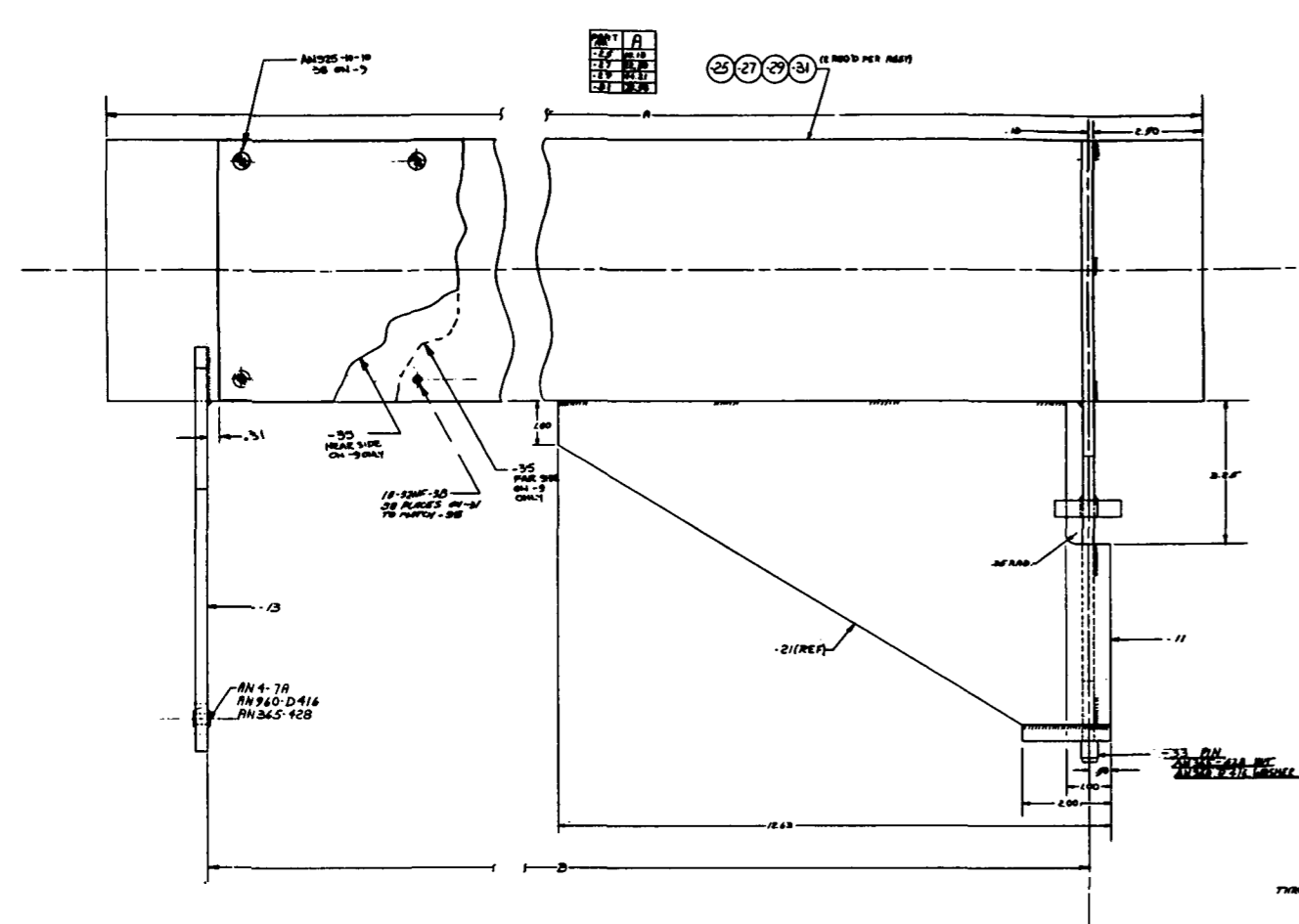

REV	DATE	DESCRIPTION	BY	CHK
1		ADDED CHAMFER TO SILL TOP SILL TO DIMS -56.15 - 20.00		

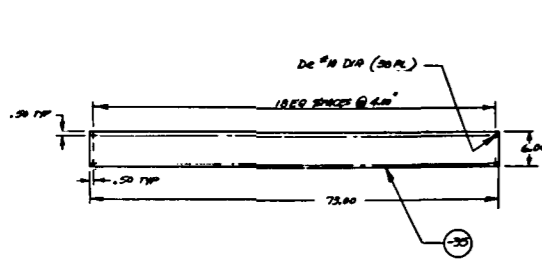

REV	DATE	DESCRIPTION
1	12/76	ASST
2	1/77	ASST

- 9 ASSY IDENT EXCEPT AS NOTED
- 7 ASSY IDENT EXCEPT AS NOTED
- 5 ASSY IDENT EXCEPT AS NOTED
- 3 ASSY SHOWN
- 1 INSTALLATION

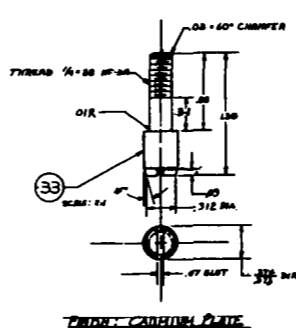
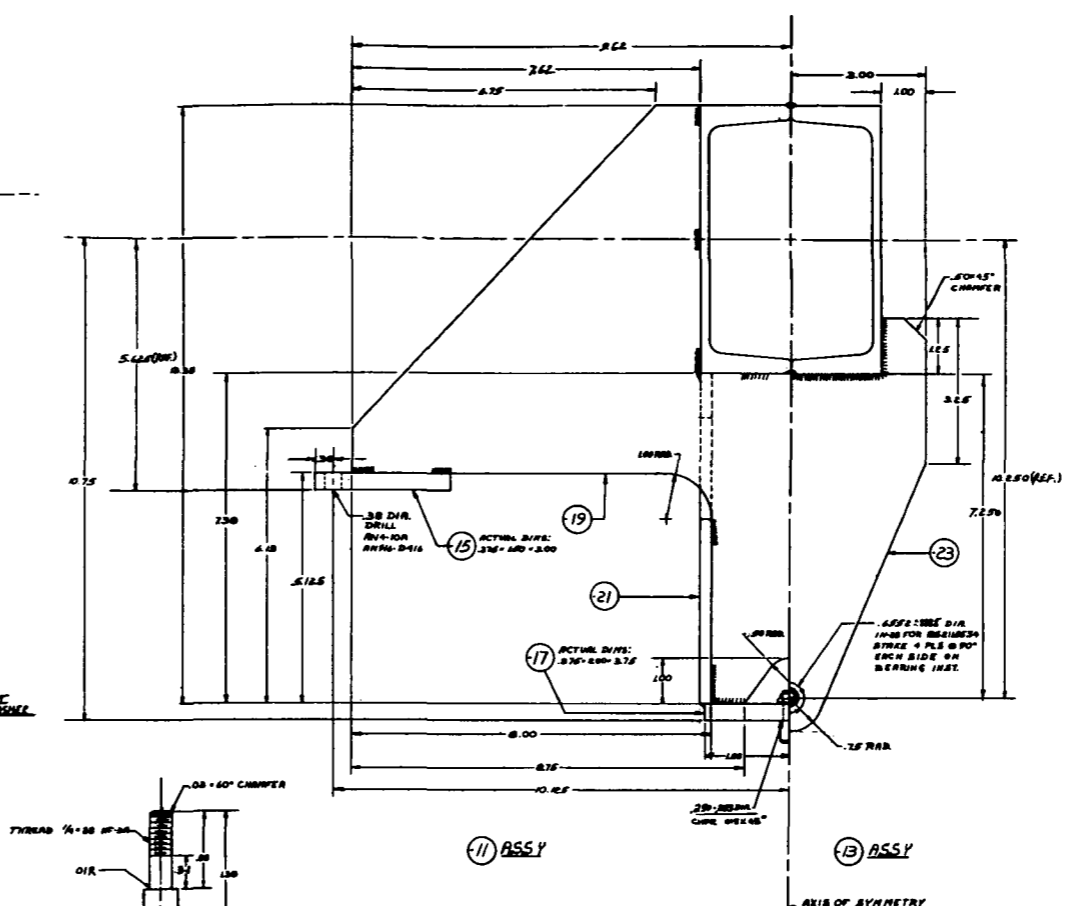

NOTES:
1. ALL WELDS TO BE OF INTERRUPTED FILLET TYPE AS SHOWN

REV	DATE	DESCRIPTION	BY	CHK	PART NO	DESCRPT	GOVT SPEC	MATERIAL	STOCK SIZE
1		ASSEMBLY							
2		ASSEMBLY							
3		ASSEMBLY							

REV	DATE	DESCRIPTION
1		NEXT ASSY

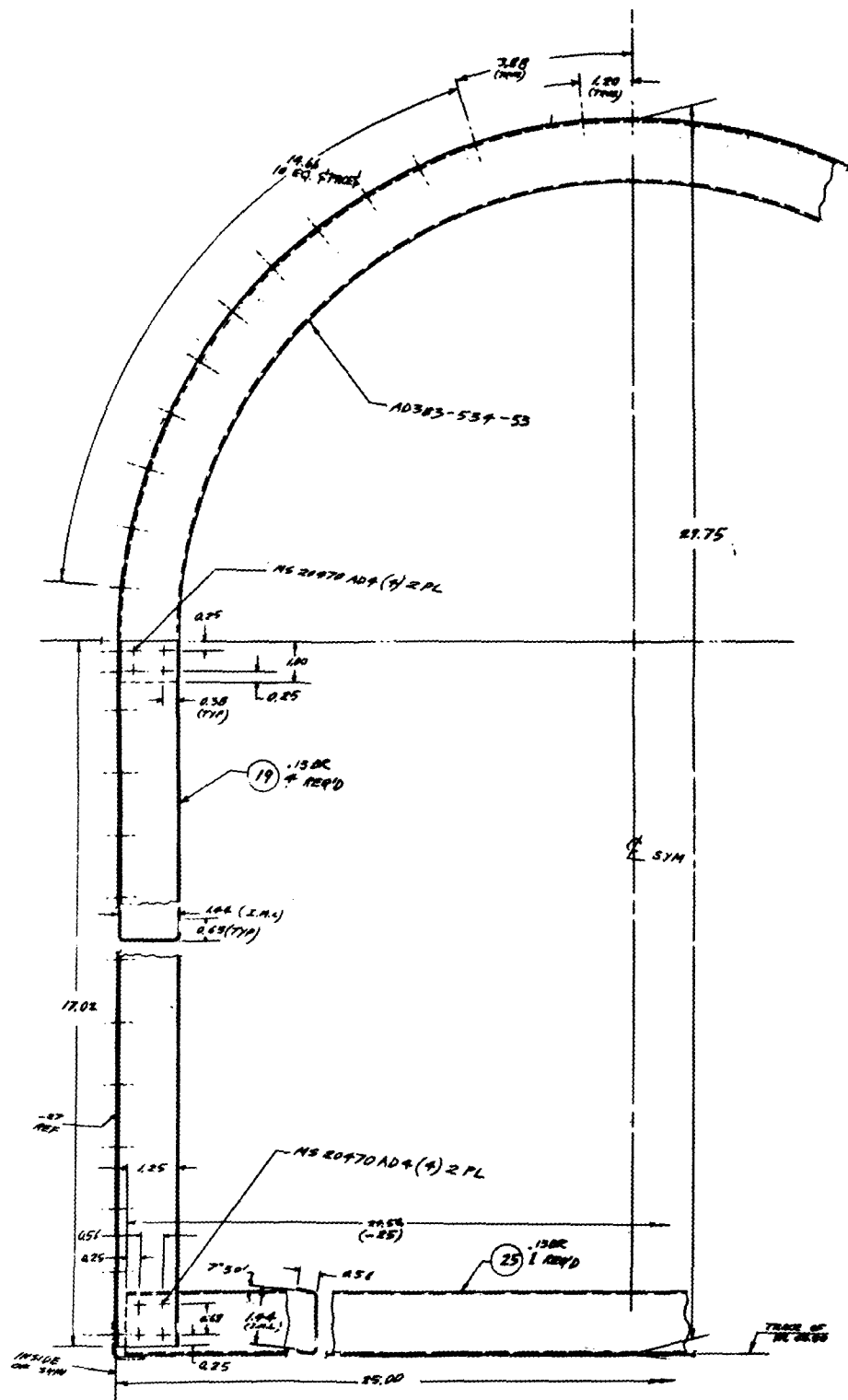

SECT C-C
-5 ASY SYN

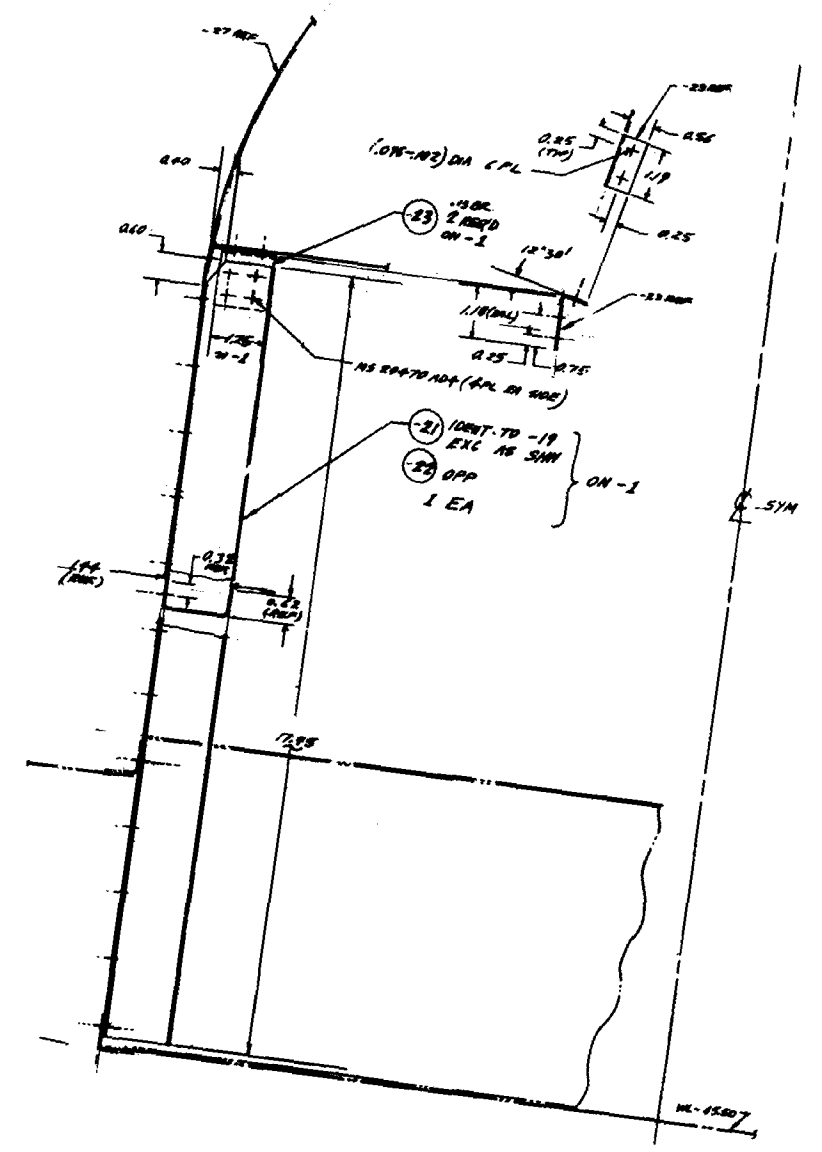

SECT B-B

Orbiter Aft Section Ass'y (Sheet 1 of 3)
AD383-528 (A)

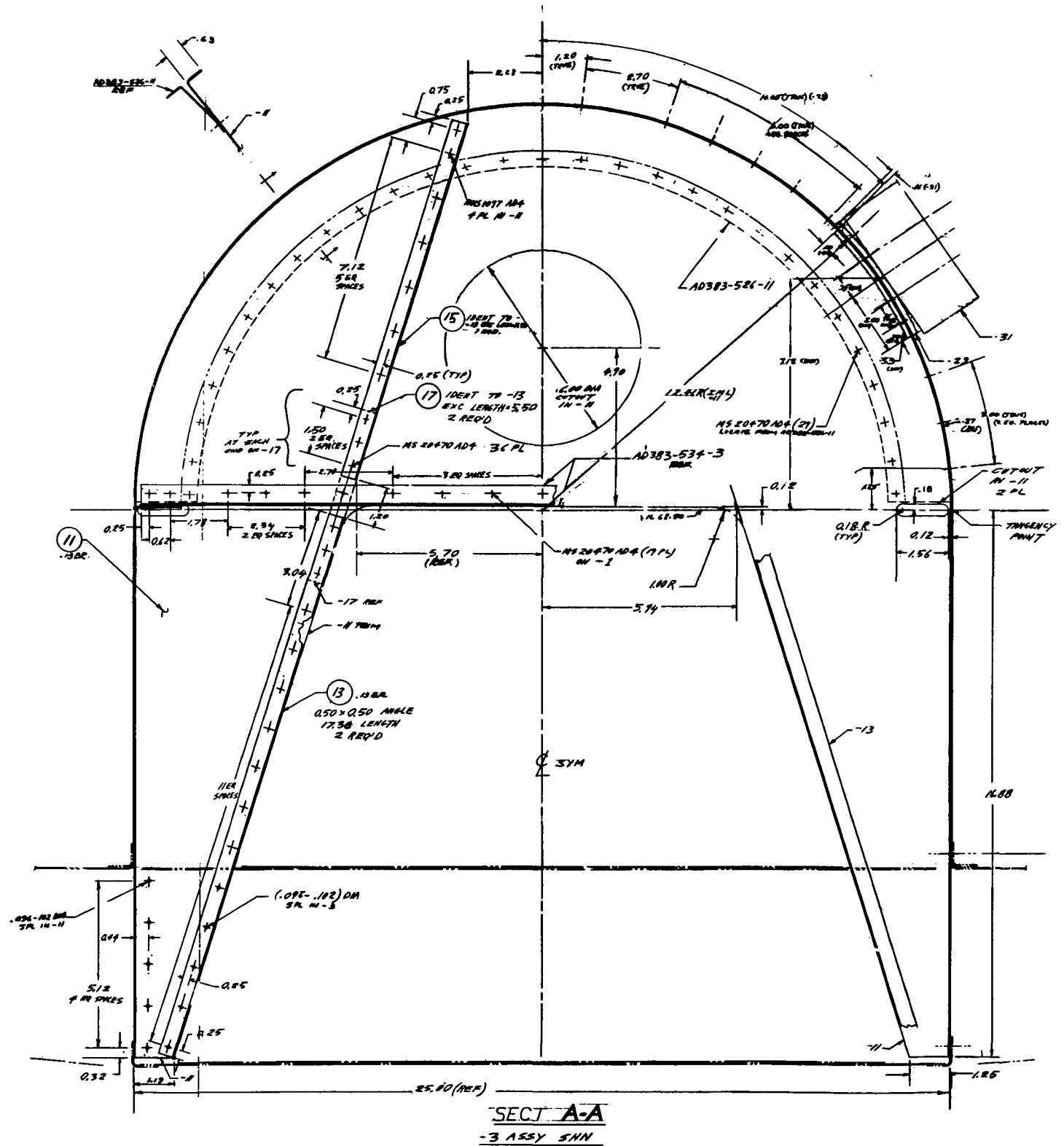

Orbiter Aft Section Ass'y (Sheet 2 of 3)
AD383-528 (A)

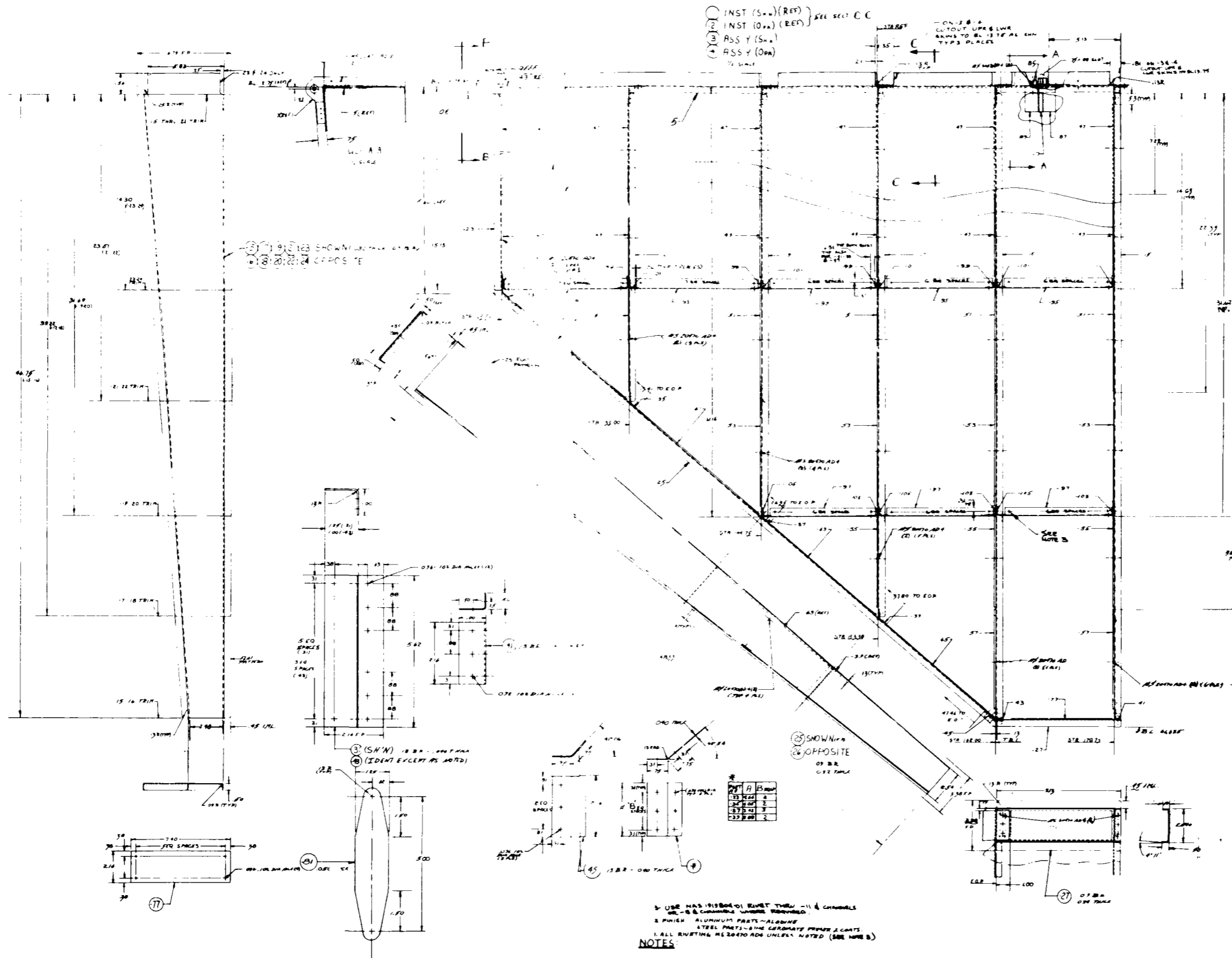

- ① INST (S-W) (RET) SEE SECT C C
- ② INST (O-W) (RET)
- ③ ASS Y (S-W)
- ④ ASS Y (O-W)

NO.	DESCRIPTION	QTY	REF.
1	AD383-529-1	1	17
2	AD383-529-2	1	18

NO.	DESCRIPTION	QTY	REF.	MATERIAL	STOCK SIZE
1	AD383-529-1	1	17	ALUMINUM	1/2" x 1/8" x 12"
2	AD383-529-2	1	18	ALUMINUM	1/4" x 1/8" x 6"
3	AD383-529-3	1	19	ALUMINUM	1/2" x 1/8" x 12"
4	AD383-529-4	1	20	ALUMINUM	1/4" x 1/8" x 6"
5	AD383-529-5	1	21	ALUMINUM	1/2" x 1/8" x 12"
6	AD383-529-6	1	22	ALUMINUM	1/4" x 1/8" x 6"
7	AD383-529-7	1	23	ALUMINUM	1/2" x 1/8" x 12"
8	AD383-529-8	1	24	ALUMINUM	1/4" x 1/8" x 6"
9	AD383-529-9	1	25	ALUMINUM	1/2" x 1/8" x 12"
10	AD383-529-10	1	26	ALUMINUM	1/4" x 1/8" x 6"
11	AD383-529-11	1	27	ALUMINUM	1/2" x 1/8" x 12"
12	AD383-529-12	1	28	ALUMINUM	1/4" x 1/8" x 6"
13	AD383-529-13	1	29	ALUMINUM	1/2" x 1/8" x 12"
14	AD383-529-14	1	30	ALUMINUM	1/4" x 1/8" x 6"
15	AD383-529-15	1	31	ALUMINUM	1/2" x 1/8" x 12"
16	AD383-529-16	1	32	ALUMINUM	1/4" x 1/8" x 6"
17	AD383-529-17	1	33	ALUMINUM	1/2" x 1/8" x 12"
18	AD383-529-18	1	34	ALUMINUM	1/4" x 1/8" x 6"
19	AD383-529-19	1	35	ALUMINUM	1/2" x 1/8" x 12"
20	AD383-529-20	1	36	ALUMINUM	1/4" x 1/8" x 6"
21	AD383-529-21	1	37	ALUMINUM	1/2" x 1/8" x 12"
22	AD383-529-22	1	38	ALUMINUM	1/4" x 1/8" x 6"
23	AD383-529-23	1	39	ALUMINUM	1/2" x 1/8" x 12"
24	AD383-529-24	1	40	ALUMINUM	1/4" x 1/8" x 6"
25	AD383-529-25	1	41	ALUMINUM	1/2" x 1/8" x 12"
26	AD383-529-26	1	42	ALUMINUM	1/4" x 1/8" x 6"
27	AD383-529-27	1	43	ALUMINUM	1/2" x 1/8" x 12"
28	AD383-529-28	1	44	ALUMINUM	1/4" x 1/8" x 6"
29	AD383-529-29	1	45	ALUMINUM	1/2" x 1/8" x 12"
30	AD383-529-30	1	46	ALUMINUM	1/4" x 1/8" x 6"

NO.	DESCRIPTION	QTY	REF.	MATERIAL	STOCK SIZE
1	AD383-529-1	1	17	ALUMINUM	1/2" x 1/8" x 12"
2	AD383-529-2	1	18	ALUMINUM	1/4" x 1/8" x 6"

1. USE NAS 1918B-01 RIVET THROUGH CHANNELS & CHANNELS UNLESS OTHERWISE SPECIFIED.
 2. FINISH ALUMINUM PARTS - ANODIZE
 3. STEEL PARTS - BARE UNLESS OTHERWISE SPECIFIED
 4. ALL RIVETING RE 2020 ADG UNLESS NOTED (SEE NOTE B)

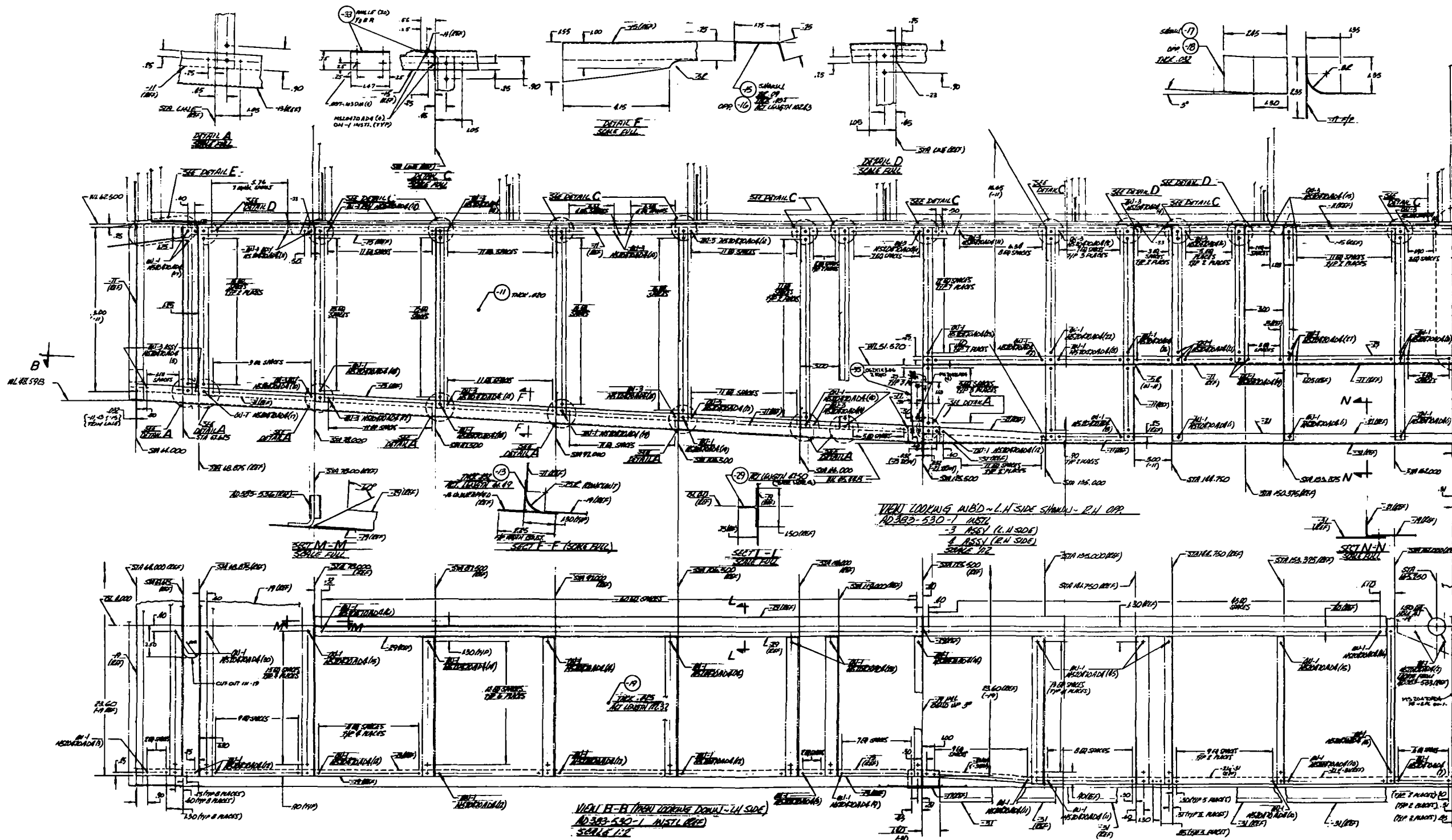

Orbiter Fuselage Side and Bottom Skin Panel Ass'y and Installation (Sheet 1 of 2)

AD383-530 (A)

REV	NO	DESCRIPTION	DATE
A	1	ADDED NOTE 4	1/1/74
B	1	REVISED - 23, 24, 8-5	
C	1	REVISED - 25, 26, 27, 28, 29, 30, 31, 32, 33, 34, 35, 36, 37, 38, 39, 40, 41, 42, 43, 44, 45, 46, 47, 48, 49, 50, 51, 52, 53, 54, 55, 56, 57, 58, 59, 60, 61, 62, 63, 64, 65, 66, 67, 68, 69, 70, 71, 72, 73, 74, 75, 76, 77, 78, 79, 80, 81, 82, 83, 84, 85, 86, 87, 88, 89, 90, 91, 92, 93, 94, 95, 96, 97, 98, 99, 100	
D	1	REVISED - 21, 22	

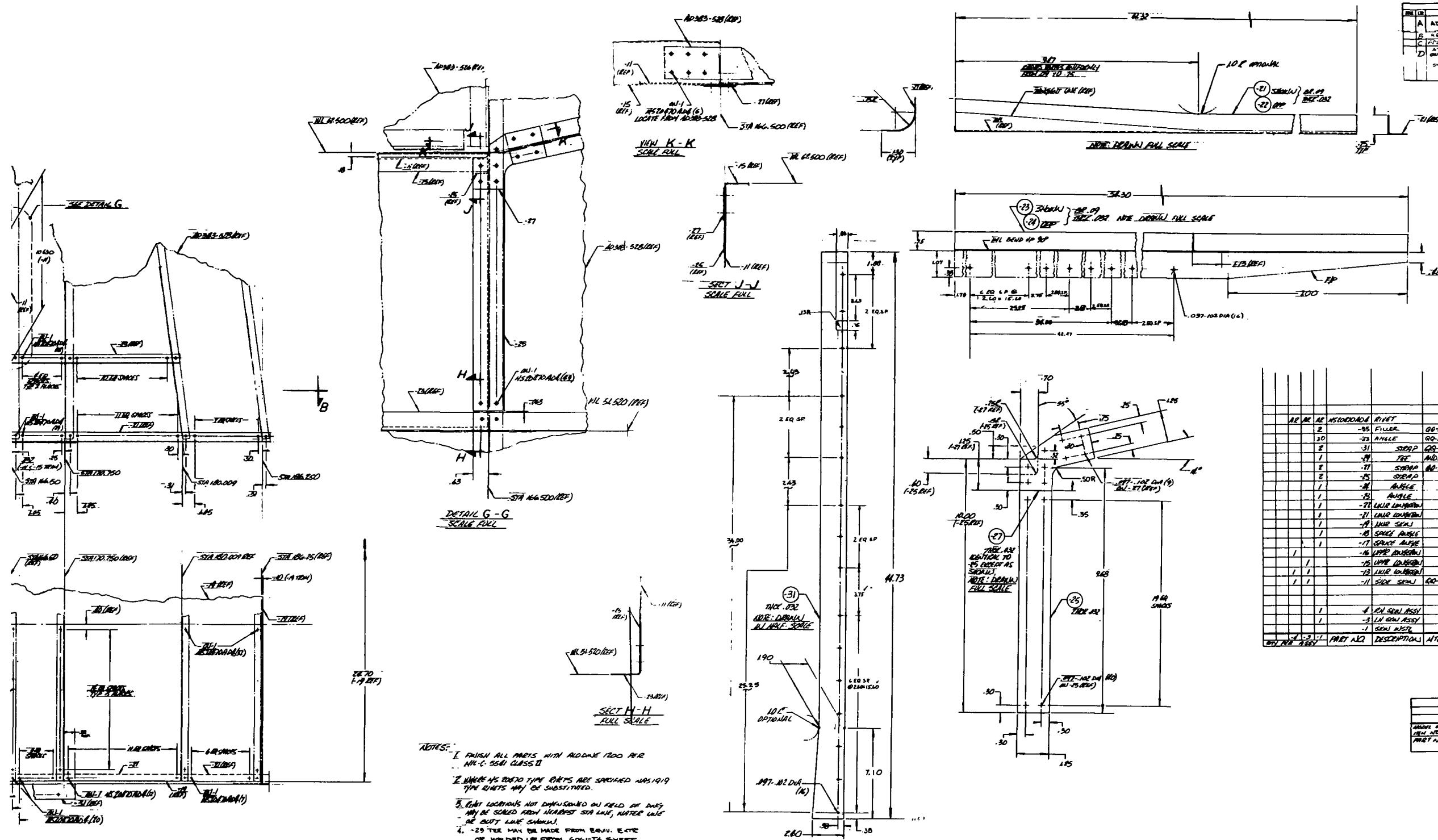

- NOTES:
1. FINISH ALL PARTS WITH ALDANE 100 PER MIL-C-5581 CLASS II
 2. UNLESS OTHERWISE SPECIFIED ALL PARTS ARE SPECIFIED UNLESS OTHERWISE NOTED.
 3. PART LOCATIONS NOT DIMENSIONED ON FIELD OF DRAWING MAY BE OBTAINED FROM NEAREST STA LINE, UNLESS OTHERWISE NOTED.
 4. -29 TEE MAY BE MADE FROM ERVU. EXTE OR WELDED UP FROM 6061-T4 SHEET

REV	NO	DESCRIPTION	DATE
1	1	REVISED - 23, 24, 8-5	
2	1	REVISED - 25, 26, 27, 28, 29, 30, 31, 32, 33, 34, 35, 36, 37, 38, 39, 40, 41, 42, 43, 44, 45, 46, 47, 48, 49, 50, 51, 52, 53, 54, 55, 56, 57, 58, 59, 60, 61, 62, 63, 64, 65, 66, 67, 68, 69, 70, 71, 72, 73, 74, 75, 76, 77, 78, 79, 80, 81, 82, 83, 84, 85, 86, 87, 88, 89, 90, 91, 92, 93, 94, 95, 96, 97, 98, 99, 100	

REV	NO	DESCRIPTION	DATE
1	1	REVISED - 23, 24, 8-5	
2	1	REVISED - 25, 26, 27, 28, 29, 30, 31, 32, 33, 34, 35, 36, 37, 38, 39, 40, 41, 42, 43, 44, 45, 46, 47, 48, 49, 50, 51, 52, 53, 54, 55, 56, 57, 58, 59, 60, 61, 62, 63, 64, 65, 66, 67, 68, 69, 70, 71, 72, 73, 74, 75, 76, 77, 78, 79, 80, 81, 82, 83, 84, 85, 86, 87, 88, 89, 90, 91, 92, 93, 94, 95, 96, 97, 98, 99, 100	

Orbiter Fuselage Side and Bottom Skin Panel Ass'y and Installation (Sheet 2 of 2)

A0383-530 (A)

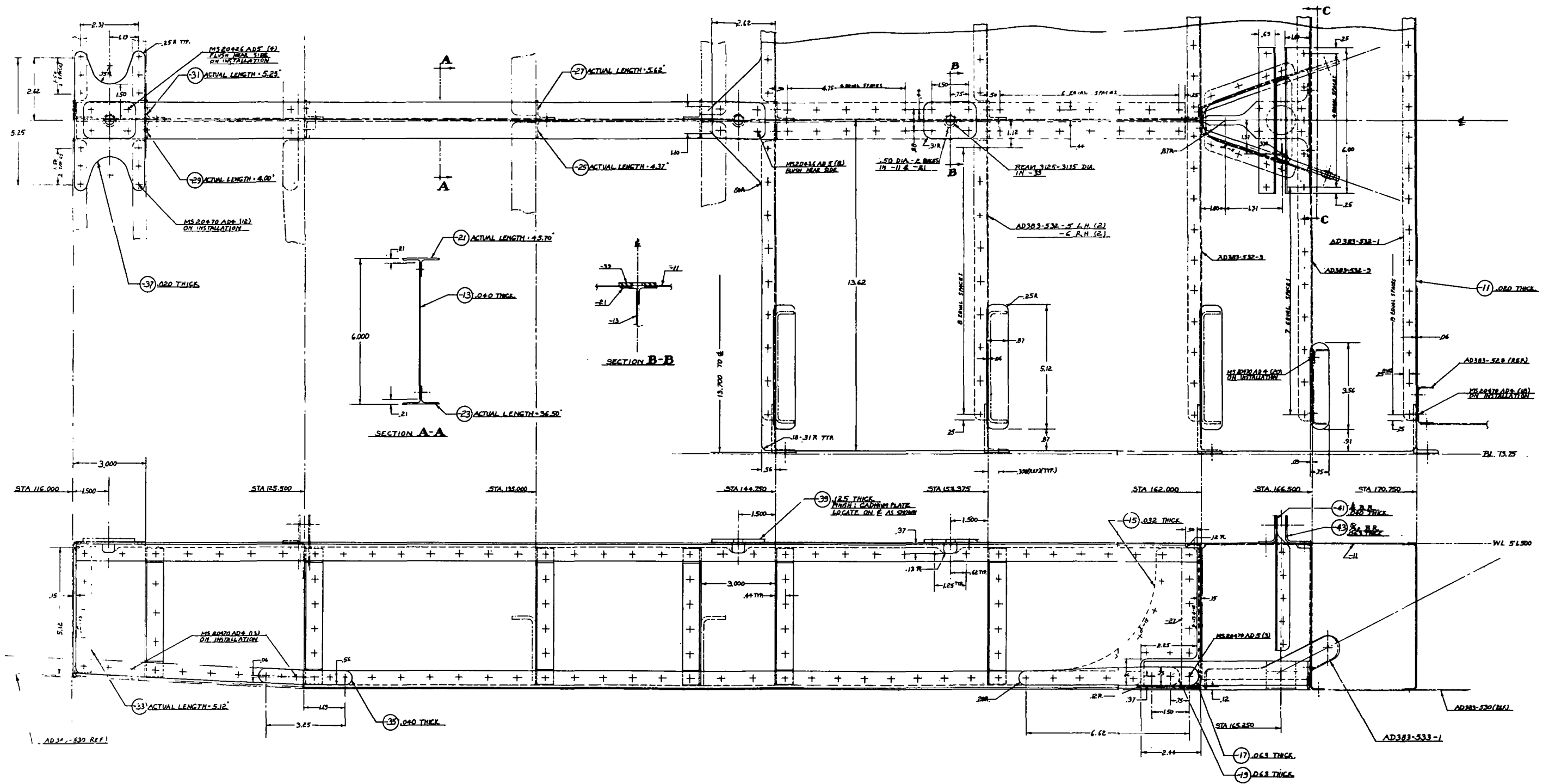

Orbiter Keel Ass'y and Installation (Sheet 1 of 2)
 AD383-531 (N/C)

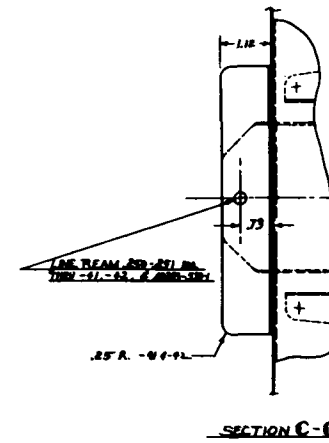

QTY PER PART	PART NO.	DESCRIPTION	MTL SPEC.	MATERIAL STOCK SIZE	QTY PER PART
1	AD383-531-1	KEEL ASSEMBLY			1
1	AD383-531-2	KEEL BEARING			1
1	AD383-531-3	KEEL BRACKET			1
1	AD383-531-4	KEEL PLATE			1
1	AD383-531-5	KEEL STRAP			1
1	AD383-531-6	KEEL STRAP			1
1	AD383-531-7	KEEL STRAP			1
1	AD383-531-8	KEEL STRAP			1
1	AD383-531-9	KEEL STRAP			1
1	AD383-531-10	KEEL STRAP			1
1	AD383-531-11	KEEL STRAP			1
1	AD383-531-12	KEEL STRAP			1
1	AD383-531-13	KEEL STRAP			1
1	AD383-531-14	KEEL STRAP			1
1	AD383-531-15	KEEL STRAP			1
1	AD383-531-16	KEEL STRAP			1
1	AD383-531-17	KEEL STRAP			1
1	AD383-531-18	KEEL STRAP			1
1	AD383-531-19	KEEL STRAP			1
1	AD383-531-20	KEEL STRAP			1
1	AD383-531-21	KEEL STRAP			1
1	AD383-531-22	KEEL STRAP			1
1	AD383-531-23	KEEL STRAP			1
1	AD383-531-24	KEEL STRAP			1
1	AD383-531-25	KEEL STRAP			1
1	AD383-531-26	KEEL STRAP			1
1	AD383-531-27	KEEL STRAP			1
1	AD383-531-28	KEEL STRAP			1
1	AD383-531-29	KEEL STRAP			1
1	AD383-531-30	KEEL STRAP			1
1	AD383-531-31	KEEL STRAP			1
1	AD383-531-32	KEEL STRAP			1
1	AD383-531-33	KEEL STRAP			1
1	AD383-531-34	KEEL STRAP			1
1	AD383-531-35	KEEL STRAP			1
1	AD383-531-36	KEEL STRAP			1
1	AD383-531-37	KEEL STRAP			1
1	AD383-531-38	KEEL STRAP			1
1	AD383-531-39	KEEL STRAP			1
1	AD383-531-40	KEEL STRAP			1
1	AD383-531-41	KEEL STRAP			1
1	AD383-531-42	KEEL STRAP			1
1	AD383-531-43	KEEL STRAP			1
1	AD383-531-44	KEEL STRAP			1
1	AD383-531-45	KEEL STRAP			1
1	AD383-531-46	KEEL STRAP			1
1	AD383-531-47	KEEL STRAP			1
1	AD383-531-48	KEEL STRAP			1
1	AD383-531-49	KEEL STRAP			1
1	AD383-531-50	KEEL STRAP			1
1	AD383-531-51	KEEL STRAP			1
1	AD383-531-52	KEEL STRAP			1
1	AD383-531-53	KEEL STRAP			1
1	AD383-531-54	KEEL STRAP			1
1	AD383-531-55	KEEL STRAP			1
1	AD383-531-56	KEEL STRAP			1
1	AD383-531-57	KEEL STRAP			1
1	AD383-531-58	KEEL STRAP			1
1	AD383-531-59	KEEL STRAP			1
1	AD383-531-60	KEEL STRAP			1
1	AD383-531-61	KEEL STRAP			1
1	AD383-531-62	KEEL STRAP			1
1	AD383-531-63	KEEL STRAP			1
1	AD383-531-64	KEEL STRAP			1
1	AD383-531-65	KEEL STRAP			1
1	AD383-531-66	KEEL STRAP			1
1	AD383-531-67	KEEL STRAP			1
1	AD383-531-68	KEEL STRAP			1
1	AD383-531-69	KEEL STRAP			1
1	AD383-531-70	KEEL STRAP			1
1	AD383-531-71	KEEL STRAP			1
1	AD383-531-72	KEEL STRAP			1
1	AD383-531-73	KEEL STRAP			1
1	AD383-531-74	KEEL STRAP			1
1	AD383-531-75	KEEL STRAP			1
1	AD383-531-76	KEEL STRAP			1
1	AD383-531-77	KEEL STRAP			1
1	AD383-531-78	KEEL STRAP			1
1	AD383-531-79	KEEL STRAP			1
1	AD383-531-80	KEEL STRAP			1
1	AD383-531-81	KEEL STRAP			1
1	AD383-531-82	KEEL STRAP			1
1	AD383-531-83	KEEL STRAP			1
1	AD383-531-84	KEEL STRAP			1
1	AD383-531-85	KEEL STRAP			1
1	AD383-531-86	KEEL STRAP			1
1	AD383-531-87	KEEL STRAP			1
1	AD383-531-88	KEEL STRAP			1
1	AD383-531-89	KEEL STRAP			1
1	AD383-531-90	KEEL STRAP			1
1	AD383-531-91	KEEL STRAP			1
1	AD383-531-92	KEEL STRAP			1
1	AD383-531-93	KEEL STRAP			1
1	AD383-531-94	KEEL STRAP			1
1	AD383-531-95	KEEL STRAP			1
1	AD383-531-96	KEEL STRAP			1
1	AD383-531-97	KEEL STRAP			1
1	AD383-531-98	KEEL STRAP			1
1	AD383-531-99	KEEL STRAP			1
1	AD383-531-100	KEEL STRAP			1

2. FINISH ALL ALUM PARTS: ALDOME.
 1. ALL RIVETING IS MS.D0670A04 UNLESS NOTED.
 NOTES:

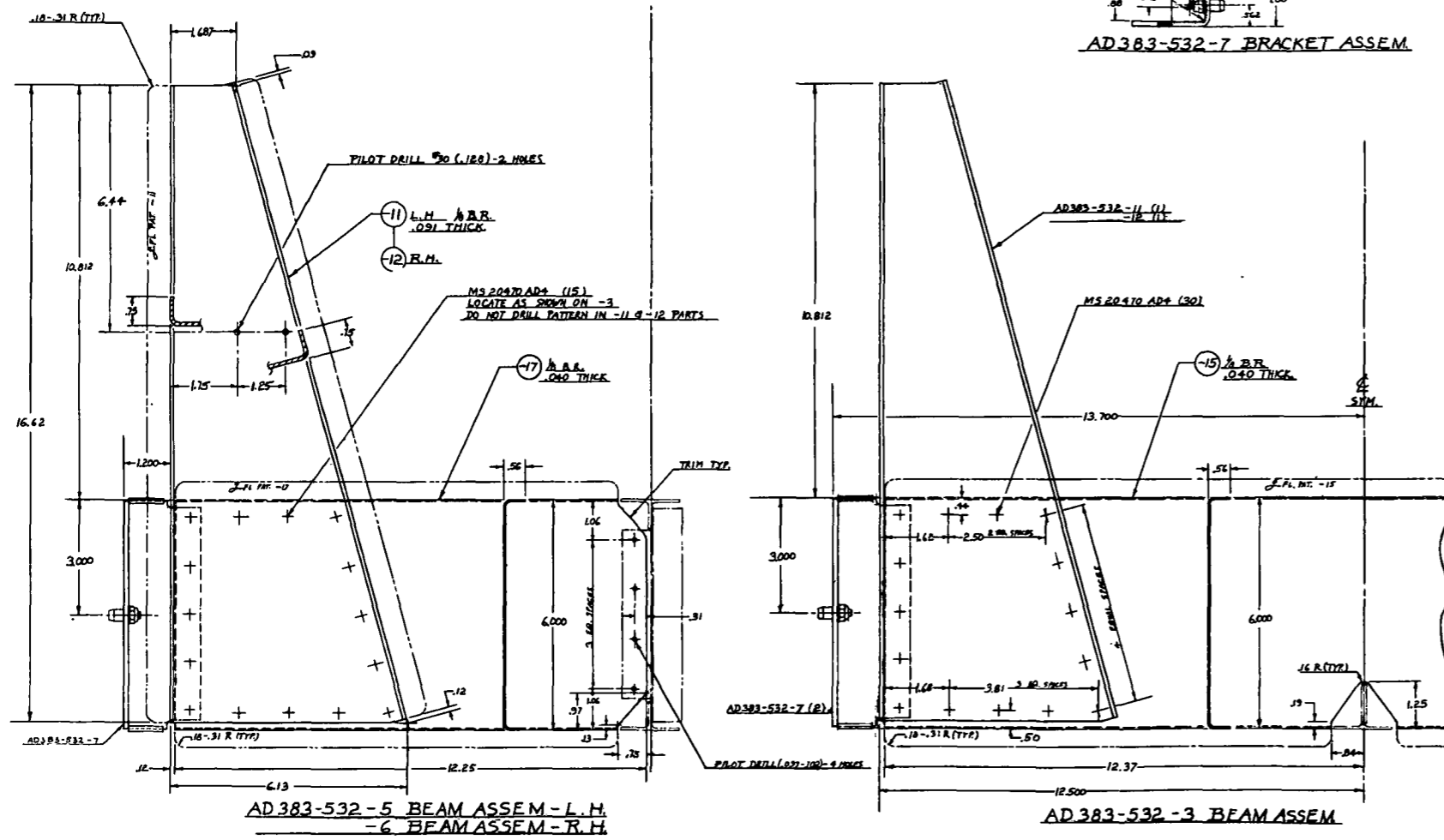
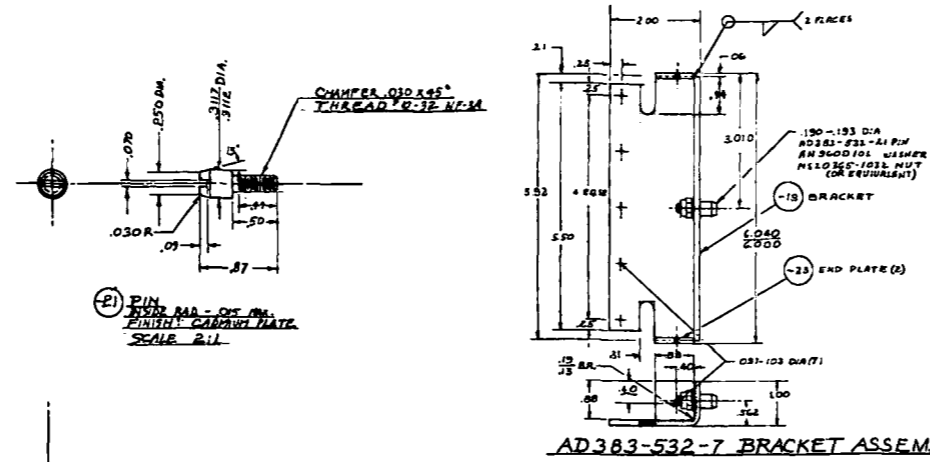

Orbiter Wing Beam Carry-Through Ass'y
(Sheet 1 of 2)

AD383-532 (B)

REV	DESCRIPTION	DATE	BY	CHKD
A	ENLARGED - 3/8 DIA - 1/8 BRACKET ADDED - 1/8 DIA - 1/8			
B	ADDED CUTOUT TO -19 ON -7			

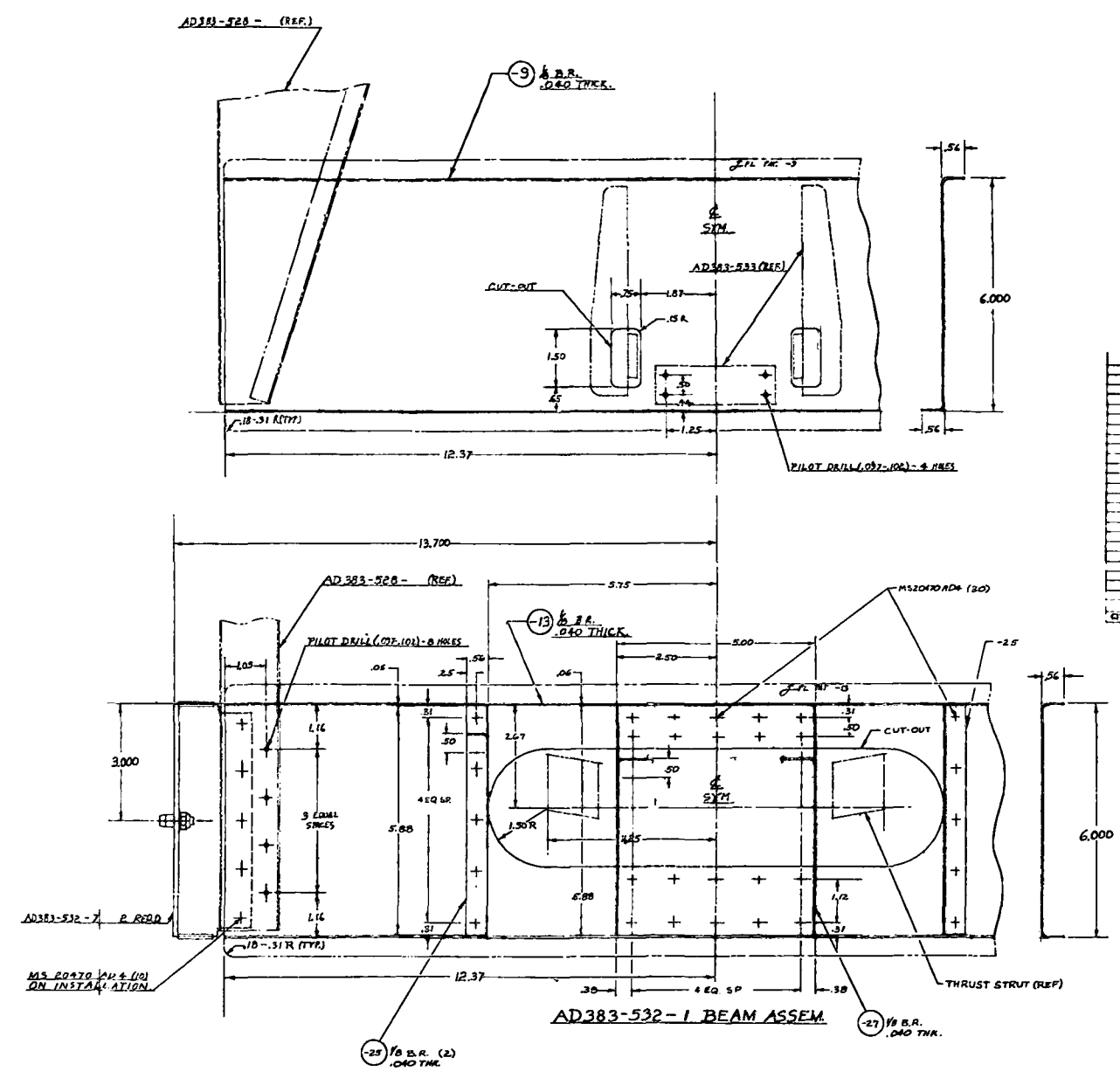

QTY	PART NO.	DESCRIPTION	GOVT SPEC.	MATERIAL	STOCK SIZE	STEP
1	AD383-532-3	CHANNEL				
2	AD383-532-4	ANGLE				
1	AD383-532-5	RIVET				
1	AD383-532-6	WASHER				
1	AD383-532-7	NUT				
2	AD383-532-8	END PLATE				
1	AD383-532-9	PIN				
1	AD383-532-10	BRACKET				
1	AD383-532-11	BEAM				
1	AD383-532-12	BEAM				
1	AD383-532-13	FRAME				
1	AD383-532-14	BEAM				
1	AD383-532-15	BEAM				
1	AD383-532-16	BEAM				
1	AD383-532-17	BEAM				
1	AD383-532-18	BEAM				
1	AD383-532-19	BEAM				
1	AD383-532-20	BEAM				
1	AD383-532-21	BEAM				
1	AD383-532-22	BEAM				
1	AD383-532-23	BEAM				
1	AD383-532-24	BEAM				
1	AD383-532-25	BEAM				
1	AD383-532-26	BEAM				
1	AD383-532-27	BEAM				
1	AD383-532-28	BEAM				
1	AD383-532-29	BEAM				
1	AD383-532-30	BEAM				
1	AD383-532-31	BEAM				
1	AD383-532-32	BEAM				
1	AD383-532-33	BEAM				
1	AD383-532-34	BEAM				
1	AD383-532-35	BEAM				
1	AD383-532-36	BEAM				
1	AD383-532-37	BEAM				
1	AD383-532-38	BEAM				
1	AD383-532-39	BEAM				
1	AD383-532-40	BEAM				
1	AD383-532-41	BEAM				
1	AD383-532-42	BEAM				
1	AD383-532-43	BEAM				
1	AD383-532-44	BEAM				
1	AD383-532-45	BEAM				
1	AD383-532-46	BEAM				
1	AD383-532-47	BEAM				
1	AD383-532-48	BEAM				
1	AD383-532-49	BEAM				
1	AD383-532-50	BEAM				
1	AD383-532-51	BEAM				
1	AD383-532-52	BEAM				
1	AD383-532-53	BEAM				
1	AD383-532-54	BEAM				
1	AD383-532-55	BEAM				
1	AD383-532-56	BEAM				
1	AD383-532-57	BEAM				
1	AD383-532-58	BEAM				
1	AD383-532-59	BEAM				
1	AD383-532-60	BEAM				
1	AD383-532-61	BEAM				
1	AD383-532-62	BEAM				
1	AD383-532-63	BEAM				
1	AD383-532-64	BEAM				
1	AD383-532-65	BEAM				
1	AD383-532-66	BEAM				
1	AD383-532-67	BEAM				
1	AD383-532-68	BEAM				
1	AD383-532-69	BEAM				
1	AD383-532-70	BEAM				
1	AD383-532-71	BEAM				
1	AD383-532-72	BEAM				
1	AD383-532-73	BEAM				
1	AD383-532-74	BEAM				
1	AD383-532-75	BEAM				
1	AD383-532-76	BEAM				
1	AD383-532-77	BEAM				
1	AD383-532-78	BEAM				
1	AD383-532-79	BEAM				
1	AD383-532-80	BEAM				
1	AD383-532-81	BEAM				
1	AD383-532-82	BEAM				
1	AD383-532-83	BEAM				
1	AD383-532-84	BEAM				
1	AD383-532-85	BEAM				
1	AD383-532-86	BEAM				
1	AD383-532-87	BEAM				
1	AD383-532-88	BEAM				
1	AD383-532-89	BEAM				
1	AD383-532-90	BEAM				
1	AD383-532-91	BEAM				
1	AD383-532-92	BEAM				
1	AD383-532-93	BEAM				
1	AD383-532-94	BEAM				
1	AD383-532-95	BEAM				
1	AD383-532-96	BEAM				
1	AD383-532-97	BEAM				
1	AD383-532-98	BEAM				
1	AD383-532-99	BEAM				
1	AD383-532-100	BEAM				

REV	DESCRIPTION	DATE	BY	CHKD
A	ENLARGED - 3/8 DIA - 1/8 BRACKET ADDED - 1/8 DIA - 1/8			
B	ADDED CUTOUT TO -19 ON -7			

REV	DESCRIPTION	DATE	BY	CHKD
A	ENLARGED - 3/8 DIA - 1/8 BRACKET ADDED - 1/8 DIA - 1/8			
B	ADDED CUTOUT TO -19 ON -7			

REV	DESCRIPTION	DATE	BY	CHKD
A	ENLARGED - 3/8 DIA - 1/8 BRACKET ADDED - 1/8 DIA - 1/8			
B	ADDED CUTOUT TO -19 ON -7			

REV	DESCRIPTION	DATE	BY	CHKD
A	ENLARGED - 3/8 DIA - 1/8 BRACKET ADDED - 1/8 DIA - 1/8			
B	ADDED CUTOUT TO -19 ON -7			

Orbiter Wing Beam Carry-Through Ass'y
(Sheet 2 of 2)

AD383-532 (B)

REV	DATE	DESCRIPTION	BY	CHKD	APP'D

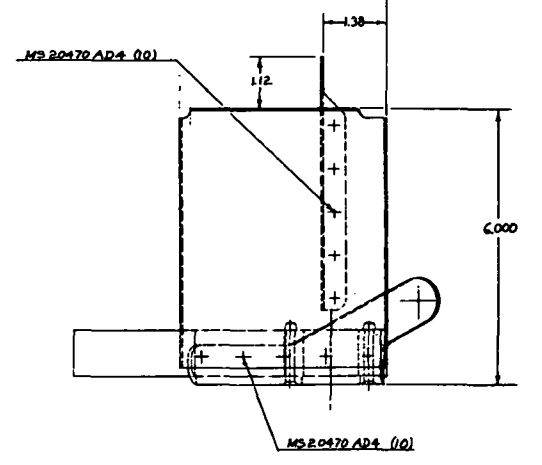
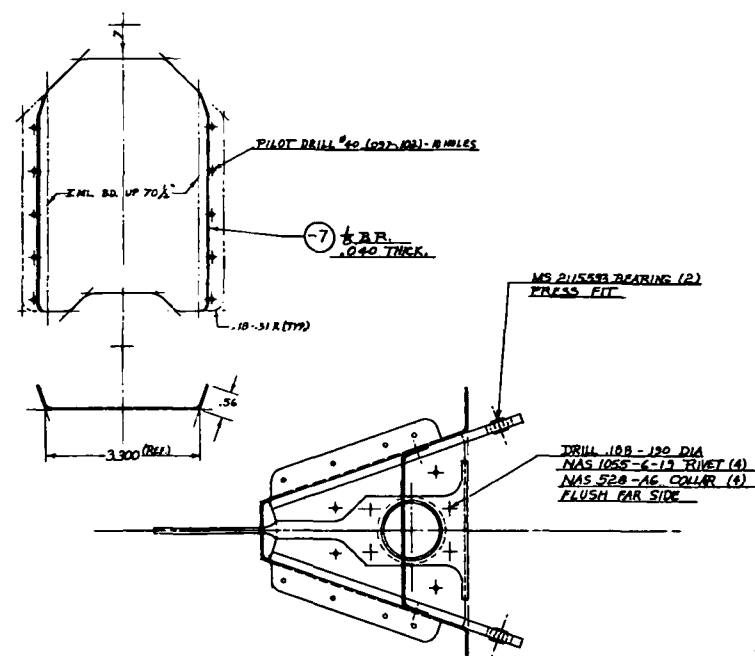
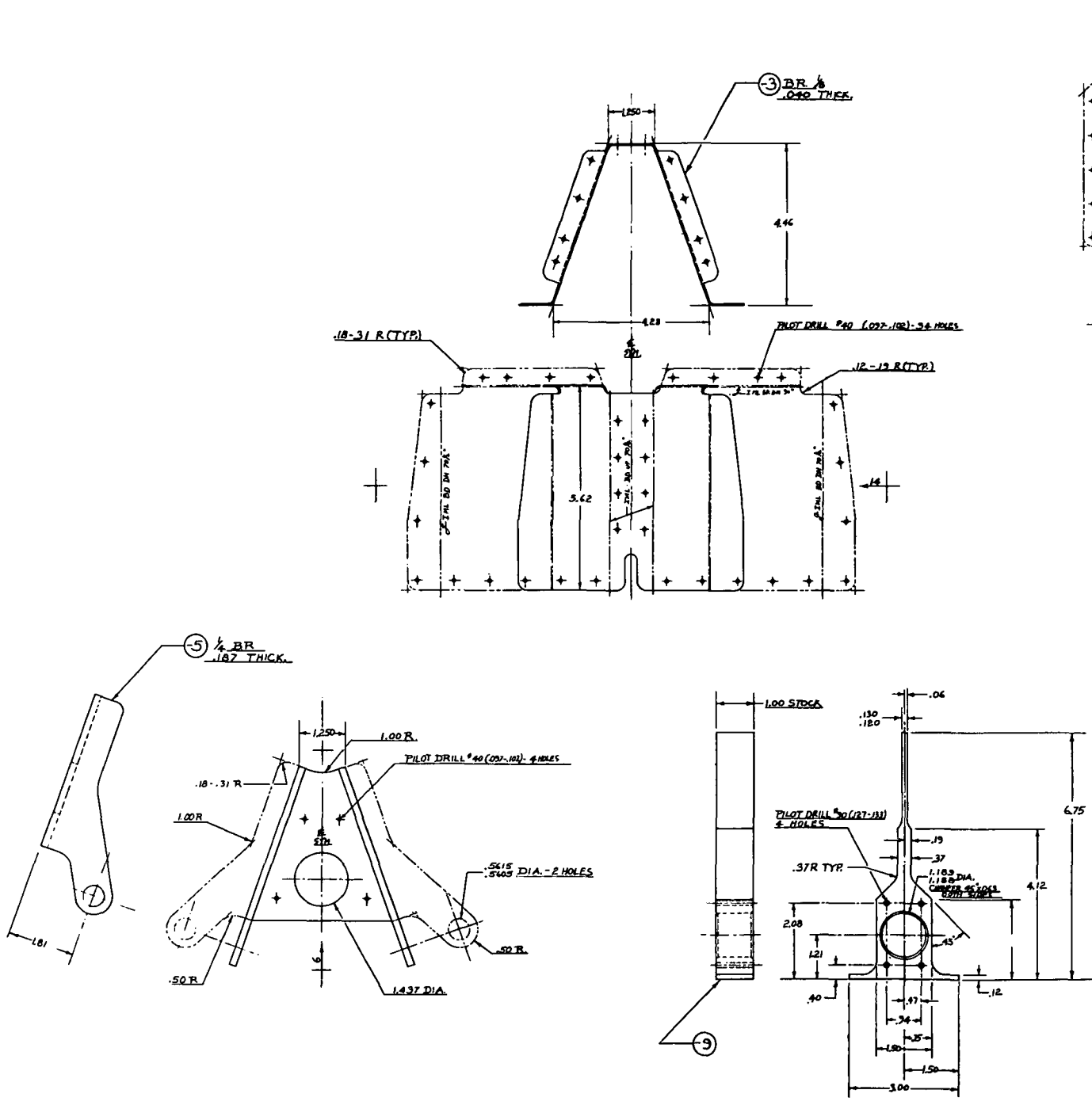

QTY	PART NO.	DESCRIPTION	GOVT. SPEC.	MATERIAL	STOCK SIZE	REV. PART
20	MS 20470 AD4	RIVET		GOVT. STD.		
2	NAS 528-16	COLLAR				
4	NAS 1058-6-13	RIVET				
2	MS 215583	BEARING		GOVT. STD.		
1	AD383-533-1	FITTING ASSEMBLY		00-A1507	2024-T301 TYP	1 X 3/16 X 7
1		BRACKET		00-A1507	2024-T301 TYP	1 X 3/16 X 7
1		PLUG		00-A1507	2024-T301 TYP	1 X 3/16 X 7
1		WASHER		00-A1507	2024-T301 TYP	1 X 3/16 X 7
1	AD383-533-1	FITTING ASSEMBLY		00-A1507	2024-T301 TYP	1 X 3/16 X 7
1		PLUG		00-A1507	2024-T301 TYP	1 X 3/16 X 7
1		WASHER		00-A1507	2024-T301 TYP	1 X 3/16 X 7

SIZE	PART NO.	DESCRIPTION	REV.
1/8 X 3/16 X 7	AD383-533-1	ORBITER	1
1/8 X 3/16 X 7	NEXT ASSEM.	MODULE	0000
1/8 X 3/16 X 7	PREV. ASSEM.	MODULE	0000
1/8 X 3/16 X 7	1/8 X 3/16 X 7	1/8 X 3/16 X 7	1/8 X 3/16 X 7

NOTE:
1. FINISH FOR ALL PARTS: ALODINE

Orbiter Aft, Interstage Fitting Ass'y
AD383-533 (N/C)

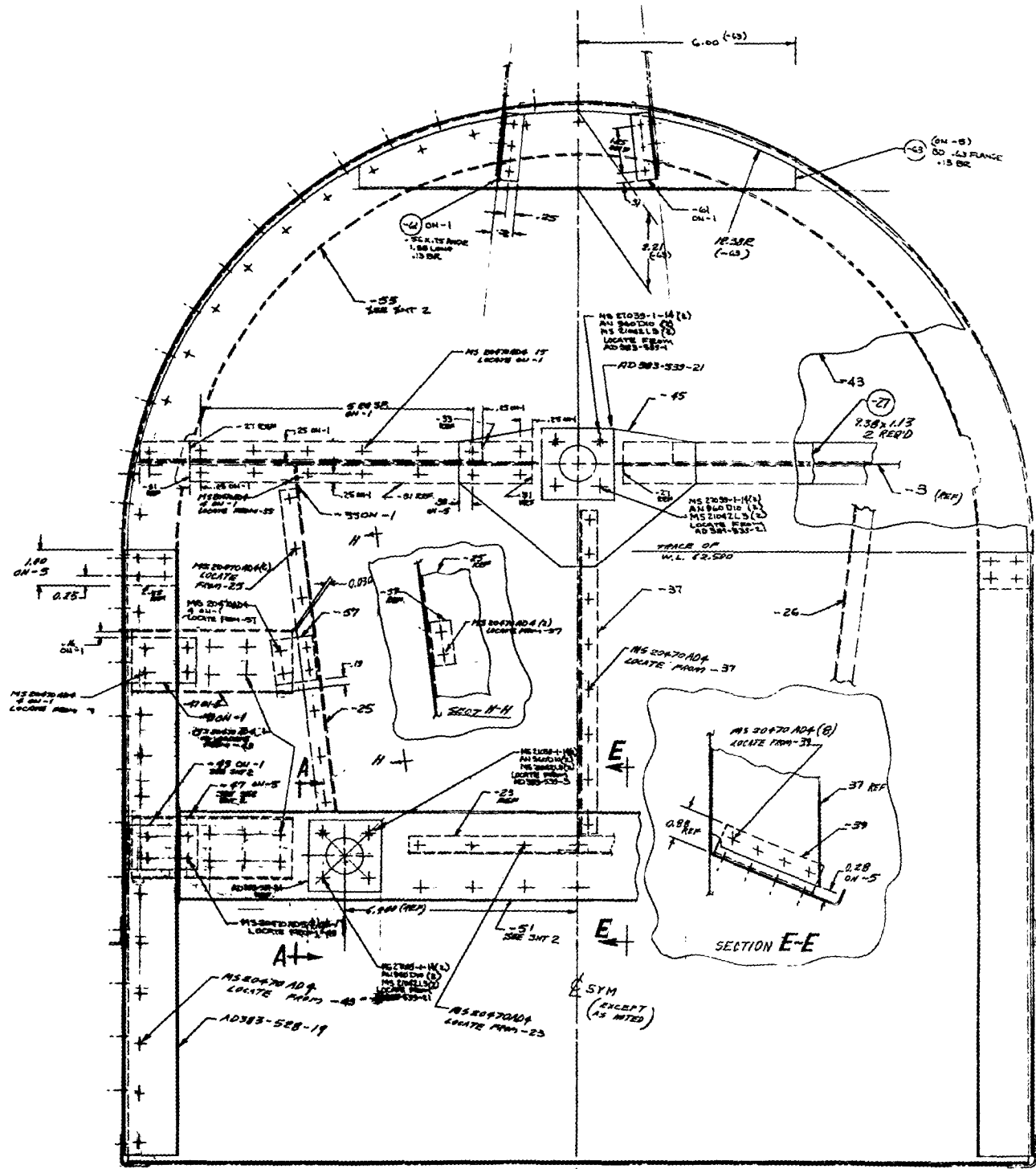

① INSTL SHN
② ASSY SHN

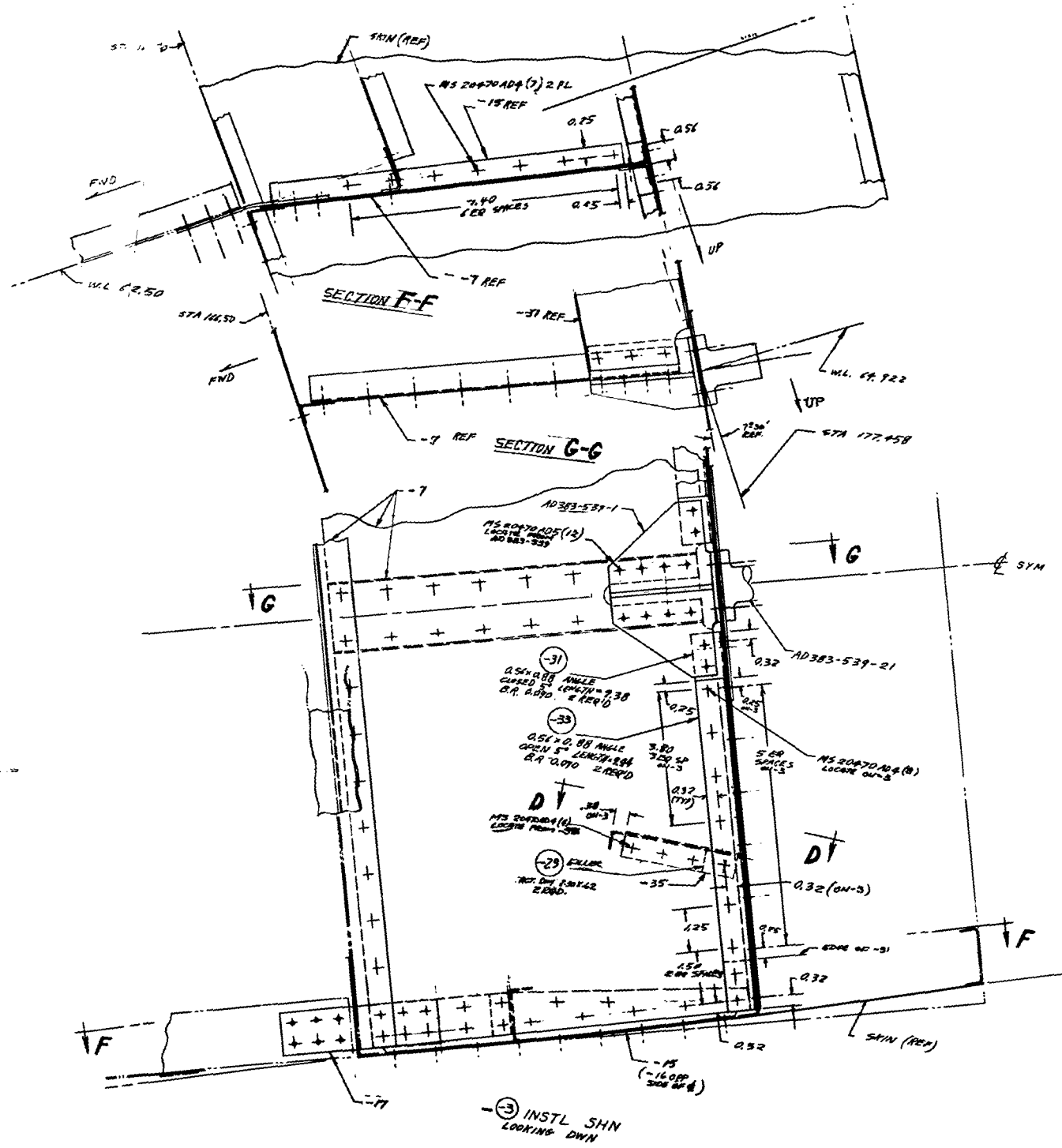

① INSTL SHN
LOOKING DOWN

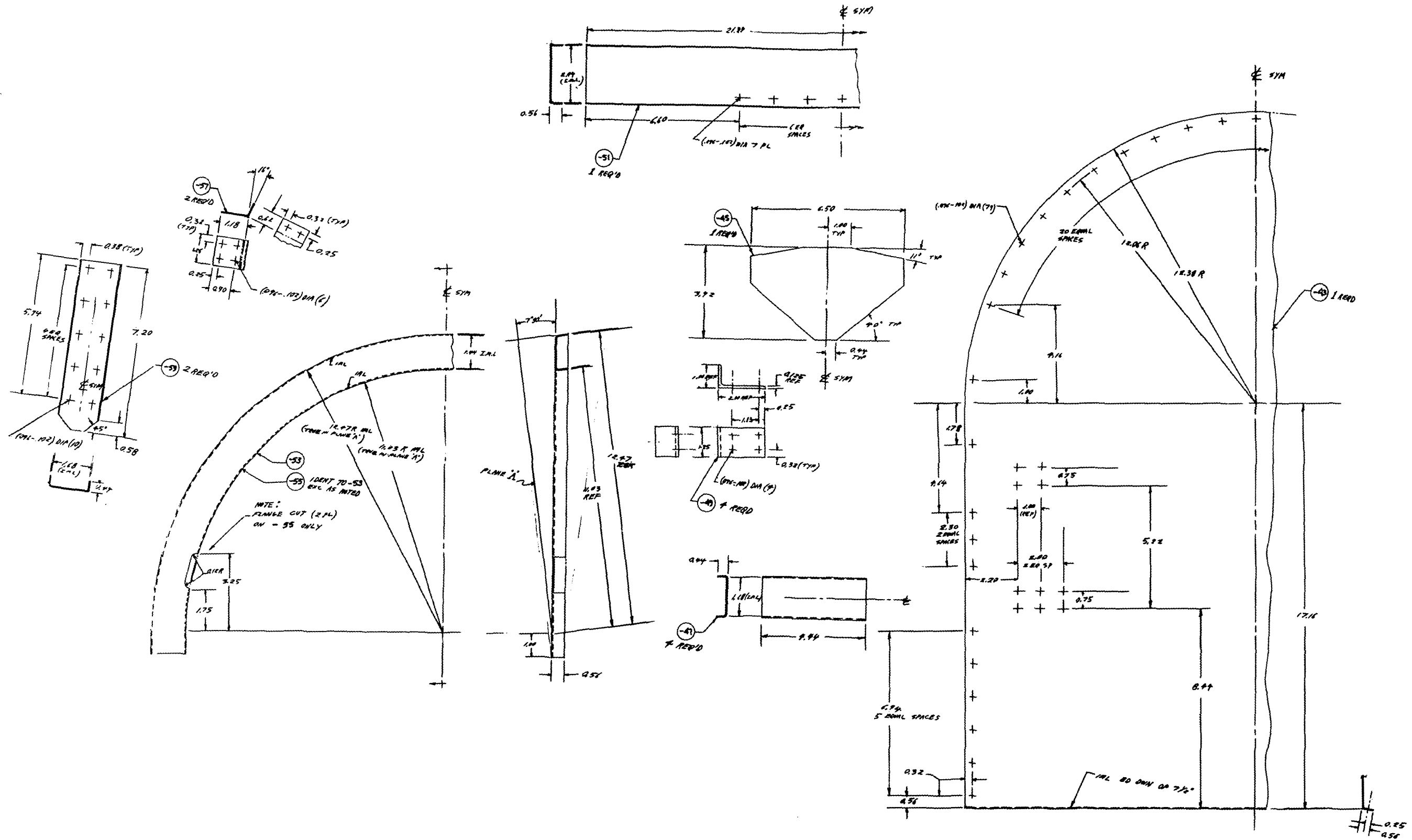

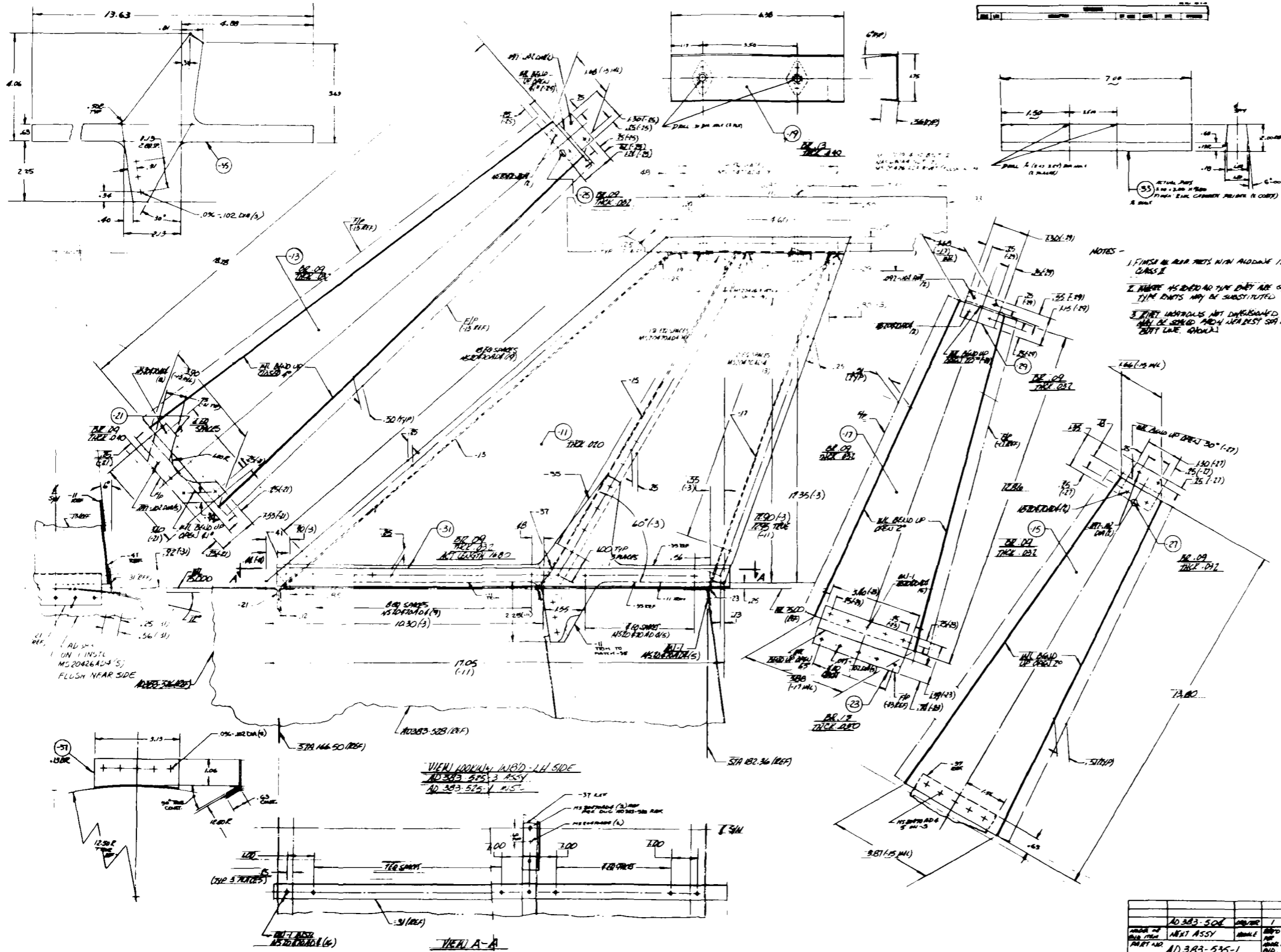

NOTES -
 1 FINISH ALL AREA WITH NYLON ANODINE 1200 PER MIL-C-5541 CLASS II
 2 WHERE REQUIRED THE DIMS ARE SPECIFIED IN INCHES UNLESS OTHERWISE NOTED
 3 DIMS UNLESS OTHERWISE SPECIFIED IN FEET OR INCHES SHALL BE IN INCHES UNLESS OTHERWISE NOTED
 4 ALL DIMS ARE TO DIM LINE UNLESS OTHERWISE NOTED

NO.	DESCRIPTION	QTY	UNIT	ASSEMBLY	REF.
4	-65	SKIN		AD 383-504	1
2	-43	GUSSET		AD 383-504	1
1	-41	FILLER		AD 383-504	1
1	-40	ANGLE - EX		AD 383-504	1
1	-39	ANGLE - LH		AD 383-504	1
2	-38	WASHER		AD 383-504	1
2	-37	SCREW		AD 383-504	1
2	-36	SCREW		AD 383-504	1
2	-35	SCREW		AD 383-504	1
2	-34	SCREW		AD 383-504	1
2	-33	SCREW		AD 383-504	1
2	-32	SCREW		AD 383-504	1
2	-31	SCREW		AD 383-504	1
2	-30	SCREW		AD 383-504	1
2	-29	SCREW		AD 383-504	1
2	-28	SCREW		AD 383-504	1
2	-27	SCREW		AD 383-504	1
2	-26	SCREW		AD 383-504	1
2	-25	SCREW		AD 383-504	1
2	-24	SCREW		AD 383-504	1
2	-23	SCREW		AD 383-504	1
2	-22	SCREW		AD 383-504	1
2	-21	SCREW		AD 383-504	1
2	-20	SCREW		AD 383-504	1
2	-19	SCREW		AD 383-504	1
2	-18	SCREW		AD 383-504	1
2	-17	SCREW		AD 383-504	1
2	-16	SCREW		AD 383-504	1
2	-15	SCREW		AD 383-504	1
2	-14	SCREW		AD 383-504	1
2	-13	SCREW		AD 383-504	1
2	-12	SCREW		AD 383-504	1
2	-11	SCREW		AD 383-504	1
1	-3	SKIN ASSY		AD 383-504	1
1	-2	SKIN ASSY		AD 383-504	1

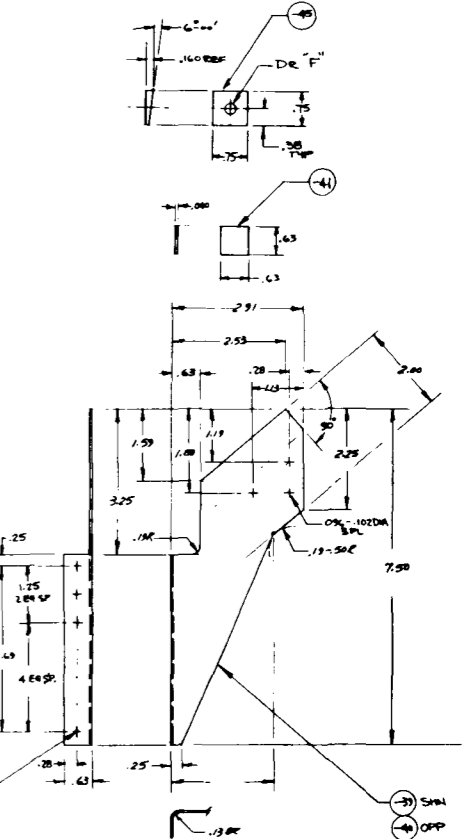

NO.	DESCRIPTION	QTY	UNIT	ASSEMBLY	REF.
1	AD 383-504	1	UNIT	AD 383-504	1
1	AD 383-505	1	UNIT	AD 383-505	1

Orbiter Fin
 Stub Installation
 AD 383-535 (A)

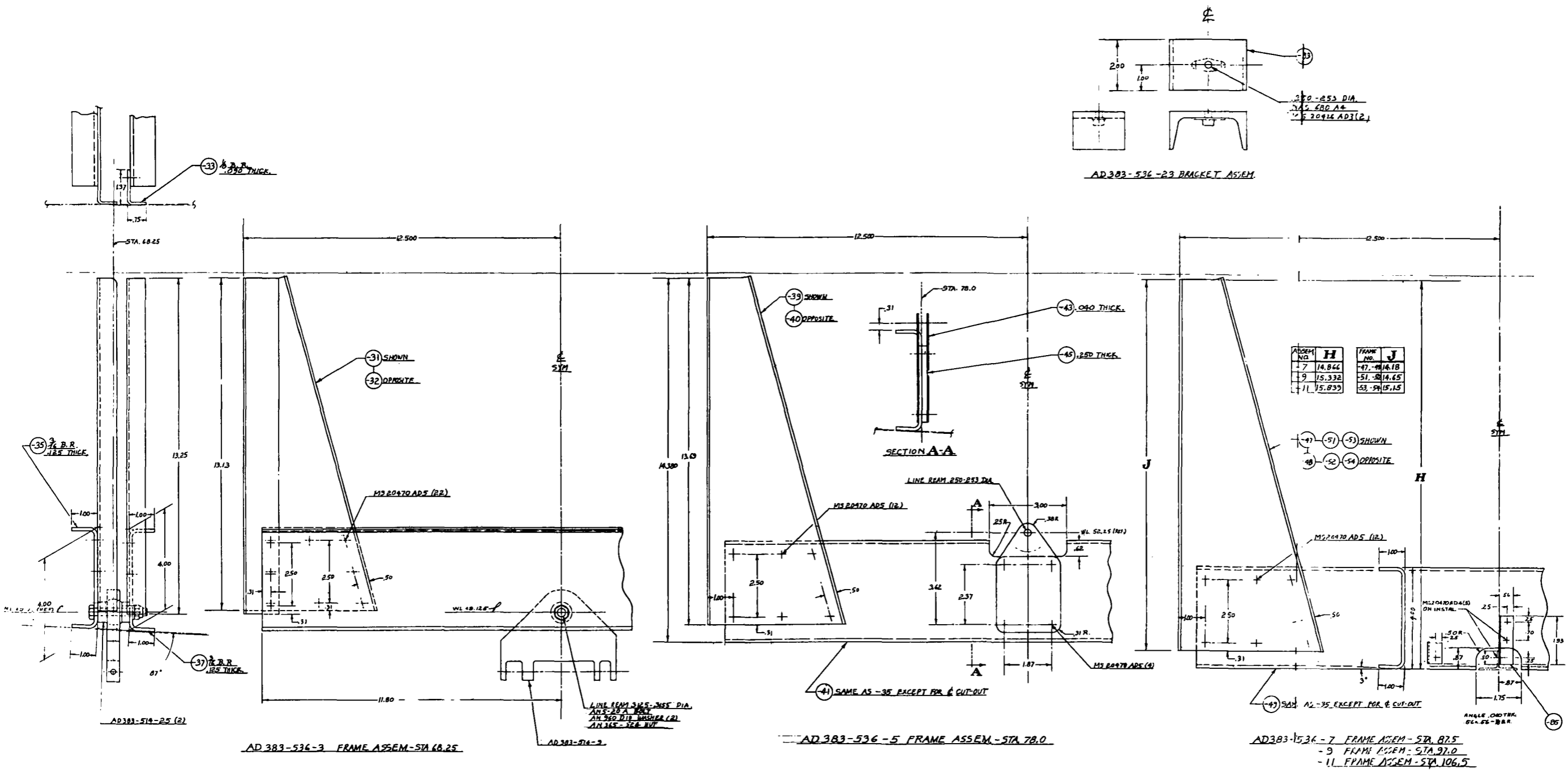

Orbiter Fuselage Forward Frame Ass'y (Sheet 1 of 3)

AD383-536 (C)

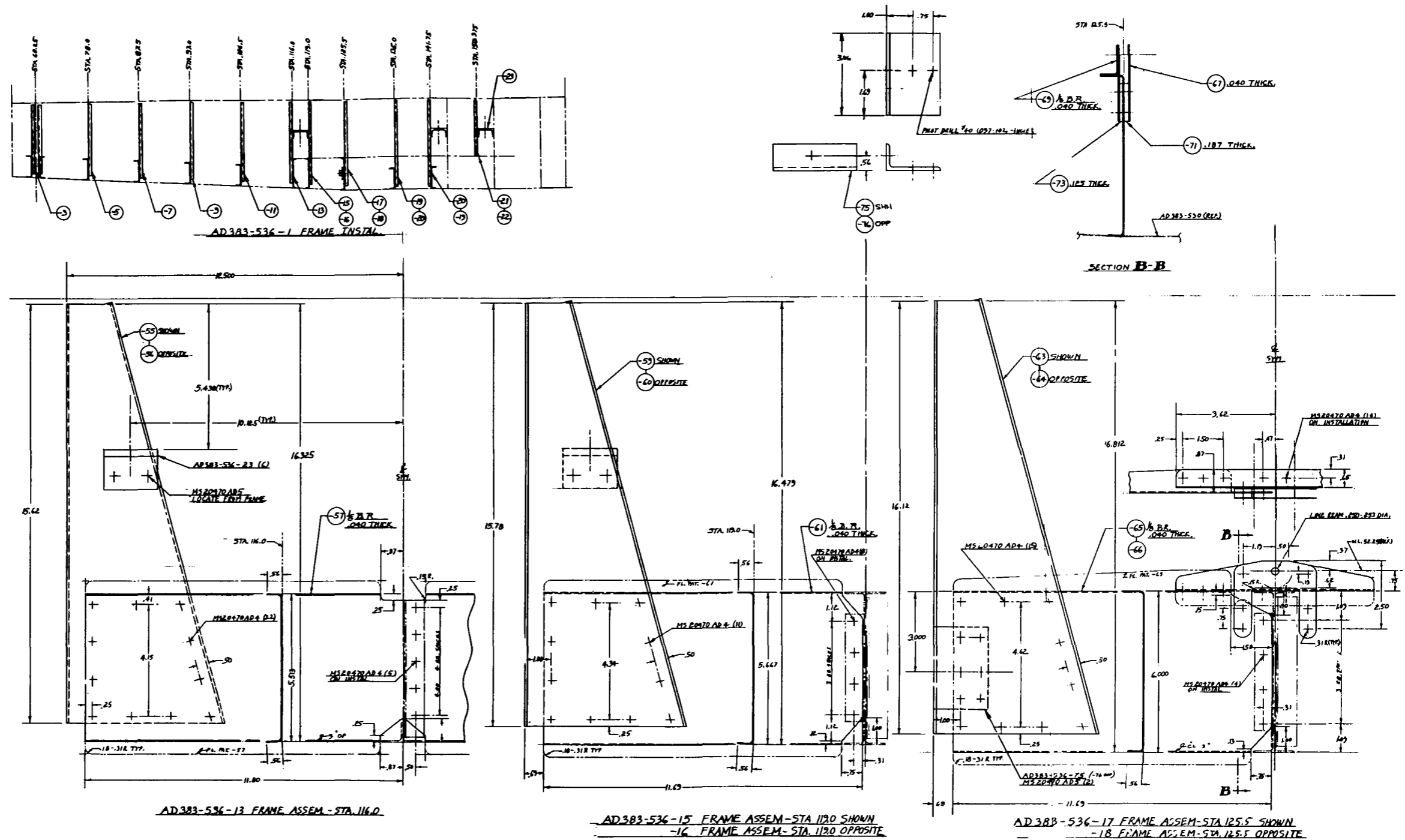

Orbiter Fuselage Forward Frame Ass'y (Sheet 2 of 3)

AD383-536 (C)

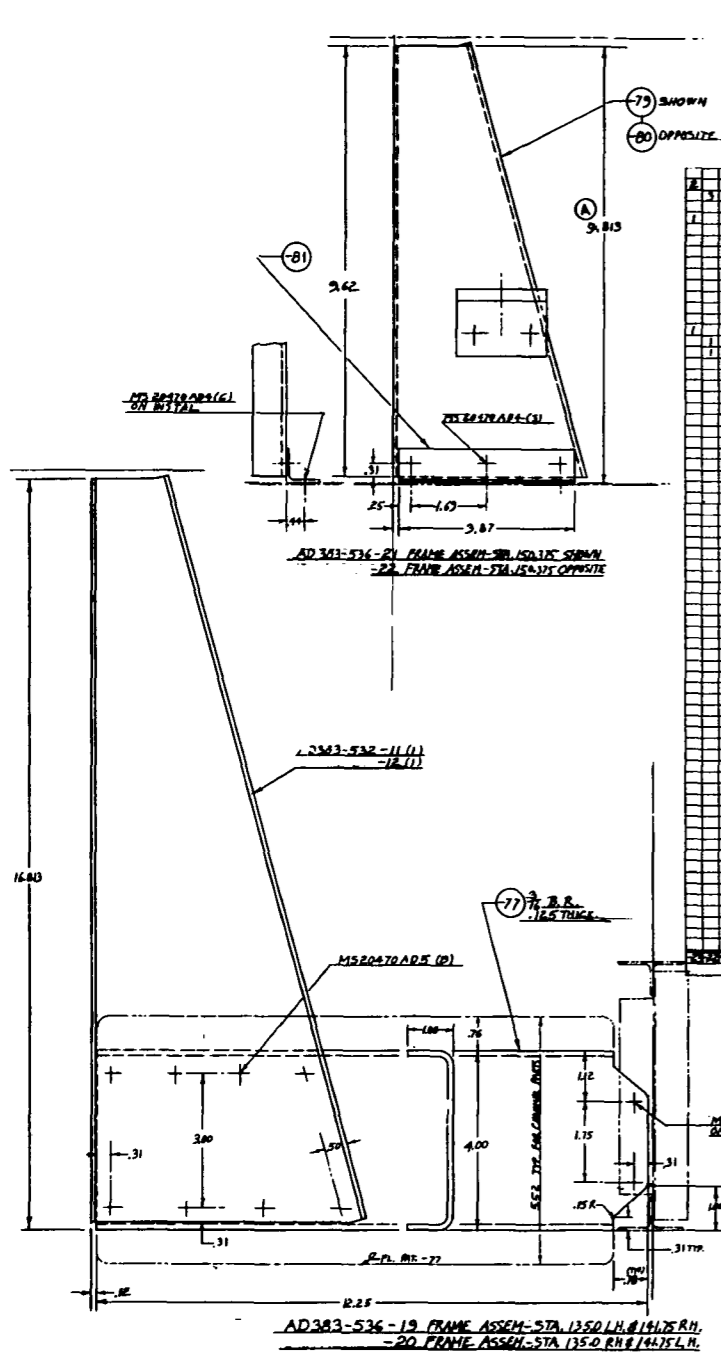

REV	DATE	DESCRIPTION	BY	CHK	APP
A	01-11-68	REVISED TO 10-875			
B	01-11-68	REVISED TO 10-875			
C	01-11-68	REVISED TO 10-875			

REV	DATE	DESCRIPTION	BY	CHK	APP
1		ASSEMBLY			
2		ASSEMBLY			
3		ASSEMBLY			
4		ASSEMBLY			
5		ASSEMBLY			
6		ASSEMBLY			
7		ASSEMBLY			
8		ASSEMBLY			
9		ASSEMBLY			
10		ASSEMBLY			
11		ASSEMBLY			
12		ASSEMBLY			
13		ASSEMBLY			
14		ASSEMBLY			
15		ASSEMBLY			
16		ASSEMBLY			
17		ASSEMBLY			
18		ASSEMBLY			
19		ASSEMBLY			
20		ASSEMBLY			
21		ASSEMBLY			
22		ASSEMBLY			
23		ASSEMBLY			
24		ASSEMBLY			
25		ASSEMBLY			
26		ASSEMBLY			
27		ASSEMBLY			
28		ASSEMBLY			
29		ASSEMBLY			
30		ASSEMBLY			
31		ASSEMBLY			
32		ASSEMBLY			
33		ASSEMBLY			
34		ASSEMBLY			
35		ASSEMBLY			
36		ASSEMBLY			
37		ASSEMBLY			
38		ASSEMBLY			
39		ASSEMBLY			
40		ASSEMBLY			
41		ASSEMBLY			
42		ASSEMBLY			
43		ASSEMBLY			
44		ASSEMBLY			
45		ASSEMBLY			
46		ASSEMBLY			
47		ASSEMBLY			
48		ASSEMBLY			
49		ASSEMBLY			
50		ASSEMBLY			
51		ASSEMBLY			
52		ASSEMBLY			
53		ASSEMBLY			
54		ASSEMBLY			
55		ASSEMBLY			
56		ASSEMBLY			
57		ASSEMBLY			
58		ASSEMBLY			
59		ASSEMBLY			
60		ASSEMBLY			
61		ASSEMBLY			
62		ASSEMBLY			
63		ASSEMBLY			
64		ASSEMBLY			
65		ASSEMBLY			
66		ASSEMBLY			
67		ASSEMBLY			
68		ASSEMBLY			
69		ASSEMBLY			
70		ASSEMBLY			
71		ASSEMBLY			
72		ASSEMBLY			
73		ASSEMBLY			
74		ASSEMBLY			
75		ASSEMBLY			
76		ASSEMBLY			
77		ASSEMBLY			
78		ASSEMBLY			
79		ASSEMBLY			
80		ASSEMBLY			
81		ASSEMBLY			
82		ASSEMBLY			
83		ASSEMBLY			
84		ASSEMBLY			
85		ASSEMBLY			
86		ASSEMBLY			
87		ASSEMBLY			
88		ASSEMBLY			
89		ASSEMBLY			
90		ASSEMBLY			
91		ASSEMBLY			
92		ASSEMBLY			
93		ASSEMBLY			
94		ASSEMBLY			
95		ASSEMBLY			
96		ASSEMBLY			
97		ASSEMBLY			
98		ASSEMBLY			
99		ASSEMBLY			
100		ASSEMBLY			

NOTE:
 1 - FINISH ALL PARTS TO DIMENSIONS
 2 - AS PER 8" X 1/2" X .07 CHANNEL

REV	DATE	DESCRIPTION	BY	CHK	APP
1		ASSEMBLY			
2		ASSEMBLY			
3		ASSEMBLY			
4		ASSEMBLY			
5		ASSEMBLY			
6		ASSEMBLY			
7		ASSEMBLY			
8		ASSEMBLY			
9		ASSEMBLY			
10		ASSEMBLY			
11		ASSEMBLY			
12		ASSEMBLY			
13		ASSEMBLY			
14		ASSEMBLY			
15		ASSEMBLY			
16		ASSEMBLY			
17		ASSEMBLY			
18		ASSEMBLY			
19		ASSEMBLY			
20		ASSEMBLY			
21		ASSEMBLY			
22		ASSEMBLY			
23		ASSEMBLY			
24		ASSEMBLY			
25		ASSEMBLY			
26		ASSEMBLY			
27		ASSEMBLY			
28		ASSEMBLY			
29		ASSEMBLY			
30		ASSEMBLY			
31		ASSEMBLY			
32		ASSEMBLY			
33		ASSEMBLY			
34		ASSEMBLY			
35		ASSEMBLY			
36		ASSEMBLY			
37		ASSEMBLY			
38		ASSEMBLY			
39		ASSEMBLY			
40		ASSEMBLY			
41		ASSEMBLY			
42		ASSEMBLY			
43		ASSEMBLY			
44		ASSEMBLY			
45		ASSEMBLY			
46		ASSEMBLY			
47		ASSEMBLY			
48		ASSEMBLY			
49		ASSEMBLY			
50		ASSEMBLY			
51		ASSEMBLY			
52		ASSEMBLY			
53		ASSEMBLY			
54		ASSEMBLY			
55		ASSEMBLY			
56		ASSEMBLY			
57		ASSEMBLY			
58		ASSEMBLY			
59		ASSEMBLY			
60		ASSEMBLY			
61		ASSEMBLY			
62		ASSEMBLY			
63		ASSEMBLY			
64		ASSEMBLY			
65		ASSEMBLY			
66		ASSEMBLY			
67		ASSEMBLY			
68		ASSEMBLY			
69		ASSEMBLY			
70		ASSEMBLY			
71		ASSEMBLY			
72		ASSEMBLY			
73		ASSEMBLY			
74		ASSEMBLY			
75		ASSEMBLY			
76		ASSEMBLY			
77		ASSEMBLY			
78		ASSEMBLY			
79		ASSEMBLY			
80		ASSEMBLY			
81		ASSEMBLY			
82		ASSEMBLY			
83		ASSEMBLY			
84		ASSEMBLY			
85		ASSEMBLY			
86		ASSEMBLY			
87		ASSEMBLY			
88		ASSEMBLY			
89		ASSEMBLY			
90		ASSEMBLY			
91		ASSEMBLY			
92		ASSEMBLY			
93		ASSEMBLY			
94		ASSEMBLY			
95		ASSEMBLY			
96		ASSEMBLY			
97		ASSEMBLY			
98		ASSEMBLY			
99		ASSEMBLY			
100		ASSEMBLY			

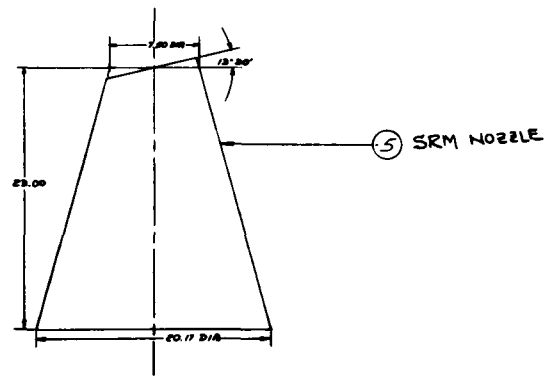
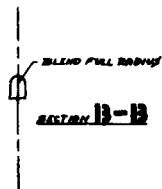
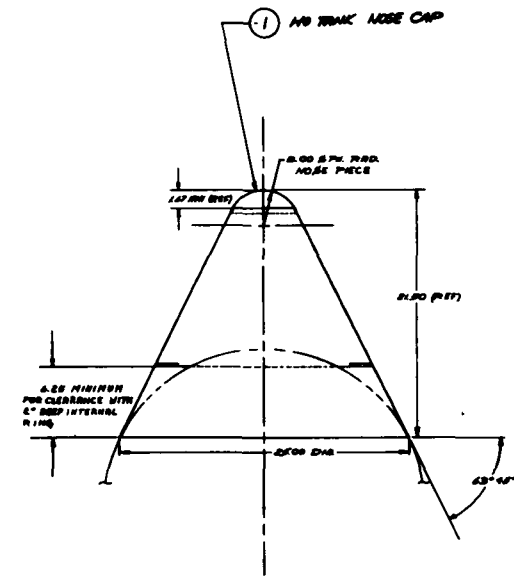
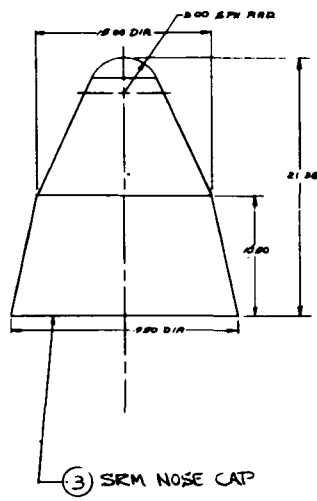
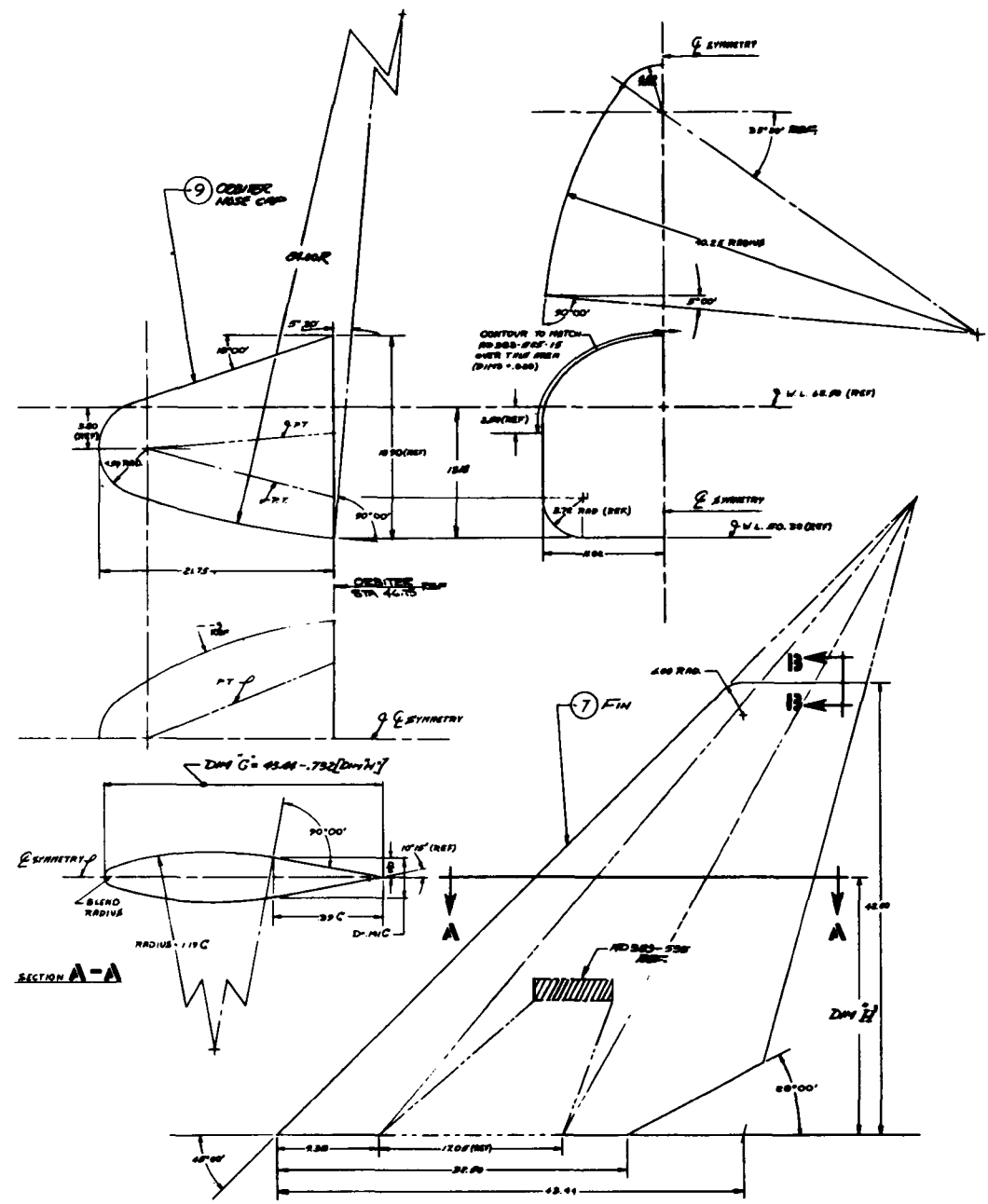

QTY	PART NO.	DESCRIPTION	MATL SPEC	MATERIAL	STOCK SIZE	STOCK NO.
	10	WING LE - R/M				
	11	WING LE - L/M				
	12	WING TIP - R/M				
	13	WING TIP - L/M				
	14	WING SE - R/M				
	15	WING SE - L/M				
	16	NOSE CAP - ORBITER				
	17	FIN - ORBITER				
	18	NOZZLE - SRM				
	19	NOSE CAP - SRM				
	20	NOSE PIECE - SRM				

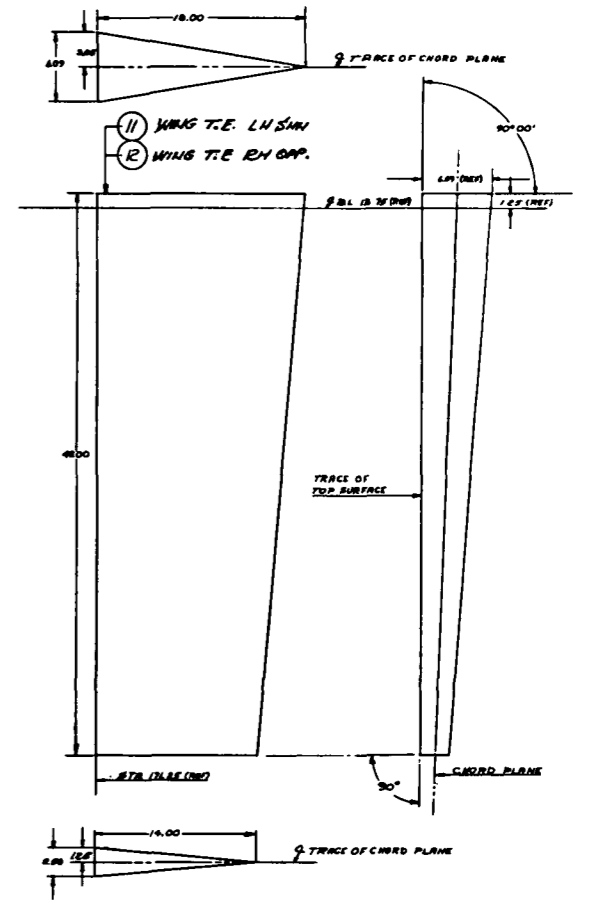
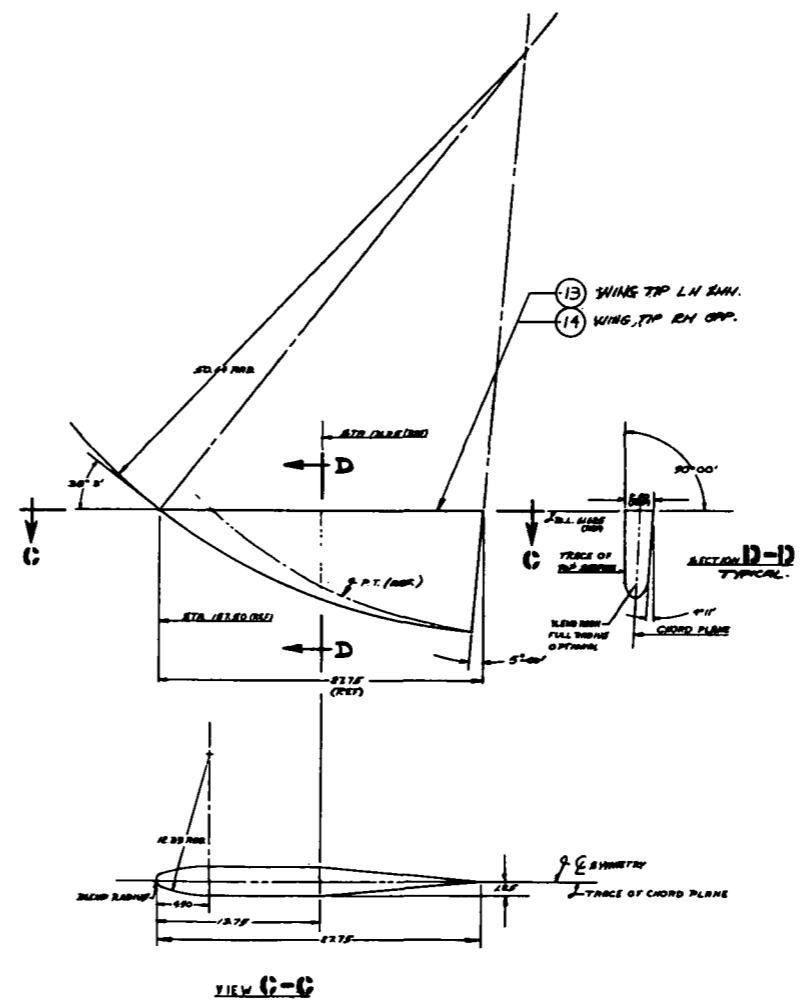
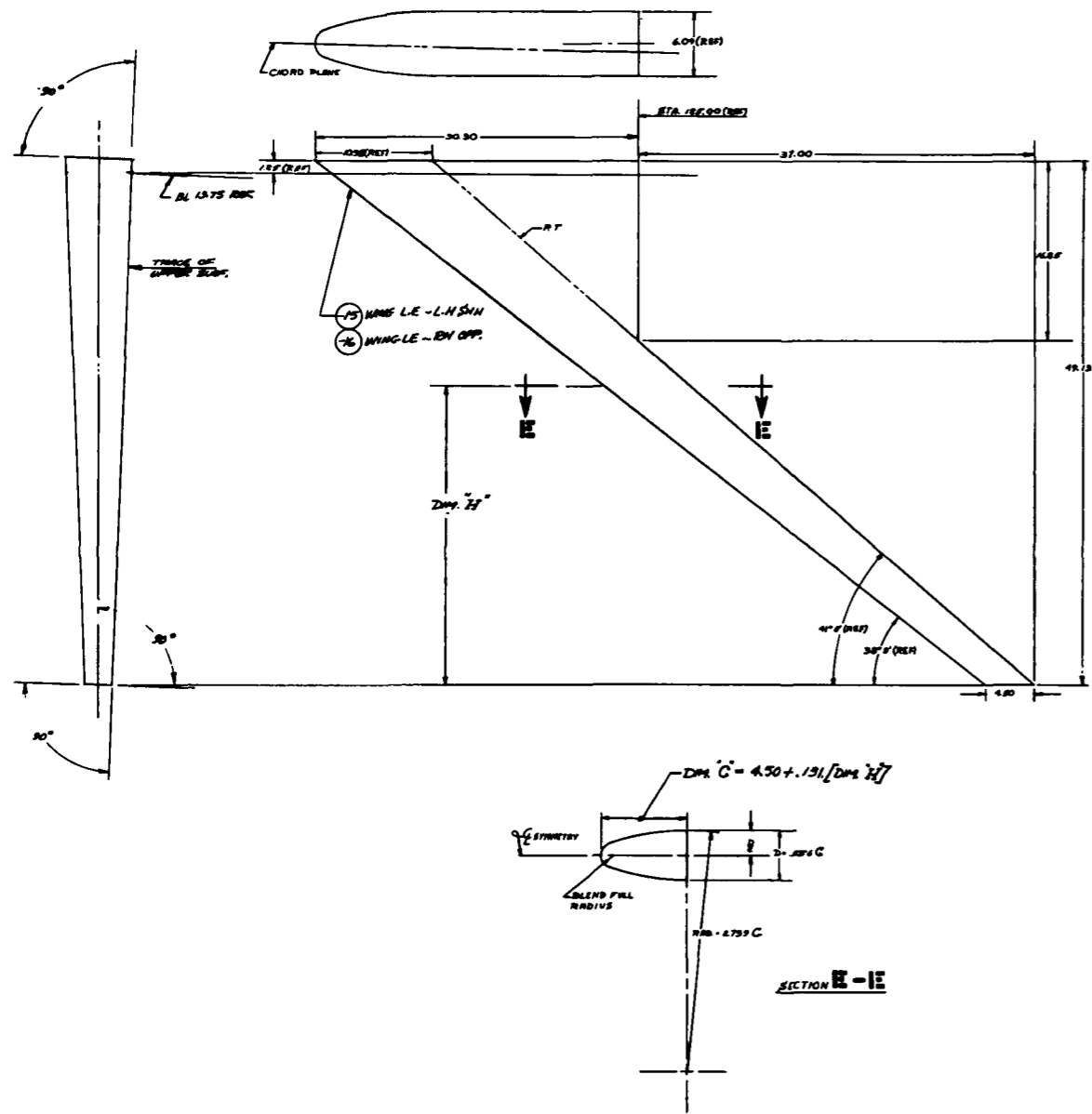

REV	DATE	BY	CHK	APP

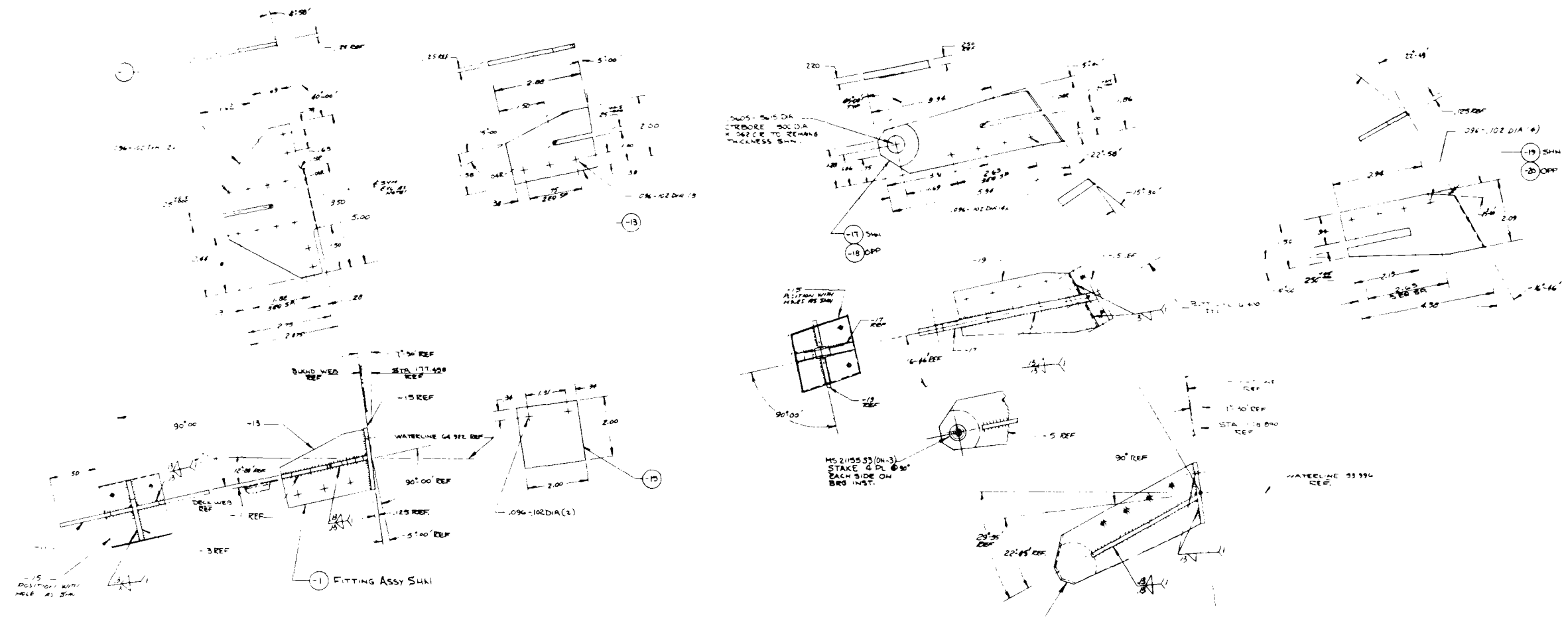

NOTES:-
 1- FUSION WELD -1-58-6 FEE MIL-W-56-4 USING AGAS FILLER ROD NO HEAT TREAT REQ AFTER WELDING
 2 FINISH -1, -5 -6 & -21 - ALDINE

- ③ FITTG ASSY SHN
- ④ FITTG ASSY CPT
- ⑤ WELDED ASSY SHN
- ⑥ WELDED ASSY OPT

QTY PER ASSY	PART NO	DESCRIPTION	GOVT SPEC	MATERIAL	STOCK QTY	REF
1	MS 2155 S3	BEARING	GOVT STD	2024-T4 RAC	1.00	2
1	AD 383-539-21	FITTING	GO-A-125/A	2024-T4 SHT	1.00	3
1	AD 383-539-22	PLATE	GO-A-125/A	2024-T4 SHT	1.00	4
1	19	PLATE	GO-A-125/A	2024-T4 SHT	1.00	5
1	18	LUG	GO-A-125/A	2024-T4 SHT	1.00	6
1	17	LUG	GO-A-125/A	2024-T4 SHT	1.00	7
1	15	PLATE	GO-A-125/A	2024-T4 SHT	1.00	8
1	14	PLATE	GO-A-125/A	2024-T4 SHT	1.00	9
1	11	PLATE	GO-A-125/A	2024-T4 SHT	1.00	10
1	6	WELDED ASSY				
1	5	WELDED ASSY				
1	4	FITTING ASSY				
1	3	FITTING ASSY				
1	AD 383-539-11	FITTING ASSY				

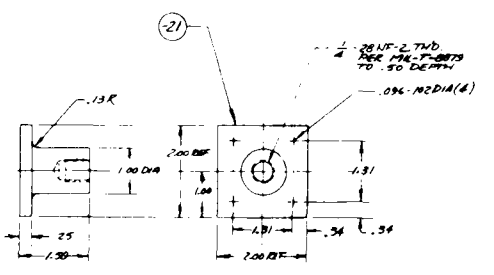

MODEL OR END VIEW	AD 383-534	ORIGIN	1 EA
NEXT ASSY		MODEL	
PART NO	AD 383-539-1-58-4	MODEL OR END VIEW	

MODEL OR END VIEW	AD 383-534	ORIGIN	3
NEXT ASSY		MODEL	
PART NO	AD 383-539-21	MODEL OR END VIEW	

Orbiter Engine Bulkhead
 (Sta 180.009) Fittings
 AD383-539 (N/C)

Appendix A2
NASTRAN MODEL II FINITE ELEMENT IDEALIZATION
SHOWING REVISIONS TO MODEL I

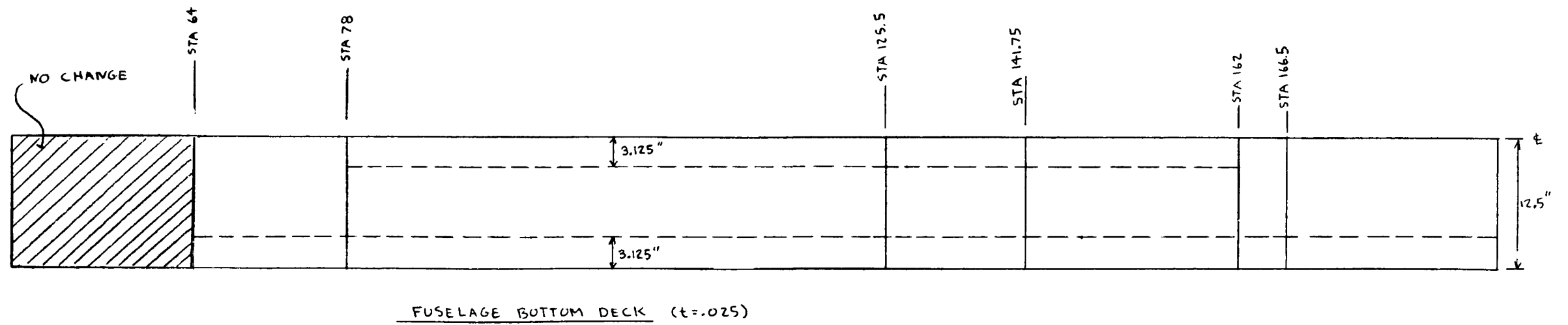
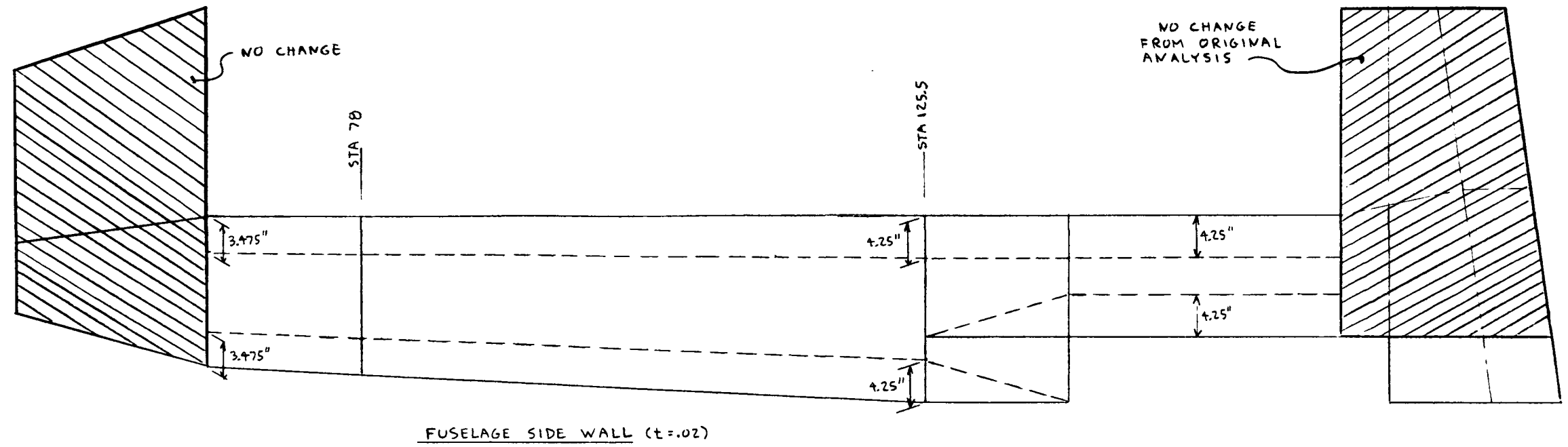

Fuselage Effective Skin Widths (When Skin is Half Effective Between Sta 78 and Sta 125.5)

INCLUDE BALLAST PLATE
CORNERS IN DYNAMIC
D.O.F. (A-SET)

DOUBLE NODES
MPC 243 Y+Z
TO 230

FUSELAGE SIDE WALL

UPPER LONGERON
TAKE OUT BEAM OFFSET,
AND ADD $I_{yy} = .002 \text{ in}^4$
(TO PICK UP DOOR INTERFACE LBS)

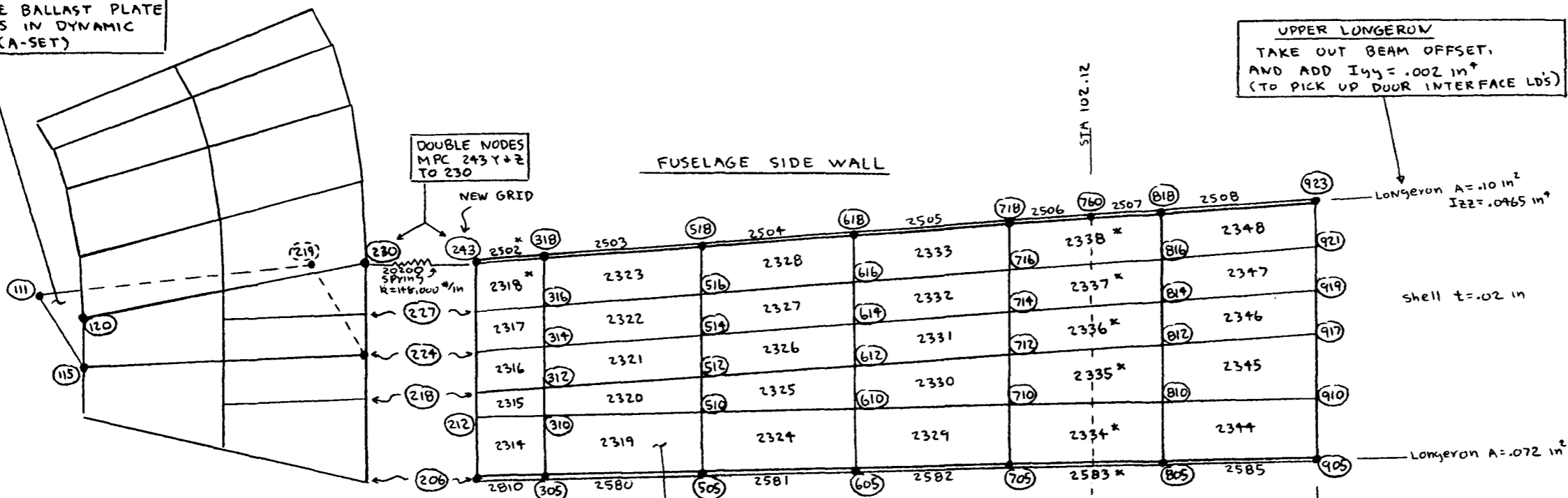

*NOTE: GRID DESIGNATION CHANGED FOR MEMBERS

REPLACE SHELL CQDMEMZ
ELEMENTS BY CSHEAR ELEMENTS

TAKE OUT GRID PTS. 751-759
CBARS 761-769 (FY)
CQDMEMZ 2230-2233
2339-2343
RODS 2584, 2568

TAKE OUT RODS 2563, 2564
GRID 401
+MPC FUY 401

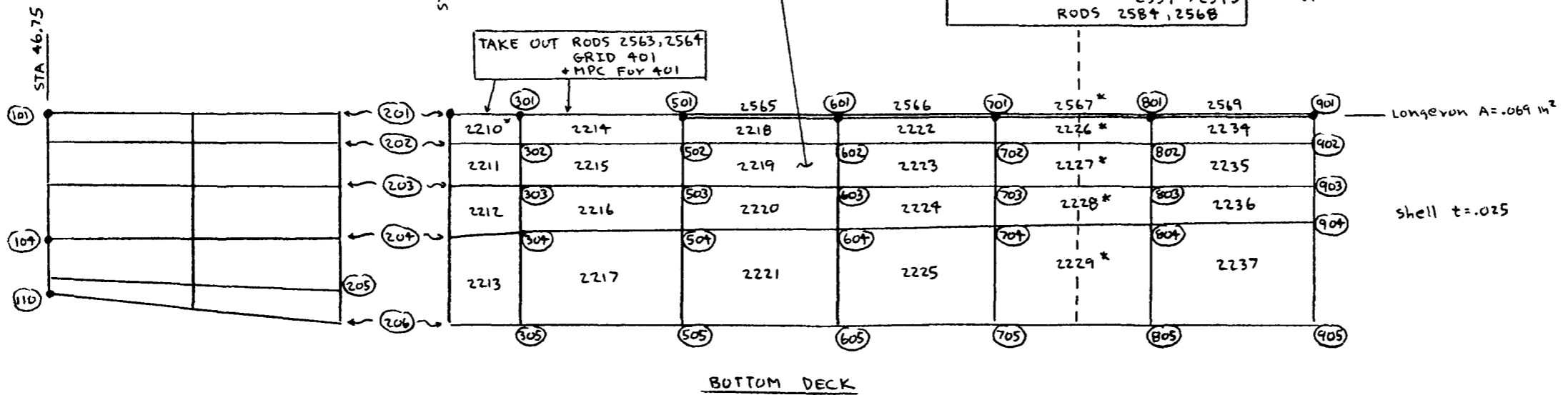

BOTTOM DECK

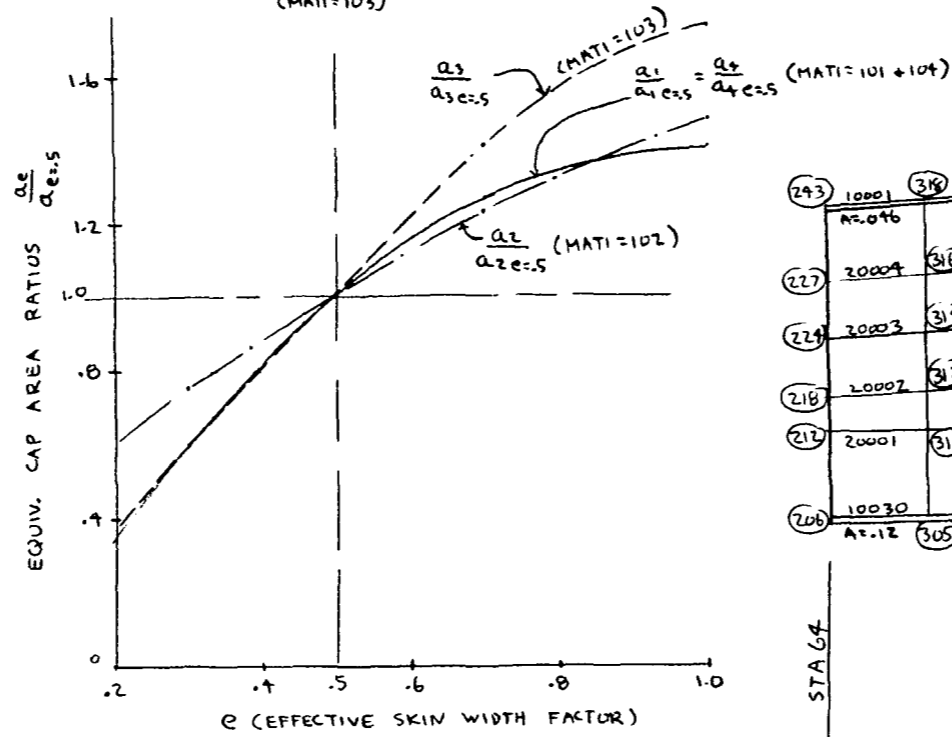
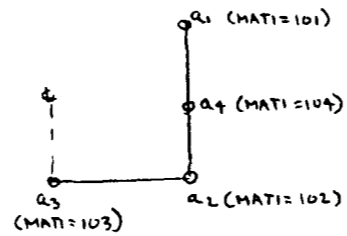

ANALYSIS set up for $e=.5$. FOR RE-ANALYSIS WITH different e , multiply the modulus of Elasticity (E) on appropriate MATI CARD by area ratio from above curves

FUSELAGE SIDE WALL

(293)	(318)	(518)	(618)	(718)	(818)	(923)
10001 A=.046	10002 A=.047	10003 A=.049	10004 A=.052	10005 A=.053	10006 A=.054	10007 A=.056
20004	20004	20011	20016	20020	20024	20028
(319)	(519)	(619)	(719)	(819)	(919)	
20003	20007	20010	20015	20019	20023	20027
(320)	(520)	(620)	(720)	(820)	(920)	
20002	20006	20010	20014	20018	20022	20026
(321)	(521)	(621)	(721)	(821)	(921)	
20001	20005	20009	20013	20017	20021	20025
(322)	(522)	(622)	(722)	(822)	(922)	
10030 A=.12	10031 A=.12	10032 A=.12	10033 A=.12	10034 A=.12	10035 A=.12	10035 A=.12

MINIMAL RODS 20001 → 20028 (A=.001)
 UPPER EQUIV. SKIN RODS 10001 → 10007 (HALF EFF. SKIN WIDTH) MATI=101
 LOWER OUTD EQUIV. SKIN RODS 10030 → 10035 " " MATI=102

MINIMAL RODS 20069 → 20089 (A=.001)
 30t RODS 20151 → 20155 (A=.015)
 LOWER & EQUIV. SKIN RODS 10050 → 10053 (HALF EFF. SKIN WIDTH) MATI=103

(201)	(301)	(501)	(601)	(701)	(801)	(901)
10050 A=.065	10051 A=.065	10052 A=.065	10053 A=.065	10054 A=.065	10055 A=.065	10056 A=.065
20069	20072	20075	20078	20081	20084	20087
(302)	(502)	(602)	(702)	(802)	(902)	
20070	20073	20076	20079	20082	20085	20088
(303)	(503)	(603)	(703)	(803)	(903)	
20071	20074	20077	20080	20083	20086	20089
(304)	(504)	(604)	(704)	(804)	(904)	
10050	10051	10052	10053	10054	10055	10056

BOTTOM DECK

Fuselage Additional Members—Sta 64 to Sta 116

* NOTE: GRID DESIGNATION CHANGED FOR MEMBERS

UPPER LONGERON
TAKE OUT BEAM OFFSET
AND ADD $I_{yy} = .002 \text{ in}^4$

LONGERON
 $A = .10 \text{ in}^2$
 $I_{zz} = .0465 \text{ in}^4$

FUSELAGE SIDE WALL

STA 129

STA 157.69

STA 166.5

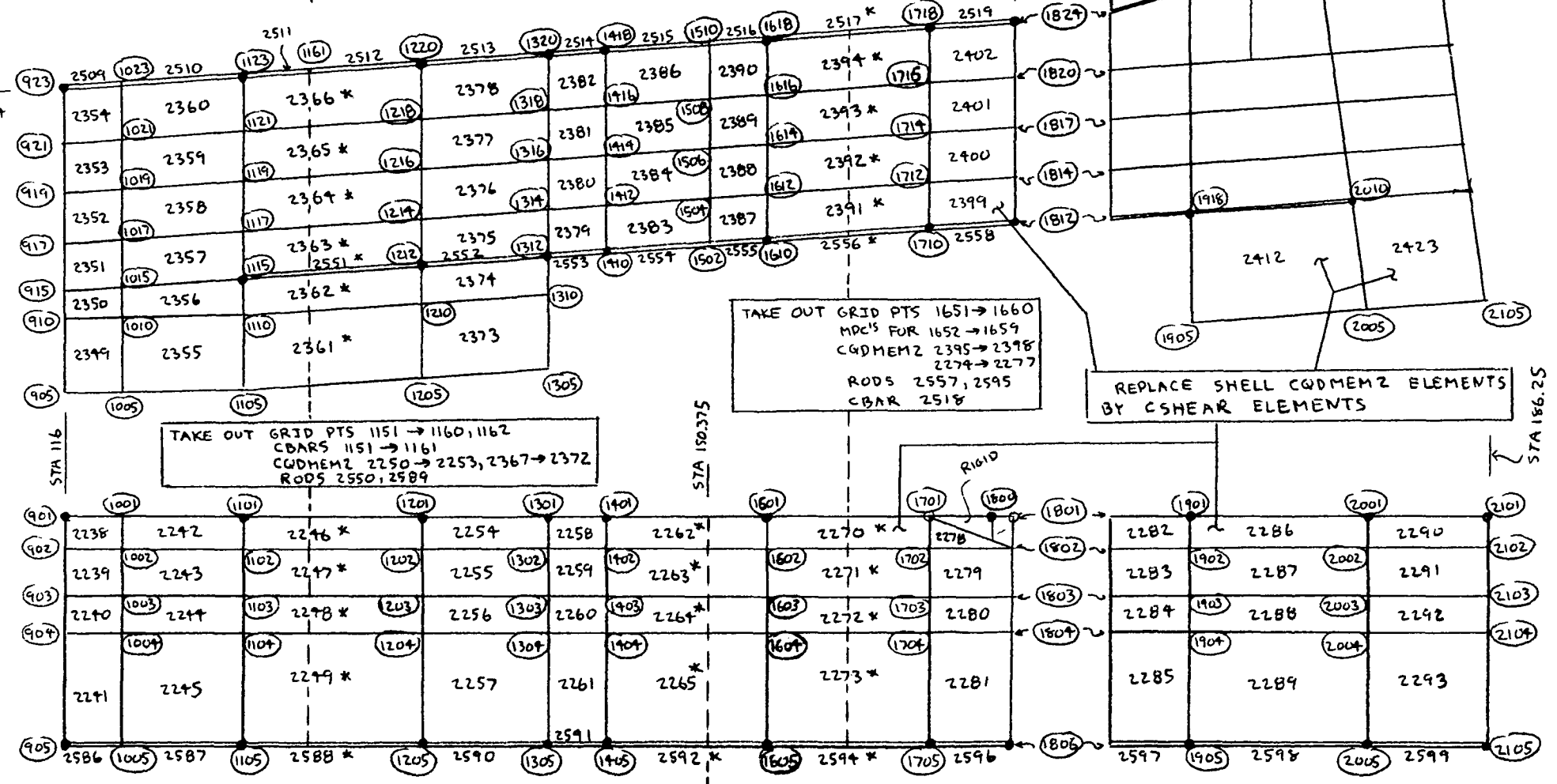

TAKE OUT GRID PTS 1151 → 1160, 1162
CBARS 1151 → 1161
CQDMEMZ 2250 → 2253, 2367 → 2372
RODS 2550, 2589

TAKE OUT GRID PTS 1651 → 1660
MPC'S FOR 1652 → 1659
CQDMEMZ 2395 → 2398
2274 → 2277
RODS 2557, 2595
CBAR 2518

REPLACE SHELL CQDMEMZ ELEMENTS
BY CSHEAR ELEMENTS

TAKE OUT GRID PTS 1511 → 1515
MPC'S FOR 1512 → 1515
CQDMEMZ 2266 → 2269
ROD 2593

BOTTOM DECK

MINIMAL RUDS 20029 → 20068 (A=.001)
 UPPER EQUIV. SKIN RUDS 10008 → 10017 (HALF EFF. SKIN WIDTH) MATI=101
 OUTBD EQUIV. SKIN RUDS 10020 → 10026 " MATI=104

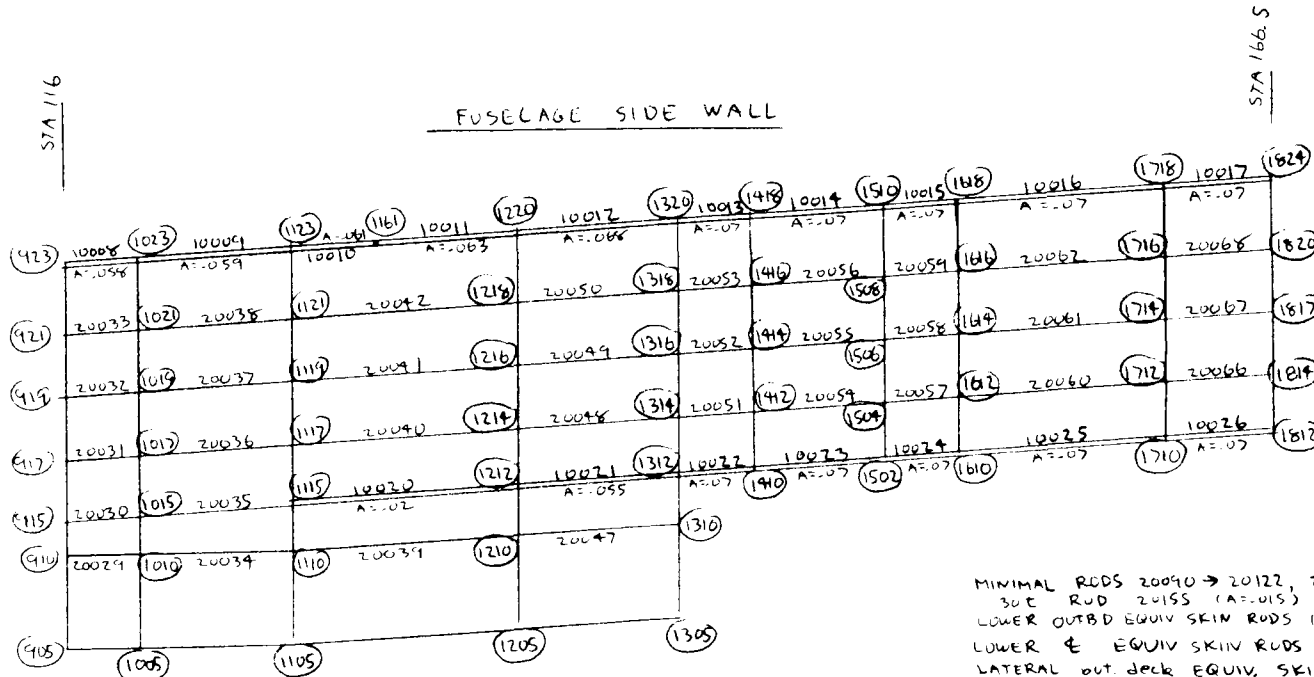

MINIMAL RUDS 20090 → 20122, 20161 → 20172 (A=.001)
 30° RUD 20155 (A=.015)
 LOWER OUTBD EQUIV SKIN RUDS 10036 → 10046 (HALF EFF SKIN WIDTH) MATI=102
 LOWER & EQUIV SKIN RUDS 10054 → 10060 " MATI=103
 LATERAL OUT. DECK EQUIV. SKIN RUDS 10061 → 10069, 10071 → 10074,
 10081 → 10084, 10091 → 10094,
 10101 → 10104, 10111 → 10114,
 10122 → 10125, 10131 → 10134

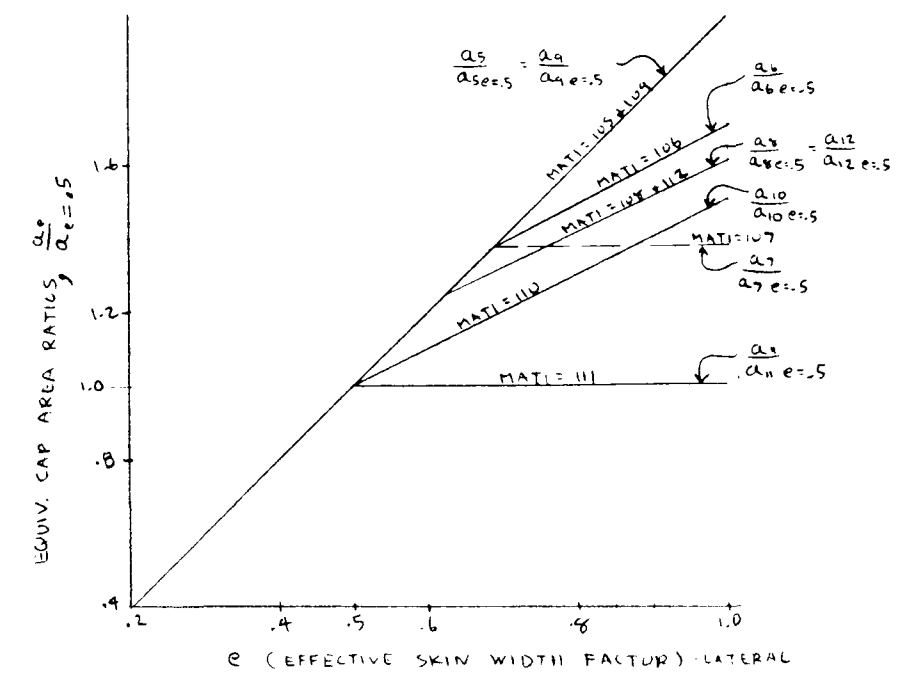
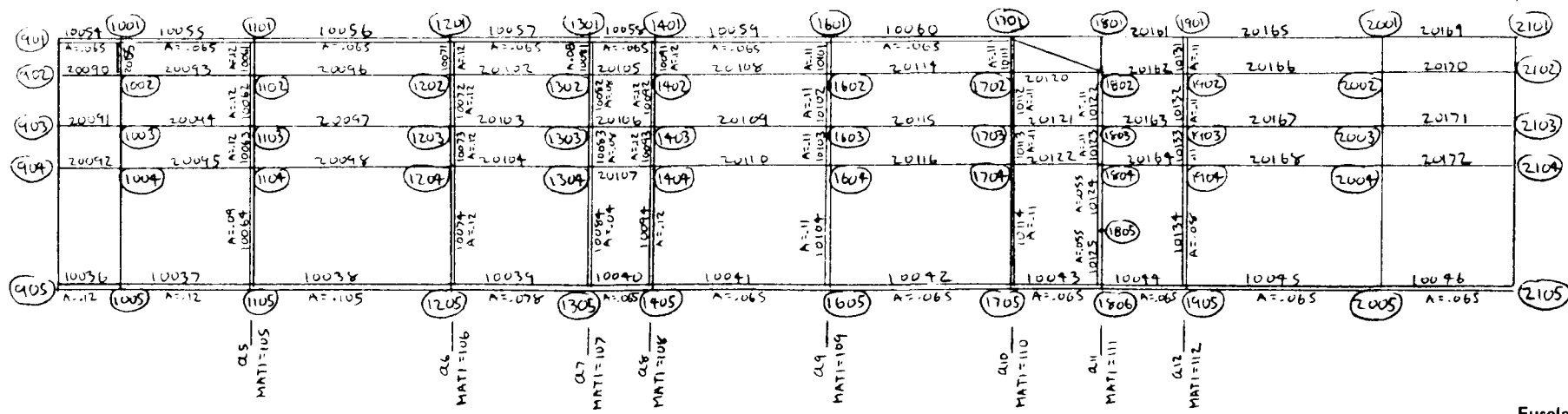

Fuselage Additional Members—Sta 116 to Sta 186.25

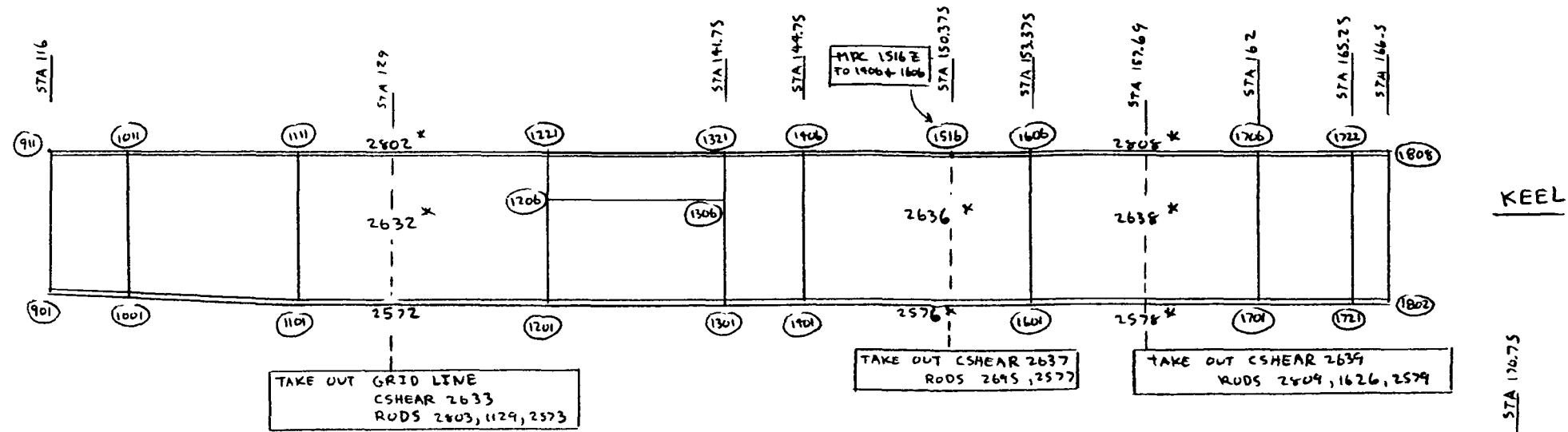

KEEL

* NOTE: GRID DESIGNATION CHANGED FOR MEMBERS

FUS. FRAMES IN WING ATTACHMENT AREA

original rod area = $\frac{t \cdot h}{6}$
Revise to $\frac{1}{2} \frac{t \cdot h}{6}$

STA	RODS	Revised AREA
125.5	1104, 1108	.03
135	1204, 1208	.056
141.75	1304, 1308	.086
144.75	1404, 1407	.03
153.75	1604, 1608	.03
162	1704, 1708	.03
166.5	1805, 1816	.03
170.75	1904, 1923	.03

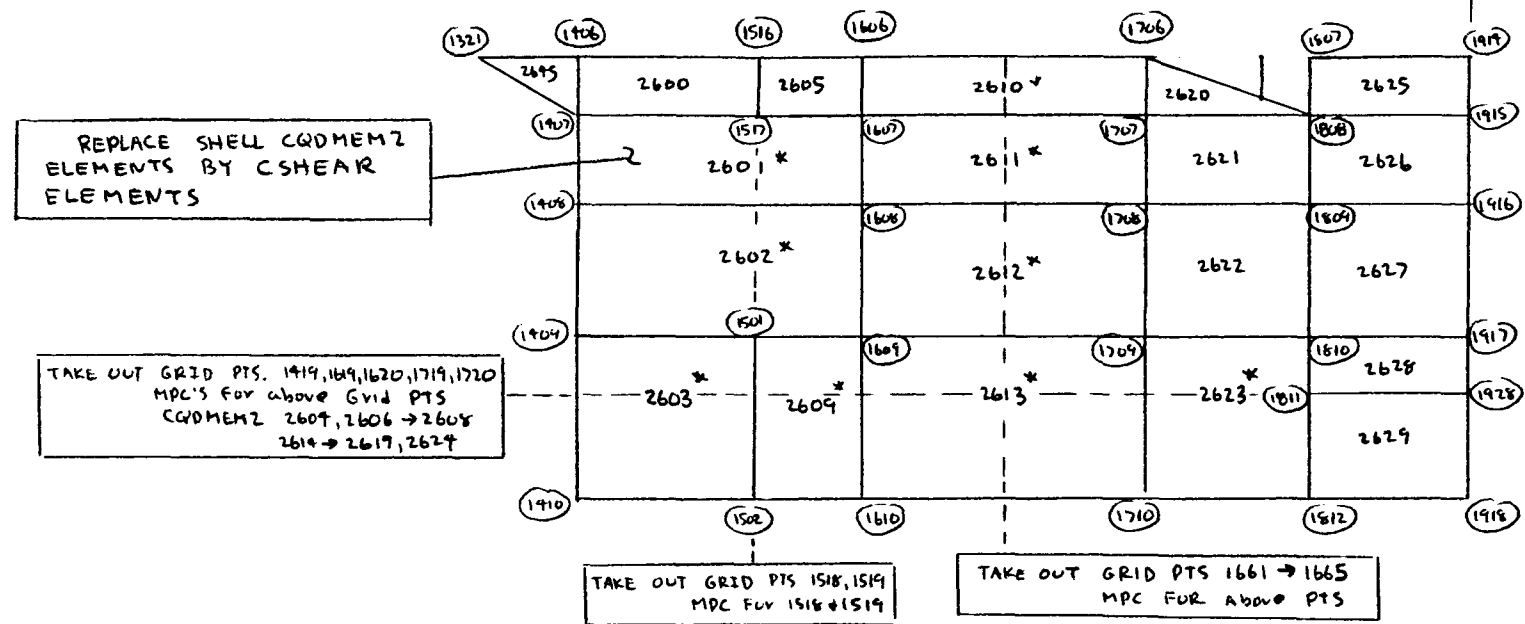

CARRY THRU DECK

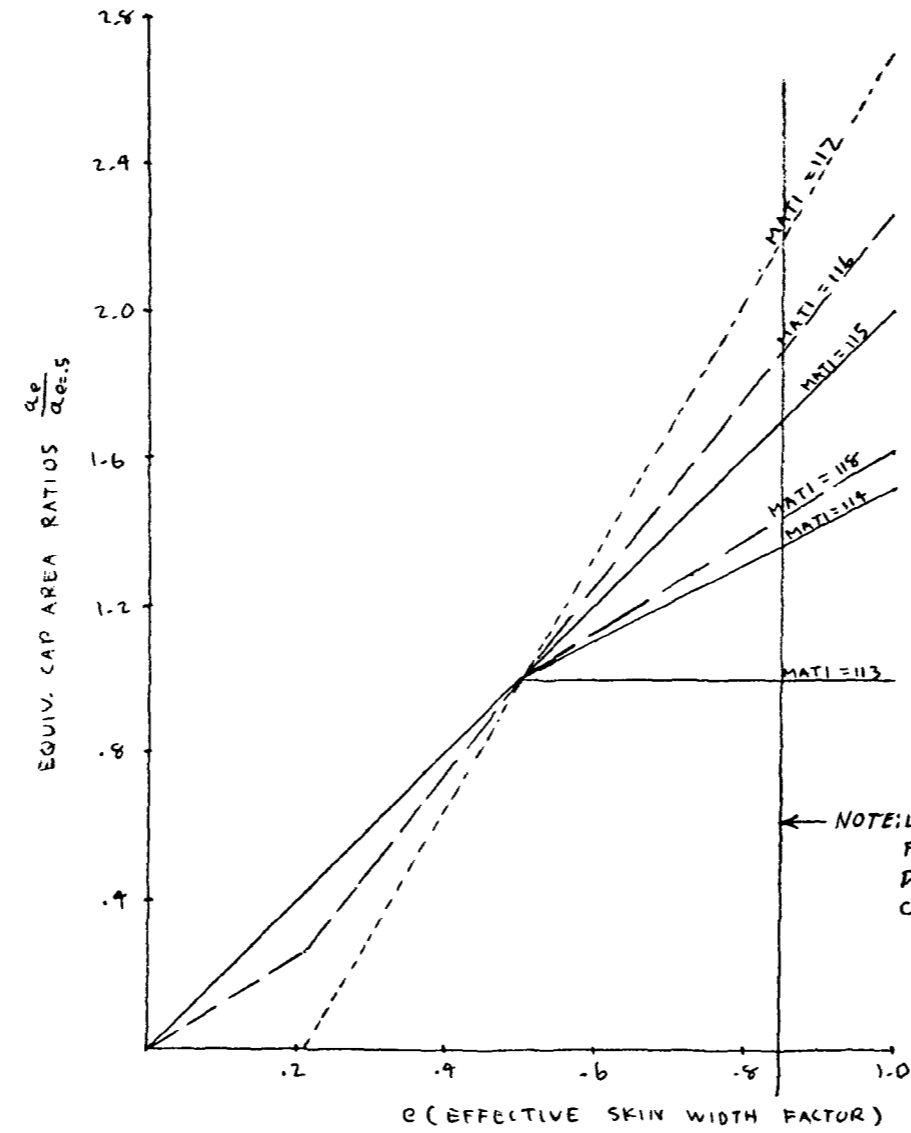

MINIMAL RODS 20124 → 20135 (A = .001)
 ROD 20136 (A = .02)
 LUMPED SKIN RODS 10151 → 10156 (A = .017)
 10160 → 10169 (MATI = 113)
 10170, 10171 (MATI = 114)
 10172 → 10178 (MATI = 115)
 10179 (MATI = 116)
 10180 (MATI = 117)
 10181 (MATI = 118)

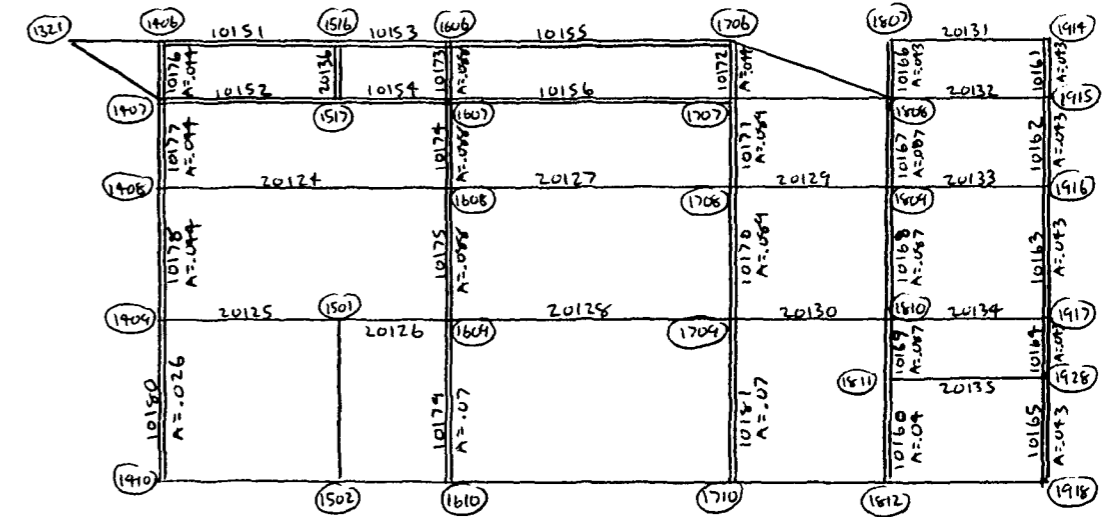

Fuselage Additional Members – Carry-Through Deck

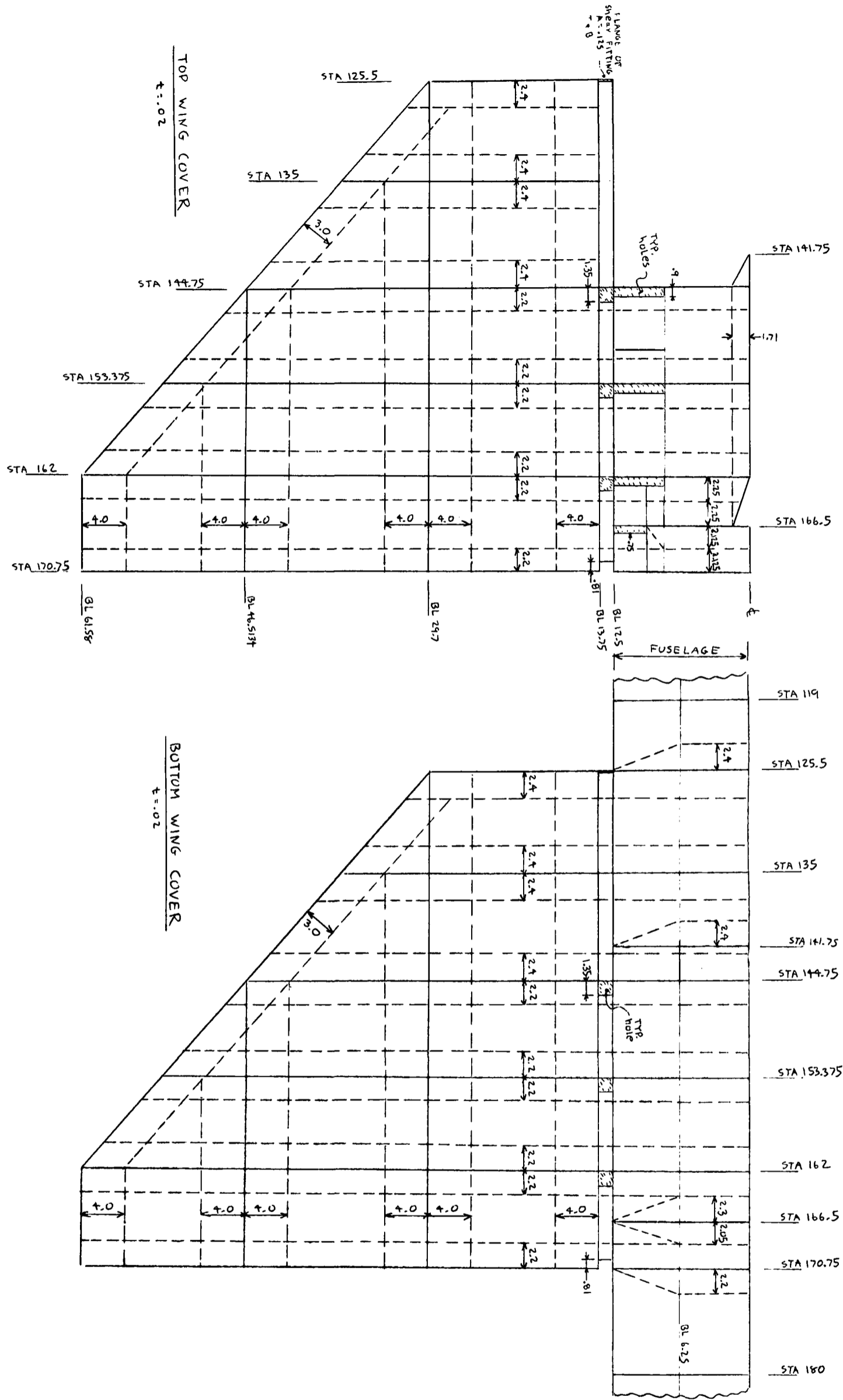

Wing Effective Skin Widths (When Skin is Half Effective)

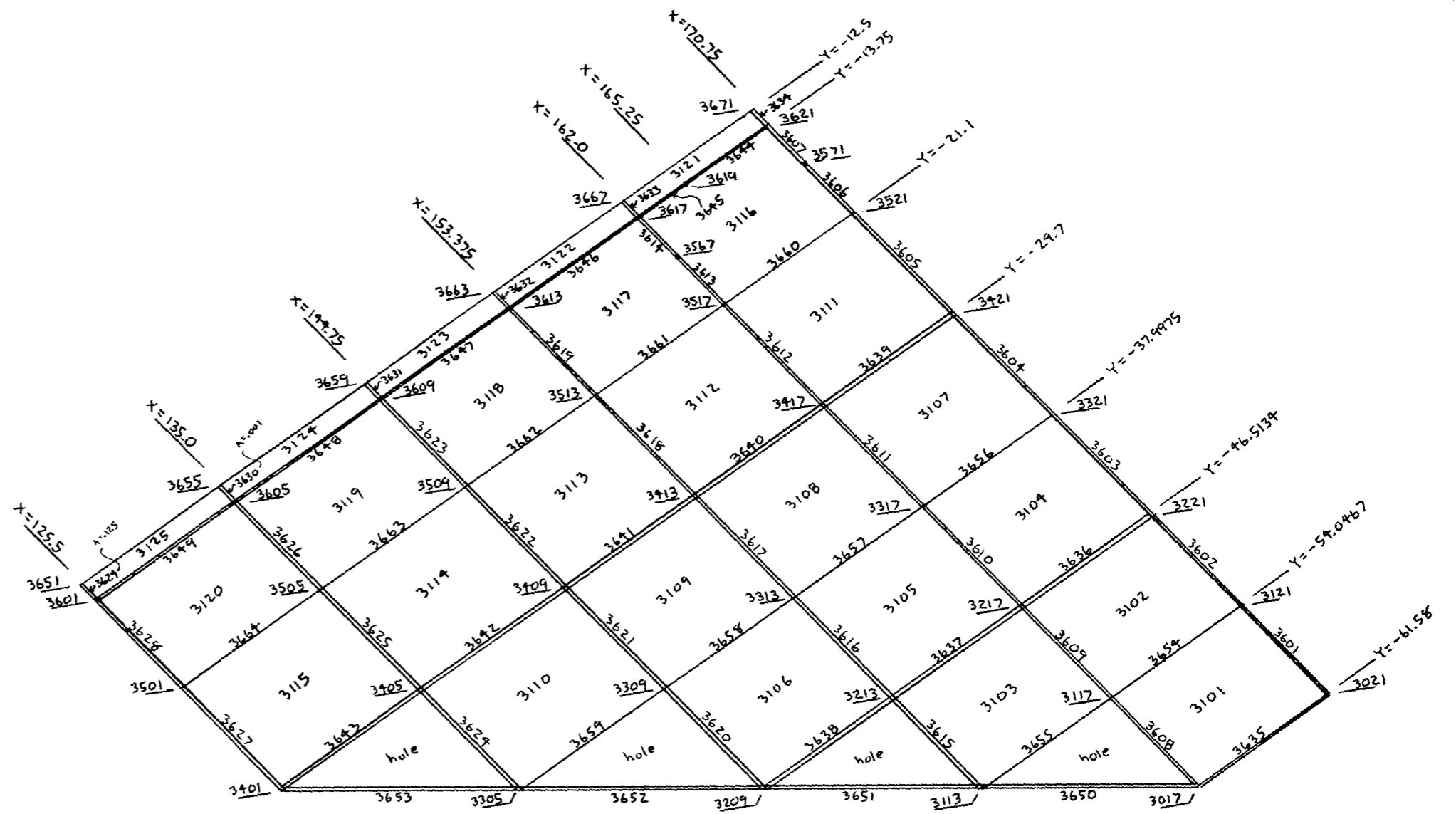

SKIN PANELS (CSHEAR) 3101 → 3125 ($t = .02, P = .1 \text{ */m}^2$)
 LUMPED EFF. SKIN RODS (SPAR DIR.) 3601 → 3634
 LUMPED EFF. SKIN RODS (RIB DIR.) 3635 → 3649
 LUMPED EFF. SKIN RODS (DIAGONAL EDGE) 3650 → 3653
 MINIMAL RODS (RIB DIR.) 3654 → 3664 ($A = .001$)

Revised Top Wing Cover (3/28/74)

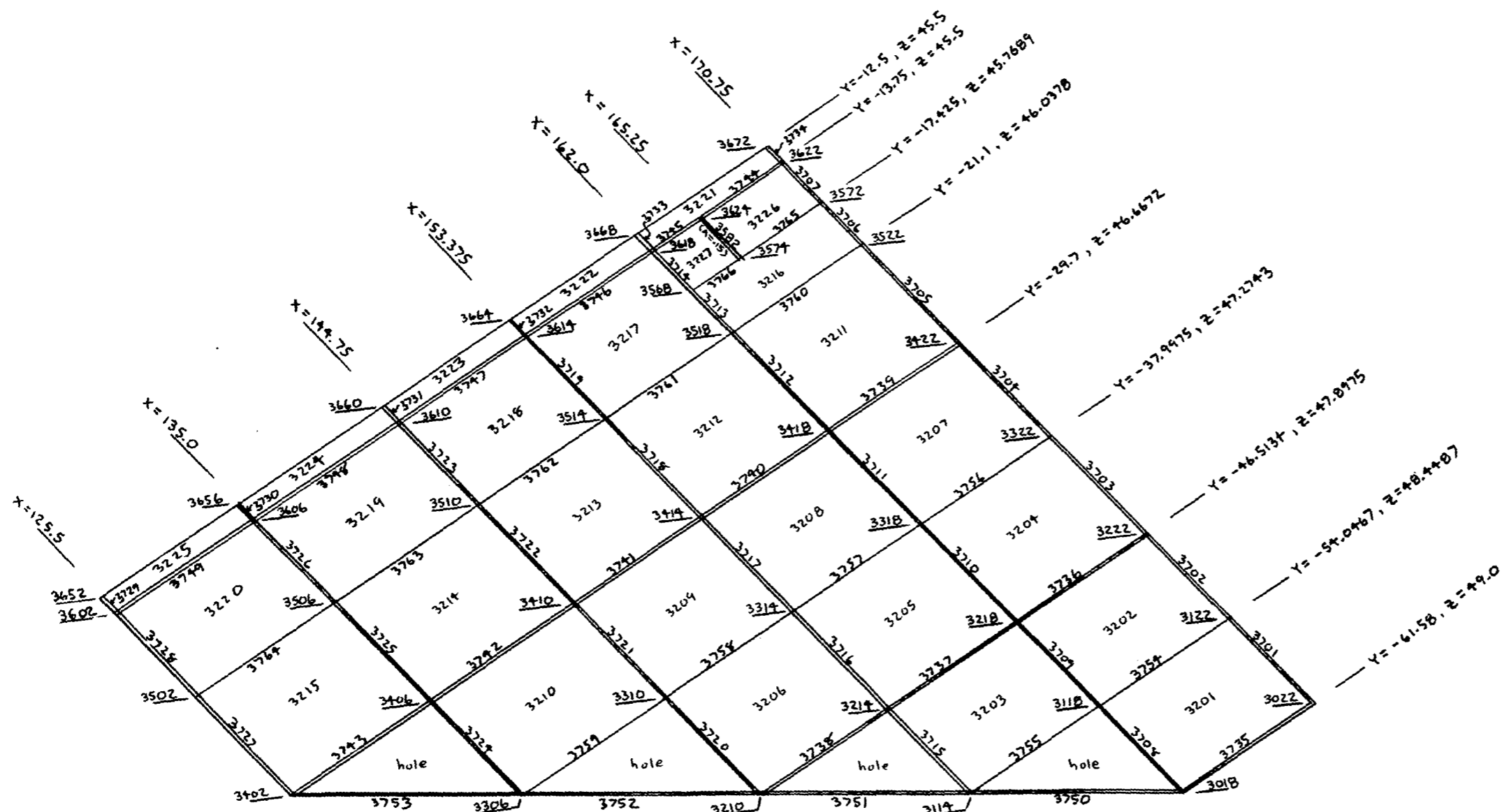

SKIN PANELS (CSHEAR) 3201 → 3227 ($t=.02, \rho=.1 \text{ in}^3$)
 LUMPED EFF. SKIN RODS (SPAR DIR.) 3701 → 3734
 LUMPED EFF. SKIN RODS (RIB DIR.) 3735 → 3749
 LUMPED EFF. SKIN RODS (DIAGONAL DIR.) 3750 → 3753
 MINIMAL RODS 3754 → 3766 ($A=.001$)
 INTERSTAGE FITTING ROD 3582 ($A=.15, \rho=.1 \text{ in}^3$)

Revised Bottom Wing Cover (3/28/74)

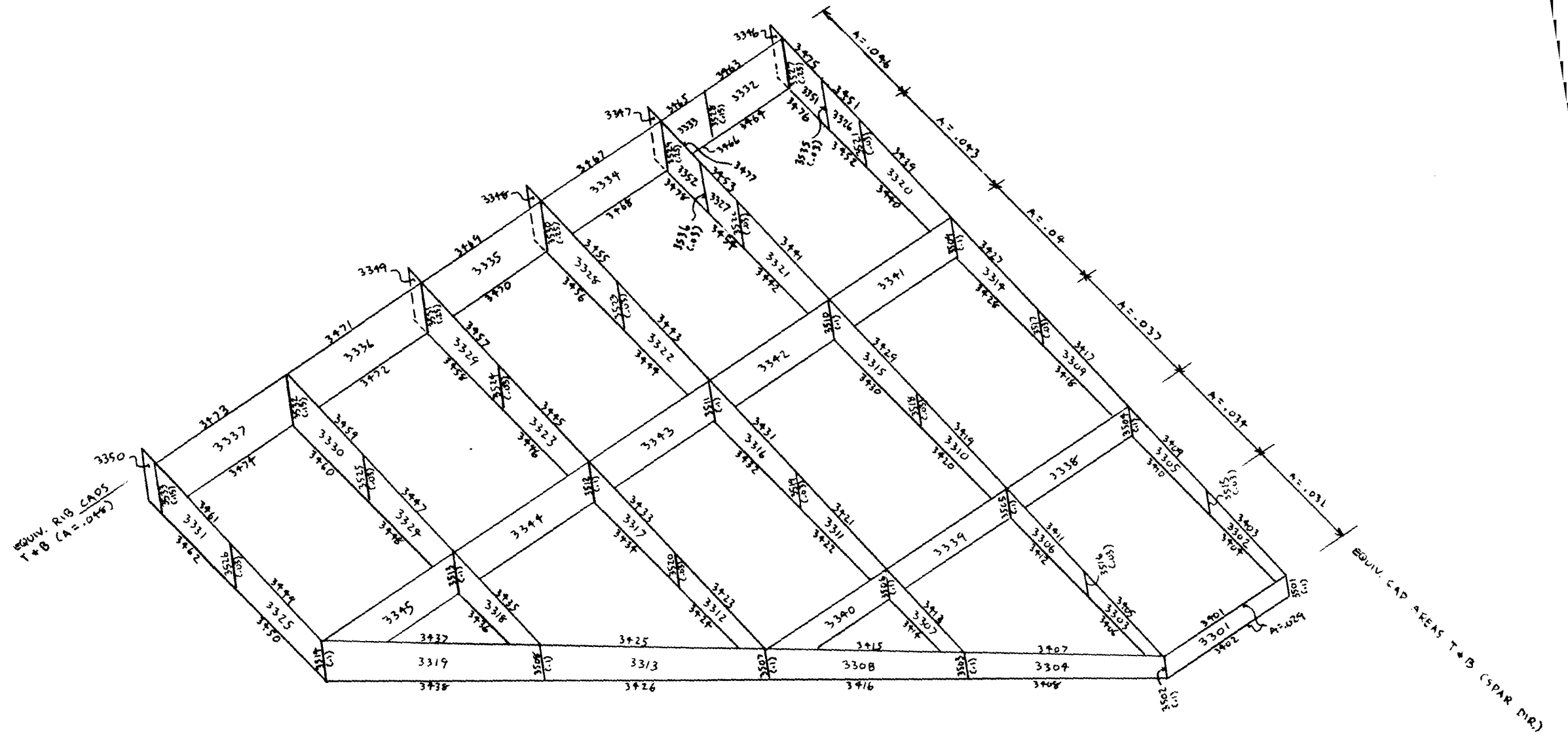

WEB PANELS WITH BALLAST OF .0135 */in² (CSHEAR) 3301 -> 3337 (t=.032, P=.1 */in²)
 3351, 3352
 ADDITIONAL RIB PANELS (CSHEAR) 3338 -> 3345 (t=.032, P=.1 */in²)
 INTERFACE SHEAR FITTINGS (CSHEAR) 3346 -> 3350 (t=.125, P=.1 */in²)
 RIB + SPAR EQUIVALENT CAPS (CRUD) 3401 -> 3474 (flange non-struct mass = .0016 */in)
 3475 -> 3478
 VERTICAL STUDS (CRUD) 3501 -> 3536

Revised Wing Ribs (3/28/74)

TAKE OUT GRID LINES

- 1) Take out GRID PTS 4061, 4063, 4065, 4067, 4111, 4113, 4115, 4117
- 2) Take out QUADZ elements + replace with CQDMEMZ elements

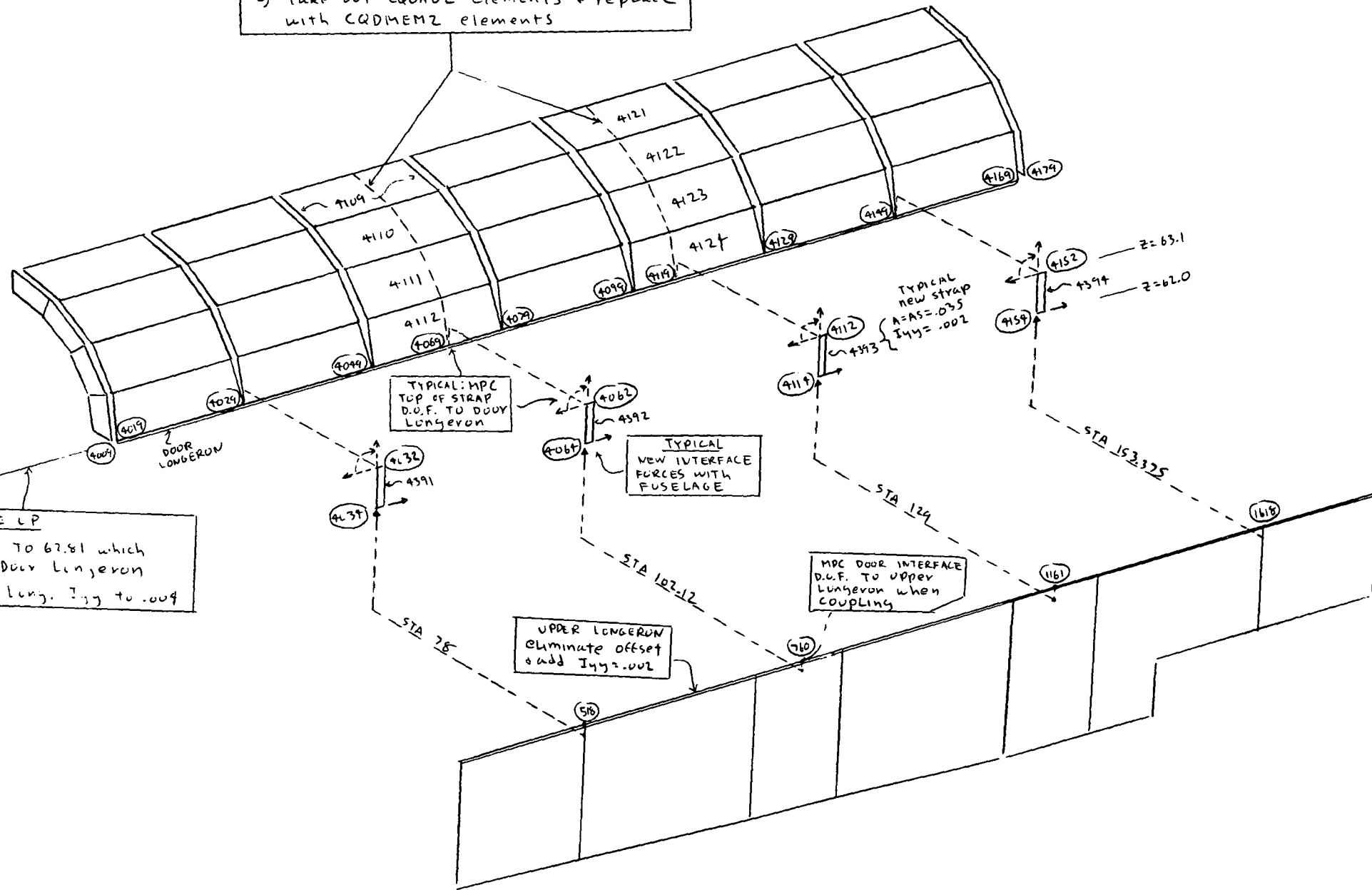

MOVE GRID LINE LP

- 1) change z-coord to 62.81 which is the N.A. of Door Longeron
- 2) change Door Long. Iyy to .004

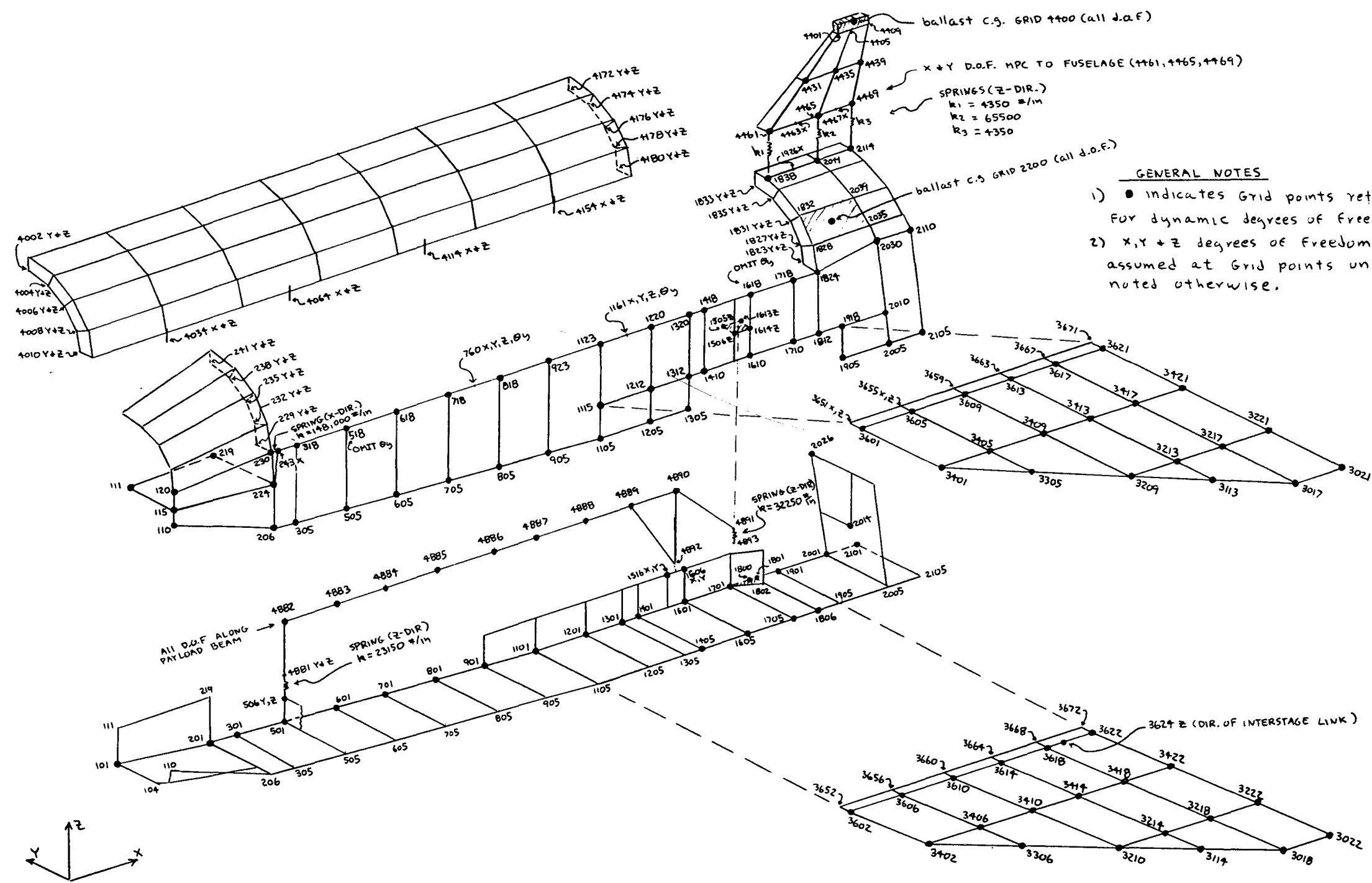

- 1) ● Indicates Grid points retained for dynamic degrees of Freedom.
- 2) x, y + z degrees of Freedom assumed at Grid points unless noted otherwise.

Appendix A3
LOAD-DEFLECTION CURVES FROM STATIC TESTS

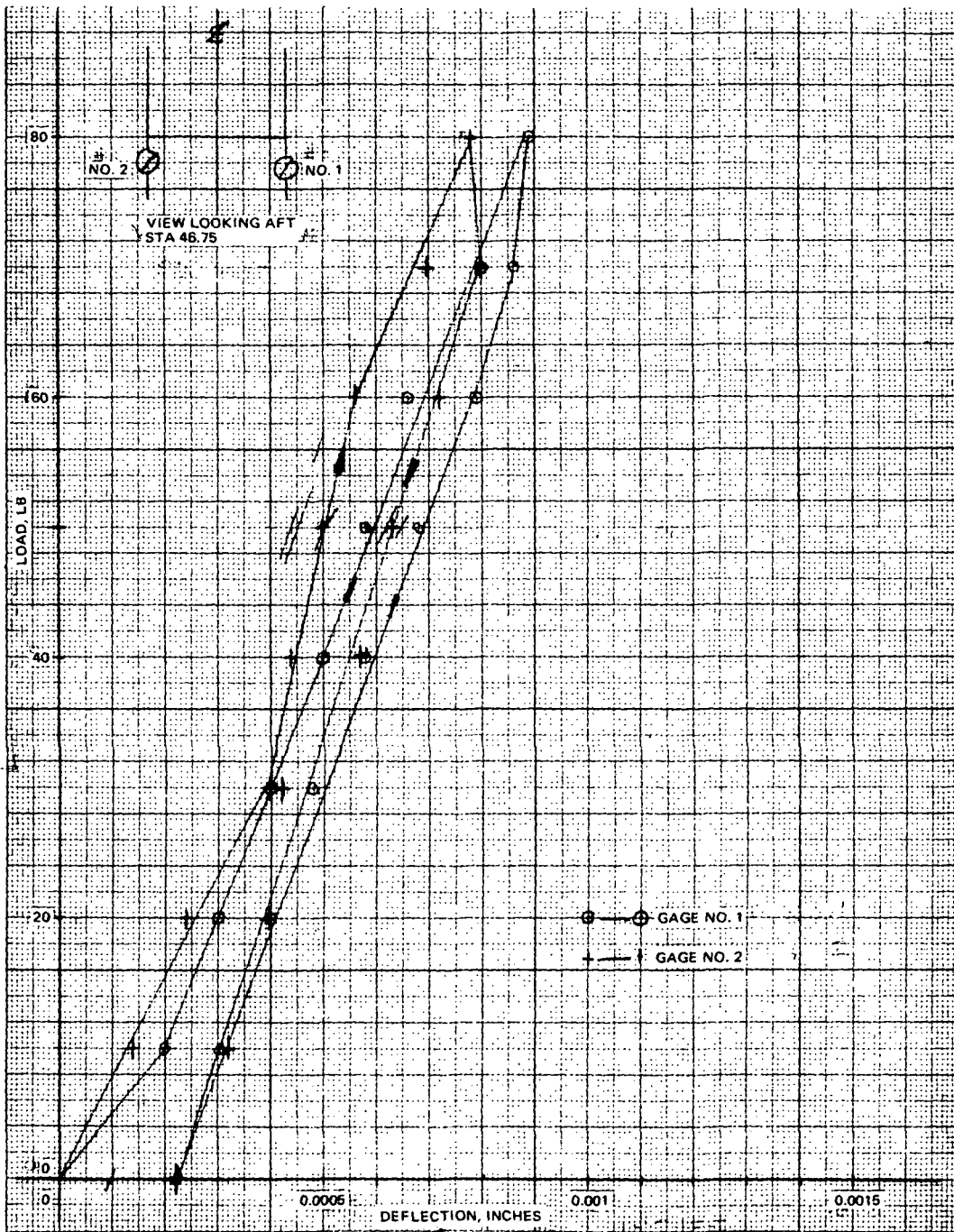

Fig. A3-1 Static Deflections (Run No. 3): -Z Load at Sta 117.5

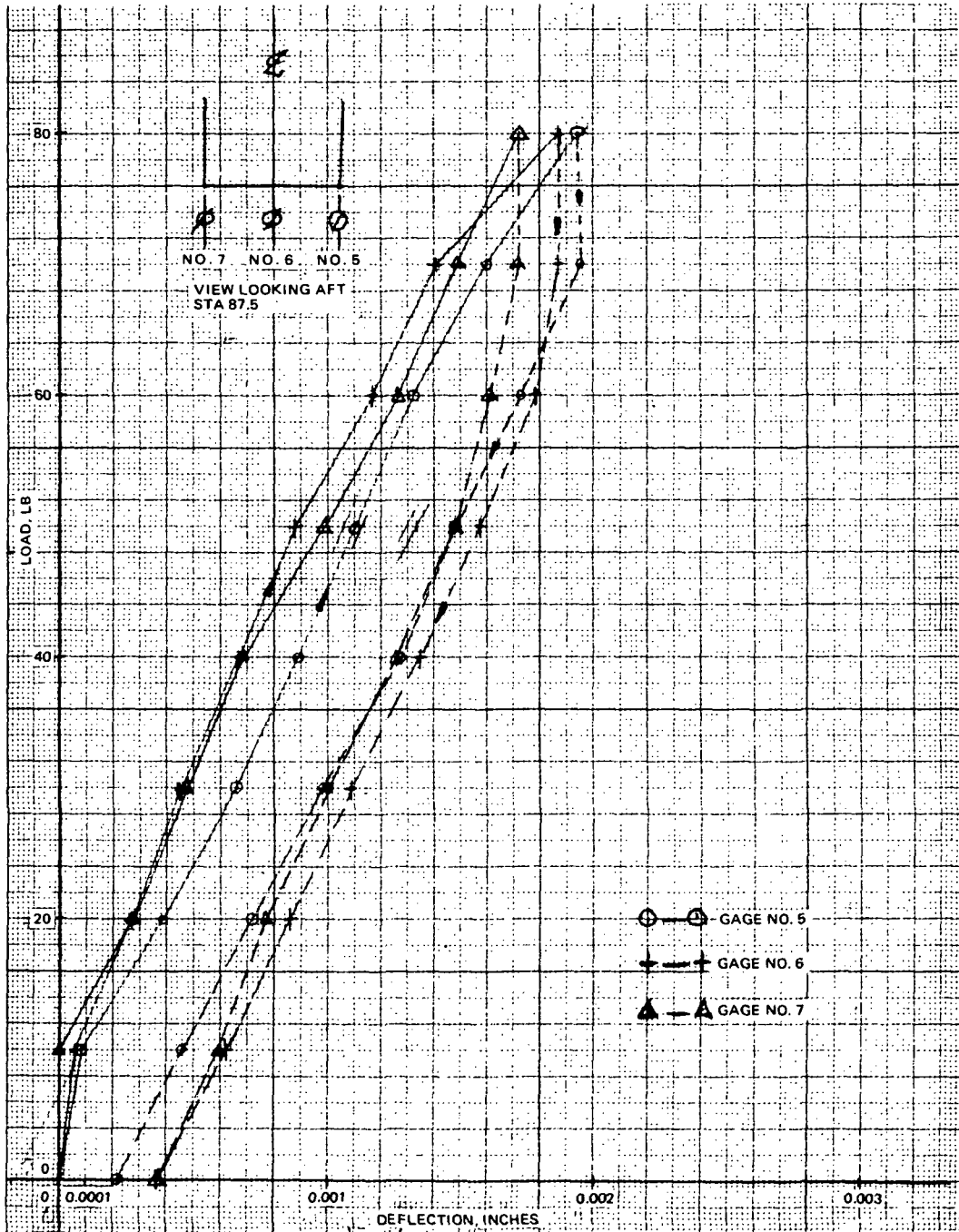

Fig. A3-2 Static Deflections (Run No. 3): -Z Load at Sta 117.5

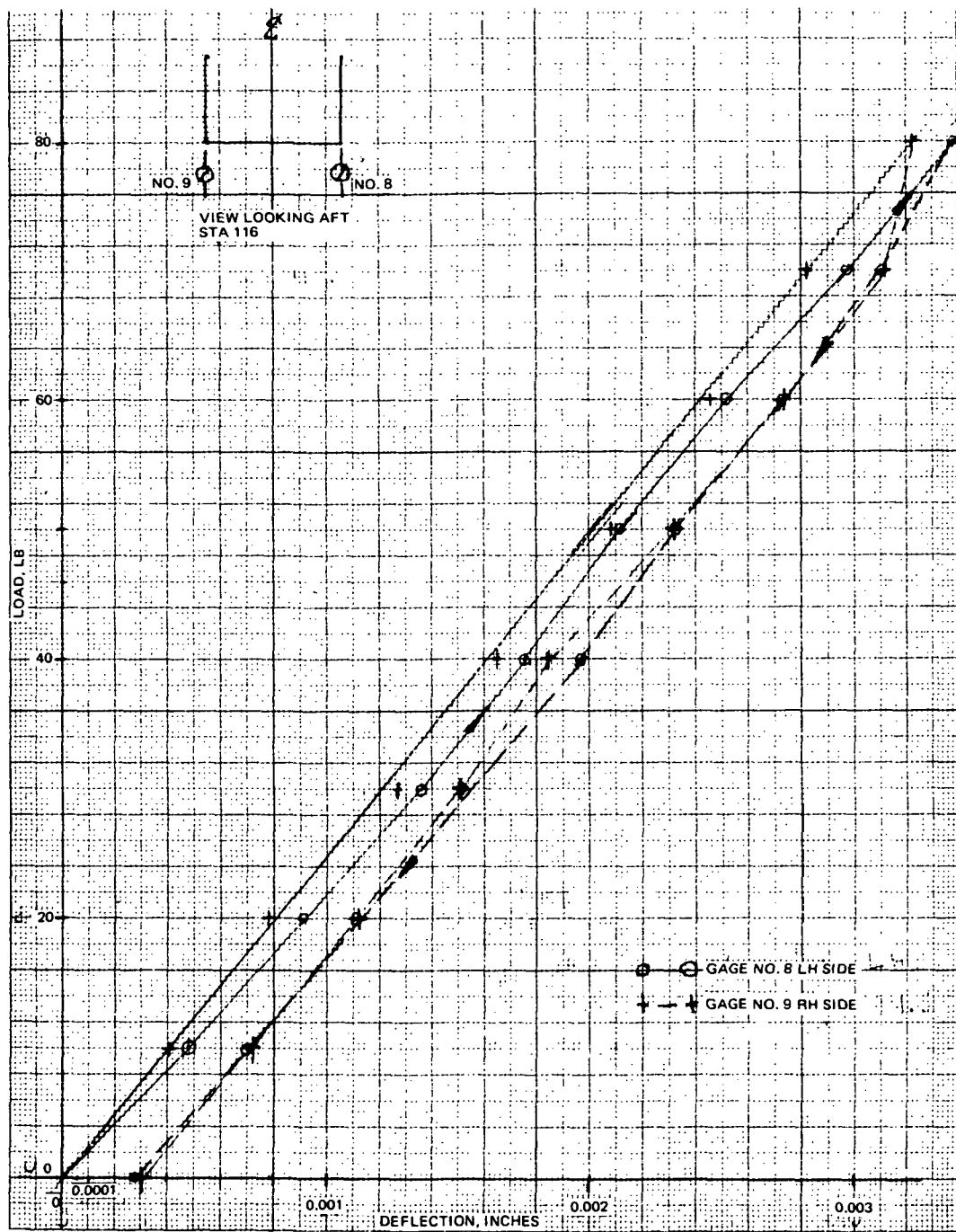

Fig. A3-3 Static Deflection (Run No. 3), -Z Load at Sta 117.5

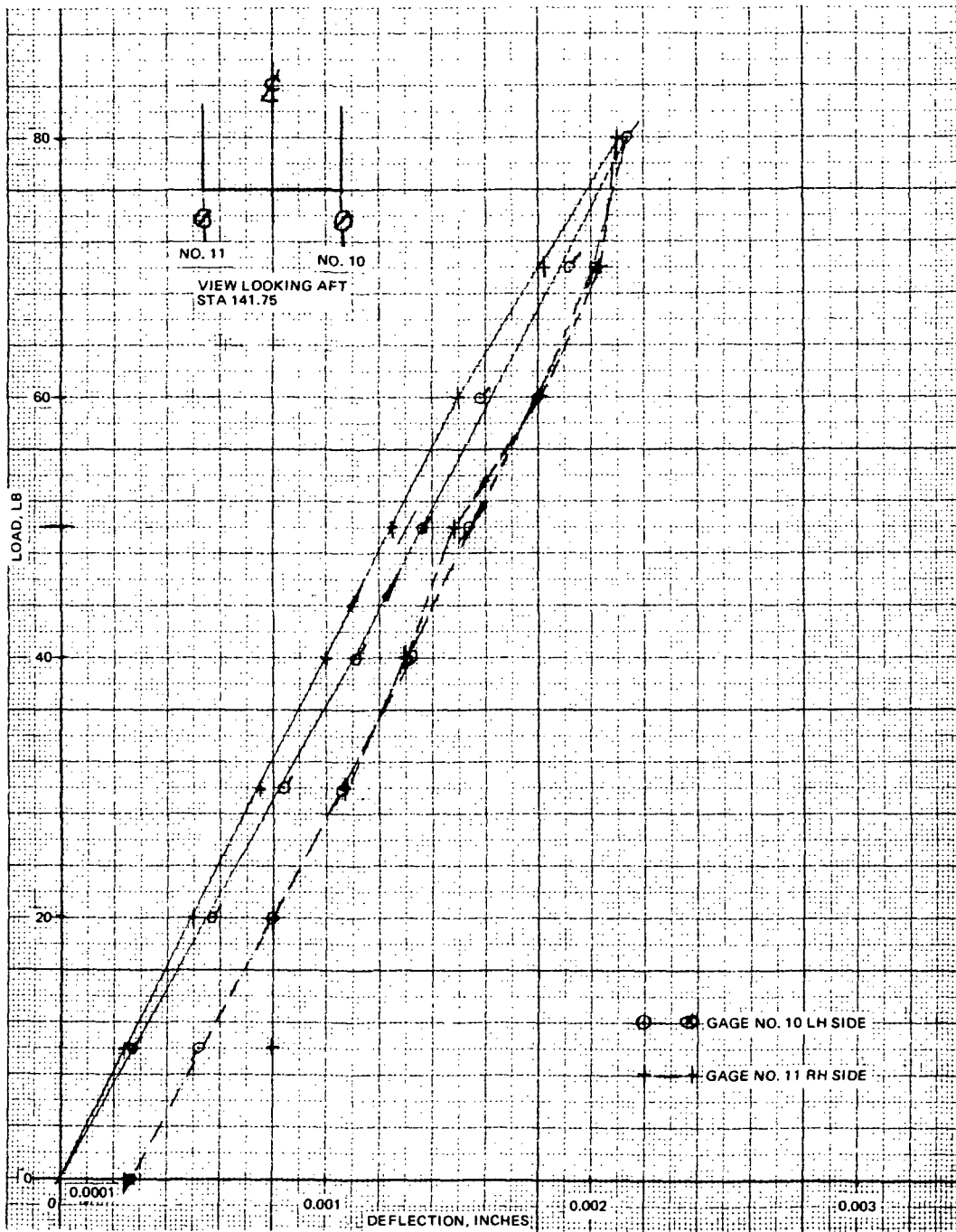

Fig. A3-4 Static Deflections (Run No. 3): -Z Load at Sta 117.5

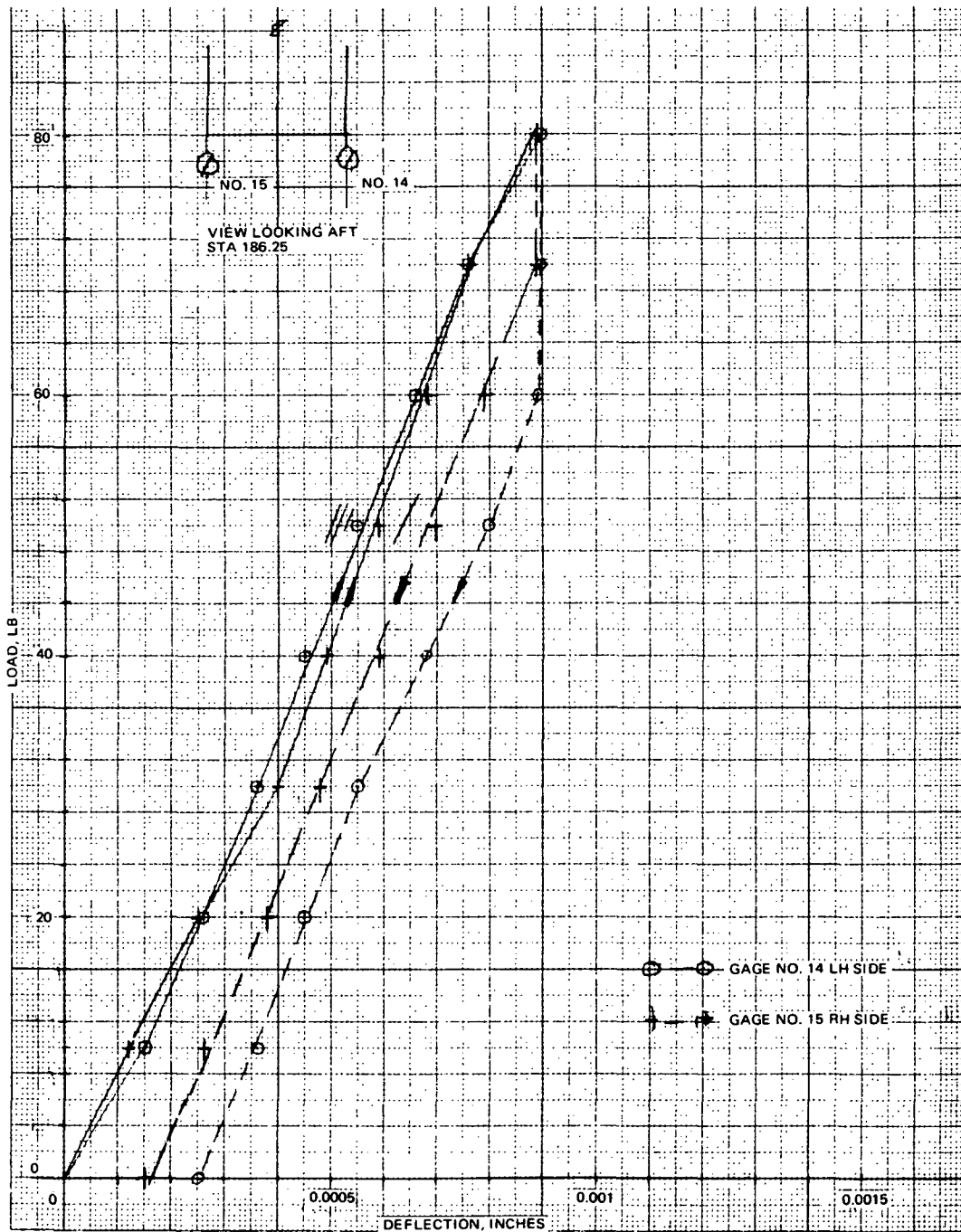

Fig. A3-5 Static Deflections (Run No. 3): -Z Load

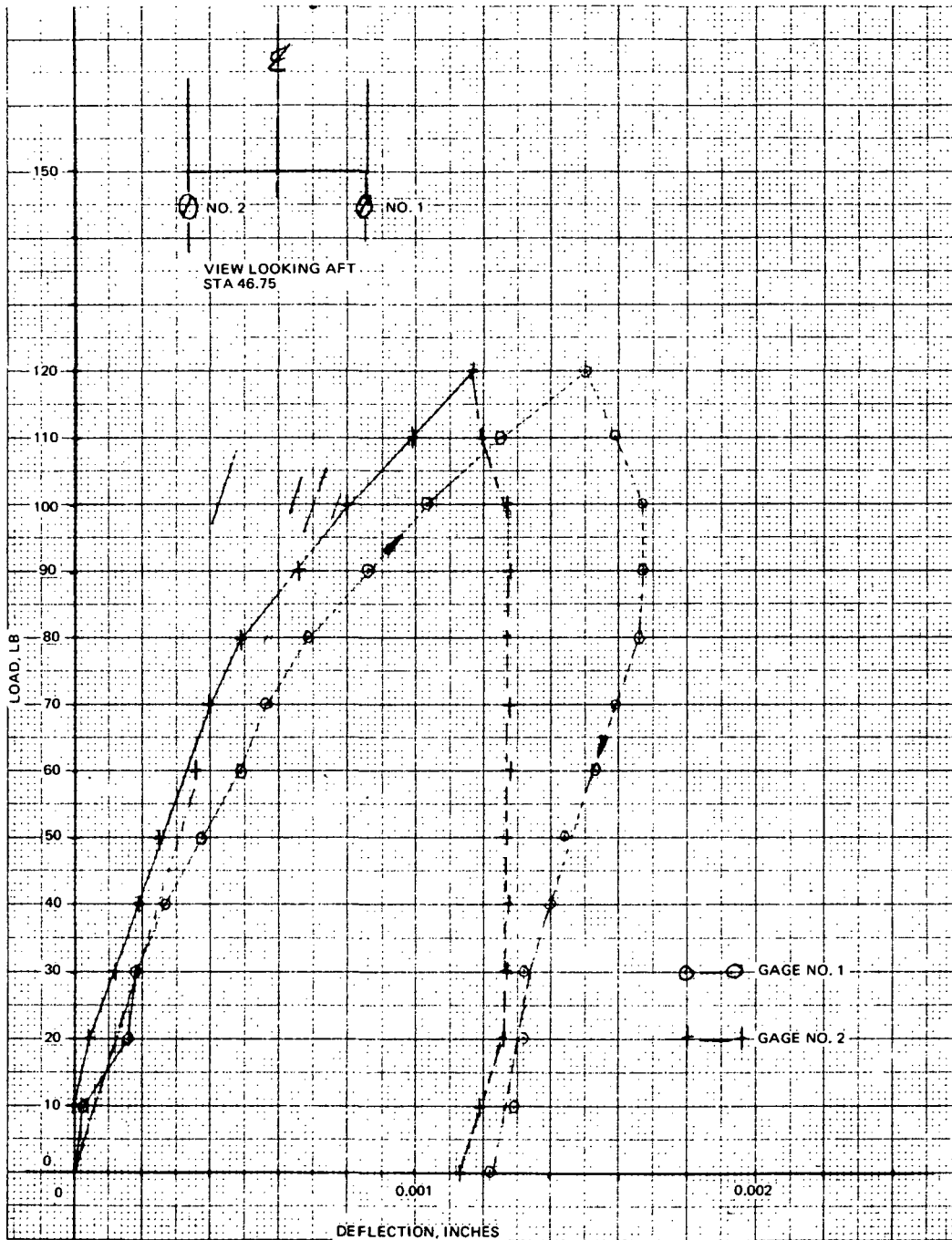

Fig. A3-6 Static Deflections (Run No. 4): +Z Load at Sta 116

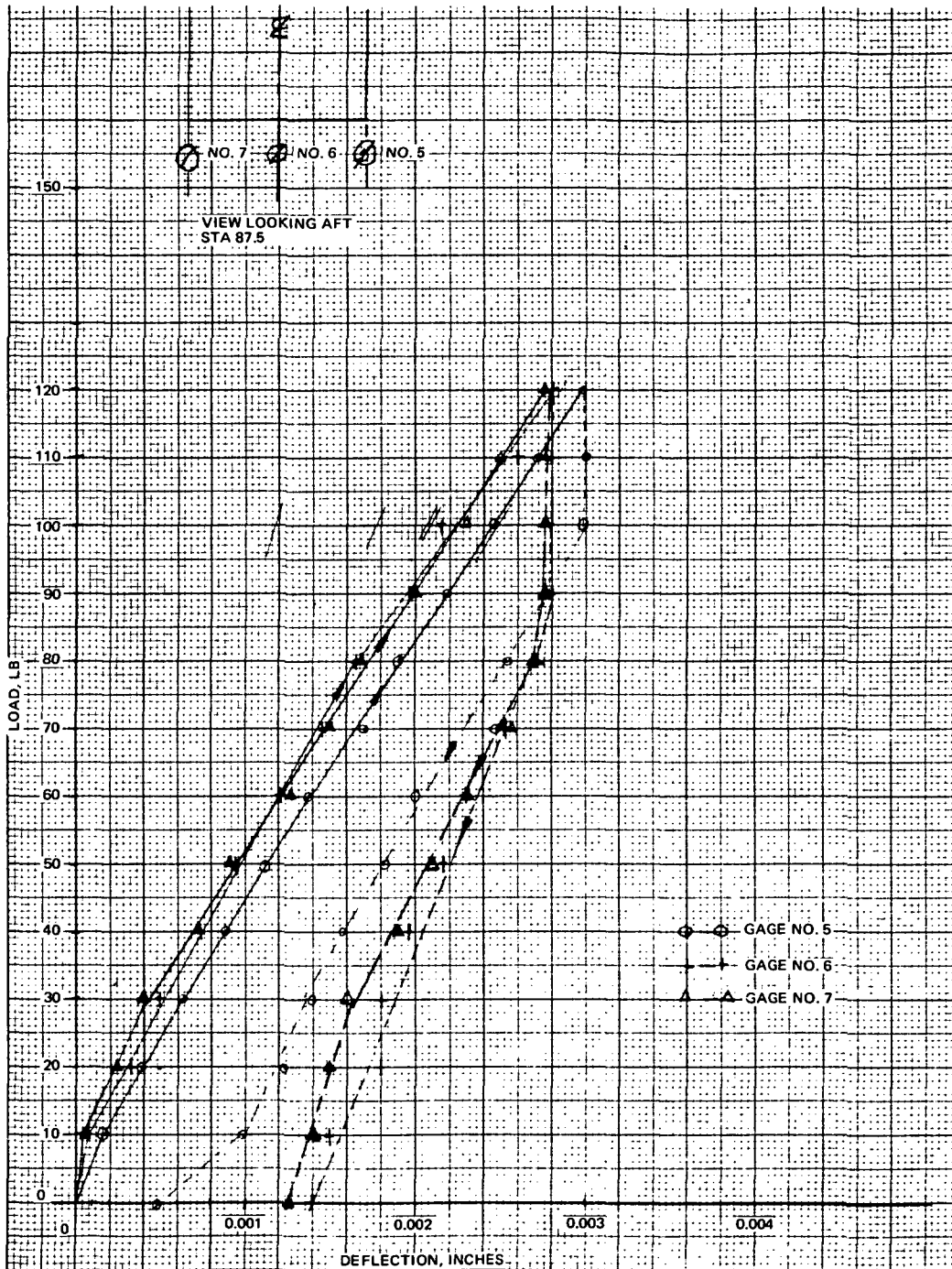

Fig. A3-7 Static Deflections (Run No. 4): +Z Load at Sta 116

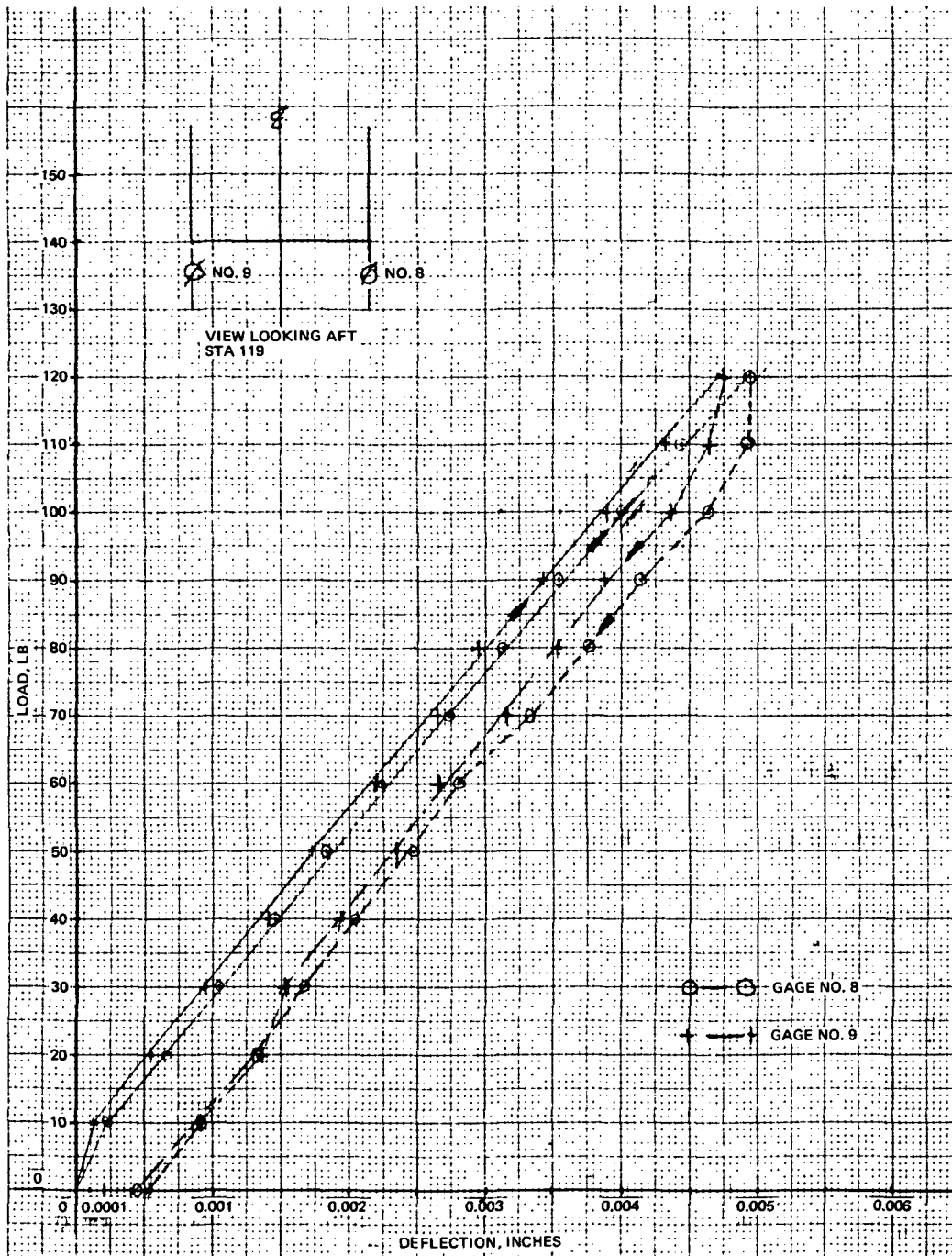

Fig. A3-8 Static Deflections (Run No. 4): +Z Load at Sta 116

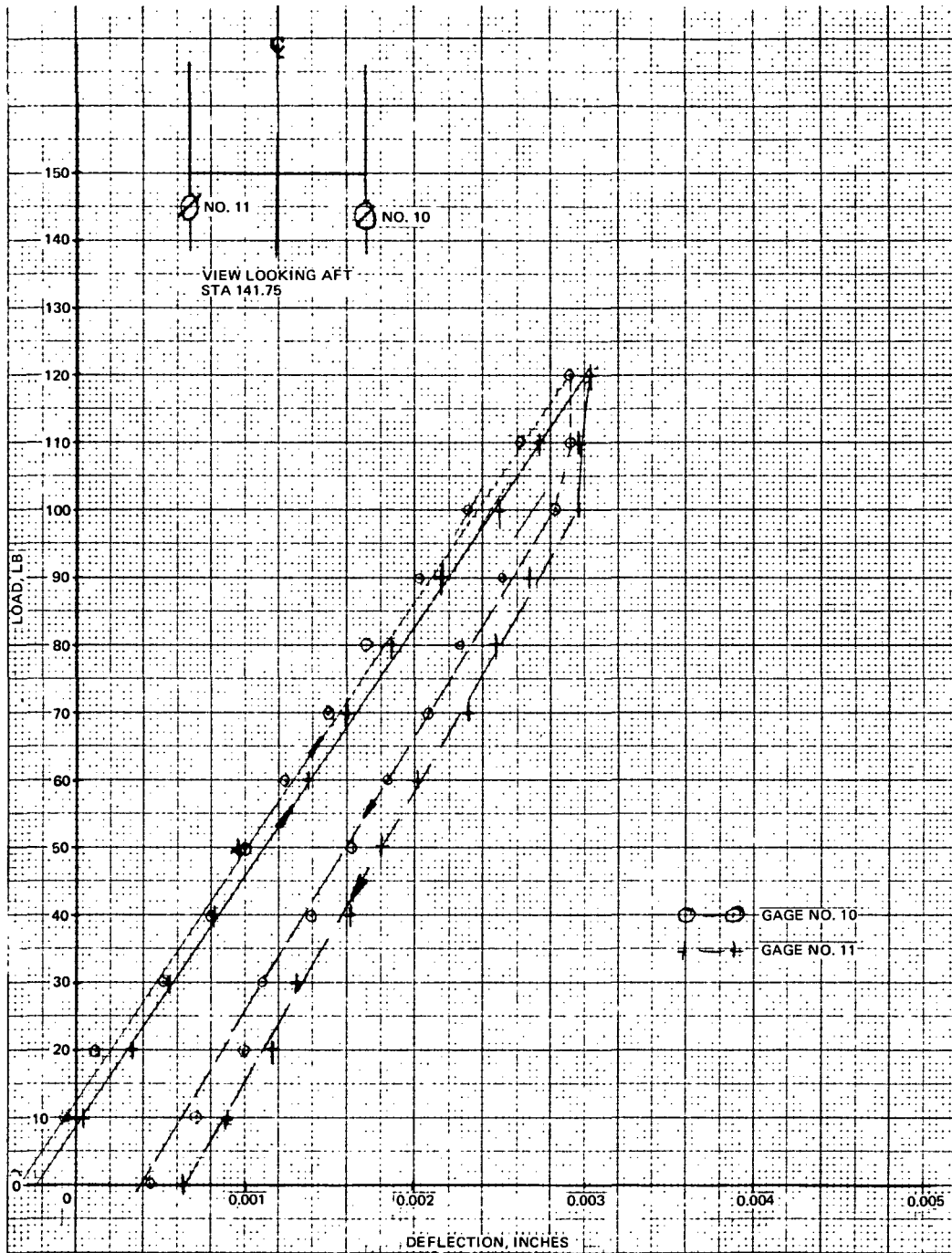

Fig. A3-9 Static Deflections (Run No. 4): +Z Load at Sta 116

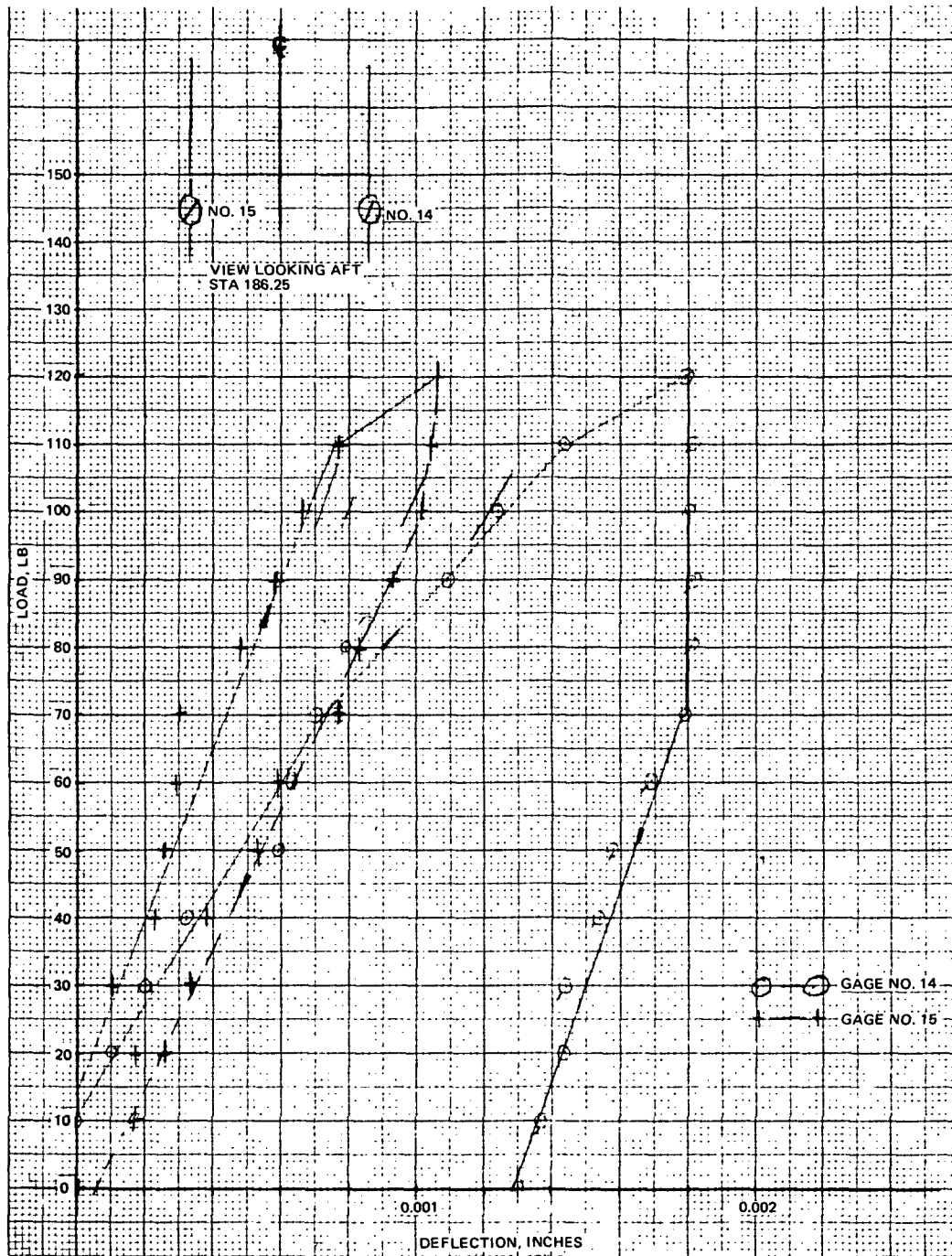

Fig. A3-10 Static Deflections (Run No. 4): +Z Load at Sta 116

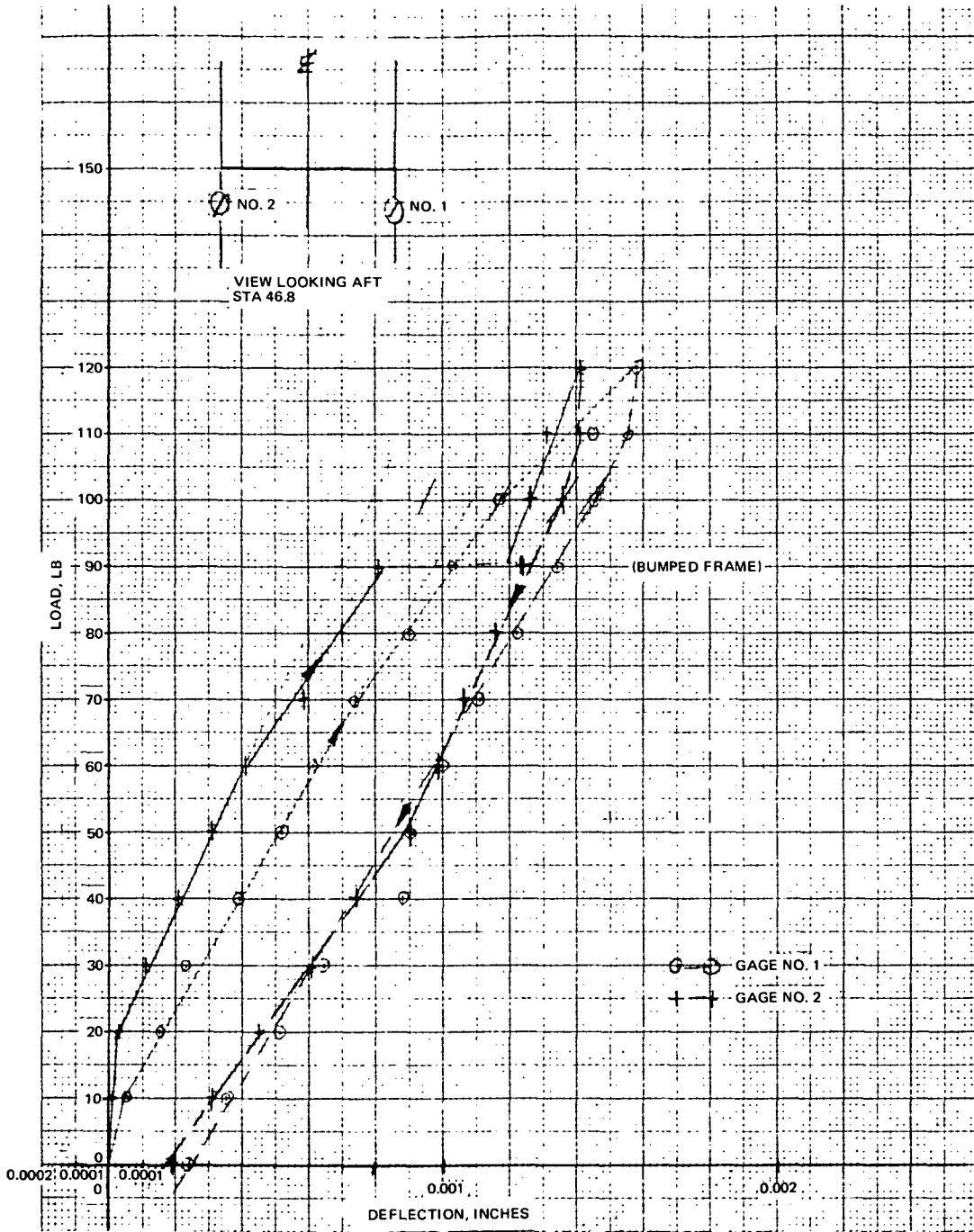

Fig. A3-11 Static Deflections (Run No. 5): +Z Load at Sta 116 (Cargo Doors Removed)

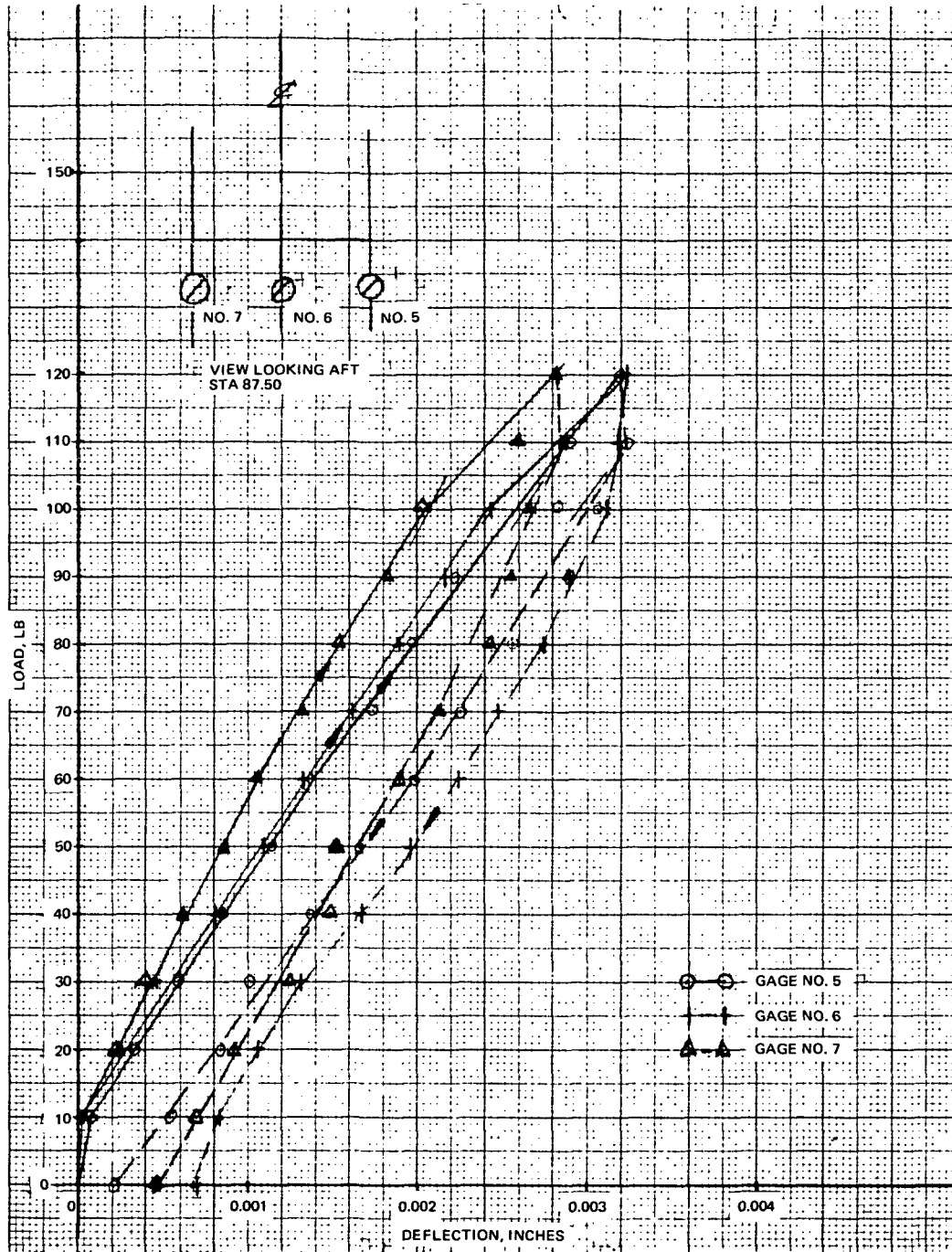

Fig. A3-12 Static Deflections (Run No. 5): +Z Load at Sta 116.0 (No Doors)

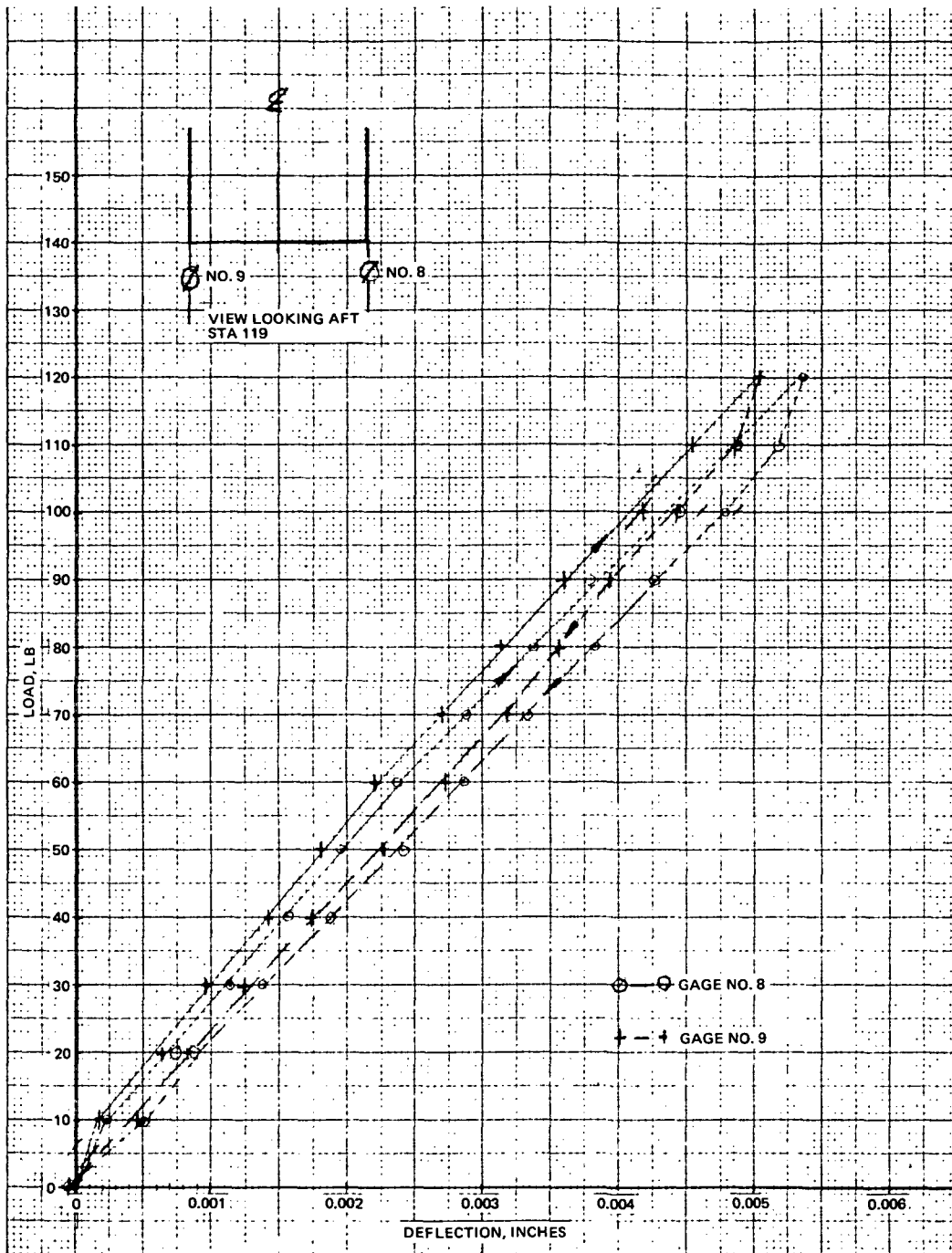

Fig. A3-13 Static Deflections (Run No. 5): +Z Load at Sta 116 (Cargo Doors Removed)

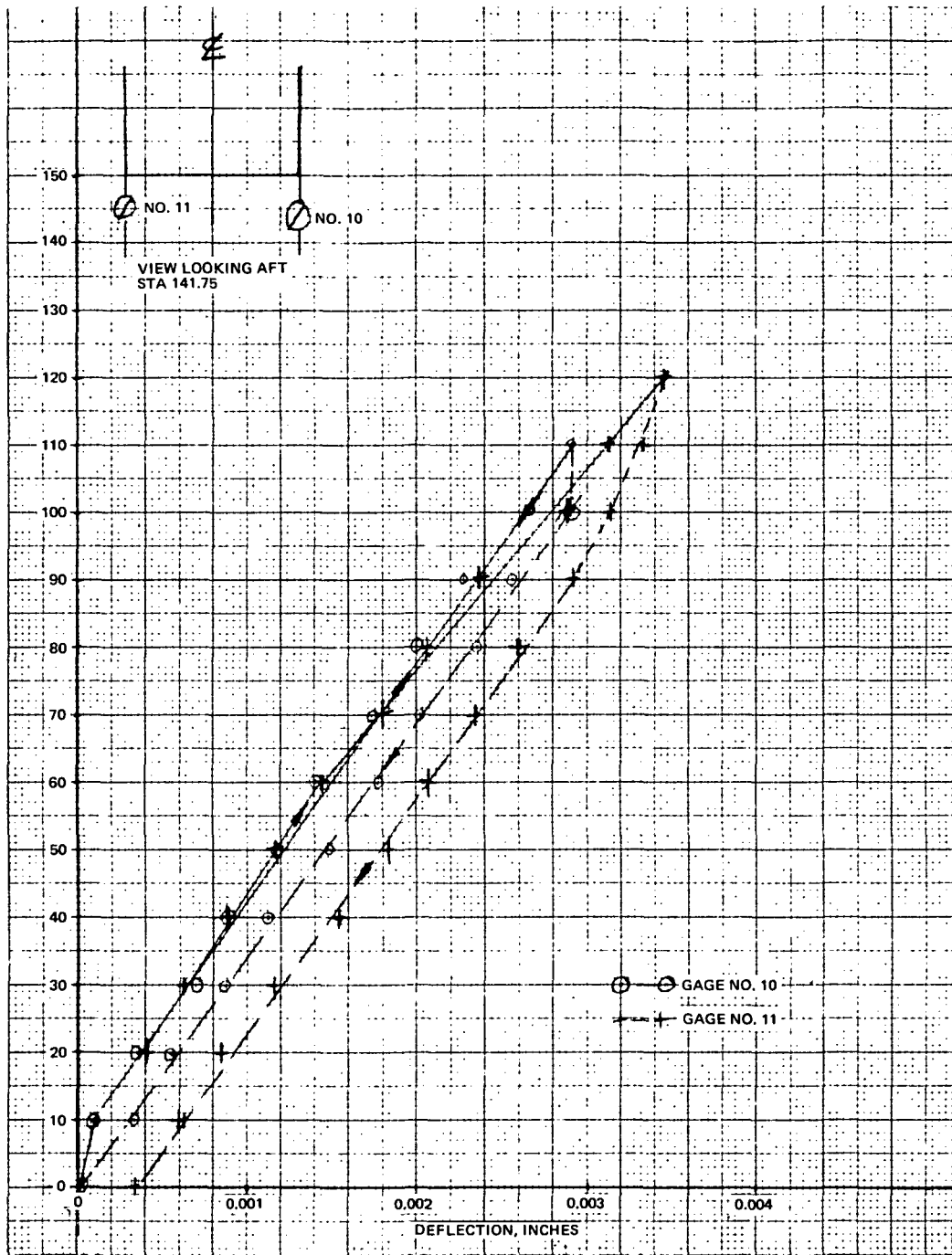

Fig. A3-14 Static Deflections (Run No. 5): Load +Z at Sta 116 (No Doors)

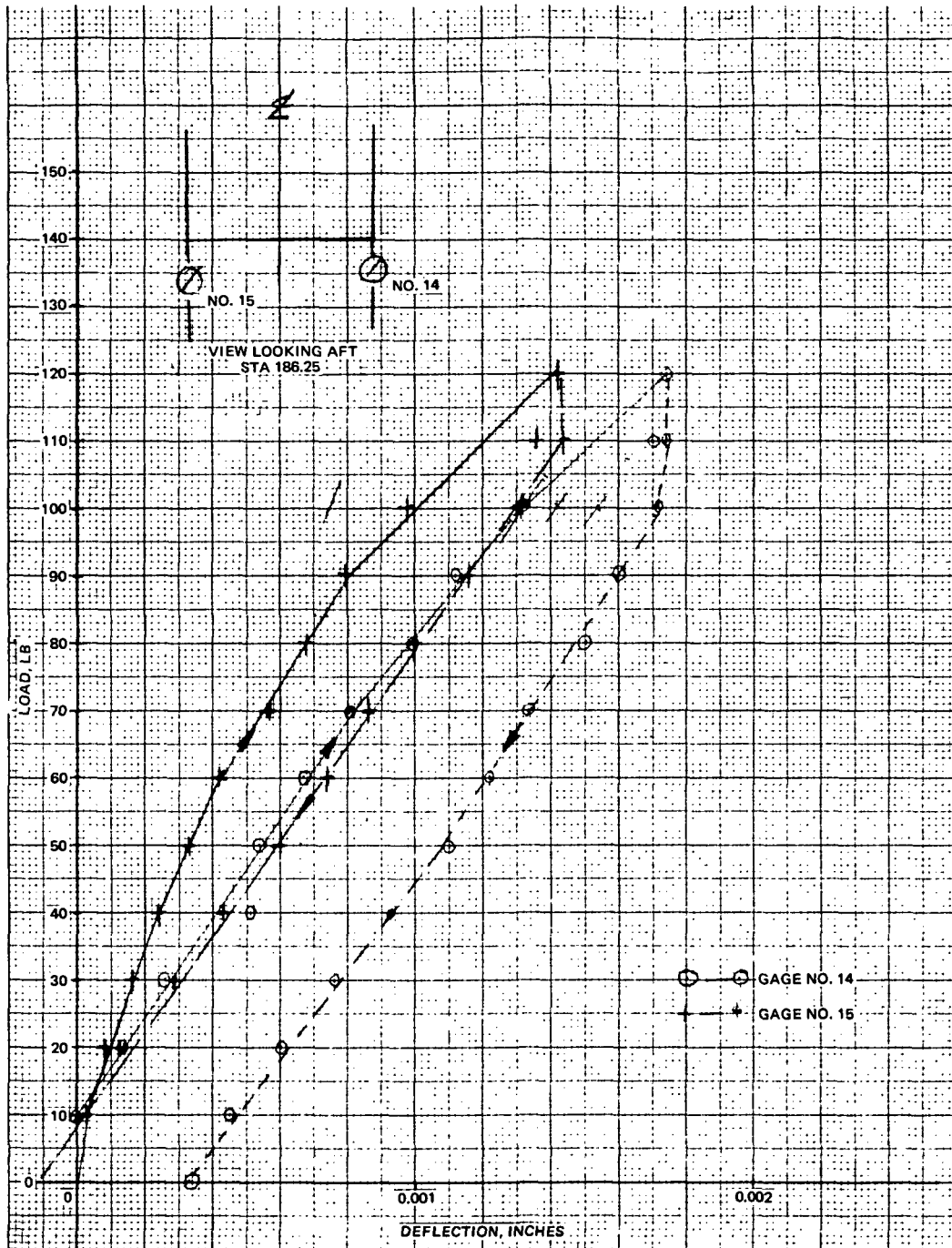

Fig. A3-15 Static Deflections (Run No. 5): +Z Load at Sta 116 (No Doors)

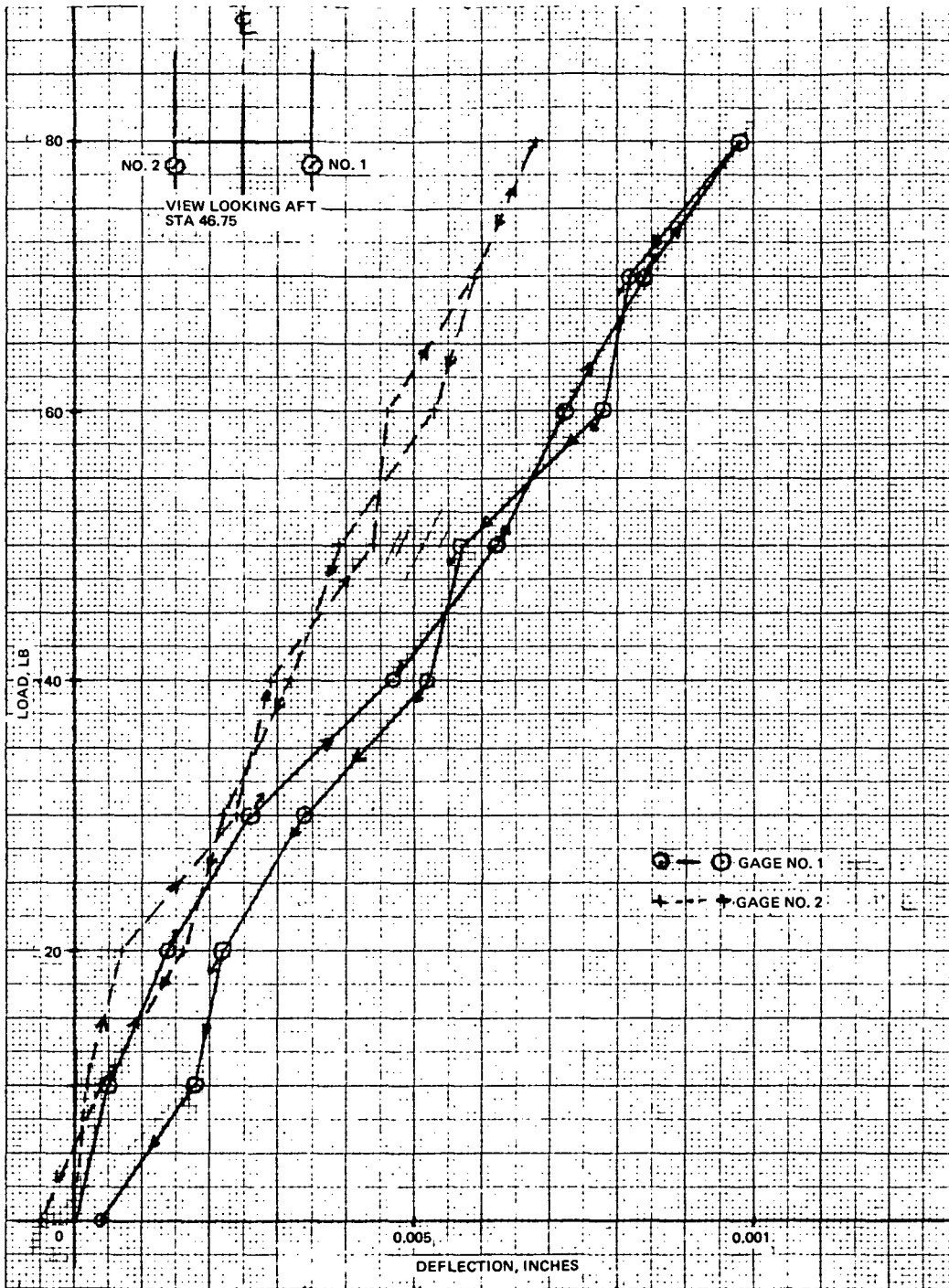

Fig. A3-16 Static Deflection (Run No. 6): -Z Load at Sta 117.5 (No Doors)

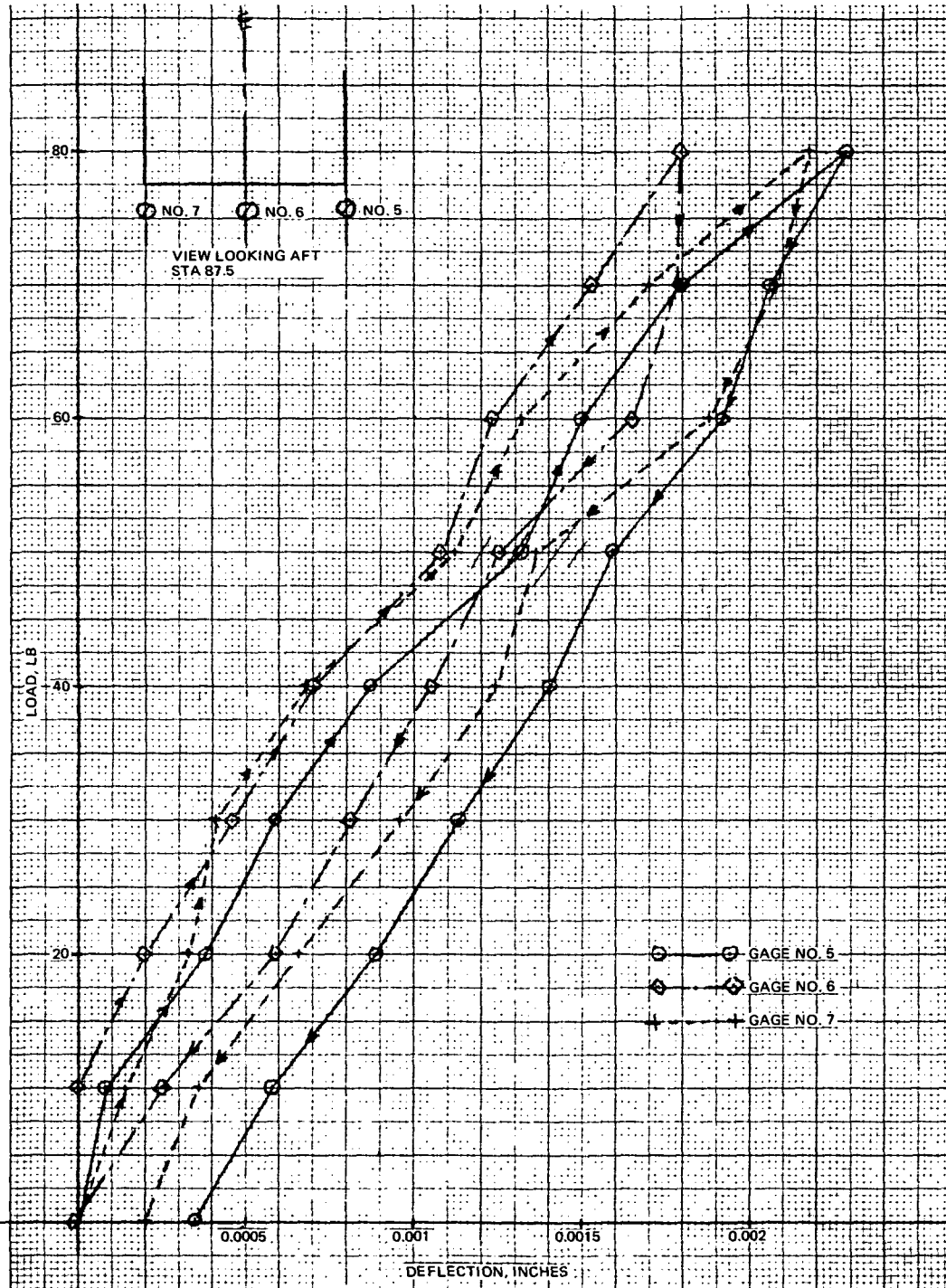

Fig. A3-17 Static Deflection (Run No. 6): -Z Load at Sta 117.5 (No Doors)

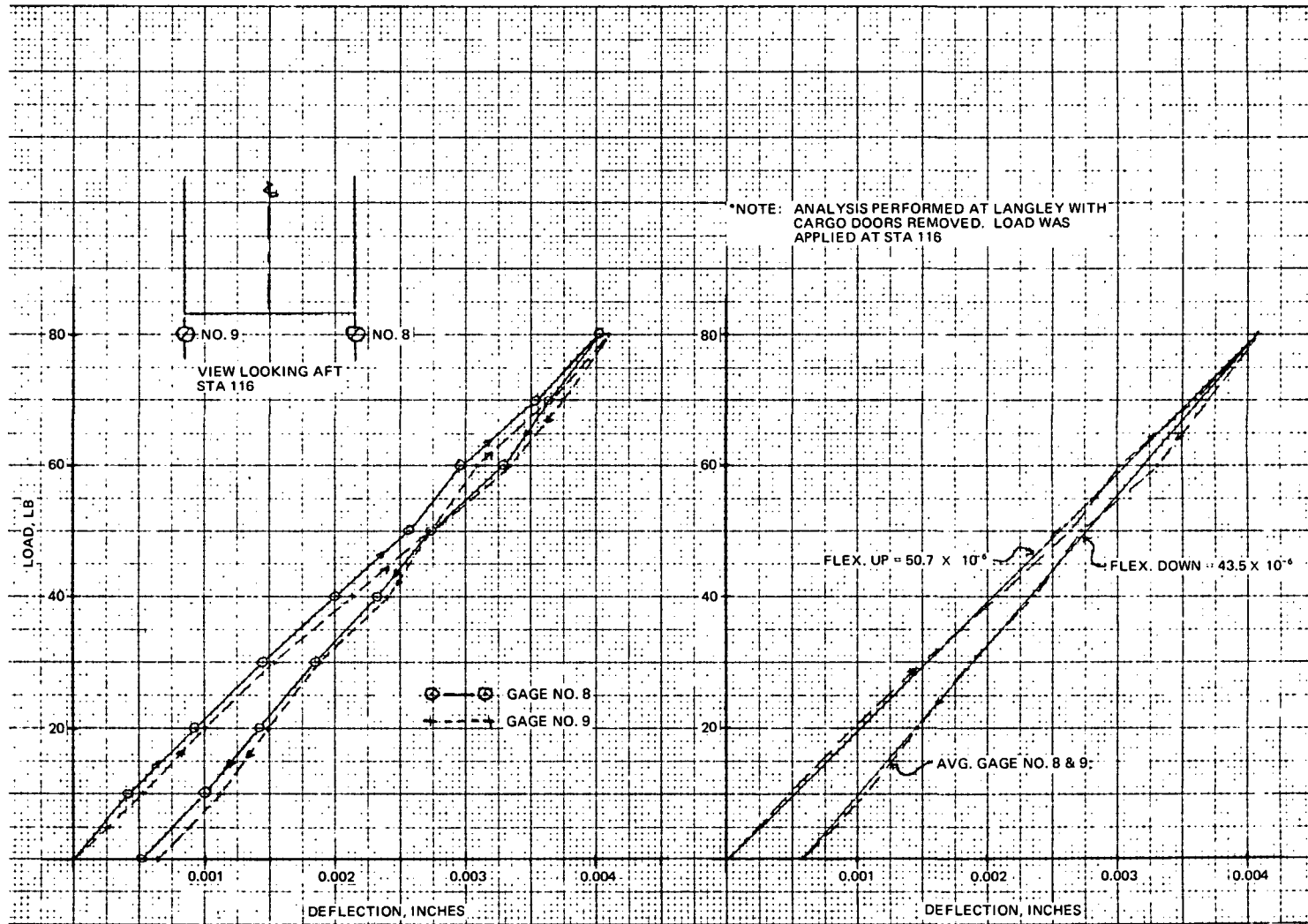

Fig. A3-18 Static Deflection (Run No. 6): -Z Load at Sta 117.5 (Cargo Doors Removed)

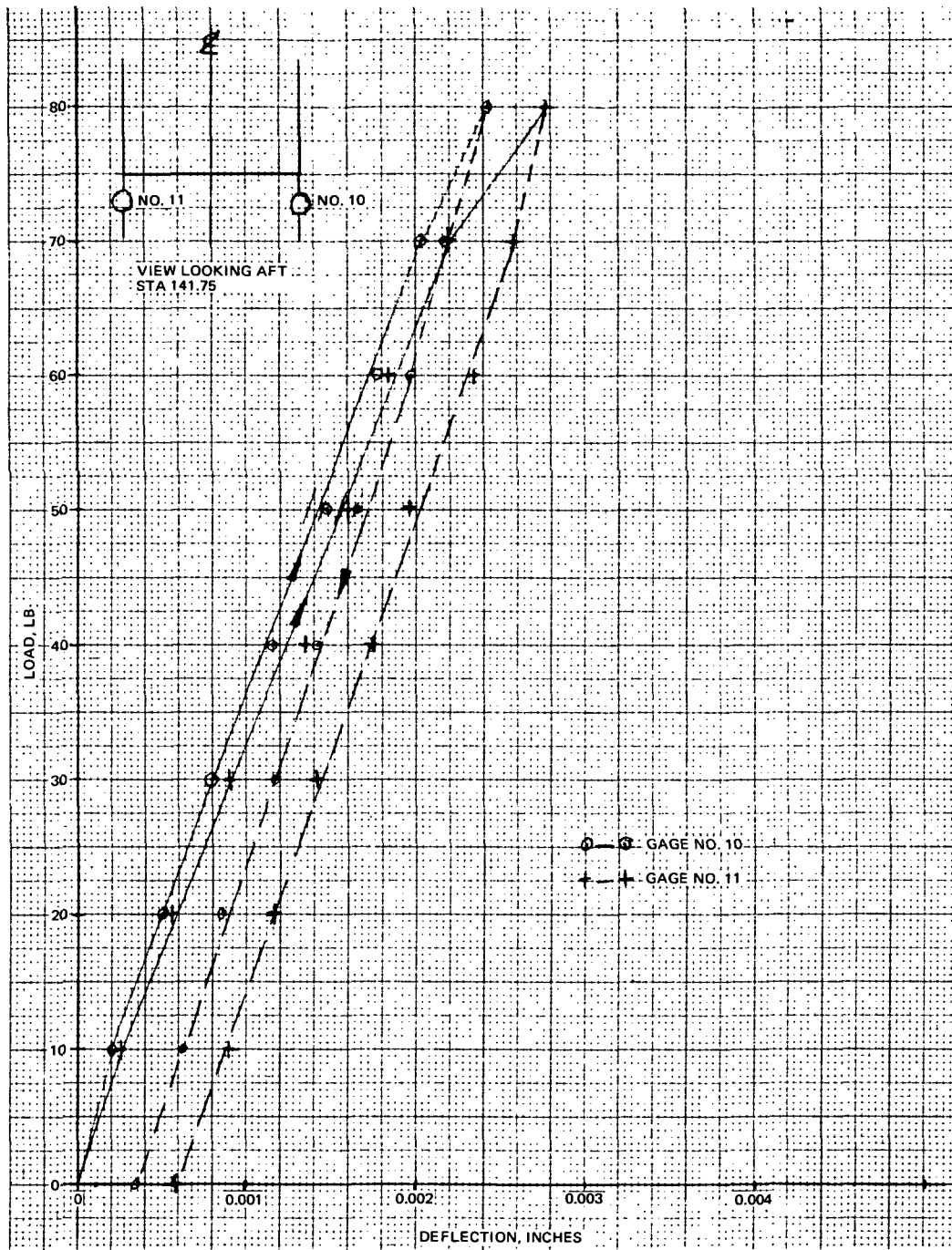

Fig. A3-19 Static Deflections (Run No. 6): Load -Z at Sta 117.5 (No Doors)

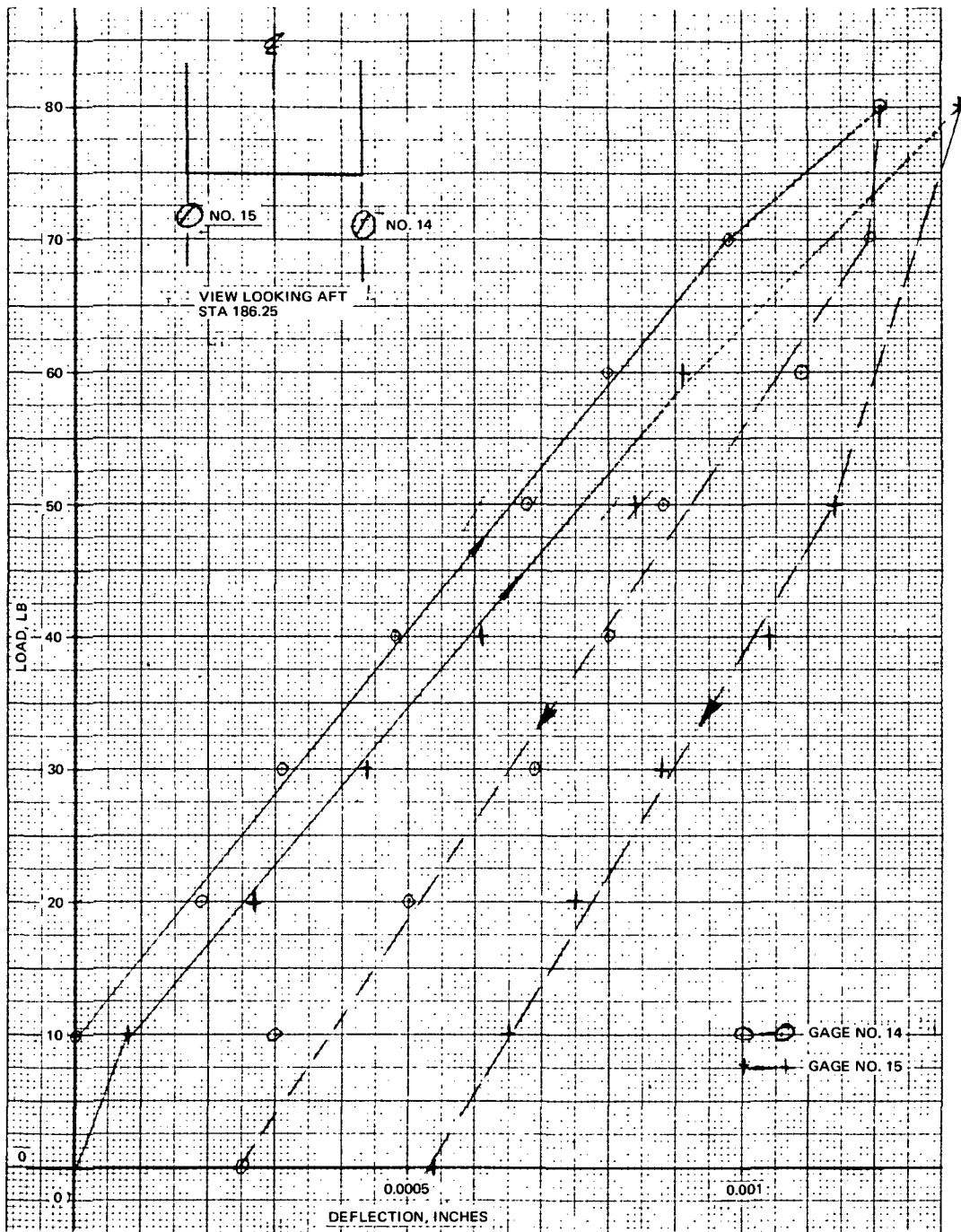

Fig. A3-20 Static Deflections (Run No. 6): -Z Load at Sta 117.5 (No Doors)

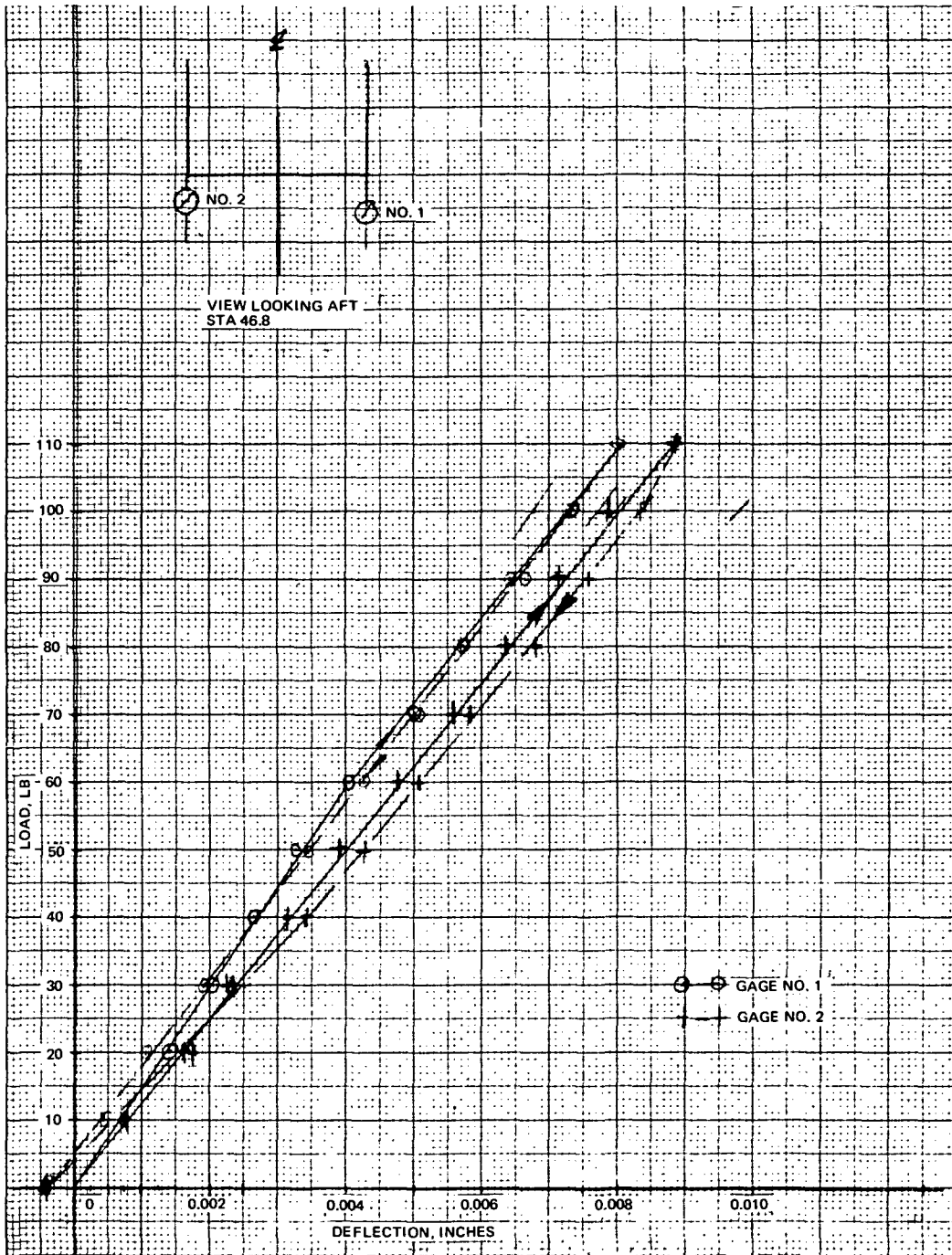

Fig. A3-21 Static Deflections (Run No. 7): -Z Load Sta 46.8 (No Doors)

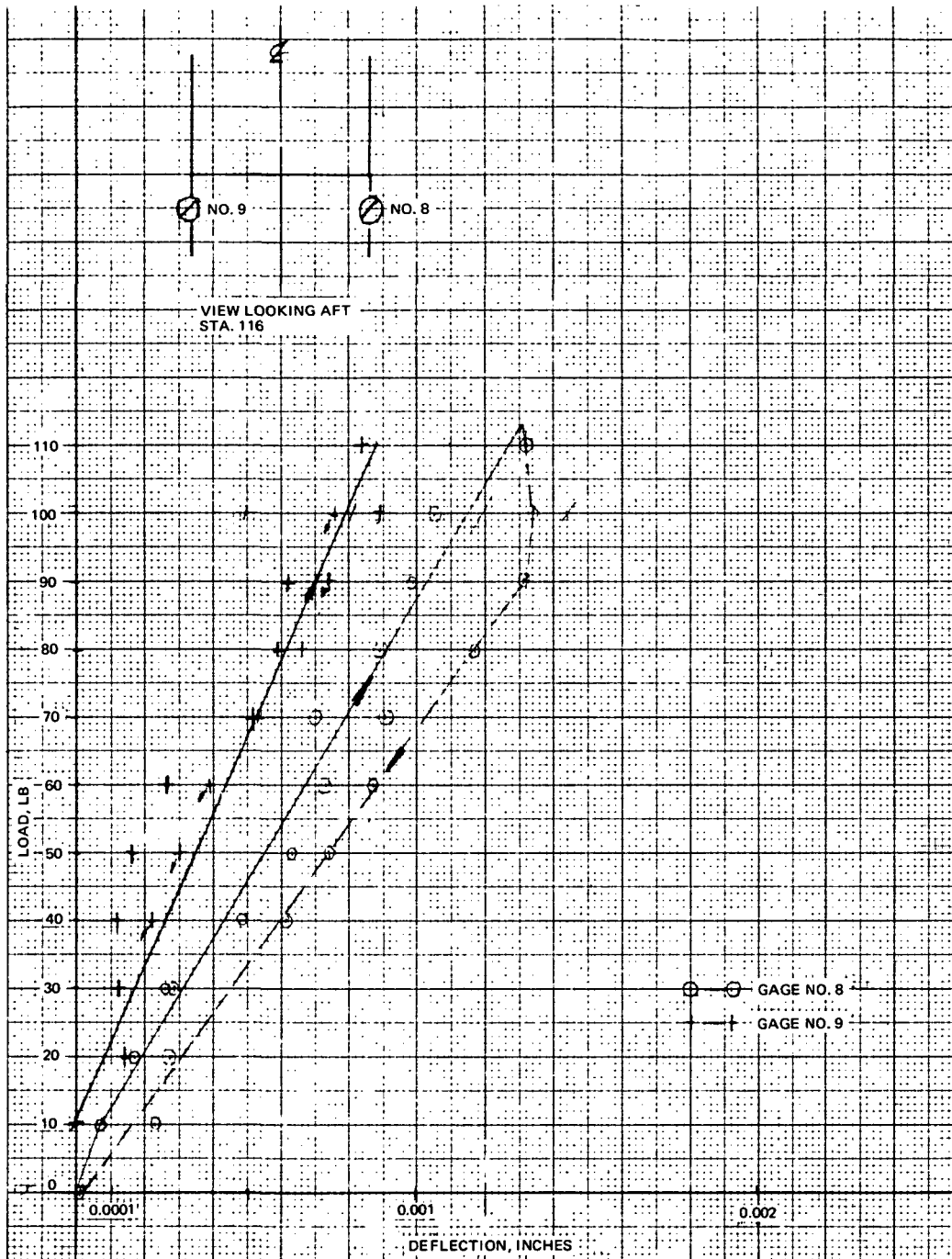

Fig. A3-22 Static Deflections (Run No. 7): -Z Load at Sta 46.8 (No Doors)

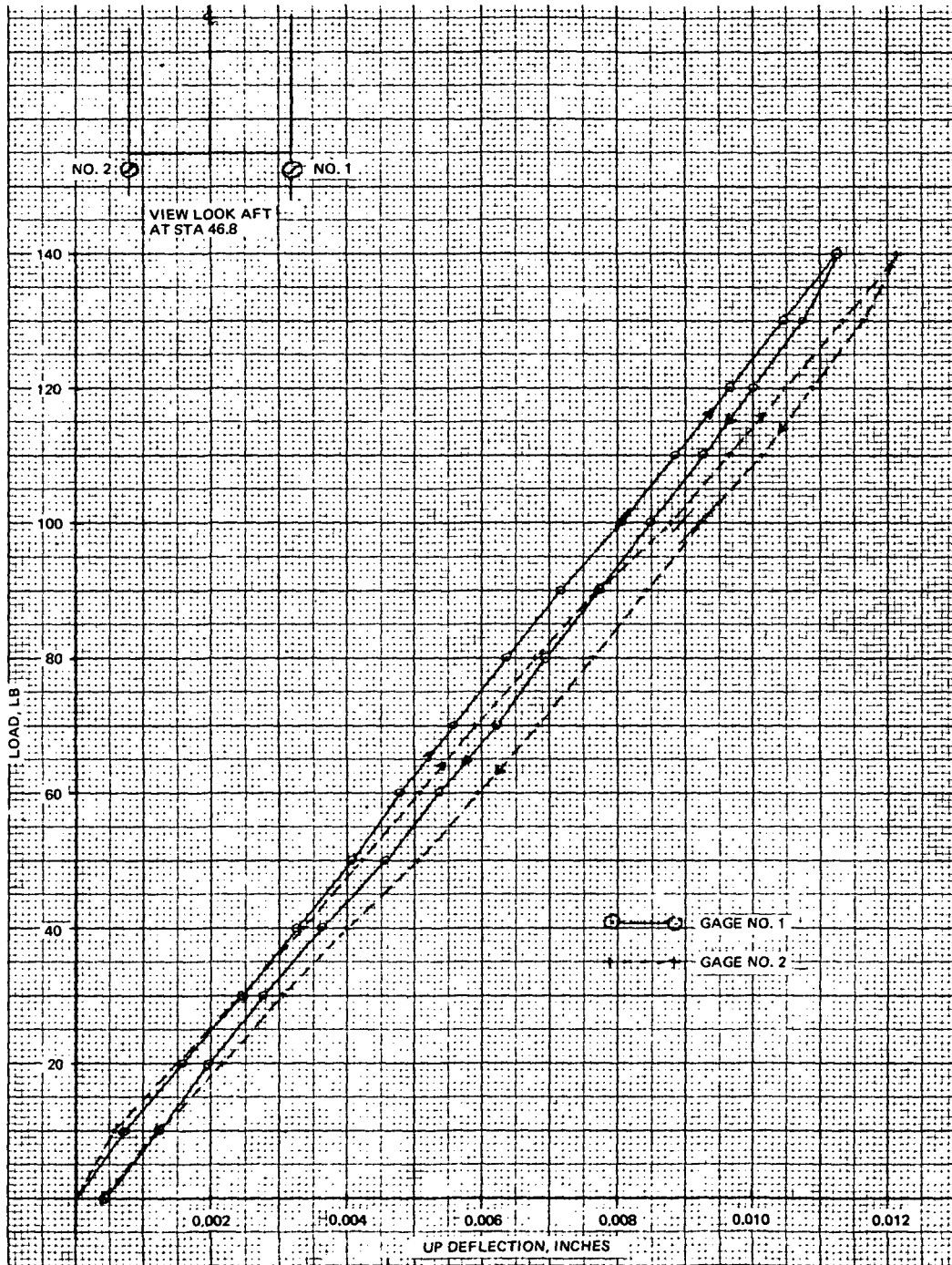

Fig. A3-23. Static Deflection (Run No. 8): +Z Load at Sta 46.8 (Cargo Doors Off)

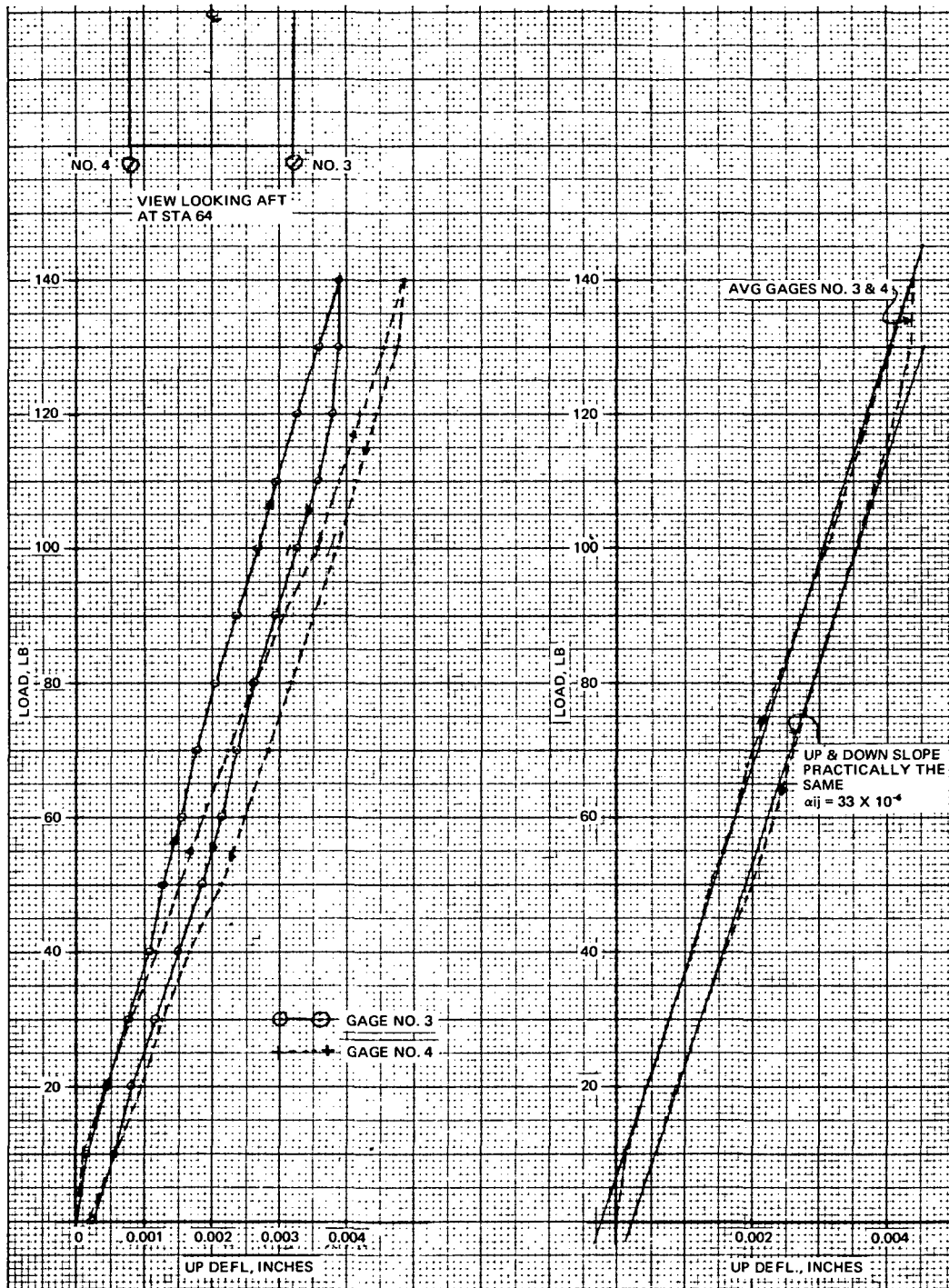

Fig. A3-24. Static Deflection (Run No. 8): +Z Load at Sta 46.8 (Cargo Doors Off)

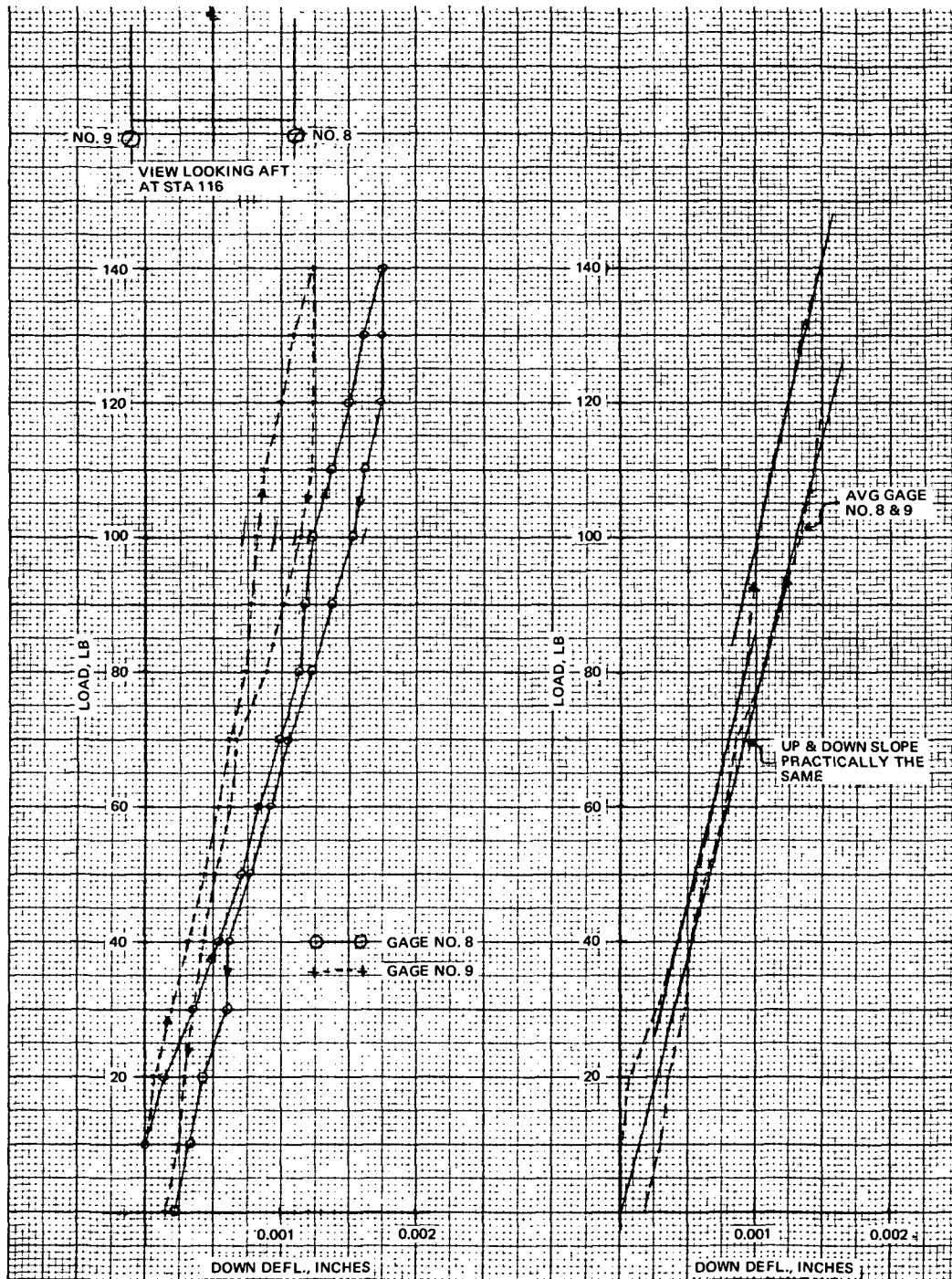

Fig. A3-25. Static Deflection (Run No. 8): +Z Load at Sta 46.8 (Cargo Doors Off)

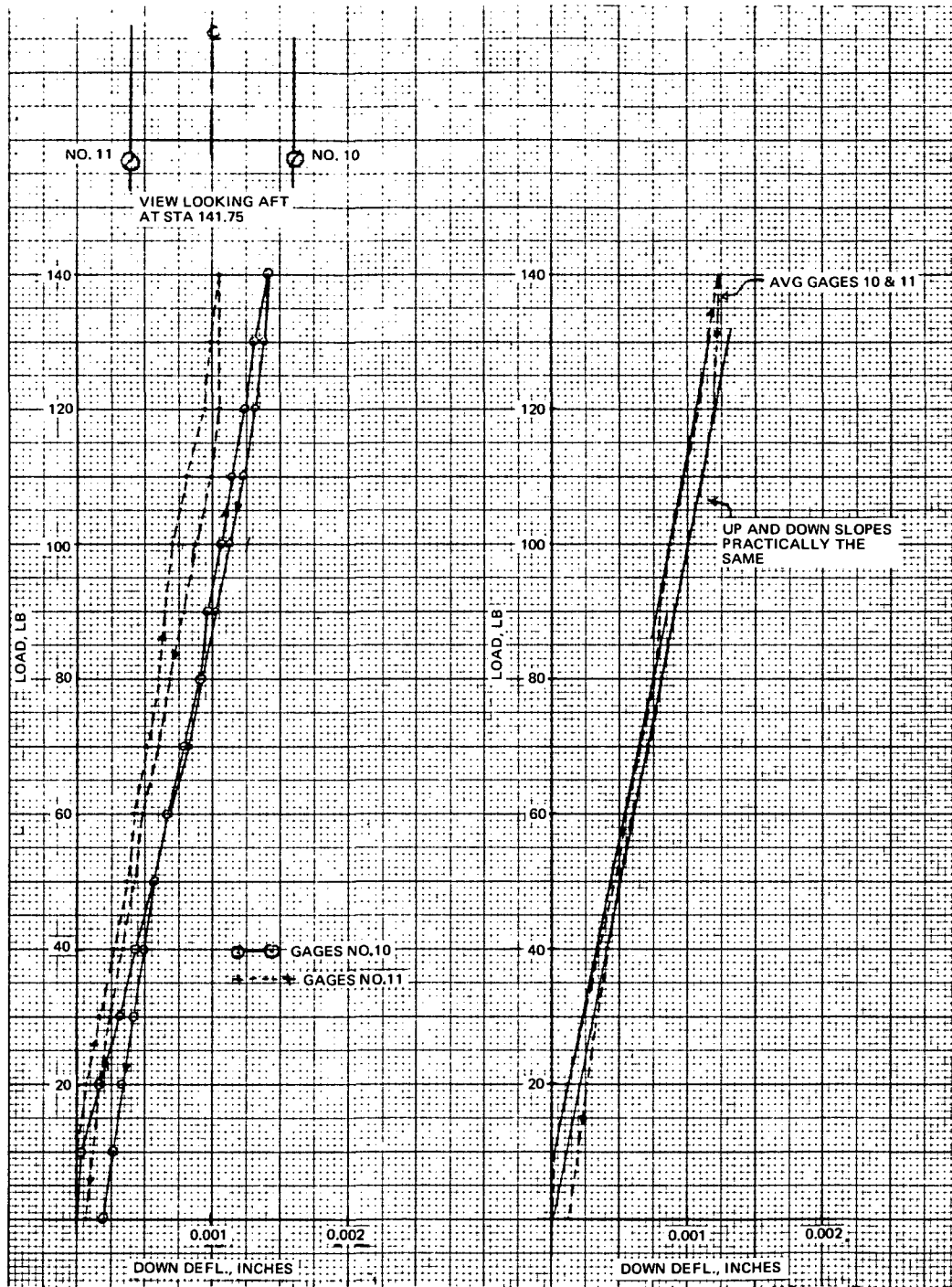

Fig. A3-26. Static Deflection (Run No. 8): +Z Load at Sta 46.8 (Cargo Doors Off)

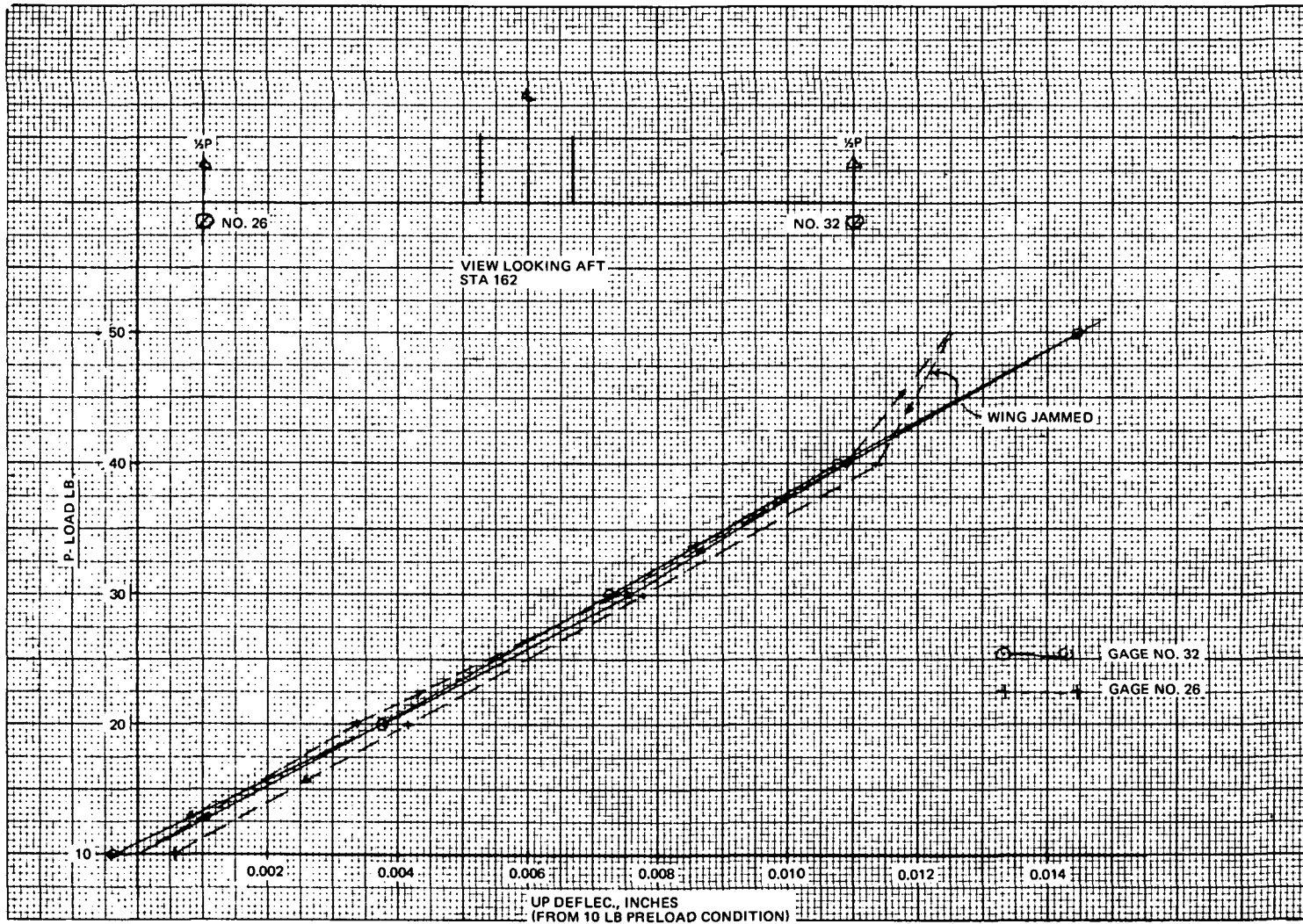

Fig. A3-27 Wing Tip (Run No. 9): +Z Load At Sta 162 (Doors on)

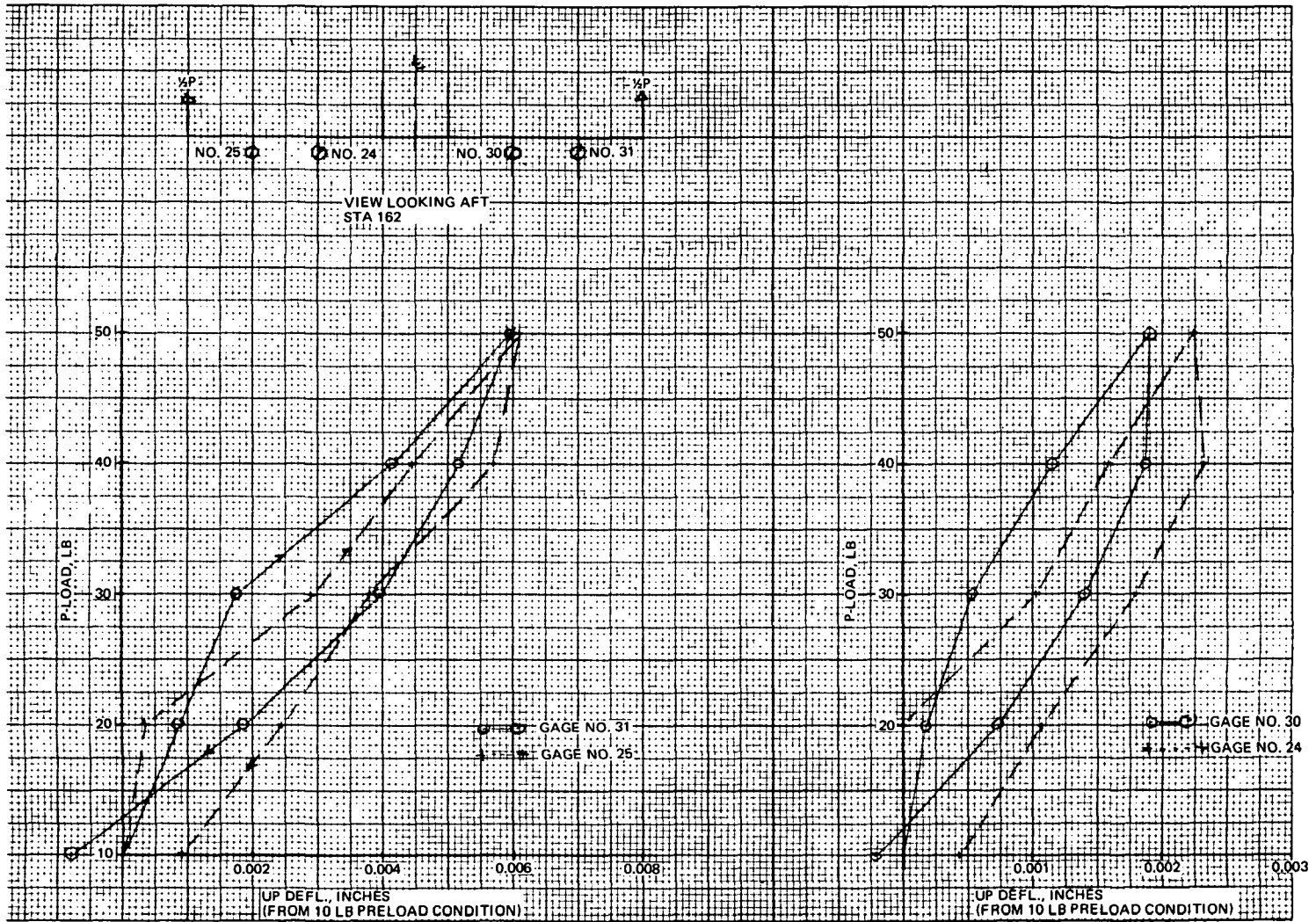

Fig. A3-28 Wing Tips (Run No. 9): +Z Load at Sta 162 (Doors on)

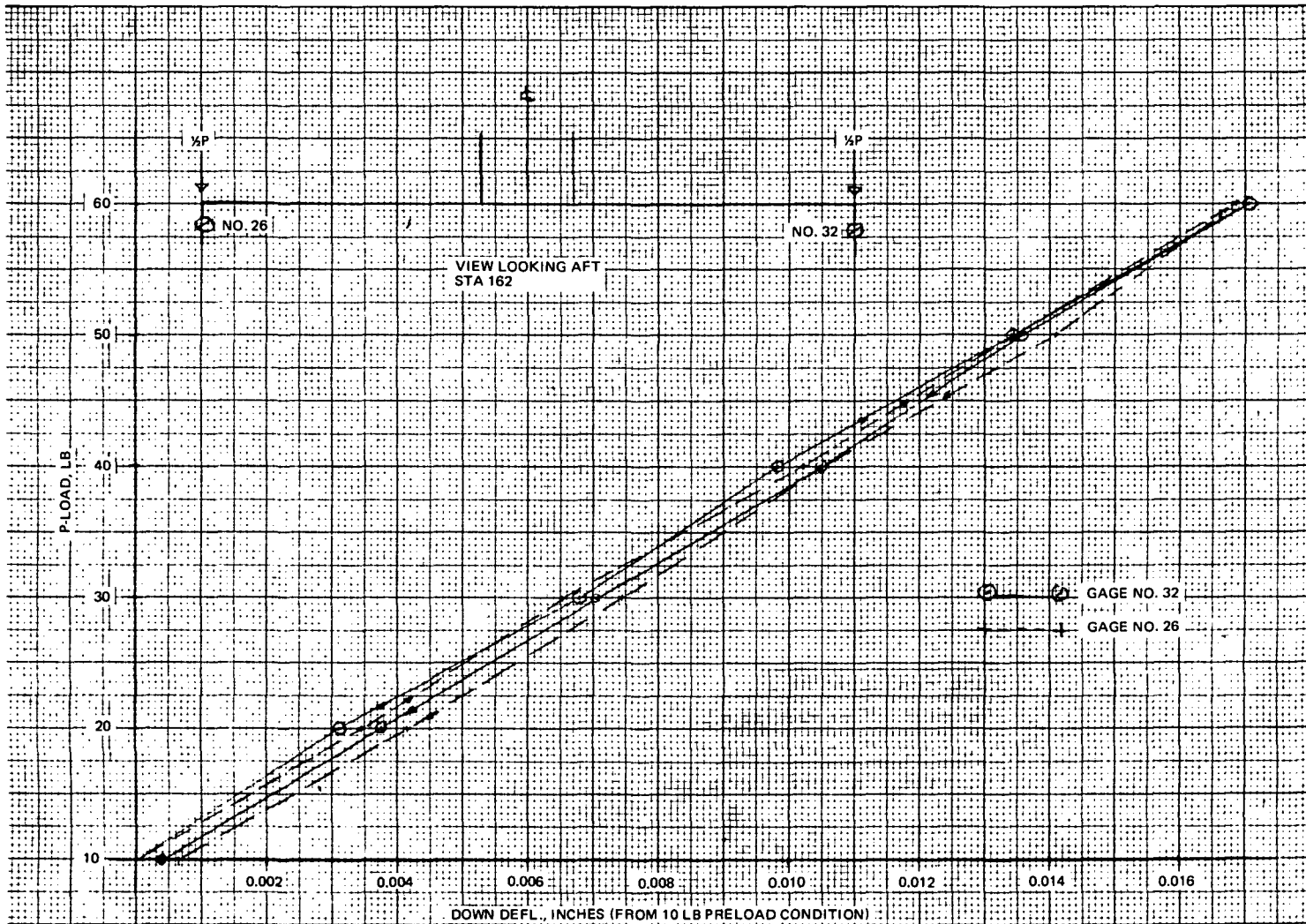

Fig. A3-29 Wing Tip (Run No. 10): -Z Load at Sta 162 (Doors On)

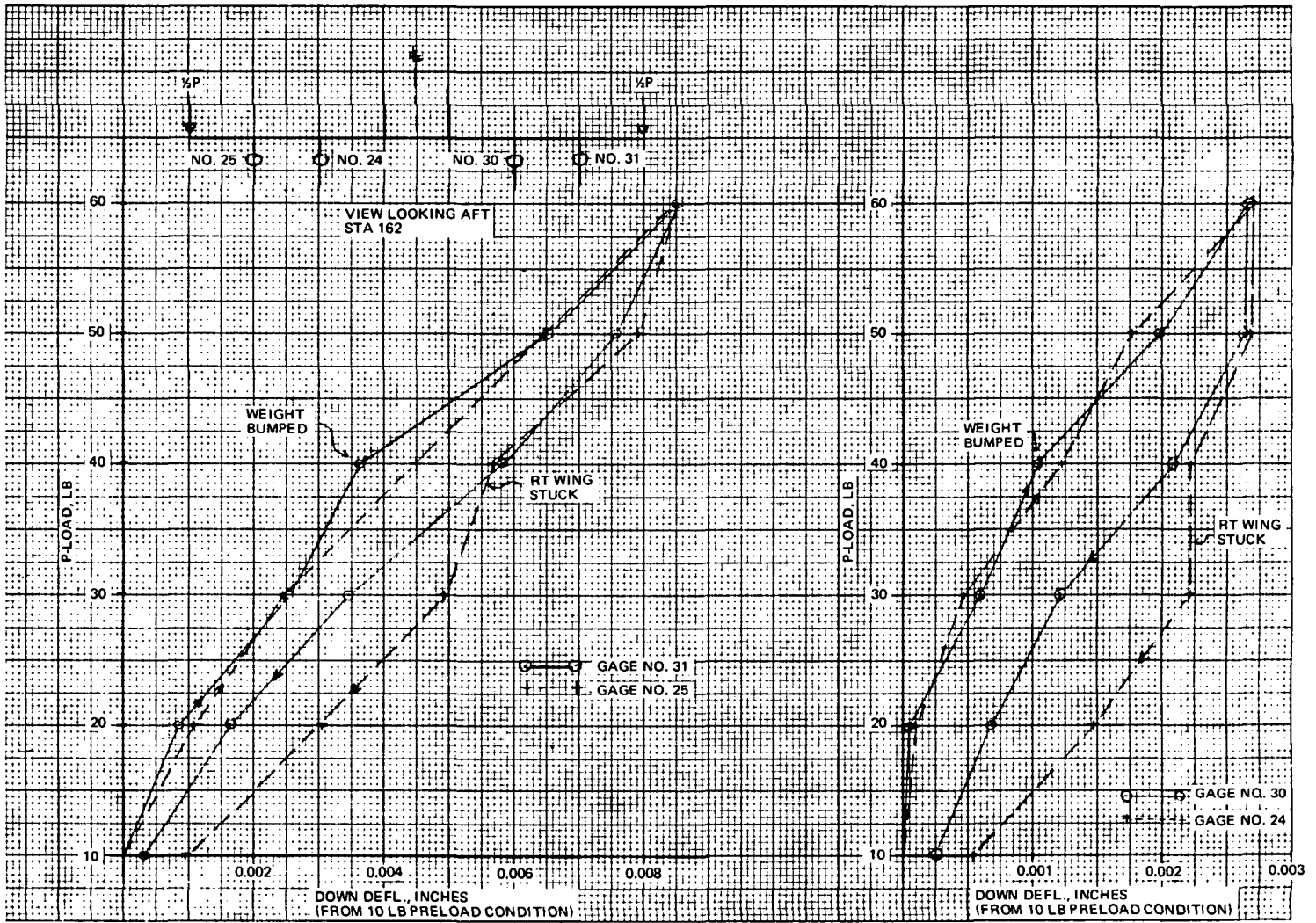

Fig. A3-30 Wing Tips (Run No. 10): -Z Load at Sta 162 (Doors On)

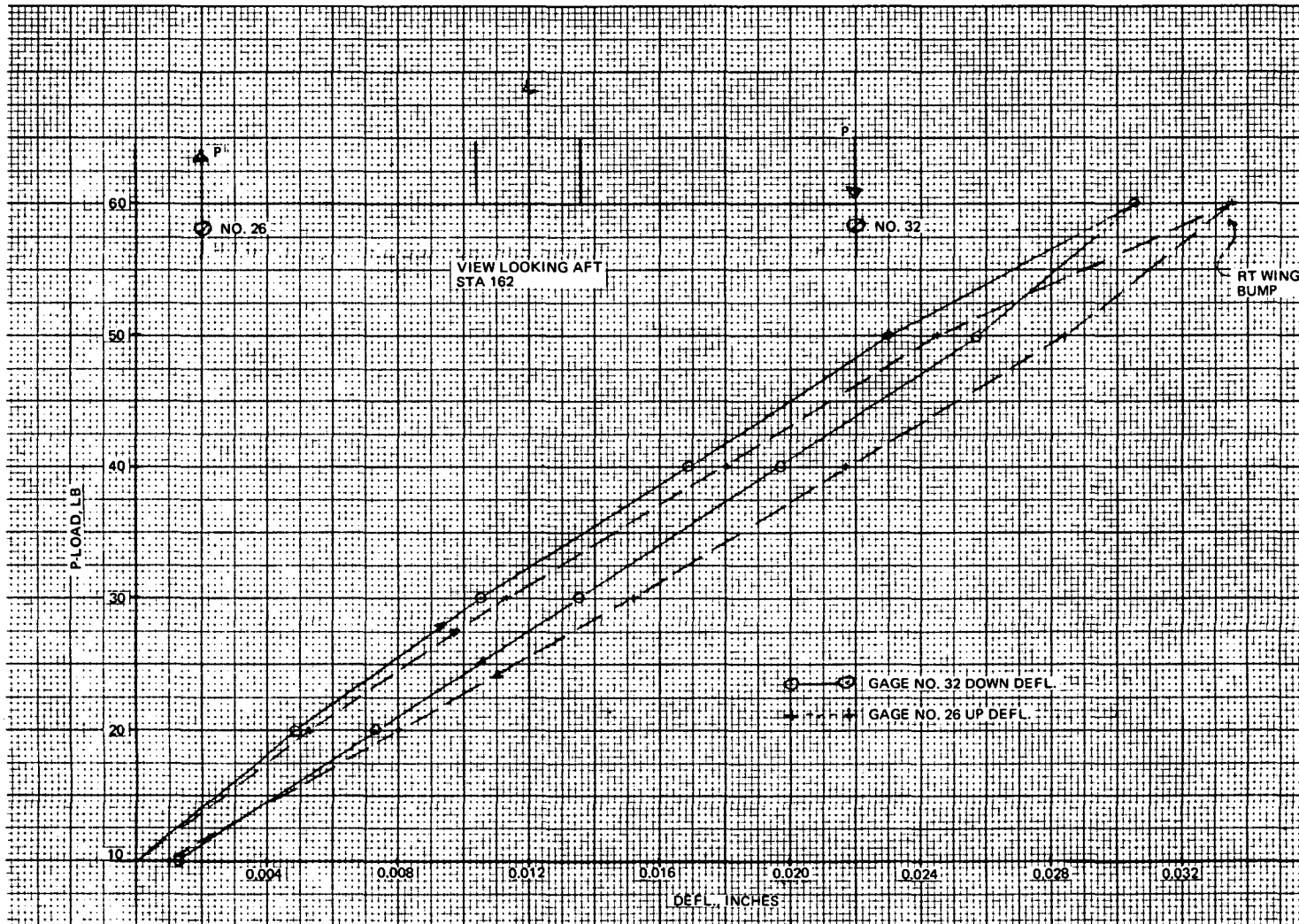

Fig. A3-31 Wing Tip (Run No. 11): Up-Down Load at Sta 162 (with Doors)

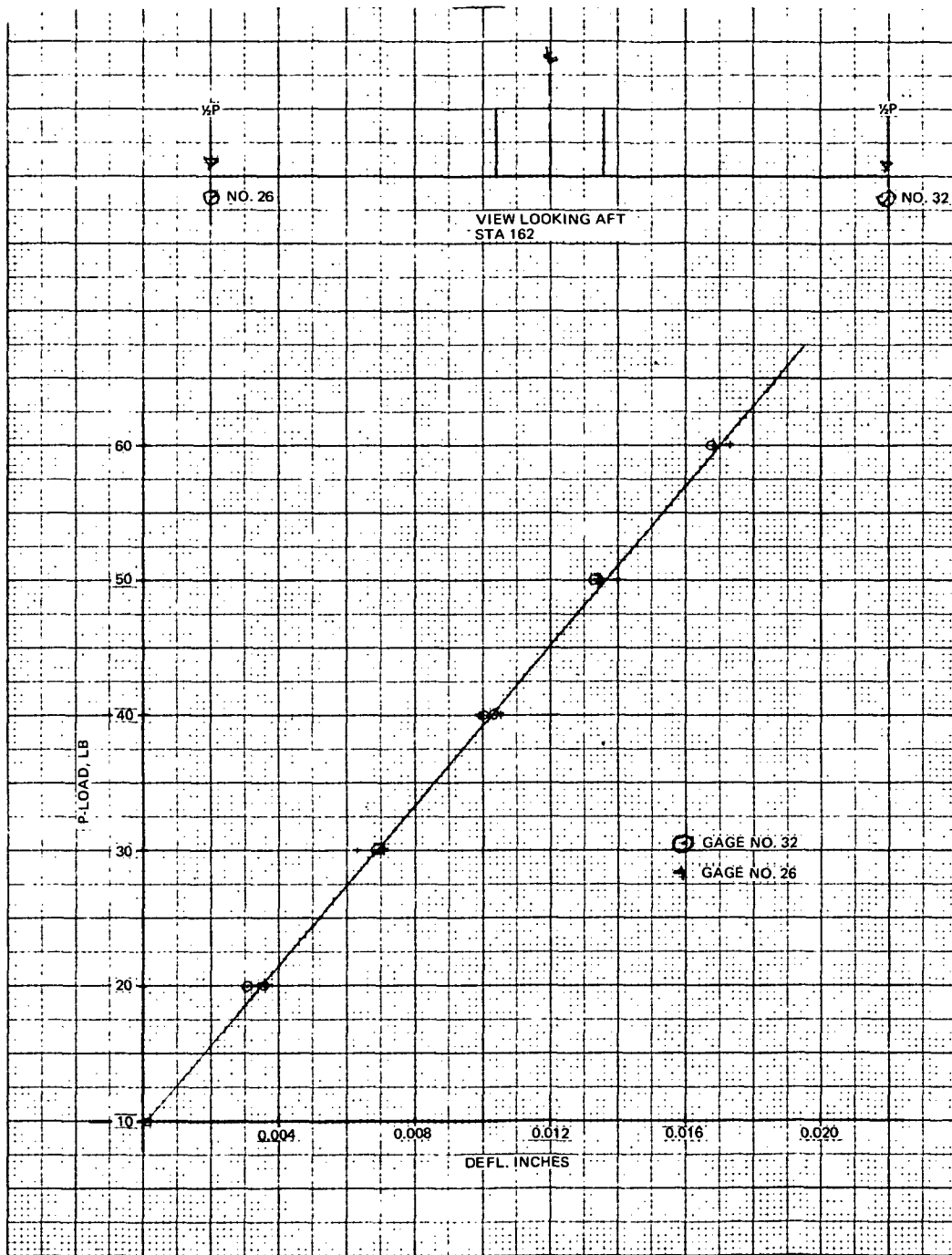

Fig. A3-32 Wing Tips (Run No. 13): -Z Load at Sta 162 (Cargo Doors On)

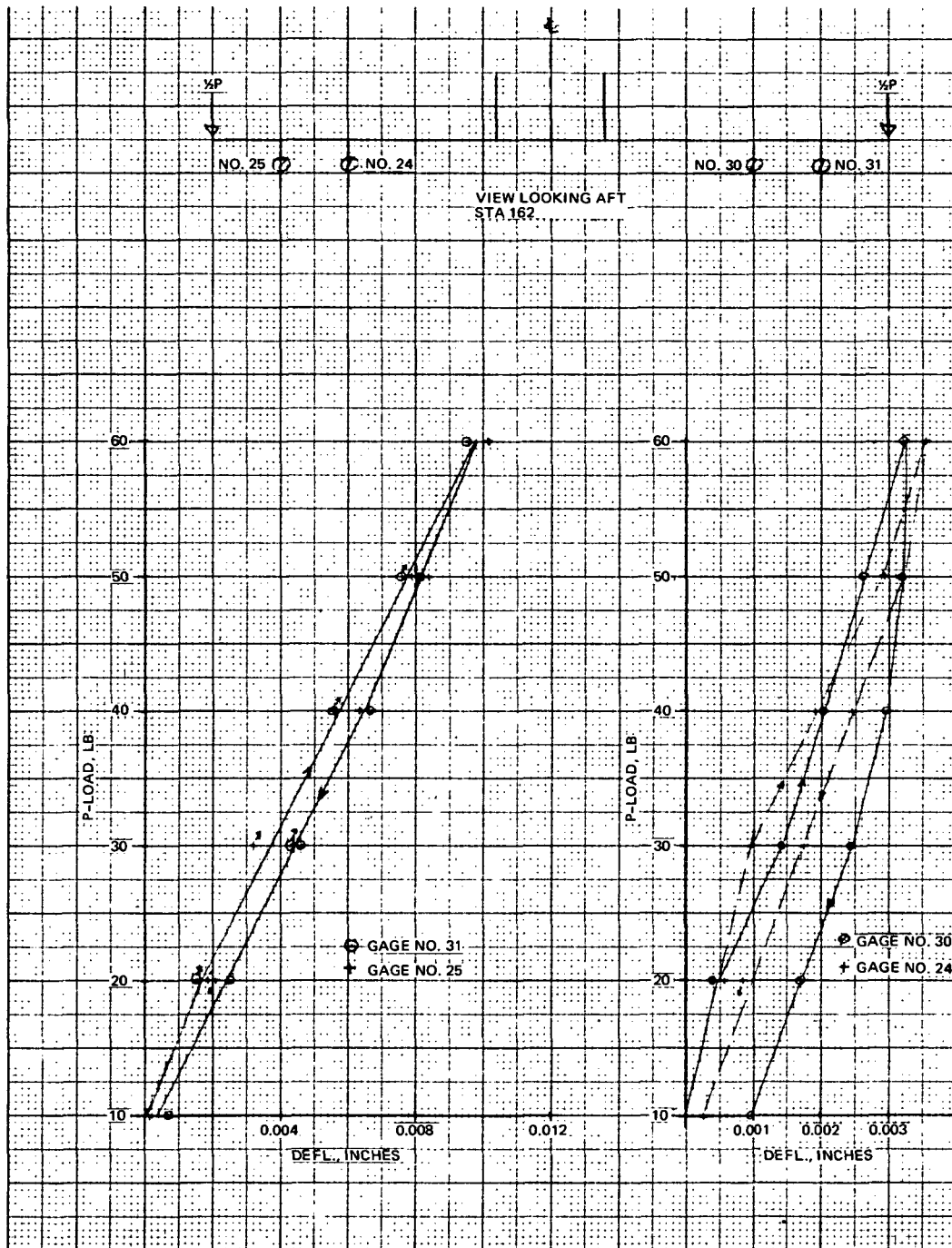

Fig. A3-33 Wing Tips (Run No. 13): -Z Load at Sta 162 (Cargo Doors On)

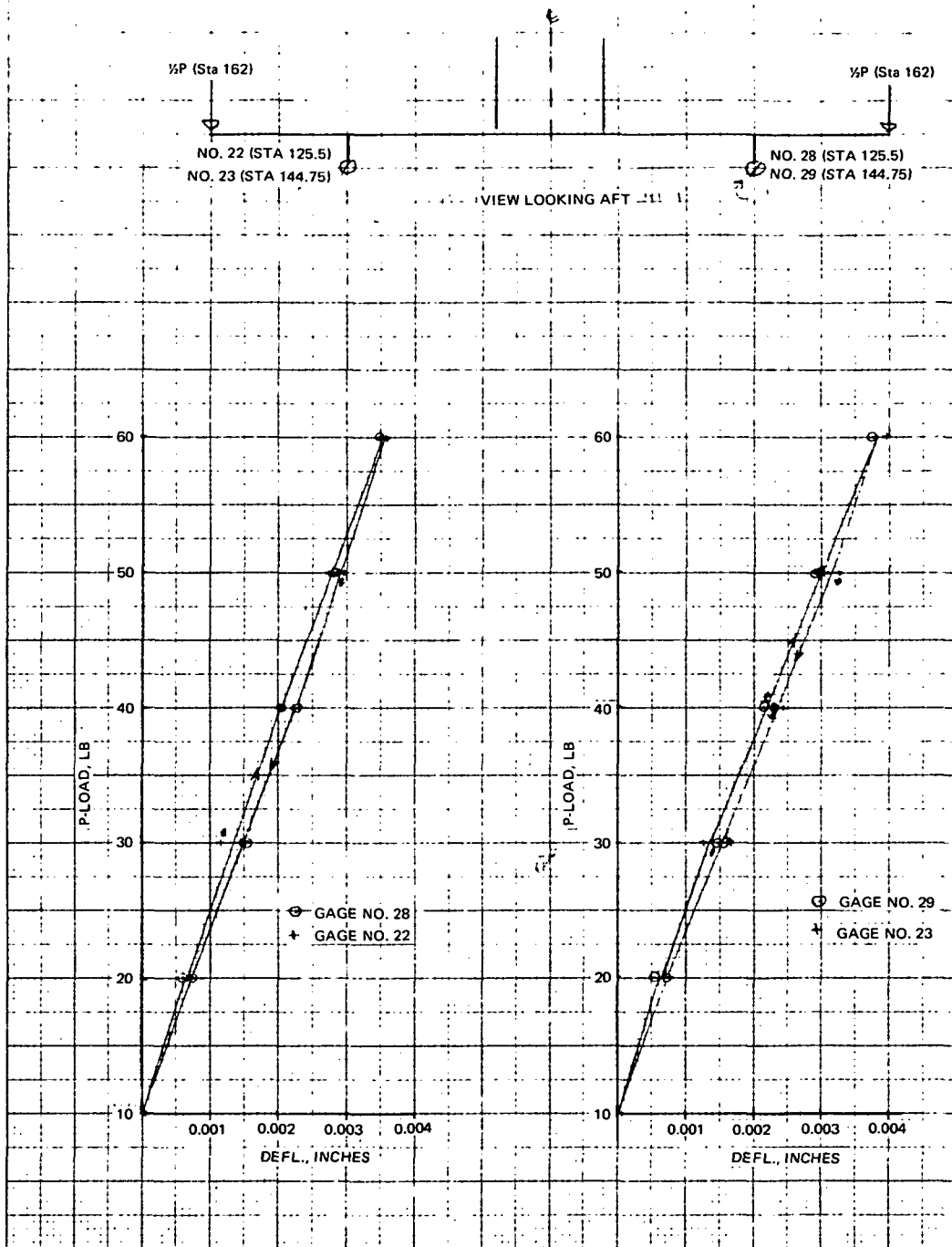

Fig. A3-34 Wing Tips (Run No. 13): -Z Load at Sta 162 (Cargo Doors On)

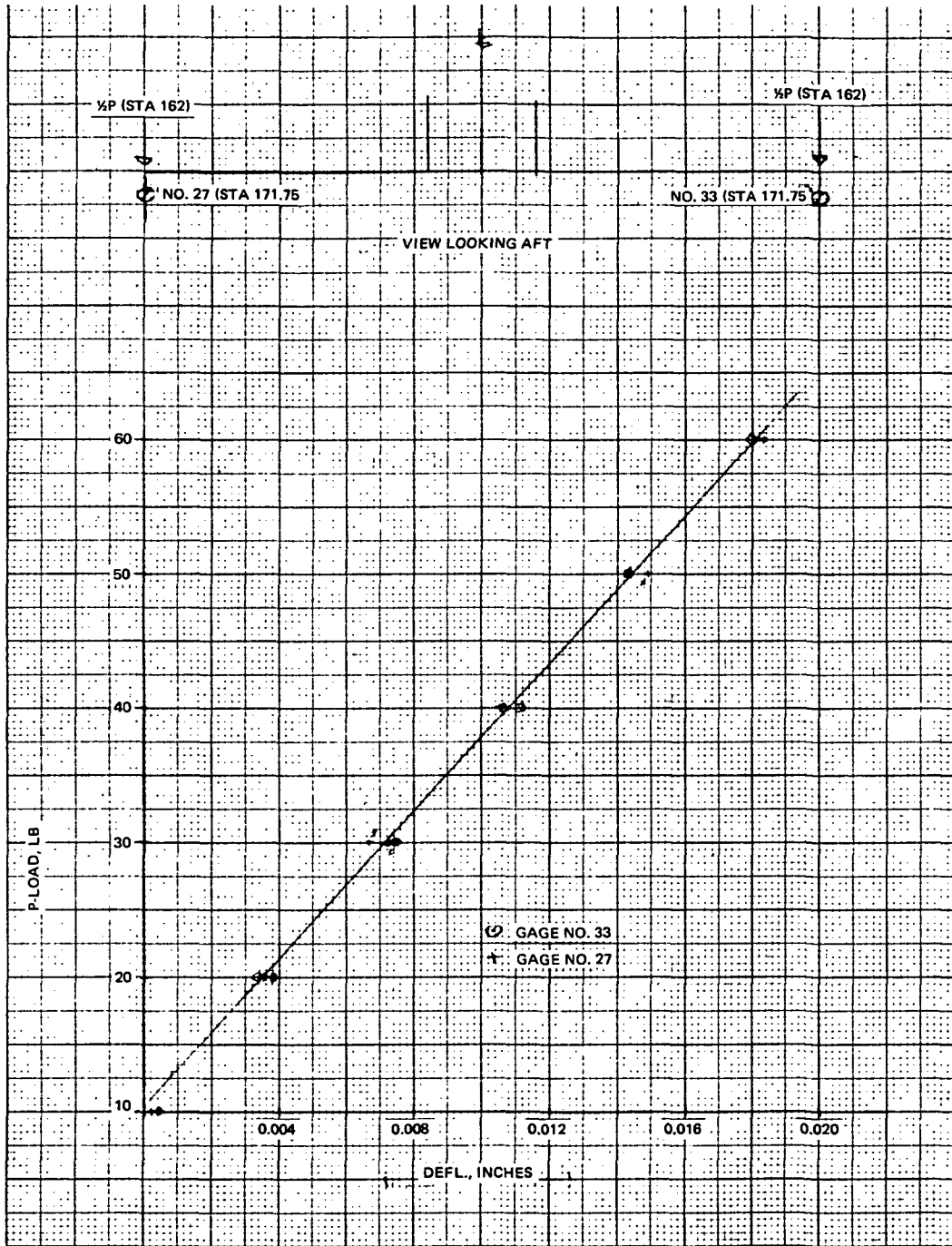

Fig. A3-35 Wing Tips (Run No. 13): -Z Load at Sta 162 (Cargo Doors On)

Appendix A4
NASTRAN SUBSTRUCTURING ANALYSIS FOR
NORMAL MODES/REVISED ALTERED RIGID
FORMAT 3 FOR PHASES 1 OR 2

APPENDIX A4

NASTRAN SUBSTRUCTURING ANALYSIS FOR NORMAL MODES REVISED ALTERED RIGID FORMAT 3 (FOR PHASE 1 OR 2)

NOTE

Refer to Volume IIIB, Appendix B1 for NASTRAN substructuring analysis used for Model I.

Incorporated New Bulk Parameters

- NOSUB - - - - - Number of reduced substructures on tape INP9.
Default = -1, which indicates a Phase 1 run, where one substructure will be reduced.
- TPCOPY ≥ 0 - - - - - Will put reduced stiffness and mass matrix (Kaa & Maa) on tape INPT. Default = -1.
- TPNAME - - - - - Label name of tape INPT. Use only when TPCOPY ≥ 0 .
- TPNAME 9 - - - - - Label name of tape INP9, which contains the column partitioning vector, reduced stiffness, and mass for each reduced substructure. The column partition vectors are used to merge the reduced stiffness and mass of each reduced substructure into a common pseudo-structure lineup. Use this parameter only when NOSUB > 0 .
- TPCOPYN ≥ 0 - - - - - Will put the pseudo-structure eigenvalues and eigenvectors in substructure lineups on tape (INP1, INP2, etc.) for further processing in Phase 3 to obtain, if desired, detailed mode shapes. This parameter not used in Phase 1. Parameter default = -1.
- TPNAMEN - - - - - Common label name of INP1, INP2, etc. Use only when TPCOPYN ≥ 0 .
- RMODE ≥ 0 - - - - - Causes restrained Free modes to be obtained. The restraints are defined on SUPORT cards, which in this case, do not have to be rigid body supports. Default = -1, where free-free modes will be automatically obtained, and the SUPORT card defines the customary rigid body supports.

Regular Bulk Parameters Used

GRDPNT - - - - - This parameter should always be used. It causes the rigid body mass matrix MO to be printed out, which can be compared with the matrix MOgg discussed in ALTER 49.

WTMASS = .002588 - - Assumes that all mass input was in weight (lbs). This was the case in analyzing the 1/8 scale model. The MO matrix discussed under GRDPNT was thus a rigid body weight matrix. If the user does not wish to work in weight terms, he need only multiply the 6 x 6 MO matrix by .002588 to compare with certain rigid body weight matrices generated in the Alters.

Changes in Substructuring Assumptions

The DMAP alters incorporated are made up essentially of checks, so that errors can be weeded out as we go from Phase to Phase. For the checks to work, certain rules must be followed. These have been applied to both Models I and II.

- (1) Any zero-stiffness degrees of freedom, and symmetric or anti-symmetric boundary constraints at the model plane of symmetry are included in the Single Point Constraint Set (SPC). No other degrees of freedom are included in this set.
- (2) Each substructure should reference the same origin on the GRDPNT parameter card and also reference the same basic coordinate system.
- (3) No scalar points should be used. The grid points established in Phase 2 were the grid points that are associated with the substructure a-set degrees of freedom. All non-strainable D.O.F. were removed by SPC's.

IMPORTANT NOTE:

When doing a coupling run (Phase 2), where all substructures have been reduced and on tape, it was necessary to input in the BULK data at least one element, to prevent a fatal error in module TA1. A minimal rod with a very small area will suffice.

ALTERS INCORPORATED (General Flow)

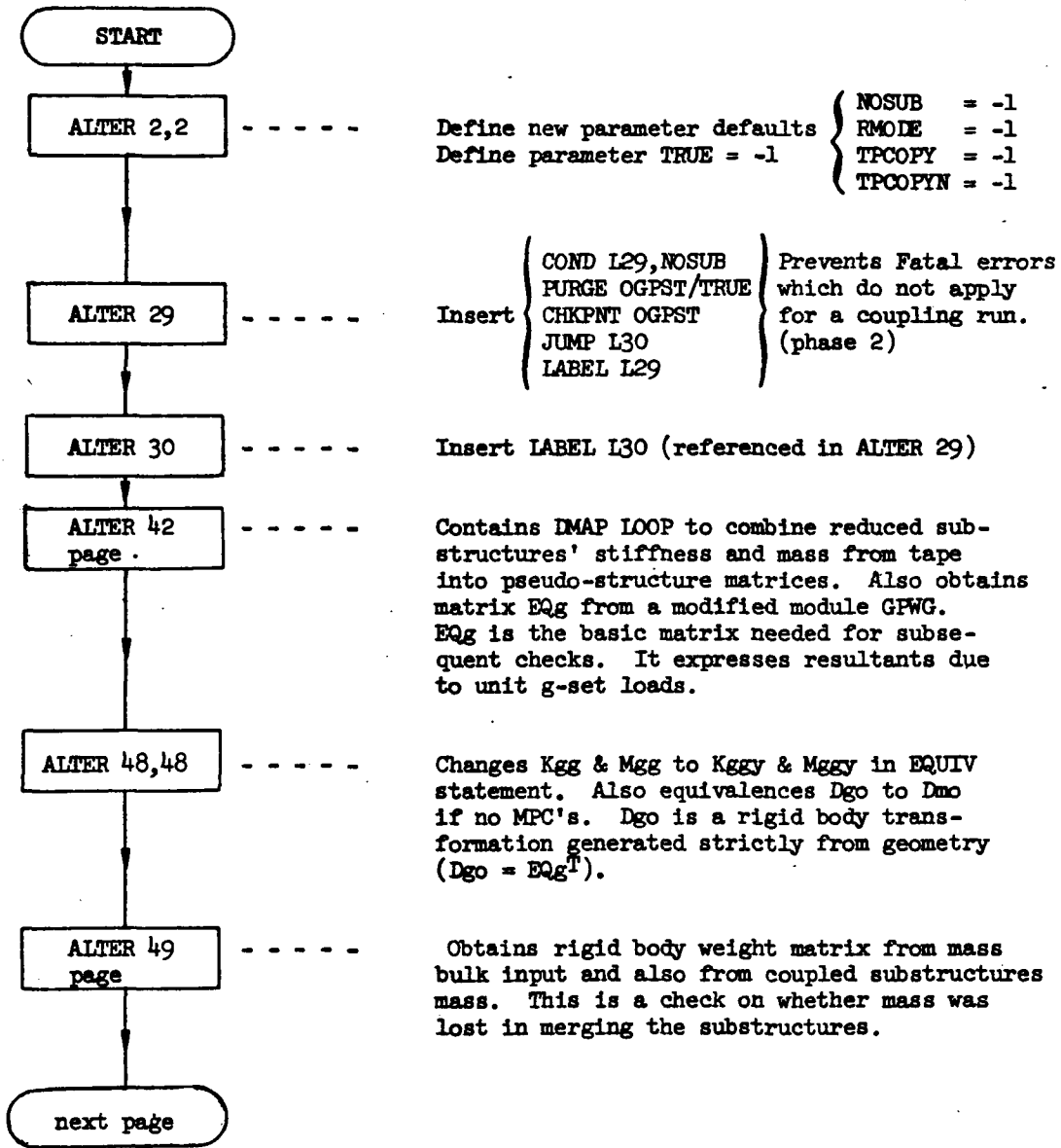

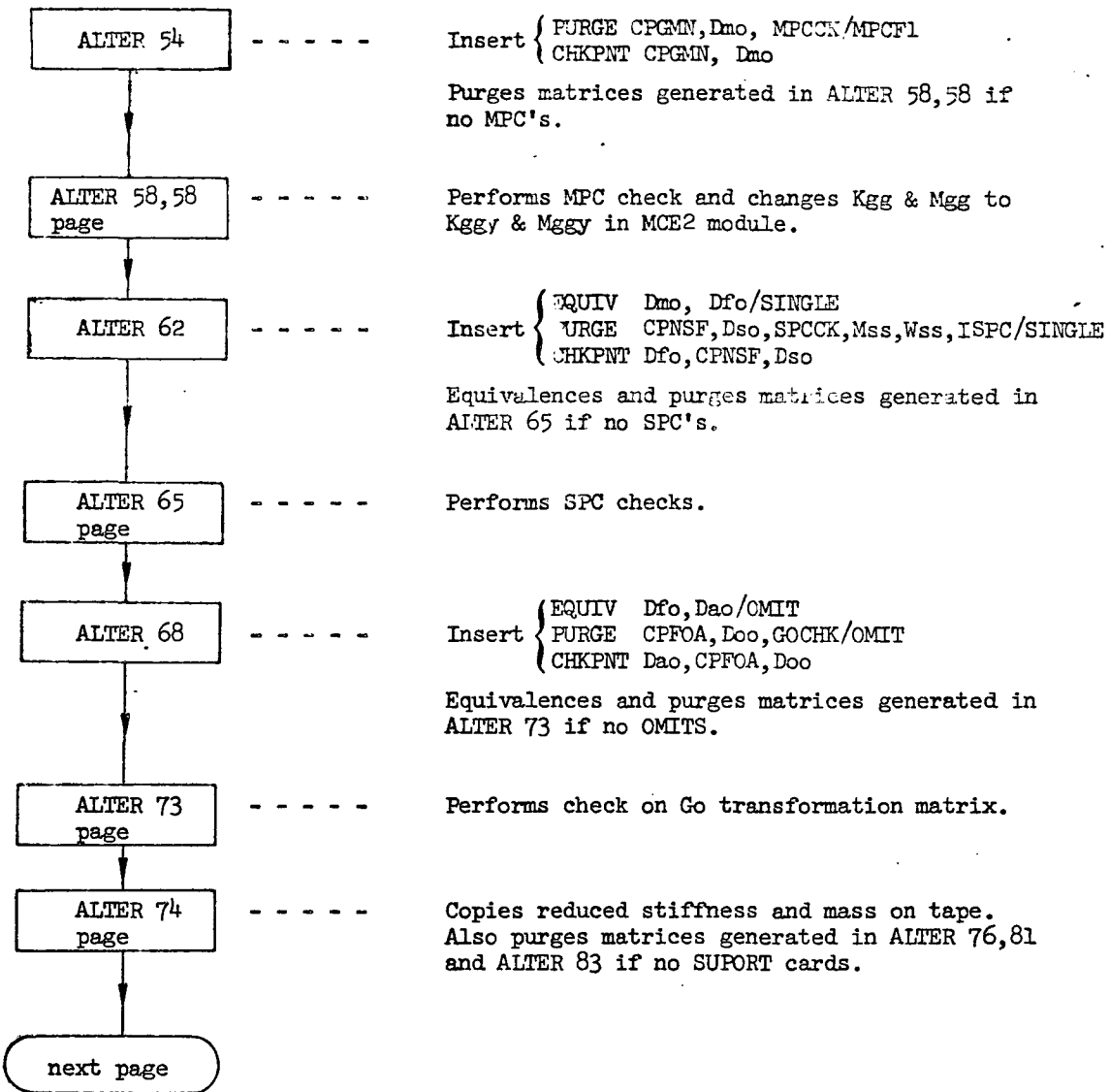

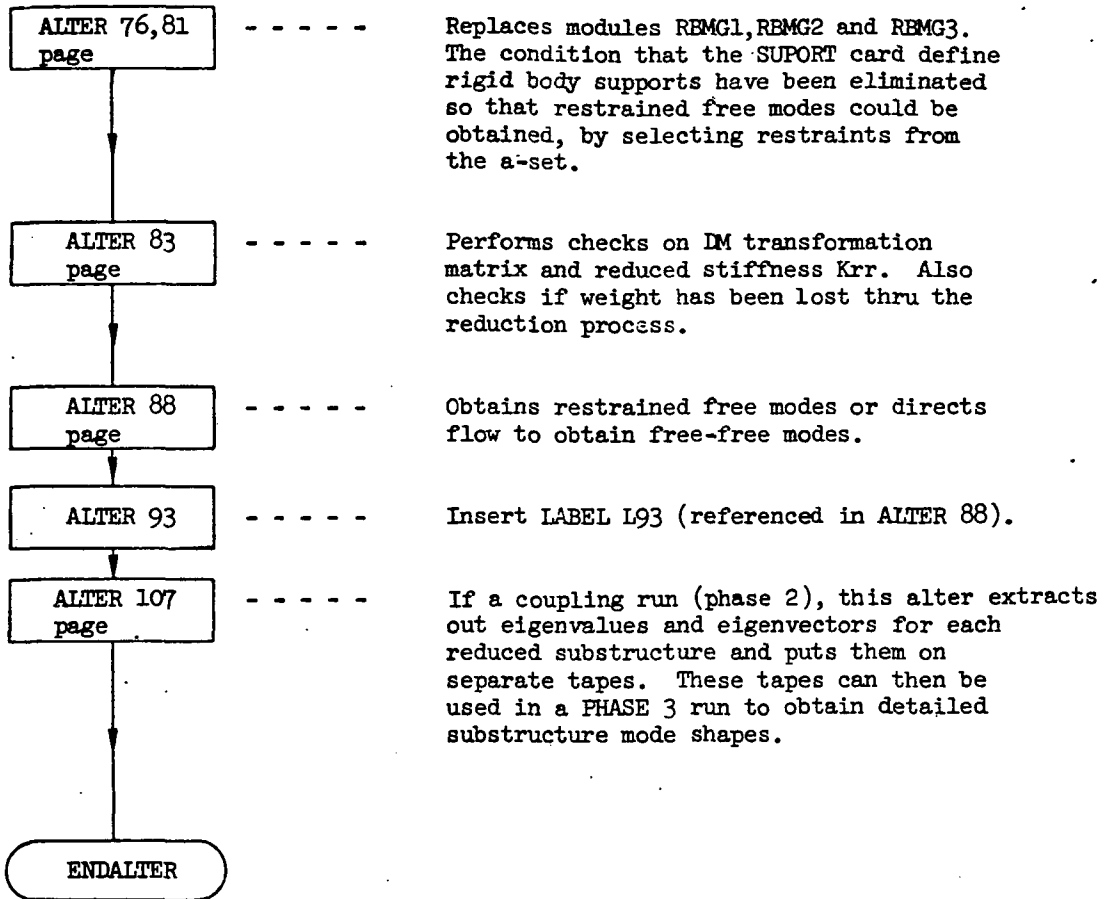

ALTER 42 (DETAILED FLOW)

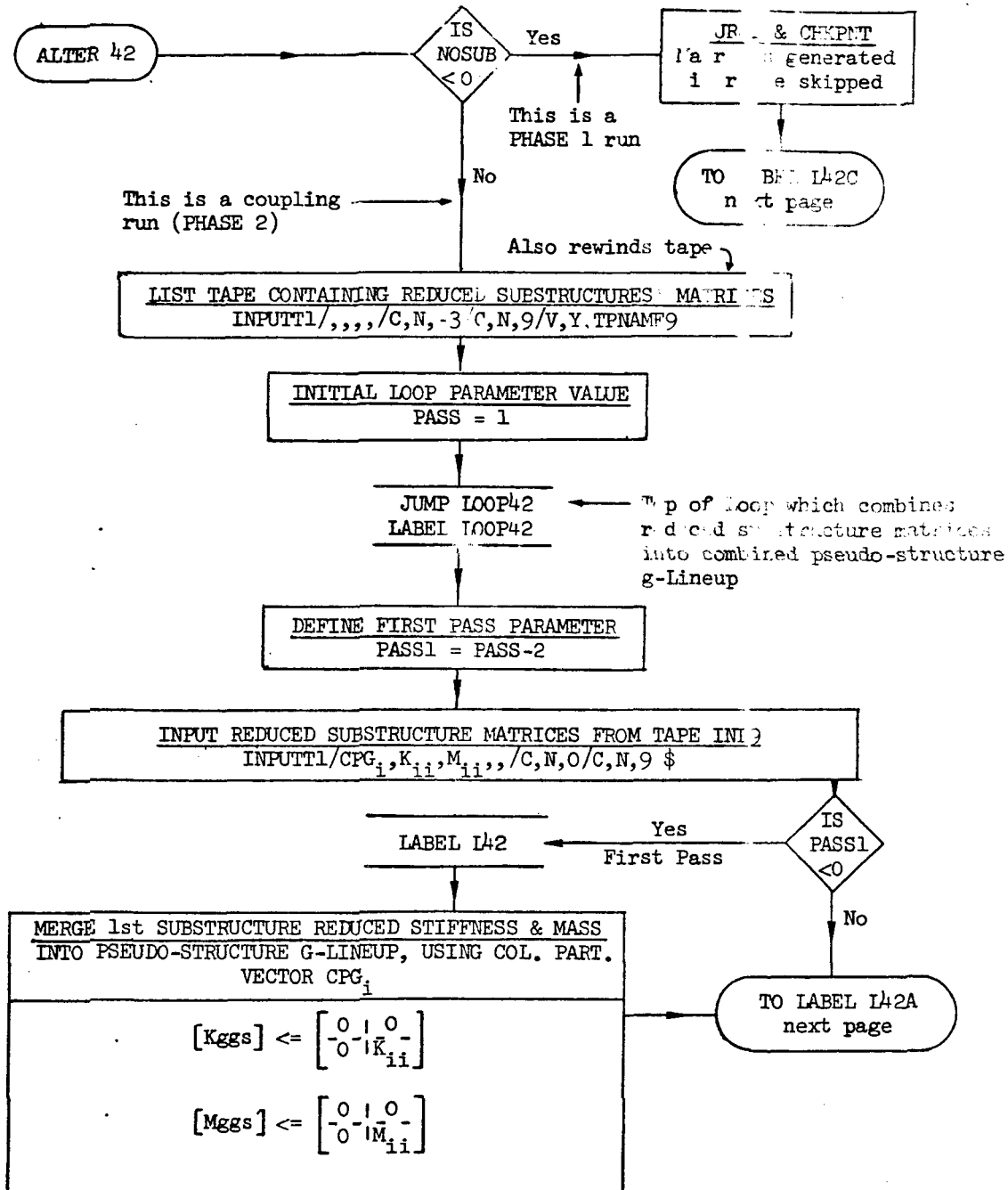

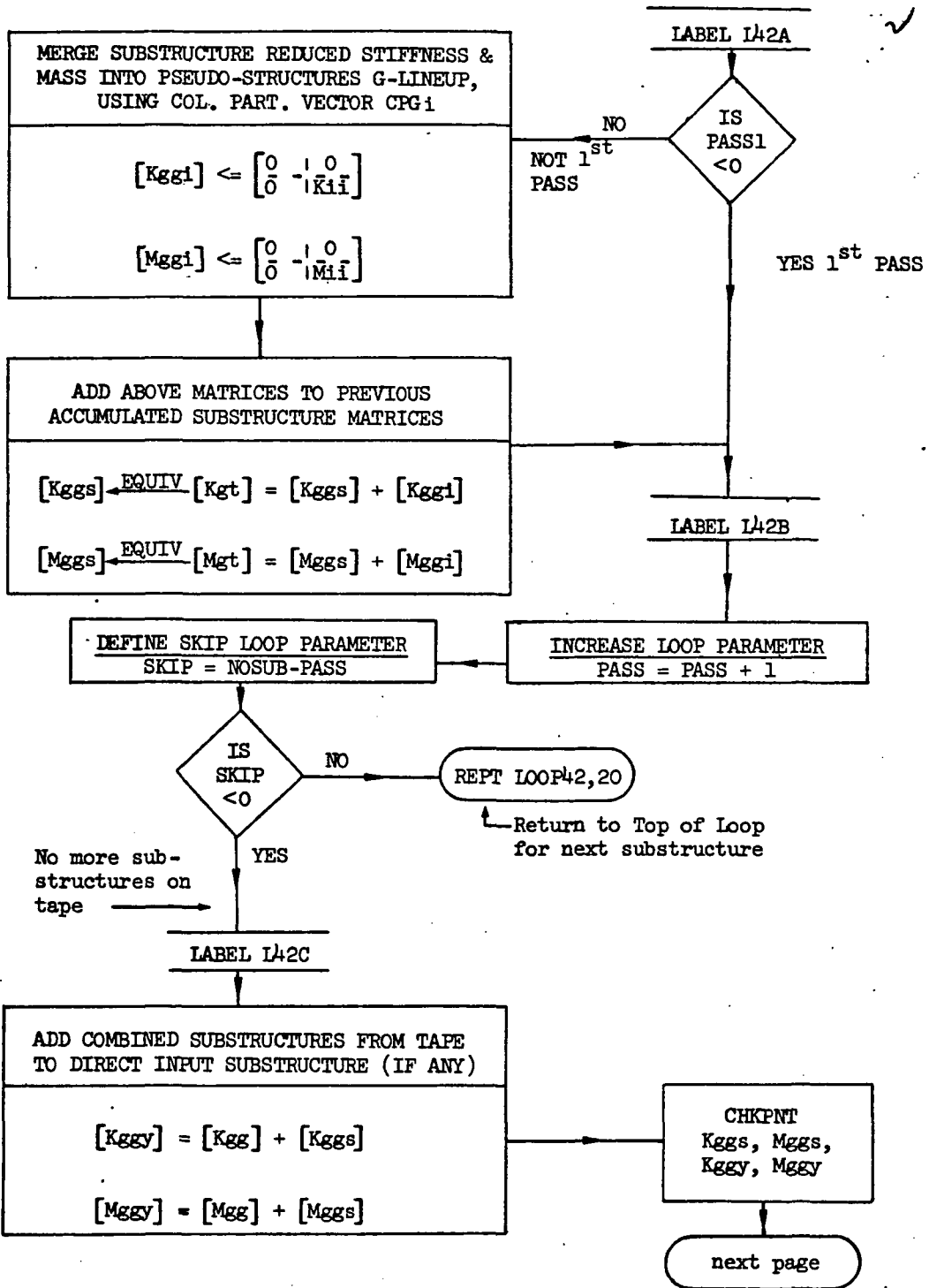

NOTE: Module GFWG has been modified to output matrix EQg. This matrix expresses the basic system resultants of unit g-set loads about a chosen origin, defined by the input parameter GRDPNT. Actually EQg is equal to the $[D]^T$ matrix discussed in the NASTRAN PROGRAMMER'S manual (Section 4.29.7)

OBTAIN EQg FROM GFWG
GFWG BGPDT,CSTM,EQEXIN,/EQg/V,Y,GRDPNT=-1/C,N,0.0 \$

RIGID BODY DEFL'S WITH RESPECT TO ORIGIN DEFL'S
 $[Dgo] = [EQg]^T$

CHKPNT
EQg, Dgo

END OF ALTER 42

ALTER 49 (DETAILED FLOW)

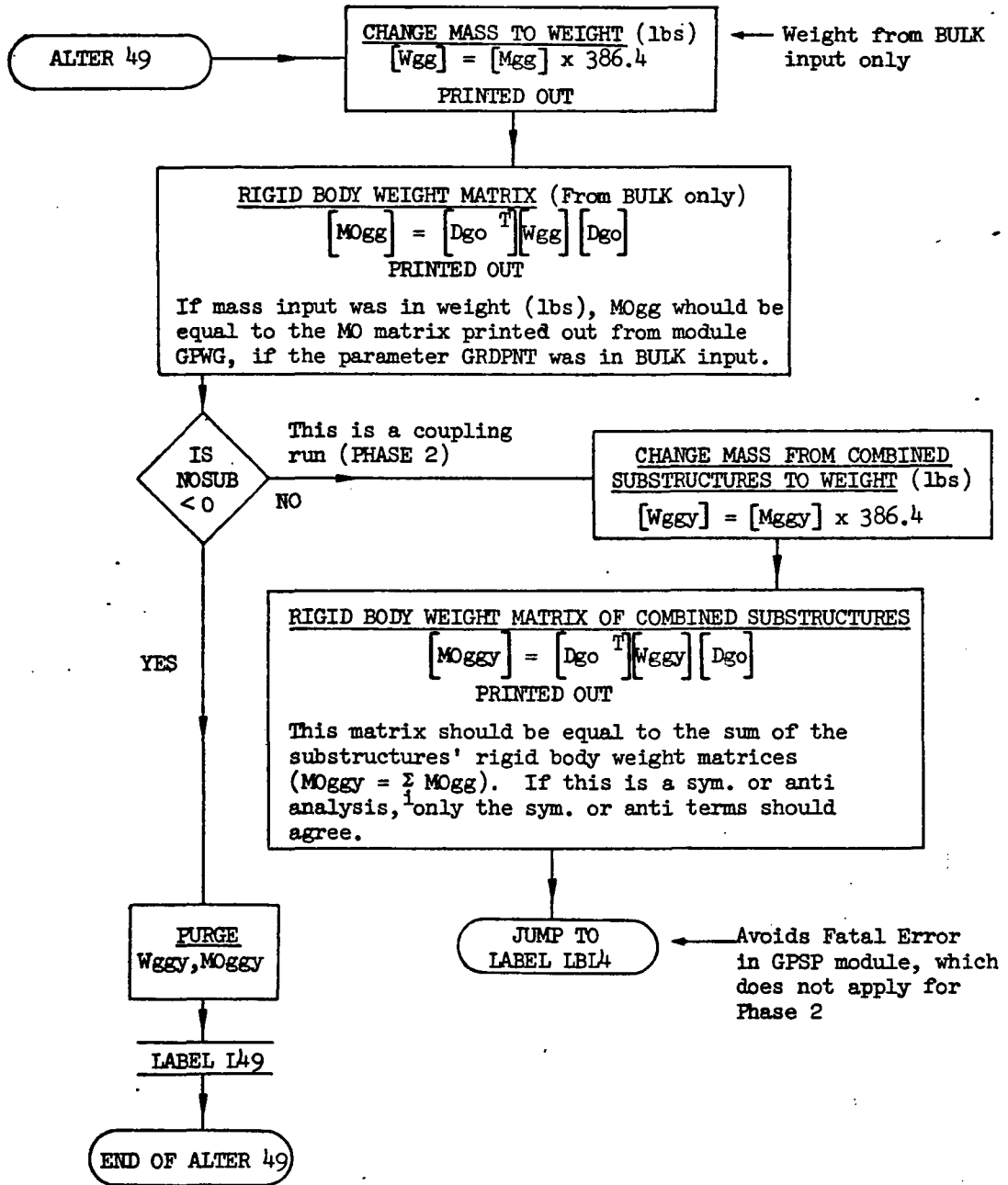

ALTER 58, 58 (DETAILED FLOW)

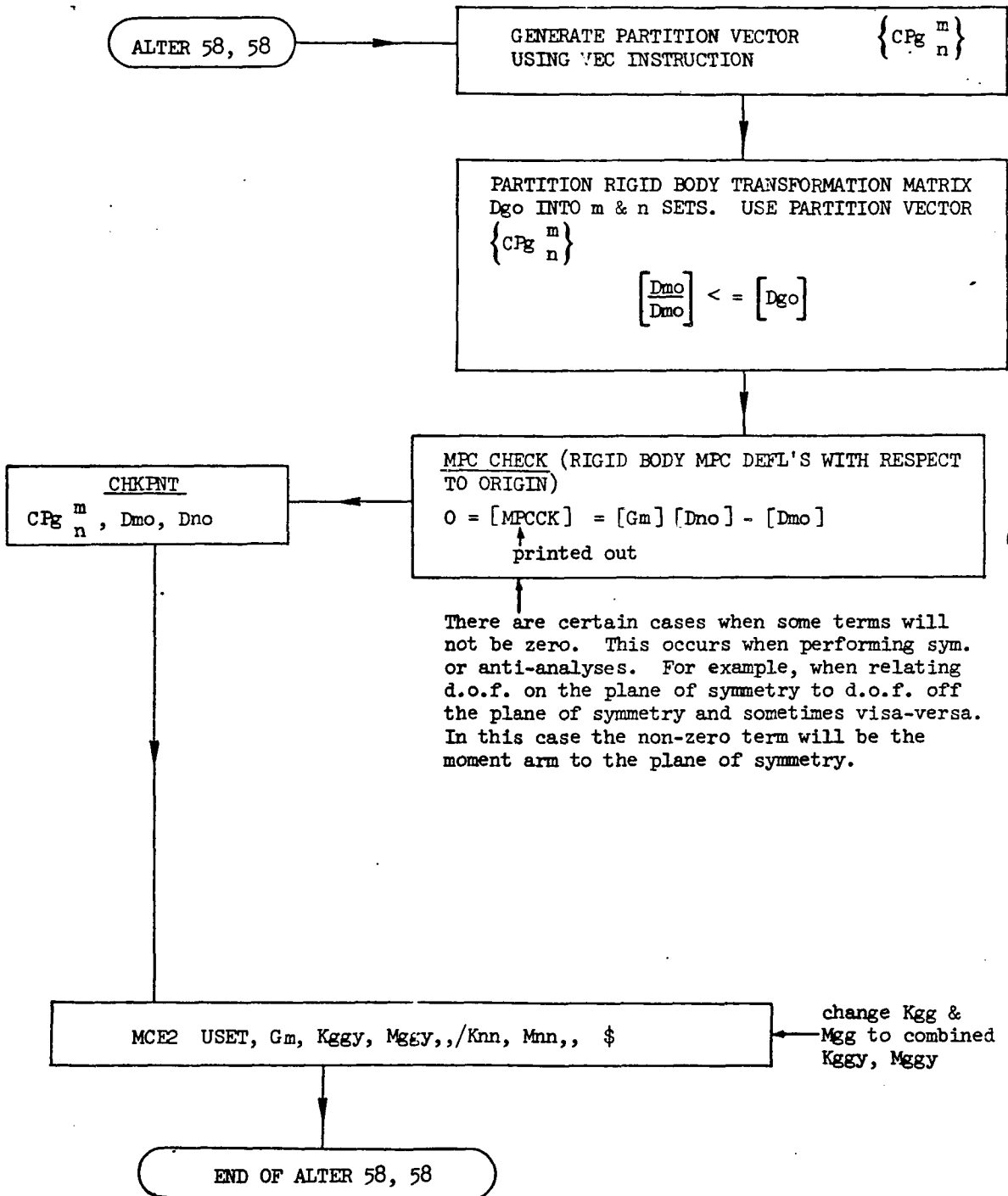

ALTER 65 (DETAILED FLOW)

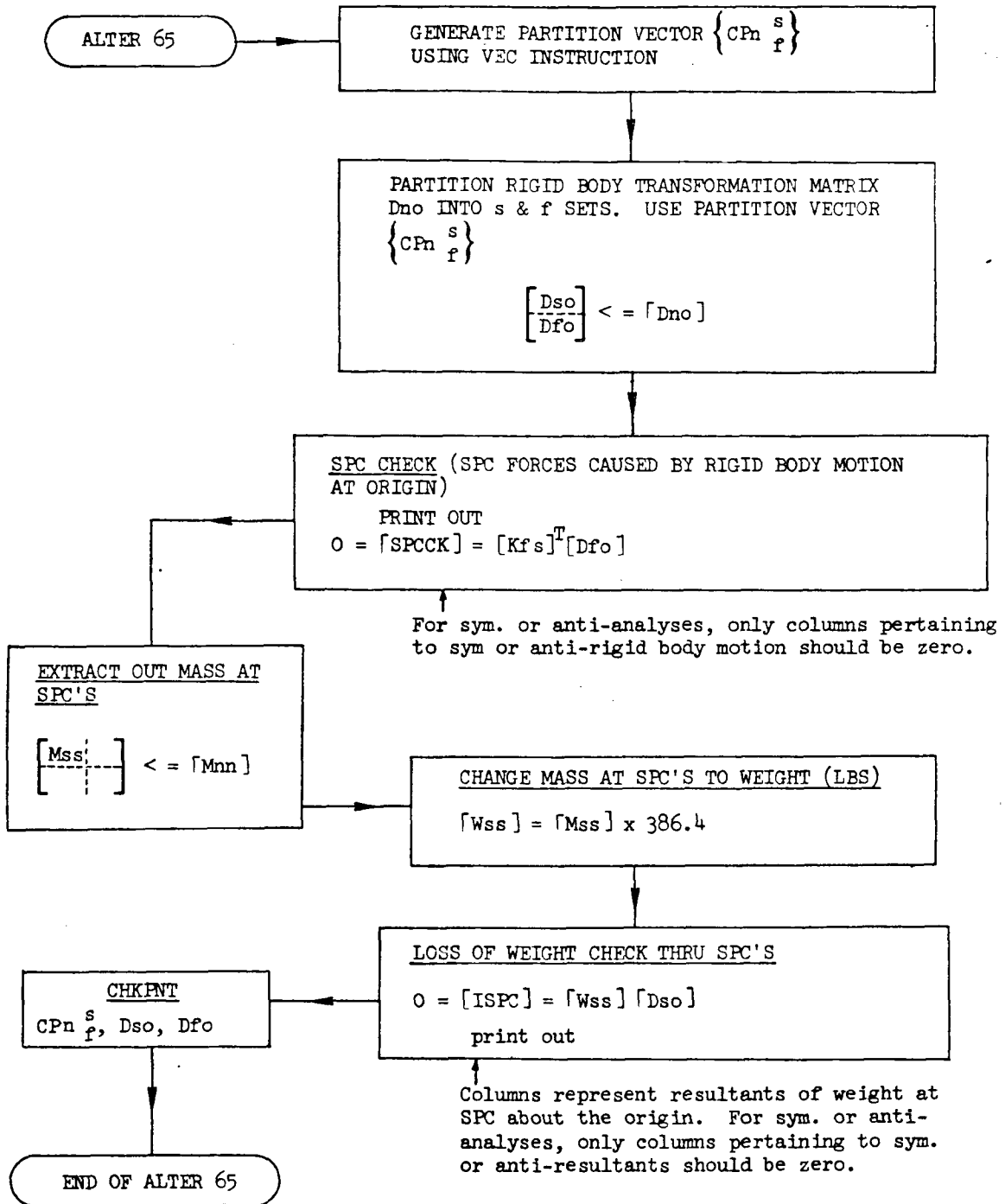

ALTER 73 (DETAILED FLOW)

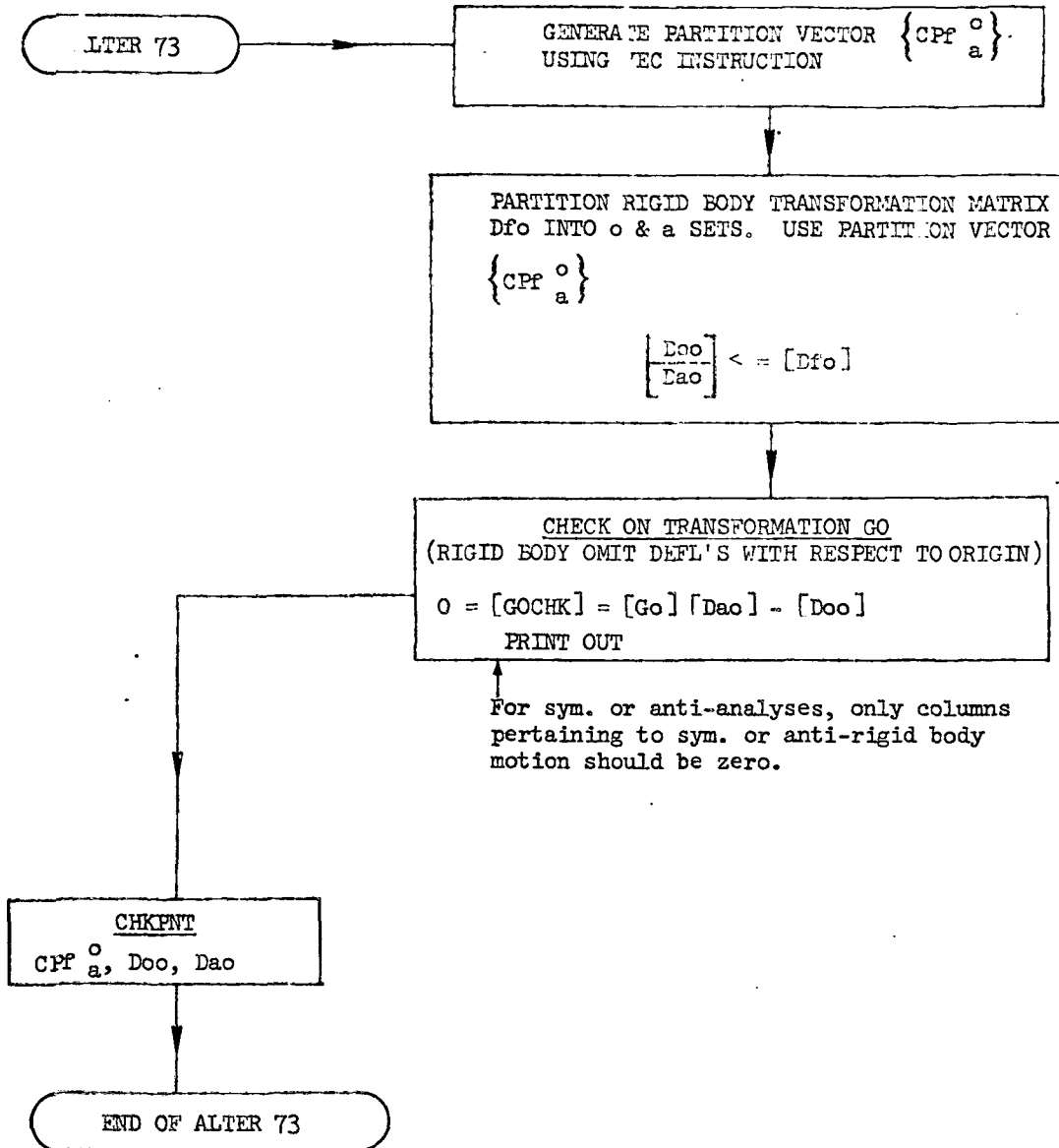

ALTER 74 (DETAILED FLOW)

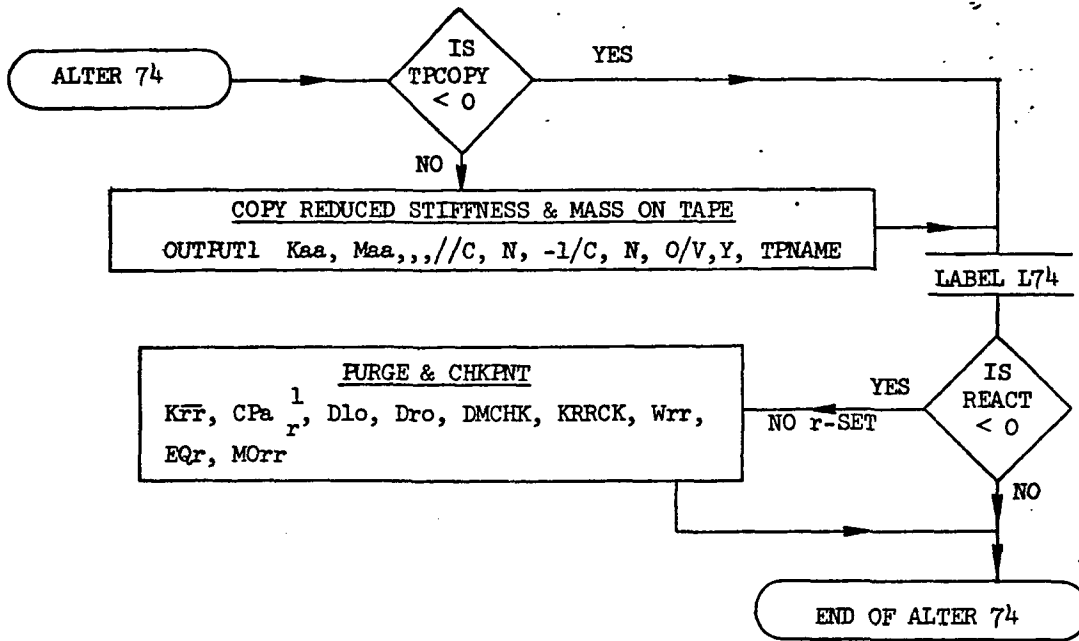

ALTER 76; 81 (DETAILED FLOW)

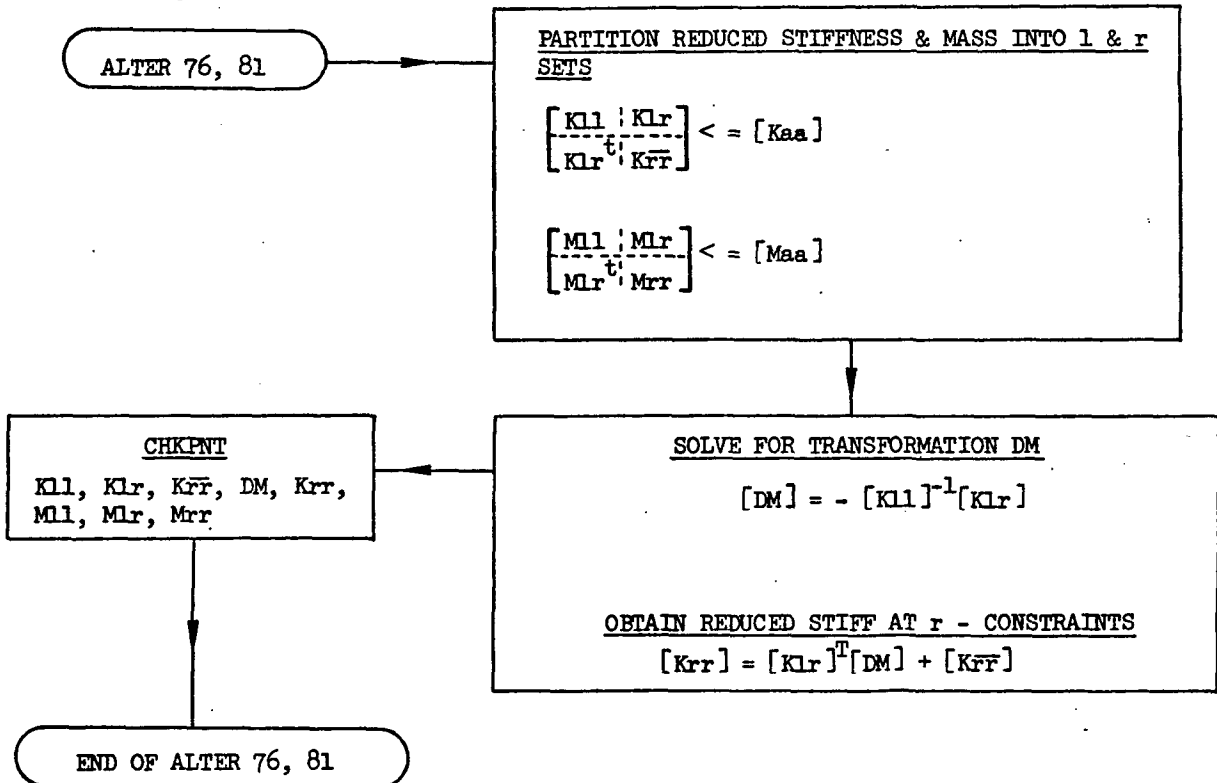

ALTER 83 (DETAILED FLOW)

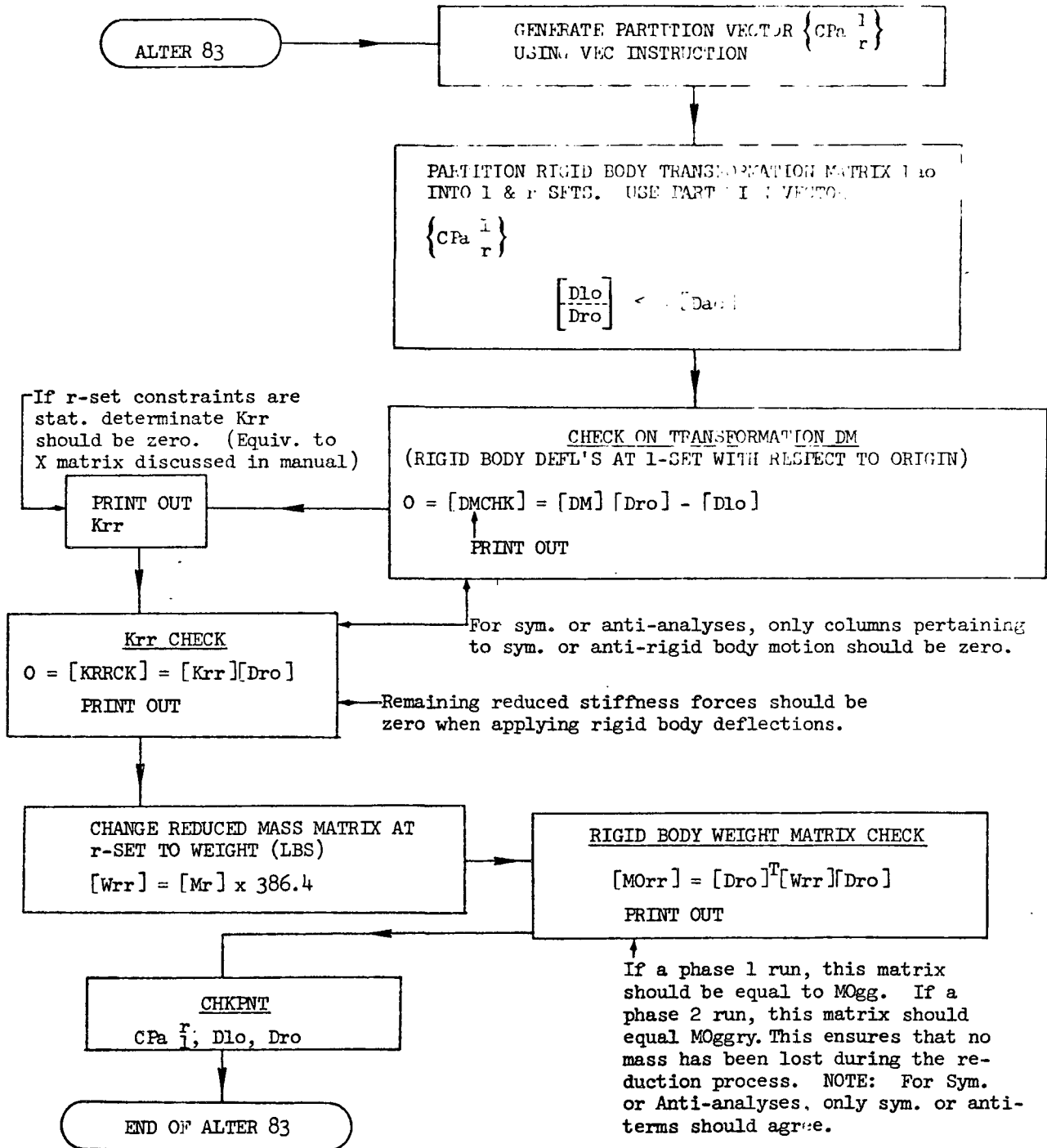

ALTER 88 (DETAILED FLOW)

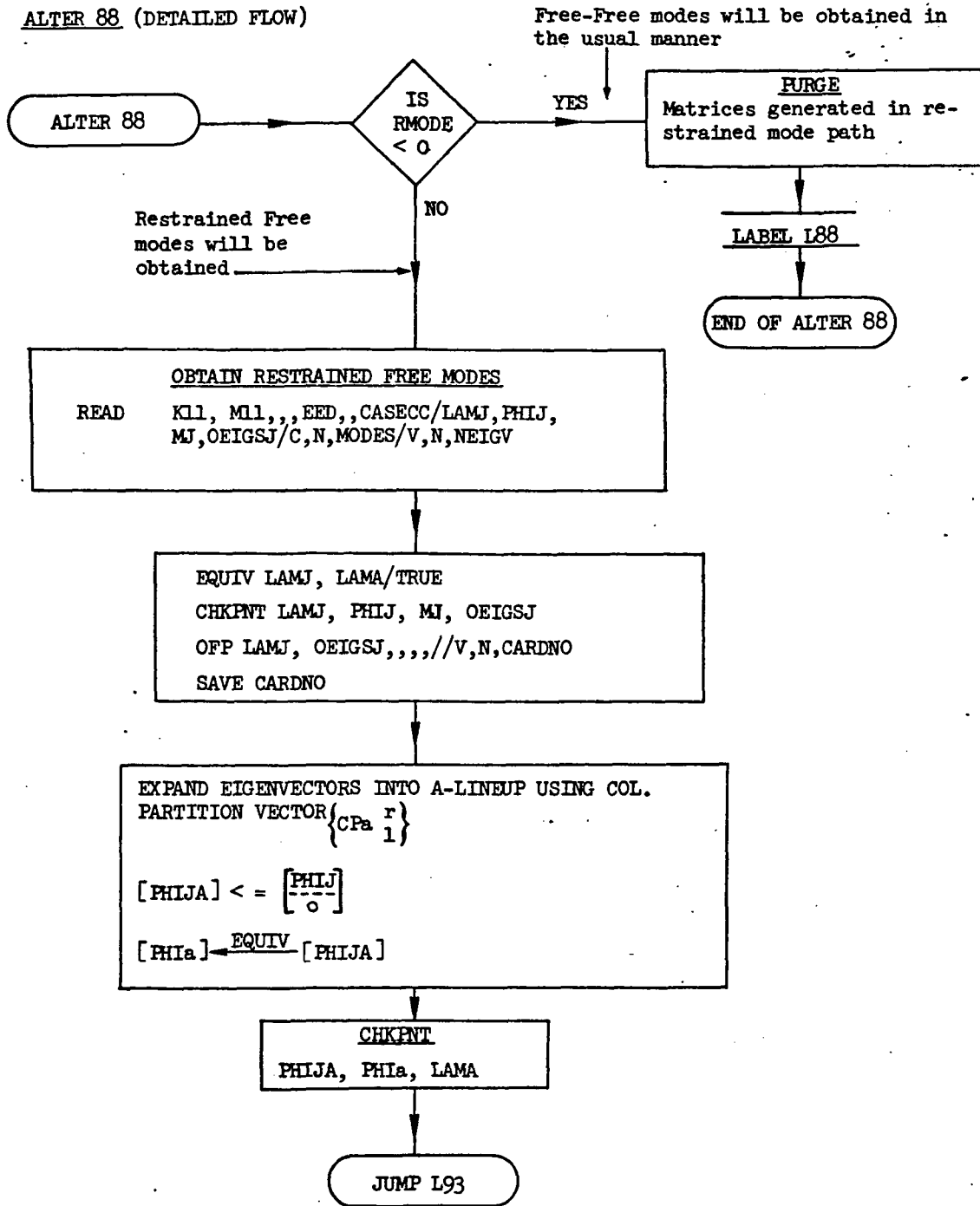

ALTER 107 (DETAILED FLOW)

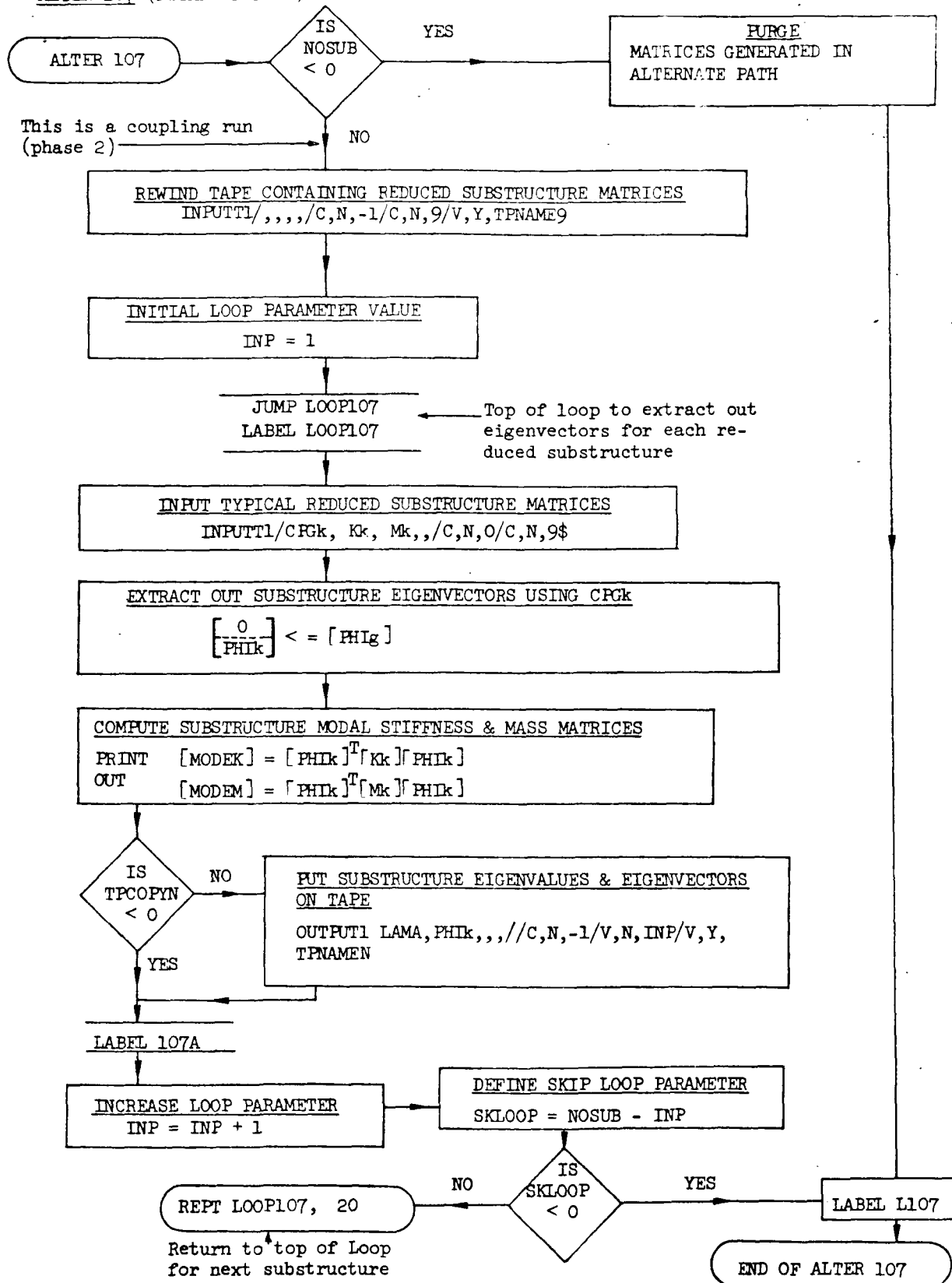

Appendix A5
NASTRAN EXECUTIVE CONTROL DECK/MODEL II ANALYSIS

NASTRAN EXECUTIVE CONTROL DECK ECHO

```

ID PHASE1 D0F5R11
APP      DISP
CHKPNT  YES
SOL      3,C
TIME     1C
DIAG     7,8,13,14,19,21,22
$ SUBSTRUCTURING ALTERS-PHASE 1 OR 2 (RIGID FORMAT 3)
ALTER 2,2 $ PARAMETER DEFAULTS
PARAM   //C,N,NCP/V,Y,NCSUB=-1   $ NO. OF SUESTRUCTURES ON TAPE
PARAM   //C,N,NCP/V,Y,RMODE=-1   $ RESTRAINED FREE MODES OBTAINED FOR &I
PARAM   //C,N,NCP/V,Y,TPCOPY=-1  $ PHASE 1 OUTPUT ON INPT FOR &I
PARAM   //C,N,NCP/V,Y,TPCOPY=-1  $ PHASE 2 OUTPUT ON INPT,ETC FOR &I
PARAM   //C,N,NCP/V,N,TRUE=-1
ALTER 29
COND    L29,NCSUB $ NO SUBSTRUCTURES ON TAPE (PHASE 1)
PURGE   CGPST/TRUE
CHKPNT  CGPST
JUMP    L30          $ SKIP MASS ERROR (PHASE 2)
LABEL   L29
ALTER 30
LABEL   L30
ALTER 42 $ IF PHASE 2, COMBINE SUESTRUCTURES
$       THE FOLLOWING MATRICES FOR EACH SUBSTRUCT. ON INP9
$       CPGI = COL. PARTITION VECTOR FOR MERGING KII & MII
$       KII & MII = REDUCED STIFFNESS & MASS
PURGE   CPGI,KII,MII,KGGI,MGGI,KGGS,MGGS,KGT,MGT/NCSUB
CHKPNT  CPGI,KII,MII,KGGI,MGGI,KGGS,MGGS,KGT,MGT
COND    L42C,NCSUB $ SKIP NOT PHASE 2
INPUTT1 /,,,/C,N,-3/C,N,9/V,Y,TPNAME9 $ LIST TAPE INP9 & REWIND
PARAM   //C,N,NCP/V,N,PASS=1 $ INITIAL LOOP PASS PARAMETER
JUMP    LCCP42
LABEL   LCCP42 $ TC OF LOOP
PARAM   //C,N,SUB/V,N,PASS1/V,N,PASS/C,N,2
INPUTT1 /CPGI,KII,MII,./C,N,0/C,N,9 $
COND    L42,PASS1 $ SKIP TC L42 IF FIRST PASS
JUMP    L42A
LABEL   L42
MERGE,  ...,KII,CPGI,/KGGI/C,N,-1/C,N,2/C,N,6
MERGE,  ...,MII,CPGI,/MGGI/C,N,-1/C,N,2/C,N,6
LABEL   L42A
COND    L42B,PASS1 $ SKIP TO L42B IF FIRST PASS
MERGE,  ...,KII,CPGI,/KGGI/C,N,-1/C,N,2/C,N,6
MERGE,  ...,MII,CPGI,/MGGI/C,N,-1/C,N,2/C,N,6
ADD     KGGI,KGGI/KGT $
EQUIV   KGT,KGGS/TRUE
ADD     MGGI,MGGI/MGT $
EQUIV   MGT,MGGS/TRUE
LABEL   L42B
PARAM   //C,N,ADJ/V,N,PASS/V,N,PASS/C,N,1

```

N A S I R A N E X E C U T I O N C O N T R O L J E T E C H O

```

PARAM //C,N,SUB/V,N,SKIP/V,Y,DCUR/V,N,PASS
COND L42C,SKIP $ SKIP OUT OF LOOP (NO MORE SUBT) (TYPED IN TAPE)
REPT LCCP42,2)
LABEL L32C
ADD KGG,KGGS/KGGY $
ADD MGG,MGGS/MGGY $
CHKPNT KGG,MGGS,KGGY,MGGY
$ MODULE GPWG HAS BEEN REVISED TO OUTPUT MATRIX LOG
$ EQG = BASIC RESULTANTS OF UNIT D-SET LOADS ABOUT CHOSEN ORIGIN
$ CHOSEN ORIGIN DEFINED BY GDFNT PARAMETER IN PULK
GPWG HGRJT,CSTY,EGEXIN,/EGG/V,Y,DFDENT=-1/C,N,0) $
TRNSP EGG,DGC $ DGC=RIGID BODY DEFLS DUE TO LOGICAL POINT
CHKPNT EGG,DGC
ALTER 48,48
EQUIV KGGY,KKN/MPCF1/MGGY,MKN/MPCF1/EGG,DNC/MPCF1
CHKPNT DNC
ALTER 49
ADD MGG,/MGG/C,Y,MASSC=(326.4,C,0) $WEIGHT MATRIX FROM JUMP ONLY
MATGPR GPL,LSET,SIL,MGG//C,N,0
SMPYAD EGG,MGG,DGC,..//MGG/C,N,0/C,N,0/C,N,0
$ MGG= RIGID BODY WEIGHT MATRIX FROM PULK INPUT
$ IT IS SAME MATRIX AS MGG MATRIX FROM MODULE GPWG
MATPRN MGG,..// $
PURGE MGGY,MGGY/ACSUH
COND L49,NOSUB $ SKIP TO L49 (PHASE 1)
ADD MGGY,/MGGY/C,Y,MASSC=(326.4,C,0) $ COMBINED WEIGHT MATRIX
SMPYAD EQG,MGGY,DGC,..//MGGY/C,N,3/C,N,1/C,N,0
MATPRN MGGY,..// $ COMBINED RIGID BODY WEIGHT MATRIX
JUMP LBL4 $ SKIP GPSP MODULE FOR PHASE 2
LABEL L49
ALTER 54
PURGE CPGMN,DND,MPCCK/MPCF1
CHKPNT CPGMN,DND
ALTER 58,58
VEC LSET/CPG4N/C,N,G/C,N,M/C,N,N $
PARTN DGC,..CPG4N/DNC,DND,../C,N,1/C,N,2/C,N,2/C,N,2 $
MPYAD GM,DND,DND/MPCCK/C,N,0/C,N,1/C,N,-1 $ MPC CHECK =0
MATGPR GPL,LSET,SIL,MPCCK//C,N,M
CHKPNT CPGMN,DND,DND
MCE2 LSET,GM,KGGY,MGGY,../KKN,MKN,.. $
ALTER 62
EQUIV DNC,DFC/SINGLE
PURGE CPNSF,JSJ,SPCCK,MSS,WSS,ISPC/SINGLE
CHKPNT DFC,CPNSF,JSJ
ALTER 65
VEC LSET/CPNSF/C,N,N/C,N,S/C,N,F $
PARTN DNC,..CPNSF/JSJ,DFD,../C,N,1/C,N,2/C,N,2/C,N,2 $
MPYAD KFS,DFD,/SPCCK/C,N,1/C,N,1/C,N,0 $ SPC CHECK
$ SPC'S RESERVED FOR ZERO STIFFNESS AND SYM,OR ANTI,BOUNDARY D.O.F.
$ SPC FORCES ZERO FOR SYM, OR ANTI RIGID BODY ORIGIN DEFL'S

```

N A S T R A N E X E C U T I V E C O N T R O L D E C K E C H O

```

MATGPR  GPL,USET,SIL,SPCCK//C,N,S
UPARTN  USET,MNN/WSS,,,/C,N,N/C,N,S/C,N,F
ADD     WSS,/WSS/C,Y,MASSC=(386.4,0,0) $ WEIGHT AT SPC'S
MPYAD   WSS,DSQ,/ISPC/C,N,0/C,N,1/C,N,0 $
$ ISPC EQUIV TO SPC INERTIA FORCES DUE TO RIGID BODY ORIGIN DEFL'S
$ SHOULD BE ZERO FOR SYM, OR ANTI RIGID BODY DEFLECTIONS
$ OTHERWISE WEIGHT IS LOST
MATGPR  GPL,USET,SIL,ISPC//C,N,S
CHKPNT  CFNSF,DSQ,DFC
ALTER 68
EQUIV   DFC,DAC/CNIT
PURGE   CPFQA,DOJ,GCCHK/OMIT
CHKPNT  DAC,CPFQA,DCC
ALTER 73
VEC     USET/CPFQA/C,N,F/C,N,C/C,N,A
PARTN   DFC,,CPFQA/DCC,DAC,,,/C,N,1/C,N,2/C,N,2/C,N,2 $
MPYAD   GC,DAC,DOJ/EOCHK/C,N,0/C,N,1/C,N,-1 $ GO CHECK
MATGPR  GPL,USET,SIL,GOCHK//C,N,0
CHKPNT  CPFQA,DOJ,DAC
ALTER 74
COND    L74,1PCOPY
OUTPUT1 KAA,MAA,,,/C,N,-1/C,N,0/V,Y,TFNAME
LABEL   L74
PURGE   KRRB,CPALR,DLC,DRQ,DMCHK,KRRCK,WRR,EGR,MCR/REACT
CHKPNT  KRRB,CPALR,DLC,DRC
ALTER 76,81
UPARTN  USET,KAA/KLL,,KLR,KRRB/C,N,/C,N,L/C,N,R
SOLVE   KLL,KLR/DM/C,N,1/C,N,-1 $
MPYAD   KLR,DM,KRRB/KRR/C,N,1
UPARTN  USET,MAA/MLL,,MLR,MRR/C,N,A/C,N,L/C,N,R $
CHKPNT  KLL,KLR,KRRB,DM,KRR,MLL,MLR,MRR
ALTER 83
VEC     USET/CPALR/C,N,A/C,N,L/C,N,F
PARTN   DAC,,CPALR/DLC,DRQ,,,/C,N,1/C,N,2/C,N,2/C,N,2 $
MPYAD   DM,DRQ,DLC/DMCHK/C,N,0/C,N,1/C,N,-1 $ DM CHECK
MATGPR  GPL,USET,SIL,DMCHK//C,N,L
MATGPR  GPL,USET,SIL,KRR//C,N,R
MPYAD   KRR,DRQ,/KRRCK/C,N,0/C,N,1/C,N,0 $   KRR CHECK
MATGPR  GPL,USET,SIL,KRRCK//C,N,R
ADD     MR,/WRR/C,Y,MASSC=(386.4,0,0)
TRNSP   DRC/EQR
SMPLYAD EGR,WRR,DRQ,,,/MORR/C,N,3/C,N,1/C,N,0 $ RIGID BODY WT.MATRIX
MATPRN  MORR,,,// $
CHKPNT  CPALR,DLC,DRQ
ALTER 88
PURGE   LAMJ,PHIJ,MJ,OEIGSJ,PHIJA/RMCDE
COND    L88,MODE $ SKIP IF RESTRAINED MODES NOT WANTED
READ    KLL,MLL,,,EED,,CASECC/LAMJ,PHIJ,MJ,OEIGSJ/C,N,MODES/V,N,NEIGV
SAVE    NEIGV
EQUIV   LAMJ,LAMA/TRUE

```

N A S T R A N E X E C U T I V E C O N T R O L D E C K E C H O

```

CHKPNT  LAMJ,PHIJ,.,.DEISSJ
OFF      LAMJ,DEISSJ,.,./V,N,CARDNC
SAVE     CARDNC
MERGE    PHIJ,.,.,CPALR/PHIJA/C,N,1/C,N,2/C,N,2
EQUIV    PHIJA,PHI1/TRUE
CHKPNT  PHIJA,PHI1,LAMA
JUMP     L93
LABEL    L93
ALTER 93
LABEL    L91
ALTER 107 & IF PHASE 2,EXTRACTS OUT SUBSTRUCTURE CONNECTED TO PHAS 3
PURGE    CPCK,KK,V4,PHIK,PHIK,MODEK,MODEM/NCEN
COND     L107,NDSUB & SKIP IF PHASE 1
INPUTT1  /.,./C,N,-1/C,N,9/V,Y,TPNAM9 & REWIND INP9
PARAM    /C,N,N09/V,N,INP=1 &
JUMP     LCCP107
LABEL    LCCP107
INPUTT1  /CPCK,KK,KK,./C,N,0/C,N,9 &
PARTN    PHIG,.,CP34/,PHIK,./C,N,1 &
TRNSP    PHIK/PHIKI
SMPYAD   PHIKI,KK,PHIK,./MODEK/C,N,3 & SUBSTRUCT. MODAL STIFFNESS
SMPYAD   PHIKI,MK,PHIK,./MODEM/C,N,3 & SUBSTRUCT. MODAL MASS
MATPRN   MODEK,MODEM,.,./ &
COND     L107A,IPCCFYN
OUTPUT1  LAMA,PHIK,.,./C,N,-1/V,N,INP/V,Y,TPNAMEN
LABEL    L107A
PARAM    /C,N,40/V,N,INP/V,N,INP/C,N,1 &
PARAM    /C,N,SU1/V,N,SKLCCF/V,Y,NDSUB/V,N,INP
COND     L107,SKLCCF
REPT     LCCP107,2)
LABEL    L107
ENDALTER
CEND

```

```

MODIFIED
SUBROUTINE GPWG                                00000010
C
C GRID POINT WEIGHT GENERATOR                  00000020
C
C INPUTS--HGPDT,CSTM,   FOEXIN,MGG           00000030
C
C OUTPUTS-- OGPWG          00000040
C
C PARAMETERS -- POINT,WTMASS                 00000050
C
C INTEGER HGPDT,CSTM,   FOEXIN,OGPWG,SCR1,SCR2,SCR3,SCR4,POINT 00000060
C
C COMMON //POINT,WTMASS                      00000070
C
C DATA HGPDT,CSTM,   FOEXIN,MGG/101,102,103,104 / 00000080
C
C DATA OGPWG /201/                          00000090
C
C DATA SCR1,SCR2,SCR3,SCR4 /301,302,303,304/ 00000100
C
C FORM D MATRIX %TRANPOSED                    00000110
C
C IP # POINT                                  00000120
C
C COMMENT***IF WTMASS#0.0 THEN OGPWG#0***
C
C IF%WTMASS.NE.0.0BGOTO 100
C
C CALL GPWG1A%POINT,HGPDT,CSTM,FOEXIN,OGPWG,POINT,IP#
C
C GOTO 10
100 CONTINUE
C
C CALL GPWG1A%POINT,HGPDT,CSTM,FOEXIN,SCR3,NOGD# 00000200
C
C CHECK FOR AN ALL SCALAR PROBLEM AND A STOP TO USER 00000210
C
C IF%NOGD .EQ. 0# GO TO 10 00000220
C
C COMPUTE MZERO# DT*MGG*D 00000230
C
C CALL TRANP1%SCR3,SCR1,2,SCR2,SCR4,0,0,0,0,0,0# 00000240
C
C CALL SSG2R%MGG,SCR1,0,SCR2,0,1,1,SCR3# 00000250
C
C CALL SSG2R%SCR1,SCR2,0,SCR4,1,1,1,SCR3# 00000260
C
C M-ZERO IS ON SCR4 00000270
C
C FORM OUTPUT STUFF 00000280
C
C IF%POINT .EQ. 0# IP # 0 00000290
C
C CALL GPWG1B%SCR4,OGPWG,WTMASS,IP# 00000300
10 RETURN 00000310
END 00000320

```

Appendix A6
INPUT BULK DATA/PHASE 1 ANALYSIS: MODEL II FUSELAGE

APPENDIX A6

PHASE I XORBITER FUSELAGE-SYMM CASE# REVISION 4/22/74
SKINS HALF EFF.LONG..85% EFF.TRANS.AT WING

MAY 6, 1974 NASTRAN 2/ 1/73 PAGE 5

C A S E C O N T R O L D E C K F C H O

CARD
COUNT

1	TITLE # PHASE I XORBITER FUSELAGE-SYMM CASE# REVISION 4/22/74
2	SUBTITLE # SKINS HALF EFF.LONG..85% EFF.TRANS.AT WING
3	FCHO # ROTH
4	MPC # 401
5	SPC # 301
6	METHOD # 1
7	REGIN HULK

INPUT BULK DATA DECK (CHD)

1	2	3	4	5	6	7	8	9	10
* CONVERT ORIGINAL SYMM EUSLAGE TO REVISED SYMM EUSLAGE									
/									
/		F	11						
/		1:							
/		1:	1:						
/		5:	71						
/		6:	17:						
/		4:4							
/		4:1							
/		4:7							
/		4:4:							
/		4:4:							
/		4:							
/		47:							
/		496							
/		499							
/		532							
/		53:							
/		553							
/		556							
/		560							
/		582							
/		593							
/		637							
/		656							
/		69:	693						
/		69:	699						
/		70:	706						
/		70:	710						
/		71:	715						
/		718	721						
/		725	726						
/		730	731						
/		734	737						
/		750							
/		768	769						
/		774	775						
/		852	934						
/		449	1057						
/		1047							
/		10:8							
/		1063	1096						
/		1135	1137						
/		1272	1273						
/		1276	1279						
/		1294	1299						
/		1300							
/		1521	1522						
/		1639	1656						
/		1809	1828						

INPUT BULK DATA DECK ECHO

	1	2	3	4	5	6	7	8	9	10
/		1831	1832							
/		1953	1954							
/		1975	1984							
/		1989	1992							
/		2029	2062							
/		2099	2102							
/		2268	2341							
/		2387	2388							
/		2395	2404							
/		2407	2441							
/		2533	2550							
/		2625	2707							
/		2722	2810							
/		2820								
/		2831								
/		2841	2864							
/		3044								
/		3048								
/		3050								
/		3103								
/		3105	3107							
/		3110	3112							
/		3118								
/		3121								
/		3135								
/		3138								
/		3140	3142							
/		3144								
/		3167								
/		3174	3175							
/		3178								
/		3185								
/		3187								
/		3189	3190							
ASET1	1	1516								
ASET1	3	241	506	1701	1801	1833				
ASET1	13	111	219	1301	1901	2026	2101			
ASET1	13	901	1101	1201	1401	1601	1606	2001		
ASET1	1	243								
ASET1	3	1505	1506	1613	1614					
ASET1	123	115	2110	224	1320	2010	2105			
ASET1	123	505	605	618	705	718	1305	1205		
ASET1	123	1212	1220	1312	1405	1410	1418	1605		
ASET1	123	1610	1705	1710	1718	1806	1812			
ASET1	1235	518	760	1161	1618					
CBAR	2502	2502	243	318	.0	1.0	.0	1		
CBAR	2503	2502	318	518	.0	1.0	.0	1		
CBAR	2504	2502	518	618	.0	1.0	.0	1		
CBAR	2505	2502	618	718	.0	1.0	.0	1		
CBAR	2506	2502	718	760	.0	1.0	.0	1		

PHASE 1 2000111 FUSelage-SYNA CASE# REVISION 4/22/74
 SKINS HALF EFF. LING. .95% EFF. TRANS. AT WING

MAY 6, 1974 NASTRAN 2/ 1/74 PAGE 8

INPUT BULK DATA DECK ECHO

1	2	3	4	5	6	7	8	9	10
CBAR	2507	2502	760	818	.0	1.0	.0	1	
CBAR	2508	2502	818	923	.0	1.0	.0	1	
CBAR	2509	2502	923	1027	.0	1.0	.0	1	
CBAR	2510	2502	1027	1123	.0	1.0	.0	1	
CBAR	2511	2502	1123	1161	.0	1.0	.0	1	
CBAR	2512	2502	1161	1220	.0	1.0	.0	1	
CBAR	2513	2502	1220	1320	.0	1.0	.0	1	
CBAR	2514	2502	1320	1418	.0	1.0	.0	1	
CBAR	2515	250	1418	1510	.0	1.0	.0	1	
CBAR	2516	250	1510	1618	.0	1.0	.0	1	
CBAR	2517	2502	1618	1718	.0	1.0	.0	1	
CBAR	2518	2502	1718	1824	.0	1.0	.0	1	
CBAR	2502	2	.10	.0065	.002	.0	.0		
CONROD	2551	1115	1212	11	.0575				
CONROD	2552	1610	1710	11	.0575				
CONROD	2567	701	801	11	.069				
CONROD	2577	1161	1201	11	.077				
CONROD	2578	1401	1601	11	.0875				
CONROD	2579	1601	1701	11	.0575				
CONROD	2583	705	805	11	.072				
CONROD	2598	1105	1205	11	.060				
CONROD	2597	1405	1605	11	.046				
CONROD	2599	1605	1705	11	.046				
CONROD	2602	1111	1221	11	.0575				
CONROD	2307	1606	1706	11	.0875				
CSHEAR	2210	12210	202	302	301	201			
CSHEAR	2211	12210	203	303	302	202			
CSHEAR	2212	12210	204	304	303	203			
CSHEAR	2213	12210	206	305	304	204			
CSHEAR	2214	12210	302	502	501	301			
CSHEAR	2215	12210	303	503	502	302			
CSHEAR	2216	12210	304	504	503	303			
CSHEAR	2217	12210	305	505	504	304			
CSHEAR	2218	12210	502	602	601	501			
CSHEAR	2219	12210	503	603	602	502			
CSHEAR	2220	12210	504	604	603	503			
CSHEAR	2221	12210	505	605	604	504			
CSHEAR	2222	12210	602	702	701	601			
CSHEAR	2223	12210	603	703	702	602			
CSHEAR	2224	12210	604	704	703	603			
CSHEAR	2225	12210	605	705	704	604			
CSHEAR	2226	12210	702	802	801	701			
CSHEAR	2227	12210	703	803	802	702			
CSHEAR	2228	12210	704	804	803	703			
CSHEAR	2229	12210	705	805	804	704			
CSHEAR	2230	12210	802	902	901	801			
CSHEAR	2231	12210	803	903	902	802			
CSHEAR	2232	12210	804	904	903	803			
CSHEAR	2233	12210	805	905	904	804			
CSHEAR	2234	12210	902	1002	1001	901			

INPUT BULK DATA DECK ECHO

	1	2	3	4	5	6	7	8	9	10
CSHEAR	2239	12210	903	1003	1002	1002	902			
CSHEAR	2240	12210	904	1004	1003	1003	903			
CSHEAR	2241	12210	905	1005	1004	1004	904			
CSHEAR	2242	12210	1002	1102	1101	1101	1001			
CSHEAR	2243	12210	1003	1103	1102	1102	1002			
CSHEAR	2244	12210	1004	1104	1103	1103	1003			
CSHEAR	2245	12210	1005	1105	1104	1104	1004			
CSHEAR	2246	12210	1102	1202	1201	1201	1101			
CSHEAR	2247	12210	1103	1203	1202	1202	1102			
CSHEAR	2248	12210	1104	1204	1203	1203	1103			
CSHEAR	2249	12210	1105	1205	1204	1204	1104			
CSHEAR	2254	12210	1202	1302	1301	1301	1201			
CSHEAR	2255	12210	1203	1303	1302	1302	1202			
CSHEAR	2256	12210	1204	1304	1303	1303	1203			
CSHEAR	2257	12210	1205	1305	1304	1304	1204			
CSHEAR	2258	12210	1302	1402	1401	1401	1301			
CSHEAR	2259	12210	1303	1403	1402	1402	1302			
CSHEAR	2260	12210	1304	1404	1403	1403	1303			
CSHEAR	2261	12210	1305	1405	1404	1404	1304			
CSHEAR	2262	12210	1402	1602	1601	1601	1401			
CSHEAR	2263	12210	1403	1603	1602	1602	1402			
CSHEAR	2264	12210	1404	1604	1603	1603	1403			
CSHEAR	2265	12210	1405	1605	1604	1604	1404			
CSHEAR	2270	12210	1602	1702	1701	1701	1601			
CSHEAR	2271	12210	1603	1703	1702	1702	1602			
CSHEAR	2272	12210	1604	1704	1703	1703	1603			
CSHEAR	2273	12210	1605	1705	1704	1704	1604			
CSHEAR	2279	12210	1703	1803	1802	1802	1702			
CSHEAR	2280	12210	1704	1804	1803	1803	1703			
CSHEAR	2281	12210	1705	1806	1804	1804	1704			
CSHEAR	2282	12210	1802	1902	1901	1901	1801			
CSHEAR	2283	12210	1803	1903	1902	1902	1802			
CSHEAR	2284	12210	1804	1904	1903	1903	1803			
CSHEAR	2285	12210	1806	1905	1904	1904	1804			
CSHEAR	2286	12210	1902	2002	2001	2001	1901			
CSHEAR	2287	12210	1903	2003	2002	2002	1902			
CSHEAR	2288	12210	1904	2004	2003	2003	1903			
CSHEAR	2289	12210	1905	2005	2004	2004	1904			
CSHEAR	2290	12210	2002	2102	2101	2101	2001			
CSHEAR	2291	12210	2003	2103	2102	2102	2002			
CSHEAR	2292	12210	2004	2104	2103	2103	2003			
CSHEAR	2293	12210	2005	2105	2104	2104	2004			
PSHEAR	12210	26	4025							
CSHEAR	2314	12320	206	305	310	312	212			
CSHEAR	2315	12320	212	310	312	314	214			
CSHEAR	2316	12320	218	312	314	316	216			
CSHEAR	2317	12320	224	314	316	318	218			
CSHEAR	2318	12320	227	316	318	320	220			
CSHEAR	2319	12320	305	505	510	512	412			
CSHEAR	2320	12320	310	510	512	514	414			

MAY 6, 1974 EASTMAN 7/1/73 PAB

INPUT BULK DATA BLOCK NO. 1

1	2	3	4	5	6	7	8	9	10
CSHEAR	2371	12370	512	512	514	514	314		
CSHEAR	2372	12370	514	514	516	516	316		
CSHEAR	2373	12370	516	516	518	518	318		
CSHEAR	2374	12370	505	505	610	610	510		
CSHEAR	2375	12370	510	510	612	612	512		
CSHEAR	2376	12370	512	512	514	514	514		
CSHEAR	2377	12370	514	514	616	616	516		
CSHEAR	2378	12370	516	516	618	618	518		
CSHEAR	2379	12370	705	705	710	710	610		
CSHEAR	2370	12370	610	710	710	710	610		
CSHEAR	2381	12370	712	712	714	714	614		
CSHEAR	2382	12370	514	714	714	714	614		
CSHEAR	2383	12370	61	71	713	713	61		
CSHEAR	2384	12370	70	70	71	71	71		
CSHEAR	2385	12370	717	717	717	717	717		
CSHEAR	2386	12370	717	717	717	717	717		
CSHEAR	2387	12370	714	714	718	718	718		
CSHEAR	2388	12370	718	718	718	718	718		
CSHEAR	2389	12370	507	507	910	910	510		
CSHEAR	2345	12320	810	910	917	917	810		
CSHEAR	2346	12320	812	912	919	919	812		
CSHEAR	2347	12320	814	914	921	921	814		
CSHEAR	2348	12320	516	921	923	923	818		
CSHEAR	2349	12320	908	1005	1010	910			
CSHEAR	2350	12320	910	1010	1015	915			
CSHEAR	2351	12320	915	1015	1017	917			
CSHEAR	2352	12320	917	1017	1019	919			
CSHEAR	2353	12320	919	1019	1021	921			
CSHEAR	2354	12320	921	1021	1023	923			
CSHEAR	2355	12320	1005	1105	1110	1010			
CSHEAR	2356	12320	1010	1110	1115	1015			
CSHEAR	2357	12320	1015	1115	1117	1017			
CSHEAR	2358	12320	1017	1117	1119	1019			
CSHEAR	2359	12320	1019	1119	1121	1021			
CSHEAR	2360	12320	1021	1121	1123	1023			
CSHEAR	2361	12320	1105	1205	1210	1110			
CSHEAR	2362	12320	1110	1210	1212	1115			
CSHEAR	2363	12320	1115	1212	1214	1117			
CSHEAR	2364	12320	1117	1214	1216	1119			
CSHEAR	2365	12320	1119	1216	1218	1121			
CSHEAR	2366	12320	1121	1218	1220	1123			
CSHEAR	2373	12320	1205	1305	1310	1210			
CSHEAR	2374	12320	1210	1310	1312	1212			
CSHEAR	2375	12320	1212	1312	1314	1214			
CSHEAR	2376	12320	1214	1314	1316	1216			
CSHEAR	2377	12320	1216	1316	1318	1218			
CSHEAR	2378	12320	1218	1318	1320	1220			
CSHEAR	2379	12320	1412	1410	1412	1314			
CSHEAR	2380	12320	1314	1412	1414	1316			
CSHEAR	2381	12320	1316	1414	1416	1318			

PHASE 1 ORBITER FUSELAGE-SYMM CASE# REVISION 4/22/74
 SKINS HALF EFF. LONG. .85% EFF. TRANS. AT WING

MAY 6. 1974 NASTRAN 2/ 1/73 PAGE 11

INPUT BULK DATA DECK FCH0

	1	2	3	4	5	6	7	8	9	10
CSHEAR	2382	12320	1318	1416	1418	1320				
CSHEAR	2383	12320	1410	1502	1504	1412				
CSHEAR	2384	12320	1412	1504	1506	1414				
CSHEAR	2385	12320	1414	1506	1508	1416				
CSHEAR	2386	12320	1416	1508	1510	1418				
CSHEAR	2387	12320	1502	1610	1612	1504				
CSHEAR	2388	12320	1504	1612	1614	1506				
CSHEAR	2389	12320	1506	1614	1616	1508				
CSHEAR	2390	12320	1508	1616	1618	1510				
CSHEAR	2391	12320	1610	1710	1712	1612				
CSHEAR	2392	12320	1612	1712	1714	1614				
CSHEAR	2393	12320	1614	1714	1716	1616				
CSHEAR	2394	12320	1616	1716	1718	1618				
CSHEAR	2399	12320	1710	1812	1814	1712				
CSHEAR	2400	12320	1712	1814	1817	1714				
CSHEAR	2401	12320	1714	1817	1820	1716				
CSHEAR	2402	12320	1716	1820	1824	1718				
PSHEAR	12320	36	.020							
CSHEAR	2412	12412	1905	2005	2010	1918				
CSHEAR	2423	12412	2005	2105	2106	2010				
PSHEAR	12412	16	.020							
CSHEAR	2600	12600	1407	1517	1516	1406				
CSHEAR	2601	12600	1408	1608	1607	1407				
CSHEAR	2602	12600	1409	1609	1608	1408				
CSHEAR	2603	12600	1410	1502	1501	1409				
CSHEAR	2605	12600	1517	1607	1606	1516				
CSHEAR	2609	12600	1502	1610	1609	1501				
CSHEAR	2610	12600	1607	1707	1706	1606				
CSHEAR	2611	12600	1608	1708	1707	1607				
CSHEAR	2612	12600	1609	1709	1708	1608				
CSHEAR	2613	12600	1610	1710	1709	1609				
CSHEAR	2621	12600	1708	1809	1808	1707				
CSHEAR	2622	12600	1709	1810	1809	1708				
CSHEAR	2623	12600	1710	1812	1810	1709				
CSHEAR	2625	12600	1808	1915	1914	1807				
CSHEAR	2626	12600	1809	1916	1915	1808				
CSHEAR	2627	12600	1810	1917	1916	1809				
CSHEAR	2628	12600	1811	1928	1917	1810				
CSHEAR	2629	12600	1812	1918	1928	1811				
PSHEAR	12600	46	.020							
CSHEAR	401	10401	301	302	407	406				
CSHEAR	402	10402	302	303	408	407				
CSHEAR	403	10403	303	304	409	408				
CSHEAR	2632	12632	1101	1201	1221	1111				
CSHEAR	2636	12636	1401	1601	1606	1406				
CSHEAR	2638	12638	1601	1701	1706	1606				
CONROD	1104	1104	1105	1	.030				.0452	
CONROD	1108	1114	1115	1	.030					
CONROD	1204	1204	1205	1	.086				.0618	
CONROD	1208	1210	1209	1	.086					

INPUT BULK DATA DECK ECHO

.	1	..	2	..	3	..	4	..	5	..	6	..	7	..	8	..	9	..	10	.
CONROD	1304		1304		1305		1				.086								.0618	
CONROD	1308		1308		1310		1				.086									
CONROD	1404		1404		1405		1				.030								.0304	
CONROD	1407		1409		1410		1				.030								.0304	
CONROD	1604		1604		1605		1				.030								.0304	
CONROD	1608		1609		1610		1				.030								.0304	
CONROD	1704		1704		1705		1				.030								.0304	
CONROD	1708		1709		1710		1				.030								.0304	
CONROD	1805		1805		1806		1				.030								.014	
CONROD	1816		1811		1812		1				.030								.014	
CONROD	1904		1904		1905		1				.03								.014	
CONROD	1923		1917		1918		1				.03								.014	
EIGR	1		INV		.0		200.		12		12								1.-3	6ETG2
CORDIR	2		2001		2040		2101													
GRID*			2006		0						179.219034								0.0	615485
*15485			51.5000		2															
GRID*			2007		0						179.219034								-1.70516	15486
*15486			51.5000		2															
GRID*			2008		0						179.219034								-4.30006	15487
*15487			51.5000		2															
GRID*			2009		0						179.219034								-6.25006	15488
*15488			51.5000		2															
GRID*			2010		0						179.219034								-12.50006	15489
*15489			51.5000		0															
GRID*			2011		0						178.890408								0.0	615490
*15490			53.9960		0															
GRID*			2012		0						178.890408								-1.70516	15491
*15491			53.9960		2															
GRID*			2013		0						178.890408								-4.30006	15492
*15492			53.9960		2															
GRID*			2014		0						178.890408								-6.40006	15493
*15493			53.9960		0															
GRID*			2015		0						178.890408								-12.50006	15494
*15494			53.9960		0															
GRID*			2016		0						178.534397								0.0	615495
*15495			56.7000		2															
GRID*			2017		0						178.534397								-1.70516	15496
*15496			56.7000		2															
GRID*			2018		0						178.534397								-4.30006	15497
*15497			56.7000		2															
GRID*			2019		0						178.534397								-6.74606	15498
*15498			56.7000		2															
GRID*			2020		0						178.534397								-12.50006	15499
*15499			56.7000		0															
GRID*			2021		0						178.182203								0.0	615500
*15500			59.3750		2															
GRID*			2022		0						178.182203								-1.70516	15501
*15501			59.3750		2															
GRID*			2023		0						178.182203								-4.30006	15502
*15502			59.3750		2															

INPUT BULK DATA CHECK CHECK

	1	2	3	4	5	6	7	8	9	10
GRID*		2024	0				175.142203		-7.08906	15503
*15503		59.3750	2							
GRID*		2025	0				174.142203		-12.50006	15504
*15504		59.3750	0							
GRID*		2026	0				177.45188		0.0	15505
*15505		64.4220	0							
GRID*		2027	0				177.45188		-1.70516	15506
*15506		64.4220	2							
GRID*		2028	0				177.45188		-4.30006	15507
*15507		64.4220	2							
GRID*		2029	0				177.45188		-7.80006	15508
*15508		64.4220	0							
GRID*		2030	0				177.45188		-12.50006	15509
*15509		64.4220	0							
GRID*		2031	0				177.140362		0.0	15510
*15510		67.2835	2							
GRID*		2032	0				177.140362		-1.70516	15511
*15511		67.2835	2							
GRID*		2033	0				177.140362		-4.30006	15512
*15512		67.2835	2							
GRID*		2034	0				177.140362		-8.18236	15513
*15513		67.2835	2							
GRID*		2035	0				177.140362		-11.54856	15514
*15514		67.2835	0							
GRID*		2036	0				176.607024		0.0	15515
*15515		71.3389	2							
GRID*		2037	0				176.607024		-1.70516	15516
*15516		71.3389	2							
GRID*		2038	0				176.607024		-4.30006	15517
*15517		71.3389	2							
GRID*		2039	0				176.607024		-8.13896	15518
*15518		71.3389	0							
GRID*		2040	0				176.1250		0.0	15519
*15519		75.0000	0							
GRID*		2041	0				176.1250		-2.00006	15520
*15520		75.0000	0							
GRID*		2042	0				176.250276		-4.78356	15521
*15521		74.0485	0							
SPC1	200	4	243	517	619	714	750	818		
SPC1	200	4	923	1027	1123	1161	1220	1320		
SPC1	200	4	1418	1510	1618	1716				
SPC1	200	5	1922							
SPC1	200	56	305	310	312	314	316			
SPC1	200	456	201	TMR	230					
SPC1	200	456	1321	151	1517					
SPC1	201	2	1601	1605	1516					
SPC1	201	24	151	164	166	165	1201	1221		
SPC1	202	13	242	301	501	601	701	1101		
SPC1	202	13	1111	1401	1406	1516	1601	1606		
SPC1	202	13	1701	1706	1723	1724				

INPUT BULK DATA DECK ECHO

.	1	..	2	..	3	..	4	..	5	..	6	..	7	..	8	..	9	..	10	.
CONROD	20001		212		310		1				.001									
CONROD	20002		218		312		1				.001									
CONROD	20003		224		314		1				.001									
CONROD	20004		227		316		1				.001									
CONROD	20005		310		510		1				.001									
CONROD	20006		312		512		1				.001									
CONROD	20007		314		514		1				.001									
CONROD	20008		316		516		1				.001									
CONROD	20009		510		610		1				.001									
CONROD	20010		512		612		1				.001									
CONROD	20011		514		614		1				.001									
CONROD	20012		516		616		1				.001									
CONROD	20013		610		710		1				.001									
CONROD	20014		612		712		1				.001									
CONROD	20015		614		714		1				.001									
CONROD	20016		616		716		1				.001									
CONROD	20017		710		810		1				.001									
CONROD	20018		712		812		1				.001									
CONROD	20019		714		814		1				.001									
CONROD	20020		716		816		1				.001									
CONROD	20025		810		910		1				.001									
CONROD	20026		812		917		1				.001									
CONROD	20027		814		919		1				.001									
CONROD	20028		816		921		1				.001									
CONROD	20029		910		1010		1				.001									
CONROD	20030		915		1015		1				.001									
CONROD	20031		917		1017		1				.001									
CONROD	20032		919		1019		1				.001									
CONROD	20033		921		1021		1				.001									
CONROD	20034		1010		1110		1				.001									
CONROD	20035		1015		1115		1				.001									
CONROD	20036		1017		1117		1				.001									
CONROD	20037		1019		1119		1				.001									
CONROD	20038		1021		1121		1				.001									
CONROD	20039		1110		1210		1				.001									
CONROD	20040		1117		1214		1				.001									
CONROD	20041		1119		1216		1				.001									
CONROD	20042		1121		1218		1				.001									
CONROD	20047		1210		1310		1				.001									
CONROD	20048		1214		1314		1				.001									
CONROD	20049		1216		1316		1				.001									
CONROD	20050		1218		1318		1				.001									
CONROD	20051		1314		1412		1				.001									
CONROD	20052		1316		1414		1				.001									
CONROD	20053		1318		1416		1				.001									
CONROD	20054		1412		1504		1				.001									
CONROD	20055		1414		1506		1				.001									
CONROD	20056		1416		1508		1				.001									
CONROD	20057		1504		1612		1				.001									
CONROD	20058		1506		1614		1				.001									

INPUT BULK DATA CHECK ECHO

1	2	3	4	5	6	7	8	9	10
CONROD	20059	1508	1616	1	.001				
CONROD	20060	1612	1712	1	.001				
CONROD	20061	1614	1714	1	.001				
CONROD	20062	1616	1716	1	.001				
CONROD	20066	1712	1814	1	.001				
CONROD	20067	1714	1817	1	.001				
CONROD	20068	1716	1820	1	.001				
CONROD	20151	601	602	1	.015				
CONROD	20152	701	702	1	.015				
CONROD	20153	801	802	1	.015				
CONROD	20154	901	902	1	.015				
CONROD	20155	1001	1002	1	.015				
CONROD	20069	202	302	1	.001				
CONROD	20070	203	303	1	.001				
CONROD	20071	204	304	1	.001				
CONROD	20072	302	502	1	.001				
CONROD	20073	303	503	1	.001				
CONROD	20074	304	504	1	.001				
CONROD	20075	502	602	1	.001				
CONROD	20076	503	603	1	.001				
CONROD	20077	504	604	1	.001				
CONROD	20078	602	702	1	.001				
CONROD	20079	603	703	1	.001				
CONROD	20080	604	704	1	.001				
CONROD	20081	702	802	1	.001				
CONROD	20082	703	803	1	.001				
CONROD	20083	704	804	1	.001				
CONROD	20084	201	301	1	.001				
CONROD	20085	301	501	1	.001				
CONROD	20087	802	902	1	.001				
CONROD	20088	803	903	1	.001				
CONROD	20089	804	904	1	.001				
CONROD	20090	902	1002	1	.001				
CONROD	20091	903	1003	1	.001				
CONROD	20092	904	1004	1	.001				
CONROD	20093	1002	1102	1	.001				
CONROD	20094	1003	1103	1	.001				
CONROD	20095	1004	1104	1	.001				
CONROD	20096	1102	1202	1	.001				
CONROD	20097	1103	1203	1	.001				
CONROD	20098	1104	1204	1	.001				
CONROD	20102	1202	1302	1	.001				
CONROD	20103	1203	1303	1	.001				
CONROD	20104	1204	1304	1	.001				
CONROD	20105	1302	1402	1	.001				
CONROD	20106	1303	1403	1	.001				
CONROD	20107	1304	1404	1	.001				
CONROD	20108	1402	1602	1	.001				
CONROD	20109	1403	1603	1	.001				
CONROD	20110	1404	1604	1	.001				

PHASE 1: WING FUSELAGE-SYMM CASE# REVISION 4/22/70
 WINGS HALF FUELING, 35% EFF. TRANS. AT WING

MAY 6, 1974 NASTRAN 27 1/70 PAGE

INPUT BULK DATA DECK F H 0

1	2	3	4	5	6	7	8	9	10
CONROD	20114	1602	1702	1	.001				
CONROD	20115	1603	1703	1	.001				
CONROD	20116	1604	1704	1	.001				
CONROD	20120	1702	1802	1	.001				
CONROD	20121	1703	1803	1	.001				
CONROD	20122	1704	1804	1	.001				
CONROD	20161	1801	1901	1	.001				
CONROD	20162	1802	1902	1	.001				
CONROD	20163	1803	1903	1	.001				
CONROD	20164	1804	1904	1	.001				
CONROD	20165	1901	2001	1	.001				
CONROD	20166	1902	2002	1	.001				
CONROD	20167	1903	2003	1	.001				
CONROD	20168	1904	2004	1	.001				
CONROD	20169	2001	2101	1	.001				
CONROD	20170	2002	2102	1	.001				
CONROD	20171	2003	2103	1	.001				
CONROD	20172	2004	2104	1	.001				
CONROD	20124	1408	1508	1	.001				
CONROD	20125	1409	1501	1	.001				
CONROD	20126	1501	1609	1	.001				
CONROD	20127	1608	1708	1	.001				
CONROD	20128	1609	1709	1	.001				
CONROD	20129	1708	1809	1	.001				
CONROD	20130	1709	1810	1	.001				
CONROD	20131	1807	1914	1	.001				
CONROD	20132	1808	1915	1	.001				
CONROD	20133	1809	1916	1	.001				
CONROD	20134	1810	1917	1	.001				
CONROD	20135	1811	1928	1	.001				
CONROD	10001	243	318	101	.046				
CONROD	10002	318	518	101	.047				
CONROD	10003	518	618	101	.049				
CONROD	10004	618	718	101	.052				
CONROD	10005	718	760	101	.053				
CONROD	10006	760	818	101	.054				
CONROD	10007	818	923	101	.056				
CONROD	10008	923	1023	101	.056				
CONROD	10009	1023	1123	101	.059				
CONROD	10010	1123	1161	101	.061				
CONROD	10011	1161	1220	101	.063				
CONROD	10012	1220	1320	101	.068				
CONROD	10013	1320	1418	101	.070				
CONROD	10014	1418	1510	101	.070				
CONROD	10015	1510	1618	101	.070				
CONROD	10016	1618	1718	101	.070				
CONROD	10017	1718	1824	101	.070				
CONROD	10020	1115	1212	104	.020				
CONROD	10021	1212	1312	104	.055				
CONROD	10022	1312	1410	104	.070				

INPUT BULK DATA DECK FCHO

1	2	3	4	5	6	7	8	9	10
CONROD	10023	1410	1502	104	.070				
CONROD	10024	1502	1610	104	.070				
CONROD	10025	1610	1710	104	.070				
CONROD	10026	1710	1812	104	.070				
CONROD	10030	206	305	102	.120				
CONROD	10031	305	505	102	.120				
CONROD	10032	505	605	102	.120				
CONROD	10033	605	705	102	.120				
CONROD	10034	705	805	102	.120				
CONROD	10035	805	905	102	.120				
CONROD	10036	905	1005	102	.120				
CONROD	10037	1005	1105	102	.120				
CONROD	10038	1105	1205	102	.105				
CONROD	10039	1205	1305	102	.078				
CONROD	10040	1305	1405	102	.065				
CONROD	10041	1405	1605	102	.065				
CONROD	10042	1605	1705	102	.065				
CONROD	10043	1705	1806	102	.065				
CONROD	10044	1806	1905	102	.065				
CONROD	10045	1905	2005	102	.065				
CONROD	10046	2005	2105	102	.065				
CONROD	10050	501	601	103	.065				
CONROD	10051	601	701	103	.065				
CONROD	10052	701	801	103	.065				
CONROD	10053	801	901	103	.065				
CONROD	10054	901	1001	103	.065				
CONROD	10055	1001	1101	103	.065				
CONROD	10056	1101	1201	103	.065				
CONROD	10057	1201	1301	103	.065				
CONROD	10058	1301	1401	103	.065				
CONROD	10059	1401	1601	103	.065				
CONROD	10060	1601	1701	103	.065				
CONROD	10061	1101	1102	105	.12				
CONROD	10062	1102	1103	105	.12				
CONROD	10063	1103	1104	105	.12				
CONROD	10064	1104	1105	105	.09				
CONROD	10071	1201	1202	106	.12				
CONROD	10072	1202	1203	106	.12				
CONROD	10073	1203	1204	106	.12				
CONROD	10074	1204	1205	106	.12				
CONROD	10081	1301	1302	107	.08				
CONROD	10082	1302	1303	107	.08				
CONROD	10083	1303	1304	107	.08				
CONROD	10084	1304	1305	107	.04				
CONROD	10091	1401	1402	108	.12				
CONROD	10092	1402	1403	108	.12				
CONROD	10093	1403	1404	108	.12				
CONROD	10094	1404	1405	108	.12				
CONROD	10101	1601	1602	109	.11				
CONROD	10102	1602	1603	109	.11				

INPUT HULK DATA DECK ECHO

	1	2	3	4	5	6	7	8	9	10
CONROD	10103	1603	1604	109	.11					
CONROD	10104	1604	1605	109	.11					
CONROD	10111	1701	1702	110	.11					
CONROD	10112	1702	1703	110	.11					
CONROD	10113	1703	1704	110	.11					
CONROD	10114	1704	1705	110	.11					
CONROD	10122	1802	1803	111	.11					
CONROD	10123	1802	1804	111	.11					
CONROD	10124	1804	1805	111	.055					
CONROD	10125	1805	1806	111	.055					
CONROD	10131	1901	1902	112	.11					
CONROD	10132	1902	1903	112	.11					
CONROD	10133	1903	1904	112	.11					
CONROD	10134	1904	1905	112	.08					
CONROD	10151	1406	1516	1	.017					
CONROD	10152	1407	1517	1	.017					
CONROD	10153	1516	1606	1	.017					
CONROD	10154	1517	1607	1	.017					
CONROD	10155	1606	1706	1	.017					
CONROD	10156	1607	1707	1	.017					
CONROD	20136	1516	1517	1	.020					
CONROD	10160	1811	1812	113	.040					
CONROD	10161	1914	1915	113	.043					
CONROD	10162	1915	1916	113	.043					
CONROD	10163	1916	1917	113	.043					
CONROD	10164	1917	1928	113	.043					
CONROD	10165	1928	1918	113	.043					
CONROD	10166	1807	1808	113	.043					
CONROD	10167	1808	1809	113	.087					
CONROD	10168	1809	1810	113	.087					
CONROD	10169	1810	1811	113	.087					
CONROD	10170	1709	1708	114	.089					
CONROD	10171	1708	1707	114	.089					
CONROD	10172	1707	1706	115	.044					
CONROD	10173	1606	1607	115	.068					
CONROD	10174	1607	1608	115	.088					
CONROD	10175	1608	1609	115	.088					
CONROD	10176	1406	1407	115	.044					
CONROD	10177	1407	1408	115	.044					
CONROD	10178	1408	1409	115	.044					
CONROD	10179	1609	1610	116	.070					
CONROD	10180	1409	1410	117	.026					
CONROD	10181	1709	1710	118	.070					
GRID	243	0	64.0	-12.5	62.5	0				
MPC	100	243	2	1.0	230	2	-1.0			
MPC	100	243	3	1.0	230	3	-1.0			
MPC	100	1516	3	8.625	1406	3	-3.0			EM1516Z
EM1516Z		1606	3	-5.625						
CELAS2	20200	148000.	230	1	243	1				
PARAM	NDSUD	-1								

PHASE 1 ORBITER FUSELAGE-SYMM CASE# REVISION 4/22/74
 SKINS HALF EFF. LONG. 94% EFF. TRANS. AT WING

MAY 6. 1974 NASTRAN 2/ 1/73 PAGE 19

INPUT BULK DATA DECK FCHD

1	2	3	4	5	6	7	8	9	10
MAT1	26	.52567		.3	.1				
MAT1	36	.52567		.3	.1				
MAT1	46	.52567		.3	.1				
MAT1	101	10.566		.3					
MAT1	102	10.566		.3					
MAT1	103	10.566		.3					
MAT1	104	10.566		.3					
MAT1	105	17.8766		.3					
MAT1	106	16.2066		.3					
MAT1	107	14.8066		.3					
MAT1	108	14.4366		.3					
MAT1	109	17.9766		.3					
MAT1	110	14.1966		.3					
MAT1	111	10.566		.3					
MAT1	112	15.4366		.3					
MAT1	113	10.566		.3					
MAT1	114	14.4066		.3					
MAT1	115	18.0766		.3					
MAT1	116	19.9566		.3					
MAT1	117	23.1066		.3					
MAT1	118	15.2266		.3					
ENDDATA									

TOTAL COUNT# 672

*** USER INFORMATION MESSAGE 207. BULK DATA NOT SORTED. XSORT WILL RE-ORDER DECK.

SORTED BULK DATA : C H O

CARD	1	2	3	4	5	6	7	8	9	10
1- ASET1	1		243							
2- ASET1	1		1516							
3- ASET1	1		1800							
4- ASET1	1		1924							
5- ASET1	3		241	506	1701	1801	1522			
6- ASET1	3		1505	1506	1613	1614				
7- ASET1	13		101	201	301	501	601	701	801	
8- ASET1	13		111	219	1701	1801	2001	2101		
9- ASET1	13		101	1101	1201	1401	1501	1606	2001	
10- ASET1	23		279	232	232	232				
11- ASET1	23		1923	1827	1841	1823				
12- ASET1	123		104	110	170	205	205	205	410	
13- ASET1	123		115	2110	224	1310	2010	2105		
14- ASET1	123		505	605	618	705	714	1305	1205	
15- ASET1	123		805	818	905	923	1105	1115	1123	
16- ASET1	123		1212	1220	1312	1405	1416	1418	1605	
17- ASET1	123		1610	1705	1710	1718	1806	1812		
18- ASET1	123		1824	1328	1905	1918	2005	2014	2030	
19- ASET1	123		2031	2114						
20- ASET1	1235		515	760	1161	1619				
21- ASET1	123456		2200							
22- CHAR	181		181	151	152	166			2	
23- CHAR	182		181	152	153	169			2	
24- CHAR	183		181	153	154	168			2	
25- CHAR	184		181	154	155	157			2	
26- CHAR	185		181	155	156	158			2	
27- CHAR	186		181	156	157	151			2	
28- CHAR	187		181	157	158	166			2	
29- CHAR	188		181	158	159	166			2	
30- CHAR	189		181	159	160	166			2	
31- CHAR	190		181	160	161	166			2	
32- CHAR	191		181	161	162	167			2	
33- CHAR	192		181	162	163	166			2	
34- CHAR	193		181	163	164	166			2	
35- CHAR	194		194	158	167	156			2	
36- CHAR	195		194	167	168	154			2	
37- CHAR	196		194	168	169	153			2	
38- CHAR	197		194	169	155	152			2	
39- CHAR	198		181	166	165	158			2	
40- CHAR	199		181	165	151	157			2	
41- CHAR	463		463	305	310	.0	1.0	.0	1	8463
42- 8463				0.0	.575	0.0	0.0	.575	0.0	
43- CHAR	464		464	310	312	.0	1.0	.0	1	8464
44- 8464				0.0	.575	0.0	0.0	.575	0.0	
45- CHAR	465		465	312	314	.0	1.0	.0	1	8465
46- 8465				0.0	.575	0.0	0.0	.575	0.0	
47- CHAR	466		466	314	316	.0	1.0	.0	1	8466
48- 8466				0.0	.575	0.0	0.0	.575	0.0	
49- CHAR	467		467	316	318	.0	1.0	.0	1	8467
50- 8467				0.0	.575	0.0	0.0	.575	0.0	

SORTED BULK DATA ECHO

CARD	1	2	3	4	5	6	7	8	9	10
51- CHAR	1231	181	1221	1206	1212				2	
52- CHAR	1232	181	1206	1201	1210				2	
53- CHAR	1927	1927	1905	1918	.0	1.0	.0	1		E1927
54- E1927			0.0	.75	0.0	0.0	.75	0.0		
55- CHAR	1928	1928	1918	1919	.0	1.0	.0	1		E1928
56- E1928			0.0	.75	0.0	0.0	.75	0.0		
57- CHAR	1929	1929	1919	1920	.0	1.0	.0	1		E1929
58- E1929			0.0	.75	0.0	0.0	.75	0.0		
59- CHAR	1930	1930	1920	1921	.0	1.0	.0	1		E1930
60- E1930			0.0	.75	0.0	0.0	.75	0.0		
61- CHAR	1931	1931	1921	1922	.0	1.0	.0	1		E1931
62- E1931			0.0	.75	0.0	0.0	.75	0.0		
63- CHAR	2101	2101	2101	2102	2110				2	
64- CHAR	2102	2102	2102	2103	2110				2	
65- CHAR	2103	2103	2103	2104	2110				2	
66- CHAR	2104	2104	2104	2105	2110				2	
67- CHAR	2105	2105	2105	2106	.0	1.0	.0	1		
68- CHAR	2106	2106	2106	2107	.0	1.0	.0	1		
69- CHAR	2107	2107	2107	2108	.0	1.0	.0	1		
70- CHAR	2108	2108	2108	2109	.0	1.0	.0	1		
71- CHAR	2109	2109	2109	2110	.0	1.0	.0	1		
72- CHAR	2110	2110	2110	2111	.0	1.0	.0	1		
73- CHAR	2111	2111	2111	2112	.0	1.0	.0	1		
74- CHAR	2112	2112	2112	2113	2101				2	
75- CHAR	2113	2113	2113	2114	2101				2	
76- CHAR	2114	2114	2114	2115	2101				2	
77- CHAR	2502	2502	243	318	.0	1.0	.0	1		
78- CHAR	2503	2502	318	518	.0	1.0	.0	1		
79- CHAR	2504	2502	518	618	.0	1.0	.0	1		
80- CHAR	2505	2502	618	718	.0	1.0	.0	1		
81- CHAR	2506	2502	718	760	.0	1.0	.0	1		
82- CHAR	2507	2502	760	818	.0	1.0	.0	1		
83- CHAR	2508	2502	818	923	.0	1.0	.0	1		
84- CHAR	2509	2502	923	1023	.0	1.0	.0	1		
85- CHAR	2510	2502	1023	1123	.0	1.0	.0	1		
86- CHAR	2511	2502	1123	1161	.0	1.0	.0	1		
87- CHAR	2512	2502	1161	1220	.0	1.0	.0	1		
88- CHAR	2513	2502	1220	1320	.0	1.0	.0	1		
89- CHAR	2514	2502	1320	1418	.0	1.0	.0	1		
90- CHAR	2515	2502	1418	1510	.0	1.0	.0	1		
91- CHAR	2516	2502	1510	1618	.0	1.0	.0	1		
92- CHAR	2517	2502	1618	1718	.0	1.0	.0	1		
93- CHAR	2519	2502	1718	1824	.0	1.0	.0	1		
94- CHAR	2713	2713	1724	1922	.0	1.0	.0	1		
95- CHAR	2722	181	1821	1930	1801				2	
96- CHAR	2723	181	1930	1934	1901				2	
97- CHAR	2724	181	1930	1929	1901				2	
98- CHAR	2725	181	1929	1922	1905				2	E8M2725
99- E8M2725		6								
100- CHAR	2726	181	1927	1926	1930				2	

SORTED BULK DATA CARD

CARD

CARD	1	2	3	4	5	6	7	8	9	10
101- CBAR	2727	181	1926	1925	1930			2		
102- CBAR	2728	181	1925	1924	1930			2		
103- CBAR	2729	181	1924	1923	1930			2		
104- CBAR	2730	181	1923	1922	1930			2		ERM2730
105- ELEM2730		6								
106- CELAS2	20200	148000	230	1	243	1				
107- CONM2	400	301	0		.39					
108- CONM2	500	501	0		.14					
109- CONM2	600	619	0		.16					
110- CONM2	1000	1019	0		.16					
111- CONM2	1300	1316	0		.16					
112- CONM2	1400	1414	0		.16					
113- CONM2	1500	1506	0		.16					
114- CONM2	1600	1614	0		.16					
115- CONM2	1800	1800	0		2.25					
116- CONM2	2000	2700	0		25.15					ERM2730
117- CONM5	44.4		232.2			214.5				
118- CONM2	2031	2011	0		.13					
119- CONM2	2032	2014	0		.33					
120- CONM2	2033	2026	0		.22					
121- CONM2	2034	2029	0		.12					
122- CONROD	101	101	102	1	.023000			.014		
123- CONROD	102	102	103	1	.023000			.014		
124- CONROD	103	103	104	1	.023000			.014		
125- CONROD	104	104	105	1	.023000			.014		
126- CONROD	105	105	110	1	.023000			.014		
127- CONROD	109	111	112	1	.072000			.790		
128- CONROD	110	112	113	1	.072000			.790		
129- CONROD	111	113	114	1	.072000			.790		
130- CONROD	112	114	115	1	.072000			.790		
131- CONROD	113	116	117	1	.154000					
132- CONROD	114	117	118	1	.154000					
133- CONROD	115	118	119	1	.154000					
134- CONROD	116	119	120	1	.154000					
135- CONROD	122	128	129	1	.000000					
136- CONROD	123	130	131	1	.000000					
137- CONROD	124	101	106	11	.006000					
138- CONROD	129	106	111	11	.006000					
139- CONROD	132	110	115	11	.003000					
140- CONROD	138	115	120	11	.003000					
141- CONROD	143	120	125	11	.003					
142- CONROD	146	125	127	11	.023000			.0200		
143- CONROD	147	126	128	1	.016000					
144- CONROD	148	127	129	1	.0394000			.0100		
145- CONROD	149	128	130	1	.009700					
146- CONROD	150	129	131	1	.023000			.0080		
147- CONROD	201	201	202	1	.009200			.0233		
148- CONROD	202	202	203	1	.009200			.0233		
149- CONROD	203	203	204	1	.009200			.0233		
150- CONROD	204	204	205	1	.009200			.0233		

PHASE 1 ORBITER FUSELAGE-SYMM CASE# REVISION 4/22/74
 SKINS HALF EFF.LONG.,RSX EFF.TRANS.AT WING

MAY 6, 1974 NASTRAN 2/ 1/73 PAGE 23

SORTED BULK DATA ECHO

CARD	COUNT	1	2	3	4	5	6	7	8	9	10
151-	CONROD	205	205	206	1	.059200				.0233	
152-	CONROD	216	219	220	1	.095000				.0174	
153-	CONROD	217	220	221	1	.095000				.0174	
154-	CONROD	218	221	222	1	.095000				.0174	
155-	CONROD	219	222	223	1	.095000				.0174	
156-	CONROD	220	223	224	1	.095000				.0174	
157-	CONROD	223	228	229	1	.040000					
158-	CONROD	224	229	230	1	.040000					
159-	CONROD	225	231	232	1	.040000					
160-	CONROD	226	232	233	1	.040000					
161-	CONROD	227	234	235	1	.040000					
162-	CONROD	228	235	236	1	.040000					
163-	CONROD	229	237	238	1	.040000					
164-	CONROD	230	238	239	1	.040000					
165-	CONROD	231	240	241	1	.040000					
166-	CONROD	232	241	242	1	.040000					
167-	CONROD	233	201	207	11	.056000					
168-	CONROD	238	206	212	11	.055400					
169-	CONROD	239	207	213	11	.056000					
170-	CONROD	244	212	218	11	.055400					
171-	CONROD	245	213	219	11	.056000					
172-	CONROD	250	218	224	11	.055400					
173-	CONROD	254	224	227	11	.055400				.0200	
174-	CONROD	255	225	228	1	.035100					
175-	CONROD	256	226	229	1	.020000					
176-	CONROD	257	227	230	1	.034600				.0200	
177-	CONROD	258	228	231	1	.035100					
178-	CONROD	259	229	232	1	.020000					
179-	CONROD	260	230	233	1	.047500				.0186	
180-	CONROD	261	231	234	1	.035100					
181-	CONROD	262	232	235	1	.020000					
182-	CONROD	263	233	236	1	.047500				.0186	
183-	CONROD	264	234	237	1	.035100					
184-	CONROD	265	235	238	1	.020000					
185-	CONROD	266	236	239	1	.047500				.0186	
186-	CONROD	267	237	240	1	.035100					
187-	CONROD	268	238	241	1	.020000					
188-	CONROD	269	239	242	1	.047500				.0186	
189-	CONROD	301	301	302	1	.172000				.0687	
190-	CONROD	302	302	303	1	.172000				.0687	
191-	CONROD	303	303	304	1	.172000				.0687	
192-	CONROD	304	304	305	1	.172000				.0716	
193-	CONROD	305	306	307	1	.172000					
194-	CONROD	306	307	308	1	.172000					
195-	CONROD	307	308	309	1	.172000					
196-	CONROD	308	309	310	1	.172000					
197-	CONROD	309	311	312	1	.091000					
198-	CONROD	310	313	314	1	.091					
199-	CONROD	311	315	316	1	.091					
200-	CONROD	312	317	318	1	.032000					

SORTED BULK DATA FCHD

CARD	COUNT	1	2	3	4	5	6	7	8	9	10
201-	CONROD	313	301	306	1		.062500				
202-	CONROD	314	302	307	1		.125000				
203-	CONROD	315	303	308	1		.125000				
204-	CONROD	316	304	309	1		.129				
205-	CONROD	317	305	310	1		.129000			.0618	
206-	CONROD	318	309	311	1		.115				
207-	CONROD	319	310	312	1		.115000			.0494	
208-	CONROD	320	311	313	1		.104000				
209-	CONROD	321	312	314	1		.104000			.0430	
210-	CONROD	322	313	315	1		.092				
211-	CONROD	323	314	316	1		.092000			.0363	
212-	CONROD	324	315	317	1		.078				
213-	CONROD	325	316	318	1		.078000			.0285	
214-	CONROD	451	406	407	1		.172000				
215-	CONROD	452	407	408	1		.172000				
216-	CONROD	453	408	409	1		.172000				
217-	CONROD	454	409	310	1		.172000				
218-	CONROD	455	301	302	1		.172000			.0687	
219-	CONROD	456	302	303	1		.172000			.0687	
220-	CONROD	457	303	304	1		.172000			.0687	
221-	CONROD	458	304	305	1		.172000			.0687	
222-	CONROD	459	301	406	1		.062500				
223-	CONROD	460	302	407	1		.125000				
224-	CONROD	461	303	408	1		.125000				
225-	CONROD	462	304	409	1		.125000				
226-	CONROD	501	501	502	1		.172000			.0513	
227-	CONROD	502	502	503	1		.172000			.0687	
228-	CONROD	503	503	504	1		.172000			.0687	
229-	CONROD	504	504	505	1		.172000			.0618	
230-	CONROD	505	506	507	1		.172000				
231-	CONROD	506	507	508	1		.172000				
232-	CONROD	507	508	509	1		.172000				
233-	CONROD	508	509	510	1		.172000				
234-	CONROD	509	511	512	1		.091000				
235-	CONROD	510	513	514	1		.091000				
236-	CONROD	511	515	516	1		.091000				
237-	CONROD	512	517	518	1		.032000				
238-	CONROD	513	501	506	1		.100000				
239-	CONROD	514	502	507	1		.125000				
240-	CONROD	515	503	508	1		.125000				
241-	CONROD	516	504	509	1		.129000				
242-	CONROD	517	505	510	1		.129000			.0618	
243-	CONROD	518	509	511	1		.115000				
244-	CONROD	519	510	512	1		.115000			.0494	
245-	CONROD	520	511	513	1		.104000				
246-	CONROD	521	512	514	1		.104000			.0430	
247-	CONROD	522	513	515	1		.092000				
248-	CONROD	523	514	516	1		.092000			.0363	
249-	CONROD	524	515	517	1		.078000				
250-	CONROD	525	516	518	1		.078000			.0285	

SORTED BULK DATA ECHO

CARD	COUNT	1	2	3	4	5	6	7	8	9	10
251-	CONROD	602	602	603	603	1	.172000			.1140	
252-	CONROD	603	603	604	604	1	.172000			.0687	
253-	CONROD	604	604	605	605	1	.172000			.061P	
254-	CONROD	605	606	607	607	1	.172000				
255-	CONROD	606	607	608	608	1	.172000				
256-	CONROD	607	608	609	609	1	.172000				
257-	CONROD	608	609	610	610	1	.172000				
258-	CONROD	609	611	612	612	1	.091000				
259-	CONROD	610	613	614	614	1	.091000				
260-	CONROD	611	613	616	616	1	.091000				
261-	CONROD	612	617	615	615	1	.092000				
262-	CONROD	613	601	606	606	1	.062500				
263-	CONROD	614	602	607	607	1	.125000				
264-	CONROD	615	603	608	608	1	.125000				
265-	CONROD	616	604	609	609	1	.129000				
266-	CONROD	617	605	610	610	1	.129000			.061P	
267-	CONROD	618	609	611	611	1	.115000				
268-	CONROD	619	610	612	612	1	.115000			.0494	
269-	CONROD	620	611	613	613	1	.104000				
270-	CONROD	621	612	614	614	1	.104000			.0430	
271-	CONROD	622	613	615	615	1	.092000				
272-	CONROD	623	614	616	616	1	.092000			.0363	
273-	CONROD	624	615	617	617	1	.078000				
274-	CONROD	625	616	618	618	1	.078000			.0285	
275-	CONROD	702	702	703	703	1	.172000			.1140	
276-	CONROD	703	703	704	704	1	.172000			.0687	
277-	CONROD	704	704	705	705	1	.172000			.0618	
278-	CONROD	705	706	707	707	1	.172000				
279-	CONROD	706	707	708	708	1	.172000				
280-	CONROD	707	708	709	709	1	.172000				
281-	CONROD	708	709	710	710	1	.172000				
282-	CONROD	709	711	712	712	1	.091000				
283-	CONROD	710	713	714	714	1	.091000				
284-	CONROD	711	715	716	716	1	.091000				
285-	CONROD	712	717	715	715	1	.032000				
286-	CONROD	713	701	706	706	1	.052500				
287-	CONROD	714	702	707	707	1	.125000				
288-	CONROD	715	703	708	708	1	.125000				
289-	CONROD	716	704	709	709	1	.129000				
290-	CONROD	717	705	710	710	1	.129000			.0618	
291-	CONROD	718	709	711	711	1	.116000				
292-	CONROD	719	710	712	712	1	.116000			.0501	
293-	CONROD	720	711	713	713	1	.104000				
294-	CONROD	721	712	714	714	1	.104000			.0430	
295-	CONROD	722	713	715	715	1	.092000				
296-	CONROD	723	714	716	716	1	.092000			.0363	
297-	CONROD	724	715	717	717	1	.074000				
298-	CONROD	725	716	718	718	1	.074000			.0285	
299-	CONROD	802	802	803	803	1	.172000			.1140	
300-	CONROD	803	803	804	804	1	.172000			.0687	

SORTED BULK DATA FCHO

CARD	COUNT	1	2	3	4	5	6	7	8	9	10
301-	CONROD	804	804	805	1		.172000			.0618	
302-	CONROD	805	806	807	1		.172000				
303-	CONROD	806	807	808	1		.172000				
304-	CONROD	807	808	809	1		.172000				
305-	CONROD	808	809	810	1		.172000				
306-	CONROD	809	811	812	1		.090000				
307-	CONROD	810	813	814	1		.090000				
308-	CONROD	811	815	816	1		.090000				
309-	CONROD	812	817	818	1		.032000				
310-	CONROD	813	801	806	1		.062500				
311-	CONROD	814	802	807	1		.125000				
312-	CONROD	815	803	808	1		.125000				
313-	CONROD	816	804	809	1		.129000				
314-	CONROD	817	805	810	1		.129000			.0618	
315-	CONROD	818	809	811	1		.116000				
316-	CONROD	819	810	812	1		.116000			.0501	
317-	CONROD	820	811	813	1		.104000				
318-	CONROD	821	812	814	1		.104000			.0430	
319-	CONROD	822	813	815	1		.092000				
320-	CONROD	823	814	816	1		.092000			.0363	
321-	CONROD	824	815	817	1		.078000				
322-	CONROD	825	816	818	1		.078000			.0285	
323-	CONROD	902	902	903	1		.056000			.0428	
324-	CONROD	903	903	904	1		.056000			.0259	
325-	CONROD	904	904	905	1		.056000			.0438	
326-	CONROD	909	911	912	1		.012000				
327-	CONROD	910	912	913	1		.056000				
328-	CONROD	911	913	914	1		.056000				
329-	CONROD	912	914	915	1		.056000				
330-	CONROD	913	916	917	1		.090000				
331-	CONROD	914	918	919	1		.090000				
332-	CONROD	915	920	921	1		.090000				
333-	CONROD	916	922	923	1		.032000				
334-	CONROD	917	901	911	11		.109000				
335-	CONROD	918	902	912	1		.040000				
336-	CONROD	919	903	913	1		.040000				
337-	CONROD	920	904	914	1		.132000				
338-	CONROD	921	905	910	1		.135000			.0438	
339-	CONROD	922	910	915	1		.123000			.0438	
340-	CONROD	927	914	916	1		.115000				
341-	CONROD	928	915	917	1		.115000			.0493	
342-	CONROD	929	916	918	1		.103000				
343-	CONROD	930	917	919	1		.103000			.0427	
344-	CONROD	931	918	920	1		.092000				
345-	CONROD	932	919	921	1		.092000			.0363	
346-	CONROD	923	920	922	1		.080000				
347-	CONROD	934	921	923	1		.080000			.0292	
348-	CONROD	1002	1002	1003	1		.058000			.0439	
349-	CONROD	1003	1003	1004	1		.058000			.0265	
350-	CONROD	1004	1004	1005	1		.058000			.0436	

SORTED BULK DATA FCHD

CARD	COUNT	1	2	3	4	5	6	7	8	9	10
351-	CONROD	1005	1011	1012	1		.012000				
352-	CONROD	1006	1012	1013	1		.058000				
353-	CONROD	1007	1013	1014	1		.058000				
354-	CONROD	1008	1014	1015	1		.058000				
355-	CONROD	1009	1016	1017	1		.090000				
356-	CONROD	1010	1018	1019	1		.090000				
357-	CONROD	1011	1020	1021	1		.090000				
358-	CONROD	1012	1022	1023	1		.072000				
359-	CONROD	1013	1001	1011	11		.109000				
360-	CONROD	1014	1002	1012	1		.040000				
361-	CONROD	1015	1003	1013	1		.040000				
362-	CONROD	1016	1004	1014	1		.172000				
363-	CONROD	1017	1005	1010	1		.135000			.0436	
364-	CONROD	1018	1010	1015	1		.123000			.0436	
365-	CONROD	1027	1014	1016	1		.115000				
366-	CONROD	1028	1015	1017	1		.115000			.0493	
367-	CONROD	1029	1016	1018	1		.103000				
368-	CONROD	1030	1017	1019	1		.103000			.0427	
369-	CONROD	1031	1018	1020	1		.092000				
370-	CONROD	1032	1019	1021	1		.092000			.0363	
371-	CONROD	1033	1020	1022	1		.080000				
372-	CONROD	1034	1021	1023	1		.080000			.0292	
373-	CONROD	1102	1102	1103	1		.060000			.0462	
374-	CONROD	1103	1103	1104	1		.060000			.0272	
375-	CONROD	1104	1104	1105	1		.030			.0452	
376-	CONROD	1105	1111	1112	1		.012000				
377-	CONROD	1106	1112	1113	1		.060000				
378-	CONROD	1107	1113	1114	1		.060000				
379-	CONROD	1108	1114	1115	1		.030				
380-	CONROD	1109	1116	1117	1		.090000				
381-	CONROD	1110	1118	1119	1		.090000				
382-	CONROD	1111	1120	1121	1		.090000				
383-	CONROD	1112	1122	1123	1		.032000				
384-	CONROD	1114	1101	1111	11		.109000				
385-	CONROD	1115	1102	1112	1		.040000				
386-	CONROD	1116	1103	1113	1		.040000				
387-	CONROD	1117	1104	1114	1		.135000				
388-	CONROD	1119	1105	1110	1		.135000			.0452	
389-	CONROD	1120	1110	1115	1		.123000			.0452	
390-	CONROD	1121	1114	1116	1		.115000				
391-	CONROD	1122	1115	1117	1		.115000			.0493	
392-	CONROD	1123	1116	1118	1		.103000				
393-	CONROD	1124	1117	1119	1		.103000			.0427	
394-	CONROD	1125	1118	1120	1		.092000				
395-	CONROD	1126	1119	1121	1		.092000			.0363	
396-	CONROD	1127	1120	1122	1		.080000				
397-	CONROD	1128	1121	1123	1		.080000			.0292	
398-	CONROD	1202	1202	1203	1		.172000			.1140	
399-	CONROD	1203	1203	1204	1		.172000			.0687	
400-	CONROD	1204	1204	1205	1		.086			.0618	

S O R T E D P U L K D A T A F C H O

CARD	COUNT	1	2	3	4	5	6	7	8	9	10
401-	CONROD	1205	1206	1207	1		.060				
402-	CONROD	1205	1207	1208	1		.172000				
403-	CONROD	1207	1208	1209	1		.172000				
404-	CONROD	1208	1210	1209	1		.086				
405-	CONROD	1209	1211	1212	1		.090000				
406-	CONROD	1210	1213	1214	1		.090000				
407-	CONROD	1211	1215	1216	1		.090000				
408-	CONROD	1212	1217	1218	1		.090000				
409-	CONROD	1213	1219	1220	1		.032000				
410-	CONROD	1214	1201	1206	11		.109000				
411-	CONROD	1215	1202	1207	1		.125000				
412-	CONROD	1216	1207	1208	1		.125000				
413-	CONROD	1217	1204	1209	1		.135000				
414-	CONROD	1218	1205	1210	1		.135000			.0618	
415-	CONROD	1219	1209	1211	1		.123000				
416-	CONROD	1220	1210	1212	1		.123000			.0550	
417-	CONROD	1221	1211	1213	1		.115000				
418-	CONROD	1222	1212	1214	1		.115000			.0493	
419-	CONROD	1223	1213	1215	1		.103000				
420-	CONROD	1224	1214	1216	1		.103000			.0427	
421-	CONROD	1225	1215	1217	1		.092000				
422-	CONROD	1226	1216	1218	1		.092000			.0363	
423-	CONROD	1227	1217	1219	1		.080000				
424-	CONROD	1228	1218	1220	1		.080000			.0292	
425-	CONROD	1229	1206	1221	11		.109				
426-	CONROD	1302	1302	1303	1		.172000			.1140	
427-	CONROD	1303	1303	1304	1		.172000			.0687	
428-	CONROD	1304	1304	1305	1		.086			.0618	
429-	CONROD	1305	1306	1307	1		.060000				
430-	CONROD	1306	1307	1308	1		.172000				
431-	CONROD	1307	1308	1309	1		.172000				
432-	CONROD	1308	1309	1310	1		.086				
433-	CONROD	1309	1311	1312	1		.090000				
434-	CONROD	1310	1313	1314	1		.090000				
435-	CONROD	1311	1315	1316	1		.090000				
436-	CONROD	1312	1317	1318	1		.090000				
437-	CONROD	1313	1319	1320	1		.032000				
438-	CONROD	1314	1301	1306	11		.109000				
439-	CONROD	1315	1302	1307	1		.125000				
440-	CONROD	1316	1303	1308	1		.125000				
441-	CONROD	1317	1304	1309	1		.135000				
442-	CONROD	1318	1305	1310	1		.135000			.0618	
443-	CONROD	1319	1309	1311	1		.123000				
444-	CONROD	1320	1310	1312	1		.123000			.0550	
445-	CONROD	1321	1311	1313	1		.115000				
446-	CONROD	1322	1312	1314	1		.115000			.0493	
447-	CONROD	1323	1313	1315	1		.103000				
448-	CONROD	1324	1314	1316	1		.103000			.0427	
449-	CONROD	1325	1315	1317	1		.092000				
450-	CONROD	1326	1316	1318	1		.092000			.0363	

SELECTED PULK DATA FROM

CARD	COUNT	1	2	3	4	5	6	7	8	9	10
451-	CONROD	1327	1317	1319	1		.080000				
452-	CONROD	1328	1318	1320	1		.070000			.0200	
453-	CONROD	1329	1306	1321	11		.1000				
454-	CONROD	1402	1402	1404	1		.070000			.0100	
455-	CONROD	1403	1402	1404	1		.050000			.0100	
456-	CONROD	1404	1404	1405	1		.0700			.0100	
457-	CONROD	1405	1407	1408	1		.060000			.0100	
458-	CONROD	1406	1408	1409	1		.060000			.0100	
459-	CONROD	1407	1409	1410	1		.0700			.0300	
460-	CONROD	1408	1411	1412	1		.050000				
461-	CONROD	1409	1413	1414	1		.050000				
462-	CONROD	1410	1415	1416	1		.050000				
463-	CONROD	1411	1417	1418	1		.072000				
464-	CONROD	1412	1401	1406	11		.109000				
465-	CONROD	1413	1402	1407	1		.040000				
466-	CONROD	1414	1403	1408	1		.040000				
467-	CONROD	1415	1404	1409	1		.132000				
468-	CONROD	1416	1405	1416	1		.122000			.0700	
469-	CONROD	1417	1409	1411	1		.115000				
470-	CONROD	1418	1410	1412	1		.115000			.0400	
471-	CONROD	1419	1411	1412	1		.103000				
472-	CONROD	1420	1412	1414	1		.103000			.0400	
473-	CONROD	1421	1413	1415	1		.092000				
474-	CONROD	1422	1414	1416	1		.092000			.0700	
475-	CONROD	1423	1415	1417	1		.080000				
476-	CONROD	1424	1416	1418	1		.080000			.0200	
477-	CONROD	1501	1501	1502	1		.140000				
478-	CONROD	1502	1503	1504	1		.091000				
479-	CONROD	1503	1505	1506	1		.091000				
480-	CONROD	1504	1507	1508	1		.091000				
481-	CONROD	1505	1509	1510	1		.032000				
482-	CONROD	1506	1501	1502	1		.115000				
483-	CONROD	1507	1502	1504	1		.115000			.0400	
484-	CONROD	1508	1503	1505	1		.103000				
485-	CONROD	1509	1504	1506	1		.103000			.0400	
486-	CONROD	1510	1505	1507	1		.092000				
487-	CONROD	1511	1506	1508	1		.092000			.0300	
488-	CONROD	1512	1507	1509	1		.080000				
489-	CONROD	1513	1508	1510	1		.080000			.0200	
490-	CONROD	1602	1602	1603	1		.060000			.0200	
491-	CONROD	1603	1603	1604	1		.060000			.0100	
492-	CONROD	1604	1604	1605	1		.0700			.0300	
493-	CONROD	1606	1607	1608	1		.060000			.0200	
494-	CONROD	1607	1608	1609	1		.060000			.0100	
495-	CONROD	1608	1609	1610	1		.0700			.0300	
496-	CONROD	1609	1611	1612	1		.091000				
497-	CONROD	1610	1613	1614	1		.091000				
498-	CONROD	1611	1615	1616	1		.091000				
499-	CONROD	1612	1617	1618	1		.072000				
500-	CONROD	1613	1601	1606	11		.109000				

SORTED BULK DATA ECHO

CARD	1	2	3	4	5	6	7	8	9	10
501-	CONROD	1614	1602	1607	1	.040000				
502-	CONROD	1615	1603	1608	1	.040000				
503-	CONROD	1616	1604	1609	1	.132000				
504-	CONROD	1617	1605	1610	1	.132000			.0304	
505-	CONROD	1618	1609	1611	1	.115000				
506-	CONROD	1619	1610	1612	1	.115000			.0493	
507-	CONROD	1620	1611	1613	1	.103000				
508-	CONROD	1621	1612	1614	1	.103000			.0427	
509-	CONROD	1622	1613	1615	1	.092000				
510-	CONROD	1623	1614	1616	1	.092000			.0363	
511-	CONROD	1624	1615	1617	1	.080000				
512-	CONROD	1625	1616	1618	1	.080000			.0292	
513-	CONROD	1702	1702	1703	1	.060000			.0231	
514-	CONROD	1703	1703	1704	1	.060000			.0139	
515-	CONROD	1704	1704	1705	1	.030			.0304	
516-	CONROD	1705	1706	1707	1	.060000			.0139	
517-	CONROD	1706	1707	1708	1	.060000			.0139	
518-	CONROD	1707	1708	1709	1	.060000			.0139	
519-	CONROD	1708	1709	1710	1	.030			.0304	
520-	CONROD	1709	1711	1712	1	.091000				
521-	CONROD	1710	1713	1714	1	.091000				
522-	CONROD	1711	1715	1716	1	.091000				
523-	CONROD	1712	1717	1718	1	.032000				
524-	CONROD	1713	1701	1706	11	.100000				
525-	CONROD	1714	1702	1707	1	.040000				
526-	CONROD	1715	1703	1708	1	.040000				
527-	CONROD	1716	1704	1709	1	.132000				
528-	CONROD	1717	1705	1710	1	.132000			.0304	
529-	CONROD	1718	1709	1711	1	.115000				
530-	CONROD	1719	1710	1712	1	.115000			.0493	
531-	CONROD	1720	1711	1713	1	.103000				
532-	CONROD	1721	1712	1714	1	.103000			.0427	
533-	CONROD	1722	1713	1715	1	.092000				
534-	CONROD	1723	1714	1716	1	.092000			.0363	
535-	CONROD	1724	1715	1717	1	.080000				
536-	CONROD	1725	1716	1719	1	.080000			.0292	
537-	CONROD	1801	1801	1802	1	.060000			.0139	
538-	CONROD	1802	1802	1803	1	.060000			.0139	
539-	CONROD	1803	1803	1804	1	.060000			.0139	
540-	CONROD	1804	1804	1805	1	.060000			.0139	
541-	CONROD	1805	1805	1806	1	.030			.014	
542-	CONROD	1806	1801	1807	1	.090000				
543-	CONROD	1807	1802	1808	1	.040000				
544-	CONROD	1808	1803	1809	1	.040000				
545-	CONROD	1809	1804	1810	1	.040000				
546-	CONROD	1810	1805	1811	1	.023000				
547-	CONROD	1811	1806	1812	1	.023000			.0140	
548-	CONROD	1812	1807	1808	1	.060000			.0139	
549-	CONROD	1813	1808	1809	1	.060000			.0139	
550-	CONROD	1814	1809	1810	1	.060000			.0139	

REPORTED FUR LATER-LYING CASES DIVISION

CARD	1	2	3	4	5	6	7	8	9	10
551- CONROD	1815	1810	1811	1		.060000			.0159	
552- CONROD	1815	1811	1812	1		.030			.019	
553- CONROD	1817	1811	1813	1		.45000				
554- CONROD	1815	1812	1814	1		.045000			.0184	
555- CONROD	1819	1813	1814	1		.040000				
556- CONROD	1820	1813	1815	1		.050000				
557- CONROD	1821	1814	1817	1		.030000			.0214	
558- CONROD	1822	1815	1817	1		.040000				
559- CONROD	1823	1815	1819	1		.076000				
560- CONROD	1824	1817	1810	1		.056000			.0251	
561- CONROD	1825	1818	1819	1		.040000				
562- CONROD	1826	1819	1820	1		.040000				
563- CONROD	1827	1819	1822	1		.062000				
564- CONROD	1828	1819	1823	1		.020000				
565- CONROD	1829	1820	1824	1		.062000			.0287	
566- CONROD	1830	1821	1822	1		.051000			.0216	
567- CONROD	1831	1822	1823	1		.061000			.0216	
568- CONROD	1832	1823	1824	1		.040000			.0216	
569- CONROD	1833	1821	1825	1		.020000				
570- CONROD	1834	1822	1826	1		.060000				
571- CONROD	1835	1823	1827	1		.040000				
572- CONROD	1836	1824	1828	1		.055000			.0430	
573- CONROD	1837	1825	1826	1		.013000				
574- CONROD	1838	1826	1827	1		.025000				
575- CONROD	1839	1827	1828	1		.040000				
576- CONROD	1840	1826	1830	1		.070000				
577- CONROD	1841	1827	1831	1		.040000				
578- CONROD	1842	1828	1832	1		.070000			.0439	
579- CONROD	1843	1829	1830	1		.030000				
580- CONROD	1844	1830	1831	1		.030000				
581- CONROD	1845	1831	1832	1		.040000				
582- CONROD	1846	1829	1833	1		.020000				
583- CONROD	1847	1830	1834	1		.065000				
584- CONROD	1848	1831	1835	1		.040000				
585- CONROD	1849	1832	1835	1		.055000			.0430	
586- CONROD	1850	1833	1834	1		.040000				
587- CONROD	1851	1834	1835	1		.040000				
588- CONROD	1852	1833	1837	1		.020000				
589- CONROD	1853	1834	1838	1		.060000				
590- CONROD	1854	1835	1836	1		.040000				
591- CONROD	1855	1837	1838	1		.055000			.0310	
592- CONROD	1856	1838	1836	1		.060000			.0430	
593- CONROD	1901	1901	1902	1		.057000			.0280	
594- CONROD	1902	1902	1903	1		.033000			.0092	
595- CONROD	1903	1903	1904	1		.060000			.0140	
596- CONROD	1904	1904	1905	1		.03			.014	
597- CONROD	1905	1901	1906	1		.020000				
598- CONROD	1906	1902	1907	1		.037000				
599- CONROD	1907	1903	1908	1		.057000				
600- CONROD	1908	1904	1909	1		.040000				

SORTED BULK DATA FCHD

CARD	1	2	3	4	5	6	7	8	9	10
601- CONROD	1909	1906	1910	1		.020000				
602- CONROD	1910	1907	1911	1		.037000				
603- CONROD	1911	1908	1912	1		.057000				
604- CONROD	1912	1909	1915	1		.040000				
605- CONROD	1913	1910	1911	1		.032000				
606- CONROD	1914	1911	1912	1		.007600				
607- CONROD	1915	1912	1913	1		.015200				
608- CONROD	1916	1910	1914	1		.020000				
609- CONROD	1917	1911	1915	1		.037000				
610- CONROD	1918	1912	1916	1		.057000				
611- CONROD	1919	1914	1917	1		.040000				
613- CONROD	1920	1914	1915	1		.052000			.0280	
613- CONROD	1921	1915	1916	1		.028000			.0065	
614- CONROD	1922	1916	1917	1		.060000			.0140	
615- CONROD	1923	1917	1918	1		.03			.014	
616- CONROD	1924	1906	1907	1		.034000				
617- CONROD	1925	1907	1908	1		.012000				
618- CONROD	1926	1908	1909	1		.024000				
619- CONROD	2001	2001	2002	1		.018000			.0222	
620- CONROD	2002	2002	2003	1		.018000			.0222	
621- CONROD	2003	2003	2004	1		.018000			.0222	
622- CONROD	2004	2004	2005	1		.018000			.0222	
623- CONROD	2005	2005	2010	1		.080000			.0284	
624- CONROD	2006	2010	2015	1		.080000			.0284	
625- CONROD	2007	2011	2012	1		.145000				
626- CONROD	2008	2012	2013	1		.145000				
627- CONROD	2009	2012	2014	1		.145000				
628- CONROD	2010	2014	2015	1		.192000			.0244	
629- CONROD	2011	2015	2020	1		.090000			.0284	
630- CONROD	2012	2014	2019	1		.073200				
631- CONROD	2013	2011	2016	1		.014800				
632- CONROD	2014	2020	2025	1		.080000			.0284	
633- CONROD	2015	2019	2024	1		.073200				
634- CONROD	2016	2016	2021	1		.014800				
635- CONROD	2017	2025	2030	1		.080000			.0284	
636- CONROD	2018	2024	2029	1		.033200				
637- CONROD	2019	2021	2026	1		.014800				
638- CONROD	2020	2030	2029	1		.088000			.0168	
639- CONROD	2021	2029	2028	1		.088000				
640- CONROD	2022	2028	2027	1		.068000				
641- CONROD	2023	2027	2026	1		.078000				
642- CONROD	2024	2030	2035	1		.080000			.0284	
643- CONROD	2025	2035	2039	1		.080000			.0284	
644- CONROD	2026	2039	2042	1		.080000			.0284	
645- CONROD	2027	2042	2041	1		.120000			.0284	
646- CONROD	2028	2041	2040	1		.120000			.0404	
647- CONROD	2029	2041	2037	1		.050000				
648- CONROD	2030	2024	2025	1		.080000				
649- CONROD	2500	160	160	11		.104000				
650- CONROD	2501	160	230	11		.104000				

SORTED BULK DATA SHEET

CASE	1	2	3	4	5	6	7	8	9	10
651- CONROD	2551	1115	1212	11		.0578				
652- CONROD	2552	1212	1312	11		.057600				
653- CONROD	2553	1312	1410	11		.057400				
654- CONROD	2554	1410	1502	11		.057200				
655- CONROD	2555	1502	1610	11		.057000				
656- CONROD	2556	1610	1710	11		.056800				
657- CONROD	2557	1710	1812	11		.056600				
658- CONROD	2558	1812	1919	11		.056400				
659- CONROD	2560	1919	2010	11		.045400				
660- CONROD	2561	2010	2111	11		.045200				
661- CONROD	2562	2111	2201	11		.045000				
662- CONROD	2565	501	601	11		.069000				
663- CONROD	2566	601	701	11		.069000				
664- CONROD	2567	701	801	11		.069				
665- CONROD	2569	801	901	11		.069000				
666- CONROD	2570	1001	1001	11		.057100				
667- CONROD	2571	1101	1101	11		.057100				
668- CONROD	2572	1101	1201	11		.0571				
669- CONROD	2574	1301	1301	11		.057500				
670- CONROD	2575	1301	1401	11		.057500				
671- CONROD	2576	1401	1601	11		.0575				
672- CONROD	2576	1501	1701	11		.0571				
673- CONROD	2580	505	505	11		.072				
674- CONROD	2581	505	605	11		.072				
675- CONROD	2582	605	705	11		.072				
676- CONROD	2583	705	805	11		.072				
677- CONROD	2585	805	905	11		.072				
678- CONROD	2586	905	1005	11		.072				
679- CONROD	2587	1005	1105	11		.072				
680- CONROD	2598	1105	1205	11		.060				
681- CONROD	2590	1205	1305	11		.0460				
682- CONROD	2591	1305	1405	11		.0460				
683- CONROD	2592	1405	1605	11		.046				
684- CONROD	2594	1605	1705	11		.046				
685- CONROD	2596	1705	1806	11		.0460				
686- CONROD	2597	1806	1905	11		.0460				
687- CONROD	2598	1905	2005	11		.0460				
688- CONROD	2599	2005	2105	11		.0460				
689- CONROD	2642	1721	1722	1		.042000				
690- CONROD	2643	1706	1722	11		.042000				
691- CONROD	2644	1722	1809	11		.042000				
692- CONROD	2647	1206	1306	1		.01				
693- CONROD	2660	115	158	11		.095				
694- CONROD	2661	158	224	11		.095				
695- CONROD	2662	111	166	11		.0915				
696- CONROD	2663	166	219	11		.0915				
697- CONROD	2696	1727	1724	1		.02				
698- CONROD	2697	1721	1723	1		.04				
699- CONROD	2698	1722	1724	1		.04				
700- CONROD	2709	1321	1930	11		.048500				

SORTED NUBK DATA RECD

CARD	1	2	3	4	5	6	7	8	9	10
701- CONROD	2710	1930	1934	11		.048500				
702- CONROD	2711	1934	2026	11		.074500				
703- CONROD	2712	1937	2029	11		.045000				
704- CONROD	2714	1922	1932	11		.060100				
705- CONROD	2715	1932	2030	11		.049800				
706- CONROD	2716	1936	2031	11		.034000				
707- CONROD	2717	1721	1935	11		.128000				
708- CONROD	2718	1935	2014	11		.420000				
709- CONROD	2719	1936	1935	11		.033200				
710- CONROD	2720	1934	1936	11		.0148				
711- CONROD	2721	1935	1935	11		.0332				
712- CONROD	2800	911	1011	11		.0875				
713- CONROD	2801	1011	1111	11		.0875				
714- CONROD	2802	1111	1221	11		.0875				
715- CONROD	2804	1221	1321	11		.0875				
716- CONROD	2805	1321	1406	11		.0875				
717- CONROD	2806	1406	1516	11		.0875				
718- CONROD	2807	1516	1606	11		.0875				
719- CONROD	2808	1606	1706	11		.0875				
720- CONROD	2810	206	305	11		.072				
721- CONROD	10001	243	318	101		.046				
722- CONROD	10002	318	518	101		.047				
723- CONROD	10003	518	618	101		.049				
724- CONROD	10004	618	718	101		.052				
725- CONROD	10005	718	760	101		.053				
726- CONROD	10006	760	818	101		.054				
727- CONROD	10007	818	923	101		.056				
728- CONROD	10008	923	1023	101		.058				
729- CONROD	10009	1023	1123	101		.059				
730- CONROD	10010	1123	1161	101		.061				
731- CONROD	10011	1161	1220	101		.063				
732- CONROD	10012	1220	1320	101		.068				
733- CONROD	10013	1320	1418	101		.070				
734- CONROD	10014	1418	1510	101		.070				
735- CONROD	10015	1510	1618	101		.070				
736- CONROD	10016	1618	1718	101		.070				
737- CONROD	10017	1718	1824	101		.070				
738- CONROD	10020	1115	1212	104		.020				
739- CONROD	10021	1212	1312	104		.055				
740- CONROD	10022	1312	1410	104		.070				
741- CONROD	10023	1410	1502	104		.070				
742- CONROD	10024	1502	1610	104		.070				
743- CONROD	10025	1610	1710	104		.070				
744- CONROD	10026	1710	1812	104		.070				
745- CONROD	10030	205	305	102		.120				
746- CONROD	10031	305	505	102		.120				
747- CONROD	10032	505	605	102		.120				
748- CONROD	10033	605	705	102		.120				
749- CONROD	10034	705	805	102		.120				
750- CONROD	10035	805	905	102		.120				

PHASE 1 ORBITER FUSELAGE-SYMM CASE# REVISION 4/22/74
 SKINS HALF EFF.LONG..85% EFF.TRANS.AT WING

MAY 6, 1974 NASTRAN 2/ 1/73 PAGE 35

S O R T E D B U L K D A T A E C H O

CARD	COUNT	1	2	3	4	5	6	7	8	9	10
751-	CONROD	10036	905	1005	102	.120					
752-	CONROD	10037	1005	1105	102	.120					
753-	CONROD	10038	1105	1205	102	.105					
754-	CONROD	10039	1205	1305	102	.078					
755-	CONROD	10040	1305	1405	102	.065					
756-	CONROD	10041	1405	1605	102	.065					
757-	CONROD	10042	1605	1705	102	.065					
758-	CONROD	10043	1705	1806	102	.065					
759-	CONROD	10044	1806	1905	102	.065					
760-	CONROD	10045	1905	2005	102	.065					
761-	CONROD	10046	2005	2105	102	.065					
762-	CONROD	10050	501	501	103	.065					
763-	CONROD	10051	601	701	103	.065					
764-	CONROD	10052	701	801	103	.065					
765-	CONROD	10053	801	901	103	.065					
766-	CONROD	10054	901	1001	103	.065					
767-	CONROD	10055	1001	1101	103	.065					
768-	CONROD	10056	1101	1201	103	.065					
769-	CONROD	10057	1201	1301	103	.065					
770-	CONROD	10058	1301	1401	103	.065					
771-	CONROD	10059	1401	1601	103	.065					
772-	CONROD	10060	1601	1701	103	.065					
773-	CONROD	10061	1101	1102	105	.12					
774-	CONROD	10062	1102	1103	105	.12					
775-	CONROD	10063	1103	1104	105	.12					
776-	CONROD	10064	1104	1105	105	.09					
777-	CONROD	10071	1201	1202	106	.12					
778-	CONROD	10072	1202	1203	106	.12					
779-	CONROD	10073	1203	1204	106	.12					
780-	CONROD	10074	1204	1205	106	.12					
781-	CONROD	10081	1301	1302	107	.08					
782-	CONROD	10082	1302	1303	107	.08					
783-	CONROD	10083	1303	1304	107	.08					
784-	CONROD	10084	1304	1305	107	.04					
785-	CONROD	10091	1401	1402	108	.12					
786-	CONROD	10092	1402	1403	108	.12					
787-	CONROD	10093	1403	1404	108	.12					
788-	CONROD	10094	1404	1405	108	.12					
789-	CONROD	10101	1601	1602	109	.11					
790-	CONROD	10102	1602	1603	109	.11					
791-	CONROD	10103	1603	1604	109	.11					
792-	CONROD	10104	1604	1605	109	.11					
793-	CONROD	10111	1701	1702	110	.11					
794-	CONROD	10112	1702	1703	110	.11					
795-	CONROD	10113	1703	1704	110	.11					
796-	CONROD	10114	1704	1705	110	.11					
797-	CONROD	10122	1302	1803	111	.11					
798-	CONROD	10123	1803	1804	111	.11					
799-	CONROD	10124	1804	1805	111	.055					
800-	CONROD	10125	1805	1806	111	.055					

SORTED BULK DATA ICHD

CARD	COUNT	1	2	3	4	5	6	7	8	9	10
801-	CONROD	10131	1901	1902	112	.11					
802-	CONROD	10132	1902	1903	112	.11					
803-	CONROD	10133	1903	1904	112	.11					
804-	CONROD	10134	1904	1905	112	.08					
805-	CONROD	10151	1406	1516	1	.017					
806-	CONROD	10152	1407	1517	1	.017					
807-	CONROD	10153	1516	1606	1	.017					
808-	CONROD	10154	1517	1607	1	.017					
809-	CONROD	10155	1606	1706	1	.017					
810-	CONROD	10156	1607	1707	1	.017					
811-	CONROD	10160	1811	1812	113	.040					
812-	CONROD	10161	1914	1915	113	.043					
813-	CONROD	10162	1915	1916	113	.043					
814-	CONROD	10163	1916	1917	113	.043					
815-	CONROD	10164	1917	1928	113	.043					
816-	CONROD	10165	1929	1918	113	.043					
817-	CONROD	10166	1807	1808	113	.043					
818-	CONROD	10167	1809	1809	113	.087					
819-	CONROD	10168	1809	1810	113	.087					
820-	CONROD	10169	1810	1811	113	.087					
821-	CONROD	10170	1709	1708	114	.089					
822-	CONROD	10171	1708	1707	114	.089					
823-	CONROD	10172	1707	1706	115	.044					
824-	CONROD	10173	1606	1607	115	.088					
825-	CONROD	10174	1607	1609	115	.088					
826-	CONROD	10175	1608	1609	115	.088					
827-	CONROD	10176	1406	1407	115	.044					
828-	CONROD	10177	1407	1408	115	.044					
829-	CONROD	10178	1408	1409	115	.044					
830-	CONROD	10179	1609	1610	116	.070					
831-	CONROD	10180	1409	1410	117	.026					
832-	CONROD	10181	1709	1710	118	.070					
833-	CONROD	20001	212	310	1	.001					
834-	CONROD	20002	218	312	1	.001					
835-	CONROD	20003	224	314	1	.001					
836-	CONROD	20004	227	316	1	.001					
837-	CONROD	20005	310	510	1	.001					
838-	CONROD	20006	312	512	1	.001					
839-	CONROD	20007	314	514	1	.001					
840-	CONROD	20008	316	516	1	.001					
841-	CONROD	20009	510	610	1	.001					
842-	CONROD	20010	512	612	1	.001					
843-	CONROD	20011	514	614	1	.001					
844-	CONROD	20012	515	616	1	.001					
845-	CONROD	20013	610	710	1	.001					
846-	CONROD	20014	612	712	1	.001					
847-	CONROD	20015	614	714	1	.001					
848-	CONROD	20016	616	716	1	.001					
849-	CONROD	20017	710	810	1	.001					
850-	CONROD	20018	712	812	1	.001					

PRINTED BULK DATA RECORD

CARD	1	2	3	4	5	6	7	8	9	10
851- CONROD	20019	714	814	1		.001				
852- CONROD	20020	716	816	1		.001				
853- CONROD	20025	810	910	1		.001				
854- CONROD	20026	812	912	1		.001				
855- CONROD	20027	814	914	1		.001				
856- CONROD	20028	816	921	1		.001				
857- CONROD	20029	810	1010	1		.001				
858- CONROD	20029	815	1015	1		.001				
859- CONROD	20031	812	1012	1		.001				
860- CONROD	20032	814	1014	1		.001				
861- CONROD	20033	816	1021	1		.001				
862- CONROD	20034	1010	1110	1		.001				
863- CONROD	20035	1015	1115	1		.001				
864- CONROD	20036	1017	1117	1		.001				
865- CONROD	20037	1019	1119	1		.001				
866- CONROD	20038	1021	1121	1		.001				
867- CONROD	20039	1110	1210	1		.001				
868- CONROD	20040	1117	1217	1		.001				
869- CONROD	20041	1119	1216	1		.001				
870- CONROD	20042	1121	1218	1		.001				
871- CONROD	20047	1210	1310	1		.001				
872- CONROD	20048	1214	1314	1		.001				
873- CONROD	20049	1216	1316	1		.001				
874- CONROD	20050	1219	1318	1		.001				
875- CONROD	20051	1314	1412	1		.001				
876- CONROD	20052	1316	1414	1		.001				
877- CONROD	20053	1318	1416	1		.001				
878- CONROD	20054	1412	1504	1		.001				
879- CONROD	20055	1414	1506	1		.001				
880- CONROD	20056	1416	1508	1		.001				
881- CONROD	20057	1504	1612	1		.001				
882- CONROD	20058	1506	1614	1		.001				
883- CONROD	20059	1508	1616	1		.001				
884- CONROD	20060	1612	1712	1		.001				
885- CONROD	20061	1614	1714	1		.001				
886- CONROD	20062	1616	1716	1		.001				
887- CONROD	20066	1712	1814	1		.001				
888- CONROD	20067	1714	1817	1		.001				
889- CONROD	20068	1716	1820	1		.001				
890- CONROD	20069	202	302	1		.001				
891- CONROD	20070	203	303	1		.001				
892- CONROD	20071	204	304	1		.001				
893- CONROD	20072	302	502	1		.001				
894- CONROD	20073	303	503	1		.001				
895- CONROD	20074	304	504	1		.001				
896- CONROD	20075	502	602	1		.001				
897- CONROD	20076	503	603	1		.001				
898- CONROD	20077	504	604	1		.001				
899- CONROD	20078	602	702	1		.001				
900- CONROD	20079	603	703	1		.001				

SORTED BULK DATA ECHO

CARD	COUNT	1	2	3	4	5	6	7	8	9	10
901-	CONROD	20080	604	704	1	.001					
902-	CONROD	20081	702	802	1	.001					
903-	CONROD	20082	703	803	1	.001					
904-	CONROD	20083	704	804	1	.001					
905-	CONROD	20084	201	301	1	.001					
906-	CONROD	20085	301	501	1	.001					
907-	CONROD	20087	802	902	1	.001					
908-	CONROD	20088	803	903	1	.001					
909-	CONROD	20089	904	004	1	.001					
910-	CONROD	20090	902	1002	1	.001					
911-	CONROD	20091	903	1003	1	.001					
912-	CONROD	20092	904	1004	1	.001					
913-	CONROD	20093	1002	1102	1	.001					
914-	CONROD	20094	1003	1103	1	.001					
915-	CONROD	20095	1004	1104	1	.001					
916-	CONROD	20096	1102	1202	1	.001					
917-	CONROD	20097	1103	1203	1	.001					
918-	CONROD	20098	1104	1204	1	.001					
919-	CONROD	20102	1202	1302	1	.001					
920-	CONROD	20103	1203	1303	1	.001					
921-	CONROD	20104	1204	1304	1	.001					
922-	CONROD	20105	1302	1402	1	.001					
923-	CONROD	20106	1303	1403	1	.001					
924-	CONROD	20107	1304	1404	1	.001					
925-	CONROD	20108	1402	1502	1	.001					
926-	CONROD	20109	1403	1503	1	.001					
927-	CONROD	20110	1404	1504	1	.001					
928-	CONROD	20114	1502	1602	1	.001					
929-	CONROD	20115	1503	1603	1	.001					
930-	CONROD	20116	1504	1604	1	.001					
931-	CONROD	20120	1702	1802	1	.001					
932-	CONROD	20121	1703	1803	1	.001					
933-	CONROD	20122	1704	1804	1	.001					
934-	CONROD	20124	1608	1708	1	.001					
935-	CONROD	20125	1409	1501	1	.001					
936-	CONROD	20126	1501	1609	1	.001					
937-	CONROD	20127	1608	1708	1	.001					
938-	CONROD	20128	1609	1709	1	.001					
939-	CONROD	20129	1708	1809	1	.001					
940-	CONROD	20130	1709	1810	1	.001					
941-	CONROD	20131	1807	1914	1	.001					
942-	CONROD	20132	1808	1915	1	.001					
943-	CONROD	20133	1809	1916	1	.001					
944-	CONROD	20134	1810	1917	1	.001					
945-	CONROD	20135	1811	1928	1	.001					
946-	CONROD	20136	1515	1717	1	.020					
947-	CONROD	20151	601	602	1	.015					
948-	CONROD	20152	701	702	1	.015					
949-	CONROD	20153	801	802	1	.015					
950-	CONROD	20154	901	902	1	.015					

SORTED BULK DATA FCHD

CARD

COUNT	1	2	3	4	5	6	7	8	9	10
951-	CONROD	20155	1001	1002	1	.015				
952-	CONROD	20161	1801	1901	1	.001				
953-	CONROD	20162	1802	1902	1	.001				
954-	CONROD	20163	1803	1903	1	.001				
955-	CONROD	20164	1804	1904	1	.001				
956-	CONROD	20165	1901	2001	1	.001				
957-	CONROD	20166	1902	2002	1	.001				
958-	CONROD	20167	1903	2003	1	.001				
959-	CONROD	20168	1904	2004	1	.001				
960-	CONROD	20169	2001	2101	1	.001				
961-	CONROD	20170	2002	2102	1	.001				
962-	CONROD	20171	2003	2103	1	.001				
963-	CONROD	20172	2004	2104	1	.001				
964-	CORDIR	2	2001	2040	2101					
965-	CORDIR	1	0	-81.5683.0		75.5985	-80.2278.0		57.5136	EC1
966-	EC1	68.25	0.0	48.432						
967-	CQDMEM2	161	10161	101	102	107	106	0.0		
968-	CQDMEM2	162	10162	102	103	108	107	0.0		
969-	CQDMEM2	163	10163	103	104	109	108	0.0		
970-	CQDMEM2	164	10164	104	105	110	109	0.0		
971-	CQDMEM2	165	10165	105	107	112	111	0.0		
972-	CQDMEM2	166	10166	107	108	113	112	0.0		
973-	CQDMEM2	167	10167	108	109	114	113	0.0		
974-	CQDMEM2	168	10168	109	110	115	114	0.0		
975-	CQDMEM2	169	10169	111	112	117	115	0.0		
976-	CQDMEM2	170	10170	112	113	118	117	0.0		
977-	CQDMEM2	171	10171	113	114	119	118	0.0		
978-	CQDMEM2	172	10172	114	115	120	119	0.0		
979-	CQDMEM2	173	10173	116	117	122	121	0.0		
980-	CQDMEM2	174	10174	117	118	123	122	0.0		
981-	CQDMEM2	175	10175	118	119	124	123	0.0		
982-	CQDMEM2	176	10176	119	120	125	124	0.0		
983-	CQDMEM2	177	10177	124	125	127	126	0.0		
984-	CQDMEM2	270	10270	201	202	208	207	0.0		
985-	CQDMEM2	271	10271	202	203	209	208	0.0		
986-	CQDMEM2	272	10272	203	204	210	209	0.0		
987-	CQDMEM2	273	10273	204	205	211	210	0.0		
988-	CQDMEM2	274	10274	205	206	212	211	0.0		
989-	CQDMEM2	275	10275	207	208	214	213	0.0		
990-	CQDMEM2	276	10276	209	209	215	214	0.0		
991-	CQDMEM2	277	10277	209	210	216	215	0.0		
992-	CQDMEM2	278	10278	210	211	217	216	0.0		
993-	CQDMEM2	279	10279	211	212	218	217	0.0		
994-	CQDMEM2	280	10280	213	214	220	219	0.0		
995-	CQDMEM2	281	10281	214	215	221	220	0.0		
996-	CQDMEM2	282	10282	215	216	222	221	0.0		
997-	CQDMEM2	283	10283	216	217	223	222	0.0		
998-	CQDMEM2	284	10284	217	218	224	223	0.0		
999-	CQDMEM2	285	10285	222	223	226	225	0.0		
1000-	CQDMEM2	286	10286	223	224	227	226	0.0		

PHASE 1 MORTIMER FUSelage-SYMM CASEB REVISED 4/22/74
 SKIN: HALF EFF. LONG. 1.5% DEF. TRANS. AT WING

MAY 6, 1974 NASTRAN 2/ 1/73 PAGE 30

SHORTED BULK DATA CHECK

CARD

COUNT	1	2	3	4	5	6	7	8	9	10
1001-	CDDMEM2	2040	12040	2001	2002	2007	2006	0.0		
1002-	CDDMEM2	2041	12041	2002	2003	2008	2007	0.0		
1003-	CDDMEM2	2042	12042	2003	2004	2009	2008	0.0		
1004-	CDDMEM2	2043	12043	2004	2005	2010	2009	0.0		
1005-	CDDMEM2	2044	12044	2005	2007	2012	2011	0.0		
1006-	CDDMEM2	2045	12045	2007	2003	2013	2012	0.0		
1007-	CDDMEM2	2046	12046	2008	2009	2014	2013	0.0		
1008-	CDDMEM2	2047	12047	2009	2010	2015	2014	0.0		
1009-	CDDMEM2	2048	12048	2011	2012	2017	2016	0.0		
1010-	CDDMEM2	2049	12049	2010	2015	2018	2017	0.0		
1011-	CDDMEM2	2050	12050	2013	2014	2019	2018	0.0		
1012-	CDDMEM2	2051	12051	2014	2015	2020	2019	0.0		
1013-	CDDMEM2	2052	12052	2016	2017	2022	2021	0.0		
1014-	CDDMEM2	2053	12053	2017	2018	2023	2022	0.0		
1015-	CDDMEM2	2054	12054	2018	2019	2024	2023	0.0		
1016-	CDDMEM2	2055	12055	2019	2020	2025	2024	0.0		
1017-	CDDMEM2	2056	12056	2021	2022	2027	2026	0.0		
1018-	CDDMEM2	2057	12057	2022	2023	2028	2027	0.0		
1019-	CDDMEM2	2058	12058	2023	2024	2029	2028	0.0		
1020-	CDDMEM2	2059	12059	2024	2025	2030	2029	0.0		
1021-	CDDMEM2	2060	12060	2026	2027	2032	2031	0.0		
1022-	CDDMEM2	2061	12061	2027	2028	2033	2032	0.0		
1023-	CDDMEM2	2062	12062	2028	2029	2034	2033	0.0		
1024-	CDDMEM2	2063	12063	2029	2030	2035	2034	0.0		
1025-	CDDMEM2	2064	12064	2031	2032	2037	2036	0.0		
1026-	CDDMEM2	2065	12065	2032	2033	2038	2037	0.0		
1027-	CDDMEM2	2066	12066	2033	2034	2039	2038	0.0		
1028-	CDDMEM2	2051	12051	2036	2037	2041	2040	0.0		
1029-	CDDMEM2	2069	12069	2037	2038	2042	2041	0.0		
1030-	CDDMEM2	2200	12200	102	152	151	101	0.0		
1031-	CDDMEM2	2201	12201	103	153	152	102	0.0		
1032-	CDDMEM2	2202	12202	104	154	153	103	0.0		
1033-	CDDMEM2	2203	12203	105	155	154	104	0.0		
1034-	CDDMEM2	2204	12204	106	156	155	110	0.0		
1035-	CDDMEM2	2205	12205	152	102	201	151	0.0		
1036-	CDDMEM2	2206	12206	153	202	202	152	0.0		
1037-	CDDMEM2	2207	12207	154	204	203	153	0.0		
1038-	CDDMEM2	2208	12208	155	205	204	154	0.0		
1039-	CDDMEM2	2209	12209	156	206	205	155	0.0		
1040-	CDDMEM2	2300	12300	110	156	155	115	0.0		
1041-	CDDMEM2	2301	12301	115	155	160	120	0.0		
1042-	CDDMEM2	2302	12302	120	160	161	125	0.0		
1043-	CDDMEM2	2303	12303	125	161	162	127	0.0		
1044-	CDDMEM2	2304	12304	127	162	164	129	0.0		
1045-	CDDMEM2	2305	12305	129	163	164	131	0.0		
1046-	CDDMEM2	2306	12306	136	206	218	157	0.0		
1047-	CDDMEM2	2307	12307	157	218	224	158	0.0		
1048-	CDDMEM2	2308	12308	158	224	227	159	0.0		
1049-	CDDMEM2	2309	12309	159	227	230	160	0.0		
1050-	CDDMEM2	2310	12310	160	230	233	161	0.0		

SORTED BULK DATA ECHO

CARD	CHUNT	1	2	3	4	5	6	7	8	9	10
1051-	CGDME#2	2311	12311	161	233	236	162	0.0			
1052-	CGDME#2	2312	12312	162	236	239	163	0.0			
1053-	CGDME#2	2313	12313	163	239	242	164	0.0			
1054-	CGDME#2	2403	12403	1812	1919	1919	1814	0.0			
1055-	CGDME#2	2404	12404	1814	1919	1920	1817	0.0			
1056-	CGDME#2	2405	12405	1817	1920	1921	1820	0.0			
1057-	CGDME#2	2406	12406	1820	1921	1922	1824	0.0			
1058-	CGDME#2	2407	12407	1824	1922	1923	1829	0.0			
1059-	CGDME#2	2408	12408	1828	1923	1924	1832	0.0			
1060-	CGDME#2	2409	12409	1832	1924	1925	1836	0.0			
1061-	CGDME#2	2410	12410	1836	1925	1926	1839	0.0			
1062-	CGDME#2	2411	12411	1839	1926	1927	1847	0.0			
1063-	CGDME#2	2413	12413	1918	2010	2015	1919	0.0			
1064-	CGDME#2	2414	12414	1919	2015	2020	1920	0.0			
1065-	CGDME#2	2415	12415	1920	2020	2025	1921	0.0			
1066-	CGDME#2	2416	12416	1921	2021	2032	1922	0.0			
1067-	CGDME#2	2417	12417	1921	2025	2030	1932	0.0			
1068-	CGDME#2	2418	12418	1922	2030	2035	1923	0.0			
1069-	CGDME#2	2419	12419	1923	2035	2039	1924	0.0			
1070-	CGDME#2	2420	12420	1924	2039	2042	1925	0.0			
1071-	CGDME#2	2421	12421	1925	2042	2041	1926	0.0			
1072-	CGDME#2	2422	12422	1926	2041	2040	1927	0.0			
1073-	CGDME#2	2424	12424	2010	2106	2107	2015	0.0			
1074-	CGDME#2	2425	12425	2015	2107	2108	2020	0.0			
1075-	CGDME#2	2426	12426	2020	2108	2109	2025	0.0			
1076-	CGDME#2	2427	12427	2025	2109	2110	2030	0.0			
1077-	CGDME#2	2428	12428	2030	2110	2111	2035	0.0			
1078-	CGDME#2	2429	12429	2035	2111	2112	2039	0.0			
1079-	CGDME#2	2430	12430	2039	2112	2113	2042	0.0			
1080-	CGDME#2	2431	12431	2042	2113	2114	2041	0.0			
1081-	CGDME#2	2432	12432	2041	2114	2115	2040	0.0			
1082-	CGDME#2	2648	12650	112	169	166	111	.0			
1083-	CGDME#2	2649	12650	169	220	219	166	.0			
1084-	CGDME#2	2650	12650	15	159	157	114	0.0			
1085-	CGDME#2	2651	12651	114	167	168	113	0.0			
1086-	CGDME#2	2652	12652	113	168	169	112	0.0			
1087-	CGDME#2	2653	12653	156	224	222	167	0.0			
1088-	CGDME#2	2654	12654	167	222	221	168	0.0			
1089-	CGDME#2	2655	12655	168	221	220	169	0.0			
1090-	CGDME#2	2656	12656	101	151	165	106	0.0			
1091-	CGDME#2	2657	12657	106	165	166	111	0.0			
1092-	CGDME#2	2658	12658	151	201	207	165	0.0			
1093-	CGDME#2	2659	12659	165	207	219	166	0.0			
1094-	CGDME#2	2700	12700	1821	1930	1929	1822	0.0			
1095-	CGDME#2	2701	12701	1822	1929	1922	1824	0.0			
1096-	CGDME#2	2702	12702	1930	1934	1933	1929	0.0			
1097-	CGDME#2	2703	12703	1929	1933	1932	1922	0.0			
1098-	CGDME#2	2704	12704	1934	2026	2029	1933	0.0			
1099-	CGDME#2	2705	12705	1933	2029	2030	1932	0.0			
1100-	CSHFAR	178	10178	126	127	129	128				

SORTED BULK DATA ECHO

CARD	1	2	3	4	5	6	7	8	9	10
1101- CSHEAR	179	10179	128	129	131	130				
1102- CSHEAR	287	10287	225	226	229	228				
1103- CSHEAR	288	10288	226	227	230	229				
1104- CSHEAR	289	10289	228	229	232	231				
1105- CSHEAR	290	10290	229	230	233	232				
1106- CSHEAR	291	10291	231	232	235	234				
1107- CSHEAR	292	10292	232	233	236	235				
1108- CSHEAR	293	10293	234	235	238	237				
1109- CSHEAR	294	10294	235	236	239	238				
1110- CSHEAR	295	10295	237	238	241	240				
1111- CSHEAR	296	10296	238	239	242	241				
1112- CSHEAR	351	10351	301	302	307	306				
1113- CSHEAR	352	10352	302	303	308	307				
1114- CSHEAR	353	10353	303	304	309	308				
1115- CSHEAR	354	10354	304	305	310	309				
1116- CSHEAR	355	10355	309	310	312	311				
1117- CSHEAR	356	10356	311	312	314	313				
1118- CSHEAR	357	10357	313	314	316	315				
1119- CSHEAR	358	10358	315	316	318	317				
1120- CSHEAR	401	10401	301	302	407	406				
1121- CSHEAR	402	10402	302	303	408	407				
1122- CSHEAR	403	10403	303	304	409	408				
1123- CSHEAR	404	10404	304	305	310	409				
1124- CSHEAR	551	10551	501	502	507	506				
1125- CSHEAR	552	10552	502	503	508	507				
1126- CSHEAR	553	10553	503	504	509	508				
1127- CSHEAR	554	10554	504	505	510	509				
1128- CSHEAR	555	10555	509	510	512	511				
1129- CSHEAR	556	10556	511	512	514	513				
1130- CSHEAR	557	10557	513	514	516	515				
1131- CSHEAR	558	10558	515	516	518	517				
1132- CSHEAR	651	10651	601	602	607	606				
1133- CSHEAR	652	10652	602	603	608	607				
1134- CSHEAR	653	10653	603	604	609	608				
1135- CSHEAR	654	10654	604	605	610	609				
1136- CSHEAR	655	10655	609	610	612	611				
1137- CSHEAR	656	10656	611	612	614	613				
1138- CSHEAR	657	10657	613	614	615	615				
1139- CSHEAR	658	10658	615	616	618	617				
1140- CSHEAR	751	10751	701	702	707	706				
1141- CSHEAR	752	10752	702	703	708	707				
1142- CSHEAR	753	10753	703	704	709	708				
1143- CSHEAR	754	10754	704	705	710	709				
1144- CSHEAR	755	10755	709	710	712	711				
1145- CSHEAR	756	10756	711	712	714	713				
1146- CSHEAR	757	10757	713	714	716	715				
1147- CSHEAR	758	10758	715	716	718	717				
1148- CSHEAR	851	10851	801	802	807	806				
1149- CSHEAR	852	10852	802	803	808	807				
1150- CSHEAR	853	10853	803	804	809	808				

S O R T E D B U L K D A T A F C H O

CARD	COUNT	1	2	3	4	5	6	7	8	9	10
1151-	CSHEAR	854	10854	804	805	810	809				
1152-	CSHEAR	855	10855	809	810	812	811				
1153-	CSHEAR	856	10856	811	812	814	813				
1154-	CSHEAR	857	10857	813	814	816	815				
1155-	CSHEAR	858	10858	815	816	818	817				
1156-	CSHEAR	851	10851	801	802	812	811				
1157-	CSHEAR	852	10852	802	803	813	812				
1158-	CSHEAR	853	10853	803	804	814	813				
1159-	CSHEAR	854	10854	804	805	815	814				
1160-	CSHEAR	859	10859	814	815	817	816				
1161-	CSHEAR	860	10860	816	817	819	818				
1162-	CSHEAR	861	10861	818	819	821	820				
1163-	CSHEAR	862	10862	820	821	823	822				
1164-	CSHEAR	1040	11040	1001	1002	1012	1011				
1165-	CSHEAR	1041	11041	1002	1003	1013	1012				
1166-	CSHEAR	1042	11042	1003	1004	1014	1013				
1167-	CSHEAR	1043	11043	1004	1005	1015	1014				
1168-	CSHEAR	1048	11048	1014	1015	1017	1016				
1169-	CSHEAR	1049	11049	1016	1017	1019	1018				
1170-	CSHEAR	1050	11050	1018	1019	1021	1020				
1171-	CSHEAR	1051	11051	1020	1021	1023	1022				
1172-	CSHEAR	1140	11140	1101	1102	1112	1111				
1173-	CSHEAR	1141	11141	1102	1103	1113	1112				
1174-	CSHEAR	1142	11142	1103	1104	1114	1113				
1175-	CSHEAR	1143	11143	1104	1105	1115	1114				
1176-	CSHEAR	1145	11145	1114	1115	1117	1116				
1177-	CSHEAR	1146	11146	1116	1117	1119	1118				
1178-	CSHEAR	1147	11147	1118	1119	1121	1120				
1179-	CSHEAR	1148	11148	1120	1121	1123	1122				
1180-	CSHEAR	1240	11240	1201	1202	1207	1206				
1181-	CSHEAR	1241	11241	1202	1203	1208	1207				
1182-	CSHEAR	1242	11242	1203	1204	1209	1208				
1183-	CSHEAR	1243	11243	1204	1205	1210	1209				
1184-	CSHEAR	1244	11244	1209	1210	1212	1211				
1185-	CSHEAR	1245	11245	1211	1212	1214	1213				
1186-	CSHEAR	1246	11246	1213	1214	1216	1215				
1187-	CSHEAR	1247	11247	1215	1216	1218	1217				
1188-	CSHEAR	1248	11248	1217	1218	1220	1219				
1189-	CSHEAR	1340	11340	1301	1302	1307	1306				
1190-	CSHEAR	1341	11341	1302	1303	1308	1307				
1191-	CSHEAR	1342	11342	1303	1304	1309	1308				
1192-	CSHEAR	1343	11343	1304	1305	1310	1309				
1193-	CSHEAR	1344	11344	1309	1310	1312	1311				
1194-	CSHEAR	1345	11345	1311	1312	1314	1313				
1195-	CSHEAR	1346	11346	1317	1314	1316	1315				
1196-	CSHEAR	1347	11347	1315	1316	1318	1317				
1197-	CSHEAR	1348	11348	1317	1318	1320	1319				
1198-	CSHEAR	1440	11440	1401	1402	1407	1406				
1199-	CSHEAR	1441	11441	1402	1403	1408	1407				
1200-	CSHEAR	1442	11442	1403	1404	1409	1408				

PHASE I XRBITER FUSFLAGE-SYMM CASED REVISION 4/22/74
 SKINS HALF EFF.LCNG.,85% EFF.TRANS.AT WING

MAY 6, 1974 NASTRAN 2/ 1/73 PAGE 44

SORTED BULK DATA ECHO

CARD	COUNT	1	2	3	4	5	6	7	8	9	10
1201-	CSHEAR	1443	11443	1404	1405	1410	1409				
1202-	CSHEAR	1444	11444	1409	1410	1412	1411				
1203-	CSHEAR	1445	11445	1411	1412	1414	1413				
1204-	CSHEAR	1446	11446	1413	1414	1416	1415				
1205-	CSHEAR	1447	11447	1415	1416	1418	1417				
1206-	CSHEAR	1540	11540	1501	1502	1504	1503				
1207-	CSHEAR	1541	11541	1503	1504	1506	1505				
1208-	CSHEAR	1542	11542	1505	1506	1508	1507				
1209-	CSHEAR	1543	11543	1507	1508	1510	1509				
1210-	CSHEAR	1640	11640	1601	1602	1607	1606				
1211-	CSHEAR	1641	11641	1602	1603	1608	1607				
1212-	CSHEAR	1642	11642	1603	1604	1609	1608				
1213-	CSHEAR	1643	11643	1604	1605	1610	1609				
1214-	CSHEAR	1644	11644	1609	1610	1612	1611				
1215-	CSHEAR	1645	11645	1611	1612	1614	1613				
1216-	CSHEAR	1646	11646	1613	1614	1616	1615				
1217-	CSHEAR	1647	11647	1615	1616	1618	1617				
1218-	CSHEAR	1740	11740	1701	1702	1707	1706				
1219-	CSHEAR	1741	11741	1702	1703	1708	1707				
1220-	CSHEAR	1742	11742	1703	1704	1709	1708				
1221-	CSHEAR	1743	11743	1704	1705	1710	1709				
1222-	CSHEAR	1744	11744	1709	1710	1712	1711				
1223-	CSHEAR	1745	11745	1711	1712	1714	1713				
1224-	CSHEAR	1746	11746	1713	1714	1716	1715				
1225-	CSHEAR	1747	11747	1715	1716	1718	1717				
1226-	CSHEAR	1860	11860	1801	1802	1808	1807				
1227-	CSHEAR	1861	11861	1802	1803	1809	1808				
1228-	CSHEAR	1862	11862	1803	1804	1810	1809				
1229-	CSHEAR	1863	11863	1804	1805	1811	1810				
1230-	CSHEAR	1864	11864	1805	1806	1812	1811				
1231-	CSHEAR	1865	11865	1811	1812	1814	1813				
1232-	CSHEAR	1866	11866	1813	1814	1817	1815				
1233-	CSHEAR	1867	11867	1815	1817	1820	1818				
1234-	CSHEAR	1868	11868	1818	1819	1823	1822				
1235-	CSHEAR	1869	11869	1819	1820	1824	1823				
1236-	CSHEAR	1870	11870	1821	1822	1826	1825				
1237-	CSHEAR	1871	11871	1822	1823	1827	1826				
1238-	CSHEAR	1872	11872	1823	1824	1828	1827				
1239-	CSHEAR	1873	11873	1826	1827	1831	1830				
1240-	CSHEAR	1874	11874	1827	1828	1832	1831				
1241-	CSHEAR	1875	11875	1829	1830	1834	1833				
1242-	CSHEAR	1876	11876	1830	1831	1835	1834				
1243-	CSHEAR	1877	11877	1831	1832	1836	1835				
1244-	CSHEAR	1878	11878	1833	1834	1838	1837				
1245-	CSHEAR	1879	11879	1834	1835	1836	1835				
1246-	CSHEAR	1940	11940	1901	1902	1907	1906				
1247-	CSHEAR	1941	11941	1902	1903	1908	1907				
1248-	CSHEAR	1942	11942	1903	1904	1909	1908				
1249-	CSHEAR	1943	11943	1906	1907	1911	1910				
1250-	CSHEAR	1944	11944	1908	1909	1913	1912				

SORTED BULK DATA ECHO

CARD	1	2	3	4	5	6	7	8	9	10
1251- CSHEAR	1945	11945	1910	1911	1915	1914				
1252- CSHEAR	1946	11946	1911	1912	1915	1915				
1253- CSHEAR	1947	11947	1912	1913	1917	1916				
1254- CSHEAR	1948	11948	1904	1905	1919	1917				
1255- CSHEAR	2210	12210	201	302	301	201				
1256- CSHEAR	2211	12210	202	303	302	202				
1257- CSHEAR	2212	12210	204	304	303	203				
1258- CSHEAR	2213	12210	205	305	304	204				
1259- CSHEAR	2214	12210	301	502	501	401				
1260- CSHEAR	2215	12210	302	503	502	402				
1261- CSHEAR	2216	12210	304	504	503	404				
1262- CSHEAR	2217	12210	305	505	504	404				
1263- CSHEAR	2218	12210	502	602	601	501				
1264- CSHEAR	2219	12210	503	603	602	502				
1265- CSHEAR	2220	12210	504	604	603	503				
1266- CSHEAR	2221	12210	505	605	604	504				
1267- CSHEAR	2222	12210	602	702	701	601				
1268- CSHEAR	2223	12210	603	703	702	602				
1269- CSHEAR	2224	12210	604	704	703	603				
1270- CSHEAR	2225	12210	605	705	704	604				
1271- CSHEAR	2226	12210	701	802	801	701				
1272- CSHEAR	2227	12210	703	803	802	702				
1273- CSHEAR	2228	12210	704	804	803	703				
1274- CSHEAR	2229	12210	705	805	804	704				
1275- CSHEAR	2234	12210	802	902	901	801				
1276- CSHEAR	2235	12210	803	903	902	802				
1277- CSHEAR	2236	12210	804	904	903	803				
1278- CSHEAR	2237	12210	905	905	904	804				
1279- CSHEAR	2238	12210	902	1002	1001	901				
1280- CSHEAR	2239	12210	903	1003	1002	902				
1281- CSHEAR	2240	12210	904	1004	1003	903				
1282- CSHEAR	2241	12210	905	1005	1004	904				
1283- CSHEAR	2242	12210	1002	1102	1101	1001				
1284- CSHEAR	2243	12210	1003	1103	1102	1002				
1285- CSHEAR	2244	12210	1004	1104	1103	1003				
1286- CSHEAR	2245	12210	1005	1105	1104	1004				
1287- CSHEAR	2246	12210	1102	1202	1201	1101				
1288- CSHEAR	2247	12210	1103	1203	1202	1102				
1289- CSHEAR	2248	12210	1104	1204	1203	1103				
1290- CSHEAR	2249	12210	1105	1205	1204	1104				
1291- CSHEAR	2254	12210	1202	1302	1301	1201				
1292- CSHEAR	2255	12210	1203	1303	1302	1202				
1293- CSHEAR	2256	12210	1204	1304	1303	1203				
1294- CSHEAR	2257	12210	1205	1305	1304	1204				
1295- CSHEAR	2258	12210	1302	1402	1401	1301				
1296- CSHEAR	2259	12210	1303	1403	1402	1302				
1297- CSHEAR	2260	12210	1304	1404	1403	1303				
1298- CSHEAR	2261	12210	1305	1405	1404	1304				
1299- CSHEAR	2262	12210	1402	1502	1501	1401				
1300- CSHEAR	2263	12210	1403	1503	1502	1402				

S O R T E D B U L K D A T A E C H O

CARD	COUNT	1	2	3	4	5	6	7	8	9	10
1301-	CSHEAR	2264	12210	1404	1604	1603	1403				
1302-	CSHEAR	2265	12210	1405	1605	1604	1404				
1303-	CSHEAR	2270	12210	1602	1702	1701	1601				
1304-	CSHEAR	2271	12210	1603	1703	1702	1602				
1305-	CSHEAR	2272	12210	1604	1704	1703	1603				
1306-	CSHEAR	2273	12210	1605	1705	1704	1604				
1307-	CSHEAR	2279	12210	1703	1803	1802	1702				
1308-	CSHEAR	2280	12210	1704	1804	1803	1703				
1309-	CSHEAR	2281	12210	1705	1806	1804	1704				
1310-	CSHEAR	2282	12210	1802	1902	1901	1801				
1311-	CSHEAR	2283	12210	1803	1903	1902	1802				
1312-	CSHEAR	2284	12210	1904	1904	1903	1803				
1313-	CSHEAR	2285	12210	1806	1905	1904	1804				
1314-	CSHEAR	2286	12210	1902	2002	2001	1901				
1315-	CSHEAR	2287	12210	1903	2003	2002	1902				
1316-	CSHEAR	2288	12210	1904	2004	2003	1903				
1317-	CSHEAR	2289	12210	1905	2005	2004	1904				
1318-	CSHEAR	2290	12210	2002	2102	2101	2001				
1319-	CSHEAR	2291	12210	2003	2103	2102	2002				
1320-	CSHEAR	2292	12210	2004	2104	2103	2003				
1321-	CSHEAR	2293	12210	2005	2105	2104	2004				
1322-	CSHEAR	2314	12320	206	305	310	212				
1323-	CSHEAR	2315	12320	212	310	312	218				
1324-	CSHEAR	2316	12320	218	312	314	224				
1325-	CSHEAR	2317	12320	224	314	316	227				
1326-	CSHEAR	2318	12320	227	316	318	243				
1327-	CSHEAR	2319	12320	305	505	510	310				
1328-	CSHEAR	2320	12320	310	510	512	312				
1329-	CSHEAR	2321	12320	312	512	514	314				
1330-	CSHEAR	2322	12320	314	514	516	316				
1331-	CSHEAR	2323	12320	316	516	518	318				
1332-	CSHEAR	2324	12320	505	605	610	510				
1333-	CSHEAR	2325	12320	510	610	612	512				
1334-	CSHEAR	2326	12320	512	612	614	514				
1335-	CSHEAR	2327	12320	514	614	616	516				
1336-	CSHEAR	2328	12320	516	616	618	518				
1337-	CSHEAR	2329	12320	605	705	710	610				
1338-	CSHEAR	2330	12320	610	710	712	612				
1339-	CSHEAR	2331	12320	612	712	714	614				
1340-	CSHEAR	2332	12320	614	714	716	616				
1341-	CSHEAR	2333	12320	616	716	718	618				
1342-	CSHEAR	2334	12320	705	805	810	710				
1343-	CSHEAR	2335	12320	710	810	812	712				
1344-	CSHEAR	2336	12320	712	812	814	714				
1345-	CSHEAR	2337	12320	714	814	816	715				
1346-	CSHEAR	2338	12320	716	816	818	718				
1347-	CSHEAR	2344	12320	805	905	910	810				
1348-	CSHEAR	2345	12320	810	910	917	812				
1349-	CSHEAR	2346	12320	812	917	919	814				
1350-	CSHEAR	2347	12320	814	919	921	816				

S O R T E D P U L K D A T A E C H O

CARD	COUNT	1	2	3	4	6	7	8	9	10
1351-	CSHEAR	2348	12320	816	921	923	818			
1352-	CSHEAR	2349	12320	905	1005	1010	910			
1353-	CSHEAR	2350	12320	910	1010	1015	915			
1354-	CSHEAR	2351	12320	915	1015	1017	917			
1355-	CSHEAR	2352	12320	917	1017	1019	919			
1356-	CSHEAR	2353	12320	919	1019	1021	921			
1357-	CSHEAR	2354	12320	921	1021	1023	923			
1358-	CSHEAR	2355	12320	1005	1105	1110	1010			
1359-	CSHEAR	2356	12320	1010	1110	1115	1015			
1360-	CSHEAR	2357	12320	1015	1115	1117	1017			
1361-	CSHEAR	2358	12320	1017	1117	1119	1019			
1362-	CSHEAR	2359	12320	1019	1119	1121	1021			
1363-	CSHEAR	2360	12320	1021	1121	1123	1023			
1364-	CSHEAR	2361	12320	1105	1205	1210	1110			
1365-	CSHEAR	2362	12320	1110	1210	1212	1115			
1366-	CSHEAR	2363	12320	1115	1212	1214	1117			
1367-	CSHEAR	2364	12320	1117	1214	1216	1119			
1368-	CSHEAR	2365	12320	1119	1216	1218	1121			
1369-	CSHEAR	2366	12320	1121	1218	1220	1123			
1370-	CSHEAR	2373	12320	1205	1305	1310	1210			
1371-	CSHEAR	2374	12320	1210	1310	1312	1212			
1372-	CSHEAR	2375	12320	1212	1312	1314	1214			
1373-	CSHEAR	2376	12320	1214	1314	1316	1216			
1374-	CSHEAR	2377	12320	1216	1316	1318	1218			
1375-	CSHEAR	2378	12320	1218	1318	1320	1220			
1376-	CSHEAR	2379	12320	1312	1410	1412	1314			
1377-	CSHEAR	2380	12320	1314	1412	1414	1316			
1378-	CSHEAR	2381	12320	1316	1414	1416	1318			
1379-	CSHEAR	2382	12320	1318	1416	1418	1320			
1380-	CSHEAR	2383	12320	1410	1502	1504	1412			
1381-	CSHEAR	2384	12320	1412	1504	1506	1414			
1382-	CSHEAR	2385	12320	1414	1506	1508	1416			
1383-	CSHEAR	2386	12320	1416	1508	1510	1418			
1384-	CSHEAR	2387	12320	1502	1610	1612	1504			
1385-	CSHEAR	2388	12320	1504	1612	1614	1506			
1386-	CSHEAR	2389	12320	1506	1614	1616	1508			
1387-	CSHEAR	2390	12320	1508	1616	1618	1510			
1388-	CSHEAR	2391	12320	1610	1710	1712	1612			
1389-	CSHEAR	2392	12320	1612	1712	1714	1614			
1390-	CSHEAR	2393	12320	1614	1714	1716	1616			
1391-	CSHEAR	2394	12320	1616	1716	1718	1618			
1392-	CSHEAR	2399	12320	1710	1812	1814	1712			
1393-	CSHEAR	2400	12320	1712	1814	1817	1714			
1394-	CSHEAR	2401	12320	1714	1817	1820	1716			
1395-	CSHEAR	2402	12320	1716	1820	1824	1718			
1396-	CSHEAR	2412	12412	1905	2005	2010	1918			
1397-	CSHEAR	2423	12412	2005	2105	2106	2010			
1398-	CSHEAR	2600	12600	1407	1517	1516	1405			
1399-	CSHEAR	2601	12600	1408	1608	1607	1407			
1400-	CSHEAR	2602	12600	1409	1609	1609	1408			

PHASE 1 XCRIBITER FUSELAGE-SYMM CASE# REVISION 4/22/74
 SKINS HALF EFF. LONG. 85% EFF. TRANS. AT WING

MAY 6. 1974 NASTRAN 2/ 1/73 PAGE 48

SORTED BULK DATA FCHD

CARD	1	2	3	4	5	6	7	8	9	10
1401-	CSHEAR	2603	12600	1410	1502	1501	1409			
1402-	CSHEAR	2605	12600	1517	1607	1506	1515			
1403-	CSHEAR	2609	12600	1502	1610	1609	1501			
1404-	CSHEAR	2610	12600	1607	1707	1706	1606			
1405-	CSHEAR	2611	12600	1608	1708	1707	1607			
1406-	CSHEAR	2612	12600	1609	1709	1708	1608			
1407-	CSHEAR	2613	12600	1610	1710	1709	1609			
1408-	CSHEAR	2621	12600	1703	1809	1808	1707			
1409-	CSHEAR	2622	12600	1709	1810	1809	1708			
1410-	CSHEAR	2623	12600	1710	1812	1810	1709			
1411-	CSHEAR	2625	12600	1808	1915	1914	1807			
1412-	CSHEAR	2626	12600	1809	1916	1915	1809			
1413-	CSHEAR	2627	12600	1810	1917	1916	1809			
1414-	CSHEAR	2628	12600	1811	1928	1917	1810			
1415-	CSHEAR	2629	12600	1812	1918	1928	1811			
1416-	CSHEAR	2630	12630	901	1001	1011	911			
1417-	CSHEAR	2631	12631	1001	1101	1111	1011			
1418-	CSHEAR	2632	12632	1101	1201	1221	1111			
1419-	CSHEAR	2634	12634	1201	1301	1306	1206			
1420-	CSHEAR	2635	12635	1301	1401	1406	1321			
1421-	CSHEAR	2636	12636	1401	1601	1606	1406			
1422-	CSHEAR	2638	12638	1601	1701	1706	1606			
1423-	CSHEAR	2640	12640	1701	1721	1722	1706			
1424-	CSHEAR	2641	12641	1721	1802	1808	1722			
1425-	CSHEAR	2646	12634	1206	1306	1321	1221			
1426-	CSHEAR	2699	12640	1721	1722	1724	1723			
1427-	CSHEAR	2706	12706	1934	2026	2011	1936			
1428-	CSHEAR	2707	12707	1933	2029	2014	1935			
1429-	CSHEAR	2708	12708	2011	2014	1935	1936			
1430-	CTRMEM	180	10180	123	124	126	0.0			
1431-	CTRMEM	297	10297	221	222	225	0.0			
1432-	CTRMEM	2067	12067	2034	2035	2039	0.0			
1433-	CTRMEM	2070	12070	2038	2039	2042	0.0			
1434-	CTRMEM	2278	12278	1701	1702	1802	0.0			
1435-	CTRMEM	2620	12620	1707	1808	1706	0.0			
1436-	CTRMEM	2645	12620	1321	1407	1406	0.0			
1437-	FIGR	1	INV	0	200.	12	12	1.-3		EF162
1438-	EEIG2	MAX								
1439-	GRID	*101		0		46.7500	0			E15001
1440-	*15001		50.3000 0							
1441-	GRID	*102		0		46.7500	-1.6757			E15002
1442-	*15002		50.3000 0							
1443-	GRID	*103		0		46.7500	-4.2686			E15003
1444-	*15003		50.3000 0							
1445-	GRID	*104		0		46.7500	-7.4000			E15004
1446-	*15004		50.3000 0							
1447-	GRID	*105		0		46.7500	-9.8784			E15005
1448-	*15005		51.2177 0							
1449-	GRID	*106		0		46.7500	0			E15006
1450-	*15006		53.4909 0							

SORTED BULK DATA ECHO

CARD	1	2	3	4	5	6	7	8	9	10
COUNT	1	2	3	4	5	6	7	8	9	10
1451- GRID	*107		0			46.7500		-1.6836		E15007
1452- *15007			53.4987 0							
1453- GRID	*108		0			46.7500		-4.2765		E15008
1454- *15008			53.5007 0							
1455- GRID	*109		0			46.7500		-7.4079		E15009
1456- *15009			53.5114 0							
1457- GRID	*110		0			46.7500		-11.0000		E15010
1458- *15010			53.5286 0							
1459- GRID	*111		0			46.7500		.0		E15011
1460- *15011			56.7000 0							
1461- GRID	*112		0			46.7500		-1.6526		E15012
1462- *15012			56.7000 0							
1463- GRID	*113		0			46.7500		-4.2951		E15013
1464- *15013			56.7000 0							
1465- GRID	*114		0			46.7500		-7.3968		E15014
1466- *15014			56.7000 0							
1467- GRID	*115		0			46.7500		-11.0000		E15015
1468- *15015			56.7000 0							
1469- GRID	*116		0			46.7500		.0		E15016
1470- *15016			59.8140 0							
1471- GRID	*117		0			46.7500		-1.6614		E15017
1472- *15017			59.8012 0							
1473- GRID	*118		0			46.7500		-4.2743		E15018
1474- *15018			59.8036 0							
1475- GRID	*119		0			46.7500		-7.4259		E15019
1476- *15019			59.7947 0							
1477- GRID	*120		0			46.7500		-11.0000		E15020
1478- *15020			59.7917 0							
1479- GRID	*121		0			46.7500		.0		E15021
1480- *15021			61.7486 0							
1481- GRID	*122		0			46.7500		-1.6861		E15022
1482- *15022			61.9758 0							
1483- GRID	*123		0			46.7500		-3.4975		E15023
1484- *15023			62.2045 0							
1485- GRID	*124		0			46.7500		-7.4380		E15024
1486- *15024			62.7470 0							
1487- GRID	*125		0			46.7500		-10.0940		E15025
1488- *15025			63.3500 0							
1489- GRID	*126		0			46.7500		-5.0116		E15026
1490- *15026			64.7821 0							
1491- GRID	*127		0			46.7500		-7.0000		E15027
1492- *15027			66.7757 0							
1493- GRID	*128		0			46.7500		-3.4538		E15028
1494- *15028			67.3699 0							
1495- GRID	*129		0			46.7500		-3.9549		E15029
1496- *15029			68.4550 0							
1497- GRID	*130		0			46.7500		.0		E15030
1498- *15030			67.7724 0							
1499- GRID	*131		0			46.7500		.0		E15031
1500- *15031			69.1287 0							

SORTED HULK DATA ECHO

CARD	COUNT	1	2	3	4	5	6	7	8	9	10
1501-	GRID	*151		0			55.3750		.0		E15032
1502-		*15032		49.4750	0						
1503-	GRID	*152		0			55.3750		-1.7051		E15033
1504-		*15033		49.4750	0						
1505-	GRID	*153		0			55.3750		-4.3000		E15034
1506-		*15034		49.4750	0						
1507-	GRID	*154		0			55.3750		-7.4000		E15035
1508-		*15035		49.4750	0						
1509-	GRID	*155		0			55.3750		-10.2000		E15036
1510-		*15036		49.4250	0						
1511-	GRID	*156		0			55.3750		-11.7500		E15037
1512-		*15037		51.0750	0						
1513-	GRID	*157		0			55.3750		-11.7500		E15038
1514-		*15038		53.9960	0						
1515-	GRID	*158		0			55.3750		-11.7500		E15039
1516-		*15039		56.7000	0						
1517-	GRID	*159		0			55.3750		-11.7500		E15040
1518-		*15040		59.2466	0						
1519-	GRID	*160		0			55.3750		-11.7500		E15041
1520-		*15041		61.1459	0						
1521-	GRID	*161		0			55.3750		-10.8742		E15042
1522-		*15042		65.3167	0						
1523-	GRID	*162		0			55.3750		-7.9194		E15043
1524-		*15043		69.0944	0						
1525-	GRID	*163		0			55.3750		-4.3917		E15044
1526-		*15044		71.3092	0						
1527-	GRID	*164		0			55.3750		.0		E15045
1528-		*15045		72.1000	0						
1529-	GRID	*165		0			55.3750		.0		E15046
1530-		*15046		53.0750	0						
1531-	GRID	*166		0			55.3750		.0		E15047
1532-		*15047		56.7000	0						
1533-	GRID	*167		0			55.3750		-7.4000		E15048
1534-		*15048		56.7000	0						
1535-	GRID	*168		0			55.3750		-4.3000		E15049
1536-		*15049		56.7000	0						
1537-	GRID	169	0	55.375	-1.7	56.7	0		.0		E15050
1538-	GRID	*201		0			64.0000		.0		E15050
1539-		*15050		48.6500	0						
1540-	GRID	*202		0			64.0000		-1.6829		E15051
1541-		*15051		48.6500	0						
1542-	GRID	*203		0			64.0000		-4.2673		E15052
1543-		*15052		48.6500	0						
1544-	GRID	*204		0			64.0000		-7.3920		E15053
1545-		*15053		48.6500	0						
1546-	GRID	*205		0			64.0000		-10.4767		E15054
1547-		*15054		48.6500	0						
1548-	GRID	*206		0			64.0000		-12.5000		E15055
1549-		*15055		48.6500	0						
1550-	GRID	*207		0			64.0000		.0		E15056

SORTED BULK DATA ECHO

CARD	COUNT	1	2	3	4	5	6	7	8	9	10
1551-	*15056			52.5961 0							
1552-	GRID	*208		0		64.0000		-1.6731		615057	
1553-	*15057			52.6058 0							
1554-	GRID	*209		0		64.0000		-4.2771		615058	
1555-	*15058			52.6116 0							
1556-	GRID	*210		0		64.0000		-7.3621		615059	
1557-	*15059			52.6059 0							
1558-	GRID	*211		0		64.0000		-10.4669		615060	
1559-	*15060			52.6206 0							
1560-	GRID	*212		0		64.0000		-12.5000		615061	
1561-	*15061			52.5961 0							
1562-	GRID	*213		0		64.0000		.0		615062	
1563-	*15062			53.8978 0							
1564-	GRID	*214		0		64.0000		-1.6698		615063	
1565-	*15063			53.9278 0							
1566-	GRID	*215		0		64.0000		-4.2742		615064	
1567-	*15064			53.9136 0							
1568-	GRID	*216		0		64.0000		-7.3789		615065	
1569-	*15065			53.9283 0							
1570-	GRID	*217		0		64.0000		-10.4836		615066	
1571-	*15066			53.9430 0							
1572-	GRID	*218		0		64.0000		-12.5000		615067	
1573-	*15067			53.9782 0							
1574-	GRID	*219		0		64.0000		.0		615068	
1575-	*15068			56.7000 0							
1576-	GRID	*220		0		64.0000		-1.6622		615069	
1577-	*15069			56.7000 0							
1578-	GRID	*221		0		64.0000		-4.2863		615070	
1579-	*15070			56.7000 0							
1580-	GRID	*222		0		64.0000		-7.3913		615071	
1581-	*15071			56.7000 0							
1582-	GRID	*223		0		64.0000		-10.4756		615072	
1583-	*15072			56.7000 0							
1584-	GRID	*224		0		64.0000		-12.5000		615073	
1585-	*15073			56.7000 0							
1586-	GRID	*225		0		64.0000		-7.4252		615074	
1587-	*15074			59.2577 0							
1588-	GRID	*226		0		64.0000		-10.4705		615075	
1589-	*15075			59.2312 0							
1590-	GRID	*227		0		64.0000		-12.5000		615076	
1591-	*15076			59.2465 0							
1592-	GRID	*228		0		64.0000		-8.4512		615077	
1593-	*15077			62.4208 0							
1594-	GRID	*229		0		64.0000		-10.5000		615078	
1595-	*15078			62.5000 0							
1596-	GRID	*230		0		64.0000		-12.5000		615079	
1597-	*15079			62.5000 0							
1598-	GRID	*231		0		64.0000		-7.8125		615080	
1599-	*15080			65.6948 0							
1600-	GRID	*232		0		64.0000		-9.7007		615081	

SORTED BULK DATA FCHD

CARD	1	2	3	4	5	6	7	8	9	10
1601- *15081			66.5181 0							
1602- GRID	*233		0		64.0000		-11.5485		E15082	
1603- *15082			67.2835 0							
1604- GRID	*234		0		64.0000		-5.9811		E15083	
1605- *15083			68.4469 0							
1606- GRID	*235		0		64.0000		-7.4247		E15084	
1607- *15084			69.9247 0							
1608- GRID	*236		0		64.0000		-8.8389		E15085	
1609- *15085			71.3389 0							
1610- GRID	*237		0		64.0000		-3.2545		E15086	
1611- *15086			70.2620 0							
1612- GRID	*238		0		64.0000		-4.0181		E15087	
1613- *15087			72.2007 0							
1614- GRID	*239		0		64.0000		-4.7835		E15088	
1615- *15088			74.0485 0							
1616- GRID	*240		0		64.0000		.0		E15089	
1617- *15089			70.1247 0							
1618- GRID	*241		0		64.0000		.0		E15090	
1619- *15090			73.0000 0							
1620- GRID	*242		0		64.0000		.0		E15091	
1621- *15091			75.0000 0							
1622- GRID	243	0	64.0	-12.5	62.5	0				
1623- GRID	*301		0		68.2500		.0		E15092	
1624- *15092			48.4320 1							
1625- GRID	*302		0		68.2500		-1.7054		E15093	
1626- *15093			48.4320 0							
1627- GRID	*303		0		68.2500		-4.3339		E15094	
1628- *15094			48.4320 0							
1629- GRID	*304		0		68.2500		-7.0226		E15095	
1630- *15095			48.4320 0							
1631- GRID	*305		0		68.2500		-12.5000		E15096	
1632- *15096			48.4320 0							
1633- GRID	*306		0		68.2500		.0		E15097	
1634- *15097			52.4251 0							
1635- GRID	*307		0		68.2500		-1.7144		E15098	
1636- *15098			52.4267 0							
1637- GRID	*308		0		68.2500		-4.3428		E15099	
1638- *15099			52.4203 0							
1639- GRID	*309		0		68.2500		-2.1150		E15100	
1640- *15100			52.4086 0							
1641- GRID	*310		0		68.2500		-12.5000		E15101	
1642- *15101			52.4051 0							
1643- GRID	*311		0		68.2500		-8.4561		E15102	
1644- *15102			53.9993 0							
1645- GRID	*312		0		68.2500		-12.5000		E15103	
1646- *15103			53.9902 0							
1647- GRID	*313		0		68.2500		-2.3238		E15104	
1648- *15104			56.7178 0							
1649- GRID	*314		0		68.2500		-12.5000		E15105	
1650- *15105			56.6989 0							

SORTED HULK DATA ECHO

CARD	1	2	3	4	5	6	7	8	9	10
1651- GRID *315			0			68.2500		-10.0720		615106
1652- *15106			59.2754 0							
1653- GRID *316			0			68.2500		-12.5000		615107
1654- *15107			59.3178 0							
1655- GRID *317			0			68.2500		-10.8750		615108
1656- *15108			62.5000 0							
1657- GRID *318			0			68.2500		-12.5000		615109
1658- *15109			62.5000 0							
1659- GRID *406			0			69.2500		.0		615111
1660- *15111			52.4186 0							
1661- GRID *407			0			68.2500		-1.7540		615112
1662- *15112			52.3976 0							
1663- GRID *408			0			68.2500		-4.3177		615113
1664- *15113			52.4151 0							
1665- GRID *409			0			68.2500		-7.0225		615114
1666- *15114			52.3956 0							
1667- GRID *501			0			78.0000		.0		615115
1668- *15115			47.9336 0							
1669- GRID *502			0			78.0000		-1.6831		615116
1670- *15116			47.9330 0							
1671- GRID *503			0			78.0000		-4.2606		615117
1672- *15117			47.9330 0							
1673- GRID *504			0			78.0000		-6.8931		615118
1674- *15118			47.9330 0							
1675- GRID *505			0			78.0000		-12.5000		615119
1676- *15119			47.9330 0							
1677- GRID *506			0			78.0000		.0		615120
1678- *15120			51.9330 0							
1679- GRID *507			0			78.0000		-1.6527		615121
1680- *15121			51.9336 0							
1681- GRID *508			0			78.0000		-4.2853		615122
1682- *15122			51.9241 0							
1683- GRID *509			0			78.0000		-7.9433		615123
1684- *15123			51.9633 0							
1685- GRID *510			0			78.0000		-12.5000		615124
1686- *15124			51.9321 0							
1687- GRID *511			0			78.0000		-8.5093		615125
1688- *15125			54.0470 0							
1689- GRID *512			0			78.0000		-12.5000		615126
1690- *15126			54.0226 0							
1691- GRID *513			0			78.0000		-9.2431		615127
1692- *15127			56.7517 0							
1693- GRID *514			0			78.0000		-12.5000		615128
1694- *15128			56.7555 0							
1695- GRID *515			0			78.0000		-9.9562		615129
1696- *15129			59.3965 0							
1697- GRID *516			0			78.0000		-12.5000		615130
1698- *15130			59.4285 0							
1699- GRID *517			0			78.0000		-10.7751		615131
1700- *15131			62.5223 0							

PHASE 1 ORBITER FUSELAGE-SYMM CASE# REVISION 4/22/74
 SKINS HALF EFF. LONG. REF. EFF. TRANS. AT WING

MAY 6, 1974 NASTRAM 2/ 1/73 PAGE 54

SORTED PULK DATA

CARD	1	2	3	4	5	6	7	8	9	10
1701- GRID *518			0			78.0000		-12.5000		815142
1702- *15132			62.5000 0							
1703- GRID *601			0			87.5000		.0		815143
1704- *15133			47.4460 0							
1705- GRID *602			0			87.5000		-1.7202		815144
1706- *15134			47.4460 0							
1707- GRID *603			0			87.5000		-4.3001		815145
1708- *15135			47.4460 0							
1709- GRID *604			0			87.5000		-6.7200		815146
1710- *15136			47.4460 0							
1711- GRID *605			0			87.5000		-12.5000		815147
1712- *15137			47.4450 0							
1713- GRID *606			0			87.5000		.0		815138
1714- *15138			51.4458 0							
1715- GRID *607			0			87.5000		-1.7297		815139
1716- *15139			51.4364 0							
1717- GRID *608			0			87.5000		-4.2897		815140
1718- *15140			51.4415 0							
1719- GRID *609			0			87.5000		-7.7806		815141
1720- *15141			51.4431 0							
1721- GRID *610			0			87.5000		-12.5000		815142
1722- *15142			51.4458 0							
1723- GRID *611			0			87.5000		-9.5012		815143
1724- *15143			54.1956 0							
1725- GRID *612			0			87.5000		-12.5000		815144
1726- *15144			54.1856 0							
1727- GRID *613			0			87.5000		-9.2334		815145
1728- *15145			56.9085 0							
1729- GRID *614			0			87.5000		-12.5000		815146
1730- *15146			56.8858 0							
1731- GRID *615			0			87.5000		-9.9471		815147
1732- *15147			59.5410 0							
1733- GRID *616			0			87.5000		-12.5000		815148
1734- *15148			59.5657 0							
1735- GRID *617			0			87.5000		-10.7919		815149
1736- *15149			62.6759 0							
1737- GRID *618			0			87.5000		-12.5000		815150
1738- *15150			62.5000 0							
1739- GRID *701			0			97.0000		.0		815151
1740- *15151			46.9600 0							
1741- GRID *702			0			97.0000		-1.6855		815152
1742- *15152			46.9600 0							
1743- GRID *703			0			97.0000		-4.2938		815153
1744- *15153			46.9600 0							
1745- GRID *704			0			97.0000		-4.5413		815154
1746- *15154			46.9600 0							
1747- GRID *705			0			97.0000		-12.5000		815155
1748- *15155			46.9600 0							
1749- GRID *706			0			97.0000		.0		815156
1750- *15156			50.9729 0							

S O R T E D B U L K D A T A E C H O

CARD	1	2	3	4	5	6	7	8	9	10
COUNT
1751- GRID *707			0			97.0000		-1.6575		615157
1752- *15157			50.9796 0							
1753- GRID *708			0			97.0000		-4.3061		615158
1754- *15158			50.9985 0							
1755- GRID *709			0			97.0000		-7.6970		615159
1756- *15159			51.0114 0							
1757- GRID *710			0			97.0000		-12.5000		615160
1758- *15160			51.0130 0							
1759- GRID *711			0			97.0000		-8.4841		615161
1760- *15161			54.0749 0							
1761- GRID *712			0			97.0000		-12.5000		615162
1762- *15162			54.1030 0							
1763- GRID *713			0			97.0000		-9.2284		615163
1764- *15163			56.8177 0							
1765- GRID *714			0			97.0000		-12.5000		615164
1766- *15164			56.8116 0							
1767- GRID *715			0			97.0000		-9.9318		615165
1768- *15165			59.4605 0							
1769- GRID *716			0			97.0000		-12.5000		615166
1770- *15166			59.4802 0							
1771- GRID *717			0			97.0000		-10.7593		615167
1772- *15167			62.5638 0							
1773- GRID *718			0			97.0000		-12.5000		615168
1774- *15168			62.5000 0							
1775- GRID *760			0			102.1200		-12.5000		615178
1776- *15178			62.5000 0							
1777- GRID *801			0			106.5000		.0		615179
1778- *15179			46.4730 0							
1779- GRID *802			0			106.5000		-1.7001		615180
1780- *15180			46.4730 0							
1781- GRID *803			0			106.5000		-4.3001		615181
1782- *15181			46.4730 0							
1783- GRID *804			0			106.5000		-6.5200		615182
1784- *15182			46.4730 0							
1785- GRID *805			0			106.5000		-12.5000		615183
1786- *15183			46.4730 0							
1787- GRID *806			0			106.5000		.0		615184
1788- *15184			50.4730 0							
1789- GRID *807			0			106.5000		-1.7191		615185
1790- *15185			50.4447 0							
1791- GRID *808			0			106.5000		-4.2991		615186
1792- *15186			50.4523 0							
1793- GRID *809			0			106.5000		-7.5991		615187
1794- *15187			50.4565 0							
1795- GRID *810			0			106.5000		-12.5000		615188
1796- *15188			50.4530 0							
1797- GRID *811			0			106.5000		-8.5761		615189
1798- *15189			53.9918 0							
1799- GRID *812			0			106.5000		-12.5000		615190
1800- *15190			53.9929 0							

SORTED BULK DATA FCHD

CARD	1	2	3	4	5	6	7	8	9	10
1801- GRID *813			0		106.5000		-9.7097		615191	
1802- *15191		56.7483	0							
1803- GRID *814			0		106.5000		-12.5000		615192	
1804- *15192		56.7328	0							
1805- GRID *815			0		106.5000		-10.0219		615193	
1806- *15193		59.3649	0							
1807- GRID *816			0		106.5000		-12.5000		615194	
1808- *15194		59.3527	0							
1809- GRID *817			0		106.5000		-10.8767		615195	
1810- *15195		62.4608	0							
1811- GRID *818			0		106.5000		-12.5000		615196	
1812- *15196		62.5000	0							
1813- GRID *901			0		116.0000		.0		615197	
1814- *15197		45.9860	0							
1815- GRID *902			0		116.0000		-1.7199		615198	
1816- *15198		45.9860	0							
1817- GRID *903			0		116.0000		-4.3200		615199	
1818- *15199		45.9860	0							
1819- GRID *904			0		116.0000		-6.4000		615200	
1820- *15200		45.9860	0							
1821- GRID *905			0		116.0000		-12.5000		615201	
1822- *15201		45.9860	0							
1823- GRID *910			0		116.0000		-12.5000		615202	
1824- *15202		49.9860	0							
1825- GRID *911			0		116.0000		.0		615203	
1826- *15203		51.5000	0							
1827- GRID *912			0		116.0000		-1.7576		615204	
1828- *15204		51.5000	0							
1829- GRID *913			0		116.0000		-4.3176		615205	
1830- *15205		51.5000	0							
1831- GRID *914			0		116.0000		-7.8776		615206	
1832- *15206		51.5000	0							
1833- GRID *915			0		116.0000		-12.5000		615207	
1834- *15207		51.5000	0							
1835- GRID *916			0		116.0000		-8.5656		615208	
1836- *15208		53.9786	0							
1837- GRID *917			0		116.0000		-12.5000		615209	
1838- *15209		53.9659	0							
1839- GRID *918			0		116.0000		-9.2480		615210	
1840- *15210		56.7000	0							
1841- GRID *919			0		116.0000		-12.5000		615211	
1842- *15211		56.7000	0							
1843- GRID *920			0		116.0000		-10.0431		615212	
1844- *15212		59.4539	0							
1845- GRID *921			0		116.0000		-12.5000		615213	
1846- *15213		59.4458	0							
1847- GRID *922			0		116.0000		-10.8527		615214	
1848- *15214		62.4512	0							
1849- GRID *923			0		116.0000		-12.5000		615215	
1850- *15215		62.5000	0							

SORTED BULK DATA ECHO

CARD	COUNT	1	2	3	4	5	6	7	8	9	10
1851-GRID	*1001		0			119.0000		.0			615216
1852-#15216			45.4330	0							
1853-GRID	*1002		0			119.0000		-1.7227			615217
1854-#15217			45.4330	0							
1855-GRID	*1003		0			119.0000		-4.2668			615218
1856-#15218			45.4330	0							
1857-GRID	*1004		0			119.0000		-6.7301			615219
1858-#15219			45.4330	0							
1859-GRID	*1005		0			119.0000		-12.5000			615220
1860-#15220			45.4330	0							
1861-GRID	*1010		0			119.0000		-12.5000			615221
1862-#15221			45.4330	0							
1863-GRID	*1011		0			119.0000		.0			615222
1864-#15222			51.5000	0							
1865-GRID	*1012		0			119.0000		-1.7317			615223
1866-#15223			51.5000	0							
1867-GRID	*1013		0			119.0000		-4.2958			615224
1868-#15224			51.5000	0							
1869-GRID	*1014		0			119.0000		-7.8816			615225
1870-#15225			51.5000	0							
1871-GRID	*1015		0			119.0000		-12.5000			615226
1872-#15226			51.5000	0							
1873-GRID	*1016		0			119.0000		-3.5667			615227
1874-#15227			53.9523	0							
1875-GRID	*1017		0			119.0000		-12.5000			615228
1876-#15228			53.9459	0							
1877-GRID	*1018		0			119.0000		-9.2480			615229
1878-#15229			56.7000	0							
1879-GRID	*1019		0			119.0000		-12.5000			615230
1880-#15230			56.7000	0							
1881-GRID	*1020		0			119.0000		-10.0176			615231
1882-#15231			59.2985	0							
1883-GRID	*1021		0			119.0000		-12.5000			615232
1884-#15232			59.3145	0							
1885-GRID	*1022		0			119.0000		-10.8639			615233
1886-#15233			62.4221	0							
1887-GRID	*1023		0			119.0000		-12.5000			615234
1888-#15234			62.5000	0							
1889-GRID	*1101		0			125.5000		.0			615235
1890-#15235			45.5000	0							
1891-GRID	*1102		0			125.5000		-1.7172			615236
1892-#15236			45.5000	0							
1893-GRID	*1103		0			125.5000		-4.2931			615237
1894-#15237			45.5000	0							
1895-GRID	*1104		0			125.5000		-6.2499			615238
1896-#15238			45.5000	0							
1897-GRID	*1105		0			125.5000		-12.5000			615239
1898-#15239			45.5000	0							
1899-GRID	*1110		0			125.5000		-12.5000			615241
1900-#15241			49.5000	0							

SORTED BULK DATA TCHD

CARD	1	2	3	4	5	6	7	8	9	10
1901- GRID	*1111		0			125.5000		.0		615242
1902- *15242			51.5000	0						
1903- GRID	*1112		0			125.5000		-1.7153		615243
1904- *15243			51.5000	0						
1905- GRID	*1113		0			125.5000		-4.3311		615244
1906- *15244			51.5000	0						
1907- GRID	*1114		0			125.5000		-7.8654		615245
1908- *15245			51.5000	0						
1909- GRID	*1115		0			125.5000		-12.5000		615246
1910- *15246			51.5000	0						
1911- GRID	*1116		0			125.5000		-8.5805		615247
1912- *15247			53.9715	0						
1913- GRID	*1117		0			125.5000		-12.5000		615248
1914- *15248			53.9662	0						
1915- GRID	*1118		0			125.5000		-9.3168		615249
1916- *15249			56.7024	0						
1917- GRID	*1119		0			125.5000		-12.5000		615250
1918- *15250			56.6818	0						
1919- GRID	*1120		0			125.5000		-10.0525		615251
1920- *15251			59.3375	0						
1921- GRID	*1121		0			125.5000		-12.5000		615252
1922- *15252			59.3175	0						
1923- GRID	*1122		0			125.5000		-10.9111		615253
1924- *15253			62.4630	0						
1925- GRID	*1123		0			125.5000		-12.5000		615254
1926- *15254			62.5000	0						
1927- GRID	*1161		0			129.0000		-12.5000		615265
1928- *15265			62.5000	0						
1929- GRID	*1201		0			135.0000		.0		615267
1930- *15267			45.5000	0						
1931- GRID	*1202		0			135.0000		-1.7800		615268
1932- *15268			45.5000	0						
1933- GRID	*1203		0			135.0000		-4.3201		615269
1934- *15269			45.5000	0						
1935- GRID	*1204		0			135.0000		-6.3001		615270
1936- *15270			45.5000	0						
1937- GRID	*1205		0			135.0000		-12.5000		615271
1938- *15271			45.5000	0						
1939- GRID	*1206		0			135.0000		.0		615272
1940- *15272			49.5000	0						
1941- GRID	*1207		0			135.0000		-1.7728		615273
1942- *15273			49.5000	0						
1943- GRID	*1208		0			135.0000		-4.3527		615274
1944- *15274			49.5000	0						
1945- GRID	*1209		0			135.0000		-7.3528		615275
1946- *15275			49.5000	0						
1947- GRID	*1210		0			135.0000		-12.5000		615276
1948- *15276			49.5000	0						
1949- GRID	*1211		0			135.0000		-7.9193		615277
1950- *15277			51.5000	0						

PHASE 1 XORBITER FUSELAGE-SYMM CASEH REVISION 4/22/74
 SKINS HALF EFF.LONG.,85% EFF.TRANS.AT WING

MAY 6, 1974 NASTRAN 2/ 1/73 PAGE 59

SORTED BULK DATA ECHO

CARD	COUNT	1	2	3	4	5	6	7	8	9	10
1951- GRID	*1212		0			135.0000		-12.5000			E15278
1952- *15278			51.5000	0							
1953- GRID	*1213		0			135.0000		-9.5672			E15279
1954- *15279			53.9925	0							
1955- GRID	*1214		0			135.0000		-12.5000			E15280
1956- *15280			57.9799	0							
1957- GRID	*1215		0			135.0000		-9.2959			E15281
1958- *15281			56.7102	0							
1959- GRID	*1216		0			135.0000		-12.5000			E15282
1960- *15282			56.7198	0							
1961- GRID	*1217		0			135.0000		-10.0244			E15283
1962- *15283			59.3679	0							
1963- GRID	*1218		0			135.0000		-12.5000			E15284
1964- *15284			59.3398	0							
1965- GRID	*1219		0			135.0000		-10.8543			E15285
1966- *15285			62.4852	0							
1967- GRID	*1220		0			135.0000		-12.5000			E15286
1968- *15286			62.5000	0							
1969- GRID	*1221		0			135.0000		.0			E15287
1970- *15287			51.5000	0							
1971- GRID	*1301		0			141.7500		-0.0000			E15288
1972- *15288			45.5000	0							
1973- GRID	*1302		0			141.7500		-1.7201			E15289
1974- *15289			45.5000	0							
1975- GRID	*1303		0			141.7500		-4.2803			E15290
1976- *15290			45.5000	0							
1977- GRID	*1304		0			141.7500		-6.2200			E15291
1978- *15291			45.5000	0							
1979- GRID	*1305		0			141.7500		-12.5000			E15292
1980- *15292			45.5000	0							
1981- GRID	*1306		0			141.7500		.0000			E15293
1982- *15293			49.5000	0							
1983- GRID	*1307		0			141.7500		-1.7173			E15294
1984- *15294			49.5000	0							
1985- GRID	*1308		0			141.7500		-4.2971			E15295
1986- *15295			49.5000	0							
1987- GRID	*1309		0			141.7500		-7.3172			E15296
1988- *15296			49.5000	0							
1989- GRID	*1310		0			141.7500		-12.5000			E15297
1990- *15297			49.5000	0							
1991- GRID	*1311		0			141.7500		-7.8558			E15298
1992- *15298			51.5000	0							
1993- GRID	*1312		0			141.7500		-12.5000			E15299
1994- *15299			51.5000	0							
1995- GRID	*1313		0			141.7500		-8.5435			E15300
1996- *15300			54.0160	0							
1997- GRID	*1314		0			141.7500		-12.5000			E15301
1998- *15301			54.0195	0							
1999- GRID	*1315		0			141.7500		-9.2480			E15302
2000- *15302			56.7000	0							

S O R T E D B U L K D A T A F C H D

CARD	1	2	3	4	5	6	7	8	9	10
2001-	GRID	*1316	0			141.7500		-12.5000		E15303
2002-	*15303		56.7000 0							
2003-	GRID	*1317	0			141.7500		-9.9654		E15304
2004-	*15304		59.7486 0							
2005-	GRID	*1318	0			141.7500		-12.5000		E15305
2006-	*15305		59.7591 0							
2007-	GRID	*1319	0			141.7500		-10.8262		E15306
2008-	*15306		62.4921 0							
2009-	GRID	*1320	0			141.7500		-12.5000		E15307
2010-	*15307		62.5000 0							
2011-	GRID	*1321	0			141.7500		.0		E15308
2012-	*15308		61.5000 0							
2013-	GRID	*1401	0			144.7500		.0		E15309
2014-	*15309		45.5000 0							
2015-	GRID	*1402	0			144.7500		-1.7051		E15310
2016-	*15310		45.5000 0							
2017-	GRID	*1403	0			144.7500		-4.3000		E15311
2018-	*15311		45.5000 0							
2019-	GRID	*1404	0			144.7500		-6.2500		E15312
2020-	*15312		45.5000 0							
2021-	GRID	*1405	0			144.7500		-12.5000		E15313
2022-	*15313		45.5000 0							
2023-	GRID	*1406	0			144.7500		.0000		E15314
2024-	*15314		51.5000 0							
2025-	GRID	*1407	0			144.7500		-1.7051		E15315
2026-	*15315		51.5000 0							
2027-	GRID	*1408	0			144.7500		-4.3000		E15316
2028-	*15316		51.5000 0							
2029-	GRID	*1409	0			144.7500		-7.9560		E15317
2030-	*15317		51.5000 0							
2031-	GRID	*1410	0			144.7500		-12.5000		E15318
2032-	*15318		51.5000 0							
2033-	GRID	*1411	0			144.7500		-8.5506		E15319
2034-	*15319		54.0569 0							
2035-	GRID	*1412	0			144.7500		-12.5000		E15320
2036-	*15320		54.0337 0							
2037-	GRID	*1413	0			144.7500		-9.2480		E15321
2038-	*15321		56.7000 0							
2039-	GRID	*1414	0			144.7500		-12.5000		E15322
2040-	*15322		56.7000 0							
2041-	GRID	*1415	0			144.7500		-9.9791		E15323
2042-	*15323		59.4427 0							
2043-	GRID	*1416	0			144.7500		-12.5000		E15324
2044-	*15324		59.4426 0							
2045-	GRID	*1417	0			144.7500		-10.8098		E15325
2046-	*15325		62.5343 0							
2047-	GRID	*1418	0			144.7500		-12.5000		E15326
2048-	*15326		62.5000 0							
2049-	GRID	*1501	0			150.3750		-7.9560		E15328
2050-	*15328		51.5000 0							

SORTED BULK DATA ECHO

CARD	COUNT	1	2	3	4	5	6	7	8	9	10
2051-GRID	*1502		0			150.3750		-12.5000		815329	
2052-*	15329		51.5000 0								
2053-GRID	*1503		0			150.3750		-8.5559		815330	
2054-*	15330		54.0337 0								
2055-GRID	*1504		0			150.3750		-12.5000		815331	
2056-*	15331		54.0439 0								
2057-GRID	*1505		0			150.3750		-9.2480		815332	
2058-*	15332		56.7000 0								
2059-GRID	*1506		0			150.3750		-12.5000		815333	
2060-*	15333		56.7000 0								
2061-GRID	*1507		0			150.3750		-0.9939		815334	
2062-*	15334		59.3964 0								
2063-GRID	*1508		0			150.3750		-12.5000		815335	
2064-*	15335		59.3944 0								
2065-GRID	*1509		0			150.3750		-10.8368		815336	
2066-*	15336		62.4944 0								
2067-GRID	*1510		0			150.3750		-12.5000		815337	
2068-*	15337		62.5000 0								
2069-GRID	*1516		0			150.3750		.0		815343	
2070-*	15343		51.5000 0								
2071-GRID	*1517		0			150.3750		-1.7051		815344	
2072-*	15344		51.5000 0								
2073-GRID	*1601		0			153.3750		-0.0000		815347	
2074-*	15347		45.5000 0								
2075-GRID	*1602		0			153.3750		-1.7051		815348	
2076-*	15348		45.5000 0								
2077-GRID	*1603		0			153.3750		-4.3000		815349	
2078-*	15349		45.5000 0								
2079-GRID	*1604		0			153.3750		-6.2500		815350	
2080-*	15350		45.5000 0								
2081-GRID	*1605		0			153.3750		-12.5000		815351	
2082-*	15351		45.5000 0								
2083-GRID	*1606		0			153.3750		-0.0000		815352	
2084-*	15352		51.5000 0								
2085-GRID	*1607		0			153.3750		-1.7051		815353	
2086-*	15353		51.5000 0								
2087-GRID	*1608		0			153.3750		-4.3000		815354	
2088-*	15354		51.5000 0								
2089-GRID	*1609		0			153.3750		-7.8560		815355	
2090-*	15355		51.5000 0								
2091-GRID	*1610		0			153.3750		-12.5000		815356	
2092-*	15356		51.5000 0								
2093-GRID	*1611		0			153.3750		-8.5302		815357	
2094-*	15357		53.9960 0								
2095-GRID	*1612		0			153.3750		-12.5000		815358	
2096-*	15358		53.9960 0								
2097-GRID	*1613		0			153.3750		-9.2480		815359	
2098-*	15359		56.7000 0								
2099-GRID	*1614		0			153.3750		-12.5000		815360	
2100-*	15360		56.7000 0								

SORTED BULK DATA ECHO

CARD	1	2	3	4	5	6	7	8	9	10
2101-GRID	*1615		0			153.3750		-9.9410		E15361
2102-GRID	*15361		59.3913	0						
2103-GRID	*1616		0			153.3750		-12.5000		E15362
2104-GRID	*15362		59.3750	0						
2105-GRID	*1617		0			153.3750		-10.7792		E15363
2106-GRID	*15363		62.4747	0						
2107-GRID	*1618		0			153.3750		-12.5000		E15364
2108-GRID	*15364		62.5000	0						
2109-GRID	*1701		0			162.0000		.0000		E15365
2110-GRID	*15382		45.5000	0						
2111-GRID	*1702		0			162.0000		-1.7051		E15382
2112-GRID	*15383		45.5000	0						
2113-GRID	*1703		0			162.0000		-4.3000		E15383
2114-GRID	*15384		45.5000	0						
2115-GRID	*1704		0			162.0000		-6.2500		E15384
2116-GRID	*15385		45.5000	0						
2117-GRID	*1705		0			162.0000		-12.5000		E15385
2118-GRID	*15386		45.5000	0						
2119-GRID	*1706		0			162.0000		.0000		E15386
2120-GRID	*15387		51.5000	0						
2121-GRID	*1707		0			162.0000		-1.7051		E15387
2122-GRID	*15388		51.5000	0						
2123-GRID	*1708		0			162.0000		-4.3000		E15388
2124-GRID	*15389		51.5000	0						
2125-GRID	*1709		0			162.0000		-7.8560		E15389
2126-GRID	*15390		51.5000	0						
2127-GRID	*1710		0			162.0000		-12.5000		E15390
2128-GRID	*15391		51.5000	0						
2129-GRID	*1711		0			162.0000		-8.5065		E15391
2130-GRID	*15392		53.9960	0						
2131-GRID	*1712		0			162.0000		-12.5000		E15392
2132-GRID	*15393		53.9960	0						
2133-GRID	*1713		0			162.0000		-9.2337		E15393
2134-GRID	*15394		56.7570	0						
2135-GRID	*1714		0			162.0000		-12.5000		E15394
2136-GRID	*15395		56.7000	0						
2137-GRID	*1715		0			162.0000		-9.9185		E15395
2138-GRID	*15396		59.3983	0						
2139-GRID	*1716		0			162.0000		-12.5000		E15396
2140-GRID	*15397		59.3750	0						
2141-GRID	*1717		0			162.0000		-10.7578		E15397
2142-GRID	*15398		62.4953	0						
2143-GRID	*1718		0			162.0000		-12.5000		E15398
2144-GRID	*15399		62.5000	0						
2145-GRID	*1721		0			165.2500		-1.2315		E15401
2146-GRID	*15402		45.5000	0						
2147-GRID	*1722		0			165.2500		-1.2315		E15402
2148-GRID	*15403		51.5000	0						
2149-GRID	*1723		0			165.2500		.0		E15403
2150-GRID	*15405		45.5000	0						

SORTED PULK DATA ECHO

CARD	1	2	3	4	5	6	7	8	9	10
2151-GRID	*1724		0			165.2500		.0		E15404
2152-#15404			51.5000	0						
2153-GRID	1800		0	165.25	.0	45.5	1			
2154-GRID	*1801		0			166.5000		.0		E15406
2155-#15406			45.5000	0						
2156-GRID	*1802		0			166.5000		-1.7051		E15407
2157-#15407			45.5000	0						
2158-GRID	*1803		0			166.5000		-4.3000		E15408
2159-#15408			45.5000	0						
2160-GRID	*1804		0			166.5000		-6.2500		E15409
2161-#15409			45.5000	0						
2162-GRID	*1805		0			166.5000		-9.4000		E15410
2163-#15410			45.5000	0						
2164-GRID	*1806		0			166.5000		-12.5000		E15411
2165-#15411			45.5000	0						
2166-GRID	*1807		0			166.5000		.0		E15412
2167-#15412			51.5000	0						
2168-GRID	*1808		0			166.5000		-1.7051		E15413
2169-#15413			51.5000	0						
2170-GRID	*1809		0			166.5000		-4.3000		E15414
2171-#15414			51.5000	0						
2172-GRID	*1810		0			166.5000		-7.8560		E15415
2173-#15415			51.5000	0						
2174-GRID	*1811		0			166.5000		-9.4000		E15416
2175-#15416			51.5000	0						
2176-GRID	*1812		0			166.5000		-12.5000		E15417
2177-#15417			51.5000	0						
2178-GRID	*1813		0			166.5000		-8.6140		E15418
2179-#15418			53.9960	0						
2180-GRID	*1814		0			166.5000		-12.5000		E15419
2181-#15419			53.9960	0						
2182-GRID	*1815		0			166.5000		-7.7630		E15420
2183-#15420			56.7000	0						
2184-GRID	*1817		0			166.5000		-12.5000		E15421
2185-#15421			56.7000	0						
2186-GRID	*1818		0			166.5000		-6.9200		E15422
2187-#15422			59.3750	0						
2188-GRID	*1819		0			166.5000		-10.5000		E15423
2189-#15423			59.3750	0						
2190-GRID	*1820		0			166.5000		-12.5000		E15424
2191-#15424			59.3750	0						
2192-GRID	*1821		0			166.5000		.0		E15425
2193-#15425			62.5000	0						
2194-GRID	*1822		0			166.5000		-5.9360		E15426
2195-#15426			62.5000	0						
2196-GRID	*1823		0			166.5000		-10.5000		E15427
2197-#15427			62.5000	0						
2198-GRID	*1824		0			166.5000		-12.5000		E15428
2199-#15428			62.5000	0						
2200-GRID	*1825		0			166.5000		.0		E15429

SORTED BULK DATA FCHO

CARD	COUNT.	1	..	2	..	3	..	4	..	5	..	6	..	7	..	8	..	9	..	10
2201~*15429						64.9000	0													
2202~GRID	*1826						0			166.5000						-5.1800				615430
2203~*15430						64.9000	0													
2204~GRID	*1827						0			166.5000						-0.7007				615431
2205~*15431						66.5181	0													
2206~GRID	*1828						0			166.5000						-11.5485				615432
2207~*15432						67.2835	0													
2208~GRID	*1829						0			166.5000						.0				615433
2209~*15433						69.9247	0													
2210~GRID	*1830						0			166.5000						-3.5980				615434
2211~*15434						69.9247	0													
2212~GRID	*1831						0			166.5000						-7.4247				615435
2213~*15435						69.9247	0													
2214~GRID	*1832						0			166.5000						-8.8389				615436
2215~*15436						71.3389	0													
2216~GRID	*1833						0			166.5000						.0				615437
2217~*15437						73.0000	0													
2218~GRID	*1834						0			166.5000						-2.8190				615438
2219~*15438						72.4000	0													
2220~GRID	*1835						0			166.5000						-4.0181				615439
2221~*15439						72.2007	0													
2222~GRID	*1836						0			166.5000						-4.7835				615440
2223~*15440						74.0485	0													
2224~GRID	*1837						0			166.5000						.0				615441
2225~*15441						75.0000	0													
2226~GRID	*1838						0			166.5000						-2.0000				615442
2227~*15442						75.0000	0													
2228~GRID	*1901						0			170.7500						.0				615444
2229~*15444						45.5000	0													
2230~GRID	*1902						0			170.7500						-1.7051				615445
2231~*15445						45.5000	0													
2232~GRID	*1903						0			170.7500						-4.3000				615446
2233~*15446						45.5000	0													
2234~GRID	*1904						0			170.7500						-6.2500				615447
2235~*15447						45.5000	0													
2236~GRID	*1905						0			170.7500						-12.5000				615448
2237~*15448						45.5000	0													
2238~GRID	*1906						0			170.7500						.0				615449
2239~*15449						47.3300	0													
2240~GRID	*1907						0			170.7500						-1.7051				615450
2241~*15450						47.3300	0													
2242~GRID	*1908						0			170.7500						-4.3000				615451
2243~*15451						47.3300	0													
2244~GRID	*1909						0			170.7500						-6.7398				615452
2245~*15452						47.3300	0													
2246~GRID	*1910						0			170.7500						.0				615453
2247~*15453						50.3300	0													
2248~GRID	*1911						0			170.7500						-1.7051				615454
2249~*15454						50.3300	0													
2250~GRID	*1912						0			170.7500						-4.3000				615455

SORTED BULK DATA ECHO

CARD	COUNT	1	2	3	4	5	6	7	8	9	10
2251-	*15455			50.3300	0						
2252-	GRID *1913				0		170.7500		-7.5428		615456
2253-	*15456			50.3300	0						
2254-	GRID *1914				0		170.7500		.0		615457
2255-	*15457			51.5000	0						
2256-	GRID *1915				0		170.7500		-1.7051		615458
2257-	*15458			51.5000	0						
2258-	GRID *1916				0		170.7500		-4.3000		615459
2259-	*15459			51.5000	0						
2260-	GRID *1917				0		170.7500		-7.8560		615460
2261-	*15460			51.5000	0						
2262-	GRID *1918				0		170.7500		-12.5000		615461
2263-	*15461			51.5000	0						
2264-	GRID *1919				0		170.7500		-12.5000		615462
2265-	*15462			53.9960	0						
2266-	GRID *1920				0		170.7500		-12.5000		615463
2267-	*15463			56.7000	0						
2268-	GRID *1921				0		170.7500		-12.5000		615464
2269-	*15464			59.3750	0						
2270-	GRID *1922				0		170.7500		-12.5000		615465
2271-	*15465			63.4400	0						
2272-	GRID *1923				0		170.7500		-11.5485		615466
2273-	*15466			67.2835	0						
2274-	GRID *1924				0		170.7500		-8.8389		615467
2275-	*15467			71.3389	0						
2276-	GRID *1925				0		170.7500		-4.7835		615468
2277-	*15468			74.0485	0						
2278-	GRID *1926				0		170.7500		-2.0000		615469
2279-	*15469			75.0000	0						
2280-	GRID *1927				0		170.7500		.0		615470
2281-	*15470			75.0000	0						
2282-	GRID *1928				0		170.7500		-9.4000		615471
2283-	*15471			51.5000	0						
2284-	GRID *1929				0		170.7500		-5.9360		615472
2285-	*15472			63.4400	0						
2286-	GRID *1930				0		170.7500		.0		615473
2287-	*15473			63.4400	0						
2288-	GRID *1931				0		173.9539		-12.5000		615474
2289-	*15474			59.3750	0						
2290-	GRID *1932				0		173.9539		-12.5000		615475
2291-	*15475			64.1484	0						
2292-	GRID *1933				0		173.9539		-6.7057		615476
2293-	*15476			64.1484	0						
2294-	GRID *1934				0		173.9539		.0		615477
2295-	*15477			64.1484	0						
2296-	GRID *1935				0		175.5633		-5.1393		615478
2297-	*15478			51.9237	0						
2298-	GRID *1936				0		175.5633		.0		615479
2299-	*15479			51.9237	0						
2300-	GRID *2001				0		180.0090		.0		615480

SORTED BULK DATA ECHO

CARD	1	2	3	4	5	6	7	8	9	10
2301- *15480			45.5000 0							
2302- GRID	*2002		0			180.0090		-1.7051		E15481
2303- *15481			45.5000 0							
2304- GRID	*2003		0			180.0090		-4.3000		E15482
2305- *15482			45.5000 0							
2306- GRID	*2004		0			180.0090		-6.2500		E15483
2307- *15483			45.5000 0							
2308- GRID	*2005		0			180.0090		-12.5000		E15484
2309- *15484			45.5000 0							
2310- GRID	*2006		0			179.219034		.0		E15485
2311- *15485			51.5000 2							
2312- GRID	*2007		0			179.219034		-1.7051		E15486
2313- *15486			51.5000 2							
2314- GRID	*2008		0			179.219034		-4.3000		E15487
2315- *15487			51.5000 2							
2316- GRID	*2009		0			179.219034		-6.2500		E15488
2317- *15488			51.5000 2							
2318- GRID	*2010		0			179.219034		-12.5000		E15489
2319- *15489			51.5000 0							
2320- GRID	*2011		0			178.890408		.0		E15490
2321- *15490			53.9960 0							
2322- GRID	*2012		0			178.890408		-1.7051		E15491
2323- *15491			53.9960 2							
2324- GRID	*2013		0			178.890408		-4.3000		E15492
2325- *15492			53.9960 2							
2326- GRID	*2014		0			178.890408		-6.4000		E15493
2327- *15493			53.9960 0							
2328- GRID	*2015		0			178.890408		-12.5000		E15494
2329- *15494			53.9960 0							
2330- GRID	*2016		0			178.534397		.0		E15495
2331- *15495			56.7000 2							
2332- GRID	*2017		0			178.534397		-1.7051		E15496
2333- *15496			56.7000 2							
2334- GRID	*2018		0			178.534397		-4.3000		E15497
2335- *15497			56.7000 2							
2336- GRID	*2019		0			178.534397		-6.7460		E15498
2337- *15498			56.7000 2							
2338- GRID	*2020		0			178.534397		-12.5000		E15499
2339- *15499			56.7000 0							
2340- GRID	*2021		0			178.182203		.0		E15500
2341- *15500			59.3750 2							
2342- GRID	*2022		0			178.182203		-1.7051		E15501
2343- *15501			59.3750 2							
2344- GRID	*2023		0			178.182203		-4.3000		E15502
2345- *15502			59.3750 2							
2346- GRID	*2024		0			178.182203		-7.0890		E15503
2347- *15503			59.3750 2							
2348- GRID	*2025		0			178.182203		-12.5000		E15504
2349- *15504			59.3750 0							
2350- GRID	*2026		0			177.45188		.0		E15505

SORTED BULK DATA FCHD

CARD	1	2	3	4	5	6	7	8	9	10
2351-	*15505		64.9220	0						
2352-	GRID	*2027	0		177.45188		-1.7051			E15506
2353-	*15506		64.9220	2						
2354-	GRID	*2028	0		177.45188		-4.3000			E15507
2355-	*15507		64.9220	2						
2356-	GRID	*2029	0		177.45188		-7.8000			E15508
2357-	*15508		64.9220	0						
2358-	GRID	*2030	0		177.45188		-12.5000			E15509
2359-	*15509		64.9220	0						
2360-	GRID	*2031	0		177.140962		.0			E15510
2361-	*15510		67.2835	2						
2362-	GRID	*2032	0		177.140962		-1.7051			E15511
2363-	*15511		67.2835	2						
2364-	GRID	*2033	0		177.140962		-4.3000			E15512
2365-	*15512		67.2835	2						
2366-	GRID	*2034	0		177.140962		-8.1823			E15513
2367-	*15513		67.2835	2						
2368-	GRID	*2035	0		177.140962		-11.5485			E15514
2369-	*15514		67.2835	0						
2370-	GRID	*2036	0		176.607024		.0			E15515
2371-	*15515		71.3389	2						
2372-	GRID	*2037	0		176.607024		-1.7051			E15516
2373-	*15516		71.3389	2						
2374-	GRID	*2038	0		176.607024		-4.3000			E15517
2375-	*15517		71.3389	2						
2376-	GRID	*2039	0		176.607024		-8.8389			E15518
2377-	*15518		71.3389	0						
2378-	GRID	*2040	0		176.1250		.0			E15519
2379-	*15519		75.0000	0						
2380-	GRID	*2041	0		176.1250		-2.0000			E15520
2381-	*15520		75.0000	0						
2382-	GRID	*2042	0		176.250276		-4.7835			E15521
2383-	*15521		74.0485	0						
2384-	GRID	*2101	0		186.2500		.0			E15522
2385-	*15522		45.5000	0						
2386-	GRID	*2102	0		186.2500		-1.7051			E15523
2387-	*15523		45.5000	0						
2388-	GRID	*2103	0		186.2500		-4.3000			E15524
2389-	*15524		45.5000	0						
2390-	GRID	*2104	0		186.2500		-6.2500			E15525
2391-	*15525		45.5000	0						
2392-	GRID	*2105	0		186.2500		-12.5000			E15526
2393-	*15526		45.5000	0						
2394-	GRID	*2106	0		185.4630		-12.5000			E15527
2395-	*15527		51.5000	0						
2396-	GRID	*2107	0		185.1320		-12.5000			E15528
2397-	*15528		53.9960	0						
2398-	GRID	*2108	0		184.7810		-12.5000			E15529
2399-	*15529		56.7000	0						
2400-	GRID	*2109	0		184.4300		-12.5000			E15530

PHASE 1 ORBITER FUSELAGE-SYMM CASE# REVISION 4/22/74
 SKINS HALF EFF. LONG., 85% EFF. TRANS. AT WING

MAY 6, 1974 NASTRAN 2/ 1/73 PAGE 68

SORTED BULK DATA ECHO

CARD	COUNT	1	2	3	4	5	6	7	8	9	10
2401-	*15530			59.3750	0						
2402-	GRID	*2110		0			183.6930		-12.5000		615531
2403-	*15531			64.9220	0						
2404-	GRID	*2111		0			183.3820		-11.5485		615532
2405-	*15532			67.2835	0						
2406-	GRID	*2112		0			182.8480		-8.8389		615533
2407-	*15533			71.3389	0						
2408-	GRID	*2113		0			182.4910		-4.7835		615534
2409-	*15534			74.0485	0						
2410-	GRID	*2114		0			182.3660		-2.0000		615535
2411-	*15535			75.0000	0						
2412-	GRID	*2115		0			182.3660		.0		615536
2413-	*15536			75.0000	0						
2414-	GRID	2200		0	171.687	-11.9606	70.4918	0			
2415-	MAT1	1		1.0567		.3					
2416-	MAT1	2		1.0567		.3		.1			
2417-	MAT1	4		1.0567		.3					
2418-	MAT1	6		1.0567		.3					
2419-	MAT1	8		1.0567		.3		.1			
2420-	MAT1	11		1.0567		.3		.1			
2421-	MAT1	12		1.0567		.3					
2422-	MAT1	16		1.0567		.3		.1			
2423-	MAT1	18		3.0067		.3		.264			
2424-	MAT1	26		.52567		.3		.1			
2425-	MAT1	28		3.0067		.3					
2426-	MAT1	36		.52567		.3		.1			
2427-	MAT1	46		.52567		.3		.1			
2428-	MAT1	101		10.566		.3					
2429-	MAT1	102		10.566		.3					
2430-	MAT1	103		10.566		.3					
2431-	MAT1	104		10.566		.3					
2432-	MAT1	105		17.8766		.3					
2433-	MAT1	106		16.2966		.3					
2434-	MAT1	107		14.5066		.3					
2435-	MAT1	108		15.4366		.3					
2436-	MAT1	109		17.8766		.3					
2437-	MAT1	110		14.1966		.3					
2438-	MAT1	111		10.566		.3					
2439-	MAT1	112		15.4366		.3					
2440-	MAT1	113		10.566		.3					
2441-	MAT1	114		14.4066		.3					
2442-	MAT1	115		18.0766		.3					
2443-	MAT1	116		19.9566		.3					
2444-	MAT1	117		23.1066		.3					
2445-	MAT1	118		15.2266		.3					
2446-	MPC	100		213	1	4.1039	207	1	-2.8022		6M213X
2447-	6M213X			219	1	-1.3017					
2448-	MPC	100		223	1	5.1087	222	1	-2.0244		6M223X
2449-	6M223X			224	1	-3.0843					
2450-	MPC	100		243	2	1.0	230	2	-1.0		

PHASE I SUBBITER FUSELAGE-SYMM CASFR REVISION 4/22/74
 SKINS HALF EFF.LONG.,65% EFF.TRANS.AT WING

MAY 6, 1974 NASTRAN 2/ 1/73 PAGE 69

SORTED BULK DATA FCHO

CARD	1	2	3	4	5	6	7	8	9	10
2451- MPC	100	243	3	1.0	230	3	-1.0			
2452- MPC	100	910	2	5.514	905	2	-1.514			EM910Y
2453- EM910Y		915	2	-4.0						
2454- MPC	100	1010	2	5.667	1005	2	-1.667			EM1010Y
2455- EM1010Y		1015	2	-4.0						
2456- MPC	100	1110	2	6.000	1105	2	-2.000			EM1110Y
2457- EM1110Y		1115	2	-4.0						
2458- MPC	100	1516	3	4.625	1406	3	-3.0			EM1516Z
2459- EM1516Z		1501	3	-5.625						
2460- MPC	100	1517	3	4.625	1407	3	-3.0			EM1517Z
2461- EM1517Z		1607	3	-5.625						
2462- MPC	100	1805	1	6.25	1804	1	-3.1			EM1805X
2463- EM1805X		1806	1	-3.15						
2464- MPC	100	1823	1	6.564	1822	1	-2.0			EM1823X
2465- EM1823X		1824	1	-4.564						
2466- MPC	100	1824	4	1.0	1823	3	-1.0			EM1824MX
2467- EM1824MX		1824	3	.5						
2468- MPC	100	1828	1	1.0	2200	1	-1.0			E48
2469- E48		2200	5	3.2083	2200	6	0.4121			
2470- MPC	100	1828	2	1.0	2200	2	-1.0			E49
2471- E49		2200	4	-3.2083	2200	6	5.187			
2472- MPC	100	1823	3	1.0	2200	3	-1.0			E50
2473- E50		2200	4	-0.4121	2200	5	-5.187			
2474- MPC	100	1832	1	1.0	2200	1	-1.0			E45
2475- E45		2200	5	-0.8471	2200	6	3.1217			
2476- MPC	100	1832	2	1.0	2200	2	-1.0			E46
2477- E46		2200	4	.8471	2200	6	5.187			
2478- MPC	100	1832	3	1.0	2200	3	-1.0			E47
2479- E47		2200	4	-3.1217	2200	5	-5.187			
2480- MPC	100	1928	3	4.644	1917	3	-3.1			EM1928Z
2481- EM1928Z		1918	3	-1.544						
2482- MPC	100	1931	2	7.439	1921	2	-4.2351			EM1931FY
2483- EM1931FY		2025	2	-3.2039						
2484- MPC	100	2035	1	1.0	2200	1	-1.0			E54
2485- E54		2200	5	3.2083	2200	6	0.4121			
2486- MPC	100	2035	2	1.0	2200	2	-1.0			E55
2487- E55		2200	4	-3.2083	2200	6	-5.454			
2488- MPC	100	2035	3	1.0	2200	3	-1.0			E56
2489- E56		2200	4	-0.4121	2200	5	5.454			
2490- MPC	100	2039	1	1.0	2200	1	-1.0			E51
2491- E51		2200	5	-0.8471	2200	6	3.1217			
2492- MPC	100	2039	2	1.0	2200	2	-1.0			E52
2493- E52		2200	4	.8471	2200	6	-4.920			
2494- MPC	100	2039	3	1.0	2200	3	-1.0			E53
2495- E53		2200	4	-3.1217	2200	5	4.920			
2496- MPC	101	1701	1	1.0	1701	3	-0.01699			EM1701XS
2497- EM1701XS		1800	1	-1.00187	1801	3	-0.04417			
2498- MPC	101	1721	1	1.0	1701	3	-0.01699			EM1721XS
2499- EM1721XS		1800	1	-1.00187	1801	3	-0.04417			
2500- MPC	101	1721	3	1.0	1701	3	-0.27778			EM1721ZS

SORTED BULK DATA ECHO

CARD	1	2	3	4	5	6	7	8	9	10
2501-EM1721ZS		1801		3	-.72222					
2502-MPC	101	1723	1		1.0	1721	1	-1.0		
2503-MPC	101	1724	1		1.0	1722	1	-1.0		
2504-MPC	101	1800	3		1.0	1701	3	-.27830	EM18002S	
2505-EM1800ZS		1800		1	-.06116	1801	3	-.72358		
2506-MPC	101	1801	1		1.0	1701	3	-.01699	EM1801XS	
2507-EM1801XS		1800		1	-1.00187	1801	3	-.04417		
2508-MPC	101	1802	1		1.0	1701	3	-.01699	EM1802XS	
2509-EM1802XS		1800		1	-1.00187	1801	3	-.04417		
2510-MPC	101	1802	3		1.0	1801	3	-1.0		
2511-MPC	102	1721	1		1.0	1701	2	.37892	EM1721XA	
2512-EM1721XA		1800		2	-.37892					
2513-MPC	102	1721	2		1.0	1800	2	-1.0		
2514-MPC	102	1721	3		1.0	1802	2	-.72225		
2515-MPC	102	1801	2		1.0	1800	2	-1.38462	EM1801YA	
2516-EM1801YA		1701		2	.38462					
2517-MPC	102	1802	1		1.0	1701	2	.52465	EM1802XA	
2518-EM1802XA		1800		2	-.52465					
2519-MPC	102	1802	2		1.0	1800	2	-1.38462	EM1802YA	
2520-EM1802YA		1701		2	.38462					
2521-MPCADD	401	100	101							
2522-MPCADD	402	100	102							
2523-PARAM	GRDPNT	0								
2524-PARAM	NOSUB	-1								
2525-PARAM	TPCOPY	1								
2526-PARAM	TPNAME	FUSSPI								
2527-PARAM	WTMASS	.002588								
2528-PBAR	181	12	.001		.001					
2529-PBAR	194	28	.001		.001					
2530-PBAR	463	2	.232		.0422	.0	.0	.0		
2531-PBAR	464	2	.232		.0422	.0	.0	.0		
2532-PBAR	465	2	.232		.0422	.0	.0	.0		
2533-PBAR	466	2	.232		.0422	.0	.0	.0		
2534-PBAR	467	2	.232		.0422	.0	.0	.0		
2535-PBAR	1927	2	.103		.0343	.0	.0	.0		
2536-PBAR	1928	2	.103		.0343	.0	.0	.0		
2537-PBAR	1929	2	.103		.0343	.0	.0	.0		
2538-PBAR	1930	2	.103		.0343	.0	.0	.0		
2539-PBAR	1931	2	.103		.0343	.0	.0	.0		
2540-PBAR	2101	2	.0992		.0325	.001	.001	.0		
2541-PBAR	2102	2	.0992		.0325	.001	.001	.0		
2542-PBAR	2103	2	.0992		.0325	.001	.001	.0		
2543-PBAR	2104	2	.0992		.0325	.001	.001	.0		
2544-PBAR	2105	2	.1048		.0355	.001	.001	.0		
2545-PBAR	2106	2	.1048		.0355	.001	.001	.0		
2546-PBAR	2107	2	.1048		.0355	.001	.001	.0		
2547-PBAR	2108	2	.1048		.0355	.001	.001	.0		
2548-PBAR	2109	2	.1048		.0355	.001	.001	.0		
2549-PBAR	2110	2	.1048		.0355	.001	.001	.0		
2550-PBAR	2111	2	.1048		.0355	.001	.001	.0		

PHASE 1: ORBITER FUSELAGE-SYMM CASE# REVISION 4/22/74
 SKINS HALF EFF. LONG. .85X EFF. TRANS. AT WING

MAY 6, 1974 NASTRAN 2/ 1/73 PAGE 71

SORTED BULK DATA FCHD

CARD	CHUNT	1	2	3	4	5	6	7	8	9	10
2551-	PHAR	2112	2		.1048	.0355	.001	.001	.0		
2552-	PHAR	2113	2		.1048	.0355	.001	.001	.0		
2553-	PHAR	2114	2		.1048	.0355	.001	.001	.0		
2554-	PHAR	2502	2		.10	.0465	.002	.0	.0		
2555-	PHAR	2713	2		.0649	.03	.0	.0	.0		
2556-	PQDMEM2	10161	6		.04000						
2557-	PQDMEM2	10162	6		.04000						
2558-	PQDMEM2	10163	6		.04000						
2559-	PQDMEM2	10164	6		.04000						
2560-	PQDMEM2	10165	6		.04000						
2561-	PQDMEM2	10166	6		.04000						
2562-	PQDMEM2	10167	6		.04000						
2563-	PQDMEM2	10168	6		.04000						
2564-	PQDMEM2	10169	6		.04000						
2565-	PQDMEM2	10170	6		.04000						
2566-	PQDMEM2	10171	6		.04000						
2567-	PQDMEM2	10172	6		.04000						
2568-	PQDMEM2	10173	6		.04000						
2569-	PQDMEM2	10174	6		.04000						
2570-	PQDMEM2	10175	6		.04000						
2571-	PQDMEM2	10176	6		.04000						
2572-	PQDMEM2	10177	6		.04000						
2573-	PQDMEM2	10270	6		.04000						
2574-	PQDMEM2	10271	6		.04000						
2575-	PQDMEM2	10272	6		.04000						
2576-	PQDMEM2	10273	6		.04000						
2577-	PQDMEM2	10274	6		.04000						
2578-	PQDMEM2	10275	6		.04000						
2579-	PQDMEM2	10276	6		.04000						
2580-	PQDMEM2	10277	6		.04000						
2581-	PQDMEM2	10278	6		.04000						
2582-	PQDMEM2	10279	6		.04000						
2583-	PQDMEM2	10280	6		.04000						
2584-	PQDMEM2	10281	6		.04000						
2585-	PQDMEM2	10282	6		.04000						
2586-	PQDMEM2	10283	6		.04000						
2587-	PQDMEM2	10284	6		.04000						
2588-	PQDMEM2	10285	6		.04000						
2589-	PQDMEM2	10286	6		.04000						
2590-	PQDMEM2	12040	6		.03200						
2591-	PQDMEM2	12041	6		.03200						
2592-	PQDMEM2	12042	6		.03200						
2593-	PQDMEM2	12043	6		.03200						
2594-	PQDMEM2	12044	6		.03200						
2595-	PQDMEM2	12045	6		.03200						
2596-	PQDMEM2	12046	6		.03200						
2597-	PQDMEM2	12047	6		.03200						
2598-	PQDMEM2	12048	6		.03200						
2599-	PQDMEM2	12049	6		.03200						
2600-	PQDMEM2	12050	6		.03200						

PHASE 1 ORBITER FUSELAGE-SYMM CASE# REVISION 4/22/74
 SKINS HALF EFF. LONG. .85X EFF. TRANS. AT WING

MAY 6, 1974 NASTRAN 2/ 1/73 PAGE 72

SORTED BULK DATA ECHO

CARD	1	2	3	4	5	6	7	8	9	10
2601-	PQDMEM2	12051	6		.03200					
2602-	PQDMEM2	12052	6		.03200					
2603-	PQDMEM2	12053	6		.03200					
2604-	PQDMEM2	12054	6		.03200					
2605-	PQDMEM2	12055	6		.03200					
2606-	PQDMEM2	12056	6		.03200					
2607-	PQDMEM2	12057	6		.03200					
2608-	PQDMEM2	12058	6		.03200					
2609-	PQDMEM2	12059	6		.03200					
2610-	PQDMEM2	12060	6		.03200					
2611-	PQDMEM2	12061	6		.03200					
2612-	PQDMEM2	12062	6		.03200					
2613-	PQDMEM2	12063	6		.03200					
2614-	PQDMEM2	12064	6		.03200					
2615-	PQDMEM2	12065	6		.03200					
2616-	PQDMEM2	12066	6		.03200					
2617-	PQDMEM2	12068	6		.03200					
2618-	PQDMEM2	12069	6		.03200					
2619-	PQDMEM2	12200	8		.02000					
2620-	PQDMEM2	12201	8		.02000					
2621-	PQDMEM2	12202	8		.02000					
2622-	PQDMEM2	12203	8		.02000					
2623-	PQDMEM2	12204	8		.02000					
2624-	PQDMEM2	12205	8		.02000					
2625-	PQDMEM2	12206	8		.02000					
2626-	PQDMEM2	12207	8		.02000					
2627-	PQDMEM2	12208	8		.02000					
2628-	PQDMEM2	12209	8		.02000					
2629-	PQDMEM2	12300	8		.02000					
2630-	PQDMEM2	12301	8		.02000					
2631-	PQDMEM2	12302	8		.02000					
2632-	PQDMEM2	12303	8		.02000					
2633-	PQDMEM2	12304	8		.02000					
2634-	PQDMEM2	12305	8		.02000					
2635-	PQDMEM2	12306	8		.02000					
2636-	PQDMEM2	12307	8		.02000					
2637-	PQDMEM2	12308	8		.02000					
2638-	PQDMEM2	12309	8		.02000					
2639-	PQDMEM2	12310	8		.02000					
2640-	PQDMEM2	12311	8		.02000					
2641-	PQDMEM2	12312	8		.02000					
2642-	PQDMEM2	12313	8		.02000					
2643-	PQDMEM2	12403	8		.02000					
2644-	PQDMEM2	12404	8		.02000					
2645-	PQDMEM2	12405	8		.02000					
2646-	PQDMEM2	12406	8		.02000					
2647-	PQDMEM2	12407	8		.02000					
2648-	PQDMEM2	12408	8		.02000					
2649-	PQDMEM2	12409	8		.02000					
2650-	PQDMEM2	12410	8		.02000					

PHASE 1 ORBITER FUSELAGE-SYMM CASE# REVISION 4/22/74
 SKINS HALF EFF. LONG., 85% EFF. TRANS. AT WING

MAY 6, 1974 NASTRAN 2/ 1/73 PAGE 73

SORTED BULK DATA ECHO

CARD	1	2	3	4	5	6	7	8	9	10
2651-	PQDMEM2	12411	8		.02000					
2652-	PQDMEM2	12413	8		.02000					
2653-	PQDMEM2	12414	8		.02000					
2654-	PQDMEM2	12415	8		.02000					
2655-	PQDMEM2	12416	8		.02000					
2656-	PQDMEM2	12417	8		.02000					
2657-	PQDMEM2	12418	8		.02000					
2658-	PQDMEM2	12419	8		.02000					
2659-	PQDMEM2	12420	8		.02000					
2660-	PQDMEM2	12421	8		.02000					
2661-	PQDMEM2	12422	8		.02000					
2662-	PQDMEM2	12424	8		.02000					
2663-	PQDMEM2	12425	8		.02000					
2664-	PQDMEM2	12426	8		.02000					
2665-	PQDMEM2	12427	8		.02000					
2666-	PQDMEM2	12428	8		.02000					
2667-	PQDMEM2	12429	8		.02000					
2668-	PQDMEM2	12430	8		.02000					
2669-	PQDMEM2	12431	8		.02000					
2670-	PQDMEM2	12432	8		.02000					
2671-	PQDMEM2	12650	18		.375					
2672-	PQDMEM2	12651	18		.375					
2673-	PQDMEM2	12652	18		.375					
2674-	PQDMEM2	12653	18		.375					
2675-	PQDMEM2	12654	18		.375					
2676-	PQDMEM2	12655	18		.375					
2677-	PQDMEM2	12656	8		.02000					
2678-	PQDMEM2	12657	8		.02000					
2679-	PQDMEM2	12658	8		.02000					
2680-	PQDMEM2	12659	8		.02000					
2681-	PQDMEM2	12700	9		.01600					
2682-	PQDMEM2	12701	9		.01600					
2683-	PQDMEM2	12702	9		.01600					
2684-	PQDMEM2	12703	9		.01600					
2685-	PQDMEM2	12704	9		.01600					
2686-	PQDMEM2	12705	9		.01600					
2687-	PSHEAR	10178	6		.04000					
2688-	PSHEAR	10179	6		.04000					
2689-	PSHEAR	10287	6		.04000					
2690-	PSHEAR	10288	6		.04000					
2691-	PSHEAR	10289	6		.04000					
2692-	PSHEAR	10290	6		.04000					
2693-	PSHEAR	10291	6		.04000					
2694-	PSHEAR	10292	6		.04000					
2695-	PSHEAR	10293	6		.04000					
2696-	PSHEAR	10294	6		.04000					
2697-	PSHEAR	10295	6		.04000					
2698-	PSHEAR	10296	6		.04000					
2699-	PSHEAR	10351	6		.12500					
2700-	PSHEAR	10352	6		.12500					

S O R T E D B U L K D A T A F C H O

CARD	COUNT	1	2	3	4	5	6	7	8	9	10
2701-	PSHEAR	10353	6		.12500						
2702-	PSHEAR	10354	6		.21600						
2703-	PSHEAR	10355	6		.09100						
2704-	PSHEAR	10356	6		.09100						
2705-	PSHEAR	10357	6		.09100						
2706-	PSHEAR	10358	6		.09100						
2707-	PSHEAR	10401	6		.12500						
2708-	PSHEAR	10402	6		.12500						
2709-	PSHEAR	10403	6		.12500						
2710-	PSHEAR	10404	6		.12500						
2711-	PSHEAR	10551	6		.12500						
2712-	PSHEAR	10552	6		.12500						
2713-	PSHEAR	10553	6		.12500						
2714-	PSHEAR	10554	6		.21600						
2715-	PSHEAR	10555	6		.09100						
2716-	PSHEAR	10556	6		.09100						
2717-	PSHEAR	10557	6		.09100						
2718-	PSHEAR	10558	6		.09100						
2719-	PSHEAR	10651	6		.12500						
2720-	PSHEAR	10652	6		.12500						
2721-	PSHEAR	10653	6		.12500						
2722-	PSHEAR	10654	6		.21600						
2723-	PSHEAR	10655	6		.09100						
2724-	PSHEAR	10656	6		.09100						
2725-	PSHEAR	10657	6		.09100						
2726-	PSHEAR	10658	6		.09100						
2727-	PSHEAR	10751	6		.12500						
2728-	PSHEAR	10752	6		.12500						
2729-	PSHEAR	10753	6		.12500						
2730-	PSHEAR	10754	6		.21600						
2731-	PSHEAR	10755	6		.09100						
2732-	PSHEAR	10756	6		.09100						
2733-	PSHEAR	10757	6		.09100						
2734-	PSHEAR	10758	6		.09100						
2735-	PSHEAR	10851	6		.12500						
2736-	PSHEAR	10852	6		.12500						
2737-	PSHEAR	10853	6		.12500						
2738-	PSHEAR	10854	6		.21600						
2739-	PSHEAR	10855	6		.09100						
2740-	PSHEAR	10856	6		.09100						
2741-	PSHEAR	10857	6		.09100						
2742-	PSHEAR	10858	6		.09100						
2743-	PSHEAR	10951	6		.04000						
2744-	PSHEAR	10952	6		.04000						
2745-	PSHEAR	10953	6		.04000						
2746-	PSHEAR	10954	6		.13100						
2747-	PSHEAR	10959	6		.09100						
2748-	PSHEAR	10960	6		.09100						
2749-	PSHEAR	10961	6		.09100						
2750-	PSHEAR	10962	6		.09100						

SORTED BULK DATA ECHO

CARD	1	2	3	4	5	6	7	8	9	10
2751-	PSHEAR	11040	6	.04000						
2752-	PSHEAR	11041	6	.04000						
2753-	PSHEAR	11042	6	.04000						
2754-	PSHEAR	11043	6	.13100						
2755-	PSHEAR	11048	6	.09100						
2756-	PSHEAR	11049	6	.09100						
2757-	PSHEAR	11050	6	.09100						
2758-	PSHEAR	11051	6	.09100						
2759-	PSHEAR	11140	6	.04000						
2760-	PSHEAR	11141	6	.04000						
2761-	PSHEAR	11142	6	.04000						
2762-	PSHEAR	11143	6	.13100						
2763-	PSHEAR	11145	6	.09100						
2764-	PSHEAR	11146	6	.09100						
2765-	PSHEAR	11147	6	.09100						
2766-	PSHEAR	11148	6	.09100						
2767-	PSHEAR	11240	6	.12500						
2768-	PSHEAR	11241	6	.12500						
2769-	PSHEAR	11242	6	.12500						
2770-	PSHEAR	11243	6	.21600						
2771-	PSHEAR	11244	6	.09100						
2772-	PSHEAR	11245	6	.09100						
2773-	PSHEAR	11246	6	.09100						
2774-	PSHEAR	11247	6	.09100						
2775-	PSHEAR	11248	6	.09100						
2776-	PSHEAR	11340	6	.12500						
2777-	PSHEAR	11341	6	.12500						
2778-	PSHEAR	11342	6	.12500						
2779-	PSHEAR	11343	6	.21600						
2780-	PSHEAR	11344	6	.09100						
2781-	PSHEAR	11345	6	.09100						
2782-	PSHEAR	11346	6	.09100						
2783-	PSHEAR	11347	6	.09100						
2784-	PSHEAR	11348	6	.09100						
2785-	PSHEAR	11440	6	.04000						
2786-	PSHEAR	11441	6	.04000						
2787-	PSHEAR	11442	6	.04000						
2788-	PSHEAR	11443	6	.13100						
2789-	PSHEAR	11444	6	.09100						
2790-	PSHEAR	11445	6	.09100						
2791-	PSHEAR	11446	6	.09100						
2792-	PSHEAR	11447	6	.09100						
2793-	PSHEAR	11540	6	.09100						
2794-	PSHEAR	11541	6	.09100						
2795-	PSHEAR	11542	6	.09100						
2796-	PSHEAR	11543	6	.09100						
2797-	PSHEAR	11640	6	.04000						
2798-	PSHEAR	11641	6	.04000						
2799-	PSHEAR	11642	6	.04000						
2800-	PSHEAR	11643	6	.13100						

S O R T E D B U L K D A T A F C H D

CARD	1	2	3	4	5	6	7	8	9	10
2801-	PSHEAR	11644	6		.09100					
2802-	PSHEAR	11645	6		.09100					
2803-	PSHEAR	11646	6		.09100					
2804-	PSHEAR	11647	6		.09100					
2805-	PSHEAR	11740	6		.04000					
2806-	PSHEAR	11741	6		.04000					
2807-	PSHEAR	11742	6		.04000					
2808-	PSHEAR	11743	6		.13100					
2809-	PSHEAR	11744	6		.09100					
2810-	PSHEAR	11745	6		.09100					
2811-	PSHEAR	11746	6		.09100					
2812-	PSHEAR	11747	6		.09100					
2813-	PSHEAR	11860	6		.04000					
2814-	PSHEAR	11861	6		.04000					
2815-	PSHEAR	11862	6		.04000					
2816-	PSHEAR	11863	6		.04000					
2817-	PSHEAR	11864	6		.08000					
2818-	PSHEAR	11865	6		.04000					
2819-	PSHEAR	11866	6		.04000					
2820-	PSHEAR	11867	6		.04000					
2821-	PSHEAR	11868	6		.04000					
2822-	PSHEAR	11869	5		.04000					
2823-	PSHEAR	11870	6		.04000					
2824-	PSHEAR	11871	6		.04000					
2825-	PSHEAR	11872	6		.04000					
2826-	PSHEAR	11873	6		.04000					
2827-	PSHEAR	11874	6		.04000					
2828-	PSHEAR	11875	6		.04000					
2829-	PSHEAR	11876	6		.04000					
2830-	PSHEAR	11877	6		.04000					
2831-	PSHEAR	11878	6		.04000					
2832-	PSHEAR	11879	6		.04000					
2833-	PSHEAR	11940	6		.08000					
2834-	PSHEAR	11941	6		.04000					
2835-	PSHEAR	11942	6		.04000					
2836-	PSHEAR	11943	6		.04000					
2837-	PSHEAR	11944	6		.04000					
2838-	PSHEAR	11945	6		.08000					
2839-	PSHEAR	11946	6		.04000					
2840-	PSHEAR	11947	6		.04000					
2841-	PSHEAR	11948	6		.04000					
2842-	PSHEAR	12210	26		.025					
2843-	PSHEAR	12320	36		.020					
2844-	PSHEAR	12412	16		.020					
2845-	PSHEAR	12600	46		.020					
2846-	PSHEAR	12630	16		.02000					
2847-	PSHEAR	12631	16		.02000					
2848-	PSHEAR	12632	16		.02000					
2849-	PSHEAR	12634	16		.02000					
2850-	PSHEAR	12635	16		.02000					

SORTED BULK DATA ECHO

CARD	COUNT	1	2	3	4	5	6	7	8	9	10
2851-	PSHEAR	12636	16		.02000						
2852-	PSHEAR	12635	16		.02000						
2853-	PSHEAR	12640	16		.04000						
2854-	PSHEAR	12641	16		.04000						
2855-	PSHEAR	12706	16		.01600						
2856-	PSHEAR	12707	16		.03200						
2857-	PSHEAR	12708	16		.03200						
2858-	PTRMEM	10180	4		.04000						
2859-	PTRMEM	10297	4		.04000						
2860-	PTRMEM	12067	4		.03200						
2861-	PTRMEM	12070	4		.032						
2862-	PTRMEM	12278	8		.02500						
2863-	PTRMEM	12620	8		.02000						
2864-	SPC1	200	1	107		THRU	109				
2865-	SPC1	200	1	116		THRU	119				
2866-	SPC1	200	1	121		THRU	124				
2867-	SPC1	200	1	126		THRU	130				
2868-	SPC1	200	1	208		THRU	211				
2869-	SPC1	200	1	214		THRU	217				
2870-	SPC1	200	1	225		226	228	229	231	232	
2871-	SPC1	200	1	234		235	237	238	240	241	
2872-	SPC1	200	1	506		THRU	509				
2873-	SPC1	200	1	511		513	515	517			
2874-	SPC1	200	1	606		THRU	609				
2875-	SPC1	200	1	611		613	615	617			
2876-	SPC1	200	1	706		THRU	709				
2877-	SPC1	200	1	711		713	715	717			
2878-	SPC1	200	1	806		THRU	809				
2879-	SPC1	200	1	811		813	815	817			
2880-	SPC1	200	1	912		THRU	914				
2881-	SPC1	200	1	916		918	920	922			
2882-	SPC1	200	1	1012		THRU	1014				
2883-	SPC1	200	1	1016		1018	1020	1022			
2884-	SPC1	200	1	1112		THRU	1114				
2885-	SPC1	200	1	1116		1118	1120	1122			
2886-	SPC1	200	1	1207		THRU	1209				
2887-	SPC1	200	1	1211		1213	1215	1217	1219		
2888-	SPC1	200	1	1307		THRU	1309				
2889-	SPC1	200	1	1311		1313	1315	1317	1319		
2890-	SPC1	200	1	1411		1413	1415	1417			
2891-	SPC1	200	1	1503		1505	1507	1509			
2892-	SPC1	200	1	1611		1613	1615	1617			
2893-	SPC1	200	1	1711		1713	1715	1717			
2894-	SPC1	200	1	1813		1815	1818	1819			
2895-	SPC1	200	1	1825		THRU	1827				
2896-	SPC1	200	1	1829		THRU	1831				
2897-	SPC1	200	1	1833		THRU	1835				
2898-	SPC1	200	1	1906		THRU	1913				
2899-	SPC1	200	1	2006		THRU	2009				
2900-	SPC1	200	1	2012		2013	2027	2028			

SORTED PULK DATA FCHD

CARD	1	2	3	4	5	6	7	8	9	10
2901- SPC1	200	1	2016	THRU	2019					
2902- SPC1	200	1	2021	THRU	2024					
2903- SPC1	200	1	2031	THRU	2034					
2904- SPC1	200	1	2036	THRU	2038					
2905- SPC1	200	4	243	518	616	713	760	818		
2906- SPC1	200	4	923	1027	1123	1161	1220	1320		
2907- SPC1	200	4	1418	1510	1616	1718				
2908- SPC1	200	5	1922							
2909- SPC1	200	6	1930							
2910- SPC1	200	40	1521	1934						
2911- SPC1	200	56	151	THRU	169					
2912- SPC1	200	56	305	310	312	314	316			
2913- SPC1	200	56	1201	1206	1221					
2914- SPC1	200	56	1908	1918	1919	1920	1921			
2915- SPC1	200	55	1923	THRU	1927					
2916- SPC1	200	56	1929							
2917- SPC1	200	456	101	THRU	131					
2918- SPC1	200	456	201	THRU	230					
2919- SPC1	200	456	231	THRU	242					
2920- SPC1	200	456	301	THRU	304					
2921- SPC1	200	456	501	THRU	517					
2922- SPC1	200	456	601	THRU	617					
2923- SPC1	200	456	701	THRU	717					
2924- SPC1	200	456	801	THRU	817					
2925- SPC1	200	456	901	THRU	905					
2926- SPC1	200	456	910	THRU	922					
2927- SPC1	200	456	1001	THRU	1005					
2928- SPC1	200	456	1010	THRU	1022					
2929- SPC1	200	456	1101	THRU	1105					
2930- SPC1	200	456	1110	THRU	1122					
2931- SPC1	200	456	1202	THRU	1205					
2932- SPC1	200	456	1207	THRU	1219					
2933- SPC1	200	456	1301	THRU	1319					
2934- SPC1	200	456	1321	1516	1517					
2935- SPC1	200	456	1401	THRU	1417					
2936- SPC1	200	456	1501	THRU	1509					
2937- SPC1	200	456	1601	THRU	1617					
2938- SPC1	200	456	1701	THRU	1717					
2939- SPC1	200	456	1721	THRU	1724					
2940- SPC1	200	456	1800							
2941- SPC1	200	456	1801	THRU	1815					
2942- SPC1	200	456	1817	THRU	1820					
2943- SPC1	200	456	1822	THRU	1823					
2944- SPC1	200	456	1825	THRU	1838					
2945- SPC1	200	456	1901	THRU	1904					
2946- SPC1	200	456	1906	THRU	1917					
2947- SPC1	200	456	1928	1935	1936					
2948- SPC1	200	456	1931	THRU	1933					
2949- SPC1	200	456	2001	THRU	2042					
2950- SPC1	200	1456	306	THRU	309					

SORTED BULK DATA ECHO

CARD	1	2	3	4	5	6	7	8	9	10
2951- SPC1	200	1456	311	313	315	317				
2952- SPC1	200	1455	406	THRU	409					
2953- SPC1	201	2	101	106	111	115	121	130		
2954- SPC1	201	2	131	201	207	213	219			
2955- SPC1	201	2	240	THRU	242					
2956- SPC1	201	2	301	306	406					
2957- SPC1	201	2	501	506	601	606	701	706		
2958- SPC1	201	2	801	806	901	911	1001	1011		
2959- SPC1	201	2	1101	1301	1321	1401	1406			
2960- SPC1	201	2	1111							
2961- SPC1	201	2	1601	1606	1516					
2962- SPC1	201	2	1701	1706	1723	1724	1800			
2963- SPC1	201	2	1721	1802						
2964- SPC1	201	2	1801	1807	1821	1825	1829	1833		
2965- SPC1	201	2	1837	1901	1906	1910	1914			
2966- SPC1	201	2	1934	1936	2001	2006	2011	2016		
2967- SPC1	201	2	2021	2026	2031	2036	2040			
2968- SPC1	201	24	151	164	166	165	1201	1221		
2969- SPC1	201	24	1927	1930						
2970- SPC1	201	246	2101	2115						
2971- SPC1	202	3	116	121	130	213	240	241		
2972- SPC1	202	3	306	406	506	606	706	806		
2973- SPC1	202	3	1825	1829	1833	1906	1910			
2974- SPC1	202	3	2006	2016	2021	2031	2036			
2975- SPC1	202	13	101	106	111	131	165			
2976- SPC1	202	13	151	164	166	201	207	219		
2977- SPC1	202	13	242	301	501	601	701	1101		
2978- SPC1	202	13	801	901	911	1001	1011			
2979- SPC1	202	13	1111	1401	1406	1516	1601	1606		
2980- SPC1	202	13	1201	1206	1221	1301	1306	1321		
2981- SPC1	202	13	1701	1706	1723	1724				
2982- SPC1	202	13	1800	1801	1807	1837				
2983- SPC1	202	13	1901	1914	1927	1936				
2984- SPC1	202	13	2001	2011	2026	2040				
2985- SPC1	202	135	1821	1930	1934					
2986- SPC1	202	135	2101	2115						
2987- SPCADD	301	200	201							
2988- SPCADD	302	200	202							
2989- SUPORT	301	3	1800	1	1806	3				
ENDDATA										

PHASE 1 ORBITER FUSELAGE-SYMM CASE# REVISION 5/10/74
 SKINS HALF EFF.LONG..85% EFF.TRANS.AT WING%G#2/3EFF.#

MAY 21, 1974 NASTRAN 2/ 1/73 PAGE 11

INPUT BULK DATA DECK ECHO

	.	1	..	2	..	3	..	4	..	5	..	6	..	7	..	8	..	9	..	10	.
Y	\$	CHANGE	REVISED	SYMM	FUSELAGE	SHELL	G	TO	2/3	EFF											
	/		2424																		
	/		2426		2427																
	MAT1		26		7.066			.3		.1											
	MAT1		36		7.066			.3		.1											
	MAT1		46		7.066			.3		.1											
	ENDDATA																				

TOTAL COUNT# 7

*NOTE: PREVIOUS RUN HAD G HALF EFFECTIVE, WHICH PRODUCED
 RESULTS THAT ARE TOO FLEXIBLE FOR CASES WHERE
 SHEAR DEFORMATION ARE IMPORTANT.

PHASE 1 XORBITER FUSELAGE-ANTI CASE# REVISION 4/22/74
SKINS HALF EFF.LONG.,85X EFF.TRANS.AT WING

MAY 11, 1974 NASTRAN 2/ 1/73 PAGE 5

CASE CONTROL DECK ECHO

CARD
COUNT

1	TITLE # PHASE 1 XORBITER FUSELAGE-ANTI CASE# REVISION 4/22/74
2	SUBTITLE # SKINS HALF EFF.LONG.,85X EFF.TRANS.AT WING
3	ECHO # BOTH
4	MPC # 402
5	SPC # 302
6	METHOD # 1
7	BEGIN BULK

PHASE 1 XORBITER FUSELAGE-ANTI CASE# REVISION 4/22/74
 SKINS HALF EFF.LONG.,85% EFF.TRANS.AT WING

MAY 11. 1974 NASTRAN 2/ 1/73 PAGE 6

INPUT BULK DATA DECK ECHO

	1	2	3	4	5	6	7	8	9	10
\$ CONVERT REVISED SYMM FUSELAGE TO REVISED ANTI FUSELAGE										
/	2	3								
/	5									
/	7	9								
/	2458	2459								
/	2524									
/	2526									
/	2989									
ASET1	2	1800								
ASET1	2	101	201	301	501	601	701	801		
ASET1	2	1516								
ASET1	2	241	506	1701	1833					
ASET1	2	111	219	1301	1901	2026	2101			
ASET1	2	901	1101	1201	1401	1601	1606	2001		
ASET1	3	1802								
PARAM	TPNAME	FUSAPI								
SUPPORT	301	2	1800	2	1806	3				
ENDDATA										

TOTAL COUNT# 18

*** USER INFORMATION MESSAGE 207. BULK DATA NOT SORTED,XSORT WILL RE-ORDER DECK.

Appendix A7
PLOTS OF MEMBER DATA/PHASE 1 ANALYSIS:
MODEL II FUSELAGE

4/25/74

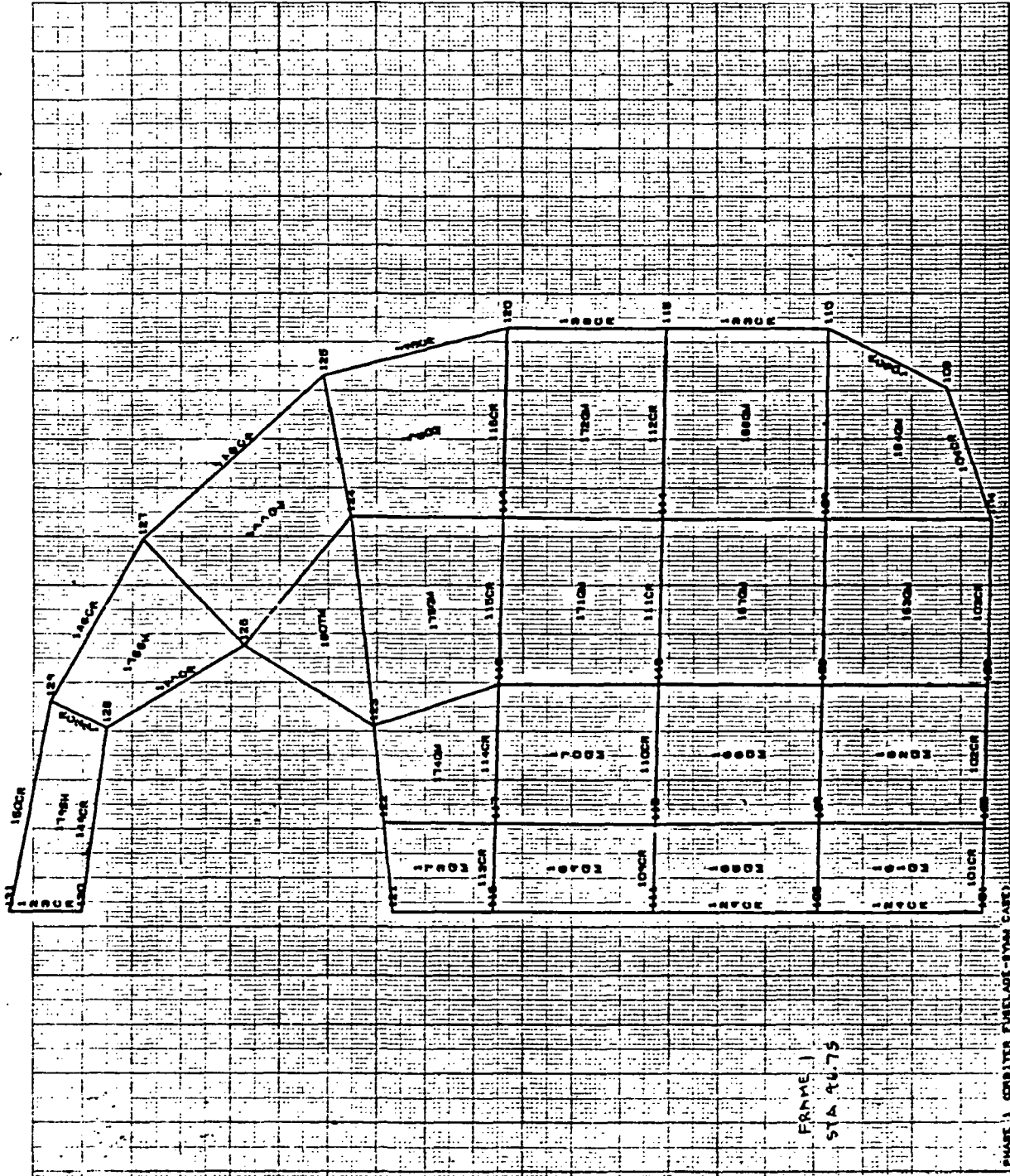

FRAME 1
STA 96.75

FRAME 1 CORBITER FUSELAGE-SWAY CASE
REVISION 4/25/74 QUAL EFFECTIVE SKINS
UNDEFORMED SHAPE

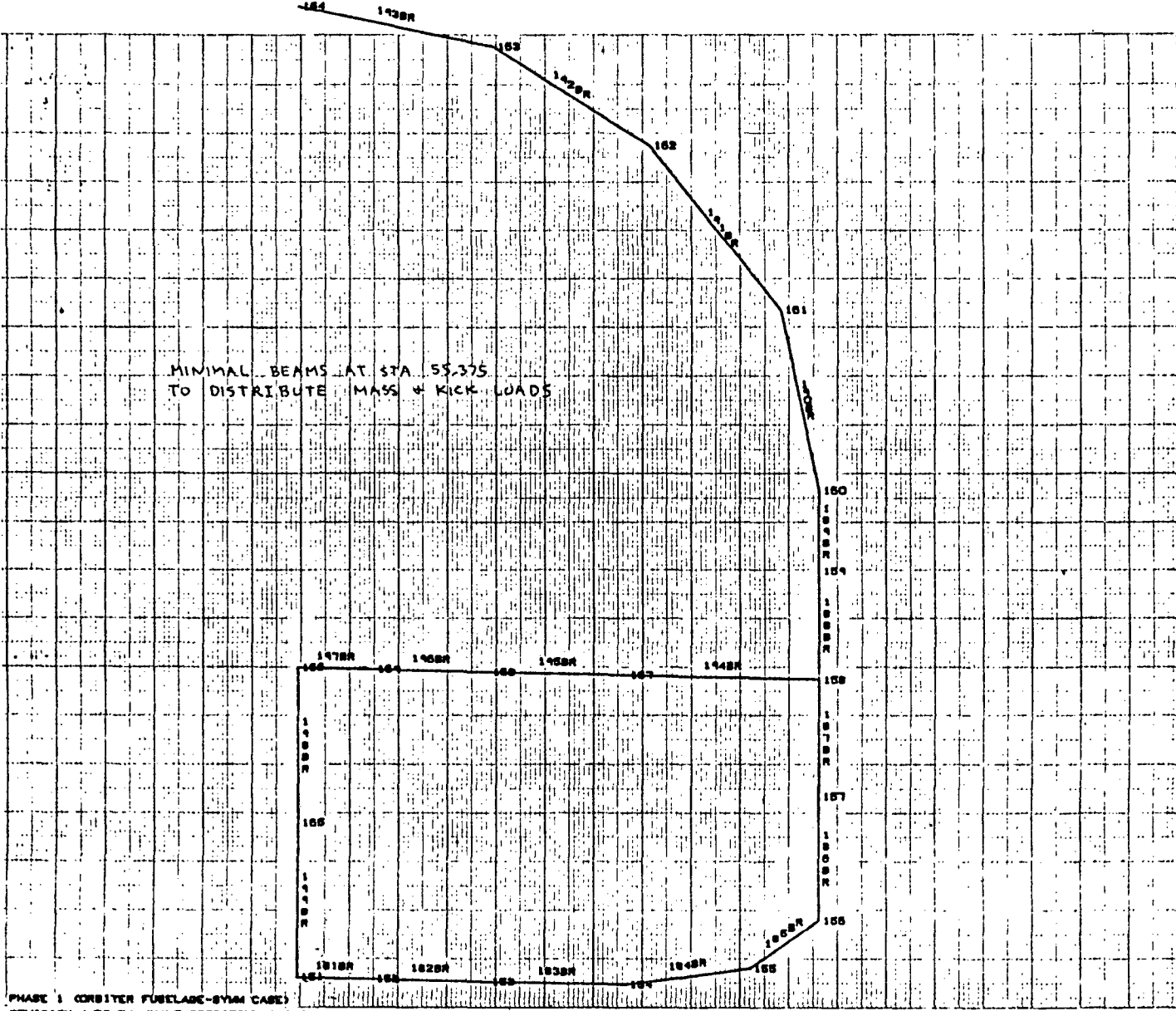

PHASE 1 ORBITER FUELADE-SYMM CASE)
REVISION 4/22/74 (HALF EFFECTIVE SKINS)

UNDEFORMED SHAPE

4/25/74

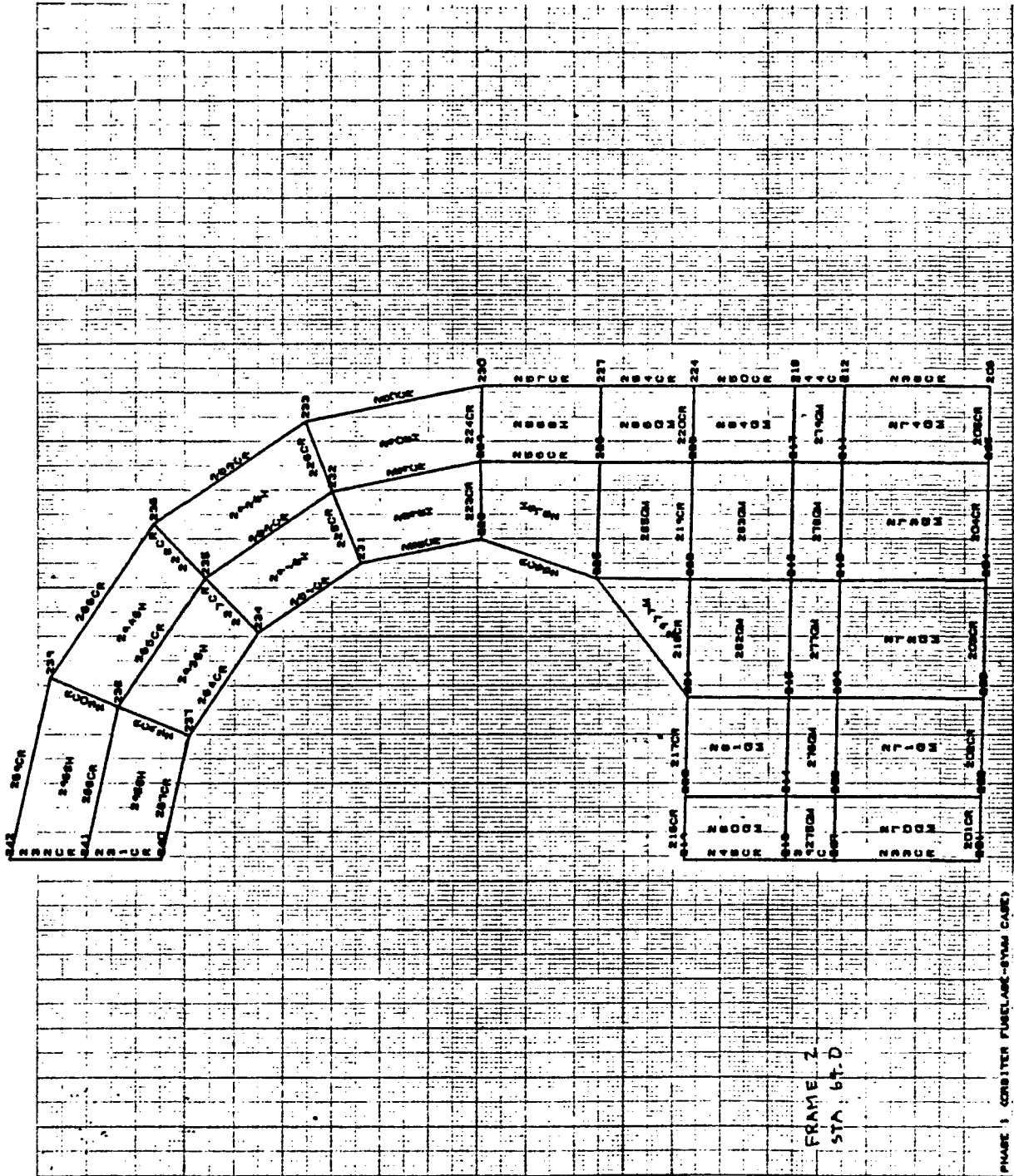

FRAME Z
STA 67-D

PHASE 1 CONBITER FUSELAGE-SYAM CASE)
REVISION 4/25/74 (HALF EFFECTIVE BRING)

UNDEFORMED SHAPE

4/28/74

4

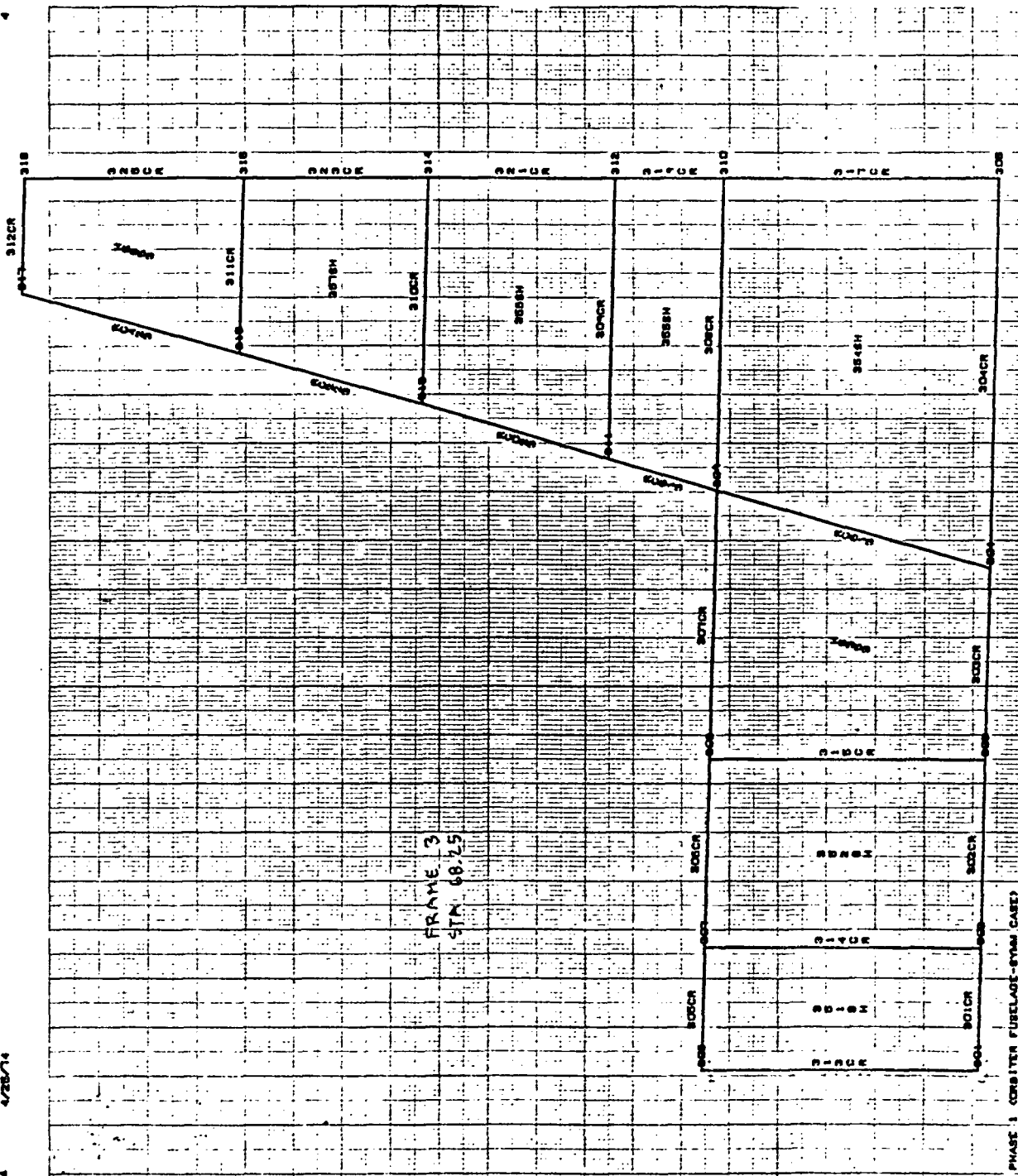

PHASE 1 CORBITER FUELAOS-STYAM CASE)
 REVISION 4/28/74 QUAL EFFECTIVE SKINS)

UNDISTORTED SHAPE

4/25/74

5

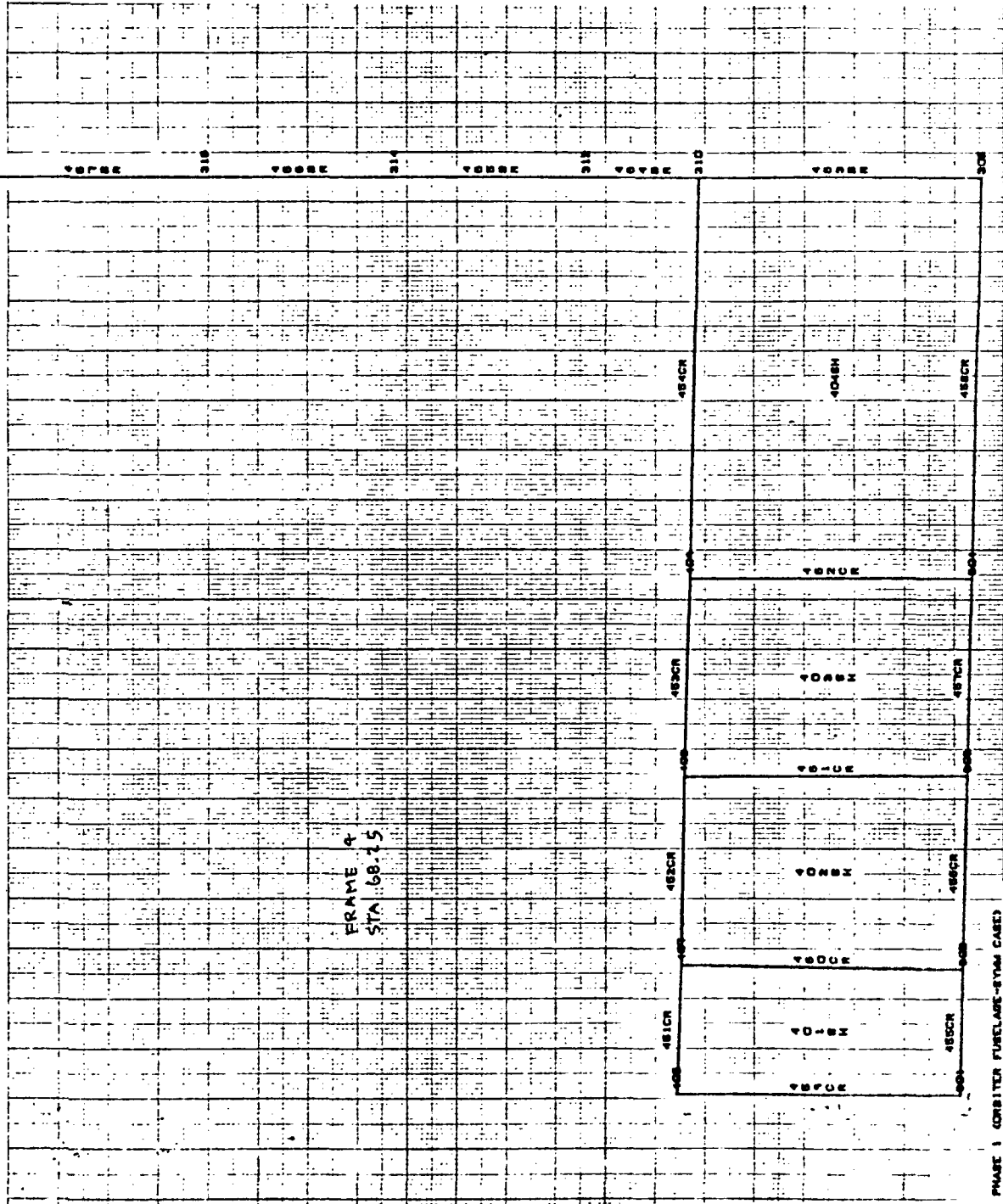

FRAME 4
STA 168-15

PHASE 1 ORBITER FUELTANK-SYMM CASE)
REVISION 4/25/74 (HALF EFFECTIVE BRINE)
UNSTOWED SHAPE

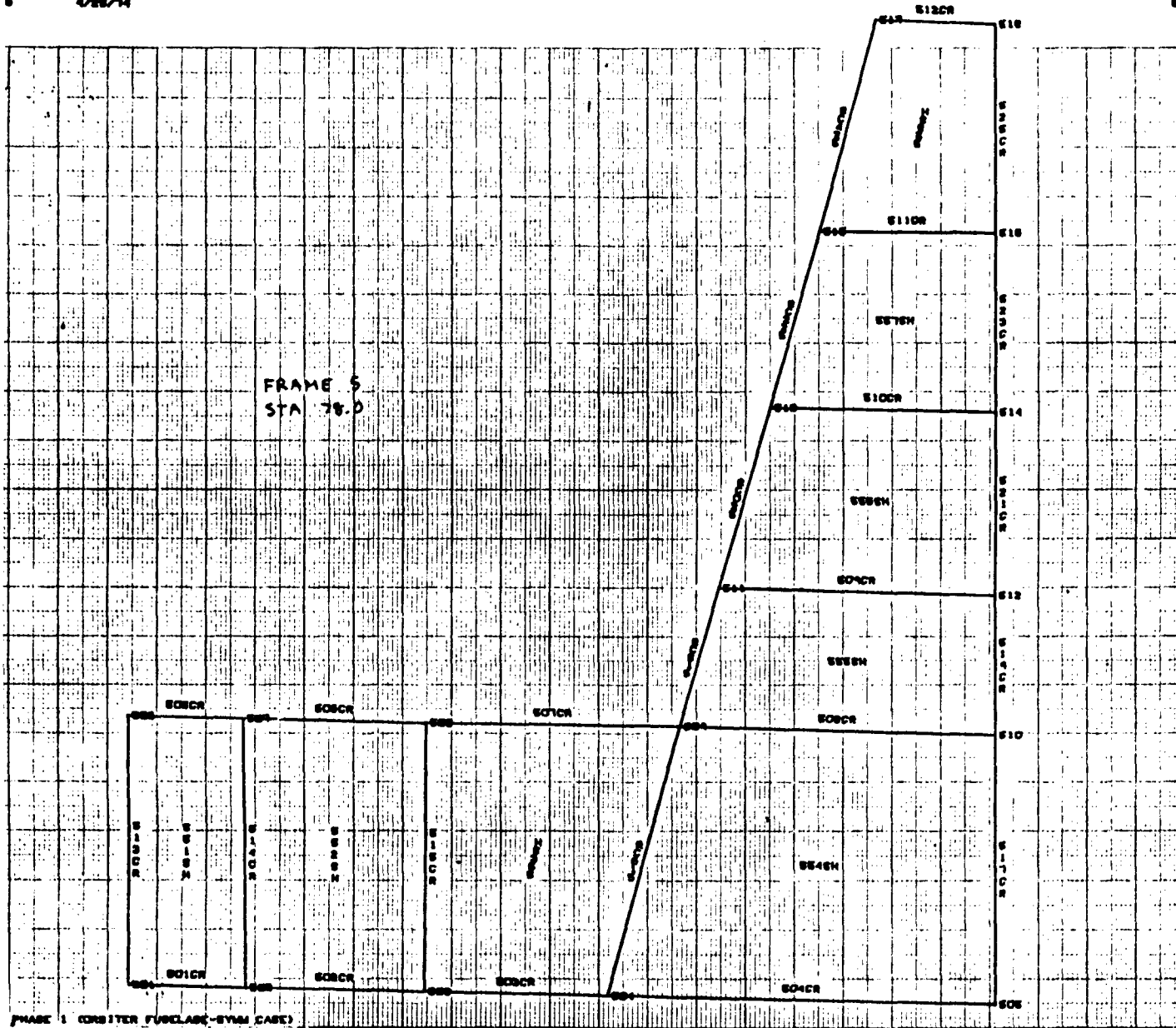

(PHASE 1 CORBITER FURCLAGE - SYMM CASE)
 REVISION 4/22/74 (HALF EFFECTIVE SKINS)

UNDEFORMED SHAPE

7 4/28/74

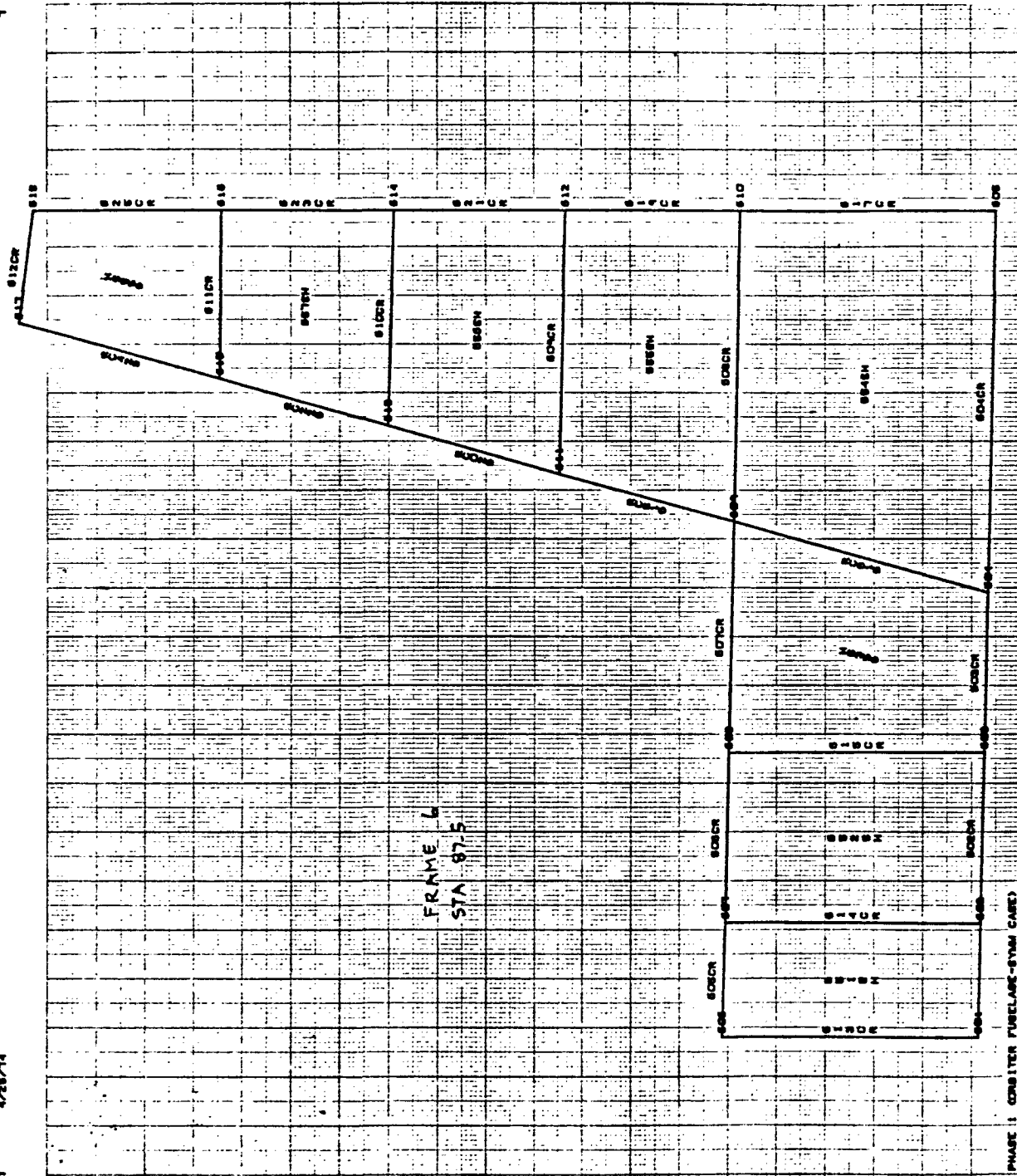

PHASE 1: CORBITER FUELAGE-SUM CASE)
 REVISION 4/22/74 (HALF EFFECTIVE SKINS)

UNDEFORMED SHAPE



FRAME 7
 STA 97.0

PHASE I CORBITER FURCLARK-SYAM CASE
 REVISION 4/23/74 QUAL EFFECTIVE BRIMS
 UNIFORMED SHAPE

4/28/74

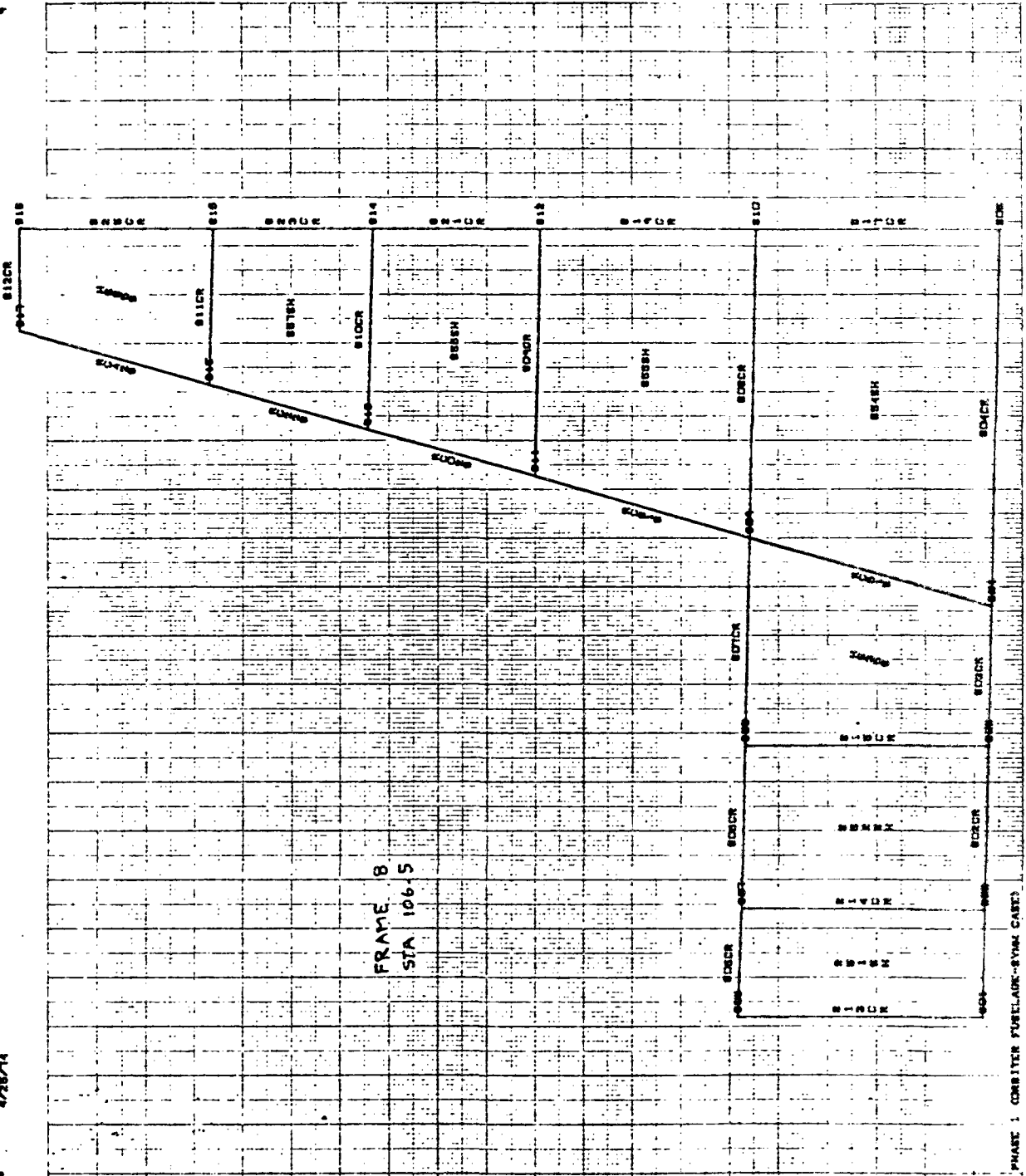

FRAME 8
STA 106.5

PHASE 1 CONCRETE FORELARK-SYMA CASE
REVISION 4/23/74 (HALF EFFECTIVE REVISION)
UNDETERMINED SHAPE

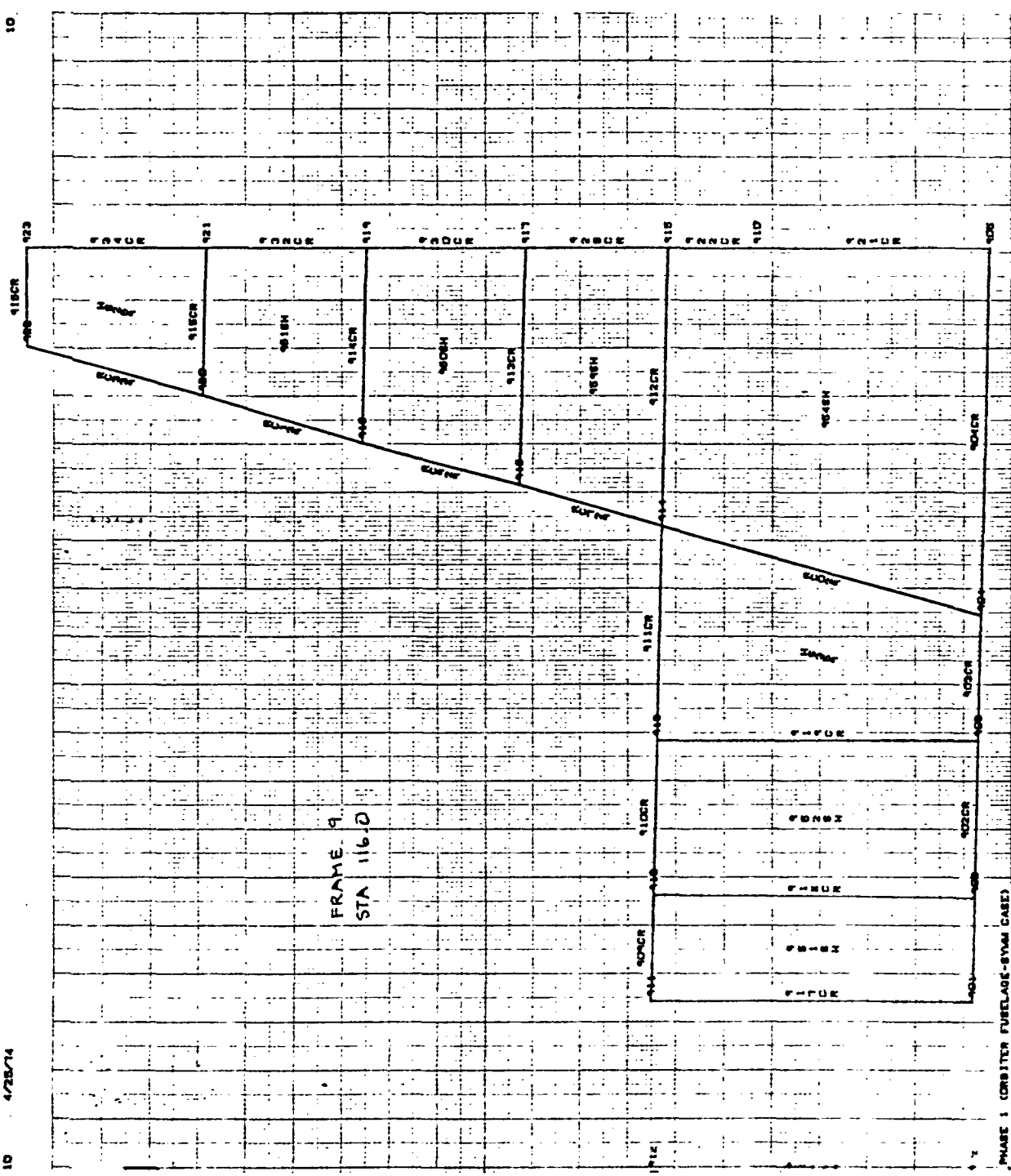

FRAME 9
STA 116.0

PHASE 1 (ORBITER FUELAJE-BYAM CASE)
REVISION 4/22/74 (HALF EFFECTIVE SKINS)
UNDISTORTED SHAPE

1012CR 1023

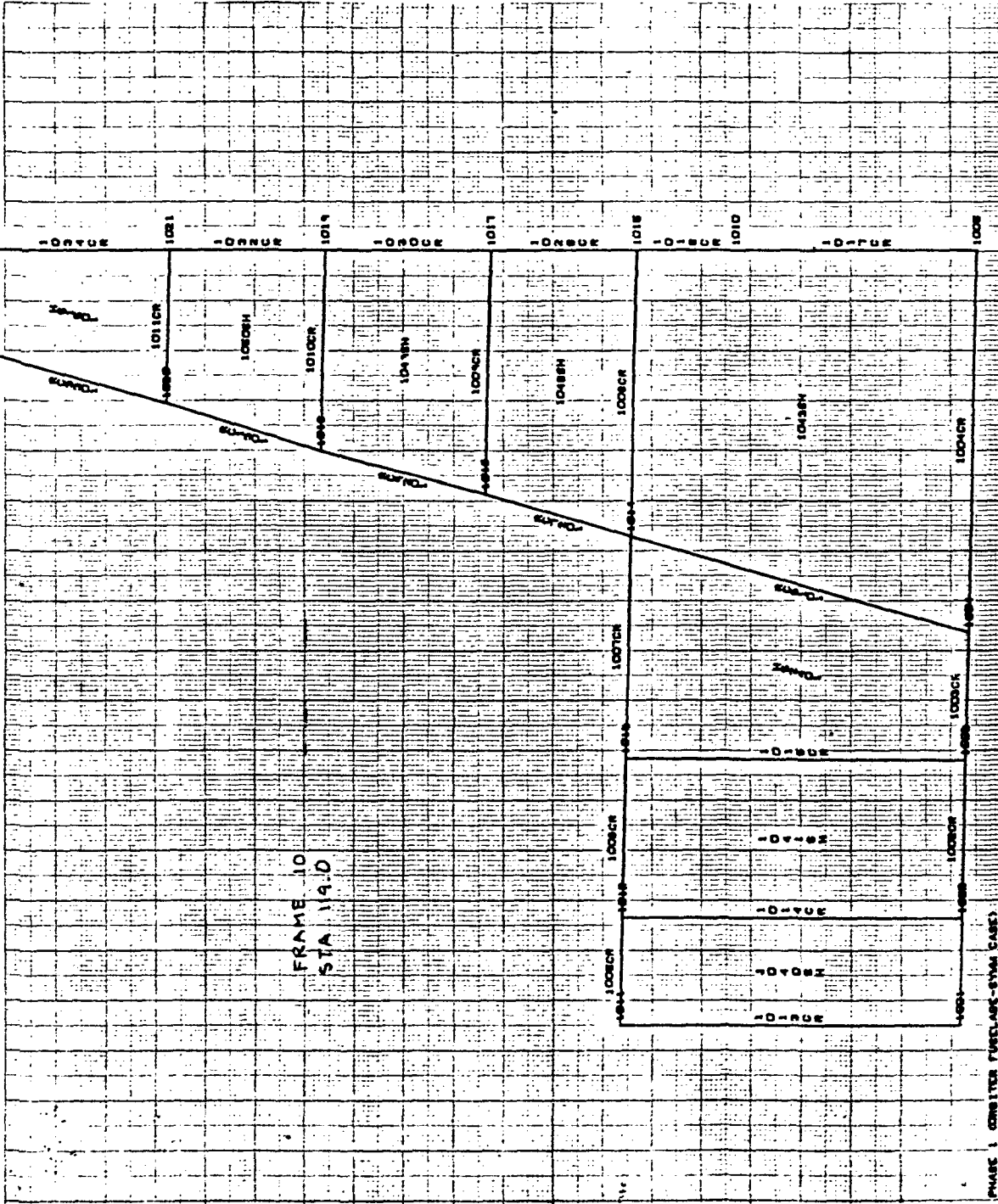

FRAME 10
STA 19.0

PHASE 1 CORRECTOR FUEL AND SHAM CASES
REVISION 4/22/74 GUALF EFFECTIVE SKIING

UNREFORMED SHAPE

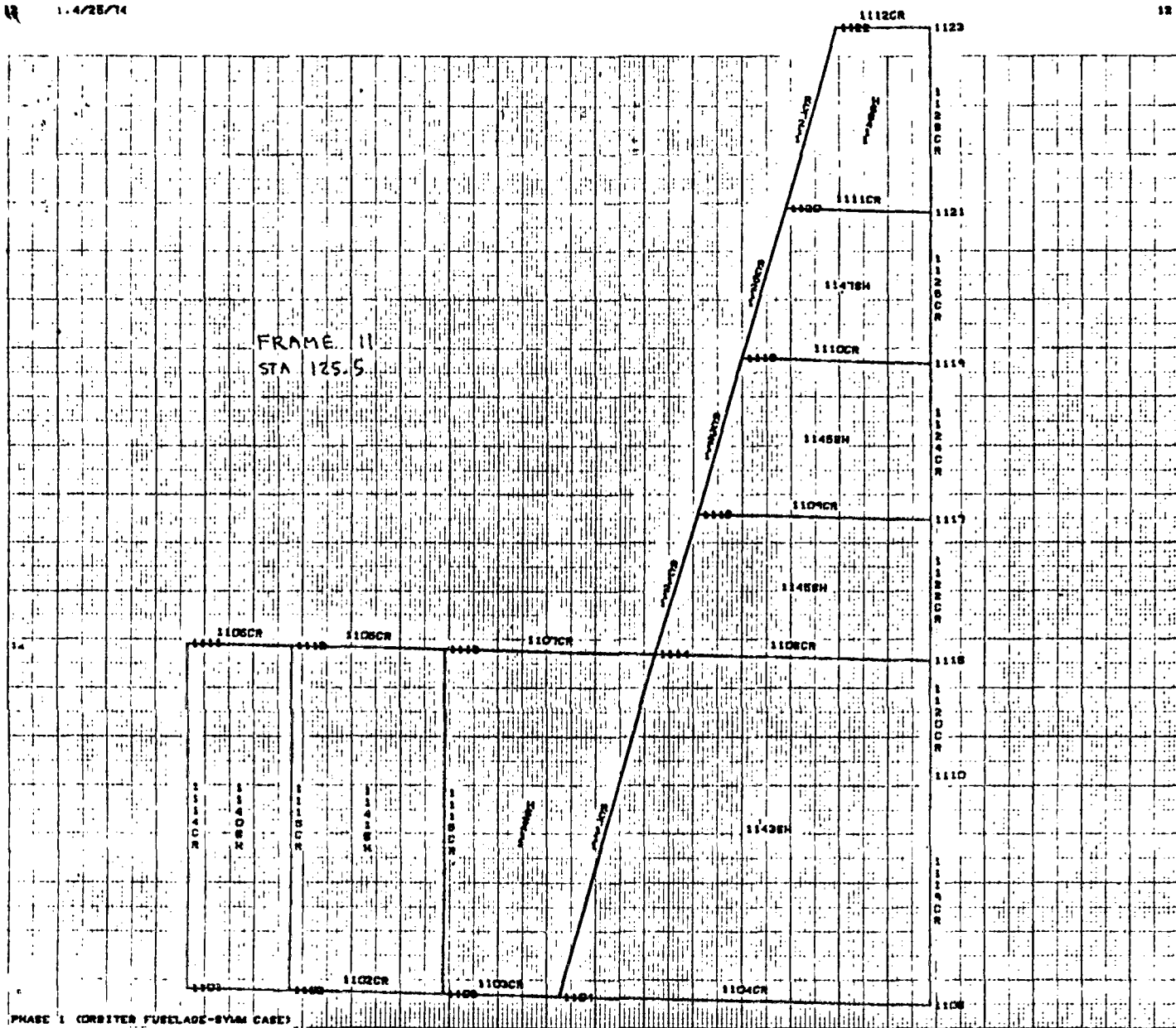

PHASE 1 (ORBITER FUSELAGE-SYMM CASE)
 REVISION 4/22/74 (HALF EFFECTIVE BRIMS)

UNDEFORMED SHAPE

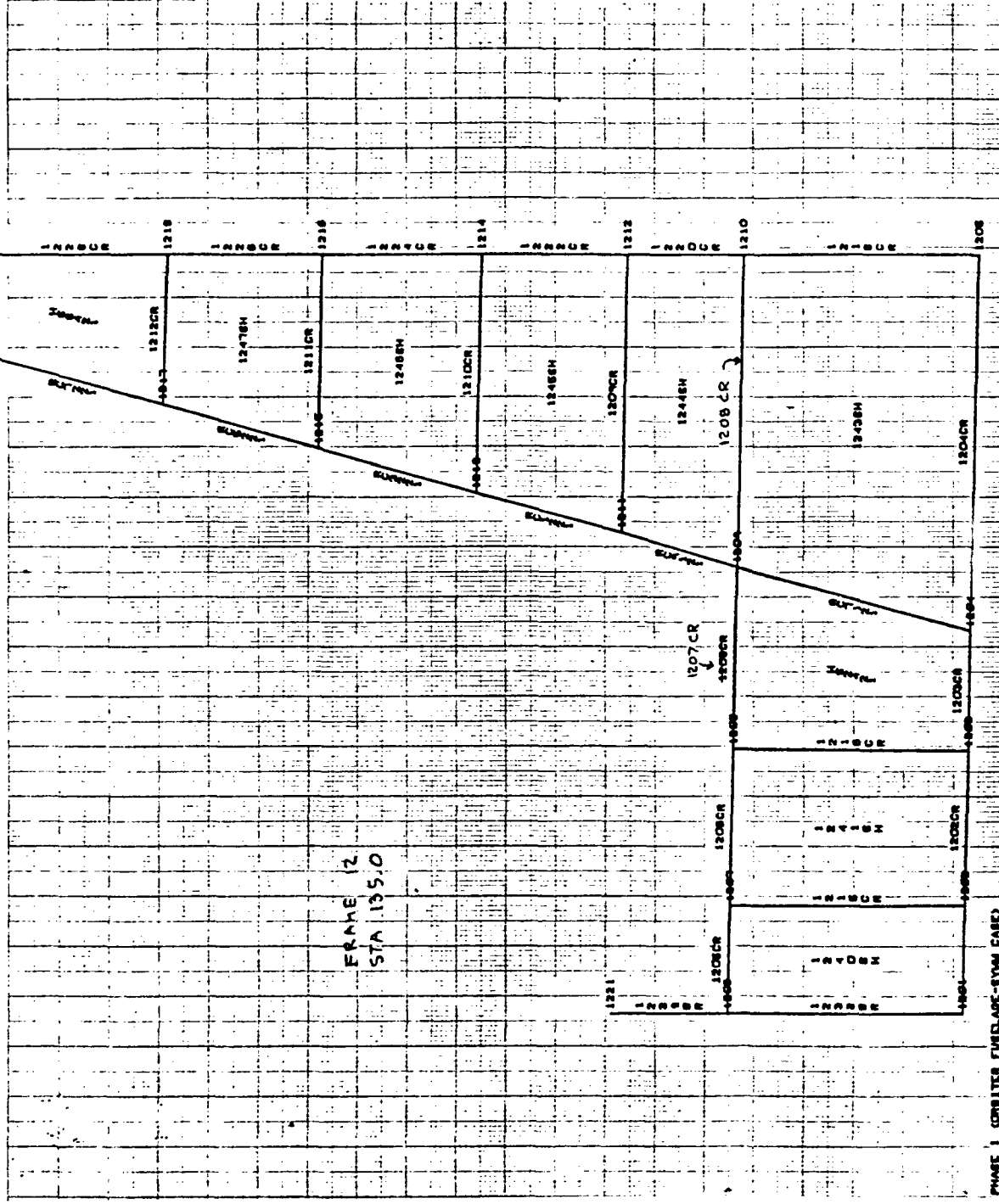

FRAME 12
STA 135.0

PHASE 1 CORBITER FUELADE-SYMA CASE)
REVISION 4/23/74 (HALF EFFECTIVE SKIING)
UNDEFORMED SHAPE

14 11 4/28/74

14

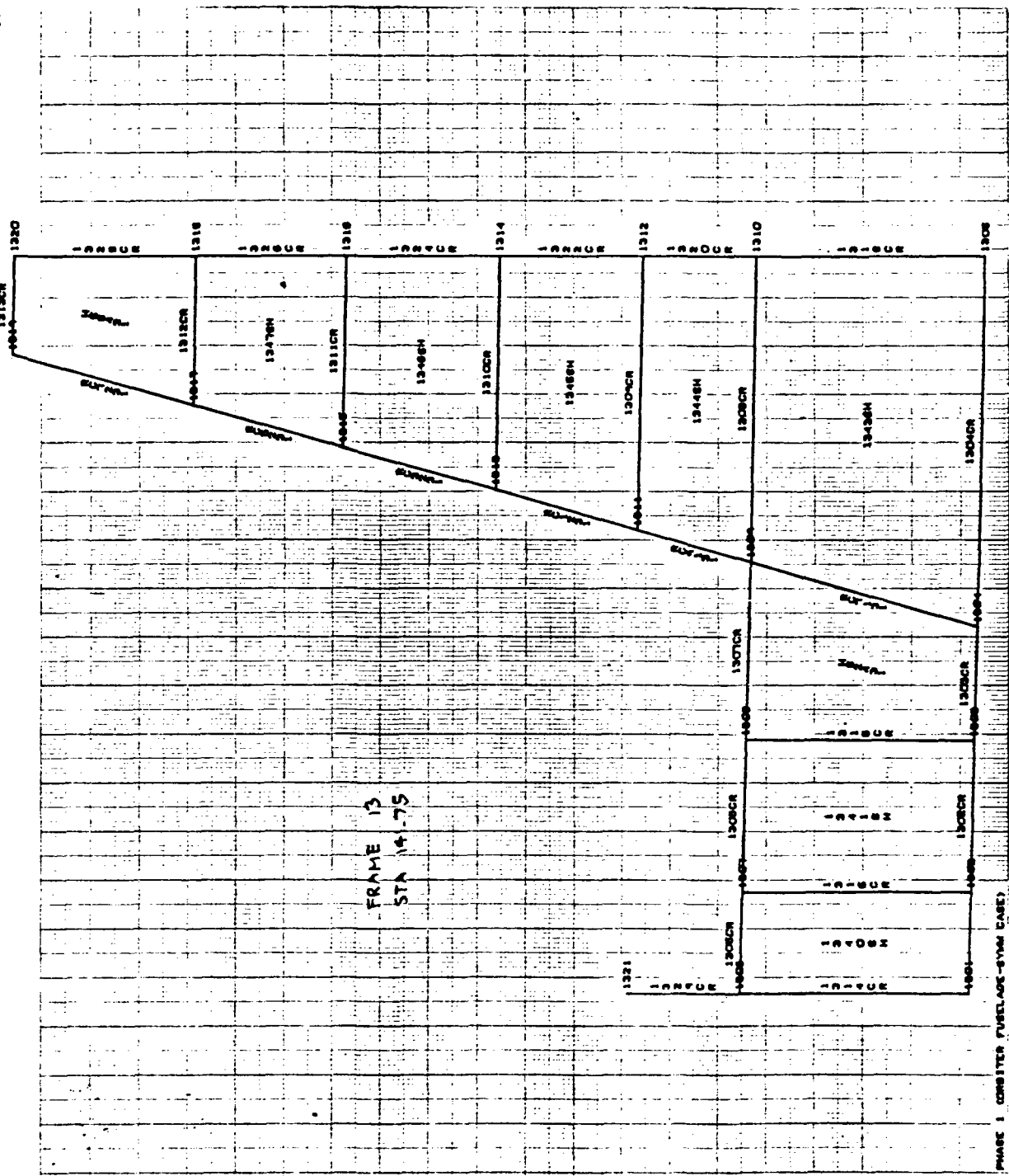

FRAME 13
STA 14.75

PHASE 1 COMPUTER FUELAGE-SYMM CASE)
REVISION 4/23/74 QUAL EFFECTIVE BRIMS)
(UNDEFORMED SHAPE

15 11 4/28/74

18

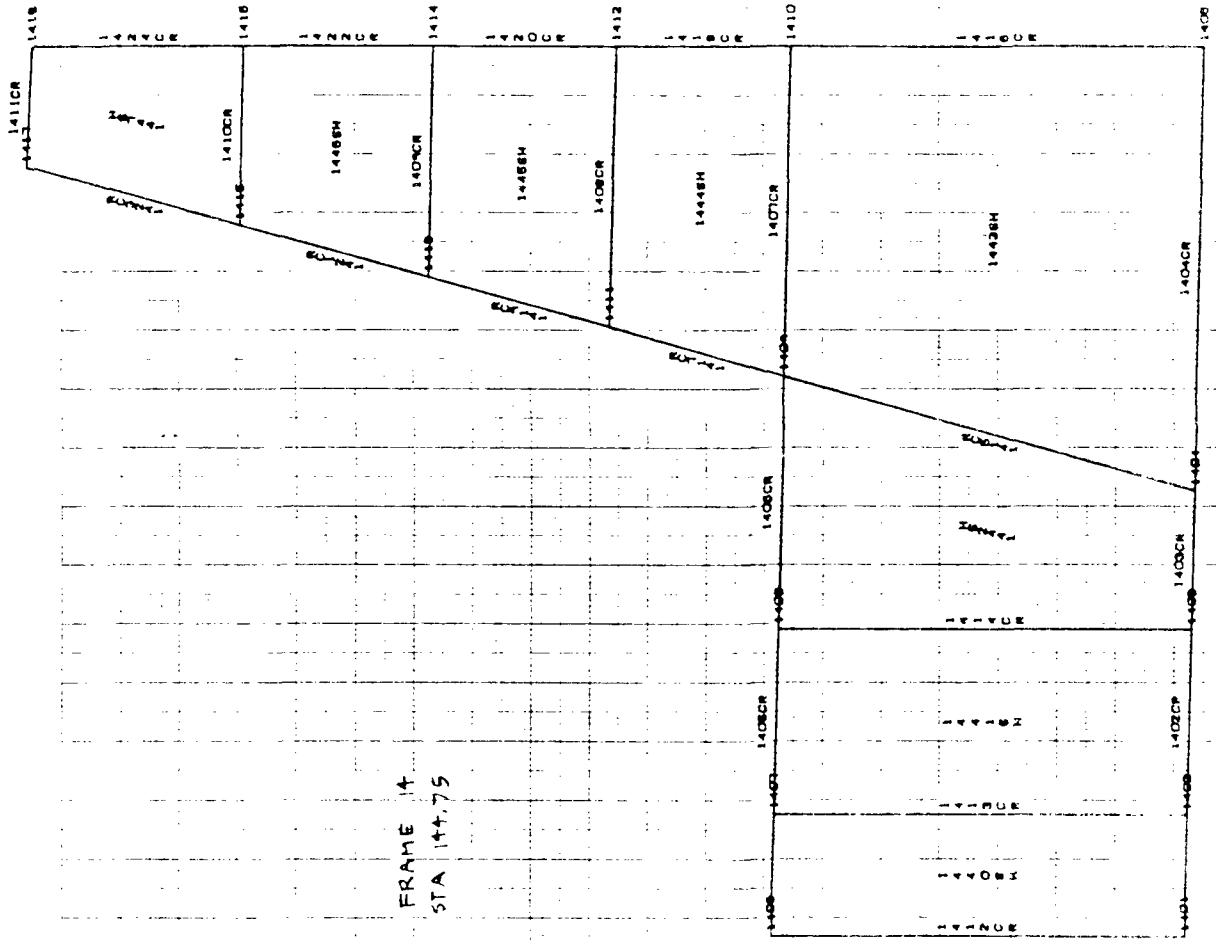

PHASE I CORBITER FURLEAD-EVM CASE
REVISION 4/22/74 (HALF EFFECTIVE BKING)

UNDEFORMED SHAPE

16 10 4/23/74

16

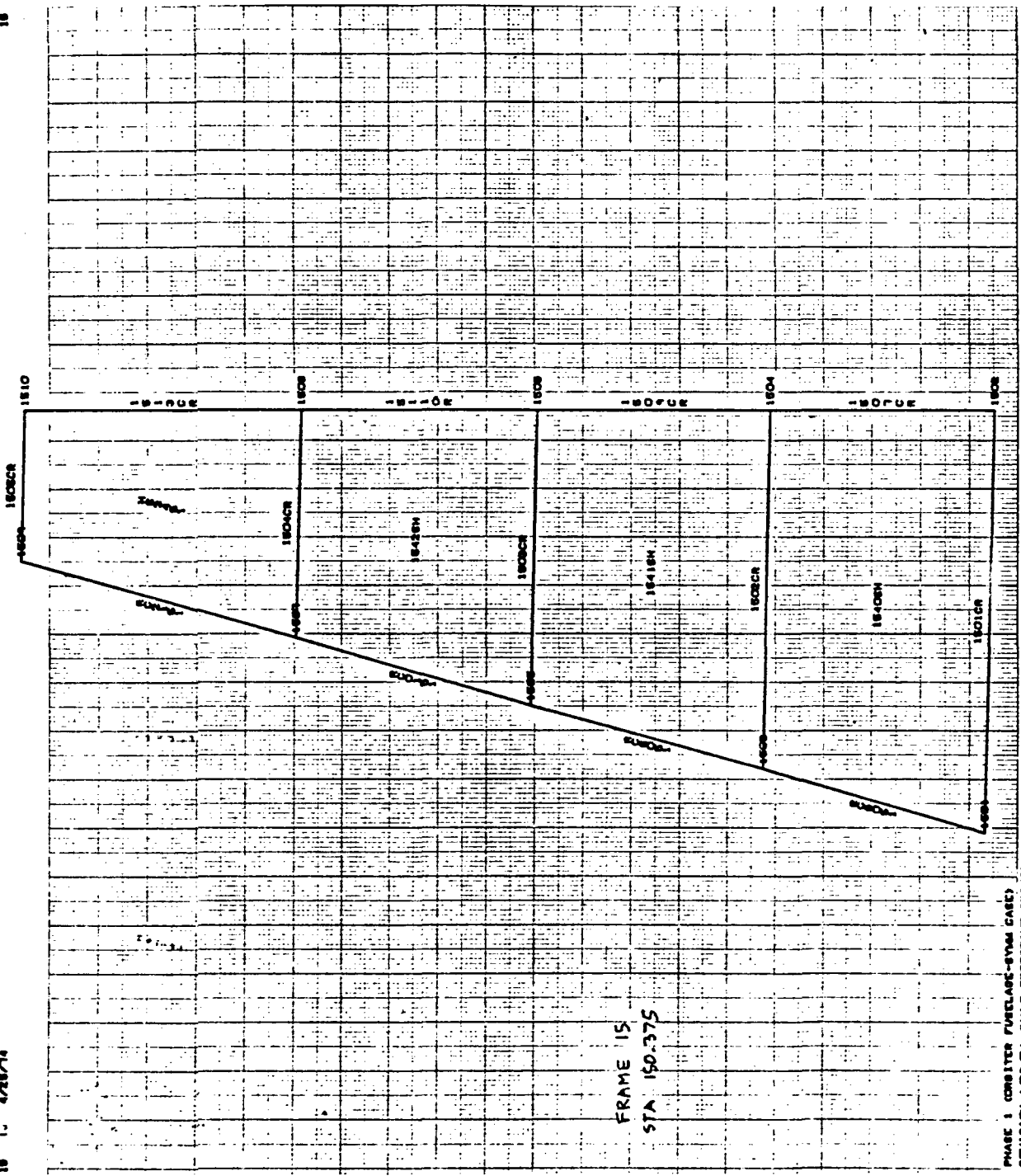

FRAME 15
STA 150.375

PHASE 1 CORBITER FURLEAS-87MM CASE)
REVISION 4/22/74 (HALF EFFECTIVE BRIMS)
UNIFORMED SHAPE

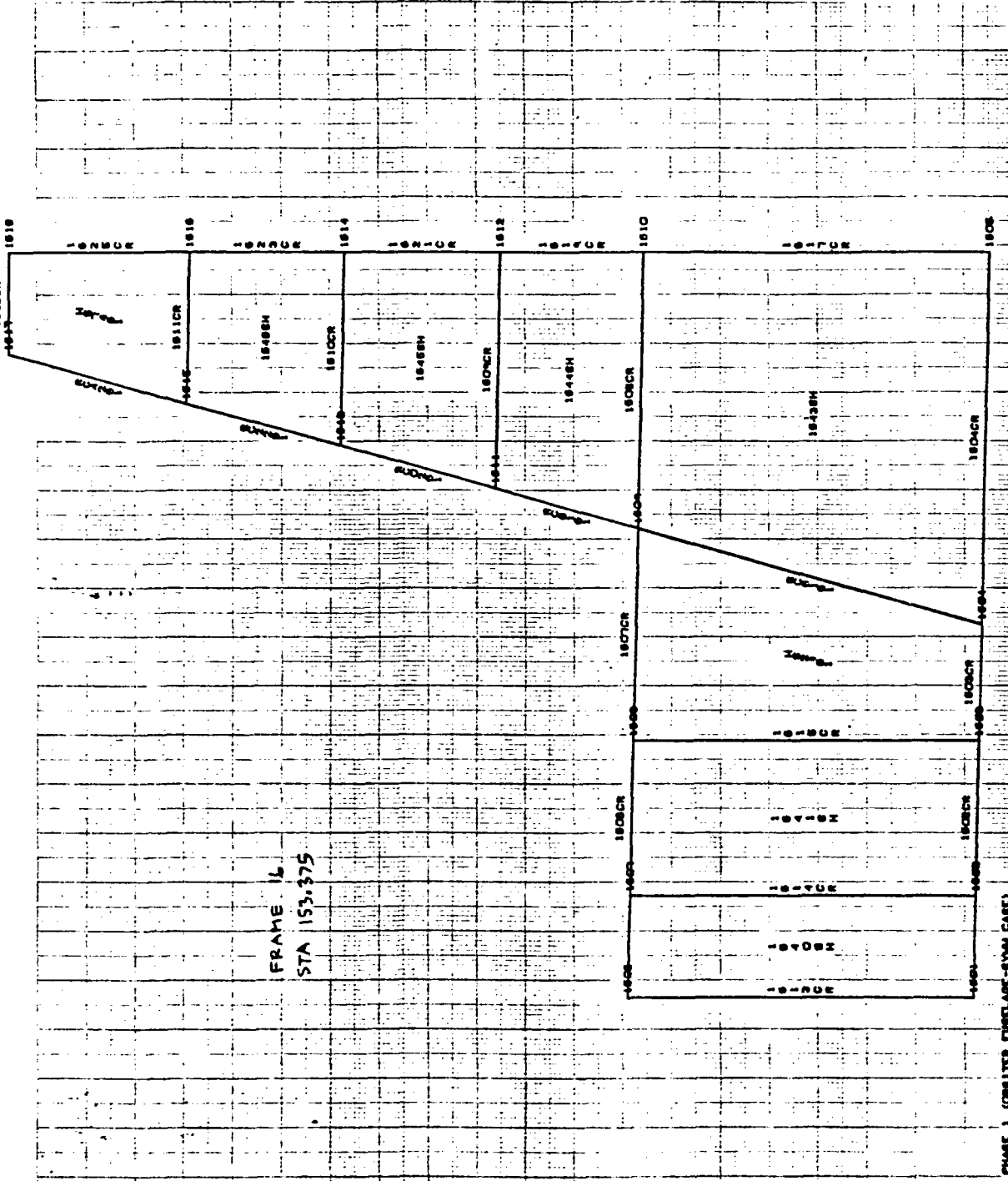

FRAME 16
 STA 153.375

PHASE 1 (ORBITER FORELIFT-8MM CASE)
 REVISION 4/23/74 (ONLY EFFECTIVE BRIMS)
 UNIFORMED SHAPE

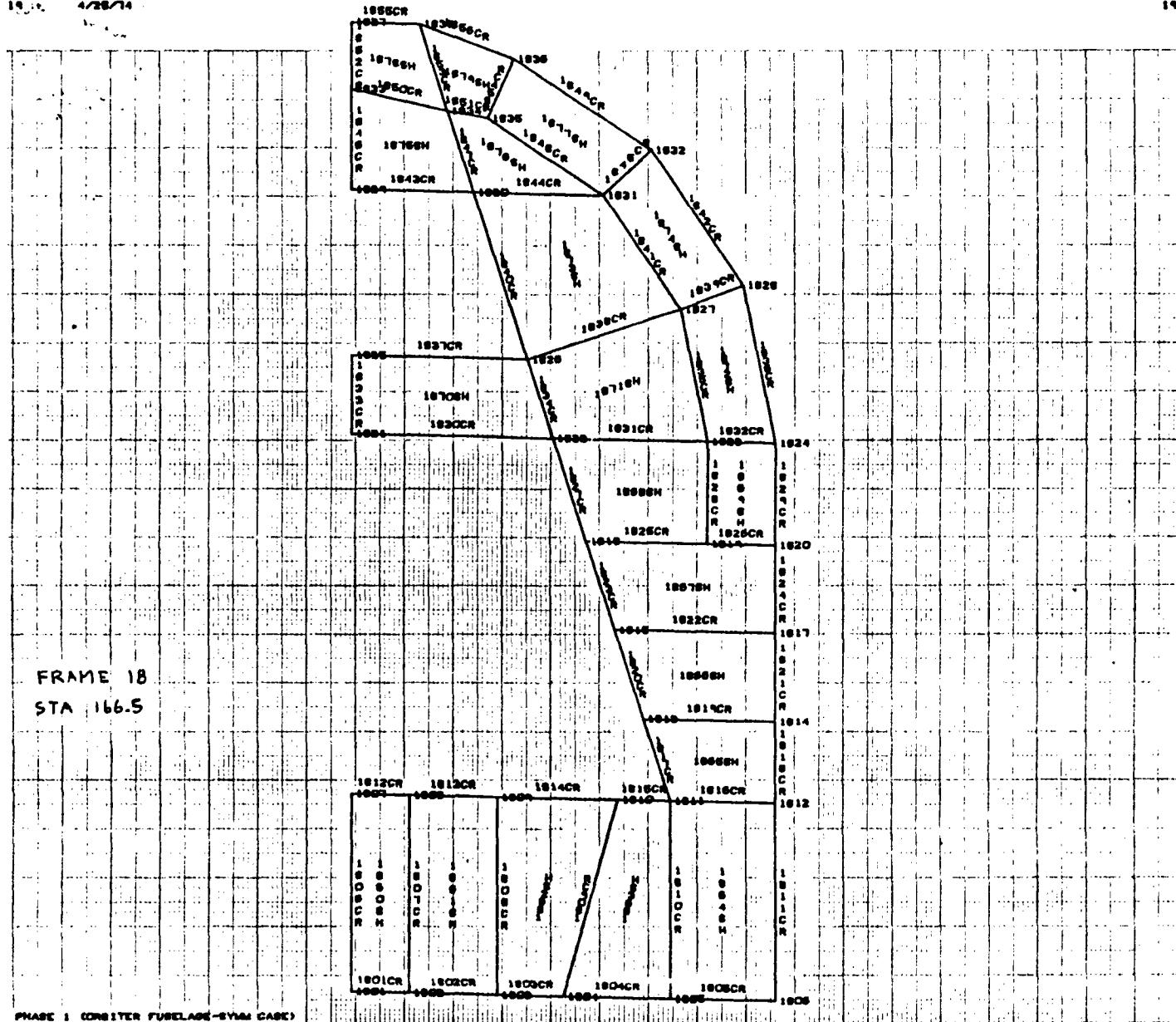

FRAME 18
STA 166.5

PHASE 1 (CONSIDER FUSELAGE-SYMM CASE)
REVISION 4/28/74 (HALF EFFECTIVE SKINS)

UNDEFORMED SHAPE

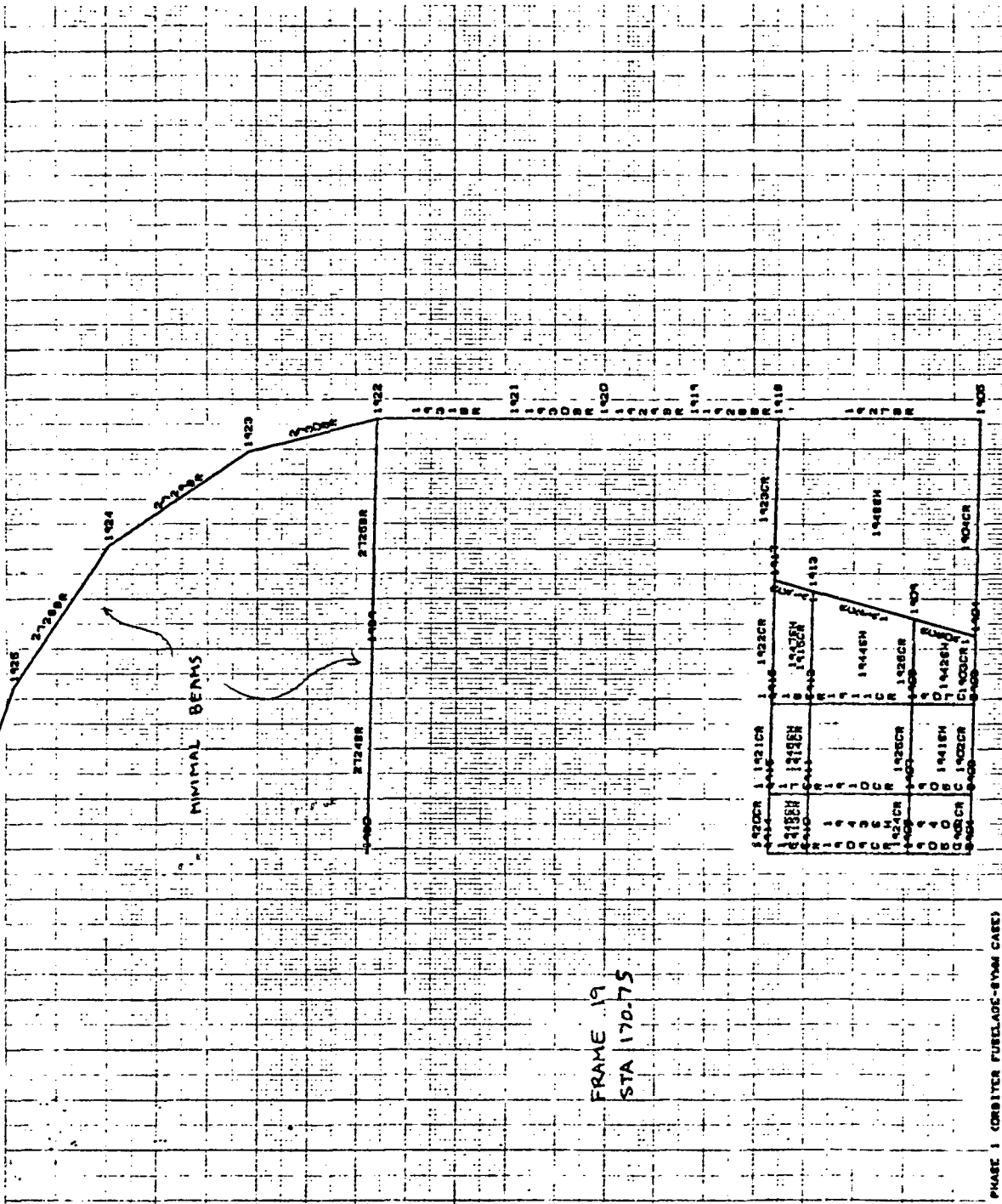

PHASE 1 (ORBITER FURLEAD-BYAM CASE)
 REVISION 4/22/74 CHALF EFFECTIVE SKINS
 UNDISTORTED SHAPE

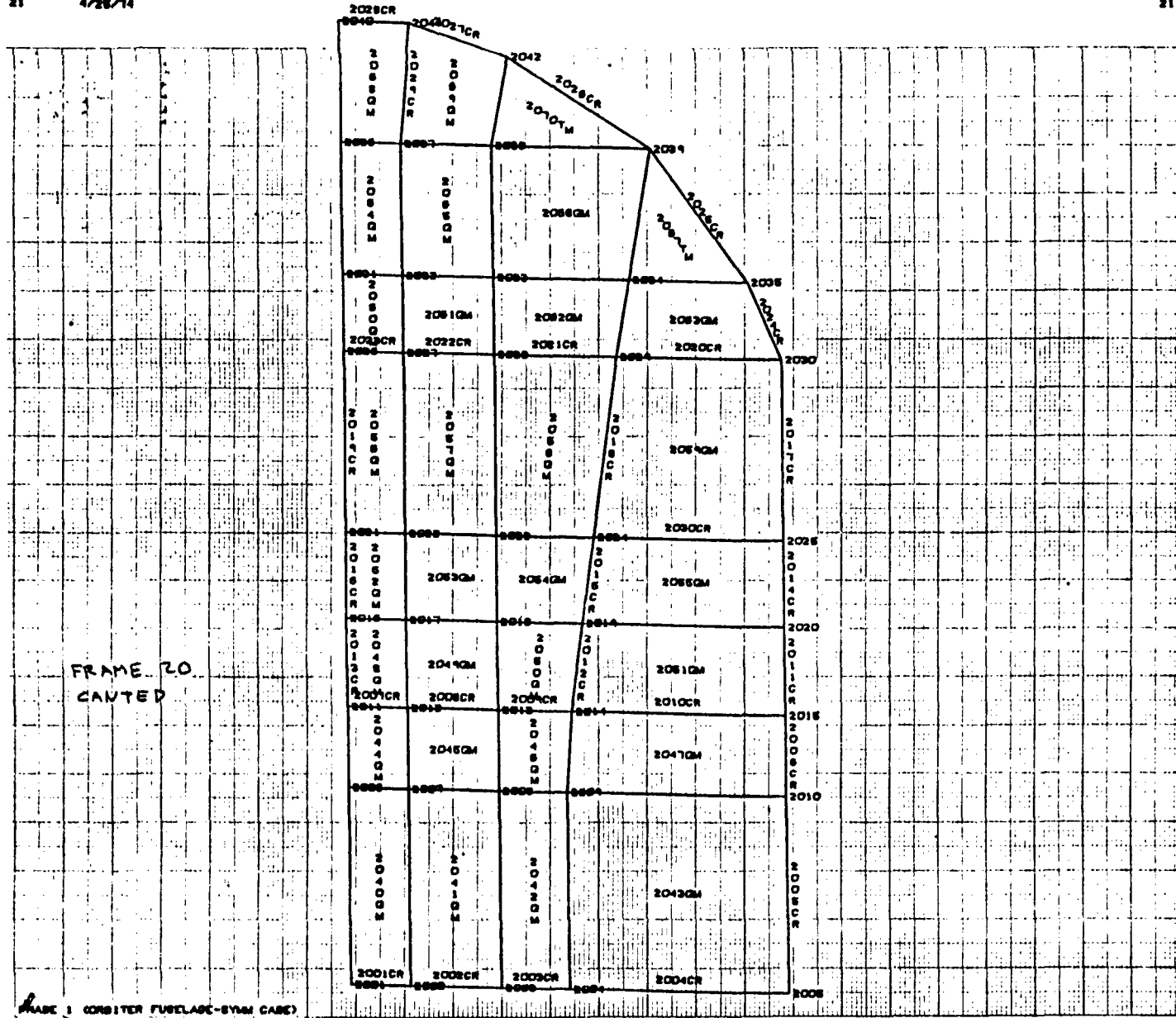
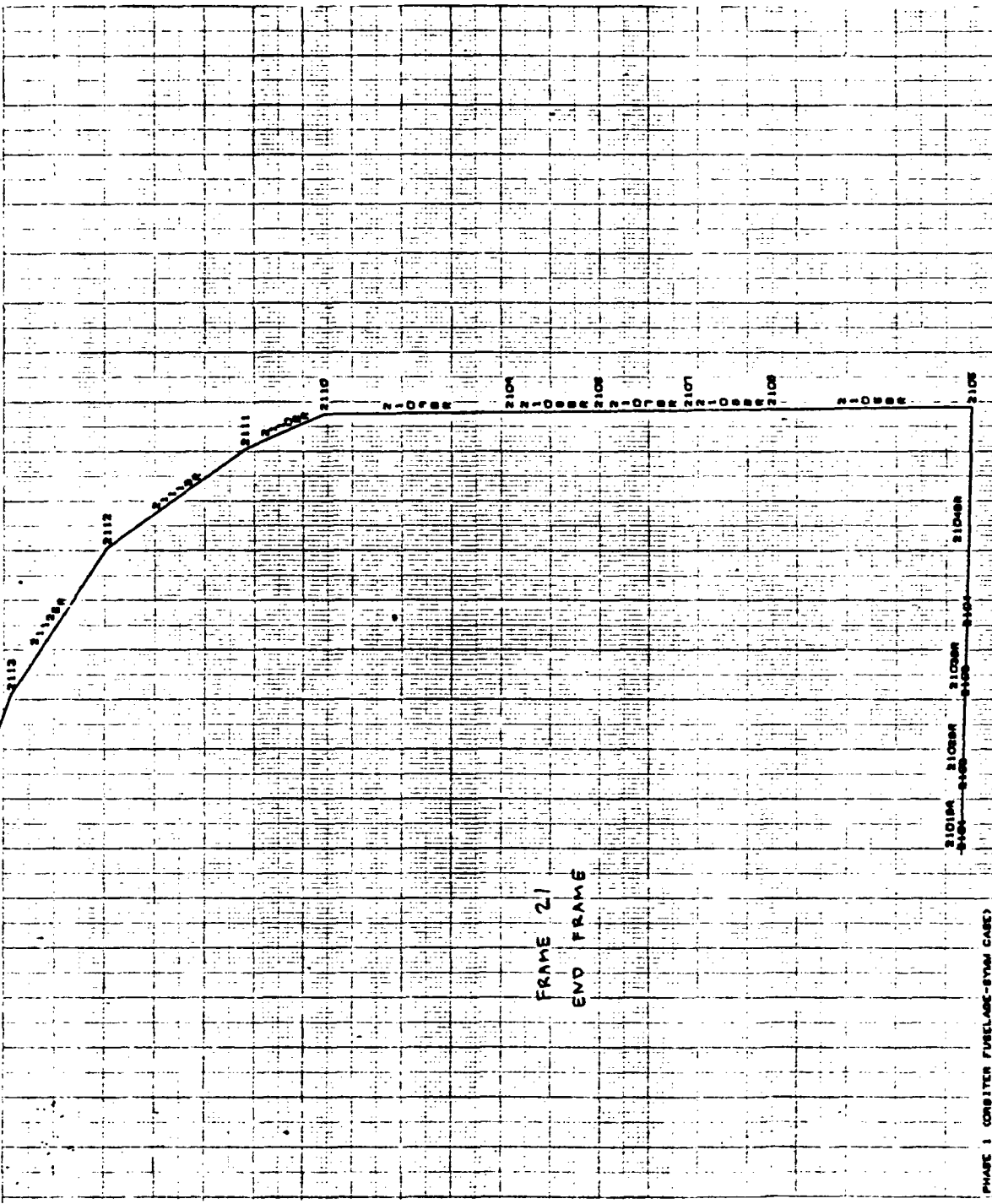

FIGURE 1 (CORBITER FUSELAGE-SYMM CASE)
 REVISION 4/22/74 (HALF EFFECTIVE SKINS)

UNDEFORMED SHAPE



FRAME 21
 END FRAME

PHASE 1 COBBLER FUSELAGE-STYAM CASE)
 REVISION 4/23/74 (HALF EFFECTIVE SKINS)
 UNDEFORMED SHAPE

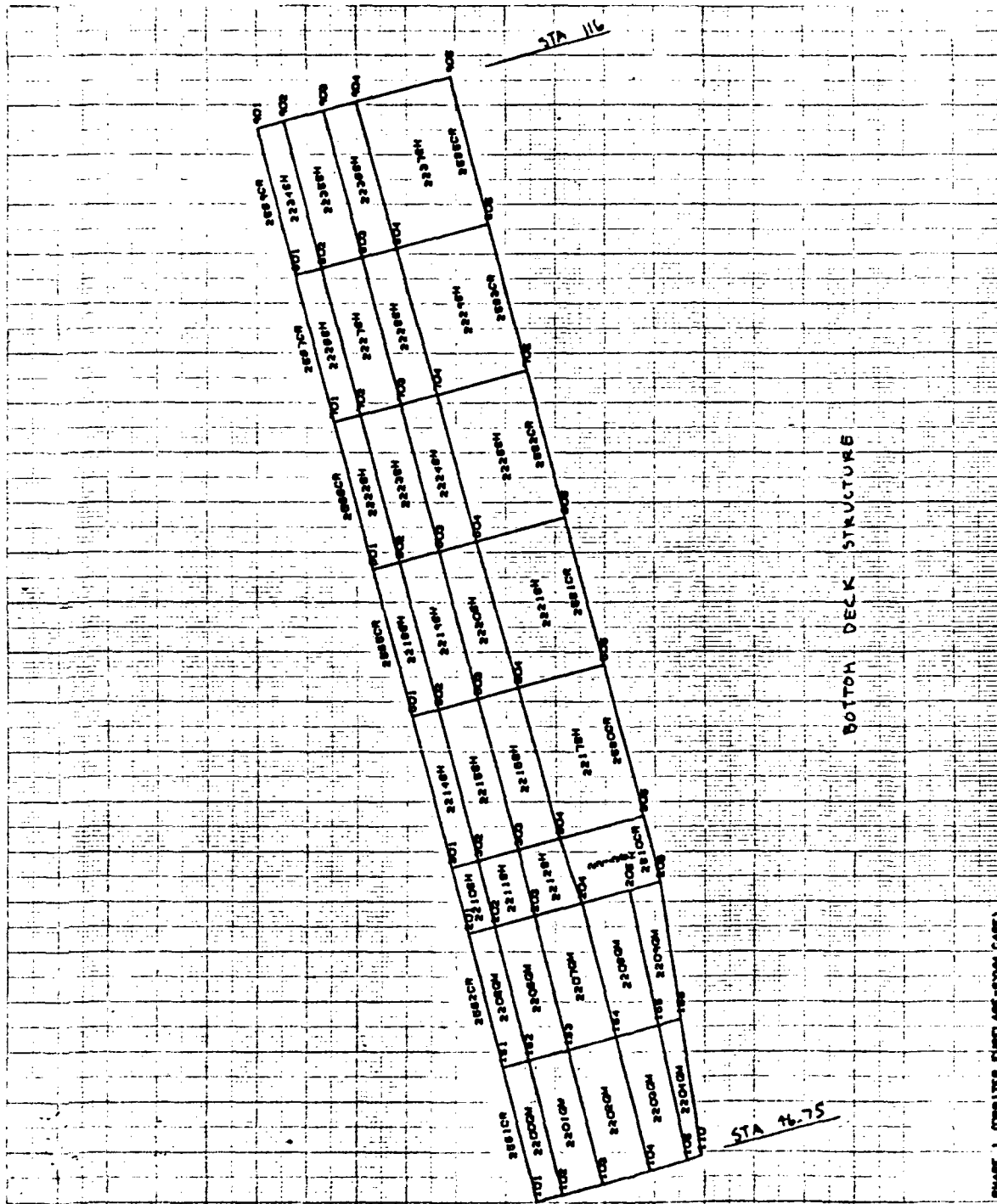

PHASE 1 CONCRETE FURCLAGE-SYMM CASE)
 REVISION 4/23/74 (HALF EFFECTIVE SKINS)
 UNIFORMED SHAPE

A7-24

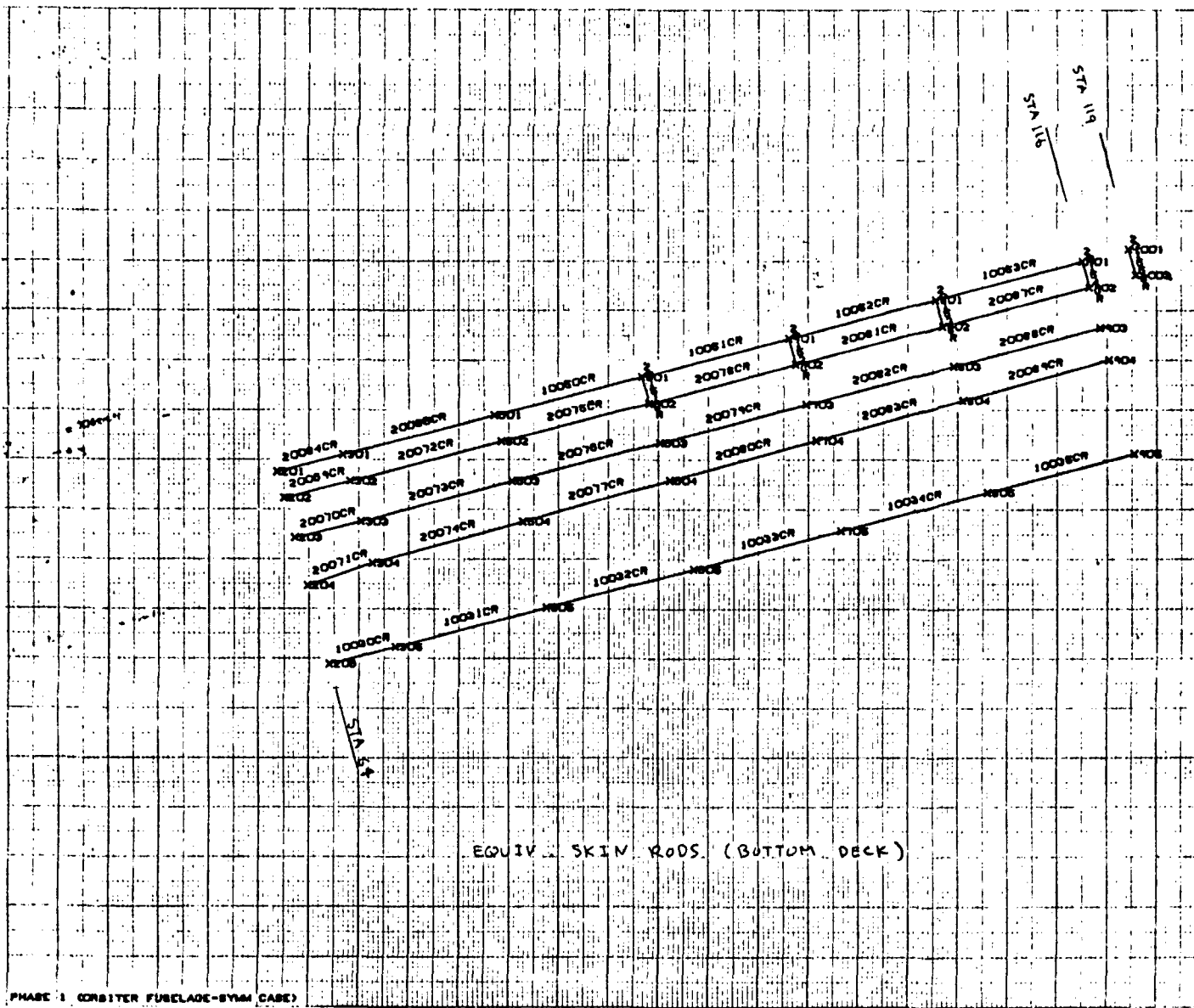

PHASE 1 ORBITER FUSELAGE-BYMM CASE)
 REVISION 4/23/74 (HALF EFFECTIVE SKINS)

UNDEFORMED SHAPE

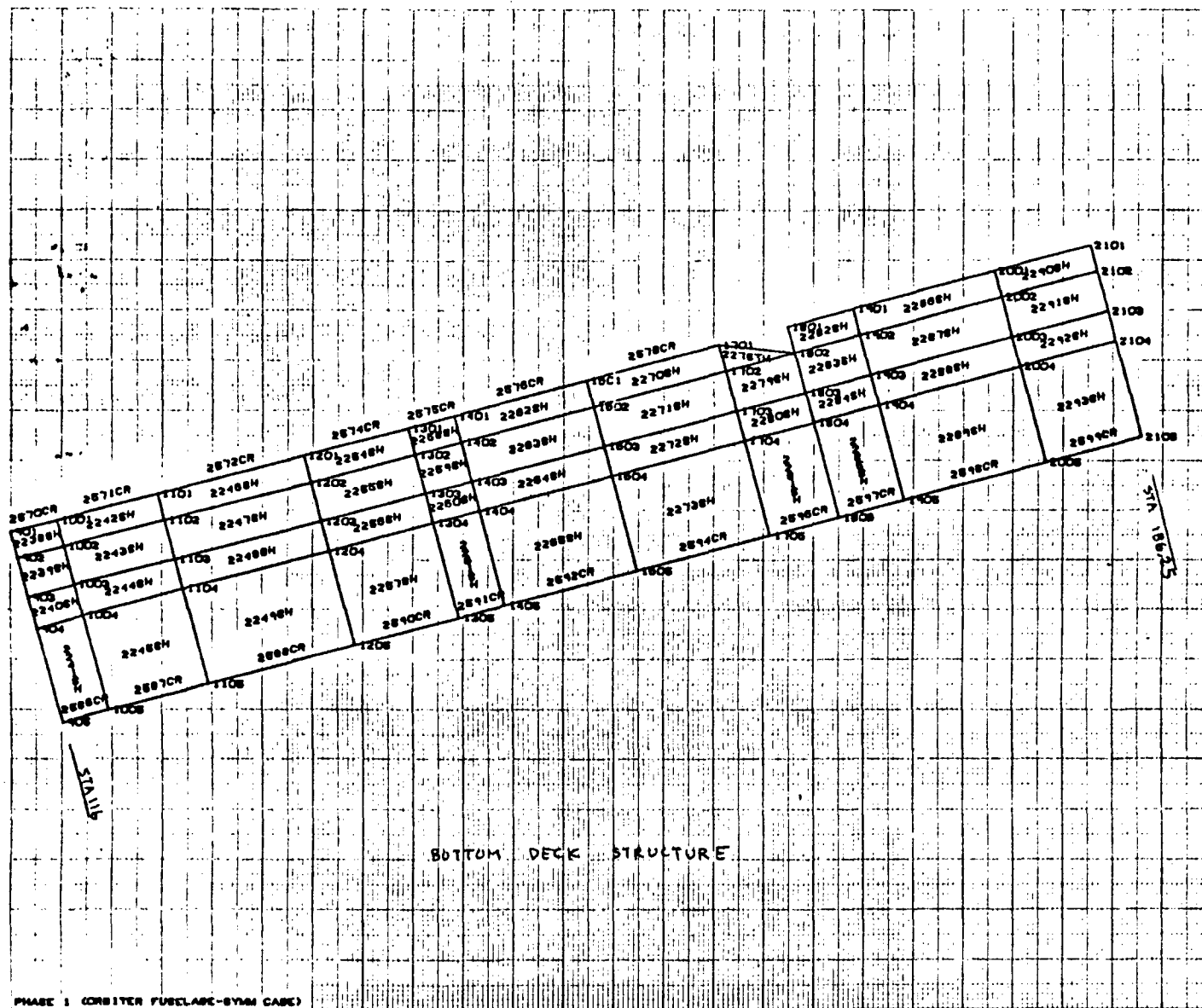

PHASE 1 (ORBITER FUSELAGE-SYMM CASE)
 REVISION 4/22/74 (HALF EFFECTIVE SKINS)

UNDEFORMED SHAPE

A7-26

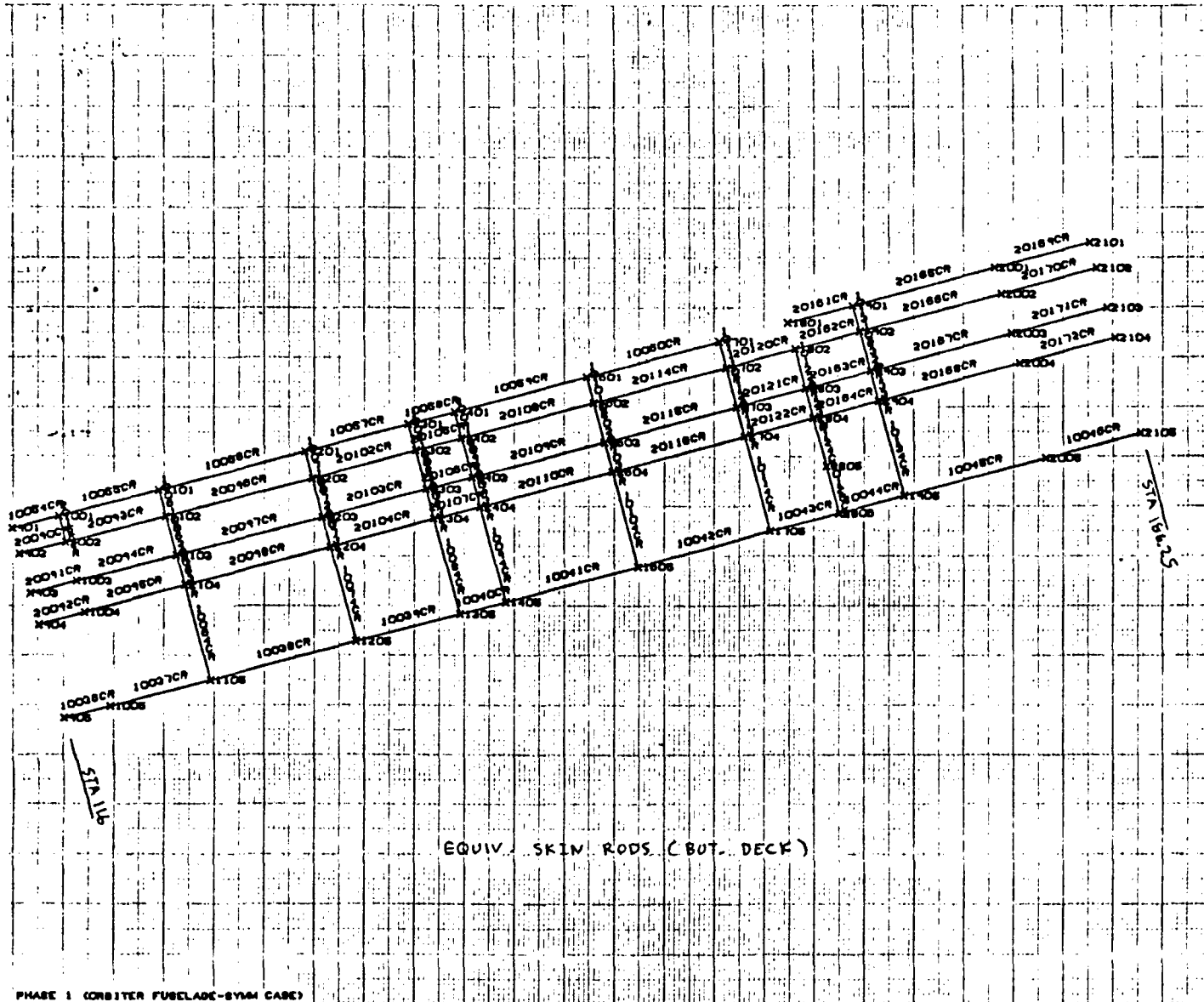

PHASE 1 (CORBITER FUSELAGE-SYMM CASE)
 REVISION 4/23/74 (HALF EFFECTIVE SKINS)

UNDEFORMED SHAPE

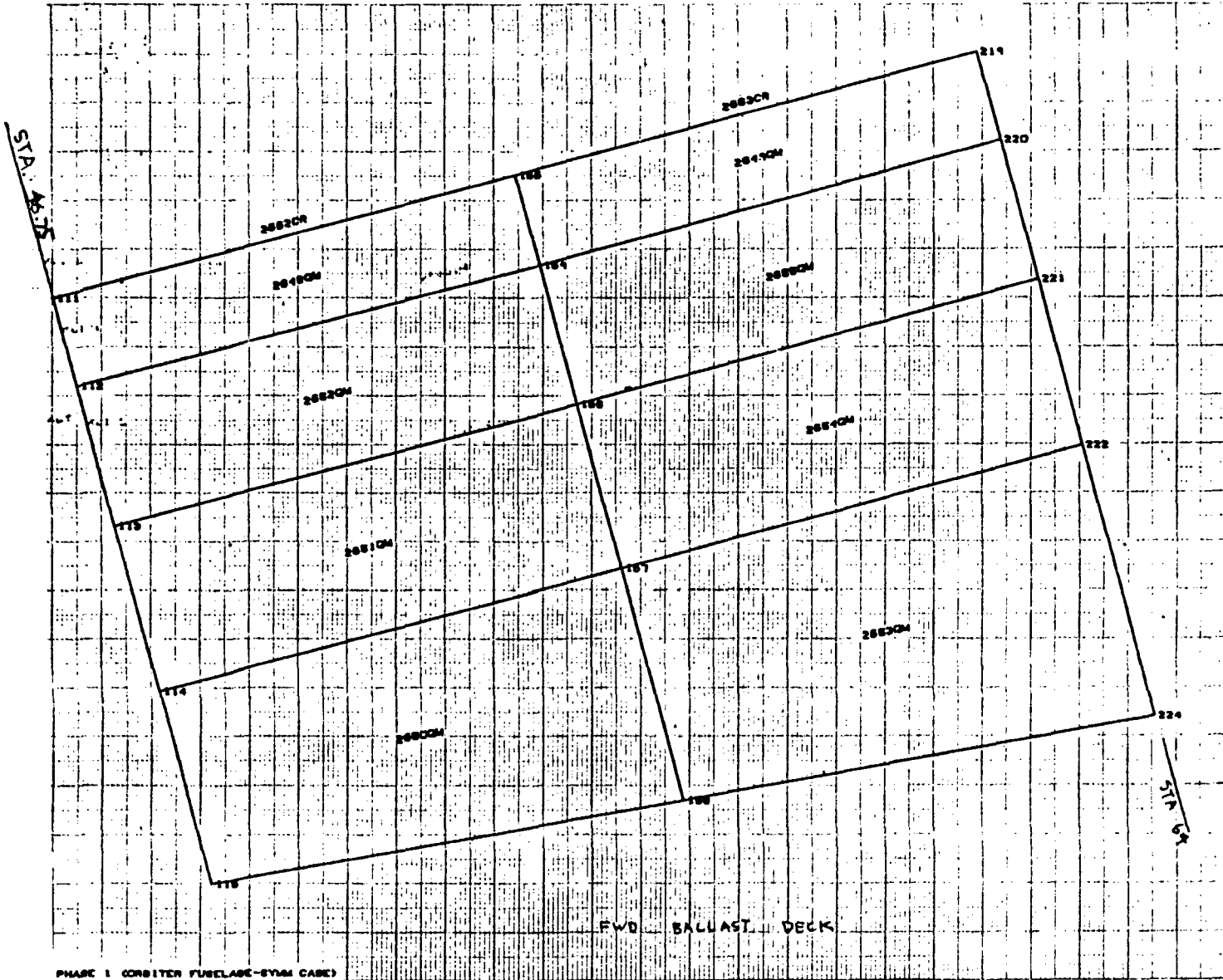

PHASE 1 CORBITER FUSELAGE-SYMM CASE)
 REVISION 4/22/74 (HALF EFFECTIVE SKINS)
 UNDEFORMED SHAPE

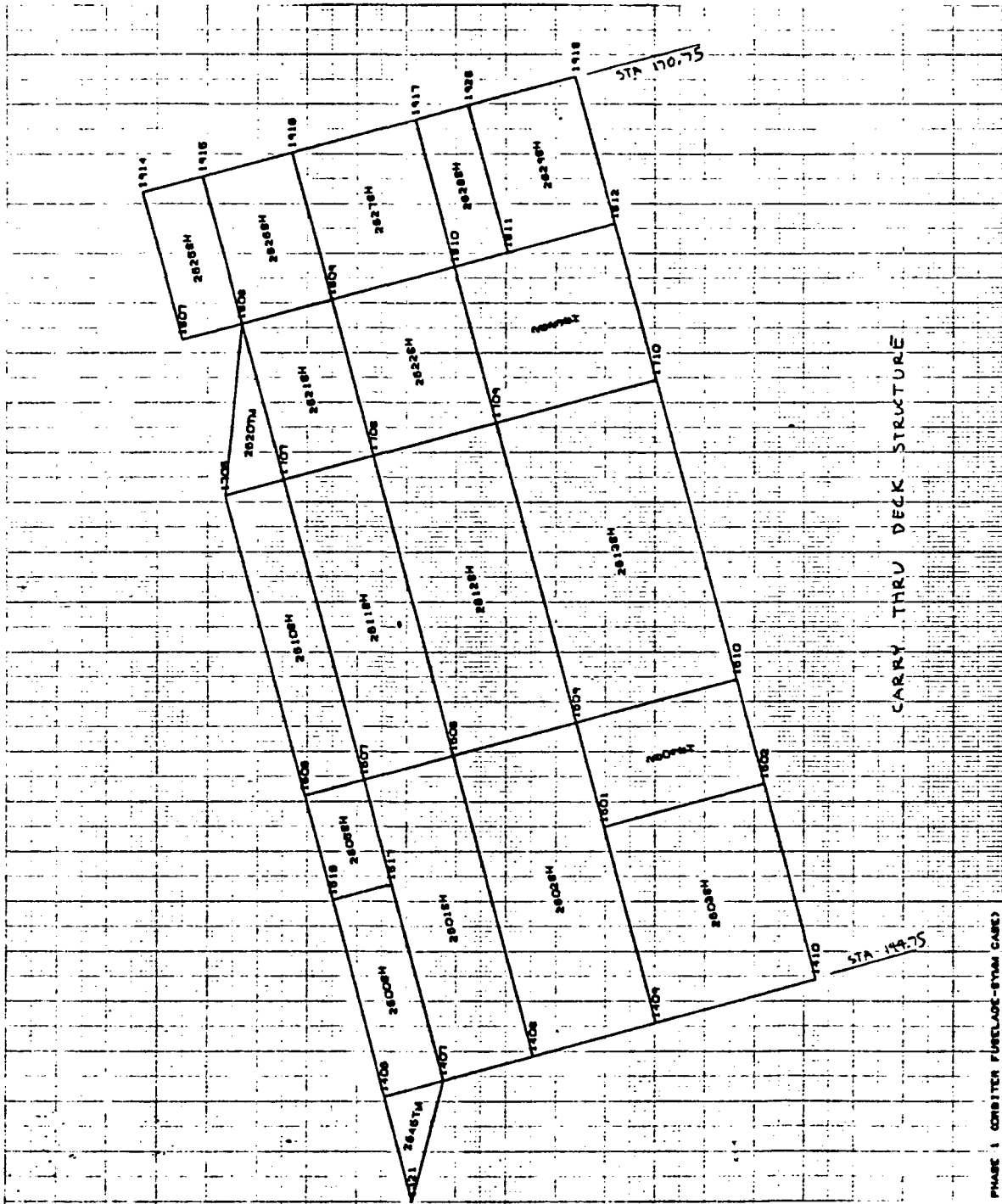

CARRY THRU DECK STRUCTURE

PHASE 1 CORBIER FURLOE-PYAM CASES
REVISION 4/22/74 (QUAL EFFECTIVE BEING)

UNDISTORTED SHAPE

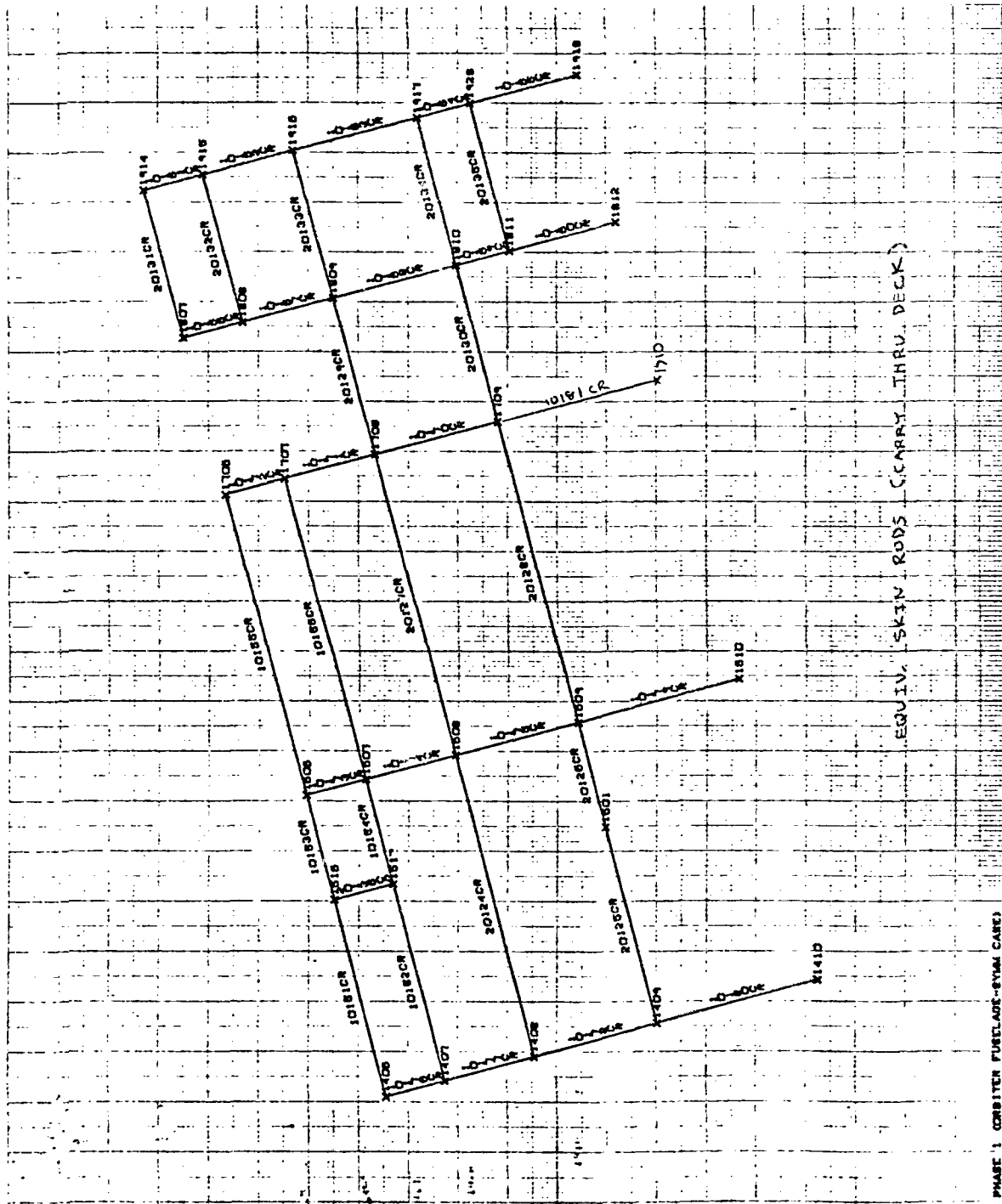

EQUIV. SKIN RODS (CARRY THRU DECK)

PHASE 1 ORBITER FUELADE-BYRM CARES
REVISION 4/22/74 (HALF EFFECTIVE SKINS)

UNDEFORMED SHAPE

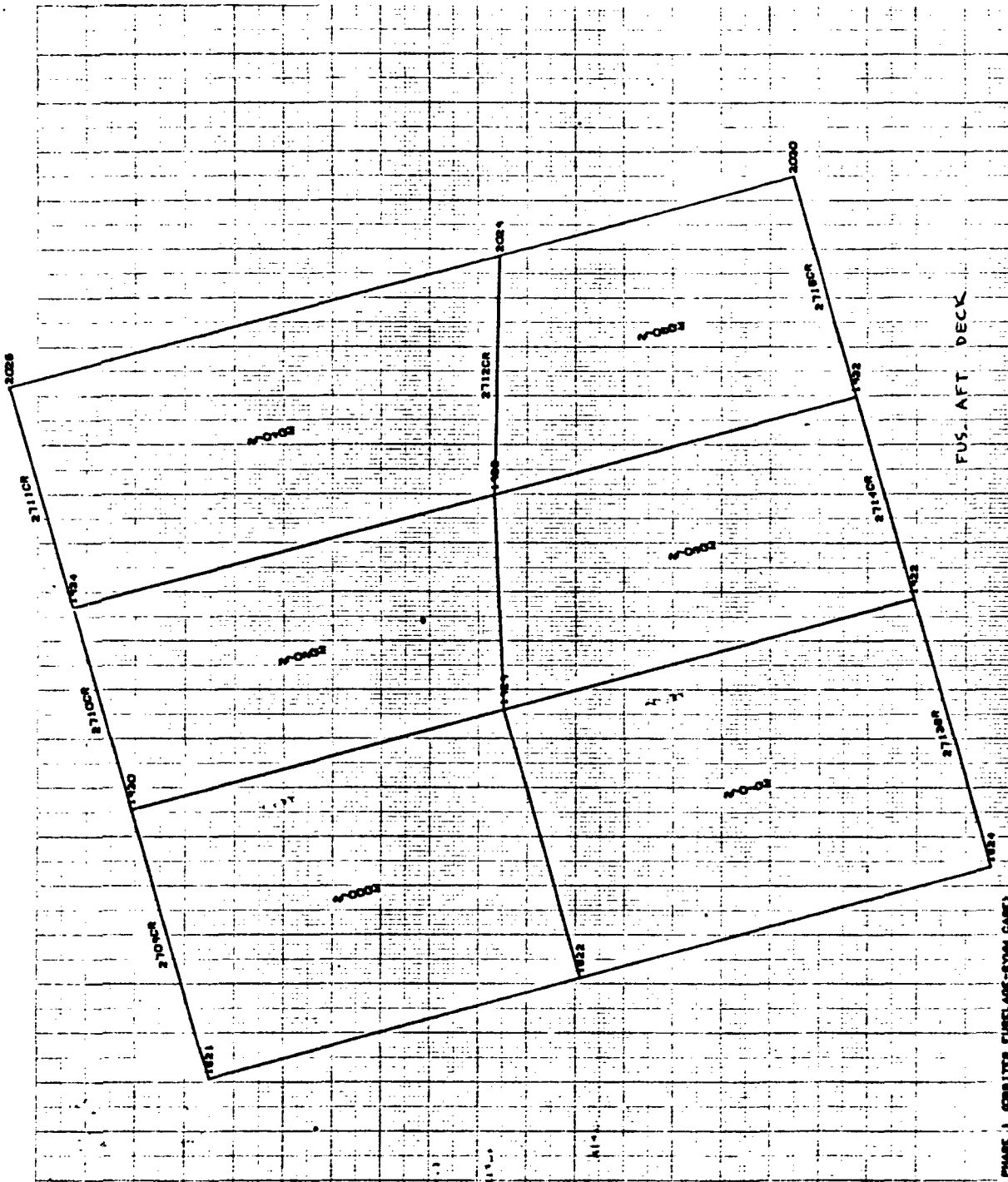

PHASE 3 CRIBBITER FURLEAGE-SYMM CASE
 REVISION 4/28/74 ONALP EFFECTIVE SKINS
 UNDEFORMED SHAPE

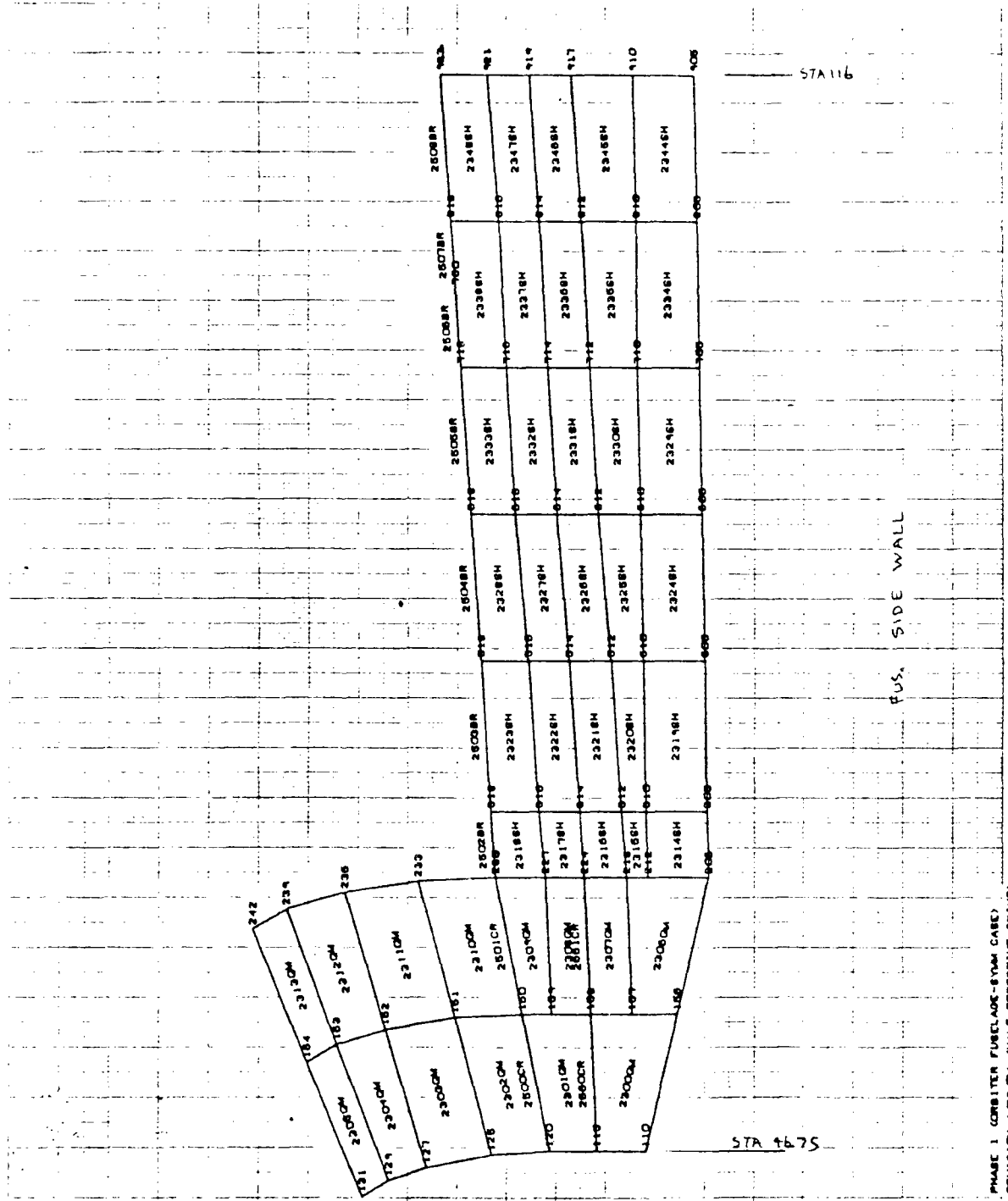

PHASE I CORBITER FUEL-AIR-SYSTEM CASE)
 REVISION 4/22/74 (HALF EFFECTIVE BRIMS)
 UNIFORMED SHAPE

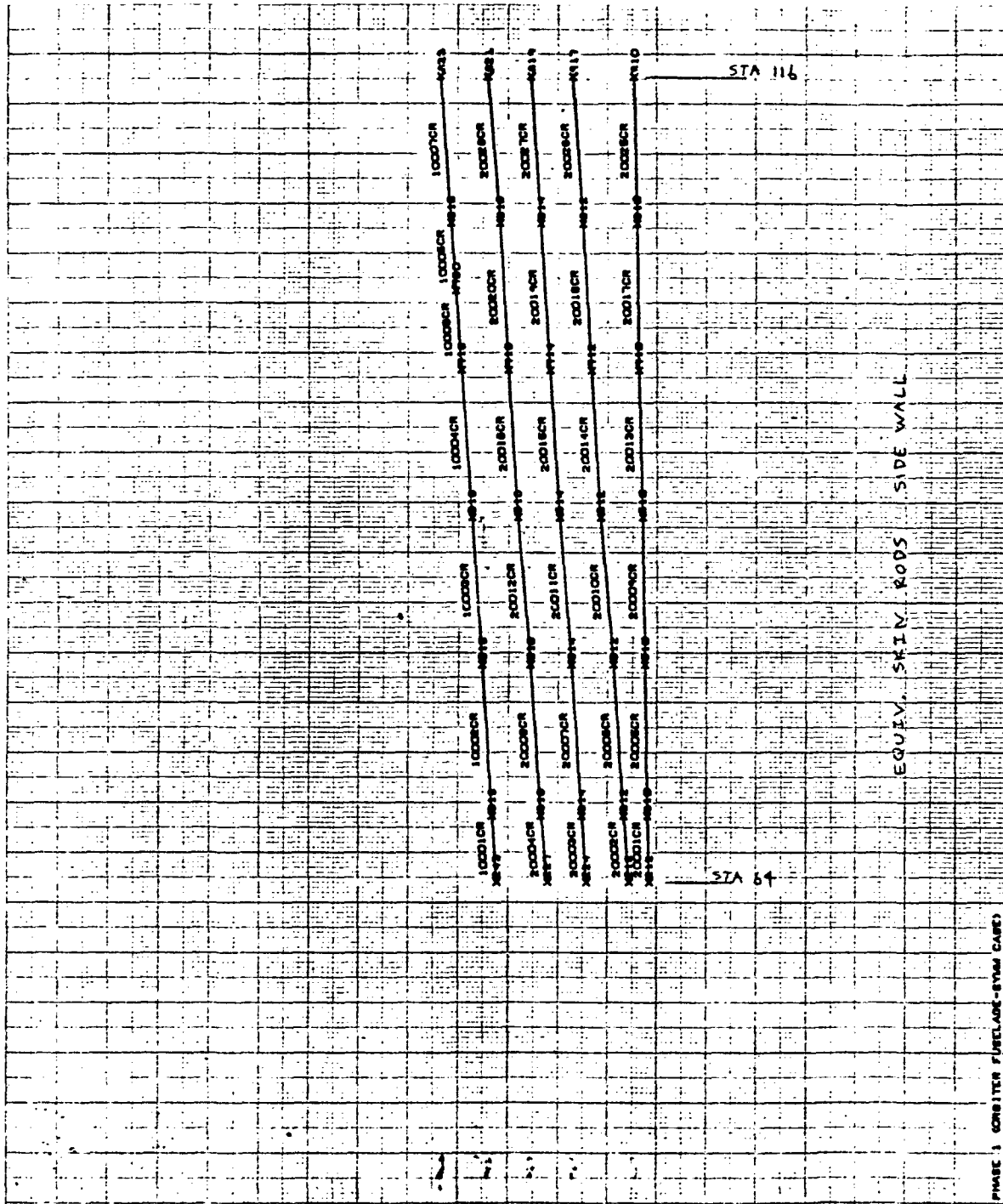

PHASE 1 CORBITER FURLEAK-SYAM CASE
 REVISION 4/22/74 CHALF EFFECTIVE BRING
 UNDEFORMED SHAPE

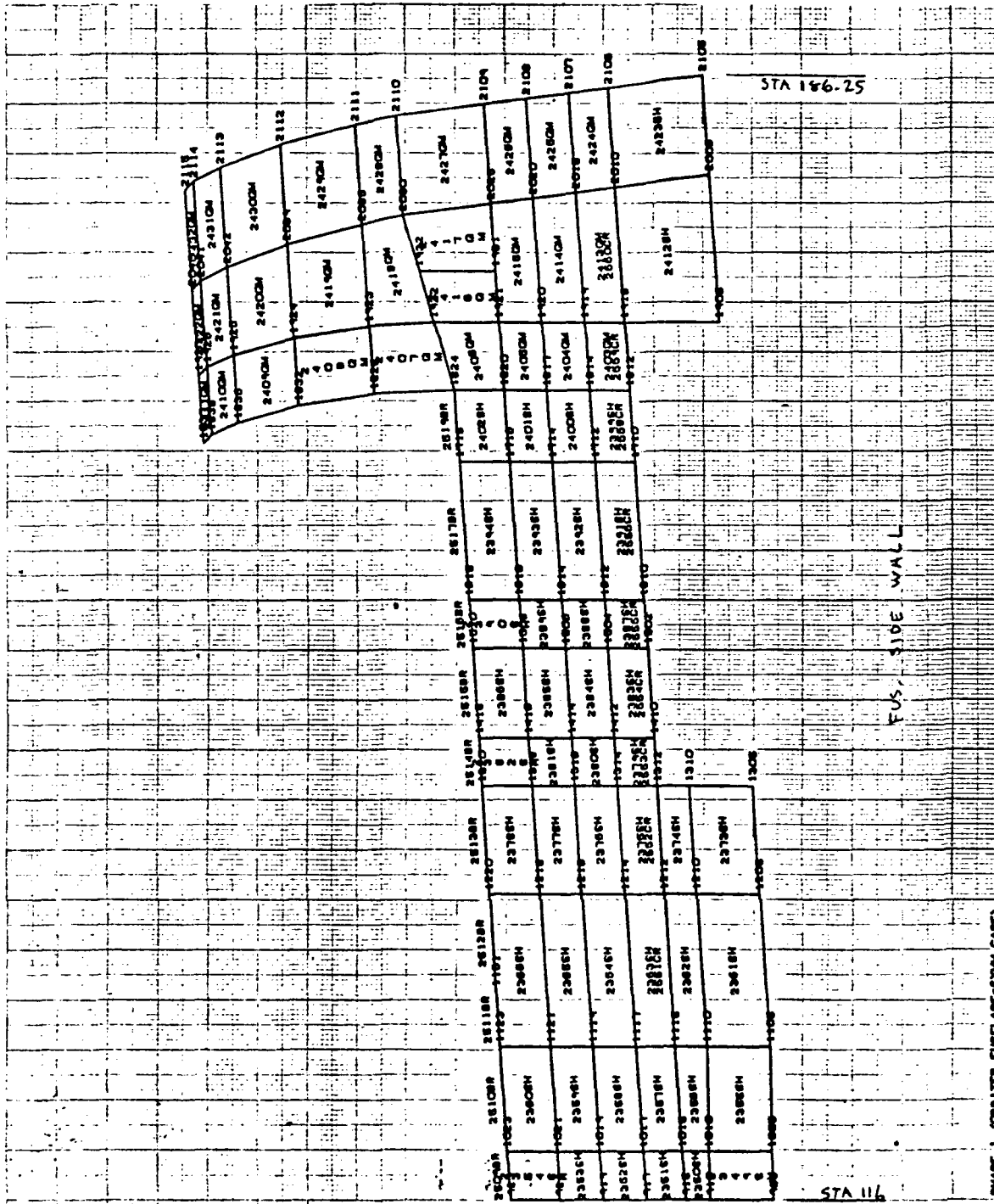

PHASE 1 CORBITER FURCLASH-SYAM CASE)
 REVISION 4/22/74 (HALF EFFECTIVE SKIMS)
 UNIFORMED SHAPE

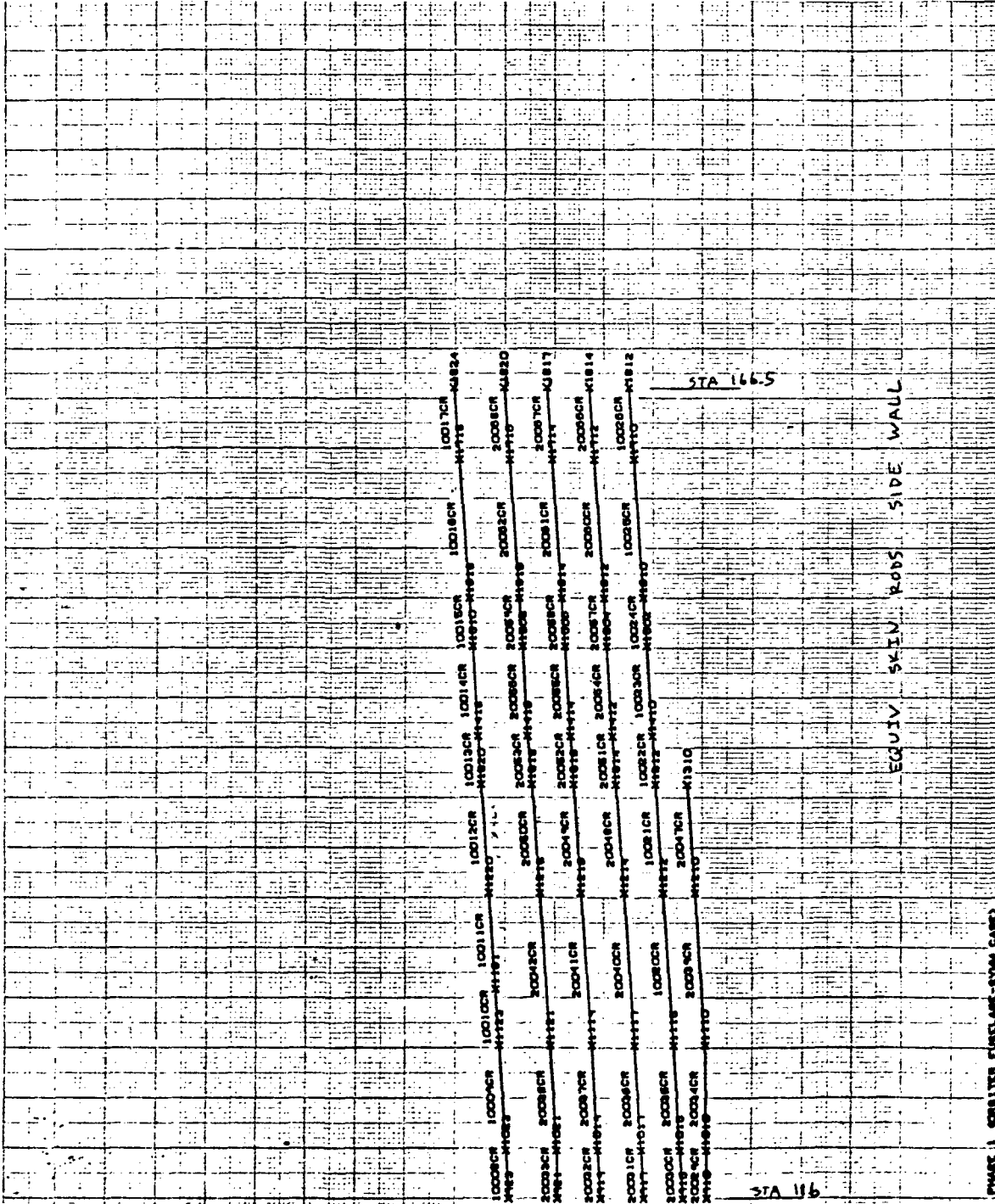

PHASE 1, 42881YER FORELASH-SYMA CASE
 REVISION 4/22/74 GUALP EFFECTIVE SKIMS
 UNIFORMED SHAPE



PHASE 1 CORBITER FORELAID-SYM CASE)
 REVISION 4/22/74 (HALF EFFECTIVE SKINS)
 UNDEFORMED SHAPE



PHASE 1 ORBITER FUELAGS-SYMA CASE
 REVISION 4/25/74 (HALF EFFECTIVE SKINS)

UNSTRETCHED SHAPE

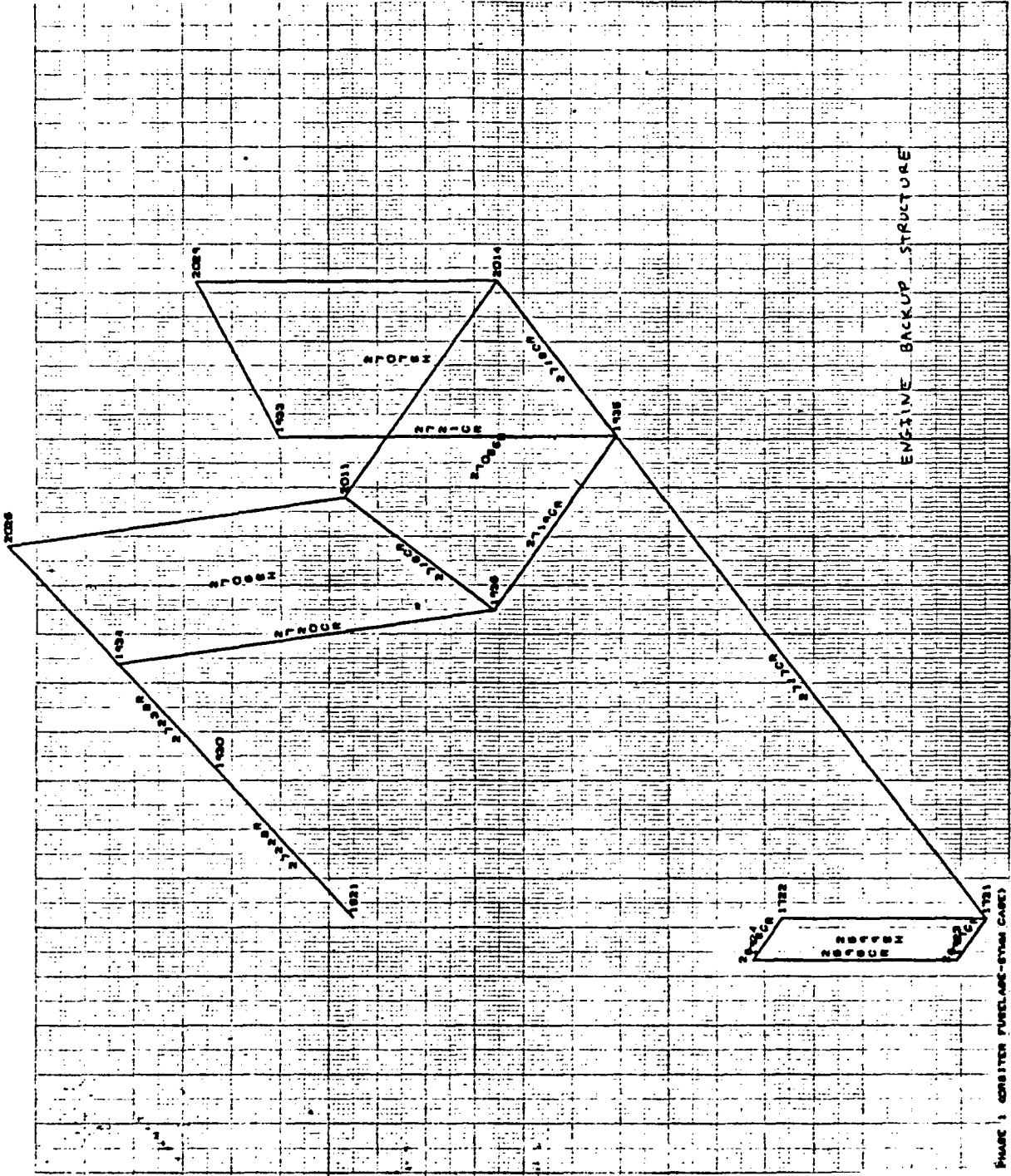

PHASE 1 CONSIDER FUELAGE-SYAM CASE)
 REVISION 4/23/74 (HALF EFFECTIVE SKINS)
 UNNOTCHED SHAPE

Appendix A8
PLOTS OF SYMMETRIC FREE-FREE MODES/PHASE 1 ANALYSIS:
MODEL II FUSELAGE

8/21/74 MAX-DEF. = 1.0000000

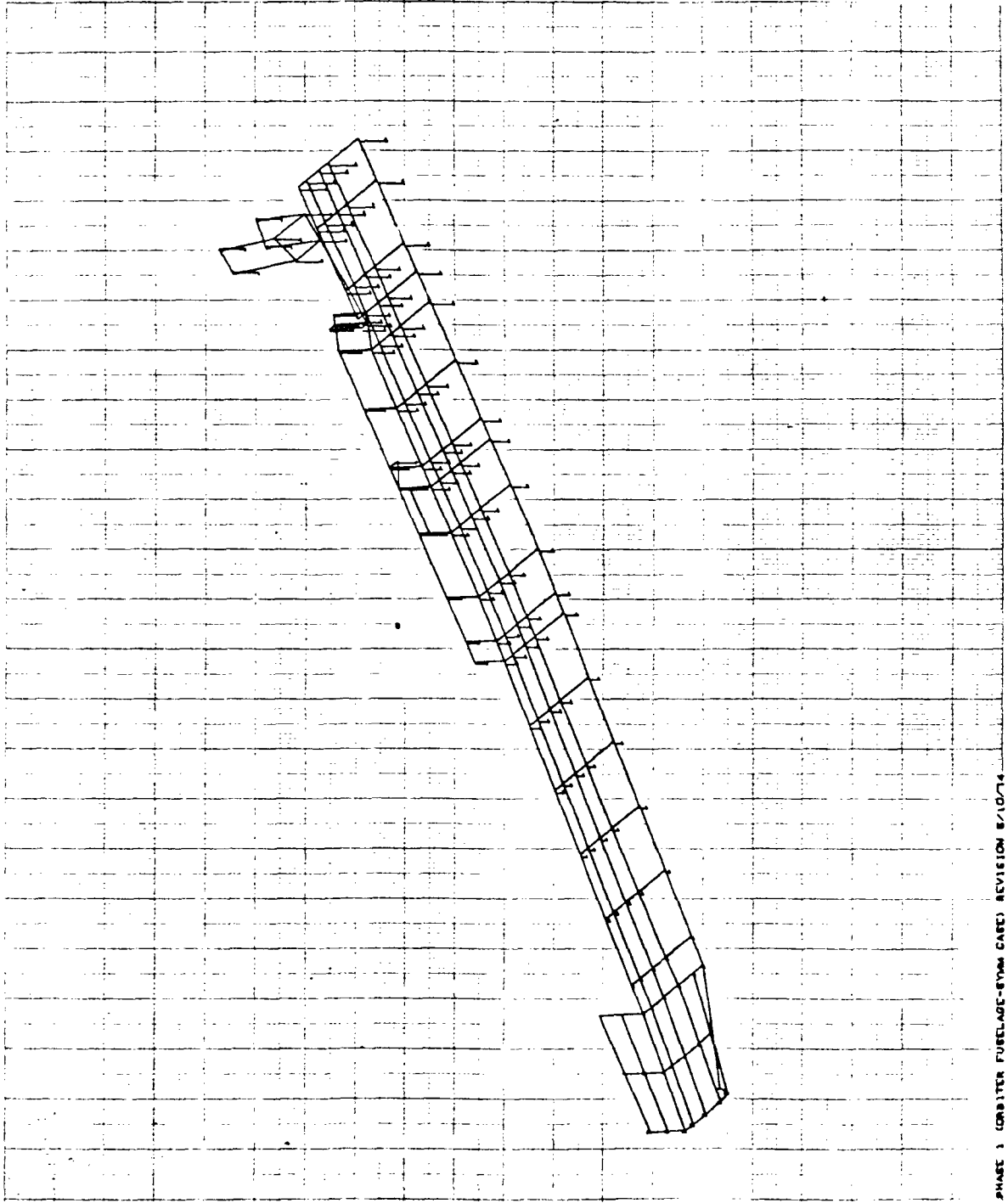

PHASE 1 (ORBITER FUSELAGE-SPIN CASE) REVISION 8/10/74
SKINS HALF EFF. LONG. .95 (EFF. TRANS. AT WING (90% EFF.)
RIPID BODY MODECS
MEDIAL DETON. FUSCASE 1 MODE 1 FREQ. 0.

8/21/74 MAN-DEF. 0 1.00000000

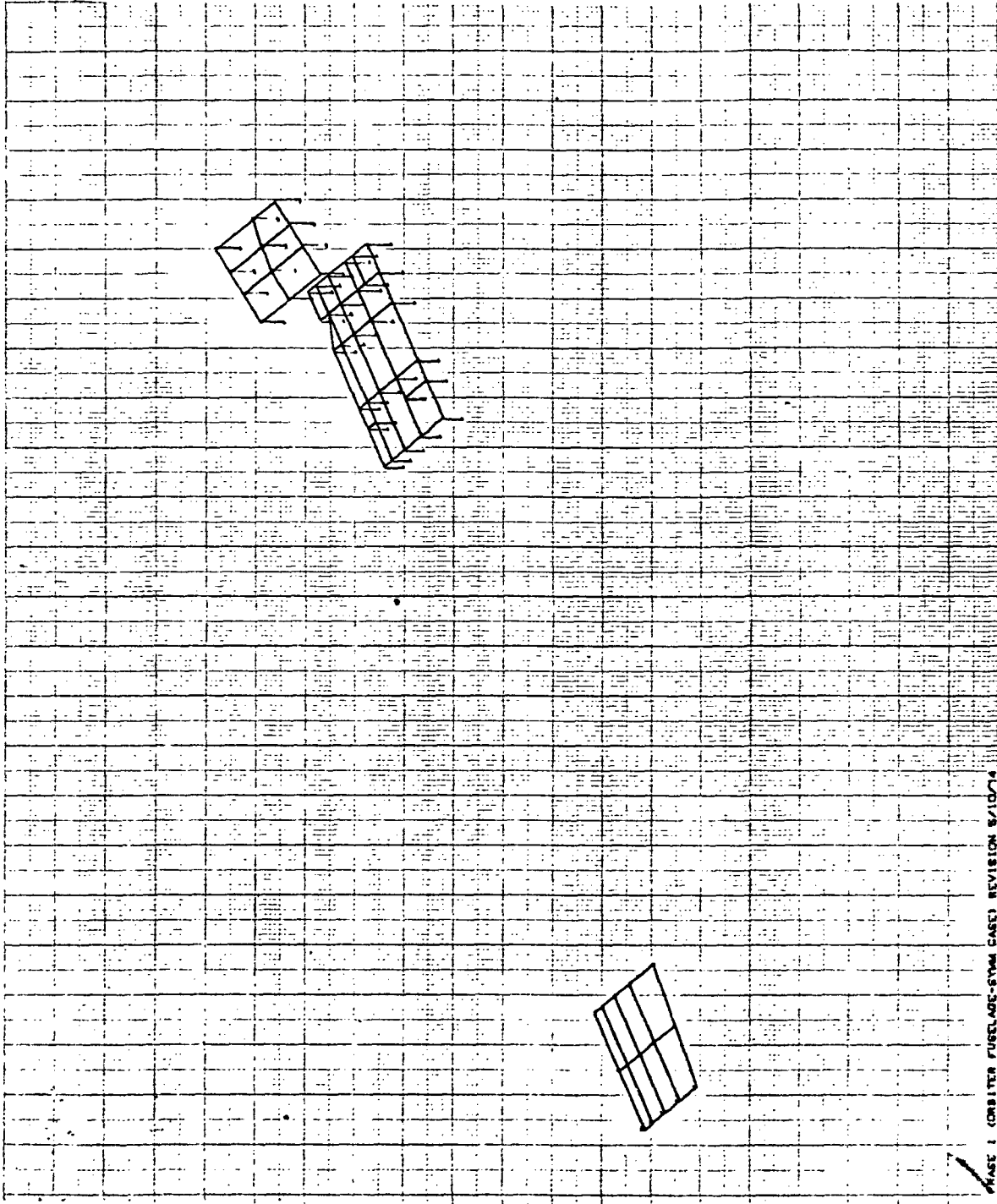

PHASE 1 (ORBITER FUSELAGE-SYMM CASE) REVISION 8/10/74
SKIN HALF EFT-LONG..88 (EFT-TRANS. AT WING CO-2/3 EFT.)
RIGID BODY MODES
MEDIAL DCFOR. SUBCASE 1 MODE 1 FREQ. 0.

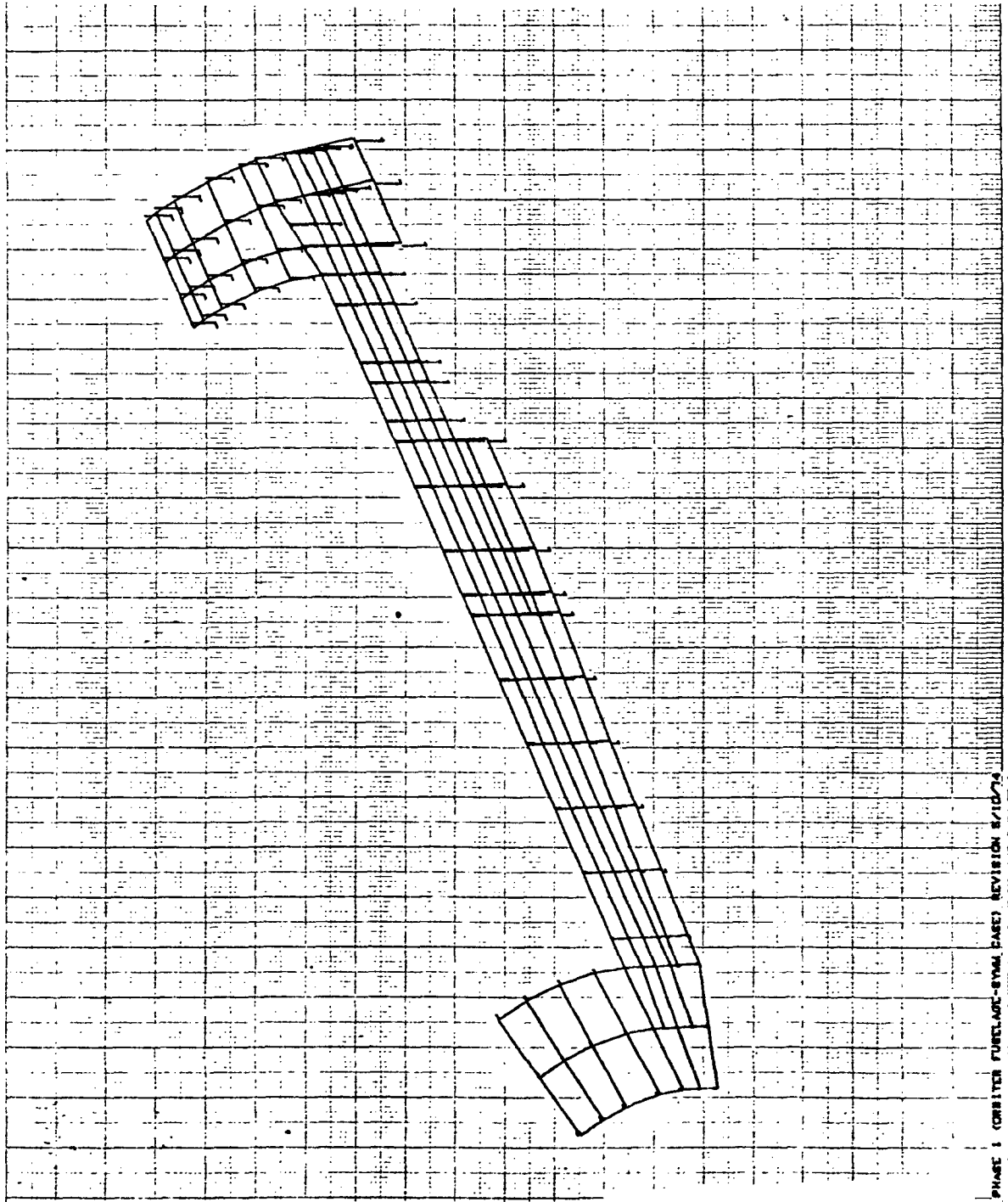

PHASE 1 (ORBITER FURTLAGE-SYMA CASE) REVISION 8/10/74
 SKINE HALF CTF.LONG..88 (CTF.TRANS.AT WING (0-2/2577.)
 R1818 BODY MODES
 MODAL DETER. SUBCASE 1 MODE 1 FREQ. 0.

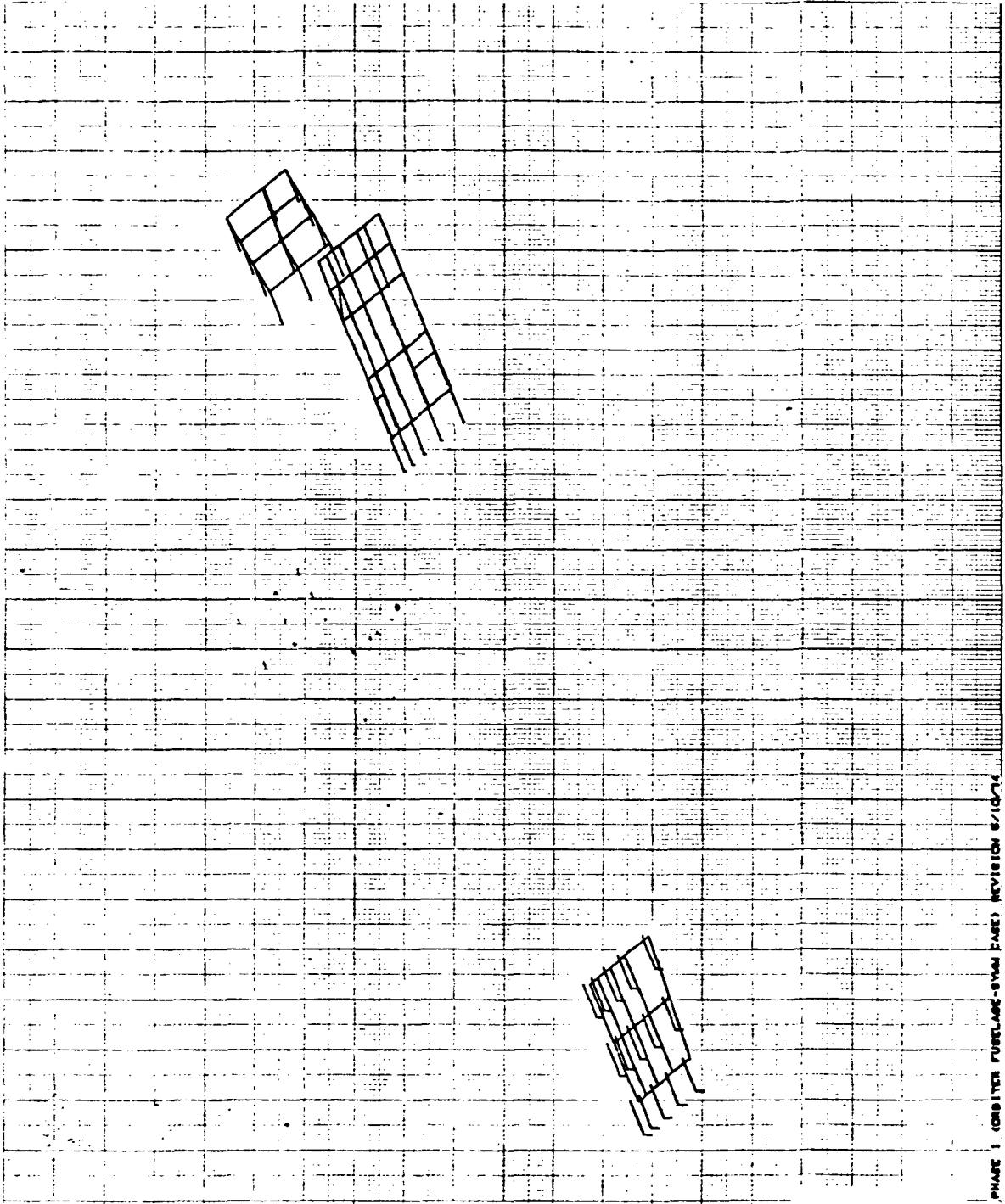

PHASE 1 (ORBITER FUSelage-SYMM CASE) REVISION 8/10/74
 SKIN HALF EFF. LONG. BE (EFF. TRANS. AT WING 0.2/3/5/7)
 RIGID BODY MODES
 MODAL DETER. SUBCASE 2 MODE 2 FREQ. 0.

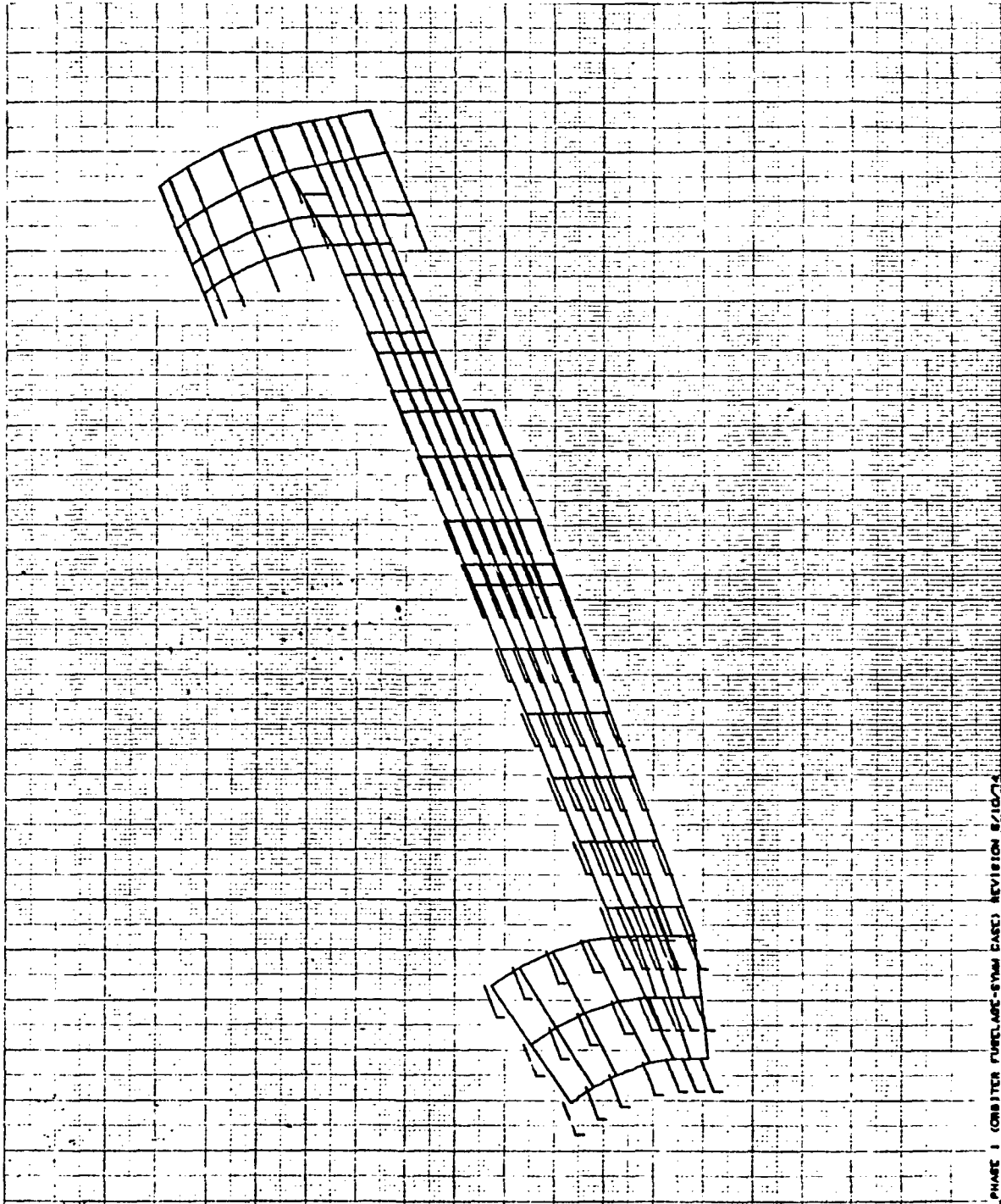

PHASE 1 (ORBITER FURCLAGE-SYMM CASE) REVISION 8/10/74
SEIMS HALF EFF. LONG. 0.88 (EFF. TRANS. AT WING (8-2-2877))
BIBO BODY MODES
MEDIAL VECTOR. SUBCASE 2 MODE 2 FREQ. 0.

3 8/21/74 MAX-DEF. = 1.0000000

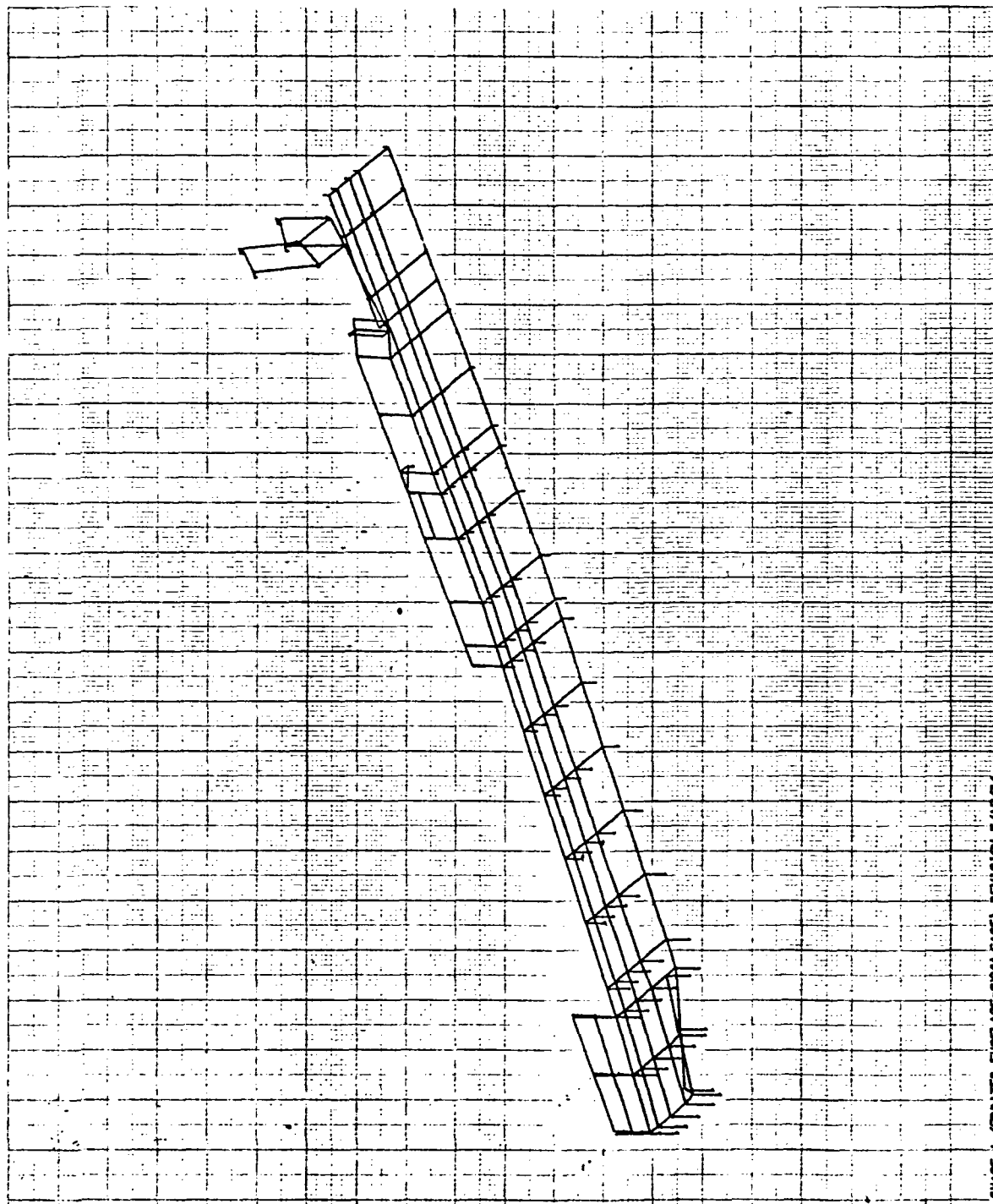

PHASE 1 CRIBITER FURFLAGE-SYMM CASE) REVISION 8/10/74
SEIWS HALF EXT. LONG. .05(EXT. TRAMP. AT WING 0.2/3/ST.)
RIGID BODY MODES
MEDIAL DCTOR. SUBCASE 3 MODE 3 FREQ. 0.

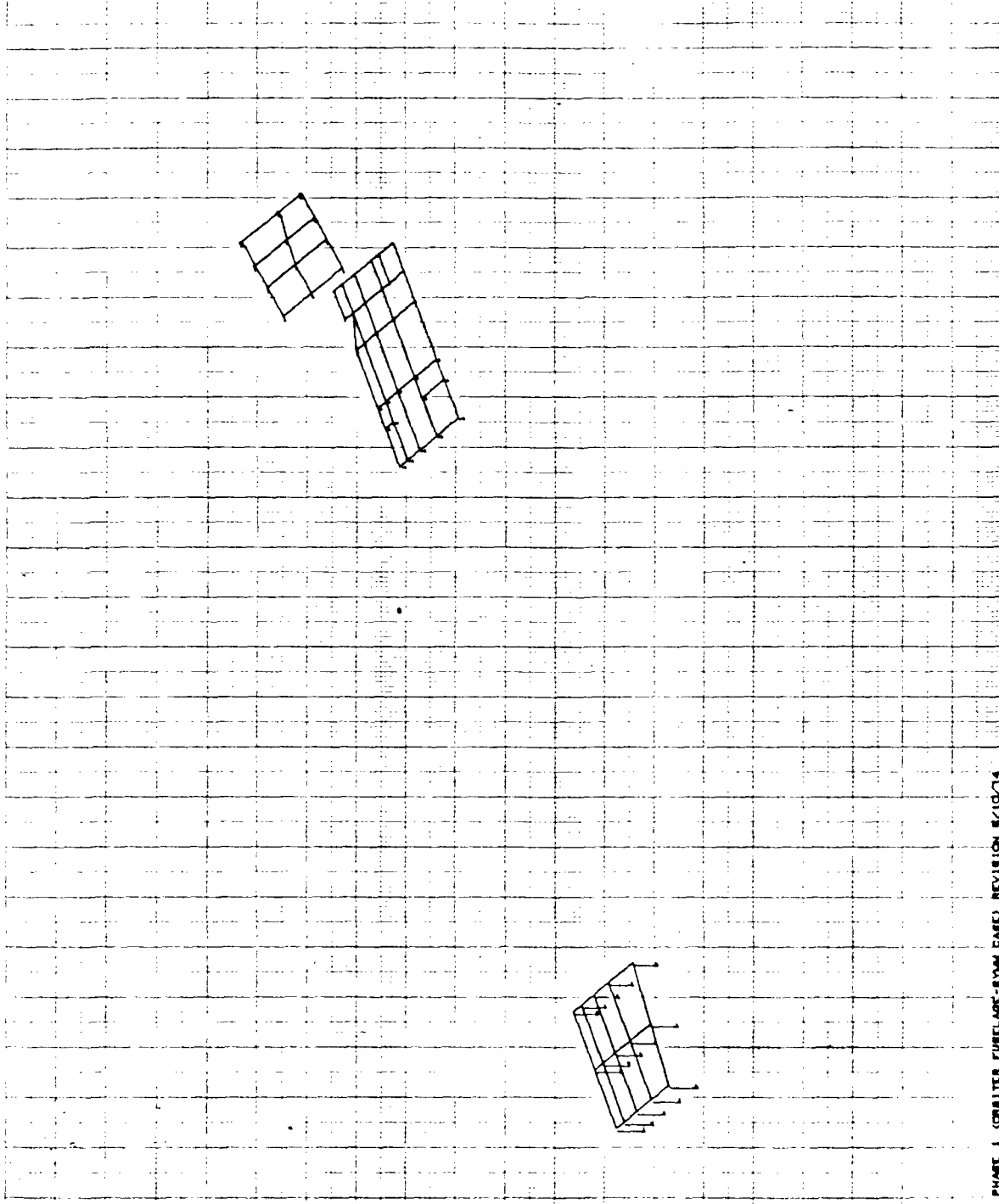

PHASE 1 (CONVERT FUSELAGE-SYMM CASE) REVISION 8/10/74
 BEING HALF EFF. LOAD. 98 C EFF. TRANS. AT WING (0+2/3EFF.)
 RIGID BODY MODES
 MODAL DEFOR. SUBCASE 3 MODE 3 FREQ. 0.

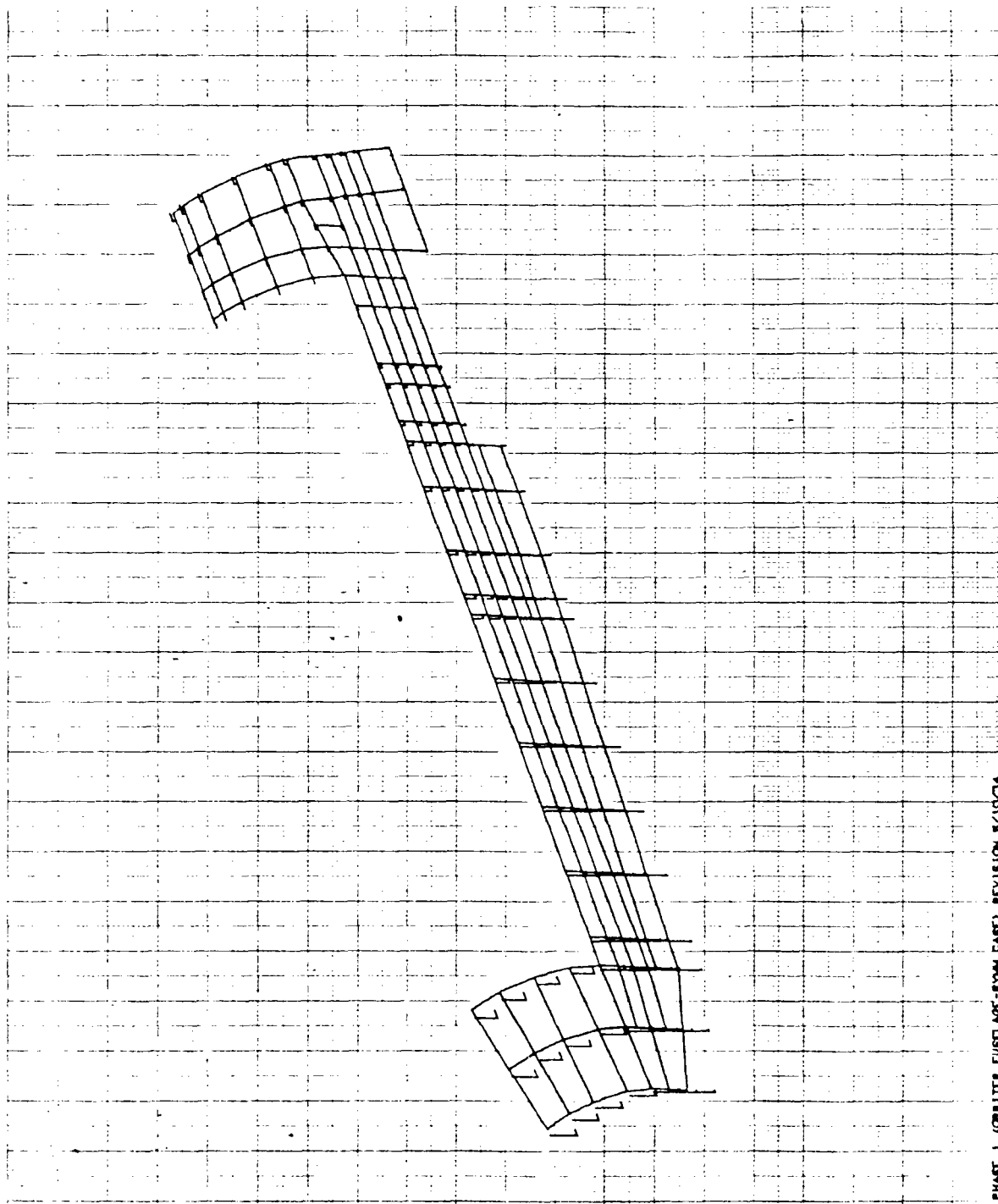

PHASE 1 (CORBITER FUSELAGE-SYMM CASE) REVISION 8/10/74
SKIN HALF EFF. LONG. .88 (EFF. TRANS. AT WING (0.2/3EFF.)
RIGID BODY MODES
MODAL ORDER. SUBCASE 3 MODE 3 FREQ. 0.

8/21/74 MAX-DEF. = 1.00000000

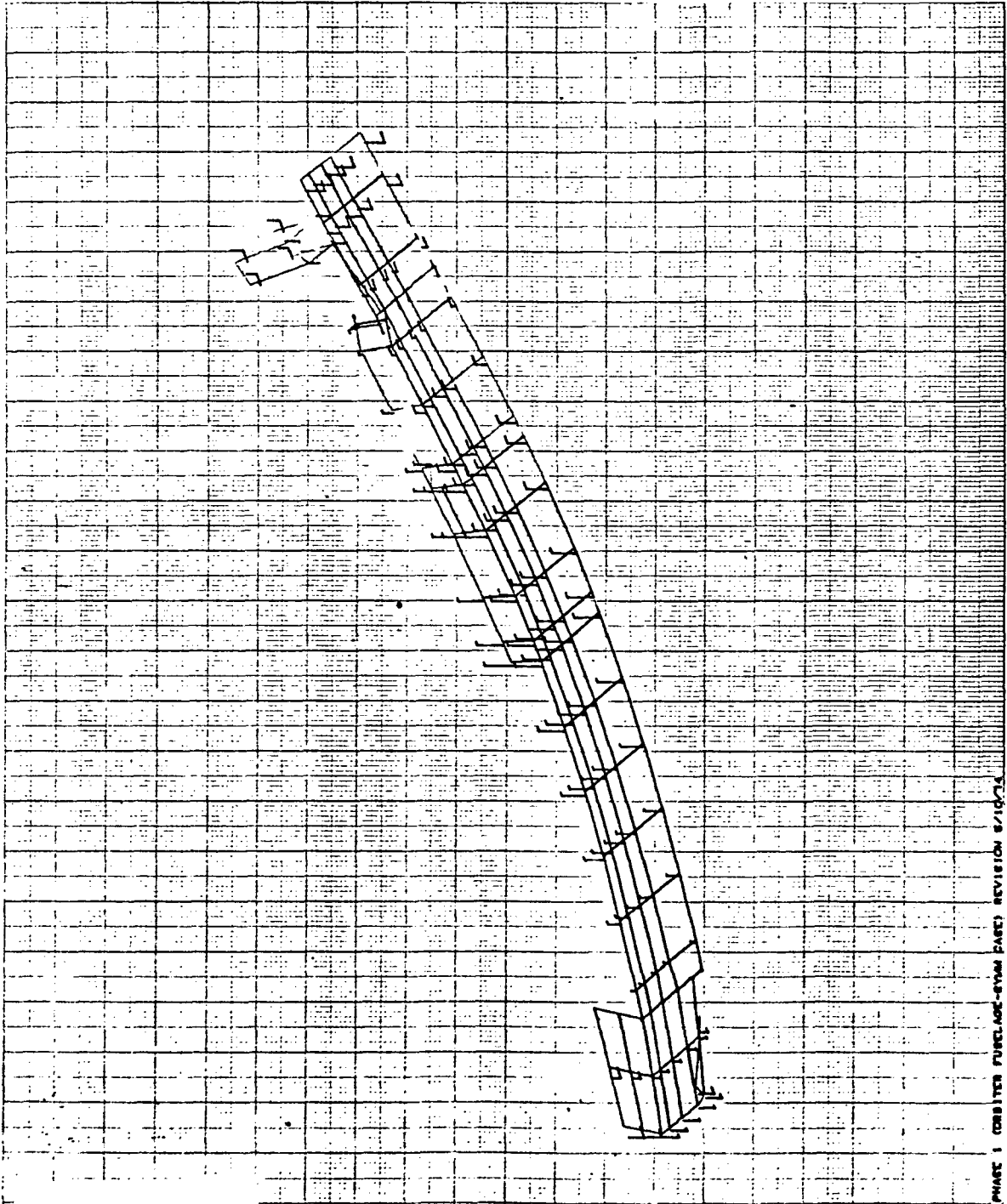

PHASE 1 (CRIBTER FURCLAGE-RYAM PASE) REVISION 8/10/73
SKINS HALF ETT. LONG. .05 (ETT. TRANS. AT WING (0-2/3ETT.)
FACE FACE MODES
MODAL VECTOR. SUBCASE 4 MODE 4 FREQ. 55.10559

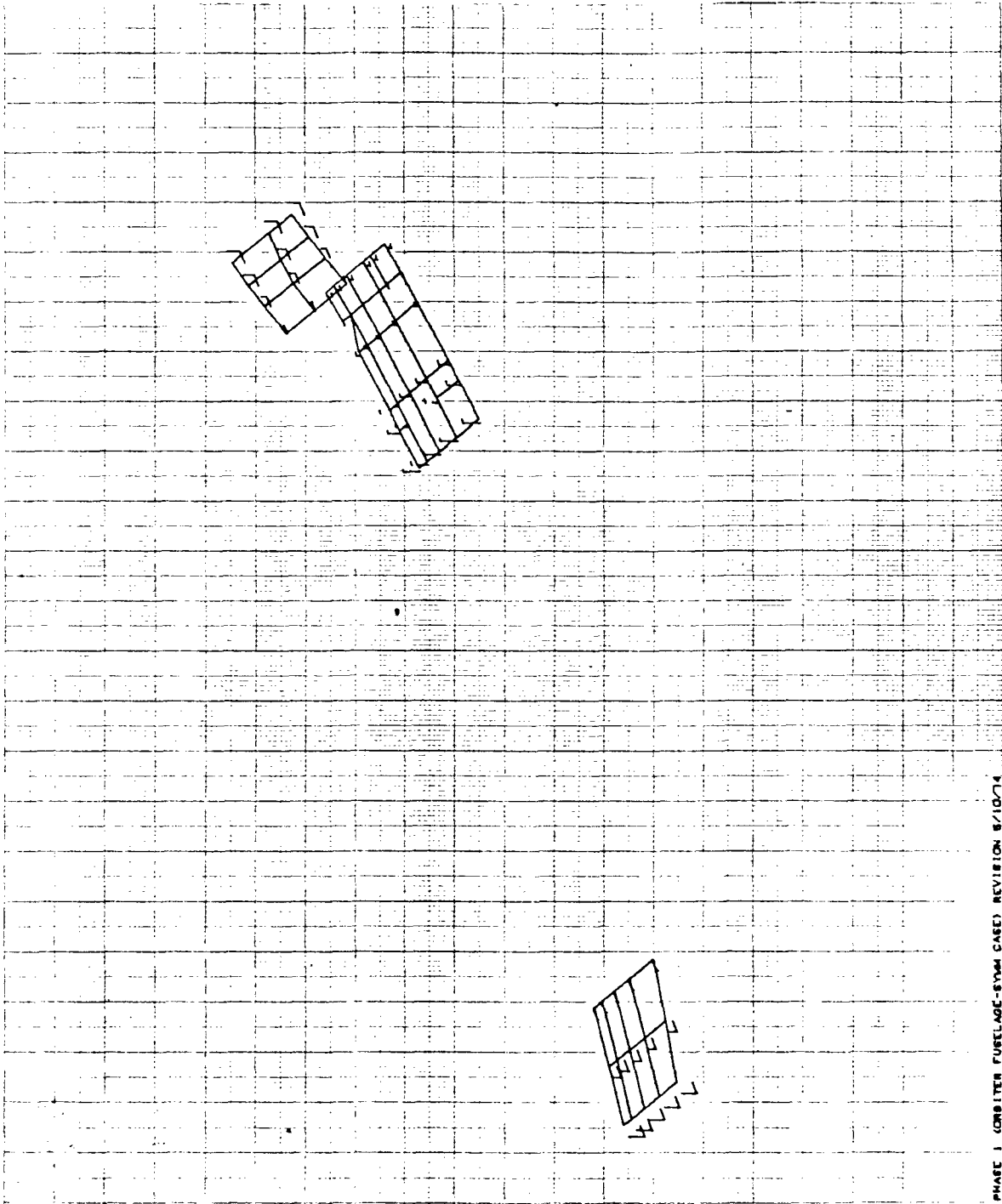

PHASE 1 (ORBITER FUELRAGE-SYM CASE) REVISION 8/10/74
 SKIRT HALF EXT. LONG. 887 EXT. TRANS. AT WING (0.2/2877.2)
 FREE FREE MODES
 MODAL DETON. SUBCASE 4 MODE 4 FREQ. 88.18588

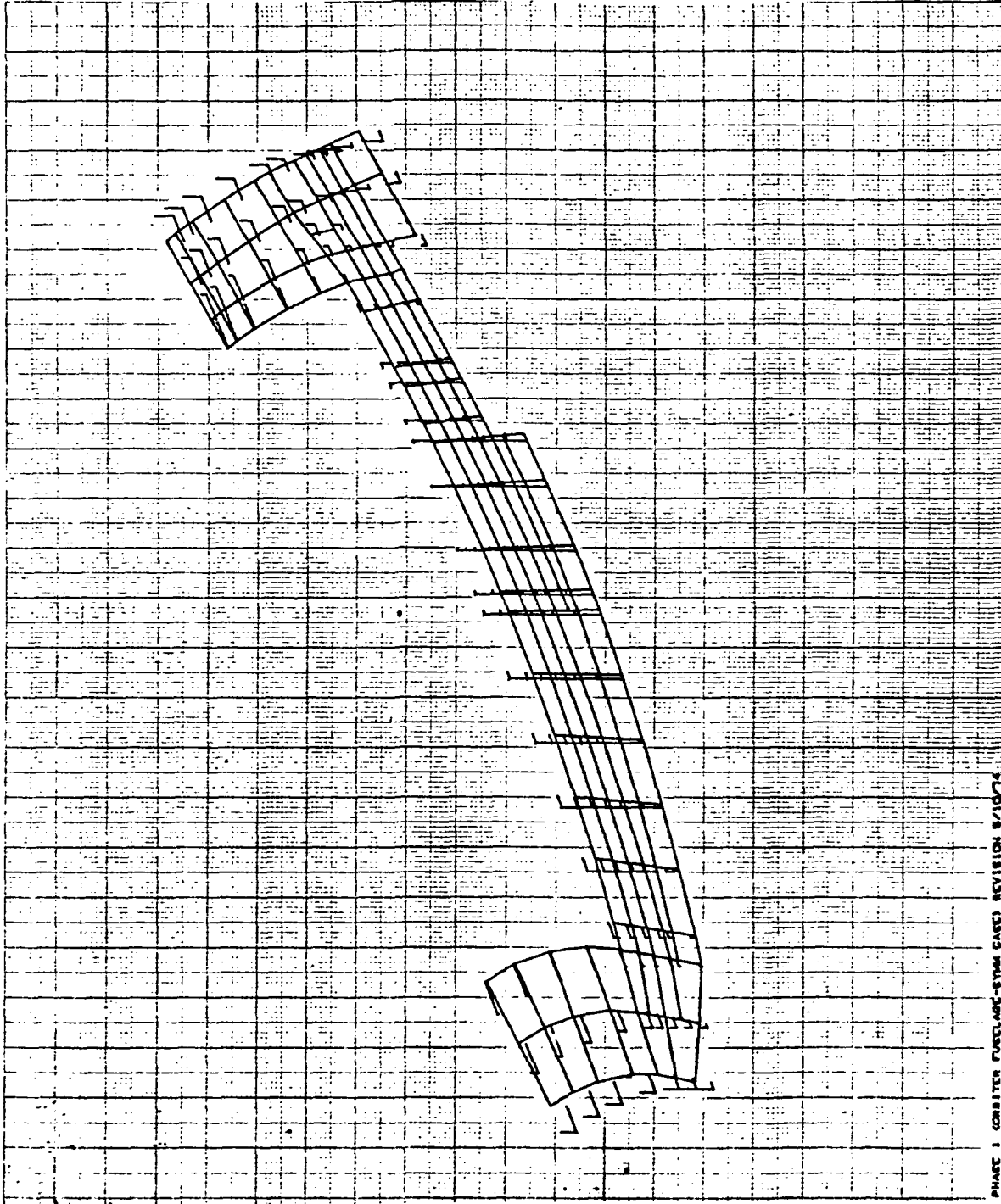

PHASE 3 CORBITER FUEL/ARC-SYMM CASE3 REVISION 8/10/74
 SKLINE HALF CTT.LONG..861 CTT.TRANS.AT N148 (8-2/2077.)
 FREE FACE MODES
 MODAL VECTOR. SUBCASE 4 MODE 4 FREQ. 66.16000

5 8/31/74 MAP-DKT. • 1.00000000

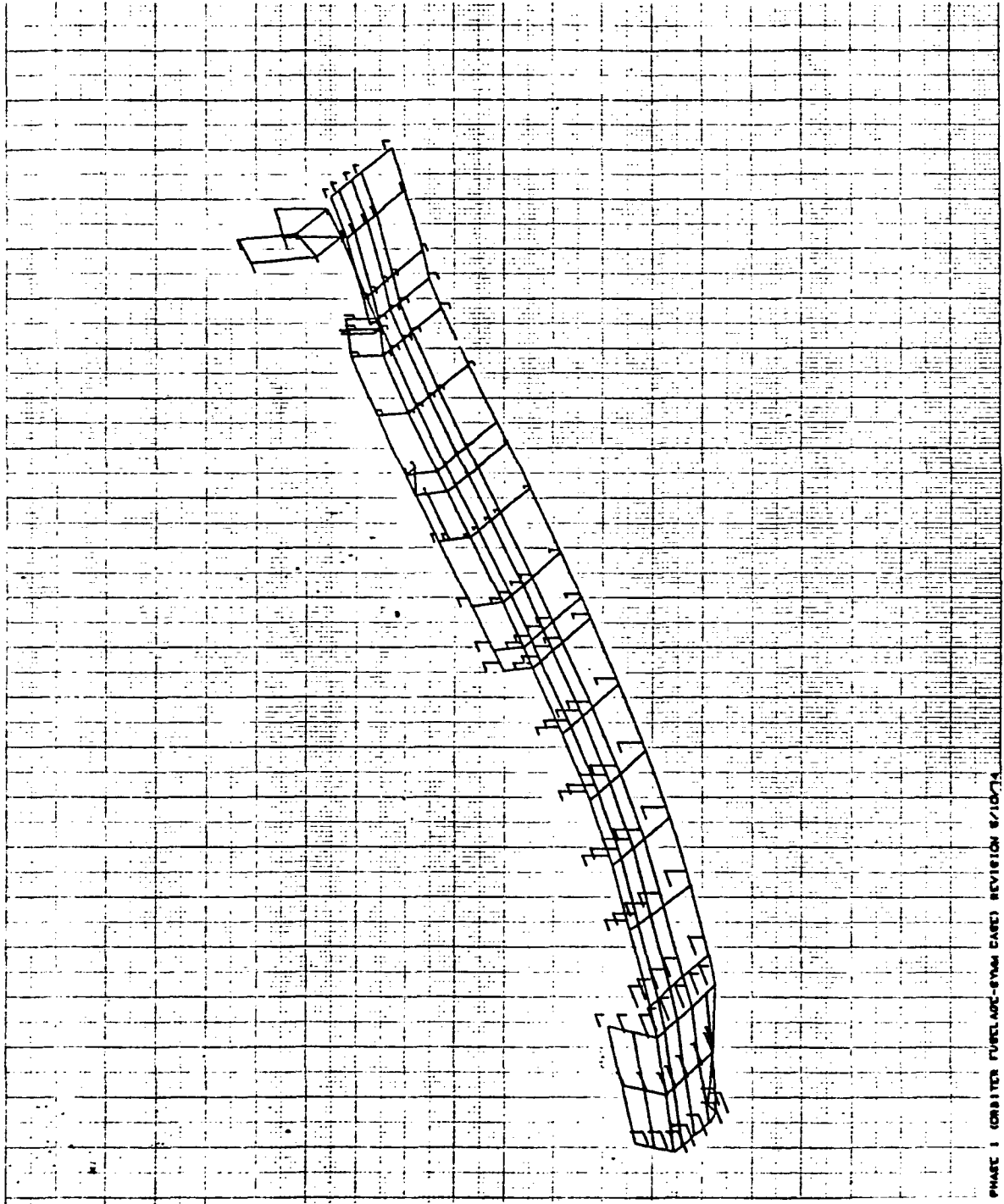

PHASE 1 (ORBITER FUELCAGE-SHAM CASE) REVISION 8/10/74
SKINE HALF EXT. LOAD. REC. EXT. TRAMS. AT WIND 08-2/3/EXT. 1
FREE FREE MODES
MEDIAL VECTOR. SUBCASE 5 MODE 5 FREQ. 109.4871

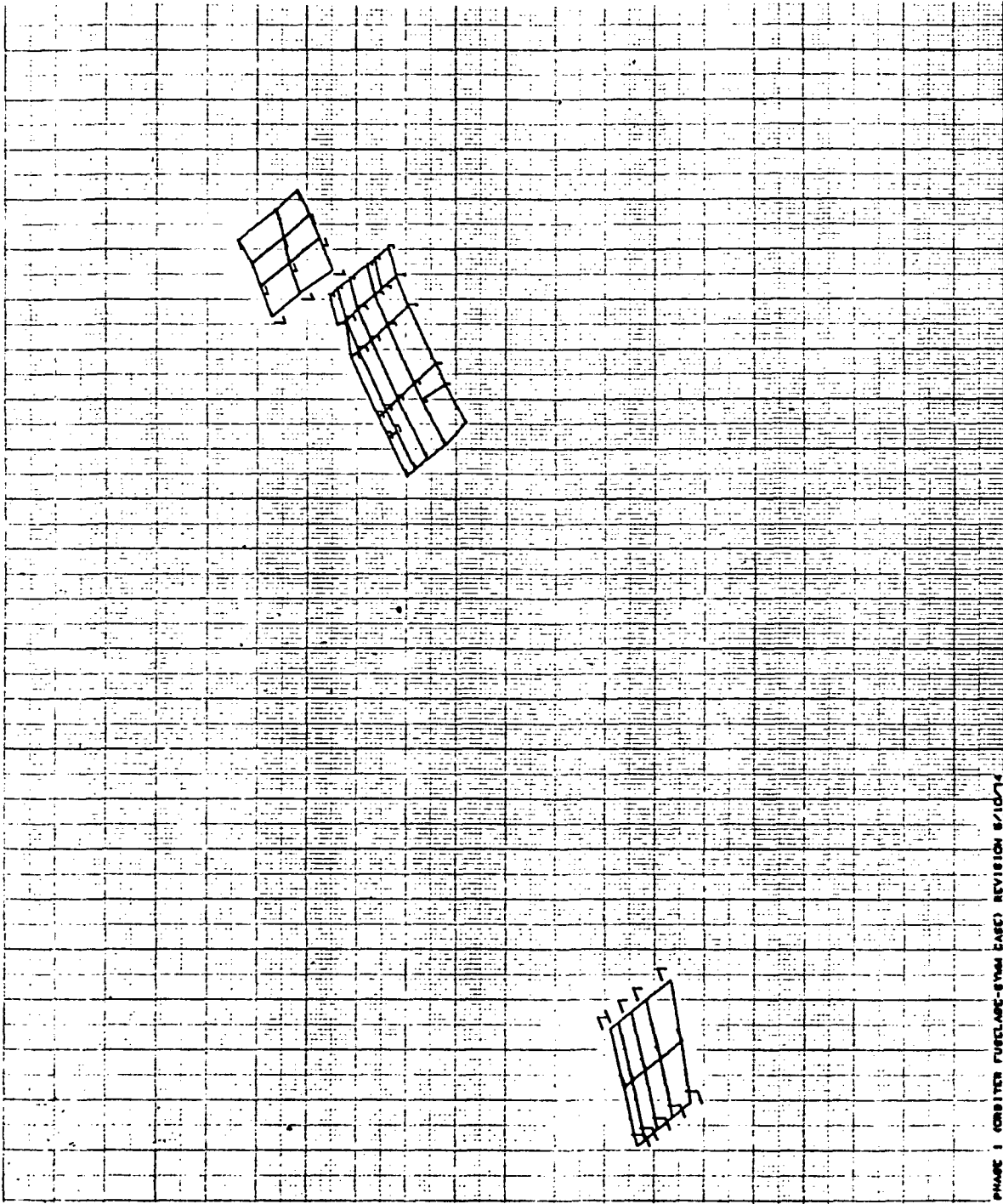

PHASE 1 (ORBITER FUSelage-STIM CASE) REVISION 8/10/74
 BEING HALF EFF. LONG. BE (EFF. TRANS. AT WING (0-2/3/ET))
 FREE FREE MODES
 MODAL REF. SURFACE 5 MODE 5 FREQ. 104.9871

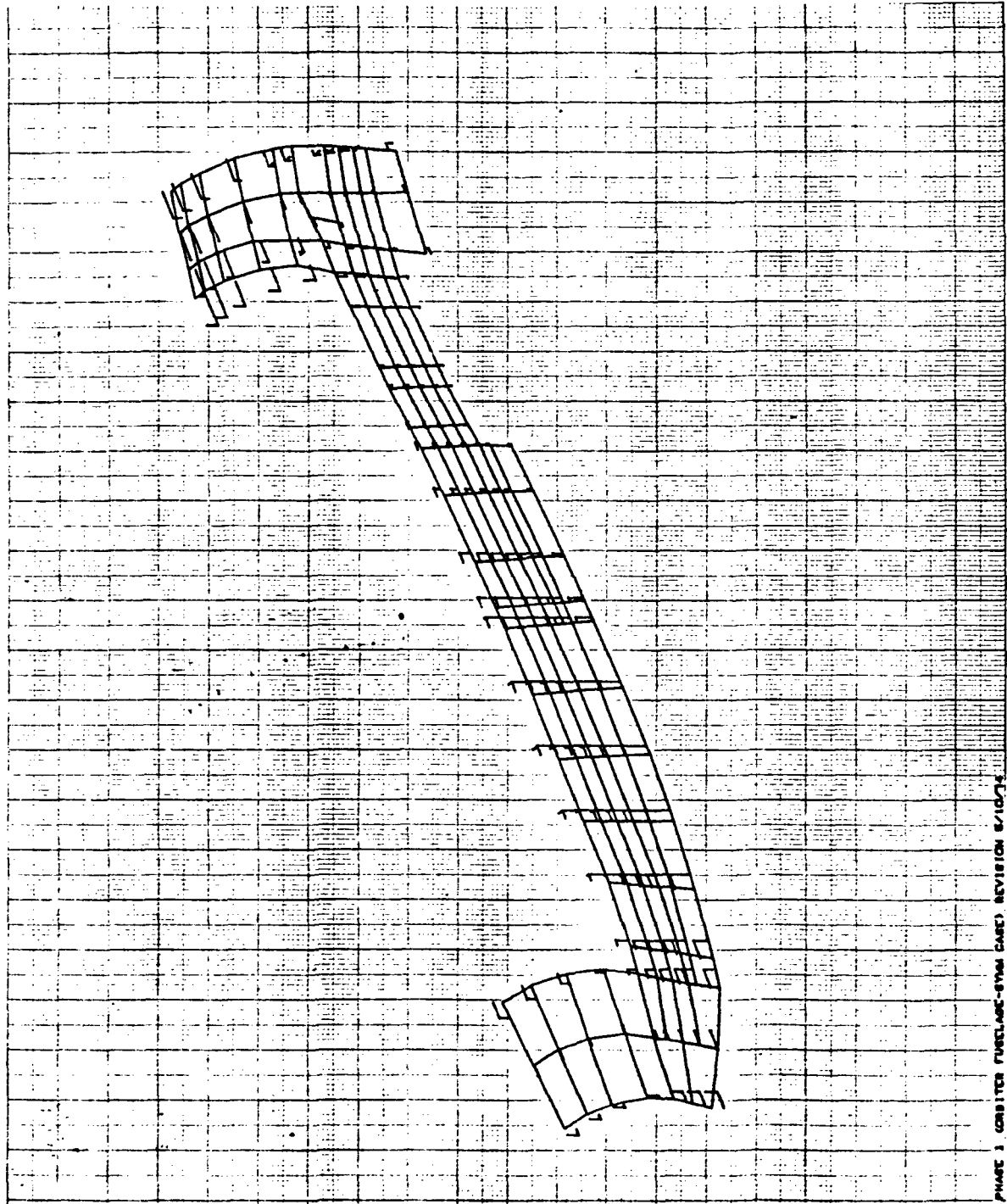

PHASE 3 ORBITER PURCHASE (SPM CASE) REVISION 8/10/74
 BEING HALF EFF. LONG. BE (EFF. TRANS. AT NING 02-2/0277.)
 FREE FREE MODES
 MODAL DEFEN. PURCHASE 5 MODE 5 FREEL. 104. 4871

6 8/21/74 MAX-DECT. = 1.46000000

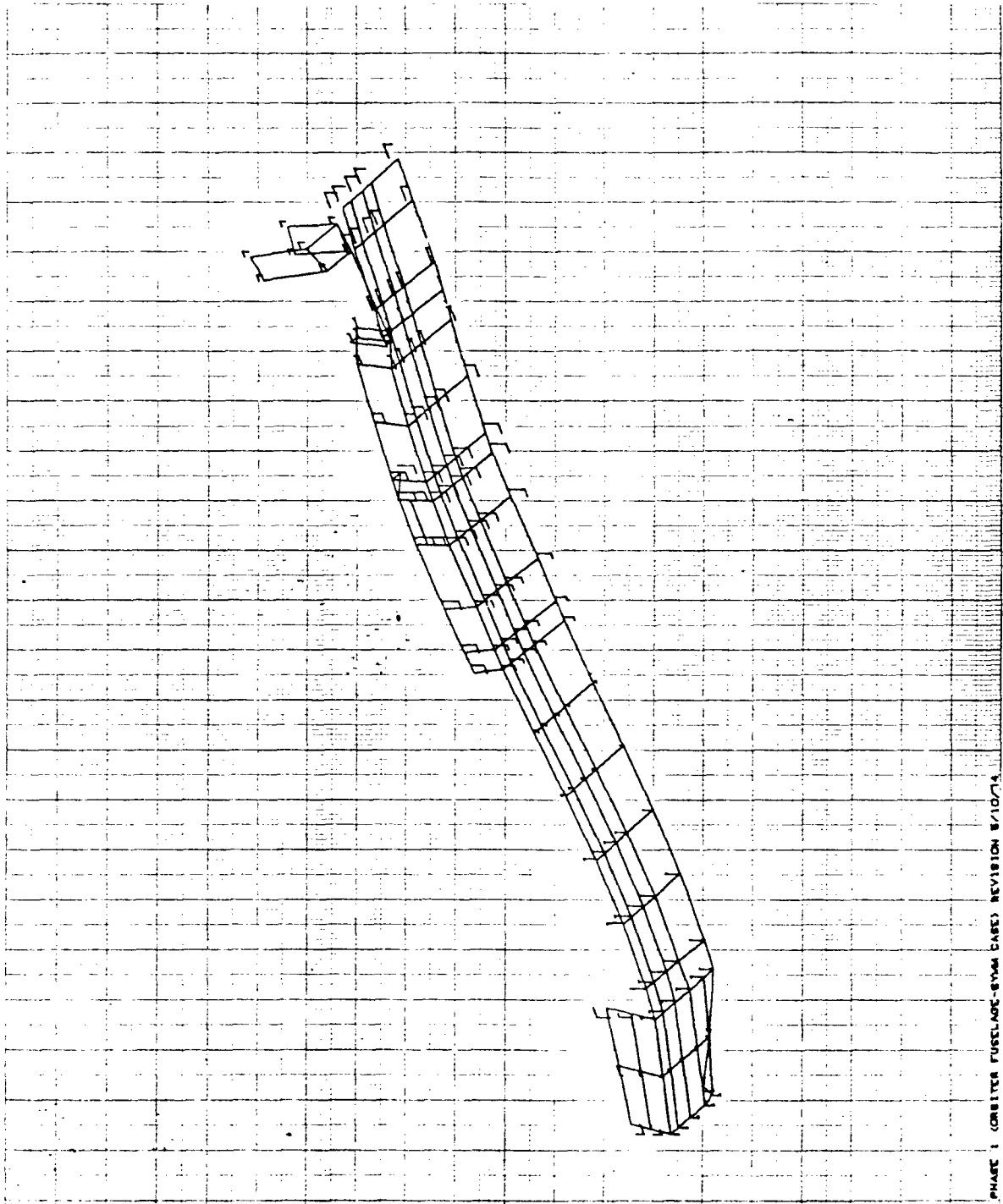

PHASE 1 ORBITER FUSELAGE-SYMM CASES REVISION 8/10/74
BEHIND HALF EFF. LONG., 86 C EFF. TRANS. AT WING 10-2/3 EFF. 1
FREE FREE MODES
MODAL DETOR., SUBCASE 8 MODE 6 FREQ. 154.3008

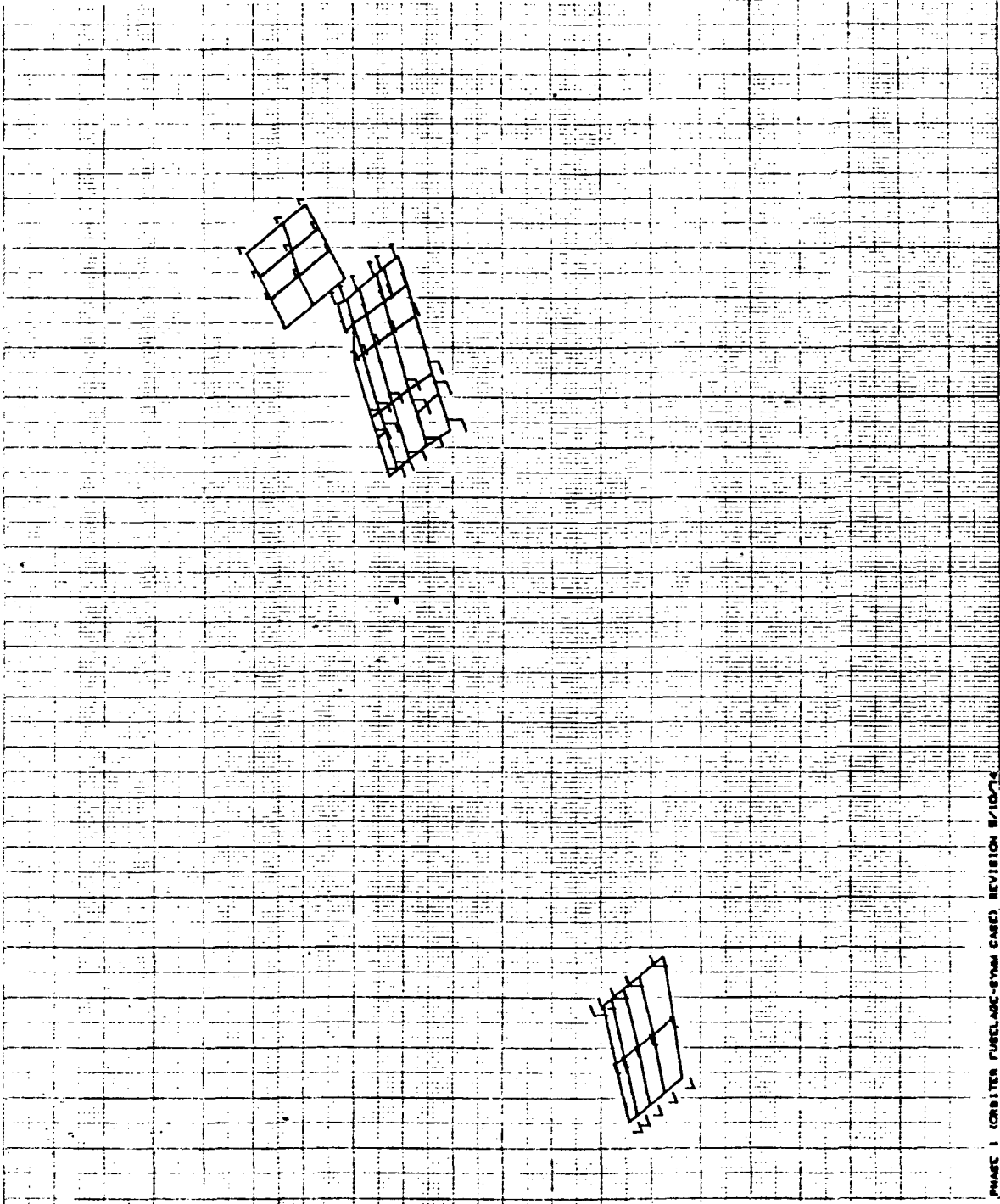

PHASE 1 (ORBITER FUELTAGE-SYMA CASE). REVISION 8/10/74
 BK108 HALF CTT..LOW..88 CTT..THAMB..AT WING 08-2/0CTT..
 FREE FREE MOSES
 MODAL DETON. SURFACE 6 MOSE 6 FREE. 154.3008

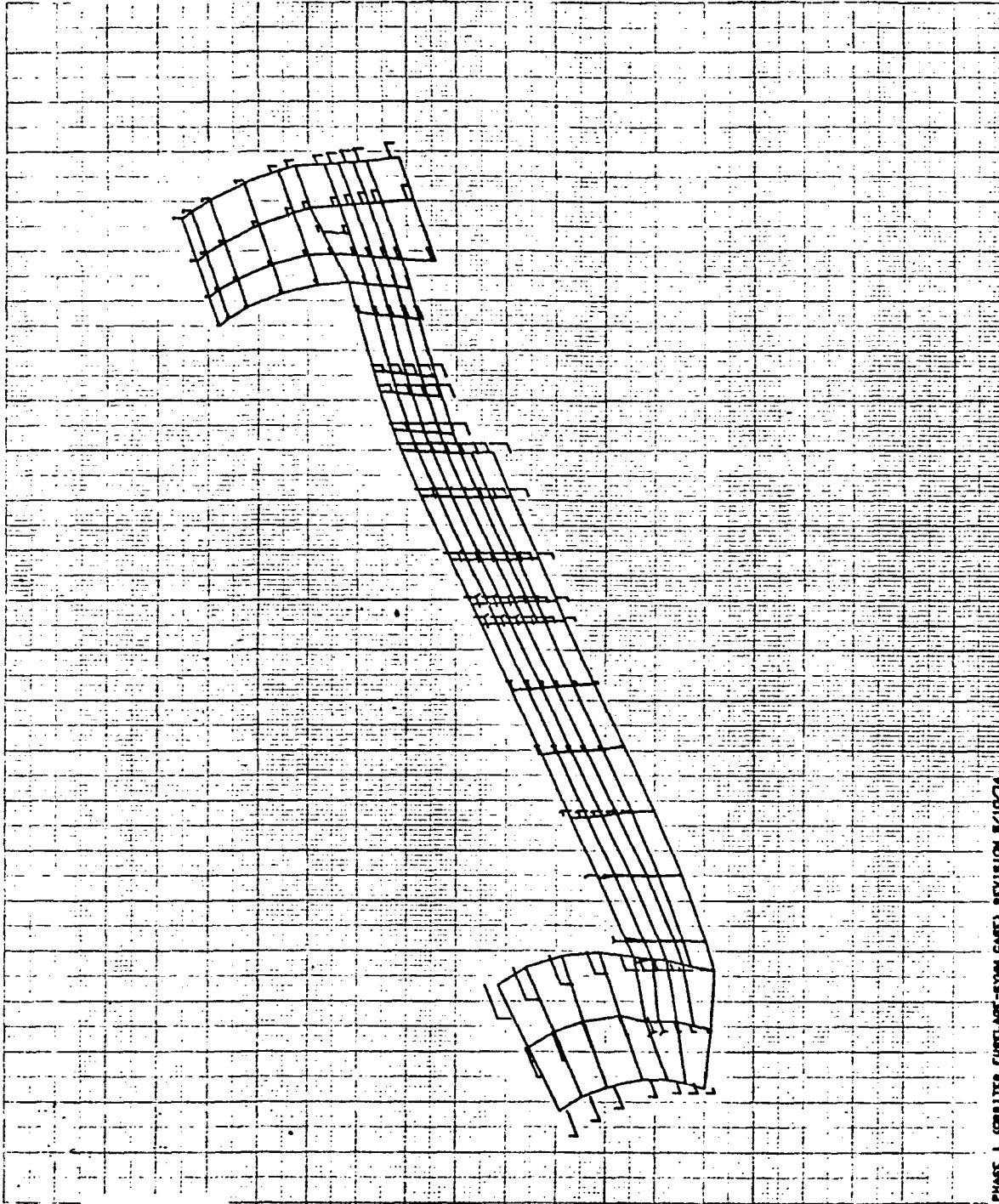

PHASE 1 CORBITER FURCLAGE-STYAM CASES REVISION 8/10/74
 BEING HALF EFF. LONG. 0.88 (EFF. TRANS. AT WING (8-2/3) EFF.)
 FREE FREE MODES
 MODAL DEFOR. SUBCASE 9 MODE 6 FREQ. 164.3028

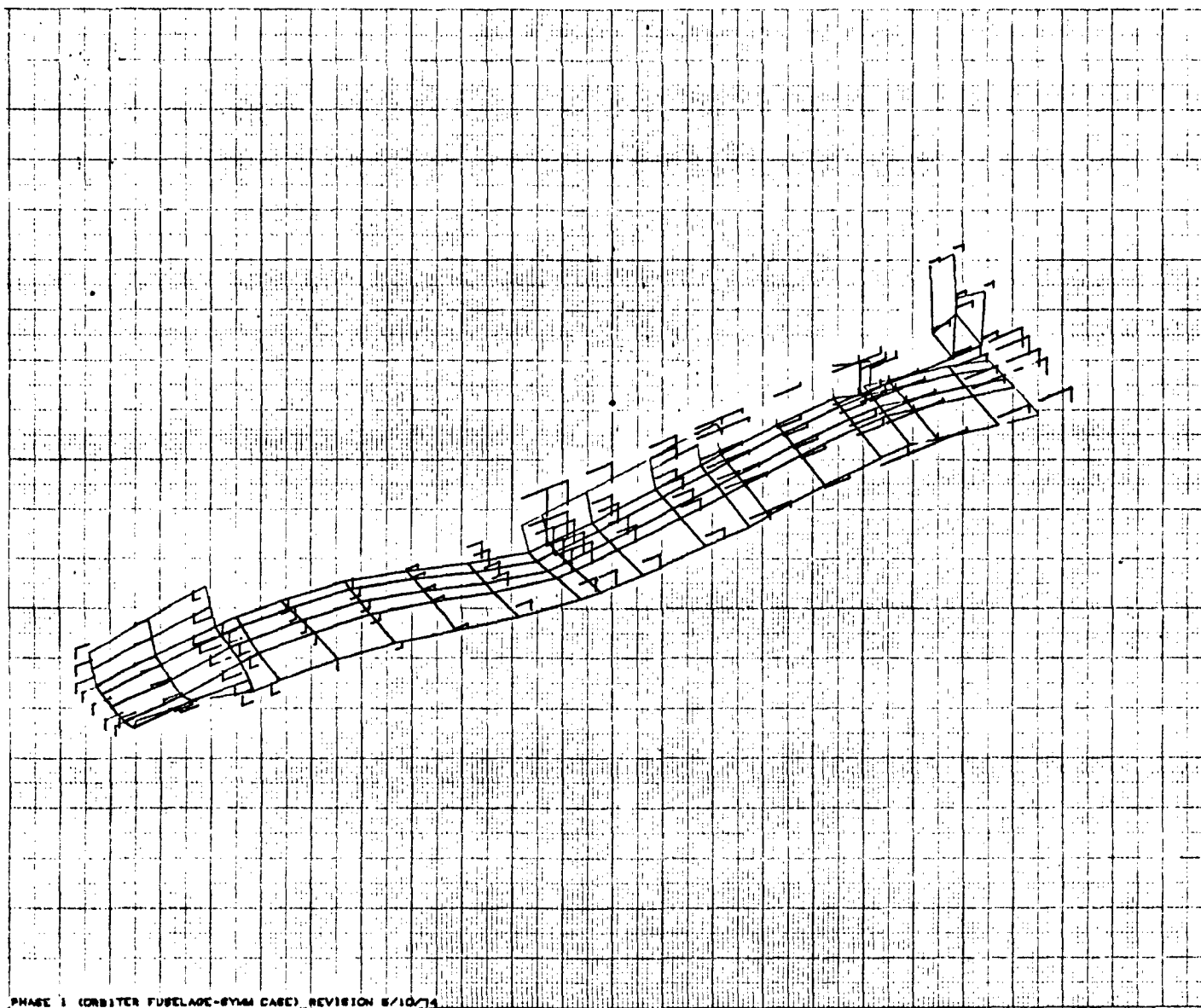

PHASE 1 (ORBITER FUSELAGE-SYMM CASE) REVISION 5/10/74
SKINS HALF EY. LONG. .95< CFF. TRANS. AT WING (0.2/3EFF.)
FREE FREE MODES
MODAL DEFOS. SUBCASE 7 MODE 7 FREQ. 199.1420

18. 8.21/1 MAX-DEF. = 1.00000000

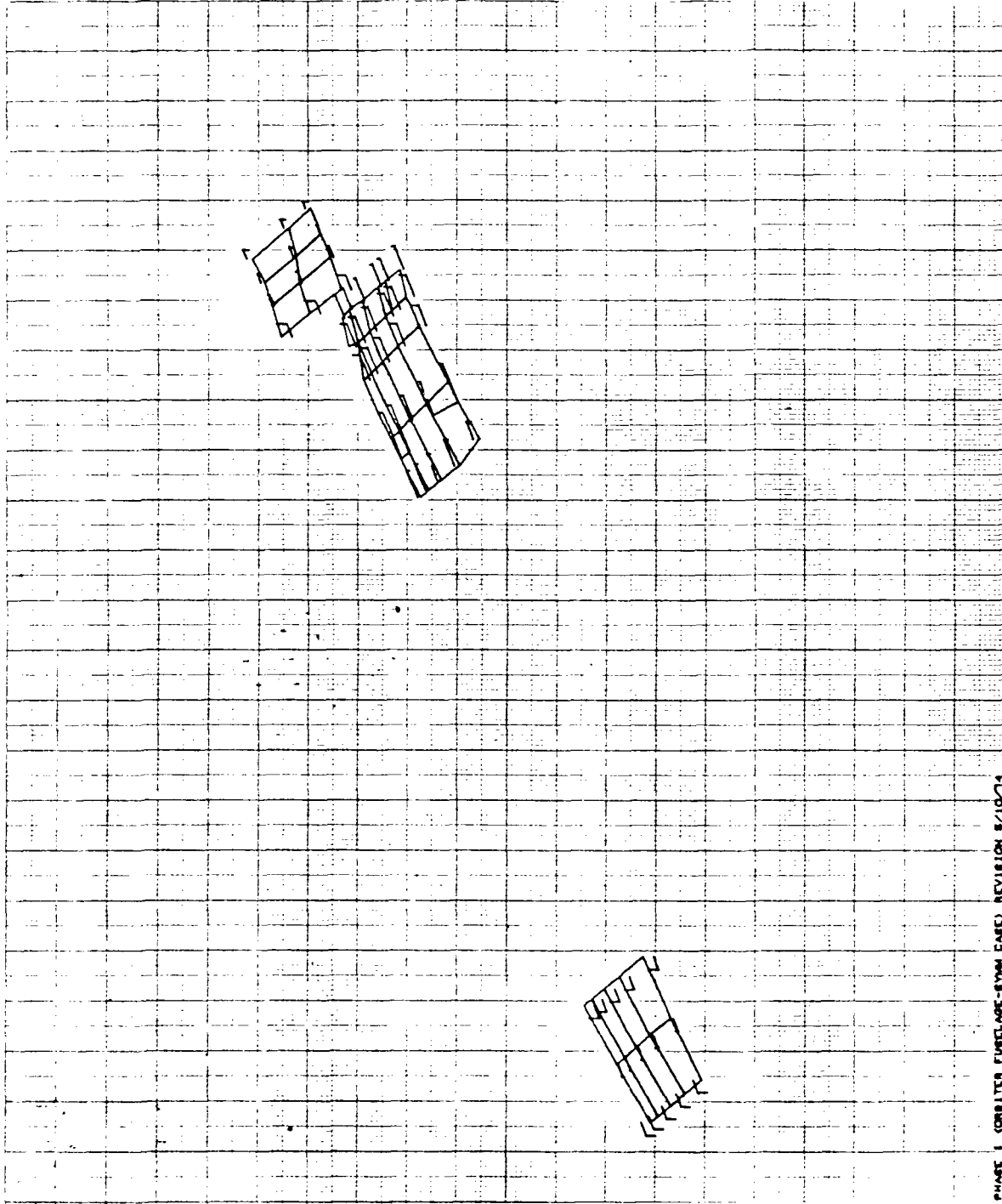

PHASE 1 (ORBITER FUELTAGE-SYMM CASE) REVISION 8/10/74
 BEING HALF CFT. LONG. .981 EFF. TRANS. AT WING (0.2/3EFF.)
 FREE FREE MODES
 MODAL DETOR. SUBCASE 7 MODE 7 FREQ. 199.1989

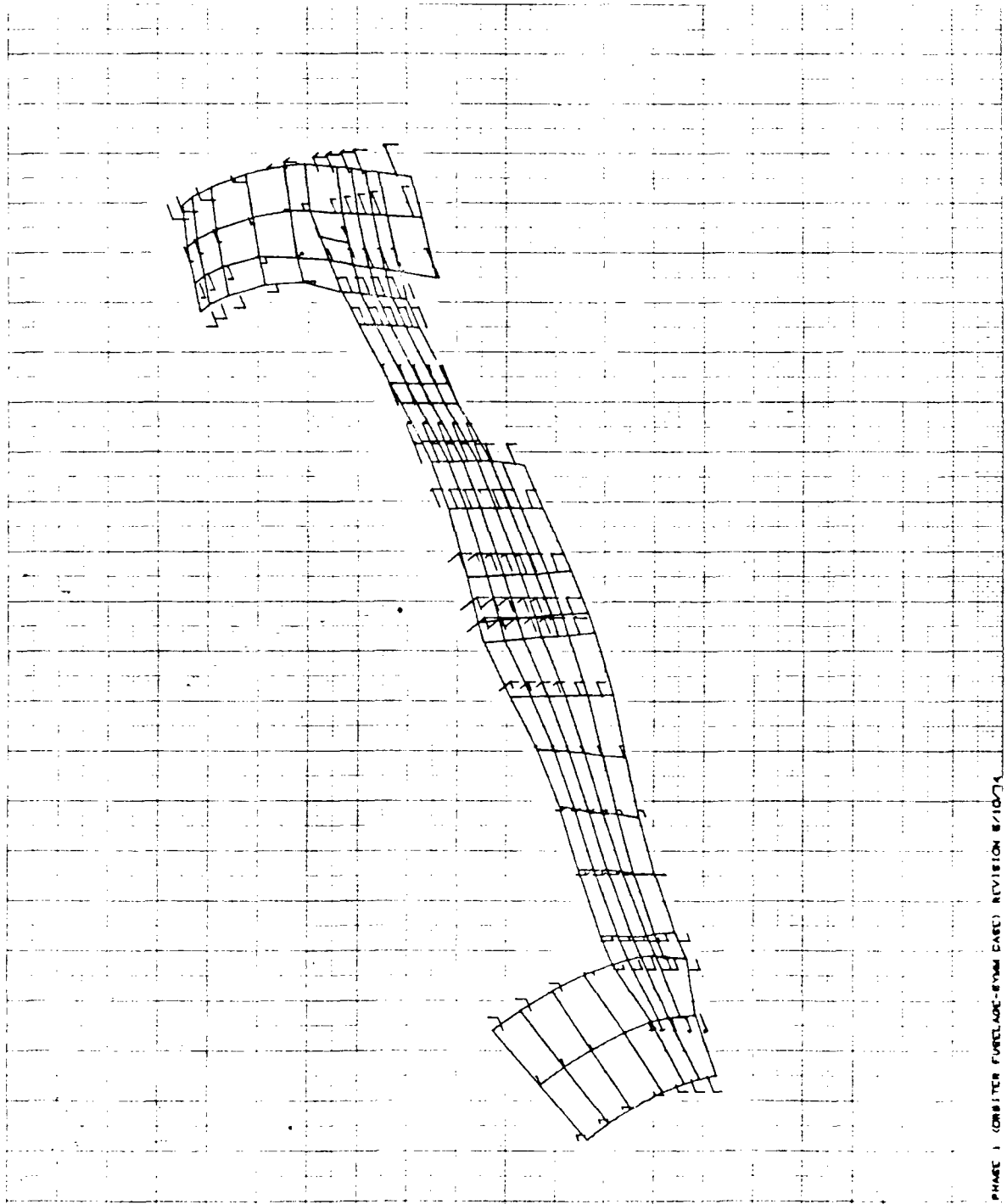

PHASE 1 (ORBITER FURCLAGE-SYMM CASE) REVISION 8/10/74
 SKINS HALF ETT. LONG. .86 (ETT. TRANS. A7 NING (0-2/3 ETT.)
 FREE FREE MODES
 MODAL VECTOR. SUBCASE 7 MODE 7 FREQ. 199.1428

8/21/74 MAX-OET. = 1.0009320

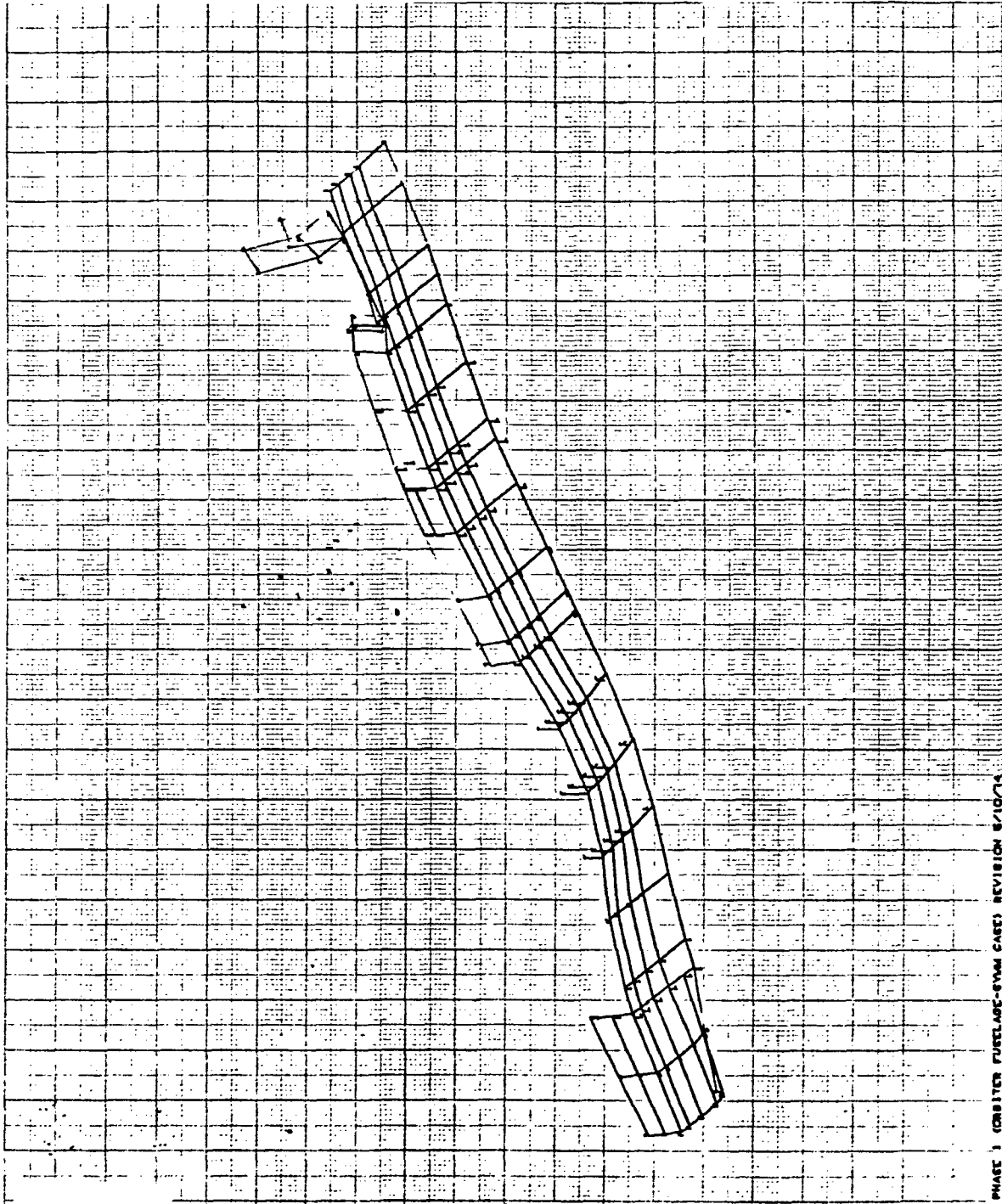

PHASE 1 (ORBITER FUELRAGE-SYM CASE) REVISION 8/10/74
SKIN HALF ETT-LONG., BEC ETT-TRANS. AT WING 08-2/3 ETT.)
FREE FREE MODES
MEDAL OETOR, SUBCASE 0 MODE 0 FREQ. 248.1804

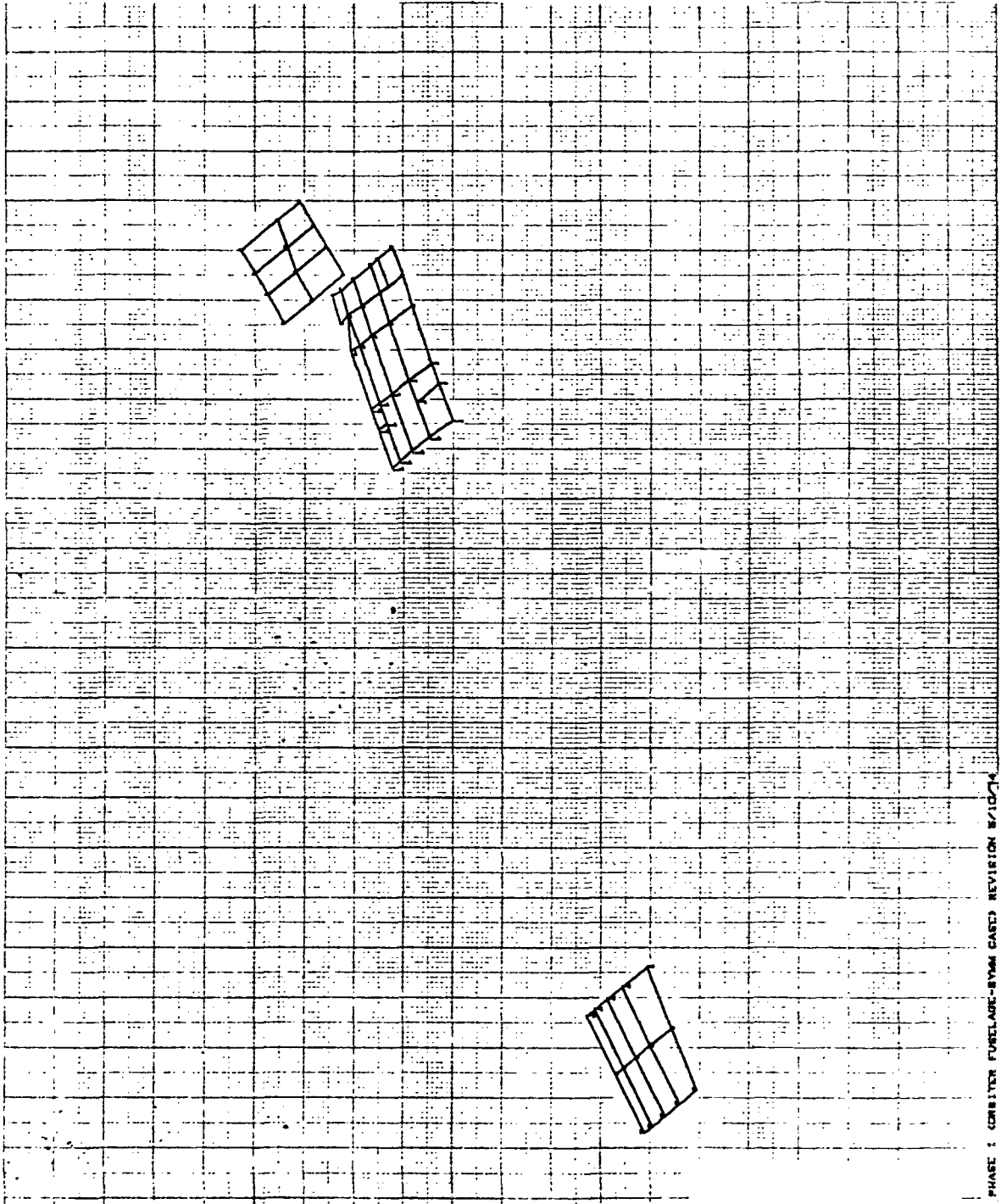

PHASE 1: CORBITER FURGLARE-8YMA GASED REVISION 8/10/74
 SKING HALF 8YF.LONG. 88C 8YF. TRANS. AT KING 02/21/77. 1
 FREE FREE MEDICE
 MEDICAL DOCTOR. 8YMGARE 8 MODE 8 FREQ. 248.1804

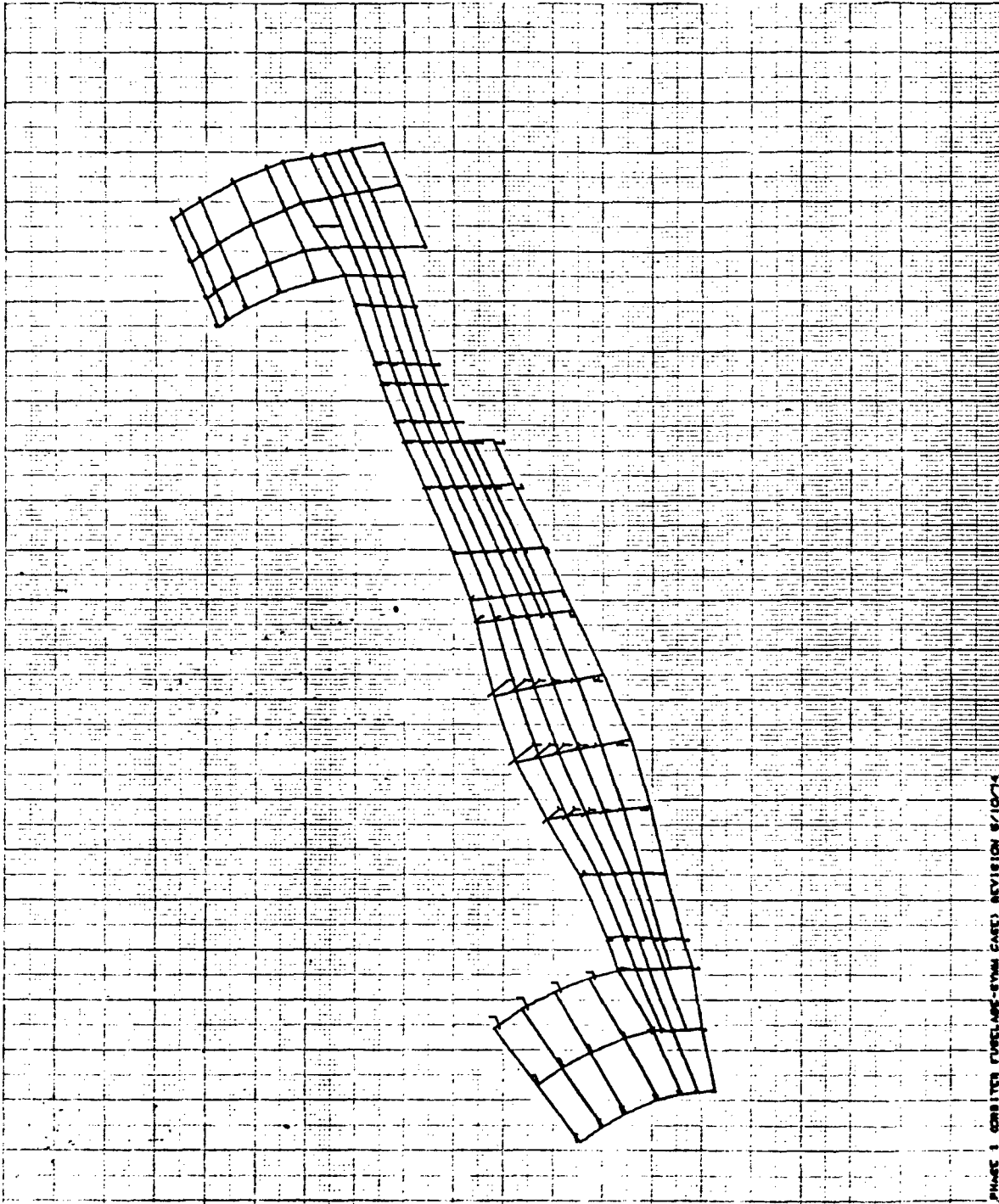

PHASE 1 ORBITER FUELAGE-SYMM CASE) REVISION 6/10/74
 BEING HALF ETT.LONG.,85% ETT.TRANS.AT WING (0-2/3ETT.)
 FREE FREE MODES
 MODAL ORDER. SUBCASE 6 MODE 6 FREQ. 246.1804

Appendix A9
PLOTS OF ANTISYMMETRIC FREE-FREE
MODES/PHASE 1 ANALYSIS:
MODEL II FUSELAGE

8/22/74 MAX-DEF. = 1.11014080

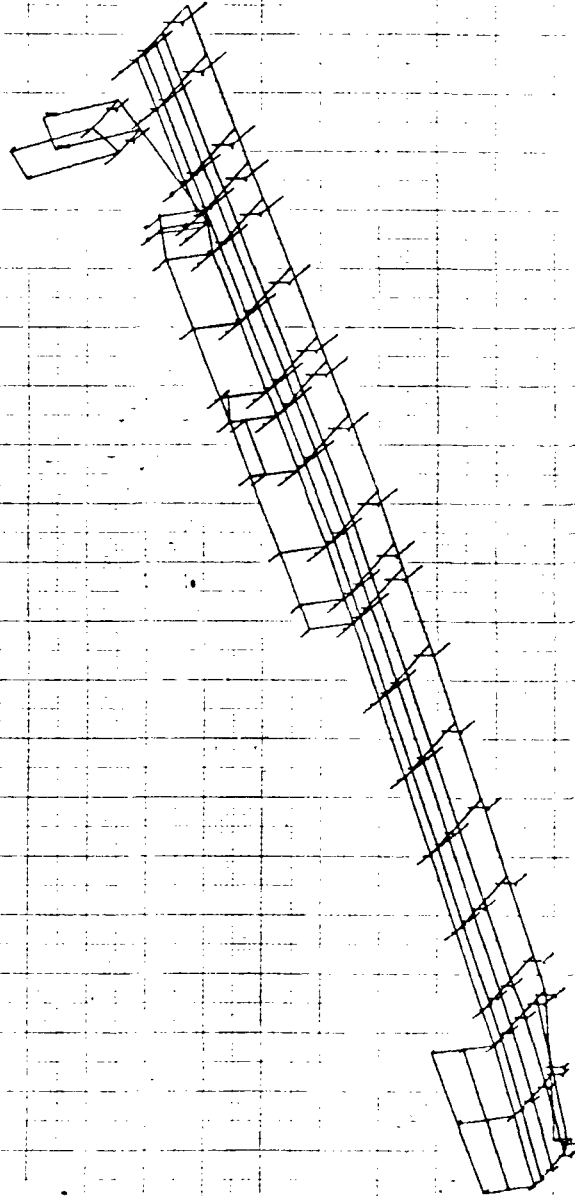

PHASE 1 (ORBITER FURCLAGE-ANTI CASE) REVISION 8/10/74
BEING HALF EFF. LONG. 1.85 (EFF. FRAME AT VING @ 23/25 EFF.)
1810 BODY MODES
MODAL DEFOR. SURFACE 1 MODE 1 FREQ. 0.

A9-2

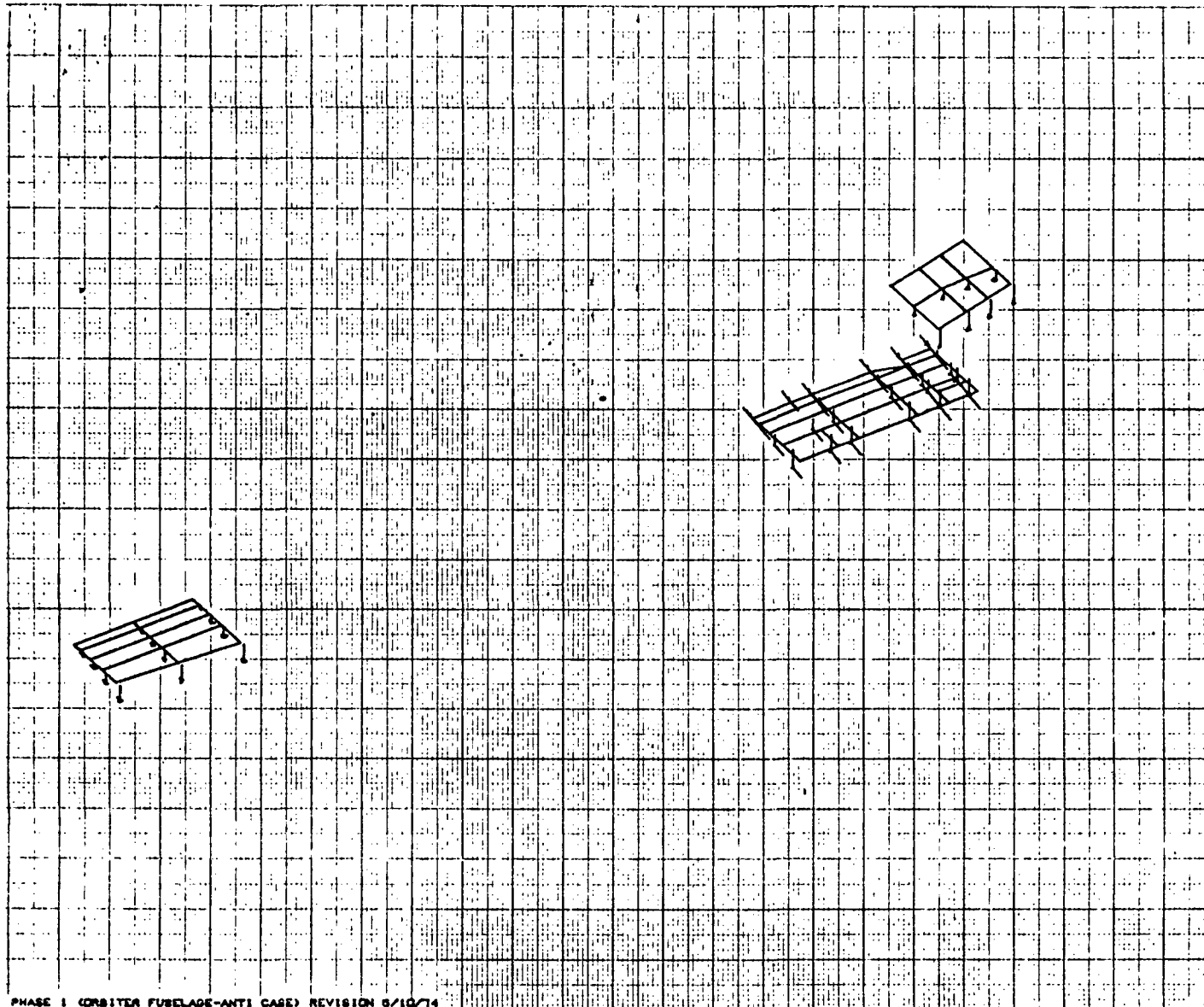

PHASE 1 (ORBITER FUSELAGE-ANTI CASE) REVISION 8/10/74
 SKINS HALF EFF. LONG. .88 (EFF. TRANS. AT WING (8-2/3EFF.)
 RIGID BODY MODES
 MODAL DEFOR. SUBCASE 1 MODE 1 FREQ. 0.

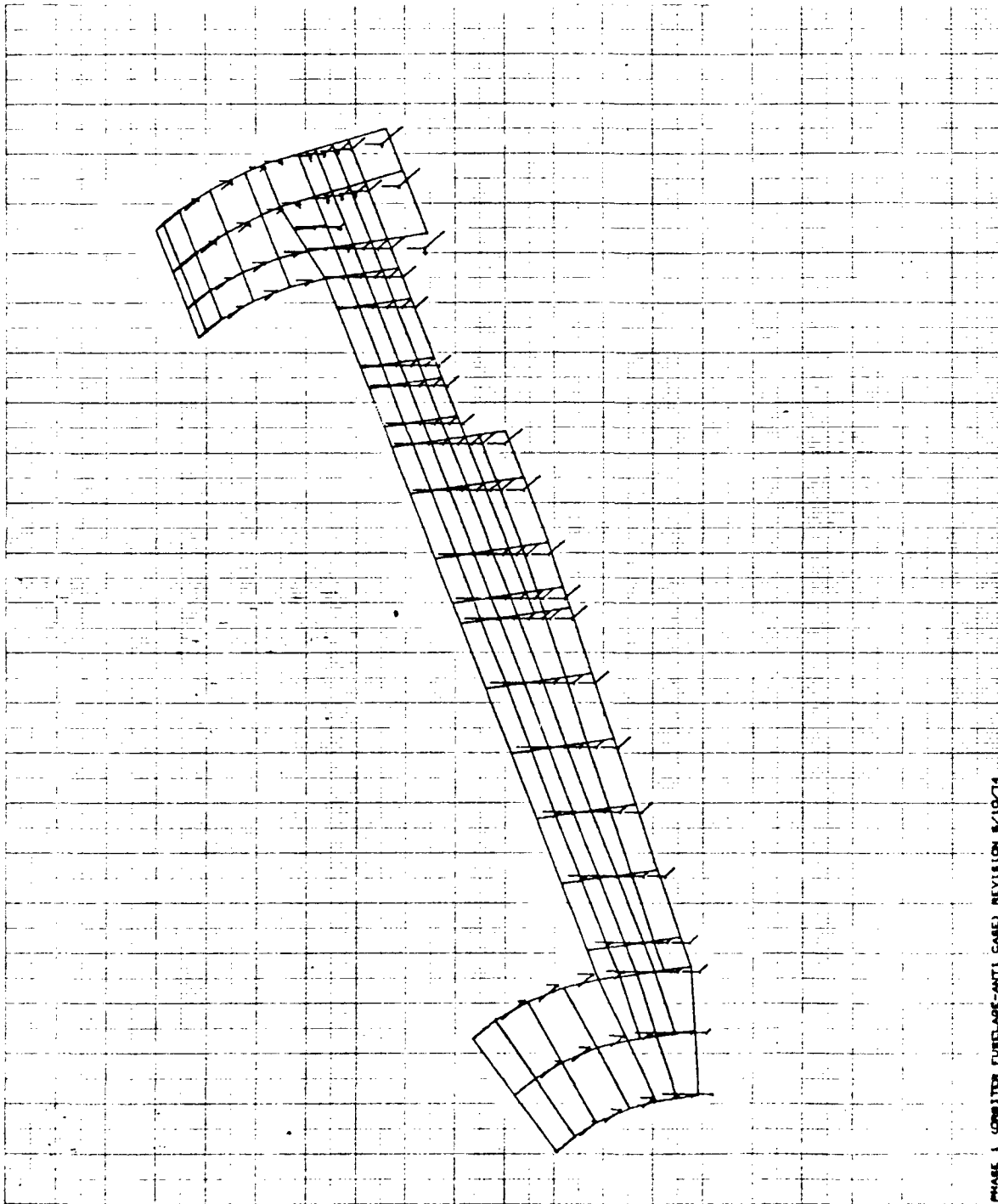

PHASE 1 (ONBITER FURCLAGE-ANTI CASE) REVISION 8/10/74
 SKINS HALF EFF. LONG. .88 (EFF. TRANS. AT WING (0-2/3EFF.)
 RIGID BODY MODES
 MEDIAL DEFOR. BURCASE 1 MODE 1 FREQ. 0.

8/22/74 MAX-DEF. = 1.00000000

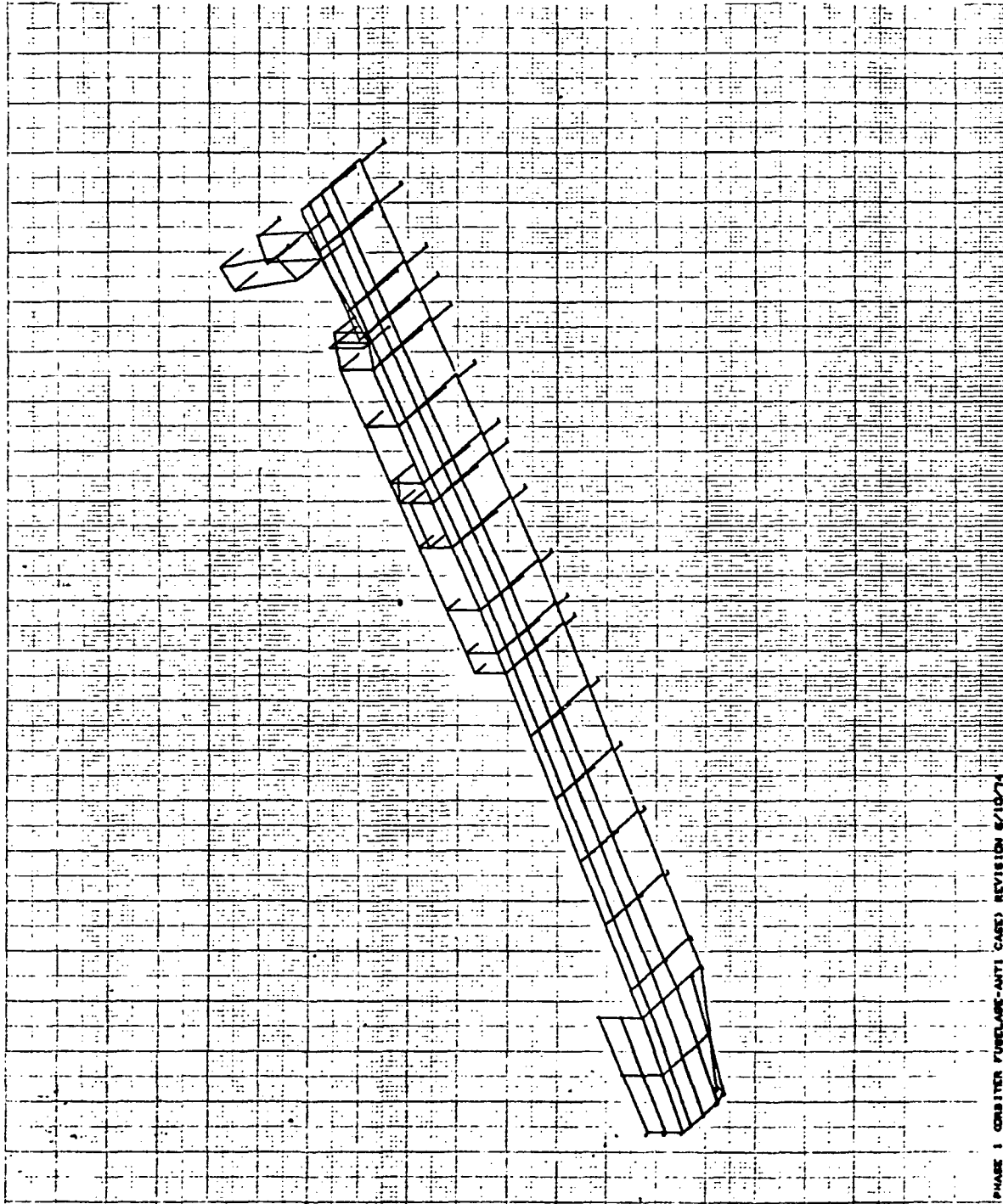

PHASE 1 CRUISER FUSELAGE-ANTI CASE) REVISION 6/10/74
ORING HALF EFF. LONG. 0.86 (EFF. TRANS. AT WING G-2/REFF.)
RIGID BODY MODES
MODAL DEFOR. SUBCASE 2 MODE 3 FREQ. 0.

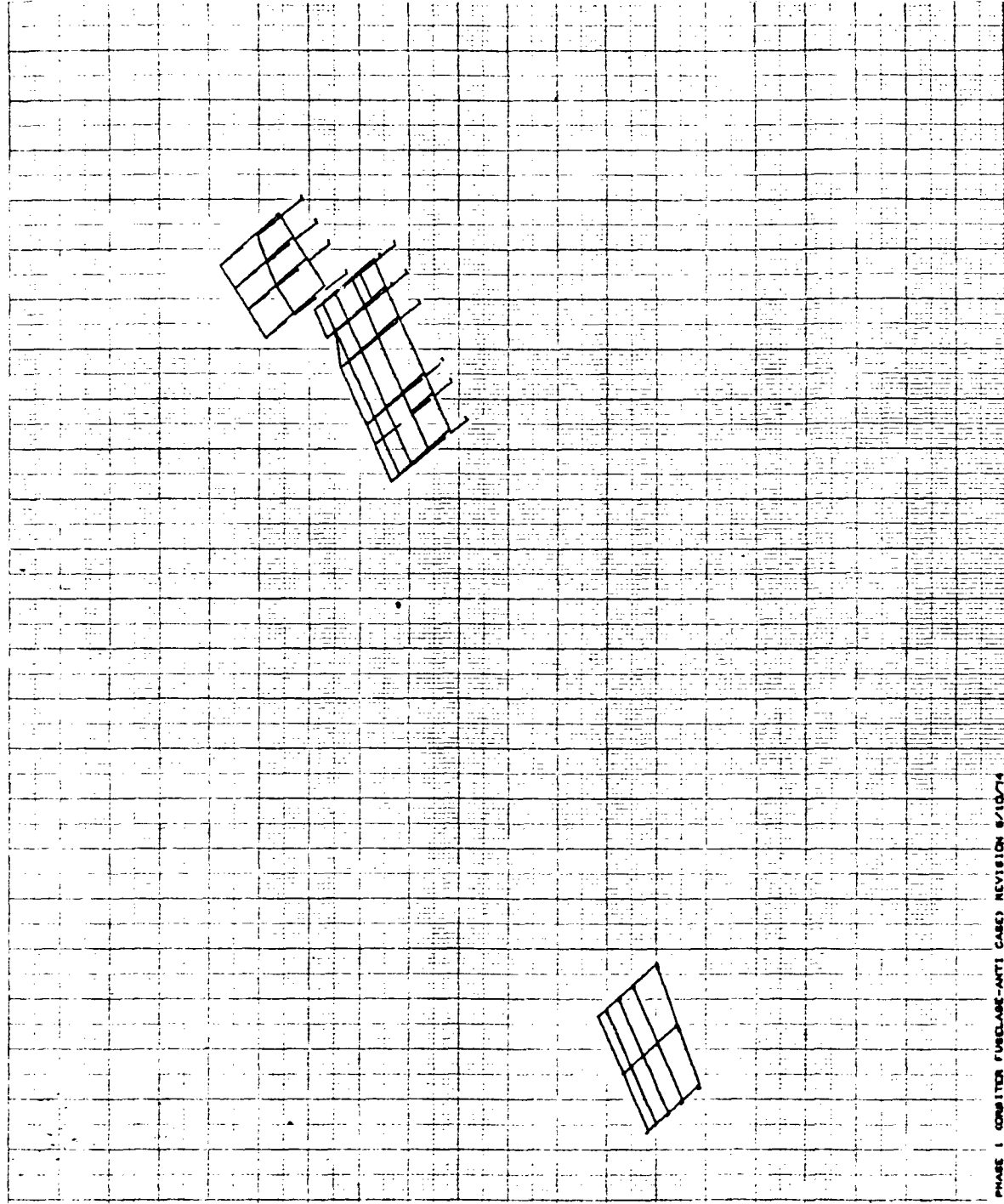

PHASE 1 COMBATOR PURCHASE-ANTI CASE) REVISION 8/10/74
 SKINS W/LF EFF.LONG.,BSC EFF.TRANS.AT WIND 10-2-SEFF.)
 :1010 BODY MODES
 MODAL DEFOR. SUBCASE 9 MODE 8 FREQ. 0.

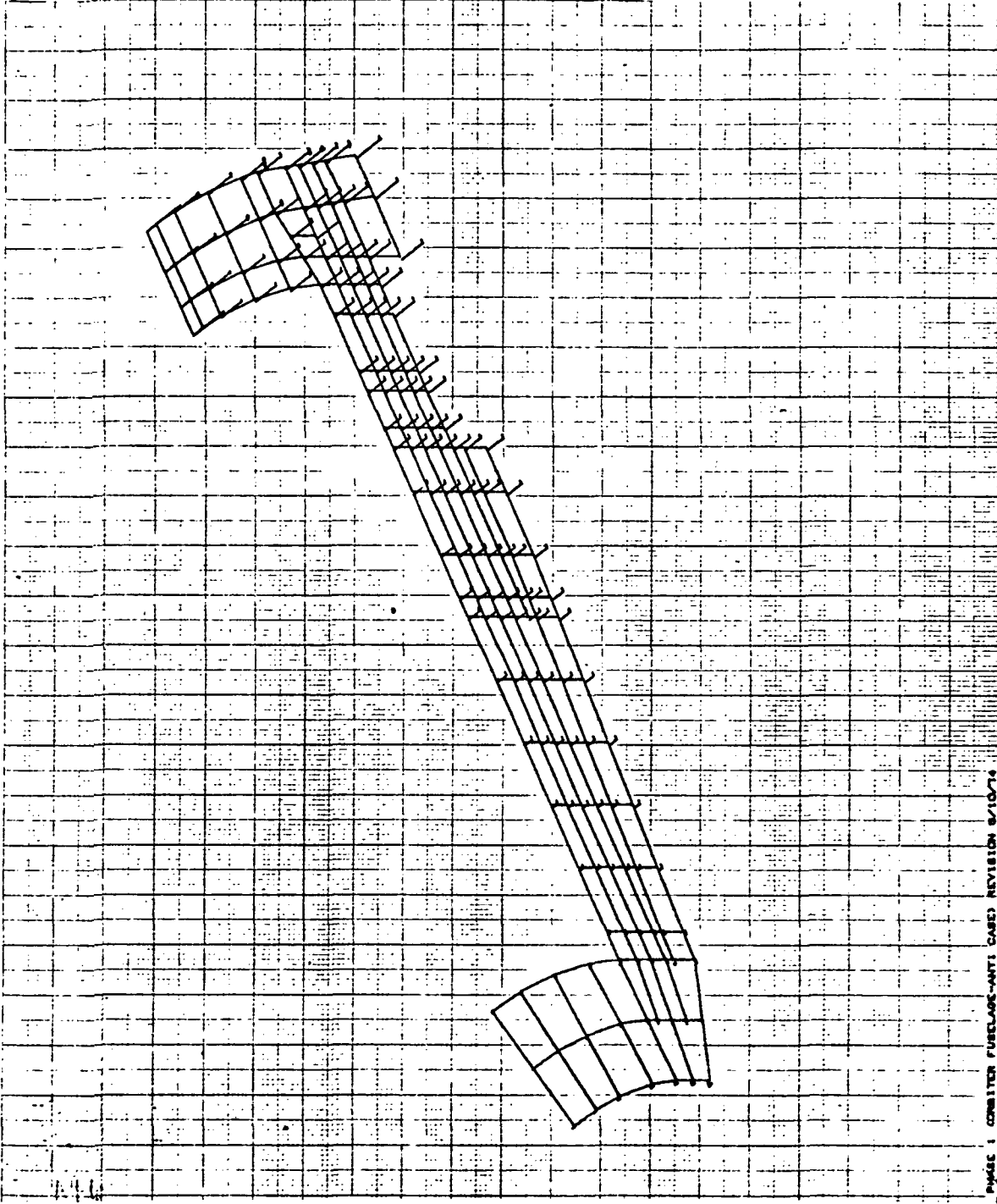

PAGE 1 CONTINER FUELAGE-ANTI CASE) REVISION 8/10/74
 (THIS HALF EFF. LONG., 88 (EFF. TRANS. AT WING 0-2/8077.)
 (1810 BODY MODES
 MODAL DEFOR. SURFACE 2 MODE 2 FREQ. 0.

8/22/74 MAX-DEF. = 1.0000000

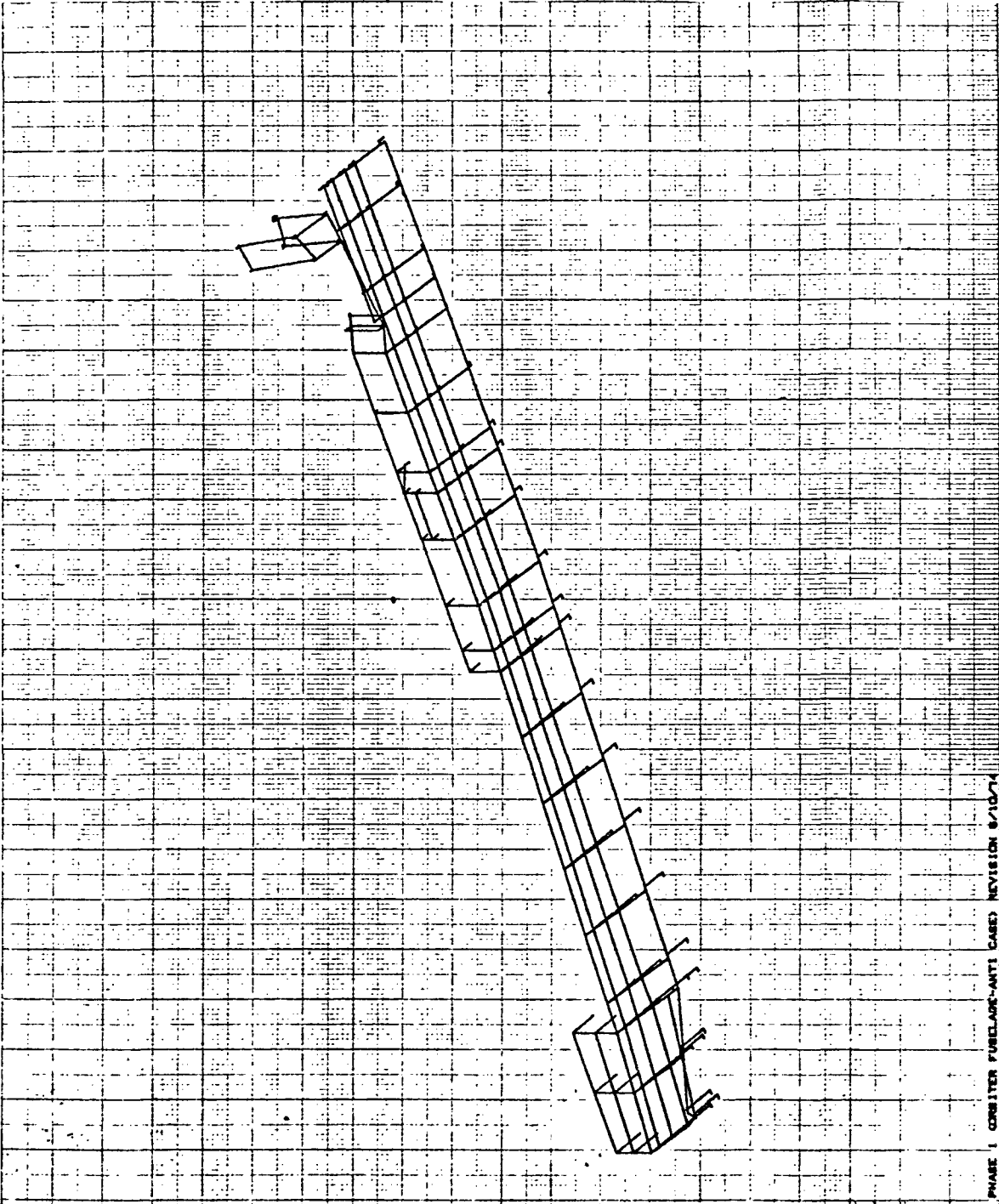

PHASE 1 ORBITER FUELAGE-ANTI CASED REVISION 8/10/74
 BEING HALF EFF. LONG. 86% EFF. TRANS. AT NINE (8-2-DEF.)
 RIBID BODY MODES
 MODAL DEFOR. SUBCASE 8 MODE 8 FREQ. 0.

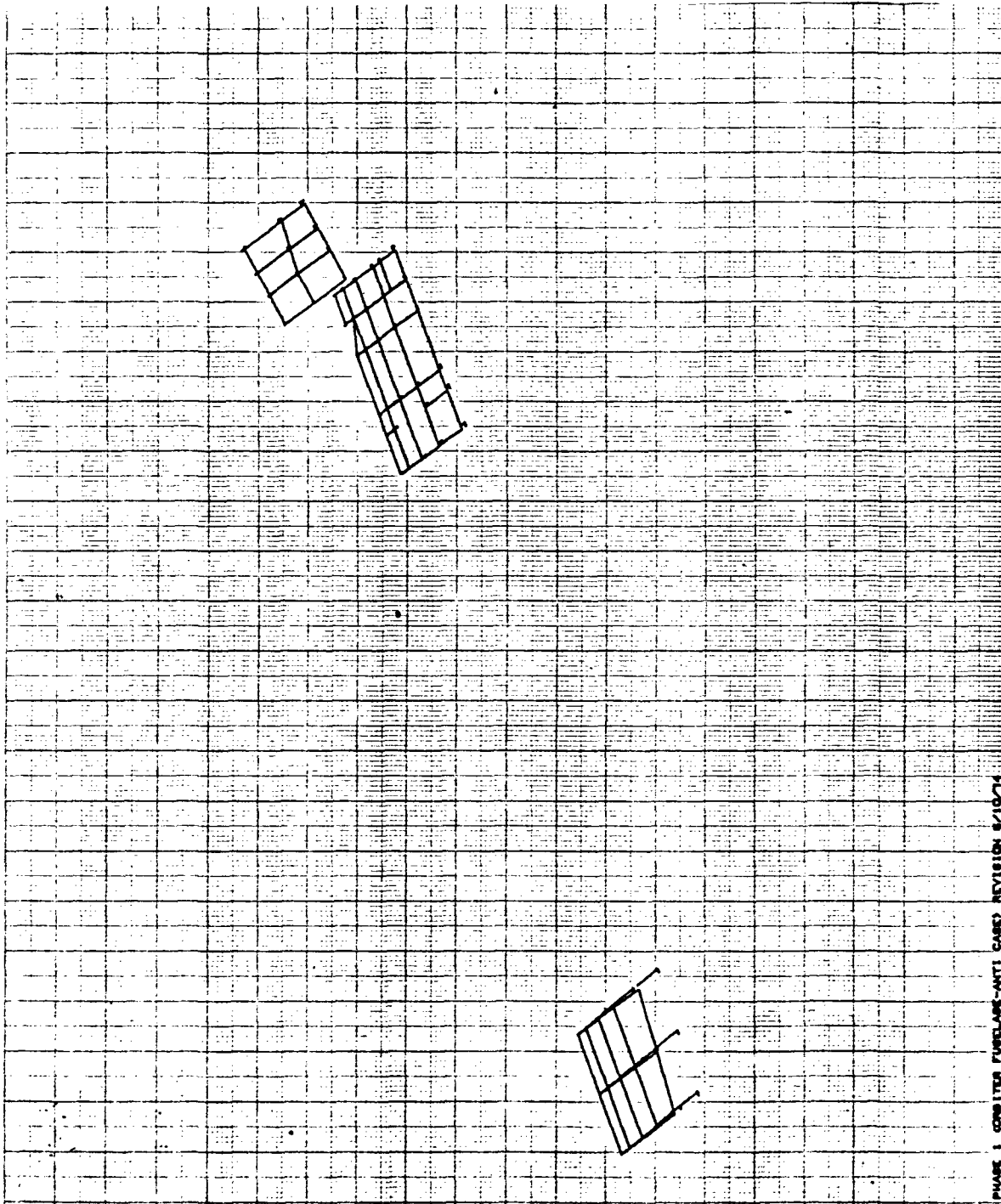

PHASE 1 COMPUTER FURCHASE-ANTI CASEY REVISION 8/10/74
 SKINS HALF EFF. LOW. 85 C EFF. TRUNK. AT WING 18-22/2EFF.)
 1810 BODY INDEX
 MODAL DEFOR. SURFACE 9 MODS 9 FREQ. 0.

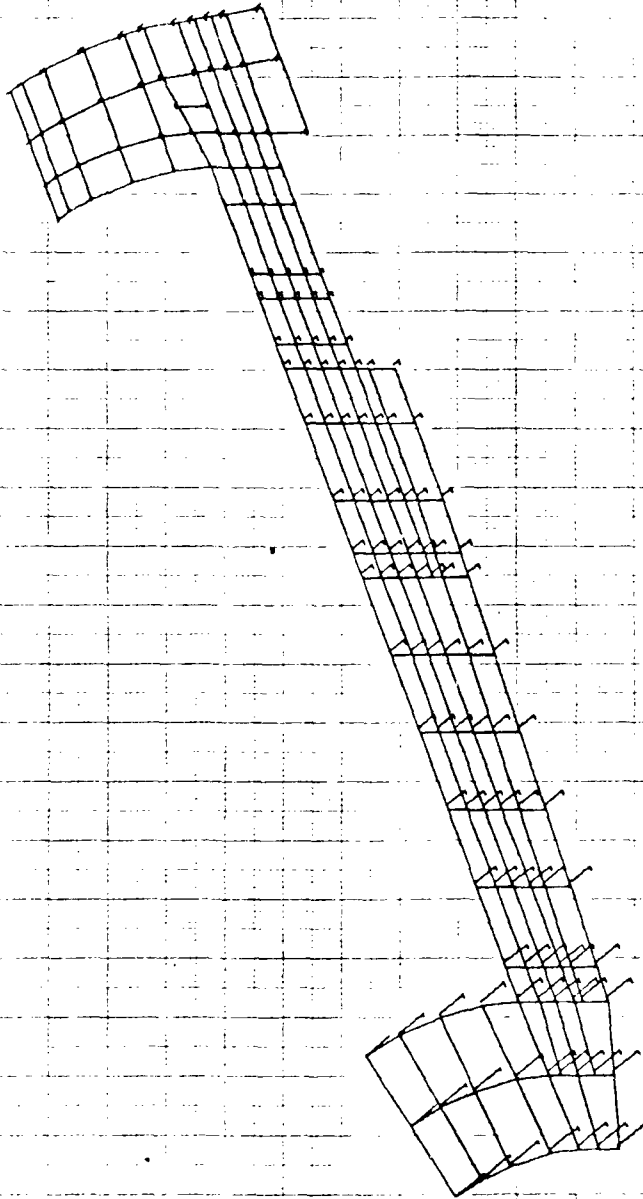

PHASE 1 CRIBITER FUELRAGE-ANTI CASE) REVISION 8/10/74
BKGHS HALF EFF. LONG. .08 (EFF. TRANS. AT WING G=2/2EFF.)
11810 BODY MODES
MODAL DEFOR. SUBCASE 3 MODE 3 FREQ. 0.

8/22/74 MAX-DEF. = 1.10092440

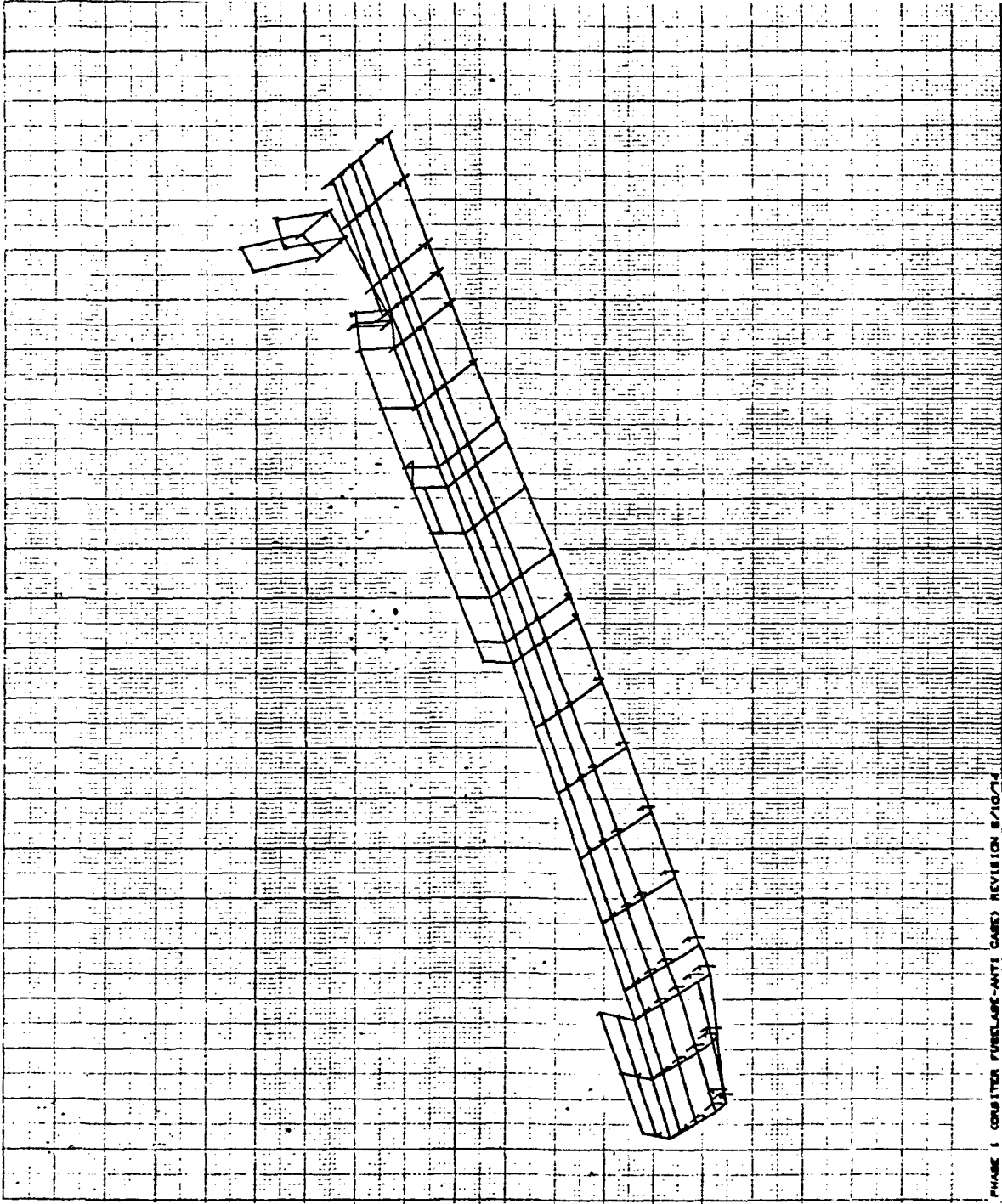

PHASE 1 CRUISER FUSELAGE-ANTI CASED REVISION 8/10/74
SKIN HALF EFF. LONG. .88 (EFF. TRANS. AT WING (80% S/REF.))
FREE FREE MODES
MODAL DEFOR. SUBCASE 4 MODE 4 FREQ. 28.08334

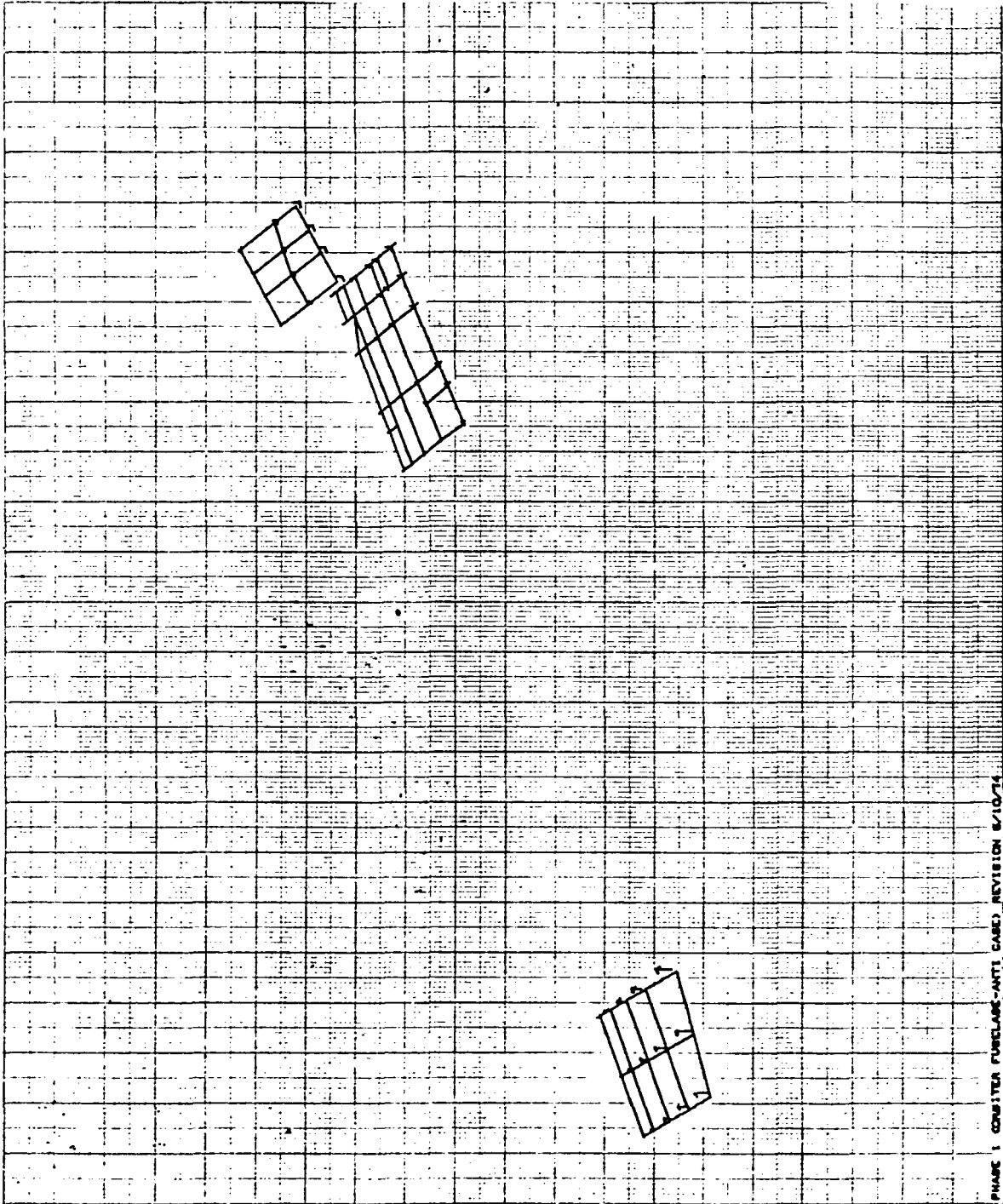

PHASE 1 COMPUTER FURCLAS-ANTI CASE, REVISION 8/10/71
 BKING HALF EFF. LONG. .85 < EFF. TRANS. AT WING (8-2/3EFF.)
 FREE FREE MODES
 MODAL DEFOR. SUBCASE 4 MODE 4 FREQ. 25.08334

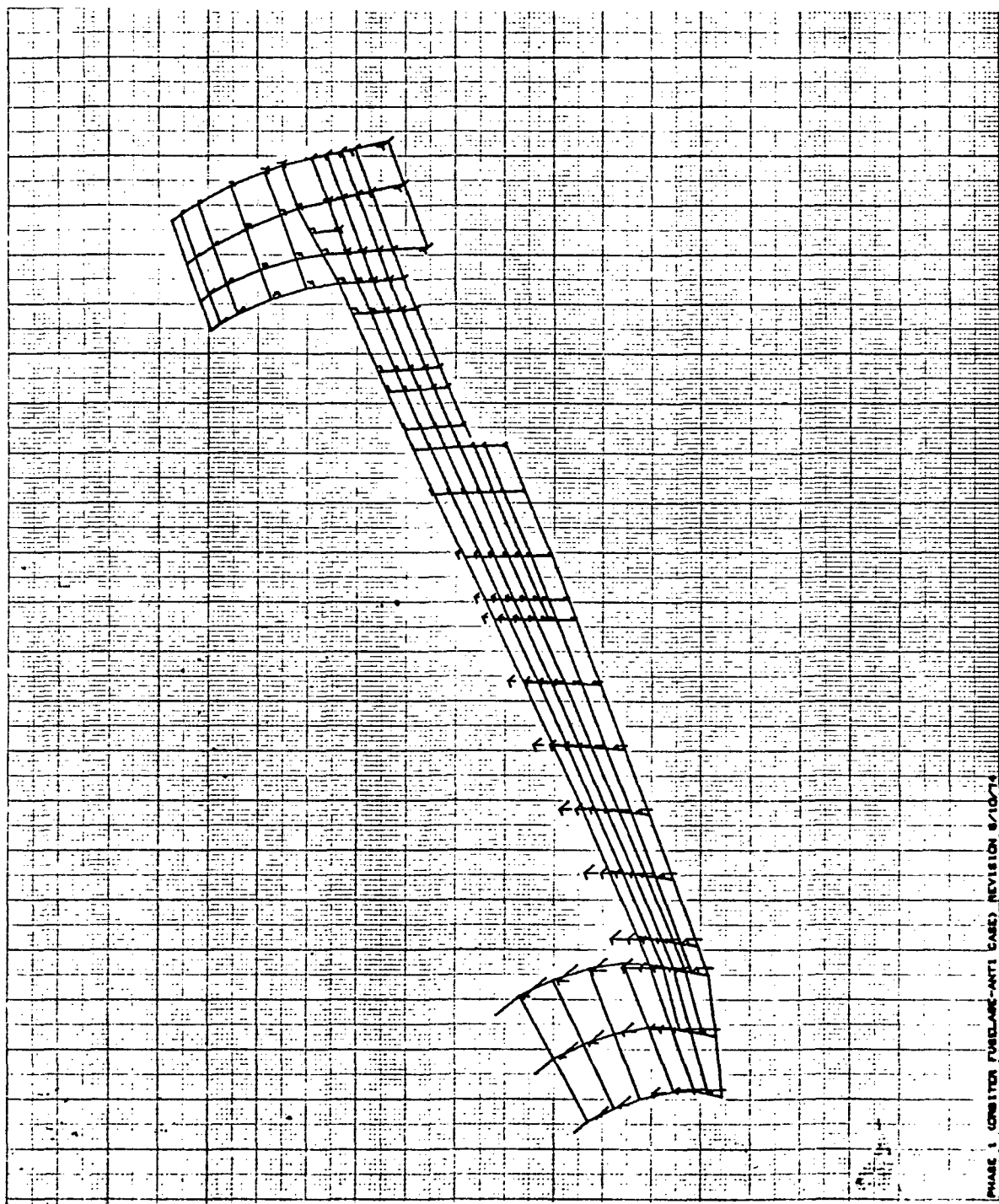

PHASE 1 (CONSTIT FUEL/ANTICASE) REVISION 8/10/74
 SKINS HALF EFF. LOW. .88 (EFF. TRANS. AT WING 18-2-2EFF.)
 FREE FREE WINGS
 MODAL DETER. SUBCASE 4 MODE 4 FREQ. 28.08334

8/22/74 MAX-DET. • 1.0279600

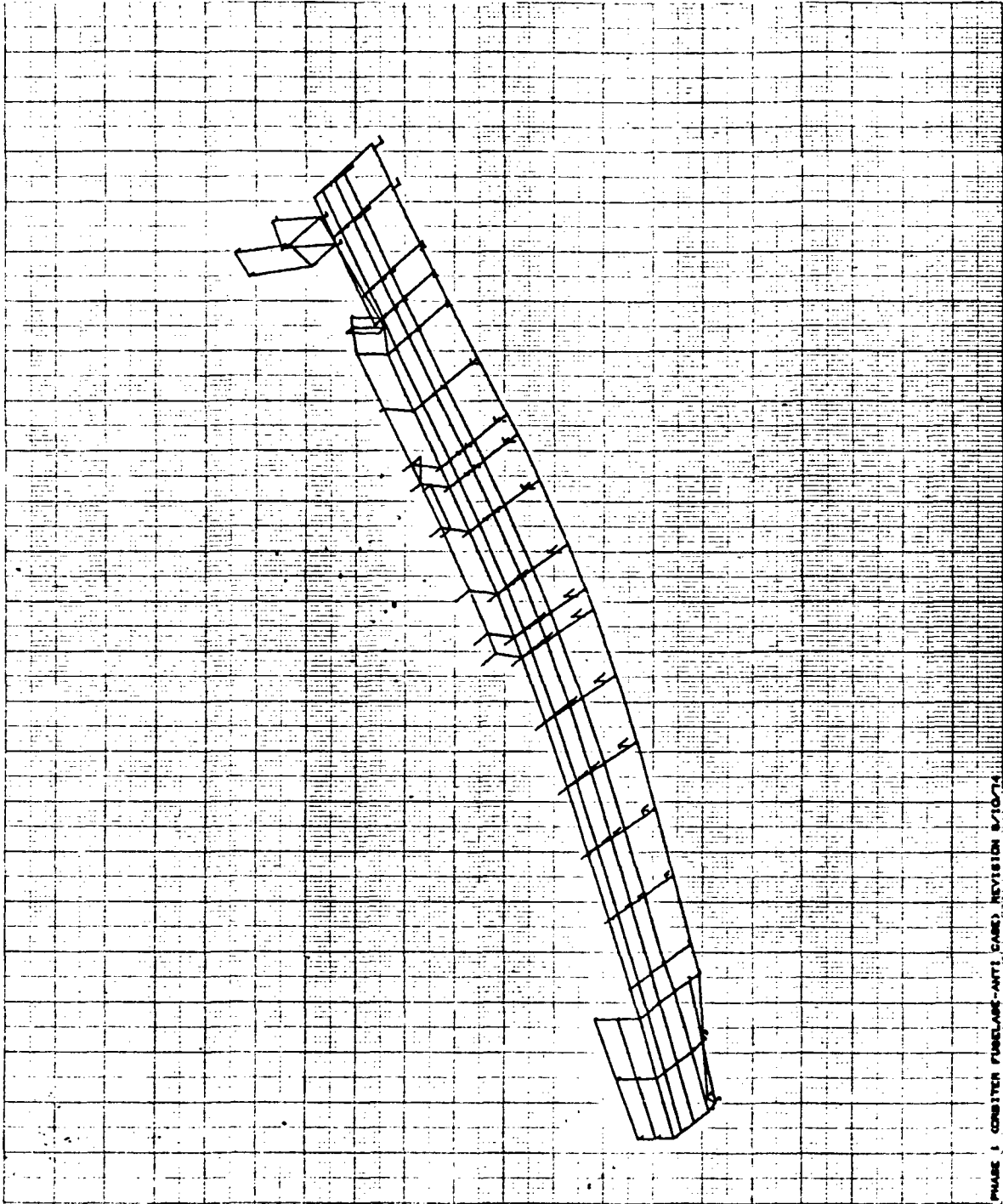

PHASE 1 CENTER FUELAGE-ANTI CASE) REVISION 8/10/74
BEING HALF EFF. LONG., BEC EFF. TRANS. AT WING Q=2.0077,
FREE FREE MODES
MODAL ORDER, SUBCASE 8 MODE 8 FREQ. 79.63304

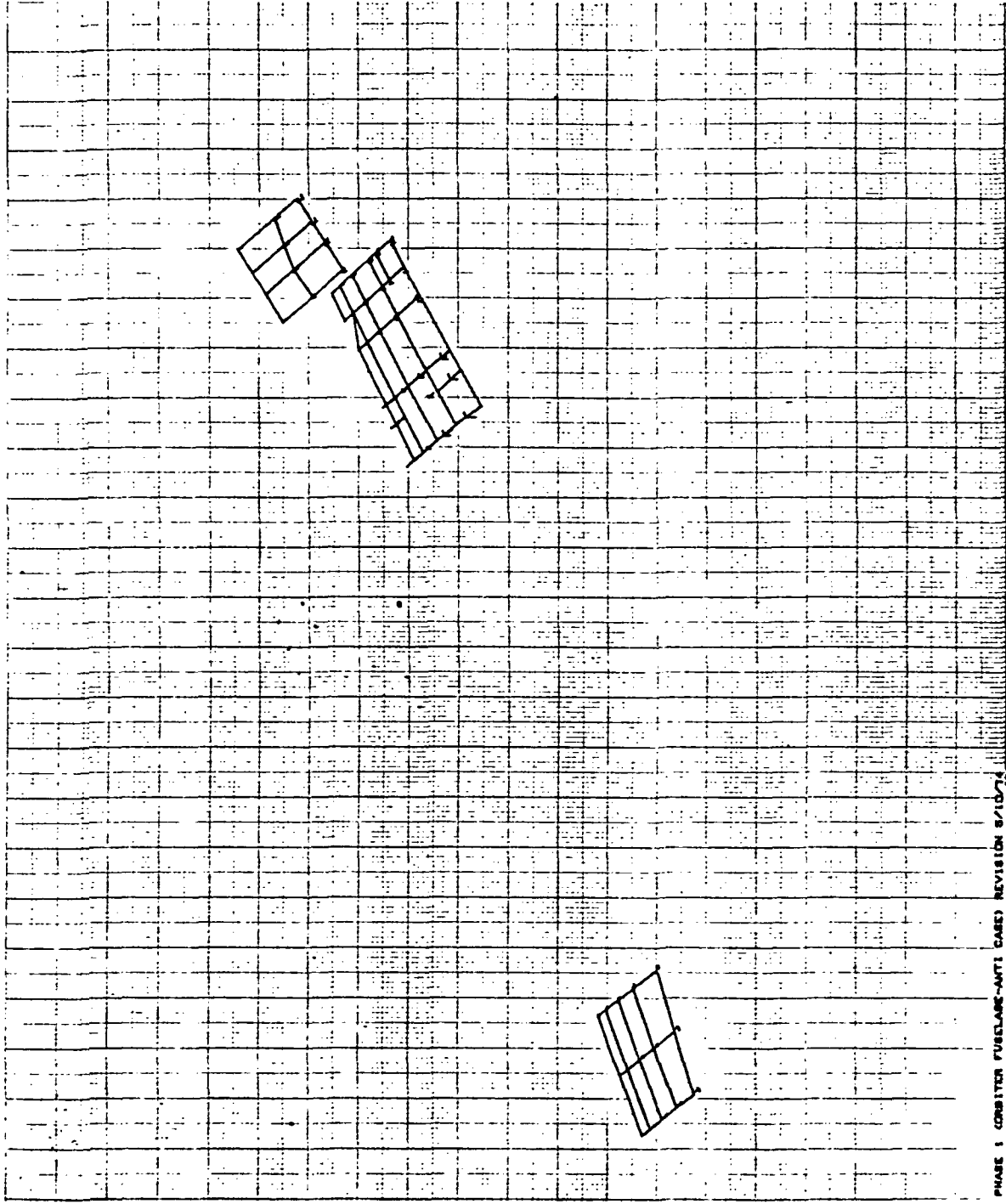

PHASE 1 CORBITTER FUEL-LINE-ANTI CASE) REVISION 8/10/74
 BEING HALF EFF. LONG. 88 (EFF. TRANS. AT WING (S-B/REFF.)
 FREE FREE MODES
 MODAL ORDER, SUBCASE 6 MODE 6 FREQ. 73.63304

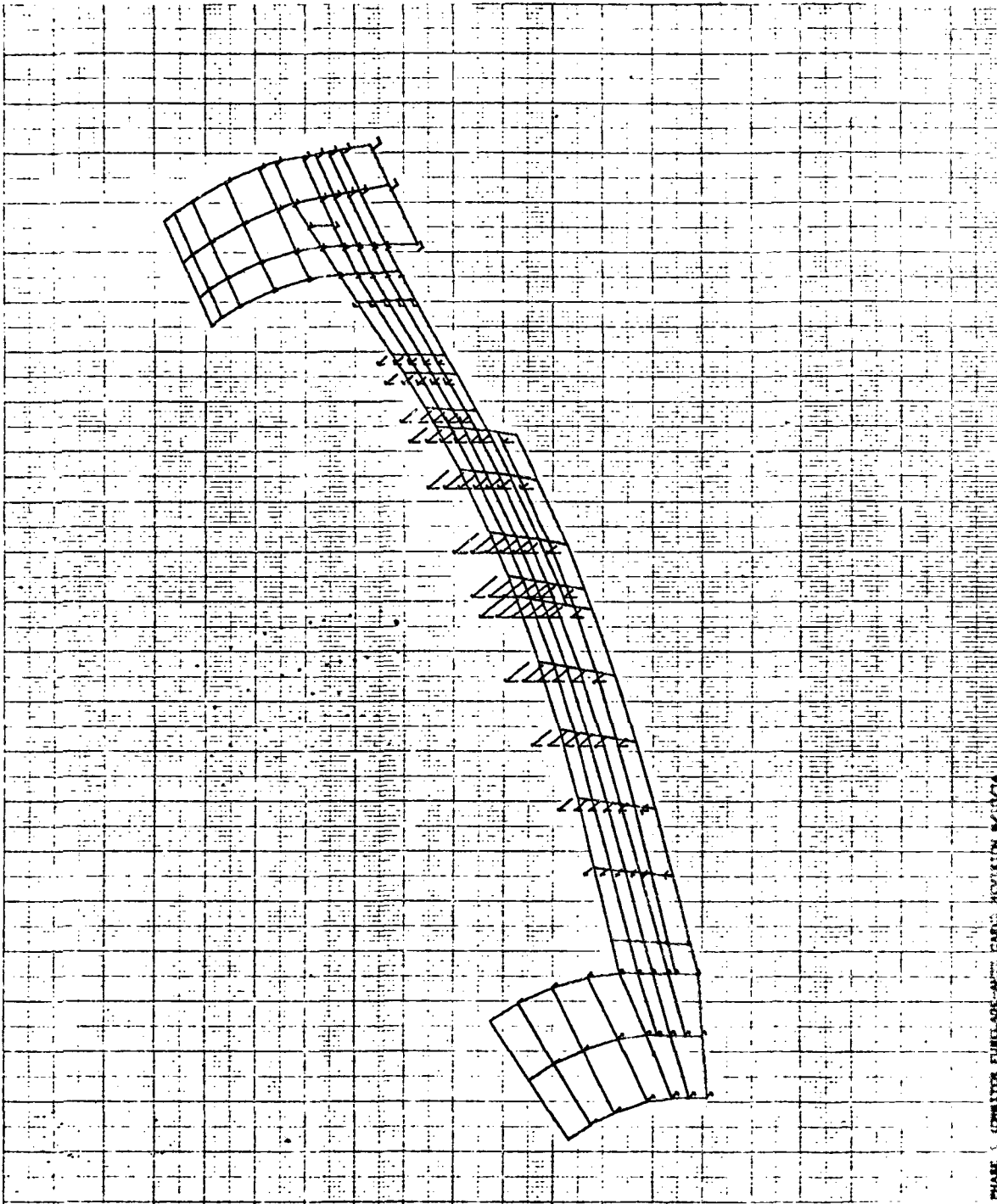

PHASE 5. COMBINATION FUEL-SOLAR-ARMS. DESIGN 6/10/74
 SKIN HALF EFF. LONG. RES. EFF. TRANS. AT SURF. 0.2/0.05/0.2
 FREE FREE MODES
 MEDIAL DEFEN. SURFACE 5. MODE 8. FREQ. 12.83304

8 5/22/74 MAX-DEF. = 1.071414870

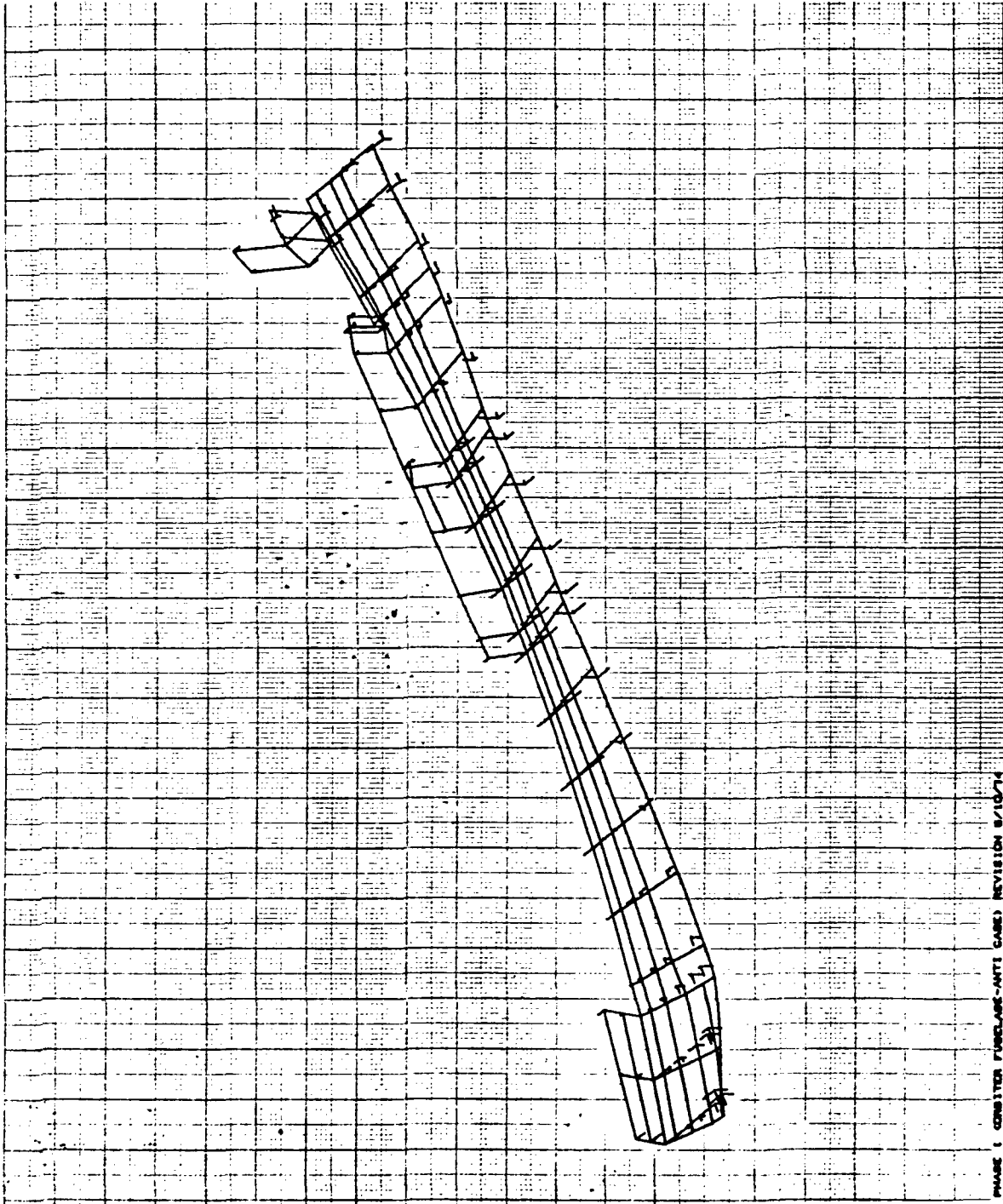

PHASE 1 CONCRETE FURGLAKE-ANTI CASE) REVISION 8/10/74
BEING HALF EFF. LONG. OR (EFF. TRANS. AT WIND (8-2-74))
FREE FREE MODES
MODAL ORDER, SUBCASE 9 MODE 9 FREQ. 110.0817

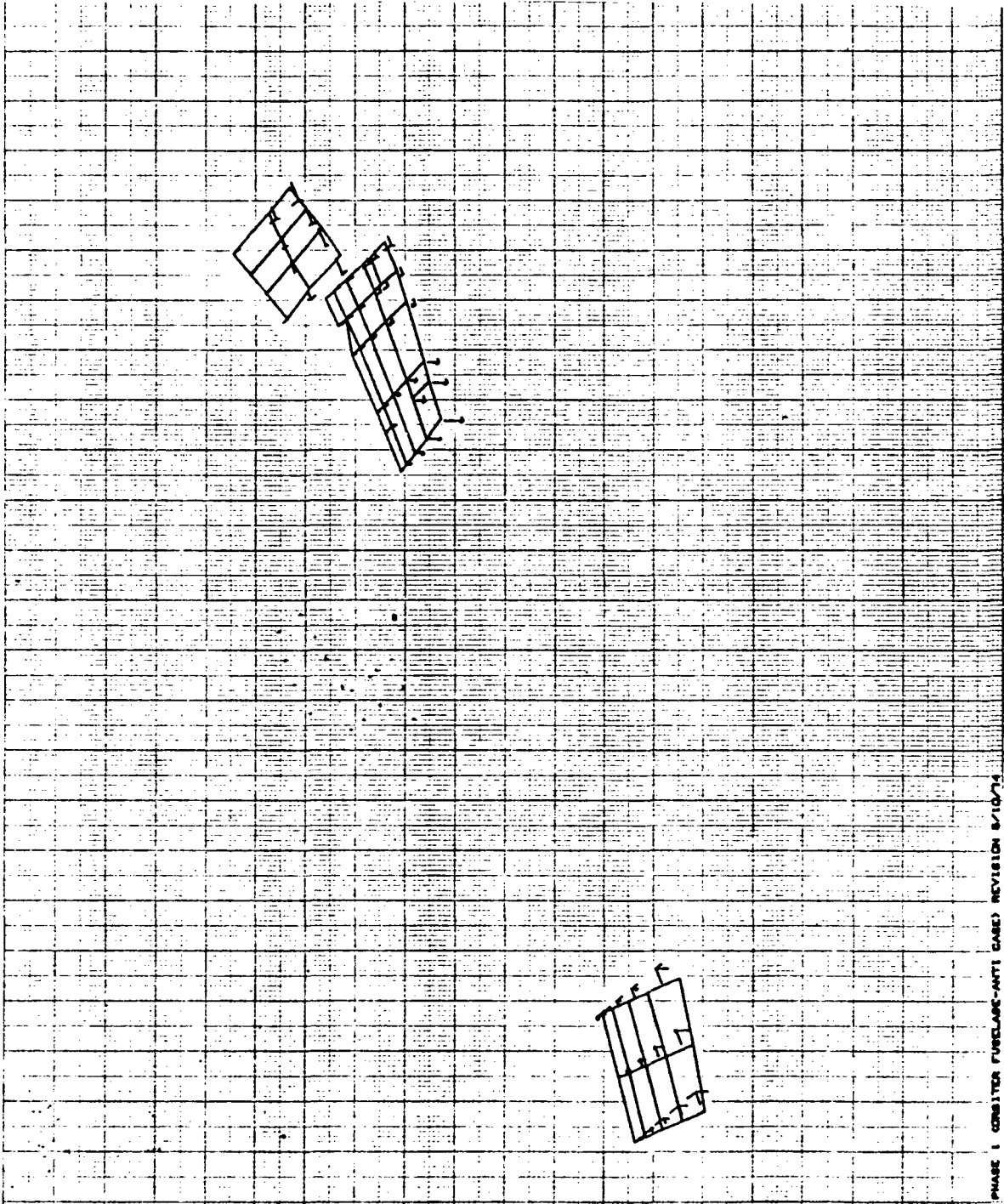

PHASE I COMBITER FUSELAGE-ANTI CASE) REVISION 8/10/74
 BRIMS HALF EFF. LONG. 86 (EFF. TRANS. AT WING 08-25/2077)
 FACE FREE MORSE
 MODAL DETON. SUBCASE 6 MORSE 6 FREQ. 110.0847

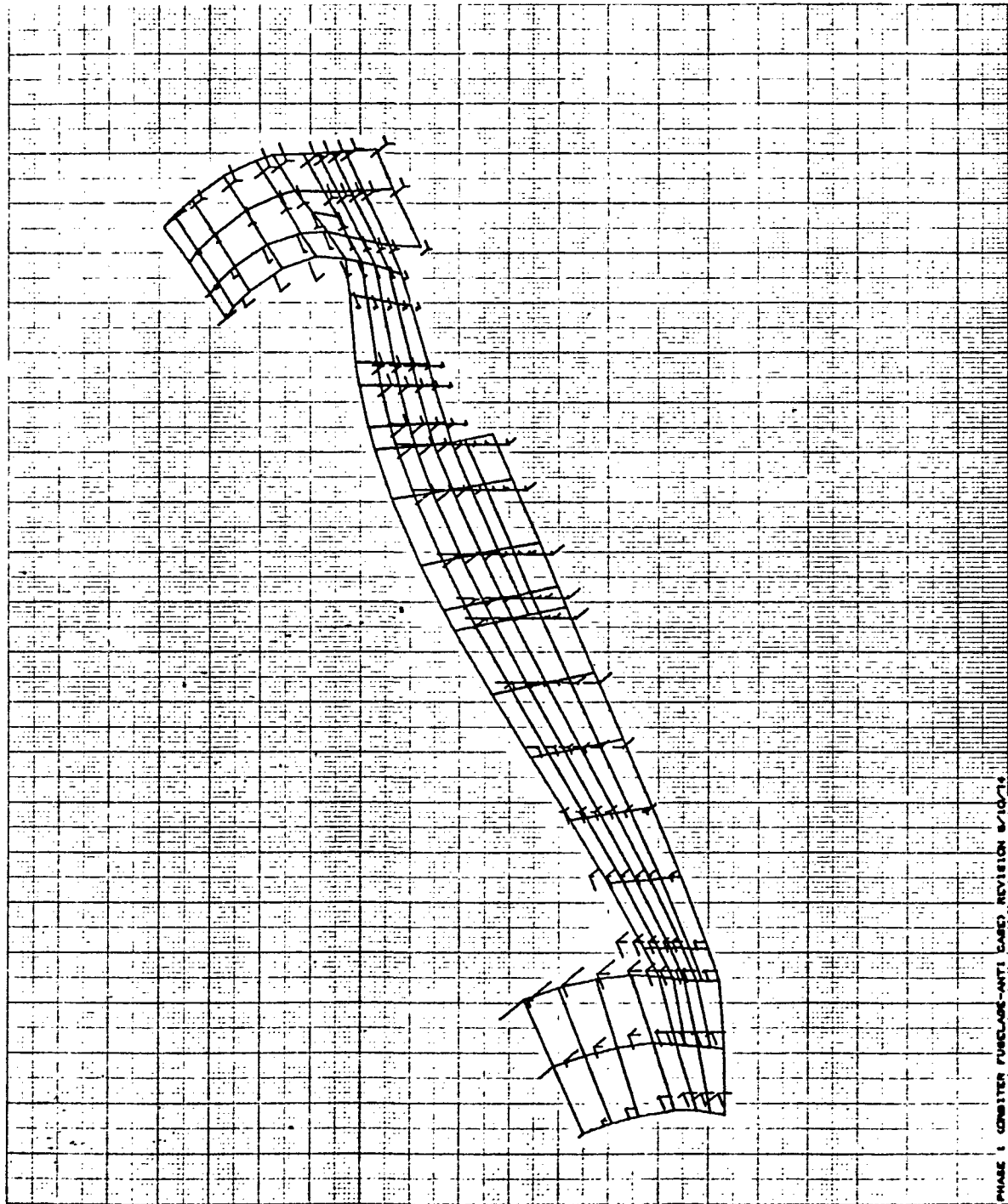

PHASE 1 COMPUTER PURCHASE-ANTI CASED REVISION 8/10/74
 SKINS HALF EFF. LONG. 0811 EFF. TRANS. AT WING (8-2/DEF.)
 FREE FREE MODES
 MODAL DETON. BURSCASE 6 MODE 6 FREQ. 110.0811

7 8/22/74 MAX-DEF. = 1.00074810

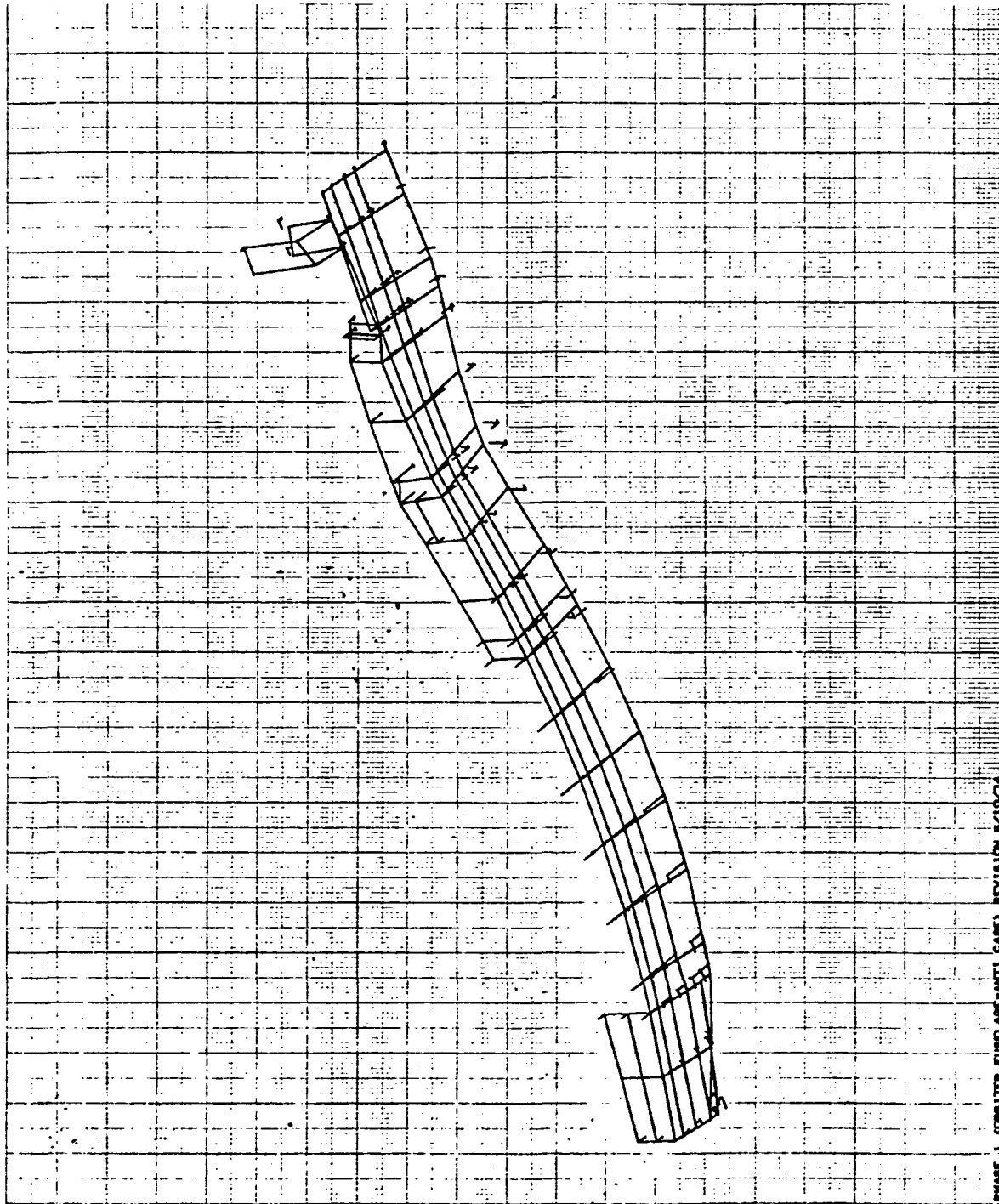

PHASE 1 COMPUTER PURCHASE-ANTI SAKC. REVISION 8/10/73
BEING HALF EFF. LONG. .98 (EFF. TRANS. AT WING CO-2/2077.)
FREE FREE MODES
MODAL DETER. SUBCASE 7 MODE 7 FREQ. 141.1578

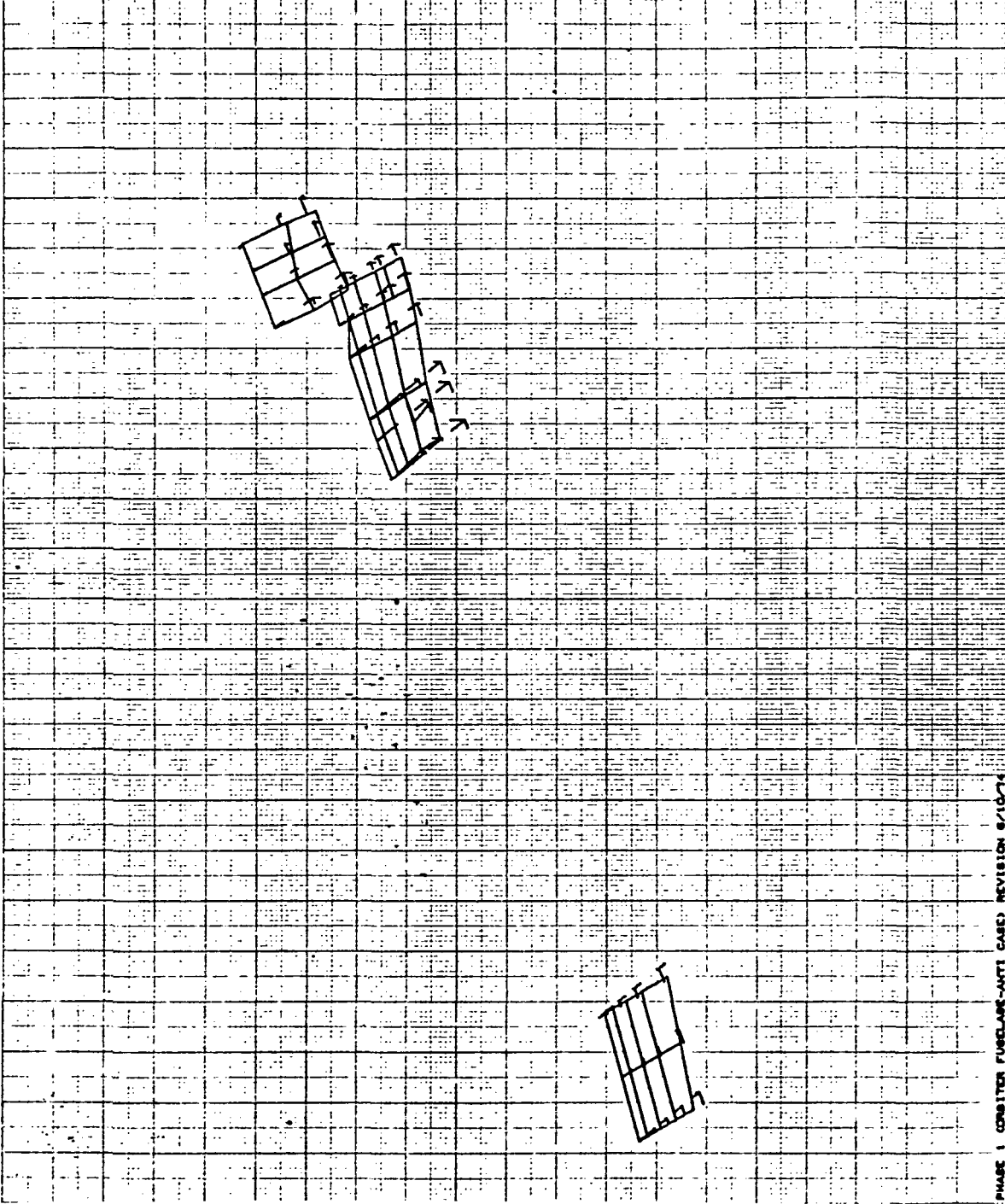

PHASE 1 CONSIDER FUEL-LINE-ANTI CASE, REVISION 8/10/74
 BKING HALF EFF. LONG. 061 EFF. TRANS. AT WING 10-2/2077.
 FREE FREE MODES
 MODAL ORDER, SUBCASE 7 MODE 7 FREQ. 141.1976

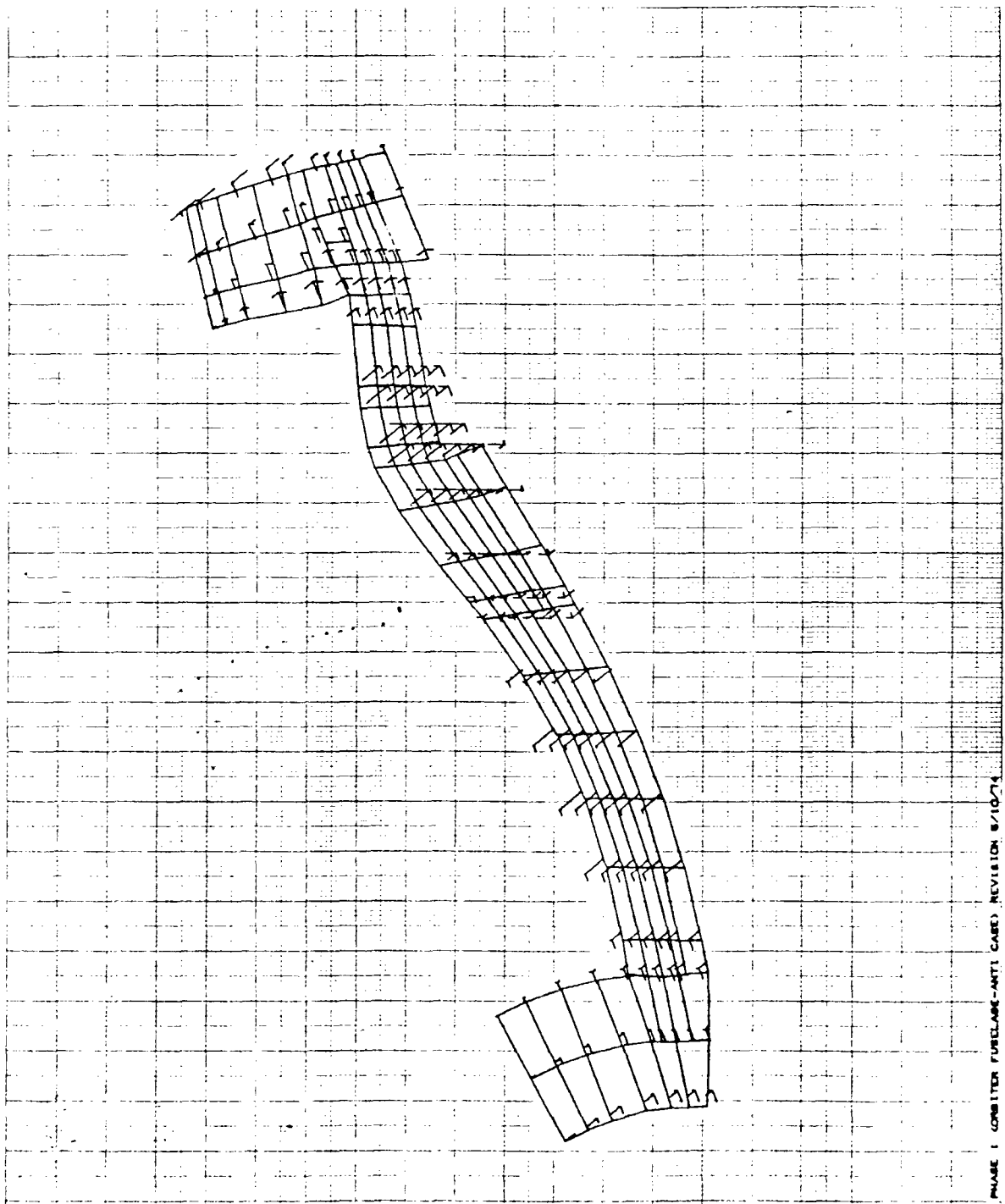

PHASE 1 CONSLITER FURFLAME-ANTI CARES) REVISION 8/10/74
 BKING HALP EFF. LONG. / 88% EFF. TRANS. AT WING (G=2/3EFF.)
 FREE FREE MODES
 MODAL DEFOR. S.B.CASE 7 MODE 7 *REQ. 141.1978

8 8/22/74 MAX-DEF. = 1.00108680

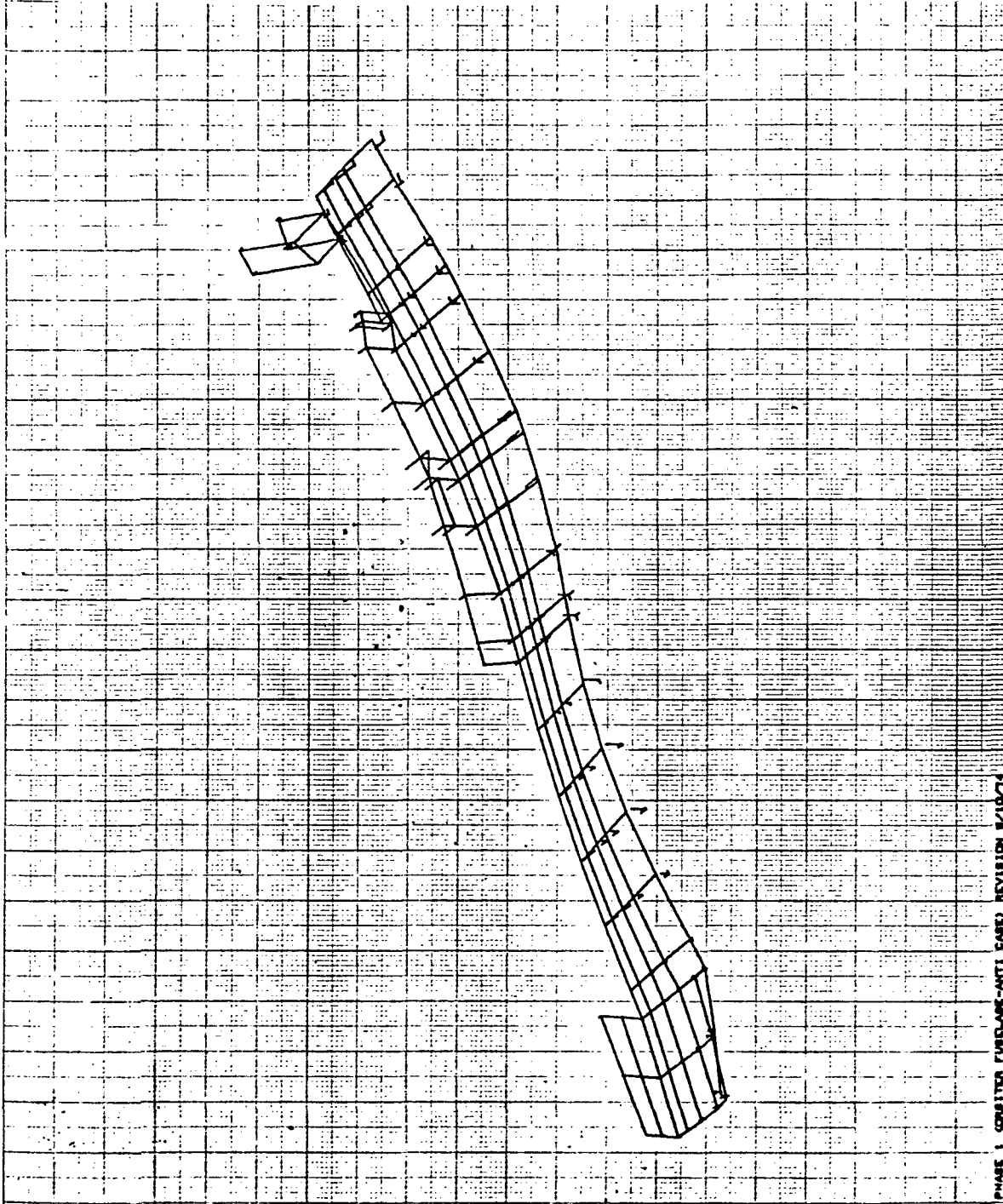

PHASE 1 CORBITER FURCLASE-ANTI CASE) REVISION 8/10/74
SERIES HALF EFF. LOW. .06 (EFF. TRANS. AT WING (8-2-SEFF.)
FREE FREE MODES
MODAL DEFOR. SUBCASE 8 MODE 8 FREQ. 179.1862

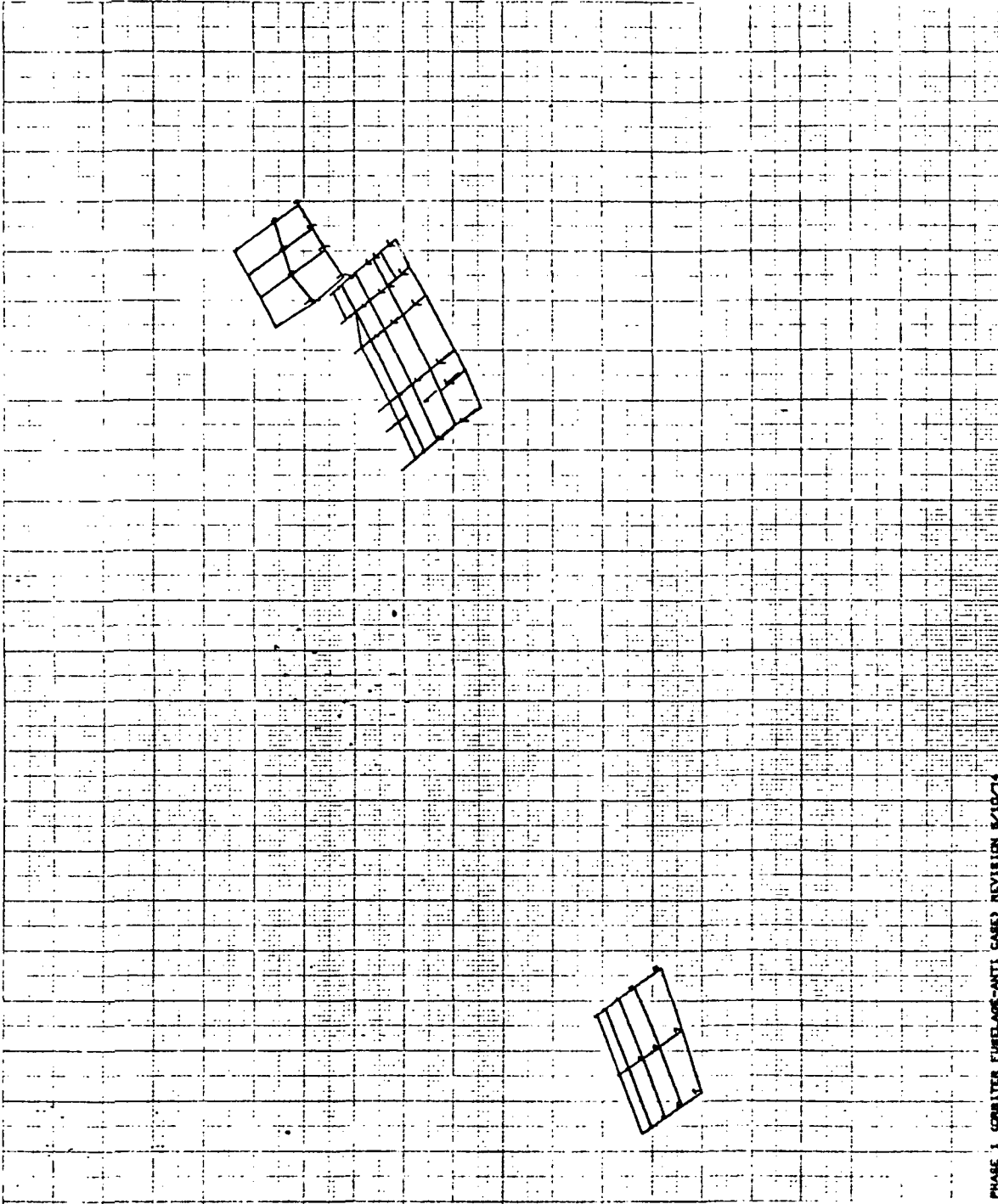

PHASE 1 CORBITER FIBELAGE-ANTI CASE) REVISION 8/10/74
 SKINE HALF EFF. LONG. / 88 C EFF. TRANS. AT WING (0=2/9EFF.)
 FREE FREE MODE
 MODAL DKTOR. SUBCASE 8 MODE 8 FREQ. 179.1863

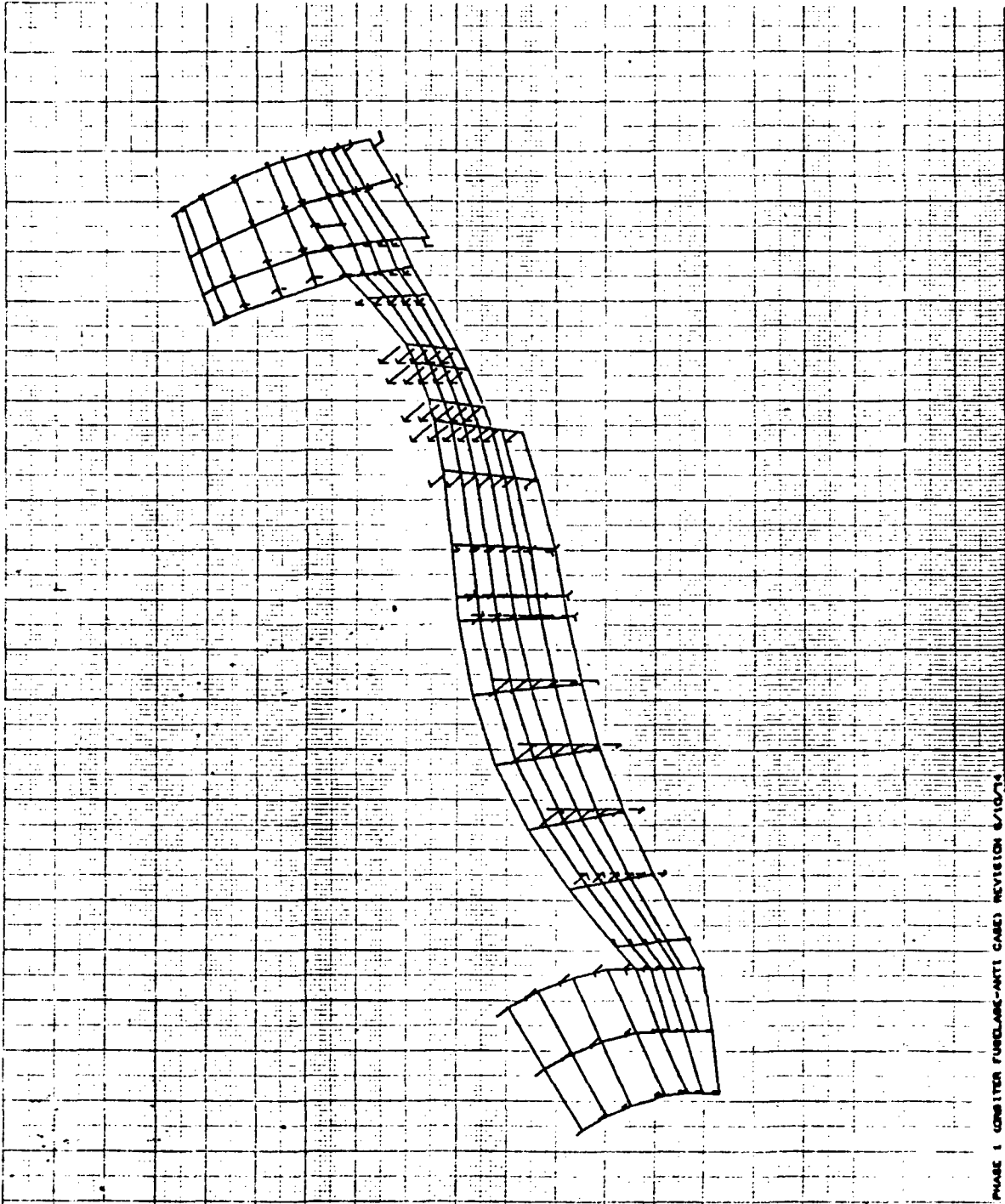

PHASE 1 COMPUTER PURCHASE-ANTI CASE) REVISION 8/10/74
 BEING HALF EFF. LONG. 881 EFF. TRANS. AT 1110 0-2-2077.
 FREE FREE ADDS
 MODAL DETON. SURCASE 8 MORE 8 FREE. 174.1982

8/28/74 MAX-DET. 1.00000000

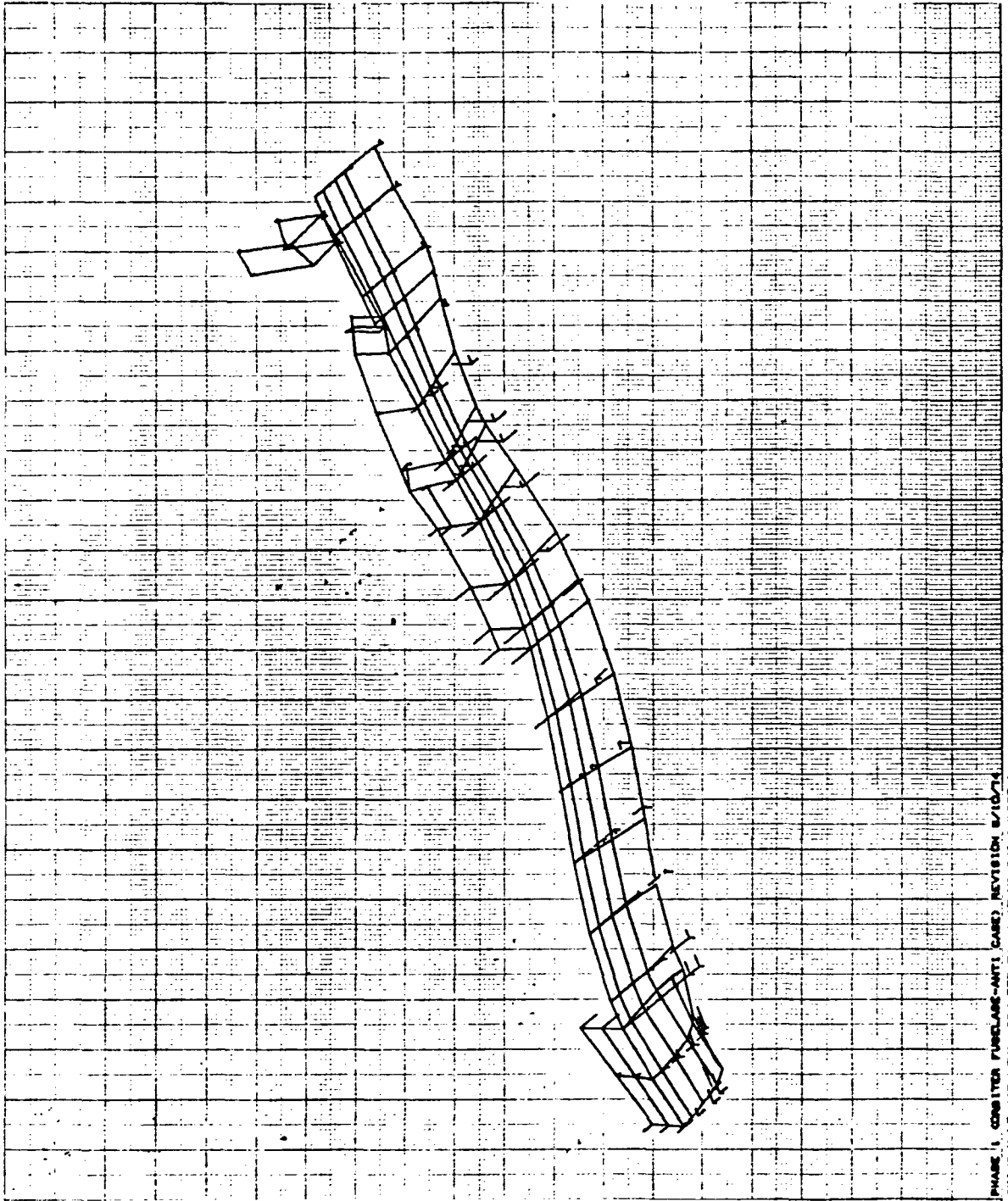

PHASE 1. COMPUTER FURCLAGE-ANTI CASE) REVISION 8/10/74
SKETCH HALF EFF. LONG. .05 (EFF. TRANS. AT WING (0-2/SEFF.)
FACE FILE MOSES
MEDAL DETOR. SUBCLAGE 9 MOSES 9 FREQ. 22.9, 9422

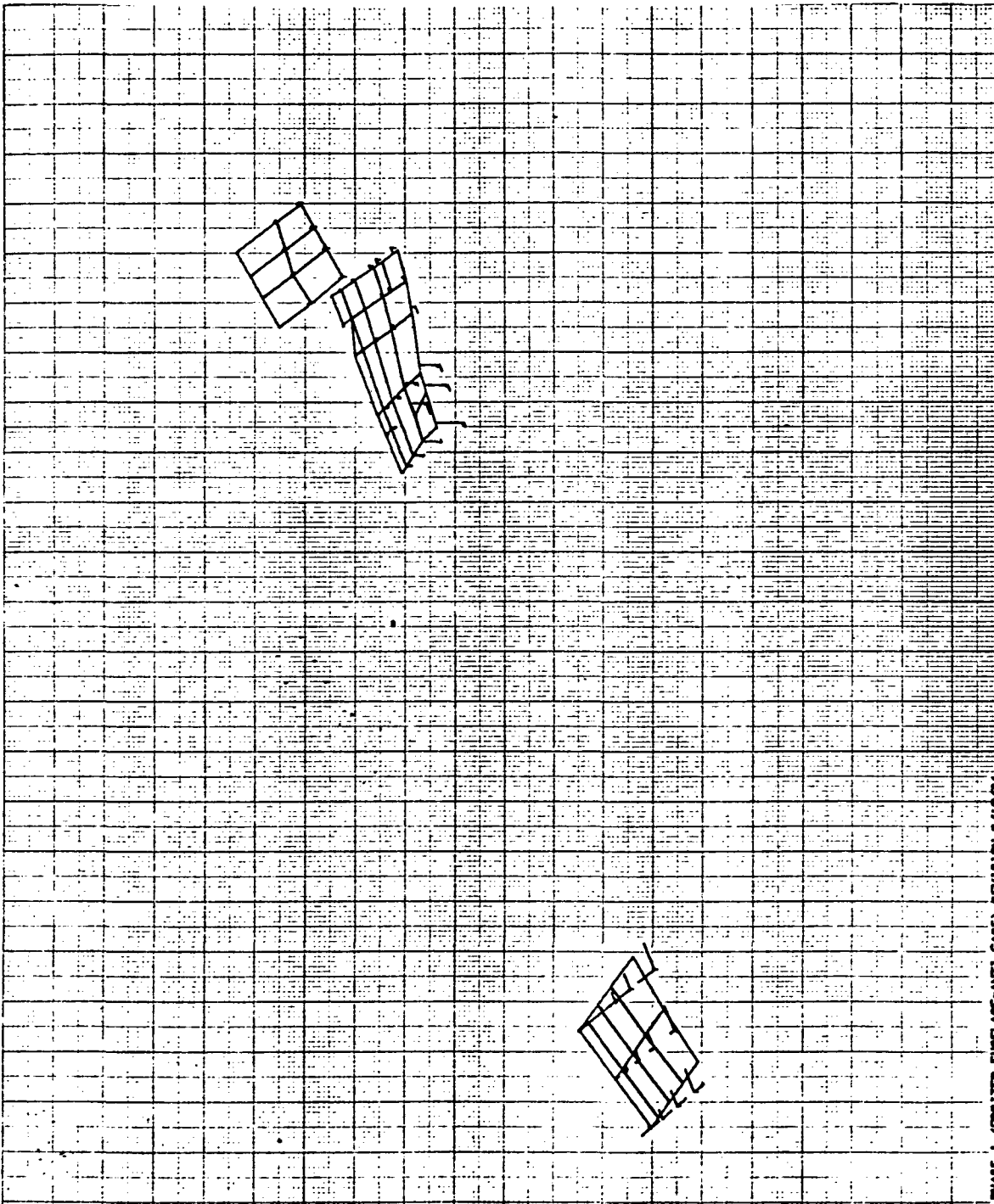

PHASE 1 (CONVERT FURCLAS-ANTI CASE) REVISION 8/10/74
 BRING HALF EFF. LONG. BE (EFF. TRANS. AT WIND 0-2/SEFF.)
 PRICE PRICE MODES
 MODAL DETER. SUBCASE 9 MODE 9 FREQ. 23.9423

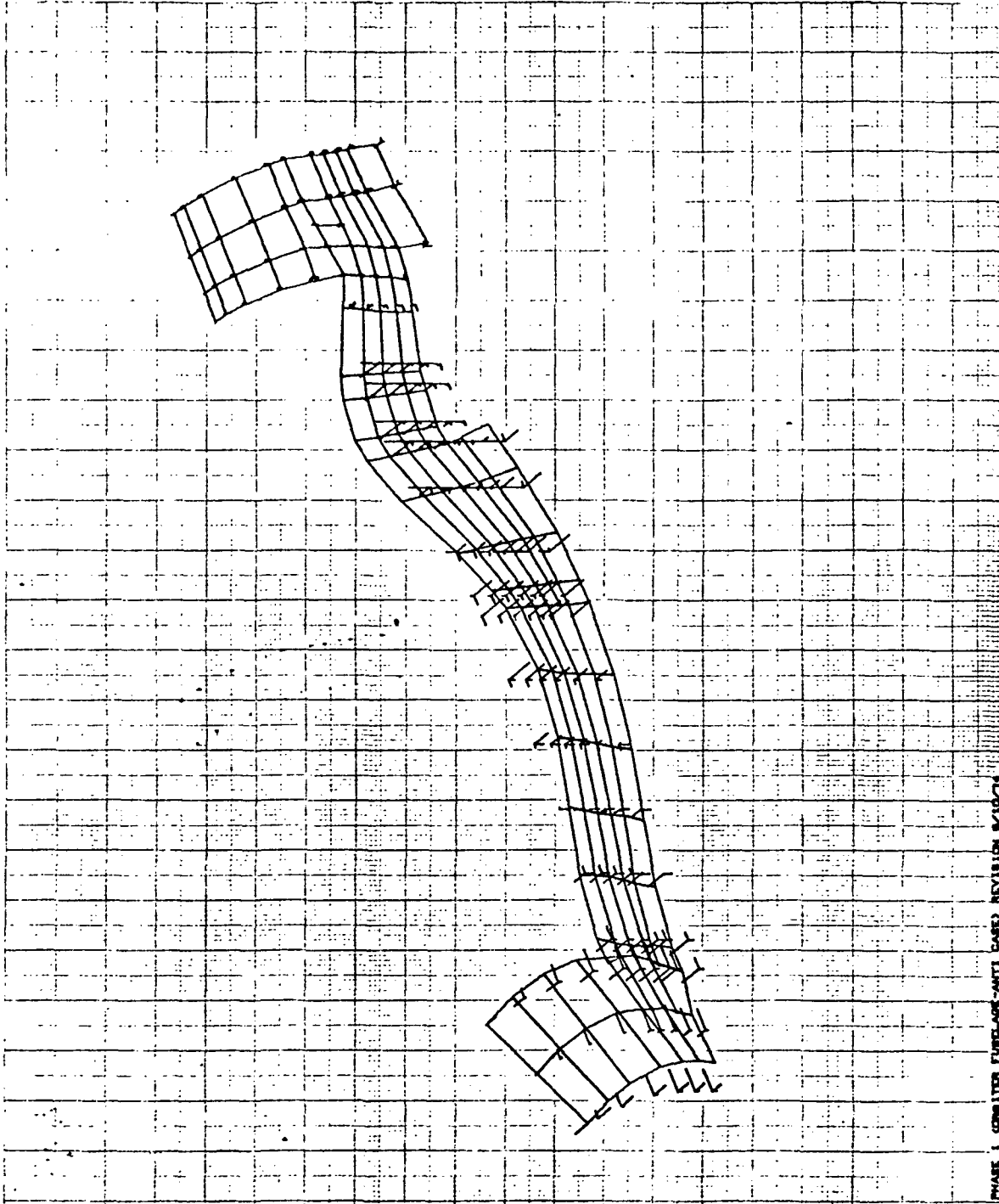

PHASE 1 COMPUTER FURCLAGE-ANTI CASES, REVISION 8/10/74
BEING HALF EFF. LONG. 88% EFF. TRANS. AT WING US-2/26FF.3
FREE FREE MODER
MODAL DEFOR. SUBCASE 9 MODE 9 FREQ. 229.9422

Appendix A10
SORTED BULK DATA/PHASE 1 ANALYSIS:
MODEL II WING

PHASE 1XORBITER WING#
REVISION 4/1/74 XCOVERS HALF EFFECTIVE#

APRIL 24, 1974 NASTRAN 2/ 1/73 PAGE 5

C A S E C O N T R O L D E C K F C H O

CARD
COUNT

1	TITLE # PHASE 1XORBITER WING#
2	SUBTITLE # REVISION 4/1/74 XCOVERS HALF EFFECTIVE#
3	MPC # 3000
4	METHOD # 2
5	BEGIN BULK

A10-1

PHASE 1 (ORBITER WING)
 REVISION 4/1/74 XCOVERS HALF EFFECTIVE

APRIL 24, 1974 NASTRAN 2/ 1/73 PAGE 6

SORTED BULK DATA ECHO

CARD	1	2	3	4	5	6	7	8	9	10
1- ASET1	3	3624								
2- ASET1	13	3651	3655							
3- ASET1	123	3017	3018	3021	3022	3113	3114	3209	CAW1	
4- CAW1	3210	3213	3214	3217	3218	3221	3222	3305	CAW2	
5- CAW2	3306	3401	3402	3405	3406	3409	3410	3413	CAW3	
6- CAW3	3414	3417	3418	3421	3422	3501	3602	3605	CAW4	
7- CAW4	3606	3609	3610	3613	3614	3617	3618	3621	CAW5	
8- CAW5	3622									
9- ASFT1	123	3652	3656	3659	3660	3663	3664			
10- ASET1	123	3667	3668	3671	3672					
11- CONROD	3582	3574	3624	3100	.15					
12- CONROD	3629	3601	3651	3600	.125					
13- CONROD	3630	3605	3655	3600	.001					
14- CONROD	3631	3609	3659	3631	.017					
15- CONROD	3632	3613	3663	3632	.061					
16- CONROD	3633	3617	3667	3632	.061					
17- CONROD	3634	3621	3671	3634	.028					
18- CONROD	3729	3602	3652	3729	.173					
19- CONROD	3730	3606	3656	3501	.096					
20- CONROD	3731	3610	3660	3731	.065					
21- CONROD	3732	3614	3664	3632	.061					
22- CONROD	3733	3618	3668	3632	.061					
23- CONROD	3734	3622	3672	3634	.028					
24- CONROD	3000	0	.0	.0	.0	.0	3.5	47.83	EC3000	
25- EC3000	100.0	3.5	47.83							
26- CONROD	3001	0	-81.5683.0		35.5985	-80.2278.0		57.5136	EC3001	
27- EC3001	68.25	.0	48.432							
28- CONROD	3002	3001	245.7536-16.463111.0003		245.7536-13.75		24.9514	EC3002		
29- EC3002	300.	-16.463111.0003								
30- CROD	3401	3401	3017	3021	3402	3401	3018	3022		
31- CROD	3403	3403	3021	3121	3404	3403	3022	3122		
32- CROD	3405	3403	3017	3117	3406	3403	3018	3118		
33- CROD	3407	3403	3017	3113	3408	3403	3018	3114		
34- CROD	3409	3409	3121	3221	3410	3409	3122	3222		
35- CROD	3411	3409	3117	3217	3412	3409	3118	3218		
36- CROD	3413	3409	3113	3213	3414	3409	3114	3214		
37- CROD	3415	3409	3113	3209	3416	3409	3114	3210		
38- CROD	3417	3417	3221	3321	3418	3417	3222	3322		
39- CROD	3419	3417	3217	3317	3420	3417	3218	3318		
40- CROD	3421	3417	3213	3313	3422	3417	3214	3314		
41- CROD	3423	3417	3209	3309	3424	3417	3210	3310		
42- CROD	3425	3417	3209	3305	3426	3417	3210	3306		
43- CROD	3427	3427	3321	3421	3428	3427	3322	3422		
44- CROD	3429	3427	3317	3417	3430	3427	3318	3418		
45- CROD	3431	3427	3313	3413	3432	3427	3314	3414		
46- CROD	3433	3427	3309	3409	3434	3427	3310	3410		
47- CROD	3435	3427	3305	3405	3436	3427	3306	3406		
48- CROD	3437	3427	3305	3401	3438	3427	3306	3402		
49- CROD	3439	3439	3421	3521	3440	3439	3422	3522		
50- CROD	3441	3439	3417	3517	3442	3439	3418	3518		

S O P T E D B U L K D A T A E C H O

CARD	COUNT	1	2	3	4	5	6	7	8	9	10
51-	CROD	3443	3439	3413	3513	3444	3439	3414	3514		
52-	CROD	3445	3439	3409	3505	3446	3439	3410	3510		
53-	CROD	3447	3439	3405	3505	3448	3439	3406	3506		
54-	CROD	3449	3439	3401	3501	3450	3439	3402	3502		
55-	CROD	3451	3451	3521	3571	3452	3451	3522	3572		
56-	CROD	3453	3451	3517	3567	3454	3451	3518	3568		
57-	CROD	3455	3451	3513	3613	3456	3451	3514	3614		
58-	CROD	3457	3451	3509	3609	3458	3451	3510	3610		
59-	CROD	3459	3451	3505	3605	3460	3451	3506	3606		
60-	CROD	3461	3451	3501	3601	3462	3451	3502	3602		
61-	CROD	3463	3463	3619	3621	3464	3463	3624	3622		
62-	CROD	3465	3463	3617	3619	3466	3463	3618	3624		
63-	CROD	3467	3463	3613	3617	3468	3463	3614	3618		
64-	CROD	3469	3463	3609	3613	3470	3463	3610	3614		
65-	CROD	3471	3463	3605	3609	3472	3463	3606	3610		
66-	CROD	3473	3463	3601	3605	3474	3463	3602	3606		
67-	CROD	3475	3451	3571	3621	3476	3451	3572	3622		
68-	CROD	3477	3451	3567	3617	3478	3451	3568	3618		
69-	CROD	3501	3501	3021	3022	3515	3515	3121	3122		
70-	CROD	3502	3501	3017	3018	3516	3515	3117	3118		
71-	CROD	3503	3501	3113	3114	3517	3515	3321	3322		
72-	CROD	3504	3501	3221	3222	3518	3515	3317	3318		
73-	CROD	3505	3501	3217	3218	3519	3515	3313	3314		
74-	CROD	3506	3501	3213	3214	3520	3515	3309	3310		
75-	CROD	3507	3501	3209	3210	3521	3515	3521	3522		
76-	CROD	3508	3501	3305	3306	3522	3515	3517	3518		
77-	CROD	3509	3501	3421	3422	3523	3515	3513	3514		
78-	CROD	3510	3501	3417	3418	3524	3515	3509	3510		
79-	CROD	3511	3501	3413	3414	3525	3515	3505	3506		
80-	CROD	3512	3501	3409	3410	3526	3515	3501	3502		
81-	CROD	3513	3501	3405	3406						
82-	CROD	3514	3501	3401	3402						
83-	CROD	3527	3527	3621	3622	3528	3528	3619	3624		
84-	CROD	3529	3527	3617	3618	3532	3528	3605	3606		
85-	CROD	3530	3527	3613	3614	3533	3528	3601	3602		
86-	CROD	3531	3527	3609	3610						
87-	CROD	3535	3515	3571	3572	3536	3515	3567	3568		
88-	CROD	3601	3601	3021	3121	3602	3601	3121	3221		
89-	CROD	3603	3601	3221	3321	3604	3601	3321	3421		
90-	CROD	3605	3601	3421	3521	3606	3601	3521	3571		
91-	CROD	3607	3601	3571	3621	3614	3608	3567	3617		
92-	CROD	3608	3608	3017	3117	3609	3608	3117	3217		
93-	CROD	3610	3608	3217	3317	3611	3608	3317	3417		
94-	CROD	3612	3608	3417	3517	3613	3608	3517	3567		
95-	CROD	3615	3608	3113	3213	3616	3608	3213	3313		
96-	CROD	3617	3608	3313	3413	3618	3608	3413	3513		
97-	CROD	3619	3608	3513	3613	3620	3620	3209	3309		
98-	CROD	3621	3620	3309	3409	3622	3620	3409	3509		
99-	CROD	3623	3620	3509	3609	3624	3624	3305	3405		
100-	CROD	3625	3624	3405	3505	3626	3624	3505	3605		

SORTED BULK DATA ECHO

CARD	COUNT	1	2	3	4	5	6	7	8	9	10
101-	CRDD	3627	3627	3401	3501	3628	3627	3501	3601		
102-	CRDD	3635	3635	3017	3021						
103-	CRDD	3636	3636	3217	3221	3637	3636	3213	3217		
104-	CRDD	3638	3636	3209	3213	3639	3636	3417	3421		
105-	CRDD	3640	3636	3413	3417	3641	3636	3409	3413		
106-	CRDD	3642	3636	3405	3409	3643	3636	3401	3405		
107-	CRDD	3644	3635	3619	3621	3645	3635	3617	3619		
108-	CRDD	3646	3635	3613	3617	3647	3635	3609	3613		
109-	CRDD	3648	3635	3605	3609	3649	3635	3601	3605		
110-	CRDD	3650	3650	3017	3113	3651	3650	3113	3209		
111-	CRDD	3652	3650	3209	3305	3653	3650	3305	3401		
112-	CRDD	3654	3600	3117	3121	3655	3600	3113	3117		
113-	CRDD	3656	3600	3317	3321	3657	3600	3313	3317		
114-	CRDD	3658	3600	3309	3313	3659	3600	3305	3309		
115-	CRDD	3660	3600	3517	3521	3661	3600	3513	3517		
116-	CRDD	3662	3600	3509	3513	3663	3600	3505	3509		
117-	CRDD	3664	3600	3501	3505						
118-	CRDD	3701	3601	3022	3122	3702	3601	3122	3222		
119-	CRDD	3703	3601	3222	3322	3704	3601	3322	3422		
120-	CRDD	3705	3601	3422	3522	3706	3601	3522	3572		
121-	CRDD	3707	3601	3572	3622						
122-	CRDD	3708	3608	3018	3118	3709	3608	3118	3218		
123-	CRDD	3710	3608	3218	3318	3711	3608	3318	3418		
124-	CRDD	3712	3608	3418	3518	3713	3608	3518	3568		
125-	CRDD	3714	3608	3568	3618						
126-	CRDD	3715	3608	3114	3214	3716	3608	3214	3314		
127-	CRDD	3717	3608	3314	3414	3718	3608	3414	3514		
128-	CRDD	3719	3608	3514	3614	3720	3620	3210	3310		
129-	CRDD	3721	3620	3310	3410	3722	3620	3410	3510		
130-	CRDD	3723	3620	3510	3610	3724	3624	3306	3406		
131-	CRDD	3725	3624	3406	3506	3726	3624	3506	3606		
132-	CRDD	3727	3627	3402	3502	3728	3627	3502	3602		
133-	CRDD	3735	3635	3018	3022						
134-	CRDD	3736	3636	3218	3222	3737	3636	3214	3218		
135-	CRDD	3738	3636	3210	3214	3739	3636	3418	3422		
136-	CRDD	3740	3636	3414	3418	3741	3636	3410	3414		
137-	CRDD	3742	3636	3406	3410	3743	3636	3402	3406		
138-	CRDD	3744	3635	3624	3622	3745	3635	3618	3624		
139-	CRDD	3746	3635	3614	3618	3747	3635	3610	3614		
140-	CRDD	3748	3635	3606	3610	3749	3635	3602	3606		
141-	CRDD	3750	3650	3018	3114	3751	3650	3114	3210		
142-	CRDD	3752	3650	3210	3306	3753	3650	3306	3402		
143-	CRDD	3754	3600	3118	3122	3755	3600	3114	3118		
144-	CRDD	3756	3600	3318	3322	3757	3600	3314	3318		
145-	CRDD	3758	3600	3310	3314	3759	3600	3306	3310		
146-	CRDD	3760	3600	3518	3522	3761	3600	3514	3518		
147-	CRDD	3762	3600	3510	3514	3763	3600	3506	3510		
148-	CRDD	3764	3600	3502	3506	3765	3600	3574	3572		
149-	CRDD	3766	3600	3568	3574						
150-	CSHE AR	3101	3101	3017	3117	3121	3021				

S O R T E D B U L K D A T A E C H O

CARD COUNT	1	2	3	4	5	6	7	8	9	10
151-	CSHEAR	3102	3101	3117	3217	3221	3121			
152-	CSHEAR	3103	3101	3113	3213	3217	3117			
153-	CSHEAR	3104	3101	3217	3317	3321	3221			
154-	CSHEAR	3105	3101	3213	3313	3317	3217			
155-	CSHEAR	3106	3101	3209	3309	3313	3213			
156-	CSHEAR	3107	3101	3317	3417	3421	3321			
157-	CSHEAR	3108	3101	3313	3413	3417	3317			
158-	CSHEAR	3109	3101	3309	3409	3413	3313			
159-	CSHEAR	3110	3101	3305	3405	3409	3309			
160-	CSHEAR	3111	3101	3417	3517	3521	3421			
161-	CSHEAR	3112	3101	3413	3513	3517	3417			
162-	CSHEAR	3113	3101	3409	3509	3513	3413			
163-	CSHEAR	3114	3101	3405	3505	3509	3409			
164-	CSHEAR	3115	3101	3401	3501	3505	3405			
165-	CSHEAR	3116	3101	3517	3617	3621	3521			
166-	CSHEAR	3117	3101	3513	3613	3617	3517			
167-	CSHEAR	3118	3101	3509	3609	3613	3513			
168-	CSHEAR	3119	3101	3505	3605	3609	3509			
169-	CSHEAR	3120	3101	3501	3601	3605	3505			
170-	CSHEAR	3121	3121	3617	3667	3671	3621			
171-	CSHEAR	3122	3121	3613	3663	3667	3617			
172-	CSHEAR	3123	3121	3609	3659	3663	3513			
173-	CSHEAR	3124	3121	3605	3655	3659	3609			
174-	CSHEAR	3125	3121	3601	3651	3655	3605			
175-	CSHEAR	3201	3101	3018	3118	3122	3022			
176-	CSHEAR	3202	3101	3118	3218	3222	3122			
177-	CSHEAR	3203	3101	3114	3214	3218	3118			
178-	CSHEAR	3204	3101	3218	3318	3322	3222			
179-	CSHEAR	3205	3101	3214	3314	3318	3218			
180-	CSHEAR	3206	3101	3210	3310	3314	3214			
181-	CSHEAR	3207	3101	3318	3418	3422	3322			
182-	CSHEAR	3208	3101	3314	3414	3418	3318			
183-	CSHEAR	3209	3101	3310	3410	3414	3314			
184-	CSHEAR	3210	3101	3306	3406	3410	3310			
185-	CSHEAR	3211	3101	3418	3518	3522	3422			
186-	CSHEAR	3212	3101	3414	3514	3518	3418			
187-	CSHEAR	3213	3101	3410	3510	3514	3414			
188-	CSHEAR	3214	3101	3406	3506	3510	3410			
189-	CSHEAR	3215	3101	3402	3502	3506	3406			
190-	CSHEAR	3216	3101	3518	3618	3622	3522			
191-	CSHEAR	3217	3101	3514	3614	3618	3518			
192-	CSHEAR	3218	3101	3510	3610	3614	3514			
193-	CSHEAR	3219	3101	3506	3606	3610	3510			
194-	CSHEAR	3220	3101	3502	3602	3606	3506			
195-	CSHEAR	3221	3121	3618	3668	3672	3622			
196-	CSHEAR	3222	3121	3614	3664	3668	3618			
197-	CSHEAR	3223	3121	3610	3660	3664	3614			
198-	CSHEAR	3224	3121	3606	3656	3660	3610			
199-	CSHEAR	3225	3121	3602	3652	3656	3606			
200-	CSHEAR	3226	3101	3574	3674	3678	3578			

PHASE 1% CORRITER WING#
 REVISION 4/1/74 %COVERS HALF EFFECTIVED

APRIL 24, 1974 NASTRAN 2/ 1/73 PAGE 10

SORTED BULK DATA ECHO

CARD	COUNT	1	2	3	4	5	6	7	8	9	10
201-	CSHEAR	3227	3101	3568	3618	3624	3574				
202-	CSHEAR	3301	3301	3017	3021	3022	3019				
203-	CSHEAR	3302	3301	3021	3121	3122	3022				
204-	CSHEAR	3303	3301	3017	3117	3118	3018				
205-	CSHEAR	3304	3301	3017	3113	3114	3018				
206-	CSHEAR	3305	3301	3121	3221	3222	3122				
207-	CSHEAR	3306	3301	3117	3217	3218	3118				
208-	CSHEAR	3307	3301	3113	3213	3214	3114				
209-	CSHEAR	3308	3301	3113	3209	3210	3114				
210-	CSHEAR	3309	3301	3221	3321	3322	3222				
211-	CSHEAR	3310	3301	3217	3317	3318	3218				
212-	CSHEAR	3311	3301	3213	3313	3314	3214				
213-	CSHEAR	3312	3301	3209	3309	3310	3210				
214-	CSHEAR	3313	3301	3209	3305	3306	3210				
215-	CSHEAR	3314	3301	3321	3421	3422	3322				
216-	CSHEAR	3315	3301	3317	3417	3418	3318				
217-	CSHEAR	3316	3301	3313	3413	3414	3314				
218-	CSHEAR	3317	3301	3309	3409	3410	3310				
219-	CSHEAR	3318	3301	3305	3405	3406	3306				
220-	CSHEAR	3319	3301	3305	3401	3402	3306				
221-	CSHEAR	3320	3301	3421	3521	3522	3422				
222-	CSHEAR	3321	3301	3417	3517	3518	3418				
223-	CSHEAR	3322	3301	3413	3513	3514	3414				
224-	CSHEAR	3323	3301	3409	3509	3510	3410				
225-	CSHEAR	3324	3301	3405	3505	3506	3406				
226-	CSHEAR	3325	3301	3401	3501	3502	3402				
227-	CSHEAR	3326	3301	3521	3571	3572	3522				
228-	CSHEAR	3327	3301	3517	3567	3568	3518				
229-	CSHEAR	3328	3301	3513	3613	3614	3514				
230-	CSHEAR	3329	3301	3509	3609	3610	3510				
231-	CSHEAR	3330	3301	3505	3605	3606	3506				
232-	CSHEAR	3331	3301	3501	3601	3602	3502				
233-	CSHEAR	3332	3301	3619	3621	3622	3624				
234-	CSHEAR	3333	3301	3617	3619	3624	3618				
235-	CSHEAR	3334	3301	3613	3617	3618	3614				
236-	CSHEAR	3335	3301	3609	3613	3614	3610				
237-	CSHEAR	3336	3301	3605	3609	3610	3606				
238-	CSHEAR	3337	3301	3601	3605	3606	3602				
239-	CSHEAR	3338	3338	3217	3221	3222	3219				
240-	CSHEAR	3339	3338	3213	3217	3218	3214				
241-	CSHEAR	3340	3338	3209	3213	3214	3210				
242-	CSHEAR	3341	3338	3417	3421	3422	3418				
243-	CSHEAR	3342	3338	3413	3417	3418	3414				
244-	CSHEAR	3343	3338	3409	3413	3414	3410				
245-	CSHEAR	3344	3338	3405	3409	3410	3406				
246-	CSHEAR	3345	3338	3401	3405	3406	3402				
247-	CSHEAR	3346	3346	3621	3671	3672	3622				
248-	CSHEAR	3347	3346	3617	3667	3668	3618				
249-	CSHEAR	3348	3346	3613	3663	3664	3614				
250-	CSHEAR	3349	3346	3609	3659	3660	3610				

SORTED BULK DATA ECHO

CARD	1	2	3	4	5	6	7	8	9	10
251-	CSHFAN	3350	3346	3601	3551	3652	3602			
252-	CSHFAN	3351	3301	3571	3621	3622	3572			
253-	CSHFAN	3352	3301	3567	3617	3618	3568			
254-	EIGR	2	INV	.1	200.	5	5		1.-3	REIG2
255-	BEIG2	MAX								
256-	GRDSE7		0				0	456		
257-	GRID	3017		162.0	-61.58	51.5				
258-	GRID	3018		162.0	-61.58	49.0				
259-	GRID	3021		170.75	-61.58	51.5				
260-	GRID	3022		170.75	-61.58	49.0				
261-	GRID	3113		153.375	-54.046751.5					
262-	GRID	3114		153.375	-54.046748.4487					
263-	GRID	3117		162.0	-54.046751.5					
264-	GRID	3118		162.0	-54.046748.4487					
265-	GRID	3121		170.75	-54.046751.5					
266-	GRID	3122		170.75	-54.046748.4467					
267-	GRID	3209		144.75	-46.513451.5					
268-	GRID	3210		144.75	-46.513447.8975					
269-	GRID	3213		153.375	-46.513451.5					
270-	GRID	3214		153.375	-46.513447.8975					
271-	GRID	3217		162.0	-46.513451.5					
272-	GRID	3218		162.0	-46.513447.8975					
273-	GRID	3221		170.75	-46.513451.5					
274-	GRID	3222		170.75	-46.513447.8975					
275-	GRID	3305		135.0	-37.997551.5					
276-	GRID	3306		135.0	-37.997547.2743					
277-	GRID	3309		144.75	-37.997551.5					
278-	GRID	3310		144.75	-37.997547.2743					
279-	GRID	3313		153.375	-37.997551.5					
280-	GRID	3314		153.375	-37.997547.2743					
281-	GRID	3317		162.0	-37.997551.5					
282-	GRID	3318		162.0	-37.997547.2743					
283-	GRID	3321		170.75	-37.997551.5					
284-	GRID	3322		170.75	-37.997547.2743					
285-	GRID	3401		125.5	-29.7	51.5				
286-	GRID	3402		125.5	-29.7	46.6672				
287-	GRID	3405		135.0	-29.7	51.5				
288-	GRID	3406		135.0	-29.7	46.6672				
289-	GRID	3409		144.75	-29.7	51.5				
290-	GRID	3410		144.75	-29.7	46.6672				
291-	GRID	3413		153.375	-29.7	51.5				
292-	GRID	3414		153.375	-29.7	46.6672				
293-	GRID	3417		162.0	-29.7	51.5				
294-	GRID	3418		162.0	-29.7	46.6672				
295-	GRID	3421		170.75	-29.7	51.5				
296-	GRID	3422		170.75	-29.7	46.6672				
297-	GRID	3501		125.5	-21.1	51.5				
298-	GRID	3502		125.5	-21.1	46.0378				
299-	GRID	3505		135.0	-21.1	51.5				
300-	GRID	3506		135.0	-21.1	46.0378				

PHASE 1 ORBITER WING
 REVISION 4/1/74 XCOVERS HALF EFFECTIVE

SORTED BULK DATA ECHO

CARD	COUNT	1	2	3	4	5	6	7	8	9	10
301-	GRID	3509			144.75	-21.1	51.5				
302-	GRID	3510			144.75	-21.1	46.0378				
303-	GRID	3513			153.375	-21.1	51.5				
304-	GRID	3514			153.375	-21.1	46.0378				
305-	GRID	3517			162.0	-21.1	51.5				
306-	GRID	3518			162.0	-21.1	46.0378				
307-	GRID	3521			170.75	-21.1	51.5				
308-	GRID	3522			170.75	-21.1	46.0378				
309-	GRID	3567			162.0	-17.425	51.5				
310-	GRID	3568			162.0	-17.425	45.7689				
311-	GRID	3571			170.75	-17.425	51.5				
312-	GRID	3572			170.75	-17.425	45.7589				
313-	GRID	3574	0		165.25	-17.425	45.7689	3000	456		
314-	GRID	3601			125.5	-13.75	51.5				
315-	GRID	3602			125.5	-13.75	45.5				
316-	GRID	3605			135.0	-13.75	51.5				
317-	GRID	3606			135.0	-13.75	45.5				
318-	GRID	3609			144.75	-13.75	51.5				
319-	GRID	3610			144.75	-13.75	45.5				
320-	GRID	3613			153.375	-13.75	51.5				
321-	GRID	3614			153.375	-13.75	45.5				
322-	GRID	3617			162.0	-13.75	51.5				
323-	GRID	3618			162.0	-13.75	45.5				
324-	GRID	3619			165.25	-13.75	51.5				
325-	GRID	3621			170.75	-13.75	51.5				
326-	GRID	3622			170.75	-13.75	45.5				
327-	GRID	3624	0		165.25	-13.75	45.5	3002	456		
328-	GRID	3651			125.5	-12.5	51.5				
329-	GRID	3652			125.5	-12.5	45.5				
330-	GRID	3655			135.0	-12.5	51.5				
331-	GRID	3656			135.0	-12.5	45.5				
332-	GRID	3659			144.75	-12.5	51.5				
333-	GRID	3660			144.75	-12.5	45.5				
334-	GRID	3663			153.375	-12.5	51.5				
335-	GRID	3664			153.375	-12.5	45.5				
336-	GRID	3667			162.0	-12.5	51.5				
337-	GRID	3668			162.0	-12.5	45.5				
338-	GRID	3671			170.75	-12.5	51.5				
339-	GRID	3672			170.75	-12.5	45.5				
340-	MAT1	3100	10.566		.3	.1					
341-	MAT1	3101	5.2566		.3	.1					
342-	MAT1	3600	10.566		.3	0.0					
343-	MAT1	3601	10.566		.3	0.0					
344-	MAT1	3631	10.566		.3	0.0					
345-	MAT1	3632	10.566		.3	0.0					
346-	MAT1	3634	10.566		.3	0.0					
347-	MAT1	3729	10.566		.3	0.0					
348-	MAT1	3731	10.566		.3	0.0					
349-	MPC	3000	3567	1	1.0	3517	1	-.5		6MC3567X	
350-	6MC3567X		3617	1	-.5						

S O P T E D B U L K D A T A E C H O

CARD	COUNT	1	2	3	4	5	6	7	8	9	10
351-	MPC	3000	3571	1	1.0	3521	1	-0.5			EMC3571X
352-	EMC3571X		3621	1	-0.5						
353-	MPC	3000	3574	3	0.75	3568	2	-0.40139			EMC3574A
354-	EMC3574A		3568	3	-5.48533572		2	-0.23719			EMC3574B
355-	EMC3574B		3572	3	-3.24133						
356-	MPC	3000	3619	2	0.75	3617	2	-5.5			EM3619Y
357-	EM3619Y		3621	2	-3.25						
358-	PARAM	GRDPNT	0								
359-	PARAM	RMODE	1								
360-	PARAM	TPCOPY	1								
361-	PARAM	TPNAME	WINGP1								
362-	PARAM	WTMASS	.002586								
363-	PROD	3401	3600	.029				.0016			
364-	PROD	3403	3600	.031				.0016			
365-	PROD	3409	3600	.034				.0016			
366-	PROD	3417	3600	.037				.0016			
367-	PROD	3427	3600	.040				.0016			
368-	PROD	3439	3600	.043				.0016			
369-	PROD	3451	3600	.046				.0016			
370-	PROD	3463	3600	.049				.0016			
371-	PROD	3501	3600	.100				.0			
372-	PROD	3515	3600	.03				.0			
373-	PROD	3527	3600	.25				.0			
374-	PROD	3528	3600	.15				.0			
375-	PROD	3600	3600	.001							
376-	PROD	3601	3601	.044							
377-	PROD	3608	3601	.088							
378-	PROD	3620	3601	.092							
379-	PROD	3624	3601	.096							
380-	PROD	3627	3601	.048							
381-	PROD	3635	3601	.08							
382-	PROD	3636	3601	.16							
383-	PROD	3650	3601	.06							
384-	PSHEAR	3101	3101	.02	.0						
385-	PSHEAR	3121	3100	.02	.0						
386-	PSHEAR	3301	3100	.032	.0135						
387-	PSHEAR	3338	3100	.032	.0						
388-	PSHEAR	3346	3100	.125	.0						
389-	SUPPORT	3624	3	3651	13	3652	123	3655	13		
390-	SUPPORT	3656	123	3659	123	3660	123	3663	123		
391-	SUPPORT	3664	123	3667	123	3668	123	3671	123		
392-	SUPPORT	3672	123								
	ENDDATA										

PHASE 1 XURNITER WINGD
4/30/74 XCOVERS 85 PERCENT EFF.#

MAY 18, 1974 NASTRAN 2/ 1/73 PAGE 6

INPUT BULK DATA DECK ECHO

.	1	..	2	..	3	..	4	..	5	..	6	..	7	..	8	..	9	..	10	.
\$	CHANGE HALF EFFECTIVE COVERS TO 85 PERCENT																			
/	341																			
/	343 348																			
MAT1	3101		8.92E6				.3		.1											
MAT1	3601		17.87E6				.3		0.0											
MAT1	3631		29.42E6				.3		0.0											
MAT1	3632		21.0E6				.3		0.0											
MAT1	3634		22.05E6				.3		0.0											
MAT1	3729		12.61E6				.3		0.0											
MAT1	3731		21.0E6				.3		0.0											
ENDDATA																				

TOTAL COUNT# 11

Appendix A11
PLOTS OF MEMBER DATA/PHASE 1 ANALYSIS:
MODEL II WING

3/23/74

1

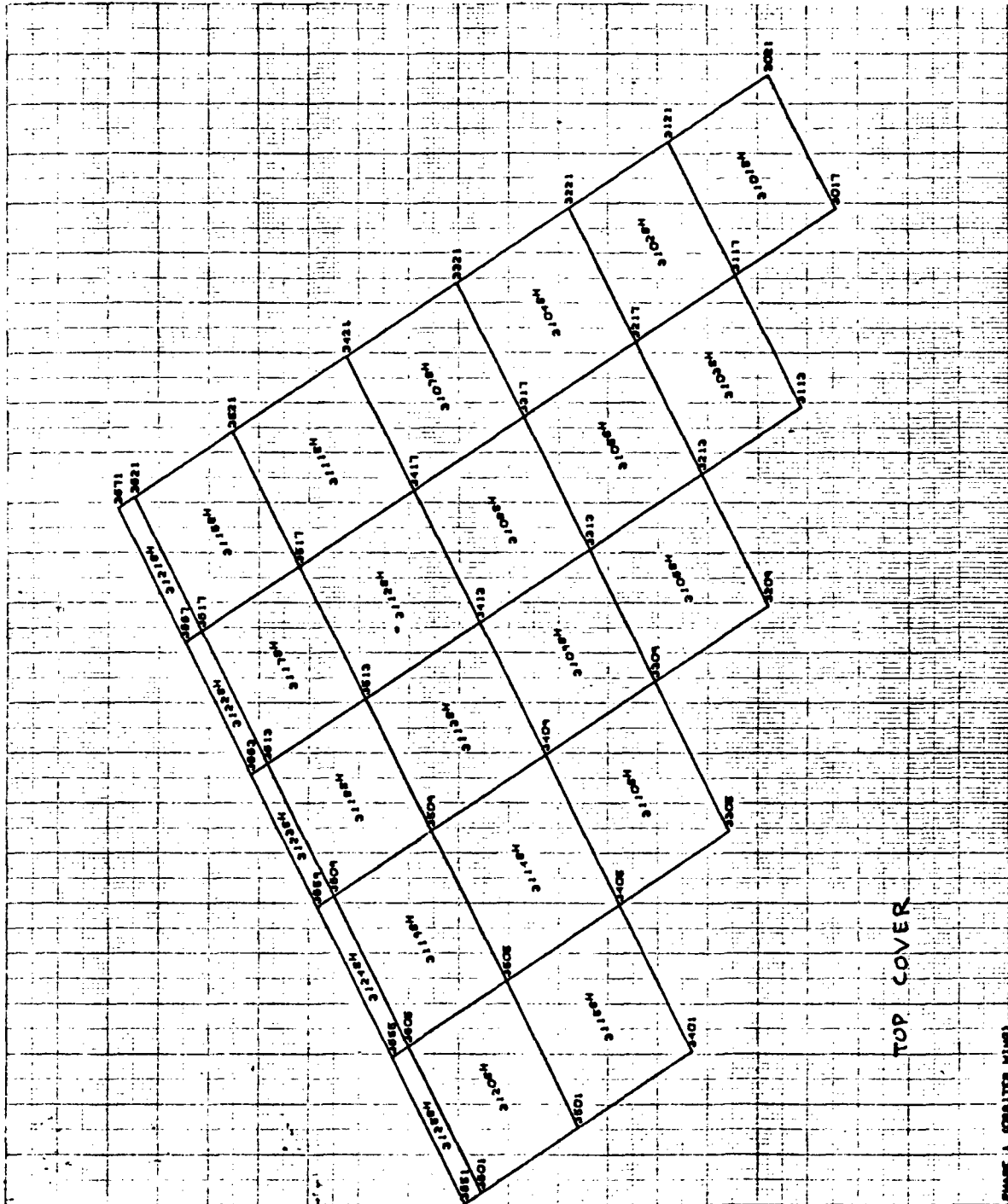

TOP COVER

FIGURE 1 (CONTINUED FROM PAGE 1)
REVISION 4/1/74 (COVERS HALF EFFECTIVE NIGHT)

UNCORRECTED SHOTS

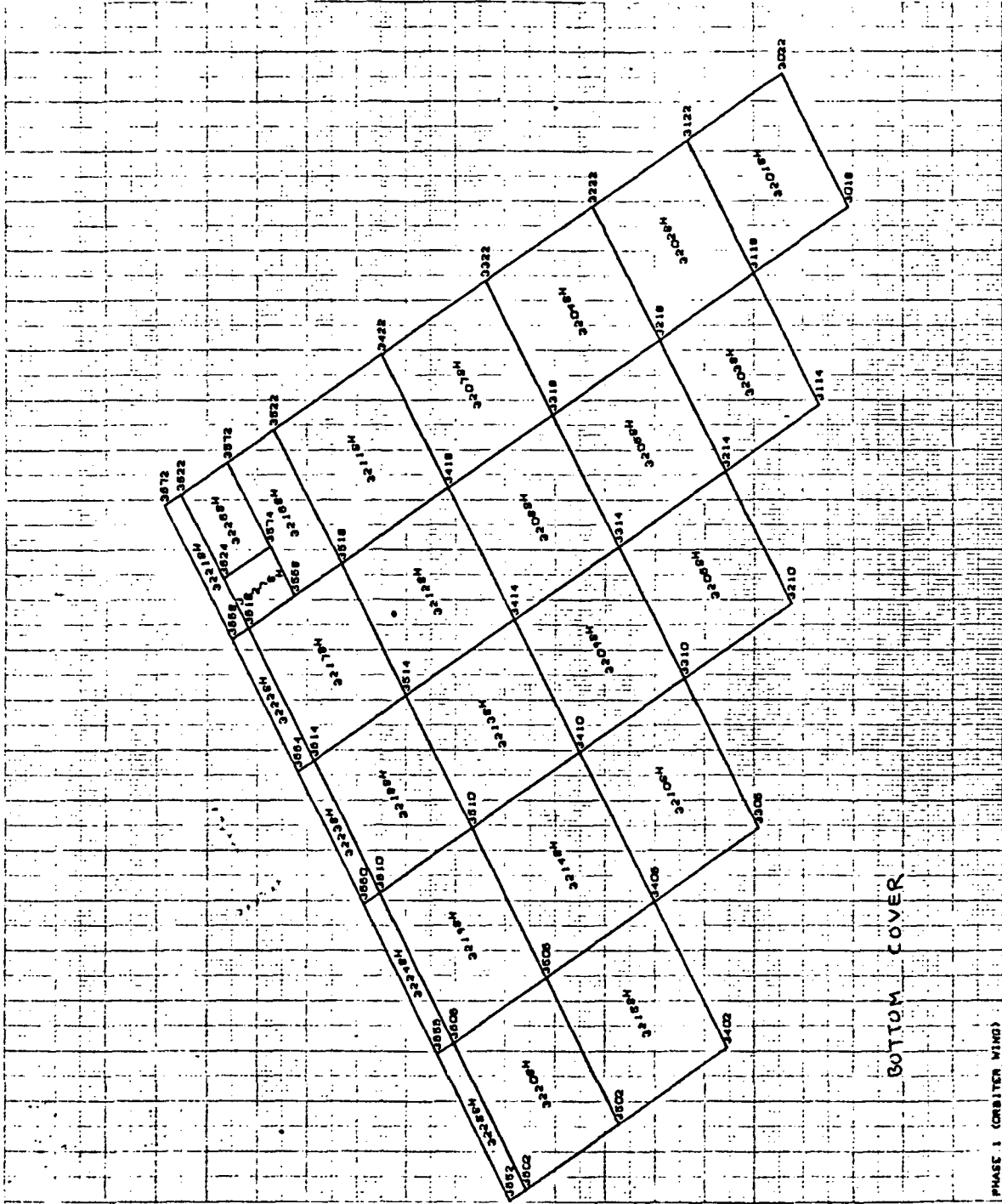

BOTTOM COVER

PHASE 1 (ORBITER WING)
 REVISION 4/1/74 COVERS HALF EFFECTIVE WIDTH
 UNIFORMED SHAPE

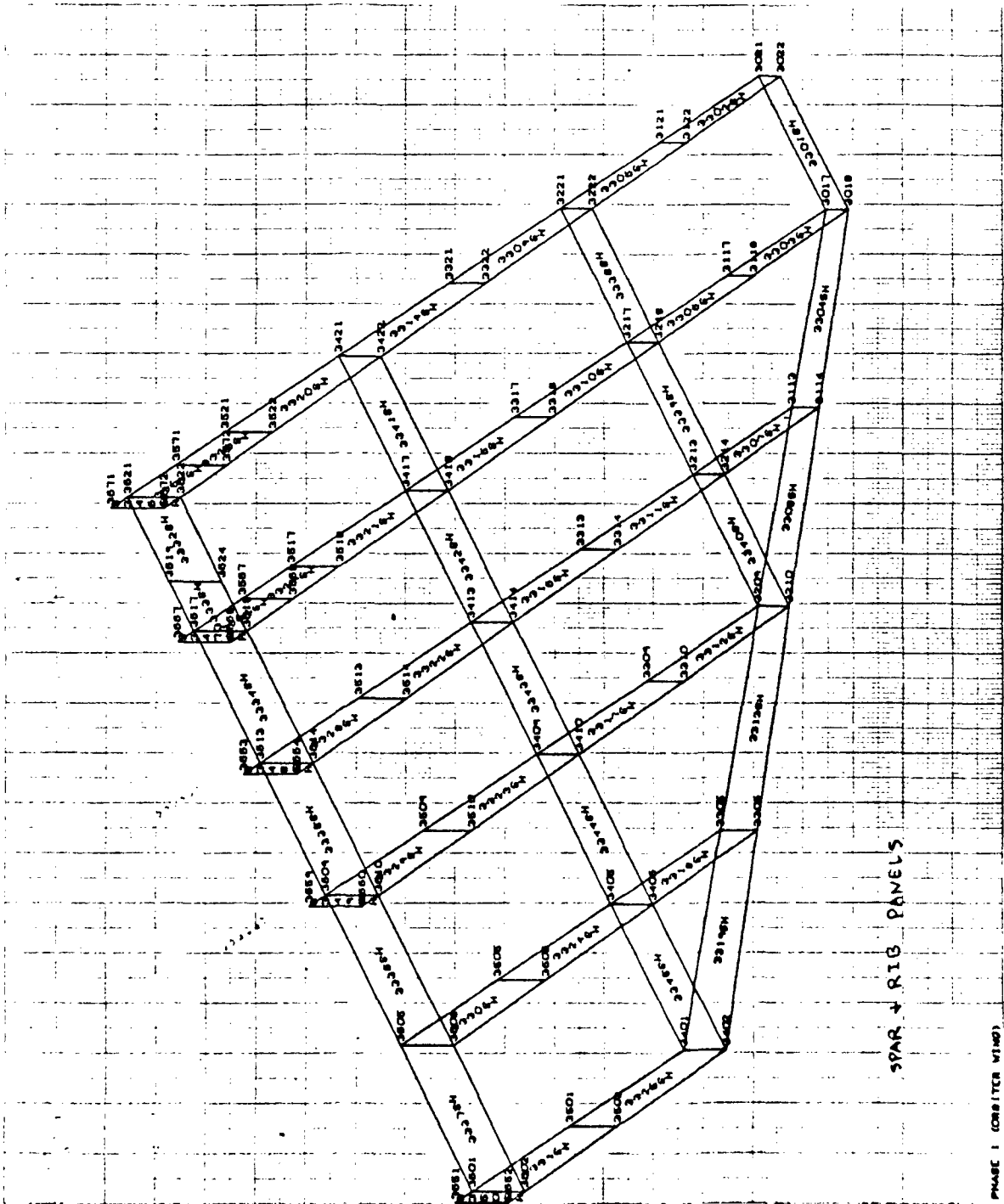

SPAR + RIB PANELS

PHASE I (ORBITER WING)
 REVISION 4/1/74 (COVERS HALF EFFECTIVE WIDTH)
 UNDEFORCED SHAPE

4/23/74

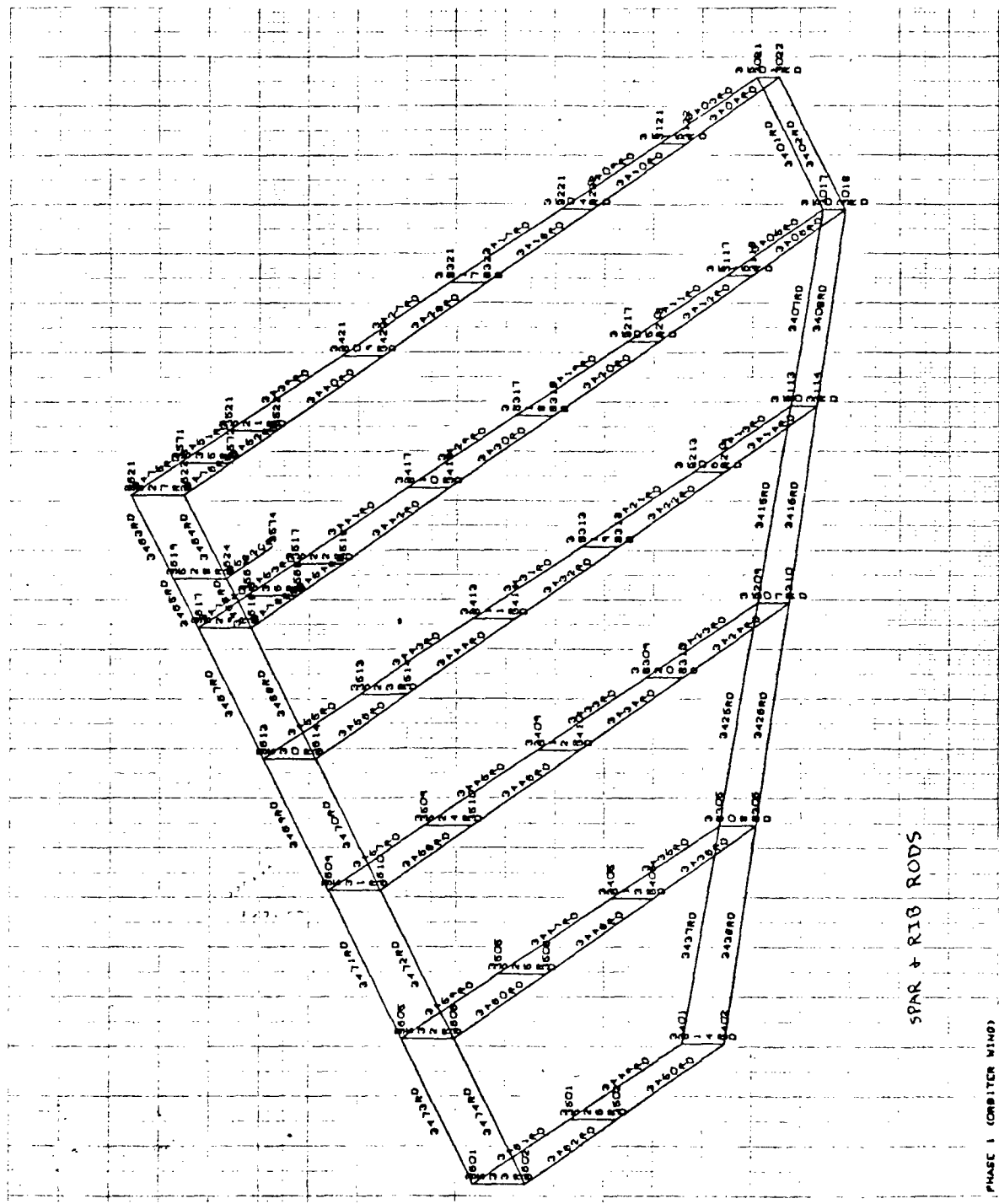

SPAR + RIB RODS

PHASE 1 (ORBITER MING)
 REVISION 4/1/74 (COVERS HALF EFFECTIVE WIDTH)
 UNDEFORMED SHAPE

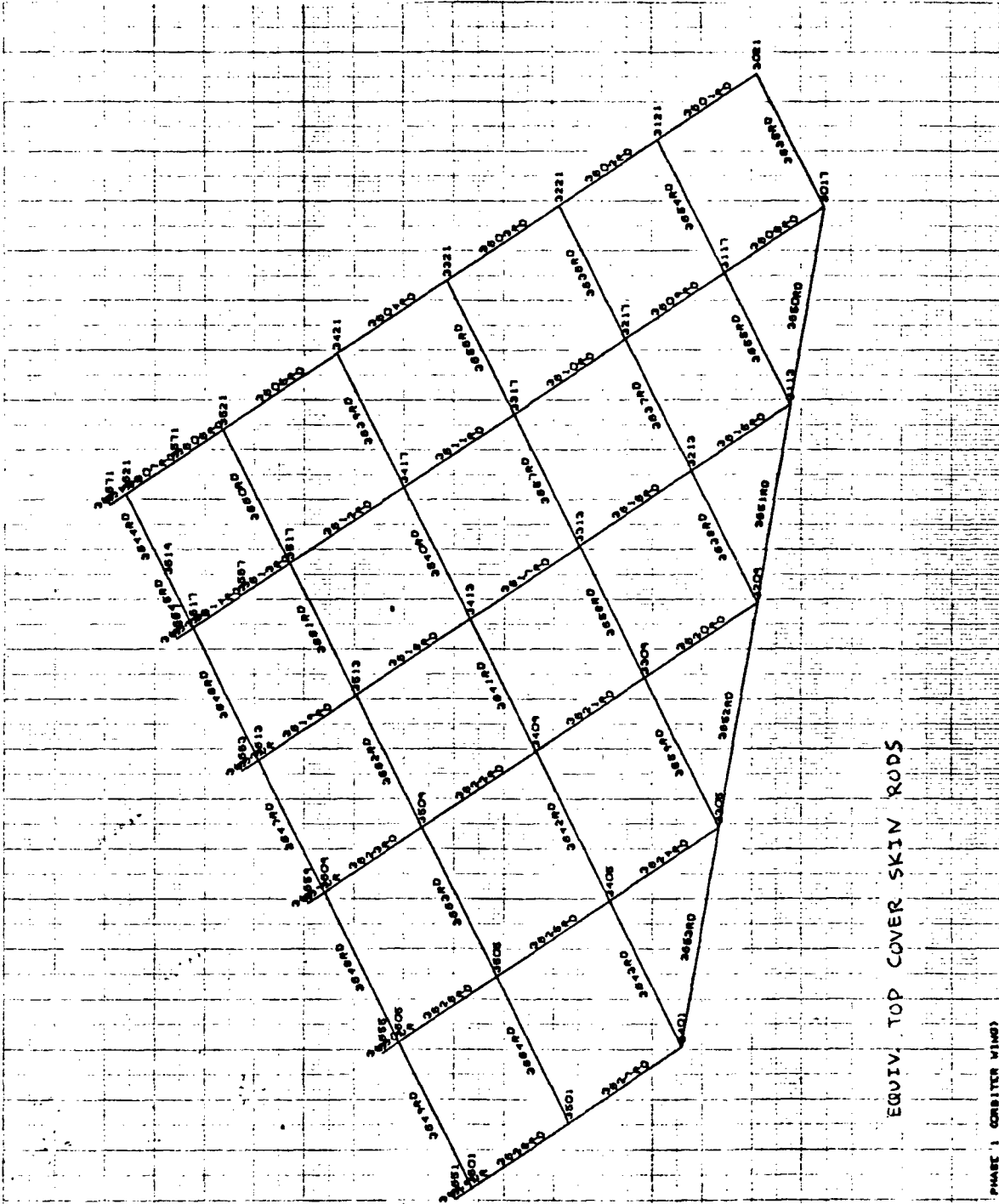

EQUIV. TOP COVER SKIN RODS

PHASE 1 (CONCRETE WING)
REVISION 4/1/74 (COVERS HALF EFFECTIVE WIDTH)

UNIFORMED SHAPE

4/23/74

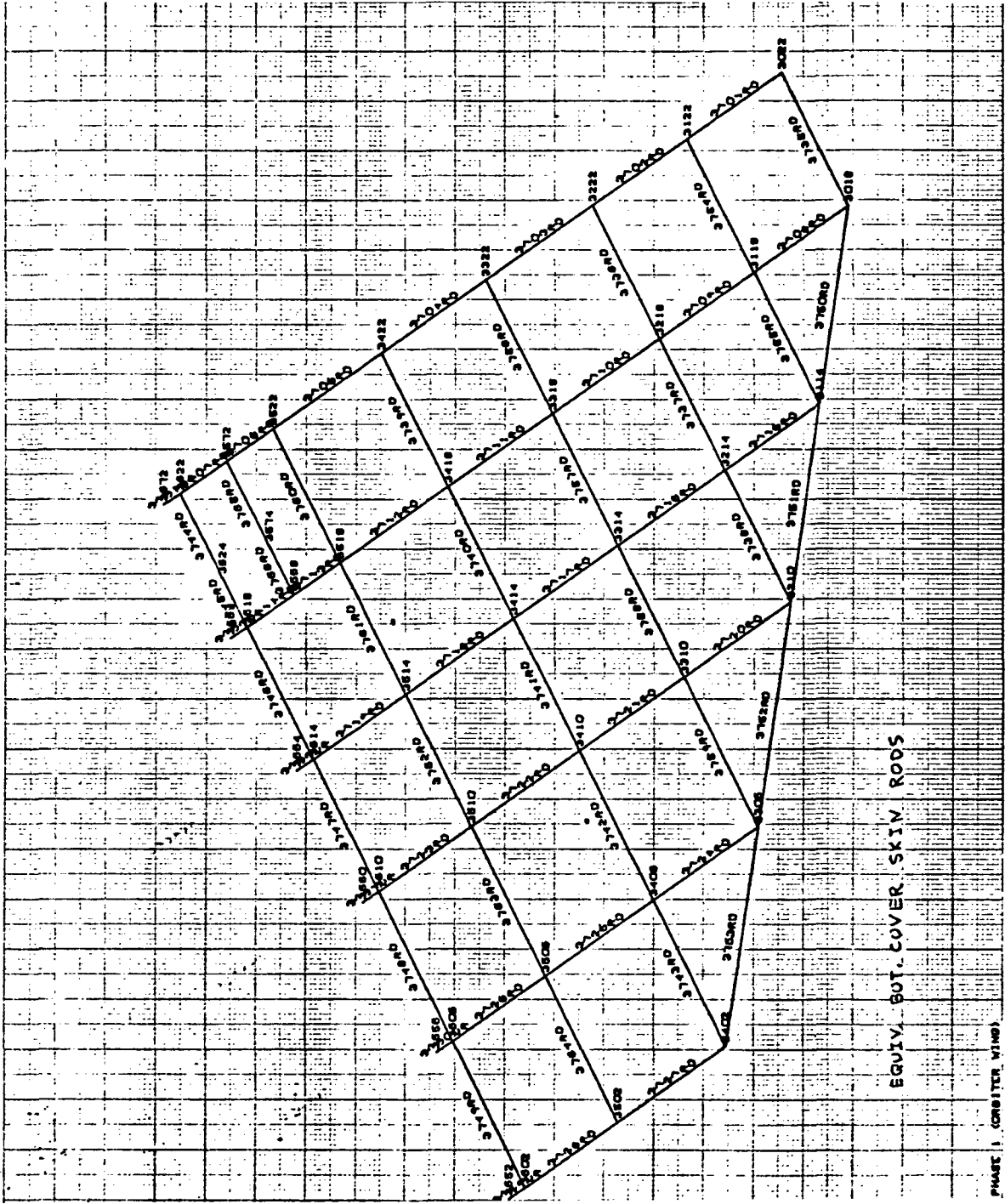

EGUV. BUT. COVER. SKIN. RODS

PHASE I (CORRITER WIND)
 REVISION 4/1/74 (COVERS HALF EFFECTIVE WIDTH)
 UNIFORMED SHAPE

Appendix A12
PLOTS OF SYMMETRIC AND ANTISYMMETRIC
MODES/PHASE 1 ANALYSIS:
MODEL II WING

1 2 3/4 MAX-DEF. = 1.0000000

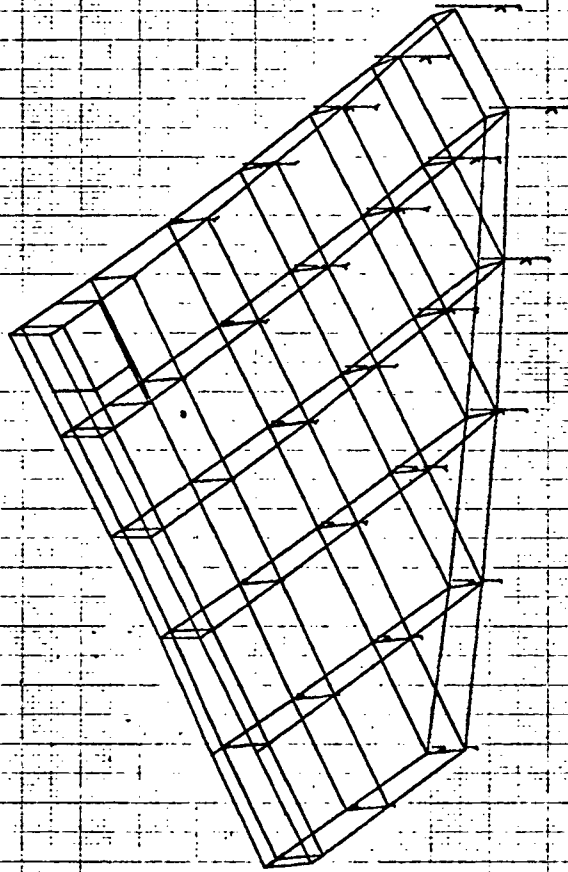

PHASE 1 (COMPLETE WING)
4/20/74 (COVERS 98 PERCENT EFF.)
FREE MODES FIXED AT INTERFACE
MODAL DEFOR. SUBCASE 1 MODE 1 FREQ. 74.81984

82 8/ 2/74 MAX-DEF. = 1.00000000

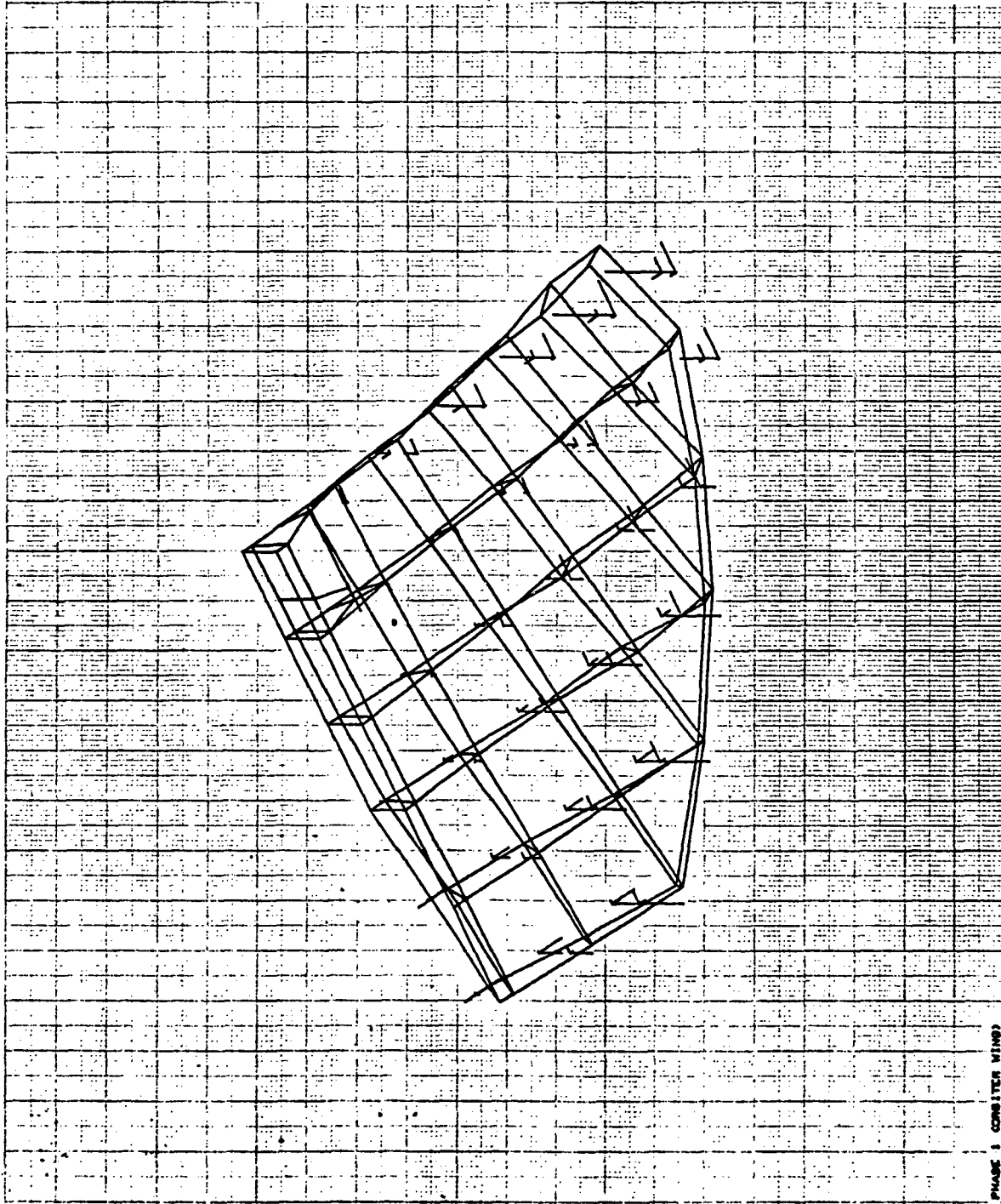

PHASE 1 (CONST. WIND)
4/20/74 COVERS 88 PERCENT (ETC.)
FIXED AXES FIXED AT INTERFACE
NORMAL RESPON. SUBCASE 2 MODE 2 PRED. 1-48.7400

2 . 8/ 2/74 MAX-REV. = 1.00004280

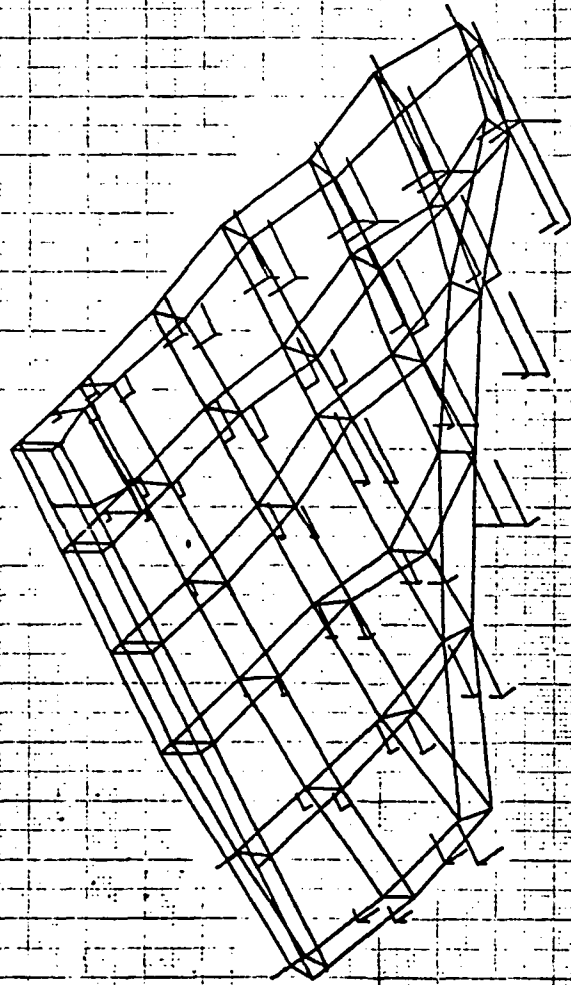

PHASE 1 (CONVERT WIND)
4/20/74 (COVERS 88 PERCENT EFF.)
FACE MODES FIXED AT INTERFACE
MEDIAL SECTION, SURFACE 3 MODE 3 FREQ. 284.8048

4 . 8/ 2/14 MAX-DEF = 1.00000000

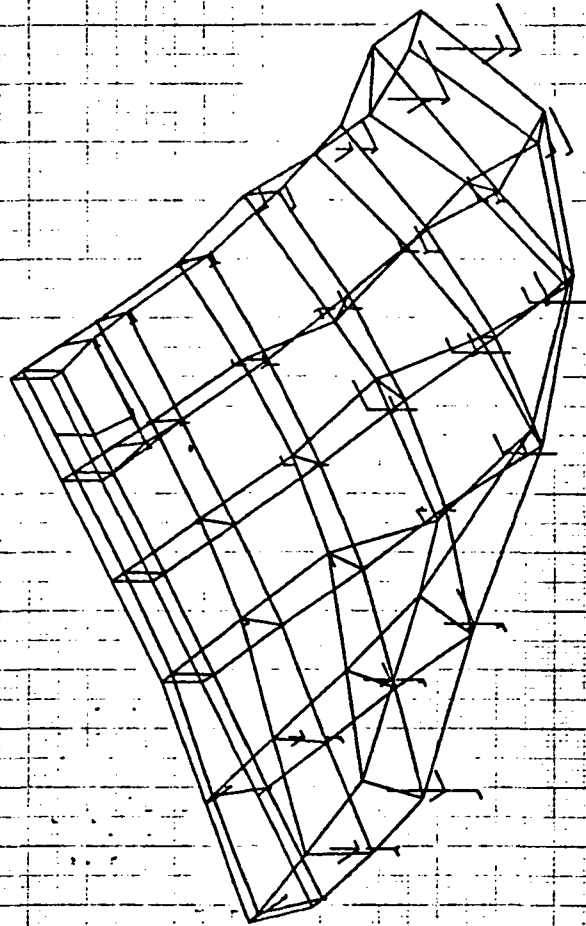

PHASE 1 (CONVERT WING)
4/20/14 (COVERS 88 PERCENT EFF.)
FREE JOINTS FIXED AT INTERFACE
MODAL DEFORM. SUBCASE 4 MODE 4 FREQ. 331.7083

Appendix A13
SORTED BULK DATA/PHASE 1 ANALYSIS:
MODEL II PAYLOAD

PHASE 1
ORBITER PAYLOAD-SYMM CASE

APRIL 30. 1974 NASTRAN 2/ 1/73 PAGE 2

C A S E C O N T R O L D E C K E C H O

CARD COUNT	
1	TITLE # PHASE 1
2	SUBTITLE # ORBITER PAYLOAD-SYMM CASE
3	METHOD # 1
4	MPC # 4891
5	SPC # 4881
6	BEGIN BULK

*** USER INFORMATION MESSAGE 207, BULK DATA NOT SORTED, XSORT WILL RE-ORDER DECK.

SORTED BULK DATA ECHO

CARD	COUNT	1	2	3	4	5	6	7	8	9	10
1- CBAR		4882	4882	4882	4883	4883	.0	1.0	.0	1	
2- CBAR		4883	4882	4882	4883	4884	.0	1.0	.0	1	
3- CBAR		4884	4882	4882	4884	4885	.0	1.0	.0	1	
4- CBAR		4885	4882	4882	4885	4886	.0	1.0	.0	1	
5- CBAR		4886	4882	4882	4886	4887	.0	1.0	.0	1	
6- CBAR		4887	4882	4882	4887	4888	.0	1.0	.0	1	
7- CBAR		4888	4882	4882	4888	4889	.0	1.0	.0	1	
8- CBAR		4889	4882	4889	4889	4890	.0	1.0	.0	1	
9- CONM2		14881	4881	0	.74						
10- CONM2		14882	4882	0	.74						EM4882
11- EM4882		25.13									
12- CONM2		14883	4883	0	.0						EM4883
13- EM4883		40.85									
14- CONM2		14884	4884	0	.0						EM4884
15- EM4884		40.85									
16- CONM2		14885	4885	0	.0						EM4885
17- EM4885		44.06									
18- CONM2		14886	4886	0	.0						EM4886
19- EM4886		40.85									
20- CONM2		14887	4887	0	.0						EM4887
21- EM4887		37.63									
22- CONM2		14888	4888	0	.0						EM4888
23- EM4888		38.16									
24- CONM2		14889	4889	0	.0						EM4889
25- EM4889		36.26									
26- CONM2		14890	4890	0	1.47						EM4890
27- EM4890		23.24									
28- CONM2		14891	4891	0	.17						
29- CONM2		14892	4892	0	1.24						
30- EIGR		1	GIV					4		1.0-4	EEIG1
31- EEIG1		MAX									
32- GRID		4881	0	78.0	.0	51.933	0	456			
33- GRID		4882	0	78.0	.0	62.5	0				
34- GRID		4883	0	87.5	.0	62.5	0				
35- GRID		4884	0	97.0	.0	62.5	0				
36- GRID		4885	0	106.5	.0	62.5	0				
37- GRID		4886	0	117.5	.0	62.5	0				
38- GRID		4887	0	125.5	.0	62.5	0				
39- GRID		4888	0	135.0	.0	62.5	0				
40- GRID		4889	0	143.25	.0	62.5	0				
41- GRID		4890	0	151.875	.0	62.5	0				
42- GRID		4891	0	151.875	-10.125	56.7	0	456			
43- GRID		4892	0	151.875	.0	51.5	0	456			
44- MAT1		4882	10.566		.3	.1					
45- MPC		4891	4881	1	1.0	4882	1	-1.0			EM4881FX
46- EM4881FX			4882	5	10.567						
47- MPC		4891	4882	3	1.0	4881	3	-1.0			
48- MPC		4891	4889	1	1.0	4890	1	-1.0			
49- MPC		4891	4889	3	1.0	4890	1	-.78409			EM4889FZ
50- EM4889FZ			4891	3	-1.0	4892	1	.78409			

SYSTEM BULK DATA ECHO

CARD

COUNT	1	2	3	4	5	6	7	8	9	10
51-	MPC	4891	4889	1	1.0	4890	1	-.09091		EM4889MY
52-	EM4889MY		4892	1	.09091					
53-	MPC	4891	4890	3	1.0	4891	3	-1.0		
54-	MPC	4891	4890	1	1.0	4890	1	-.09091		EM4890MY
55-	EM4890MY		4892	1	.09091					
56-	MPC	4891	4891	1	1.0	4890	1	-.47273		EM4891FX
57-	EM4891FX		4892	1	-.52727					
58-	MPC	4891	4891	2	1.0	4892	2	-.52727		EM4891FY
59-	EM4891FY		4890	2	-.47273					
60-	MPC	4891	4892	1	1.0	4891	1	-1.0		
61-	PARAM	COUPMASS1								
62-	PARAM	GRDPTIT 0								
63-	PARAM	NMGN 1								
64-	PARAM	IPCOPY 1								
65-	PARAM	TPNAME PAYSY1								
66-	PARAM	WTMASS .002588								
67-	DSAP	4882	4882	1.770	21.07	23.23	31.00	.245		
68-	PLUTEL	4891	4881	4882						
69-	PLUTEL	4892	4889	4892						
70-	PLUTEL	4893	4890	4892						
71-	PLUTEL	4894	4890	4891						
72-	SPI	4891	4891	2		4892	2			
73-	SPI	4891	246	4882	1.00	4890				
74-	SUPPORT	4881	3	4891	3	4892	1			

ENDDATA

PHASE 1
ORBITER PAYLOAD,ANTI CASE

MAY 2, 1974 NASTRAN 2/ 1/73 PAGE 2

C A S E C O N T R O L D E C K E C H O

CARD
COUNT

1	TITLE # PHASE 1
2	SURTITLE # ORBITER PAYLOAD,ANTI CASE
3	MPC # 4892
4	SPC # 4882
5	METHOD # 1
6	BEGIN BULK

*** USER INFORMATION MESSAGE 207, BULK DATA NOT SORTED,XSORT WILL RE-ORDER DECK.

SORTED BULK DATA ECHO

CARD	COUNT	1	2	3	4	5	6	7	8	9	10
1-	CBAR	4882	4882	4882	4883	.0	1.0	.0	1		
2-	CBAR	4883	4882	4883	4884	.0	1.0	.0	1		
3-	CBAR	4884	4882	4884	4885	.0	1.0	.0	1		
4-	CBAR	4885	4882	4885	4886	.0	1.0	.0	1		
5-	CBAR	4886	4882	4886	4887	.0	1.0	.0	1		
6-	CBAR	4887	4882	4887	4888	.0	1.0	.0	1		
7-	CBAR	4888	4882	4888	4889	.0	1.0	.0	1		
8-	CRAR	4889	4882	4889	4890	.0	1.0	.0	1		
9-	CONM2	14881	4881	0	.24						
10-	CONM2	14882	4882	0	.74						EM4882
11-	EM4882	25.13									
12-	CONM2	14883	4883	0	.0						EM4883
13-	EM4883	40.85									
14-	CONM2	14884	4884	0	.0						EM4884
15-	EM4884	40.85									
16-	CONM2	14885	4885	0	.0						EM4885
17-	EM4885	44.08									
18-	CONM2	14886	4886	0	.0						EM4886
19-	EM4886	40.85									
20-	CONM2	14887	4887	0	.0						EM4887
21-	EM4887	37.63									
22-	CONM2	14888	4888	0	.0						EM4888
23-	EM4888	38.16									
24-	CONM2	14889	4889	0	.0						EM4889
25-	EM4889	36.28									
26-	CONM2	14890	4890	0	1.47						EM4890
27-	EM4890	23.24									
28-	CONM2	14891	4891	0	.17						
29-	CONM2	14892	4892	0	1.24						
30-	EIGR	1	GIV				4		1.0-4		EMEIG1
31-	EMEIG1	MAX									
32-	GRID	4881	0	78.0	.0	51.933	0	456			
33-	GRID	4882	0	78.0	.0	62.5	0				
34-	GRID	4883	0	87.5	.0	62.5	0				
35-	GRID	4884	0	97.0	.0	62.5	0				
36-	GRID	4885	0	106.5	.0	62.5	0				
37-	GRID	4886	0	117.5	.0	62.5	0				
38-	GRID	4887	0	125.5	.0	62.5	0				
39-	GRID	4888	0	135.0	.0	62.5	0				
40-	GRID	4889	0	143.25	.0	62.5	0				
41-	GRID	4890	0	151.875	.0	62.5	0				
42-	GRID	4891	0	151.875	-10.125	56.7	0	456			
43-	GRID	4892	0	151.875	.0	51.5	0	456			
44-	MAT1	4882	10.586	.3	.1						
45-	MPC	4892	4882	4	1.0	4881	2	-.09463			EM4882MX
46-	EM4882MX		4882	2	.09463						
47-	MPC	4892	4889	4	1.0	4891	3	.09877			
48-	MPC	4892	4890	2	1.0	4891	3	-1.08642			EM4890FY
49-	EM4890FY		4892	2	-1.0						
50-	MPC	4892	4890	4	1.0	4891	3	.09877			

SORTED BULK DATA ECHO

CARD	1	2	3	4	5	6	7	8	9	10
51- MPC	4892	4891	1	1.0	4890	1	-1.0			EM4891FX
52- EM4891FX		4890	6	-10.125						
53- MPC	4892	4891	2	1.0	4891	3	-0.51358			EM4891FY
54- EM4891FY		4892	2	-1.0						
55- PARAM	COUPMASS1									
56- PARAM	GRDPNT 0									
57- PARAM	RMODE 1									
58- PARAM	TPCOPY 1									
59- PARAM	TPNAME PAYAPI									
60- PARAM	WTMASS .002588									
61- PBAR	4882	4882	5.775	21.87	23.23	31.00	.245			
62- PLOTEL	4891	4881	4882							
63- PLOTEL	4892	4889	4892							
64- PLOTEL	4893	4890	4892							
65- PLOTEL	4894	4890	4891							
66- SPC	4882	4881	13		4892	13				
67- SPC1	4882	135	4882	THRU	4890					
68- SUPORT	4881	2	4891	3	4892	2				
ENDDATA										

Appendix A14
PLOTS OF SYMMETRIC AND ANTISYMMETRIC
MODES/PHASE 1 ANALYSIS:
MODEL II PAYLOAD

427174

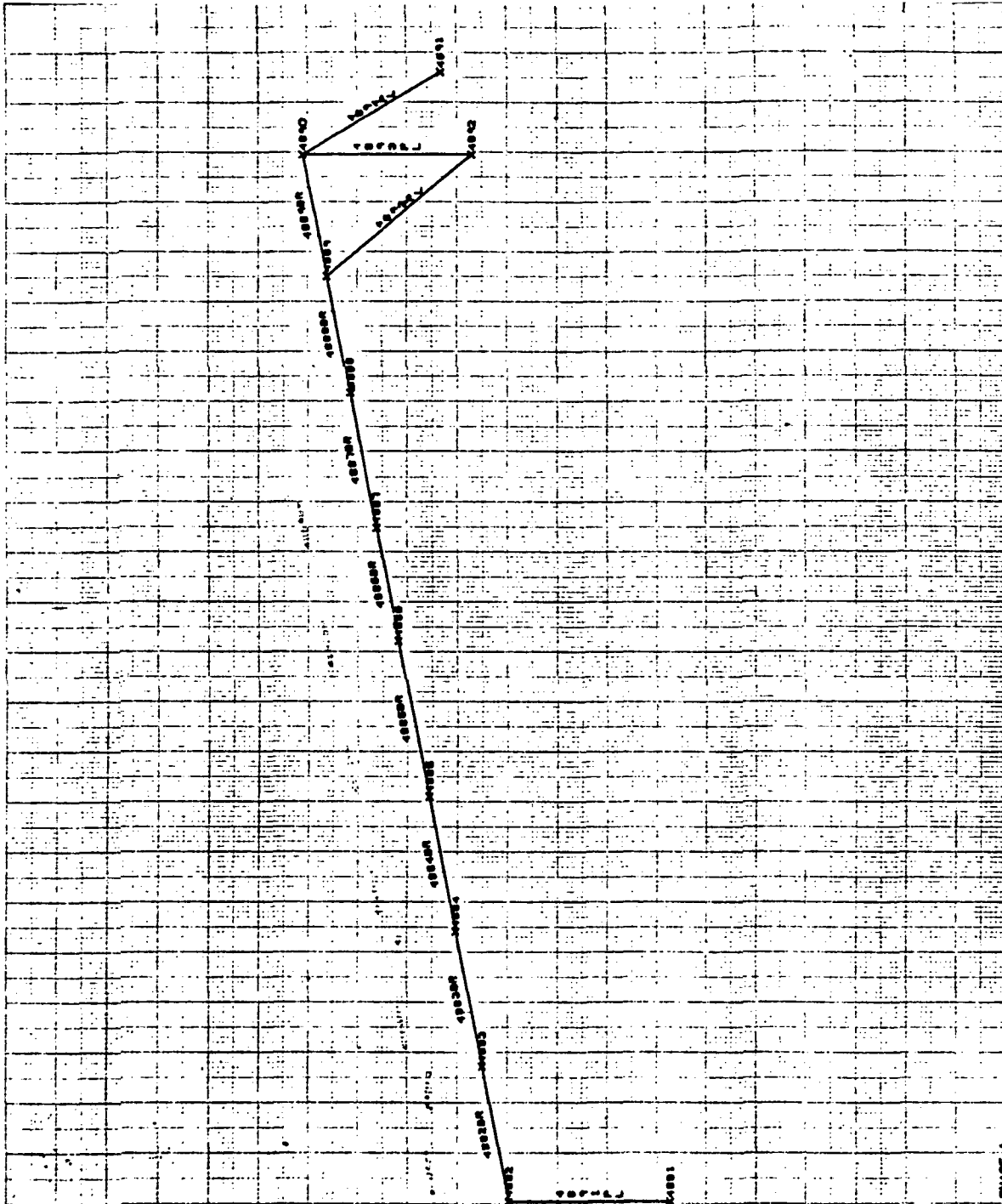

PHASE 1
CREATOR: PAVLOV, STANISLAV
UNDEFINED SHAPE

12 4/27/74 MAX-DEF. = 1,00000000

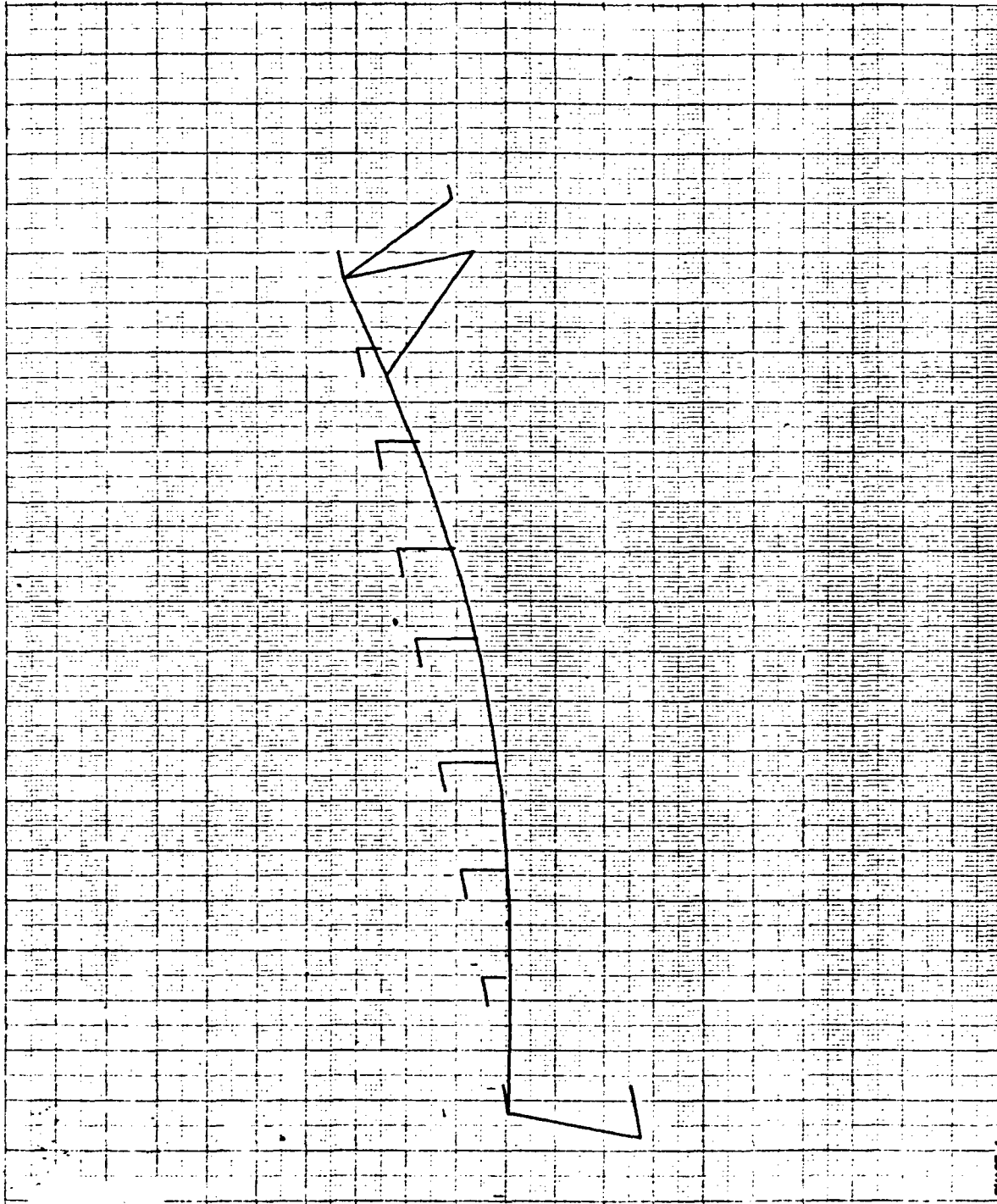

PHASE 1
GREATER PAYLOAD, 87M CASE
FREE MODES FIXED AT INTERFACE
MODAL VECTOR, SUBCASE 1 MODE 1 FREQ. 81.18491

4/27/74 MAX-DEF. = 1.00000000

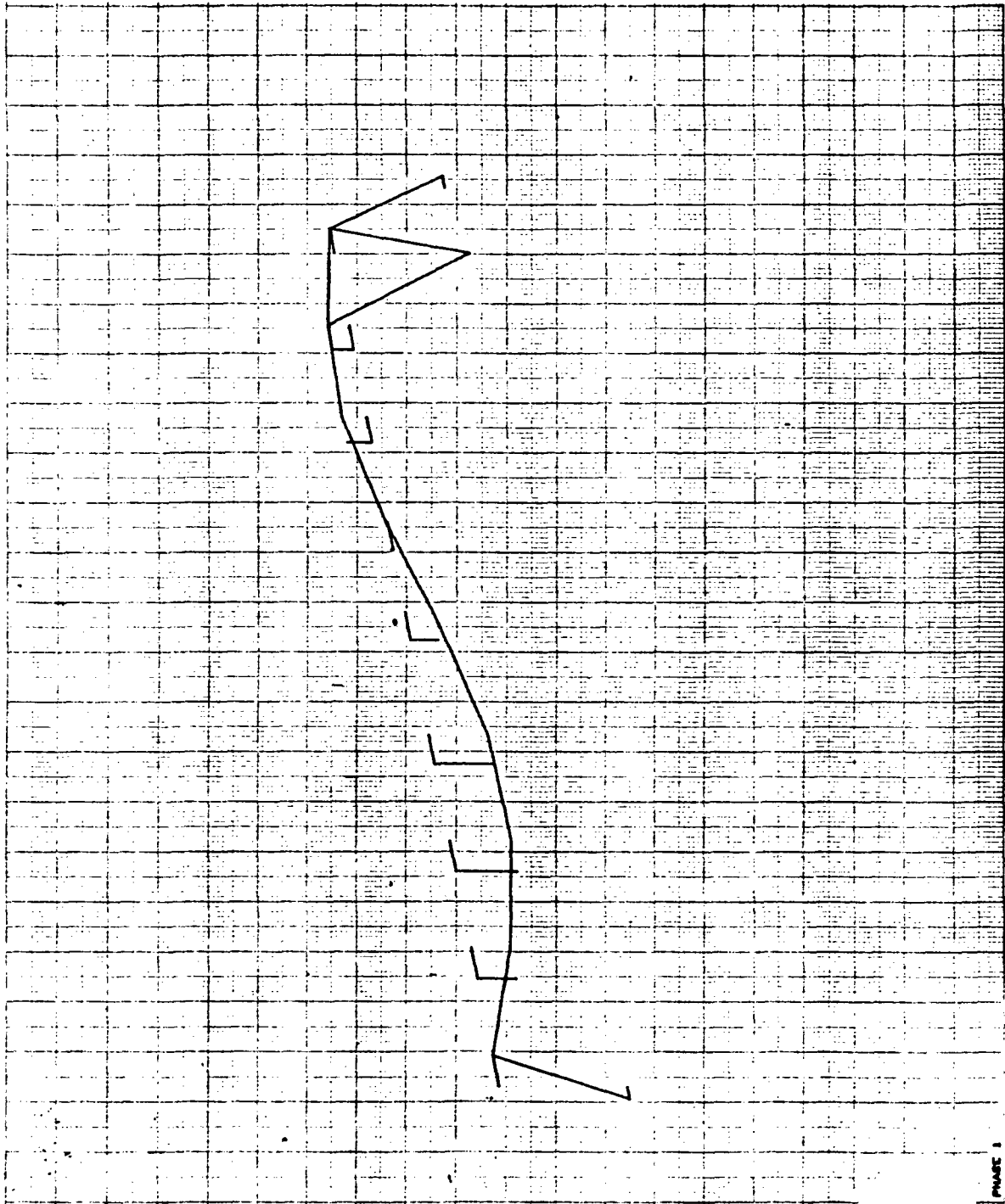

PHASE 1
ORBITER PAYLOAD, STYAN CASE
PRICE MODES P100 AT INTERFACE
MODAL ORDER, SUBCASE 2 MODE 2 FREQ. 200.5140

4/21/74 MAX-DOT. = 1.8576000

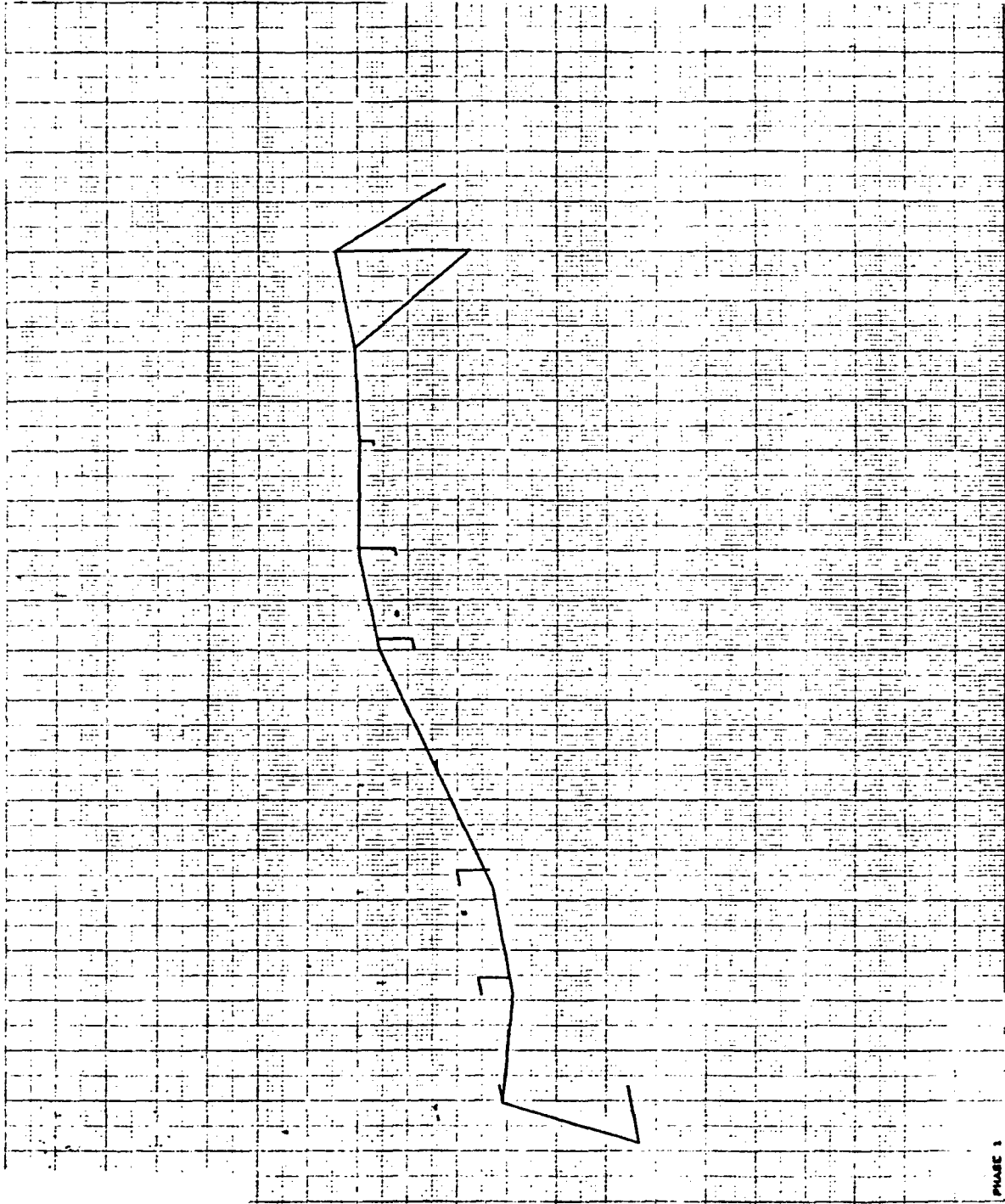

PHASE 1
ORBITER PAYLOAD, SYMM CASE
FREE BODIES FIXED AT INTERFACE
MODAL DETOR. SUBCASE 3 MODE 9 FREQ. 837.6407

4/27/74 MAX-DEF. = 1.00000000

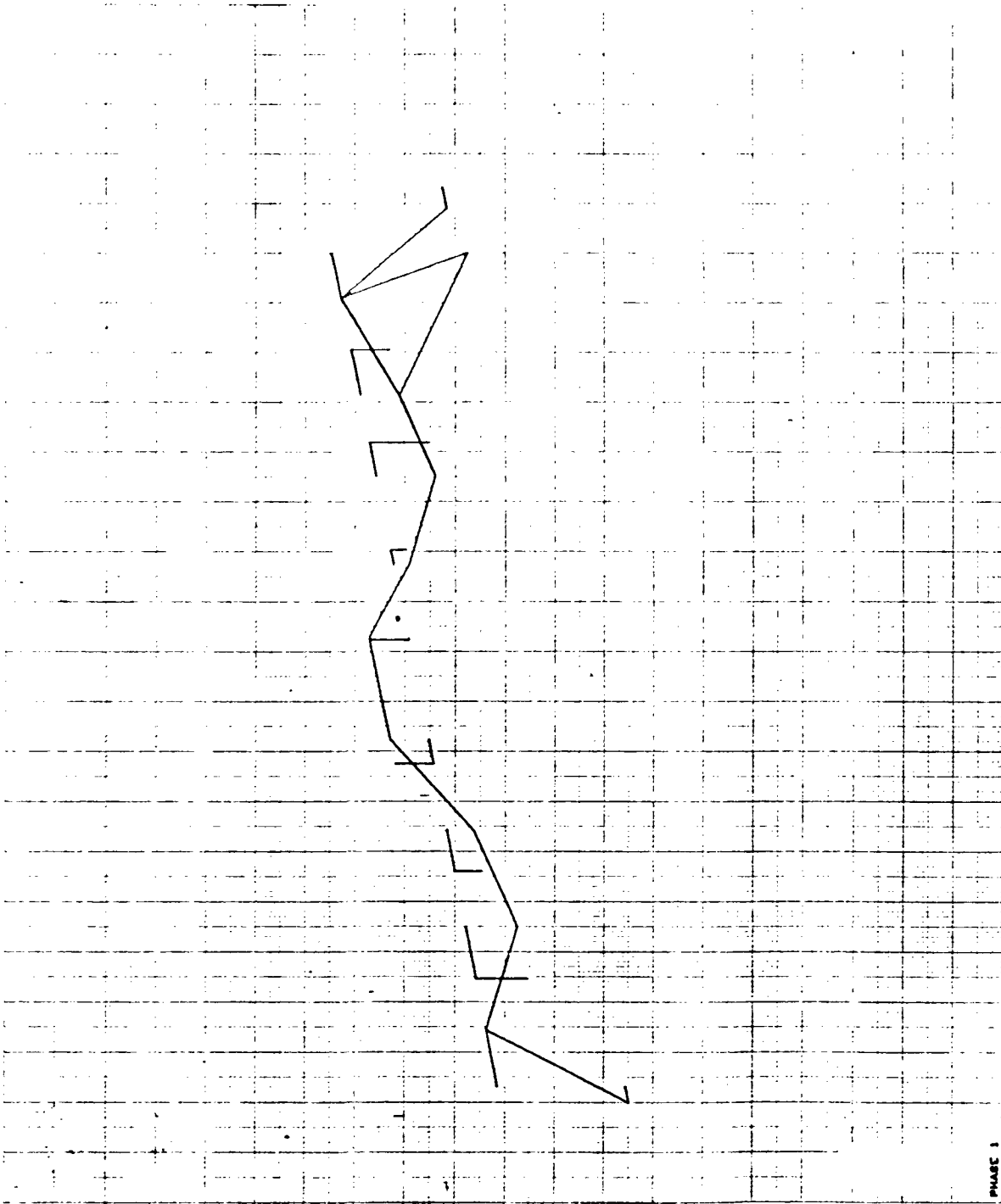

PHASE 1
GREATER PAYLOAD, SYMM CASE
FREE MODES FIXED AT INTERFACE
MODAL DCFON. BURCASE 4 MODE 4 FREQ. 1021.383

8/1/74 MAX-DEF. = 1.00000000

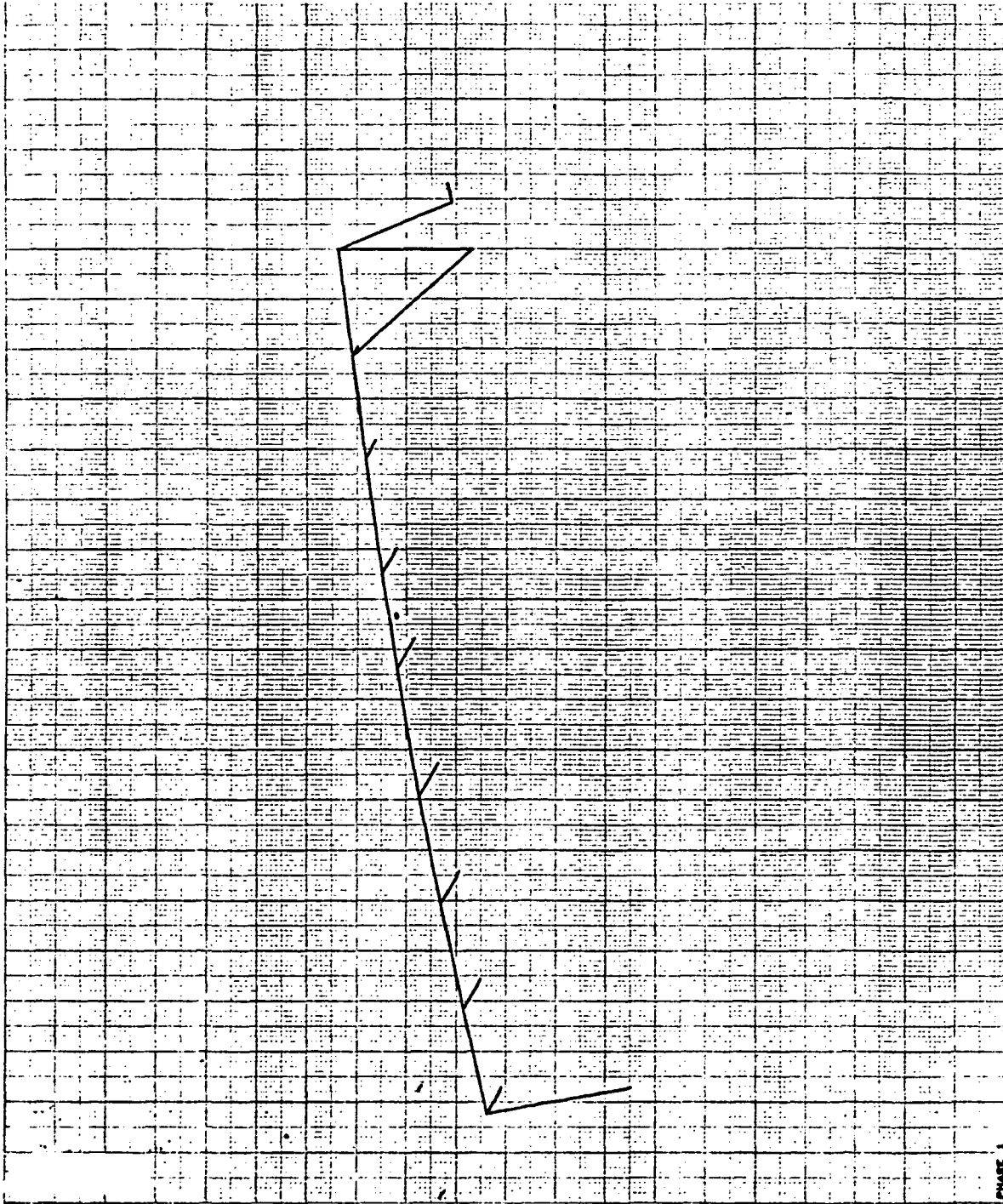

PHASE 1
ORBITER PAYLOAD, ANTI CASE
PRICE MODES FIXED AT INTERFACE
MEDAL SECTOR, SURGARE 1 MODE 1 PREQ. 89-9-0087

2 15/174 MAX-DEF. = 1.0000000

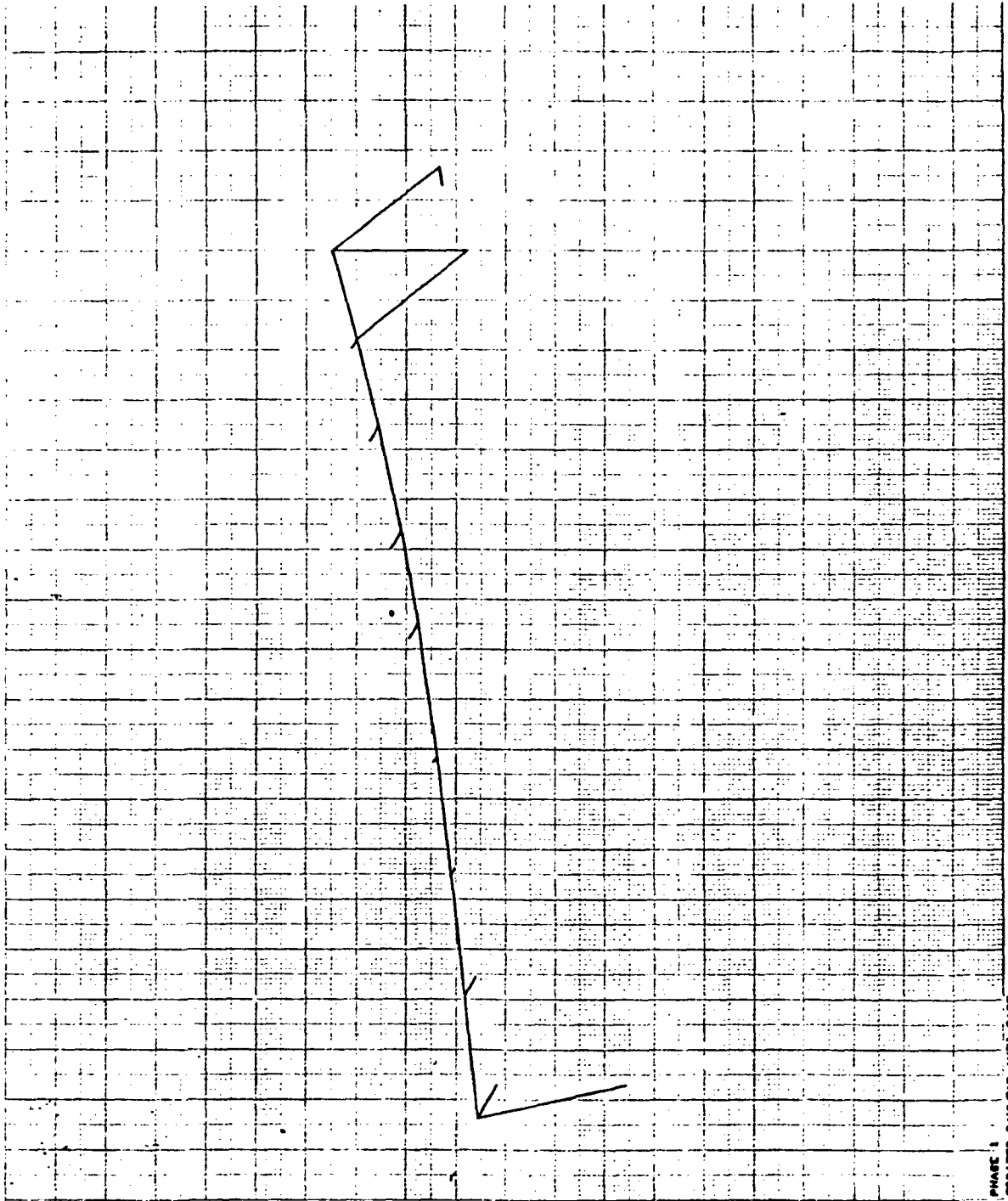

PHASE 1
ORBITER PAYLOAD AMTI CASE
FREE MODES FIXED AT INTERFACE
MODAL DEFOR. SUBCASE 2 MODE 2 FREQ. 176.3516

3 . 02 1714 MAX-DEF. = 1.00000000

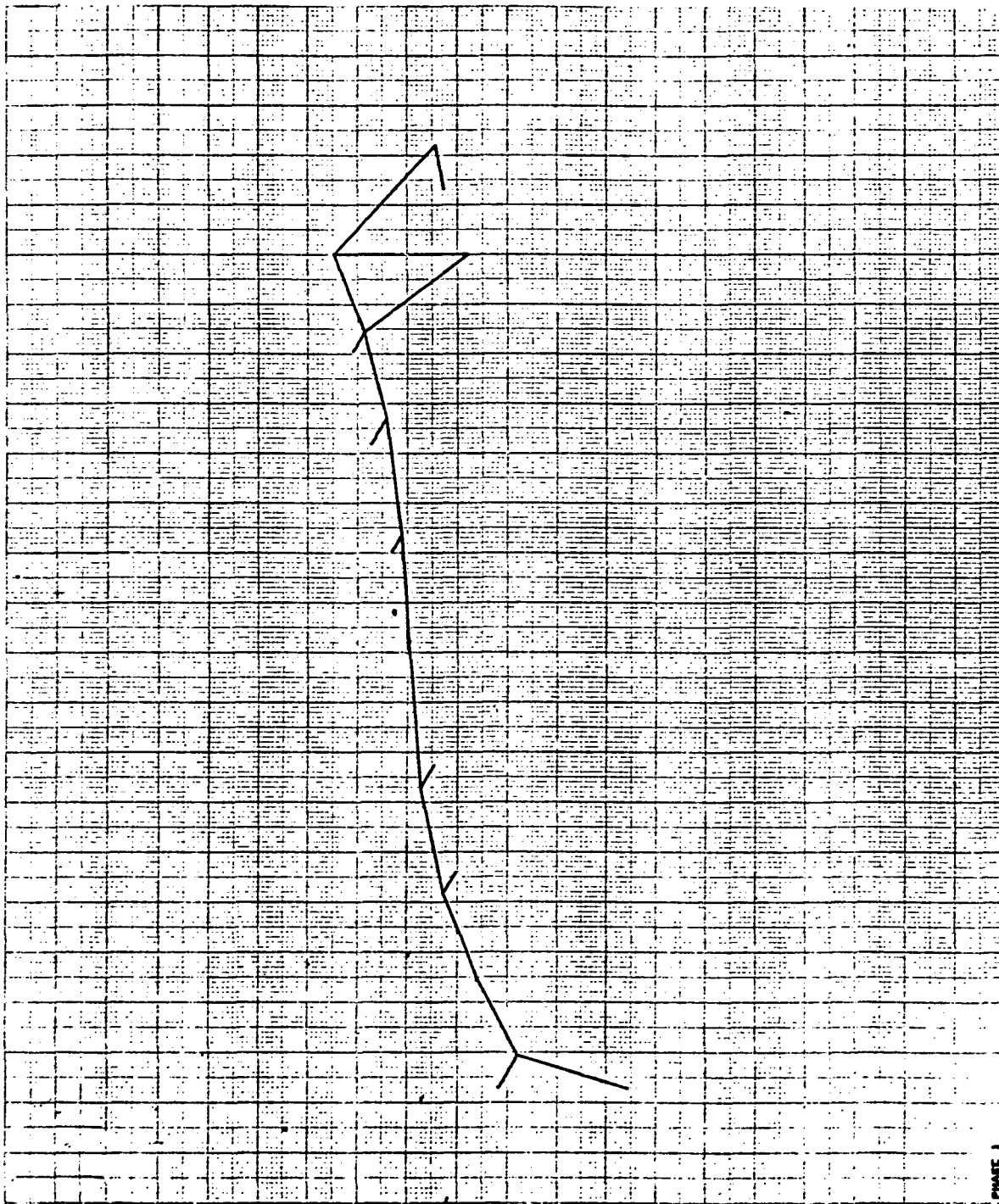

PHASE 1
ORBITER PAYLOAD AMT1 CASE
FREE MOVES FILLED AT INTERFACE
MODAL DEFER. SURFACE 3 MODE 3 PNO. 483.7611

6/174 MAX-DEF. = 1.24916790

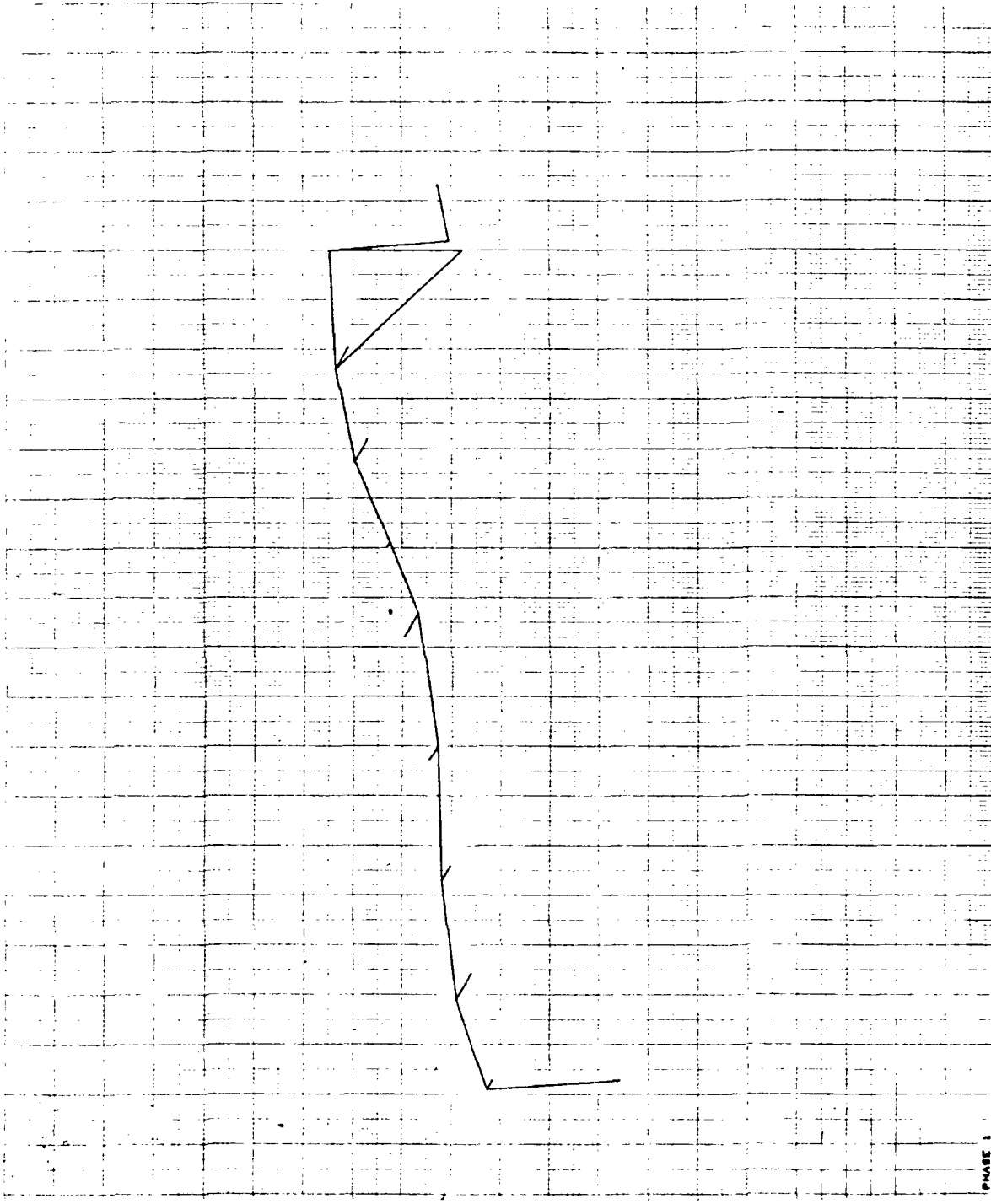

PHASE 1
ORBITER PAYLOAD AMTI CASE
FREE MODES FIXED AT INTERFACE
MODAL DEFOR. SURFACE 4 MODE 4 FREQ. 818.0043

Appendix A15
SORTED BULK DATA/PHASE 1 ANALYSIS:
MODEL II CARGO DOORS

PHASE 1 ORBITER DOORS, SYM CASE #
REVISION 3/6/74 XADDED STRAPS#

APRIL 16, 1974 NASTRAN 2/ 1/73 PAGE 2

C A S E C O N T R O L D E C K E C H O

CARD
COUNT

1	TITLE # PHASE 1 ORBITER DOORS, SYM CASE #
2	SUBTITLE # REVISION 3/6/74 XADDED STRAPS#
3	ECHO # BOTH
4	MPC # 4000
5	SPC # 4001
6	METHOD # 2
7	BEGIN BULK

INPUT BULK DATA DECK ECHO

	1	2	3	4	5	6	7	8	9	10
\$ CONVERT ORIGINAL SYM.DOORS TO REVISED SYM.DOORS										
/	2									
/	37	52								
/	209	216								
/	225									
/	235									
/	245									
/	259									
/	261	270								
/	272									
/	274									
/	276									
/	278									
/	292									
/	294	303								
/	305									
/	307									
/	309									
/	311									
/	325									
/	339									
/	349									
/	373									
/	375									
/	386	388								
/	390	391								
/	402	404								
/	408	410								
/	417									
ASET 1	13	4034	4064	4114	4154					
CQDMEM2	4109	4101	4051	4053	4073	4071	0.			
CQDMEM2	4110	4101	4053	4055	4075	4073	0.			
CQDMEM2	4111	4101	4055	4057	4077	4075	0.			
CQDMEM2	4112	4101	4057	4049	4079	4077	0.			
CQDMEM2	4121	4101	4101	4103	4123	4121	0.			
CQDMEM2	4122	4101	4103	4105	4125	4123	0.			
CQDMEM2	4123	4101	4105	4107	4127	4125	0.			
CQDMEM2	4124	4101	4107	4099	4129	4127	0.			
EIGR	2	GIV				15				
EIG1	MAX								1.0-4	EIG1
GRID	4009	0	64.0	-12.5	62.81	0	456			
GRID	4019	0	64.0	-12.5	62.81	0	4			
GRID	4029	0	78.0	-12.5	62.81	0	4			
GRID	4049	0	93.28	-12.5	62.81	0	4			
GRID	4051	0	93.28	0.0	75.0	0	456			
GRID	4053	0	93.28	-4.7835	74.0485	0	456			
GRID	4055	0	93.28	-8.8389	71.3389	0	456			
GRID	4057	0	93.28	-11.5485	67.2835	0	456			
GRID	4069	0	102.12	-12.5	62.81	0	4			
GRID	4071	0	107.92	0.0	75.0	0	456			

INPUT BULK DATA DECK ECHO

	1	2	3	4	5	6	7	8	9	10
GRID	4073	0	107.92	-4.7835	74.0485	0	456			
GRID	4075	0	107.92	-8.8389	71.3389	0	456			
GRID	4077	0	107.92	-11.5485	67.2635	0	456			
GRID	4079	0	107.92	-12.5	62.81	0	4			
GRID	4099	0	122.56	-12.5	62.81	0	4			
GRID	4101	0	122.56	0.0	75.0	0	456			
GRID	4103	0	122.56	-4.7835	74.0485	0	456			
GRID	4105	0	122.56	-8.8389	71.3389	0	456			
GRID	4107	0	122.56	-11.5485	67.2835	0	456			
GRID	4119	0	129.0	-12.5	62.81	0	4			
GRID	4121	0	137.2	0.0	75.0	0	456			
GRID	4123	0	137.2	-4.7835	74.0485	0	456			
GRID	4125	0	137.2	-8.8389	71.3389	0	456			
GRID	4127	0	137.2	-11.5485	67.2835	0	456			
GRID	4129	0	137.2	-12.5	62.81	0	4			
GRID	4149	0	153.375	-12.5	62.81	0	4			
GRID	4169	0	166.5	-12.5	62.81	0	4			
GRID	4179	0	166.5	-12.5	62.81	0	456			
PBAR	4381	4100	.056	.006	.004		0.0			
SPC	4001	4041	2		4051	2				
SPC	4001	4071	2		4081	2				
SPC	4001	4091	2		4101	2				
SPC	4001	4121	2		4131	2				
SPC	4002	4051	1		4051	3				
SPC	4002	4071	1		4071	3				
SPC	4002	4101	1		4101	3				
SPC	4002	4121	1		4121	3				
SUPPORT	4034	3	4154	13						
CBAR	4391	4391	4032	4034	.0	1.0	.0	1		
CBAR	4392	4391	4062	4064	.0	1.0	.0	1		
CBAR	4393	4391	4112	4114	.0	1.0	.0	1		
CBAR	4394	4391	4152	4154	.0	1.0	.0	1		
GRID	4032	0	78.0	-12.5	63.10	0	246			
GRID	4034	0	78.0	-12.5	62.00	0	246			
GRID	4062	0	102.12	-12.5	63.10	0	246			
GRID	4064	0	102.12	-12.5	62.00	0	246			
GRID	4112	0	129.0	-12.5	63.10	0	246			
GRID	4114	0	129.0	-12.5	62.00	0	246			
GRID	4152	0	153.375	-12.5	63.10	0	246			
GRID	4154	0	153.375	-12.5	62.00	0	246			
MPC	4000	4032	1	1.0	4029	1	-1.0		€4032X	
€4032X		4029	5	-.29						
MPC	4000	4032	3	1.0	4029	3	-1.0			
MPC	4000	4032	5	1.0	4029	5	-1.0			
MPC	4000	4062	1	1.0	4069	1	-1.0		€4062X	
€4062X		4069	5	-.29						
MPC	4000	4062	3	1.0	4069	3	-1.0			
MPC	4000	4062	5	1.0	4069	5	-1.0			
MPC	4000	4112	1	1.0	4119	1	-1.0		€4112X	
€4112X		4119	5	-.29						

PHASE 1XORBITER DOORS.SYM CASE#
 REVISION 3/6/74 XADDED STRAPSD

APRIL 16, 1974 NASTRAN 2/ 1/73 PAGE 5

INPUT BULK DATA DECK ECHO

	1	2	3	4	5	6	7	8	9	10
MPC	4000	4112	3	1.0	4119	3	-1.0			
MPC	4000	4112	5	1.0	4119	5	-1.0			
MPC	4000	4152	1	1.0	4149	1	-1.0			4152X
4152X		4149	5	-0.29						
MPC	4000	4152	3	1.0	4149	3	-1.0			
MPC	4000	4152	5	1.0	4149	5	-1.0			
PBAR	4391	4100	.035		.002		0.0			EST1
EST1										EST2
EST2		1.0								
ENDDATA										

TOTAL COUNT# 110

*** USER INFORMATION MESSAGE 207, BULK DATA NOT SORTED, XSORT WILL RE-ORDER DECK.

SORTED BULK DATA ECHO

CARD	1	2	3	4	5	6	7	8	9	10
1- ASET1	3	4002	4172							
2- ASET1	13	4034	4064	4114	4154					
3- ASET1	23	4176	4004	4006	4008	4010	4178	4174	EAST1	
4- EAST1	4180									
5- BAROR		4381			.0	1.0	.0	1		
6- CBAR	4381		4019	4029						
7- CBAR	4382		4029	4049						
8- CBAR	4383		4049	4069						
9- CBAR	4384		4069	4079						
10- CBAR	4385		4079	4099						
11- CBAR	4386		4099	4119						
12- CBAR	4387		4119	4129						
13- CBAR	4388		4129	4149						
14- CBAR	4389		4149	4169						
15- CBAR	4391	4391	4032	4034	.0	1.0	.0	1		
16- CBAR	4392	4391	4062	4064	.0	1.0	.0	1		
17- CBAR	4393	4391	4112	4114	.0	1.0	.0	1		
18- CBAR	4394	4391	4152	4154	.0	1.0	.0	1		
19- CORD2R	4015	0	64.0	.0	62.5	64.0	-8.8389	71.3389	CCS4015	
20- ECS4015	200.0	0.0	62.5							
21- CQDMEM2	4101	4101	4011	4013	4023	4021	0.0			
22- CQDMEM2	4102	4101	4013	4015	4025	4023	0.0			
23- CQDMEM2	4103	4101	4015	4017	4027	4025	0.0			
24- CQDMEM2	4104	4101	4017	4019	4029	4027	0.0			
25- CQDMEM2	4105	4101	4031	4033	4043	4041	0.0			
26- CQDMEM2	4106	4101	4033	4035	4045	4043	0.0			
27- CQDMEM2	4107	4101	4035	4037	4047	4045	0.0			
28- CQDMEM2	4108	4101	4037	4029	4049	4047	0.0			
29- CQDMEM2	4109	4101	4051	4053	4073	4071	0.0			
30- CQDMEM2	4110	4101	4053	4055	4075	4073	0.0			
31- CQDMEM2	4111	4101	4055	4057	4077	4075	0.0			
32- CQDMEM2	4112	4101	4057	4049	4079	4077	0.0			
33- CQDMEM2	4117	4101	4081	4083	4093	4091	0.0			
34- CQDMEM2	4118	4101	4083	4085	4095	4093	0.0			
35- CQDMEM2	4119	4101	4085	4087	4097	4095	0.0			
36- CQDMEM2	4120	4101	4087	4079	4099	4097	0.0			
37- CQDMEM2	4121	4101	4101	4103	4123	4121	0.0			
38- CQDMEM2	4122	4101	4103	4105	4125	4123	0.0			
39- CQDMEM2	4123	4101	4105	4107	4127	4125	0.0			
40- CQDMEM2	4124	4101	4107	4099	4129	4127	0.0			
41- CQDMEM2	4129	4101	4131	4133	4143	4141	0.0			
42- CQDMEM2	4130	4101	4133	4135	4145	4143	0.0			
43- CQDMEM2	4131	4101	4135	4137	4147	4145	0.0			
44- CQDMEM2	4132	4101	4137	4129	4149	4147	0.0			
45- CQDMEM2	4133	4101	4151	4153	4163	4161	0.0			
46- CQDMEM2	4134	4101	4153	4155	4165	4163	0.0			
47- CQDMEM2	4135	4101	4155	4157	4167	4165	0.0			
48- CQDMEM2	4136	4101	4157	4149	4169	4167	0.0			
49- CROD	4001	4001	4001	4003	4041	4001	4011	4013		
50- CROD	4002	4001	4003	4005	4042	4001	4013	4015		

SORTED BULK DATA FCHO

CARD	1	2	3	4	5	6	7	8	9	10
51- CROD	4003	4001	4005	4007	4043	4001	4015	4017		
52- CROD	4004	4001	4007	4009	4044	4001	4017	4019		
53- CROD	4005	4001	4021	4023	4045	4001	4031	4033		
54- CROD	4006	4001	4023	4025	4046	4001	4033	4035		
55- CROD	4007	4001	4025	4027	4047	4001	4035	4037		
56- CROD	4008	4001	4027	4029	4048	4001	4037	4039		
57- CROD	4009	4001	4041	4043	4049	4001	4051	4053		
58- CROD	4010	4001	4043	4045	4050	4001	4053	4055		
59- CROD	4011	4001	4045	4047	4051	4001	4055	4057		
60- CROD	4012	4001	4047	4049	4052	4001	4057	4049		
61- CROD	4013	4001	4071	4073	4053	4001	4081	4083		
62- CROD	4014	4001	4073	4075	4054	4001	4083	4085		
63- CROD	4015	4001	4075	4077	4055	4001	4085	4087		
64- CROD	4016	4001	4077	4079	4056	4001	4087	4079		
65- CROD	4017	4001	4091	4093	4057	4001	4101	4103		
66- CROD	4018	4001	4093	4095	4058	4001	4103	4105		
67- CROD	4019	4001	4095	4097	4059	4001	4105	4107		
68- CROD	4020	4001	4097	4099	4060	4001	4107	4099		
69- CROD	4021	4001	4121	4123	4061	4001	4131	4133		
70- CROD	4022	4001	4123	4125	4062	4001	4133	4135		
71- CROD	4023	4001	4125	4127	4063	4001	4135	4137		
72- CROD	4024	4001	4127	4129	4064	4001	4137	4129		
73- CROD	4025	4001	4141	4143	4065	4001	4151	4153		
74- CROD	4026	4001	4143	4145	4066	4001	4153	4155		
75- CROD	4027	4001	4145	4147	4067	4001	4155	4157		
76- CROD	4028	4001	4147	4149	4068	4001	4157	4149		
77- CROD	4029	4001	4161	4163	4069	4001	4171	4173		
78- CROD	4030	4001	4163	4165	4070	4001	4173	4175		
79- CROD	4031	4001	4165	4167	4071	4001	4175	4177		
80- CROD	4032	4001	4167	4169	4072	4001	4177	4179		
81- CROD	4081	4081	4002	4004	4091	4081	4012	4014		
82- CROD	4082	4081	4004	4006	4092	4081	4014	4016		
83- CROD	4083	4081	4006	4008	4093	4081	4016	4018		
84- CROD	4084	4081	4008	4010	4094	4081	4018	4020		
85- CROD	4085	4081	4162	4164	4095	4081	4172	4174		
86- CROD	4086	4081	4164	4166	4096	4081	4174	4176		
87- CROD	4087	4081	4166	4168	4097	4081	4176	4178		
88- CROD	4088	4081	4168	4170	4098	4081	4178	4180		
89- CROD	4145	4145	4022	4024	4153	4145	4072	4074		
90- CROD	4146	4145	4024	4026	4154	4145	4074	4076		
91- CROD	4147	4145	4026	4028	4155	4145	4076	4078		
92- CROD	4148	4145	4028	4030	4156	4145	4078	4080		
93- CROD	4149	4145	4042	4044	4157	4145	4092	4094		
94- CROD	4150	4145	4044	4046	4158	4145	4094	4096		
95- CROD	4151	4145	4046	4048	4159	4145	4096	4098		
96- CROD	4152	4145	4048	4050	4160	4145	4098	4100		
97- CROD	4161	4145	4122	4124	4165	4145	4142	4144		
98- CROD	4162	4145	4124	4126	4166	4145	4144	4146		
99- CROD	4163	4145	4126	4128	4167	4145	4146	4148		
100- CROD	4164	4145	4128	4130	4168	4145	4148	4150		

S O R T E D B U L K D A T A F C H D

CARD

CARD COUNT	1	2	3	4	5	6	7	8	9	10
101- CROD	4301	4301	4001	4002	4341	4201	4011	4012		
102- CROD	4302	4302	4003	4004	4342	4302	4013	4014		
103- CROD	4303	4302	4005	4006	4343	4302	4015	4016		
104- CROD	4304	4302	4007	4008	4344	4302	4017	4018		
105- CROD	4305	4301	4009	4010	4345	4301	4019	4020		
106- CROD	4306	4301	4021	4022	4346	4301	4031	4022		
107- CROD	4307	4302	4023	4024	4347	4302	4033	4024		
108- CROD	4308	4302	4025	4026	4348	4302	4035	4026		
109- CROD	4309	4302	4027	4028	4349	4302	4037	4028		
110- CROD	4310	4302	4029	4030						
111- CROD	4311	4301	4041	4042	4350	4301	4051	4042		
112- CROD	4312	4302	4043	4044	4351	4302	4053	4044		
113- CROD	4313	4302	4045	4046	4352	4302	4055	4046		
114- CROD	4314	4302	4047	4048	4353	4302	4057	4048		
115- CROD	4315	4302	4049	4050						
116- CROD	4316	4301	4071	4072	4354	4301	4081	4072		
117- CROD	4317	4302	4073	4074	4355	4302	4083	4074		
118- CROD	4318	4302	4075	4075	4356	4302	4085	4076		
119- CROD	4319	4302	4077	4078	4357	4302	4087	4078		
120- CROD	4320	4302	4079	4080						
121- CROD	4321	4301	4091	4092	4358	4301	4101	4092		
122- CROD	4322	4302	4093	4094	4359	4302	4103	4094		
123- CROD	4323	4302	4095	4096	4360	4302	4105	4096		
124- CROD	4324	4302	4097	4098	4361	4302	4107	4098		
125- CROD	4325	4302	4099	4100						
126- CROD	4326	4301	4121	4122	4362	4301	4131	4122		
127- CROD	4327	4302	4123	4124	4363	4302	4133	4124		
128- CROD	4328	4302	4125	4126	4364	4302	4135	4126		
129- CROD	4329	4302	4127	4128	4365	4302	4137	4128		
130- CROD	4330	4302	4129	4130						
131- CROD	4331	4301	4141	4142	4366	4301	4151	4142		
132- CROD	4332	4302	4143	4144	4367	4302	4153	4144		
133- CROD	4333	4302	4145	4146	4368	4302	4155	4146		
134- CROD	4334	4302	4147	4148	4369	4302	4157	4148		
135- CROD	4335	4302	4149	4150						
136- CROD	4336	4301	4161	4162	4370	4301	4171	4172		
137- CROD	4337	4302	4163	4164	4371	4302	4173	4174		
138- CROD	4338	4302	4165	4166	4372	4302	4175	4176		
139- CROD	4339	4302	4167	4168	4373	4302	4177	4178		
140- CROD	4340	4301	4169	4170	4374	4301	4179	4180		
141- CSHEAR	4201	4201	4001	4003	4004	4002				
142- CSHEAR	4202	4201	4003	4005	4006	4004				
143- CSHEAR	4203	4201	4005	4007	4008	4006				
144- CSHEAR	4204	4201	4007	4009	4010	4009				
145- CSHEAR	4205	4201	4021	4023	4024	4022				
146- CSHEAR	4206	4201	4023	4025	4026	4024				
147- CSHEAR	4207	4201	4025	4027	4028	4026				
148- CSHEAR	4208	4201	4027	4029	4030	4028				
149- CSHEAR	4209	4201	4041	4043	4044	4042				
150- CSHEAR	4210	4201	4043	4045	4046	4044				

S O R T E D B U L K D A T A E C H O

CARD	COUNT	1	2	3	4	5	6	7	8	9	10
151-	CSHEAR	4211	4201	4045	4047	4048	4046				
152-	CSHEAR	4212	4201	4047	4049	4050	4048				
153-	CSHEAR	4213	4201	4071	4073	4074	4072				
154-	CSHEAR	4214	4201	4073	4075	4076	4074				
155-	CSHEAR	4215	4201	4075	4077	4078	4076				
156-	CSHEAR	4216	4201	4077	4079	4080	4078				
157-	CSHEAR	4217	4201	4091	4093	4094	4092				
158-	CSHEAR	4218	4201	4093	4095	4096	4094				
159-	CSHEAR	4219	4201	4095	4097	4098	4096				
160-	CSHEAR	4220	4201	4097	4099	4100	4098				
161-	CSHEAR	4221	4201	4121	4123	4124	4122				
162-	CSHEAR	4222	4201	4123	4125	4126	4124				
163-	CSHEAR	4223	4201	4125	4127	4128	4126				
164-	CSHEAR	4224	4201	4127	4129	4130	4128				
165-	CSHEAR	4225	4201	4141	4143	4144	4142				
166-	CSHEAR	4226	4201	4143	4145	4146	4144				
167-	CSHEAR	4227	4201	4145	4147	4148	4146				
168-	CSHEAR	4228	4201	4147	4149	4150	4148				
169-	CSHEAR	4229	4201	4161	4163	4164	4162				
170-	CSHEAR	4230	4201	4163	4165	4166	4164				
171-	CSHEAR	4231	4201	4165	4167	4168	4166				
172-	CSHEAR	4232	4201	4167	4169	4170	4168				
173-	CSHEAR	4241	4201	4011	4013	4014	4012				
174-	CSHEAR	4242	4201	4013	4015	4016	4014				
175-	CSHEAR	4243	4201	4015	4017	4018	4016				
176-	CSHEAR	4244	4201	4017	4019	4020	4018				
177-	CSHEAR	4245	4201	4031	4033	4024	4022				
178-	CSHEAR	4246	4201	4033	4035	4025	4024				
179-	CSHEAR	4247	4201	4035	4037	4028	4026				
180-	CSHEAR	4248	4201	4037	4029	4030	4028				
181-	CSHEAR	4249	4201	4051	4053	4044	4042				
182-	CSHEAR	4250	4201	4053	4055	4046	4044				
183-	CSHEAR	4251	4201	4055	4057	4048	4046				
184-	CSHEAR	4252	4201	4057	4049	4050	4048				
185-	CSHEAR	4253	4201	4081	4083	4074	4072				
186-	CSHEAR	4254	4201	4083	4085	4076	4074				
187-	CSHEAR	4255	4201	4085	4087	4078	4076				
188-	CSHEAR	4256	4201	4087	4079	4080	4078				
189-	CSHEAR	4257	4201	4101	4103	4094	4092				
190-	CSHEAR	4258	4201	4103	4105	4096	4094				
191-	CSHEAR	4259	4201	4105	4107	4098	4096				
192-	CSHEAR	4260	4201	4107	4099	4100	4098				
193-	CSHEAR	4261	4201	4131	4133	4124	4122				
194-	CSHEAR	4262	4201	4133	4135	4126	4124				
195-	CSHEAR	4263	4201	4135	4137	4128	4126				
196-	CSHEAR	4264	4201	4137	4129	4130	4128				
197-	CSHEAR	4265	4201	4151	4153	4144	4142				
198-	CSHEAR	4266	4201	4153	4155	4146	4144				
199-	CSHEAR	4267	4201	4155	4157	4148	4146				
200-	CSHEAR	4268	4201	4157	4149	4150	4148				

SORTED BULK DATA ECHO

CARD	1	2	3	4	5	6	7	8	9	10
201-	CSHEAR	4269	4201	4171	4173	4174	4172			
202-	CSHEAR	4270	4201	4173	4175	4176	4174			
203-	CSHEAR	4271	4201	4175	4177	4178	4176			
204-	CSHEAR	4272	4201	4177	4179	4180	4178			
205-	EIGR	2	GIV				15			
206-	EFIG1	MAX							1.0-4	EFIG1
207-	GRID	4001	0	64.0	.0	75.0	0		456	
208-	GRID	4002	0	64.0	.0	73.0	0		1456	
209-	GRID	4003	0	64.0	-4.7835	74.0485	0		456	
210-	GRID	4004	0	64.0	-4.0181	72.2007	0		1456	
211-	GRID	4005	0	64.0	-8.8389	71.3389	4015		456	
212-	GRID	4006	0	64.0	-7.4247	69.9247	0		1456	
213-	GRID	4007	0	64.0	-11.5485	67.2835	0		456	
214-	GRID	4008	0	64.0	-9.7007	66.5181	0		1456	
215-	GRID	4009	0	64.0	-12.5	62.81	0		456	
216-	GRID	4010	0	64.0	-10.5	62.5	0		1456	
217-	GRID	4011	0	64.0	.0	75.0	0		456	
218-	GRID	4012	0	64.0	.0	73.0	0		1456	
219-	GRID	4013	0	64.0	-4.7835	74.0485	0		456	
220-	GRID	4014	0	64.0	-4.0181	72.2007	0		1456	
221-	GRID	4015	0	64.0	-8.8389	71.3389	4015		456	
222-	GRID	4016	0	64.0	-7.4247	69.9247	0		1456	
223-	GRID	4017	0	64.0	-11.5485	67.2835	0		456	
224-	GRID	4018	0	64.0	-9.7007	66.5181	0		1456	
225-	GRID	4019	0	64.0	-12.5	62.81	0		4	
226-	GRID	4020	0	64.0	-10.5	62.5	0		1456	
227-	GRID	4021	0	78.0	.0	75.0	0		456	
228-	GRID	4022	0	78.0	.0	73.0	0		1456	
229-	GRID	4023	0	78.0	-4.7835	74.0485	0		456	
230-	GRID	4024	0	78.0	-4.0181	72.2007	0		1456	
231-	GRID	4025	0	78.0	-8.8389	71.3389	0		456	
232-	GRID	4026	0	78.0	-7.4247	69.9247	0		1456	
233-	GRID	4027	0	78.0	-11.5485	67.2835	0		456	
234-	GRID	4028	0	78.0	-9.7007	66.5181	0		1456	
235-	GRID	4029	0	78.0	-12.5	62.81	0		4	
236-	GRID	4030	0	78.0	-10.5	62.5	0		1456	
237-	GRID	4031	0	78.0	.0	75.0	0		456	
238-	GRID	4032	0	78.0	-12.5	63.10	0		246	
239-	GRID	4033	0	78.0	-4.7835	74.0485	0		456	
240-	GRID	4034	0	78.0	-12.5	62.00	0		246	
241-	GRID	4035	0	78.0	-8.8389	71.3389	0		456	
242-	GRID	4037	0	78.0	-11.5485	67.2835	0		456	
243-	GRID	4041	0	93.28	.0	75.0	0		456	
244-	GRID	4042	0	93.28	.0	73.0	0		1456	
245-	GRID	4043	0	93.28	-4.7835	74.0485	0		456	
246-	GRID	4044	0	93.28	-4.0181	72.2007	0		1456	
247-	GRID	4045	0	93.28	-8.8389	71.3389	0		456	
248-	GRID	4046	0	93.28	-7.4247	69.9247	0		1456	
249-	GRID	4047	0	93.28	-11.5485	67.2835	0		456	
250-	GRID	4048	0	93.28	-9.7007	66.5181	0		1456	

SORTED BULK DATA ECHO

CARD	1	2	3	4	5	6	7	8	9	10
251- GRID	4049	0	93.28	-12.5	62.81	0	4			
252- GRID	4050	0	93.28	-10.5	62.5	0	1456			
253- GRID	4051	0	93.28	.0	75.0	0	456			
254- GRID	4053	0	93.28	-4.7835	74.0485	0	456			
255- GRID	4055	0	93.28	-8.8389	71.3389	0	456			
256- GRID	4057	0	93.28	-11.548567	2835	0	456			
257- GRID	4062	0	102.12	-12.5	63.10	0	246			
258- GRID	4064	0	102.12	-12.5	62.00	0	246			
259- GRID	4069	0	102.12	-12.5	62.81	0	4			
260- GRID	4071	0	107.92	.0	75.0	0	456			
261- GRID	4072	0	107.92	.0	73.0	0	1456			
262- GRID	4073	0	107.92	-4.7835	74.0485	0	456			
263- GRID	4074	0	107.92	-4.0181	72.2007	0	1456			
264- GRID	4075	0	107.92	-8.8389	71.3389	0	456			
265- GRID	4076	0	107.92	-7.4247	69.9247	0	1456			
266- GRID	4077	0	107.92	-11.548567	2835	0	456			
267- GRID	4078	0	107.92	-9.7007	66.5181	0	1456			
268- GRID	4079	0	107.92	-12.5	62.81	0	4			
269- GRID	4080	0	107.92	-10.5	62.5	0	1456			
270- GRID	4081	0	107.92	.0	75.0	0	456			
271- GRID	4083	0	107.92	-4.7835	74.0485	0	456			
272- GRID	4085	0	107.92	-8.8389	71.3389	0	456			
273- GRID	4087	0	107.92	-11.548567	2835	0	456			
274- GRID	4091	0	122.56	.0	75.0	0	456			
275- GRID	4092	0	122.56	.0	73.0	0	1456			
276- GRID	4093	0	122.56	-4.7835	74.0485	0	456			
277- GRID	4094	0	122.56	-4.0181	72.2007	0	1456			
278- GRID	4095	0	122.56	-8.8389	71.3389	0	456			
279- GRID	4096	0	122.56	-7.4247	69.9247	0	1456			
280- GRID	4097	0	122.56	-11.548567	2835	0	456			
281- GRID	4098	0	122.56	-9.7007	66.5181	0	1456			
282- GRID	4099	0	122.56	-12.5	62.81	0	4			
283- GRID	4100	0	122.56	-10.5	62.5	0	1456			
284- GRID	4101	0	122.56	.0	75.0	0	456			
285- GRID	4103	0	122.56	-4.7835	74.0485	0	456			
286- GRID	4105	0	122.56	-8.8389	71.3389	0	456			
287- GRID	4107	0	122.56	-11.548567	2835	0	456			
288- GRID	4112	0	129.0	-12.5	63.10	0	246			
289- GRID	4114	0	129.0	-12.5	62.00	0	246			
290- GRID	4119	0	129.0	-12.5	62.81	0	4			
291- GRID	4121	0	137.2	.0	75.0	0	456			
292- GRID	4122	0	137.2	.0	73.0	0	1456			
293- GRID	4123	0	137.2	-4.7835	74.0485	0	456			
294- GRID	4124	0	137.2	-4.0181	72.2007	0	1456			
295- GRID	4125	0	137.2	-8.8389	71.3389	0	456			
296- GRID	4126	0	137.2	-7.4247	69.9247	0	1456			
297- GRID	4127	0	137.2	-11.548567	2835	0	456			
298- GRID	4128	0	137.2	-9.7007	66.5181	0	1456			
299- GRID	4129	0	137.2	-12.5	62.81	0	4			
300- GRID	4130	0	137.2	-10.5	62.5	0	1456			

SORTED BULK DATA ECHO

CARD

COUNT	1	2	3	4	5	6	7	8	9	10
301-	GRID	4131	0	137.2	.0	75.0	0	456		
302-	GRID	4133	0	137.2	-4.7835	74.0485	0	456		
303-	GRID	4135	0	137.2	-8.8389	71.3389	0	456		
304-	GRID	4137	0	137.2	-11.5485	67.2835	0	456		
305-	GRID	4141	0	153.375	.0	75.0	0	456		
306-	GRID	4142	0	153.375	.0	73.0	0	1456		
307-	GRID	4143	0	153.375	-4.7835	74.0485	0	456		
308-	GRID	4144	0	153.375	-4.0181	72.2007	0	1456		
309-	GRID	4145	0	153.375	-8.8389	71.3389	0	456		
310-	GRID	4146	0	153.375	-7.4247	69.9247	0	1456		
311-	GRID	4147	0	153.375	-11.5485	67.2835	0	456		
312-	GRID	4148	0	153.375	-9.7007	66.5181	0	1456		
313-	GRID	4149	0	153.375	-12.5	62.81	0	4		
314-	GRID	4150	0	153.375	-10.5	62.5	0	1456		
315-	GRID	4151	0	153.375	.0	75.0	0	456		
316-	GRID	4152	0	153.375	-12.5	63.10	0	246		
317-	GRID	4153	0	153.375	-4.7835	74.0485	0	456		
318-	GRID	4154	0	153.375	-12.5	62.00	0	246		
319-	GRID	4155	0	153.375	-8.8389	71.3389	0	456		
320-	GRID	4157	0	153.375	-11.5485	67.2835	0	456		
321-	GRID	4161	0	166.5	.0	75.0	0	456		
322-	GRID	4162	0	166.5	.0	73.0	0	1456		
323-	GRID	4163	0	166.5	-4.7835	74.0485	0	456		
324-	GRID	4164	0	166.5	-4.0181	72.2007	0	1456		
325-	GRID	4165	0	166.5	-8.8389	71.3389	4015	456		
326-	GRID	4166	0	166.5	-7.4247	69.9247	0	1456		
327-	GRID	4167	0	166.5	-11.5485	67.2835	0	456		
328-	GRID	4168	0	166.5	-9.7007	66.5181	0	1456		
329-	GRID	4169	0	166.5	-12.5	62.81	0	4		
330-	GRID	4170	0	166.5	-10.5	62.5	0	1456		
331-	GRID	4171	0	166.5	.0	75.0	0	456		
332-	GRID	4172	0	166.5	.0	73.0	0	1456		
333-	GRID	4173	0	166.5	-4.7835	74.0485	0	456		
334-	GRID	4174	0	166.5	-4.0181	72.2007	0	1456		
335-	GRID	4175	0	166.5	-8.8389	71.3389	4015	456		
336-	GRID	4176	0	166.5	-7.4247	69.9247	0	1456		
337-	GRID	4177	0	166.5	-11.5485	67.2835	0	456		
338-	GRID	4178	0	166.5	-9.7007	66.5181	0	1456		
339-	GRID	4179	0	166.5	-12.5	62.81	0	456		
340-	GRID	4180	0	166.5	-10.5	62.5	0	1456		
341-	MAT1	4100	10.566		.3	.1				
342-	MAT1	4200	10.566		.3	.0				
343-	MPC	4000	4011	1	1.0	4001	1	-1.0		
344-	MPC	4000	4011	2	1.0	4001	2	-1.0		
345-	MPC	4000	4013	1	1.0	4003	1	-1.0		
346-	MPC	4000	4015	1	1.0	4005	1	-1.0		
347-	MPC	4000	4015	2	1.0	4005	2	-1.0		
348-	MPC	4000	4017	1	1.0	4007	1	-1.0		
349-	MPC	4000	4019	1	1.0	4009	1	-1.0		
350-	MPC	4000	4019	3	1.0	4009	3	-1.0		

SORTED BULK DATA ECHO

CARD	COUNT	1	2	3	4	5	6	7	8	9	10
351- MPC	4000	4032	1	1.0	4029	1	-1.0				E4032X
352- E4032X		4029	5	-0.29							
353- MPC	4000	4032	3	1.0	4029	3	-1.0				
354- MPC	4000	4032	5	1.0	4029	5	-1.0				
355- MPC	4000	4062	1	1.0	4069	1	-1.0				E4062X
356- E4062X		4069	5	-0.29							
357- MPC	4000	4062	3	1.0	4069	3	-1.0				
358- MPC	4000	4062	5	1.0	4069	5	-1.0				
359- MPC	4000	4112	1	1.0	4119	1	-1.0				E4112X
360- E4112X		4119	5	-0.29							
361- MPC	4000	4112	3	1.0	4119	3	-1.0				
362- MPC	4000	4112	5	1.0	4119	5	-1.0				
363- MPC	4000	4152	1	1.0	4149	1	-1.0				E4152X
364- E4152X		4149	5	-0.29							
365- MPC	4000	4152	3	1.0	4149	3	-1.0				
366- MPC	4000	4152	5	1.0	4149	5	-1.0				
367- MPC	4000	4161	1	1.0	4171	1	-1.0				
368- MPC	4000	4161	2	1.0	4171	2	-1.0				
369- MPC	4000	4163	1	1.0	4173	1	-1.0				
370- MPC	4000	4165	1	1.0	4175	1	-1.0				
371- MPC	4000	4165	2	1.0	4175	2	-1.0				
372- MPC	4000	4167	1	1.0	4177	1	-1.0				
373- MPC	4000	4169	1	1.0	4179	1	-1.0				
374- MPC	4000	4169	3	1.0	4179	3	-1.0				
375- PARAM	GRDPNT	0									
376- PARAM	TPCOPY	1									
377- PARAM	TPNAME	DOORSP1									
378- PARAM	ITMASS	.002588									
379- PBAR	4381	4100	.056	.006	.004		.0				
380- PBAR	4391	4100	.035		.002		.0				EST1
381- EST1											EST2
382- EST2		1.0									
383- PQDMEM2	4101	4100	.016	.0							
384- PROD	4001	4200	.034	.0	.0	.0088					
385- PROD	4081	4200	.011	.0	.0	.0					
386- PROD	4145	4200	.022	.0	.0	.0					
387- PROD	4301	4200	.016	.0	.0	.0					
388- PROD	4302	4200	.032	.0	.0	.0					
389- PSHEAR	4201	4200	.032	.0							
390- SPC	4001	4001	2		4012	2					
391- SPC	4001	4002	2		4172	2					
392- SPC	4001	4021	2		4031	2					
393- SPC	4001	4022	2		4042	2					
394- SPC	4001	4041	2		4051	2					
395- SPC	4001	4071	2		4081	2					
396- SPC	4001	4072	2		4092	2					
397- SPC	4001	4091	2		4101	2					
398- SPC	4001	4121	2		4131	2					
399- SPC	4001	4122	2		4142	2					
400- SPC	4001	4141	2		4151	2					

SORTED BULK DATA FCHD

CARD	1	2	3	4	5	6	7	8	9	10
401- SPC	4001	4171	2			4162	2			
402- SPC	4002	4001	1			4001	2			
403- SPC	4002	4002	3			4172	3			
404- SPC	4002	4011	3			4012	3			
405- SPC	4002	4021	1			4021	3			
406- SPC	4002	4022	3			4042	3			
407- SPC	4002	4031	1			4031	3			
408- SPC	4002	4041	1			4041	3			
409- SPC	4002	4051	1			4051	3			
410- SPC	4002	4071	1			4071	3			
411- SPC	4002	4072	3			4092	3			
412- SPC	4002	4081	1			4081	3			
413- SPC	4002	4091	1			4091	3			
414- SPC	4002	4101	1			4101	3			
415- SPC	4002	4121	1			4121	3			
416- SPC	4002	4122	3			4142	3			
417- SPC	4002	4131	1			4131	3			
418- SPC	4002	4141	1			4141	3			
419- SPC	4002	4151	1			4151	3			
420- SPC	4002	4161	3			4162	3			
421- SPC	4002	4171	1			4171	3			
422- SUPORT	4034	3	4154	13						
ENDDATA										

PHASE 1XORBITER DOORS,ANTI CASE#
REVISION 3/6/74 XADDED STRAPS#

APRIL 17. 1974 NASTRAN 2/ 1/73 PAGE 5

C A S F C O N T R O L D E C K E C H O

CARD
COUNT

1	TITLE # PHASE 1XORBITER DOORS,ANTI CASE#
2	SURTITLE # REVISION 3/6/74 XADDED STRAPS#
3	ECHO # BOTH
4	MPC # 4000
5	SPC # 4002
6	METHOD # 1
7	BEGIN BULK

INPUT BULK DATA DECK ECHO

```
. 1 .. 2 .. 3 .. 4 .. 5 .. 6 .. 7 .. 8 .. 9 .. 10 .  
$ CONVERT REVISED SYM.DOORS TO REVISED ANTI.DOORS  
/  
/ 1  
/ 377  
/ 422  
ASET1 2 4002 4172  
PARAM TPNAME DORAP1  
SUPORT 4002 2 4172 2 4176 23 4004 23  
SUPORT 4006 23 4008 23 4010 23 4178 23  
SUPORT 4174 23 4180 23 4034 3 4064 3  
SUPORT 4114 3 4154 3  
PARAM RMODE 1  
EIGR 1 GIV 4 1.0-4 6E1G2  
6EIG2 MAX  
ENDDATA
```

TOTAL COUNT# 14

*** USER INFORMATION MESSAGE 207. BULK DATA NOT SORTED,XSORT WILL RE-ORDER DECK.

Appendix A16
PLOTS OF MEMBER DATA/PHASE 1 ANALYSIS:
MODEL II CARGO DOORS

5/25/74

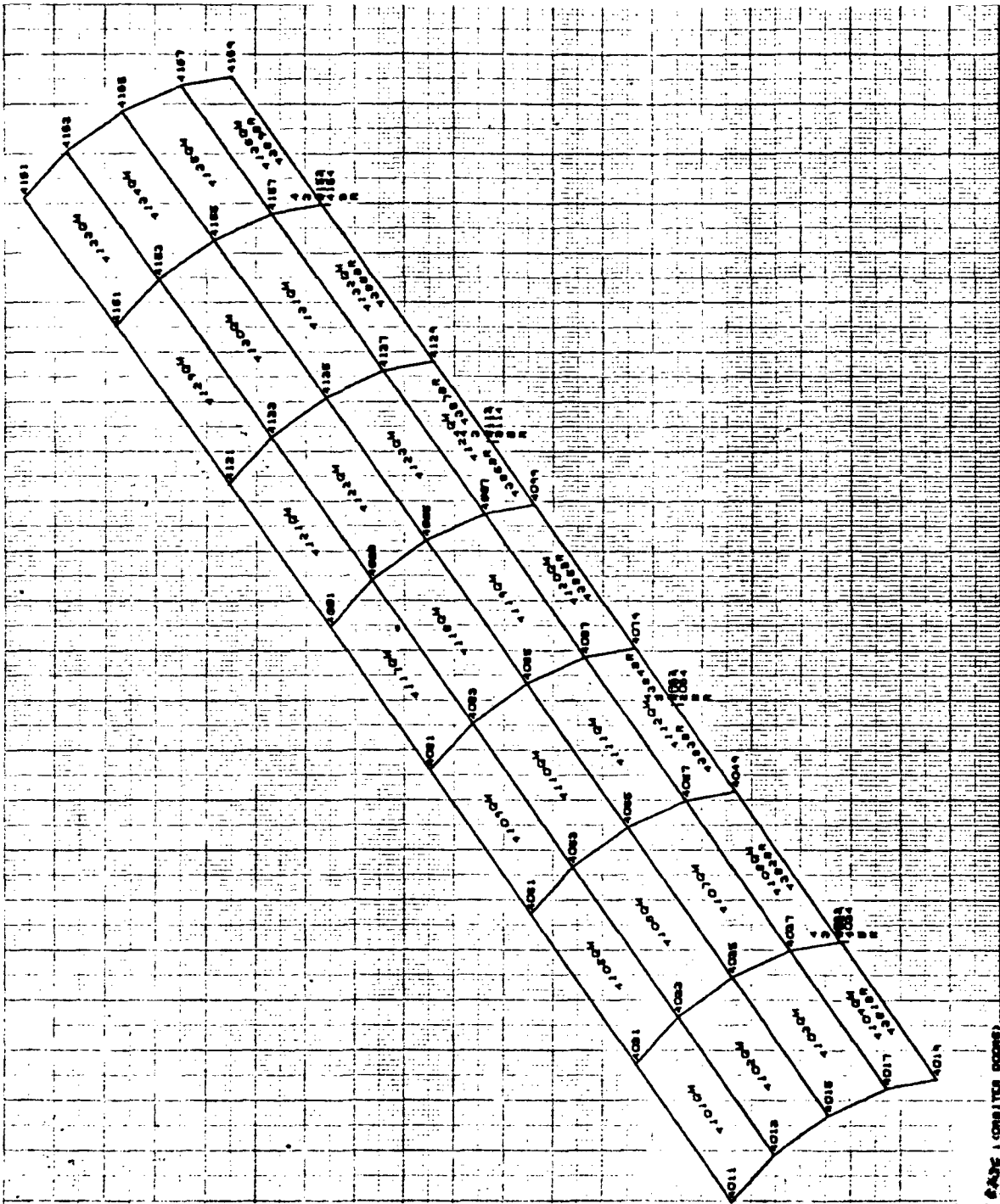

SCALE: 1/8" = 1' (CONSIDER BORDERS)
 REVISION 5/25/74 (ADDED STRAPS)
 UNIFORMED SHARP

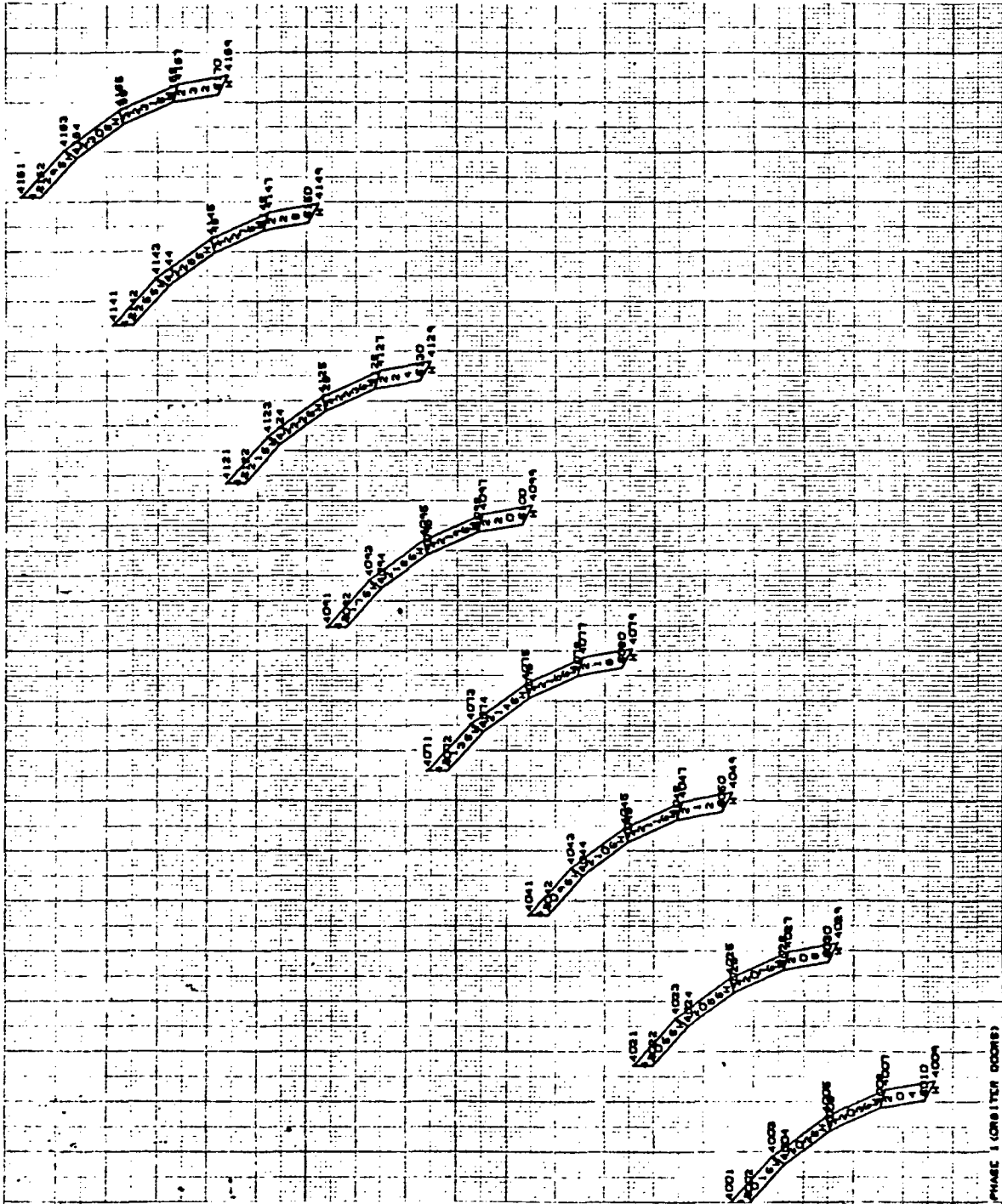

PHASE I CORBITER OCCURS
 REVISION 3/2/74 (ADDED STRIPS)
 UNDEFORMED SHAPE

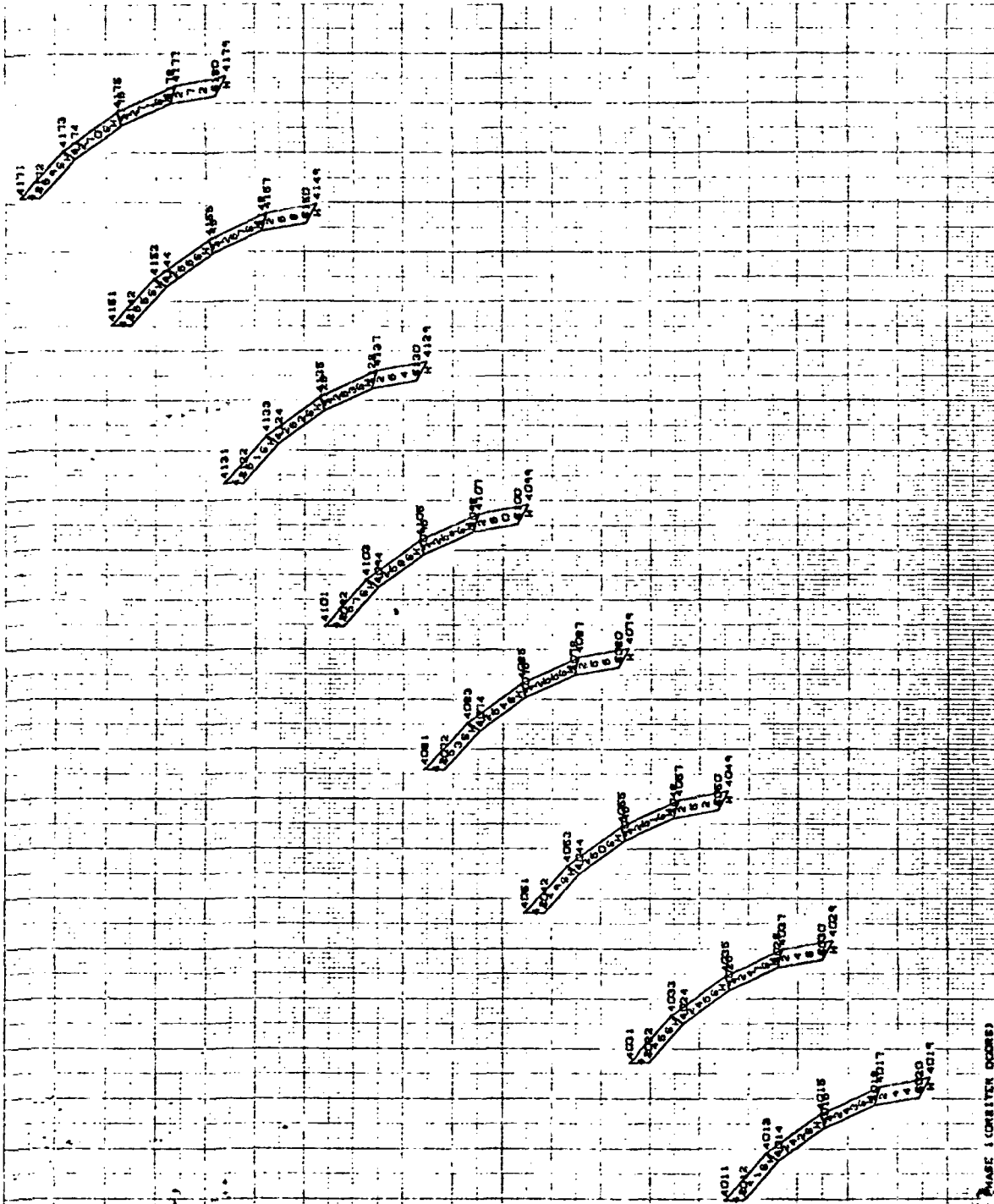

PHASE I CRACK DOORS
 REVISION 3/4/74 (ADDED STRAPS)
 UNDISTORTED SHAPE

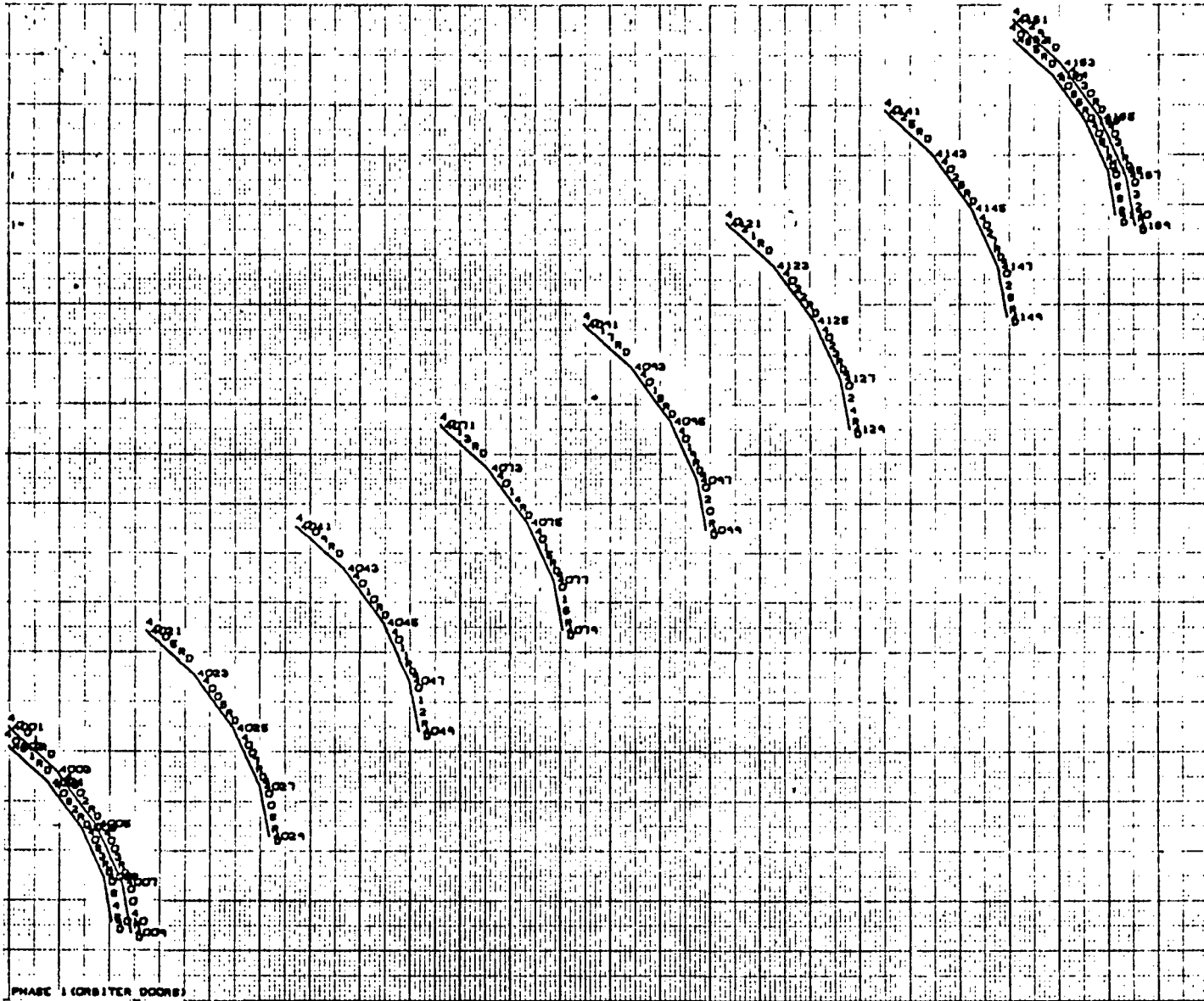

PHASE 1 ORBITER DOORS
REVISION 3/9/74 (ADDED STRAPS)

UNIFORMED SHAPE

5 6/28/74

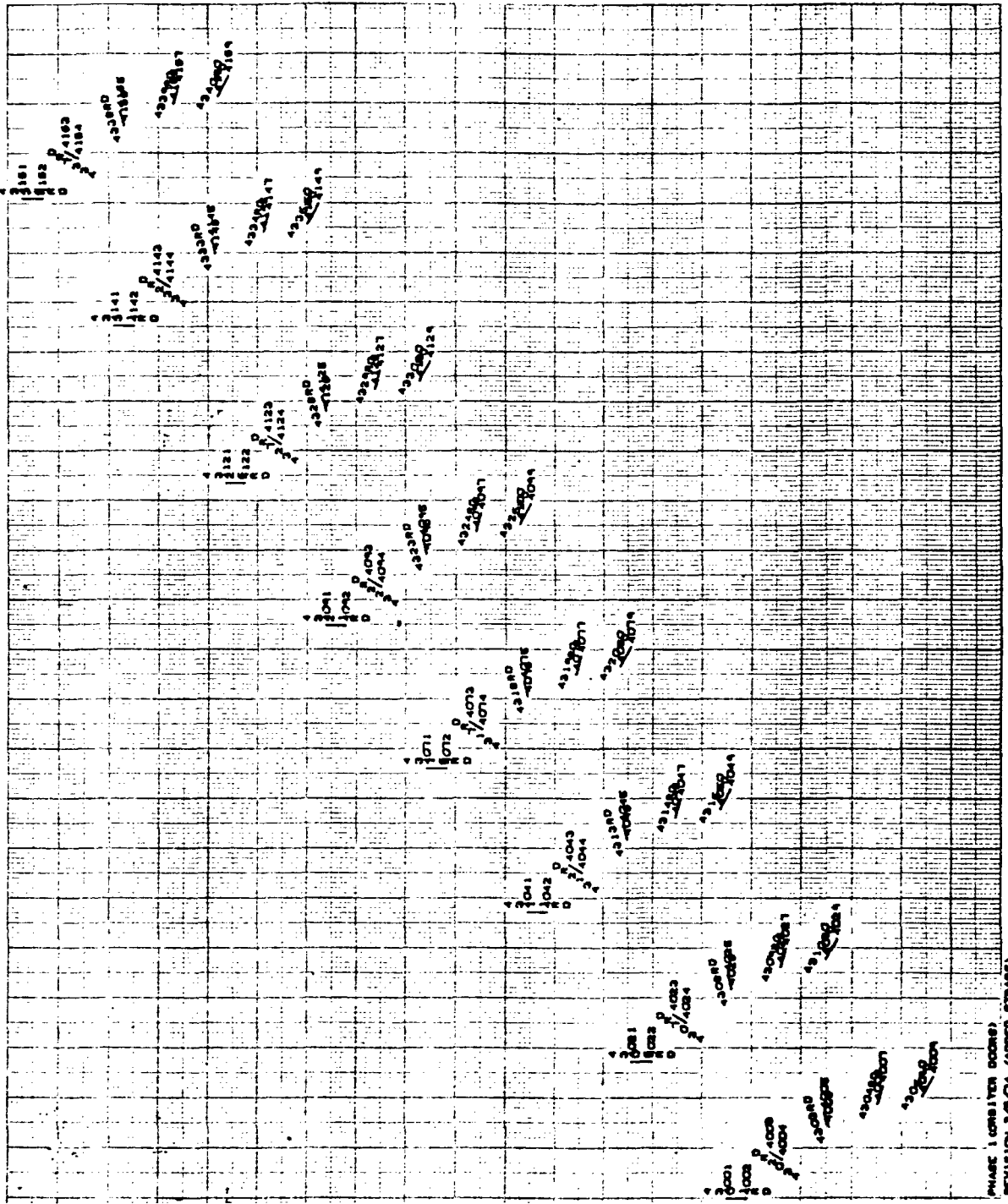

PHASE I ORBITER DECORP
REVISION 3/9/74 (ARDC STRAPS)
UNREFORMED SHAPES

8/25/74

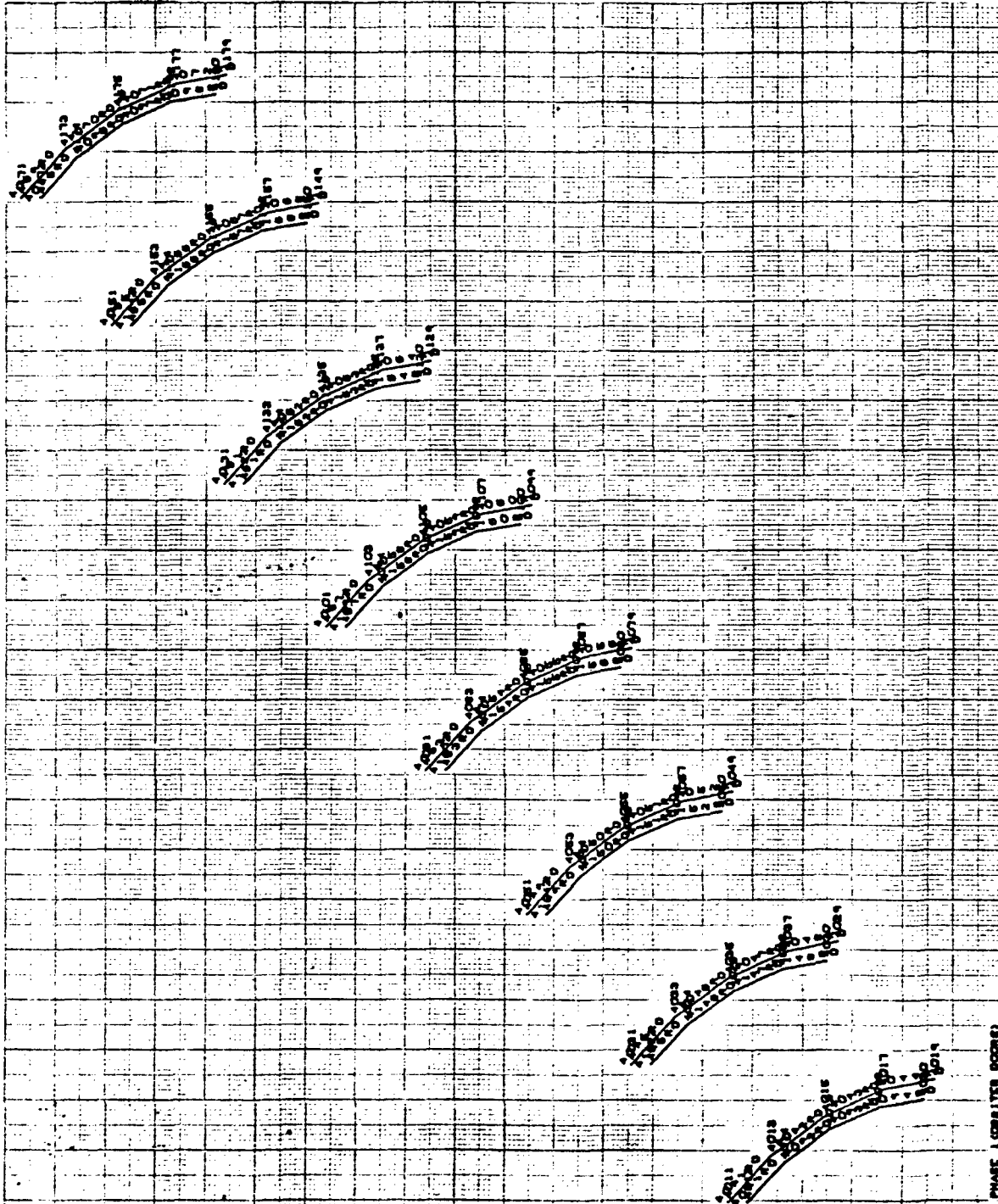

PHASE I (CRUISER DOORS)
REVISION 2/7/74 (ADDED STRAPS)

UNDEFORMED SHAPE

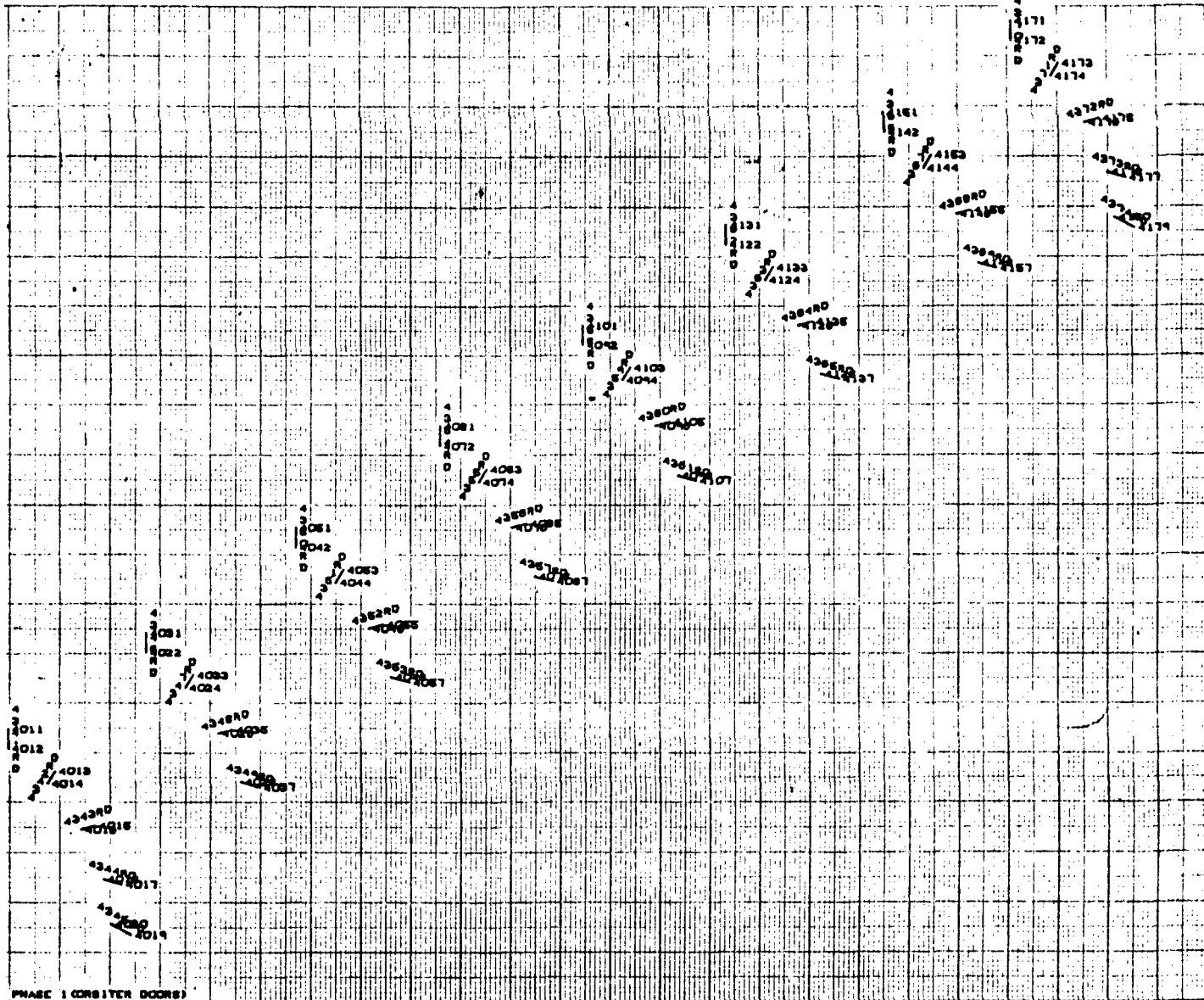

PHASE 1 (ORBITER DOORS)
REVISION 8/8/74 (ADDED STRAPS)

UNDEFORMED SHAPE

Appendix A17
PLOTS OF SYMMETRIC AND ANTISYMMETRIC
MODES/PHASE 1 ANALYSIS:
MODEL II CARGO DOORS

3/23/74 MAX-DEF. = 0.0000000

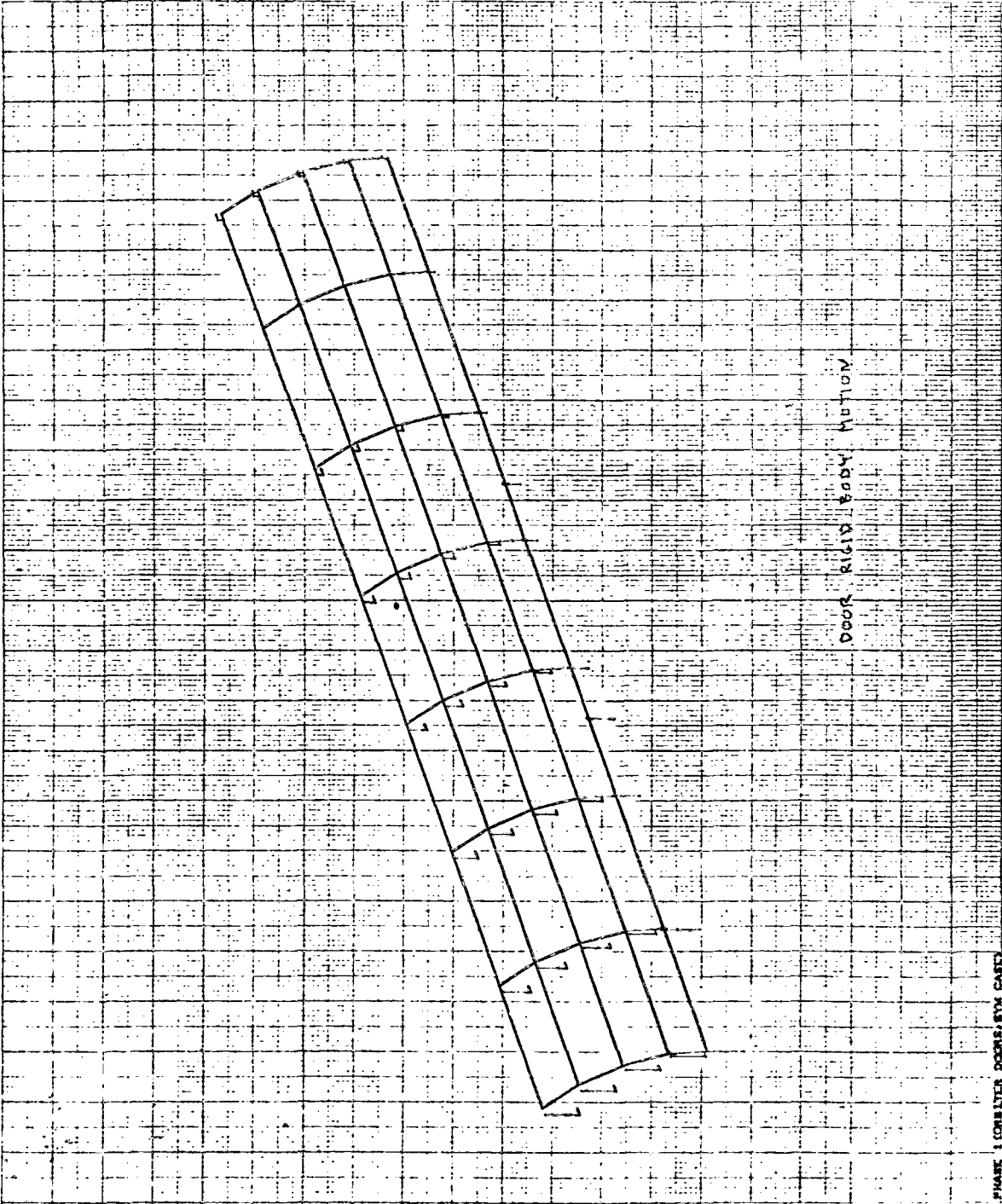
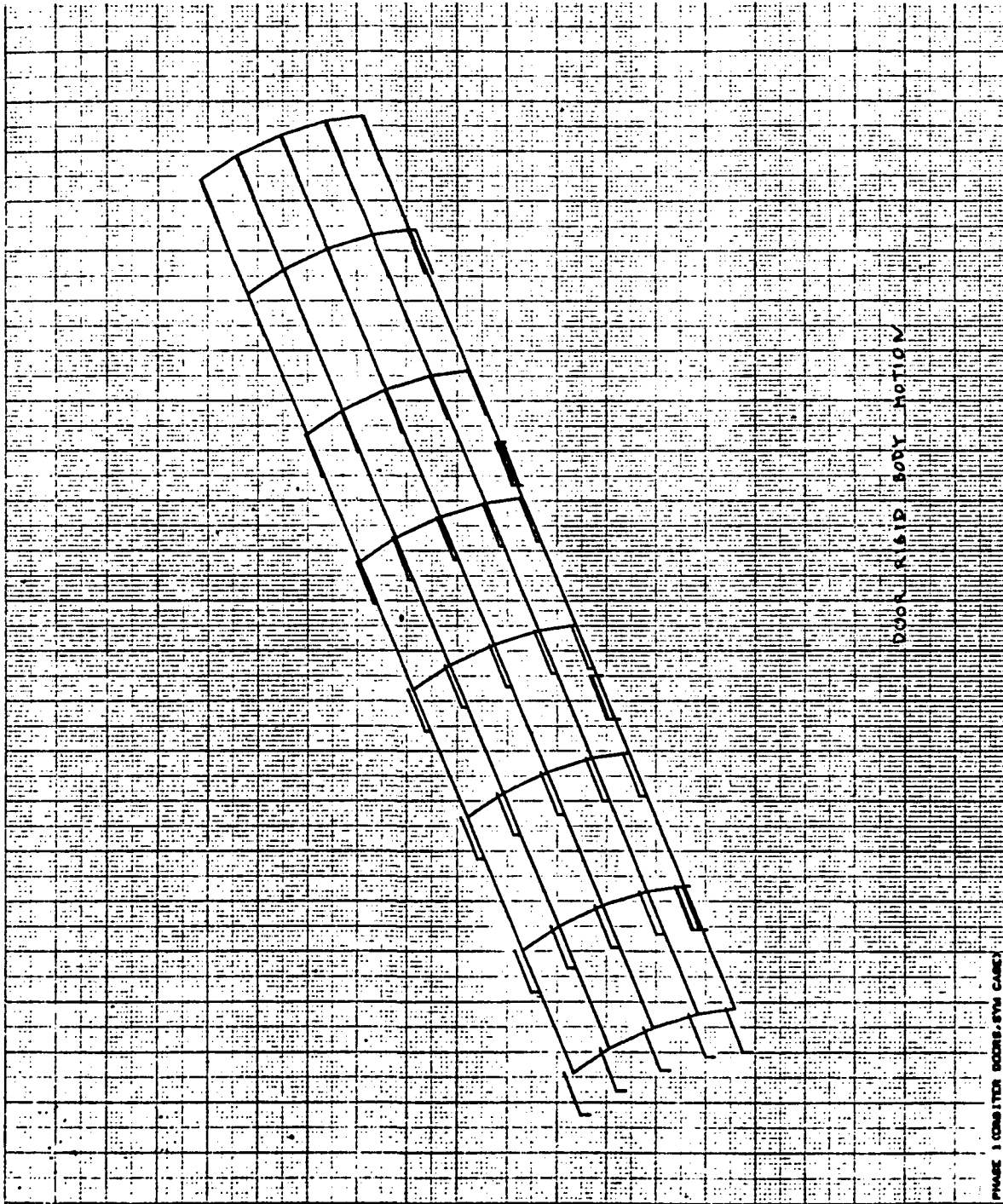

FIGURE 1 (CONTINUED)
REVISION 3/28/74 (ADDED STRAPS)
FREE FREE MODES
MEDAL DETOR. SUBCASE 1 MODE 1 FREQ. 0.

3/23/74 MAX DEF. = 1.0000000



DOOR RIBBED BODY MOTION

PHASE 1 COMPUTER SCISSOR STRAP CASE
REVISION 3/23/74 (ADDED STRAPS)
PRICE PRICE M0000
MEDAL DEFEN. SURFACE 2 MODE 2 PRICE 0.

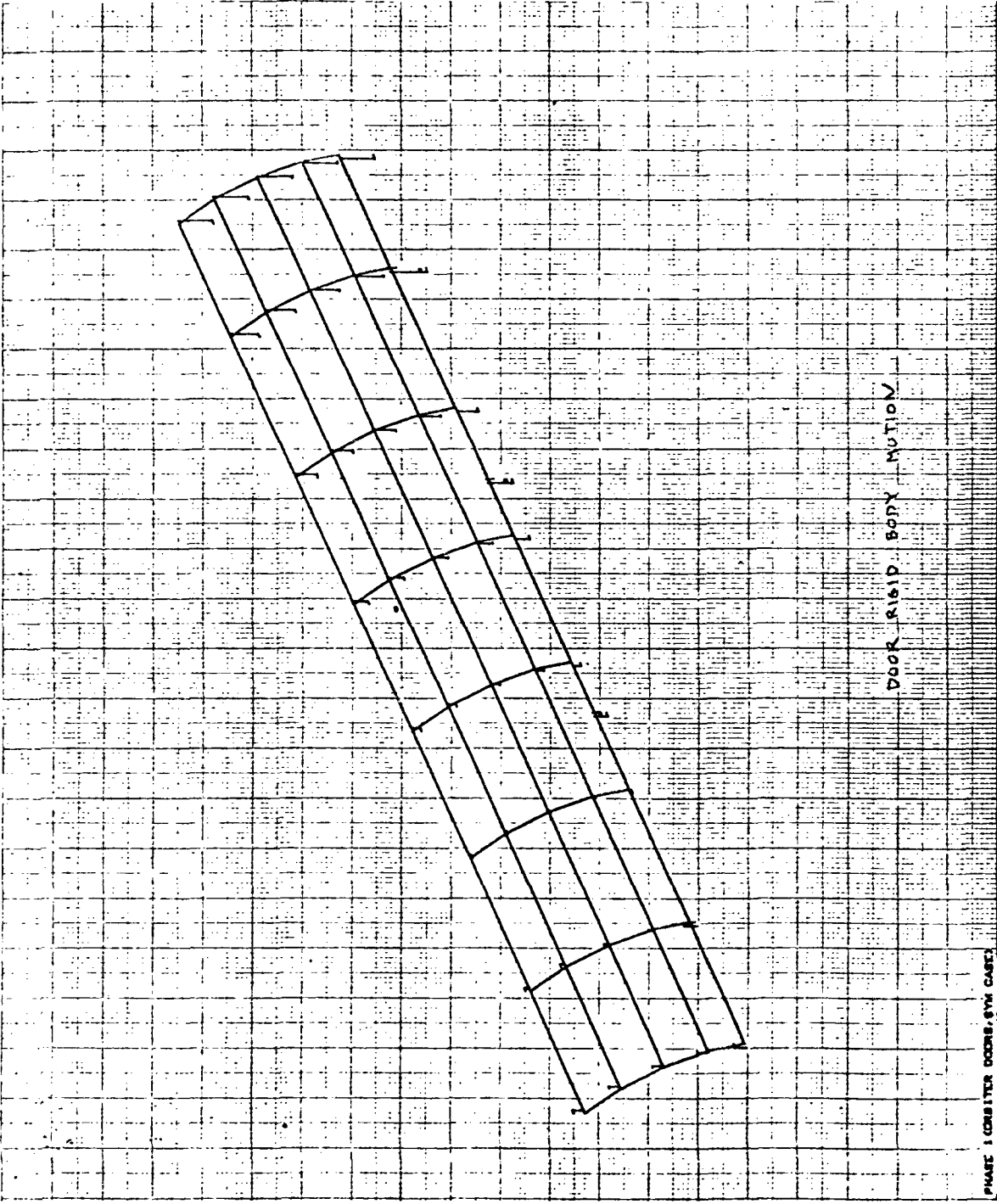

PHASE 1 CRIBBITER DOORS, SYN CASE
 REVISION 2/8/74 (ADDED STRAPS)
 FREE FREE MODES
 MODAL DEFOR. SUBCASE 3 MODE 3 FREQ. 0.

3/23/74 MAX-REF. = 1.00000000

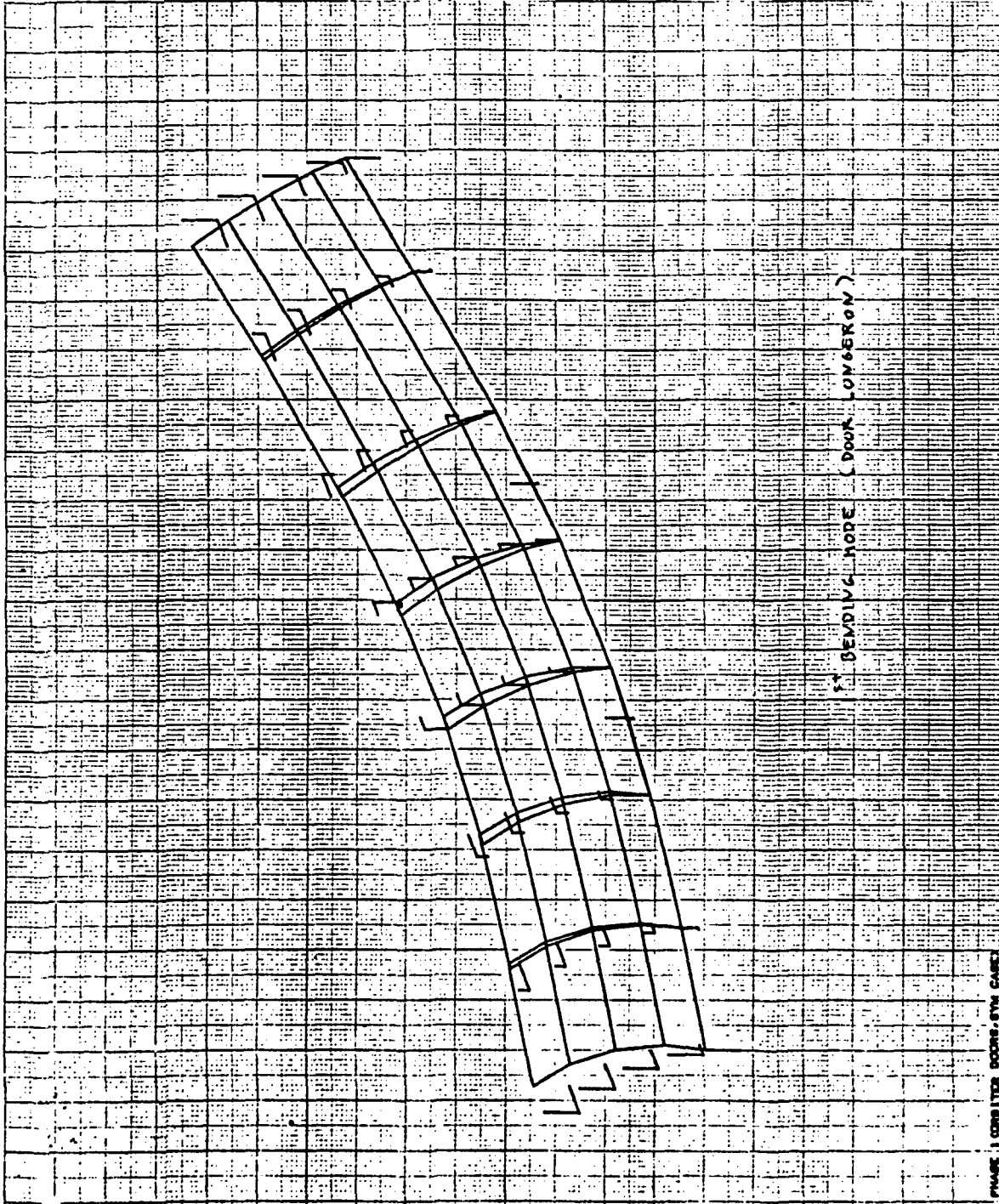

3/23/74 MAX-DEC. 1.00000000

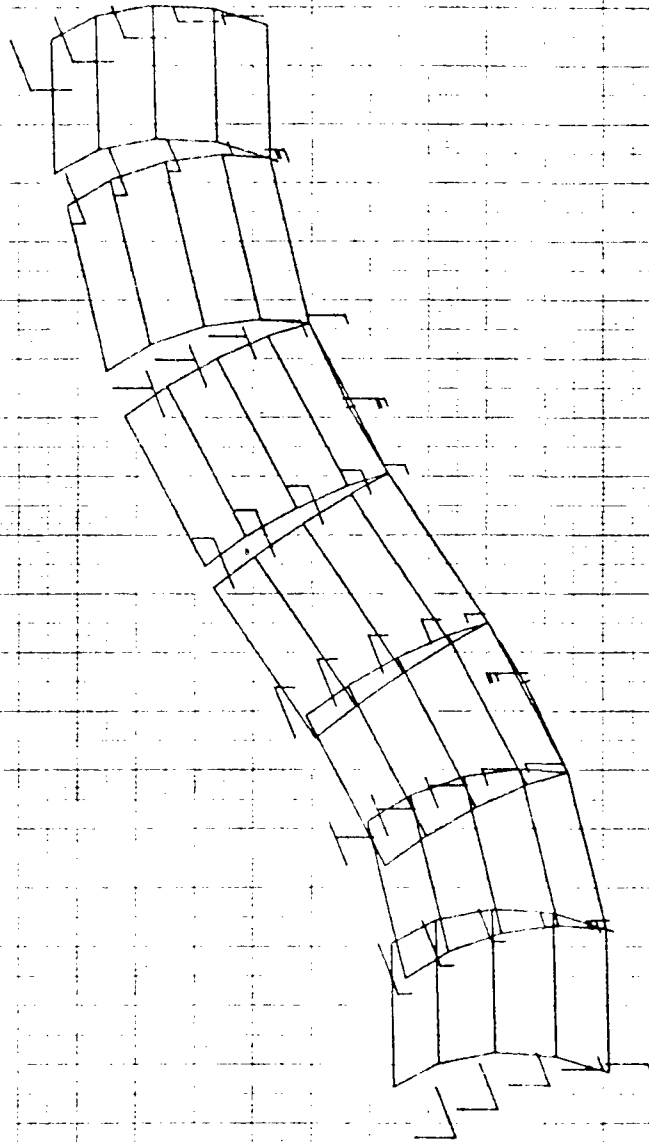

2nd BENDING MODE (DOOR LONGERON)

PHASE 1 (ORBITER DOORS, STM CASE)
REVISION 3/8/74 (ADDED STRAPS)
FREE FREE MODES
MODAL DETOR. SUBCASE 5 MODE 5 FREQ. 10.9376

3/23/74 MAX-DEF. = 1.04877910

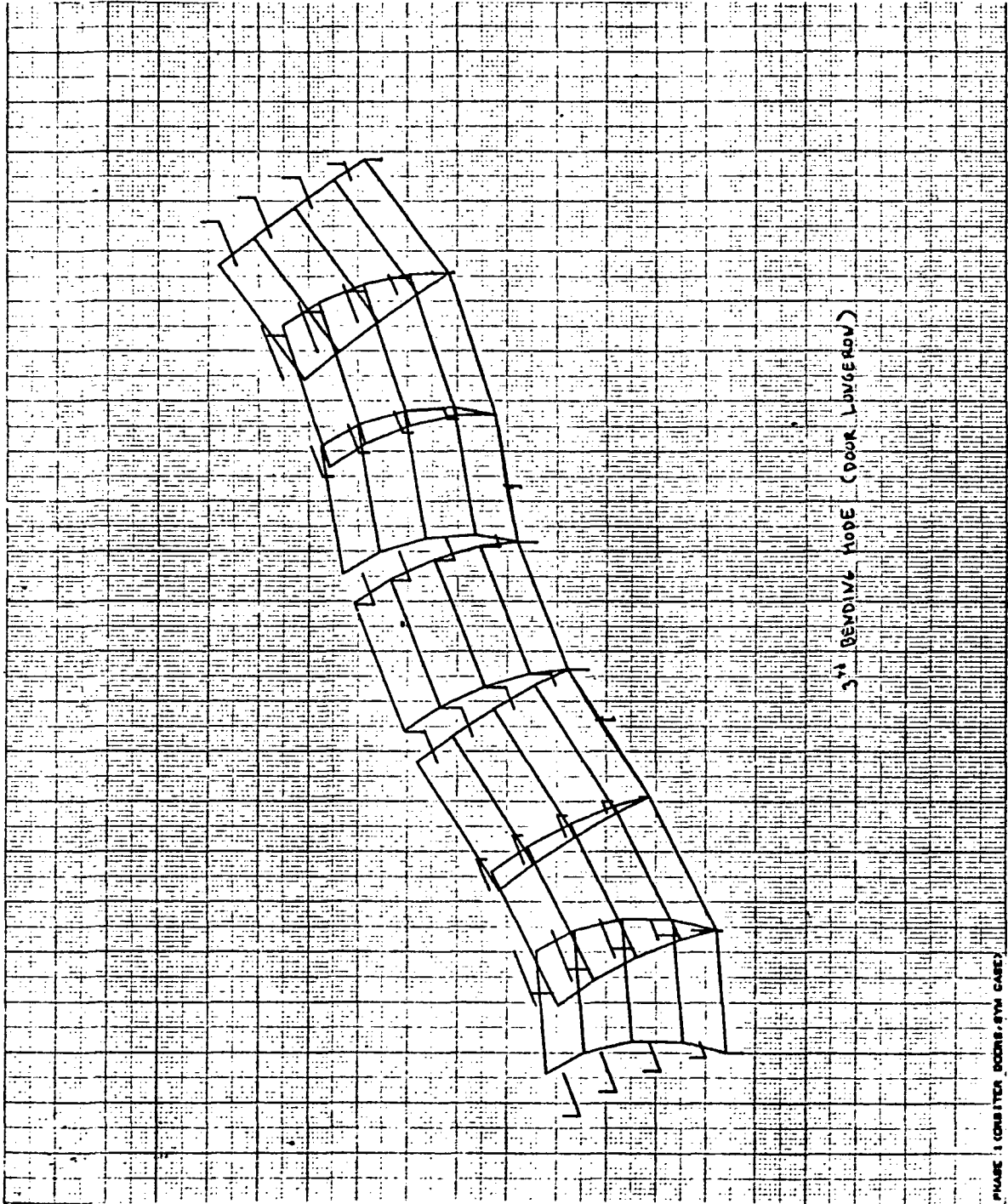

3rd BENDIVE HOPE (DOOR LUGGERON)

PHASE 1 (ORBITER DOOR-SYM CASE)
REVISION 3/23/74 (ADDED STRAPS)
PRICE FREE MOSES
MODAL SECTOR, SURFACE 6 MODE 6 PRED. 14, 00303

3/23/74 MAX-DEF. = 1.15480470

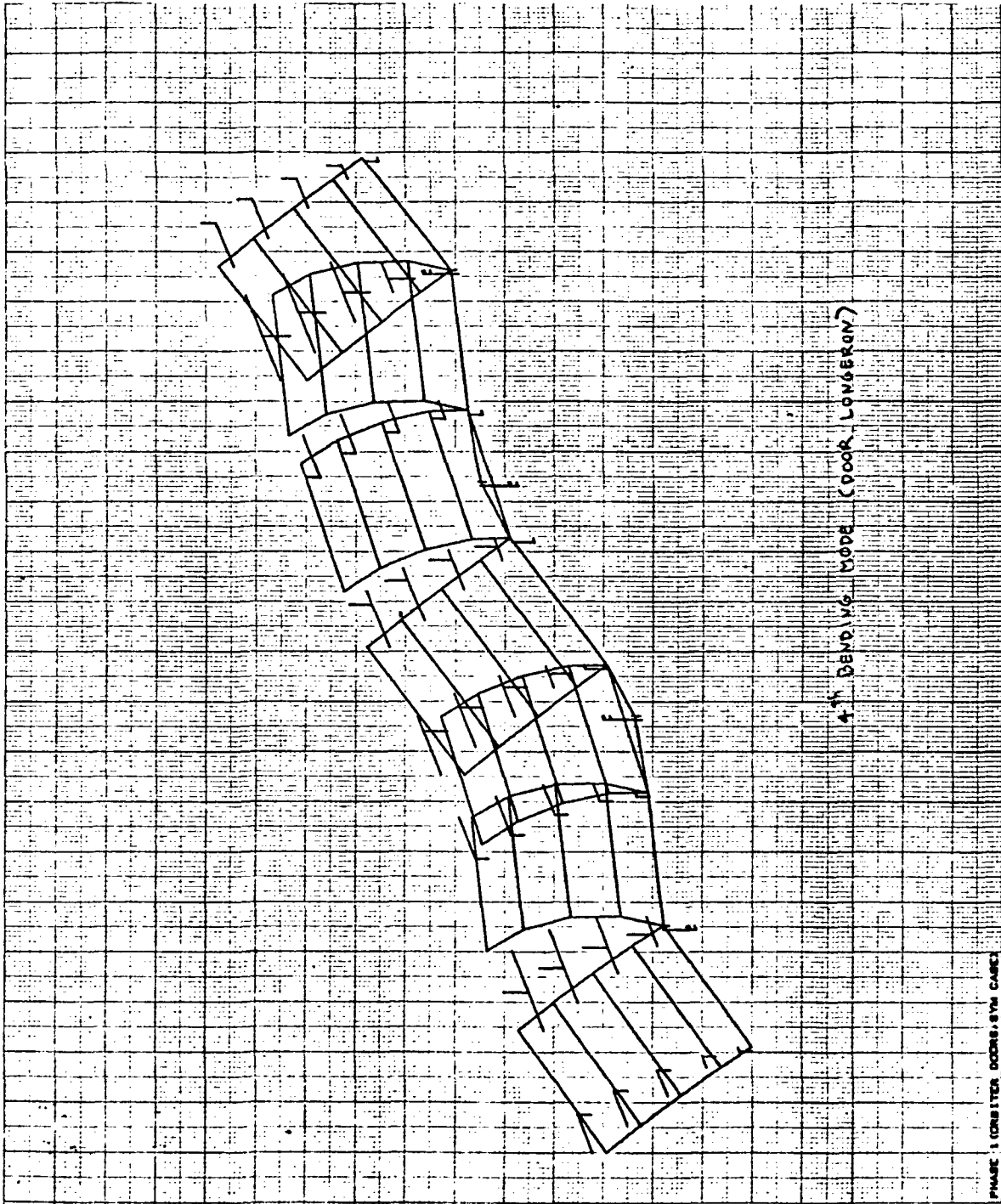

PHASE 1 (LIMITER DOORS, 5TH CASE)
REVISION 3/8/74 (ADDED STRAPS)
FREE FREE MODES
MODAL DEFOR. SUBCASE 7 MODE 7 FREQ. 30.0418

3/23/74 MAX-DEF. = 2.0460680

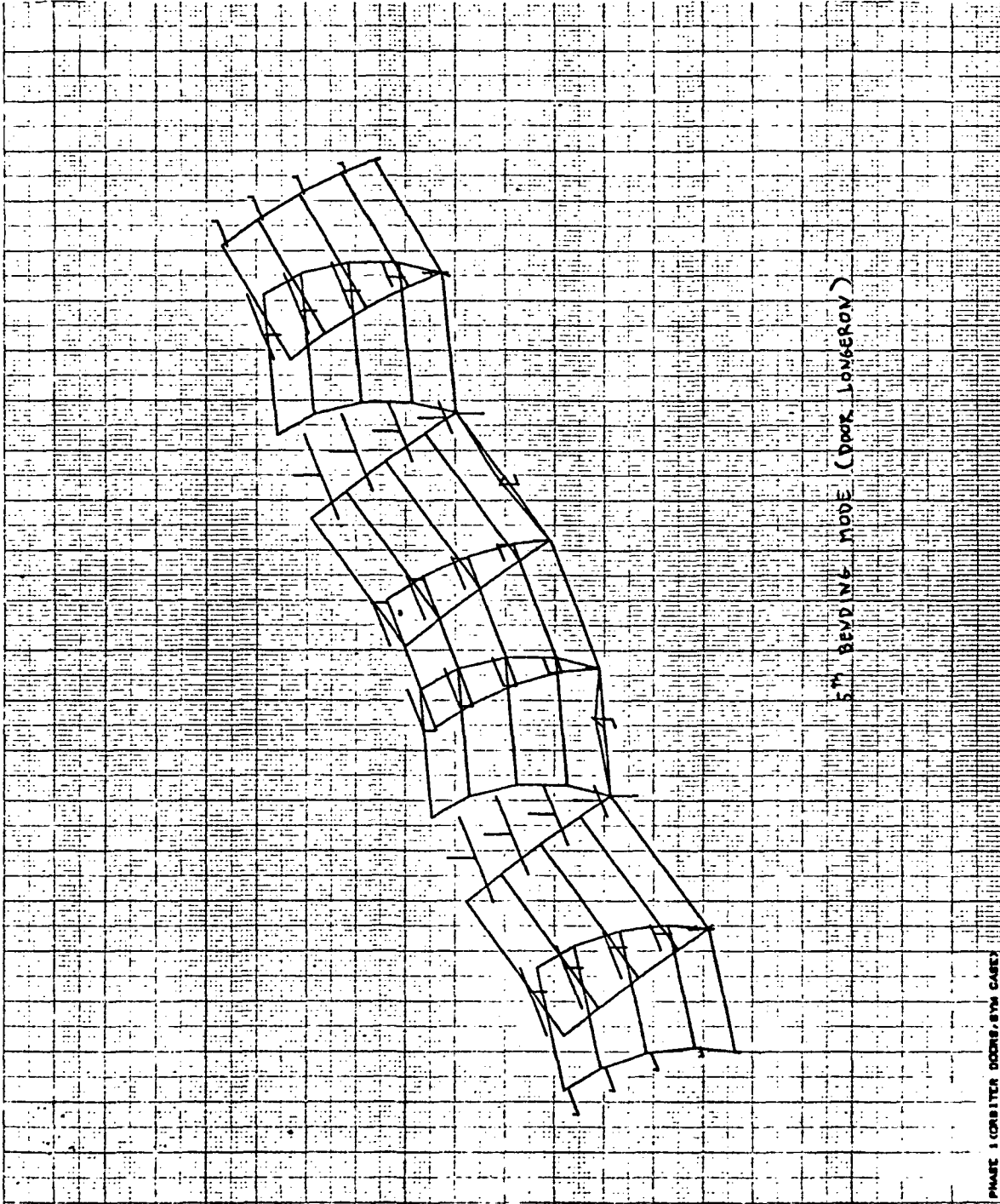

PHASE 1 (ORBITER DOORS, 87M CASE)
REVISION 3/9/74 (ADDED STRAPS)
FREE FREE MODES
MODAL DEFOR. SURFACE 8 MODE 8 FREQ. 69.28788

3/23/74 MAX-DET. • 9.24750820

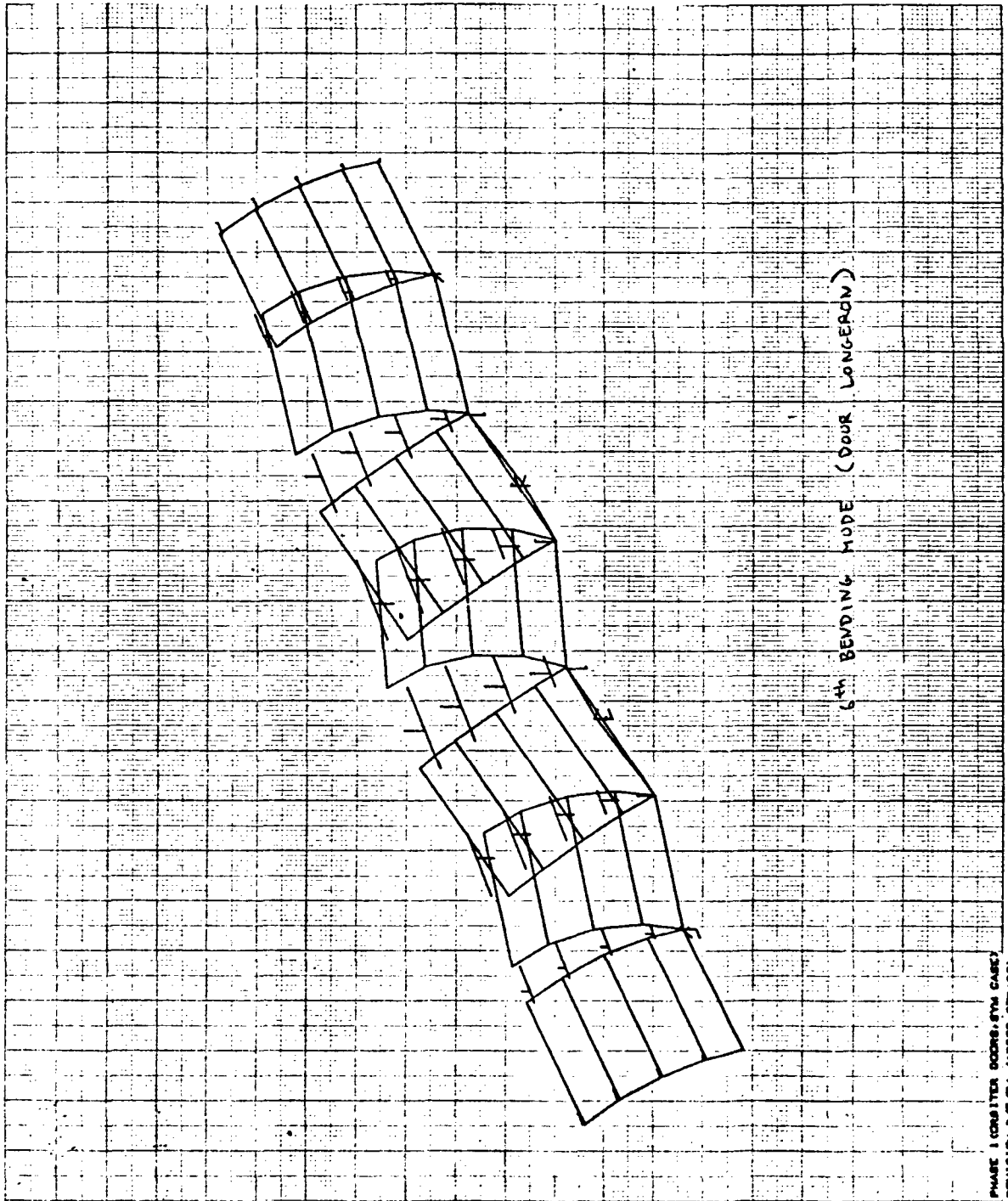

6th BENDING MODE (DOOR LONGERON)

PHASE I CRIBBITOR DOORS, 87M CASE
REVISION 3/8/74 (ADDED STRAPS)
PRICE FREE MODES
MODAL VECTOR, SUBCASE 9 MODE 9 FREQ. 94.67348

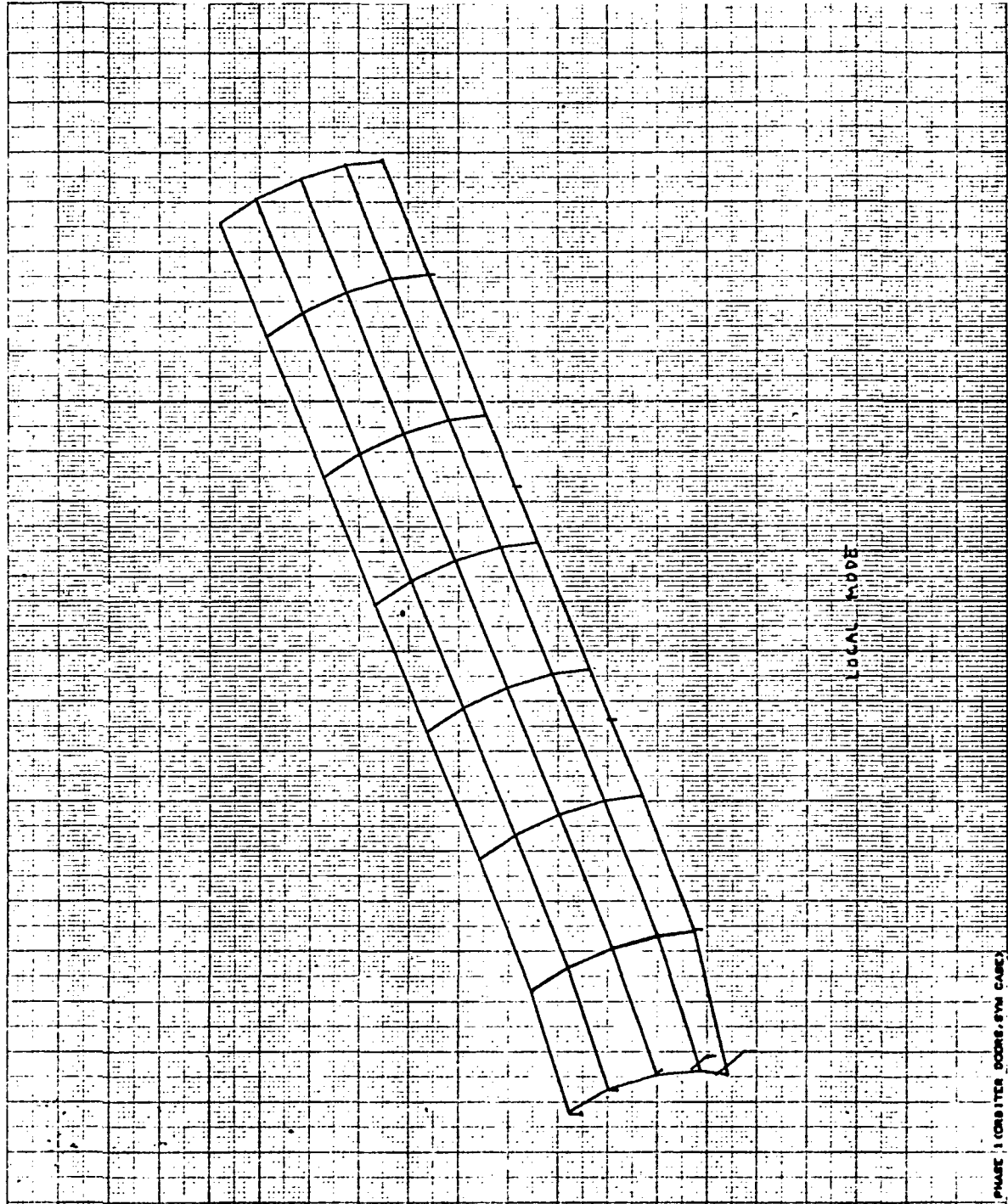

PHASE 1 (ORBITER DOORS SYN CASE)
 REVISION 3/19/74 (ADDED STRAPS)
 FREE FREE MODES
 MODAL VECTOR. SUBCASE 10 MODE 10 FREQ. 188.5143

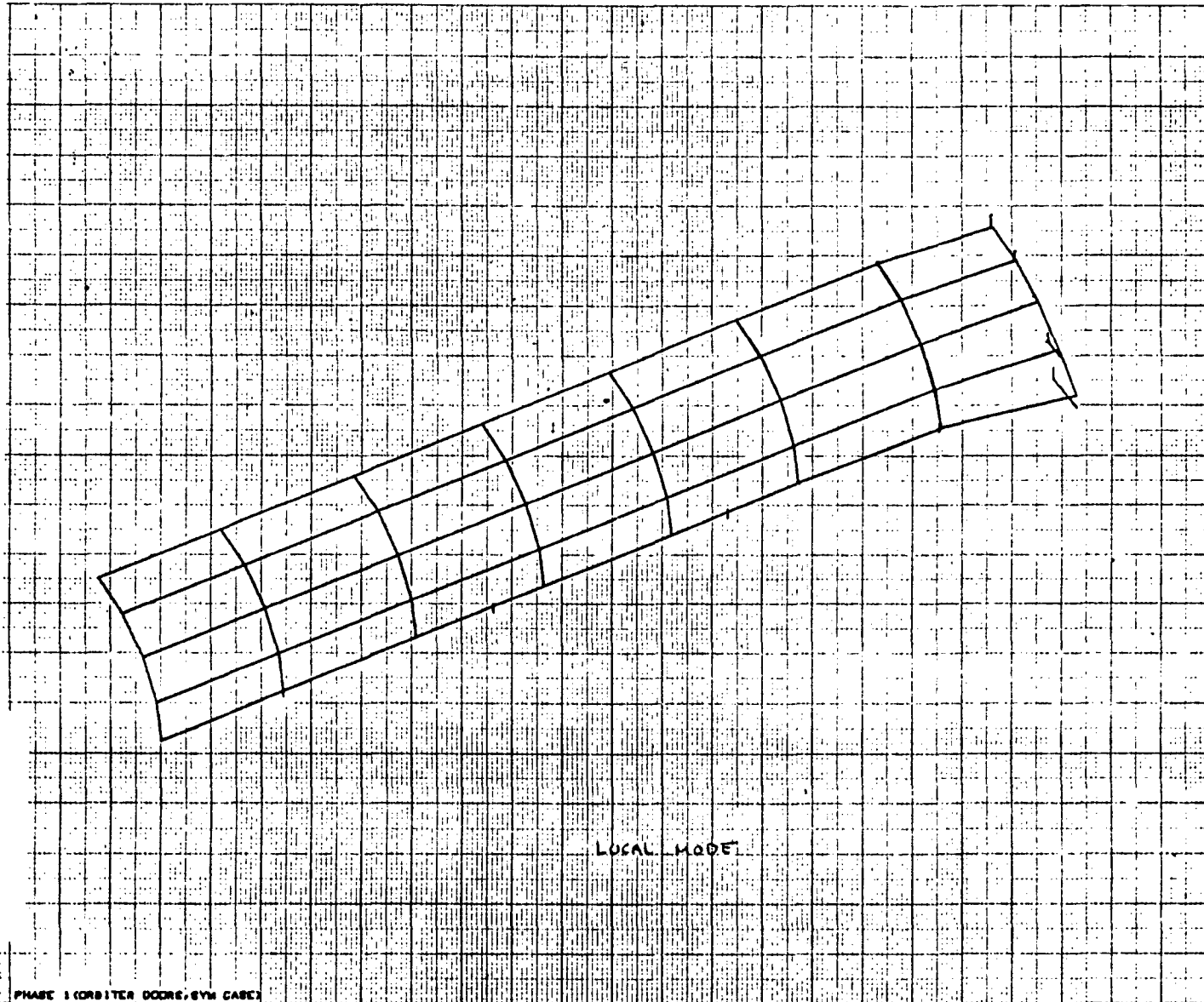

PHASE 1 (ORBITER DOOR, EYM CASE)
REVISION 3/8/74 (ADDED STRAPS)
FREE FREE MODES
MODAL DEFOR. SUBCASE 11 MODE 11 FREQ. 141.4618

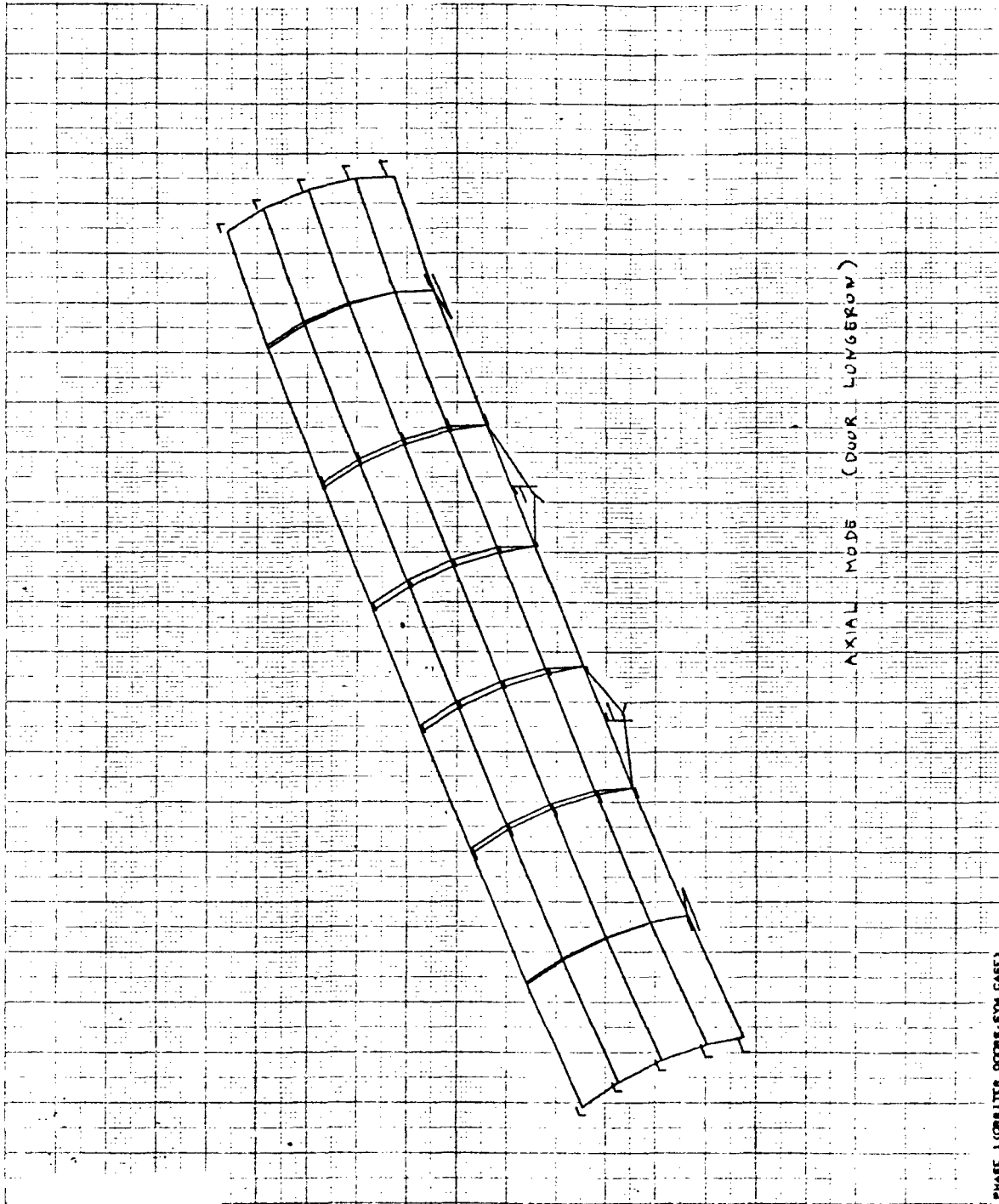

PHASE 1 (ORBITER DOORS, SYM CASE)
 REVISION 3/9/74 (ADDED STRAPS)
 FREE FREE MODES
 MODAL DEFOR. SUBCASE 12 MODE 12 FREQ. 760.3764

AXIAL MODE (DOOR LONGERON)

3/21/74 MAX-DEF. = 2.67812520

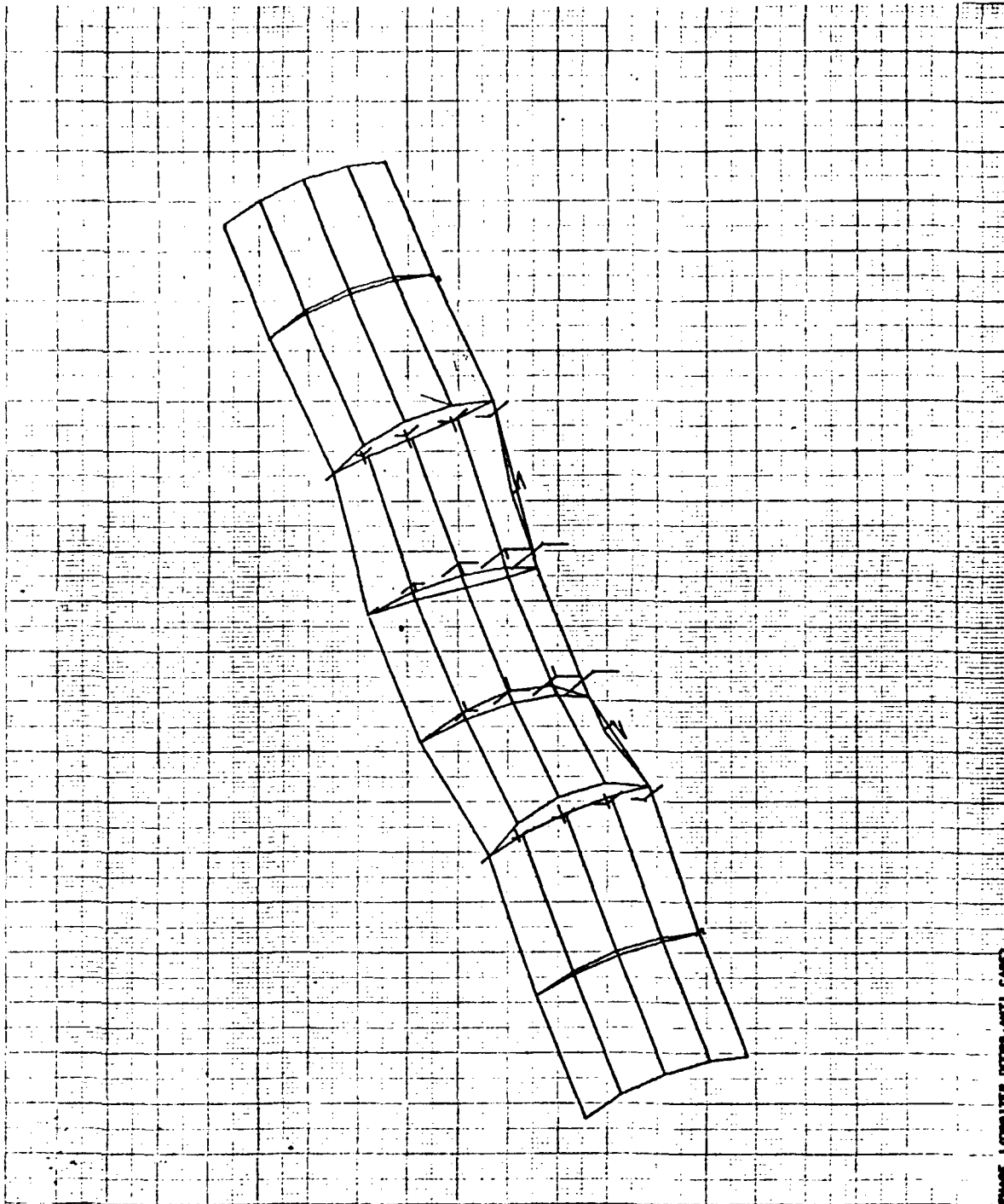

PHASE 1 COMPUTER DOORS, ANTI-CARD
REVISION 3/19/74 (GOOD STRAPS)
RESTRAINED FREE MOVES
MEDIAL DEFOR. SUBCASE 1 MODE 1 PREQ. 181.7187

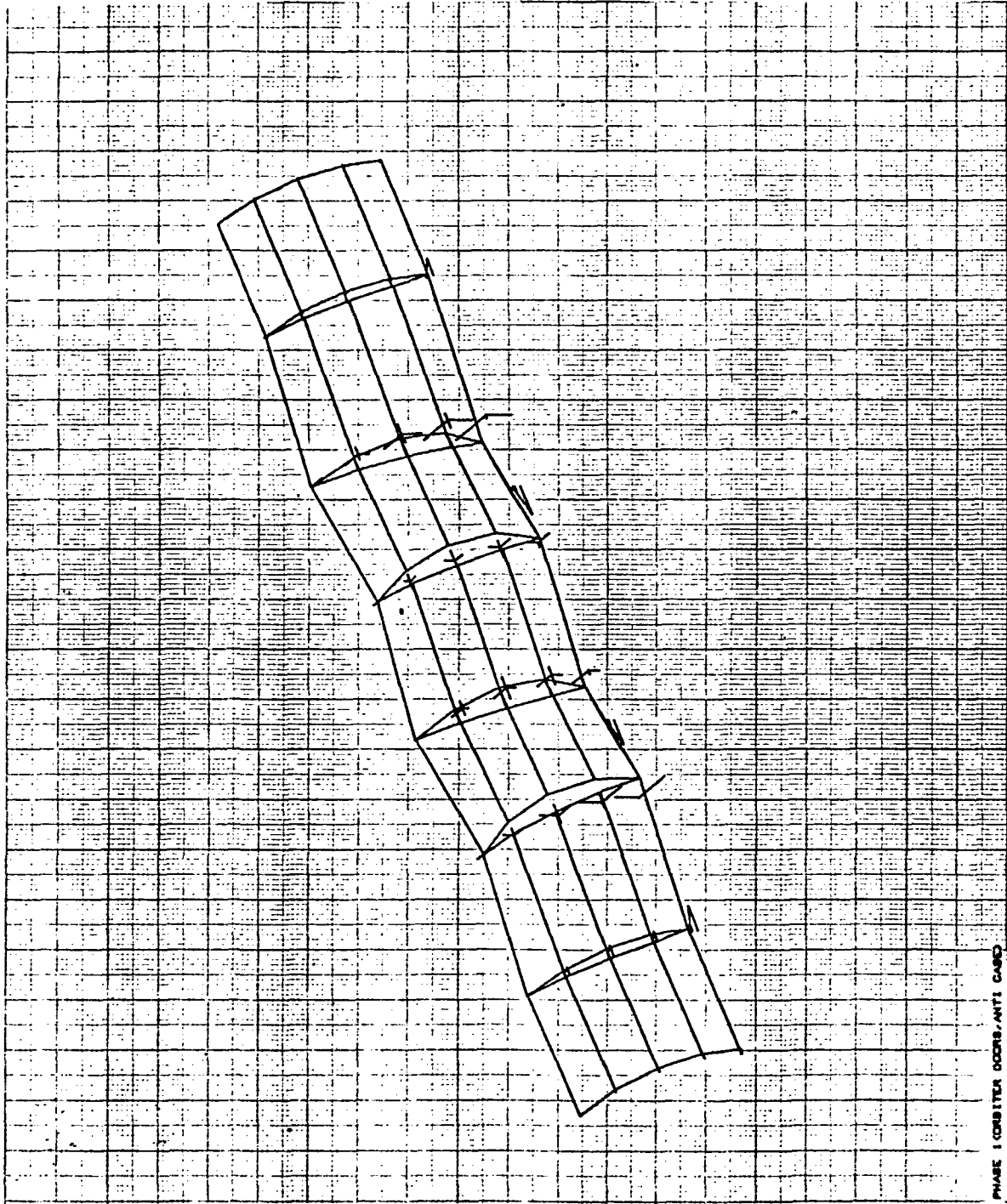

PHASE 1 ORBITER DOORS/ANTI CARD
REVISION 9/9/74 (ADDED STRAPS)
RESTRAINED FREE MODES
MODAL DEFOR. SUBCASE 2 MODE 2 FREQ. 919.8189

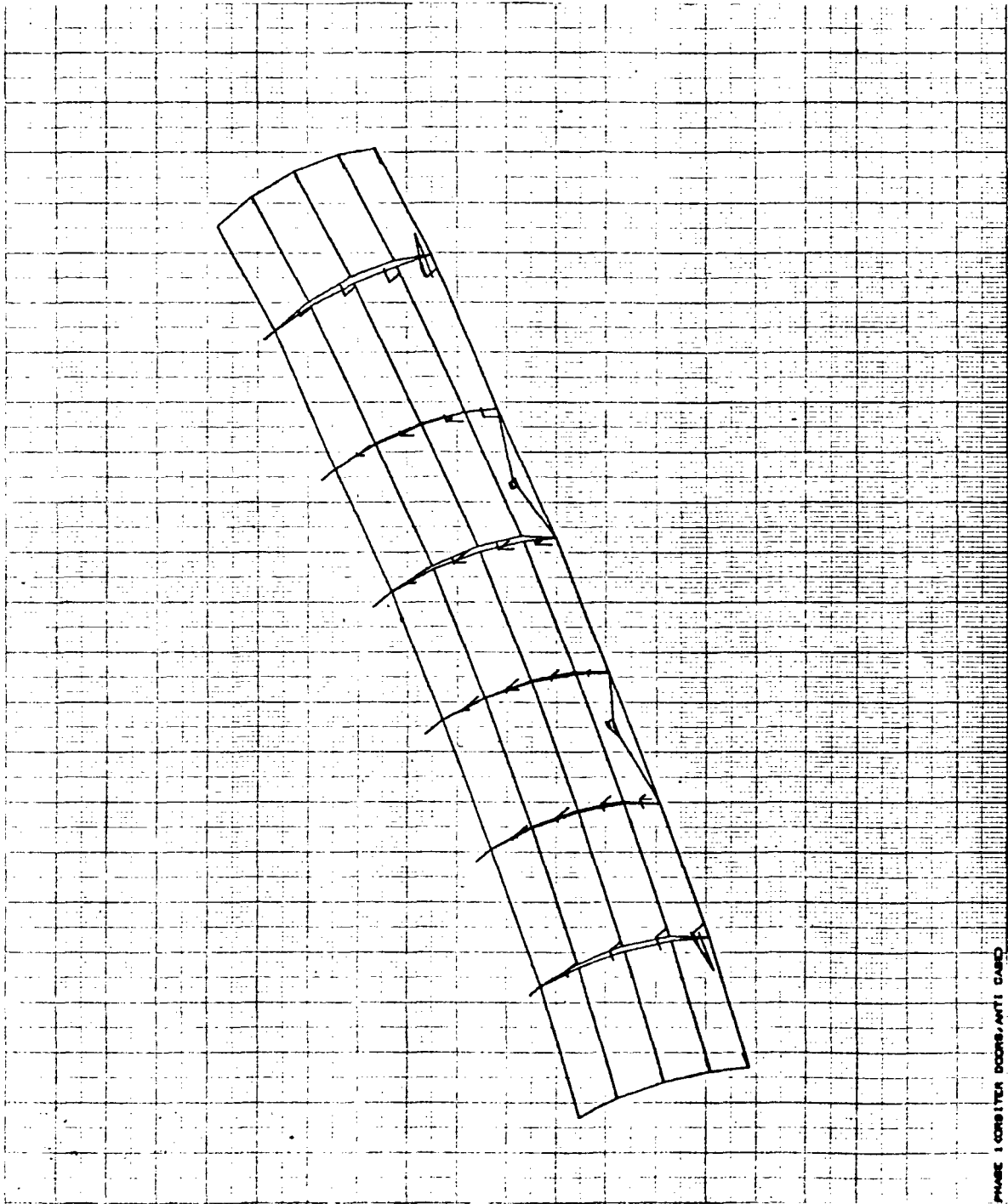

PHASE 1 CORBITER DOORS/ANTI CASES
REVISION 3/27/74 (ADDED STRAPS)
RESTRAINED FREE MODES
MODAL DEFOR. SURFACE 3 MODE 3 FREQ. 261.3387

9/21/74 MAX-DEF. = 1.0000000

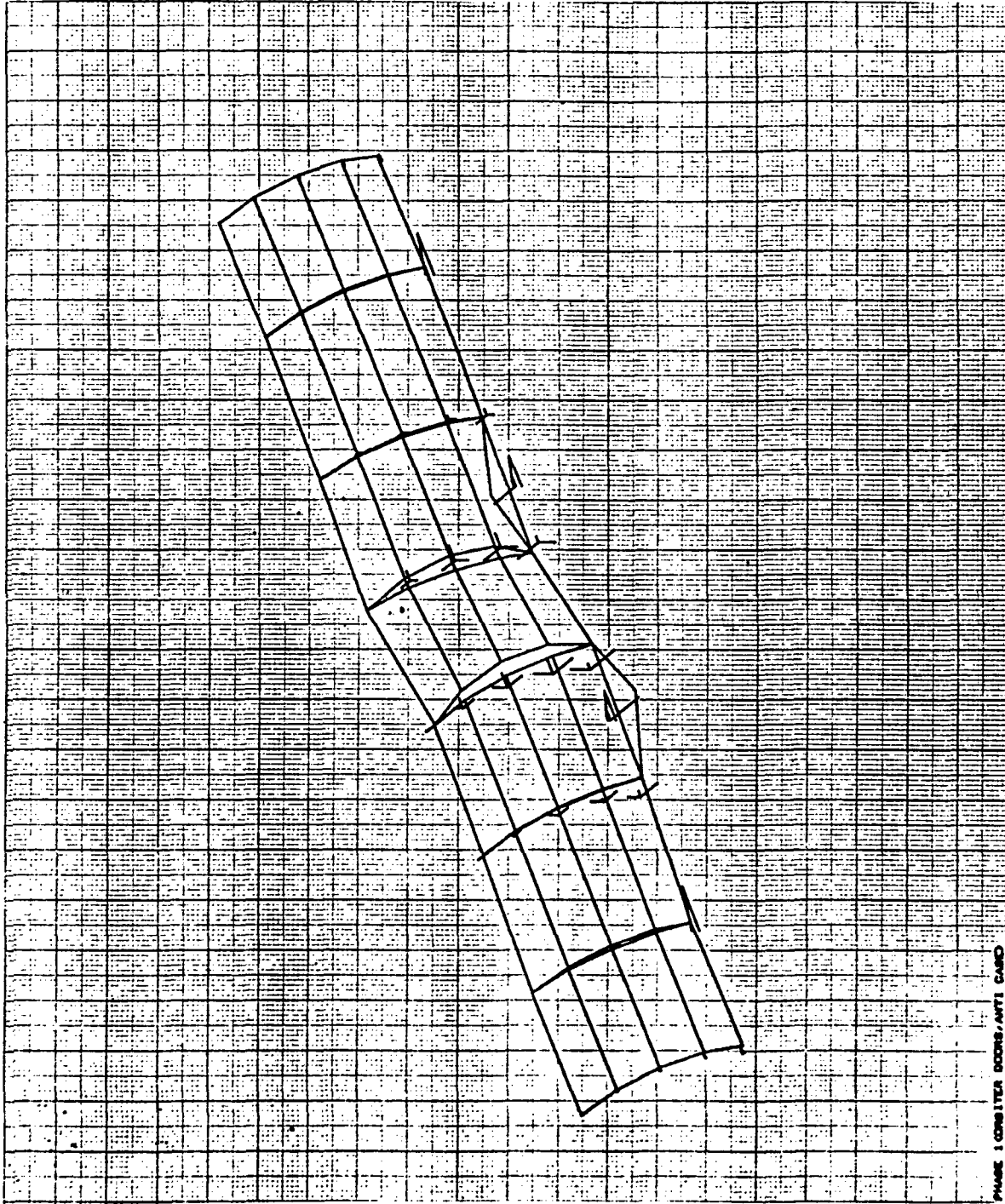

PHASE 1 COMPUTER DOORS,ANTI CARO
REVISION 3/9/74 (ADDED STRAPS)
RESTRAINED FIRE MODES
ACORDA BOSTON. SUBCASE 4. MODE 4. PROJ. 880.3008

Appendix A18
SORTED BULK DATA/PHASE 1 ANALYSIS:
MODEL II FIN

PHASE 1 ASYMM CASE-FIND
REVISED INTERFACE PTS. 4/25/74

APRIL 30. 1974 NASTRAN 2/ 1/73 PAGE 2

CASE CONTROL DECK ECHO

CARD
COUNT

1	TITLE # PHASE 1 ASYMM CASE-FIND
2	SUBTITLE # REVISED INTERFACE PTS. 4/25/74
3	ECHO # BOTH
4	IPC # 4451
5	SPC # 4401
6	METHOD # 1
7	BEGIN BULK

INPUT BULK DATA DECK ECHO

```

. 1 .. 2 .. 3 .. 4 .. 5 .. 6 .. 7 .. 8 .. 9 .. 10 .
$ CONVERT ORIGINAL SYMM FIN TO REVISED SYMM FIN
/      2      3
/      128    136
/      191
/      197
/      348
ASET1  123    4461    4469
GRID   4462    0    166.5    .0    75.0    4412    456
GRID   4470    0    182.3663    .0    75.0    4420    456
MPC    4449    4462    1    1.0    4461    1    -.652940    EMC4462A
EMC4462A  4461    4461    3    .75741
MPC    4449    4470    1    1.0    4469    1    -.942470    EMC4470A
EMC4470A  4469    4469    3    .33429
PARAM  NOSUB  -1
SUPORT 4461    123    4465    123    4469    123
ENDDATA
```

TOTAL COUNT# 16

SORTED BULK DATA ECHO

CARD	COUNT	1	2	3	4	5	6	7	8	9	10
1-	ASET1	1	4463	4467							
2-	ASET1	123	4431	4435	4439	4465					
3-	ASET1	123	4461	4469							
4-	ASET1	135	4400								
5-	CUNM1	4400	4400	0	3.000	.0	3.000	.0	.0	ECM1	
6-	ECM1	3.000	0.0	0.0	0.0	0.0	1.5630	0.0	0.0	0.0	ECM2
7-	ECM2	0.0	13.225	0.0	0.0	0.0	0.0	0.0	0.0	12.79	
8-	CONROD	4490	4401	4411	4401	.036				.0026	
9-	CONROD	4491	4402	4412	4401	.019					
10-	CONROD	4492	4405	4415	4401	.026				.0016	
11-	CONROD	4493	4406	4416	4401	.019					
12-	CONROD	4494	4409	4419	4401	.036				.0026	
13-	CONROD	4495	4410	4420	4401	.019					
14-	CONROD	4496	4411	4421	4401	.037				.0026	
15-	CONROD	4497	4412	4422	4401	.023					
16-	CONROD	4498	4415	4425	4401	.027				.0016	
17-	CONROD	4499	4416	4426	4401	.023					
18-	CONROD	4500	4419	4429	4401	.037				.0026	
19-	CONROD	4501	4420	4430	4401	.023					
20-	CONROD	4502	4421	4431	4401	.040				.0026	
21-	CONROD	4503	4422	4432	4401	.027					
22-	CONROD	4504	4425	4435	4401	.030				.0016	
23-	CONROD	4505	4426	4436	4401	.027					
24-	CONROD	4506	4429	4439	4401	.040				.0026	
25-	CONROD	4507	4430	4440	4401	.027					
26-	CONROD	4508	4431	4441	4401	.042				.0026	
27-	CONROD	4509	4432	4442	4401	.032					
28-	CONROD	4510	4435	4445	4401	.032				.0016	
29-	CONROD	4511	4436	4446	4401	.032					
30-	CONROD	4512	4439	4449	4401	.042				.0026	
31-	CONROD	4513	4440	4450	4401	.032					
32-	CONROD	4514	4441	4451	4401	.044				.0026	
33-	CONROD	4515	4442	4452	4401	.037					
34-	CONROD	4516	4445	4455	4401	.090				.0072	
35-	CONROD	4517	4446	4456	4401	.037					
36-	CONROD	4518	4449	4459	4401	.044				.0026	
37-	CONROD	4519	4450	4460	4401	.037					
38-	CONROD	4520	4451	4461	4401	.026				.0026	
39-	CONROD	4521	4452	4462	4401	.066					
40-	CONROD	4522	4455	4465	4401	.120				.0100	
41-	CONROD	4523	4456	4466	4401	.040					
42-	CONROD	4524	4459	4469	4401	.026				.0026	
43-	CONROD	4525	4460	4470	4401	.068					
44-	CONROD	4526	4461	4463	4400	.072					
45-	CONROD	4527	4463	4465	4400	.072					
46-	CONROD	4528	4465	4467	4400	.150					
47-	CONROD	4529	4467	4469	4400	.072					
48-	CORD2R	4412	0	166.5	.0	75.0	181.0	.0	87.5	EC4412	
49-	EC4412	200.0	0.0	75.0							
50-	CORD2R	4413	0	166.5	-2.0	75.0	166.5	-0.84	87.5	EC4413	

SORTED BULK DATA ECHO

CARD	1	2	3	4	5	6	7	8	9	10
51- EC4413	200.0	-2.0	75.0							
52- CORD2K	4416	0	176.1253.0	75.0	183.3422.0	87.5	EC4416			
53- EC4416	200.0	0.0	75.0							
54- CORD2K	4420	0	182.3663.0	75.0	186.8	.0	87.5	EC4420		
55- EC4420	200.0	0.0	75.0							
56- CQDMEM2	4401	4401	4401	4403	4413	4411	0.0			
57- CQDMEM2	4402	4401	4403	4405	4415	4413	0.0			
58- CQDMEM2	4403	4401	4405	4407	4417	4415	0.0			
59- CQDMEM2	4404	4401	4407	4409	4419	4417	0.0			
60- CQDMEM2	4405	4401	4411	4413	4423	4421	0.0			
61- CQDMEM2	4406	4401	4413	4415	4425	4423	0.0			
62- CQDMEM2	4407	4401	4415	4417	4427	4425	0.0			
63- CQDMEM2	4408	4401	4417	4419	4429	4427	0.0			
64- CQDMEM2	4409	4401	4421	4423	4433	4431	0.0			
65- CQDMEM2	4410	4401	4423	4425	4435	4433	0.0			
66- CQDMEM2	4411	4401	4425	4427	4437	4435	0.0			
67- CQDMEM2	4412	4401	4427	4429	4439	4437	0.0			
68- CQDMEM2	4413	4401	4431	4433	4443	4441	0.0			
69- CQDMEM2	4414	4401	4433	4435	4445	4443	0.0			
70- CQDMEM2	4415	4401	4435	4437	4447	4445	0.0			
71- CQDMEM2	4416	4401	4437	4439	4449	4447	0.0			
72- CQDMEM2	4417	4401	4441	4443	4453	4451	0.0			
73- CQDMEM2	4418	4401	4443	4445	4455	4453	0.0			
74- CQDMEM2	4419	4401	4445	4447	4457	4455	0.0			
75- CQDMEM2	4420	4401	4447	4449	4459	4457	0.0			
76- CQDMEM2	4421	4401	4451	4453	4463	4461	0.0			
77- CQDMEM2	4422	4401	4453	4455	4465	4463	0.0			
78- CQDMEM2	4423	4401	4455	4457	4467	4465	0.0			
79- CQDMEM2	4424	4401	4457	4459	4469	4467	0.0			
80- CRUD	4461	4461	4401	4403						
81- CRUD	4463	4461	4403	4405						
82- CRUD	4465	4461	4405	4407						
83- CRUD	4467	4461	4407	4409						
84- CRUD	4469	4461	4401	4402						
85- CRUD	4470	4461	4405	4406						
86- CRUD	4471	4461	4409	4410						
87- CRUD	4472	4472	4411	4412						
88- CRUD	4473	4472	4421	4422						
89- CRUD	4474	4472	4431	4432						
90- CRUD	4475	4472	4441	4442						
91- CRUD	4476	4472	4451	4452						
92- CRUD	4477	4472	4415	4416						
93- CRUD	4478	4472	4425	4426						
94- CRUD	4479	4472	4435	4436						
95- CRUD	4480	4472	4445	4446						
96- CRUD	4481	4472	4455	4456						
97- CRUD	4482	4472	4419	4420						
98- CRUD	4483	4472	4429	4430						
99- CRUD	4484	4472	4439	4440						
100- CRUD	4485	4472	4449	4450						

SORTED BULK DATA ECHO

CARD	COUNT	1	2	3	4	5	6	7	8	9	10
101-	CRGD	4485	4472	4459	4460						
102-	CRGD	4487	4487	4461	4462						
103-	CRGD	4488	4487	4465	4466						
104-	CRGD	4489	4487	4469	4470						
105-	CSHEAR	4431	4431	4401	4402	4404	4403				
106-	CSHEAR	4432	4431	4403	4404	4406	4405				
107-	CSHEAR	4433	4431	4405	4406	4408	4407				
108-	CSHEAR	4434	4431	4407	4408	4410	4409				
109-	CSHEAR	4435	4435	4401	4402	4412	4411				
110-	CSHEAR	4436	4435	4411	4412	4422	4421				
111-	CSHEAR	4437	4435	4421	4422	4432	4431				
112-	CSHEAR	4438	4435	4431	4432	4442	4441				
113-	CSHEAR	4439	4435	4441	4442	4452	4451				
114-	CSHEAR	4440	4435	4451	4452	4462	4461				
115-	CSHEAR	4441	4435	4405	4406	4416	4415				
116-	CSHEAR	4442	4435	4415	4416	4426	4425				
117-	CSHEAR	4443	4435	4425	4426	4436	4435				
118-	CSHEAR	4444	4435	4435	4436	4446	4445				
119-	CSHEAR	4445	4435	4445	4446	4456	4455				
120-	CSHEAR	4446	4435	4455	4456	4466	4465				
121-	CSHEAR	4447	4435	4409	4410	4420	4419				
122-	CSHEAR	4448	4435	4419	4420	4430	4429				
123-	CSHEAR	4449	4435	4429	4430	4440	4439				
124-	CSHEAR	4450	4435	4439	4440	4450	4449				
125-	CSHEAR	4451	4435	4449	4450	4460	4459				
126-	CSHEAR	4452	4435	4459	4460	4470	4469				
127-	PIGR	1	GIV								
128-	EEIG1	MAX									
129-	GRID	4400	0	184.1	.0	88.5					
130-	GRID	4401	0	181.0	-0.84	87.5	0	456			
131-	GRID	4402	0	181.0	.0	87.5	0	456			
132-	GRID	4403	0	182.1711-0.84		87.5	0	456			
133-	GRID	4404	0	182.1711.0		87.5	0	456			
134-	GRID	4405	0	183.3422-0.84		87.5	0	456			
135-	GRID	4406	0	183.3422.0		87.5	0	456			
136-	GRID	4407	0	185.0711-0.84		87.5	0	456			
137-	GRID	4408	0	185.0711.0		87.5	0	456			
138-	GRID	4409	0	186.8	-0.84	87.5	0	456			
139-	GRID	4410	0	186.8	.0	87.5	0	456			
140-	GRID	4411	0	179.26	-0.9792	86.0	0	456			
141-	GRID	4412	0	179.26	.0	86.0	4412	456			
142-	GRID	4413	0	180.8006-0.9792		86.0	4413	456			
143-	GRID	4415	0	182.4762-0.9792		86.0	0	456			
144-	GRID	4416	0	182.4762.0		86.0	4416	456			
145-	GRID	4417	0	184.3721-0.9792		86.0	4413	456			
146-	GRID	4419	0	186.268	-0.9792	86.0	0	456			
147-	GRID	4420	0	186.268	.0	86.0	4420	456			
148-	GRID	4421	0	176.94	-1.1648	84.0	0	456			
149-	GRID	4422	0	176.94	.0	84.0	4412	456			
150-	GRID	4423	0	178.9732-1.1648		84.0	4413	456			

1.0-4 EEIG1

SORTED BULK DATA ECHO

CARD	COUNT	1	2	3	4	5	6	7	8	9	10
151- GRID	4425	0			181.3215-1.1648	84.0	0		456		
152- GRID	4426	0			161.3215.0	84.0	4416		456		
153- GRID	4427	0			183.4400-1.1648	84.0	4413		456		
154- GRID	4429	0			185.5586-1.1648	84.0	0		456		
155- GRID	4430	0			185.5586.0	84.0	4420		456		
156- GRID	4431	0			174.04 -1.3968	81.5	0		456		
157- GRID	4432	0			174.04 .0	81.5	4412		456		
158- GRID	4433	0			176.689 -1.3968	81.5	4413		456		
159- GRID	4435	0			179.8781-1.3968	81.5	0		456		
160- GRID	4436	0			179.8781.0	81.5	4416		456		
161- GRID	4437	0			182.275 -1.3968	81.5	4413		456		
162- GRID	4439	0			164.6718-1.3968	81.5	0		456		
163- GRID	4440	0			184.6718.0	81.5	4420		456		
164- GRID	4441	0			171.14 -1.6288	79.0	0		456		
165- GRID	4442	0			171.14 .0	79.0	4412		456		
166- GRID	4443	0			174.4048-1.6288	79.0	4413		456		
167- GRID	4445	0			178.4347-1.6288	79.0	0		456		
168- GRID	4446	0			178.4347.0	79.0	4416		456		
169- GRID	4447	0			181.1099-1.6288	79.0	4413		456		
170- GRID	4449	0			163.7851-1.6288	79.0	0		456		
171- GRID	4450	0			183.7851.0	79.0	4420		456		
172- GRID	4451	0			168.82 -1.8144	77.0	0		456		
173- GRID	4452	0			168.82 .0	77.0	4412		456		
174- GRID	4453	0			172.5774-1.8144	77.0	4413		456		
175- GRID	4455	0			177.28 -1.8144	77.0	0		456		
176- GRID	4456	0			177.28 .0	77.0	4416		456		
177- GRID	4457	0			180.1778-1.8144	77.0	4413		456		
178- GRID	4459	0			183.0757-1.8144	77.0	0		456		
179- GRID	4460	0			183.0757.0	77.0	4420		456		
180- GRID	4461	0			166.5 -2.0	75.0	0		456		
181- GRID	4462	0			166.5 .0	75.0	4412		456		
182- GRID	4463	0			170.75 -2.0	75.0	4413		456		
183- GRID	4465	0			176.1253-2.0	75.0	0		456		
184- GRID	4466	0			176.1253.0	75.0	4416		456		
185- GRID	4467	0			179.2458-2.0	75.0	4413		456		
186- GRID	4469	0			182.3663-2.0	75.0	0		456		
187- GRID	4470	0			182.3663.0	75.0	4420		456		
188- MAT1	4400	10.566			.3	.1					
189- MAT1	4401	10.566			.3	.0					
190- MPC	4449	4412	1		1.0	4411	1		-.652940		EMC4412A
191- EMC4412A		4411	3		.75741						
192- MPC	4449	4416	1		1.0	4415	1		-.866025		EMC4416A
193- EMC4416A		4415	3		.50						
194- MPC	4449	4420	1		1.0	4419	1		-.942470		EMC4420A
195- EMC4420A		4419	3		.33429						
196- MPC	4449	4422	1		1.0	4421	1		-.652940		EMC4422A
197- EMC4422A		4421	3		.75741						
198- MPC	4449	4426	1		1.0	4425	1		-.866025		EMC4426A
199- EMC4426A		4425	3		.50						
200- MPC	4449	4430	1		1.0	4429	1		-.942470		EMC4430A

SORTED BULK DATA ECHO

CARD

CARD	COUNT	1	2	3	4	5	6	7	8	9	10
201-	EMC4430A		4429	3	.33429						
202-	MPC	4449	4432	1	1.0	4431	1		-.652940		EMC4432A
203-	EMC4432A		4431	3	.75741						
204-	MPC	4449	4436	1	1.0	4435	1		-.866025		EMC4436A
205-	EMC4436A		4435	3	.50						
206-	MPC	4449	4440	1	1.0	4439	1		-.942470		EMC4440A
207-	EMC4440A		4439	3	.33429						
208-	MPC	4449	4442	1	1.0	4441	1		-.652940		EMC4442A
209-	EMC4442A		4441	3	.75741						
210-	MPC	4449	4446	1	1.0	4445	1		-.866025		EMC4446A
211-	EMC4446A		4445	3	.50						
212-	MPC	4449	4450	1	1.0	4449	1		-.942470		EMC4450A
213-	EMC4450A		4449	3	.33429						
214-	MPC	4449	4452	1	1.0	4451	1		-.652940		EMC4452A
215-	EMC4452A		4451	3	.75741						
216-	MPC	4449	4456	1	1.0	4455	1		-.866025		EMC4456A
217-	EMC4456A		4455	3	.50						
218-	MPC	4449	4460	1	1.0	4459	1		-.942470		EMC4460A
219-	EMC4460A		4459	3	.33429						
220-	MPC	4449	4462	1	1.0	4461	1		-.652940		EMC4462A
221-	EMC4462A		4461	3	.75741						
222-	MPC	4449	4466	1	1.0	4465	1		-.866025		EMC4466A
223-	EMC4466A		4465	3	.50						
224-	MPC	4449	4470	1	1.0	4469	1		-.942470		EMC4470A
225-	EMC4470A		4469	3	.33429						
226-	MPC	4450	4401	1	1.0	4400	1		-1.0		EMC4401X
227-	EMC4401X		4400	5	1.0	4400	6		-0.84		
228-	MPC	4450	4401	2	1.0	4400	2		-1.0		EMC4401Y
229-	EMC4401Y		4400	4	-1.0	4400	6		3.1		
230-	MPC	4450	4401	3	1.0	4400	3		-1.0		EMC4401Z
231-	EMC4401Z		4400	4	.84	4400	5		-3.1		
232-	MPC	4450	4402	1	1.0	4400	1		-1.0		EMC4402X
233-	EMC4402X		4400	5	1.0	4400	6		0.0		
234-	MPC	4450	4402	2	1.0	4400	2		-1.0		EMC4402Y
235-	EMC4402Y		4400	4	-1.0	4400	6		3.1		
236-	MPC	4450	4402	3	1.0	4400	3		-1.0		EMC4402Z
237-	EMC4402Z		4400	4	.00	4400	5		-3.1		
238-	MPC	4450	4403	1	1.0	4400	1		-1.0		EMC4403X
239-	EMC4403X		4400	5	1.0	4400	6		-0.84		
240-	MPC	4450	4403	2	1.0	4400	2		-1.0		EMC4403Y
241-	EMC4403Y		4400	4	-1.0	4400	6		1.9289		
242-	MPC	4450	4403	3	1.0	4400	3		-1.0		EMC4403Z
243-	EMC4403Z		4400	4	.84	4400	5		-1.9289		
244-	MPC	4450	4404	1	1.0	4400	1		-1.0		EMC4404X
245-	EMC4404X		4400	5	1.0	4400	6		0.0		
246-	MPC	4450	4404	2	1.0	4400	2		-1.0		EMC4404Y
247-	EMC4404Y		4400	4	-1.0	4400	6		1.9289		
248-	MPC	4450	4404	3	1.0	4400	3		-1.0		EMC4404Z
249-	EMC4404Z		4400	4	.00	4400	5		-1.9289		
250-	MPC	4450	4405	1	1.0	4400	1		-1.0		EMC4405X

S O R T E D B U L K D A T A E C H O

CARD

COUNT	1	2	3	4	5	6	7	8	9	10
251-	EMC4405X		4400	5	1.0	4400	6	-0.84		
252-	MPC	4450	4405	2	1.0	4400	2	-1.0		EMC4405Y
253-	EMC4405Y		4400	4	-1.0	4400	6	0.7578		
254-	MPC	4450	4405	3	1.0	4400	3	-1.0		EMC4405Z
255-	EMC4405Z		4400	4	.84	4400	5	-0.7578		
256-	MPC	4450	4406	1	1.0	4400	1	-1.0		EMC4406X
257-	EMC4406X		4400	5	1.0	4400	6	0.0		
258-	MPC	4450	4406	2	1.0	4400	2	-1.0		EMC4406Y
259-	EMC4406Y		4400	4	-1.0	4400	6	0.7578		
260-	MPC	4450	4406	3	1.0	4400	3	-1.0		EMC4406Z
261-	EMC4406Z		4400	4	.00	4400	5	-0.7578		
262-	MPC	4450	4407	1	1.0	4400	1	-1.0		EMC4407X
263-	EMC4407X		4400	5	1.0	4400	6	-0.84		
264-	MPC	4450	4407	2	1.0	4400	2	-1.0		EMC4407Y
265-	EMC4407Y		4400	4	-1.0	4400	6	-.9711		
266-	MPC	4450	4407	3	1.0	4400	3	-1.0		EMC4407Z
267-	EMC4407Z		4400	4	.84	4400	5	0.9711		
268-	MPC	4450	4408	1	1.0	4400	1	-1.0		EMC4408X
269-	EMC4408X		4400	5	1.0	4400	6	0.0		
270-	MPC	4450	4408	2	1.0	4400	2	-1.0		EMC4408Y
271-	EMC4408Y		4400	4	-1.0	4400	6	-.9711		
272-	MPC	4450	4408	3	1.0	4400	3	-1.0		EMC4408Z
273-	EMC4408Z		4400	4	.00	4400	5	0.9711		
274-	MPC	4450	4409	1	1.0	4400	1	-1.0		EMC4409X
275-	EMC4409X		4400	5	1.0	4400	6	-0.84		
276-	MPC	4450	4409	2	1.0	4400	2	-1.0		EMC4409Y
277-	EMC4409Y		4400	4	-1.0	4400	6	-2.7000		
278-	MPC	4450	4409	3	1.0	4400	3	-1.0		EMC4409Z
279-	EMC4409Z		4400	4	.84	4400	5	2.7		
280-	MPC	4450	4410	1	1.0	4400	1	-1.0		EMC4410X
281-	EMC4410X		4400	5	1.0	4400	6	0.0		
282-	MPC	4450	4410	2	1.0	4400	2	-1.0		EMC4410Y
283-	EMC4410Y		4400	4	-1.0	4400	6	-2.7000		
284-	MPC	4450	4410	3	1.0	4400	3	-1.0		EMC4410Z
285-	EMC4410Z		4400	4	.00	4400	5	2.7		
286-	MPC	4450	4411	2	3.2162	4411	2	-1.66843		EMC4411A
287-	EMC4411A		4411	3	.15483	4415	2	-1.53430		EMC4411B
288-	EMC4411B		4415	3	.142356					
289-	MPC	4450	4417	2	1.0	4415	2	-.497861		EMC4417A
290-	EMC4417A		4415	3	.046201	4419	2	-.497861		EMC4417B
291-	EMC4417B		4419	3	.046201					
292-	MPC	4450	4423	2	4.3815	4421	2	-2.33825		EMC4423A
293-	EMC4423A		4421	3	.21699	4425	2	-2.02450		EMC4423B
294-	EMC4423B		4425	3	.187874					
295-	MPC	4450	4427	2	1.0	4425	2	-.497861		EMC4427A
296-	EMC4427A		4425	3	.046201	4429	2	-.497861		EMC4427B
297-	EMC4427B		4429	3	.046201					
298-	MPC	4450	4433	2	5.8381	4431	2	-3.17546		EMC4433A
299-	EMC4433A		4431	3	.294682	4435	2	-2.63767		EMC4433B
300-	EMC4433B		4435	3	.244775					

SORTED BULK DATA ECHO

CARD	COUNT	1	2	3	4	5	6	7	8	9	10
301- MPC	4450	4437	2	1.0	4435	2	-0.497861		EMC4437A		
302- EMC4437A		4435	3	.046201	4439	2	-0.497861		EMC4437B		
303- EMC4437B		4439	3	.046201							
304- MPC	4450	4443	2	7.2947	4441	2	-4.01266		EMC4443A		
305- EMC4443A		4441	3	.372375	4445	2	-3.25083		EMC4443B		
306- EMC4443B		4445	3	.301677							
307- MPC	4450	4447	2	1.0	4445	2	-0.497861		EMC4447A		
308- EMC4447A		4445	3	.046201	4449	2	-0.497861		EMC4447B		
309- EMC4447B		4449	3	.046201							
310- MPC	4450	4453	2	8.46	4451	2	-4.68248		EMC4453A		
311- EMC4453A		4451	3	.434534	4455	2	-3.74133		EMC4453B		
312- EMC4453B		4455	3	.347195							
313- MPC	4450	4457	2	1.0	4455	2	-0.497861		EMC4457A		
314- EMC4457A		4455	3	.046201	4459	2	-0.497861		EMC4457B		
315- EMC4457B		4459	3	.046201							
316- MPC	4450	4463	2	9.6253	4461	2	-5.35230		EMC4463A		
317- EMC4463A		4461	3	.496694	4465	2	-4.23182		EMC4463B		
318- EMC4463B		4465	3	.392713							
319- MPC	4450	4467	2	1.0	4465	2	-0.497861		EMC4467A		
320- EMC4467A		4465	3	.046201	4469	2	-0.497861		EMC4467B		
321- EMC4467B		4469	3	.046201							
322- MPCADD	4451	4449	4450								
323- PARAM	GRDPNT	0									
324- PARAM	NOSUB	-1									
325- PARAM	RNODE	1									
326- PARAM	TPCOPY	1									
327- PARAM	TPNAME	FINSPI									
328- PARAM	WTMASS	.002588									
329- PQDMEM2	4401	4400	.02	.0							
330- PROD	4461	4400	.034	.0	.0	.0					
331- PRUD	4472	4401	.034	.0	.0	.0					
332- PROD	4487	4400	.064	.0	.0	.0					
333- PSHEAR	4431	4400	.04	.0							
334- PSHEAR	4435	4400	.032	.0							
335- SPC	4401	4400	246								
336- SPC	4402	4400	135								
337- SPC1	4401	2	4412	4416	4420	4422	4426	4430	ESPS1		
338- ESPS1	4432	4436	4440	4442	4446	4450	4452	4456	ESPS2		
339- ESPS2	4460	4462	4466	4470							
340- SPC1	4402	13	4412	4416	4420	4422	4426	4430	ESPA1		
341- ESPA1	4432	4436	4440	4442	4446	4450	4452	4456	ESPA2		
342- ESPA2	4460	4462	4466	4470							
343- SUPORT	4461	123	4465	123	4469	123					
ENDDATA											

CASE CONTROL DECK ECHO 1

CARD
COUNT

1	TITLE # PHASE 1 XANTI CASE-FIND
2	SUBTITLE # REVISED INTERFACE PTS. 4/25/74
3	ECHO # BOTH
4	MPC # 4450
5	SPC # 4402
6	METHOD # 1
7	BEGIN BULK

INPUT BULK DATA DECK ECHO

```

. 1 .. 2 .. 3 .. 4 .. 5 .. 6 .. 7 .. 8 .. 9 .. 10 .
$ CONVERT REVISED SYMM FIN TO REVISED ANTI FIN
/
/      4
/      327
ASET1  246  4400
PARAM  TPNAME  FINAPI
ENDDATA
```

TOTAL COUNT# 6

Appendix A19
PLOTS OF MEMBER DATA/PHASE 1 ANALYSIS: MODEL II FIN

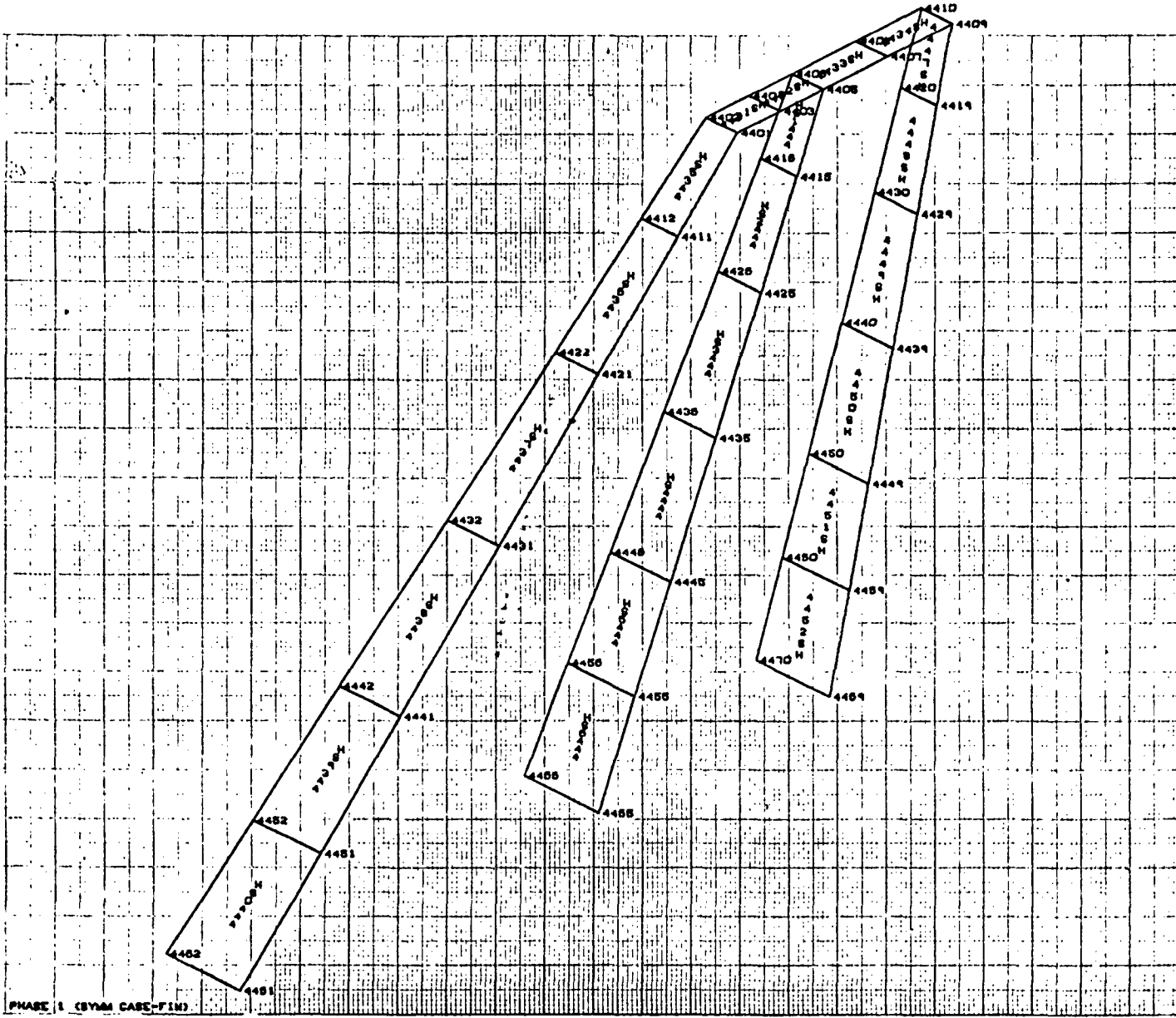

PHASE 1 (SYMM CASE-FIN)

UNDEFORMED SHAPE

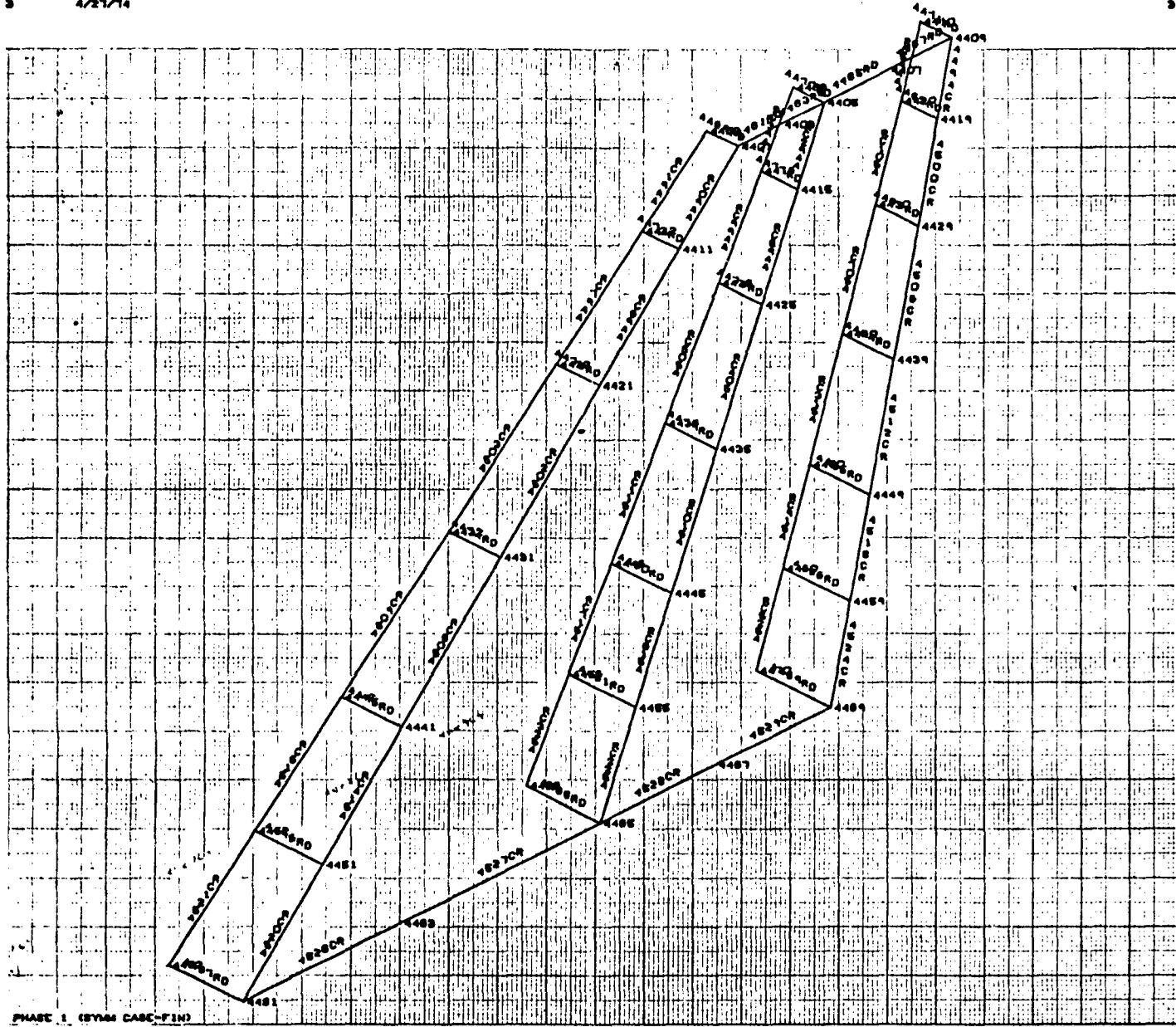

PHASE 1 (SYN CASE-FIN)

UNIFORMED SHAPE

Appendix A20
PLOTS OF SYMMETRIC AND ANTISYMMETRIC
MODES/PHASE 1 ANALYSIS: MODEL II FIN

4/27/74 MAX-DEF. = 1.723E-006

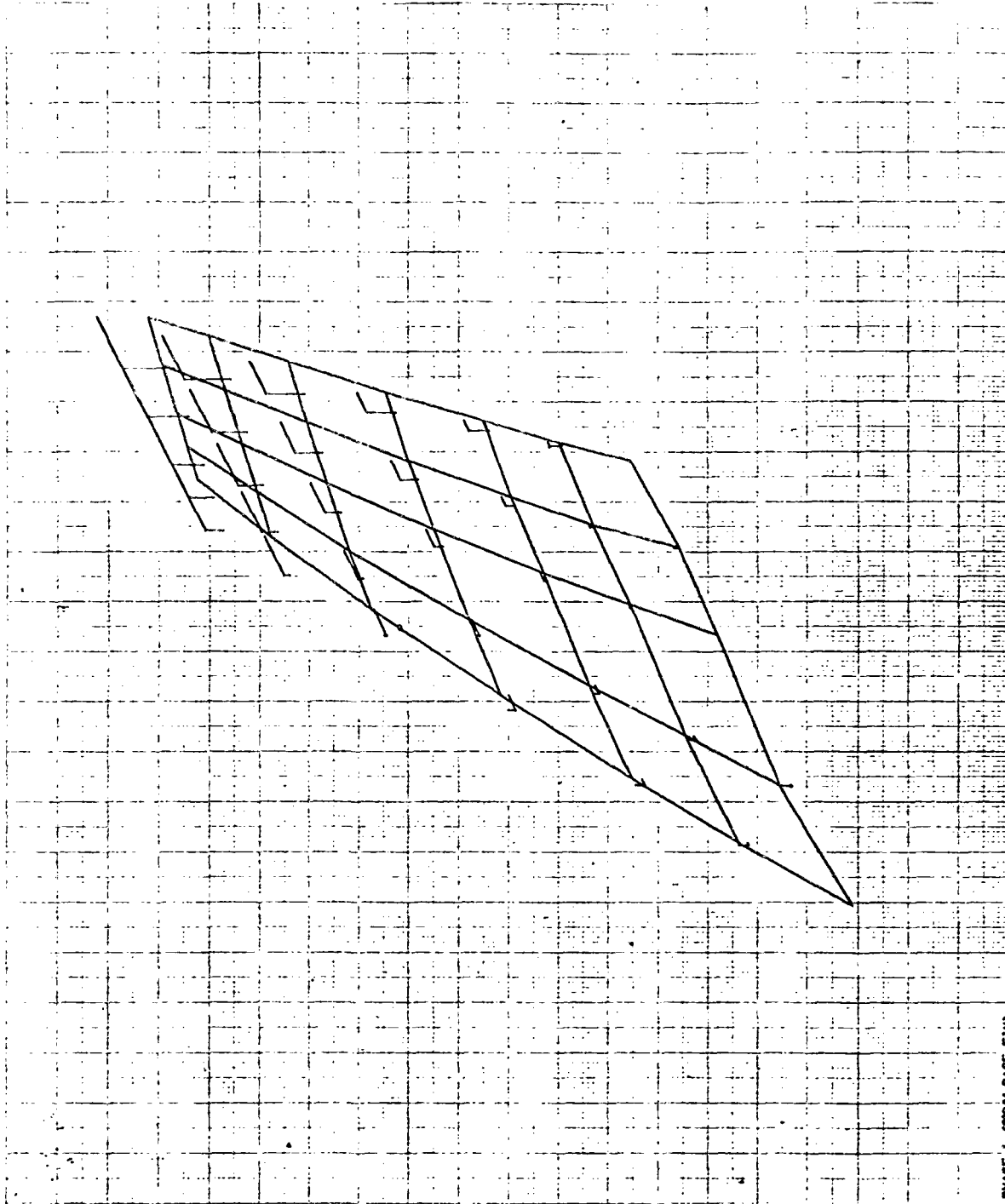

PHASE 1 (FROM CASE-FIN)
REVISED INTERFACE P/B. 4/28/74
FREE MODES FIXED AT INTERFACE
MODAL DEFOR. SUBCASE 1 MODE 1 FREQ. 281.5714

4/21/74 MAX-DEF. = 1.0000000

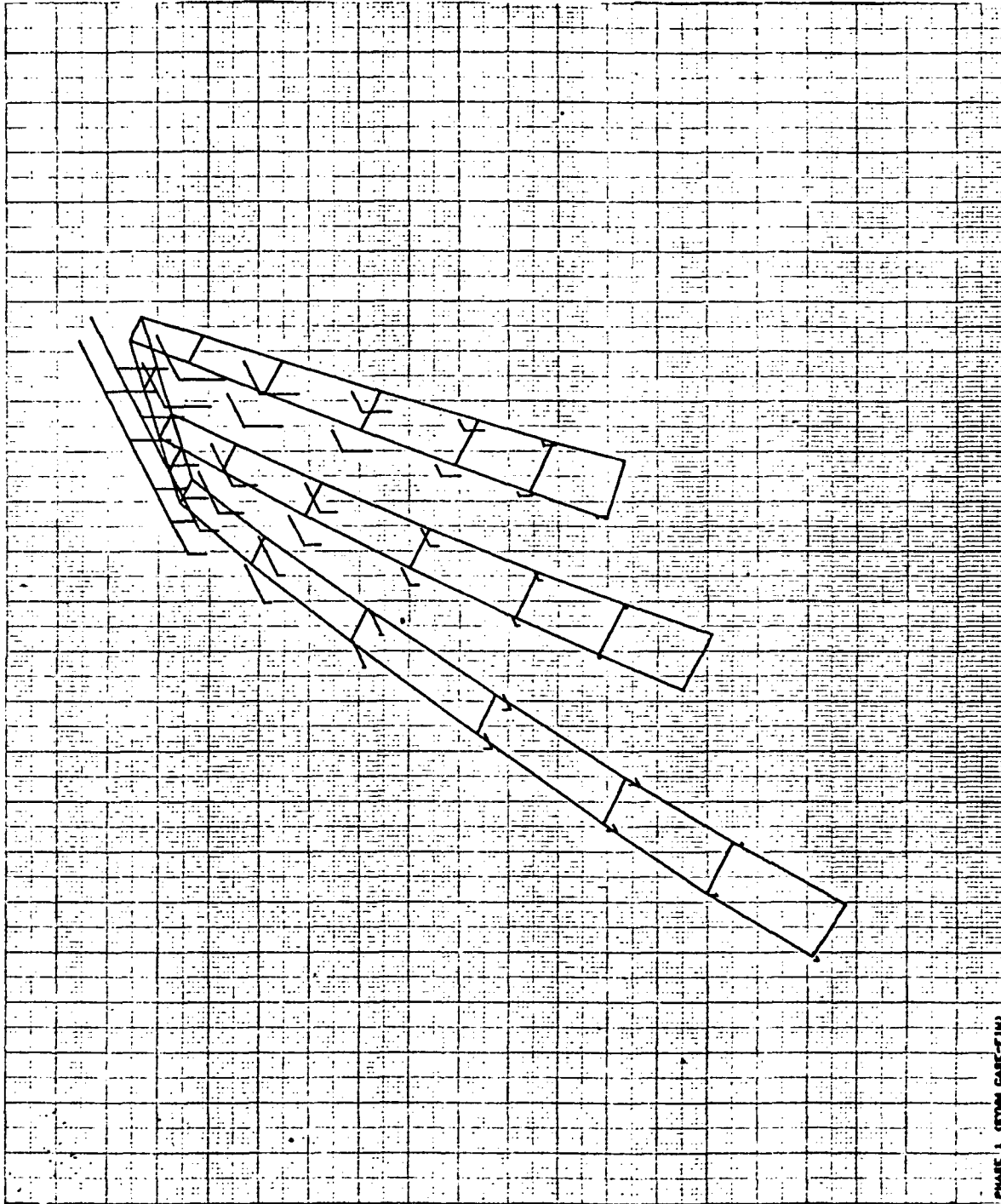

PHASE 1 (FROM CASE-FIN)
REVISED INTERFACE PTS. 4/28/74
FREE NODES FIXED AT INTERFACE
MEDIAL DETOR. SUBCASE 1 MODE 1 FREQ. 281.2719

4/28/74 MAX-DE . . . 1.0000000

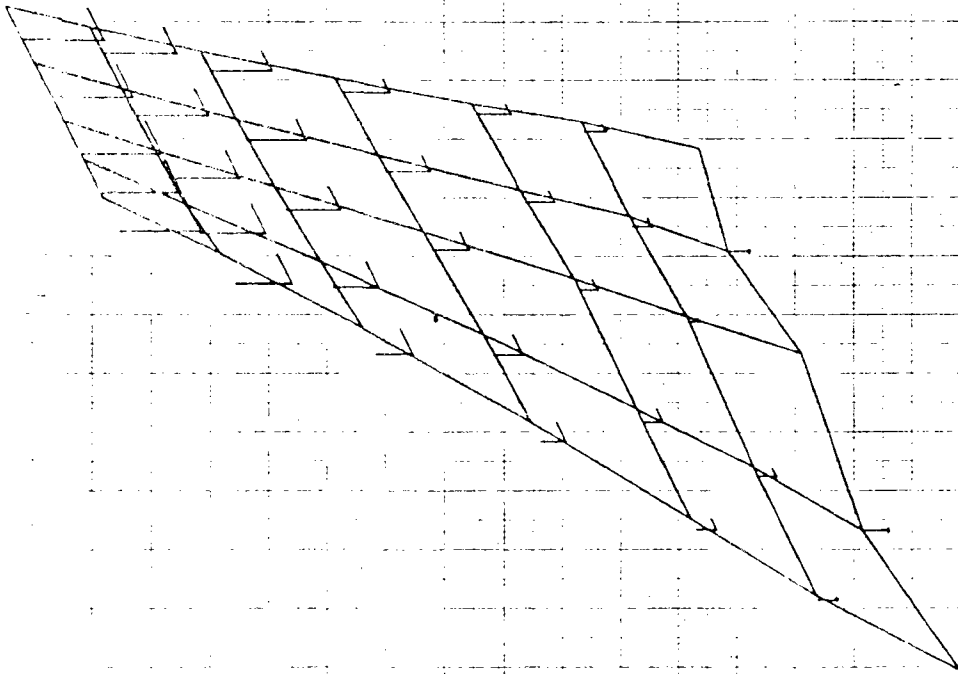

PHASE 1 (SYM CASE-FIN)
REVISED INTERFACE P/B. 4/28/74
FREE MODES FIXED AT INTERFACE
MODAL DEFOR. SUBCASE 2 MODE 2 FREQ. 892.2824

4/23/74 MAX-DCT. • 1.0008330

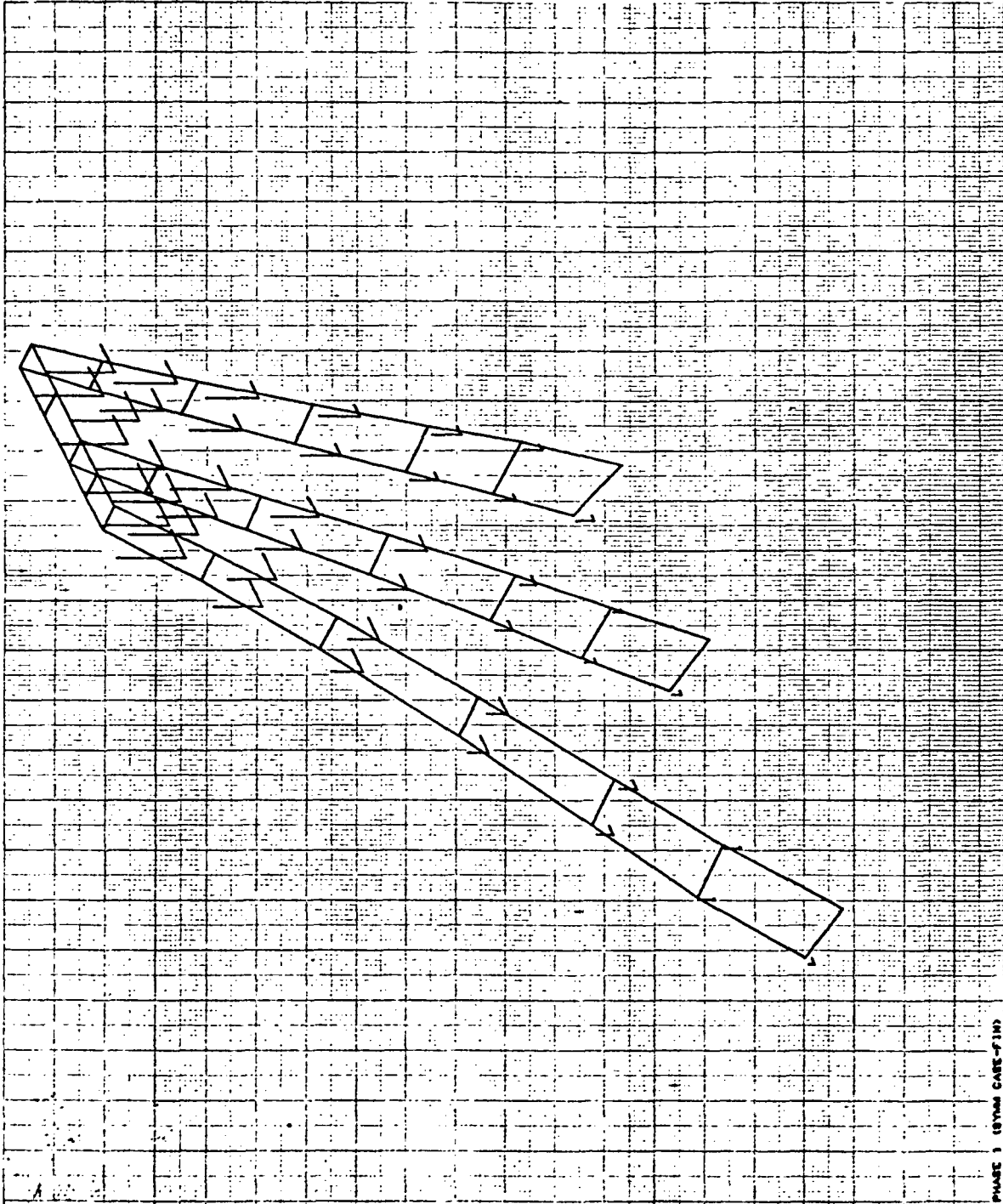

PHASE 3 (BYNAM CASE-F18)
REVISED INTERFACE PTS. 4/26/74
FREE MODES FIXED AT INTERFACE
MODAL ORDER, SUBCASE 2 MODE 2 FREQ. 883.3624

6 6/27/71 MOD-DLG.

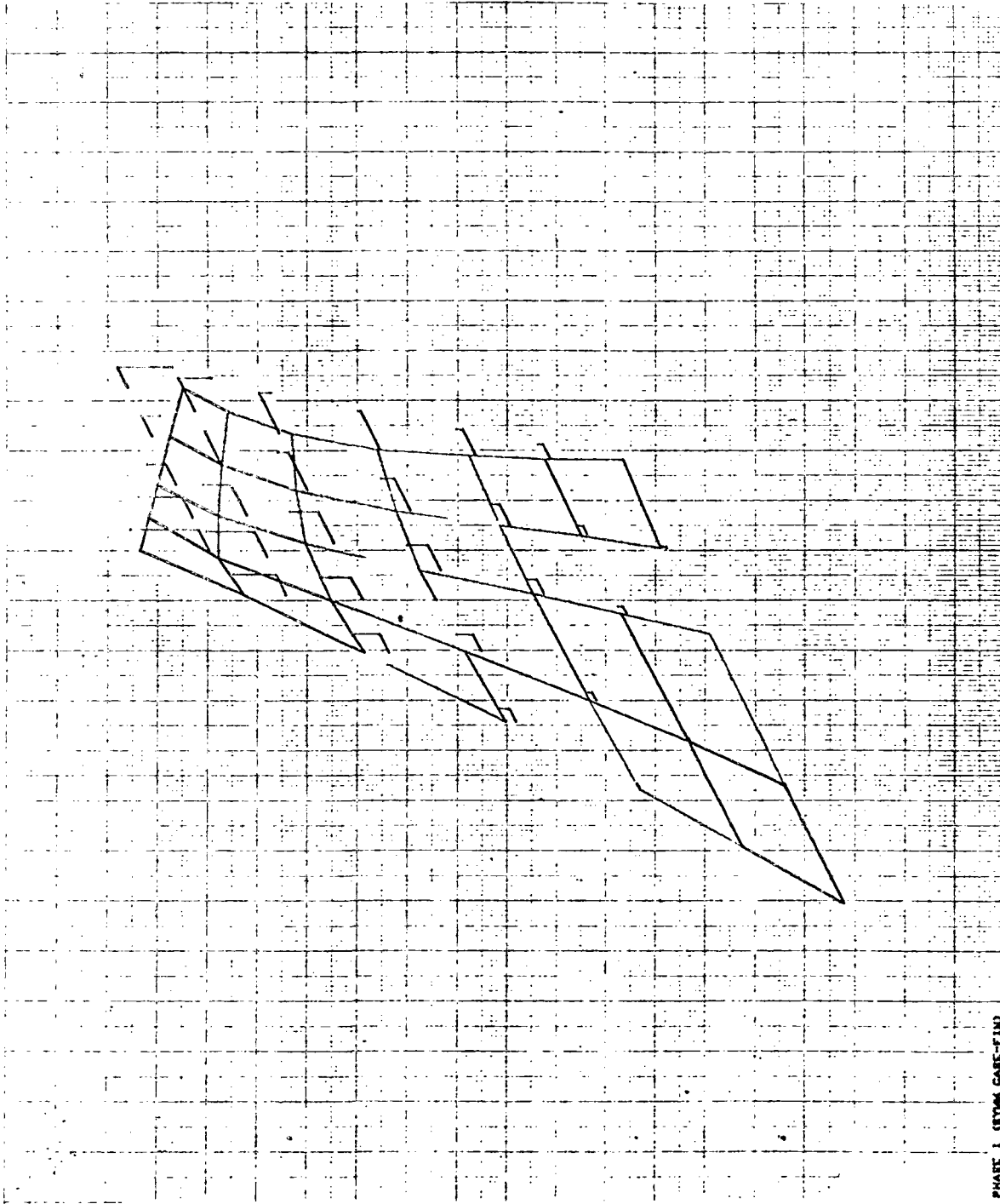

PHASE 1 (BYM CASE-FIN)
REVISED INTERFACE PTS. 4/28/74
FREE BODYS FIXED AT INTERFACE
MODAL DEFOR. SUBCASE 3 MODE 3 FREQ. 1264.421

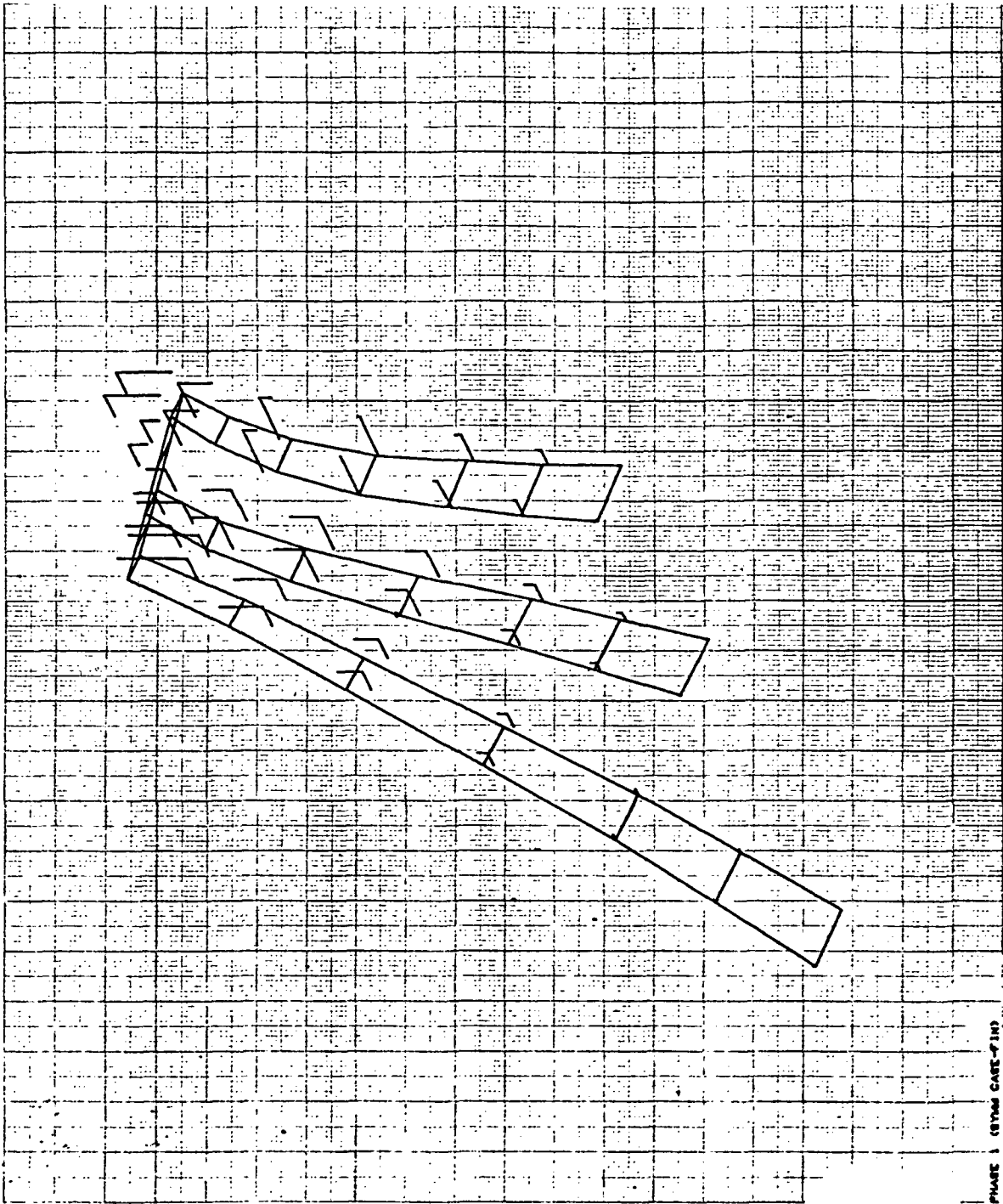

PHASE 1 (STAGE CASE-1IN)
REVISED INTERFACE PTS. 4/26/74
FACE MODES FIXED AT INTERFACE
MEDIAL DCTOR. SUBCASE 9 MODE 9 FREQ. 12891.421

4/25/74 MAX-UL: 1.0000000000

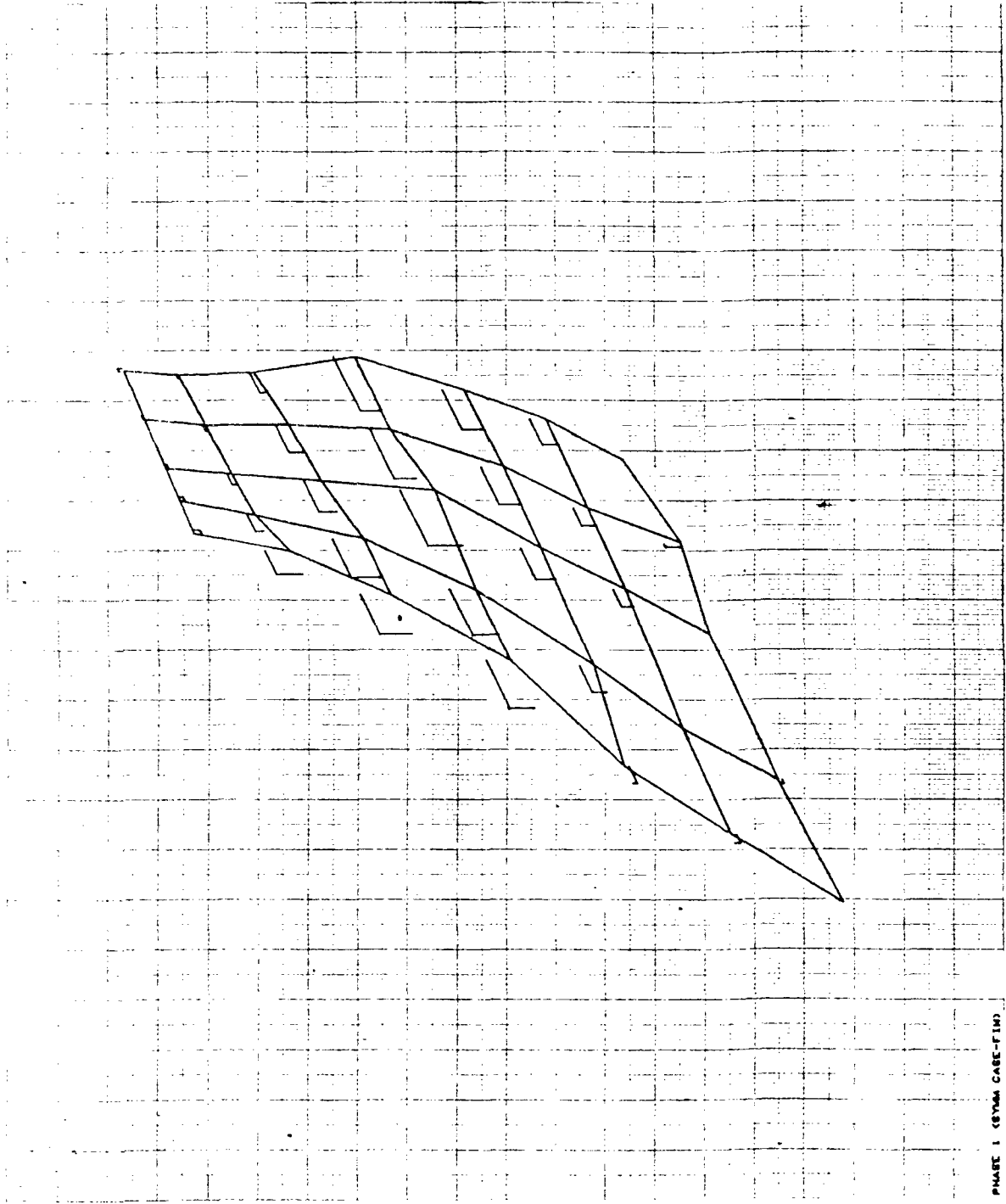

PHASE 1 (SYMM CASE-FIN)
REVISED INTERFACE PTS. 4/25/74
FREE MODES FIXED AT INTERFACE
MODAL DEFOR. SUBCASE 4 MODE 4 FREQ. 3348.740

4/27/74 MAX-DEF. = 1.0000000

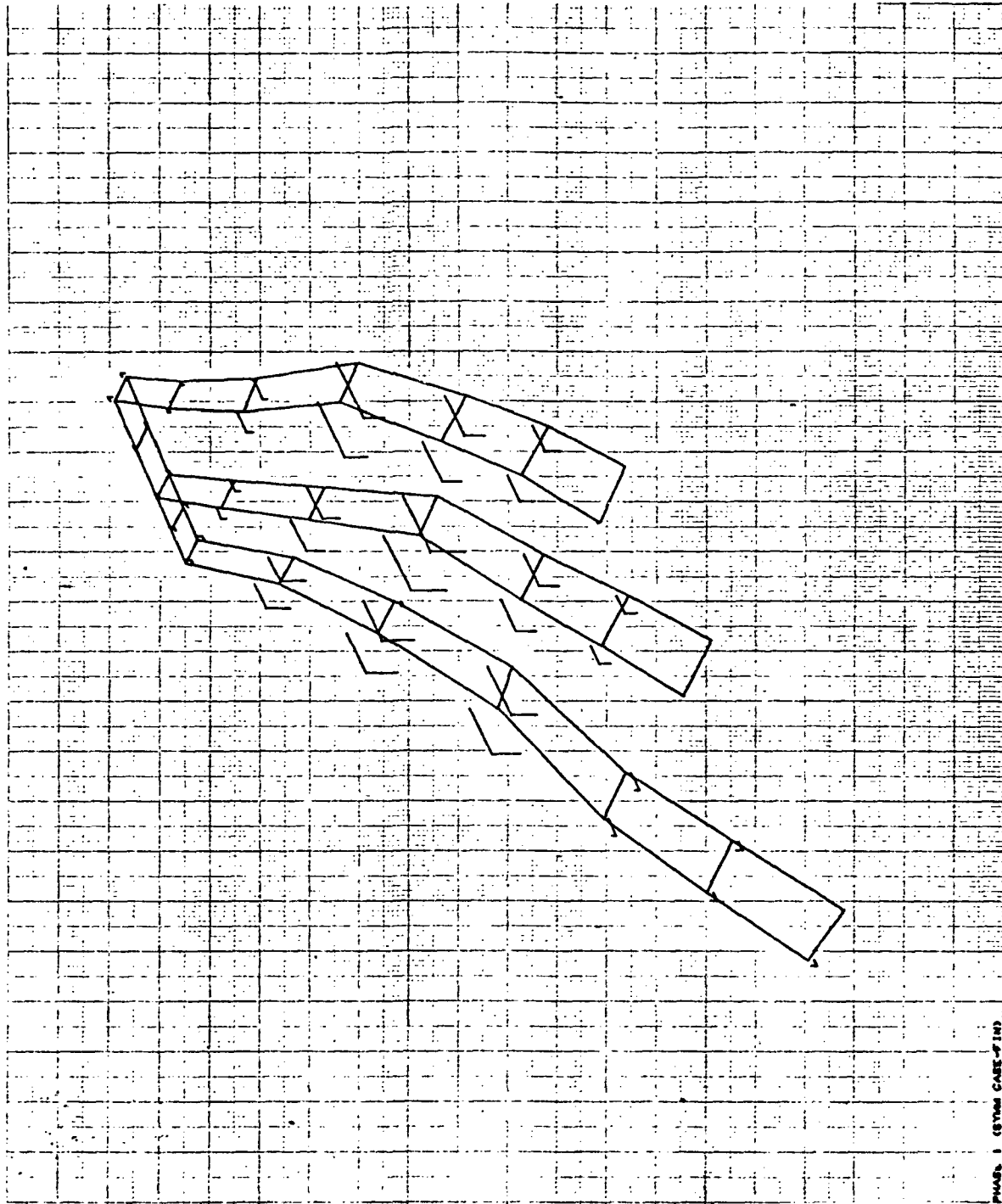

PHASE 1 (SYM CASE-FIN)
REVISED INTERFACE PTE. 4/28/74
FREE MODES FIXED AT INTERFACE
MODAL DEFOR. SUBCASE 4 MODE 4 FREQ. 3348.740

MANEVO 10/1/74

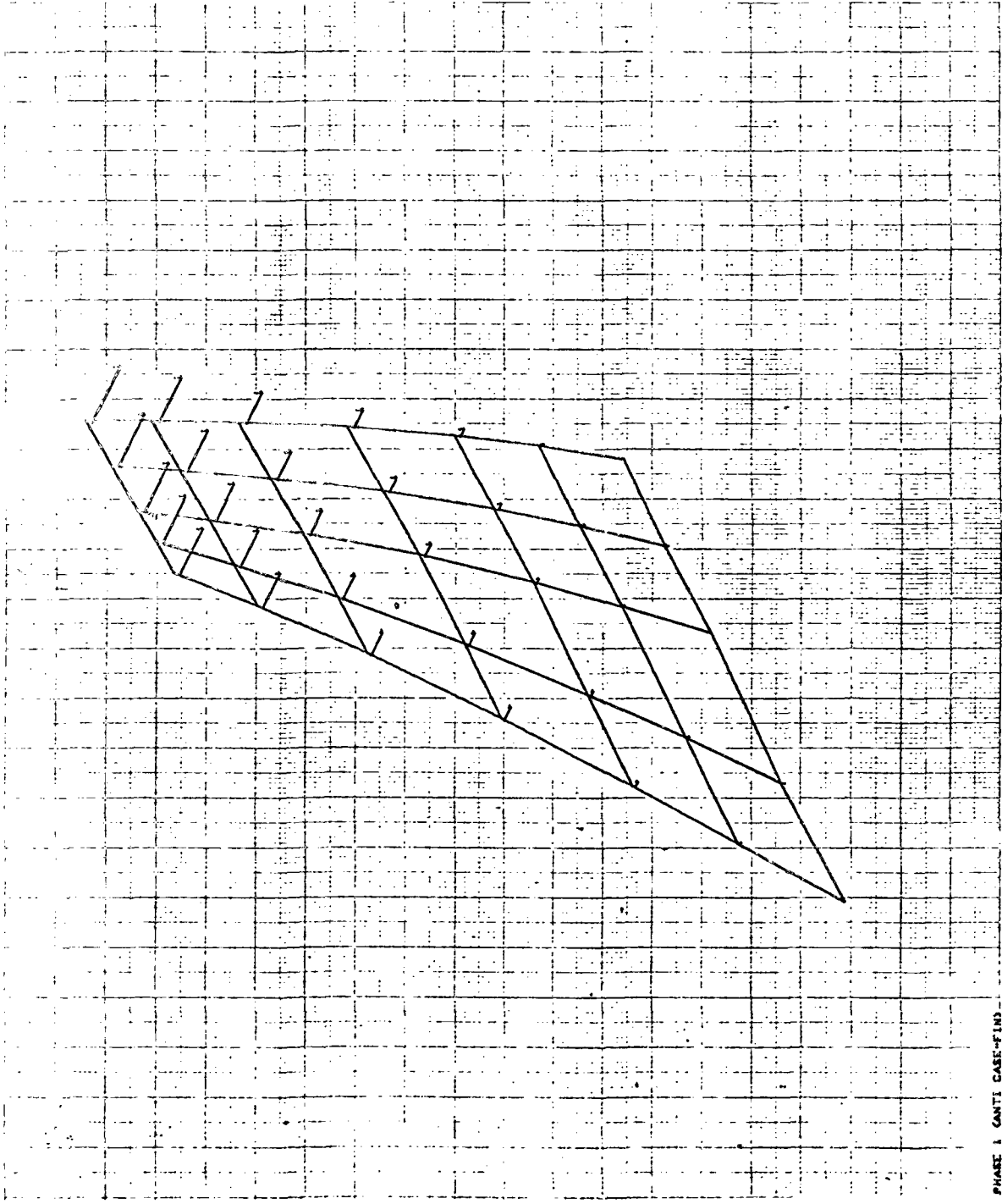

PHASE 1 GANTI CASE-FIN)
REVISED INTERFACE PTS. 4/28/74
FREE MOORS FIXED AT INTERFACE
MEDAL DOSTOR. SUBCASE 1 MODE 1 FREQ. 137.5640

4/20/74 MAX-REF. 1.0000000

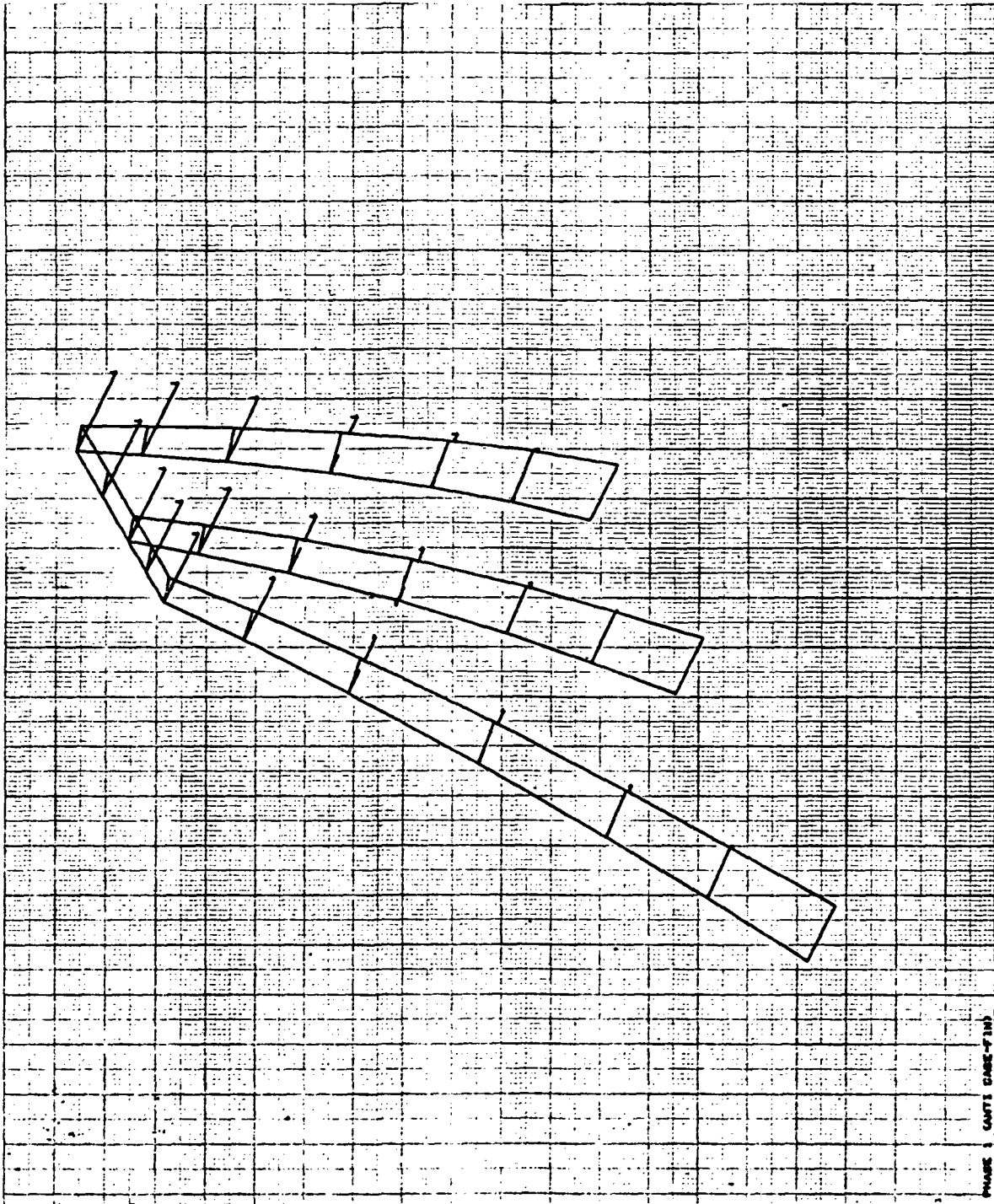

PHASE 1 GWT'S CASE-FIN)
REVISED INTERFACE PTS. 4/25/74
FREE HOLES FINED AT INTERFACE
NORMAL VECTOR. SURFACE 1 HOLES 1 FREQ. 137.9840

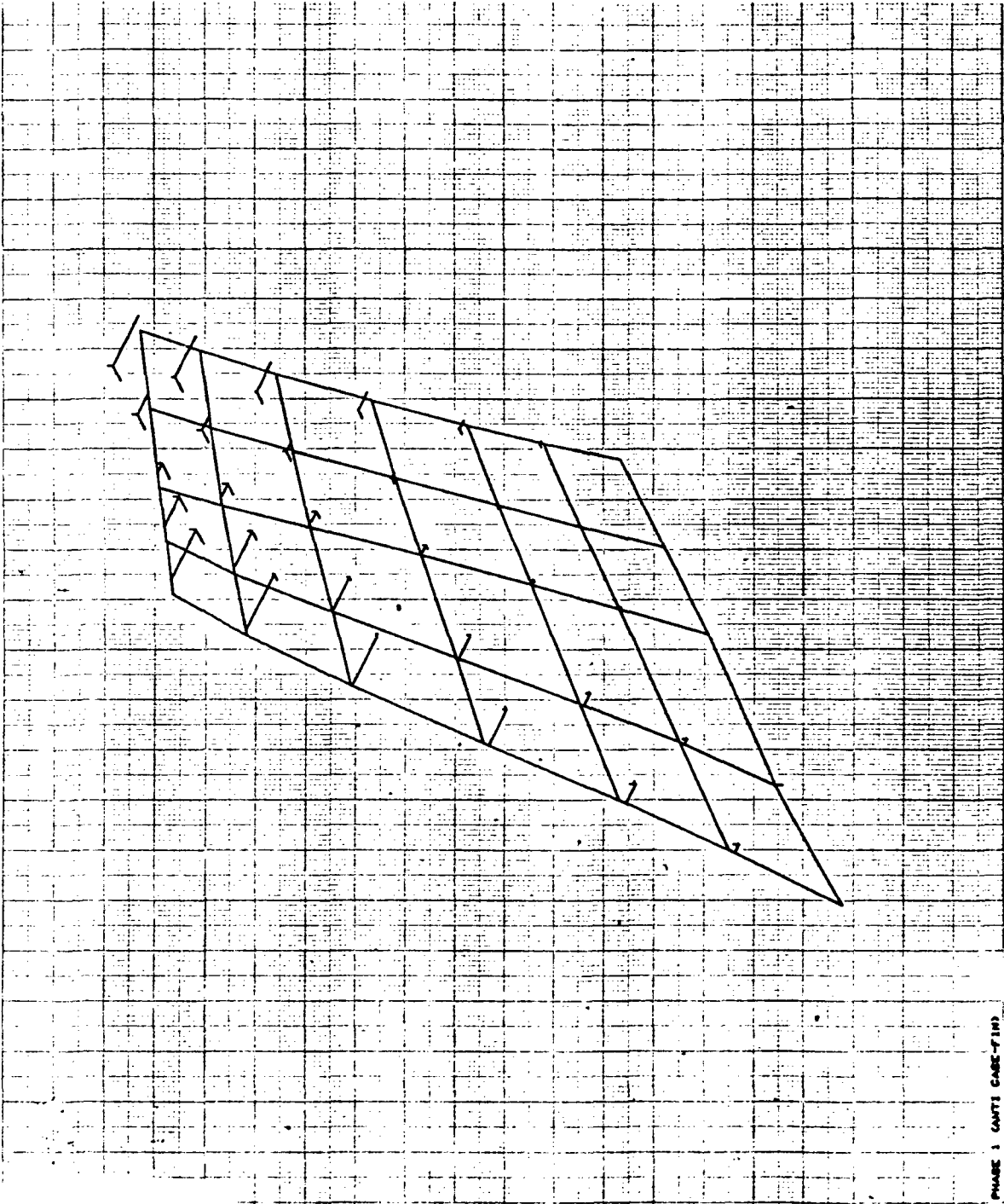

PHASE 1 (ANTI CASE-FIN)
REVISED INTERFACE PTS. 4/28/74
FREE MODES PLOTTED AT INTERFACE
MEDIAL DOTOR. SUBCASE 2 MODE 2 FREQ. 488.7713

4/30/74 MAX-DEF. = 1.53820760

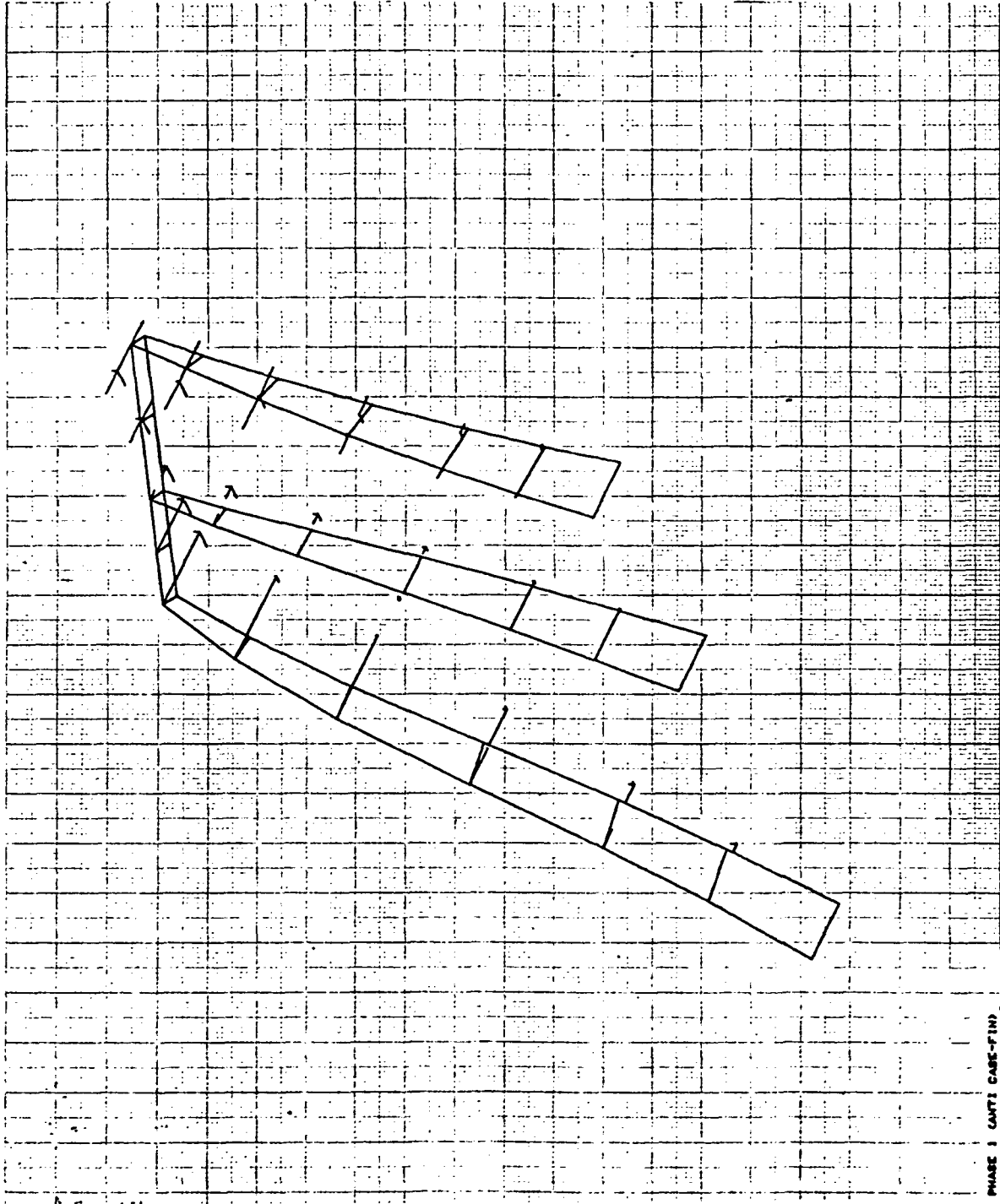

PHASE 3 (ANT? CASE-FIN)
REVISED INTERFACE PTR. 4/28/74
FREE NODES FIXED AT INTERFACE
MODAL DEFOR. SUBCASE 3 MODE 2 FREQ. 462.7713

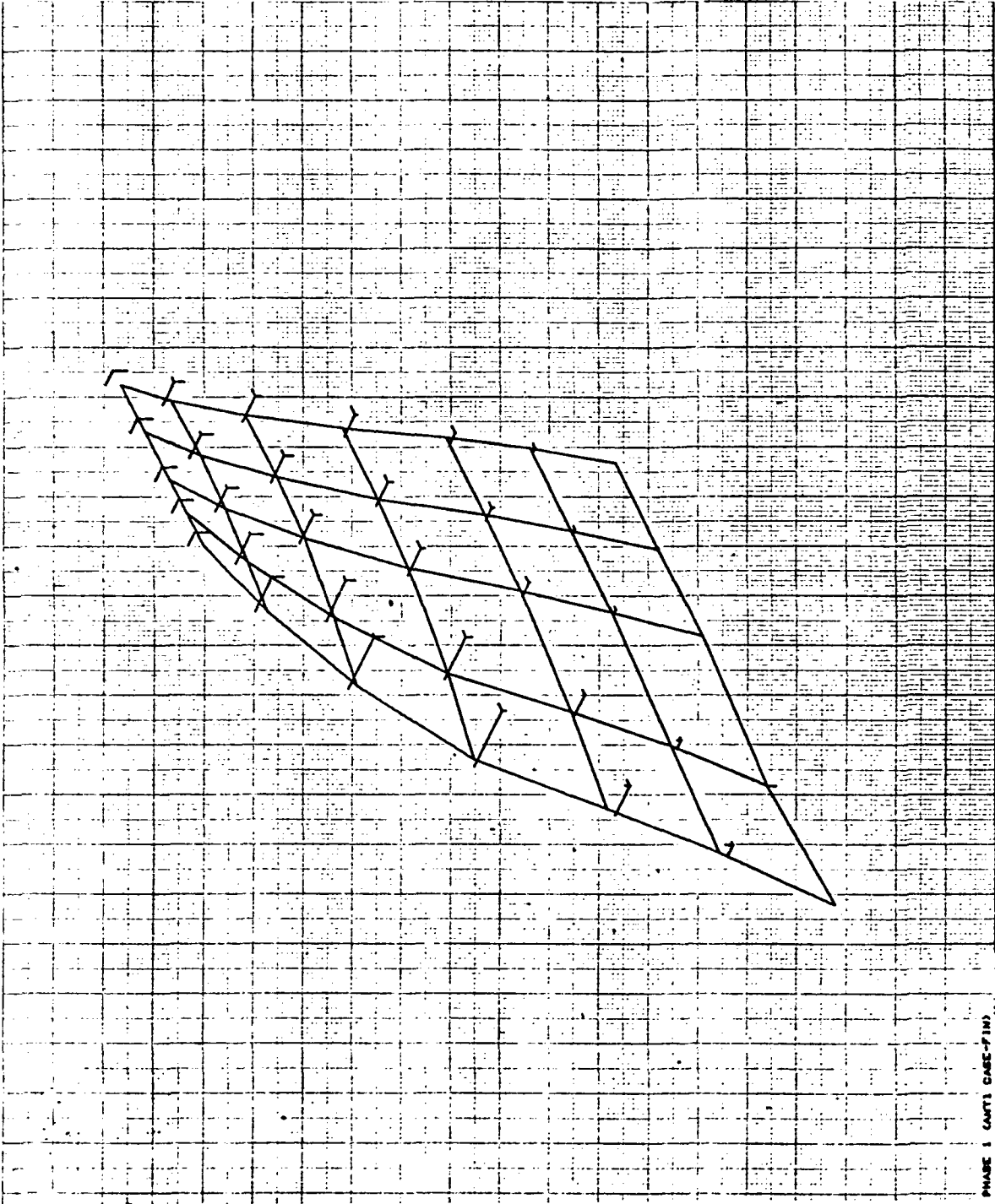

PHASE 1 (PART CASE-FIN)
REVISED INTERFACE PTS. 4/28/74
FREE MODES FIXED AT INTERFACE
MODAL DICTOR. SUBCASE 3 MODE 3 FREQ. 1907.131

4/28/74 MAX-DEF. = 1.00000000

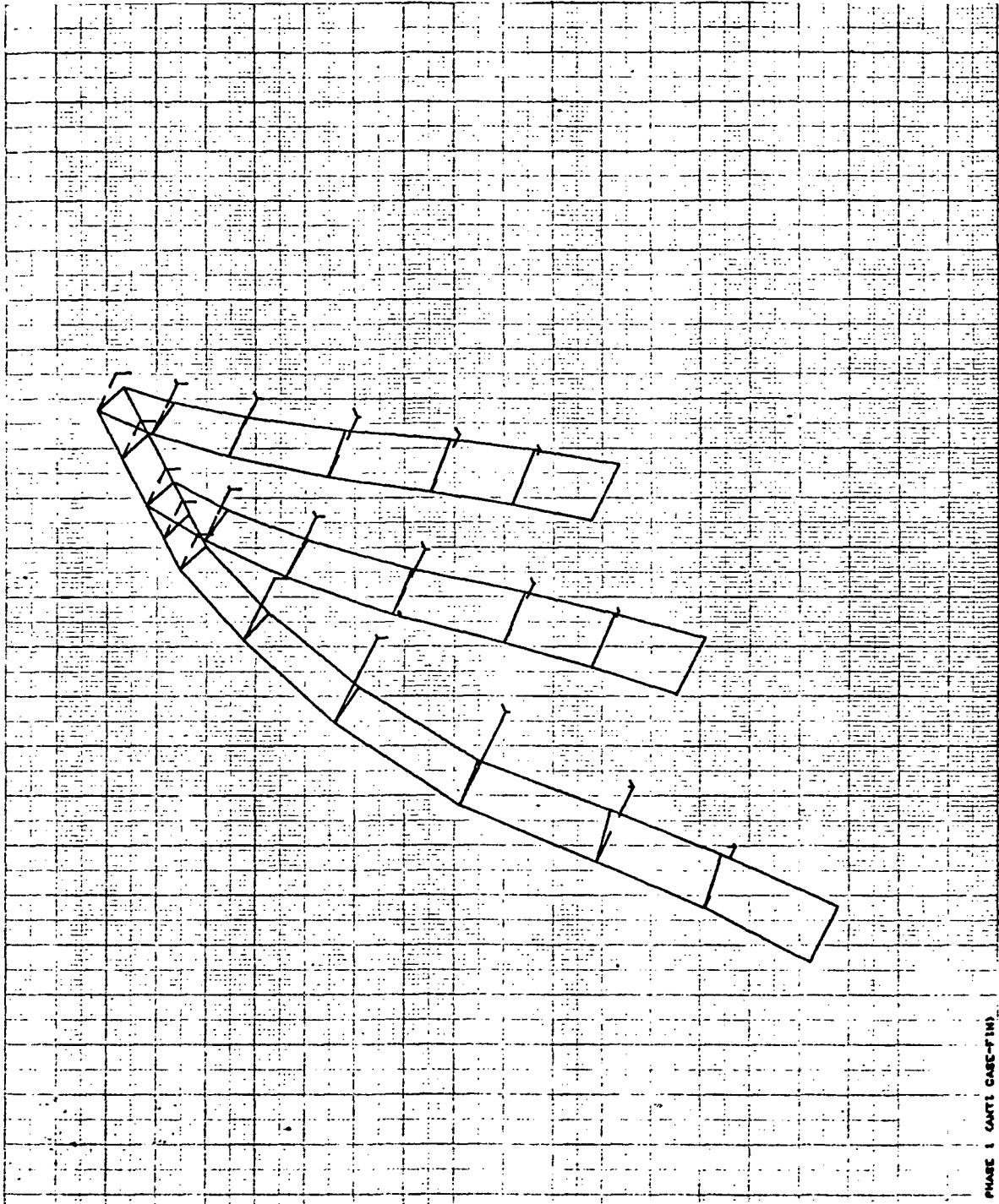

PHASE 1 (ANTI CASE-FIN)
REVISED INTERFACE PTR. 4/28/74
FREE MODES FIXED AT INTERFACE
MODAL DEFOR. SURFACE 3 MODE 3 FREQ. 1907.191

4/30/74 MAX-DEF. = 1.00000000

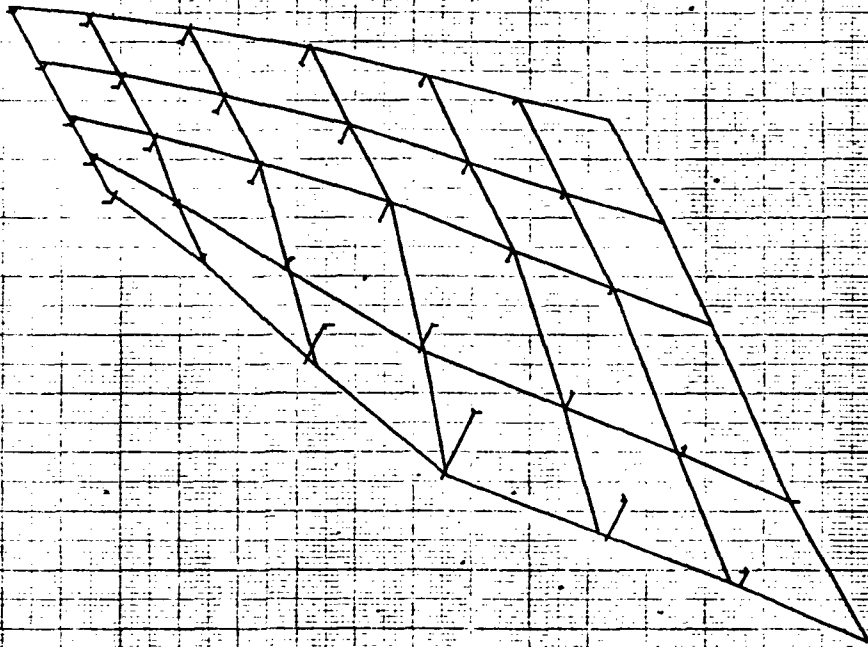

PHASE 3 (ANTI GASE-FIN)
REVISED INTERFACE PTR. 4/28/74
PRICE MODES FIXED AT INTERFACE
MODAL SECTOR, SUBCASE 4 MODE 4 FIG. 1007.000

4/28/74 MAX-DEF. = 1.00000000

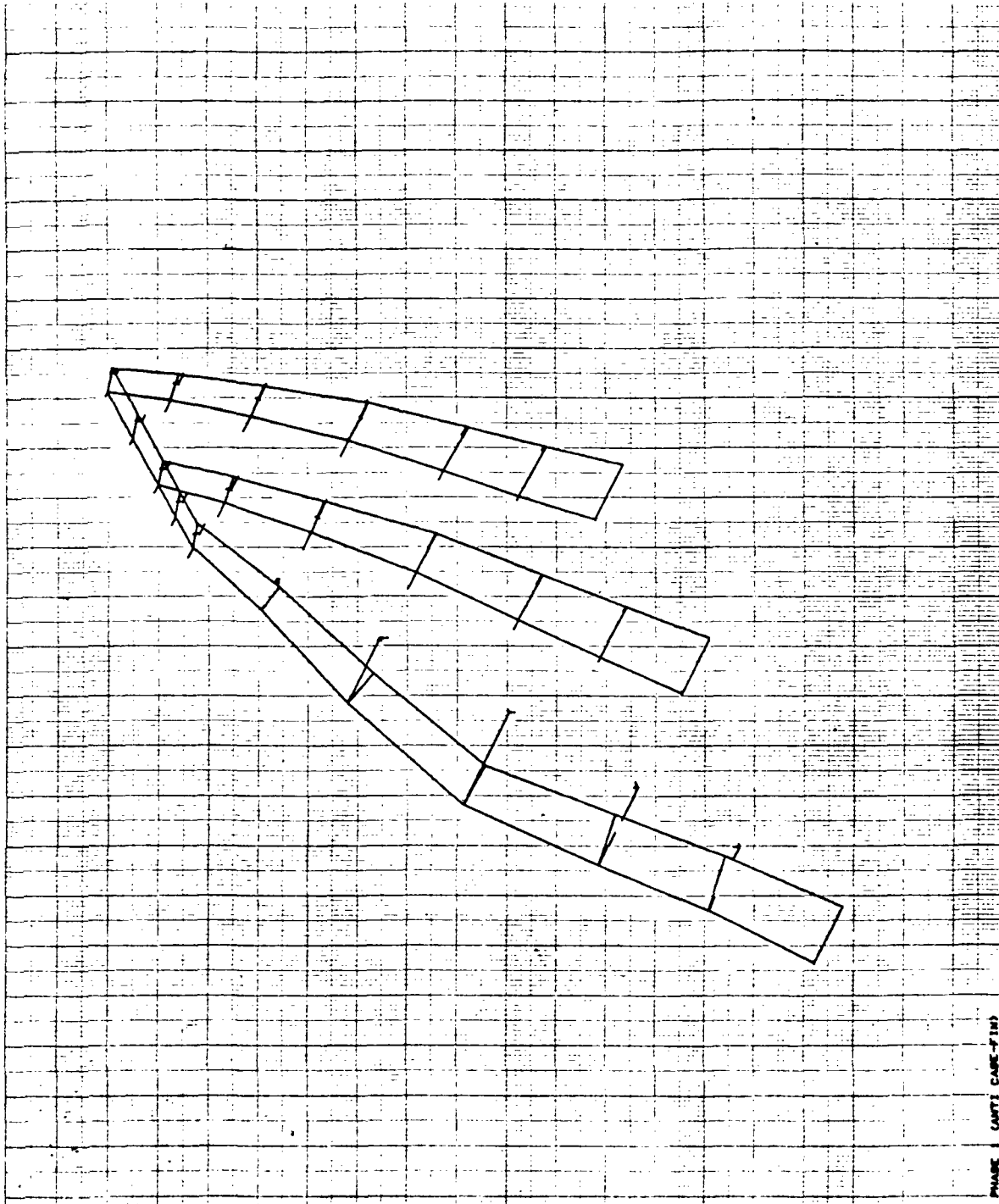

PHASE 1 CARTI CASE-FIN)
REVISED INTERFACE P/B. 4/28/74
FREE NODES FIXED AT INTERFACE
LOCAL DEFCH. SUBCASE 4 MODE 4 FREQ. 1067.899

Appendix A21
INPUT BULK DATA/PHASE 2 ANALYSIS:
MODEL II ORBITER INCLUDING COPY RUNS
AND STATIC TEST RUNS

N A S T R A N E X E C U T I V E C O N T R O L D E C K E C H O

```
ID PHASE2 ORBTSK1R
RESTART PHASE2 ,ORBTSK1 , 7/ 3/73. 55248.
1, XVPS . FLAGS # 0. REEL # 1. FILE # 6
2, REENTER AT DMAP SEQUENCE NUMBER 2
$ END OF CHECKPOINT DICTIONARY
APP DISP
SOL 3.0
TIME 45
DIAG 7,8,13,14,19,21,22
ALTER 2.7
EXIT
ENDALTER
CEND
```

CASE CONTROL DECK ECHO

CARD
COUNT
1 TITLE * PHASE 2 REVISED 5/20/74
2 SUBTITLE * ORBITER SYMM CASE
3 ECHO * BOTH
4 SPC * 11
5 MPC * 21
6 METHOD * 1
7 MAXLINES * 35000
8 BEGIN BULK

INPUT BULK DATA DECK ECHO

```

. 1 .. 2 .. 3 .. 4 .. 5 .. 6 .. 7 .. 8 .. 9 .. 10 .
$ CONVERT ORIG. SYM PHASE 2 TO REVISED SYM PHASE 2
/
/      11
/      28
/      30      45
/      50
/      50
/      110     115
/      118     123
/      128     129
/      134     137
/      139
/      152     157
/      162     163
/      166     169
/      172     173
/      178     179
/      195     199
/      208     209
/      235     236
/      240
/      251
/      253
/      255
/      257
/      259     260
/      265     266
/      311     312
/      315     316
/      319     320
/      323     324
/      327     328
/      336     339
/      352     353
/      356
/      358     359
/      372
/      415     419
/      425     429
/      436     442
/      449     455
/      462     467
/      482     489
/      507
/      512     518
/      537     540
/      548
/      551     553
/      556     558
/      565     567

```

INPUT BULK DATA DECK ECHO

	1	2	3	4	5	6	7	8	9	10
/		570	579							
/		580	585							
/		587								
/		589	590							
/		591	592							
/		594								
/		598								
/		602	603							
/		607								
/		617	618							
/		620								
/		623								
/		630								
/		633								
/		645	647							
/		706								
/		724	729							
/		733								
/		735	739							
/		742	744							
/		747	748							
ASET1		1	243							
ASET1		3	4461	4465	4469					
ASET1		13	111	219	1301	1901	2101			
ASET1		13	901	1101	1201	1401	1601	2001	2026	
ASET1		123	110	120	206	230	305	318		
ASET1		123	115	224	1320	2010	2105	2110		
EIGR		1	INV	.0	180.	20	20		1.-3	EIG1
GRID		111	0	46.75	0.0	56.7	0			
GRID		115	0	46.75	-11.0	56.7	0			
GRID		219	0	64.00	0.0	56.7	0			
GRID		224	0	64.00	-12.5	56.7	0			
GRID		243	0	64.00	-12.5	62.5	0			
*15132			62.50	0		46				
*15178			62.50	0		46				
*15265			62.50	0		46				
GRID		1301	0	141.75	0.0	45.5	0			
GRID		1320	0	141.75	-12.5	62.5	0			
*15364			62.50	0		46				
GRID		1901	0	170.75	0.0	45.5	0			
GRID	*	2010		0		179.219034		-12.5		E15489
*15489			51.5	0						
GRID	*	2014		0		178.890408		-6.4		E15493
GRID	*	2026		0		177.45188		0.0		E15505
GRID	*	2030		0		177.45188		-12.5		E15509
GRID	*	2035		0		177.140962		-11.5485		E15514
GRID	*	2039		0		176.607024		-8.8389		E15518
GRID		2101	0	186.25	0.0	45.5	0			
GRID		2105	0	186.25	-12.5	45.5	0			
GRID		2110	0	183.693	-12.5	64.922	0			

INPUT BULK DATA DECK ECHO

	1	2	3	4	5	6	7	8	9	10
GRID	4034	0	78.0	-12.5	62.0	0	2456			
GRID	4064	0	102.12	-12.5	62.0	0	2456			
GRID	4114	0	129.0	-12.5	62.0	0	2456			
GRID	4154	0	153.375	-12.5	62.0	0	2456			
GRID	4461	0	166.5	-2.0	75.0	0	456			
GRID	4469	0	182.3663	-2.0	75.0	0	456			
MPC	100	243	2	1.0	230	2	-1.0			
MPC	100	243	3	1.0	230	3	-1.0			
MPC	101	1800	3	1.0	1701	3	-.27630			EM1800ZS
EM1800ZS		1800	1	-.06116	1801	3	-.72358			
MPC	4010	4034	1	1.0	518	1	-1.0			EM4034X
EM4034X		518	5	0.5						
MPC	4010	4034	3	1.0	518	3	-1.0			
MPC	4010	4064	1	1.0	760	1	-1.0			EM4064X
EM4064X		760	5	0.5						
MPC	4010	4064	3	1.0	760	3	-1.0			
MPC	4010	4114	1	1.0	1161	1	-1.0			EM4114X
EM4114X		1161	5	0.5						
MPC	4010	4114	3	1.0	1161	3	-1.0			
MPC	4010	4154	1	1.0	1618	1	-1.0			EM4154X
EM4154X		1618	5	0.5						
MPC	4010	4154	3	1.0	1618	3	-1.0			
EMPCSYM	4810	4891	4811							
EMPCANTI	4810	4892	4812							
PARAM	NDSUB	5								
PLOTEL	1000	243	318							
PLOTEL	1001	120	230		1002	318	518			
PLOTEL	1009	1320	1418		1010	1418	1618			
PLOTEL	1017	2041	2114		1018	1220	1320			
PLOTEL	1019	2030	2110		1020	1115	1212			
PLOTEL	1027	110	115		1028	206	224			
PLOTEL	1047	2010	2030		1048	1905	1918			
PLOTEL	1049	2005	2010		1050	2030	2035			
PLOTEL	1059	605	705		1060	805	905			
PLOTEL	1073	1101	1201		1074	1201	1301			
PLOTEL	1079	1801	1901		1080	1305	1405			
PLOTEL	1201	1918	2010							
PLOTEL	1203	115	224		1204	115	120			
PLOTEL	1205	224	230		1206	224	243			
PLOTEL	1207	1312	1320		1208	111	115			
PLOTEL	1209	219	224		1210	111	219			
PLOTEL	1211	705	805		1212	2005	2105			
PLOTEL	1213	1301	1401		1214	1901	2001			
PLOTEL	1215	2001	2101		1216	101	111			
PLOTEL	1217	201	219		1218	1301	1305			
PLOTEL	1219	1901	1905		1220	2101	2105			
PLOTEL	2992	3617	3621		3055	3618	3622			
PLOTEL	4408	4435	4465							
PLOTEL	4409	4461	4465		4410	4465	4469			
PLOTEL	4411	4431	4461		4412	4439	4469			

INPUT BULK DATA DECK ECHO

	1	2	3	4	5	6	7	8	9	10
SPC1	1000	1	1F23	1827	1831	1833	1835			
SPC1	1001	23	1516							
SPC1	1001	2	111	219	241	1301	1901	2101		
SPC1	1001	2	1601	1606	1701	1800	1801	1833		
SPC1	1001	2	1802	2001	2026					
SPC1	1002	13	111	219	1301	1901	2101	1800		
SPC1	1002	3	241	1833						
SPC1	1002	13	1516	1601	1606	1701	1801			
SPC1	1002	13	2001	2026						
PARAM	TPCOPYN	1								
PARAM	TPNAMEN	SYMF16								
PARAM	TPCOPY	-1								
CELAS2	11	4350.	4461	3	1838	3				
CELAS2	12	4350.	4469	3	2114	3				
CELAS2	13	65500.	4465	3	2041	3				
CELAS2	14	23150.	4881	3	506	3				
CELAS2	15	32250.	4891	3	4893	3				
GRID	4893	0	151.875	-10.125	56.7	0	12456			
MPC	4810	4893	3	1.0	1505	3	-.36516		EM4893ZA	
EM4893ZA		1506	3	-.13484	1613	3	-.36516		EM4893ZB	
EM4893ZB		1614	3	-.13484						
MPC	4891	4882	3	1.0	4881	3	-1.0			
EM4889ZA		4891	3	-1.0	1516	1	.392045		EM4889ZB	
EM4889ZB		1606	1	.392045						
MPC	4891	4890	3	1.0	4891	3	-1.0			
MPC	4891	4892	3	1.0	4891	3	-1.0			
MPC	4892	4889	4	1.0	4891	3	.09877			
MPC	4892	4890	2	1.0	4891	3	-1.08642		EM4890YA	
EM4890YA		1516	2	-.5	1606	2	-.5			
MPC	4892	4890	4	1.0	4891	3	.09877			
MPC	4892	4891	2	1.0	4891	3	-.51358		EM4891YA	
EM4891YA		1516	2	-.5	1606	2	-.5			
MPC	4892	4891	1	1.0	4890	1	-1.0		EM4891XA	
EM4891XA		4890	6	-10.125						
ENDDATA										

TOTAL COUNT# 185

*** USER INFORMATION MESSAGE 207. BULK DATA NOT SORTED. XSORT WILL RE-ORDER DECK.

SORTED BULK DATA ECHO

CARD	COUNT	1	2	3	4	5	6	7	8	9	10
1-	ASET1	1		245							
2-	ASET1	1		1516	1606	1800					
3-	ASET1	1		4990							
4-	ASET1	3		506	1701						
5-	ASET1	3		1505	1506	1613	1614				
6-	ASET1	3		1801							
7-	ASET1	3		3624							
8-	ASET1	3		4461	4465	4469					
9-	ASET1	13		101	201	301	501	601	701	801	
10-	ASET1	13		111	219	1301	1901	2101			
11-	ASET1	13		901	1101	1201	1401	1601	2001	2026	
12-	ASET1	15		4882							
13-	ASET1	123		110	120	206	230	305	318		
14-	ASET1	123		115	224	1320	2010	2105	2110		
15-	ASET1	123		505	518	605	618	705	718	805	
16-	ASET1	123		918	905	923	1105	1115	1123	1205	
17-	ASET1	123		1212	1220	1305	1312	1405	1410	1418	
18-	ASET1	123		1605	1610	1618	1705	1710	1718	1806	
19-	ASET1	123		1812	1824	1838	1905	1918	2005	2014	
20-	ASET1	123		2020	2041	2114					
21-	ASET1	123		3017	3018	3021	3022	3113	3114	3209	
22-	ASET1	123		3210	3213	3214	3217	3218	3221	3222	
23-	ASET1	123		3305	3306	3401	3402	3405	3406	3409	
24-	ASET1	123		3410	3413	3414	3417	3418	3421	3422	
25-	ASET1	123		3601	3602	3605	3606	3609	3610	3613	
26-	ASET1	123		3614	3617	3618	3621	3622			
27-	ASET1	123		4431	4435	4439					
28-	ASET1	135		4400							
29-	ASET1	135		4883	THRU	4888					
30-	ASET1	123456		2200							
31-	CELAS2	11		4350.	4461	3	1838	3			
32-	CELAS2	12		4350.	4469	3	2114	3			
33-	CELAS2	13		65500.	4465	3	2041	3			
34-	CELAS2	14		23150.	4881	3	506	3			
35-	CELAS2	15		32250.	4891	3	4893	3			
36-	CORD2R	1		0	-81.5683	0	35.5985	-80.2278	0	57.5136	EC1
37-	EC1	68.25		0.0	48.432						
38-	CORD2R	3001		0	-81.5683	0	35.5985	-80.2278	0	57.5136	EC3001
39-	EC3001	68.25		0.0	48.432						
40-	CORD2R	3002		3001	245.7536	-16.4631	111.0003	245.7536	-13.75	24.9514	EC3002
41-	EC3002	300.		-16.4631	11.0003						
42-	CORD2R	4413		0	166.5	-2.0	75.0	166.5	-0.84	87.5	EC4413
43-	EC4413	200.0		-2.0	75.0						
44-	CORD2R	4416		0	176.1253	0	75.0	183.3422	0	87.5	EC4416
45-	EC4416	200.0		0.0	75.0						
46-	EIGR	1		INV	0	180.	20	20		1.-3	EE1G1
47-	EE1G1	MAX									
48-	GRDSET			0				0	456		
49-	GRID	*101		0			46.7500		0		EC15001
50-	*15001			50.3000	0						

SORTED BULK DATA ECHO

CARD COUNT	1	2	3	4	5	6	7	8	9	10
51- GRID	*104			0		46.7500		-7.4000		E15004
52- *15004			50.3000	0						
53- GRID	*110			0		46.7500		-11.0000		E15010
54- *15010			53.5286	0						
55- GRID	111		0	46.75	0.0	56.7	0			
56- GRID	115		0	46.75	-11.0	56.7	0			
57- GRID	*120			0		46.7500		-11.0000		E15020
58- *15020			59.7917	0						
59- GRID	*201			0		64.0000		.0		E15050
60- *15050			48.6500	0						
61- GRID	*206			0		64.0000		-12.5000		E15055
62- *15055			48.6500	0						
63- GRID	219		0	64.00	0.0	56.7	0			
64- GRID	224		0	64.00	-12.5	56.7	0			
65- GRID	*229			0		64.0000		-10.5000		E15078
66- *15078			62.5000	0						
67- GRID	*230			0		64.0000		-12.5000		E15079
68- *15079			62.5000	0						
69- GRID	*232			0		64.0000		-9.7007		E15081
70- *15081			66.5181	0						
71- GRID	*235			0		64.0000		-7.4247		E15084
72- *15084			69.9247	0						
73- GRID	*238			0		64.0000		-4.0181		E15087
74- *15087			72.2007	0						
75- GRID	*241			0		64.0000		.0		E15090
76- *15090			73.0000	0						
77- GRID	243		0	64.00	-12.5	62.5	0			
78- GRID	*301			0		68.2500		.0		E15092
79- *15092			48.4320	1						
80- GRID	*305			0		68.2500		-12.5000		E15096
81- *15096			48.4320	0						
82- GRID	*318			0		68.2500		-12.5000		E15109
83- *15109			62.5000	0						
84- GRID	*501			0		78.0000		.0		E15115
85- *15115			47.9330	0						
86- GRID	*505			0		78.0000		-12.5000		E15119
87- *15119			47.9330	0						
88- GRID	*506			0		78.0000		.0		E15120
89- *15120			51.9330	0						
90- GRID	*518			0		78.0000		-12.5000		E15132
91- *15132			62.50	0		46				
92- GRID	*601			0		87.5000		.0		E15133
93- *15133			47.4460	0						
94- GRID	*605			0		87.5000		-12.5000		E15137
95- *15137			47.4460	0						
96- GRID	*618			0		87.5000		-12.5000		E15150
97- *15150			62.5000	0						
98- GRID	*701			0		97.0000		.0		E15151
99- *15151			46.9600	0						
100- GRID	*705			0		97.0000		-12.5000		E15155

SORTED BULK DATA ECHO

CARD	1	2	3	4	5	6	7	8	9	10
101-	*15155		46.9600	0						
102-	GRID	*715	0		97.0000		-12.5000			E15168
103-	*15163		62.5000	0						
104-	GRID	*750	0		102.1200		-12.5000			E15178
105-	*15172		62.50	0	46					
106-	GRID	*801	0		106.5000		.0			E15179
107-	*15179		46.4730	0						
108-	GRID	*802	0		106.5000		-12.5000			E15183
109-	*15182		46.4730	0						
110-	GRID	*813	0		106.5000		-12.5000			E15196
111-	*15196		62.5000	0						
112-	GRID	*901	0		116.0000		.0			E15197
113-	*15197		45.9260	0						
114-	GRID	*905	0		116.0000		-12.5000			E15201
115-	*15201		45.9260	0						
116-	GRID	*923	0		116.0000		-12.5000			E15215
117-	*15215		62.5000	0						
118-	GRID	*1101	0		125.5000		.0			E15235
119-	*15235		45.5000	0						
120-	GRID	*1105	0		125.5000		-12.5000			E15239
121-	*15239		45.5000	0						
122-	GRID	*1115	0		125.5000		-12.5000			E15246
123-	*15246		51.5000	0						
124-	GRID	*1123	0		125.5000		-12.5000			E15254
125-	*15254		62.5000	0						
126-	GRID	*1161	0		129.0000		-12.5000			E15265
127-	*15265		62.50	0	46					
128-	GRID	*1201	0		135.0000		.0			E15267
129-	*15267		45.5000	0						
130-	GRID	*1205	0		135.0000		-12.5000			E15271
131-	*15271		45.5000	0						
132-	GRID	*1212	0		135.0000		-12.5000			E15278
133-	*15278		51.5000	0						
134-	GRID	*1220	0		135.0000		-12.5000			E15286
135-	*15286		62.5000	0						
136-	GRID	1301	0	141.75	0.0	45.5	0			
137-	GRID	*1305	0			141.7500		-12.5000		E15292
138-	*15292		45.5000	0						
139-	GRID	*1312	0			141.7500		-12.5000		E15299
140-	*15299		51.5000	0						
141-	GRID	1320	0	141.75	-12.5	62.5	0			
142-	GRID	*1401	0			144.7500		.0		E15309
143-	*15309		45.5000	0						
144-	GRID	*1405	0			144.7500		-12.5000		E15313
145-	*15313		45.5000	0						
146-	GRID	*1410	0			144.7500		-12.5000		E15318
147-	*15318		51.5000	0						
148-	GRID	*1418	0			144.7500		-12.5000		E15326
149-	*15326		62.5000	0						
150-	GRID	*1505	0			150.3750		-9.2480		E15332

SORTED BULK DATA ECHO

CARD	COUNT	1	2	3	4	5	6	7	8	9	10
151-	*15332			56.7000	0						
152-	GRID	*1506		0		150.3750			-12.5000		E15333
153-	*15333			56.7000	0						
154-	GRID	*1516		0		150.3750			.0		E15343
155-	*15343			51.5000	0						
156-	GRID	*1601		0		153.3750			-0.0000		E15347
157-	*15347			45.5000	0						
158-	GRID	*1605		0		153.3750			-12.5000		E15351
159-	*15351			45.5000	0						
160-	GRID	*1606		0		153.3750			-0.0000		E15352
161-	*15352			51.5000	0						
162-	GRID	*1610		0		153.3750			-12.5000		E15356
163-	*15356			51.5000	0						
164-	GRID	*1613		0		153.3750			-9.2480		E15359
165-	*15359			56.7000	0						
166-	GRID	*1614		0		153.3750			-12.5000		E15360
167-	*15360			56.7000	0						
168-	GRID	*1618		0		153.3750			-12.5000		E15364
169-	*15364			62.50	0	46					
170-	GRID	*1701		0		162.0000			.0000		E15382
171-	*15382			45.5000	0						
172-	GRID	*1705		0		162.0000			-12.5000		E15386
173-	*15386			45.5000	0						
174-	GRID	*1710		0		162.0000			-12.5000		E15391
175-	*15391			51.5000	0						
176-	GRID	*1718		0		162.0000			-12.5000		E15399
177-	*15399			62.5000	0						
178-	GRID	1800	0	165.25	.0	45.5	1				
179-	GRID	*1801		0		166.5000			.0		E15406
180-	*15406			45.5000	0						
181-	GRID	*1802		0		166.5000			-1.7051		E15407
182-	*15407			45.5000	0						
183-	GRID	*1806		0		166.5000			-12.5000		E15411
184-	*15411			45.5000	0						
185-	GRID	*1812		0		166.5000			-12.5000		E15417
186-	*15417			51.5000	0						
187-	GRID	*1823		0		166.5000			-10.5000		E15427
188-	*15427			62.5000	0						
189-	GRID	*1824		0		166.5000			-12.5000		E15428
190-	*15428			62.5000	0						
191-	GRID	*1827		0		166.5000			-9.7007		E15431
192-	*15431			66.5181	0						
193-	GRID	*1828		0		166.5000			-11.5485		E15432
194-	*15432			67.2835	0						
195-	GRID	*1831		0		166.5000			-7.4247		E15435
196-	*15435			69.9247	0						
197-	GRID	*1332		0		166.5000			-8.8389		E15436
198-	*15436			71.3389	0						
199-	GRID	*1833		0		166.5000			.0		E15437
200-	*15437			73.0000	0						

SORTED BULK DATA ECHO

CARD	COUNT	1	2	3	4	5	6	7	8	9	10
251- GRID		3306			135.0	-37.997547	2743				
252- GRID		3401			125.5	-29.7	51.5				
253- GRID		3402			125.5	-29.7	46.6672				
254- GRID		3405			135.0	-29.7	51.5				
255- GRID		3406			135.0	-29.7	46.6672				
256- GRID		3409			144.75	-29.7	51.5				
257- GRID		3410			144.75	-29.7	46.6672				
258- GRID		3413			153.375	-29.7	51.5				
259- GRID		3414			153.375	-29.7	46.6672				
260- GRID		3417			162.0	-29.7	51.5				
261- GRID		3418			162.0	-29.7	46.6672				
262- GRID		3421			170.75	-29.7	51.5				
263- GRID		3422			170.75	-29.7	46.6672				
264- GRID		3601			125.5	-13.75	51.5				
265- GRID		3602			125.5	-13.75	45.5				
266- GRID		3605			135.0	-13.75	51.5				
267- GRID		3606			135.0	-13.75	45.5				
268- GRID		3609			144.75	-13.75	51.5				
269- GRID		3610			144.75	-13.75	45.5				
270- GRID		3613			153.375	-13.75	51.5				
271- GRID		3614			153.375	-13.75	45.5				
272- GRID		3617			162.0	-13.75	51.5				
273- GRID		3618			162.0	-13.75	45.5				
274- GRID		3621			170.75	-13.75	51.5				
275- GRID		3622			170.75	-13.75	45.5				
276- GRID		3624	0		165.25	-13.75	45.5	3002		12456	
277- GRID		3651	0		125.5	-12.5	51.5	0		2456	
278- GRID		3652			125.5	-12.5	45.5				
279- GRID		3655	0		135.0	-12.5	51.5	0		2456	
280- GRID		3656			135.0	-12.5	45.5				
281- GRID		3659			144.75	-12.5	51.5				
282- GRID		3660			144.75	-12.5	45.5				
283- GRID		3663			153.375	-12.5	51.5				
284- GRID		3664			153.375	-12.5	45.5				
285- GRID		3667			162.0	-12.5	51.5				
286- GRID		3668			162.0	-12.5	45.5				
287- GRID		3671			170.75	-12.5	51.5				
288- GRID		3672			170.75	-12.5	45.5				
289- GRID		4002	0		64.0	.0	73.0	0		1456	
290- GRID		4004	0		64.0	-4.0181	72.2007	0		1456	
291- GRID		4006	0		64.0	-7.4247	69.9247	0		1456	
292- GRID		4008	0		64.0	-9.7007	66.5181	0		1456	
293- GRID		4010	0		64.0	-10.5	62.5	0		1456	
294- GRID		4034	0		78.0	-12.5	62.0	0		2456	
295- GRID		4064	0		102.12	-12.5	62.0	0		2456	
296- GRID		4114	0		129.0	-12.5	62.0	0		2456	
297- GRID		4154	0		153.375	-12.5	62.0	0		2456	
298- GRID		4172	0		166.5	.0	73.0	0		1456	
299- GRID		4174	0		166.5	-4.0181	72.2007	0		1456	
300- GRID		4176	0		156.5	-7.4247	69.9247	0		1456	

SORTED BULK DATA ECHO

CARD	1	2	3	4	5	6	7	8	9	10
301-	GRID	4178	0	166.5	-9.7007	66.5181	0	1456		
302-	GRID	4180	0	166.5	-10.5	62.5	0	1456		
303-	GRID	4400	0	134.1	.0	88.5	0	0		
304-	GRID	4401	0	131.0	-0.84	87.5	0	456		
305-	GRID	4405	0	183.3422	-0.84	87.5	0	456		
306-	GRID	4409	0	155.8	-0.84	87.5	0	456		
307-	GRID	4431	0	174.04	-1.3968	81.5	0	456		
308-	GRID	4435	0	179.8781	-1.3968	91.5	0	456		
309-	GRID	4439	0	164.6718	-1.3968	81.5	0	456		
310-	GRID	4461	0	166.5	-2.0	75.0	0	456		
311-	GRID	4463	0	170.75	-2.0	75.0	4413	23456		
312-	GRID	4465	0	176.1253	-2.0	75.0	0	456		
313-	GRID	4467	0	179.2458	-2.0	75.0	4413	23456		
314-	GRID	4469	0	182.3663	-2.0	75.0	0	456		
315-	GRID	4881	0	79.0	.0	51.933	0	456		
316-	GRID	4882	0	73.0	.0	62.5	0	0		
317-	GRID	4883	0	87.5	.0	62.5	0	0		
318-	GRID	4884	0	97.0	.0	62.5	0	0		
319-	GRID	4885	0	105.5	.0	62.5	0	0		
320-	GRID	4886	0	117.5	.0	62.5	0	0		
321-	GRID	4887	0	125.5	.0	62.5	0	0		
322-	GRID	4888	0	135.0	.0	62.5	0	0		
323-	GRID	4889	0	143.25	.0	62.5	0	0		
324-	GRID	4890	0	151.875	.0	62.5	0	0		
325-	GRID	4891	0	151.875	-10.125	56.7	0	456		
326-	GRID	4892	0	151.875	.0	51.5	0	456		
327-	GRID	4893	0	151.875	-10.125	56.7	0	12456		
328-	MPC	100	243	2	1.0	230	2	-1.0		
329-	MPC	100	243	3	1.0	230	3	-1.0		
330-	MPC	100	1828	1	1.0	2200	1	-1.0		848
331-	848		2200	5	3.2083	2200	6	0.4121		
332-	MPC	100	1828	2	1.0	2200	2	-1.0		849
333-	849		2200	4	-3.2083	2200	6	5.187		
334-	MPC	100	1823	3	1.0	2200	3	-1.0		850
335-	850		2200	4	-4.121	2200	5	-5.187		
336-	MPC	100	1832	1	1.0	2200	1	-1.0		845
337-	845		2200	5	-0.8471	2200	6	3.1217		
338-	MPC	100	1832	2	1.0	2200	2	-1.0		846
339-	846		2200	4	.8471	2200	6	5.187		
340-	MPC	100	1832	3	1.0	2200	3	-1.0		847
341-	847		2200	4	-3.1217	2200	5	-5.187		
342-	MPC	100	2035	1	1.0	2200	1	-1.0		854
343-	854		2200	5	3.2083	2200	6	0.4121		
344-	MPC	100	2035	2	1.0	2200	2	-1.0		855
345-	855		2200	4	-3.2083	2200	6	-5.454		
346-	MPC	100	2035	3	1.0	2200	3	-1.0		856
347-	856		2200	4	-4.121	2200	5	5.454		
348-	MPC	100	2039	1	1.0	2200	1	-1.0		851
349-	851		2200	5	-0.8471	2200	6	3.1217		
350-	MPC	100	2039	2	1.0	2200	2	-1.0		852

SORTED BULK DATA ECHO

CARD	COUNT	1	2	3	4	5	6	7	8	9	10
351-	652			2200	4	.8471	2200	6	-4.920		
352-	MPC	100		2039	3	1.0	2200	3	-1.0		653
353-	653			2200	4	-3.1217	2200	5	4.920		
354-	MPC	101		1701	1	1.0	1701	3	-.01699		6M1701XS
355-	6M1701XS			1800	1	-1.00187	1801	3	-.04417		
356-	MPC	101		1800	3	1.0	1701	3	-.27830		6M1800ZS
357-	6M1800ZS			1800	1	-.06116	1801	3	-.72358		
358-	MPC	101		1801	1	1.0	1701	3	-.01699		6M1801XS
359-	6M1801XS			1800	1	-1.00187	1801	3	-.04417		
360-	MPC	101		1802	1	1.0	1701	3	-.01699		6M1802XS
361-	6M1802XS			1800	1	-1.00187	1801	3	-.04417		
362-	MPC	101		1802	3	1.0	1801	3	-1.0		
363-	MPC	102		1801	2	1.0	1800	2	-1.38462		6M1801YA
364-	6M1801YA			1701	2	.38462					
365-	MPC	102		1802	1	1.0	1701	2	.52465		6M1802XA
366-	6M1802XA			1800	2	-.52465					
367-	MPC	102		1802	2	1.0	1800	2	-1.38462		6M1802YA
368-	6M1802YA			1701	2	.38462					
369-	MPC	3010		3651	1	1.0	1115	1	-1.0		
370-	MPC	3010		3651	3	1.0	1115	3	-1.0		
371-	MPC	3010		3652	1	1.0	1105	1	-1.0		
372-	MPC	3010		3652	2	1.0	1105	2	-1.0		
373-	MPC	3010		3652	3	1.0	1105	3	-1.0		
374-	MPC	3010		3655	1	1.0	1212	1	-1.0		
375-	MPC	3010		3655	3	1.0	1212	3	-1.0		
376-	MPC	3010		3656	1	1.0	1205	1	-1.0		
377-	MPC	3010		3656	2	1.0	1205	2	-1.0		
378-	MPC	3010		3656	3	1.0	1205	3	-1.0		
379-	MPC	3010		3659	1	1.0	1410	1	-1.0		
380-	MPC	3010		3659	2	1.0	1410	2	-1.0		
381-	MPC	3010		3659	3	1.0	1410	3	-1.0		
382-	MPC	3010		3660	1	1.0	1405	1	-1.0		
383-	MPC	3010		3660	2	1.0	1405	2	-1.0		
384-	MPC	3010		3660	3	1.0	1405	3	-1.0		
385-	MPC	3010		3663	1	1.0	1610	1	-1.0		
386-	MPC	3010		3663	2	1.0	1610	2	-1.0		
387-	MPC	3010		3663	3	1.0	1610	3	-1.0		
388-	MPC	3010		3664	1	1.0	1605	1	-1.0		
389-	MPC	3010		3664	2	1.0	1605	2	-1.0		
390-	MPC	3010		3664	3	1.0	1605	3	-1.0		
391-	MPC	3010		3667	1	1.0	1710	1	-1.0		
392-	MPC	3010		3667	2	1.0	1710	2	-1.0		
393-	MPC	3010		3667	3	1.0	1710	3	-1.0		
394-	MPC	3010		3668	1	1.0	1705	1	-1.0		
395-	MPC	3010		3668	2	1.0	1705	2	-1.0		
396-	MPC	3010		3668	3	1.0	1705	3	-1.0		
397-	MPC	3010		3671	1	1.0	1918	1	-1.0		
398-	MPC	3010		3671	2	1.0	1918	2	-1.0		
399-	MPC	3010		3671	3	1.0	1918	3	-1.0		
400-	MPC	3010		3672	1	1.0	1905	1	-1.0		

FOR TED BULK DATA ECHO

CARD	1	2	3	4	5	6	7	8	9	10
401- MPC	3010	3672	2		1.0	1905	2	-1.0		
402- MPC	3010	3672	3		1.0	1905	3	-1.0		
403- MPC	4010	4004	2		1.0	233	2	-1.0		
404- MPC	4010	4004	3		1.0	233	3	-1.0		
405- MPC	4010	4006	2		1.0	235	2	-1.0		
406- MPC	4010	4006	3		1.0	235	3	-1.0		
407- MPC	4010	4008	2		1.0	232	2	-1.0		
408- MPC	4010	4008	3		1.0	232	3	-1.0		
409- MPC	4010	4010	2		1.0	229	2	-1.0		
410- MPC	4010	4010	3		1.0	229	3	-1.0		
411- MPC	4010	4034	1		1.0	518	1	-1.0		EM4034X
412- EM4034X		518		5	0.5					
413- MPC	4010	4034	3		1.0	518	3	-1.0		
414- MPC	4010	4064	1		1.0	760	1	-1.0		EM4064X
415- EM4064X		760		5	0.5					
416- MPC	4010	4064	3		1.0	760	3	-1.0		
417- MPC	4010	4114	1		1.0	1161	1	-1.0		EM4114X
418- EM4114X		1161		5	0.5					
419- MPC	4010	4114	3		1.0	1161	3	-1.0		
420- MPC	4010	4154	1		1.0	1618	1	-1.0		EM4154X
421- EM4154X		1618		5	0.5					
422- MPC	4010	4154	3		1.0	1618	3	-1.0		
423- MPC	4010	4174	2		1.0	1835	2	-1.0		
424- MPC	4010	4174	3		1.0	1835	3	-1.0		
425- MPC	4010	4176	2		1.0	1831	2	-1.0		
426- MPC	4010	4176	3		1.0	1831	3	-1.0		
427- MPC	4010	4178	2		1.0	1827	2	-1.0		
428- MPC	4010	4178	3		1.0	1827	3	-1.0		
429- MPC	4010	4180	2		1.0	1823	2	-1.0		
430- MPC	4010	4180	3		1.0	1823	3	-1.0		
431- MPC	4011	4002	3		1.0	241	3	-1.0		
432- MPC	4011	4172	3		1.0	1833	3	-1.0		
433- MPC	4012	4002	2		1.0	241	2	-1.0		
434- MPC	4012	4172	2		1.0	1833	2	-1.0		
435- MPC	4410	4461	1		1.0	1838	1	-1.0		
436- MPC	4410	4461	2		1.0	1838	2	-1.0		
437- MPC	4410	4463	1		1.0	1926	1	-1.0		
438- MPC	4410	4465	1		1.0	2041	1	-1.0		
439- MPC	4410	4465	2		1.0	2041	2	-1.0		
440- MPC	4410	4467	1		1.0	2041	1	-0.5		EM4467X
441- EM4467X		2114		1	-0.5					
442- MPC	4410	4469	1		1.0	2114	1	-1.0		
443- MPC	4410	4469	2		1.0	2114	2	-1.0		
444- MPC	4450	4401	1		1.0	4400	1	-1.0		EMC4401X
445- EMC4401X		4400		5	1.0	4400	6	-0.84		
446- MPC	4450	4401	2		1.0	4400	2	-1.0		EMC4401Y
447- EMC4401Y		4400		4	-1.0	4400	6	3.1		
448- MPC	4450	4401	3		1.0	4400	3	-1.0		EMC4401Z
449- EMC4401Z		4400		4	.24	4400	5	-3.1		
450- MPC	4450	4405	1		1.0	4400	1	-1.0		EMC4405X

SORTED BULK DATA ECHO

CARD	1	2	3	4	5	6	7	8	9	10
451-	EMC4405X		4400	5	1.0	4400	6	-0.84		
452-	MPC	4450	4405	2	1.0	4400	2	-1.0		EMC4405Y
453-	EMC4405Y		4400	4	-1.0	4400	6	0.7578		
454-	MPC	4450	4405	3	1.0	4400	3	-1.0		EMC4405Z
455-	EMC4405Z		4400	4	.84	4400	5	-0.7578		
456-	MPC	4450	4409	1	1.0	4400	1	-1.0		EMC4409X
457-	EMC4409X		4400	5	1.0	4400	6	-0.84		
458-	MPC	4450	4409	2	1.0	4400	2	-1.0		EMC4409Y
459-	EMC4409Y		4400	4	-1.0	4400	6	-2.7000		
460-	MPC	4450	4409	3	1.0	4400	3	-1.0		EMC4409Z
461-	EMC4409Z		4400	4	.84	4400	5	2.7		
462-	MPC	4810	4893	3	1.0	1505	3	-.36516		EM4893ZA
463-	EM4893ZA		1506	3	-.13484	1613	3	-.36516		EM4893ZB
464-	EM4893ZB		1614	3	-.13484					
465-	MPC	4811	4892	1	1.0	1516	1	-0.5		EM4892X
466-	EM4892X		1606	1	-0.5					
467-	MPC	4812	4881	2	1.0	506	2	-1.0		
468-	MPC	4812	4892	2	1.0	1516	2	-0.5		EM4892Y
469-	EM4892Y		1606	2	-0.5					
470-	MPC	4891	506	1	1.0	4882	1	-1.0		EM4881FX
471-	EM4881FX		4882	5	10.567					
472-	MPC	4891	4882	3	1.0	4881	3	-1.0		
473-	MPC	4891	4889	1	1.0	4890	1	-1.0		
474-	MPC	4891	4889	3	1.0	4890	1	-.78409		EM4889ZA
475-	EM4889ZA		4891	3	-1.0	1516	1	.392045		EM4889ZB
476-	EM4889ZB		1606	1	.392045					
477-	MPC	4891	4889	5	1.0	4890	1	-.09091		EM4889MY
478-	EM4889MY		1516	1	.045455	1606	1	.045455		
479-	MPC	4891	4890	3	1.0	4891	3	-1.0		
480-	MPC	4891	4890	5	1.0	4890	1	-.09091		EM4890MY
481-	EM4890MY		1516	1	.045455	1506	1	.045455		
482-	MPC	4891	4891	1	1.0	4890	1	-.47273		EM4891FX
483-	EM4891FX		1516	1	-.263635	1606	1	-.263635		
484-	MPC	4891	4891	2	1.0	1516	2	-.263635		EM4891FY
485-	EM4891FY		1606	2	-.263635	4890	2	-.47273		
486-	MPC	4891	4892	3	1.0	4891	3	-1.0		
487-	MPC	4892	4882	4	1.0	505	2	-.09463		EM4882MX
488-	EM4882MX		4882	2	.09463					
489-	MPC	4892	4889	4	1.0	4891	3	.09877		
490-	MPC	4892	4890	2	1.0	4891	3	-1.08642		EM4890YA
491-	EM4890YA		1516	2	-.5	1606	2	-.5		
492-	MPC	4892	4890	4	1.0	4891	3	.09877		
493-	MPC	4892	4891	1	1.0	4890	1	-1.0		EM4891XA
494-	EM4891XA		4890	6	-10.125					
495-	MPC	4892	4891	2	1.0	4891	3	-.51358		EM4891YA
496-	EM4891YA		1516	2	-.5	1606	2	-.5		
497-	MPCADD	21	100	101	3010	4010	4011	4450	4410	EMPCSYM
498-	EMPCSYM	4810	4891	4811						
499-	MPCADD	22	100	102	3010	4010	4012	4450	4410	EMPCANTI
500-	EMPCANTI	4810	4892	4812						

SORTED BULK DATA ECHO

CARD	COUNT	1	2	3	4	5	6	7	8	9	10
501-	PARAM	NDUSUR	5								
502-	PARAM	TPCOPY	-1								
503-	PARAM	TPCOPYN	1								
504-	PARAM	TPNAMEN	SYMEIG								
505-	PARAM	TPNAME9	ORCOUPS								
506-	PLOTEL	1000	243	513							
507-	PLOTEL	1001	120	230		1002	318	518			
508-	PLOTEL	1003	518	618		1004	618	718			
509-	PLOTEL	1005	718	818		1006	818	923			
510-	PLOTEL	1007	923	1123		1008	1123	1220			
511-	PLOTEL	1009	1320	1418		1010	1418	1618			
512-	PLOTEL	1011	1618	1718		1012	1718	1824			
513-	PLOTEL	1013	1824	2030		1014	1828	2035			
514-	PLOTEL	1015	1832	2039		1016	1838	2041			
515-	PLOTEL	1017	2041	2114		1018	1220	1320			
516-	PLOTEL	1019	2030	2110		1020	1115	1212			
517-	PLOTEL	1021	1212	1312		1022	1312	1410			
518-	PLOTEL	1023	1410	1610		1024	1610	1710			
519-	PLOTEL	1025	1710	1812		1026	1812	1918			
520-	PLOTEL	1027	110	115		1028	206	224			
521-	PLOTEL	1029	305	318		1030	505	518			
522-	PLOTEL	1031	605	618		1032	705	718			
523-	PLOTEL	1033	805	818		1034	905	923			
524-	PLOTEL	1035	1105	1115		1036	1115	1123			
525-	PLOTEL	1037	1205	1212		1038	1212	1220			
526-	PLOTEL	1039	1305	1312		1040	1410	1418			
527-	PLOTEL	1041	1610	1618		1042	1710	1718			
528-	PLOTEL	1043	1812	1824		1044	1824	1828			
529-	PLOTEL	1045	1828	1832		1046	1832	1838			
530-	PLOTEL	1047	2010	2030		1048	1905	1918			
531-	PLOTEL	1049	2005	2010		1050	2030	2035			
532-	PLOTEL	1051	2035	2039		1052	2039	2041			
533-	PLOTEL	1055	110	206		1056	206	305			
534-	PLOTEL	1057	305	505		1058	505	605			
535-	PLOTEL	1059	605	705		1060	805	905			
536-	PLOTEL	1061	905	1105		1062	1105	1205			
537-	PLOTEL	1063	1205	1305		1064	1905	2005			
538-	PLOTEL	1065	101	201		1066	201	301			
539-	PLOTEL	1067	301	501		1068	501	601			
540-	PLOTEL	1069	601	701		1070	701	801			
541-	PLOTEL	1071	801	901		1072	901	1101			
542-	PLOTEL	1073	1101	1201		1074	1201	1301			
543-	PLOTEL	1075	1401	1601		1076	1601	1701			
544-	PLOTEL	1077	1701	1801		1078	1701	1802			
545-	PLOTEL	1079	1801	1901		1080	1305	1405			
546-	PLOTEL	1081	1405	1605		1082	1605	1705			
547-	PLOTEL	1083	1705	1806		1084	1806	1905			
548-	PLOTEL	1085	101	104		1086	104	110			
549-	PLOTEL	1087	201	206		1088	301	305			
550-	PLOTEL	1089	501	505							

SORTED BULK DATA ECHO

CARD	1	2	3	4	5	6	7	8	9	10
551- PLOTEL	1091	601	605	1092	701	705				
552- PLOTEL	1093	801	805	1094	901	905				
553- PLOTEL	1095	1101	1105	1096	1201	1205				
554- PLOTEL	1097	1401	1405	1098	1601	1605				
555- PLOTEL	1099	1701	1705	1100	1801	1802				
556- PLOTEL	1101	1802	1806	1102	2001	2005				
557- PLOTEL	1201	1918	2010							
558- PLOTEL	1203	115	224	1204	115	120				
559- PLOTEL	1205	224	230	1206	224	243				
560- PLOTEL	1207	1312	1320	1208	111	115				
561- PLOTEL	1209	219	224	1210	111	219				
562- PLOTEL	1211	705	805	1212	2005	2105				
563- PLOTEL	1213	1301	1401	1214	1901	2001				
564- PLOTEL	1215	2001	2101	1216	101	111				
565- PLOTEL	1217	201	219	1218	1301	1305				
566- PLOTEL	1219	1901	1905	1220	2101	2105				
567- PLOTEL	2992	3617	3621	3055	3618	3622				
568- PLOTEL	2993	3613	3617	3054	3614	3618				
569- PLOTEL	2994	3609	3613	3053	3610	3614				
570- PLOTEL	2995	3605	3609	3052	3606	3610				
571- PLOTEL	2996	3601	3605	3051	3602	3606				
572- PLOTEL	2997	3421	3621	3050	3422	3622				
573- PLOTEL	2998	3417	3617	3049	3418	3618				
574- PLOTEL	2999	3413	3613	3048	3414	3614				
575- PLOTEL	3000	3409	3609	3047	3410	3610				
576- PLOTEL	3001	3017	3021	3024	3018	3022				
577- PLOTEL	3002	3017	3113	3025	3018	3114				
578- PLOTEL	3003	3113	3209	3026	3114	3210				
579- PLOTEL	3004	3113	3213	3027	3114	3214				
580- PLOTEL	3005	3017	3217	3028	3018	3218				
581- PLOTEL	3006	3021	3221	3029	3022	3222				
582- PLOTEL	3007	3209	3213	3030	3210	3214				
583- PLOTEL	3008	3213	3217	3031	3214	3218				
584- PLOTEL	3009	3217	3221	3032	3218	3222				
585- PLOTEL	3010	3209	3305	3033	3210	3306				
586- PLOTEL	3011	3305	3401	3034	3306	3402				
587- PLOTEL	3012	3305	3405	3035	3306	3406				
588- PLOTEL	3013	3209	3409	3036	3210	3410				
589- PLOTEL	3014	3213	3413	3037	3214	3414				
590- PLOTEL	3015	3217	3417	3038	3218	3418				
591- PLOTEL	3016	3221	3421	3039	3222	3422				
592- PLOTEL	3017	3401	3405	3040	3402	3406				
593- PLOTEL	3018	3405	3409	3041	3406	3410				
594- PLOTEL	3019	3409	3413	3042	3410	3414				
595- PLOTEL	3020	3413	3417	3043	3414	3418				
596- PLOTEL	3021	3417	3421	3044	3418	3422				
597- PLOTEL	3022	3401	3601	3045	3402	3602				
598- PLOTEL	3023	3405	3605	3046	3406	3606				
599- PLOTEL	3056	3017	3018							
600- PLOTEL	3057	3021	3022							

SORTED BULK DATA ECHO

CARD	COUNT	1	2	3	4	5	6	7	8	9	10
601-	PLOTEL	3058	3113	3114							
602-	PLOTEL	3059	3209	3210							
603-	PLOTEL	3060	3213	3214							
604-	PLOTEL	3061	3217	3218							
605-	PLOTEL	3062	3221	3222							
606-	PLOTEL	3063	3305	3306							
607-	PLOTEL	3064	3401	3402							
608-	PLOTEL	3065	3405	3406							
609-	PLOTEL	3066	3409	3410							
610-	PLOTEL	3067	3413	3414							
611-	PLOTEL	3068	3417	3418							
612-	PLOTEL	3069	3421	3422							
613-	PLOTEL	3070	3601	3602							
614-	PLOTEL	3071	3605	3606							
615-	PLOTEL	3072	3609	3610							
616-	PLOTEL	3073	3613	3614							
617-	PLOTEL	3074	3617	3618							
618-	PLOTEL	3075	3621	3622							
619-	PLOTEL	4401	4401	4405							
620-	PLOTEL	4402	4405	4409							
621-	PLOTEL	4403	4431	4435							
622-	PLOTEL	4404	4435	4439							
623-	PLOTEL	4405	4401	4431							
624-	PLOTEL	4406	4405	4435							
625-	PLOTEL	4407	4409	4439							
626-	PLOTEL	4408	4435	4465							
627-	PLOTEL	4409	4461	4465		4410	4465	4469			
628-	PLOTEL	4411	4431	4461		4412	4439	4469			
629-	PLOTEL	4882	4882	4883							
630-	PLOTEL	4883	4883	4884							
631-	PLOTEL	4884	4884	4885							
632-	PLOTEL	4885	4885	4886							
633-	PLOTEL	4886	4886	4887							
634-	PLOTEL	4887	4887	4888							
635-	PLOTEL	4888	4888	4889							
636-	PLOTEL	4889	4889	4890							
637-	PLOTEL	4891	506	4882							
638-	PLOTEL	4892	4889	4892							
639-	PLOTEL	4893	4890	4892							
640-	PLOTEL	4894	4890	4891							
641-	SPC	4401	4400	246							
642-	SPC	4402	4400	135							
643-	SPC	4881	4881	12		4892	2				
644-	SPC	4882	4881	13		4892	13				
645-	SPC1	1000	1	229	232	235	238	241			
646-	SPC1	1000	1	1823	1827	1831	1833	1835			
647-	SPC1	1000	12	1505	1506	1613	1614				
648-	SPC1	1000	23	1926							
649-	SPC1	1001	2	101	201	301	501	506	601		
650-	SPC1	1001	2	111	219	241	1301	1901	2101		

SORTED BULK DATA ECHO

CARD	COUNT	1	2	3	4	5	6	7	8	9	10
651- SPC1	1001	2	701	801	901	1101	1201	1401			
652- SPC1	1001	2	1601	1606	1701	1800	1801	1833			
653- SPC1	1001	2	1802	2001	2026						
654- SPC1	1001	23	1516								
655- SPC1	1002	3	241	1833							
656- SPC1	1002	13	101	201	301	501	506	601			
657- SPC1	1002	13	111	219	1301	1901	2101	1800			
658- SPC1	1002	13	701	801	901	1101	1201	1401			
659- SPC1	1002	13	1516	1601	1606	1701	1801				
660- SPC1	1002	13	2001	2026							
661- SPC1	4001	2	4002	4172							
662- SPC1	4002	3	4002	4172							
663- SPC1	4881	246	4882	THRU	4890						
664- SPC1	4882	135	4882	THRU	4890						
665- SPCADD	11	1000	1001	4001	4401	4881					
666- SPCADD	12	1000	1002	4002	4402	4882					
667- SUPORT	301	3	1800	1	3624	3					
ENDDATA											

C A S E C O N T R O L D E C K E C H O

CARD
COUNT

1 TITLE = PHASE 2 REVISED 5/20/74
2 SUBTITLE = ORBITER ANTI CASE
3 MAXLINES = 30000
4 ECHO = BOTH
5 SPC = 12
6 MPC = 22
7 METHOD = 1
8 VECTOR = ALL
9 SUBCASE 1
10 LABEL = RIGID BODY MODES
11 SPCFORCES = ALL
12 MDES = 3
13 SUBCASE 4
14 LABEL = FREE FREE MODES
15 MODES = 17
16 CLIPLOT(PLCT)
17 SET 41 = INCLUDE 2990 THRU 3075,4401 THRU 4412,1000 THRU 1004,
18 1201 THRU 1212
19 SET 42 = INCLUDE 3024 THRU 3055,4882 THRU 4894,1055 THRU 1102,
20 1210 THRU 1220
21 PLCTTER CALCCMP 765,105
22 AXES =MY,X,Z
23 VIEW = 30.0,45.0,0.0
24 MAXIMUM DEFORMATION 10.0
25 FIND SCALE,ORIGIN 42,SET 42
26 PLCT MODAL DEFORMATION 1 THRU 15,SET 41,SHAPE,VECTOR XYZ
27 PLCT MODAL DEFORMATION 1 THRU 15,SET 42,SHAPE,VECTOR XYZ
28 BEGIN BULK

INPUT BULK DATA DECK ECHO

	1	2	3	4	5	6	7	8	9	10
\$ CONVERT	REVISED	SYM	PHASE 2	TO	REVISED	ANTI				
/	2	4								
/	6									
/	9	12								
/	28	29								
/	504	505								
/	667									
ASET1	2	1516	1606	1800						
ASET1	6	4890								
ASET1	2	506	1701							
ASET1	3	1802								
ASET1	2	101	201	301	501	601	701	801		
ASET1	2	111	219	1301	1901	2101				
ASET1	2	901	1101	1201	1401	1601	2026	2001		
ASET1	26	4882								
ASET1	26	4889								
ASET1	246	4400								
ASET1	246	4883	THRU	4888						
PARAM	TPNAMEN	ANTIEIG								
PARAM	TPNAME9	ORCOUPA								
SUPORT	301	2	1800	2	3624	3				
ENDDATA										

TOTAL COUNT= 22

*** USER INFORMATION MESSAGE 207. BULK DATA NOT SORTED, XSORT WILL RE-ORDER DECK.

N A S T R A N E X E C U T I V E C O N T R O L D E C K E C H O

ID TAPE COPY1

APP DMAP

TIME 3

DIAG 14

BEGIN \$ DMAP TO CONSOLIDATE TAPES ONTO 1 TAPE \$ INCLUDE PARTITION VECTORS \$

\$ SEE NASTRAN SOURCE PROGRAM COMPILATION FOR LISTING OF DMAP SEQUENCES \$

END

CEND

SYMM TAPE COPY RUN
CONSOLIDATES PHASE 1 TAPES ONTO 1 TAPE FOR PHASE 2

MAY 25. 1974 NASTRAN 2/ 1/73 PAGE 2

CASE CONTROL DECK ECHO

CARD
COUNT

1	TITLE # SYMM TAPE COPY RUN
2	SUBTITLE # CONSOLIDATES PHASE 1 TAPES ONTO 1 TAPE FOR PHASE 2
3	ECHO # BOTH
4	BEGIN BULK

SORTED BULK DATA ECHO

CARD COUNT	1	2	3	4	5	6	7	8	9	10
1-	DMI	CPDURS	0	2	1	2		1152	1	
2-	DMI	CPDURS	1	921	1.0	925	.0	1.0	1.0	EDORS1
3-	EDORS1	931	0.0	1.0	1.0	937	0.0	1.0	1.0	EDORS2
4-	EDORS2	943	0.0	1.0	1.0	949	1.0	0.0	1.0	EDORS3
5-	EDORS3	955	1.0	0.0	1.0	961	1.0	0.0	1.0	EDORS4
6-	EDORS4	967	1.0	0.0	1.0	973	0.0	0.0	1.0	EDORS5
7-	EDORS5	979	0.0	1.0	1.0	985	0.0	1.0	1.0	EDORS6
8-	EDORS6	991	0.0	1.0	1.0	997	0.0	1.0	1.0	
9-	DMI	CPFINS	0	2	1	2		1152	1	
10-	DMI	CPFINS	1	1003	1.0	.0	1.0	.0	1.0	CFINS1
11-	CFINS1	1027	1.0	1.0	1.0	1033	1.0	1.0	1.0	CFINS2
12-	CFINS2	1039	1.0	1.0	1.0	1045	1.0	1.0	1.0	CFINS3
13-	CFINS3	1051	1.0	0.0	0.0	1057	1.0	1.0	1.0	CFINS4
14-	CFINS4	1063	1.0	0.0	0.0	1069	1.0	1.0	1.0	
15-	DMI	CPFUSS	0	2	1	2		1152	1	
16-	DMI	CPFUSS	1	1	1.0	.0	1.0	.0	.0	CFUSS1
17-	CFUSS1	7	1.0	1.0	1.0	13	1.0	1.0	1.0	CFUSS2
18-	CFUSS2	19	1.0	0.0	1.0	25	1.0	1.0	1.0	CFUSS3
19-	CFUSS3	31	1.0	1.0	1.0	37	1.0	0.0	1.0	CFUSS4
20-	CFUSS4	43	1.0	1.0	1.0	49	1.0	0.0	1.0	CFUSS5
21-	CFUSS5	55	1.0	1.0	1.0	61	0.0	1.0	1.0	CFUSS6
22-	CFUSS6	67	1.0	1.0	1.0	73	0.0	1.0	1.0	CFUSS7
23-	CFUSS7	79	0.0	1.0	1.0	85	0.0	1.0	1.0	CFUSS8
24-	CFUSS8	91	0.0	0.0	1.0	97	1.0	0.0	0.0	CFUSS9
25-	CFUSS9	103	1.0	0.0	1.0	109	1.0	1.0	1.0	CFUSS10
26-	CFUSS10	115	1.0	1.0	1.0	121	1.0	0.0	1.0	CFUSS11
27-	CFUSS11	127	1.0	1.0	1.0	133	0.0	0.0	1.0	CFUSS12
28-	CFUSS12	139	1.0	1.0	1.0	0.0	1.0	0.0	1.0	CFUSS13
29-	CFUSS13	147	1.0	0.0	0.0	151	1.0	1.0	1.0	CFUSS14
30-	CFUSS14	157	1.0	1.0	1.0	163	1.0	0.0	1.0	CFUSS15
31-	CFUSS15	169	1.0	1.0	1.0	175	1.0	1.0	1.0	CFUSS16
32-	CFUSS16	181	1.0	1.0	1.0	0.0	1.0	0.0	1.0	CFUSS17
33-	CFUSS17	189	1.0	0.0	0.0	193	1.0	1.0	1.0	CFUSS18
34-	CFUSS18	199	1.0	1.0	1.0	205	1.0	0.0	1.0	CFUSS19
35-	CFUSS19	211	1.0	1.0	1.0	217	1.0	1.0	1.0	CFUSS20
36-	CFUSS20	223	1.0	0.0	1.0	229	1.0	1.0	1.0	CFUSS21
37-	CFUSS21	235	1.0	1.0	1.0	241	1.0	1.0	1.0	CFUSS22
38-	CFUSS22	247	1.0	1.0	1.0	0.0	1.0	0.0	1.0	CFUSS23
39-	CFUSS23	255	1.0	0.0	0.0	259	1.0	1.0	1.0	CFUSS24
40-	CFUSS24	265	1.0	1.0	1.0	271	1.0	1.0	1.0	CFUSS25
41-	CFUSS25	277	1.0	0.0	1.0	283	1.0	1.0	1.0	CFUSS26
42-	CFUSS26	289	1.0	1.0	1.0	295	1.0	1.0	1.0	CFUSS27
43-	CFUSS27	301	1.0	0.0	1.0	307	1.0	1.0	1.0	CFUSS28
44-	CFUSS28	313	1.0	1.0	1.0	319	1.0	1.0	1.0	CFUSS29
45-	CFUSS29	325	0.0	0.0	1.0	331	0.0	0.0	1.0	CFUSS30
46-	CFUSS30	337	1.0	0.0	0.0	343	1.0	0.0	1.0	CFUSS31
47-	CFUSS31	349	1.0	1.0	1.0	355	1.0	0.0	1.0	CFUSS32
48-	CFUSS32	361	1.0	1.0	1.0	367	0.0	0.0	1.0	CFUSS33
49-	CFUSS33	373	0.0	0.0	1.0	379	1.0	1.0	1.0	CFUSS34
50-	CFUSS34	0.0	1.0	0.0	0.0	387	1.0	0.0	0.0	CFUSS35

SYMM TAPE COPY RUN
 CONSOLIDATES PHASE 1 PAPPS ONTO 1 TAPE FOR PHASE 2

MAY 25, 1974 NASTRAN 2/ 1/73 PAGE 7

S O R T E D B U L K D A T A E C H O

CARD	1	2	3	4	5	6	7	8	9	10
51-	EFUSS35	391	1.0	1.0	1.0	397	1.0	1.0	1.0	EFUSS36
52-	EFUSS36	403	1.0	1.0	1.0	409	1.0	0.0	0.0	EFUSS37
53-	EFUSS37	415	0.0	0.0	1.0	427	1.0	1.0	1.0	EFUSS38
54-	EFUSS38	433	1.0	1.0	1.0	439	0.0	1.0	1.0	EFUSS39
55-	EFUSS39	445	1.0	1.0	1.0	451	0.0	1.0	1.0	EFUSS40
56-	EFUSS40	463	0.0	1.0	1.0	475	0.0	0.0	1.0	EFUSS41
57-	EFUSS41	481	0.0	1.0	1.0	487	1.0	1.0	1.0	EFUSS42
58-	EFUSS42	493	1.0	0.0	1.0	499	1.0	1.0	1.0	EFUSS43
59-	EFUSS43	505	1.0	1.0	1.0	511	1.0	0.0	0.0	EFUSS44
60-	EFUSS44	517	1.0	0.0	1.0	523	1.0	1.0	1.0	EFUSS45
61-	EFUSS45	529	1.0	1.0	1.0	535	1.0	1.0	1.0	EFUSS46
62-	EFUSS46	541	1.0	0.0	1.0	547	1.0	1.0	1.0	EFUSS47
63-	EFUSS47	565	1.0	1.0	1.0	571	1.0	0.0	1.0	EFUSS48
64-	EFUSS48	577	1.0	1.0	1.0	583	1.0	1.0	1.0	EFUSS49
65-	EFUSS49	589	1.0	1.0	1.0	595	1.0	1.0	1.0	EFUSS50
66-	EFUSS50	1.0	1.0	1.0						
67-	DMI	CPPAYS	0	2	1	2		1152	1	
68-	DMI	CPPAYS	1	1077	1.0	1081	1.0	1085	1.0	EPAYS1
69-	EPAYS1	1087	1.0	0.0	1.0	1090	0.0	1.0	0.0	EPAYS2
70-	EPAYS2	1093	1.0	0.0	1.0	1096	0.0	1.0	0.0	EPAYS3
71-	EPAYS3	1099	1.0	0.0	1.0	1102	0.0	1.0	0.0	EPAYS4
72-	EPAYS4	1105	1.0	0.0	1.0	1108	0.0	1.0	0.0	EPAYS5
73-	EPAYS5	1111	1.0	0.0	1.0	1114	0.0	1.0	0.0	EPAYS6
74-	EPAYS6	1117	1.0	0.0	1.0	1120	0.0	1.0	0.0	EPAYS7
75-	EPAYS7	1129	1.0	0.0	0.0	1135	0.0	0.0	1.0	EPAYS8
76-	EPAYS8	1141	1.0							
77-	DMI	CPWING	0	2	1	2		1152	1	
78-	DMI	CPWING	1	601	1.0	1.0	1.0	.0	.0	EWING1
79-	EWING1	607	1.0	1.0	1.0	613	1.0	1.0	1.0	EWING2
80-	EWING2	619	1.0	1.0	1.0	625	1.0	1.0	1.0	EWING3
81-	EWING3	631	1.0	1.0	1.0	637	1.0	1.0	1.0	EWING4
82-	EWING4	643	1.0	1.0	1.0	649	1.0	1.0	1.0	EWING5
83-	EWING5	655	1.0	1.0	1.0	661	1.0	1.0	1.0	EWING6
84-	EWING6	667	1.0	1.0	1.0	673	1.0	1.0	1.0	EWING7
85-	EWING7	679	1.0	1.0	1.0	685	1.0	1.0	1.0	EWING8
86-	EWING8	691	1.0	1.0	1.0	697	1.0	1.0	1.0	EWING9
87-	EWING9	703	1.0	1.0	1.0	709	1.0	1.0	1.0	EWING10
88-	EWING10	715	1.0	1.0	1.0	721	1.0	1.0	1.0	EWING11
89-	EWING11	727	1.0	1.0	1.0	733	1.0	1.0	1.0	EWING12
90-	EWING12	739	1.0	1.0	1.0	745	1.0	1.0	1.0	EWING13
91-	EWING13	751	1.0	1.0	1.0	757	1.0	1.0	1.0	EWING14
92-	EWING14	763	1.0	1.0	1.0	769	1.0	1.0	1.0	EWING15
93-	EWING15	775	1.0	1.0	1.0	781	1.0	1.0	1.0	EWING16
94-	EWING16	787	1.0	1.0	1.0	793	1.0	1.0	1.0	EWING17
95-	EWING17	799	1.0	1.0	1.0	805	1.0	1.0	1.0	EWING18
96-	EWING18	811	1.0	1.0	1.0	817	1.0	1.0	1.0	EWING19
97-	EWING19	823	1.0	1.0	1.0	829	1.0	1.0	1.0	EWING20
98-	EWING20	835	1.0	1.0	1.0	841	0.0	0.0	1.0	EWING21
99-	EWING21	847	1.0	0.0	1.0	853	1.0	1.0	1.0	EWING22
100-	EWING22	859	1.0	0.0	1.0	865	1.0	1.0	1.0	EWING23

SYMM TAPE COPY RUN
CONSOLIDATES PHASE 1 TAPES ONTO 1 TAPE FOR PHASE 2

MAY 25, 1974 NASTRAN 2/ 1/73 PAGE 8

SORTED BULK DATA ECHO

CARD	1	2	3	4	5	6	7	8	9	10
COUNT										
101- EWING23	471		1.0	1.0	1.0	877	1.0	1.0	1.0	EWING24
102- EWING24	883		1.0	1.0	1.0	889	1.0	1.0	1.0	EWING25
103- EWING25	895		1.0	1.0	1.0	901	1.0	1.0	1.0	EWING26
104- EWING26	907		1.0	1.0	1.0	913	1.0	1.0	1.0	
ENDDATA										

SYMM TAPE COPY RUN
CONSOLIDATES PHASE 1 TAPES ONTO 1 TAPE FOR PHASE 2

MAY 25, 1974 NASTRAN 2/ 1/73 PAGE 9

N A S T R A N S O U R C E P R O G R A M C O M P I L A T I O N
D M A P - D M A P I N S T R U C T I O N
N O .

```
1 BEGIN $ DMAP 10 CONSOLIDATE TAPES ONTO 1 TAPE INCLUDE PARTITION VECTORS#
2 INPUT1 /KFUSS,MFUSS.../C,N,-3/C,N,1/C,N,FUSSP1
3 OUTPUT1 CPFUSS,KFUSS,MFUSS.../C,N,-1/C,N,6/C,N,ORCOUPS
4 INPUT1 /KWING,MWING.../C,N,-3/C,N,2/C,N,WINGP1
5 OUTPUT1 CPWING,KWING,MWING.../C,N,0 /C,N,5/C,N,ORCOUPS
6 INPUT1 /KDORS,MDORS.../C,N,-3/C,N,3/C,N,DORSP1
7 OUTPUT1 CPDORS,KDORS,MDORS.../C,N,0 /C,N,6/C,N,ORCOUPS
8 INPUT1 /KFINS,MFINS.../C,N,-3/C,N,4/C,N,FINSP1
9 OUTPUT1 CPFINS,KFINS,MFINS.../C,N,0 /C,N,6/C,N,ORCOUPS
10 INPUT1 /KPAYS,MPAYS.../C,N,-3/C,N,5/C,N,PAYSP1
11 OUTPUT1 CPPAYS,KPAYS,MPAYS.../C,N,0 /C,N,6/C,N,ORCOUPS
12 MATPRN CPFUSS,CPWING,CPDORS,CPFINS,CPPAYS // $
13 SEEMAT KFUSS,KWING,KDORS,KFINS,KPAYS // C,N,PRINT
14 SEEMAT MFUSS,MWING,MDORS,MFINS,MPAYS // C,N,PRINT
15 END
```

NO ERRORS FOUND - EXECUTE NASTRAN PROGRAM

NASTRAN EXECUTIVE CONTROL DECK ECHO

MAY 25, 1974 NASTRAN 2/ 1/73 PAGE 1

ID TAPE COPY2

APP DMAP

TIME 4

DIAG 14

BEGIN \$ DMAP TO CONSOLIDATE TAPES ONTO 1 TAPE%INCLUDE PARTITION VECTORS\$

%SEE NASTRAN SOURCE PROGRAM COMPILATION FOR LISTING OF DMAP SEQUENCES

END

CEND

ANTI TAPE COPY RUN
CONSOLIDATES PHASE 1 TAPES ONTO 1 TAPE FOR PHASE 2

MAY 25, 1974 NASTRAN 2/ 1/73 PAGE 2

C A S E C O N T R O L D E C K E C H O

CARD
COUNT

1	TITLE # ANTI TAPE COPY RUN
2	SUBTITLE # CONSOLIDATES PHASE 1 TAPES ONTO 1 TAPE FOR PHASE 2
3	ECHO # BOTH
4	BEGIN BULK

SOFTENED BULK DATA ECHO

CARD	1	2	3	4	5	6	7	8	9	10
1-	DM1	CPDORA	0	2	1	2		1152	1	
2-	DM1	CPDORA	1	200	1.0	925	0.0	1.0	1.0	EDORA1
3-	EDORA1	931	0.0	1.0	1.0	937	0.0	1.0	1.0	EDORA2
4-	EDORA2	943	0.0	1.0	1.0	949	1.0	0.0	1.0	EDORA3
5-	EDORA3	955	1.0	0.0	1.0	961	1.0	0.0	1.0	EDORA4
6-	EDORA4	967	1.0	0.0	1.0	973	0.0	1.0	0.0	EDORA5
7-	EDORA5	979	0.0	1.0	1.0	985	0.0	1.0	1.0	EDORA6
8-	EDORA6	991	0.0	1.0	1.0	997	0.0	1.0	1.0	
9-	DM1	CFEINA	0	2	1	2		1152	1	
10-	DM1	CFEINA	1	1004	1.0	0	1.0	0	1.0	FEINA1
11-	FEINA1	1027	1.0	1.0	1.0	1033	1.0	1.0	1.0	FEINA2
12-	FEINA2	1035	1.0	1.0	1.0	1045	1.0	1.0	1.0	FEINA3
13-	FEINA3	1051	1.0	0.0	0.0	1057	1.0	1.0	1.0	FEINA4
14-	FEINA4	1063	1.0	0.0	0.0	1069	1.0	1.0	1.0	
15-	DM1	CFEUSA	0	2	1	2		1152	1	
16-	DM1	CFEUSA	1	2	1.0	7	1.0	1.0	1.0	FEUSA1
17-	FEUSA1	13	1.0	1.0	1.0	19	0.0	1.0	0.0	FEUSA2
18-	FEUSA2	25	1.0	1.0	1.0	31	1.0	1.0	1.0	FEUSA3
19-	FEUSA3	37	0.0	1.0	0.0	43	1.0	1.0	1.0	FEUSA4
20-	FEUSA4	49	0.0	1.0	0.0	55	1.0	1.0	1.0	FEUSA5
21-	FEUSA5	61	0.0	1.0	1.0	67	1.0	1.0	1.0	FEUSA6
22-	FEUSA6	73	0.0	1.0	1.0	79	0.0	1.0	1.0	FEUSA7
23-	FEUSA7	85	0.0	1.0	1.0	91	0.0	1.0	0.0	FEUSA8
24-	FEUSA8	97	1.0	0.0	0.0	103	0.0	1.0	0.0	FEUSA9
25-	FEUSA9	109	1.0	1.0	1.0	115	1.0	1.0	1.0	FEUSA10
26-	FEUSA10	121	0.0	1.0	0.0	127	1.0	1.0	1.0	FEUSA11
27-	FEUSA11	133	0.0	1.0	0.0	139	1.0	1.0	1.0	FEUSA12
28-	FEUSA12	142	0.0	1.0	0.0	145	0.0	1.0	0.0	FEUSA13
29-	FEUSA13	151	1.0	1.0	1.0	157	1.0	1.0	1.0	FEUSA14
30-	FEUSA14	163	0.0	1.0	0.0	169	1.0	1.0	1.0	FEUSA15
31-	FEUSA15	175	1.0	1.0	1.0	181	1.0	1.0	1.0	FEUSA16
32-	FEUSA16	184	0.0	1.0	0.0	187	0.0	1.0	0.0	FEUSA17
33-	FEUSA17	193	1.0	1.0	1.0	199	1.0	1.0	1.0	FEUSA18
34-	FEUSA18	205	0.0	1.0	0.0	211	1.0	1.0	1.0	FEUSA19
35-	FEUSA19	217	1.0	1.0	1.0	223	0.0	1.0	0.0	FEUSA20
36-	FEUSA20	229	1.0	1.0	1.0	235	1.0	1.0	1.0	FEUSA21
37-	FEUSA21	241	1.0	1.0	1.0	247	1.0	1.0	1.0	FEUSA22
38-	FEUSA22	250	0.0	1.0	0.0	253	0.0	1.0	0.0	FEUSA23
39-	FEUSA23	259	1.0	1.0	1.0	265	1.0	1.0	1.0	FEUSA24
40-	FEUSA24	271	1.0	1.0	1.0	277	0.0	1.0	0.0	FEUSA25
41-	FEUSA25	283	1.0	1.0	1.0	289	1.0	1.0	1.0	FEUSA26
42-	FEUSA26	295	1.0	1.0	1.0	301	0.0	1.0	0.0	FEUSA27
43-	FEUSA27	307	1.0	1.0	1.0	313	1.0	1.0	1.0	FEUSA28
44-	FEUSA28	319	1.0	1.0	1.0	325	0.0	0.0	1.0	FEUSA29
45-	FEUSA29	331	0.0	0.0	1.0	337	0.0	1.0	0.0	FEUSA30
46-	FEUSA30	343	0.0	1.0	0.0	349	1.0	1.0	1.0	FEUSA31
47-	FEUSA31	355	0.0	1.0	0.0	361	1.0	1.0	1.0	FEUSA32
48-	FEUSA32	367	0.0	0.0	1.0	373	0.0	0.0	1.0	FEUSA33
49-	FEUSA33	379	1.0	1.0	1.0	382	0.0	1.0	0.0	FEUSA34
50-	FEUSA34	385	0.0	1.0	0.0	391	1.0	1.0	1.0	FEUSA35

SORTED BULK DATA ECHO

CARD	COUNT	1	2	3	4	5	6	7	8	9	10
51-	EFUSA35	397	1.0	1.0	1.0	403	1.0	1.0	1.0	EFUSA36	
52-	EFUSA36	409	0.0	1.0	0.0	421	0.0	0.0	1.0	EFUSA37	
53-	EFUSA37	427	1.0	1.0	1.0	433	1.0	1.0	1.0	EFUSA38	
54-	EFUSA38	439	0.0	1.0	1.0	445	1.0	1.0	1.0	EFUSA39	
55-	EFUSA39	451	0.0	1.0	1.0	463	0.0	1.0	1.0	EFUSA40	
56-	EFUSA40	475	0.0	1.0	0.0	481	0.0	1.0	1.0	EFUSA41	
57-	EFUSA41	487	1.0	1.0	1.0	493	0.0	1.0	0.0	EFUSA42	
58-	EFUSA42	499	1.0	1.0	1.0	505	1.0	1.0	1.0	EFUSA43	
59-	EFUSA43	511	1.0	0.0	0.0	517	0.0	1.0	0.0	EFUSA44	
60-	EFUSA44	523	1.0	1.0	1.0	529	1.0	1.0	1.0	EFUSA45	
61-	EFUSA45	535	1.0	1.0	1.0	541	0.0	1.0	0.0	EFUSA46	
62-	EFUSA46	547	1.0	1.0	1.0	565	1.0	1.0	1.0	EFUSA47	
63-	EFUSA47	571	0.0	1.0	0.0	577	1.0	1.0	1.0	EFUSA48	
64-	EFUSA48	583	1.0	1.0	1.0	589	1.0	1.0	1.0	EFUSA49	
65-	EFUSA49	595	1.0	1.0	1.0	1.0	1.0	1.0			
66-	DMI	CPPAYA	0	2	1	2		1152	1		
67-	DMI	CPPAYA	1	1076	1.0	1082	1.0	1086	1.0	EPAYA1	
68-	EPAYA1	1087	0.0	1.0	0.0	1090	1.0	0.0	1.0	EPAYA2	
69-	EPAYA2	1093	0.0	1.0	0.0	1096	1.0	0.0	1.0	EPAYA3	
70-	EPAYA3	1099	0.0	1.0	0.0	1102	1.0	0.0	1.0	EPAYA4	
71-	EPAYA4	1105	0.0	1.0	0.0	1108	1.0	0.0	1.0	EPAYA5	
72-	EPAYA5	1111	0.0	1.0	0.0	1114	1.0	0.0	1.0	EPAYA6	
73-	EPAYA6	1117	0.0	1.0	0.0	1120	1.0	0.0	1.0	EPAYA7	
74-	EPAYA7	1123	0.0	1.0	0.0	1126	0.0	0.0	1.0	EPAYA8	
75-	EPAYA8	1134	1.0	1137	1.0	1142	1.0				
76-	DMI	CPWING	0	2	1	2		1152	1		
77-	DMI	CPWING	1	601	1.0	1.0	1.0	.0	.0	EWING1	
78-	EWING1	607	1.0	1.0	1.0	613	1.0	1.0	1.0	EWING2	
79-	EWING2	619	1.0	1.0	1.0	625	1.0	1.0	1.0	EWING3	
80-	EWING3	631	1.0	1.0	1.0	637	1.0	1.0	1.0	EWING4	
81-	EWING4	643	1.0	1.0	1.0	649	1.0	1.0	1.0	EWING5	
82-	EWING5	655	1.0	1.0	1.0	661	1.0	1.0	1.0	EWING6	
83-	EWING6	667	1.0	1.0	1.0	673	1.0	1.0	1.0	EWING7	
84-	EWING7	679	1.0	1.0	1.0	685	1.0	1.0	1.0	EWING8	
85-	EWING8	691	1.0	1.0	1.0	697	1.0	1.0	1.0	EWING9	
86-	EWING9	703	1.0	1.0	1.0	709	1.0	1.0	1.0	EWING10	
87-	EWING10	715	1.0	1.0	1.0	721	1.0	1.0	1.0	EWING11	
88-	EWING11	727	1.0	1.0	1.0	733	1.0	1.0	1.0	EWING12	
89-	EWING12	739	1.0	1.0	1.0	745	1.0	1.0	1.0	EWING13	
90-	EWING13	751	1.0	1.0	1.0	757	1.0	1.0	1.0	EWING14	
91-	EWING14	763	1.0	1.0	1.0	769	1.0	1.0	1.0	EWING15	
92-	EWING15	775	1.0	1.0	1.0	781	1.0	1.0	1.0	EWING16	
93-	EWING16	787	1.0	1.0	1.0	793	1.0	1.0	1.0	EWING17	
94-	EWING17	799	1.0	1.0	1.0	805	1.0	1.0	1.0	EWING18	
95-	EWING18	811	1.0	1.0	1.0	817	1.0	1.0	1.0	EWING19	
96-	EWING19	823	1.0	1.0	1.0	829	1.0	1.0	1.0	EWING20	
97-	EWING20	835	1.0	1.0	1.0	841	0.0	0.0	1.0	EWING21	
98-	EWING21	847	1.0	0.0	1.0	853	1.0	1.0	1.0	EWING22	
99-	EWING22	859	1.0	0.0	1.0	865	1.0	1.0	1.0	EWING23	
100-	EWING23	871	1.0	1.0	1.0	877	1.0	1.0	1.0	EWING24	

ANTI TAPE COPY RUN
CONSOLIDATES PHASE 1 TAPES ONTO 1 TAPE FOR PHASE 2

MAY 25. 1974 NASTRAN 2/ 1/73 PAGE 8

CARD	S O R T E D B U L K D A T A F C H O									
COUNT	1	2	3	4	5	6	7	8	9	10
101-	EWING24	888	1.0	1.0	1.0	889	1.0	1.0	1.0	EWING25
102-	EWING25	895	1.0	1.0	1.0	901	1.0	1.0	1.0	EWING26
103-	EWING26	907	1.0	1.0	1.0	913	1.0	1.0	1.0	
	ENDATA									

ANTI TAPE COPY RUN
CONSOLIDATES PHASE 1 TAPES ONTO 1 TAPE FOR PHASE 2

MAY 25, 1974 NASTRAN 2/ 1/73 PAGE 9

N A S T R A N S O U R C E P R O G R A M C O M P I L A T I O N
DMAP-DMAP INSTRUCTION
NO.

```
1 BEGIN $ DMAP TO CONSOLIDATE TAPES ONTO 1 TAPE%INCLUDE PARTITION VECTORS%
2 INPUT1 /KFUSA,MFUSA,,,/C,N,-3/C,N,1/C,N,FUSAP1
3 OUTPUT1 CPFUSA,KFUSA,MFUSA,,//C,N,-1/C,N,6/C,N,ORCOUPA
4 INPUT1 /KWING,MWING,,,/C,N,-3/C,N,2/C,N,WINGP1
5 OUTPUT1 CPWING,KWING,MWING,,//C,N,0 /C,N,6/C,N,ORCOUPA
6 INPUT1 /KDORA,MDORA,,,/C,N,-3/C,N,3/C,N,DORAP1
7 OUTPUT1 CPDORA,KDORA,MDORA,,//C,N,0 /C,N,6/C,N,ORCOUPA
8 INPUT1 /KFINA,MFINA,,,/C,N,-3/C,N,4/C,N,FINAP1
9 OUTPUT1 CPFINA,KFINA,MFINA,,//C,N,0 /C,N,6/C,N,ORCOUPA
10 INPUT1 /KPAYA,MPAYA,,,/C,N,-3/C,N,5/C,N,PAYAP1
11 OUTPUT1 CPPAYA,KPAYA,MPAYA,,//C,N,0 /C,N,6/C,N,ORCOUPA
12 MATPRN CPFUSA,CPWING,CPDORA,CPFINA,CPPAYA // $
13 SEEMAT KFUSA,KWING,KDORA,KFINA,KPAYA // C,N,PRINT
14 SEEMAT MFUSA,MWING,MDORA,MFINA,MPAYA // C,N,PRINT
15 END
```

NO ERRORS FOUND - EXECUTE NASTRAN PROGRAM

ID PHASE2 ORBTST1

RESTART	PHASE2	,ORBTSR1R, 5/15/74,	24077,			
1.	XVPS	.	FLAGS # 0.	REEL #	1.	FILE # 7
2.	REENTER AT DMAP SEQUENCE NUMBER				6	
3.	GPL	.	FLAGS # 0.	RFFL #	1.	FILE # 8
4.	EQEXIN	.	FLAGS # 0.	RFFL #	1.	FILE # 9
5.	GPDT	.	FLAGS # 0.	RFFL #	1.	FILE # 10
6.	CSTM	.	FLAGS # 0.	REEL #	1.	FILE # 11
7.	BGPDT	.	FLAGS # 0.	REEL #	1.	FILE # 12
8.	SIL	.	FLAGS # 0.	REEL #	1.	FILE # 13
9.	XVPS	.	FLAGS # 0.	REEL #	1.	FILE # 14
10.	REENTER AT DMAP SEQUENCE NUMBER				8	
11.	ECT	.	FLAGS # 0.	RFFL #	1.	FILE # 15
12.	XVPS	.	FLAGS # 0.	REEL #	1.	FILE # 16
13.	REENTER AT DMAP SEQUENCE NUMBER				19	
14.	PLTPAR	.	FLAGS # 0.	REEL #	1.	FILE # 17
15.	GPSETS	.	FLAGS # 0.	RFFL #	1.	FILE # 18
16.	ELSETS	.	FLAGS # 0.	RFFL #	1.	FILE # 19
17.	XVPS	.	FLAGS # 0.	RFFL #	1.	FILE # 20
18.	REENTER AT DMAP SEQUENCE NUMBER				21	
19.	XVPS	.	FLAGS # 0.	REEL #	1.	FILE # 21
20.	GPTT	.	FLAGS # 0.	REEL #	0.	FILE # 0
21.	REENTER AT DMAP SEQUENCE NUMBER				26	
22.	EST	.	FLAGS # 0.	REEL #	1.	FILE # 22
23.	ECPT	.	FLAGS # 0.	REEL #	1.	FILE # 23
24.	GPCT	.	FLAGS # 0.	RFFL #	1.	FILE # 24
25.	XVPS	.	FLAGS # 0.	REEL #	1.	FILE # 25
26.	GEI	.	FLAGS # 0.	RFFL #	0.	FILE # 0
27.	OGPST	.	FLAGS # 0.	REEL #	0.	FILE # 0
28.	REENTER AT DMAP SEQUENCE NUMBER				28	
29.	KGGX	.	FLAGS # 0.	REEL #	1.	FILE # 26
30.	GPST	.	FLAGS # 0.	REEL #	1.	FILE # 27
31.	XVPS	.	FLAGS # 0.	RFFL #	1.	FILE # 28
32.	REENTER AT DMAP SEQUENCE NUMBER				30	
33.	XVPS	.	FLAGS # 0.	REEL #	1.	FILE # 29
34.	REENTER AT DMAP SEQUENCE NUMBER				32	
35.	XVPS	.	FLAGS # 0.	REEL #	1.	FILE # 30
36.	MGG	.	FLAGS # 0.	REEL #	0.	FILE # 0
37.	REENTER AT DMAP SEQUENCE NUMBER				39	
38.	KGGX	.	FLAGS # 4.	REEL #	1.	FILE # 26
39.	KGG	.	FLAGS # 4.	REEL #	1.	FILE # 26
40.	XVPS	.	FLAGS # 0.	RFFL #	1.	FILE # 31
41.	REENTER AT DMAP SEQUENCE NUMBER				43	
42.	XVPS	.	FLAGS # 0.	RFFL #	1.	FILE # 32
43.	CPGI	.	FLAGS # 0.	REEL #	0.	FILE # 0
44.	K11	.	FLAGS # 0.	RFFL #	0.	FILE # 0
45.	M11	.	FLAGS # 0.	RFFL #	0.	FILE # 0
46.	KGG1	.	FLAGS # 0.	REEL #	0.	FILE # 0
47.	MGG1	.	FLAGS # 0.	REEL #	0.	FILE # 0

N A S T R A N E X E C U T I V E C O N T R O L D E C K E C H O

MAY 18, 1974 NASTRAN 2/ 1/73 PAGE 2

48.	KGGS	.	FLAGS # 0.	REEL # 0.	FILE # 0
49.	MGGS	.	FLAGS # 0.	REEL # 0.	FILE # 0
50.	KGT	.	FLAGS # 0.	REEL # 0.	FILE # 0
51.	MGT	.	FLAGS # 0.	REEL # 0.	FILE # 0
52.	REENTER AT DMAP SEQUENCE NUMBER			43	
53.	KGT	.	FLAGS # 4.	REEL # 1.	FILE # 33
54.	KGGS	.	FLAGS # 4.	REEL # 1.	FILE # 33
55.	MGT	.	FLAGS # 4.	REEL # 1.	FILE # 34
56.	MGGS	.	FLAGS # 4.	REEL # 1.	FILE # 34
57.	KGGY	.	FLAGS # 0.	REEL # 1.	FILE # 35
58.	MGGY	.	FLAGS # 0.	REEL # 1.	FILE # 36
59.	XVPS	.	FLAGS # 0.	REEL # 1.	FILE # 37
60.	REENTER AT DMAP SEQUENCE NUMBER			43	
61.	EQG	.	FLAGS # 0.	REEL # 1.	FILE # 38
62.	DGD	.	FLAGS # 0.	REEL # 1.	FILE # 39
63.	XVPS	.	FLAGS # 0.	REEL # 1.	FILE # 40
64.	REENTER AT DMAP SEQUENCE NUMBER			49	
65.	XVPS	.	FLAGS # 0.	REEL # 1.	FILE # 41
66.	DNO	.	FLAGS # 0.	REEL # 0.	FILE # 0
67.	REENTER AT DMAP SEQUENCE NUMBER			50	
68.	RG	.	FLAGS # 0.	REEL # 1.	FILE # 42
69.	USET	.	FLAGS # 0.	REEL # 1.	FILE # 43
70.	XVPS	.	FLAGS # 0.	REEL # 1.	FILE # 44
71.	KRR	.	FLAGS # 0.	REEL # 0.	FILE # 0
72.	KLR	.	FLAGS # 0.	REEL # 0.	FILE # 0
73.	DM	.	FLAGS # 0.	REEL # 0.	FILE # 0
74.	MLR	.	FLAGS # 0.	REEL # 0.	FILE # 0
75.	MR	.	FLAGS # 0.	REEL # 0.	FILE # 0
76.	GM	.	FLAGS # 0.	REEL # 0.	FILE # 0
77.	GO	.	FLAGS # 0.	REEL # 0.	FILE # 0
78.	KFS	.	FLAGS # 0.	REEL # 0.	FILE # 0
79.	QG	.	FLAGS # 0.	REEL # 0.	FILE # 0
80.	KNN	.	FLAGS # 0.	REEL # 0.	FILE # 0
81.	MNN	.	FLAGS # 0.	REEL # 0.	FILE # 0
82.	REENTER AT DMAP SEQUENCE NUMBER			55	
83.	XVPS	.	FLAGS # 0.	REEL # 1.	FILE # 45
84.	CPGMN	.	FLAGS # 0.	REEL # 0.	FILE # 0
85.	DMD	.	FLAGS # 0.	REEL # 0.	FILE # 0
86.	REENTER AT DMAP SEQUENCE NUMBER			58	
87.	GM	.	FLAGS # 0.	REEL # 1.	FILE # 46
88.	XVPS	.	FLAGS # 0.	REEL # 1.	FILE # 47
89.	REENTER AT DMAP SEQUENCE NUMBER			59	
90.	CPGMN	.	FLAGS # 0.	REEL # 1.	FILE # 48
91.	DMD	.	FLAGS # 0.	REEL # 1.	FILE # 49
92.	DND	.	FLAGS # 0.	REEL # 1.	FILE # 50
93.	XVPS	.	FLAGS # 0.	REEL # 1.	FILE # 51
94.	REENTER AT DMAP SEQUENCE NUMBER			60	
95.	KNN	.	FLAGS # 0.	REFL # 1.	FILE # 52
96.	MNN	.	FLAGS # 0.	REEL # 1.	FILE # 53
97.	XVPS	.	FLAGS # 0.	REEL # 1.	FILE # 54

98.	REENTER AT DMAP SEQUENCE NUMBER	63		
99.	XVPS	. FLAGS # 0.	REEL # 1.	FILE # 55
100.	KFF	. FLAGS # 0.	REFL # 0.	FILE # 0
101.	MFF	. FLAGS # 0.	REFL # 0.	FILE # 0
102.	REENTER AT DMAP SEQUENCE NUMBER	63		
103.	XVPS	. FLAGS # 0.	REFL # 1.	FILE # 56
104.	DFD	. FLAGS # 0.	REFL # 0.	FILE # 0
105.	CPNSF	. FLAGS # 0.	REEL # 0.	FILE # 0
106.	DSO	. FLAGS # 0.	REFL # 0.	FILE # 0
107.	REENTER AT DMAP SEQUENCE NUMBER	66		
108.	KFS	. FLAGS # 0.	REEL # 1.	FILE # 57
109.	KFF	. FLAGS # 0.	REEL # 1.	FILE # 58
110.	MFF	. FLAGS # 0.	REFL # 1.	FILE # 59
111.	XVPS	. FLAGS # 0.	REEL # 1.	FILE # 60
112.	REENTER AT DMAP SEQUENCE NUMBER	66		
113.	CPNSF	. FLAGS # 0.	REEL # 1.	FILE # 61
114.	DSO	. FLAGS # 0.	REFL # 1.	FILE # 62
115.	DFD	. FLAGS # 0.	REFL # 1.	FILE # 63
116.	XVPS	. FLAGS # 0.	REEL # 1.	FILE # 64
117.	REENTER AT DMAP SEQUENCE NUMBER	69		
118.	XVPS	. FLAGS # 0.	REEL # 1.	FILE # 65
119.	CAA	. FLAGS # 0.	REEL # 0.	FILE # 0
120.	MAA	. FLAGS # 0.	REEL # 0.	FILE # 0
121.	REENTER AT DMAP SEQUENCE NUMBER	69		
122.	XVPS	. FLAGS # 0.	REEL # 1.	FILE # 66
123.	DAO	. FLAGS # 0.	REEL # 0.	FILE # 0
124.	CPFOA	. FLAGS # 0.	REFL # 0.	FILE # 0
125.	DOO	. FLAGS # 0.	REEL # 0.	FILE # 0
126.	REENTER AT DMAP SEQUENCE NUMBER	72		
127.	GO	. FLAGS # 0.	REFL # 1.	FILE # 67
128.	CAA	. FLAGS # 0.	REEL # 1.	FILE # 68
129.	XVPS	. FLAGS # 0.	REEL # 1.	FILE # 69
130.	REENTER AT DMAP SEQUENCE NUMBER	74		
131.	MAA	. FLAGS # 0.	REEL # 1.	FILE # 70
132.	XVPS	. FLAGS # 0.	REFL # 1.	FILE # 71
133.	REENTER AT DMAP SEQUENCE NUMBER	74		
134.	CPFOA	. FLAGS # 0.	REFL # 1.	FILE # 72
135.	DOO	. FLAGS # 0.	REEL # 1.	FILE # 73
136.	DAO	. FLAGS # 0.	REFL # 1.	FILE # 74
137.	XVPS	. FLAGS # 0.	REEL # 1.	FILE # 75
138.	REENTER AT DMAP SEQUENCE NUMBER	75		
139.	XVPS	. FLAGS # 0.	REEL # 1.	FILE # 76
140.	KRRB	. FLAGS # 0.	REFL # 0.	FILE # 0
141.	CPALR	. FLAGS # 0.	REEL # 0.	FILE # 0
142.	DLO	. FLAGS # 0.	REEL # 0.	FILE # 0
143.	DRO	. FLAGS # 0.	REFL # 0.	FILE # 0
144.	REENTER AT DMAP SEQUENCE NUMBER	82		
145.	KLL	. FLAGS # 0.	REEL # 1.	FILE # 77
146.	KLR	. FLAGS # 0.	REEL # 1.	FILE # 78
147.	KRRB	. FLAGS # 0.	REEL # 1.	FILE # 79

N A S T R A N E X E C U T I V E C O N T R O L D E C K E C H O

MAY 18, 1974 NASTRAN 2/ 1/73 PAGE 4

148.	DM	.	FLAGS # 0.	REEL #	1.	FILE #	80
149.	KRR	.	FLAGS # 0.	REEL #	1.	FILE #	81
150.	MLL	.	FLAGS # 0.	REEL #	1.	FILE #	82
151.	MLR	.	FLAGS # 0.	REEL #	1.	FILE #	83
152.	MRR	.	FLAGS # 0.	REEL #	1.	FILE #	84
153.	XVPS	.	FLAGS # 0.	RFFL #	1.	FILE #	85
154.	REENTER AT DMAP SEQUENCE NUMBER 84						
155.	MR	.	FLAGS # 0.	REEL #	1.	FILE #	86
156.	XVPS	.	FLAGS # 0.	REEL #	1.	FILE #	87
157.	REENTER AT DMAP SEQUENCE NUMBER 84						
158.	CPALR	.	FLAGS # 0.	REEL #	1.	FILE #	88
159.	DLO	.	FLAGS # 0.	REEL #	1.	FILE #	89
160.	DRO	.	FLAGS # 0.	RFFL #	1.	FILE #	90
161.	XVPS	.	FLAGS # 0.	REEL #	1.	FILE #	91
162.	REENTER AT DMAP SEQUENCE NUMBER 89						
163.	EED	.	FLAGS # 0.	REEL #	1.	FILE #	92
164.	XVPS	.	FLAGS # 0.	REEL #	1.	FILE #	93
165.	REENTER AT DMAP SEQUENCE NUMBER 92						
166.	LAMA	.	FLAGS # 0.	REEL #	1.	FILE #	94
167.	PHIA	.	FLAGS # 0.	REEL #	1.	FILE #	95
168.	MI	.	FLAGS # 0.	REEL #	1.	FILE #	96
169.	OEIGS	.	FLAGS # 0.	REEL #	1.	FILE #	97
170.	XVPS	.	FLAGS # 0.	REEL #	1.	FILE #	98
171.	REENTER AT DMAP SEQUENCE NUMBER 97						
172.	PHIG	.	FLAGS # 0.	REEL #	1.	FILE #	99
173.	QG	.	FLAGS # 0.	REEL #	1.	FILE #	100
174.	XVPS	.	FLAGS # 0.	REEL #	1.	FILE #	101
175.	REENTER AT DMAP SEQUENCE NUMBER 100						
176.	SIL	.	FLAGS # 4.	REEL #	1.	FILE #	13
177.	SIP	.	FLAGS # 4.	REEL #	1.	FILE #	13
178.	BGPDT	.	FLAGS # 4.	REEL #	1.	FILE #	12
179.	BGPDP	.	FLAGS # 4.	REEL #	1.	FILE #	12
180.	XVPS	.	FLAGS # 0.	REEL #	1.	FILE #	102

\$ END OF CHECKPOINT DICTIONARY

TIME 20

APP DISP

SOL 3.0

DIAG 7,8,13,14,19,21,22

\$ ALTERS FOR OBTAINING STATIC TEST DEFL,S FROM RIGID FORMAT 3

\$ CHKPNT TAPE FROM PHASE 2 MODAL ANALYSIS WHICH USED ALTERED R.F.3

ALTER 2.7

ALTER 19.94

\$ DEFL@S UNIT LOADS

SOLVE KLL,/FLL/C,N,1/C,N,1/C,N,2/C,N,2

MERGE FLL,,,CPALR, /FAA /C,N,-1/C,N,2/C,N,6

\$ DEFL@S XTEST CASES

\$ SCTEST IS INPUT MATRIX WHICH CONVERTS DYNAMIC A-SET UNIT LOADS TO

\$ TEST CASES

MPYAD FAA,SCTEST,/PHIA/C,N,0/C,N,1/C,N,0 \$

N A S T R A N E X E C U T I V E C O N T R O L D E C K E C H O

MAY 18, 1974 NASTRAN 2/ 1/73 PAGE 5

```
ALTER 105,107
$ NODE LOADS
MPYAD        KGGY,PHIG,/PGG/C,N,0/C,N,1/C,N,0 $
$ EQUIL. CHECK
MPYAD        FOC,PGG,/EQPGG/C,N,0/C,N,1/C,N,0 $
MATPRN      FOPGG,,, // $
SDR2        CASECC,CSTM,MPT,DIT,EQFXIN,SIL,,,HGPDP,PGG,OG,PHIG,EST,/OPG1,
            QQG1,OPHTG,DES1,DEF1,PPHIG/C,N,STATICS
OPF        OPG1,QQG1,OPHTG,,,//V,N,CARDNO
SAVE        CARDNO $
ALTER 109,109
PLOT        PLTPAR,GPSFIS,FLSETS,CASECC,RGPDTEQFXIN,SIP,PPHIG,/PLOTX2/
            V,N,NSIL/V,N,LUSFT/V,N,JUMPLOT/V,N,PLTFLG/V,N,PFILE $
ENDALTER
CEND
```

C A S F C O N T R O L D E C K E C H O

CARD
COUNT

1 TITLE # ORBITER STATIC TEST CASES ON INTERSTAGE SUPPORTS
2 SUBTITLE # REVISED 5/7/74 SYMM CASE
3 MAXLINES # 30000
4 ECHO # BOTH
5 VECTOR # ALL
6 DLOAD # ALL
7 SUBCASE 1
8 LABEL # UNIT PZ DOWN ON FULL ORBITER %FUS. NOSE-STA 46.75-GRID 120#
9 SUBCASE 2
10 LABEL # UNIT PZ DOWN ON FULL ORBITER %MID FUS. -STA 116.0-GRID 905#
11 SUBCASE 3
12 LABEL # UNIT PZ DOWN ON FULL ORBITER %WING TIP -GRID 3017#
13 SUBCASE 4
14 LABEL # UNIT PX AFT ON FULL ORBITER %FIN BALLAST-GRID 4400#
15 SUBCASE 5
16 LABEL # UNIT PX AFT ON FULL ORBITER %OMS BALLAST-GRID 2200#
17 SUBCASE 6
18 LABEL # UNIT PZ UP ON FULL ORBITER %MID PAYLOAD-STA 117.5-GRID 4886#
19 OUTPUT%PLOT#
20 SET 41 # INCLUDE 2990 THRU 3075,4401 THRU 4412,1000 THRU 1064,
21 1201 THRU 1212
22 SET 42 # INCLUDE 3024 THRU 3055,4882 THRU 4894,1055 THRU 1102,
23 1211 THRU 1220
24 PLOTTER CALCOMP 765,105
25 AXES #MY,X,Z
26 VIEW # 30.0,45.0,0.0
27 MAXIMUM DEFORMATION 10.0
28 FIND SCALE,ORIGIN 42,SET 42
29 PLOT STATIC DEFORMATION 1 THRU 6, SET 41,SHAPE,VECTOR XYZ
30 PLOT STATIC DEFORMATION 1 THRU 6, SET 42,SHAPE,VECTOR XYZ
31 BEGIN BULK

INPUT BULK DATA DECK ECHO

```
. 1 .. 2 .. 3 .. 4 .. 5 .. 6 .. 7 .. 8 .. 9 .. 10 .  
$ SCTEST IS INPUT MATRIX WHICH CONVERTS DYNAMIC A-SET UNIT LOADS TO  
$ TEST CASES  
DMI      SCTEST      0      2      1      2      362      6  
DMI      SCTEST      1      13     -.5  
DMI      SCTEST      2      73     -.5  
DMI      SCTEST      3     208     -.5  
DMI      SCTEST      4     327      .5  
DMI      SCTEST      5     200      .5  
DMI      SCTEST      6     354      .5  
ENDDATA
```

TOTAL COUNT# . 10

1) PHASE2 ORBTAT1

```

RESTART PHASE2 ,ORBTAR1R, 5/25/74. 68175.
  1,  XVPS      ,  FLAGS = 0,  REEL = 1,  FILE =    7
  2,  REENTER AT DMAP SEQUENCE NUMBER    6
  3,  GPL       ,  FLAGS = 0,  REEL = 1,  FILE =    8
  4,  COEXIN    ,  FLAGS = 0,  REEL = 1,  FILE =    9
  5,  GPD1      ,  FLAGS = 0,  REEL = 1,  FILE =   10
  6,  CSTM      ,  FLAGS = 0,  REEL = 1,  FILE =   11
  7,  BGPDT     ,  FLAGS = 0,  REEL = 1,  FILE =   12
  8,  SIL       ,  FLAGS = 0,  REEL = 1,  FILE =   13
  9,  XVPS      ,  FLAGS = 0,  REEL = 1,  FILE =   14
10,  REENTER AT DMAP SEQUENCE NUMBER    8
11,  ECT       ,  FLAGS = 0,  REEL = 1,  FILE =   15
12,  XVPS      ,  FLAGS = 0,  REEL = 1,  FILE =   16
13,  REENTER AT DMAP SEQUENCE NUMBER   19
14,  PLTPAR    ,  FLAGS = 0,  REEL = 1,  FILE =   17
15,  GPSETS    ,  FLAGS = 0,  REEL = 1,  FILE =   18
16,  ELSETS    ,  FLAGS = 0,  REEL = 1,  FILE =   19
17,  XVPS      ,  FLAGS = 0,  REEL = 1,  FILE =   20
18,  REENTER AT DMAP SEQUENCE NUMBER   21
19,  XVPS      ,  FLAGS = 0,  REEL = 1,  FILE =   21
20,  GPTT      ,  FLAGS = 0,  REEL = 0,  FILE =    0
21,  REENTER AT DMAP SEQUENCE NUMBER   26
22,  EST       ,  FLAGS = 0,  REEL = 1,  FILE =   22
23,  ECPT      ,  FLAGS = 0,  REEL = 1,  FILE =   23
24,  GPCT      ,  FLAGS = 0,  REEL = 1,  FILE =   24
25,  XVPS      ,  FLAGS = 0,  REEL = 1,  FILE =   25
26,  GEI       ,  FLAGS = 0,  REEL = 0,  FILE =    0
27,  OGPST     ,  FLAGS = 0,  REEL = 0,  FILE =    0
28,  REENTER AT DMAP SEQUENCE NUMBER   28
29,  KGGX      ,  FLAGS = 0,  REEL = 1,  FILE =   26
30,  GPST      ,  FLAGS = 0,  REEL = 1,  FILE =   27
31,  XVPS      ,  FLAGS = 0,  REEL = 1,  FILE =   28
32,  REENTER AT DMAP SEQUENCE NUMBER   30
33,  XVPS      ,  FLAGS = 0,  REEL = 1,  FILE =   29
34,  REENTER AT DMAP SEQUENCE NUMBER   32
35,  XVPS      ,  FLAGS = 0,  REEL = 1,  FILE =   30
36,  MGG       ,  FLAGS = 0,  REEL = 0,  FILE =    0
37,  REENTER AT DMAP SEQUENCE NUMBER   39
38,  KGGX      ,  FLAGS = 4,  REEL = 1,  FILE =   26
39,  KJG       ,  FLAGS = 4,  REEL = 1,  FILE =   26
40,  XVPS      ,  FLAGS = 0,  REEL = 1,  FILE =   31
41,  REENTER AT DMAP SEQUENCE NUMBER   43
42,  XVPS      ,  FLAGS = 0,  REEL = 1,  FILE =   32
43,  CPGI      ,  FLAGS = 0,  REEL = 0,  FILE =    0
44,  KII       ,  FLAGS = 0,  REEL = 0,  FILE =    0
45,  MII       ,  FLAGS = 0,  REEL = 0,  FILE =    0
46,  KGGI      ,  FLAGS = 0,  REEL = 0,  FILE =    0
47,  MGGI      ,  FLAGS = 0,  REEL = 0,  FILE =    0
    
```

48.	KGG5	.	FLAGS = 0.	REEL = 0.	FILE = 0
49.	MGG5	.	FLAGS = 0.	REEL = 0.	FILE = 0
50.	KGT	.	FLAGS = 0.	REEL = 0.	FILE = 0
51.	MGT	.	FLAGS = 0.	REEL = 0.	FILE = 0
52.	REENTER	AT DMAP SEQUENCE NUMBER	43		
53.	KGT	.	FLAGS = 4.	REEL = 1.	FILE = 33
54.	KGG5	.	FLAGS = 4.	REEL = 1.	FILE = 33
55.	MGT	.	FLAGS = 4.	REEL = 1.	FILE = 34
56.	MGG5	.	FLAGS = 4.	REEL = 1.	FILE = 34
57.	KGGY	.	FLAGS = 0.	REEL = 1.	FILE = 35
58.	MGGY	.	FLAGS = 0.	REEL = 1.	FILE = 36
59.	XVPS	.	FLAGS = 0.	REEL = 1.	FILE = 37
60.	REENTER	AT DMAP SEQUENCE NUMBER	43		
61.	EQG	.	FLAGS = 0.	REEL = 1.	FILE = 38
62.	DGU	.	FLAGS = 0.	REEL = 1.	FILE = 39
63.	XVPS	.	FLAGS = 0.	REEL = 1.	FILE = 40
64.	REENTER	AT DMAP SEQUENCE NUMBER	49		
65.	XVPS	.	FLAGS = 0.	REEL = 1.	FILE = 41
66.	DNO	.	FLAGS = 0.	REEL = 0.	FILE = 0
67.	REENTER	AT DMAP SEQUENCE NUMBER	50		
68.	RG	.	FLAGS = 0.	REEL = 1.	FILE = 42
69.	CSET	.	FLAGS = 0.	REEL = 1.	FILE = 43
70.	XVPS	.	FLAGS = 0.	REEL = 1.	FILE = 44
71.	KRR	.	FLAGS = 0.	REEL = 0.	FILE = 0
72.	KLR	.	FLAGS = 0.	REEL = 0.	FILE = 0
73.	DM	.	FLAGS = 0.	REEL = 0.	FILE = 0
74.	MLR	.	FLAGS = 0.	REEL = 0.	FILE = 0
75.	MR	.	FLAGS = 0.	REEL = 0.	FILE = 0
76.	GM	.	FLAGS = 0.	REEL = 0.	FILE = 0
77.	GO	.	FLAGS = 0.	REEL = 0.	FILE = 0
78.	KFS	.	FLAGS = 0.	REEL = 0.	FILE = 0
79.	QS	.	FLAGS = 0.	REEL = 0.	FILE = 0
80.	KNN	.	FLAGS = 0.	REEL = 0.	FILE = 0
81.	MNN	.	FLAGS = 0.	REEL = 0.	FILE = 0
82.	REENTER	AT DMAP SEQUENCE NUMBER	55		
83.	XVPS	.	FLAGS = 0.	REEL = 1.	FILE = 45
84.	CPGMN	.	FLAGS = 0.	REEL = 0.	FILE = 0
85.	DMO	.	FLAGS = 0.	REEL = 0.	FILE = 0
86.	REENTER	AT DMAP SEQUENCE NUMBER	59		
87.	GM	.	FLAGS = 0.	REEL = 1.	FILE = 46
88.	XVPS	.	FLAGS = 0.	REEL = 1.	FILE = 47
89.	REENTER	AT DMAP SEQUENCE NUMBER	59		
90.	CPGMN	.	FLAGS = 0.	REEL = 1.	FILE = 48
91.	DMO	.	FLAGS = 0.	REEL = 1.	FILE = 49
92.	DNO	.	FLAGS = 0.	REEL = 1.	FILE = 50
93.	XVPS	.	FLAGS = 0.	REEL = 1.	FILE = 51
94.	REENTER	AT DMAP SEQUENCE NUMBER	60		
95.	KNN	.	FLAGS = 0.	REEL = 1.	FILE = 52
96.	MNN	.	FLAGS = 0.	REEL = 1.	FILE = 53
97.	XVPS	.	FLAGS = 0.	REEL = 1.	FILE = 54

N A S T R A N E X E C U T I V E C O N T R O L D E C K E C H O

MAY 29, 1974 NASTRAN 2/ 1/73 PAGE 3

98.	REENTER AT DMAP SEQUENCE NUMBER	63		
99.	XVPS	, FLAGS = 0,	REEL = 1,	FILE = 55
100.	KFF	, FLAGS = 0,	REEL = 0,	FILE = 0
101.	MFF	, FLAGS = 0,	REEL = 0,	FILE = 0
102.	REENTER AT DMAP SEQUENCE NUMBER	63		
103.	XVPS	, FLAGS = 0,	REEL = 1,	FILE = 56
104.	DFD	, FLAGS = 0,	REEL = 0,	FILE = 0
105.	CPNSF	, FLAGS = 0,	REEL = 0,	FILE = 0
106.	DSO	, FLAGS = 0,	REEL = 0,	FILE = 0
107.	REENTER AT DMAP SEQUENCE NUMBER	66		
108.	KFS	, FLAGS = 0,	REEL = 1,	FILE = 57
109.	KFF	, FLAGS = 0,	REEL = 1,	FILE = 58
110.	MFF	, FLAGS = 0,	REEL = 1,	FILE = 59
111.	XVPS	, FLAGS = 0,	REEL = 1,	FILE = 60
112.	REENTER AT DMAP SEQUENCE NUMBER	66		
113.	CPNSF	, FLAGS = 0,	REEL = 1,	FILE = 61
114.	DSO	, FLAGS = 0,	REEL = 1,	FILE = 62
115.	DFD	, FLAGS = 0,	REEL = 1,	FILE = 63
116.	XVPS	, FLAGS = 0,	REEL = 1,	FILE = 64
117.	REENTER AT DMAP SEQUENCE NUMBER	69		
118.	XVPS	, FLAGS = 0,	REEL = 1,	FILE = 65
119.	KAA	, FLAGS = 0,	REEL = 0,	FILE = 0
120.	MAA	, FLAGS = 0,	REEL = 0,	FILE = 0
121.	REENTER AT DMAP SEQUENCE NUMBER	69		
122.	XVPS	, FLAGS = 0,	REEL = 1,	FILE = 66
123.	DAO	, FLAGS = 0,	REEL = 0,	FILE = 0
124.	CPFOA	, FLAGS = 0,	REEL = 0,	FILE = 0
125.	DOU	, FLAGS = 0,	REEL = 0,	FILE = 0
126.	REENTER AT DMAP SEQUENCE NUMBER	72		
127.	GO	, FLAGS = 0,	REEL = 1,	FILE = 67
128.	KAA	, FLAGS = 0,	REEL = 1,	FILE = 68
129.	XVPS	, FLAGS = 0,	REEL = 1,	FILE = 69
130.	REENTER AT DMAP SEQUENCE NUMBER	74		
131.	MAA	, FLAGS = 0,	REEL = 1,	FILE = 70
132.	XVPS	, FLAGS = 0,	REEL = 1,	FILE = 71
133.	REENTER AT DMAP SEQUENCE NUMBER	74		
134.	CPFOA	, FLAGS = 0,	REEL = 1,	FILE = 72
135.	DOU	, FLAGS = 0,	REEL = 1,	FILE = 73
136.	DAO	, FLAGS = 0,	REEL = 1,	FILE = 74
137.	XVPS	, FLAGS = 0,	REEL = 1,	FILE = 75
138.	REENTER AT DMAP SEQUENCE NUMBER	75		
139.	XVPS	, FLAGS = 0,	REEL = 1,	FILE = 76
140.	KRRB	, FLAGS = 0,	REEL = 0,	FILE = 0
141.	CPALR	, FLAGS = 0,	REEL = 0,	FILE = 0
142.	DLO	, FLAGS = 0,	REEL = 0,	FILE = 0
143.	DRD	, FLAGS = 0,	REEL = 0,	FILE = 0
144.	REENTER AT DMAP SEQUENCE NUMBER	82		
145.	KLL	, FLAGS = 0,	REEL = 1,	FILE = 77
146.	KLR	, FLAGS = 0,	REEL = 1,	FILE = 78
147.	KRRB	, FLAGS = 0,	REEL = 1,	FILE = 79

148.	DM	,	FLAGS = 0,	REEL = 1,	FILE = 30
149.	KRM	,	FLAGS = 0,	REEL = 1,	FILE = 31
150.	MLL	,	FLAGS = 0,	REEL = 1,	FILE = 32
151.	MLR	,	FLAGS = 0,	REEL = 1,	FILE = 33
152.	MRR	,	FLAGS = 0,	REEL = 1,	FILE = 34
153.	XVPS	,	FLAGS = 0,	REEL = 1,	FILE = 35
154.	REENTER AT DMAP SEQUENCE NUMBER 84				
155.	MZ	,	FLAGS = 0,	REEL = 1,	FILE = 36
156.	XVPS	,	FLAGS = 0,	REEL = 1,	FILE = 37
157.	REENTER AT DMAP SEQUENCE NUMBER 84				
158.	CPADR	,	FLAGS = 0,	REEL = 1,	FILE = 88
159.	JLG	,	FLAGS = 0,	REEL = 1,	FILE = 89
160.	JRC	,	FLAGS = 0,	REEL = 1,	FILE = 90
161.	XVPS	,	FLAGS = 0,	REEL = 1,	FILE = 91
162.	REENTER AT DMAP SEQUENCE NUMBER 89				
163.	EEU	,	FLAGS = 0,	REEL = 1,	FILE = 92
164.	XVPS	,	FLAGS = 0,	REEL = 1,	FILE = 93
165.	REENTER AT DMAP SEQUENCE NUMBER 92				
166.	LAMA	,	FLAGS = 0,	REEL = 1,	FILE = 94
167.	PLA	,	FLAGS = 0,	REEL = 1,	FILE = 95
168.	MI	,	FLAGS = 0,	REEL = 1,	FILE = 96
169.	DEIGS	,	FLAGS = 0,	REEL = 1,	FILE = 97
170.	XVPS	,	FLAGS = 0,	REEL = 1,	FILE = 98
171.	REENTER AT DMAP SEQUENCE NUMBER 97				
172.	PHIG	,	FLAGS = 0,	REEL = 1,	FILE = 99
173.	QS	,	FLAGS = 0,	REEL = 1,	FILE = 100
174.	XVPS	,	FLAGS = 0,	REEL = 1,	FILE = 101
175.	REENTER AT DMAP SEQUENCE NUMBER 100				
176.	SIL	,	FLAGS = 4,	REEL = 1,	FILE = 13
177.	SIP	,	FLAGS = 4,	REEL = 1,	FILE = 13
178.	HGPDT	,	FLAGS = 4,	REEL = 1,	FILE = 12
179.	JGDDP	,	FLAGS = 4,	REEL = 1,	FILE = 12
180.	XVPS	,	FLAGS = 0,	REEL = 1,	FILE = 102

\$ END OF CHECKPOINT DICTIONARY

TIME 20

APP DISP

SOL 3.0

DIA 7,8,13,14,19,21,22

\$ ALTERS FOR OBTAINING STATIC TEST DEFL'S FROM RIGID FORMAT 3

\$ CHKPT TAPE FROM PHASE 2 MODAL ANALYSIS WHICH USED ALTERED R.F. 3

ALTER 2,7

ALTER 19,94

\$ DEFL'S UNIT LOADS

SJLVL KLL,/FLL/C,N,1/C,N,1/C,N,2/C,N,2

MERGE FLL,,,CPADR,/FAA/C,N,-1/C,N,2/C,N,6

\$ DEFL'S (TEST CASES)

\$ SCTEST IS INPUT MATRIX WHICH CONVERTS DYNAMIC A-SET UNIT LOADS TO

\$ TEST CASES

MPYAD FAA,SCTEST,/FHIA/C,N,0/C,N,1/C,N,0

ALTER 108,107

N A S T R A N E X E C U T I V E C O N T R O L D E C K E C H O

MAY 29. 1974 NASTRAN 2/ 1/73 PAGE 5

```

$ NJDE LLOADS
MPYAD       KGGY,PHIG,/PGG/C,N,0/C,N,1/C,N,0 $
$ EQUIL. CHECK
MPYAD       EQG,PGG,/EGFGG/C,N,0/C,N,1/C,N,0 $
MATPRN      EOPGG,... // $
SDR2        CASECC,CSTM,MPT,DIT,EGEXIN,SIL,...,BGFDF,PGG,OG,PHIG,EST,/DPG1,
            OGG1,OPHIG,OESI,CEFI,PPHIG/C,N,STATICS
UFP         DPG1,OGG1,OPHIG,...//V,N,CARDNC
SAVE        CARDNO $
ALTER 109,109
PLJT        PLTPAR,GPSETS,ELSETS,CASECC,BGPD,EGEXIN,SIP,PPHIG,/PLOTX2/
            V,N,NSIL/V,N,LLSET/V,N,JUMPLCT/V,N,PLFLG/V,N,PFILE $
ENDALTER
CEND

```

ORBITER STATIC TEST CASES ON INTERSTAGE SUPPORTS
REVISED 5/20/74 ANTI CASE

MAY 29, 1974 NASTRAN 2/ 1/73 PAGE 6

C A S E C C N T R O L D E C K E C H O

CARD
COUNT

1 TITLE = ORBITER STATIC TEST CASES ON INTERSTAGE SUPPORTS
2 SHTITLE = REVISED 5/20/74 ANTI CASE
3 MAXLINES = 30000
4 ECHO = 3LTH
5 VECTOR = ALL
6 CLOAD = ALL
7 SUBCASE 1
8 LABEL = UNIT FY ON FULL ORBITER (MID FUS.-STA 116.0 WL 51.5)
9 SUBCASE 2
10 LABEL = NOSE TORSION .11 IN-LBS (-PZ=.5 AT STA 46.75,GRID 120)
11 SUBCASE 3
12 LABEL = MID TORSION .61.6 IN-LBS (-PZ=.5 AT WING TIP, GRID 3017)
13 SUBCASE 4
14 LABEL = UNIT FY ON FULL ORBITER (FIN BALLAST,GRID 4400)
15 OUTPUT(PLCT)
16 SET 41 = INCLUDE 2990 THRU 3075,4401 THRU 4412,1000 THRU 1064,
17 1201 THRU 1212
18 SET 42 = INCLUDE 3024 THRU 3055,4882 THRU 4894,1055 THRU 1102,
19 1211 THRU 1220
20 PLOTTER CALCOMP 765,105
21 AXES =MY,X,Z
22 VIEW = 30.0,45.0,0.0
23 MAXIMUM DEFORMATION 10.0
24 FIND SCALE,CRIGIN 42,SET 42
25 PLCT STATIC DEFORMATION 1 THRU 4, SET 41,SHAPE,VECTOR XYZ
26 PLCT STATIC DEFORMATION 1 THRU 4, SET 42,SHAPE,VECTOR XYZ
27 BEGIN BULK

JR3ITER STATIC TEST CASES CN INTERSTAGE SUPPORTS
REVISED 5/20/74 ANTI CASE

MAY 29, 1974 NASTRAN 2/ 1/73 PAGE 7

INPUT BULK DATA DECK ECHO

. 1 .. 2 .. 3 .. 4 .. 5 .. 6 .. 7 .. 8 .. 9 .. 10 .

\$ SCTEST IS INPUT MATRIX WHICH CONVERTS DYNAMIC A-SET UNIT LOADS TO

\$ TEST CASES

DMI	SCTEST	0	2	1	2	34E	4
DMI	SCTEST	1	62	.3305075	6E	.1694925	
DMI	SCTEST	2	11	-.5			
DMI	SCTEST	3	189	-.5			
DMI	SCTEST	4	308	.5			

ENDDATA

TOTAL COUNT= 8

Appendix A22
PLOTS OF SYMMETRIC FREE-FREE
MODES/PHASE 2 ANALYSIS:
MODEL II ORBITER

1 8/24/74 MAX-DIST. • LOOSENING

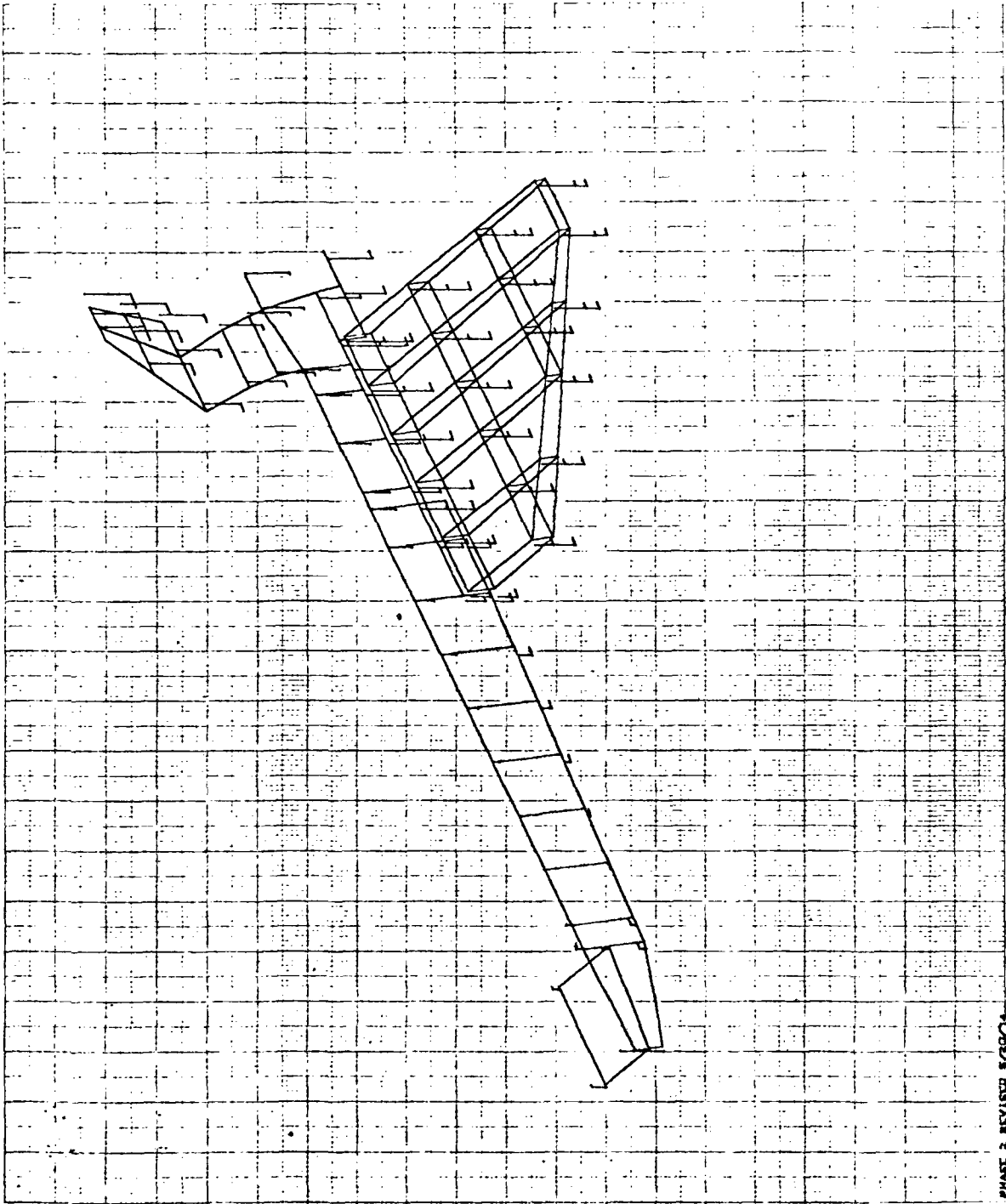

PHASE 2 REVISED 8/20/74
CRITICAL STYMA CASE
RIGID BODY MODES
MEDIAL DETOR. SUBCASE 1 MODE 1 FREQ. 0.

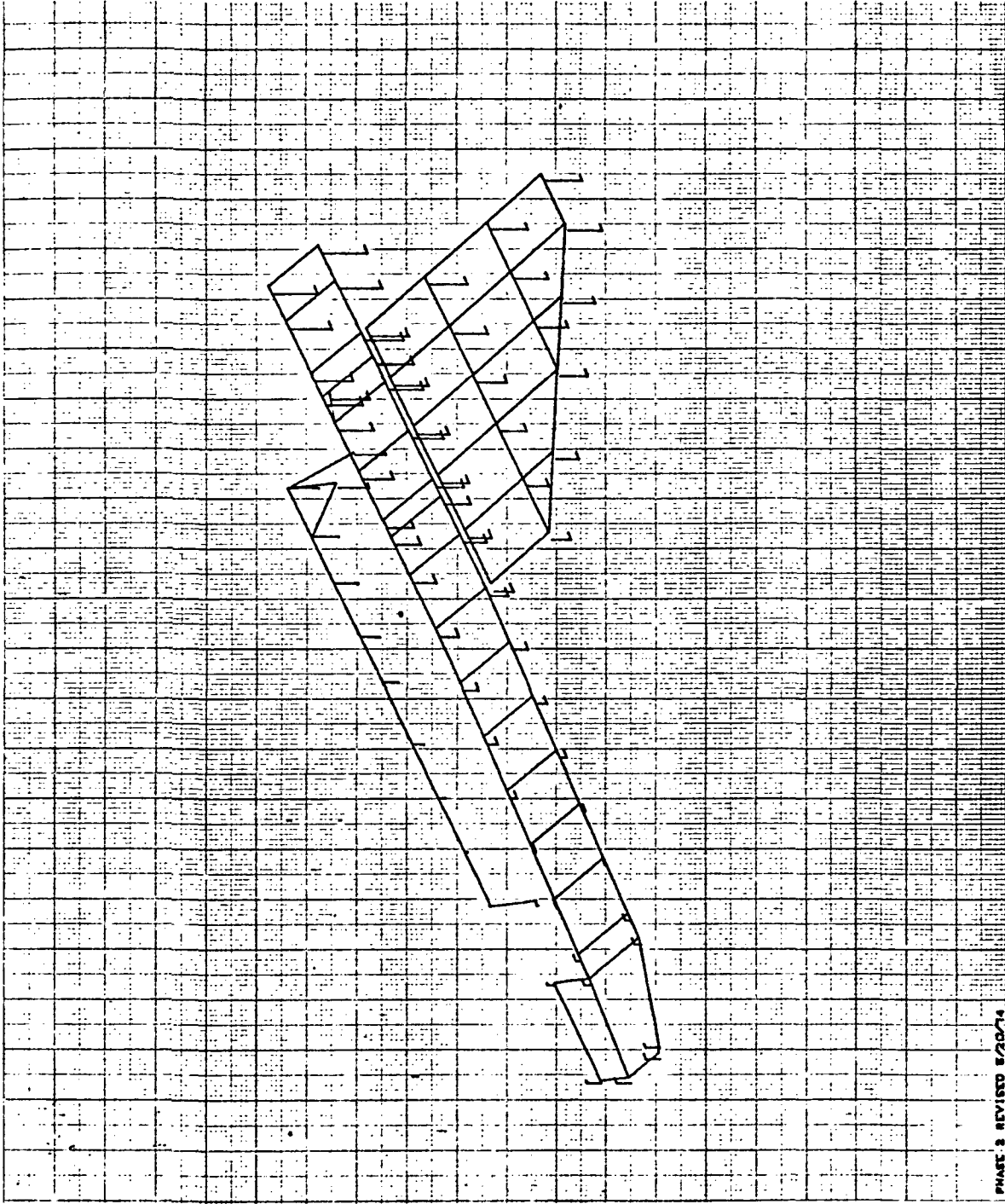

PHASE 2 REVISED 5/20/74
ORBITER SYMM CASE
RIGID BODY MODES
MODAL DETER. SUBCASE 1 MODE 1 PAGE 0.

8/24/74 MAX-DEV. • D. 98889112

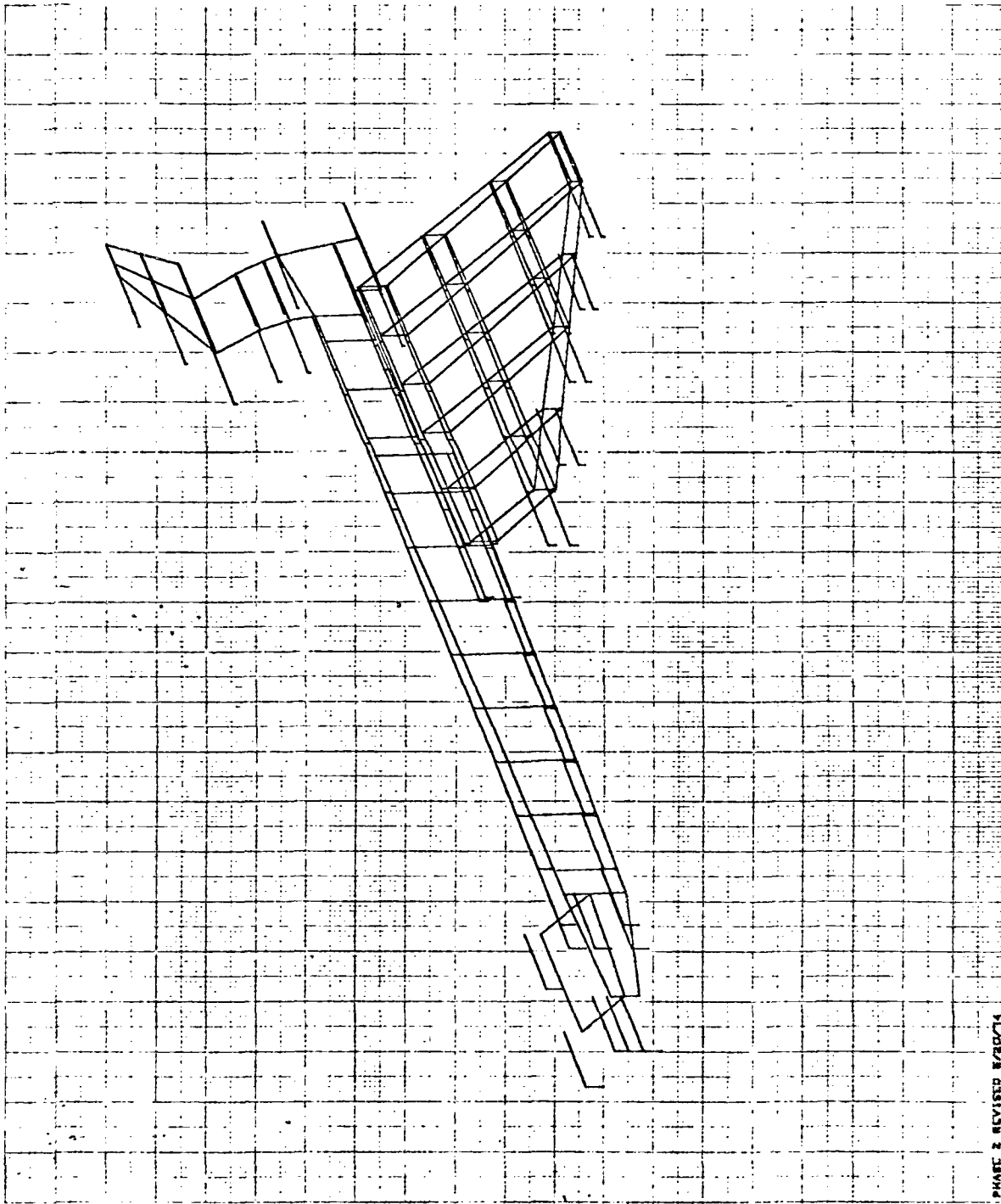

PHASE 2 REVISED 8/20/74
ORBITER SYMM CASE
RIGID BODY MODES
MEDAL DETOR. SUBCASE 2 MODE 2 FINL. Q.

IF 11 573474 WAVELENGTH = 0.1648112

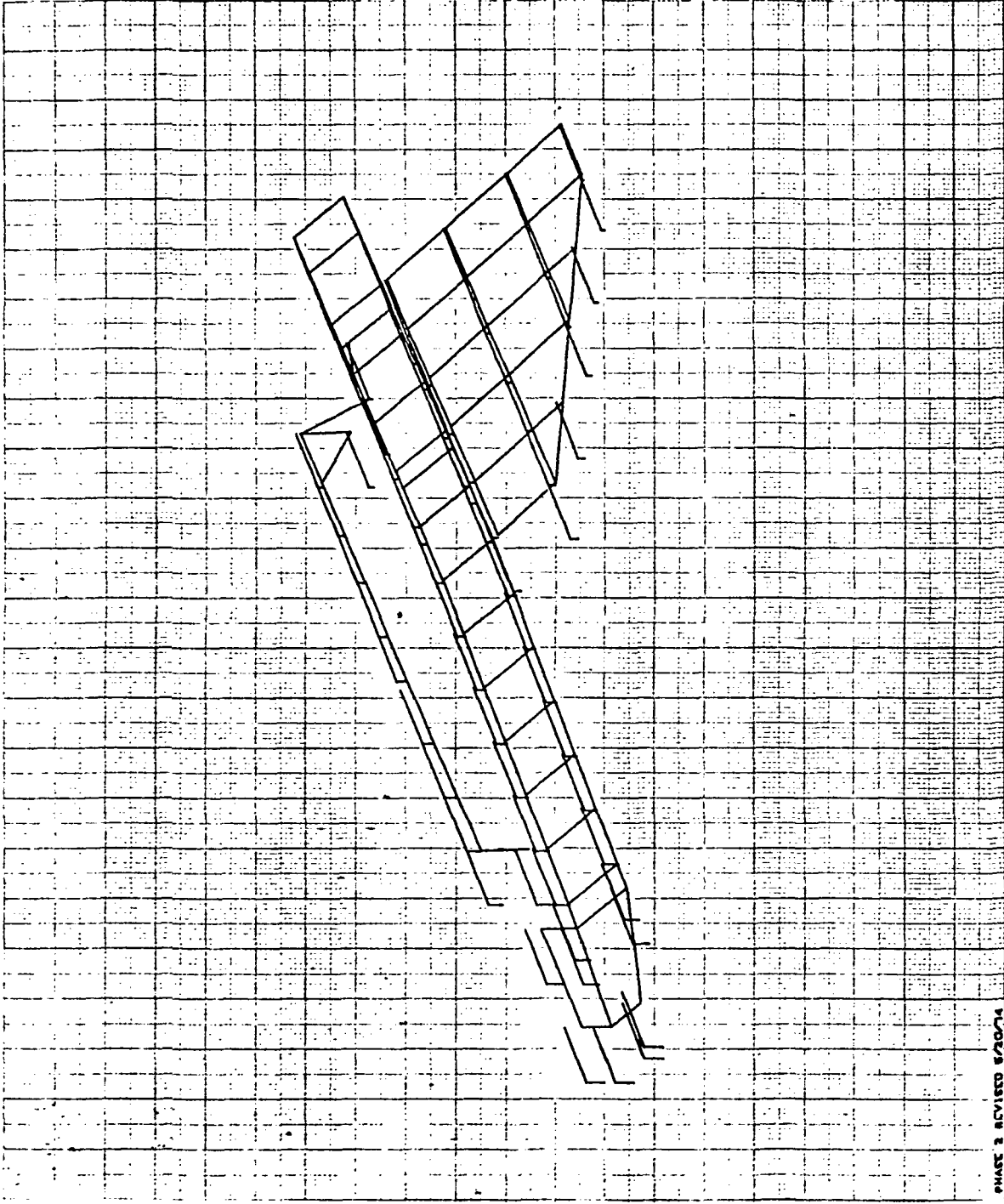

PHASE 2 REVISED 5/20/74
CRISTEN STAM CASE
RIGID BODY MODES
MODAL DETON. SURFACE 2 MODE 2 FREQ. 0.

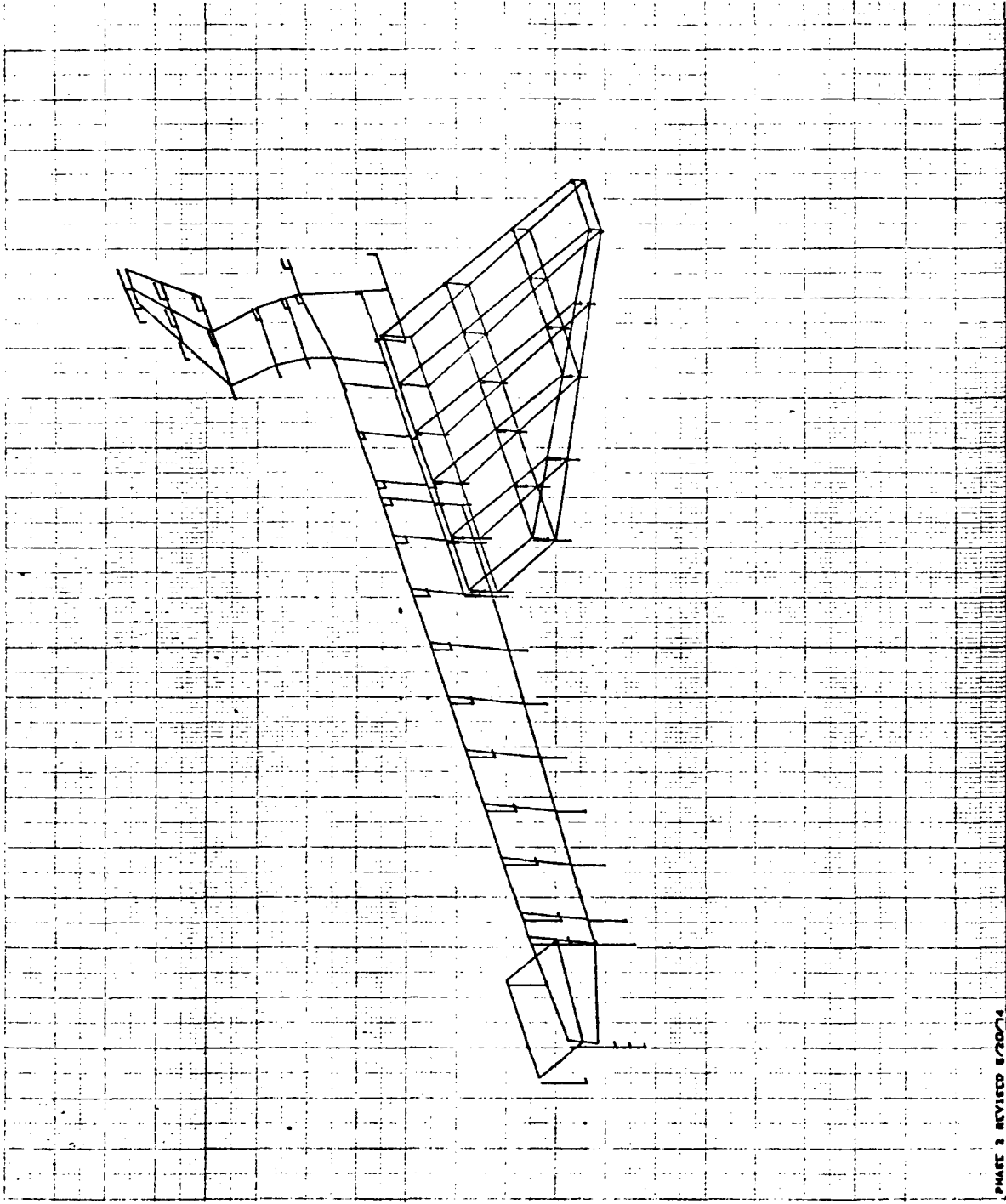

PHASE 2 REVISED 8/20/74
ORBITER SYM CASE
RIGID BODY MODES
MODAL DETCH. SUBCASE 3 MODE 3 FREQ. 0.

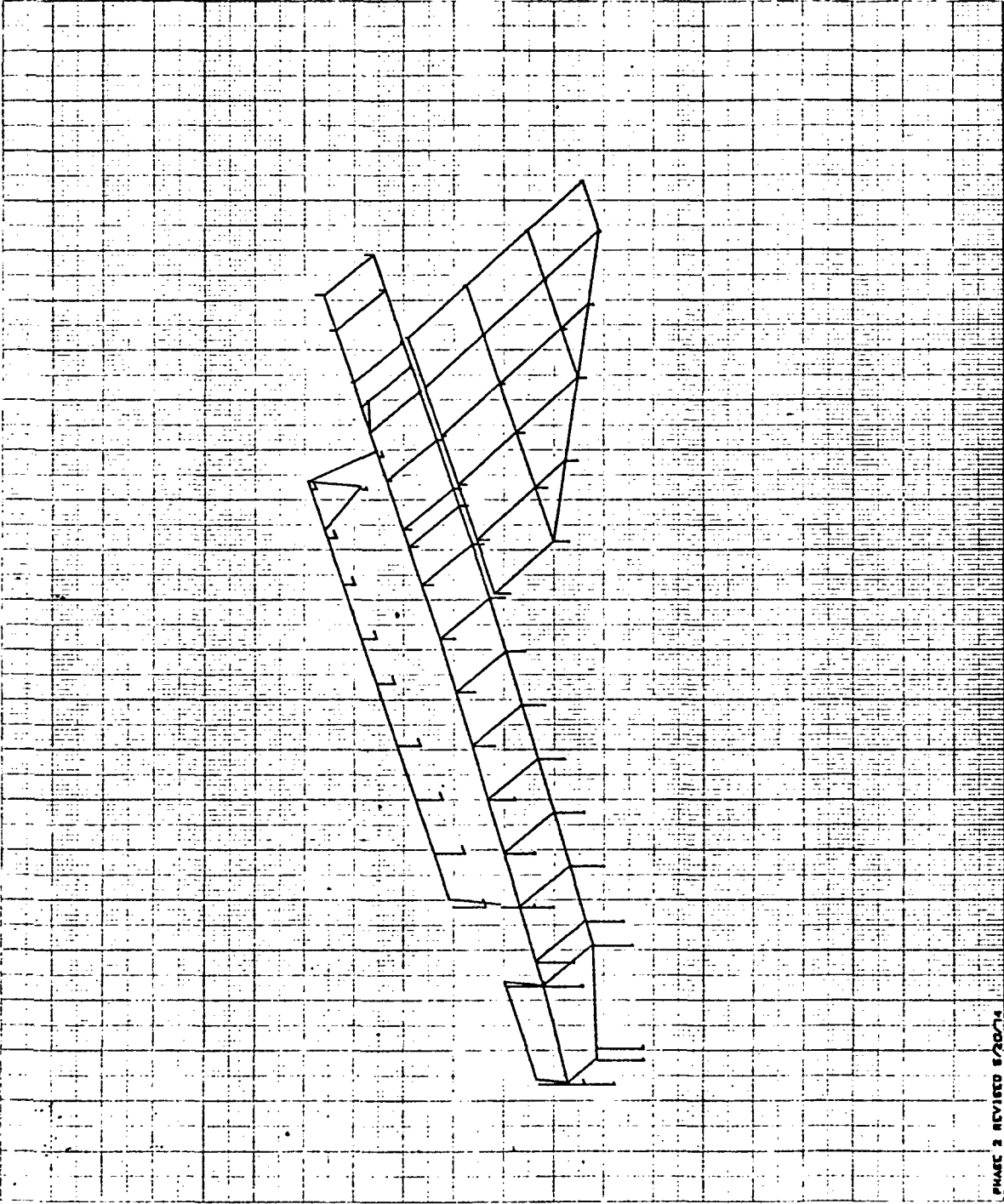

PHASE 2 REVISED 5/20/74
ORBITER SYMM CASE
RIGID BODY MODES
MODAL DETON. SURFACE 3 MODE 3 FREQ. 0.

8/24/74 MAX-REV. 4 1.00000000

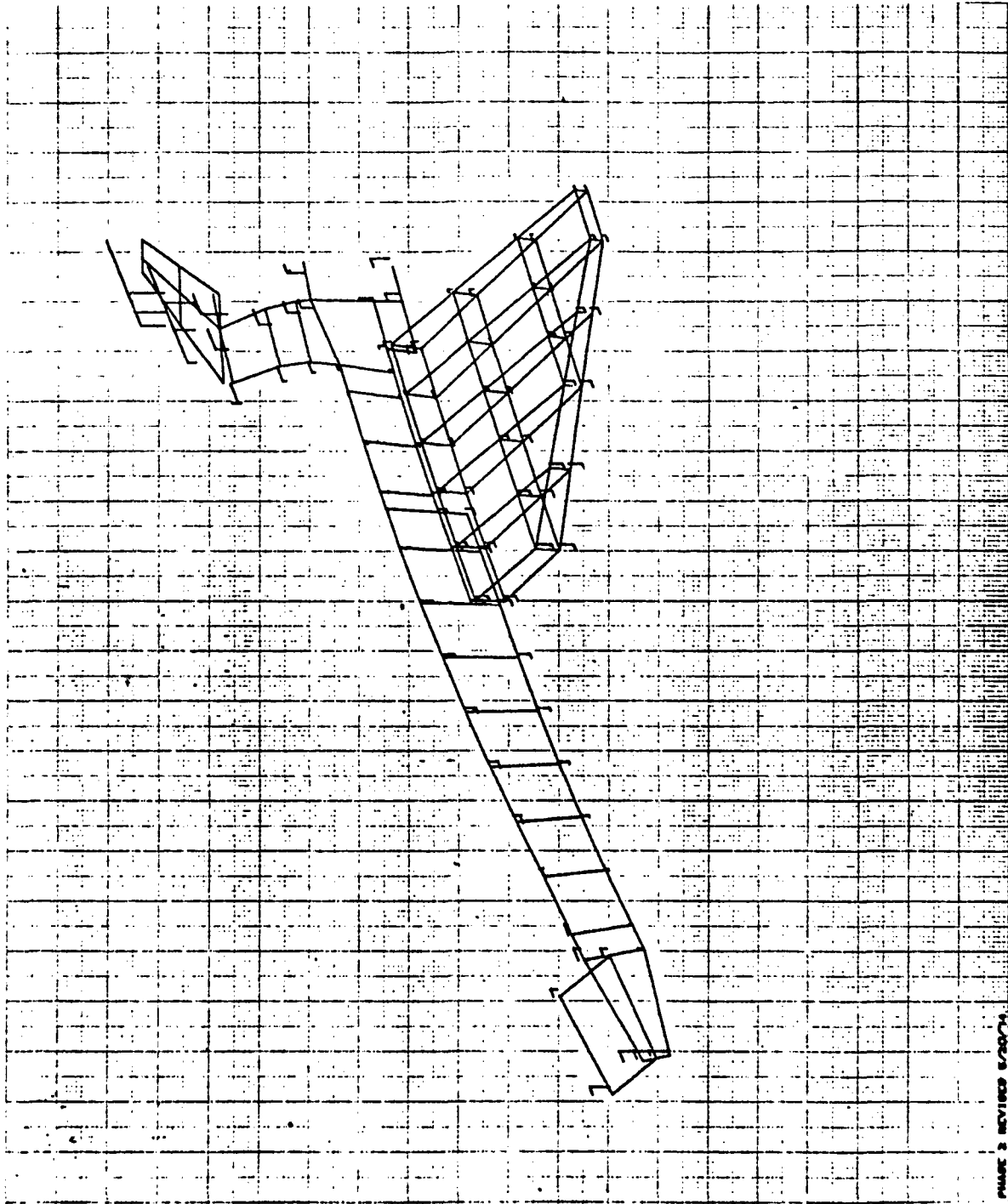

PHASE 2 REVISED 8/20/74
OMITTED STAIN CASE
FREE FREE WORKS
NORMAL MOTOR. SURFACE 4 MARK 4. FIG. 44.2574

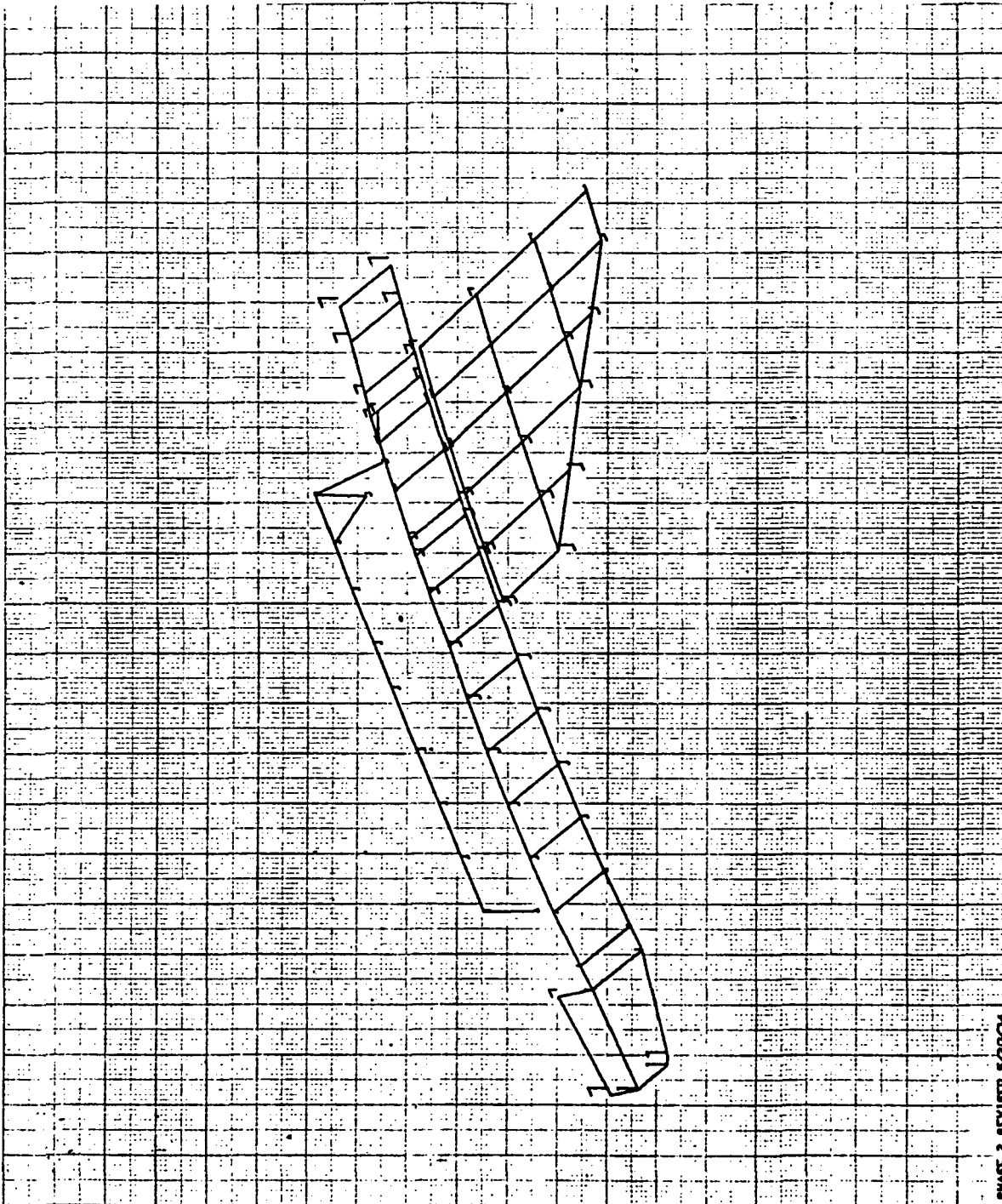

PHASE 2 REVISED 5/20/74
ORBITER SYMM CASE
FREE FREE MODES
MODAL DEFOR. SUBCASE 4 MODE 4 FREQ. 44.2874

5 5/24/74 MAX-DEF. = 1.00000000

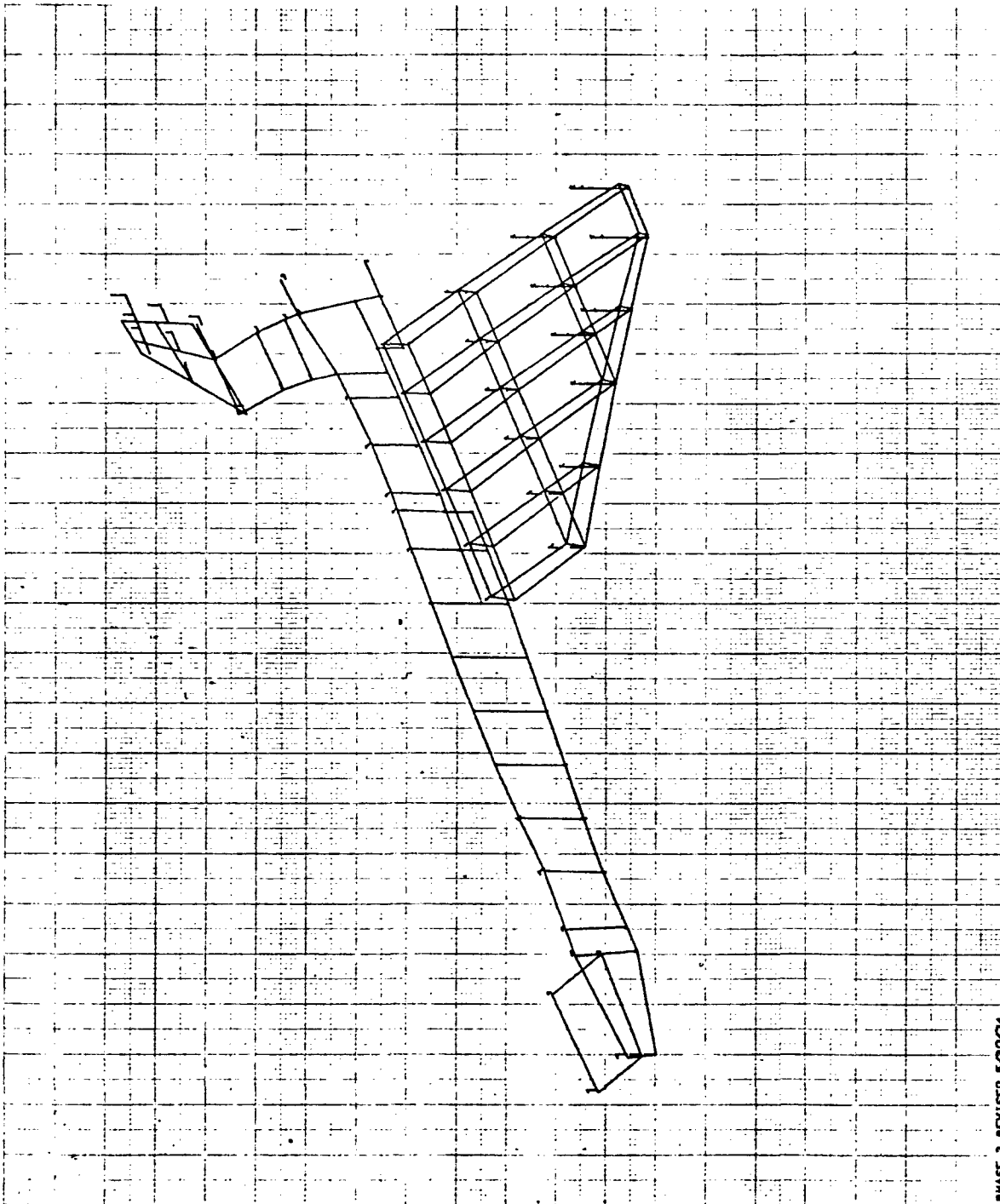

PHASE 2 REVISED 5/20/74
ORBITER SYM CASE
FREE FREE MODES
MODAL DETOR. SUBCASE 5 MODE 5 FREQ. 54.40893

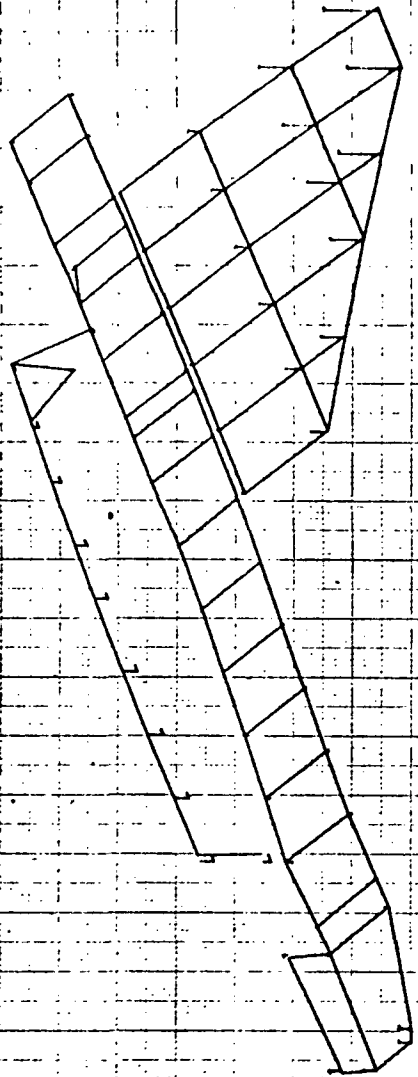

PHASE 2 REVISED 8/20/74
 ORBITER SYMM CASE
 FREE FREE MODES
 MODAL DETOR. SUBCASE 6 MODE 6 FREQ. 64.40883

5/24/74 MAX-DE' 1.00000000

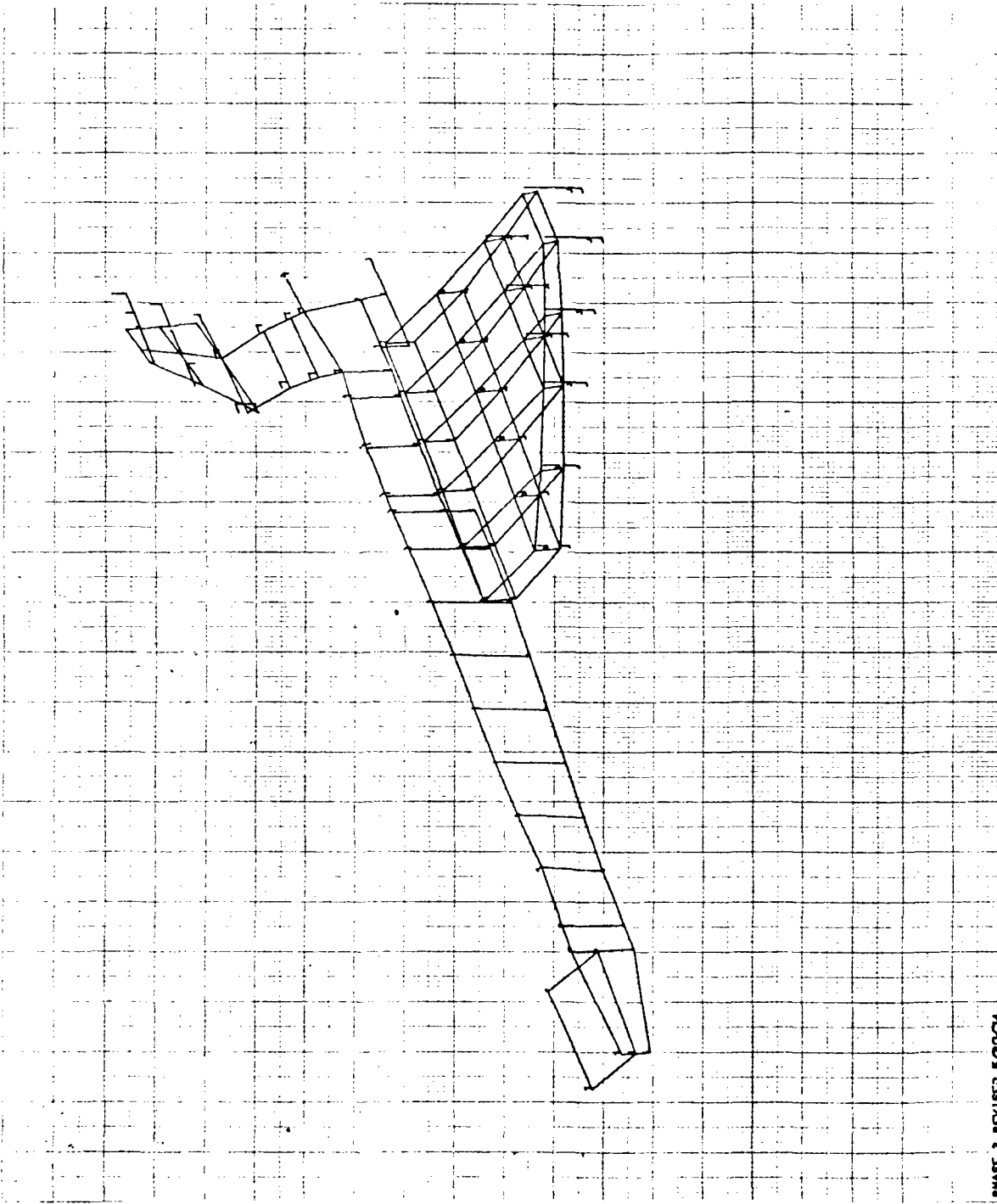

PHASE 2 REVISED 6/20/74
ORBITER SYMM CASE
FREE FREE MODES
MEDAL DETER. SUBCASE 8 MODE 8 FREQ. 63.46187

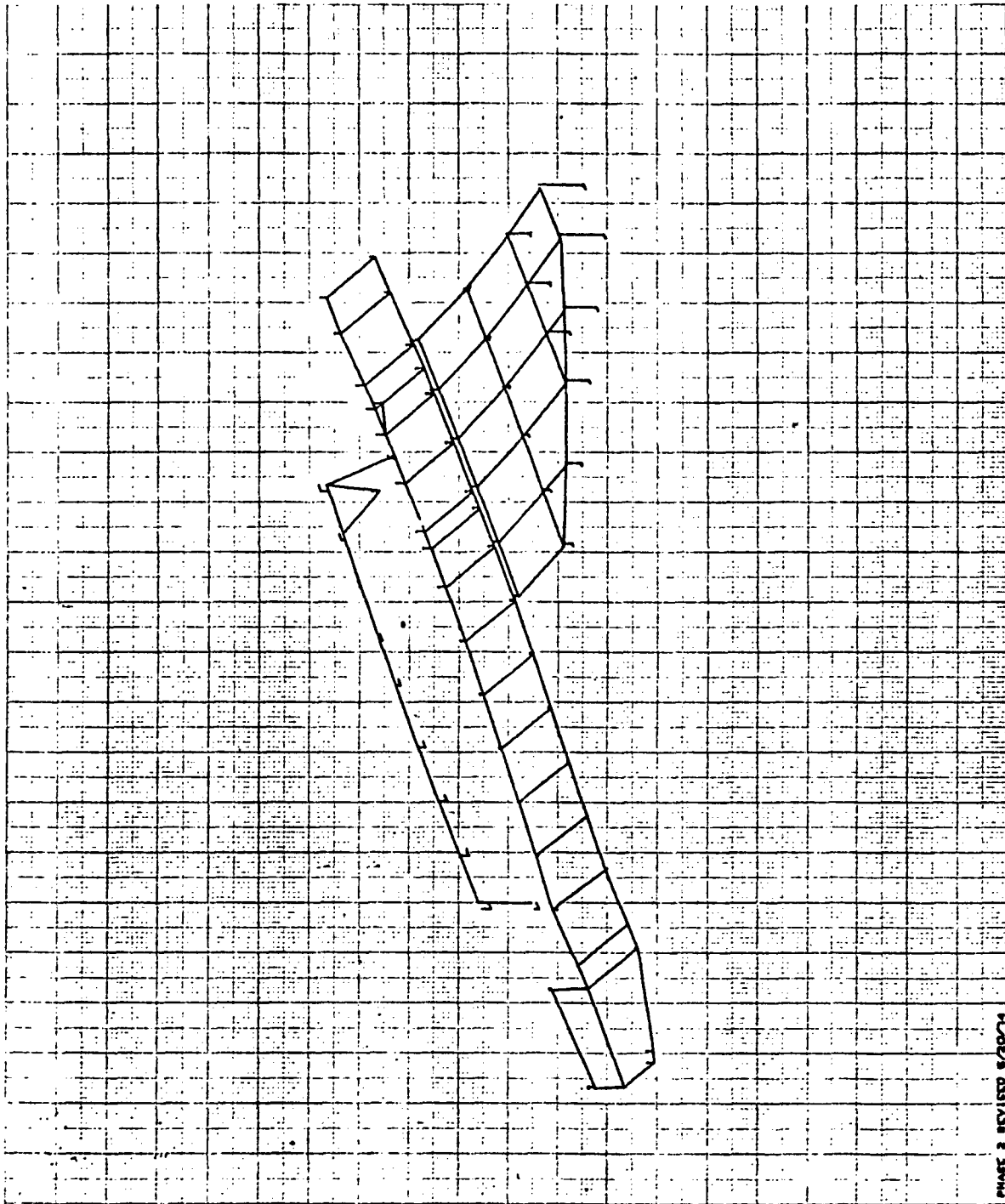

PHASE 2 REVISED 8/20/74
ORBITER STYMA CASE
FREE FREE HINGE
MODAL VECTOR. SWACASE 6 MODE 6 FREQ. 82.98187

6/24/74 MAX-DEF. = 1.00000000

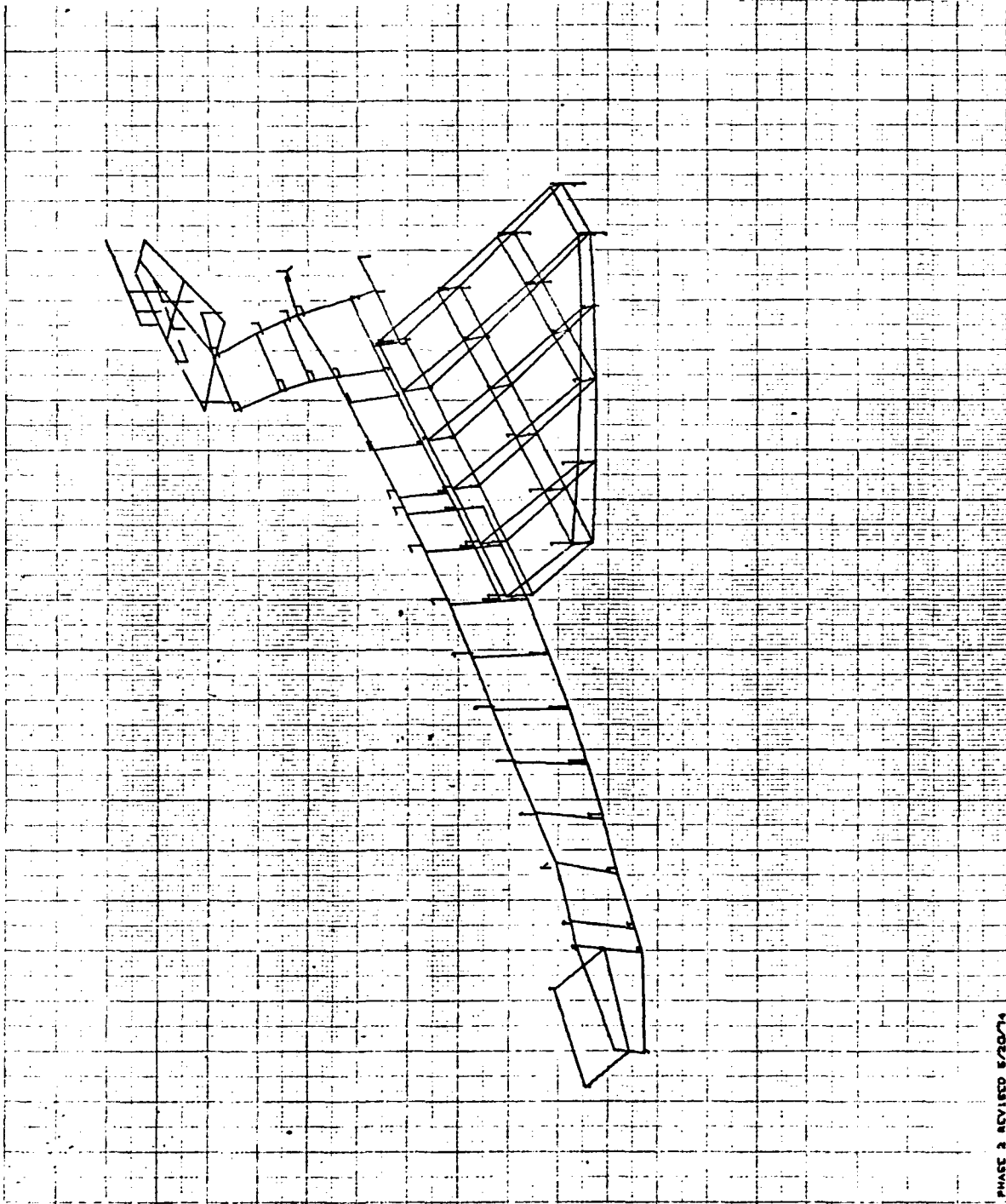

PHASE 2 REVISED 5/20/74
ORBITER SYMM CASE
FREE FREE MODES
MODAL DEFOR. SURFACE 7 MODE 7 FREQ. 60.15444

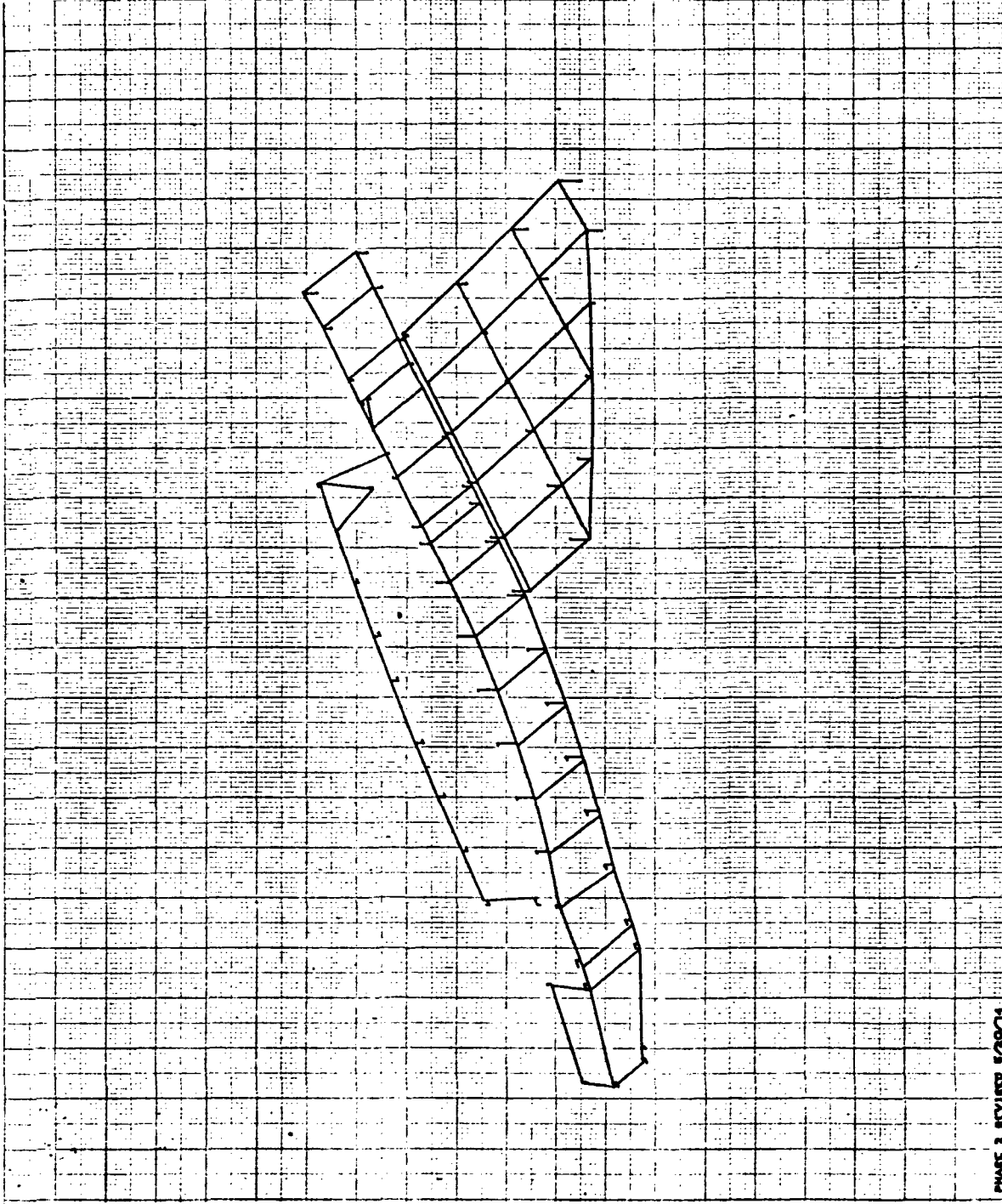

PHASE 2 REVISED 8/20/74
 ORBITER SYM CASE
 FREE FREE MODES
 MODAL DETON. SURFACE 7 MODE 7 FREQ. 60.18444

6 5/24/74 MAX-DET. = 1.00000000

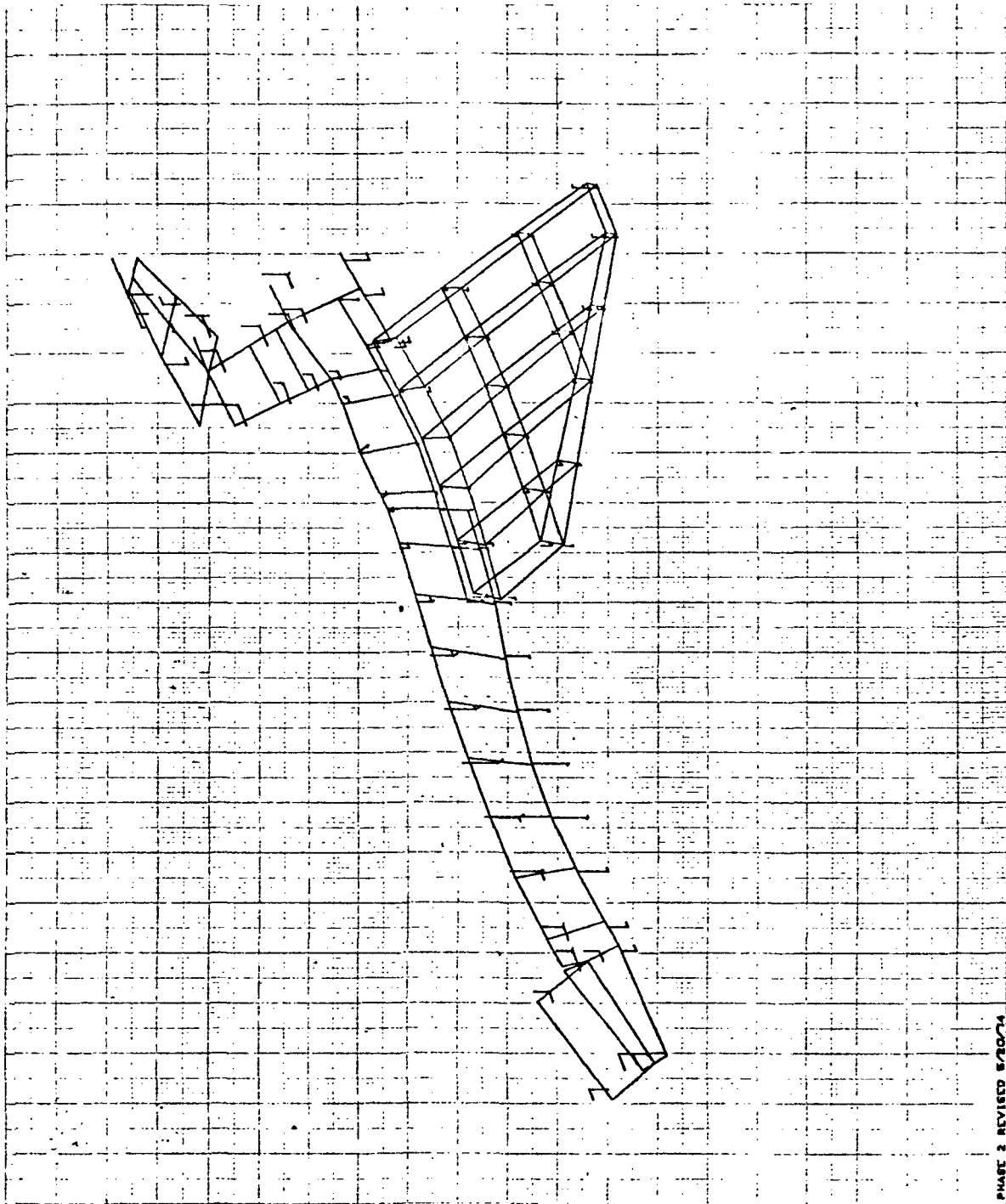

PHASE 2 REVISED 5/30/74
ORBITER SYMM CASE
FACE FREE MODES
MODAL DETOR. SUBCASE 8 MODE 8 FREQ. 109.8041

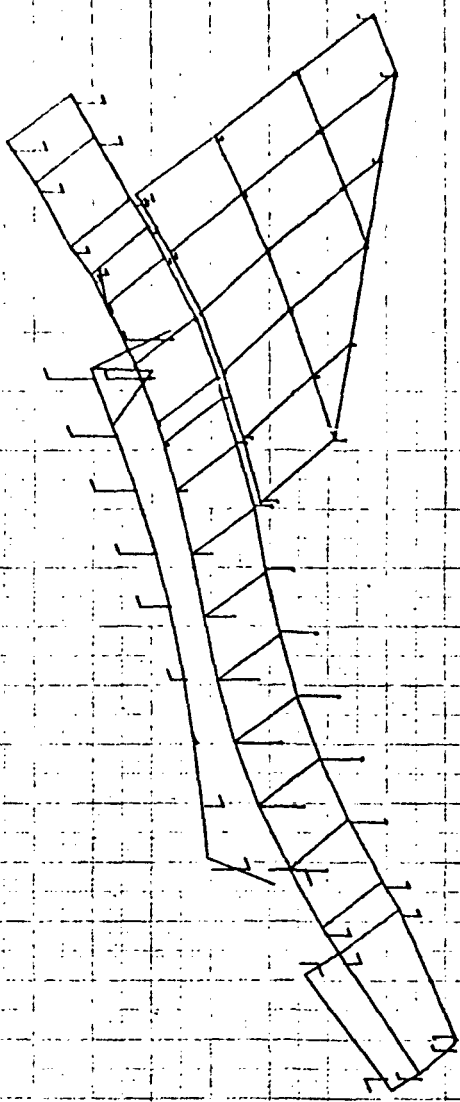

PHASE 3 REVISED 6/20/74
 CRIBITER SYMM CASE
 FREE FREE MODES
 MODAL DEFUR. EUSCARE 6 MODE 6 FREQ. 100.8041

8/24/74 MAX-DEF. = 1.00000000

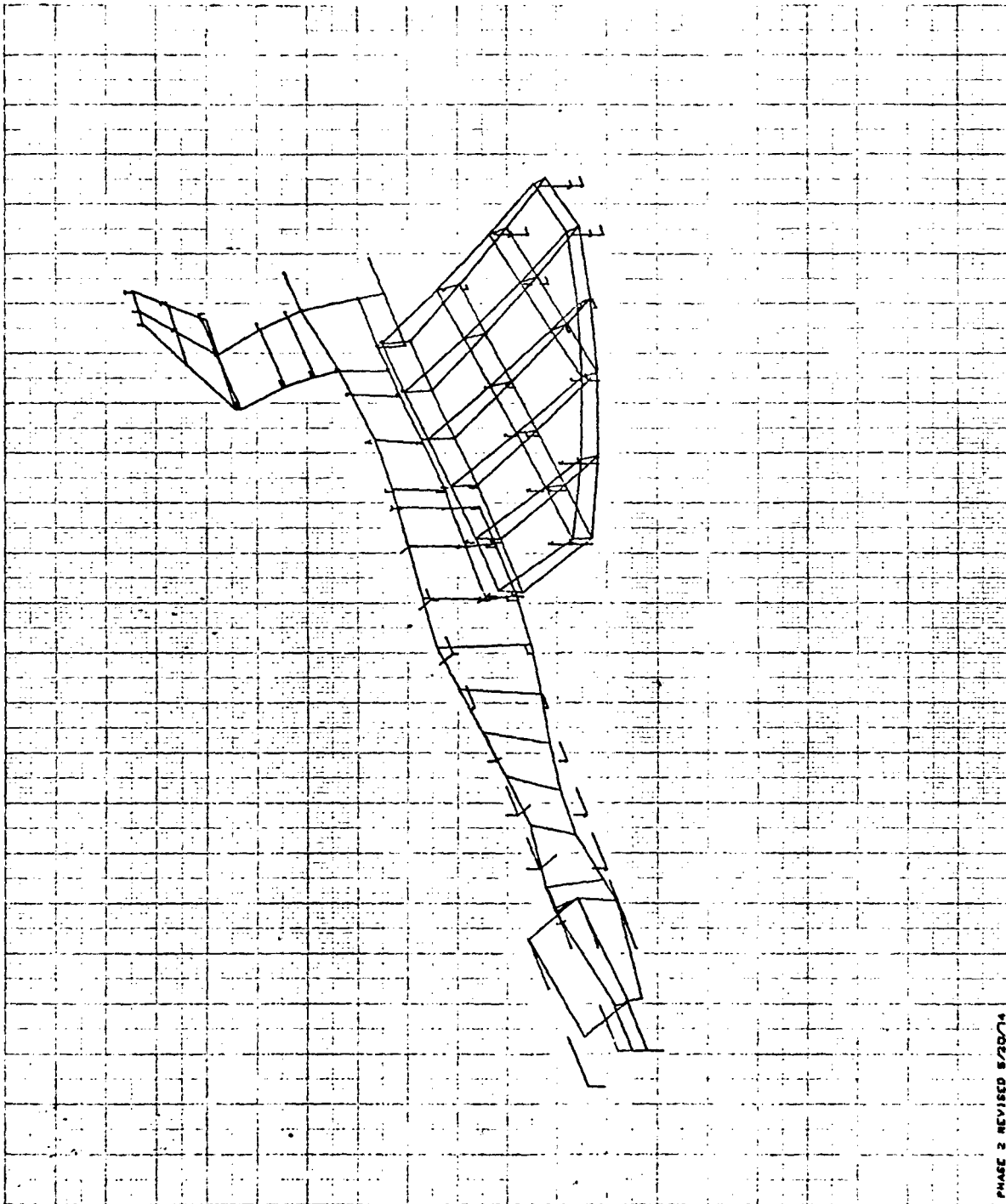

PHASE 2 REVISED 8/20/74
DRITTER SYMM CASE
FREE FREE MODES
MODAL DEFOR. SUBCASE 9 MODE 9 FREQ. 115.9678

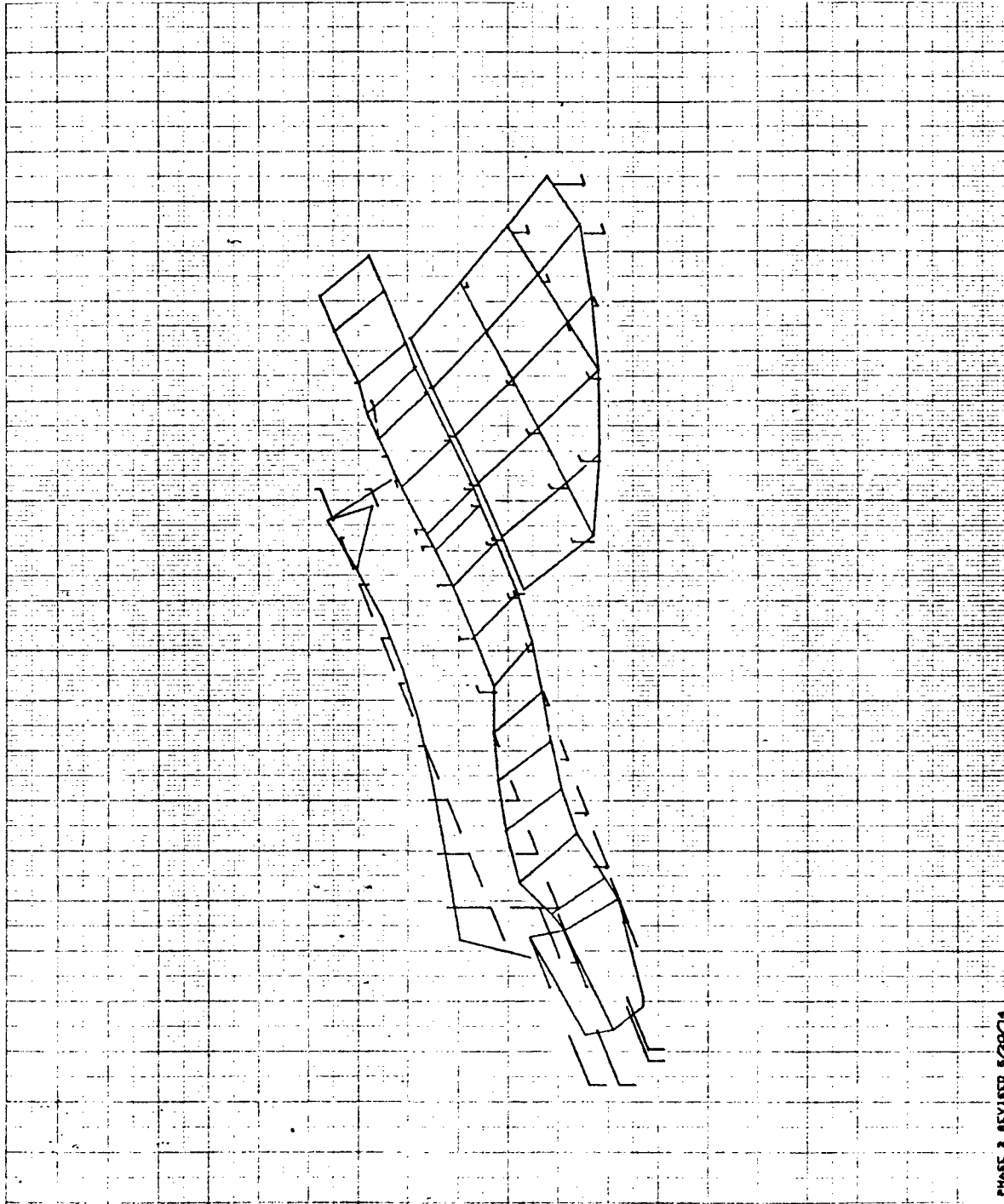

PHASE 2 REVISED 6/20/74
ORBITER SYMM CASE
FREE FREE MODES
MODAL DEFOR. SUBCASE 9 MODE 9 FREQ. 118.9678

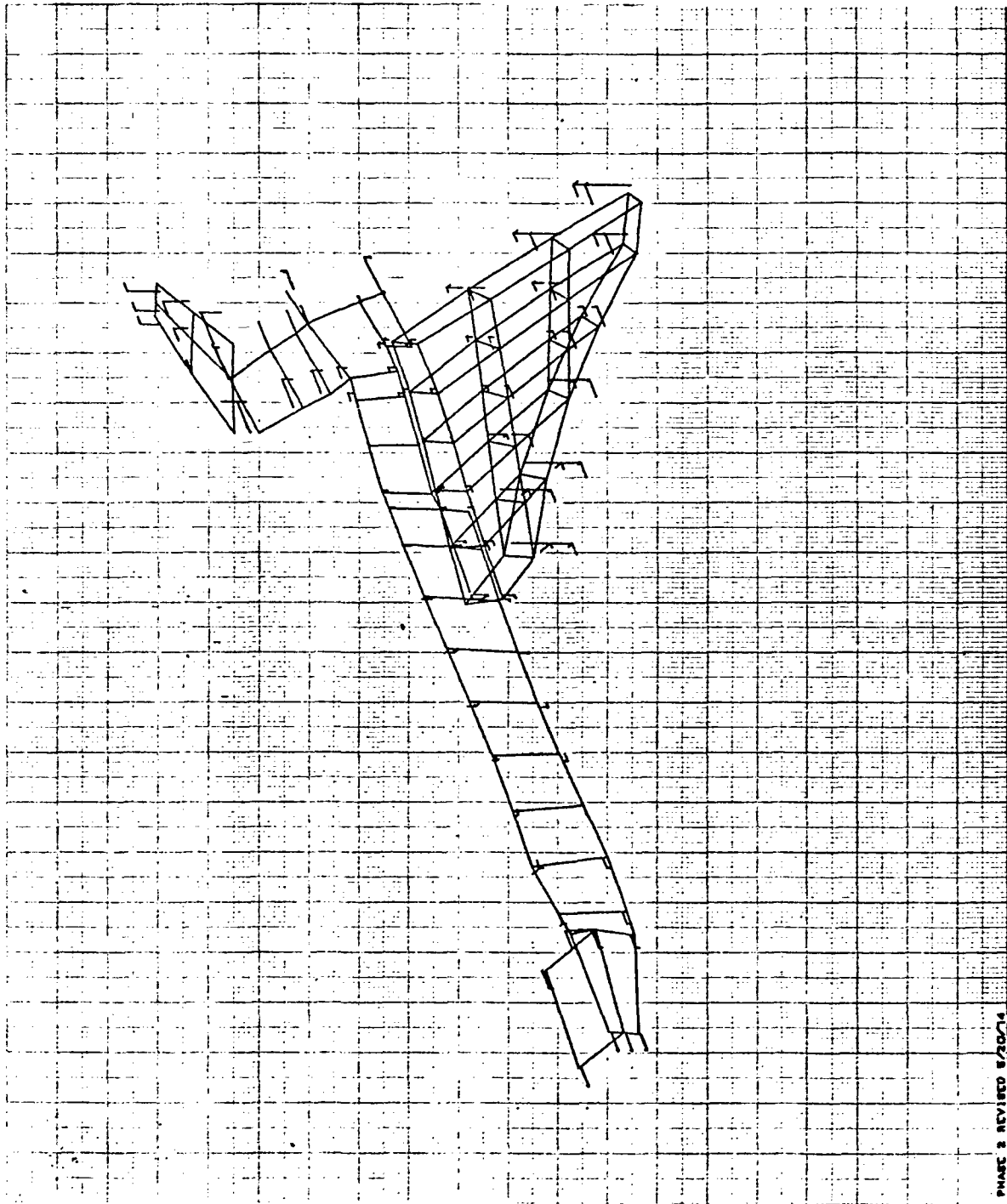

PHASE 2 REVISED 8/20/74
ORBITER STWAVE CASE
FREE FREE MODES
MODAL DEFOR. SUBCASE 10 MODE 10 FREQ. 131.6180

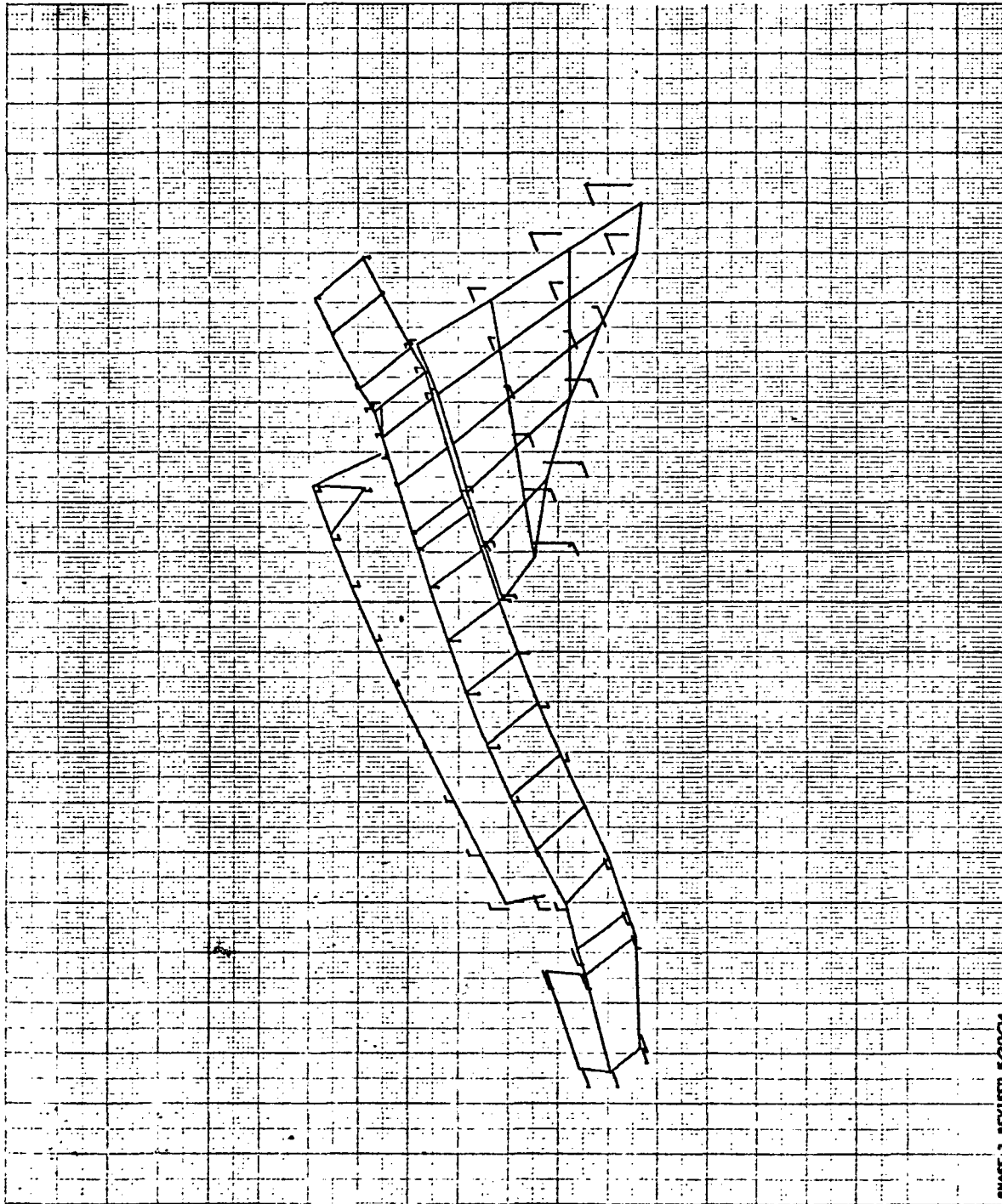

PHASE 3 REVISED 6/20/74
CRIBTER SYMM CASE
FREE FREE MOORE
MODAL DETOR. SUBCASE 10 MODE 10 FREQ. 131.6130

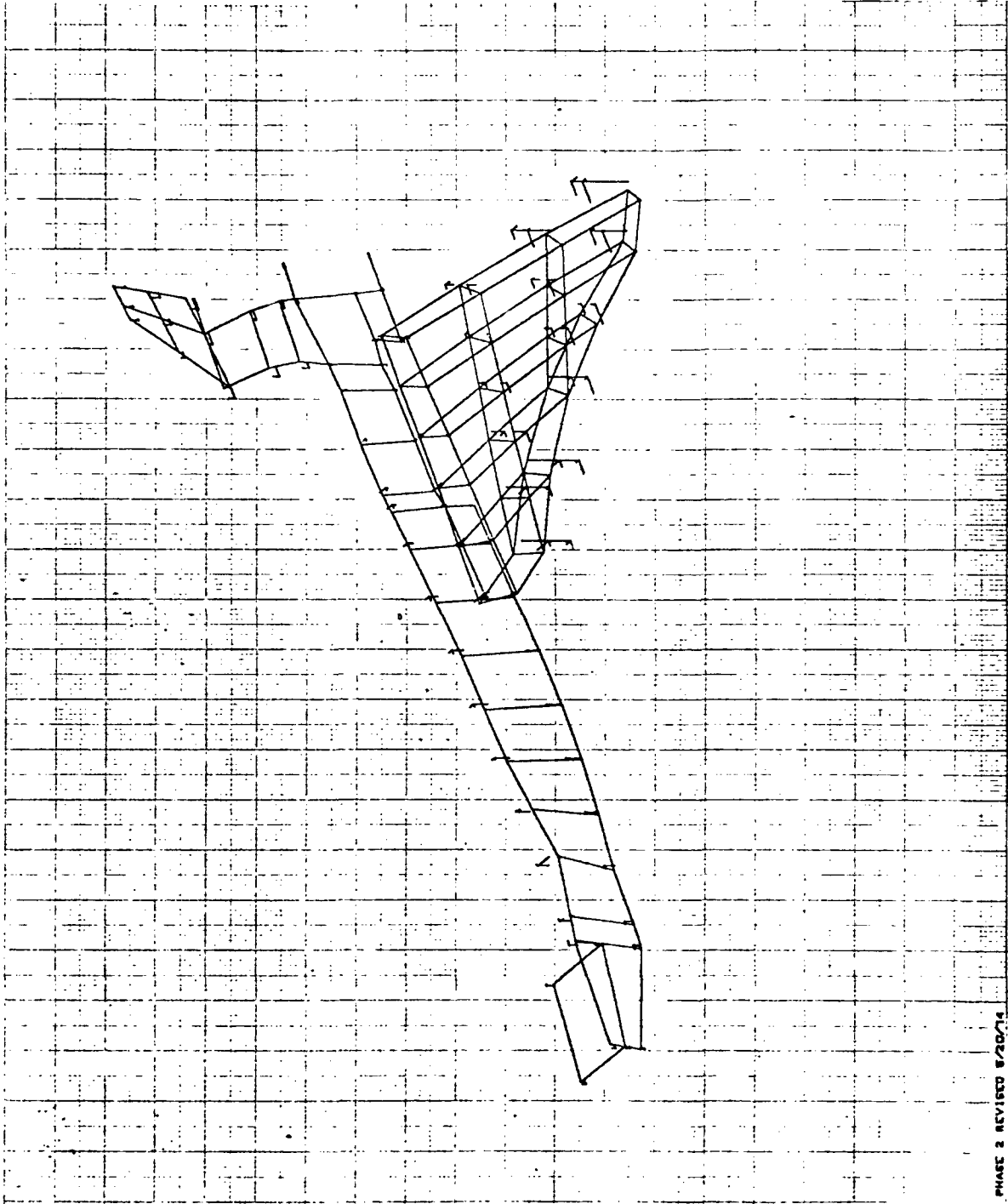

PHASE 2 REVISED 8/20/74
ORBITER SYMM CASE
FREE FREE MODES
MODAL DEFOR. SUBCASE 11 MODE 11 FREQ. 134.7417

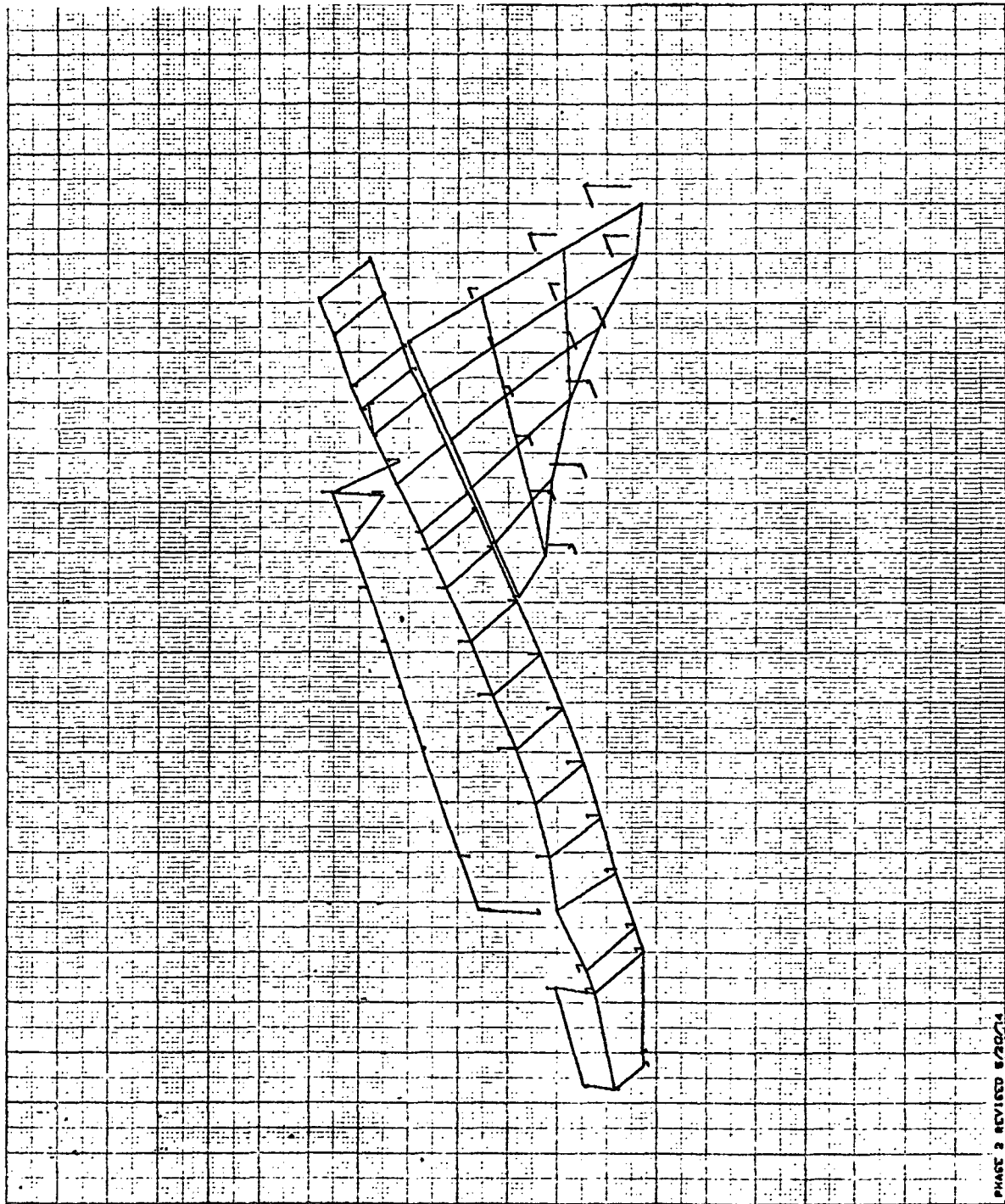

PHASE 2 REVISED 5/20/74
 ORBITER SYMM CASE
 FREE FREE MODES
 MODAL DEFOR. SURFACE 11

MODE 11 FREQ. 139.7417

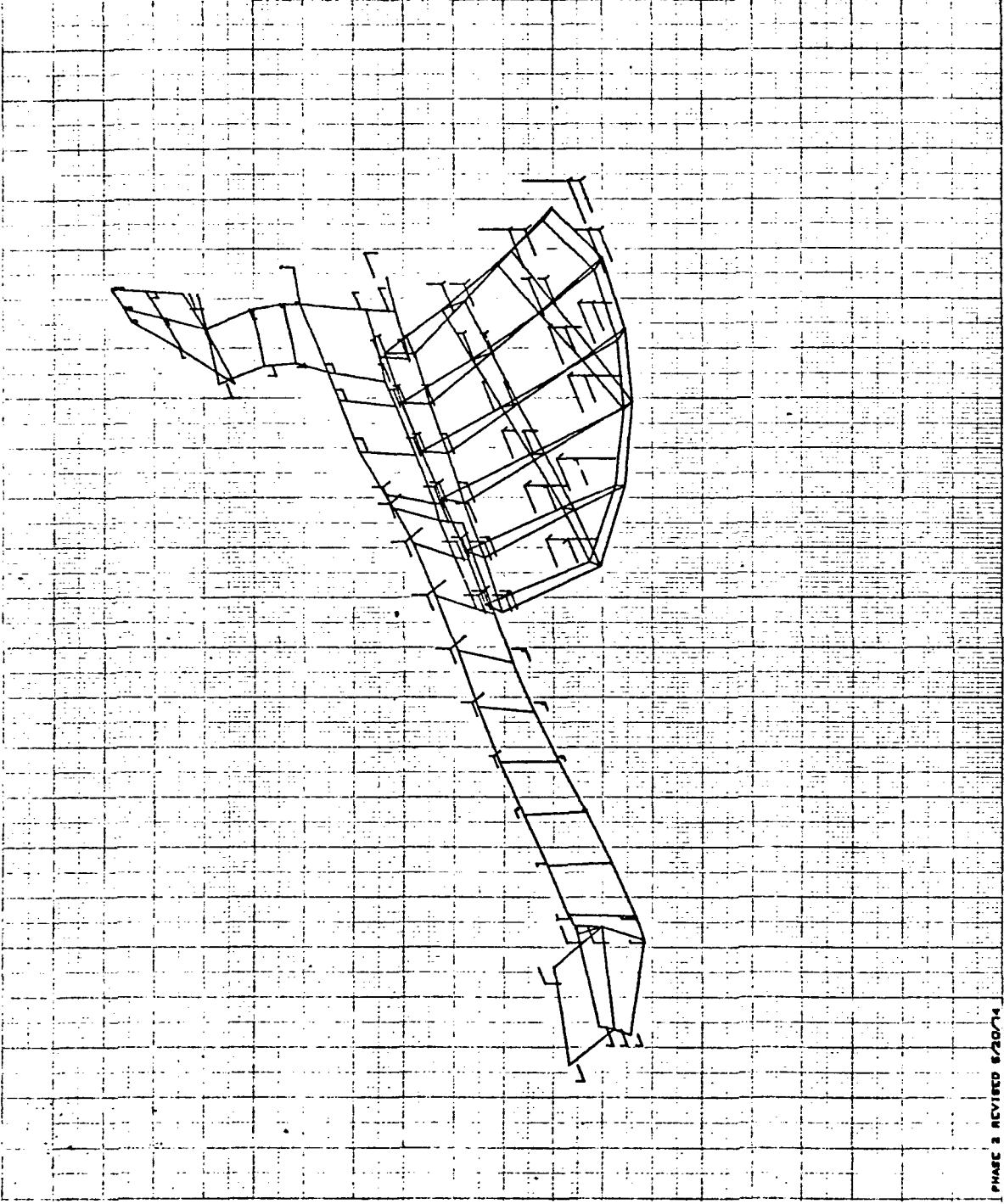

PHASE 2 REVISED 8/20/74
ORBITER SYMM CASE
FREE FREE MODES
MODAL DEFOR. SURFACE 12 MODE 12 FREQ. 170.4634

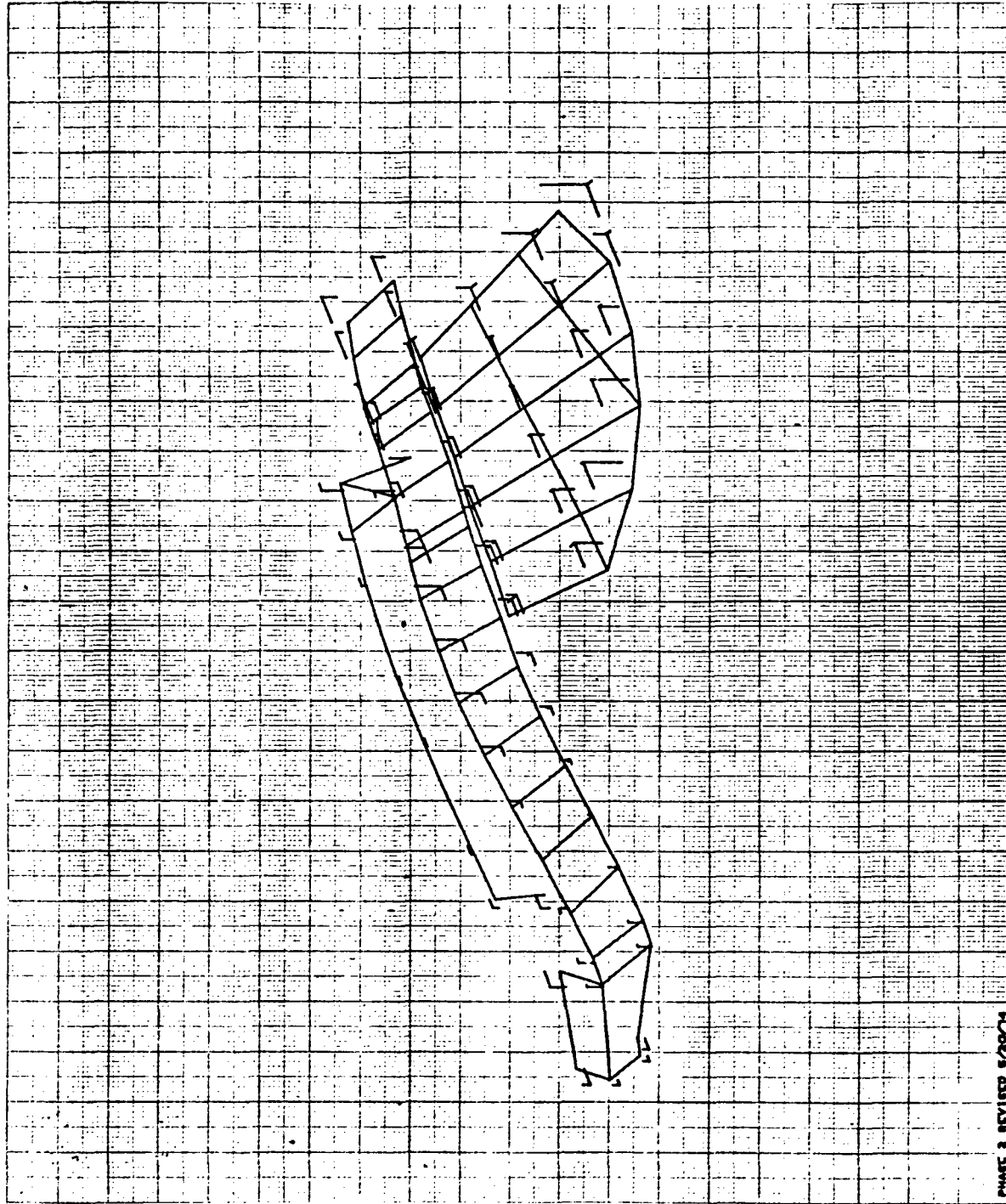

PHASE 2 REVISED 5/20/74

ORIGINATED BY WJW GABE

PRICE PRICE NUMBER

MOONAL DETON. SUGGARE 12 MOORE 12 PRICE. 170. 4829

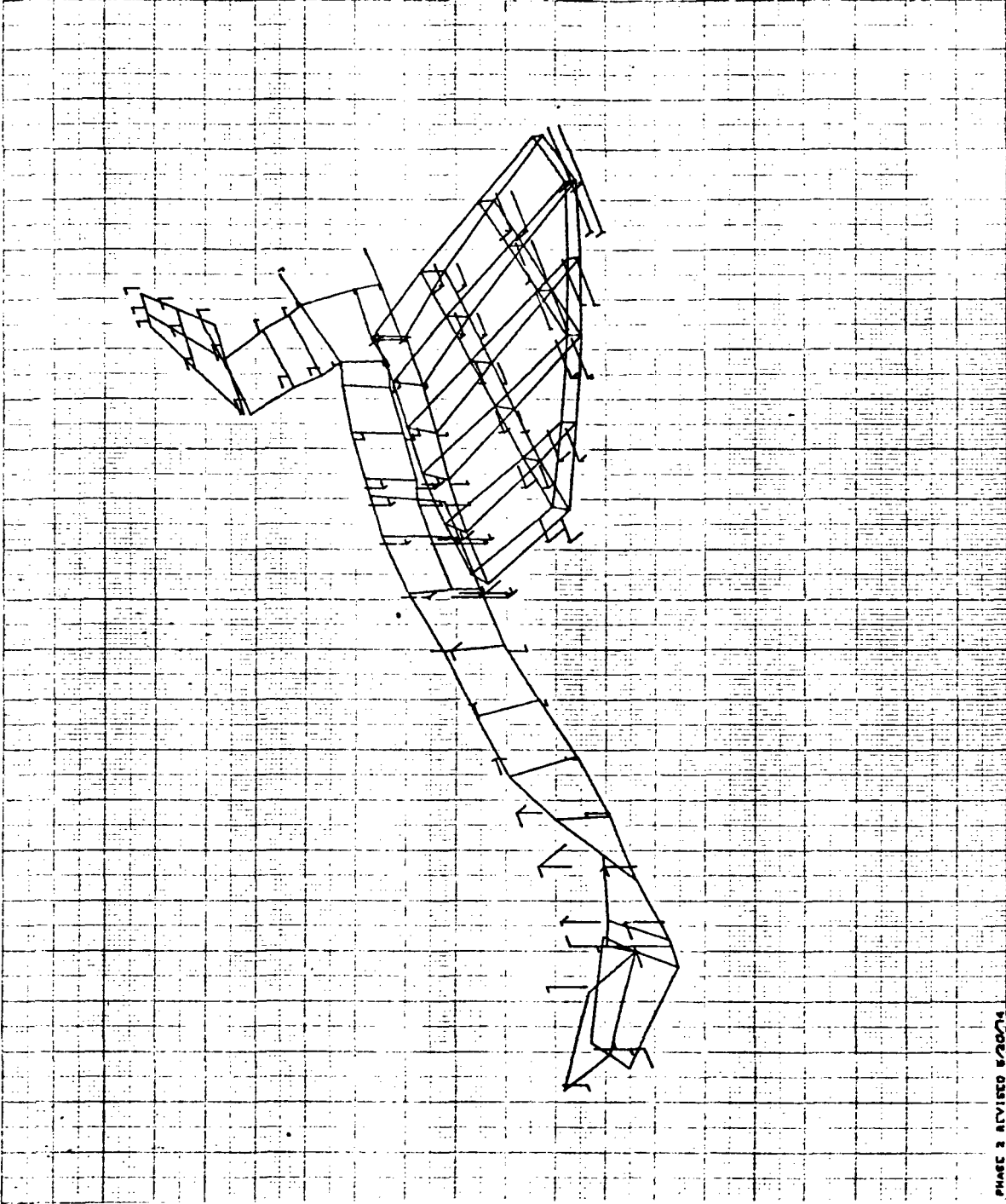

PHASE 2 REVISED 8/20/74
 ORBITER SYMM CASE
 FREE FACE MODES
 MODAL DEFOR. SURFACE 13

MODE 13 FREQ. 106.0942

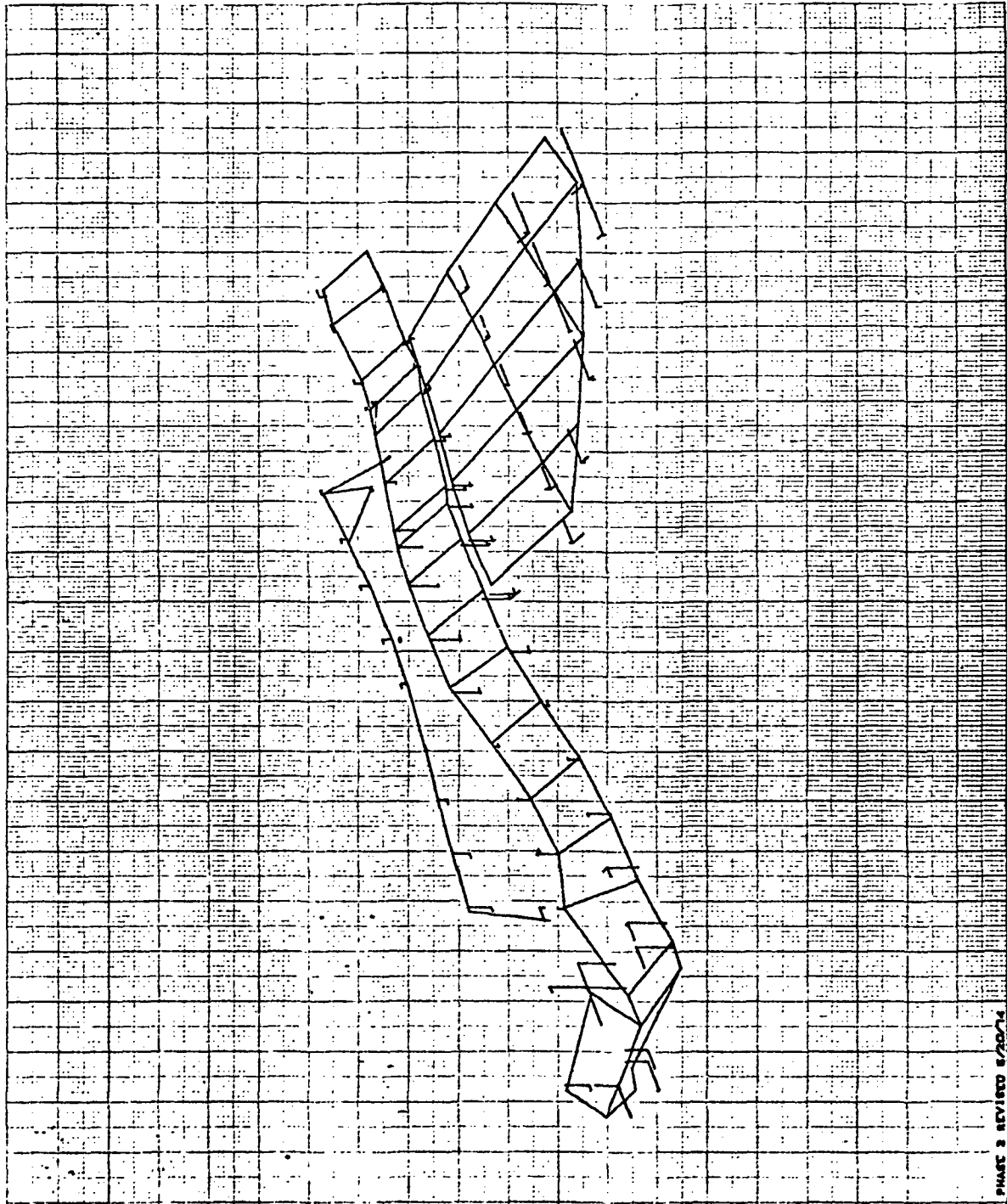

PHASE 3 REVISED 6/20/74
 ORBITER STIM CASE
 FIRST FREE MODES
 MODAL ORDER. SURFACE 13 MODE 13 FREQ. 185.0343

Appendix A23
PLOTS OF ANTISYMMETRIC FREE-FREE
MODES/PHASE 2 ANALYSIS:
MODEL II ORBITER

6/28/74 MAX-DEF. = 1.00000000

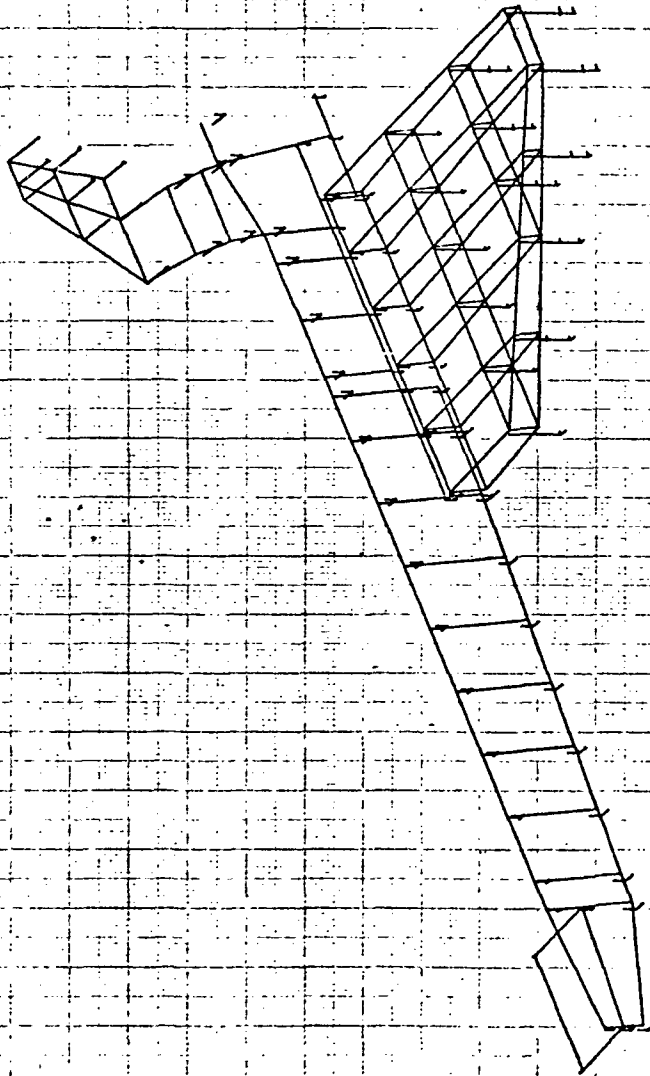

PHASE 2 REVISED 8/20/74
ORBITER AMTI CASE
RIGID BODY MODES
MODAL DEFORM. SUBCASE 1 MODE 1 FREQ. 0.

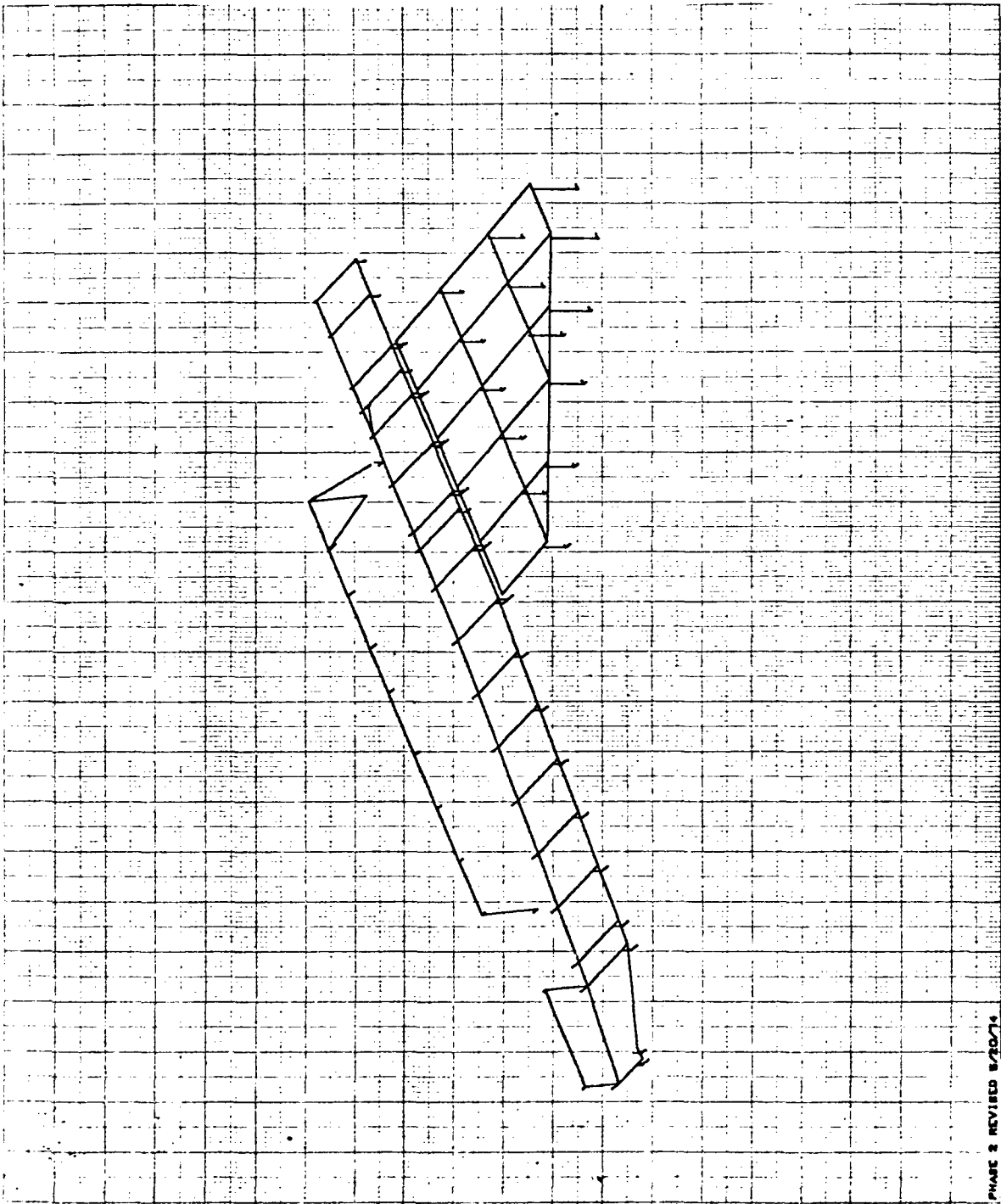

PHASE 2 REVISED 8/20/74
CRUTTER ANT1 CASE
RIGID BODY MODES
MODAL DEFOR. SUBCASE 1 MODE 1 FREQ. 0.

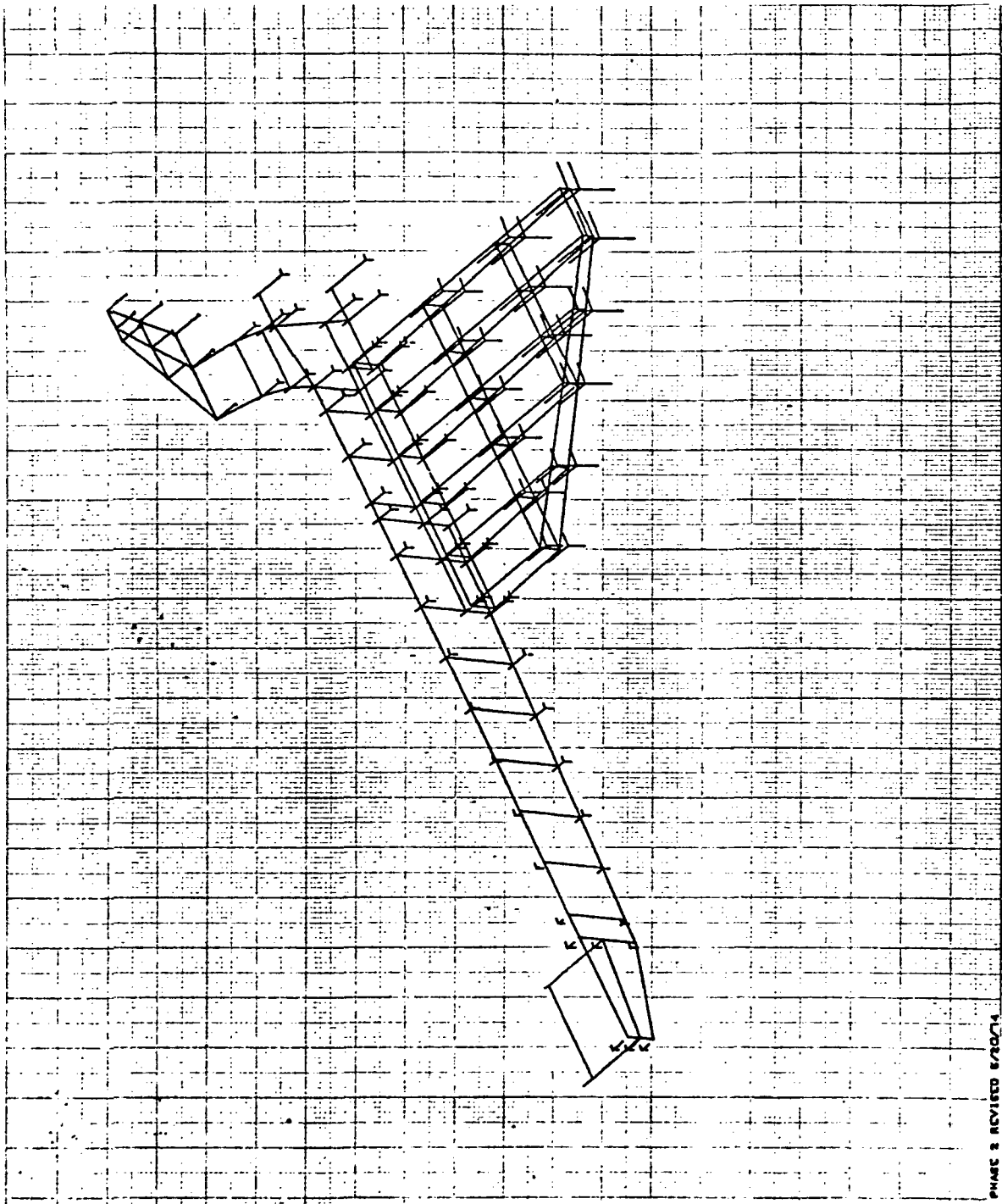

PHASE 2 REVISED 8/30/74
ORBITER PART 3 CASE
R1910 BODY MOORE
MEDAL DOCTR. SURFACE 2 MODE 2 FREQ. 0.

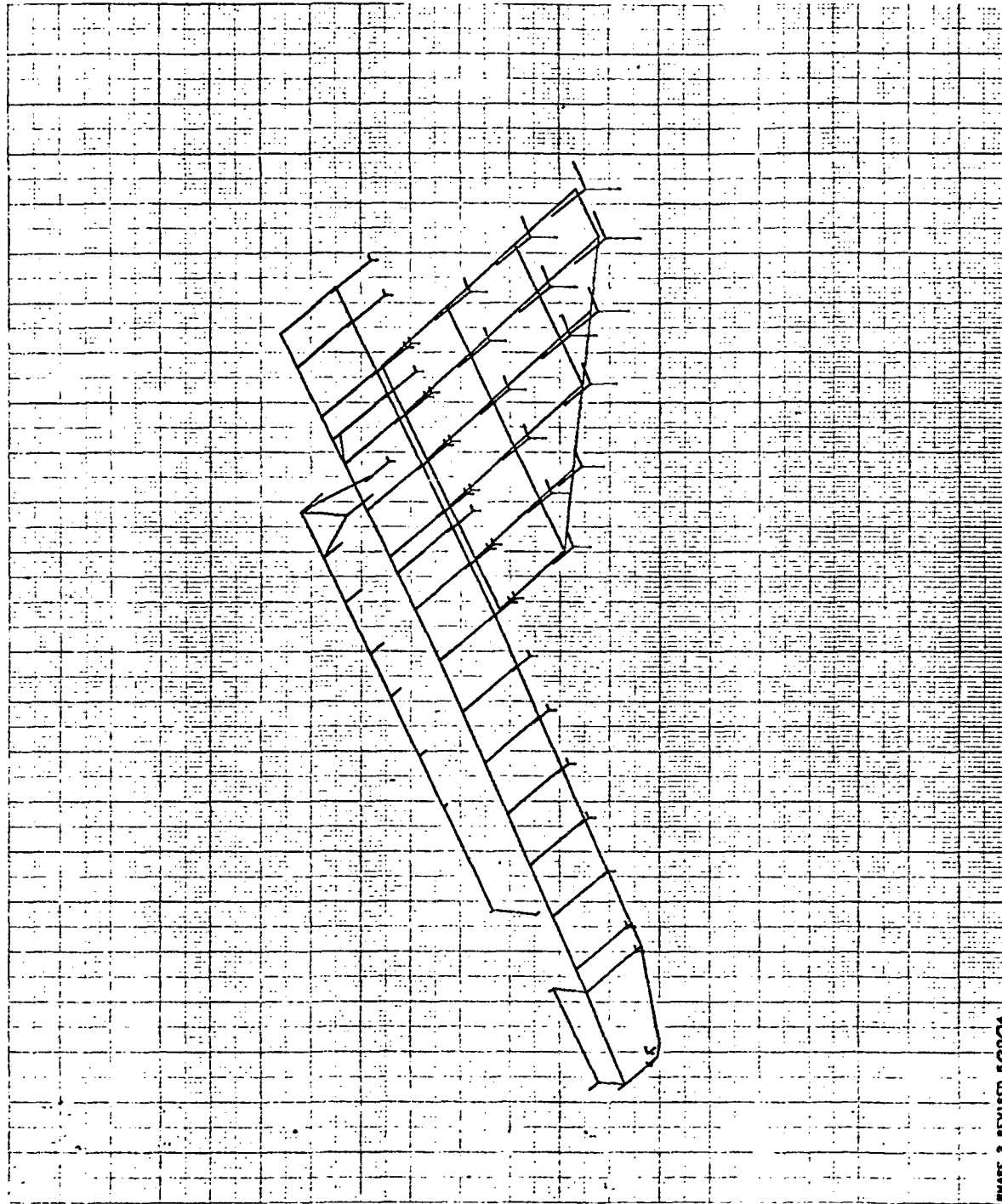

PHASE 2 REVISED 5/20/74
ORBITER ANTI CASE
RIGID BODY MODES
MODAL DEFORM. SUBCASE 2 MODE 2 FREQ. 0.

3 8/28/74 MAX-DCT = 1,00000000

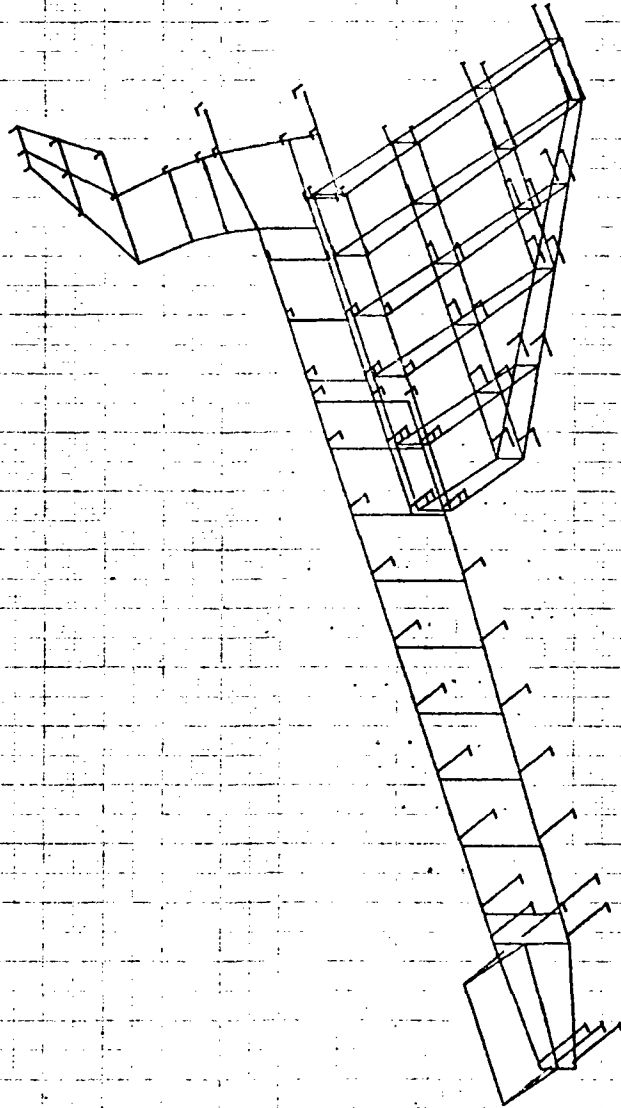

PHASE 3 REVISED 8/20/74
ORBITER ARTI CASE
RIGID BODY MODEL
MEDIAL DCTOR. SURFACE 3 AXIS 3 FREQ. 0.

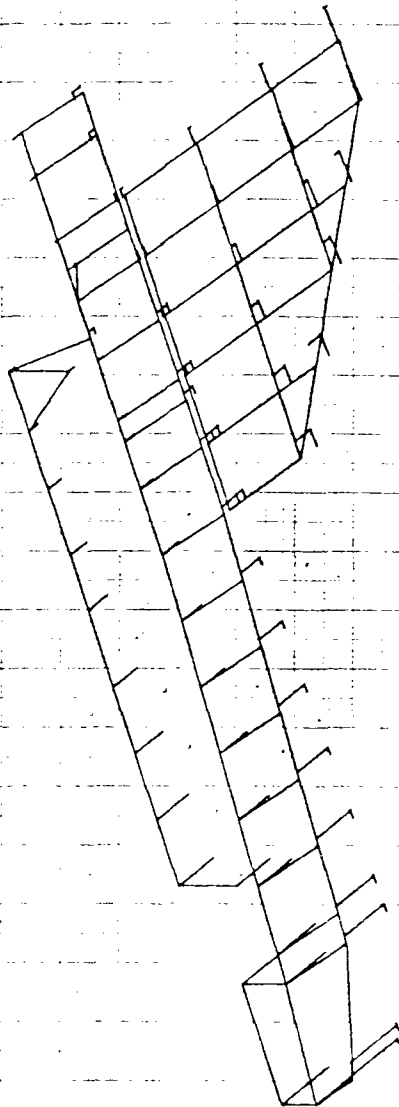

PHASE 2 REVISED 8/20/74
ORBITER AMTI CASE
RIGID BODY MODES
MODAL DEFOR. SUBCASE 3 MODE 3 FREQ. 0

6 8/25/74 MAX-DEF = 1.00000000

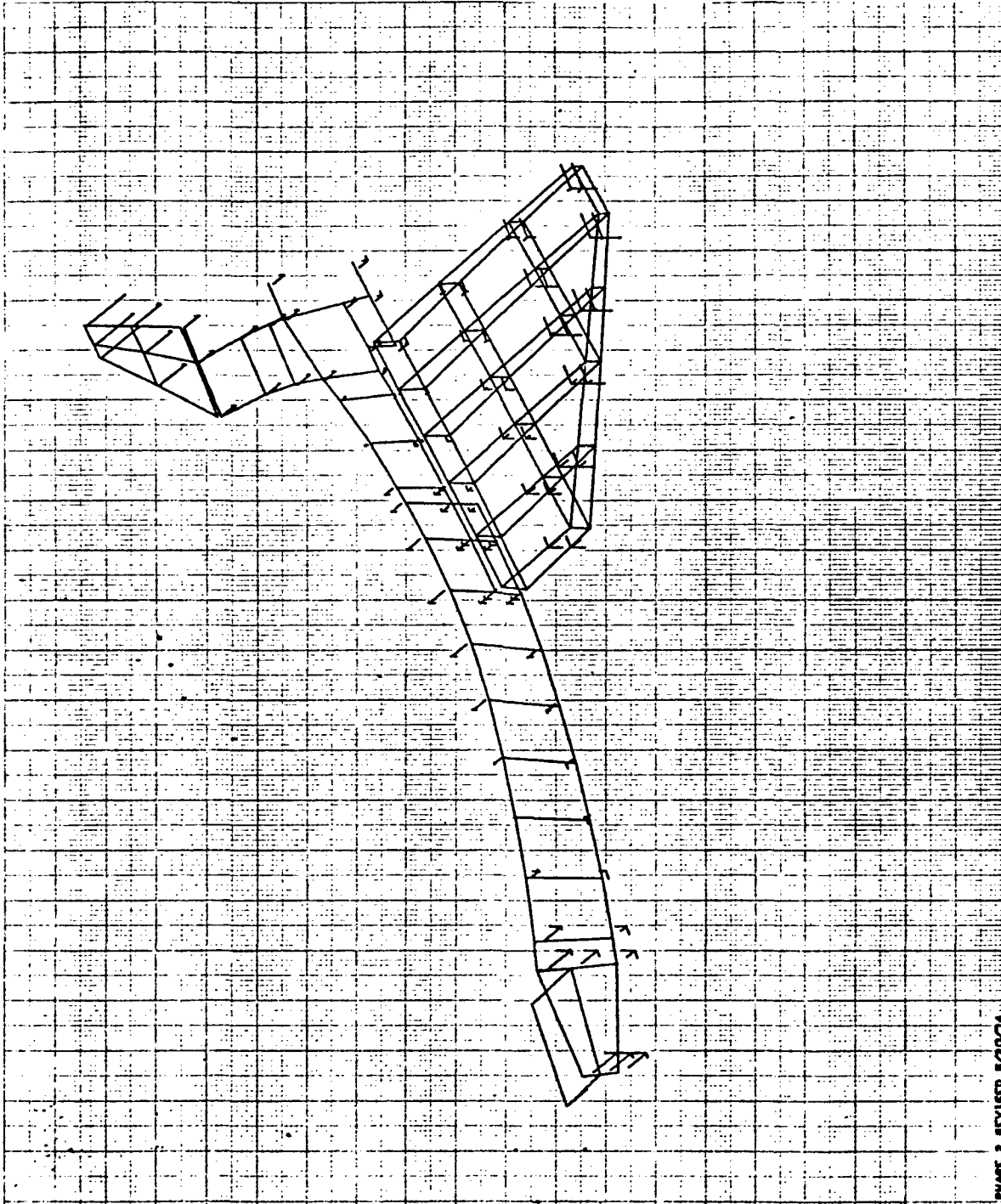

PHASE 2 REVISED 8/20/74
ORBITER ART1 CASE
FREE FREE MODES
MEDIAL DCTOR. SUBCASE 4
MODE 4 FREQ. 42.17846

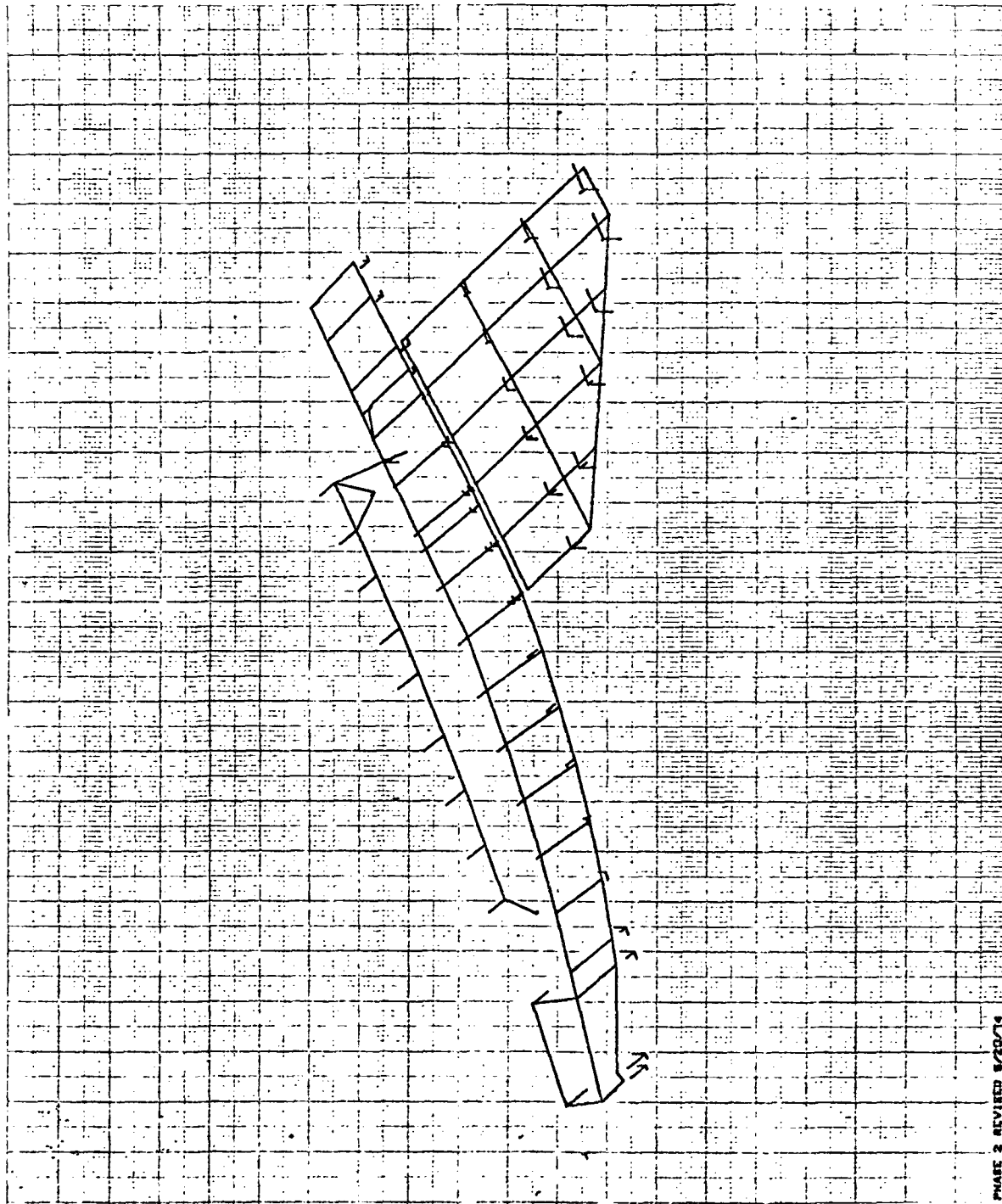

PHASE 2 REVISED 8/20/74
ORBITER ANTI CASE
FREE FREE MODES
MODAL DFORM. SUBCASE 4 MODES 4 FREQ. 42.175-48

5 8/25/74 MAX-DEF. = 1.00000000

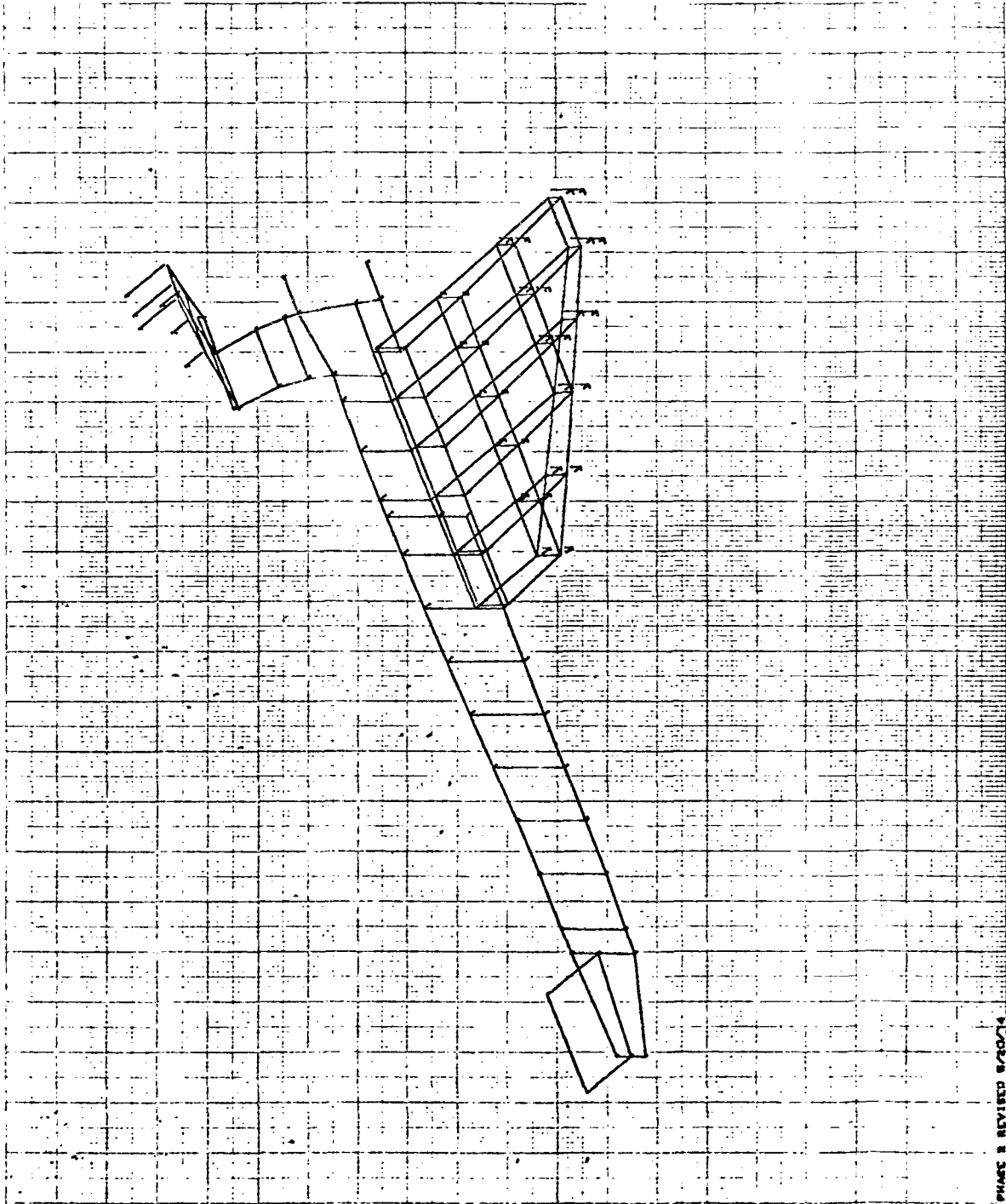

PHASE 2 REVISED 8/20/74
ORBITER ANTI CASE
FREE FREE MODES
MODAL DETOR. SURFACE 6 MODS 6 FREQ. 51.00041

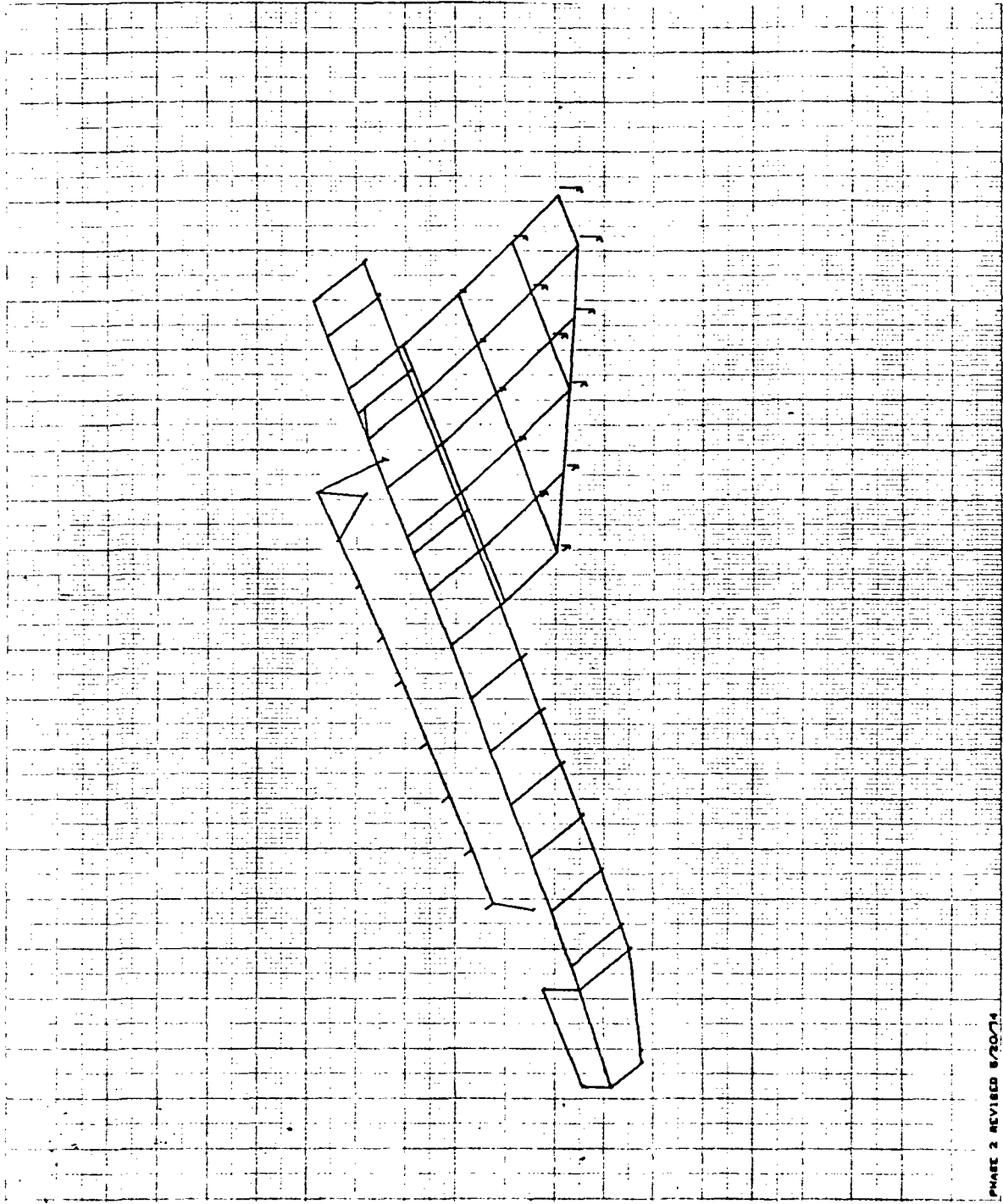

PHASE 2 REVISED 8/20/74
ORBITER ANTI CASE
FREE FREE MODES
MODAL VECTOR. SUBCASE 5 MODE 5 FREQ. 87.00849

8/28/74 142-007, s. 1.00000000

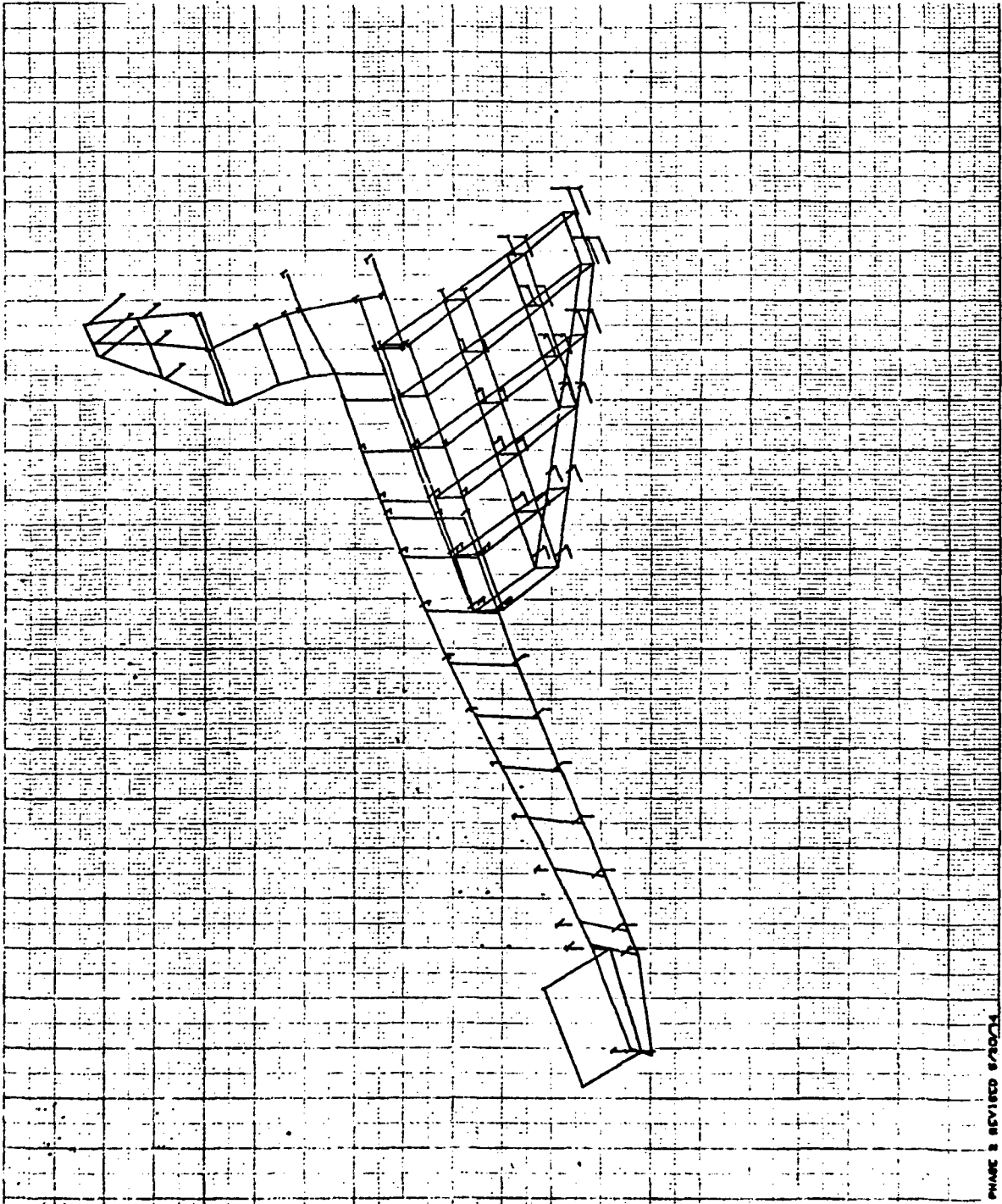

PHASE 2 REVISED 8/20/74
DESIGNER AMTI GARE
FRICE FRET MOORE
NORMAL DETAIL SURVIVANCE 6 MODC 6 FREQ. 6.67890

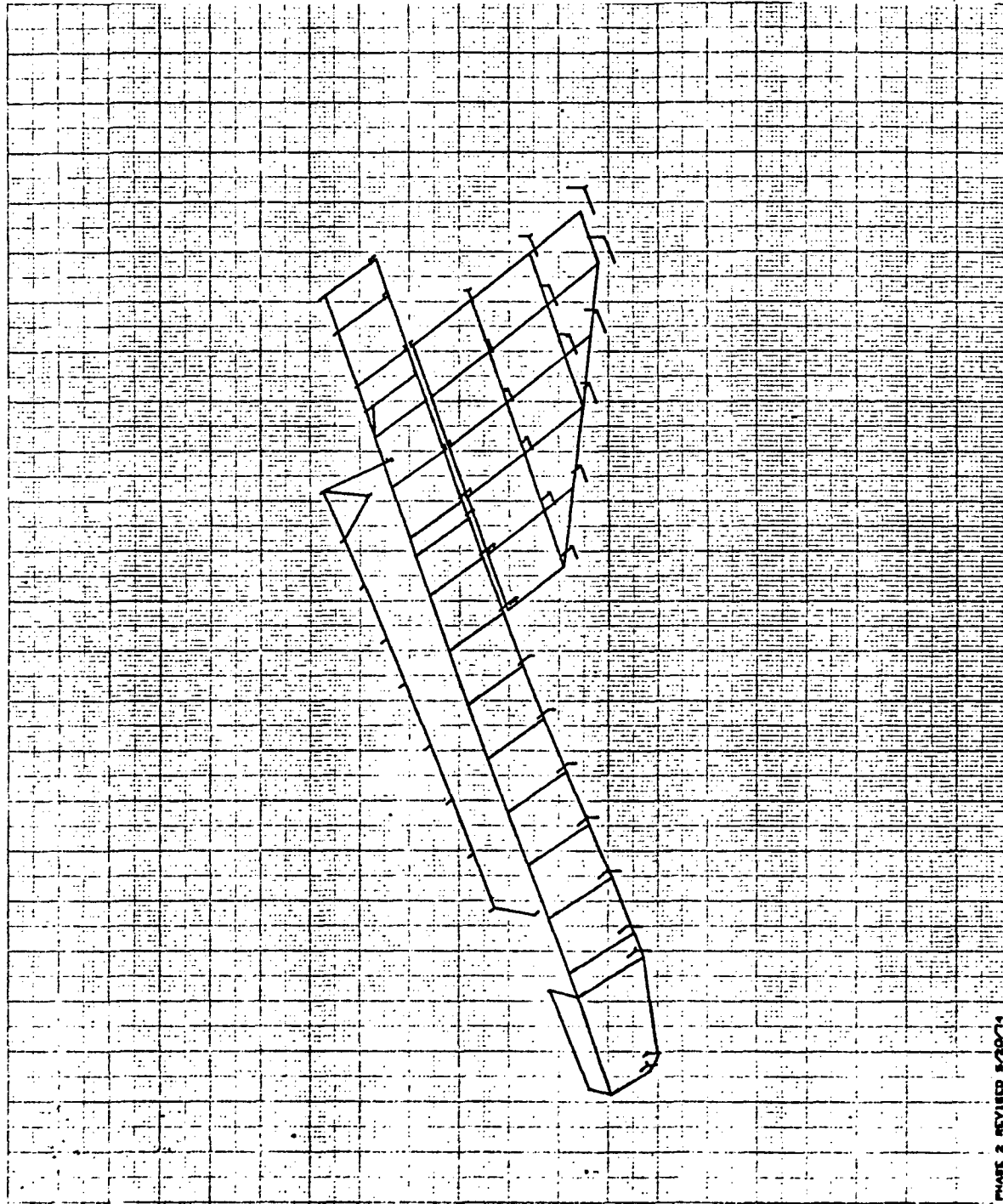

PHASE 2 REVISED 8/20/74
ORBITER ANTI CASE
FREE FACE MODES
MEDIAL DEFOR. SURFACE 8 MODE 6 FREQ. 59.87980

1 8782/74 MAX-DEF. = 1.00000000

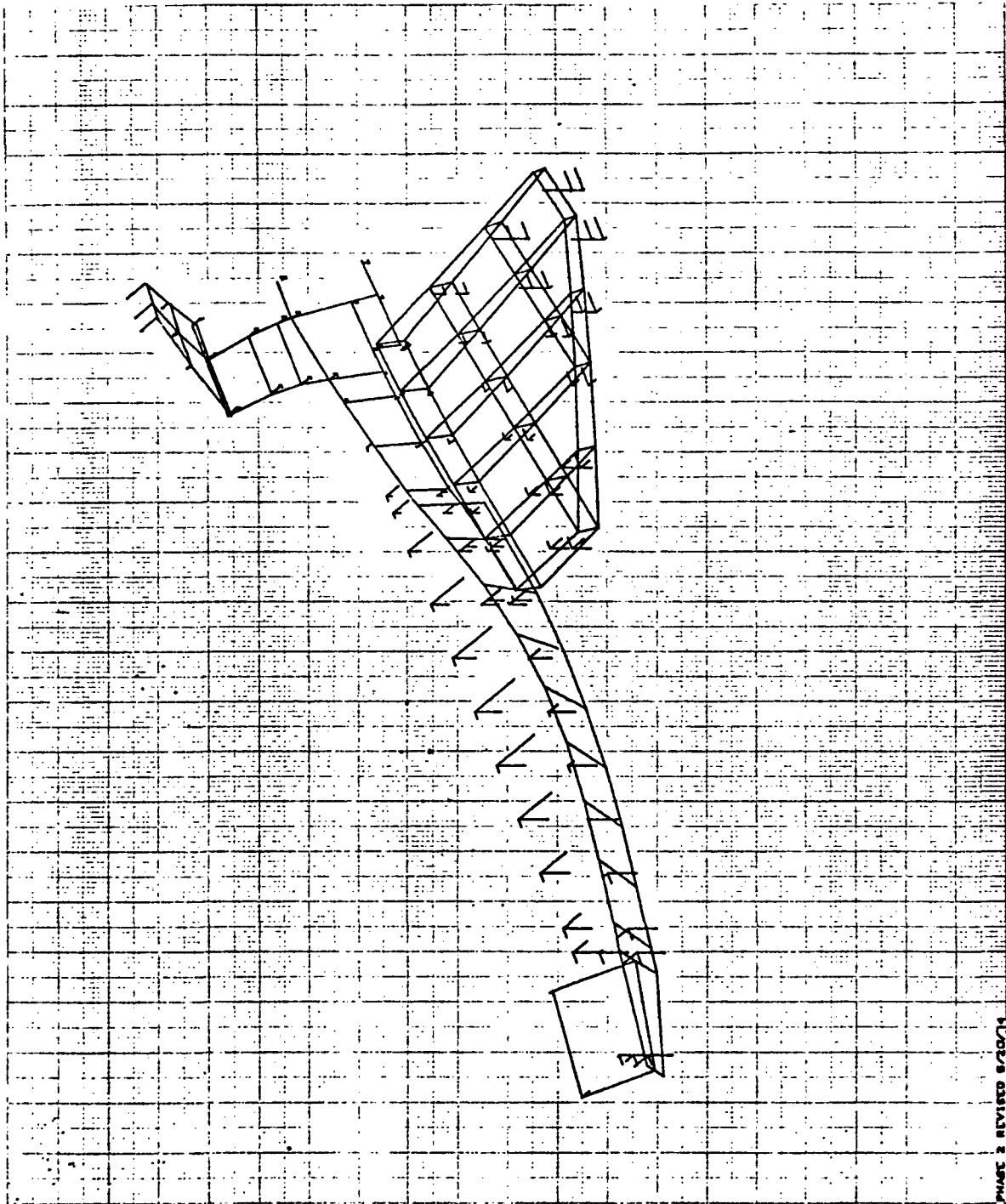

PHASE 2 REVISED 8/20/74
ORBITER ANTI CASE
FREE FREE MODES
MEDIAL VECTOR, SUBCASE 7 MODE 7 FREQ. 71.88448

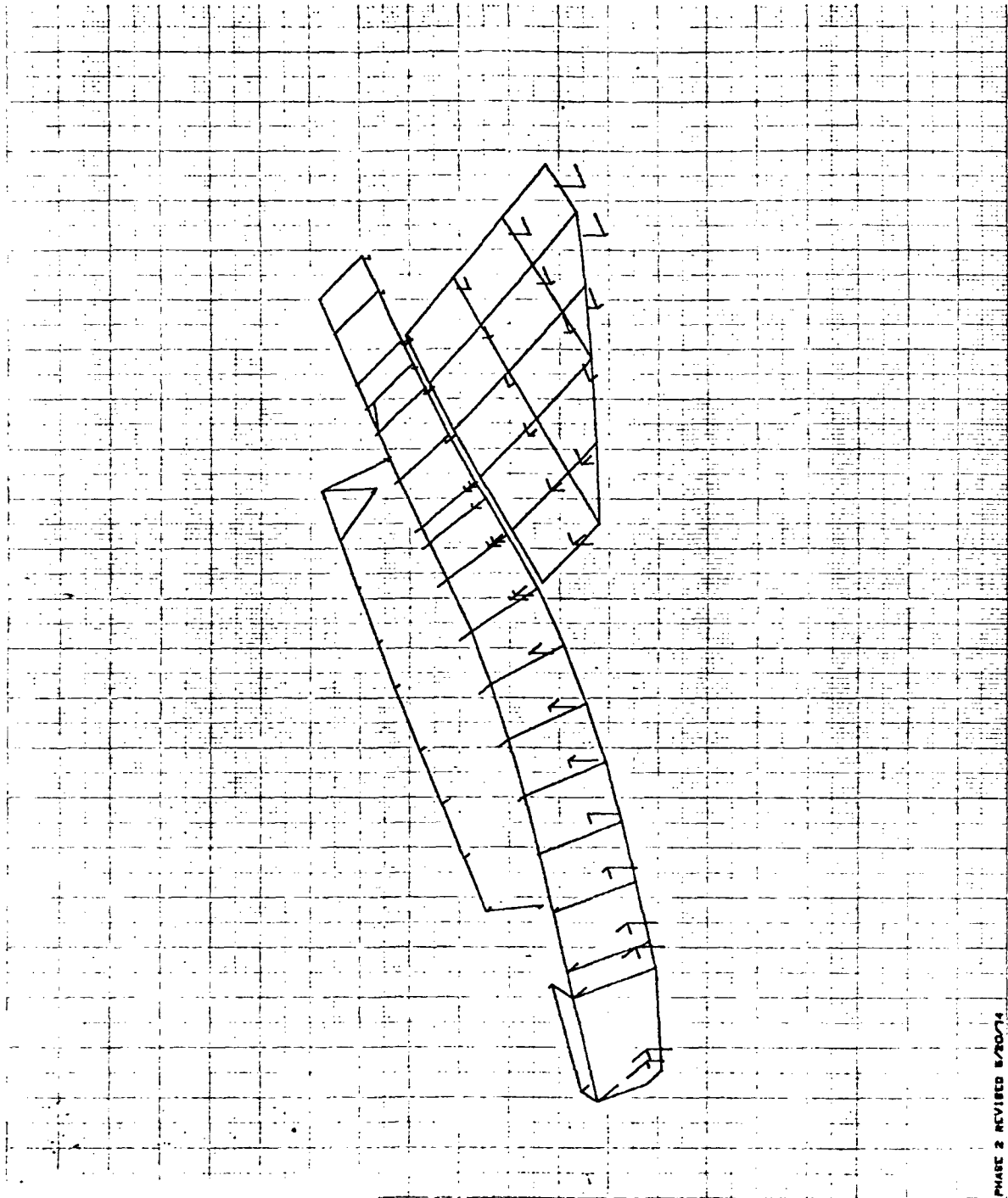

PHASE 2 REVISED 5/20/74
 ORBITER ANTI GASE
 FREE FREE MODES
 MODAL DEFOR. BURCARB 7 MODE 7 FREQ. 71.88448

8 8/25/74 MAX-DEF. = 1.00000000

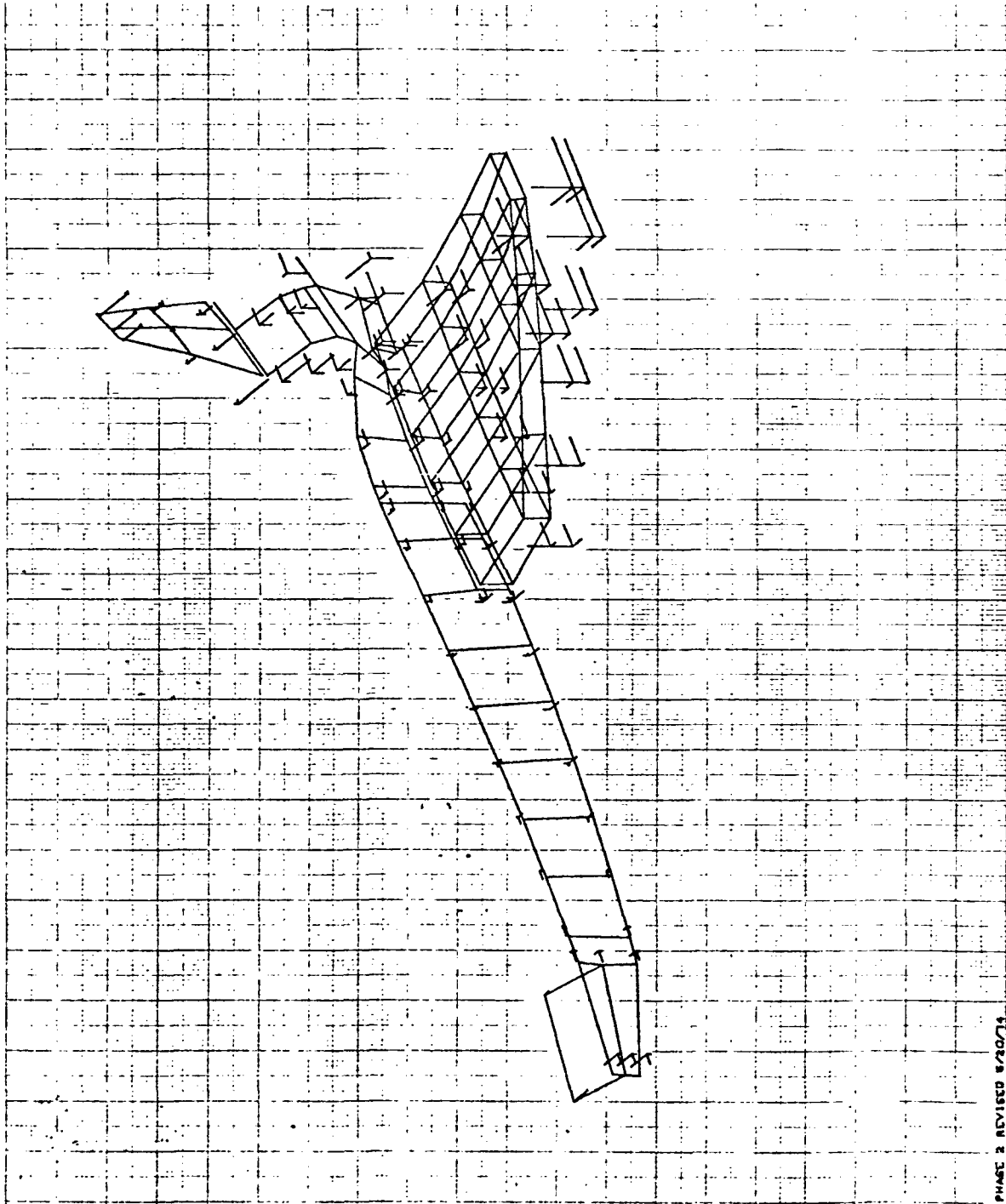

PHASE 2 REVISED 8/20/74
ORBITER ANTI CASE
FACE FREE MODES
MODAL DETOR. SUBCASE 8 MODC 8 FREQ. 78.0023

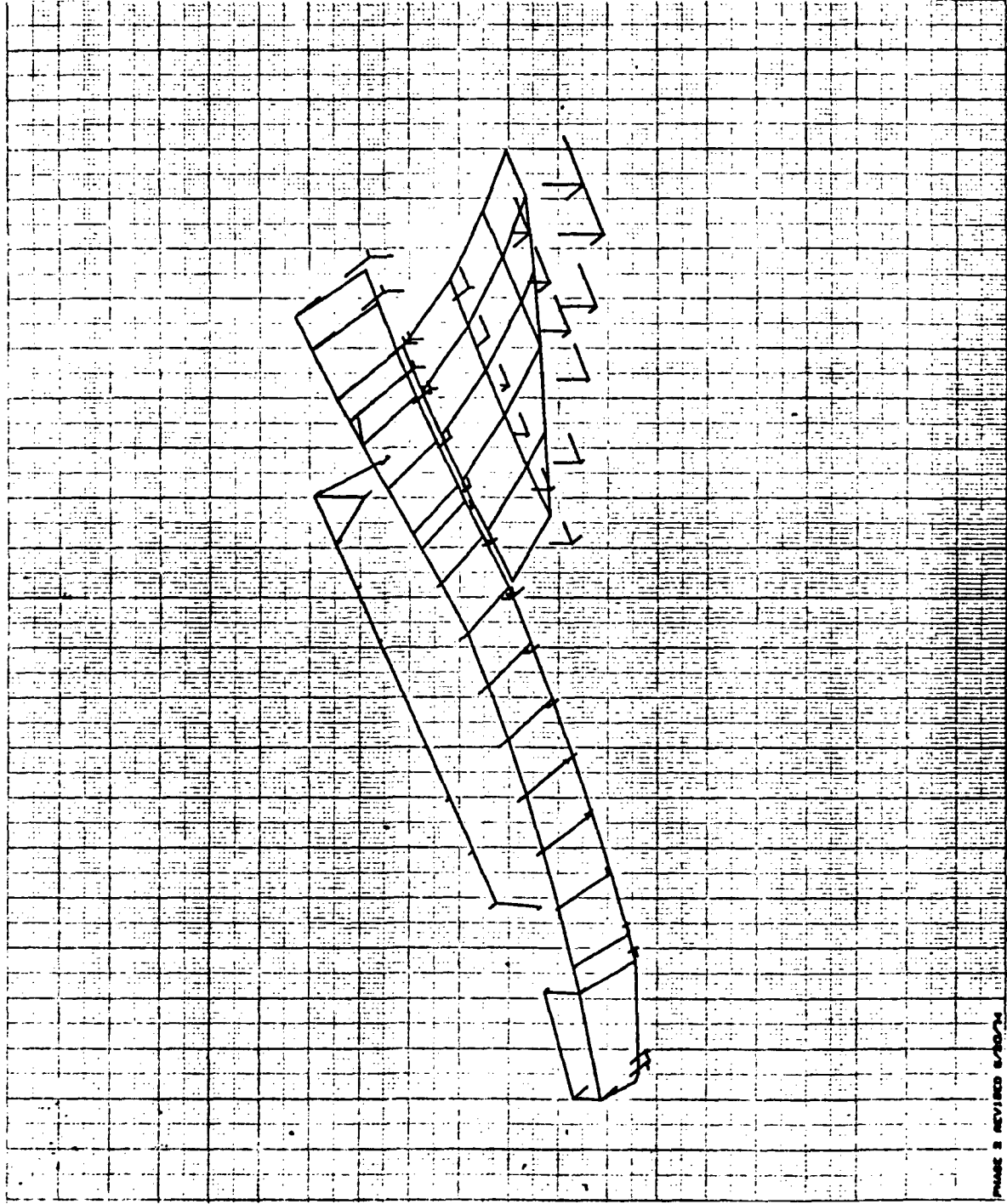

PHASE 2 REVISED 8-20-74
ORBITER ARTI CASE
FREE FREE MORCS
MORAL SECTOR, SUBCASE 6 MORSE 6 (MOG. 76. 10182)

8/26/74 MAX-DEF. = 1.00000000

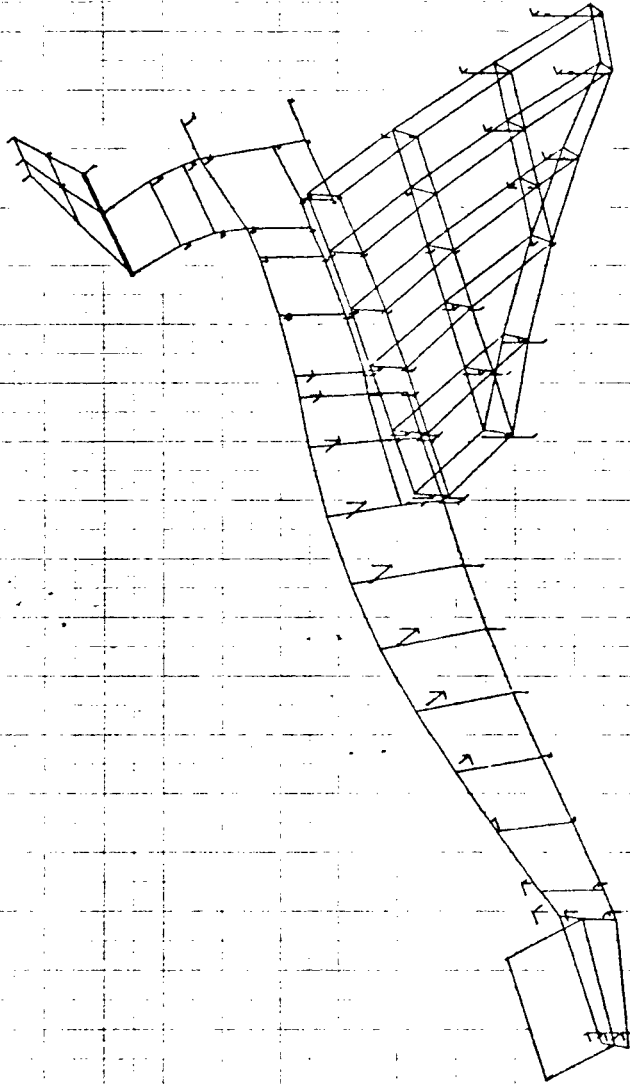

PHASE 2 REVISED 8/20/74
GREATER ANTI CASE
FREE FREE MODES
MODAL DETON. SUBCASE 9 MODE 1 FREQ. 109.8374

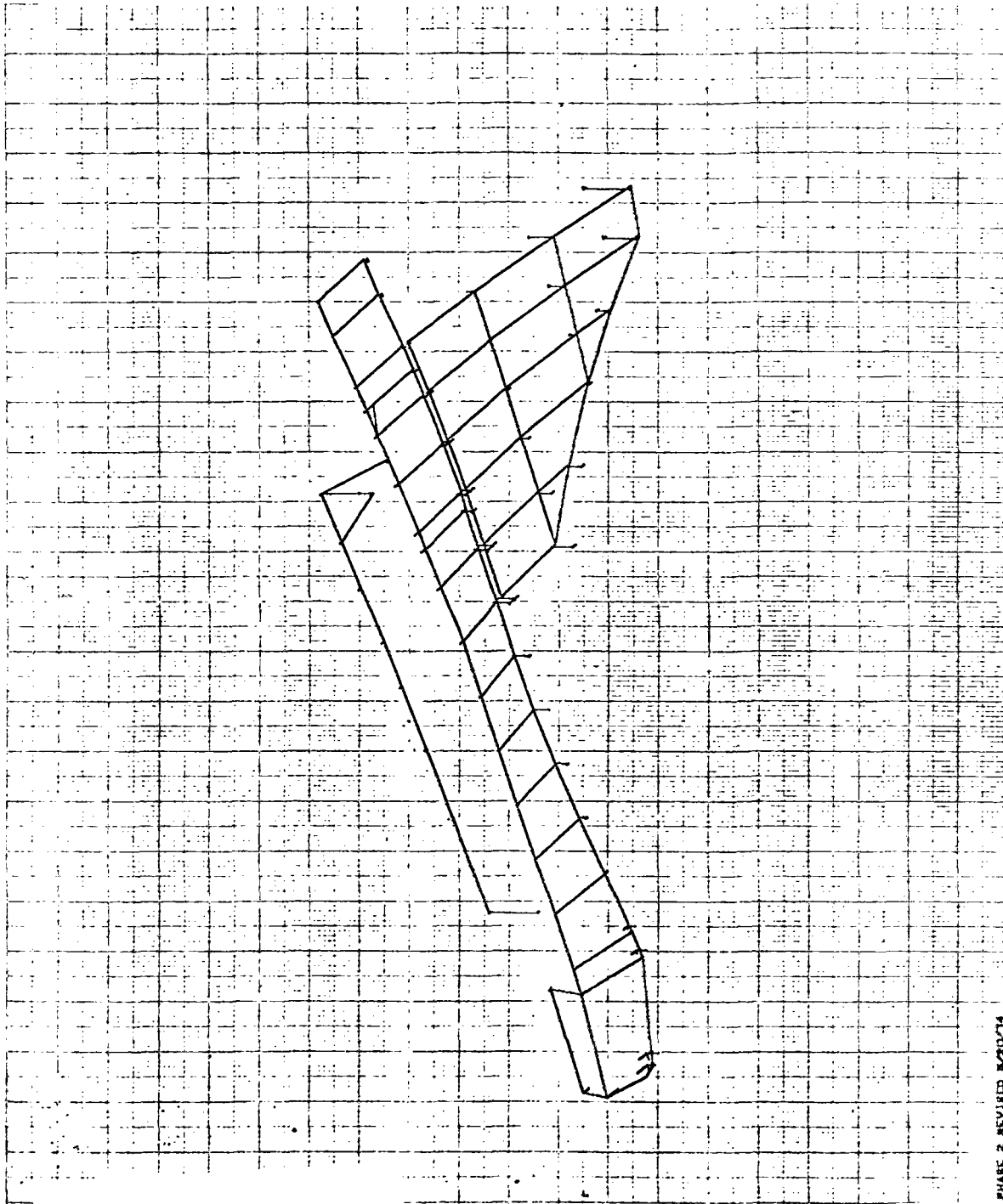

PHASE 2 REVISED B-21074
ONBITER ANTI CASE
FREE FREE MODES
MODAL ORDER: SUBCASE 9 MODE 9 FREQ. 109.8374

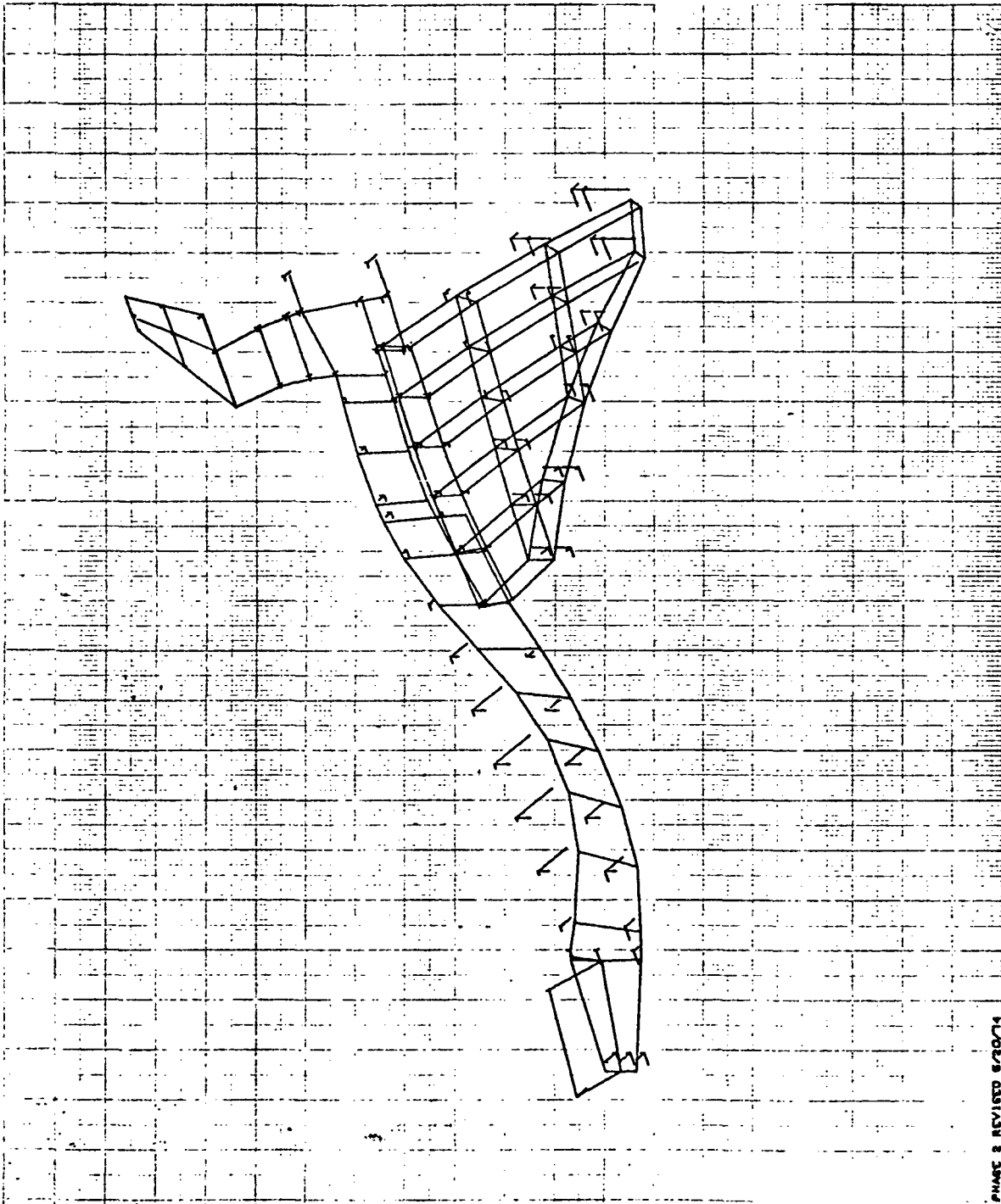

PHASE 2 REVISED 8/30/74
ORBITER ANTI CASE
FACE FREE MODES
MODAL DETOR, SURFACE 10 MODE 10 FREQ. 120.3483

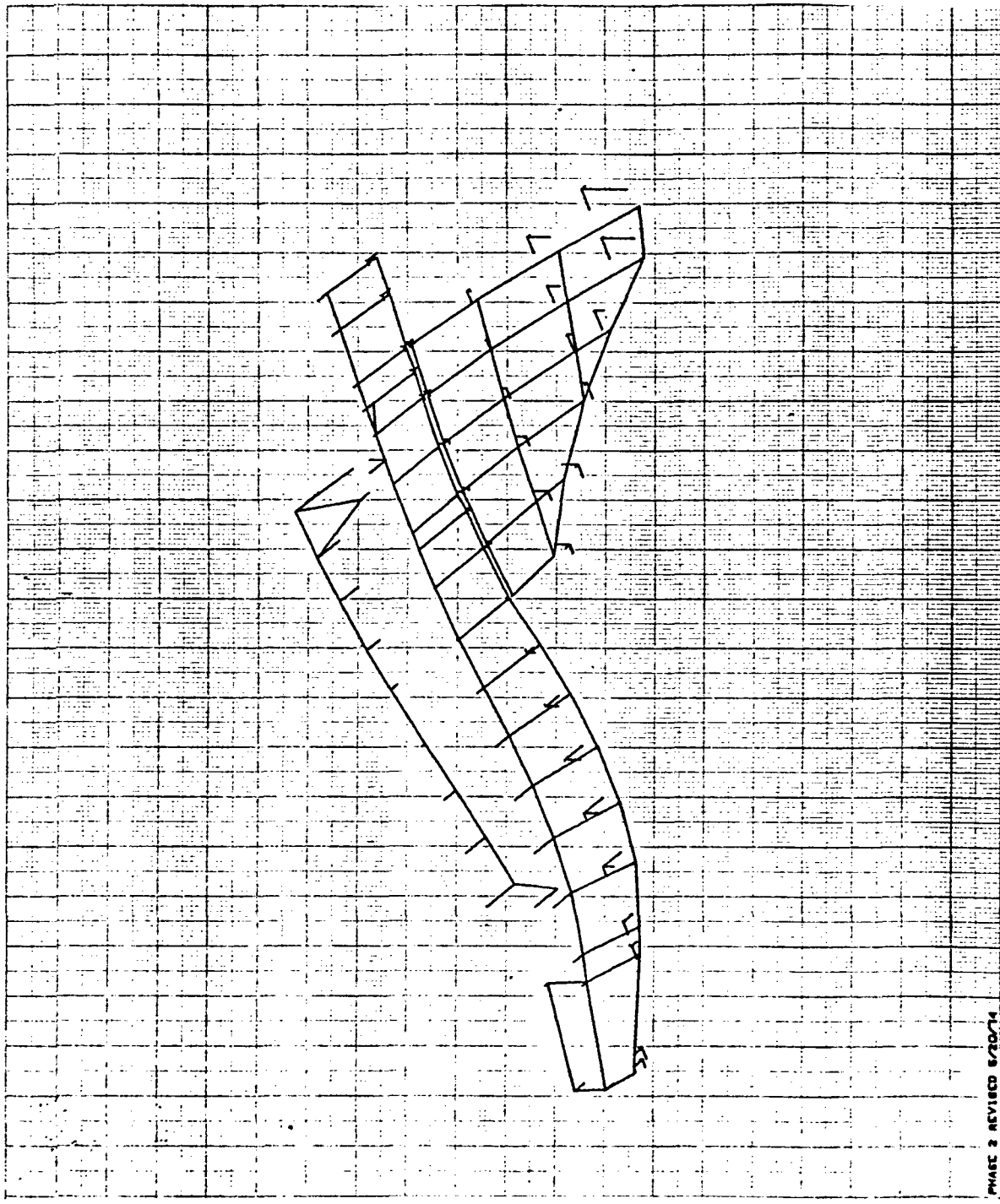

PHASE 2 REVISED 5/20/74
ORBITER ANTI CASE
FREE FREE MODES
MODAL DEFOR. SURFACE 10 MODE 10 FREQ. 120.3463

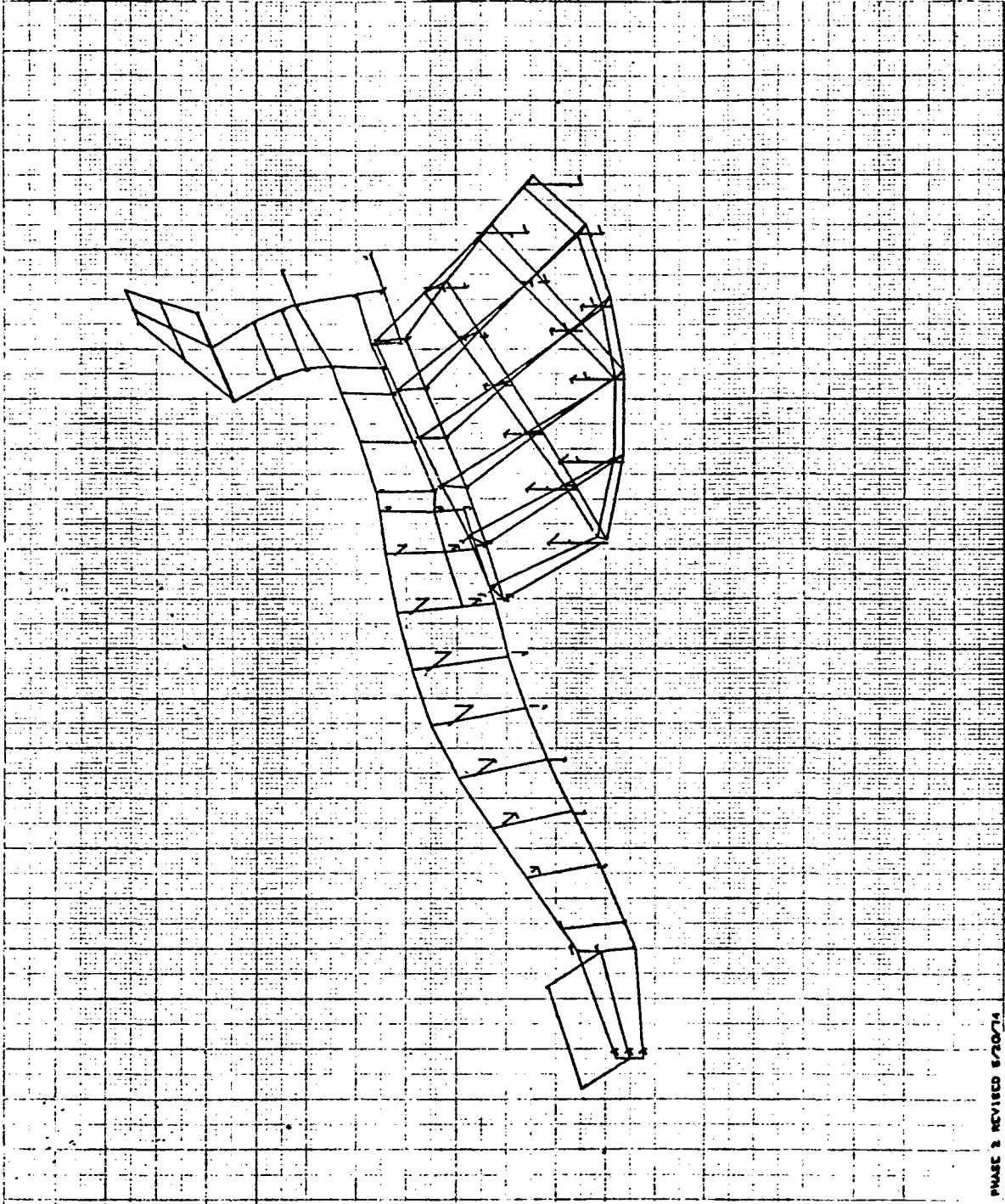

PHASE 2 REVISED 5/20/74
 ORBITER AM71 CASE
 FREE FREE MODES
 MODAL DETCH. SUBCASE 11 MODE 11 FREQ. 146.8179

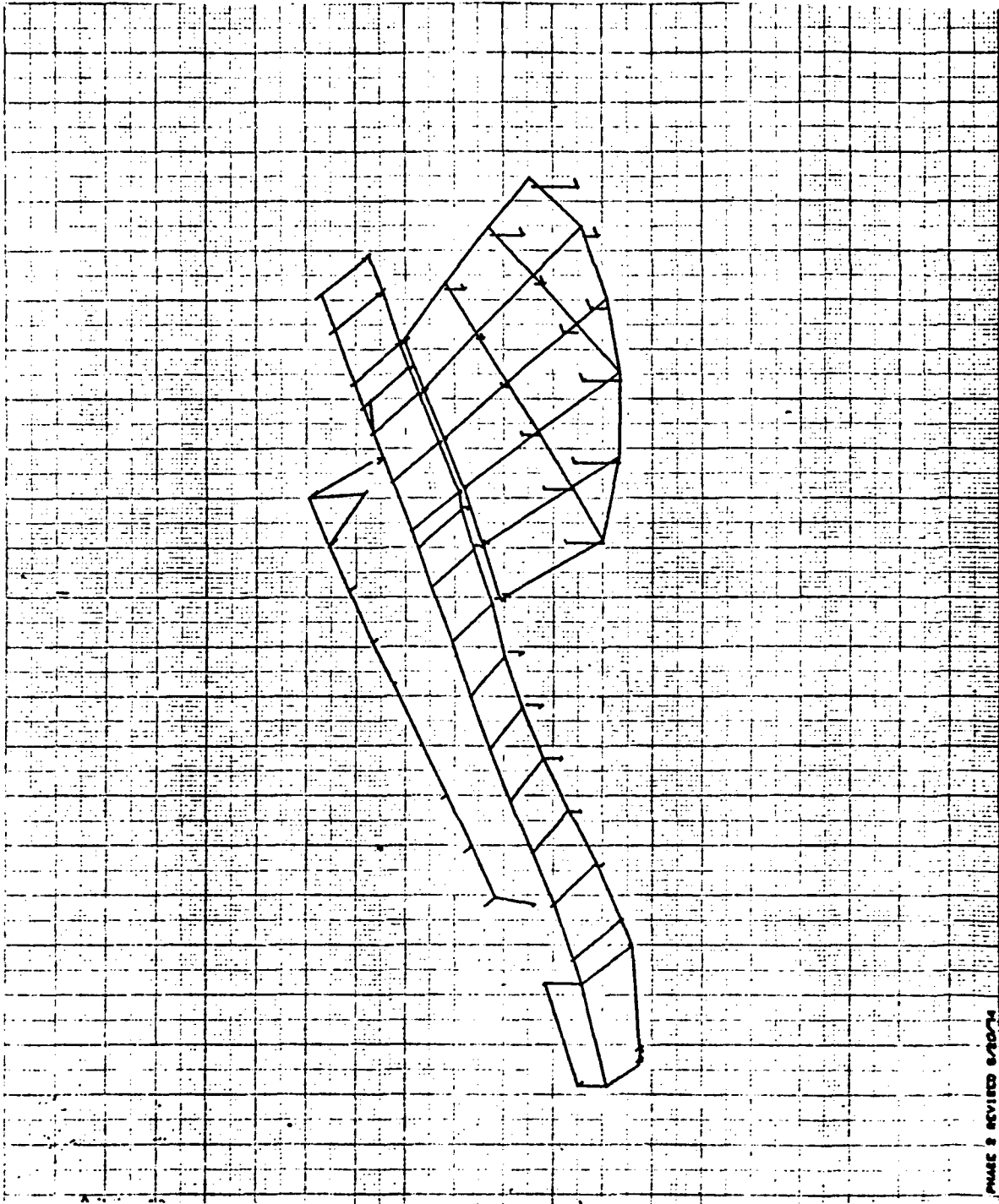

PHASE 2 REVISED 5/20/74
 ORBITER ANTI GARE
 FREE FREE MODES
 MODAL DEFOM. SUBCASE 11 FREQ. 149.5179

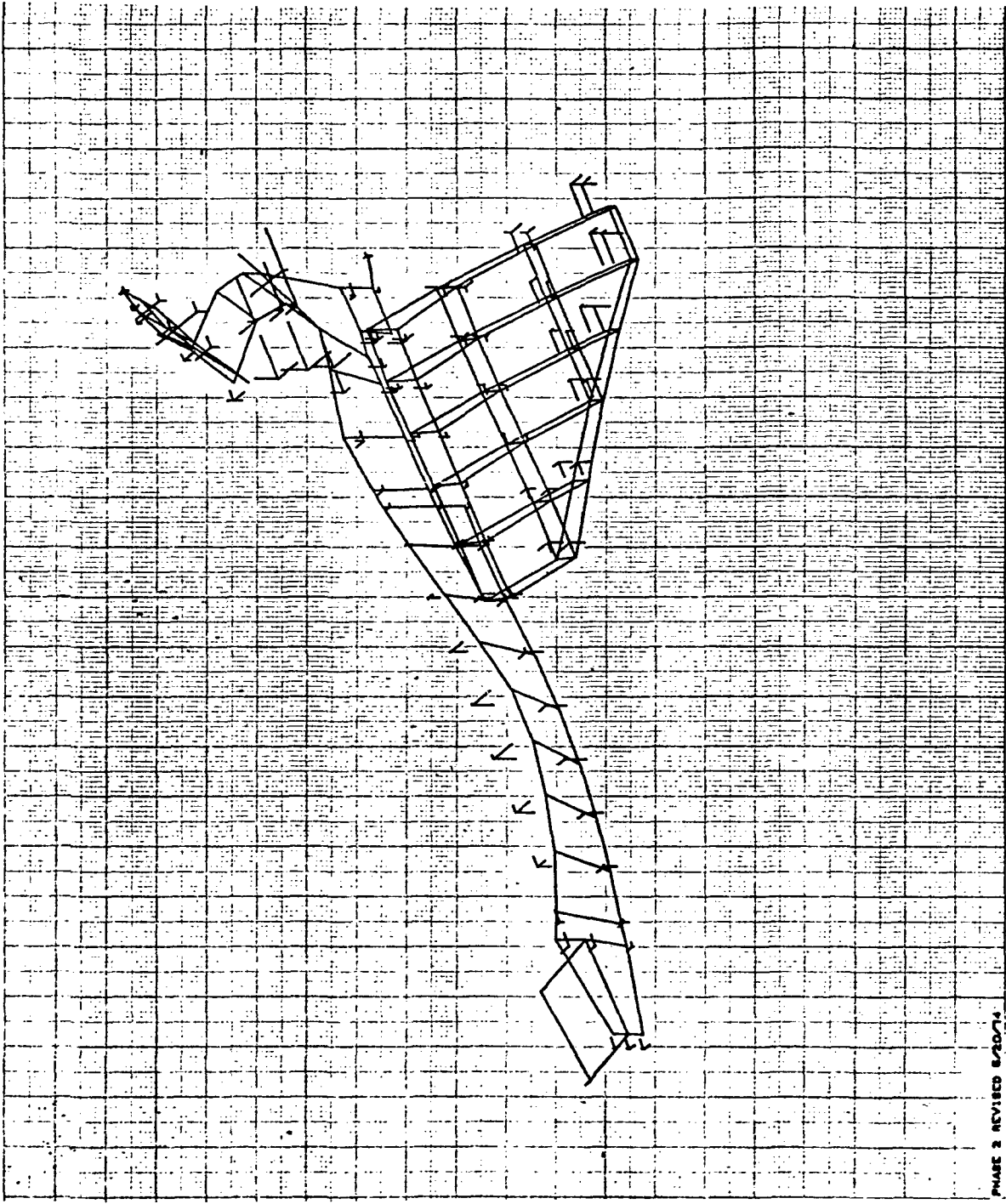

PHASE 2 REVISED 8/20/74
ORBITER ANT) CASE
FACE FACE MODES
MEDAL DEFOR. SURFACE 12 MODE 12 FREQ. 189.2644

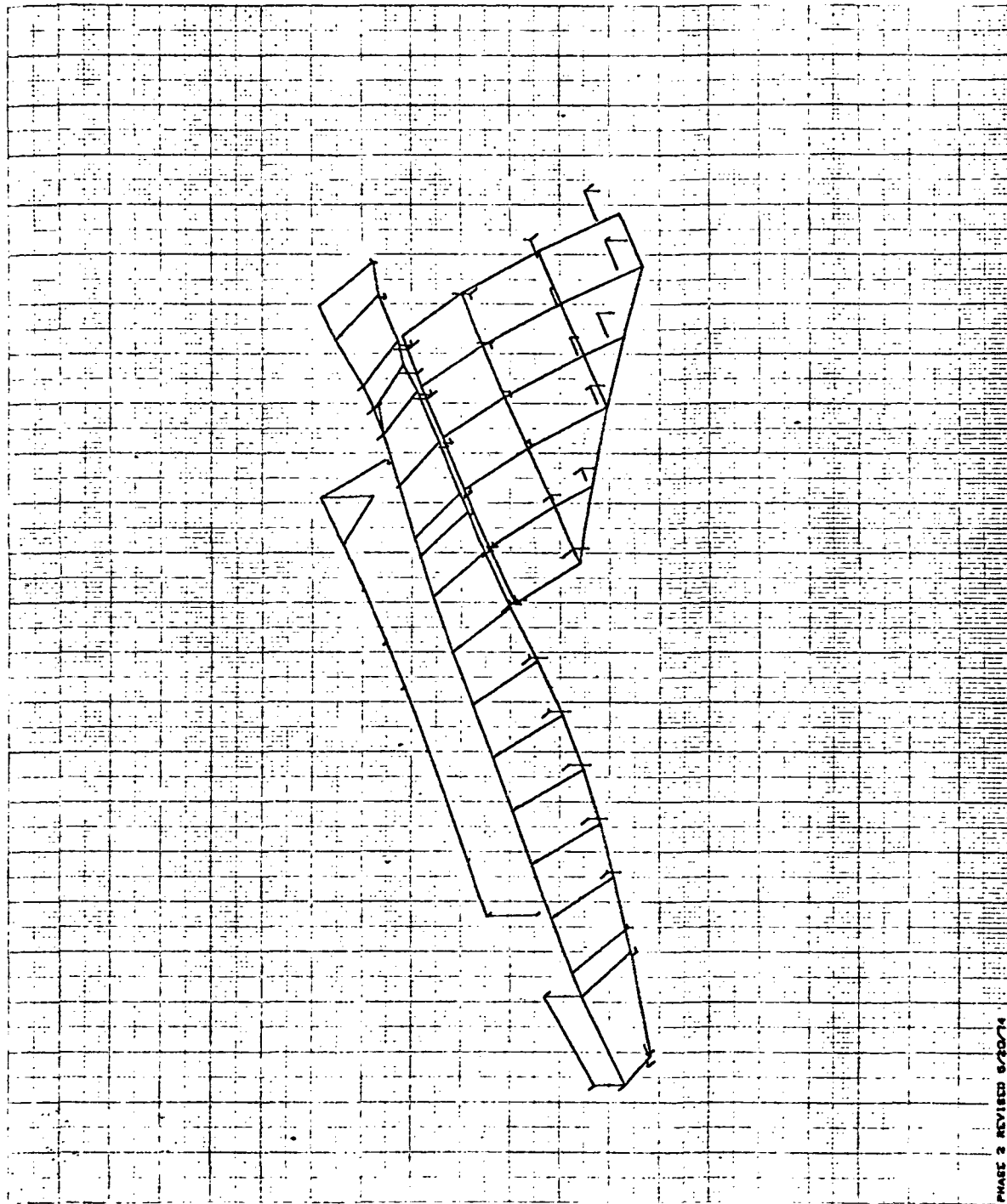

PHASE 2 REVISED 8/20/74

ORBITER ANTI CASE

FREE FREE MODES

MODAL DEFOR. SUBCASE 12 MODE 12 FREQ. 159.2544

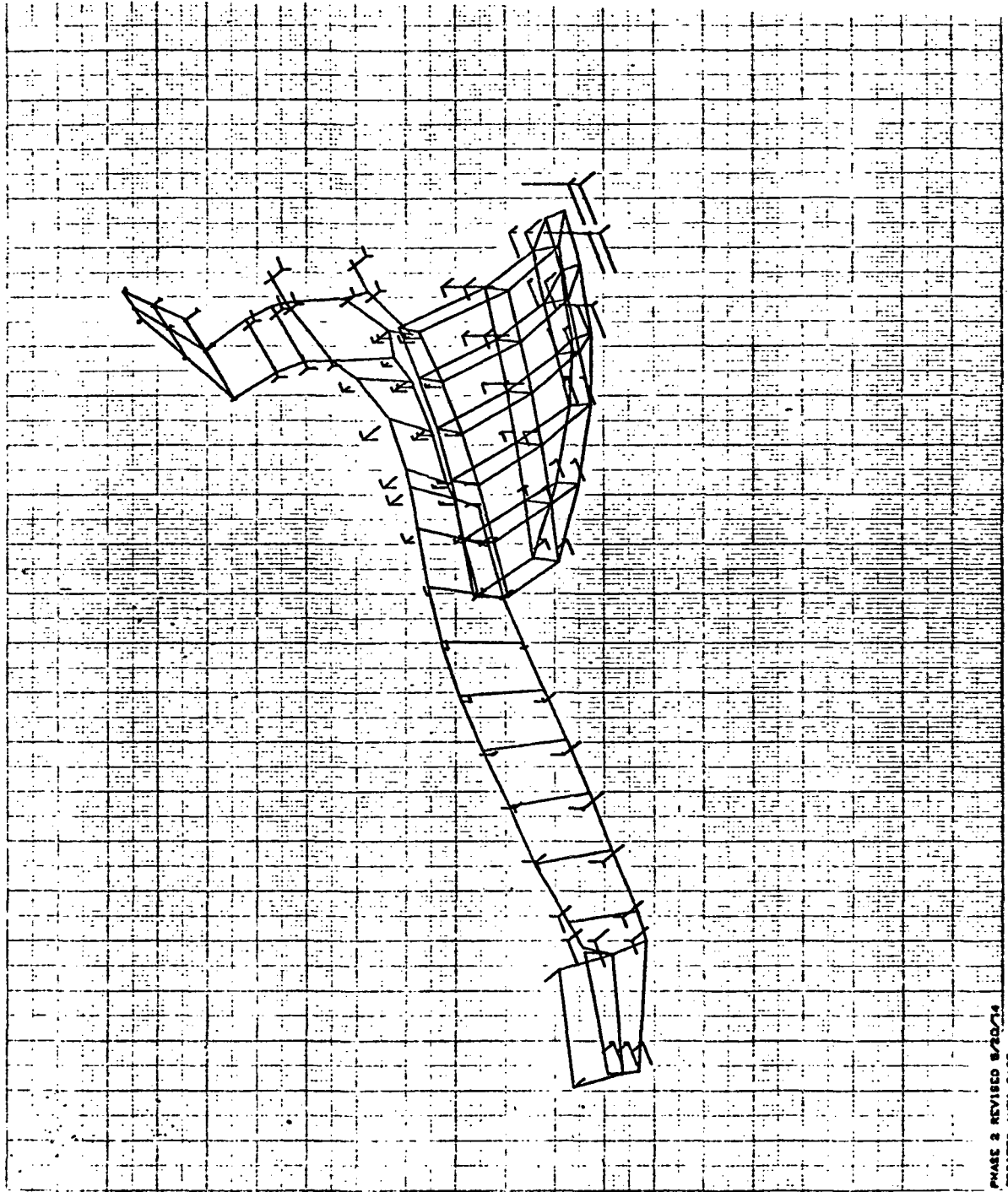

PHASE 2 REVISED 8/20/74
 ORBITER ANTI CASE
 FREE FREE MODES
 MODAL DEFOR. SUBCASE 19 MODE 19 FREQ. 149.1083

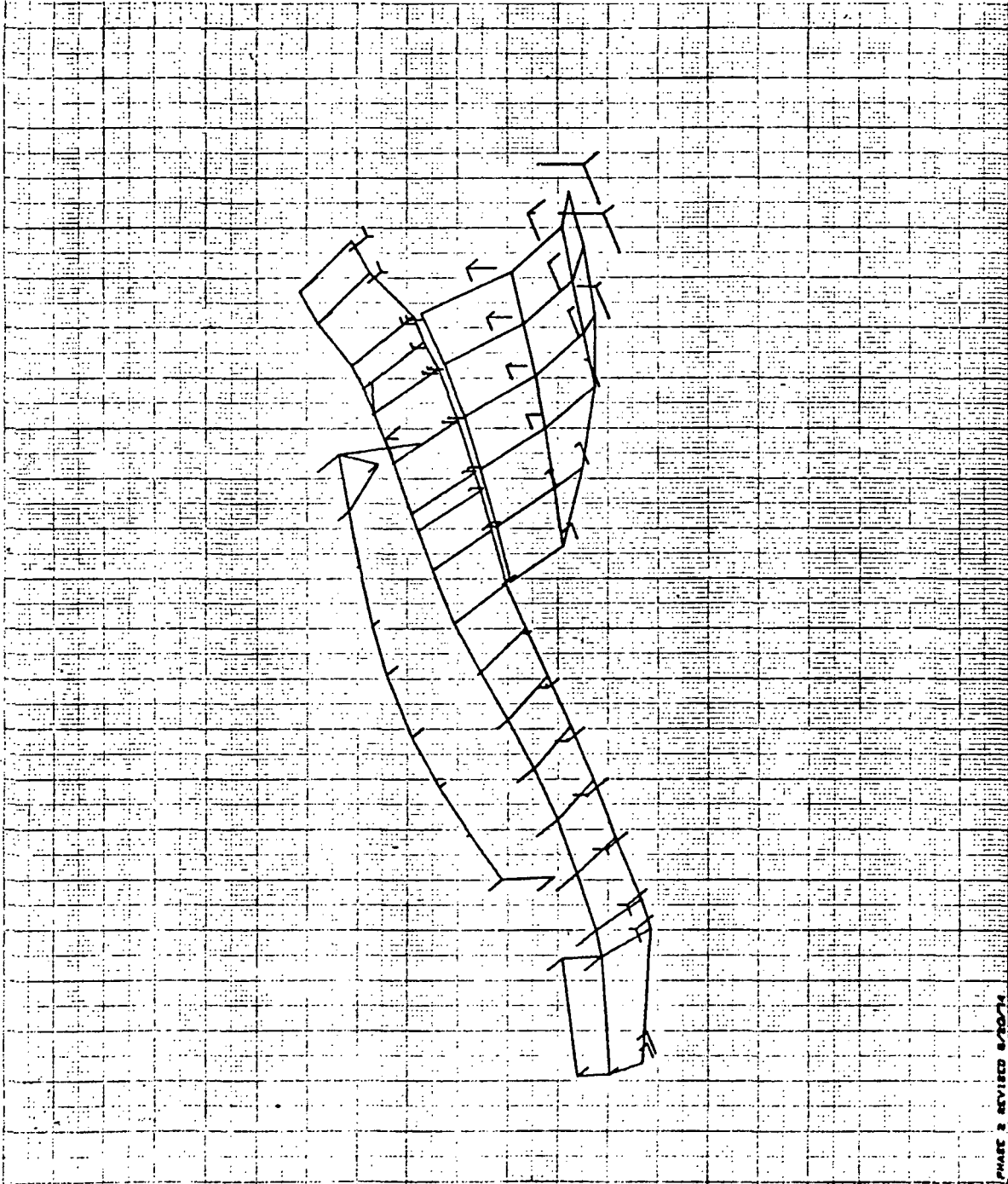

PHASE 2 REVISED 8/30/74
 ORBITER ANTI CASE
 FREE FREE MODES
 MODAL DEFOR. BURCASE 13 MODE 13 FREQ. 146.1083

