

*4 copies*

DEC 10 2 52 PM '74

M.S.C. D.B. 31

NASA CR-

141573

ANNUAL REPORT ON WORK COMPLETED ON  
TOTAL BODY CALCIUM ANALYSIS  
UNDER CONTRACT NAS 9-13029  
NOVEMBER 1, 1972 to OCTOBER 1, 1974

to the

NATIONAL AERONAUTICS AND SPACE ADMINISTRATION  
JOHNSON SPACECRAFT CENTER  
HOUSTON, TEXAS

by

Tom K. Lewellen, Ph.D.  
Wil B. Nelp, M.D.

Division of Nuclear Medicine  
University of Washington School of Medicine  
Seattle, Washington 98195

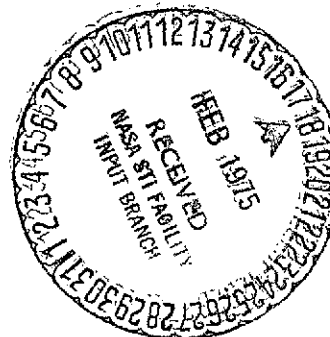

November 9, 1974

(NASA-CR-141573) TOTAL BODY CALCIUM ANALYSIS Annual Report, 1 Nov. 1972 - 1 Oct. 1974 (Washington Univ.) 46 p HC \$3.75 CSCI 06P	N75-16212
	Unclas 08977
	G3/52

## TABLE OF CONTENTS

1. Introduction
2. Development of the Gas Collection System
  - 2.1 Prototype System
  - 2.2 Rebreathing System
  - 2.3 Sampling Cylinders
  - 2.4 System Performance
3. Development of the Gas Purification System
  - 3.1 General Description
  - 3.2 System Performance
4. Development of the  $^{37}\text{Ar}$  Counting System
  - 4.1 General Description
  - 4.2 Pulse Shape Discrimination
  - 4.3 Proportional Detectors-Existing and Planned
  - 4.4 System Performance
5. Development of the 14 MeV Neutron Irradiation Facility
  - 5.1  $(n, \alpha)$  Reaction Cross Sections
  - 5.2 Preliminary Activation Uniformity Measurements
  - 5.3 Description of Irradiation Facility
  - 5.4 Free Air Uniformity Measurements
  - 5.5 Activation Uniformity in Patient Enclosure
  - 5.6 Neutron Generator Maintenance
  - 5.7 Planned Expansion of Facility
6. Measurement of  $^{37}\text{Ar}$  Excretion Rates in Humans
  - 6.1 Measurement Technique

6.2 Excretion Rate

6.3 Correlation of  $^{37}\text{Ar}$  with TBC

7. Summary and Discussion

7.1 General

7.2 Preliminary Evaluation of the Excretion Rate Data

7.3 Continuing and Future Studies

8. References

9. Publications

10. Distribution

## 1. Introduction

This report covers work performed under NASA contract NAS 9-13029 from November 1, 1972 to November 1, 1974. The basic goal of this work has been to develop a technique to quantitate total body calcium (TBC) in humans utilizing the  $^{40}\text{Ca} (n, \alpha) ^{37}\text{Ar}$  reaction. The initial development of the technique, using rats and dogs, was done by H.E. Palmer of Battelle Northwest Laboratories and has been described in detail elsewhere (1,2,3). The basic technique uses total body neutron irradiation to produce the  $^{37}\text{Ar}$  in vivo. The radio argon, which diffuses into the blood stream and is excreted thru the lungs, is recovered from the exhaled breath and counted inside a proportional detector.

As is shown in Figure 1, two radioisotopes of argon are produced in vivo by fast neutron irradiation. Since the  $^{41}\text{Ar}$  is produced from both calcium and potassium, the  $^{37}\text{Ar}$  is the preferred isotope. In fact, a much larger amount of  $^{37}\text{Ar}$  is produced than of  $^{41}\text{Ar}$  due to the large abundance of  $^{40}\text{Ca}$  (99.7% of natural calcium) and the larger reaction cross sections for the  $(n, \alpha)$  reaction on  $^{40}\text{Ca}$  than for the  $^{41}\text{Ar}$  reactions (4,5). The half-lives of the two isotopes (1.8 hours for  $^{41}\text{Ar}$  and 35 days for  $^{37}\text{Ar}$ ) allows the removal of the small amount of  $^{41}\text{Ar}$  in the samples by delaying counting the samples until the  $^{41}\text{Ar}$  has decayed away; a delay of a few hours.

The primary reason for undertaking the development of the  $^{37}\text{Ar}$  technique is to lower the dose required for TBC measurements. Current techniques, including the system at the University of Washington (6,7,8) uses total body counting to measure  $^{49}\text{Ca}$  ( $T_{1/2} = 8.8$  min.) which is formed from  $^{48}\text{Ca}$ , in vivo, by slow neutron capture. The reduction of

# PRODUCTION AND DECAY OF RADIOACTIVE ARGON

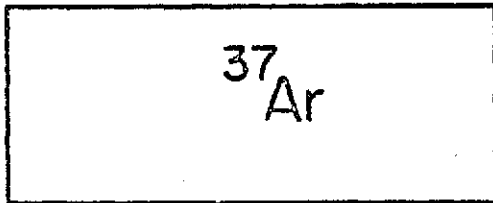
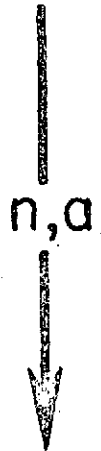
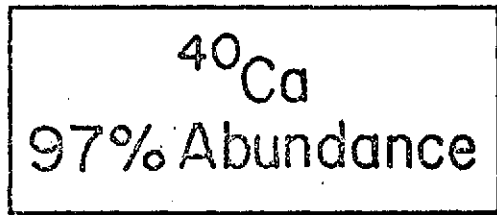

$t_{1/2} = 35.1$  Days

Electron Capture Decay Emits  
2.6 KeV X-Rays and Auger Electrons

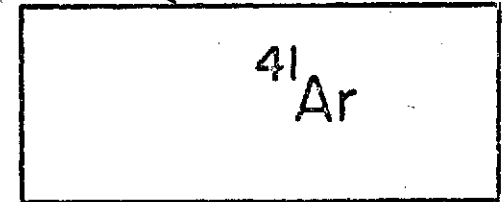
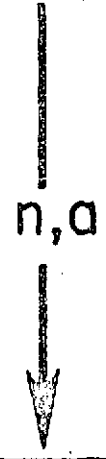
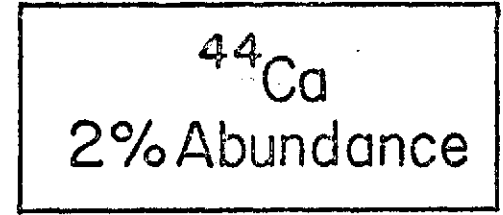
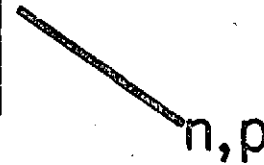
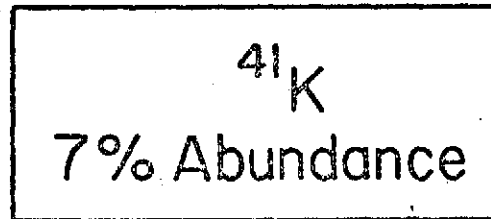

$t_{1/2} = 1.83$  Hours

Beta Decay  
Emits 1.29 MeV Gamma

FIGURE 1

patient dose with the  $^{37}\text{Ar}$  system can be accomplished for two basic reasons. First,  $^{40}\text{Ca}$  is approximately a factor of 500 more abundant than  $^{48}\text{Ca}$ . Thus, a neutron is more likely to be within the interaction distance of a  $^{40}\text{Ca}$  nucleus than a  $^{48}\text{Ca}$  nucleus. The actual reduction in the number of neutrons needed for activation (i.e. the dose) depends on the differences in the reaction cross sections (4,5). However, using neutrons with energies greater than 6 MeV should result in dose reductions of one to two orders of magnitude (2).

The second reason for dose reduction is the efficiency of the proportional detector. In contrast to the 2-3% efficiency of whole body detectors used for the  $^{49}\text{Ca}$  technique, the detection of  $^{37}\text{Ar}$  decay events in a proportional detector is virtually 100%. Argon-37 decays by Auger electrons having an energy of 2.62 KeV. Since the range of such electrons at 1 atm is less than 0.02 mm, virtually all the electrons will be absorbed in the detector. This higher efficiency means less activity of  $^{37}\text{Ar}$  is required, resulting in a lower patient dose.

Other advantages offered by the  $^{37}\text{Ar}$  technique include the elimination of other radioisotopes from the sample, allowing a simple, accurate determination of the background. At the same time, since the  $^{37}\text{Ar}$  system counts the radio-argon after it has been recovered from the patient's exhaled breath, problems of self absorption of gamma rays and geometrical corrections due to different patient body sizes encountered in whole body counters are eliminated.

The major emphasis during this reporting period has been measurements of the rate of excretion of  $^{37}\text{Ar}$  following total body neutron

irradiation, the development of the radio-argon collection, purification and counting systems and the development of a patient irradiation facility using a 14 MeV neutron generator. A detailed presentation of the results of our research and development efforts as well as a discussion of the applications of these results and the direction of our efforts for the next year are presented in the following sections of this report.

## 2. Development of the Gas Collection System

### 2.1 Prototype System

The exhaled breath samples of the first three patients we studied (see Section VI for results) were taken with a temporary system in cooperation with H.E. Palmer of Battelle Northwest Laboratories while the purification and counting systems at the University were still being assembled. The system, diagrammed in Figure 2, supplied O<sub>2</sub>-He to the patient through a standard pulmonary function mouth piece while the exhaled breath was collected in an expansion bag. The patient was maintained on an O<sub>2</sub>-He atmosphere in order to minimize nitrogen in the sample since it is very difficult to separate small amounts of <sup>37</sup>Ar from a large volume of nitrogen. Due to the size of the expansion bag, the maximum sample collection time at a respiration rate of 10 liters/minute was 10 minutes. After the sample was taken, the bag was flushed thru parts of the purification system which H.E. Palmer developed for animal studies (1,2). The semi-purified gas was trapped in an activated charcoal trap which was cooled by liquid nitrogen (LN<sub>2</sub>). The trap was then transported to Battelle facilities in Richland, Washington for final gas purification and counting of the <sup>37</sup>Ar.

### 2.2 Rebreathing System

The early studies demonstrated the need for a system which

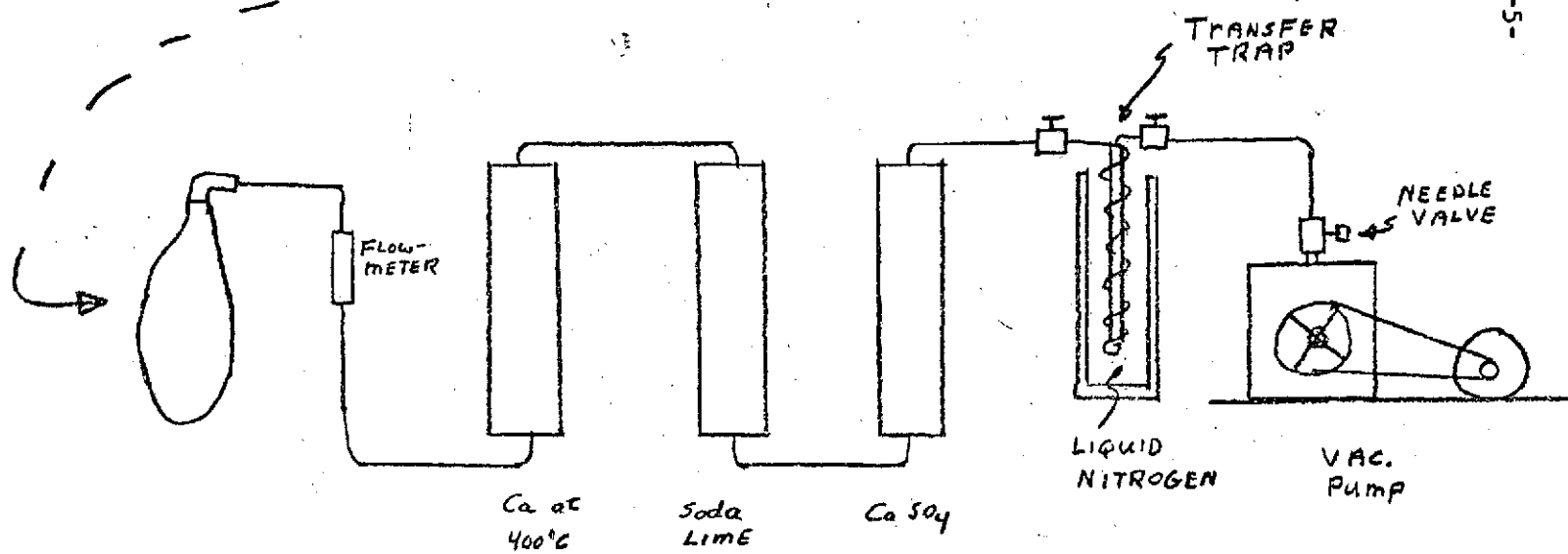
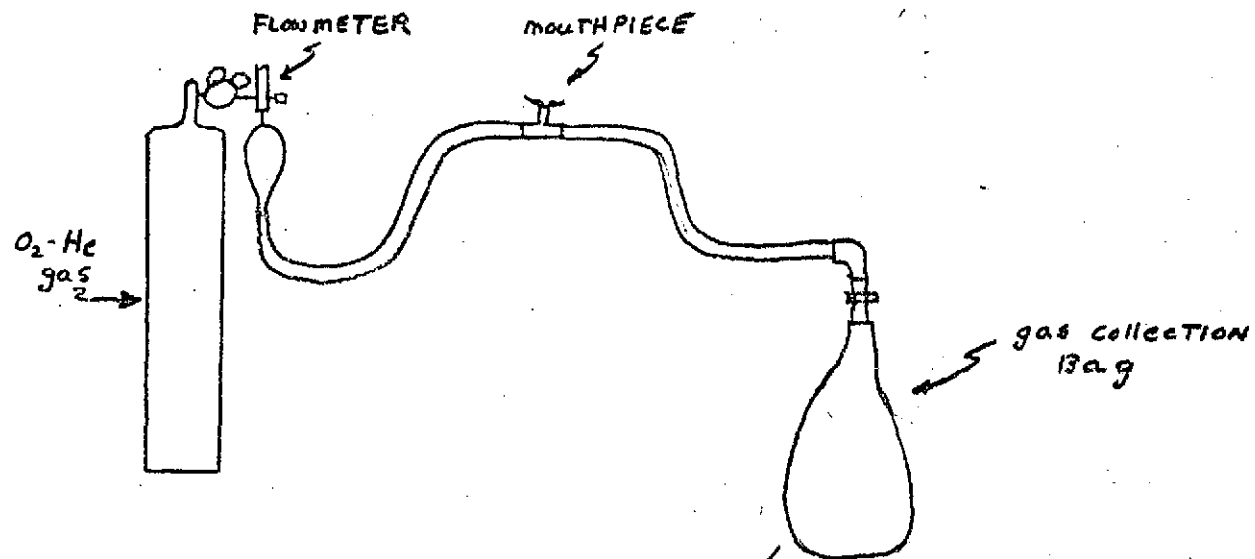

FIGURE 2 - TEMPORARY GAS COLLECTION SYSTEM



could take samples ranging from a few minutes to several hours in length, allow for long term storage of the samples at room temperature, and keep the volume of gas to be purified at a fixed, small volume on the order of 30 liters. The volume requirement was adapted to keep the size of the purification system essentially the same as that used for animal studies and keep the consumption of helium at a reasonable level. Both of these requirements result in lower setup and operating costs. In addition, the minimum use of oxygen in the rebreathing system results in a smaller volume of stable argon in the sample. This stable argon, (introduced primarily by the oxygen supply) is important in determining the required volume of the proportional detector in the counting system, as explained in Section 4.

A diagram of the system is shown in Figure 3. Prior to the start of sample collection, the mask is fitted to the patient and the system is flushed with O<sub>2</sub>-He for 5-10 minutes. This removes most of the nitrogen in the patient's lungs and the system and simplifies the separation of argon from the nitrogen.

After flushing, the system is put on closed-circuit operation. CO<sub>2</sub> is absorbed by a soda lime canister and O<sub>2</sub> metered into the system automatically by keeping the bellows volume within preset limits. The gas in the system is circulated by means of the fan. Originally the fan was driven by a magnetically coupled drive system but is now driven by a ferro-magnetic liquid rotating seal system.

FIGURE 3

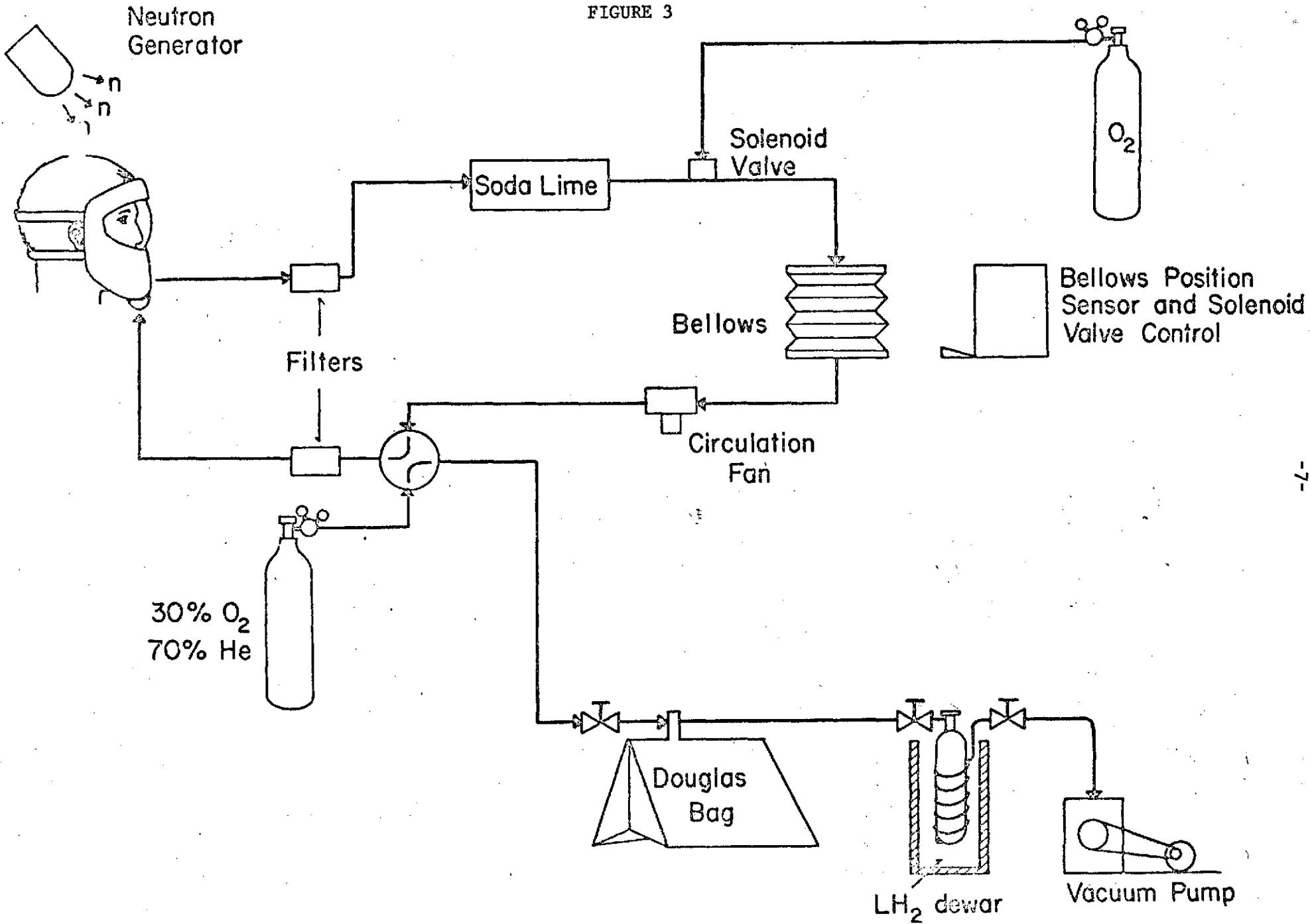

GAS COLLECTION SYSTEM

The bellows position is monitored by a simple system of magnetic reed relays which control the oxygen solenoid valve. During the development of the system, an  $O_2$  analyzer was used to verify adequate concentrations of  $O_2$  in the system. The magnetic relay system keeps the oxygen concentration in the system between 25% and 30%.

The rebreathing system is mounted on a cart so that it can be easily moved with the patient. The breath collection system is housed in a second cart and consists of a 100 liter Douglas bag, vacuum pump,  $LN_2$  dewar, and space for five sampling cylinders (Figure 3). At the end of the sample collection interval, the system, (with the patient wearing the mask) is flushed with  $O_2$ -He and the gas is collected in the Douglas bag. The flushing continues until 100 liters has been collected. The rebreathing system is then returned to closed circuit operation or the patient is removed from the mask. At the same time, the gas in the Douglas bag is pumped into the sampling cylinder. Since the cylinder is immersed in  $LN_2$ , the sieve material traps all gases except helium which is vented off thru the vacuum pump. Since the rebreathing system contains 30%  $O_2$ - 70% He gas mixture, only 30 liters of gas is trapped in the sampling cylinder. The cylinder is then closed and stored at room temperature until processed.

### 2.3 Sampling Cylinders

Each sampling cylinder is a standard 4 liter stainless steel cylinder with a coil of 3/8" copper tubing wound around the lower two-thirds of the cylinder. The cylinder and copper tubing are filled with 4 liters of type 5-A molecular sieve material. One end of the

copper tubing is connected to the bottom outlet of the cylinder and the other end to a section of 3/8" stainless steel tubing which in turn connects to a standard 3/8" orifice Hoke ball valve. The top end of the sampling cylinder is connected to a second Hoke ball valve and, as a safety feature, a rupture disc set to vent if the cylinder exceeds 150 PSI. Several manufacturers' ball valves were tested to determine their operational characteristics when cooled to LN<sub>2</sub> temperatures. It was determined that by taking advantage of the low thermal conductivity of stainless steel and immersing only the lower 80% of the sampling cylinder in LN<sub>2</sub> during the gas collection procedure, the standard Hoke ball valves operate most satisfactorily without special maintenance procedures. A total of eight sampling cylinders have been built.

#### 2.4 System Performance

The system produces a sample volume in each cylinder of 30 liters whether the sample collection interval is 10 minutes or 6 hours. The system has few mechanical devices and, except for changing the gas supplies and the soda lime canister, is essentially maintenance free. Thus far, 60 samples have been successfully obtained out of 66 "attempts".

To check the integrity of the system a sample of <sup>41</sup>Ar is periodically placed in rebreathing the system and recovered in the sampling cylinder. Argon-41 is used since its 1.4 MeV gamma ray can be easily measured before and after it is processed. Recovery from the system is consistently greater than 99.5%.

A further development of the system currently scheduled is the design and fabrication of a helmet to replace the face mask. The helmet is desirable for patient comfort during long collections. Although the face mask has been used successfully for collection intervals of up to four hours on volunteers, a helmet would be less restrictive and would be easier to use with elderly patients.

### 3. Development of the Gas Purification System

#### 3.1 General Description

The gas purification system is diagrammed in Figure 4. This system is based on the apparatus developed by H.E. Palmer (2) for animal studies. The system will process 30 liters of gas, the majority of which is oxygen, in approximately 1.5 hours.

The gas from a sampling cylinder is flushed through the system by He (Figure 4). First the gases are passed through a column of copper, maintained at 400°C, to remove oxygen, then through columns of soda lime to remove CO<sub>2</sub>, CaSO<sub>4</sub> and Aquasorb to remove water vapor and calcium, at 600°C, to remove nitrogen and any remaining oxygen. Finally, the argon is trapped in molecular sieve material at liquid nitrogen temperature and the helium is pumped off.

As mentioned, there is a significant volume of stable argon in the sample which comes primarily from the commercial O<sub>2</sub> gas used in the rebreathing system (0.03%). For instance, during a 6 hour breath collection, the rebreathing system uses 80 liters of O<sub>2</sub>-He and approximately 180 liters of O<sub>2</sub>, which results in about 13.00 cc

FIGURE 4

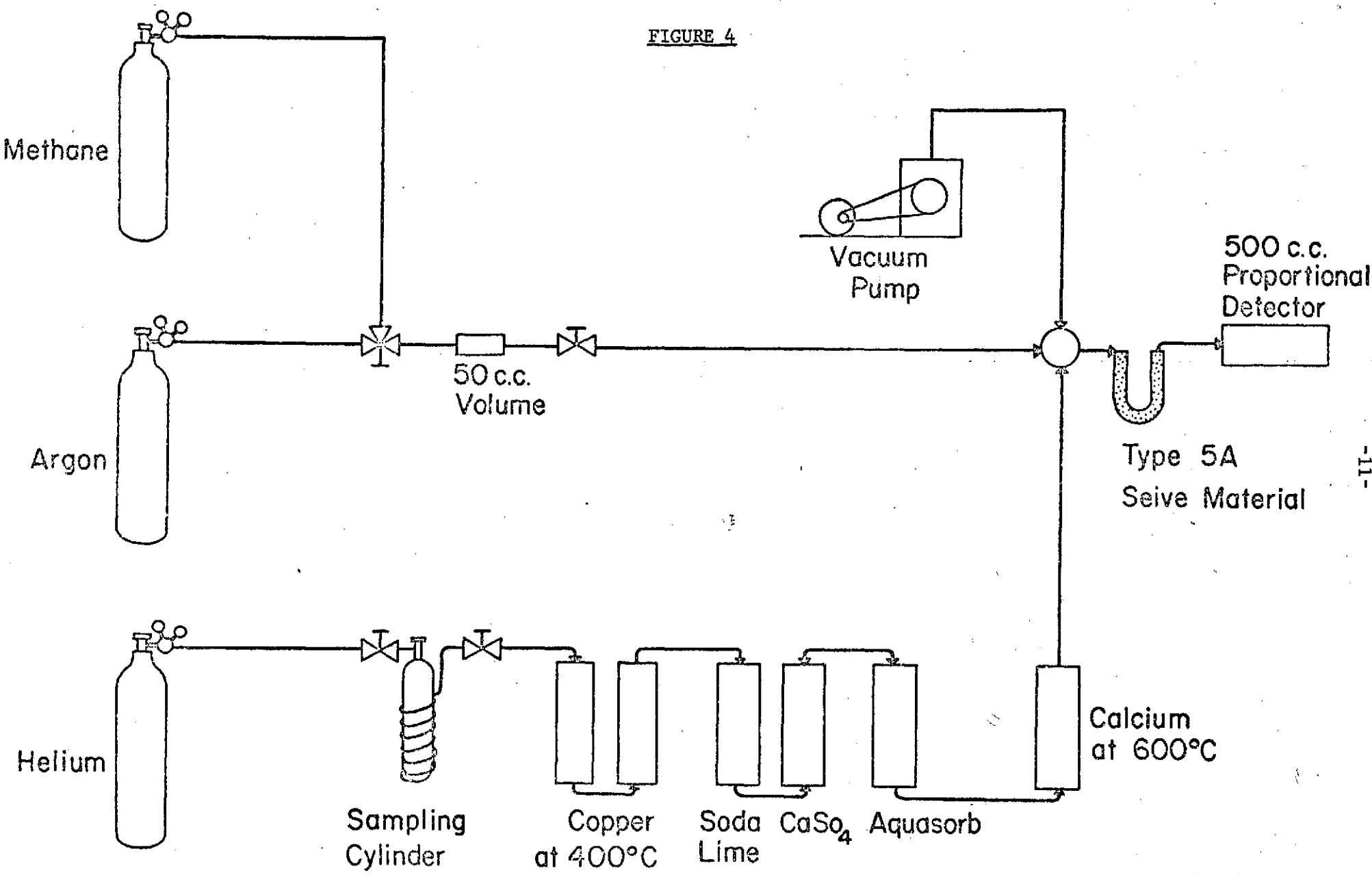

GAS PURIFICATION SYSTEM

of stable argon. This gas with the  $^{37}\text{Ar}$  from the patient is flushed into the proportional detector with an argon-methane gas to 1 atmosphere pressure (absolute) with a final gas mixture of 90% argon and 10% methane.

To assure the correct percentages of the detector gas, a filling manifold, as diagramed in Figure 4, is used. First, methane is metered into a 50 cc volume (10% of the volume of the proportional detector currently in use) at atm (absolute) pressure. Then, this volume and the trap are flushed with argon into the proportional detector at a pressure of 1 atm (absolute). Thus, the final gas mixture in the detector is 90% argon and 10% methane regardless of how much stable argon is present in the sample.

The copper used in the system to remove oxygen is in the form of short lengths of wire less than 1/4" long and 0.025" diameter which can be purchased in the cupric oxide form and then reduced with hydrogen at 400°C. This makes a very reactive column for oxygen removal and can be easily regenerated from oxide to copper with hydrogen for indefinite reuse. The  $\text{CaSO}_4$  and Aquasorb are commercial drying agents. The molecular sieve material is Linde Type 5A which is outgased under a vacuum for about 15 minutes at a temperature of 250°C before being used to absorb the  $^{37}\text{Ar}$ .

### 3. System Performance

The system operates most satisfactorily. Recovery checks through the system show a loss of less than 0.25% of the sample

when tested with  $^{41}\text{Ar}$  (1.4 MeV gamma ray emission) and is quite adequate for patient studies. The system could be rebuilt and made essentially automatic and portable if needed.

#### 4. Development of the $^{37}\text{Ar}$ Counting System

##### 4.1 General Description

The counting system is diagrammed in Figure 5. The  $^{37}\text{Ar}$  is loaded into the proportional detector and the detector is placed between two 9" diameter X 4" thick NaI(Tl) crystals. The detector is surrounded by 4" thick lead shielding. The NaI detectors are used as anti-coincidence shields to reduce cosmic ray background. As indicated in Figure 5, any event in the proportional detector which occurs in coincidence with an event in either of the NaI detectors will not be accepted by the multi-channel analyzer.

##### 4.2 Pulse Shape Discrimination

The system also uses pulse-shape discrimination to further reduce the background counting rate. Pulse shape discrimination is achieved by measuring the rise time of each pulse (see Figure 6). Pulses which originate from the 2.62 Auger electron rise rapidly since all the primary ionization takes place in a small area (range of 2.62 Auger electrons in the detector is approximately .02 mm). A gamma ray that interacts in the detector in a series of Compton interactions produces primary ions over a larger area, resulting in more time required to collect the ions which causes a longer pulse rise time. In contrast, electronic noise has very fast pulse rise times, faster than the pulse rise times of  $^{37}\text{Ar}$  events.



FIGURE 5

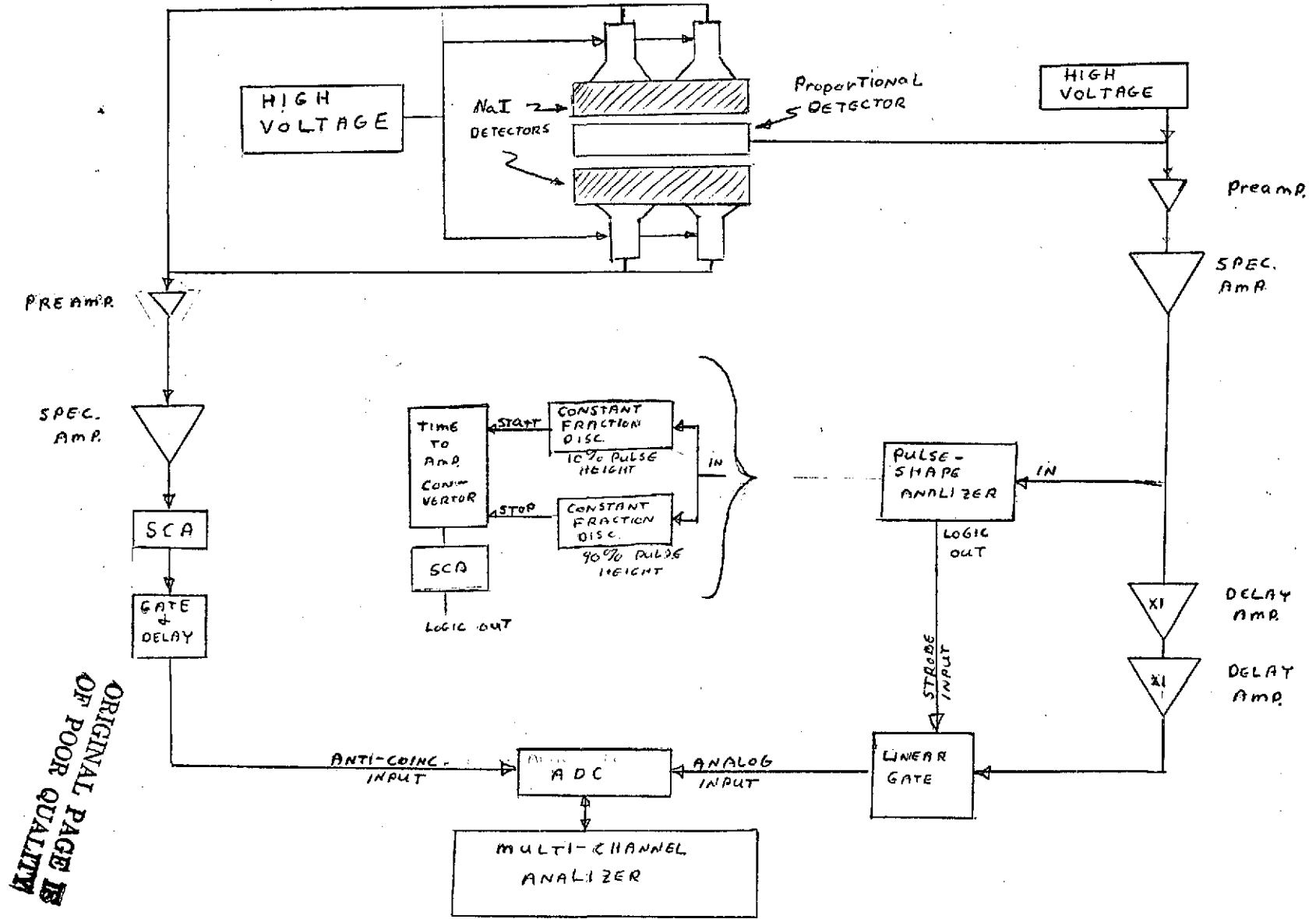

ORIGINAL PAGE IS OF POOR QUALITY

LOW BACKGROUND PROPORTIONAL DETECTOR COUNTING SYSTEM

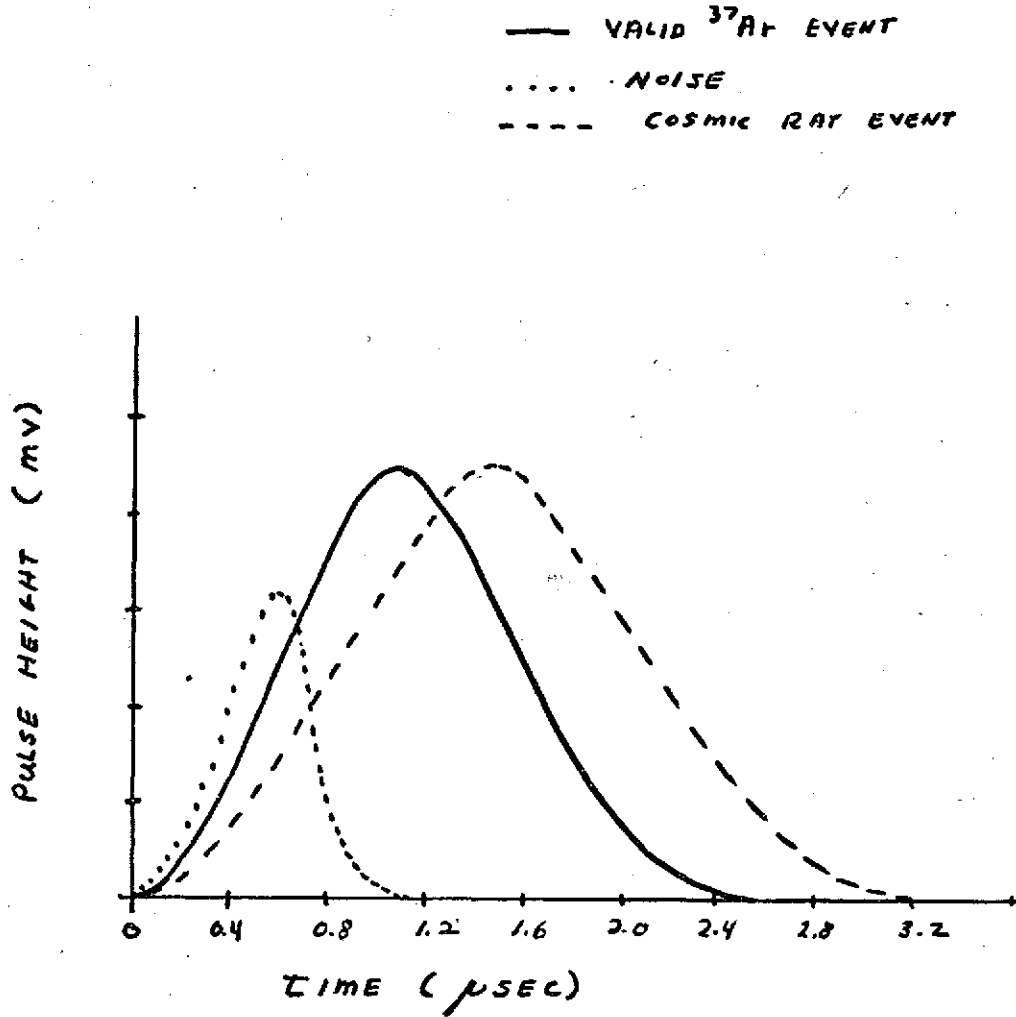

FIGURE 6 - PULSE SHAPES FROM  
PROPORTIONAL DETECTOR

A pulse shape analyzer (PSA) manufactured by Ortec is used to measure the pulse rise times and put out a logic pulse only if rise times fall within a preset range. The proportional detector energy signal to the multi-channel analyzer is routed through a linear gate controlled by the PSA. Thus, an event will not be stored in the multi-channel analyzer unless the PSA has also put out a logic pulse.

#### 4.3 Proportional Detectors-Existing and Planned

Several proportional detectors, all supplied by H.E. Palmer of Battelle Northwest, have been used. The detectors used most recently have volumes of 500 cc and are made of reasonably pure materials (3). The 500 cc volume was selected to assure that the amount of stable argon in the samples would be a small fraction of the detector volume. As discussed in Section 3, the maximum stable argon volume we have measured is only 13 cc. Thus, detectors of 100 cc or smaller could be used. The lower volume limit is determined by the amount of gas needed to flush the argon from the final trap in the purification system into the detector.

If argon transfer were done by a Toepler pump, detector volumes as small as 15 cc would be feasible. The detector volume is important since the smaller the volume, the lower the background counting rate. The 500 cc detectors have a background rate of 0.9 counts/min. By decreasing the volume to 15 cc, this rate would be reduced to approximately 0.025 counts/min. Such a detector is being designed and will use zone refined quartz to minimize contaminants in the detector walls. The background rate of this detector should be less than 0.02 counts/min.

The 500 cc detector is adequate for TBC measurements with patient doses of 10 mrad (see Section VI) since there are 10,000  $^{37}\text{Ar}$  events in 16 hours of counting. With lower patient doses the small, ultra-low background detector being designed should allow the same precision of measurement as currently obtained, even if counting intervals of up to 15 days were required. Since the longest counting interval planned is 5 days, the new small detector will provide more than adequate performance.

#### 4.4 System Performance

In operation, the counting system has been reliable and is easy to operate. A typical spectrum is shown in Figure 7. This figure shows both the  $^{37}\text{Ar}$  spectrum and a spectrum obtained with a  $^{55}\text{Fe}$  source which is used to set the amplifier gain at the beginning of each sample counting. The background is essentially flat, reproducible and quite precisely determined.

### 5. Development of the 14 MeV Neutron Irradiation Facility

#### 5.1 (n, $\alpha$ ) Reaction Cross Sections

The cross section for the  $^{40}\text{Ca}(n, \alpha)^{37}\text{Ar}$  reaction is 138 millibarns at a neutron energy of 14 MeV (4). The cross section increases to 430 millibarns as the neutron energy decreases to 6 MeV (5). At lower energies, the cross section rapidly decreases, and at 2 MeV it is 4.7 millibarns. Unfortunately, there are no experimental data or cross section values between 6 and 14 MeV in the literature, so that the peak cross section value is unknown. When a neutron beam passes through a thickness of water, both the average energy and the number of neutrons are reduced by thermalization and capture. In the case of the activation of  $^{40}\text{Ca}$  to produce  $^{37}\text{Ar}$ , the loss of

FIGURE 7

Typical  $^{37}\text{Ar}$  Proportional Counter Energy Spectrum with  $^{55}\text{Fe}$  Spectrum Used for Energy Calibration

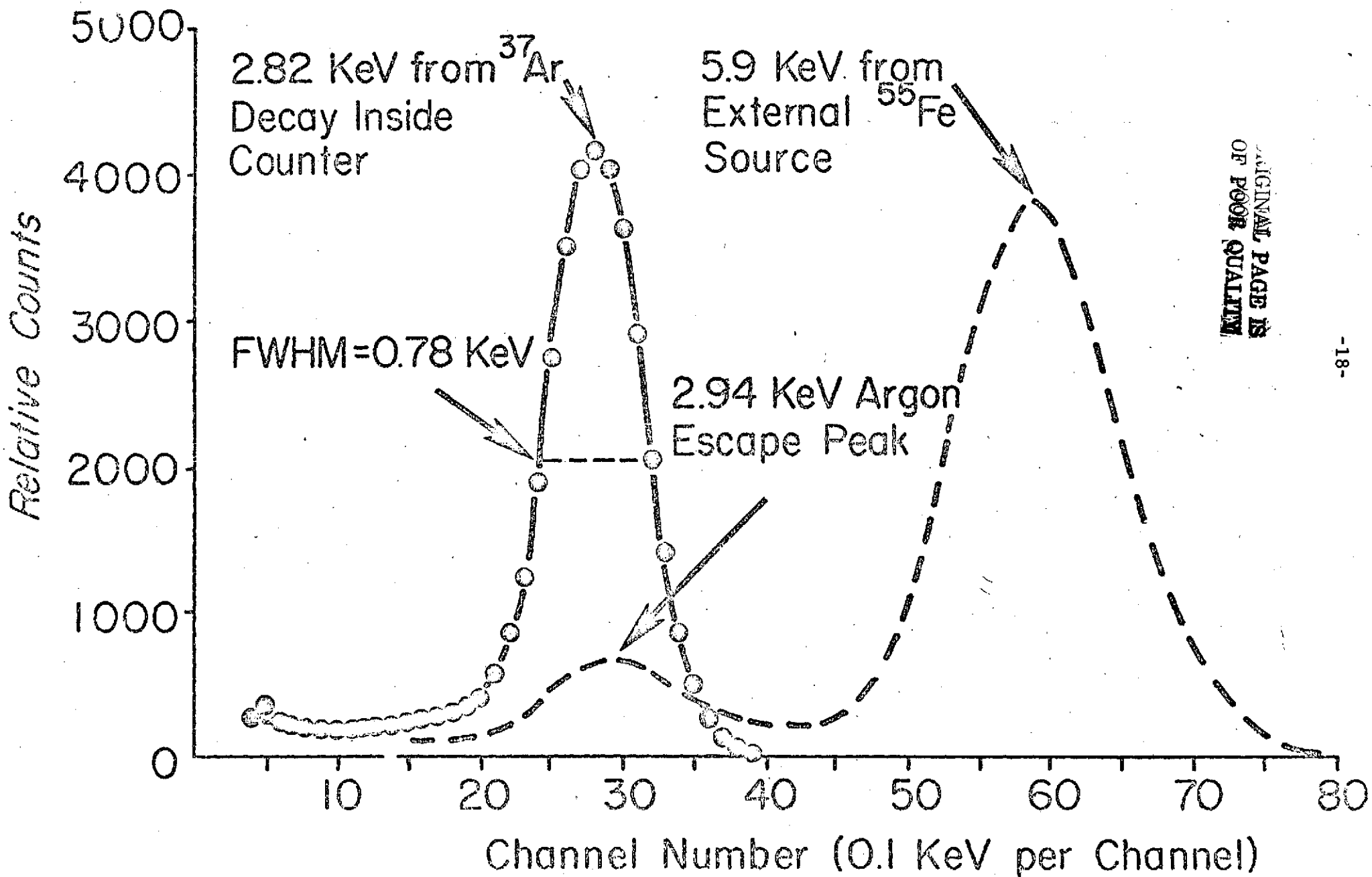

neutrons by absorption with greater penetration into the body is somewhat compensated by the higher cross section of reaction for the remaining lower energy neutrons. Because of this effect, the uniformity of the activation of  $^{40}\text{Ca}$  by a beam of fast neutrons should be greater than that of a reaction in which the cross section becomes lower as the neutron energy is reduced.

### 5.2 Preliminary Activation Uniformity Measurements

A 14 MeV neutron generator should provide an excellent irradiation source for the  $^{37}\text{Ar}$  technique. In order to measure the uniformity of activation, a series of measurements were conducted by H.E. Palmer using a Kaman model A-711 14 MeV neutron generator at Battelle Northwest Laboratories. The study was done using a water phantom 11" thick, 18" high and 18" wide. A tube containing a calcium nitrate solution, was placed at various positions in the phantom. The  $^{37}\text{Ar}$  produced during neutron irradiation is released to a stream of helium and collected on charcoal for measurement. The release of  $^{37}\text{Ar}$  from the calcium solution is not immediate, and 2 hours are required for 99% recovery.

Figure 8 shows the relative activation of  $^{40}\text{Ca}$  to  $^{37}\text{Ar}$  at various positions from the front surface of the water phantom. In practice, the patient will be irradiated from both the front and back, thus two curves for irradiation (from both sides) are added to obtain the bilateral summation curve shown in Figure 8, which is straight within  $\pm 2.6\%$ .

# UNIFORMITY OF $^{37}\text{Ar}$ PRODUCTION IN ELEVEN INCH THICK WATER PHANTOM

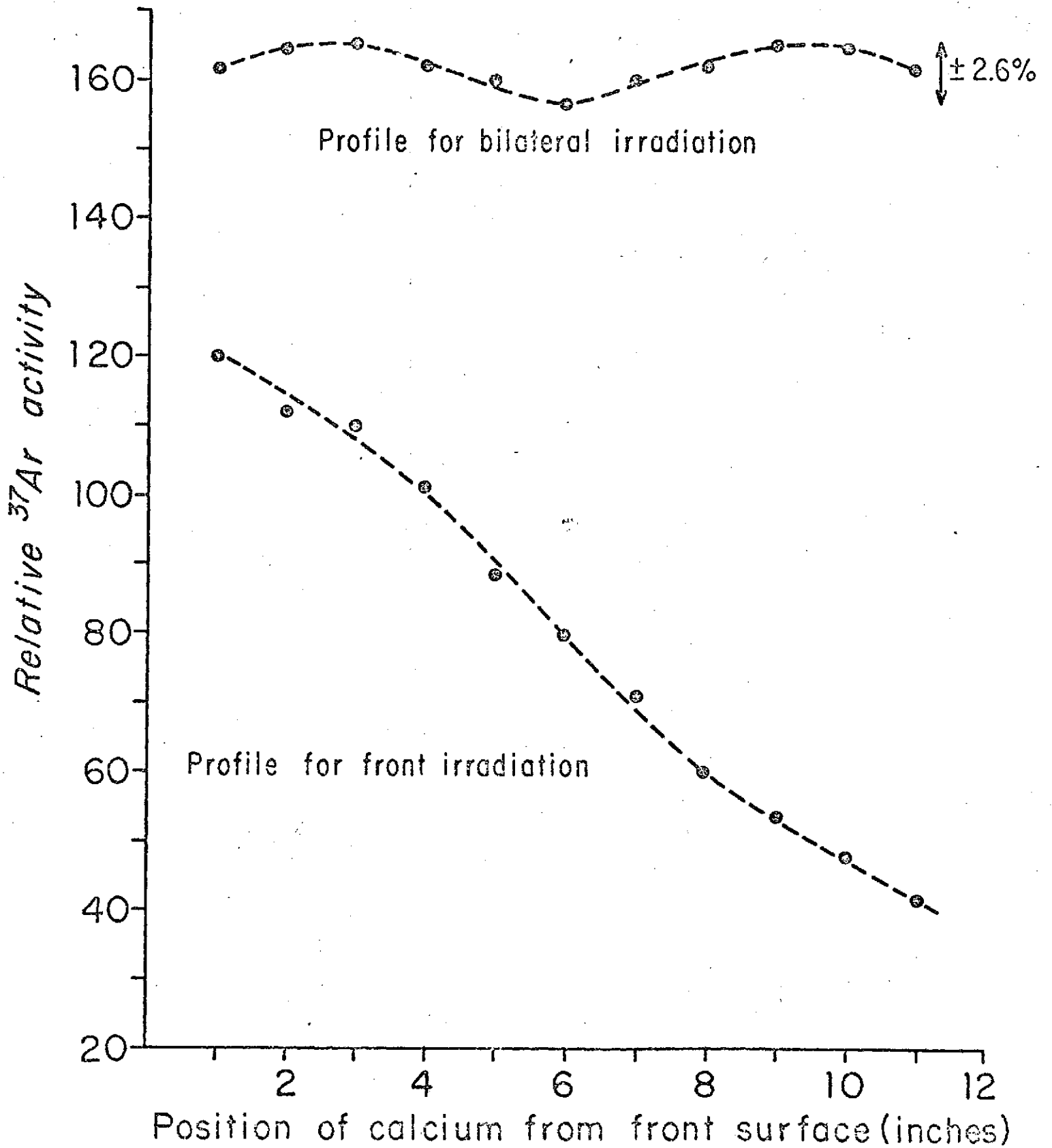

Phantom data taken at Battelle Laboratories by H.E. Palmer

FIGURE 8

Since the thickness of most people can be easily compressed to 11" or less, and thinner sections of the body can be covered with water to produce an effective 11" thickness over the entire body, it should be possible to activate the calcium within 2.6% regardless of its position within the body.

### 5.3 Description of Irradiation Facility

A patient irradiation facility, for 14 MeV neutrons, is under development. The patient enclosure, illustrated in Figure 9, consists of an aluminum water tank, 12" thick, 24" wide and 6 feet high. An adjustable platform inside the tank is positioned to place the patient's shoulders just below the top of the tank. The patient stands inside a plastic liner and the space between the tank walls and the liner is filled with water. The tank sets on a turntable to allow bilateral irradiations. The dose delivered to the patient is monitored and controlled by two detector systems, a tissue equivalent ion chamber and a CsI crystal covered with cadmium and coupled to a photomultiplier tube.

As indicated in Figure 10, the ionization chamber output goes to an integrating electrometer. The electrometer output, routed through an isolation amplifier, is recorded on a digital voltmeter. The CsI detector output, boosted by a preamplifier, is amplified and fed into a single channel analyzer (SCA). The SCA selects fast neutron events and totals the number of such events by driving a scaler. The control logic box allows a digital comparator to "look at" either the digital voltmeter or the scaler. When the number in



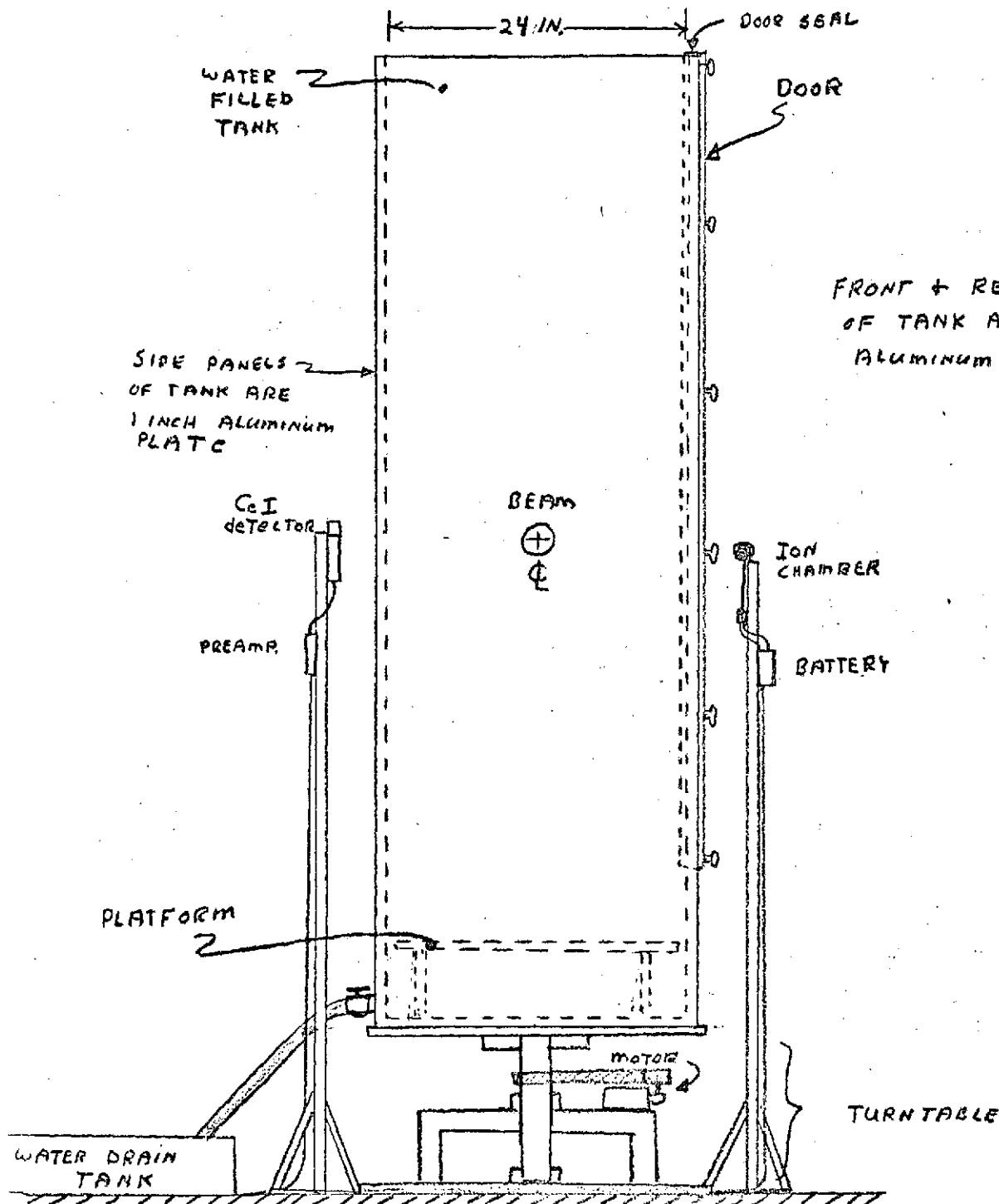

FRONT + REAR PANELS OF TANK ARE 1/8 INCH ALUMINUM SHEET

ORIGINAL PAGE IS OF POOR QUALITY

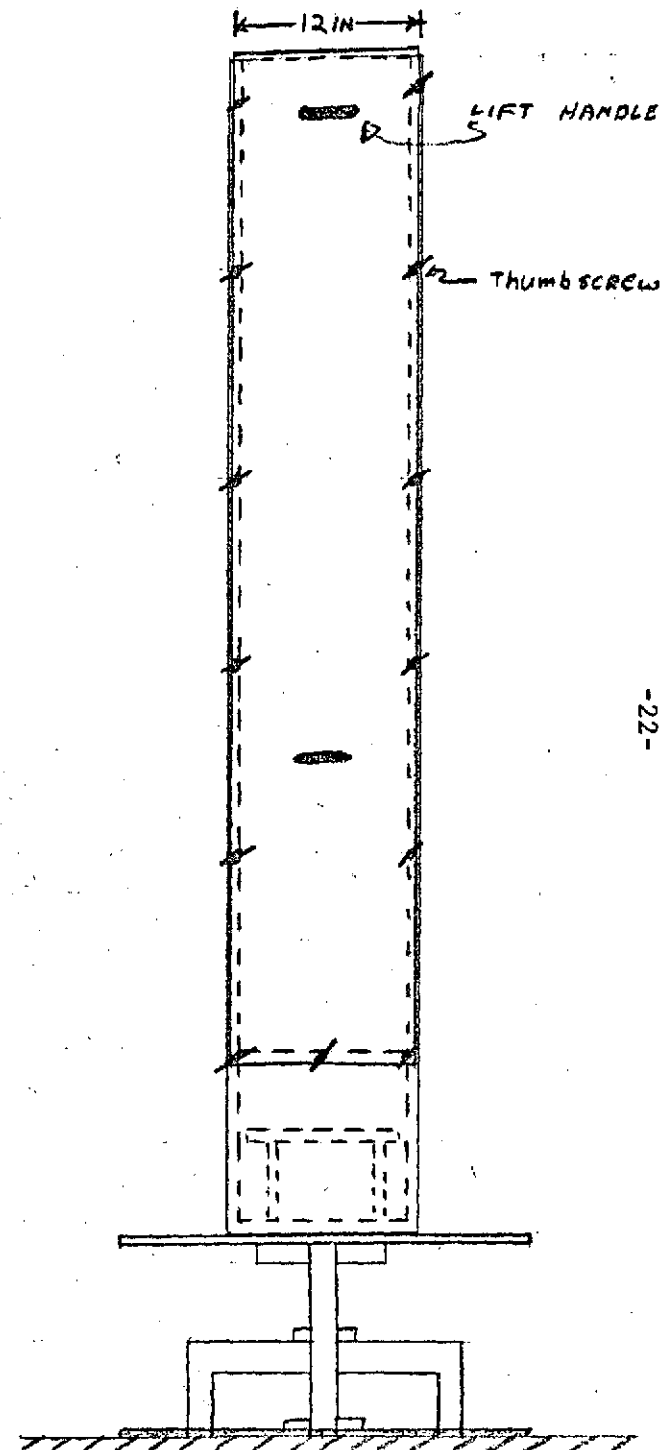
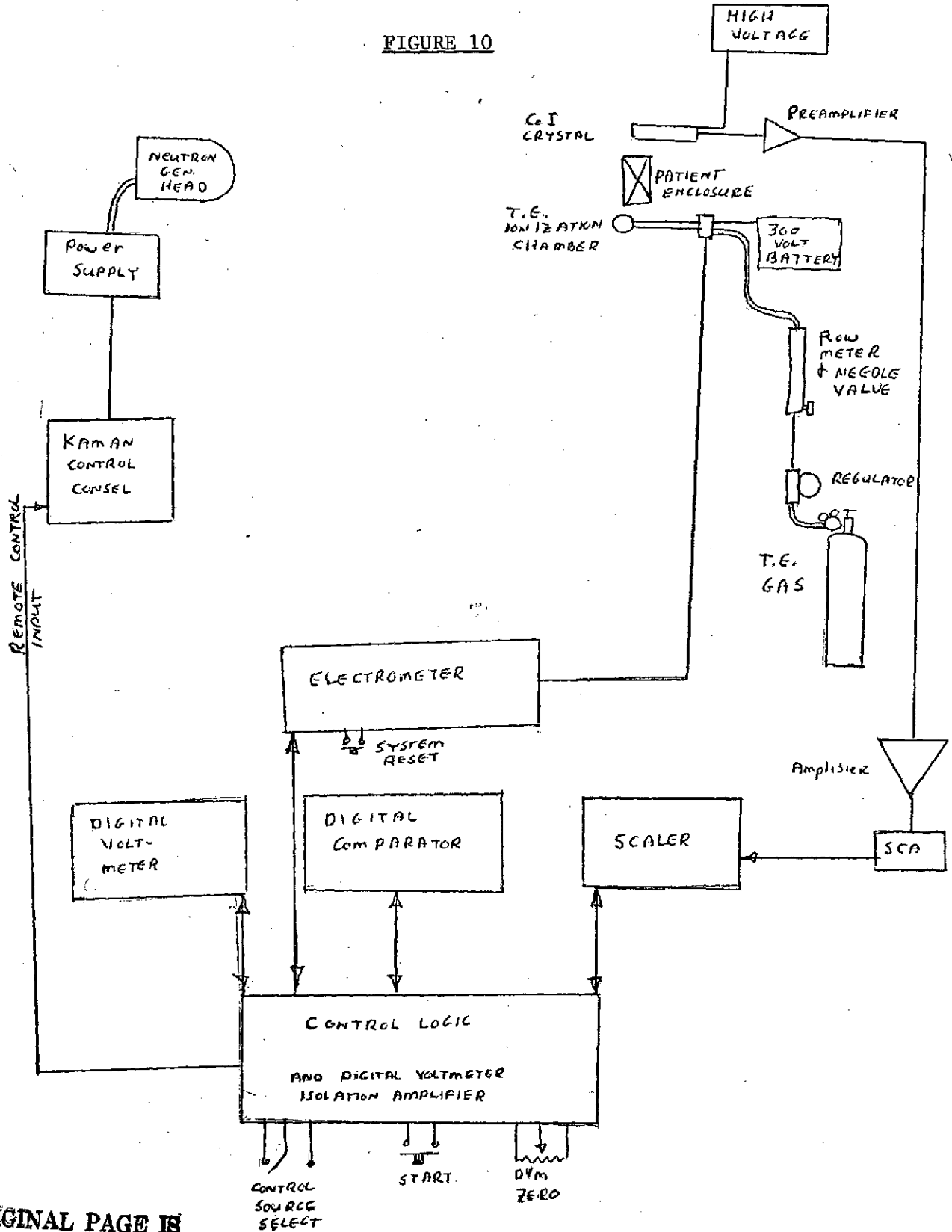

FIGURE 9- PATIENT ENCLOSURE

FIGURE 10



ORIGINAL PAGE IS  
OF POOR QUALITY

the selected device is equal to that entered into the comparator, the control logic will turn off the neutron generator. Further, the control system will not let the generator be turned on until the system reset (located on the electrometer chassis) has been activated. The control logic electronics was designed and built at the University. The dose control system functions well and is operational. The patient enclosure has been installed and is ready for use.

The irradiation facility is housed in an underground room, in the University Hospital (Figure 11). It was necessary to install neutron shielding in the area to eliminate exposure of personnel in adjacent areas. The arrangement of the facility is indicated in Figure 11. The distance between the neutron generator and the patient enclosure has been selected to provide a free-air irradiation field uniformity of  $\pm 3\%$  or better based on the usual  $\frac{1}{r^2}$  flux distribution produced by point sources.

#### 5.4 Free Air Uniformity Measurements

Figure 12 indicates the placement of dosimeters for and figure 13 displays the results of measurements of the free-air fast neutron flux densities at the patient position. The dashed lines indicate the expected flux distribution of the system behaved as a point source. The measurements were made by irradiating a grid of aluminum pellets and subsequently counting the  $^{24}\text{Na}$  formed by an  $(n, \alpha)$  reaction. As indicated in Figure 12, measurements were made (1) on a horizontal line, perpendicular to the beam at 50" from the floor, (2) on a vertical line perpendicular to the beam center line and (3) at the corners of a rectangle which would enclose the patient.

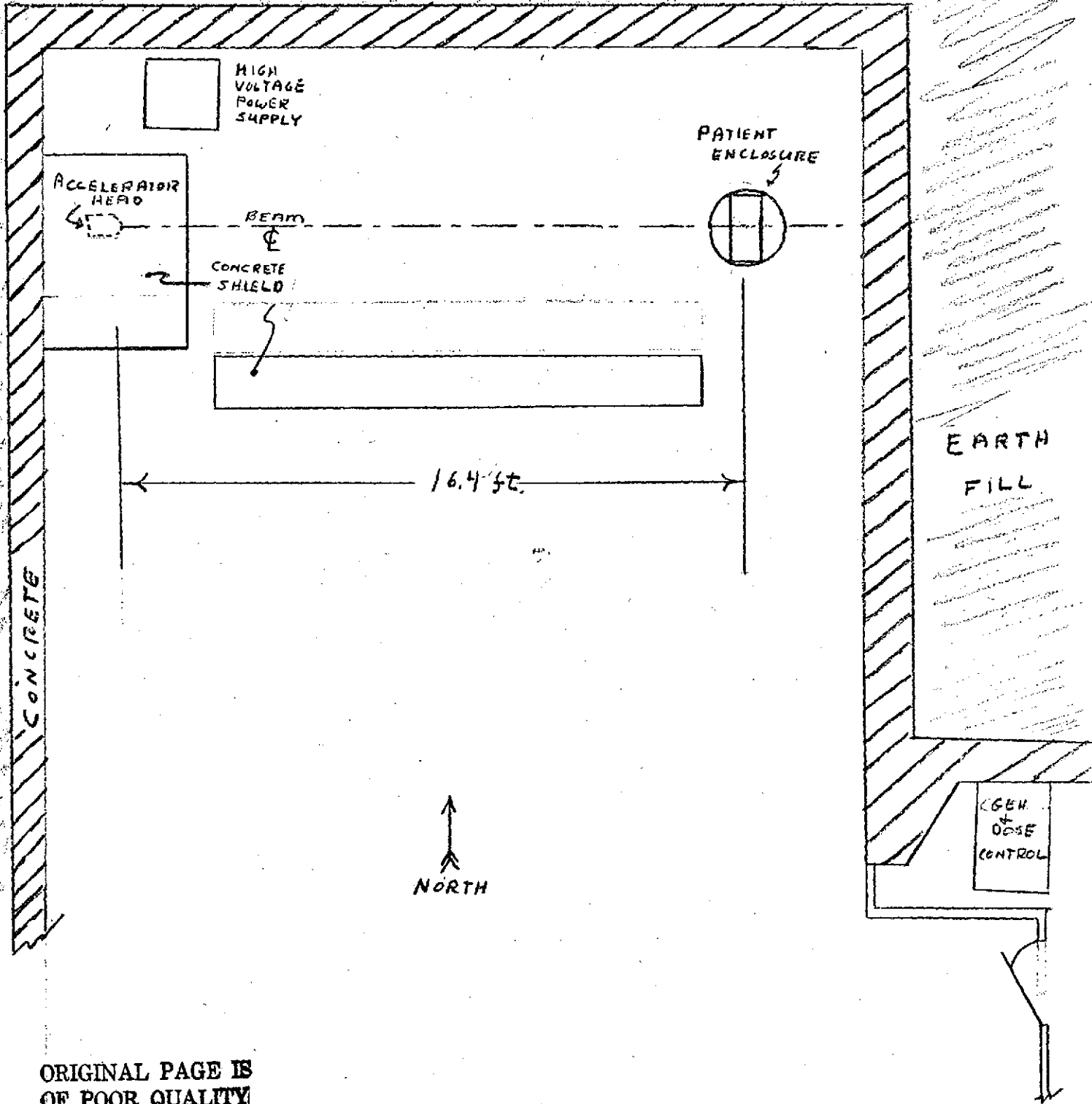

ORIGINAL PAGE IS  
OF POOR QUALITY

FIGURE 11  
IRRADIATION FACILITY  
FLOOR PLAN

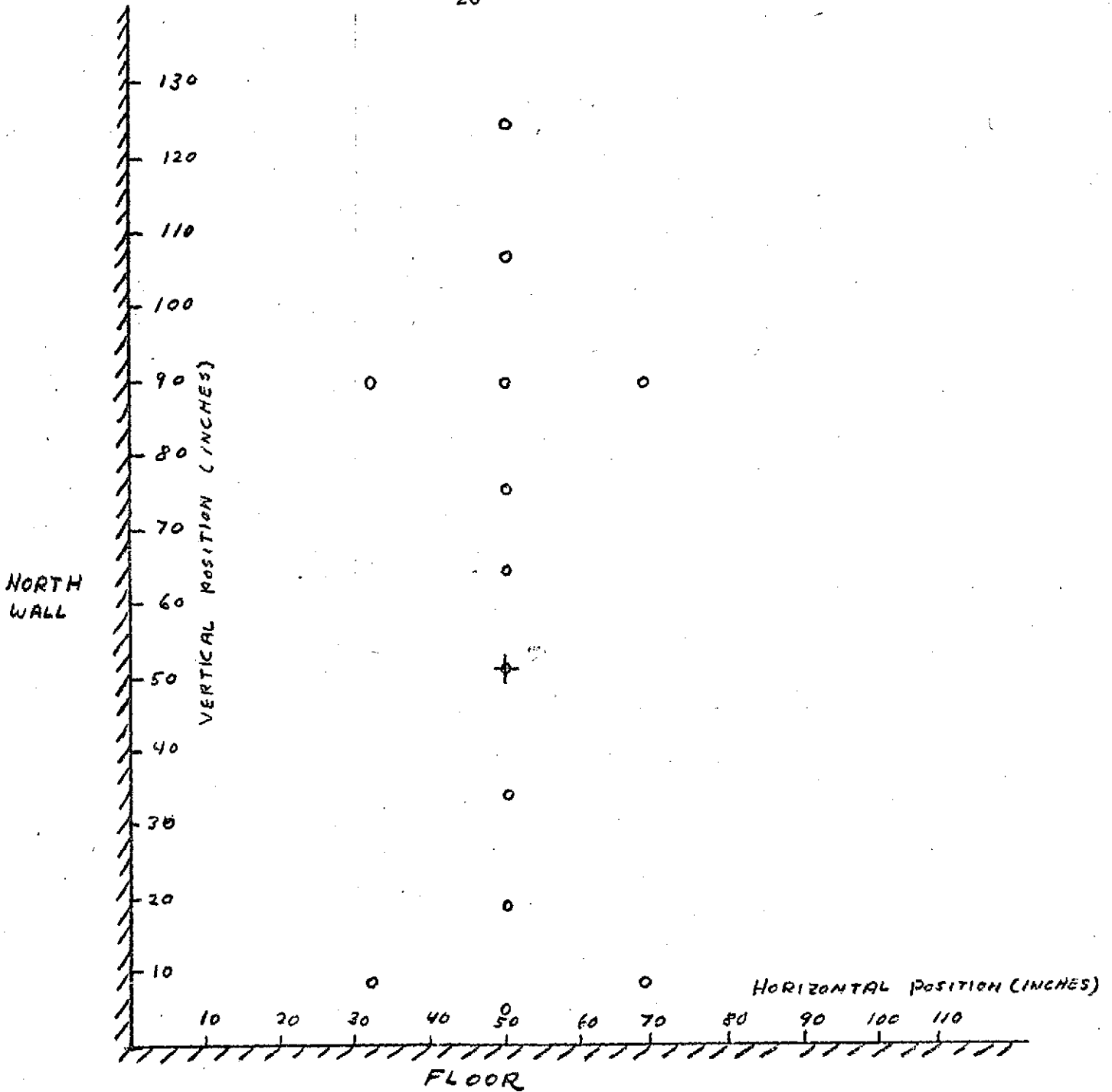

FIGURE 12 - DOSEMETER POSITIONS FOR FREE AIR UNIFORMITY MEASUREMENTS.

o = AL Pellet

SCALES ARE IN INCHES

+ INDICATES BEAM CENTER LINE, 16.4 SEET FROM NEUTRON GENERATOR

ORIGINAL PAGE IS OF POOR QUALITY

FAST NEUTRON FLUX AT PATIENT POSITION - 14 MV FACILITY  
MEASURED BY ACTIVATION ANALYSIS,  $^{27}\text{Al}(n, \alpha)^{24}\text{Na}$  REACTION

FLUX MEASURED IN AIR, NO MODERATING MATERIAL

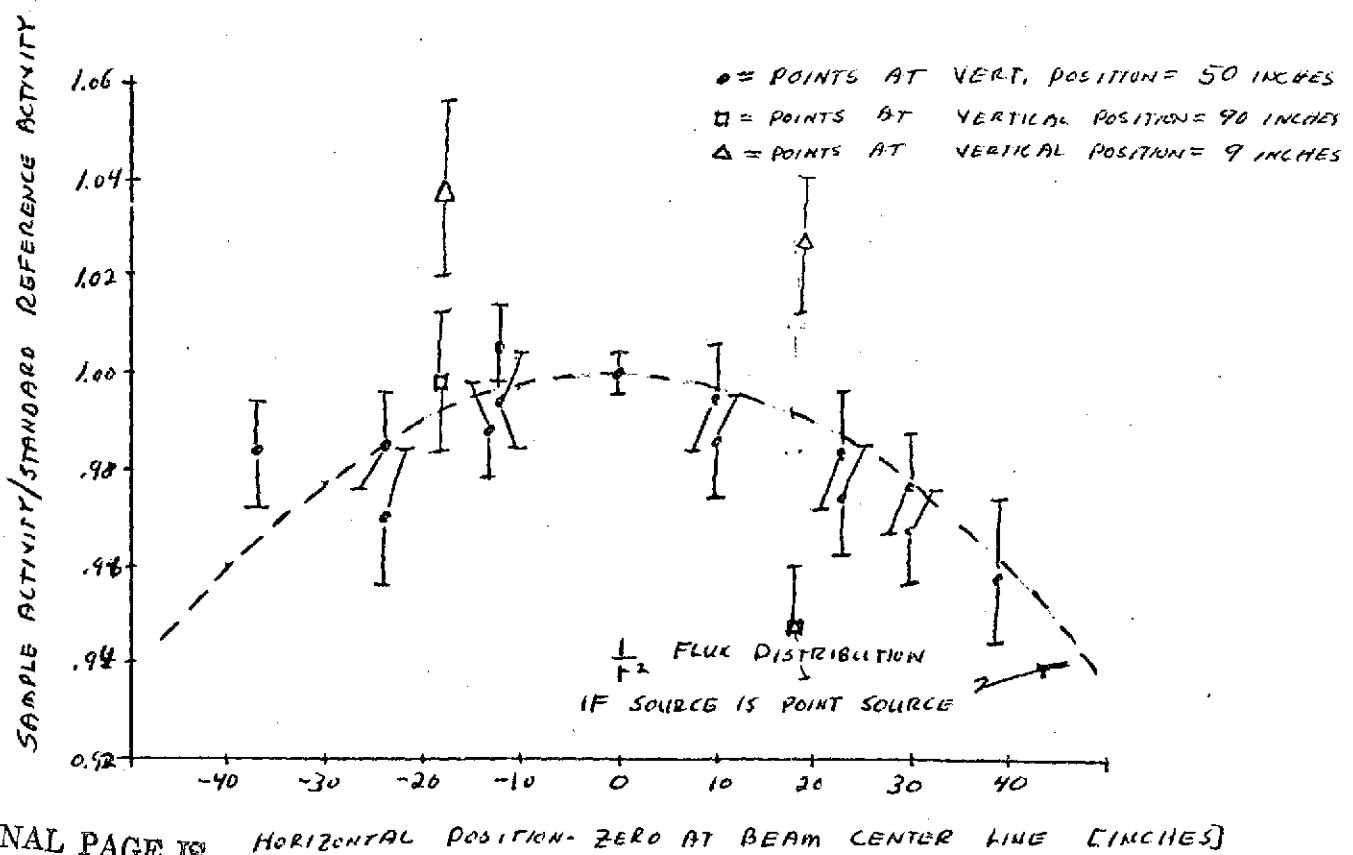
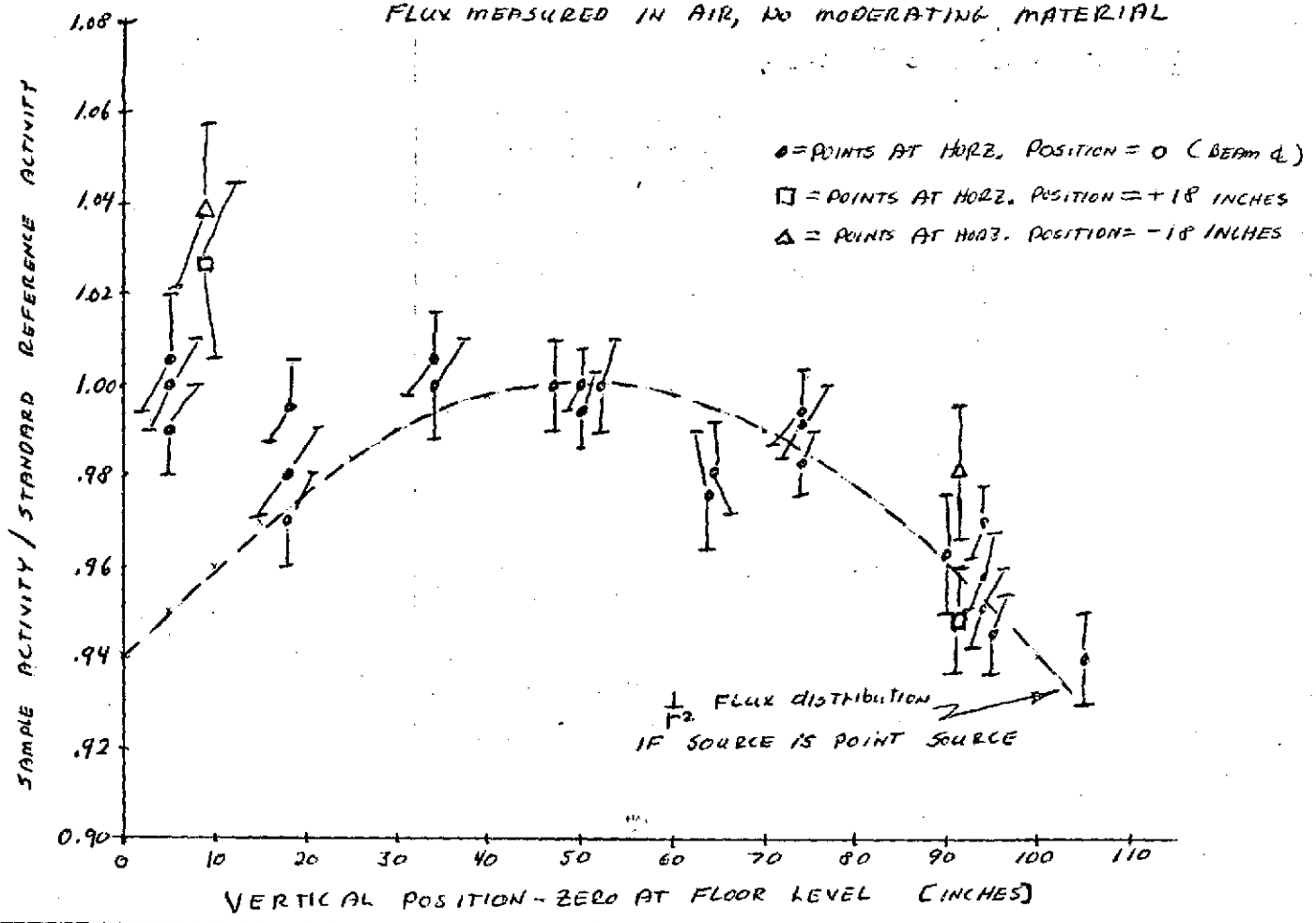

ORIGINAL PAGE IS  
OF POOR QUALITY

HORIZONTAL POSITION - ZERO AT BEAM CENTER LINE [INCHES]

FIGURE 13

Except within a foot of the floor, the measured flux distribution follows the predicted distribution exceptionally well.

Since the patient enclosure is designed such that the patient's feet are at least two feet off the floor, the facility provides the ideal fast neutron flux distribution at the patient position.

#### 5.5 Activation Uniformity in Patient Enclosure

The last step in preparing the facility for use is to measure the activation uniformity of calcium within the actual patient enclosure. These measurements will be performed in a manner similar to those made by H.E. Palmer. The dosimeter will be a glass ampoule measuring 19 mm x 52 mm filled with 10 ml of calcium nitrate solution and sealed. A matrix of ampoules (Fig 14) will be placed in the water filled patient irradiation "tank" as indicated in Figure 14 be irradiated for 24 hours, then processed at the rate of two a day and counted for  $^{37}\text{Ar}$  content. In order to remove the  $^{37}\text{Ar}$  from the calcium nitrate, the ampoule will be placed in a gas tight container equipped with a bubbler. The ampoule will then be broken and helium bubbled through the liquid to deliver the  $^{37}\text{Ar}$  to the purifying and counting systems. This step has been delayed, as has been the development of the entire facility, by a series of serious malfunctions of the neutron generator.

#### 5.6 Neutron Generator Maintenance

This type of neutron generator, accelerating deuterium into a tritium target, generally provides a highly reliable and inexpensive source of fast neutrons. Unfortunately, the generator we have been using has been in use for 7 years with the consequence that several major components failed, primarily from "old age". This, under normal circumstances, would not be overly serious. However, due to the current general shortage of parts and the significant design changes

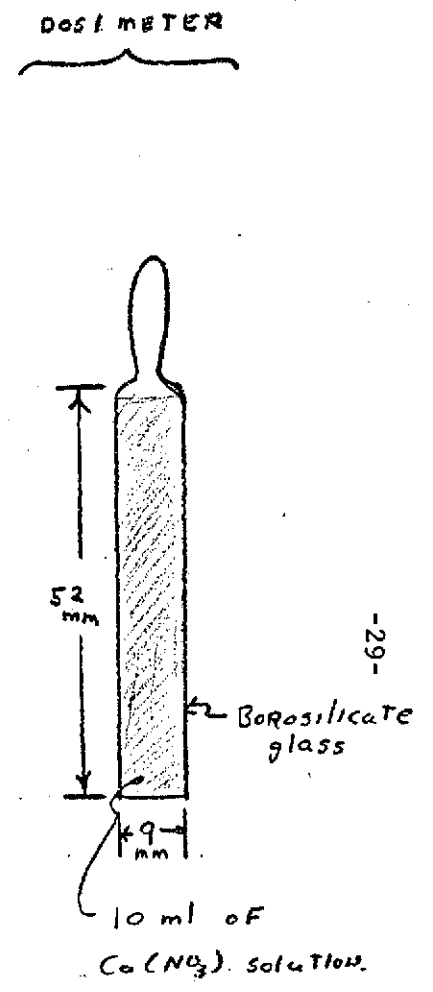
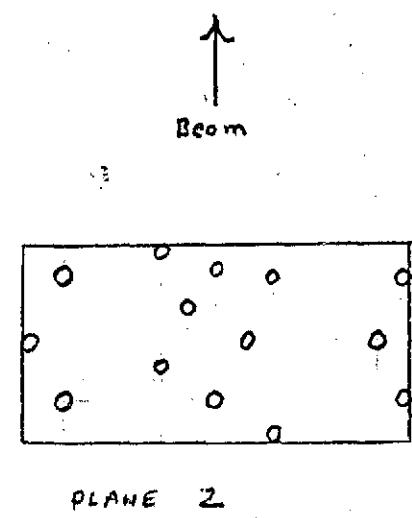
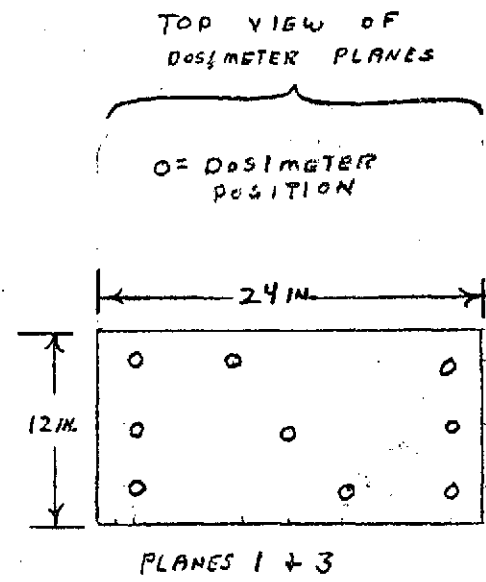
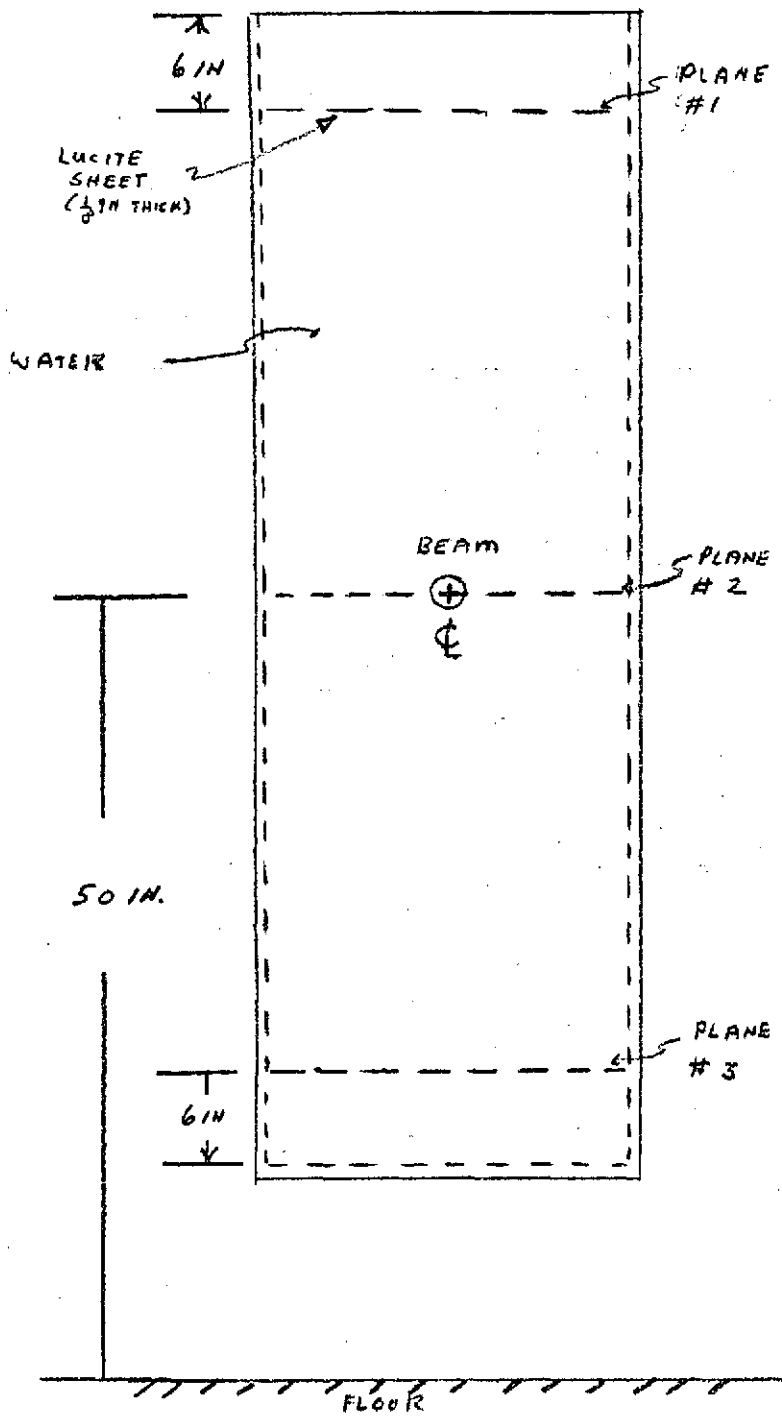

THE CONCENTRATION OF THE SOLUTION IS 100 grams of  $Ca(NO_3)_2 \cdot 4H_2O$  PER 100 ml WATER.

FIGURE 14 - DOSIMETER POSITION FOR PATIENT IRRADIATION FACILITY UNIFORMITY



of currently available generators, we were forced to redesign and modify major sections of the generator using parts that were available. This effort has been moderately successful, but time consuming. During the process, several improvements in the generator control circuits were made as a result of consultations with Kaman Nuclear design engineers.

Two re-occurring problems, failure of high voltage cables and rectifiers in the high voltage power supplies, have not been eliminated, but have been considerably reduced. These failures seem to be associated with voltage surges caused by sparks in the accelerator head. Modifications required to eliminate the problem have only recently been proposed by Kaman personnel and are sufficiently expensive and time consuming to require consideration of acquiring a new generator.

At the time of writing this report, the old generator is operational and the final series of activation uniformity measurements in the patient enclosure are underway. A request for a new generator is under consideration by the appropriate NASA personnel.

#### 5.7 Planned Expansion of Facility

During the next year, the irradiation facility will be expanded to allow both total body and regional irradiations. The modification for regional studies consists primarily of an adjustable collimator constructed from mild steel. If such studies prove feasible, an adjustable collimator system, similar to that developed for fast neutron therapy (12) at the University of Washington cyclotron, will be constructed.

## 6. Measurements of $^{37}\text{Ar}$ Excretion Rates in Humans

### 6.1 Measurement Techniques

During the last year it has been possible to study the rate of  $^{37}\text{Ar}$  excretion in the exhaled breath in 16 humans. Ten of these individuals were "normal" (no evidence of bone disease) volunteers ranging in age from 26 to 96 years. The other six individuals were patients with known bone wasting disease. These patients were selected from a large group of individuals undergoing body calcium measurements under University of Washington research protocols.

The basic procedure for each of these patients was to undergo neutron irradiation at the University of Washington cyclotron facility (7). During irradiation, the patient is exposed to a neutron beam with an average energy of 8 MeV. A fraction of the neutrons have energies as high as 14 MeV, and consequently measurable amounts of  $^{37}\text{Ar}$  from the  $^{40}\text{Ca}(n, \alpha)$  reaction are produced.

The basic aim of the cyclotron irradiation procedure was to produce the  $^{48}\text{Ca}(n, \gamma)^{49}\text{Ca}$  thermal neutron capture reaction and immediately detect the  $\gamma$  rays emitted by  $^{49}\text{Ca}$  in a NaI whole body counter (7). Thus a measurement of total body calcium by our routine  $^{49}\text{Ca}$  technique as well as observations of the excretion rate of radio-argon were made for each patient. These observations were begun in humans at the cyclotron facility in order to develop the  $^{37}\text{Ar}$  collection and quantification systems while the 14 MeV irradiation facility was being developed as well as determine the basic characteristics of the rate of excretion of  $^{37}\text{Ar}$  through the lungs.

To accomplish the  $^{37}\text{Ar}$  measurements, the patients were attached to the gas collection apparatus (Section 2) at various intervals during and up to 24 hours after neutron irradiation. The collection intervals ranged from 2 minutes to 2 hours with the majority of intervals being 45 minutes. On the average, 4 samples at various times post irradiation were recovered from each subject. A total of 60 breath samples were collected and analyzed for  $^{37}\text{Ar}$ .

### 6.2 Excretion Rate Data

From this data, the rate of excretion of  $^{37}\text{Ar}$  following neutron irradiation has been characterized. The data is seen, in composite form, in Figure 15. In this figure, the excretion rate is expressed as the  $^{37}\text{Ar}$  excreted per minute in the exhaled breath in relation to the patient's total body calcium in kilograms (the vertical axis). This rate of excretion is related to the time following irradiation at which it is measured (the horizontal axis). In these measurements the actual time of irradiation is brief, lasting on the average for  $1\frac{1}{2}$  minutes.

It is apparent from Figure 15 that the rate of  $^{37}\text{Ar}$  excretion is maximum immediately following irradiation, with the peak rate occurring within the first 5-20 minutes. Thereafter, the excretion rate rapidly diminishes and after 3-4 hours is less than 2% of the maximum rate. After 10-12 hours, the excretion rate is extremely low with 2 hour breath samples containing less than 1 dpm. The average characteristics of the combined data can be described by the dashed line in Figure 15 which is derived mathematically by iterative least-squares fitting techniques. The resulting equation is:

ARCUM EXCRETION RATE DATA - LINEAR PLOT

NEUTRON SOURCE = CYCLOTRON IRRADIATION FACILITY

RATE OF EXCRETION OF  $^{37}\text{AR}$  [DPM OF ACTIVITY / MIN - KG BODY CALCIUM]

□ = AVERAGE OF 10 POINTS AT  $t = 0.5$  HRS WHICH ARE WITHIN ONE STANDARD DEVIATION OF EACH OTHER

△ = AVERAGE OF 4 POINTS AT  $t = 0.75$  HRS WHICH ARE WITHIN ONE STANDARD DEVIATION OF EACH OTHER

○ = AVERAGE OF 8 POINTS AT  $t = 1.0$  HRS WHICH ARE WITHIN ONE STANDARD DEVIATION OF EACH OTHER

● = INDIVIDUAL PATIENT DATA POINTS

--- IS PLOT OF THE EQUATION  
 $R = 4.99e^{-1.73t} + 0.174e^{-0.267t}$

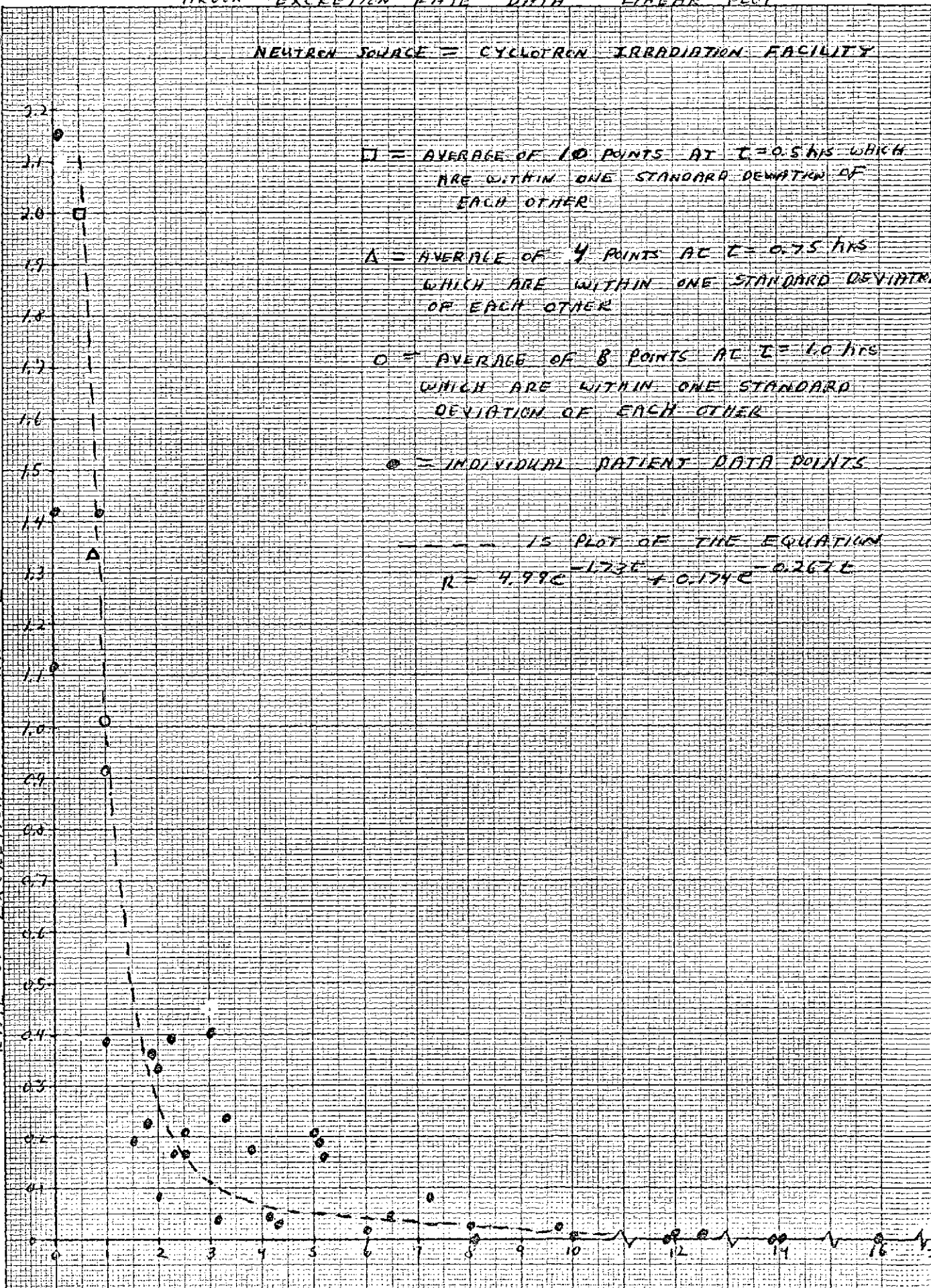

TIME AFTER IRRADIATION SAMPLE TAKEN [HOURS]

$$(1) \text{ Rate} = Ae^{-1.733 t} + Be^{-0.267 t} \quad t \geq 0.5 \text{ hours}$$

t in units of hours

$$A = 4.99 \quad B = 0.174$$

The arguments of the exponentials imply two biological half-lives:  
t fast = 24 minutes      t slow = 156 minutes

Figure 16 represents plots of the continuous excretion rates for two individuals and is typical of the data for all patients. The rates demonstrate the same general characteristics as seen in Figure 15. In any of the patients studied, the excretion rate follows a smooth, continuous pattern and can be "fit" with equation 1 by changing the values of A and B. Such "fits" are indicated for the patient data plotted in Figure 16. The data in Figure 16 represent the extremes of the rate data of Figure 15. At this point, the reasons for the variability and the ability to fit the data by simply changing the constants in equation 1 are speculative, although the fastest rate of excretion occurred in the youngest individual.

### 6.3 Correlation of $^{37}\text{Ar}$ with TBC

In 10 individuals an additional analysis was made of the excretion rate at 30 minutes post irradiation. It is of major interest that this excretion rate has a high correlation with the amount of total body calcium. These results are depicted in Figure 17. In this figure the vertical axis represents the amount of  $^{37}\text{Ar}$  contained in a one minute sample taken at 30 minutes post irradiation. The horizontal axis is the total body calcium in kilograms as determined by the  $^{49}\text{Ca}$  technique. The data demonstrates the fact that the excretion of  $^{37}\text{Ar}$  at 30 minutes is proportional to TBC. The correlation coefficient for a linear

GROUP EXCRETION RATES AND DATA "FITS" FOR INDIVIDUAL PATIENTS

NEUTRON SOURCE = CYCLOTRON IRRADIATION FACILITY

DATA FITS ARE ALL OF THE BASIC EQ 4

RATE =  $Ae^{-1.73t} + Be^{-0.267t}$

O = PATIENT NO. 7 - OSTEOPOROSIC FEMALE, 65 YRS OLD - MEASURED JAN & MARCH 1973  
A = 3.17 B = 0.760

P = PATIENT NO. 6 - NORMAL FEMALE, 26 YRS OLD - MEASURED JAN 1974  
A = 4.57 B = 0.173

RATE OF EXCRETION OF <sup>37</sup>Ar [DPM OF ACTIVITY / MIN - KG OF BODY CALCIUM]

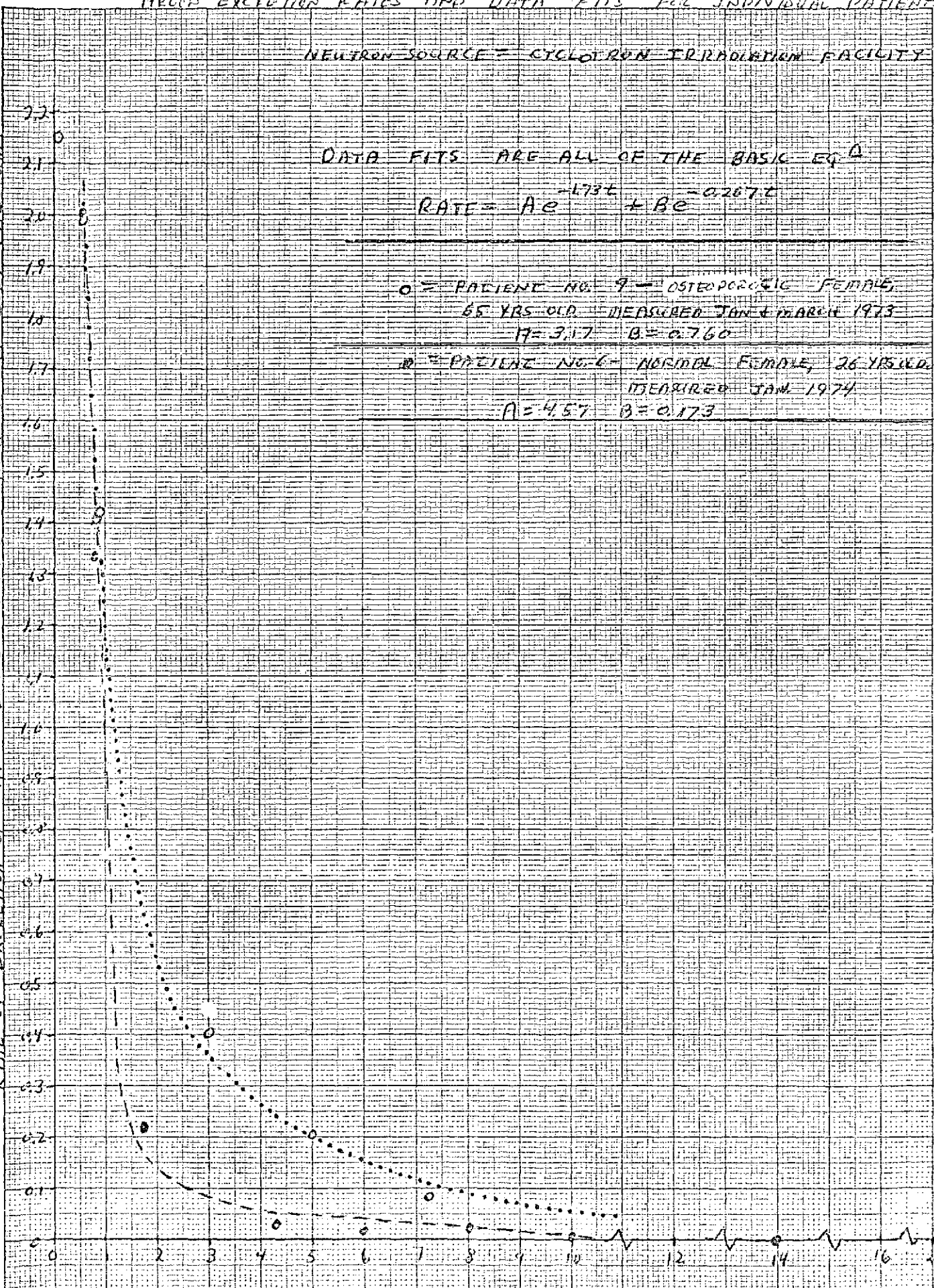

TIME AFTER IRRADIATION SAMPLE TAKEN [HOURS]

COMPARISON OF TOTAL BODY  
CALCIUM TO THE  $^{37}\text{Ar}$  EXCRETION RATE IN  
HUMANS AT 0.5 HOURS AFTER IRRADIATION

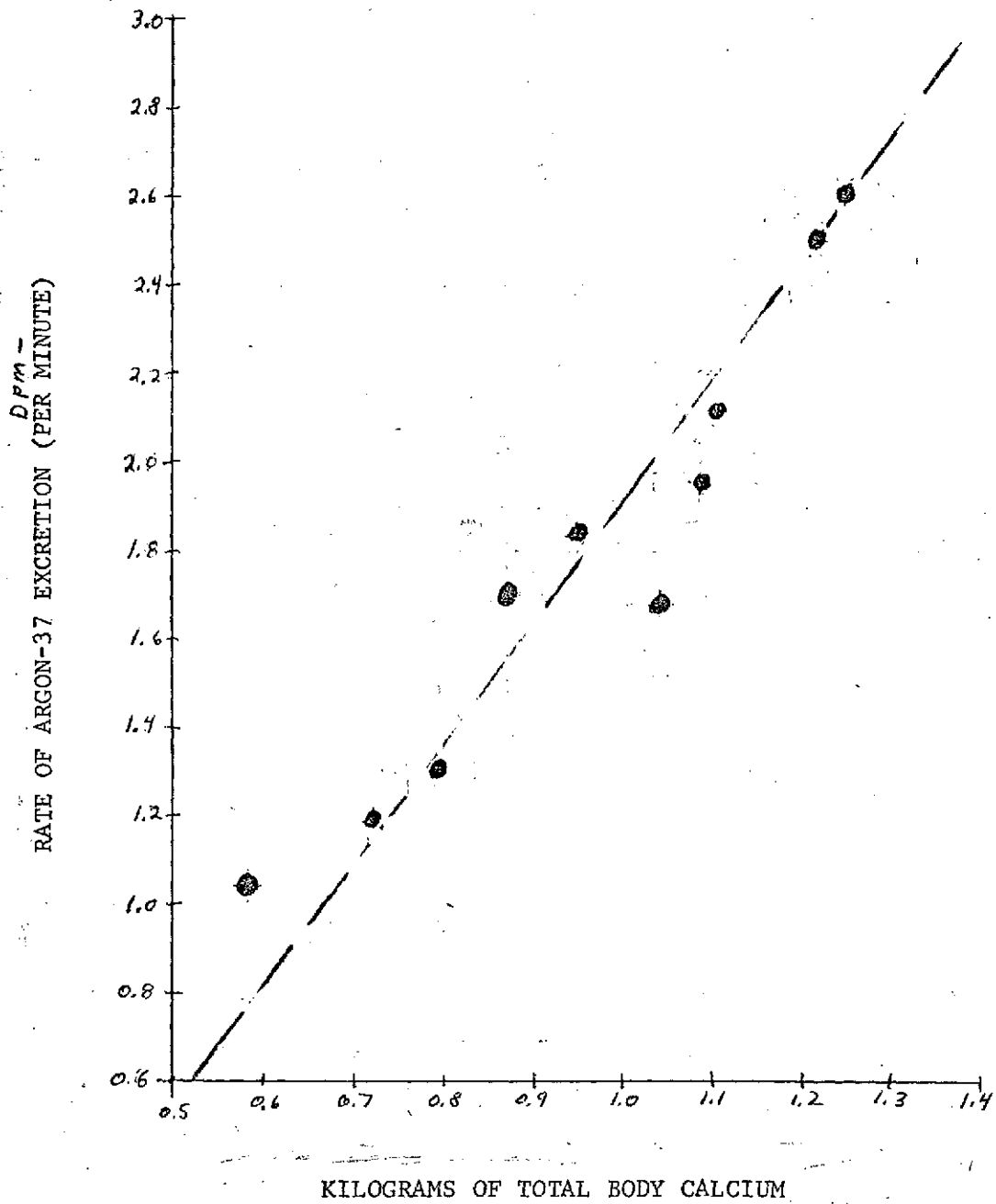

regression analysis is 0.98.

The excretion rate at 30 minutes post irradiation was used in this preliminary study due to the inability to collect all the  $^{37}\text{Ar}$  excreted during the first 4-6 hours post irradiation. The total collection could not be performed due to the whole body counting procedure which is carried out several time post irradiation when quantitating TBC with the  $^{49}\text{Ca}$  technique.

## 7. Summary and Discussion

### 7.1 General

We have demonstrated that the method for collection and counting of the  $^{37}\text{Ar}$  excreted in the exhaled breath following whole body neutron irradiation can be accomplished with reliability and precision gas collection, purification and counting systems have been designed, fabricated and developed into operational status. At 14 MeV neutron irradiation facility has been designed and developed and will shortly be operational. During the past year, 60 samples of the  $^{37}\text{Ar}$  excretion rate have been obtained from 16 patients irradiated at the University of Washington cyclotron.

### 7.2 Preliminary Interpretation of the Excretion Rate Data

As mentioned in Section 6.2 the initial excretion data (composite and for individuals) is characterized by Figures 15 and 16. Mathematically the rate of excretion has also been characterized (Equation #1) and by these observations suggests the following:

- 1) The maximum rate of  $^{37}\text{Ar}$  excretion occurs at 5-20 minutes following irradiation.



- 2) By 8-10 hours following irradiation, the excretion of  $^{37}\text{Ar}$  in the breath is extremely small, less than 0.005 of the rate at 10-20 minutes post irradiation.
- 3) By 6 hours post irradiation, 98-99% of the argon excreted during the first 24 hours post irradiation has been released.
- 4) The analyses of the excretion rate curve (Figure 15) shows a fast component with a half-life of 24 minutes and a slow component with a half-life of 154 minutes. Thus, by 3 hours post irradiation, 99% of the fast component and 55% of the smaller, slow component has been released.
- 5) From the data on Figure 15 and the known neutron dose for the cyclotron irradiations, it can be shown that when a patient with 1 kilogram of TBC is irradiated at the cyclotron facility and the exhaled breath is collected for the first 3 hours post irradiation, a dose of only 10 mrad is required to obtain 10,000  $^{37}\text{Ar}$  events (1% counting statistics) during a 16 hour counting period. This dose is only 1/20 of the dose required to obtain similar counting statistics with the  $^{49}\text{Ca}$  technique.

Of equal interest is the relationship in these preliminary data between the 30 minute  $^{37}\text{Ar}$  excretion rate of each subject to the amount of calcium (bone mass) in his body (TBC) as simultaneously determined by the  $^{49}\text{Ca}$  method (Figure 17). The 30 min. excretion rate demonstrates a remarkably consistent relationship to total bone mass. The correlation in Figure 17 is evident and has an r value of 0.98. This suggests to

us that a simple measurement of  $^{37}\text{Ar}$  excretion immediately following irradiation may provide a reliable measurement of TBC in grams. This would be potentially very applicable for population and large sample surveys.

The most appropriate collection interval to provide precise serial measurements of TBC in any individual to monitor bone mass change has yet to be determined. The excretion rate data suggests that a 3 to 6 hour period after irradiation will be adequate. This will be studied in more detail when the low dose 14 MeV system is operational.

The relationship of the various structural components of the skeleton (i.e. trabecular and cortical bone) and their proportionate mass may be reflected in the  $^{37}\text{Ar}$  excretion rate data. The fast component may result primarily from trabecular bone which has relatively high blood flow, extracellular volume and active bone surface. Thus, the  $^{37}\text{Ar}$  produced in this bone would be delivered to the lungs more rapidly. Conversely, cortical bone (dense bone) with relatively less blood flow, extracellular volume and exposed bone surface may release the  $^{37}\text{Ar}$  more slowly and hence be responsible for the slow component of the  $^{37}\text{Ar}$  excretion rate (Figure 15). Consequently, differential analysis of the  $^{37}\text{Ar}$  excretion rate curve in a given patient may provide a valuable index of the relative amounts of cortical versus trabecular bone. Since trabecular bone (the fast component) is more likely to show more pathological alteration with disease or loss of gravitational stress, serial analysis may show important quantitative changes in the two components as a "disease" state progression or remits.

Although most of the  $^{37}\text{Ar}$  excreted in these studies appears in the first 8-10 hours, it is still unclear if some  $^{37}\text{Ar}$  is still retained in the body in small amounts over extended periods of time. In studies of rats and dogs, there does not appear to be any significant long term retention of  $^{37}\text{Ar}$ . However, in vitro studies by R. Bigler (9) of dead bone irradiated with neutrons suggested that as much as 30% of the  $^{37}\text{Ar}$  formed was not released, even after grinding the bone. Based on their estimate of specific activation ( $\mu\text{Ci}$  of  $^{37}\text{Ar}$  produced per unit of neutron exposure) and a single human irradiation, Bigler et al suggested similar  $^{37}\text{Ar}$  retention may occur in vivo.

They estimated a retention fraction similar to that found in early studies of radon retention (10,11), which was quite constant. If the same were true for  $^{37}\text{Ar}$ , then the collection of only the initial part of the total  $^{37}\text{Ar}$  produced should not cause inaccuracies in TBC measurements. This point will be extensively explored as we proceed in our investigation. At present it remains a question, and in view of the data in Figures 15-17, does not seem likely to interfere with the value of the  $^{37}\text{Ar}$  method for determining absolute and serial changes in TBC.

### 7.3 Continuing and Future Studies

As discussed in Section 5, the measurement of the uniformity of activation in the patient enclosure is currently underway and will be completed in one month. Following this, the 14 MeV facility will be ready for use in patient studies. Among the patients to be studied during the next year are 30 individuals with osteoporosis whose body calcium will be measured using the  $^{49}\text{Ca}$  cyclotron technique under

University of Washington research protocols. With a second activation using the  $^{37}\text{Ar}$  method these individuals will provide an excellent basis for establishing a final calibration (accuracy) of the  $^{37}\text{Ar}$  technique. In addition, 10 or more normal individuals who have recently had their TBC measured at the cyclotron facility will undergo one or more measurements at the 14 MeV facility during the next year. These repeated measurements on the same individual (done within two weeks) will determine the precision of the TBC measurement by the  $^{37}\text{Ar}$  technique.

The question of how to verify that the fast component of the  $^{37}\text{Ar}$  excretion rate is primarily from tubercular bone mass will be approached through regional calcium measurements. Activation of an area such as the lumbar spine which is primarily tubercular bone should produce primarily  $^{37}\text{Ar}$  excreted with the short biological half-life. Conversely, regional irradiation of primarily cortical bone, such as the central portion of the long leg bones, should produce more  $^{37}\text{Ar}$  being excreted with the longer biological half-life.

The development of regional activation analysis also has great potential in studying calcium loss problems in critical areas such as the spine.

The necessary development work, (discussed earlier in this report), is underway and consists primarily of developing an extremely low background detector system and building of a suitable collimator system for the 14 MeV neutron beam. The new detector system is needed in order to increase detection sensitivity and permit a low dose for a regional study.

In many of the  $^{37}\text{Ar}$  studies from patients during the next year, serial breath samples will be taken so the character of the excretion rate can be fully delineated. Most measurements will consist of 6 one hour samples, taken continuously, starting with onset of irradiation. Thus, the accuracy and precision of the technique as a function of how many hours (1 to 6) of breath collection are used will be determined.

8. REFERENCES

- 1) Palmer, H.E.: The total body calcium in animals and humans by measuring  $^{37}\text{Ar}$  in expired air after neutron irradiation. *J. Nucl. Med.* 14: 522-527.
- 2) Palmer, H.E.: Kinetic aspects of bone mineral metabolism: Battelle Northwest Final Report to the National Aeronautics and Space Administration Manned Spacecraft Center, Houston, Texas. For Period Jan. 4, 1973 to Jan. 3, 1974. Under Contract NAS 9-12463, Jan. 1973.
- 3) Palmer, H.E.: Continued investigation of kinetic aspects of bone mineral metabolism. Battelle Northwest Final Report to the National Aeronautics and Space Administration. Lyndon B. Johnson Space Center, Houston, Texas. For Period Feb. 1, 1973 to Feb. 28, 1974. Under Contract NAS 9-13235, Feb. 1974.
- 4) Jessen, P., Bormann, M., Dreyer, F. and Neurene, H.: Experimental excitation functions for (n,p) (n,t) (n,2n) (n, np) and (n,  $\alpha$ ) reactions. *Nucl. Data.* 1 No. 2:155, 1966.
- 5) Urech, S., Jeannet, E. and Rossel, J.: The (n,p) and (n, $\alpha$ ) reactions on  $^{40}\text{Ca}$  with 6 MeV neutrons. *Helv. Phys. Acta.* 34:954, 1962.
- 6) Palmer, H.E., Nelp, W.B., Murano, R., et al: The feasibility of in vivo neutron activation analysis of total body calcium and other elements of body composition. *Phys. Med. Biol.* 13:266-279, 1968.
- 7) Nelp, W.B., Palmer, H.E., Murano, R., Pailthorp, K.G., Hinn, G.M., Rich, C., Williams, J.L., Rudd, T.G. and Denney, J.D.: Measurement of total body calcium (bone mass) in vivo with the use of total body neutron activation analysis. *J. Lab. Clin. Med.* 76:151, 1970.
- 8) Nelp, W.B., Denney, J.D., Murano, R., Hinn, G.M., Williams, J.L., Rudd, T.R. and Palmer, H.E.: Absolute measurement of total body calcium (bone mass) in vivo. *J. Lab. Clin. Med.* 79:430, 1972.
- 9) Bigler, R.E.: Sloan-Kettering Institute for Cancer Research, New York, New York. Private communication.
- 10) Mays, C.W., Cochran, T.H. and Jee, W.S.S.: Radium and radon retention in mice. *Health Physics.* 2:615-619, 1963.
- 11) Mays, C.W., Van Dilla, M.A., Floyd, R.L. and Arnold, J.S.: Radon retention in radium-injected beagles. *Radiation Res.* 8:480-489, 1958.
- 12) Bichsel, H., Eenmaa, J., Glass, G., Lewellen, T., Williams, D., Wootton, P., Wykoff, W.G.: Primary shielding for a fast neutron beam to be used for radiation therapy. *Bull. Am. Phys. Soc.* ( ). 17:1181, 1972.

9. PUBLICATIONS

Lewellen, T.K., Nelp, W.B., Palmer, H.E., Murano, R., Hinn, G.M., Chesnut, C.H.: Argon-37 excretion in humans following total body neutron activation (abstract) J. Nucl. Med., June 1974.

Lewellen, T.K., Nelp, W.B., Palmer, H.E.: Argon-37 excretion in humans following total body neutron activation. Trans. of the Amer. Nucl. Soc., June 1974.

Palmer, H.E., Lewellen, T.K., Chesnut, C.H., Nelp, W.B.: Body composition determination by measurement of total body activation products in expired air. Proc. 3rd Conf. on Application of Small Accelerators. AEC, October 1974.

10. DISTRIBUTION

No. of  
Copies

23

Lyndon B. Johnson Space Center  
Houston, Texas 77058

Malcolm C. Smith (21)  
Paul C. Rambaut (1)  
Carolyn S. Huntoon (1)

University of Washington  
Division of Nuclear Medicine  
Seattle, Washington 98195

7

Wil B. Nelp (1)  
Tom K. Lewellen (6)