

**NASA CONTRACTOR
REPORT**



NASA CR-2441

NASA CR-2441

PREDICTION OF SONIC BOOM FROM EXPERIMENTAL NEAR-FIELD OVERPRESSURE DATA

Volume I - Method and Results

by C. R. Glatt, D. S. Hague, and S. J. Reiners

Prepared by

AEROPHYSICS RESEARCH CORPORATION

Hampton, Va. 23666

for Langley Research Center



NATIONAL AERONAUTICS AND SPACE ADMINISTRATION • WASHINGTON, D. C. • FEBRUARY 1975

1. Report No. NASA CR-2441	2. Government Accession No.	3. Recipient's Catalog No.	
4. Title and Subtitle Prediction of Sonic Boom from Experimental Near-Field Overpressure Data. Volume I - Method and Results		5. Report Date February 1975	
		6. Performing Organization Code	
7. Author(s) C. R. Glatt, D. S. Hague and S. J. Reiners		8. Performing Organization Report No.	
		10. Work Unit No.	
9. Performing Organization Name and Address Aerophysics Research Corporation P.O. Box 7007 Hampton, Virginia 23666		11. Contract or Grant No. NAS 1-12579	
		13. Type of Report and Period Covered Contractor Report	
12. Sponsoring Agency Name and Address National Aeronautics and Space Administration Washington D.S. 20546		14. Sponsoring Agency Code	
		15. Supplementary Notes One of two final reports	
16. Abstract A computerized procedure for predicting sonic boom from experimental near-field overpressure data has been developed. The procedure extrapolates near-field pressure signatures for a specified flight condition to the ground by the Thomas method. Near-field pressure signatures are interpolated from a data base of experimental pressure signatures. The program is an independently operated ODIN (Optimal Design Integration) program which obtains flight path information from other ODIN programs or from input.			
17. Key Words (Suggested by Author(s)) Sonic Boom, overpressure, pressure signature, data base, extrapolation		18. Distribution Statement Unclassified - Unlimited STAR Category 02	
19. Security Classif. (of this report) Unclassified	20. Security Classif. (of this page) Unclassified	21. No. of Pages 78	22. Price* \$4.75

Page Intentionally Left Blank

PREFACE

This report was prepared under contract NAS 1-12579, "Expansion and Extension of the SBOOM Computer Program." The study was carried out during the period from July, 1973 through December, 1973. The study was funded by the National Aeronautics and Space Administration, Langley Research Center, Space Systems Division.

The study effort resulted in the development of two new computer programs, one for generating and maintaining a data base of near-field pressure signatures and the other for predicting sonic boom as a result of overflight of shuttle type reentry vehicles. The study results extend the work performed under contract NAS 2-6147 to NASA Ames Research Center in which the basic method of predicting and optimizing shuttle trajectories based on sonic boom constraints was developed. Both contracts employed a pressure signature extrapolation technique and wind tunnel measurements developed by Ames Research Center.

The data base management system developed for the original contract and used extensively for two dimensional sonic boom prediction proved inadequate for the three-dimensional requirements of the present contract. A new data management system was developed which is versatile enough to handle present and future needs of the sonic boom methods employed.

The report is presented in two volumes:

Volume I Method and Results

Volume II Data Base Construction

The first volume describes the method employed for estimating ground overpressures from wind tunnel measurement. Some results are presented and the use of the computer program is described. Volume II describes the data management system employed in the data base construction and maintenance. A separate computer program developed for this purpose is also described.

Page Intentionally Left Blank

CONTENTS

	Page
SUMMARY.....	1
INTRODUCTION.....	2
DISCUSSION OF THE PROGRAM.....	5
Sonic Boom Prediction.....	5
Pressure Signature Data Base.....	6
Interpolation Procedures.....	8
Near-Field Extrapolation.....	11
Enriching the Near-Field Signature Data Base.....	24
RESULTS.....	31
Ascent Path Optimization Without Sonic Boom Constraints.....	33
A Note on the Ascent Solutions and the Superboom Problem.....	41
Descent Paths.....	42
USE OF THE PROGRAM.....	50
General Input Procedure.....	50
NAMELIST Data Format.....	52
SBOOM Program Input.....	53
Input Flight Conditions.....	57
Flight Conditions Tape.....	57
Flight Conditions from POST.....	57
Basic Deck Setup.....	61
Deck Setup for Use of SBOOM with POST.....	61
Deck Setup for Use of SBOOM within ODIN.....	61
REFERENCES.....	67
APPENDIX A - TEST CASE.....	68

PREDICTION OF SONIC BOOM FROM EXPERIMENTAL NEAR-FIELD
OVERPRESSURE DATA. VOLUME I - METHOD AND RESULTS.

BY C. R. Glatt, D. S. Hague and S. J. Reiners
Aerophysics Research Corporation

SUMMARY

A technique for prediction of ground level sonic boom overpressures generated by the flight of space shuttle vehicles is presented. The method is in the form of a digital computer program which contains the following key elements:

1. A data base of typical near-field space shuttle orbiter pressure signatures generated by extensive wind tunnel testing at specified flight conditions.
2. An interpolation procedure which operates on the near-field space shuttle signature data base to produce the near-field space shuttle pressure signature for any flight condition.
3. A trajectory analysis module capable of generating the space shuttle flight path.
4. A method for estimating ground level pressure signatures corresponding to each flight condition encountered along the space shuttle trajectory. This method is based on extrapolation of a near-field pressure signature to sea level conditions.
5. An optimization procedure by which the sea level overpressures generated are reduced by trajectory perturbation.
6. A method of automatically generating graphical representations of measured and estimated pressure signatures.

The technique is discussed in detail and examples are presented which illustrate flight paths which generate sea level overpressures. The experimental pressure signatures used to construct the near-field signature data base and the procedure for extrapolating a near-field signature to sea level were developed by NASA personnel prior to this study. The near-field signature data base and interpolation procedure were developed as the result of prior government sponsored research. The present report describes the extension of the method to encompass roll angle predictions as well as Mach number and angle of attack.

INTRODUCTION

A sonic boom computer program (SBOOM) based on the prediction technique of Thomas (reference 1) is presented. The prediction technique calculates far-field overpressure from near-field pressure signatures measured in the wind tunnel. The program is used as an independent program for the determination of sonic boom characteristics of a specified vehicle and environment for input flight conditions or the program can be linked to a trajectory prediction program through the use of the linking system described in Reference 2.

Wind tunnel data for a space shuttle delta wing orbiter configuration has been digitized and stored as a pressure signature data base using a newly developed access and retrieval system which provides unlimited expansion as more signature data is acquired. A program, GETTAB, has been written for the purpose of storing measured pressure signatures in the data base. The program also performs certain mapping of known signatures into signatures for flight regions where data is unavailable. The data base is accessed by the SBOOM program and pressure signatures for input flight conditions can be estimated using the geometric similarity rule developed. The data base and procedure developed estimates pressure signatures in the flight regime,

Angle of Attack	($10 < \alpha < 45$)
Mach Number	($1.2 < M < 10$)
Roll Angle	($0 < \phi < 180$)

The flight regimes span the normal range expected during reentry but does not cover all conditions expected during launch. Tests at Ames Research Center indicate that plume effects invalidate the data under launch conditions unless a "plume factor" is employed. A research effort to generate launch data including plume effects is now underway at Ames.

The original SBOOM program was incorporated into the Trajectory Optimization Program (ATOP) of references 3 through 5 as an independent link to form the Sonic Boom Trajectory Optimization Program. In operation, the ATOP program generates a special file of data containing the trajectory information needed by the SBOOM subprogram. SBOOM then interrogates the special file of information in a repetitious manner generating sonic boom overpressure data at each point along the trajectory. The SBOOM program reported here has been isolated as an independent program. As such, SBOOM can obtain trajectory information from any trajectory program and still access the data base of pressure signatures. Options are

available for reading trajectory tapes from ATOP and the Program to Optimize Simulated Trajectories (POST, unpublished NASA program).

The combined SBOOM/POST/AESOP simulation illustrated in figure 1 can be used in optimizing both pitch-plane and roll-pitch-plane trajectories for the shuttle vehicle with sonic boom constraints. The AESOP parameter optimization program of reference 6 is employed for this purpose. The ODIN Executive System of reference 2 is used to link the independent programs POST, SBOOM and AESOP to optimize trajectories based on sonic boom constraints.

An additional feature of the SBOOM and GETTAB programs is the ability of these programs to generate plots of the pressure signature data from the data base. This is done by an interface with a separate plotting program.

This report is presented in two volumes. Volume I contains a discussion of the SBOOM program and results obtained from the use of the data base to estimate near-field pressure signatures. Volume II presents a discussion of the GETTAB program, the method of access and retrieval, and plots of the entire pressure signature data base.

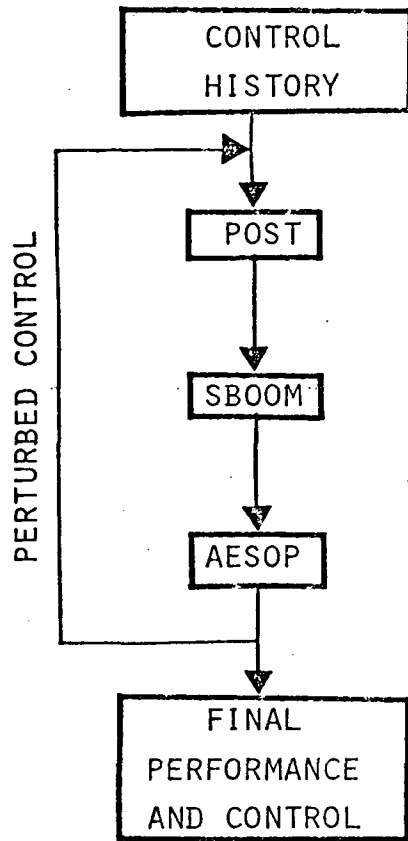

- PARAMETERIZED CONTROL
- CALCULATE VEHICLE PERFORMANCE
- COMPUTE OVERPRESSURE CONSTRAINTS
- PERTURB CONTROL PARAMETERS

FIGURE 1 ILLUSTRATION OF THE USE OF SBOOM WITHIN ODIN

DISCUSSION OF THE PROGRAM
Sonic Boom Prediction

The computer program described in this report uses the method of Thomas (reference 1) for extrapolating near-field signatures out to the far field, without use of a F-function to account for nonlinear waveform distortion. Effects of aircraft acceleration and atmospheric temperature, pressure and wind gradients are included in the theory. The approach used is to describe the waveform of the sonic boom wave by several waveform parameters and then to obtain equations for the parameters as functions of time. This approach has the advantages that (1) the theory is simpler and more intuitive than the Whitham theory, (2) it provides a more convenient method for extrapolating experimental signatures because the signature is dealt with directly, rather than through the use of a F-function and (3) shock locations are determined by a much neater method than the classical area balancing technique used in F-function extrapolations.

To describe the waveform of the sonic boom wave at any instant of time, we approximate the waveform by an arbitrary number of linear segments and define the waveform parameters Δp_i , m_i and λ_i of each segment as follows:

Δp_i is the pressure rise across the shock at the juncture of segments i and $i - 1$. Often there will be no shock at the juncture, in which case Δp_i is zero, m_i is the slope of segment i , which may be positive or negative. Finally, λ_i is the length of segment i . A completely general waveform can be described using these waveform parameters.

To determine the waveform parameters as functions of time, it is assumed that the time rate of change of any waveform parameter can be obtained by superposition of the rate of change assuming the wave propagates as a linear, nonplane wave and the rate of change assuming the wave propagates as a nonlinear, plane wave; it is, for example:

$$\left(\frac{d\Delta p_i}{dt}\right)_{\substack{\text{nonlinear} \\ \text{nonplane}}} = \left(\frac{d\Delta p_i}{dt}\right)_{\substack{\text{linear} \\ \text{nonplane}}} + \left(\frac{d\Delta p_i}{dt}\right)_{\substack{\text{nonlinear} \\ \text{plane}}}$$

The linear wave term accounts for the affects of changing ray tube area and changing atmospheric properties. The nonlinear, plane wave term, which is also influenced by the atmospheric properties, accounts for the nonlinear distortion of the waveform. Details of the waveform parameter method are given in reference 1.

Pressure Signature Data Base

The procedure for determining sonic boom overpressures on the ground produced by vehicles flying at supersonic speeds is to define the near-field pressure signatures and then to extrapolate these signatures to the far-field (ground). Experience has shown that the best estimates of ground overpressure can be obtained by resorting to experiment rather than theory to determine near-field pressure signatures.

The sonic boom pressure signature data base is a collection of the results of several wind tunnel experiments in which near-field pressure signatures are measured for a range of anticipated flight conditions. These experiments have been conducted for a delta-wing shuttle vehicle. The Mach numbers ranged from 1.2 to 10.2. The angles of attack and roll angles ranged from 0 to 60 degrees and 0 to 180 degrees respectively. Even though current booster and orbiter configurations may differ from the one being investigated, the pressure signatures for the shape being tested are reasonably representative of the ones of interest provided the angle of attack is not small. This is borne out of comparison of results of straight and delta wing shapes discussed in reference 7.

Models having the shape shown in figure 2 have been tested in the Ames 3.35 by 3.35 meter (11 by 11 foot) 2.74 by 2.13 meter (9 x 7 foot) and 2.44 by 2.13 meter (8 x 7 foot) wind tunnels, and the jet propulsion laboratory .508 meter (20 inch) supersonic and the 0.533 meter (21 inch) hyper-sonic wind tunnels. The various angles of attack and roll angles were obtained by rotating the model and sting assembly relative to the pressure measuring equipment. The models were mounted on a linear actuator which permitted them to be translated longitudinally in the wind tunnels relative to the fixed pressure measuring equipment. Flow

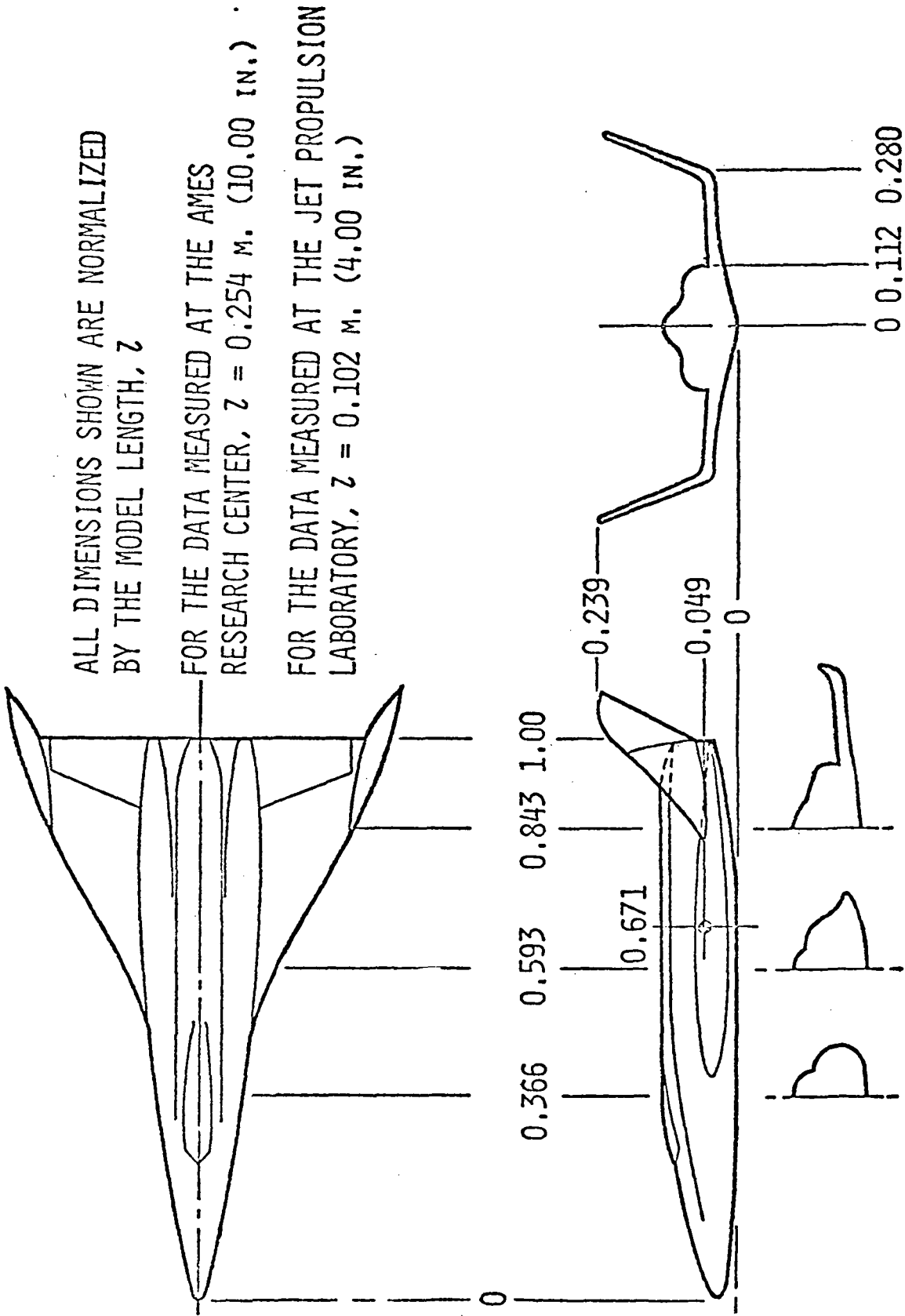

FIGURE 2 MODEL SKETCH

field pressures were detected by two degree included angle conical static pressure probe mounted on the wind tunnel wall which was connected to a capacitance type pressure transducer. Measured near-field sonic boom overpressures are presented in reference 7. A summary of the test conditions which resulted are presented in figure 3.

The wind tunnel test results are converted to digital form so that the pressure signatures can be used directly in the SBOOM computer program. To insure the validity of the data transcribed from graph to digital data, CALCOMP plots of the digitalized data were generated using an independent plotting program. These plots were drawn to the exact scale of those presented in reference 7. They were carefully compared with the original plots by overlaying one on the other.

After the comparison of the digitalized data with the wind tunnel results, the data was transferred directly into the pressure signature data base using the auxiliary storage and retrieval program GETTAB described in Volume II. These data are available on data cell and may be used by simply attaching the proper file when executing the SBOOM program.

Interpolation Procedures

The use of stratified data represented by the wind tunnel test conditions required the development of some interpolation procedures based on the geometric similarity of the pressure signatures.

Interpolation. - The program contains an interpolation rule based on geometric similarity of the actual pressure signatures measured in the wind tunnel. This approach, illustrated in figure 4, considers each near-field pressure signature to be comprised of four segments as follows:

ANGLE OF ATTACK DEG.	MACH NUMBER							DATA FIGURE NO.
	1.20	1.68	2.17	2.70	3.98	5.96	7.75	
0					A	A	A	3
10	B	B	B		C	C	C	4
25		A	A	A	C	C	C	5
45					C	C	C	6
60		A	A	A				7
	I	II		III	IV	V		
	WIND TUNNEL							

Nominal Roll Angle Schedule, deg:

A = 0

B = 0, 30, 60, 90

C = 0, 30, 60, 90, 120, 150, 180

Wind Tunnel Code

I. 3.35 x 3.35 meter (11 x 11 ft)

II. 2.74 x 2.13 meter (9 x 7 ft)

III. 2.44 x 2.13 meter (8 x 7 ft)

IV. 0.508 meter (20-in)

V. 0.533 meter (21-in)

} Ames

} Jet Propulsion Laboratory

FIGURE 3 NEAR-FIELD OVERPRESSURE TEST
CONDITIONS SUMMARY.

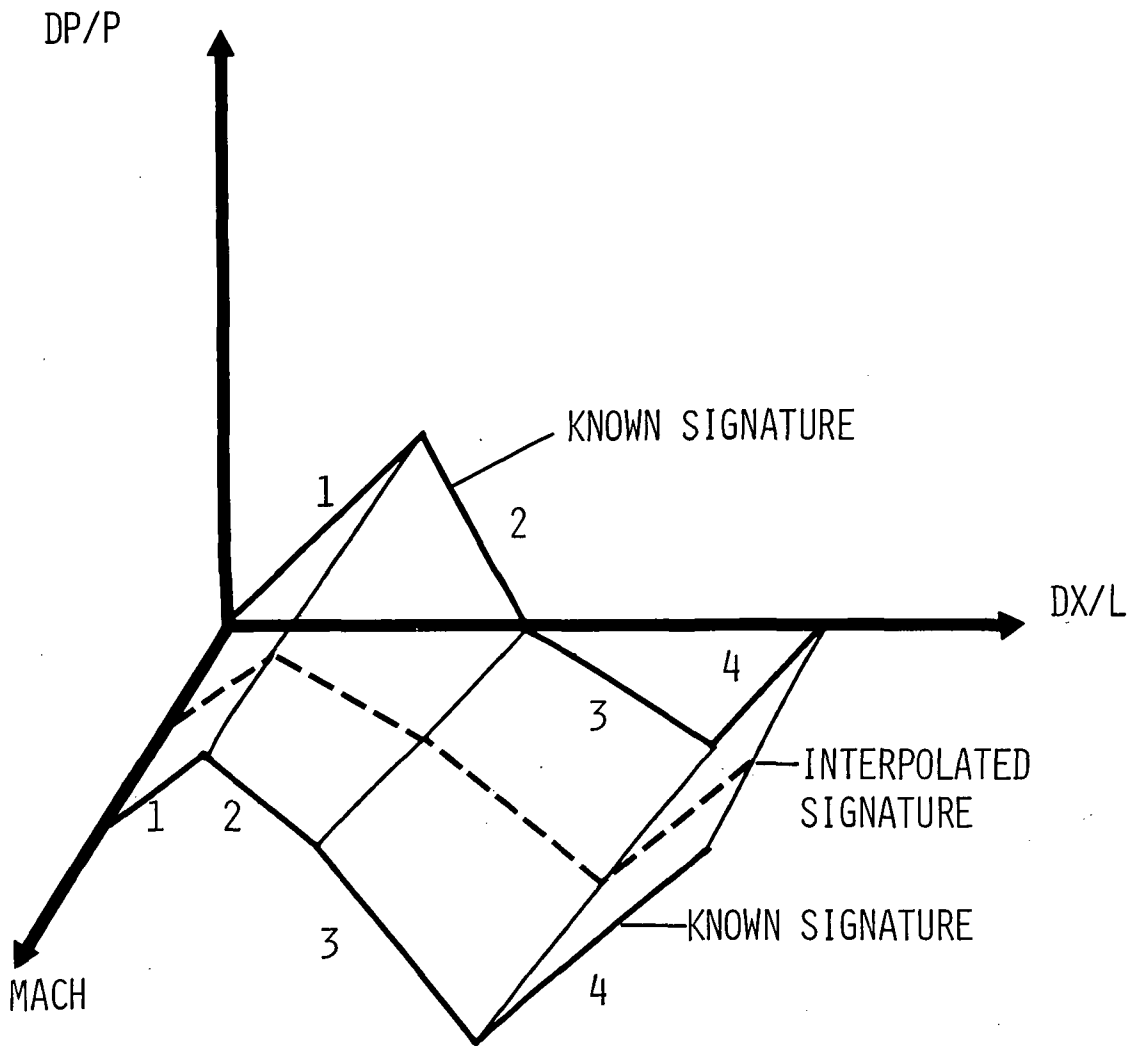

FIGURE 4 ILLUSTRATION OF THE GEOMETRIC SIMILARITY RULE.

1. First significant overpressure to maximum overpressure.
2. Maximum overpressure to first following zero overpressure.
3. First zero overpressure (after max DP/P) to minimum overpressure.
4. Minimum overpressure to last significant point in signature.

NOTE: A Trailing Zero Pressure Point Should be Added to all Signatures where They are Omitted.

Corresponding signature segments are mapped into each other using linear interpolation within the segments and a variable which spans the range 0 to 1 within each segment. Some possible signature types are illustrated in figure 5 which illustrates the diversity of signature type within the data base. The method developed will uniquely map any signature of figure 5 into any other signature of figure 5. Some interpolations at the mid point between pairs of idealized signatures are illustrated in figure 6. Some continuous mappings of one signature into another are presented in figure 7 using signatures actually contained within the data base. Figure 7 indicates which pair of the signatures contained in reference 7 are used and whether an interpolation or extrapolation is used.

Interpolation between given signatures proceed linearly between like segments. An interpolation for the corresponding h/l value (distance from the model to the point of overpressure measurement normalized to the model length) is also determined simultaneously with the signature interpolation by linear interpolation. Signatures produced in this manner have characteristics geometrically similar to the given signatures and the method provides a fairly accurate interpolation procedure.

Comprehensive testing of the technique included interpolation between known signatures for a known signature. These tests showed good correlation between the known and the interpolated signatures as illustrated in figure 8. Typical results of extrapolating an interpolated near-field signature to the ground and an original data base signature to the ground are presented in figure 9. Interpolation by the geometric similarity rule always interpolates first in the roll angle plane, then the Mach plane and finally the angle of attack plane. This produces better results than any other order of interpolation. Figure 10 illustrates the interpolation procedure and figure 11 shows some typical results.

Near-Field Extrapolation

Since data is not always available for interpolation, a polynomial extrapolation technique was developed for generating pressure signatures outside the range of the test data. The technique

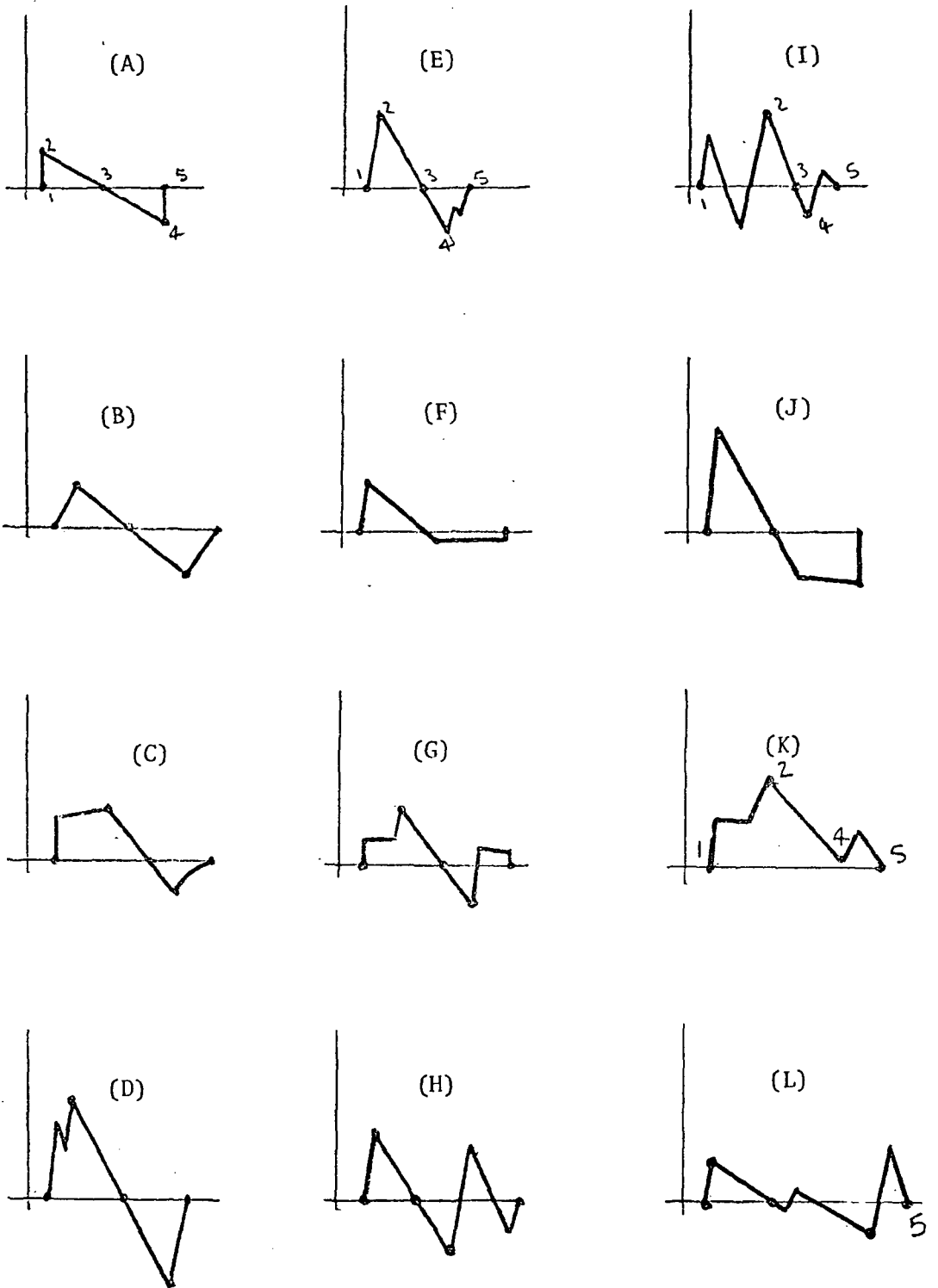

FIGURE 5 SCHEMATIC OF POSSIBLE SIGNATURE TYPES.

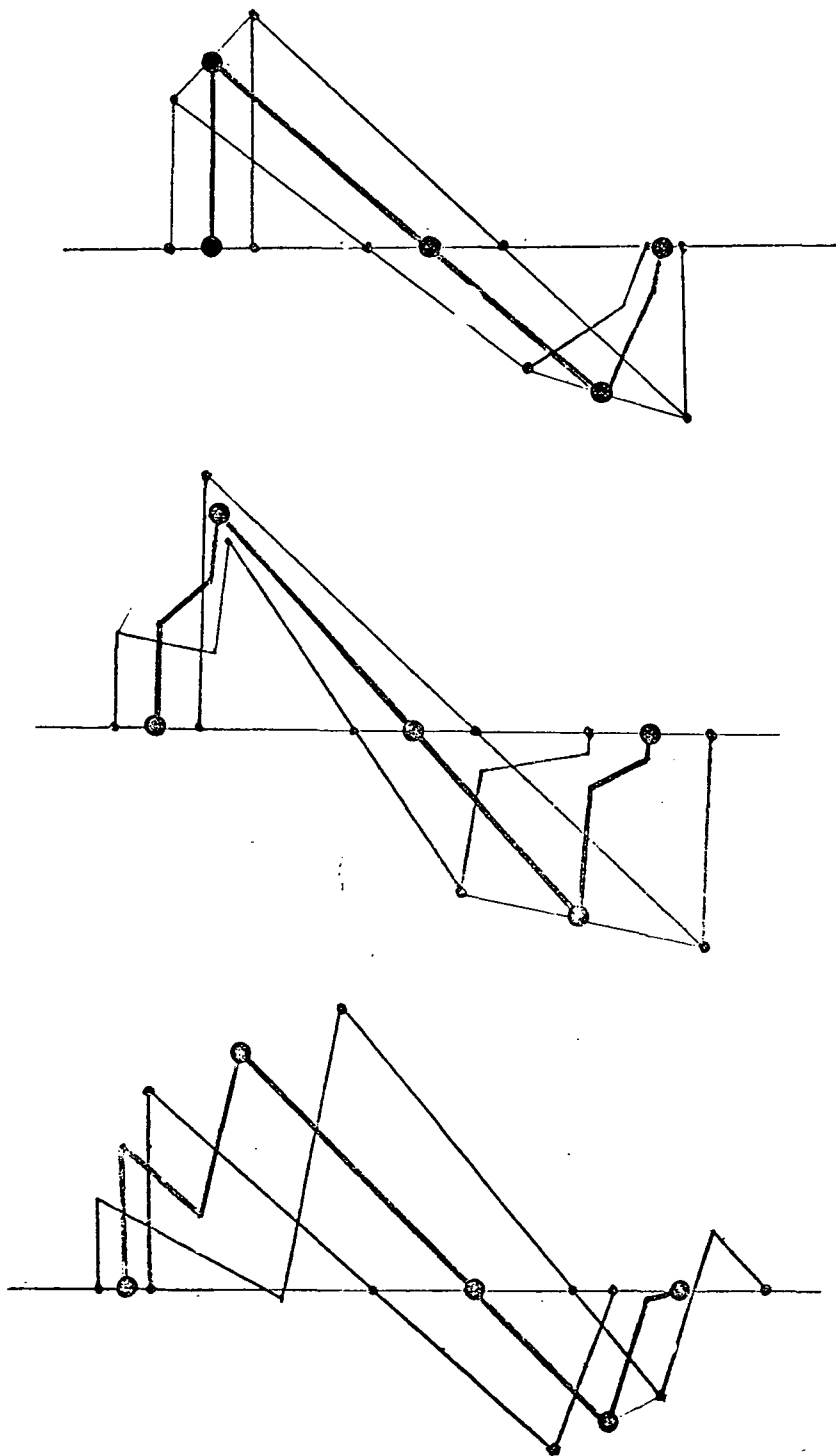
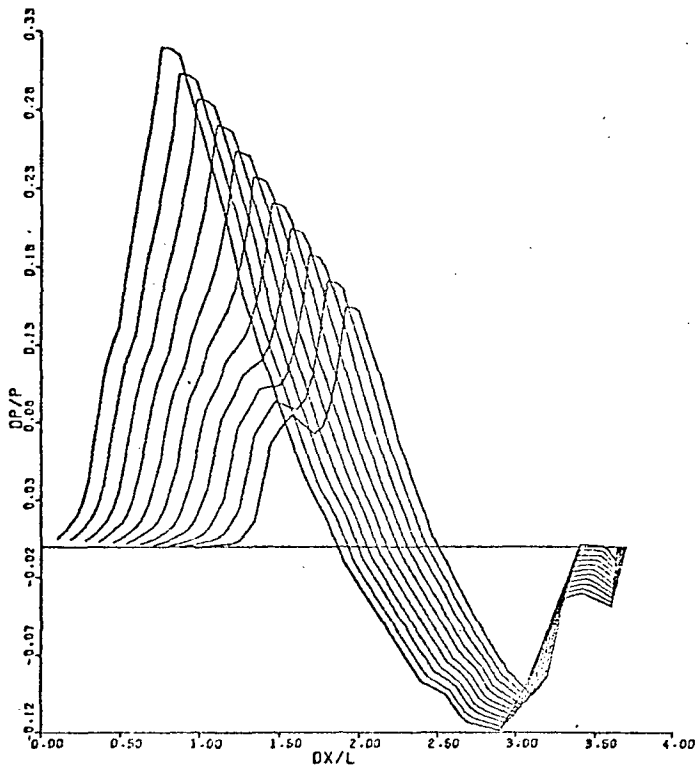

FIGURE 6 EXAMPLE INTERPOLATIONS OF IDEALIZED PRESSURE SIGNATURES.

PRESSURE SIGNATURE INTERPOLATION FIG 3.B - 3.A



PRESSURE SIGNATURE INTERP.

FIG 3.B - 3C

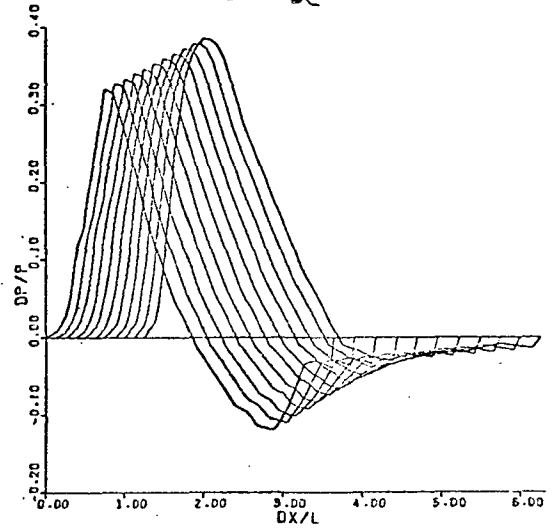

PRESSURE SIGNATURE INTERP

PRESSURE SIGNATURE INTERP. FIG 4.F - 4.H

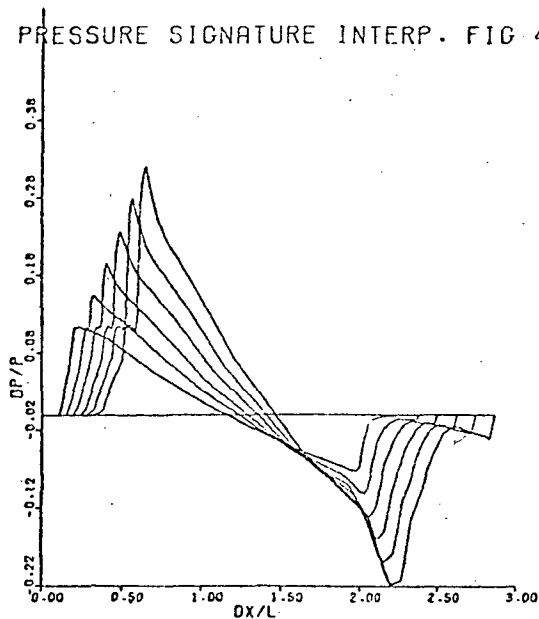

FIG 5.F - 5.G -

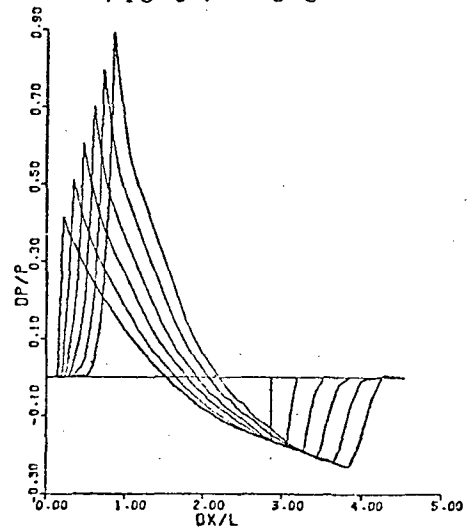
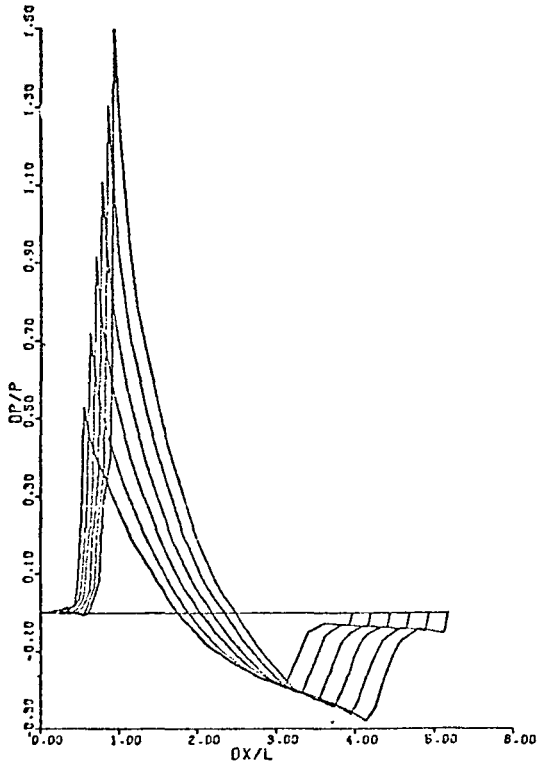
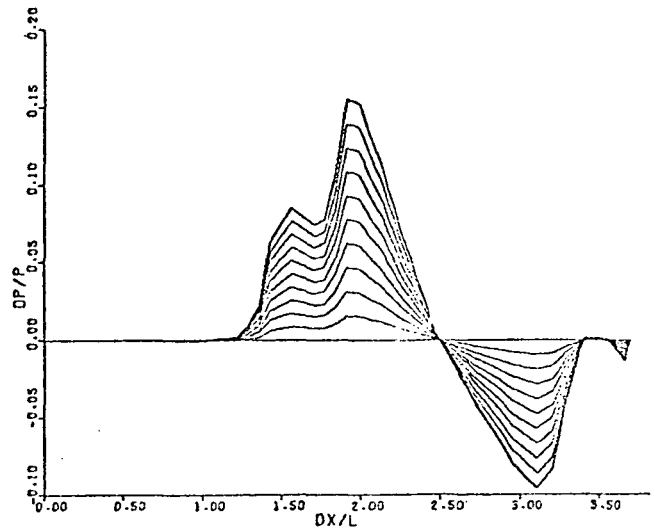

FIGURE 7A SOME TYPICAL NEAR-FIELD SIGNATURE INTERPOLATIONS AND EXTRAPOLATIONS.

PRESSURE SIGNATURE INTERP. FIG 6.A - 6.E



PRESSURE SIGNATURE EXTRAP. FIG 3.A



PRESSURE SIGNATURE INTERP FIG 7.A - 7.B

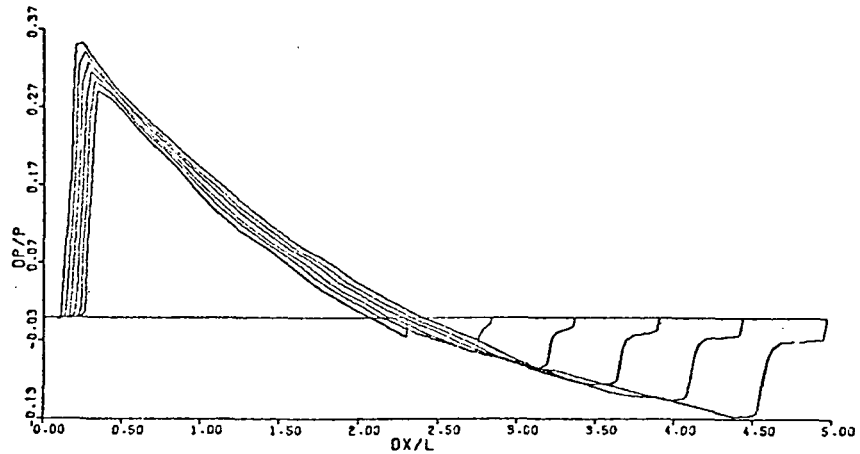

FIGURE 7B SOME TYPICAL NEAR-FIELD SIGNATURE INTERPOLATIONS AND EXTRAPOLATIONS.

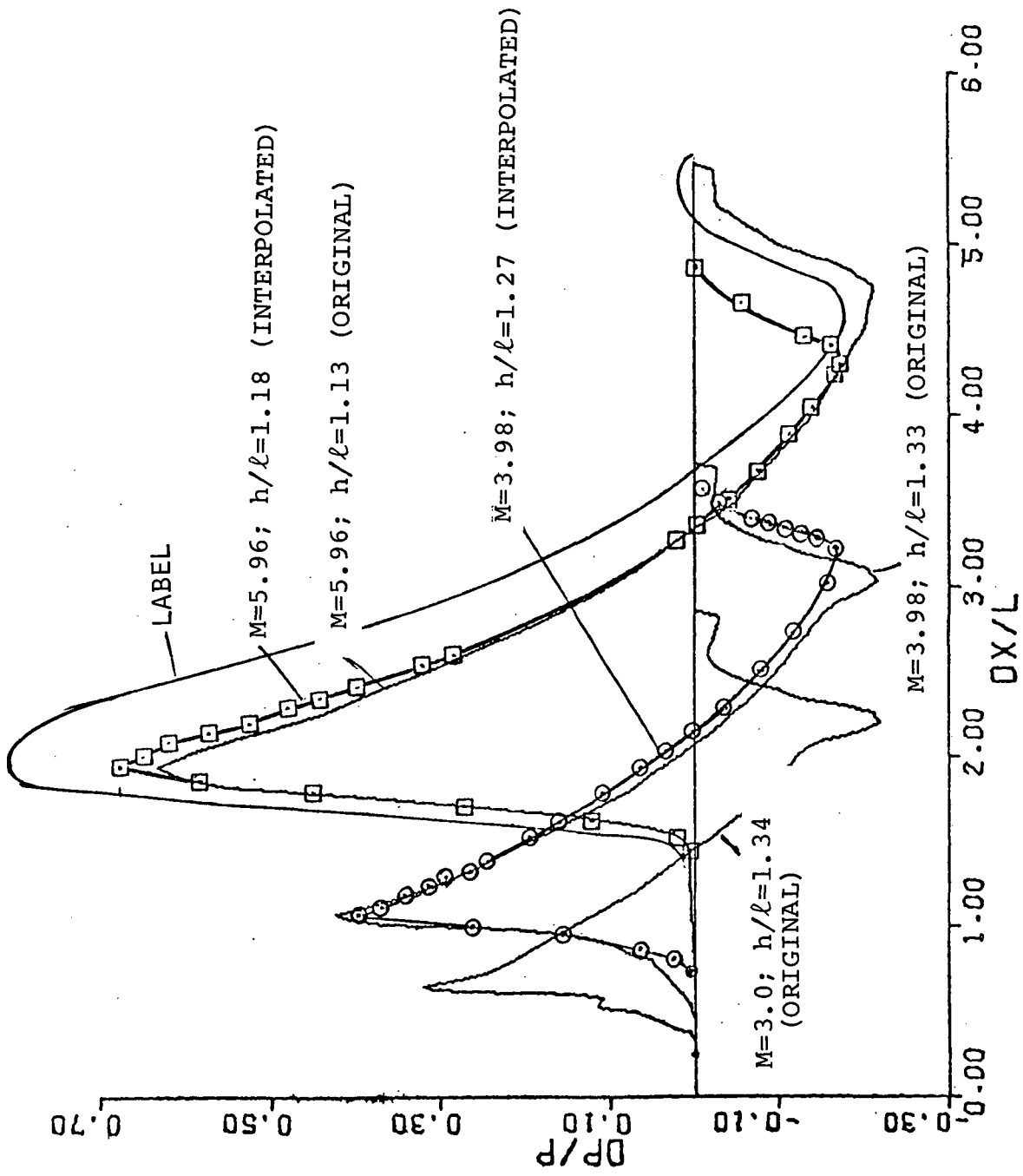

FIGURE 8 TYPICAL COMPARISON BETWEEN INTERPOLATED
 NEAR-FIELD SIGNATURES AND MEASURED SIGNATURES.

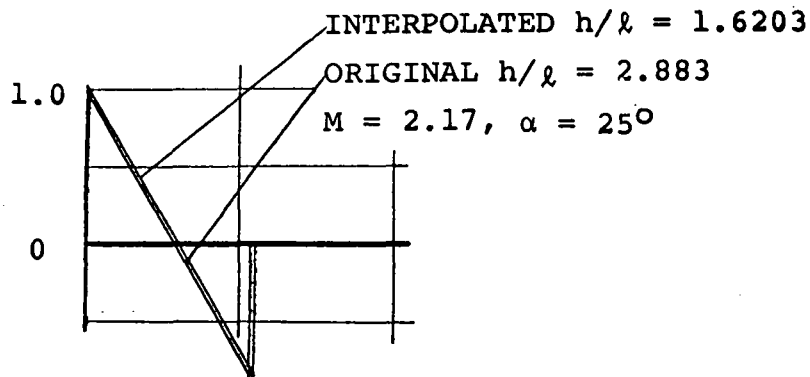
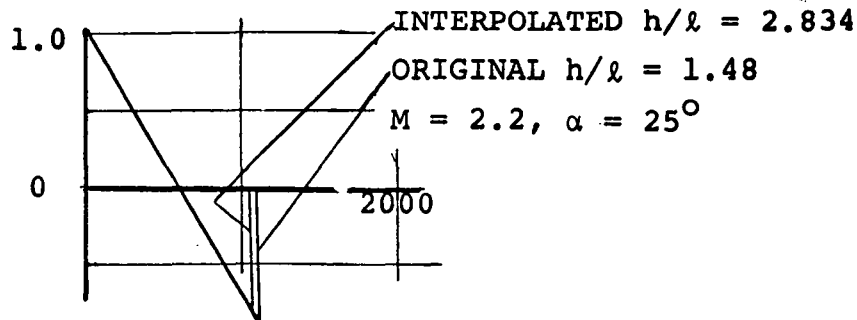
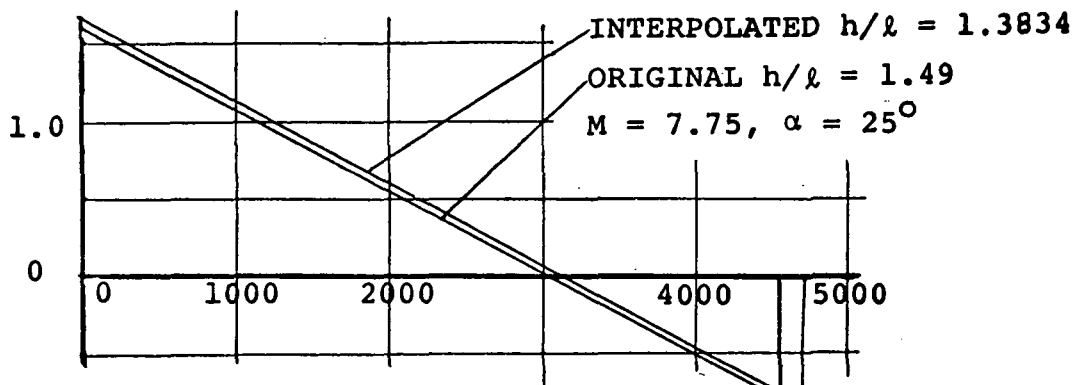
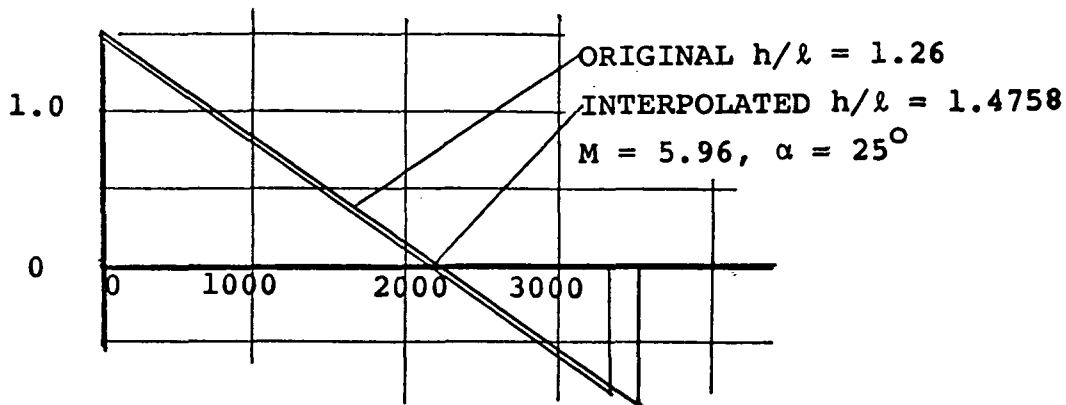

FIGURE 9A EXTRAPOLATION OF INTERPOLATED NEAR-FIELD SIGNATURES TO SEA LEVEL (MACH NUMBER INTERPOLATION)

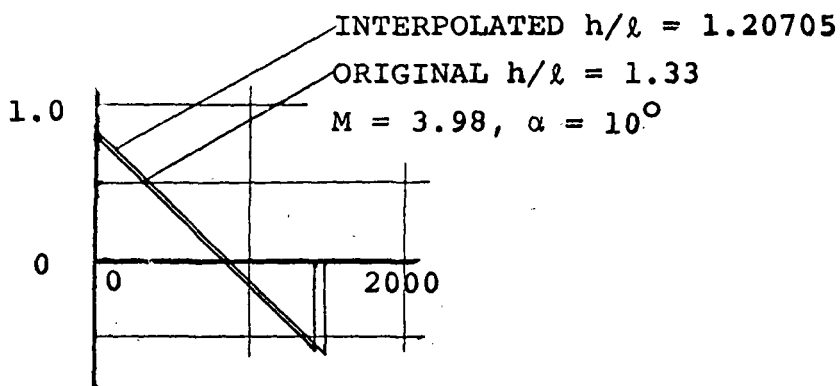
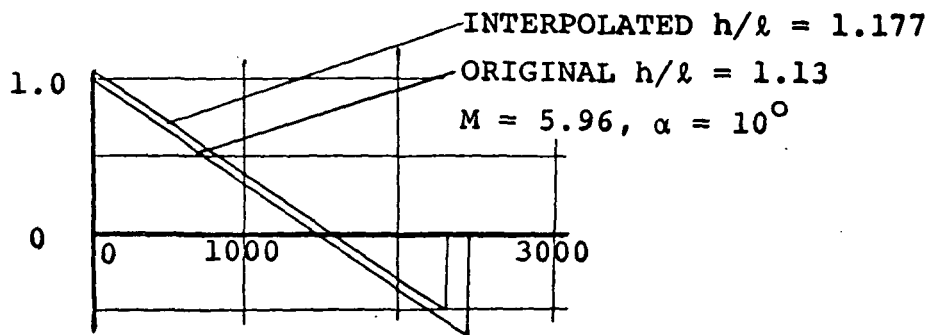

FIGURE 9B EXTRAPOLATION OF INTERPOLATED NEAR-FIELD SIGNATURES
 TO SEA LEVEL (MACH NUMBER INTERPOLATION).

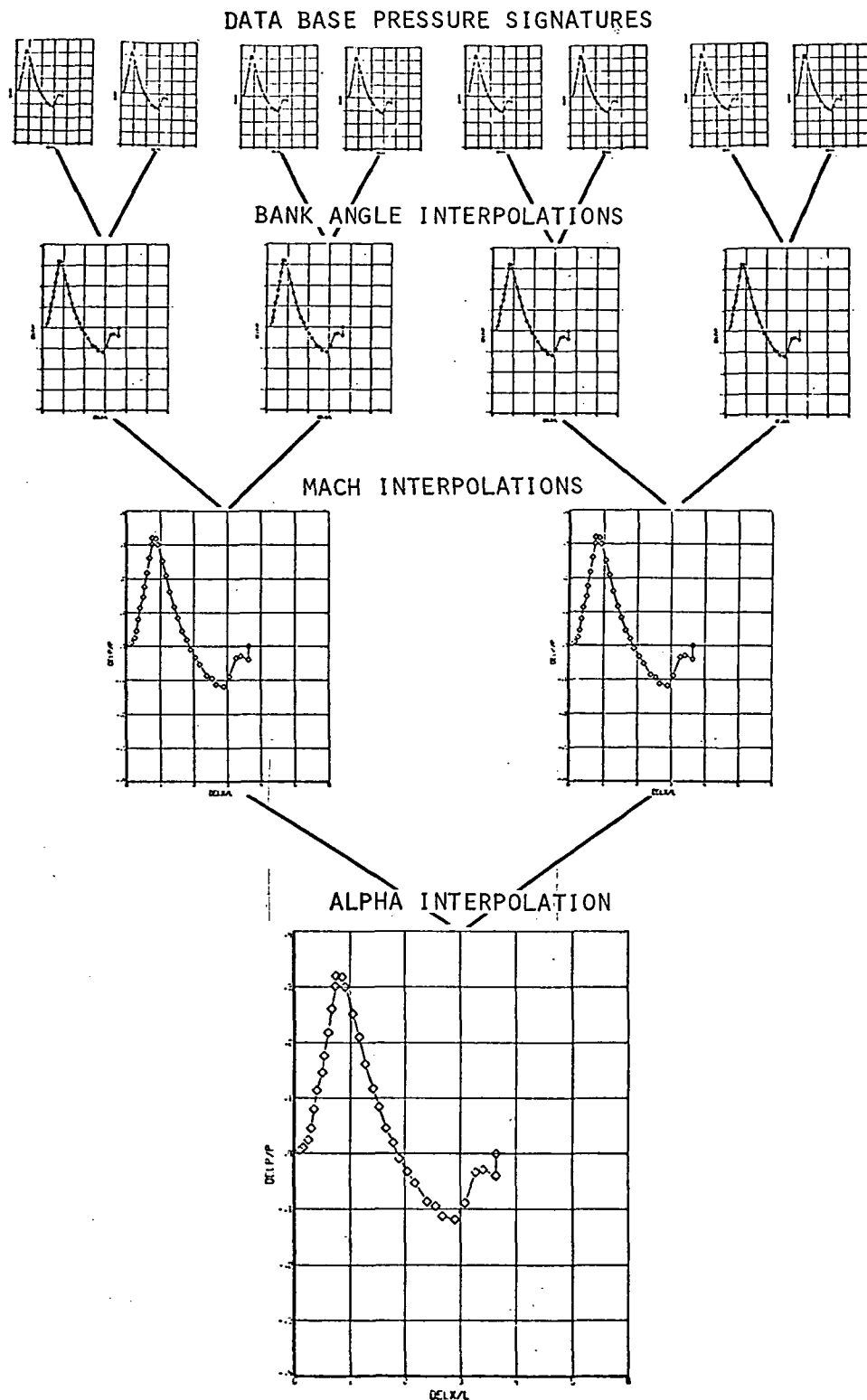
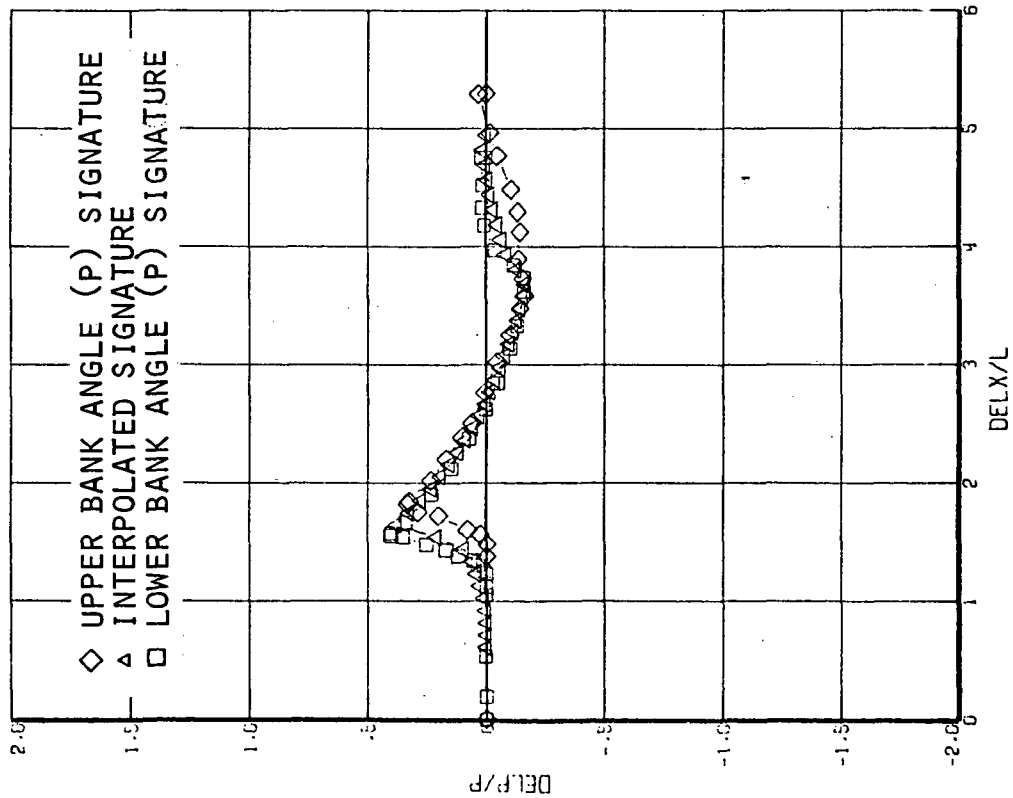

FIGURE 10 ILLUSTRATION OF PRESSURE SIGNATURE INTERPOLATION PROCEDURE.

M = 3.960, P = 10.000, P = 0.000, 08.100, 10.000, M/L = 1.330, 1.330, 1.326.



M = 5.960, P = 10.000, P = 0.000, 07.900, 10.000, M/L = 1.130, 1.120, 1.126.

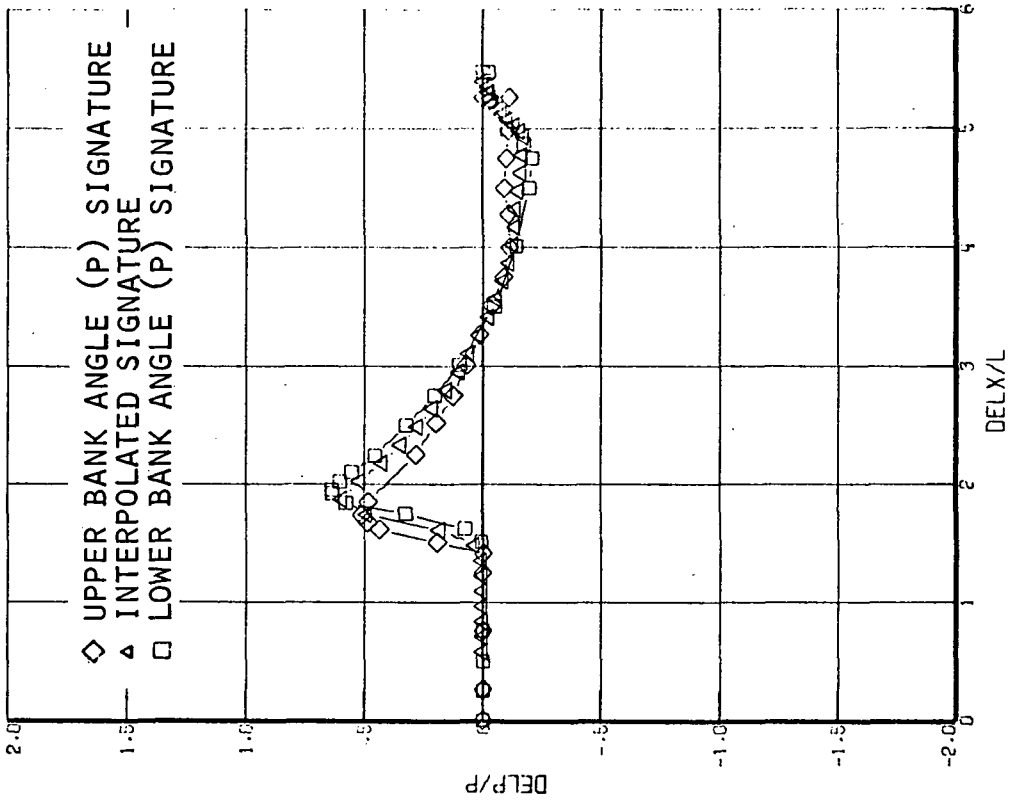
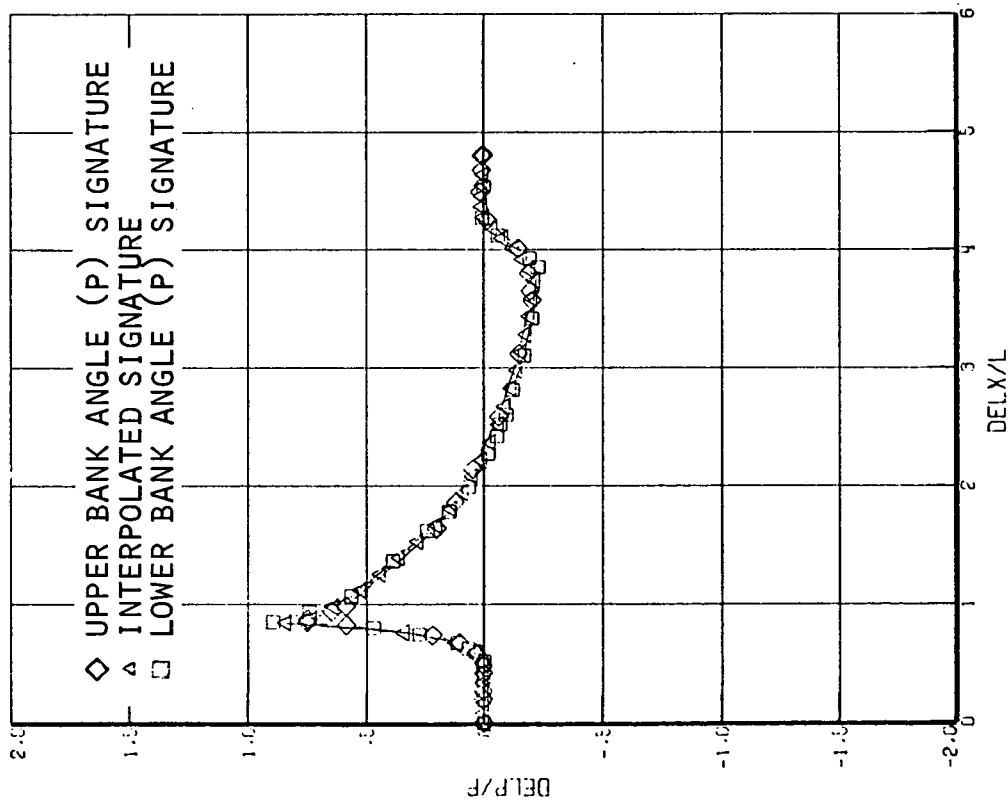

FIGURE 11A BANK ANGLE (P) INTERPOLATIONS AT MACH (M) = 3.98 AND 5.96,
ALPHA (A) = 10 DEGREES.

M = 3.990, $\beta = 25.000$, $P = 0.000$, 25.900 , 10.000 , $H/L = 1.460$, 1.430 , 1.448 .



M = 5.960, $\beta = 25.000$, $P = 0.000$, 25.100 , 10.000 , $H/L = 1.280$, 1.740 , 1.451 .

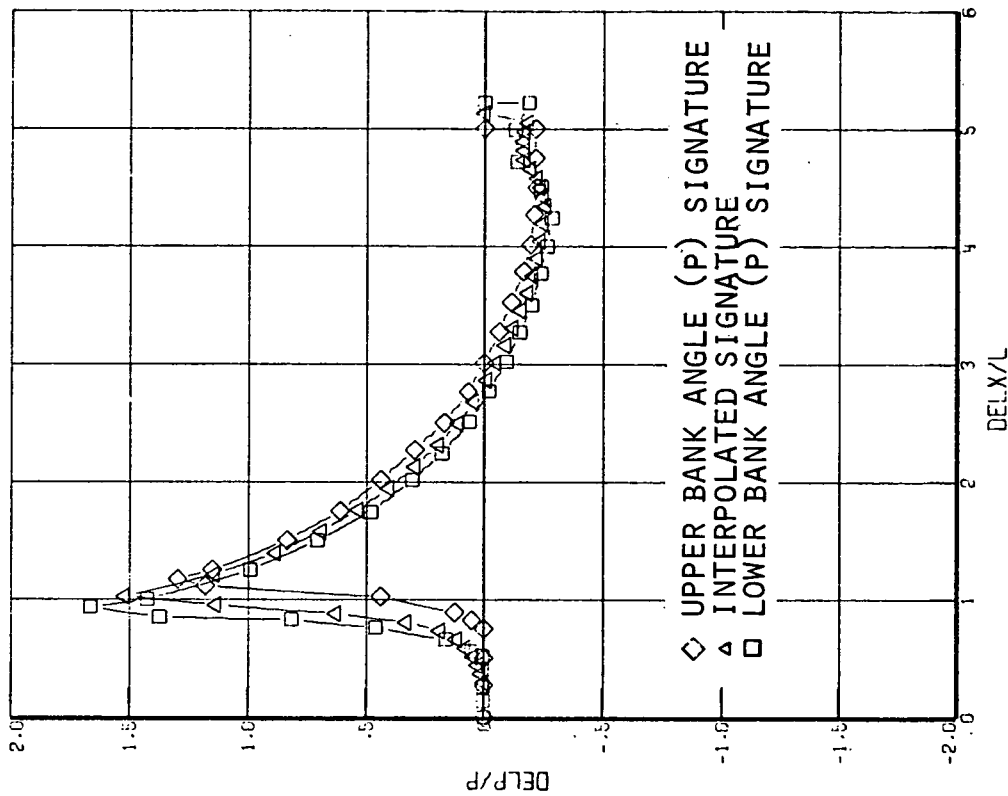
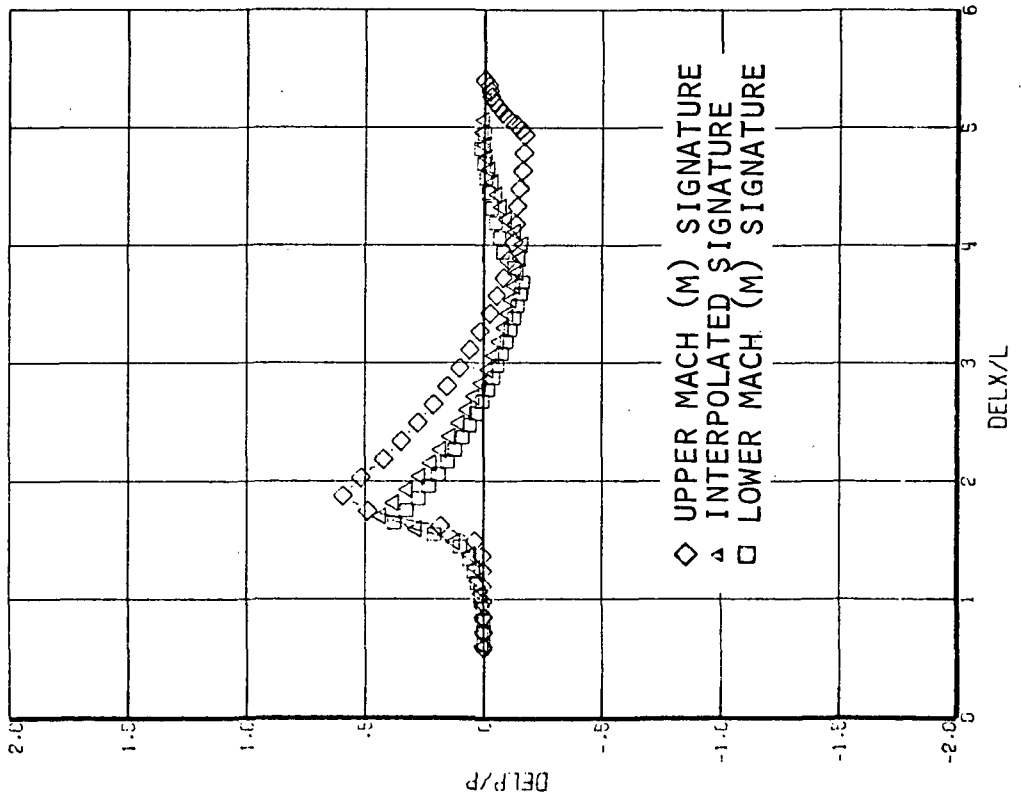

FIGURE 11B BANK ANGLE (P) INTERPOLATIONS AT MACH (M) = 3.98 AND 5.96,

ALPHA (A) = 10 DEGREES.

Mc 3.390, 5.350, 4.500, Re 10,000, P= 10.000, H/L, 1.326, 1.126, 1.274.



Mc 3.390, 5.350, 4.500, Re 25,000, P= 10.000, H/L, 1.449, 1.451, 1.419.

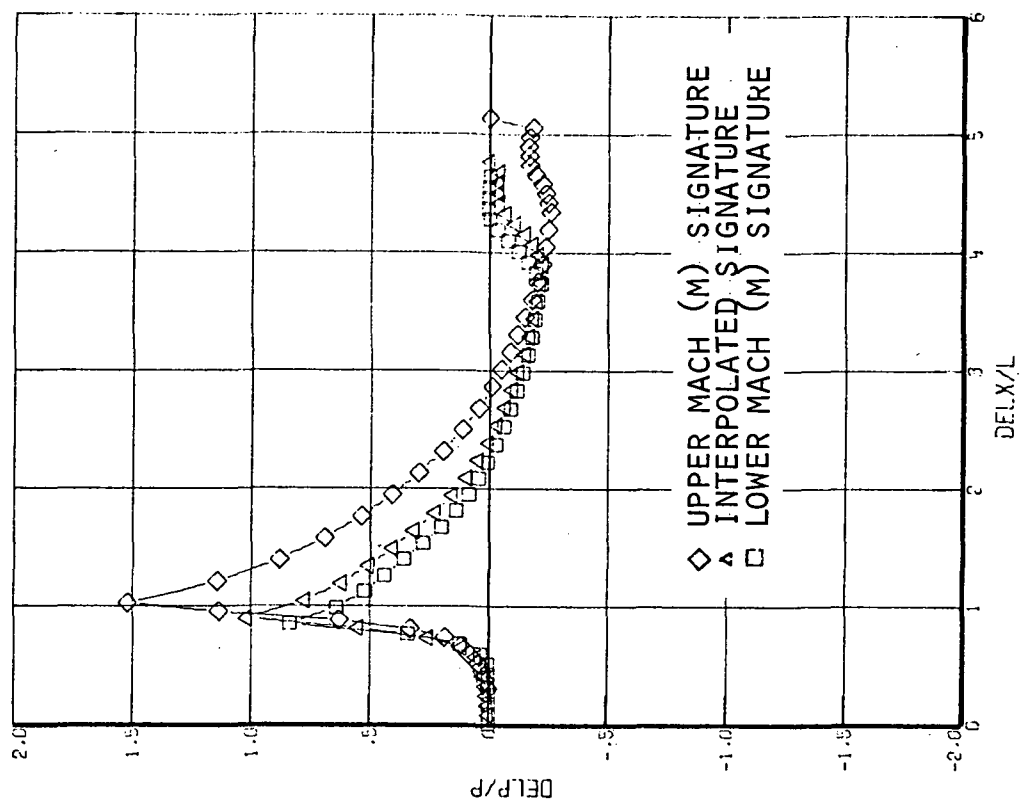

FIGURE 11C MACH (M) NUMBER INTERPOLATIONS AT ALPHA (A) = 10 AND 25 DEGREES.

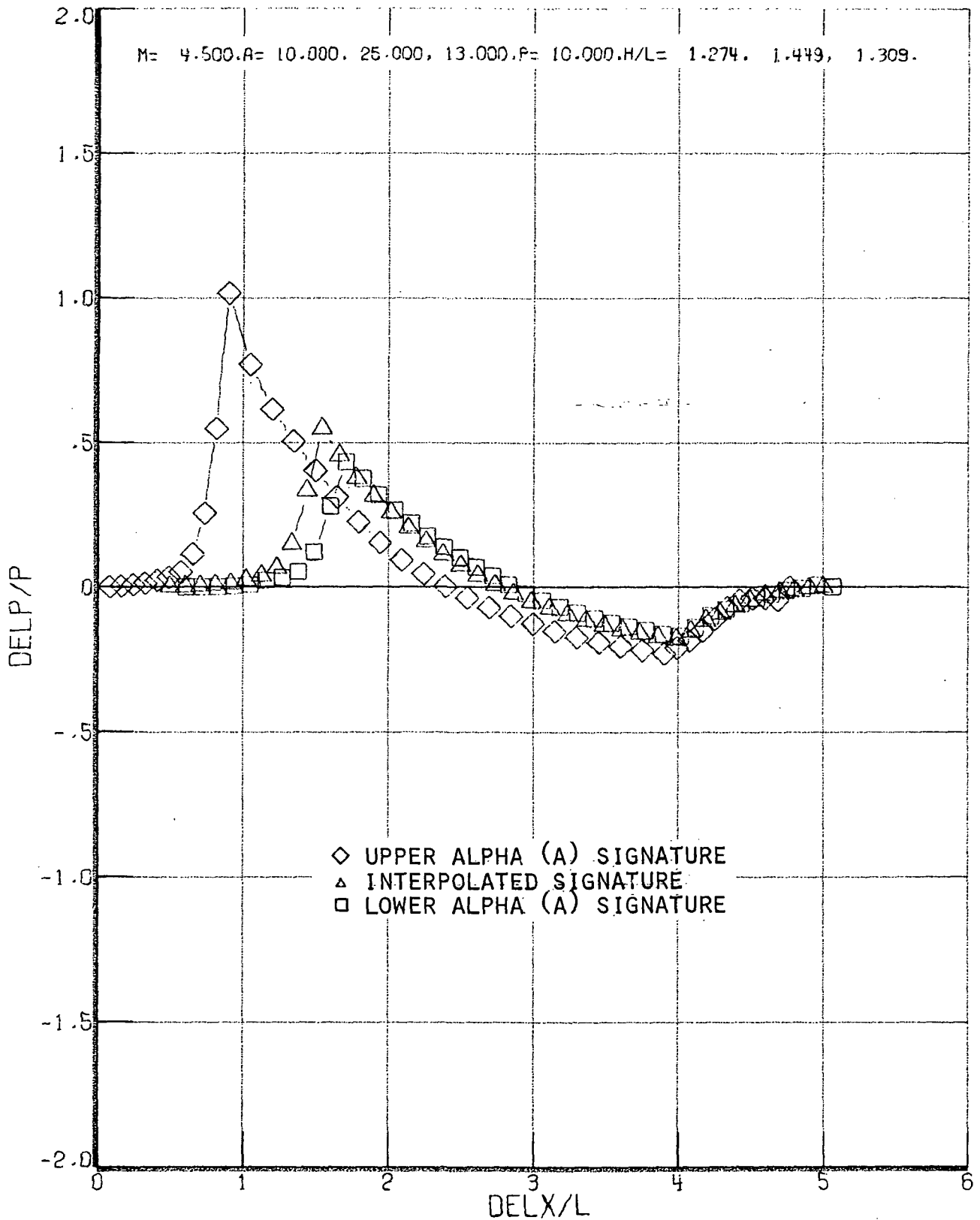

FIGURE 11D ANGLE OF ATTACK (A) INTERPOLATION.

developed used the input stations ($\Delta\chi/\ell$) of the given curve and scales the $\Delta P/P$ values of the given curve by the following factor:

$$(M1/M2)^k$$

where $M1$ is the Mach number of the given curve, $M2$ is the Mach number of the desired curve, and k is a constant equal to 2 for extrapolating high Mach number signatures to higher Mach numbers and 1.5 for extrapolating low Mach number signatures to lower Mach numbers. No methods have been developed for extrapolating in the angle of attack or roll angle planes.

Tests of the extrapolation technique included extrapolation of given experimental data base signatures for other data base experimental curves. Results of these curves showed the extrapolation technique used was quite accurate in the Mach plane, figures 12 and 13.

Enriching the Near-Field Signature Data Base

The near-field interpolation and extrapolation procedures developed were used to produce an enriched near-field data base of signatures. In this way the amount of uncontrolled extrapolation of near-field experimental signatures during a trajectory analysis is minimized. Figure 14 illustrates the flight conditions for which wind tunnel measurements of pressure signatures were available. Low and high angle of attack data was very sparse so were omitted from the final data base. Mach 2.7 data was omitted because the interpolation method for augmenting this data produces the same results as those obtained from the SBOOM program. The flight conditions stored in the final data base are shown in figure 15. Estimations of pressure signatures outside this region will generate the boundary signature. The arrows in figure 15 indicate the source of the data for the pressure signature augmentations.

Maximum ground overpressures obtained by a far-field extrapolation of the enriched data base of near-field signatures is summarized in figure 16. The data ranges spanned in the original tests of reference 7 are indicated by solid symbols. The smooth variation of maximum ground overpressure with angle of attack and Mach number appears to verify the procedure. All results in figure 16 are obtained by a far-field extrapolation of the stored near-field signatures from unaccelerated flight at 30480 meters. Near-field signatures are stored at each point indicated by symbols in the enriched data base.

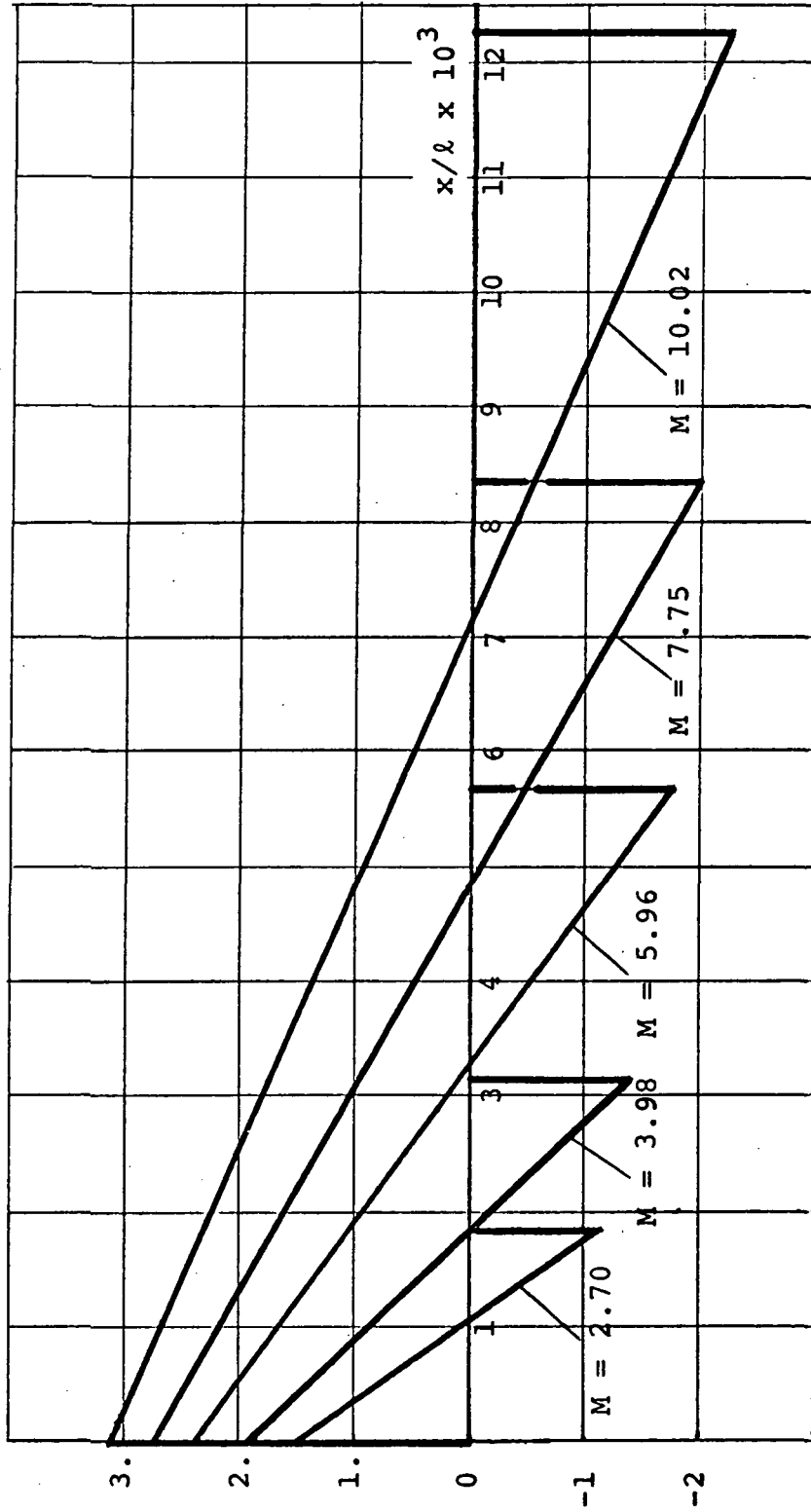

FIGURE 12

$\phi = 0^\circ$, $\alpha = 60^\circ$, Parabolic Extrapolations
 from Mach = 2.70, $h/l = 3.54$

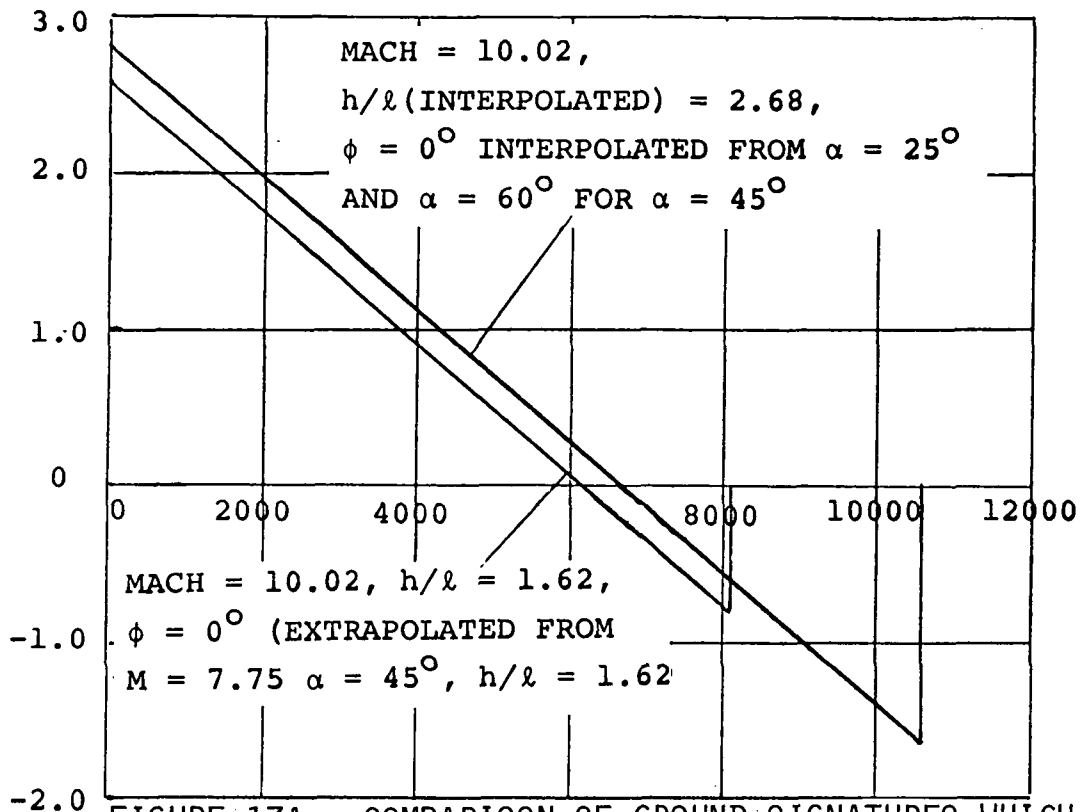

FIGURE 13A COMPARISON OF GROUND SIGNATURES WHICH RESULT FROM NEAR-FIELD DATA BASE EXTRAPOLATIONS.

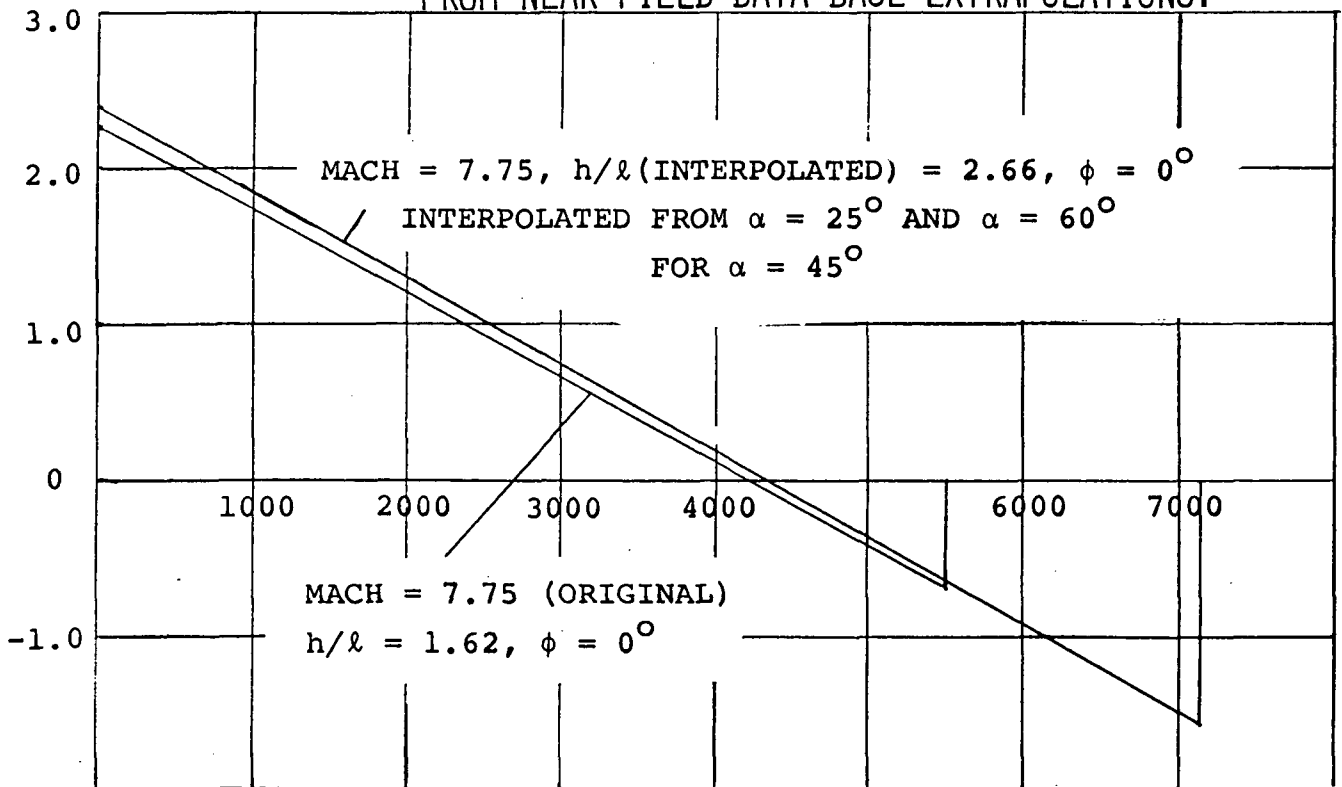

FIGURE 13B COMPARISON OF GROUND SIGNATURES WHICH RESULT FROM NEAR-FIELD DATA BASE EXTRAPOLATIONS.

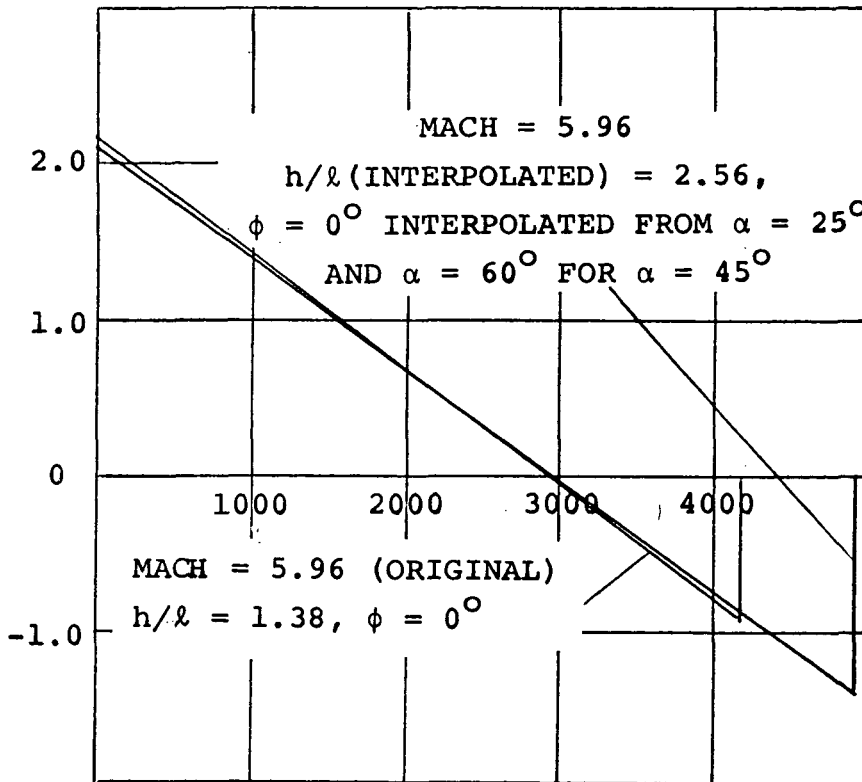

FIGURE 13C COMPARISON OF GROUND SIGNATURES WHICH RESULT FROM NEAR-FIELD DATA BASE EXTRAPOLATIONS.

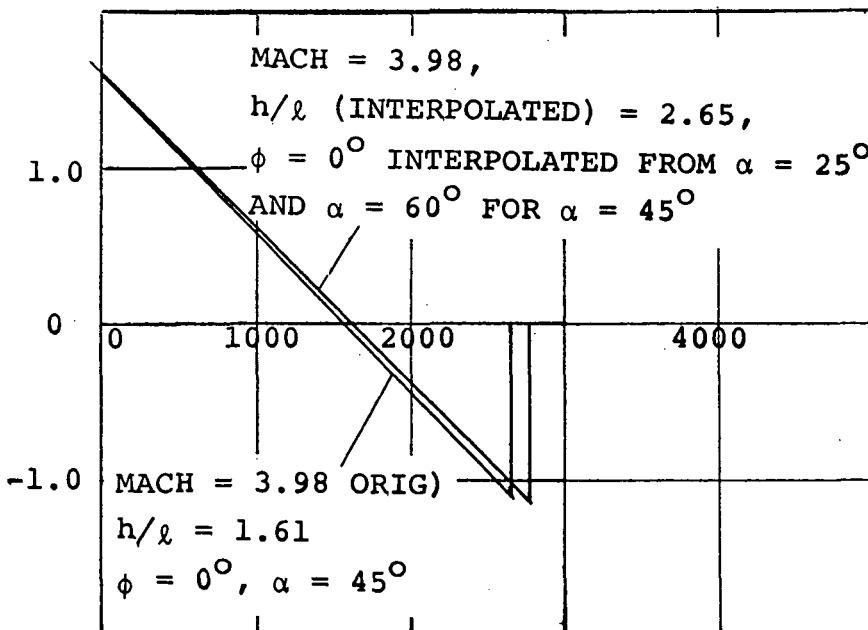
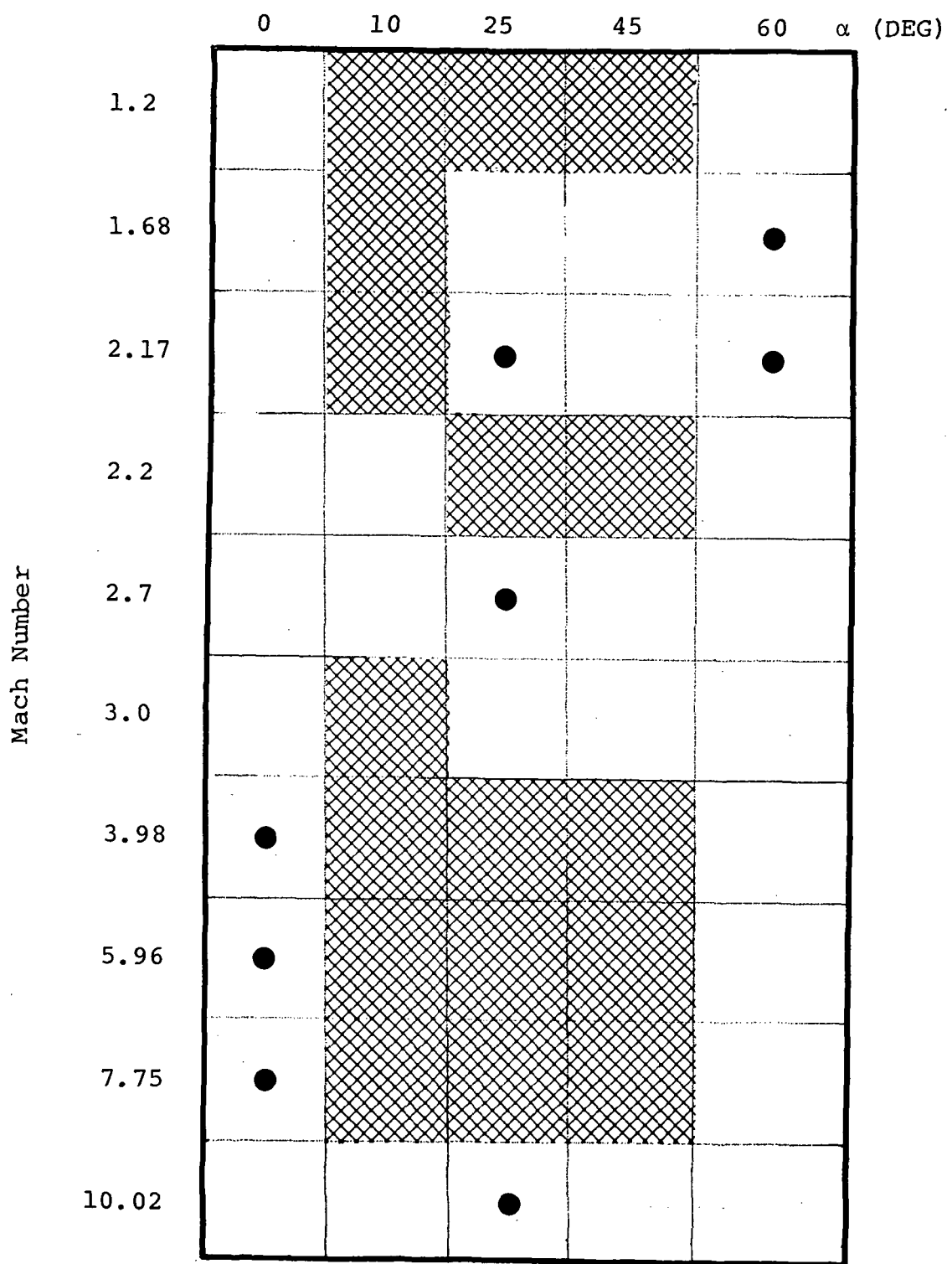

FIGURE 13D COMPARISON OF GROUND SIGNATURES WHICH RESULT FROM NEAR-FIELD DATA BASE EXTRAPOLATIONS.



LEGEND:

- Full Roll Angle Range
- Data at Zero Roll Angle Only

FIGURE 14 MEASURED SONIC BOOM PRESSURE SIGNATURES.

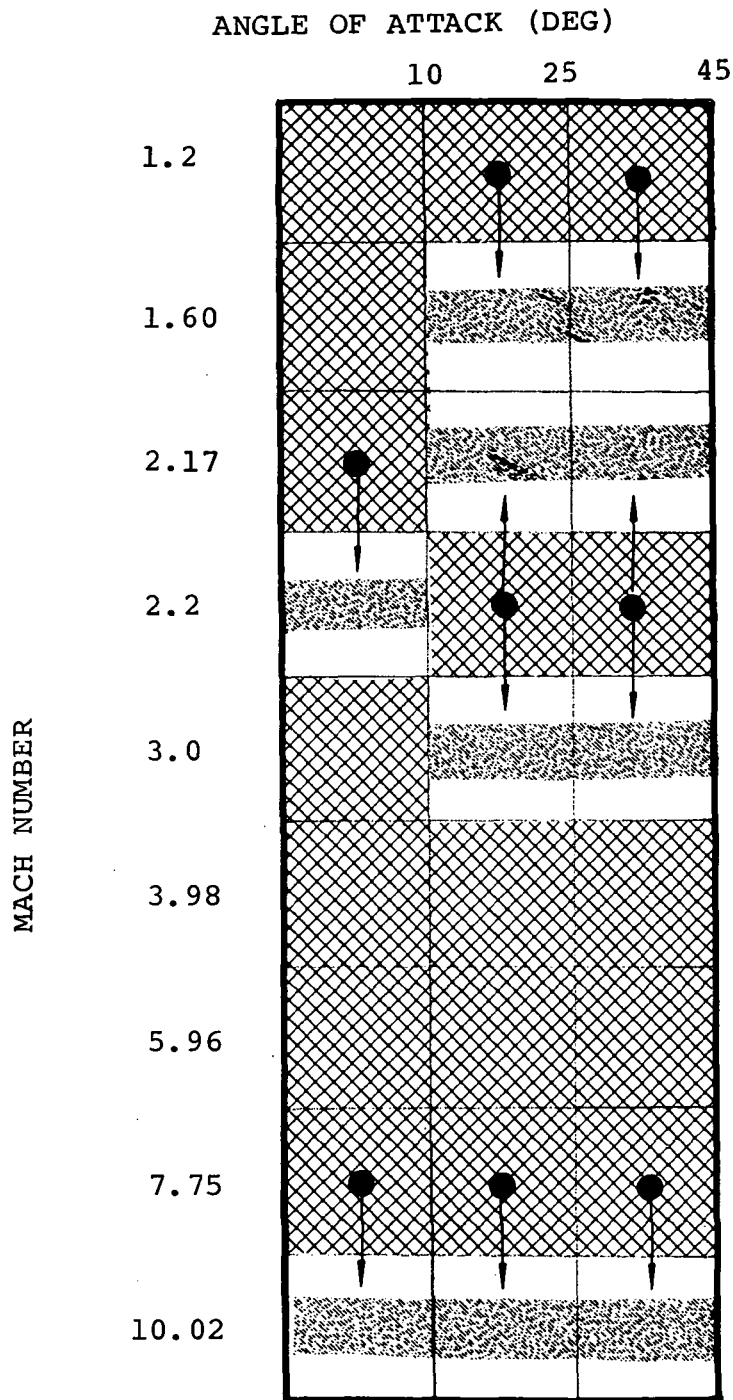

LEGEND:

- Actual Recorded Signatures.
- Extrapolated Signatures.
- Source of Extrapolated Values.

FIGURE 15 AUGMENTED SONIC BOOM PRESSURE SIGNATURE DATA BASE DEFINITION.

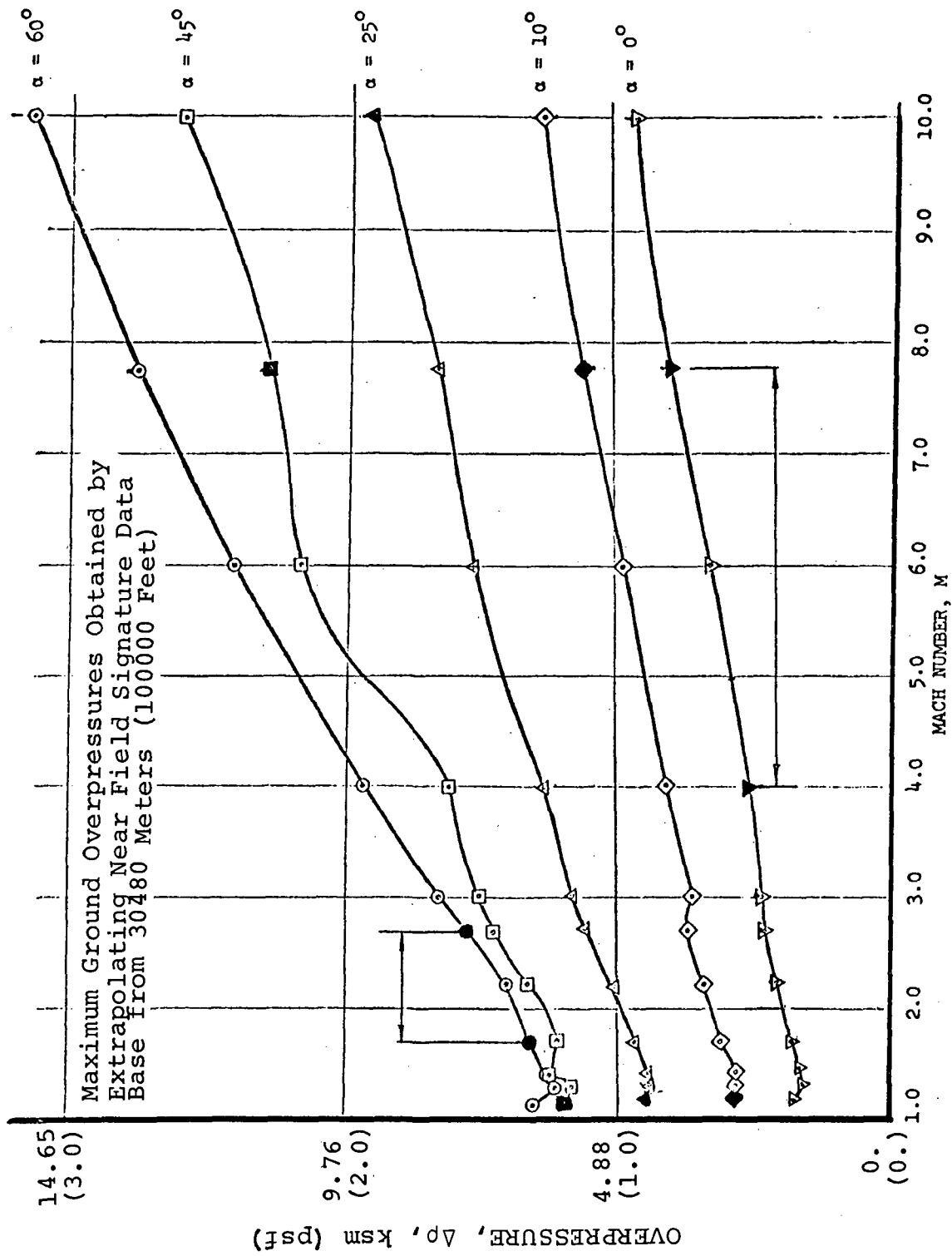

FIGURE 16 RESULTS OBTAINED FROM MODIFIED PROCEDURE.

RESULTS

The technique for estimation of space shuttle ground overpressures described in the preceding section is summarized in figure 17. Measured near-field wing tunnel signatures are collected into a data base of known signatures as a function of:

Mach number,	M
Angle of attack	α
Roll angle,	ϕ

Given any two signatures in the data base, an interpolation procedure based on geometric similarity produces an intermediate signature. By successive interpolation the signature corresponding to any point P in the (M, α, ϕ) space can be found from the signatures stored at the discrete points (M_i, α_j, ϕ_k) . The interpolated signature, which corresponds to a flight condition generated by the trajectory is then extrapolated to the ground using the Thomas waveform parameter method. This procedure is repeated for all or a selected set of points along the trajectory and a measure of the ground overpressure is calculated for the trajectory. This measure may be any of several functions including:

$$F_1 = \text{Max}_r \left(\frac{\Delta p}{P_0} \right)_r ; \quad r = 1, 2, \dots, R_T$$

where the r points correspond to the selected set of trajectory points R_T in number.

$$F_2 = \int_{t_1}^{t_2} \text{Max} [(\Delta p - \bar{\Delta p}), 0] dt$$

Where t_1 and t_2 define the trajectory period of interest, $t_1 < t < t_2$, and $\bar{\Delta p}$ is the acceptable overpressure. Successive trajectories are then generated by systematically perturbing the vehicle control variable history, usually angle of attack or pitch angle. The systematic control variable perturbations are generated by the application of multivariable search technique, reference 6, which generally fall into one of several classes of search, for example:

1. One parameter at a time.
2. Systematic multi-parameter, such as steepest-descent or second order.
3. Randomized.

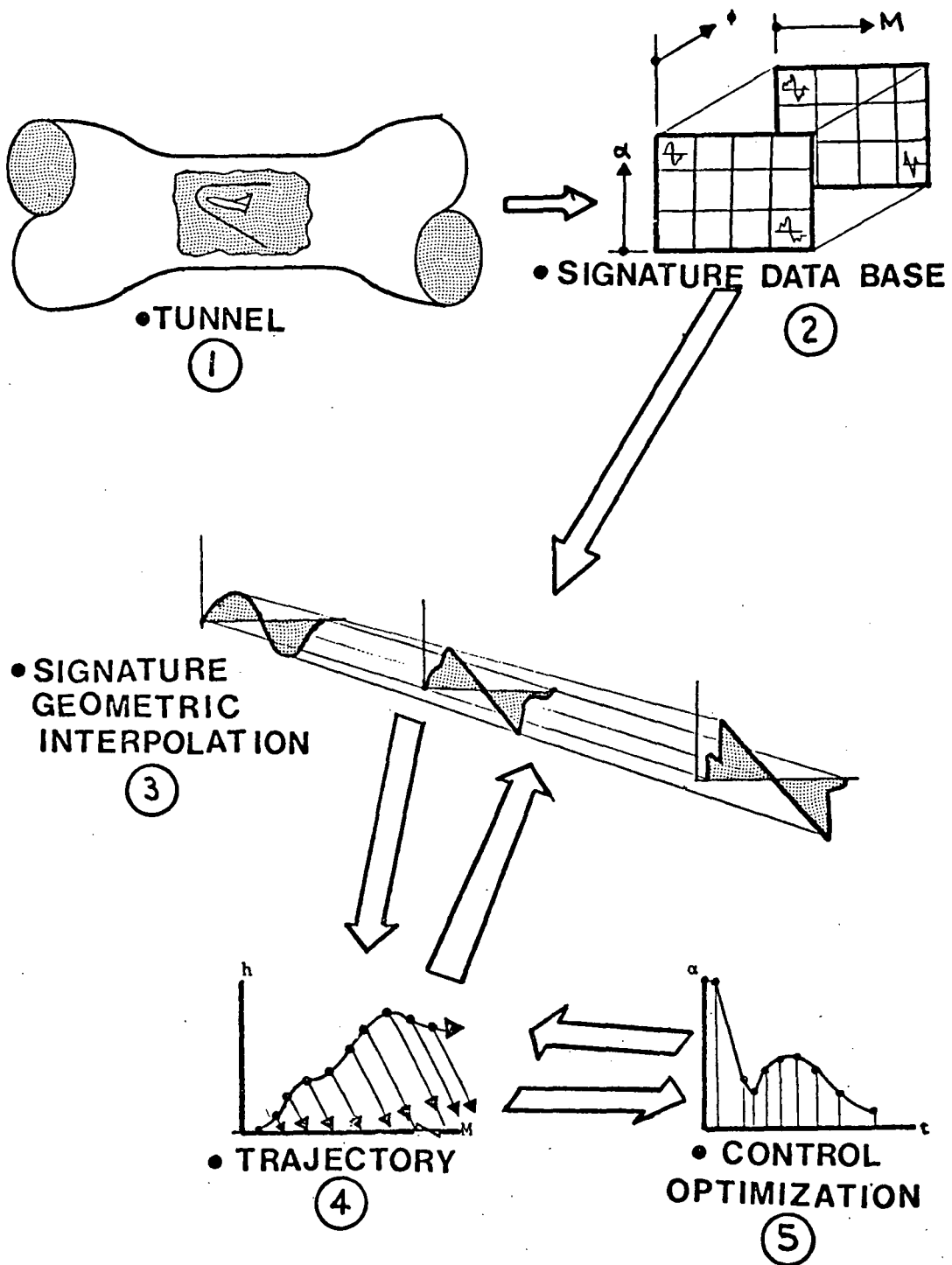

SCHEMATIC

FIGURE 17 SCHEMATIC OF SONIC BOOM ESTIMATION TECHNIQUE.

4. Acceleration, which improves the results previously obtained by searches of Types 1, 2 or 3.

The objective of these searches is to define the control history which minimizes F_1 or F_2 along the trajectory and thus the degree of objection to overland flight by space shuttle vehicles. It should be noted that, strictly speaking, the flight path optimization problem posed is a complicated problem in the variational calculus. The manner in which such a problem can be transformed into simpler multivariable search class by control parameterization has been discussed in detail in reference 6. Basically, the continuous control history, $\alpha(t)$, is replaced by a parameterization, $\alpha_i(T_i)$. Between any two time points, T_i and T_{i+1} , an interpolation rule is used to define the instantaneous control. The finite set of parameters, $\alpha_i(T_i)$, then form the basis for applying multivariable search techniques to the trajectory optimization problem.

Behavior of the ground overpressure measure F_1 along a typical shuttle ascent path is presented in figure 18. Here, the trajectory is typified by the Mach altitude schedule flown with the F_1 altitude schedule superimposed. The path illustrated is a high dynamic pressure path. Ground overpressure peaks early in the flight with the vehicle in a low altitude/low supersonic Mach number condition. For the vehicle and path combination chosen, significant overpressures approximating 1 psf are still propagated to the ground as the vehicle passes through 100,000 feet at Mach 12. Time points are shown at four second intervals in the ascent path of figure 18.

Ascent Path Optimization Without Sonic Boom Constraints

The vehicle considered is an early, fully reusable shuttle configuration. The control parameterization and vehicle configuration are illustrated in figure 19. Initial trajectory optimization studies were performed to establish the maximum payload ascent path. This path is defined as:

$$\text{Max. } (M_f)$$

subject to the terminal constraints

$$\Psi_1 = h_f - 303805 = 0$$

$$\Psi_2 = \gamma_f = 0$$

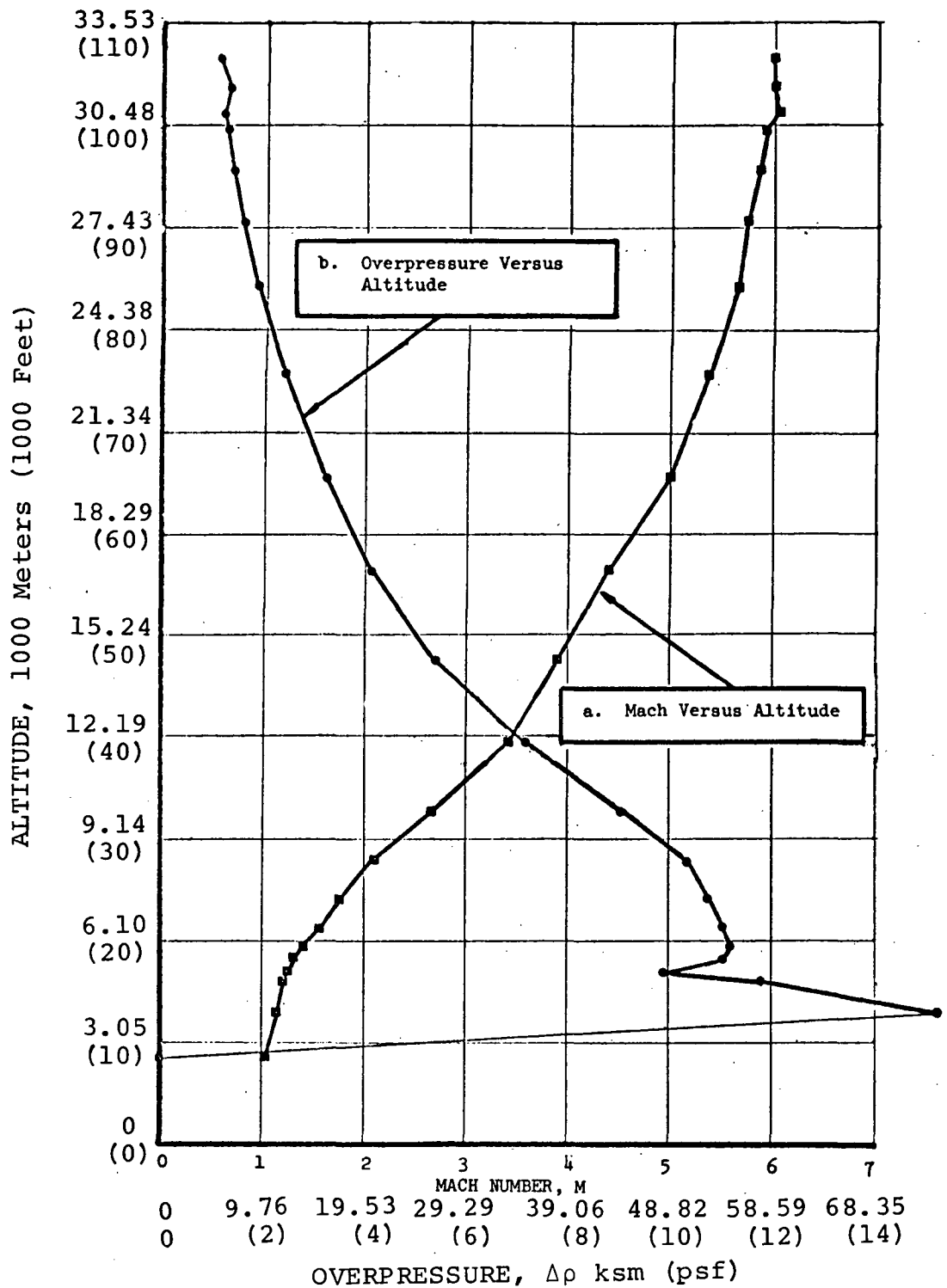

FIGURE 18 TYPICAL MAXIMUM GROUND OVERPRESSURE ON HIGH DYNAMIC PRESSURE PATH.

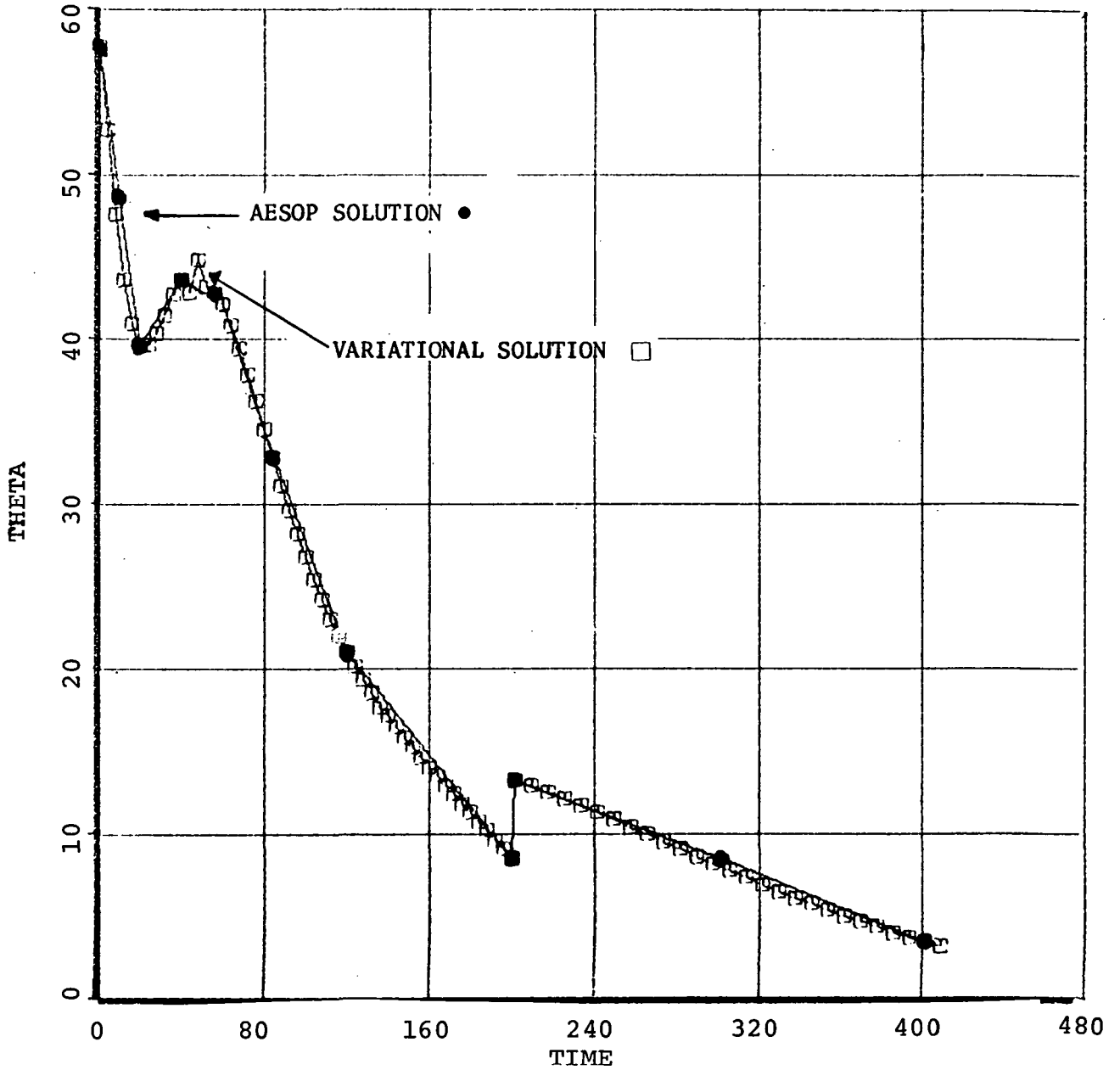

FIGURE 19 COMPARISON OF VARIATION AND PARAMETERIZED CONTROL HISTORIES

$$\Psi_3 = V_f - 24495 = 0$$

where M_f = final mass

h_f = final altitude

γ_f = final flight path angle

V_f = final velocity

The problem was solved using the two alternative optimization procedures contained within the atmospheric flight path optimization program ATOP; these are:

1. Variational calculus
2. Multivariable search

Results of the trajectory optimization are presented in figure 20 in the Mach altitude plane. The region of overpressure constraint violation is shown in the shaded area. The region is bounded on the left by the 2 psf overpressure boundary and on the right by the superboom (ray tube area goes to zero at the ground - theoretically infinite overpressure). The constraint region is approximate and determined from a large number of sonic boom calculations at various flight conditions. The "optimum" trajectory passes through the region in the interval Mach 2 to Mach 3 and 40000 to 70000 feet altitude.

It is evident from figure 20 that the "optimum" trajectory not only violated the sonic boom constraint but in accordance with the criteria presented, there is no feasible trajectory that will not violate it. However, the higher the altitude from which the boom emanates, the less severe the ground level superboom. This effect is not predicted by the method. Therefore, the trajectory optimization based on sonic boom constraint was conducted by raising the superboom altitude as illustrated in figure 21.

The resulting ascent paths are illustrated in the Mach altitude plane in figure 22. As the anticipated altitude at which the superboom boundary is crossed increased, orbital payload falls as indicated by the solid line in figure 23. This behavior was, therefore, consistent with the trajectories which were used to generate the approximate Mach altitude region in which ground overpressures in excess of 2 psf would be generated.

A final optimal ascent was then computed in which the integral of the time in which a ground overpressure in excess of 2 psf was minimized while the orbital payload was constrained to three per cent less than the now known maximum value, that is,

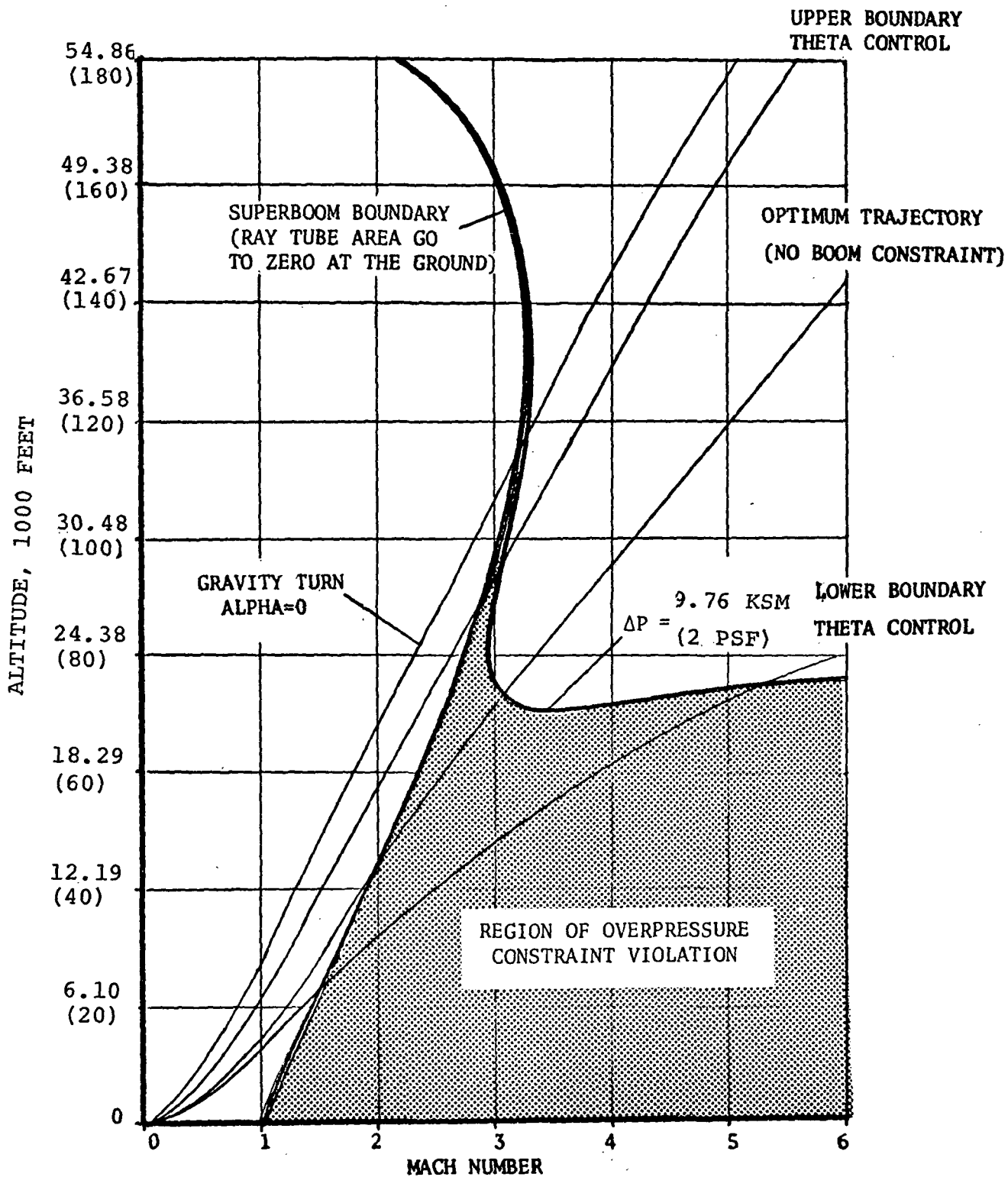

FIGURE 20 APPROXIMATE OVERPRESSURE CONSTRAINT BOUNDARIES.

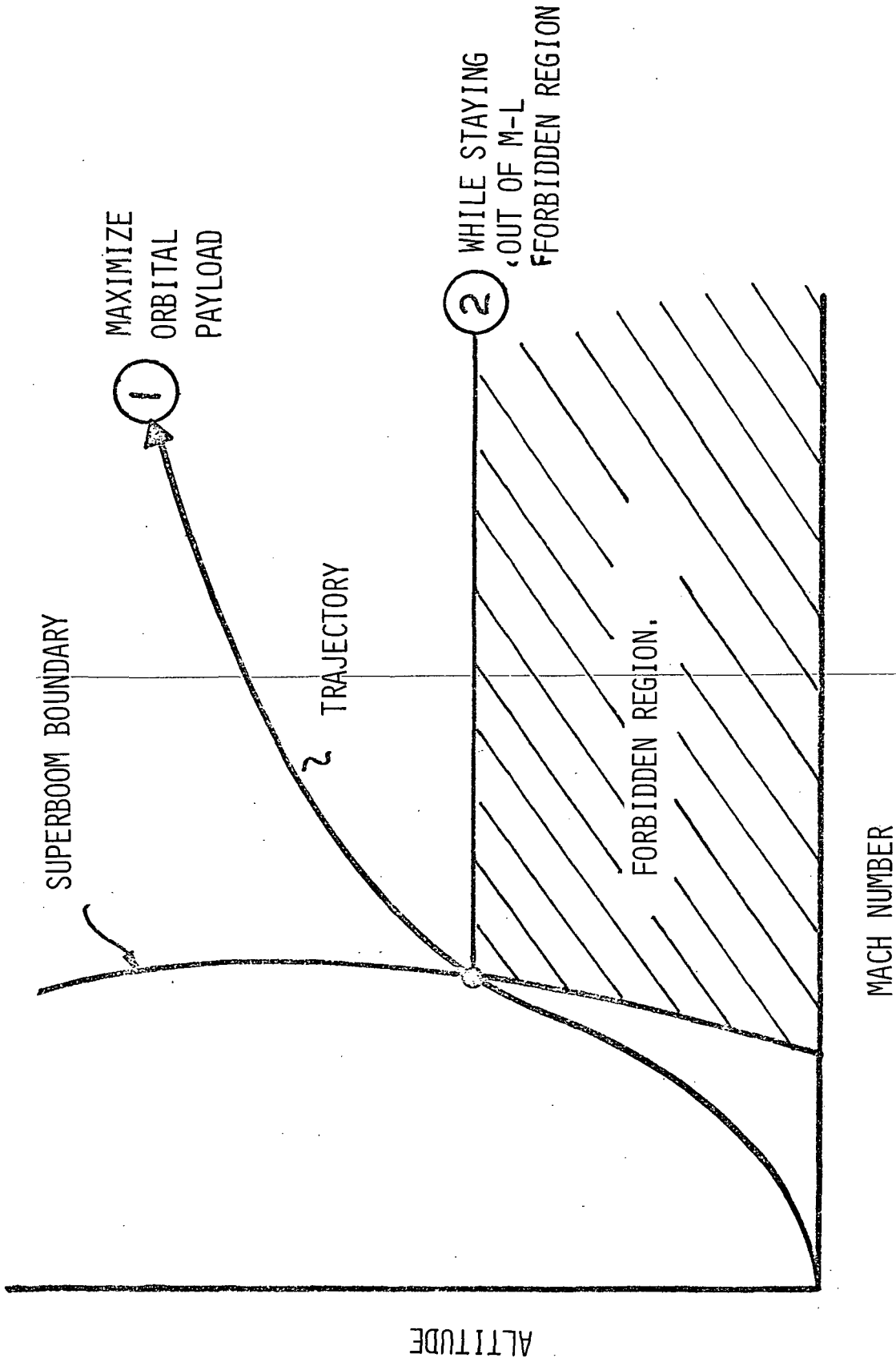

FIGURE 21 RAISING THE SUPERBOOM ALTITUDE IN TRAJECTORY OPTIMIZATION.

INITIAL ASCENT FLIGHT PATH

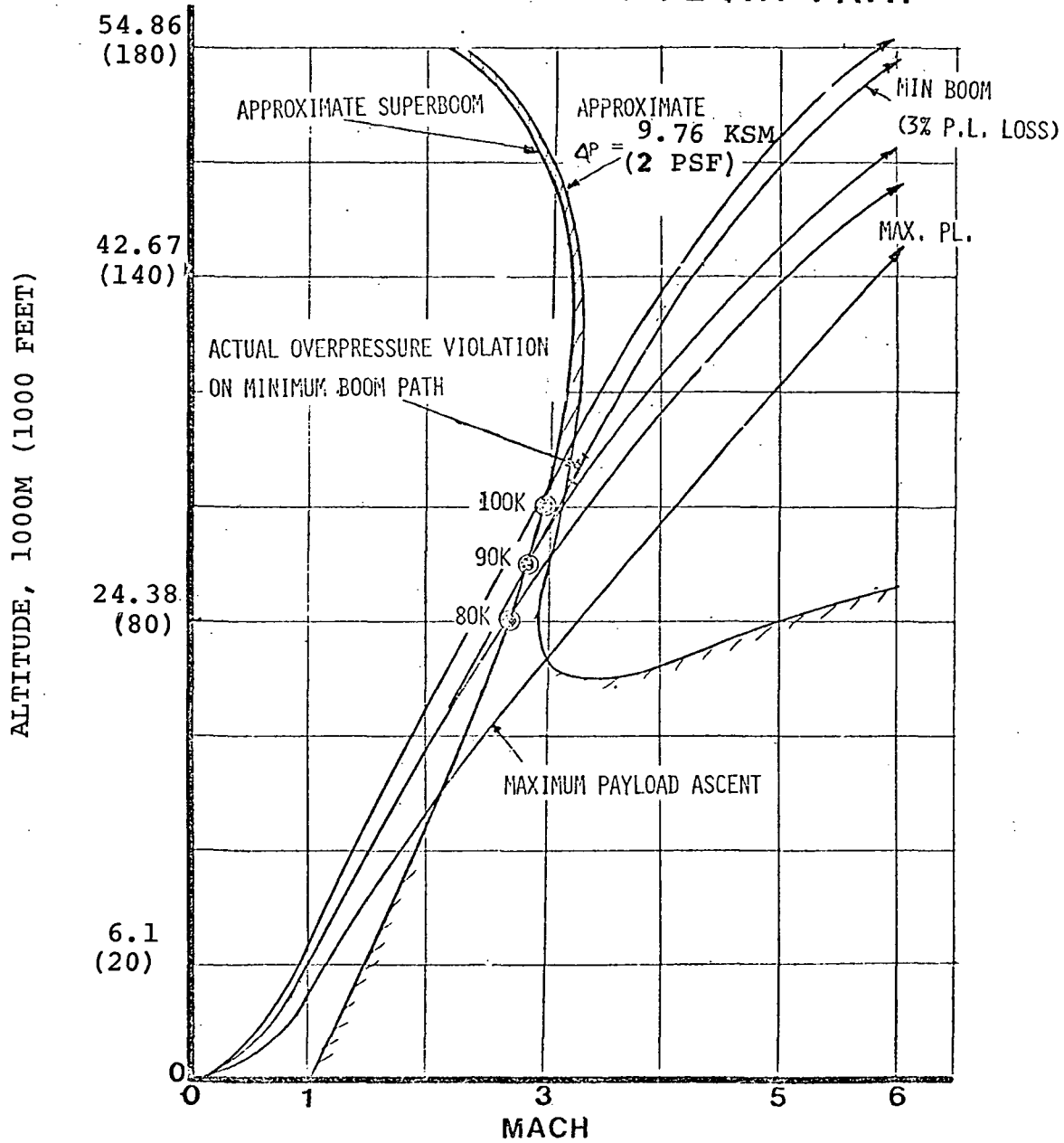

FIGURE 22 OPTIMAL TRAJECTORIES BASED ON SONIC BOOM CONSTRAINTS.

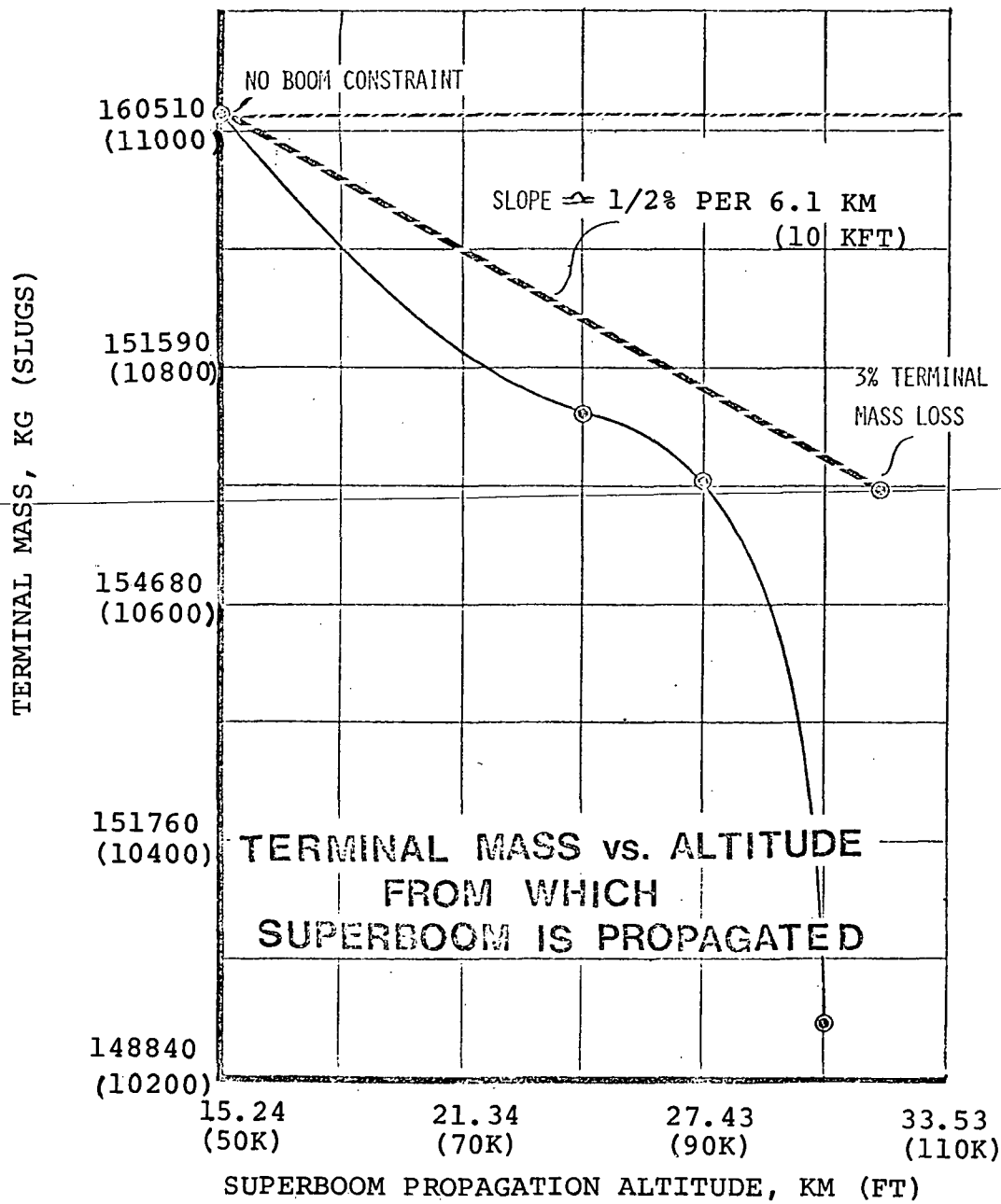

FIGURE 23 PERFORMANCE DEGRADATION AS A RESULT OF RAISING SUPERBOOM ALTITUDE.

Min (F_2) with $\bar{\Delta}p = 2$

$$\Psi_1 = h_f - 303805 = 0$$

$$\Psi_2 = \gamma_f = 0$$

$$\Psi_3 = V_f - 24495 = 0$$

$$\Psi_4 = M_f - 10700 = 0$$

Thus, in this case, the ground overpressure is minimized directly and no assumption is made regarding the location of the ground overpressure violation in the Mach altitude plane.

The results are incorporated into figures 22 and 23. In figure 22 the actual Mach altitude plane region responsible for ground overpressures in excess of 2 psf has moved slightly to the right of the assumed value. However, the duration of the violation is slightly less than anticipated as could be expected from the optimization process which properly accounts for all factors entering into the ground overpressure level not simply the Mach altitude effects. From figure 23 it can be seen that the cost in orbital payload required to raise the flight altitude at which a ground superboom is generated is approximately 1/2 per cent per 10,000 feet of altitude.

A Note on the Ascent Solutions and the Superboom Problem

Superbooms are created when the wave ray tubes emanated by the vehicle become very small. In the present report, the superboom boundary is taken to be the point at which a ray tube area goes to zero. This would indicate an infinite pressure in the overpressure estimation methods now available. In actuality, the condition of a ray tube going to zero indicates a very high localized ground overpressure. In the studies of this section, this condition cannot be eliminated; however, the higher the vehicle altitude, which propagates a signature (which ultimately produces a ground superboom), the less intense the resulting ground overpressure will be. This was the rationale behind attempting to raise the anticipated superboom boundary crossing point.

The question arises as to whether or not the superboom can be eliminated. This is equivalent to requiring one of two conditions to occur, either:

1. The rays must still be coalescing at sea level.

2. The ray tube must go to zero at an altitude significantly greater than sea level.

The space shuttle generates a continuous spectrum of signatures along its flight path, and barring severe nonstandard atmospheric discontinuities (or possible use of roll angle), there is no manner in which the vehicle trajectory can suddenly pass from Type 1 to Type 2 or vice versa.

Now, at higher altitudes of, say, 100,000 feet conditions leading to the ray tube going to zero at altitude are readily created. For example, in figure 20 the entire region of the supersonic Mach altitude plane to the left of the superboom boundary is such a region. As the trajectory approaches the superboom boundary from the left in this plane, the condition of a ray tube approaching zero at precisely ground level is approached. Once through the boundary, finite pressure signatures are experienced at the ground and the superboom is effectively underground. This behavior is illustrated in figure 24.

In figure 24(A) the vehicle lies to the left of the superboom boundary, and no sonic boom is felt at the ground. In 24 (B) the ground superboom occurs and the ray tube goes to zero at precisely sea level. In 24(C) the vehicle lies to the right of the superboom boundary, and finite ground pressures are generated.

Detailed examination of the factors entering into the generation of the superboom appears to indicate that a key factor in the ray tube focusing is the fact that the space shuttle trajectory is largely convex upwards. With this shape, after the first few moments of flight the flight path angle derivative, $\dot{\gamma}$, is negative. This trajectory behavior tends to lead to a focusing of the wave and the attendant superboom.

Descent Paths

Space shuttle orbiter aerodynamic characteristics and a nominal descent path pitch control history were supplied by NASA's Johnson Space Center. The nominal control history generated the reentry Mach altitude profile history of figure 25 in the ATOP program. Figure 26 presents the ground overpressure history produced by the nominal reentry. A maximum overpressure of 1.74 psf was encountered in this reentry path. The vehicle emitted the wave which propagated into this worst sea level condition while descending through 65,000 feet at Mach 1.25.

It can be seen from figure 26 that the space shuttle descent maximum ground overpressure problem is essentially one of a terminal maneuver. Above a velocity of 4500 feet per second the maximum

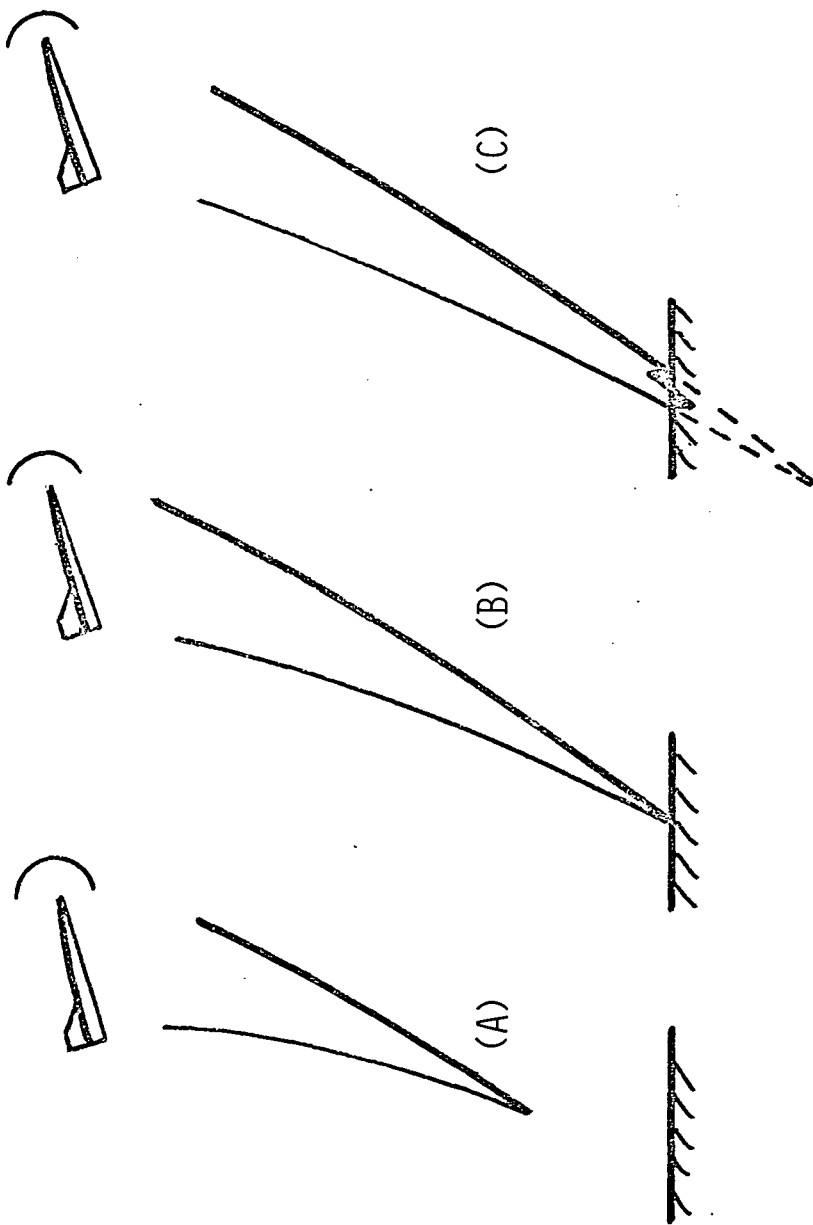

FIGURE 24 GENERATION OF THE GROUND LEVEL SUPERBOOM.

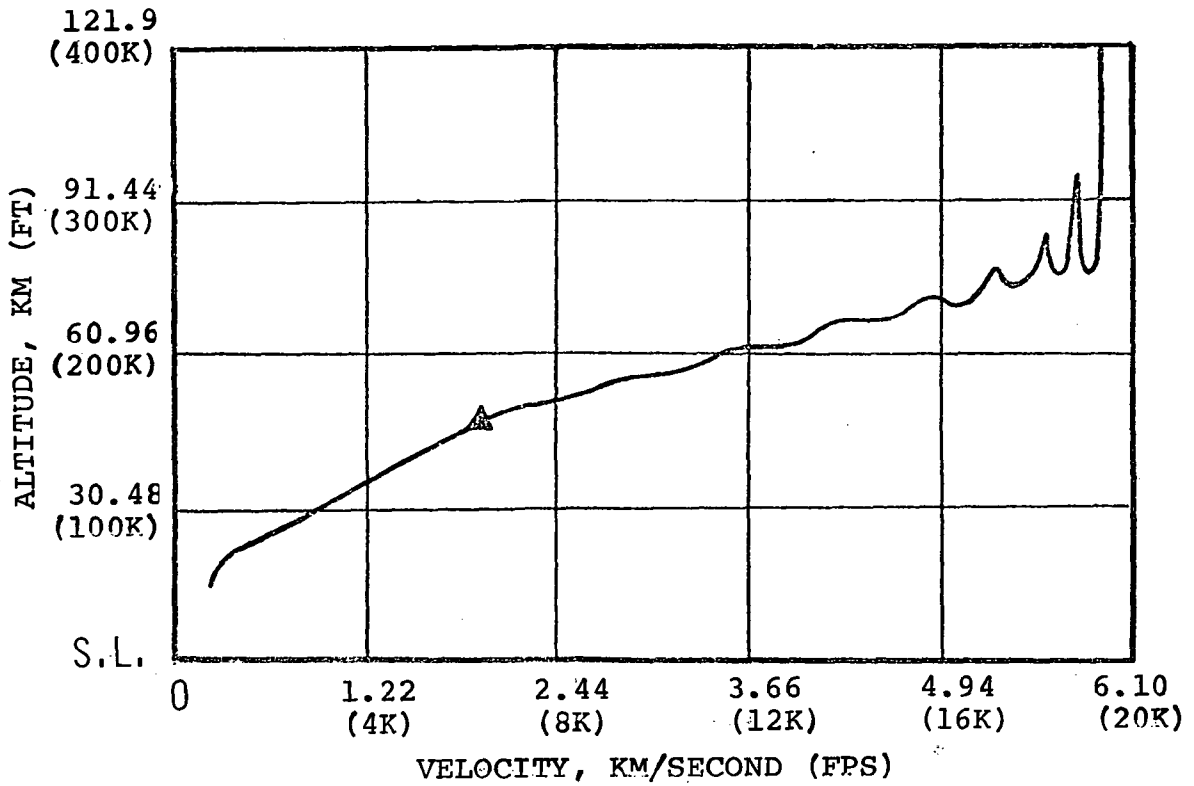

FIGURE 25 NOMINAL REENTRY PATH

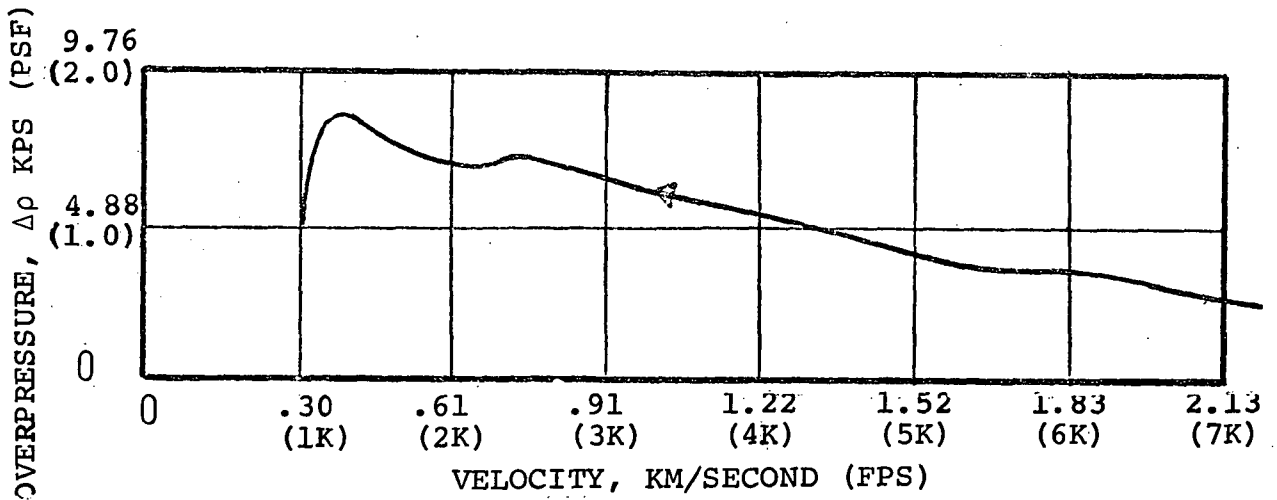

FIGURE 26 NOMINAL PATH OVERPRESSURES

overpressure is less than 1.0 psf. Accordingly, a one parameter family of descent paths characterized by constant angle of attack control was optimized to produce the minimum ground overpressure with trajectory cutoff at Mach 1.05. That is:

$$\text{Min } (F_1)$$

$$\psi_i = (M_{N_f} - 1.05) = 0.0$$

The angle of attack range investigated was $0 < \alpha < 60^\circ$. Minimum boom was found at the maximum angle of attack of 60° where the maximum ground overpressure was found to be 1.32 psf propagated from 99,000 feet at Mach 1.88. This minimum "maximum ground overpressure" path is presented in figure 27 together with the JSC nominal descent and two intermediate paths producing ground overpressures of 1.62 psf at $\alpha = 24^\circ$ and 1.58 psf at $\alpha = 40^\circ$. Introducing the high angle of attack as the space shuttle vehicle passes through Mach 5 produces a high lofting maneuver which reduces the Mach number at a given altitude. The flight path point responsible for the maximum overpressure then tends to move to higher altitude and Mach number with increasing angle of attack while the magnitude of the maximum overpressure diminishes.

It should be noted that the aerodynamic information provided by JSC is limited to $\alpha_{\text{max}} = 24^\circ$. Thus, the program used extrapolated aerodynamics on the higher angle of attack reentry paths. The variation of maximum ground overpressure with the angle of attack value is presented in figure 28. If angle of attack is limited to 24° , then the corresponding maximum ground overpressure encountered is 1.62 psf, a seven per cent (7%) decrease in the nominal trajectory.

Further optimization studies were then undertaken using two and four parameters to represent the control history as discussed in reference 8. The results are summarized in figure 29. If the angle of attack range investigated is limited to $0 < \alpha < 24^\circ$, the best two parameter solution produces a maximum ground overpressure of 1.43 psf. The best four parameter solution produces 1.42 psf.

If the angle of attack range investigated is increased to $0 < \alpha < 60^\circ$, the best two parameter solution is identical to the constant $\alpha = 60^\circ$ solution of 1.32 psf. By using four parameters a slight improvement is produced, and the maximum ground overpressure recorded is 1.31 psf.

Subsequently, the reentry paths were optimized starting from the point where the vehicle passed through Mach 10.0 using the angle

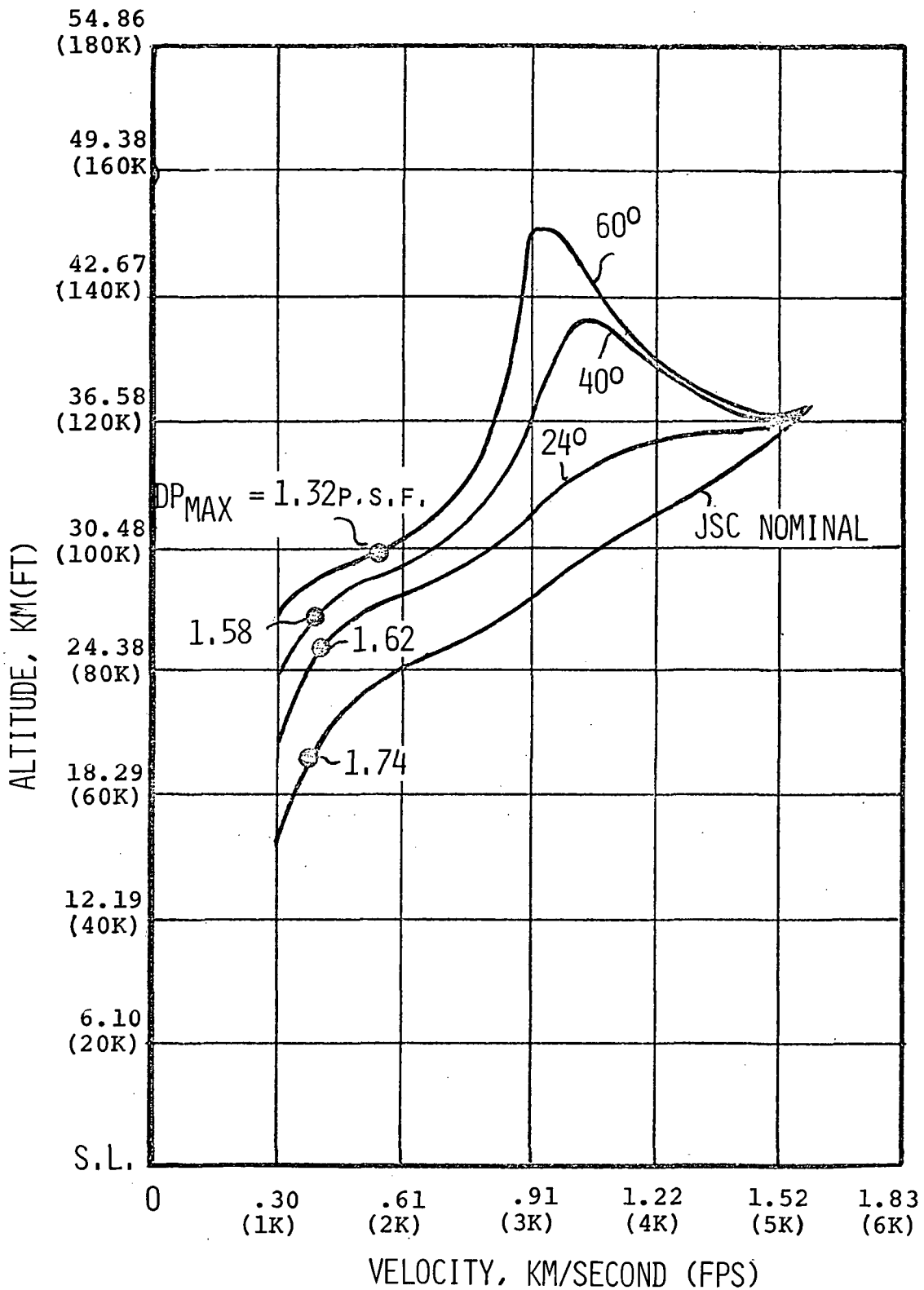

FIGURE 27 TERMINAL DESCENT PATHS, CONSTANT α AND NOMINAL.

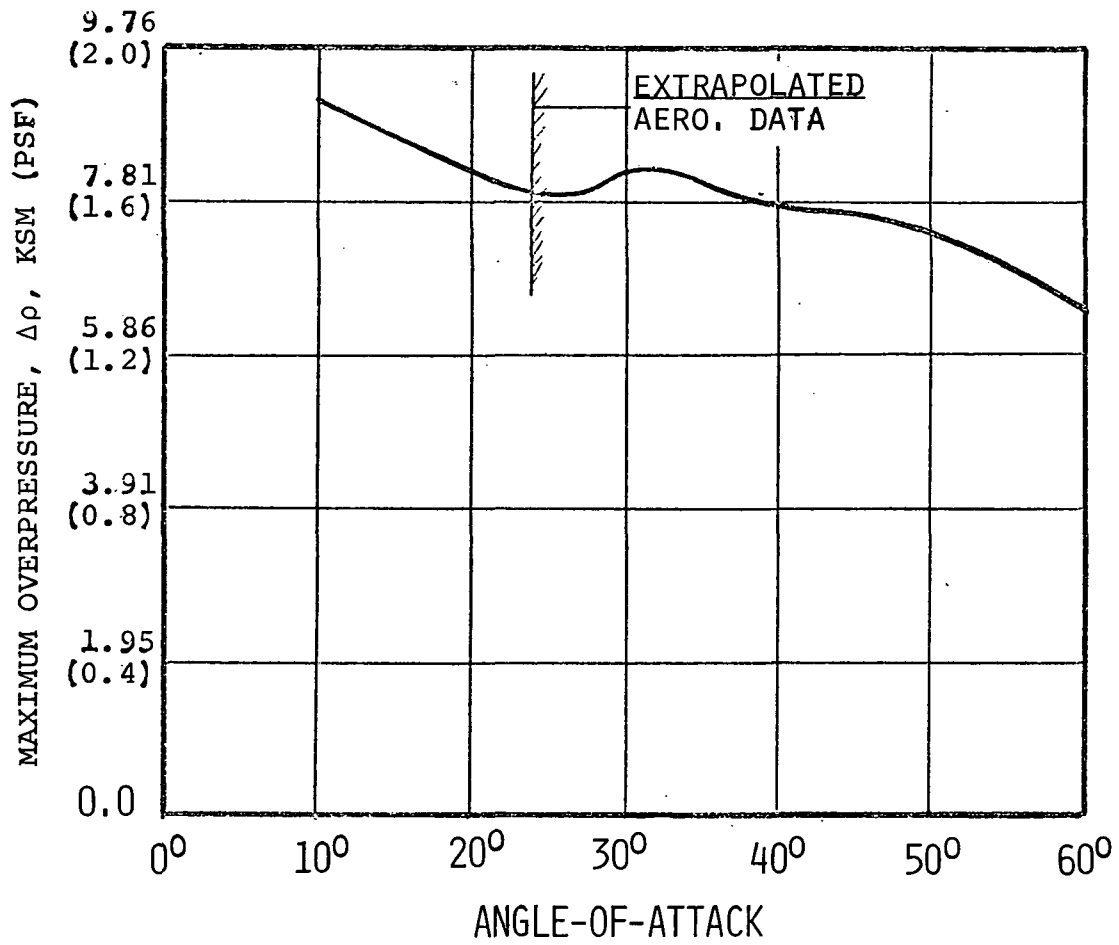

FIGURE 28 MAXIMUM OVERPRESSURES, CONSTANT α DESCENTS.

TRAJECTORY	ANGLE OF ATTACK	ΔP_{MAX}	% GAIN	H*
MSC NOMINAL	VARYING	8.49 KSM (1.74 P.S.F.)	0	19.8 KM (65000')
BEST CONSTANT α	24°	7.91 (1.62)	7%	25.4 KM (83500')
BEST 2-PARAMETER	13°, 22.9°	6.98 (1.43)	18%	25.4 KM (83400')
BEST 4-PARAMETER	15°, 13.2° 15.2°, 25°	6.93 (1.42)	18%	26.7 KM (87600')
BEST CONSTANT α	60°	6.44 (1.32)	24%	29.9 KM (98000')
BEST 2-PARAMETER	60°, 60°	6.44 (1.32)	24%	29.9 KM (98000')
BEST 4-PARAMETER	60°, 56°, 55.5°, 60°	6.40 (1.31)	24%	29.7 KM (97400')

LOW ANGLE

HIGH ANGLE

FIGURE 29 MAXIMUM OVERPRESSURES ON CONSTANT α REENTRIES.

of attack range $0 < \alpha < 24^\circ$. The results are summarized below. Only a slight gain resulted in going to angle of attack modulation at Mach 10 rather than Mach 5.

<u>TRAJECTORY</u>	<u>ΔP_{max}</u>	<u>ANGLE OF ATTACK</u>
Best constant α	1.53	23.4°
Best two parameter	1.49	$9.7^\circ, 23.9^\circ$
Best four parameter	1.45	$8^\circ, 17^\circ, 12.9^\circ, 22^\circ$.

Finally, some pitch control optimization studies were undertaken with the following results:

<u>TRAJECTORY</u>	<u>ΔP_{max}</u>	<u>PITCH ANGLE</u>
Best constant pitch	1.41	12.04°
Best two parameter	1.40	$18.8^\circ, 12.5^\circ$

The last result was the best solution obtained without extrapolation of the MSC aerodynamic data.

USE OF THE PROGRAM

Input to the program consists primarily of vehicular data, atmospheric properties, aircraft flight conditions and near-field pressure signatures data. Atmospheric properties are input in the form of temperature and wind profiles. The atmospheric pressure variations with altitude are computed in the program from input temperature profiles using the perfect gas law and the hydrostatic equation. Winds in both the northerly and easterly direction can be input allowing winds shear. However, vertical winds and atmospheric turbulence are not accounted for in this program.

Flight conditions include Mach number, altitude, flight path angle and aircraft acceleration. The three components of aircraft acceleration are expressed in terms of the time rates of change of Mach number, flight path angle and heading respectively. The near-field pressure signature data consists of the signature itself and the corresponding location relative to the aircraft. The signature is input in the form of P/P_0 (more commonly known as DP/P) versus X , where X is the special coordinate measured parallel to the aircraft velocity vector. The signature can be input directly and if done so, it should be consistent with the flight conditions specified. The flight conditions that affect the near-field signature are Mach number and lift coefficient. Therefore, the lift coefficient should first be estimated from the aircraft weight, flight altitude, Mach number and aircraft acceleration. The near-field signature corresponding to the Mach number and the required lift coefficient can then be determined experimentally by wind tunnel tests or by theoretical means. Normally a near-field signatures are determined in the wind tunnel. Signatures are obtained at several lift coefficients or angles of attack and in several azimuthal planes of the model. The near-field signature corresponding to the specific lift coefficient and locations relative to the model can then be estimated by interpolation.

General Input Procedure

The use of the SBOOM program is illustrated in figure 30. Measured pressure signatures from wind tunnel tests (or any other source) are stored in a pressure signature data base by the GETTAB program (see Volume II). Vehicle properties and atmospheric conditions are read into the SBOOM program through the normal input channels. Flight conditions may also be read into the program by the same channels. However, flight conditions may be obtained from a trajectory program via an auxiliary input device (tape or disk). In figure 30, the POST program is illustrated.

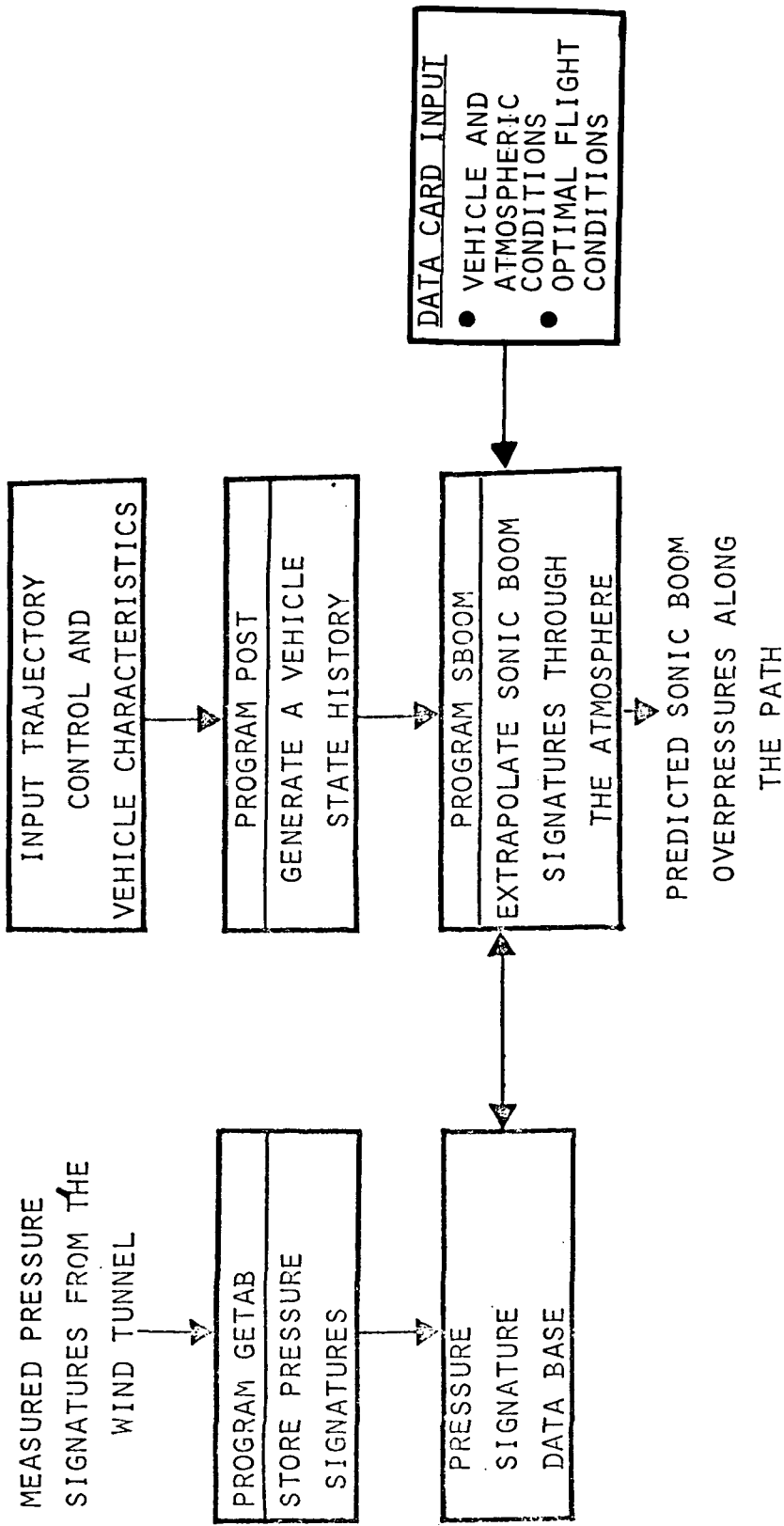

FIGURE 30 ILLUSTRATION OF THE USE OF SB00M.

NAMELIST Data Format

The program uses NAMELIST input for the following reasons:

1. It is a simple name oriented input easily understood by most engineers.
2. The format is standard and does not require relearning from program to program.
3. It is easily modified by the engineer or programmer when adding input variables to the program.

When NAMELIST read is encountered in a program, the entire input file is scanned up to an end-of-file or a record with a \$ in column 2 followed immediately by the namelist name requested by the program. Succeeding data items are read until a second \$ is encountered signifying the end of the NAMELIST. Any data on the input file before the requested namelist is found will be ignored. All data between the opening and closing \$ are interpreted by NAMELIST.

The data item within the NAMELIST statement may be in any of three forms:

$$v = c,$$

$$a = d_1, \dots, d_j,$$

$$a(n) = d_1, \dots, d_m,$$

v is a variable name; c is a constant; a is an array name, and n is an integer constant subscript, d_j are simple constants or repeated constants of the form $k*c$, where k is the repetition factor. Data items and constants must be separated by commas.

The number of constants, including repetitions, given for an unsubscripted array name must equal the number of elements in that array. For a subscripted array name, the number of constants need not equal, but may not exceed, the number of array elements needed to fill the array.

The specified constant of the NAMELIST statement may be integer, real, double precision, complex of the form (c_1, c_2) or logical of the form T, or .TRUE., F, or .FALSE.. A logical or complex variable may be set only to a logical

and complex constant, respectively. Any other variable may be set to an integer, real or double precision constant. Such a constant is converted to the type of its associated variable.

Constants and repeated constant fields may not include embedded blanks. Blanks, however, may appear elsewhere in data records.

The entire card record excluding the first character is permitted. More than one card may be used for input data, and arrays may be split between cards. All except the last record must end with a constant followed by a comma, and no sequence numbers may appear. The first column of each record is ignored.

The set of data items may consist of any subset of the variable names associated with the NAMELIST name. These names need not be in any particular order.

SBOOM Program Input

The input procedure for the SBOOM program is illustrated in figure 31. The initial read of the \$SBIN namelist input establishes the vehicle properties and atmospheric data. The \$SBIN input list is summarized in figure 32. The source for the flight conditions data is also established from the above read. After the flight conditions are determined, the corresponding pressure signature is determined by the geometry similarity rule. Then the Thomas extrapolation procedure is executed. The program then returns for new flight conditions.

The flight conditions data can be obtained from four different sources depending on the input value of IROPTN read in the \$SBIN namelist above.

- IROPTN = 0 Flight conditions read in the namelist \$FCON.
- IROPTN = 1 Conditions read from a binary tape in fixed format.
- IROPTN = 2 Flight conditions read from a binary tape in the old POST format.
- IROPTN = 3 Flight conditions read from a binary tape in the new format (NAS 1-12165).

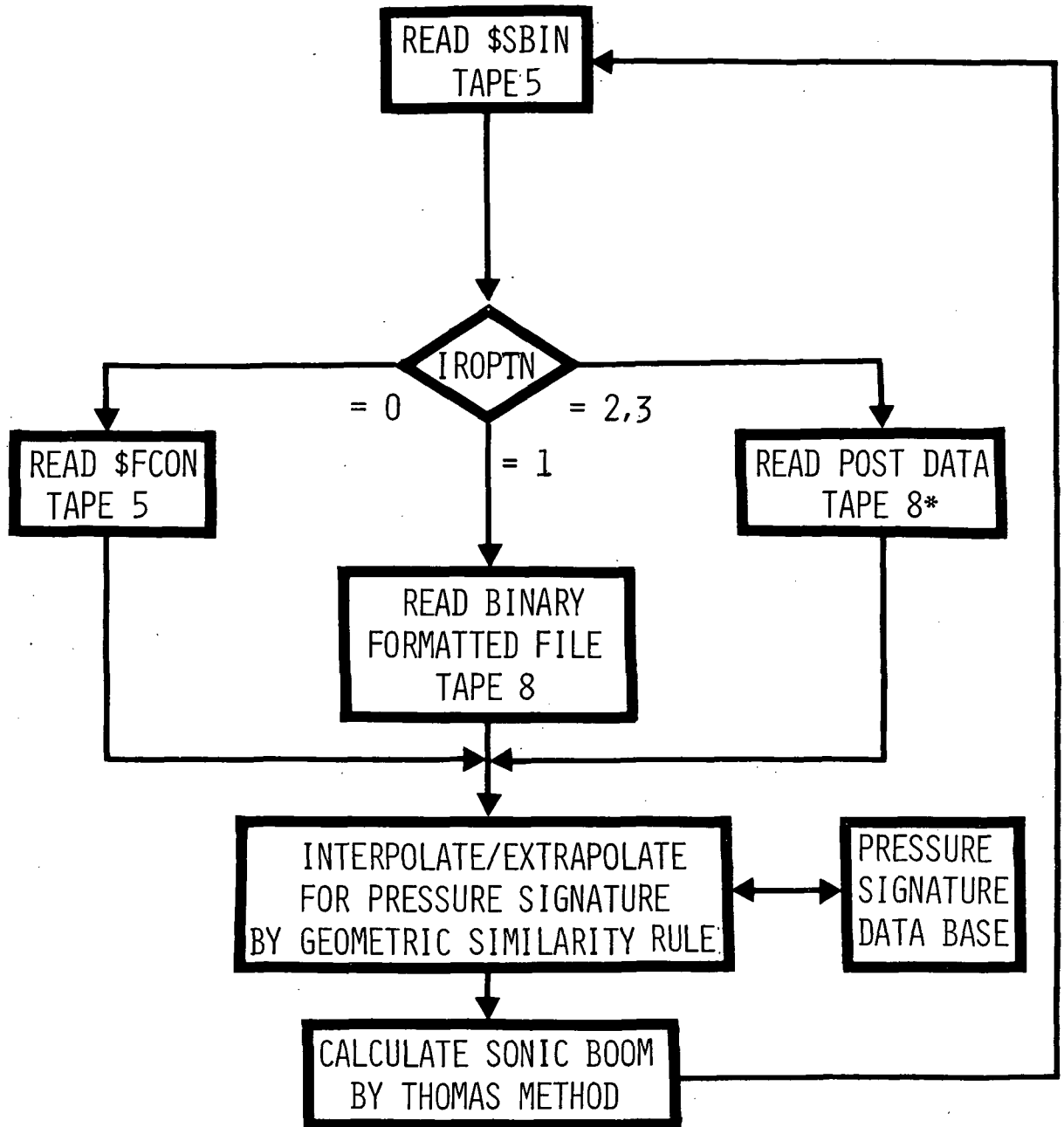

*IROPTN = 2 OR 3 DEPENDING ON WHICH POST FORMAT IS EMPLOYED.

FIGURE 31 SBOOM INPUT FLOW LOGIC

<u>NAMELIST Name</u>	<u>Nominal Values</u>	
PRINTN	.FALSE.	Printout switch for Thomas boom program FALSE - no printout TRUE - complete normal printout
AL VEHLEN	100	Vehicle length in feet
REFL REFLEC	1.9	Ground reflection factor
OCODE	2	1 - requested signature in milliseconds 2 - requested signature in feet
NTEMP	7	Number of atmospheric temperature points
NWINDE	2	Number of easterly wind points
NWINDN	2	Number of northerly wind points
T0(I)	100*0.	Temperatures
ZT(I)	100*0.	Altitude of temperature points in FT*10 ³
ZWE(I)	100*0.	Altitude of easterly wind points in FT*10 ³
VOE(I)	100*0.	Easterly wind velocities
ZWN(I)	100*0.	Altitude of northerly wind points in FT*10 ³
VON(I)	100*0.	Northerly wind velocities
NALT	1	Number of altitudes at which requested signature is desired.
ALT(I)	50*0.	Altitude at which requested signature is desired (feet)

FIGURE 32A NAMELIST \$SBIN INPUT.

<u>NAMELIST Name</u>	<u>Nominal Values</u>	
INDSBM	1	Sonic Boom frequency indicator.
ACCOVP	2.0	Maximum acceptable overpressure (psf)
T1BOOM	60.	Flight condition data on tape is not processed before this time (trajectory time units).
T2BOOM	160.	Flight conditions data on tape will be ignored beyond the time (trajectory time units).
HRACON	0.	Altitude below which the ray tube constraint will be calculated (ft).
PLOT	.FALSE.	Plot option for pressure signature interpolation. If .TRUE., an input file for the independent plot program is generated which generates data base source signatures and the interpolated signatures for each flight condition.
PRNTRP	.FALSE.	Print option for pressure signature interpolation. If .TRUE., the source signatures and interpolated signatures are printed.
POSTPT	.FALSE.	Print options for POST trajectory tape. If .TRUE., tape will be dumped.
NSWEEP	0	Number of lateral sonic boom extrapolations to be computed to the right and to the left of the ground track. (NSWEEP = 2 means 2 extrapolations each side.)
DELXRG	1.0	Steps in cross range (statute miles) to be used for computing lateral sonic boom extrapolations (overpressure observations written Unit 12).

FIGURE 32B NAMELIST \$SBIN INPUT.

Input Flight Conditions. - If the read option (IROPTN = 0) is selected, the user supplies successive \$FCON input lists for the desired flight conditions which he wishes to evaluate. The \$FCON input list is summarized in figure 33. Many of the flight conditions have more than one name corresponding to (1) the original Thomas program names, (2) the ATOP input names and (3) the POST input names. Multiple flight conditions input is illustrated in figure 34.

Flight Conditions Tape. - If IROPTN is set to 1, flight conditions data must be read in a binary format of the following twelve items on one record in order.

TIME	Trajectory Time (Sec)
HGC7F	Vehicle altitude (Feet)
GAM7D	Flight path angle (Deg)
GAM7D1	Time derivative of flight path angle (deg/sec)
SIG7D	Heading angle (Deg)
PHILD	Latitude (Deg)
THL7D	Longitude (Deg)
AMACH	Vehicle Mach number
AMACH1	Time derivative of Mach number
BA77D	Bank of roll angle (Deg)
SIG7D1	Time derivative of heading angle (Deg/sec)
ALPHD	Angle of attack (Deg)

The above list of names and descriptions corresponds to the names from the ATOP program. However, this same format may be generated from any trajectory program and stored on a binary file on the above format for use by the SBOOM program. If the flight conditions tape is used, the trajectory time range to be evaluated may be specified by the \$SBIN input, T1BOOM and T2BOOM.

Flight Conditions from POST. - Special read options (IROPTN = 2 or 3) have been incorporated in the SBOOM program which permits the regular output tape from the POST programs to be interrogated for the required flight condition information. The only limitation is that the first item on the POST output list for each print

<u>NAMELIST</u> <u>Name</u>	<u>Nominal</u> <u>Values</u>	
MACH AMACH	0.	Vehicle Mach number
FLTALT HGC7F ALTITO	100000.	Vehicle Altitude (feet)
MDOT AMACH1 MACHDT	0.	Time derivative of Mach number (per sec)
PSIDOT SIG7D1	0.	Time derivative of heading angle (deg/sec)
GAMDOT GAM7D1	0.	Time derivative of flight path angle (deg/sec)
FPA GAM7D GAMMAR	0.	Flight path angle (deg)
LONGP THL7D LONG	0.	Longitude (deg)
LATP PHILD GDLAT	0.	Latitude (deg)
HEAD SIG7D SIGMAR	0.	Heading angle (deg)
POG	2116.2	Atmospheric ground pressure (psf)
BA77D BNKANG	0.	Roll angle (deg)
ALPHA ALPHD	0.	Angle of attack (deg)
TIME	0.	Trajectory Time (sec)

FIGURE 33A NAMELIST \$FCON INPUT.

<u>NAMELIST NAME</u>	<u>NOMINAL VALUES</u>	
NX	0	Number of input values for X(I) and DPP(I).
X(I)	50*0	Spatial coordinate measured parallel to the vehicle velocity vector, the independent variable for the near-field pressure signature (can be input in any unit of length).
DPP(I)	50*0	The value of overpressure $\Delta\rho/\rho$ corresponding to X(I).
ML	0.	Model reference length in the same units of length as for X(I).
ROVERL	0.	Radial distance (non-dimensional by the aircraft length) from the flight path corresponding to the input pressure signature.
NALT	1	Number of altitudes at which extrapolated signatures are desired.
ALT	50*0	The altitudes at which extrapolated signatures are desired.
PHI	0	Angle of extrapolation measured from the vertical (downward). The angle (PHI - BNKANG) must be the orientation of the signature used in the sonic boom calculation.

FIGURE 33B NAMELIST \$FCON INPUT.

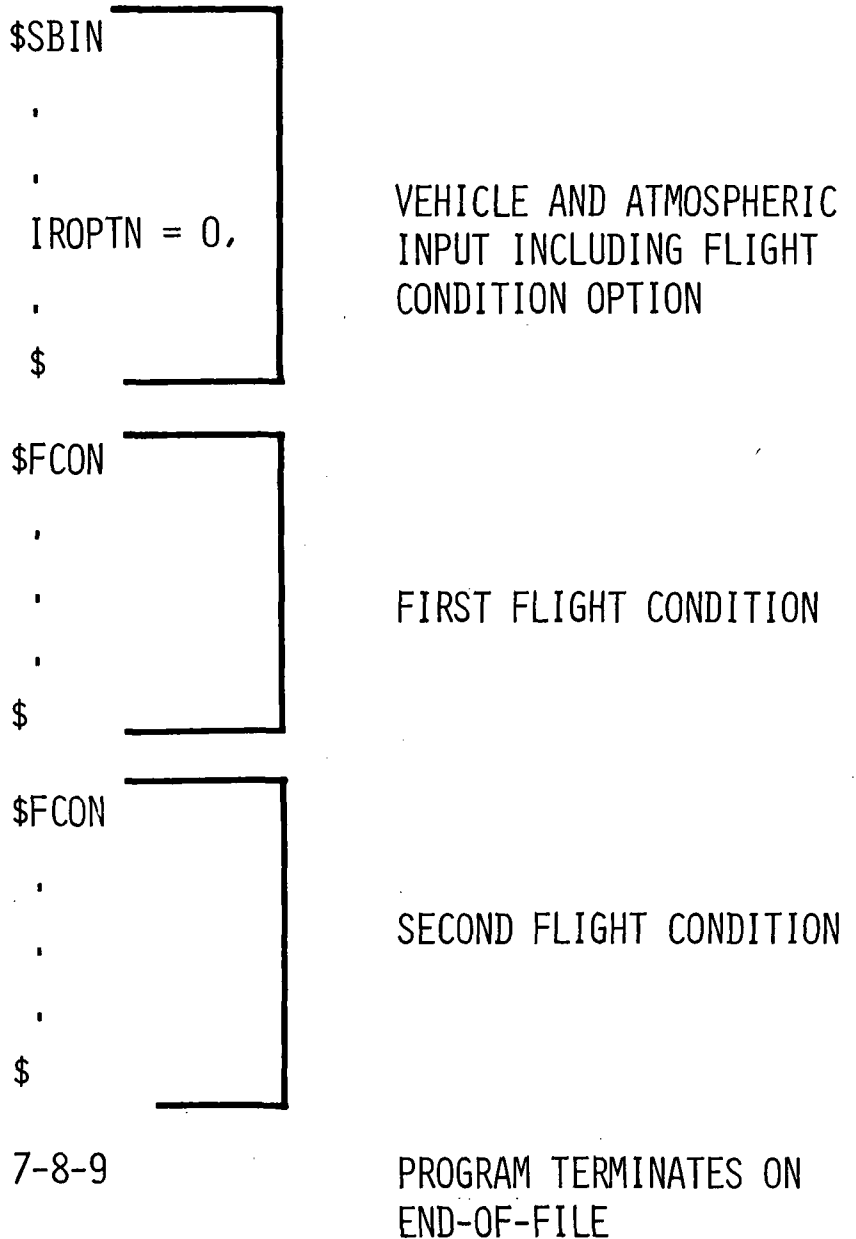

FIGURE 34 MULTIPLE FLIGHT CONDITIONS USING \$FCON

step must be TIME. The program interrogates the file for the other flight conditions specified in figure 35 until a new value of TIME is encountered. If all conditions are not present on the file, the nominal values shown in figure 35 are assumed.

It should be noted the POST output tapes are entirely different formats for IROPTN = 2 and IROPTN = 3. The user must be aware of which version of POST is being used. Option 3 uses the POST version generated under Contract NAS 1-12165.

Basic Deck Setup. - The program may be used independently, sequentially with POST or other programs, or it may be used in ODIN for optimization or trajectory matching studies. The deck setup for the SBOOM program independent of a ancillary programs (see Volume II) consists of the above described program input data preceded by a set of control cards. The control cards vary depending primarily upon the source of the flight conditions. The basic deck setup is illustrated in figure 36. The illustrated setup assumes the pressure signature data base and flight conditions have been previously stored on data cell. The file replacement parameters for the pressure signature data base and the flight conditions file are the fourth and fifth file parameter on the SBOOM execution card respectively. If the flight conditions are read from input or were generated by a prior execution in the same job, the FETCH card for FLTCN would not be necessary. The program loads in 61000 octal and executes in 53500 octal core locations.

The file parameters for the SBOOM program include the following:

NMLIST	BCD output file for ODIN data base modification.
FLTCN	Binary flight conditions file.
PSIGS	Binary pressure signature data base file.
SIGPLT	BCD file for generating pressure signature interpolations from the independent plot programs.
FCONPLT	Binary file of input flight conditions (from T1BOOM to T2BOOM).
CONTOUR	Binary file of pressure signatures observations written when NSWEEP greater than zero.

Deck Setup for Use of SBOOM with POST. - Figure 37 illustrates the use of SBOOM with POST for evaluation of sonic boom constraints along a POST generated trajectory.

Deck Setup for Use of SBOOM within ODIN. - Figure 38 illustrates the use of SBOOM with ODIN for a sonic boom footprint study.

<u>POST</u> <u>NAME</u>	<u>NOMINAL</u> <u>VALUE</u>	<u>DESCRIPTION</u>
TIME	-	TIME (SEC)
ALTITO	0.	ALTITUDE (FT)
GAMMAR	0.	FLIGHT PATH ANGLE (DEG)
GAMDOT	0.	TIME DERIVATIVE OF FLIGHT PATH ANGLE (DEG/SEC)
SIGMAR	0.	HEADING (DEG)
GDLAT	0.	LATITUDE (DEG)
LONG	0.	LONGITUDE (DEG)
MACH	1.0101	MACH NUMBER
MACHDT	0.	TIME RATE OF MACH CHANGE (PER SEC)
BNKANG	0.	BANK ANGLE (DEG)
SIGDOT	0.	TIME RATE OF CHANGE OF HEADING (DEG/SEC)
ALPHA	0.	ANGLE OF ATTACK (DEG)

FIGURE 35 FLIGHT CONDITIONS FROM POST.

```
JOB - - -  
USER, - - -  
FETCH,A3682,SPRZ14,BINARY,,FETCH.  
FETCH,DA423,,DATA,,,PSIGS.  
FETCH,A4190,,BINARY,,FLTCON.  
FETCH,A4193,,BINARY,,SBOOM.  
SBOOM,,,NMLIST,FLTCON,PSIGS,SIGPLT.  
7-8-9  
DATA  
6-7-8-9
```

FIGURE 36 DECK SETUP FOR SBOOM USING STORED FLIGHT
CONDITIONS TAPE.

```
JOB - - -  
USER. - - -  
FETCH,A3682,SPRZ14,BINARY,,FETCH.  
FETCH,DA423,,DATA,,,PSIGS.  
FETCH,A4199,,BINARY,,POSTF.  
FETCH,A4193,,BINARY,,SBOOM.  
POSTF.  
SBOOM,,,,PROFIL.  
7-8-9  
    (POST DATA)  
7-8-9  
    (SBOOM DATA)  
6-7-8-9
```

FIGURE 37 DECK SETUP FOR USING POST WITH SBOOM.

```
JOB - - -  
USER - - -  
FETCH,A3682,SPRZ14,BINARY,,GOGET.  
7-8-9  
7-8-9  
'CREATE DBASE'  
    (INITIAL DATA BASE DEFINITIONS)  
*EOF  
'EXECUTE POST'  
    (POST DATA)  
*EOF  
'EXECUTE VARIAN'  
    (NO DATA - THIS EXECUTION INITIALIZES THE ODIN PLOT SYSTEM)  
*EOF  
'EXECUTE SBOOM'  
    (SBOOM DATA)  
*EOF  
'EXECUTE PLOTTER'  
    (PLOTTER DATA)  
*EOF  
'END ODIN'
```

FIGURE 38 USE OF SBOOM WITHIN ODIN.

The loop is established around POST, SBOOM and PLOTTER whereby the flight conditions and trajectory performance are generated by POST, the sonic boom criteria are generated by SBOOM and the plotted results are generated by PLOTTER. The independent plot program is executed to generate the pressure signature contours along the flight path. (See reference 2 for complete details on the use of ODIN.) Appendix A discusses the results for the test case illustrated in figure 38.

REFERENCES

1. Thomas, Charles L.: Extrapolation of Wind Tunnel Sonic Boom Signatures without Use of the Whitham F-Functions, NASA SP-255, pp-205, Third Conference on Sonic Boom Research Held at NASA Headquarters, Washington D.C., October 29-30, 1970.
2. Glatt, C. R., Hague, D. S. and Watson, D. A.: DIALOG: An Executive Computer Program for Linking Independent Computer Programs. NASA CR-2296, September 1973.
3. Hague, D. S.: Three-Degree of Freedom Problem Optimization Formulation, FDL-TDR-64-1, Part 1, Volume III, 1964.
4. Mobley, R. L. and Vorwald, R. F.: Three-Degree of Freedom Problem Optimization Formulation, FDL-TDR-64-1, Part 2, Volume III, 1964.
5. Hague, D. S.: Application of the Variational Steepest-Descent Method to High Performance Aircraft Trajectory Optimization, NASA CR-73366, August 1969.
6. Hague, D. S. and Glatt, C. R.: An Introduction to Multi-variable Search Techniques for Parameter Optimization, NASA CR-73200, April 1968.
7. Hicks, Raymond M., Mendoza, Joel P.: Wind Tunnel Pressure Signatures for a Delta Wing Space Shuttle Fuel Tank. NASA TM-X-62, 119, SSPD-80, April 1972.
8. Hague, D. S., Glatt, C. R. and Jones, R. T.: Integration of Aerospace Vehicle Performance and Design Optimization, AIAA Paper No. 72-948, September 1972.

APPENDIX A - TEST CASE

This appendix illustrates the type of analysis available from the expanded sonic boom prediction program by using it with the ODIN system and associated program modules. The analysis involved the use of the POST Program, the Sonic Boom Program and an independent plot program. POST was used for calculating and optimizing a reentry trajectory. Optimization was based on maximum cross range as the performance criteria and bank angle as a control function. Angle of attack was held constant through most of the reentry trajectory but was decreased in the linear manner during the latter portion of the reentry. The Mach-Altitude (M-h) flight profile for the trajectory is illustrated in figure A-1. The region in which the ground overpressure becomes a factor in the analysis is illustrated in the lower portion of the M-h plane below about Mach 3. Figure A-2 shows a time history of the control angles (angle of attack and bank angle) throughout the reentry. Angle of attack was fixed and bank angle was determined in the optimization process described above.

Figure A-3 shows the ground track in terms of latitude and longitude. The region of ground overpressure significance is illustrated in the inset view, a small scale portion of the ground track near the end of the simulated trajectory. The outline of the overpressure boundary ($\Delta p/p > 0$) on the ground track is illustrated in dash lines in the inset. Figure A-4 shows the sonic boom overpressure contours in terms of cross range and trajectory time. The zero overpressure boundaries of figure A-4 map into the overpressure boundary illustrated (by dash lines) in figure A-3. The contours illustrated in figure A-4 were generated by the independent plot program using a mesh of points and associated overpressure generated by the SBOOM Program. The sonic boom program has the capability of determining overpressure at various points on the ground by sweeping through a sequence of projection angles adjacent to the vertical plane. For each sweep angle the SBOOM Program extrapolates a sonic boom signature obtained from the data base onto the ground. Each sweep angle represents a point in the overpressure contour mesh. The resulting mesh points from the extrapolations are stored for later use by the independent plot program in generating the contour map. It should be noted that the contour map does not represent a true projection of the sonic boom footprints, since it is plotted as a function of time along a curved ground track (and not in the latitude-longitude plane). The peak overpressures near the lower portion of the figure represent focusing which is also indicated in the upper portion of the inset in figure A-3. The data from figure A-4 has not been entirely mapped into the ground track of figure A-3. Cross cuts of maximum overpressure versus range from the ground track at fixed time are illustrated in figure A-5.

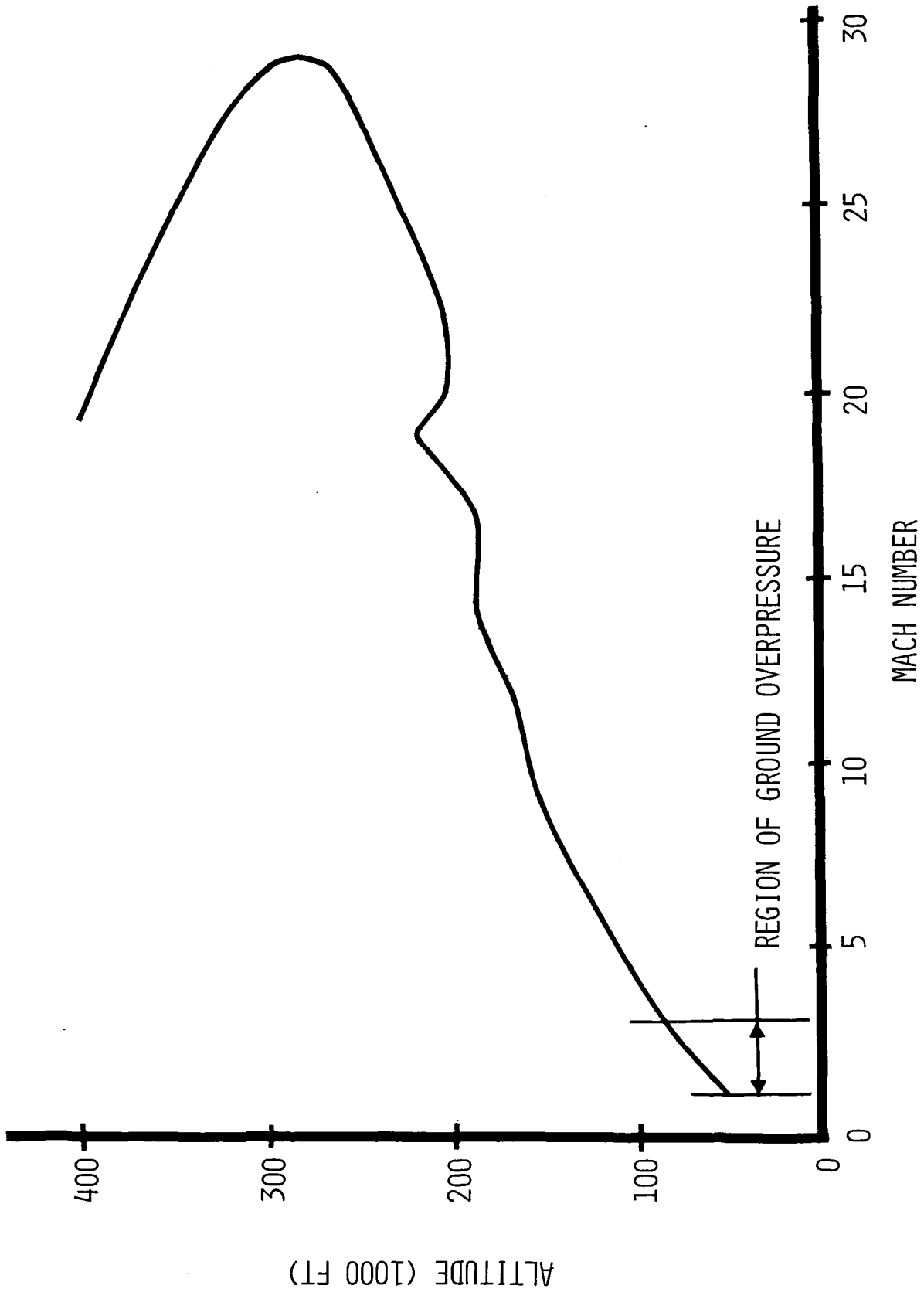
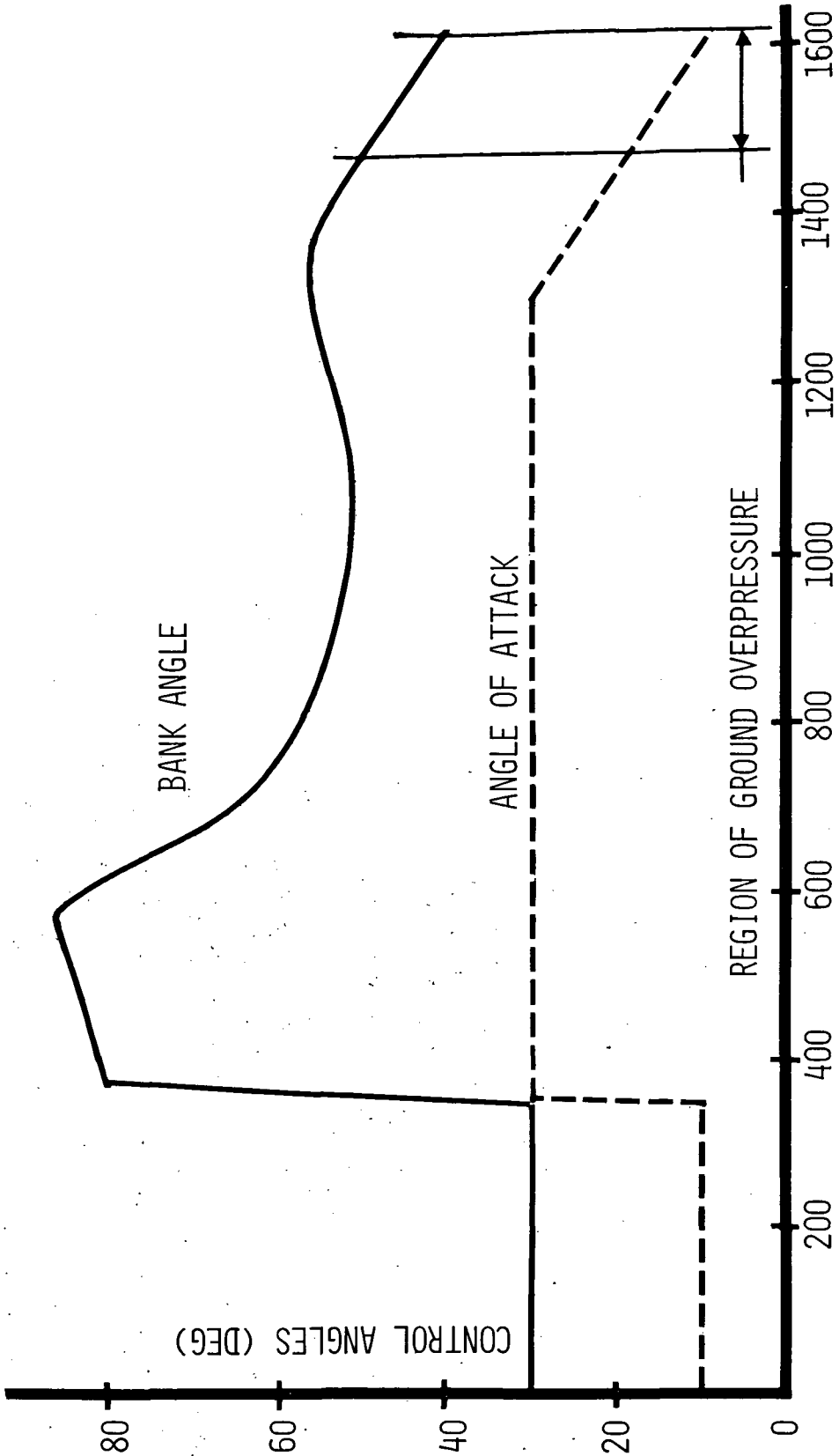
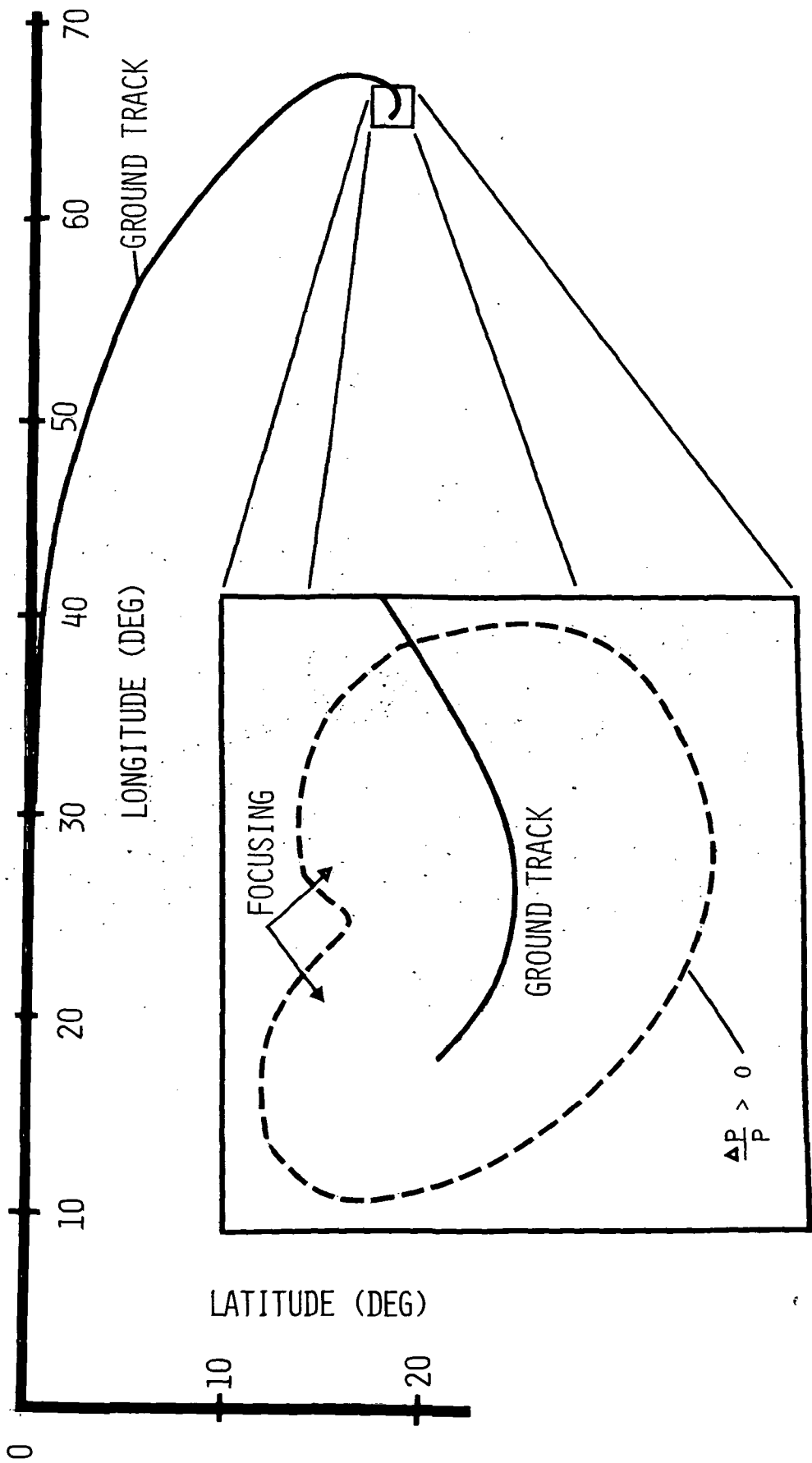

FIGURE A1 MACH-ALTITUDE PROFILE



TIME (SECONDS)

FIGURE A2 REENTRY CONTROL ANGLE HISTORIES



REGION OF GROUND OVERPRESSURE

FIGURE A3 REENTRY GROUND TRACK

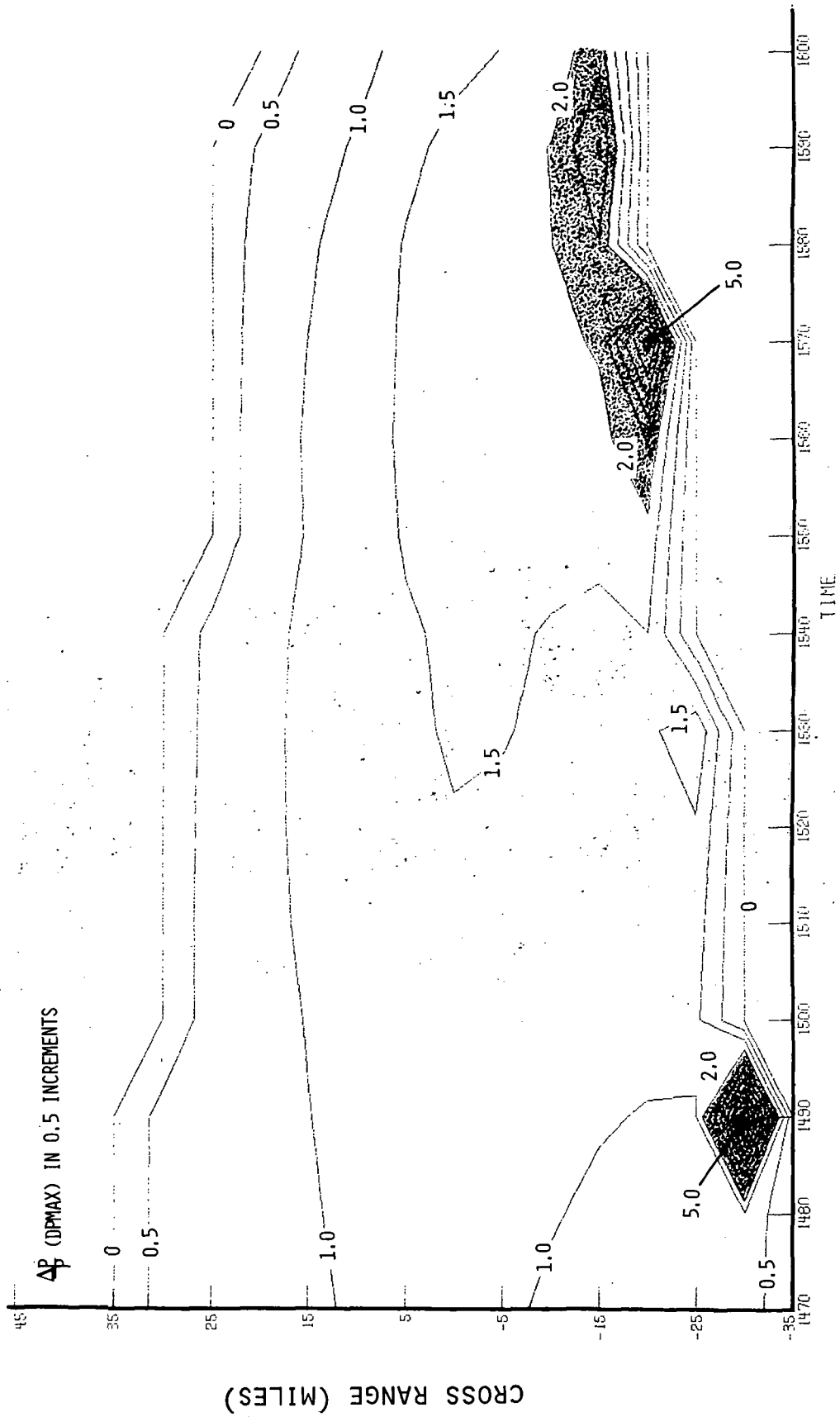

FIGURE A-4 SONIC BOOM OVERPRESSURE CONTOURS.

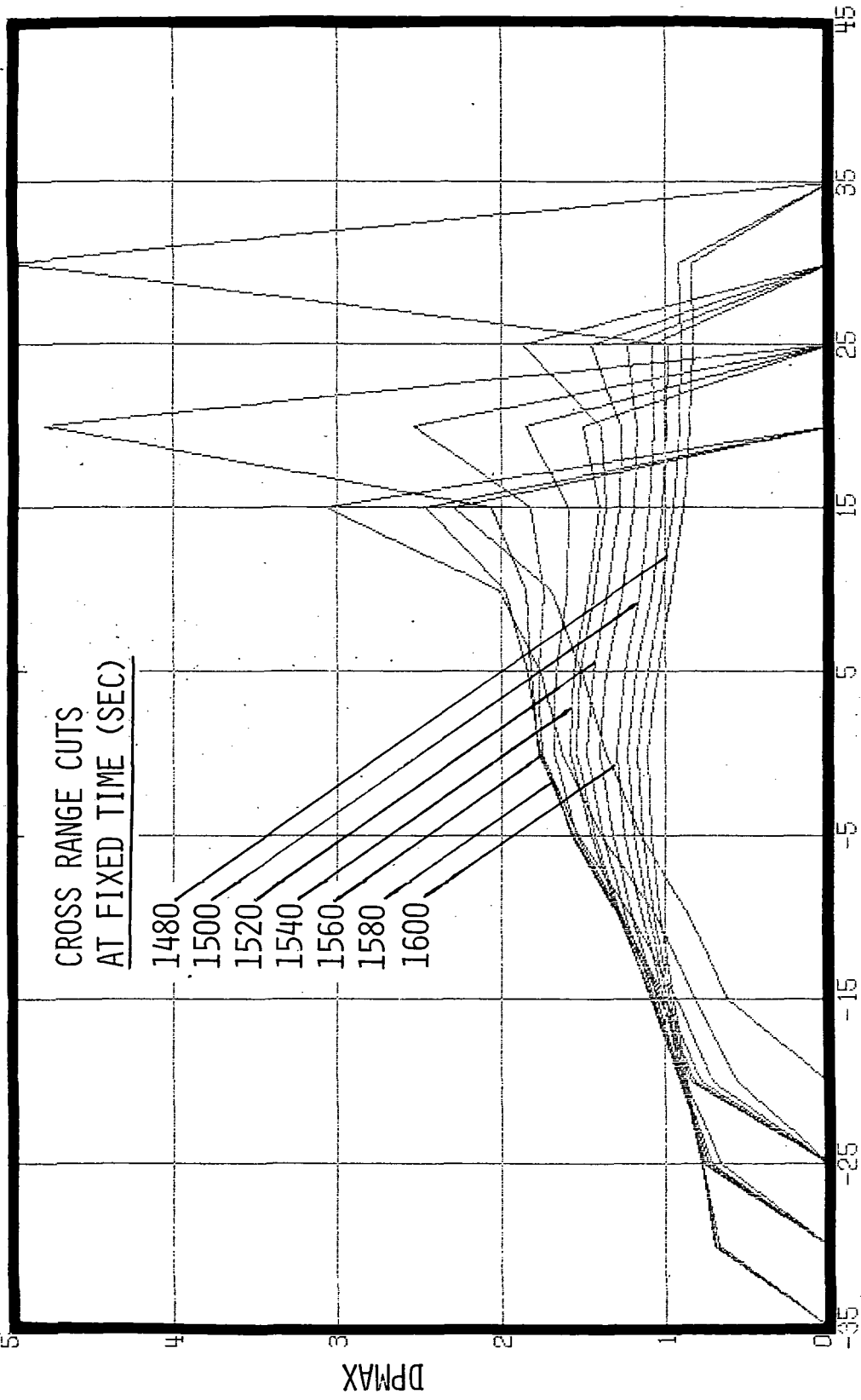

FIGURE A5 GROUND OVERPRESSURE LEFT (-) AND RIGHT (+) OF GROUND TRACK

Peak overpressures are illustrated to the right of the ground track and represent the focusing illustrated in figures A-3 and A-4.

The data presented herein represents an illustration of analyses which may be performed with the SBOOM Program when used within the ODIN system. Indeed the analysis can be extended using computer tools available within the ODIN system for studying the sonic boom problem. It should be noted that the present study does not represent a complete analysis. For example, the focusing which produces high overpressures on the ground could be alleviated by "unbanking" the aircraft in the region where focusing occurs. Further, the data suggests that promising results could be obtained by some trajectory optimizing on the basis of sonic boom overpressure rather than just cross range.

National Aeronautics and Space Administration

WASHINGTON, D. C. 20546

OFFICIAL BUSINESS
Penalty For Private Use, \$300.00POSTAGE AND FEES PAID
NATIONAL AERONAUTICS AND
SPACE ADMINISTRATION
NASA-451FEES PAID
NATIONAL AERONAUTICS AND
SPACE ADMINISTRATIONSPECIAL FOURTH CLASS MAIL
BOOK

152-025-C1-U AL 750117 S11092AU

NASA
SCIEN. & TECH INFO FACILITY
ATTN: DOCUMENT SUPPLY DEPT
P O BOX 33
COLLEGE PARK MD 20740

POSTMASTER :

If Undeliverable (Section 158
Postal Manual) Do Not Return

"The aeronautical and space activities of the United States shall be conducted so as to contribute . . . to the expansion of human knowledge of phenomena in the atmosphere and space. The Administration shall provide for the widest practicable and appropriate dissemination of information concerning its activities and the results thereof."

—NATIONAL AERONAUTICS AND SPACE ACT OF 1958

NASA SCIENTIFIC AND TECHNICAL PUBLICATIONS

TECHNICAL REPORTS: Scientific and technical information considered important, complete, and a lasting contribution to existing knowledge.

TECHNICAL NOTES: Information less broad in scope but nevertheless of importance as a contribution to existing knowledge.

TECHNICAL MEMORANDUMS: Information receiving limited distribution because of preliminary data, security classification, or other reasons. Also includes conference proceedings with either limited or unlimited distribution.

CONTRACTOR REPORTS: Scientific and technical information generated under a NASA contract or grant and considered an important contribution to existing knowledge.

TECHNICAL TRANSLATIONS: Information published in a foreign language considered to merit NASA distribution in English.

SPECIAL PUBLICATIONS: Information derived from or of value to NASA activities. Publications include final reports of major projects, monographs, data compilations, handbooks, sourcebooks, and special bibliographies.

TECHNOLOGY UTILIZATION PUBLICATIONS: Information on technology used by NASA that may be of particular interest in commercial and other non-aerospace applications. Publications include Tech Briefs, Technology Utilization Reports and Technology Surveys.

Details on the availability of these publications may be obtained from:

SCIENTIFIC AND TECHNICAL INFORMATION OFFICE

NATIONAL AERONAUTICS AND SPACE ADMINISTRATION

Washington, D.C. 20546