

**NASA**

**NATIONAL AERONAUTICS AND SPACE ADMINISTRATION**

NASA CR-

141511

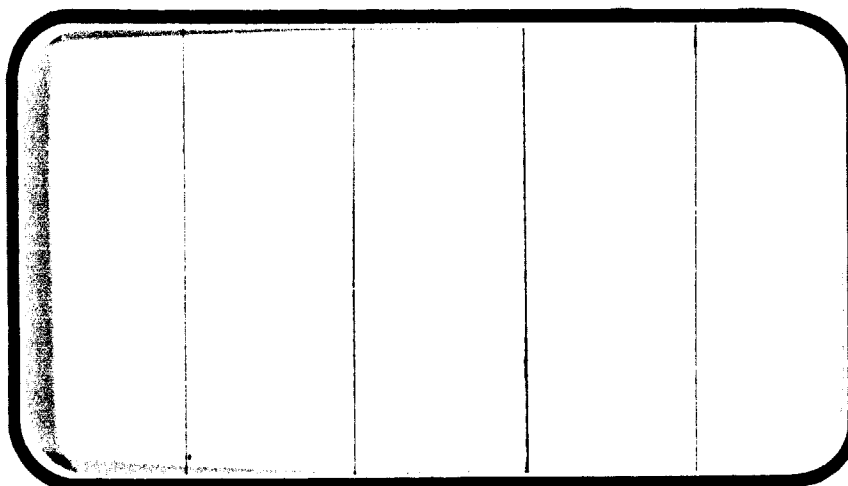

(NASA-CR-141511) REENTRY AERODYNAMIC  
CHARACTERISTICS OF A SPACE SHUTTLE SOLID  
ROCKET BOOSTER (MSFC MODEL 454) AT HIGH  
ANGLES OF ATTACK AND HIGH MACH NUMBER IN THE  
NASA/LANGLEY FOUR-FOOT UNITARY PLAN WIND

N75-18298

G3/18    Unclassified  
13296

**SPACE SHUTTLE**

**AEROTHERMODYNAMIC DATA REPORT**



**JOHNSON SPACE CENTER**

**HOUSTON, TEXAS**

**DATA Management services**

SPACE DIVISION



**CHRYSLER CORPORATION**

February, 1975

DMS-DR-2150  
NASA CR-141,511

REENTRY AERODYNAMIC CHARACTERISTICS OF A  
SPACE SHUTTLE SOLID ROCKET BOOSTER (MSFC MODEL  
454) AT HIGH ANGLES OF ATTACK AND HIGH MACH  
NUMBER IN THE NASA/LANGLEY FOUR-FOOT UNITARY  
PLAN WIND TUNNEL (SA25F)

by

J. Johnson, NASA/MSFC  
W. F. Braddock, NSI

Prepared Under NASA Contract Number NAS9-13247

by

Data Management Services  
Chrysler Corporation Space Division  
New Orleans, La., 70189

for

Engineering Analysis Division  
Johnson Space Center  
National Aeronautics and Space Administration  
Houston, Texas

WIND TUNNEL TEST SPECIFICS:

Test Number: LaRC 4' UPWT 1087  
NASA Series No.: SA25F  
Model Number: MSFC 454  
Test Dates: March 4 - 11, 1974  
Occupancy Hours: 30

FACILITY COORDINATOR:

Mr. Robert E. Pitcock  
Marshall Space Flight Center  
Mail Stop ED32  
Huntsville, Alabama 35801

Phone: (205) 453-0172

PROJECT ENGINEERS:

Mr. J. Johnson  
Marshall Space Flight Center  
Mail Stop ED32  
Huntsville, Alabama 35801

Phone: (205) 453-0172

Mr. W. D. Braddock  
Northrop Services, Inc.  
6025 Technology Drive  
Huntsville, Alabama 35807

Phone: (205) 837-0580

C. D. Trescot, Jr.  
Mail Code 406  
NASA/Langley Research Center  
Langley Station  
Hampton, Virginia 23665

Phone: (804) 827-3181

DATA MANAGEMENT SERVICES:

Prepared by: Liaison -- V. W. Sparks  
Operations -- D. B. Watson

Reviewed by: G. G. McDonald, J. L. Glynn

Approved: N. D. Kemp  
N. D. Kemp, Manager  
Data Management Services

Concurrence: J. G. Swider  
J. G. Swider, Manager  
Flight Technology Branch

Chrysler Corporation Space Division assumes no responsibility for the data presented other than display characteristics.

REENTRY AERODYNAMIC CHARACTERISTICS OF A  
SPACE SHUTTLE SOLID ROCKET BOOSTER (MSFC MODEL  
454) AT HIGH ANGLES OF ATTACK AND HIGH MACH  
NUMBER IN THE NASA/LANGLEY FOUR-FOOT UNITARY PLAN WIND  
TUNNEL (SA25F)

By

J. Johnson, NASA/MSFC  
W. F. Braddock, NSI

ABSTRACT

A force test of a 2.112 percent scale Space Shuttle Solid Rocket Booster (SRB), MSFC Model 454, was conducted in test section #2 of the Langley Research Center's Unitary Plan Wind Tunnel. This test, UPWT 1087, occupied the tunnel for 30 hours between March 4 and March 11, 1974. Sixteen (16) runs (pitch polars) were performed over an angle of attack range from 144 through 179 degrees. Test Mach numbers were 2.30, 2.70, 2.96, 3.48, 4.00 and 4.63. The first three Mach numbers had a test Reynolds number of 1.5 million per foot. The remaining three were at 2.0 million per foot. The model was tested in the following configurations:

1. SRB without external protuberances
2. SRB with an electrical tunnel and a SRB/ET thrust attachment structure.

Schlieren photographs were taken during testing of the first configuration. The second configuration was tested at roll angles of 45, 90 and 135 degrees.

## TABLE OF CONTENTS

	PAGE
ABSTRACT	iii
INDEX OF MODEL FIGURES	2
INDEX OF DATA FIGURES	3
NOMENCLATURE	4
INTRODUCTION	8
MODEL AND SUPPORT HARDWARE	9
CONFIGURATIONS INVESTIGATED	12
TEST FACILITY DESCRIPTION	13
DATA ACQUISITION AND REDUCTION	14
DATA PRESENTATION	17
REFERENCES	19
TABLES	
I    TEST CONDITIONS	20
II   DATA SET/RUN NUMBER COLLATIONS	21
III  MODEL COMPONENT DIMENSIONS	22
IV   PLOT SUMMARY	28
FIGURES	
MODEL	29
DATA	35
APPENDIX	
TABULATED SOURCE DATA	

## INDEX OF MODEL FIGURES

FIGURE	DESCRIPTION	PAGE
1	Body and Missile Axis Systems	29
2	142 Inch Diameter SRB-0.02112 Scale Model (SRB Configuration 139 - MSFC Model #454)	30
3	SRB/ET Attachment Ring (MSFC Model #454)	31
4	Electrical Tunnel and SRB/ET Thrust Attachment Structure (MSFC Model #454)	32
5	Major Model Sections	33
6	Cavity Pressure Tap Locations	34

INDEX OF DATA FIGURES

TITLE	CONDITIONS VARYING	PLOTTED COEFFICIENT SCHEDULE	PAGE
Static Stability Characteristics of SRB With Attachment Ring	MACH	(A)	1-6
Effect of Roll Angle on Static Stability Characteristics of SRB	PHI MACH	(A)	7-24

PLOTTED COEFFICIENTS SCHEDULE

(A)  $C_{NM}$ ,  $C_A$ ,  $C_{LMM}$ ,  $C_{YM}$ ,  $C_{YNM}$ ,  $C_{BL}$  Versus ALPHA



NOMENCLATURE

<u>SYMBOL</u>	<u>PLOT SYMBOL</u>	<u>DEFINITION</u>	<u>UNITS</u>
$A_b$		base area; cross-sectional area of the cylindrical section of the model	$\text{in}^2$
$A_c$		cavity area, area of the opening required for the balance and sting	$\text{in}^2$
BMC	BMC	Balance Moment Center	
$b_{\text{ref}}$	BREF	reference span (diameter of the cylindrical section of the model)	in.
$l_{\text{body}}$		length of the body	in.
$l_{\text{ref}}$	LREF	reference length (diameter of the cylindrical section of the model)	in.
M	MACH	Mach number	
MRP	MRP	Moment Reference Point (located by XMRP, YMRP, and ZMRP)	in.
$P_{b_i}$		base pressures	psi
$P_t$		free stream total pressure	psi
$P_\infty$		free stream static pressure	psi
$q_\infty$	Q(PSF)	free stream dynamic pressure	psi
$R_N$		Reynolds number based on $l_{\text{ref}}$	
$R_N/\text{ft}$	RN/L	Reynolds number per unit length	per ft.
$S_{\text{ref}}$	SREF	reference area (cross sectional area of the cylindrical section of the model)	$\text{in}^2$
$T_t$		tunnel total temperature	$^{\circ}\text{F}$
$C_{pc}$	CPC	pressure coefficient of balance cavity	

NOMENCLATURE (Continued)

<u>SYMBOL</u>	<u>PLOT SYMBOL</u>	<u>DEFINITION</u>	<u>UNITS</u>
X, Y, Z		body axes system coordinates (for an airplane, the X, Z-plane is the plane of symmetry, the origin of the axes system is the center of gravity or any other convenient point, and the X axis is the airplane longitudinal axis)	in.
X <sub>c.g.</sub>		distance of center of gravity from nose of body	in.
X <sub>m</sub> , Y <sub>m</sub> , Z <sub>m</sub>		missile axes (see text)	in.
XMRP, YMRP, ZMRP	XMRP, YMRP, ZMRP	Abbreviations for the location of the Moment Reference Point in the missile axis system	in.
$\alpha_T$	ALPHA	total angle-of-attack, angle between the X <sub>m</sub> -axis and a vector in the direction of the relative wind	degrees
$\phi$	PHI	roll angle; i.e., angle between the missile Y <sub>m</sub> -axis and the body Y-axis (from a pilot's viewpoint in an airplane, a positive roll angle is a clockwise rotation).	degrees
C <sub>A</sub>	CA	total axial force coefficient in the body axis system	
C <sub>A<sub>b</sub></sub>	CAB	base axial force coefficient (same in both missile and body axis systems)	
C <sub>A<sub>f</sub>m</sub>	CAF	forebody axial force coefficient, C <sub>A</sub> - C <sub>A<sub>b</sub></sub>	
C <sub>A<sub>m</sub></sub>	CA	total axial force coefficient in the missile axis system, F <sub>A<sub>m</sub></sub> /q <sub>∞</sub> S <sub>ref</sub>	
C <sub>l</sub>	CL	rolling moment coefficient in the body axis system	
C <sub>l<sub>m</sub></sub>	CEL	rolling moment coefficient in the missile axis system, M <sub>Y<sub>m</sub></sub> /q <sub>∞</sub> S <sub>ref</sub> l <sub>ref</sub>	

NOMENCLATURE (Continued)

<u>SYMBOL</u>	<u>PLOT SYMBOL</u>	<u>DEFINITION</u>	<u>UNITS</u>
$C_m$	CLM	pitching moment coefficient in the body axis system	
$C_{m_m}$	CLMM	pitching moment coefficient in the missile axis system, $M_{y_m}/q_\infty S_{ref}$	
$C_N$	CN	normal force coefficient in the body axis system	
$C_{N_m}$	CNM	normal force coefficient in the missile axis system, $F_{N_m}/q_\infty S_{ref}$	
$C_n$	CYN	yawing moment coefficient in the body axis system	
$C_{n_m}$	CYNM	yawing moment coefficient in the missile axis system, $M_{z_m}/q_\infty S_{ref}$	
$C_{P_{b1}}$		base pressure coefficient: $\frac{P_{b1}-P_\infty}{q_\infty}$	
$C_y$	CY	side force coefficient in the body axis system	
$C_{y_m}$	CYM	side force coefficient in the missile axis system, $F_{y_m}/q_\infty S_{ref}$	
$X_{cp}/l$	$\Delta CP/L$	center of pressure location in fraction of body length from nose; $\left[ \frac{X_{c.p.}}{l_{body}} - \frac{C_{m_m}}{C_{N_m}} \cdot \frac{l_{ref}}{l_{body}} \right]$	
$F_{y_m}$	SF	side force in the missile axis system, positive in the positive direction of $Y_m$	lb
$F_{A_m}$	AF	total axial force in the missile axis system, positive in the negative direction of $X_m$	lb
$F_{N_m}$	NF	normal force in the missile axis system, positive in the negative direction of $Z_m$	lb

NOMENCLATURE (Concluded)

<u>SYMBOL</u>	<u>PLOT SYMBOL</u>	<u>DEFINITION</u>	<u>UNITS</u>
$M_{X_m}$	RM	rolling moment in the missile axis system; i.e., moment about the $X_m$ -axis (a positive rolling moment tends to rotate the positive $Y_m$ -axis toward the positive $Z_m$ -axis)	in.-lb
$M_{Y_m}$	PM	pitching moment in the missile axis system; i.e., moment about the $Y_m$ -axis (a positive pitching moment tends to rotate the positive $Z_m$ -axis toward the positive $X_m$ -axis)	in.-lb
$M_{Z_m}$	YM	yawing moment in the missile axis system; i.e., moment about the $Z_m$ -axis (a positive yawing moment tends to rotate the positive $X_m$ -axis toward the positive $Y_m$ -axis)	in.-lb
$\beta$	BETA	angle of sideslip	deg.
$C_L$	CL	lift coefficient (stability-axis system)	
$C_D$	CD	drag coefficient (stability-axis system)	

SUBSCRIPTS

b	base
c	cavity
c.g.	center of gravity
i	identifies the location of the base pressure measurements
m	missile axis system
ref	reference conditions
t	total conditions
∞	free stream conditions

## INTRODUCTION

In a continuing effort to determine the aerodynamic characteristics of a space shuttle solid rocket booster (SRB) during reentry, a test was conducted at the Langley Research Center 4 foot Unitary Plan wind tunnel. Static stability coefficients were obtained at high Mach numbers and high angles of attack. This report describes the test that was performed and presents the data that were obtained.

Wind tunnel conditions during this test were as follows: Mach numbers were 2.3, 2.7, 3.0, 3.5, 4.0, and 4.63; angle of attack range was 144 through 179 degrees; and Reynolds numbers were 1.5 and 2.0 million per foot.

The two model configurations investigated during this test were:

- o SRB without external protuberances
- o SRB with an electrical tunnel and a SRB/ET thrust attachment structure

## MODEL AND SUPPORT HARDWARE

### MODEL

The model, MSFC wind tunnel model 454, was a 0.02112 scale model of the 142-inch diameter Space Shuttle solid rocket booster. Details of the model are presented in Figures 2, 3, and 4 and Table III. Figure 2 presents the major dimensions of the model. Figure 3 presents the dimensions and location of a scaled attachment ring. Figure 4 presents the dimensions and location of the electrical tunnel and external tank thrust attachment structure protuberances which were attached to the model during selected portions of this test.

The model was made in seven sections. These sections, as identified in Figure 5, are a nose, a strake ring, two fill rings, a balance body, a balance body end section, and a tail section. The model was made in these seven sections to facilitate testing at all angles of attack from 0 to 180 degrees. The features that were utilized for this test were:

- o The two fill rings were assembled upstream of the balance to position the anticipated center of pressure as close as possible to the balance center.
- o The tail section was mounted upstream and the nose and strake ring sections were mounted downstream to simulate high angles of attack approaching 180 degrees. A truncated cone nose section (Figure 2) allowed the passage of the sting.

The model is designed so that roll angles of 0, 45, 90, 135, 180, 225, 270, and 315 degrees can be simulated. These roll angles can be achieved by rolling the nose and tail sections relative to the balance body. The nose and tail sections can be rolled in 22 1/2 degree increments; however, screw holes in the balance body and sting outlet section for the electrical tunnel are only provided every 45 degrees. Therefore, roll angle changes are limited to changes in 45 degree increments. The roll angle sign convention for the SRB protuberances is shown in Figure 4.

For more information on the capabilities of this model, see Reference 2.

#### SUPPORT HARDWARE

The support hardware was provided by the test facility and included:

Knuckle #4 (angle of attack mechanism)

Knuckle offset (adjusted to 7 1/2 inches)

1.5° coupling

Sting UT 30

Balance #834

Knuckle #4 was the normal angle of attack mechanism for the facility and had a range from -14 to +21 degrees. The action of the knuckle produced a fore and aft translation as well as an angle of attack change.

The center of rotation produced by knuckle #4 was behind the model. With a model as long as the one used, and at angles at which it was tested, a knuckle offset was necessary. This offset placed the centerline of the sting 7 1/2 inches below the centerline of knuckle #4.

To adjust the -14 to +21 degrees range of knuckle #4 to angles more desirable for this test, a 15 degree coupling was used. This gave balance angles of 1 to 36 degrees which for a tail forward model gave angles of attack of 179 to 144 degrees.



## CONFIGURATIONS INVESTIGATED

The run schedule, i.e., data set collation sheet, for this test, LaRC UPWT 1087, is shown in Table II. This table contains the data set identifiers for the test and gives the nominal conditions at which various configurations were tested. These conditions are angle of attack ( $\alpha_T$ ), roll angle ( $\phi$ ), and Mach number.

Configuration SRB w/attach ring was a 2.112 percent scale model of a 142 inch diameter SRB configuration, less electrical tunnel and external tank thrust attachment structure (Figures 2 and 3).

The configuration SRB w/attach ring, electrical tunnel, and thrust attachment, was formed by adding the two scaled protuberances to the previous configuration as shown in Figure 4. This configuration, tested at roll angles of 45, 90, and 135 degrees, was created by placing the scaled electrical tunnel and SRB/ET thrust attach structure on the model at the appropriate roll angle. Investigations were made over an alpha range from 144 to 179 degrees at Mach numbers of 2.3 through 4.63. A description of the individual model components is given in Table III.

## TEST FACILITY DESCRIPTION

This wind tunnel test was conducted in the Unitary Plan Wind Tunnel (UPWT) at the Langley Research Center. The UPWT is a two leg, closed return, continuous run type wind tunnel. The test sections are four by four feet in cross section and seven feet long. The Mach number range is from 1.5 to 3.0 in the low Mach number test section and 2.3 to 4.63 in the test section used during this test. This high Mach number test section has a Reynolds number capability as high as  $7.7 \times 10^6$  per foot. Additional details about this facility are presented in Reference 1.

## DATA ACQUISITION AND REDUCTION

The parameters measured and recorded during this test were:

- o Wind tunnel conditions ( $P_\infty$ ,  $P_t$ ,  $T_t$ )
- o Six-component force and moment data
- o Sting attitude
- o Cavity pressure

Tunnel conditions were used to calculate the Mach number, the dynamic pressure, and the Reynolds number (Table I); the six-component force and moment data were used to calculate static stability coefficients; the sting attitude, nominal model attitude, and deflection calibrations were used to calculate the model angle of attack; and the cavity pressures were used to calculate cavity pressure coefficients.

Figure 6 shows the location of the cavity pressure tubes. A tabulation of the cavity pressure coefficients ( $C_{p_{c_i}}$ ) are included in the appendix to this report.

As stated above, the six component force and moment data were used to calculate six-component static stability coefficients. These data were measured with Langley Research Center Balance #834. The rated capacities of this balance are listed in Table I. The six coefficients,  $C_{A_m}$ ,  $C_{L_m}$ ,  $C_{D_m}$ ,  $C_{N_m}$ ,  $C_{m_m}$ , and  $C_{Y_m}$ , are coefficients in the missile axis system.

The missile axis system ( $X_M, Y_M, Z_M$ ) is a non-rolling body axis system that is frequently used in wind tunnel tests and studies of missile flight dynamics. It is a system of axes that never rotates about the missile or model longitudinal axis. The orientations of the missile axes coefficients

are defined in Figure 1. The missile axis system is identical with the body axis system at zero roll angle.

Six-component static aerodynamic coefficients in the missile axis system may be converted to coefficients in the body axis system with the following six equations:

$$\begin{aligned}
 C_A &= C_{A_m} \\
 C_N &= C_{N_m} \cos \phi + C_{Y_m} \sin \phi \\
 C_Y &= -C_{N_m} \sin \phi + C_{Y_m} \cos \phi \\
 C_l &= C_{l_m} \\
 C_m &= C_{m_m} \cos \phi + C_{n_m} \sin \phi \\
 C_n &= -C_{m_m} \sin \phi + C_{n_m} \cos \phi
 \end{aligned}$$

The following reference dimensions were used to calculate the static stability coefficients:

<u>Parameter</u>	<u>Full Scale</u>	<u>Model Scale</u>
Reference Area ( $S_{ref}$ )		
based on body cross section	109.98 ft <sup>2</sup>	7.069 in. <sup>2</sup>
Reference Length ( $l_{ref}$ ) = ( $b_{ref}$ ) =		
model diameter	142 in.	3.000 in.
Moment Reference Center (from body nose)		
*XMRP (1.134 inches upstream of balance center)	986.97 in.	20.834 in.
XMRP	0	0
ZMRP	0	0

\*Note: XMRP (56.69% of total length without portion of nose removed, measured from nose tip)

The force and moment data were corrected for model weight tares but tunnel flow angularity was assumed to be zero.

Schlieren photographs were made during this test.

## DATA PRESENTATION

Data are presented in two forms: (1) aerodynamic static stability coefficients are plotted as a function of angle-of-attack and (2) data tables are presented that include six static stability coefficients, two cavity pressure coefficients, wind tunnel flow conditions, and model attitude.

### Data Plots

The plots of the six static stability coefficients are presented in the following groups:

- o Static stability characteristics of SRB (with attachment ring).
- o Static stability characteristics of SRB (with attach ring, electrical tunnel, and thrust attachment) for various roll angles.

Table IV presents, for each configuration or comparison of configurations, the roll angles and the Mach numbers for which data are available.

### Data Tables

Data tables, identified as tabulated source data, are presented for each of the 16 runs that were made during this test, with the exception of run 12. Run 12 was found to have been made at tunnel conditions other than what was desired. Facility personnel elected to delete this run. The data are presented in the order of data set number. Each data set contains information that describes the model configuration, the model attitude, the tunnel flow conditions, and the model reference dimensions. Each data set contains a listing of the six static aerodynamic stability coefficients and two cavity pressure coefficients ( $C_{p_{c1}}$ ). Zeros appeared in the

cavity pressure columns for runs 1 through 6. Equipment problems during these runs resulted in unreliable pressure data. Therefore, these pressure coefficients are not shown in the tabulated listing.

If a cavity pressure correction is desired, the cavity area to be used is:

$$A_c = 3.976 \text{ in.}^2$$

#### REFERENCES

1. "Unitary Plan Wind Tunnel Facilities," National Advisory Committee for Aeronautics; 1956.
2. DMS-DR-2161, "Aerodynamic Characteristics of a 1/2-Inch Diameter Solid Rocket Booster (Configuration 139)," Radford, W. D., Johnson, J. D., Burstadt. P. L.,



Table 1.

TEST: LARC UPWT 1087		DATE: March 1974		
<b>TEST CONDITIONS</b>				
MACH NUMBER	REYNOLDS NUMBER (per foot)	DYNAMIC PRESSURE (pounds/sq. inch)	STAGNATION TEMPERATURE (degrees Fahrenheit)	STAGNATION PRESSURE (pounds/sq. inch)
2.30	$1.5 \times 10^6$	2.36	155	7.97
2.70	↓	2.16	155	9.85
2.96	↓	2.01	155	11.34
3.48	$2.0 \times 10^6$	2.26	150	19.76
4.00	↓	2.02	185	27.39
4.63	↓	1.62	185	36.69

BALANCE UTILIZED: LARC #834

	CAPACITY:	ACCURACY:	COEFFICIENT TOLERANCE:
NF	<u>300 lbs</u>	_____	_____
SF	<u>200 lbs</u>	_____	_____
AF	<u>60 lbs</u>	_____	_____
PM	<u>1000 in.-lbs</u>	_____	_____
RM	<u>100 in.-lbs</u>	_____	_____
YM	<u>400 in.-lbs</u>	_____	_____

COMMENTS:

TABLE II.

TEST: SAZ6F		DATA SET/RUN NUMBER COLLATION SUMMARY								DATE: MARCH 1974			
DATA SET IDENTIFIER	CONFIGURATION	SCHD.	PARAMETERS/VALUES	NO. OF RUNS	MACH NUMBERS ( OR ALTERNATE INDEPENDENT VARIABLE )								
					2.3	2.7	3.0	3.5	4.0	4.63	TEST RUN NUMBERS		
RH3001	SRB w/ATTACH RING A 0°	A 1		6	1/0	2/0	3/0	4/0	5/0	6/0			
	SRB w/ATTACH RING												
	ELECT TUNNEL												
RH3002*	THRUST ATTACHMENT B AS*	B AS*		3		7/0			9/0	8/0			
RH3003*		B AS*		3		13/0			10/0	11/0			
RH3004*		B AS*		3		14/0			15/0	16/0			
R DATA	CNM	SA	ICLMHICYM	ICYNM	ICBL	ICL	ICD	IQ(PSE)	MACH ALPHA 19				
P DATA	CPC1	ICPC2	IQ(PSE)						MACH ALPHA 13				
TYPE OF DATA SCHEDULES	A=144-179 D Δα=2° B=144-155 D Δα=2°; 155-179 D Δα=4°			COEFFICIENT SCHEDULES					IQVAR (1)	IQVAR (2)	NDV		

\* DATA SETS WITH "P" DATA

Table III.

MODEL COMPONENT DIMENSIONS

MODEL COMPONENT: Nose

GENERAL DESCRIPTION: 142-inch diameter SRB nose, cone angle is 18° with a spherical radius nose cap. (This nose was truncated to allow passage of the sting when the model was nose-mounted for testing at 144 degrees  $\leq \alpha \leq$  179 degrees)

MODEL DRAWING NUMBER: MSFC #80M42621  
MSFC #80M42622

<u>DIMENSIONS:</u>	<u>THEORETICAL</u>		<u>ACTUAL MEASURED</u>
	<u>FULL-SCALE</u>	<u>MODEL SCALE</u>	<u>MODEL SCALE</u>
Length	<u>188 in.</u>	<u>3.971 in.</u>	<u>3.892 in.</u>
Max. Width	<u>142 in.</u>	<u>3.000 in.</u>	<u>3.000 in.</u>
Max. Depth	<u>142 in.</u>	<u>3.000 in.</u>	<u>3.000 in.</u>
Fineness Ratio	<u>1.32</u>	<u>1.32</u>	<u>1.297</u>
Area			
Max. Cross-Sectional	<u>109.97 ft<sup>2</sup></u>	<u>7.069 in.<sup>2</sup></u>	<u>        </u>
Planform	<u>        </u>	<u>        </u>	<u>        </u>
Wetted	<u>        </u>	<u>        </u>	<u>        </u>
Base	<u>109.97 ft<sup>2</sup></u>	<u>7.069 in.<sup>2</sup></u>	<u>        </u>
Length (when truncated for sting mounting)	<u>        </u>	<u>1.130 in.</u>	<u>1.130 in.</u>

Table III. (Continued)

MODEL COMPONENT: Body

GENERAL DESCRIPTION: 142-inch diameter SRB body for SRB configuration 139.

MODEL DRAWING NUMBER: 80M42621, 80M42623, 80M32580, 80M51331, 80M42646, 80M32581  
80M42626

<u>DIMENSIONS:</u>	<u>THEORETICAL</u>		<u>ACTUAL MEASURED</u>
	<u>FULL-SCALE</u>	<u>MODEL SCALE</u>	<u>MODEL SCALE</u>
Length	<u>1407.8 in.</u>	<u>29.734 in.</u>	<u>29.757 in.</u>
Max. Width	<u>142 in.</u>	<u>3.000 in.</u>	<u>3.001 in.</u>
Max. Depth	<u>142 in.</u>	<u>3.000 in.</u>	<u>3.001 in.</u>
Fineness Ratio	<u>9.91</u>	<u>9.91</u>	<u>9.915</u>
Area			
Max. Cross-Sectional	<u>109.98 ft<sup>2</sup></u>	<u>7.069 in.<sup>2</sup></u>	<u>                    </u>
Planform	<u>                    </u>	<u>                    </u>	<u>                    </u>
Wetted	<u>                    </u>	<u>                    </u>	<u>                    </u>
Base	<u>109.97 ft<sup>2</sup></u>	<u>7.069 in.<sup>2</sup></u>	<u>                    </u>

Table III. (Continued)

MODEL COMPONENT: Engine/Shroud

GENERAL DESCRIPTION: 142-inch diameter SRB engine shroud/nozzle combination for SRB configuration 139.

MODEL DRAWING NUMBER: 80M42626, 80M32613

<u>DIMENSIONS:</u>	<u>THEORETICAL</u>		<u>ACTUAL MEASURED</u>
	<u>FULL-SCALE</u>	<u>MODEL SCALE</u>	<u>MODEL SCALE</u>
<u>Engine Shroud</u>			
Length	<u>93 in.</u>	<u>1.964 in.</u>	<u>1.975 in.</u>
Max. Width	<u>192 in.</u>	<u>4.055 in.</u>	<u>4.062 in.</u>
Max. Depth	<u>192 in.</u>	<u>4.055 in.</u>	<u>4.062 in.</u>
Max. Cross Sectional Area	<u>201.1 ft<sup>2</sup></u>	<u>12.914 in.<sup>2</sup></u>	<u>12.959 in.<sup>2</sup></u>
<u>Engine Nozzle</u>			
Length	<u>52 in.</u>	<u>1.102 in.</u>	<u>1.095 in.</u>
Max. Width	<u>141.7 in.</u>	<u>2.993 in.</u>	<u>2.994 in.</u>
Max. Depth	<u>141.7 in.</u>	<u>2.993 in.</u>	<u>2.994 in.</u>
Max. Cross Sectional Area	<u>109.52 ft<sup>2</sup></u>	<u>7.040 in.<sup>2</sup></u>	<u>7.040 in.<sup>2</sup></u>

Table III. (Continued)

MODEL COMPONENT: Attachment Ring

GENERAL DESCRIPTION: An attachment ring (used to attach the SRB to the ET)

is located 27.773 inches model scale (1315 inches full scale) from the nose of  
the vehicle.

MODEL DRAWING NUMBER: 80M32547, 80M32582

<u>DIMENSIONS:</u>	<u>THEORETICAL</u>		<u>ACTUAL MEASURED</u>
	<u>FULL-SCALE</u>	<u>MODEL SCALE</u>	<u>MODEL SCALE</u>
Length	_____	_____	_____
Max. Width	<u>10.98 in.</u>	<u>0.232 in.</u>	_____
Max. Depth	<u>9.99 in.</u>	<u>0.211 in.</u>	_____
Fineness Ratio	_____	_____	_____
Area			
Max. Cross-Sectional	_____	_____	_____
Planform	_____	_____	_____
Wetted	_____	_____	_____
Base	_____	_____	_____

Table III.(Continued)

MODEL COMPONENT: Electrical Tunnel

GENERAL DESCRIPTION: The electrical tunnel runs along the outside the SRB tank to protect the various electrical cables from aerodynamic loading.

MODEL DRAWING NUMBER: 80M42642

<u>DIMENSIONS:</u>	<u>THEORETICAL</u>		<u>ACTUAL MEASURED</u>
	<u>FULL-SCALE</u>	<u>MODEL SCALE</u>	<u>MODEL SCALE</u>
Length	<u>1274 in.</u>	<u>26.9 in.</u>	<u>          </u>
Max. Width	<u>13 in.</u>	<u>0.275 in.</u>	<u>          </u>
Max. Depth	<u>6 in.</u>	<u>0.127 in.</u>	<u>          </u>
Fineness Ratio	<u>          </u>	<u>          </u>	<u>          </u>
Area			
Max. Cross-Sectional	<u>          </u>	<u>          </u>	<u>          </u>
Planform	<u>          </u>	<u>          </u>	<u>          </u>
Wetted	<u>          </u>	<u>          </u>	<u>          </u>
Base	<u>          </u>	<u>          </u>	<u>          </u>

Table III. (Concluded)

MODEL COMPONENT: SRB/ET Thrust Attachment Structure

GENERAL DESCRIPTION: This structure is mounted aft the intersection of nose and body and is used to attach the SRB to the ET.

MODEL DRAWING NUMBER: 80M42641

<u>DIMENSIONS:</u>	<u>THEORETICAL</u>		<u>ACTUAL MEASURED</u>
	<u>FULL-SCALE</u>	<u>MODEL SCALE</u>	<u>MODEL SCALE</u>
Length	<u>~ 47.3 in.</u>	<u>~1.000 in.</u>	_____
Max. Width	<u>~ 129.9 in.</u>	<u>~2.744 in.</u>	_____
Max. Depth	<u>~ 7.4 in.</u>	<u>~0.157 in.</u>	_____
Fineness Ratio	_____	_____	_____
Area			
Max. Cross-Sectional	_____	_____	_____
Planform	_____	_____	_____
Wetted	_____	_____	_____
Base	_____	_____	_____



Table IV. PLOT SUMMARY

INVESTIGATION	ROLL ANGLE				MACH NUMBER					
	0	45	90	135	2.3	2.7	3.0	3.5	4.0	4.63
Static stability characteristics of SRB with attachment ring	X				X	X	X	X	X	X
Effect of roll on static stability characteristics of SRB (with protuberances)		X	X	X		X			X	X

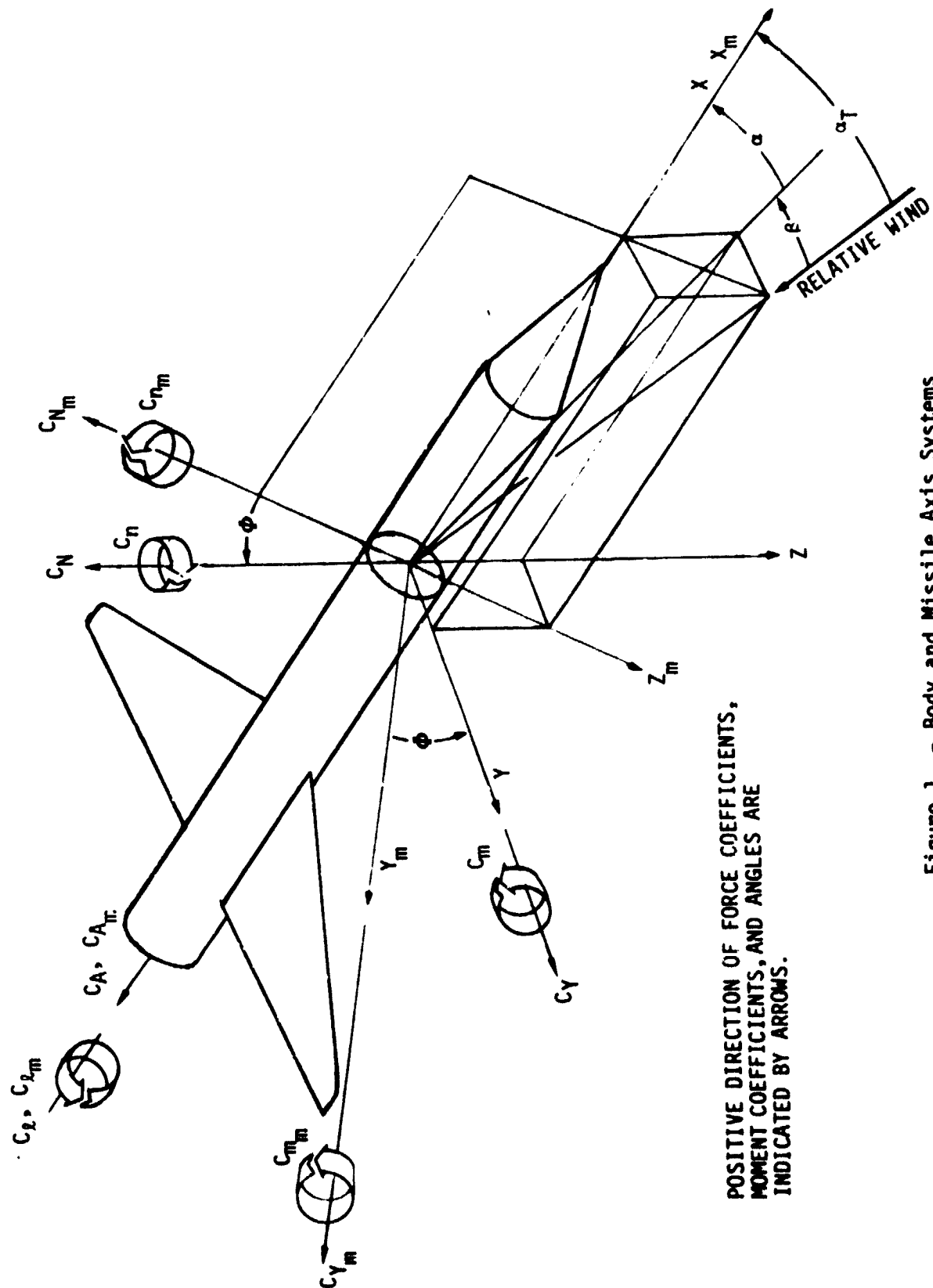

POSITIVE DIRECTION OF FORCE COEFFICIENTS, MOMENT COEFFICIENTS, AND ANGLES ARE INDICATED BY ARROWS.

Figure 1. - Body and Missile Axis Systems

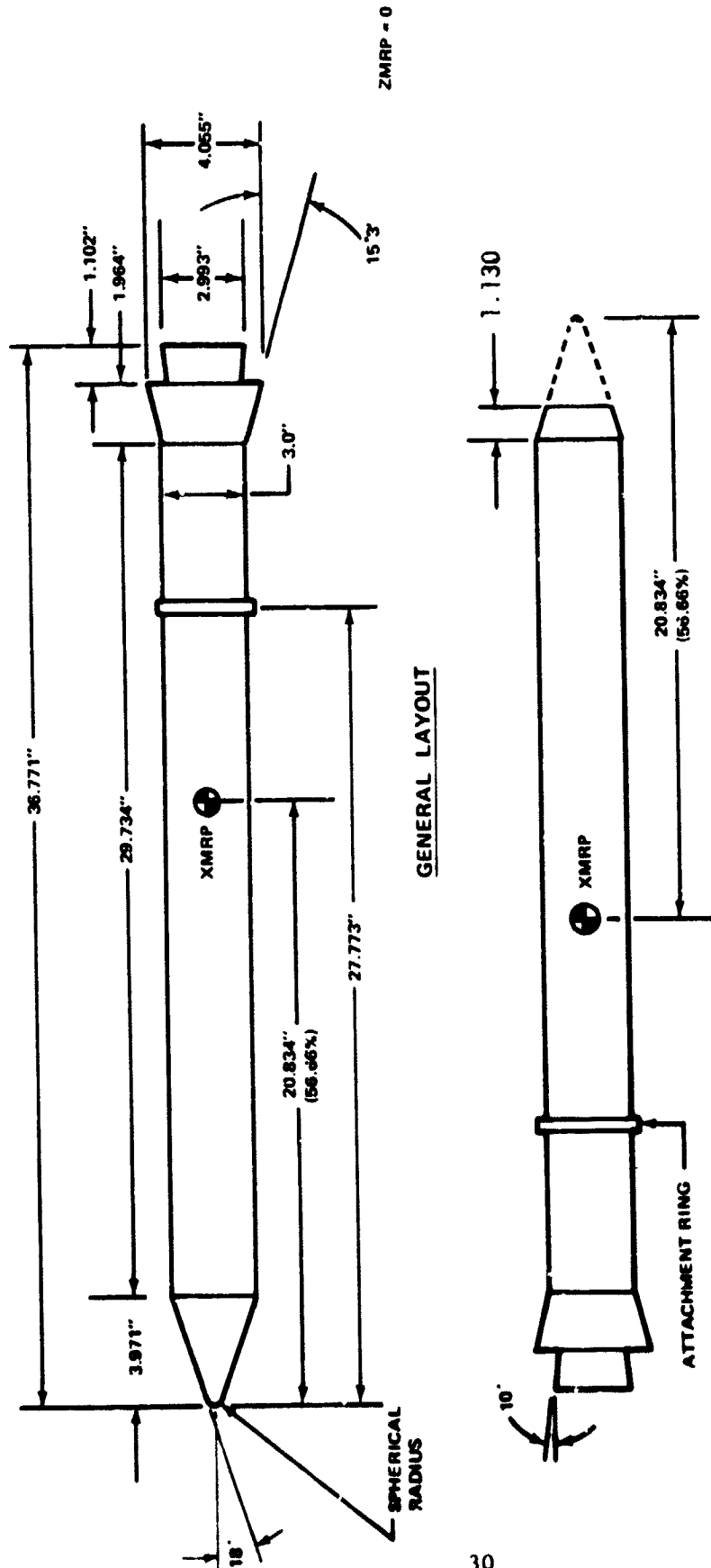

(ENGINE SHROUD/NOZZLE SYMMETRIC WITH BODY)

Figure 2. 142 INCH DIAMETER SRB - 0.02112 SCALE MODEL (SRB CONFIGURATION 139 - MSFC MODEL #454)

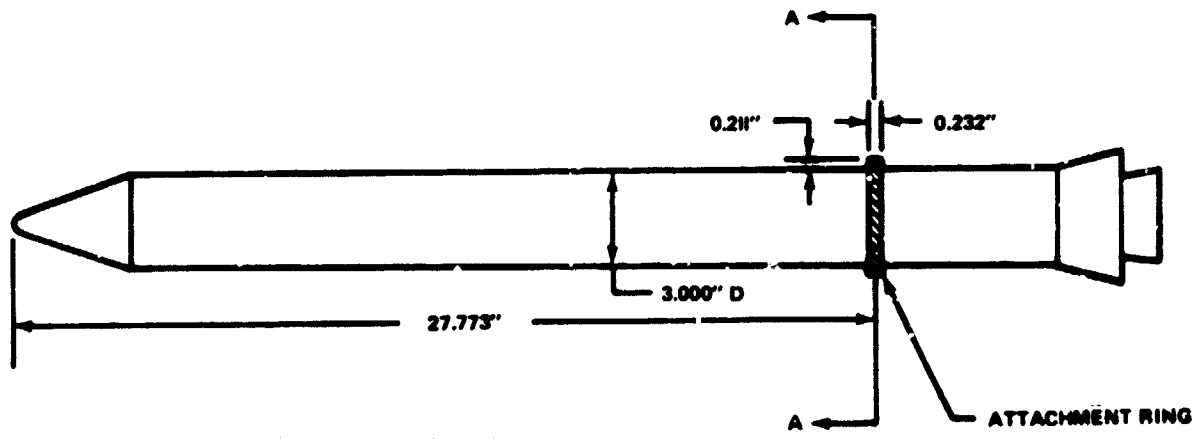
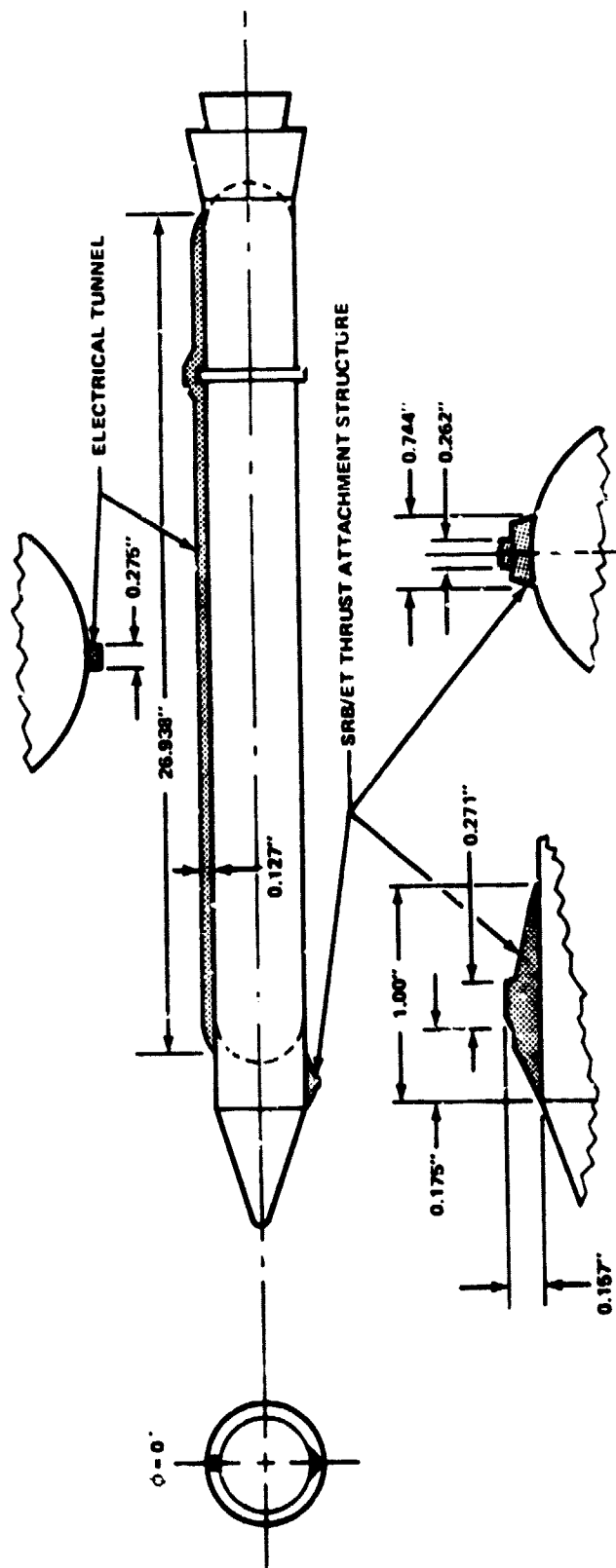
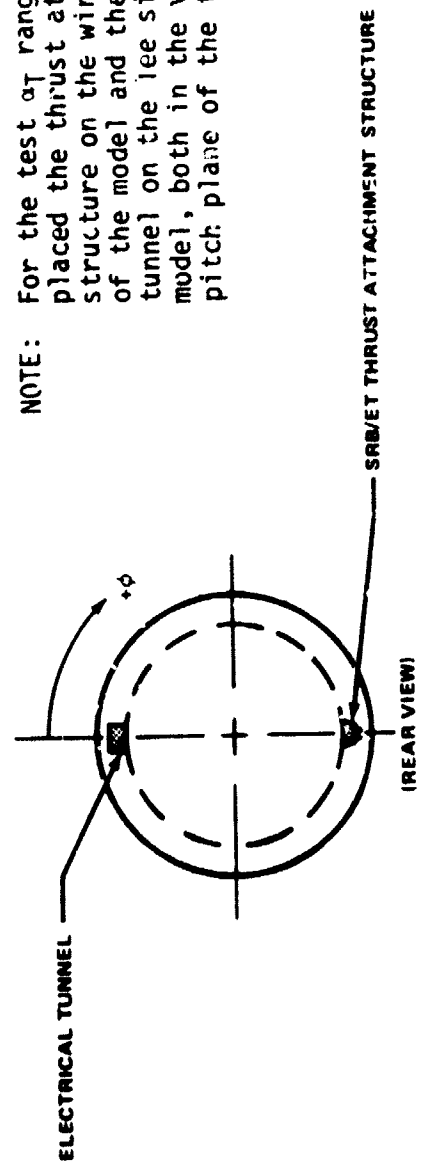

Figure 3. SRB/ET ATTACHMENT RING (MSFC MODEL #454)



ELECTRICAL TUNNEL AND SRB/ET THRUST ATTACHMENT STRUCTURE

NOTE: For the test at range,  $\phi=0^\circ$  placed the thrust attachment structure on the windward side of the model and the electrical tunnel on the lee side of the model, both in the vertical pitch plane of the tunnel.



ROLL ( $\phi$ ) SIGN CONVENTION

Figure 4. ELECTRICAL TUNNEL AND SRB/ET THRUST ATTACHMENT STRUCTURE (MSFC MODEL #454)

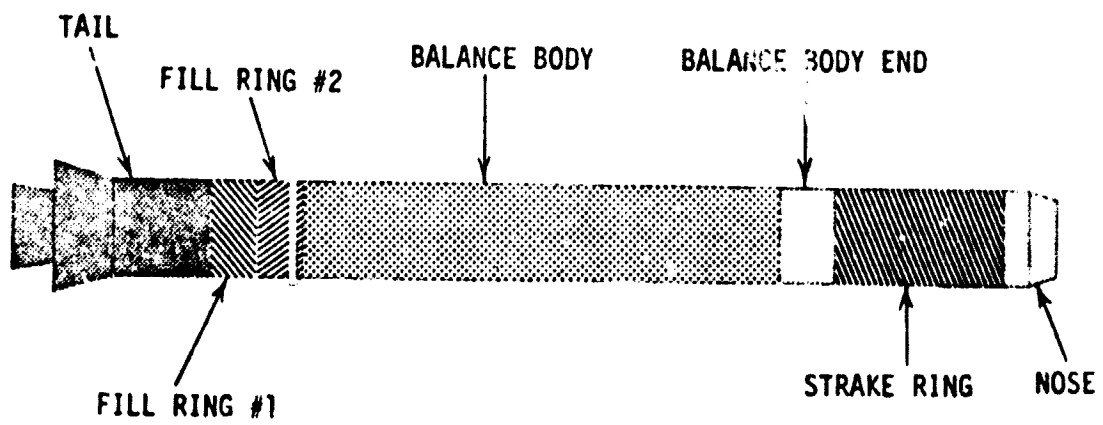

Figure 5. MAJOR MODEL SECTIONS

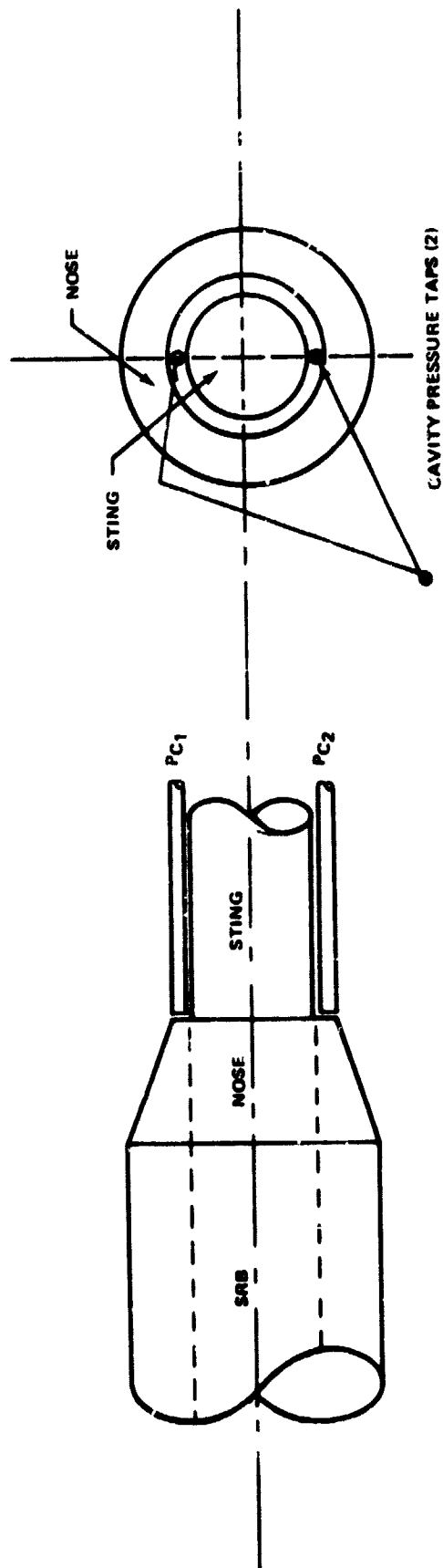

Figure 6. CAVITY PRESSURE TAP LOCATIONS

DATA FIGURES



SA-25F LARC UPWT 1087 MSFC 454

(RH9001)

SYMBOL  
 2.300  
 2.700  
 2.900  
 3.400  
 4.000  
 4.600

PARAMETRIC VALUES  
 BETA .000 PHI .000  
 A 3.000 B 1.000  
 C .000 D 6.000  
 E .000

REFERENCE INFORMATION  
 SREF 7.0000 SO.IN.  
 LBREF 3.0000 IN.OES  
 BRFP 3.0000 IN.OES  
 XTRP 20.8040 IN.OES  
 YTRP .0000 IN.OES  
 ZTRP .0000 IN.OES  
 SCALE .0211 SCALE

MISSILE AXIS NORMAL FORCE COEFFICIENT, CNM

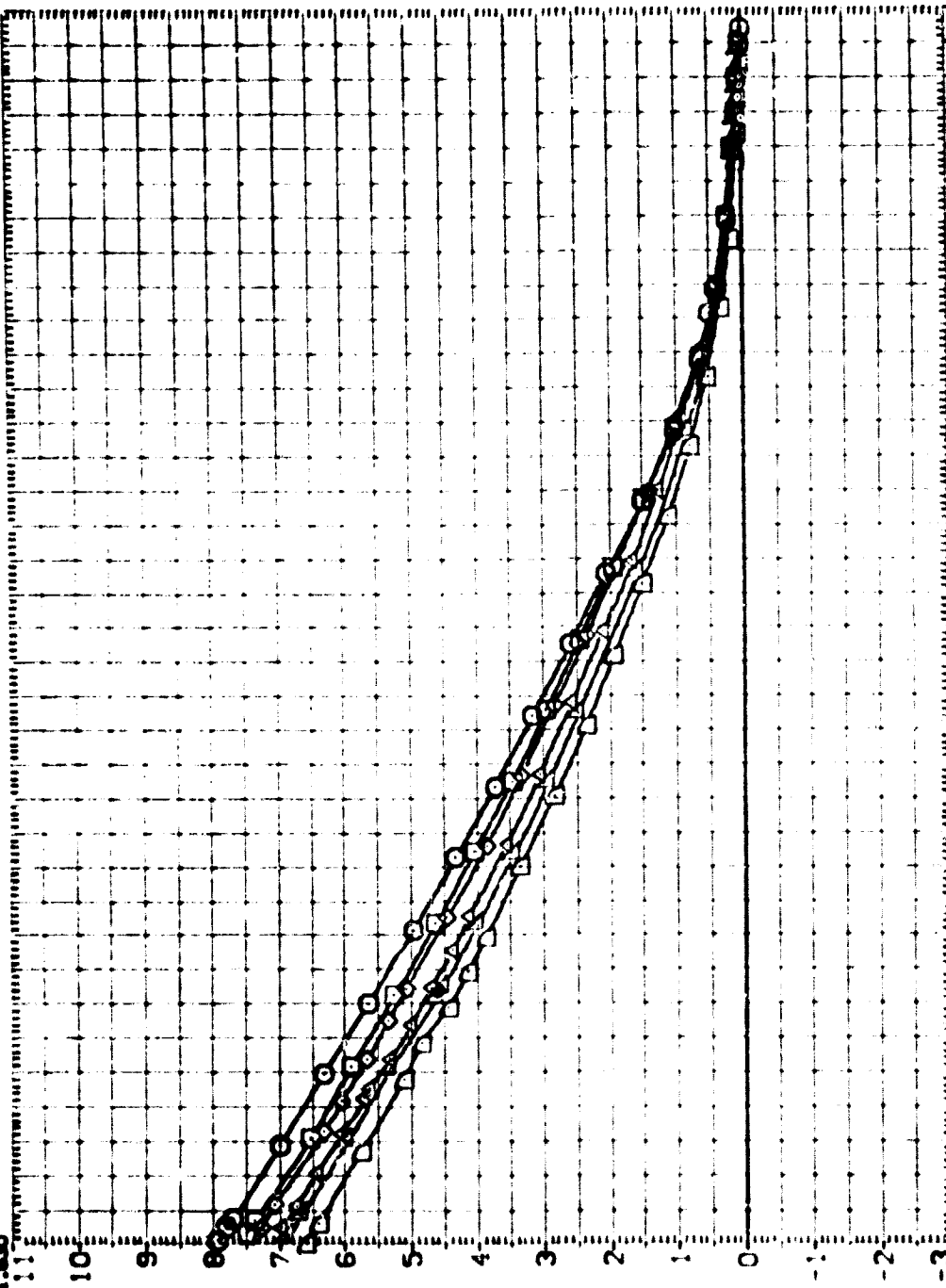

ANGLE OF ATTACK, ALPHA, DEGREES  
 144 148 152 156 160 164 168 172 176 180

STATIC STABILITY CHARACTERISTICS OF SRB WITH ATTACHMENT RING

(RH9001)

SA-25F LARC UPWT 1087 MSFC 454

SYMBOL  
□ ○ ◇ △ ▽

PARAMETRIC VALUES	
MACH	4.630
BETA	.000
A	3.000
C	.000
E	.000
PHI	.000
B	1.000
D	6.000

REFERENCE INFORMATION	
REF	7.0690
LRREF	3.0000
BRREF	3.0000
ZMRP	20.8040
YMRP	.0000
ZMRP	.0000
SCALE	.0211

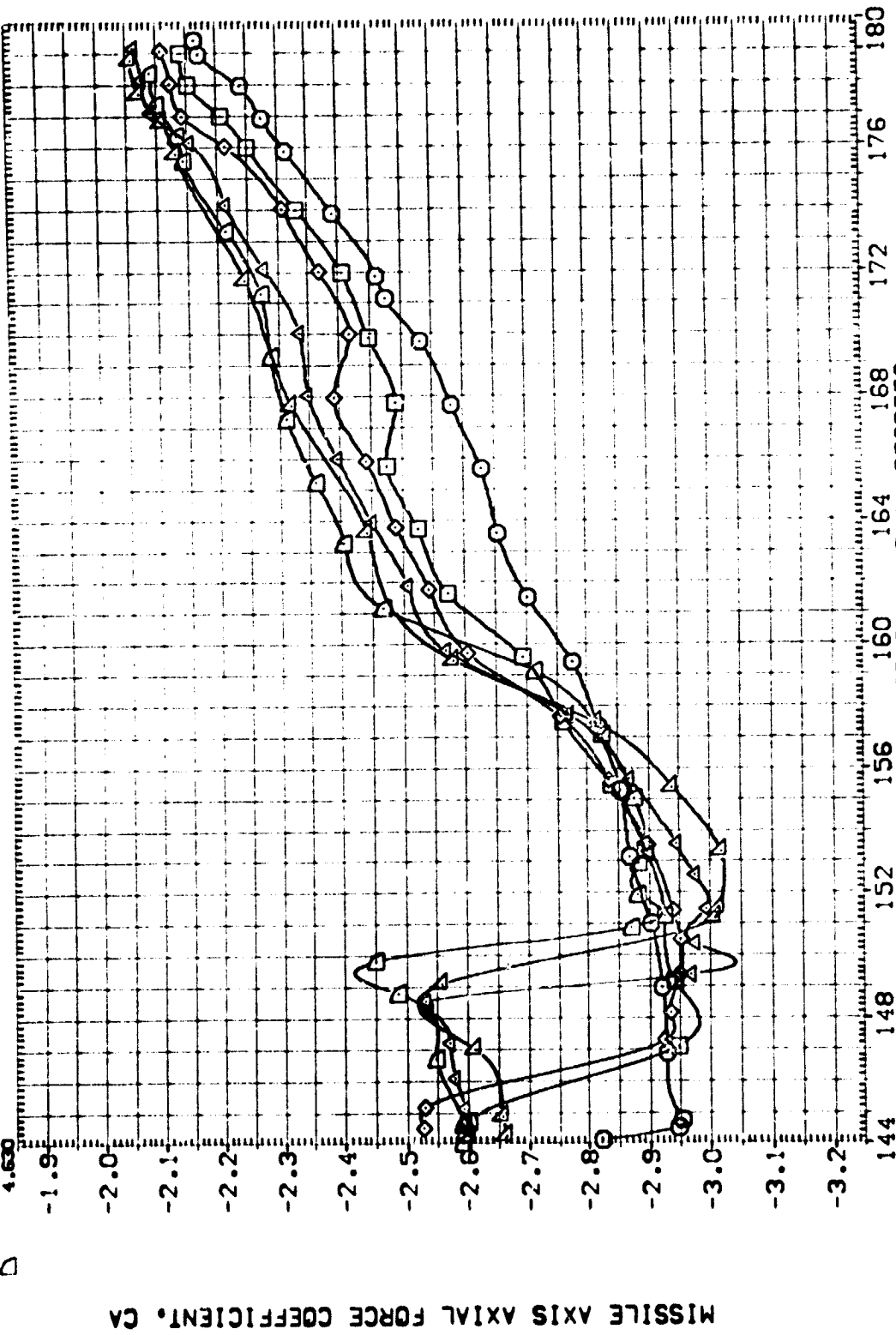

STATIC STABILITY CHARACTERISTICS OF SRB WITH ATTACHMENT RING

SA-25F LARC UPWT 1087 MSFC 454

(RH9001)

REFERENCE INFORMATION  
 SREF 7.0660  
 LREF 3.0000  
 XMRP 3.0000  
 YMRP 20.8340  
 ZMRP .0000  
 SCALE .0211

PARAMETRIC VALUES  
 PH1 .000  
 B 1.000  
 D 6.000

BETA  
 A .000  
 C 3.000  
 E .000

SYMB.  
 □ □ ◇ ◇ △ △

MISSILE AXIS PITCHING MOMENT COEFFICIENT, CLM

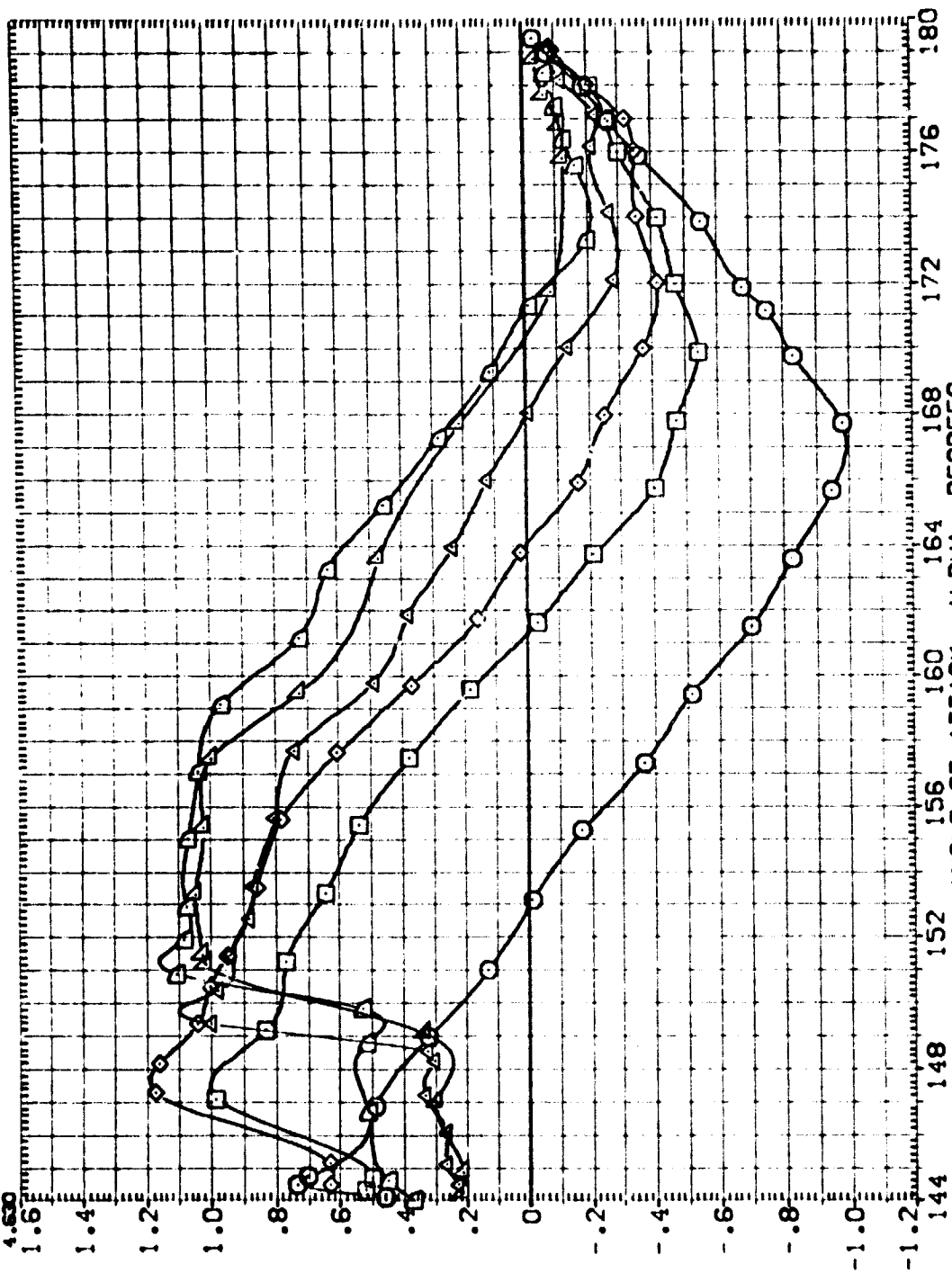

STATIC STABILITY CHARACTERISTICS OF SRB WITH ATTACHMENT RING

(RH9001)

SA-25F LARC UPWT 1087 MSFC 454

SYMBOL  
 ◻ ◊ ◀ ▶ ▽

MACH	BETA	PHI	PARAMETRIC VALUES
2.300	.000	.000	
2.700	3.000	B	1.000
2.900	.000	D	6.000
3.400	.000		
4.000			
4.600			

REFERENCE INFORMATION

SREF	7.0690	SO. IN.
LREF	3.0000	INCHES
BREF	3.0000	INCHES
XMRP	20.8340	INCHES
YMRP	.0000	INCHES
ZMRP	.0000	INCHES
SCALE	.0211	SCALE

MISSILE AXIS SIDE FORCE COEFFICIENT, C<sub>YM</sub>

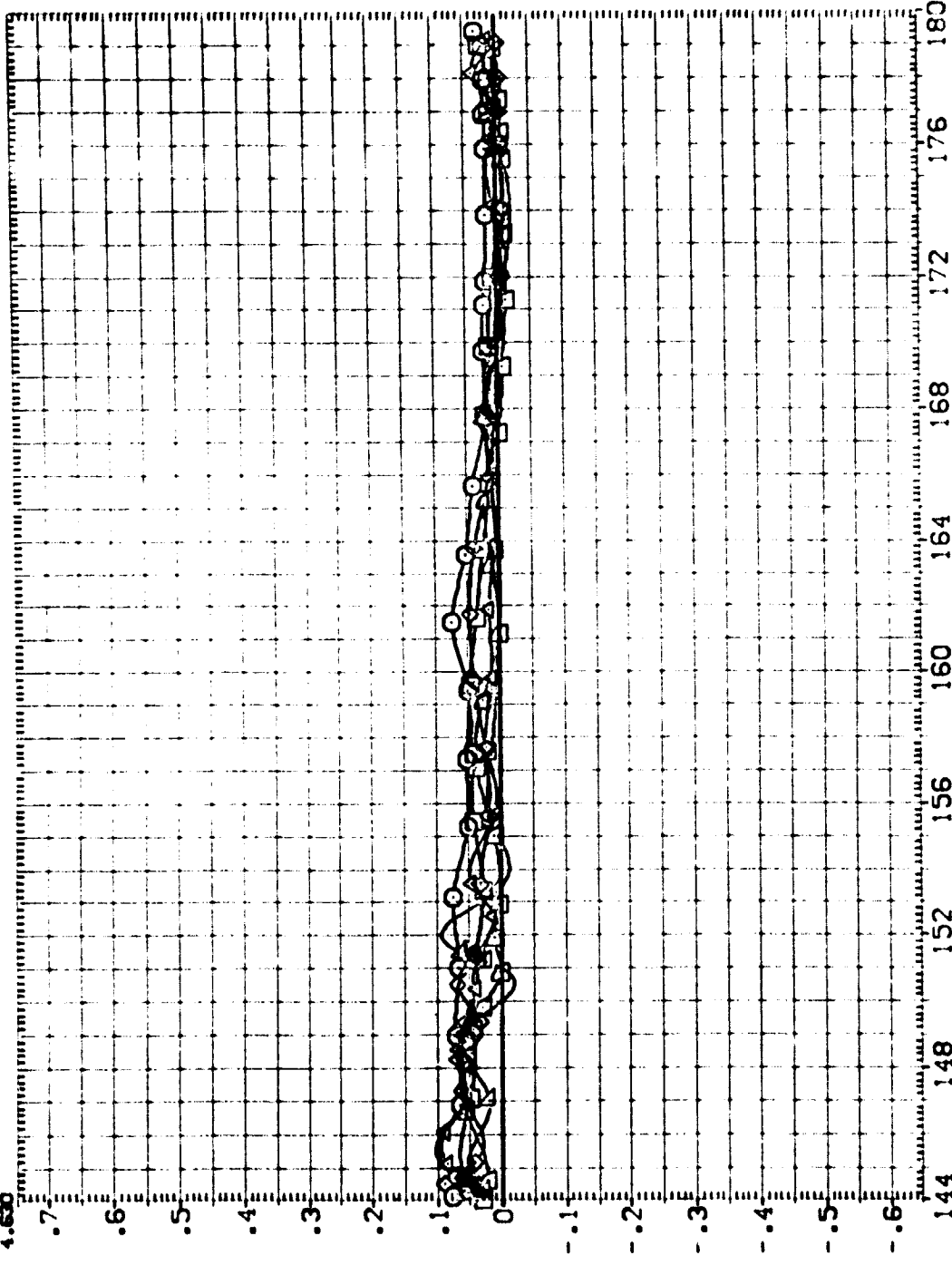

STATIC STABILITY CHARACTERISTICS OF SRB WITH ATTACHMENT RING

SA-25F LARC UPWT 1087 MSFC 454

(RH9001)

SYMBL  
 □ □ ◊ ◊ ◊ ◊

MACH  
 2.300  
 2.700  
 2.960  
 3.460  
 4.000  
 4.630

BETA  
 A  
 C  
 E

PARAMETRIC VALUES  
 PH1  
 B  
 D

.000  
 3.000  
 .000  
 .000

.000  
 1.000  
 6.000

REFERENCE INFORMATION  
 SREF 7.0680  
 LREF 3.0000  
 BREF 3.0000  
 XMRP 20.9340  
 YMRP .0000  
 ZMRP .0000  
 SCALE .02:1

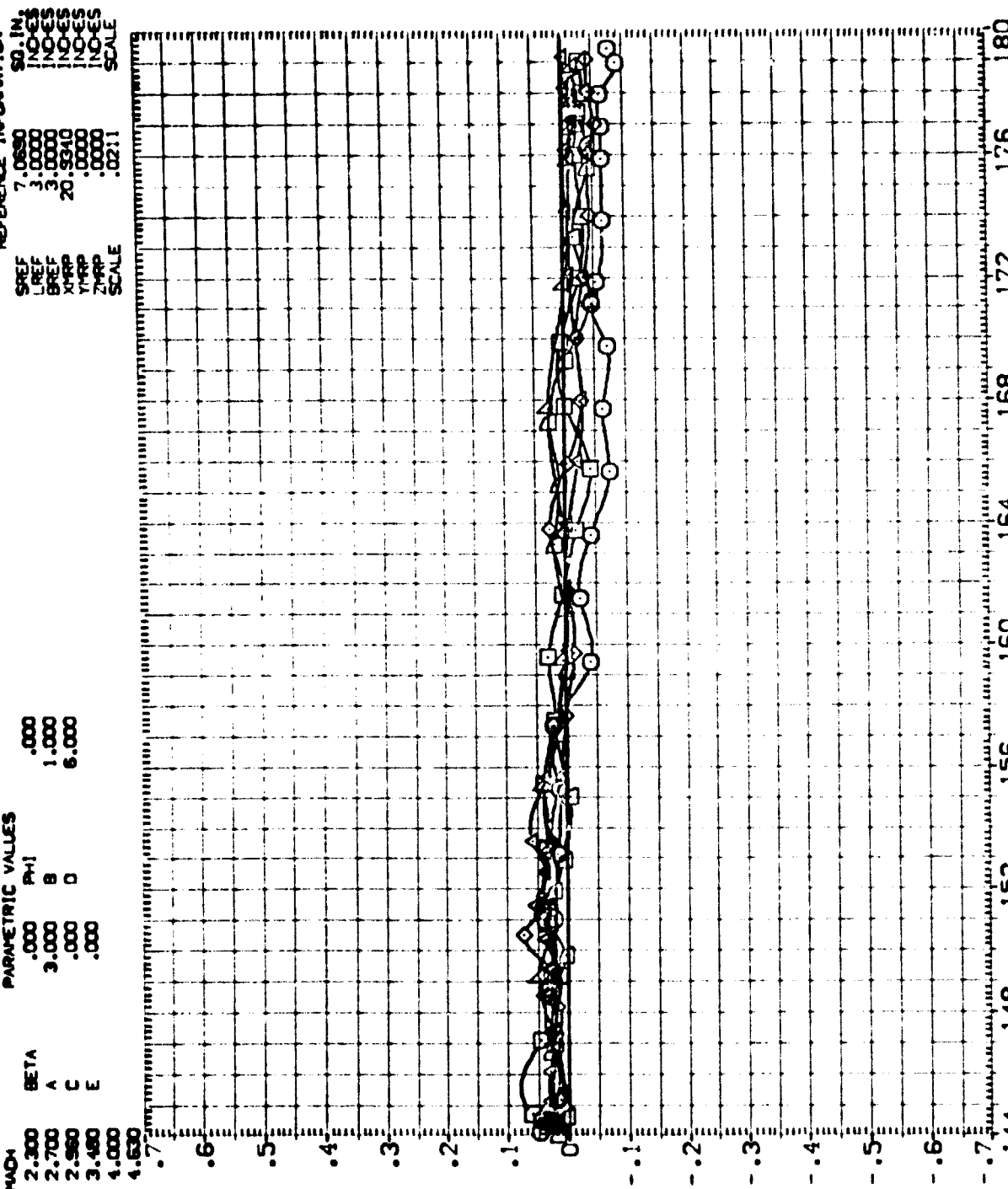

MISSILE AXIS YAWING MOMENT COEFFICIENT, CYM

STATIC STABILITY CHARACTERISTICS OF SRB WITH ATTACHMENT RING

SA-25F LARC UPWT 1087 MSFC 454

(RH9001)

SYMBOL

□ ○ ◇ Δ ∇

MACH  
2.300  
2.700  
2.960  
3.480  
4.000  
4.630

BETA  
A  
C  
E

PARAMETRIC VALUES

.000 PHI  
3.000 B  
.000 D  
.000

SREF  
LRFF  
BRFF  
XMRP  
YMRP  
ZMRP  
SCALE

REFERENCE INFORMATION  
7.0580 SQ. IN.  
3.0000 IN.-ES  
3.0000 IN.-ES  
20.8340 IN.-ES  
.0000 IN.-ES  
.0000 IN.-ES  
.0211 SCALE

MISSILE AXIS ROLLING MOMENT COEFFICIENT, CBL

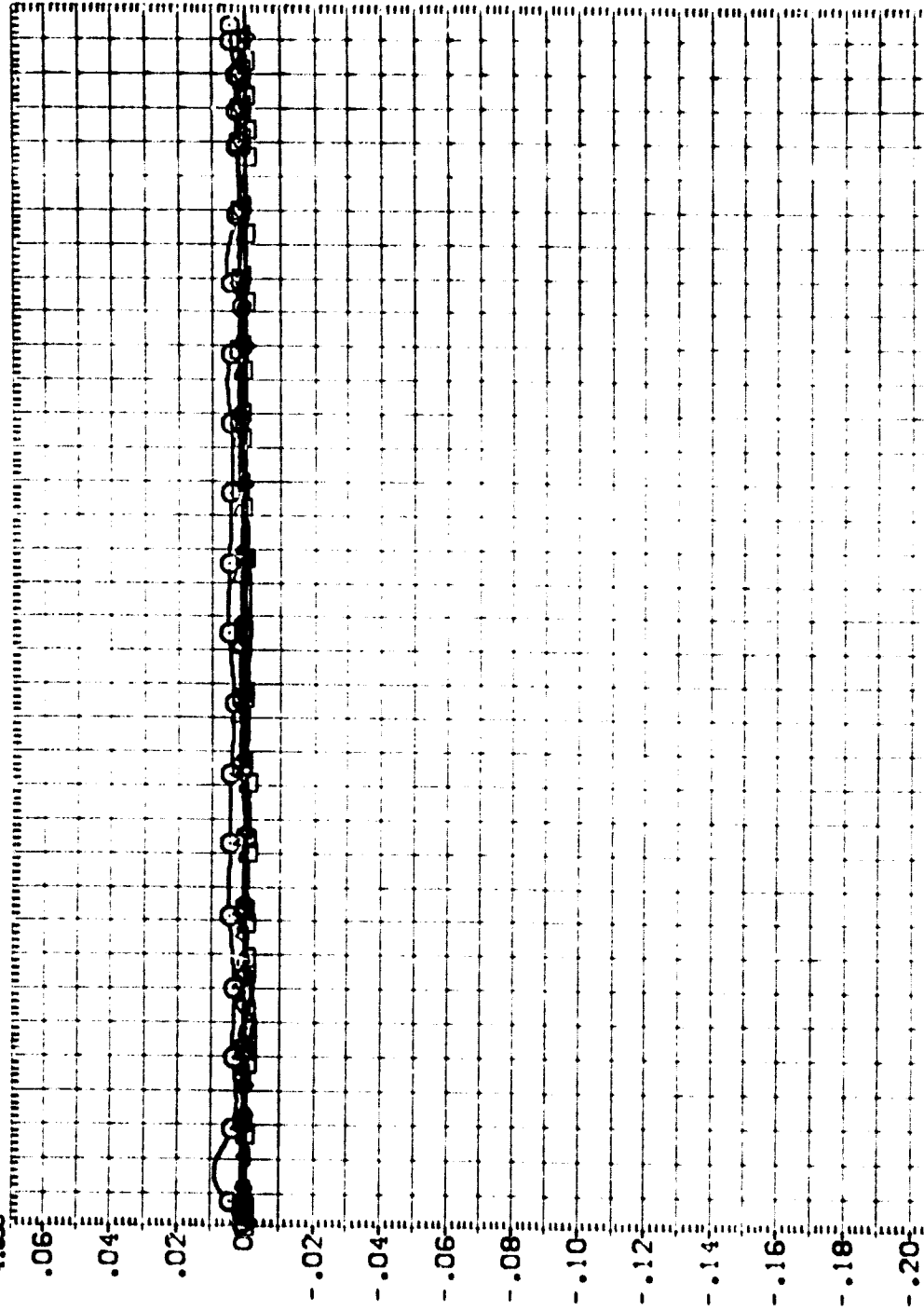

144 148 152 156 160 164 168 172 176 180

ANGLE OF ATTACK, ALPHA, DEGREES

STATIC STABILITY CHARACTERISTICS OF SRB WITH ATTACHMENT RING

DATA SET SYMBOL CONFIGURATION DESCRIPTION

[R-6001]	SA-25F	LARC	UPVT	1087	MSFC	45A
[R-6002]	SA-25F	LARC	UPVT	1087	MSFC	45A
[R-6003]	SA-25F	LARC	UPVT	1087	MSFC	45A
[R-6004]	SA-25F	LARC	UPVT	1087	MSFC	45A

PHI BETA

.000	.000
45.000	.000
135.000	.000

REFERENCE INFORMATION

SREF	7.0890	50.1IN.
LREF	3.0000	IN-OES
BREF	3.0000	IN-OES
XMRP	20.8310	IN-OES
YMRP	.0000	IN-OES
ZMRP	.0000	IN-OES
SCALE	.0211	SCALE

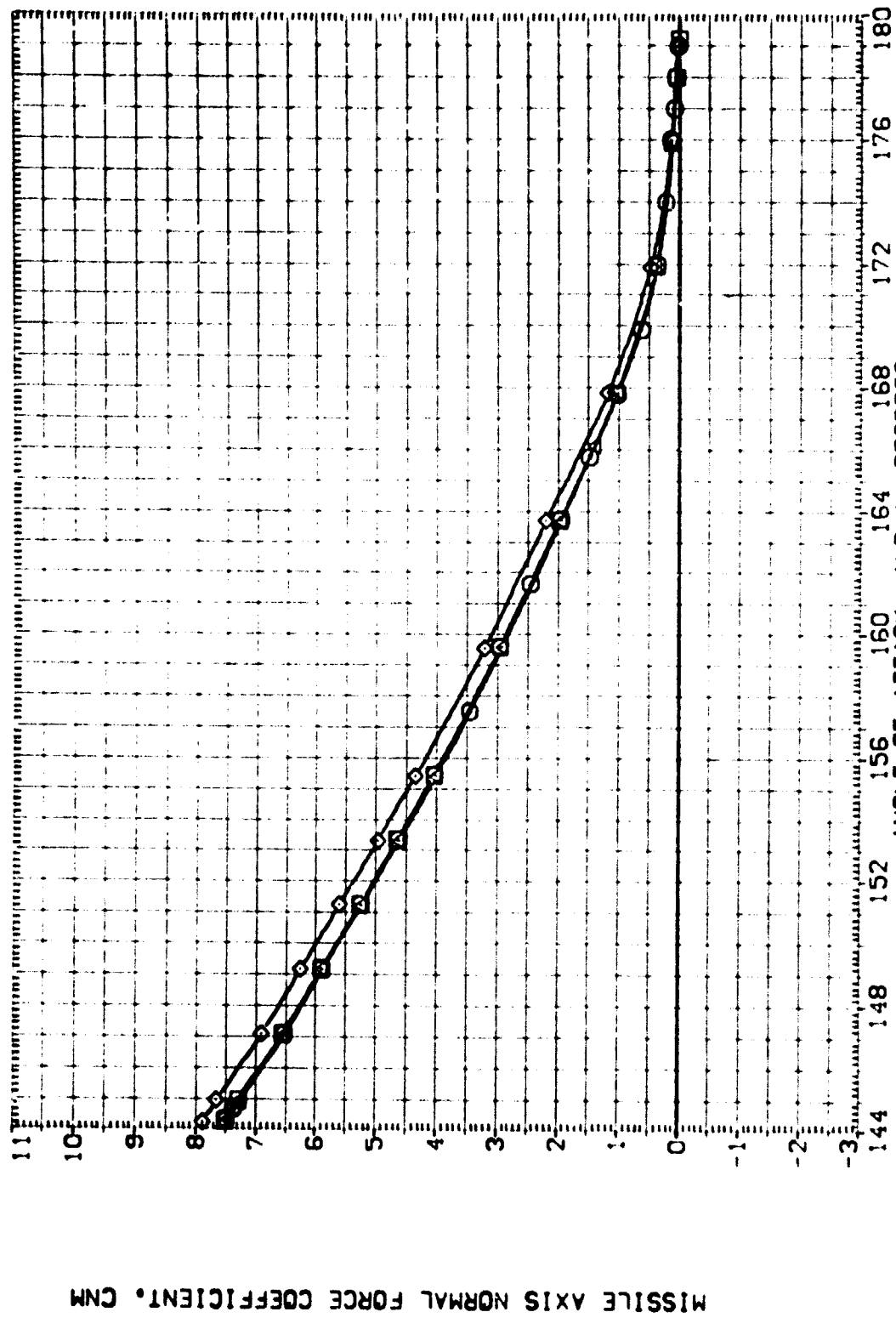

MISSILE AXIS NORMAL FORCE COEFFICIENT, CNM

EFFECT OF ROLL ANGLE ON STATIC STABILITY CHARACTERISTICS OF SRB

(A)MACH = 2.70

DATA SET SYMBOL: (A-0001), (R-0002), (R-0003), (R-0004)

CONFIGURATION DESCRIPTION: SA-25F LARC UPVT 1087 MSC 45A, SA-25F LARC UPVT 1087 MSC 45A, SA-25F LARC UPVT 1087 MSC 45A, SA-25F LARC UPVT 1087 MSC 45A

PHI: .000, 45.000, 90.000, 135.000

BETA: .000, .000, .000

TH ATTACH: ELT, TH ATTACH, ELT, TH ATTACH, ELT

REFERENCE INFORMATION: SREF 7.0690 SQ. IN., LREF 3.0000 IN.-ES, BREF 3.0000 IN.-ES, XMRP 20.8240 IN.-ES, YMRP .0000 IN.-ES, ZMRP .0000 IN.-ES, SCALE .0211

MISSILE AXIS NORMAL FORCE COEFFICIENT, CNM

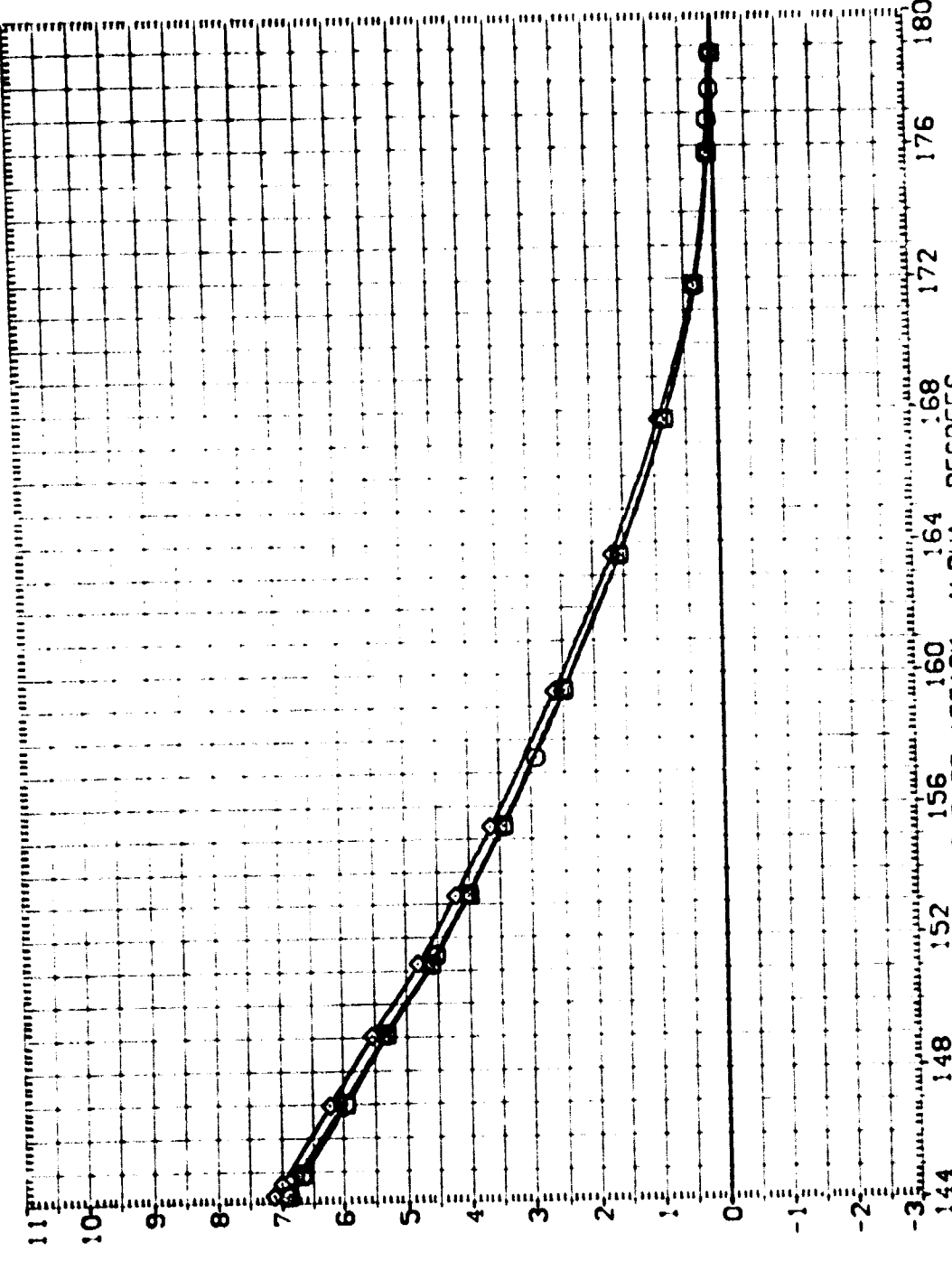

EFFECT OF ROLL ANGLE ON STATIC STABILITY CHARACTERISTICS OF SRB

(B)MACH = 4.00



DATA SET SYMBOL CONFIGURATION DESCRIPTION

(R-6001)	SA-25F	LARC	UPVT	1087	MSFC	45A	ELT	TH	ATTACH	PHI	BETA	REFERENCE INFORMATION
(R-6002)	SA-25F	LARC	UPVT	1087	MSFC	45A	ELT	TH	ATTACH	45.000	.000	SREF 7.0690
(R-6003)	SA-25F	LARC	UPVT	1087	MSFC	45A	ELT	TH	ATTACH	90.000	.000	LREF 3.0000
(R-6004)	SA-25F	LARC	UPVT	1087	MSFC	45A	ELT	TH	ATTACH	135.000	.000	BREF 3.0000
												XRRP 20.8340
												YRRP .0000
												ZRRP .0000
												INCOES .0211
												SCALE

MISSILE AXIS NORMAL FORCE COEFFICIENT, CNM

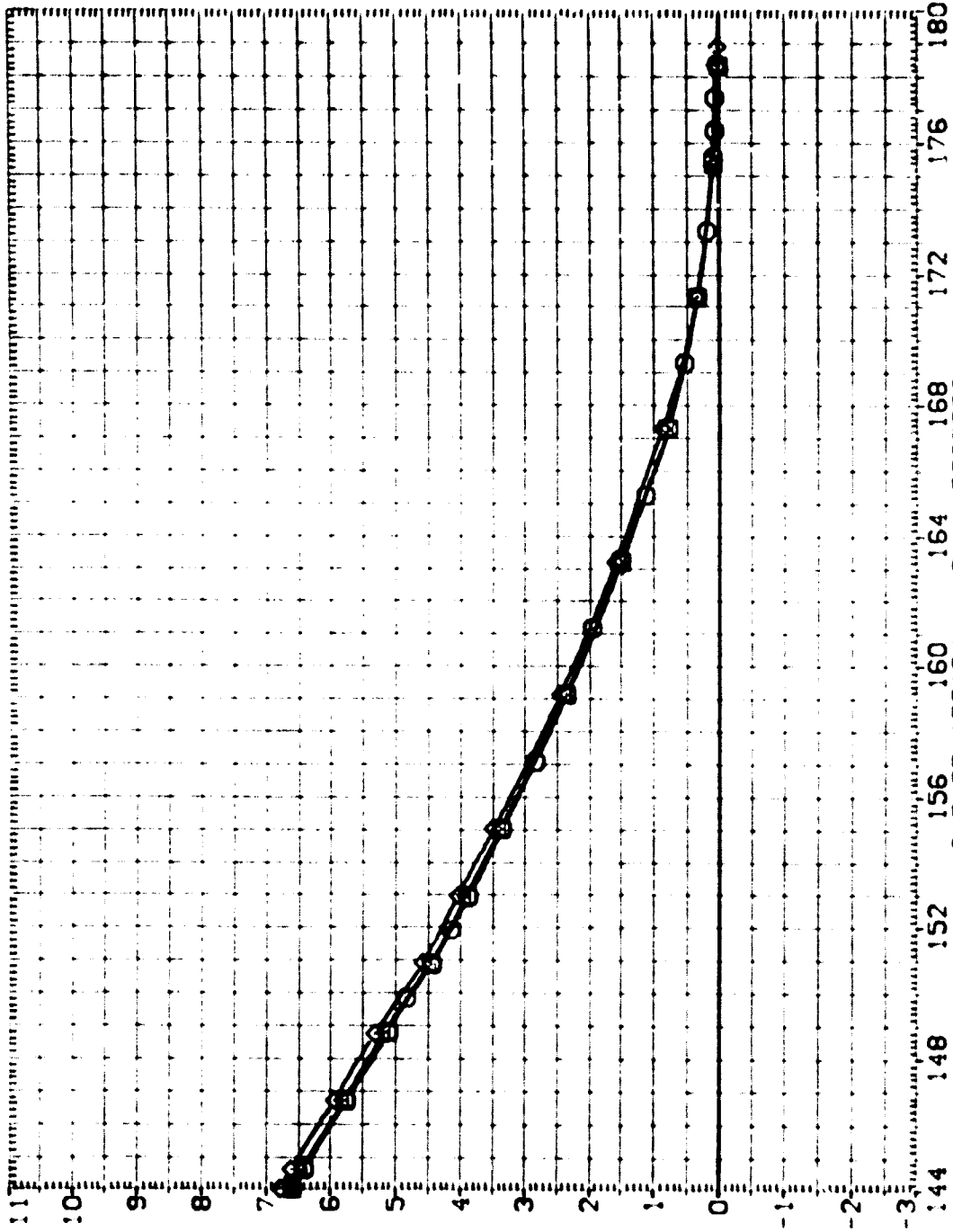

EFFECT OF ROLL ANGLE ON STATIC STABILITY CHARACTERISTICS OF SRB

(C)MACH = 4.63

DATA SET SYMBL. CONFIGURATION DESCRIPTION

(A-500)	SA-25F	LARE	UPNT	1087	MSFC	45A
(B-500)	SA-25F	LARE	UPNT	1087	MSFC	45A
(C-500)	SA-25F	LARE	UPNT	1087	MSFC	45A
(D-500)	SA-25F	LARE	UPNT	1087	MSFC	45A

PHI BETA

PHI	BETA
.000	.000
45.000	.000
90.000	.000
135.000	.000

TH ATTACH

TH ATTACH
TH ATTACH
TH ATTACH

ELT

ELT
ELT
ELT

REFERENCE INFORMATION

SREF	7.0690	SO, IN.
LREF	3.0000	IN-OES
BREF	3.0000	IN-OES
XMRP	20.8940	IN-OES
YMRP	.0000	IN-OES
ZMRP	.0000	IN-OES
SCALE	.0211	SCALE

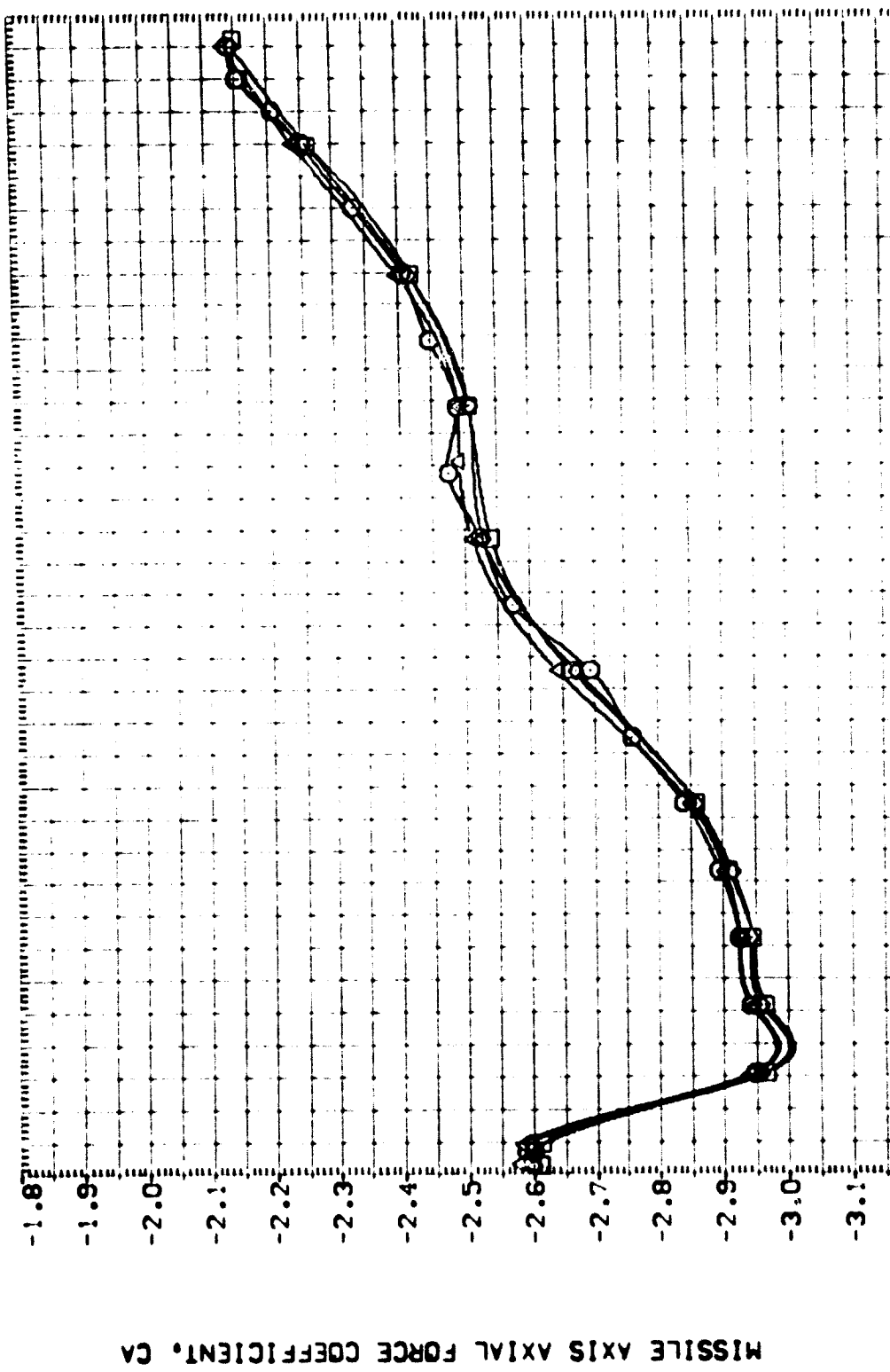

ANGLE OF ATTACK, ALPHA, DEGREES

144	148	152	156	160	164	168	172	176	180
-----	-----	-----	-----	-----	-----	-----	-----	-----	-----

EFFECT OF ROLL ANGLE ON STATIC STABILITY CHARACTERISTICS OF SRB

(A)MACH = 2.70

REFERENCE INFORMATION  
 SREF 7.0650 50. IN.  
 LREF 3.0000 IN-CES  
 BREF 3.0000 IN-CES  
 X-APP 20.8640 IN-CES  
 Y-APP .0000 IN-CES  
 Z-APP .0000 IN-CES  
 SCALE .0211 SCALE

BETA  
 P-1 .000  
 45.000  
 90.000  
 135.000

DATA SET SYMBOL CONFIGURATION DESCRIPTION  
 (A-0001) SA-25F LARC UPVT 1087 MSFC 454  
 (A-0002) SA-25F LARC UPVT 1087 MSFC 454  
 (A-0003) SA-25F LARC UPVT 1087 MSFC 454  
 (A-0004) SA-25F LARC UPVT 1087 MSFC 454

ELT TH ATTACH  
 ELT TH ATTACH  
 ELT TH ATTACH

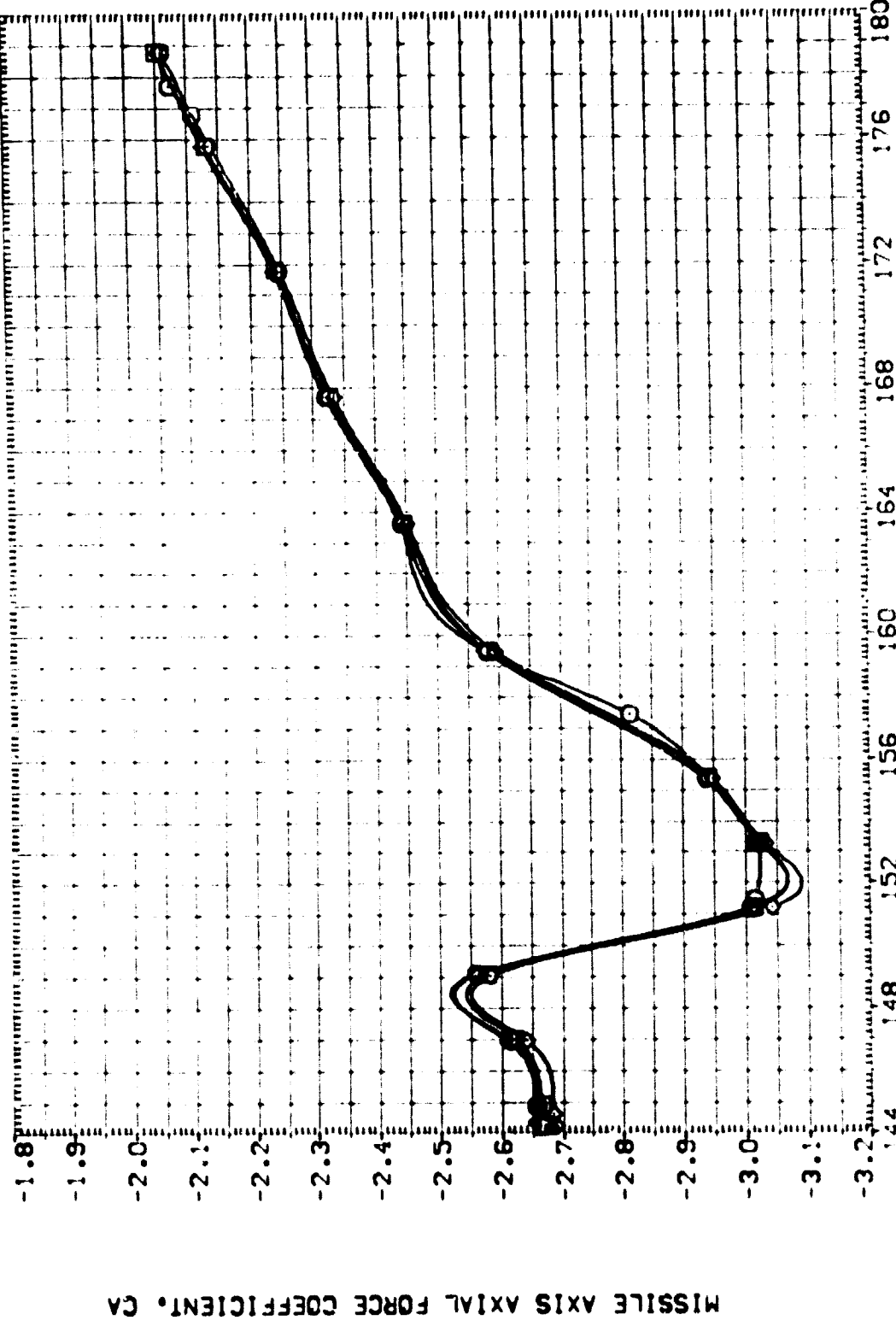

EFFECT OF ROLL ANGLE ON STATIC STABILITY CHARACTERISTICS OF SRB

(B)MACH = 4.00

DATA SET SYMBL. CONFIGURATION DESCRIPTION

SA-25F	LARC	UPVT	1087	MSFC	154
SA-25F	LARC	UPVT	1087	MSFC	154
SA-25F	LARC	UPVT	1087	MSFC	154
SA-25F	LARC	UPVT	1087	MSFC	154

PHI .000 BETA .000  
 .45 .000  
 .90 .000  
 .135 .000

TH ATTACH  
 TH ATTACH  
 TH ATTACH

ELT  
 ELT  
 ELT

REFERENCE INFORMATION

SREF	7.0580	50. IN
LREF	3.0000	INCHES
BREF	3.0000	INCHES
XPRP	20.8340	INCHES
YPRP	.0000	INCHES
ZPRP	.0000	INCHES
SCALE	.0211	SCALE

MISSILE AXIS AXIAL FORCE COEFFICIENT, CA

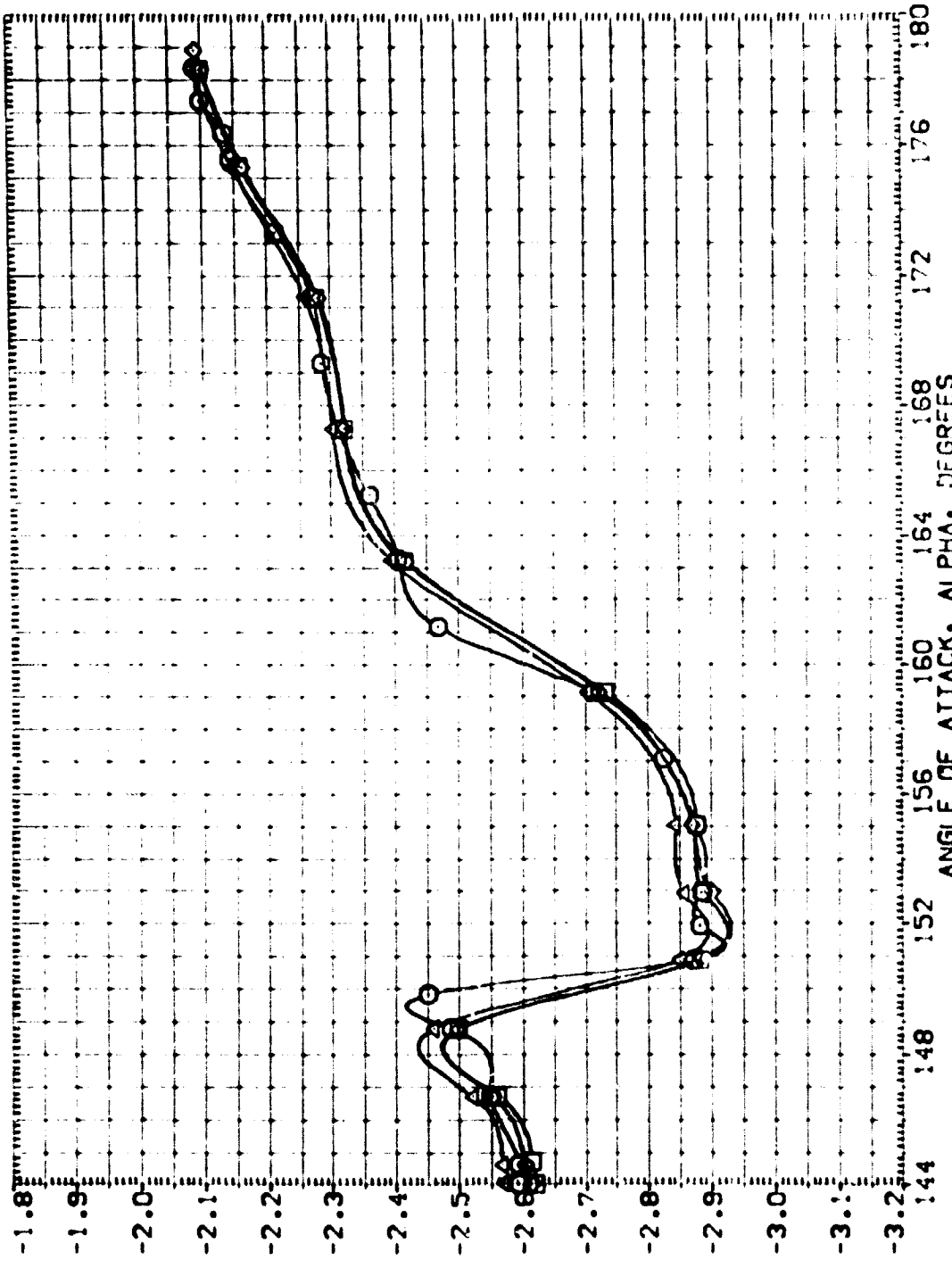

EFFECT OF ROLL ANGLE ON STATIC STABILITY CHARACTERISTICS OF SRB

(C)MACH = 4.63

REFERENCE INFORMATION  
 SREF 7.0590 50. IN.  
 LREF 3.0000 INOCS  
 BREF 3.0000 INOCS  
 XMRP 20.8040 INOCS  
 YMRP .0000 INOCS  
 ZMRP .0000 INOCS  
 SCALE .0211 SCALE

BETA .000  
 PH1 .000  
 PH2 45.000  
 PH3 90.000  
 PH4 135.000

TM ATTACH  
 TH ATTACH  
 TH ATTACH

CONFIGURATION DESCRIPTION  
 SA-25F LARC UPVT 1087 MSC 45A  
 SA-25F LARC UPVT 1087 MSC 45A  
 SA-25F LARC UPVT 1087 MSC 45A  
 SA-25F LARC UPVT 1087 MSC 45A

DATA SET SYMBO  
 [R-5001] □  
 [R-5002] ○  
 [R-5003] △  
 [R-5004] ◇

MISSILE AXIS PITCHING MOMENT COEFFICIENT, CLM

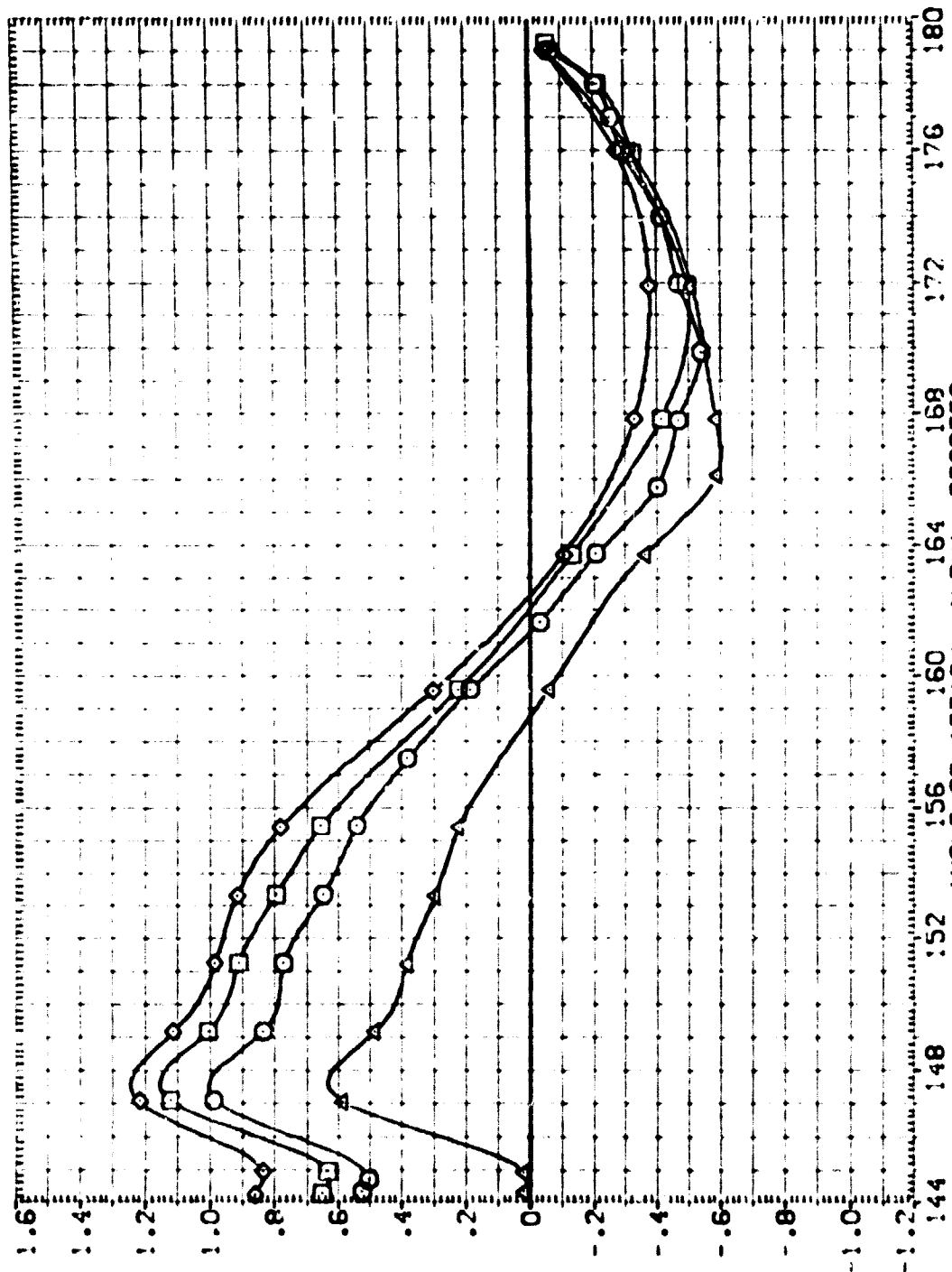

EFFECT OF ROLL ANGLE ON STATIC STABILITY CHARACTERISTICS OF SRB

(A)MACH = 2.70

DATA SET SYMBOL CONFIGURATION DESCRIPTION  
 (A-0001) SA-25F LARC UPVT 1087 MSFC 45A  
 (A-0002) SA-25F LARC UPVT 1087 MSFC 45A  
 (A-0003) SA-25F LARC UPVT 1087 MSFC 45A  
 (A-0004) SA-25F LARC UPVT 1087 MSFC 45A

ELT TM ATTACH  
 ELT TM ATTACH  
 ELT TM ATTACH

PHI BETA  
 .000 .000  
 45.000 .000  
 90.000 .000  
 135.000 .000

REFERENCE INFORMATION  
 SREF 7.0850 50.1N  
 LREF 3.0000 IN-OES  
 XREF 3.0000 IN-OES  
 YMRP 20.8340 IN-OES  
 ZMRP .0000 IN-OES  
 SCALE .0211 SCALE

MISSILE AXIS PITCHING MOMENT COEFFICIENT, CLMM

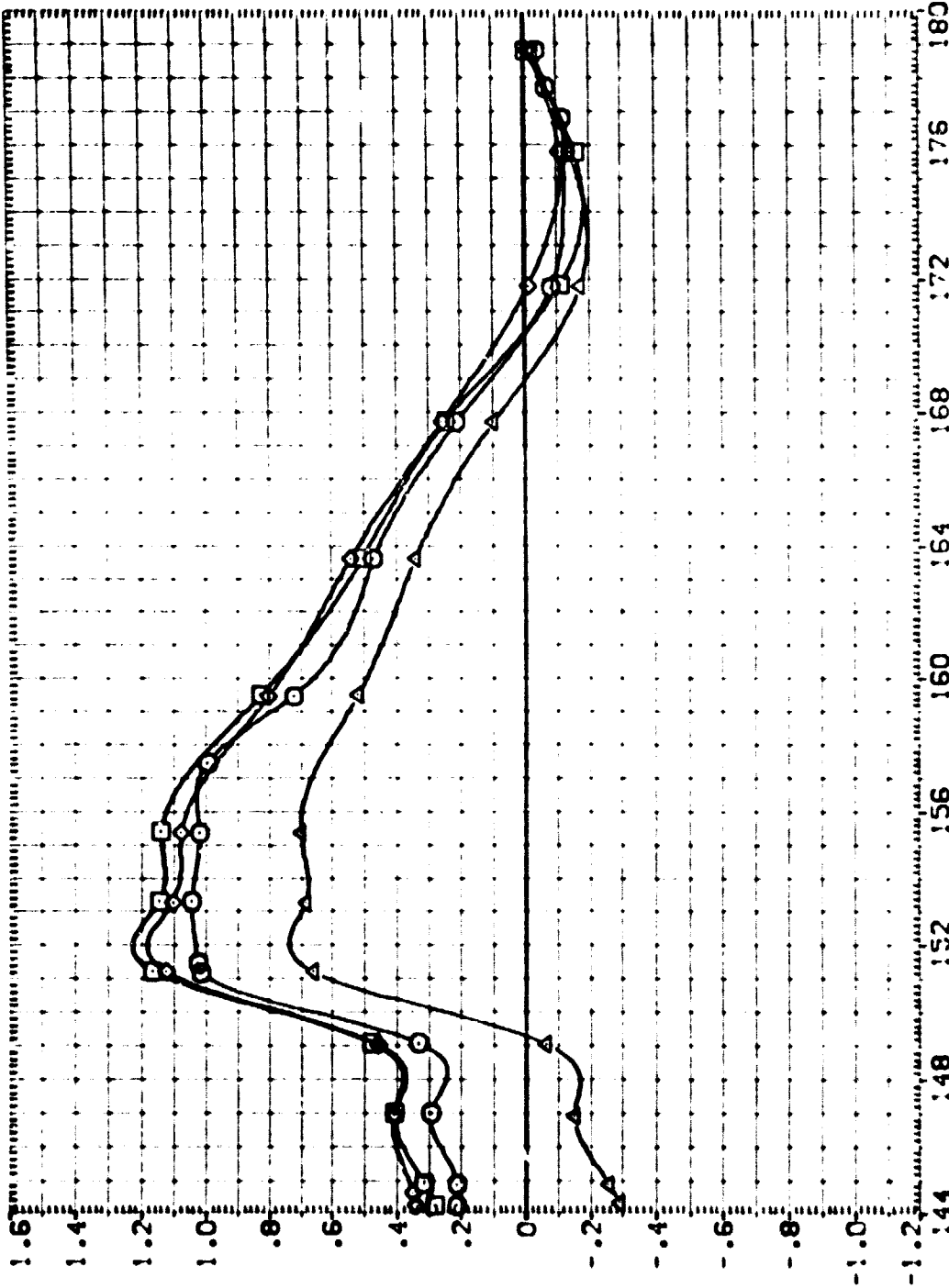

EFFECT OF ROLL ANGLE ON STATIC STABILITY CHARACTERISTICS OF SRB

(B)MACH = 4.00

DATA SET SYMBOL CONFIGURATION DESCRIPTION

SA-001	LA-001	LA-001	LA-001	LA-001	LA-001	LA-001	LA-001	LA-001	LA-001
SA-002	LA-002	LA-002	LA-002	LA-002	LA-002	LA-002	LA-002	LA-002	LA-002
SA-003	LA-003	LA-003	LA-003	LA-003	LA-003	LA-003	LA-003	LA-003	LA-003
SA-004	LA-004	LA-004	LA-004	LA-004	LA-004	LA-004	LA-004	LA-004	LA-004

PHI BETA

PHI	BETA
0.000	.000
45.000	.000
90.000	.000
135.000	.000

REFERENCE INFORMATION

SREF	7.0650	90. IN
LREF	3.0000	IN OCS
SREF	3.0000	IN OCS
XMRP	20	IN OCS
YMRP	.0000	IN OCS
ZMRP	.0000	IN OCS
SCALE	.0211	SCALE

MISSILE AXIS PITCHING MOMENT COEFFICIENT, CLM

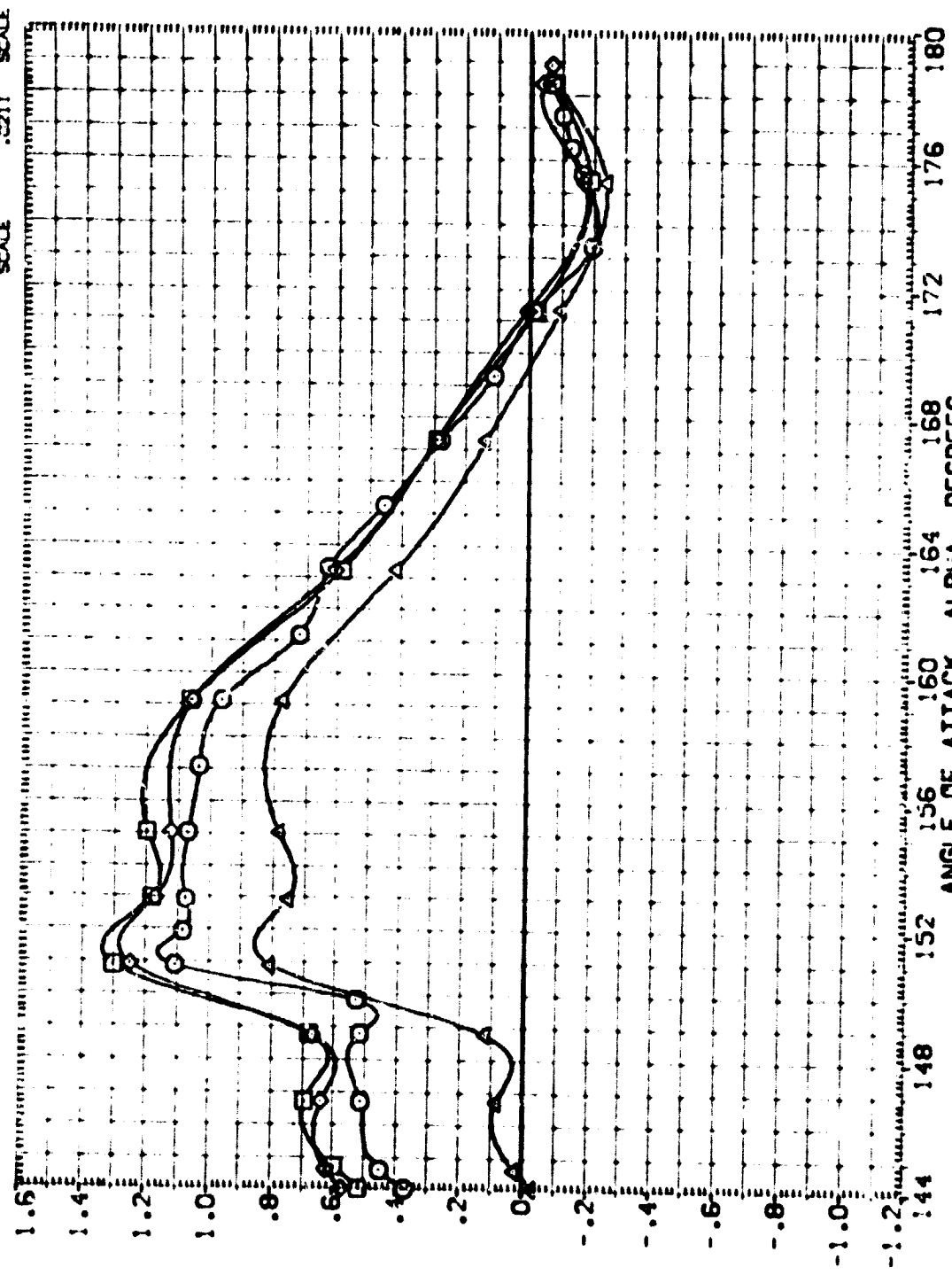

ANGLE OF ATTACK, ALPHA, DEGREES

(C)MACH = 4.63

DATA SET SYMBOL: (A-6001) (A-6002) (A-6003) (A-6004)

CONFIGURATION DESCRIPTION: SA-25F LAIRC UPVT 1087 MSFC 454 SA-25F LAIRC UPVT 1087 MSFC 454 SA-25F LAIRC UPVT 1087 MSFC 454 SA-25F LAIRC UPVT 1087 MSFC 454

TH ATTACH: TH ATTACH TH ATTACH TH ATTACH

ELT: ELT ELT ELT

PHI: .000 45.000 90.000 135.000

BETA: .000 .000 .000 .000

REFERENCE INFORMATION: SREF 3.0000 SO.IN. INCHES LREF 3.0000 INCHES BREF 20.8340 INCHES XMRP .0000 INCHES YMRP .0000 INCHES ZMRP .0211 INCHES SCALE

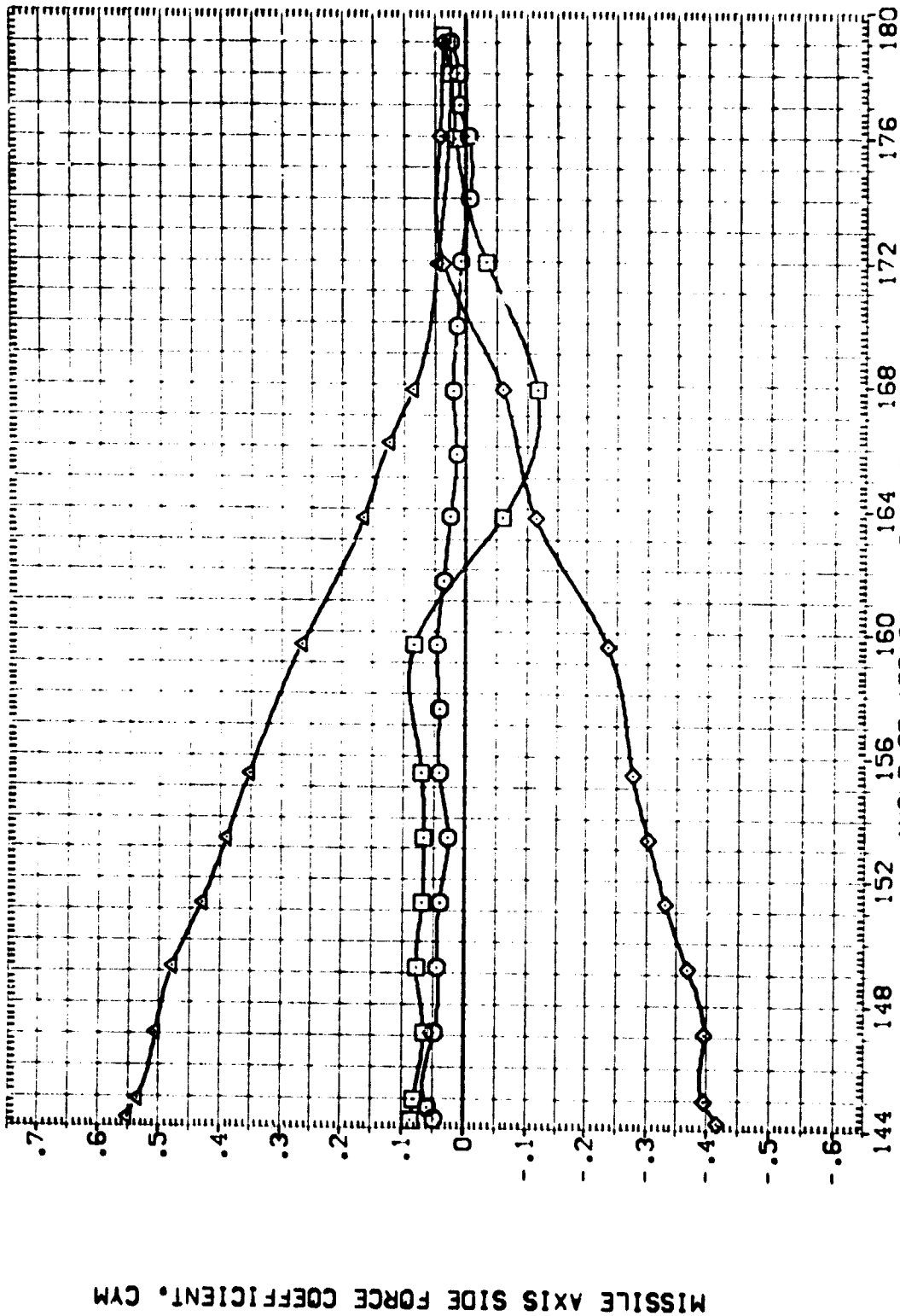

EFFECT OF ROLL ANGLE ON STATIC STABILITY CHARACTERISTICS OF SRB

(A)MACH = 2.70



DATA SET SYMBOL: [R-6001] [R-6002] [R-6003] [R-6004]

CONFIGURATION DESCRIPTION: SA-25F LARC LPVT 1087 MSFC 454 SA-25F LARC LPVT 1087 MSFC 454 SA-25F LARC LPVT 1087 MSFC 454 SA-25F LARC LPVT 1087 MSFC 454

ELT TH ATTACH: ELT TH ATTACH ELT TH ATTACH ELT TH ATTACH

PHI: .000 45.000 90.000 135.000

BETA: .000 .000 .000 .000

REFERENCE INFORMATION: SREF 7.0690 50. IN INCHES LREF 3.0000 10. INCHES BREF 3.0000 10. INCHES XMRP 20. 8040 INCHES YMRP .0000 INCHES ZMRP .0000 INCHES SCALE .0211

MISSILE AXIS SIDE FORCE COEFFICIENT, C<sub>YM</sub>

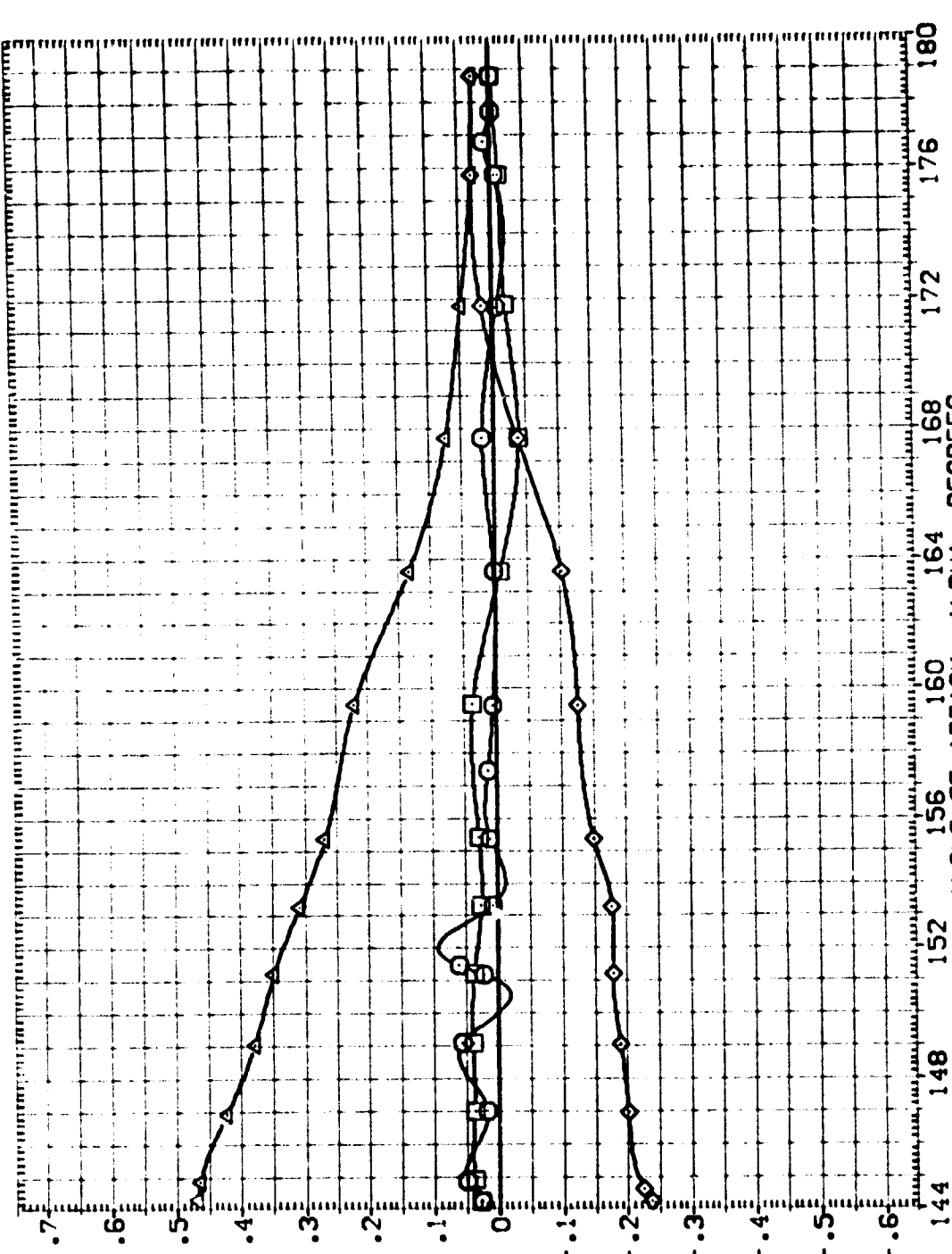

EFFECT OF ROLL ANGLE ON STATIC STABILITY CHARACTERISTICS OF SRB

(B)MACH = 4.00

DATA SET SYMBOL: (A-8001) (R-8002) (R-8003) (R-8004)

CONFIGURATION DESCRIPTION: SA-25F LARC LPVT 1087 MSFC 45A SA-25F LARC LPVT 1087 MSFC 45A SA-25F LARC LPVT 1087 MSFC 45A SA-25F LARC LPVT 1087 MSFC 45A

PHI: .000 .000 .000 .000

BETA: .000 .000 .000 .000

TM ATTACH: TM ATTACH TM ATTACH TM ATTACH

ELT: ELT ELT ELT ELT

REFERENCE INFORMATION: SREF 7.0680 50. IN LREF 3.0000 IN-CES BREF 3.0000 IN-CES XMRP 20.8340 IN-CES YMRP .0000 IN-CES ZMRP .0000 IN-CES SCALE .0211 SCALE

MISSILE AXIS SIDE FORCE COEFFICIENT, C<sub>YM</sub>

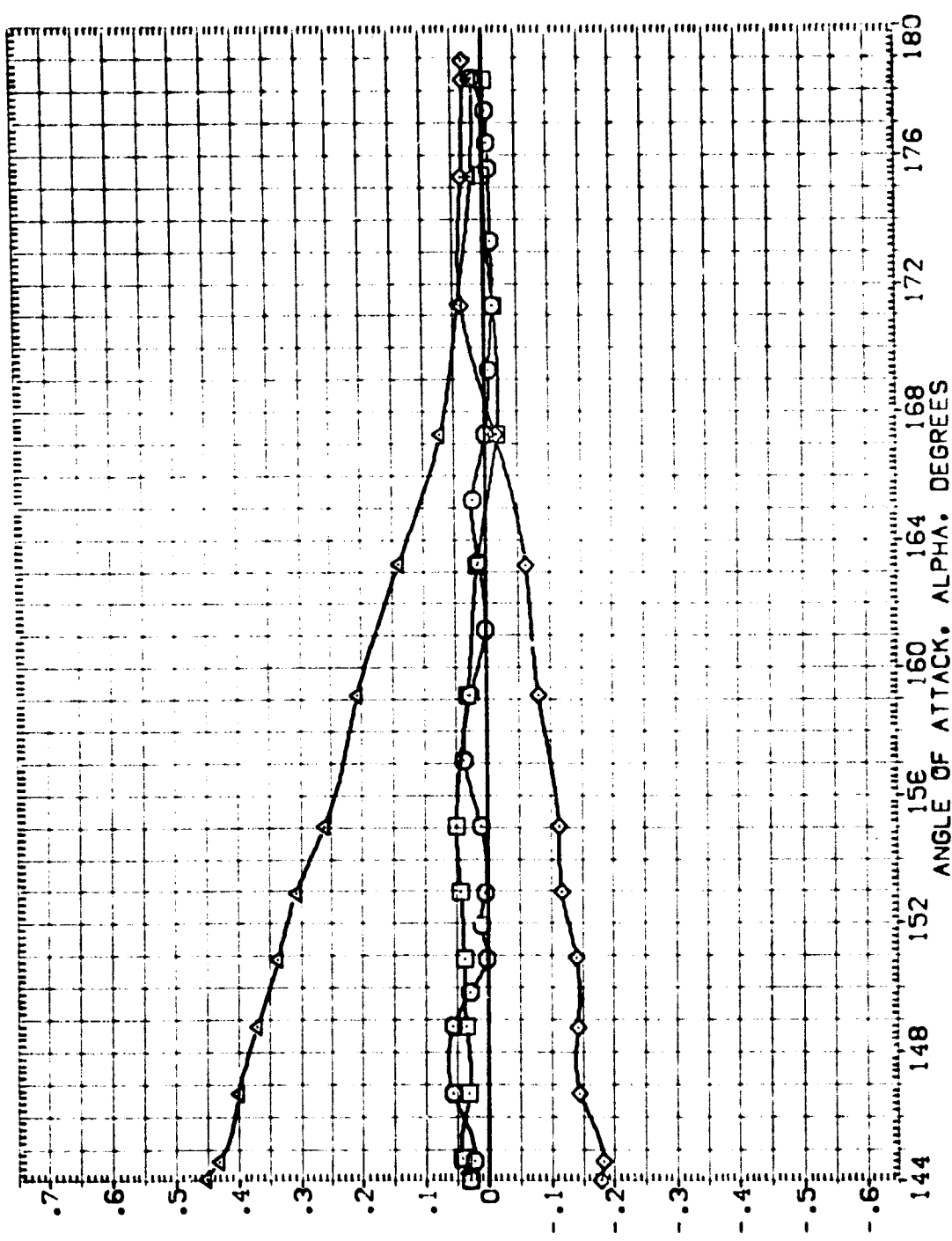

EFFECT OF ROLL ANGLE ON STATIC STABILITY CHARACTERISTICS OF SRB

(C)MACH = 4.63

DATA SET SYMBOL CONFIGURATION DESCRIPTION

(A-5001)	SA-25F	LARC	UPVT	1087	MSFC	454
(R-5002)	SA-25F	LARC	UPVT	1087	MSFC	454
(R-5003)	SA-25F	LARC	UPVT	1087	MSFC	454
(R-5004)	SA-25F	LARC	UPVT	1087	MSFC	454

PMI BETA

.000	.000
45.000	.000
90.000	.000
135.000	.000

REFERENCE INFORMATION

SREF	7.0690	50. IN.
LREF	3.0000	IN-ES
BREF	3.0000	IN-ES
XMRP	20.6340	IN-ES
YMRP	.0000	IN-ES
ZMRP	.0000	IN-ES
SCALE	.0211	SCALE

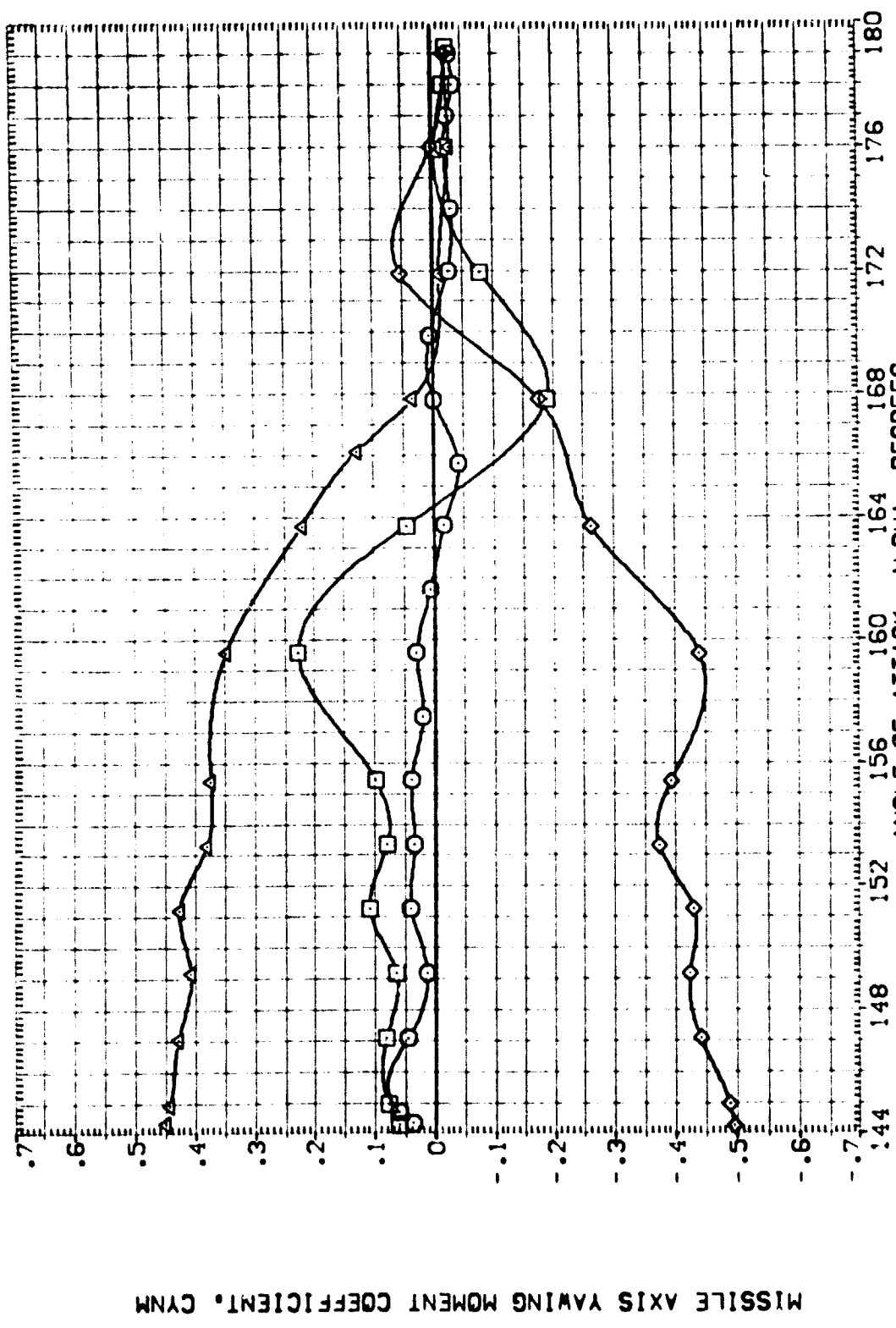

EFFECT OF ROLL ANGLE ON STATIC STABILITY CHARACTERISTICS OF SRB

(A)MACH = 2.70

MISSILE AXIS YAWING MOMENT COEFFICIENT, C<sub>ym</sub>

DATA SET SYMBOL CONFIGURATION DESCRIPTION  
 [A-0001] SA-25F LARC UPVT 1087 MSFC 45A  
 [R-0002] SA-25F LARC UPVT 1087 MSFC 45A  
 [R-0003] SA-25F LARC UPVT 1087 MSFC 45A  
 [R-0004] SA-25F LARC UPVT 1087 MSFC 45A

PHI BETA  
 .000 .000  
 45.000 .000  
 90.000 .000  
 135.000 .000

TH ATTACH TH ATTACH  
 ELT TH ATTACH ELT TH ATTACH  
 ELT TH ATTACH ELT TH ATTACH

REFERENCE INFORMATION  
 SREF 7.0690 SQ. IN.  
 LREF 3.0000 INCHES  
 BREF 3.0000 INCHES  
 XMRP 20.8340 INCHES  
 YMRP .0000 INCHES  
 ZMRP .0000 INCHES  
 SCALE .0211

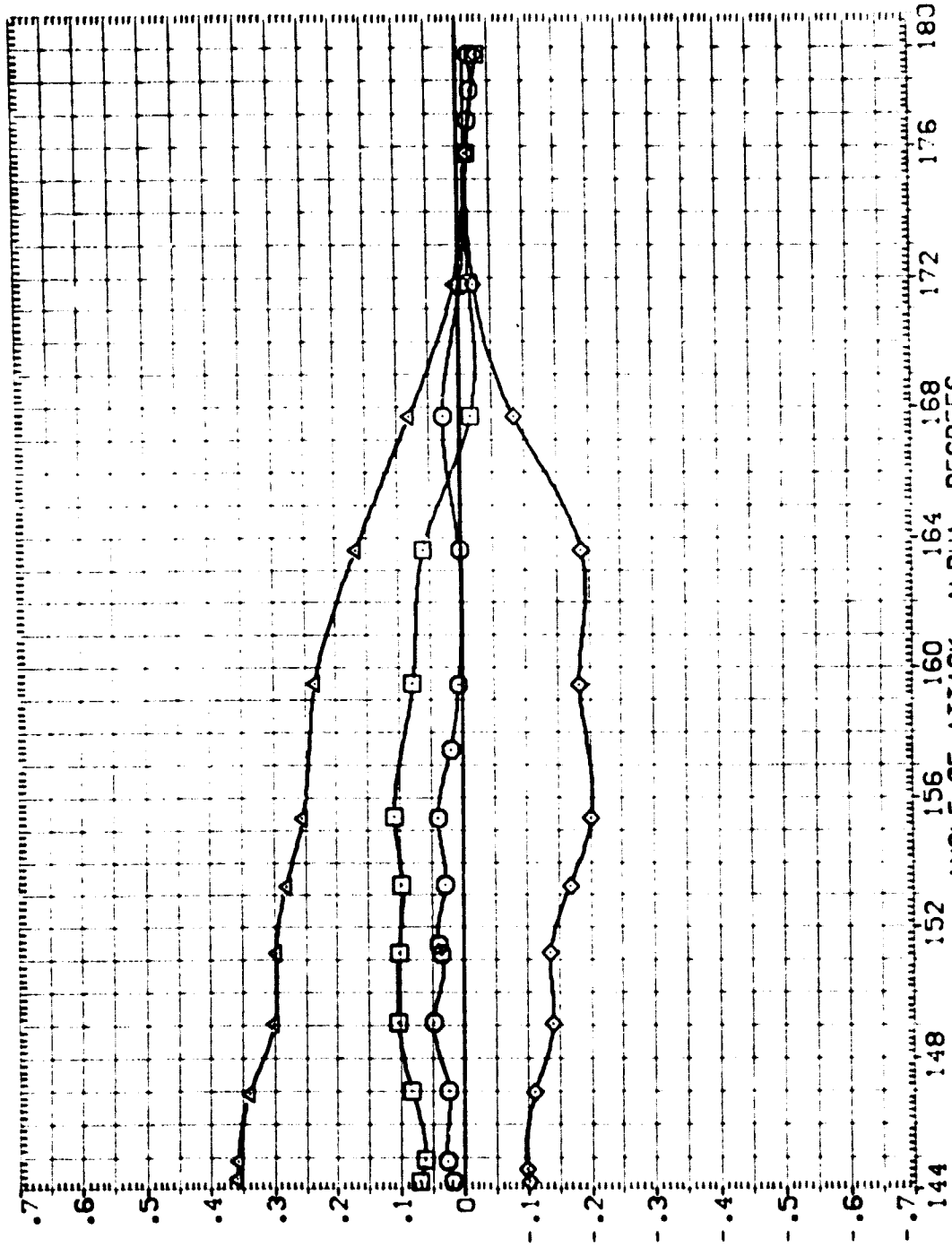

EFFECT OF ROLL ANGLE ON STATIC STABILITY CHARACTERISTICS OF SRB

(B)MACH = 4.00

DATA SET SYMBOL    CONFIGURATION DESCRIPTION    PH1    BETA    TH ATTACH    ELT    TH ATTACH    ELT

[A-5001]    SA-25F LARC UPVT 1087 MSFC 45A    .000    .000    45.000    .000    .000    .000

[R-5002]    SA-25F LARC UPVT 1087 MSFC 45A    .000    .000    90.000    .000    .000    .000

[R-5003]    SA-25F LARC UPVT 1087 MSFC 45A    .000    .000    90.000    .000    .000    .000

[R-5004]    SA-25F LARC UPVT 1087 MSFC 45A    .000    .000    135.000    .000    .000    .000

REFERENCE INFORMATION

SREF 7.0690    SQ. IN.

LREF 3.0000    INCHES

BREF 3.0000    INCHES

XMRP 20    INCHES

ZMRP .0000    INCHES

SCALE .02:1    INCHES

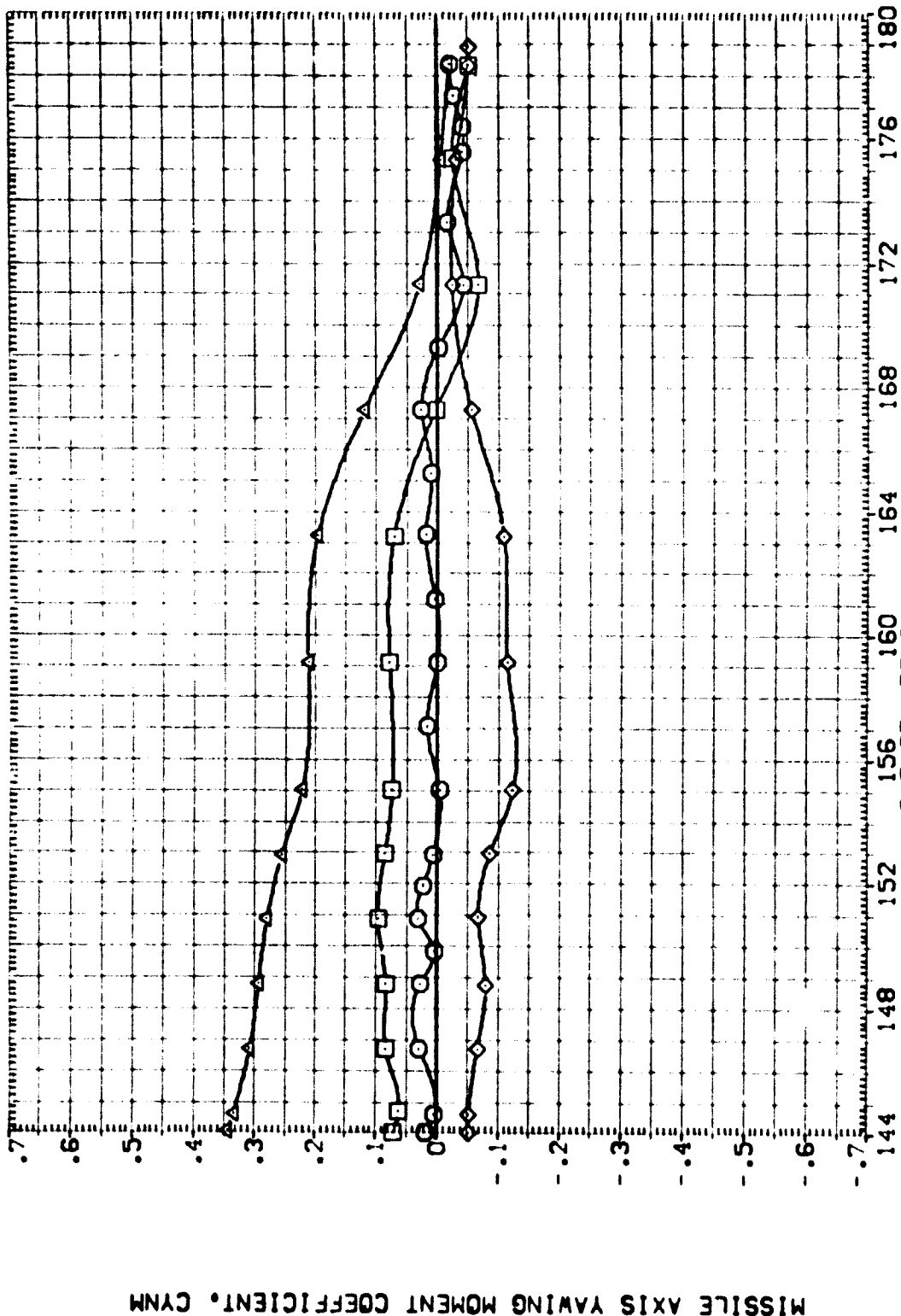

MISSILE AXIS YAWING MOMENT COEFFICIENT, CYNM

EFFECT OF ROLL ANGLE ON STATIC STABILITY CHARACTERISTICS OF SRB

(C)MACH = 4.63

DATA SET SYMBO. CONFIGURATION DESCRIPTION

[A-0001]	SA-25F	LARE	LPVT	1087	MSFC	45A	ELT	TM	ATTACH	PHI	BETA
[A-0002]	SA-25F	LARE	LPVT	1087	MSFC	45A	ELT	TM	ATTACH	0.000	0.000
[A-0003]	SA-25F	LARE	LPVT	1087	MSFC	45A	ELT	TM	ATTACH	45.000	0.000
[A-0004]	SA-25F	LARE	LPVT	1087	MSFC	45A	ELT	TM	ATTACH	135.000	0.000

REFERENCE INFORMATION

SREF	7.0690	50. IN
LARE	3.0000	IN-OES
BREF	3.0000	IN-OES
XPRP	20.6940	IN-OES
YPRP	.0000	IN-OES
ZPRP	.0000	IN-OES
SCALE	.0211	SCALE

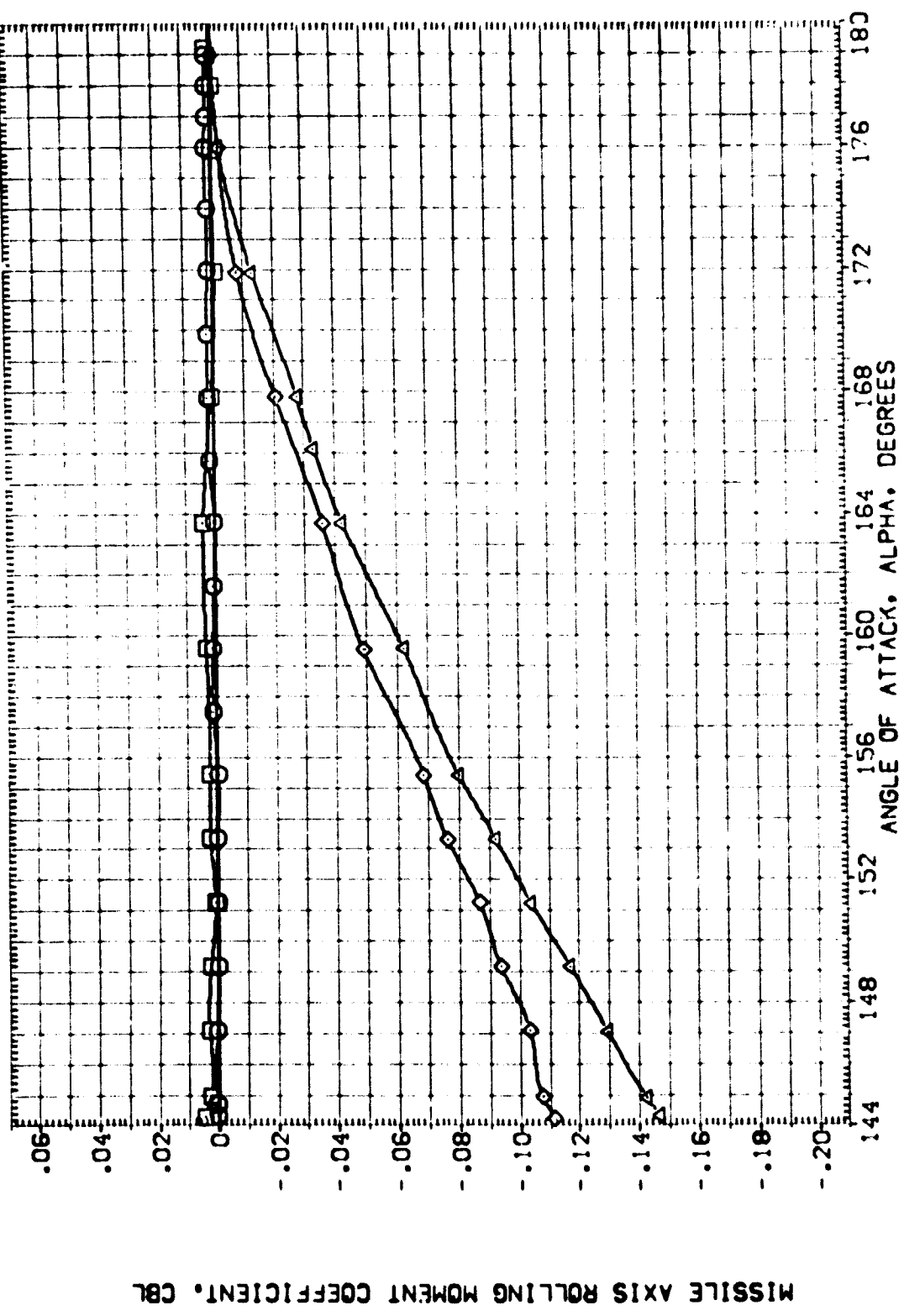

EFFECT OF ROLL ANGLE ON STATIC STABILITY CHARACTERISTICS OF SRB

(A)MACH = 2.70

DATA SET SYMBOLS  
 (A-6001)  
 (R-6002)  
 (R-6003)  
 (R-6004)

CONFIGURATION DESCRIPTION  
 SA-25F LARC UPVT 1087 MSFC 45A  
 SA-25F LARC UPVT 1087 MSFC 45A  
 SA-25F LARC UPVT 1087 MSFC 45A  
 SA-25F LARC UPVT 1087 MSFC 45A

PHI ATTACH  
 TH ATTACH  
 TH ATTACH  
 TH ATTACH

BETA  
 .000  
 .000  
 .000  
 .000

REFERENCE INFORMATION  
 SREF 7.0690 50. IN.  
 LREF 3.0000 IN.-ES  
 BREF 3.0000 IN.-ES  
 XMRP 20.8240 IN.-ES  
 YMRP .0000 IN.-ES  
 ZMRP .0000 IN.-ES  
 SCALE .0211 SCALE

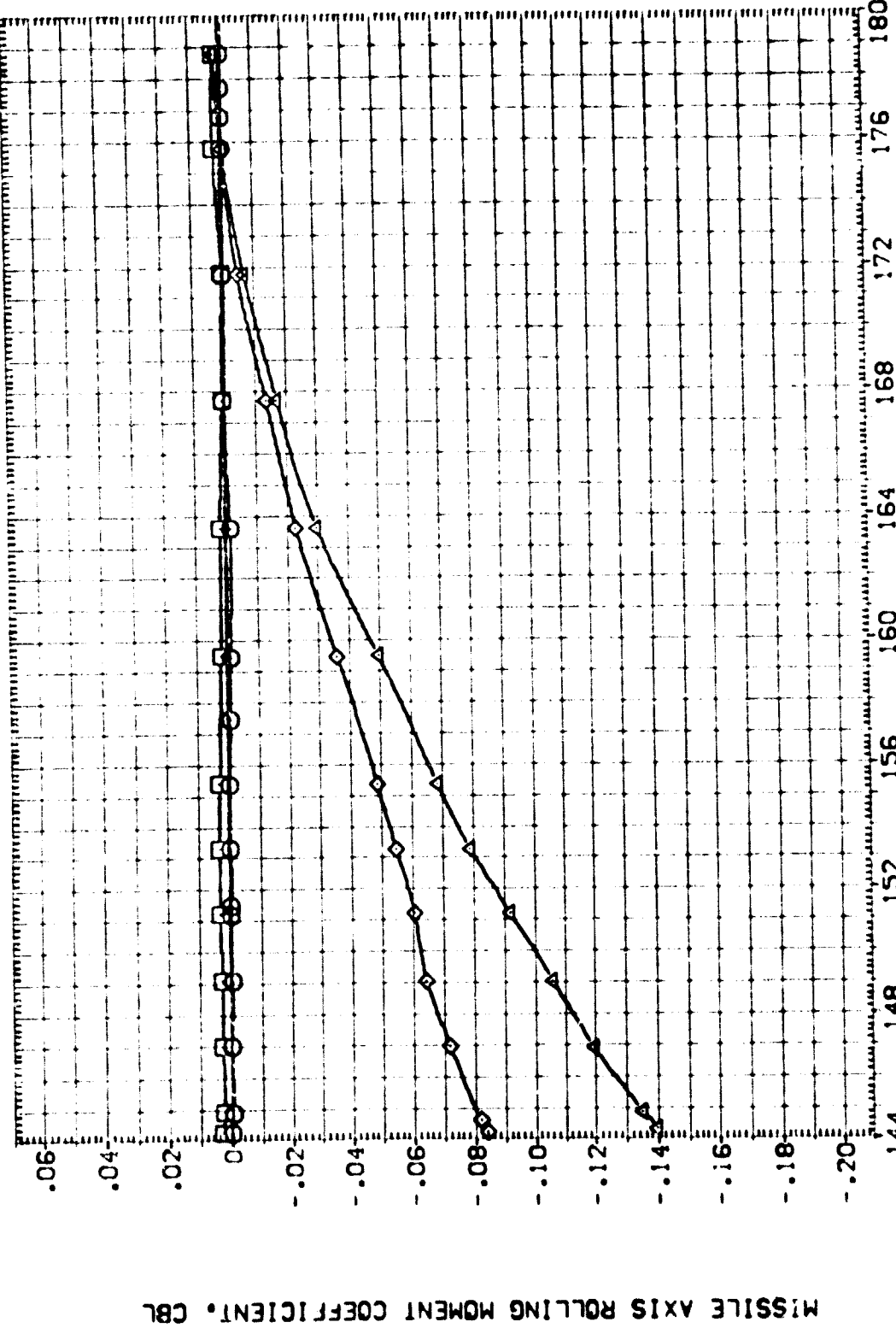

EFFECT OF ROLL ANGLE ON STATIC STABILITY CHARACTERISTICS OF SRB

(B)MACH = 4.00

MISSILE AXIS ROLLING MOMENT COEFFICIENT, CRL

DATA SET SYMBL CONFIGURATION DESCRIPTION  
 (R-6001) SA-25F LARC UPVT 1087 MSC 45A  
 (R-6002) SA-25F LARC UPVT 1087 MSC 45A  
 (R-6003) SA-25F LARC UPVT 1087 MSC 45A  
 (R-6004) SA-25F LARC UPVT 1087 MSC 45A

PHI .000  
 BETA .000

TM ATTACH  
 TH ATTACH

ELT  
 ELT

REFERENCE INFORMATION  
 SREF 7.0690 SC.IN  
 LREF 3.0000 IN.OES  
 BREF 3.0000 IN.OES  
 XMRP 20.8370 IN.OES  
 YMRP .0000 IN.OES  
 ZMRP .0000 IN.OES  
 SCALE .0211 SCALE

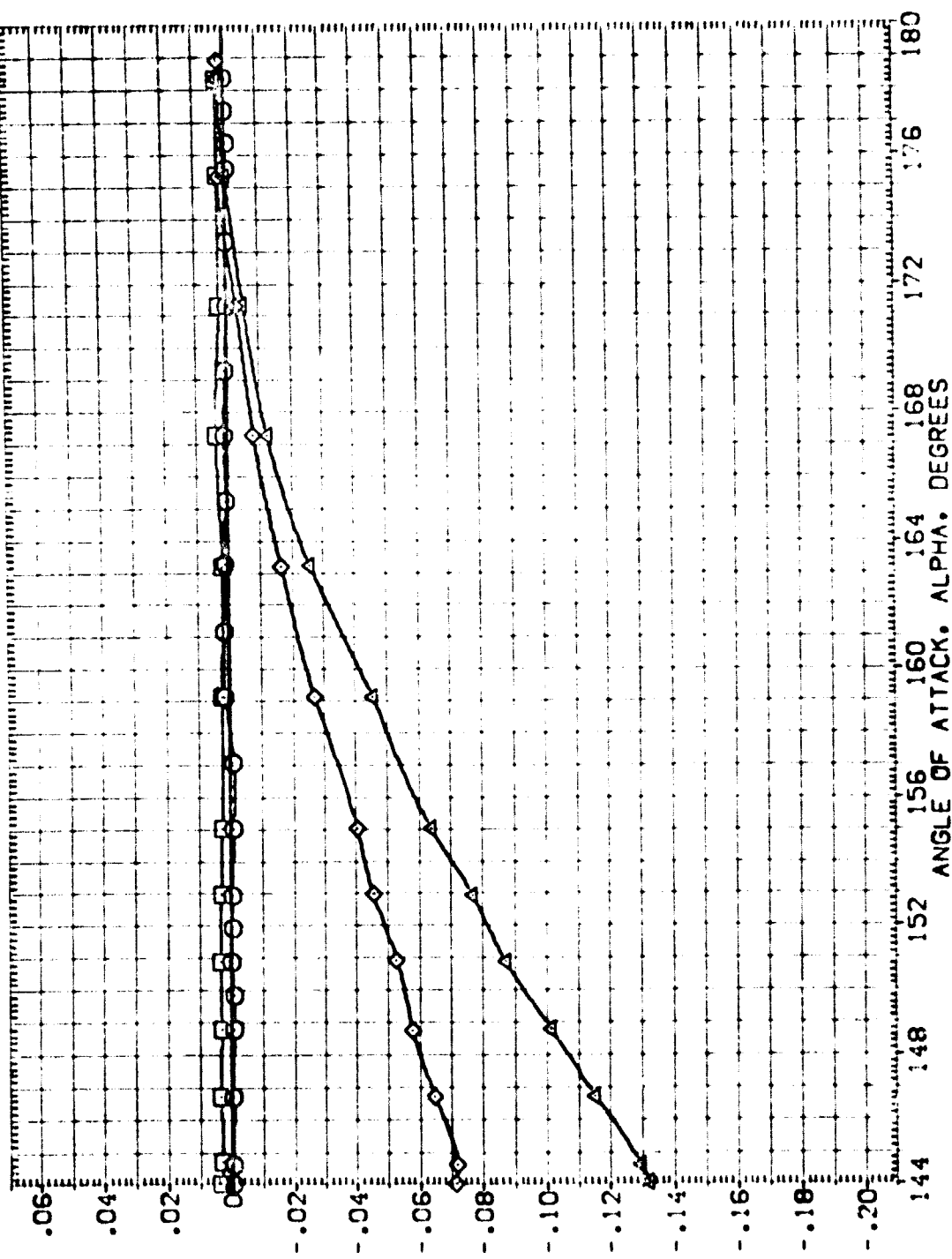

EFFECT OF ROLL ANGLE ON STATIC STABILITY CHARACTERISTICS OF SRB

(C)MACH = 4.63



APPENDIX

TABULATED SOURCE DATA

Plotted data listings are available on request from  
Data Management Services.

3A-25F LARC UPWT 1987 M5FC 454

(RM9901) ( 14 FEB 75 )

REFERENCE DATA

BREF = 7.0000 30-IM. HMP = 29.0340 INCHES  
 LREF = 3.0000 INCHES VMP = .0000 INCHES  
 BREF = 3.0000 INCHES ZMP = .0000 INCHES  
 SCALE = .0211 SCALE

PARAMETRIC DATA

PHI = .000

RUN NO. 1/0 MW/L = 1.50 GRADIENT INTERVAL = -5.00/ 5.00

MACH	ALPHA	CMW	CA	CUM	CVM	CVMM	CBL	CL	CD	0 (PSF)
2.300	144.111	7.93871	-2.02203	.45949	.07743	.04775	.00011	-4.77565	6.93891	341.47734
2.300	144.485	7.85428	-2.94762	.73644	.05021	-.04631	.00051	-4.64003	6.93232	341.71425
2.300	144.747	7.75100	-2.93333	.70236	.07014	.03370	.00395	-4.58457	6.85700	340.50000
2.300	145.053	6.99703	-2.92864	.48932	.07410	-.02371	.00360	-4.25439	6.27795	340.50000
2.300	148.963	6.31677	-2.92144	.32233	.07097	.02329	.00333	-3.90619	5.76074	340.33201
2.300	131.029	3.65319	-2.90104	-.12729	.06639	-.02266	.00309	-3.54962	5.27623	340.50000
2.300	133.155	4.98755	-2.86913	-.01477	.07468	.01386	.00461	-3.11656	4.80318	340.61854
2.300	135.257	4.32795	-2.83329	-.16993	.05095	-.01496	.00462	-2.73714	4.40232	340.64815
2.300	137.337	3.75610	-2.81758	-.36407	.03204	-.02331	.00448	-2.36196	4.03939	340.26317
2.300	139.414	3.15884	-2.77625	-.51066	.04930	-.04009	.00344	-1.98797	3.70966	340.26317
2.300	181.316	2.59203	-2.70208	-.69992	.07470	-.02279	.00507	-1.60776	3.38441	340.38163
2.300	183.383	2.05003	-2.65436	-.82361	.03183	-.04083	.00486	-1.16228	3.12552	340.33201
2.300	185.655	1.50757	-2.62898	-.94805	.03981	-.07243	.00433	-.80923	2.92052	340.32240
2.300	187.712	1.03204	-2.58072	-.96055	.01953	-.06299	.00453	-.49914	2.74124	340.29278
2.300	169.761	.64423	-2.53148	-.83116	.02276	-.07095	.00439	-.18398	2.60568	340.44085
2.300	171.149	.49761	-2.47478	-.74398	.02101	-.04506	.00095	-.11089	2.52187	340.33163
2.300	171.875	.41404	-2.46102	-.67733	.01878	-.05317	.00470	-.06203	2.49483	339.78935
2.300	173.859	.24291	-2.39182	-.59225	.01606	-.06497	.00271	.01437	2.40408	339.84758
2.300	175.892	.13160	-2.31429	-.35979	.01709	-.06463	.00279	.03451	2.31777	339.78935
2.300	176.927	.06771	-2.27557	-.26920	.01786	-.06431	.00283	.03510	2.27697	339.99665
2.300	177.951	.05673	-2.23977	-.18839	.01909	-.06382	.00286	.01540	2.24065	340.08549
2.300	178.991	-.02018	-2.17177	-.07896	.01831	-.09039	.00445	.01807	2.17178	341.00352
2.300	179.443	-.02238	-2.16553	-.03419	.03098	-.07698	.00434	.02342	2.16540	340.73599
GRADIENT					.00000		.00000			.00000

ORIGINAL PAGE IS  
OF POOR QUALITY

SA-23F LARC UPVT 1987 WSFC 434

REFERENCE DATA

REF = 7.0000 50.1M. HIMP = 20.2349 INCHES  
 LREF = 3.0000 INCHES VMIP = .0000 INCHES  
 BREF = 3.0000 INCHES VMIP = .0000 INCHES  
 SCALE = .0211 SCALE

RUN NO. 2 / 0 BM/L = 1.50 GRADIENT INTERVAL = -.5.00/ 9.00

FMI = .000

PARAMETRIC DATA

MICH	ALPHA	CWM	CA	CLMWH	CVM	CYMN	CBL	CL	CD	D(FSF)
2.700	144.309	7.30906	-2.59661	.52116	.04756	.03689	.00024	-4.50053	5.48746	310.41002
2.700	144.678	7.36625	-2.59960	.50067	.05018	.05992	.00039	-4.50706	5.38023	310.72295
2.700	147.095	6.52717	-2.94762	.98634	.04770	.04560	.00041	-3.47874	5.02061	310.65720
2.700	149.170	5.90040	-2.94153	.83187	.04283	.01492	-.00018	-3.55912	5.54978	310.65720
2.700	151.258	5.24955	-2.92455	.76876	.04047	.04120	.00004	-3.19647	5.09955	310.65720
2.700	153.361	4.62208	-2.89404	.64303	.02678	.03525	-.00010	-2.83385	4.55923	310.65720
2.700	155.445	4.04190	-2.83977	.54063	.04151	.03006	-.00037	-2.49624	4.26263	310.61316
2.700	157.514	3.46077	-2.76020	.37790	.04232	.02000	-.00122	-2.14197	3.47397	310.65720
2.700	159.575	2.95003	-2.69512	.18492	.04622	.03035	.00107	-.82401	3.55518	310.59145
2.700	161.643	2.45322	-2.57223	-.03391	.03573	.00647	.00059	-1.31829	3.21393	310.54761
2.700	163.719	1.95365	-2.52395	-.21216	.02321	-.01744	.00012	-1.16961	2.97102	310.61336
2.700	165.758	1.48363	-2.47390	-.40122	-.01523	-.04131	.00174	-.82940	2.76286	310.41611
2.700	167.809	1.03403	-2.40952	-.69949	.02170	-.00091	.00206	-.48502	2.63173	310.54761
2.700	169.890	.63438	-2.44707	-.93391	.01466	.00551	.00206	-.19499	2.52043	310.54761
2.700	171.972	.30052	-2.40543	-.47007	.00732	-.02624	.00157	-.04087	2.42499	310.85416
2.700	173.987	.24253	-2.33119	-.41320	-.00619	-.03162	.00173	-.00239	2.34377	310.50378
2.700	175.902	.14504	-2.25055	-.29655	-.00415	-.02116	.00183	.01303	2.25528	310.50378
2.700	177.014	.09586	-2.20766	-.25869	-.00933	-.02583	.00169	.01929	2.20966	310.46166
2.700	178.028	.07146	-2.15238	-.21074	.01019	-.03516	.00157	.00303	2.15357	310.50378
2.700	179.015	.02235	-2.14077	-.07155	.02390	-.03006	.00158	.01444	2.14084	310.39419
2.700		.00000	.00000	.00000	.00000	.00000	.00000	.00000	.00000	.00000



SA-2SF LARC UPWT 1987 WSPC 434

(RM9901) (14 FEB 75)

REFERENCE DATA

BREF = 7.0000 30.1M. WMP = 20.0340 INCHES  
 LOOP = 3.0000 INCHES WMP = .0000 INCHES  
 BREF = 3.0000 INCHES WMP = .0000 INCHES  
 SCALE = .0211 SCALE

PARAMETRIC DATA

PMI = .000

SUM NO. 3 / 0 BIM/L = 1.50 GRADIENT INTERVAL = -3.00 / 3.00

MACH	ALPHA	CUM	CA	CLMM	CYN	CYMM	CBL	CL	CD	0 (PSF)
2.000	144.201	7.27014	-2.32759	.63184	.00931	.03210	-.00023	-4.45103	6.27949	200.39100
2.000	143.130	7.07160	-2.32971	.63230	-.04190	.01431	-.00002	-4.33707	6.11710	200.60001
2.000	147.270	6.31700	-2.02203	1.17494	.02809	.02141	-.00001	-3.75412	5.07615	200.64427
2.000	140.170	6.06407	-2.03447	1.16292	-.05344	.01033	-.00004	-3.36815	5.60126	200.60001
2.000	145.381	5.07215	-2.03000	1.04181	.03299	.03017	.00010	-2.37662	5.42933	200.37333
2.000	150.091	5.34717	-2.03103	1.00331	-.06769	.07302	.00033	-3.20051	5.20214	200.64427
2.000	131.440	5.07431	-2.03919	.94959	.04476	.03377	-.00007	-3.05242	5.00702	200.50200
2.000	133.333	4.45300	-2.03763	.85010	-.03119	.02791	-.00020	-2.59501	4.57848	200.31709
2.000	135.026	3.65900	-2.03320	.78097	-.01806	.01217	-.00047	-2.34134	4.17348	200.33709
2.000	137.649	3.33373	-2.75604	.60334	-.02241	-.00219	.00138	-2.03523	3.81674	200.37333
2.000	139.724	2.03473	-2.60372	.37331	-.03992	-.01278	.00073	-1.75678	3.42473	200.59100
2.000	161.750	2.35173	-2.54242	.15608	-.04548	-.00105	.00055	-1.43769	3.13500	200.35562
2.000	167.790	1.09376	-2.40697	-.01916	-.03930	.02684	.00060	-1.12459	2.91661	200.76039
2.000	163.919	1.43935	-2.40073	-.16261	-.01469	-.00340	.00037	-.80246	2.71763	200.35562
2.000	167.930	1.03333	-2.39049	-.24016	-.00971	-.02821	.00220	-.51304	2.53300	200.35562
2.000	170.003	.63733	-2.41640	-.36857	-.00100	-.02068	-.00007	-.22793	2.49301	200.37333
2.000	172.013	.41031	-2.30733	-.41479	-.00634	-.03355	.00196	-.07773	2.40140	200.40469
2.000	174.047	.26096	-2.30666	-.41479	-.00005	-.04468	.00181	-.02033	2.32129	200.71320
2.000	176.034	.12990	-2.21202	-.34656	-.00635	-.04422	.00175	.02345	2.21651	200.62634
2.000	177.023	.03370	-2.14273	-.31699	-.00341	-.03428	.00161	.00765	2.14523	200.46696
2.000	178.036	.07748	-2.12309	-.19992	-.00339	-.04310	.00180	-.00539	2.12530	200.37333
2.000	179.009	.02307	-2.10920	-.09363	-.00354	-.04262	-.00040	.00811	2.10931	200.37333
GRADIENT										

ORIGINAL PAGE IS OF POOR QUALITY

3A-25F LARC UNWT 1987 W5FC 654

(049001) (14 FEB 73)

REFERENCE DATA

DATE = 7.0000 50.14, WMP = 20.0340 INCHES  
LOEF = 3.0000 INCHES, WMP = .0000 INCHES  
DATE = 3.0000 INCHES, WMP = .0000 INCHES  
SCALE = .0211 SCALE

PARAMETRIC DATA

PMI = .000

SUM NO. 4/0 RM/L = 2.00 GRADIENT INTERVAL = -5.00/ 5.00

MACH	ALPHA	CUM	CA	CLMM	CYM	CYMM	CBL	CL	0 (FSF)
3.400	144.466	6.90300	-2.59655	.23025	.04100	.01491	-.00022	-4.19779	6.118
3.400	149.112	6.73946	-2.59333	.26735	.08687	.03092	-.00047	-4.04484	5.36206
3.400	148.091	6.42875	-2.58213	.26554	.08919	.03214	-.00054	-3.69334	5.72732
3.400	147.297	5.94643	-2.56993	.33437	.03448	.01800	-.00030	-3.59088	5.43520
3.400	148.829	5.71633	-2.55300	.30475	.07079	.02442	-.00055	-3.52576	5.15494
3.400	148.352	5.62803	-2.53044	.32360	.06930	.04214	-.00030	-3.48110	5.09503
3.400	149.363	5.31120	-2.96921	.98667	.03914	.02926	-.00204	-3.05631	5.26118
3.400	151.471	6.69540	-2.99319	.93967	.03976	.04000	-.00177	-2.87965	5.05337
3.400	152.343	4.39441	-2.97498	.88323	.01240	.03799	-.00029	-2.51882	4.67209
3.400	153.964	4.12275	-2.94877	.86813	.04487	.03532	-.00019	-2.38064	4.47228
3.400	155.686	3.54844	-2.66029	.80110	.00626	.03337	-.00009	-2.04944	4.07481
3.400	157.750	3.03900	-2.77051	.74128	.02151	.01212	-.00050	-1.75236	3.75535
3.400	159.797	2.57714	-2.56847	.69073	.01242	-.00113	-.00085	-1.53159	3.30044
3.400	161.877	2.10440	-2.50553	.37988	.01372	-.00070	-.00093	-1.22063	3.03591
3.400	163.940	1.63252	-2.44804	.23733	.00710	-.00453	-.00075	-.91049	2.81063
3.400	165.993	1.27279	-2.39373	.12378	.01114	-.02190	-.00029	-.65504	2.63256
3.400	168.066	.91534	-2.34797	-.01048	.01422	-.02979	-.00006	-.41001	2.48651
3.400	170.067	.58122	-2.33367	-.13558	-.00148	-.01840	-.00010	-.16998	2.33894
3.400	172.113	.33982	-2.27670	-.26210	-.00335	-.01105	-.00007	-.02426	2.30179
3.400	174.159	.20721	-2.21336	-.26574	-.00524	-.00689	-.00003	.01919	2.23216
3.400	176.153	.11454	-2.15451	-.21360	-.00910	-.00628	-.00004	.03018	2.15734
3.400	177.163	.09173	-2.08974	-.22355	-.00336	-.01976	-.00013	.01234	2.09171
3.400	178.171	.06730	-2.07544	-.12319	-.03308	-.00544	-.00026	-.00103	2.07613
3.400	179.177	.04088	-2.06330	.17603	.01217	-.00478	-.00000	-.01526	2.06373
3.400	GRADIENT	.00000	.00000	.00000	.00000	.00000	.00000	.00000	.00000



SA-23F LARC UPWT 1087 NSFC 454

(RH9001) ( 14 FEB 75 )

REFERENCE DATA

SREF = 7.0000 33.1M. YMRP = 20 9340 INCHES  
 LREF = 3.0000 INCHES YMRP = .0000 INCHES  
 BREF = 3.0000 INCHES ZMRP = .0000 INCHES  
 SCALE = .0211 SCALE

PARAMETRIC DATA

FMI = .000

RUN NO. S/D RN/L = 2.00 GRADIENT INTERVAL = -5.00/ 5.00

MACH	ALPHA	CNN	CA	CLMN	CYN	CYMN	CBL	CL	CD	θ (PSF)
4.000	144.245	6.85902	-2.66366	.21336	-.02757	.01887	-.00025	-4.00983	6.18949	290.54234
4.000	144.879	6.55999	-2.65610	.21168	-.03009	.02699	-.00041	-3.91853	6.00351	290.58660
4.000	146.977	5.96409	-2.61382	.29585	-.01813	.02458	-.00018	-3.57612	5.44186	290.59398
4.000	149.077	5.32017	-2.55763	.33558	-.05693	.04852	-.00035	-3.24964	4.92803	290.54234
4.000	151.195	4.59972	-3.00804	1.01713	-.02219	.03503	-.00007	-2.58121	4.83212	290.54234
4.000	151.455	4.52385	-3.01532	1.02611	-.06129	.03917	-.00028	-2.53304	4.81051	290.57923
4.000	153.307	4.05763	-3.01778	1.04500	-.00896	.02939	-.00002	-2.22489	4.49544	290.49071
4.000	155.384	3.47784	-2.93943	1.02134	-.01218	.04015	-.00000	-1.90105	4.19427	290.59398
4.000	157.450	2.92115	-2.81474	.99715	-.01467	.01982	-.00043	-1.61838	3.71977	290.61611
4.000	159.481	2.47792	-2.58123	.72492	-.00596	.00551	-.00082	-1.41597	3.28601	290.61611
4.000	153.612	1.57115	-2.44140	.47067	-.00245	.00306	-.00124	-.81851	2.78350	290.61611
4.000	167.698	.84573	-2.32012	.21205	-.01777	.02316	-.00081	-.33196	2.44704	290.63086
4.000	171.751	.52956	-2.24437	-.08410	-.00687	-.00239	-.00028	-.00412	2.26844	290.63824
4.000	173.790	.10314	-2.13055	-.12637	-.00547	-.01247	-.00002	.05357	2.13248	290.55299
4.000	176.805	.07653	-2.10869	-.11885	-.00950	-.01721	-.00021	-.41110	2.10968	290.66691
4.000	177.739	.05096	-2.07079	-.06704	-.00305	-.02188	-.00013	.00076	2.07119	290.66691
4.000	178.815	.02491	-2.03782	-.03781	-.00132	-.02125	-.00013	-.01766	2.03789	290.66691
4.000	GRADIENT	.00000	.00000	.00000	.00000	.00000	.00000	.00000	.00000	.00000

ORIGINAL PAGE IS OF POOR QUALITY

SA-25F LARC UPLT 1987 MSFC 434

(RM9001) (14 FEB 75)

REFERENCE DATA

SREF = 7.0000 30-IN. XMRP = 20.0340 INCHES  
LREF = 3.0000 INCHES YMRP = .0000 INCHES  
BREF = 3.0000 INCHES ZMRP = .0000 INCHES  
SCALE = .0211 SCALE

PARAMETRIC DATA

PHI = .000

RUN NO. 6/ 0 RN/L = 2.00 GRADIENT INTERVAL = -3.00/ 5.00

MACH	ALPHA	CMM	CA	CLMM	CYM	CYMM	CBL	CL	CO	Q (FSF)
4.630	144.025	6.58320	-2.59289	.37361	.02846	-.01896	-.00048	-3.60603	5.96674	232.66627
4.630	144.627	6.45223	-2.59232	.45304	-.02224	-.00360	-.00061	-3.71967	5.82003	232.66627
4.630	146.719	5.75986	-2.54812	.51268	-.05656	-.02045	-.00073	-3.41687	5.29093	232.66627
4.630	148.796	5.11830	-2.46550	.51941	-.05354	-.02728	-.00088	-3.09011	4.77765	232.66627
4.630	149.830	4.84704	-2.44987	.52961	-.02919	-.00428	-.00098	-2.95920	4.53398	232.66627
4.630	150.895	4.44659	-2.87041	1.11009	-.00156	-.03240	-.00008	-2.48894	4.67083	232.66627
4.630	151.931	4.14117	-2.80075	1.08382	-.01094	-.02263	-.00040	-2.30015	4.48969	232.66627
4.630	152.954	3.86713	-2.86236	1.07495	-.00474	-.00711	-.00062	-2.13350	4.32574	232.66627
4.630	153.026	3.33227	-2.87740	1.06958	-.01112	-.00403	-.00098	-1.82400	4.02370	232.66627
4.630	157.059	2.83633	-2.82436	1.03650	-.03643	-.01759	-.00110	-1.51174	3.70627	232.66627
4.630	159.146	2.34756	-2.71220	.95677	-.02619	-.00006	-.00138	-1.22828	3.37022	232.66627
4.630	161.178	1.94440	-2.46710	.72466	-.00214	-.00339	-.00139	-1.04446	2.96249	232.66627
4.630	163.278	1.50824	-2.40450	.63114	-.01182	-.01927	-.00131	-.75250	2.73678	232.66627
4.630	165.246	1.13377	-2.35881	.43487	-.02150	-.00946	-.00084	-.49759	2.57029	232.66627
4.630	167.312	.79785	-2.31103	.27789	-.00567	-.02645	-.00107	-.27078	2.42983	232.66627
4.630	169.312	.55620	-2.28545	.11174	-.00656	-.00186	-.00055	-.12270	2.34895	232.66627
4.630	171.329	.34722	-2.27083	-.01434	-.01111	-.04305	-.00011	-.00092	2.29723	232.66627
4.630	173.341	.19427	-2.21317	-.19616	-.01111	-.01702	-.00005	-.06367	2.22077	232.66627
4.630	175.570	.09657	-2.14472	-.16346	-.00861	-.04192	-.00033	-.06909	2.14578	232.66627
4.630	176.595	.06402	-2.13295	-.12581	-.00715	-.04140	-.00033	-.07921	2.13274	232.66627
4.630	177.396	.06398	-2.09920	-.10307	-.00375	-.02725	-.00015	-.03146	2.09994	232.66627
4.630	178.580	.03086	-2.09037	-.06669	-.01556	-.02009	-.00024	-.02823	2.09040	232.66627
4.630		.00000	.00000	.00000	-.00000	.00000	.00000	.00000	.00000	.00000

GRADIENT



PARAMETRIC DATA

REF = 7.0000 50-1M. YMRP = 20.0340 INCHES  
 LREF = 3.0000 INCHES YMRP = .0000 INCHES  
 BREF = 3.0000 INCHES YMRP = .0000 INCHES  
 SCALE = .0211 SCALE

RNI = 45.000

GRADIENT INTERVAL = -5.00/ 5.00

MACH	ALPHA	CNH	CA	CLMH	CYN	CYMH	CBL	CL	CD	θ (FSF)
2.700	144.254	7.52603	-2.61067	.64784	.08485	.06009	.00445	-4.56307	6.51554	310.69029
2.700	144.935	7.29209	-2.61366	.62921	.06134	.07793	.00237	-4.46765	6.32910	310.69829
2.700	147.079	6.54775	-2.96681	1.12163	.06565	.08106	.00289	-3.68392	6.04898	310.81254
2.700	149.177	5.99921	-2.95515	1.00431	.07795	.06552	.00236	-3.54659	5.56900	310.70103
2.700	151.271	5.25545	-2.94404	.90825	.06804	.10543	.00077	-3.19341	5.10776	310.30652
2.700	153.358	4.64328	-2.90863	.78931	.06761	.07925	.00228	-2.84603	4.68191	310.81062
2.700	155.448	4.04581	-2.85745	.65219	.07016	.09876	.00231	-2.49272	4.28018	310.28460
2.700	159.590	2.95115	-2.66479	.22093	.08276	.22719	.00340	-1.83558	3.52666	310.43802
2.700	163.714	1.95977	-2.53976	-.13531	-.05052	.04700	.00403	-1.16890	2.98744	310.45994
2.700	167.853	1.03936	-2.50570	-.41427	-.11672	-.00092	.00228	-.46886	2.56830	310.28460
2.700	171.953	.39235	-2.41740	-.49634	-.03371	-.07855	-.00075	-.04018	2.44712	310.30652
2.700	175.938	.11985	-2.28963	-.32580	-.01599	-.00389	-.00020	.04053	2.26244	311.16130
2.700	179.014	-.04636	-2.15779	-.21983	.02612	-.01940	-.00048	.02825	2.15811	311.16130
2.700	179.214	-.00239	-2.14823	-.06077	.03722	-.02502	.00151	.03187	2.14799	311.24897
GRADIENT		.00000	.00000	.00000	.00000	.00000	.00000	.00000	.00000	.00000

GRADIENT INTERVAL = -5.00/ 5.00

MACH	ALPHA	CNH	CA	CLMH	CYN	CYMH	CBL	CL	CD	θ (FSF)
4.000	144.237	6.88236	-2.67104	.28515	.02854	.07060	.00272	-4.02355	6.18970	290.68987
4.000	144.933	6.65848	-2.66473	.31888	.03732	.06330	.00252	-3.91569	6.00862	290.68250
4.000	146.978	5.96263	-2.62190	.41009	-.03827	.08343	.00272	-3.57060	5.44777	290.67512
4.000	149.082	5.31929	-2.57651	.47860	.04034	.10402	.00290	-3.23964	4.94348	290.66774
4.000	151.210	4.59922	-3.01317	1.16615	.03900	.10261	.00316	-2.57957	4.85570	290.60136
4.000	153.310	4.00599	-3.02272	1.14785	.02622	.09747	.00308	-2.22135	4.49996	290.62348
4.000	155.407	3.43835	-2.94136	1.13990	.02426	.09307	.00307	-1.90231	4.10549	290.57923
4.000	159.494	2.47682	-2.58385	.62817	.03717	.07888	.00218	-1.41474	3.28777	290.68250
4.000	163.599	1.57185	-2.44602	.50657	-.00788	.05048	.00193	-.33370	2.79031	290.58660
4.000	167.722	.84781	-2.32643	.24727	-.03933	-.01643	.00080	-.00000	2.45351	290.61611
4.000	171.800	.33078	-2.23984	-.11203	-.02122	-.01652	.00021	-.00079	2.26412	290.32105
4.000	175.766	.07747	-2.12893	-.15788	-.01223	-.01520	.00226	.07919	2.12886	290.27679
4.000	179.825	-.00104	-2.04916	-.00393	-.00148	-.03183	.00198	.04305	2.04870	290.36331
GRADIENT		.00000	.00000	.00000	.00000	.00000	.00000	.00000	.00000	.00000

ORIGINAL PAGE IS  
 OF POOR QUALITY



SA-2SF LARC UPWT 1007 WSFC 454 ELT TM ATTACH (RM9002) ( 14 FEB 75 )

REFERENCE DATA

SREP = 7.0690 SQ.IN. XMRP = 20.8340 INCHES  
LREF = 3.0000 INCHES YMRP = .0000 INCHES  
BREF = 3.0000 INCHES ZMRP = .0000 INCHES  
SCALE = .0211 SCALE

PARAMETRIC DATA

PHI = 45.000

RUN NO. 0 / 0 RNL/L = 2.01 GRADIENT INTERVAL = -5.00/ 5.00

MACH	A PWA	CMM	CA	CLMH	CYM	CYMM	CBL	CL	CD	θ (PSF)
4.630	144.030	6.59530	-2.61974	.51660	.02938	.07044	.00310	-3.79990	5.99405	233.50038
4.630	144.693	6.41356	-2.61402	.59739	.04214	.06216	.00287	-3.72310	5.83998	233.50038
4.630	146.707	5.77335	-2.55962	.69430	.03056	.08277	.00319	-3.42074	5.30865	233.50038
4.630	148.800	5.12413	-2.49773	.68243	.03317	.08369	.00300	-3.09768	4.79607	233.50038
4.630	150.806	4.46255	-2.48058	1.30503	.03813	.09708	.00337	-2.49719	4.68787	233.50038
4.630	152.966	3.88541	-2.48763	1.18472	.04353	.08550	.00293	-2.14838	4.33812	233.50038
4.630	153.040	3.37236	-2.47513	1.19839	.04984	.07439	.00259	-1.84370	4.03064	233.50038
4.630	159.149	2.33951	-2.41407	1.06502	.03032	.07862	.00248	-1.21405	3.38536	233.50038
4.630	163.199	1.50225	-2.32079	.59120	.01488	.07163	.00197	-.74036	2.74524	233.50038
4.630	167.313	.79562	-2.27696	.29273	-.01687	.00302	.00373	-.26550	2.43885	233.50038
4.630	171.321	.34593	-2.15951	-.02206	-.01385	-.05727	.00235	.00162	2.30309	233.50038
4.630	173.375	.09599	-2.09905	-.07730	-.00267	-.05267	.00226	.06146	2.16032	233.50038
4.630	178.332	-.00110	-.00000	.00000	.00000	.00000	.00000	.00000	2.09815	233.50038
		.00000	.00000	.00000	.00000	.00000	.00000	.00000	.00000	.00000



REFERENCE DATA

BREF : 7.0000 30-IN. XMRP = 20.0340 INCHES  
 LREF : 3.0000 INCHES YMRP = .0000 INCHES  
 BREF : 3.0000 INCHES ZMRP = .0000 INCHES  
 SCALE : .0211 SCALE

PARAMETRIC DATA

PMI = 90.000

RUN NO. 13/0 RNL = 1.19 GRADIENT INTERVAL = -5.00/ 5.00

WACH	ALPHA	CNM	CA	CLMM	CYM	CYMM	CBL	CL	CU	0 (PSF)
2.700	144.224	7.89932	-2.60111	.85600	-.41709	-.49497	-.11133	-4.88008	6.72230	307.54493
2.700	144.926	7.63307	-2.59359	.83340	-.39550	-.48760	-.10749	-4.77362	6.52082	307.61068
2.700	147.056	6.90923	-2.95774	1.21893	-.39641	-.44065	-.10342	-4.18982	6.23948	307.47918
2.700	149.135	6.25762	-2.95013	1.11096	-.36944	-.42274	-.05376	-3.65985	5.74811	307.50109
2.700	151.230	5.60356	-2.94225	.98200	-.33086	-.42932	-.08668	-3.49936	5.27575	307.52301
2.700	153.328	4.96942	-2.91357	.91262	-.30141	-.37177	-.07609	-3.13258	4.83436	307.47918
2.700	155.414	4.33055	-2.83864	.77629	-.27571	-.39305	-.06841	-2.76673	4.40957	307.47918
2.700	159.553	3.21099	-2.67225	.0094	-.23465	-.43971	-.04887	-2.07515	3.62562	307.50109
2.700	163.694	2.19410	-2.52796	-.10786	-.11445	-.26147	-.03554	-1.39617	3.04232	307.28192
2.700	167.824	1.18810	-2.50768	-.33033	-.05043	-.17568	-.02052	-.53244	2.70186	307.47918
2.700	171.914	.48591	-2.41683	-.37867	.03711	-.05359	-.00801	-.14111	2.46117	307.52301
2.700	175.991	.13137	-2.25793	-.27529	.04220	.00161	-.00248	.02682	2.26159	307.35959
2.700	179.019	.01963	-2.14569	-.05134	.03805	-.02400	-.00057	.01711	2.14571	307.47918
	GRADIENT	.00000	.00000	.00000	.00000	.00000	.00000	.00000	.00000	.00000

RUN NO. 10/0 RNL = 2.00 GRADIENT INTERVAL = -5.00/ 5.00

WACH	ALPHA	CNM	CA	CLMM	CYM	CYMM	CBL	CL	CU	0 (PSF)
4.000	144.218	7.12073	-2.60766	.34114	-.23631	-.10220	-.06373	-4.20323	6.34385	290.79462
4.000	144.589	6.99781	-2.60453	.35081	-.22496	-.09834	-.08171	-4.14782	6.24272	290.68987
4.000	148.956	6.21049	-2.64029	.40964	-.20064	-.11191	-.07186	-3.76626	5.59970	290.67512
4.000	149.029	5.34817	-2.58120	.45818	-.18819	-.13981	-.06422	-3.42883	5.06833	290.64561
4.000	151.200	4.05889	-3.04256	1.12408	-.17724	-.13577	-.06036	-2.74828	4.98292	290.66774
4.000	153.282	4.21367	-3.03172	1.10530	-.17704	-.16897	-.05445	-2.45075	4.50247	290.60873
4.000	155.360	3.63680	-2.94849	1.07875	-.14908	-.20111	-.04861	-2.07641	4.19623	290.61611
4.000	159.485	2.61457	-2.59442	.80102	-.12626	-.19488	-.03561	-1.53952	3.34617	290.61611
4.000	163.615	1.69616	-2.45059	.54289	-.10244	-.18568	-.02289	-.93597	2.82954	290.61611
4.000	167.756	.94462	-2.33184	.23745	-.03927	-.08421	-.01355	-.42643	2.47950	290.60136
4.000	171.769	.35888	-2.24741	-.01153	.01727	-.02392	-.00470	-.03352	2.27566	290.52759
4.000	175.812	.11370	-2.13615	-.11080	.02921	-.01447	-.00035	.04261	2.13875	290.44645
4.000	179.821	.02137	-2.05925	-.01905	.02633	-.00373	-.00171	.02100	2.05926	290.43170
	GRADIENT	.00000	.00000	.00000	.00000	.00000	.00000	.00000	.00000	.00000

ORIGINAL PAGE IS OF POOR QUALITY

SA-23F LARC UPWT 1007 WSC 454 ELT TM ATTACH

(RM9003) ( 14 FEB 75 )

REFERENCE DATA

SREF = 7.0000 SO.IN. KMP = 20.0340 INCHES  
 LREF = 3.0000 INCHES YMP = .0000 INCHES  
 BRP = 3.0000 INCHES ZMP = .0000 INCHES  
 SCALE = .9211 SCALE

PARAMETRIC DATA

FMI = 90.000

RUN NO. 11/ 0 BN/L = 2.01 GRADIENT INTERVAL = -5.00/ 5.00

WACH	ALPHA	CWM	CA	CLWM	CYM	CYMM	CBL	CL	CD	θ (FSF)
4.030	144.009	0.79122	-2.61265	.57209	-1.17005	-.05162	-.07125	-3.95912	6.10509	233.54011
4.030	144.613	5.61177	-2.69201	.62289	-.18265	-.05323	-.07149	-3.86347	5.95018	233.54011
4.030	146.792	5.94063	-2.55230	.63893	-.14555	-.06551	-.06471	-3.57846	5.35902	233.54011
4.030	148.769	5.31050	-2.49763	.65918	-.14171	-.07946	-.05757	-3.25279	4.89326	233.54011
4.030	150.938	4.59389	-2.00152	1.25253	-.13986	-.06703	-.05262	-2.61574	4.75025	233.54011
4.030	152.986	4.04313	-2.09987	1.17266	-.11736	-.08572	-.04514	-2.28336	4.42068	233.54011
4.030	153.011	3.48898	-2.86879	1.12418	-.11314	-.12379	-.04031	-1.94963	4.07376	233.54011
4.030	159.139	2.44205	-2.72237	1.05839	-.08156	-.11431	-.02690	-1.51326	3.41382	233.54011
4.030	163.210	1.59129	-2.41666	.61046	-.06237	-.10932	-.01643	-.82336	2.77331	233.54011
4.030	167.280	.89329	-2.31979	.29258	-.01638	-.03565	-.00823	-.35117	2.45729	233.54011
4.030	171.328	.34918	-2.27947	.00882	.03666	-.02434	-.00313	-.00140	2.30606	233.54011
4.030	173.335	.10312	-2.16402	-.16664	.03465	-.03150	.00216	.06725	2.16573	233.54011
4.030	178.347	.02677	-2.10089	-.03717	.03183	-.05137	.00197	.03384	2.10059	233.12100
4.030	178.926	.02950	-2.09087	-.06766	.03184	-.05236	.00193	.00967	2.09106	233.54011
4.030	GRADIENT	.00000	.00000	.00000	.00000	.00000	.00000	.00000	.00000	.00000



PARAMETRIC DATA

REF = 7.0000 30-IN. XMP = 20.0340 INCHES  
 LREF = 3.0000 INCHES YMP = .0000 INCHES  
 BREF = 3.0000 INCHES ZMP = .0000 INCHES  
 SCALE = .0215 SCALE

RUN NO. 14/ D RM/L = 1.50 GRADIENT INTERVAL = -5.00/ 5.00

MACH	ALPHA	CMM	CA	CLMM	CYM	CYMM	CBL	CL	CD	Q (PSF)
2.700	144.327	7.43685	-2.57780	.01680	.53294	.44968	-1.14643	-4.55438	6.44261	311.05171
2.700	144.914	7.27231	-2.58347	.01700	.53507	.44275	-1.14220	-4.46588	6.29418	311.02979
2.700	147.041	6.53219	-2.93997	.58499	.50588	.42955	-1.12933	-3.88148	6.02056	310.81062
2.700	149.180	5.89388	-2.94556	.48272	.47926	.40788	-1.11695	-3.54188	5.54540	310.81062
2.700	151.233	5.23949	-2.92502	.38161	.42973	.42609	-1.03888	-3.18322	5.06551	310.59145
2.700	153.329	4.61135	-2.94449	.29449	.38344	.38013	-.09205	-2.81806	4.66316	310.67912
2.700	155.412	4.00939	-2.84950	.21967	.35213	.37409	-.07998	-2.46017	4.25939	310.54761
2.700	159.577	2.92025	-2.64178	-.06219	.26615	.34818	-.05192	-1.81487	3.49472	311.16130
2.700	163.708	1.93347	-2.51002	-.36313	.16463	.22074	-.04213	-1.15363	2.95219	311.09555
2.700	166.142	1.39158	-2.49195	-.59108	.12419	.12709	-.03285	-.75422	2.75272	310.94212
2.700	167.836	1.01242	-2.49071	-.56689	.08822	.03496	-.02752	-.46485	2.64812	311.07363
2.700	171.920	.38026	-2.39775	-.51309	.04611	-.01074	-.01322	-.03946	2.42739	311.05171
2.700	175.985	.13047	-2.23773	-.32240	.02741	-.02835	-.02276	-.02555	2.24137	310.96404
2.700	179.021	.04447	-2.13193	-.06215	.02356	-.01931	-.02039	-.02802	2.13238	310.67912
GRADIENT		.00000	.00000	.00000	.00000	.00000	.00000	.00000	.00000	.00000

RUN NO. 15/ D RM/L = 2.00 GRADIENT INTERVAL = -5.00/ 5.00

MACH	ALPHA	CMM	CA	CLMM	CYM	CYMM	CBL	CL	CD	Q (PSF)
4.000	144.318	6.89388	-2.65384	-.29044	.46962	.36001	-1.13954	-4.05169	6.17675	290.62348
4.000	144.837	6.72060	-2.65517	-.23826	.46490	.35797	-1.13505	-3.96715	6.03971	290.62348
4.000	146.927	6.02648	-2.50901	-.14989	.42230	.33969	-1.11919	-3.62625	5.47501	290.64361
4.000	149.045	5.33392	-2.55576	-.06377	.37882	.30075	-1.0587	-3.25939	4.93535	290.63066
4.000	151.206	4.61771	-3.01135	.66151	.34869	.29797	-.03185	-2.79633	4.86318	290.49809
4.000	153.282	4.02353	-3.02389	.68702	.30688	.28126	-.07881	-2.23631	4.51071	290.46858
4.000	155.362	3.45622	-2.93585	.70309	.26906	.23450	-.04631	-1.91944	4.11026	290.44643
4.000	159.492	2.48064	-2.57637	.52131	.22240	.23420	-.04936	-1.42085	3.28214	290.48333
4.000	163.614	1.57660	-2.43869	.34236	.13363	.16743	-.02953	-.82660	2.78499	290.68967
4.000	167.701	.89053	-2.31880	.09748	.07501	.08169	-.01705	-.33710	2.44675	290.66774
4.000	171.767	.32945	-2.23736	-.17368	.04821	.05828	-.00693	-.00568	2.26148	290.63224
4.000	175.801	.11383	-2.12318	-.14406	.02934	-.00972	-.00033	-.04194	2.13281	290.66774
4.000	179.818	.04764	-2.05240	-.02846	.02801	-.01048	.00197	-.00522	2.05295	290.58660
GRADIENT		.00000	.00000	.00000	.00000	.00000	.00000	.00000	.00000	.00000

ORIGINAL PAGE IS OF POOR QUALITY

SA-23F LARC UPWT 1007 MSFC 456 ELT TH ATTACH

(RM9004) ( 14 FEB 75 )

REFERENCE DATA

SHEET = 7.0000 SQ. IN. SHEET = 20.0340 INCHES  
 LREQ = 3.0000 INCHES YMRP = .0000 INCHES  
 SHEET = 3.0000 INCHES ZMRP = .0000 INCHES  
 SCALE = .0211 SCALE

PARAMETRIC DATA

PMI = 135.000

RUN NO. 16/0 RM/L = 2.00 GRADIENT INTERVAL = -5.00/ 5.00

MACH	ALPHA	CMM	CA	CLMM	CYM	CYMM	CBL	CL	CD	θ (PSF)
4.030	144.075	6.62379	-2.30032	-.03100	.45203	.34217	-.13215	-3.05040	5.96750	232.97561
4.030	144.624	6.44292	-2.36634	.02229	.43155	.33377	-.12924	-3.76763	5.82257	232.97561
4.030	146.690	5.80433	-2.32111	.08485	.40027	.30719	-.11539	-3.46622	5.29449	232.97561
4.030	148.785	5.16636	-2.45007	.12004	.36992	.29382	-.10139	-3.14407	4.78039	232.97561
4.030	150.089	4.46398	-2.04679	.00310	.33635	.27946	-.08697	-2.51515	4.65891	232.97561
4.030	152.955	3.91085	-2.05662	.75206	.30734	.25427	-.07567	-2.19141	4.32613	232.97561
4.030	155.019	3.37337	-2.04155	.70270	.26123	.22241	-.06358	-1.85773	4.00036	232.97561
4.030	159.140	2.39034	-2.70326	.77370	.20714	.21236	-.04320	-1.23368	3.56300	232.97561
4.030	163.215	1.51843	-2.39317	.41747	.14056	.19775	-.02365	-.76092	2.72907	232.97561
4.030	167.209	.80255	-2.30200	.13537	-.07234	.11892	-.01240	-.27636	2.42218	232.97561
4.030	171.343	.34713	-2.25069	-.09843	-.04231	.02932	-.00533	-.00320	2.28321	232.97561
4.030	175.352	.11031	-2.14554	-.23802	.01948	-.00573	-.00017	.06391	2.14742	232.97561
4.030	179.390	.06025	-2.06562	-.08074	-.01742	-.01953	.00053	-.00126	2.00649	232.97561
GRADIENT		.00000	.00000	.00000	.00000	.00000	.00000	.00000	.00000	.00000



SA-2SF LABR UPMT 1987 W3FC 454 ELY TN ATTACH (PW0002) ( 14 FEB 75 )

REFERENCE DATA

WREF = 7.0000 SQ. IN.    WREF = 20.0340 INCHES  
 LREF = 3.0000 INCHES    WREF = .0000 INCHES  
 WREF = 3.0000 INCHES    WREF = .0000 INCHES  
 SCALE = .0211 SCALE

PARAMETRIC DATA

PW1 = 45.000

RUN NO. 7 / 0    RM/L = 1.50    GRADIENT INTERVAL = -5.00/ 5.00

MACH	ALPHA	CPCI	CPCZ	Q (PSF)
2.700	144.254	-.13213	-.13276	310.89829
2.700	144.935	-.13213	-.13384	310.89829
2.700	147.079	-.13519	-.13891	310.83254
2.700	149.177	-.13516	-.13580	310.70103
2.700	151.271	-.13201	-.13572	310.30652
2.700	153.358	-.13211	-.13274	310.81062
2.700	155.449	-.12893	-.13264	310.28480
2.700	159.590	-.12586	-.12650	310.43802
2.700	163.714	-.12281	-.12343	310.45954
2.700	167.833	-.11662	-.12030	310.28460
2.700	171.953	-.09817	-.10180	310.30652
2.700	175.938	-.07589	-.07746	311.16130
2.700	178.014	-.06775	-.07131	311.16130
2.700	179.214	-.06472	-.06827	311.24897
	GRADIENT	.00000	.00000	.00000

RUN NO. 8 / 0    RM/L = 2.00    GRADIENT INTERVAL = -5.00/ 5.00

MACH	ALPHA	CPCI	CPCZ	Q (PSF)
4.000	144.237	-.03743	-.03815	290.68987
4.000	144.903	-.03743	-.04144	290.68250
4.000	148.978	-.04072	-.04144	290.67312
4.000	149.082	-.04400	-.04473	290.66774
4.000	151.210	-.04727	-.04801	290.60136
4.000	153.310	-.05385	-.05789	290.62348
4.000	155.407	-.05384	-.05789	290.57923
4.000	159.484	-.05714	-.06119	290.68250
4.000	163.599	-.05713	-.05789	290.58660
4.000	167.722	-.05385	-.05460	290.61611
4.000	171.800	-.04723	-.04787	290.32105
4.000	175.786	-.04065	-.04467	290.27679
4.000	178.825	-.03738	-.04139	290.36331
	GRADIENT	.00000	.00000	.00000

ORIGINAL PAGE IS OF POOR QUALITY

PARAMETRIC DATA

PMI = 43.000

REFERENCE DATA

STEP 1 7.0000 30.14. WMP = 20.0340 INCHES  
 STEP 2 3.0000 INCHES VMP = .0000 INCHES  
 STEP 3 3.0000 INCHES WMP = .0000 INCHES  
 SCALE 0 .0211 SCALE

RUN NO. 070 BM/L = 2.01 GRADIENT INTERVAL = -3.00/ 3.00

WCH	ALPHA	CPCI	CPCZ	O (PSF)
4.630	144.030	-.01844	-.02347	233.50038
4.630	144.093	-.01844	-.02347	233.50038
4.630	146.747	-.02253	-.02347	233.50038
4.630	148.800	-.02253	-.02757	233.50038
4.630	150.886	-.02662	-.02757	233.50038
4.630	152.986	-.03071	-.03376	233.50038
4.630	155.040	-.03480	-.03986	233.50038
4.630	159.149	-.03480	-.04396	233.50038
4.630	163.199	-.03480	-.04396	233.50038
4.630	167.313	-.03480	-.03376	233.50038
4.630	171.321	-.03071	-.03376	233.50038
4.630	175.375	-.02662	-.03167	233.50038
4.630	179.352	-.02253	-.02757	233.50038
	GRADIENT	.00000	.00000	.00000



(PW0003) ( 14 FEB 75 )

SA-RSP LARC UPWT 1007 MSFC 456 ELY TM ATTACH

PARAMETRIC DATA

REFERENCE DATA

BWP = 7.0000 36.14. BWP = 20.0300 INCHES  
 LWP = 3.0000 INCHES VWP = .0000 INCHES  
 SWP = 3.0000 INCHES PWP = .0000 INCHES  
 SCALE = .0211 SCALE

RM1 = 90.000

RUN NO. 13/0 RM/L = 1.49 GRADIENT INTERVAL = -5.00/ 5.00

MACH	ALPHA	CPC1	CPC2	0 (PSF)
2.700	144.224	-13348	-13113	307.54453
2.700	144.926	-13659	-13114	307.61056
2.700	147.056	-13657	-13112	307.47918
2.700	149.155	-13347	-13112	307.50109
2.700	151.290	-13347	-13113	307.52301
2.700	153.326	-13346	-13112	307.47918
2.700	155.414	-13346	-13112	307.47918
2.700	159.553	-13056	-12801	307.50109
2.700	163.694	-12100	-12173	307.26192
2.700	167.824	-11484	-11556	307.47918
2.700	171.914	-09933	-10001	307.52301
2.700	175.991	-07443	-07194	307.36959
2.700	179.019	-06026	-06376	307.47918
	GRADIENT	.00000	.00000	.00000

RUN NO. 10/0 RM/L = 2.00 GRADIENT INTERVAL = -5.00/ 5.00

MACH	ALPHA	CPC1	CPC2	0 (PSF)
4.000	144.218	-04091	-04493	290.70462
4.000	144.369	-04091	-04164	290.60987
4.000	146.936	-04419	-04493	290.67512
4.000	149.029	-09404	-05480	290.64561
4.000	151.200	-05732	-06139	290.66774
4.000	153.262	-05732	-06138	290.60873
4.000	155.300	-06060	-06138	290.61611
4.000	159.483	-06060	-06467	290.61611
4.000	163.615	-05732	-06138	290.61611
4.000	167.706	-05403	-05809	290.60138
4.000	171.769	-05074	-05479	290.52759
4.000	175.812	-04415	-04489	290.44645
4.000	179.821	-04008	-04159	290.43170
	GRADIENT	.00000	.00000	.00000

ORIGINAL PAGE IS OF POOR QUALITY



PARAMETRIC DATA

PMI = 90.000

REF = 1.0000 10.1M. WMP = 20.0340 INCHES  
 LRE = 3.0000 INCHES WMP = .0000 INCHES  
 REF = 3.0000 INCHES WMP = .0000 INCHES  
 SCALE = .0211 SCALE

BUN NO. 11/0 RM/L = 2.01 GRADIENT INTERVAL = -5.00/ 5.00

WICH	ALPHA	CPCI	CPC2	0 (PSF)
4.030	144.000	-.02277	-.02372	233.54011
4.030	144.613	-.02277	-.02372	233.54011
4.037	146.702	-.02606	-.02372	233.54011
4.030	149.769	-.02606	-.02792	233.54011
4.030	150.930	-.03904	-.03601	233.54011
4.030	152.966	-.04321	-.04421	233.54011
4.030	155.011	-.03912	-.04011	233.54011
4.030	159.139	-.03912	-.04011	233.54011
4.030	163.210	-.03912	-.04011	233.54011
4.030	167.204	-.03912	-.04011	233.54011
4.037	171.326	-.03504	-.04011	233.54011
4.030	173.335	-.03093	-.03691	233.54011
4.030	178.347	-.02676	-.03185	233.12100
4.030	178.926	-.03033	-.03192	233.54011
	GRADIENT	.00000	.00000	.00000



SA-23F LARC WPMUT 1907 MSFC 436 FLT TW ATTACH

(P400004) ( 14 FEB 73 )

REFERENCE DATA

DRPF = 7.0000 30.14, DRMP = 70.0300 INCHES  
LARY = 3.0000 INCHES, YMRP = .0000 INCHES  
DRCF = 3.0000 INCHES, ZMRP = .0000 INCHES  
SCALE = .0211 SCALE

PARAMETRIC DATA

PMI = 133.000

RUN NO. 147 0 RMVL = 1.00 GRADIENT INTERVAL = 5.00/ 5.00

MACH	ALPHA	CFC1	CFC2	C (PSF)
2.700	144.327	-13606	-13765	311.03171
2.700	144.914	-13603	-13765	311.02979
2.700	137.041	-13691	-13761	310.81082
2.700	149.100	-13304	-13433	310.81062
2.700	151.233	-13300	-13449	310.59145
2.700	153.329	-13301	-13450	310.67912
2.700	155.412	-13379	-13440	310.54761
2.700	159.377	-13094	-13460	311.16130
2.700	163.709	-12409	-12336	311.09353
2.700	166.142	-12150	-12225	310.94212
2.700	167.836	-11348	-12228	311.07363
2.700	171.920	-10013	-10074	311.03171
2.700	175.983	-07247	-07609	310.96404
2.700	179.021	-06621	-06882	310.67312
	GRADIENT	.00000	.00000	.00000

RUN NO. 157 0 RMVL = 2.00 GRADIENT INTERVAL = 5.00/ 5.00

MACH	ALPHA	CFC1	CFC2	C (PSF)
4.000	144.318	-03927	-04334	290.62340
4.000	144.937	-03927	-04334	290.62340
4.000	146.927	-04236	-04664	290.64561
4.000	149.045	-04236	-04663	290.63006
4.000	151.206	-04911	-04991	290.49009
4.000	153.282	-05369	-06320	290.46458
4.000	155.362	-05367	-05979	290.46445
4.000	159.492	-05096	-05979	290.48333
4.000	163.614	-05099	-06310	290.64907
4.000	167.751	-05242	-05901	290.60774
4.000	171.767	-04913	-05322	290.63024
4.000	175.803	-03929	-04684	290.60774
4.000	179.016	-03500	-04004	290.58600
	GRADIENT	.00000	.00000	.00000

ORIGINAL PAGE IS  
OF POOR QUALITY

PARAMETRIC DATA

SA-25F LARC UPMT 1007 MSFC 45A ELY TM ATTACH  
 REFERENCE DATA  
 WAMP : 7.0000 10.1M. WAMP : 20.0300 INCHES  
 LAMP : 3.0000 INCHES WAMP : .0000 INCHES  
 WAMP : 3.0000 INCHES WAMP : .0000 INCHES  
 SCALE : .0211 SCALE

BLN NO. 15/0 BM/L = 2.00 GRADIENT INTERVAL 7 -5.00/ 5.00

WAMP	ALPHA	CFC1	CFC2	θ (FSF)
4.630	144.075	-.02064	-.02375	232.97561
4.630	144.624	-.02064	-.02376	232.97561
4.630	145.590	-.02054	-.02376	232.97561
4.630	146.785	-.02074	-.02386	232.97561
4.630	150.009	-.02204	-.02906	232.97561
4.630	152.955	-.03293	-.07808	232.97561
4.630	155.319	-.04113	-.04219	232.97561
4.630	159.140	-.04113	-.04629	232.97561
4.630	163.279	-.03703	-.04629	232.97561
4.630	167.289	-.03703	-.04219	232.97561
4.630	171.340	-.03293	-.03608	232.97561
4.630	175.332	-.02474	-.03337	232.97561
4.630	179.340	-.02474	-.02906	232.97561
4.630	GRADIENT	.00000	.00000	.00000

