

N75 20847

SAN DIEGO GAS & ELECTRIC COMPANY
IMPERIAL VALLEY GEOTHERMAL ACTIVITIES:
A STATUS REPORT

Thomas C. Hinrichs
San Diego Gas & Electric Company
San Diego, California

San Diego Gas & Electric and its wholly owned subsidiary New Albion Resources Co. have been affiliated with Magma Power Company, Magma Energy Inc. and Chevron Oil Company for the last 2-1/2 years in carrying out geothermal research and development in the private lands of the Imperial Valley. The steps undertaken in the program will be reviewed and the sequence that must be considered by companies considering geothermal research and development will be emphasized. Activities at the south end of the Salton Sea and in the Heber area of Imperial Valley are leading toward development of demonstration facilities within the near future. The current status of the project will be reported.

San Diego Gas & Electric Company became interested in entering the geothermal arena in 1971. Two factors weighed heavily in making the decision. One was the realization that the availability of low cost natural gas for boiler fuel in our electric power plants was to diminish very rapidly. The other factor was that the work being carried out in the Imperial Valley by the University of California Riverside team, under the sponsorship of the United States Bureau of Reclamation was demonstrating a potential geothermal resource within an economic distance of our Company's service area. San Diego Gas & Electric serves San Diego County and a portion of southern Orange County with their electric distribution system.

San Diego Gas & Electric Company actually became involved in geothermal activities through an agreement with San Diego Gas & Electric Company's wholly owned resource subsidiary New Albion Resources Company (NARCO) and the Magma Power Company and Magma Energy Inc. The agreement provided that in return for funding drilling and testing on Magma leases in the Imperial Valley NARCO could obtain an interest in the leases.

During early 1972 drilling was carried out in several areas of the Valley to identify locations that appeared promising for development. The most promising areas were the Niland area at the south end of the Salton Sea and the Heber area south of the town of El Centro. A second well was drilled at each of these locations to confirm the initial findings and also to provide a reinjection capability for flow testing.

Flow testing at the Niland site was carried out in mid-1972 with a large wellhead separator that was loaned to us by the Union Oil Company. The test performed provided information on well deliverability, fluid characteristics and other necessary information needed to initiate design work on a test facility to determine if power generation from the resource would be feasible.

In August of 1972 the C.F. Braun Company of Alhambra, California, was contracted with to design and procure major equipment for a geothermal test facility. The facility was designed on the binary system using a single steam flash with the steam and brine from the flash tank being directed through heat exchangers, which would heat isobutane. This work was completed in early 1973. An area of uncertainty in the design was the longevity of the brine heat exchangers. The Company chose to run some small scale field tests prior to starting construction on the geothermal test facility.

During 1973 a small scale test facility was constructed and installed at the Niland site. Figure 1 illustrates the flow diagram for the 1973 test hardware. Well fluids from the producing well entered the separator at 150 psig. Steam from the top of the separator passed through the heat exchanger, and brine leaving the bottom of the separator flowed through another heat exchanger. The temperature of both the steam and the brine was approximately 370°F. The mineral content of the geothermal brine from the Niland reservoir being produced was approximately 200,000 ppm. The solids in the steam leaving the test separator were 40,000 to 80,000 ppm. In both the steam and brine exchangers heat transfer performance declined from an initial value to the design limits in approximately 100 hours of operation.

Testing continued until the fall of 1973 and a satisfactory solution for mitigating the brine and steam scaling was not developed and starting of construction of the large geothermal test facility was delayed.

In early 1974 test work was resumed to develop effective methods of separating steam from the geothermal brine and scrubbing the steam to achieve as pure a product as possible. Brine heat exchanger testing was discontinued. Figure 2 shows the flow diagram of the 1974 test apparatus. These tests, which were completed during the summer of 1974, consisted of passing steam through separators, scrubbers and heat exchangers. The goal was to determine if scrubbing the steam would eliminate the severe scaling problems.

The first phase of the testing consisted of evaluating different types of steam separators. The separator selected yields steam on the outlet with a solids content of approximately 200 ppm, thus yielding a reduction from the initial well fluid of 200,000 ppm. Figure 3 is a cutaway view of the separator showing the interior of the vessel. Both the first stage (150 psig) and the second stage (50 psig) separators are the same in configuration. Well fluid enters the separator at the port located in the bottom left side and impinges on the vessel end dome where a plate provides for protection of the vessel wall. Separator steam leaves through the upper port at the right. Brine collects at the bottom of the vessel and flows to the second stage unit through the port at the lower right of the figure.

Figure 4 illustrates the internals of the steam scrubber. Steam from the separator enters the scrubber through the lower left-hand port. The steam then flows upwards through five trays which hold pure water. The water contacting the steam scrubs entrained solids in the steam. Clean steam exits at the top and wash water continuously added to the scrubber enters at the top of the vessel and cascades to the drain at the bottom. During the 1974 test the solids in the steam leaving the scrubber were 10 ppm to 20 ppm in comparison to the 100 to 200 ppm entering the scrubbers from the separator.

Figure 5 illustrates the type of heat exchangers used during the test. The first stage heat exchanger utilized steam flowing on the outside of the tubes while the second stage utilized steam flowing through the tubes. Approximately 1,000 pounds per hour of steam for both the first and second stage flowed through the heat exchangers and was completely condensed. Distilled water was circulated in a closed loop through the heat exchanger to provide the cooling mechanism.

Figure 6 illustrates some most encouraging results by comparing the overall heat transfer coefficient versus time of operation for the 1973 and 1974 first stage tests. The 1974 test results indicate the heat exchangers will operate for 3200 hours before reaching the design conditions requiring cleanup whereas the 1973 results reached the design condition in 108 hours. Total operating time for the first stage heat exchanger during the 1974 test was 398 hours, which was sufficient to establish the trend to predict the number of hours of operating before reaching design.

Figure 7 shows similar data for the second stage steam heat exchangers. 1973 test results indicated 81 hours to reach design conditions requiring cleaning. 1974 test data indicates the second stage heat exchangers will operate 10,050 hours before reaching design conditions. Operating time for the second stage heat exchangers during the 1974 test was 587 hours.

Figure 8 illustrates the flow diagram of what we anticipate the major geothermal test facility to consist of, utilizing three stages of steam separation instead of two used during the recent small scale test work. This three stage steam flash process would not make use of the brine in the heat exchangers, but rather would flash the brine to steam in three stages and then upon recondensing the steam would be combined with the residual brine and reinjected in the injection wells. The steam would be passed through scrubbers to be further cleaned after separation and run through heat exchangers against an isobutane working fluid which would power the turbine generator. The San Diego Gas & Electric Company has contracted with the Ben Holt Company of Pasadena to do the necessary redesign work on the geothermal test facility and it is anticipated that field construction will start in early 1975.

At the Heber location, following the drilling of two wells by NARCO and Magma Energy Inc., Chevron Oil Company drilled a well on their adjacent lease. In 1973 the three companies entered into an acreage pooling agreement and are carrying out extensive testing in the Heber area with Chevron acting as operator for the parties.

Because the resource at Heber is in the moderate temperature range the fluid must be pumped to enable a sufficiently high temperature to be maintained at the surface. The process anticipated to be applicable at Heber is Magma Energy's Magmamax Power Process illustrated in Fig. 9.

Since early this year Chevron has been operating two shaft driven pumps in two wells at Heber and injecting the pumped fluid into a third well. Through this operation valuable reservoir information has been accumulated and operating experience in pumping gained.

Recently San Diego Gas & Electric Company has installed a heat exchanger test module at the site and is collecting information on heat exchanger performance. The Heber fluids are much less in salinity than the Salton Sea fluids (approximately 1/10 of the total dissolved solids) and it may be feasible that direct heat exchanger operations can be performed with the Heber fluids.

With the information obtained from the well production activity Chevron is carrying out evaluation of the reservoir. Three additional wells have been drilled in the area to gain more needed information relative to reservoir potential. An additional two months are anticipated before the heat exchanger testing is completed.

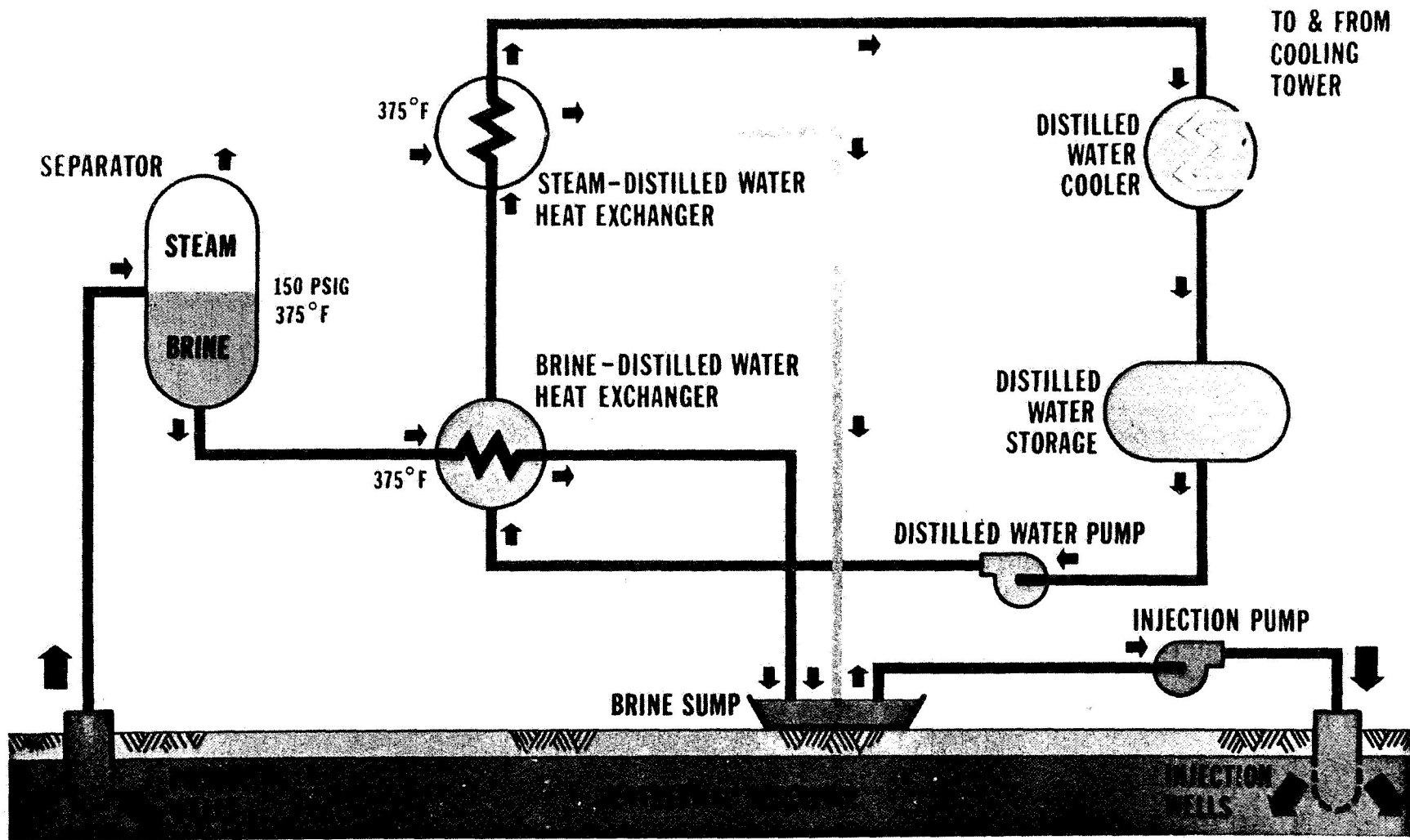

Fig. 1. 1973 geothermal field test system

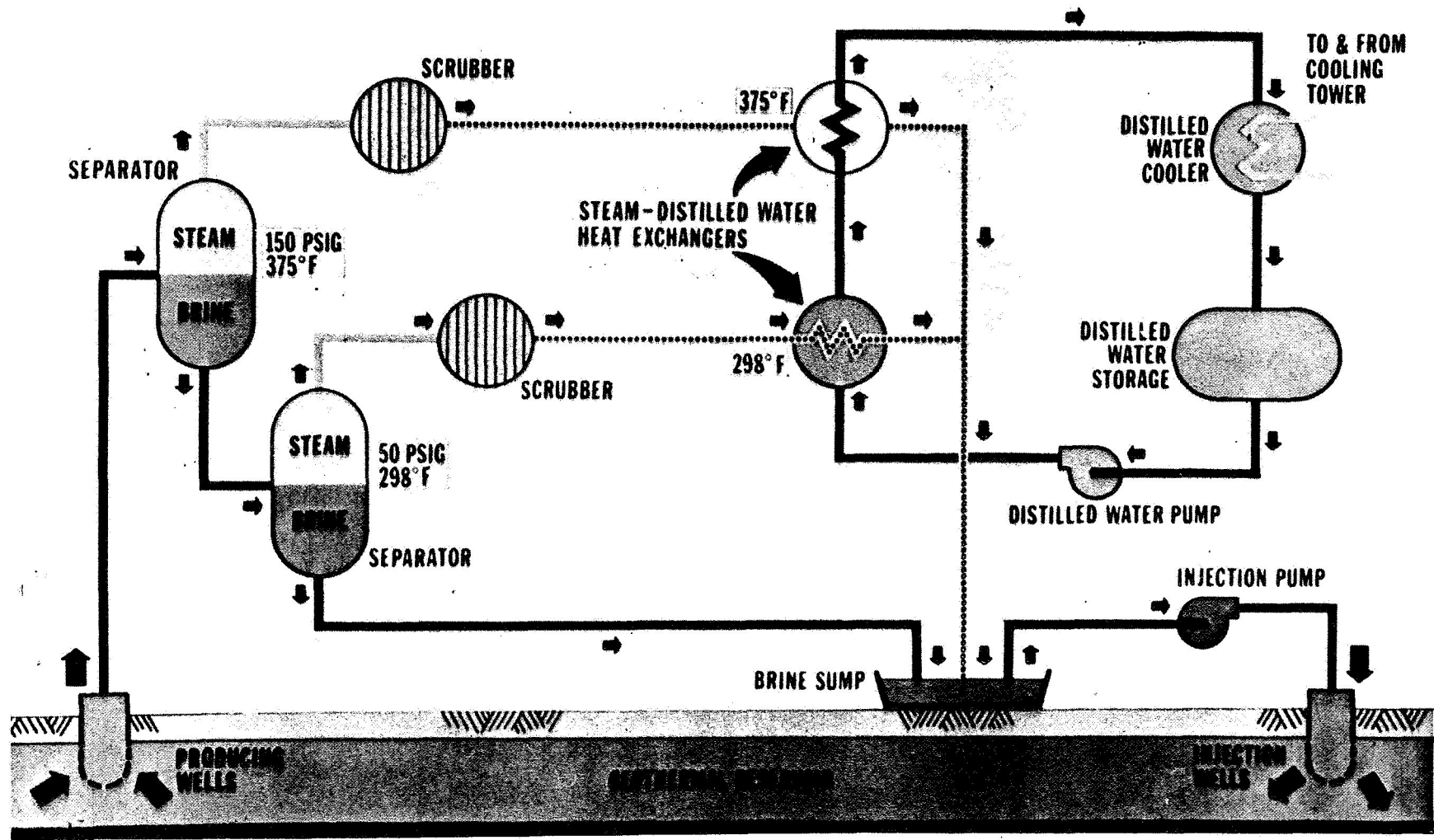

Fig. 2. 1974 geothermal field test two-stage flash system

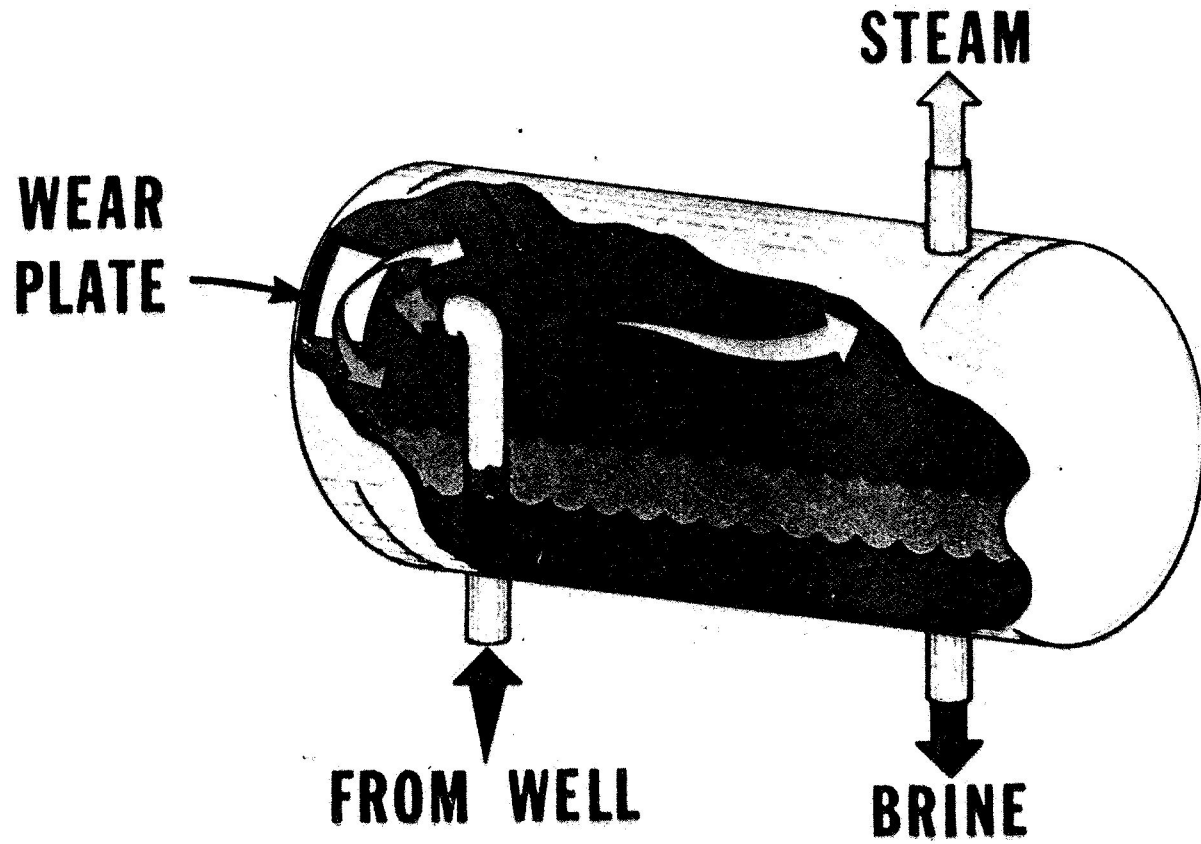

Fig. 3. C.F. Braun scale-model separator, 1974 field test

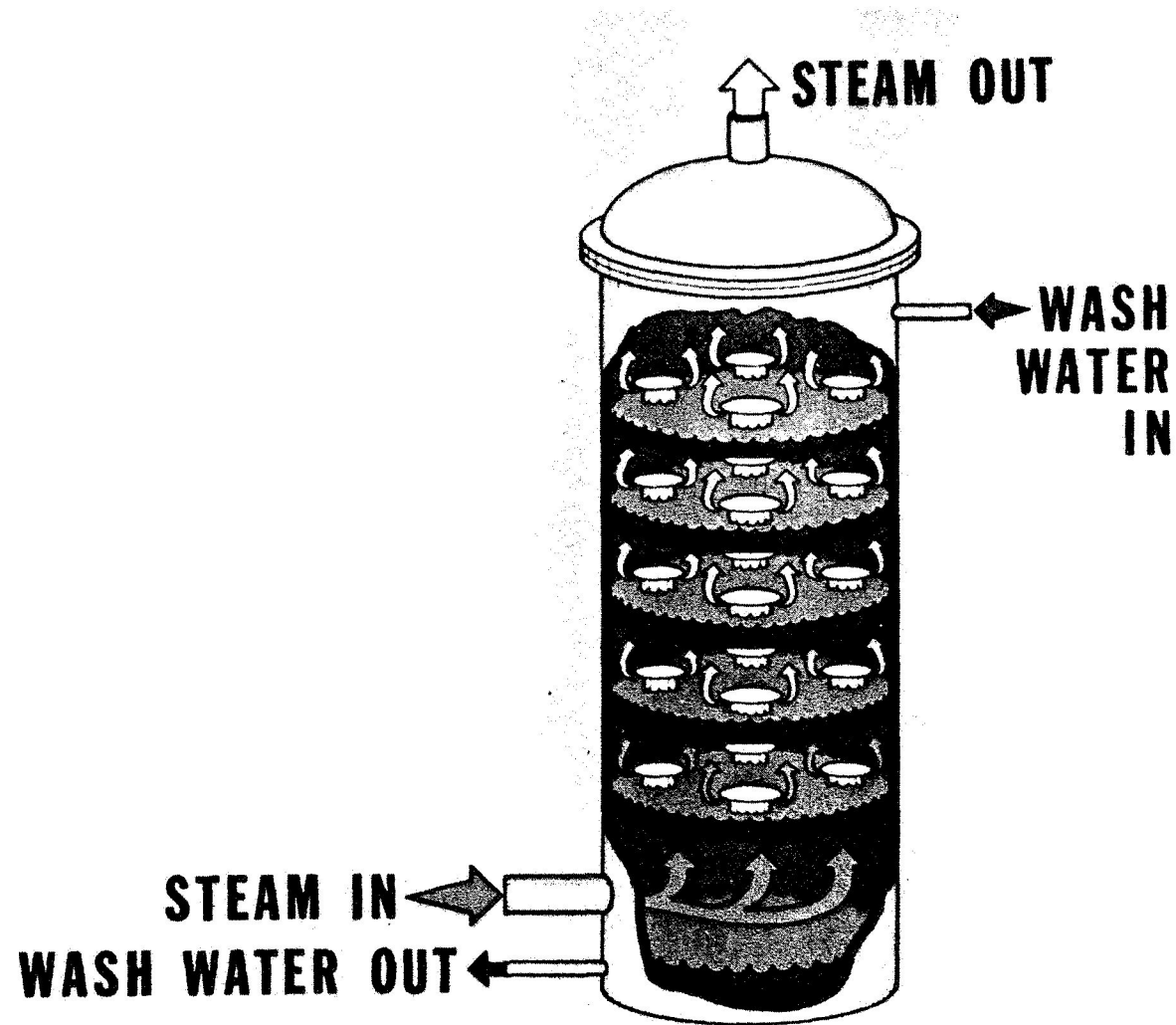

Fig. 4. Ben Holt steam scrubber, 1974 field test

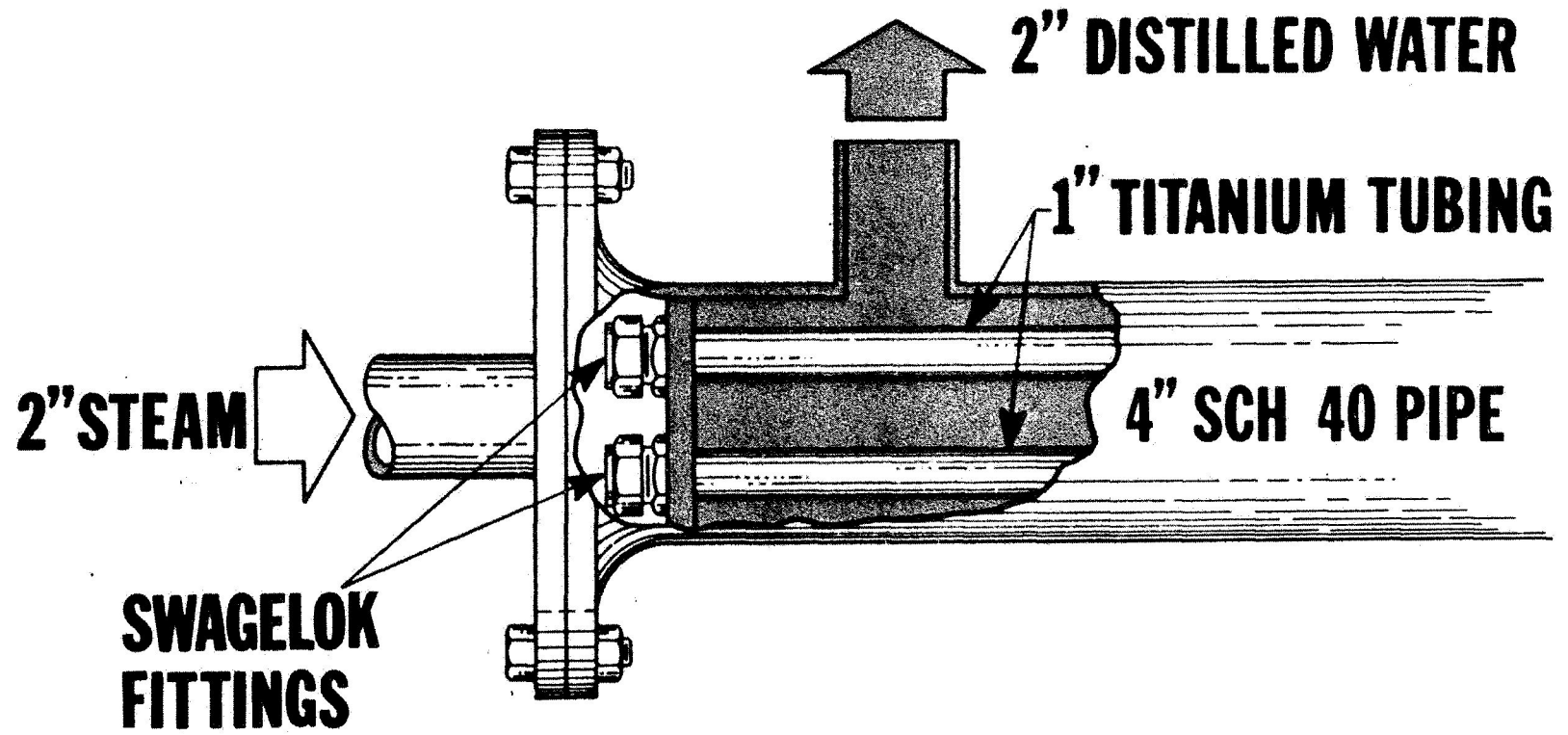

Fig. 5. Heat exchanger

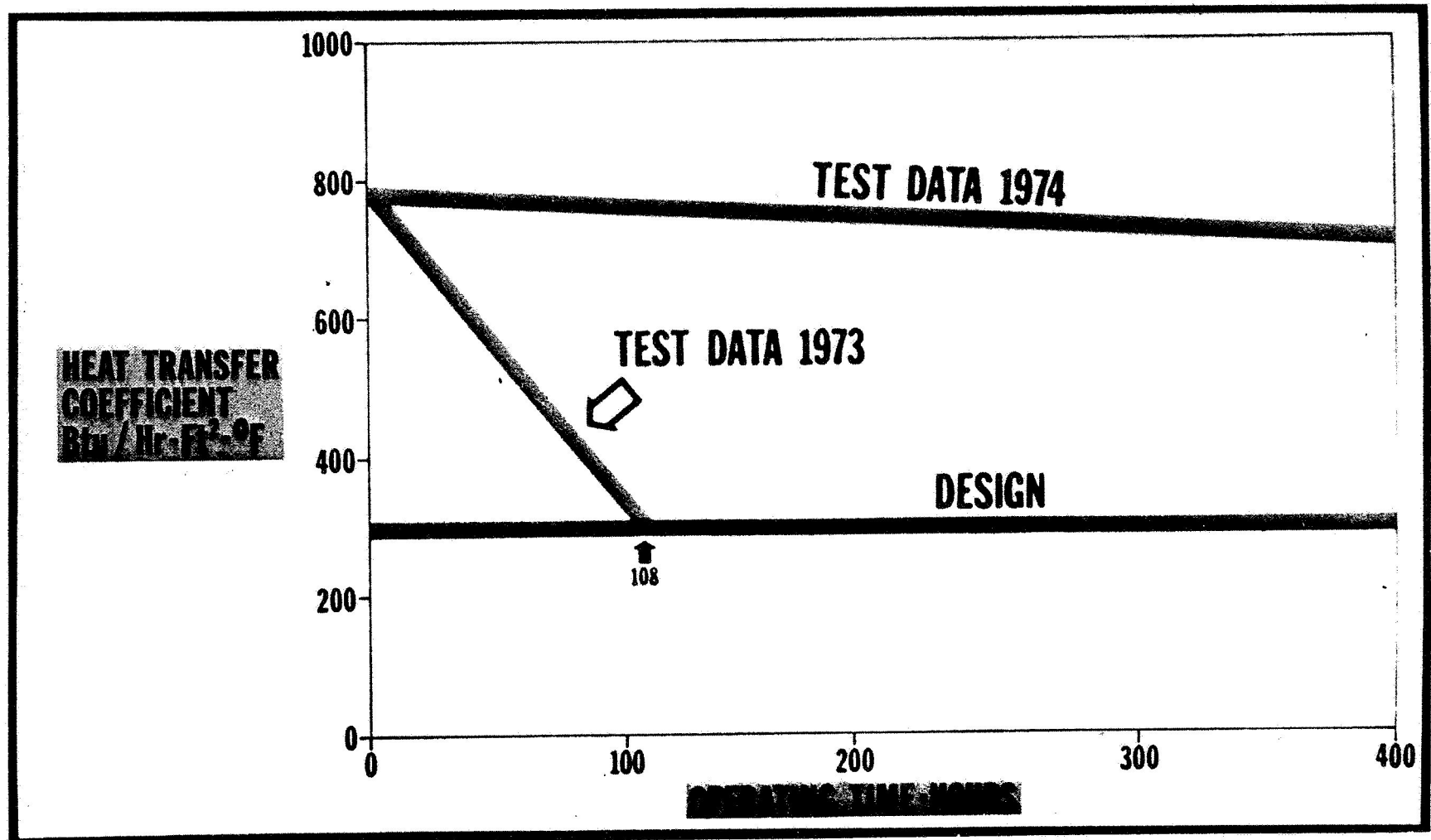

Fig. 6. First stage heat exchanger tests

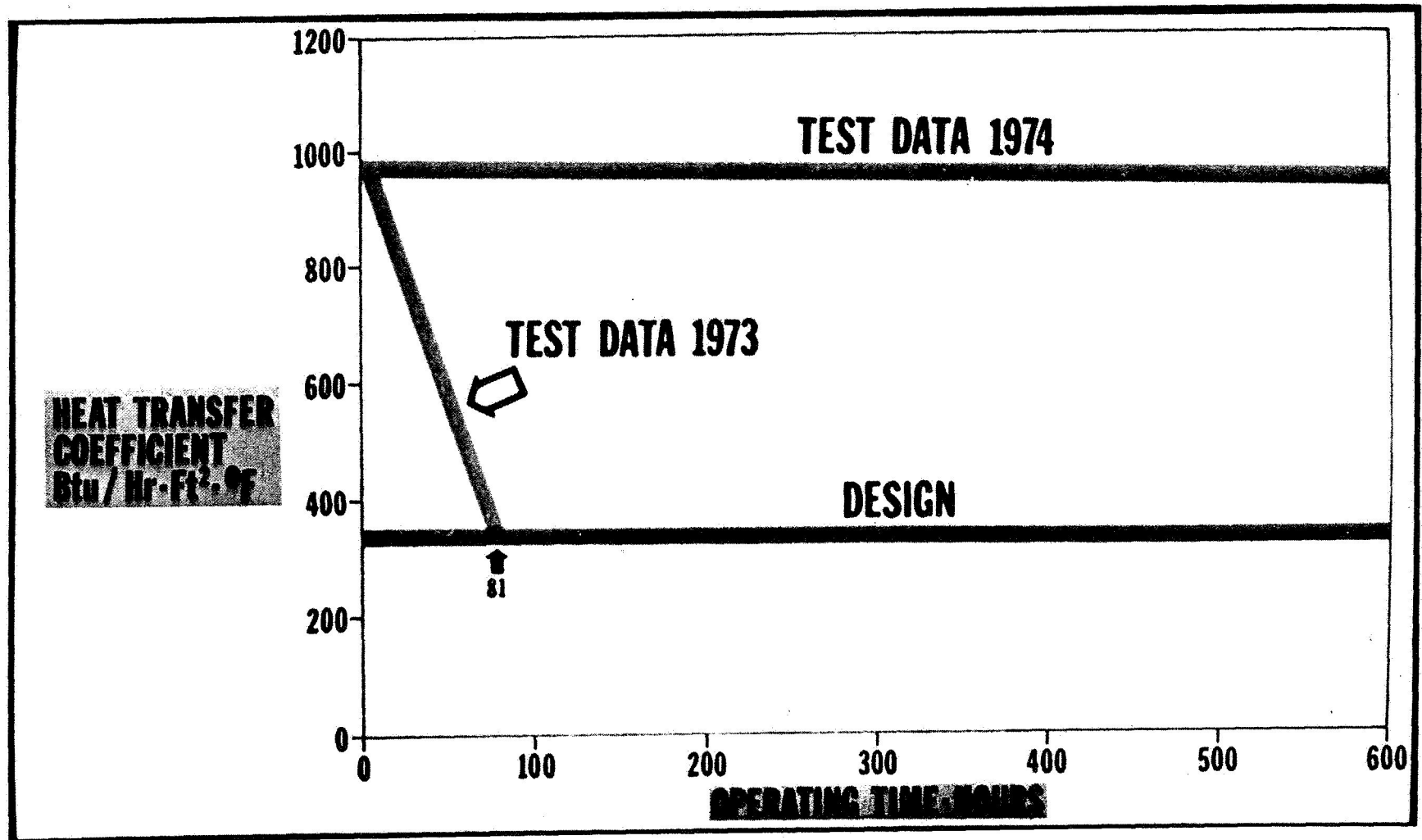

Fig. 7. Second stage heat exchanger tests

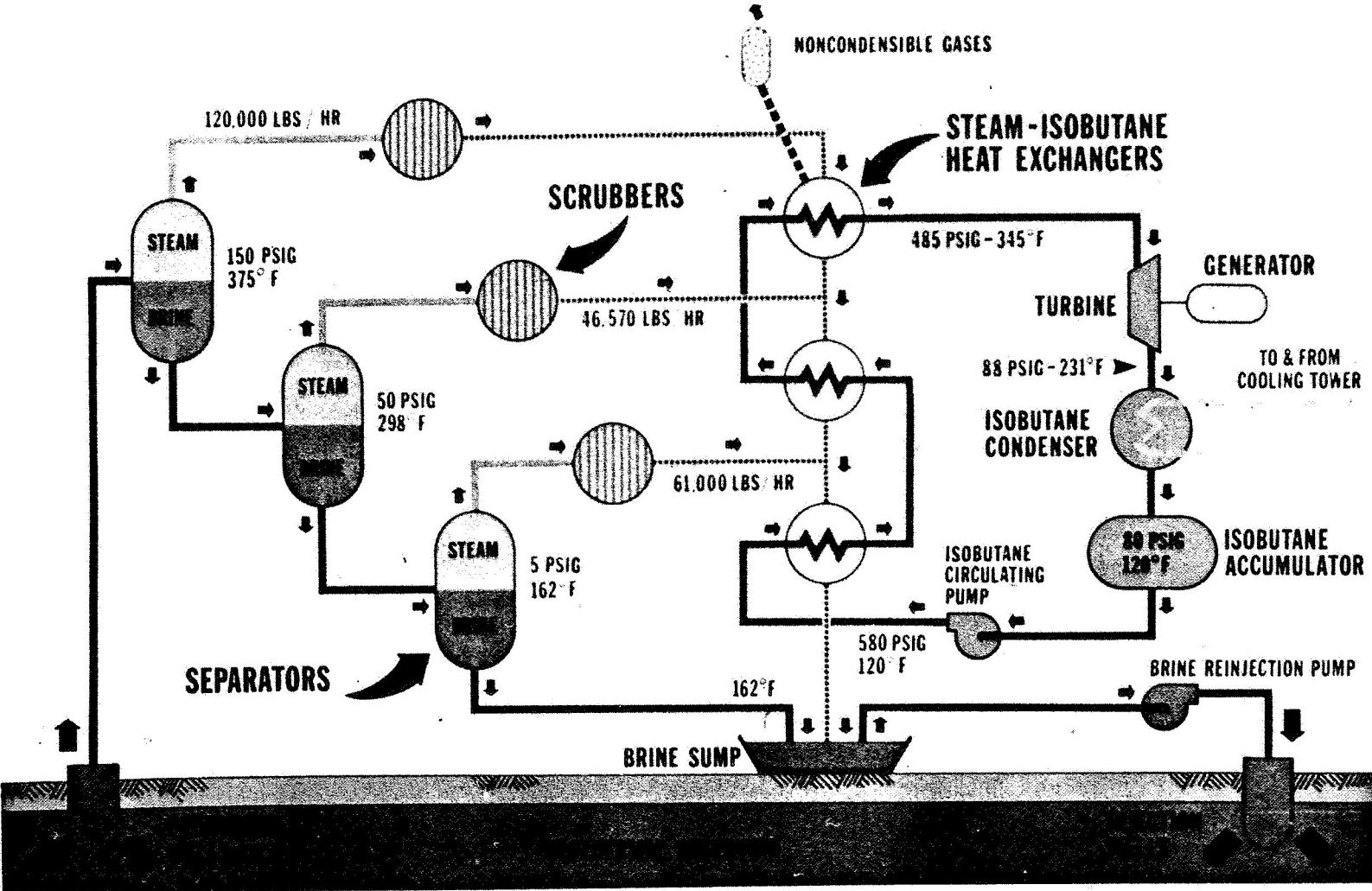

Fig. 8. Three-stage steam flash

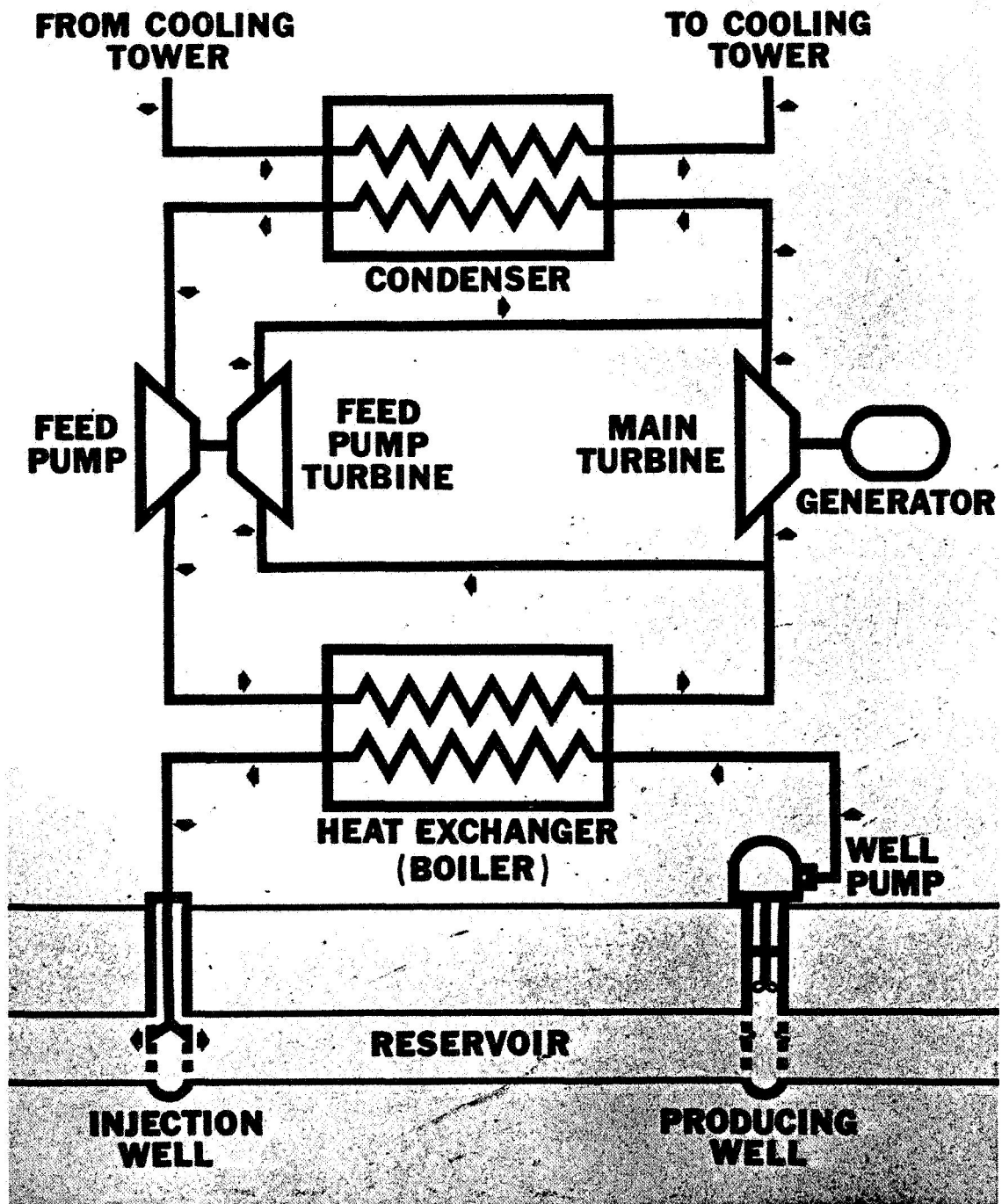

Fig. 9. Magmamax process