

NASA TECHNICAL MEMORANDUM

NASA TM X-72695

NASA TM X-72695

(NASA-TM-X-72695) THE EFFECT OF CHINE TIRES
ON NOSE GEAR WATER-SPRAY CHARACTERISTICS OF
A TWIN ENGINE AIRPLANE (NASA) : 26 p HC \$3.75
CSCL 01C

N75-23555

Unclas

G3/05 21787

THE EFFECT OF CHINE TIRES ON NOSE GEAR WATER-SPRAY CHARACTERISTICS
OF A TWIN-ENGINE PROPJET AIRPLANE

By

Thomas J. Yager, Sandy M. Stubbs

and John L. McCarty

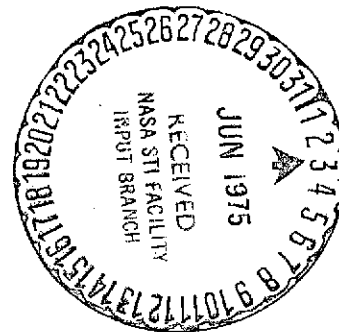

This informal documentation medium is used to provide accelerated or special release of technical information to selected users. The contents may not meet NASA formal editing and publication standards, may be revised, or may be incorporated in another publication.

NATIONAL AERONAUTICS AND SPACE ADMINISTRATION
LANGLEY RESEARCH CENTER, HAMPTON, VIRGINIA 23665

1. Report No. TM X-72695		2. Government Accession No.		3. Recipient's Catalog No.	
4. Title and Subtitle THE EFFECT OF CHINE TIRES ON NOSE GEAR WATER-SPRAY CHARACTERISTICS OF A TWIN-ENGINE PROPJET AIRPLANE				5. Report Date May 1975	
				6. Performing Organization Code	
7. Author(s) Thomas J. Yager, Sandy M. Stubbs, and John L. McCarty				8. Performing Organization Report No.	
9. Performing Organization Name and Address NASA Langley Research Center Hampton, VA 23665				10. Work Unit No. 505-08-31-01	
				11. Contract or Grant No.	
12. Sponsoring Agency Name and Address National Aeronautics & Space Administration Washington, D. C. 20546				13. Type of Report and Period Covered Technical Memorandum	
				14. Sponsoring Agency Code	
15. Supplementary Notes					
16. Abstract <p>An experimental investigation was performed to evaluate the effectiveness of nose gear chine tires in eliminating or minimizing the engine spray ingestion problem encountered on several occasions by the Merlin IV, a twin-engine propjet airplane. Accelerate-stop tests were conducted with the airplane equipped with several nose gear tire configurations on the Landing Research Runway at the NASA Wallops Flight Center. Test parameters included airplane ground speed, surface water depth and wind conditions.</p> <p>A study of the photographic and television coverage indicated that under similar test conditions the spray from the chine tires presented less of a potential engine spray ingestion problem than the conventional tires. Neither tire configuration appeared to pose any ingestion problem at aircraft speeds in excess of the hydroplaning speed for each tire, however, significant differences were noted in the spray patterns of the two sets of tires at sub-hydroplaning speeds. At sub-hydroplaning speeds, the conventional tires produced substantial spray above the wing which approached the general area of the engine air inlet at lower test speeds. The chine tires produced two distinct spray plumes at sub-hydroplaning speeds: one low-level plume which presented no apparent threat of ingestion, and one which at most test speeds was observed to be below the wing leading edge and thus displaced from the intakes on the engine nacelle.</p>					
17. Key Words (Suggested by Author(s)) (STAR category underlined) Aircraft Flooded runways Tire Airplane ground operation Spray ingestion tion Spray pattern				18. Distribution Statement Unclassified - Unlimited	
19. Security Classif. (of this report) Unclassified		20. Security Classif. (of this page) Unclassified		21. No. of Pages 24	22. Price* \$3.25

* Available from { The National Technical Information Service, Springfield, Virginia 22151
STIF/NASA Scientific and Technical Information Facility, P.O. Box 33, College Park, MD 20740

THE EFFECT OF CHINE TIRES ON NOSE GEAR WATER-SPRAY CHARACTERISTICS
OF A TWIN-ENGINE PROPJET AIRPLANE

By

Thomas J. Yager, Sandy M. Stubbs,
and John L. McCarty

SUMMARY

An experimental investigation was performed to evaluate the effectiveness of nose gear chine tires in eliminating or minimizing the engine spray ingestion problem encountered on several occasions by the Merlin IV, a twin-engine propjet airplane. Accelerate-stop tests were conducted with the airplane equipped with several nose gear tire configurations on the Landing Research Runway at the NASA Wallops Flight Center. Test parameters included airplane ground speed, surface water depth and wind conditions.

A study of the photographic and television coverage indicated that under similar test conditions the spray from the chine tires presented less of a potential engine spray ingestion problem than the conventional tires. Neither tire configuration appeared to pose any ingestion problem at aircraft speeds in excess of the hydroplaning speed for each tire, however, significant differences were noted in the spray patterns of the two sets of tires at sub-hydroplaning speeds. At sub-hydroplaning speeds, the conventional tires produced substantial spray above the wing which approached the general area of the engine air inlet at the lower test speeds. The chine tires produced two distinct spray plumes at sub-hydroplaning speeds: one low-level plume which presented no apparent threat of ingestion, and one which at most test speeds was observed to be below the wing leading edge and thus displaced from the intakes on the engine nacelle.

INTRODUCTION

The degradation in the ground handling characteristics of aircraft during takeoff and landing operations under adverse weather conditions has long been recognized and studies have been, and continue to be, conducted in attempts to improve aircraft stopping and directional control performance. The problems encountered by an airplane during operations on a flooded or slush-covered runway, however, are not limited to reduced stopping and steering capability. Airplane operators have reported several incidents of engine "flameout" resulting from engine ingestion of the water on slush spray thrown up by the aircraft landing gear tires. Engine flameouts could mean insufficient thrust available to complete a take-off or impaired reverse thrust capability for landing rollout; both complicated by the directional control

requirements generally introduced when flameouts occur on multi-engine aircraft.

Such a spray ingestion problem has been encountered during operations of the Merlin IV, a twin-engine, propjet, business-type airplane manufactured by Swearingen Aviation Corporation. On several occasions, this airplane suffered a loss of power attributed to the ingestion of slush and water spray which emanated from the nose gear tires. Typically, this problem occurred under crosswind conditions, only with the downwind engine, at speeds approaching 60 knots while operating in fairly deep slush. In addition to entering the engine air intake, the slush was observed to restrict the air flow to the oil cooler also located at the front of the engine nacelle. In an attempt to alleviate this operational problem, NASA was requested by the FAA to assist the airplane manufacturer in exploring the merits of equipping the nose gear of that airplane with "chine" tires. A chine tire is one constructed with an extending lip molded into the sidewall just above the tread. This type of tire is generally designed to deflect water and slush to the side and away from intakes on aft-fuselage mounted jet engines. Such tires are currently in service on several commercial jet transports.

The purpose of this paper is to present the results from an experimental study to evaluate the effectiveness of nose gear chine tires in eliminating or minimizing the spray ingestion problem associated with the Merlin IV airplane. Accelerate-stop tests were conducted with the airplane on the Landing Research Runway at the NASA Wallops Flight Center. That runway was selected because it was equipped with easily isolated, level, test sections well-suited for controlling the water depth. Tests were made with several nose-gear tire configurations over a range of airplane ground speeds, surface water depths, and wind conditions.

APPARATUS AND TEST PROCEDURE

Test Aircraft

The aircraft used in this investigation was a Merlin IV executive twin-engine propjet manufactured by Swearingen Aviation Corp. A photograph of the test airplane is presented in figure 1 and sketches which provide geometric details are presented in figure 2. The airplane has a dual nose gear which on slush-covered runways has been observed under certain conditions to introduce spray into the engine air intake located above the propeller hub and into the oil cooler inlet located below and slightly aft of the hub. The location of these intakes relative to the nose gear is noted in figure 2(b). Also noted is the mean location of the wing leading edge between the engine nacelle and the fuselage, as it is used later for identifying spray locations. For this investigation, the aircraft was lightly loaded and its mass was estimated to be 3855 kg (8500 lbf). At this mass, the static loading on the nose gear was approximately 4.45 kN (1000 lbf).

The forward baggage compartment doors were removed from the test aircraft to provide space for mounting a motion picture camera, visible in figure 1. This camera provided a near head-on view of the spray in the vicinity of

the engine.

Test Tires

Photographs of the nose gear test tires are presented in figure 3(a) and cross-sectional schematics are presented in figure 3(b). Tire A, the standard tire currently in use on the test airplane, is a size 16 x 4.4 type VII aircraft tire. Unfortunately, a chine tire is not commercially available in this size; the nearest being a size 18 x 4.4 which, when fully inflated, is approximately 5.1 cm (2 in.) larger in diameter than the standard tire for this airplane. Two chine tires of this size but of different configuration were selected for testing in this study and designated as tires C and D. As shown in figure 3(b), the chine for tire C extended 1.37 cm (0.54 in.) beyond the sidewall at a radius 3.63 cm (1.43 in.) less than the undeflected tire radius. The chine for tire D protruded 1.32 cm (0.52 in.) beyond the sidewall at a radius 2.92 cm (1.15 in.) less than that of the undeflected tire. Thus, for equal load and inflation pressure, the chine of tire D was slightly closer to the runway surface than that of tire C.

Test tire B is a conventional tire of the same size as that of the two chine tires, and was included in the program to provide data for evaluating directly any possible merits for a chine tire. The standard size 16 x 4.4 tire (tire A) was tested at an inflation pressure of 550 kPa (80 psi) whereas the larger size tires were inflated to only 340 kPa (50 psi) - the pressure identified by the airplane manufacturer necessary to provide the same load factor on the aircraft structure. The tread pattern of the various test tires differed because tires with a uniform pattern were not available when the program was conducted. These tread differences, observable in figure 3, were considered to have an insignificant effect on the developed water spray patterns.

Runway Test Surfaces

The tests were conducted on the 2670m (8750 ft) Landing Research Runway at Wallops Flight Center because the unique, flat-surface test section of that runway provided a means for obtaining a uniform controlled water depth which was considered essential for describing the water spray patterns developed by the airplane during a test run. Figure 4 presents a geometric layout of the runway test section and shows the three areas which were flooded for testing. Each area consisted of a strip 1.8m (6 ft) wide to accommodate the nose gear and 107m (350 ft) long, bounded by dams and flooded to designated depths by means of fire department tank trucks as shown in figure 5. Test areas 1 and 2 were flooded to a nominal water depth of 1.27 cm (0.5 in.) and test area 3 was flooded to a depth of 2.54 cm (1 in.). Dams were also installed 7.6m (25 ft) either side of the centerline of each flooded test strip to retard the water dispersion across the entire 45.7 m (150 ft) runway width.

The surface of the runway in test areas 1 and 3 was smooth concrete whereas that of area 2 was equipped with transverse grooves 0.63 cm (1/4 in.) wide and deep, spaced 2.54 cm (1 in.) apart. Thus, areas 1 and 2, flooded to

the same nominal depth, provided the opportunity to evaluate what effects grooving might have on the nose wheel water spray characteristics during flooded runway operations.

Photographic Coverage

The extensive photographic coverage of the tests supplied the only means for gathering spray data. Motion picture (16 mm) cameras, a 70 mm sequence camera, 35 mm hand-held cameras and television cameras were employed for each test run and the photographs in figure 6 indicate the scope of the coverage. The onboard motion picture camera was mounted just outside the fuselage at the forward baggage compartment door and looked aft at the engine and the wing leading edge (figure 6(a)). This camera was placed on the downwind side of the airplane since it was the downwind engine which was most susceptible to flameout due to spray ingestion. The photograph of figure 6(b) is typical of the 35 mm camera coverage obtained by observers positioned on the downwind side of the runway adjacent to each of the three test areas. A motion picture camera together with a television camera were mounted onboard a helicopter to provide an overhead view (figure 6(c)) of some of the test runs. An Intermediate Focal Length Optical Tracker (IFLOT) trailer, mounted with two motion picture cameras equipped with different lenses, was located on each side of the runway and at the end of test area 3. Film frames obtained from the two cameras on the downwind IFLOT trailer are shown in figure 6(d) (150 mm lens) and figure 6(e) (85 mm lens). Also mounted on this downwind IFLOT was a television camera whose signals, like those from the helicopter TV camera, were recorded on tape for immediate viewing. The motion picture cameras on the upwind IFLOT were identical to those on the downwind side but, instead of a TV camera, that IFLOT was equipped with a 70 mm sequence camera which was used during some of the runs, primarily for documentary photographs.

A single, tripod-mounted 16 mm motion picture camera was positioned at the edge of the runway near the end of test area 3 in an attempt to obtain a nearly head-on view of the spray pattern. This camera, operated remotely for safety reasons, could not be panned to track the airplane or zoomed to get a better view of test areas 1 and 2 in the distance. Consequently, it was used only to aid in defining the spray characteristics of the airplane while traversing test area 3 (see figure 6(f)).

Test Procedure

The procedure for each test run began with the wetting process. After the tank trucks flooded the three 1.83 m (6 ft) wide test strips to approximately the desired depths (1.27 cm (0.5 in.) in areas 1 and 2; 2.54 cm (1 in.) in area 3), observers at each area recorded the average of many water-depth measurements and the runway was cleared. For each run, the pilot accelerated the airplane rapidly to the desired test speed and attempted to maintain that speed as the airplane traversed the three test areas with the nose gear centered in the flooded strips. Motion picture cameras were started prior to the airplane entering the first test area; other cameras were operated after the spray pattern had been developed in each test area. Following each run, the observer at each test area would again measure water depths and instruct

the tank trucks as to the amount of water needed for the next test.

The aircraft ground speed was monitored by a stationary radar system positioned at the edge of the runway. During the course of a test run, an observer with radio communications to the test aircraft called out to the pilot the ground speed values as obtained by the radar and the pilot adjusted the airplane speed accordingly. The nominal test ground speeds were 40, 60, 80, 95 and 110 knots.

Table I is a compilation of all test run conditions and identifies for each test the tires installed on the dual wheel nose gear of the airplane, the wind speed and heading, including the crosswind component, the average aircraft ground speed and the average water-depth reading in each of the three test areas. Tire A was tested first since it was the standard tire for the airplane and the one with which the pilot was familiar in terms of airplane handling qualities. Furthermore, tire A was similar to that used on the airplane when spray ingestion problems had been experienced. Tire B was next tested to make an orderly transition from the standard equipment 0.4 m (16 in.) tire to the 0.46 m (18 in.) tire. For the initial chine tire tests, each of the chine tires, C and D, were installed only on the downwind side of the dual tire nose gear with a conventional 0.46 m (18 in.) tire retained on the upwind side. Subsequent to these tests, dual tires of the same chine design were run over an expanded speed range including one run with reverse thrust applied as the airplane entered test area 3 (run 17 for tire D and run 22 for tire C). The test program was concluded with additional runs on dual standard tires (tire A) at water depths more consistent than in the initial runs with that tire (runs 1, 2 and 3).

RESULTS AND DISCUSSION

The results from this experimental program were derived primarily from a study of the photographic and television coverage employed during the course of each test. Figures 7, 8 and 9 are typical photographs presented to illustrate the effects of such test variables as aircraft ground speed, tire configuration, and surface water depth on the spray pattern produced by the nose gear during flooded runway operations. Figure 10 attempts to summarize all of the test data by defining the approximate grid location of the downwind water-spray core in the vertical plane which contains the wing leading edge. These core locations are based upon estimates made by observers reviewing the photographic and television coverage and hence are somewhat subjective. The spray patterns from the conventional and chine tires are discussed in the paragraphs which follow.

Conventional Tires

Tire A was tested because it was the tire employed when the airplane had experienced spray ingestion problems while in service. Tire B was tested because it was a conventional tire of the same size as the two chine tires. These tires provided baseline data for comparison with the chine-equipped tires.

The spray pattern of the conventional tire is highly dependent upon the aircraft ground speed as noted in figures 7(a) and 10. Below the critical hydroplaning speed (the hydroplaning speed V , in knots, is approximated by the equation, $V = \sqrt{p}$, where p is the tire inflation pressure in psi), a large portion of the spray appears to emanate from the side of the tire footprint, yet there is an apparent bow wave which throws spray ahead of and over the tire to the extent that the tire is typically hidden in spray mist (see figure 7(a)). Above the critical hydroplaning speed, no bow wave is evident, the tire is quite visible, and the spray is directed aft and to the side of the tire footprint.

As noted in figures 7 and 10, the core of the spray from the side of the tire does approach the engine nacelle at the low test speeds. This core appears to move inboard with increasing speed until, at super-hydroplaning speeds (80 knots calculated for tire A, 64 knots for tire B), the core is well inboard of the nacelle.

As a rule of thumb, the water depth required on the surface to produce dynamic hydroplaning conditions must be equal to or greater than the groove depth in the tire thread. For the nose gear tires used in these tests, the average tread groove depth was approximately 0.4 cm (0.16 in.). Thus, the two nominal test water depths in this investigation (1.27 cm and 2.54 cm (0.5 in. and 1.0 in.)) were both well above the minimum depth required for hydroplaning. A comparison of the data for tire A in figure 10(a) with that in figure 10(c) indicates that the pattern of the spray and the approximate location of its core were essentially the same for the two flooded conditions, both below and above the hydroplaning speed. The photographic coverage did suggest, however, that the volume of water in the core of the spray was greater for the deeper depth.

The data for tire A in figure 10(a) and 10(b) also indicate that when the runway is flooded to the depths examined in this study, surface grooving has no effect on the spray pattern.

The spray pattern from the larger tire B is shown in figure 10 to be essentially the same as that of tire A although tire B appeared to throw more water above the wing. This slightly higher core location for tire B could possibly mean a potentially more hazardous spray problem. In neither case, however, was the spray ingestion problem experienced by this airplane on several occasions in the field, duplicated. Nevertheless, it is apparent from the observed data that perhaps under higher crosswinds which would require some aircraft yaw, a significant spray could be caused to enter the downwind air-and oil-cooler intakes of this airplane.

Chine Tires

The spray pattern from the two test chine tires was quite similar to that from the conventional tires at speeds above the critical hydroplaning speed. The calculated hydroplaning speed for these tires (at an inflation pressure of 340 kPa (50 psi)) is 64 knots, but photographs in figure 7(b)

indicate that the critical hydroplaning speed is somewhere between 75 and 92 knots. This higher experimental hydroplaning speed for these tires is possibly due to carcass stiffness effects.

At super-hydroplaning speeds there was no detectable bow wave and the spray, which emanated aft and to the side of the footprint, was inboard of the nacelle and well below the wing leading edge. However, significant differences were noted in the spray patterns of the two sets of tires at sub-hydroplaning speeds. Like the standard tire, the chine tire produced a bow wave when not hydroplaning, but that portion of the spray which was directed from the side of the footprint was altogether different. Two distinct spray plumes were evident. One resembled a suppressed plume from a standard tire and the other had a core which was directed towards the main landing gear. Both plumes are visible in the appropriate photographs of figures 6 through 9. The lower plume was not identified in figure 10 because it did not appear to pose any potential spray ingestion problem to the engine. All photographic coverage indicated that under similar test conditions, the core location of the upper plume was lower than the spray core from the standard tires. In fact, the core was below the wing at most test speeds regardless of the surface water depth or whether the surface was grooved or ungrooved. Thus, the use of chine tires as opposed to standard tires on the nose gear appears to reduce the threat of engine spray ingestion for the Merlin IV airplane.

It is not readily apparent from the figures, but the general consensus of the observers was that tire C, which had a chine further away from the runway surface (smaller radius) than tire D, was slightly superior in suppressing the water spray during flooded runway operations.

CONCLUDING REMARKS

An experimental investigation was performed to evaluate the effectiveness of nose gear chine tires in eliminating or minimizing the engine spray ingestion problem encountered in service on several occasions by the Merlin IV, a twin-engine propjet airplane. The following remarks are based upon the results of this investigation.

A study of the photographic and television coverage indicated that under similar test conditions, the spray from the chine tires presented less of a potential engine spray ingestion problem than the spray from conventional tires. Neither tire configuration appeared to pose any ingestion problem at aircraft speeds in excess of the hydroplaning speed for each tire. At these high speeds, there was no detectable bow wave for any tire and the spray, which issued from the side and rear of the footprint, was inboard of the nacelle and well below the wing leading edge. At aircraft speeds below the hydroplaning speed, however, significant differences were noted in the spray patterns of the two sets of tires. The conventional tires produced substantial spray above the wing at sub-hydroplaning speeds and this spray approached the general area of the engine air inlet, particularly at the lower test speeds of 40 and 60 knots. The chine tires produced two distinct spray plumes at sub-hydroplaning speeds: one low-level plume which was directed

towards the main landing gear and hence presented no apparent threat of ingestion, and one which resembled a suppressed plume from a conventional tire. The core of this latter plume was observed at most test speeds to be below the wing leading edge and thus displaced from the intakes on the engine nacelle. The general consensus of the observers was that of the two chine tires examined, the tire whose chine was further from the runway surface (smaller radius) appeared to provide the better spray pattern dispersion.

Additional studies in this investigation indicated that the spray pattern associated with each tire was, for all practical purposes, independent of the water depth at depths greater than that required for hydroplaning. Further, at these water depths, surface grooving appeared to have no effect on the spray pattern.

TABLE I.- COMPILATION OF TEST RUN CONDITIONS

Runway 4/22

Aircraft Run Heading = 220°

Run no.	Nose gear test tires		Wind speed, knots	Wind heading deg.	Cross-wind comp., knots	Test area #1			Test area #2			Test area #3		
	Left	Right				A/C avg speed, knots	A.W.D.**		A/C avg speed, knots	A.W.D.**		A/C avg speed, knots	A.W.D.**	
							cm	in		cm	in		cm	in
1	A	A	5	100	4	41	1.3	0.5	42	1.0	0.4	41	1.3	0.5
2	A	A	4	120	4	66	1.3	0.5	65	1.0	0.4	65	1.5	0.6
3	A	A	5	120	5	83	1.3	0.5	79	1.3	0.5	74	2.5	1.0
4	B	B	7	160	6	38	1.5	0.6	38	1.5	0.6	38	2.5	1.0
5	B	B	5	160	4	60	1.5	0.6	58	1.5	0.6	60	1.8	0.7
6	B	B	6	150	6	79	1.3	0.5	73	1.5	0.6	73	2.3	0.9
7	B	C	5	160	4	41	1.3	0.5	44	1.5	0.6	36	2.0	0.8
8	B	C	3	160	3	61	1.3	0.5	63	1.5	0.6	62	2.0	0.8
9	B	C	3	170	2	81	1.3	0.5	79	1.5	0.6	76	2.5	1.0
10	B	D	5	150	5	40	1.3	0.5	40	1.5	0.6	42	2.5	1.0
11	B	D	4	170	3	61	1.3	0.5	58	1.5	0.6	62	2.5	1.0
12	B	D	2	150	2	79	1.3	0.5	78	1.5	0.6	80	2.3	0.9
13	D	D	8	240	3	40	1.5	0.6	42	1.8	0.7	42	2.0	0.8
14	D	D	8	240	3	59	1.3	0.5	61	2.0	0.8	64	2.0	0.8
15	D	D	9	260	6	78	1.3	0.5	82	2.3	0.9	82	2.0	0.8
16	D	D	7	270	5	105	1.5	0.6	106	2.5	1.0	106	2.0	0.8
17*	D	D	7	260	4	109	1.5	0.6	73	2.8	1.1	42	2.3	0.9
18	C	C	9	310	9	42	1.5	0.6	41	1.8	0.7	40	2.5	1.0
19	C	C	8	320	8	60	1.0	0.4	58	1.5	0.6	60	2.0	0.8
20	C	C	6	310	6	85	1.5	0.6	79	1.5	0.6	74	2.0	0.8
21	C	C	8	300	8	104	1.3	0.5	94	1.3	0.5	92	2.0	0.8
22*	C	C	8	300	8	92	1.3	0.5	85	1.3	0.5	55	2.0	0.8
23	A	A	7	320	7	39	1.3	0.5	40	1.3	0.5	40	2.0	0.8
24	A	A	8	320	8	60	1.3	0.5	57	1.5	0.6	59	2.3	0.9
25	A	A	7	320	7	79	1.3	0.5	72	1.5	0.6	72	2.3	0.9
26	A	A	9	340	8	94	1.8	0.7	94	1.5	0.6	99	2.3	0.9

*Run conducted with reverse thrust in test area #3

**Average water depth

PRECEDING PAGE BLANK NOT FILLED

ORIGINAL PAGE IS
OF POOR QUALITY



Figure 1.- Photograph of the test airplane.

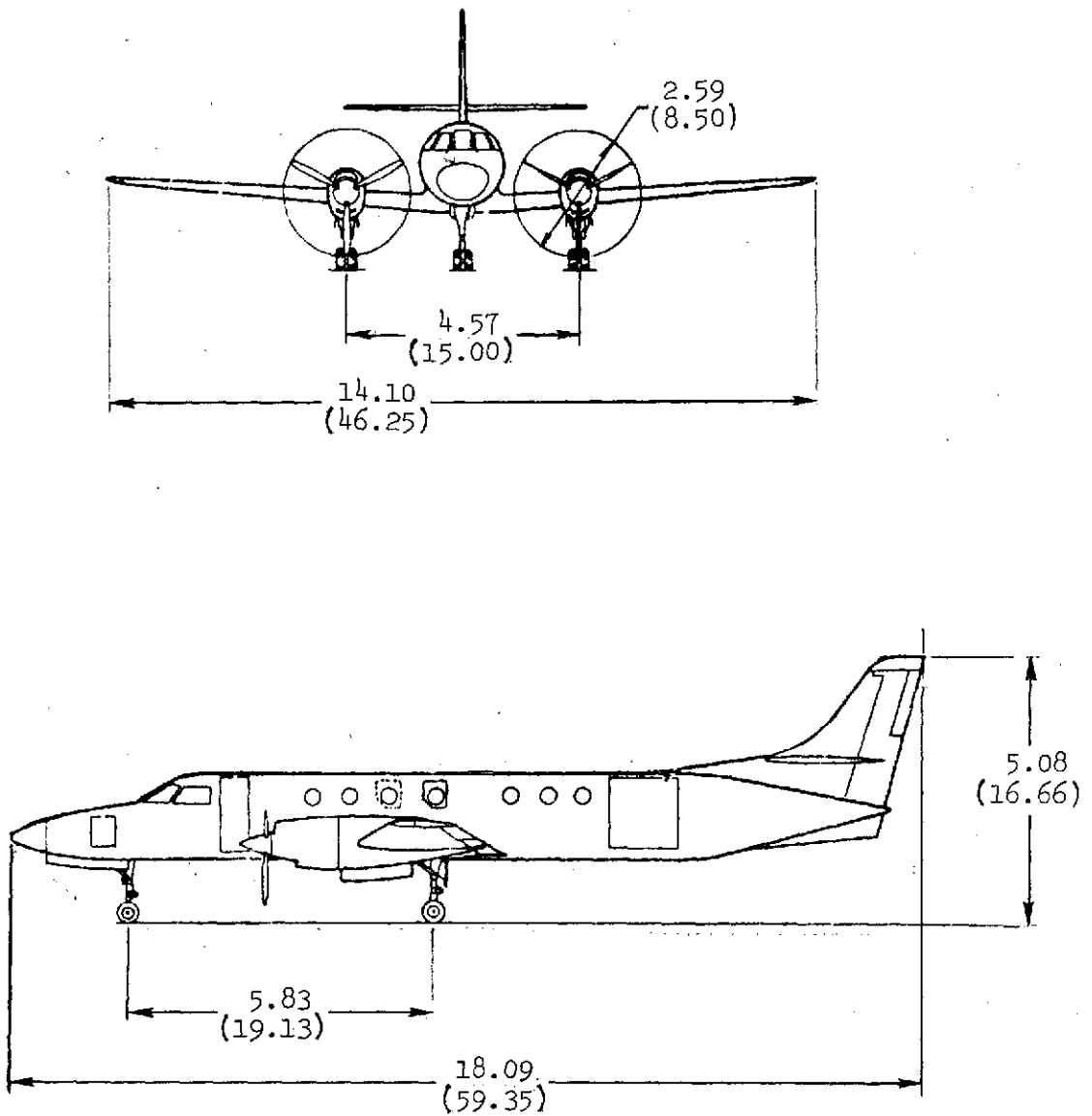

(a) General arrangement.

Figure 2.- Geometric details of the test airplane.

(Dimensions are given in meters and parenthetically in feet.)

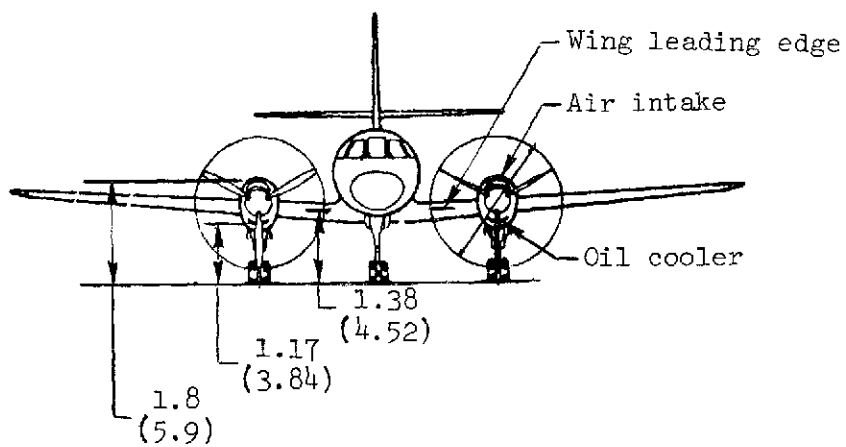
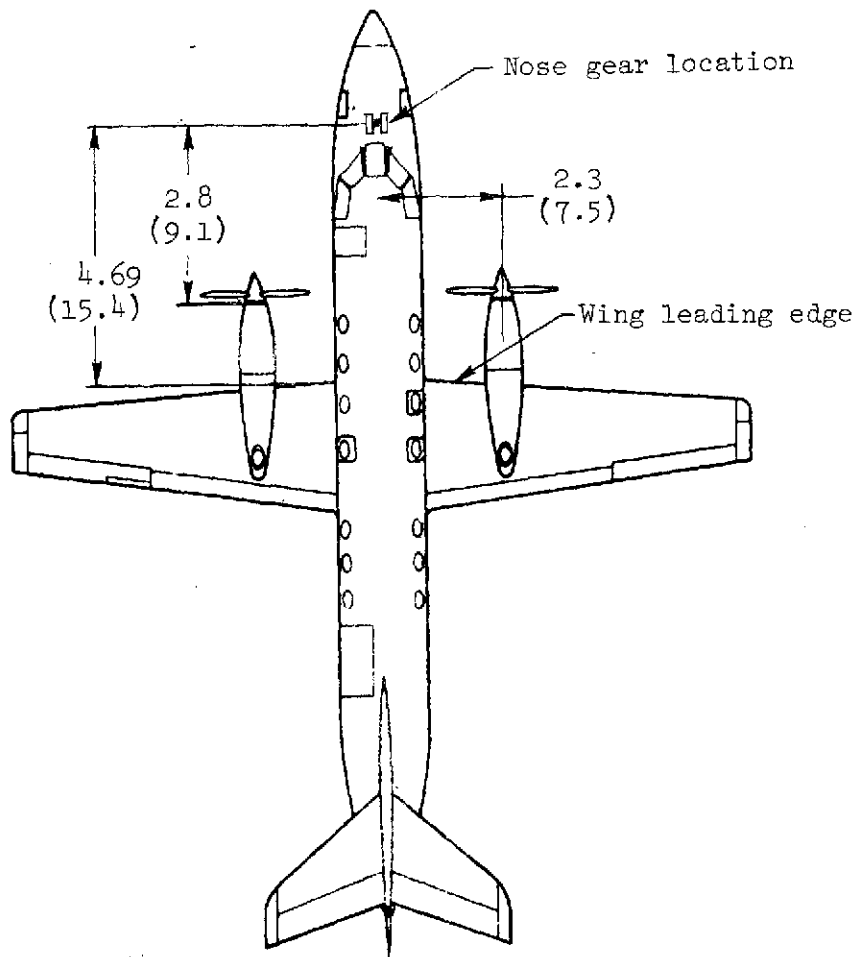

(b) Wing leading edge and air inlet locations.

Figure 2.- Concluded.

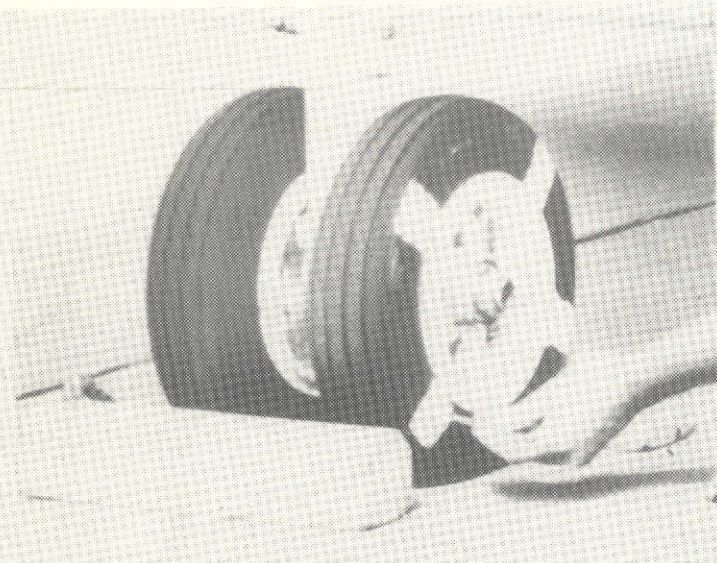

Tire A

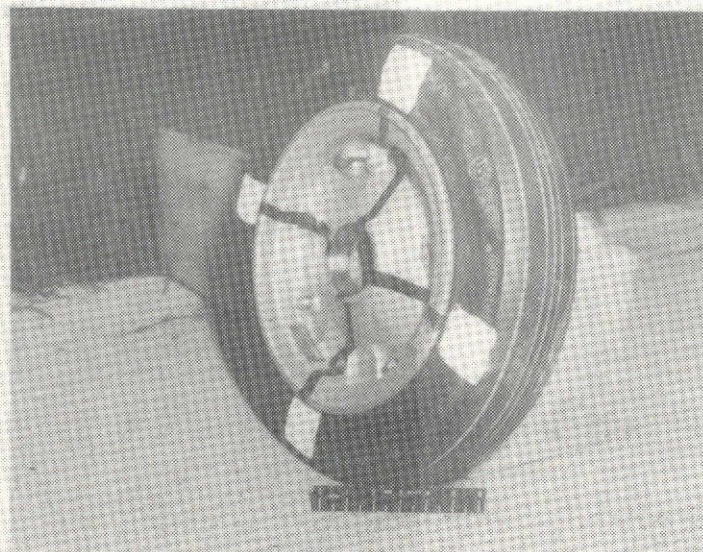

Tire B

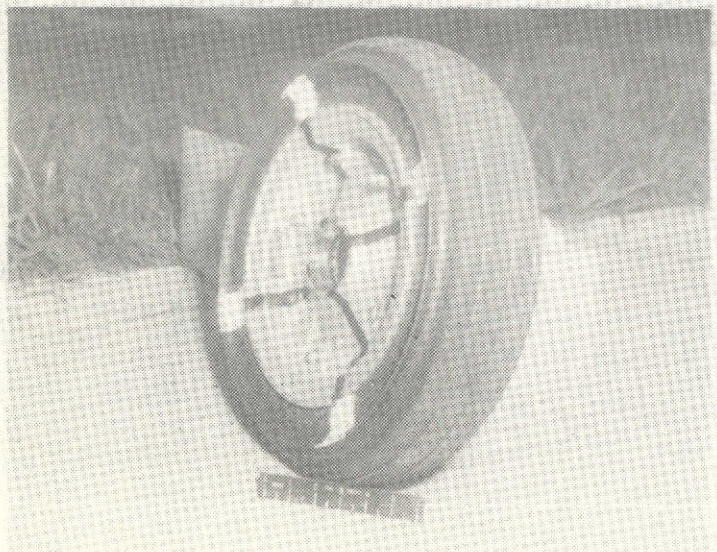

Tire C

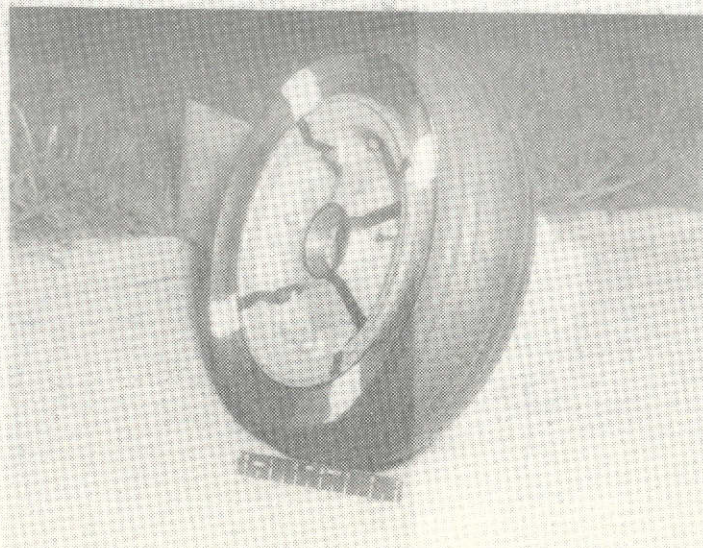

Tire D

(a) Photographs of nose gear test tires.

Figure 3.- Details of nose gear test tires.

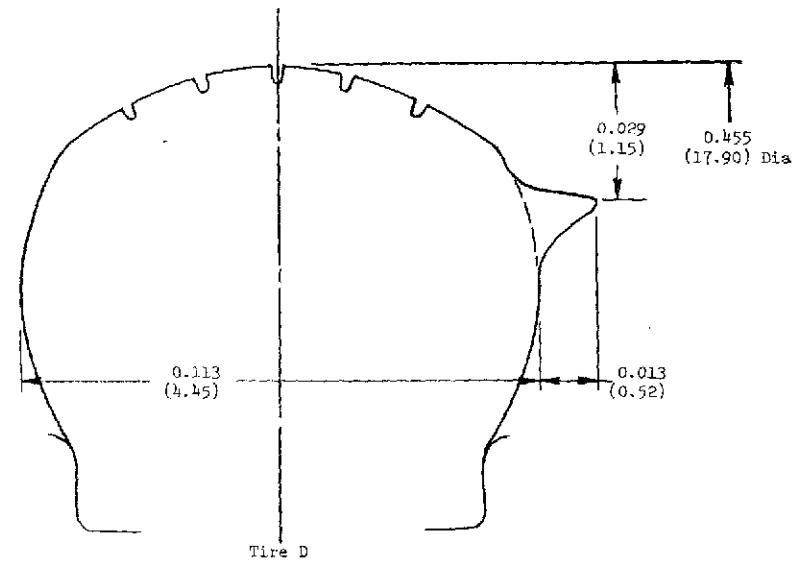
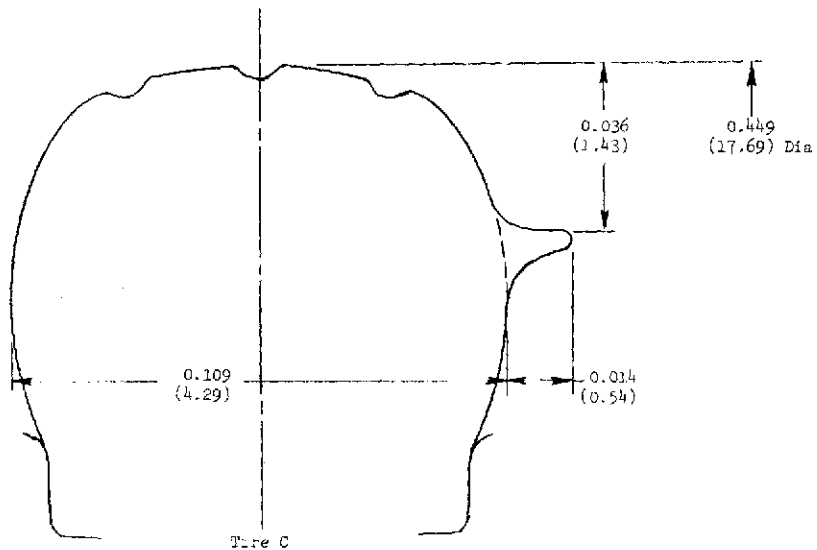
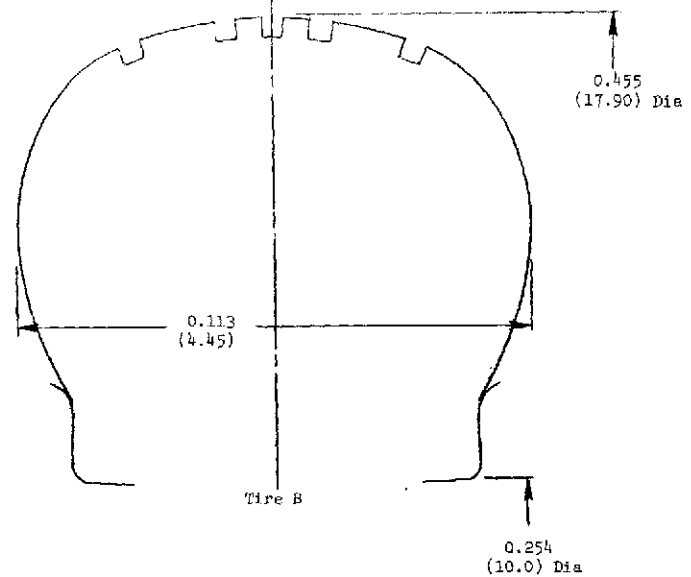
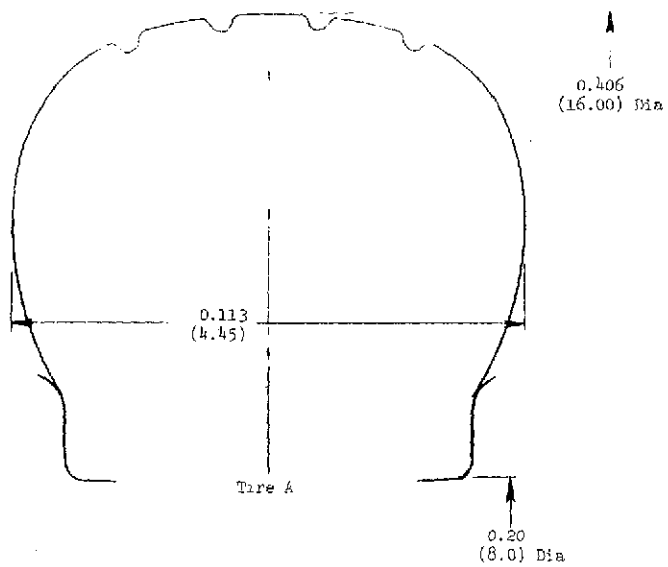

(b) Cross section details of test tires
(Dimensions are given in meters and parenthetically in inches.)

Figure 3.- Concluded

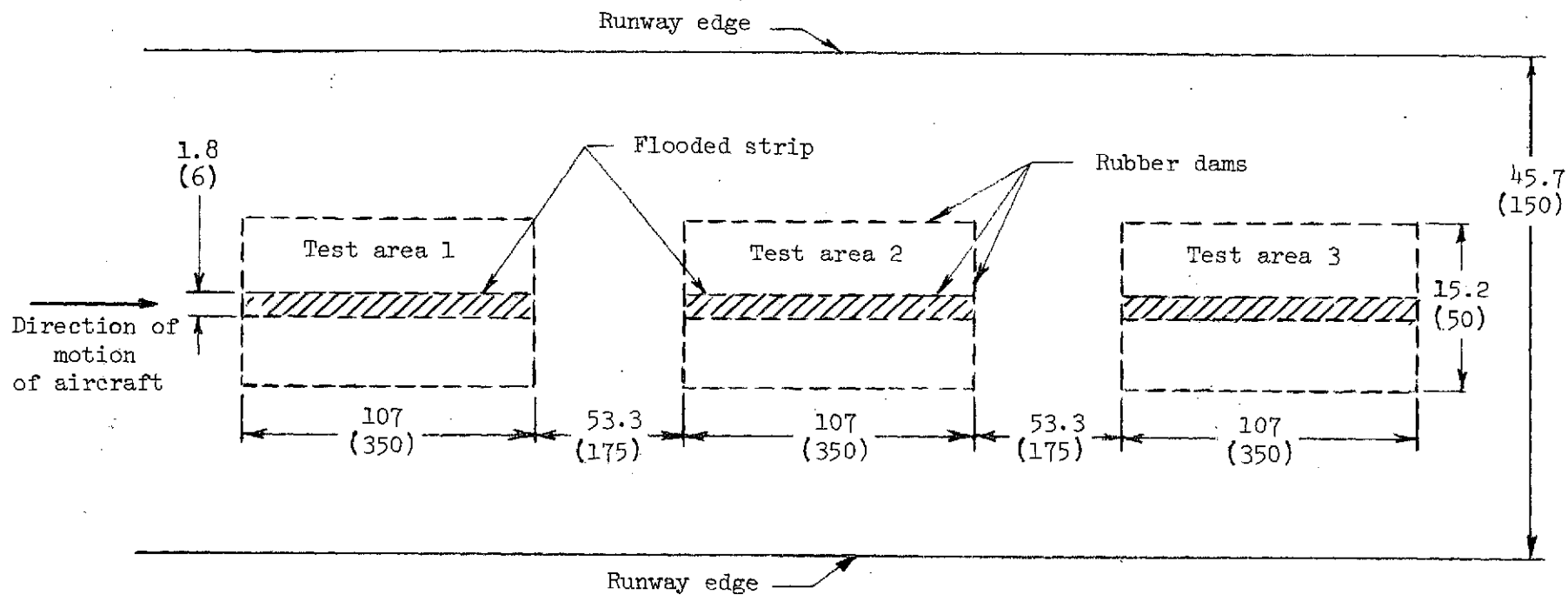
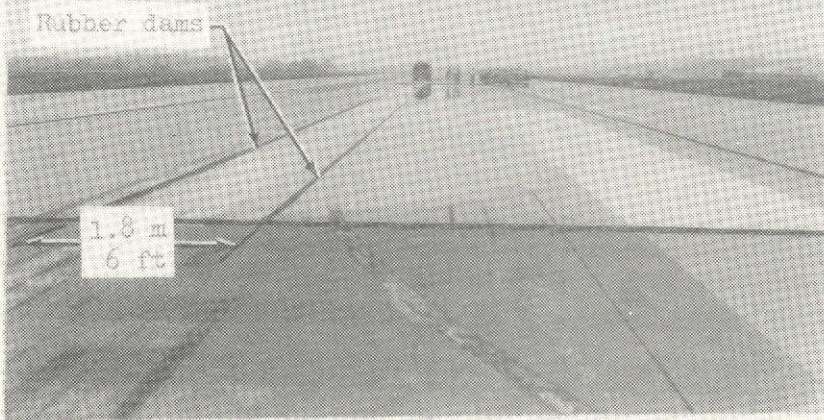

Figure 4.- Research runway test section layout for spray ingestion investigation.
 (Dimensions are given in meters and parenthetically in feet.)



(a) Runway wetting procedure



(b) Wetted nose gear strip

Figure 5.- Photographs of test runway preparations.

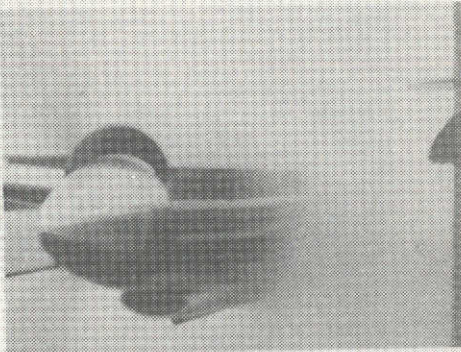

(a) Onboard motion picture camera

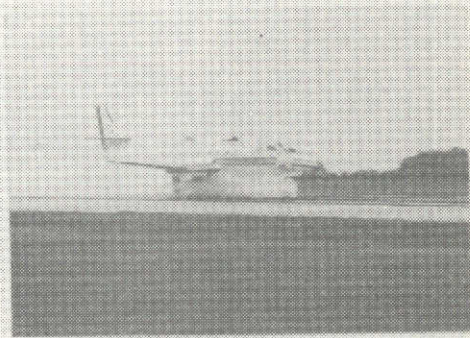

(b) 35 mm camera

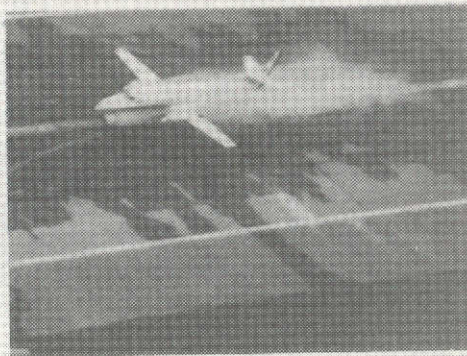

(c) Helicopter motion picture camera

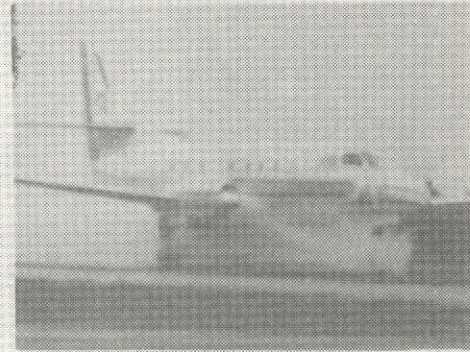

(d) Side tracking camera with 150 mm lens

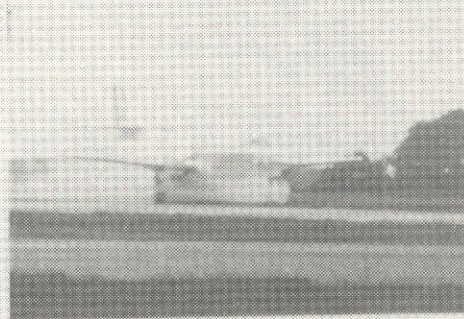

(e) Side tracking camera with 85 mm lens

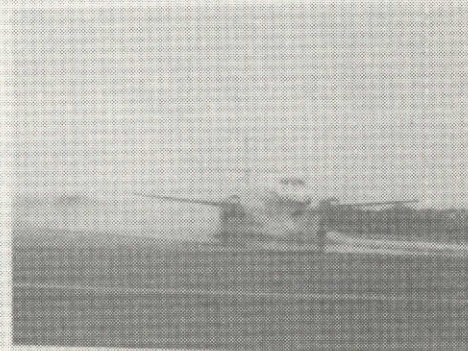

(f) Edge-of-runway camera

Figure 5.- Typical photographs from various cameras used to determine nose-wheel shim characteristics.
Bus 11: Tire D on right side of nose gear, tire B on left; Test speed = 62 knots; Sea level
water depth = 2.5 m (1.0 in.).

ORIGINAL PAGE IS
OF POOR QUALITY

ORIGINAL PAGE IS
OF POOR QUALITY

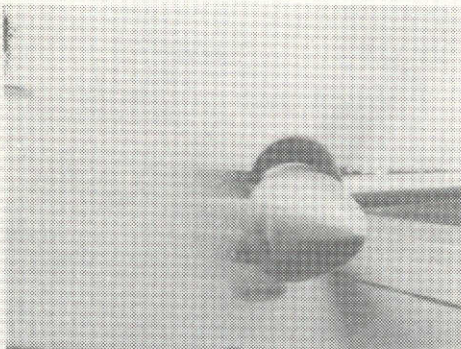

40 kts, Run 21

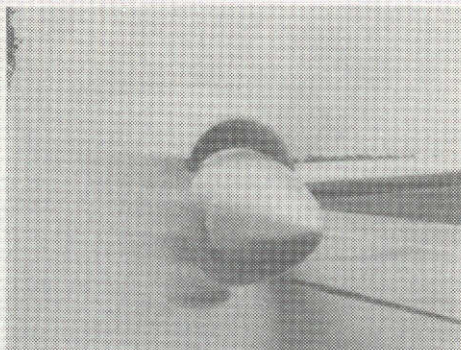

59 kts, Run 22

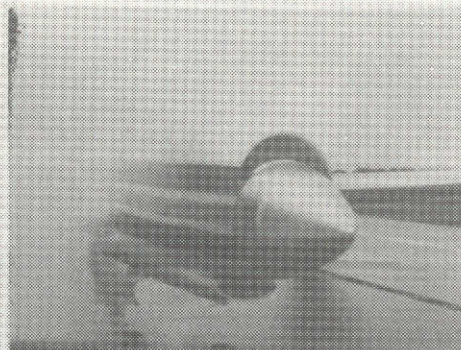
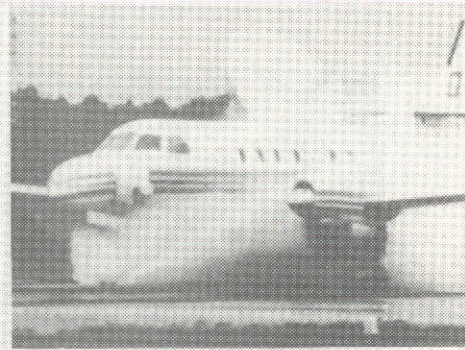

78 kts, Run 23

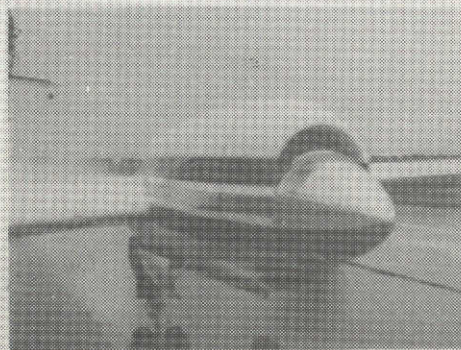

99 kts, Run 24

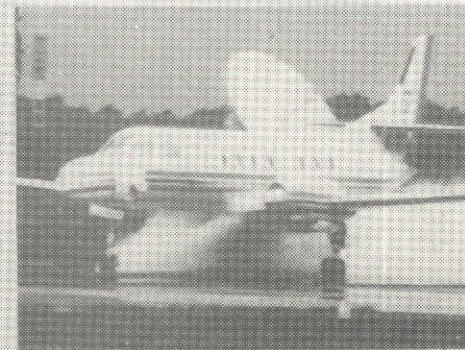

(a) Test Wire A: Nominal water depth = 8.79 cm (3.46 in.).

Figure 7.- Typical photographs chosen to show the effect of speed on spray characteristics.

ORIGINAL PAGE IS
OF POOR QUALITY

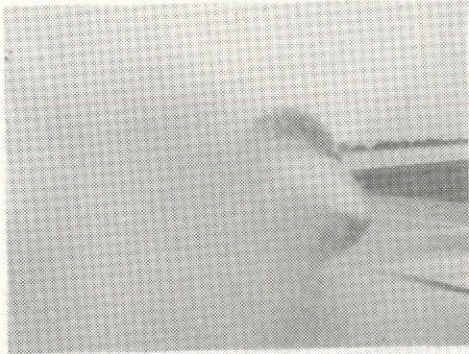

40 kts, Run 19.

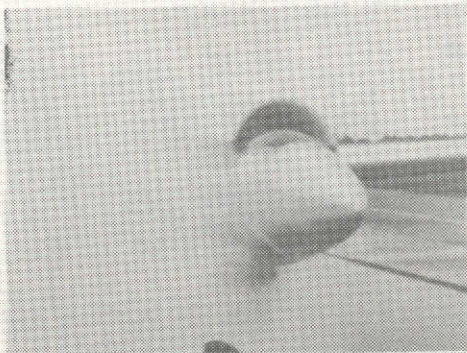

60 kts, Run 19.

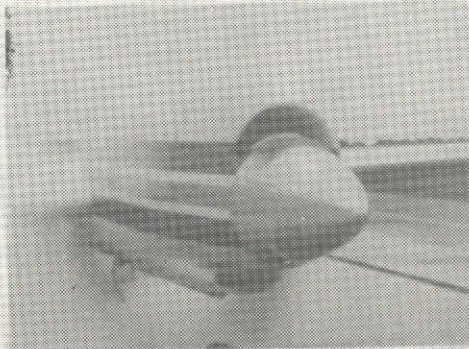

75 kts, Run 20.

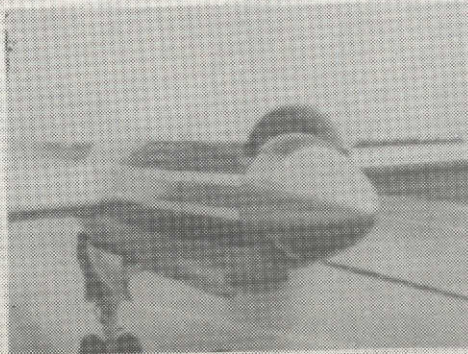

92 kts, Run 21.

(6) Test Case 2. Neutral water depth = 2.0 cm (0.8 in.)

Figure 7.- Concluded

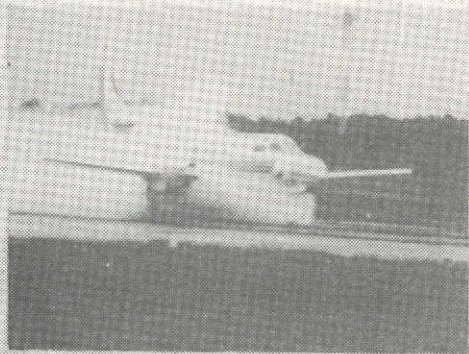

(a) Test wire A, Run 24.

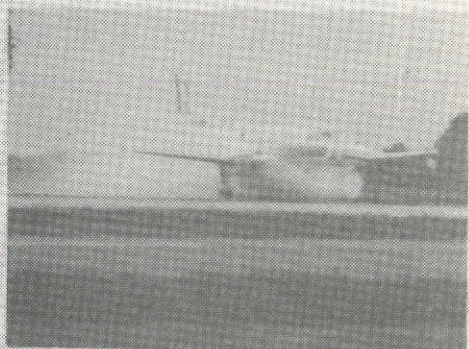
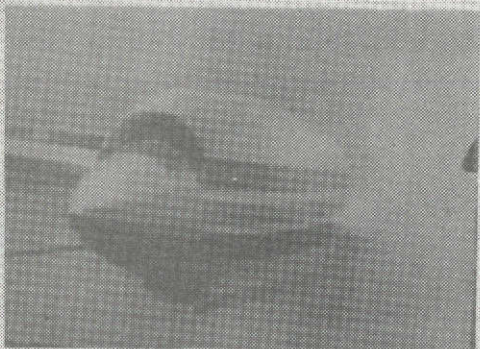

(b) Test wire B, Run 5.

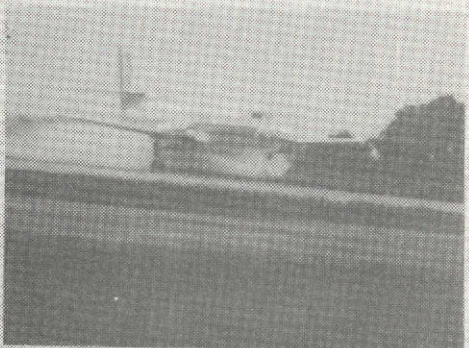

(c) Test wire C, Run 2.

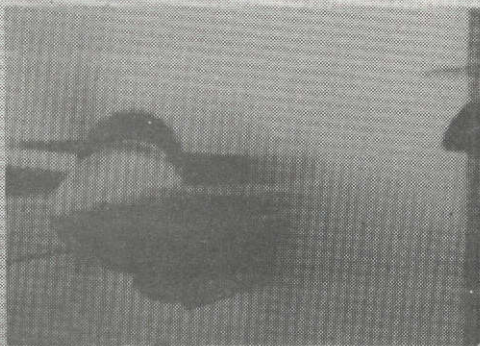

(d) Test wire D, Run 11.

Figure 8 - Typical photographs chosen to show the spray characteristics associated with the four test wires. Nominal test speed = 60 kts; Nominal water depth = 4.54 cm (1.8 in.).

ORIGINAL PAGE IS
OF POOR QUALITY

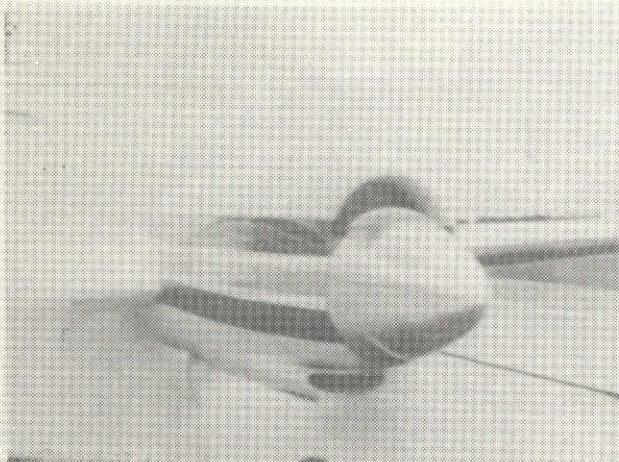

(a) Nominal water depth = 1.27 cm (0.5 in.)

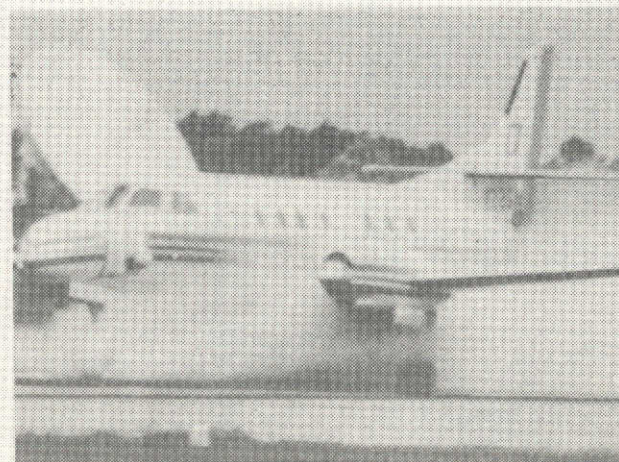
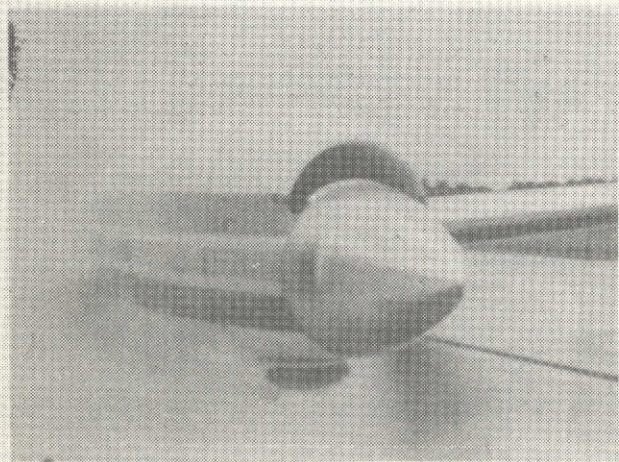

(b) Nominal water depth = 2.54 cm (1.0 in.)

Figure 9.- Typical photographs chosen to show the effect of water depth on spray characteristics.

Run 14: Test time D; Speed = 64 kts.

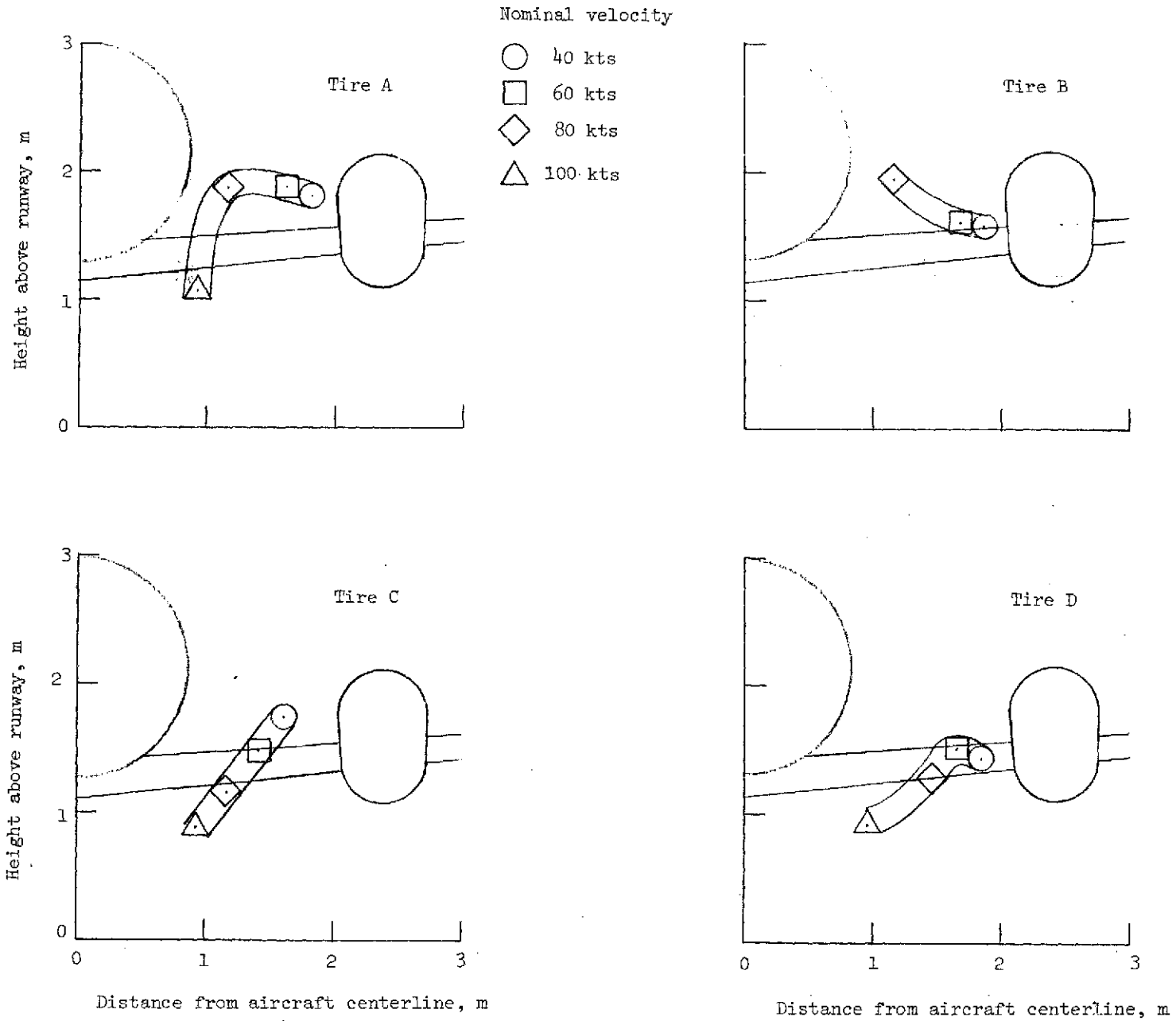

(a) Test area 1. Nominal water depth = 1.27 cm (0.5 in.)

Figure 10.- Location of spray core in the vertical plane of the wing leading edge.

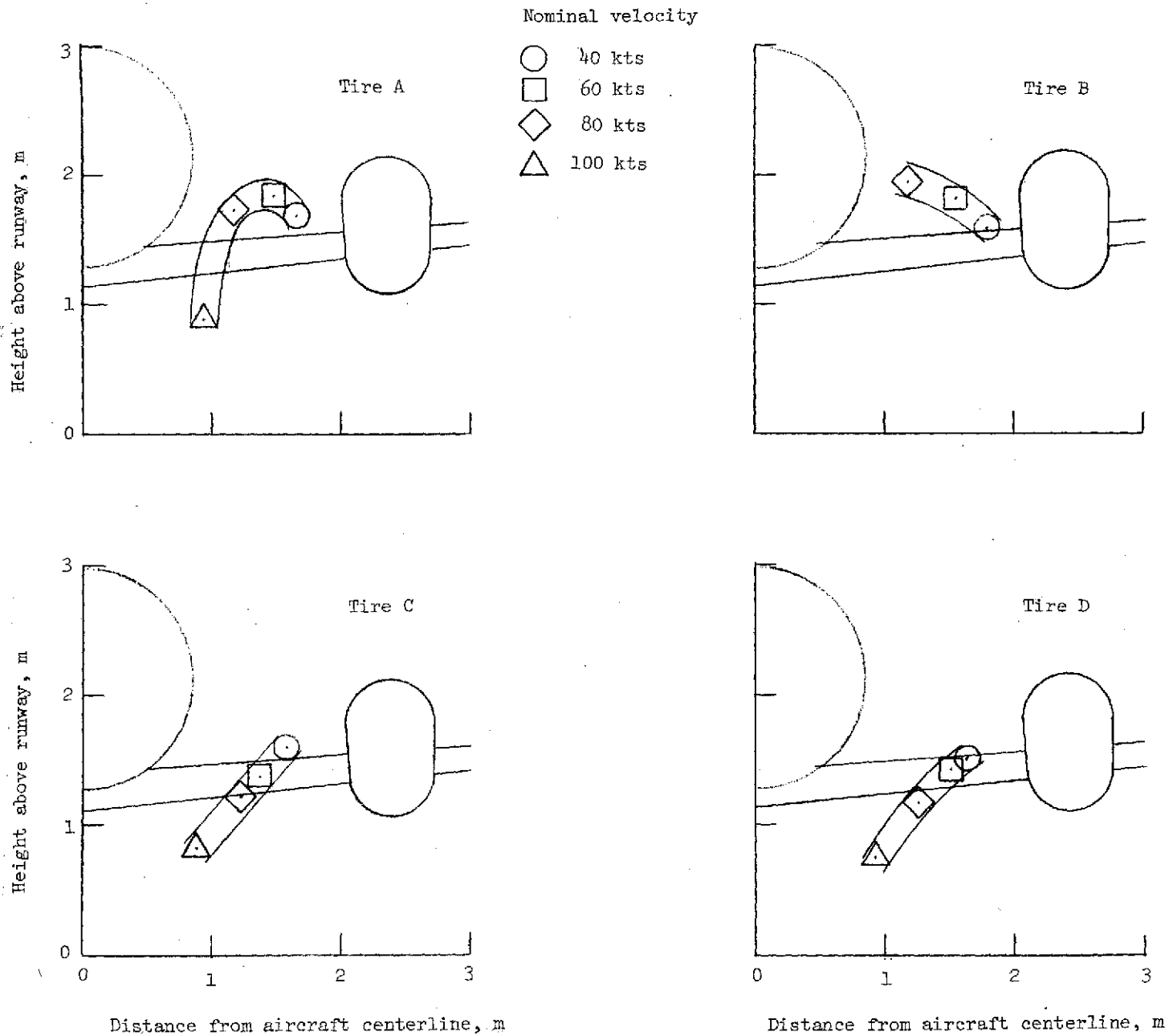

(b) Test area 2. Nominal water depth = 1.27 cm (0.5 in.)

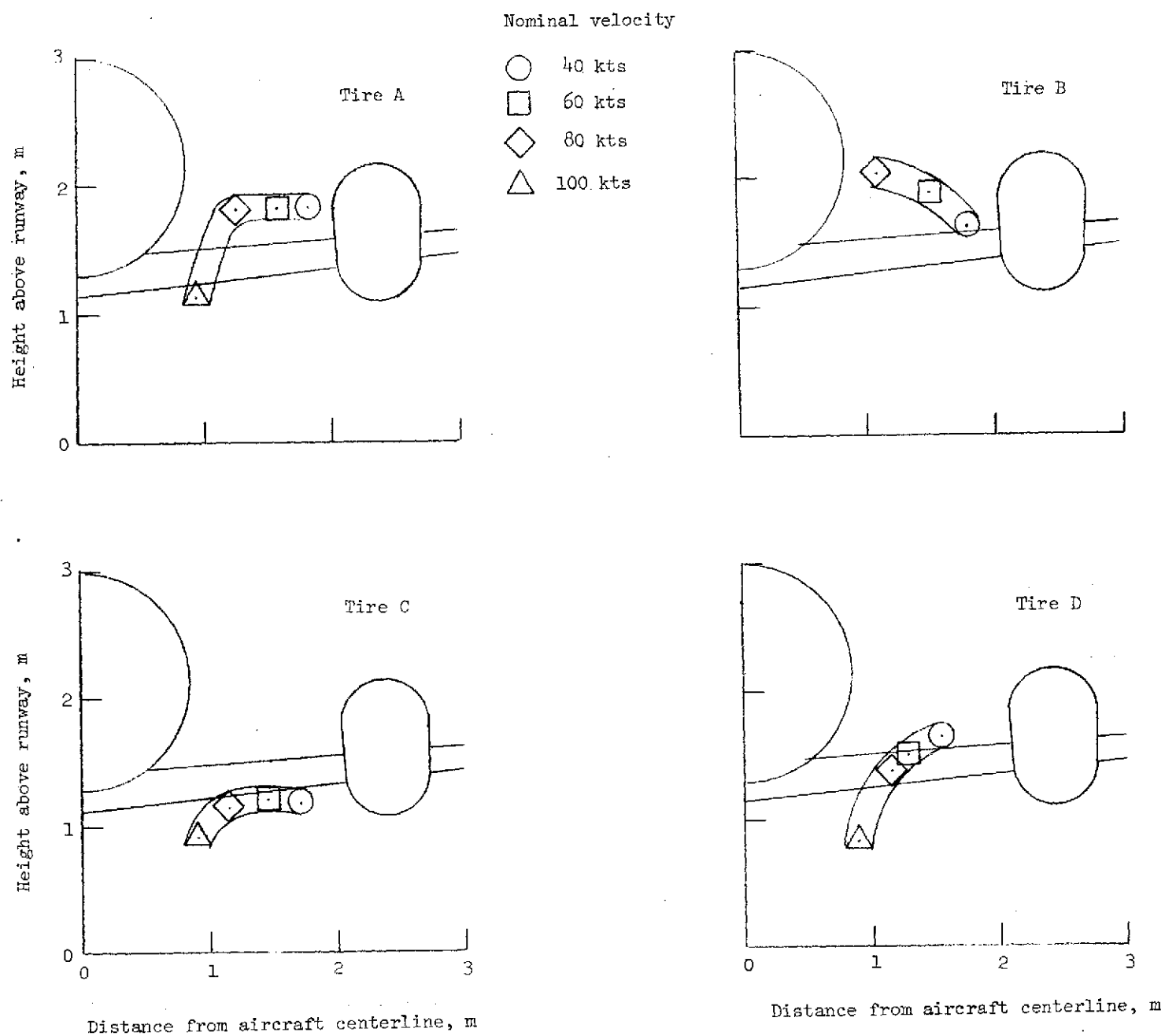

(c) Test area 3. Nominal water depth = 2.54 cm (1.0 in.)