

## General Disclaimer

### One or more of the Following Statements may affect this Document

- This document has been reproduced from the best copy furnished by the organizational source. It is being released in the interest of making available as much information as possible.
- This document may contain data, which exceeds the sheet parameters. It was furnished in this condition by the organizational source and is the best copy available.
- This document may contain tone-on-tone or color graphs, charts and/or pictures, which have been reproduced in black and white.
- This document is paginated as submitted by the original source.
- Portions of this document are not fully legible due to the historical nature of some of the material. However, it is the best reproduction available from the original submission.



NASA CR-

141867

# MAS2-8 RADAR AND DIGITAL CONTROL UNIT

Remote Sensing Laboratory  
RSL Technical Report 177-37

J. Michael Oberg

Fawwaz T. Ulaby

October, 1974

(NASA-CR-141867) MAS2-8 RADAR AND DIGITAL  
CONTROL UNIT (Kansas Univ. Center for  
Research, Inc.) 99 p HC \$4.75 CACL 20F

N75-26846

Unclas

G3/74 26667

Supported by:

**NATIONAL AERONAUTICS AND SPACE ADMINISTRATION**  
Lyndon B. Johnson Space Center  
Houston, Texas 77058

CONTRACT NAS 9-10261



**THE UNIVERSITY OF KANSAS CENTER FOR RESEARCH, INC.**

2291 Irving Hill Drive—Campus West Lawrence, Kansas 66045



## TABLE OF CONTENTS

	Page
ABSTRACT . . . . .	ii
1.0 SYSTEM DESIGN . . . . .	1
1.1 Background . . . . .	1
1.2 System Parameters . . . . .	1
1.3 Method of Operation . . . . .	2
2.0 DIGITAL CONTROL UNIT . . . . .	4
2.1 General Information . . . . .	4
2.2 Interfacing and Auxiliary Circuitry . . . . .	4
2.3 Method of Operation . . . . .	5
2.4 Theory of Operation . . . . .	5
2.4.1 General . . . . .	5
2.4.2 Logic Symbology . . . . .	6
2.4.3 Module Descriptions . . . . .	6
2.4.3.1 Control Module—Board J . . . . .	6
2.4.3.2 Return Module—Board L . . . . .	7
2.4.3.3 Data Module—Board N . . . . .	7
2.4.3.4 Multiplexer Module— Boards P, R . . . . .	8
2.4.3.5 Frequency Module—Board D . . . . .	8
2.4.3.6 Angle and Band Modules—Board F . . . . .	8
2.4.3.7 Polarization and Device Modules— Board H . . . . .	8
2.4.3.8 LED Drivers—Boards A, B, C . . . . .	8
2.4.3.9 DVM Logic Converters—Board T . . . . .	9
2.5 Programming the DCU . . . . .	9
2.5.1 General . . . . .	9
2.5.2 Programming the pROM . . . . .	9
2.5.3 Erasing the pROM . . . . .	11
2.6 Maintenance and Repair . . . . .	11
2.7 DCU Cables and Pin Connections . . . . .	11
3.0 CONCLUSIONS . . . . .	35
REFERENCES . . . . .	36
Appendix 1. DCU Control Program . . . . .	37
Appendix 2. Sample Output . . . . .	40
Appendix 3. ASCII Code (Even Parity) . . . . .	42
Appendix 4. 7400 TTL Logic Family . . . . .	43
Appendix 5. MAS 2-8 Antenna Patterns . . . . .	45
Appendix 6. System Calibration Data . . . . .	96

## ABSTRACT

MAS 2-8 (2-8 GHz Microwave Active Spectrometer ) is a ground-based sensor system used by the Remote Sensing Laboratory at the University of Kansas. The system has been continually modified since its first use in 1972. The most recent major modification was that of a control subsystem to automate the data-taking operation. The system operation and a detailed discussion of the design and operation of the control unit will be presented.

## 1.0 SYSTEM DESIGN

### 1.1 Background

The desire for new and better microwave sensors has led to the continuing development of ground-based spectrometer systems. The first spectrometer built at the Center for Research, Inc. was a one-antenna 4-8 GHz slow-sweep pulse radar [1]. The pulse radar, however, was found to be unusable at the close ranges required to mount the system on a boom truck.

Moe [2] designed a 4-8 GHz spectrometer using FM-CW modulation and a single antenna. This operation requires the use of a circulator to separate the transmit and return signals. At the time, no circulator was available with sufficient isolation and the received data was obscured in local oscillator noise.

The current system, designed by Ulaby [3], uses FM-CW modulation with separate transmit and receive antennas to eliminate isolation problems. An early form of the system was used in the summer of 1972 to collect agricultural signatures from 4-8 GHz. The present system extends the frequency range to cover 2-8 GHz and allows automated data-taking.

### 1.2 System Parameters

The MAS 2-8 radar system is mounted on a 20-meter truck-mounted boom to provide an observation platform for obtaining agricultural signatures. The electric power is provided by a portable 15KW generator. An accompanying van carries major support electronics. The major system parameters are given below:

Platform height	20 meters
Antennas	1-meter parabolic dishes with $f/D = .42$
Feeds	2-8 GHz Log-periodic; single linear polarization
Incidence angle capability	0-70° in 10° increments
Radar	
Operation mode	FM-CW
Center frequency	2.25-7.75 GHz in .5 GHz steps
Frequency sweep	450 MHz
Modulation type	Triangle-wave
Modulation rate	100-500 Hz
IF frequency	57 KHz
IF bandwidth	10 KHz

## Radar (Continued)

Detection type	RMS
Transmit power	10 dBm (10 mW) minimum
Dynamic range	80 dB minimum
Polarization	VV, VH, HH

The parameters varied during a data set are: center frequency (including a band change), polarization, angle, system configuration (calibration or data mode), and FM rate. All of these parameters except the last are usually controlled by the digital control unit. The received RMS signal for each combination of these parameters is recorded.

### 1.3 Method of Operation

The MAS 2-8 system consists of two major subdivisions: those components mounted on the boom and those mounted in the van. Signals between these two subdivisions pass through a 30-meter multiconductor cable. These signals may be further divided into control, power and IF signals.

The boom truck supports a 20-meter boom, to which the microwave subsystem and receiver hardware are mounted. The system generator is mounted on the truck bed. Controls for positioning the boom and for setting the outriggers are located on the side of the truck. After the boom truck and van have been parked near a target field, the boom truck should be stabilized with the outriggers and the boom raised and positioned over the field. As the boom is raised, the multiconductor cable will unwind from the truck bed. When the boom is positioned, the cable should be connected to the side of the van. Also the power cable from the generator should be connected to the power jack on the rear of the van.

Now start the generator and go inside the van. Throw the master circuit breaker in the breaker box located in the rear of the van. Adjust the lights and air-conditioning to comfortable levels. Turn on both van and boom power (switches are located on the operator's panel) and allow time for the equipment to warm up.

There should now be a picture of the field on the TV monitor and an IF spectrum on the spectrum analyzer. Turn the angle positioner to scan the anticipated target area for irregularities. When this is found suitable, return to  $0^{\circ}$  and switch to automatic operation. Check the paper tape supply on the punch. Now press the CONT switch on the DCU and adjust the FM rate for a maximum reading on the RMS voltmeter. Press continue and the DCU will begin taking data.

All necessary parameters of the system can be controlled from the operator's panel, if desired. A brief description of the controls and their operation follows.

The master power switches control AC power to the boom and van subsystems independently. Normally, both switches should be energized.

The polarization switches control the polarization motors on the transmit and receive antennas. Their operation is self-explanatory.

The band select switch determines which oscillator is used as the frequency source and also selects the appropriate modulation parameters.

The manual FM override switch allows the FM rate to be adjusted by the potentiometer labeled FM rate. Otherwise, the FM rate will be automatically controlled to provide a constant IF. (This feature is currently inoperative and FM rate must be controlled manually).

The device selector allows either calibration or data modes of operation. The calibration mode replaces the antennas with a delay line.

The AUTO/MAN switch selects either automatic or manual control of the frequency, angle, polarization, band, and device.

The angle selector allows selection of any angle from  $0^{\circ}$  to  $70^{\circ}$  in  $10^{\circ}$  steps.

The frequency selector allows selection of the center frequency to be used within a selected band.

## 2.0 DIGITAL CONTROL UNIT

### 2.1 General Information

The Digital Control Unit (DCU) automatically changes all system parameters except FM rate and records the return signal on paper tape. The DCU is controlled by a programmable Read-Only-Memory, which allows the use of any desired control sequence(s). Separate data-taking and calibration sequences were used for our purposes. The programs used are listed in Appendix 1 and a sample output is given in Appendix 2.

The DCU uses TTL logic and a description of the 7400 logic family is given in Appendix 4. TTL was used because of its ease of design and availability, but was not necessarily the most suitable logic. TTL is a moderately fast logic and some additional noise problems resulted from this unnecessary speed capability. A much more suitable logic would have been CMOS, but this was more expensive and much harder to obtain.

### 2.2 Interfacing and Auxiliary Circuitry

In order to allow digital control of all major system parameters, various interface circuits were required. The first of these was a digital frequency control. A D/A converter is used with appropriate scaling to set the center frequency of the microwave oscillators. Then this voltage is summed with the FM triangle-wave and used to drive the frequency control of the oscillators. The frequency band is selected by switching the microwave transfer switch to the desired oscillator. Current amplifiers (relays and transistors) interface the switch with the DCU.

Polarization is selected by selecting the proper drive polarity for the polarization motors, which turn until the selected dish opens a limit switch.

Controlling the angle requires some form of angle indication. This function is accomplished by using a potentiometer with a plumb-bob attached to the shaft. As the antenna mount rotates, the potentiometer shaft is turned. By applying a constant voltage across the pot, a voltage proportional to the angle is obtained. Comparing this voltage with the output of a D/A converter and driving the positioner motor to decrease the error results in digitally-selected angles.



## 2.3 Method of Operation

When the system is ready to take data, switch the AUTO/MAN switch on the operator's panel to AUTO and the momentary CONT/PAUSE switch on the DCU to CONT. The RUN indicator should now be on. The system is now completely automatic and the operator's panel is disabled. To halt automatic control at any time, switch to PAUSE. To continue operations from the same point, switch back to CONT. If it is desired to start over again, press the momentary RESET switch and then switch to CONT.

If manual operation is desired at any time after automatic control has been initiated, switch the DCU to PAUSE and then switch to MANUAL on the operator's panel. Manual operation of the operator's panel with the DCU running will not harm the DCU but may result in extraneous output on the data punch.

NOTE: The indicators on the DCU Front Panel are valid only in the automatic mode of operation. When using the operator's panel for manual control, the switch positions indicate the parameter settings.

To follow the actions of the DCU, refer to Appendix 1, which lists the control program. If any irregularity arises, switch the DCU to PAUSE and try to determine the fault. If the trouble is isolated to the DCU, see Section 2.6 for troubleshooting and repair.

## 2.4 Theory of Operation

### 2.4.1 General

The DCU is a one-address machine with 256 eight-bit words of programmable Read-Only-Memory. All instructions are double-word; the first word contains the op code and the second word contains an address or ASCII character. The address determines the location of the next instruction to be executed if the current instruction sends a false return. Otherwise a true return causes sequential execution. By use of an instruction which always results in a false return, an unconditional branch operation can be achieved. The use of an instruction with a test operation results in conditional branches, which may be used to create iterative loops. Thus simple flowcharts may be easily implemented on this machine.

The DCU operates asynchronously; that is, every instruction, upon completion, generates a signal which initiates the execution of the next instruction. This allows the fastest implementation of many operations which require a variable amount of execution time.

All instructions are designed as independent modules, which allows easy insertion or deletion of instructions. Thus the instruction set may be changed as the system requires.

#### 2.4.2 Logic Symbology

The DCU uses standard TTL positive logic with 0.0-0.8V representing "0" and 2.0-5.0V representing "1". The normal fan-in is one unit load: 40  $\mu$ A @ 2.4V and -1.6 mA @ .4V. Most outputs can drive 10 unit loads. The DC noise margin is 400 mV minimum. Pin configurations for the 7400 family are given in Appendix 4.

#### 2.4.3 Module Descriptions

##### 2.4.3.1 Control Module—Board J

When the DCU is first powered-up or whenever the RESET switch is pressed, a 10ms reset pulse is generated by the P.O.R. monostable multivibrator (IC M). This signal initializes all flip-flops and counters and "jams" a HALT instruction into the instruction register (IC's E, F). This assures a stable start-up condition after the reset pulse.

The rising edge of the  $\overline{\text{POR}}$  signal causes the instruction monostable (IC D) to pulse the instruction flip-flop. The flip-flop then strobes the instruction register, loading the first instruction. The rising edge of  $\overline{\text{Q}}$  causes the address monostable (IC G) to clock the address register (IC's B, C) which causes the first address to be read out of the pROM. The falling edge of  $\overline{\text{Q}}$  retriggers the instruction monostable, clocking the instruction FF. This leaves all registers ready for a new memory cycle. The next rising edge of  $\overline{\text{Q}}$  does not retrigger the address register, since the odd address disables it until the cycle monostable generates a cycle pulse.

The first instruction is always a PAUSE to prevent DCU operation until the CONT switch is pressed. Both the HALT and PAUSE instructions are ORed to produce the PAUSE signal. This signal fires the return monostable (IC N) and resets the RUN FF.

After 5ms (long enough for the memory cycle to finish), the RETURN  $\overline{\text{Q}}$  goes high, clocking the Return FF, which goes low. Thus the A1 and B inputs to the Cycle monostable (IC J) are both low, and DCU operation is disabled until the CONT switch is pressed. The CONT switch presets the Run FF, logically enabling the DCU.

The rising edge of  $Q$  triggers the B input of the cycle monostable. This gates the T/F signal into the Address register and causes the second word of the last instruction to be loaded if the T/F signal is high.

The  $\overline{Q}$  output triggers the address monostable, which immediately clocks the address register. However, if the T/F is high, the load will mask the clock transition and the address will not change. After  $6\mu s$ , the instruction monostable is triggered and the instruction FF latches the new op-code into the instruction register. The instruction decoder then enables the proper instruction module.

$6\mu s$  later, the address monostable is triggered again, clocking the second (odd) word of the instruction. The instruction monostable fires once more, resetting the instruction FF. The address monostable is now disabled since the address register contains an odd address. Thus all signals are stable until the return monostable is triggered by a RETURN signal from the return module, initiating a new instruction cycle.

#### 2.4.3.2 Return Module--Board L

This board consists of two 16-input multiplexers which enable only the selected instruction module to send a RETURN or T/F signal to the control module. A low T/F input is true and a low-to-high transition generates the RETURN signal. The monostable generates a return for the SENSE instruction.

#### 2.4.3.3 Data Module--Board N

This module generates the PUNCH command as well as the range and function digits for the data punch. The range from the DVM is converted to TTL levels and gated to the data punch when S is high. Otherwise, the range will be all zeros. The function digit uses only one bit, indicating which IF amplification is being used. (Currently, only one preset IF amplification is used).

The PUNCH command is generated according to the source. If the DVM is being read ( $S = "1"$ ), the command is given after the last of the following conditions is met:

- 1) The data punch is ready to punch ( $HOLDOFF = "1"$ ),
- 2) The POR or manual reset pulse is not on ( $\overline{POR} = "1"$ ),
- 3) The DATA enable has been given ( $\overline{DATA} = "0"$ ),
- 4) The DVM is ready to be read ( $PRINT = "1"$ ), and
- 5) The data monostable has timed out ( $\overline{Q} = "1"$ , 1.5sec).

If  $S = "0"$ , the PUNCH command is given immediately following the  $\overline{DATA}$  enable. This assumes the frequency counter will be stable before it is read (see Appendix 1).

#### 2.4.3.4 Multiplexer Module—Boards P, R

P and R form the data multiplexer that selects four BCD digits from either the frequency counter or the digital voltmeter. These digits are then sent to the data punch to be recorded. The monostable on Board P generates the return and clocks the select FF. The select FF controls which device the multiplexers will output. Board R contains hold-off circuitry which disables the display latch on both data devices, preventing changes while the data is being punched. IC-C is wired as a set-reset flip-flop which generates the BYPASS command to the data punch during the PUNCH instruction.

#### 2.4.3.5 Frequency Module—Board D

As discussed earlier, the system center frequency is controlled by a digital code. The code is held in a counter/register, which is incremented each time an enable is received from the control module. The control outputs are decoded to produce separate signals for each frequency LED on the Front Panel. A monostable generates the return signal after allowing sufficient time for the oscillators to settle to the new frequency.

#### 2.4.3.6 Angle and Band Modules—Board F

The angle module is identical to the frequency module discussed above, except the return is generated by the Digital Angle Control (Discussed in Section 2.2). The emitter-follower is used to improve noise immunity and drive capability of the return signal. The other flip-flop in IC-C is used to select the band. A monostable is used to generate the band return.

#### 2.4.3.7 Polarization and Device Modules—Board H

A two-bit digital code generator creates the control signals for transmit and receive polarizations. The return signal is generated by the polarization control and is shaped by the level shifter and Schmitt trigger circuit to obtain a suitable TTL signal.

The device module consists of a flip-flop and a monostable. The use of the Q output to clock the flip-flop results in the necessary edge inversion of the enable signal.

The other Schmitt trigger on the board is used to shape the angle return before it is sent to the return module from the angle module.

#### 2.4.3.8 LED Drivers—Boards A, B, C

These boards each contain 16 darlington pairs with current-limiting base and collector resistors. All LED's are connected to 5V and are on when the base is driven by a "1". The +5V LED driver is tied to 5V and the -12V LED is driven by a

voltage-divider circuit which turns on the LED if the negative supply line is below -9 VDC (the minimum operating voltage of the pROM).

#### 2.4.3.9 DVM Logic Converters—Board T

The voltage levels used by the HP3440A digital voltmeter are not standard TTL levels and have to be converted. The DVM logic levels are -30V for "1" and -2V for "0". The converters invert the logic levels which are later inverted again in the data multiplexer. The 16 converters on this board are identical and their operation is apparent from the schematic.

## 2.5 Programming the DCU

### 2.5.1 General

The control program for the DCU is stored in a pROM which can be programmed as described in Section 2.5.2. The language used in the pROM consists of double-word instructions; the first word is one of the  $c_p$ -codes listed in Table 1 and the second word is the address of the next instruction to be executed if the present operation yields a false return. The second word is also used as data for the PRINT SPECIAL instruction. The program actually used is listed in Appendix 1.

### 2.5.2 Programming the pROM

The DCU is controlled by the program stored in the pROM. This program may be changed, as necessary, by re-programming the pROM. This process is facilitated by the use of an accompanying programmer unit.

The programmer unit consists of a programming board with socket and timing electronics plus a keyboard with the data and address switches. External power supplies are required to provide +12V, 13V (floating), -35V and 5V (floating). The -35V and the floating 13V supplies are used in series to obtain -48V, which must be able to supply 750 mA for 10ms periods with a low duty cycle ( $\leq 2\%$ ).

To use the programmer, first insert a blank pROM in the programming socket. Next, turn on the +12V and 5V (floating) supplies. Set the address and data switches for the first word of the new program. Now turn on the -35V and 13V (floating) supplies. Cycle the pulse switch 10 times, allowing approximately 1 second per cycle.

After the first word has been programmed, turn off the last two supplies and set the switches for the next word. Now turn the high voltage supplies back on and cycle the pulse switch. Repeat these steps until the entire program has been entered.

TABLE 1  
DCU Op-Codes

Op-Code	Octal		Functional Description
	1st word	2nd word	
DATA	360	xxx	Punches data from selected device on HP3489A. Second word is ignored.
FREQ	361	A	Increments center frequency and branches to A if FREQ < 8. When FREQ = 8, FREQ → 0 and no branch occurs.
POL	362	A	Increments antenna polarization and branches to A if POL < 3. When POL = 3, POL → 0 and no branch occurs.
BAND	363	A	Changes frequency band and branches to A when BAND = 0. (BAND = 0 selects 2-4GHz; BAND = 1 selects 4-8GHz.)
ANGLE	364	A	Increments antenna angle and branches to A when ANGLE < 8. When ANGLE = 8, ANGLE → 0 and no branch occurs.
DEVICE	365	A	Changes system configuration. DEVICE = 0 configures system in radar mode, DEVICE = 1 allows calibration. Branch to A occurs on DEVICE = 0.
GO TO	366	A	Unconditional branch to A.
PAUSE	367	xxx	Turns off RUN mode; waits for a CONTINUE. Second word is ignored.
PUNCH	370	ccc	Causes ASC II character in second word to be punched in HP3489A.
SENSE	371	A	Senses condition of SENSE switch and branches to instruction stored in A, if SENSE = 1.
SELECT	372	xxi	Sets SELECT FF according to i; i = 0 selects the Frequency Counter, i = 1 selects the DVM.
	373		Unused
	374		"
	375		"
	376		"
HALT	377	xxx	Turns off RUN mode.

### 2.5.3 Erasing the pROM

If it is desired to change the program in the pROM or a mistake has been made in programming, the pROM must first be erased by use of an ultraviolet light. The memory should be placed within an inch of the light and left exposed for 1/2 hour.

When the memory is fully erased, all locations will contain "1's". Therefore, if a "1" is accidentally written, it may be reprogrammed to a "0" without erasing first. Unfortunately, if it is desired to change a "0" to a "1", the entire memory must be erased and reprogrammed.

### 2.6 Maintenance and Repair

The DCU is electrically reliable and most problems are due to faults in board connections or improper cable connections. However, if the problem is not remedied by checking these connections, Table 2 can be used to isolate most common faults. After the problem has been isolated to a board, refer to the theory of operation for that board.

### 2.7 DCU Cables and Pin Connections

A list of the pin connections and their functions for each connector is given on the following pages.

TABLE 2

Troubleshooting Hints

Symptom	Possible Cause
1. Display not lit.	Check +5VDC supply
2. Display lit, -12V LED off.	Check -12VDC supply
3. Display normal, RUN LED remains off after pressing CONT.	Press RESET and try again. If RUN still remains off, check MODE switch on Board J for NORM.
4. RUN on, but Display static	Check Cable connections on Board L for possible return errors.
5. RESET switch does not work and DCU does not come up in proper state when power is applied.	Check POR monostable and RESET switch.
6. Angle LED's, POL, and DEVICE LED's not on.	Check Board A for solid connection or bad driver.
7. FREQ LED's off.	Check Board B.
8. Power and RUN LED's off, Display lit.	Check Board C.
9. DCU "hangs" after FREQ instruction.	Check return from Board D.
10. DCU "hangs" after ANGLE instruction.	Check return from Board H and Board F.
11. Punched data from DVM is garbled.	Check logic converters on Board T.



## J1 -- DCU / Operator's Panel Cable

Connector Pin	DCU Backplane Pin	Function
J1-1	D18	Freq Code (LSB)
J1-2	D19	Freq Code (2SB)
J1-3	D20	Freq Code (MSB)
J1-4	n.c.	
J1-5	n.c.	
J1-6	F9	Angle Code (LSB)
J1-7	F10	Angle Code (2SB)
J1-8	F11	Angle Code (MSB)
J1-9	H26	Polarization Return
J1-10	H13	Transmit Polarization
J1-11	H14	Receive Polarization
J1-12	F24	Band Control
J1-13	F25	Angle Return
J1-14	H15	Radar Mode
J1-15	n.c.	
J1-16	H16	Calibration Mode
J1-17	n.c.	
J1-18	n.c.	
J1-19	N20	Function Bit
J1-20	T33 (GND)	Ground
J1-21	n.c.	
J1-22	n.c.	
J1-23	n.c.	
J1-24	n.c.	

## J2 -- DCU / Frequency Counter Cable

Connector Pin	DCU Backplane Pin	Function
J2-1	R8	FREQ $1 \times 10^0$
J2-2	R7	FREQ $2 \times 10^0$
J2-3	n.c.	
J2-4	n.c.	
J2-5	R4	FREQ $1 \times 10^1$
J2-6	R3	FREQ $2 \times 10^1$
J2-7	n.c.	
J2-8	n.c.	
J2-9	P8	FREQ $1 \times 10^2$
J2-10	P7	FREQ $2 \times 10^2$
J2-11	n.c.	
J2-12	n.c.	
J2-13	P4	FREQ $1 \times 10^3$
J2-14	P3	FREQ $2 \times 10^3$
J2-15	n.c.	
J2-16	n.c.	
J2-17	n.c.	
J2-18	n.c.	
J2-19	n.c.	
J2-20	n.c.	
J2-21	n.c.	
J2-22	n.c.	
J2-23	n.c.	
J2-24	n.c.	
J2-25	B27	FREQ HOLD OFF
J2-26	R5	FREQ $8 \times 10^0$
J2-27	R6	FREQ $4 \times 10^0$
J2-28	n.c.	
J2-29	n.c.	
J2-30	R1	FREQ $8 \times 10^1$
J2-31	R2	FREQ $4 \times 10^1$
J2-32	n.c.	
J2-33	n.c.	
J2-34	P5	FREQ $8 \times 10^2$
J2-35	P6	FREQ $4 \times 10^2$
J2-36	n.c.	
J2-37	n.c.	
J2-38	P1	FREQ $8 \times 10^3$
J2-39	P2	FREQ $4 \times 10^3$
J2-40	n.c.	
J2-41	n.c.	
J2-42	n.c.	
J2-43	n.c.	
J2-44	n.c.	
J2-45	n.c.	
J2-46	n.c.	
J2-47	n.c.	
J2-48	n.c.	
J2-49	n.c.	
J2-50	T83 (GND)	GROUND

### J3 -- DCU / DVM Cable

Connector Pin	DCU Backplane Pin	Function
J3-1	N25	RANGE (1)
J3-2	N24	RANGE (2)
J3-3	T31	DVM $1 \times 10^0_a$
J3-4	T29	DVM $2 \times 10^0_a$
J3-5	T23	DVM $1 \times 10^1_a$
J3-6	T21	DVM $2 \times 10^1_a$
J3-7	T15	DVM $1 \times 10^2_a$
J3-8	T13	DVM $2 \times 10^2_a$
J3-9	T7	DVM $1 \times 10^3_a$
J3-10	T5	DVM $2 \times 10^3_a$
J3-11	n.c.	
J3-12	n.c.	
J3-13	n.c.	
J3-14	n.c.	
J3-15	n.c.	
J3-16	n.c.	
J3-17	n.c.	
J3-18	n.c.	
J3-19	n.c.	
J3-20	n.c.	
J3-21	n.c.	
J3-22	R26	DVM HOLDOFF
J3-23	N18	DVM PRINT COMMAND
J3-24	n.c.	
J3-25	n.c.	
J3-26	N23	RANGE (4)
J3-27	N22	RANGE (8)
J3-28	T27	DVM $4 \times 10^0_a$
J3-29	T25	DVM $8 \times 10^0_a$
J3-30	T19	DVM $4 \times 10^1_a$
J3-31	T17	DVM $8 \times 10^1_a$
J3-32	T11	DVM $4 \times 10^2_a$
J3-33	T9	DVM $8 \times 10^2_a$
J3-34	T3	DVM $4 \times 10^3_a$
J3-35	T1	DVM $8 \times 10^3_a$
J3-36	n.c.	
J3-37	n.c.	
J3-38	n.c.	
J3-39	n.c.	
J3-40	n.c.	
J3-41	n.c.	
J3-42	n.c.	
J3-43	T33 (GND)	GROUND
J3-44	n.c.	
J3-45	n.c.	
J3-46	n.c.	
J3-47	n.c.	
J3-48	n.c.	
J3-49	n.c.	
J3-50	n.c.	

### J4 -- DCU / Data Punch (By-Pass) Cable

Connector Pin	DCU Backplane Pin	Function
J4-1	n.c.	
J4-2	n.c.	
J4-3	n.c.	
J4-4	n.c.	
J4-5	n.c.	
J4-6	n.c.	
J4-7	n.c.	
J4-8	n.c.	
J4-9	n.c.	
J4-10	n.c.	
J4-11	n.c.	
J4-12	n.c.	
J4-13	n.c.	
J4-14	R31	BYPASS COMMAND
J4-15	L16	HOLDOFF
J4-16	J8	PUNCH COMMAND
J4-17	J27	b8
J4-18	J26	b7
J4-19	J25	b6
J4-20	J24	b5
J4-21	J23	b4
J4-22	J22	b3
J4-23	J21	b2
J4-24	N17	b1
J4-25	n.c.	
J4-26	n.c.	
J4-27	n.c.	
J4-28	n.c.	
J4-29	n.c.	
J4-30	n.c.	
J4-31	n.c.	
J4-32	n.c.	
J4-33	n.c.	
J4-34	n.c.	
J4-35	n.c.	
J4-36	n.c.	
J4-37	n.c.	
J4-38	n.c.	
J4-39	n.c.	
J4-40	n.c.	
J4-41	n.c.	
J4-42	n.c.	
J4-43	n.c.	
J4-44	n.c.	
J4-45	n.c.	
J4-46	n.c.	
J4-47	n.c.	
J4-48	n.c.	
J4-49	n.c.	
J4-50	n.c.	

## J5 -- DCU / Data Punch (BCD) Cable

Connector Pin	DCU Backplane Pin	Function
J5-1	n.c.	
J5-2	R25	HOLDOFF
J5-3	n.c.	
J5-4	n.c.	
J5-5	N28	RANGE (2)
J5-6	T33 (GND)	FUNCTION (2)
J5-7	N29	RANGE (1)
J5-8	N21	FUNCTION (1)
J5-9	R21	$8 \times 10^0$
J5-10	R17	$8 \times 10^1$
J5-11	P21	$8 \times 10^2$
J5-12	P17	$8 \times 10^3$
J5-13	n.c.	
J5-14	n.c.	
J5-15	n.c.	
J5-16	n.c.	
J5-17	R23	$2 \times 10^0$
J5-18	R19	$2 \times 10^1$
J5-19	P23	$2 \times 10^2$
J5-20	P19	$2 \times 10^3$
J5-21	n.c.	
J5-22	n.c.	
J5-23	n.c.	
J5-24	n.c.	
J5-25	n.c.	
J5-26	T33 (GND)	Ground
J5-27	N19	PUNCH COMMAND
J5-28	n.c.	
J5-29	T33 (GND)	POLARITY
J5-30	N27	RANGE (4)
J5-31	T33 (GND)	FUNCTION (4)
J5-32	N26	RANGE (8)
J5-33	T33 (GND)	FUNCTION (8)
J5-34	R22	$4 \times 10^0$
J5-35	R18	$4 \times 10^1$
J5-36	P22	$4 \times 10^2$
J5-37	P18	$4 \times 10^3$
J5-38	n.c.	
J5-39	n.c.	
J5-40	n.c.	
J5-41	n.c.	
J5-42	R24	$1 \times 10^0$
J5-43	R20	$1 \times 10^1$
J5-44	P24	$1 \times 10^2$
J5-45	P20	$1 \times 10^3$
J5-46	n.c.	
J5-47	n.c.	
J5-48	n.c.	
J5-49	n.c.	
J5-50	n.c.	

## Board A -- DCU Backplane Pin Connections

Pin	Connections	Function
A1	F1	LED 0° Control
A2	LED 0°	LED 0° Driver
A3	F2	LED 10° Control
A4	LED 10°	LED 10° Driver
A5	F3	LED 20° Control
A6	LED 20°	LED 20° Driver
A7	F4	LED 30° Control
A8	LED 30°	LED 30° Driver
A9	F5	LED 40° Control
A10	LED 40°	LED 40° Driver
A11	F6	LED 50° Control
A12	LED 50°	LED 50° Driver
A13	F7	LED 60° Control
A14	LED 60°	LED 60° Driver
A15	F8	LED 70° Control
A16	LED 70°	LED 70° Driver
A17	H2	LED VT Control
A18	LED VT	LED VT Driver
A19	H1	LED HT Control
A20	LED HT	LED HT Driver
A21	H4	LED VR Control
A22	LED VR	LED VR Driver
A23	H3	LED HR Control
A24	LED HR	LED HR Driver
A25	H6	LED CAL Control
A26	LED CAL	LED CAL Driver
A27	H7	LED ACT Control
A28	LED ACT	LED ACT Driver
A29	n.c.	
A30	LED PAS	LED PAS Driver
A31	F13	LED 2-4 Control
A32	LED 2-4	LED 2-4 Driver
A33	GND	Ground
A34	n.c.	
AC5	5V	5V

## Board B -- DCU Backplane Pin Connections

Pin	Connection(s)	Function
B1	F14	LED 4-8 Control
B2	LED 4-8	LED 4-8 Driver
B3	D1	LED F1 Control
B4	LED F1	LED F1 Driver
B5	D2	LED F2 Control
B6	LED F2	LED F2 Driver
B7	D3	LED F3 Control
B8	LED F3	LED F3 Driver
B9	D4	LED F4 Control
B10	LED F4	LED F4 Driver
B11	D5	LED F5 Control
B12	LED F5	LED F5 Driver
B13	D6	LED F6 Control
B14	LED F6	LED F6 Driver
B15	D7	LED F7 Control
B16	LED F7	LED F7 Driver
B17	D8	LED F8 Control
B18	LED F8	LED F8 Driver
B19	n.c.	
B20	n.c.	
B21	n.c.	
B22	n.c.	
B23	n.c.	
B24	n.c.	
B25	n.c.	
B26	n.c.	
B27	n.c.	
B28	n.c.	
B29	n.c.	
B30	n.c.	
B31	n.c.	
B32	n.c.	
B33	GND	Ground
B34	n.c.	
B35	5V	5V

### Board C -- DCU Backplane Pin Connections

Pin	Connection(s)	Function
C1	n.c.	
C2	n.c.	
C3	n.c.	
C4	n.c.	
C5	n.c.	
C6	n.c.	
C7	n.c.	
C8	n.c.	
C9	n.c.	
C10	n.c.	
C11	5V	
C12	LED -12V	LED -12V Control
C13	5V	LED -12V Driver
C14	LED 5V	LED 5V Control
C15	J19	LED 5V Driver
C16	LED RUN	LED RUN Control
C17	n.c.	LED RUN Driver
C18	n.c.	
C19	n.c.	
C20	n.c.	
C21	n.c.	
C22	n.c.	
C23	n.c.	
C24	n.c.	
C25	n.c.	
C26	n.c.	
C27	n.c.	
C28	n.c.	
C29	n.c.	
C30	n.c.	
C31	n.c.	
C32	n.c.	
C33	GND	Ground
C34	-12V	-12V
C35	5V	5V



## Board D -- DCU Backplane Pin Connections

Pin	Connection(s)	Function
D1	B3	LED F1 Control
D2	B5	LED F2 Control
D3	B7	LED F3 Control
D4	B9	LED F4 Control
D5	B11	LED F5 Control
D6	B13	LED F6 Control
D7	B15	LED F7 Control
D8	B17	LED F8 Control
D9	n.c.	
D10	n.c.	
D11	n.c.	
D12	n.c.	
D13	n.c.	
D14	n.c.	
D15	n.c.	
D16	n.c.	
D17	n.c.	
D18	J1-1	FREQ CODE (LSB)
D19	J1-2	FREQ CODE (2SB)
D20	J1-3	FREQ CODE (MSB)
D21	n.c.	
D22	n.c.	
D23	n.c.	
D24	n.c.	
D25	n.c.	
D26	n.c.	
D27	n.c.	
D28	L3	FREQ T/F
D29	J31	
D30	L4	FREQ RETURN
D31	J2	FREQ ENABLE
D32	n.c.	
D33	GND	Ground
D34	n.c.	
D35	5V	5V

## Board F -- DCU Backplane Pin Connections

Pin	Connection(s)	Function
F1	A1	LED 0° Control
F2	A3	LED 10° Control
F3	A5	LED 20° Control
F4	A7	LED 30° Control
F5	A9	LED 40° Control
F6	A11	LED 50° Control
F7	A13	LED 60° Control
F8	A15	LED 70° Control
F9	J1-6	ANGLE CODE (LSB)
F10	J1-7	ANGLE CODE (2SB)
F11	J1-8	ANGLE CODE (MSB)
F12	n.c.	
F13	A31	LED 2-4 Control
F14	B1	LED 4-8 Control
F15	n.c.	
F16	n.c.	
F17	n.c.	
F18	n.c.	
F19	n.c.	
F20	n.c.	
F21	n.c.	
F22	n.c.	
F23	H11	ANGLE RETURN b
F24	J1-12	BAND Control
F25	J1-13, L10	ANGLE RETURN a
F26	L8	BAND RETURN
F27	L9	ANGLE T/F
F28	L7	BAND T/F
F29	J5	ANGLE ENABLE
F30	J4	BAND ENABLE
F31	J31, D25	POR
F32	n.c.	
F33	GND	Ground
F34	n.c.	
F35	5V	5V

## Board H -- DCU Backplane Pin Connections

Pin	Connection(s)	Function
H1	n.c.	
H2	A17	LED VT Control
H3	A23	LED HR Control
H4	A21	LED VR Control
H5	A19	LED HT Control
H6	A25	LED CAL Control
H7	A27	LED ACT Control
H8	n.c.	
H9	n.c.	
H10	n.c.	
H11	F23	ANGLE RETURN b
H12	L10	ANGLE RETURN c
H13	J1-10	TRANSMIT POL
H14	J1-11	RECEIVE POL
H15	J1-14	ACT MODE
H16	J1-16	CAL MODE
H17	n.c.	
H18	n.c.	
H19	n.c.	
H20	n.c.	
H21	n.c.	
H22	n.c.	
H23	n.c.	
H24	L6	POL RETURN b
H25	L12	DEVICE RETURN
H26	J1-9	POL RETURN a
H27	L11	DEVICE T/F
H28	L5	POL T/F
H29	J6	DEVICE ENABLE
H30	J3	POL ENABLE
H31	n.c.	
H32	J32, N32	$\overline{\text{POR}}$
H33	GND	Ground
H34	n.c.	
H35	5V	5V

## Board J -- DCU Backplane Pin Connections

Pin	Connection(s)	Function
J1	N31	DATA ENABLE
J2	D31	FREQ ENABLE
J3	H30	POL ENABLE
J4	F30	BAND ENABLE
J5	F29	ANGLE ENABLE
J6	H29	DEVICE ENABLE
J7	L14	GOTO ENABLE
J8	J4-16, R29	PUNCH ENABLE
J9	L27	SENSE ENABLE
J10	D29	SELECT ENABLE
J11	n.c.	
J12	n.c.	
J13	L29	INSTRUCTION (1)
J14	L30	INSTRUCTION (2)
J15	L31	INSTRUCTION (4)
J16	L32	INSTRUCTION (8)
J17	L26	RETURN
J18	L25	T/F
J19	C15	LED RUN Control
J20	N16	b1a
J21	J4-23	b2
J22	J4-22	b3
J23	J4-21	b4
J24	J4-20	b5
J25	J4-19	b6
J26	J4-18	b7
J27	J4-17	b8
J28	RESET SW	RESET
J29	PAUSE SW	PAUSE
J30	CONT SW	CONT
J31	F31, D29	POR
J32	H32, N32	$\overline{\text{POR}}$
J33	GND	Ground
J34	-12V	-12V
J35	5V	5V

## Board L -- DCU Backplane Pin Connections

Pin	Connection(s)	Function
L1	GND	DATA T/F
L2	R25, N15	DATA RETURN
L3	D28	FREQ T/F
L4	D30	FREQ RETURN
L5	H28	POL T/F
L6	H24	POL RETURN
L7	F28	BAND T/F
L8	F26	BAND RETURN
L9	F27	ANGLE T/F
L10	F25	ANGLE RETURN
L11	H27	DEVICE T/F
L12	H25	DEVICE RETURN
L13	5V	GOTO T/F
L14	J7	GOTO RETURN
L15	GND	PUNCH T/F
L16	J4-15, R28	PUNCH RETURN
L17	SENSE SW	SENSE T/F
L18	n.c.	
L19	GND	SELECT T/F
L20	P31	SELECT RETURN
L21	n.c.	
L22	n.c.	
L23	n.c.	
L24	n.c.	
L25	J18	T/F
L26	J17	RETURN
L27	J9	SENSE ENABLE
L28	n.c.	
L29	J13	INSTRUCTION (1)
L30	J14	INSTRUCTION (2)
L31	J15	INSTRUCTION (4)
L32	J16	INSTRUCTION (8)
L33	GND	Ground
L34	n.c.	
L35	5V	5V

## Board N -- DCU Backplane Pin Connections

Pin	Connection(s)	Function
N1	n.c.	
N2	n.c.	
N3	n.c.	
N4	n.c.	
N5	n.c.	
N6	n.c.	
N7	n.c.	
N8	n.c.	
N9	n.c.	
N10	n.c.	
N11	n.c.	
N12	n.c.	
N13	n.c.	
N14	P32	$\bar{S}$
N15	L2	HOLDOFF
N16	J20	b1a
N17	P28, J4-24	b1b
N18	J3-23	DVM PRINT COMMAND
N19	J5-27	PUNCH
N20	J1-19	FUNCTION (1)a
N21	J5-8	FUNCTION (1)b
N22	J3-27	DVM RANGE (8)
N23	J3-26	DVM RANGE (4)
N24	J3-2	DVM RANGE (2)
N25	J3-1	DVM RANGE (1)
N26	J5-32	RANGE (8)
N27	J5-30	RANGE (4)
N28	J5-5	RANGE (2)
N29	J5-7	RANGE (1)
N30	P30, R30	S
N31	J1	DATA ENABLE
N32	J32	POR
N33	GND	Ground
N34	n.c.	
N35	5V	5V

## Board P -- DCU Backplane Pin Connections

Pin	Connection(s)	Function
P1	J2-38	FREQ 8 x 10 <sup>3</sup>
P2	J2-39	FREQ 4 x 10 <sup>3</sup>
P3	J2-14	FREQ 2 x 10 <sup>3</sup>
P4	J2-13	FREQ 1 x 10 <sup>3</sup>
P5	J2-34	FREQ 8 x 10 <sup>2</sup>
P6	J2-35	FREQ 4 x 10 <sup>2</sup>
P7	J2-10	FREQ 2 x 10 <sup>1</sup>
P8	J2-9	FREQ 1 x 10 <sup>1</sup>
P9	T2	DVM 8 x 10 <sup>3</sup> b
P10	T4	DVM 4 x 10 <sup>3</sup> b
P11	T6	DVM 2 x 10 <sup>3</sup> b
P12	T8	DVM 1 x 10 <sup>2</sup> b
P13	T10	DVM 8 x 10 <sup>2</sup> b
P14	T12	DVM 4 x 10 <sup>2</sup> b
P15	T14	DVM 2 x 10 <sup>2</sup> b
P16	T16	DVM 1 x 10 <sup>2</sup> b
P17	J5-12	8 x 10 <sup>3</sup>
P18	J5-37	4 x 10 <sup>3</sup>
P19	J5-20	2 x 10 <sup>3</sup>
P20	J5-45	1 x 10 <sup>2</sup>
P21	J5-11	8 x 10 <sup>2</sup>
P22	J5-36	4 x 10 <sup>2</sup>
P23	J5-19	2 x 10 <sup>2</sup>
P24	J5-44	1 x 10 <sup>2</sup>
P25	n.c.	
P26	n.c.	
P27	n.c.	
P28	N17	
P29	J10	
P30	R30, N30	
P31	L20	
P32	N14	
P33	GND	
P34	n.c.	
P35	5V	

Board R -- DCU Backplane Pin Connections

Pin	Connection(s)	Function
R1	J2-30	FREQ $8 \times 10^1$
R2	J2-31	FREQ $4 \times 10^1$
R3	J2-6	FREQ $2 \times 10^1$
R4	J2-5	FREQ $1 \times 10^1$
R5	J2-26	FREQ $8 \times 10^0$
R6	J2-27	FREQ $4 \times 10^0$
R7	J2-2	FREQ $2 \times 10^0$
R8	J2-1	FREQ $1 \times 10^0$
R9	T18	DVM $8 \times 10^1$ b
R10	T20	DVM $4 \times 10^1$ b
R11	T22	DVM $2 \times 10^1$ b
R12	T24	DVM $1 \times 10^1$ b
R13	T26	DVM $8 \times 10^0$ b
R14	T28	DVM $4 \times 10^0$ b
R15	T30	DVM $2 \times 10^0$ b
R16	T32	DVM $1 \times 10^0$ b
R17	J5-10	$8 \times 10^1$
R18	J5-35	$4 \times 10^1$
R19	J5-18	$2 \times 10^1$
R20	J5-43	$1 \times 10^1$
R21	J5-9	$8 \times 10^0$
R22	J5-34	$4 \times 10^0$
R23	J5-17	$2 \times 10^0$
R24	J5-42	$1 \times 10^0$
R25	L2, J5-2	HOLDOFF
R26	J3-22	DVM HOLDOFF
R27	J2-25	FREQ HOLDOFF
R28	L16	
R29	J8	
R30	P30, N30	
R31	J4-14	
R32	n.c.	
R33	GND	
R34	n.c.	
R35	5V	



## Board T -- DCU Backplane Pin Connections

Pin	Connection(s)	Function
T1	J3-35	DVM 8 x 10 <sup>3</sup> <sub>a</sub>
T2	P9	DVM 8 x 10 <sup>3</sup> <sub>b</sub>
T3	J3-34	DVM 4 x 10 <sup>3</sup> <sub>a</sub>
T4	P10	DVM 4 x 10 <sup>3</sup> <sub>b</sub>
T5	J3-10	DVM 2 x 10 <sup>3</sup> <sub>a</sub>
T6	P11	DVM 2 x 10 <sup>3</sup> <sub>b</sub>
T7	J3-9	DVM 1 x 10 <sup>3</sup> <sub>a</sub>
T8	P12	DVM 1 x 10 <sup>3</sup> <sub>b</sub>
T9	J3-33	DVM 8 x 10 <sup>2</sup> <sub>a</sub>
T10	P13	DVM 8 x 10 <sup>2</sup> <sub>b</sub>
T11	J3-32	DVM 4 x 10 <sup>2</sup> <sub>a</sub>
T12	P14	DVM 4 x 10 <sup>2</sup> <sub>b</sub>
T13	J3-8	DVM 2 x 10 <sup>2</sup> <sub>a</sub>
T14	P15	DVM 2 x 10 <sup>2</sup> <sub>b</sub>
T15	J3-7	DVM 1 x 10 <sup>2</sup> <sub>a</sub>
T16	P16	DVM 1 x 10 <sup>2</sup> <sub>b</sub>
T17	J3-31	DVM 8 x 10 <sup>1</sup> <sub>a</sub>
T18	R9	DVM 8 x 10 <sup>1</sup> <sub>b</sub>
T19	J3-30	DVM 4 x 10 <sup>1</sup> <sub>a</sub>
T20	R10	DVM 4 x 10 <sup>1</sup> <sub>b</sub>
T21	J3-6	DVM 2 x 10 <sup>1</sup> <sub>a</sub>
T22	R11	DVM 2 x 10 <sup>1</sup> <sub>b</sub>
T23	J3-5	DVM 1 x 10 <sup>1</sup> <sub>a</sub>
T24	R12	DVM 1 x 10 <sup>1</sup> <sub>b</sub>
T25	J3-29	DVM 8 x 10 <sup>0</sup> <sub>a</sub>
T26	R13	DVM 8 x 10 <sup>0</sup> <sub>b</sub>
T27	J3-28	DVM 4 x 10 <sup>0</sup> <sub>a</sub>
T28	R14	DVM 4 x 10 <sup>0</sup> <sub>b</sub>
T29	J3-4	DVM 2 x 10 <sup>0</sup> <sub>a</sub>
T30	R15	DVM 2 x 10 <sup>0</sup> <sub>b</sub>
T31	J3-3	DVM 1 x 10 <sup>0</sup> <sub>a</sub>
T32	R16	DVM 1 x 10 <sup>0</sup> <sub>b</sub>
T33	GND	Ground
T34	n.c.	
T35	5V	5V

ORIGINAL PAGE IS  
OF POOR QUALITY

IC	TYPE	IC	TYPE	IC	TYPE	IC	TYPE	IC	TYPE	IC	TYPE	IC	TYPE	IC	TYPE	IC	TYPE
A	74120R	E	7474	F	7474	J	74121	M	74121	N	74121	O	74121	P	74121	Q	74121
B	74197	F	7474	J	74121	N	74121	O	74121	P	74121	Q	74121	R	74121	S	74121
C	74197	G	74121	K	74154	L	74121	M	74121	N	74121	O	74121	P	74121	Q	74121
D	74121	H	7400														

DWG	Board J	Control Module
ENG	J.M.O.	CENTER FOR RESEARCH, INC.
TECH	Mike Oberly	Lawrence, Kansas
	Mike Rehringer	
	8/74	
	3/74	
	5/74	

SHEET	OF
1	1



- 10 → 1 >
- 11 → 2 >
- 12 → 3 >
- 13 → 4 >
- 14 → 5 >
- 15 → 6 >
- 16 → 7 >
- 18 → 8 >
- 19 → 9 >
- 110 → 10 >
- 111 → 11 >
- 112 → 12 >
- E1 → 13 >
- E2 → 14 >
- E3 → 15 >
- E4 → 16 >
- RUN → 19 >
- D1 → 20 >
- D2 → 21 >
- E → 22 >
- D4 → 23 >
- D5 → 24 >
- D6 → 25 >
- D7 → 26 >
- D8 → 27 >
- POR → 31 >
- POR → 32 >
- 33 >
- 34 > -12V DC
- 35 > +5V DC

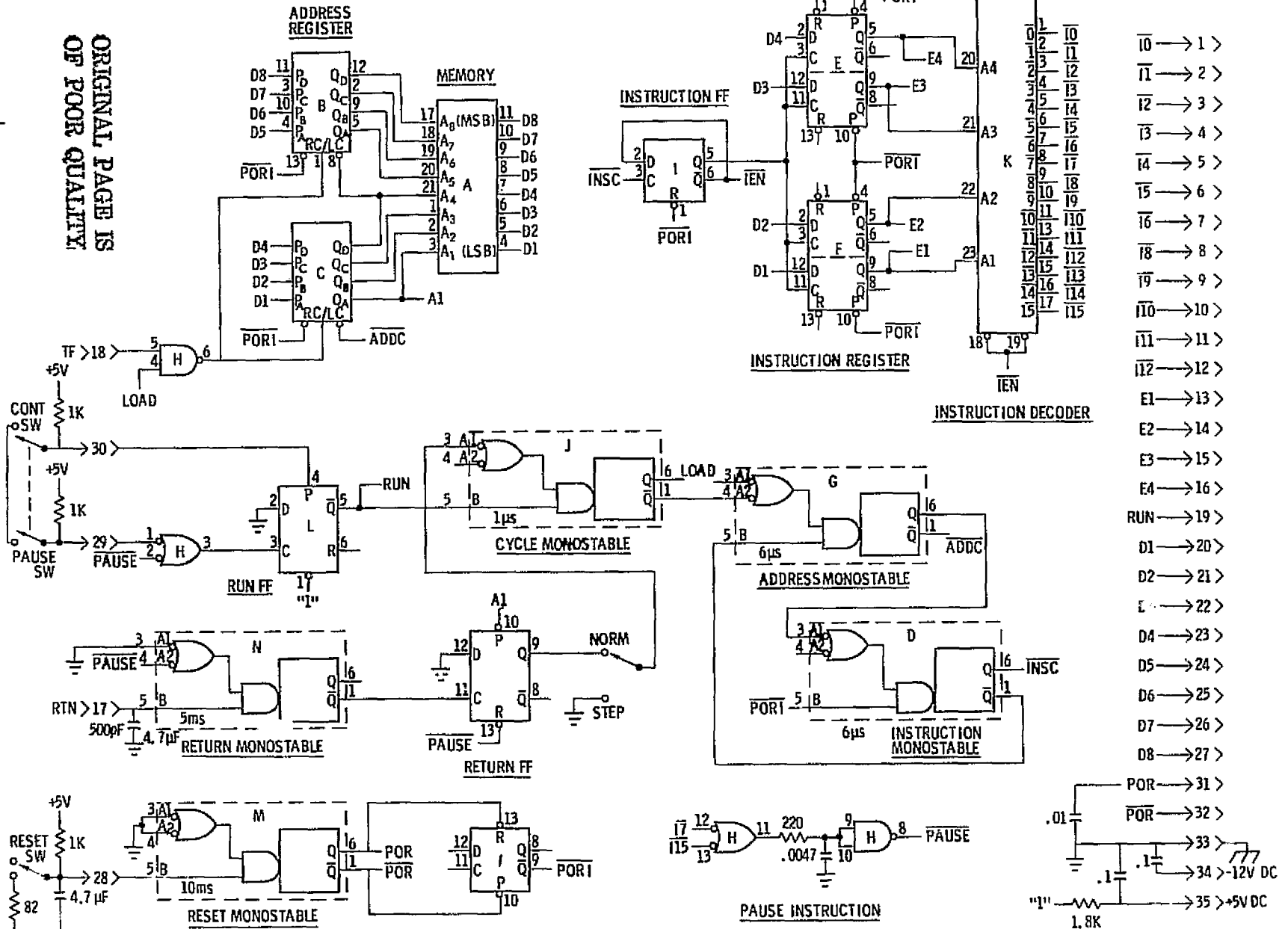

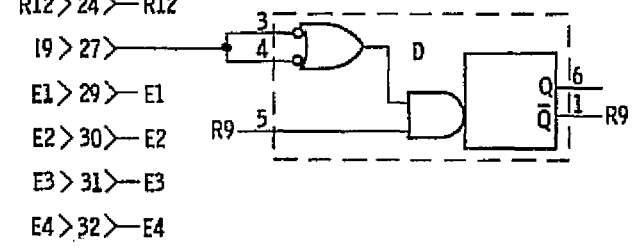
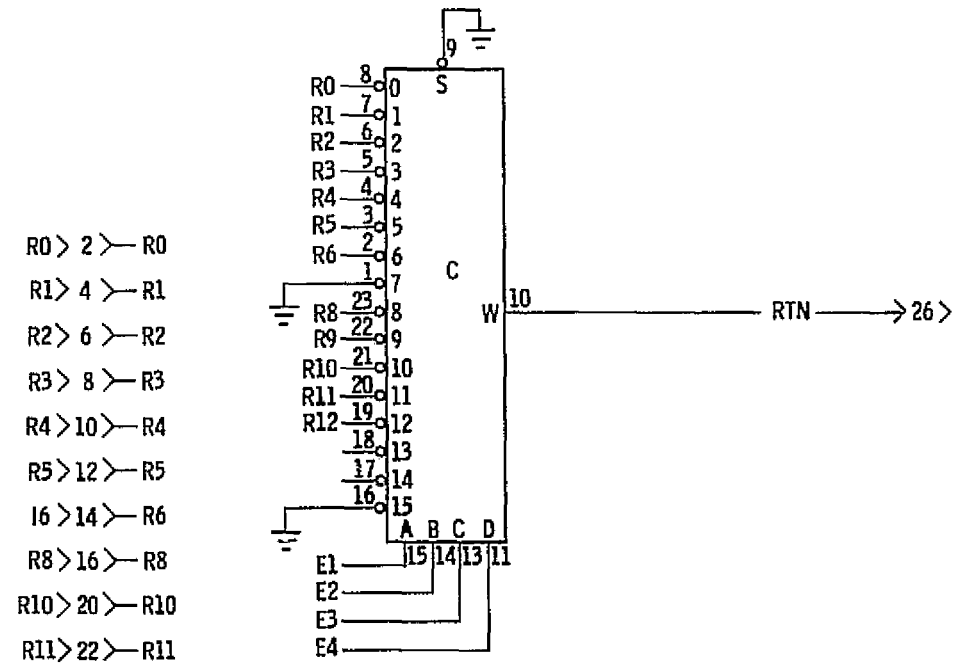
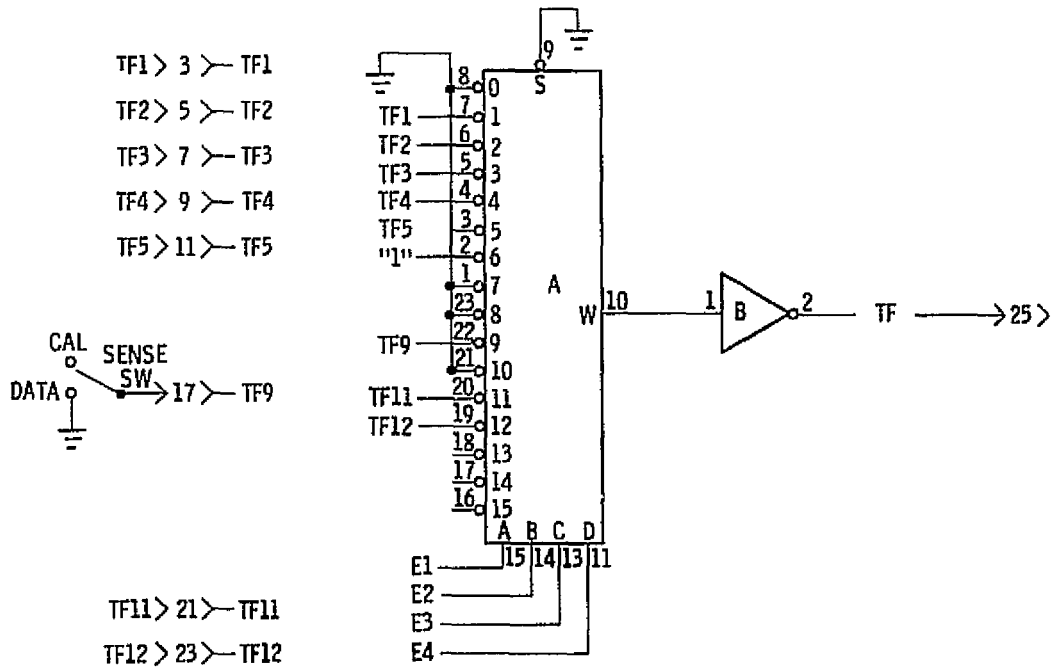
		IC	TYPE	Board L		Return Module
		A	74150	DWG	J. M. O. 9/74	CENTER FOR RESEARCH, INC. Lawrence, Kansas
		B	7404	ENG	Mike Oberg 3/74	
		C	74150	TECH	Mike Reitnauer 5/74	
		D	74121			

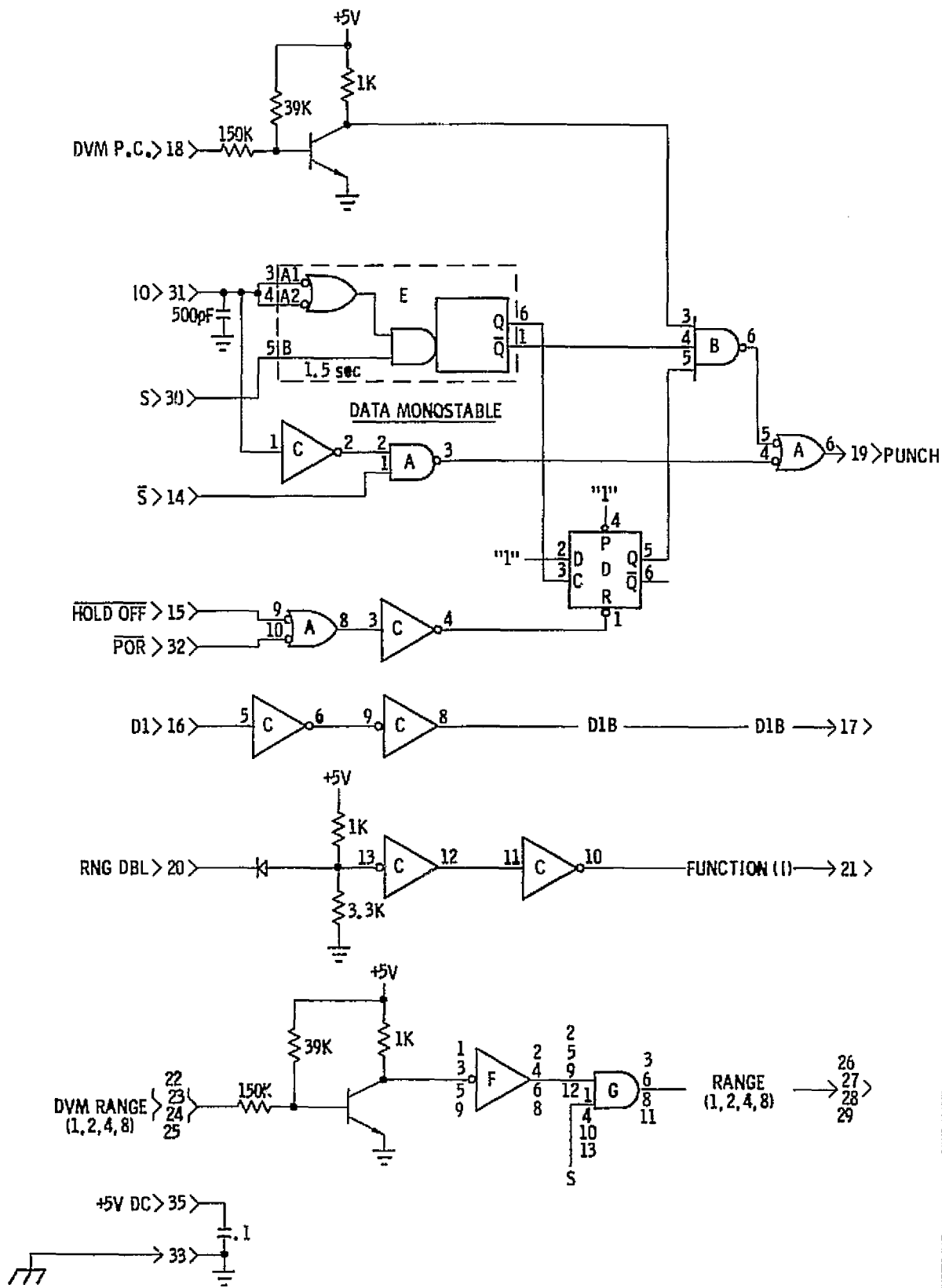

IC	TYPE	IC	TYPE	Board N	Punch/Data Module
A	7400	E	74121	DWG J.M.O. 8/74	CENTER FOR RESEARCH, INC. Lawrence, Kansas
B	7410	F	7404	ENG Mike Oberg 3/74	
C	7404	G	7408	TECH Mike Reitnauer 5/74	
D	7474				



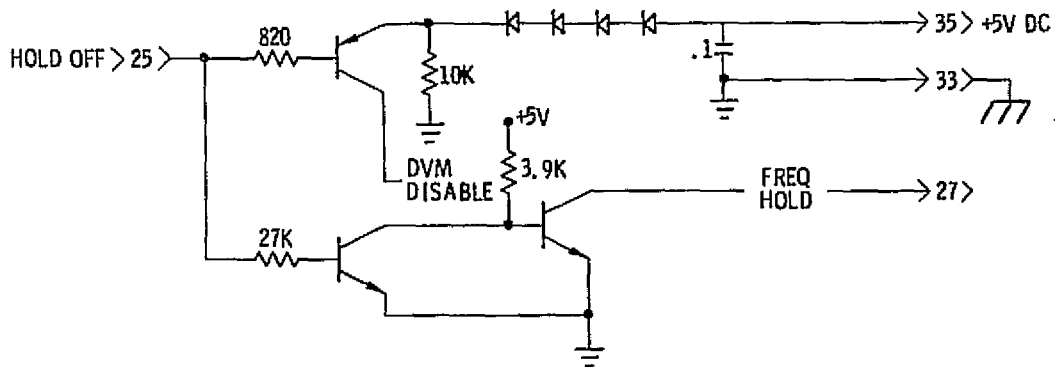
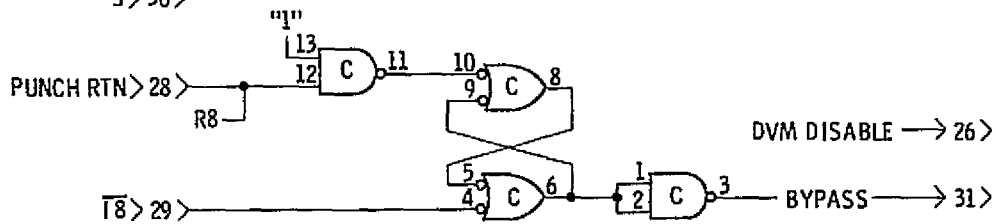
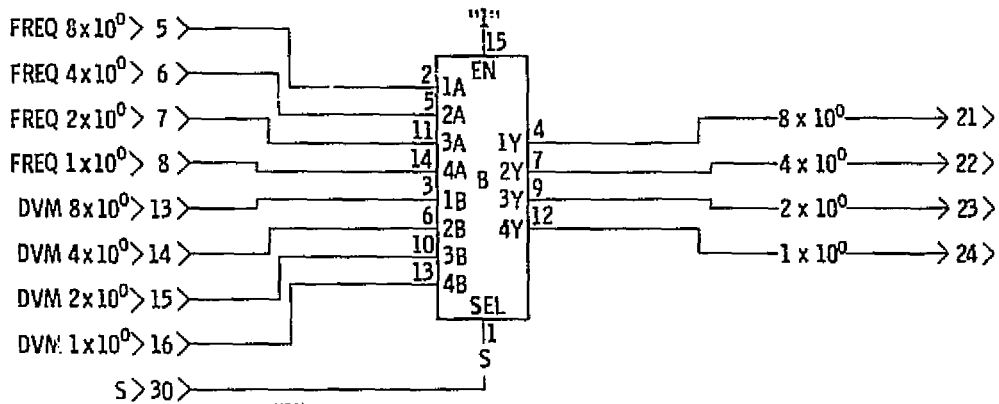
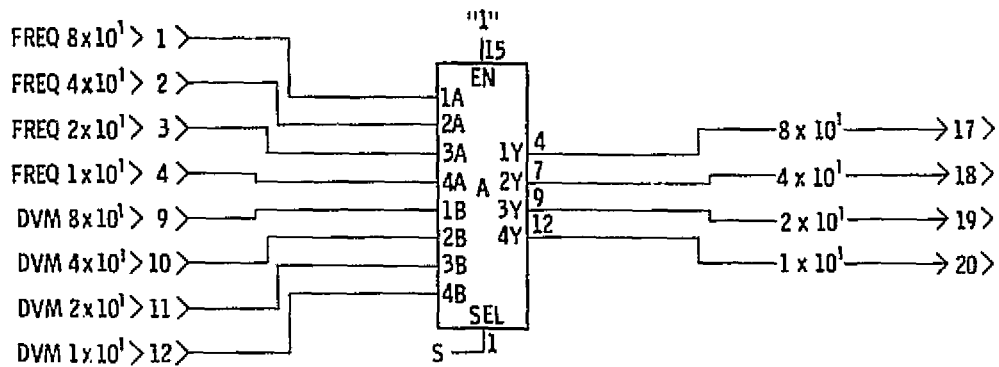

IC	TYPE	Board R	Multiplexer B
A	74158	DWG J.M.O. 9/74	CENTER FOR RESEARCH, INC. Lawrence, Kansas
B	74158	ENG Mike Oberg 3/74	
C	7400	TECH Mike Reitnauer 5/74	

### 3.0 CONCLUSIONS

The system is currently undergoing several major modifications. These include: extending frequency to cover 1-8 GHz, adding minicomputers for data control and pre-processing, using dual-polarized feeds to eliminate dish rotation, and automating still more of the system's operation. All these are natural and desirable changes. Not only do these additions make system use more convenient, they result in a system much closer to what would be necessary if the sensor were airborne.

If the scatterometer research is to prove practical, a sensor for use on an aircraft or satellite must eventually be developed. To make the transition to a longer range, thought will have to be given to such areas as effective antenna beamwidths and methods for beam limiting, such as IF filtering. Antenna alignment problems may push for another look at a one-antenna system. Not only are the sampling rate and timing critical; doppler effects may require some system modifications. Range variations caused by fluctuations in aircraft elevation will also have to be considered.

Obviously, much time and effort will be required before a usable airborne sensor can be obtained. However, it is nevertheless interesting to look ahead to such a time and predict possible uses for such a sensor. The MAPS II system and others like it have shown the potential for such a system to monitor soil moisture, crop type and crop maturity. If such a potential could be realized, irrigation and flood control could be optimized, crop harvest and therefore market conditions could be more accurately forecast, and a myriad of related land-use functions could be better fulfilled. Thus, such a sensor could prove to be quite a valuable tool for the soil scientist or agricultural economist.

#### 4.0 REFERENCES

- [1] Waite, W. P., "Broad-Spectrum Electromagnetic Backscatter," CRES Technical Report 133-17, University of Kansas Center for Research, Inc., Lawrence, September, 1970.
- [2] Moe, R., "Spectral Characteristics of Agricultural Lands at Microwave Frequencies," CRES Technical Report 133-27, University of Kansas Center for Research, Inc., Lawrence, April, 1973.
- [3] Ulaby, F. T., "4-8 GHz Microwave Active and Passive Spectrometer (MAPS) Volume 1: Radar Section," CRES Technical Report 177-34, University of Kansas Center for Research, Inc., Lawrence, April, 1973.



APPENDIX 1  
DCU CONTROL PROGRAM

000	367	377 START	PAUSE	
002	371	134	SENSE	CALBRT
004	370	123	PUNCH	'S'
006	370	324	PUNCH	'T'
010	370	101	PUNCH	'A'
012	370	322	PUNCH	'R'
014	370	324	PUNCH	'T'
016	370	215	PUNCH	'cr'
020	370	012	PUNCH	'Lf'
022	370	306 BEGIN	PUNCH	'F'
024	370	115	PUNCH	'M'
026	372	000	SELECT	FCNTR
030	367	377	PAUSE	
		*	WAIT FOR OPERATOR TO SET FM	
032	360	377	DATA	
034	370	215	PUNCH	'cr'
036	370	012	PUNCH	'Lf'
040	372	001	SELECT	DVM
		*	2-4GHZ	
042	370	120 B1	PUNCH	'P'
044	370	317	PUNCH	'O'
046	370	314	PUNCH	'L'
050	370	215	PUNCH	'cr'
052	370	012	PUNCH	'Lf'
054	360	377 B2	DATA	
056	361	060	FREQ	*+1
060	361	054	FREQ	B2
062	370	215	PUNCH	'cr'
064	370	012	PUNCH	'Lf'
066	363	070	BAND	*+1
		*	4-8GHZ	
070	360	377	DATA	
072	361	074	FREQ	*+1
074	360	377	DATA	
076	361	100	FREQ	*+1
100	360	377	DATA	
102	361	104	FREQ	*+1
104	360	377	DATA	
106	361	110	FREQ	*+1
		*	GET READY FOR SECOND	
		*	LINE OF 4-8 DATA	
110	370	215	PUNCH	'cr'
112	370	012	PUNCH	'Lf'
114	360	377	DATA	
116	361	114	FREQ	*-1

120					
122	363	377		BAND	EOM
124	370	215		PUNCH	'cr'
126	370	012		PUNCH	'LF'
130	362	042		POL	BI
132	364	022		ANGLE	BEGIN
	377	377		HALT	
			*	END OF DATA RUN	
			*	BEGINNING OF CALIBRATION	
134	365	134	CALBRT	DEVICE	*
136	370	303		PUNCH	'C'
140	370	101		PUNCH	'A'
142	370	314		PUNCH	'L'
144	370	215		PUNCH	'cr'
146	370	012		PUNCH	'LF'
150	370	306		PUNCH	'F'
152	370	115		PUNCH	'M'
154	372	000		SELECT	FCNTR
156	367	377		PAUSE	
			*	WAIT FOR FM ADJUST	
160	360	377		DATA	
162	370	215		PUNCH	'cr'
164	370	012		PUNCH	'LF'
166	372	001		SELECT	DVM
			*	2-4 GHZ	
170	360	377	C1	DATA	
172	361	174		FREQ	*+1
174	361	170		FREQ	C1
176	370	215		PUNCH	'cr'
200	370	012		PUNCH	'LF'
			*	4-8 GHZ	
202	363	204		BAND	*+1
204	360	377		DATA	
206	361	210		FREQ	*+1
210	360	377		DATA	
212	361	214		FREQ	*+1
214	360	377		DATA	
216	361	220		FREQ	*+1
220	360	377		DATA	
222	361	224		FREQ	*+1
224	370	215		PUNCH	'cr'
226	370	012		PUNCH	'LF'
230	360	377		DATA	
232	361	230		FREQ	*-1
234	363	377		BAND	EOM
236	370	215		PUNCH	'cr'
240	370	012		PUNCH	'LF'
242	365	000		DEVICE	START
244	366	242		GO TO	*-1
				END	

LABELS USED IN THIS ASSEMBLY

BI	042
B2	054
BEGIN	022
C1	170
CALBRT	134
DVM	001
EOM	377
FCNTR	000
START	000

## APPENDIX 2

### SAMPLE OUTPUT

The following page shows a sample output for a calibration and three data angles. This output is taken directly off of a teletype with the data paper tape input.

The calibration output begins with "CAL" and then lists the required FM rate in Hz. The next three lines list the recorded signal for 2.25 to 7.75 GHz in ascending order.

The data sequence begins with "START", which indicates that all system parameters have been initialized. The FM rate is then printed, followed by "POL". The first "POL" indicates that the following 12 points were recorded for VV polarization. The second "POL" indicates VH polarization and the third "POL" indicates HH polarization. The occurrence of the next FM reading signifies the start of a new angle. Thus the sample shows the output for  $0^\circ$ ,  $10^\circ$  and  $20^\circ$ .

CAL

FMI +0362E-0

1 +1757E-3 1 +2254E-3 1 +2194E-3 1 +1789E-3  
1 +1479E-5 1 +9764E-5 1 +2327E-4 1 +2251E-4  
1 +2003E-4 1 +2013E-4 1 +1548E-4 1 +8559E-5

START

FMI +0437E-0

POL

1 +8223E-4 1 +1903E-3 1 +1271E-3 1 +1527E-3  
1 +2470E-5 1 +1115E-4 1 +3396E-4 1 +3400E-4  
1 +1641E-4 1 +2531E-4 1 +2920E-4 1 +1046E-4

POL

1 +1291E-4 1 +2314E-4 1 +4022E-4 1 +4483E-4  
1 +0622E-5 1 +3995E-5 1 +6999E-5 1 +7720E-5  
1 +0994E-4 1 +1348E-4 1 +9168E-5 1 +4489E-5

POL

1 +7372E-4 1 +1744E-3 1 +1073E-3 1 +1958E-3  
1 +2275E-5 1 +1285E-4 1 +3059E-4 1 +1767E-4  
1 +2227E-4 1 +3192E-4 1 +1881E-4 1 +7707E-5

FMI +0391E-0

POL

1 +5239E-4 1 +1071E-3 1 +2340E-3 1 +7186E-4  
1 +2128E-5 1 +9799E-5 1 +1613E-4 1 +2430E-4  
1 +2146E-4 1 +2829E-4 1 +2800E-4 1 +1510E-4

POL

1 +2053E-4 1 +3637E-4 1 +5269E-4 1 +4968E-4  
1 +0436E-5 1 +2419E-5 1 +7778E-5 1 +8936E-5  
1 +1157E-4 1 +1148E-4 1 +1243E-4 1 +4077E-5

POL

1 +7048E-4 1 +1213E-3 1 +8316E-4 1 +7971E-4  
1 +0826E-5 1 +6801E-5 1 +1804E-4 1 +1809E-4  
1 +1573E-4 1 +2467E-4 1 +2663E-4 1 +1153E-4

FMI +0397E-0

POL

1 +5427E-4 1 +9831E-4 1 +0952E-3 1 +1365E-3  
1 +1530E-5 1 +8844E-5 1 +2781E-4 1 +2400E-4  
1 +2978E-4 1 +4533E-4 1 +2801E-4 1 +1993E-4

POL

1 +4493E-4 1 +4454E-4 1 +5956E-4 1 +6518E-4  
1 +0768E-5 1 +4716E-5 1 +1653E-4 1 +1230E-4  
1 +0305E-5 1 +8447E-5 1 +9639E-5 1 +7938E-5

POL

1 +7350E-4 1 +1321E-3 1 +1455E-3 1 +7989E-4  
1 +1013E-5 1 +6536E-5 1 +3799E-4 1 +2844E-4  
1 +0674E-4 1 +3337E-4 1 +0442E-4 1 +1281E-4

APPENDIX 3. ASCII CODE (EVEN PARITY)

<u>Character</u>	<u>Octal Code</u>
A	101
B	102
C	303
D	104
E	305
F	306
G	107
H	110
I	311
J	312
K	113
L	314
M	115
N	116
O	317
P	120
Q	321
R	322
S	123
T	324
U	125
V	126
W	327
X	330
Y	131
Z	132
0	240
1	041
2	042
3	243
4	044
5	245
6	246
7	047
8	050
9	251
[CR]	215
[LF]	012
␣	240
=	275
(	050
)	051
+	053
-	055
.	056
>	276
<	074
/	257

## APPENDIX 4 7400 TTL LOGIC FAMILY

This appendix will summarize the basic rules and pin configurations needed to use the IC's incorporated in the DCU. The loading rules have been discussed in Section 2.4.2 under logic symbology and only a few brief comments need be added. The maximum input voltages are  $-0.5V$  and  $+5.5V$ . The maximum supply voltages ( $V_{cc}$  to  $G_{nd}$ ) are  $-0.5V$  and  $+7.0V$ . For further information concerning the 7400 family, see Texas Instrument's catalog on TTL.

The pin configurations for the IC's used in the DCU are illustrated on the following page.

7400 TTL Pin Configurations

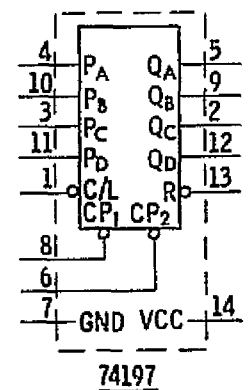
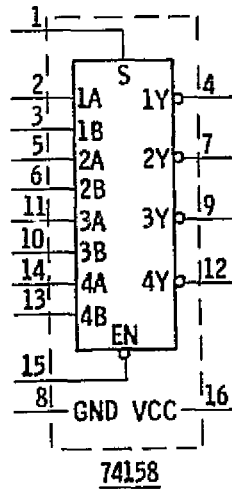
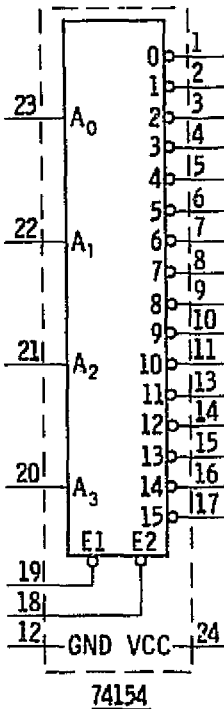
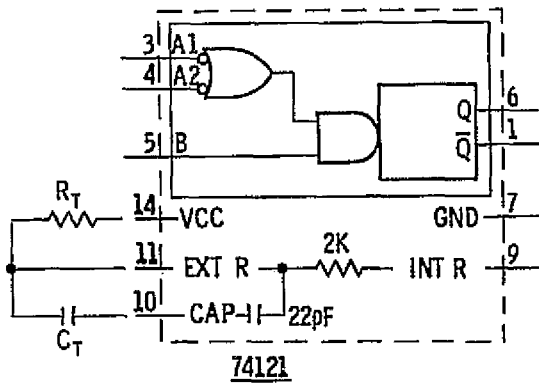
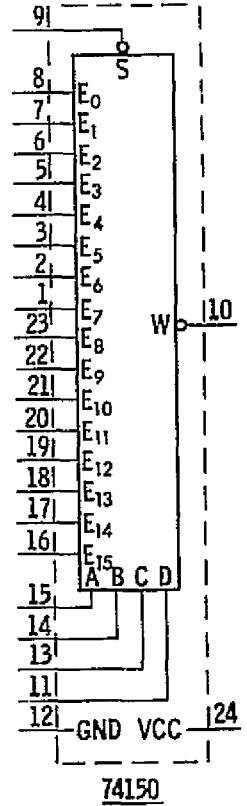
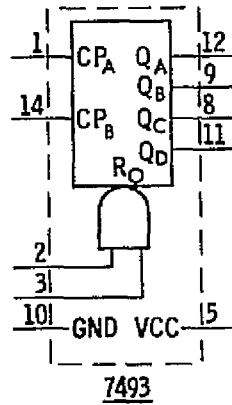
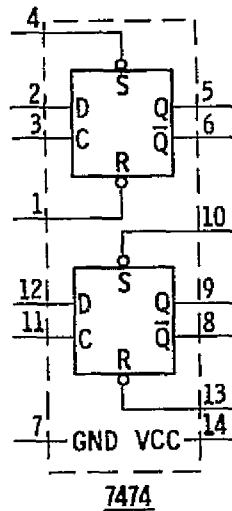
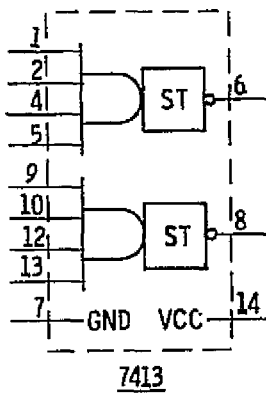
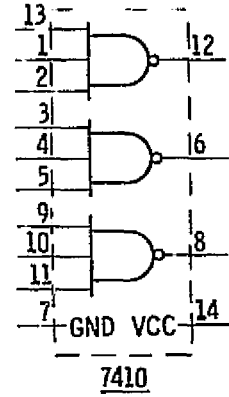
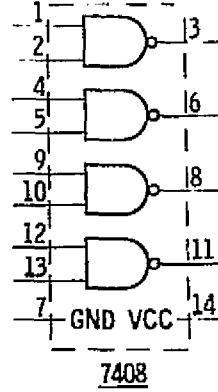
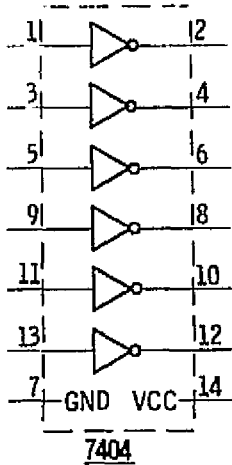
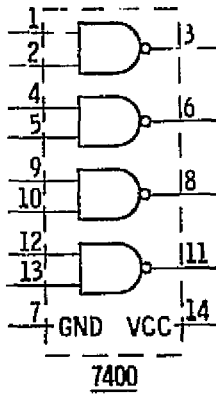

ORIGINAL PAGE IS OF POOR QUALITY



## APPENDIX 5

### MAS 2-8 ANTENNA PATTERNS\*

#### Purpose

The purpose of this memo is to document and calculate the effective antenna beamwidths using antenna pattern measurements made in February, 1974.

#### Procedure

The following steps were involved:

- 1) Antenna pattern measurements: The measurements were made at the antenna range. The first 16 polar plots (Figures 1 to 16) in the appendix show azimuth and elevation cross-sections of the transmitting and receiving antenna gains vs. angle. The horn was horizontally polarized and cuts were obtained at frequencies of 8, 7, 6, 5, 4, 3 and 2.5 GHz. Unfortunately, the two antennas were not aligned when the plots were taken for 2.5 GHz.
  
- 2) Effective antenna gains (gain of transmitting antenna x gain of receiving antenna) were then plotted against angle for every frequency and for each of the following conditions. See Figures 17 to 44.

Condition	Cross-Section	Transmitting Antenna	Receiving Antenna
(a)	Azimuth	horizontally polarized	horizontally polarized
(b)	Elevation	horizontally polarized	horizontally polarized
(c)	Azimuth	horizontally polarized	vertically polarized
(d)	Elevation	horizontally polarized	vertically polarized

\*This appendix is a reprint of CRES Technical Memorandum 177-49 by Percy P. Batlivala.

- 3) For each plot, areas were calculated using the 9100B HP calculator— to a level of 30 dB below maximum. Beamwidths were obtained by dividing each area by 1000 (30 dB). Refer to Table 1 for beamwidths.

Table 1. Beamwidth in degrees for combinations of frequency and polarization for both azimuth and elevation.

Frequency	Az <sup>*1</sup> H,H	EI <sup>*2</sup> H,H	Az H <sup>*3</sup> V	EI HV <sup>*4</sup>
2.5 GHz	7.2	6.2	6.2	7.0
3 GHz	4.23	5.21	4.3	4.41
4 GHz	4.17	3.67	3.73	3.79
5 GHz	3.44	3.3	3.24	2.97
6 GHz	2.54	2.61	2.4	2.51
7 GHz	2.27	2.6	2.24	2.37
8 GHz	2.04	2.3	2.2	2.25

\*1 - Azimuth, \*2 - Elevation, \*3 - Transmitting Antenna horizontally polarized,  
 \*4 - Receiving Antenna vertically polarized.

- 4) Beamwidths at intermediate frequencies were obtained as follows. Plots were made of frequency (on a log scale) vs. beamwidth in degrees (on a linear scale) for each of the four conditions stated previously. A straight line which resulted in a minimum mean squared error was fitted through the points. Beamwidths at intermediate frequencies were read of these graphs and are tabulated in Table 2. See Figures 45 to 48.

Table 2. Effective beamwidths tabulated at 12 frequencies, HH and HV polarizations and azimuth and elevation.

Frequency in GHz	Az, H,H	El, H,H	Az, H,V	El, H,V
2.25	6.15	6.00	5.60	5.60
2.75	5.45	5.40	5.00	5.00
3.25	4.80	4.85	4.50	4.50
3.75	4.40	4.40	4.10	4.10
4.25	4.00	4.00	3.70	3.70
4.75	3.60	3.70	3.35	3.35
5.25	3.25	3.35	3.10	3.10
5.75	2.95	3.10	2.80	2.80
6.25	2.65	2.80	2.55	2.55
6.75	2.40	2.60	2.30	2.30
7.25	2.15	2.30	2.10	2.10
7.75	1.90	2.10	1.90	1.90

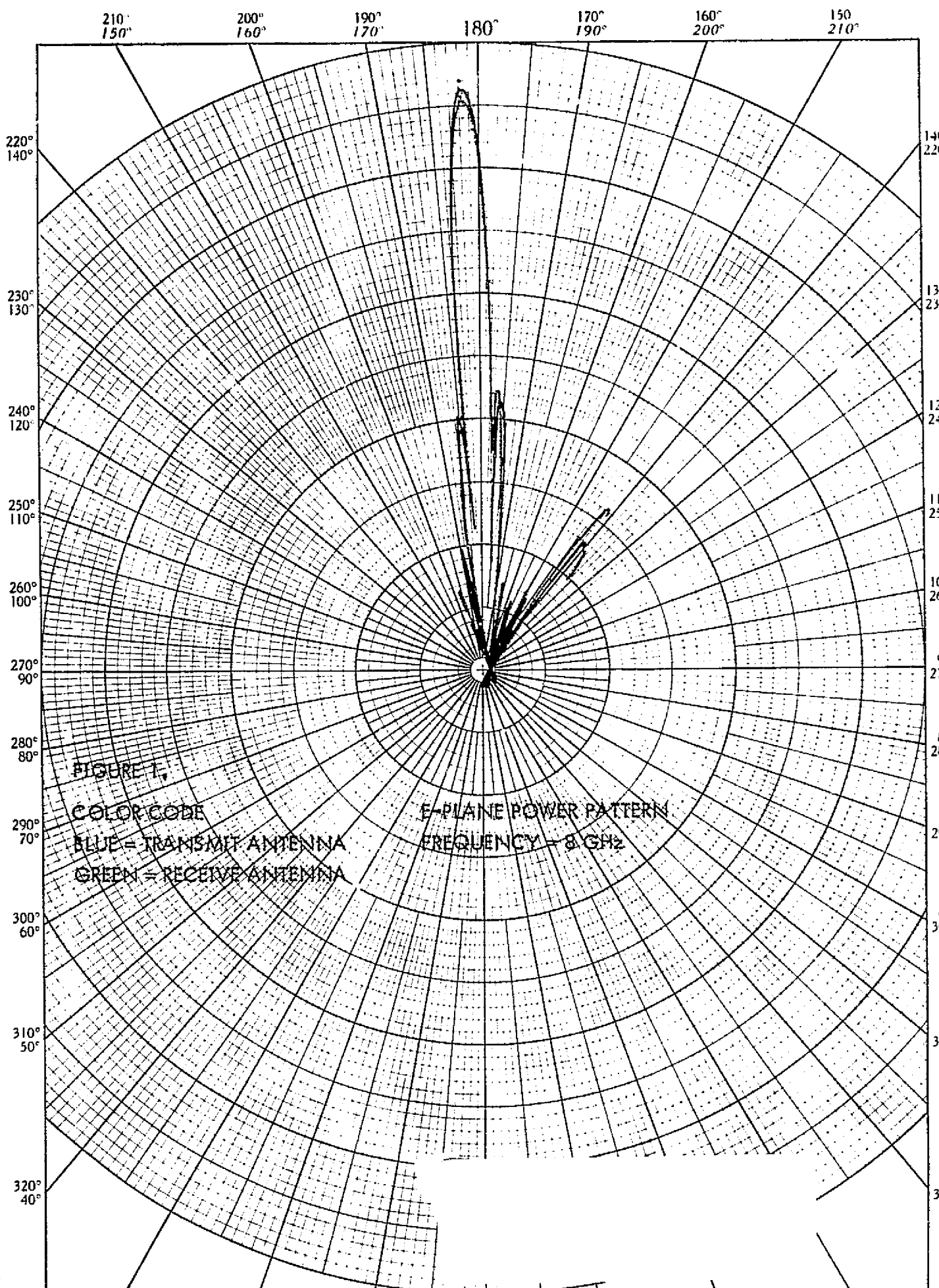

FIGURE 1,

COLOR CODE

BLUE = TRANSMIT ANTENNA

GREEN = RECEIVE ANTENNA

E-PLANE POWER PATTERN

FREQUENCY - 8 GHz

48 0

330°  
30°

340°  
20°

350°  
10°

10°  
350°

20°  
340°

30°  
330°

210°  
150°

200°  
160°

190°  
170°

180°

170°  
190°

160°  
200°

150°  
210°

220°  
140°

230°  
130°

240°  
120°

250°  
110°

260°  
100°

270°  
90°

280°  
80°

290°  
70°

300°  
60°

310°  
50°

320°  
40°

140  
220

130°  
230°

120°  
240

110°  
250°

100°  
260°

90°  
270°

80°  
280°

70°  
290°

60°  
300°

50°  
310°

40°  
320°

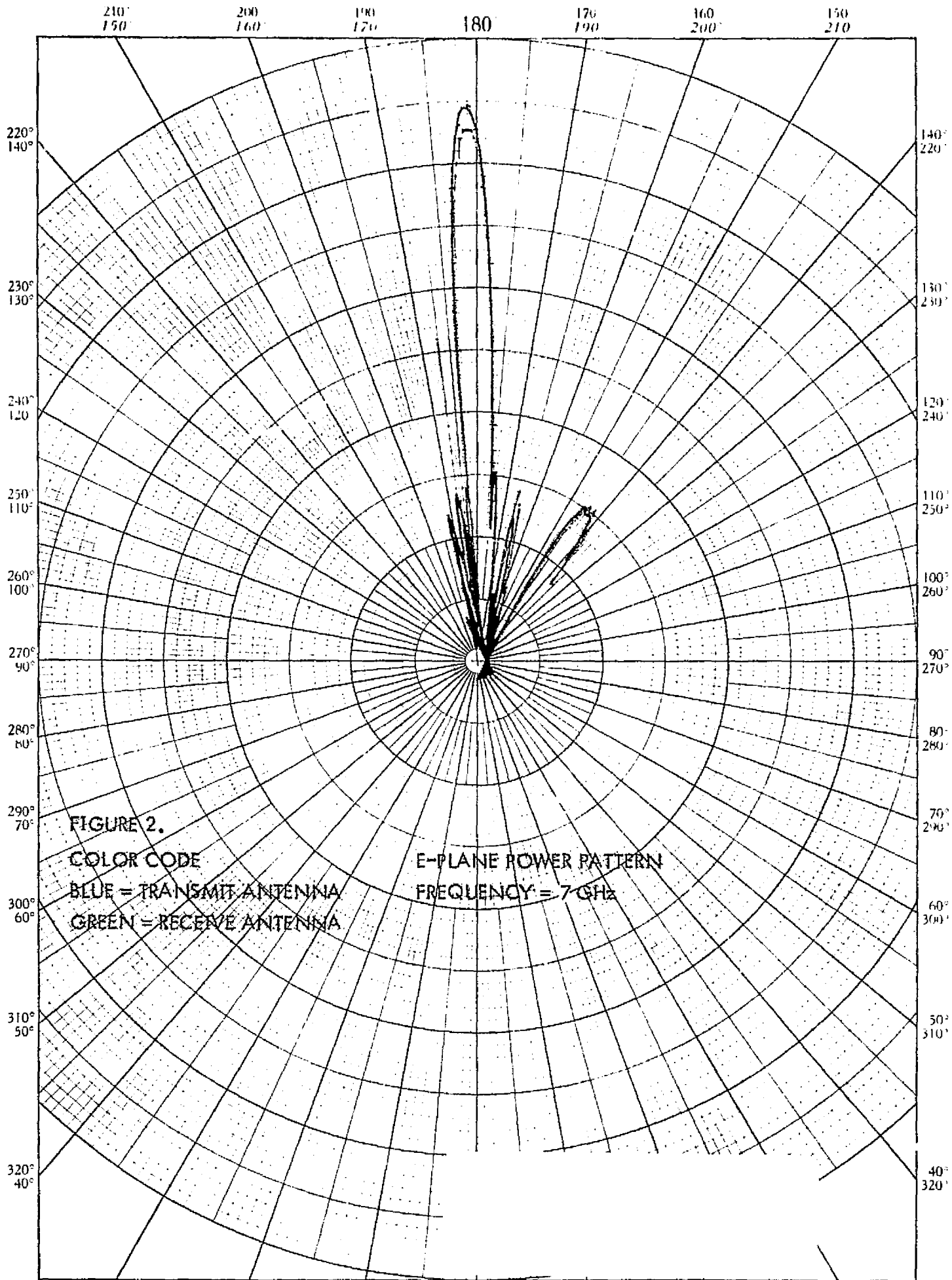

FIGURE 2.

COLOR CODE

BLUE = TRANSMIT ANTENNA

GREEN = RECEIVE ANTENNA

E-PLANE POWER PATTERN

FREQUENCY = 7 GHz

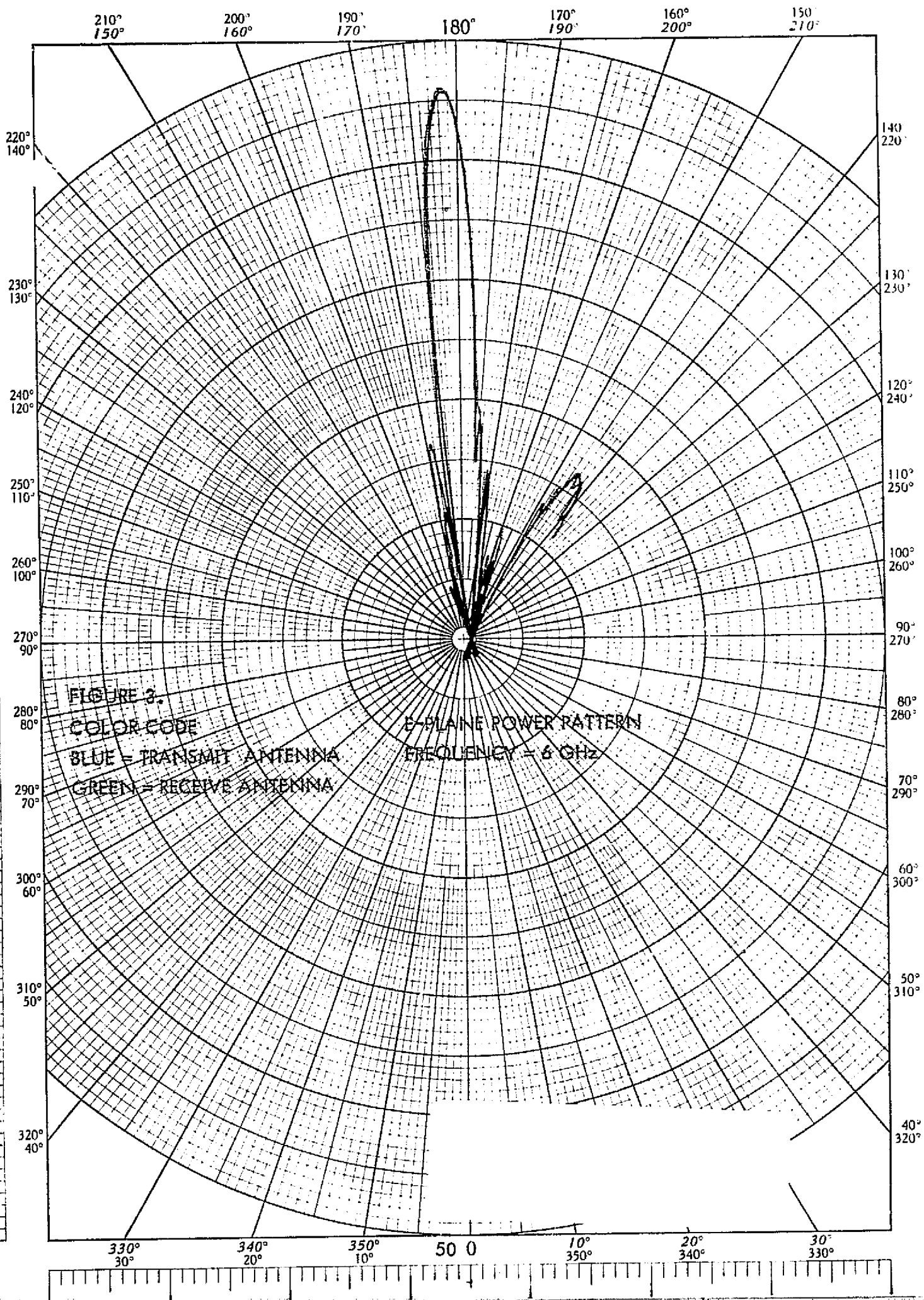

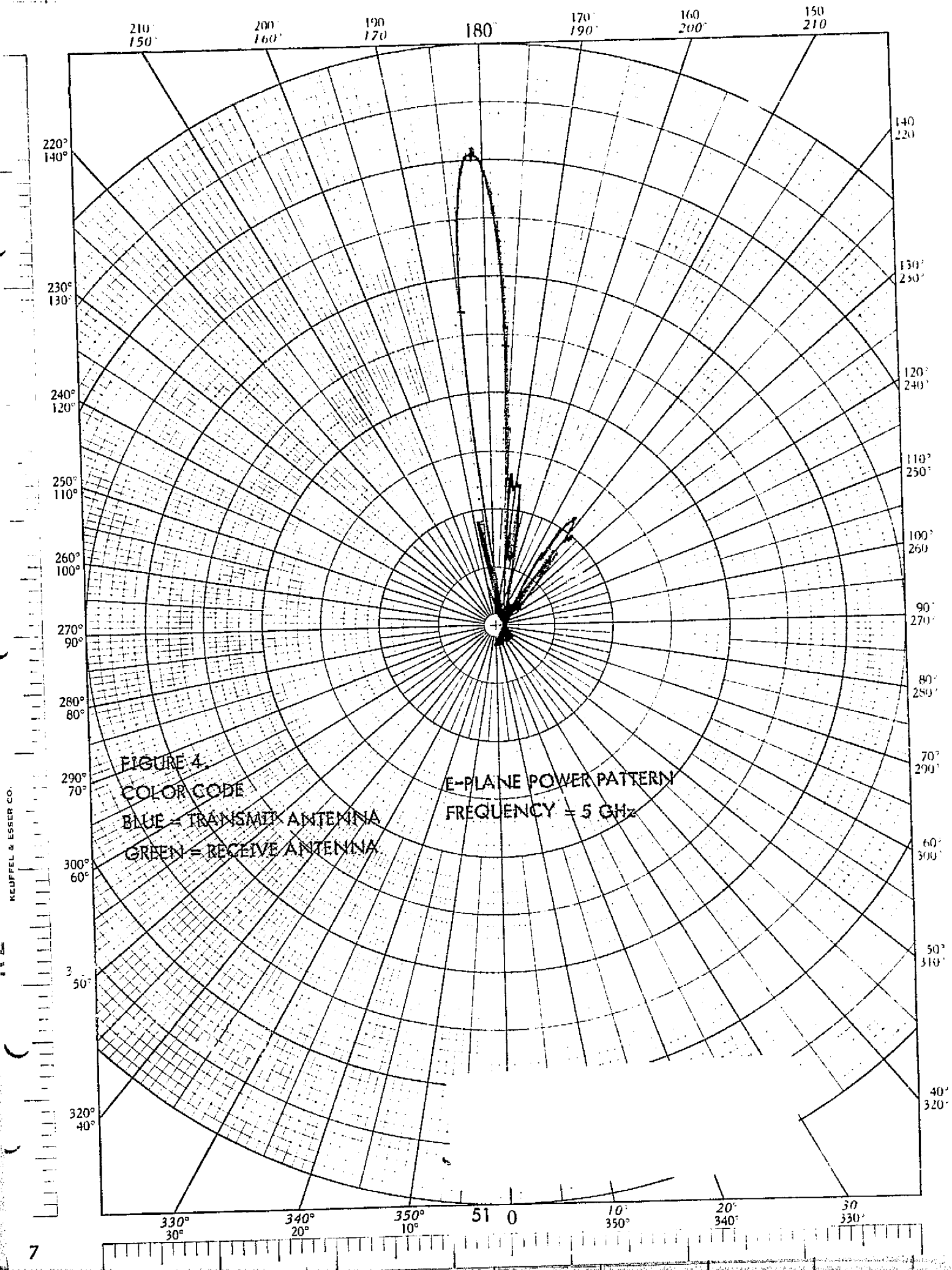

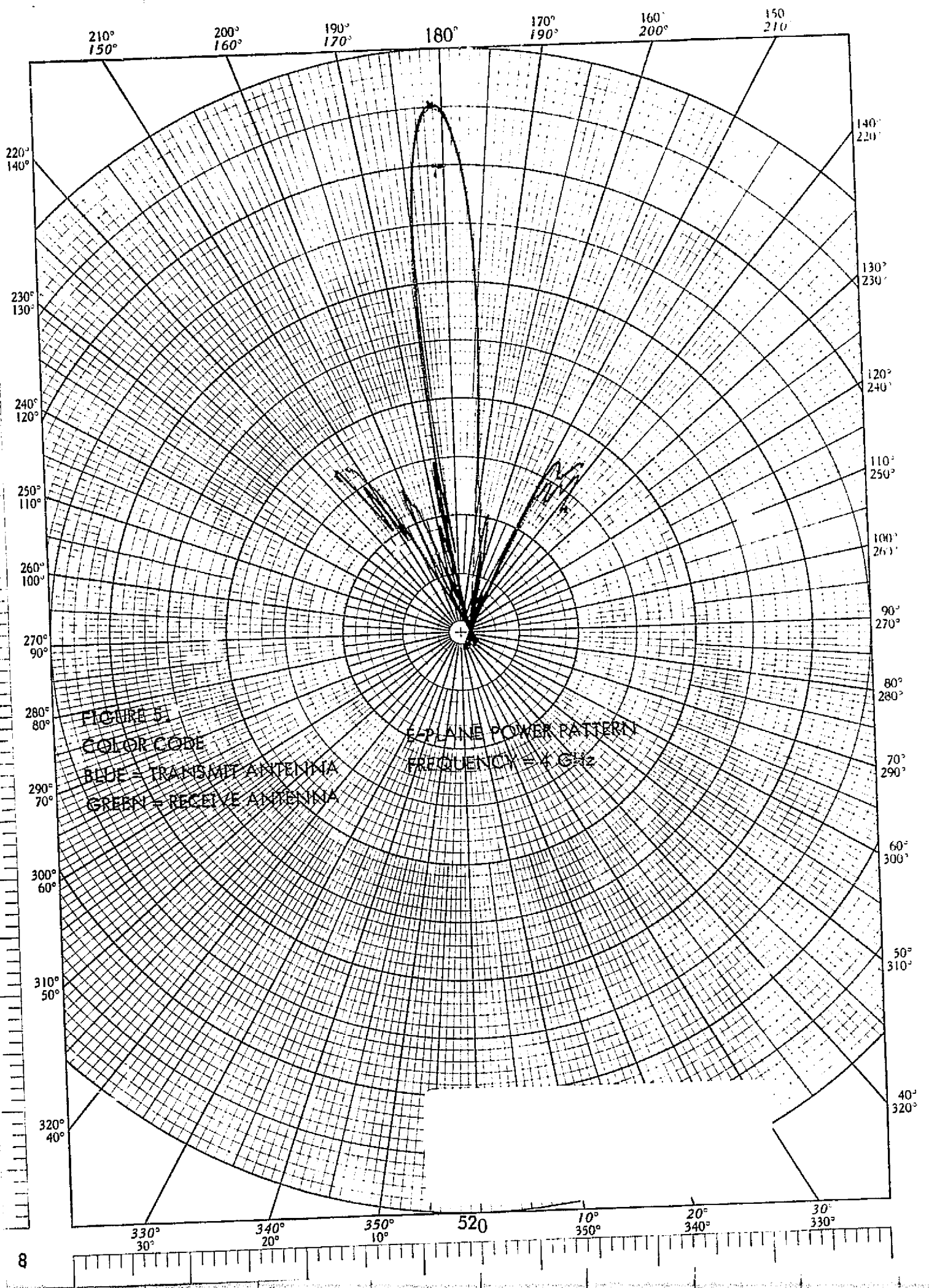



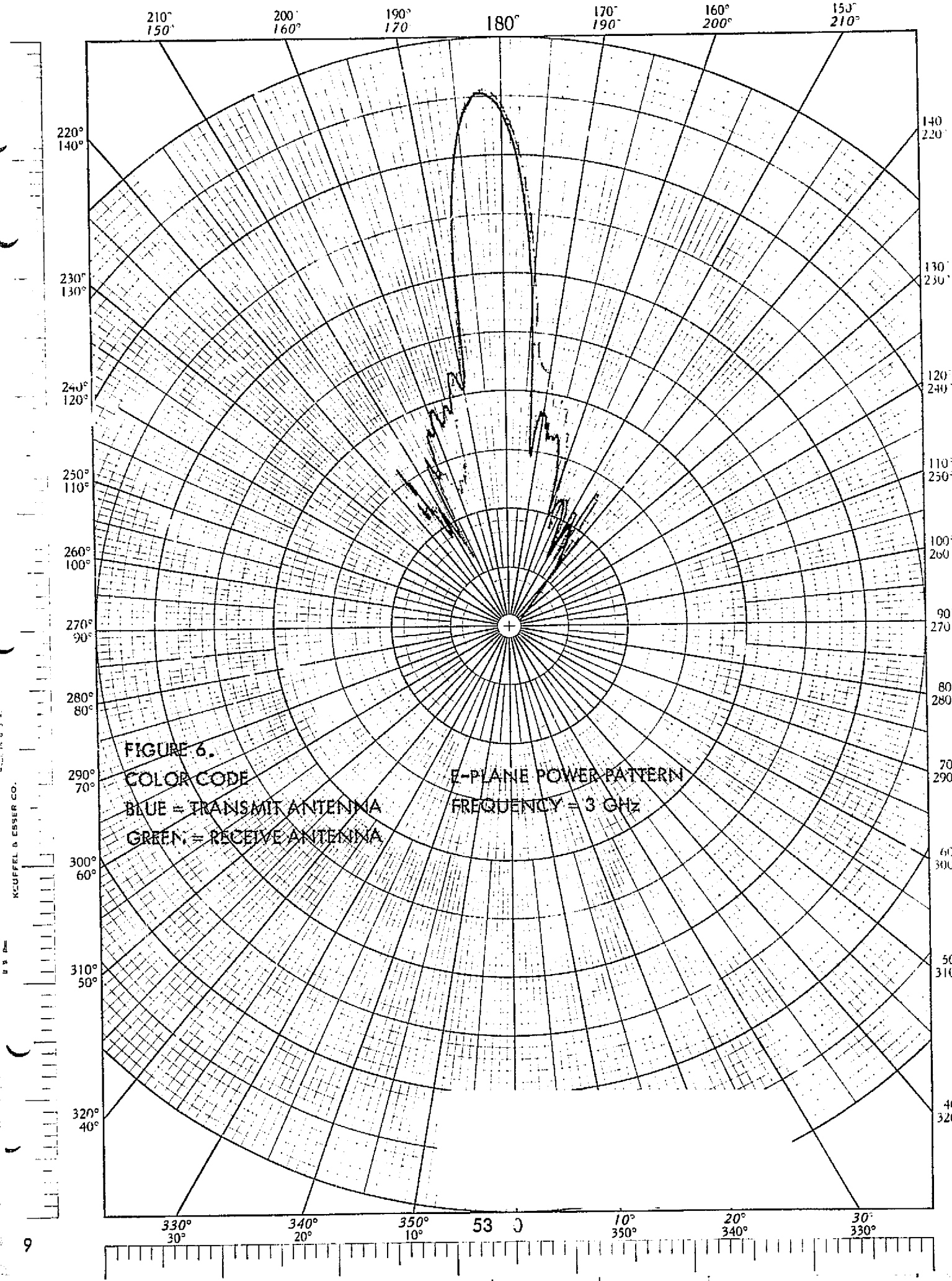

FIGURE 6.

COLOR CODE

BLUE = TRANSMIT ANTENNA

GREEN = RECEIVE ANTENNA

E-PLANE POWER PATTERN

FREQUENCY = 3 GHz

MUFFEL & ESSER CO.

11 3 1/2

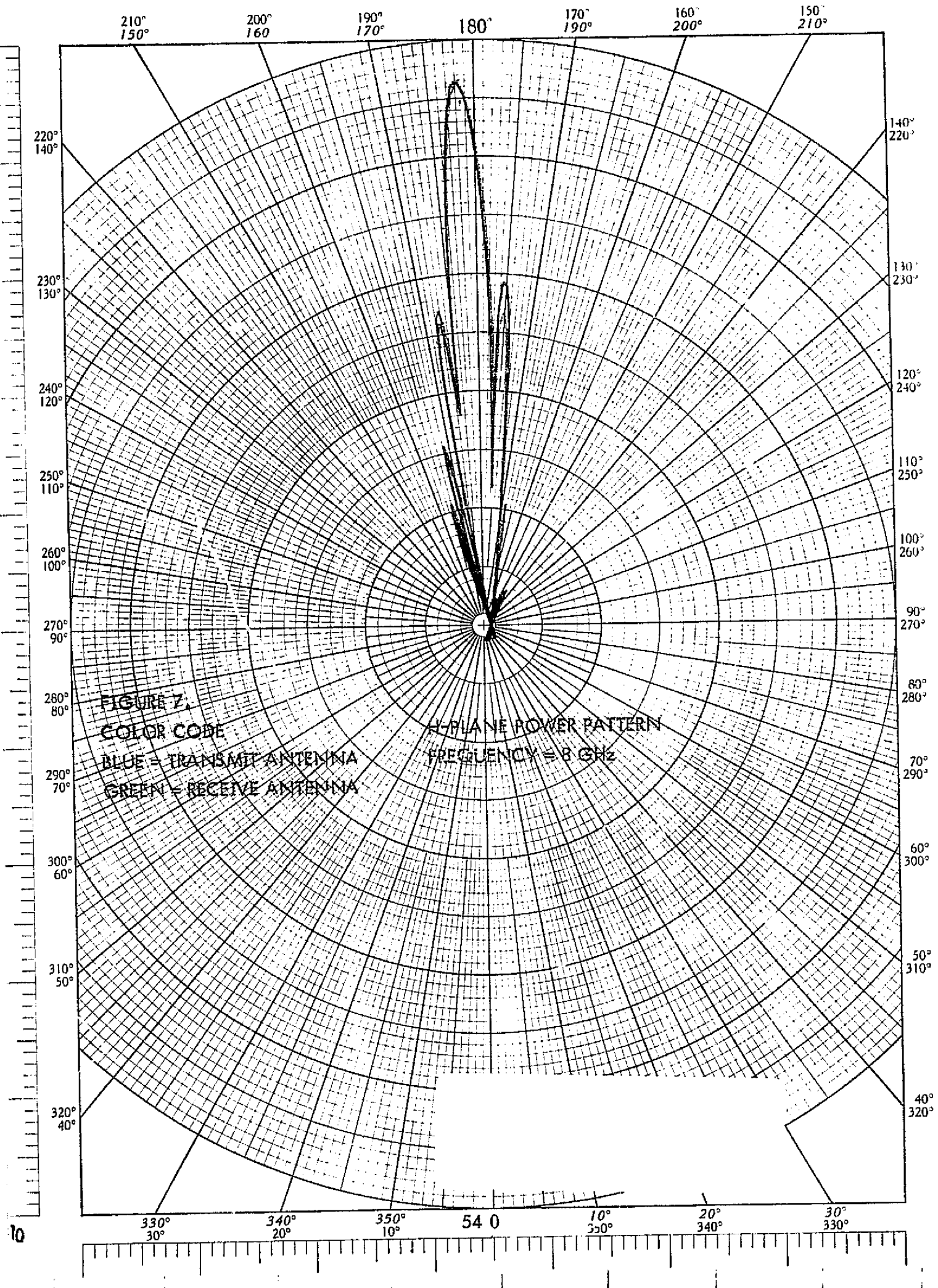

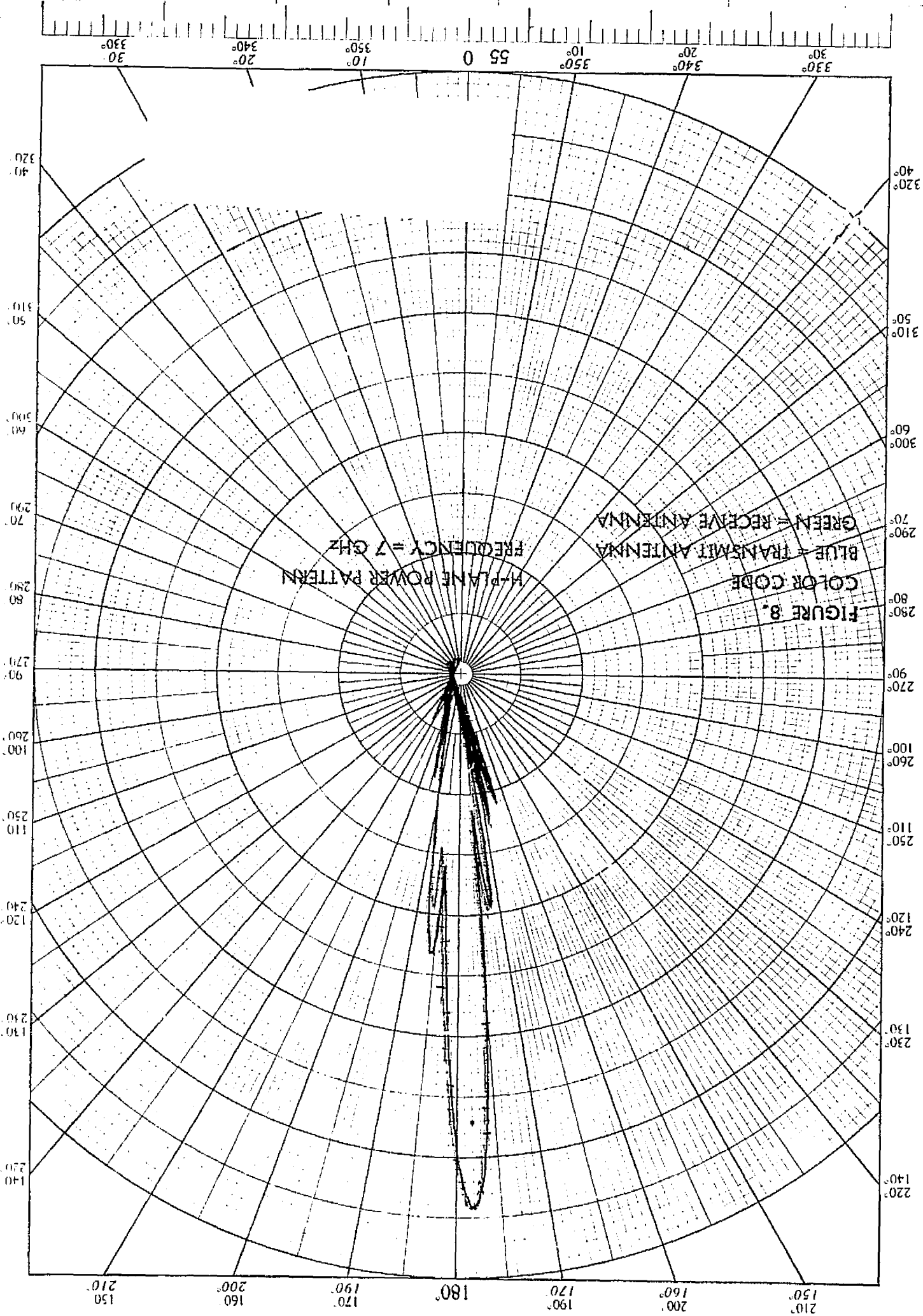

FIGURE 8.

210° 150°  
200° 160°  
190° 170°  
180°  
170° 190°  
160° 200°  
150° 210°

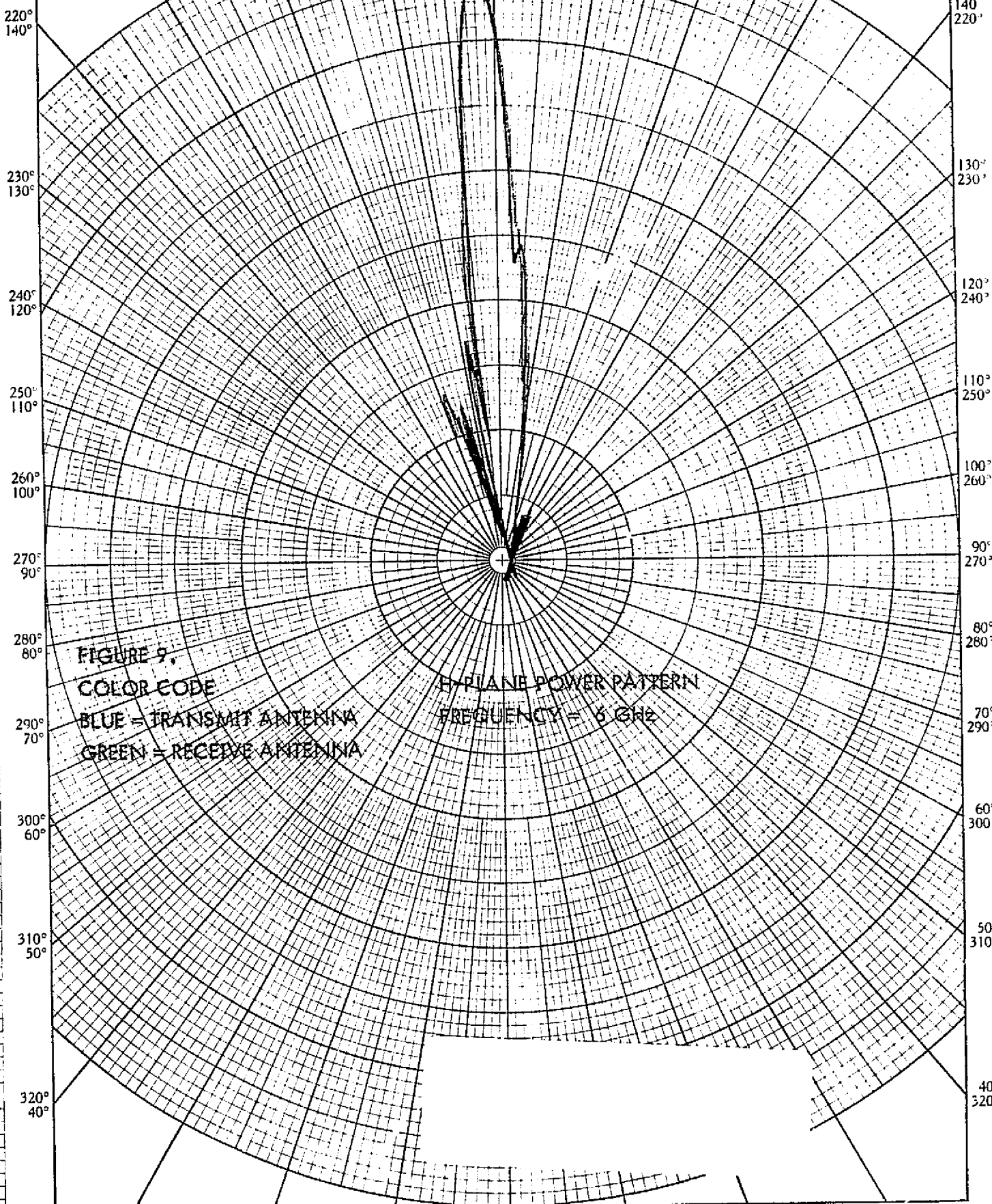
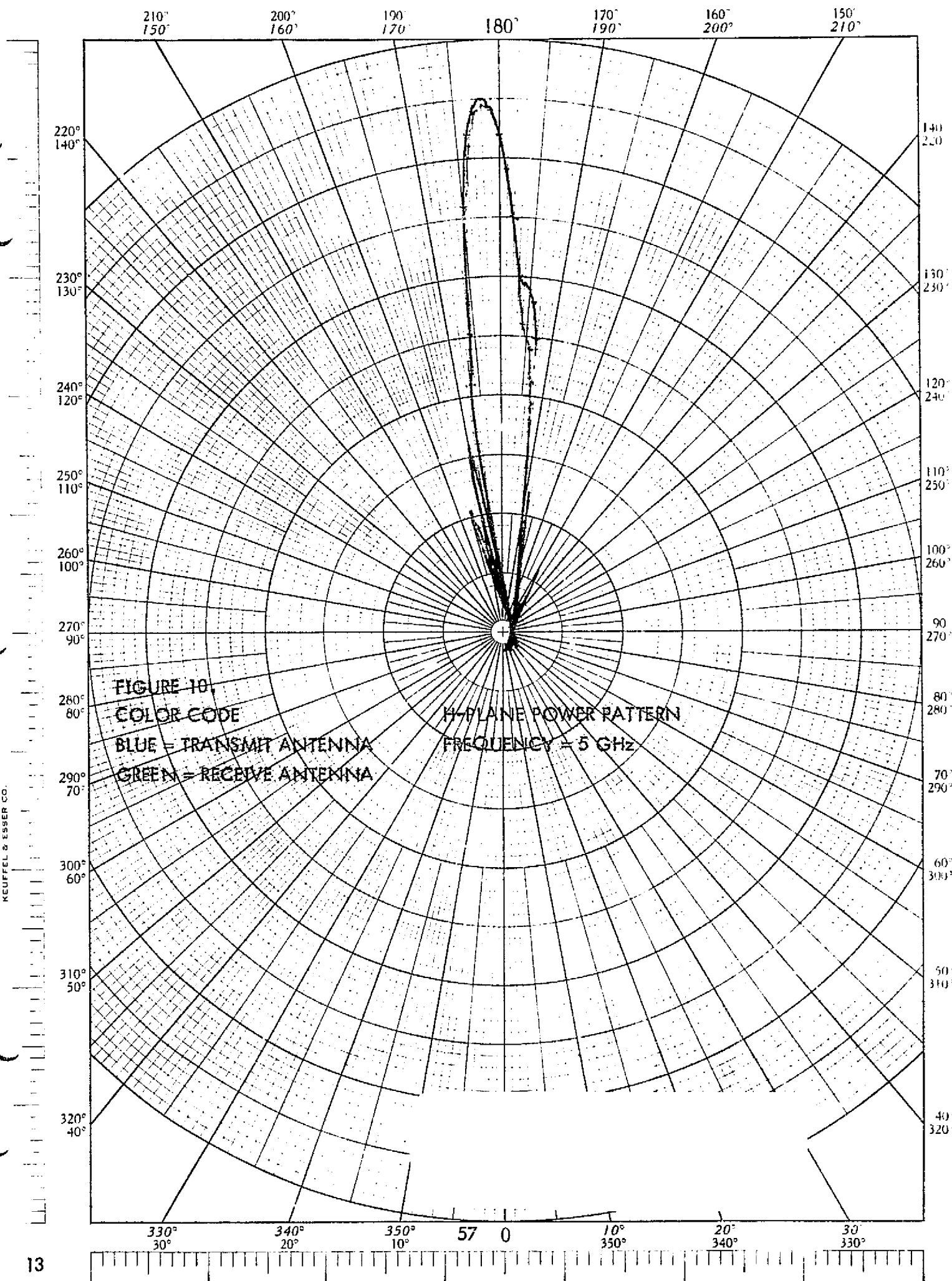
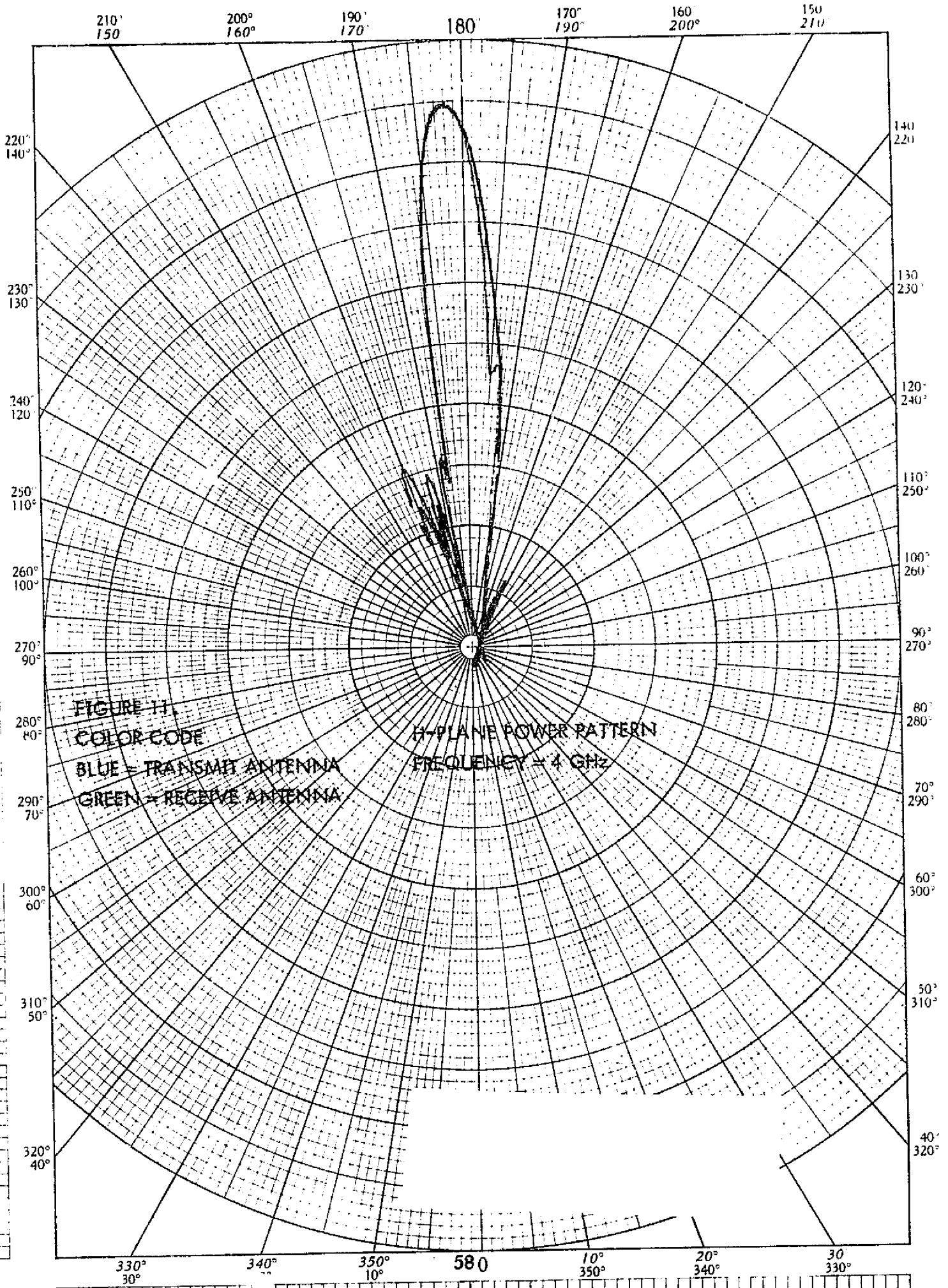

FIGURE 9.  
COLOR CODE  
BLUE = TRANSMIT ANTENNA  
GREEN = RECEIVE ANTENNA

H-PLANE POWER PATTERN  
FREQUENCY = 8 GHz

330° 30° 340° 20° 350° 10° 56 0 10° 350° 20° 340° 20° 330°





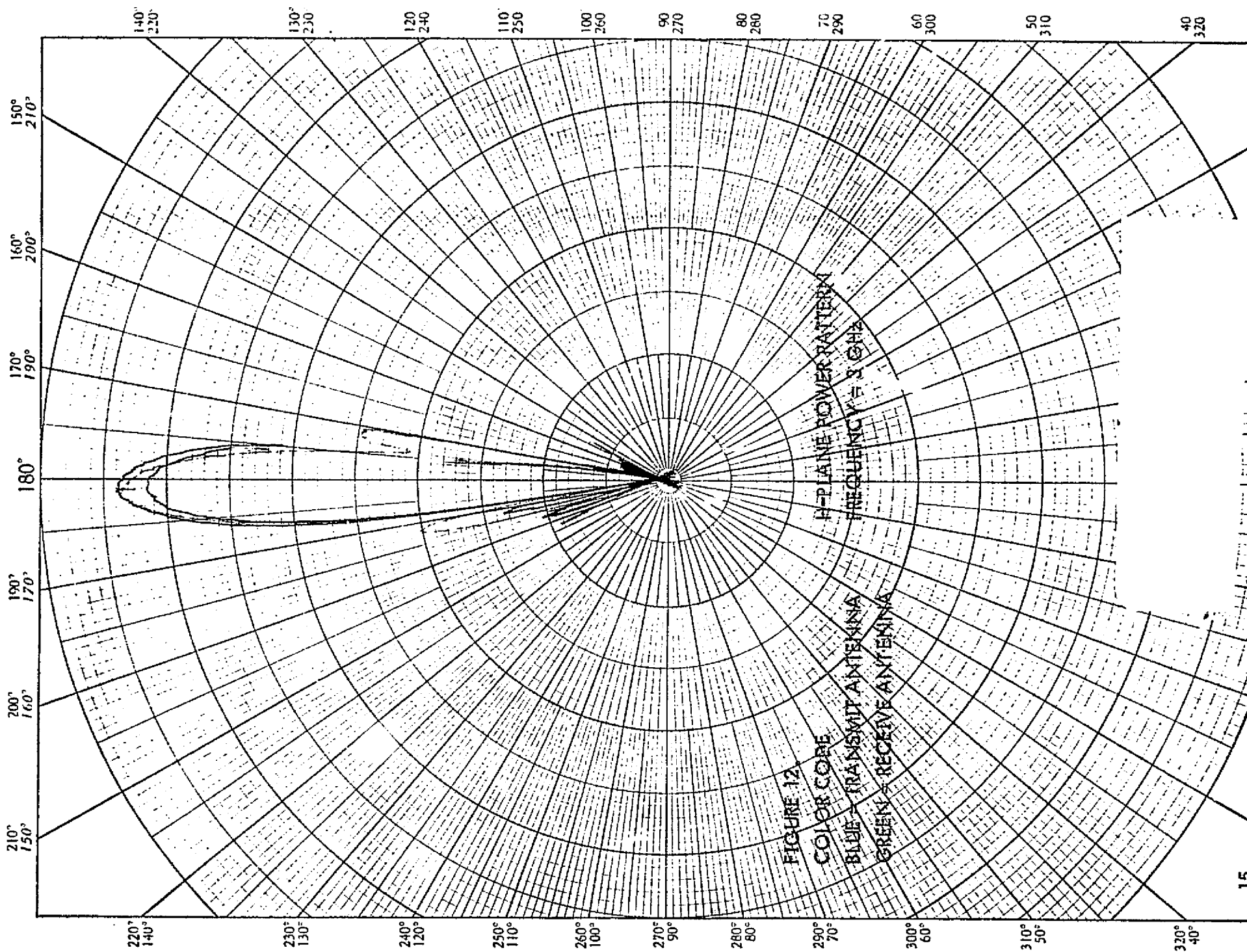
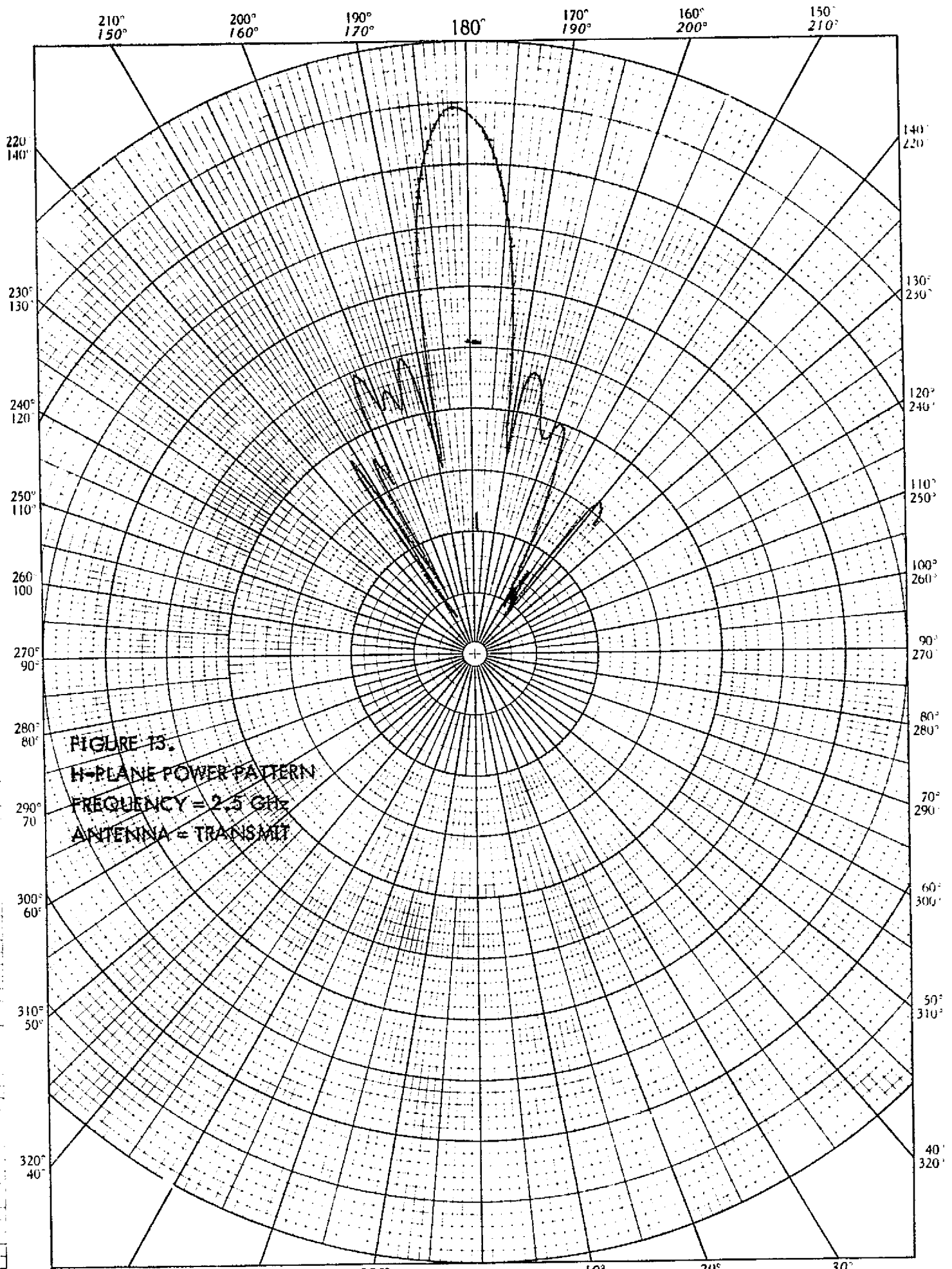

FIGURE 12





210 150      200 160      190 170      180      170 190      160 200      150 210

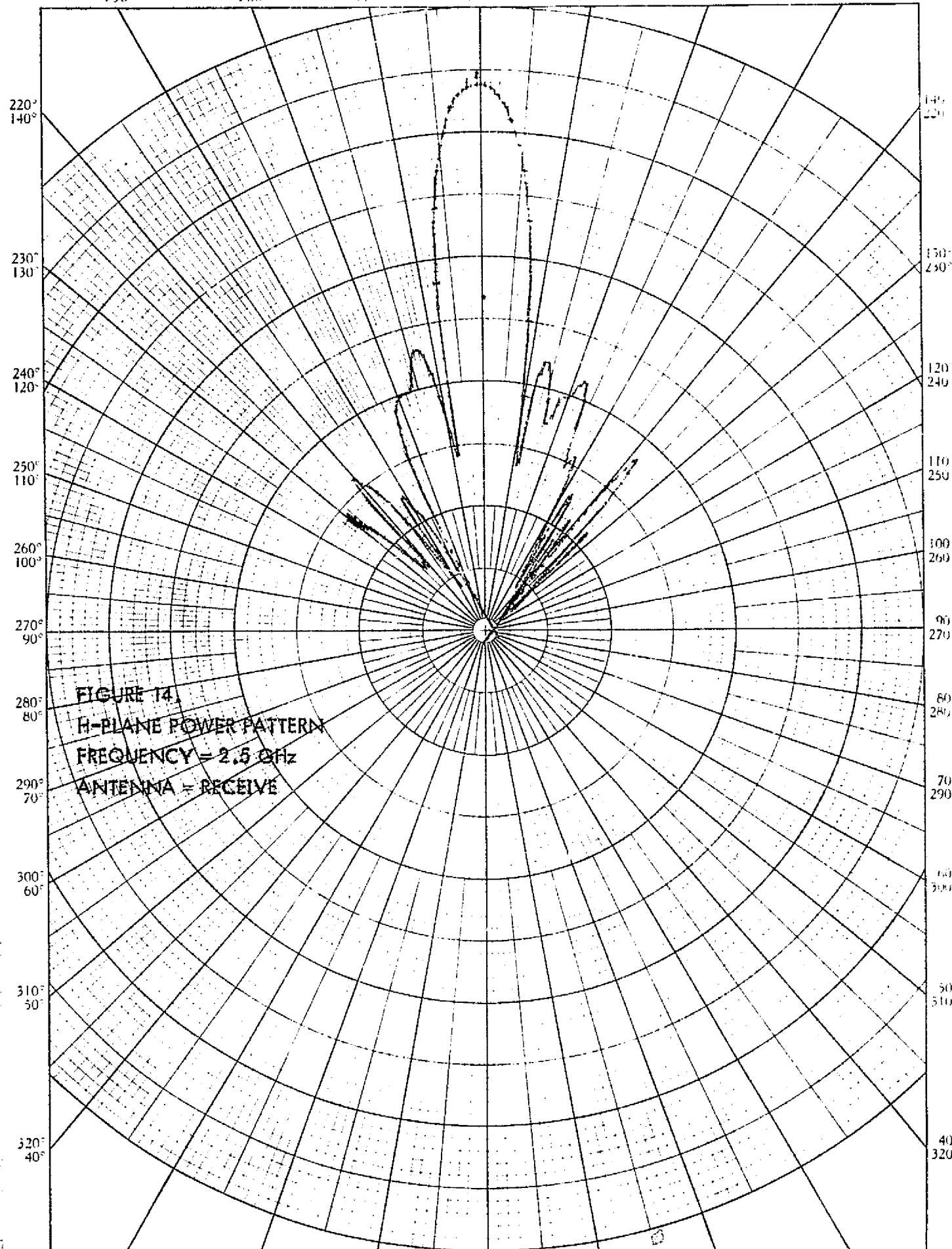
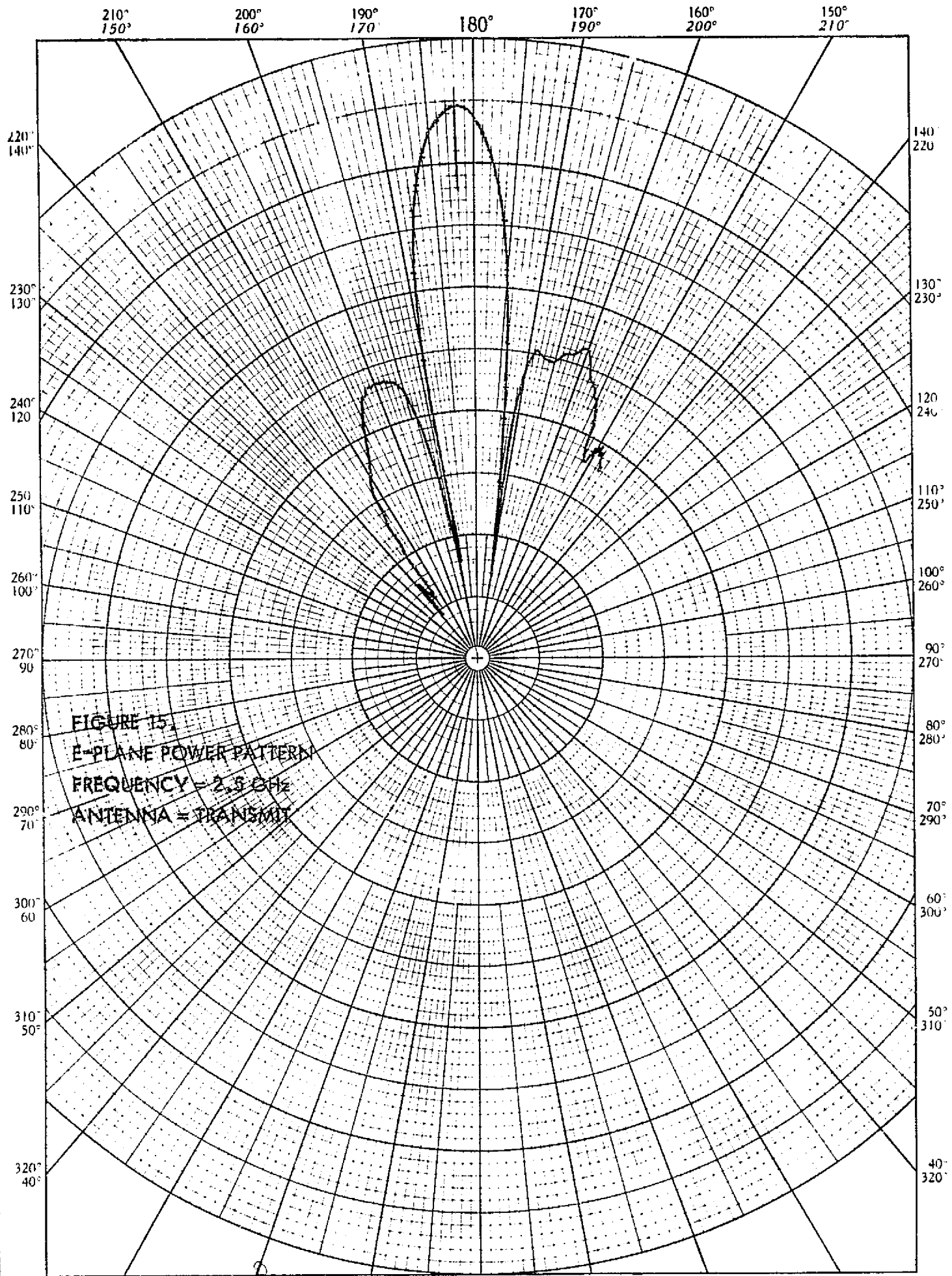

FIGURE 14  
H-PLANE POWER PATTERN  
FREQUENCY = 2.5 GHz  
ANTENNA = RECEIVE

KEUFIEL IN ESSER CO.



210° 150  
200 160  
190 170  
180  
170 190  
160 200  
150 210

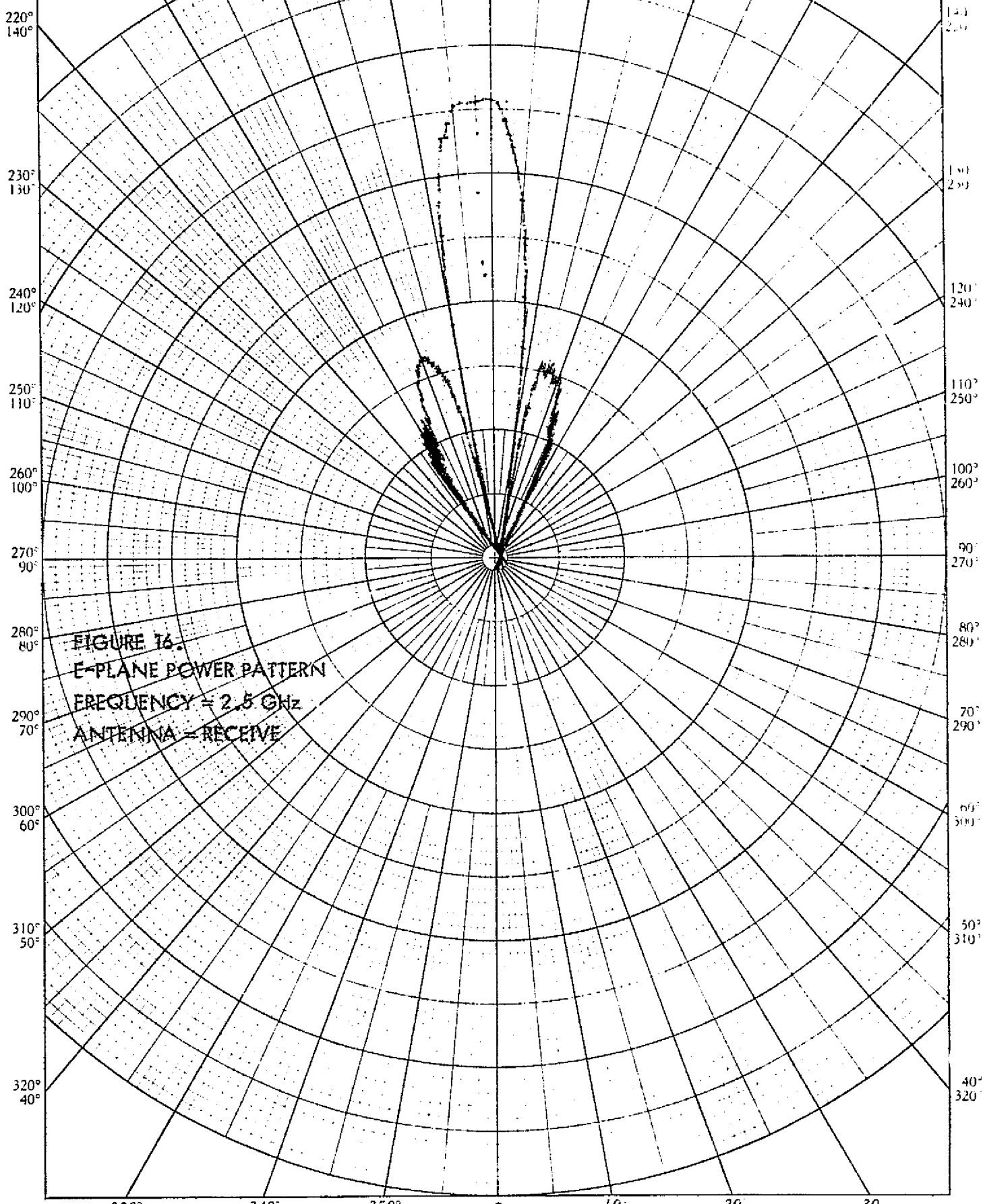

FIGURE 16.  
E-PLANE POWER PATTERN  
FREQUENCY = 2.5 GHz  
ANTENNA = RECEIVE

KEUFFEL & ESSER CO.

Figure 17. Effective Principal Plane Power Pattern

Frequency: 2.5 GHz  
Transmitting Antenna: H  
Receiving Antenna: H  
Effective Beamwidth:  $6.2^\circ$   
Elevation

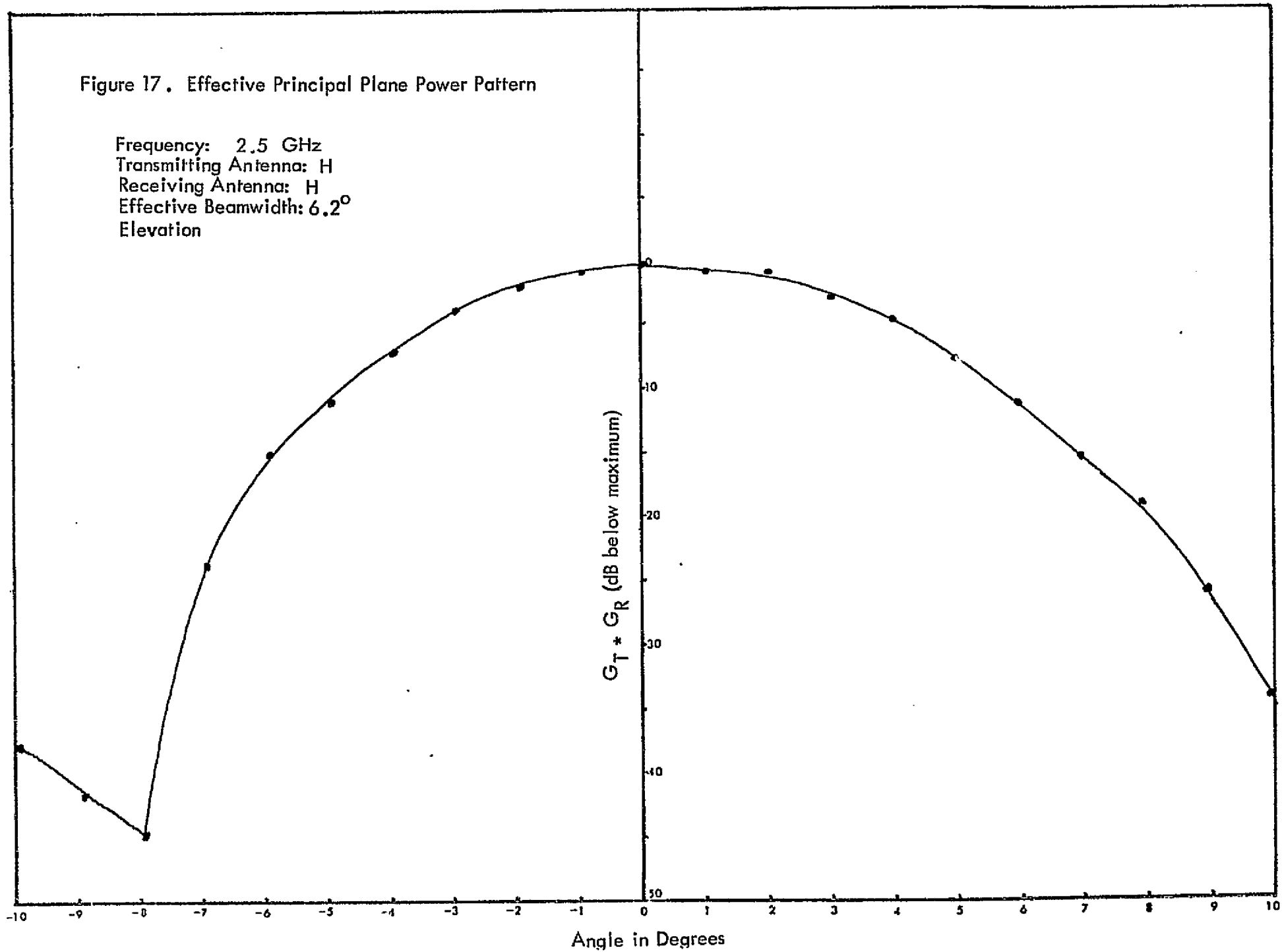

Figure 18 . Effective Principal Plane Power Pattern

Frequency: 2.5 GHz \*

Transmitting Antenna: H

Receiving Antenna: H

Effective Beamwidth:  $7.2^\circ$

Azimuth

\*Assuming that both transmitting and receiving patterns are correctly aligned.

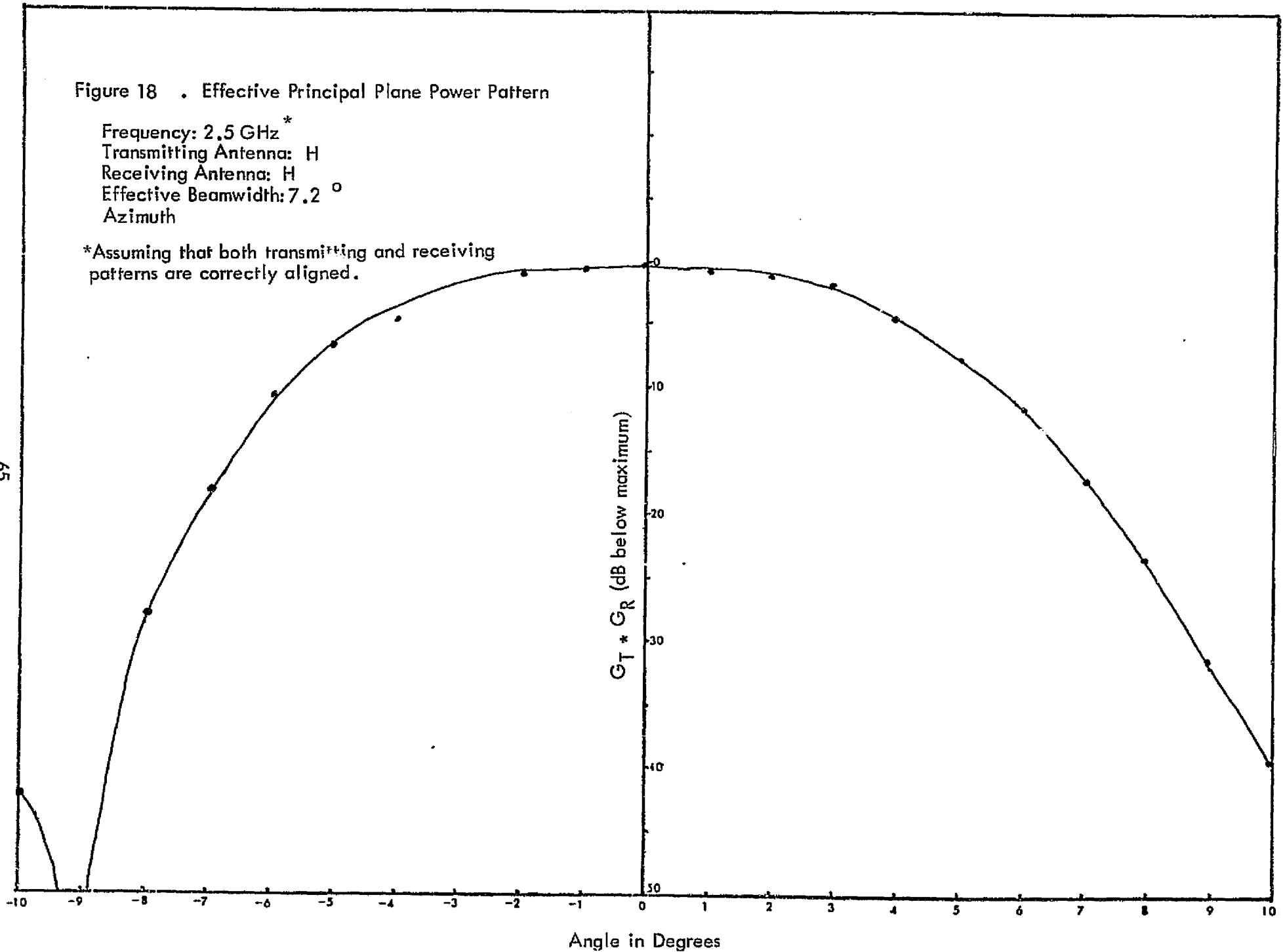

Figure 19 . Effective Principal Plane Power Pattern

Frequency: 2.5 GHz\*  
Transmitting Antenna: H  
Receiving Antenna: V  
Effective Beamwidth:  $7.0^\circ$   
Elevation

\*Assuming that both transmitting and receiving patterns are correctly aligned.

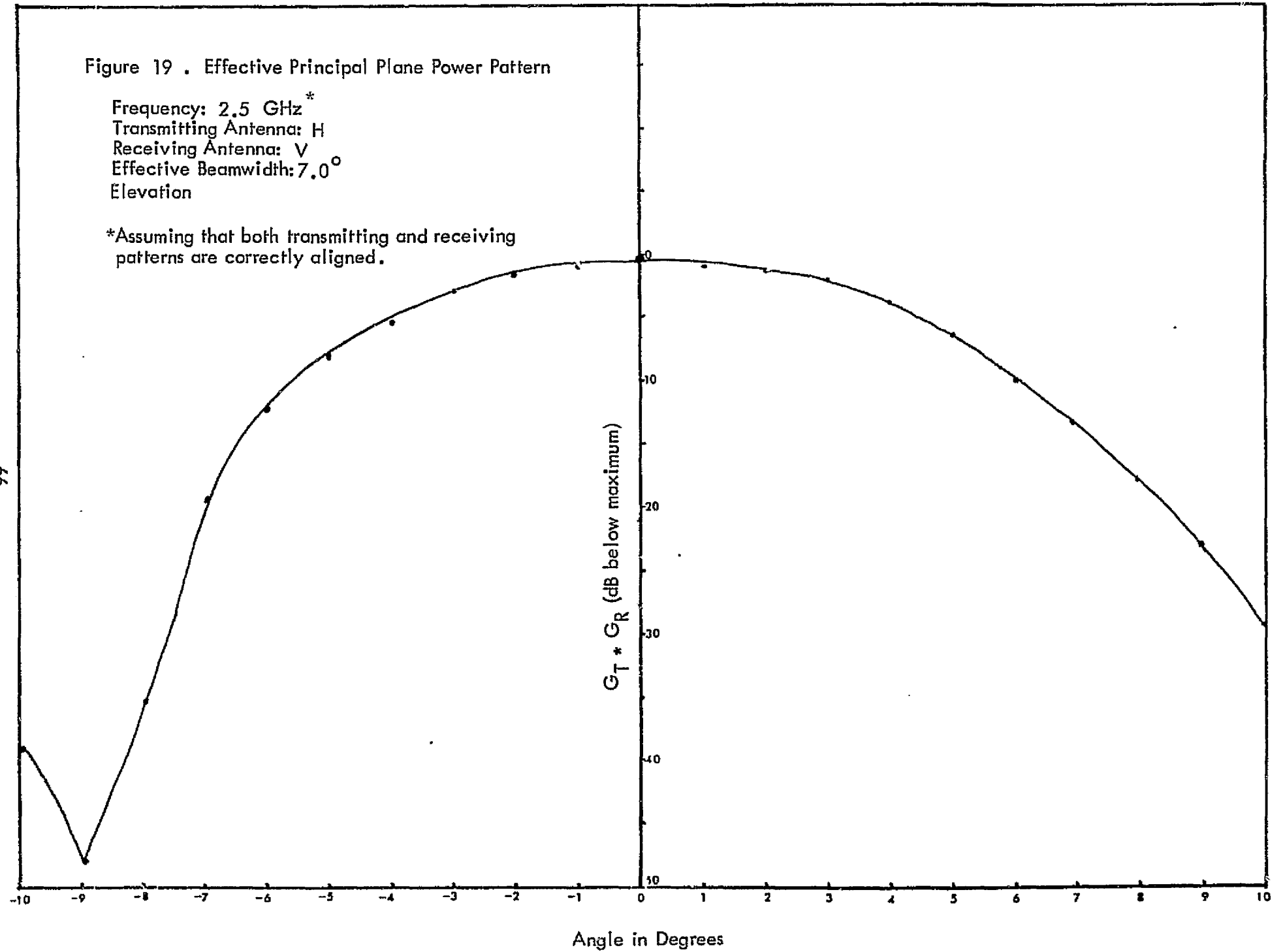

Figure 20 . Effective Principal Plane Power Pattern

Frequency: 2.5 GHz\*  
Transmitting Antenna: H  
Receiving Antenna: V  
Effective Beamwidth: 6.2°  
Azimuth

\*Assuming that both transmitting and receiving patterns are correctly aligned.

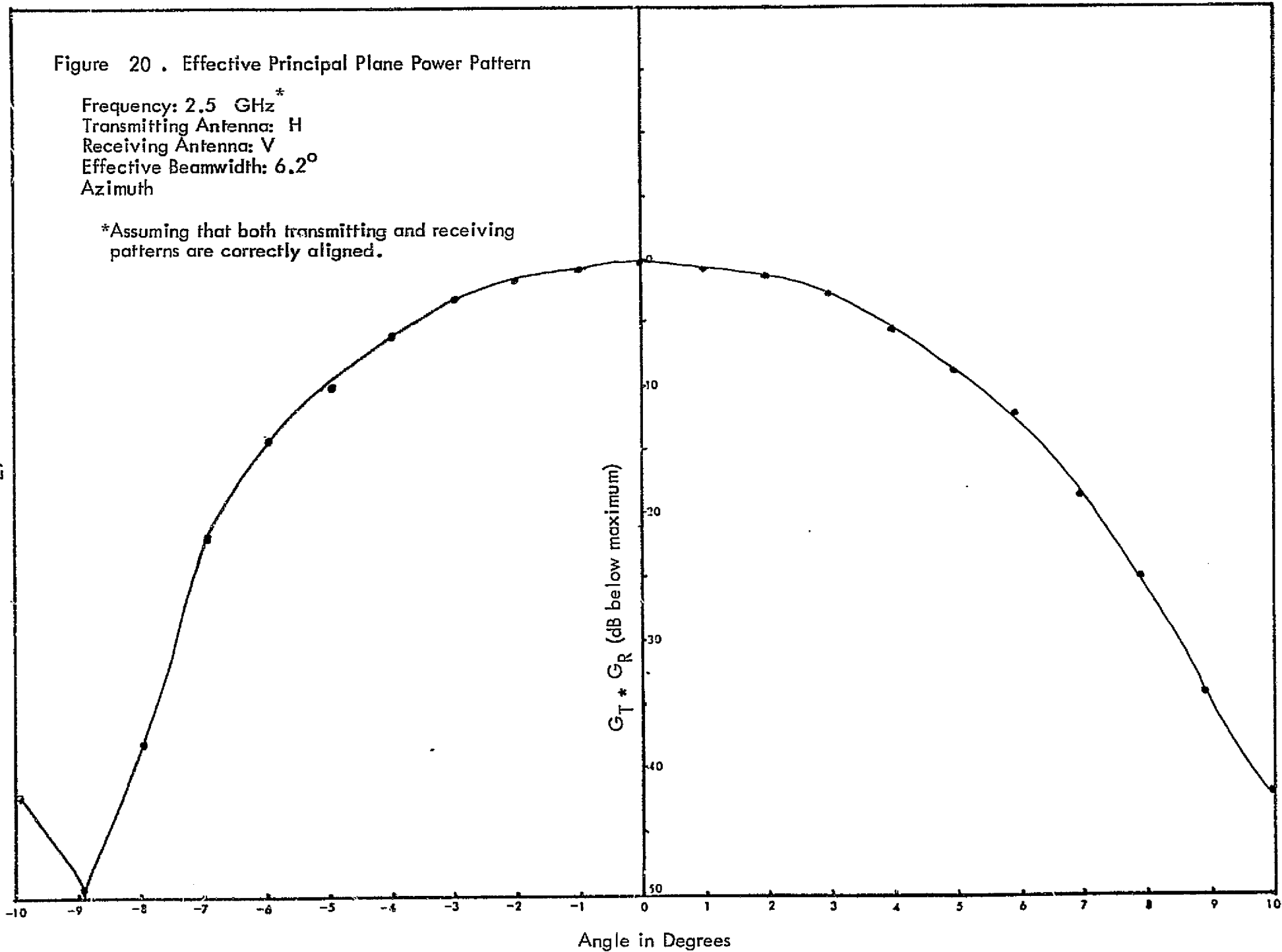

Figure 21. Effective Principal Plane Power Pattern

Frequency: 3 GHz  
Transmitting Antenna: H  
Receiving Antenna: H  
Effective Beamwidth:  $5.21^\circ$   
Elevation

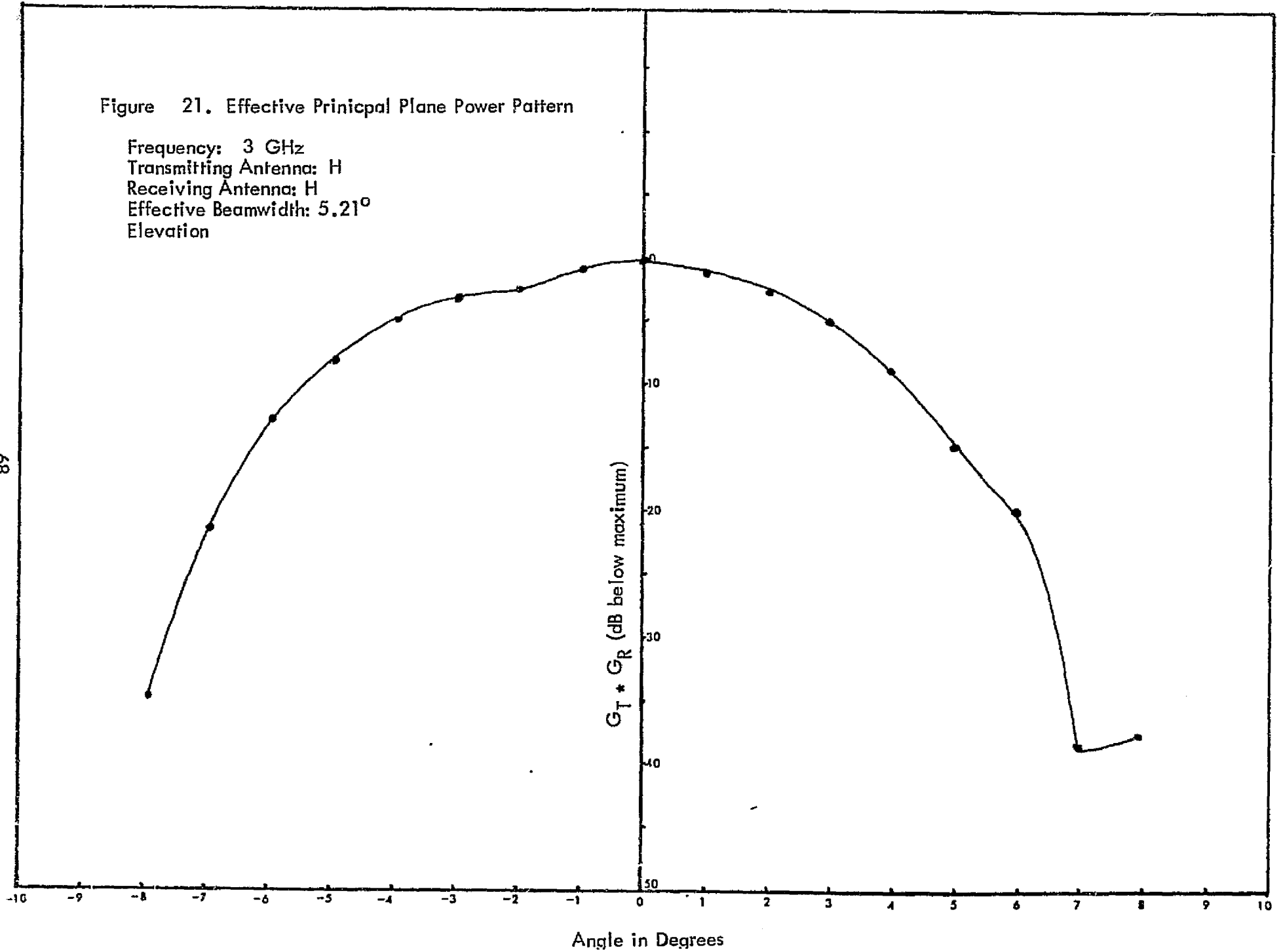



Figure 22. Effective Principal Plane Power Pattern

Frequency: 3 GHz  
Transmitting Antenna: H  
Receiving Antenna: H  
Effective Beamwidth:  $4.23^\circ$   
Azimuth

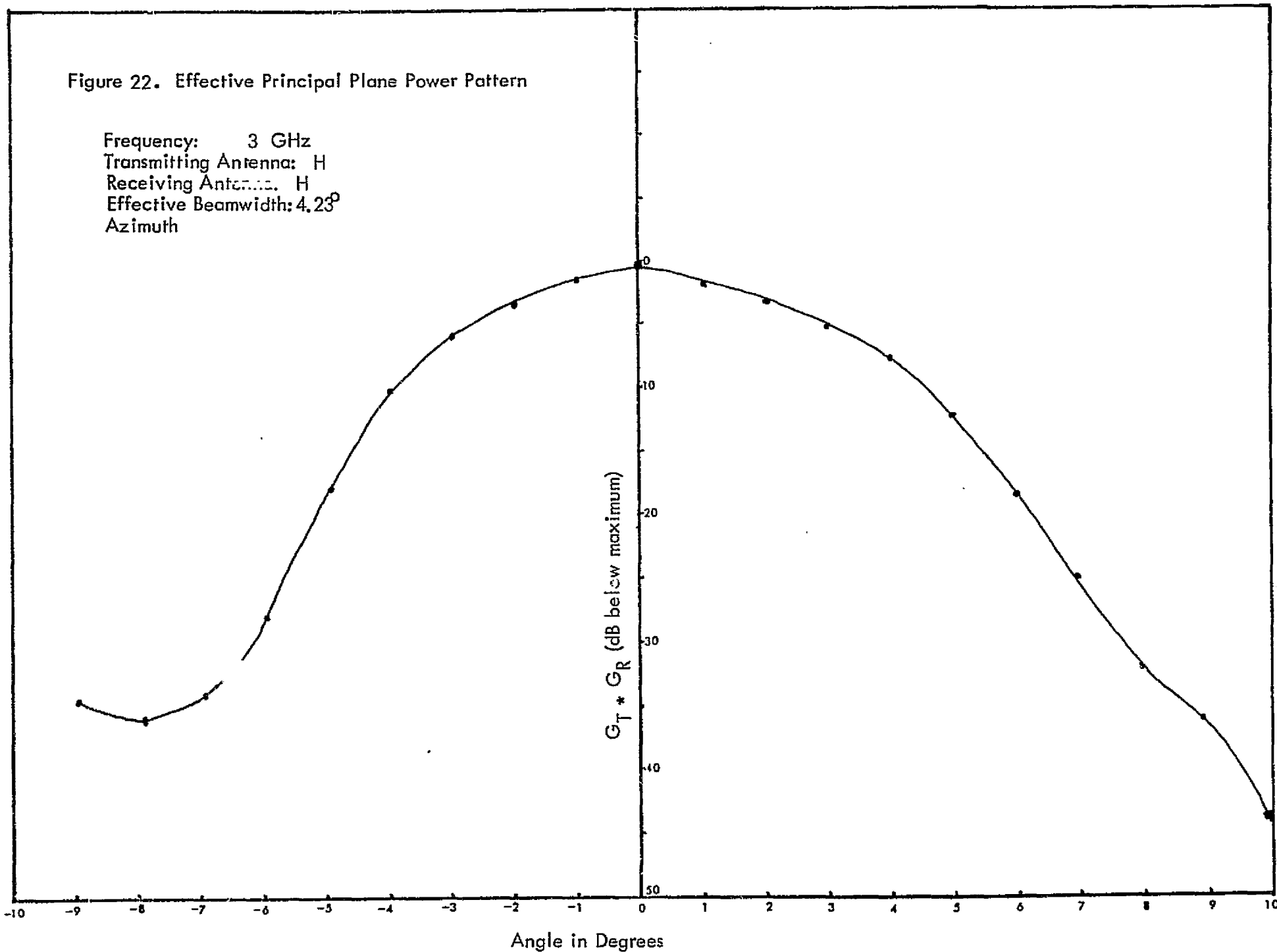

Figure 23 . Effective Principal Plane Power Pattern

Frequency: 3 GHz  
Transmitting Antenna: H  
Receiving Antenna: V  
Effective Beamwidth:  $4.41^\circ$   
Elevation

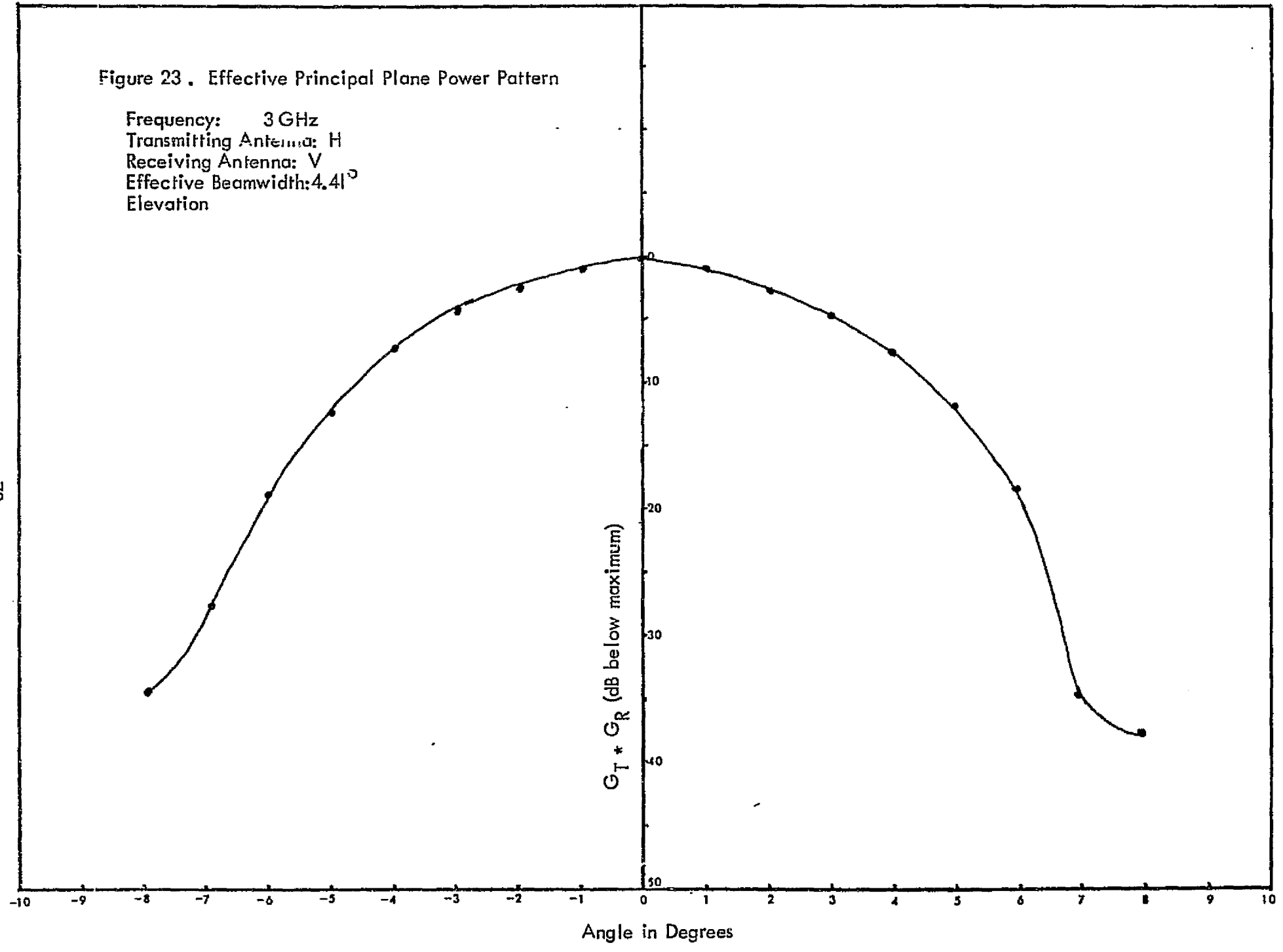

Figure 24 . Effective Principal Plane Power Pattern

Frequency: 3 GHz  
Transmitting Antenna: H  
Receiving Antenna: V  
Effective Beamwidth:  $4.3^\circ$   
Azimuth

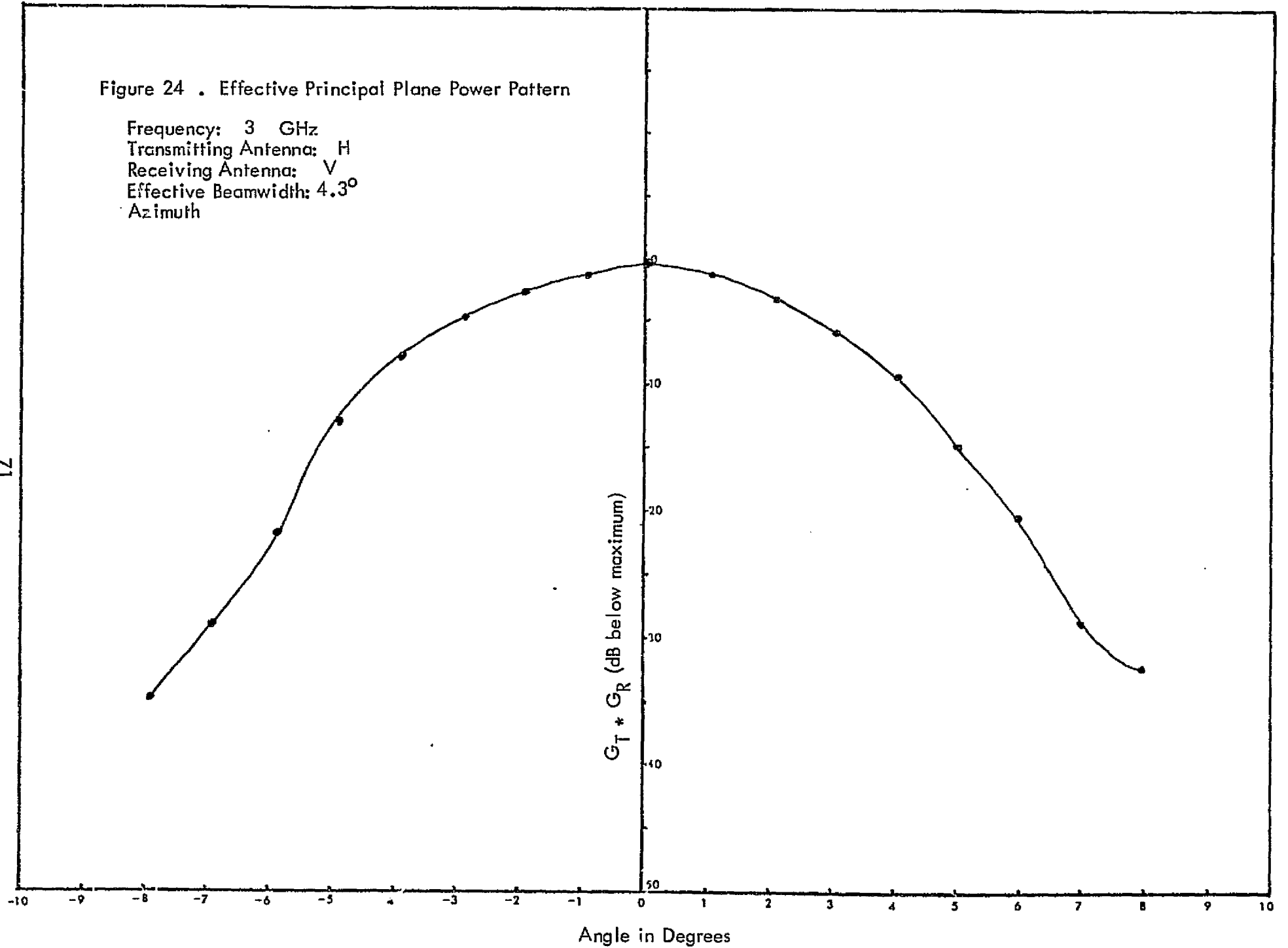

Figure 25 . Effective Principal Plane Power Pattern

Frequency: 4 GHz  
Transmitting Antenna: H  
Receiving Antenna: H  
Effective Beamwidth:  $3.67^\circ$   
Elevation

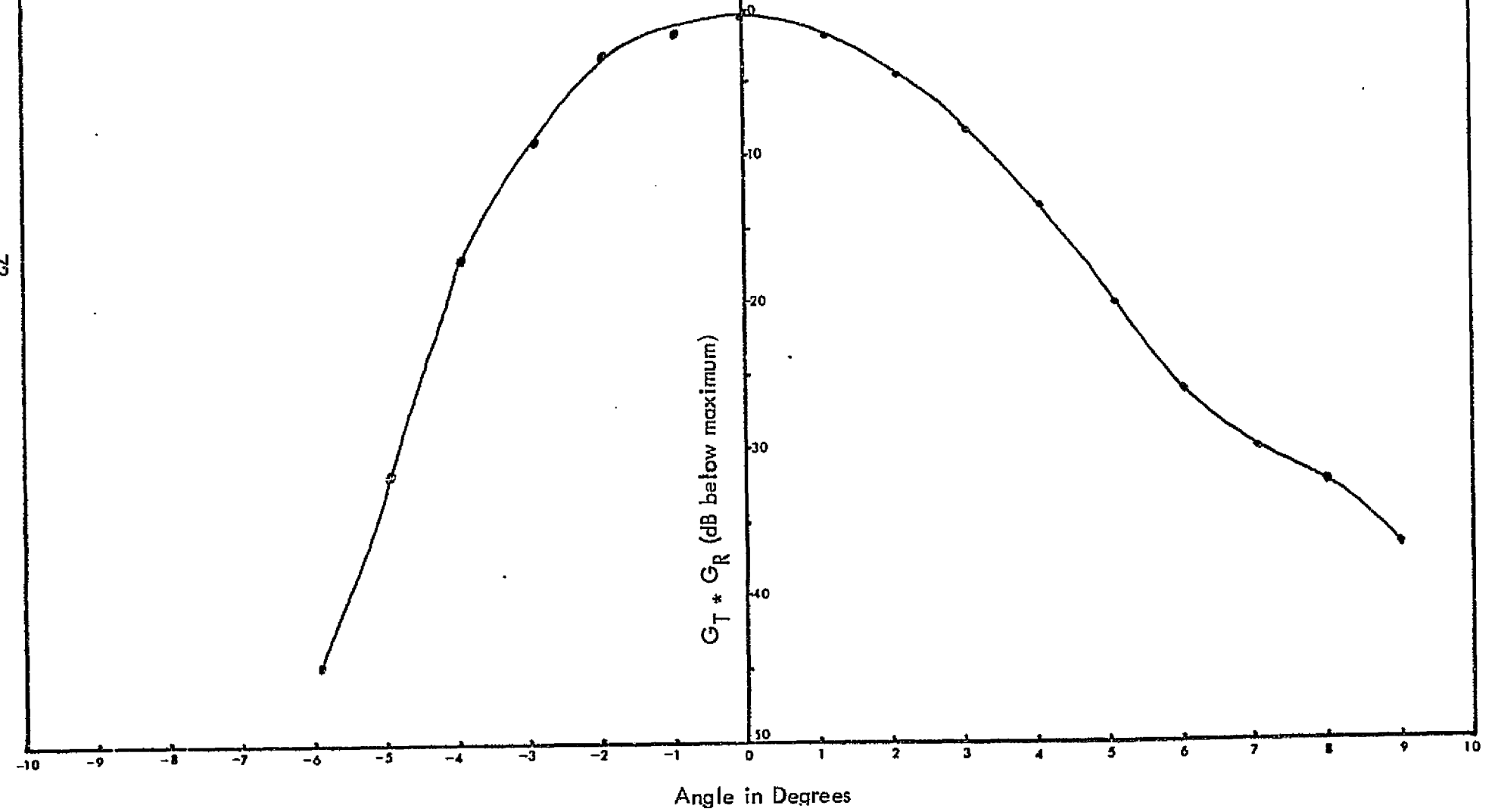
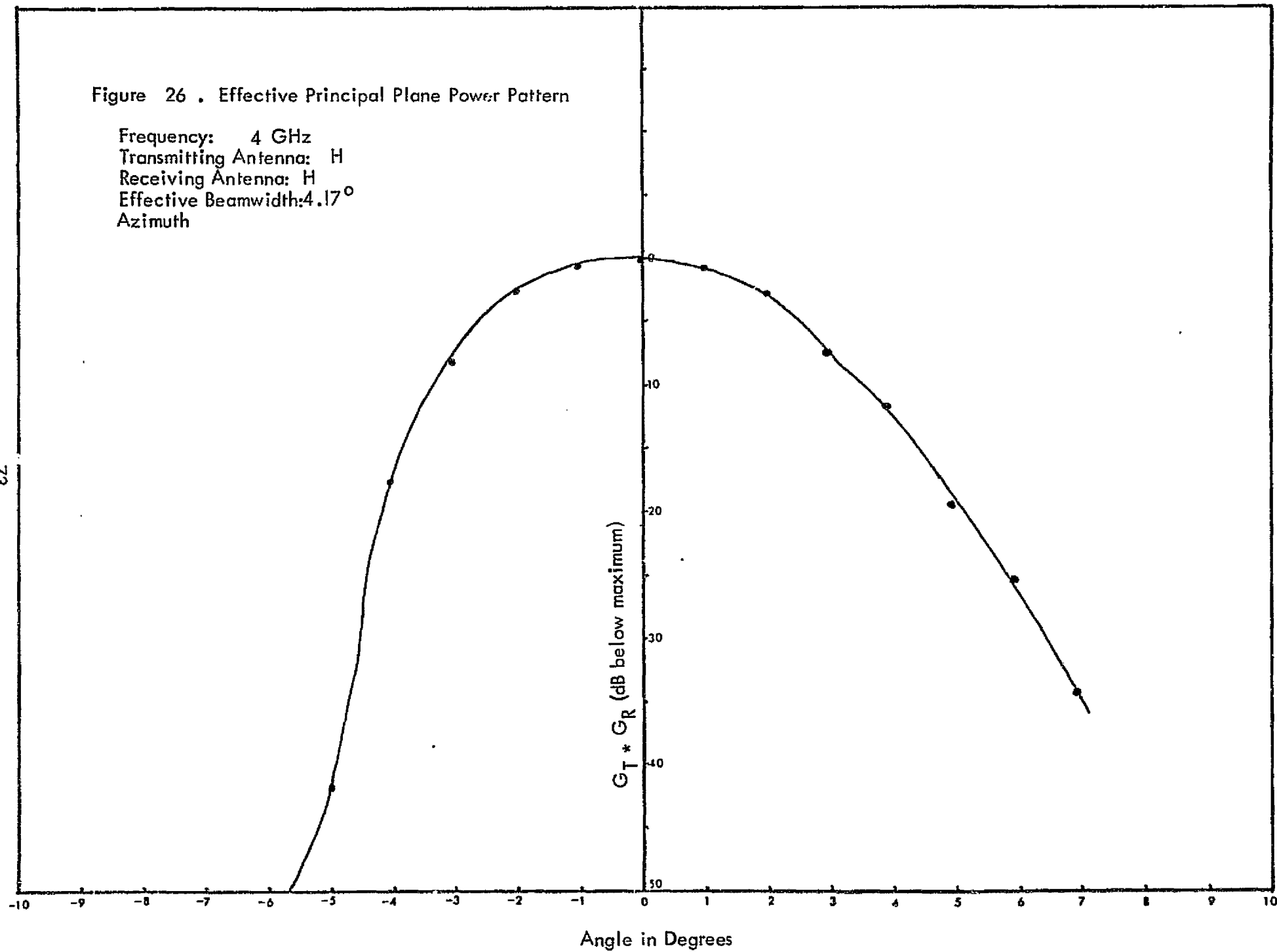

Figure 26 . Effective Principal Plane Power Pattern

Frequency: 4 GHz  
Transmitting Antenna: H  
Receiving Antenna: H  
Effective Beamwidth:  $4.17^\circ$   
Azimuth



73

Figure 27 . Effective Prinicipal Plane Power Pattern

Frequency: 4 GHz  
Transmitting Antenna: H  
Receiving Antenna: V  
Effective beamwidth:  $3.79^\circ$   
Elevation

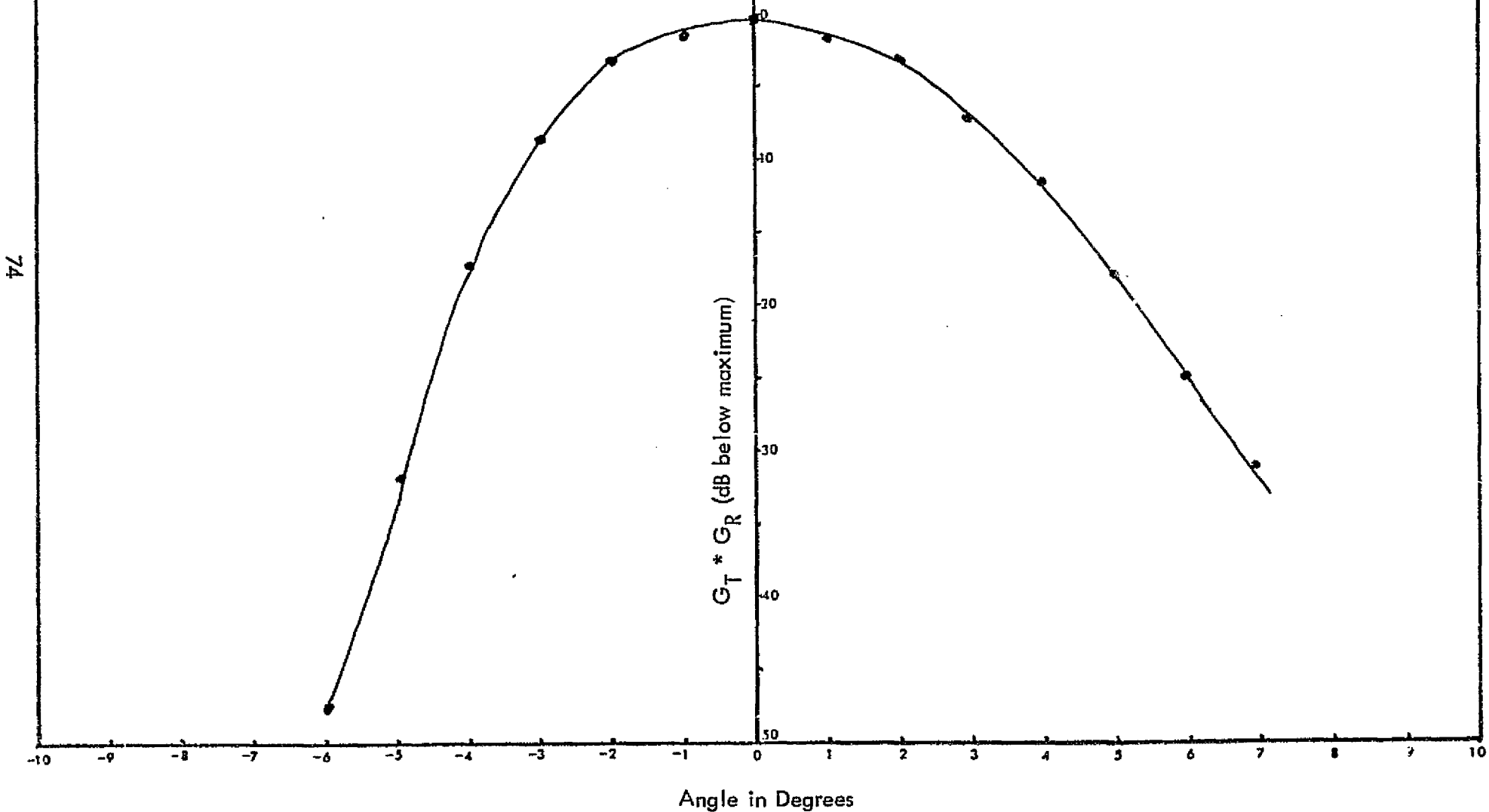
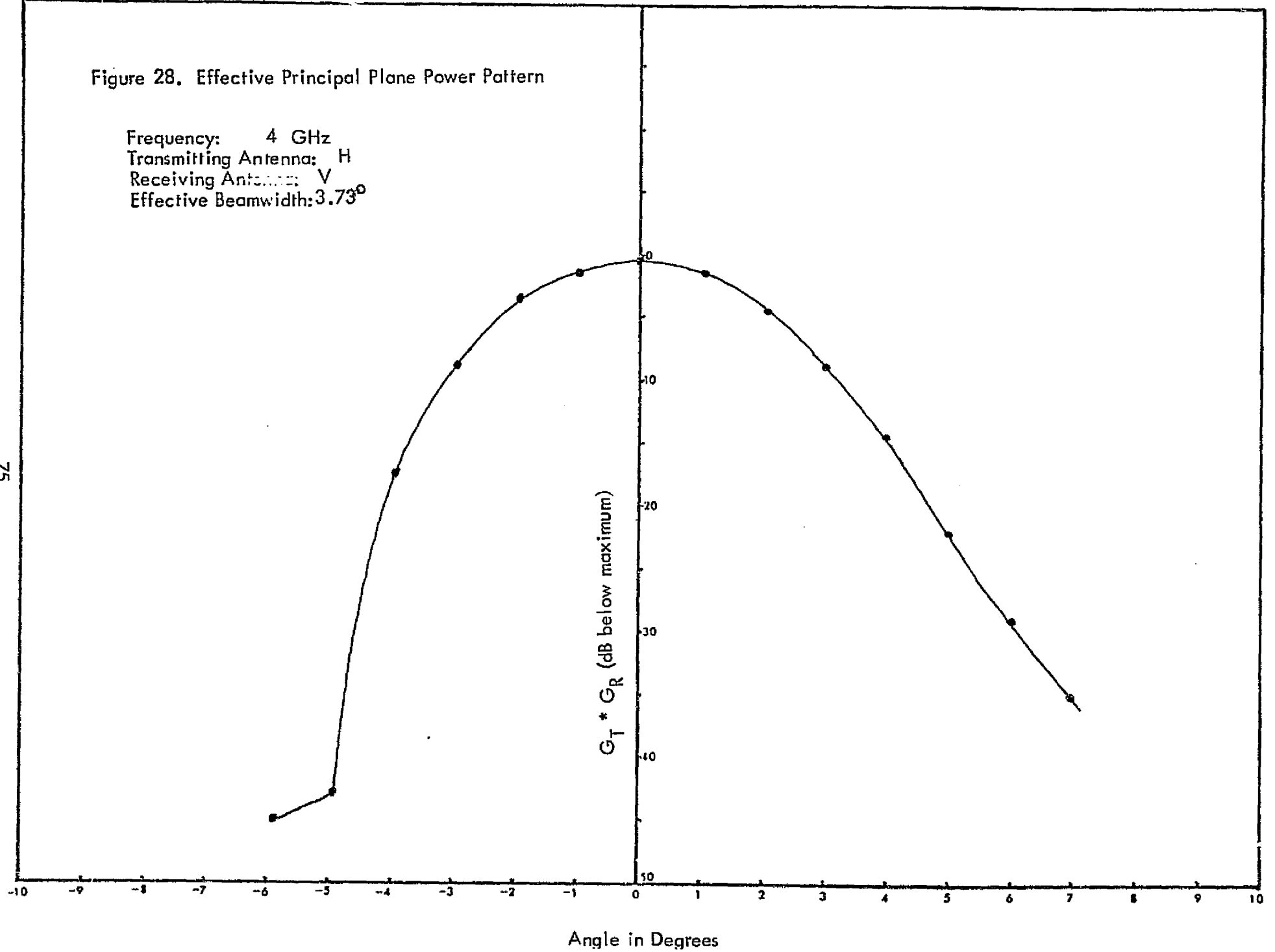

Figure 28. Effective Principal Plane Power Pattern

Frequency: 4 GHz  
Transmitting Antenna: H  
Receiving Antenna: V  
Effective Beamwidth:  $3.73^\circ$

75



Angle in Degrees

Figure 29. Effective Principal Plane Power Pattern

Frequency: 5 GHz  
Transmitting Antenna: H  
Receiving Antenna: H  
Effective Beamwidth:  $3.3^\circ$   
Elevation

76

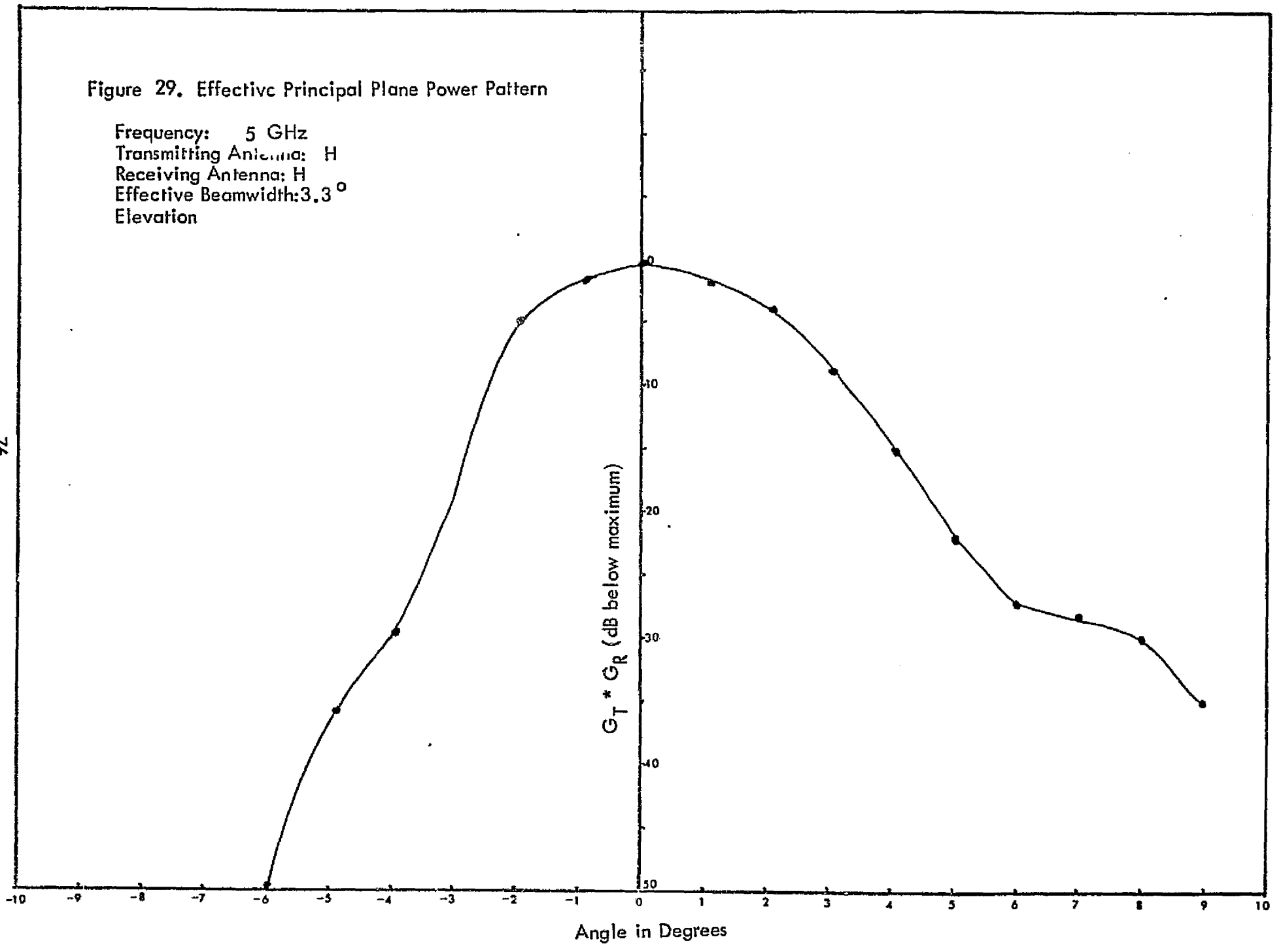



Figure 30 . Effective Principal Plane Power Pattern

Frequency: 5 GHz  
Transmitting Antenna: H  
Receiving Antenna: H  
Effective Beamwidth:  $3.44^\circ$   
Azimuth

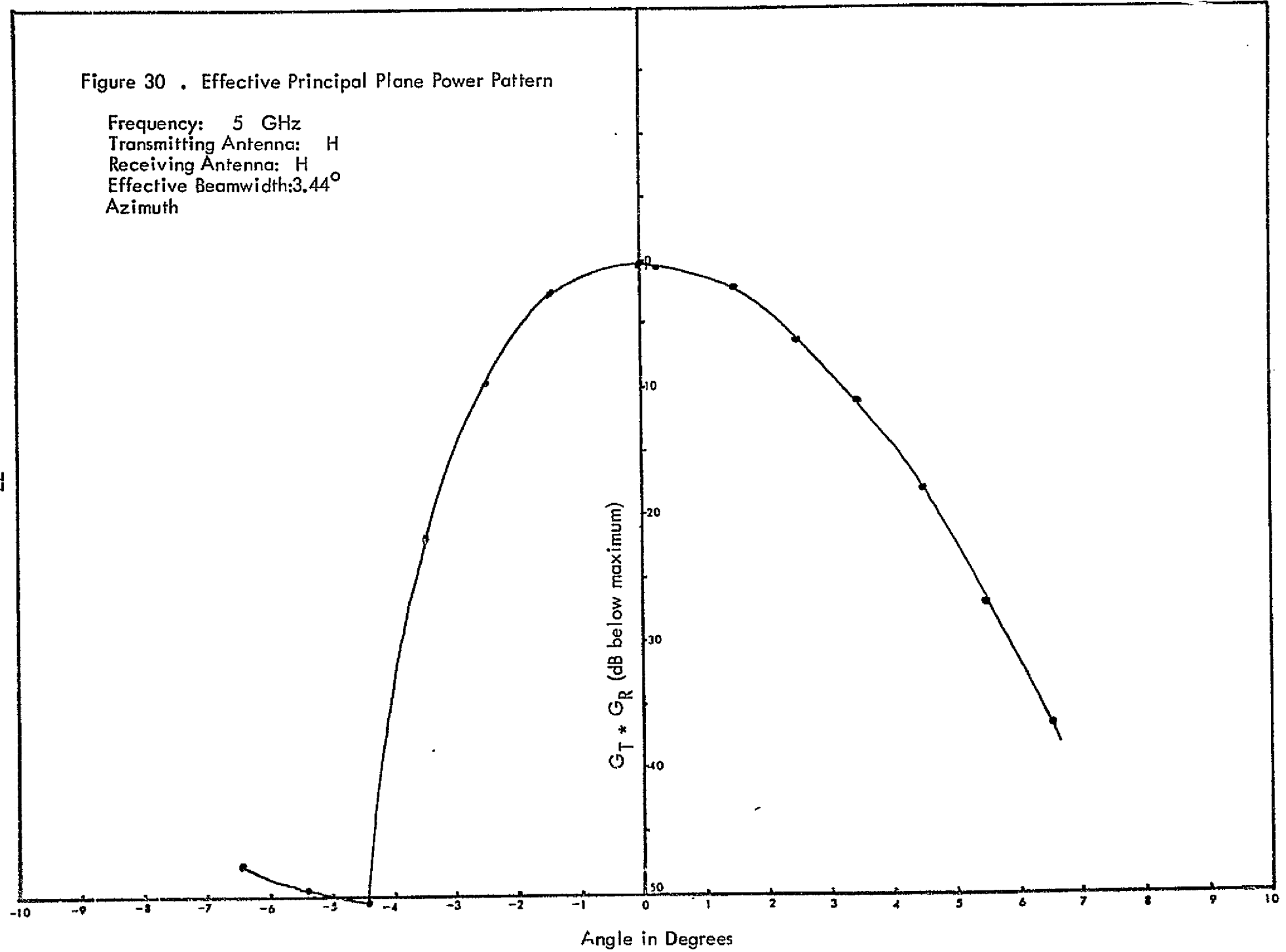
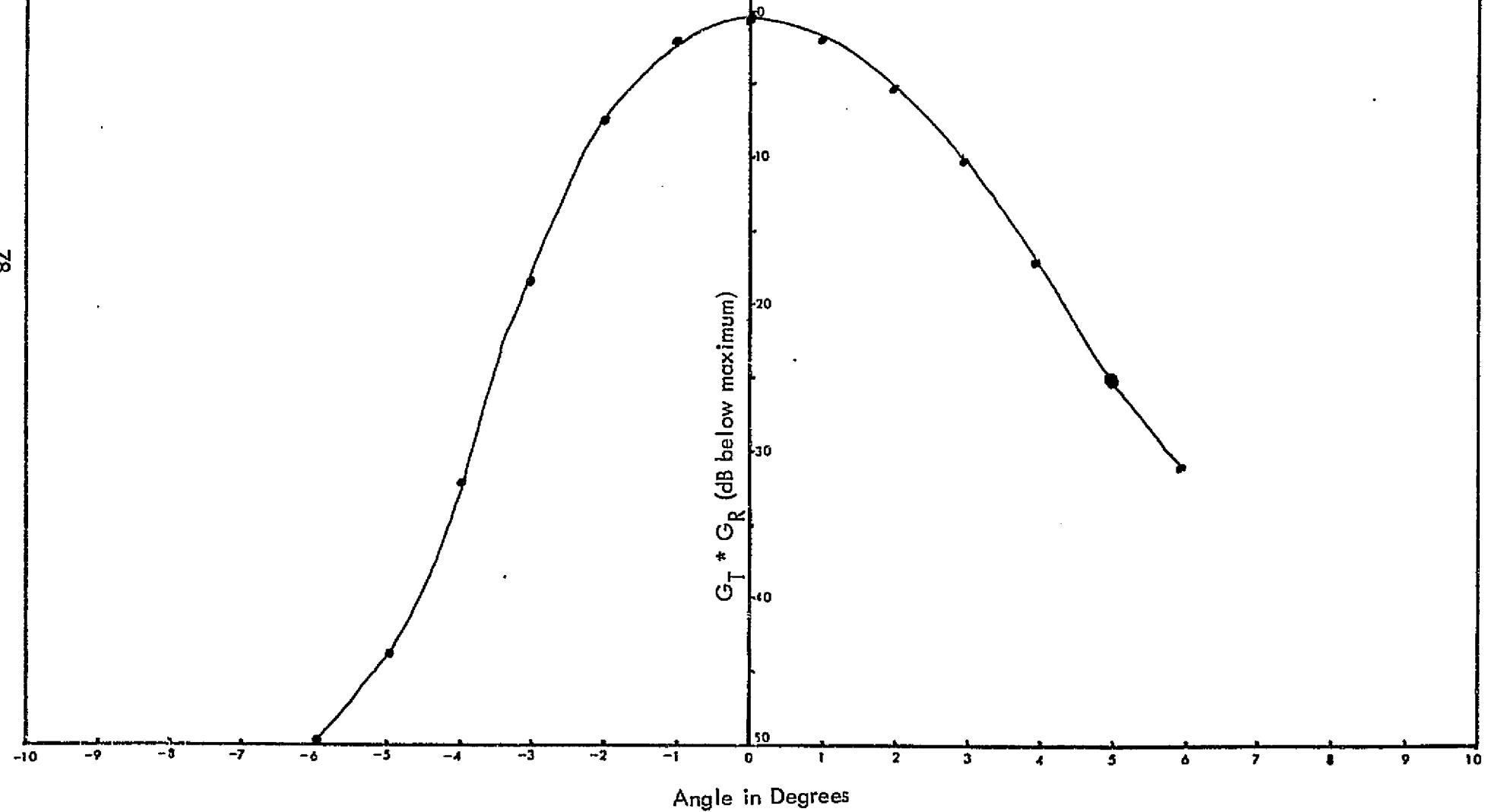

Figure 31 . Effective Principal Plane Power Pattern

Frequency: 5 GHz  
Transmitting Antenna: H  
Receiving Antenna: V  
Effective Beamwidth:  $2.97^\circ$   
Elevation



78

Figure 32 . Effective Principal Plane Power Pattern

Frequency: 5 GHz  
Transmitting Antenna: H  
Receiving Antenna: V  
Effective Beamwidth:  $3.24^\circ$   
Azimuth

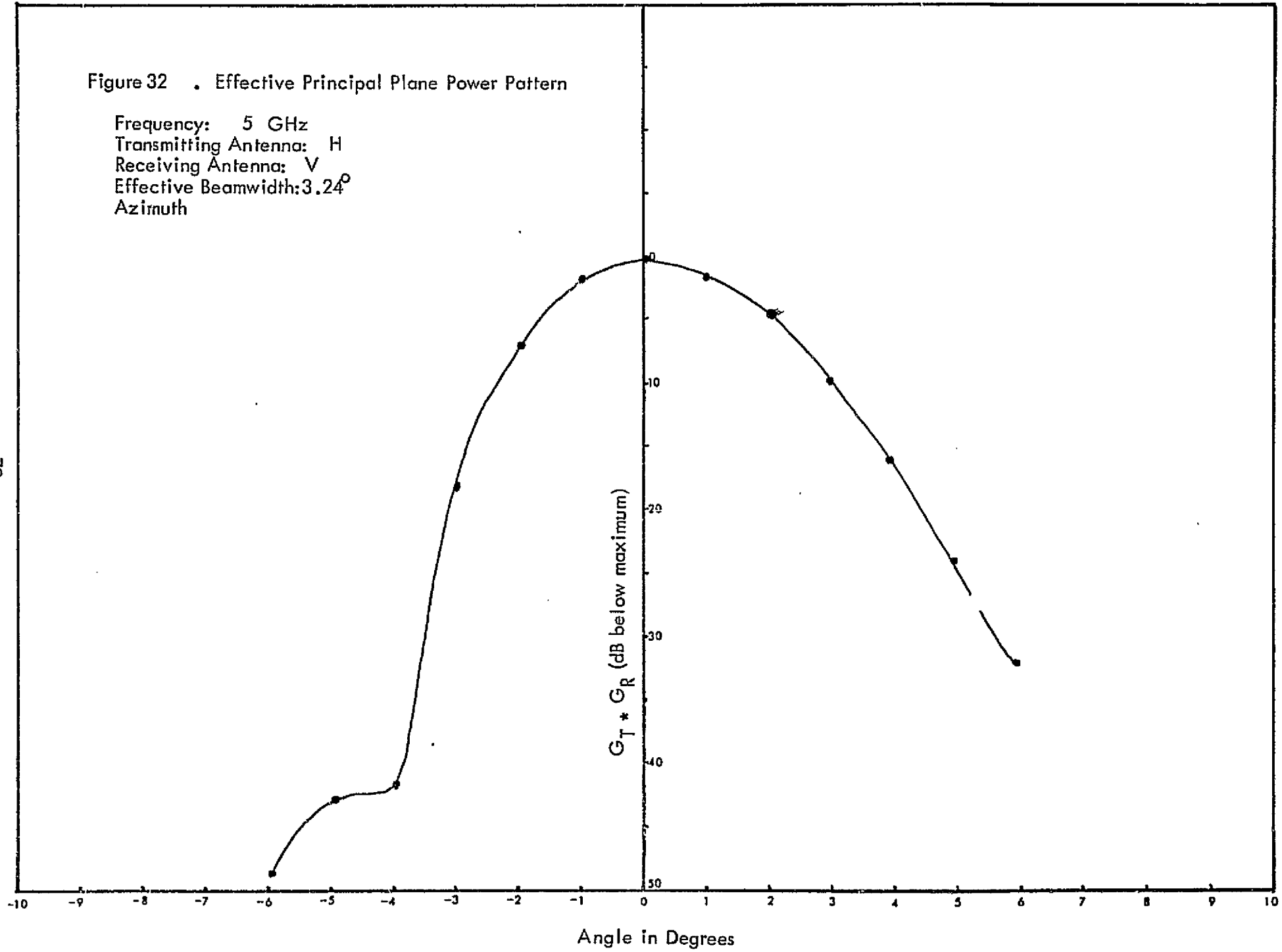

79

Angle in Degrees

$G_T * G_R$  (dB below maximum)

Figure 33 . Effective Principal Plane Power Pattern

Frequency: 6 GHz  
Transmitting Antenna: H  
Receiving Antenna: H  
Effective Beamwidth:  $2.61^\circ$   
Elevation

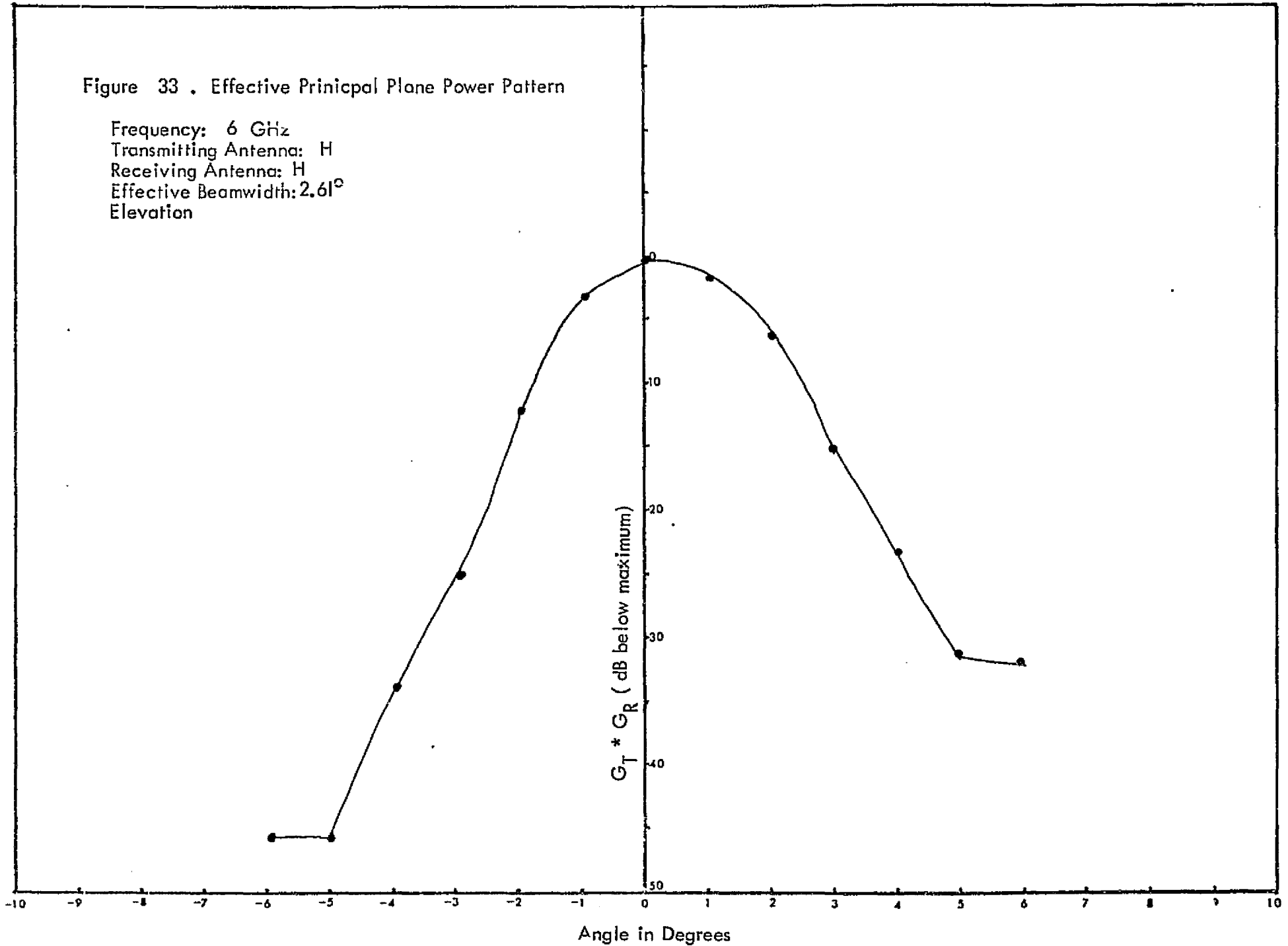

Figure 34 . Effective Principal Plane Power Pattern

Frequency: 6 GHz  
Transmitting Antenna: H  
Receiving Antenna: H  
Effective Beamwidth:  $2.54^\circ$   
Azimuth

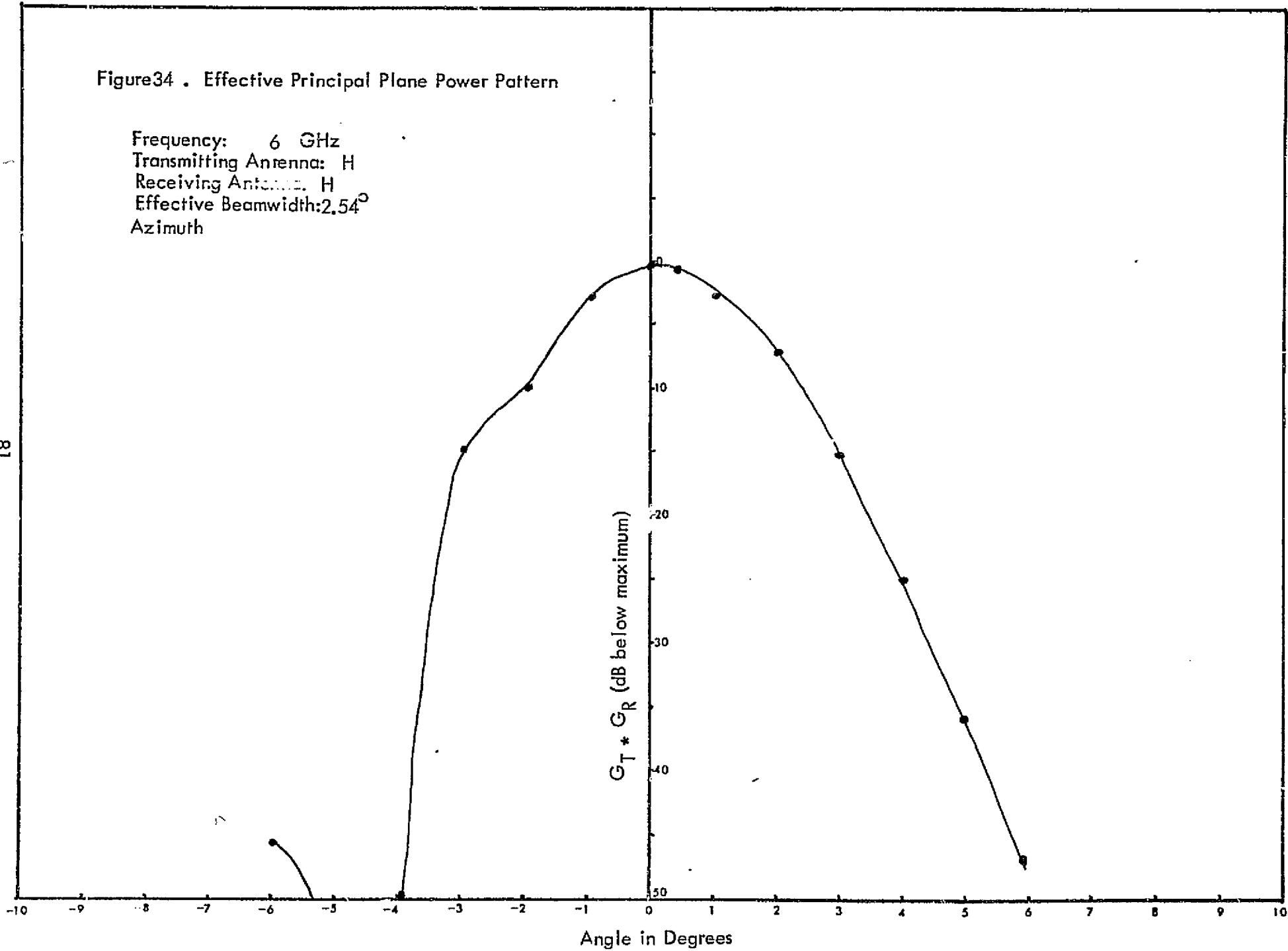

Figure 35 . Effective Principal Plane Power Pattern

Frequency: 6 GHz  
Transmitting Antenna: H  
Receiving Antenna: V  
Effective Beamwidth:  $2.51^\circ$   
Elevation

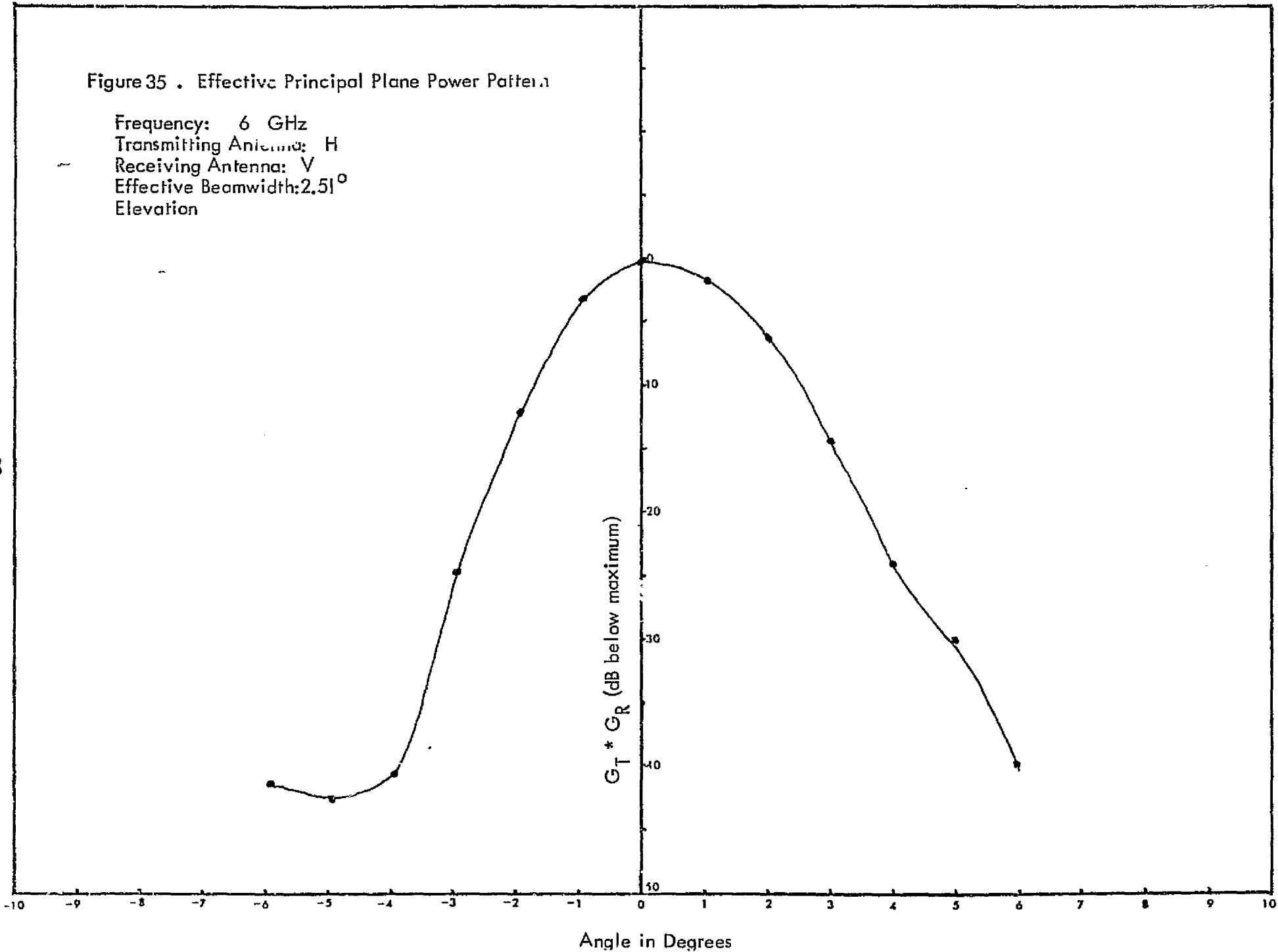

Figure 36 . Effective Principal Plane Power Pattern

Frequency: 6 GHz  
Transmitting Antenna: H  
Receiving Antenna: V  
Effective Beamwidth:  $2.4^\circ$   
Azimuth

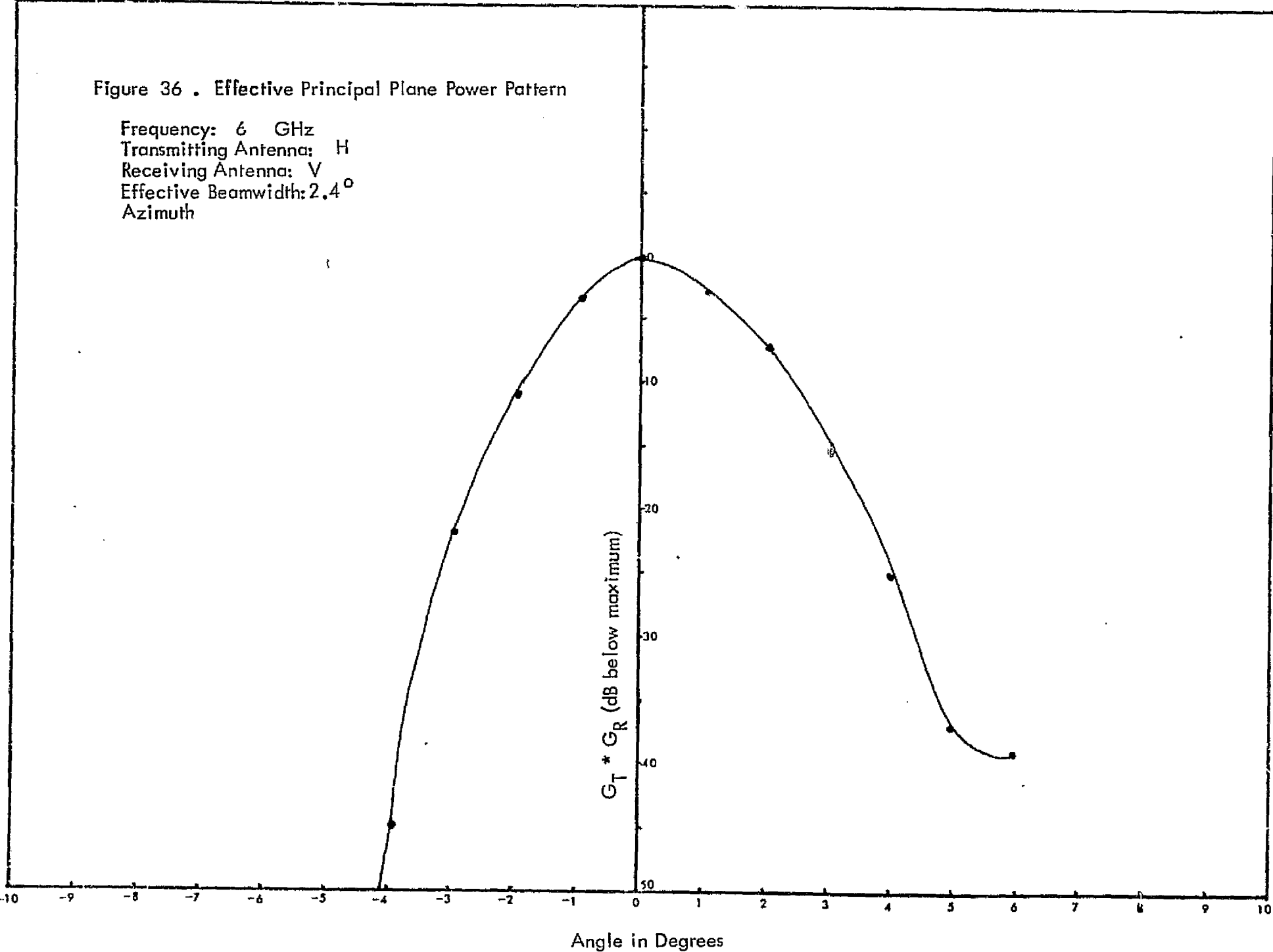

Figure 37 . Effective Principal Plane Power Pattern

Frequency: 7 GHz  
Transmitting Antenna: H  
Receiving Antenna: H  
Effective Beamwidth:  $2.60^\circ$   
Elevation

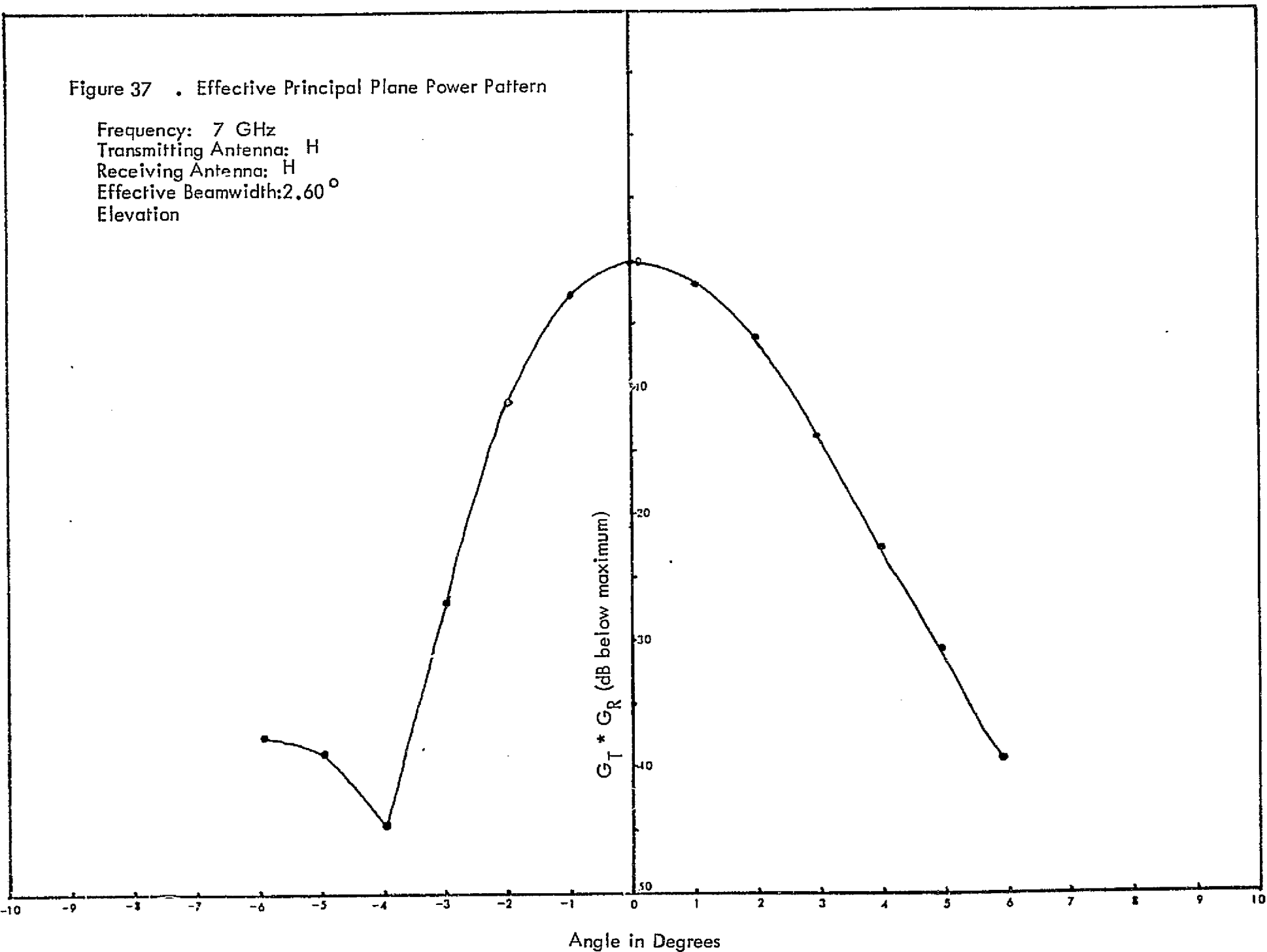



Figure 38 . Effective Principal Plane Power Pattern

Frequency: 7 GHz  
Transmitting Antenna: H  
Receiving Antenna: H  
Effective Beamwidth:  $2.27^\circ$   
Azimuth

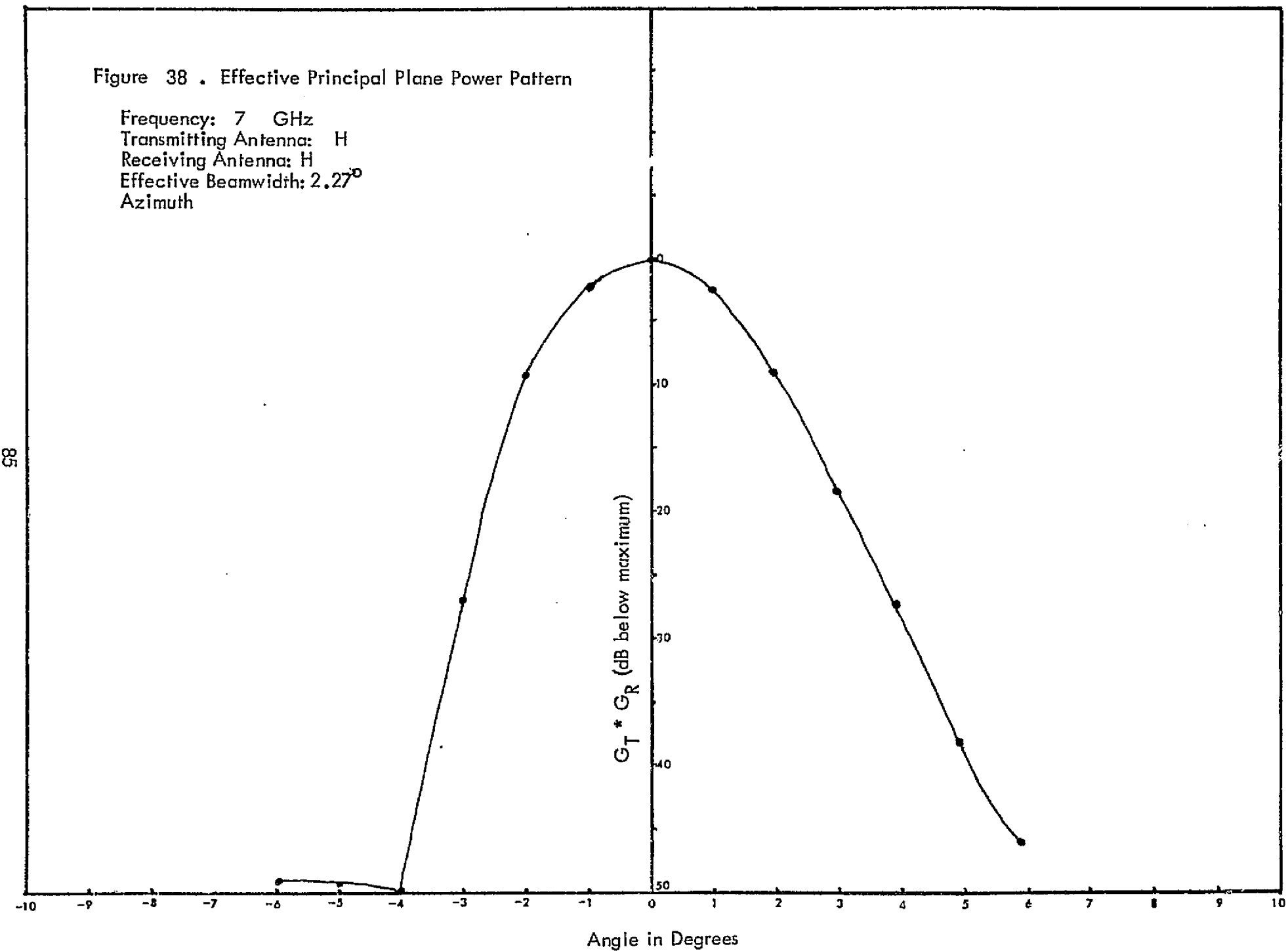

Figure 39 . Effective Principal Plane Power Pattern

Frequency: 7 GHz  
Transmitting Antenna: H  
Receiving Antenna: V  
Effective Beamwidth:  $2.37^\circ$   
Elevation

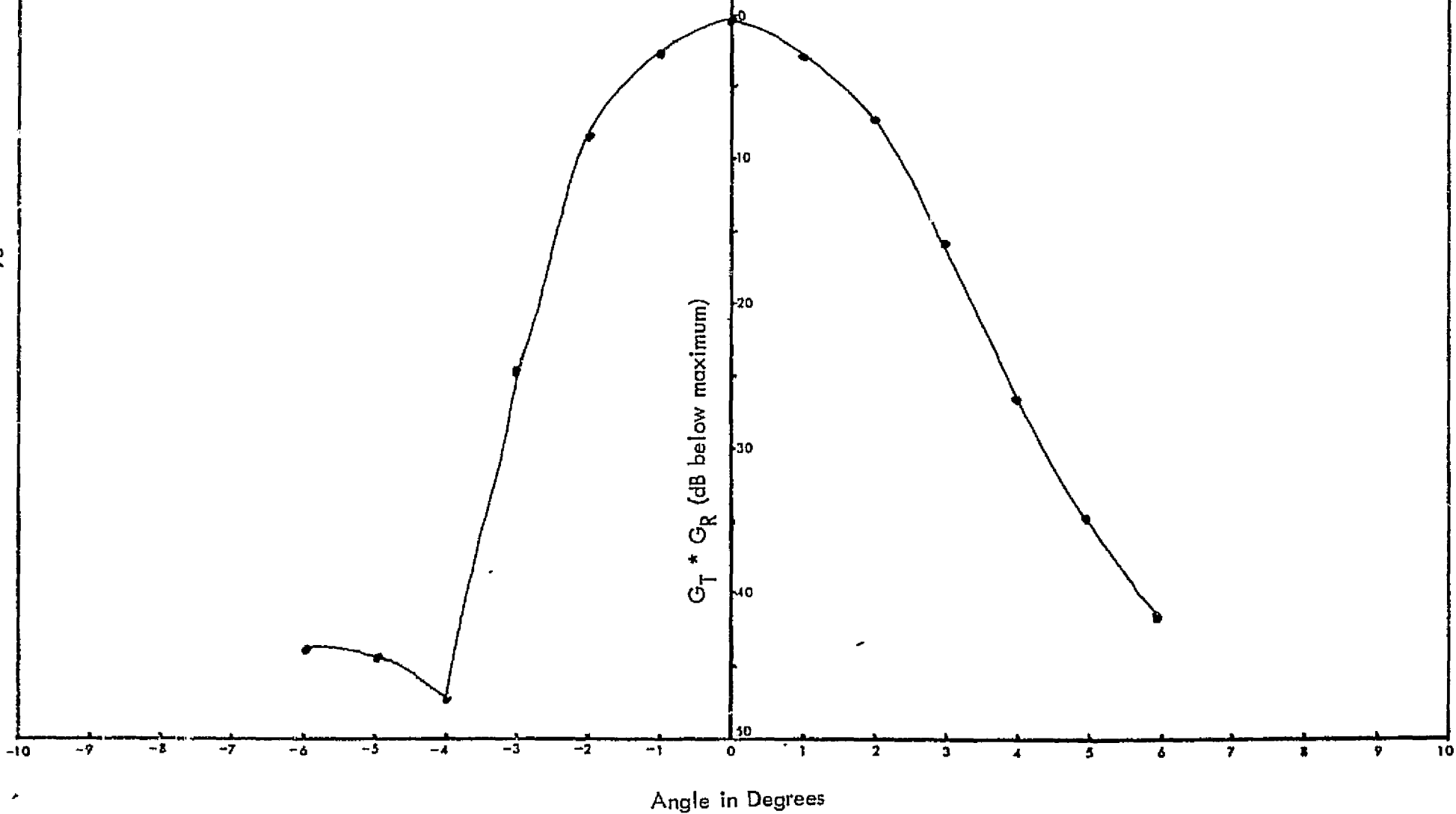

Figure 40. Effective Principal Plane Power Pattern

Frequency: 7 GHz  
Transmitting Antenna: H  
Receiving Antenna: V  
Effective Beamwidth:  $2.24^\circ$   
Azimuth

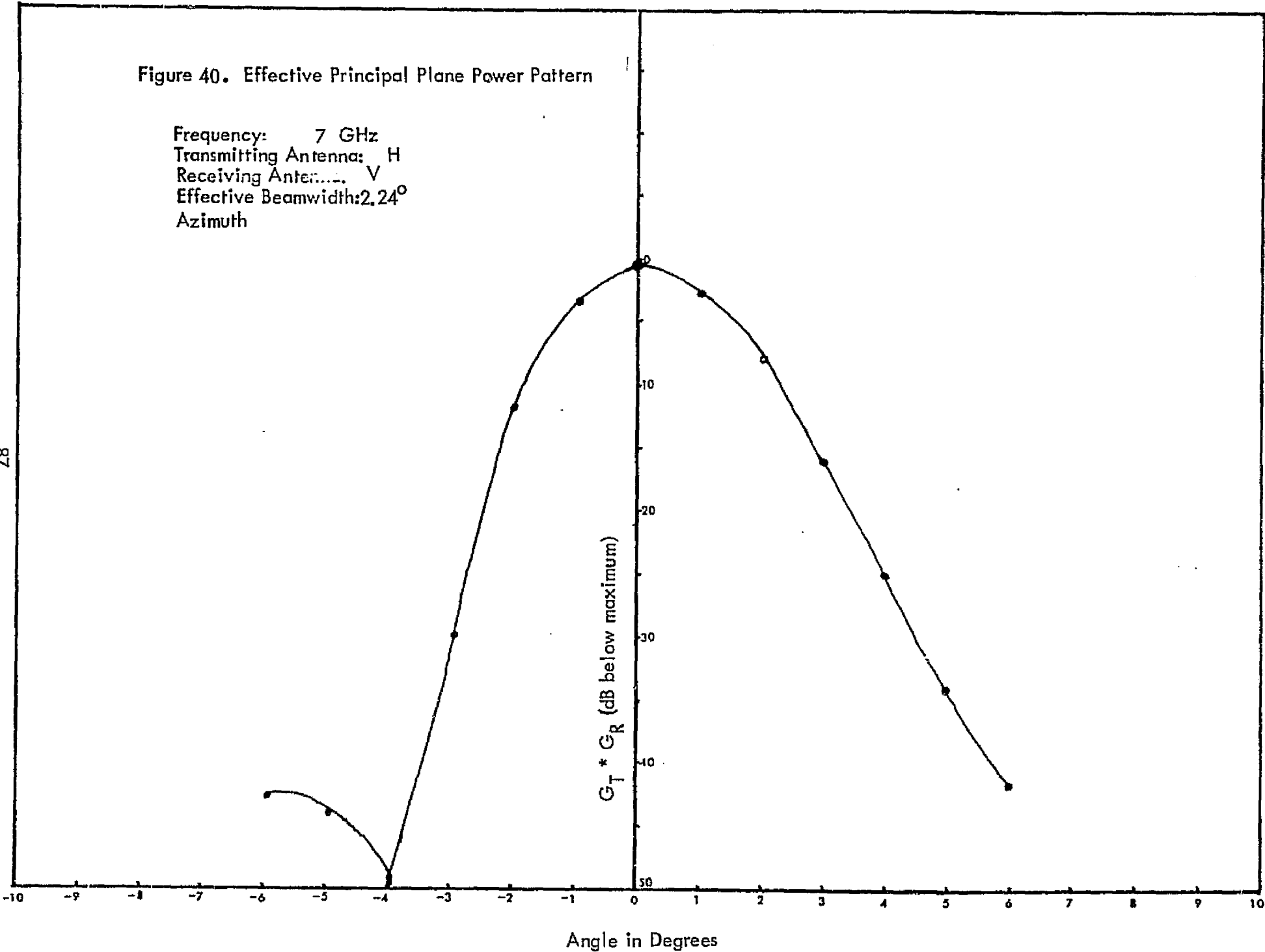

Figure 41. Effective Principal Plane Power Pattern

Frequency: 8 GHz  
Transmitting Antenna: H  
Receiving Antenna: H  
Effective Beamwidth:  $2.3^\circ$   
Elevation

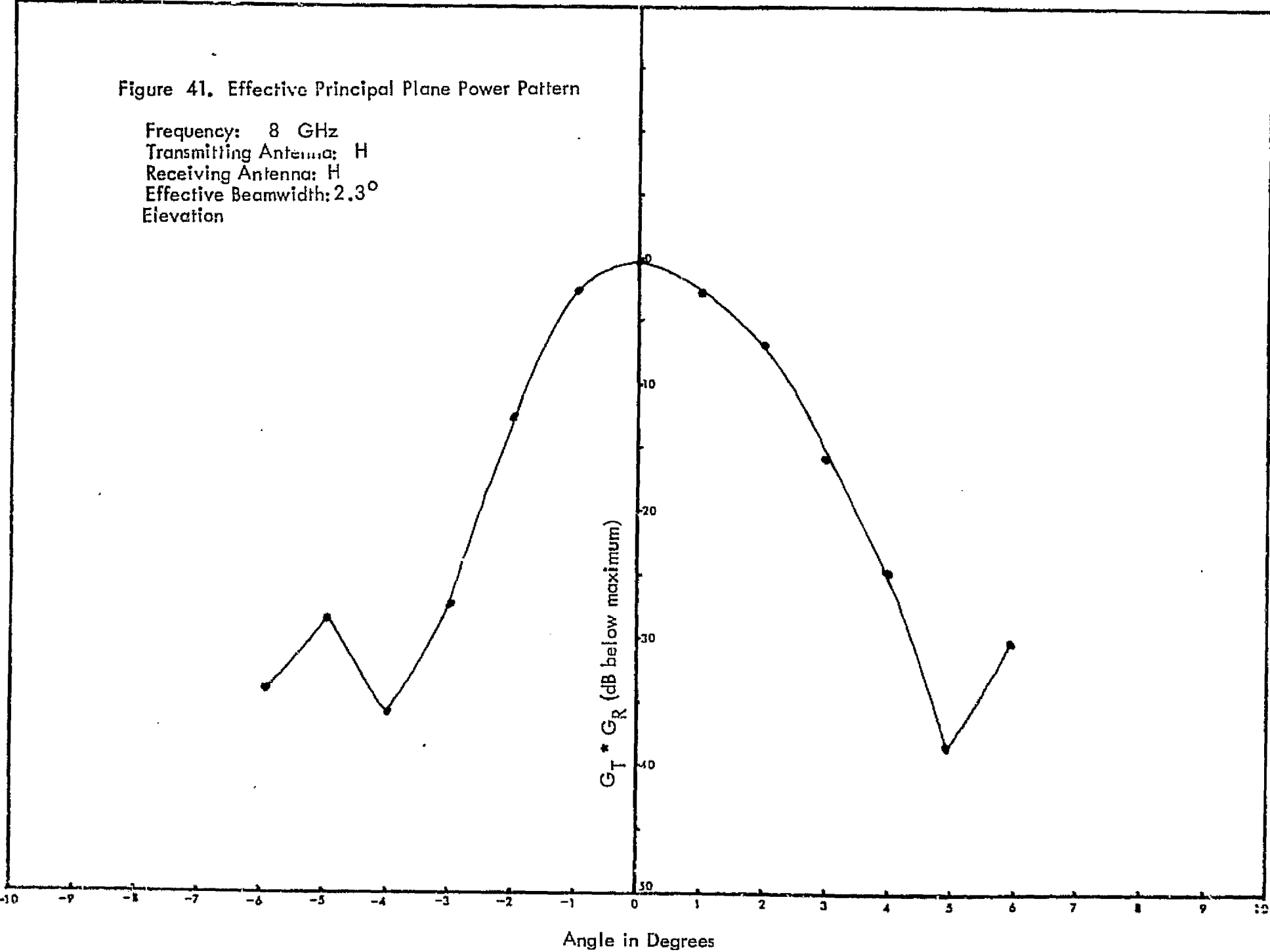

Figure 42 . Effective Principal Plane Power Pattern

Frequency: 8 GHz  
Transmitting Antenna: H  
Receiving Antenna: H  
Effective Beamwidth: 2.04°  
Azimuth

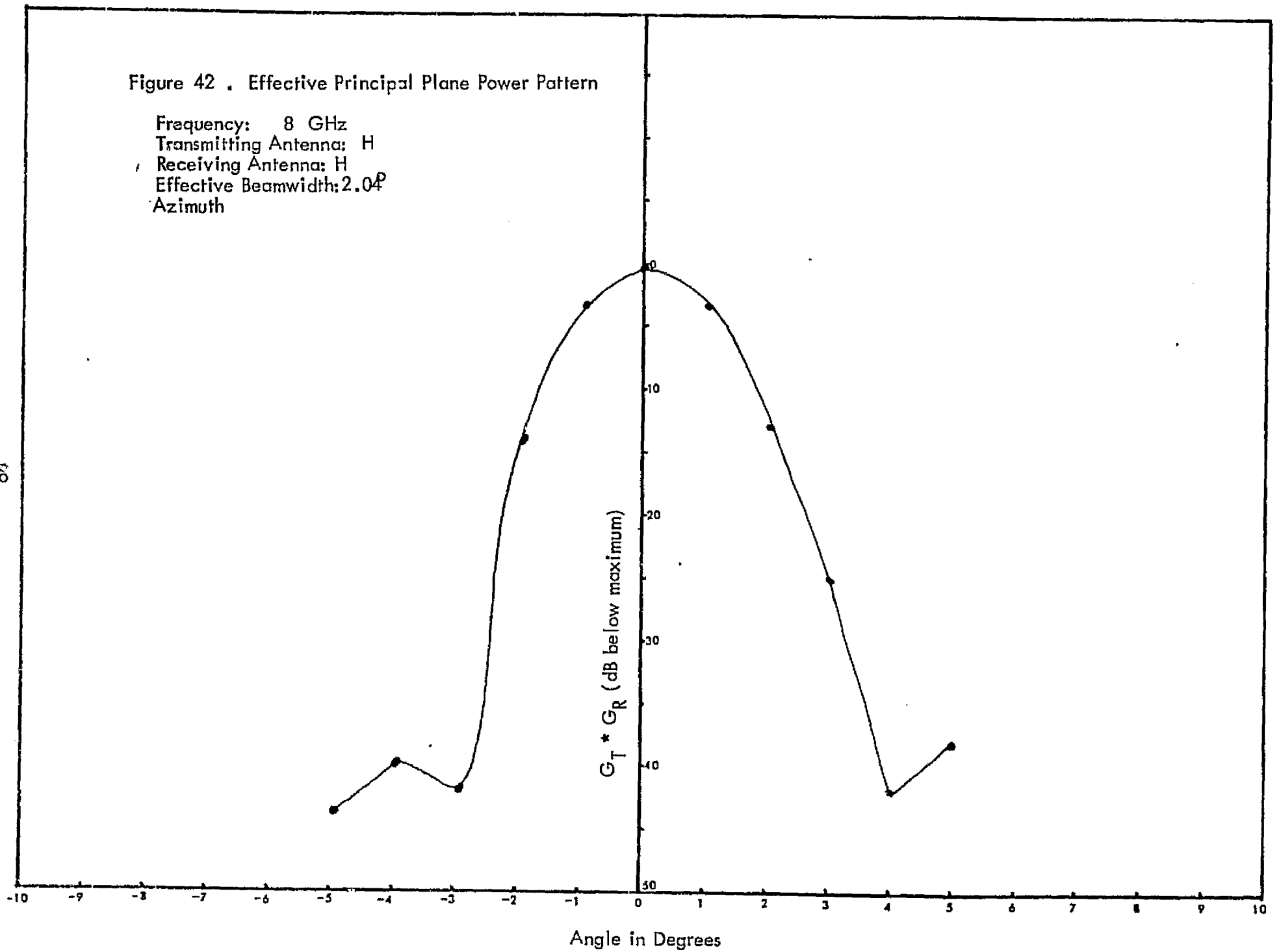

Figure 43 . Effective Principal Plane Power Pattern

Frequency: 8 GHz  
Transmitting Antenna: H  
Receiving Antenna: V  
Effective Beamwidth:  $2.245^\circ$   
Elevation

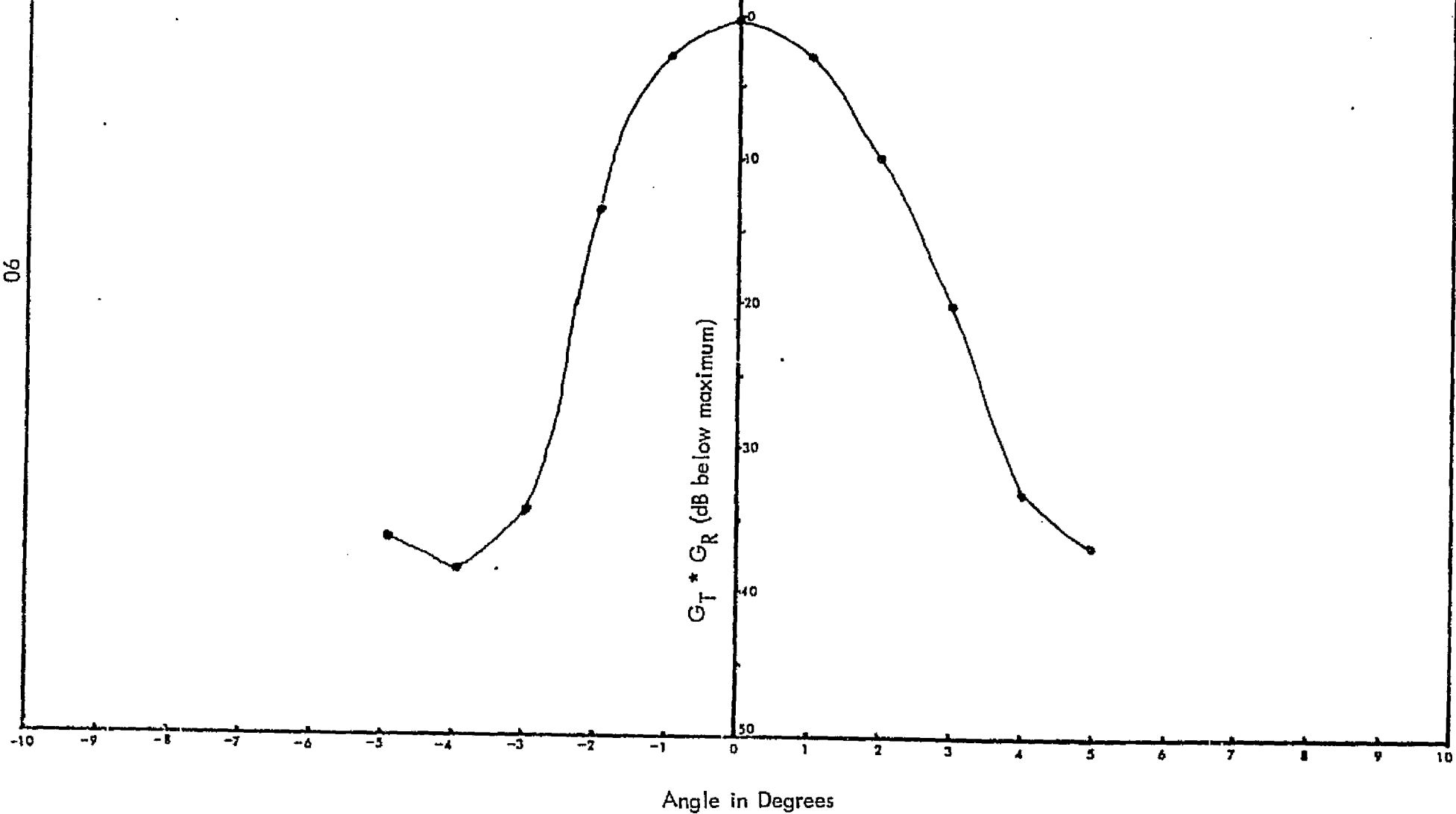

Figure 44 . Effective Principal Plane Power Pattern

Frequency: 8 GHz  
Transmitting Antenna: H  
Receiving Antenna: V  
Effective Beamwidth:  $2.2^\circ$   
Azimuth

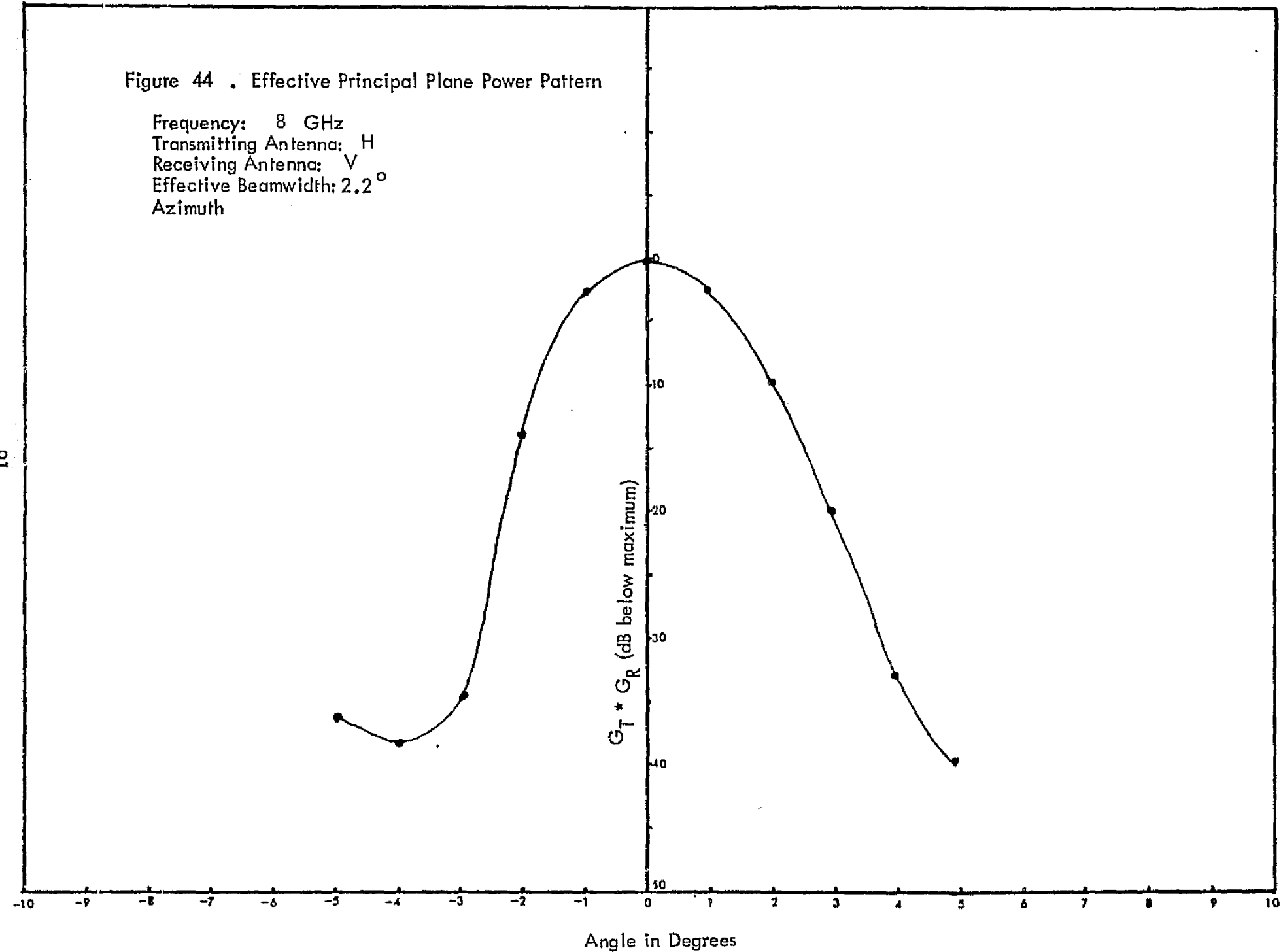

Figure 45. Effective Beamwidth vs. Frequency

Transmit Antenna: H  
Receive Antenna: H  
Elevation

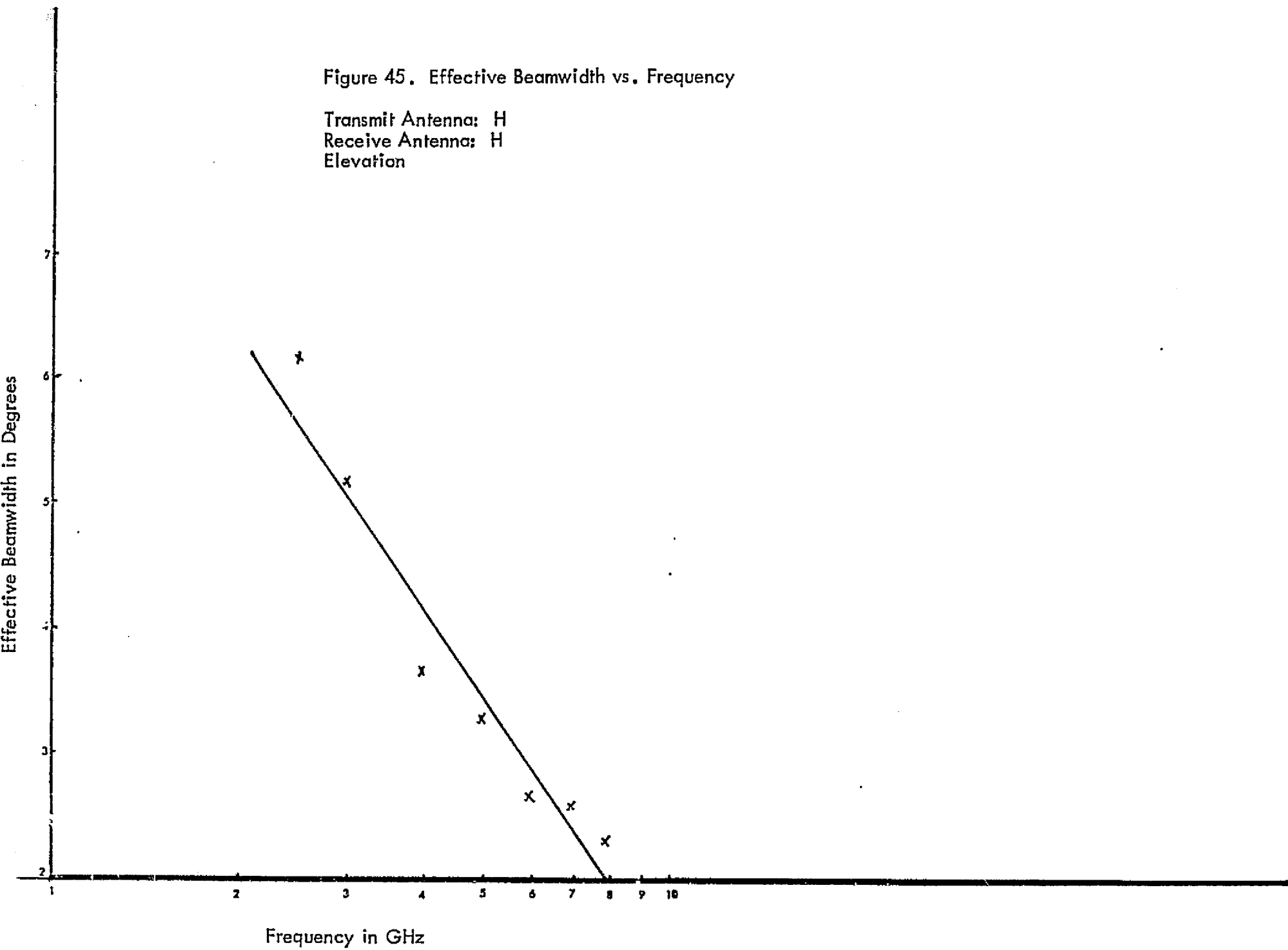



Figure 46. Effective Beamwidth vs. Frequency

Transmit Antenna: H  
Receive Antenna: H  
Azimuth

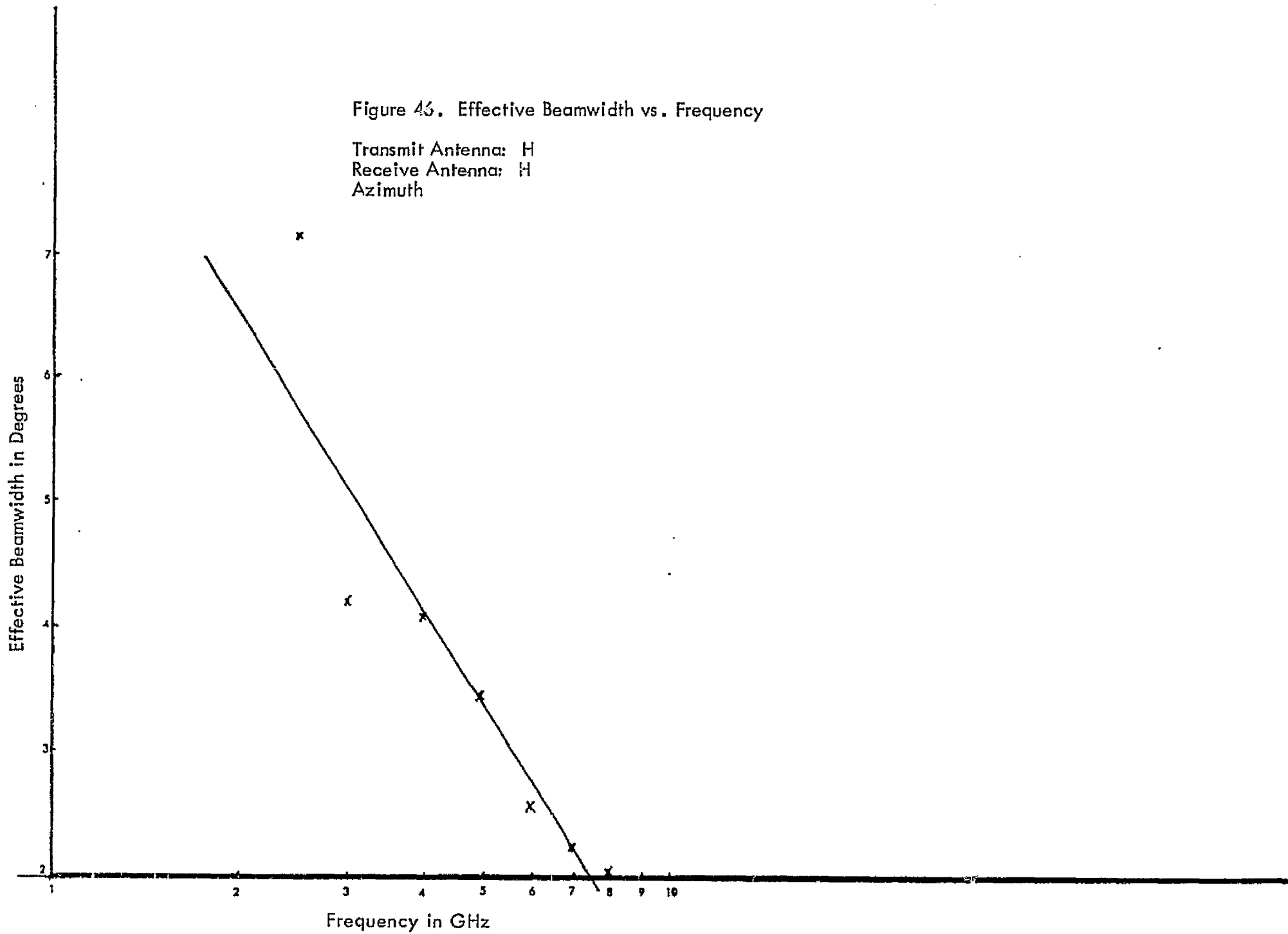
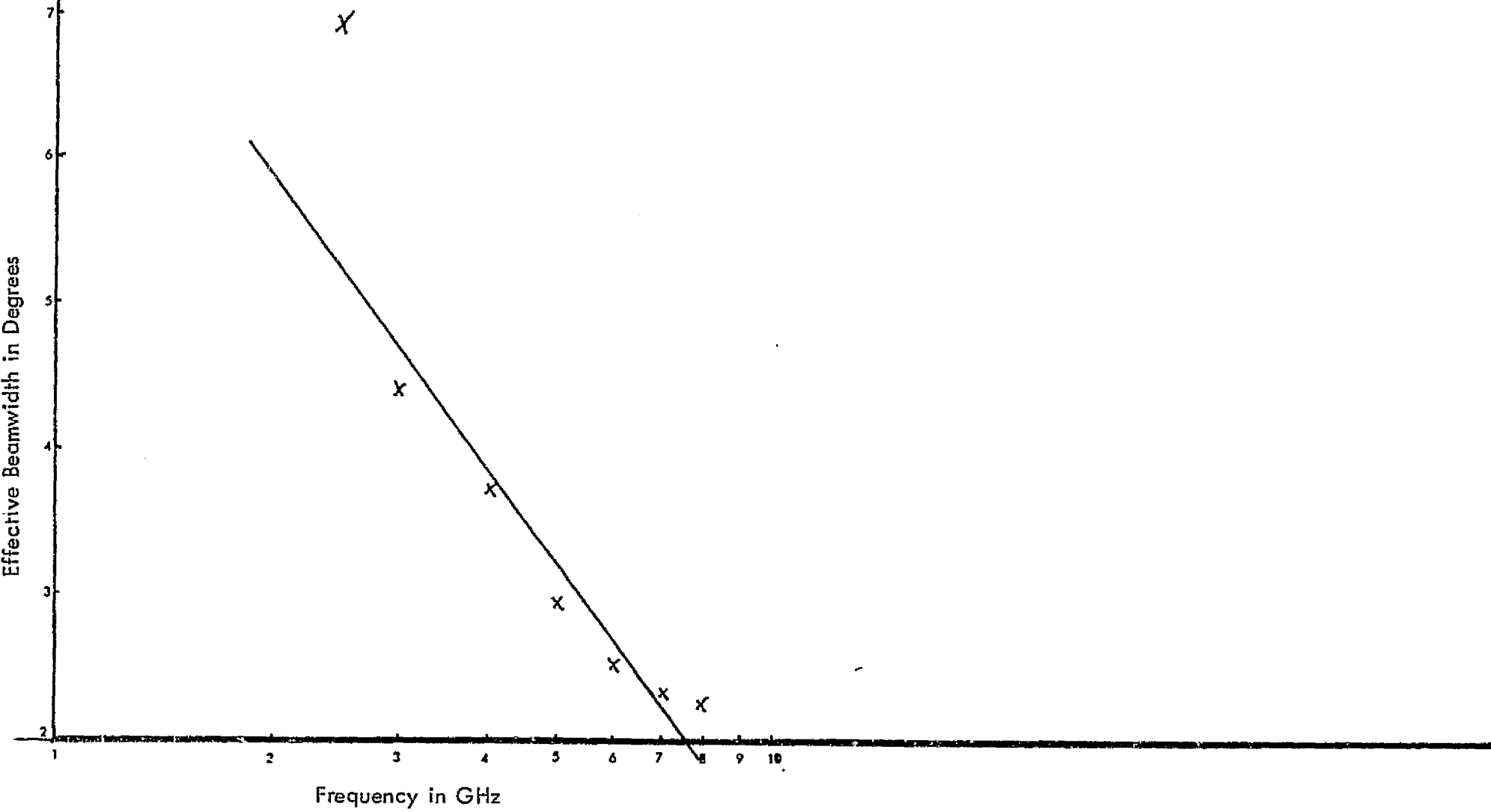

Figure 47. Effective Beamwidth vs. Frequency

Transmit Antenna: H  
Receive Antenna: V  
Elevation



M-7

Figure 48. Effective Beamwidth vs. Frequency

Transmit Antenna: H  
Receive Antenna: V  
Azimuth

Effective Beamwidth in Degrees

7  
6  
5  
4  
3  
2

1 2 3 4 5 6 7 8 9 10

Frequency in GHz

x

x

x

x

x

x

x

x

APPENDIX 6  
SYSTEM CALIBRATION DATA

The following graphs were used in conjunction with the antenna patterns in Appendix 5 to calibrate the system against a Luneberg lens. The delay line attenuation (Figure 49) was used to estimate dynamic range of the system by adding attenuation to the delay line until the noise level was reached. The bandpass filter characteristics (Figure 50) determine when the filter will limit the antenna beamwidth determined from the patterns in Appendix 5. The RMS/DC linearity (Figure 51) places a maximum on the dynamic range of the system without changing the IF gain.

FIGURE 49.  
Delay Line Loss vs. Frequency

