

NASA TECHNICAL NOTE



NASA TN D-8027 C.1

NASA TN D-8027

2. 2/24

LOAN COPY: RETURN TO
AFWL TECHNICAL LIBRARY
KIRTLAND AFB, NM



4. FLIGHT EVALUATION OF THE M2-F3
LIFTING BODY HANDLING QUALITIES
AT MACH NUMBERS FROM 0.30 TO 1.61

Robert W. Kempel, William H. Dana, and Alex G. Sim

Flight Research Center

Edwards, Calif. 93523



3. NATIONAL AERONAUTICS AND SPACE ADMINISTRATION • WASHINGTON, D. C. • JULY 1975

5.



0133863

1. Report No. NASA TN D-8027	2. Government Accession No.	3. Recipient's Catalog No.	
4. Title and Subtitle FLIGHT EVALUATION OF THE M2-F3 LIFTING BODY HANDLING QUALITIES AT MACH NUMBERS FROM 0.30 TO 1.61		5. Report Date July 1975	6. Performing Organization Code
7. Author(s) Robert W. Kempel, William H. Dana, and Alex G. Sim		8. Performing Organization Report No. H-852	
9. Performing Organization Name and Address NASA Flight Research Center P. O. Box 273 Edwards, California 93523		10. Work Unit No. 521-71-01	11. Contract or Grant No.
12. Sponsoring Agency Name and Address National Aeronautics and Space Administration Washington, D. C. 20546		13. Type of Report and Period Covered Technical Note	
15. Supplementary Notes		14. Sponsoring Agency Code	
16. Abstract <p>Percentage distributions of 423 pilot ratings obtained from 27 flights are used to indicate the general level of handling qualities of the M2-F3 lifting body. Eighty percent of the ratings were 3.5 or better, and 20 percent were 4.0 to 7.0. Percentage distributions are compared on the basis of longitudinal and lateral-directional handling qualities, control system, control system status, and piloting task. Ratings of longitudinal handling qualities at low speed (subsonic configuration) were slightly better than those for transonic and supersonic speed (transonic configuration); however, the ratings of lateral-directional handling qualities were unaffected by speed and configuration.</p> <p>Specific handling qualities problems are discussed in detail, and comparisons are made with pertinent handling qualities criteria.</p>			
17. Key Words (Suggested by Author(s)) Handling qualities Lifting bodies Stability and control		18. Distribution Statement Unclassified - Unlimited	
19. Security Classif. (of this report) Unclassified		20. Security Classif. (of this page) Unclassified	21. No. of Pages 43
		22. Price* \$3.75	
Category: 08			

FLIGHT EVALUATION OF THE
M2-F3 LIFTING BODY HANDLING QUALITIES AT
MACH NUMBERS FROM 0.30 TO 1.61

Robert W. Kempel, William H. Dana, and Alex G. Sim
Flight Research Center

INTRODUCTION

The National Aeronautics and Space Administration and the U.S. Air Force jointly investigated the flight characteristics of several lifting body configurations to develop a reentry vehicle that could be maneuvered along a variety of atmospheric entry paths. The first configuration tested in flight was the lightweight M2-F1 (ref. 1). These tests were followed by flights of the heavyweight M2-F2 (refs. 2 and 3), the HL-10 (ref. 4), and the X-24A (ref. 5) lifting bodies at subsonic, transonic, and low supersonic speeds.

The M2-F2 lifting body was extensively damaged during a gear-up landing. The vehicle was rebuilt and a fixed center fin was added. The modified vehicle was designated the M2-F3.

Twenty-seven flights were made in the M2-F3 flight test program. The numbering sequence of the flights began with flight 17. (Flight 16 was the last M2-F2 flight.) During the program, the M2-F3 reached a maximum Mach number of 1.61 and a maximum altitude of 21 794 meters (71 501 feet).

This report discusses the M2-F3 handling qualities in general and the longitudinal and lateral-directional handling qualities in detail. Comparisons are made between the stability and control characteristics of the basic unaugmented vehicle and the augmented vehicle (stability augmentation and command augmentation systems on). Pilot ratings of the vehicle's handling qualities during specific tasks are given together with pilot comments. Flight stability and control characteristics determined from the data of reference 6 are compared with pilot evaluations where possible.

SYMBOLS

Physical quantities in this report are given in the International System of Units (SI) and parenthetically in U.S. Customary Units. All measurements were taken in U.S. Customary Units. Conversion factors are included in reference 7.

a_n	normal acceleration, g
a_y	lateral acceleration, g
b	reference body span, m (ft)
C_ℓ	rolling-moment coefficient, $\frac{\text{Rolling moment}}{\bar{q}Sb}$
$C_{\ell\delta_a}$	aileron-effectiveness parameter, $\frac{\partial C_\ell}{\partial \delta_a}$, per deg
C_m	pitching-moment coefficient, $\frac{\text{Pitching moment}}{\bar{q}S\bar{c}}$
$C_{m\alpha}$	longitudinal static stability parameter, $\frac{\partial C_m}{\partial \alpha}$, per deg
C_n	yawing-moment coefficient, $\frac{\text{Yawing moment}}{\bar{q}Sb}$
$C_{n\delta_a}$	yawing moment due to aileron parameter, $\frac{\partial C_n}{\partial \delta_a}$, per deg
\bar{c}	reference longitudinal length, m (ft)
F_{es}	longitudinal stick force, N (lb)
h	altitude, m (ft)
K_p	roll stability augmentation system gain, deg/deg/sec
K_{p_c}	roll command augmentation system gain, deg/deg/sec
K_q	pitch stability augmentation system gain, deg/deg/sec

K_{q_c}	pitch command augmentation system gain, deg/deg/sec
K_r	yaw stability augmentation system gain, deg/deg/sec
K_{stick}	side stick gain, deg/sec/deg
K_α	angle-of-attack hold gain, deg/deg
L_{δ_a}	dimensionalized aileron-effectiveness parameter, $\frac{\bar{q} S b}{\text{Rolling moment of inertia}} C_{l_{\delta_a}}, \text{ per sec}^2$
M	Mach number
p	roll rate, deg/sec
q	pitch rate, deg/sec
\bar{q}	dynamic pressure, hN/m ² (lb/ft ²)
r	yaw rate, deg/sec
S	reference planform area, m ² (ft ²)
s	Laplace transform operator, rad/sec
t	time, sec
V	velocity, m/sec (ft/sec)
α	angle of attack, deg or rad
β	angle of sideslip, deg
δ_a	aileron deflection, $\delta_{u_{left}} - \delta_{u_{right}}$, deg
δ_{es}	longitudinal stick deflection, cm (in.)
δ_ℓ	lower flap deflection, deg
$\delta_{\ell s}$	lateral stick deflection, cm (in.)
δ_r	rudder deflection, $\delta_{r_{left}} + \delta_{r_{right}}$, deg
δ_{rp}	rudder pedal deflection, cm (in.)

δ_{ses}	longitudinal side stick deflection, deg
δ_{sls}	lateral side stick deflection, deg
δ_u	upper flap position, $\frac{1}{2}(\delta_{u_{left}} + \delta_{u_{right}})$, deg
ζ_d	Dutch roll damping ratio
ζ_{RS}	roll-spiral damping ratio
ζ_{sp}	longitudinal short-period damping ratio
θ	pitch attitude angle, deg
τ_R	roll mode time constant, sec
ϕ	angle of bank, deg
$\left \frac{\phi}{\beta} \right $	bank-angle-to-sideslip-angle ratio of the Dutch roll mode
ω_d	damped natural Dutch roll mode frequency, rad/sec
ω_{n_d}	undamped natural Dutch roll mode frequency, rad/sec
$\omega_{n_{sp}}$	undamped natural longitudinal short-period mode frequency, rad/sec
ω_{RS}	undamped natural roll-spiral mode frequency, rad/sec

Subscripts:

av average

max maximum

SAS stability augmentation system

The sign convention used in this report to define the positive direction of forces, moments, velocities, angular displacements, and angular velocities is related to a right-hand orthogonal body fixed-axis system. The origin of this system is at the vehicle center of gravity. Positive directions, as viewed from the pilot's location, are forward, to the right, and down. Positive rotations are clockwise as viewed in the positive directions. By definition, right aileron and up normal acceleration are considered positive.

TEST VEHICLE

The M2-F3 vehicle (figs. 1(a) and 1(b)) is a 13° , blunt, half cone with a boat-tailed afterbody and three aft vertical fins. The vehicle was powered by a four-chambered XLR11 rocket engine. Each chamber produced approximately 9786 newtons (2200 pounds) of vacuum thrust. Liquid oxygen was used as the oxidizer and water alcohol as the propellant.

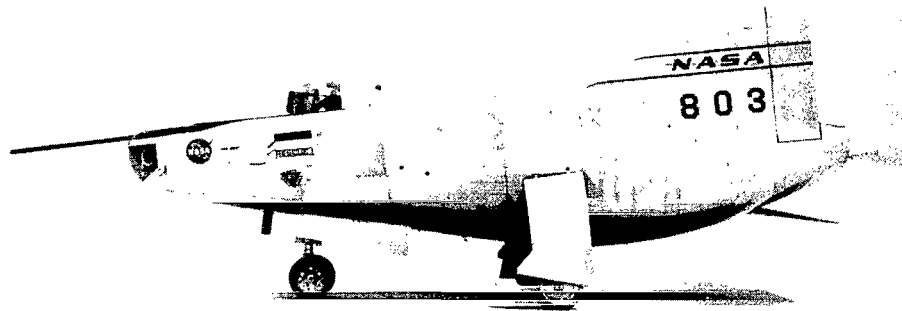

(a) Side view.

E-21535

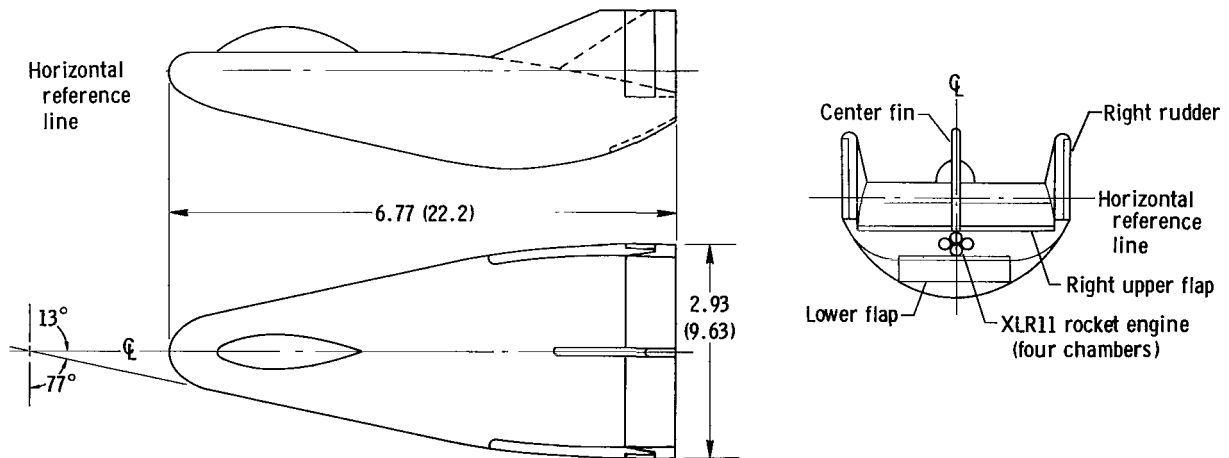

(b) Three-view drawing. Dimensions in meters (feet).

Figure 1. M2-F3 lifting body vehicle.

The physical characteristics of the vehicle are presented in table 1. Reference dimensions used in the data analysis are included in the table.

TABLE 1.- PHYSICAL CHARACTERISTICS OF M2-F3 VEHICLE

Body -	
Planform area, m ² (ft ²):	
Actual	14.49 (156.0)
Reference	14.86 (160.0)
Longitudinal length, m (ft):	
Actual and reference	6.77 (22.2)
Span, m (ft):	
Actual	2.93 (9.63)
Reference	3.03 (9.95)
Leading-edge sweep, deg	77
Lower flap -	
Area, m ² (ft ²)	1.42 (15.25)
Span, m (ft)	1.65 (5.42)
Chord, m (ft)	0.86 (2.81)
Design hinge moment, m-N (in-lb)	7570 (67 000)
Upper flaps, two -	
Area, each, m ² (ft ²)	0.85 (9.20)
Span, each, m (ft)	1.26 (4.21)
Chord, m (ft)	0.68 (2.23)
Design hinge moment, each, m-N (in-lb)	3390 (30 000)
Vertical stabilizers, two -	
Area, each, m ² (ft ²)	1.50 (16.10)
Height, trailing edge, m (ft)	1.16 (3.79)
Chord, m (ft):	
Root	2.24 (7.36)
Tip	0.79 (2.58)
Leading-edge sweep, deg	62.3
Center fin -	
Area, m ² (ft ²)	1.12 (12.02)
Height, trailing edge, m (ft)	1.26 (4.13)
Chord, m (ft):	
Root, at horizontal reference plane	1.59 (5.21)
Tip	0.30 (1.00)
Leading-edge sweep, deg	58
Rudders, two -	
Area, each, m ² (ft ²)	0.49 (5.27)
Span, each, m (ft)	1.28 (4.20)
Chord, m (ft)	0.38 (1.25)
Design hinge moment, each, m-N (in-lb)	2600 (23 000)
Center of gravity, reference -	
Decimal fraction of chord	0.496

Aerodynamic Control and Vehicle Configurations

Aerodynamic control was provided by a lower flap (pitch control), a differential upper flap (roll control), and rudders (on the outboard surfaces of the outboard vertical fins) (figs. 1 and 2). The rudders could be deflected in unison to serve as speed brakes. The center vertical fin was fixed.

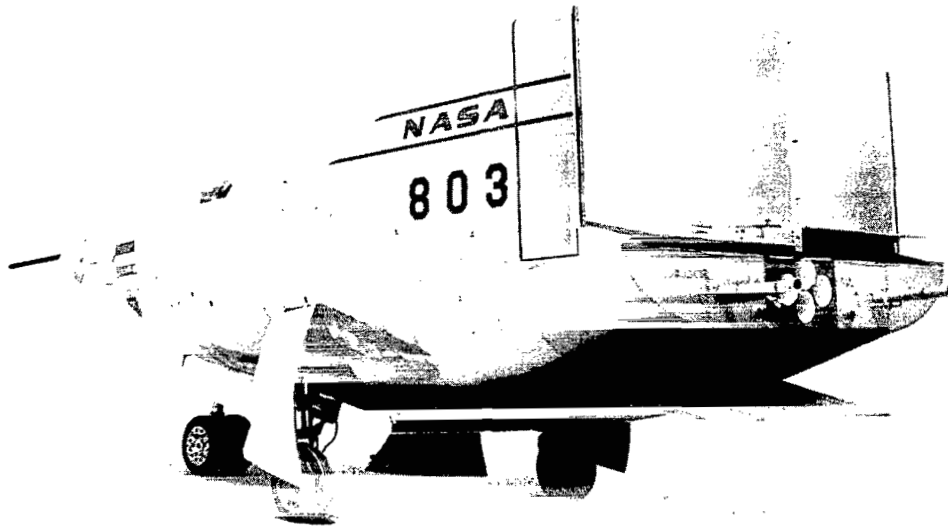

Figure 2. M2-F3 rear quarter view showing lower flap, upper flap, rudder, and fixed center fin. E-21533

Two vehicle upper flap configurations—transonic and subsonic—were used. The transonic configuration provided stability at transonic speeds; the subsonic configuration provided low drag (increased lift-to-drag ratio) for approach and landing. Upper-flap positions of -11.8° and -20° were used for the subsonic and transonic configurations, respectively.

Reaction Control Rocket System

In addition to the aerodynamic control surfaces, small hydrogen-peroxide-fueled rocket motors were installed to study their use as a means of vehicle control and damping augmentation in the atmosphere. This system consisted of four 400-newton- (90-pound-) thrust rockets which were fired in pairs. These rockets were on the aft base area of the vehicle.

FLIGHT CONTROL SYSTEM

The selection of M2-F3 flight control system characteristics was initially based on M2-F2 glide flight experience; however, extensive analysis of the M2-F3 vehicle was later required because of changes in aileron characteristics resulting from the fixed center fin and the rapid Mach envelope expansion planned for the vehicle.

Changes in control system characteristics were made by using a piloted hybrid simulation to verify optimum damper gains and compensation time constants. This simulation included rate and authority limits, a nonlinear longitudinal aerodynamic model, and a linear lateral-directional aerodynamic model. In addition to the piloted simulation, linear analyses, including root loci and time response, were performed before the first flight and during the flight test program as aerodynamic data were updated. Open- and closed-loop studies with various control systems, augmentation damper gains, compensation parameters, flight conditions, and aerodynamic derivative variations were made. Pilot evaluation of system stability and performance was the final criterion upon which parameter selection was based. The "best" estimate of the M2-F3 aerodynamic derivatives, mass characteristics, and open-loop dynamics is presented in reference 6.

Manual Controls

Primary system.—The characteristics of the center stick, rudder pedals, and corresponding control surfaces are presented in table 2. The pilot was provided with center stick and rudder pedal force feel by the use of coil-spring bungees, which provided force proportional to stick or rudder pedal position. Fine pitch trim was accomplished by biasing the center stick neutral no-load position of the coil-spring bungee to the desired commanded lower flap trim position. Roll trim was accomplished by biasing the individual upper flap aileron position.

TABLE 2.—CENTER STICK, RUDDER PEDAL, AND CONTROL SURFACE CHARACTERISTICS

Control	Authority, cm (in.)	Force gradient, N/cm (lb/in.)	Breakout force, N (lb)	Surface	Authority, deg	Gearing, deg/cm (deg/in.)	Rate limit, deg/sec
δ_{es}	12.19 (4.8) -10.92 (-4.3)	3.33 (1.9)	13.35 (3)	Lower flap	10 48.5	1.67 (4.23)	25
$\delta_{\ell s}$	$\pm 7.11 (\pm 2.8)$	7.88 (4.5)	5.56 (1.25)	Aileron	± 20	2.82 (7.15)	30
δ_{rp}	$\pm 11.18 (\pm 4.4)$	41.33 (23.6)	22.24 (5)	Rudder	± 4.5	0.40 (1.02)	22

The pilot made fine trim commands through a two-degree-of-freedom "beep" switch at the top of the center stick. Coarse longitudinal trim and configuration change were accomplished by means of a trim wheel on the left console which biased the upper flap. Rudder trim was through the rudder trim switch on the left console.

Secondary system.—Speed brake commands were made through a switch on the XLR11 rocket throttle handle. Maximum speed brake authority was 20° and

could be commanded from zero to maximum at approximately 2.9 degrees per second.

Two hydrogen-peroxide rockets were provided for use in landing the vehicle if energy became low during the final approach. Each of the rockets could provide approximately 2224 newtons (500 pounds) of thrust. The landing rockets were also controlled through a switch on the XLR11 rocket throttle handle.

The landing gear was deployed by pneumatic actuators controlled through a lever on the left of the instrument panel.

Cockpit displays.—The cockpit instrument display included indicators of air-speed, altitude, angle of attack, normal acceleration, and control surface position. A three-axis attitude indicator provided attitude and angle-of-sideslip information. Figures 3(a), 3(b), and 3(c) show the left console, instrument panel, and right console, respectively.

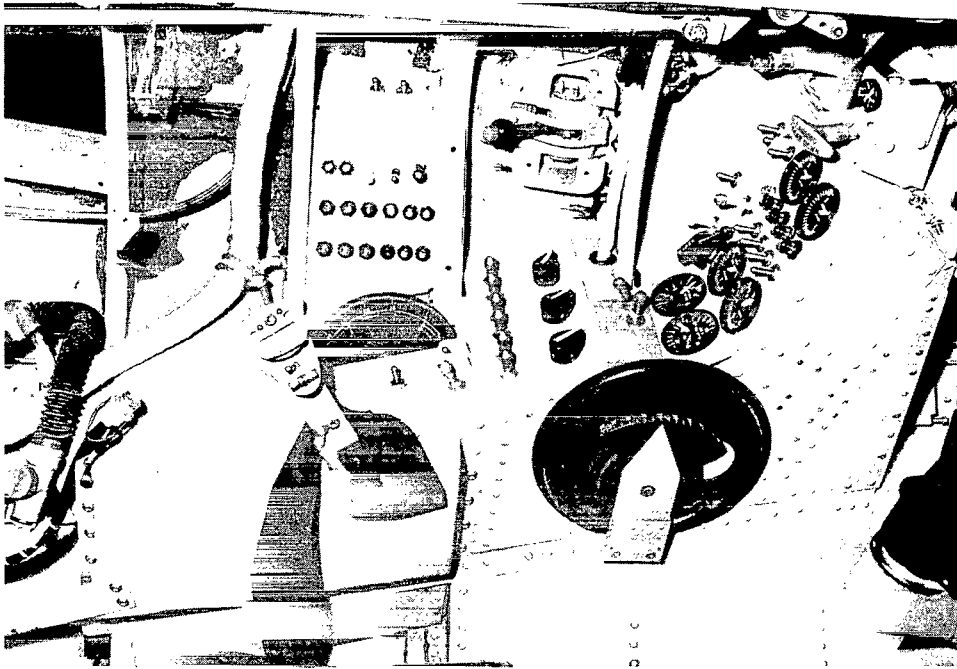

(a) Left console.

E-22387

Figure 3. Arrangement of M2-F3 cockpit controls.

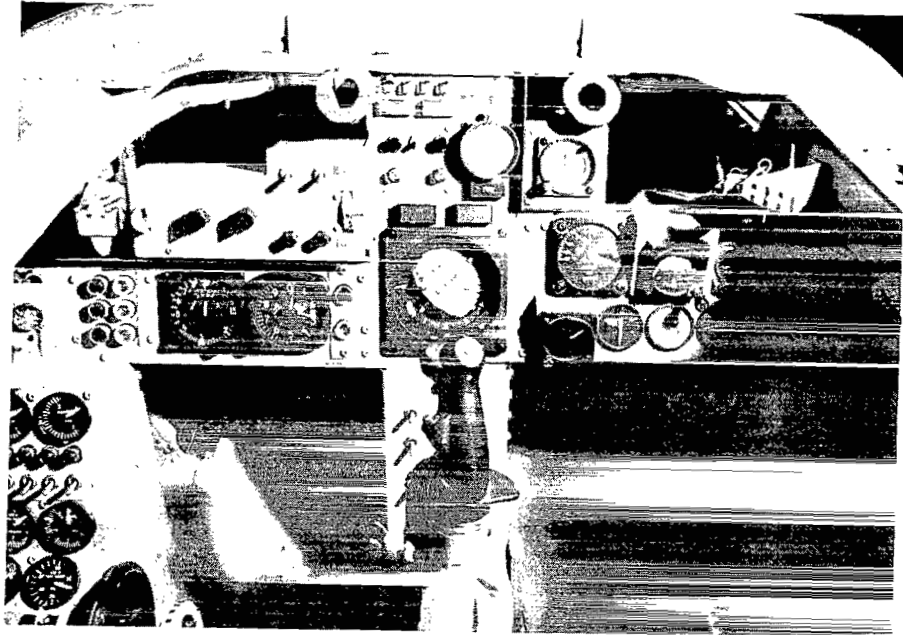

(b) Instrument panel.

E-25141

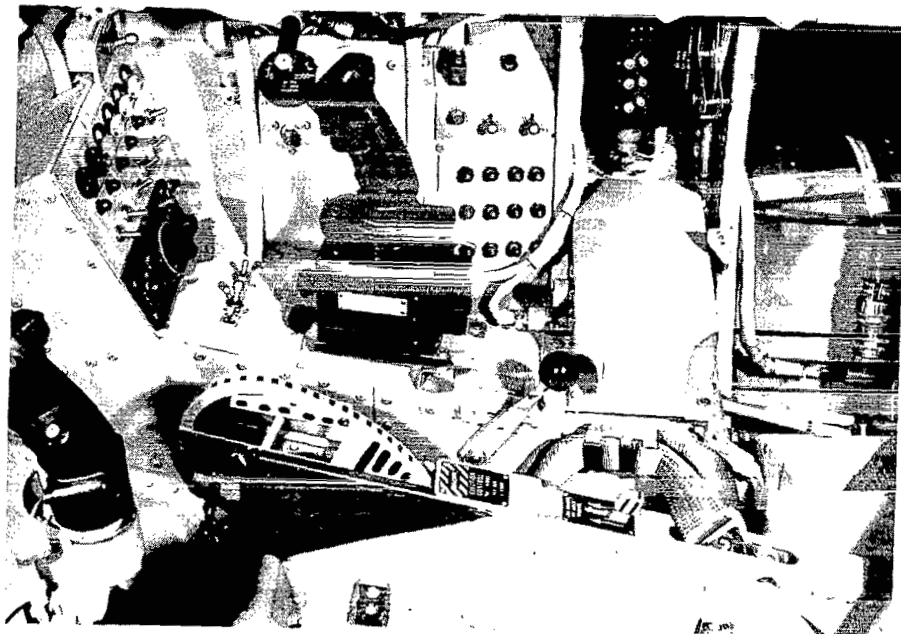

(c) Right console.

E-25140

Figure 3. Concluded.

Automatic Controls

Stability augmentation system.—A limited authority, rate feedback stability augmentation system (SAS) provided damping augmentation about all three axes. A simplified block diagram of the flight control system is shown in figure 4. The feedback signals were provided by conventional rate gyros. The pilot selected system gains ranging from 0 to 1 in increments of 0.1 in terms of degrees of surface deflection per degree per second of angular rate. The gains were fixed unless the pilot changed the position of the SAS control switch, which was on the left console in the cockpit (fig. 3(a)). The yaw rate signal was modified by an electronic high-pass (washout) filter so that the rudder returned to zero deflection as the yaw rate approached steady state. This kept constant-rate turns from being impeded by a SAS-commanded rudder input which would resist the steady yaw rate.

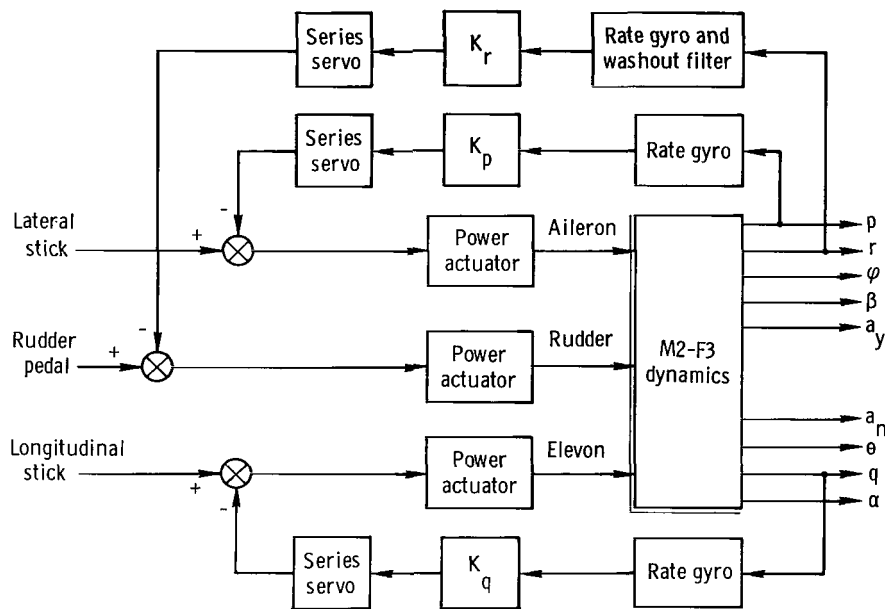

Figure 4. Simplified block diagram of M2-F3 flight control system.

Command augmentation system.—After flight 29 a rate command augmentation system (CAS) was added to the vehicle. A simplified block diagram of the system is shown in figure 5. This system made use of the basic M2-F3 control system hardware. Vehicle rate damping in the CAS mode was provided through the pitch and roll rate gyros and the existing SAS series servo actuators. Control was also provided through the limited authority SAS servos. To provide adequate longitudinal control over the entire range of angle of attack a trim follow-up system was installed. (CAS trim follow-up ranged from 0° to 52° of lower flap.) The CAS aileron authority was the same as the SAS aileron authority, $\pm 10^\circ$ or half the pilot authority

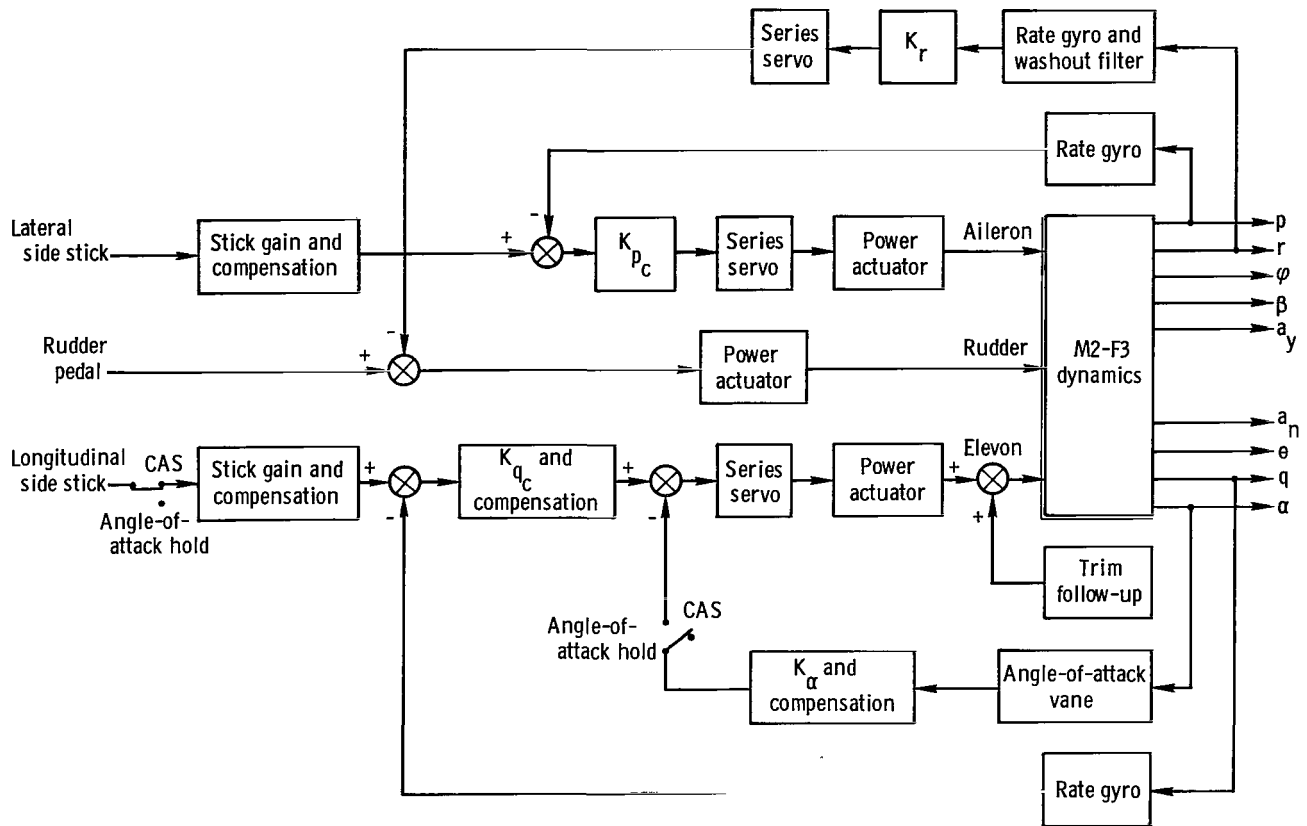

Figure 5. Simplified block diagram of M2-F3 command augmentation system. CAS engaged; angle-of-attack hold disengaged.

in the SAS mode. A selectable angle-of-attack hold mode was included as part of the CAS. Cockpit control of the CAS was through a side stick (table 3). The CAS was mechanized in the pitch and roll axes only.

TABLE 3.—SIDE STICK AND CONTROL SURFACE CHARACTERISTICS

Control	Authority, deg	Force gradient, N/deg (lb/deg)	Breakout force, N (lb)	Surface	Authority, deg	Gearing, deg of surface/deg of stick
δ_{ses}	± 25	1.21 (0.272)	9.31 (2.09)	Lower flap	∓ 7.5	0.3
δ_{sls}	± 30	1.31 (0.293)	6.46 (1.45)	Aileron	± 10	0.333

Figures 6(a), 6(b), and 6(c) illustrate the operation of the longitudinal SAS, CAS, and angle-of-attack hold modes, respectively. The SAS provided only angular rate damping, the CAS provided rate command and angular rate damping, and the angle-of-attack hold provided rate damping. With the CAS in operation, the cockpit angle-of-attack hold switch engaged, and the pilot's side stick in the centered

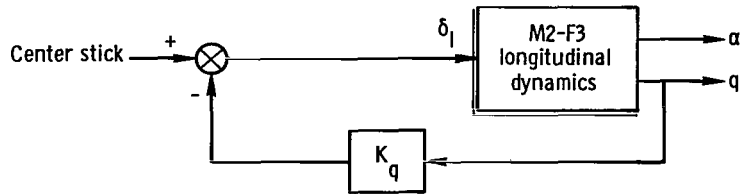

(a) SAS.

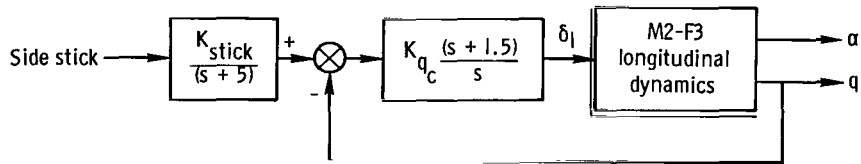

(b) CAS.

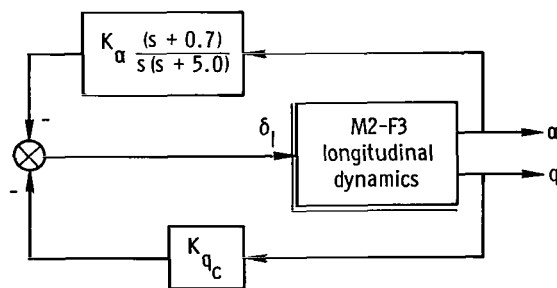

(c) Angle-of-attack hold.

Figure 6. Simplified block diagram of M2-F3 longitudinal control system modes.

position, constant angle of attack was maintained. The side stick was provided with a centered position detent so that when the stick was out of center, angle-of-attack hold was disengaged and a rate was commanded until some new angle of attack was reached. Centering the stick reengaged the angle-of-attack hold. If the hold was not desired, the cockpit switch was turned off and only rate command was operative. A vernier was provided in the form of a switch on the side stick so that angle of attack could be changed without taking the stick out of detent. Center stick control with the SAS could be regained at any time by disengaging the CAS switch on the instrument panel or on the center stick.

Reaction Control Rocket System

The four reaction control rockets were controlled either through the manual reaction control system (RCS) or the automatic rate feedback reaction augmentation system (RAS). From flight 23 to flight 29 the RCS and RAS were activated by the pilot (about the roll axis only) through a simple toggle switch on the right console. From flight 30 to flight 43 the pilot controlled the RCS through a side stick installed in the vehicle for use with the CAS. For these flights the system was mechanized to evaluate either the rolling or the pitching handling qualities, but not both. A simplified block diagram of the RCS and RAS mechanization is presented in figure 7.

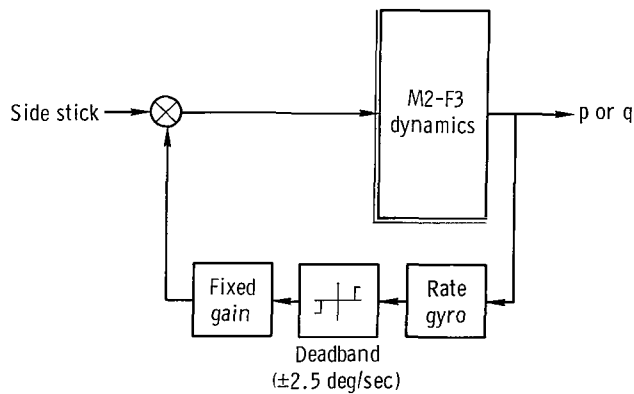
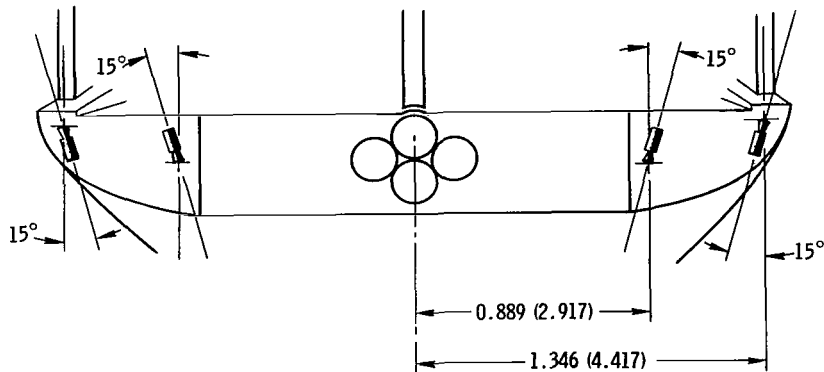

Figure 7. Simplified block diagram of M2-F3 pitch or roll RCS and RAS mechanization.

Two candidate rocket geometries (fig. 8) were established from wind-tunnel data on the basis of the yawing moment produced when the system was configured to control the roll axis. Roll control was achieved by using an outboard and opposite inboard rocket combination. The wind-tunnel data indicated that geometry 1 would provide proverse yaw during a roll maneuver; however, flight test results indicated that better handling qualities resulted when geometry 2, which was predicted to produce no yawing moment, was used. Geometry 2 was thus used throughout most of the M2-F3 program. All longitudinal evaluations were made

using geometry 2. Wind-tunnel and flight-determined reaction control rocket data are presented in reference 6.



(a) Geometry 1.

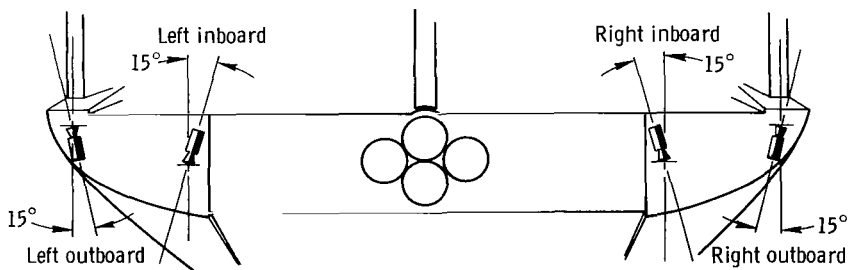

(b) Geometry 2.

Figure 8. M2-F3 reaction control rocket geometries. Dimensions in meters (feet).

FLIGHT TESTS

Flight Envelope

The approximate operational flight envelope of the M2-F3 vehicle is shown in figure 9 in terms of altitude and Mach number. The flight envelope was bounded at the bottom by the dynamic pressure structural limit of 191.5 hN/m^2 (400 lb/ft^2) and at the top by an estimated minimum stability and control effectiveness boundary of 23.95 hN/m^2 (50 lb/ft^2). The shaded area indicates the general envelope in which the M2-F3 was flown.

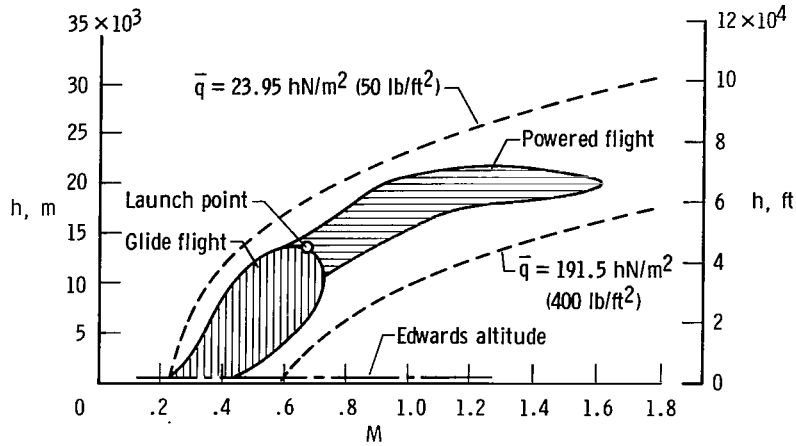

Figure 9. Approximate M2-F3 altitude and Mach number envelope.

Test Procedures

The M2-F3 vehicle was launched from a B-52 airplane at an altitude of approximately 13 720 meters (45 000 feet) and a Mach number of 0.67. Because of the extensive M2-F2 glide flight experience, only three glide flights were necessary for pilot checkout and to investigate the M2-F3 vehicle's aerodynamics with the center fin installed.

Figure 10 shows typical ground tracks for the terminal approach and landing pattern of an M2-F3 flight. During flight, ground radar tracked the vehicle and

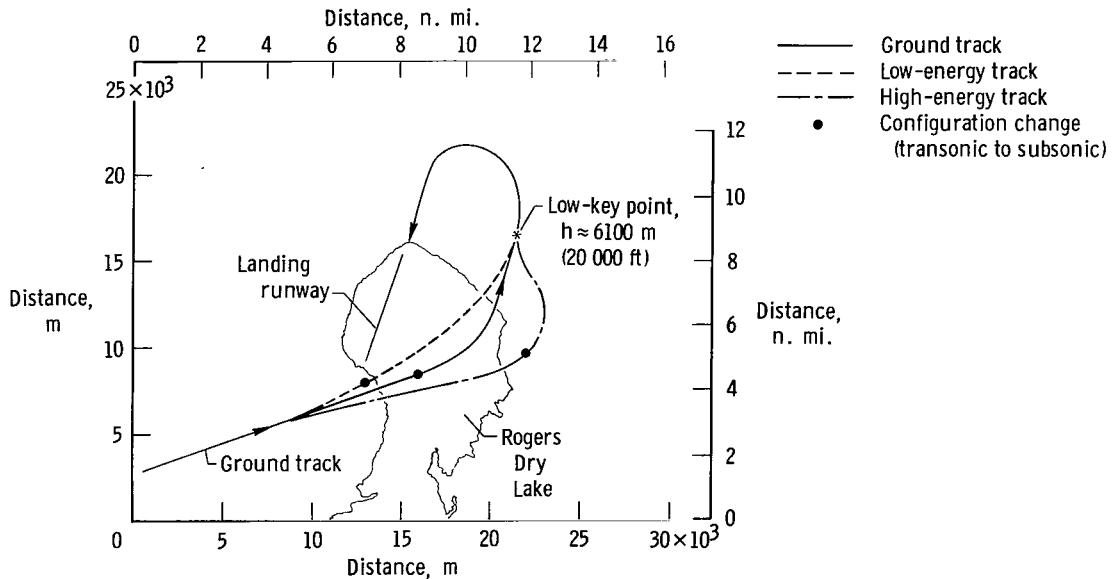

Figure 10. Typical M2-F3 flight ground tracks for the terminal approach and landing pattern.

provided mission control with ground track and altitude information. Deviations from the planned profile, because of such factors as high or low energy, were radioed to the pilot so he could take corrective action. The low-key point on the ground track was the point at which 180° were left to turn to final approach. As shown, low key occurred at an altitude of approximately 6100 meters (20 000 feet).

A typical powered flight (fig. 11) began with launch in the transonic configuration at an altitude of 13 720 meters (45 000 feet). The launch point was approximately 74 kilometers (40 nautical miles) southwest of Rogers Dry Lake. Ten seconds after launch, the vehicle was rotated to an angle of attack of 14° as the engine was ignited. Vehicle rotation was then continued to a pitch attitude of approximately 40° , which was held for 19 seconds. The vehicle climbed to an altitude of 16 150 meters (53 000 feet) and attained a Mach number of 0.82, where it was pushed over to 0° angle of attack and accelerated to Mach 1.36 at 94 seconds after launch. Maximum Mach number was reached at rocket engine burnout. Vehicle configuration change from transonic to subsonic occurred at approximately 255 seconds at Mach 0.6. At this point the pilot visually navigated to the downwind leg and into the landing pattern. The final phase of the flight was a 180° turn to the final approach and landing. The powered portion of the flight averaged 92 seconds and the unpowered portion averaged 301 seconds, for a total average flight time of 393 seconds.

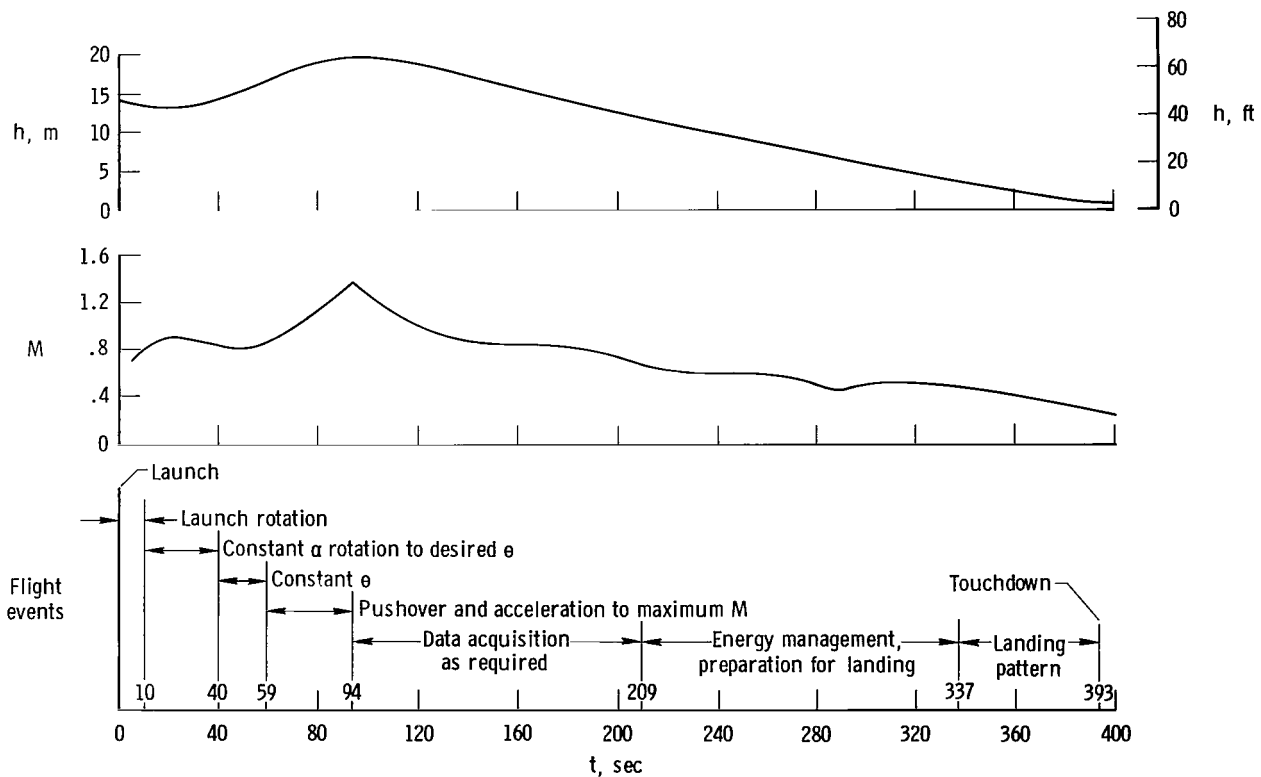

Figure 11. Typical M2-F3 powered flight profile.

Several landings were made at an alternate dry lake when conditions were unfavorable at Rogers Dry Lake. No problems were encountered on these landings.

PILOT RATINGS

The in-flight handling qualities of the M2-F3 vehicle were assessed by four research pilots. The pilots all had lifting body experience, although most of their experience was with fighter-type aircraft. On each flight the pilots were asked to evaluate selected maneuvers and tasks at specified angles of attack and Mach numbers. Some of the tasks were part of the basic flight profile, such as the powered boost, turns, and flare. Narrative and numerical evaluations of the vehicle's handling qualities and response characteristics were obtained immediately after each flight. The numerical pilot ratings were based on the modified Cooper-Harper rating scale (ref. 8) shown in table 4(a). Table 4(b) presents levels of flying qualities from Military Specification MIL-F-8785B (ref. 9). As shown, level 1 corresponds to pilot ratings from 1.0 to 3.5, level 2 from 3.5 to 6.5, and level 3 from 6.5 to 9.5. For comparison with the Military Specification the M2-F3 vehicle was considered to be a Class II vehicle, that is, a mediumweight aircraft with low-to-medium maneuverability. The flight phases considered to be applicable were nonterminal (Category B) and terminal (Category C). The nonterminal flight phase is defined as being normally accomplished by using gradual maneuvers with no precision tracking, although a requirement for accurate flightpath control may exist. A terminal flight phase is defined as being accomplished by using gradual maneuvers that usually require accurate flightpath control.

DISCUSSION

General Handling Qualities

Overall stability and control.—Figure 12 shows the percentage distribution of the 423 pilot ratings obtained during the 27 flights of the M2-F3 vehicle. The most frequently assigned rating of 3.0 constituted approximately 31 percent of those obtained. Eighty percent of the ratings were 3.5 or better; that is, the handling qualities were considered to be satisfactory without improvement. Twenty percent of the ratings were from 4.0 to 7.0. (Only one rating of 7.0 was given.)

Figures 13 and 14 present the percentage distribution of the pilot ratings of the longitudinal and lateral-directional handling qualities, respectively. The data are presented as an implicit function of speed, in that results are presented for both the subsonic and transonic configurations.

For the longitudinal handling qualities (figs. 13(a) and 13(b)) the ratings for the lower speeds (subsonic configuration) were slightly better than those for the transonic and supersonic speeds (transonic configuration). For the subsonic configuration 87.6 percent of the ratings were 3.5 or better, and for the transonic configuration 69.8 percent were 3.5 or better.

TABLE 4.—MODIFIED COOPER-HARPER HANDLING QUALITIES RATING SCALE AND MILITARY SPECIFICATION DEFINITION OF FLYING QUALITIES LEVELS

(a) Modified Cooper-Harper rating scale (from ref. 8)

(b) Military Specification definition of levels of flying qualities (from ref. 9)

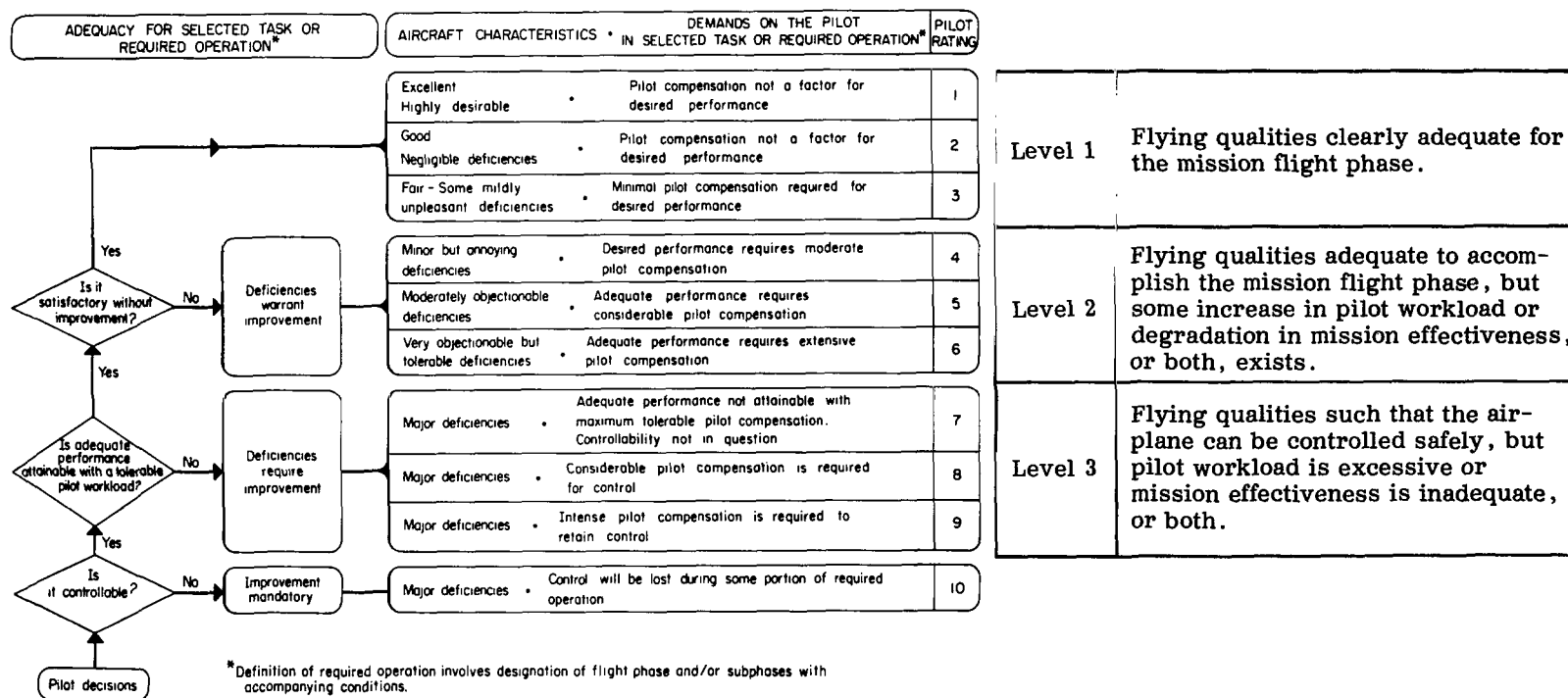

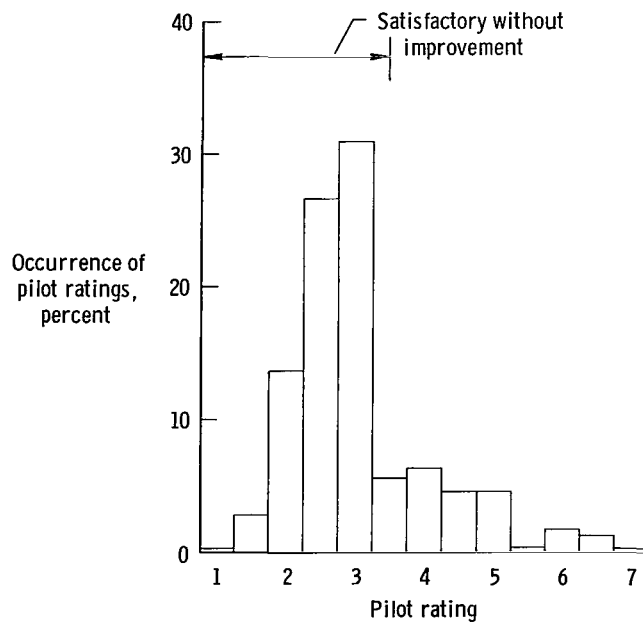
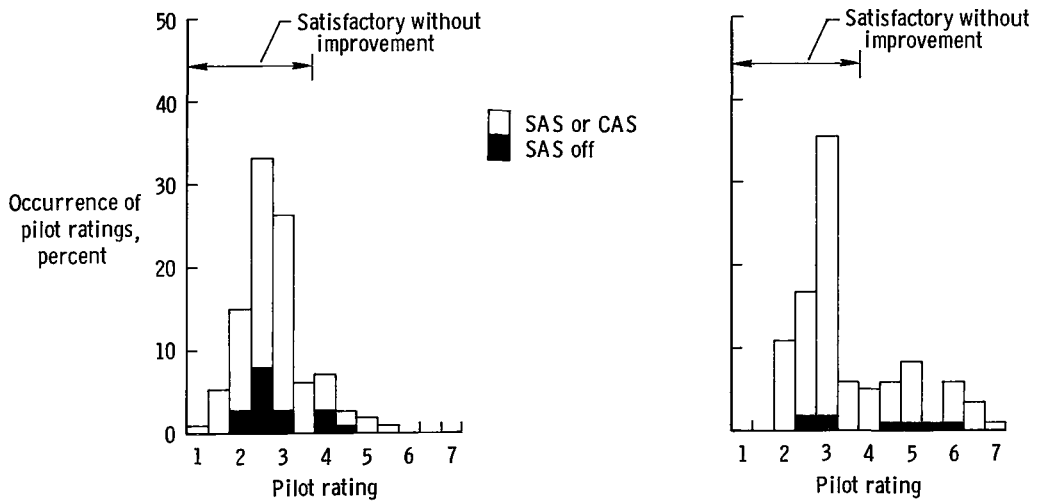

Figure 12. Percentage distribution of pilot ratings. Total ratings, 423.



(a) Subsonic speeds and subsonic configuration. SAS or CAS on, 94 ratings (83.2 percent); SAS off, 19 ratings (16.8 percent); total ratings, 113.

(b) Transonic and supersonic speeds and transonic configuration. SAS or CAS on, 111 ratings (93.3 percent); SAS off, 8 ratings (6.7 percent); total ratings, 119.

Figure 13. Percentage distribution of longitudinal pilot ratings for subsonic, transonic, and supersonic speeds. SAS on and off; total ratings, 232.

For the lateral-directional handling qualities (figs. 14(a) and 14(b)), speed and configuration had little effect on the ratings. For the subsonic configuration 87.3 per cent of the ratings were 3.5 or better, and for the transonic configuration 76.4 per cent of the ratings were 3.5 or better.

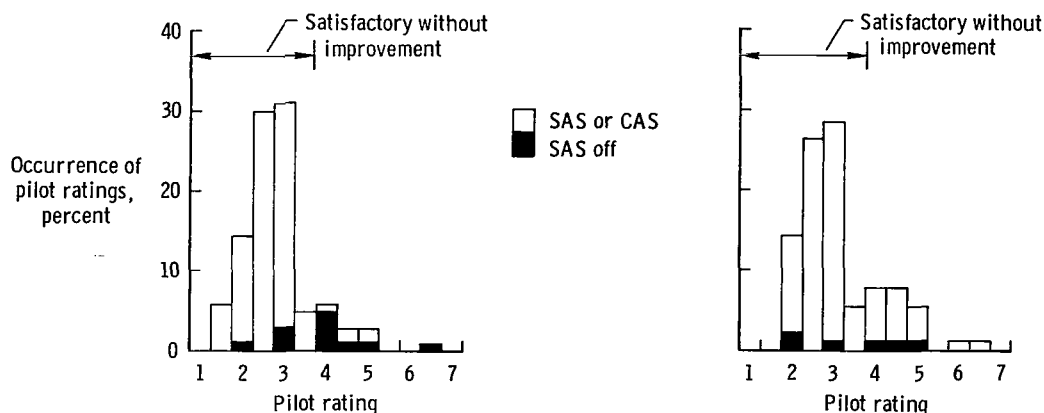

(a) Subsonic speeds and subsonic configuration. SAS or CAS on, 90 ratings (88.2 percent); SAS off, 12 ratings (11.8 percent); total ratings, 102.

(b). Transonic and supersonic speeds and transonic configuration. SAS or CAS on, 83 ratings (93.3 percent); SAS off, 6 ratings (6.7 percent); total ratings, 89.

Figure 14. Percentage distribution of lateral-directional pilot ratings for subsonic, transonic, and supersonic speeds. SAS on and off; total ratings, 191.

Approximately 10 percent of the 423 ratings were for SAS-off conditions. The handling qualities of the M2-F3 vehicle under these conditions were considered to be generally satisfactory. Although many maneuvers were performed with the SAS off, most of the pilot ratings were better than 5.0. The SAS-off conditions evaluated were either in the longitudinal axis ($K_q = 0$) or the lateral-directional axis ($K_p = K_r = 0$), but not both. The damping ratio for the longitudinal short-period mode and the Dutch roll mode with the SAS off was generally 0.1 or less. The roll mode time constant with the SAS off was generally greater than 5 seconds. The M2-F3 vehicle was typical of vehicles with very low aspect ratios, in that the natural roll damping was low, resulting in aileron control that was very sensitive with the roll and yaw SAS off. Longitudinal SAS-off characteristics were generally satisfactory at the flight conditions selected. Conditions at which stability was marginal were not investigated in this mode.

Although the vehicle's SAS-on handling qualities were considered to be generally satisfactory, SAS-on handling qualities problems did occur in some portions of the flight envelope. Two particular problems—the powered boost constant-high-angle-of-attack longitudinal task, and a SAS-induced lateral-directional transonic instability—are discussed later.

Comparison of stability augmentation system and command augmentation system ratings.—Figures 15(a) and 15(b) compare pilot ratings for the SAS and the CAS for the subsonic and transonic configurations. (Pitch and roll tasks were combined.) For this comparison, only ratings which evaluated the SAS and the CAS for the same task are included. For the subsonic configuration only 10.9 percent of the ratings were for the CAS mode; no significant difference in handling qualities is indicated with the CAS on. For the transonic configuration almost half of the ratings were for the CAS mode; an improvement of 0.5 in pilot ratings (3.0 to 2.5) is indicated with the CAS on.

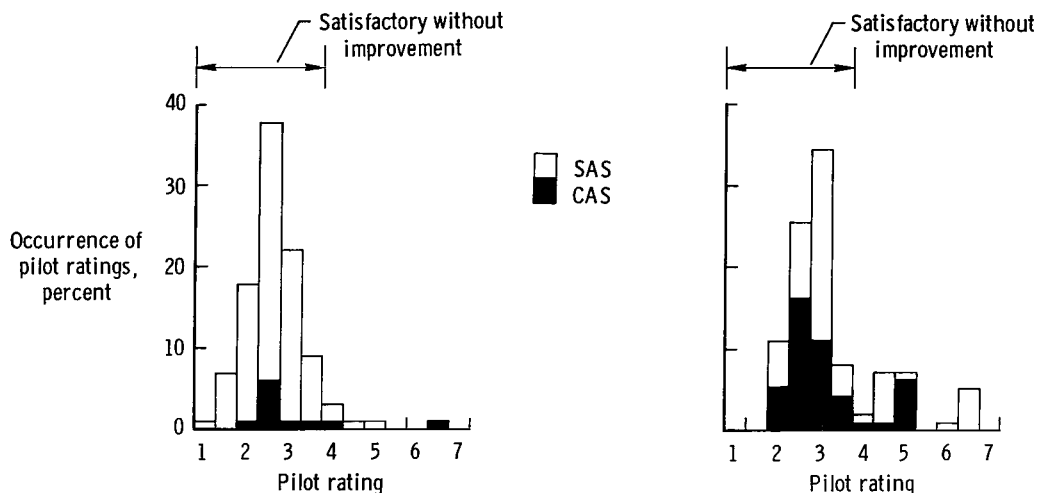

(a) *Subsonic speeds and subsonic configuration.* SAS, 90 ratings (89.1 percent); CAS, 11 ratings (10.9 percent); total ratings, 101.

(b) *Transonic and supersonic speeds and transonic configuration.* SAS, 58 ratings (56.8 percent); CAS, 44 ratings (43.2 percent); total ratings, 102.

Figure 15. Comparison of SAS and CAS pilot ratings for subsonic, transonic, and supersonic speeds. Total ratings, 203; pitch and roll tasks.

Reaction rocket control and damping augmentation.—In the lateral axis, reaction rocket control was adequate for maneuvering as well as for stability augmentation, although in the manual or RCS mode, control sensitivity resulted in "jerky" attitude changes and received a pilot rating of 5.0. In the rate feedback or RAS mode, with normal pilot aileron control, the damping augmentation was rated 2.0.

In the longitudinal axis, the RCS mode could not compensate for aerodynamic trim. In the RAS mode, however, damping augmentation was considered to be good. Pilot ratings for the pitch RAS mode were generally 2.0 to 2.5 when only minimal damping was required. For more demanding situations, such as when the vehicle's natural damping was low, the rate damping requirements exceeded the RAS

capability, and pilot ratings were 4.0 to 4.5. On one flight an asymmetrical dead-band existed so that the RAS was activated when the nose-down rate was 1 deg/sec and the nose-up rate was 5 deg/sec. This resulted in pilot ratings from 5.0 to 6.0.

Even though the RAS was not optimized, the proof-of-concept was established. The results of this study are particularly significant in light of the RAS damping with aerodynamic trim proposed for the space shuttle vehicle.

Longitudinal Handling Qualities

Longitudinal stability and control.—Generally, the longitudinal static stability characteristics of the M2-F3 vehicle were satisfactory (ref. 6). The linear longitudinal static stability characteristics were satisfactory throughout the flight envelope, except from Mach 0.86 to 1.05. In this range the pitching-moment coefficient characteristics became nonlinear, as illustrated in figure 16 in which pitching-moment

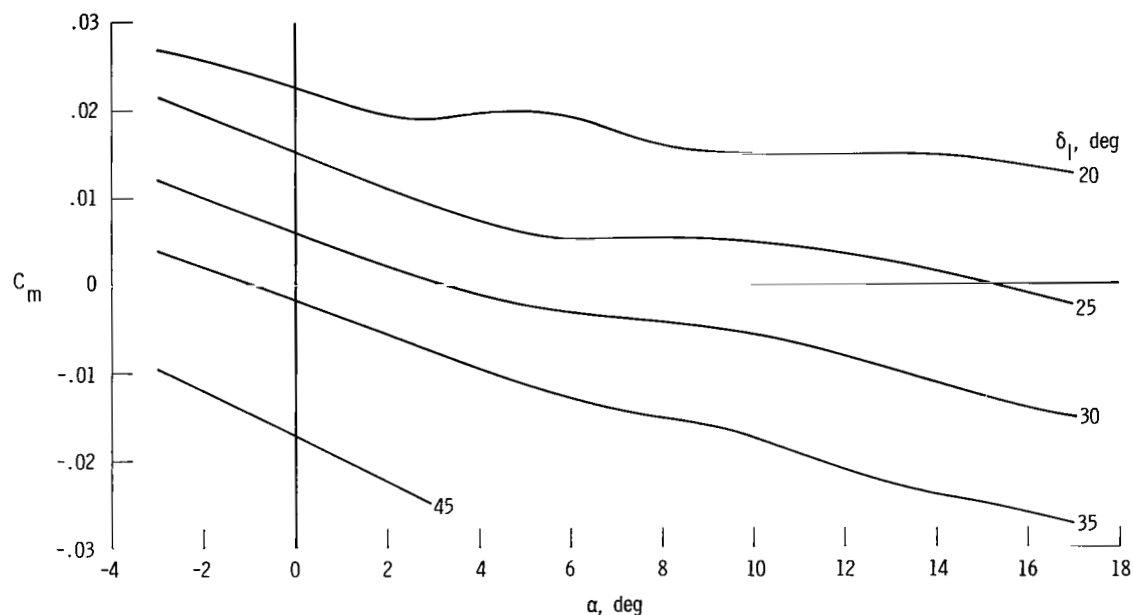

Figure 16. Pitching-moment curve from wind-tunnel data (ref. 6).
 $M = 0.95$; $\delta_u = -20^\circ$; center of gravity = $0.496\bar{c}$.

coefficient is plotted against angle of attack. Figure 17 presents the wind-tunnel and flight-determined static stability parameter, C_{m_α} , as a function of Mach number for several angles of attack. As shown, the static stability at transonic speeds was low. Consequently, the handling qualities were relatively poor. Lower flap control effectiveness remained at an acceptable level throughout the flight envelope.

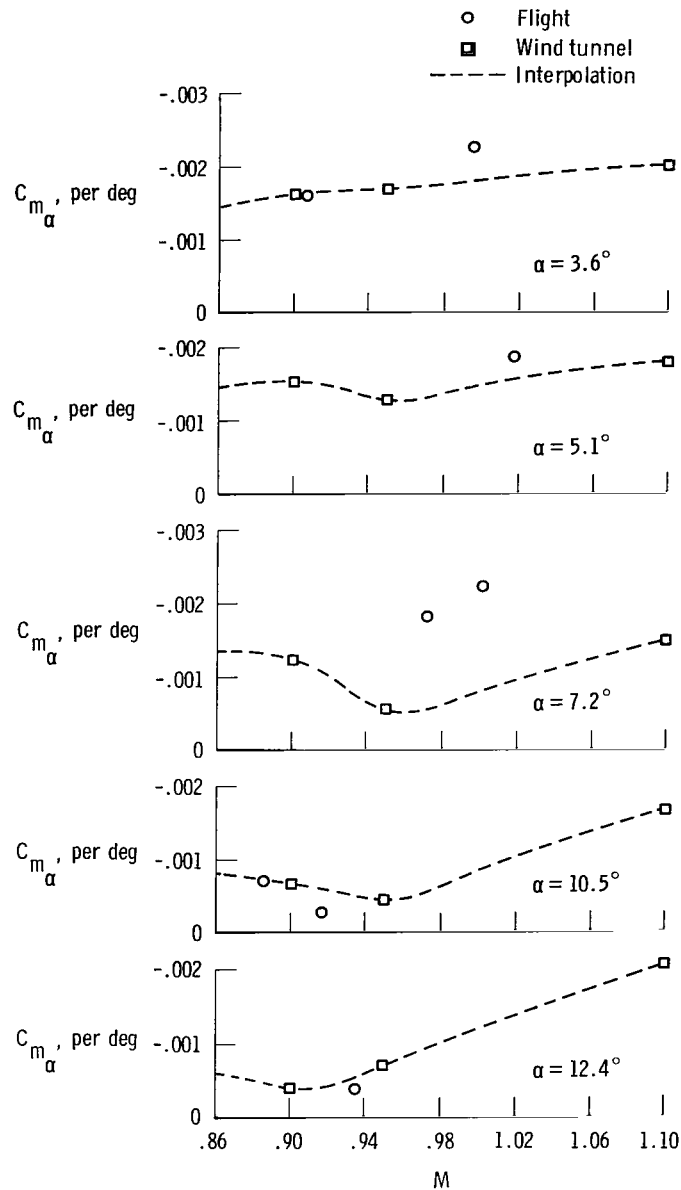

Figure 17. Comparison of static stability parameter obtained from flight data in the transonic speed region with wind-tunnel predictions (ref. 6). $\delta_u = -20^\circ$; δ_ℓ as required for trim.

The flight-determined longitudinal stability boundary is shown as a function of angle of attack and Mach number in figure 18. Trim limits are included. It is evident that, between Mach 0.7 and 0.96, the vehicle could enter an unstable region. The unstable region was never penetrated with the SAS off, although flight in this region was necessary during the powered boost. A maximum SAS-on limit of 15°

angle of attack was established, but was exceeded occasionally. This limit was a compromise between the angle of attack required for satisfactory SAS-on longitudinal stability and that required to promptly attain the powered boost flightpath angle.

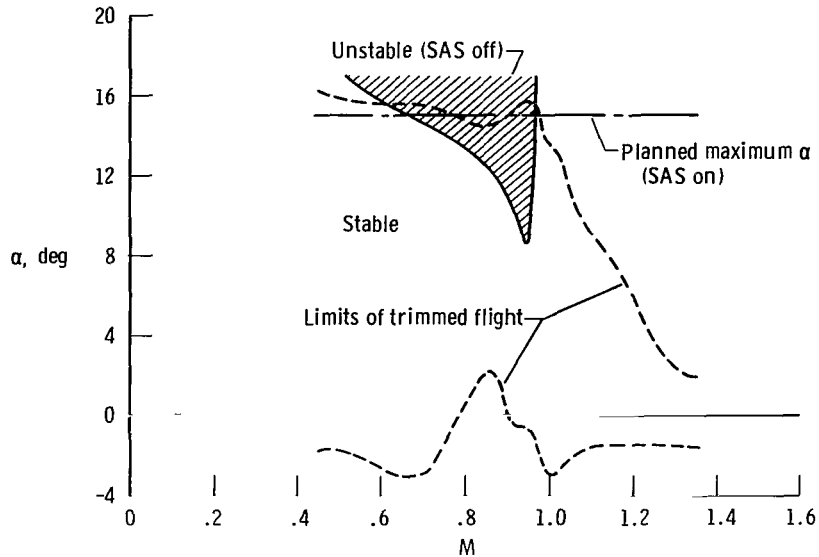

Figure 18. M2-F3 trimmed flight envelope and the longitudinal SAS-off stability boundary. $\delta_u = -20^\circ$; center of gravity = $0.496\bar{c}$.

Powered boost.—The powered boost portion of the flight profile consisted of three distinct tasks: maintaining a constant high angle of attack (15° limit) to the desired pitch attitude, maintaining a constant pitch attitude to the desired altitude, and pushing over to a low angle of attack to attain maximum Mach number. For the powered flights the vehicle was launched with the center of gravity at the approximate aft limit (50.5 percent \bar{c}), which resulted in static instability with the SAS off at high angle of attack and subsonic speed. With the SAS on, the stability was marginal, resulting in a demanding handling qualities task in which precise control of angle of attack was required. Indicative of the magnitude of this problem was a situation which occurred on one flight. With the SAS on, the pilot inadvertently allowed the angle of attack to reach 21° when his attention was directed to the rocket engine ignition sequence.

Figure 19 shows the distribution of pilot ratings for the longitudinal powered boost task in which the SAS and the CAS were used. These ratings are significantly worse than those for other tasks. Of these ratings 51.6 percent were between 4.0 and 6.5; the most common rating was 5.0 (22.6 percent).

To improve the handling qualities in this portion of the flight profile an angle-of-attack hold mode option was included as part of the CAS. Early experiences with the angle-of-attack hold were disappointing, as indicated by the frequent pilot rating

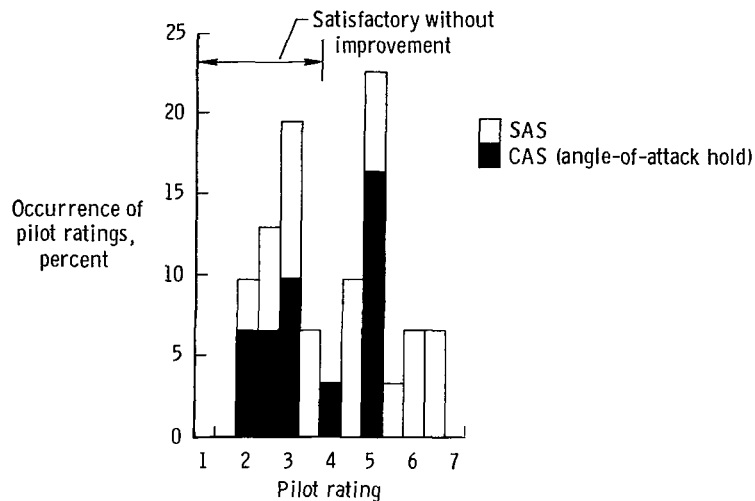

Figure 19. Percentage distribution of longitudinal transonic speed and transonic configuration pilot ratings for powered boost. Total ratings, 31.

of 5.0. This rating was given primarily because of the difficulty in engaging the angle-of-attack hold, as a result of the poor side stick characteristics (for example, the narrow detent and low breakout force). In addition, it was necessary for the pilot to wear a pressure suit while he performed dynamic maneuvers, which aggravated the effect of the low breakout force, narrow detent, and force gradient of the side stick. Another problem which distracted the pilots was the approximately $\pm 0.5^\circ$ angle-of-attack drift associated with the angle-of-attack hold system. Modifications to the breakout force and the width of the detent combined with increased pilot experience indicated that the CAS could be made to function as intended.

Figure 20 is an example of the use of the SAS and the CAS with angle-of-attack hold to perform the powered boost. The pilot indicated that when the SAS was on he could not stabilize angle of attack. He rated the task at 6.0. On the following flight he used the CAS with the angle-of-attack hold. His comments concerning this task were as follows:

Longitudinal damping was significantly improved in comparison with normal SAS-on boost. Angle-of-attack control was positive and apparently better than indicated during simulation. The 14° angle of attack was easily established during rotation and the angle-of-attack hold was especially effective after engagement at 14° angle of attack, and wander was almost nonexistent. At no time did I observe more than 0.5° angle-of-attack excursion from the desired 14° . Pilot rating during boost was 2.0.

An improvement in pilot rating from 6.0 to 2.0 was realized from one flight to the next. It should be pointed out that this improvement was not typical.

The constant-pitch-attitude portion of the boost was much improved by using the CAS. Pilot comments concerning this task were as follows:

As the aircraft reached 40° theta, the angle-of-attack hold was disengaged. With no pilot input, and thus a zero pitch rate commanded, the CAS held the aircraft at precisely 40° theta. The rate command loop appeared to be much tighter than the angle-of-attack hold loop. This portion of the flight was given a pilot rating of 2.5, which compared to a pilot rating of 5.0 for the same task using SAS.

The CAS with the angle-of-attack hold was a welcome addition to the vehicle, and its potential was recognized even though difficulties were encountered. Some of the discrepancies which prevented realization of the full potential included the following:

- (1) In the angle-of-attack hold mode, during high pitching rates, the desired angle of attack was attained and, as the stick was centered to engage the hold, the pitch rate decayed, thus reducing the angle of attack from the desired value.
- (2) The low total system gain permitted an angle-of-attack deviation of more than 0.5° at high angles of attack.
- (3) The generally poor side stick characteristics could not be changed without affecting the overall integrity of the controller (e.g., force gradient, deadband, and breakout force).

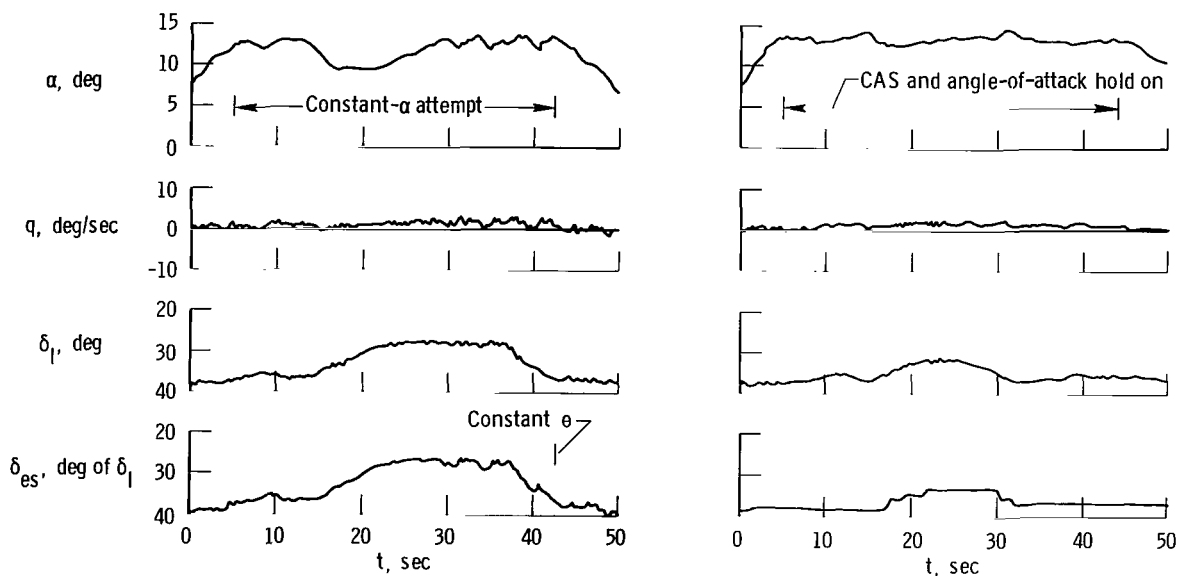

(a) SAS, $M_{av} = 0.85$, $\bar{q}_{av} = 89.47 \text{ hN/m}^2$ (190 lb/ft²), power on, $K_q = 1 \text{ deg/deg/sec}$, pilot rating = 6.0.

(b) CAS and angle-of-attack hold, $M_{av} = 0.80$, $\bar{q}_{av} = 84.76 \text{ hN/m}^2$ (180 lb/ft²), power on, $K_{q^c} = 1 \text{ deg/deg/sec}$, pilot rating = 2.0.

Figure 20. Comparison of M2-F3 powered boost using SAS and CAS with angle-of-attack hold.

Short-period mode characteristics.—Table 5 shows representative M2-F3 short-period mode characteristics and pilot ratings for selected flight conditions.

TABLE 5.—REPRESENTATIVE M2-F3 LONGITUDINAL RESPONSE CHARACTERISTICS AND PILOT RATINGS FOR SELECTED FLIGHT CONDITIONS

Configuration	Pilot rating	M	hN/m^2 \bar{q} , (lb/ft ²)	α , deg	K_q , deg/deg/sec	$\omega_{n_{sp}}$, rad/sec	ζ_{sp}	a_n/α , g/rad
Subsonic	2.5	0.70	128.8 (269)	1.7	1.0	2.96	2.23	7.45
Subsonic	3.0	0.51	141.3 (295)	1.3	0.4	2.89	1.25	7.64
Transonic	3.0	0.67	42.6 (89)	1.0	1.0	1.45	1.31	2.43
Transonic	3.0	0.89	110.1 (230)	8.5	0.4	2.70	0.988	4.87
Transonic	2.5	1.10	43.1 (90)	4.6	1.0	2.21	0.738	2.10
Transonic	3.0	1.09	57.0 (119)	4.1	0	2.48	0.083	2.25

Frequency, damping ratio, and acceleration sensitivity were computed by using the flight data of reference 6. These data are typical of those obtained throughout the flight test program, except in the powered boosts.

Longitudinal stability and damping for the flight conditions shown in the table were relatively good. The frequency and acceleration sensitivity characteristics are compared in figure 21 with the current Military Specification for piloted airplanes (ref. 9). The data for the M2-F3 vehicle were generally within the level 1 boundary.

Longitudinal trim.—

Changes in longitudinal trim associated with shifts in the center of pressure and aerodynamic center encountered during the M2-F3 flight test program were caused by changing transonic Mach number, configuration change from transonic to subsonic, speed brake deployment, and landing gear extension.

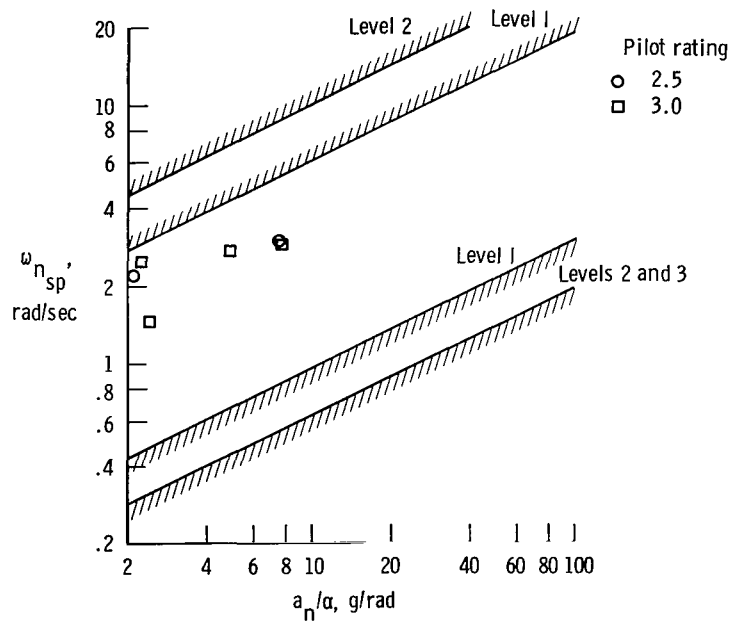

Figure 21. Comparison of M2-F3 longitudinal short-period mode frequency and acceleration sensitivity characteristics with Category B requirements from reference 9. $M = 0.51$ to 1.10 ; $\alpha = 1.0^\circ$ to 8.5° ; $K_q = 0$ to 1.0 deg/deg/sec.

The transonic speed range ($M = 0.88$ to 1.04) power-on and power-off trim curves are summarized in reference 6. Changes in trim angle of attack varied from 3° to 4° in a nose-down direction. The pilots generally believed that this trim change was easily controlled and that the transient longitudinal characteristics were not a problem. This pitch-down tendency did, however, cause a lateral-directional instability, which is discussed later.

The configuration change on each of the three lifting bodies (M2-F3, HL-10, and X-24A) was approached cautiously. One pilot made the following comments about a flight on which the SAS was operating:

Of the three lifting bodies, the M2-F3 exhibited the least troublesome characteristics [during configuration change]. This was due in large part to the training provided by excellent simulation of this maneuver. The pilot rating for this maneuver was 3.5.

The same pilot made the following comments for a flight on which the CAS was used:

A "hands off" configuration change was performed utilizing alpha-hold. It held angle of attack better than the simulator. The pilot rating for this maneuver using CAS was 2.5.

A large nose-down pitching moment was associated with speed brake deployment. Simulation indicated that when full speed brake was deployed maximum elevator deflection could be reached in the landing flare. To avoid this problem the pilots returned the speed brakes to the zero position before starting the flare.

Landing gear deployment, as previously mentioned, produced a relatively large nose-down pitching moment. Landing gear extension time was approximately 1 second, thus the pitching-moment transient was abrupt. No particular problems were reported by the pilots as a result of the magnitude or abruptness of the trim change. Pilot ratings were generally 2.5. One pilot reported the following:

I did notice a tendency for a slight pilot-induced oscillation after gear deployment, but not severe enough to be of concern. [Pitch damper setting was $K_q = 0.4$ deg/deg/sec.]

Final approach, flare, and landing.—Lifting body landing procedures and rationale are described in detail in reference 10. The four phases of the landing consisted of: (1) a high-constant-speed (555.6 km/hr (300 knots)) final approach, starting at approximately 3050 meters ($10\ 000$ feet) altitude, (2) a $1.5g$ flare 305 meters (1000 feet) above ground level, (3) landing gear extension at 30.5 meters (100 feet) or less, and (4) touchdown. All landings were unpowered with relatively steep final approach glidepath angles of approximately -30° . The CAS was never used during the final approach, flare, and landing because of the lack of redundancy in the automatic pitch trim system, although it was used up to the final approach.

Pilot comments indicated a tendency toward a longitudinal pilot-induced oscillation (PIO) before touchdown as a result of the overly sensitive longitudinal center stick. To assist the pilot, the basic vehicle damping was improved by increasing the

pitch SAS gain to 0.3 deg/deg/sec or, preferably, 0.4 deg/deg/sec before touch-down. The following pilot comment was made:

I wouldn't want it any more sensitive. I felt that I was right on the threshold of a longitudinal PIO. [Pitch damper gain of $K_q = 0.3$ deg/deg/sec.]

Figure 22(a) compares the computed short-period mode frequency and damping characteristics for landing flare and touchdown with the Military Specification of reference 9. Data for the vehicle with the SAS on are within the level 1 boundary.

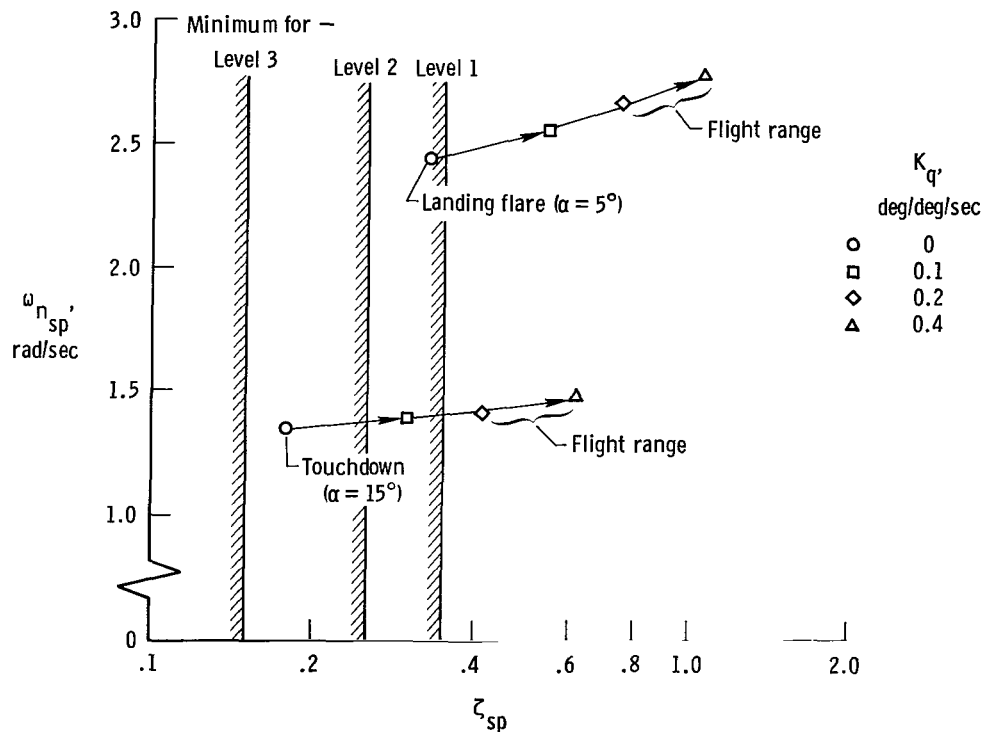

(a) Frequency and damping.

Figure 22. Comparison of M2-F3 subsonic configuration longitudinal short-period mode landing characteristics with minimum Category C levels from reference 9. Landing flare: $\bar{q} = 146.5 \text{ hN/m}^2$ (306 lb/ft²), $V = 162.2 \text{ m/sec}$ (532 ft/sec), $M = 0.5$; touchdown: $\bar{q} = 47.9 \text{ hN/m}^2$ (100 lb/ft²), $V = 106.7 \text{ m/sec}$ (350 ft/sec), $M = 0.35$.

Figure 22(b) shows that the short-period mode frequency and acceleration sensitivity data are also within the level 1 boundary for the vehicle with the SAS on.

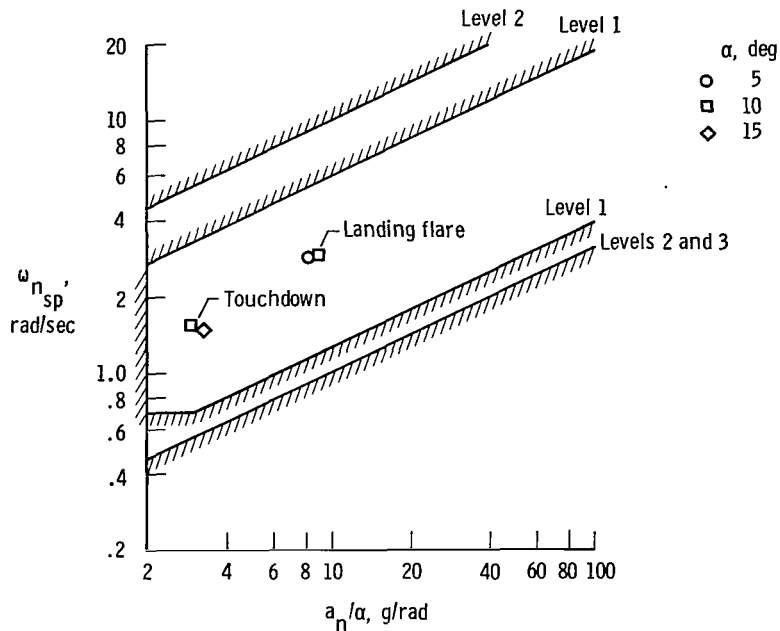

(b) Frequency and acceleration sensitivity, $K_q = 0.4 \text{ deg/deg/sec}$.

Figure 22. Concluded.

Figure 23 compares the M2-F3 SAS-on longitudinal stick force and stick travel per unit normal load factor (for the short-period dynamics of fig. 22(a)) with the

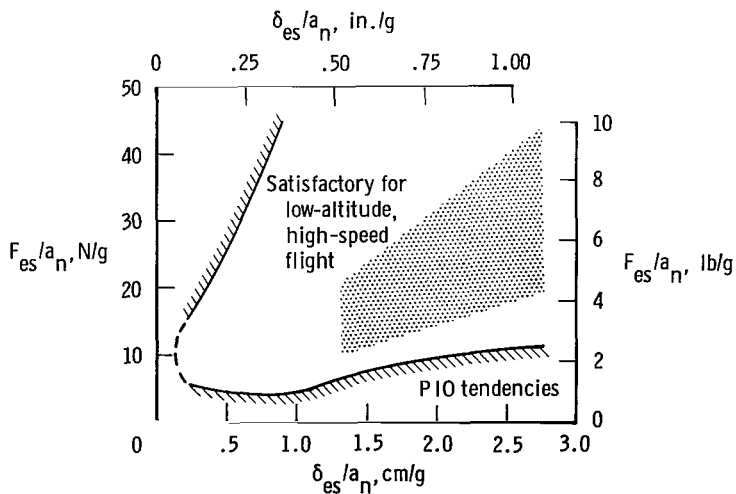

Figure 23. Comparison of the M2-F3 longitudinal stick force and stick travel per unit load factor (for the dynamics of fig. 22(a)) with the criterion of reference 11.

satisfactory low-altitude, high-speed flight boundary from reference 11. The longitudinal sensitivity of the M2-F3 vehicle is indicated by the shaded area, which approaches the PIO boundary. Although the M2-F3 vehicle was considered to be sensitive to longitudinal control and tended toward pilot-induced oscillations, its handling qualities were rated as satisfactory on the basis of the criterion of reference 11.

The pilots considered the M2-F3 handling qualities and flight characteristics to be good during the landing approach. Figure 24 presents the pilot ratings for this task. Approximately 95 percent of the ratings were 3.5 or better. Typical pilot comments were as follows:

The M2-F3 landing task was straightforward. There was ample normal acceleration capability available for the flare, and stick force per unit g was linear. A nose-down pitching moment did occur at landing gear extension and was expected to cause a handling qualities problem, but in fact was quite easily corrected for with back stick. Generally, there was adequate normal acceleration capability after gear deployment, and most touchdowns were very smooth.

All flights were performed under visual flight rules (VFR). The final portions of the flight required accurate space positioning from the low-key point (fig. 10) to touchdown, which was done visually. Pilot comments concerning M2-F3 visibility were as follows:

Over-the-deck vision out of the M2-F3 was quite good forward. To the sides, the deck blocked most downward vision, and field of view was unsatisfactory. When navigating, it was necessary for the pilot to roll the vehicle considerably to see the ground abeam his position. Also, just before touchdown, the deck blocked the pilot's view of the runway lines used for height reference.

To provide forward vision at high deck angles, particularly at landing, there was a window in the M2-F3 nose. The right side of this window was blocked approximately 50 percent by instruments and other equipment. The left side originally provided good vision for landing and was used extensively just prior to touchdown. When the CAS was added, switch panels encroached upon about three-quarters of the left nose window. This caused the final phases of landing to be much more

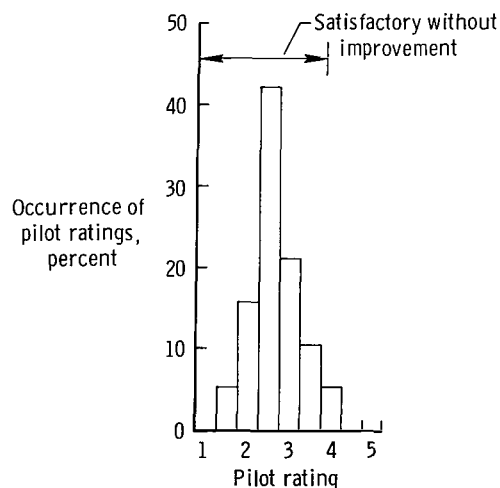

Figure 24. Percentage distribution of longitudinal pilot ratings for the landing task. Total ratings, 19.

challenging, and longitudinal control during landing was not as smooth after the CAS panel was installed. Pilots who checked out in the M2-F3, however, were warned that forward visibility at high deck angles was inadequate. Therefore, pilots compensated by looking obliquely over the deck during landing, and they indicated that this technique allowed good landing vision even with the CAS panel installed.

Lateral-Directional Handling Qualities

Lateral-directional stability and control.—The M2-F3 lateral-directional stability characteristics were dominated by aerodynamic characteristics unique to this class of lifting body vehicle. These included very high effective dihedral and low natural roll damping. In addition, the mass distribution was highly concentrated about the roll axis, resulting in a low rolling moment of inertia (ref. 6). As a result of these characteristics, the Dutch roll mode exhibited relatively high frequency, and a coupled roll-spiral mode usually existed with the roll and yaw SAS off (ref. 3).

Extreme adverse yawing moment due to aileron was a problem on the M2-F2 vehicle which necessitated large aileron-to-rudder crossfeed compensation. Wind-tunnel tests indicated that the yawing moment due to aileron would be favorable with the fixed center fin on the M2-F3 vehicle and would have little effect on other aerodynamic characteristics. With the improved aileron characteristics and proper selection of SAS and CAS gains, stability and control characteristics were generally satisfactory (refs. 3 and 6). One exception was that at transonic speeds, low angle of attack, and certain SAS gain settings the Dutch roll mode was unstable, as is discussed later.

Powered boost.—The lateral-directional handling qualities in the powered boost were generally considered to be good. One pilot commented as follows:

In general, during the launch, rotation, and climb phase of the flight, the lateral-directional axes were never a concern. Pilot ratings were consistently 2.5 or better. Because of the difficulty in performing the pitch task during the boost portion of the flight, very little time was allowed to assess lateral-directional handling qualities. A testimony to the excellent lateral-directional characteristics is the fact that they could be ignored while concentrating on the pitch task. I feel that this fact in itself warrants a pilot rating of at least 2.0 to 2.5.

Wind-shear-induced disturbances.—During the powered boost portion of the flight, the pilots frequently commented about uncommanded lateral disturbances. In an attempt to determine the cause of the disturbances, photographs of the M2-F3 contrail were made from a ground position directly below the vehicle. These photographs were correlated with the pilot's voice transmissions to observe the nature of the contrail whenever he stated that an uncommanded upset had occurred. The photographs showed that parts of the contrail became increasingly displaced, with time, from the original contrail. Thus many of the disturbances were attributed to wind shear. Although no serious problems occurred as a result of this phenomenon, it did complicate an already complex task.

Dutch roll and roll mode characteristics.—Table 6 presents representative M2-F3 Dutch roll and roll mode characteristics (computed from flight data of ref. 6) and pilot ratings together with task, configuration, and flight condition. Figure 25 compares the Dutch roll mode frequency and damping ratio with the criterion of reference 9. The data for the vehicle with the SAS on generally exceeded the level 1 requirement, which resulted in pilot ratings of 3.5 or better. For reduced SAS gains and with the SAS off, the data tended toward the minimum level boundaries and in some instances were below the minimums. The associated pilot ratings were 3.5 or worse. With the yaw SAS off and the roll SAS on, the Dutch roll damping became relatively light, as indicated by the pilot rating of 5.0.

When evaluating lateral-directional handling qualities of lifting bodies, the Dutch roll mode cannot be evaluated independent of the roll mode. Figure 26 compares the lateral control power, $L_{\delta_a} \delta_{a_{max}}$, with the roll mode time constant criterion of reference 12, and the minimum roll mode time constant requirements from reference 9 with the data of table 6. As shown in table 6, a coupled roll-spiral mode was calculated to exist. These data are included in figure 26. As for the Dutch roll mode criteria comparison, the SAS-on data generally meet the level 1 requirements, with better pilot ratings, and the SAS-off data fall toward the lower level boundaries, with poorer pilot ratings. It is believed that the general agreement of the flight data with the criteria of references 9 and 12 is satisfactory. No criteria, as such, exist for the coupled roll-spiral mode, except that the Military Specification does not permit its existence.

Few specific pilot comments concerning the SAS-off low Dutch roll mode damping were received. However, numerous comments were made concerning the SAS-off roll damping and accompanying apparent aileron sensitivity. The ailerons provided adequate roll control and damping augmentation. Because of the low level of natural roll damping, the ailerons with the roll SAS off appeared to command roll acceleration rather than rate. Consequently, when the pilots performed maneuvers in this mode, they accelerated to large roll rates in short periods of time and frequently commented that the vehicle was very sensitive in roll. In this configuration roll rate per unit stick was reported to have been too high. One pilot commented:

The only surprise I had during the entire flight occurred after I had turned the roll damper off. I was asked [by mission control] to make a right turn for flightpath control. I put in considerable (initial) aileron, not remembering that K_p was at zero. I was rewarded with a significant amount of roll rate. As soon as I remembered that I was at zero roll damping, I adjusted my own control [technique], and no further surprises occurred.

During this maneuver the vehicle rolled through approximately 66° of bank angle before recovery was made.

Generally, with the roll and yaw SAS off, modal response characteristics computed by using the flight data of reference 6 (table 6) indicated that a coupled roll-spiral mode would exist. Although the coupled roll-spiral mode was difficult to

TABLE 6.—REPRESENTATIVE LATERAL-DIRECTIONAL RESPONSE CHARACTERISTICS
AND PILOT RATINGS OF THE M2-F3 LIFTING BODY VEHICLE

Task	Configuration	Pilot rating	M	\bar{q} , hN/m ² (lb/ft ²)	α , deg	K_p , deg/deg/sec	K_r , deg/deg/sec	ω_{nd} , rad/sec	ζ_d	τ_R , sec	ω_{RS} , rad/sec	ζ_{RS}	$L_{\delta_a} \delta_{a_{max}}$, rad/sec ²	$\left \frac{\phi}{\beta} \right $
Roll control and bank angle evaluation	Subsonic	1.5	0.49	109.7 (229)	7.4	0.4	0.2	5.06	0.336	0.306	---	---	3.86	3.5
		3.0	0.47	93.4 (195)	10.5	0	0	5.76	0.071	---	0.283	0.700	3.29	3.0
		4.0	0.43	67.5 (141)	13.6	0	0	5.57	0.053	---	0.251	0.760	2.38	2.7
		2.5	0.71	109.2 (228)	2	0.4	0.4	4.10	0.291	0.230	---	---	3.84	3.9
		2.5	0.64	126.9 (265)	6.8	0.4	0.4	5.46	0.389	0.245	---	---	4.47	3.5
		3.5	0.68	76.6 (160)	9	0.4	0.4	4.73	0.283	0.422	---	---	2.70	3.5
		3.0	0.68	93.4 (195)	10	0.4	0.4	5.37	0.317	0.352	---	---	3.29	3.2
		2.0	0.63	76.6 (160)	10	0.4	0.4	4.87	0.291	0.422	---	---	2.70	3.1
		2.0	0.46	89.1 (186)	6.7	0.4	0.4	4.50	0.372	0.353	---	---	3.14	3.7
		Stability and control evaluation	Transonic	3.5	0.66	42.6 (89)	-1.3	0	0	2.19	0.042	---	0.131	0.790
3.0	1.20			47.9 (100)	9.5	0.1	0.4	3.30	0.128	2.041	---	---	1.03	3.2
4.0	0.94			27.8 (58)	8.5	0.1	0.4	2.13	0.089	---	0.221	0.995	0.81	3.2
5.0	1.32			80.9 (169)	-1.4	0.2	0	3.20	0.022	0.735	---	---	1.68	5.6
4.5	0.66			42.6 (89)	-1.3	0	0	2.19	0.042	---	0.131	0.793	1.55	6.1
Subsonic	3.0		0.52	62.2 (130)	4.6	0	0	3.48	0.062	---	0.264	0.687	2.14	4.4
	4.0		0.60	95.8 (200)	0.4	0	0	3.62	0.112	---	0.236	0.414	3.37	5.7
	3.0		0.70	128.8 (269)	1.7	0.4	0.4	4.45	0.338	0.187	---	---	4.64	3.7
	2.5		0.52	143.6 (300)	2.5	0.4	0.4	4.44	0.475	0.182	---	---	5.06	4.2
	3.5		0.52	164.2 (343)	0	0.4	0.1	4.30	0.248	0.143	---	---	5.92	3.8
2.0	0.49	128.3 (268)	3.6	0.4	0.4	4.45	0.464	0.215	---	---	4.46	4.3		

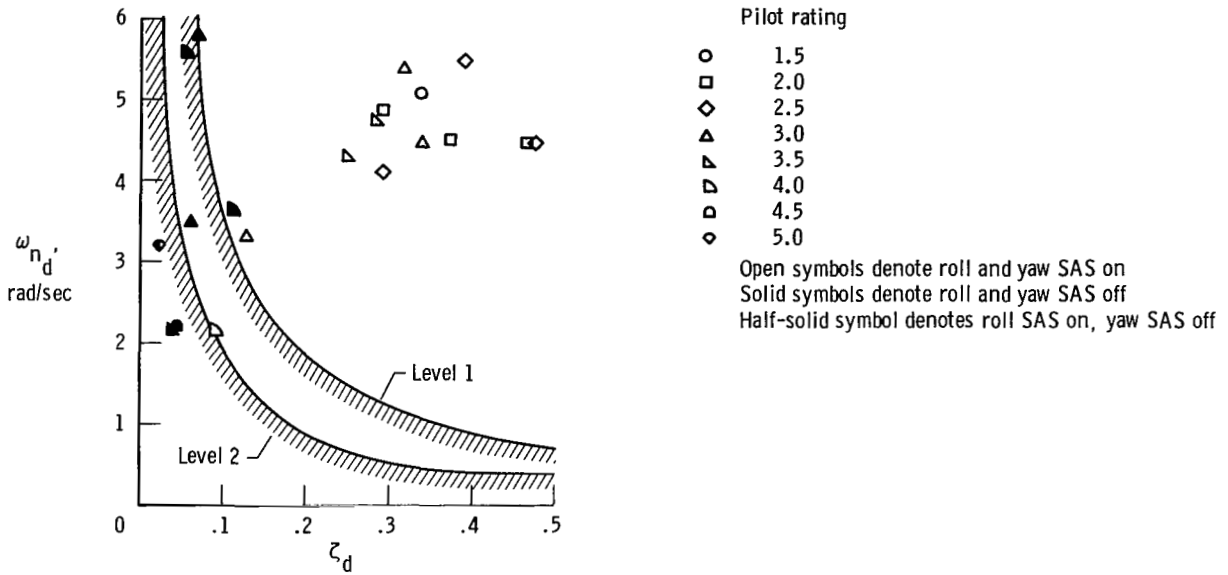

Figure 25. Comparison of M2-F3 Dutch roll mode frequency and damping ratio with criterion of reference 9 for Class II aircraft, Category B.

$$\left(\omega_{n_d}\right)^2 \left| \frac{\Phi}{\beta} \right| > 20 \text{ (rad/sec)}^2.$$

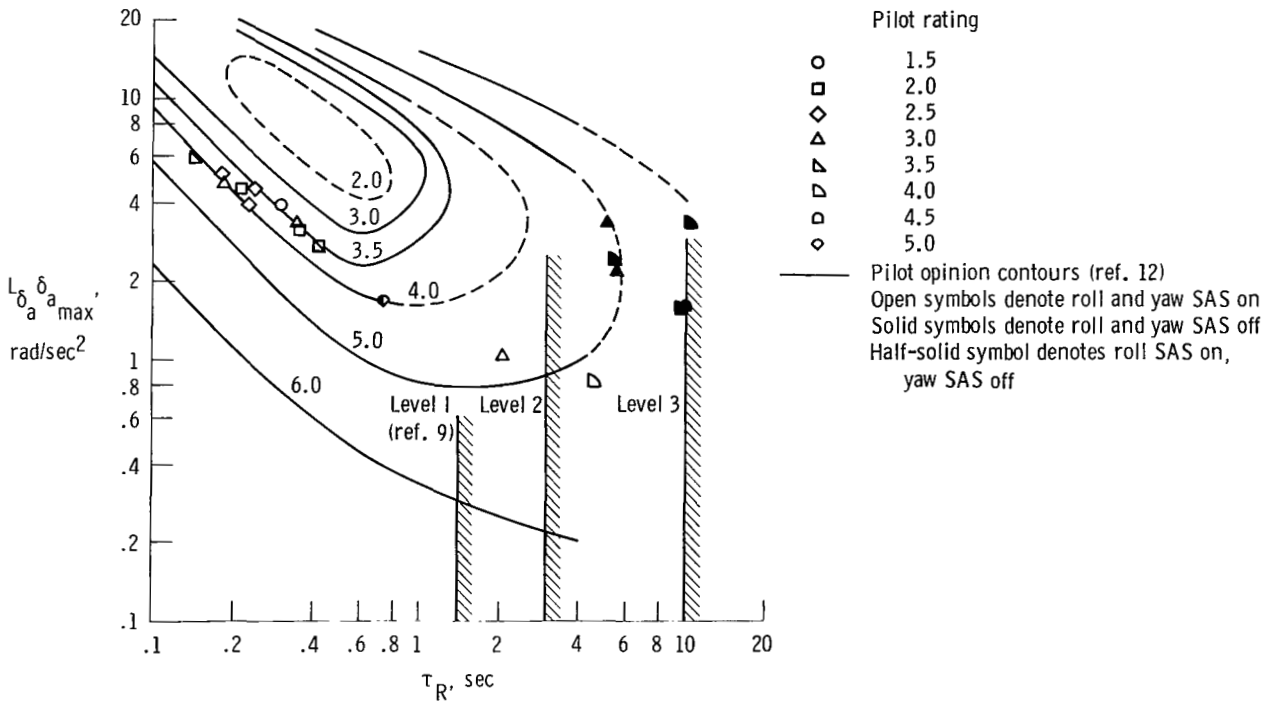

Figure 26. Comparison of M2-F3 lateral control power and roll mode time constant with criteria from references 9 and 12.

identify explicitly in flight, careful flight maneuver conditioning did reveal it on one flight. Pilot coupling with this mode was not a handling qualities problem as it was with the M2-F2 vehicle (ref. 3). In an attempt to determine the pilot's ability to control a vehicle with suspected coupled roll-spiral characteristics, a number of traffic patterns were flown with the roll and yaw SAS off. General pilot comments were as follows:

Any roll maneuvering was accompanied by jerkiness and some over-control. However, the vehicle was entirely controllable and would receive a pilot rating of 4.0.

Transonic Dutch roll mode instability.—Figure 27 presents data from the first and most severe Dutch roll mode instability experienced in the transonic flight region. As shown, this oscillation was relatively severe, even though large bank angle excursions were not experienced. The SAS input and the total control input are shown. The pilot did not command rudder pedal during this time interval; therefore, rudder SAS is the total rudder input. The longitudinal transonic trim change occurred between 13 seconds and 17 seconds. Vehicle characteristics in this Mach range were not as repeatable as desired; however, the derivative extraction routine described in reference 6 was used in an attempt to determine if any unpredicted derivative variations were occurring in the transonic speed region.

Figure 28 compares the aileron rolling- and yawing-moment coefficients obtained from flight data and wind-tunnel data. From Mach 0.9 to 1.0 consistent derivatives were extremely difficult to obtain. Flight data indicated that the aileron control effectiveness may have been greatly reduced at angles of attack below 5° , but this was not clearly substantiated.

Figure 29 presents a theoretical root-loci analysis of the time history of figure 27. This type of analysis has limitations in that the system being analyzed is assumed to be linear, that is, the angle of attack, dynamic pressure, and Mach number are assumed to be constant and the aerodynamic derivatives are assumed to be linear. It is obvious from figure 27 that the first three conditions are not met; however, flight-determined linear aerodynamic derivatives were used. Even though the first three conditions were violated, it was believed that an analysis of this type could aid in understanding the mechanism by which the instability was initiated and point to a possible solution. The approximate average flight angle of attack, dynamic pressure, and Mach number were selected for the analysis. For comparison, the approximate frequency and damping data obtained during the unstable and stable portions of the time history of figure 27 are presented in figure 29. The variable in this figure is roll or yaw SAS gain. At the flight SAS gains ($K_p = 0.4$ deg/deg/sec and $K_r = 0.2$ deg/deg/sec) the vehicle is predicted to be unstable, and as roll gain is increased from this point the vehicle becomes more unstable. The most stable point is at a roll SAS gain of zero. As the yaw SAS gain is increased, above $K_r = 0.2$ deg/deg/sec, stability is also achieved. Thus, increasing yaw gain is a stabilizing influence, but increasing roll gain is a destabilizing influence.

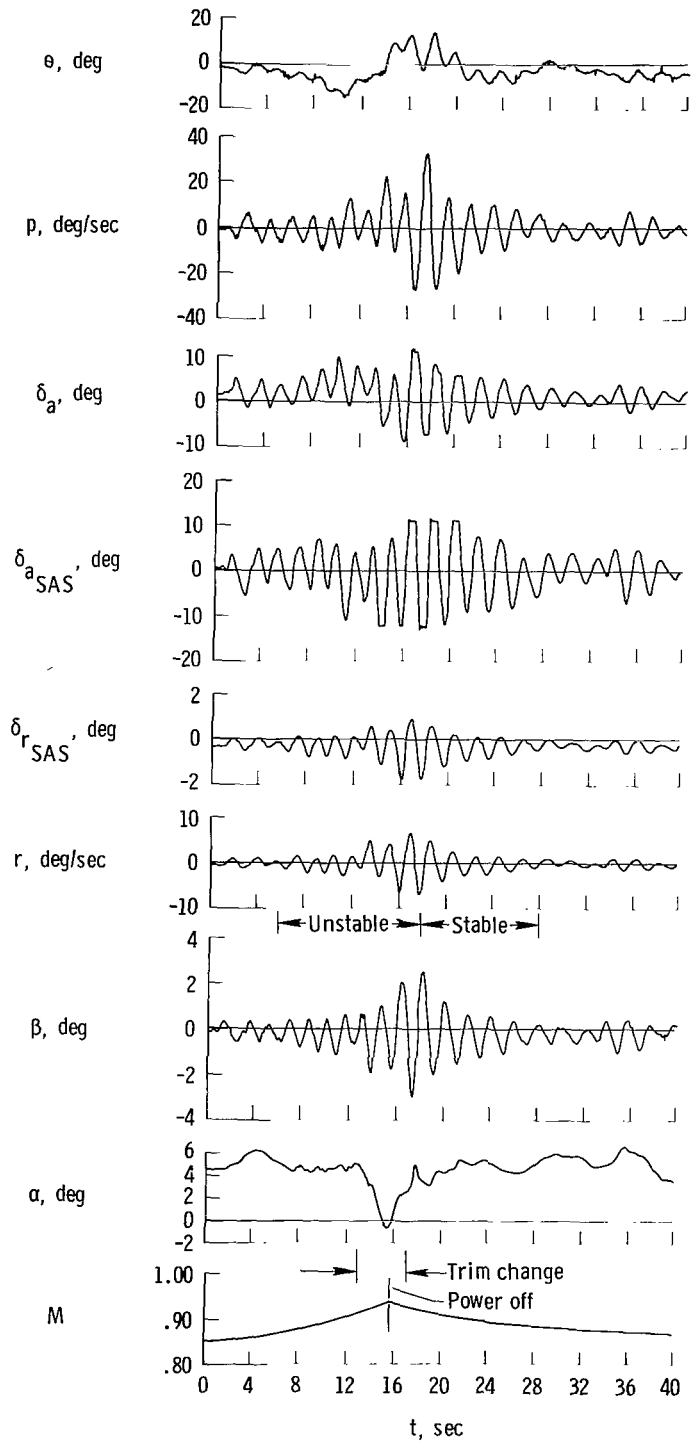

Figure 27. M2-F3 transonic SAS-on Dutch roll mode instability. $K_p = 0.4$ deg/deg/sec; $K_r = 0.2$ deg/deg/sec.

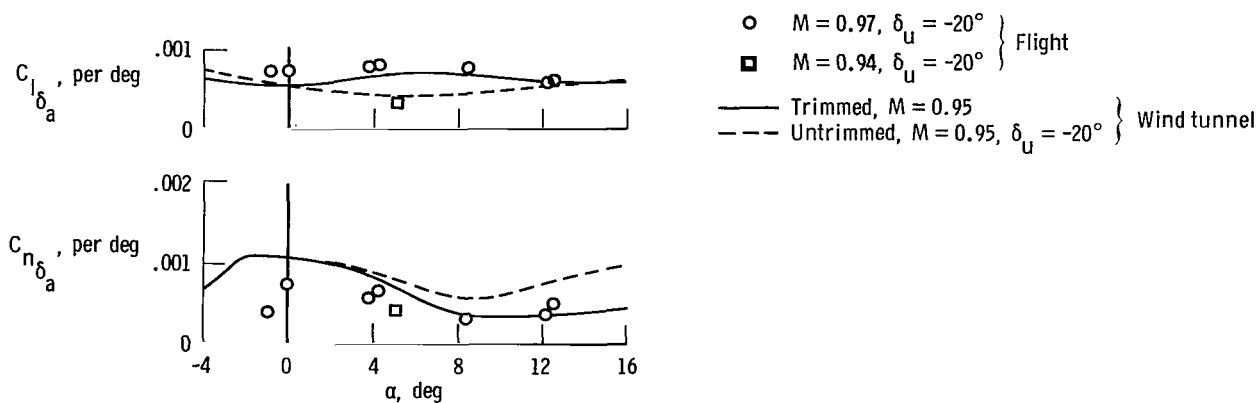

Figure 28. Comparison of aileron rolling-moment and yawing-moment effectiveness obtained from transonic flight data (ref. 6) and wind-tunnel data.

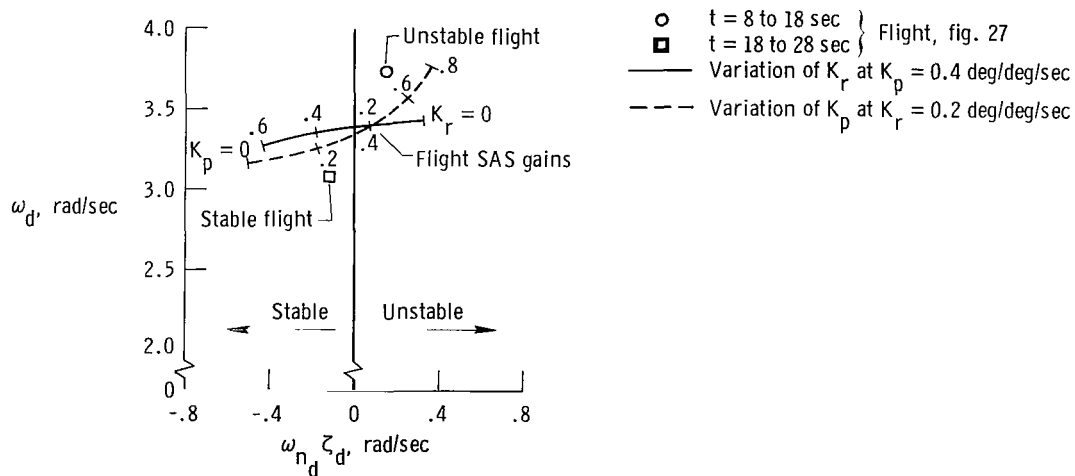

Figure 29. Theoretical root loci of the M2-F3 Dutch roll mode instability of figure 27 using linear flight-determined derivatives from reference 6. $\alpha = 2.7^\circ$; $M = 0.93$; $V = 283.5$ m/sec (930 ft/sec); $\bar{q} = 57.5$ hN/m² (120 lb/ft²).

The primary cause of this instability was the combination of low aileron roll effectiveness, $C_{l\delta_a}$, and high favorable or proverse aileron yawing-moment, $C_{n\delta_a}$, characteristics. The ailerons thus produced a relatively low roll damping moment through the roll SAS while a relatively large proverse yawing moment proportional to roll rate was being generated. This combination, together with the high effective dihedral and low natural roll damping, caused the divergence. As a result of this analysis, it was decided to traverse the transonic region using a higher yaw SAS gain and a lower roll SAS gain. With this configuration no further problems were encountered with the Dutch roll mode transonic instability.

Final approach and landing.—The lateral-directional handling qualities during final approach and landing were considered to be satisfactory. The typical pilot rating for this task was 2.0. One pilot reported the following:

Lateral-directional control was excellent during landing. Roll control response remained excellent down to minimum landing speed and was not noticeably coupled with yaw. Directional stability and damping remained satisfactory to touchdown.

On one flight a landing was made with the roll and yaw SAS off. The pilot rated this lateral-directional task 4.5. Pilot comments concerning this landing were as follows:

This landing was satisfactory, but I would not be enthusiastic to land in this condition again. This was due to the quickness of the roll control and the possibility that in the presence of turbulence short-term upsets close to the ground would be unsatisfactory.

With the exception of the wind shears during boost, all turbulence observed by the pilots occurred on the final approach, when a tight lateral tracking task was being performed (lining up with the runway). Generally, the turbulence was sensed only in the lateral axis in the form of high roll rate and small amplitude upsets. This type of response was due to the excessively high effective dihedral. At first, exposure to low-level turbulence made the pilots apprehensive because of the unusual nature of the vehicle's response. With experience, this apprehension decreased as the pilot became confident that the vehicle was not on the threshold of a divergent lateral oscillation. One pilot reported the following:

Turbulence response was noticeable as a high frequency lateral oscillation. Upsets were not generally objectionable from either riding or handling qualities aspects.

In contrast to these comments another program pilot reported the following:

The riding qualities of the M2-F3 in turbulence are better than in the other two lifting bodies (HL-10, X-24A). The response to turbulence was not nearly as quick as in the other two; instead it responded more like an F-104 in that it was manifested primarily as normal acceleration inputs rather than rapid roll inputs as in the X-24A.

Frequently, a wingman flying close escort in an F-104 airplane would not detect any turbulence or perceptible motion of the M2-F3 vehicle as turbulence was penetrated.

To reduce pilot apprehension, a transport aircraft (with low wing loading) was flown through the M2-F3 approach corridor a few minutes before each flight of the M2-F3 vehicle and the M2-F3 pilot was informed of the location and severity of the turbulence. Turbulence was of continuing concern, as evidenced by the fact that launch ground rules throughout the M2-F3 flight program contained a constraint requiring low-altitude turbulence to be less than moderate. "Moderate" was considered to be the maximum level of turbulence under which it would be acceptable to proceed with a launch. This term was agreed upon by the pilots in the lifting body program.

CONCLUDING REMARKS

A flight study to assess the longitudinal and lateral-directional handling qualities of the M2-F3 lifting body vehicle indicated that the vehicle's handling qualities were generally satisfactory. Eighty percent of the pilot ratings were 3.5 or better; 31 percent were 3.0, the most frequently assigned rating, indicating that the handling qualities were fair; and 20 percent of the ratings were from 4.0 to 7.0.

The longitudinal handling qualities at low speeds (subsonic configuration) were slightly better than at transonic and supersonic speeds (transonic configuration); 87.6 percent of the ratings for the subsonic configuration and 69.8 percent for the transonic configuration were 3.5 or better. The lateral-directional handling qualities were unchanged by speed and configuration; 87.3 percent of the ratings for the subsonic configuration and 76.4 percent for the transonic configuration were 3.5 or better. The pilot evaluations were generally for the vehicle with the stability augmentation system (SAS) on; only 10 percent of the ratings were for the SAS off. Generally, the SAS-off handling qualities were satisfactory at the conditions selected for investigation.

The most difficult handling qualities task presented to the pilots was longitudinal control during the constant-high-angle-of-attack portion of the powered boost. The pilot ratings for this task were significantly worse than those for other portions of the flight or other tasks. Of these ratings 51.6 percent were between 4.0 and 6.5; the most frequently assigned rating was 5.0. To improve the handling qualities an angle-of-attack hold mode was included with the installation of the command augmentation system. Because of the poor physical characteristics of the command augmentation system side stick and the requirement that the pilots wear a pressure suit, which aggravated the effect of the poor stick characteristics, the anticipated improvement with this system was never fully achieved. The potential of the command augmentation system was recognized, however, and the system was a welcome addition to the vehicle.

All other longitudinal handling qualities were considered to be satisfactory, although some tendencies toward pilot-induced oscillations were noted in the final approach and landing flare. Ninety-five percent of the pilot ratings for the approach and landing task were 3.5 or better.

The lateral-directional stability characteristics were dominated by aerodynamic characteristics unique to this class of lifting body. These included very high effective dihedral, low natural roll damping, and a high concentration of mass about the roll axis. As a result of these characteristics, the M2-F3 vehicle was subject to roll-spiral mode coupling with the roll and yaw SAS off. However, pilot coupling with this mode was not a handling qualities problem, as it was with the M2-F2 vehicle.

At transonic speeds a Dutch roll mode instability occurred with the SAS on. A linear analysis revealed that this instability was induced by the roll SAS when the roll gain was higher than the yaw gain. The primary cause of this instability was the aileron aerodynamic roll effectiveness and yawing-moment effectiveness at transonic speeds. The problem was eliminated with the selection of higher yaw SAS gains and lower roll SAS gains at transonic speeds.

The lateral-directional handling qualities during the final approach were considered to be satisfactory. The typical pilot rating for this task was 2.0. The aerodynamic characteristics of the M2-F3 vehicle produced an unusual turbulence response, which the pilots observed as low-amplitude high-frequency lateral oscillations. No significant handling qualities problems were encountered as a result of the turbulence.

The reaction control rockets were generally satisfactory when used for damping augmentation. When used for control, they proved to be too sensitive in the roll axis and could not provide adequate trim control moment in the longitudinal axis.

*Flight Research Center
National Aeronautics and Space Administration
Edwards, Calif., April 16, 1975*

REFERENCES

1. Smith, Harriet J.: Evaluation of the Lateral-Directional Stability and Control Characteristics of the Lightweight M2-F1 Lifting Body at Low Speeds. NASA TN D-3022, 1965.
2. Holleman, Euclid C.: Stability and Control Characteristics of the M2-F2 Lifting Body Measured During 16 Glide Flights. NASA TM X-1593, 1968.
3. Kempel, Robert W.: Analysis of a Coupled Roll-Spiral-Mode, Pilot-Induced Oscillation Experienced With the M2-F2 Lifting Body. NASA TN D-6496, 1971.
4. Kempel, Robert W.; and Manke, John A.: Flight Evaluation of HL-10 Lifting Body Handling Qualities at Mach Numbers From 0.30 to 1.86. NASA TN D-7537, 1974.
5. Flight Test Results Pertaining to the Space Shuttlecraft. NASA TM X-2101, 1970.
6. Sim, Alex G.: Flight-Determined Stability and Control Characteristics of the M2-F3 Lifting Body Vehicle. NASA TN D-7511, 1973.
7. Mechtly, E. A.: The International System of Units - Physical Constants and Conversion Factors. Second Revision. NASA SP-7012, 1973.
8. Cooper, George E.; and Harper, Robert P., Jr.: The Use of Pilot Rating in the Evaluation of Aircraft Handling Qualities. NASA TN D-5153, 1969.
9. Flying Qualities of Piloted Airplanes. Military Specification MIL-F-8785B (ASG), Aug. 7, 1969.
10. Dana, William H.; and Gentry, J. R.: Pilot Impressions of Lifting Body Vehicles. Flight Test Results Pertaining to the Space Shuttlecraft. NASA TM X-2101, 1970, pp. 73-88.
11. A'Harrach, Ralph C.: Low Altitude, High-Speed Handling and Riding Qualities. AGARD Rep. 443, Apr. 1963.
12. Creer, Brent Y.; Stewart, John D.; Merrick, Robert B.; and Drinkwater, Fred J. III: A Pilot Opinion Study of Lateral Control Requirements for Fighter-Type Aircraft. NASA Memo 1-29-59A, 1959.

NATIONAL AERONAUTICS AND SPACE ADMINISTRATION
WASHINGTON, D.C. 20546

OFFICIAL BUSINESS
PENALTY FOR PRIVATE USE \$300

**SPECIAL FOURTH-CLASS RATE
BOOK**

POSTAGE AND FEES PAID
NATIONAL AERONAUTICS AND
SPACE ADMINISTRATION
451



740 001 C1 U A 750711 S00903DS
DEPT OF THE AIR FORCE
AF WEAPONS LABORATORY
ATTN: TECHNICAL LIBRARY (SUL)
KIRTLAND AFB NM 87117

POSTMASTER: If Undeliverable (Section 158
Postal Manual) Do Not Return

"The aeronautical and space activities of the United States shall be conducted so as to contribute . . . to the expansion of human knowledge of phenomena in the atmosphere and space. The Administration shall provide for the widest practicable and appropriate dissemination of information concerning its activities and the results thereof."

—NATIONAL AERONAUTICS AND SPACE ACT OF 1958

NASA SCIENTIFIC AND TECHNICAL PUBLICATIONS

TECHNICAL REPORTS: Scientific and technical information considered important, complete, and a lasting contribution to existing knowledge.

TECHNICAL NOTES: Information less broad in scope but nevertheless of importance as a contribution to existing knowledge.

TECHNICAL MEMORANDUMS: Information receiving limited distribution because of preliminary data, security classification, or other reasons. Also includes conference proceedings with either limited or unlimited distribution.

CONTRACTOR REPORTS: Scientific and technical information generated under a NASA contract or grant and considered an important contribution to existing knowledge.

TECHNICAL TRANSLATIONS: Information published in a foreign language considered to merit NASA distribution in English.

SPECIAL PUBLICATIONS: Information derived from or of value to NASA activities. Publications include final reports of major projects, monographs, data compilations, handbooks, sourcebooks, and special bibliographies.

TECHNOLOGY UTILIZATION PUBLICATIONS: Information on technology used by NASA that may be of particular interest in commercial and other non-aerospace applications. Publications include Tech Briefs, Technology Utilization Reports and Technology Surveys.

Details on the availability of these publications may be obtained from:

SCIENTIFIC AND TECHNICAL INFORMATION OFFICE

NATIONAL AERONAUTICS AND SPACE ADMINISTRATION
Washington, D.C. 20546