

NASA CONTRACTOR REPORT

NASA CR-2533

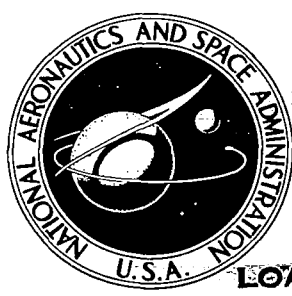

NASA
CCF-
PR-1
c.1

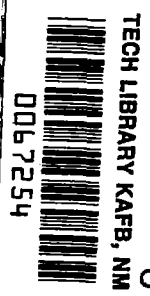

006 7254

LOAN-COPY: IRI
AFWE TECHNICAL
KIRTLAND AFB, N. M.

CARBIDE COATED FIBERS IN GRAPHITE-ALUMINUM COMPOSITES

Progress Report No. 1: September 1, 1973 -
January 31, 1974

*Richard J. Imprescia, Leonard S. Levinson,
Robert D. Reiswig, Terry C. Wallace,
and Joel M. Williams*

Prepared by
LOS ALAMOS SCIENTIFIC LABORATORY
Los Alamos, N. Mex. 87544
for Langley Research Center





0067254

1. Report No. NASA CR-2533		2. Government Accession No.		3. Recipient's Catalog No.	
4. Title and Subtitle CARBIDE COATED FIBERS IN GRAPHITE-ALUMINUM COMPOSITES Progress Report No. 1: September 1, 1973 - January 31, 1974				5. Report Date AUGUST 1975	
				6. Performing Organization Code	
7. Author(s) Richard J. Imprescia, Leonard S. Levinson, Robert D. Reiswig, Terry C. Wallace, and Joel M. Williams				8. Performing Organization Report No. LA-5567-PR	
				10. Work Unit No. 506-16-21-01	
9. Performing Organization Name and Address Los Alamos Scientific Laboratory Los Alamos, New Mexico 87544				11. Contract or Grant No. L-75,900	
				13. Type of Report and Period Covered Contractor Report	
12. Sponsoring Agency Name and Address National Aeronautics and Space Administration Washington, DC 20546				14. Sponsoring Agency Code	
15. Supplementary Notes Progress Report					
16. Abstract <p>This report describes the first phase of a NASA-supported program at the Los Alamos Scientific Laboratory (LASL) aimed at developing carbon fiber-aluminum matrix composites. Two of the principal difficulties in manufacturing such materials are the difficulty in wetting carbon with liquid aluminum and the degradation that occurs in the fibers at high temperatures when aluminum carbide forms. LASL's approach to overcoming these problems is to use protective-coupling layers of refractory metal carbides on the graphite fibers prior to their incorporation into the composites. Such layers should be directly wettable by liquid aluminum and should act as diffusion barriers to prevent the formation of aluminum carbide.</p> <p>Chemical vapor deposition has been used to uniformly deposit thin, smooth, continuous coats of ZrC on the carbon fibers of tows derived from both rayon and polyacrylonitrile. Wet chemical coating of the fibers, followed by high-temperature treatment, has also been used, and shows promise as an alternative coating method.</p> <p>Experiments have been performed to demonstrate the ability of aluminum alloys to wet carbide surfaces. Titanium carbide, zirconium carbide and carbide-coated graphite surfaces have been successfully wetted. Initial attempts to wet surfaces of ZrC-coated carbon fibers also appear successful.</p>					
17. Key Words (Suggested by Author(s)) Graphite-aluminum composites Graphite fibers Aluminum alloy matrices Refractory carbide coatings				18. Distribution Statement Unclassified - Unlimited Subject Category 24 Composite Materials	
19. Security Classif. (of this report) Unclassified		20. Security Classif. (of this page) Unclassified		21. No. of Pages 28	22. Price* \$3.75

CARBIDE COATED FIBERS IN GRAPHITE-ALUMINUM COMPOSITES

Progress Report No. 1: September 1, 1973 - January 31, 1974

By Richard J. Imprescia, Leonard S. Levinson, Robert D. Reiswig,
Terry C. Wallace and Joel M. Williams
Los Alamos Scientific Laboratory

SUMMARY

This report describes the first phase of a NASA-supported program at the Los Alamos Scientific Laboratory (LASL) aimed at developing carbon fiber-aluminum matrix composites. Two of the principal difficulties in manufacturing such materials are the difficulty in wetting carbon with liquid aluminum and the degradation that occurs in the fibers at high temperatures when aluminum carbide forms. LASL's approach to overcoming these problems is to use protective-coupling layers of refractory metal carbides on the graphite fibers prior to their incorporation into the composites. Such layers should be directly wettable by liquid aluminum and should act as diffusion barriers to prevent the formation of aluminum carbide.

Chemical vapor deposition has been used to uniformly deposit thin, smooth, continuous coats of ZrC on the carbon fibers of tows derived from both rayon and polyacrylonitrile. Wet chemical coating of the fibers, followed by high-temperature treatment, has also been used, and shows promise as an alternative coating method.

Experiments have been performed to demonstrate the ability of aluminum alloys to wet carbide surfaces. Titanium carbide, zirconium carbide and carbide-coated graphite surfaces have been successfully wetted. Initial attempts to wet surfaces of ZrC-coated carbon fibers also appear successful.

INTRODUCTION

Because of their potential for extremely high strength-to-density and modulus-to-density ratios, considerable interest has been generated in carbon fiber-aluminum matrix composites. Two principal barriers, however, to the successful development of carbon-aluminum composites are the difficulty in wetting carbon with liquid aluminum,¹ and the degradation of the fibers that results when aluminum carbide (Al_4C_3) forms.² Although direct wetting of graphite fibers by aluminum alloys has been accomplished by altering the surface of the fibers by special chemical treatment, little is known about the process due to its proprietary status.³ A promising alternative to this method is to use protective-coupling layers which are deposited on graphite fibers prior to their incorporation into the composites. Properly chosen and applied, such layers should serve several purposes: (1) their presence should permit direct wetting by liquid aluminum, (2) they should provide an effective coupling for the transfer of shear stress from the matrix to the fibers, and (3) they should eliminate, or greatly reduce, the reaction between aluminum and carbon to form Al_4C_3 . The formation of Al_4C_3 is undesirable because of the consumption

of carbon from the fibers, with the concomitant degradation of their properties,³ and because Al_4C_3 tends to hydrolyze in the presence of water to form methane.⁴ If a coating can be found which does not, itself, degrade the graphite fibers, and in which the diffusion rates of carbon and aluminum are sufficiently low, it should be possible to use carbon-aluminum composites at higher service temperatures and to employ higher fabrication temperatures, while avoiding the formation of Al_4C_3 .

Refractory metal carbides are promising for use as protective-coupling layers on graphite fibers. Recent studies indicate that titanium carbide (TiC) can provide an effective protective barrier to prevent reaction between graphite and aluminum,^{1,5} and also promote wetting of graphite by liquid aluminum.⁶

The work described here has been directed toward developing methods for producing refractory carbide, protective-coupling coats on graphite fibers that will permit their incorporation into a carbon-aluminum composite having desirable mechanical properties. Specific objectives of the program are to:

- establish the deposition parameters for producing thin, uniform coats of at least two refractory carbides on carbon, optimize the coat thickness and determine the extent of damage to the fibers, if any, due to the coating process
- demonstrate the ability of aluminum to wet refractory carbide surfaces, including the surfaces of carbide-coated graphite, and evaluate the effectiveness of carbide coats on carbon as diffusion barriers to prevent the formation of Al_4C_3
- develop a technique for, and perform liquid Al infiltration on small samples of carbide-coated yarn
- determine tensile strength, elastic modulus and mode of fracture of Al-infiltrated carbide-coated yarns.

Significant progress has been made toward achieving these objectives. Thin, smooth, continuous zirconium carbide (ZrC) coats have been deposited uniformly on individual fibers throughout carbon tows using chemical vapor deposition methods. Preliminary experiments have also been done using wet chemical coating methods, and the initial results are encouraging. Surfaces of TiC, ZrC and ZrC-coated graphite have been successfully wetted with Al and Al alloys, and initial attempts to infiltrate ZrC-coated graphite fibers with Al look promising.

EXPERIMENTAL

Materials

Fibers.- The following commercial carbon fibers were obtained from their respective manufacturers for use in coating experiments: Hitron 401, Thornel 50 and Thornel 75, which are rayon-base fibers; HTS, HMS and Fortafil 6T, which

are PAN-base; and a monofilament fiber which is derived from pitch. The reported properties⁷ and SEM photomicrographs of typical samples are given in APPENDIX A.

Coating Materials.- For chemical vapor deposition coating experiments, two materials were obtained: reactor grade zirconium tetrachloride ($ZrCl_4$) and commercial grade, purified titanium tetrachloride ($TiCl_4$). For wet chemical coating, an aqueous solution of tetramethylammonium titanate and dextrose was used. The preparation of the titanate is given in APPENDIX A.

Aluminum Alloys.- Four aluminum alloys were selected for wetting and infiltration experiments. Three of these were the standard commercial alloys 1100, 4047 and 6061; and one was a LASL-produced Al-13% Si alloy. The chemical compositions are given in APPENDIX A.

Fiber Coating Experiments

Two approaches were taken for the production of refractory metal carbide coatings on carbon fibers. The first of these was chemical vapor deposition (CVD) using a refractory metal halide as the metal-bearing component of the coating gas. The other approach was to dip-coat the fibers in a metal-bearing aqueous solution, dry it in air, then convert the coat to carbide by heating at elevated temperatures.

Chemical Vapor Deposition.- Of the two refractory metal halides selected for this work, $ZrCl_4$ was chosen for the initial CVD experiments. ($TiCl_4$ will be used in experiments later in the program). The vapor coating apparatus, the processing procedures and the chemistry of the deposition process are discussed in APPENDIX B and in Reference 8.

Basically, there are two chemical reactions involving the decomposition of refractory metal salts which can lead to the formation of metal carbide coats on carbon substrates. For $ZrCl_4$ and $TiCl_4$ these are

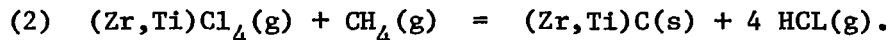
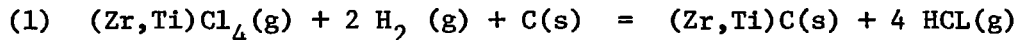

In equation 1, the carbon necessary for the formation of the metal carbide is provided by the substrate which is to be coated. This reaction may weaken the carbon fiber, the extent of weakening depending on the thickness of the developed coat, and how localized the carbon removal is. For the reaction of equation 2, the carbon is supplied in the coating gas as methane (CH_4), and therefore degradation of the fiber by carbon consumption should be avoided. In addition to the coating gases, an inert diluent gas (Ar or He) is added, and excess H_2 and HCl may be added. By varying the composition (partial pressures) of the coating, diluent and other gases, the deposition kinetics can be varied. Of course, deposition temperature also has a marked influence on the kinetics.

The process conditions for 24 CVD fiber coating runs, and the metallographic observations of the ZrC coats produced are summarized in Table I. All runs included samples of HMS and Thornel 50 fiber tows except the first run (9-20, Table I) which was made with Fortafil 6T instead of HMS. To avoid the reaction of fiber carbon with the coating gas (equation 1), the initial runs (9-20 through 10-11) were made with a coating gas mixture of $ZrCl_4$ and CH_4 , using Ar as the diluent. None of the resulting ZrC fiber-coats was satisfactory. Some fibers had coats which were agglomerates of large, nodular crystals, and others had virtually no coats. Typical examples of these extremes are shown in Figs. 1 and 2. The distribution of coat thicknesses throughout the tows was also very poor, as shown in Fig. 3. The outer fibers could be well coated, but frequently welded together, while the inner fibers could have no coat at all.

The variation in ZrC coat thickness from outer to inner fibers of a carbon fiber tow (Fig. 3) should be reduced by increasing the HCl concentration in the coating gas. This modification should slow the rate of the reaction shown in equation 2, permit more of the unreacted coating gas mixture to penetrate the inside of the tow, and decrease the coat thickness gradient. Two runs were made (10-16 and 10-17) with increased HCl, but the resulting coats, although improved, still lacked uniformity in thickness from the outer to inner fibers of the tow.

The development of the large nodular crystals (Fig. 1) indicates that the coating gas was saturated with $ZrCl_4$, which could lead to a high degree of gas phase nucleation of ZrC. This saturation would cause a depletion of the $ZrCl_4$ in the coating gas, decrease the ZrC nucleation rate on the fiber substrate, and promote the growth of large nodular crystals. Lowering the concentrations of $ZrCl_4$ and CH_4 should overcome the tendency toward gas phase nucleation. A change in the diluent gas from Ar to He should increase the mobility of the coating gases and lead to a more uniform distribution of coat thicknesses throughout the tow. Three runs were made (11-16, 11-7 and 11-8) with these modifications to the coating gas, but only slight, if any, improvements in the coats or their thickness distributions through the tows were observed.

In recognizing the possibility that some CH_4 may be generated by a reaction between the H_2 in the coating gas and the graphite of the coating apparatus during coating, the CH_4 was completely eliminated from run 11-9. This was done to determine the effect of a very small, or possibly zero, concentration of CH_4 in the coating gas. The resulting coats produced in this run were a significant improvement over any of the others made up to this time. They were uniform, and although the coat thickness gradient through the tow was still significant, all of the fibers in both the HMS and the Thornel 50 tows appeared to have undergone at least some coating.

To follow up the encouraging result of run 11-9, five more runs (12-4 through 12-10) were made without CH_4 and the deposition temperature was varied from 1573 K (1300°C) to 2073 K (1800°C). For the two higher temperature runs (12-4 and 12-5) the ZrC deposits were so heavy that a continuous ZrC crust formed around the outer fibers of the tow, lowering the coating rate on the inner fibers. This is illustrated Fig. 4 which shows the coated Thornel 50 fibers from Run 12-4. Not only was the tow encapsulated by the ZrC crust, but there was considerable consumption of carbon from the outer fibers during formation of

TABLE I
PROCESS CONDITIONS AND RESULTS FOR FIBER COATING RUNS^a

Run No.	Deposition:		Gas Flow Rate, STP (l/min)						Max Thick. (μm)	ZrC Coat Appearance	
	Temperature K(°C)	Time (min)	ZrCl ₄	CH ₄	H ₂	Ar	He	HCl		Outer Fibers	Inner Fibers
9-20	2073 (1800)	15	0.40	0.40	1.80	23	0	0	2	lg xtals; welds	uncoated
9-21	1973 (1700)	15	0.40	0.40	1.80	23	0	0	1	incomplete; welds	uncoated
9-24	1873 (1600)	15	0.40	0.40	1.80	23	0	0	Trace	incomplete; nodules	uncoated
9-25	1773 (1500)	15	0.40	0.40	1.80	23	0	0	0.5	incomplete; nodules	uncoated
9-26	1673 (1400)	15	0.40	0.40	1.80	23	0	0	Trace	incomplete; flaky	uncoated
9-27	1773 (1500)	10	1.31	2.0	4.0	23	0	0	Trace	v. few nodules	uncoated
9-28	1873 (1600)	15	1.31	1.2	2.5	23	0	0	0.5	nearly complete; welds	few nodules
10-1	1673 (1400)	15	1.31	1.2	2.5	23	0	0	Trace	loose ZrC particles	uncoated
10-3	1773 (1500)	15	1.31	1.2	2.5	23	0	0	0.5	incomplete	few nodules
10-9	1873 (1600)	5	1.31	1.2	2.5	23	0	0	Trace	incomplete	uncoated
10-10	1773 (1500)	5	1.31	1.2	2.5	23	0	0	Trace	nodules	uncoated
10-11	1673 (1400)	5	1.31	1.2	2.5	23	0	0	None	loose ZrC particles	uncoated
10-16	1973 (1700)	15	1.31	1.2	2.5	23	0	2.0	1	partial-to-complete	few nodules
10-17	1973 (1700)	30	1.31	1.2	2.5	23	0	2.0	2	partial-to-complete	few nodules
11-6	1973 (1700)	15	0.40	0.30	8.0	23	0	0	2	lg xtals; welds	incomplete
11-7	1973 (1700)	15	0.40	0.30	8.0	0	23	0	1-2	incomplete	incomplete
11-8	1973 (1700)	15	0.30	0.20	8.0	0	23	0	Trace	nodules	uncoated
11-9	1973 (1700)	15	0.53	0	8.0	0	23	0	2-4	partial-to-complete	incomplete
12-4	2073 (1800)	15	0.46	0	8.0	0	23	0	5-10	thick crust; welds	uncoated
12-5	1873 (1600)	15	0.46	0	8.0	0	23	0	4	thick crust; welds	uncoated
12-6	1673 (1400)	15	0.46	0	8.0	0	23	0	≤ 1	uniform, complete and smooth throughout tow	
12-7	1573 (1300)	15	0.46	0	8.0	0	23	0	≤ 0.5	uniform, complete and smooth throughout tow	
12-10	1573 (1300)	15	0.23	0	8.0	0	23	0	≤ 0.5	uniform, complete and smooth throughout tow	
12-20	1573 (1300)	15	0.46	0	8.0	0	23	0	≤ 0.5	uniform, complete and smooth throughout tow	

^a All fiber coating runs were made using Thornel 50 and HMS fibers, except Run 9-20 for which Thornel 50 and Fortafil 6T were used.

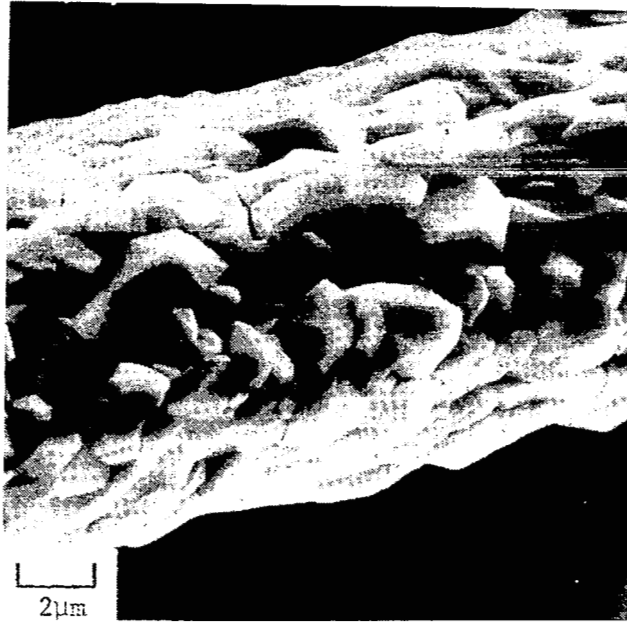

Fig. 1. SEM photomicrograph of thick ZrC coat on outer Thornel 50 fiber from run 9-20.

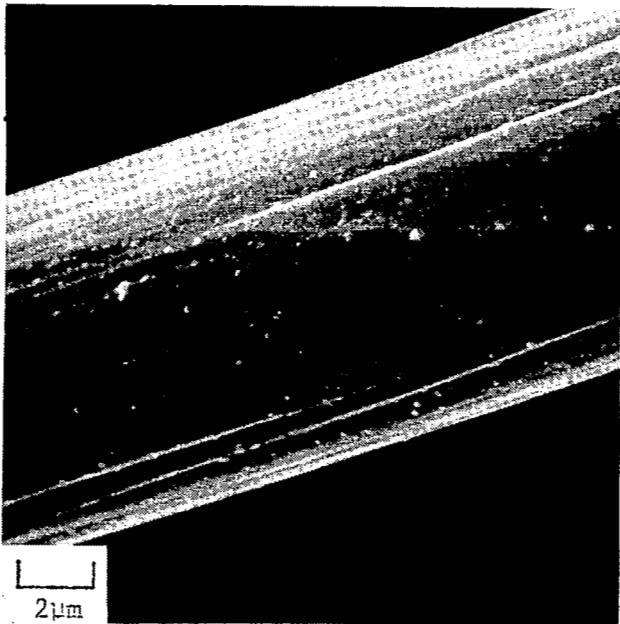

Fig. 2. SEM photomicrograph of inner HMS fiber from run 9-28, showing initiation of ZrC coat.

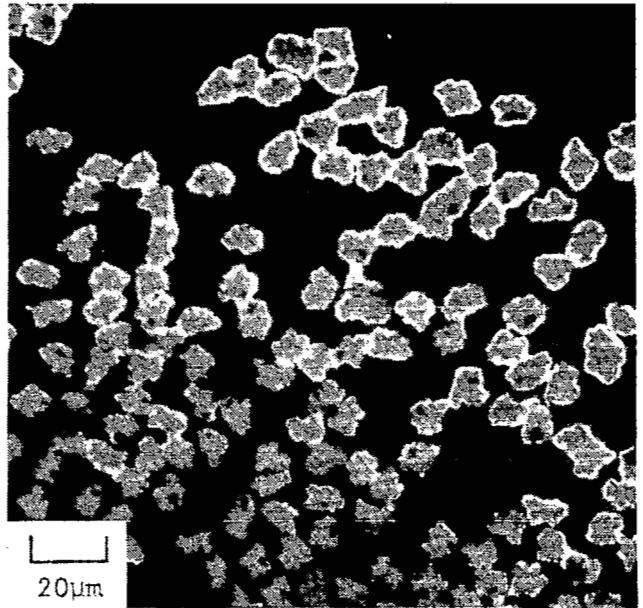

Fig. 3. Optical photomicrograph of outer edge of polished section through Thornel 50 fibers coated in run 9-21.

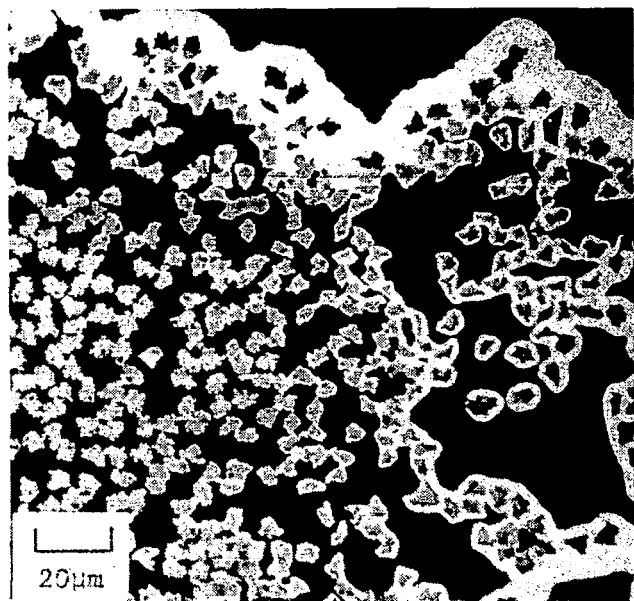
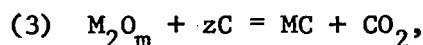
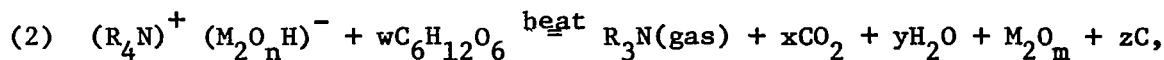
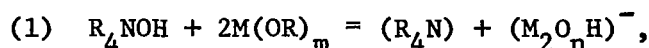

Fig. 4. Optical photomicrograph of Thornel 50 fibers CVD-coated with ZrC in Run 12-4.

the ZrC. The other three runs were quite successful. The coats on both the Thornel 50 and the HMS tows were complete, uniform and smooth. For the three runs, the coat thicknesses varied from $< 0.5 \mu\text{m}$ to $1 \mu\text{m}$ (Table 1). Typical examples of these coats are shown in the photomicrographs of Figs. 5 and 6. The coats were so smooth, uniform and continuous that on initial examination with the SEM it appeared as though the fibers were not coated at all (Fig. 5a). Only after performing elemental scans for zirconium (Fig. 5b) using SEM x-ray image analysis were the coats definitely identified. Optical microscopy further established the uniformity of coating throughout the tows. Although a few of the fibers appeared to be welded together at points of contact (Fig. 6), all of the fibers throughout a given tow were uniformly coated with essentially the same thickness of ZrC.

To evaluate the reproducibility of these successful coating conditions, and to prepare a supply of coated fibers for infiltration experiments, several similar coating runs are being made. One has been completed (run 12-20) using the conditions of run 12-7, and has given a similar product. Following these runs, efforts will be directed toward producing TiC coats on fibers.

Wet Chemical Coating.- An alternative to the CVD coating method is a wet chemical method. The principle is quite simple. Quaternary ammonium metalates are water soluble and will decompose at red heat to produce metal oxides. When heated at elevated temperature these oxides will convert to carbides if carbon is present. The carbon source can be the fiber but is best provided by dextrose which is also water soluble. The chemical equations are roughly:



where R is an organic radical and M is a metal. Such metalates are ill-defined, however, and the amount of dextrose needed to supply all the carbon must be determined experimentally. Excess carbon will result in a carbide dispersed in a carbon matrix while too little carbon will cause the metal to convert fiber carbon to carbide. The excess carbon could possibly be eliminated by subsequent

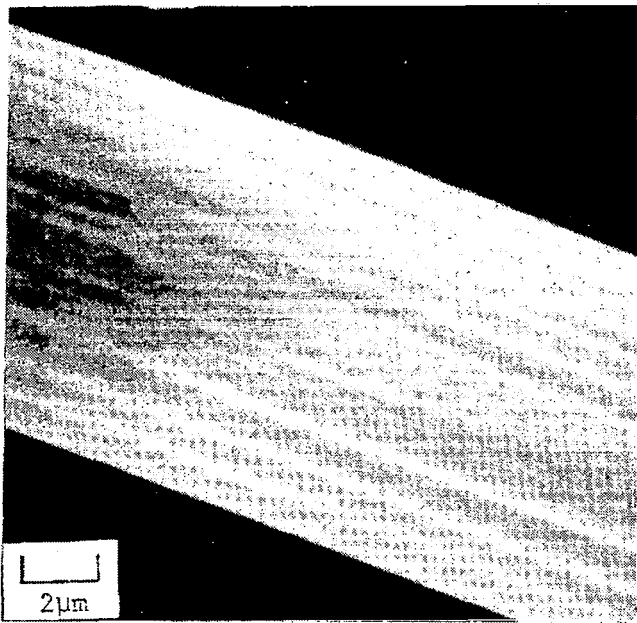

(a)

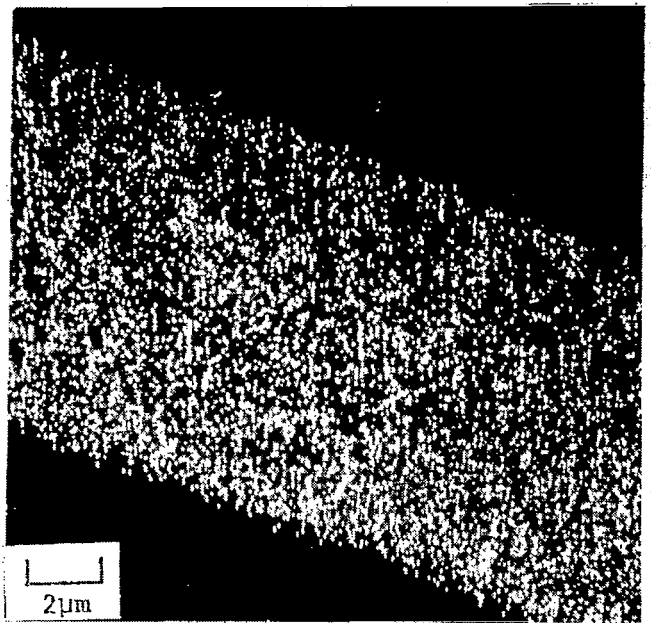

(b)

Fig. 5. SEM photomicrographs of HMS fiber CVD-coated with ZrC in Run 12-10. (a) Specimen image, and (b) Zr x-ray image.

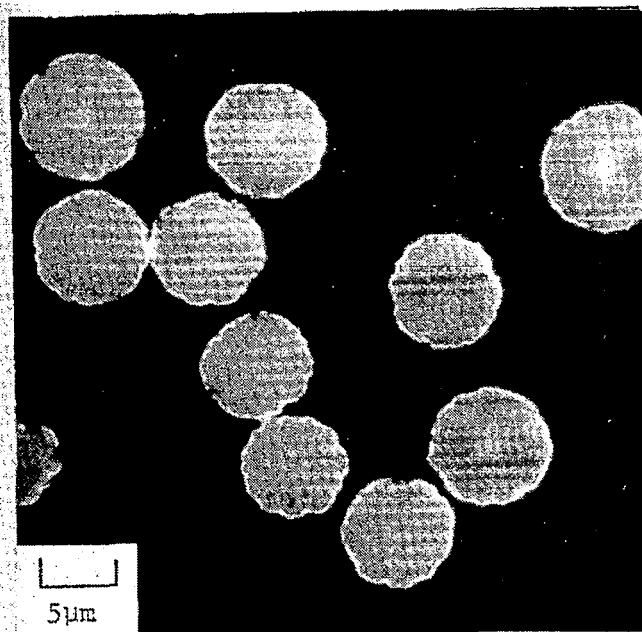

(a)

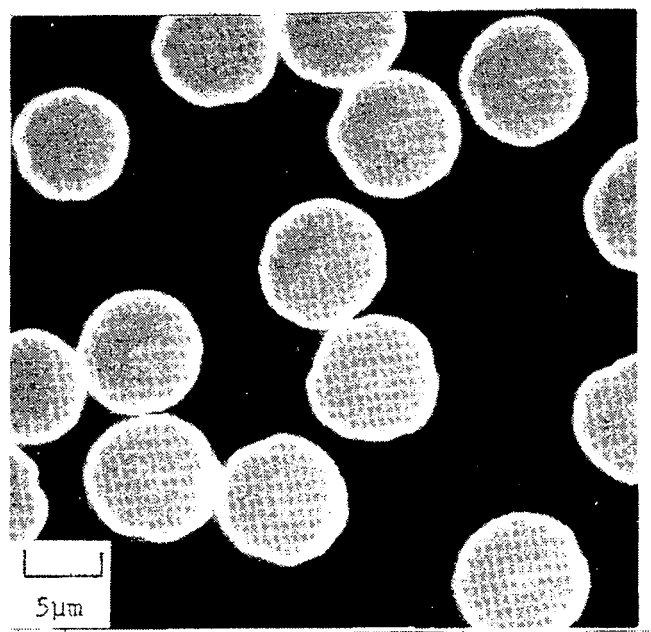

(b)

Fig. 6. Optical photomicrographs of HMS fibers CVD-coated with ZrC in (a) Run 12-7, and (b) 12-6.

conversion to carbide by CVD techniques using the corresponding metal halide.

This technique should provide uniform fiber coatings and uniform coating thicknesses throughout the tow. The wetting ability of the solution will not only allow coverage of the outer fibers but will also permit rapid penetration of the tow. Because the system is unreactive in the initial coating step, the concentration of metal in the solution will be uniform at all points in the tow.

Marginal success has been achieved by hand dipping carbon fibers in a Ti-bearing aqueous solution to form TiC coats. Lengths of Thornel 75 fiber tow 150 mm long were dipped at room temperature in a solution prepared by mixing 0.1 liter of Ti stock solution (see APPENDIX A) with 0.011 kg dextrose. For a single dipping, the sample was dried in air at 383 K (110°C) for 1 hour, then heated in argon to a coking temperature of 1173 K (900°C) to decompose the metalate. For multiple dipping, the sample was handled in either of two ways: (1) dried after each dip, then finally coked at 1173 K (900°C), or (2) dried and coked after each dip. Following the final coking, all fiber samples were heated to 1973 K (1700°C) in helium. Figure 7 shows the specimen image and the Ti x-ray image determined by SEM on a sample which was dipped and dried three times before the final coking. Figure 8 shows similar views of another sample which was dipped three times, but was coked after each dip-dry cycle. Although the Ti obviously is unevenly distributed on the fiber surfaces of both samples, these preliminary results are encouraging. It may be possible to produce a more uniform distribution of the coat by properly wiping the tows after dipping. So far, the dipped samples have not been wiped.

Work on wet chemical methods will continue. But because of the outstanding successes with CVD, the wet chemical method will not be emphasized.

Wetting Experiments

To demonstrate the ability of aluminum to wet refractory metal carbides, several wetting experiments were performed with a variety of carbide surfaces. These included bulk ZrC and TiC, ZrC-coated pyrolytic graphite (PyG), and ZrC-coated artificial graphite (grade AUC). The ZrC and TiC were hot-pressed products and the ZrC-coats on both graphites were deposited using the conditions of the CVD runs listed in Table I.

Initial attempts to wet the ZrC-coated PyG were unsuccessful because of the formation of Al₂O₃ films. The procedure was as follows. A short length of grade 1100 Al wire or 4047 Al-Si alloy wire was laid across a ZrC-coated face of a polished PyG block approximately 10 x 10 x 10 mm. The block was then placed in a furnace, heated to 623 K (350°C) for 30 min, then to 823 K (550°C) for 30 min, and finally to 973 K (700°C) for 15 min. The furnace environment was either vacuum (1×10^{-3} Pa) or a high purity inert gas (Ar or He). In all cases, a surface coating, which undoubtedly was Al₂O₃, formed on the wire, encapsulating the Al, preventing it from flowing onto the surface of the coated block. Apparently, this is not an uncommon problem. In a private communication, C. R. Manning, North Carolina State University, pointed out that it is very difficult to overcome the formation of Al₂O₃ and that the solutions are not clear. From his work⁶ he found that gettering the system with active

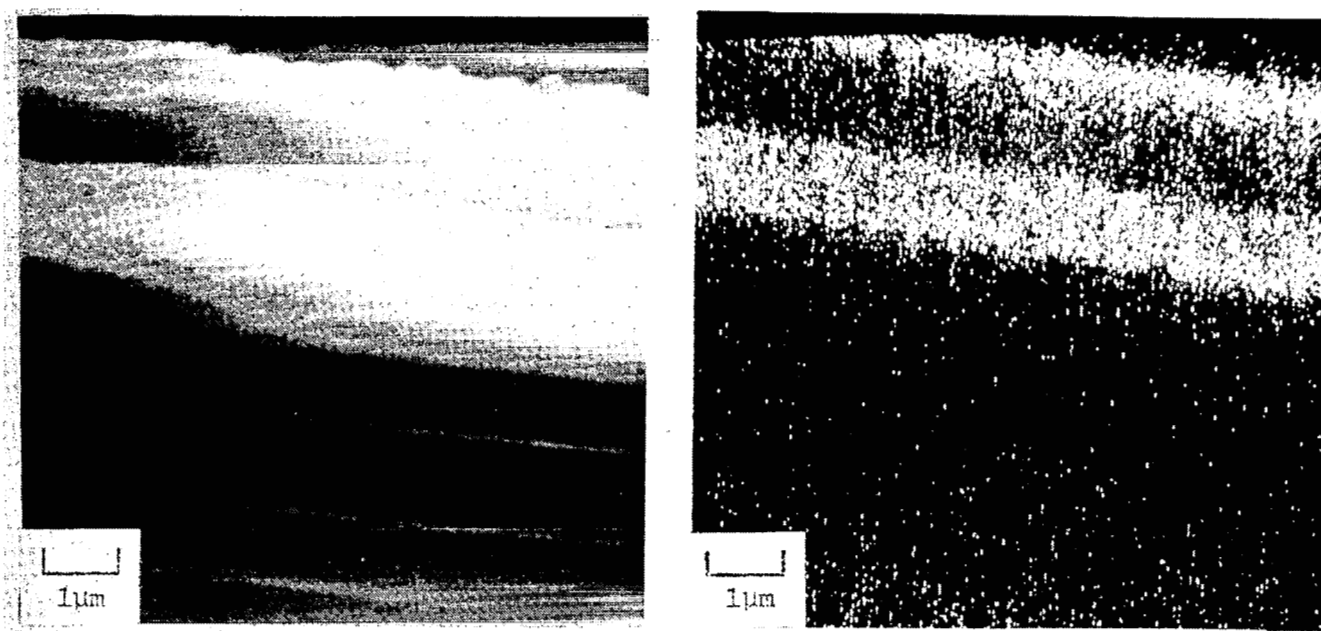

(a)

(b)

Fig. 7. SEM photomicrographs of Thornel 75 fiber wet-chemical-dipped three times with Ti solution; no coking heat-treatment between dips. (a) Specimen image, and (b) Ti x-ray image.

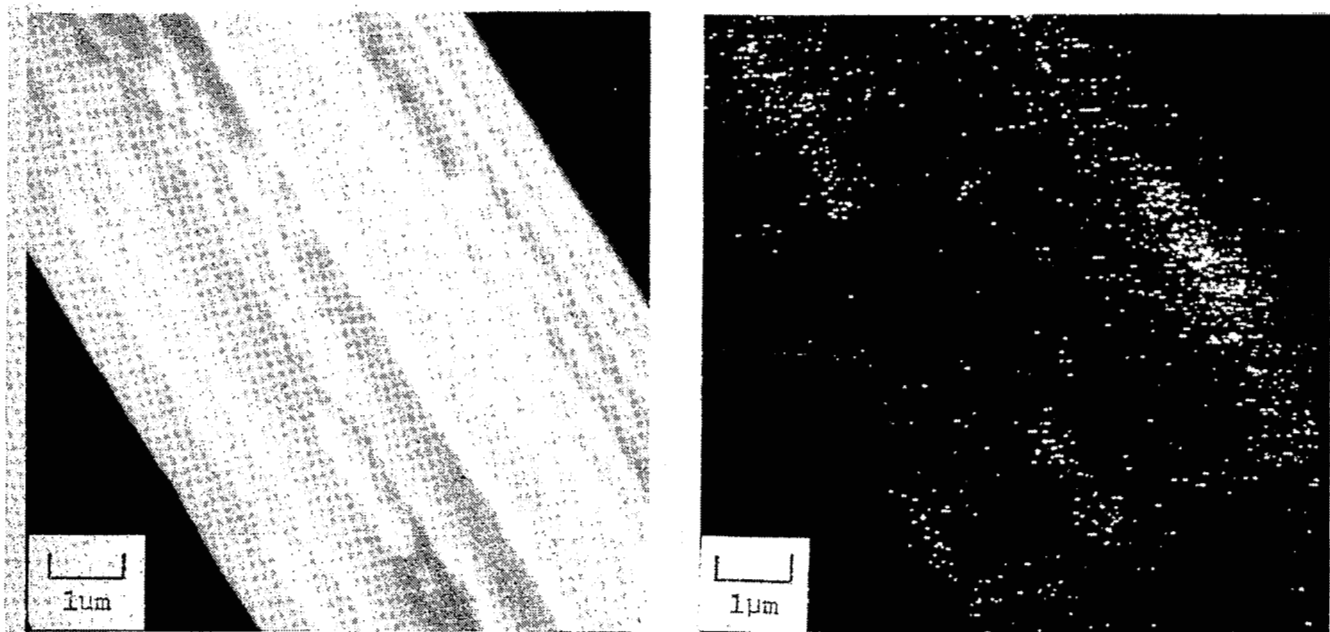

(a)

(b)

Fig. 8. SEM photomicrographs of Thornel 75 fiber wet-chemical-dipped three times with Ti solution; 1173 K (900°C) coking heat-treatment between dips. (a) Specimen image, and (b) Ti x-ray image.

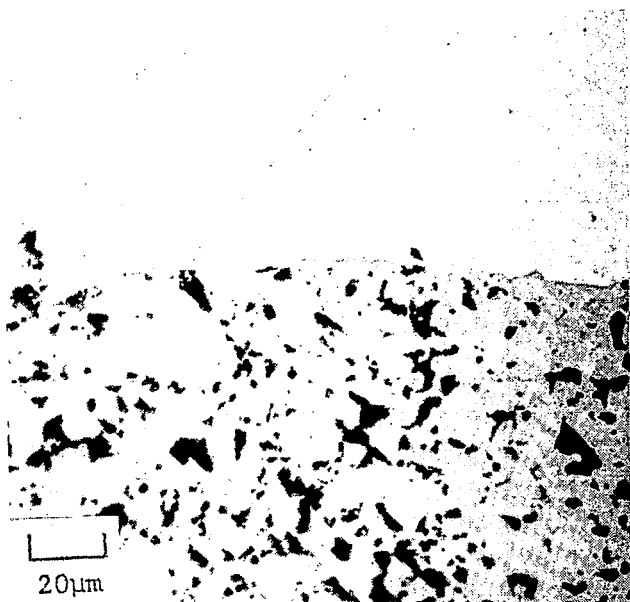

Fig. 9. Optical photomicrograph showing wetting of TiC (bottom) by 1100 Al (top).

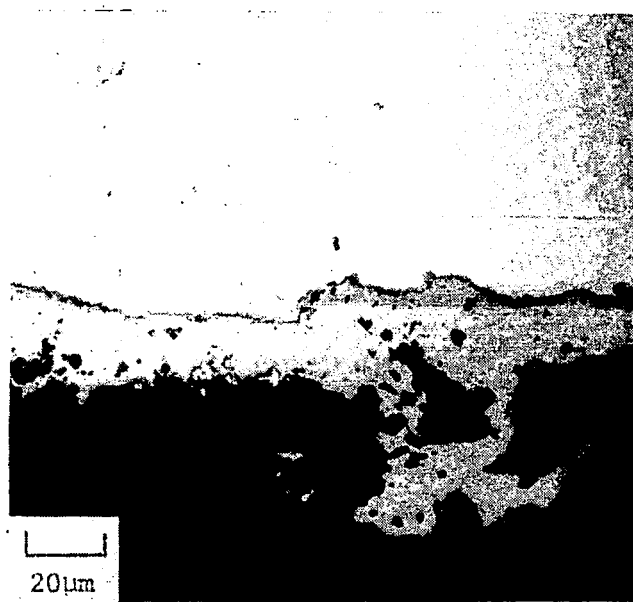

Fig. 10. Optical photomicrograph showing wetting of ZrC coat (middle) on AUC graphite (bottom) by 1100 Al (top).

metals sometimes gave satisfactory results.

Another problem associated with the wetting of these particular PyG blocks was that they were coated in the earlier CVD runs (Table I), and the poor quality of their coats may have influenced the wetting behavior. Therefore, several runs were made with bulk ZrC and TiC substrates. In one of these, a freshly exposed surface on a chip of TiC was plunged into a bath of 1100 Al at approximately 1053 K (780°C) for a few seconds in an inert-atmosphere. The excellent wetting between the TiC and the aluminum at this interface is shown in Fig. 9. In the other runs, the samples were prepared as follows. Small blocks of alloy were placed on the surfaces of small discs of TiC or ZrC. These were then placed in a graphite crucible and heated rapidly to 1053 K (780°C) in a vacuum furnace at 1×10^{-3} Pa. Prior to heating, the system was gettered with hot (1173 K) uranium chips in a gettering furnace that was placed in series with sample furnace. Several wetting experiments were made with this arrangement using the 1100 and 4047 Al alloys, and the LASL Al-Si alloy with ZrC and TiC substrates. Partial wetting occurred in most of these experiments, but the problem with the formation of Al_2O_3 persisted. To achieve significant wetting of the carbide surfaces, it was necessary to place a small weight on top of the alloy prior to heating, so that the Al_2O_3 film would rupture when the alloy became molten, permitting it to flow onto the surface. Several successful runs were made with this technique, and an example is given in Fig. 10, which shows the wetting of a small disc of ZrC-coated AUC graphite with 1100 Al alloy. (The ZrC coat was quite thick, $\sim 25\mu m$, and was deposited under conditions similar to those of run 12-4, except that a small amount of CH_4 , 0.1 l/min, was added and the deposition time was increased almost an order of magnitude.)

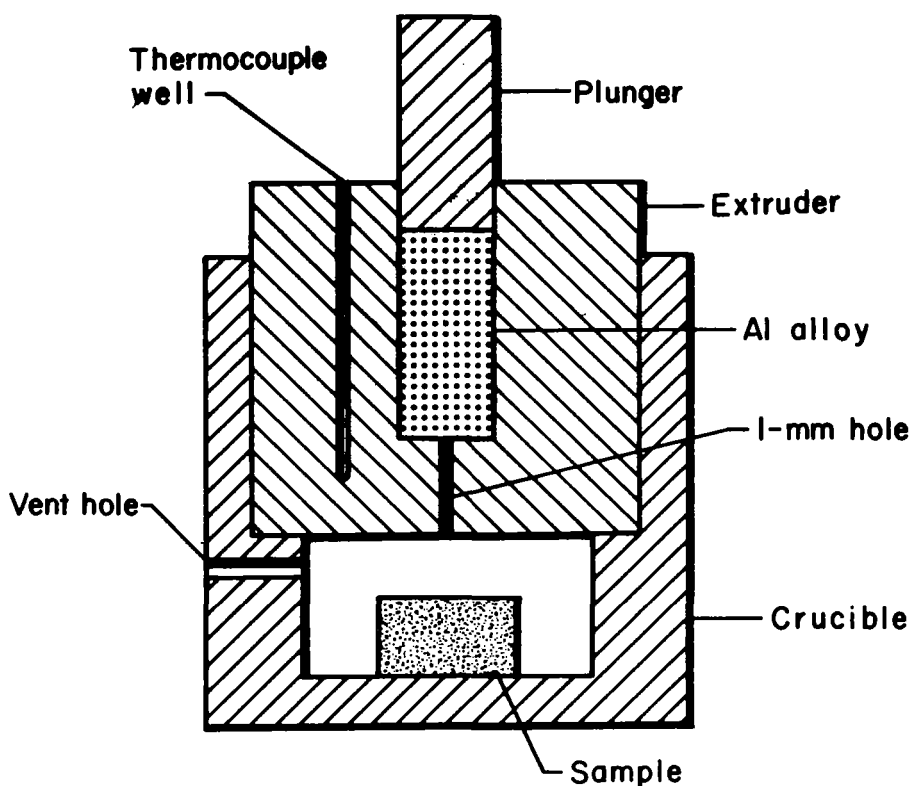
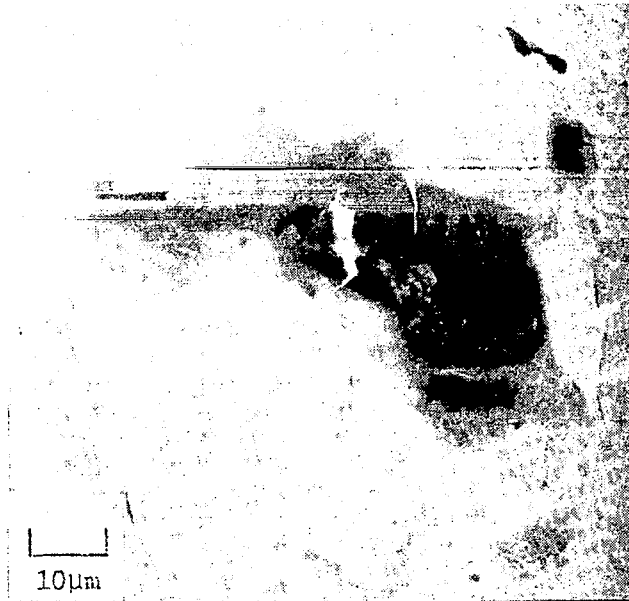
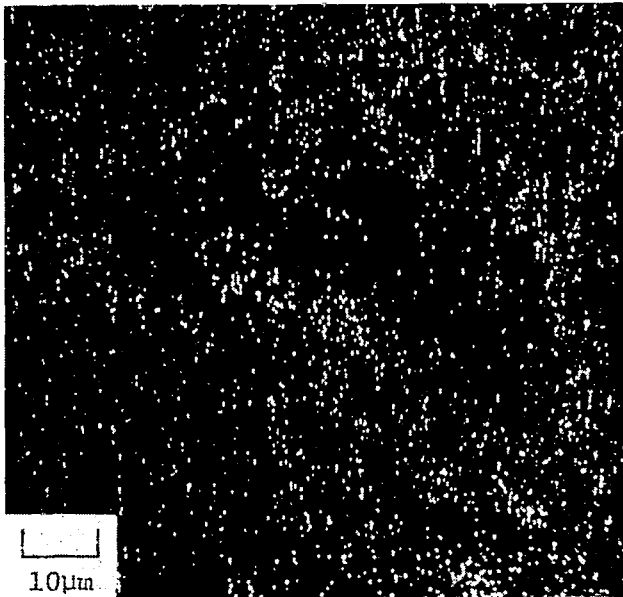

Fig. 11. Schematic of fixture for wetting refractory metal surfaces with fresh molten aluminum alloys.

In a further attempt to overcome the Al_2O_3 formation problem and to expose carbide surfaces to fresh, molten Al alloys, the fixture shown in Fig. 11 was constructed. It was made from graphite and is used as follows. With the sample and alloy located as shown, the fixture is placed into a vertically oriented, quartz tube, vacuum furnace. The furnace is heated rapidly to a temperature above the melting point of the alloy, at a pressure of 1×10^{-3} Pa. The plunger is then pushed into the extruder causing a stream of fresh, molten metal to be directed onto the carbide surface. In the initial experiments, this system was used for the wetting of ZrC-coated PyG blocks. The wetting, so far, seems to be good. The metal appears to flow easily on the carbide surfaces, in contrast to some of the earlier experiments where the metal became encapsulated in a film of Al_2O_3 and essentially retained its original shape. Because of the nature of PyG, however, it has been difficult to examine microscopically the metal/carbide interface. The bonding between the c-face layer planes in graphite is so weak that during preparation of the metallographic samples the surface layers tend to cleave away the carbide coat which clings to the alloy. Figure 12 shows the SEM specimen image (Fig. 12a), and the Zr (Fig. 12b) and Al-Si (Fig. 12c) x-ray images of an area that pulled away from a block of ZrC-coated PyG. The block was coated in run 12-6 (Table I) and was wetted with the LASL Al-Si alloy at 903 K (630°C) by the above procedure. The presence of both Zr and Al-Si at the interface indicates that wetting was successful. The dark area in the center of Fig. 12a shows up in both x-ray scans



(a)



(b)

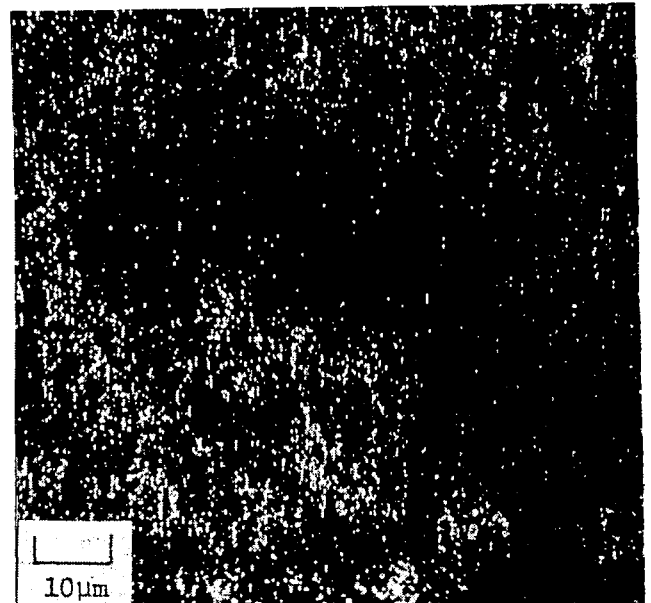

(c)

Fig. 12. SEM photomicrographs showing (a) specimen image, (b) Zr x-ray image, and (c) Al-Si x-ray image of an area on ZrC-coated PyG which was wetted with Al-13% Si alloy and then torn from the PyG substrate.

as a shadow, and evidently represents a thin layer of PyG which was torn away from the surface of the block. This provides further support that wetting took place.

Because of the problems associated with the examination of Al-wetted carbide-coated PyG, most future work in this area will be done with carbide-coated polycrystalline graphites. These samples will be used primarily to evaluate the effectiveness of carbide coats as diffusion barriers to prevent the formation of Al_4C_3 .

Infiltration Experiments

Initial experiments on the infiltration of ZrC-coated carbon fibers with Al alloys are being done on small samples of tow approximately 30 mm long. Figure 13 shows a sketch of the graphite fixture used for the experiments. The infiltration procedure is as follows:

1. A block of infiltrant alloy is machined to fit closely into the mold.
2. Carbide-coated fibers are inserted into the central hole of the penetrator and the fixture is assembled.
3. The fixture is placed in a vertical quartz tube which is surrounded by a removable furnace.
4. The assembly is heated in vacuum or an inert atmosphere to a temperature above the melting point of the metal.
5. The penetrator is forced into the liquid metal with the push-rod.
6. After a short time the furnace is removed from the quartz tube and the fixture is allowed to cool.
7. The fixture is disassembled and the sample is removed from the penetrator.

On insertion of the penetrator into the melt, most of the surface oxide which forms should be pushed away from the tip of the penetrator, exposing the fibers to fresh molten metal. Initially, melt that is displaced by the penetrator will flow out of the overflow holes. After the overflow holes are closed off by the penetrator the metal will flow up the central hole in the penetrator, through the fibers, up the sides of the push-rod and overflow at the top of the mold.

Several infiltrations have been made on samples of Thornel 50 which were coated with ZrC in CVD run 12-4. This material had the thick crusty ZrC coat, discussed above, which essentially encapsulated the tow (Fig. 4), and was selected mainly to do the preliminary work in establishing the infiltration technique, and to avoid depleting the supply of well-coated fibers. In the first few infiltrations severe temperature gradients existed and the alloy would not wet the tow. With proper insulation of the furnace system this was corrected and two successful infiltrations were made. Figure 14 shows one of these where

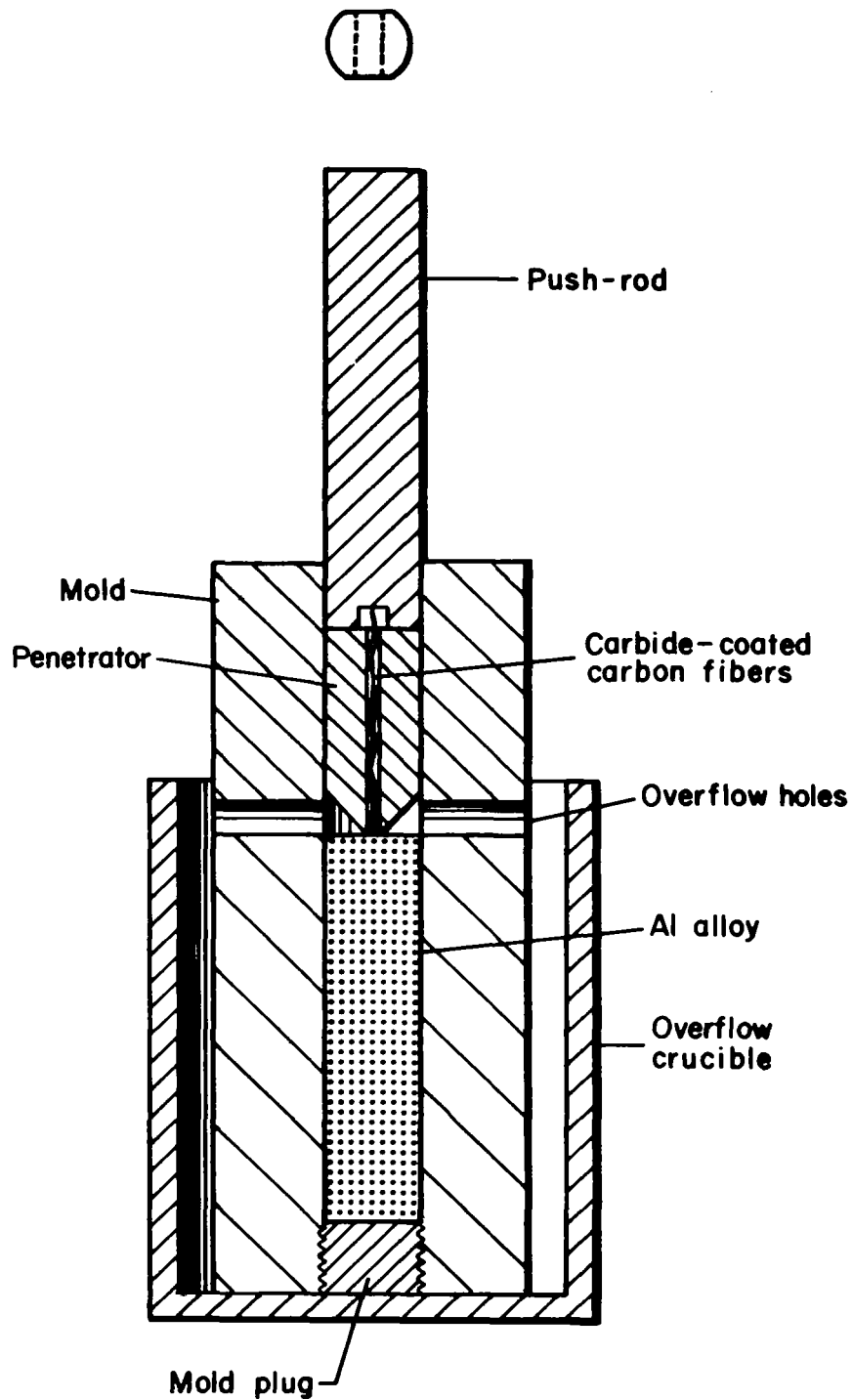

Fig. 13. Infiltration fixture. Approximately to scale.

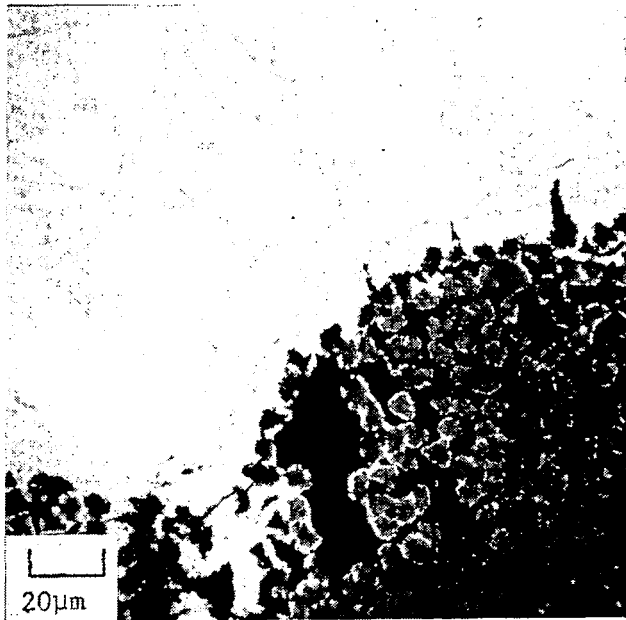

Fig. 14. Wetting of ZrC-coated Thornel 50 fiber tow with Al-13% Si alloy.

the crusty ZrC surface of the Thornel 50 tow was wetted by the LASL Al-Si alloy. This infiltration was done at 973 K (700°C) and a pressure of 1×10^{-3} Pa. Future experiments will be done using fiber tows having uniform, smooth carbide coats.

CONCLUSIONS

1. Chemical vapor deposition has been used successfully to produce ZrC coats on carbon fibers derived from both PAN and rayon. The coats were thin ($\leq 1.0 \mu\text{m}$), continuous and of uniform thickness throughout the fibers of each type of tow.
2. Wet chemical methods for applying coats, which subsequently can be converted to metal carbides, also show promise for coating carbon fibers.
3. Initial attempts to wet CVD-coated fibers with Al and Al alloys

were successful.

4. Surfaces of bulk TiC and ZrC, and of ZrC-coated polycrystalline and pyrolytic graphites were successfully wetted with Al and Al alloys.

APPENDIX A

Materials

Fibers

The first step in this program was to obtain a number of commercial carbon fiber tows, derived either from rayon, PAN or pitch, from different manufacturers. Several were procured and they are listed in Table AI together with their reported properties.⁷ Optical and scanning electron microscopy (SEM) have been performed on these fibers. SEM photographs of typical samples are given in Figs. A1 and A2.

The three rayon-derived fibers are similar. Their cross sections are crenulated in outline, and many appear to have cylindrical holes whose axes are oriented parallel to the fiber axes. Slight optical anisotropy effects are visible across the fiber cross sections, but the main effects are around the holes in the fibers and around the outer edges of the fibers, where polarization crosses are sometimes visible. The Thornel 50 fibers have fewer holes in cross section and appear denser than the other two. The Hitron 401 has a lower degree of optical anisotropy than the Thornels, which are optically nearly equivalent.

The PAN fibers obtained from Hercules are considerably different from those of Great Lakes Carbon Corporation. The Hercules fibers are rounded in cross section, whereas the Great Lakes Fortafil fibers are "dogbone-" or "dumbbell-shaped" (Fig. A2a.). In the Hercules fibers, slight optical anisotropy effects are visible on small areas in the interior of the cross sections and, possibly, at the edges of some of the fibers. The dogbone-shaped Fortafil

TABLE AI
PROPERTIES^a OF COMMERCIAL CARBON FIBERS

<u>Fiber</u>	<u>Manufacturer</u>	<u>Precursor</u>	<u>Fil. Diam. (μm)</u>	<u>Density 10³ kg/m³</u>	<u>Tensile Modulus (10¹⁰ Pa)</u>	<u>Tensile Strength (10¹⁰ Pa)</u>	<u>Ply/Yarn</u>	<u>Fil/ply</u>
Hitron 401	HITCO	Rayon	6.2	1.67	28	205	1	3,200
Thornel 50	Union Carbide	Rayon	6.5	1.67	39	215	2	720
Thornel 75	Union Carbide	Rayon	5.6	1.82	54	260	2	720
HTS	Hercules	PAN	7.8	1.78	26	275	1	10,000
HMS	Hercules	PAN	7.5	1.96	38	200	1	10,000
Fortafil 6T	Great Lakes	PAN	12.7/5.0 ^b	1.90	41	290	1	38,000
Monofilament ^c	Great Lakes	Pitch	38	1.65	4	69	-	----

^aTaken from Reference 7, unless otherwise indicated.

^bMaximum length/maximum width of the "dogbone" cross-section, reported by the manufacturer.

^cProperties reported by the manufacturer.

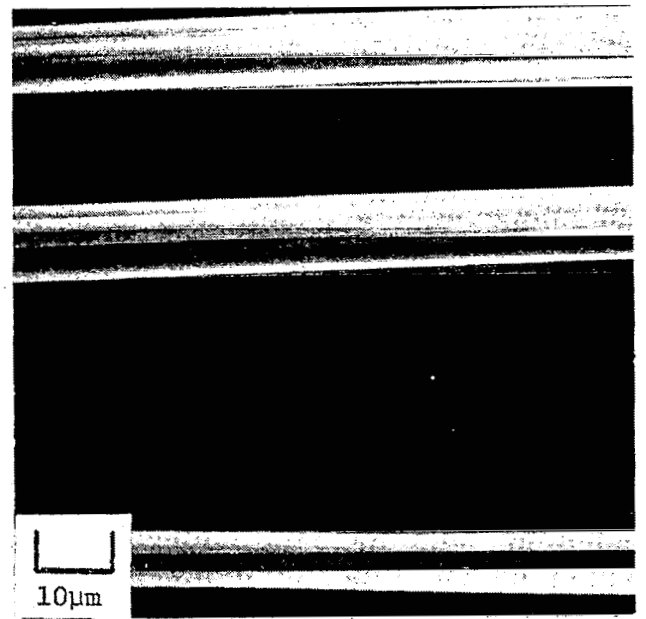
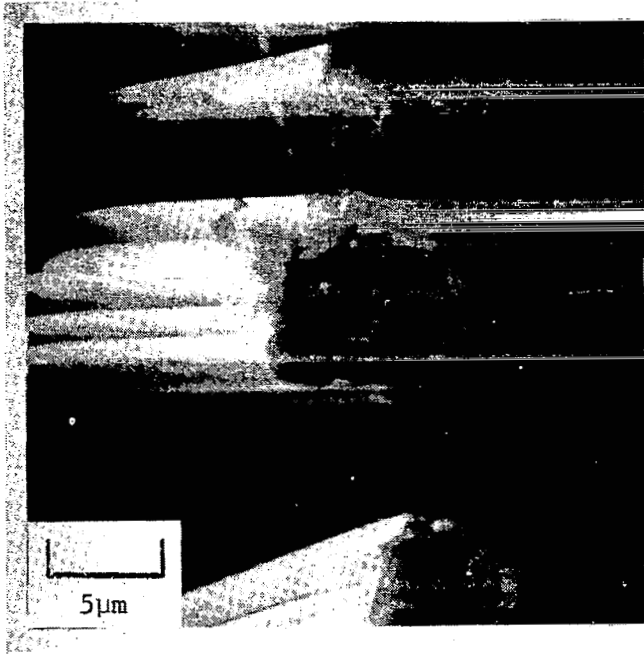

a

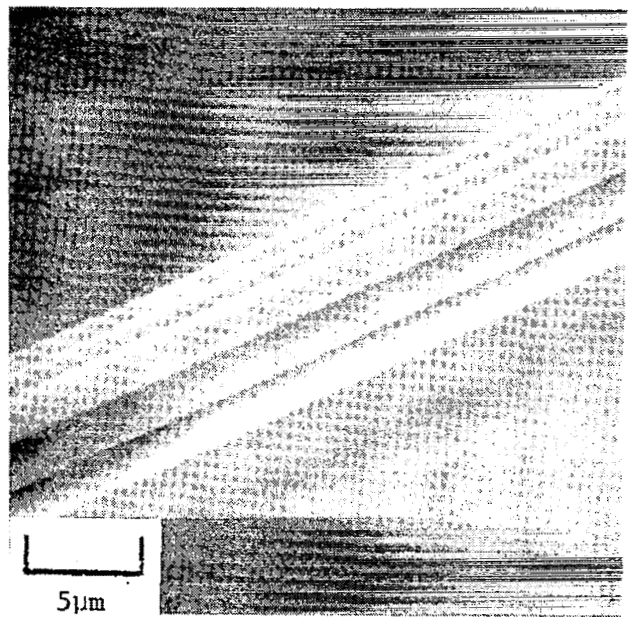
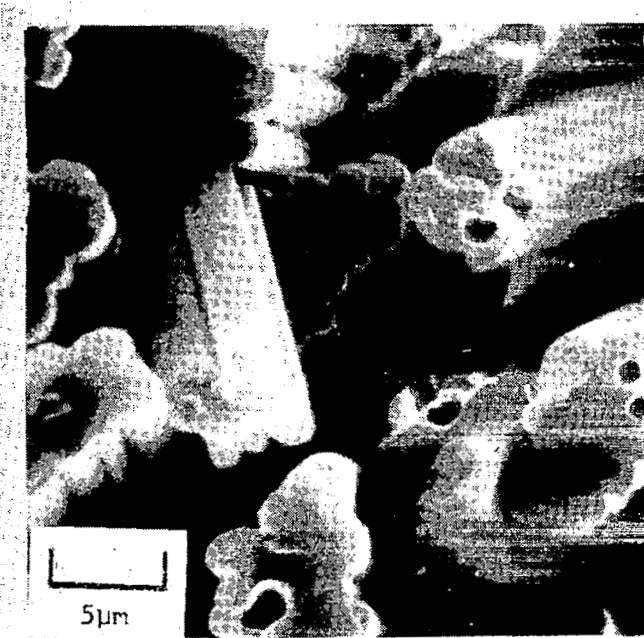

b

Fig. A1 Scanning electron photomicrographs of carbon fibers derived from rayon precursors. (A) Hitron 401, (b) Thorne1 50.

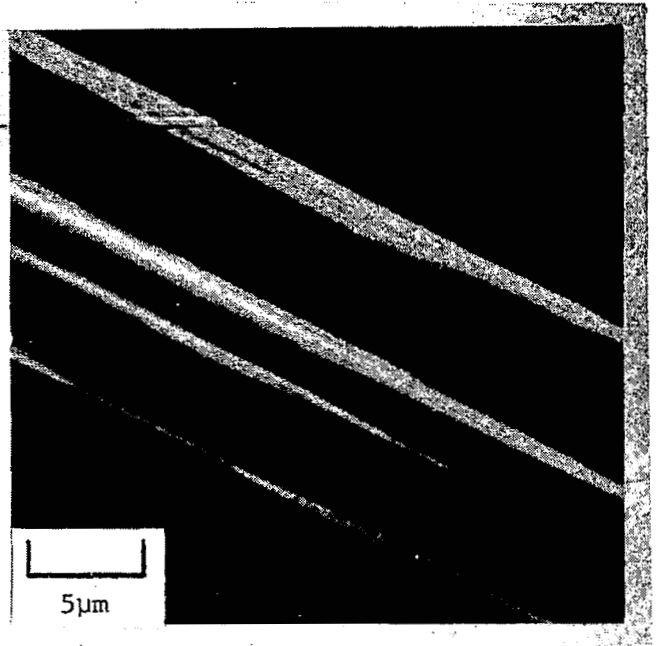
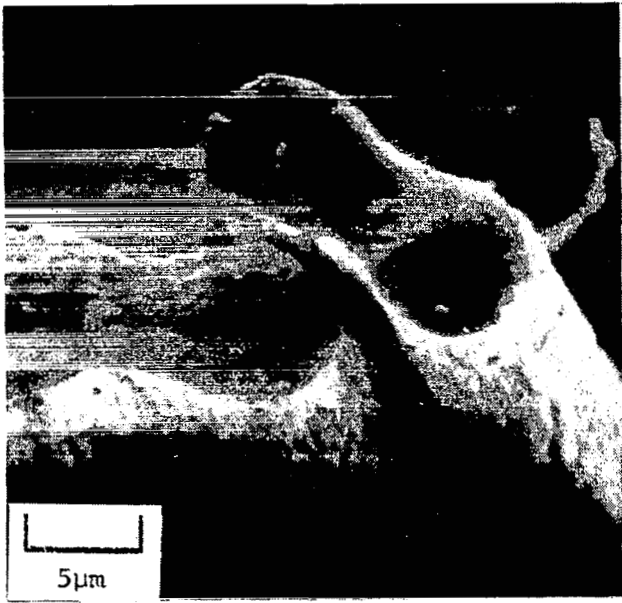

a

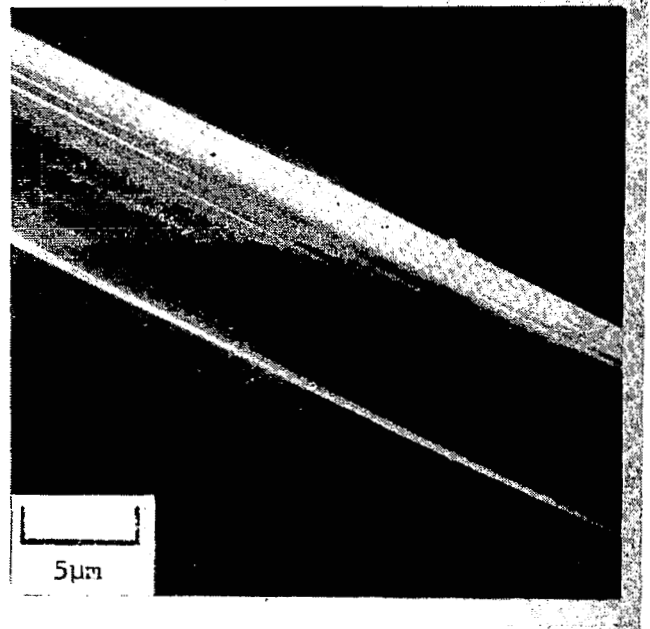
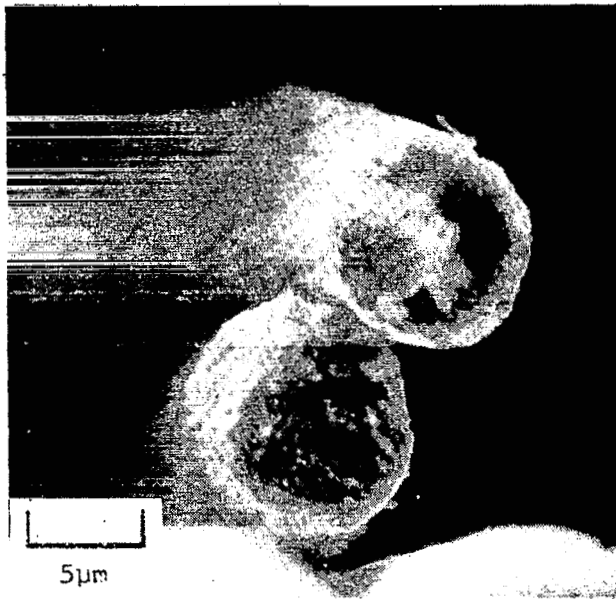

b

Fig. A2. Scanning electron photomicrographs of carbon fibers derived from PAN precursors. (a) Fortafil 6T, (b) Hercules HMS.

fibers have very slightly crenulated edges, and show optical anisotropy, both in the interior and at the edges of the fibers.

The pitch-base monofilament fiber is much larger than the others, is rounded in cross section and has a very smooth surface exhibiting few irregularities.

Coating Materials

Two coating materials were chosen for CVD experiments, reactor grade $ZrCl_4$ and commercial grade purified $TiCl_4$. Wet chemical coating experiments were done with an aqueous solution of tetramethylammonium titanate and dextrose. The titanate was prepared by mixing 0.0623 kg tetraisopropyl titanate with 0.0997 kg of a methanol solution containing 20 wt % tetramethylammonium hydroxide and 0.1 liter of water. The alcohol is distilled off and the solution is diluted with water to 0.1 liter, producing a stock solution of 0.105 kg Ti per liter.

Aluminum Alloys

Three standard commercial aluminum alloys and one LASL-produced Al-Si alloy were selected for use in the wetting and infiltration experiments. These are listed in Table AII together with their chemical compositions.

TABLE AII

COMPOSITION OF ALUMINUM ALLOYS

Alloy	Element (Wt %) ^a									
	Fe	Si	Cu	Zn	Mg	Mn	Cr	Ti	Other	Al
1100	--1.0 ^b	--	0.2	0.1	--	0.05	--	--	0.15 max	rem
4047	0.8	11-13	0.3	0.2	0.1	0.15	--	--	0.15 max	rem
6061	0.7	0.6	0.25	0.25	1.0	0.15	0.25	0.05	0.15 max	rem
LASL Al-Si	0.35	13.4	0.40	0.01	2.45	0.40	--	--	0.18 max	rem

^a Percentages for the standard grades are nominal handbook values. For the LASL alloy the values are the results of quantitative analyses on five replicate samples.

^b Combined Fe and Si.

APPENDIX B

VAPOR COATING EQUIPMENT AND PROCEDURES

Furnace Assembly

Coating operations are performed in an assembly consisting of an outer "bell-jar" shell and an inductively heated inner graphite coating crucible. Figures B1 and B2 are photographs of the bell-jar and the coating crucible, respectively. The outer shell consists of three double-walled water-cooled sections. On assembly, these sections are bolted together and sealed by O-rings. Sight ports (shutterable quartz windows) are located 90 deg apart on the O.D. of the two upper sections. One port, located in the center section is used as a window for optical measurement of the temperature. A blow-out port prevents excessive buildup of pressure within the chamber yet permits evacuation prior to each coating run. Cooling water interlocks prevent power input to the induction coil unless minimum water flow requirements are met.

Coating is carried out within the inductively heated graphite crucible positioned near the center of the shell. Dimensions of the crucible are 305 mm O.D., 38 mm wall thickness, and 445 mm length. A temperature sight-hole 6 mm I.D. by 16 mm deep was drilled into the O.D. 89 mm below the top plane. The gas inlet and outlet connections are graphite tubes threaded on their O.D.'s for gas sealing and structural support. The crucible is insulated by wrapping first with three layers of 6 mm thick carbon felt; then with five layers of 3 mm Fiberfrax ceramic fiber paper and finally with 2 mm thick mica sheet. The wrapped crucible is supported on a CarboCell block within a 356 mm I.D. water cooled induction coil.

Coating System

A gas flow diagram of the coating system is shown in Fig. B3. Argon is supplied from a liquid argon dewar with a capacity of 7190 liters. The CH_4 and H_2 gases are supplied from batteries of steel gas cylinders. The H_2 is routed through drying tubes before entering the gas manifold.

A vaporizer or powder feeder supplies refractory metal salt to the inlet side of the gas manifold where it is mixed with preheated manifold gases and carried through electrically heated lines into the coating crucible. Titanium tetrachloride (TiCl_4), which is a liquid at room temperature, is first converted to a gas by the vaporizer before mixing with the manifold gases, whereas the zirconium tetrachloride (ZrCl_4) is fed by the powder feeder directly into the gases as a fluidized powder, which is flash-vaporized upon entering the crucible.

The exhaust gas trap positioned outside the furnace shell is used both as an ambient condenser and a particulate filter. To facilitate the removal of particulate material from the exiting gas stream, the inner core was

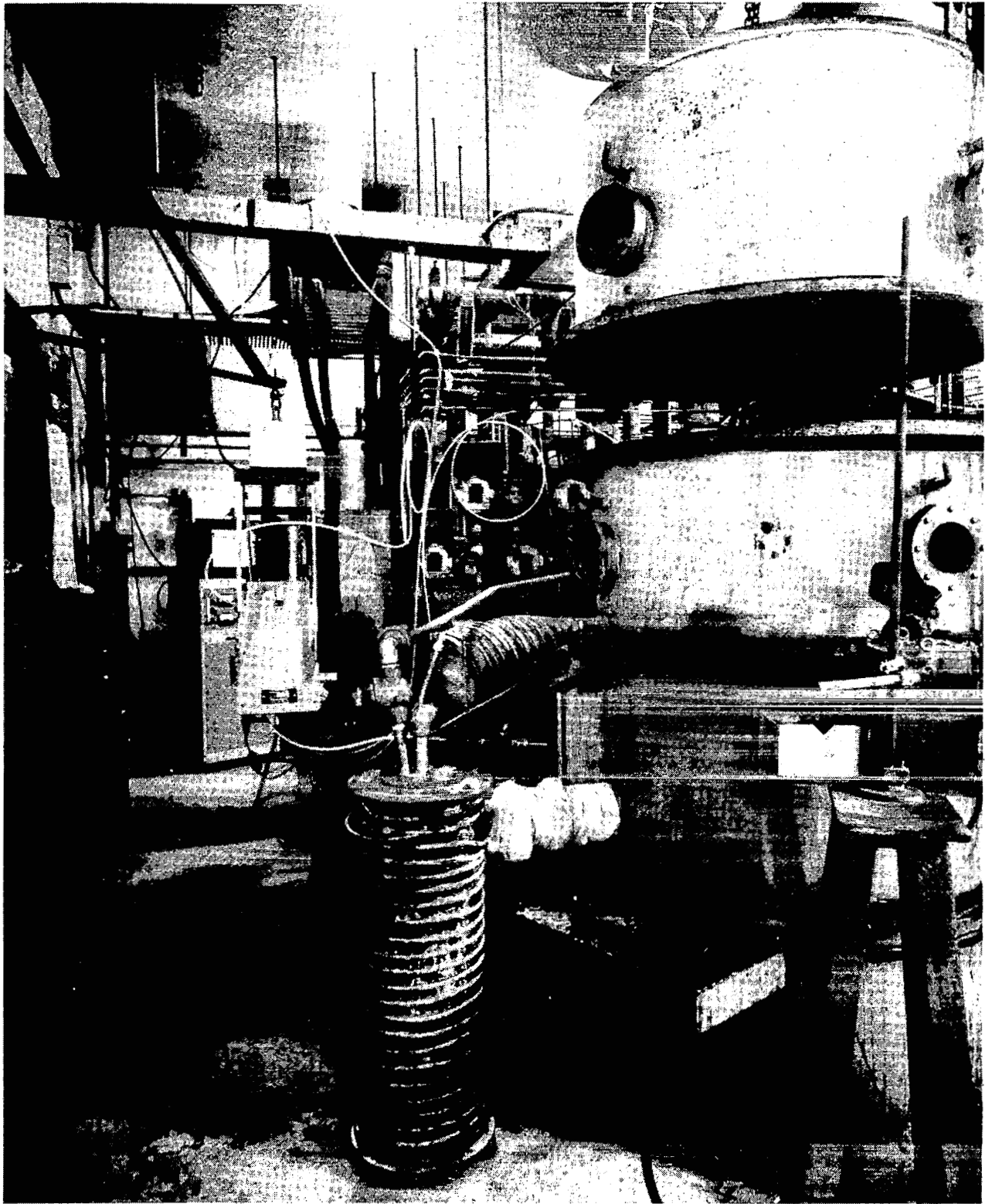

Fig. B1. Coating furnace bell-jar.

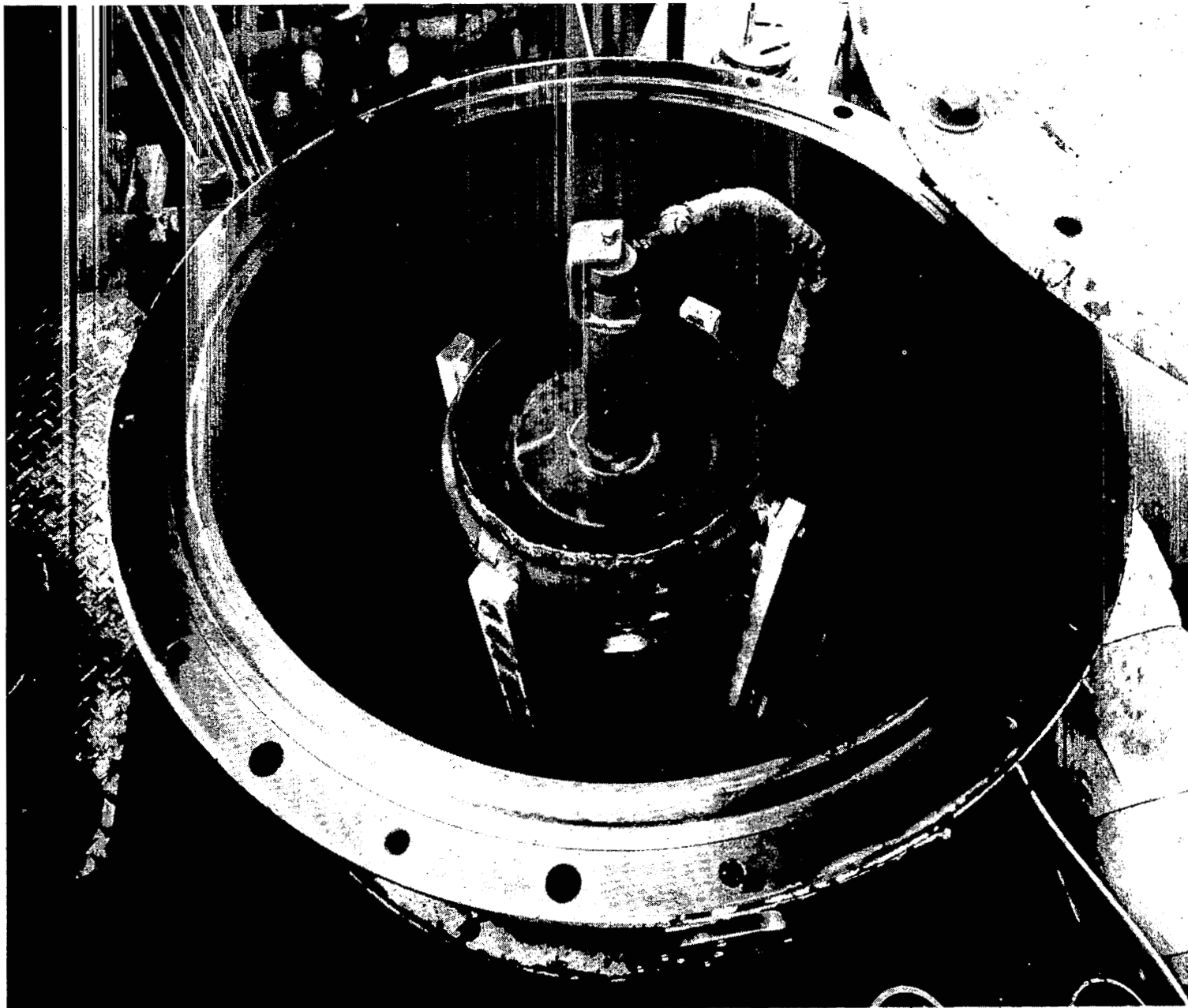

Fig. B2. Coating crucible with induction coil.

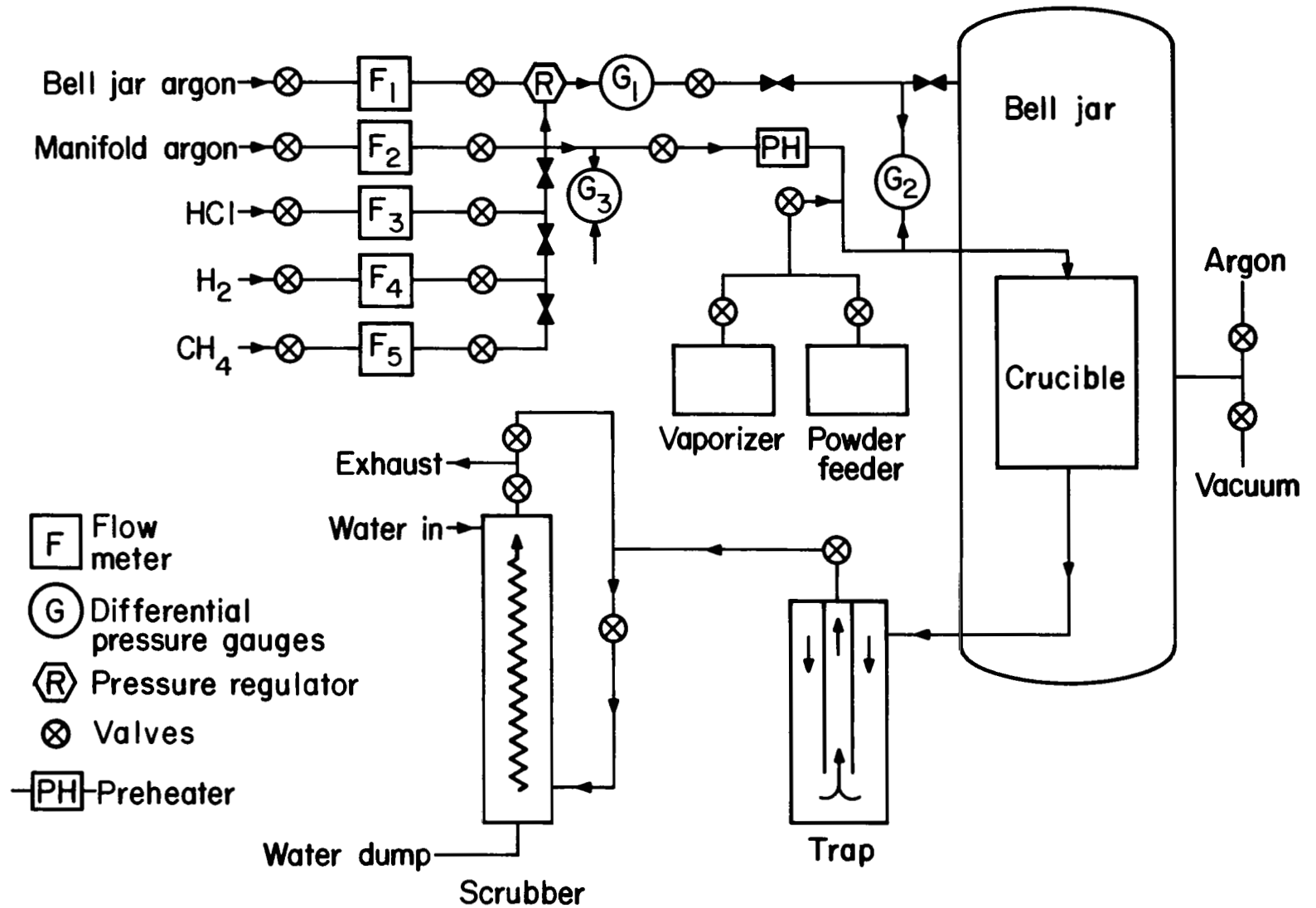

Fig. B3. Gas flow diagram of coating system.

loosely wrapped with fiber glass batting. After the trap, the gas stream is routed to a scrubber where dissolution of the gaseous HCl takes place. Water from the scrubber is dumped and the gaseous component is vented through a stack.

All stainless steel gas manifold lines leading to and from the coating crucible were electrically heated to prevent blockage by condensation of salts during passage of the coating gas stream.

Power is supplied to the induction work coil by a 100 kW, 10 kHz motor-generator set.

The coating temperature is measured by sighting through the shutterable quartz window into the sight hole with an optical pyrometer. The pyrometer was calibrated against a U. S. Bureau of Standards tungsten ribbon secondary standard.

Fixturing

Figure B4 shows a typical fixture used for coating fibers. It consists of a graphite plate 220 mm diam and 10 mm thick, with a 135 mm square hole in its center. Adjacent to two opposite sides of this square hole are rows of threaded holes which are used with graphite screws and washers to clamp the ends of

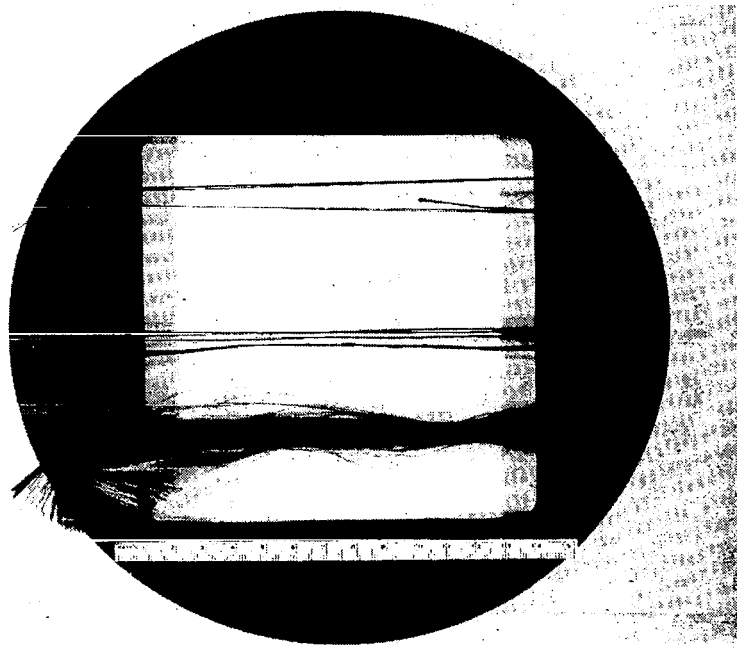

Fig. B4. Fiber coating fixture.

yarn tows, which are loosely suspended across the square hole. New fixtures are thoroughly coated before using them in fiber-coating runs. In practice the fixture is located near the center of the coating crucible, whose cylindrical axis coincides with that of the fixture.

Operational Procedure

Start Up.- Furnace assembly proceeds in the following order: (a) the sample fixture is placed on graphite spacer rings in the coating crucible near its center; (b) a perforated baffle is positioned above the sample fixture to disperse the coating gases uniformly over the fibers; (c) the crucible is pressure-sealed by means of a threaded closure plate; (d) the top surface of the crucible is insulated using a number of layers of carbon felt; (e) a stainless steel gas connection is made on the end of the crucible inlet pipe; and (f) the top shell is lowered in position over the crucible and sealed.

The coating gas system is made ready as follows:

1. Prior to each run the furnace assembly is evacuated then back-filled with Ar to a pressure 2.0 to 2.7 kPa above atmospheric.
2. The coating gas manifold lines are opened and manifold Ar is introduced to purge the gas manifold system.
3. The shell Ar pressure is adjusted and regulated to maintain an over-pressure nearly 6.7 kPa above that of the gas manifold pressure.
4. Induction power is turned on and the crucible is heated at a rate sufficient to reach a stabilized coating temperature in approximately 1.5 h. Electrical power to the accessory equipment (vaporizer furnace and gas manifold heating tapes) is turned on at such time that their nominal operation temperatures are stabilized during crucible heat up.

Coating.- The coating process is initiated and maintained throughout the coating period as follows:

1. CH_4 and H_2 are introduced into the gas manifold at prescribed rates.
2. The vaporizer valve is opened or the powder feeder is started after the above gas flow rates have been established. The salt delivery rate is controlled by the vaporizer furnace temperature or the powder feed rate.
3. The crucible wall temperature is regulated by adjusting the induction power output.
4. A check of all systems is routinely made and recorded.

Normal Shut-down.- After coating for the prescribed period of time, the following procedure is used to terminate the process:

1. The vaporizer valve is closed.
2. The CH₄, H₂ and shell Ar supply valves are closed.
3. The induction power is left on for a period of five minutes after the above valving and then turned off. This procedure allows the gas manifold Ar pressure to become positive with respect to the shell pressure before cool-down.
4. A cool-down period of 15 to 20 hours is required before disassembly. It is noted that the manifold Ar flow has been maintained from beginning to end.

REFERENCES

1. Gomez, M. P., Packer, C. M. and Karlak, R. F., "High Temperature Kinetics in the Solid State," Lockheed Missiles and Space Company Report AFML-TR-69-55 (1969).
2. Blankenburgs, G., "The Effect of Carbide Formation on the Mechanical Behavior of Carbon-Aluminum Composites," J. Austr. Inst. Met. 14, 236-241 (1969).
3. Rossi, R. C., Pepper, R. T., Upp, J. W. and Riley, W. C., "Development of Aluminum-Graphite Composites," Ceramic Bull. 50, No. 5, 484-487 (1971).
4. Kirk, R. E. and Othmer, D. F., Editors, Encyclopedia of Chemical Technology, Volume 2, "Carbides," pp. 827-829, Interscience (1948).
5. Union Carbide Corporation, Case Institute of Technology and Bell Aerospace Company, "Integrated Research on Carbon Composite Materials," AFML-TR-66-346, Section VIII, Oct. 1966, pp. 193-215.
6. Manning, C. R., Jr. and Gurganas, T. B., "Wetting Binary Aluminum Alloys in Contact with Be, B_4C , and Graphite," J. Am. Ceram. Soc. 52, 115-118 (1969).
7. Butler, B. L., "Application of Engineering Data on Carbon Fibers to Carbon/Carbon Composites," Sandia Laboratories Report SLA-73-0385B, September 1973.
8. Wallace, T. C., "Chemical Vapor Deposition of ZrC in Small Bore Carbon-Composite Tubes," Proceedings of the Fourth International Conference on Chemical Vapor Deposition, Boston, Massachusetts, Oct. 7-11, 1973, pp. 91-106.