

**NASA TECHNICAL
MEMORANDUM**

NASA TM X-62,469

NASA TM X-62,469

**DESIGN, COST, AND ADVANCED TECHNOLOGY APPLICATIONS
FOR A MILITARY TRAINER AIRCRAFT**

Gary C. Hill and Michael Harper

**Ames Research Center
Moffett Field, California 94035**

(NASA-TM-X-62469) DESIGN, COST, AND
ADVANCED TECHNOLOGY APPLICATIONS FOR A
MILITARY TRAINER AIRCRAFT (NASA) 36 F HC
\$4.00 CSCL 01C

N76-11079

Unclas
G3/05 03079

August 1975



1. Report No. TM X-62,469	2. Government Accession No.	3. Recipient's Catalog No.	
4. Title and Subtitle DESIGN COST, AND ADVANCED TECHNOLOGY APPLICATIONS FOR A MILITARY TRAINER AIRCRAFT		5. Report Date	
		6. Performing Organization Code	
7. Author(s) Gary C. Hill and Michael Harper		8. Performing Organization Report No. A-6226	
		10. Work Unit No. 791-40-03	
9. Performing Organization Name and Address NASA Ames Research Center Moffett Field, California 94035		11. Contract or Grant No.	
		13. Type of Report and Period Covered Technical Memorandum	
12. Sponsoring Agency Name and Address National Aeronautics and Space Administration Washington, D. C. 20546		14. Sponsoring Agency Code	
		15. Supplementary Notes	
16. Abstract This report examines the potential impact of advanced aerodynamic and propulsive technologies in terms of operating and acquisition costs on conceptual mission and performance requirements for a future undergraduate jet pilot trainer aircraft.			
17. Key Words (Suggested by Author(s)) Jet trainer aircraft Advanced aerodynamics Advanced propulsion Operating and acquisition costs		18. Distribution Statement Unlimited STAR Category - 05	
19. Security Classif. (of this report) Unclassified	20. Security Classif. (of this page) Unclassified	21. No. of Pages 35	22. Price* \$3.75

SYMBOLS

AR	Aspect Ratio
C_L	Lift Coefficient
L/D	Lift-to-Drag Ratio
t/c	Thickness-to-Chord Ratio
SLS	Static Sea Level, Standard Day
TAS	True Air Speed
TOGW	Takeoff Gross Weight
TSFC	Thrust Specific Fuel Consumption
V	Velocity
W/S	Wing Loading
Λ	Sweep of Leading Edge
λ	Taper Ratio

DESIGN, COST, AND ADVANCED TECHNOLOGY APPLICATIONS
FOR A MILITARY TRAINER AIRCRAFT

Gary C. Hill and Michael Harper

INTRODUCTION

The Naval Air Systems Command has invited the Aeronautical Systems Office (Code FM) of the NASA Ames Research Center to participate in the conceptual stage of defining requirements for future undergraduate jet pilot training aircraft. This aircraft, designated VTX, is a potential alternative for the T-2 and TA-4 aircraft currently in the Naval Air Training Command inventory.

The VEDA Corporation, under contract to the Naval Air Development Center (NADC), Warminster, PA, developed conceptual mission models and preliminary baseline performance requirements for the VTX after surveying the training command and other Naval activities.^(ref. 1) These are summarized in the appendix of this report. Using these initial guideline requirements, the General Aviation Synthesis Program (GASP) developed at Ames Research Center^(ref. 2) was utilized to explore the design feasibility, the potential impact for new technologies, and the operating and acquisition costs that might be associated with the VTX aircraft.

The purpose of this report is to provide an assessment of the impact these performance requirements might have on the design and cost of a potential new trainer aircraft. Payoffs that might be achieved through application of advanced technologies are also examined, and their sensitivities in terms of weight and cost are determined.

SYNTHESIS

Calibration

Preliminary to the design work, GASP was calibrated to an appropriate aircraft type and technology level by duplicating the weights and performance of the T-2B and the T-37B aircraft. Adjustments were made to reflect the higher structural weights required for carrier suitability. Both aircraft exhibited good correlation with the GASP equations, based on general aviation aircraft. Several other aircraft (the Lear Jet, TA-4, and F-86) were used for comparison and verification of special aspects of the analysis.

Baseline Development

The VTX configuration shown in figure 1 was developed by the Air Vehicle Technology Department of the Naval Air Development Center (NADC) in a companion study.^(ref. 3) This configuration was input into GASP to develop the baseline for this study. The Garrett AiResearch TFE-731-2 engine^(ref. 4) was also used in this development. Installed-engine performance was calculated from the TFE-731-2 installation on the Lear-35 aircraft. All of the performance requirements of reference 1 are met by the baseline; key characteristics derived by GASP are shown in table I.

The cost figures of table I are derived by GASP on an accounting basis appropriate to general aviation class aircraft. Because they do not reflect accurate values for a military aircraft, all further references to cost will be shown as fractions of these base dollars. Although the values do not apply, the elements affecting costs should be related sufficiently that they are valid for demonstrating relative measure.

TABLE I - BASELINE CHARACTERISTICS

Takeoff gross weight	4989.5 kg (11000 lb)
Fuel capacity	1451.5 kg (3200 lb)
Engine SLS thrust rating (uninstalled)	14176.5 Nwt (3167 lb)
Wing area	17.47 m ² (188 ft ²)
Wing aspect ratio	6
Wing thickness/chord	0.1
Cost per aircraft	\$1000000
Cost per flight hour	\$100

Physical Characteristics

Reference 1 lists several desirable physical characteristics. The synergistic effects of some of these are summarized below:

1. Tandem seating, as opposed to side-by-side, is not optimum from the designer's desire to minimize weight and wetted area. A takeoff gross-weight increase of approximately 8% was shown by reference 5. However, operational, higher speed, and safety considerations outweighed these factors in configuration selection.

2. The specifications for good visibility, good cross-wind landing capabilities, and engine inlets located to minimize foreign object damage (FOD) are the most restrictive to the configuration options. A wide, main landing gear track for increased cross-wind landing capabilities implies that the wing be mounted low/mid on the fuselage. To minimize FOD, the inlet should be as high off the ground as possible. Wing and inlet are usually the primary obstructions to cockpit visibility, and aft mounting of the engine helps locate both wing and inlet further aft and out of the pilot's field of view.
3. The performance of turbofan engines is much more sensitive to pressure recovery losses in the inlet than turbojet engines. Pod/nacelle mounting minimizes pressure recovery losses by minimizing the inlet duct length and eliminating internal turning of the flow; however, there is an additional drag incurred from the nacelles. In terms of overall performance effects, the internal/external engine selection is not major. The podded engine arrangement for the baseline allowed comparative analysis without unduly penalizing higher bypass turbofan engines.

These physical characteristics, as well as the performance requirements of reference 1, are all met by the baseline. There are known problems associated with aft fuselage-mounted engine nacelles. These include wing leading-edge vortex ingestion, nacelle/wing flow field interference, and tail blanking by the nacelle at high angles of attack. These are secondary performance factors that do not affect this conceptual analysis.

Specification of two engines, while desirable for safety reasons, will usually not result in the most economical aircraft. Although for turbofan engines the pressure recovery losses of a bifurcated inlet might offset the simplicity advantages of the single-engine design. It is more often the economic advantage of an existing engine of approximately the desired size and cycle or half the required size (as for the baseline engine), that will determine whether the final product is single- or twin-engine. If sufficient funds or production base to offset the cost of development and tooling of the ideal engine exist, then operational, maintenance, and attrition costs can all be considered.

Sizing

A primary function of the design synthesis process is the estimation of the takeoff gross weight (TOGW). TOGW is an all-important parameter because of its dominance in predicting costs, both acquisition and operating.

The work of NADC^(ref. 3) determined that the representative Operational Navigation (Low Level O Nav) mission had the most stringent fuel requirements. This mission was used as the sizing criteria throughout this study. Table II details the calculations of fuel consumption by leg for the O Nav mission. TOGW and cost sensitivities to the range and dash-leg speed requirements of the O Nav mission are presented in figure 2. Reducing the speed or range requirements will have substantial payoffs, until insufficient fuel to complete the next most stringent mission is encountered.

TABLE II - OPERATIONAL NAVIGATION (LOW LEVEL 0 Nav) MISSION PROFILE

Leg	Weight, kg (lb)	Fuel Used, kg (lb)	Altitude, m (ft)	TAS, kts	Time, min	Dis- tance, n. mi.	L/D	Fuel Flow, kg/hr (lb/hr)
Start	4990 (11000)							
Taxi	4976 (10970)	14 (30)	0	0	5	0		163 (360)
Takeoff	4929 (10866)	47 (104)	0	0	2	0		1420 (3130)
Climb	4905 (10814)	24 (52)	1524 (5000)	260	1	4	10.7	1429 (3150)
Cruise	4867 (10730)	38 (84)	1524 (5000)	260	5	21	10.5	457 (1008)
Dash	4428 (9762)	439 (968)	152 (500)	360	33.3	200	6.0	790 (1742)
Attack	4305 (9492)	122 (270)	152 (500)		5	0		1470 (3240)
Dash	3870 (8532)	435 (960)	152 (500)	360	33.3	200	5.6	789 (1740)
Climb	3847 (8482)	23 (50)	1524 (5000)	260	1	4	10.0	1361 (3000)
Cruise	3810 (8400)	37 (82)	1524 (5000)	260	5	21	8.8	446 (984)
Approach & Landing	3694 (8143)	117 (257)	0		15			446 (1028)
Reserves	3538 (7800)	156 (343)	0		35			267 (588)

AERODYNAMICS

Wing Sizing

Of primary concern to the aerodynamics is the wing size. The wing is sized by one of the high-lift requirements, which were the maneuver load factor and the approach speed for the VTX. High-lift requirements drive the wing size up at the expense of cruise economy, which prefers a small wing for less drag and weight. The next most important factor in these high-lift situations is the lift coefficient limits ($C_{L_{max}}$). Lift coefficient limits are dependent upon wing geometry (AR , t/c , Λ , λ), airfoil section, flaps, power setting, Reynold's number, and other configuration-dependent subtleties, and also varies with Mach number. Since accurate predictions of these limits are difficult to make, the tested performance of aerodynamically similar aircraft are also shown in figures 3 and 4. These figures show that both of the high-lift requirements are met by the baseline configuration.

Figure 3 presents the maximum lift coefficient in the "dirty" (flaps and gear down) configuration needed to meet specified approach speeds ($V_{approach}$) at various wing loadings. The wing loadings for the baseline are shown in terms of fuel load fraction. Because it was not specified in reference 1, the approach-stall margin was taken to be 1.2, and the landing weight to include the 50-min fuel reserve from the mission profile section. Figure 3 shows that the predictions for the baseline coincide closely with the performance of known and tested aircraft.

Figure 4 illustrates the lift coefficient required to perform the 4-g turn, again at various wing loadings (W/S) shown as fuel load fractions for baseline. The lift coefficient limits are also shown for the

baseline, T-37, and T-2 aircraft. The dark solid line showing the C_L required to achieve a 4-g turn by the baseline at combat weight is within its predicted $C_{L_{max}}$ limits and within the T-2 and T-37 $C_{L_{max}}$ limits as well.

Wing Geometry

Wing geometry is a compromise between maximizing cruise efficiency and providing high $C_{L_{max}}$ to meet point performance criteria. Higher cruise L/D ratios are achieved by higher aspect ratios (AR); however, structural weight is also increased. The AR influences so many of the key design variables, including $C_{L_{max}}$, that it usually receives considerable study during more detailed design refinements.

Lower sweep angles and thinner airfoil sections also improve aerodynamic efficiency. However, smaller t/c's are usually not desirable for subsonic designs because of the resulting increased structural weight and the decrease in available fuel volume. Figure 5 shows some theoretical calculations of sweep and thickness effects on the critical Mach number, the point where the compressibility drag starts its sharp increase. If a relaxation of maximum Mach number (V_{max}) from 0.8 could be operationally justified, then these two design parameters could be freed to benefit other design objectives.

Handling Characteristics

Carrier approach handling characteristics are the single most critical area where the role of basic and advanced jet trainers might not be satisfied by a single design. The transition from primary

trainer to high performance fleet aircraft with only one intermediate step might result in costly retraining at either phase. Approach handling characteristics are determined mainly by AR, sweep, and wing loading, which are usually optimized to best meet the mission and performance requirements. A design of the performance level required to meet fundamental training objectives and minimize expense could have approach handling characteristics atypical of tactical jet carrier aircraft.

Although military specifications such as ref. 5 guarantee satisfactory (safe) handling qualities, handling characteristics are rarely a conceptual stage design consideration. Further study of the effects of optimizing mission performance on approach handling characteristics might be appropriate early in the design process. Simulation and analysis could establish explicit handling characteristic objectives, and could integrate other considerations, such as damping, the backside of the power-required curve, and power response times also.

A suggested solution for the carrier approach handling qualities is a variable or artificial stability capability to give control/feel characteristics of a much higher performance vehicle. In investigating present variable stability aircraft it was found that they are extremely expensive due mainly to their research nature. However, this concept should not be ruled out for this application because a simpler, less sophisticated system would suffice. Most probably, only the pitch-axis stability characteristics need be modified, and eliminating the infinite variability of research applications would allow this to be accomplished at reasonable expense. If suitable carrier approach handling characteristics is a major design issue, then variable stability should be considered.

Another handling consideration is the asymmetrical thrust requirements that result from the engine-out situation in twin-engine aircraft. It is this parameter that predominates in sizing the vertical tail for twin-engine aircraft; but, more important for this application is the increased syllabus time required for engine-out training which could increase total training costs.

Advanced Aerodynamics

The higher aspect ratio of the baseline configuration does provide some increased performance over the $AR = 5$ of the T-2, as can be seen in figure 6. An emerging technology that has potential applications for the VTX is the supercritical airfoil section. The supercritical design allows for thicker wings and delayed drag rise for improved aerodynamic and structural performance. Application of the GA(W)-1, a 17% thick airfoil section under development and flight tested by NASA, is also shown in figure 6. The ability of even a supercritical airfoil of 17% thickness to achieve 0.8 Mach V_{max} is optimistic since high-speed testing of this section has not been done. However, the potential structural and aerodynamic benefits of supercritical technology are reasonably represented and are notably significant.

An even further advancement for this application would be supercritical aerodynamics combined with strakes to provide vortex lifting at high angles of attack, as on the YF-16 and YF-17 prototype aircraft. This application is somewhat limited, however, because the maneuver requirements are not as stringent and because more benefit is derived from a higher sweep and a lower AR where more wing area is affected by the vortex (figure 7). Sufficient parametric studies have not been accom-

plished to enable full synthesis study integration at this time. However, research to date does indicate high probability of achieving significant improvements with proper strake design.

PROPULSION

Engine Sizing

In the previous section on aerodynamics, the sizing of the wing to meet certain performance requirements was the first order of concern. Similarly, in this section the task of sizing the engine(s) is addressed first. It is the takeoff distance and sustained-turn requirements that are the most difficult to satisfy.

The takeoff distance of 914.4 m (3000 ft) over a 15.24 m (50 ft) obstacle on a hot, 39.44°C (103°F), day was found to be more thrust demanding (slightly) than the sustained 4-g turn requirement. Figure 8 compares the takeoff performance of the baseline, the T-2B, and the TA-4. It shows that the hot-day requirement translates into standard-day field length performance roughly equivalent to the T-2B, with a higher thrust-to-weight ratio making up for higher wing loading. (Note the shorter ground roll.) A later figure will show a relaxed takeoff requirement could substantially reduce TOGW while still meeting the sustained turn requirement for engine cycles of a lower bypass ratio than the baseline.

Experience in general aviation aircraft design has shown that meeting FAR single-engine climb requirements is usually more difficult than achieving a specified field length. Reference 1 contains no specifications in this regard. This is important if the design field length capability is to be realized in practice, since minimum field length is

accomplished at high-lift flap settings which is also a high drag configuration, making single-engine climb performance especially critical.

In sizing the wing, it was necessary to insure that there was sufficient lift for the 4-g turn. To sustain that 4-g turn without sacrificing altitude or airspeed, thrust must be greater than or equal to the drag at that flight condition. Figure 9 shows the matching of thrust available and the thrust required for the 4-g turn at 5468.4 m (18000 ft). As shown, the 4-g turn for the VTX can be sustained at either maximum continuous or takeoff (military) power setting. Maneuver performance is difficult to predict, because both the high angle-of-attack lift limits (figure 4) and the nonlinear lift-induced drag are somewhat uncertain.

Engine Cycle

Engine cycle selection involves choosing the proper temperatures, pressure ratios, bypass ratio (BPR), and other cycle variables to best meet the desired performance, fuel economy, and cost for the application in mind. Of these, the BPR is the most significant variable over which the designer has control. Using the library of engine cycles given in table III, a sensitivity analysis of the BPR was performed for the baseline; in each case the engine of table III was scaled to the appropriate thrust rating, weight, dimensions, and fuel consumption. There are other candidate engines, but these were used for expediency and data availability.

Figure 10 summarizes trends associated with the performance of these engine cycles. The middle line on the graph shows the thrust specific fuel consumption (TSFC) given at maximum power, static sea level, and standard-day (SLS) rating conditions. Fuel economy, as indicated by lower TSFC, increases with BPR. However, from the top line showing the

TABLE III - LIBRARY OF ENGINE CYCLES

ENGINE DESIGNATION	MANUFACTURER	BYPASS RATIO	FAN PRESSURE RATIO	TURBINE INLET TEMPERATURE, °K (°R)	SLS RATINGS		COMMENTS
					THRUST Nwt (lb)	TSFC*	
CJ 610	General Electric	0	-	3338.7 (2145)	13456 (3025)	.995	C1v11 J-85
F 107	Williams	1.035	2.104	3565.5 (2271)	2802.4 (630)	.609	Cruise missile
TFE-731-2	Garrett	2.83	1.45	3565.5 (2260)	15568.8 (3500)	.493	Lear Jet-35
36-10	Garrett	3	1.6	3455.7 (2210)	5248.9 (1180)	.527	Study engines
	Garrett	5	1.40	3455.9 (2210)	6316.5 (1420)	.409	
	Garrett	7	1.3	3455.7 (2210)	6650 (1495)	.375	

*Thrust specific fuel consumption.

TSFC at cruise conditions, we see that after BPR = 1 the advantage of the higher bypass engine is not nearly so significant. This was borne out in the subsequently described aircraft-sizing analysis.

The bottom line on figure 10 shows that the disadvantage of turbofan engines is the lapse rate, or drop off in thrust, at increased Mach number and altitude. This is critical in meeting cruise, maneuver, and V_{\max} criteria. The singular points for the TFE-731-2 engine, which all fall on the "goodness" side of the trend lines, illustrate that it is a higher performance engine than the rest of this family. The trends of the curves are valid for any set of engines of similar cycle quality.

Figure 11 shows the aircraft TOGW's resulting from the various engine cycles (BPR from 0 to 7) and the engine-sizing requirements for takeoff, sustained turn, and V_{\max} . It is shown that engines of bypass ratio 1 to 2 could achieve a lower TOGW than the TFE-731-2. For cycles of lower BPR than the baseline, a substantial weight saving could be achieved (while still meeting all other requirements), if the hot-day, 914.4 m (3000 ft), takeoff distance requirement were relaxed. Note also that the Mach = 0.8, V_{\max} cruise requirement assures that a 3-g sustained turn capability can be met for BPR > 3. The analysis shown assumed a constant wing loading for all aircraft. Optimization of the wing loading might reduce takeoff gross weights further for "off baseline" cases. The predictive certainty in the region between the baseline and the turbojet (BPR = 0) is degraded by the lack of data on 13345 Nwt (3000 lb) thrust class engines; however, the results are felt to be valid for conceptual level design.

Relative costs for aircraft meeting all of the requirements are also plotted against BPR in figure 12. The cost lines correspond to the

hot-day takeoff and 4-g sustained turn lines of figure 11, and have the same general shape. The relationship of acquisition costs and TOGW are well known; but, this figure shows the operating costs as well are more sensitive to the minimizing of takeoff gross weight than to the decreased thrust specific fuel consumption of the higher BPR engines. The analysis of figure 12 puts all engines in a common production base and does not reflect the cost advantage of selecting an existing engine, such as the TF33-3B. A full life cycle cost analysis would be necessary to identify the truly cost-effective solution, however.

The overriding determinant of engine costs is the production base. The studies by Garrett AiResearch Corporation^(refs. 6,7) have shown that an engine developed for a military trainer could spawn a generation of turbofan engines for use by all levels of general aviation. This fact has implications beyond just the increase of the production base for greater amortization of the engine development costs. The competitive position of the United States in the world market, the balance of trade, and the ecological advantages of the quieter, cleaner turbofan engines will also be affected.

CONCLUSIONS

This analysis has assessed the weight and costs for which the conceptual objectives might be achieved. The most critical requirements have been identified and quantified. The potential impacts of advanced aerodynamic and propulsion technologies have also been shown. Hopefully, these will be a useful and significant contribution to development of VTX conceptual requirements.

Some specific conclusions are summarized below.

1. The sizing requirements of O Nav mission, approach speed, 4-g sustained turn, and hot-day takeoff should be further examined to insure their operational necessity, as they have the largest design impacts.
2. The aspects of the carrier landing-approach handling characteristics should be examined very closely, and for this application, they should be given high design priority.
3. Supercritical and vortex lifting technologies have applications and potential payoffs. Both will require dedicated development.
4. Turbofan propulsion, with BPR between 0.75 and 3.0, has definite performance and economic advantages for VTX.
5. There are significant long- and short-term payoffs for an engine developed specifically for this project. Civil applications may more than offset the added development expense.

APPENDIX

This summary of VTX jet trainer aircraft performance and physical characteristics and mission profiles is reprinted from reference 1.

Performance Characteristics

0.80 maximum Mach number

Approximately 110 knots approach speed

1000 n. mi. range

35000 ft service ceiling (minimum)

2000-3000 ft takeoff distance (distance over a 50 ft obstacle--hot day)

2000-3000 ft landing distance (distance over a 50 ft obstacle--standard day)

+7.33, -3.0 g at design TOGW (MIL SPEC)

Capability to pull 4-g sustained turn at 18000 ft at design weight

Pitch, yaw, and roll stability consistent with current MIL SPEC

Roll rate consistent with T-2C

Rate of climb at sea level, standard day of 6000-8000 ft/minute
at design weight (minimum)

Spin capable and easily recoverable

Better acceleration capability than TA-4J

Cross-wind landing capabilities similar to T-2C.

Physical Characteristics

Tandem seating for crew of two

Two turbofan engines

Fuel dumping capability consistent with current trainer aircraft

Single-point, hot pressure fueling

All internal fuel

Forward, aft, and lateral visibility for student and instructor
at least as good as that in T-2C

Cockpit space similar to that of T-2C

Volume for 100 lb of baggage

Self-starting capability

Day carrier suitable

Spotting factor consistent with T-2C

Pressurized cockpit

Oxygen system

Provision of hardpoints for mounting of (1) podded MK-4 type
gun and (2) PMBR (practice multiple bomb rack) with (6) MK-76
type bombs each

Inlet(s) location such as to minimize FOD problems

Landing gear width such as to provide good cross-wind landing

0-0 ejection seat capability

JP-4/JP-5 fuel utilization

Provision for speedbrakes for deceleration and approaches

Uninstalled avionics weight: 200 lbs

Uninstalled instruments weight: 150 lbs

(1) podded MK-4 type gun with 200 rounds of ammunition

(2) PMBR with (12) MK-76 type bombs

Operating costs similar to T-2C

Maintenance manhours/flight hour less than 7

VIX DESIGN MISSION PROFILES

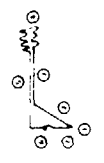
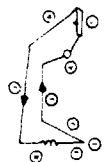
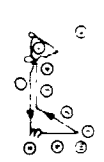
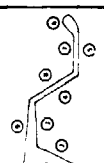
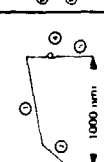
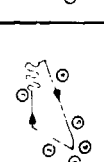
FAMILIARIZATION	CROSS COUNTRY NAVIGATION	OPERATIONAL (LOW LEVEL) NAVIGATION	AIR COMBAT MANEUVERING	CARRIER QUALIFICATIONS	GUNNER/WEAPON DELIVERY
 <p>1) WARM UP & TAKEOFF 5 min IDLE + 2 min MRT</p> <p>2) CLIMB TO 20,000 ft</p> <p>3) CRUISE & FAN (LEG REQUIRED FOR 1000 nm TOTAL RANGE) 25 min AT BCV 15 min AT MAX SPEED</p> <p>4) CRUISE & DESCENT 20,000 ft TO 1000 ft/ 30 min</p> <p>5) LANDING TRAINING (7 TOUCH AND-GO'S + 1 FULL STOP) 5 min EACH</p> <p>6) LANDING RESERVE 35 min BLV</p>	 <p>1) WARM UP & TAKEOFF 5 min IDLE + 2 min MRT</p> <p>2) CLIMB TO BCA</p> <p>3) CRUISE BCAY (LEG REQUIRED FOR 1000 nm TOTAL RANGE)</p> <p>4) APPROACH & LANDING</p> <p>5) LANDING RESERVES 50 min BLV (INCLUDES APPROACH)</p>	 <p>1) WARM UP & TAKEOFF 5 min IDLE + 2 min MRT</p> <p>2) CLIMB TO 5000 ft</p> <p>3) CRUISE/BCV/25 nm</p> <p>4) IDLE DESCENT TO 500 ft</p> <p>5) DASH 500 ft/360 KTAS (200 nm)</p> <p>6) SIMULATED ATTACK (5 min AT V_{max})</p> <p>7) DASH 500 ft/360 KTAS (200 nm)</p> <p>8) CLIMB TO 5,000 ft</p> <p>9) CRUISE/BCV/25 nm</p> <p>10) APPROACH & LANDING</p> <p>11) LANDING RESERVE 50 min BLV (INCLUDES APPROACH)</p>	 <p>1) WARM UP & TAKEOFF 5 min IDLE + 2 min MRT</p> <p>2) CLIMB TO 20,000 ft</p> <p>3) CRUISE 20,000 ft/BCV (50 nm)</p> <p>4) ENGAGE IN ACM MANEUVERS 10 min (V_{max})</p> <p>5) CLIMB FROM -0,000 ft TO 20,000 ft</p> <p>6) COMPLETE FOUR REPETITIONS OF 4) & 5)</p> <p>7) CRUISE 20,000 ft/BCV</p> <p>8) LOITER 20 min/BLV/2000 ft</p> <p>9) APPROACH & LANDING</p> <p>10) LANDING RESERVES 50 min BLV (INCLUDES APPROACH)</p>	 <p>1) WARM UP & TAKEOFF 5 min IDLE + 2 min MRT</p> <p>2) CLIMB TO 20,000 ft</p> <p>3) CRUISE 20,000 ft/BCV (100 nm)</p> <p>4) LOITER 5000 ft/BLV (15 min)</p> <p>5) CARRIER QUAL ALLOWANCE TOUCH AND GO'S • 8 ARRESTED LANDINGS 15 min • 1 FULL STOP 15 min • 1 AT IDLE FOR EACH ARRESTMENT)</p> <p>6) CLIMB TO BCA</p> <p>7) CRUISE BCAY (100 nm)</p> <p>8) APPROACH & LANDING</p> <p>9) LANDING RESERVES 50 min BLV (INCLUDES APPROACH)</p>	 <p>1) WARM UP & TAKEOFF 5 min IDLE + 2 min MRT</p> <p>2) CLIMB TO 15,000 ft</p> <p>3) CRUISE 15,000 ft/BCV (50 nm)</p> <p>4) GUNNERY PRACTICE 20 min/360 KTAS 10 min/BCV</p> <p>5) CRUISE 15,000 ft/BCV (50 nm)</p> <p>6) APPROACH & LANDING</p> <p>7) LANDING RESERVES 50 min BLV (INCLUDES APPROACH)</p>

***SYLLABUS REQUIREMENTS**

- 360 KTAS LOW LEVEL ONAV FOR TA 4J
- LANDING RESERVE (1000 ft) EQUALS 35 min ENDURANCE AT S.L. FOR T 2C

REFERENCES

1. Anonymous: "Undergraduate Jet Pilot Training Aircraft Requirements Study," VEDA Corporation, Report VW 1856U/4.577-31, June 13, 1975.
2. Galloway, Thomas L. and Waters, Mark H.: "Computer Aided Parametric Analysis for General Aviation Aircraft," Society of Automotive Engineers, Paper No. 730-332, presented April 1973.
3. Becker, W. E.: "Navy Jet Trainer (VTX) Conceptual Design Studies," Naval Air Development Center, Report No. 75198-30, publication pending.
4. Anonymous: "Civil Aircraft Turbofan Engine Specification," Report No. SC-8010-D, AiResearch Model TFE-731-2, AiResearch Manufacturing Company of Arizona of the Garrett Corporation, January 5, 1973.
5. Anonymous: "Flying Qualities of Piloted Airplanes," Military Specification MIL-F-8785B (ASG), 7 Aug 1969.
6. Heldenbrand, R. W.; Merrill, G. L.; and Burnett, G. A.: "Study of Small Civil Turbofan Engines Application to Military Trainer Airplanes," NASA CR-137575, April 1975.
7. Merrill, G. L.; Burnett, G. A.; Alsworth, C. C.: "A Study of Small Turbofan Engines Applicable to General-Aviation Aircraft," NASA CR-114630, September 1973.

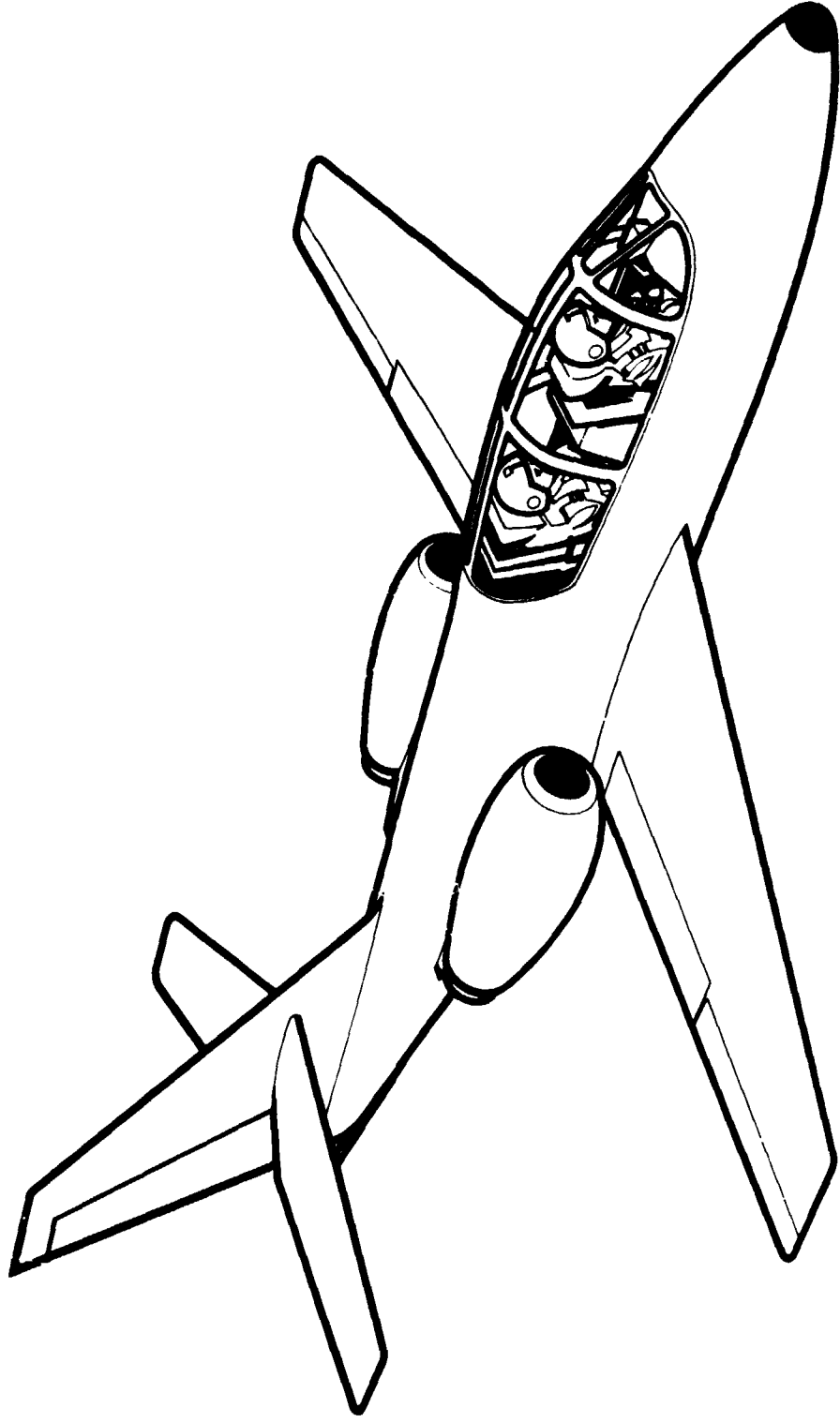

Figure 1.- VTX Configuration.

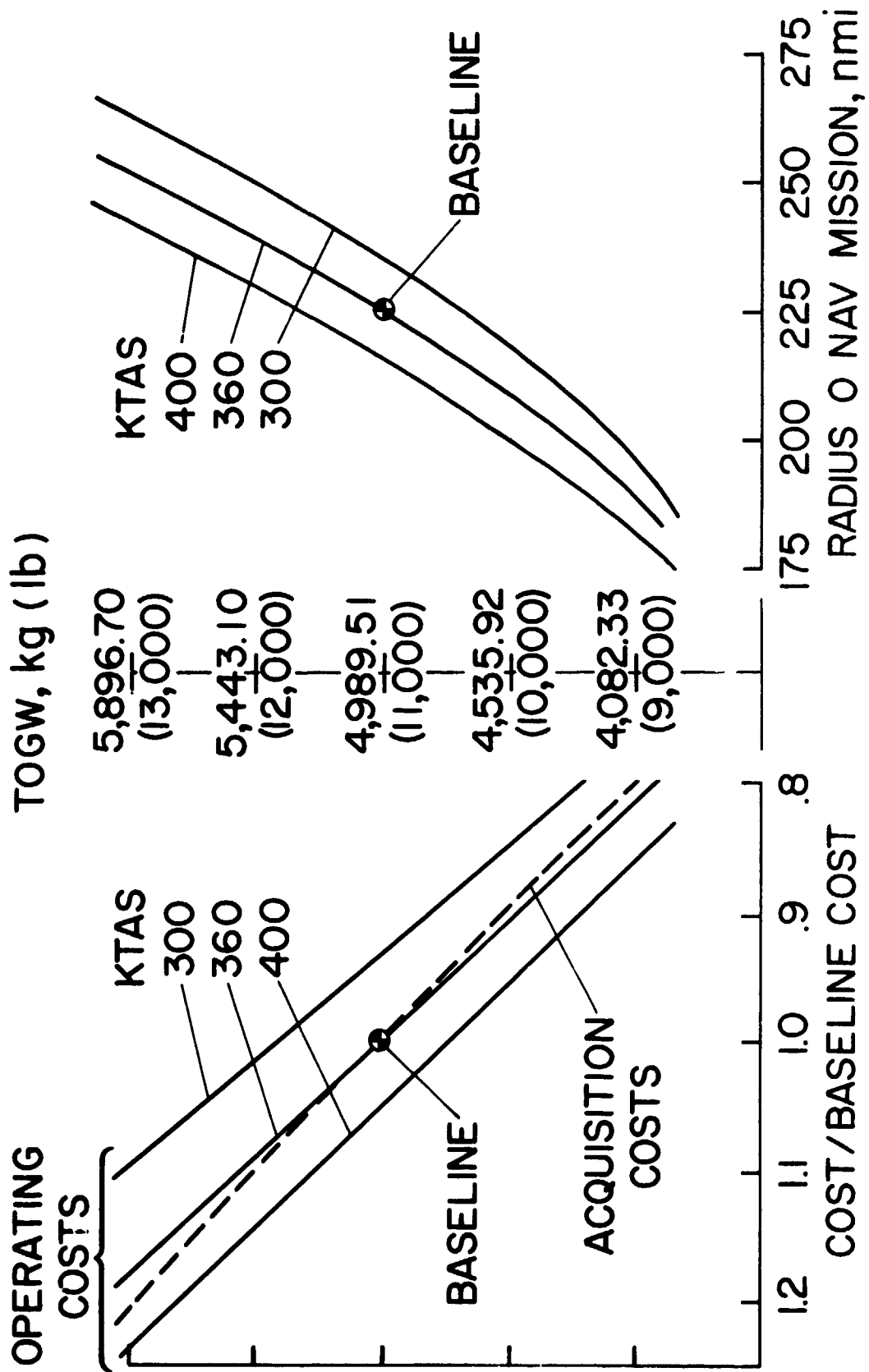

Figure 2.- Mission Radius and Speed Sensitivities.

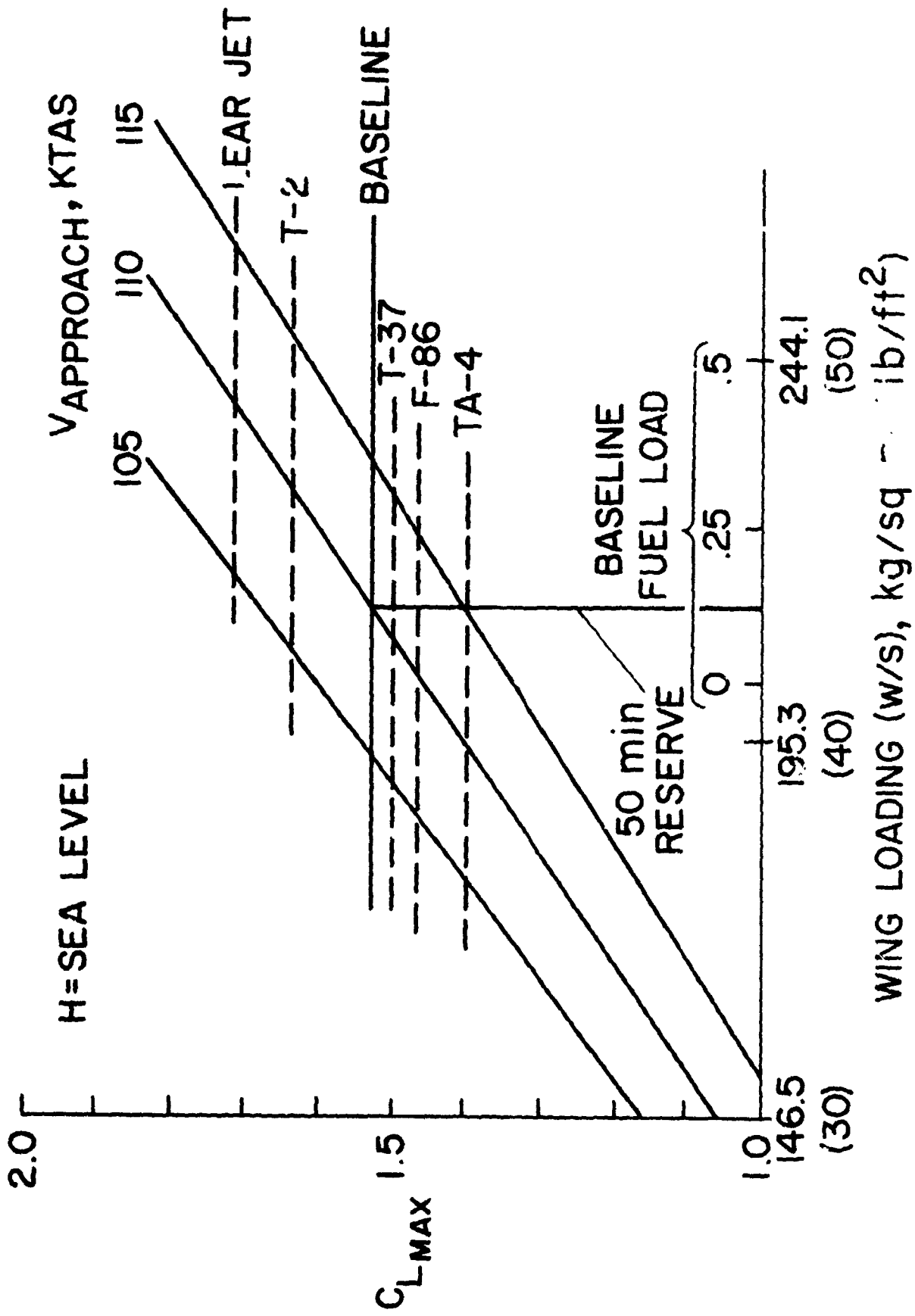

Figure 3.- Maximum Lift Coefficient - Approach.

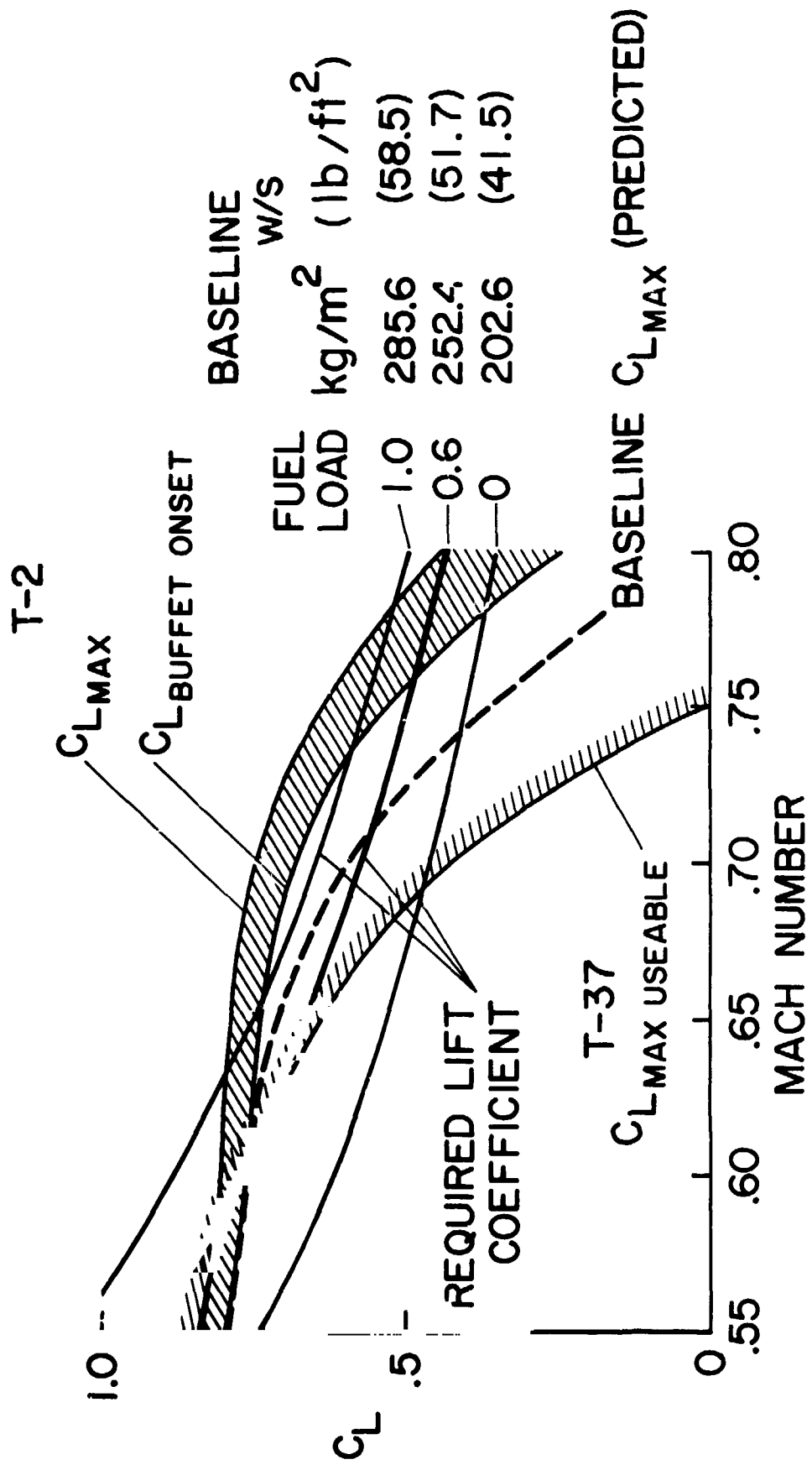

Figure 4.- Maximum Lift Coefficient - 4 g Turn.

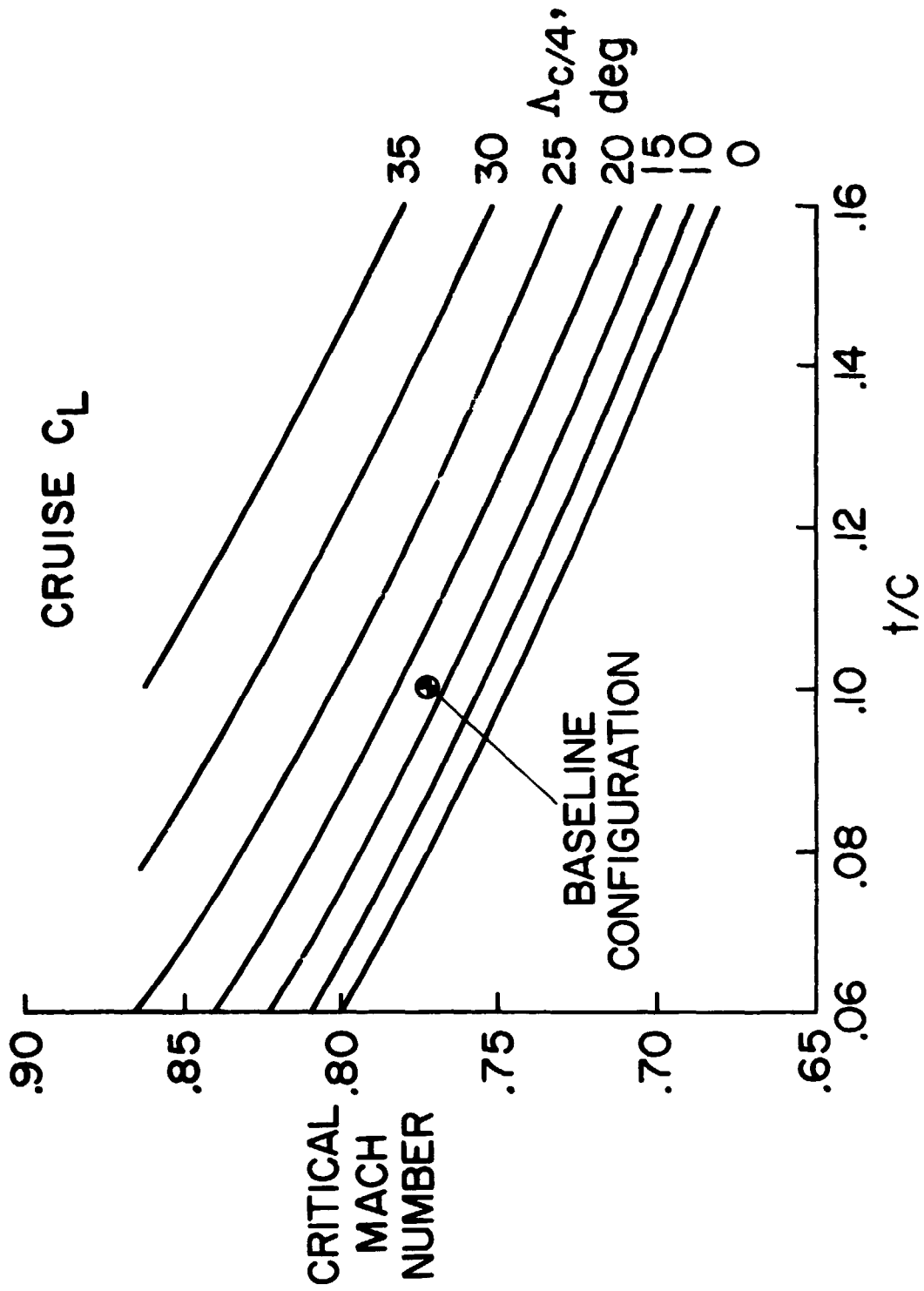

Figure 5.- Critical Mach Number.

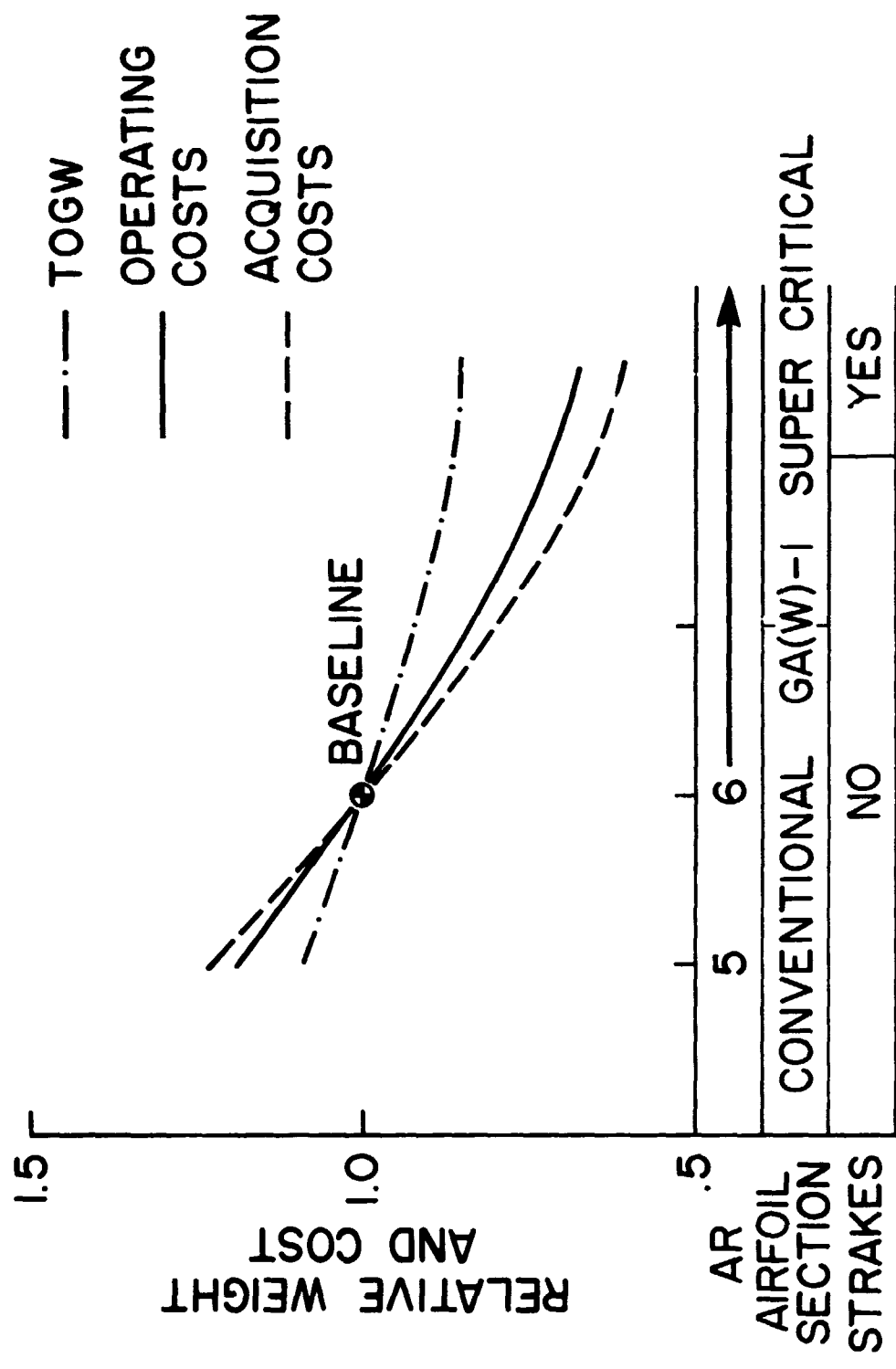

Figure 6.- Effects of Advanced Aerodynamics.

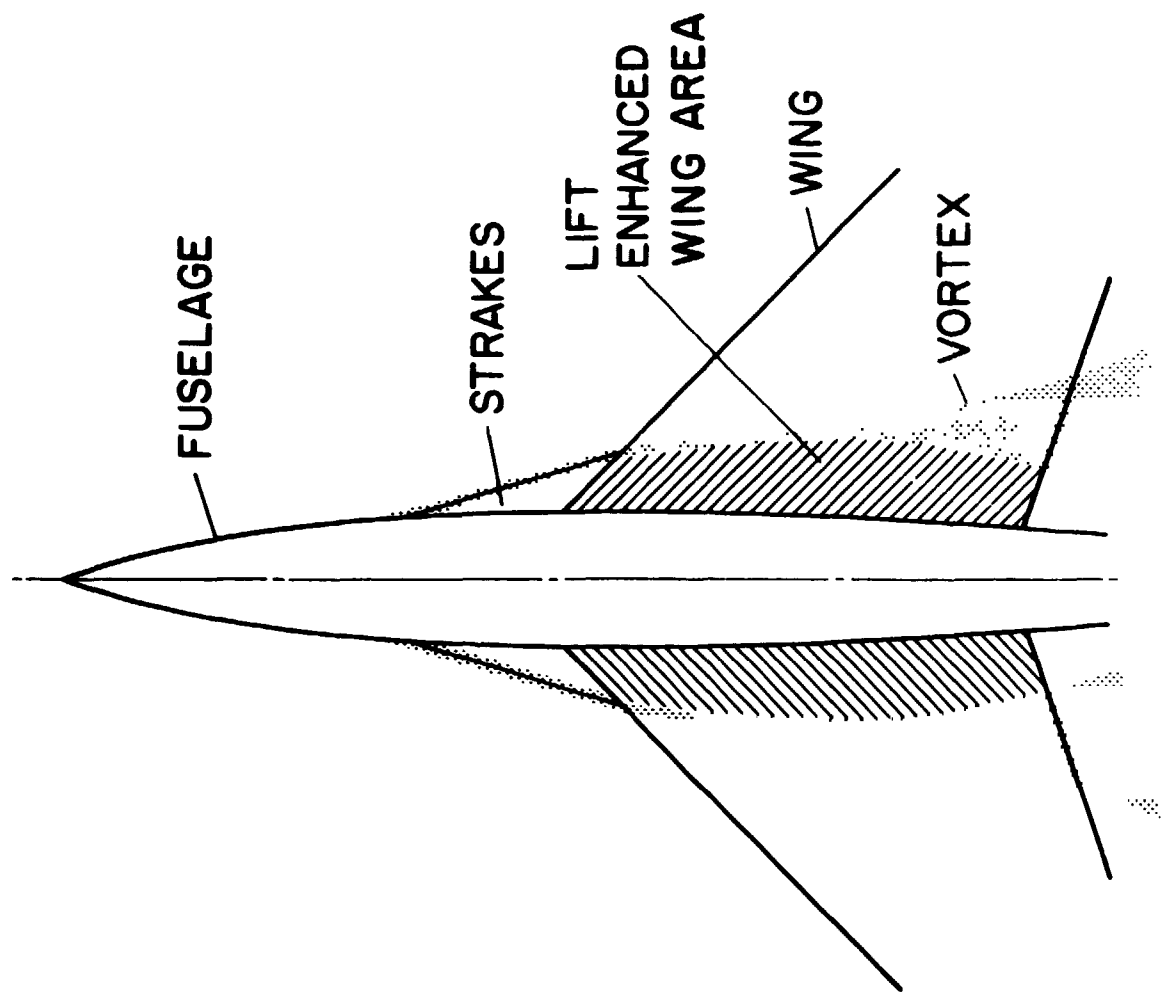

Figure 7.- Vortex Lift Enhancement.

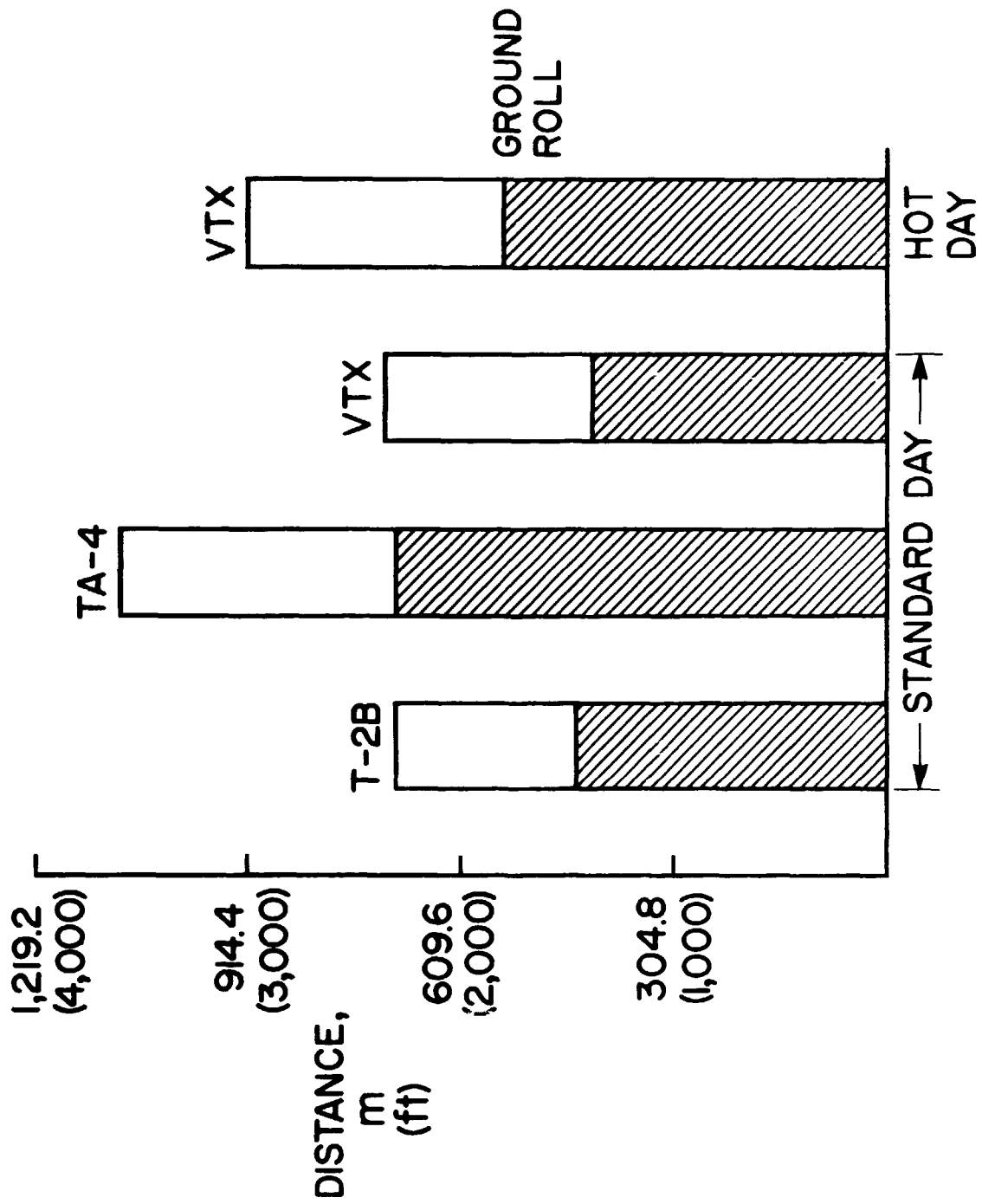

Figure 8.- Takeoff Distance Over a 15¼ m (50 ft) Obstacle.

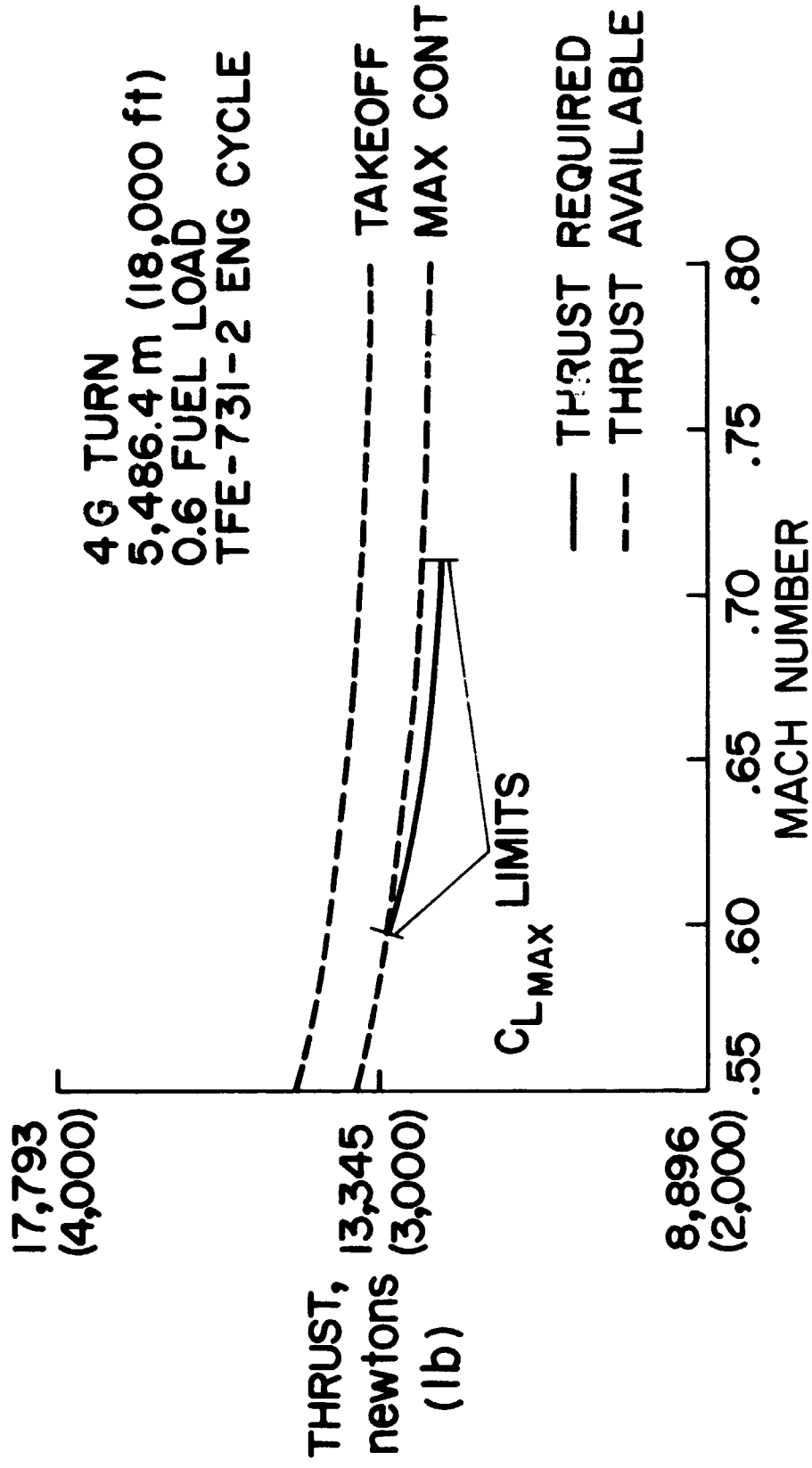

Figure 9.- Thrust Required/Thrust Available - 4 g Turn.

○ TFE-731-2 ENGINE

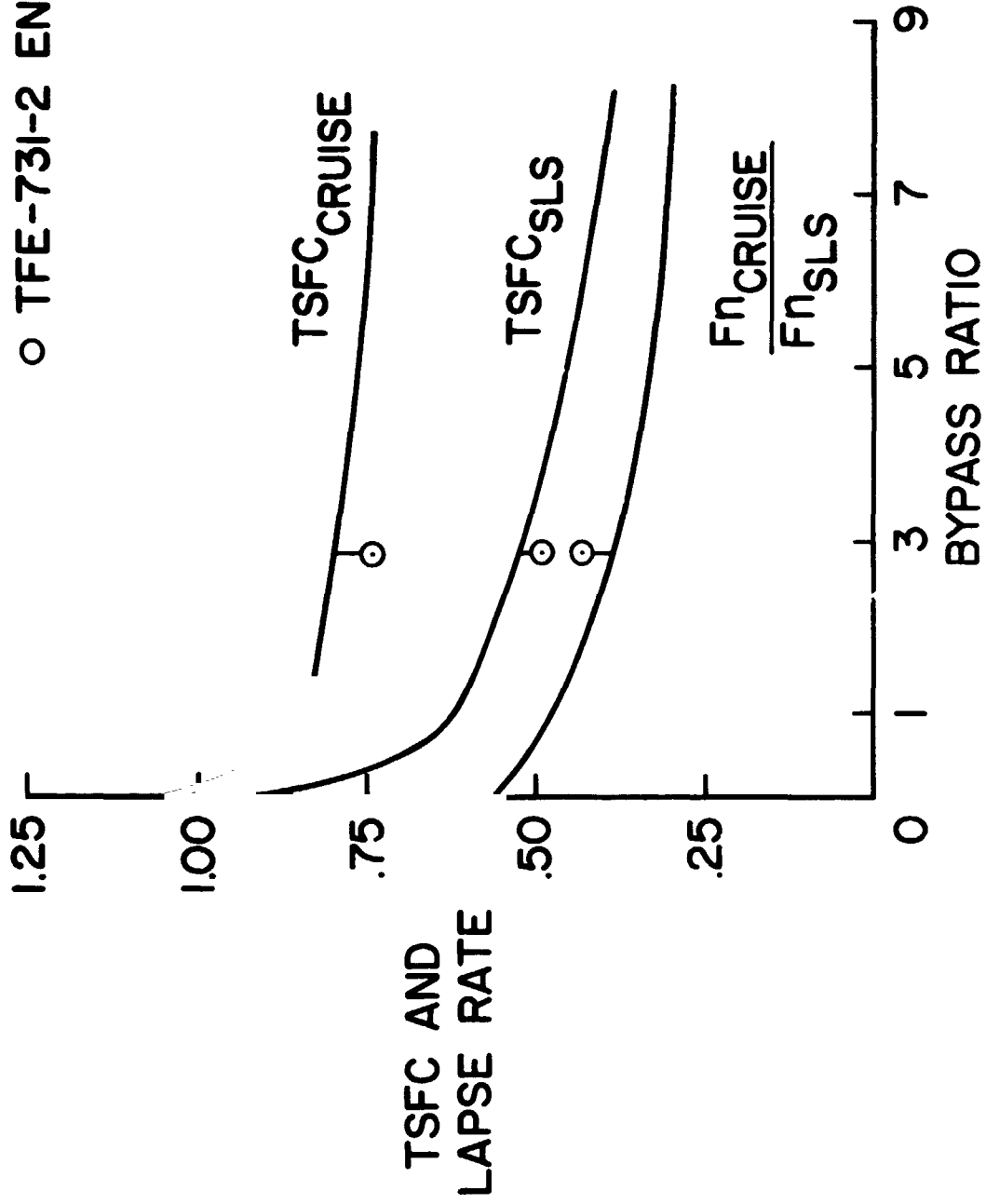

Figure 10.- TSFC and Lapse Rate versus BPR.

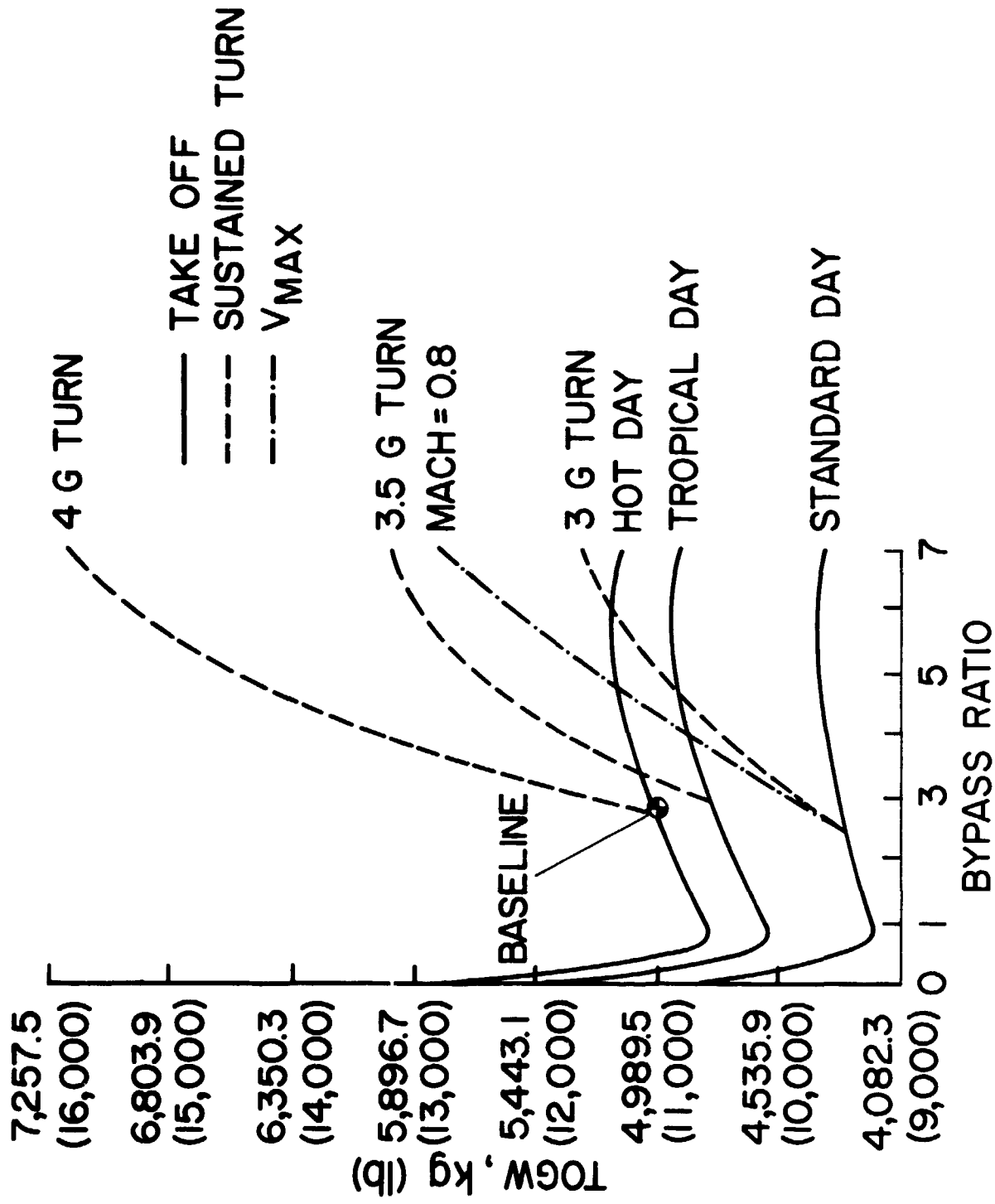

Figure 11.- TOGW Sensitivity to BPR.

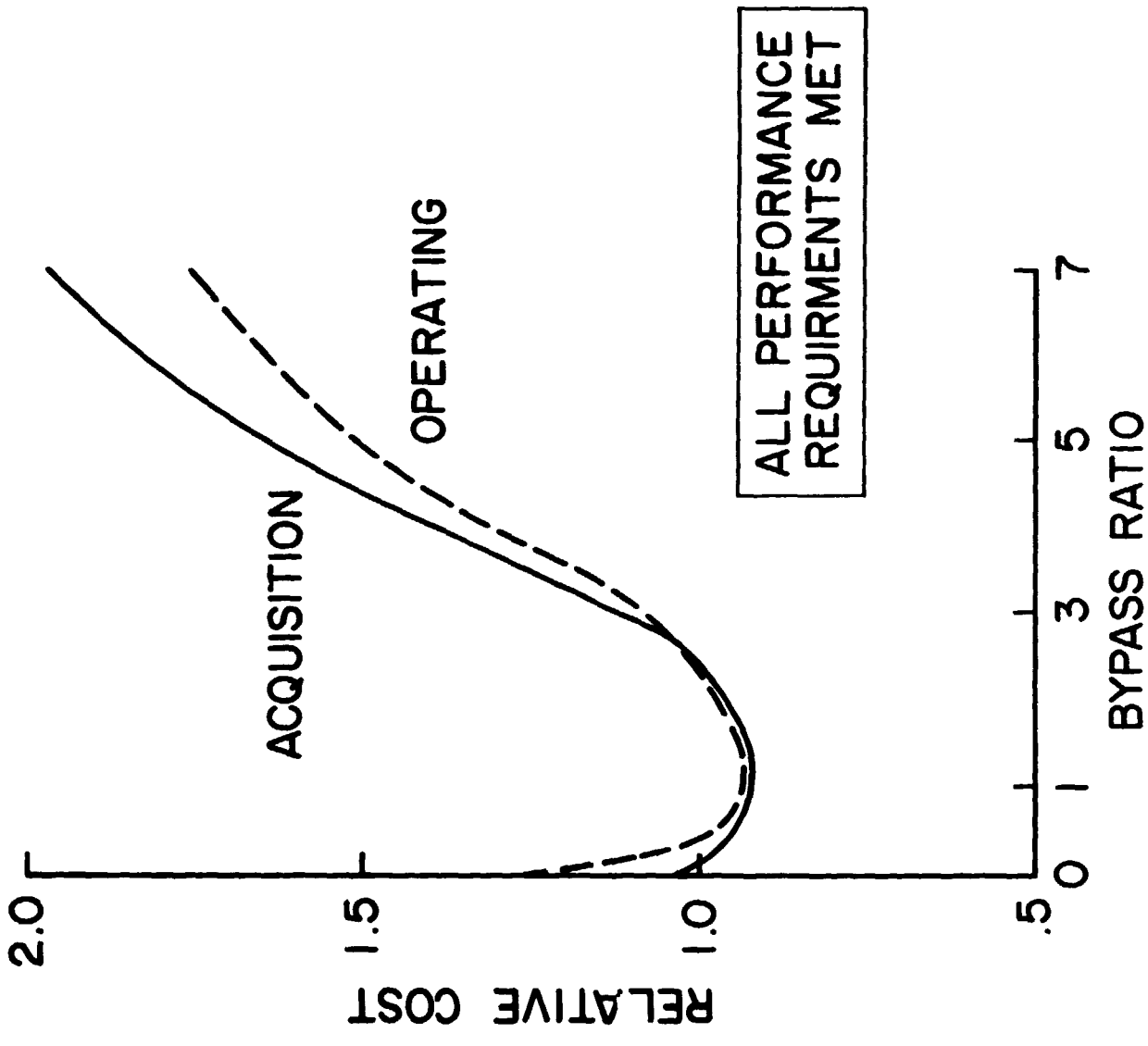

Figure 12.- Cost Variations with BPR.