

General Disclaimer

One or more of the Following Statements may affect this Document

- This document has been reproduced from the best copy furnished by the organizational source. It is being released in the interest of making available as much information as possible.
- This document may contain data, which exceeds the sheet parameters. It was furnished in this condition by the organizational source and is the best copy available.
- This document may contain tone-on-tone or color graphs, charts and/or pictures, which have been reproduced in black and white.
- This document is paginated as submitted by the original source.
- Portions of this document are not fully legible due to the historical nature of some of the material. However, it is the best reproduction available from the original submission.

NASA TECHNICAL MEMORANDUM

JSC-09728

NASA TM X-56164
September 1975



**DEVELOPMENT AND CHARACTERISTICS OF THE HARDWARE
FOR SKYLAB EXPERIMENT S015**

(NASA-TM-X-58164) DEVELOPMENT AND
CHARACTERISTICS OF THE HARDWARE FOR SKYLAB
EXPERIMENT S015 (NASA) 44 p HC \$4.00

N76-11407

CSSL 14E

Unclass

G3/35

03085



**NATIONAL AERONAUTICS AND SPACE ADMINISTRATION
LYNDON B. JOHNSON SPACE CENTER
HOUSTON, TEXAS 77058**

1. Report No. NASA TM X-58164		2. Government Accession No.		3. Recipient's Catalog No.	
4. Title and Subtitle DEVELOPMENT AND CHARACTERISTICS OF THE HARDWARE FOR SKYLAB EXPERIMENT S015				5. Report Date September 1975	
				6. Performing Organization Code JSC-09728	
7. Author(s) Robert G. Thirolf				8. Performing Organization Report No.	
9. Performing Organization Name and Address Lyndon B. Johnson Space Center Houston, Texas 77058				10. Work Unit No. 948-60-00-15-72	
				11. Contract or Grant No.	
12. Sponsoring Agency Name and Address National Aeronautics and Space Administration Washington, D.C. 20546				13. Type of Report and Period Covered Technical Memorandum	
				14. Sponsoring Agency Code	
15. Supplementary Notes					
16. Abstract <p>Details are given regarding the hardware for the Skylab S015 Experiment, which was designed to detect the effects of zero gravity on cell growth rates. Experience gained in hardware-related considerations is presented for use of researchers concerned with future research of this type and further study of the S015 results. Brief descriptions are given of the experiment hardware, the hardware configuration for the critical design review, the major configuration changes, the final configuration, and the postflight review and analysis. An appendix describes pertinent documentation, film, and hardware that are available to qualified researchers; sources for additional or special information are given.</p>					
17. Key Words (Suggested by Author(s)) <ul style="list-style-type: none"> * Experiment Hardware * Skylab Experiments * Zero Gravity * Cell Growth Rate * Human Cells 			18. Distribution Statement STAR Subject Category: 35 (Instrumentation and Photography)		
19. Security Classif. (of this report) Unclassified		20. Security Classif. (of this page) Unclassified		21. No. of Pages 43	22. Price* \$3.75

*For sale by the National Technical Information Service, Springfield, Virginia 22151

NASA — JSC

**DEVELOPMENT AND CHARACTERISTICS OF THE HARDWARE
FOR SKYLAB EXPERIMENT S015**

**Robert G. Thirolf
Lyndon B. Johnson Space Center
Houston, Texas 77058**

CONTENTS

Section	Page
SUMMARY	1
INTRODUCTION	1
EXPERIMENT HARDWARE	2
Description	2
Configuration for Critical Design Review	3
First Major Configuration Change	4
Second Major Configuration Change	6
DESIGN SUMMARY OF FINAL CONFIGURATION	6
POSTFLIGHT HARDWARE REVIEW	7
RESULTS	8
Environmental Parameters	8
General Requirements	9
Major Problems	10
Documentation	11
CONCLUDING REMARKS	11
REFERENCE	12
APPENDIX — AVAILABLE DOCUMENTS, DRAWINGS, HARDWARE UNITS, AND EXPERIMENT DATA	34

TABLES

Table		Page
I	PIN ASSIGNMENTS AND PURPOSES OF CONNECTIONS	13
II	CHARACTERISTICS OF ASSEMBLIES FOR CAMERA-MICROSCOPE SECTION . . .	15
III	CHARACTERISTICS OF THE GCM SECTION	19
IV	SUMMARY OF MAJOR FAILURES DURING SO15 HARDWARE TESTS	23
V	MOTOR CHARACTERISTICS AFTER REMAGNETIZATION	24

FIGURES

Figure		Page
1	External configuration of SO15 flight unit	25
2	Experiment SO15 location in CM	25
3	Experiment SO15 mounting in CM compartment B6	26
4	Rear view of flight unit with cover removed	26
5	Growth curve module	27
6	The CDR configuration of SO15 experiment	27
7	Camera-microscope section	28
8	Camera-microscope diagram	28
9	Microscope pump/chamber assembly	29
10	Camera-microscope cell chambers and media pumps (film magazines removed)	30
11	Cytochemical experiment section (replaced by the GCM)	31
12	The GCM section	31
13	Biological experiment assembly (subassembly for GCM)	32
14	Photographs of GSU	
	(a) External view	33
	(b) Cover removed and CDR configuration in place	33

DEVELOPMENT AND CHARACTERISTICS OF THE HARDWARE

FOR SKYLAB EXPERIMENT S015

By Robert G. Thirolf
Lyndon B. Johnson Space Center

SUMMARY

In planning and conducting an in-flight experiment, one of the important prerequisites is an understanding of the flight hardware as a physical unit together with complete knowledge of its operation, the range of its capabilities, and the problems that may occur. Experience gained from the Skylab S015 Experiment (effect of zero gravity on living human cells) is presented in this report, which also gives hardware details that are pertinent for experiment analysis and that are important for similar research projects. The appendix provides information regarding the flight hardware units and the related equipment and documentation that are available to qualified researchers on a limited basis.

INTRODUCTION

The purpose of the Skylab S015 Experiment was to provide more extensive observations of the effects of zero gravity on living human cells. The observations were made during and after the 59-day flight on Skylab 3. A strain of diploid human embryonic lung cells, WI-38, was chosen for this purpose and was mounted within the command module (CM). The area of interest concerned observations designed to detect the effects of zero gravity on cell growth rates and on cell structure as observed by light microscopy and histochemistry. Studies of the effects of zero gravity on the cell function and the cell cycle were recorded by time-lapse motion picture photography and microspectrophotometry. Subsequent study of the returned living cells included karyotyping, G- and C-banding, and analyses of the culture media used. Some of the living cells returned were subcultured and were banked by deep-freeze techniques for possible future experiments.

The S015 experiment was designed to achieve four major objectives: to maintain living cell cultures by supplying them with proper nutrients and maintaining them at body temperature near 309 K (36° C), to produce 20X and 40X phase-contrast time-lapse motion pictures of living cells for 28 days, to fix a group of cell cultures at predetermined intervals to measure their growth rate, and to return in a viable state a sufficient number of cells for postflight subculture and preservation.

The flight unit for the experiment was fully automated. Like most equipment developed for space flight, the hardware design was restricted by limitations of size, weight, and power; high reliability and safety standards were achieved. Biological compatibility of materials and the necessity to sterilize some of the components at high temperatures were major constraints not usually encountered in flight hardware design.

The Life Sciences Directorate of the NASA Lyndon B. Johnson Space Center (JSC) acknowledges the efforts of the following persons who had major roles in contributing to the development of the Skylab Experiment S015, its hardware, and its success: Dr. P. O'B. Montgomery, Jr., for serving as principal investigator (PI) in conceiving the experiment and in directing its development and all the analysis and reporting activities (also for his patience in maintaining an interest in the experiment through the many NASA changes that he had to accommodate); Dr. Leonard Hayflick for his contribution of the WI-38 cells, for his many consultations with Dr. Montgomery, and for banking the returned live specimens in his laboratory facility; and James E. Cook for his services as chief engineer for the program. Cook was wholly responsible for the design, development, testing, and processing of the experiment. This was practically a 100-percent in-house effort with fabrication of detailed machined parts, electronic subassemblies, and complex mechanisms, through final assembly being accomplished in the shops and laboratories at Woodlawn Hospital, Dallas, Texas, under Cook's direction. He did a fabulous job in keeping up with the paperwork demands of the system.

Thanks are also extended to Dr. Joseph Paul, Dave Campbell, Rich Summers, Dr. Werner Schulz, Jerry Murrell, Harry Jarrett, and John Dyal of the group at Woodlawn Hospital; to Bob Matthias of the Dallas office of the Defense Contract Administration Services Region; to Jim Evans, NASA project engineer of the experiment through the acceptance of the hardware design at the Critical Design Review; to Tom Larkin, Ed Armstrong, Lou Hammer, and Dick McComb of JSC for their support at the many Houston and Dallas meetings and reviews of the hardware; to Marty Czaban, Randy Tilley, and Hollis Neal who labored many hours into the night during the integration testing and prelaunch preparations at the NASA John F. Kennedy Space Center (KSC); and to E. Van Haafton and Arch White, of the Bulova Watch Co., for their help with the Accutron timers.

As an aid to the reader, where necessary the original units of measure have been converted to the equivalent value in the Système International d'Unités (SI). The SI units are written first, and the original units are written parenthetically thereafter.

EXPERIMENT HARDWARE

Description

The S015 hardware consisted of a single self-contained unit (fig. 1) installed in the CM, which supplied the power and maintained an ambient temperature of 283 to 308 K (10° to 35° C). Location of the unit in CM compartment B6

is illustrated in figure 2; a mounting diagram is shown in figure 3. The unit was hermetically sealed to provide an internal pressure of ground-level atmosphere. The fully loaded package weighed 10 kilograms (22 pounds) and measured 40 by 19 by 17 centimeters (16 by 7.6 by 6.8 inches).

Internally, the package was divided into a camera-microscope section and a separately sealed growth curve experiment section. Figure 4 illustrates the interior arrangement with the camera-microscope section on top, the growth curve experiment section below, and the circuit boards (required to fully automate the experiments) located between the two. The growth curve experiment was conducted in a module (fig. 5) that was easily removed for biological servicing. The module was separated into two identical independent assemblies to provide some degree of duplication and control in the experiment design.

Configuration for Critical Design Review

The SO15 flight hardware configuration (fig. 6) that was approved at the Critical Design Review (CDR) on February 25, 1970, consisted of two sections: a camera-microscope section and a cytochemical section.

The camera-microscope section (fig. 7) consisted of two independent systems. One system photographed specimens through a 20X microscope; the other system photographed through a 40X microscope. Each microscope (including the lamp used to illuminate the specimen) measured only 7 by 4 by 2.5 centimeters (2.8 by 1.6 by 1 inches). The phase-contrast image produced by the microscope was projected through a tube and reflected by a mirror onto the film. The mirror could be rotated, allowing an observer to view the image with the cover in place and sealed and also allowing the microscope to be focused during ground-based checkout. A locking device was provided to hold the objective lens in position after focusing. No shutter was required because the lamp was turned off after each exposure.

The camera operation (fig. 8) was unusual because film registration was accomplished by using photocells to sense sprocket-hole position in the film instead of using the usual sprocket wheels or claws. This arrangement reduced weight and eliminated troublesome film loops and takeup-reel slip clutches. It was limited in speed, however, because it required the takeup reel to stop for each frame. Periodically, an internal timer turned on the microscope exposure lamp for a short period to expose one film frame. As the lamp turned off, a pulse was generated that triggered a silicon-controlled rectifier (SCR). The SCR completed a circuit that allowed the film-takeup drive motor and registration lamp to operate. The motor advanced the film until a small beam of light passed through the next sprocket hole and contacted the phototransistor. The phototransistor output switched on a transistor connected across the SCR. The SCR stopped conducting because of the shunt path, but the transistor maintained the circuit until the edge of the sprocket hole again interrupted the light path, turning off the transistor and stopping the motor. The cycle was then ready to be repeated for the next frame.

Film for the camera was supplied from a replaceable film pack containing two rolls of 16-millimeter film 100 meters (328 feet) long. The 40X microscope

camera had a photographic rate of 5 frames per minute for 40-minute intervals twice each day. The rate of the 20X microscope camera was one frame for each 3.2 minutes, continuously.

Each microscope assembly held a living-cell specimen growing in a 0.05-cubic-centimeter (0.003 cubic inch) chamber formed by a gasket sandwiched between two glass disks. Tubes were attached to the gasket for injecting fresh liquid nutrient media and for removing waste media. The chamber was kept in a heated block that was thermostatically controlled to maintain body temperature.

Cells suspended in a liquid medium were injected into the chamber (fig. 9). After a few hours, the cells settled into a thin layer and became firmly attached to the lower glass disk. The chamber was then installed in the microscope cell chambers (fig. 10). The thin layer of cells formed a flat plane on which the objective lens was focused.

Fresh nutrients were supplied twice a day from a cylindrical reservoir containing a piston. The piston forced fresh media into the chamber, and waste media was forced into the space in the back of the piston. The piston was advanced by a motor that rotated a lead screw that drove the threaded piston. Separate media-pump reservoirs were provided for each specimen chamber.

The cytochemical experiment section (fig. 11) consisted of two biopack assemblies of 12 cell chambers each together with media pumps for providing fresh nutrients to the cells and provisions for labeling with radioactive trace elements, rinsing, and fixing. The only difference between the two biopack assemblies was that the media pump for Biopack I was sized to support a 4-day operating period, whereas the media pump for Biopack II was sized to support a 10-day operating period. An automatic thermal control circuit maintained the cell chambers at 309 K (range: 306 to 310 K) (98° F, range: 92.5° to 99° F) until the end of the 4- and 10-day periods. At the ends of these operating periods, the cells were treated with the isotopes, then fixed so that they could be returned for postflight analysis.

Two Accutron clock movements, which drove commutator-type switches (three switches on each movement), were used as the basic timing elements for the experiment package.

The package size was 16.5 by 19 by 39.4 centimeters (6.5 by 7.5 by 15.5 inches) and was totally enclosed in a sealed aluminum container. It was originally designed to be used in CM compartment B6 during the first manned Skylab mission. The only active interface with the spacecraft was the requirement of 28-volt direct-current (dc) power with an overall average of 16 watts at 283 K (50° F) ambient temperature.

First Major Configuration Change

In response to questions raised by the scientific community relative to some aspects of the experiment, a meeting was held February 3, 1972. Five

prominent scientists¹ in the field of cell research attended the meeting, reviewed the CDR hardware configuration, and made recommendations. These five scientists concluded that the camera-microscope section was an excellent concept and design; but the cytochemical experiment section, although well developed for what had been intended, would not produce adequate statistical data to enable firm conclusions to be drawn from its operation. They also recommended that no changes were necessary for the camera-microscope sections, but the entire cytochemical experiment section should be redesigned to develop a statistically defensible growth curve for human cells in zero gravity.

Three weeks after this meeting (February 24, 1972), the design of a growth curve module (GCM), shown in figure 12, was presented (complete with drawings and a working model) to NASA Headquarters. The GCM used the same base plate and electrical connectors of the cytochemical experiment section, and it was confined to the same space envelope to minimize the impact of the change on the overall experiment package. Two duplicate assemblies would be provided on the base plate to assure reliability through redundancy. Each assembly (fig. 13) would consist of nine cell chambers, a media pump, and a fixative pump. One chamber would be fixed in each assembly on alternate days for 10 days to provide 10 points for plotting a growth curve. If one of the assemblies failed either functionally or biologically, the loss would be experienced only by missing alternate data points in the growth curve.

The specimens were fed automatically by a media pump, which was advanced by the media-pump motor upon clock initiation. The media passed through a preheater (a reservoir attached to the heated holder) before entering the chambers. A tape program reader, driven by the media-pump motor, used a polyester tape that was punched with two rows of holes. Microswitch actuators rode on the tape and dropped into the holes. One row of holes determined the amount of media for each feeding, and the other row initiated cycles to inject fixative into one chamber at a time.

Fixation was accomplished as follows. Upon command by the programmer, the fixative-pump motor began to drive a sector gear. The sector gear rotated a fixing valve 22.5° (and the fixative pump 315°), then disengaged. This rotation connected lines from a fixative pump to the chamber to be fixed and disconnected the chamber from the media-supply lines. As the motor continued to operate, the sector gear engaged a gear on the fixative pump. Fixative was injected and the cycle was terminated by a cam switch on the motor. This cycle was repeated to fix the other chambers. Each time a specimen was fixed, it no longer required feeding. The tape programmer terminated the media-pump cycle sooner so that only enough media for the remaining unfixed chambers would be supplied. Four of the nine chambers were not fixed but were returned with live cells so they could be subcultured upon return to Earth.

¹The meeting was called by Dr. Joseph Saunders of NASA Headquarters and was held at Woodlawn Hospital, Dallas, Texas. The five scientists were: Dr. H. Earle Swim, University of Kentucky; Dr. Vincent Christofalo, Wistar Institute; Dr. Kenneth S. McCarty, Duke University; Dr. Paul F. Kruse, Jr., Noble Foundation; and Dr. Calvin H. Ward, Rice University.

No changes were recommended for the photographic section of the experiment. The final design changes and documentation revisions were submitted with Engineering Change Proposal (ECP) 19 dated May 16, 1972. Approval by the Skylab Program Office was granted by Configuration Control Board Directive (CCBD) 2X0584 on June 16, 1972.

Second Major Configuration Change

A fully loaded S015 flight unit, awaiting installation in the CM, was available at KSC on May 14, 1973, when a decision was made to delay the launch of Skylab 2 because of electrical and thermal problems with the orbiting workshop. On May 15, the S015 unit was returned to the principal investigator's facility for reloading to support a delayed Skylab 2 launch. On May 23, a decision was made that the S015 hardware would not be used for Skylab 2, therefore, a plan was implemented to rework the hardware for Skylab 3, which was planned as a 56-day mission. (Duration of the mission was actually 59 days.)

The greatest problem associated with the change in assignment from the 28-day to the 56-day mission was the amount of nutrients that would be available to feed the cells. The media pumps were designed to provide optimum feeding periods for 28 days; no time was available for designing new pumps, and no space was available within the experiment package to accept larger pumps. A study was started by the PI to determine minimum feeding periods and the maximum intervals between feedings that would still result in a good probability of returning live cells.

A new feeding program was developed from this investigation, and a new tape was punched for the programmer in the flight hardware. Another change required that the heaters keeping the GCM cells at 310 K (98° F) be turned off on mission day 12, which would allow the temperatures of the cells to decrease to approximately 283 K (50° F) as a result of the CM ambient thermal state. The cells would thus be maintained in a somewhat dormant condition. Also, a decision was made not to change the frame rates or programs for the 20X and 40X camera-microscopes, but to provide a crew procedure for turning off both cameras on mission day 28, at which time all the film would have been expended. These changes were approved by CCBD 3X0442A on June 21, 1973.

When these changes were made, it was noted that some long-term deleterious effects had occurred in the cells that were being maintained at 283 K (50° F). A decision was made that, instead of turning the heaters off, it would be better to switch to a 295-K (72° F) thermostat on day 12 to decrease the cell activity. This change was approved by CCBD 3X0490 on June 28, 1973.

DESIGN SUMMARY OF FINAL CONFIGURATION

The overall package of the S015 flight hardware, based on the final design, had the following characteristics.

1. Enclosure: Airtight with O-ring seal, internal pressure initially $101\ 325 \pm 333\ \text{N/m}^2$ ($760 \pm 25\ \text{mm Hg}$), leak rate verified to be less than $50.6\ \text{cm}^3\ \text{N}/(\text{m}^2\ \text{sec})$ ($5 \times 10^{-4}\ \text{cm}^3\ \text{atm}/\text{sec}$).

2. Weight: 10.09 kilograms (22.25 pounds).

3. Size: 39.4 centimeters (15.5 inches) wide, 16.5 centimeters (6.5 inches) high, and 23 centimeters (9.05 inches) deep (including 3.8-centimeter (1.5 inch) handles).

4. Center of gravity: When the package faceplate is observed with the labels upright, the center of gravity is located at 20.1 centimeters (7.9 inches) from the left edge of the flange, 8.9 centimeters (3.5 inches) from the top of the flange, and 11.2 centimeters (4.4 inches) from the rear of the package.

5. Power: Input voltage was 21 to 30 volts dc, peak power at 28 volts dc was 45 watts, and average power was 16 watts (days 1 to 28 at an ambient temperature of 283 K (50° F)).

6. Interface connectors: Two electrical interface connectors were provided; connector J1 was used only for power from the spacecraft, and connector J2 was used for ground checkout. The pin assignments and purpose of each connection are given in table I. At the front of the flight unit, provisions also existed at the upper right corner for a structural ground strap to be used with a number 10-32 screw.

The camera-microscope section was composed of several assemblies, the characteristics of which are given in table II. The GCM section consisted of two identical assemblies, designated as GCM-1 and GCM-2. To provide a redundant seal, the complete GCM section was housed in an airtight container within the overall package enclosure. A recorder gave "on-off" indication on 8-millimeter photographic film of the following events: GCM-1 and GCM-2 media-pump motor operations, fixative-pump motor operations, high out-of-limit temperature, and low out-of-limit temperature. Characteristics of the GCM section are described in table III.

POSTFLIGHT HARDWARE REVIEW

Skylab Experiment S015, which was conducted during Skylab 3, used the flight unit designated as serial number (S/N) 004. The flight unit (in a ground support unit similar to the one shown in fig. 14) was picked up by Dr. P. O'B. Montgomery and James E. Cook, University of Texas, and Robert G. Thirolf, JSC, on September 26, 1973, at 10:20 a.m. Pacific daylight time aboard the U.S.S. New Orleans at the North Island Naval Air Station, San Diego, California. Before the unit was removed from its stowed location aboard the recovery vessel, checks were made of the cell-chamber temperatures; all temperature readings were normal. The unit was taken to a laboratory at the

Stanford Medical School, Palo Alto, California, where the first activity was a visual check of the 20X and 40X chambers. The check was made by means of an auxiliary eyepiece through the two ports on the front of the experiment package. The check indicated that focus through both microscopes was still sharp and the appearance of the cells was that which was expected. The flight unit was then taken to a photographic darkroom, and the 16-millimeter film was placed in cans for transfer to JSC, Houston, Texas, where the film was developed and reported to be of excellent quality. The specimens had remained viable throughout the 28-day photography period of the Skylab 3 mission. Detailed analysis of the film was conducted by the PI in Dallas.

Postflight checks indicated the proper operation of all assemblies that controlled the feed/fix periods, and checks indicated proper operation of the experiment clocks. In addition, both "fix" valves were in position 5, which was correct for this stage of the experiment operation. All preliminary post-flight inspections indicated that the experiment hardware properly performed its intended function; the specimens were in very good condition except that the live cells returned in the GCM-1 subassembly were fewer and less viable than in the GCM-2 subassembly. However, the GCM-2 cells were in excellent condition and fully met the experiment requirement for the return of live cells. The cells were subcultured, and ampoules of the subcultured cells were deep frozen and placed in a bank at Stanford University for future research.

At present, there are no detectable differences between the cells that were flown for 59 days in a zero gravity state and those that were maintained as ground control specimens under identical conditions except for the one-g gravitational field (ref. 1).

RESULTS

A postflight analysis of the S015 flight unit was conducted by evaluating its performance in terms of the performance requirements documented in End Item Specification (EIS) MSC-01150F. (This document and related material of limited distribution are listed in the appendix.) The analysis revealed that the hardware met all the EIS performance requirements.

Environmental Parameters

The following environmental parameters were introduced into the EIS at NASA direction (without identical requirements from the PI or hardware developer).

1. Environmental parameters for ground handling were as follows.
 - a. Temperature: 230 to 336 K (-45° to 145° F)
 - b. Pressure: -23 442.17 to 103 421.4 N/m² (-3.4 to 15 psia)

c. Sand and dust atmosphere: equivalent to 140-mesh silica flour; particle velocity up to 2.54 m/sec (500 ft/min), particle density of 0.01236 kg/m³ (0.35 g/ft³)

d. Salt atmosphere: 5 percent salt solution for 48 hours

2. Environmental parameters for prelaunch were as follows.

a. Temperature: 272 to 325 K (30° to 125° F)

b. Salt atmosphere: 3 μg/cm³/day salt accumulation, in accordance with MIL-STD-810B, Method 507, Procedure I, except the 72-hour duration

3. Environmental parameter for launch and boost was 95 percent oxygen atmosphere at 34 473.8 N/m² (5 psia), 95 percent relative humidity, and 308 K (95° F) for 120 hours.

4. Environmental parameter for reentry shock was 78g for 10 to 15 milliseconds in the +X direction.

5. Environmental parameters for flight were as follows: random vibration with acceleration spectral density increasing at the rate of 3 dB/octave from 20 to 80 hertz; constant vibration at 0.06 g²/Hz from 80 to 400 hertz; decrease at the rate of 3 dB/octave to 2000 hertz. The excitation shall act along each of three orthogonal axes for a duration of 2.5 minutes per axis.

The intention of the PI was that the experiment hardware would always be handled as a piece of precision laboratory equipment. These handling requirements seemed excessively severe, and this conclusion is probably justified by the fact that these severe conditions were not applicable during performance of the experiment on Skylab 3. For the flight parameter, the characteristics given for EIS random-vibration spectral density were undoubtedly severe. During random vibration testing to these requirements, the Accutron clocks always experienced an offset from their initial time settings, and this condition persisted for all units tested. However, a postflight inspection at Stanford Medical School indicated that a normal 40X-camera operating cycle started at 6:00 p.m. Pacific daylight time, thus indicating that the launch vibrations had no effect on the clock and that it was operating with no shift from its preflight setting.

General Requirements

Based on experience with the EIS requirements, the following general requirements appear unrealistic when viewed in retrospect of actual conditions.

1. Testing: The original electronic-design concepts for the experiment hardware were based on Apollo Program requirements that required electromagnetic interference (EMI) standards based on the suppression of voltage spikes. For EMI testing, the EIS specified MIL-STD-461, which is directed toward

current spikes. This resulted in a slight "out of tolerance" condition for which a waiver was readily granted.

2. Reliability: The following EIS reliability factors seem quite artificial because they were not related to "real world" conditions.

a. A reliability factor of 0.9995 for safety of personnel and flight vehicle/module

b. A reliability factor of 0.999 for accomplishment of primary mission objectives and prevention of any effect on launch schedule as the result of failure

c. A reliability factor of 0.99 for accomplishment of the experiment objective

Major Problems

Table IV is a summary of all the major failures that occurred in the entire program, starting with the assembly checkout and concluding with the actual prelaunch activities at KSC. Four identical units were involved in the test program. The qualification unit was S/N 001 and the three potential flight units were designated by serial numbers 002, 003, and 004. The decision to choose S/N 004 as the actual flight unit was based on the types of failures that occurred and the condition of the biological specimens at the prelaunch period.

Most of the failures (table IV) were conventional in nature and were expected for a program of this type with its complexity of units, the number of units involved, and the amount of testing required. However, the nature of two failures justifies special attention.

1. Problem: The 20X-camera light illuminated, but the drive motor was stalled and the camera was not functioning (K-KD-0582 and K-KD-0585 in table IV). Investigation indicated that, although the motors were the "permanent magnet" type, they should be remagnetized (in an assembled condition) each time they were disassembled. This function had not been performed even though the motors were disassembled for inspection, gearbox modification, and cleaning. All six motors for the flight units were returned to the manufacturer for inspection and remagnetization. Data in table V clearly indicate that the motor characteristics were improved after remagnetization. The decreases in motor speed and starting voltage are the expected results of increased field flux density.

2. Problem: The GCM-2 program tape did not advance or feed the cell specimens (K-KD-0588 in table IV). The resistance-capacitance time constant in the control circuitry prevented the initiating clock signal from triggering a tape advance/feed cycle. Although there was nothing particularly critical about the rise time of the clock signal (it was just considered to be a nominal contact closure), investigation revealed instances when as long as 15 seconds

were required (from the time of initial contact) for the voltage through the contact to reach 28 volts. Multiple oscillograph photographs of other clock contact closures indicated a lack of consistency in the rise time for repeated operation of the same contact and lack of consistency between contacts. Rise time values ranged from those that were too fast to be measured with the 1-cm/sec horizontal sweep rate, which was used for the measurements, to the 15 seconds previously mentioned.

In retrospect, the occurrence of such problems is understood when one becomes aware of the mechanism of the contact closure. The clock consisted of conventional Accutron clock movements driving circular commutating wheels by means of a gear assembly and wiping against a fixed contact wire. Because of the turning rates of the commutator and because of the sizes of the elements involved, the closure rate of the conducting wheel and the fixed wiping wire was approximately 4.6×10^{-7} m/sec (18 μ m/sec). At this point in the circuit, the electrons had a high degree of indecisiveness as to the proper time to push across this junction.

The problem was resolved by modifying the circuit to the closure of a microswitch, which had a consistent rise time of 0 to 28 volts in 3 milliseconds. The switch was already in the assembly as an electromechanism controlled by the clock (but not sensitive to the signal rise time of the clock), and the microswitch operation occurred at a proper time to serve as the tape advance/feed signal.

Documentation

Based on experience gained from implementing the S015 hardware and its interrelationship with the Skylab Program, the Skylab documentation appeared to have too much redundancy and to encompass too many documents. In reviewing documentation procedures, the amount of paperwork required to support the Specification Change Notice procedures appeared to serve no useful purpose. Specific recommendations are to replace the written test specification with a block diagram that would show the test plan for each hardware item with references to applicable sections of the test procedures. The test procedures should be expanded to include discrete values for the specified test measurements.

CONCLUDING REMARKS

Postflight analysis indicated that the Skylab S015 Experiment met all the experiment objectives specified in the performance requirements. Experience gained during the S015 hardware considerations indicates that hardware design, function, testing, qualification, documentation, and anticipated problems are important elements of the design and postflight analysis of in-flight experiments. Hardware design of future in-flight experiments should include considerations of possible mission problems and contingencies. Special attention

should be given to relating in-flight hardware to performance specifications and to actual in-flight performance.

Lyndon B. Johnson Space Center
National Aeronautics and Space Administration
Houston, Texas, June 24, 1975
948-60-00-15-72

REFERENCE

1. Montgomery, P. O'B., Jr.; Cook, J. E.; Reynolds, R. C.; Paul, J. S.; et al.: The Response of Single Human Cells to Zero Gravity. The Proceedings of the Skylab Life Sciences Symposium, August 27-29, 1974, Vol. II. NASA TM X-58154, 1974, pp. 467-491.

TABLE I.- PIN ASSIGNMENTS AND PURPOSES OF CONNECTIONS

Pin	Purpose
Connector J1	
1	Not used
2	+27.5 ± 2.5 V dc input
3	Not used
4	27.5 V dc return
5	Not used
6	Not used
7	Not used
Connector J2 ^a	
1	+5.0 V dc input for pressure transducer bridge (for measuring internal package pressure)
2	Output for pressure transducer bridge
3	Direct-current return
4	Case ground (used instead of bonding strap during checkout)
5	20× focus (+28 V dc applied to this pin turns on 20× lamp for focusing microscope; an inhibit signal is also applied to this pin, through the jumper from pin 13, to modify the camera frame rate)
6	+27.5 ± 2.5 V dc input power
7	40× focus (+28 V dc applied to this pin turns on 40× lamp for focusing microscope)
8	Thermistor return
9	Output for GCM-1 thermistor

^aFor ground checkout; during flight a mating connector with a jumper between pins 5 and 13 was installed.

TABLE I.- PIN ASSIGNMENTS AND PURPOSES OF CONNECTIONS - Concluded

Pin	Purpose
Connector J2 ^a - Concluded	
10	Not used
11	Not used
12	Output for GCM-2 thermistor
13	20× camera inhibit signal
14	Output for case thermistor
15	Not used
16	Output for 40× camera thermistor
17	Output for 20× camera thermistor
18	Not used
19	Output for pressure transducer bridge

^aFor ground checkout; during flight a mating connector with a jumper between pins 5 and 13 was installed.

TABLE II.- CHARACTERISTICS OF ASSEMBLIES FOR
CAMERA-MICROSCOPE SECTION

Characteristic	40× camera	20× camera
Microscope assembly		
Type	Phase contrast	Same as 40× camera
Objective	40× magnification	20× magnification
Focus	Manual during ground checkout; locked during flight; mirror rotated to viewports and exposure lamps turned on continuously during ground focus operation	Same as 40× camera
Optical path length to film and to focusing reticle by way of front surface mirror.	21.34 cm (8.4 in.)	Same as 40× camera
Exposure lamp assembly		
Type	Four incandescent bulbs behind annular mask; 0.523 cm (0.206 in.) inside diameter, 0.597 cm (0.235 in.) outside diameter	Same as 40× camera except 0.358 cm (0.141 in.) inside diameter, 0.411 cm (0.162 in.) outside diameter
Ratings (each lamp):		
Voltage	5 V	Same as 40× camera
Current	115 mA	Same as 40× camera

TABLE II.- CHARACTERISTICS OF ASSEMBLIES FOR
CAMERA-MICROSCOPE SECTION - Continued

Characteristic	40× camera	20× camera
Specimen chamber assembly		
Type	Annular gasket 0.159 cm (0.0625 in.) thick, sandwiched between two coverslips	} Same as 40× camera
Coverslip thickness	0.018 ± 0.003 cm (0.007 ± 0.001 in.)	
Specimen area	0.64 cm (0.25 in.) diameter	
Thermal control	Heater controlled by thermostat	
Specimen temperature	310 K; range: 307 to 310 K (99° F; range: 93.5° to 100° F)	
Temperature monitoring	Thermistor readout by ground-support equipment (GSE) for ground checkout only	
Media exchange assembly		
Type	Fresh-media and waste-media separated by movable piston; connected to specimen chambers by tubes	Same as 40× camera
Amount supplied by each piston advance (feeding)	0.2 ml	Same as 40× camera
Time of feeding	Twice daily	Same as 40× camera
Timing control	Internal clock no. 1	Internal clock no. 2
Capacity	70 feedings (9.8 ml)	Same as 40× camera

TABLE II.- CHARACTERISTICS OF ASSEMBLIES FOR

CAMERA-MICROSCOPE SECTION - Continued

Characteristic	40x camera	20x camera
Media exchange assembly - Concluded		
Time required for each feeding	Less than 2 min	Same as 40x camera
Drive	Direct-current motor; cam switch controls amount of feeding	Same as 40x camera
Camera assembly		
Type	Lamp-photocell frame registration; dc motor advance	Same as 40x camera
Film	Kodak type 2496; black and white; 0.010 cm (0.004 in.) Estar base; 16 mm; 99 m (325 ft) including leader; loaded in special film pack	Same as 40x camera
Timing control	Internal clock no. 1	Internal clock no. 2 provides time base for a divide-by-16 counter
Timing sequence: Photocycle start Photocycle duration Frame rate Exposure time	Twice daily 40 ± 2 min 5 frames/min 1.75 ± 0.5 min	Continuous Continuous 1 frame/3.2 min Same as 40x camera
Indicator lamp	Turns "on" and "off" with film advance motor	Same as 40x camera
Camera control switch		
"OFF" position	furns "off" 40x camera, associated media pump, and heater	Turns "off" 20x camera, associated media pump, and heater

TABLE II.- CHARACTERISTICS OF ASSEMBLIES FOR
CAMERA-MICROSCOPE SECTION - Concluded

Characteristic	40× camera	20× camera
Camera control switch - Concluded		
"NORMAL" position	Internal clock no. 1 controls operation (5 frames/min for 40 min every 12 hr); power applied to media pump and heater circuits	20× camera operates continuously at 1 frame/3.2 min; power applied to media pump and heater circuits
"TEST" position	40× camera operates continuously at 5 frames/min; power applied to media pump and heater circuits	None
"DOT" position	None	20× camera operates at 1 frame/3.2 min for 40 min every 12 hr; power applied to media pump and heater circuits
Camera rate change assembly		
Type	Not applicable	Circuit board contains 4-bit binary counter that counts pulses provided by internal clock no. 2
Function	Not applicable	Circuit inhibits the 20× camera from advancing, except on every 16th clock pulse. This operation changes the camera rate from 5 frames/min to 1 frame/3.2 min. Circuit also provides 5 pulses/min to drive the recorder stepping motor

TABLE III.- CHARACTERISTICS OF THE GCM SECTION

Characteristic	GCM-1	GCM-2
Media pump assembly		
Type	Fresh media and waste media separated by movable piston	Same as GCM-1
Capacity	140 ml	140 ml
Time of feeding	Once a day	Same as GCM-1
Amount of feeding	1 ml per chamber per day; after day 12, reduced to 0.5 ml per 2-day period	Same as GCM-1
Timing control	Internal clock no. 1	Internal clock no. 2
Feeding, each revolution of pump shaft	2 ml	2 ml
Indicator lamp	When GCM-1 pump operates, the BP-1 lamp illuminates	When GCM-2 pump operates, the BP-2 lamp illuminates
Fixative pump assembly		
Type	Fresh media and waste media separated by movable piston	} Same as GCM-1
Capacity	16 ml	
Ejection/advance	1.7 ml	
Advance control	Upon command by program tape	

TABLE III.- CHARACTERISTICS OF THE GCM SECTION - Concluded

Characteristic	GCM-1	GCM-2
Specimen chamber assembly		
Number of chambers	9	} Same as GCM-1
Size of each chamber:		
Usable chamber area	285 mm ²	
Chamber depth	1.8 mm	
Media volume	0.51 ml	
Coverslip size	25 mm diameter, 2 mm thick	
Chamber holder and preheater assemblies		
Thermal control	Two redundant thermostats set for 309 ± 1.8 K (36° ± 1.8° C), operative for days 1 to 2; 1 thermostat set for 295 ± 2 K (22° ± 2° C), operative for days 12 to 59	} Same as GCM-1
Preheater media volume	10 ml	
Preheater temperature control	Preheater attached to chamber holder, maintained at chamber temperature	

TABLE III.- CHARACTERISTICS OF THE GCM SECTION - Continued

Characteristic	GCM-1	GCM-2
Heater control switch		
"ON" position	Specimen chamber holders controlled at 309 ± 1.8 K ($36^\circ \pm 1.8^\circ$ C)	Same as GCM-1
"OFF" position	Specimen chamber holders controlled at 295 ± 2 K ($22^\circ \pm 2^\circ$ C)	Same as GCM-1
Drive train assembly		
<p>Media-pump and fixative-pump motors:</p> <p>Type</p> <p>Speed</p> <p>Rated torque</p> <p>Stall torque</p> <p>Advance control:</p> <p>Media-pump motor</p> <p>Fixative-pump motor</p>	<p>Direct-current planetary gear-motor</p> <p>Approximately 1 rpm (at 28 V dc)</p> <p>2.12 N-m (300 oz-in.)</p> <p>11.30 N-m (1600 oz-in.)</p> <p>Initiated by clock</p> <p>Initiated by programmer</p>	<p>} Same as GCM-1</p>

TABLE III.- CHARACTERISTICS OF THE GCM SECTION - Concluded

Characteristic	GCM-1	GCM-2
Drive train assembly - Concluded		
Programmer:		
Type	Uses two rows of holes punched in a polyester tape, 16 mm (0.63 in.) wide and 0.13 mm (0.005 in.) thick, to actuate two microswitches	} Same as GCM-1
Advance control	Initiated by clock: driven by media-pump motor	
Recorder:		
Type	Eight optical fibers transmit information to 8-mm photographic film from light-emitting diodes located on the circuit boards	} Same as GCM-1
Film speed	2.54 mm/hr (0.1 in/hr)	

TABLE IV.- SUMMARY OF MAJOR FAILURES DURING S015 HARDWARE TESTS

FIAR ^a number	Serial number	Problem	Occurrence	Corrective action
DCH-DE4-015	001	Set point on thermostat drifted	Acceptance test	Replaced thermostat Revised screening procedures for thermostats
DCH-DE4-029	001	Transistor had mechanical failure	Qualification test	Replaced transistor
DCH-DE4-036 DCH-DE4-040	001 002	Timers shifted during vibration	Qualification retest	Modified timers to resist vibration forces
DCH-DE4-044	002	EMI filter shorted	Assembly checkout	Replaced filter Revised screening procedure for filters
DCH-DE4-045	002	Biopack switch no. 1 was intermittent	EMI check	Replaced switch
DCH-DE4-051	004	Biopack switch no. 1 operation felt "rough"	Final assembly	Replaced switch
DCH-DE4-052	004	Film drive unit of 20x camera stalled	Acceptance test	Replaced motor
DCH-DE4-060	002	Loss of temperature control; heat transfer grease was omitted from heating resistor	GCM acceptance test	Changed resistors; added silicone grease
DCH-DE4-061	003	20x camera motor had intermittent operation	Acceptance test	Motor cleaned and retested
DCH-DE4-062 DCH-DE4-063	003 004	Transistor shorted	Acceptance test	Spurious oscillations caused excessive voltage on transistor; circuit modified
K-KD-0582 K-KD-0585	004 002	20x camera motor stalled	Flight readiness test	Magnets of all motors were remagnetized
K-KD-0583	003	GCM-1 failed to heat	Flight readiness test	Replaced cell chamber mounting assembly
K-KD-0584	002	20x camera Accutron clock malfunction (S/N 002)	Flight readiness test	Wheel and jewels replaced in clock
K-KD-0588	004	GCM-2 program tape did not advance or feed cells	16-day test	Control circuit modified

^aFailure Investigation Action Report.

TABLE V.- MOTOR CHARACTERISTICS AFTER REMAGNETIZATION

Motor serial number	Remagnetization state	Minimum starting voltage, v	Speed, ^a rpm, at 50 v
751	Before	13.0	20.3
	After	8.0	8.8
750	Before	5.5	23.3
	After	4.0	9.0
1037	Before	16.0	23.8
	After	7.0	8.8
1038	Before	8.0	19.5
	After	9.0	8.3
1211	Before	9.0	22.5
	After	6.8	8.5
1210	Before	22.0	23.0
	After	7.5	9.0

^aGearbox shaft output; 50 volts recommended by motor vendor as test voltage.



Figure 1.- External configuration of S015 flight unit.

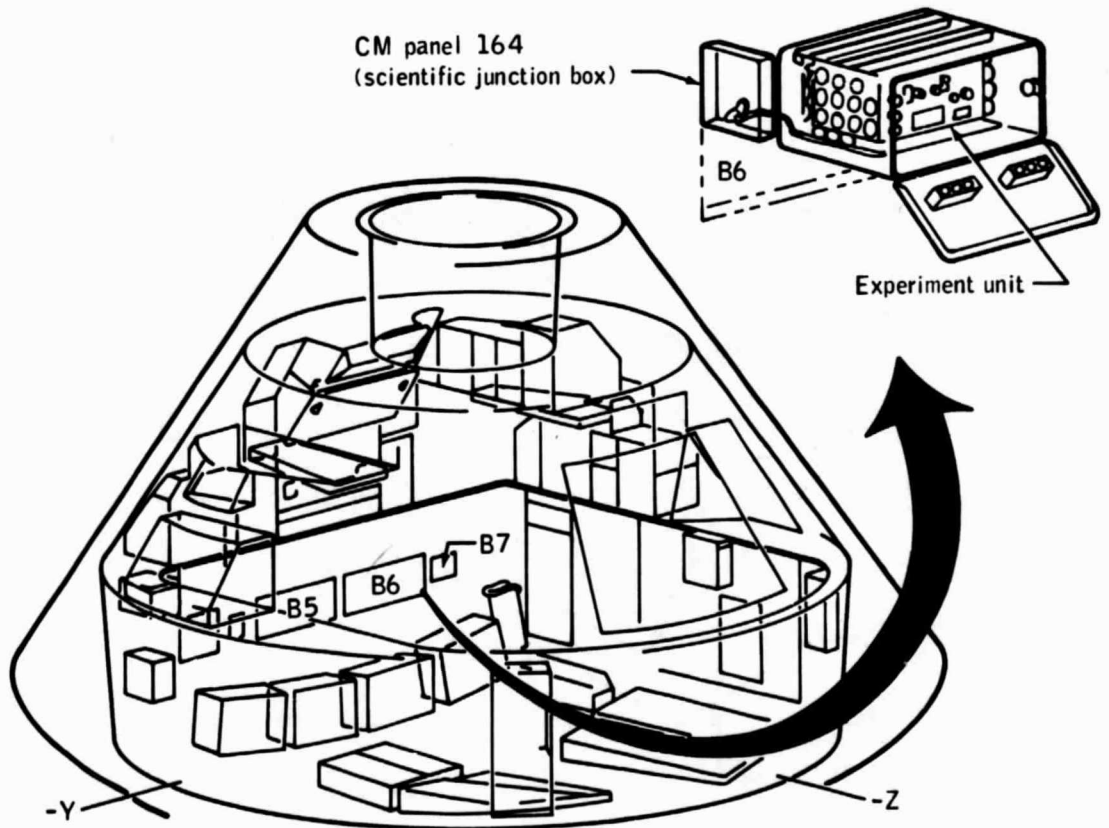

Figure 2.- Experiment S015 location in CM.

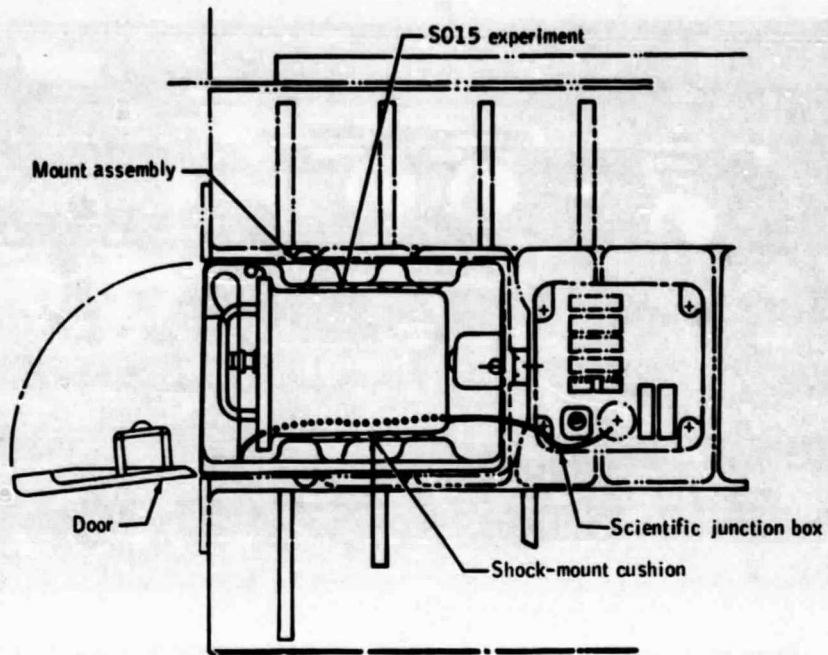

Figure 3.- Experiment S015 mounting in CM compartment B6.

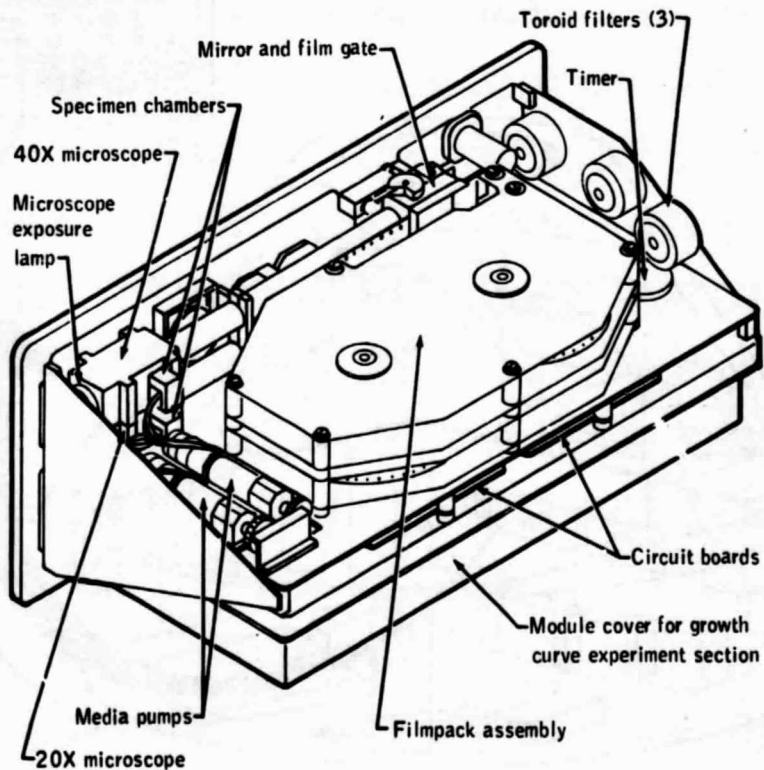

Figure 4.- Rear view of flight unit with cover removed.

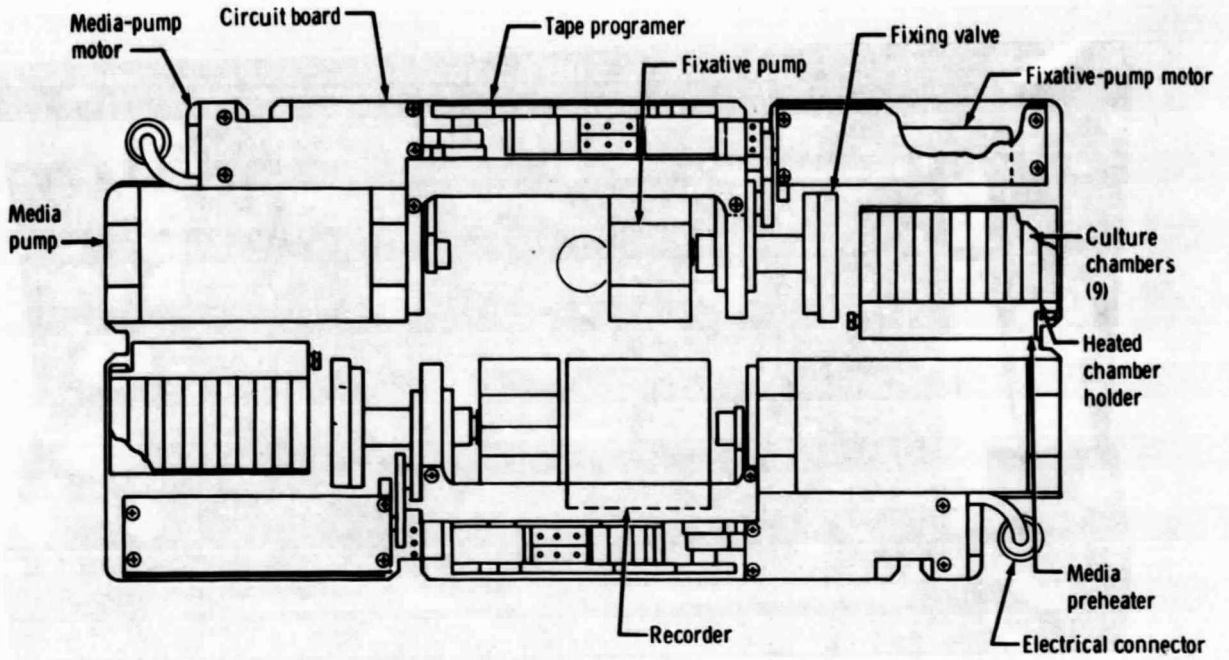

Figure 5.- Growth curve module.

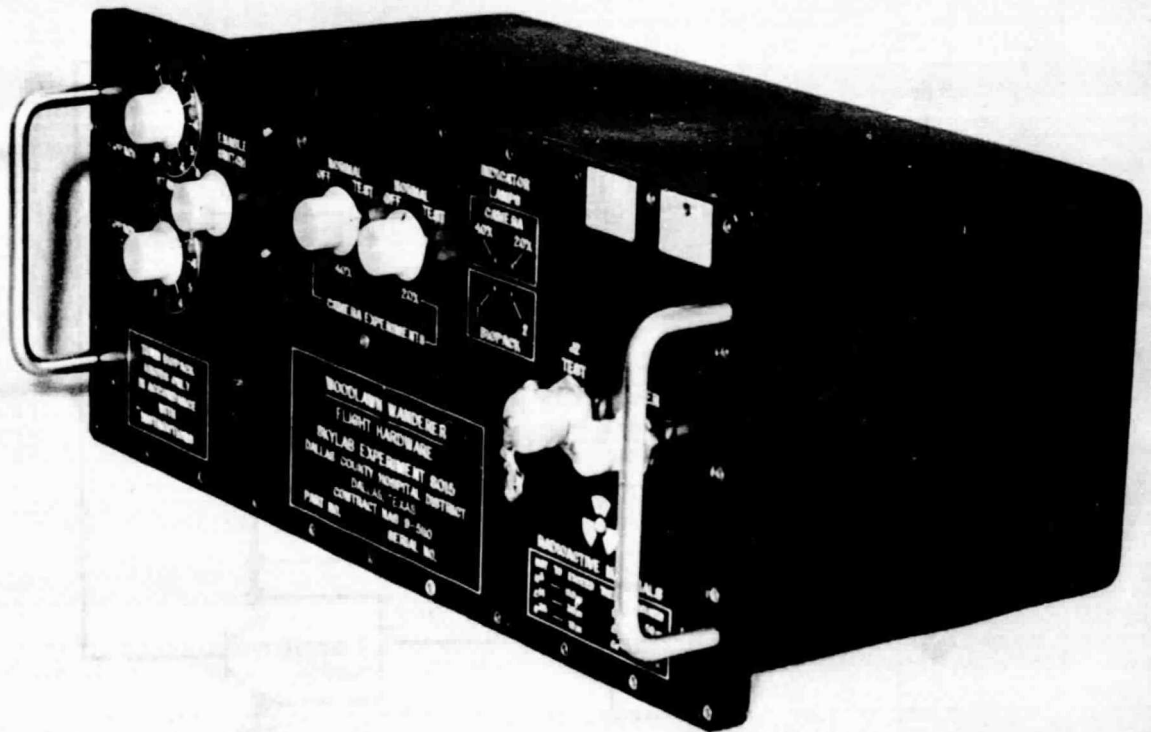

Figure 6.- The CDR configuration of S015 experiment.

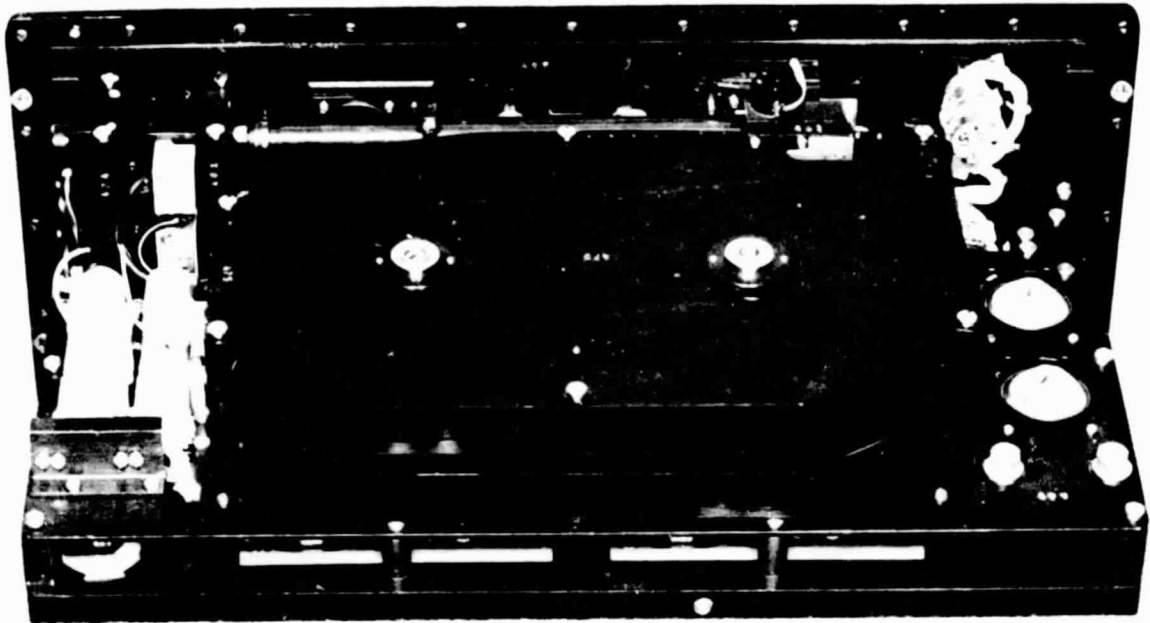

Figure 7.- Camera-microscope section.

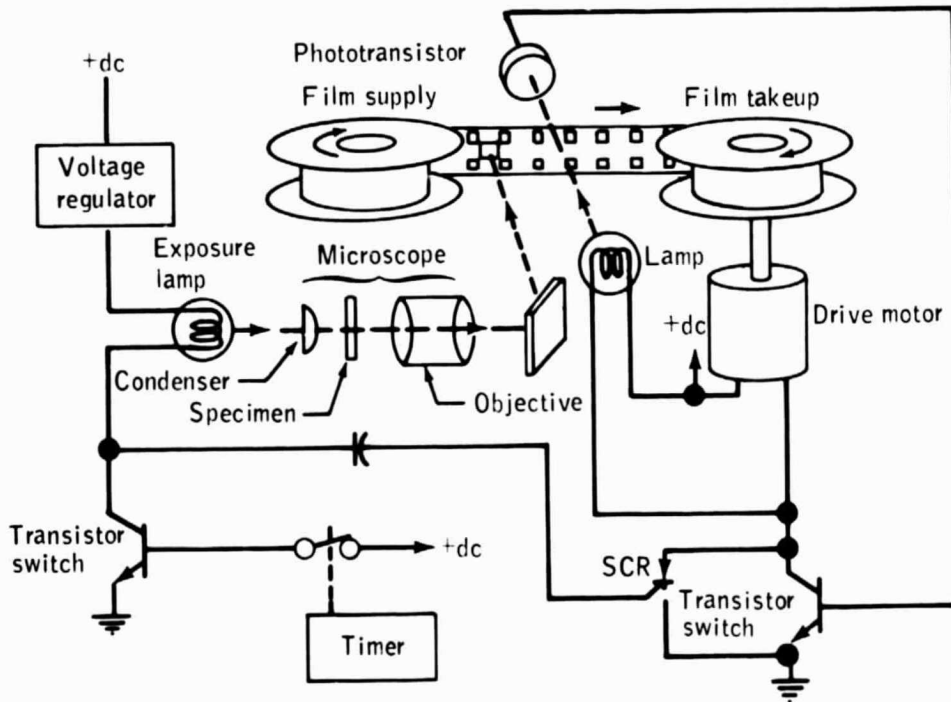

Figure 8.- Camera-microscope diagram.

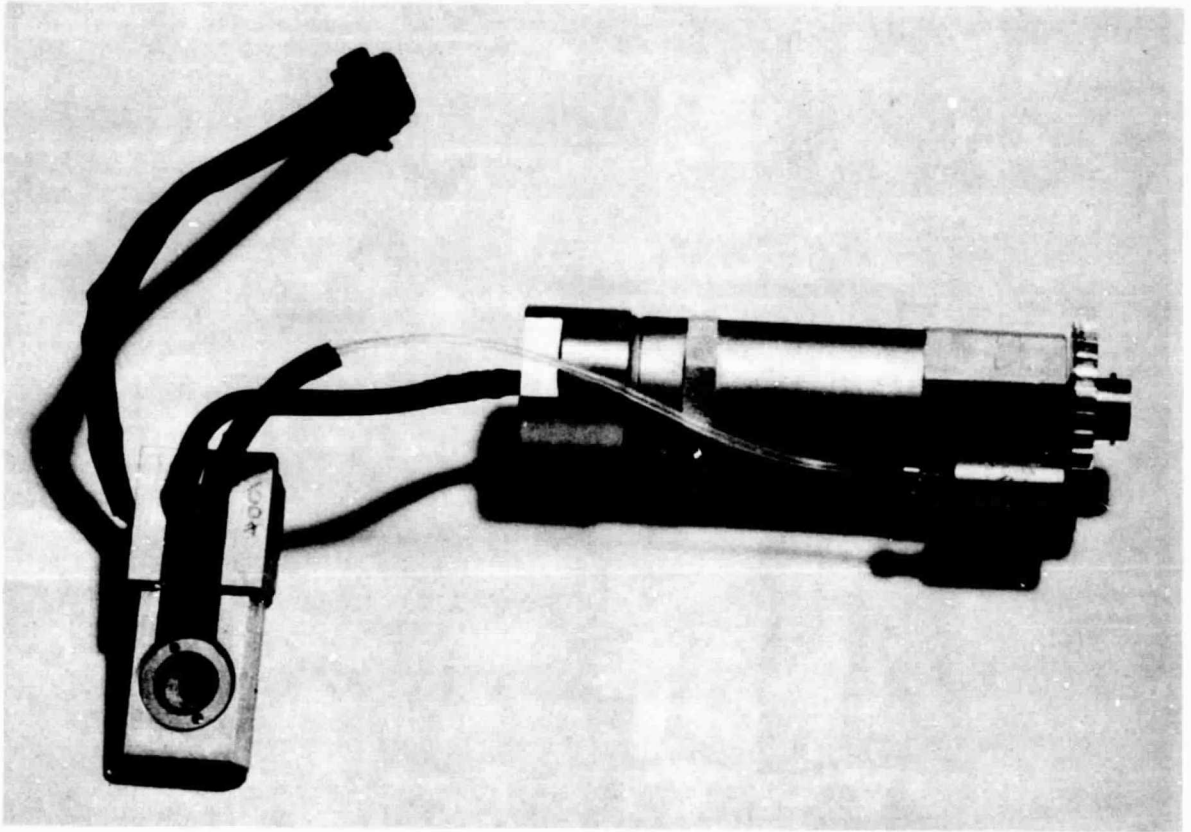

Figure 9.- Microscope pump/chamber assembly.

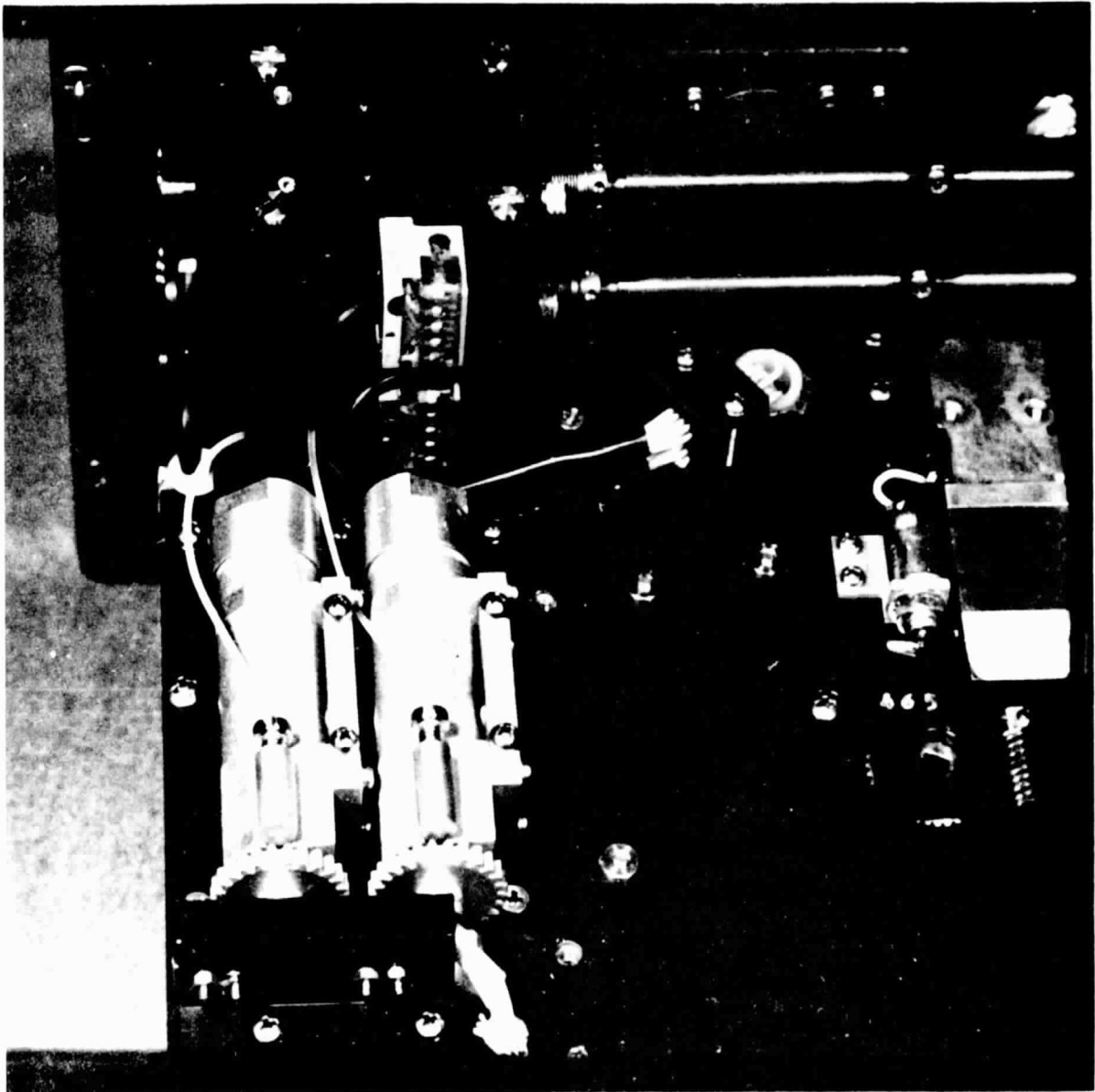

Figure 10.- Camera-microscope cell chambers and media pumps
(film magazines removed).

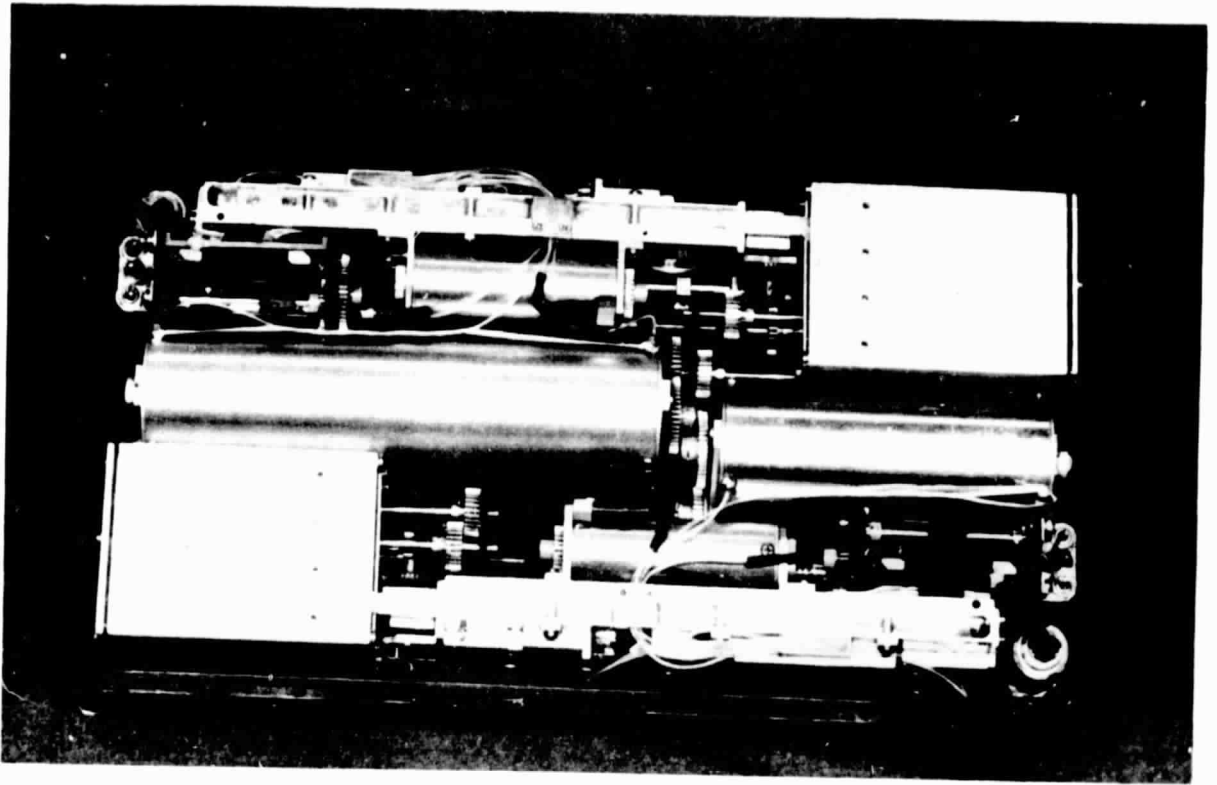

Figure 11.- Cytochemical experiment section (replaced by the GCM).

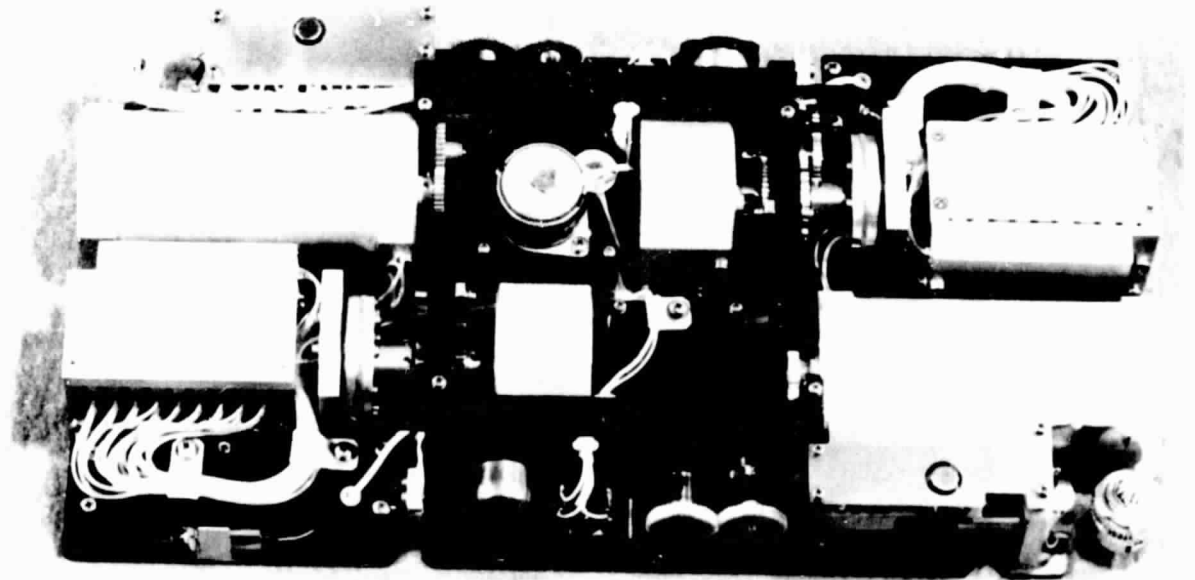

Figure 12.- The GCM section.

ORIGINAL PAGE IS
OF POOR QUALITY

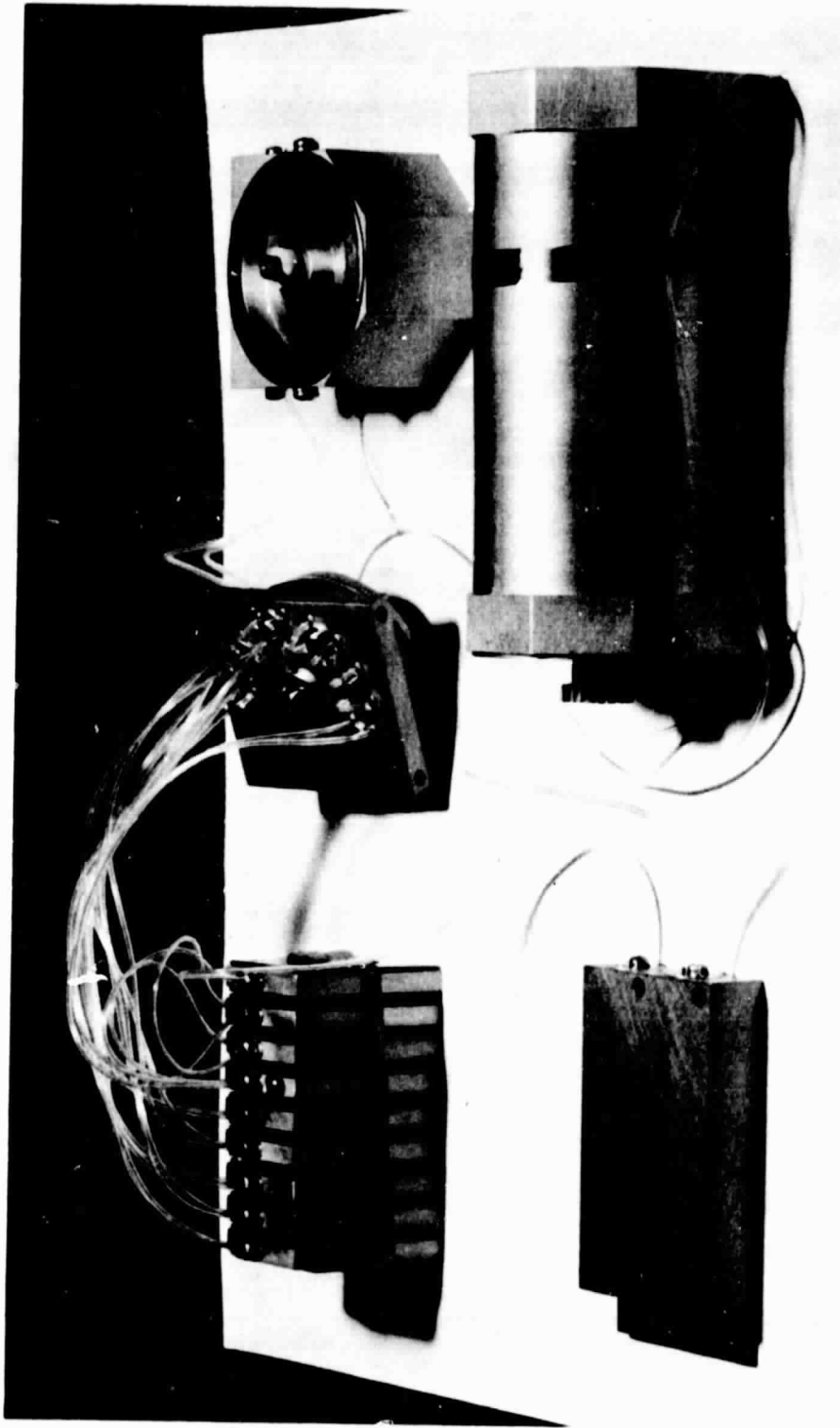
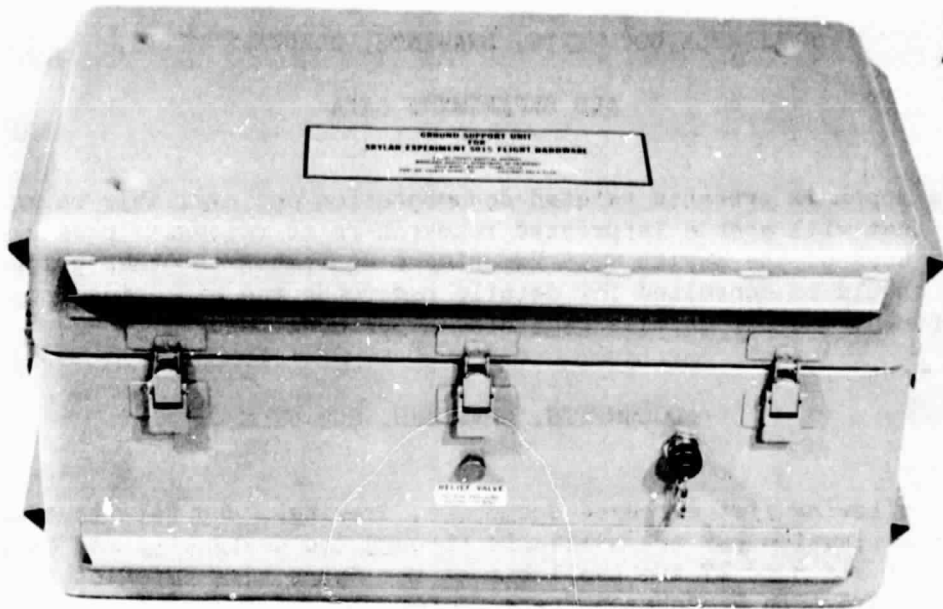
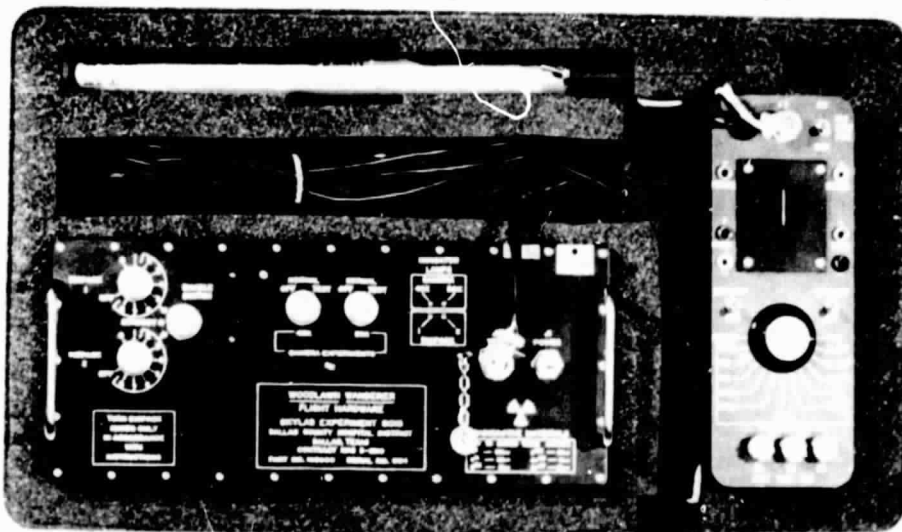

Figure 13.- Biological experiment assembly (subassembly for GCM).



(a) External view.



(b) Cover removed and CDR configuration in place.

Figure 14.- Photographs of GSU.

APPENDIX

AVAILABLE DOCUMENTS, DRAWINGS, HARDWARE UNITS, AND EXPERIMENT DATA

This appendix presents related documentation and available background material that will enable interested researchers to recognize possible applications and uses of the Skylab S015 Experiment equipment in other projects. (Reference 1 should be consulted for details regarding the biological aspects of the experiment and for details regarding experiment results.)

DOCUMENTS, DRAWINGS, AND FILM

The following list concerns documents, drawings, and film that have limited distribution but are available through the designated JSC facility. Items 1 to 5 and 8 to 47 are available at the Space Life Sciences Archival Library, NASA Lyndon B. Johnson Space Center, Houston, Texas 77058. The library is under the direction of Dr. Edward C. Moseley, Code DB8, telephone (713) 483-5071. Items 6 and 7 are available at the Photographic Laboratory at JSC.

1. MSC-01150 End Item Specification, Flight Hardware, AAP Experiment S015 for Effect of Zero Gravity on Single Human Cells. Sept. 6, 1968
2. MSC-KA-D-68-1 Apollo Applications Program, Experiment Hardware General Rev. B Requirements. Jan. 27, 1970
3. MSC-KW-D-69-20 Experiment Requirements Document for Effects of Zero G on Rev. C Single Human Cells, Experiment S015. Mar. 5, 1973
4. S015 FIAR's Failure Investigation Action Reports (Experiment S015). Oct. 21, 1970 - May 1, 1973
5. (No number) Experiment S015, Inventory of Stored Specimens and Data
6. S-73-290 Complete Flight Film, 20X and 40X Photomicrographs
7. S-75-007 Edited copy of Flight Film (6 minutes at 24 frames per second)
8. DCHD3619 Block Diagram of S015 Flight Hardware System
9. 118021 Diagram, Schematic, Fluid Flow, G.C.M.
10. 103772-2 Diagram, Electronic Schematic, Skylab Exp. S015 Modified for Growth Curve Module

11. 118020 Diagram, Wiring, Electrical, G.C.M.
12. SK-B Figure Sketch of Growth Curve Module
13. 118003 Biological Assy, G.C.M.
14. 118013 Chamber Assy, Unfixed Specimens
15. 118011 Chamber Assy, Specimen, G.C.M.
16. 118007 Pump Assy, Media, G.C.M.
17. 118005 Pump Assy, Fixative, G.C.M.
18. 118009 Valve Assy, Fixative, G.C.M.
19. 118006 Program Assy, G.C.M.
20. 103087 Tubing, Media
21. 118403 Program Tape, G.C.M.
22. SK-A Program Tape Loading
23. (No number) Loading Procedure for Growth Curve Module of Skylab Experiment S015
24. SOP-B-105 Fill Procedure for S015 Biopack Experiment Assemblies (103948)
25. SOP-M-120 Procedure to Set Timers, S015 Experiment
26. SOP-B-101 Compatibility Test for Materials
27. SOP-B-102 Cleaning of Materials
28. SOP-M-110 Lubrication for Parts Contacting Biological Materials
29. SOP-M-106 Bonding or Encapsulation Using Epon 828/V125 Compound
30. SOP-M-103 Molding Procedure Using 1079-K Fluorel Rubber
31. SOP-M-123 Procedure for Flaring Teflon Tubes
32. 103322 Tube Flaring Fixture
33. SOP-M-118001 Assembly Procedure, Growth Curve Module
34. SOP-M-118002 Assembly Procedure, Drive Assembly, GCM, DCHD Part No. 118002-1

- 35. SOP-M-118003 Assembly Procedure, Biological Assembly, DCHD Part No. 118003-1
- 36. SOP-M-118005 Fixative Pump Assembly, GCM, DCHD Part No. 118005-1
- 37. SOP-M-118006 Assembly Procedure, Program Assembly, DCHD Part No. 118006-1
- 38. SOP-M-118007 Assembly Procedure, Media Pump Assembly, GCM, DCHD Part No. 118007-1
- 39. JOP-M-118009 Assembly Procedure, Fixative Valve Assembly, GCM, DCHD Part No. 118009-1
- 40. SOP-M-118010 Assembly and Test Procedure, Chamber Holder Assembly, GCM, DCHD Part No. 118010-1
- 41. SOP-M-118011 Assembly and Test Procedure, Specimen Chamber Assembly, DCHD Part No. 118011-1
- 42. 103914 Diagram, Electronic Schematic, Battery Charger and Test Set
- 43. 103546 Printed Circuit Board Assy, Test Set, G.S.U.
- 44. 103589 Calibration Unit, G.S.U.
- 45. SK-C Film Loading, Skylab Experiment S015
- 46. SOP-M-118014 Assembly Procedure, Recorder Assembly, GCM
- 47. SOP-M-118016 Assembly Procedure, Fiber Optics Assembly, GCM, DCHD Part No. 118016-1

The preceding items are listed in descending order of importance based on general use and study. Items 8 to 41 would be required for hardware familiarization and for preparation of a unit for operation. Items 45, 46, and 47 are listed for information only. This recorder was a last-minute development that was added to provide a record of various motor operations and temperature states to assist in a postflight analysis of any failures that might occur within the unit. This record was not needed, because all evidence indicated successful operation of all parameters that would have been recorded. The film in the recorder stopped moving after approximately 1 hour of operation. There was no evident reason for the failure, and a detailed failure analysis program was not conducted. Numerous successful operations of the recorder were accomplished in preflight operations, but more development effort is apparently required to ensure a higher degree of reliability.

An edited version of the flight film (item 7) was prepared and titles were added. Both the 20X and 40X segments of this film were cropped at points where

the cells in both cultures became confluent, which was approximately 10 days after subculture. The total running time for this film is 6 minutes at 24 frames per second.

AVAILABLE HARDWARE

For possible application and future use of the S015 equipment in other projects, JSC has three complete flight units available to qualified researchers through Bernard J. Mieszkuc, Code DD6, Biology Branch, Life Sciences Directorate, NASA Lyndon B. Johnson Space Center, Houston, Texas 77058, telephone (713) 483-3419. Related equipment, available through this JSC facility, includes a flight-configured qualification unit, five ground-support units, numerous spare parts and assemblies, and special tools and fixtures required to prepare these experimental units for operation. A complete set of production drawings are available at JSC; some of this material is on microfilm. A training unit and two mockups are also available to qualified researchers.

EXPERIMENT CELLS

The cells that were returned alive have been subcultured and are banked in a frozen state at the laboratory of Dr. Leonard Hayflick, Stanford University School of Medicine.

OTHER INFORMATION SOURCES

For additional information relative to the S015 experiment, the following individuals may be contacted, depending on the area of interest.

P. O'B. Montgomery, Jr., M.D.
Experiment S015 Principal Investigator
University of Texas
Southwestern Medical School at Dallas
Department of Pathology
5323 Harry Hines Blvd.
Dallas, Texas 75235
Phone: (214) 341-5729

Dr. Leonard Hayflick
Experiment S015 Coinvestigator
Stanford University School of Medicine
Department of Medical Microbiology
Stanford, California 94305
Phone: (415) 497-3435

James E. Cook
Experiment S015 Chief Engineer
University of Texas
Southwestern Medical School at Dallas
Department of Pathology
5323 Harry Hines Blvd.
Dallas, Texas 75235
Phone: (214) 688-2613

Robert G. Thirolf
Experiment S015 Project Engineer
Life Sciences Directorate (DE4)
NASA Lyndon B. Johnson Space Center
Houston, Texas 77058
Phone: (713) 483-2181