

**NASA TECHNICAL  
MEMORANDUM**



**NASA TM X-3345**

**NASA TM X-3345**

**PERFORMANCE OF INLET STAGE  
OF TRANSONIC COMPRESSOR**

*Donald C. Urasek, Ronald J. Steinke,  
and George W. Lewis, Jr.*

*Lewis Research Center  
Cleveland, Ohio 44135*



**NATIONAL AERONAUTICS AND SPACE ADMINISTRATION • WASHINGTON, D. C. • FEBRUARY 1976**

1. Report No. NASA TM X -3345		2. Government Accession No.		3. Recipient's Catalog-No.	
4. Title and Subtitle PERFORMANCE OF INLET STAGE OF TRANSONIC COMPRESSOR				5. Report Date February 1976	
				6. Performing Organization Code	
7. Author(s) Donald C. Urasek, Ronald J. Steinke, and George W. Lewis, Jr.				8. Performing Organization Report No. E-8056	
9. Performing Organization Name and Address Lewis Research Center National Aeronautics and Space Administration Cleveland, Ohio 44135				10. Work Unit No. 505-04	
				11. Contract or Grant No.	
12. Sponsoring Agency Name and Address National Aeronautics and Space Administration Washington, D. C. 20546				13. Type of Report and Period Covered Technical Memorandum	
				14. Sponsoring Agency Code	
15. Supplementary Notes					
16. Abstract The overall and blade-element performances are presented over the stable flow operating range of the stage at the design tip speed of 426 m/sec. Stage peak efficiency of 0.83 was obtained at a weight flow of 28.8 kg/sec and a pressure ratio of 1.52. The stall margin for the stage was 8 percent based on weight flow and pressure ratio at peak efficiency and stall. The rotor appears to be stalling prematurely as evidenced by high rotor tip losses.					
17. Key Words (Suggested by Author(s)) Turbomachinery Compressor Axial-flow			18. Distribution Statement Unclassified - unlimited STAR Category 02 (rev.)		
19. Security Classif. (of this report) Unclassified		20. Security Classif. (of this page) Unclassified		21. No. of Pages 71	22. Price* \$6.25

\* For sale by the National Technical Information Service, Springfield, Virginia 22161

# PERFORMANCE OF INLET STAGE OF TRANSONIC COMPRESSOR

by Donald C. Urasek, Ronald J. Steinke, and George W. Lewis, Jr.

Lewis Research Center

## SUMMARY

The first stage of a transonic multistage compressor was tested with inlet guide vanes. Radial surveys of the flow conditions in front of the inlet guide vanes (IGV's), between the IGV's and the rotor, between the rotor and stator, and behind the stator were made over the stable operating flow range of the stage at the design tip speed of 426 meters per second. The surveys were taken at 11 radial positions and all resulting flow and performance calculations were translated to the blade leading and trailing edges. Peak efficiency for both the rotor and stage occurred at 28.8 kilograms per second as compared to the design value of 29.7 kilograms per second. Rotor and stage peak efficiency values were 0.86 and 0.83, respectively, as compared to the design values of 0.88 and 0.86. Corresponding values of total pressure ratio at peak efficiency weight flow for the rotor and stage were 1.56 and 1.52, respectively, as compared to the design values of 1.62 and 1.61. The stall margin for the stage was 8 percent, based on pressure ratio and weight flow at peak efficiency and stall conditions. The stage appears to be stalling prematurely as evidenced by high rotor tip losses, deviation angles, and low velocity ratios. This may, in part, be a result of what appears to be a relatively thick boundary layer entering the rotor resulting in locally high incidence angles. The low velocities leaving the rotor tip results in high incidence angles to the stator in the tip region.

## INTRODUCTION

The NASA Lewis Research Center is engaged in a research program on axial-flow compressors for advanced airbreathing engines. The program is directed primarily towards providing the technology to permit reducing the size and weight of the compressor while obtaining higher levels of performance. In support of this program a 51-centimeter-diameter, five-stage compressor having a design weight flow of 29.7 kilograms per second with a pressure ratio of 9.27 was fabricated and tested with inlet

guide vanes (IGV's). Stage matching problems were apparent in the initial testing of this compressor. Limited performance data obtained from these tests indicated that the first stage was not meeting its design performance which may have caused or at least appeared to be contributing to the matching problem. To more completely evaluate the performance of the first stage compressor with its IGV's, it was separately tested in the Lewis single-stage test facility.

This report presents the design data and experimental performance of the first stage of the five-stage compressor with IGV's. The stage, designated stage 66 (inlet guide vanes, rotor 66, stator 66) has a design pressure ratio of 1.61 at a design weight flow of 29.7 kilograms per second. Design efficiency for the stage is 0.863.

The data presented in this report are in tabular as well as in plotted form. The symbols are defined and the equations are given in appendixes A and B. The definitions and units used for the tabular data are presented in appendix C.

## AERODYNAMIC DESIGN

Three computer programs were used in the design of the five-stage compressor. These programs are (1) streamline analysis program, (2) blade geometry program, and (3) blade coordinate program. These three computer programs are presented in detail in references 1 and 2, and only a brief description of each is presented in this report.

The streamline analysis program was used to calculate the flow field parameters at several axial locations including planes approximating the blade leading and trailing edges for both the rotor and stator. The weight flow, rotative speed, flow path geometry, and radial distributions of total pressure and temperature are inputs in this program. The program accounts for both streamline curvature and entropy gradients. Boundary layer blockage factors are also included.

The distributions of velocity, total pressure, and total temperature calculated in the streamline analysis program are utilized in the blade geometry program to compute blade geometry parameters. Total loss for the blades was primarily based on the experimental rotor loss data presented in reference 1 with modifications caused by influences of other data which is unreported at this time. The profile loss was then estimated by subtracting a calculated shock loss from the total loss. The shock loss calculation was based on the method presented in reference 3.

The blade geometry parameters are utilized in the blade coordinate program (ref. 2) to compute blade elements on conical surfaces passing through the blade row. In this program the blade elements are then stacked on a line passing through their centers of gravity and cartesian blade coordinates are computed which are used directly in fabrication.

The overall design parameters for the rotor and stator are listed in table I and the flow path is shown in figure 1. This stage was designed for an overall pressure ratio of 1.61 at a weight flow of 29.7 kilograms per second ( $196 \text{ (kg/sec)/m}^2$  of annulus area). Design stage efficiency (rotor inlet to stator outlet) is 0.863.

The design tip speed was 426 meters per second. The rotor and stator were designed for tip solidities of 1.4 and 1.5, respectively. The rotor had 57 blades with an aspect ratio of 3.1 and the stator had 64 blades with an aspect ratio of 2.7.

The blade-element design parameters for the rotor are presented in table II. This rotor was designed for a radially constant total pressure ratio of 1.62. The stator blade-element design parameters are given in table III. The blade geometry is presented in table IV for the rotor and in table V for the stator. The rotor has multiple circular-arc blade shapes while the stator had a double circular-arc blade shape.

The equations used for calculating overall blade-element performance parameters are presented in appendix B. All definitions and units presented in the tables are given in appendix C.

A drawing of the inlet guide vane is shown in figure 2. The vanes utilized multiple circular-arc blade profiles. There were 26 vanes having a tip solidity of 1.0 and an aspect ratio of 2.4. Maximum thickness location was at approximately 37 percent of chord from the leading edge. The vanes were made in two segments that could be pivoted at the maximum thickness location. The forward section was stationary while the rear segment was adjustable for varying rotor inlet prewhirl. All tests in this report were conducted with the vanes aligned in the axial direction.

## APPARATUS AND PROCEDURE

### Compressor Test Facility

The compressor stage was tested in the Lewis single-stage compressor facility which is described in detail in reference 4. A schematic diagram of the facility is shown in figure 3.

Atmospheric air enters the test facility through an inlet located on the roof of the building, flows through the flow measuring orifice and into the plenum chamber upstream of the test stage. The air then passes through the experimental compressor stage into the collector and is exhausted to the atmosphere. Weight flow is controlled with a sleeve valve in the collector.

## Test Stage

Photographs of the IGV, rotor, and stator are shown in figure 4. The rotor blades have vibration dampers located at about 40 percent span from the outlet rotor tip. The maximum thickness of the damper is 0.180 centimeter. The nonrotating radial tip clearance of the rotor was a nominal 0.05 centimeter at ambient conditions. To accommodate survey instrumentation, the axial spacing between the IGV hub trailing edge and rotor hub leading edge was 2.50 centimeters. The axial spacing between the rotor hub trailing edge and the stator hub leading edge was 2.66 centimeters.

## Instrumentation

The compressor weight flow was determined from measurements on a calibrated thin-plate orifice. The temperature at the orifice was determined from an average of two Chromel-constantan thermocouples. Orifice pressures were measured by calibrated transducers.

Radial surveys of the flow were made upstream of the inlet guide vanes (IGV's), between the IGV's and rotor, between the rotor and stator, and downstream of the stator. Two combination survey probes at each station were used to measure total pressure, total temperature, and flow angle. A photograph of the combination probe is shown in figure 5. Each probe was positioned with a null-balancing, stream-directional sensitive control system that automatically aligned the probe to the direction of flow. The probes were angularly aligned in an air tunnel. The thermocouple material was Chromel constantan.

The circumferential locations of the two survey probes, at each of the four measuring stations are shown in figure 6. The probes between the IGV's and rotor, and downstream of the stator were circumferentially traversed one blade passage counterclockwise from the nominal values shown. One IGV blade passage is  $13.87^\circ$  and one stator blade passage is  $5.63^\circ$ .

An electronic speed counter, in conjunction with a magnetic pickup, was used to measure rotative speed (rpm).

The estimated errors of the data based on inherent accuracies of the instrumentation and recording system are as follows:

Flow rate, kg/sec . . . . .	±0.3
Rotative speed, rpm . . . . .	±30
Flow angle, deg . . . . .	±1
Temperature, K . . . . .	±0.6
Guide vane inlet total pressure, N/cm <sup>2</sup> . . . . .	±0.01
Rotor inlet total pressure, N/cm <sup>2</sup> . . . . .	±0.01
Rotor outlet total pressure, N/cm <sup>2</sup> . . . . .	±0.10
Stator outlet total pressure, N/cm <sup>2</sup> . . . . .	±0.10

### Test Procedure

The stage survey data were taken at five weight flows ranging from maximum flow to the near-stall conditions at design speed. Data were recorded at 11 radial positions for each weight flow.

At each radial position the combination probes behind both the IGV's and stator were circumferentially traversed to nine different locations across the blade passages. Values of total pressure, total temperature, and flow angle were recorded at each circumferential position. At the last circumferential position, values of total pressure, total temperature, and flow angle were also recorded upstream of the IGV's and between the rotor and stator. All probes were then traversed to the next radial position and the circumferential traverse procedure repeated.

The back pressure on the stage was increased by closing the sleeve valve in the collector until a stalled condition was detected by a sudden drop in stage outlet total pressure. This pressure was measured by a probe located at mid-passage and was recorded on an X-Y plotter. Stall was corroborated with a sudden increase in noise level.

### Calculation Procedure

Data was reduced using a streamline-analysis computer program which calculates all static pressures at each measuring station and flow angles at stations behind the rotating blade row. The inputs to this program include corrected weight flow, corrected speed, total pressure, and total temperature behind a rotating blade row and weight flow, total pressure, total temperature, and flow angle behind a fixed blade row. Static pressure is calculated within the program from considerations of continuity of mass flow and radial equilibrium which includes streamline curvature terms.

At each radial station nine circumferential values of total temperature, total pressure, and flow angle across both the IGV and stator gaps were area averaged to obtain

the IGV and stator values presented at each radial position.

The data, measured at the four measuring stations, have been translated to the blade leading and trailing edges by the method presented in reference 1.

Orifice weight flow, total pressure, static pressure and temperatures were all corrected to standard sea-level conditions based on the IGV inlet conditions.

## RESULTS AND DISCUSSION

The results from this investigation are presented in three main sections. The overall performances for the rotor and the stage are presented first. Radial distributions of several performance parameters are then presented for the IGV's, rotor, and stator. Finally the blade-element data are presented for both the rotor and stator. The data presented are computer plotted; occasionally a data point falls outside the range of parameters shown in the figure and is omitted.

All of the plotted data together with some additional performance parameters are presented in tabular form. The overall performance data are presented in table VI. The blade element data are presented for the IGV, rotor, and stator in tables VII, VIII, and IX, respectively. The definitions and units used for the tabular data are presented in appendix C.

### Overall Performance

The overall rotor performance is based on the data obtained between measuring stations 1 and 2 and overall stage performance is based on the data obtained between measuring stations 1 and 3 (see fig. 1). The overall performance for the rotor and for the stage, at the design blade tip speed of 425 meters per second, are presented in figures 7 and 8, respectively. Averaged values of total pressure ratio, total temperature ratio, and temperature rise efficiency are plotted as a function of equivalent weight flow. Data are presented at several weight flows over the stage stable operating flow range. Design point values are shown as solid symbols on both figures.

At a near design weight flow of 29.4 kilograms per second ( $195 \text{ (kg/sec)/m}^2$  of annulus area) the stage experimental overall temperature rise efficiency of 0.827 was 3.6 points lower than the value based on design losses. The experimental stage pressure ratio and temperature ratio were 1.48 and 1.14 as compared to the design values of 1.61 and 1.17. Peak efficiency for the stage was 0.830 and occurred at an equivalent weight flow of 28.8 kilograms per second. Stage pressure ratio at the peak efficiency point was 1.52.



The rotor experimental overall temperature rise efficiency of 0.85 at the near design weight flow of 29.4 kilograms per second was three points lower than the design value of 0.88. The rotor total pressure ratio and total temperature ratio were 1.52 and 1.15 as compared to the design values of 1.62 and 1.17. Rotor peak efficiency of 0.86 occurred at a pressure ratio of 1.56 and at a weight flow of 28.8 kilograms per second.

Stall margin for the stage was 8 percent based on equivalent weight flow and total pressure ratio at which peak efficiency occurred as compared with the values near stall.

### Radial Distributions

Radial distribution of several flow and performance parameters at design speed are shown for the inlet guide vane, rotor, and stator in figures 9 to 11, respectively. The data shown represent the flow condition at near stall, peak efficiency, and choke. (Design values are shown by solid symbols.) Flow and performance results at the peak efficiency weight flow of 28.8 kilograms per second are compared with the design values.

Inlet guide vane. - The radial distribution of total loss coefficient for the inlet guide vanes (IGV's) is shown in figure 9. Substantial loss was recorded in the end wall regions. The compressor was designed without an IGV as previously noted. The IGV was designed and incorporated prior to testing. The aerodynamic design of the compressor therefore did not account for any loss associated with an IGV and the resulting total pressure profile entering the first stage rotor. In the design of the compressor a radially constant total pressure was assumed across the rotor inlet. A total boundary layer blockage of 2 percent was assumed in the design. It is noted that even ahead of the IGV inlet, a noticeable defect in total pressure exists at 5 percent of span as shown in the tabular data. This defect reflects an appreciable outer wall boundary layer entering the IGV.

Rotor. - The radial distributions of pressure ratio (fig. 10) at all weight flows is lower than design, particularly in the tip region where pressure ratio deteriorates rapidly. The total temperature ratio at peak efficiency weight flow is greater than design in the outer 50 percent of span and lower than design in the inner 50 percent of span. Resulting temperature rise efficiency in the tip region is considerably lower than design at all weight flows. The meridional velocity ratio deteriorates from 0.8 at 20 percent of span to 0.4 at 5 percent of span. The deviation angle gradient is very steep in the tip region with an accompanying rapid increase in loss. From this, it would appear that the rotor is stalling prematurely at the tip and limiting the range of the stage. This may, in part, be a result of what appears to be a relatively thick boundary layer entering the IGV coupled with the locally high losses through the IGV at the tip,

resulting in appreciably higher than design incidence angles ( $3^{\circ}$ ) in the tip region.

With the rotor tip not passing the mass flow, a redistribution of flow within the blade passage took place. The blade passage between the damper and the hub passes additional weight flow as indicated by the meridional velocity ratio distribution. The higher meridional velocity ratio apparently unloads the inner 50 percent of the blade as indicated by the diffusion-factor distribution. The deviation angle in the hub region has a sharp gradient. This is not reflected in the design values which were based on a modification of Carter's Rule.

An appreciable defect in pressure ratio and efficiency was noted in the damper region resulting in gradients in flow parameters entering the stator. Aerodynamic design of this rotor did not account for these effects.

It appears that the rotor did not meet its design flow as a result of premature tip stalling and damper effects.

Stator. - The reduced flow in the rotor tip resulted in very high incidence angles at the stator tip (fig. 11). The higher than design flow between rotor damper and hub resulted in low incidence angles to the stator. Stator losses are high from 30 percent of span to the hub.

#### Variation with Incidence Angle

The variations of selected blade-element performance parameters are presented as a function of incidence angle in figure 12 for the rotor and in figure 13 for the stator. The data are presented at design speed for the blade-element locations of 5, 10, 30, 50, 70, 90, and 95 percent of blade span from the rotor outlet blade tip. Design values are shown by solid symbols. The incidence angle curves are presented primarily for future use in comparing the performance of these blades with other blade designs. Thus, only a few brief observations will be made from the curves at present.

Rotor. - In both the hub and tip region of the blade, incidence angles were greater than the design value of  $0^{\circ}$  over the whole flow range of the stage. The meridional velocity ratio was greater than design at 70, 90, and 95 percent of span and considerably less than design at 5 percent span. Apparently there is a radial shift in the flow away from the rotor tip. The diffusion factor at all elements were less than design at design incidence. The losses at design incidence were greater or equal to design at all elements except at 90 percent of span. At 5 percent span and decreasing incidence angle the increase in loss parameter at  $1^{\circ}$  incidence angle while loss coefficient continues to decrease is attributed to an abrupt decrease in rotor outlet relative meridional flow angle.

Stator. - As a result of the radial flow shift occurring through the rotor the stator

blading is operating at incidence angles considerably off design across the entire blade span except at 10 and 30 percent of span. Absolute values of minimum loss were less than design in both the hub and tip region. Minimum loss occurred at incidence angles greater than design at 5 and 10 percent of span, near design at 30 and 50 percent of span, and less than design at 70, 90, and 95 percent of span.

## SUMMARY OF RESULTS

This report has presented both the aerodynamic design parameters and the overall and blade-element performance of the first stage of a transonic multistage compressor. Detailed radial surveys of the flow conditions in front of the IGV's, between the IGV's and the rotor, between the rotor and stator and behind the stator were made over the stage stable operating flow range at design speed. Flow and performance parameters were calculated across 11 radial positions. The following principal results were obtained:

1. At design speed, the stage peak efficiency of 0.83 occurred at a pressure ratio of 1.52 and a weight flow of 28.8 kilograms per second.
2. Rotor peak efficiency of 0.86 occurred at a pressure ratio of 1.56 and at a weight flow of 28.8 kilograms per second.
3. Stage stall margin was 8 percent based on pressure ratio and weight flow at the peak efficiency and stall conditions.
4. The rotor tip appears to be stalling prematurely as evidenced by high rotor tip losses, high deviation angles, and low velocity ratios.
5. Premature stalling of the rotor tip appears to limit the flow range of the stage. Large boundary layer in the rotor tip region and gradients due to the rotor damper result in severe gradients at the stator inlet.

Lewis Research Center,  
National Aeronautics and Space Administration,  
Cleveland, Ohio, October 8, 1975,  
505-04.

## APPENDIX A

### SYMBOLS

$A_{an}$	annulus area at rotor leading edge, $m^2$
$A_f$	frontal area at rotor leading edge, $m^2$
$C_p$	specific heat at constant pressure, $1004 \text{ J}/(\text{kg})(\text{K})$
$D$	diffusion factor
$i_{mc}$	mean incidence angle, angle between inlet air direction and line tangent to blade mean camber line at leading edge, deg
$i_{ss}$	suction-surface incidence angle, angle between inlet air direction and line tangent to blade suction surface at leading edge, deg
$N$	rotative speed, rpm
$P$	total pressure, $\text{N}/\text{cm}^2$
$p$	static pressure, $\text{N}/\text{cm}^2$
$r$	radius, cm
$SM$	stall margin
$T$	total temperature, K
$U$	wheel speed, m/sec
$V$	air velocity, m/sec
$W$	weight flow, kg/sec
$Z$	axial distance referenced from rotor blade hub leading edge, cm
$\alpha_c$	cone angle, deg
$\alpha_s$	slope of streamline, deg
$\beta$	air angle (angle between air velocity and axial direction), deg
$\beta'_c$	relative meridional air angle based on cone angle, $\arctan(\tan \beta'_m \cos \alpha_c / \cos \alpha_s)$ , deg
$\gamma$	ratio of specific heats
$\delta$	ratio of rotor-inlet total pressure to standard pressure of $10.13 \text{ N}/\text{cm}^2$
$\delta^0$	deviation angle, angle between exit air direction and tangent to blade mean camber line at trailing edge, deg

$\theta$	ratio of rotor inlet total temperature to standard temperature of 288.2 K
$\eta$	efficiency
$\kappa_{mc}$	angle between blade mean camber line and meridional plane, deg
$\kappa_{ss}$	angle between blade suction-surface camber line at leading edge and meridional plane, deg
$\sigma$	solidity, ratio of chord to spacing
$\bar{\omega}$	total loss coefficient
$\bar{\omega}_p$	profile loss coefficient
$\bar{\omega}_s$	shock loss coefficient

**Subscripts:**

ad	adiabatic (temperature rise)
id	ideal
LE	blade leading edge
m	meridional direction
mom	momentum-rise
p	polytropic
TE	blade trailing edge
z	axial direction
$\theta$	tangential direction
0	instrumentation plane upstream of inlet guide vanes
1	instrumentation plane upstream of rotor
2	instrumentation plane between rotor and stator
3	instrumentation plane downstream of stator

**Superscript:**

'	relative to blade
---	-------------------

## APPENDIX B

### EQUATIONS

Suction-surface incidence angle -

$$i_{ss} = (\beta'_c)_{LE} - \kappa_{ss} \quad (B1)$$

Mean incidence angle -

$$i_{mc} = (\beta'_c)_{LE} - (\kappa_{mc})_{LE} \quad (B2)$$

Deviation angle -

$$\delta^o = (\beta'_c)_{TE} - (\kappa_{mc})_{TE} \quad (B3)$$

Diffusion factor -

$$D = 1 - \frac{V'_{TE}}{V'_{LE}} + \left| \frac{(rV_\theta)_{TE} - (rV_\theta)_{LE}}{(r_{TE} + r_{LE})\sigma(V'_{LE})} \right| \quad (B4)$$

Total loss coefficient -

$$\bar{\omega} = \frac{(P'_{id})_{TE} - P'_{TE}}{P'_{LE} - p_{LE}} \quad (B5)$$

Profile loss coefficient -

$$\bar{\omega}_p = \bar{\omega} - \bar{\omega}_s \quad (B6)$$

Total loss parameter -

$$\frac{\bar{\omega} \cos(\beta'_m)_{TE}}{2\sigma} \quad (B7)$$

Profile loss parameter -

$$\frac{\bar{\omega}_p \cos(\beta'_m)_{TE}}{2\sigma} \quad (B8)$$

Adiabatic (temperature rise) efficiency -

$$\eta_{ad} = \frac{\left(\frac{P_{TE}}{P_{LE}}\right)^{(\gamma-1)/\gamma} - 1}{\frac{T_{TE}}{T_{LE}} - 1} \quad (B9)$$

Momentum-rise efficiency -

$$\eta_{mom} = \frac{\left(\frac{P_{TE}}{P_{LE}}\right)^{(\gamma-1)/\gamma} - 1}{\frac{(UV_\theta)_{TE} - (UV_\theta)_{LE}}{T_{LE} C_p}} \quad (B10)$$

Equivalent weight flow -

$$\frac{W\sqrt{\theta}}{\delta} \quad (B11)$$

Equivalent rotative speed -

$$\frac{N}{\sqrt{\theta}} \quad (B12)$$

Weight flow per unit annulus area -

$$\frac{\left(\frac{W\sqrt{\theta}}{\delta}\right)}{A_{an}} \quad (B13)$$

Weight flow per unit frontal area -

$$\frac{\left(\frac{W\sqrt{\theta}}{\delta}\right)}{A_f} \quad (\text{B14})$$

Head-rise coefficient -

$$\frac{C_p T_{LE}}{U_{tip}^2} \left[ \left(\frac{P_{TE}}{P_{LE}}\right)^{(\gamma-1)/\gamma} - 1 \right] \quad (\text{B15})$$

Flow coefficient -

$$\left(\frac{V_z}{U_{tip}}\right)_{LE} \quad (\text{B16})$$

Stall margin -

$$SM = \left[ \frac{\left(\frac{P_{TE}}{P_{LE}}\right)_{stall} \times \left(\frac{W\sqrt{\theta}}{\delta}\right)_{ref}}{\left(\frac{P_{TE}}{P_{LE}}\right)_{ref} \times \left(\frac{W\sqrt{\theta}}{\delta}\right)_{stall}} - 1 \right] \times 100 \quad (\text{B17})$$

Polytropic efficiency -

$$\eta_p = \frac{\ln\left(\frac{P_{TE}}{P_{LE}}\right)^{(\gamma-1)/\gamma}}{\ln\left(\frac{T_{TE}}{T_{LE}}\right)} \quad (\text{B18})$$



## APPENDIX C

### DEFINITIONS AND UNITS USED IN TABLES

ABS	absolute
AERO CHORD	aerodynamic chord, cm
AREA RATIO	ratio of actual flow area to critical area (where local Mach number is one)
BETAM	meridional air angle, deg
CONE ANGLE	angle between axial direction and conical surface representing blade element, deg
DELTA INC	difference between mean camber blade angle and suction-surface blade angle at leading edge, deg
DEV	deviation angle (defined by eq. (B3)), deg
D-FACT	diffusion factor (defined by eq. (B4))
EFF	adiabatic efficiency (defined by eq. (B9))
IN	inlet (leading edge of blade)
INCIDENCE	incidence angle (suction surface defined by eq. (B1) and mean defined by eq. (B2)), deg
KIC	angle between the blade mean camber line at the leading edge and the meridional plane, deg
KOC	angle between the blade mean camber line at the trailing edge and the meridional plane, deg
KTC	angle between the blade mean camber line at the transition point and the meridional plane, deg
LOSS COEFF	loss coefficient (total defined by eq. (B5) and profile defined by eq. (B6))
LOSS PARAM	loss parameter (total defined by eq. (B7) and profile defined by eq. (B8))
MERID	meridional
MERID VEL R	meridional velocity ratio
OUT	outlet (trailing edge of blade)
PERCENT SPAN	percent of blade span from tip at rotor outlet

PHISS	suction-surface camber ahead of assumed shock location, deg
PRESS	pressure, N/cm <sup>2</sup>
PROF	profile
RADII	radius, cm
REL	relative to blade
RI	inlet radius (leading edge of blade), cm
RO	outlet radius (trailing edge of blade), cm
RP	radial position
RPM	equivalent rotative speed, rpm
SETTING ANGLE	angle between aerodynamic chord and meridional plane, deg
SOLIDITY	ratio of aerodynamic chord to blade spacing
SPEED	speed, m/sec
SS	suction surface
STREAMLINE SLOPE	slope of streamline, deg
TANG	tangential
TEMP	temperature, K
TI	thickness of blade at leading edge, cm
TM	thickness of blade at maximum thickness, cm
TO	thickness of blade at trailing edge, cm
TOT	total
TOTAL CAMBER	difference between inlet and outlet blade mean camber lines, deg
VEL	velocity, m/sec
WT FLOW	equivalent weight flow, kg/sec
X FACTOR	ratio of suction-surface camber ahead of assumed shock location of multiple-circular-arc blade section to that of double-circular-arc blade section
ZIC	axial distance to blade leading edge from inlet, cm
ZMC	axial distance to blade maximum thickness point from inlet, cm
ZOC	axial distance to blade trailing edge from inlet, cm
ZTC	axial distance to transition point from inlet, cm

## REFERENCES

1. Ball, Calvin L.; Janetzke, David C.; and Reid, Lonnie: Performance of a 1380 Foot-Per-Second Tip-Speed Axial-Flow Compressor Rotor with Blade Tip Solidity of 1.5. NASA TM X-2379, 1971.
2. Crouse, James E.; Janetzke, David C.; and Schwirian, Richard E.: A Computer Program for Composing Compressor Blading from Simulated Circular-Arc Elements on Conical Surfaces. NASA TN D-5437, 1969.
3. Schwenk, Francis C.; Lewis, George W.; and Hartmann, Melvin J.: A Preliminary Analysis of the Magnitude of Shock Losses in Transonic Compressors. NACA RM E57A30, 1957.
4. Urasek, Donald C.; and Janetzke, David C.: Performance of Tandem-Bladed Transonic Compressor Rotor with Tip Speed of 1375 Feet Per Second. NASA TM X-2484, 1972.

TABLE I. - DESIGN OVERALL PARAMETERS FOR

STAGE 66

ROTOR TOTAL PRESSURE RATIO.....	1.621
STAGE TOTAL PRESSURE RATIO	1.606
ROTOR TOTAL TEMPERATURE RATIO.....	1.168
STAGE TOTAL TEMPERATURE RATIO	1.168
ROTOR ADIABATIC EFFICIENCY.....	0.881
STAGE ADIABATIC EFFICIENCY	0.863
ROTOR POLYTROPIC EFFICIENCY.....	0.888
STAGE POLYTROPIC EFFICIENCY	0.871
ROTOR HEAD RISE COEFFICIENT.....	0.237
STAGE HEAD RISE COEFFICIENT	0.232
FLOW COEFFICIENT.....	0.464
WT FLOW PER UNIT FRONTAL AREA	147.469
WT FLOW PER UNIT ANNULUS AREA.....	197.021
WT FLOW	29.710
RPM.....	16042.300
TIP SPEED	425.426

TABLE II. - DESIGN BLADE-ELEMENT PARAMETERS FOR ROTOR 66

RP	RADII		ABS BETAM		REL BETAM		TOTAL TEMP		TOTAL PRESS	
	IN	OUT	IN	OUT	IN	OUT	IN	RATIO	IN	RATIO
TIP	25.324	25.222	0.	43.2	65.2	63.5	288.2	1.198	10.13	1.621
1	24.794	24.657	-0.	42.7	64.5	62.4	288.2	1.193	10.13	1.621
2	24.216	24.092	0.	42.2	63.8	61.4	288.2	1.187	10.13	1.621
3	23.041	22.962	0.	41.3	62.4	59.2	288.2	1.177	10.13	1.621
4	21.841	21.831	0.	41.0	60.9	56.7	288.2	1.169	10.13	1.621
5	20.866	20.927	0.	41.3	59.8	54.3	288.2	1.165	10.13	1.621
6	19.878	20.023	0.	41.9	58.7	51.7	288.2	1.162	10.13	1.621
7	19.378	19.571	0.	42.3	58.1	50.1	288.2	1.161	10.13	1.621
8	16.811	17.310	0.	44.8	55.1	40.3	288.2	1.158	10.13	1.621
9	15.470	16.180	0.	46.6	53.3	35.2	288.2	1.157	10.13	1.621
10	14.079	15.049	0.	48.6	51.4	24.2	288.2	1.158	10.13	1.621
11	13.361	14.484	0.	49.6	50.3	18.9	288.2	1.158	10.13	1.621
HUB	12.700	13.919	-0.	50.5	49.2	13.2	288.2	1.159	10.13	1.621

RP	ABS VEL		REL VEL		MERID VEL		TANG VEL		WHEEL SPEED	
	IN	OUT	IN	OUT	IN	OUT	IN	OUT	IN	OUT
TIP	196.6	197.5	468.6	322.3	196.6	143.9	0.	135.3	425.4	423.7
1	198.4	198.6	461.4	315.2	198.4	145.9	-0.	134.8	416.5	414.2
2	200.1	199.6	453.4	308.3	200.1	147.8	0.	134.2	406.8	404.7
3	202.6	201.1	436.9	294.6	202.6	151.1	0.	132.8	387.1	385.7
4	203.8	203.3	419.7	279.4	203.8	153.5	0.	133.3	366.9	366.8
5	203.8	206.0	405.5	265.3	203.8	154.7	0.	136.0	350.5	351.6
6	203.0	209.1	390.8	250.7	203.0	155.5	0.	139.8	333.9	336.4
7	202.4	211.0	383.4	243.3	202.4	156.0	0.	142.1	325.5	328.8
8	197.3	222.7	344.5	207.1	197.3	158.0	0.	156.9	282.4	290.8
9	193.5	231.0	324.0	189.9	193.5	158.8	0.	167.7	259.9	271.8
10	189.0	241.5	302.8	175.1	189.0	159.7	0.	181.2	236.5	252.8
11	186.5	247.6	291.8	169.6	186.5	160.5	0.	188.5	224.5	243.3
HUB	184.2	254.0	281.9	165.8	184.2	161.5	-0.	196.0	213.4	233.8

RP	ABS MACH NO		REL MACH NO		MERID MACH NO		STREAMLINE SLOPE		MERID PEAK SS	
	IN	OUT	IN	OUT	IN	OUT	IN	OUT	VEL R	MACH NO
TIP	0.598	0.546	1.426	0.891	0.598	0.398	-3.94	-4.94	0.732	1.524
1	0.604	0.550	1.405	0.874	0.604	0.404	-3.63	-4.14	0.735	1.514
2	0.610	0.555	1.381	0.857	0.610	0.411	-3.19	-3.31	0.738	1.504
3	0.618	0.562	1.332	0.823	0.618	0.422	-1.87	-1.56	0.746	1.483
4	0.622	0.570	1.280	0.784	0.622	0.431	-0.06	0.36	0.753	1.463
5	0.622	0.579	1.237	0.746	0.622	0.435	1.63	1.98	0.759	1.450
6	0.619	0.590	1.192	0.707	0.619	0.439	3.47	3.68	0.766	1.439
7	0.617	0.595	1.169	0.687	0.617	0.440	4.45	4.56	0.770	1.434
8	0.601	0.632	1.048	0.588	0.601	0.448	9.90	9.38	0.800	1.418
9	0.588	0.658	0.985	0.541	0.588	0.452	13.05	12.15	0.820	1.410
10	0.573	0.690	0.919	0.500	0.573	0.457	16.51	15.28	0.845	1.340
11	0.565	0.709	0.885	0.486	0.565	0.460	18.39	17.02	0.861	1.298
HUB	0.558	0.729	0.854	0.476	0.558	0.464	20.14	18.81	0.876	1.261

RP	PERCENT SPAN	INCIDENCE		DEV	D-FACT	EFF	LOSS COEFF		LOSS PARAM	
		MEAN	SS				TOT	PROF	TOT	PROF
TIP	0.	2.7	0.0	4.7	0.416	0.747	0.198	0.108	0.032	0.017
1	5.00	2.9	-0.0	4.5	0.419	0.767	0.181	0.097	0.029	0.016
2	10.00	3.2	0.0	4.3	0.421	0.789	0.164	0.086	0.027	0.014
3	20.00	3.7	0.0	4.0	0.425	0.836	0.127	0.060	0.021	0.010
4	30.00	4.3	0.0	3.7	0.433	0.877	0.097	0.041	0.017	0.007
5	38.00	4.7	0.0	3.6	0.445	0.896	0.084	0.036	0.014	0.006
6	46.00	5.1	0.0	3.6	0.460	0.911	0.074	0.034	0.013	0.006
7	50.00	5.3	0.0	3.7	0.468	0.917	0.070	0.034	0.012	0.006
8	70.00	6.1	0.0	4.7	0.510	0.939	0.059	0.037	0.011	0.007
9	80.00	6.4	0.0	5.6	0.531	0.940	0.063	0.048	0.012	0.009
10	90.00	6.6	0.0	6.7	0.546	0.936	0.076	0.070	0.014	0.013
11	95.00	6.6	0.0	7.2	0.546	0.934	0.082	0.080	0.015	0.014
HUB	100.00	6.2	0.1	7.8	0.543	0.933	0.088	0.087	0.015	0.015

TABLE III. - DESIGN BLADE-ELEMENT PARAMETERS FOR STATOR 66

RP	RADII		ABS BETAM		REL BETAM		TOTAL TEMP		TOTAL PRESS	
	IN	OUT	IN	OUT	IN	OUT	IN	RATIO	IN	RATIO
TIP	24.968	25.121	39.6	0.	39.6	0.	345.2	1.005	16.42	0.985
1	24.447	24.358	39.2	-0.	39.2	-0.	343.7	1.000	16.42	0.990
2	23.937	23.897	38.8	0.	38.8	0.	342.2	1.000	16.42	0.993
3	22.913	22.970	38.0	0.	38.0	0.	339.1	1.000	16.42	0.994
4	21.886	22.038	37.7	0.	37.7	0.	336.8	1.000	16.42	0.994
5	21.063	21.290	38.0	0.	38.0	0.	335.7	1.000	16.42	0.994
6	20.240	20.544	38.6	0.	38.6	0.	334.9	1.000	16.42	0.994
7	19.827	20.172	39.0	0.	39.0	0.	334.6	1.000	16.42	0.993
8	17.767	18.326	41.3	0.	41.3	0.	333.6	1.000	16.42	0.991
9	16.739	17.412	43.0	0.	43.0	0.	333.5	1.000	16.42	0.988
10	15.715	16.499	44.9	0.	44.9	0.	333.7	1.000	16.42	0.980
11	15.207	16.040	45.8	0.	45.8	0.	333.8	1.000	16.42	0.972
HUB	14.834	15.494	46.4	-0.	46.4	-0.	333.8	1.000	16.42	0.962

RP	ABS VEL		REL VEL		MERID VEL		TANG VEL		WHEEL SPEED	
	IN	OUT	IN	OUT	IN	OUT	IN	OUT	IN	OUT
TIP	214.3	174.3	214.3	174.3	165.0	174.3	136.7	0.	0.	0.
1	215.0	176.1	215.0	176.1	166.5	176.1	135.9	-0.	0.	0.
2	215.5	177.0	215.5	177.0	168.0	177.0	135.0	0.	0.	0.
3	216.3	177.8	216.3	177.8	170.6	177.8	133.1	0.	0.	0.
4	217.6	177.8	217.6	177.8	172.2	177.8	132.9	0.	0.	0.
5	219.4	177.7	219.4	177.7	172.8	177.7	135.1	0.	0.	0.
6	221.5	177.3	221.5	177.3	173.1	177.3	138.3	0.	0.	0.
7	222.9	177.0	222.9	177.0	173.2	177.0	140.2	0.	0.	0.
8	231.5	174.3	231.5	174.3	173.8	174.3	152.9	0.	0.	0.
9	237.8	170.9	237.8	170.9	174.0	170.9	162.1	0.	0.	0.
10	245.9	165.0	245.9	165.0	174.3	165.0	173.5	0.	0.	0.
11	250.5	161.0	250.5	161.0	174.7	161.0	179.5	0.	0.	0.
HUB	254.1	155.8	254.1	155.8	175.1	155.8	184.1	-0.	0.	0.

RP	ABS MACH NO		REL MACH NO		MERID MACH NO		STREAMLINE SLOPE		MERID PEAK SS	
	IN	OUT	IN	OUT	IN	OUT	IN	OUT	VEL R	MACH NO
TIP	0.595	0.478	0.595	0.478	0.459	0.478	-3.54	-2.24	1.056	0.962
1	0.599	0.485	0.599	0.485	0.464	0.485	-2.48	-0.99	1.057	0.956
2	0.602	0.489	0.602	0.489	0.469	0.489	-1.49	-0.25	1.054	0.949
3	0.607	0.493	0.607	0.493	0.479	0.493	0.35	1.18	1.042	0.935
4	0.613	0.495	0.613	0.495	0.486	0.495	2.03	2.56	1.033	0.930
5	0.620	0.496	0.620	0.496	0.488	0.496	3.33	3.68	1.028	0.936
6	0.627	0.495	0.627	0.495	0.490	0.495	4.64	4.84	1.024	0.947
7	0.632	0.495	0.632	0.495	0.491	0.495	5.32	5.44	1.022	0.953
8	0.659	0.487	0.659	0.487	0.495	0.487	8.93	8.61	1.003	0.999
9	0.679	0.478	0.679	0.478	0.497	0.478	10.94	10.35	0.983	1.034
10	0.704	0.460	0.704	0.460	0.499	0.460	13.07	12.21	0.947	1.079
11	0.719	0.448	0.719	0.448	0.501	0.448	14.17	13.20	0.921	1.103
HUB	0.730	0.433	0.730	0.433	0.503	0.433	14.98	14.39	0.890	1.131

RP	PERCENT SPAN	INCIDENCE		DEV	D-FACT	EFF	LOSS COEFF		LOSS PARAM	
		MEAN	SS				TOT	PROF	TOT	PROF
TIP	0.	4.0	-3.0	8.7	0.401	0.	0.115	0.115	0.039	0.039
1	5.00	3.9	-2.9	8.4	0.389	0.	0.045	0.045	0.015	0.015
2	10.00	3.7	-2.8	8.2	0.381	0.	0.034	0.034	0.011	0.011
3	20.00	3.7	-2.5	7.8	0.368	0.	0.029	0.029	0.009	0.009
4	30.00	3.5	-2.3	7.6	0.362	0.	0.026	0.026	0.008	0.008
5	38.00	3.3	-2.1	7.5	0.364	0.	0.027	0.027	0.008	0.008
6	46.00	3.2	-1.9	7.5	0.369	0.	0.028	0.028	0.008	0.008
7	50.00	3.1	-1.9	7.5	0.373	0.	0.028	0.028	0.008	0.008
8	70.00	2.8	-1.5	7.7	0.403	0.	0.034	0.034	0.008	0.008
9	80.00	2.6	-1.3	7.8	0.432	0.	0.045	0.045	0.010	0.010
10	90.00	2.4	-1.1	8.0	0.475	0.	0.071	0.071	0.015	0.015
11	95.00	2.4	-1.0	8.0	0.500	0.	0.096	0.096	0.020	0.020
HUB	100.00	2.7	-0.6	8.1	0.529	0.	0.130	0.130	0.026	0.026

TABLE IV. - BLADE GEOMETRY FOR ROTOR 66

RP	PERCENT RADII			BLADE ANGLES			DELTA INC	CONE ANGLE
	SPAN	RI	RO	KIC	KTC	KOC		
TIP	0.	25.324	25.222	62.51	63.11	58.81	2.68	-3.238
1	5.	24.794	24.657	61.59	62.04	57.92	2.93	-4.225
2	10.	24.216	24.092	60.60	60.87	57.03	3.20	-3.688
3	20.	23.041	22.962	58.61	58.47	55.18	3.75	-2.213
4	30.	21.841	21.831	56.67	55.94	52.98	4.27	-0.268
5	38.	20.866	20.927	55.14	53.75	50.75	4.69	1.522
6	46.	19.878	20.023	53.63	51.48	48.06	5.07	3.444
7	50.	19.378	19.571	52.87	50.29	46.46	5.26	4.458
8	70.	16.811	17.310	48.96	44.21	35.52	6.08	10.070
9	80.	15.470	16.180	46.91	40.93	27.52	6.39	13.261
10	90.	14.079	15.049	44.75	37.49	17.34	6.59	16.722
11	95.	13.361	14.484	43.60	35.80	11.47	6.65	18.571
HUB	100.	12.700	13.919	42.52	34.26	5.34	6.68	19.462

RP	BLADE THICKNESSES			AXIAL DIMENSIONS			
	TI	TM	TO	ZIC	ZMC	ZTC	ZOC
TIP	0.025	0.115	0.025	0.808	1.689	1.936	2.604
1	0.028	0.126	0.028	0.778	1.688	1.910	2.636
2	0.030	0.138	0.030	0.746	1.687	1.879	2.667
3	0.035	0.161	0.035	0.681	1.684	1.809	2.730
4	0.041	0.184	0.041	0.615	1.680	1.726	2.795
5	0.044	0.202	0.044	0.561	1.677	1.650	2.852
6	0.048	0.218	0.048	0.505	1.672	1.565	2.913
7	0.050	0.227	0.050	0.476	1.670	1.518	2.946
8	0.059	0.265	0.059	0.320	1.650	1.244	3.130
9	0.062	0.282	0.062	0.226	1.635	1.075	3.237
10	0.066	0.298	0.066	0.117	1.616	0.879	3.347
11	0.068	0.305	0.068	0.057	1.606	0.772	3.399
HUB	0.069	0.312	0.069	0.000	1.596	0.672	3.450

RP	AERO SETTING TOTAL			SOLIDITY	X FACTOR	PHISS	AREA RATIO
	CHORD	ANGLE	CAMBER				
TIP	3.875	62.15	3.70	1.391	0.592	2.83	1.045
1	3.884	61.13	3.67	1.425	0.641	3.19	1.040
2	3.884	60.03	3.58	1.459	0.693	3.58	1.034
3	3.882	57.79	3.43	1.531	0.788	4.35	1.024
4	3.881	55.42	3.69	1.613	0.868	5.19	1.014
5	3.882	53.32	4.39	1.685	0.921	5.96	1.007
6	3.884	51.04	5.57	1.766	0.961	6.76	1.004
7	3.886	49.78	6.41	1.810	0.977	7.17	1.003
8	3.914	42.24	13.44	2.081	1.002	9.03	0.997
9	3.947	37.23	19.39	2.263	1.000	9.90	0.999
10	4.003	31.06	27.41	2.494	1.000	10.69	1.005
11	4.044	27.55	32.13	2.635	1.000	10.94	1.009
HUB	4.073	23.95	37.18	2.776	1.000	11.13	1.013

TABLE V. - BLADE GEOMETRY FOR STATOR 66

RP	PERCENT RADII		BLADE ANGLES			DELTA INC	CONE ANGLE
	SPAN	RI RO	KIC	KTC	KOC		
TIP	0.	24.968 25.121	35.67	21.55	-8.65	7.04	2.507
1	5.	24.447 24.358	35.39	21.72	-8.37	6.76	-1.470
2	10.	23.937 23.897	35.05	21.85	-8.18	6.53	-0.657
3	20.	22.913 22.970	34.29	22.08	-7.79	6.21	0.944
4	30.	21.886 22.038	34.18	22.54	-7.56	5.78	2.481
5	38.	21.063 21.290	34.68	23.15	-7.51	5.45	3.716
6	46.	20.240 20.544	35.41	23.90	-7.52	5.13	4.985
7	50.	19.827 20.172	35.86	24.32	-7.53	4.97	5.642
8	70.	17.767 18.326	38.55	26.75	-7.66	4.23	9.148
9	80.	16.739 17.412	40.37	28.31	-7.79	3.89	11.009
10	90.	15.715 16.499	42.46	30.08	-7.96	3.57	12.824
11	95.	15.207 16.040	43.47	30.99	-8.02	3.42	13.652
HUB	100.	14.834 15.494	44.21	31.67	-8.09	3.32	10.909

RP	BLADE THICKNESSES			AXIAL DIMENSIONS			
	TI	TM	TO	ZIC	ZMC	ZTC	ZOC
TIP	0.065	0.297	0.067	6.042	7.700	7.068	9.523
1	0.064	0.286	0.064	6.040	7.701	7.045	9.524
2	0.062	0.276	0.062	6.037	7.701	7.021	9.524
3	0.057	0.261	0.057	6.032	7.703	6.969	9.526
4	0.054	0.243	0.054	6.031	7.703	6.932	9.527
5	0.051	0.230	0.051	6.034	7.703	6.912	9.529
6	0.048	0.217	0.048	6.039	7.702	6.896	9.531
7	0.047	0.211	0.047	6.042	7.702	6.889	9.531
8	0.040	0.182	0.040	6.061	7.699	6.855	9.534
9	0.037	0.169	0.037	6.075	7.697	6.841	9.535
10	0.035	0.156	0.035	6.093	7.695	6.828	9.535
11	0.033	0.151	0.033	6.102	7.693	6.820	9.535
HUB	0.032	0.147	0.032	6.109	7.693	6.814	9.535

RP	AERO SETTING TOTAL			SOLIDITY	X FACTOR	PHISS	AREA RATIO
	CHORD	ANGLE	CAMBER				
TIP	3.650	13.53	44.32	1.484	1.000	18.33	1.139
1	3.648	13.51	43.75	1.523	1.000	17.64	1.149
2	3.647	13.44	43.24	1.553	1.000	16.95	1.157
3	3.647	13.25	42.07	1.619	1.000	15.62	1.169
4	3.650	13.31	41.74	1.693	1.000	14.69	1.180
5	3.654	13.58	42.19	1.758	1.000	14.34	1.187
6	3.660	13.95	42.93	1.828	1.000	14.12	1.193
7	3.663	14.17	43.39	1.866	1.000	14.04	1.195
8	3.690	15.44	46.21	2.083	1.000	13.81	1.207
9	3.709	16.29	48.16	2.213	1.000	13.87	1.216
10	3.732	17.25	50.42	2.360	1.000	13.99	1.227
11	3.743	17.72	51.49	2.440	1.000	14.00	1.231
HUB	3.702	18.06	52.30	2.487	1.000	14.00	1.234



TABLE VI. - OVERALL PERFORMANCE FOR STAGE 1

(100 PERCENT OF DESIGN SPEED)

Parameter	Reading Number				
	845	856	867	884	895
ROTOR TOTAL PRESSURE RATIO	1.591	1.581	1.553	1.517	1.445
STAGE TOTAL PRESSURE RATIO	1.558	1.548	1.518	1.478	1.392
ROTOR TOTAL TEMPERATURE RATIO	1.166	1.163	1.157	1.149	1.135
STAGE TOTAL TEMPERATURE RATIO	1.166	1.161	1.153	1.143	1.125
ROTOR ADIABATIC EFFICIENCY	0.853	0.855	0.855	0.847	0.822
STAGE ADIABATIC EFFICIENCY	0.813	0.823	0.830	0.827	0.790
ROTOR POLYTROPIC EFFICIENCY	0.863	0.864	0.864	0.856	0.831
STAGE POLYTROPIC EFFICIENCY	0.825	0.834	0.840	0.836	0.800
ROTOR HEAD RISE COEFFICIENT	0.228	0.224	0.216	0.201	0.176
STAGE HEAD RISE COEFFICIENT	0.217	0.213	0.204	0.188	0.157
FLOW COEFFICIENT	0.395	0.406	0.416	0.426	0.434
**EQUIVALENT VALUES BASED ON STAGE INLET**					
WEIGHT FLOW	27.78	28.38	28.81	29.40	29.82
WEIGHT FLOW PER UNIT ANNULUS AREA	184.23	188.18	191.08	194.99	197.76
WEIGHT FLOW PER UNIT FRONTAL AREA	137.90	140.85	143.02	145.95	148.03
WHEEL SPEED, RPM	6008.6	16037.4	15986.6	16072.0	16091.2
TIP SPEED	424.5	425.3	423.9	426.2	426.7
PERCENT OF DESIGN SPEED	99.8	100.0	99.7	100.2	100.3
**CUMULATIVE VALUES**					
COMPRESSOR TOTAL PRESSURE RATIO	1.549	1.538	1.508	1.467	1.381
COMPRESSOR TOTAL TEMPERATURE RATIO	1.169	1.165	1.156	1.146	1.129
COMPRESSOR ADIABATIC EFFICIENCY	0.788	0.795	0.799	0.794	0.752
COMPRESSOR POLYTROPIC EFFICIENCY	0.801	0.808	0.810	0.804	0.763

TABLE VII. - BLADE-ELEMENT DATA AT BLADE EDGES FOR INLET GUIDE VANE

(a) Reading 845

RP	RADI		ABS BETAM		REL BETAM		TOTAL TEMP		TOTAL PRESS	
	IN	OUT	IN	OUT	IN	OUT	IN	RATIO	IN	RATIO
1	25.072	24.971	-2.0	-0.5	-2.0	-0.5	289.1	1.002	10.04	0.989
2	24.412	24.354	-1.5	0.3	-1.5	0.3	288.8	1.003	10.14	0.995
3	23.058	23.096	-1.1	1.3	-1.1	1.3	288.7	1.003	10.14	0.994
4	21.659	21.806	-0.8	0.9	-0.8	0.9	288.2	1.003	10.14	0.995
5	20.508	20.752	0.5	0.9	0.5	0.9	287.9	1.003	10.14	0.996
6	19.334	19.682	0.1	0.8	0.1	0.8	287.9	1.002	10.14	0.996
7	18.738	19.139	1.5	0.7	1.5	0.7	287.9	1.003	10.14	0.996
8	15.624	16.350	2.3	-0.3	2.3	-0.3	287.5	1.002	10.14	0.994
9	13.960	14.889	2.5	0.3	2.5	0.3	287.6	1.002	10.14	0.994
10	12.192	13.365	2.1	0.8	2.1	0.8	287.9	1.002	10.14	0.993
11	11.255	12.573	1.9	1.4	1.9	1.4	288.5	1.001	10.14	0.988

RP	ABS VEL		REL VEL		MERID VEL		TANG VEL		WHEEL SPEED	
	IN	OUT	IN	OUT	IN	OUT	IN	OUT	IN	OUT
1	141.9	156.0	141.9	156.0	141.8	155.9	-5.0	-1.4	0.	0.
2	147.8	163.3	147.8	163.3	147.8	163.3	-3.7	0.9	0.	0.
3	150.7	167.3	150.7	167.3	150.7	167.2	-2.9	3.8	0.	0.
4	150.0	167.2	150.0	167.2	149.9	167.2	-2.1	2.7	0.	0.
5	149.8	167.6	149.8	167.6	149.8	167.6	1.2	2.6	0.	0.
6	149.0	167.1	149.0	167.1	149.0	167.1	0.3	2.3	0.	0.
7	148.5	166.7	148.5	166.7	148.4	166.7	3.9	2.0	0.	0.
8	144.4	162.2	144.4	162.2	144.2	162.2	5.9	-1.0	0.	0.
9	141.5	158.7	141.5	158.7	141.4	158.7	6.1	0.8	0.	0.
10	137.9	153.5	137.9	153.5	137.8	153.5	5.2	2.1	0.	0.
11	135.8	148.8	135.8	148.8	135.7	148.7	4.6	3.5	0.	0.

RP	ABS MACH NO		REL MACH NO		MERID MACH NO		MERID PEAK SS	
	IN	OUT	IN	OUT	IN	OUT	VEL R	MACH NO
1	0.424	0.467	0.424	0.467	0.423	0.467	1.100	0.424
2	0.442	0.490	0.442	0.490	0.442	0.490	1.105	0.442
3	0.451	0.502	0.451	0.502	0.451	0.502	1.110	0.451
4	0.449	0.503	0.449	0.503	0.449	0.503	1.115	0.449
5	0.449	0.504	0.449	0.504	0.449	0.504	1.119	0.449
6	0.447	0.503	0.447	0.503	0.447	0.503	1.121	0.447
7	0.445	0.502	0.445	0.502	0.445	0.502	1.123	0.445
8	0.432	0.488	0.432	0.488	0.432	0.488	1.124	0.432
9	0.424	0.477	0.424	0.477	0.423	0.477	1.123	0.424
10	0.412	0.460	0.412	0.460	0.412	0.460	1.114	0.412
11	0.405	0.445	0.405	0.445	0.405	0.445	1.096	0.405

RP	PERCENT		INCIDENCE		DEV	D-FACT	EFF	LOSS COEFF		LOSS PARAM	
	SPAN		MEAN	SS				TOT	PROF	TOT	PROF
1	5.00		-2.0	-14.0	-0.5	-0.086	0.	0.095	0.095	0.048	0.048
2	10.00		-1.5	-13.5	0.3	-0.089	0.	0.042	0.042	0.021	0.021
3	20.00		-1.1	-13.1	1.3	-0.089	0.	0.044	0.044	0.021	0.021
4	30.00		-0.8	-12.8	0.9	-0.101	0.	0.037	0.037	0.016	0.016
5	38.00		0.5	-11.5	0.9	-0.115	0.	0.029	0.029	0.012	0.012
6	46.00		0.1	-11.9	0.8	-0.116	0.	0.030	0.030	0.012	0.012
7	50.00		1.5	-10.5	0.7	-0.118	0.	0.030	0.030	0.011	0.011
8	70.00		2.3	-9.7	-0.3	-0.108	0.	0.047	0.047	0.015	0.015
9	80.00		2.4	-9.6	0.3	-0.112	0.	0.054	0.054	0.016	0.016
10	90.00		2.1	-9.9	0.8	-0.108	0.	0.066	0.066	0.017	0.017
11	95.00		1.9	-10.1	1.4	-0.095	0.	0.109	0.109	0.026	0.026

TABLE VII. - Continued.

(b) Reading 856

RP	RADII		ABS BETAM		REL BETAM		TOTAL TEMP		TOTAL PRESS	
	IN	OUT	IN	OUT	IN	OUT	IN	RATIO	IN	RATIO
1	25.072	24.971	-2.2	-0.5	-2.2	-0.5	289.1	1.003	10.03	0.990
2	24.412	24.354	-1.4	0.0	-1.4	0.0	288.8	1.003	10.13	0.994
3	23.058	23.096	-1.0	0.9	-1.0	0.9	288.5	1.003	10.14	0.994
4	21.659	21.806	-0.1	0.7	-0.1	0.7	288.1	1.003	10.14	0.995
5	20.508	20.752	-0.2	0.8	-0.2	0.8	288.0	1.003	10.14	0.996
6	19.334	19.682	1.3	0.7	1.3	0.7	287.9	1.003	10.14	0.996
7	18.738	19.139	1.4	0.7	1.4	0.7	287.8	1.003	10.14	0.996
8	15.624	16.350	1.5	-0.6	1.5	-0.6	287.7	1.002	10.14	0.993
9	13.960	14.889	2.3	-0.1	2.3	-0.1	287.7	1.002	10.14	0.993
10	12.192	13.365	2.5	0.9	2.5	0.9	288.0	1.002	10.14	0.990
11	11.255	12.573	2.2	1.0	2.2	1.0	288.5	1.001	10.14	0.985

RP	ABS VEL		REL VEL		MERID VEL		TANG VEL		WHEEL SPEED	
	IN	OUT	IN	OUT	IN	OUT	IN	OUT	IN	OUT
1	145.2	161.4	145.2	161.4	145.1	161.4	-5.6	-1.5	0.	0.
2	151.5	168.3	151.5	168.3	151.4	168.3	-3.7	0.1	0.	0.
3	154.5	172.2	154.5	172.2	154.5	172.1	-2.7	2.8	0.	0.
4	153.6	172.1	153.6	172.1	153.6	172.1	-0.3	2.1	0.	0.
5	153.4	172.4	153.4	172.4	153.4	172.4	-0.4	2.4	0.	0.
6	152.7	171.9	152.7	171.9	152.7	171.9	3.4	2.0	0.	0.
7	152.3	171.4	152.3	171.4	152.2	171.4	3.6	2.0	0.	0.
8	148.5	166.8	148.5	166.8	148.4	166.8	3.8	-1.7	0.	0.
9	145.5	163.1	145.5	163.1	145.4	163.1	5.9	-0.2	0.	0.
10	141.8	157.2	141.8	157.2	141.7	157.1	6.3	2.5	0.	0.
11	139.5	152.1	139.5	152.1	139.4	152.1	5.4	2.6	0.	0.

RP	ABS MACH NO		REL MACH NO		MERID MACH NO		MERID PEAK SS	
	IN	OUT	IN	OUT	IN	OUT	VEL R	MACH NO
1	0.434	0.484	0.434	0.484	0.434	0.484	1.112	0.434
2	0.454	0.506	0.454	0.506	0.453	0.506	1.112	0.454
3	0.463	0.518	0.463	0.518	0.463	0.518	1.114	0.463
4	0.461	0.518	0.461	0.518	0.461	0.518	1.120	0.461
5	0.460	0.519	0.460	0.519	0.460	0.519	1.123	0.460
6	0.458	0.518	0.458	0.518	0.458	0.518	1.126	0.458
7	0.457	0.516	0.457	0.516	0.457	0.516	1.126	0.457
8	0.445	0.502	0.445	0.502	0.445	0.502	1.123	0.445
9	0.436	0.490	0.436	0.490	0.436	0.490	1.122	0.436
10	0.424	0.472	0.424	0.472	0.424	0.472	1.109	0.424
11	0.417	0.456	0.417	0.456	0.417	0.456	1.091	0.417

RP	PERCENT		INCIDENCE		DEV	D-FACT	EFF	LOSS COEFF		LOSS PARAM	
	SPAN	MEAN	SS	TOT				PROF	TOT	PROF	
1	5.00	-2.2	-14.2	-0.5	-0.097	0.	0.084	0.084	0.043	0.043	
2	10.00	-1.4	-13.4	0.0	-0.099	0.	0.044	0.044	0.022	0.022	
3	20.00	-1.0	-13.0	0.9	-0.098	0.	0.041	0.041	0.019	0.019	
4	30.00	-0.1	-12.1	0.7	-0.113	0.	0.034	0.034	0.015	0.015	
5	38.00	-0.2	-12.2	0.8	-0.116	0.	0.030	0.030	0.012	0.012	
6	46.00	1.3	-10.7	0.7	-0.122	0.	0.029	0.029	0.011	0.011	
7	50.00	1.4	-10.6	0.7	-0.122	0.	0.031	0.031	0.012	0.012	
8	70.00	1.5	-10.5	-0.6	-0.111	0.	0.051	0.051	0.016	0.016	
9	80.00	2.3	-9.7	-0.1	-0.109	0.	0.058	0.058	0.017	0.017	
10	90.00	2.5	-9.5	0.9	-0.102	0.	0.088	0.088	0.022	0.022	
11	95.00	2.2	-9.8	1.0	-0.086	0.	0.134	0.134	0.032	0.032	

TABLE VII. - Continued.

(c) Reading 867

RP	RAD II		ABS BETAM		REL BETAM		TOTAL TEMP		TOTAL PRESS	
	IN	OUT	IN	OUT	IN	OUT	IN	RATIO	IN	RATIO
1	25.072	24.971	-1.6	-0.5	-1.6	-0.5	289.0	1.003	10.03	0.989
2	24.412	24.354	-1.5	0.1	-1.5	0.1	288.6	1.003	10.14	0.994
3	23.058	23.096	-1.5	0.9	-1.5	0.9	288.5	1.003	10.14	0.995
4	21.659	21.806	-0.4	0.6	-0.4	0.6	288.1	1.003	10.14	0.996
5	20.598	20.752	-0.5	0.8	-0.5	0.8	287.9	1.003	10.14	0.996
6	19.334	19.682	1.8	0.7	1.8	0.7	287.8	1.003	10.14	0.996
7	18.738	19.139	1.0	0.6	1.0	0.6	287.9	1.003	10.14	0.996
8	15.624	16.350	2.1	-0.5	2.1	-0.5	287.7	1.002	10.14	0.993
9	13.960	14.889	2.9	-0.0	2.9	-0.0	287.8	1.002	10.14	0.991
10	12.192	13.365	2.4	0.6	2.4	0.6	288.0	1.002	10.14	0.988
11	11.255	12.573	1.8	0.3	1.8	0.3	288.5	1.001	10.14	0.980

RP	ABS VEL		REL VEL		MERID VEL		TANG VEL		WHEEL SPEED	
	IN	OUT	IN	OUT	IN	OUT	IN	OUT	IN	OUT
1	148.0	165.2	148.0	165.2	148.0	165.2	-4.1	-1.3	0.	0.
2	154.4	172.3	154.4	172.3	154.3	172.3	-4.1	0.3	0.	0.
3	157.4	176.3	157.4	176.3	157.3	176.3	-4.1	2.6	0.	0.
4	156.4	176.1	156.4	176.1	156.4	176.1	-1.2	1.7	0.	0.
5	156.2	176.3	156.2	176.3	156.2	176.3	-1.4	2.5	0.	0.
6	155.7	175.7	155.7	175.7	155.6	175.7	4.9	2.2	0.	0.
7	155.1	175.2	155.1	175.2	155.1	175.2	2.8	1.9	0.	0.
8	151.3	170.0	151.3	170.0	151.2	170.0	5.5	-1.4	0.	0.
9	148.3	166.0	148.3	166.0	148.1	166.0	7.4	-0.1	0.	0.
10	144.4	159.3	144.4	159.3	144.3	159.3	5.9	1.7	0.	0.
11	142.2	152.9	142.2	152.9	142.1	152.9	4.5	0.9	0.	0.

RP	ABS MACH NO		REL MACH NO		MERID MACH NO		MERID PEAK SS	
	IN	OUT	IN	OUT	IN	OUT	VEL R	MACH NO
1	0.443	0.496	0.443	0.496	0.443	0.496	1.117	0.443
2	0.463	0.519	0.463	0.519	0.463	0.519	1.117	0.463
3	0.472	0.531	0.472	0.531	0.472	0.531	1.121	0.472
4	0.470	0.531	0.470	0.531	0.470	0.531	1.126	0.470
5	0.469	0.532	0.469	0.532	0.469	0.532	1.129	0.469
6	0.468	0.530	0.468	0.530	0.467	0.530	1.129	0.468
7	0.466	0.528	0.466	0.528	0.466	0.528	1.129	0.466
8	0.454	0.512	0.454	0.512	0.454	0.512	1.124	0.454
9	0.445	0.500	0.445	0.500	0.444	0.500	1.121	0.445
10	0.432	0.478	0.432	0.478	0.432	0.478	1.104	0.432
11	0.425	0.458	0.425	0.458	0.425	0.458	1.076	0.425

RP	PERCENT		INCIDENCE		DEV	D-FACT	EFF	LOSS COEFF		LOSS PARAM	
	SPAN	MEAN	SS	TOT				PROF	TOT	PROF	
1	5.00	-1.6	-13.6	-0.4	-0.107	0.	0.087	0.087	0.044	0.044	
2	10.00	-1.5	-13.5	0.1	-0.103	0.	0.044	0.044	0.022	0.022	
3	20.00	-1.5	-13.5	0.8	-0.101	0.	0.036	0.036	0.017	0.017	
4	30.00	-0.4	-12.4	0.6	-0.118	0.	0.031	0.031	0.013	0.013	
5	38.00	-0.5	-12.5	0.8	-0.118	0.	0.029	0.029	0.012	0.012	
6	46.00	1.8	-10.2	0.7	-0.122	0.	0.030	0.030	0.012	0.012	
7	50.00	1.0	-11.0	0.6	-0.127	0.	0.032	0.032	0.012	0.012	
8	70.00	2.1	-9.9	-0.5	-0.109	0.	0.052	0.052	0.017	0.017	
9	80.00	2.8	-9.2	-0.0	-0.105	0.	0.068	0.068	0.020	0.020	
10	90.00	2.3	-9.7	0.6	-0.096	0.	0.098	0.098	0.025	0.025	
11	95.00	1.8	-10.2	0.3	-0.070	0.	0.169	0.169	0.040	0.040	

TABLE VII. - Continued.

(d) Reading 884

RP	RADI I		ABS BETAM		REL BETAM		TOTAL TEMP		TOTAL PRESS	
	IN	OUT	IN	OUT	IN	OUT	IN	RATIO	IN	RATIO
1	25.072	24.971	-1.5	-0.6	-1.5	-0.6	289.1	1.003	10.02	0.990
2	24.412	24.354	-1.4	-0.0	-1.4	-0.0	288.7	1.003	10.14	0.994
3	23.058	23.096	-0.9	0.6	-0.9	0.6	288.6	1.003	10.14	0.996
4	21.659	21.806	-0.1	0.5	-0.1	0.5	288.1	1.003	10.14	0.996
5	20.508	20.752	-0.3	0.7	-0.3	0.7	288.0	1.003	10.14	0.996
6	19.334	19.682	-0.0	0.8	-0.0	0.8	287.9	1.003	10.14	0.995
7	18.738	19.139	0.2	0.8	0.2	0.8	287.8	1.003	10.14	0.995
8	15.624	16.350	2.3	-0.1	2.3	-0.1	287.6	1.003	10.15	0.992
9	13.960	14.889	2.6	0.1	2.6	0.1	287.7	1.002	10.14	0.990
10	12.192	13.365	2.0	0.4	2.0	0.4	287.9	1.002	10.14	0.985
11	11.255	12.573	2.2	0.7	2.2	0.7	288.4	1.001	10.14	0.981

RP	ABS VEL		REL VEL		MERID VEL		TANG VEL		WHEEL SPEED	
	IN	OUT	IN	OUT	IN	OUT	IN	OUT	IN	OUT
1	151.6	170.4	151.6	170.4	151.5	170.4	-4.0	-1.6	0.	0.
2	158.5	177.3	158.5	177.3	158.4	177.3	-3.8	-0.1	0.	0.
3	161.8	181.5	161.8	181.5	161.8	181.5	-2.6	2.0	0.	0.
4	160.8	181.2	160.8	181.2	160.8	181.2	-0.3	1.5	0.	0.
5	160.7	181.2	160.7	181.2	160.7	181.1	-0.9	2.3	0.	0.
6	159.8	180.5	159.8	180.5	159.8	180.5	-0.1	2.6	0.	0.
7	159.1	179.9	159.1	179.9	159.1	179.9	0.5	2.4	0.	0.
8	154.9	174.5	154.9	174.5	154.7	174.5	6.2	-0.3	0.	0.
9	151.8	170.1	151.8	170.1	151.7	170.1	6.9	0.4	0.	0.
10	147.7	163.5	147.7	163.5	147.6	163.5	5.1	1.1	0.	0.
11	145.1	158.6	145.1	158.6	145.0	158.6	5.5	2.0	0.	0.

RP	ABS MACH NO		REL MACH NO		MERID MACH NO		MERID PEAK SS	
	IN	OUT	IN	OUT	IN	OUT	VEL R	MACH NO
1	0.454	0.512	0.454	0.512	0.454	0.512	1.125	0.454
2	0.476	0.534	0.476	0.534	0.475	0.534	1.119	0.476
3	0.486	0.548	0.486	0.548	0.486	0.548	1.122	0.486
4	0.484	0.547	0.484	0.547	0.484	0.547	1.127	0.484
5	0.483	0.547	0.483	0.547	0.483	0.547	1.127	0.483
6	0.481	0.545	0.481	0.545	0.481	0.545	1.129	0.481
7	0.479	0.543	0.479	0.543	0.479	0.543	1.130	0.479
8	0.465	0.527	0.465	0.527	0.465	0.527	1.128	0.465
9	0.456	0.513	0.456	0.513	0.455	0.513	1.122	0.456
10	0.442	0.492	0.442	0.492	0.442	0.492	1.108	0.442
11	0.434	0.476	0.434	0.476	0.434	0.476	1.094	0.434

RP	PERCENT	INCIDENCE		DEV	D-FACT	EFF	LOSS COEFF		LOSS PARAM	
	SPAN	MEAN	SS				TOT	PROF	TOT	PROF
1	5.00	-1.5	-13.5	-0.6	-0.116	0.	0.076	0.076	0.038	0.038
2	10.00	-1.4	-13.4	-0.0	-0.107	0.	0.042	0.042	0.021	0.021
3	20.00	-0.9	-12.9	0.6	-0.109	0.	0.030	0.030	0.014	0.014
4	30.00	-0.1	-12.1	0.5	-0.122	0.	0.029	0.029	0.013	0.013
5	38.00	-0.3	-12.3	0.7	-0.119	0.	0.030	0.030	0.013	0.013
6	46.00	-0.0	-12.0	0.8	-0.123	0.	0.031	0.031	0.012	0.012
7	50.00	0.2	-11.8	0.8	-0.126	0.	0.032	0.032	0.012	0.012
8	70.00	2.3	-9.7	-0.1	-0.114	0.	0.059	0.059	0.019	0.019
9	80.00	2.6	-9.4	0.1	-0.109	0.	0.075	0.075	0.022	0.022
10	90.00	2.0	-10.0	0.4	-0.101	0.	0.119	0.119	0.030	0.030
11	95.00	2.2	-9.8	0.7	-0.088	0.	0.155	0.155	0.036	0.036

TABLE VII. - Concluded.

(e) Reading 895

RP	RADI		ABS BETAM		REL BETAM		TOTAL TEMP		TOTAL PRESS	
	IN	OUT	IN	OUT	IN	OUT	IN	RATIO	IN	RATIO
1	25.072	24.971	-1.8	-0.5	-1.8	-0.5	289.0	1.003	10.03	0.989
2	24.412	24.354	-1.8	-0.3	-1.8	-0.3	288.8	1.003	10.14	0.994
3	23.058	23.096	-0.9	0.3	-0.9	0.3	288.3	1.004	10.14	0.995
4	21.659	21.806	0.1	0.4	0.1	0.4	288.1	1.003	10.14	0.996
5	20.508	20.752	0.2	0.6	0.2	0.6	287.9	1.003	10.14	0.996
6	19.334	19.682	0.0	0.7	0.0	0.7	287.9	1.003	10.14	0.995
7	18.738	19.139	1.2	0.8	1.2	0.8	287.9	1.003	10.14	0.995
8	15.624	16.350	2.5	-0.3	2.5	-0.3	287.8	1.003	10.14	0.992
9	13.960	14.889	2.6	0.5	2.6	0.5	287.8	1.002	10.14	0.989
10	12.192	13.365	3.0	0.7	3.0	0.7	288.0	1.002	10.14	0.983
11	11.255	12.573	1.7	0.6	1.7	0.6	288.5	1.001	10.14	0.977

RP	ABS VEL		REL VEL		MERID VEL		TANG VEL		WHEEL SPEED	
	IN	OUT	IN	OUT	IN	OUT	IN	OUT	IN	OUT
1	154.9	174.4	154.9	174.4	154.9	174.4	-5.0	-1.6	0.	0.
2	161.4	181.2	161.4	181.2	161.3	181.2	-5.1	-0.8	0.	0.
3	164.3	185.1	164.3	185.1	164.3	185.1	-2.5	1.0	0.	0.
4	163.4	185.0	163.4	185.0	163.4	185.0	0.4	1.2	0.	0.
5	163.2	184.9	163.2	184.9	163.2	184.9	0.7	1.9	0.	0.
6	162.4	184.1	162.4	184.1	162.4	184.0	0.1	2.2	0.	0.
7	161.9	183.6	161.9	183.6	161.9	183.5	3.5	2.7	0.	0.
8	157.8	178.1	157.8	178.1	157.7	178.1	6.8	-1.0	0.	0.
9	154.6	173.4	154.6	173.4	154.4	173.4	7.1	1.6	0.	0.
10	150.6	166.0	150.6	166.0	150.3	165.9	7.9	2.1	0.	0.
11	148.1	160.4	148.1	160.4	148.1	160.4	4.3	1.5	0.	0.

RP	ABS MACH NO		REL MACH NO		MERID MACH NO		MERID PEAK SS	
	IN	OUT	IN	OUT	IN	OUT	VEL R	MACH NO
1	0.464	0.525	0.464	0.525	0.464	0.525	1.126	0.464
2	0.485	0.547	0.485	0.547	0.484	0.547	1.124	0.485
3	0.494	0.560	0.494	0.560	0.494	0.560	1.127	0.494
4	0.492	0.560	0.492	0.560	0.492	0.560	1.132	0.492
5	0.491	0.559	0.491	0.559	0.491	0.559	1.133	0.491
6	0.489	0.557	0.489	0.557	0.489	0.557	1.133	0.489
7	0.487	0.555	0.487	0.555	0.487	0.555	1.134	0.487
8	0.474	0.538	0.474	0.538	0.474	0.538	1.130	0.474
9	0.464	0.523	0.464	0.523	0.464	0.523	1.123	0.464
10	0.451	0.499	0.451	0.499	0.451	0.499	1.104	0.451
11	0.444	0.482	0.444	0.482	0.443	0.482	1.083	0.444

RP	PERCENT		INCIDENCE		DEV	D-FACT	EFF	LOSS COEFF		LOSS PARAM	
	SPAN	MEAN	SS	TOT				PROF	TOT	PROF	
1	5.00	-1.8	-13.8	-0.5	-0.115	0.	0.078	0.078	0.039	0.039	
2	10.00	-1.8	-13.8	-0.3	-0.110	0.	0.042	0.042	0.021	0.021	
3	20.00	-0.9	-12.9	0.3	-0.117	0.	0.031	0.031	0.014	0.014	
4	30.00	0.1	-11.9	0.4	-0.130	0.	0.025	0.025	0.011	0.011	
5	38.00	0.2	-11.8	0.6	-0.130	0.	0.028	0.028	0.012	0.012	
6	46.00	0.0	-12.0	0.7	-0.128	0.	0.032	0.032	0.012	0.012	
7	50.00	1.2	-10.8	0.8	-0.132	0.	0.033	0.033	0.013	0.013	
8	70.00	2.5	-9.5	-0.3	-0.113	0.	0.058	0.058	0.019	0.019	
9	80.00	2.6	-9.4	0.5	-0.112	0.	0.078	0.078	0.022	0.022	
10	90.00	3.0	-9.0	0.7	-0.093	0.	0.130	0.130	0.033	0.033	
11	95.00	1.6	-10.4	0.6	-0.079	0.	0.180	0.180	0.042	0.042	

TABLE VIII. - BLADE-ELEMENT DATA AT BLADE EDGES FOR ROTOR 1

(a) Reading 845

RP	RADII		ABS BETAM		REL BETAM		TOTAL TEMP		TOTAL PRESS	
	IN	OUT	IN	OUT	IN	OUT	IN	RATIO	IN	RATIO
1	24.795	24.656	-0.5	61.9	67.8	72.2	289.7	1.222	9.93	1.558
2	24.216	24.092	0.3	51.2	66.2	64.9	289.6	1.206	10.08	1.588
3	23.040	22.962	1.2	44.6	64.0	59.2	289.5	1.182	10.08	1.606
4	21.841	21.831	0.8	42.2	63.0	56.5	289.0	1.170	10.09	1.610
5	20.866	20.927	0.8	43.6	61.9	53.2	288.7	1.174	10.10	1.634
6	19.878	20.023	0.7	43.3	60.8	52.0	288.7	1.162	10.10	1.583
7	19.378	19.571	0.6	42.2	60.2	50.5	288.6	1.157	10.10	1.589
8	16.812	17.310	-0.3	41.9	57.7	40.2	288.3	1.151	10.08	1.597
9	15.471	16.180	0.3	44.1	55.9	36.3	288.2	1.144	10.07	1.565
10	14.079	15.049	0.7	44.4	54.1	32.2	288.3	1.133	10.07	1.510
11	13.360	14.483	1.2	48.6	53.3	19.6	288.8	1.153	10.02	1.602

RP	ABS VEL		REL VEL		MERID VEL		TANG VEL		WHEEL SPEED	
	IN	OUT	IN	OUT	IN	OUT	IN	OUT	IN	OUT
1	169.9	176.1	450.4	271.1	169.9	83.0	-1.4	155.3	415.7	413.4
2	179.1	191.4	444.5	282.9	179.1	119.9	0.9	149.3	407.6	405.5
3	184.8	201.0	421.2	279.4	184.8	143.2	3.8	141.0	382.3	381.0
4	185.3	204.8	408.6	274.9	185.3	151.8	2.7	137.5	366.8	366.7
5	186.0	211.9	394.2	256.1	185.9	153.4	2.6	146.2	350.2	351.2
6	185.3	207.8	379.8	246.0	185.2	151.4	2.3	142.4	333.8	336.3
7	184.7	209.1	372.2	243.7	184.7	155.0	2.0	140.3	325.1	328.4
8	179.2	224.5	335.5	218.6	179.2	167.0	-0.9	150.1	282.7	291.1
9	175.4	222.4	313.2	198.3	175.4	159.7	0.8	154.7	260.2	272.2
10	171.2	220.1	289.9	186.0	170.2	157.4	2.0	153.9	236.7	253.0
11	165.4	247.5	276.6	173.9	165.4	163.8	3.3	185.6	225.0	243.9

RP	ABS MACH NO		REL MACH NO		MERID MACH NO		MERID PEAK SS	
	IN	OUT	IN	OUT	IN	OUT	VEL R	MACH NO
1	0.511	0.478	1.354	0.735	0.511	0.225	0.489	1.576
2	0.540	0.525	1.340	0.776	0.540	0.329	0.669	1.547
3	0.558	0.559	1.273	0.777	0.558	0.398	0.775	1.482
4	0.561	0.574	1.236	0.770	0.561	0.425	0.819	1.495
5	0.563	0.594	1.193	0.718	0.563	0.430	0.825	1.482
6	0.561	0.585	1.149	0.693	0.561	0.426	0.817	1.477
7	0.559	0.591	1.126	0.688	0.559	0.438	0.839	1.474
8	0.542	0.640	1.014	0.623	0.542	0.476	0.932	1.496
9	0.530	0.635	0.946	0.566	0.530	0.456	0.911	1.438
10	0.513	0.632	0.874	0.534	0.513	0.452	0.925	1.354
11	0.497	0.710	0.832	0.499	0.497	0.470	0.991	1.305

RP	PERCENT SPAN		INCIDENCE		DEV	D-FACT	EFF	LOSS COEFF		LOSS PARAM	
	SPAN	MEAN	MEAN	SS				TOT	PROF	TOT	PROF
1	5.00	6.2	3.3	14.2	0.520	0.607	0.341	0.251	0.037	0.027	
2	10.00	5.6	2.4	7.9	0.478	0.685	0.266	0.185	0.039	0.027	
3	20.00	5.4	1.6	4.0	0.443	0.797	0.167	0.109	0.028	0.018	
4	30.00	6.4	2.1	3.5	0.430	0.857	0.117	0.062	0.020	0.011	
5	38.00	6.7	2.0	2.5	0.459	0.866	0.116	0.069	0.021	0.012	
6	46.00	7.2	2.1	4.0	0.457	0.864	0.117	0.076	0.020	0.013	
7	50.00	7.4	2.1	4.0	0.448	0.903	0.084	0.046	0.015	0.008	
8	70.00	8.7	2.7	4.6	0.458	0.945	0.053	0.025	0.010	0.005	
9	80.00	9.0	2.6	8.7	0.478	0.945	0.057	0.042	0.010	0.008	
10	90.00	9.3	2.7	14.7	0.467	0.943	0.062	0.058	0.011	0.010	
11	95.00	9.7	3.0	8.0	0.502	0.943	0.076	0.075	0.014	0.013	

TABLE VIII. - Continued.

(b) Reading 856

RP	RAD II		ABS BETAM		REL BETAM		TOTAL TEMP		TOTAL PRESS	
	IN	OUT	IN	OUT	IN	OUT	IN	RATIO	IN	RATIO
1	24.795	24.656	-0.5	61.5	67.2	73.1	289.9	1.214	9.93	1.534
2	24.216	24.092	0.0	49.0	65.6	64.5	289.6	1.200	10.08	1.584
3	23.040	22.962	0.8	43.2	63.6	59.6	289.4	1.178	10.08	1.589
4	21.841	21.831	0.6	41.5	62.3	56.8	289.0	1.168	10.09	1.592
5	20.866	20.927	0.7	43.2	61.2	53.4	288.8	1.172	10.10	1.623
6	19.878	20.023	0.6	42.6	60.1	52.4	288.7	1.160	10.10	1.564
7	19.378	19.571	0.6	41.3	59.6	50.6	288.6	1.154	10.10	1.578
8	16.812	17.310	-0.5	39.7	57.0	39.1	288.3	1.149	10.08	1.588
9	15.471	16.180	-0.0	42.2	55.3	34.1	288.3	1.146	10.07	1.578
10	14.079	15.049	0.8	42.5	53.3	30.7	288.4	1.132	10.04	1.511
11	13.360	14.483	0.8	46.7	52.6	19.4	288.8	1.151	9.99	1.590

RP	ABS VEL		REL VEL		MERID VEL		TANG VEL		WHEEL SPEED	
	IN	OUT	IN	OUT	IN	OUT	IN	OUT	IN	OUT
1	176.2	169.4	454.5	278.2	176.2	80.8	-1.5	148.9	417.5	415.1
2	185.0	190.4	447.5	290.0	185.0	124.9	0.1	143.7	407.5	405.4
3	190.8	200.1	429.2	288.6	190.8	145.9	2.8	136.9	387.3	386.0
4	191.3	203.1	412.1	277.6	191.3	152.1	2.1	134.7	367.1	367.0
5	191.7	211.2	397.8	258.2	191.7	153.9	2.4	144.6	350.9	351.9
6	191.0	206.6	383.5	249.0	191.0	152.1	2.0	139.8	334.5	337.0
7	190.4	209.1	375.6	247.5	190.3	157.2	2.0	137.9	325.8	329.0
8	184.7	229.9	338.8	227.9	184.7	176.8	-1.6	147.0	282.5	290.8
9	180.6	232.0	317.0	207.7	180.6	171.9	-0.2	155.8	260.4	272.3
10	174.5	227.4	292.2	194.8	174.5	167.5	2.4	153.7	236.8	253.1
11	169.4	250.9	279.1	182.4	169.4	172.0	2.5	182.6	224.3	243.2

RP	ABS MACH NO		REL MACH NO		MERID MACH NO		MERID PEAK SS	
	IN	OUT	IN	OUT	IN	OUT	VEL R	MACH NO
1	0.531	0.460	1.368	0.755	0.531	0.219	0.458	1.568
2	0.559	0.523	1.352	0.797	0.559	0.343	0.675	1.536
3	0.578	0.557	1.300	0.804	0.578	0.406	0.765	1.495
4	0.580	0.569	1.249	0.778	0.580	0.426	0.795	1.483
5	0.581	0.592	1.206	0.724	0.581	0.432	0.803	1.470
6	0.579	0.582	1.163	0.702	0.579	0.428	0.796	1.464
7	0.577	0.591	1.139	0.700	0.577	0.444	0.826	1.460
8	0.559	0.657	1.026	0.651	0.559	0.505	0.957	1.474
9	0.546	0.664	0.959	0.595	0.546	0.492	0.951	1.436
10	0.527	0.654	0.882	0.560	0.527	0.482	0.960	1.345
11	0.510	0.721	0.840	0.524	0.510	0.495	1.016	1.300

RP	PERCENT		INCIDENCE		DEV	D-FACT	EFF	LOSS COEFF		LOSS PARAM	
	SPAN	MEAN	SS	TOT				PROF	TOT	PROF	
1	5.00	5.6	2.7	15.2	0.504	0.608	0.327	0.237	0.033	0.024	
2	10.00	5.0	1.8	7.4	0.462	0.702	0.244	0.164	0.036	0.024	
3	20.00	5.0	1.2	4.4	0.429	0.795	0.163	0.098	0.027	0.016	
4	30.00	5.7	1.4	3.8	0.426	0.847	0.122	0.067	0.021	0.011	
5	38.00	6.0	1.4	2.7	0.457	0.861	0.119	0.072	0.021	0.013	
6	46.00	6.5	1.4	4.3	0.453	0.852	0.124	0.083	0.021	0.014	
7	50.00	6.7	1.4	4.1	0.442	0.902	0.082	0.045	0.014	0.008	
8	70.00	8.0	1.9	3.6	0.434	0.947	0.051	0.024	0.009	0.004	
9	80.00	8.3	1.9	6.5	0.456	0.951	0.051	0.035	0.009	0.006	
10	90.00	8.6	2.0	13.1	0.441	0.946	0.058	0.054	0.010	0.009	
11	95.00	9.0	2.4	7.8	0.474	0.936	0.083	0.082	0.015	0.015	



TABLE VIII. - Continued.

(c) Reading 867

RP	RADII		ABS BETAM		REL BETAM		TOTAL TEMP		TOTAL PRESS	
	IN	OUT	IN	OUT	IN	OUT	IN	RATIO	IN	RATIO
1	24.795	24.656	-0.4	60.9	66.6	74.1	289.9	1.200	9.92	1.484
2	24.216	24.092	0.1	45.2	65.0	64.2	289.6	1.183	10.08	1.550
3	23.040	22.962	0.8	40.1	63.0	59.4	289.4	1.166	10.09	1.550
4	21.841	21.831	0.5	39.8	61.7	56.7	289.0	1.161	10.09	1.561
5	20.866	20.927	0.7	42.4	60.4	53.5	288.8	1.168	10.10	1.586
6	19.878	20.023	0.6	41.6	59.4	52.8	288.7	1.154	10.10	1.522
7	19.378	19.571	0.6	39.7	58.9	50.6	288.7	1.148	10.10	1.544
8	16.812	17.310	-0.4	37.8	56.4	38.6	288.4	1.145	10.07	1.568
9	15.471	16.180	-0.0	40.4	54.6	32.8	288.4	1.144	10.05	1.565
10	14.079	15.049	0.5	40.9	52.9	29.3	288.5	1.132	10.02	1.509
11	13.360	14.483	0.3	45.1	52.6	19.9	288.8	1.149	9.94	1.569

RP	ABS VEL		REL VEL		MERID VEL		TANG VEL		WHEEL SPEED	
	IN	OUT	IN	OUT	IN	OUT	IN	OUT	IN	OUT
1	180.7	160.0	454.8	284.9	180.7	77.9	-1.3	139.7	416.1	413.7
2	189.8	186.6	448.4	302.0	189.8	131.4	0.3	132.5	406.5	404.4
3	195.9	198.7	430.8	298.7	195.9	152.1	2.6	127.9	386.3	385.0
4	196.3	202.3	413.7	282.9	196.3	155.5	1.7	129.3	365.8	365.7
5	196.7	209.3	398.6	260.1	196.6	154.6	2.5	141.1	349.2	350.2
6	195.8	203.9	385.1	252.1	195.8	152.4	2.2	135.4	333.8	336.2
7	195.0	208.0	377.0	252.2	195.0	160.1	1.9	132.9	324.5	327.7
8	188.5	233.9	340.6	236.3	188.5	184.7	-1.4	143.4	282.3	290.7
9	184.1	237.5	317.5	215.3	184.1	181.0	-0.1	153.8	258.6	270.5
10	177.1	233.8	293.9	202.6	177.1	176.6	1.7	153.2	236.2	252.4
11	170.3	251.9	280.7	188.9	170.3	177.7	0.8	178.5	223.9	242.8

RP	ABS MACH NO		REL MACH NO		MERID MACH NO		MERID PEAK SS	
	IN	OUT	IN	OUT	IN	OUT	VEL R	MACH NO
1	0.545	0.436	1.371	0.776	0.545	0.212	0.431	1.551
2	0.575	0.516	1.357	0.835	0.575	0.364	0.692	1.519
3	0.594	0.556	1.307	0.836	0.594	0.426	0.776	1.479
4	0.596	0.568	1.256	0.795	0.596	0.437	0.792	1.466
5	0.597	0.588	1.211	0.731	0.597	0.434	0.786	1.449
6	0.595	0.575	1.170	0.712	0.595	0.430	0.779	1.446
7	0.592	0.590	1.145	0.715	0.592	0.454	0.821	1.440
8	0.572	0.670	1.033	0.677	0.572	0.530	0.980	1.457
9	0.557	0.682	0.961	0.618	0.557	0.520	0.983	1.417
10	0.535	0.674	0.887	0.584	0.535	0.509	0.997	1.342
11	0.513	0.725	0.845	0.544	0.513	0.512	1.043	1.308

RP	PERCENT	INCIDENCE		DEV	D-FACT	EFF	LOSS COEFF		LOSS PARAM	
	SPAN	MEAN	SS				TOT	PROF	TOT	PROF
1	5.00	5.0	2.1	16.2	0.482	0.597	0.318	0.231	0.031	0.022
2	10.00	4.3	1.1	7.2	0.427	0.727	0.209	0.131	0.031	0.020
3	20.00	4.3	0.6	4.2	0.401	0.805	0.145	0.083	0.024	0.014
4	30.00	5.0	0.7	3.7	0.412	0.844	0.119	0.066	0.020	0.011
5	38.00	5.3	0.6	2.8	0.451	0.840	0.132	0.088	0.023	0.015
6	46.00	5.8	0.7	4.7	0.444	0.827	0.139	0.100	0.024	0.017
7	50.00	6.0	0.7	4.1	0.428	0.892	0.087	0.052	0.015	0.009
8	70.00	7.4	1.3	3.0	0.410	0.947	0.049	0.024	0.009	0.004
9	80.00	7.6	1.2	5.2	0.431	0.948	0.052	0.038	0.010	0.007
10	90.00	8.2	1.6	11.8	0.418	0.945	0.058	0.054	0.010	0.009
11	95.00	9.0	2.4	8.2	0.452	0.924	0.096	0.095	0.017	0.017

TABLE VIII. - Continued.

(d) Reading 884

RP	RADII		ABS BETAM		REL BETAM		TOTAL TEMP		TOTAL PRESS	
	IN	OUT	IN	OUT	IN	OUT	IN	RATIO	IN	RATIO
1	24.795	24.656	-0.5	59.6	65.9	75.4	289.9	1.184	9.92	1.415
2	24.216	24.092	-0.0	41.1	64.4	63.5	289.7	1.172	10.07	1.516
3	23.040	22.962	0.6	35.5	62.4	58.9	289.4	1.152	10.10	1.510
4	21.841	21.831	0.4	36.6	61.1	56.2	289.0	1.153	10.10	1.528
5	20.866	20.927	0.6	40.4	59.9	53.6	288.9	1.162	10.10	1.547
6	19.878	20.023	0.7	40.2	58.8	53.7	288.8	1.147	10.10	1.457
7	19.378	19.571	0.7	38.4	58.2	51.1	288.7	1.144	10.09	1.491
8	16.812	17.310	-0.1	35.5	55.6	38.9	288.4	1.138	10.06	1.536
9	15.471	16.180	0.1	37.2	54.0	33.8	288.3	1.136	10.04	1.531
10	14.079	15.049	0.3	39.3	52.3	27.6	288.4	1.134	9.99	1.532
11	13.360	14.483	0.6	43.9	51.6	20.2	288.7	1.147	9.95	1.552

RP	ABS VEL		REL VEL		MERID VEL		TANG VEL		WHEEL SPEED	
	IN	OUT	IN	OUT	IN	OUT	IN	OUT	IN	OUT
1	186.8	148.1	458.3	296.3	186.8	74.8	-1.7	127.8	416.8	414.5
2	195.9	187.2	452.8	316.1	195.9	141.0	-0.1	123.1	408.2	406.1
3	202.3	200.6	436.0	315.9	202.3	163.3	2.0	116.5	388.2	386.9
4	202.7	204.9	419.3	296.2	202.7	164.6	1.5	122.1	368.5	368.4
5	202.7	209.8	403.9	269.4	202.7	159.8	2.3	135.9	351.7	352.7
6	201.7	200.2	388.9	258.4	201.7	152.9	2.6	129.2	335.0	337.5
7	200.9	207.1	381.5	258.5	200.9	162.2	2.4	128.7	326.7	330.0
8	194.1	235.7	343.8	246.6	194.1	191.9	-0.3	136.8	283.4	291.8
9	189.1	239.8	322.0	229.9	189.1	191.0	0.3	144.9	261.0	272.9
10	182.1	244.1	298.1	213.3	182.1	188.9	1.0	154.5	237.1	253.4
11	177.2	254.9	285.2	195.8	177.2	183.8	1.8	176.6	225.3	244.2

RP	ABS MACH NO		REL MACH NO		MERID MACH NO		MERID PEAK SS	
	IN	OUT	IN	OUT	IN	OUT	VEL R	MACH NO
1	0.564	0.405	1.385	0.811	0.564	0.205	0.401	1.542
2	0.594	0.520	1.373	0.879	0.594	0.392	0.720	1.515
3	0.615	0.565	1.326	0.890	0.615	0.460	0.807	1.477
4	0.617	0.579	1.276	0.837	0.617	0.465	0.812	1.465
5	0.617	0.591	1.230	0.759	0.617	0.450	0.789	1.446
6	0.614	0.566	1.184	0.731	0.614	0.432	0.758	1.434
7	0.611	0.588	1.161	0.734	0.611	0.461	0.808	1.432
8	0.590	0.678	1.044	0.710	0.590	0.552	0.988	1.435
9	0.574	0.692	0.977	0.663	0.574	0.551	1.010	1.422
10	0.551	0.706	0.902	0.617	0.551	0.547	1.037	1.345
11	0.535	0.736	0.861	0.565	0.535	0.530	1.037	1.301

RP	PERCENT	INCIDENCE		DEV	D-FACT	EFF	LOSS COEFF		LOSS PARAM	
	SPAN	MEAN	SS				TOT	PROF	TOT	PROF
1	5.00	4.3	1.4	17.4	0.452	0.565	0.318	0.231	0.028	0.020
2	10.00	3.8	0.6	6.5	0.395	0.734	0.192	0.112	0.029	0.017
3	20.00	3.7	-0.0	3.7	0.361	0.820	0.124	0.059	0.021	0.010
4	30.00	4.4	0.2	3.3	0.383	0.843	0.113	0.058	0.020	0.010
5	38.00	4.7	0.1	2.9	0.431	0.818	0.143	0.097	0.025	0.017
6	46.00	5.1	0.1	5.7	0.428	0.770	0.173	0.135	0.029	0.023
7	50.00	5.4	0.1	4.7	0.414	0.841	0.122	0.087	0.021	0.015
8	70.00	6.7	0.6	3.4	0.380	0.945	0.048	0.024	0.009	0.005
9	80.00	7.1	0.7	6.2	0.388	0.951	0.047	0.031	0.009	0.006
10	90.00	7.6	1.0	10.1	0.391	0.965	0.037	0.033	0.007	0.006
11	95.00	8.0	1.3	8.6	0.435	0.909	0.111	0.109	0.020	0.019

TABLE VIII. - Concluded.

(e) Reading 895

RP	RADII		ABS BETAM		REL BETAM		TOTAL TEMP		TOTAL PRESS	
	IN	OUT	IN	OUT	IN	OUT	IN	RATIO	IN	RATIO
1	24.795	24.656	-0.5	44.4	65.5	69.2	289.9	1.163	9.92	1.364
2	24.216	24.092	-0.2	33.6	63.9	63.7	289.7	1.142	10.08	1.414
3	23.040	22.962	0.3	30.7	61.9	59.9	289.3	1.131	10.09	1.433
4	21.841	21.831	0.3	31.7	60.5	57.1	289.0	1.132	10.10	1.438
5	20.866	20.927	0.5	36.0	59.3	55.5	288.9	1.141	10.10	1.458
6	19.878	20.023	0.6	36.8	58.2	57.0	288.8	1.126	10.09	1.334
7	19.378	19.571	0.7	35.8	57.6	54.0	288.8	1.126	10.09	1.376
8	16.812	17.310	-0.3	33.7	55.1	38.7	288.5	1.135	10.06	1.488
9	15.471	16.180	0.5	34.4	53.3	35.4	288.4	1.130	10.03	1.503
10	14.079	15.049	0.6	37.3	51.9	25.9	288.5	1.134	9.97	1.535
11	13.360	14.483	0.5	40.7	51.3	20.6	288.8	1.142	9.91	1.532

RP	ABS VEL		REL VEL		MERID VEL		TANG VEL		WHEEL SPEED	
	IN	OUT	IN	OUT	IN	OUT	IN	OUT	IN	OUT
1	191.6	161.2	461.8	324.7	191.6	115.2	-1.6	112.7	418.6	416.2
2	200.6	181.7	456.2	341.5	200.6	151.3	-0.8	100.7	408.9	406.8
3	206.9	194.4	439.5	333.0	206.9	167.1	1.0	99.3	388.7	387.4
4	207.5	199.9	421.7	313.1	207.5	170.0	1.2	105.1	368.3	368.1
5	207.4	200.0	406.8	285.5	207.4	161.7	1.9	117.7	351.9	352.9
6	206.2	184.2	391.9	271.1	206.2	147.5	2.2	110.3	335.4	337.8
7	205.5	194.2	383.8	267.7	205.5	157.4	2.6	113.6	326.8	330.1
8	198.6	239.3	347.3	255.2	198.6	199.1	-1.0	132.8	284.0	292.4
9	193.2	246.2	323.5	243.4	193.2	203.2	1.5	139.0	261.0	272.9
10	185.2	256.1	299.8	226.4	185.1	203.6	2.0	155.3	237.8	254.2
11	179.3	261.0	286.9	211.4	179.3	198.0	1.5	170.1	225.4	244.4

RP	ABS MACH NO		REL MACH NO		MERID MACH NO		MERID PEAK SS	
	IN	OUT	IN	OUT	IN	OUT	VEL R	MACH NO
1	0.580	0.447	1.398	0.900	0.580	0.319	0.601	1.539
2	0.609	0.511	1.386	0.961	0.609	0.426	0.754	1.512
3	0.630	0.552	1.339	0.946	0.630	0.475	0.807	1.475
4	0.633	0.569	1.286	0.891	0.633	0.184	0.819	1.454
5	0.633	0.567	1.241	0.809	0.633	0.459	0.780	1.437
6	0.629	0.523	1.195	0.770	0.629	0.419	0.715	1.426
7	0.626	0.553	1.170	0.763	0.626	0.449	0.766	1.418
8	0.604	0.690	1.056	0.736	0.604	0.574	1.003	1.424
9	0.587	0.714	0.982	0.706	0.587	0.590	1.052	1.406
10	0.561	0.744	0.908	0.658	0.561	0.592	1.100	1.339
11	0.542	0.757	0.866	0.613	0.542	0.574	1.104	1.302

RP	PERCENT SPAN		INCIDENCE MEAN SS		DEV	D-FACT	EFF	LOSS COEFF		LOSS PARAM	
	SPAN	MEAN	SS	TOT				PROF	TOT	PROF	
1	5.00	3.9	1.0	11.3	0.384	0.569	0.284	0.196	0.035	0.024	
2	10.00	3.3	0.1	6.7	0.328	0.734	0.162	0.081	0.025	0.012	
3	20.00	3.3	-0.4	4.7	0.315	0.826	0.104	0.038	0.017	0.006	
4	30.00	3.8	-0.4	4.1	0.334	0.829	0.108	0.053	0.018	0.009	
5	38.00	4.2	-0.5	4.7	0.383	0.808	0.133	0.087	0.022	0.015	
6	46.00	4.6	-0.5	9.0	0.387	0.682	0.206	0.167	0.032	0.026	
7	50.00	4.8	-0.5	7.5	0.383	0.755	0.165	0.130	0.027	0.021	
8	70.00	6.2	0.1	3.1	0.359	0.893	0.089	0.066	0.017	0.012	
9	80.00	6.4	0.0	5.8	0.344	0.953	0.042	0.028	0.008	0.005	
10	90.00	7.1	0.5	8.4	0.351	0.969	0.033	0.028	0.006	0.005	
11	95.00	7.7	1.0	8.9	0.379	0.912	0.103	0.101	0.018	0.018	

TABLE IX. - BLADE-ELEMENT DATA AT BLADE EDGES FOR STATOR 1

(a) Reading 845

RP	RADII		ABS BETAM		REL BETAM		TOTAL TEMP		TOTAL PRESS	
	IN	OUT	IN	OUT	IN	OUT	IN	RATIO	IN	RATIO
1	24.447	24.359	59.3	1.8	59.3	1.8	354.2	0.989	15.47	1.019
2	23.937	23.896	48.1	2.9	48.1	2.9	349.3	0.996	16.01	1.000
3	22.913	22.969	41.2	1.7	41.2	1.7	342.2	0.997	16.18	0.991
4	21.887	22.037	38.9	-0.5	38.9	-0.5	338.1	0.998	16.25	0.986
5	21.064	21.290	40.3	1.1	40.3	1.1	338.9	0.992	16.51	0.964
6	20.239	20.544	40.0	-0.7	40.0	-0.7	335.5	0.997	16.00	0.965
7	19.827	20.173	38.8	-0.8	38.8	-0.8	333.8	0.998	16.05	0.959
8	17.767	18.326	38.4	0.8	38.4	0.8	331.9	0.994	16.11	0.965
9	16.739	17.412	40.5	-0.9	40.5	-0.9	329.8	0.997	15.76	0.976
10	15.715	16.500	40.5	-2.2	40.5	-2.2	326.5	1.011	15.20	1.014
11	15.207	16.040	44.7	-1.2	44.7	-1.2	332.9	0.996	16.06	0.942

RP	ABS VEL		REL VEL		MERID VEL		TANG VEL		WHEEL SPEED	
	IN	OUT	IN	OUT	IN	OUT	IN	OUT	IN	OUT
1	182.2	171.1	182.2	171.1	93.1	171.0	156.6	5.2	0.	0.
2	201.9	176.6	201.9	176.6	134.9	176.4	150.3	8.9	0.	0.
3	214.3	180.4	214.3	180.4	161.1	180.3	141.3	5.4	0.	0.
4	218.6	179.3	218.6	179.3	170.2	179.3	137.1	-1.6	0.	0.
5	224.6	173.6	224.6	173.6	171.3	173.6	145.2	3.5	0.	0.
6	219.4	163.9	219.4	163.9	168.1	163.9	140.9	-2.1	0.	0.
7	220.9	160.7	220.9	160.7	172.1	160.7	138.5	-2.1	0.	0.
8	235.5	154.8	235.5	154.8	184.6	154.8	146.2	2.1	0.	0.
9	230.4	153.4	230.4	153.4	175.3	153.4	149.5	-2.5	0.	0.
10	226.7	146.3	226.7	146.3	172.3	146.2	147.4	-5.5	0.	0.
11	251.3	136.7	251.3	136.7	178.6	136.6	176.8	-2.9	0.	0.

RP	ABS MACH NO		REL MACH NO		MERID MACH NO		MERID PEAK SS	
	IN	OUT	IN	OUT	IN	OUT	VEL R	MACH NO
1	0.495	0.466	0.495	0.466	0.253	0.466	1.837	1.149
2	0.555	0.483	0.555	0.483	0.371	0.483	1.308	1.054
3	0.598	0.499	0.598	0.499	0.450	0.499	1.119	0.993
4	0.615	0.499	0.615	0.499	0.479	0.499	1.054	0.959
5	0.633	0.483	0.633	0.483	0.482	0.483	1.014	1.006
6	0.620	0.456	0.620	0.456	0.475	0.456	0.975	0.966
7	0.627	0.448	0.627	0.448	0.488	0.448	0.934	0.944
8	0.674	0.433	0.674	0.433	0.528	0.433	0.838	0.954
9	0.660	0.430	0.660	0.430	0.502	0.430	0.875	0.950
10	0.652	0.408	0.652	0.408	0.496	0.408	0.849	0.905
11	0.722	0.380	0.722	0.380	0.513	0.380	0.765	1.084

RP	PERCENT		INCIDENCE		DEV	D-FACT	EFF	LOSS COEFF		LOSS PARAM	
	SPAN	MEAN	SS	TOT				PROF	TOT	PROF	
1	5.00	24.0	17.2	10.2	0.334	0.	-0.126	-0.126	-0.041	-0.041	
2	10.00	13.1	6.6	11.2	0.351	0.	0.000	0.000	0.000	0.000	
3	20.00	7.0	0.8	9.6	0.354	0.	0.040	0.040	0.012	0.012	
4	30.00	4.8	-1.0	7.1	0.366	0.	0.060	0.060	0.018	0.018	
5	38.00	5.7	0.2	8.7	0.405	0.	0.154	0.154	0.044	0.044	
6	46.00	4.6	-0.5	6.9	0.430	0.	0.151	0.151	0.041	0.041	
7	50.00	3.0	-1.9	6.9	0.442	0.	0.176	0.176	0.047	0.047	
8	70.00	-0.1	-4.3	8.5	0.487	0.	0.135	0.135	0.032	0.032	
9	80.00	0.2	-3.7	6.9	0.481	0.	0.094	0.094	0.021	0.021	
10	90.00	-1.8	-5.4	5.9	0.494	0.	-0.055	-0.055	-0.012	-0.012	
11	95.00	1.4	-2.0	6.9	0.599	0.	0.196	0.196	0.040	0.040	

TABLE IX. - Continued.

(b) Reading 856

RP	RADI		ABS BETAM		REL BETAM		TOTAL TEMP		TOTAL PRESS	
	IN	OUT	IN	OUT	IN	OUT	IN	RATIO	IN	RATIO
1	24.447	24.359	58.9	2.4	58.9	2.4	351.9	0.993	15.23	1.017
2	23.937	23.896	45.8	3.0	45.8	3.0	347.5	0.995	15.96	0.995
3	22.913	22.969	39.9	-0.1	39.9	-0.1	340.9	0.994	16.03	0.997
4	21.887	22.037	38.2	-0.5	38.2	-0.5	337.4	0.997	16.06	0.991
5	21.064	21.290	39.9	1.1	39.9	1.1	338.6	0.991	16.40	0.964
6	20.239	20.544	39.3	-1.9	39.3	-1.9	334.9	0.995	15.80	0.966
7	19.827	20.173	37.9	-1.5	37.9	-1.5	333.1	0.997	15.93	0.962
8	17.767	18.326	36.1	0.5	36.1	0.5	331.3	0.994	16.00	0.965
9	16.739	17.412	38.5	-1.0	38.5	-1.0	330.5	0.994	15.89	0.966
10	15.715	16.500	38.6	-2.7	38.6	-2.7	326.6	1.010	15.17	1.009
11	15.207	16.040	42.7	-1.4	42.7	-1.4	332.5	0.997	15.88	0.949

RP	ABS VEL		REL VEL		MERID VEL		TANG VEL		WHEEL SPEED	
	IN	OUT	IN	OUT	IN	OUT	IN	OUT	IN	OUT
1	175.3	165.4	175.3	165.4	90.5	165.3	150.2	6.9	0.	0.
2	201.8	176.6	201.8	176.6	140.8	176.4	144.6	9.2	0.	0.
3	214.1	183.1	214.1	183.1	164.4	183.1	137.2	-0.4	0.	0.
4	217.1	181.5	217.1	181.5	170.6	181.5	134.3	-1.7	0.	0.
5	224.0	174.8	224.0	174.8	171.9	174.7	143.6	3.3	0.	0.
6	218.4	165.5	218.4	165.5	169.0	165.4	138.3	-5.5	0.	0.
7	221.4	165.5	221.4	165.5	174.7	165.4	136.1	-4.4	0.	0.
8	243.0	167.6	243.0	167.6	196.3	167.6	143.2	1.5	0.	0.
9	242.1	166.3	242.1	166.3	189.6	166.2	150.6	-3.0	0.	0.
10	235.8	160.2	235.8	160.2	184.1	160.0	147.2	-7.6	0.	0.
11	256.3	152.2	256.3	152.2	188.3	152.1	173.9	-3.6	0.	0.

RP	ABS MACH NO		REL MACH NO		MERID MACH NO		MERID PEAK SS	
	IN	OUT	IN	OUT	IN	OUT	VEL R	MACH NO
1	0.477	0.451	0.477	0.451	0.246	0.450	1.827	1.100
2	0.557	0.485	0.557	0.485	0.388	0.484	1.253	1.012
3	0.599	0.509	0.599	0.509	0.460	0.509	1.114	0.962
4	0.611	0.506	0.611	0.506	0.480	0.506	1.064	0.940
5	0.631	0.487	0.631	0.487	0.484	0.487	1.017	0.995
6	0.618	0.462	0.618	0.462	0.478	0.462	0.978	0.948
7	0.629	0.463	0.629	0.463	0.496	0.463	0.947	0.928
8	0.698	0.471	0.698	0.471	0.564	0.471	0.854	0.933
9	0.696	0.468	0.696	0.468	0.545	0.468	0.877	0.954
10	0.680	0.449	0.680	0.449	0.531	0.448	0.869	0.899
11	0.739	0.425	0.739	0.425	0.542	0.424	0.808	1.060

RP	PERCENT		INCIDENCE		DEV	D-FACT	EFF	LOSS COEFF		LOSS PARAM	
	SPAN	MEAN	SS	SS				TOT	PROF	TOT	PROF
1	5.00	23.6	16.9	10.8	0.325	0.	-0.118	-0.118	-0.039	-0.039	
2	10.00	10.8	4.3	11.3	0.341	0.	0.027	0.027	0.009	0.009	
3	20.00	5.6	-0.6	7.7	0.343	0.	0.014	0.014	0.004	0.004	
4	30.00	4.1	-1.7	7.1	0.348	0.	0.039	0.039	0.012	0.012	
5	38.00	5.3	-0.2	8.7	0.397	0.	0.152	0.152	0.043	0.043	
6	46.00	4.0	-1.2	5.7	0.421	0.	0.148	0.148	0.040	0.040	
7	50.00	2.1	-2.9	6.1	0.421	0.	0.162	0.162	0.043	0.043	
8	70.00	-2.4	-6.6	8.2	0.448	0.	0.124	0.124	0.030	0.030	
9	80.00	-1.8	-5.7	6.8	0.454	0.	0.124	0.124	0.028	0.028	
10	90.00	-3.7	-7.3	5.3	0.457	0.	-0.034	-0.034	-0.007	-0.007	
11	95.00	-0.6	-4.0	6.8	0.545	0.	0.167	0.167	0.034	0.034	

TABLE IX. - Continued.

(c) Reading 867

RP	RADII		ABS BETAM		REL BETAM		TOTAL TEMP		TOTAL PRESS	
	IN	OUT	IN	OUT	IN	OUT	IN	RATIO	IN	RATIO
1	24.447	24.359	58.2	2.4	58.2	2.4	347.9	0.994	14.72	1.021
2	23.937	23.896	41.9	1.8	41.9	1.8	342.7	0.996	15.62	0.990
3	22.913	22.969	36.7	-1.0	36.7	-1.0	337.4	0.995	15.63	1.000
4	21.887	22.037	36.4	-0.8	36.4	-0.8	335.5	0.997	15.76	0.990
5	21.064	21.290	39.1	0.9	39.1	0.9	337.2	0.989	16.01	0.965
6	20.239	20.544	38.3	-2.3	38.3	-2.3	333.2	0.993	15.37	0.969
7	19.827	20.173	36.4	-2.0	36.4	-2.0	331.5	0.995	15.59	0.961
8	17.767	18.326	34.1	-1.0	34.1	-1.0	330.2	0.992	15.80	0.964
9	16.739	17.412	36.5	-1.3	36.5	-1.3	329.9	0.991	15.74	0.966
10	15.715	16.500	37.0	-3.7	37.0	-3.7	326.6	1.005	15.12	1.000
11	15.207	16.040	41.1	-1.9	41.1	-1.9	331.8	0.995	15.60	0.962

RP	ABS VEL		REL VEL		MERID VEL		TANG VEL		WHEEL SPEED	
	IN	OUT	IN	OUT	IN	OUT	IN	OUT	IN	OUT
1	165.7	166.7	165.7	166.7	87.2	166.6	140.9	7.0	0.	0.
2	199.5	179.5	199.5	179.5	148.4	179.4	133.3	5.6	0.	0.
3	214.3	186.9	214.3	186.9	171.8	186.8	128.1	-3.2	0.	0.
4	217.2	186.7	217.2	186.7	174.7	186.6	129.0	-2.6	0.	0.
5	222.4	179.2	222.4	179.2	172.7	179.2	140.2	2.9	0.	0.
6	216.0	169.8	216.0	169.8	169.5	169.7	134.0	-6.8	0.	0.
7	221.3	170.2	221.3	170.2	178.2	170.1	131.2	-5.8	0.	0.
8	249.0	179.1	249.0	179.1	206.2	179.0	139.7	-3.0	0.	0.
9	249.6	177.3	249.6	177.3	200.6	177.2	148.6	-4.0	0.	0.
10	244.0	173.4	244.0	173.4	194.9	173.1	146.7	-11.1	0.	0.
11	258.8	168.9	258.8	168.9	195.0	168.8	170.0	-5.6	0.	0.

RP	ABS MACH NO		REL MACH NO		MERID MACH NO		MERID PEAK SS	
	IN	OUT	IN	OUT	IN	OUT	VEL R	PEAK SS
1	0.452	0.457	0.452	0.457	0.238	0.456	1.910	1.032
2	0.554	0.496	0.554	0.496	0.412	0.496	1.208	0.934
3	0.603	0.523	0.603	0.523	0.483	0.522	1.088	0.905
4	0.613	0.523	0.613	0.523	0.493	0.523	1.068	0.906
5	0.628	0.502	0.628	0.502	0.488	0.502	1.037	0.972
6	0.612	0.476	0.612	0.476	0.480	0.476	1.002	0.920
7	0.630	0.478	0.630	0.478	0.507	0.478	0.955	0.896
8	0.718	0.506	0.718	0.506	0.595	0.506	0.868	0.908
9	0.720	0.501	0.720	0.501	0.579	0.501	0.884	0.938
10	0.706	0.489	0.706	0.489	0.564	0.488	0.888	0.888
11	0.747	0.474	0.747	0.474	0.563	0.474	0.865	1.029

RP	PERCENT SPAN	INCIDENCE		DEV	D-FACT	EFF	LOSS COEFF		LOSS PARAM	
		MEAN	SS				TOT	PROF	TOT	PROF
1	5.00	22.9	16.2	10.9	0.260	0.	-0.161	-0.161	-0.053	-0.053
2	10.00	7.0	0.4	10.1	0.307	0.	0.051	0.051	0.016	0.016
3	20.00	2.5	-3.7	6.9	0.317	0.	0.001	0.001	0.000	0.000
4	30.00	2.3	-3.4	6.8	0.319	0.	0.046	0.046	0.014	0.014
5	38.00	4.4	-1.0	8.5	0.369	0.	0.149	0.149	0.042	0.042
6	46.00	3.0	-2.1	5.3	0.391	0.	0.141	0.141	0.038	0.038
7	50.00	0.6	-4.4	5.6	0.395	0.	0.168	0.168	0.045	0.045
8	70.00	-4.4	-8.6	6.8	0.416	0.	0.124	0.124	0.030	0.030
9	80.00	-3.8	-7.6	6.6	0.425	0.	0.117	0.117	0.027	0.027
10	90.00	-5.4	-9.0	4.4	0.423	0.	-0.001	-0.001	-0.000	-0.000
11	95.00	-2.2	-5.7	6.2	0.483	0.	0.123	0.123	0.025	0.025

TABLE IX. - Continued.

(d) Reading 884

RP	RADII		ABS BETAM		REL BETAM		TOTAL TEMP		TOTAL PRESS	
	IN	OUT	IN	OUT	IN	OUT	IN	RATIO	IN	RATIO
1	24.447	24.359	57.0	1.8	57.0	1.8	343.4	0.992	14.03	1.024
2	23.937	23.896	37.8	0.6	37.8	0.6	339.4	0.993	15.27	0.977
3	22.913	22.969	32.2	-2.2	32.2	-2.2	333.5	0.996	15.24	0.988
4	21.887	22.037	33.2	-1.1	33.2	-1.1	333.1	0.997	15.43	0.983
5	21.064	21.290	37.0	0.4	37.0	0.4	335.7	0.987	15.62	0.960
6	20.239	20.544	36.9	-2.9	36.9	-2.9	331.3	0.991	14.71	0.975
7	19.827	20.173	35.1	-2.8	35.1	-2.8	330.2	0.992	15.04	0.959
8	17.767	18.326	31.8	-2.0	31.8	-2.0	328.2	0.992	15.46	0.973
9	16.739	17.412	33.3	-2.0	33.3	-2.0	327.6	0.993	15.37	0.975
10	15.715	16.500	35.2	-3.3	35.2	-3.3	327.1	0.996	15.31	0.977
11	15.207	16.040	39.7	-1.6	39.7	-1.6	331.2	0.992	15.43	0.971

RP	ABS VEL		REL VEL		MERID VEL		TANG VEL		WHEEL SPEED	
	IN	OUT	IN	OUT	IN	OUT	IN	OUT	IN	OUT
1	153.7	169.5	153.7	169.5	83.8	169.5	128.9	5.3	0.	0.
2	202.2	186.4	202.2	186.4	159.8	186.4	123.9	2.1	0.	0.
3	219.2	195.8	219.2	195.8	185.6	195.7	116.7	-7.4	0.	0.
4	222.2	196.9	222.2	196.9	185.8	196.9	121.8	-3.9	0.	0.
5	224.2	189.9	224.2	189.9	179.0	189.9	135.0	1.5	0.	0.
6	212.7	179.0	212.7	179.0	170.0	178.8	127.8	-9.1	0.	0.
7	221.0	179.8	221.0	179.8	180.8	179.6	127.0	-8.8	0.	0.
8	253.2	191.6	253.2	191.6	215.3	191.5	133.3	-6.5	0.	0.
9	255.1	188.8	255.1	188.8	213.2	188.7	140.1	-6.5	0.	0.
10	256.8	187.6	256.8	187.6	209.9	187.3	148.0	-10.6	0.	0.
11	263.2	188.0	263.2	188.0	202.4	187.9	168.2	-5.2	0.	0.

RP	ABS MACH NO		REL MACH NO		MERID MACH NO		MERID PEAK SS VEL R MACH NO	
	IN	OUT	IN	OUT	IN	OUT		
1	0.421	0.468	0.421	0.468	0.229	0.468	2.023	0.940
2	0.565	0.520	0.565	0.520	0.446	0.520	1.167	0.873
3	0.622	0.552	0.622	0.552	0.526	0.552	1.054	0.835
4	0.631	0.556	0.631	0.556	0.528	0.555	1.059	0.862
5	0.635	0.535	0.635	0.535	0.507	0.535	1.061	0.939
6	0.604	0.505	0.604	0.505	0.483	0.505	1.051	0.878
7	0.630	0.508	0.630	0.508	0.516	0.508	0.993	0.869
8	0.734	0.545	0.734	0.545	0.624	0.545	0.889	0.859
9	0.741	0.537	0.741	0.537	0.619	0.537	0.885	0.871
10	0.747	0.533	0.747	0.533	0.610	0.532	0.892	0.887
11	0.762	0.532	0.762	0.532	0.586	0.532	0.928	1.013

RP	PERCENT SPAN	INCIDENCE		DEV	D-FACT	EFF	LOSS COEFF		LOSS PARAM	
		MEAN	SS				TOT	PROF	TOT	PROF
1	5.00	21.7	14.9	10.2	0.161	0.	-0.208	-0.208	-0.068	-0.068
2	10.00	2.8	-3.7	8.9	0.272	0.	0.119	0.119	0.038	0.038
3	20.00	-2.1	-8.3	5.7	0.282	0.	0.053	0.053	0.016	0.016
4	30.00	-0.9	-6.7	6.5	0.280	0.	0.073	0.073	0.022	0.022
5	38.00	2.4	-3.0	8.0	0.322	0.	0.168	0.168	0.048	0.048
6	46.00	1.6	-3.6	4.7	0.333	0.	0.115	0.115	0.031	0.031
7	50.00	-0.7	-5.7	4.8	0.350	0.	0.176	0.176	0.047	0.047
8	70.00	-6.7	-11.0	5.8	0.374	0.	0.091	0.091	0.022	0.022
9	80.00	-7.0	-10.9	5.9	0.387	0.	0.083	0.083	0.019	0.019
10	90.00	-7.2	-10.7	4.8	0.398	0.	0.073	0.073	0.015	0.015
11	95.00	-3.6	-7.0	6.5	0.418	0.	0.090	0.090	0.018	0.018

TABLE IX. - Concluded.

(e) Reading 895

RP	RADI		ABS BETAM		REL BETAM		TOTAL TEMP		TOTAL PRESS	
	IN	OUT	IN	OUT	IN	OUT	IN	RATIO	IN	RATIO
1	24.447	24.359	41.1	0.0	41.1	0.0	337.2	0.987	13.53	0.983
2	23.937	23.896	30.5	-1.4	30.5	-1.4	330.8	0.996	14.25	0.980
3	22.913	22.969	27.6	-3.3	27.6	-3.3	327.3	0.996	14.46	0.968
4	21.887	22.037	28.6	-2.7	28.6	-2.7	327.1	0.997	14.53	0.965
5	21.064	21.290	32.8	-1.0	32.8	-1.0	329.6	0.989	14.72	0.951
6	20.239	20.544	33.7	-3.9	33.7	-3.9	325.2	0.993	13.47	0.986
7	19.827	20.173	32.6	-4.3	32.6	-4.3	325.3	0.990	13.88	0.959
8	17.767	18.326	29.9	-3.0	29.9	-3.0	327.4	0.986	14.97	0.957
9	16.739	17.412	30.4	-3.3	30.4	-3.3	325.8	0.990	15.08	0.958
10	15.715	16.500	33.0	-2.4	33.0	-2.4	327.2	0.988	15.30	0.955
11	15.207	16.040	36.3	0.1	36.3	0.1	329.8	0.989	15.18	0.974

RP	ABS VEL		REL VEL		MERID VEL		TANG VEL		WHEEL SPEED	
	IN	OUT	IN	OUT	IN	OUT	IN	OUT	IN	OUT
1	172.7	184.7	172.7	184.7	130.1	184.7	113.6	0.1	0.	0.
2	199.9	203.6	199.9	203.6	172.3	203.6	101.3	-5.0	0.	0.
3	214.8	211.0	214.8	211.0	190.3	210.7	99.5	-12.0	0.	0.
4	219.3	211.6	219.3	211.6	192.6	211.4	104.9	-10.1	0.	0.
5	215.9	207.2	215.9	207.2	181.4	207.2	116.9	-3.6	0.	0.
6	196.9	196.0	196.9	196.0	163.8	195.5	109.2	-13.5	0.	0.
7	208.1	195.2	208.1	195.2	175.2	194.7	112.2	-14.5	0.	0.
8	259.3	209.3	259.3	209.3	224.8	209.1	129.3	-11.0	0.	0.
9	265.7	211.5	265.7	211.5	229.3	211.1	134.3	-12.2	0.	0.
10	272.8	213.8	272.8	213.8	228.7	213.7	148.7	-8.9	0.	0.
11	273.5	217.8	273.5	217.8	220.3	217.8	162.0	0.3	0.	0.

RP	ABS MACH NO		REL MACH NO		MERID MACH NO		MERID PEAK SS	
	IN	OUT	IN	OUT	IN	OUT	VEL R	MACH NO
1	0.480	0.519	0.480	0.519	0.361	0.519	1.420	0.798
2	0.566	0.578	0.566	0.578	0.488	0.578	1.181	0.730
3	0.614	0.604	0.614	0.604	0.544	0.603	1.107	0.718
4	0.628	0.606	0.628	0.606	0.552	0.605	1.097	0.749
5	0.615	0.592	0.615	0.592	0.517	0.592	1.142	0.820
6	0.562	0.561	0.562	0.561	0.467	0.560	1.193	0.753
7	0.596	0.559	0.596	0.559	0.502	0.558	1.111	0.768
8	0.755	0.602	0.755	0.602	0.654	0.601	0.930	0.817
9	0.778	0.609	0.778	0.609	0.671	0.608	0.921	0.786
10	0.799	0.616	0.799	0.616	0.670	0.615	0.934	0.868
11	0.798	0.625	0.798	0.625	0.643	0.625	0.989	0.958

RP	PERCENT	INCIDENCE		DEV	D-FACT	EFF	LOSS COEFF		LOSS PARAM	
	SPAN	MEAN	SS				TOT	PROF	TOT	PROF
1	5.00	5.9	-0.9	8.5	0.147	0.	0.115	0.115	0.036	0.038
2	10.00	-4.5	-11.1	6.8	0.153	0.	0.105	0.105	0.034	0.034
3	20.00	-6.6	-12.8	4.6	0.178	0.	0.143	0.143	0.044	0.044
4	30.00	-5.6	-11.3	4.9	0.190	0.	0.149	0.149	0.044	0.044
5	38.00	-1.8	-7.3	6.6	0.198	0.	0.217	0.217	0.062	0.062
6	46.00	-1.7	-6.8	3.7	0.174	0.	0.071	0.071	0.019	0.019
7	50.00	-3.2	-8.2	3.3	0.224	0.	0.194	0.194	0.052	0.052
8	70.00	-8.6	-12.8	4.7	0.321	0.	0.137	0.137	0.033	0.033
9	80.00	-9.9	-13.8	4.6	0.327	0.	0.128	0.128	0.029	0.029
10	90.00	-9.3	-12.9	5.7	0.336	0.	0.132	0.132	0.028	0.028
11	95.00	-7.0	-10.4	8.2	0.321	0.	0.075	0.075	0.015	0.015



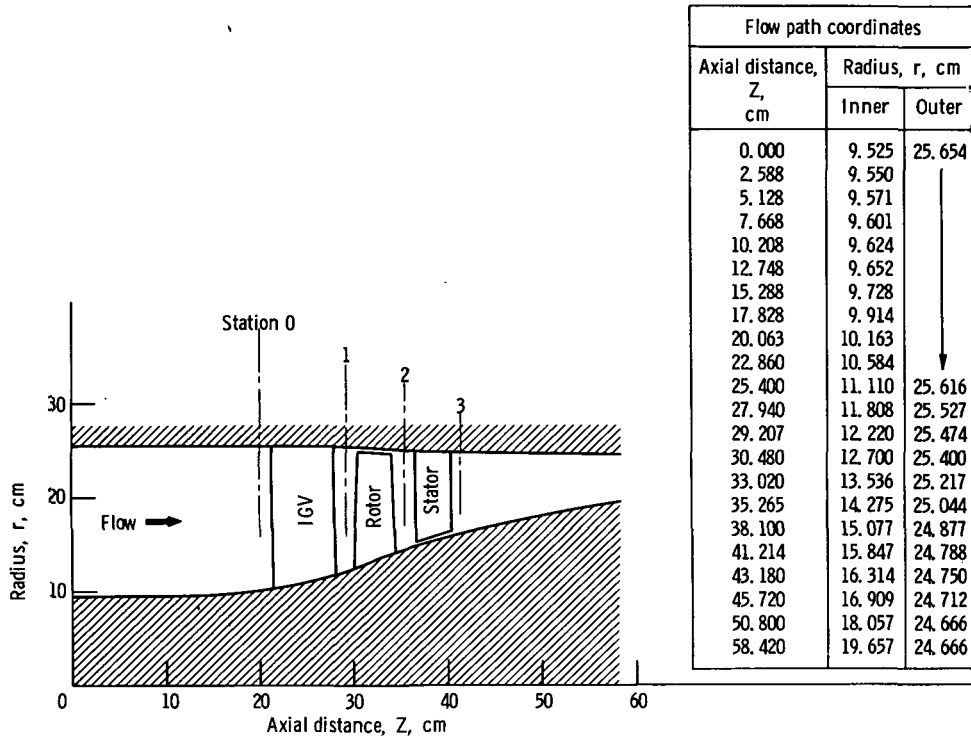
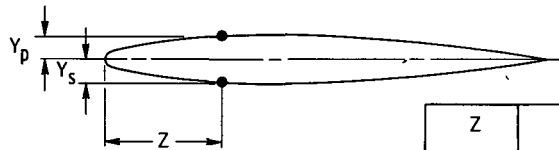

Figure 1. - Flow path for IGV and stage showing axial location of instrumentation.



Blade chord, cm . . . . . 5.95  
 Maximum thickness, cm . . . . . 0.596  
 Leading edge radius, cm . . . . . 0.0596  
 Trailing edge radius, cm . . . . . 0.2098  
 Number of blades . . . . . 26  
 Blade tip solidity . . . . . 1.0

Z	$Y_p$	$Y_s$
0.0000	-0.0597	0.0597
0.2540	-0.1092	0.1092
0.5080	-0.1532	0.1532
0.7620	-0.1910	0.1910
1.0160	-0.2230	0.2230
1.2700	-0.2494	0.2494
1.5240	-0.2703	0.2703
1.7780	-0.2852	0.2852
2.0320	-0.2946	0.2946
2.2860	-0.2984	0.2984
2.5400	-0.2974	0.2974
2.7940	-0.2939	0.2939
3.0480	-0.2875	0.2875
3.3020	-0.2784	0.2784
3.5560	-0.2667	0.2667
3.8100	-0.2520	0.2520
4.0640	-0.2347	0.2347
4.3180	-0.2146	0.2146
4.5720	-0.1918	0.1918
4.8260	-0.1661	0.1661
5.0800	-0.1377	0.1377
5.3340	-0.1064	0.1064
5.5880	-0.0724	0.0724
5.8420	-0.0356	0.0356
6.0960	0.0038	-0.0038

Figure 2. - Inlet guide vane.

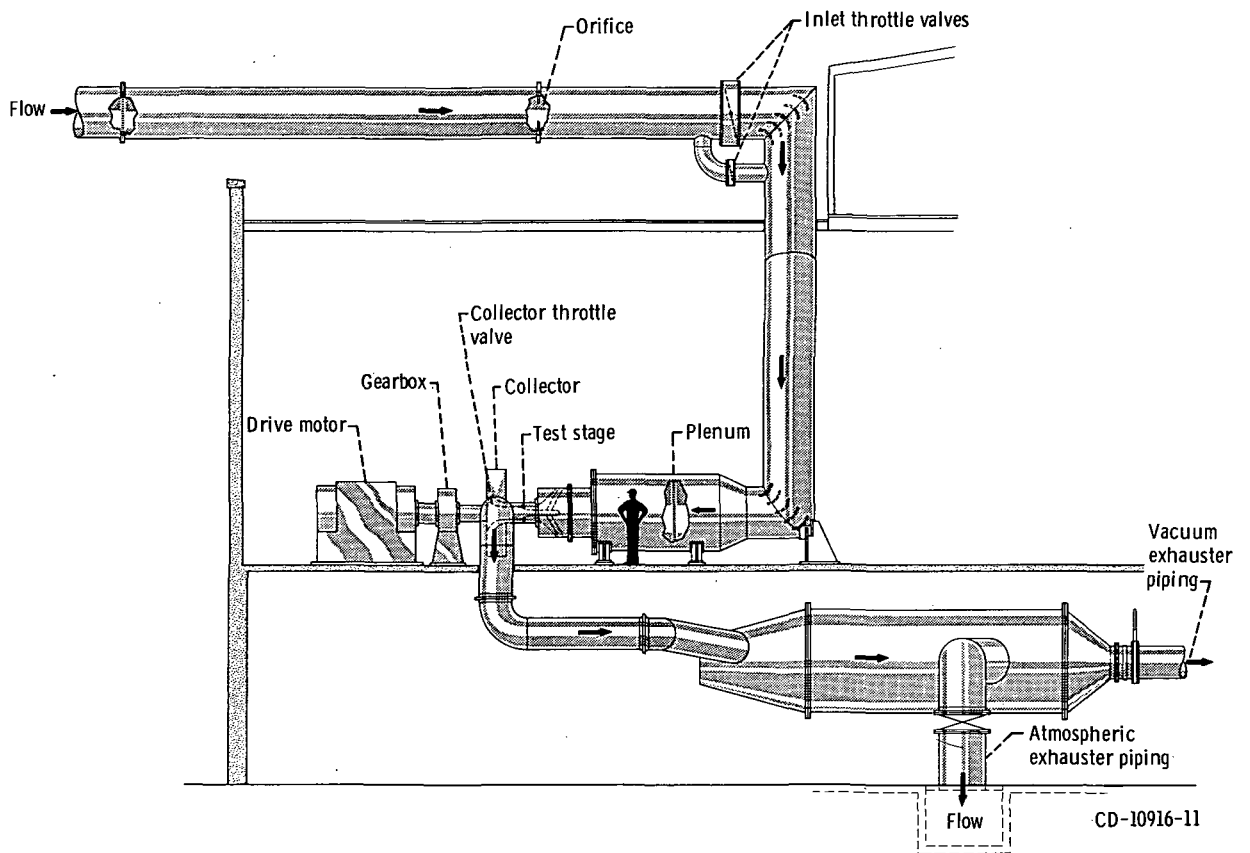
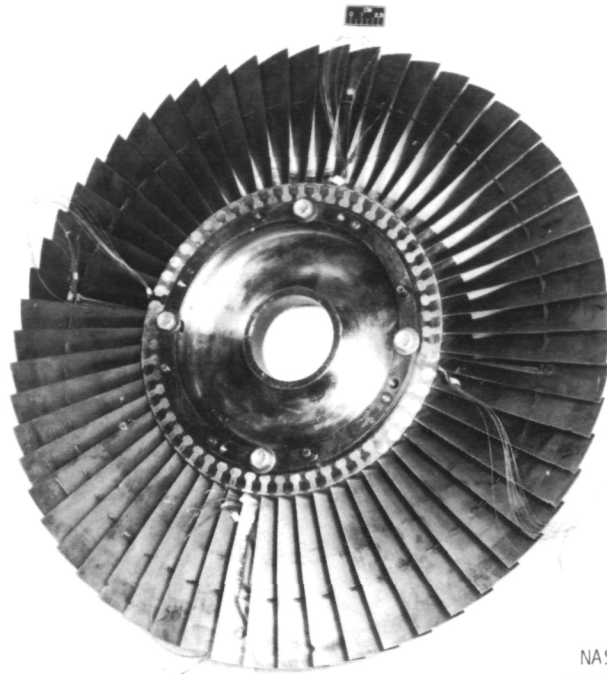
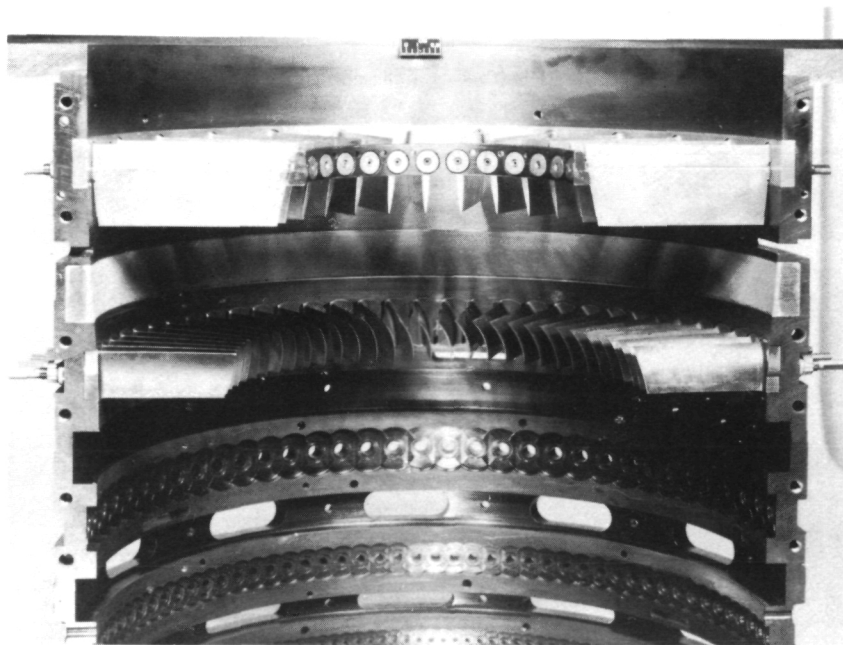

Figure 3. - Compressor test facility.



NASA  
C-74-3199

(a) Rotor.



(b) Compressor casing with IGV's and stators installed.

Figure 4. - Test hardware.

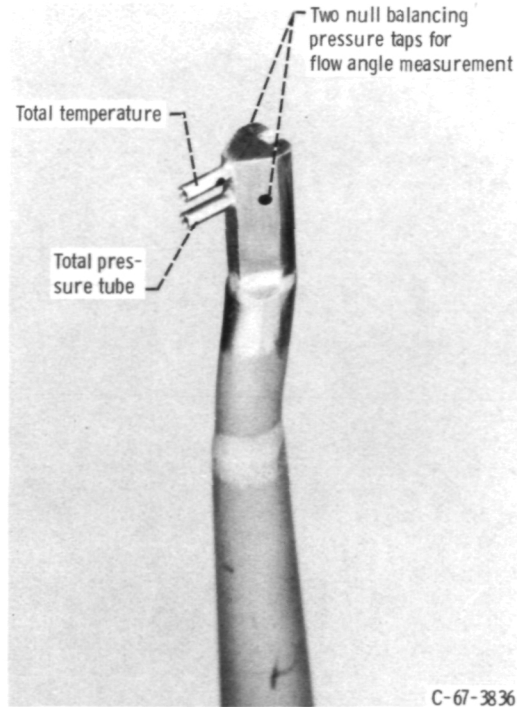

C-67-3836

Figure 5. - Combination total pressure, total temperature, and flow angle survey probe (double barrel).

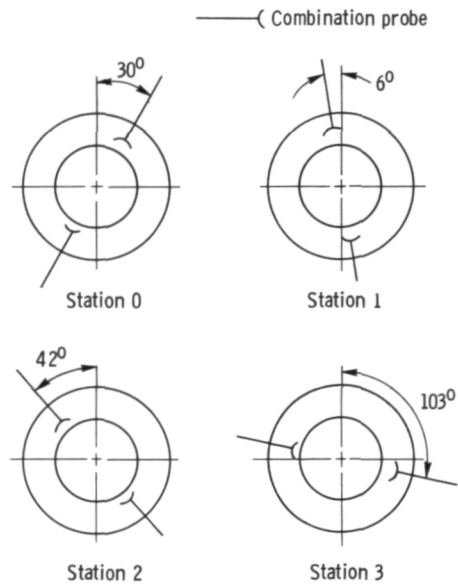

Figure 6. - Circumferential locations of measurements (looking downstream; clockwise rotation).

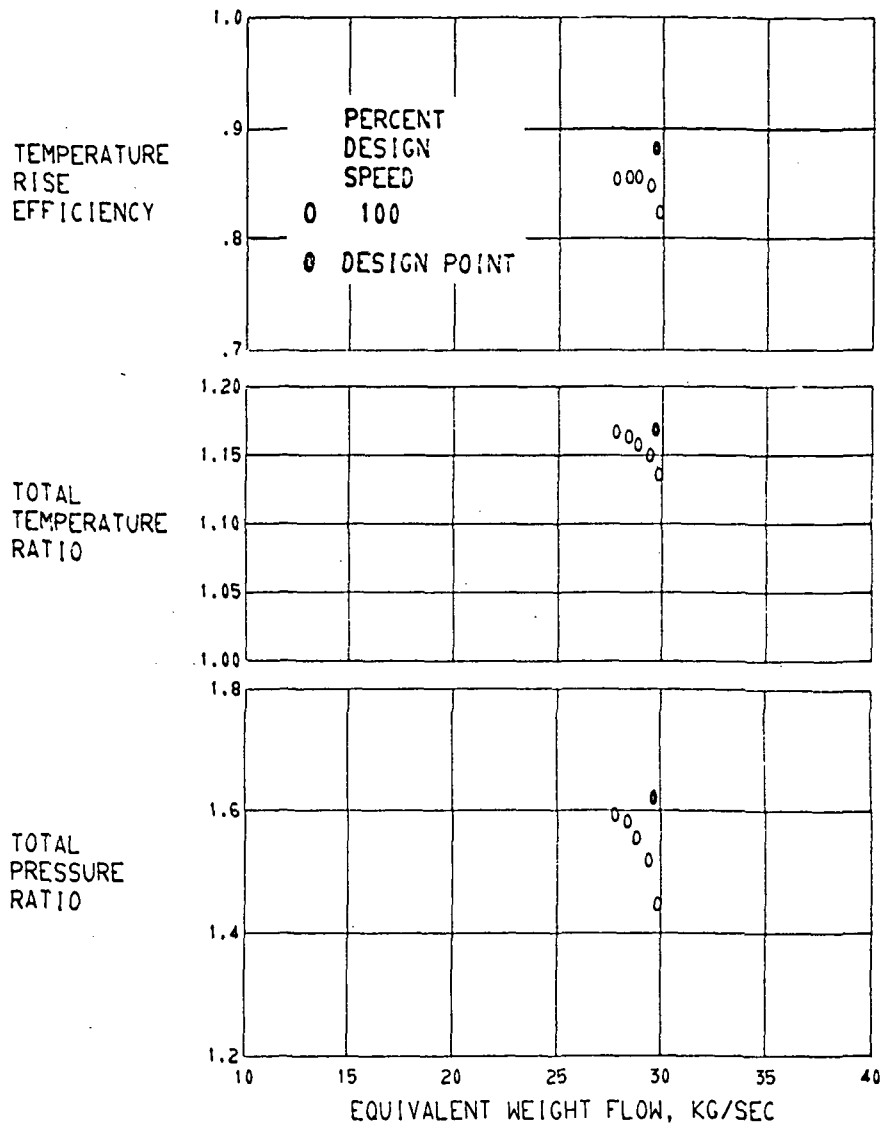

FIGURE 7. - OVERALL PERFORMANCE FOR ROTOR 66.

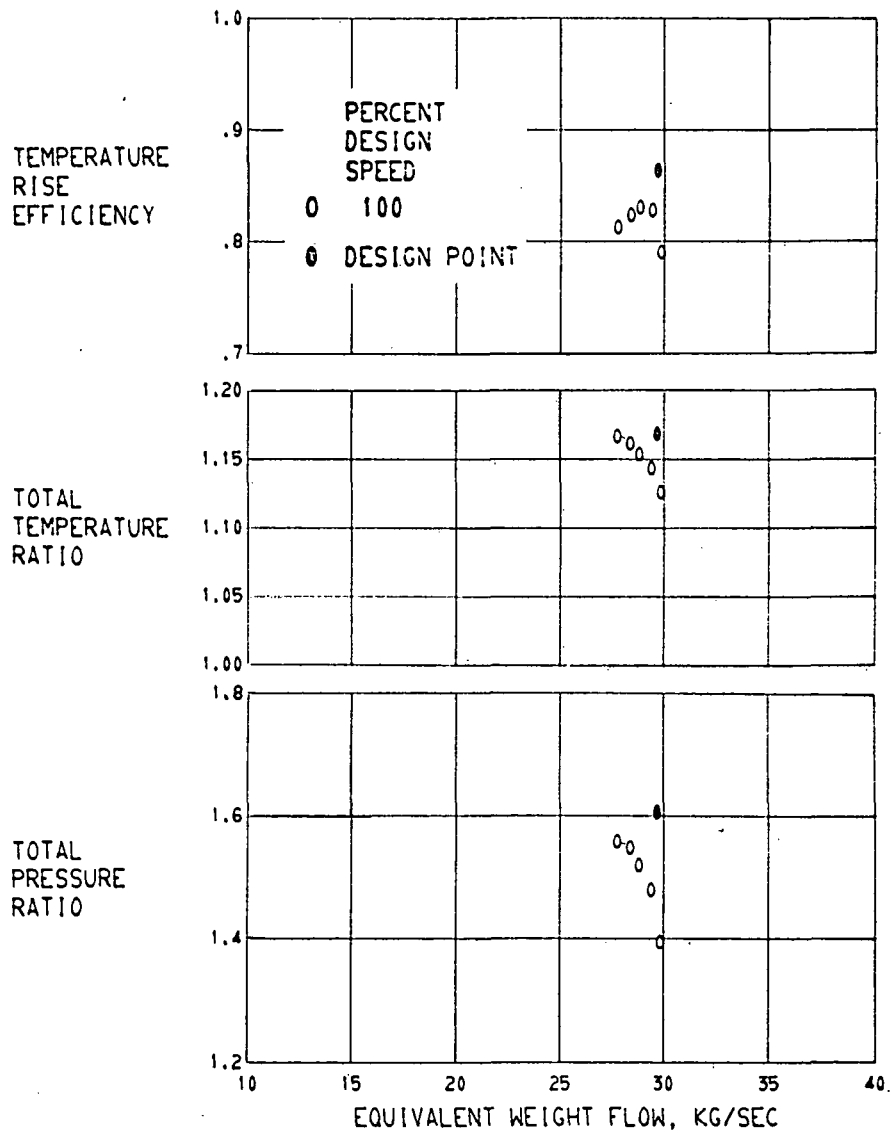

FIGURE 8. - Overall performance for stage 66-66.

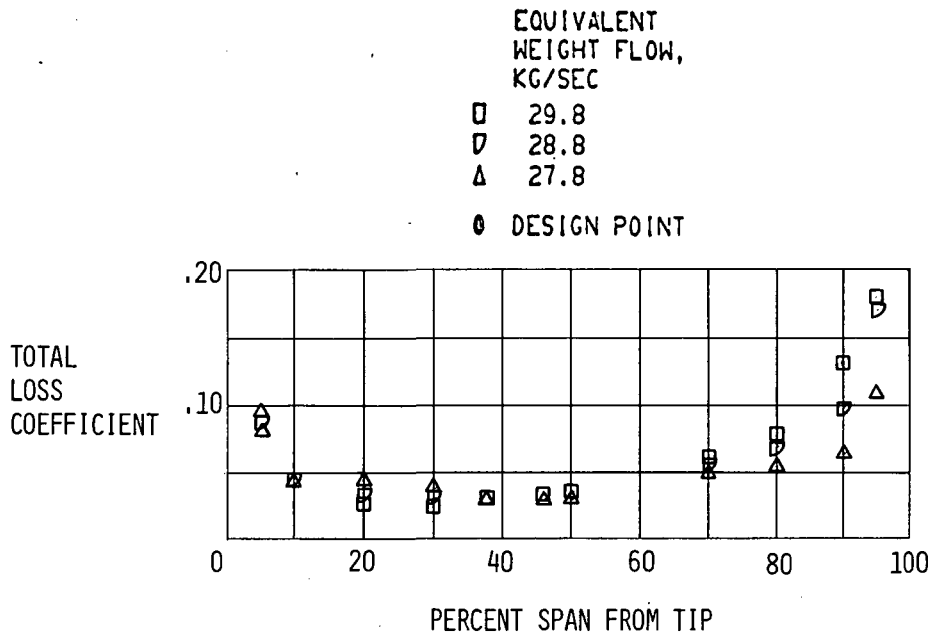
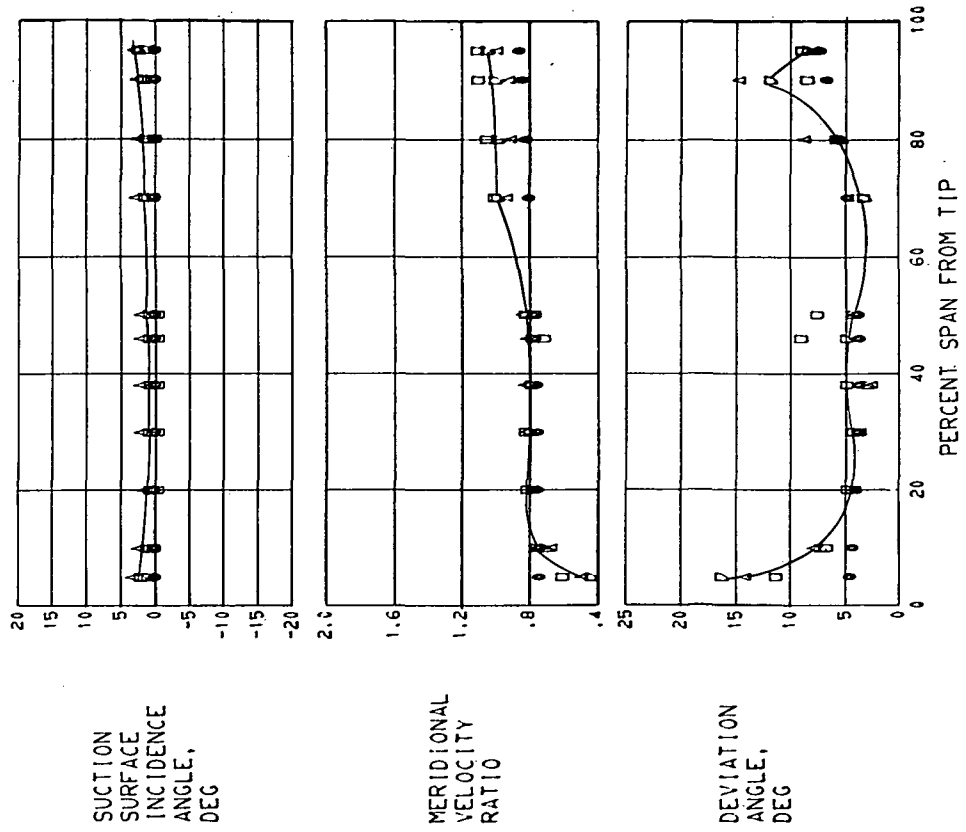
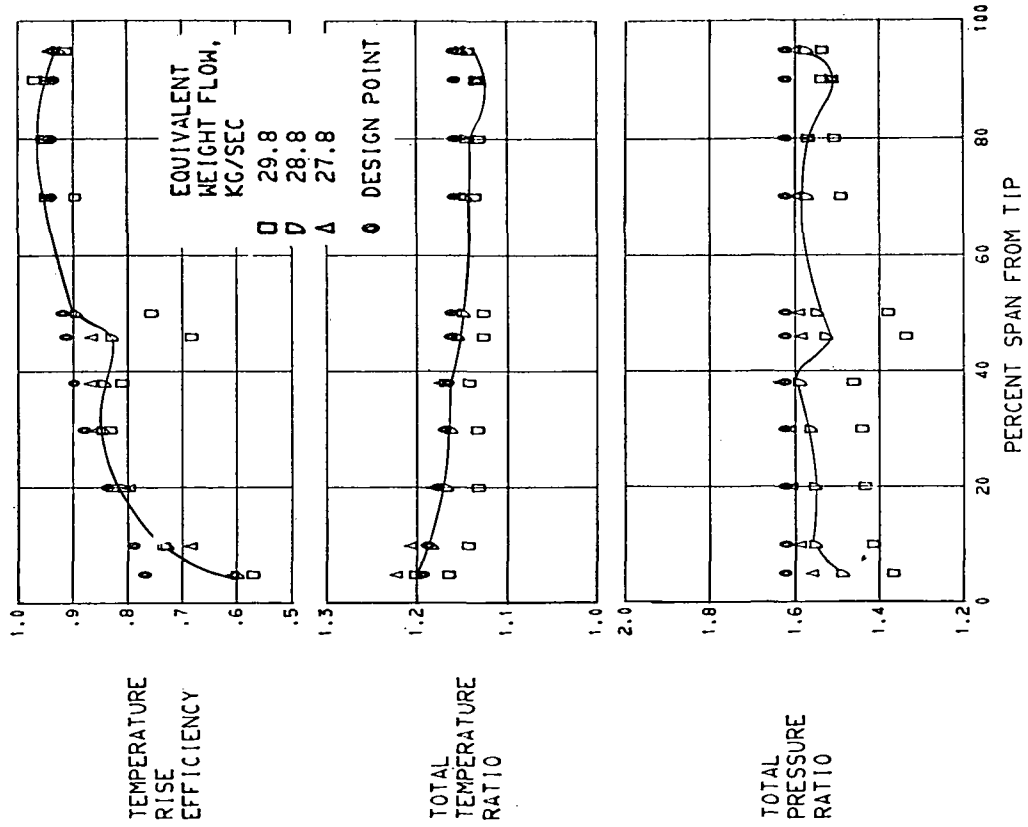

FIGURE 9. - RADIAL DISTRIBUTION OF INLET GUIDE VANE TOTAL LOSS COEFFICIENT.





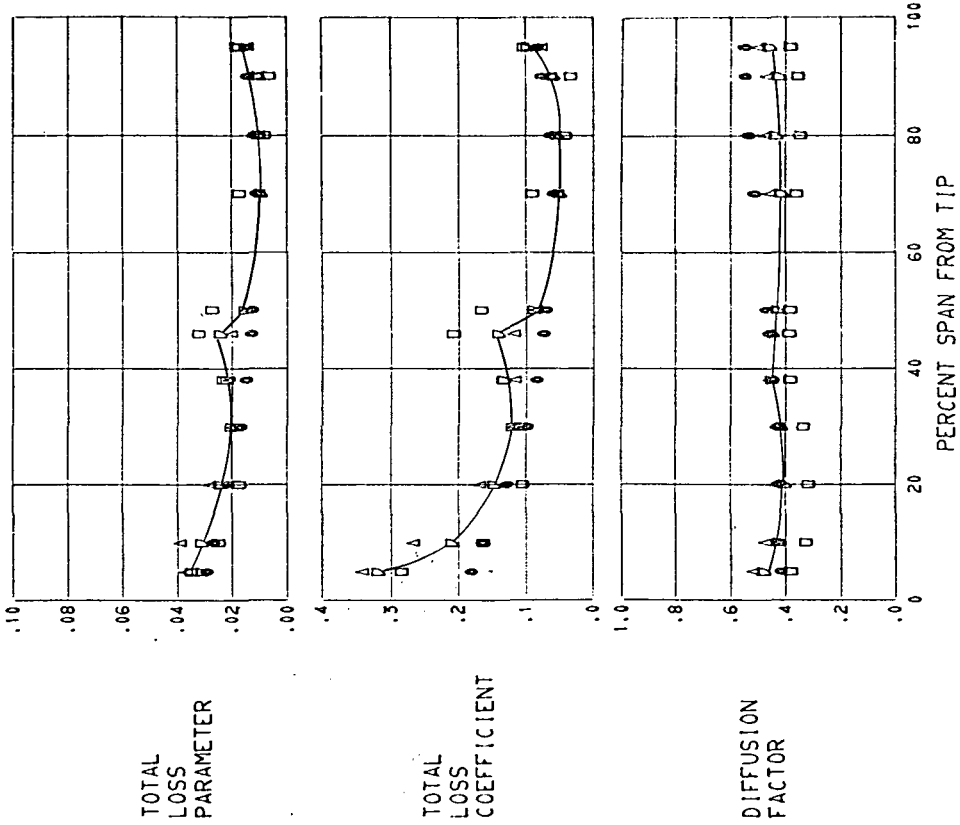

FIGURE 10. - RADIAL DISTRIBUTION OF PERFORMANCE FOR ROTOR 66, 100 PERCENT DESIGN.

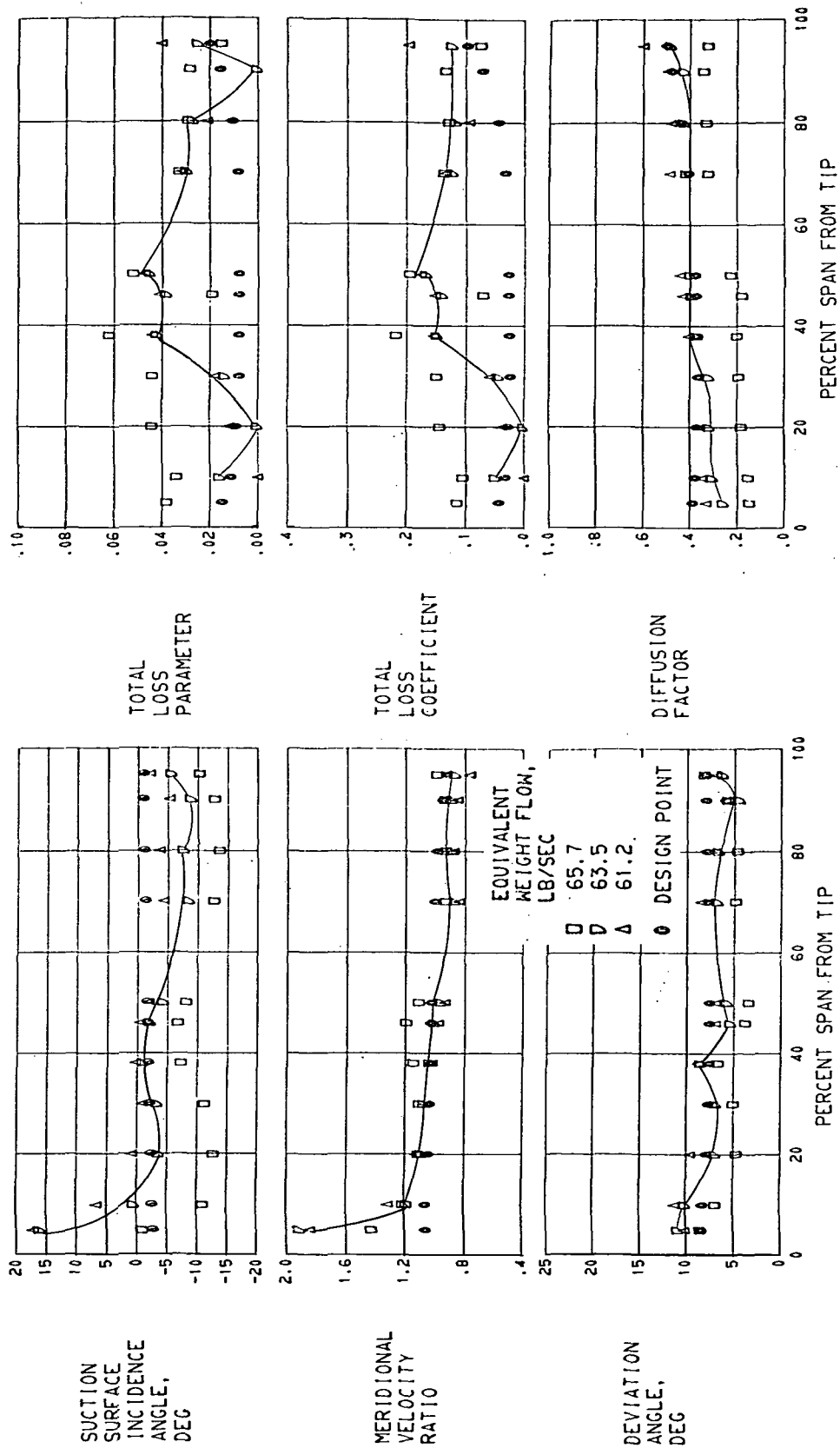
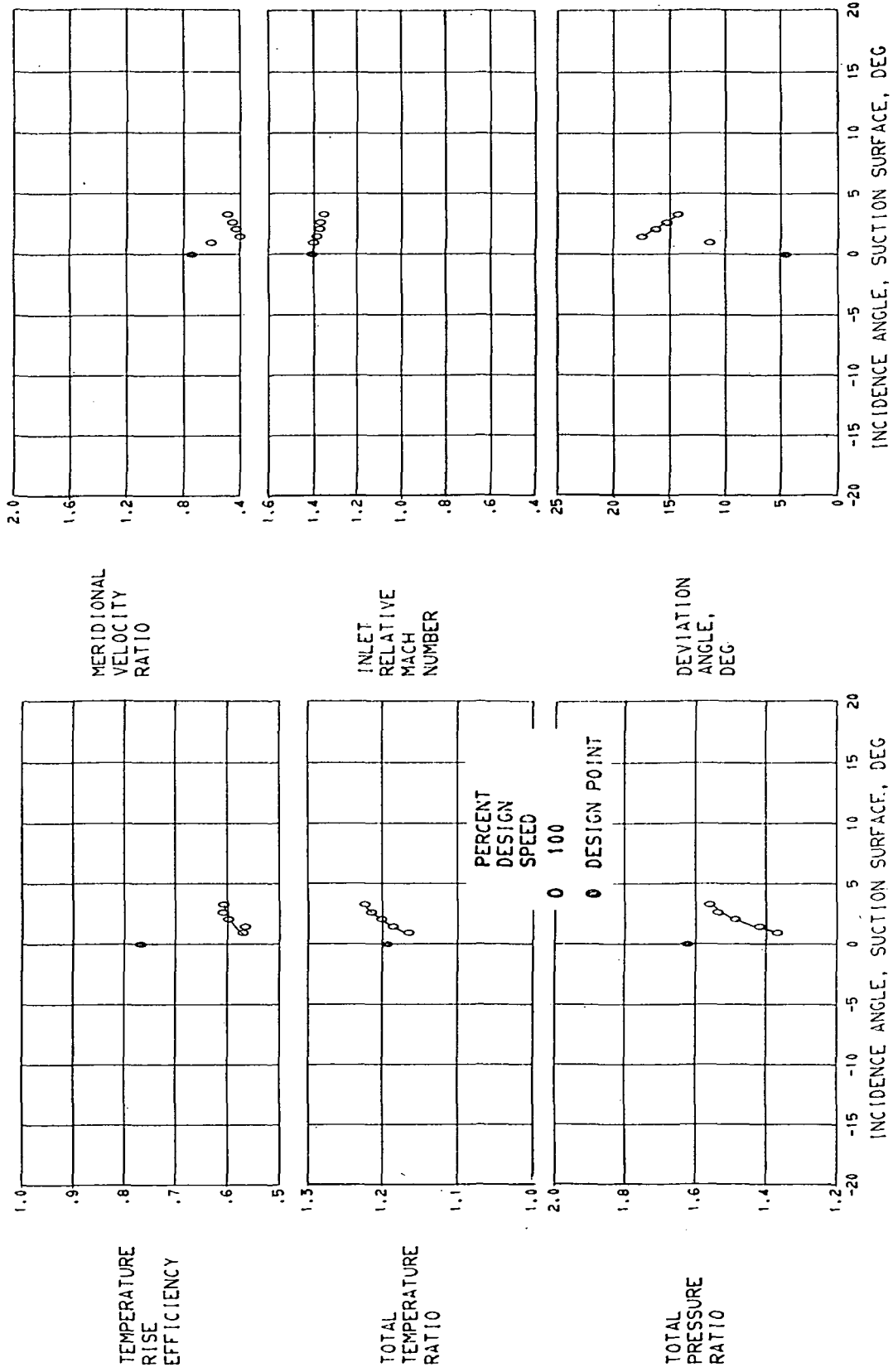
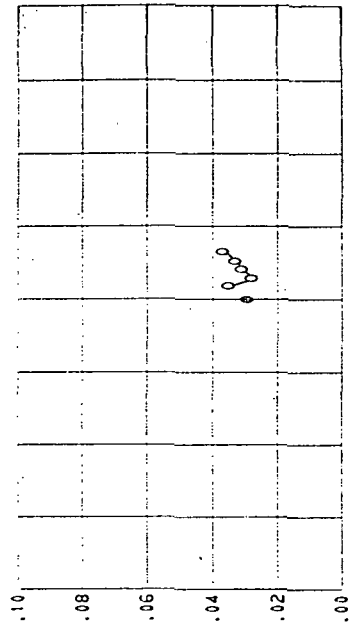

FIGURE 11. - RADIAL DISTRIBUTION OF PERFORMANCE FOR STATOR 66. 100 PERCENT DESIGN SPEED.

**Page Intentionally Left Blank**



TOTAL  
LOSS  
PARAMETER



TOTAL  
LOSS  
COEFFICIENT

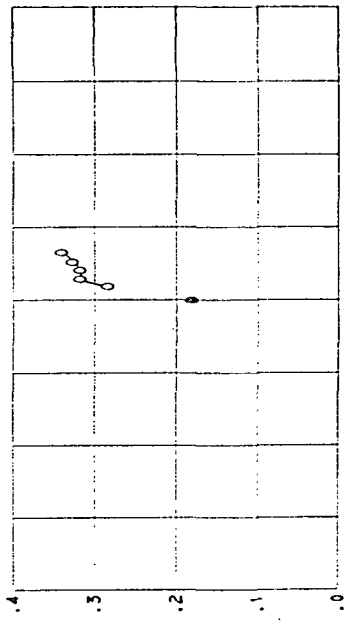

DIFFUSION  
FACTOR

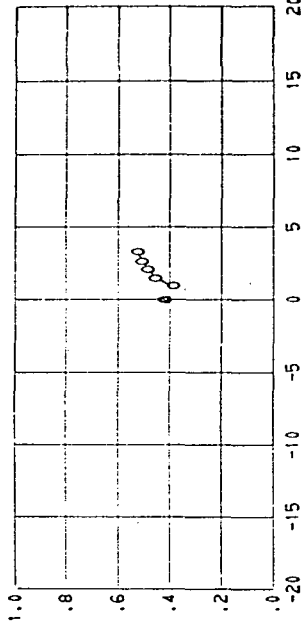

(A) 5.0 PERCENT SPAN.

FIGURE 12. - BLADE-ELEMENT PERFORMANCE FOR ROTOR 66.

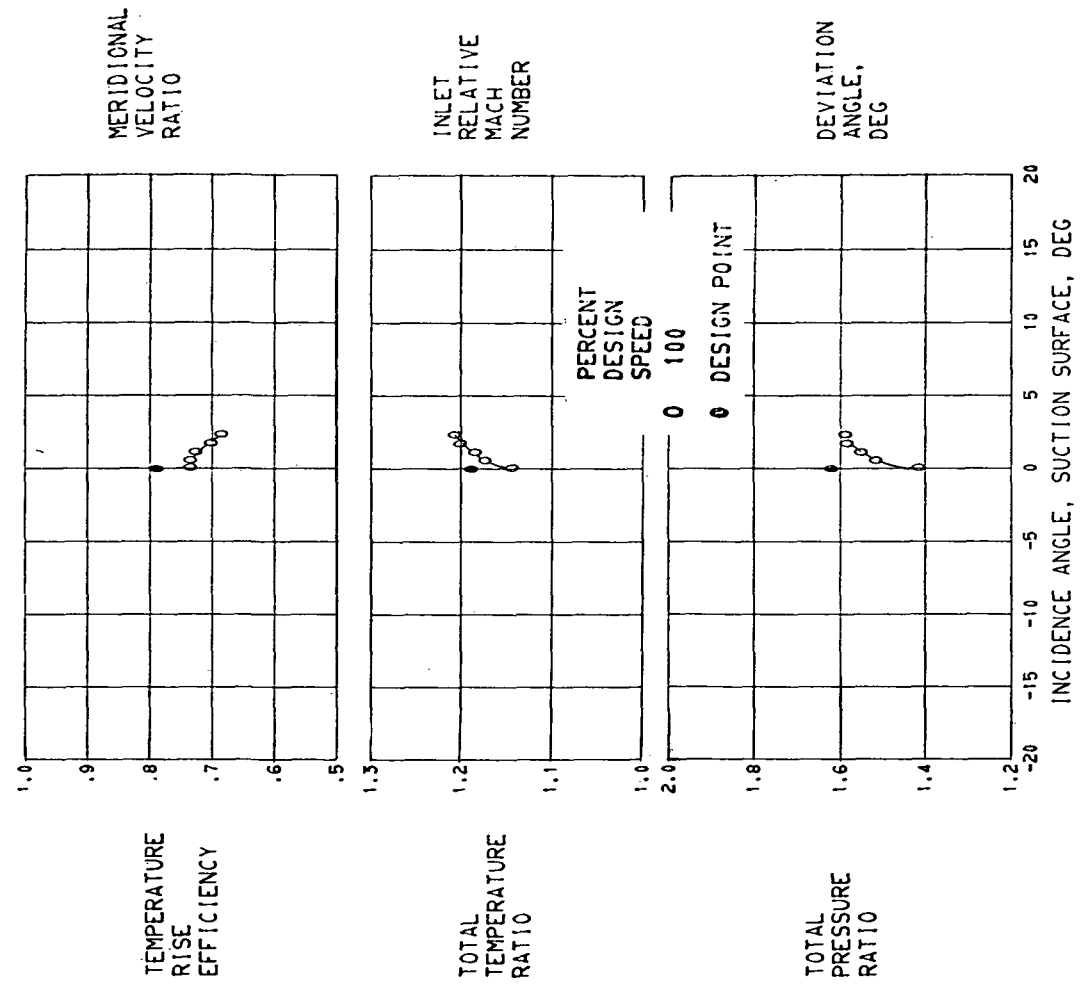
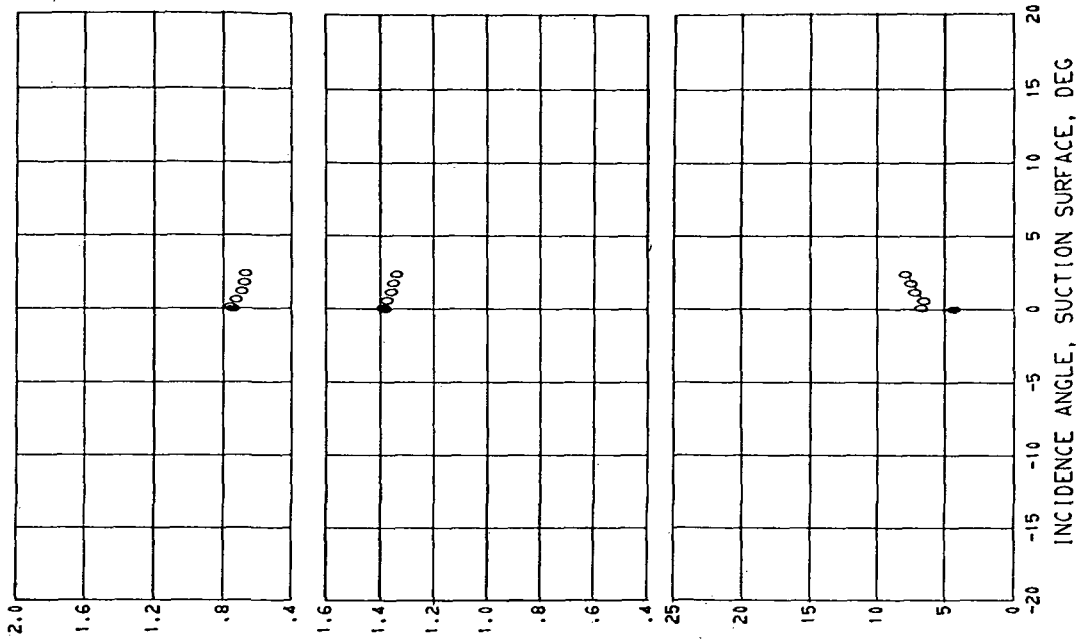

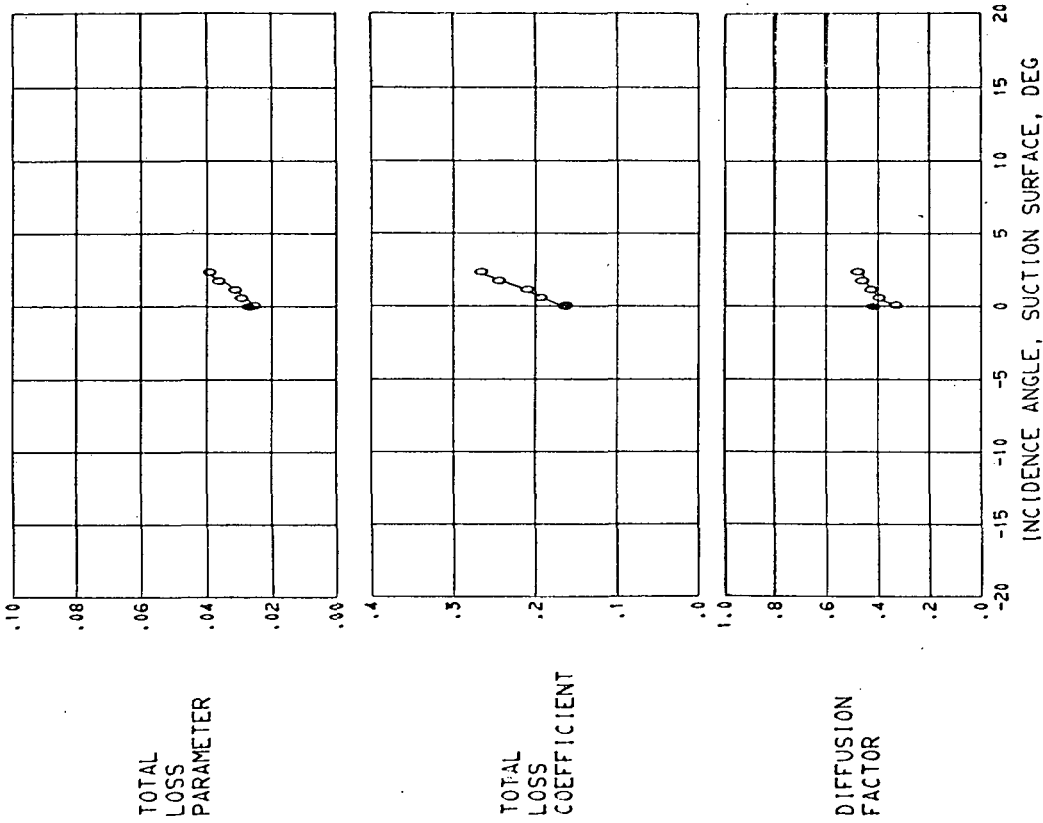

(B) 10.0 PERCENT SPAN.

FIGURE 12. - CONTINUED. BLADE-ELEMENT PERFORMANCE FOR ROTOR 66.

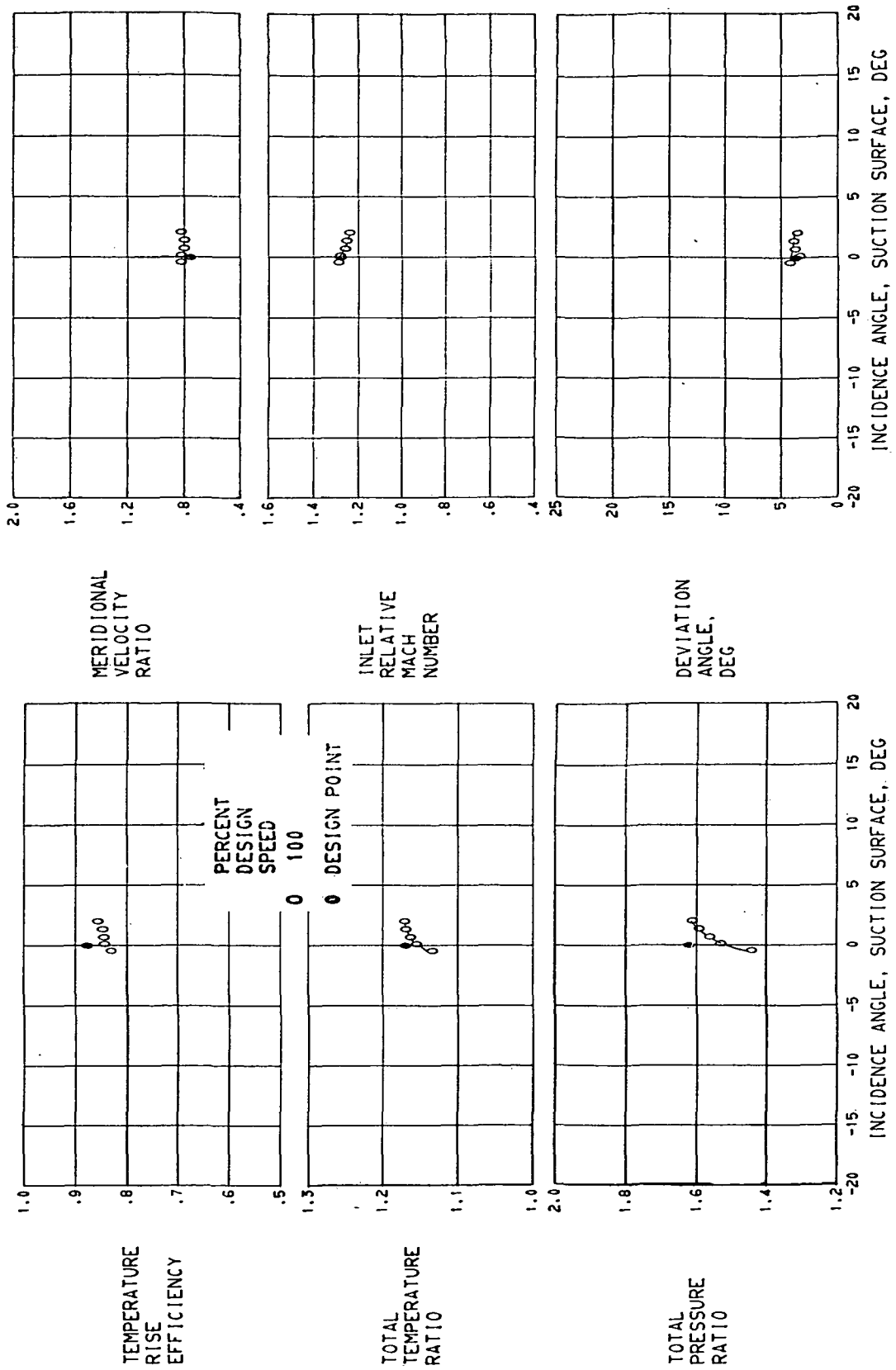

TEMPERATURE RISE EFFICIENCY

MERIDIONAL VELOCITY RATIO

TOTAL TEMPERATURE RATIO

INLET RELATIVE MACH NUMBER

TOTAL PRESSURE RATIO

DEVIATION ANGLE, DEG

PERCENT DESIGN SPEED

DESIGN POINT

INCIDENCE ANGLE, SUCTION SURFACE, DEG

INCIDENCE ANGLE, SUCTION SURFACE, DEG



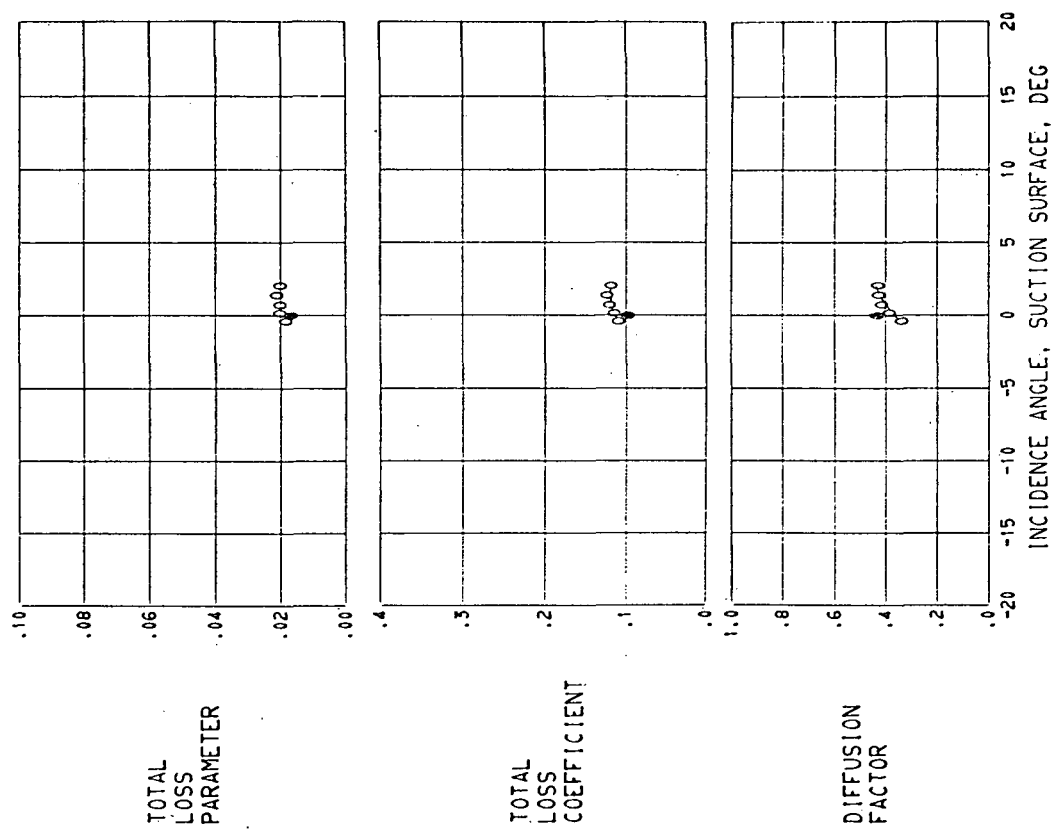

(C) 30.0 PERCENT SPAN.

FIGURE 12. - CONTINUED. BLADE-ELEMENT PERFORMANCE FOR ROTOR 66.

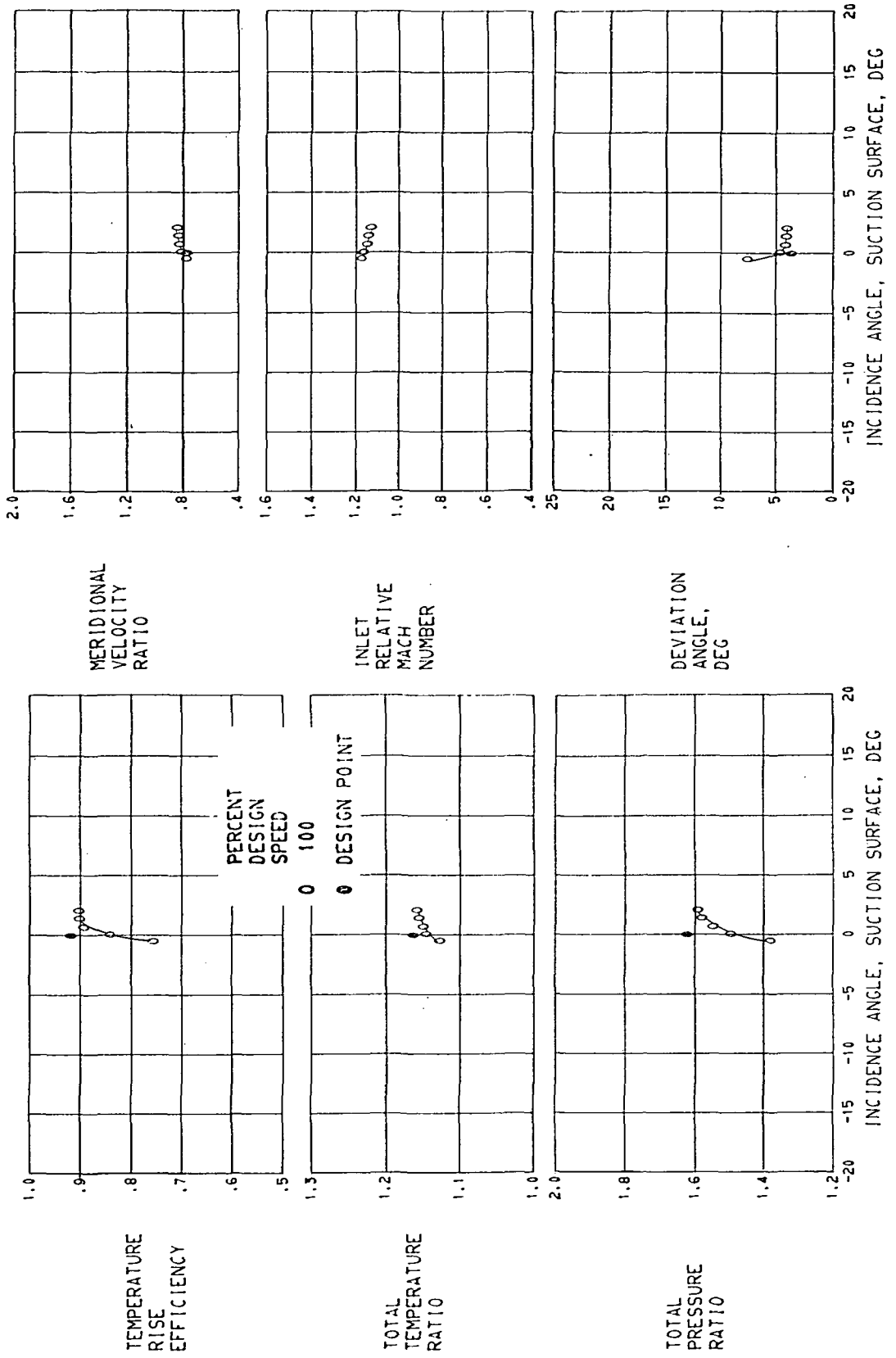

TEMPERATURE RISE EFFICIENCY

MERIDIONAL VELOCITY RATIO

TOTAL TEMPERATURE RATIO

INLET RELATIVE MACH NUMBER

TOTAL PRESSURE RATIO

DEVIATION ANGLE, DEG

PERCENT DESIGN SPEED

DESIGN POINT

INCIDENCE ANGLE, SUCTION SURFACE, DEG

INCIDENCE ANGLE, SUCTION SURFACE, DEG

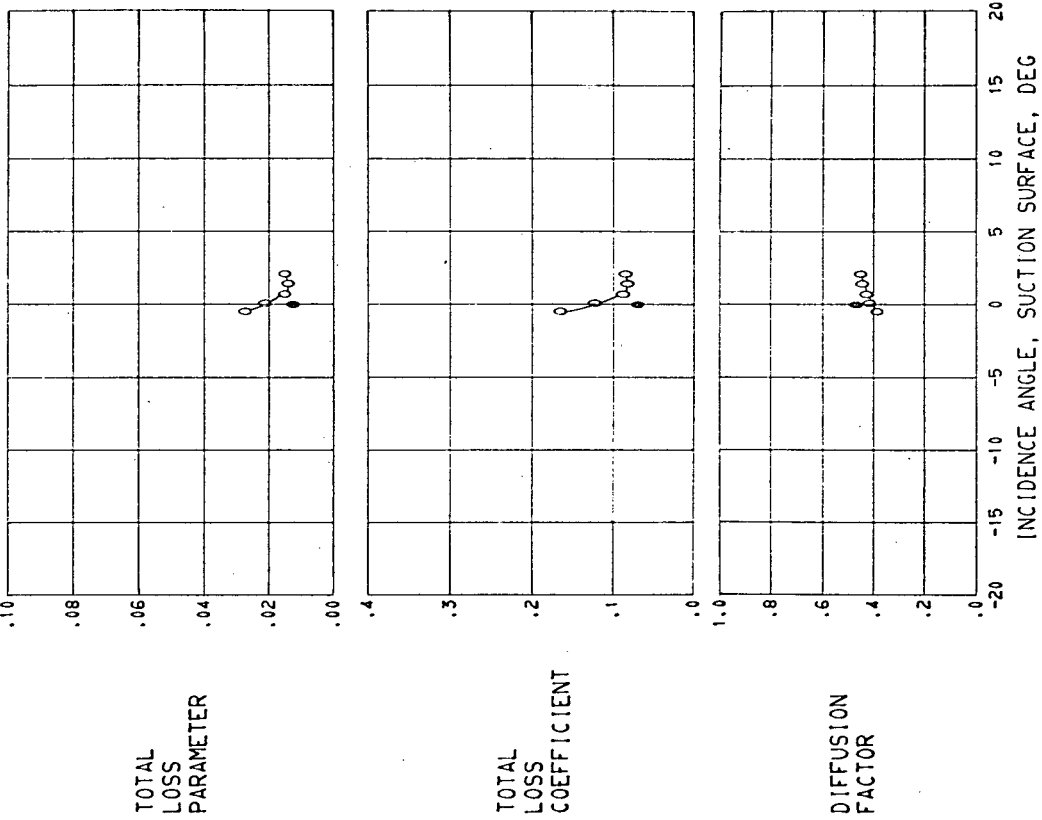

(D) 50.0 PERCENT SPAN.

FIGURE 12. - CONTINUED. BLADE-ELEMENT PERFORMANCE FOR ROTOR 66.

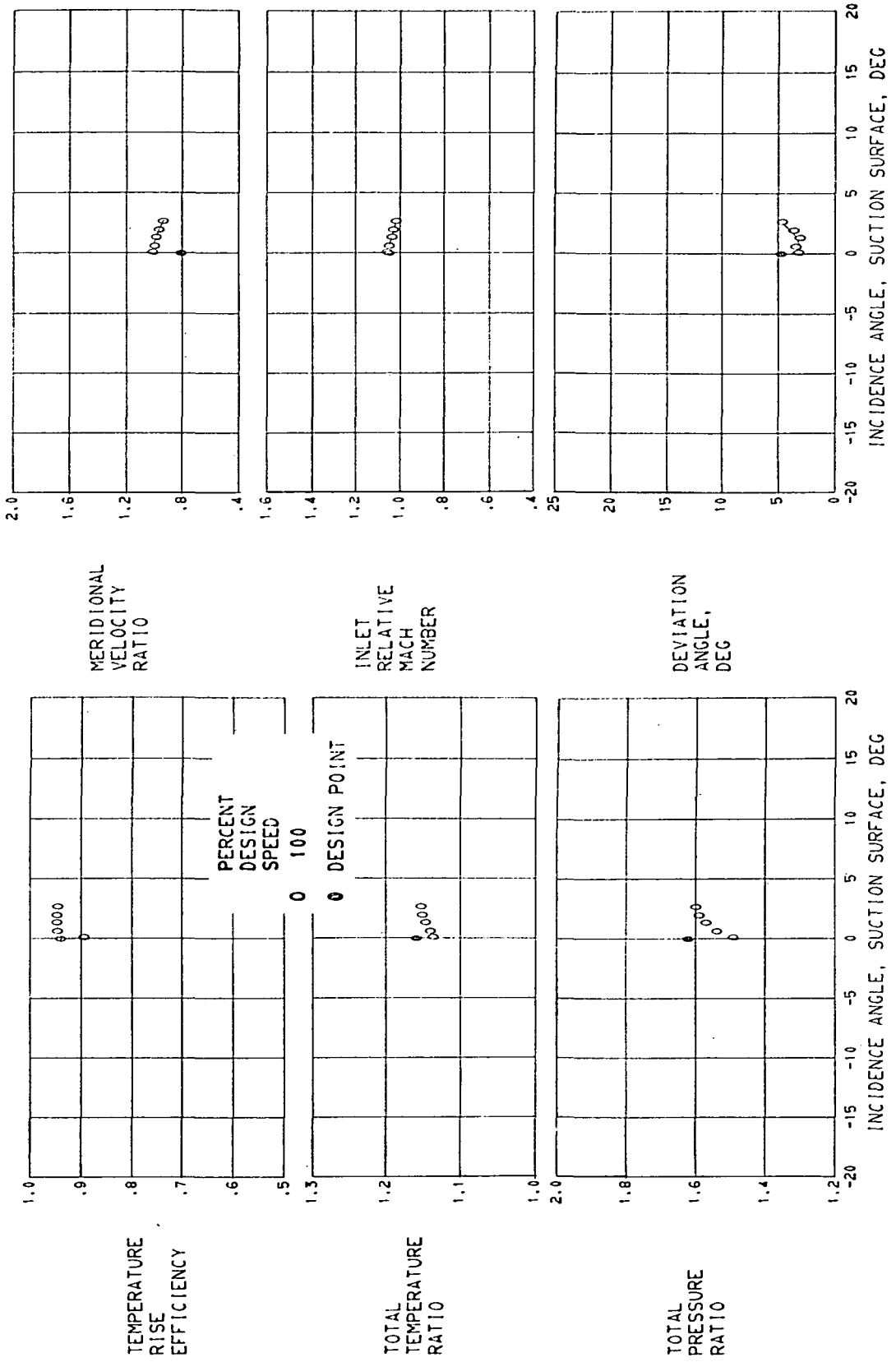

TOTAL  
LOSS  
PARAMETER

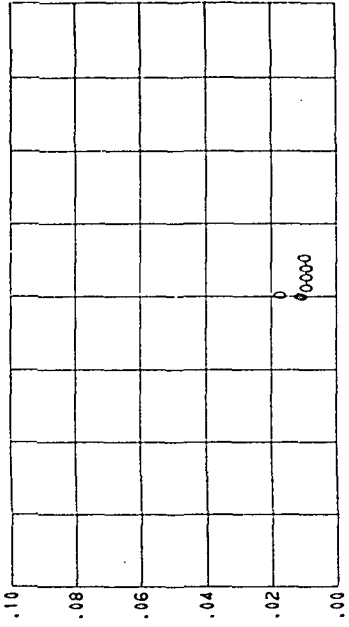

TOTAL  
LOSS  
COEFFICIENT

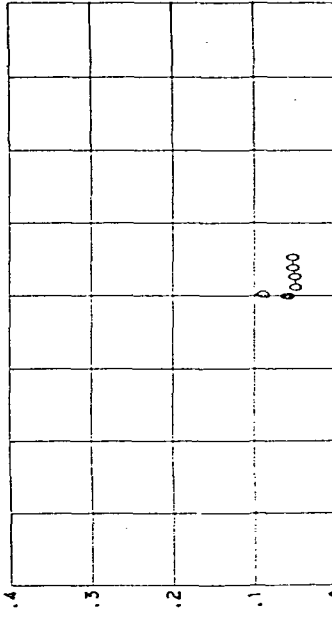

DIFFUSION  
FACTOR

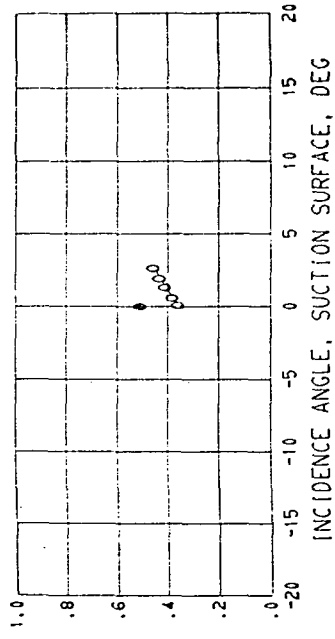

(E) 70.0 PERCENT SPAN.

FIGURE 12. - CONTINUED. BLADE-ELEMENT PERFORMANCE FOR ROTOR 66.

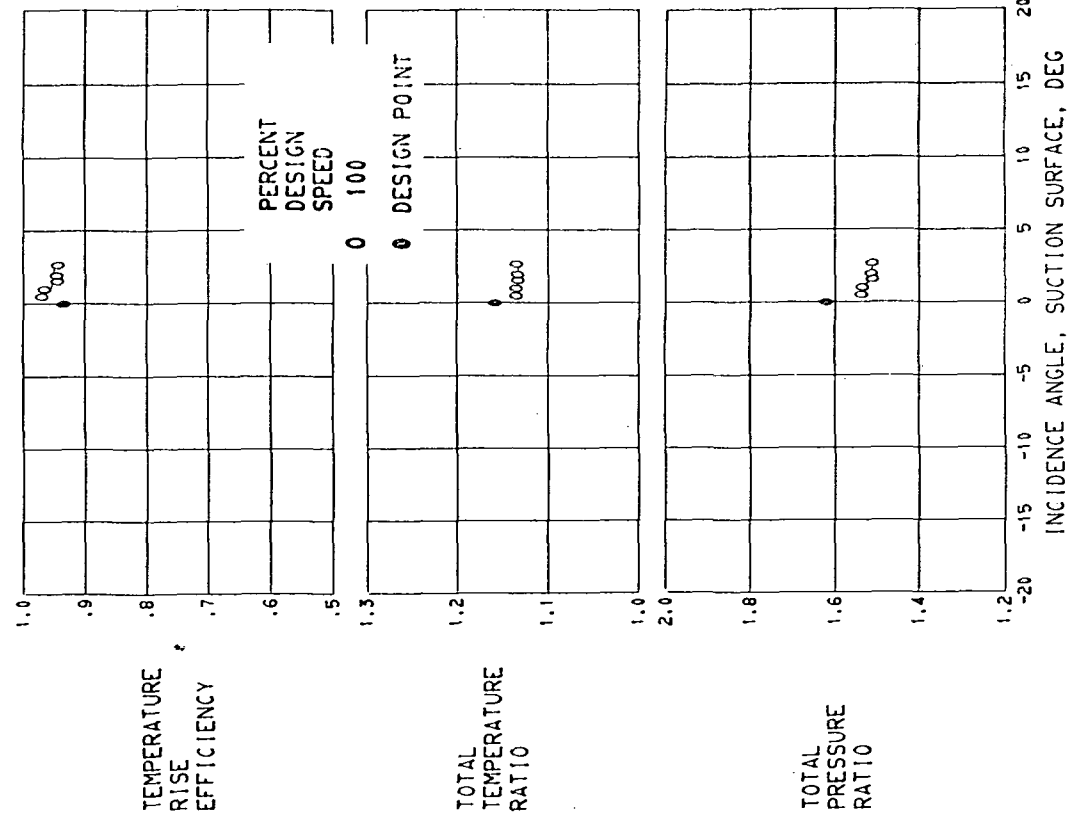
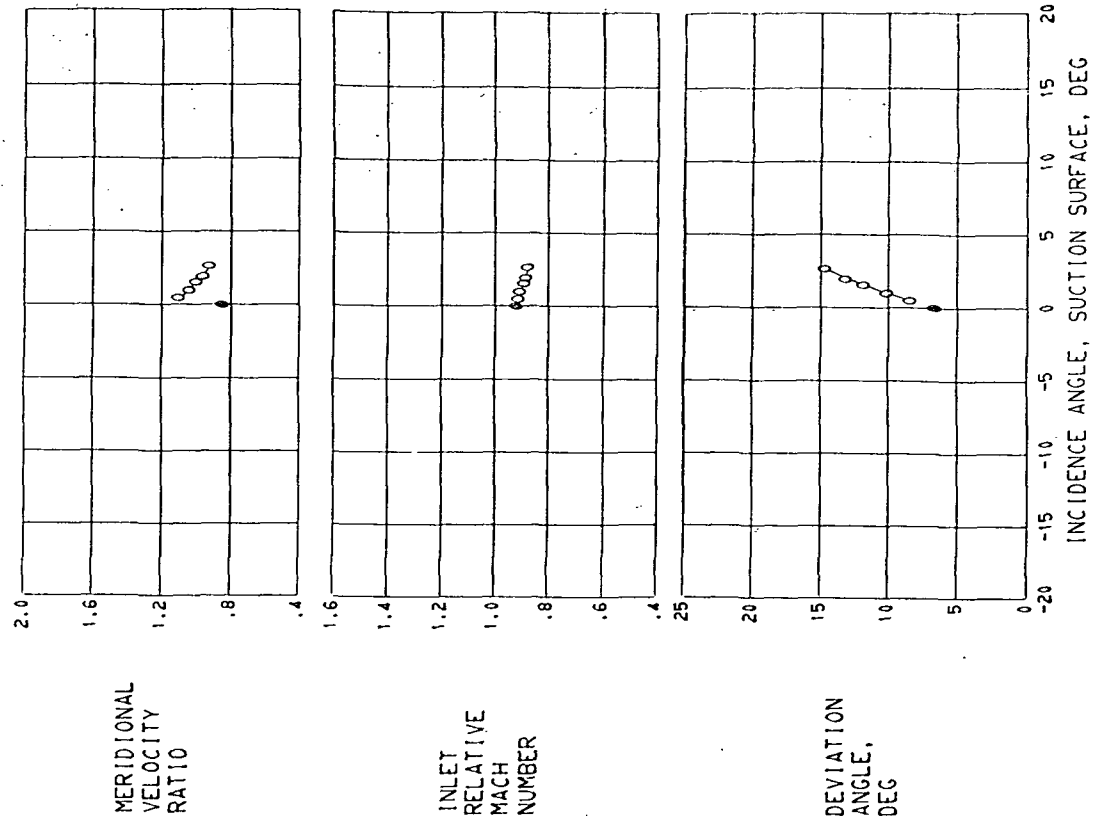

MERIDIONAL VELOCITY RATIO

INLET RELATIVE MACH NUMBER

DEVIATION ANGLE, DEG

TEMPERATURE RISE EFFICIENCY

TOTAL TEMPERATURE RATIO

TOTAL PRESSURE RATIO

PERCENT DESIGN SPEED

DESIGN POINT

INCIDENCE ANGLE, SUCTION SURFACE, DEG

INCIDENCE ANGLE, SUCTION SURFACE, DEG

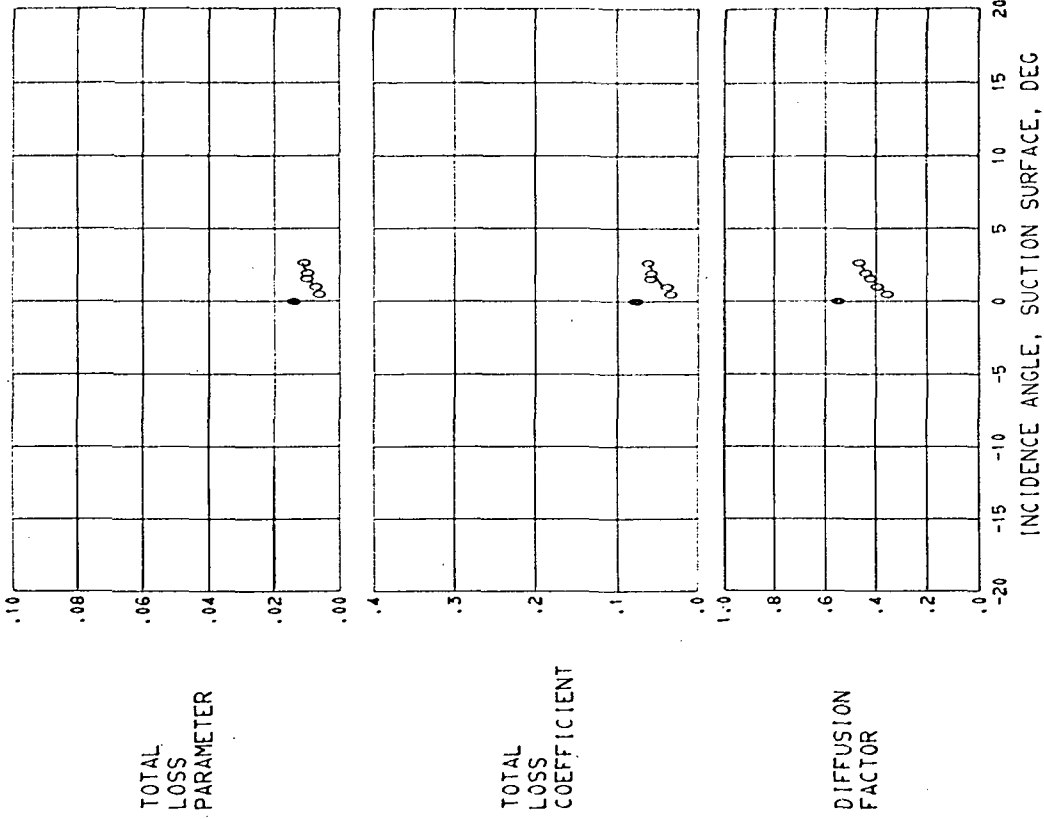

(F) 90.0 PERCENT SPAN.

FIGURE 12. - CONTINUED. BLADE-ELEMENT PERFORMANCE FOR ROTOR 66.

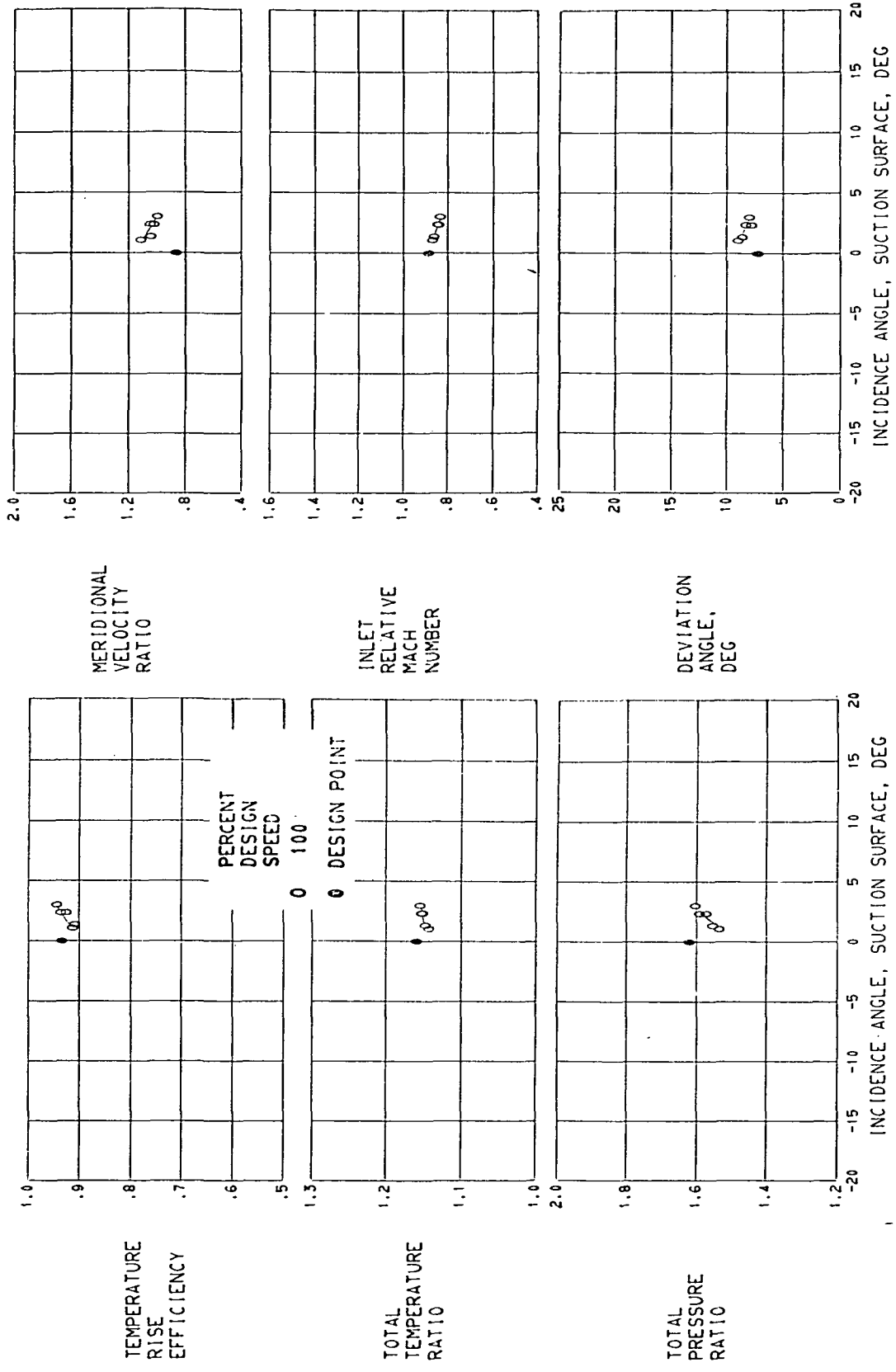



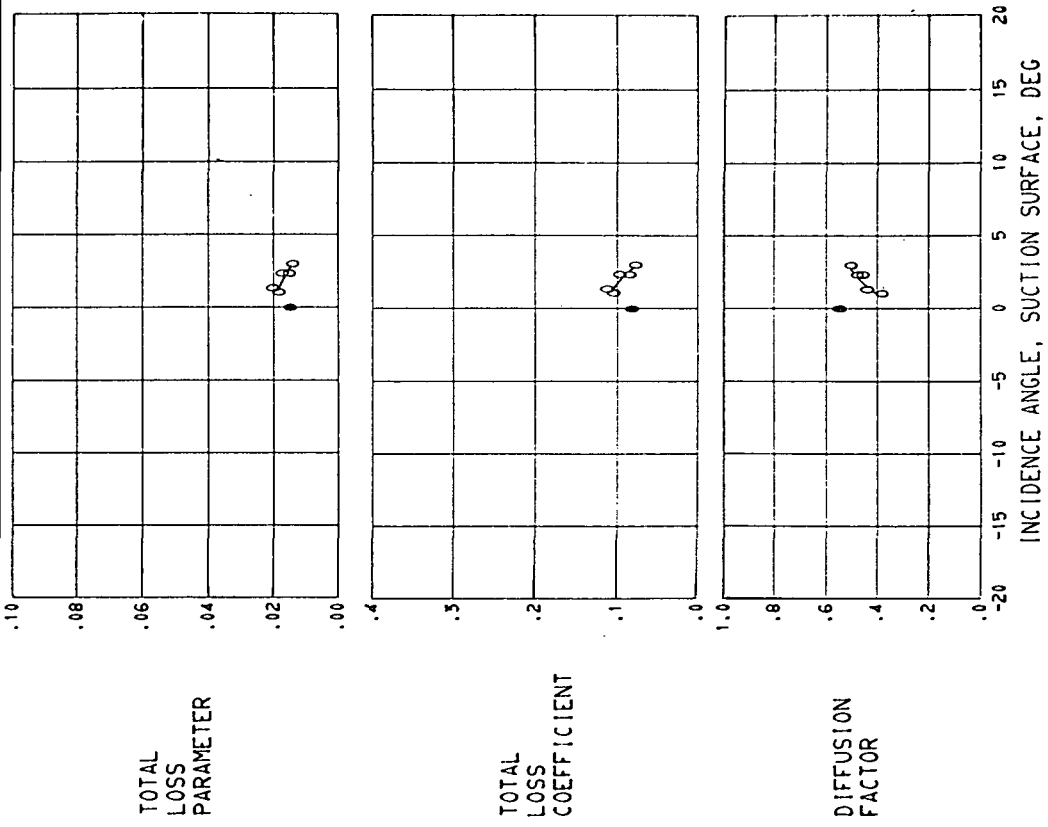

(G) 95.0 PERCENT SPAN.

FIGURE 12. - CONCLUDED. BLADE-ELEMENT PERFORMANCE FOR ROTOR 66.

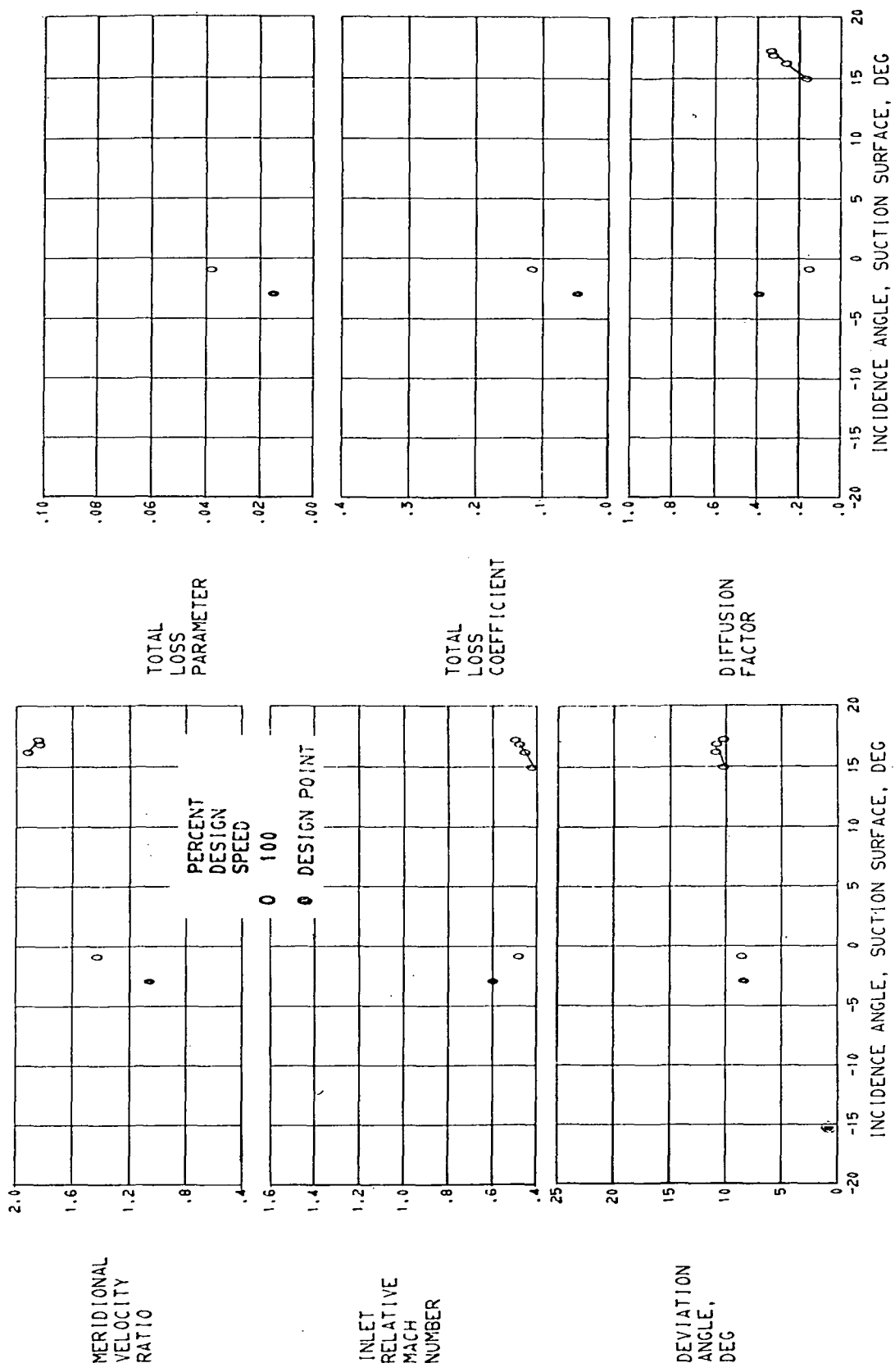

(A) 5.0 PERCENT SPAN.

FIGURE 13. - BLADE-ELEMENT PERFORMANCE FOR STATOR 66.

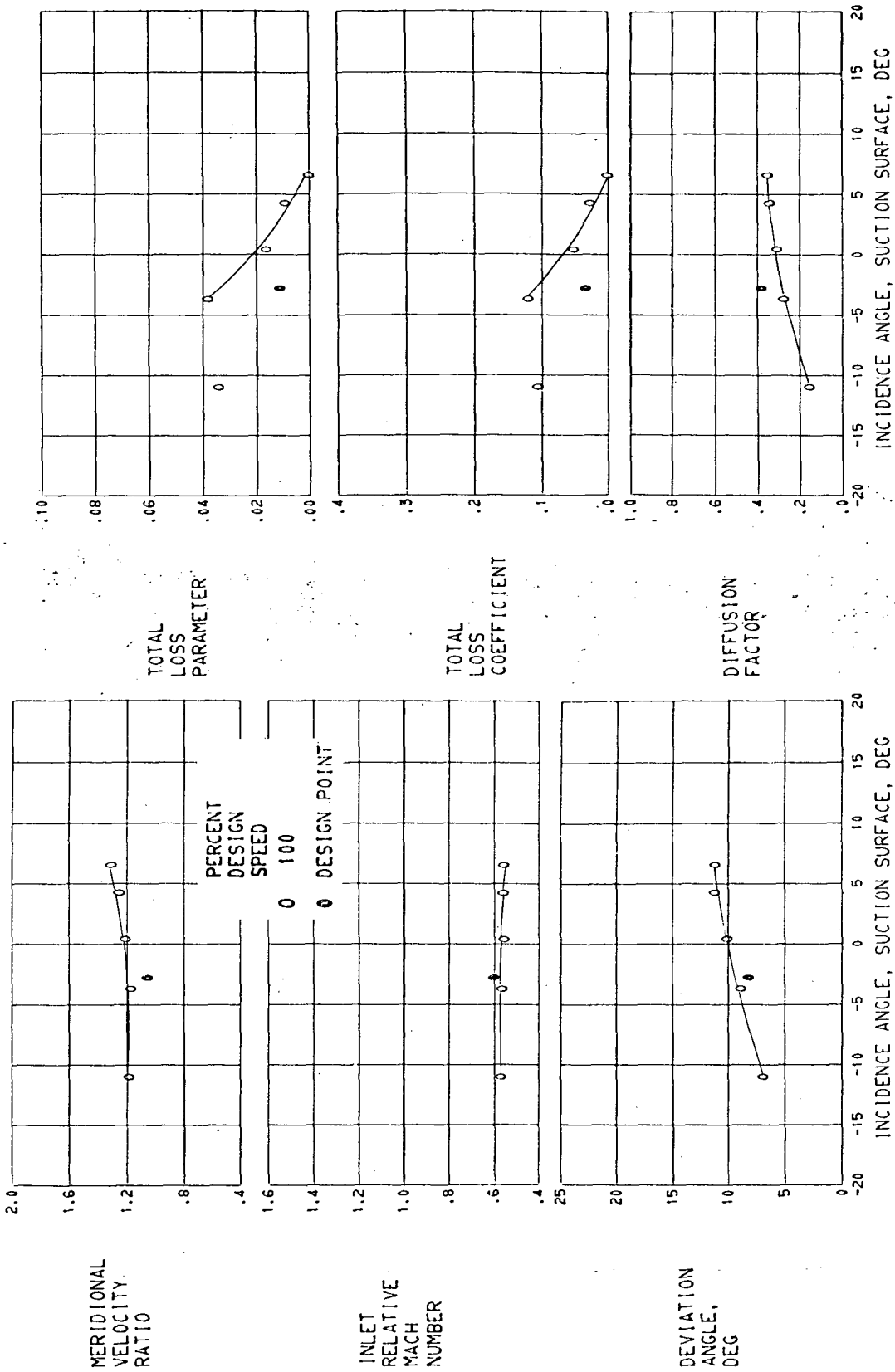

(B) 10.0 PERCENT SPAN.

FIGURE 13. - CONTINUED. BLADE-ELEMENT PERFORMANCE FOR STATOR 66.

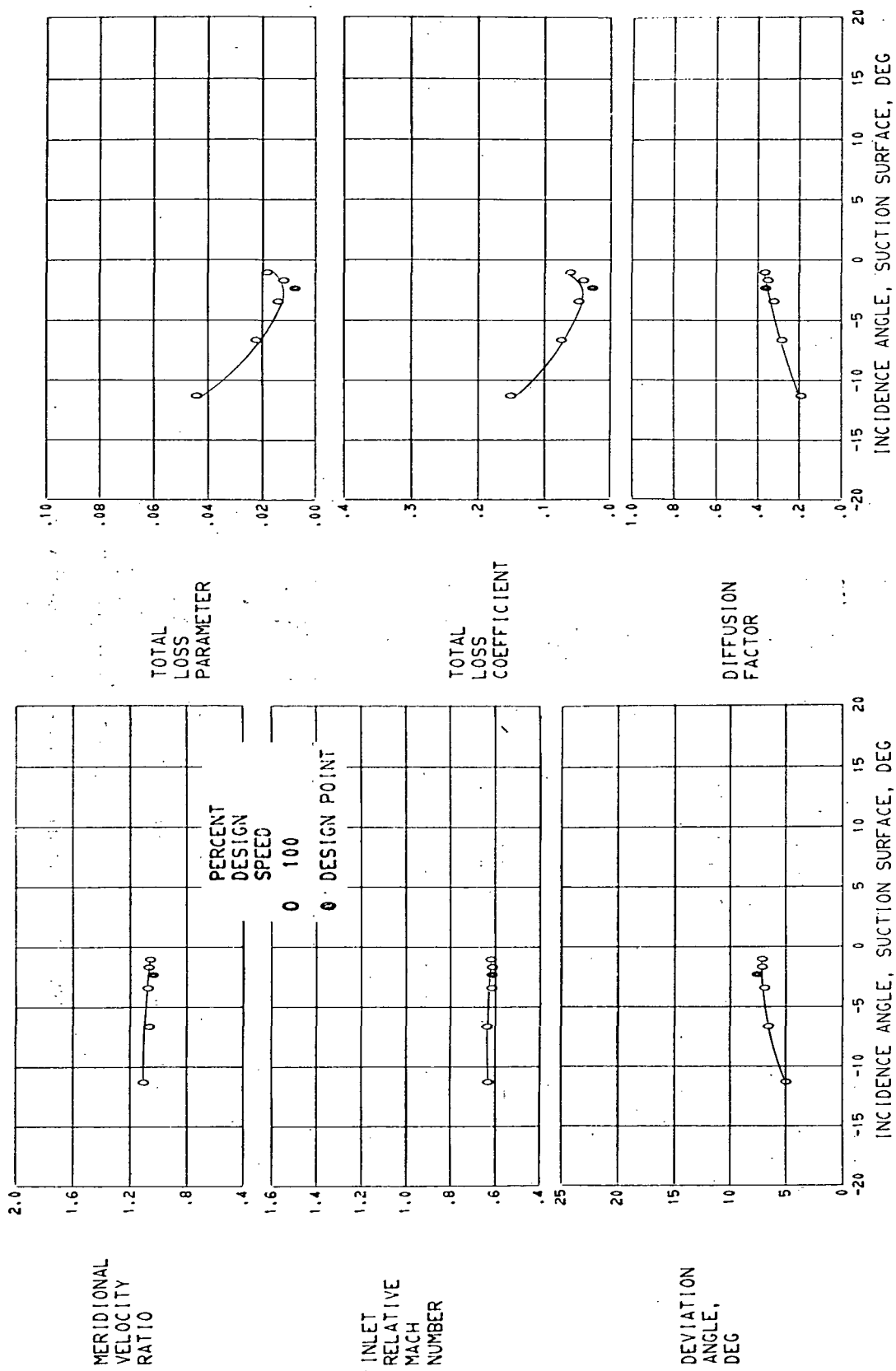

(C) 30.0 PERCENT SPAN.

FIGURE 13. - CONTINUED. BLADE-ELEMENT PERFORMANCE FOR STATOR 66.

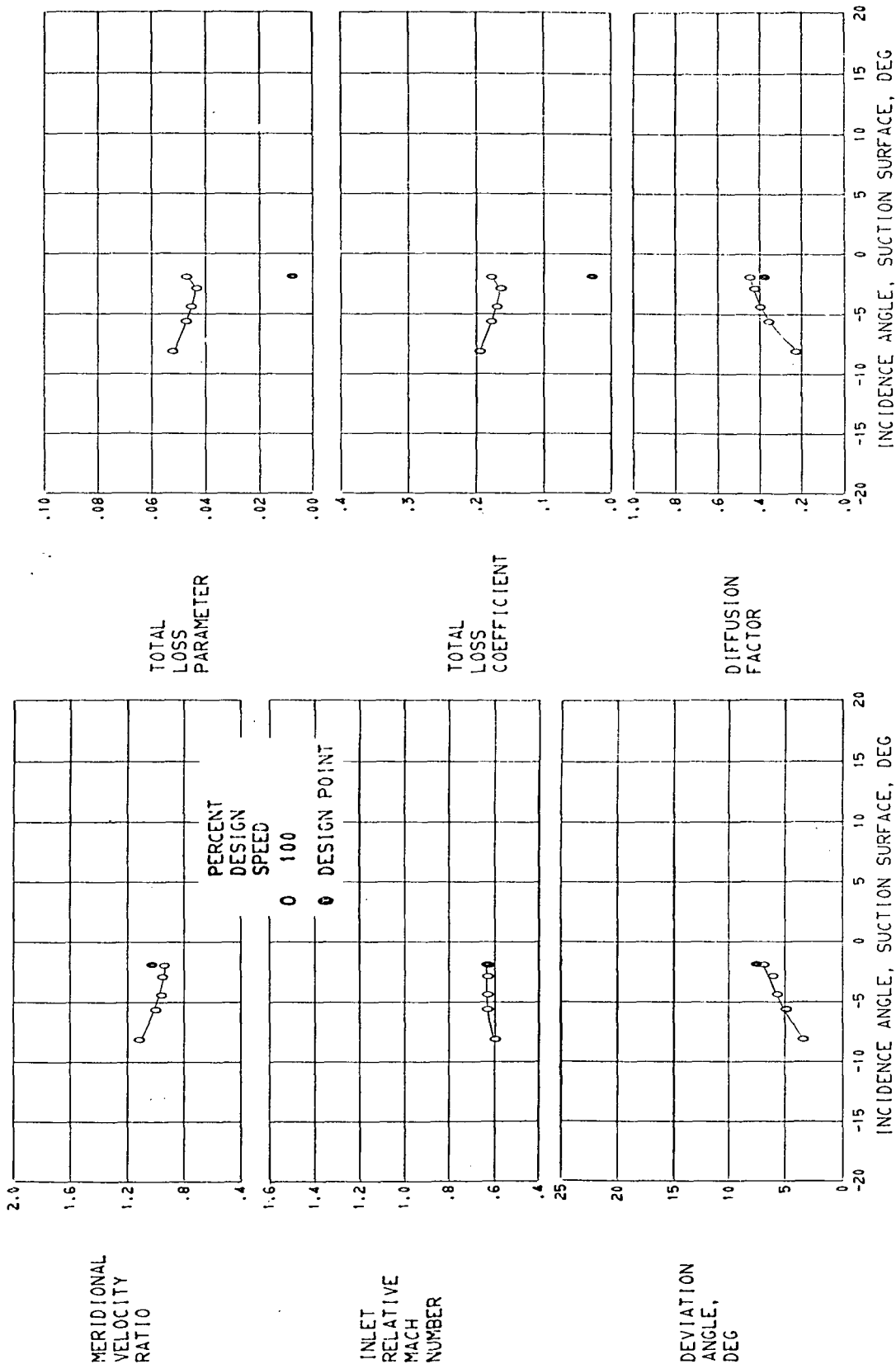

(D) 50.0 PERCENT SPAN.

FIGURE 13. - CONTINUED. BLADE-ELEMENT PERFORMANCE FOR STATOR 66.

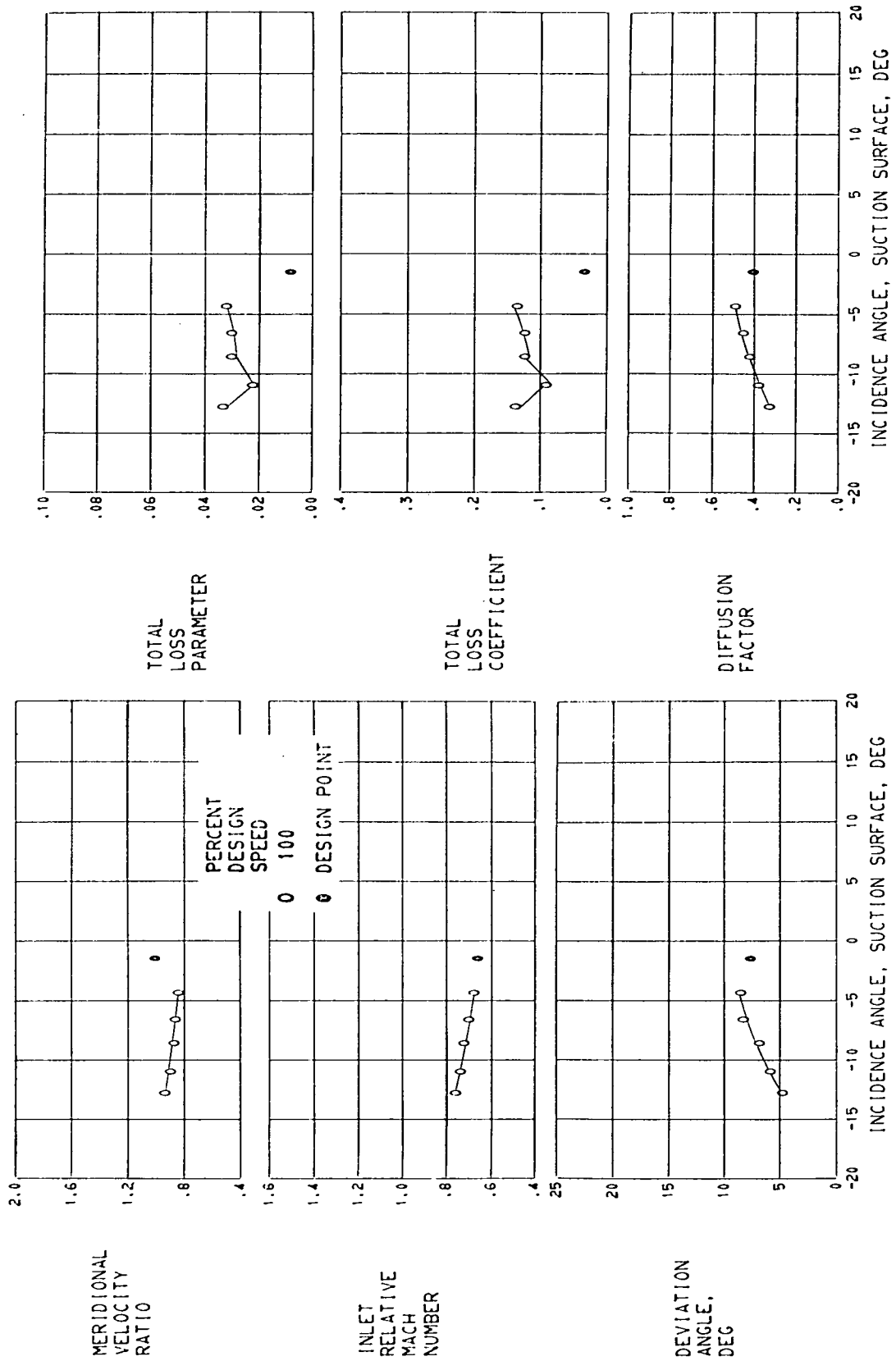

(E) 70.0 PERCENT SPAN.

FIGURE 13, - CONTINUED, BLADE-ELEMENT PERFORMANCE FOR STATOR 66.

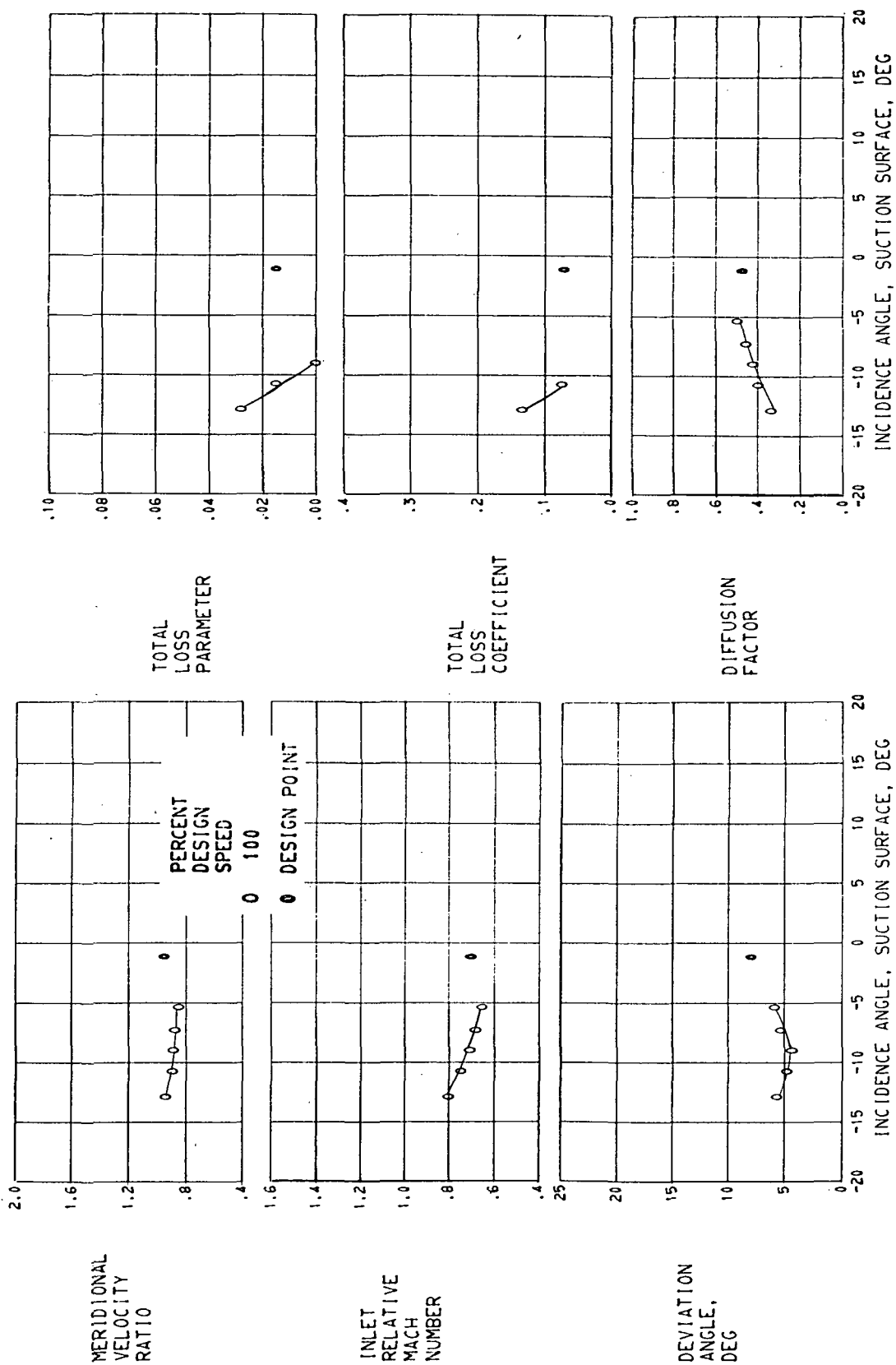

(F) 90.0 PERCENT SPAN.

FIGURE 13. - CONTINUED, BLADE-ELEMENT PERFORMANCE FOR STATOR 66.

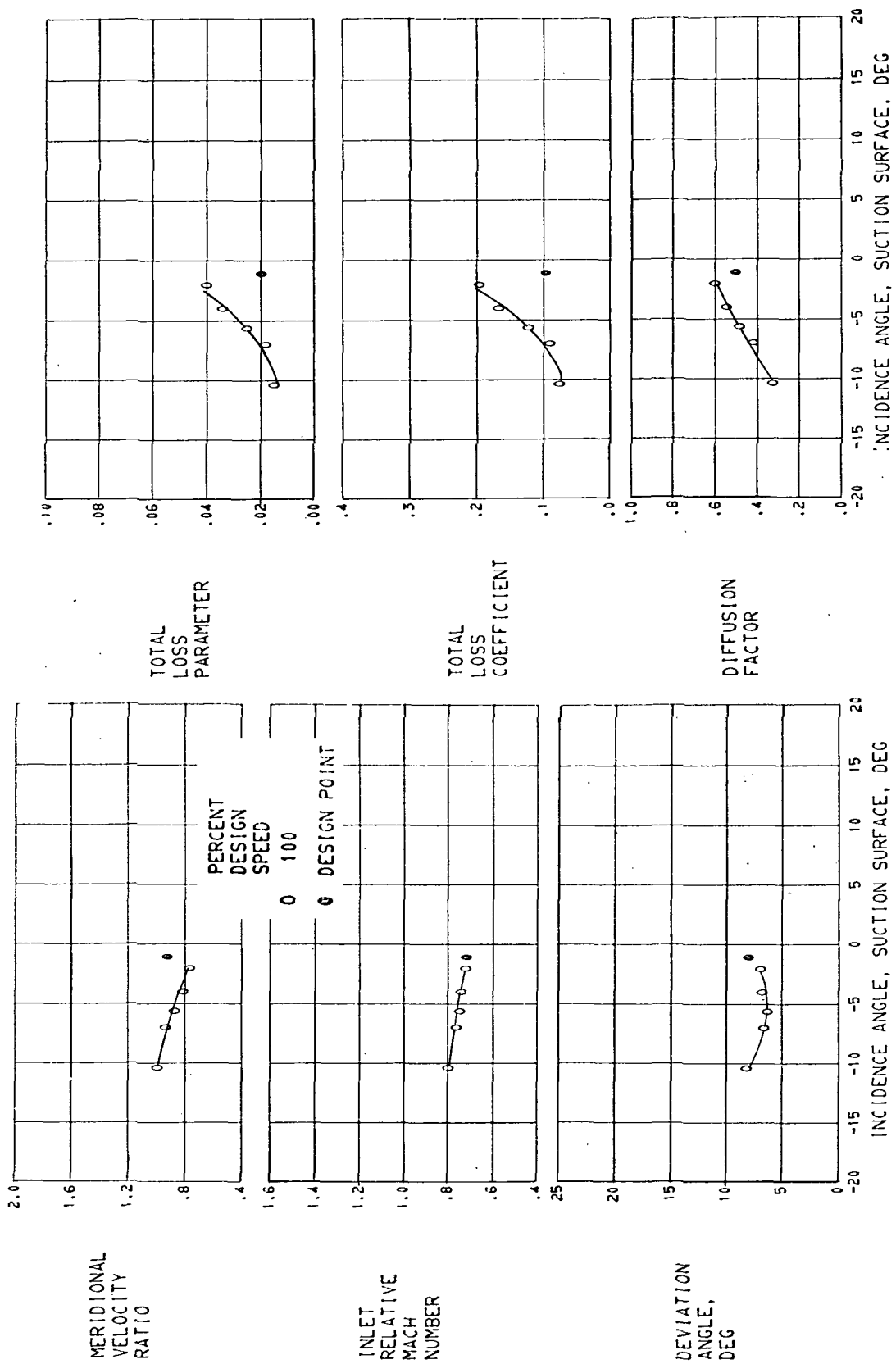

(G) 95.0 PERCENT SPAN.

FIGURE 13. - CONCLUDED. BLADE-ELEMENT PERFORMANCE FOR STATOR 66.





POSTMASTER: If Undeliverable (Section 158  
Postal Manual) Do Not Return

*"The aeronautical and space activities of the United States shall be conducted so as to contribute . . . to the expansion of human knowledge of phenomena in the atmosphere and space. The Administration shall provide for the widest practicable and appropriate dissemination of information concerning its activities and the results thereof."*

—NATIONAL AERONAUTICS AND SPACE ACT OF 1958

## NASA SCIENTIFIC AND TECHNICAL PUBLICATIONS

**TECHNICAL REPORTS:** Scientific and technical information considered important, complete, and a lasting contribution to existing knowledge.

**TECHNICAL NOTES:** Information less broad in scope but nevertheless of importance as a contribution to existing knowledge.

**TECHNICAL MEMORANDUMS:** Information receiving limited distribution because of preliminary data, security classification, or other reasons. Also includes conference proceedings with either limited or unlimited distribution.

**CONTRACTOR REPORTS:** Scientific and technical information generated under a NASA contract or grant and considered an important contribution to existing knowledge.

**TECHNICAL TRANSLATIONS:** Information published in a foreign language considered to merit NASA distribution in English.

**SPECIAL PUBLICATIONS:** Information derived from or of value to NASA activities. Publications include final reports of major projects, monographs, data compilations, handbooks, sourcebooks, and special bibliographies.

**TECHNOLOGY UTILIZATION PUBLICATIONS:** Information on technology used by NASA that may be of particular interest in commercial and other non-aerospace applications. Publications include Tech Briefs, Technology Utilization Reports and Technology Surveys.

*Details on the availability of these publications may be obtained from:*

**SCIENTIFIC AND TECHNICAL INFORMATION OFFICE**

**NATIONAL AERONAUTICS AND SPACE ADMINISTRATION**

**Washington, D.C. 20546**