

! N76-21085

INTERPRETATION OF COMET SPECTRA

C. Arpigny

INTRODUCTION

This report will be devoted to a discussion of the theoretical interpretation of the spectra of comets and in this discussion we shall consider successively a number of molecules that have been studied recently : CN, CH, C₂, C₃, OH, CH⁺. The first two of this list, CN and CH, have been analysed in greatest detail until now, so that we shall be rather brief on the other molecules. We shall try to indicate what kind of information can be derived from these studies concerning the conditions prevailing in cometary atmospheres and to show which fundamental data are needed in the calculation of the theoretical spectra.

Before going into the main part of the report, however, I should like to present a résumé of a paper of a general character which is concerned with the Spectral Classification of Comets and which is due to Dr. Bouška.

Up to now a few hundred spectra of several tens of comets have been obtained at different observatories over the world. On the one hand, there are high-dispersion spectra photographed with slit spectrographs attached to large telescopes, and on the other, small-dispersion spectra obtained by means of objective prisms.

It seems therefore useful to introduce a classification of the spectra of the cometary heads. It is evident that it is impossible to put into practice a classification similar to that used for stellar spectra. The classification of cometary spectra could rather be like the classification of meteoric spectra.

The cometary spectra show mostly two components :

- (C) continuum which is the solar spectrum reflected on the dust particles present in the cometary coma, and
- (E) emission bands (CN, C₂, C₃ and some others) connected with the intrinsic radiation of molecules in the cometary atmosphere.

The apparent intensity of these components may be weak (1), normal (2) or strong (3). In some exceptional cases continuum or emission bands may be absent (0). Consequently the classification may be as follows :

Continuum	Emission Bands	Apparent Intensity
C0	E0	absent
C1	E1	weak
C2	E2	normal
C3	E3	strong

In most cometary spectra the CN (0,0) band is dominant, in others the Swan bands of C₂; this may be expressed by the following symbols

- c - cyanogen bands dominant,
- s - Swan bands dominant.

The presence of the sodium doublet D_{1,2} observed in cometary spectra at heliocentric distances $r \leq 1$ a.u. may be denoted by the symbol n.

Metallic lines are observed exceptionally, for instance in the spectra of Sun-grazing comets. Such spectra may be denoted by the symbol M.

The cometary spectrum depends, of course, on the comet's heliocentric distance and this distance must therefore be given in the classification of the cometary spectra.

The following examples illustrate the proposed classification :

- C3E2c(0.6) Comet Arend-Roland (1957 III). Strong continuum, normal intensity of emission bands, CN (0.0) dominating; $r = 0.6$ a.u.
- C1E2s(1.2) Comet Ikeya-Everhart (1966 IV). Weak continuum, normal intensity of emission bands, Swan bands C_2 ($\Delta v = +1$) dominating; $r = 1.2$ a.u.

I should like to make two very quick comments to this proposed classification scheme, which would indeed be useful for rapid communication through the IAU circulars, as well as for statistical studies of comet spectra.

First, the strength of the continuum, especially with respect to the discrete emissions, depends strongly upon the dispersion of the spectrogram used, so that it would seem desirable to specify this dispersion in the classification symbol. This point is illustrated on Figures 1 and 2, which show the region of the CN violet (0,0) band in Comet Bennett (1970 II) as observed at $r \approx 1.0$ a.u. at the Haute-Provence Observatory using 12 \AA/mm and 7 \AA/mm reciprocal dispersions respectively. The continuum, which is strong even in this ultraviolet part of the spectrum, is nevertheless appreciably weaker relative to the discrete emissions when recorded at a higher dispersion.

The second remark is that the classification would be even more useful if it contained some information about the spectra of the ions, in particular of CO^+ .

I should now apologize to those who are well acquainted with cometary spectroscopy, but it seems worthwhile, for those who are not so familiar with this subject, to start with a short summary of the basic ideas underlying the interpretation of the spectra of comets. This anyhow will set the stage for what we are going to discuss later on. A more complete presentation can be found elsewhere (Arpigny 1971).

When one examines all the possible mechanisms he can think of

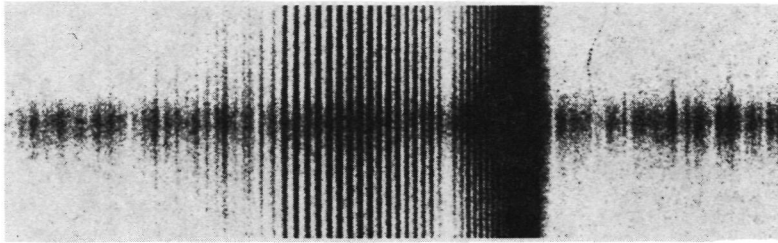

Fig. 1 - The region of the CN Violet (0,0) band in Comet Bennett (1970II) - (Haute-Provence Observatory; original reciprocal dispersion : 12 Å/mm).

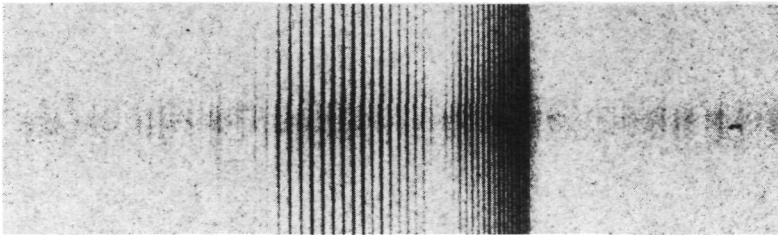

Fig. 2 - The region of the CN Violet (0,0) band in Comet Bennett (1970II) (Haute-Provence Observatory; original reciprocal dispersion : 7 Å/mm).

for exciting the electronic transitions observed in cometary spectra, he finds that the only plausible process is one of resonance-fluorescence in which solar radiation is absorbed in their resonance transitions by the cometary molecules, which re-emit right away in the same electronic systems. This is due to the very long timescales associated with the other processes, typically of the order of 10^5 to 10^6 sec or larger. The processes in question are, for instance, collisional excitation by cometary heavy particles or electrons or by solar wind particles and the long characteristic times are due either to low densities, or to the low energies available, to rather small cross-sections, or to a combination of these. By contrast, the characteristic times for absorption of solar radiation in the "optical" region are of the order of 10 to 100 sec for the molecules or atoms observed in comets near one a.u. from the sun. The corresponding relaxation time or the time for a steady state to be established is about several 100 to several 1000 sec. Now the excitation conditions, which depend upon the intensity of the solar radiation available at the various transitions and hence upon the heliocentric distance r and upon the heliocentric radial velocity dr/dt , remain essentially constant during a time of that order and we are therefore justified in assuming that stationary conditions will indeed be reached.

CN.

As an example, we shall consider the emissions of cyanogen and we shall first simplify the situation in order to emphasize the essential features of the mechanism. Thus, we shall (a) assume that the only transitions to be considered are those in the (0,0) Violet band (b) neglect the small spin splitting in the X and B $^2\Sigma^+$ electronic states (c) consider that all the CN radicals are moving at the same velocity relative to the sun, i.e. the orbital dr/dt . According to our assumptions, we have only two kinds of electronic transitions, P and R transitions. In addition to these, pure rotational transitions in the ground state must be included. Under

steady-state conditions we equate the rates of population and of depopulation of the rotational levels and by considering the absorption-emission cycles which connect these levels it is easy to obtain at once a set of equations involving the populations, x_N , of the lower rotational levels only. For level N ($\neq N''$, rotational quantum number) we have

$$x_{N-2} \cdot (\bar{s}_R)_{N-2} (s_P)_N C_{00} + x_{N+1} A_{N+1,N}^{\text{rot}} + x_{N+2} \cdot (\bar{s}_P)_{N+2} (s_R)_N C_{00} \\ = x_N \{ [(\bar{s}_R)_N (s_P)_{N+2} + (\bar{s}_P)_N (s_R)_{N-2}] C_{00} + A_{N,N-1}^{\text{rot}} \} \quad (1)$$

where the C's and the A's are transition rates per molecule in the initial level; C_{00} is the overall absorption rate in the (0,0) band. \bar{s} and s are the absorption and emission intensity factors, respectively, representing the appropriate rotational line strength divided by the statistical weight of the initial level of the transition. \bar{s} contains in addition the residual intensity factor, i_λ , which takes account of the energy available in the solar spectrum at the excitation wavelength of the transition. For example, the first term in equation (1) is the rate of the RP fluorescence process $N-2 \rightarrow N' = N-1 \rightarrow N$ ($x_{N-2} (\bar{s}_R)_{N-2} C_{00}$ = transition rate for absorption of the R (N-2) line; $(s_P)_N$ = branching ratio for the downward P(N) transition).

Once the system represented by eq. (1) has been solved (in practice about 30 rotational levels must be included in the lower electronic state), the populations of the upper levels as well as the relative intensities of the lines can be readily computed. These populations and intensities will be governed by two effects :

- (i) the first effect is the balance between the two kinds of processes:
 - a) the fluorescence cycles tend to increase the rotational energy of the molecules in the electronic ground state (if we start out with all molecules in the lowest rotational level, the distribution of molecules will be spread toward higher levels via RP cycles);

- b) the pure rotational transitions on the contrary tend to return molecules back to lower levels;
- (ii) besides this competition, the spectral energy distribution in the exciting solar radiation plays a predominant role.

The fluorescence terms in the steady-state equations all contain C_{00} , while the pure rotation transition terms are proportional to A^{rot} and the determining factor is the ratio between these, represented by a quantity

$$R \div \frac{\mu^2 r^2}{f_{00}}$$

μ being the permanent dipole moment of the molecule, f_{00} the f -value of the electronic transition. The distribution of populations will go through a maximum which will occur at a smaller rotational energy, the larger R is. Thus, for a given molecule, with μ and f_{00} fixed, the maximum will occur at lower rotational quantum numbers for the larger heliocentric distances. On the other hand, at a given r , the rotational "excitation temperature" will be different for the different molecules. It will be low for heteronuclear molecules, and large for homonuclear molecules like C_2 or for an atom like F_e which has a number of low-lying metastable terms. In the latter case (R very small) it can be shown that the excitation temperature approximates the colour temperature of the exciting solar radiation in the relevant wavelength range.

If we now consider the second effect mentioned above, i.e. the effect of the solar spectrum, we see that the very irregular character of this spectrum, with numerous Fraunhofer lines in the region of the CN Violet system for example, is responsible for the irregularities observed in the intensity profiles of the cometary emissions. This interpretation was given for the first time some 30 years ago by Swings (1941) who also pointed out that the intensity distribution would be very sensitive to the heliocentric radial velocity of the comet.

The first computations based on such a simplified ("zeroth order approximation") model were made about 10 years ago by Carrington (1962) and by myself (1964). The comparison of the observed and theoretical spectra for Comet Mrkos (1957V) showed that the general character of the distribution was rather well represented by the computations, but there were some discrepancies. In particular, the R(7) and R(8) lines were predicted appreciably too high. It was hoped that the situation would be improved if one included transitions in the Red system of CN in the calculations because there are fewer absorption lines in the red region of the solar spectrum and this would smooth out the distribution of populations. While this is indeed the case, one is still left with differences which can reach about 35 % for a few weak lines in the region of higher quantum numbers. Another example of simplified model calculations is given in Figure 3. This is the R branch of the CN (0,0) band in Comet Bennett (1970 II). The spectrum was computed by Aikman et al (1974) and one sees again a good general agreement, although a few significant differences are noticed between observed and theoretical spectra.

Let us note that from the value of Q required to compute the synthetic spectra one can derive a value for the dipole moment if f_{00} is known and we may mention in passing that the value obtained from the zeroth order approximation was used in the interpretation of the excitation of interstellar CN radicals (Field and Hitchcock 1966) at a time when no experimental determination existed for μ . This is an example where, even if the value for μ was crude, cometary spectroscopy has been of some help in connection with an outstanding astrophysical problem, which in fact was related with no less than the origin of the Universe !

We shall come back to the analysis of the rotational structure of CN, but let us first say a few words about the relative band intensities in the Red and Violet systems of this radical in comets. We consider nine vibrational levels in each of the $X^2\Sigma^+$, $A^2\Pi$, and

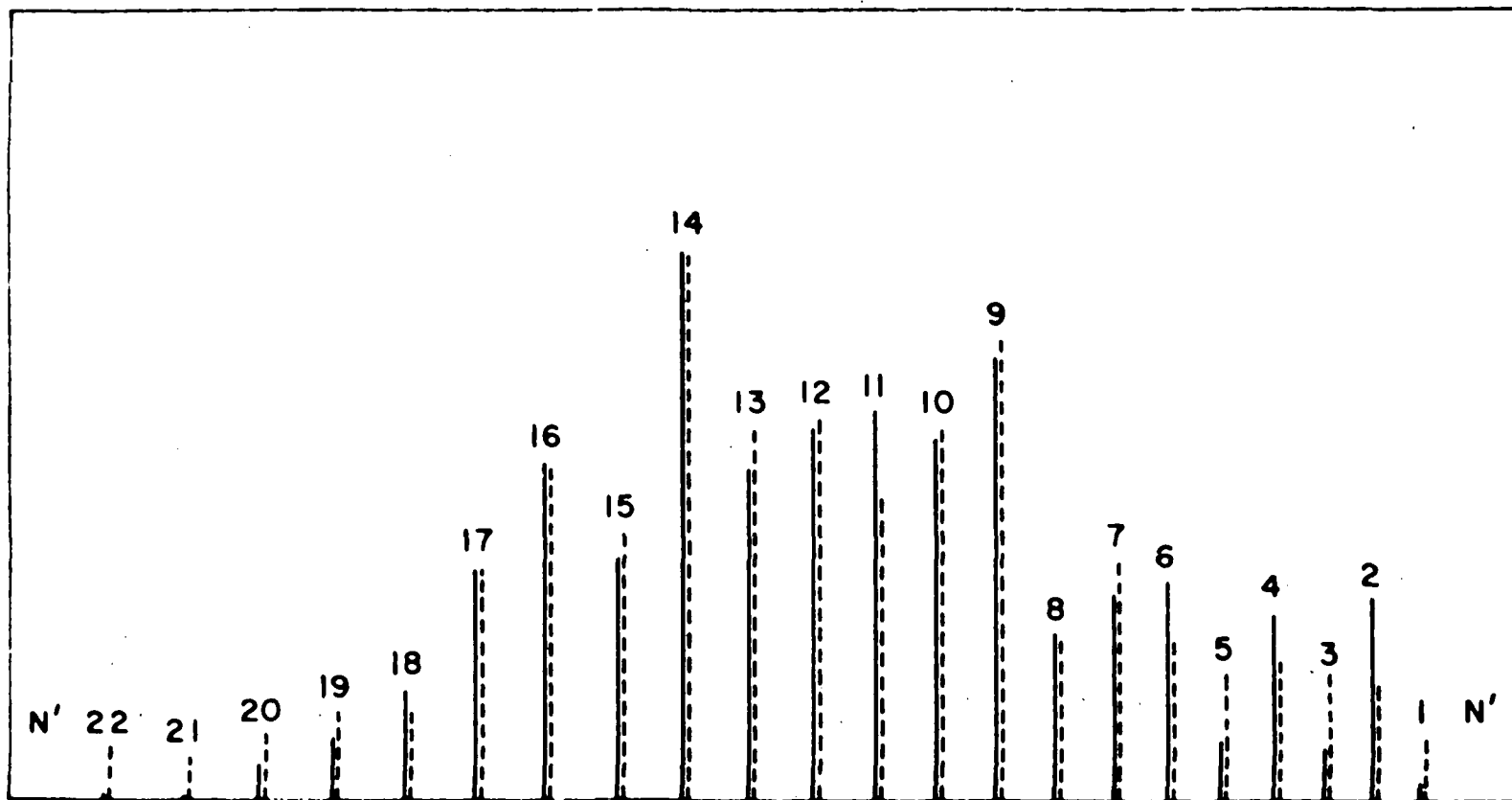

Fig. 3 - The R-branch of the CN Violet (0,0) band in Comet Bennett (1970II). Dashed lines : observed spectrum; solid lines : spectrum calculated on the basis of the simplified model assumptions (taken from Aikman et al, 1974).

B 2E+ electronic states and write steady-state equations under solar radiation excitation. Just as we have defined a quantity \mathcal{R} for the rotational structure, we define here $\nu = A_{10}^{\text{vib}} / C_{00}^{\nu}$, A_{10}^{vib} being the Einstein coefficient for spontaneous emission of the vibration-rotation fundamental band and C_{00}^{ν} the absorption rate in the Violet (0,0) band. A_{10}^{vib} is not known, so that ν must be treated as a variable. Another relevant quantity is the ratio of the f-values of the Violet and Red (0,0) bands, $f_{00}^{\nu} / f_{00}^{\text{R}}$ (hereafter called FR), about which there is also some uncertainty. Some computations have been made recently by T. Danks and myself (1973) in an attempt to interpret O'Dell's and some older observations by Dufay and Swings of some CN Red and Violet bands in comets Tago-Sato-Kosaka (1969 XI) and Mrkos (1957 V), respectively. By varying ν (or ν_1 , its value at $r = 1$ a.u.) and FR and looking for a fit with the observed intensity ratios, we find a region defined in Figure 4 by the thick-lined box inside which the fit is possible. We have here two cases corresponding to two different sets of relative f-values within the Red and Violet systems. The dot and error bar indicate the most recent experimental value for FR and we see that in one case there is no overlap while in the other there is. The thin lines indicate how the right-hand boundary of the "fitting" box is shifted for a change by 5 % and by 10 % in the observed value of R_{31} / R_{20} , the ratio of the Red (3, 1) and (2, 0) bands. The sensitivity is very high indeed. The conclusion of our study is that ν_1 is certainly > 10 , i.e. $A_{10}^{\text{vib}} > 1 \text{ sec}^{-1}$, and that $\text{FR} \geq 15$, but new, accurate measurements of several band intensity ratios in comets would be most welcome.

We now return to the rotational structure of the CN comet spectra. A number of important refinements were brought about by Malaise (1970) a few years ago, especially with respect to the model of the coma. As far as the CN molecule itself is concerned, Malaise considers radiative transitions in the (0, 0) Violet band and in several Red bands, as well as pure rotation and vibration-

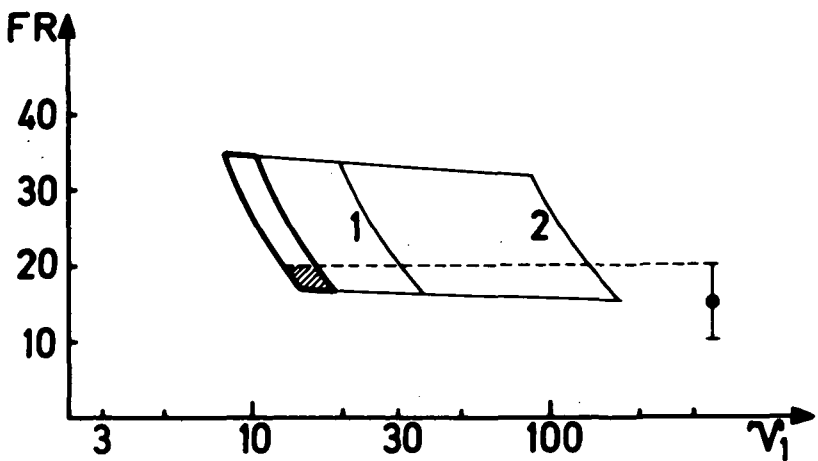
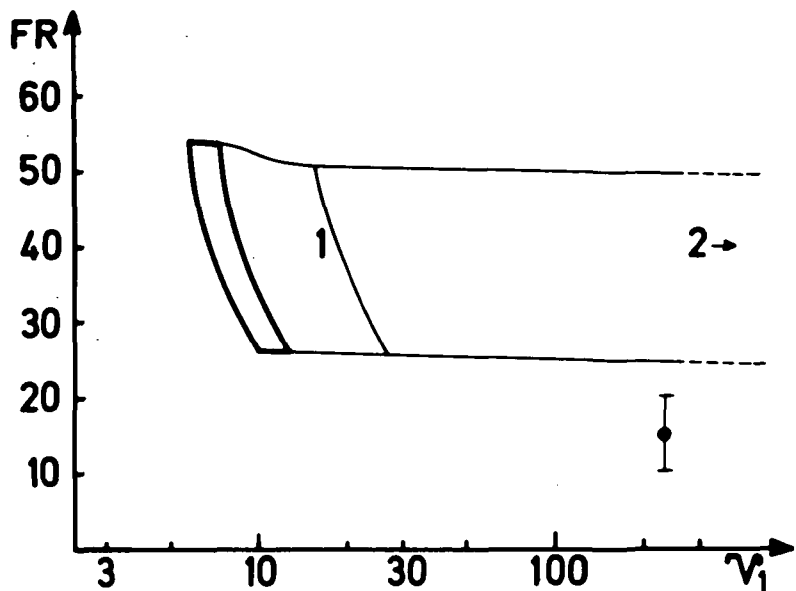

Fig. 4 - The regions of possible fit between the observed and calculated CN band intensity ratios for two different sets of relative f-values within the Red and Violet systems (see text).

rotation transitions in the ground state. He also takes account of the spin splitting, as required. Besides these radiative transitions, Malaise introduces for the first time in such calculations the effects of some collisional processes which could excite the rotational levels within the ground electronic state. Such transitions among rotational levels require much less energy and have larger cross-sections than the electronic excitations and if the densities of exciting molecules are high enough, the collisions may compete with or even dominate the radiative transitions within the ground state. One immediately realizes the considerable interest of this, because it gives a hope to estimate total particle densities or the densities of the main constituents of the cometary gas, as opposed to the already known densities of the observed radicals, which are minor constituents. If the collisions are predominant, the lower rotational levels of CN will be populated according to Boltzmann's law at the temperature of the colliding particles and the way in which Malaise takes account of the collisions is as follows. The population of each lower rotational level is written as a linear combination of the corresponding Boltzmann population and pure fluorescence population :

$$x = \alpha x^B + (1 - \alpha)x^F, \quad (2)$$

where α gives a measure of the relative importance of the collisional and radiative mechanisms and is taken from the relation

$$\frac{\alpha}{1-\alpha} = \frac{T_F}{T_C} = n \bar{v} \sigma \cdot \tau_F, \quad (3)$$

τ_F being the time necessary to reach a steady-state under fluorescence conditions (this is estimated to be a few 100 sec for CN at 1 a.u. from the sun), τ_C the collision time, n the density of exciting molecules, \bar{v} the average relative velocity, and σ the cross-section for collisional excitation. Now this looks reasonable at first sight, since the expression (2) gives correct asymptotic values at the extremes of high and low densities. When n is high, the collisions

dominate, the ratio (3) will be large, hence α will be near unity and the populations will be Boltzmannian, while for low n the ratio is small, hence α will be near zero and we have essentially pure fluorescence populations. However, the validity of eq. (2) in the intermediate situations is highly questionable, as we shall see later on when we discuss the case of the CH radical. At any rate, n and therefore α are functions of position within the comet and the calculations have to be made and eq. (2) used at a number of points. An integration is then performed along the line of sight. For this, of course, model distributions must be appropriately chosen for $n(R)$ and $n_{\text{CN}}(R)$, R being the distance from the centre of the comet. The former distribution is adjusted while making the computations of synthetic spectra, whereas the latter is derived from the observed radial profile of CN emissions (intensity distribution in the direction perpendicular to the dispersion). Furthermore, it can be shown that the cometary gas is optically thin in the light of CN, so that the integration reduces to a simple summation. On the other hand, the kinetic temperature of the exciting molecules (related to \bar{v}) is considered to be constant throughout the comet, which is only a rough approximation.

Another important effect comes in also, that is the influence of the motions of the radicals within the atmosphere of the comet. Such motions are of course expected, but their existence is actually inferred in the interpretation of the so-called Greenstein effect, which consists in differences in the relative intensities of the spectral lines in different regions of the comet, for instance on the two sides of the nucleus. The model adopted is one of uniform, isotropic expansion where the radicals move radially away from the center with velocity v_0 . What counts, of course, is the component of this v_0 on the direction to the sun and Malaise computes a projection factor in terms of the phase angle sun-comet-earth, assuming that the sun lies in the plane defined by the slit of the spectrograph and the line of sight. This assumption is often not

valid, however, and this does introduce in some cases significant errors in the residual intensities i_λ which enter the steady-state equations. The heliocentric radial component of v_0 obviously varies with position along the line of sight and this is another reason for making an integration.

Four high-dispersion and four medium-dispersion spectra of comets obtained at the Haute-Provence Observatory were studied by Malaise. The comparison between observed and theoretical spectra shows a rather satisfactory agreement, but there are again a few lines for which the discrepancy reaches about 20 %. Two quantities come out of this kind of analysis. One is T , the kinetic temperature of the colliding molecules and the other is the expression $n_0 \sigma \tau_F / \sqrt{M}$, where n_0 is the total density (or a minimum value for this total density, if the exciting species is not a predominant constituent) at some reference distance from the nucleus, say at $R = 10^4$ km, while M is the reduced mass of CN and the exciting molecule. There are three comets for which Malaise finds important collisional effects, namely Seki-Lines (1962 III), Ikeya (1963 I), and P/Encke (1961 I) (α_0 , the value of α at $R = 10^4$ km, equal to 0.90, 0.90 and 0.55, respectively). Assuming the gas to be made primarily of H_2O or CO for instance, and taking σ equal to the gas-kinetic cross-section, one derives (after multiplication of the second member of eq. (9) of Malaise (1970) by a correcting factor of $1/\pi$, that of eq. (11) by $2/\pi$) : $n_0 \approx 10^9 \text{ cm}^{-3}$ for the first two comets, and $n_0 \approx 10^8 \text{ cm}^{-3}$ for P/Encke. The corresponding total production rates are $Q \approx 10^{33}$ and $10^{32} \text{ molec. sec}^{-1}$, respectively. These are lower limits if the production of the exciting molecules does not take place entirely in a region the dimensions of which are small compared to 10^4 km. The first figure is some three orders of magnitude larger than $Q(H_2O)$ observed in Comet Bennett (1970II), which belongs to the same general class of rather bright objects as Seki-Lines and Ikeya, while the second figure exceeds by about four orders of magnitude the value of $Q(H_2O)$ derived for Comet Encke itself at a similar heliocentric distance during its perihelion passage of 1970. One may also say that with

the above densities and production rates the total mass loss ΔM of each of these comets during one revolution around the sun would be close to or even greater than its mass M , as shown in Table 1. The ΔM 's computed here are based upon the Q 's quoted above, parabolic orbits, and various power laws for the variation of Q with heliocentric distance $Q \div r^{-n}$, with $n = n_0 + n_1 \sqrt{r}$, n_0 and n_1 being in each case chosen in such a way that n lies near 2 to 2.5 for r near one a.u. - cf Keller and Lillie, 1974). On the other hand, the M 's are evaluated using the radii derived by Miss Roemer (1965) from "nuclear" magnitudes (the albedo is taken here equal to 0.1, probably on the low side of the actual value) together with a density of one g.cm^{-3} . The corresponding values of M represent upper limits to the masses of the comets, for the nuclear magnitude tends to overestimate the luminosity of the nucleus, hence its radius, because of a non-negligible contribution from a halo surrounding the nucleus, and if we have to do with separated particles rather than with just a monolithic nucleus, the total mass for a given total reflecting area will be smaller than if we assume the presence of only one single body. Clearly there is a very serious difficulty regarding the molecular densities which Malaise's results lead to. There are only two factors multiplying n_0 in the expression given earlier that could possibly influence the conclusions, namely σ and τ_F .

The value adopted for σ , i.e. $2 \times 10^{-15} \text{ cm}^2$, does not appear to be too small by any significant factor and on the contrary can be deemed rather good from what is known about cross-sections for translational to rotational energy transfer (Gordon et al, 1968). One might consider that the agents producing rotational excitation are charged particles. With the very large cross-section calculated by Crawford et al (1969) for excitation of CN by slow ($\approx 0.05 \text{ ev}$) electrons, in order to reach the collision rates of 0.03 to 0.3 sec^{-1} in question here one would need 10^5 such electrons per cm^3 or more, which seems rather high, although we have unfortunately no direct evidence about electrons in comets. As far as heavy ions are concerned, while it cannot be expected that the corresponding cross-sections be

Table 1.
A Comparison Between Mass Losses and Masses for Three Comets.

Comet	$\Delta M (10^{16} \text{ g.})$	$M (10^{16} \text{ g.})$
Seki-Lines (1962III)	$\geq 100-300$	≤ 40
Ikeya (1963I)	$\geq 20-30$	≤ 20
P/Encke (1961I)	$\geq 5-7$	≤ 2

ΔM is calculated as follows. It is assumed, for the sake of simplicity in these order of magnitude estimates, that the rate of mass loss is the same after perihelion as it was before, so that

$$\Delta M = 2 \int_0^{\infty} Q \, dt \quad (t = 0 \text{ at perihelion}).$$

Now, if Q_s is the value of Q derived from a spectrum taken at $r = r_s$ and if $n_s = n(r_s)$, we can write

$$Q = Q_s \left(\frac{r}{r_s}\right)^{n_s} \left(\frac{q}{r}\right)^n \quad (q = \text{perihelion distance}),$$

while for a parabolic orbit we have $r = q(1+\beta^2)$ and $\tau = \beta + 3\beta^2$, provided that $\beta = \tan(w/2)$ ($w =$ true anomaly) and we have substituted $\tau = C^{-1}t$, with $C = (293)^{1/2} \cdot (3k)^{-1}$ ($k =$ Gaussian gravitational constant). Finally, we obtain

$$\Delta M = 6CQ_s \left(\frac{r_s}{q}\right)^{n_s} \int_0^{\infty} (1+\beta^2)^{1-n(\beta)} d\beta,$$

which is readily evaluated by a numerical integration. Note that the use of a parabolic orbit is a good approximation even for Comet Encke because the contribution to the integral gets small once r becomes large compared to 1 a.u. or β large compared with $(q^{-1} - 1)^{1/2}$ (the perihelion distances of the three comets are 0.03, 0.63, and 0.34 a.u. respectively). Besides, the ΔM 's are essentially unchanged if it is assumed that the activity of the comets stops at some distance r_M from the sun, say 3 a.u., and the upper limit of the integral accordingly replaced by $\beta_M = (r_M/q - 1)^{1/2}$.

three or four orders of magnitude larger than the gas kinetic cross-sections, it is also unlikely that the production rate of ionized species be much larger than the production rate for the neutrals.

On the other hand, one might think that one way out of the difficulty would be to say that τ_F has been wildly underestimated. In fact, however, this relaxation time was computed for CN excited by sunlight some ten years ago (Arpigny, 1964) and the result was of the order of 10^2 sec at one a.u. from the sun, which indeed agrees with the value adopted by Malaise. Besides, it may be pointed out that if one reduced the densities considerably by artificially increasing τ_F , for instance, by several orders of magnitude, then he would be faced with another problem, namely that the collision times even further in, say at 10^3 km from the nucleus, would become large compared with the radiative lifetimes of the rotational levels, so that the concept of a Boltzmann distribution of populations would become meaningless.

Let us now make a remark illustrating another point, related to the fundamental data required for the computation of the synthetic spectra. Malaise found in particular for a spectrum of Comet Ikeya (1963I) that the reason why collisions were needed to reproduce the observed spectrum was that fluorescence alone predicted too small intensities for the lower rotational lines relative to the higher, whereas a better agreement could be obtained by introducing "mixed" populations (eq. 2) and adjusting the "rotational temperature" properly. However, it can be argued that the relative intensities of the lower rotational lines could be increased, under pure fluorescent excitation, by increasing the value of \mathcal{R} , i.e. of the dipole moment of CN. Indeed, the experimental value of μ is about twice the value used by Malaise. More should be said about the values of \mathcal{R} and of ν adopted by this author, but such a discussion would be outside the scope of the present review.

Something should also be said about the wavelengths scales. In spite of Malaise's very careful and thorough discussion of the data on the λ 's of the CN Violet lines that were available when he made

his computations, he had to use λ 's which, we know now from recent analyses, were in a number of cases in error by up to 15-20 mÅ (although many lines had better λ 's). This is significant because such displacements in the solar spectrum can produce appreciable changes in i_λ . The new λ 's are accurate within $\approx \pm 2$ mÅ. Furthermore, we now have separate wavelengths ($\Delta\lambda = 15-30$ mÅ) for the components of the spin doublets (down to $N = 7$), which were unresolved previously. On the other hand, Malaise had to make use of solar spectra of the center of the disk which were also affected by wavelength uncertainties of the order of 5-10 mÅ. Recordings of the solar spectrum, of the integrated light from the disk, with considerably more accurate wavelengths ($|\Delta\lambda| \lesssim 2-3$ mÅ) now exist. Use of the new data should hopefully give a satisfactory interpretation of the Greenstein effect and thus allow a good determination of the velocities of the CN radicals in the coma (The velocities given by Malaise correspond to shifts that are smaller than 10 mÅ, so that the wavelengths scales should preferably be known with a rather high accuracy !).

Finally, let us have a look at Figure 5, which shows a very beautiful spectrum of Comet Bennett (1970II) taken by Preston with the 100-inch telescope on Mount Wilson. At the reciprocal dispersion of 4.5 Å/mm the P-branch of the CN Violet (0,0) band is completely resolved. We also see a number of weak lines in between the principal lines : these belong to the (1,1) band and they should be included in a refined treatment, especially for example if one wants to make a search for isotopic lines, which also fall in between the lines of the main band. Notice a somewhat stronger line just shortward of R(14) : this is a blend of the P(2) line of the (1,1) band with a perturbed line. There are a few such perturbed lines in the R and in the P branch of the (0,0) band and their analysis in very high-dispersion comet spectra could provide some insight on the formation of CN radicals in excited states and on the rates of collisional processes.

In conclusion, it is clear that CN in comets deserves further study. The more detailed analysis of the rotational structure of the Violet (0,0) band shows a good agreement between computed and observed

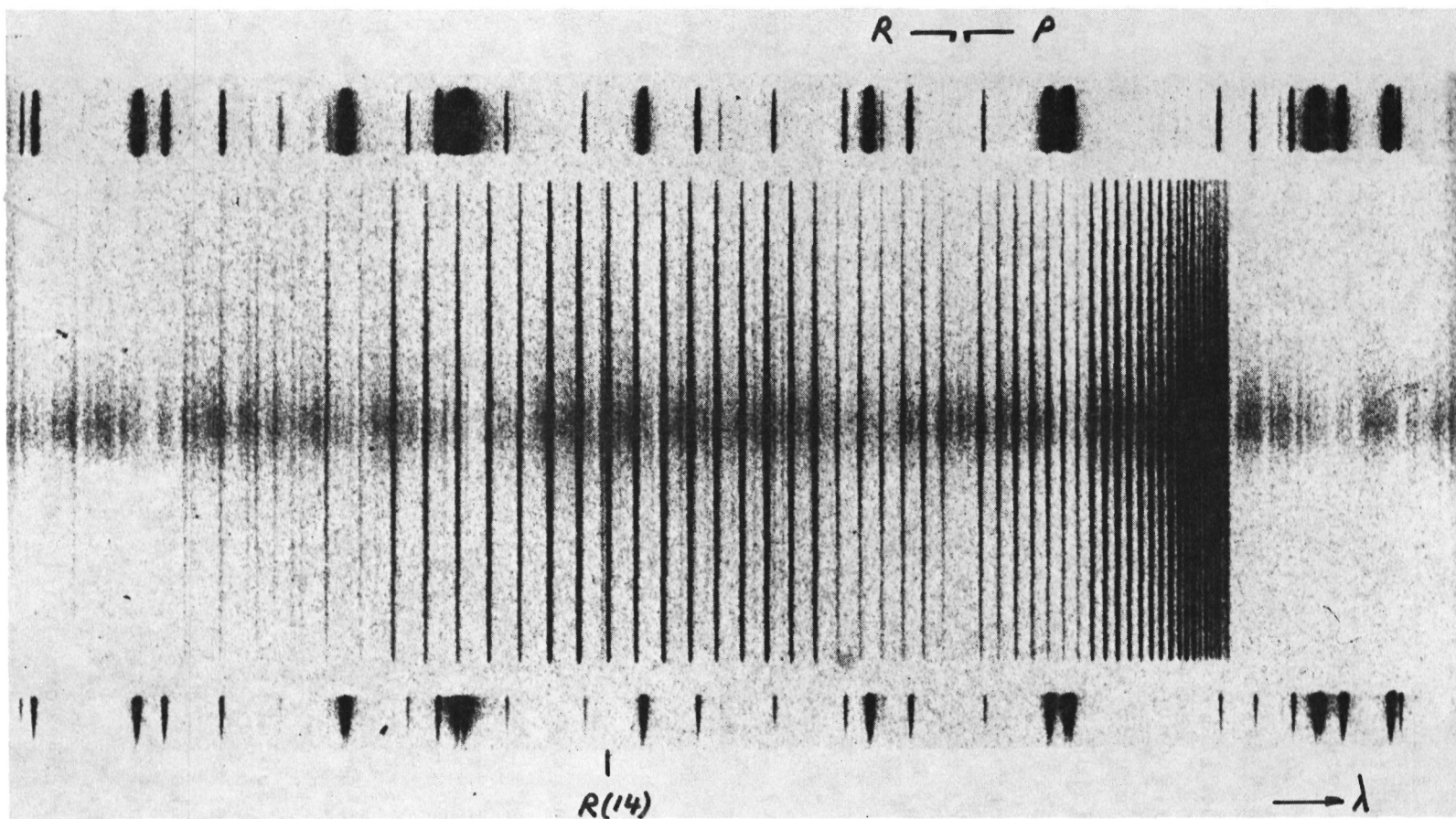

Fig. 5 - The CN Violet (0,0) band in Comet Bennett (1970II) (Mount Wilson Observatory; original dispersion : 4.5 Å/mm). Note the weak lines due to the (1,1) band in between the stronger features. The emission next to R(14) on the left is partly due to a perturbed line.

spectra, but we have seen that the zeroth order approximation already gave rather good results. This is indeed a rather awkward situation and in order to interpret the finer details and thus to assess the actual importance of collisional effects, to derive reliable information on the densities, temperatures, and velocities within cometary atmospheres, if it is in fact necessary to treat the excitation mechanism rigorously, to use the most precise fundamental data available, to improve upon the model of the coma. It would even be desirable, in my opinion, to have recourse to photoelectric photometry, to avail ourselves of a higher accuracy in the observations themselves, just because the margin between the results of the simplified analysis and those of the more refined treatment is rather narrow.

CH.

We now come to the spectrum of the λ 4300 band of the CH radical, Figure 6 shows density tracings of this emission in four comets observed at the Haute-Provence Observatory (V90, V927, V964) and at the McDonald Observatory (8384C). It is seen that the whole band reduces to a few rotational lines and that the relative intensities of these lines are rather different in different spectra. The comparison between one observed spectrum and the corresponding computed spectrum based on a zeroth order approximation (Arpigny, 1965) showed a fairly good agreement, with differences of 20 to 30 % in the relative intensities of one or two lines. However, the value to be adopted for μ^2/f_{00} in that case was about 5 times smaller than the experimental value for this ratio. I should now like to present some preliminary results obtained very recently by Miss Klutz and myself and based on a considerably more elaborate treatment.

We include fluorescence transition in the (0,0) bands of the $A^2\Delta - X^2\Pi$ and in the $B^2\Sigma - X^2\Pi$ systems of CH and take account of the spin-doubling in the various electronic states, as well as of the Λ -doubling in the $^2\Pi$ state. On the other hand, we adopt the isothermal model for the coma, with uniform, isotropic expansion with velocity v_0 . The heliocentric radial component of v_0 is computed correctly, taking account of the angle between the sun-comet-earth

V 90

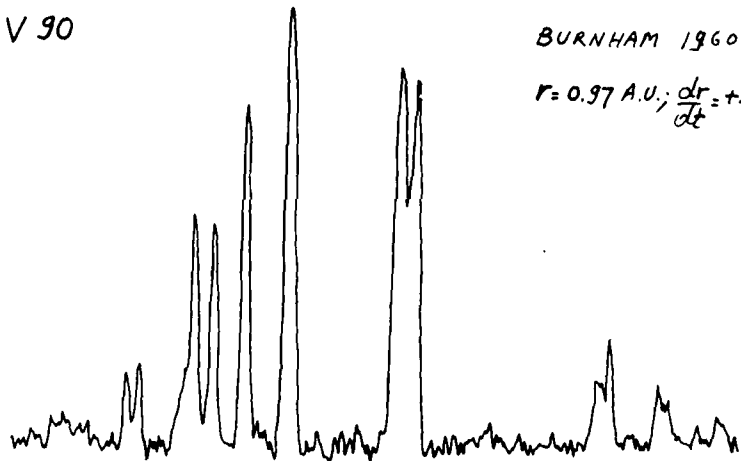

BURNHAM 1960 II

$r = 0.97 \text{ A.U.}; \frac{dr}{dt} = +29.62 \text{ km/sec}$

V 927

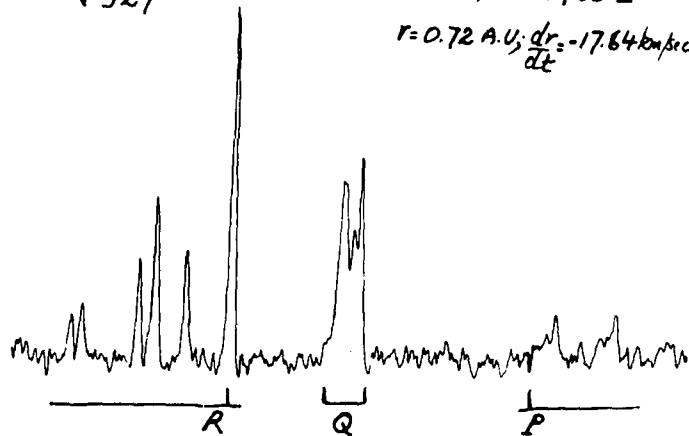

IKEYA 1963 I

$r = 0.72 \text{ A.U.}; \frac{dr}{dt} = -17.64 \text{ km/sec}$

V 964

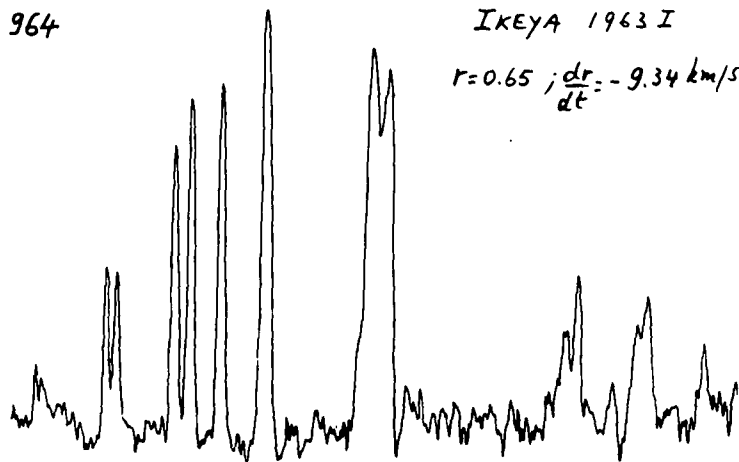

IKEYA 1963 I

$r = 0.65; \frac{dr}{dt} = -9.34 \text{ km/sec}$

8384C

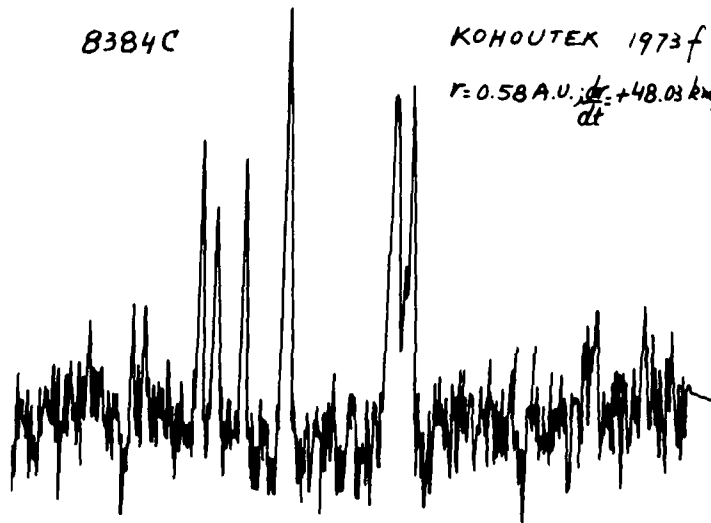

KOHOUTEK 1973 f

$r = 0.58 \text{ A.U.}; \frac{dr}{dt} = +48.03 \text{ km/sec}$

Fig. 6 - The (0,0) band of the $A^2\Delta - X^2\Pi$ system of CH in four comets (density tracings).

plane and the plane defined by the line of sight and the slit of the spectrograph. The colliding particles that could excite the lower rotational levels are distributed according to $n(R) \div R^{-k}$, R being the distance from the centre of the comet and $k \leq 2$. For the same reasons as before, we have to solve steady-state equations at several points along the line of sight and we introduce the effects of the collisions right at this stage rather than using linear combinations of Boltzmann and pure fluorescence terms for the populations of the lower levels. In other words, in addition to radiative, we also have collisional matrix elements of the form $n\nu\sigma$. We have considered several models for the cross-sections corresponding to different selection rules and to different laws of variation with the rotational quantum number, but we have been unable to distinguish between these models from this first investigation.

The results obtained so far will be illustrated by means of the example of a spectrum (V927) of Comet Ikeya (1963I). We shall consider three kinds of situations :

- (1) cases in which the radiative processes dominate in the ground electronic state,
- (2) cases where the collisional processes are predominant among the lower rotational levels, or
- (3) intermediate cases.

Let us first take the radiation-dominated (\mathcal{R} -d) case and refer to the upper part of Figure 7, where we plot the computed relative intensities of the various lines against the fundamental parameter \mathcal{R}_1 . Then each curve is marked with two vertical bars representing the corresponding observed intensity with its error limits. A fit with the observations is obtained of course if the various \mathcal{R}_1 intervals so defined do overlap. As we see, this does not happen for this \mathcal{R} -d case, whatever \mathcal{R}_1 may be. The experimental values of μ and of f_{00} yield a value of $50 \times 10^{-6} \text{ cm}^3$ for \mathcal{R}_1 , and it is clear that for this value the higher rotational lines are predicted too weak, the lower rotational lines too strong. How about the collision-dominated (\mathcal{C} -d) case ? This is illustrated in the lower part of

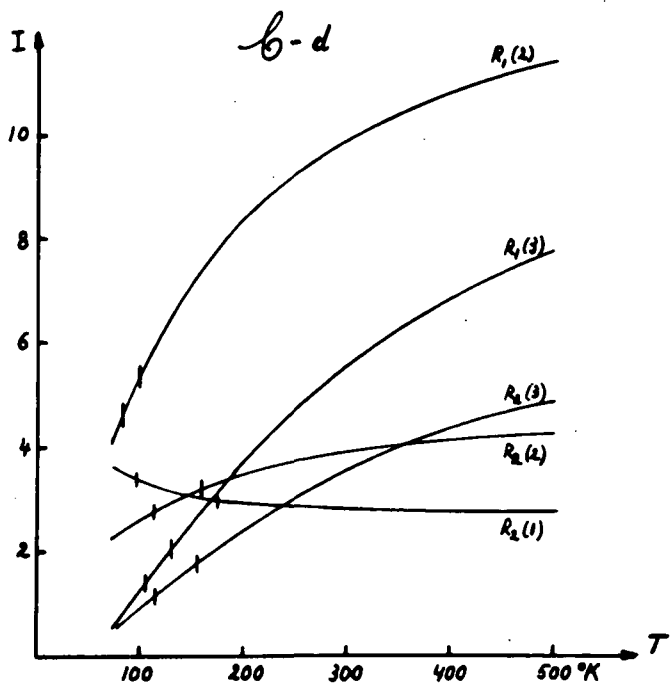
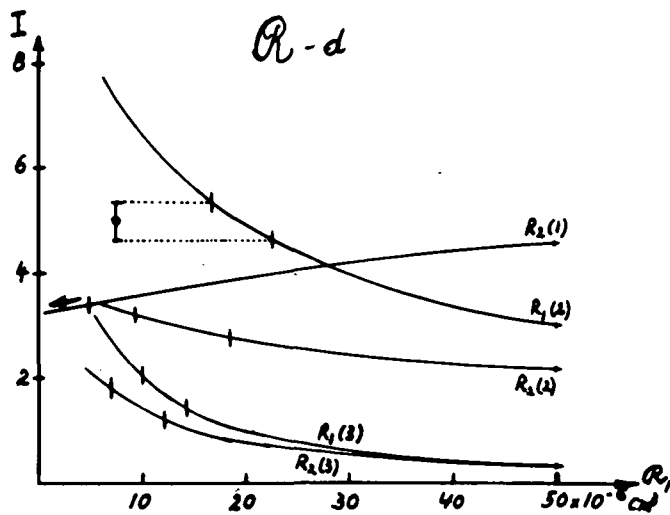

Fig. 7 - The relative intensity curves for the principal lines under radiation-dominated (top) and collision-dominated conditions (bottom). The vertical bars on each curve represent the corresponding observed intensity with its error limits. The intensities are normalized to $R_1(1) = 1$.

Figure 7 where the abscissae are the values of the kinetic temperature of the colliding molecules. Here again we find no solution. The value of T nearest to a solution would be rather low, near 100°K , but $R_1(2)$ and $R_2(3)$ are mutually exclusive and there is indeed no fit. From these extreme cases it can be concluded that n_o , the density at $R = 10^4$ km, must be contained in the interval from about 10^4 cm^{-3} to about 10^8 cm^{-3} (this is for gas kinetic cross-sections and H_2O exciting molecules).

Thus we are led to turn to intermediate cases. Let us take R_1 equal to the experimental value and fix T at 600°K , for instance. In Figure 8, then, we plot the relative intensities versus $\log n_o$ and we have a solution, corresponding to $n_o \approx 5 \times 10^4 \text{ cm}^{-3}$. It is instructive to examine the spectra themselves, which are represented schematically in Figure 9, the intensity of each line being shown by a vertical line. The observed spectrum appears as solid lines, the theoretical spectrum as dotted lines, all normalized at $R_1(1)$. This is done for five values of n_o , each value being indicated at the top of the corresponding spectrum. As mentioned above, with $R_1 = 50 \times 10^{-6} \text{ cm}^{-3}$ the pure fluorescence predicts too weak higher rotational lines; there is a deficiency in rotational excitation energy and we supply this energy by putting in molecules at some appropriate T . With $n_o = 5 \times 10^3 \text{ cm}^{-3}$ we do not have enough molecules, so that the higher lines are still too faint whereas at $n_o = 5 \times 10^5 \text{ cm}^{-3}$ on the contrary these lines become too strong because there are too many molecules. It would seem from this that a unique solution exists, corresponding to $n_o \approx 5 \times 10^4 \text{ cm}^{-3}$. That such is not the case, however, is seen when one wonders about the value of T . It turns out that situations similar to the one we have just met with occur at temperatures in the range of roughly $400 - 800^\circ\text{K}$. What happens is shown in Figure 10. As we go from 600 to 800°K , for example, the relative intensity curves given here for two lines move in such a way that the n_o intervals still overlap so that we still get a solution. The value of n_o is well defined in each case because the

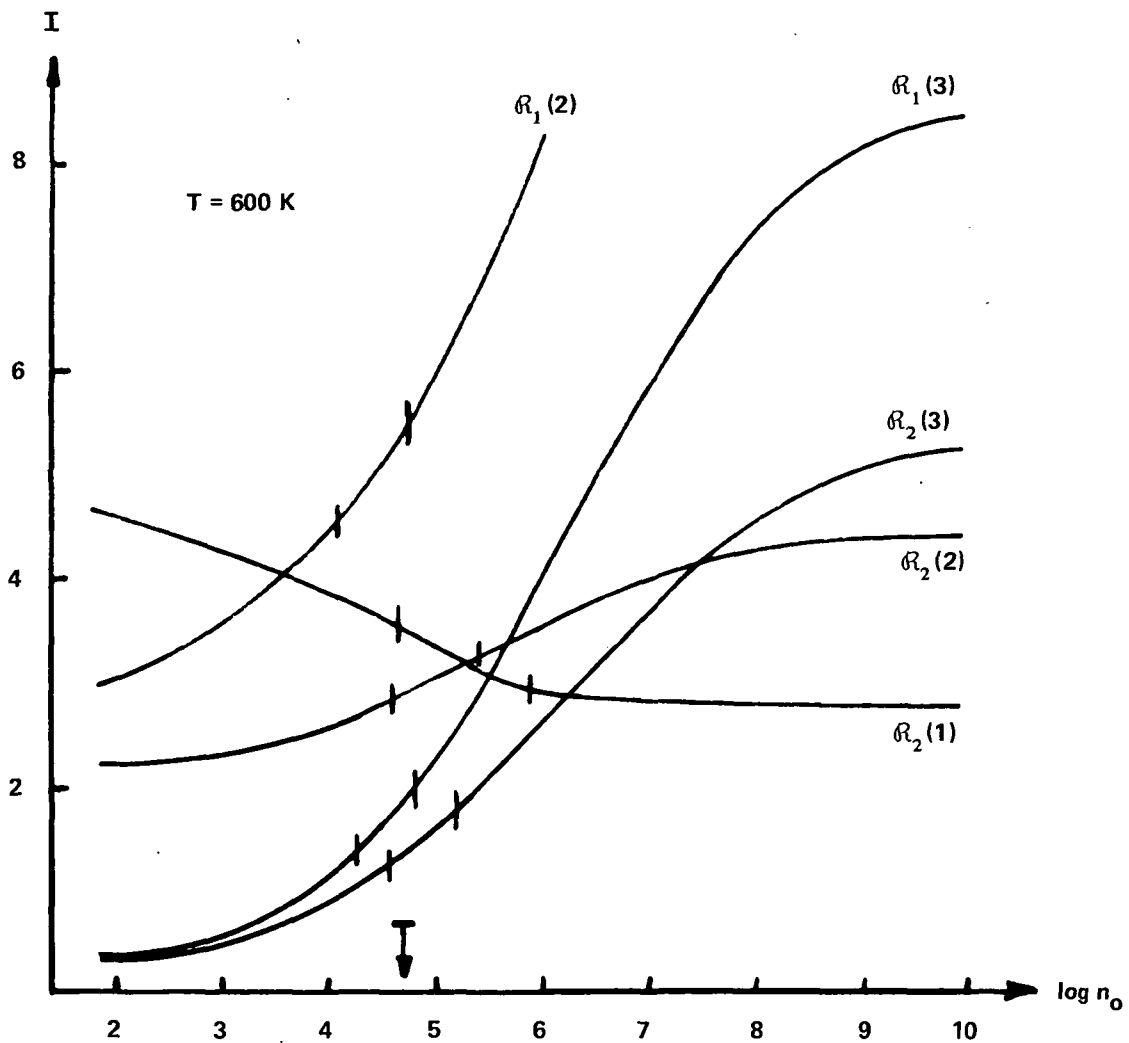

Fig. 8 - Relative intensity curves for the principal lines of CH under intermediate conditions. The vertical bars on each curve represent the corresponding observed intensity with its error limits. The intensities are normalized to $R_1(1)$. The arrow indicates the approximate value of $\log n_0$ for which a fit with the observations is possible.

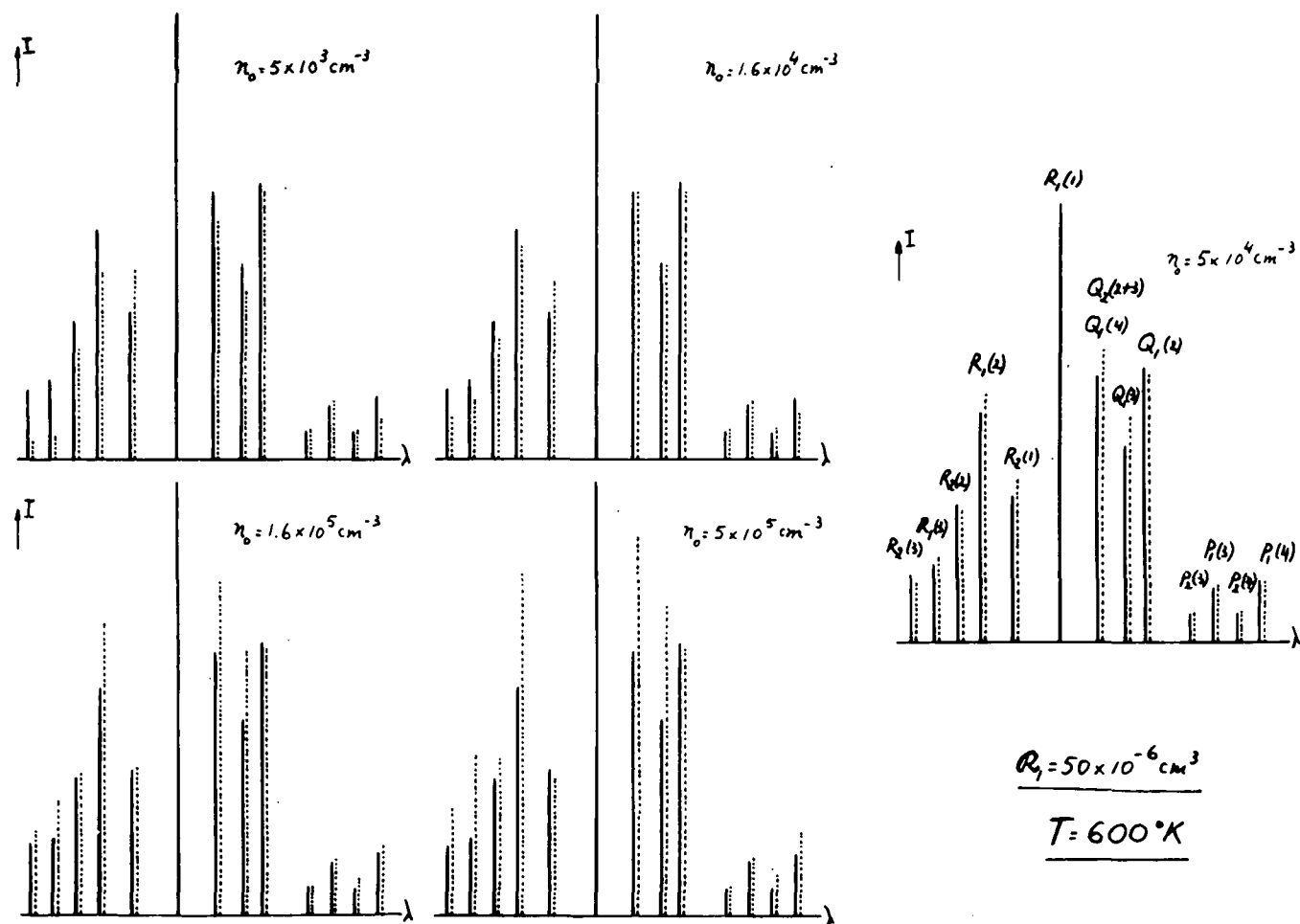

Fig. 9 - Comparison between the observed spectrum (solid lines) and corresponding spectra of CH calculated (dotted lines) for intermediate cases with various densities of exciting molecules.

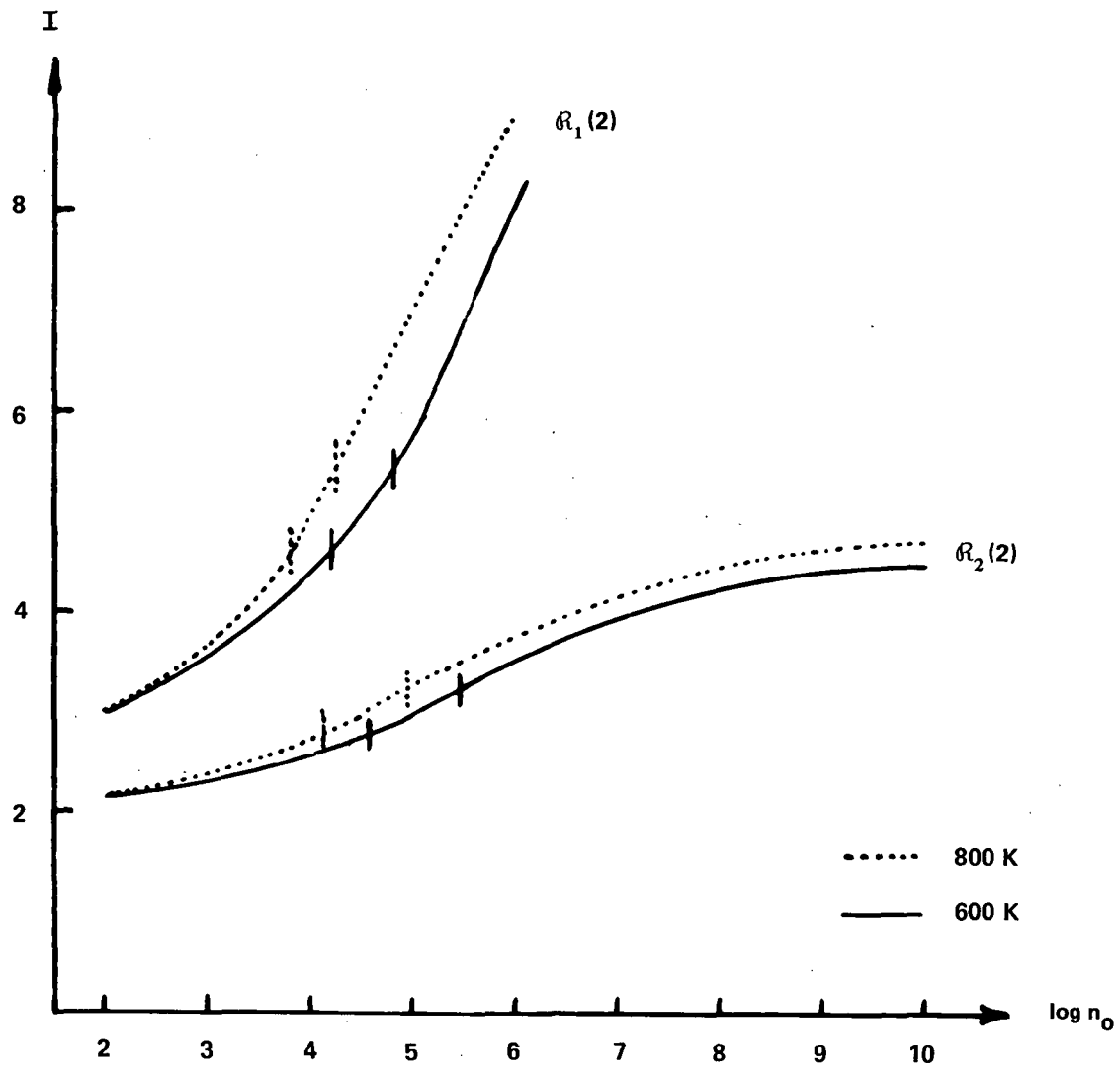

Fig.10 - Relative intensity curves for two CH lines under intermediate conditions at two different temperatures.

overlap of the intervals is small. For $T = 400^\circ\text{K}$, n_0 is found to be $\approx 10^5 \text{ cm}^{-3}$, while at $T = 800^\circ\text{K}$ it is $\approx 2 \times 10^4 \text{ cm}^{-3}$. At lower T we need more molecules to supply the missing excitation energy.

Similar situations are encountered for some other spectra of comets Burnham (1960I), Ikeya (1963I), Bennett (1970II), and Kohoutek (1973XII), which we are studying. The densities fall in the range $10^4 - 10^6 \text{ cm}^{-3}$ and the temperatures are ill-defined, covering a range of several hundred degrees. Here also it is felt that if very accurate observations obtained by photoelectric photometry were available, one would be in a better position to make the adjustment of the parameters and to improve the model of the cometary atmosphere. On the other hand, if the same molecules contribute to the excitation of the lower rotational levels of CH and CN for example, which seems likely, then the values for the densities and temperatures that come out from the analysis of the emissions of these (as well as of other) radicals in one given comet spectrum should obviously agree. This condition will have to be borne in mind in future studies.

We can take advantage of the fact that we are able here to calculate steady-state populations with radiative and collisional terms and at the same time to compute pure fluorescence populations as well as Boltzmann populations, in order to test the validity of a linear approximation such as that described in the discussion of CN. In other words, referring to eq. (2) we have the means of knowing x (corresponding to a given density n of exciting molecules) as well as x^B and x^F , hence we can deduce α . If eq. (2) had any general meaning, the same value should of course be obtained for α when using the populations of all the levels. This has been done for a number of values of n corresponding to R-d, C-d, and intermediate cases as defined above, with the result that α is anything but constant for the various rotational levels. When n is very low or very high, α is very nearly equal to zero or to one for all levels, as expected. However, it covers a very wide range (e.g.

0.10 to 1.45, or 0.20 to 1.25) when n is intermediate. This is not unexpected either, because the radiative lifetimes of the different lower rotational levels are different (in particular owing to the Swings effect), so that the ratio of the characteristic time against radiative transition to the characteristic collision time is not the same for the different levels. Similar conclusions would most probably apply to the case of CN.

Finally, let us mention that only for one spectrum, namely a spectrum of Comet Bennett (1970II) has it been possible to estimate the expansion velocity v_0 of the radicals, the other spectra being rather insensitive to velocity shifts in the interval $0-1 \text{ km. sec}^{-1}$. In the case of this spectrum of Comet Bennett the intensity distributions on the two sides of the centre are very different from one another and it is found that v_0 is equal to $1.0 \pm 0.3 \text{ km. sec}^{-1}$.

C₂.

Now a few words about the C₂ radical. The high rotational and vibrational excitation temperatures derived from the Swan system are interpreted in terms of the resonance-fluorescence mechanism as due to the homonuclear character of this molecule, i.e. to the very small value of R_1 . However, when one looks at the spectra or at the intensity distribution one meets with difficulties here also. For example, one finds appreciably different vibrational temperatures in different band sequences. Gebel (1970) compares the values observed for flux ratios like $F(\Delta v = +1)/F(\Delta v = 0)$ and $F(\Delta v = -1)/F(\Delta v = 0)$ to the corresponding theoretical values for various temperatures and finds that the former indicates relatively low T_{vib} ($\sim 3000^\circ\text{K}$), while the latter corresponds to higher vibrational excitation temperatures ($> 6000^\circ\text{K}$). This can be attributed to an underpopulation of the upper v'' levels with respect to the lower v'' levels, because the $\Delta v = +1$ sequence is produced to a considerable extent by transitions from the upper v'' levels, while the $\Delta v = -1$

sequence is formed mainly from the lower v'' levels. No explanation has yet been given for this anomaly. An attempt by Gebel to explain this anomaly by considering pure vibration transitions, which can be shown to be very weak anyway, has failed as can be seen in Figure 11. I should like to point out in this context that a determination of the variation of the transition moment with internuclear distance for the Swan system would be most welcome for the relative f -values of the various bands are important data that come into the interpretation of these C_2 emissions.

There is also the question of the presence of the Phillips system. A few bands of this system near 8000 Å have been detected for the first time by O'Dell (1971) in Comet Tago-Sato-Kosaka (1969IX) and it should be interesting to observe them again in various comets to derive the singlet/triplet ratio for this might give some information concerning the production mechanism of C_2 .

As far as the rotational lines of the Swan bands are concerned, a number of anomalies have been found. For instance, in a detailed study of dozens of lines in several high-dispersion spectra Woszczyk (1970) has found that seventy percent of the lines could be interpreted qualitatively by the resonance-fluorescence process, but that the intensities of the remaining lines remained unexplained.

The study of the C_2 emissions has yielded important information, namely estimates of the $^{12}C/^{13}C$ isotopic ratio in three comets: Ikeya (1963I) (Stawikowski and Greenstein, 1964), Tago-Sato-Kosaka (1969IX) (Owen 1973), and Kohoutek (1973XII) (Danks et al 1974, Kikuchi and Okazaki, 1975). The isotopic shift for the shortward-degraded (1,0) Swan band amounts to +8 Å, so that the isotopic band head falls well outside that of the main band. Photoelectric scans of this region near 4737 Å have been obtained for the first time on Comet Kohoutek (1973XII) by Danks, Lambert and myself with the McDonald 107-inch reflector and the Tull coude scanner. The scans reproduced in Figure 12 have a resolution comparable with that of the previous photographic observations (≈ 0.4 - 0.5 Å). Unfortunately, the $^{12}C^{13}C$ (1,0) band is blended with NH_2 emissions. In the hope

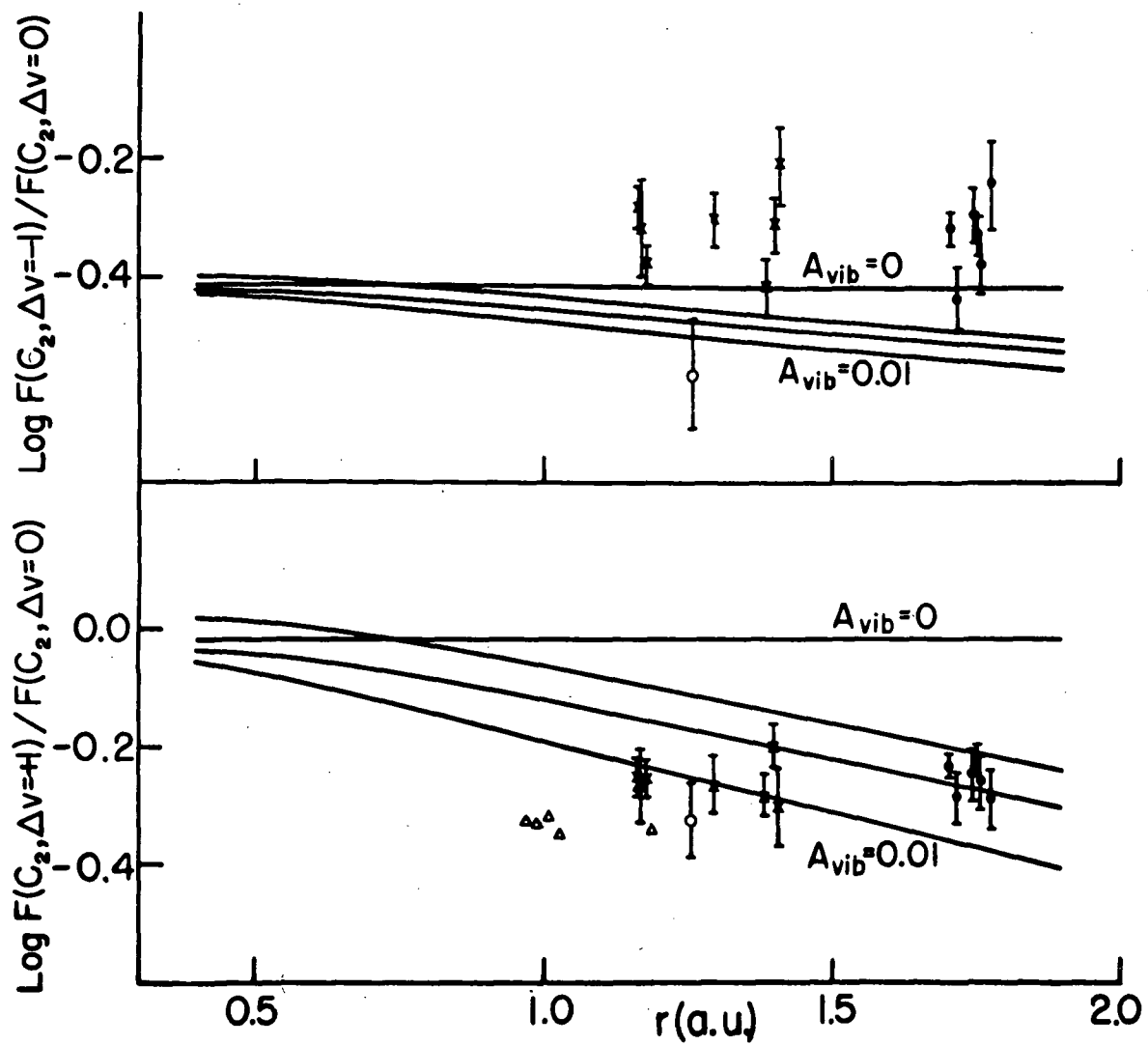

Fig.11 - Calculated (solid lines) and observed band sequences flux ratios for various comets (taken from Gebel 1970).

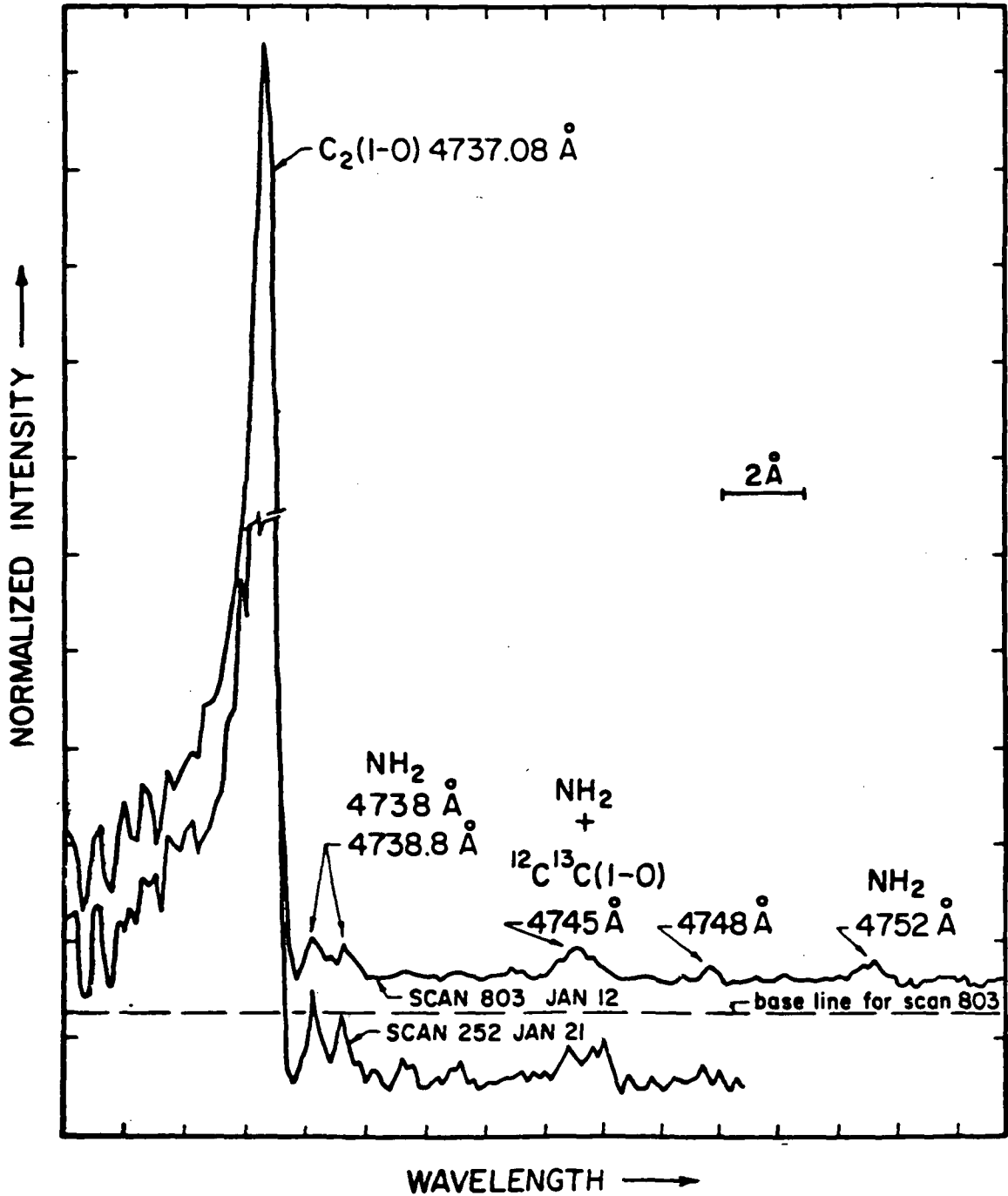

Fig.12 - Photoelectric scans of Comet Kohoutek (1973XII) at a resolution of 0.4 \AA . The ${}^{12}\text{C}^{13}\text{C} + \text{NH}_2$ blend is seen at 4745 \AA .

of separating these emissions we have used a higher resolution ($\approx 0.15 \text{ \AA}$), which is illustrated in Figure 13 where we see that the NH_2 contribution is made of four lines. Two of these are separated from the $^{12}\text{C}^{13}\text{C}$ band, but the other two are still badly blended with this band. Thus the relative intensities of the NH_2 lines must be estimated by comparison with the laboratory spectrum and by correcting these intensities for the effect of the solar absorption lines in an approximate way. In this way we can subtract the contribution of NH_2 to the blend. An example of the comparison between observed and synthesized spectra is shown in Figure 14. Once we know how much $^{12}\text{C}^{13}\text{C}$ contributes to the blend, we derive the isotopic ratio by relating the intensity of this blend to that of the main band head. Care must be exercised in this analysis because it has been found that the overall strength of NH_2 is variable. The values obtained for the $^{12}\text{C}/^{13}\text{C}$ ratio in the comets quoted above agree within the observational errors with the terrestrial ratio of about 90. In order to be really significant this isotopic ratio should be determined in many comets, using high-resolution spectra as far as possible. This unfortunately eliminates a large number of comets, which are too faint. Nevertheless, the importance of this ratio lies in the fact that it is related to the problem of the origin of the comets and that it can tell us something about the conditions that prevailed in the regions where these bodies were formed.

C₃

The C_3 radical in comets affords another embarrassing example. I should just like to report briefly here on the work of Sauval (Uccle Observatory) who is studying the excitation of the $\lambda 4050$ band of the $^1\Pi - ^1\Sigma$ electronic transition in Comet Ikeya (1963I). Computations have been made under the simplified model assumptions for the \mathcal{R} -d and for the \mathcal{C} -d case and it has been found impossible to reproduce the observed intensity profile satisfactorily. The C_3 radical having no permanent dipole moment, one would expect a

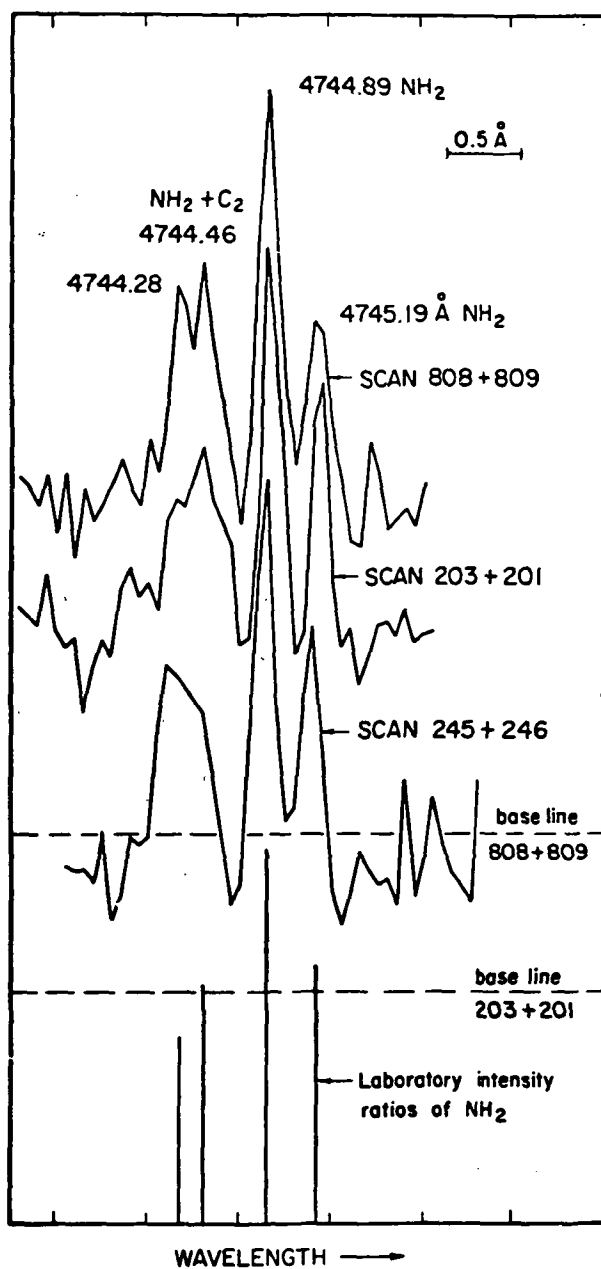

Fig.13 - High-resolution (0.15 \AA) scans of the $^{12}\text{C}^{13}\text{C} + \text{NH}_2$ 4745 \AA blend in Comet Kohoutek (1973XII). The similarity of the comet spectrum to the laboratory spectrum is apparent. The two NH_2 lines at the red end of the complex are completely beyond the shortward-degraded $^{12}\text{C}^{13}\text{C}$ (1,0) band head.

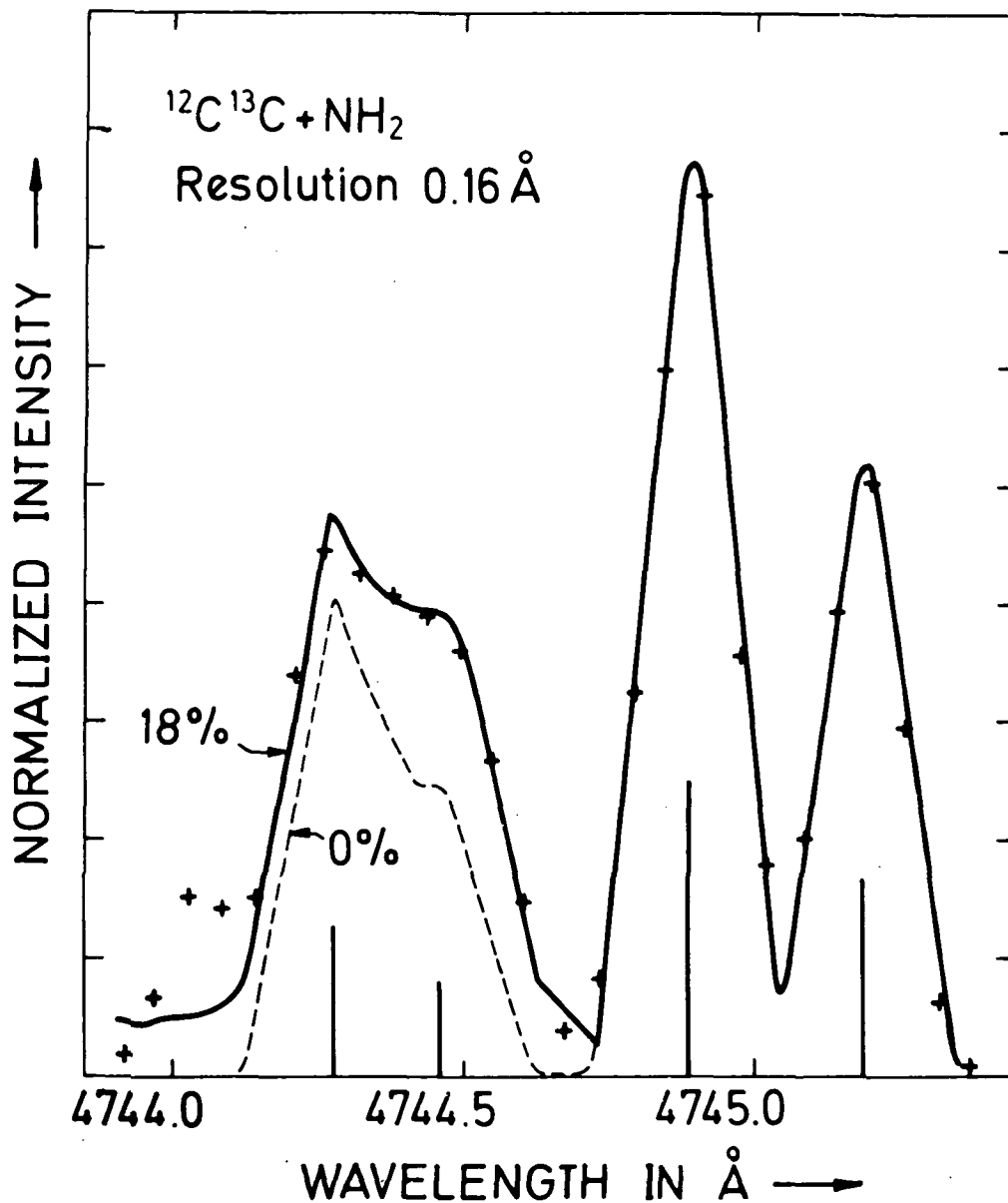

Fig.14 - Observed (crosses) and synthesized (solid line) 4745 \AA blend of $^{12}\text{C}^{13}\text{C} + \text{NH}_2$ at high resolution. The position of the NH_2 lines as well as their adopted relative intensities are indicated; notice by comparing with the laboratory intensities shown in Fig. 13 that the $\lambda 4744.46$ line was appreciably weakened by the effects of the solar absorption lines in this case. Also shown is the profile (dashed line) that would correspond to pure NH_2 emissions.

rather high excitation temperature, similar to that of C_2 , if collisions are negligible. However, the observed excitation temperature is certainly smaller than $300^\circ K$. In order to obtain theoretical spectra that bear a little resemblance to the observed spectra it is necessary to adopt a value for the quadrupole moment of C_3 which is some 10^5 times larger than the quadrupole moment of the similar molecule CO_2 for instance. On the other hand, if collisions are important, then the exciting molecules must have a rather low temperature and the cross-sections for collisional excitation of C_3 must be much larger than for C_2 (the latter statement, in fact, holds not only for C_3 , but also for all the other cometary radicals). Further study of the C_3 emissions in comets is certainly desirable and for this we badly need data on the transition probabilities for the various electronic, vibrational and rotational transitions.

CH⁺.

I have included this molecule because it is the first ion for which cometary spectra have been calculated. The work here is due to Vreux (Liège). The spectrum is very simple, being a $^1\Pi - ^1\Sigma$ transition reduced to only a few lines of the (0,0) band. Figure 15 shows a comparison between observed and computed spectra for Comet Bennett (1970II). The observed spectrum is at the upper left and the computed spectra correspond to pure fluorescence. The agreement is rather good for $f_{00} = 8 \times 10^{-3}$ and $\mu = 1.5$ Debye, a value close to the expected value for the dipole moment of CH^+ . In Figure 16 we have again the observed spectrum and now \mathcal{C} -d spectra for $T = 100^\circ K$ (upper right) and $T = 150^\circ K$ (lower left). These do not fit with the observed spectra and if we decreased the temperature below $100^\circ K$ we should increase the ratio $R(0)/R(1)$ and the situation would get worse. Whereas if we increased the temperature above $150^\circ K$, we should increase the ratios $Q(2)/Q(1)$ and $Q(3)/Q(2)$, which would also be going in the wrong direction. The conclusion to be drawn from this

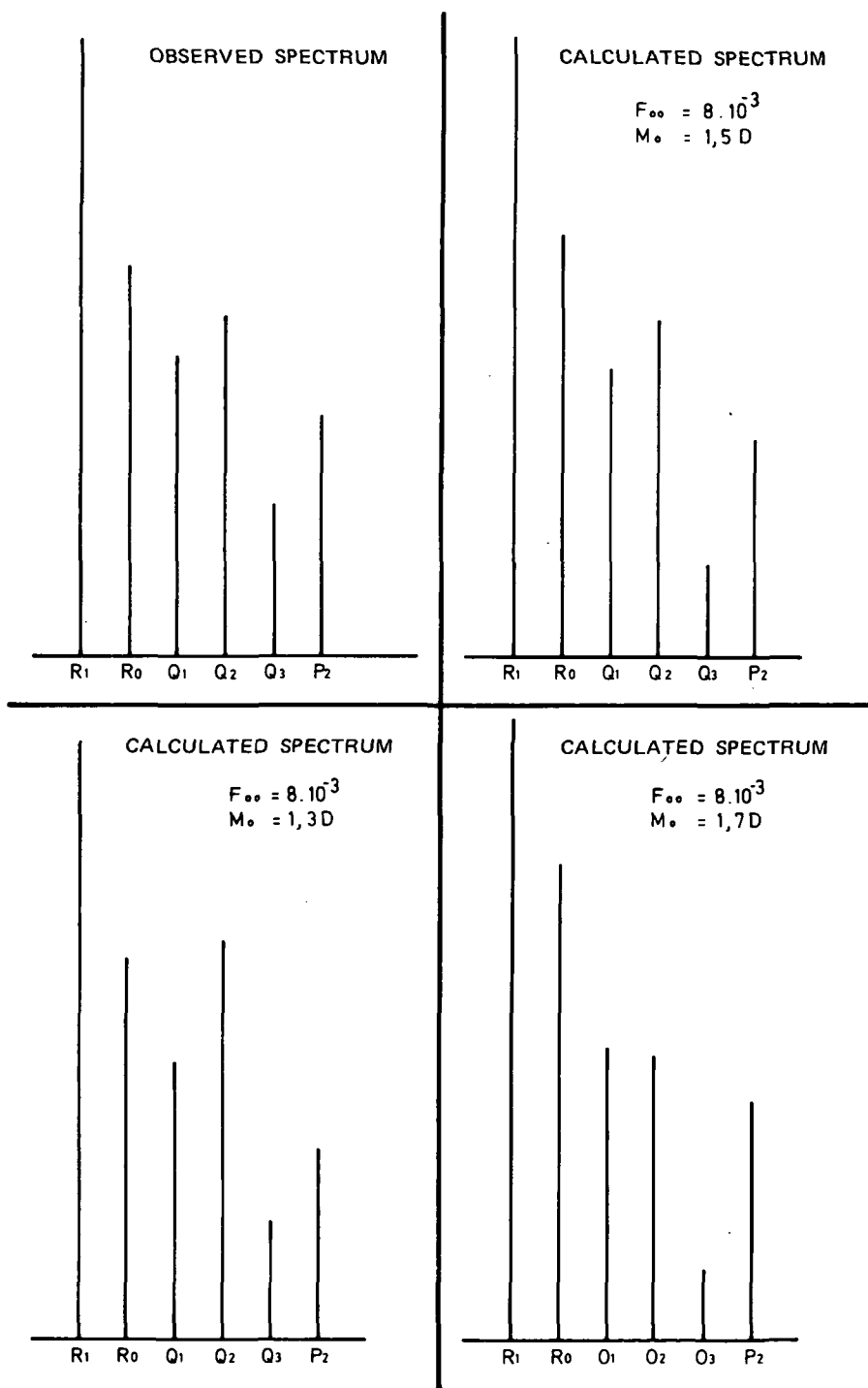

Fig.15 - Observed spectrum of CH^+ (upper left) and corresponding spectra computed under R -d conditions. The best fit appears at the upper right.

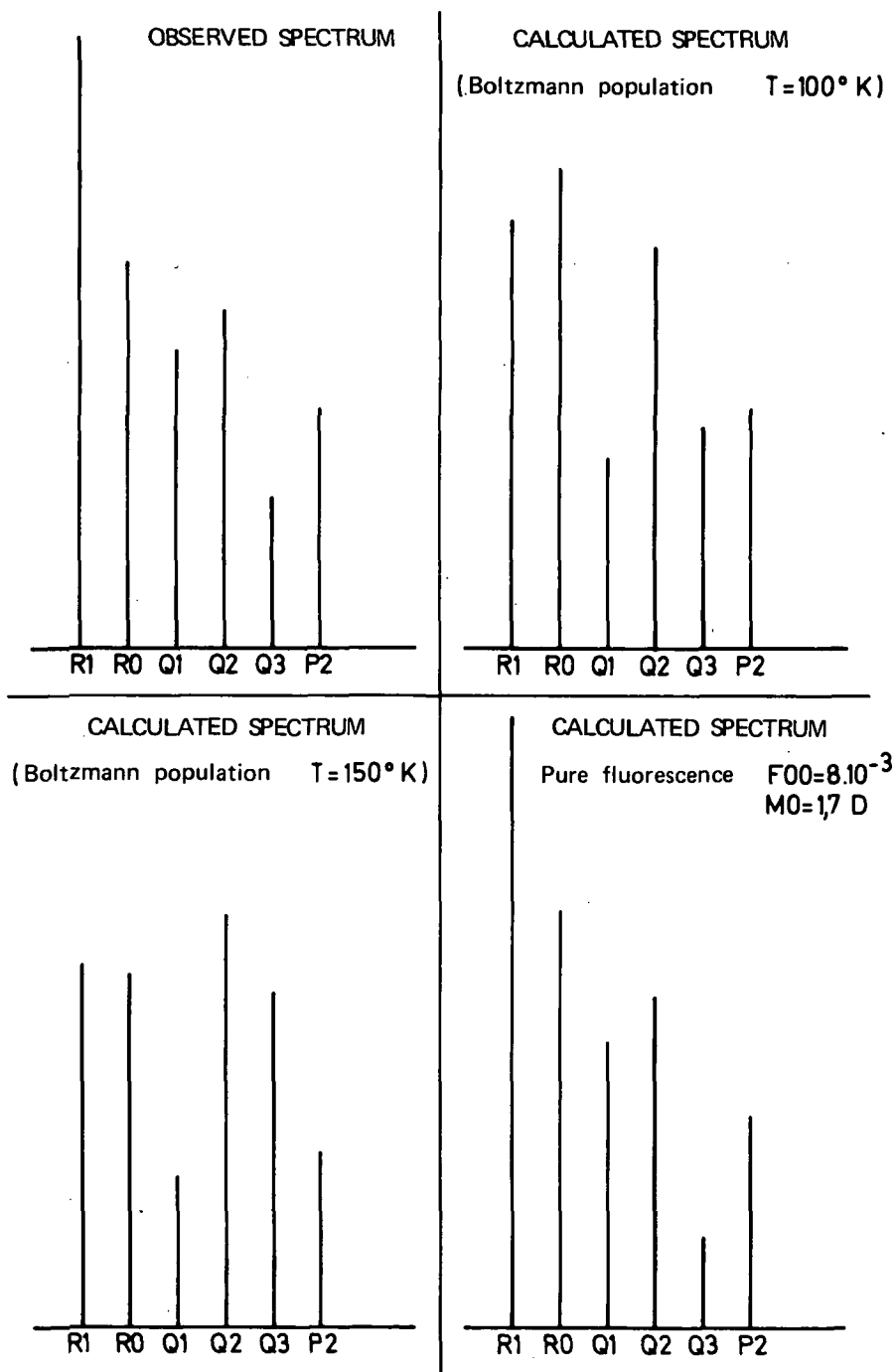

Fig.16 - Observed spectrum of CH^+ (upper left) and corresponding spectra computed under \mathcal{C} -d conditions (upper right and lower left). The pure fluorescence spectrum is reproduced at the lower right.

is that the density of possible colliding molecules is $\ll 10^9 \text{ cm}^{-3}$ at a distance of about 3×10^4 km from the nucleus, where the spectrum was recorded. On the other hand, it may be mentioned that there is a puzzling situation concerning the oscillator strength f_{00} for which the value found here (8×10^{-3}) is rather different from the experimental value derived from lifetime measurements (68×10^{-3} ; Smith, 1971) as well as from the upper limit obtained from the negative result of a search for CH^+ lines in the solar spectrum, which gives $f_{00} \leq 1 \times 10^{-3}$ (Grevesse and Sauval, 1971). Another laboratory value reported recently (11.5×10^{-3} ; Brzozowski et al, 1974) is closer to the "cometary" value; it is also in better agreement with a theoretical estimate (6.5×10^{-3}) based on calculations by Yoshimine et al (1973). This f -value is also of prime importance for the study of the interstellar medium where one needs to know the column densities of CH^+ and of CH in interstellar clouds in the discussion of the formation mechanisms of these radicals.

OH.

Let us change the subject a little and consider the OH 18 cm radio lines in comets. I shall be very brief on this since a review of this question will be presented by E. Gérard shortly. The fluorescence of the OH radical in the $A \ ^2\Sigma - X \ ^2\Pi$ system has been analysed by Mies (1974) to obtain the populations of the Λ -sublevels of the ground rotational level, in which almost all OH radicals are, and he found that the 18 cm lines can appear either in emission or in absorption according to the heliocentric radial velocity of the comets. Then Mies has proceeded to evaluate the degree of polarization of the radio and uv radiations under fluorescence conditions. For this one must compute the population distribution in the 16 magnetic hyperfine states corresponding to the ground level $^2\Pi_{3/2}$, $J = 3/2$. Now, provided the exciting radiation is not polarized, the populations of two of these states differing only

by the sign of the magnetic quantum number will be the same, so that the molecules will be aligned by solar pumping and this will produce some linear polarization of the radiation, the amount of polarization observed from the earth depending upon the phase angle. The maximum linear polarizations for the main radio lines (2-2 and 1-1 transitions) are -15 % and -10 % for the absorption case observed in November 1973 in Comet Kohoutek (1973XII), while for the emission observed in January 1974 the maximum linear polarizations are - 3.5 % and -0.9 %. These polarizations are too small to be detected with present-day techniques. For the uv radiation the maximum polarization is 5 % and this differs by only 1.5 % from the degree of polarization predicted for non aligned, equilibrium populations of the hyperfine states. The calculations have also shown that it was a very good approximation to ignore the details of the distribution of the radicals among the hyperfine states when computing the inversion ratio corresponding to the two Λ -sublevels of the ground level.

Let us conclude with a very brief historical note. If one were to describe the evolution of the study of comet spectra since the early days of Secchi and Huggins, he could distinguish the following periods :

- the beginning were of course characterized by the endeavour to specify the carriers of the various emissions detected in the cometary spectrum; thus the now well-known radicals and atoms were gradually identified; this pure identification phase is in fact still going on, as shown by the recent discovery of H_2O^+ and of H_2O for instance, and further efforts should be made yet to improve the identification lists;
- the qualitative interpretation period started in 1911 when K. Schwarzschild put forward the idea of fluorescence, which was taken again by Wurm in particular in the 1930's; this phase culminated in 1941 when Swings resolved the puzzle of the very irregular and unusual intensity profiles of the cometary molecular

- bands by invoking the effect of the Fraunhofer lines;
- this was followed by a semi-quantitative interpretation phase marked by the works of McKellar and of Hunaerts in the 1940's and 1950's; these authors already had some success in reproducing the general characteristics of the cometary emissions, although they avoided the problem of solving the statistical equilibrium;
 - the first quantitative analyses were carried out in the early 60's soon after the first high-dispersion spectra had been secured by Greenstein; these studies, which are based on the solution of the appropriate steady-state equations, require the use of a high-speed computer with a large memory;
 - maybe the next phase will be called the model atmosphere period which is still in a stage of infancy; what I have tried to show here is that when we enter this certainly more rewarding phase we are forced to be rather exacting concerning the accurate knowledge of all the data which are required in the calculations because we have to do now with secondary effects which manifest themselves as rather slight departures from the results obtained with a simplified theory; the latter point also indicates that it would be desirable to base these computations on observation material of the highest quality, possibly using photoelectric photometry.

REFERENCES

- Aikman, G.C.L., Balfour, W.J., and Tatum, J.B. 1974, *Icarus*, 21, 303.
- Arpigny, C. 1964, *Ann. d'Ap.*, 27, 393.
- Arpigny, C. 1965, *Nature et Origine des Comètes*, 13th Liège Symposium, p. 155.
- Arpigny, C. 1971, *J. Phys.* C5a, 32, 129.
- Brzozowski, J., Elander, N., Erman, P., and Lyyra, M. 1974, *Ap. J.*, 193, 741.
- Carrington, T. 1962, *Ap. J.*, 135, 883.
- Crawford, O.H., Allison, A.C., and Dalgarno, A. 1969, *Astr. & Ap.*, 2, 451.
- Danks, A.C., and Arpigny, C. 1973, *Astr. & Ap.*, 29, 347.
- Danks, A.C., Lambert, D.L., and Arpigny, C. 1974, *Ap. J.*, 194, 745.
- Field, G.B., and Hitchcock, J.L. 1966, *Ap. J.*, 146, 1.
- Gebel, W.L. 1970, *Ap. J.* 161, 765.
- Gordon, R.G., Klemperer, W., and Steinfeld, J.I. 1968, *Ann. Rev. Phys. Chem.*, 19, 215.
- Grevesse, N., and Sauval, J. 1971, *Astr. & Ap.*, 14, 477.
- Keller, H.V., and Lillie, C.F. 1974, *Astr. & Ap.*, 34, 187.
- Kikuchi, S., and Okazaki, A. 1975, *Publ. Astr. Soc. Japan*, 27, 107.
- Malaise, D. 1970, *Astr. & Ap.*, 5, 209.
- Mies, F.H. 1974, *Ap. J.*, 191, L145.
- O'Dell, C.R. 1971, *Ap. J.*, 164, 511.
- Owen, T. 1973, *Ap. J.*, 184, 33.
- Roemer, E. 1965, *Nature et Origine des Comètes*, 13th Liège Symposium, p. 23.
- Smith, W.H. 1971, *J. Chem. Phys.*, 54, 1384.
- Stawikowski, A., and Greenstein, J.L. 1964, *Ap. J.*, 140, 1280.
- Swings, P. 1941, *Lick Obs. Bull.*, 19, 131.
- Woszczyk, A. 1970, *Studia Soc. Sc. Torunensis*, 4, 23.
- Yoshimine, M. Green, S., and Thaddeus, P. 1973, *Ap. J.*, 183, 899.