

# LASER PLASMADYNAMIC ENERGY CONVERSION\*

K. Shimada

Jet Propulsion Laboratory

INTRODUCTION

N76-21520

For efficient conversion of laser energy to electrical energy, which is required for realizing the transmission of energy via laser beam, various methods are being investigated at several laboratories under NASA sponsorship. One such method, described in this paper, utilizes the generation of electrons and ions by interacting an intense laser beam with cesium vapor. Theoretical calculation shows that the conversion efficiency is as high as 40 percent if the entire photon energy is utilized in ionizing the cesium vapor that is generated initially by the incoming laser beam. An output voltage is expected to be generated across two electrodes, one of which is the liquid cesium, by keeping the other electrode at a different work function. Evaluation of the laser plasmadynamic (LPD) converter has been performed using pulsed ruby and Nd-glass lasers. Although the results obtained to date indicate an efficiency two orders or magnitude smaller than that of theoretical predictions, an unoptimized LPD converter did demonstrate the capability of converting laser energy at large power levels. The limitations in the performance may be due to converter geometry, the type of lasers used, and other limitations inherent to the cesium plasma.

## DESCRIPTION OF THE LPD CONVERTER

The LPD converter is a diode having one electrode holding approximately 1 g of liquid cesium and one electrode made of stainless steel having a semi-spherical surface (fig. 1). The cesium electrode is designated as an emitter and the other electrode as a collector. The radius of the sphere is 8 mm. An incoming laser beam is introduced through a hole in the collector with a lens so that the beam strikes the cesium surface at its focal point. For an estimated focal spot area of  $1 \text{ mm}^2$ , the peak power density at the focal point is approximately  $1.6 \times 10^3 \text{ W/cm}^2$  with a 1-J pulse with a duration of  $600 \mu\text{sec}$  – the value which was used during the experiments. Steps involved in the operation of the LPD converter are: (1) evaporation of a small amount of cesium at the focal spot; (2) generation of cesium ions and electrons by interacting the laser beam with evaporated cesium atoms having a large particle density (obtained immediately following the evaporation) and (3) separation of ions and electrons by means of built-in potential energy difference between two electrodes having two different work functions. To achieve higher work functions at the collector, it is provided with a sheathed heater which is capable of raising the collector temperature up to  $800^\circ\text{C}$ . At this temperature the collector work function will be approximately 3 eV, and therefore,

---

\*This paper presents the results of one phase of research carried out at the Jet Propulsion Laboratory, California Institute of Technology, under Contract NAS 7-100 sponsored by the National Aeronautics and Space Administration.

the contact potential will be 1.2 eV between the collector and the cesium electrode (work function equaling 1.8 eV). Therefore, the ideal open-circuit voltage will be 1.2 V with its (conventional) polarity being positive at the collector electrode.

Other features of the converter include: (1) one sapphire window for introduction of the laser beam, (2) another window for visual observation of the interior of the converter, (3) cesium liquid held in a cup-shaped portion of a copper rod whose temperature is controlled by means of an external heater and a water-cooled heat sink, and (4) an evacuated stainless steel cross envelope, 1-1/2" in diameter. During the experiments, the temperature of this envelope was kept at least 50°C higher than the cesium reservoir temperature, by means of heater tapes and a thermal blanket, to avoid formation of any parasitic reservoir.

## EXPERIMENTAL SETUP

An optically-pumped laser, which could operate either with a ruby or a Nd-glass rod, and the LPD converter were mounted on an optical bench. The laser beam was reflected by a mirror and focused by a lens before entering the converter through a sapphire window. To measure the laser power incident on the cesium liquid, a known amount of laser power was sampled by a mirror having a calibrated reflectivity. Transmittances of lenses and a window were calibrated to obtain the laser energy incident on the cesium liquid target. The measuring circuit is shown schematically in figure 2. The LPD converter was connected to an external circuit having a resistor and a power supply, the latter of which was short circuited during the operation of the converter as an energy conversion device. However, the power supply was left connected during the measurements requiring acquisition of volt-coulomb characteristics.

Volt-coulomb characteristics were preferred over the volt-ampere characteristics because of the pulsed operation of the LPD converter. The total charge output per laser pulse was obtained by integrating the current output with an analogue integrator, with respect to time, for a duration of 600  $\mu$ sec, a period that equalled the laser pulse duration. At the same time, the sampled laser pulse and the resultant LPD output were displayed on an oscilloscope to determine their wave forms and temporal relationships. For measurements of output energy, the time integral of the joule heat loss was obtained by integrating the square of the voltage across the load resistor. During all of the above measurements, the cesium temperature was maintained slightly above its melting point, and the collector temperature was varied and maintained higher than any other parts of the converter.

## EXPERIMENTAL RESULTS

Figure 3 shows four oscillograms each showing the laser (top trace) and electrical outputs (bottom trace). The left figure on the top shows the characteristic of electric current (negative) and the right figure shows the characteristic of the ion current (positive) collected by the collector electrode. These curves were obtained by irradiating the biased LPD converter with a laser pulse at approximately 0.5 J of energy at the target cesium. The bias of +0.5 V means that the collector electrode is positive with respect to the cesium electrode so that the current is dominated by electrons. The time scales are 100  $\mu$ sec/cm except the figure for applied voltage of -2.0 V which is

200  $\mu\text{sec}/\text{cm}$ . The current scales are 0.2A/cm for the electron current and 0.5A/cm for the ion current.

These results show that: (1) charge separations are achieved with voltages of the order of 1 V; (2) electron current closely follows individual laser pulses, thus showing comparatively jagged wave forms; and (3) the current at an applied voltage of  $-2.0$  V indicates that the current wave form is smooth (likely a characteristic of heavy particle flow such as caused by ions). The largest current observed reached as high as 3 A, which corresponded to a current density of  $300 \text{ A}/\text{cm}^2$  from the area of  $1 \text{ mm}^2$  where the laser beam was focused. The bottom left figure shows the open-circuit voltage observed with an elevated collector temperature. The largest peak value observed was  $+1.5$  V. The polarity as well as the magnitude depends on the temperature of the collector; the polarity is negative at the collector when its temperature is low and the polarity becomes positive when the collector temperature is raised to drive off condensing cesium. An open circuit voltage of  $1.5$  V is considered reasonable since the LPD converter was operated under pulsed conditions, although it was a few tenths of a volt higher than expected with a CW laser.

Figures 4 and 5 show the volt-coulomb curves obtained with the ruby laser. The major difference between two figures is the difference in the current  $I_{\text{CH}}$  through the collector heater. The estimated collector temperature at  $I_{\text{CH}} = 2.6$  A is  $200^\circ\text{C}$  and  $450^\circ\text{C}$  at  $I_{\text{CH}} = 7.5$  A. Curves in the second quadrant indicate that the net charge collected is positive when the collector bias is negative while the curves in the fourth quadrant show the opposite. In figure 4, a trend for the collected charge to saturate is observed when the magnitude of bias voltage is of the order of 1 V. The open-circuit voltage, (which occurs when the collected charge is zero), is approximately  $-0.5$  V.

It should be pointed out that the power-generating quadrants are the first and the third quadrant. At a low collector temperature ( $I_{\text{CH}} = 2.6$  A), the power is generated mainly by electrons. On the other hand, it is seen that the power is generated in the first quadrant by net positive charges when the collector temperature is raised ( $I_{\text{CH}} = 7.5$  A in fig. 5).

Although the temperature dependence of the output was qualitatively in agreement with expectations, the magnitude of the output was far less than what was expected. Possible explanations for this lack of output and an extrapolated performance will be discussed in Section V. In figure 5, a large increase of the collected charge in the second quadrant is evident in contrast to no change in the net charge in the fourth quadrant of the figure. Considering the fact that: (1) the increase in positive charge to the collector was only observed when the laser pulse was applied, and (2) the calculated thermionic electron emission from the collector, which would have contributed to the net increase, was far too small to account for the increase, the observed increase of positive charge may be due to more effective neutralization of positive space charge by thermionically emitted electrons.

Figure 6 shows similar results using a Nd-glass laser instead of a ruby laser. The shapes of the curves are similar to the previous curves with the exception of the reduced amount of charge collection. If the charges were solely generated by multi-photon ionization process, one would expect a much larger reduction with a Nd-glass laser ( $\lambda = 1.06 \mu$ ) than with a ruby laser ( $\lambda = 0.69 \mu$ ). (Further discussion of this matter is also given in Section V.)

Other experiments were performed to determine: (1) the functional relationship between the laser input and the charge output; (2) the dependence of charge output on cesium reservoir

temperature; and (3) the effect of the duration of the laser input on the output charge. The results of the first two experiments are shown in figures 7 and 8, respectively.

These curves were generated by measuring the output charge with a constant bias voltage of 4.0 V. A linear dependence of the output charge on the light input, up to an input of 1.4 J is shown in figure 7. The output is seen to fall off above this input level due to the depletion of cesium liquid in the reservoir caused by a rapid vaporization. Figure 8 also supports the above reasoning. At an increased reservoir temperature, the gaseous cesium increases relative to the liquid cesium. Figure 8 also indicates that the gaseous cesium is not contributing significantly to the ionization at a density of  $10^{14}/\text{cc}$  ( $T_{\text{CS}} \approx 150^\circ\text{C}$ ). Instead, the laser-cesium interaction must be occurring immediately following the application of laser the pulse (within a few hundred  $\mu\text{sec}$ ). During this time the evaporated cesium does not expand significantly or maintain high gas density sufficient enough to result in a significant net ionization cross section.

An additional experiment (results are not included in this report) indicated that the duration of the laser pulse can be cut down to 100  $\mu\text{sec}$  from the original 600  $\mu\text{sec}$  without affecting the charge output. The results also indicated that a subsequent pulse, which followed 100  $\mu\text{sec}$  after the first, did not produce a noticeable amount of charge. Though it is not conclusive at this point, the result may be explained by the existence of a threshold laser energy level, a level that was not exceeded with the subsequent pulse nor with an increased duration of the first laser pulse.

## DISCUSSION OF RESULTS

To gain some insight into the mechanism of cesium ionization in an LPD converter, an order of magnitude estimation of charge output was made using a theory (ref. 1) based upon a simultaneous multiple photon process. For the wavelength of a ruby laser ( $0.69 \mu$ ), each ion produced requires three ruby photons since the photon and ionization energies are 1.79 eV and 3.89 eV, respectively. The total number of generated ions calculated from this theory was much too small in comparison with the observed charge output, of the order of 500  $\mu\text{C}$  ( $3.13 \times 10^{15}$  electrons). On the other hand, if each ion is produced by a simultaneous two-photon collision with an excited cesium atom (excitation energy of cesium = 1.47eV) which could be generated efficiently by a single photon collision, experimental results are in better agreement with the calculation. It leads us to believe that very efficient ionization could be obtained with a laser whose photon energy is slightly above that of the cesium ionization energy as long as the cesium gas density is larger than  $10^{18}/\text{cc}$  at which an interaction length will be less than a few millimeters. Such a density would occur at the focal point on the cesium surface.

As an alternate explanation to account for the net charge output, cesium gas breakdown conditions were calculated (ref. 2) by considering the laser beam as an electromagnetic wave. As shown in figure 9, the electrostatic field intensity required for a breakdown is 872 V/cm at its minimum point on the curve. This value, as well as the cesium gas pressure, which would occur locally at the focal point of the laser, are both in a correct order of magnitude being used in the LPD experiments. However, there is another important mechanism which could contribute to the cesium ionization, that is, the inverse bremsstrahlung absorption of laser energy by the preionized cesium gas. A comparison of results obtained from the ruby and the Nd-glass lasers tends to support this idea since the inverse bremsstrahlung absorption will occur more efficiently at longer

wavelength, whereas the direct photon-caesium process drops off very rapidly as the photon energy decreases. This absorption mechanism merits further investigation.

The output voltage behaved qualitatively as expected. For example, the output voltage became positive when the collector was heated to 450°C (723°K) so that its work function was increased to approximately 2.2 eV. At this point, the output voltage would have been 0.4 eV (that is, 2.2 - 1.8). To achieve a higher output voltage the collector temperature should have been much higher. Unfortunately, the experiments were not possible since a caesium gas breakdown occurred without an application of laser pulse as occurs in a thermionic diode.

Lastly, the relative insensitivity of the output charge on the output voltage was considered. Although it is not conclusive, a space charge limitation or the charge recombination, or both, may account for the observed charge transport.

In summary, the LPD converter did demonstrate the feasibility of converting laser energy to electrical energy by producing electric charges of the order of 1000  $\mu\text{C}$ . The measured conversion efficiency was 0.01 percent (10  $\mu\text{J}$  output at 100 mJ input). If the output was not impeded by the transport process and if the collector temperature was made high enough to produce an output voltage of 2.0 V, the efficiency could have been 2 percent (1000  $\mu\text{C}$  output at 2.0 V).

A modification of the converter geometry and of the electrode material is being planned to increase efficiency and to verify the laser energy absorption theory.

#### REFERENCES

1. Tozer, B. A.: Theory of the Ionization of Gases by Laser Beams. Phys. Rev., Vol. 137, no. 6A, 15 Mar. 1965, p. 1665-1667.
2. Brown, S. C.: Basic Data of Plasma Physics. John Wiley and Sons, Inc., N. Y., 1959, p. 142-150.

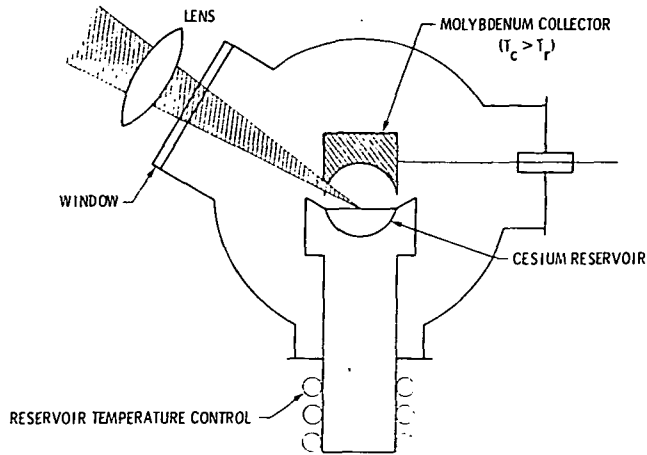

Figure 1.— Schematic drawing of an LPD converter (collector electrode was made of stainless steel for this experiment instead of molybdenum as shown).

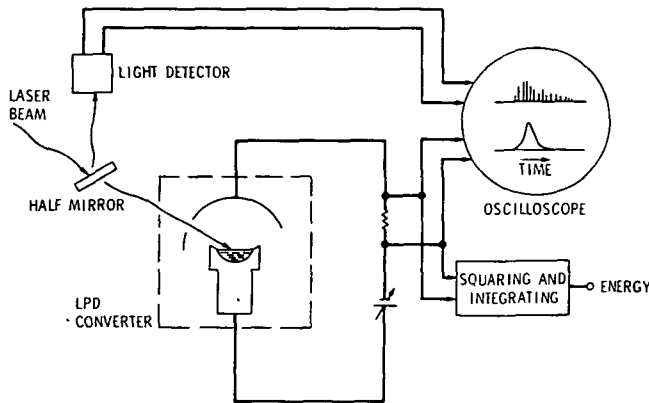

Figure 2.— Measuring circuit.

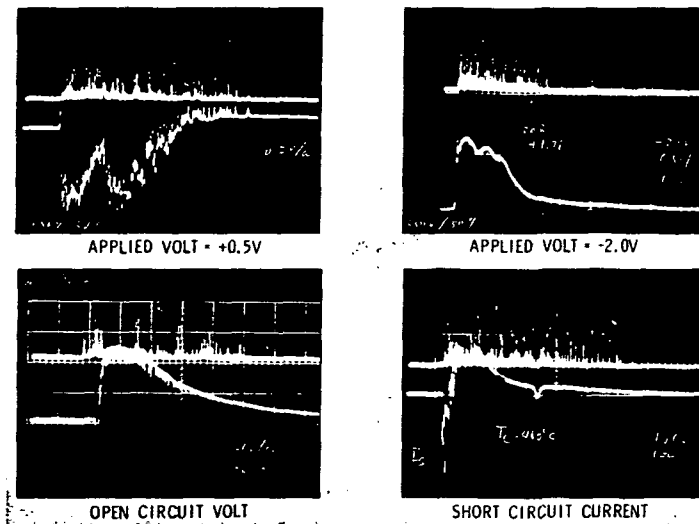

Figure 3.— Oscillogram of LPD outputs.

ORIGINAL PAGE IS  
OF POOR QUALITY.

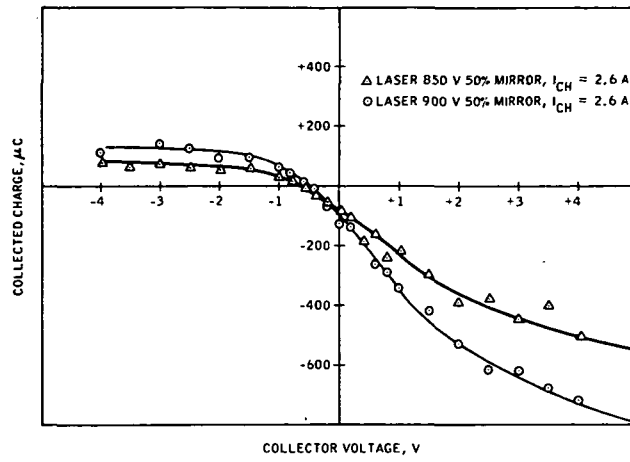

Figure 4.— Volt-coulomb curves with  $I_{CH} = 2.6A$   
( $T_C = 200^\circ C$ ).

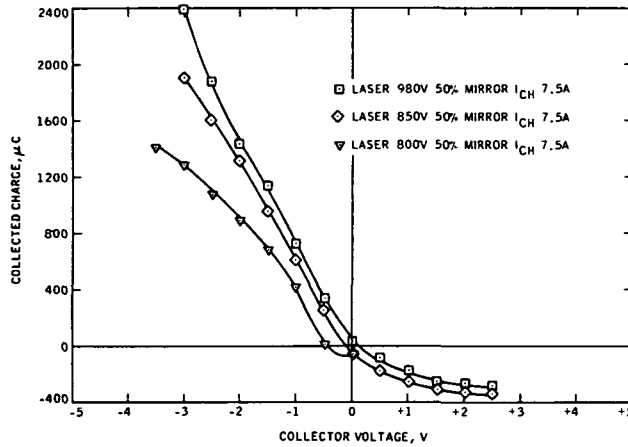

Figure 5.— Volt-coulomb curves with  $I_{CH} = 7.5A$   
( $T_C = 405^\circ C$ ).

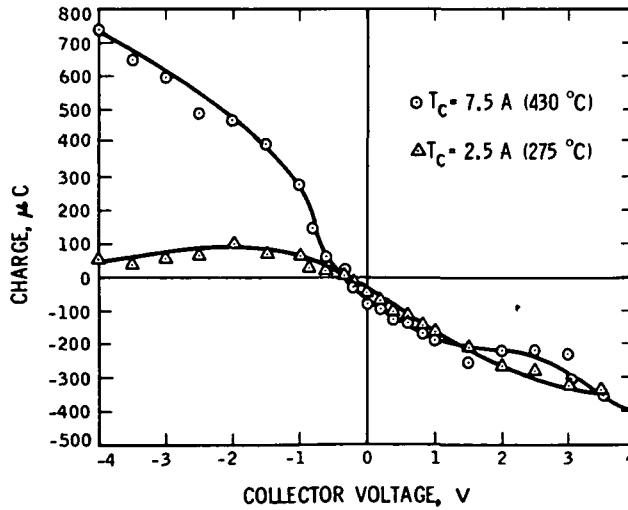

Figure 6.— Volt-coulomb curves with a Nd-glass laser.

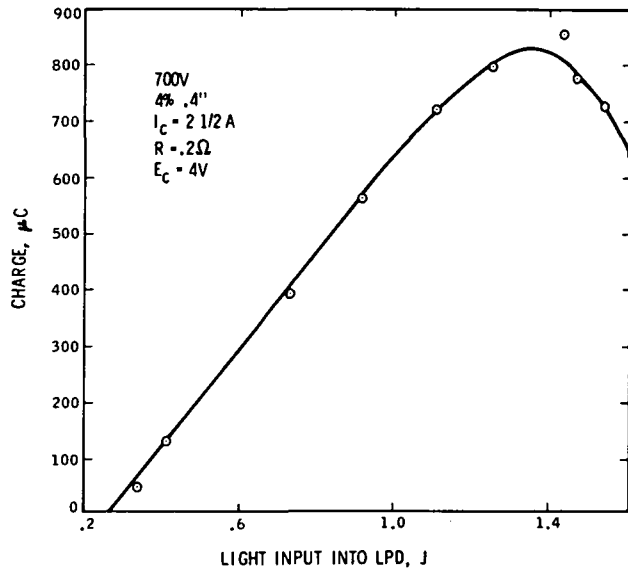

Figure 7.— Charge output vs light input.

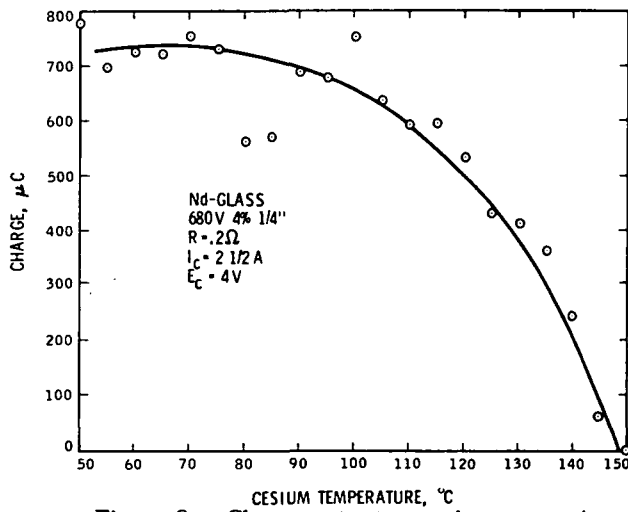

Figure 8.— Charge output vs cesium reservoir temperature.

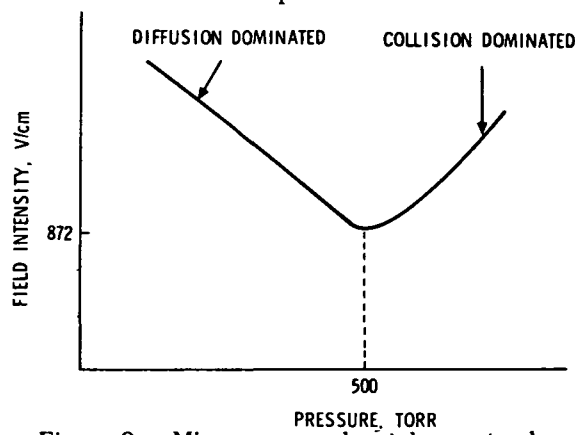

Figure 9.— Microwave gas breakdown at a laser frequency.



## DISCUSSION

Malcolm Gower, NASA Ames Research Center — Are the ions produced by a multiphoton process?

Answer: Yes, that's one way. In that case it has to be three photons with ruby.

Malcolm Gower, NASA Ames Research Center — Well below 3000 Å the cesium dimer has a much, much larger cross section than the monomer.

Answer: Yes, we heard this very recently and we will be looking at it.

Max Garbuny, Westinghouse — How much energy goes into heat of vaporization — a lot? This system seems to lend itself to MHD.

Answer: Yes, a lot goes into vaporization. For MHD, however, we would rather have a gaseous phase than liquid, that is, we would use something more like Ned Razor's talk.

Abe Hertzberg, University of Washington — Dr. Razor, in the same connection, did you consider recombination effects in your theoretical work?

Ned Razor, Razor Associates — These are not important at the  $10^{15} \text{cm}^{-3}$  densities we have considered.

K. Shimada: However, ours are much higher than that, where this is important.