

General Disclaimer

One or more of the Following Statements may affect this Document

- This document has been reproduced from the best copy furnished by the organizational source. It is being released in the interest of making available as much information as possible.
- This document may contain data, which exceeds the sheet parameters. It was furnished in this condition by the organizational source and is the best copy available.
- This document may contain tone-on-tone or color graphs, charts and/or pictures, which have been reproduced in black and white.
- This document is paginated as submitted by the original source.
- Portions of this document are not fully legible due to the historical nature of some of the material. However, it is the best reproduction available from the original submission.

NASA TECHNICAL
MEMORANDUM

NASA TM X-62, 461

NASA TM X-62, 461

TRANSONIC AERODYNAMIC CHARACTERISTICS OF A WING/BODY
COMBINATION INCORPORATING JET FLAPS

(NASA-TM-X-62461) TRANSONIC AERODYNAMIC
CHARACTERISTICS OF A WING/BODY COMBINATION
INCORPORATING JET FLAPS (NASA) 137 p HC
\$6.00 CSCL 01A

N76-26153

G3/02 Unclassified
42352

John L. Holmberg

Ames Research Center
Moffett Field, California 94035

September 1975



1. Report No. NASA TM X-62,461	2. Government Accession No.	3. Recipient's Catalog No.	
4. Title and Subtitle Transonic Aerodynamic Characteristics of a Wing/Body Combination Incorporating Jet Flaps		5. Report Date September, 1975	6. Performing Organization Code
		8. Performing Organization Report No. A-6203	10. Work Unit No. 505-06-31
7. Author(s) John L. Holmberg		11. Contract or Grant No.	13. Type of Report and Period Covered Technical Memorandum
9. Performing Organization Name and Address NASA-Ames Research Center Moffett Field, Ca. 94035		14. Sponsoring Agency Code	
		12. Sponsoring Agency Name and Address	
15. Supplementary Notes			
16. Abstract <p>A 0.25-scale semispan wing/body model with two types of jet flaps proposed by Rockwell International was tested in the Ames 11- by 11-Foot Transonic wind Tunnel. The objective of that testing was to measure the static aerodynamic forces and moments and wing pressure distributions on six configurations differentiated by wing camber, jet flap type, and jet flap angle. Maximum thrust coefficients were limited to 0.12. Angle of attack was varied from -4° to 15° for Mach numbers between 0.6 and 0.95 at a constant unit Reynolds number of 18.0 million/m (5.5 million/ft).</p> <p>Due to the limited scope of this test and in the absence of any rigorous analysis, no final conclusions should be drawn concerning the relative effectiveness of the two flap systems. More refined designs and considerably more testing will be required even to establish the practicability of the total-exhausting jet flap concept.</p>			
17. Key Words (Suggested by Author(s)) Wind Tunnel Test Semispan Model Jet Flap Configurations		18. Distribution Statement Unlimited STAR Category 02	
19. Security Classif. (of this report) Unclassified	20. Security Classif. (of this page) Unclassified	21. No. of Pages 139	22. Price* \$5.75

TABLE OF CONTENTS

	Page
SUMMARY	1
INTRODUCTION.....	1
SYMBOLS	2
TEST FACILITY	3
MODEL DESCRIPTION	3
TESTING AND DATA REDUCTION PROCEDURES	4
RESULTS AND DISCUSSION	5
CONCLUDING REMARKS	6
TABLES	
1. CONFIGURATION DEFINITIONS	8
2. WING STATIC PRESSURE ORIFICE LOCATIONS	9
3. TEST CONDITIONS SUMMARY	10
4. REFERENCE DIMENSIONS	11
5. INDEX OF DATA FIGURES	12
FIGURES	
1. DEFINITION OF AXIS SYSTEMS FOR A SEMISPAN MODEL.....	13
2. MODEL INSTALLATION SCHEMATIC	14
3. WING PLANFORM DETAILS	15
4. REPRESENTATIVE AIRFOIL SECTIONS	16
5. COMPARISON OF TRAPPED FLOW AND ADEN FLAPS	17
6. TUNNEL INSTALLATION - 3/4 FRONT VIEW	18

TRANSONIC AERODYNAMIC CHARACTERISTICS OF A WING/BODY COMBINATION INCORPORATING JET FLAPS

John L. Holmberg

Ames Research Center

SUMMARY

A 0.25-scale semispan wing/body model with two types of jet flaps proposed by Rockwell International was tested in the Ames 11- by 11-Foot Transonic Wind Tunnel. The objective of that testing was to measure the static aerodynamic forces and moments and wing pressure distributions on six configurations differentiated by wing camber, jet flap type, and jet flap angle. Maximum thrust coefficients were limited to 0.12. Angle of attack was varied from -4° to 15° for Mach numbers between 0.6 and 0.95 at a constant unit Reynolds number of 18.0 million/m (5.5 million/ft).

Due to the limited scope of this test and in the absence of any rigorous analysis, no final conclusions should be drawn concerning the relative effectiveness of the two flap systems. More refined designs and considerably more testing will be required even to establish the practicability of the total-exhausting jet flap concept.

INTRODUCTION

One of the basic goals for the next generation of fighter aircraft is increased maneuverability in the transonic flight regime. One approach to achieving this goal involves ducting the total engine exhaust out through the trailing edges of the wings, thereby providing both thrust and a jet flap effect to increase lift without incurring a large induced drag penalty. Rockwell International has proposed two methods for controlling the effective angle of total-exhausting jet flaps. The first method, the Trapped Flow (TF) flap, turns the exhaust flow by deflecting the whole internal duct/external airfoil structure along the 62.5 percent chordline. The second method, the Augmented Deflected Exhaust Nozzle (ADEN) flap, keeps the entire internal duct in a fixed position; the upper surface of the airfoil section, being 5.5 percent longer in chord than the lower surface and hinged along the top edge of the duct exit, acts as a deflector plate to turn the emerging jet. Each of these total-exhausting jet flap systems is intended to be used with a variable leading-edge-camber airfoil. Both flap concepts were tested in the Ames 11- by 11-Foot Transonic Wind Tunnel. Presented herein are results from that investigation with minimal analysis.

SYMBOLS

Standard body and stability axis systems and sign conventions are shown in figure 1. All force and moment coefficients include thrust effects.

<u>Symbol</u>	<u>Definition</u>
AE	jet exit area
A(i)	base areas (i = 1 through 8)
ALPHA	wing angle of attack, deg
B	wing span
BETA	angle of yaw (always 0 deg)
C	local wing chord
\bar{c}	mean aerodynamic chord
CD	drag coefficient = drag corrected for base pressure/Q (S/2)
CL	lift coefficient = lift corrected for base pressure/Q (S/2)
CLM	pitching moment coefficient = pitching moment about model station 1.4487 m (57.036 in) corrected for base pressure/Q \bar{c} (S/2)
CONF	configuration number
CP	pressure coefficient = (local pressure - P _{INF})/Q
CTG	thrust coefficient = (FGST + (P _O -P _{INF})AE)/Q (S/2)
DELFI	inboard jet flap angle, deg
DELFM	leading-edge flap angle, deg
DELFO	outboard conventional flap angle, deg
DELJ	effective jet angle, deg

<u>Symbol</u>	<u>Definition</u>
FGSTLB	static thrust, lb
FGSTNT	static thrust, N
MACH	free-stream Mach number
PINF	free-stream static pressure
PO	ambient pressure during static thrust calibration
Q	free-stream dynamic pressure
RN/L	free-stream unit Reynolds number, millions/ft
RN/M	free-stream unit Reynolds number, millions/m
S	wing reference area
X	distance along local chord from leading edge
Y	distance along span from fuselage centerline

TEST FACILITY

The Ames 11- by 11-Foot Wind Tunnel is a closed-return, continuous-flow, variable-density tunnel with a flexible-wall nozzle. All four walls enclosing the test section are ventilated with porous slots of 5.6 percent open area ratio to permit operation over a Mach number range continuously variable from 0.4 to 1.4. During this test, however, the slots in the floor were covered with tape to form an image plane for the semispan model.

MODEL DESCRIPTION

The 0.25-scale left-hand wing and left fuselage half were mounted above a nonmetric spacer to raise the centerline of the model above the displacement thickness of the boundary layer on the tunnel floor (fig. 2). Both the TF flap and the ADEN flap extended over the inboard 50 percent of the exposed span (fig. 3). A conventional flap on the cranked portion of the wing remained at zero deflection for all but one configuration. The basic airfoil section had a maximum thickness to chord ratio of 8.5 percent at the 20 percent chord position and a maximum camber of 2 percent at the 50 percent chord position; the inboard portion of the trailing edge was opened just enough to accommodate the jet flap ducts.

(fig. 4). Full-span, segmented leading-edge flaps were used to effect variable camber, and angle blocks were inserted between the wing and the TF or ADEN flaps to represent deflections about fixed hinge lines (fig. 5). The specific combinations of leading-edge deflection, jet flap type, and jet flap angle associated with the six configurations tested are described in table 1. The locations of the 164 static pressure orifices positioned along chordlines at 4 span stations are indicated in table 2.

TESTING AND DATA REDUCTION PROCEDURES

The complete wing/body combination (figs. 6 and 7) was mounted on a five-component strain gage balance which was submerged beneath the floor of the test section. High pressure air simulating engine exhaust was supplied to the model through a piping system which bridged the balance (fig. 8). A complete balance calibration was performed in the tunnel at the beginning of the test with all of the high pressure fittings connected to account fully for the influence of the piping bridge on primary sensitivities and interactions between components.

Before each configuration was tested, a static thrust calibration was performed with the tunnel off to evaluate the magnitude and direction of the jet flap thrust vector at blowing rates of up to 5 kg/s (11 lb-mass/s). Flow rates were measured by a sonic nozzle flowmeter upstream of the balance assembly. During these calibration runs, flow inhibitor fences were positioned perpendicular to the wing just ahead of the jet flap to minimize induced flow and associated aerodynamic loads.

Static force and moment data were recorded for each configuration at angles of attack from -4° to 15° with Mach numbers in the range 0.6 to 0.95 at a constant unit Reynolds number of 18.0 million/m (5.5 million/ft). Wing pressure distributions were recorded at angles of attack of 0° , 4° , 8° , 12° , and 15° for specific configuration number/Mach number combinations as shown in table 3. Natural boundary layer transition from laminar to turbulent conditions was permitted throughout the test.

All force and moment coefficients presented in this report include the effects of jet flap thrust. Those coefficients are corrected for an effective base pressure which was determined in the following manner:

$$\text{Effective base pressure coefficient} = (2/S) \sum CP(i) A(i)$$

Jet Off: $i = 1$ through 8

Jet On: $i = 7, 8$

where $i = 1$ through 6 denote the six cavities within the jet flap duct exit and $i = 7, 8$ denote base areas along the trailing edge of the wing

(table 4). Pitching moment coefficients are always referenced to model station 1.4487 m (57.036 in).

RESULTS AND DISCUSSION

A complete index of all data figures is included in table 5. However, several points concerning information presented in those figures warrant special comment.

Rockwell International's method of supplying high pressure air to the model introduced two potential sources of inaccuracy into the measurement of forces and moments. Those sources were mechanical hysteresis in the joints at each end of the piping bridging the balance and thermal gradients in the balance due to the expansion of high pressure air into a plenum which was mounted directly to the top of that balance. Data recorded under identical test conditions before and after long series of blowing and nonblowing runs did show evidence of shifts in the zero-load reference output voltage levels of the strain gage bridges (fig. 9). Such zero shifts could have been attributable to either source. A special series of data points was generated to evaluate the maximum anticipated imprecisions resulting from zero shifts. With the wind tunnel not running, balance readings were recorded periodically during 10 min jet-on (maximum blowing rate)/jet-off cycles. Measured forces and moments were reduced to coefficient form based on an artificial Q of 47800 N/m^2 [1000 lb/ft^2 ; see fig. 10(a)]. A thermocouple mounted on the balance near the upper set of strain gages monitored changes in temperature during those same cycles [fig. 10(b)]. The results of that special series indicated that representative precisions of data presented in this report are $CL \pm 0.012$, $CD \pm 0.0030$, and $CLM \pm 0.002$.

An effective jet angle $DELJ$ was defined as a function of jet mass flow rate during the static thrust calibration of each configuration (fig. 11). This angle was resolved from balance data as follows:

$$DELJ = \text{Arctan} (\text{normal force/axial force})$$

Maximum axial forces recorded during the calibrations were approximately 70 percent of balance capacity for that component. However, the corresponding normal forces were less than 3 percent of capacity. As a result, the accuracy of the determination of $DELJ$ was quite poor. The simple geometric inboard jet flap angle $DELFI$ was a more meaningful indicator of the probable jet angle.

Several blowing and nonblowing runs were conducted at a unit Reynolds number of 13.1 million/m (4.0 million/ft). The changes noted between data recorded at the two Reynolds numbers were generally predictable.

Decreasing the Reynolds number increased drag, reduced the lift curve slope, and moved the center of pressure forward (fig. 12).

The basic wing/body/TF flap configuration (2) was stable at all conditions tested; maximum blowing rates increased its lift curve slope by roughly 10 percent (fig. 13). Drooping the leading edge of the wing 8° (configuration 3) delayed the onset of separation at higher angles of attack, moved the center of pressure aft, and increased the lift curve slope by 8 to 10 percent. Deflecting the TF flap and conventional outboard flap to 3.5° (configuration 4) increased CL uniformly by 0.07 over the ALPHA range studied and increased both stability and minimum drag.

The basic ADEN flap configuration (5) had a slightly lower minimum drag than the corresponding TF flap configuration (3); however its CL at zero angle of attack and lift curve slope were lower, and it was less stable. The ADEN flap responded to blowing with a positive shift in CL but with little change in lift curve slope. The TF flap responded to blowing in just the opposite manner. Increasing ADEN flap deflections (configurations 6 and 7) without blowing shifted CL positively and moved the center of pressure aft. Maximum blowing rates increased lift increments substantially beyond those attributable to nonblowing ADEN flap deflections and/or direct thrust effects; this result was especially noticeable at lower Mach numbers (fig. 14).

None of the configurations tested demonstrated any particular sensitivity of lateral center of pressure to blowing rate (figures demonstrating this fact were deemed too trivial for presentation). However, the other integrated aerodynamic characteristics previously discussed are reflected in the individual chord-wise pressure distributions recorded over both surfaces of the wing (fig. 15).

CONCLUDING REMARKS

Due to the limited scope of this test and in the absence of any rigorous analysis, no final conclusions should be drawn concerning the relative effectiveness of the TF and ADEN flap systems. More refined designs and considerably more testing will be required even to establish the practicability of the total-exhausting jet flap concept. However, some valuable lessons in blowing, semispan model testing techniques were learned. The most significant of those lessons was that the balance must be effectively insulated from the model whenever high pressure air is expanded to ambient conditions producing severe localized cooling. Based on the results of this and related tests, Ames has developed specialized servo-controlled heaters which maintain preset temperature differentials between the model, balance, and pressure lines. With these heaters thermally isolating the model from the balance and proper thermal compensation within the individual balance bridges, simulations of jets at higher pressures with higher

mass flow rates will no longer compromise the accuracy of aerodynamic force measurements.

Ames Research Center
National Aeronautics and Space Administration
Moffett Field, California 94035

August 21, 1975

TABLE 1. - CONFIGURATION DEFINITIONS

Configuration number	Flap type	DELFI, deg	DELFO, deg	DELFM deg
2	TF	0	0	0
3	TF	0	0	8
4	TF	3.5	3.5	8
5	ADEN	0	0	8
6	ADEN	15	0	8
7	ADEN	30	0	8

TABLE 2. - WING STATIC PRESSURE ORIFICE LOCATIONS
 (DELFM = 8°)
 Locations are given as decimal fractions of local chord length (X/C).

2Y/B =	Upper Surface				Lower Surface			
	.25	.45	.65	.80	.25	.45	.65	.80
	0	0	0	0				
	.023	.023	.022	.022	.023	.023	.022	b .022
	.046	.046	.044	.044	.046	.046	.044	.044
	.069	.068	.067	.066	.069	.068	.067	.066
	.092	.091	.089	.088	.092	.091	.089	.088
	.139	.137	.133	.132	.185	.182	.178	.176
	.185	.182	.178	.176	a .278	a .274	a .268	a .269
	.231	.228	.222	.220	.353	.362	.377	.384
a	.273	a .265	a .268	a .255	.445	.454	.466	b .472
a	.303	a .320	b .300	a .300	.538	.545	.555	.560
	.353	.362	a .330	a .340	.630	.636	.644	.648
	.399	.408	.377	.384	.723	.772	.733	.736
	.445	.454	.422	.428	.815	.818	.822	.824
	.491	.499	.466	.472	.861	.863	.867	.868
	.538	.545	.511	.516	.908	.909	.911	.912
	.584	.590	.555	.560	.935	.935	.956	.956
	.630	.636	.600	.604				
b	.676	b .681	.644	.648	a An orifice not on configuration 2.			
	.723	.727	.689	.692				
	.769	b .772	b .733	.736	b An orifice plugged throughout the test.			
	.815	.818	.778	.780				
	.861	.863	.822	.824	c An orifice on the ADEN flap only.			
	.908	.909	.867	.868				
c	.939	c .939	.911	.912				
	.954	.954	.956	.956				
c	.984	c .984						
c	.988	c .988						

TABLE 3. - TEST CONDITIONS SUMMARY^a

CONF	ALPHA	CTG	RN/L	MACH NUMBER								
				0	0.6	0.7	0.8	0.875	0.9	0.925	0.95	
2	0	V	0	F								
2	A	0	5.5		F	F,P	F	F	F,P	F	F,P	
2	A	.04	5.5						F			
2	A	.08	5.5						F			
2	A	.12	5.5			F,P	F		F,P		F,P	
3	A	0	5.5			F,P	F		F,P		F,P	
3	A	.12	5.5			F	F		F		F	
4	0	V	0	F								
4	A	0	5.5		F	F,P	F	F	F,P		F,P	
4	A	.04	5.5						F			
4	A	.08	5.5						F			
4	A	.12	5.5			F,P	F		F,P		F,P	
4	A	0	4.0			F			F			
4	A	.12	4.0			F			F			
5	0	V	0	F								
5	A	0	5.5			F			F,P		F	
5	A	.04	5.5			F			F,P*		F	
5	A	.08	5.5			F			F,P*		F	
5	A	.12	5.5			F			F,P		F	
6	0	V	0	F								
6	A	0	5.5			F			F,P		F	
6	A	.04	5.5			F			F,P*			
6	A	.08	5.5			F			F,P*			
6	A	.12	5.5			F			F,P		F	
7	0	V	0	F								
7	A	0	5.5			F			F,P			
7	A	.04	5.5			F			F,P*			
7	A	.08	5.5			F			F,P*			
7	A	.12	5.5			F			F,P			

^aSchedules:

A = -4,-3,-2,-1,0,1,2,3,4,5,6,7,8,10,12,14,15,0 deg.
 V = Static thrust calibration, 0<CTG<0.12.

F = Force data.

P = Pressure distributions at 0,4,8,12,15 deg.

P* = Pressure distributions at 4 deg. only.

TABLE 4. - REFERENCE DIMENSIONS

<u>Base area</u>	<u>Configurations 2-4</u>		<u>Configurations 5-7</u>	
A(1)	0.000953 m ²	(0.01026 ft ²)	0.001131 m ²	(0.01218 ft ²)
A(2)	0.000848	(0.00912)	0.000864	(0.00930)
A(3)	0.000772	(0.00831)	0.000795	(0.00856)
A(4)	0.000709	(0.00763)	0.000719	(0.00774)
A(5)	0.000620	(0.00668)	0.000632	(0.00680)
A(6)	0.000578	(0.00621)	0.000696	(0.00749)
A(7)	0.000185	(0.00200)	0	(0)
A(8)	0.000084	(0.00090)	0	(0)
AE	0.003942	(0.04243)	0.004066	(0.04376)

Wing span = 1.3737 m (4.5069 ft)

Mean aerodynamic chord = 0.5920 m (1.9421 ft)

Wing reference area = 0.7548 m² (8.125 ft²)

TABLE 5. - INDEX OF DATA FIGURES

Figure	Caption	Page
9	Repeatability evaluation.	21
10(a)	Effects of jet-on jet-off cycling on wind-off balance zeros.	25
10(b)	Balance temperature at upper gages during jet cycling.	26
11	Static thrust calibration.	27
12	Reynolds number sensitivity.	32
13	Effects of blowing.	40
14	Flap effects.	74
15	Pressure distributions.	86

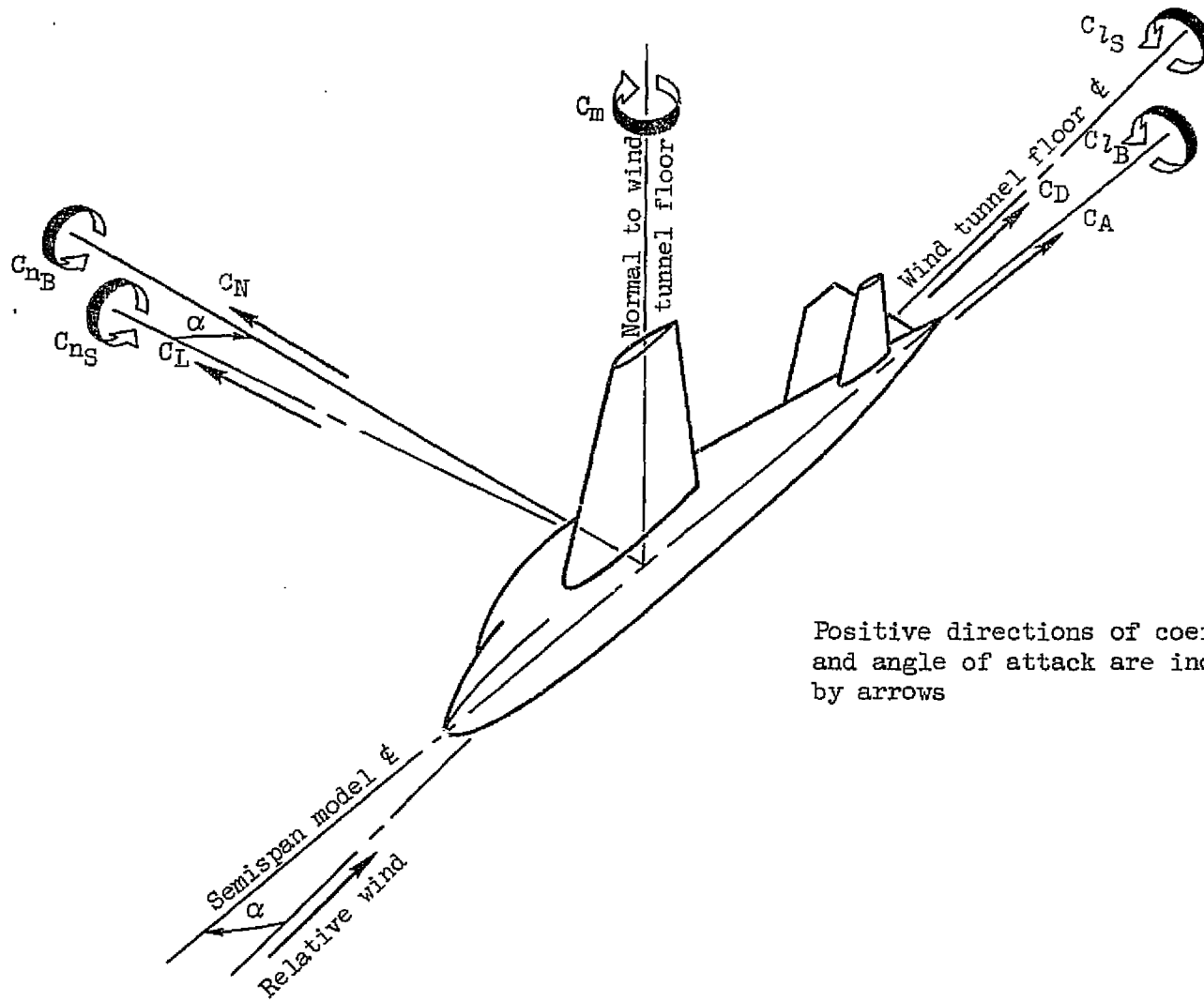

Positive directions of coefficients and angle of attack are indicated by arrows

Figure 1. - Definition of axis systems for a semispan model.

ORIGINAL PAGE IS
OF POOR QUALITY

Note: All dimensions are in
meters and (inches)

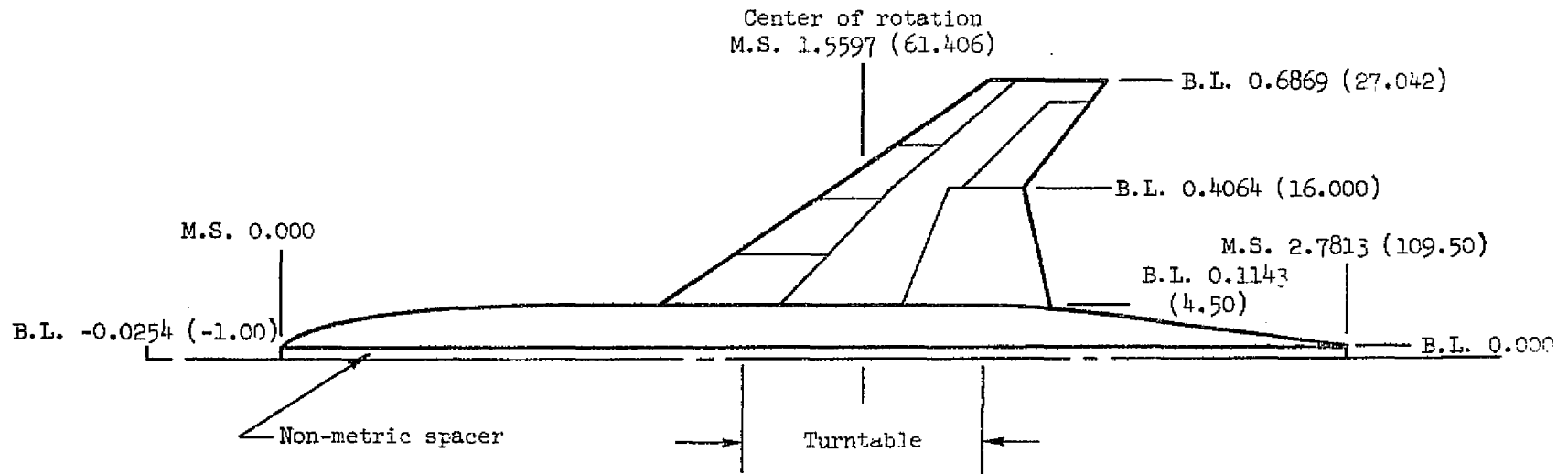

14

Figure 2. - Model installation schematic.

Note: All dimensions are in meters and (inches)

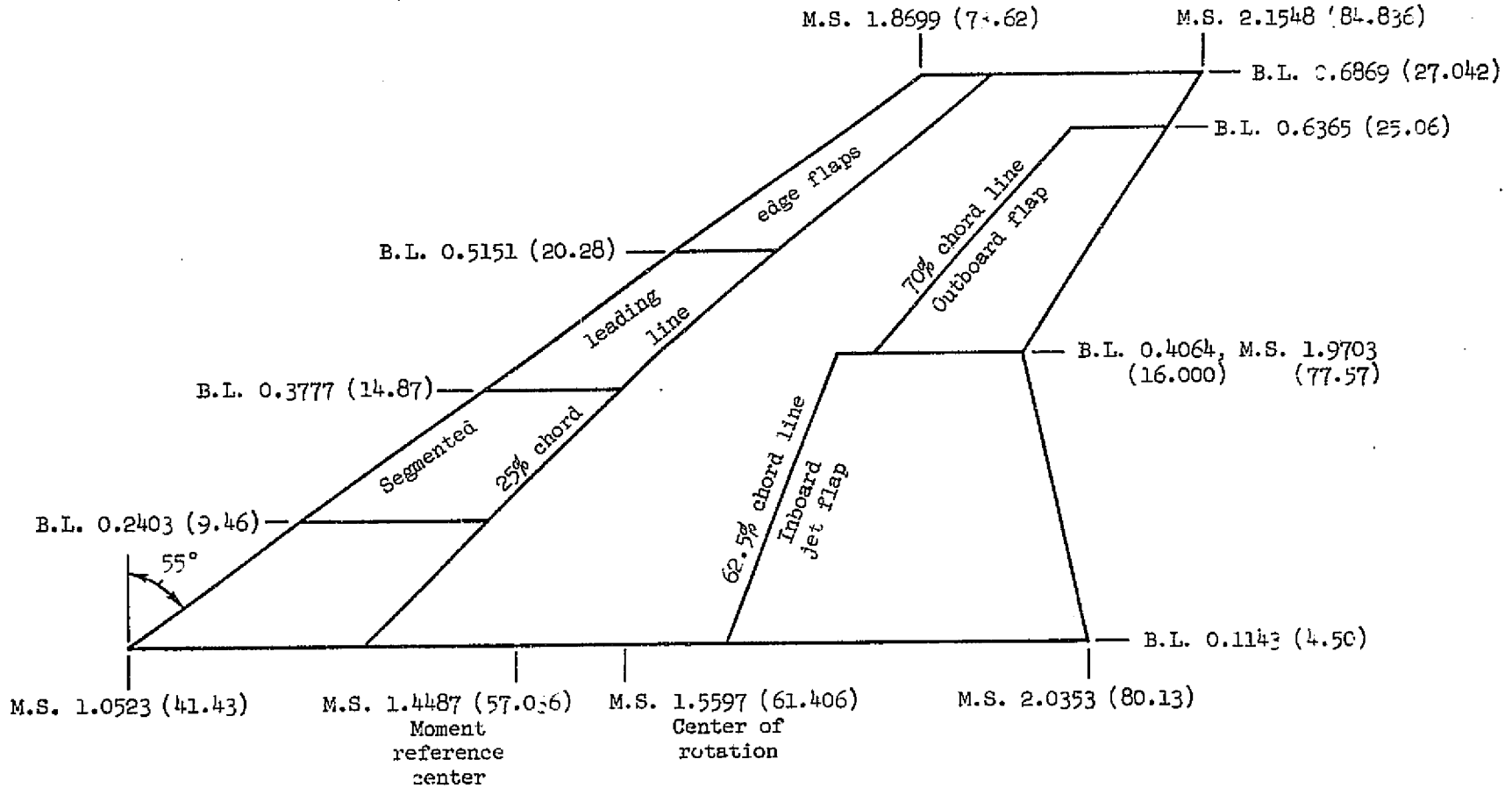
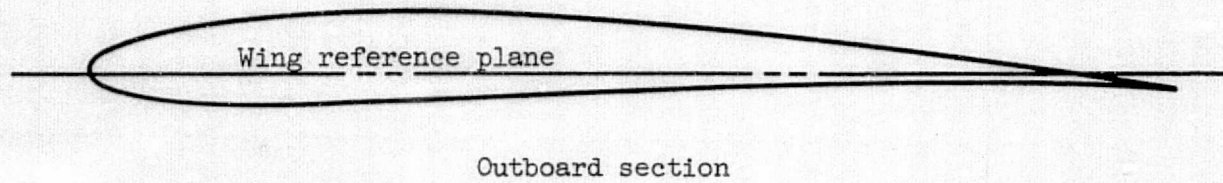

Figure 3. - Wing planform details.



No leading edge or flap deflections shown for either section

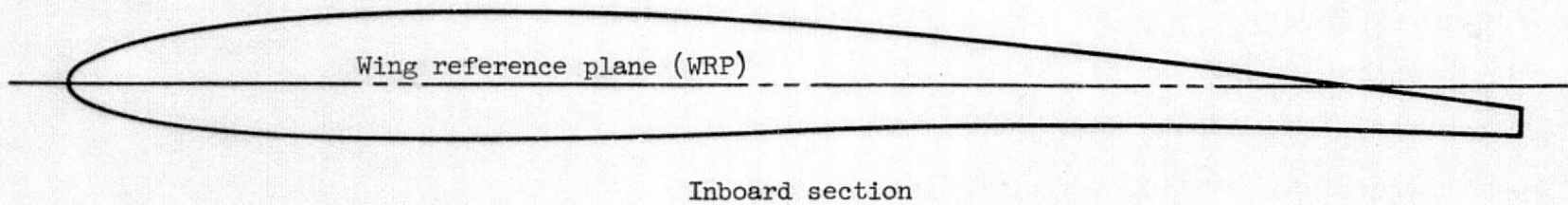

Figure 4. - Representative airfoil sections.

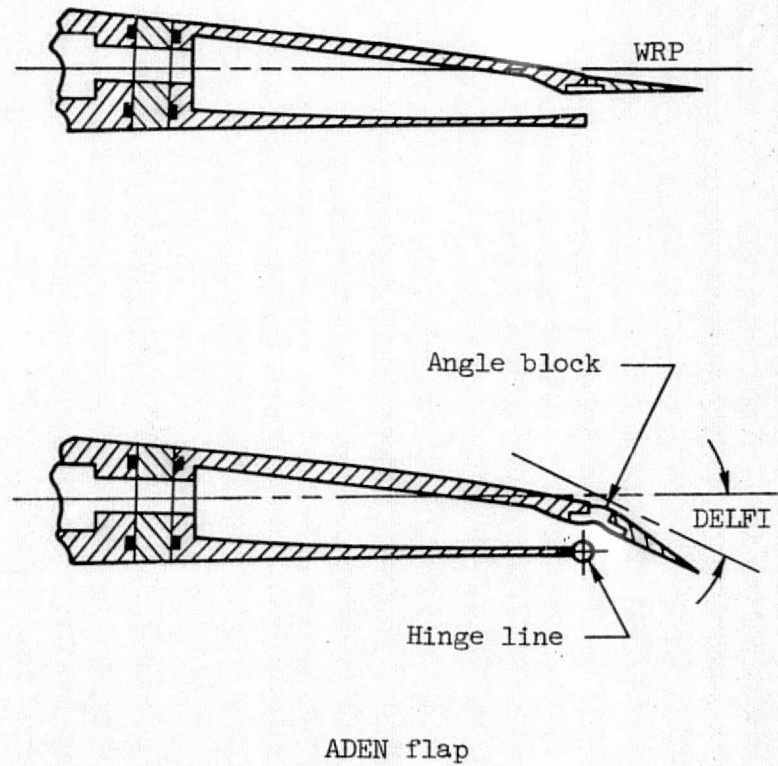
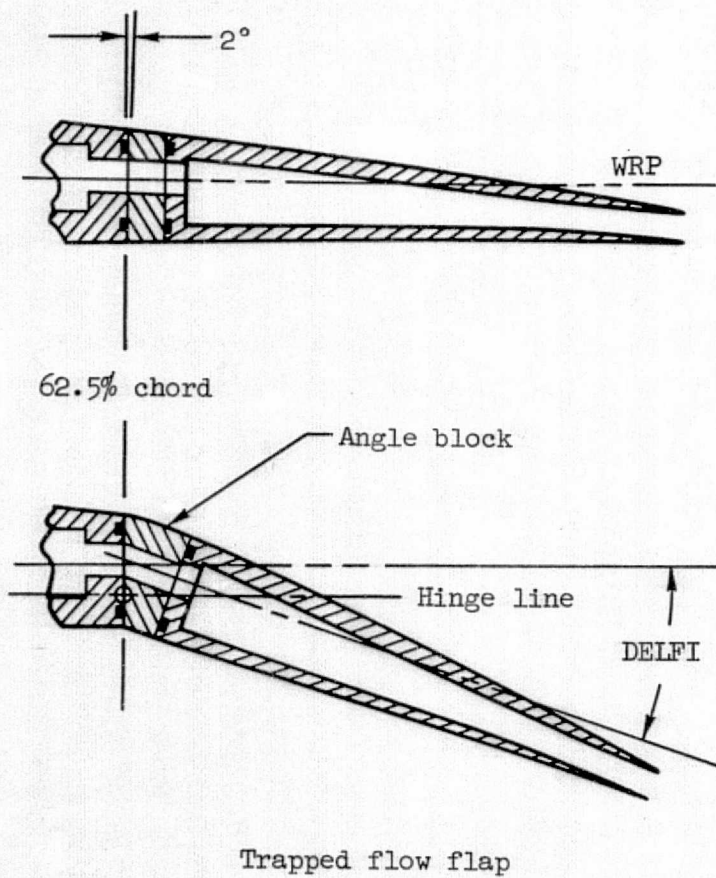

Figure 5. - Comparison of Trapped Flow and ADEN flaps.

ORIGINAL PAGE IS
OF POOR QUALITY

18

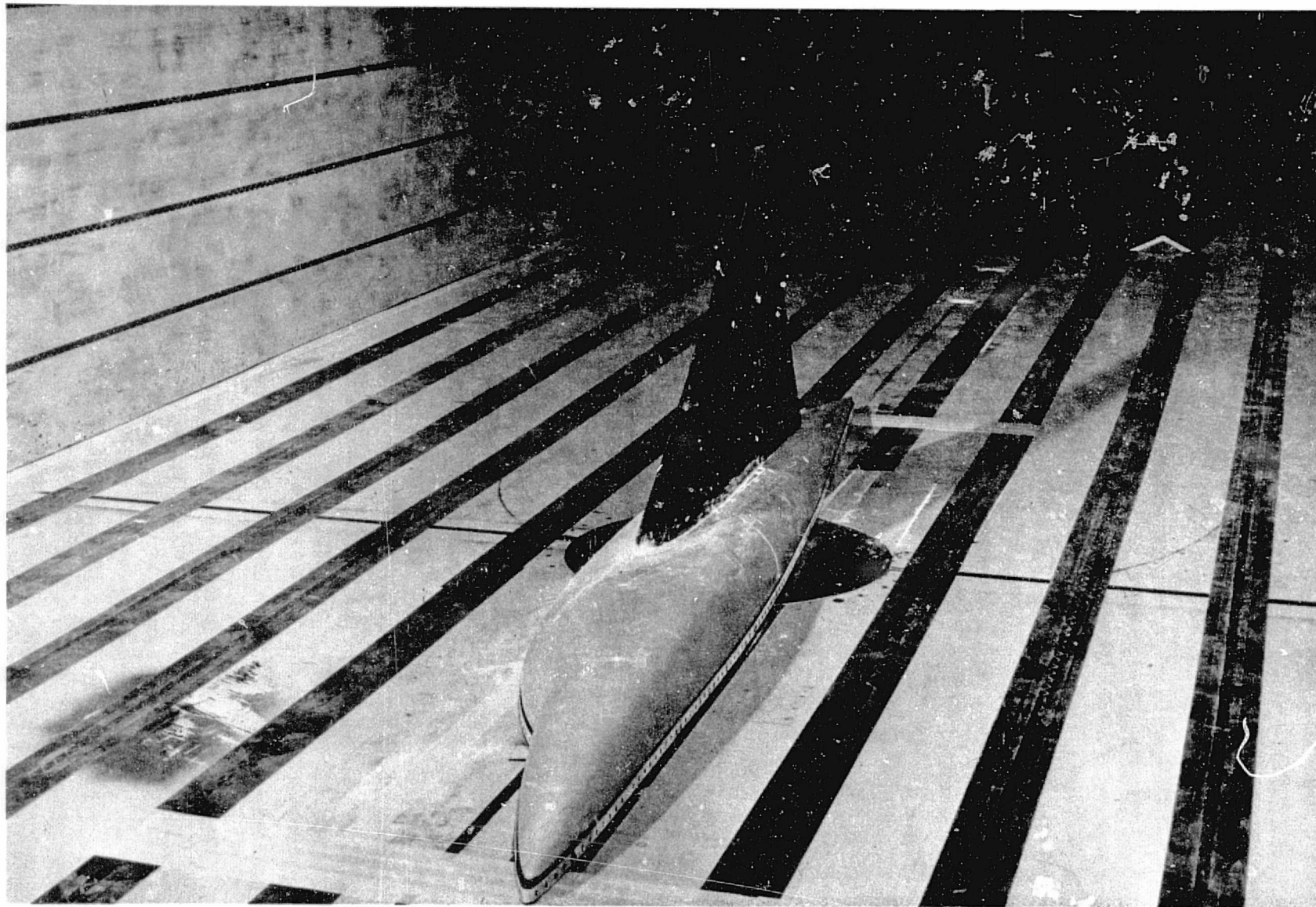

Figure 6. - Tunnel installation - 3/4 front view.

ORIGINAL PAGE IS
OF POOR QUALITY

19

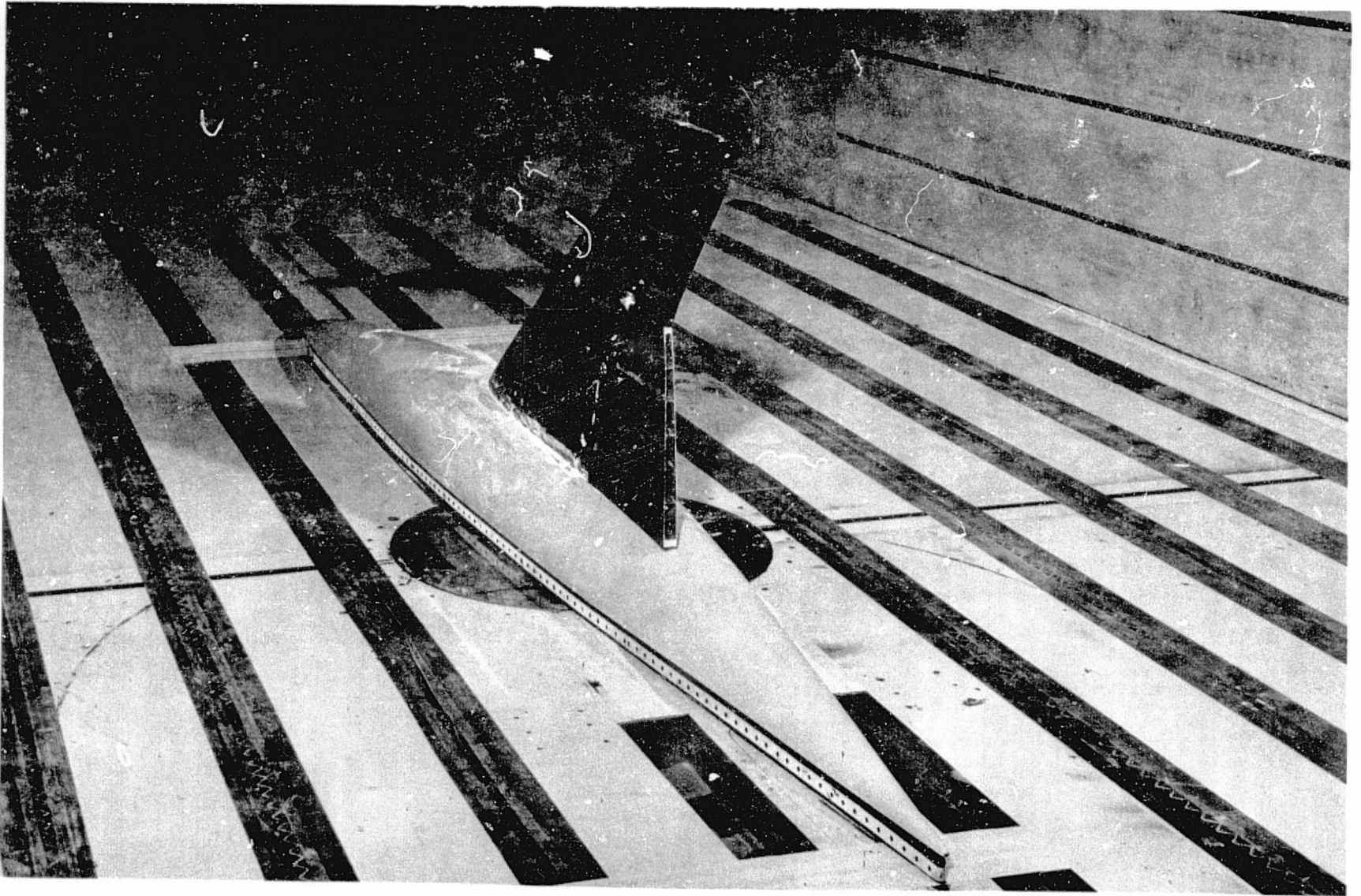

Figure 7. - Tunnel installation - 3/4 aft view.

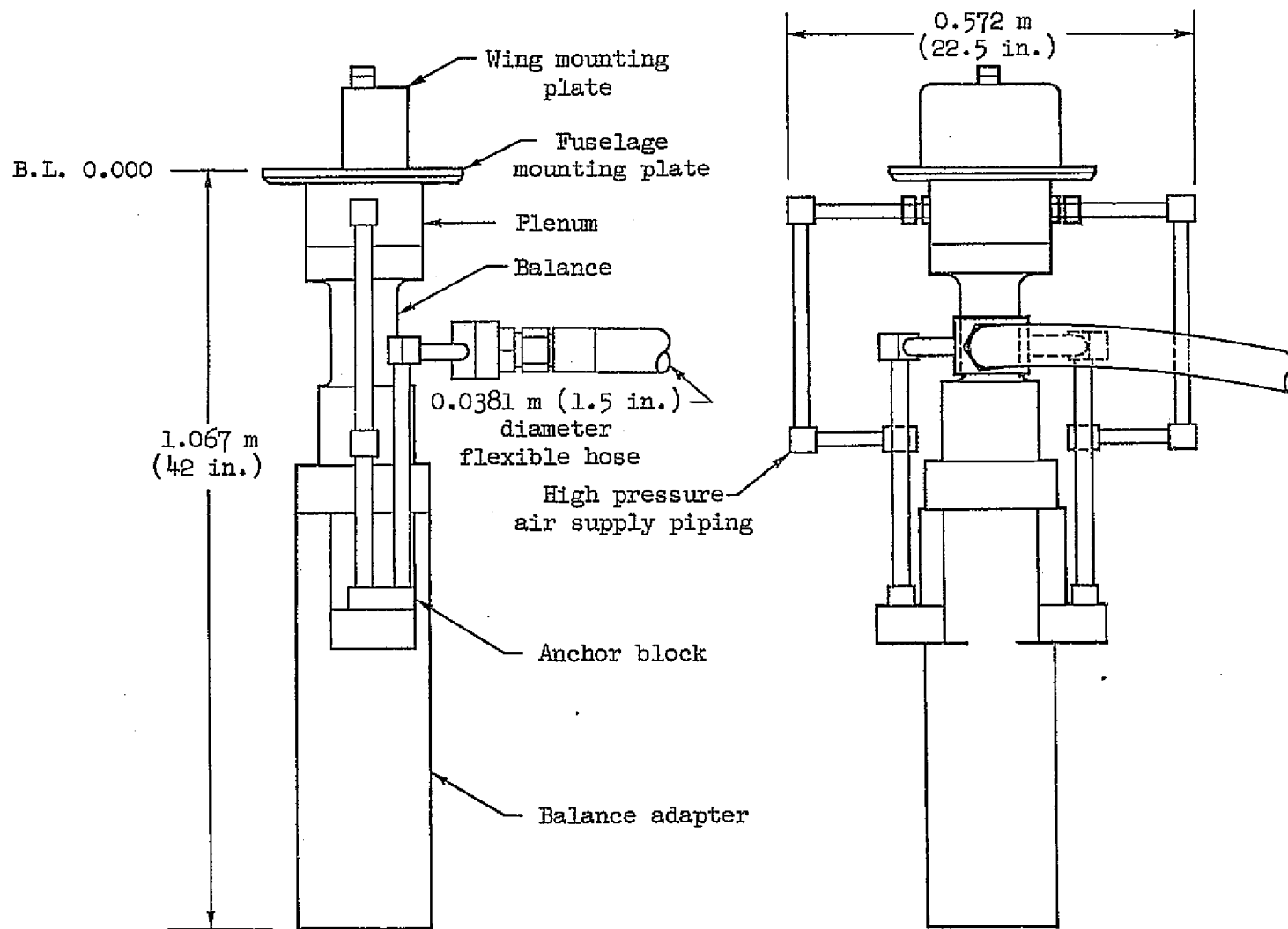

Figure 8. - High pressure air supply system schematic.

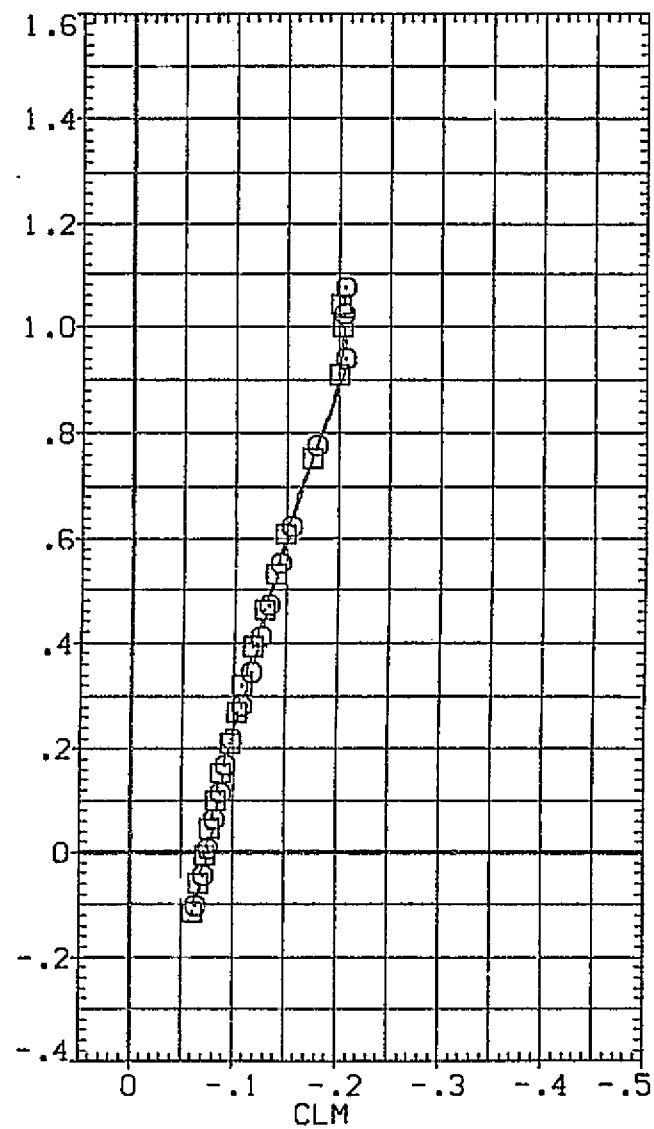
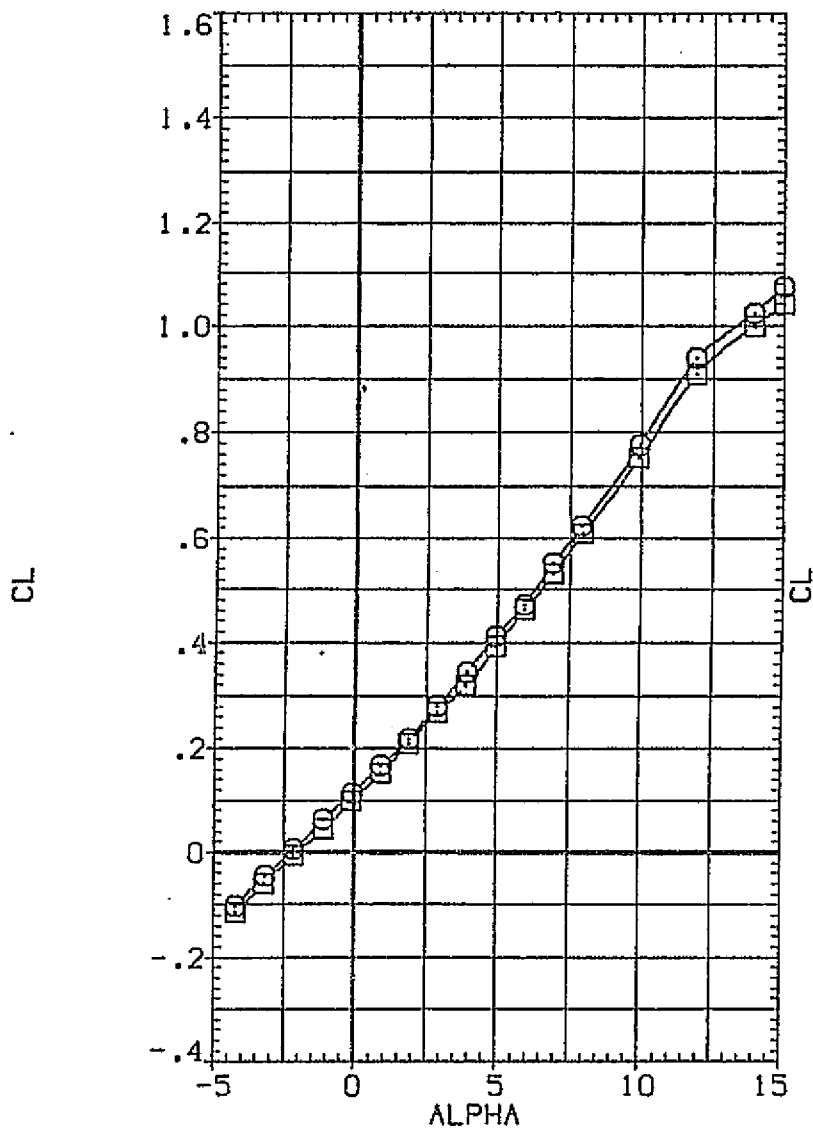

FIG. 9 REPEATABILITY EVALUATION- CONFIGURATION 2
 (A)MACH = .70

DATA SET SYMBOL	CONFIGURATION DESCRIPTION	RN/L	CTG
(BAT003)	CONFIGURATION 2 CL DESIGN=0.2	5.500	.000
(AAT003)	CONFIGURATION 2 CL DESIGN=0.2	5.500	.000

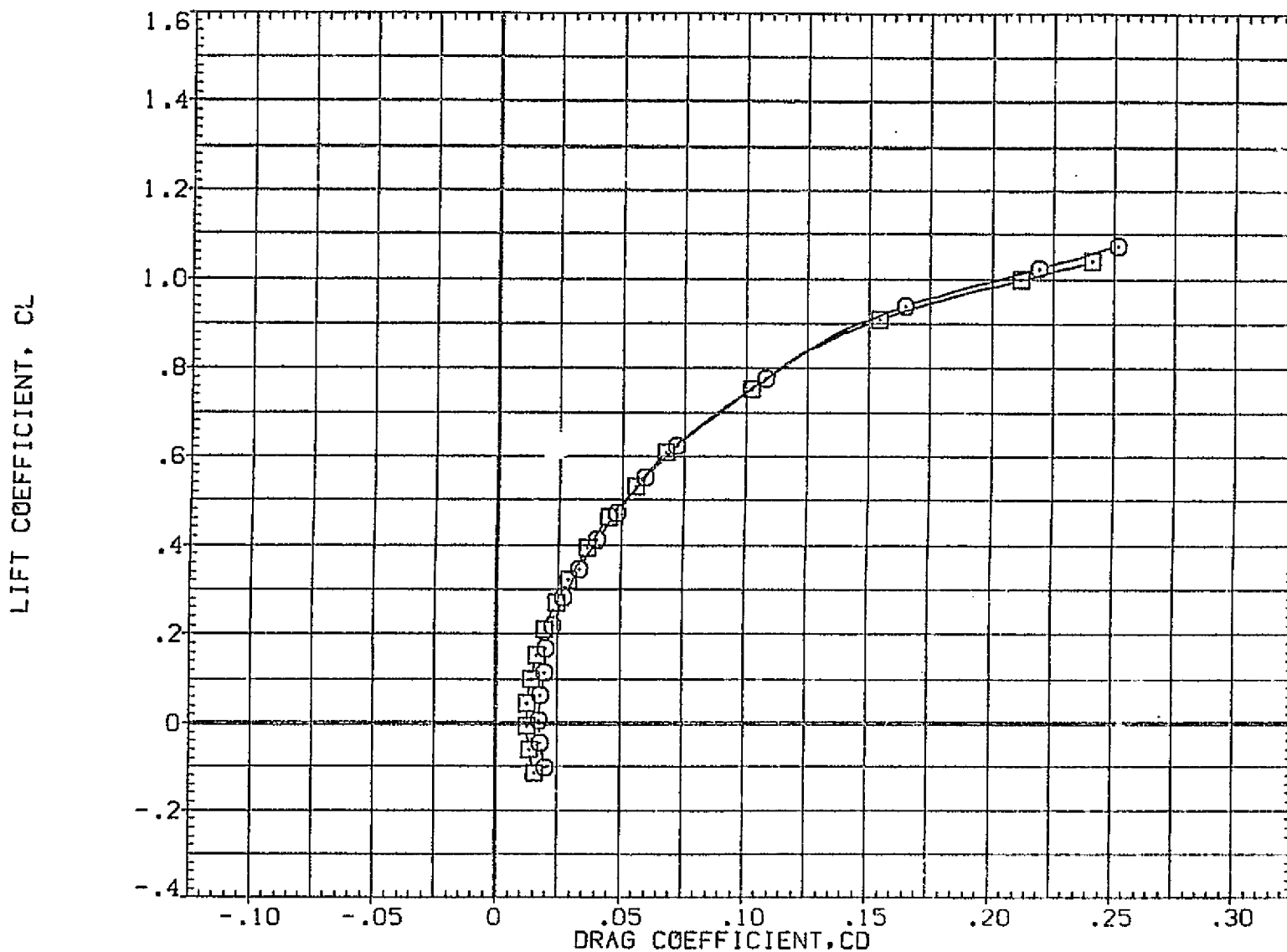

FIG. 9 REPEATABILITY EVALUATION- CONFIGURATION 2
 CAJMACH = .70

DATA SET SYMBOL CONFIGURATION DESCRIPTION
 (BAT010) ○ CONFIGURATION 4 CL DESIGN=0.5
 (AAT010) □ CONFIGURATION 4 CL DESIGN=0.5

RN/L CTG
 5.500 .000
 5.500 .000

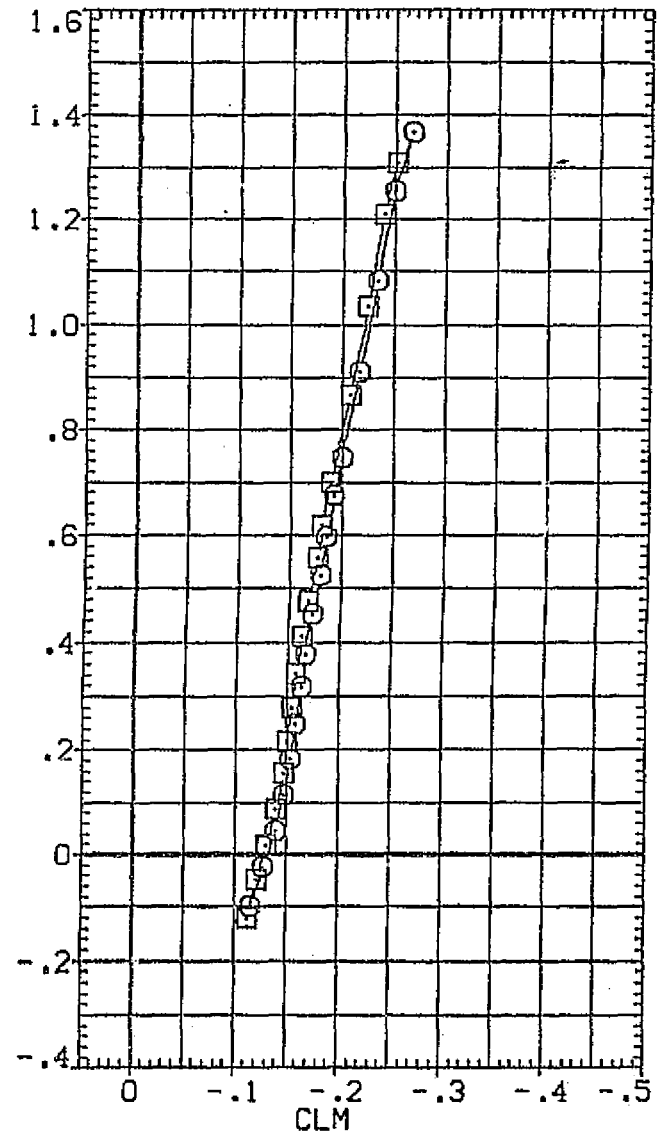
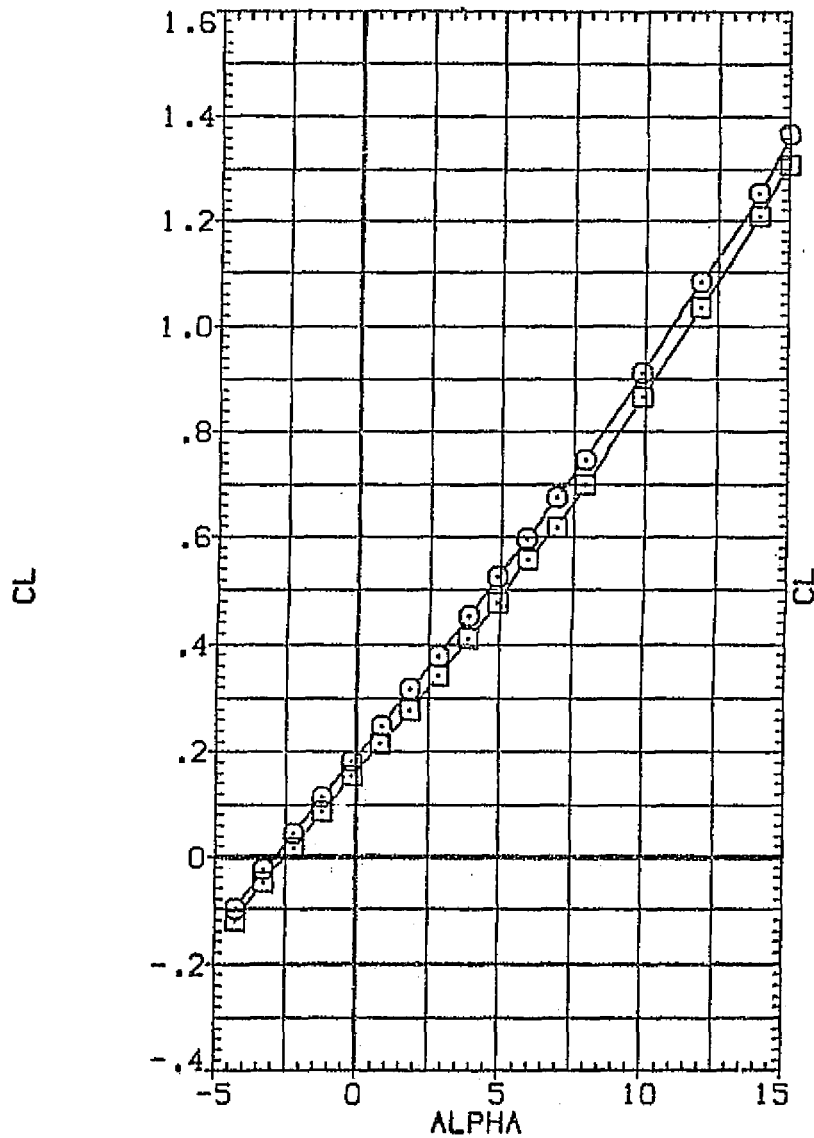

FIG. 9 REPEATABILITY EVALUATION- CONFIGURATION 4
 (A) MACH = .70

DATA SET SYMBOL	CONFIGURATION	DESCRIPTION
(BATD10)	□	CONFIGURATION 4 CL DESIGN=0.5
(AATD10)	○	CONFIGURATION 4 CL DESIGN=0.5

RN/L	CTG
5.500	.000
5.500	.000

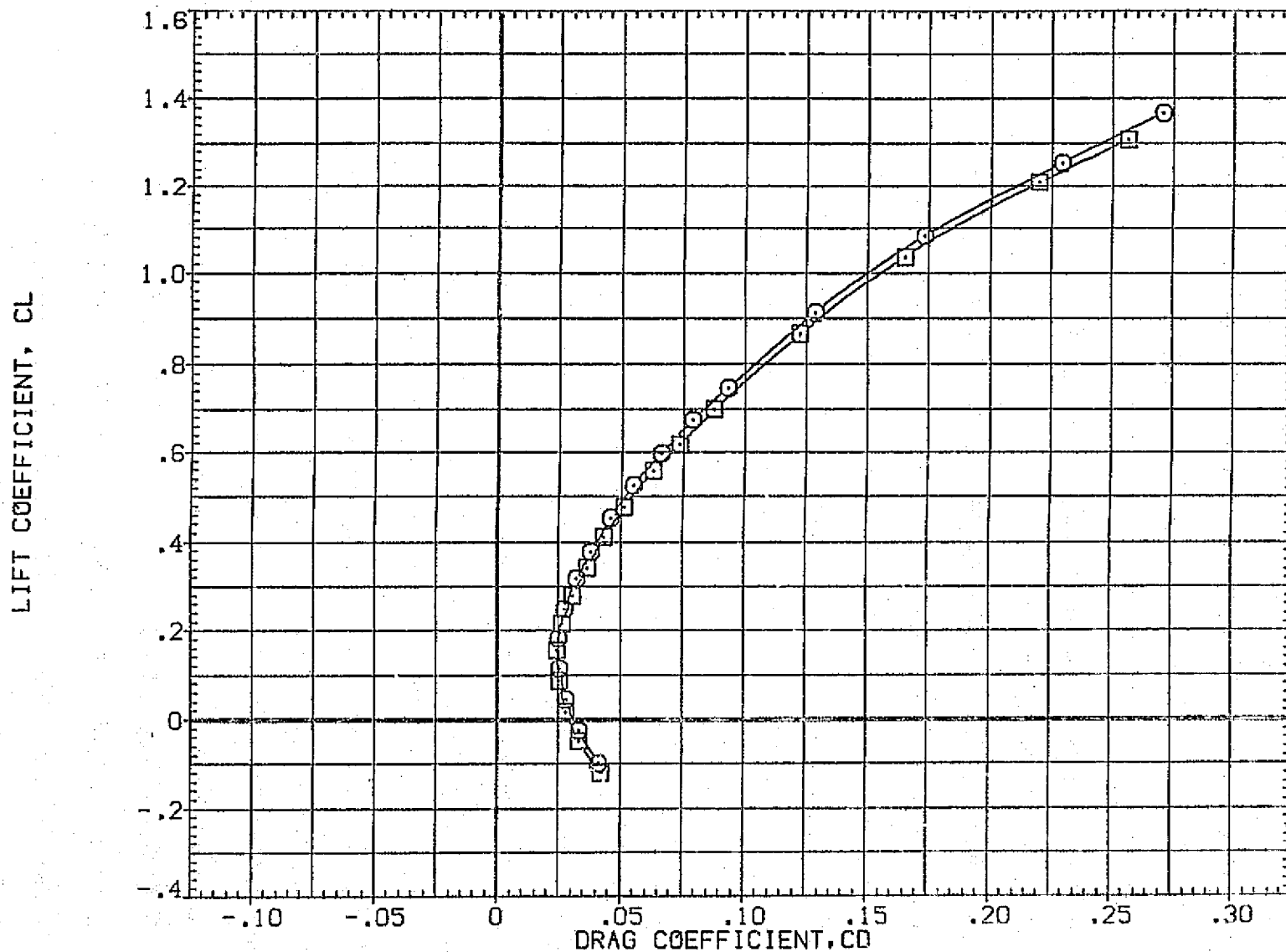

FIG. 9 REPEATABILITY EVALUATION- CONFIGURATION 4
 (A)MACH = .70

SYMBOL	DATA	PARAMETRIC VALUES			
○	CL	MACH	.000	ALPHA	.000
□	CD	BETA	.000	DELFI	.000
◇	CLM	DELFG	.000	DELFM	8.000
		RN/L	.000		

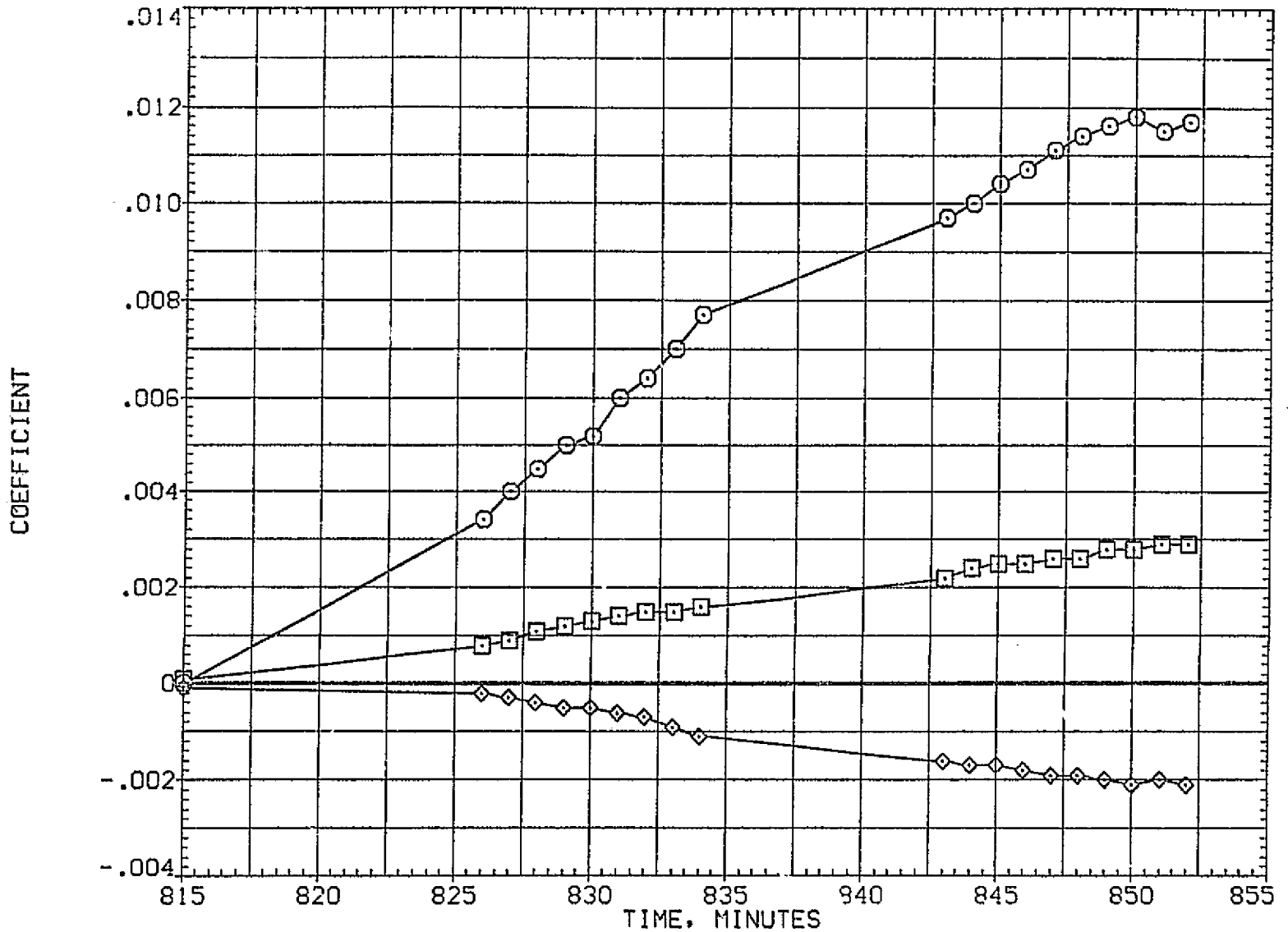
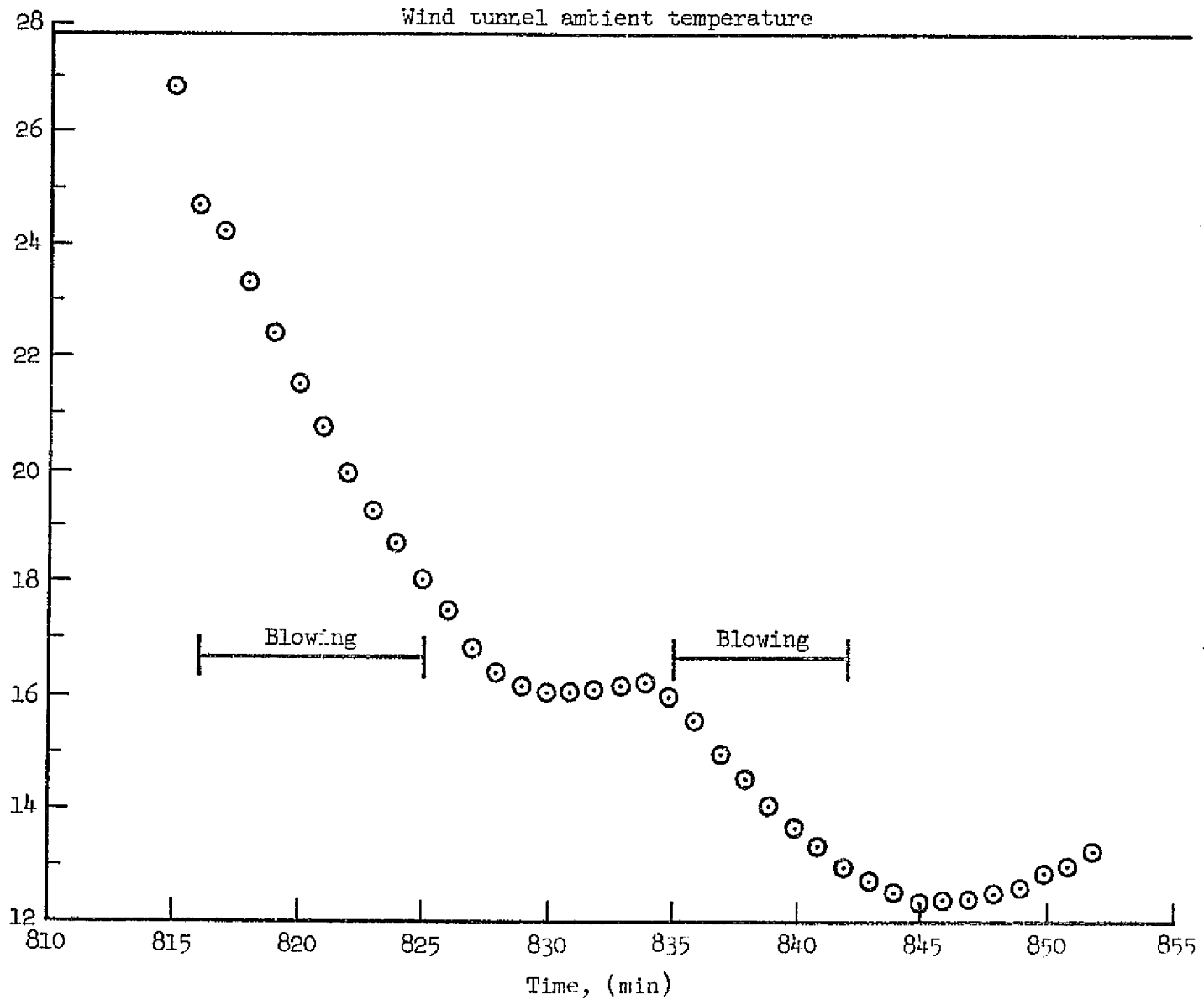

FIG. 10A EFFECTS OF JET-ON/JET-OFF CYCLING ON WIND OFF BALANCE ZEROS



(b) Balance temperature at upper gages during jet cycling.

Figure 10. - Concluded.

SYMBOL	MACH	PARAMETRIC VALUES			
○	.000	ALPHA	.000	BETA	.000
		DELFI	.000	DELFO	.000
		DELFM	.000	RN/L	.000

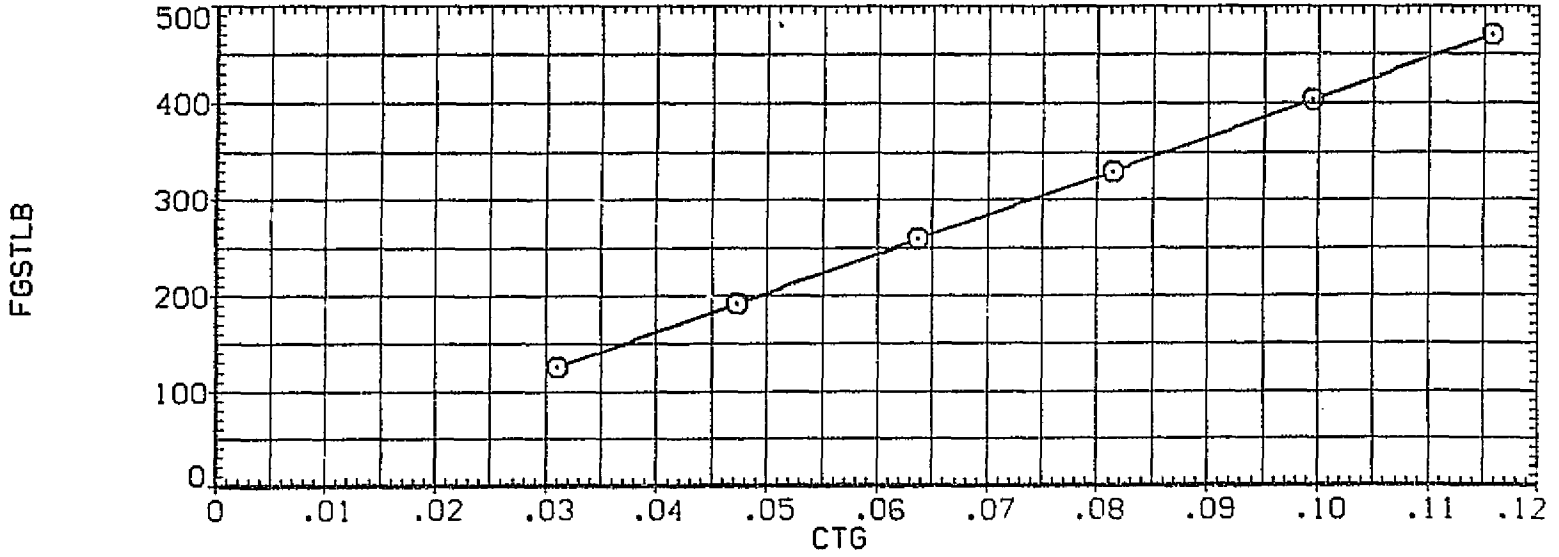
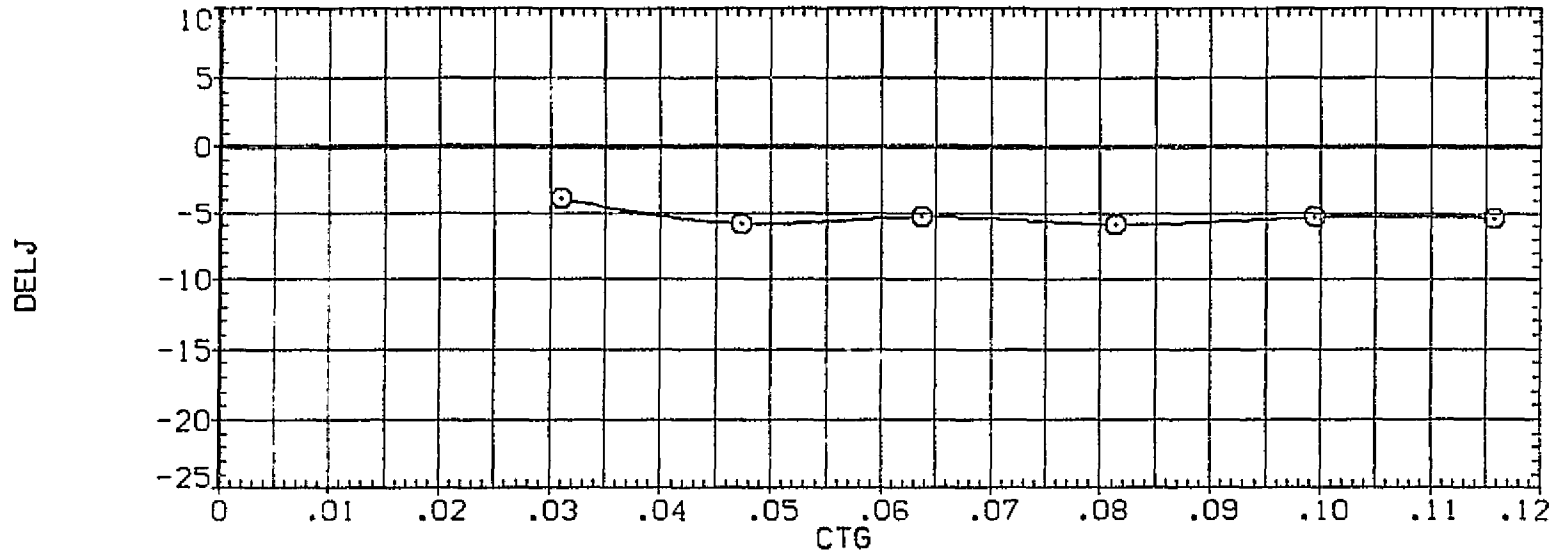

FIG. 11 STATIC THRUST CALIBRATION- CONFIGURATIONS 2 AND 3

SYMBOL	MACH	PARAMETRIC VALUES			
		ALPHA	BETA	DELFO	DELFM
○	.000	.000	.000	3.500	3.500
		3.500	3.500	8.000	.000

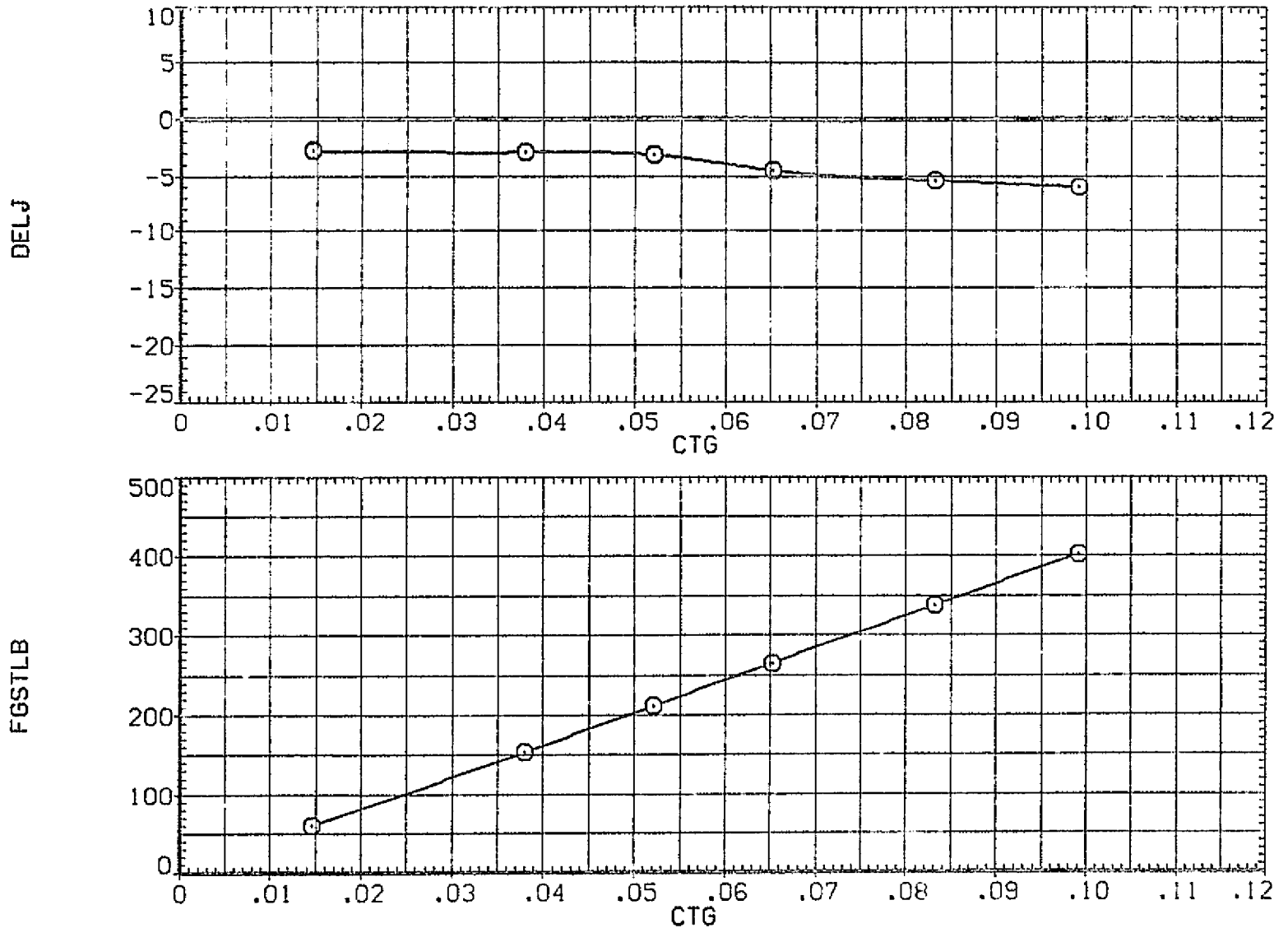

FIG. 11 STATIC THRUST CALIBRATION- CONFIGURATION 4

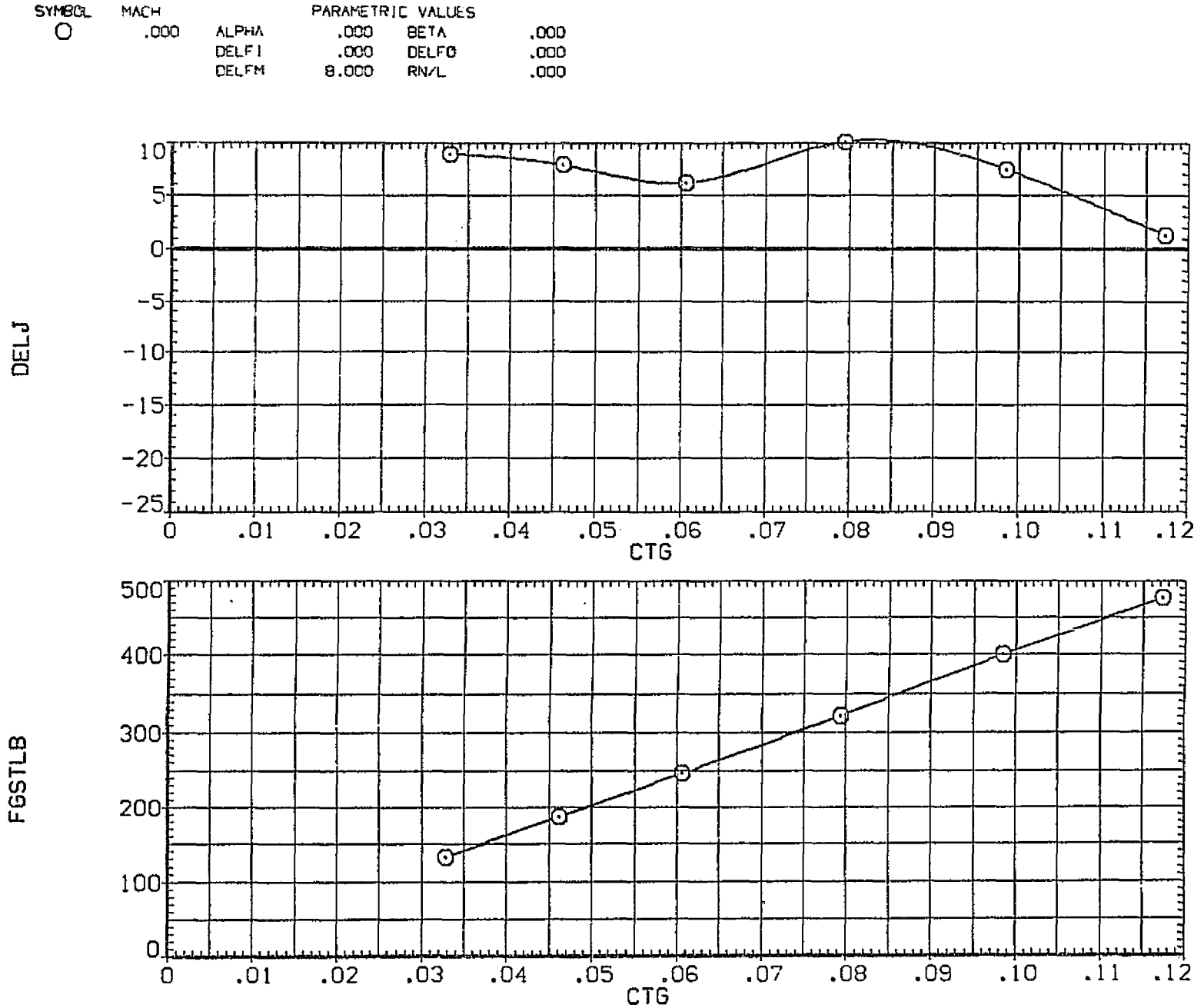

FIG. 11 STATIC THRUST CALIBRATION- CONFIGURATION 5

SYMBOL	MACH	PARAMETRIC VALUES			
○	.000	ALPHA	.000	BETA	.000
		DELFI	15.000	DELFO	.000
		DELFM	8.000	RN/L	.000

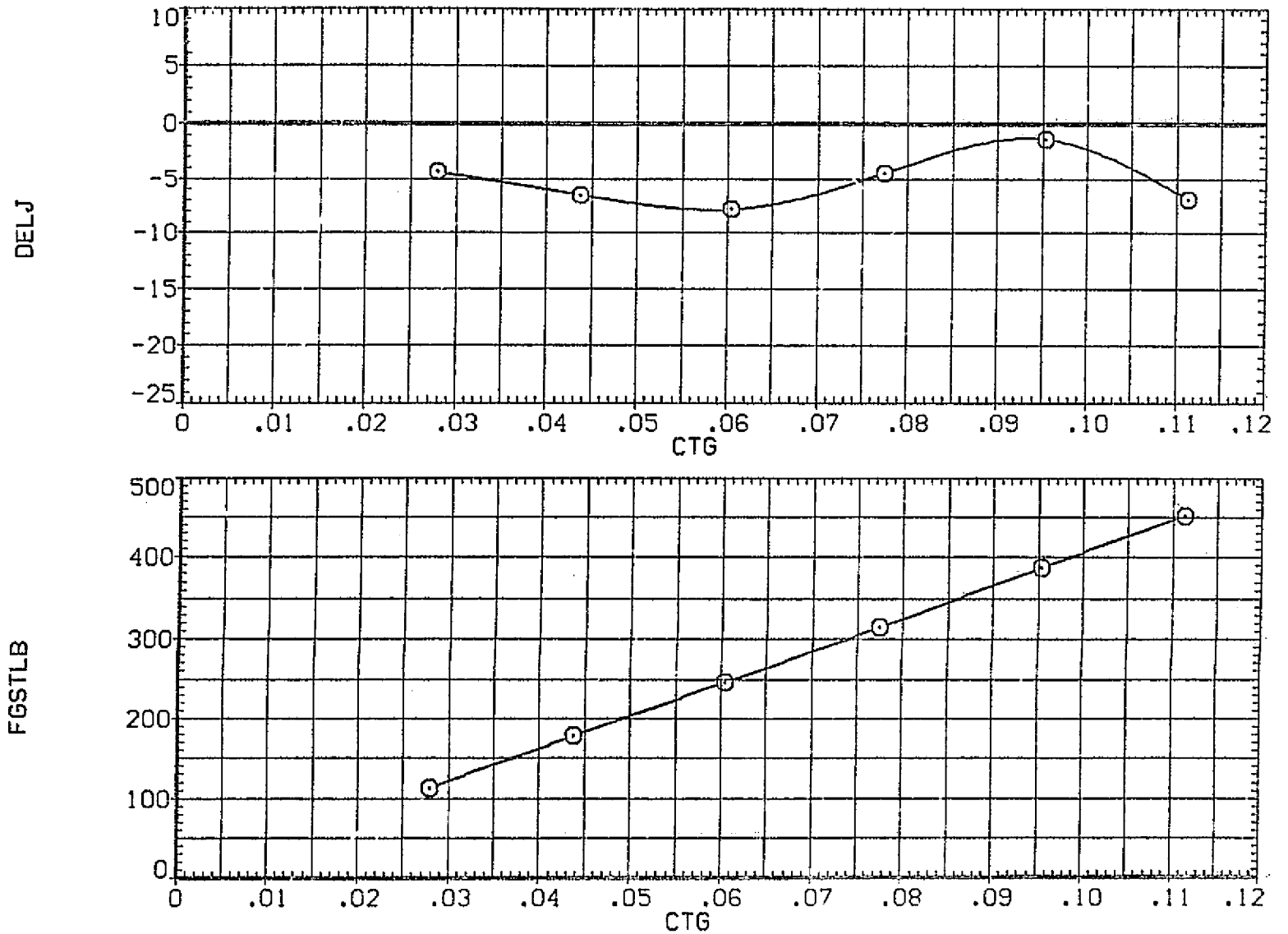

FIG. 11 STATIC THRUST CALIBRATION- CONFIGURATION 6

SYMBOL	MACH	PARAMETRIC VALUES			
○	.000	ALPHA	.000	BETA	.000
		DELFI	30.000	DELFO	.000
		DELFM	8.000	RN/L	.000

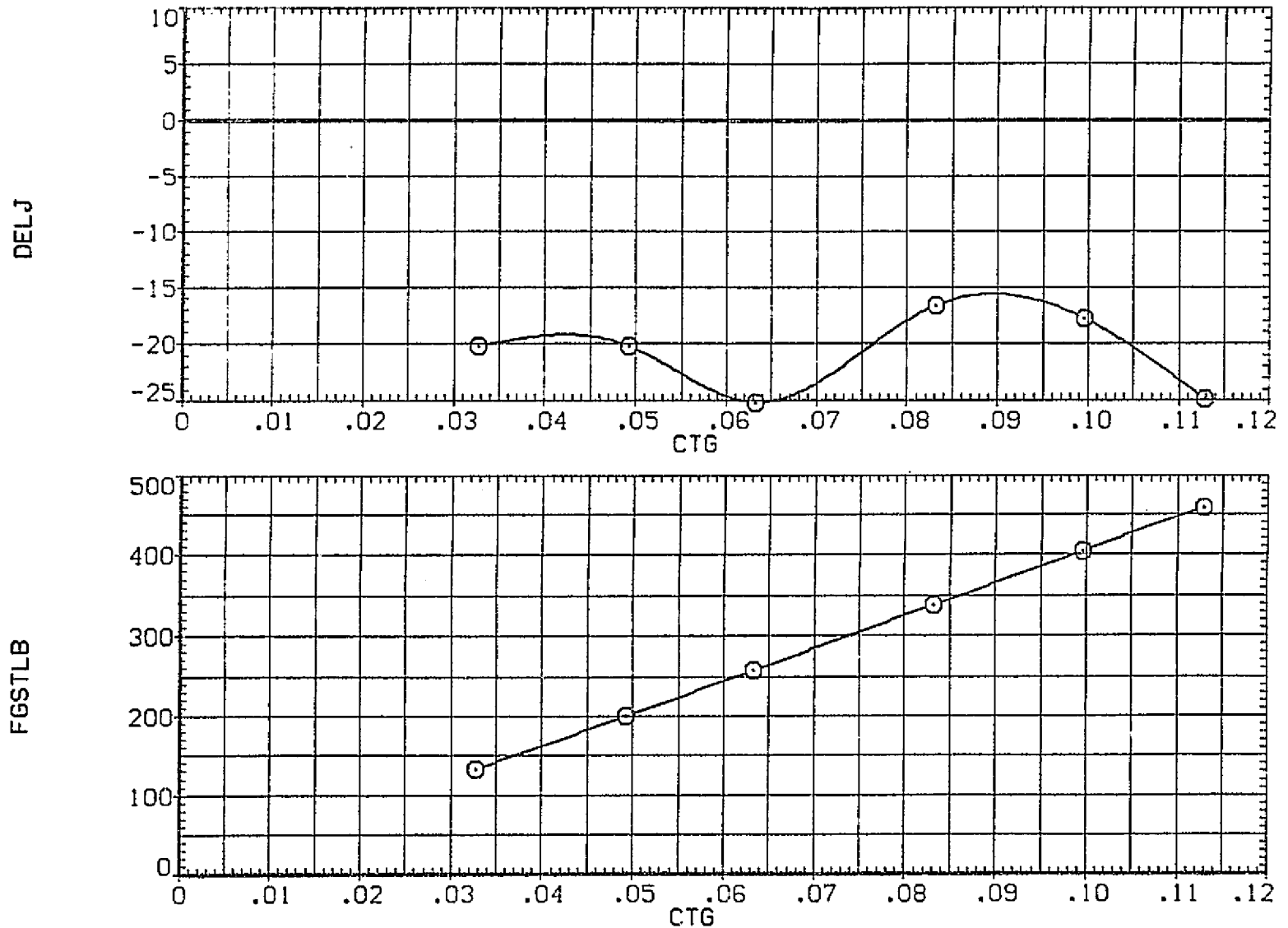

FIG. 11 STATIC THRUST CALIBRATION- CONFIGURATION 7

DATA SET SYMBOL CONFIGURATION DESCRIPTION
 (RAT014) ○ CONFIGURATION 4 CL DESIGN=0.5
 (RAT010) □ CONFIGURATION 4 CL DESIGN=0.5

RN/L CTG
 4.000 .000
 5.500 .000

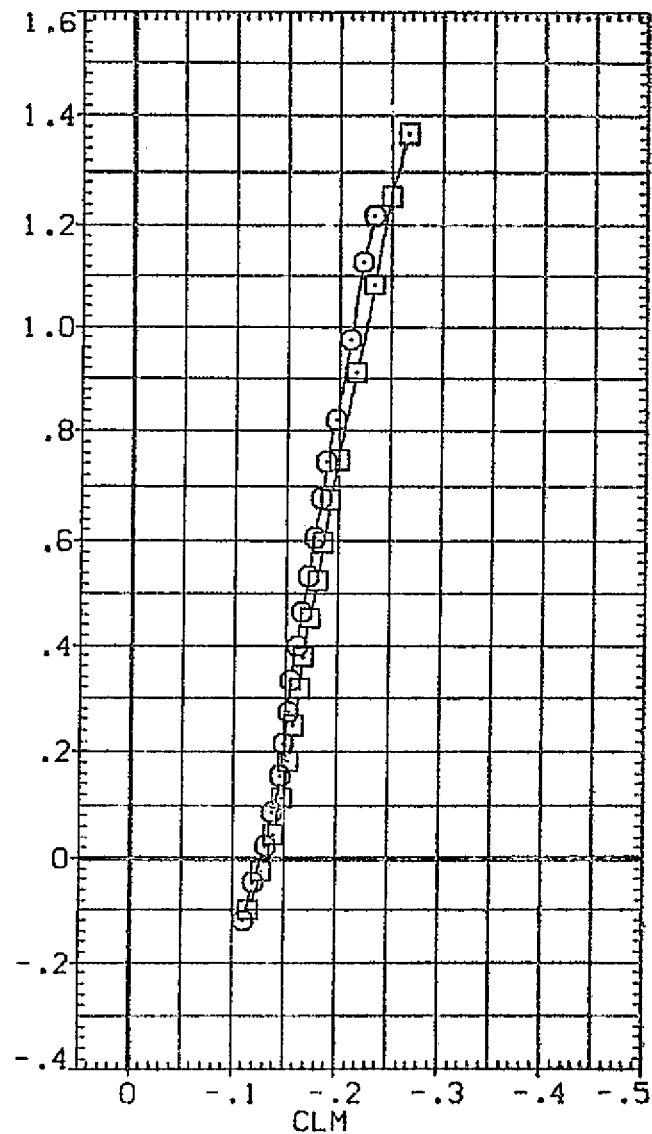
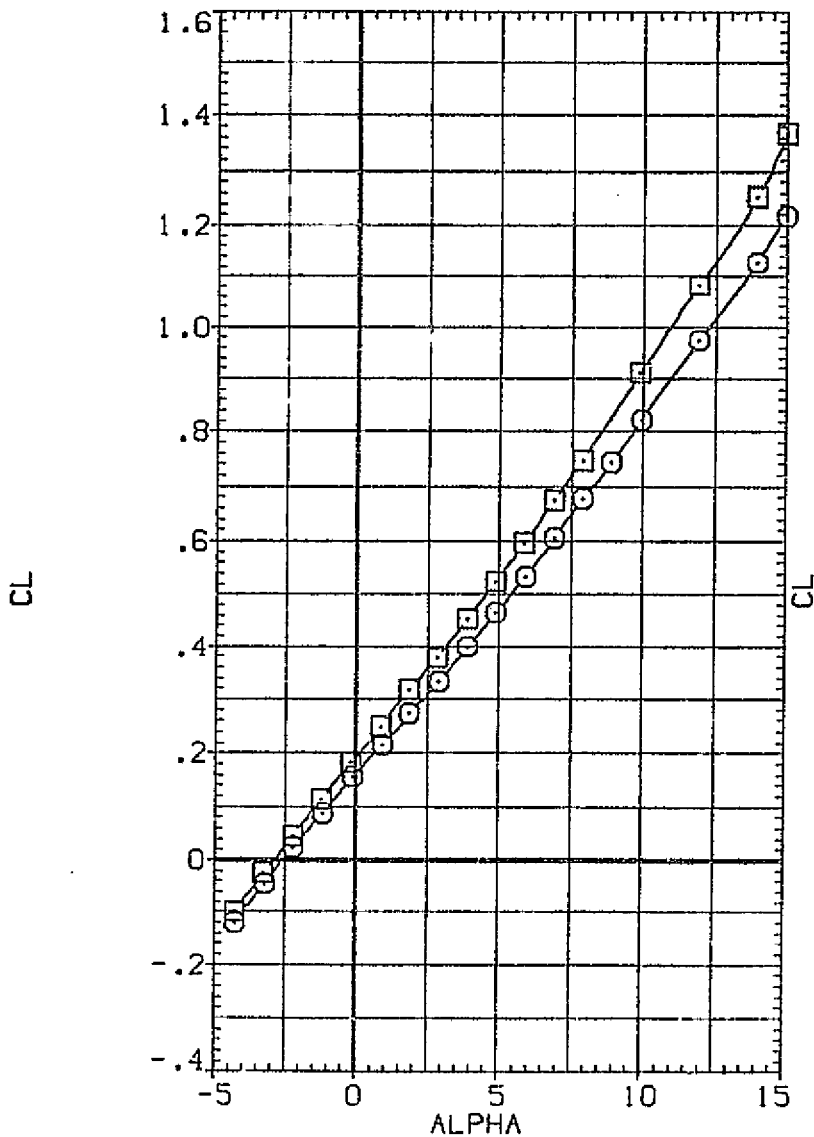

FIG. 12 REYNOLDS NUMBER SENSITIVITY WITH JET OFF
 (A) MACH = .70

DATA SET SYMBOL	CONFIGURATION DESCRIPTION
(RATO14)	○ CONFIGURATION 4 CL DESIGN=0.5
(RATO10)	□ CONFIGURATION 4 CL DESIGN=0.5

RN/L	CTG
4.000	.000
5.500	.000

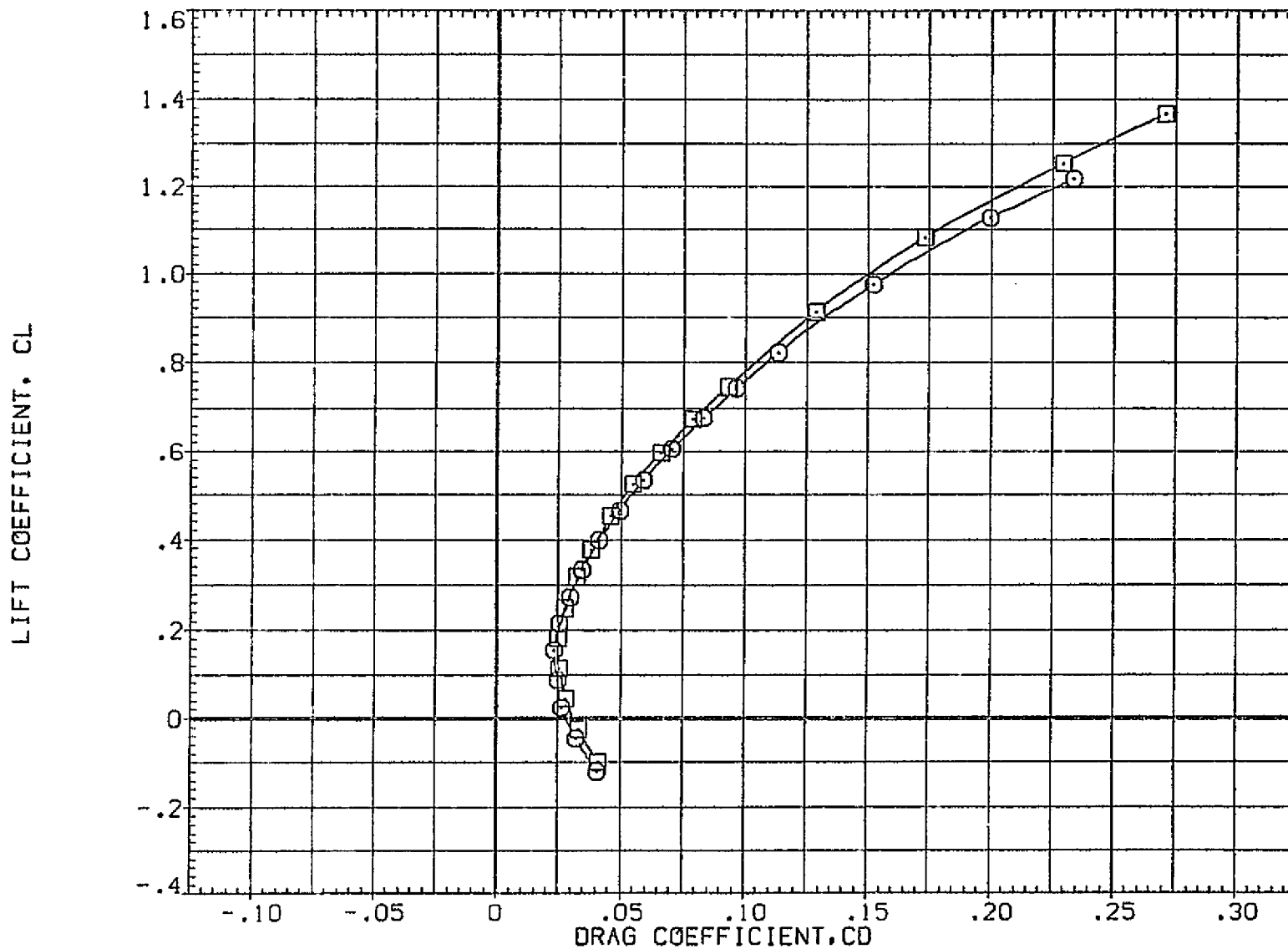

FIG. 12 REYNOLDS NUMBER SENSITIVITY WITH JET OFF

(A) MACH = .70

DATA SET SYMBOL CONFIGURATION DESCRIPTION
 (RAT014) ○ CONFIGURATION 4 CL DESIGN=0.5
 (RAT010) □ CONFIGURATION 4 CL DESIGN=0.5

RN/L CTG
 4.000 .000
 5.500 .000

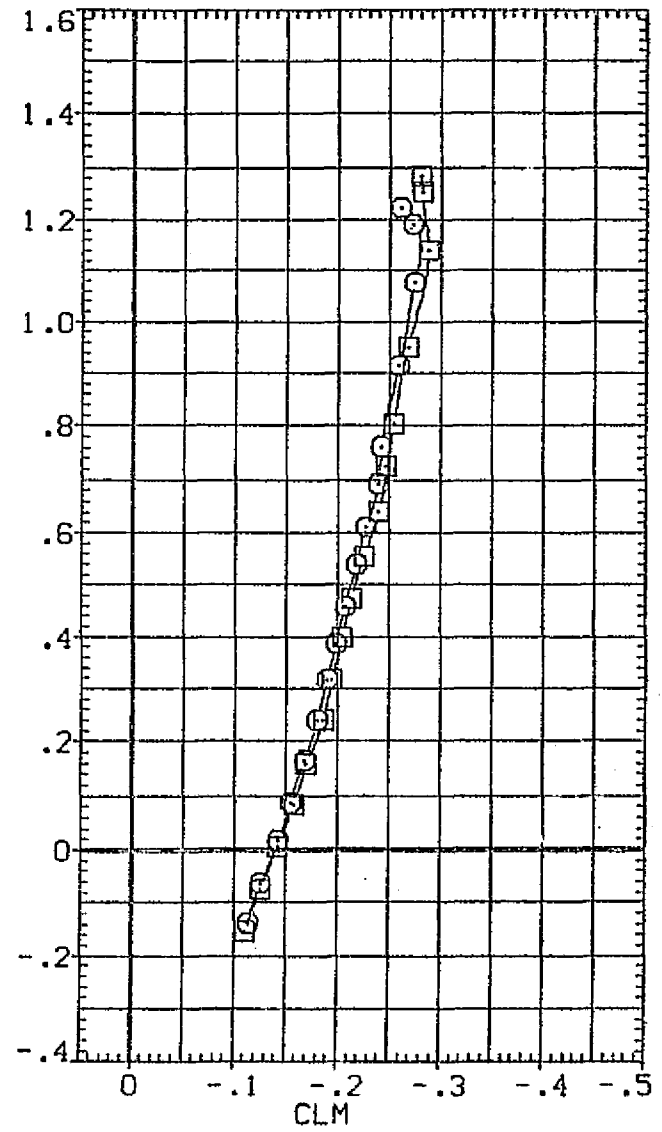
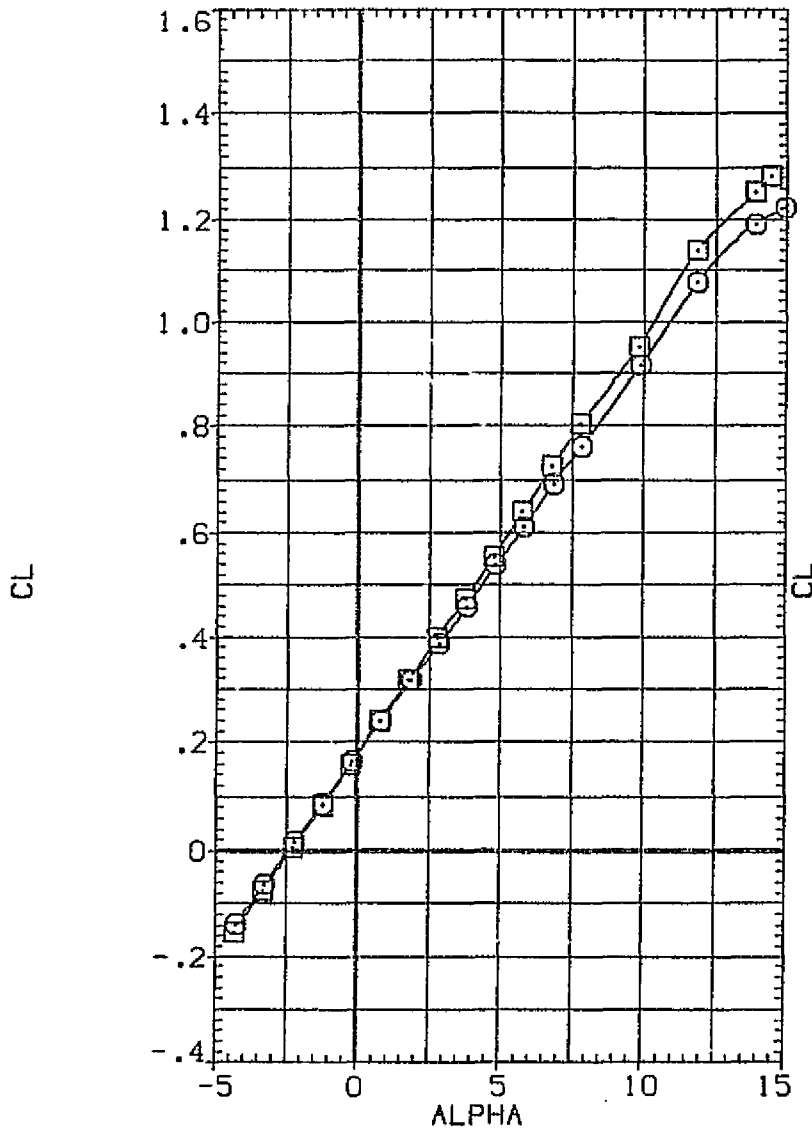

FIG. 12 REYNOLDS NUMBER SENSITIVITY WITH JET OFF
 (B)MACH = .90

DATA SET SYMBOL	CONFIGURATION	DESCRIPTION
(RAT014)	□	CONFIGURATION 4 CL DESIGN=0.5
(RAT010)	○	CONFIGURATION 4 CL DESIGN=0.5

RN/L	CTG
4.000	.000
5.500	.000

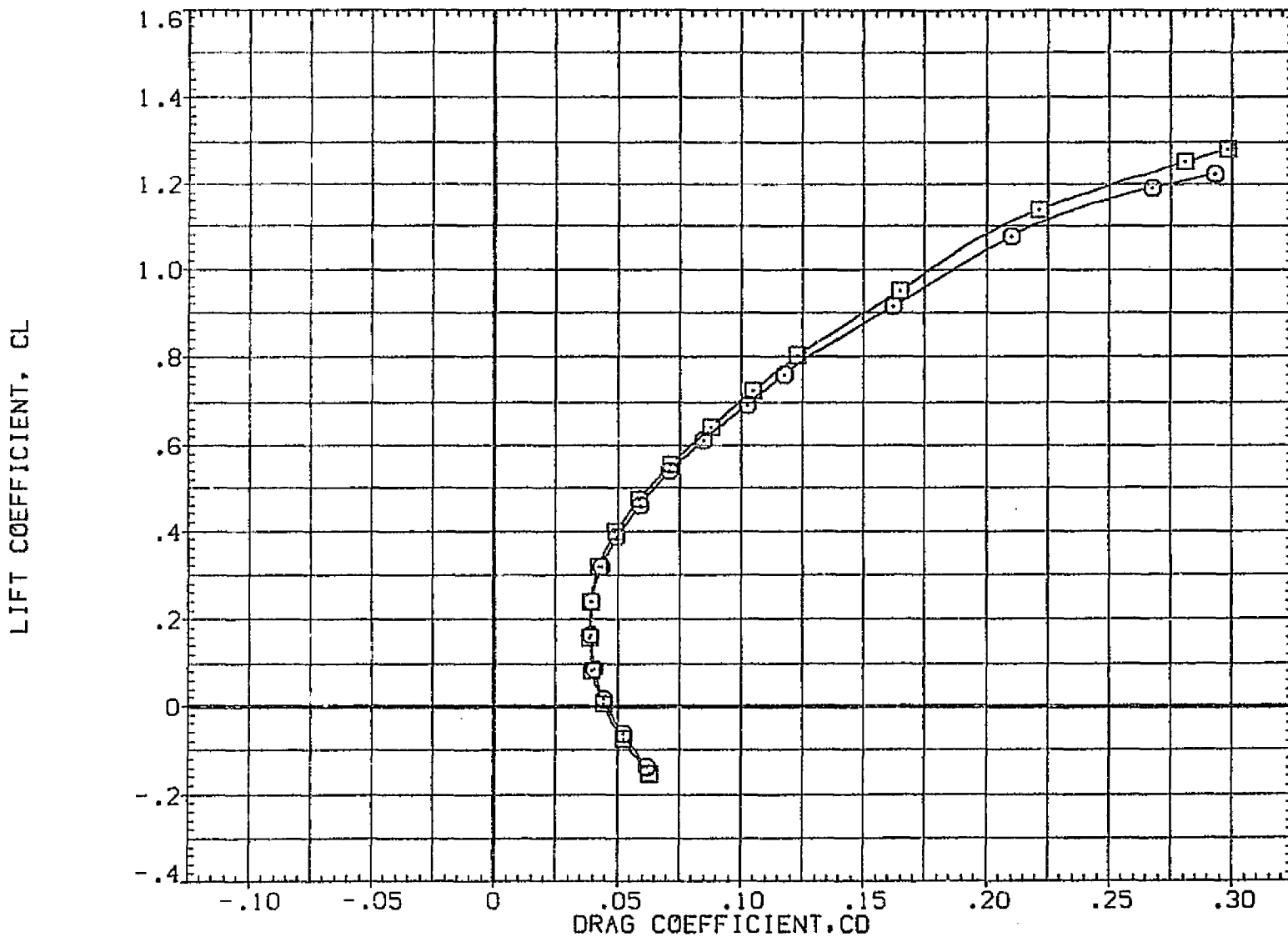

FIG. 12 REYNOLDS NUMBER SENSITIVITY WITH JET OFF

(B)MACH = .90

DATA SET SYMBOL CONFIGURATION DESCRIPTION
 (RATO15) ○ CONFIGURATION 4 CL DESIGN=0.5
 (RATO13) □ CONFIGURATION 4 CL DESIGN=0.5

RN/L CTG
 4.000 .120
 5.500 .120

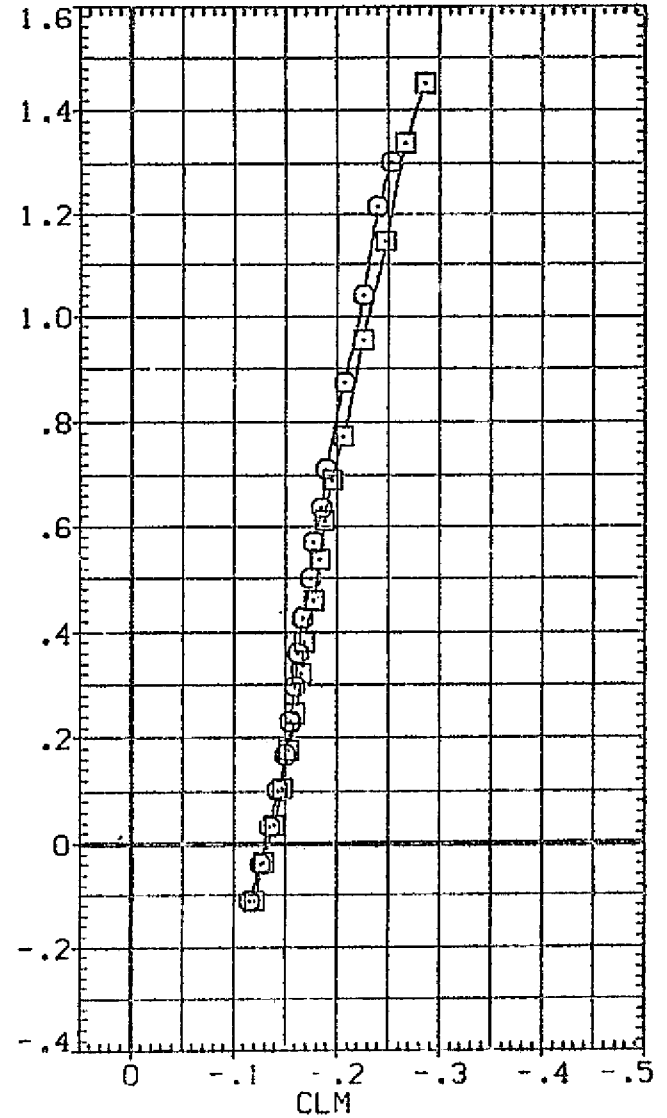
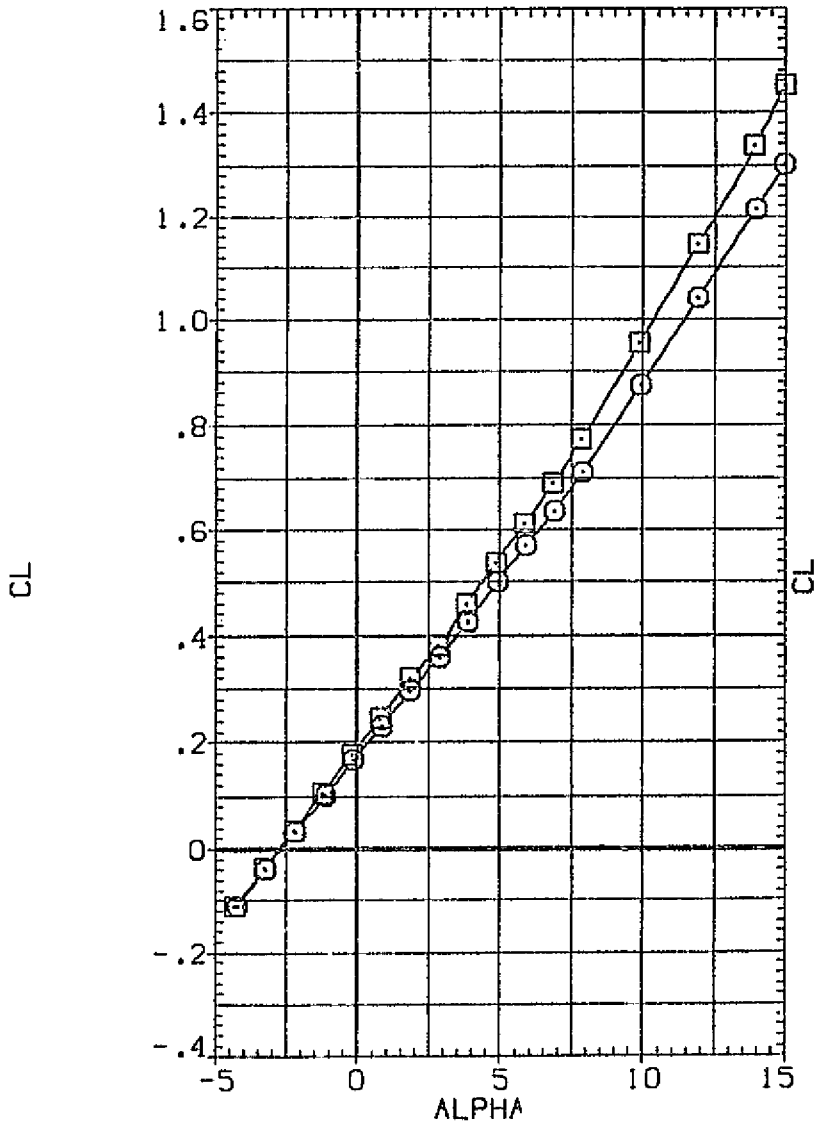

FIG. 12 REYNOLDS NUMBER SENSITIVITY WITH JET ON
 (A) MACH = .70

DATA SET SYMBOL	CONFIGURATION	DESCRIPTION
(RAT015)	○	CONFIGURATION 4 CL DESIGN=0.5
(RAT013)	□	CONFIGURATION 4 CL DESIGN=0.5

RN/L	CTG
4.000	.120
5.500	.120

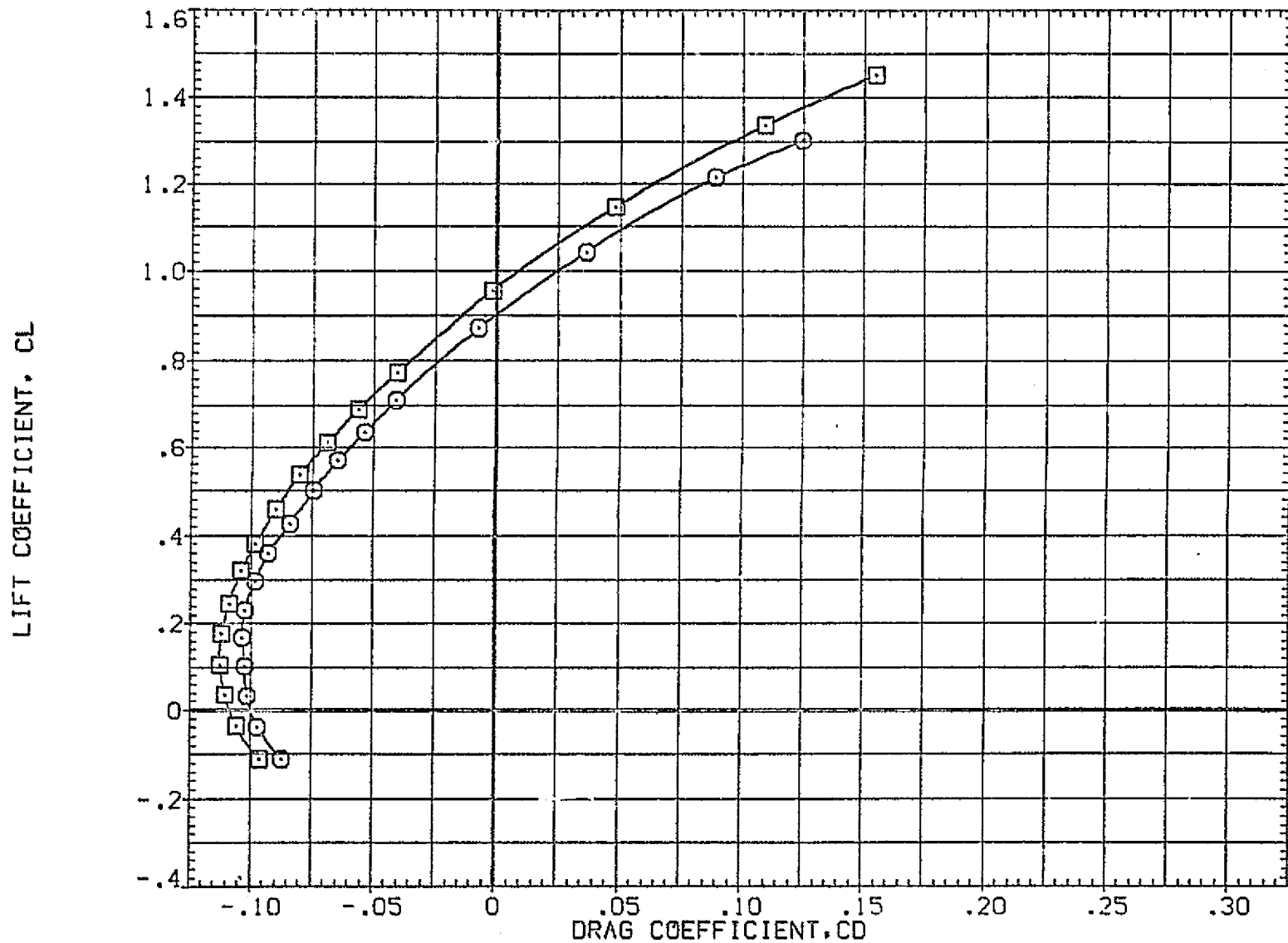

FIG. 12 REYNOLDS NUMBER SENSITIVITY WITH JET ON
 (A) MACH = .70

DATA SET SYMBOL	CONFIGURATION	DESCRIPTION
(RATO15)	○	CONFIGURATION 4 CL DESIGN=0.5
(RATO13)	□	CONFIGURATION 4 CL DESIGN=0.5

RN/L	CTG
4.000	.120
5.500	.120

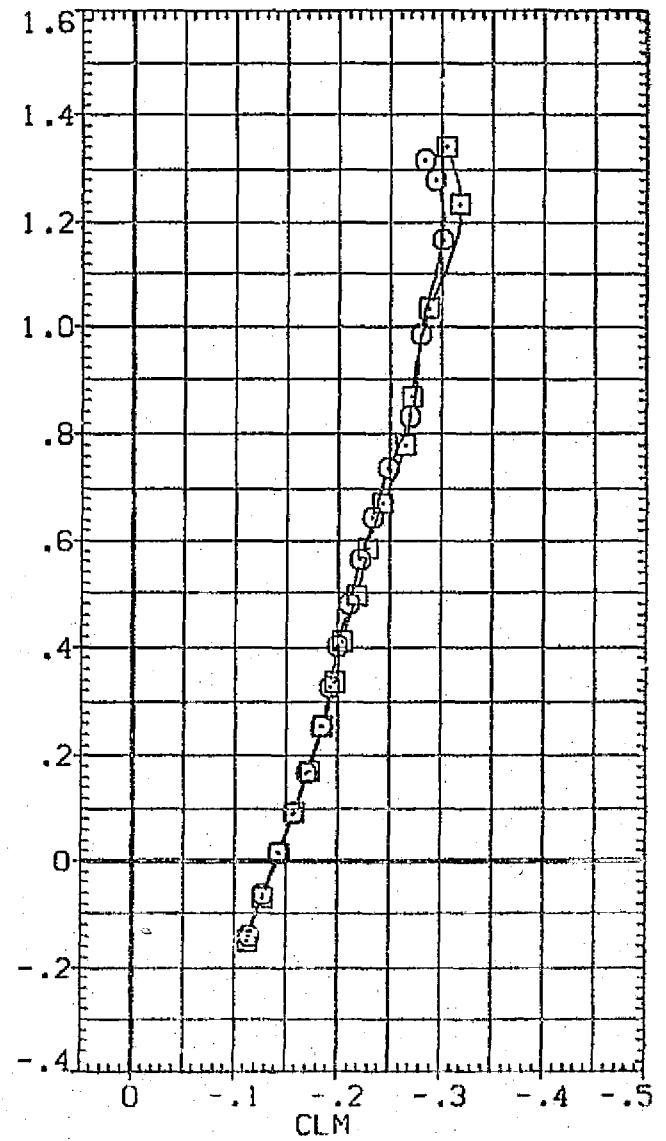
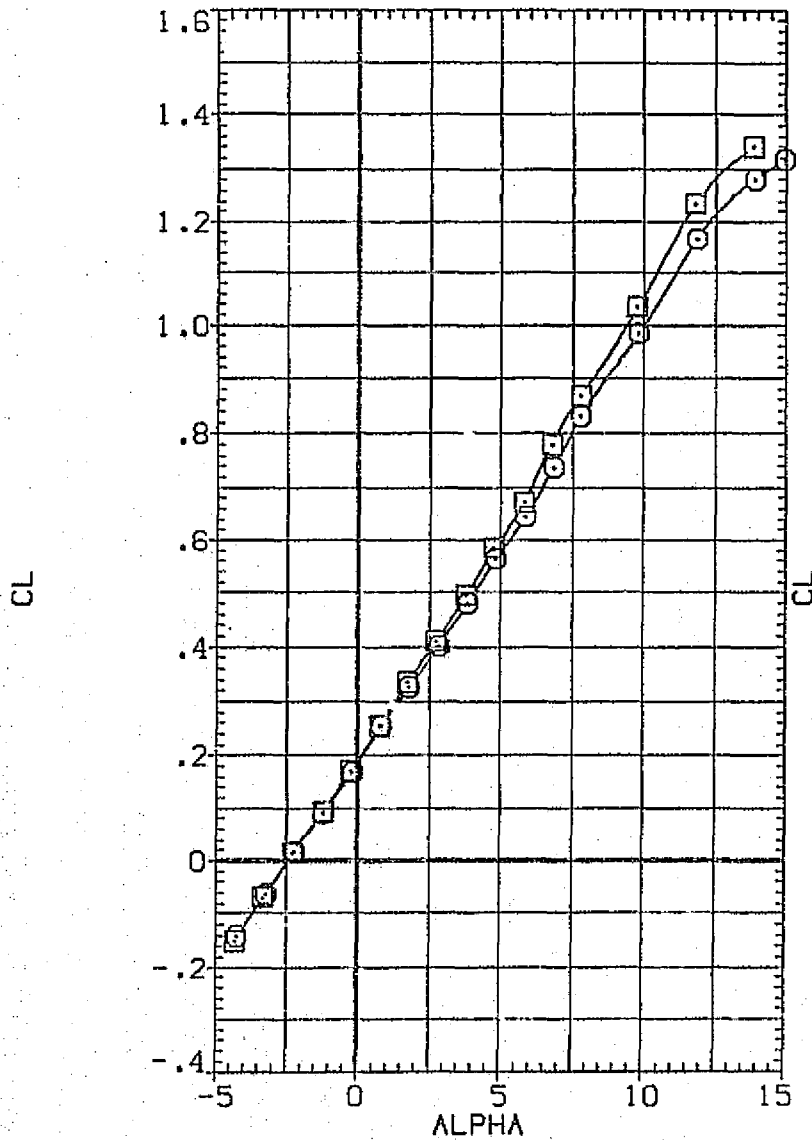

FIG. 12 REYNOLDS NUMBER SENSITIVITY WITH JET ON
 (B)MACH = .90

DATA SET SYMBOL	CONFIGURATION	DESCRIPTION
(RATO:5)	○	CONFIGURATION 4 CL DESIGN=0.5
(RATO:3)	□	CONFIGURATION 4 CL DESIGN=0.5

RN/L	CTG
4,000	.120
5,500	.120

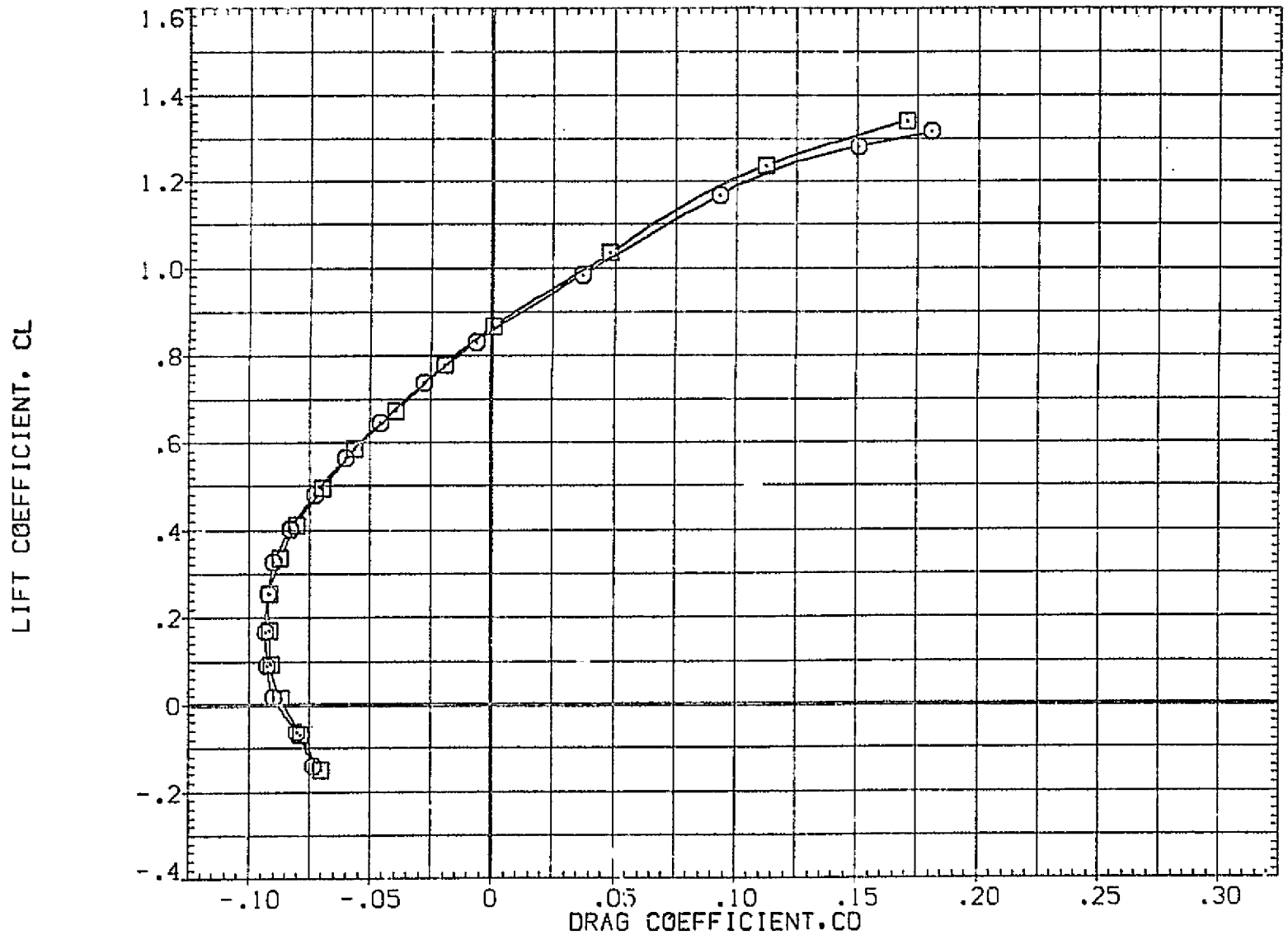

FIG. 12 REYNOLDS NUMBER SENSITIVITY WITH JET ON

(B)MACH = .90

DATA SET SYMBOL	CONFIGURATION DESCRIPTION
{RAT003} ○	CONFIGURATION 2 CL DESIGN=0.2
{RAT006} □	CONFIGURATION 2 CL DESIGN=0.2

RN/L	CTG
5.500	.000
5.500	.120

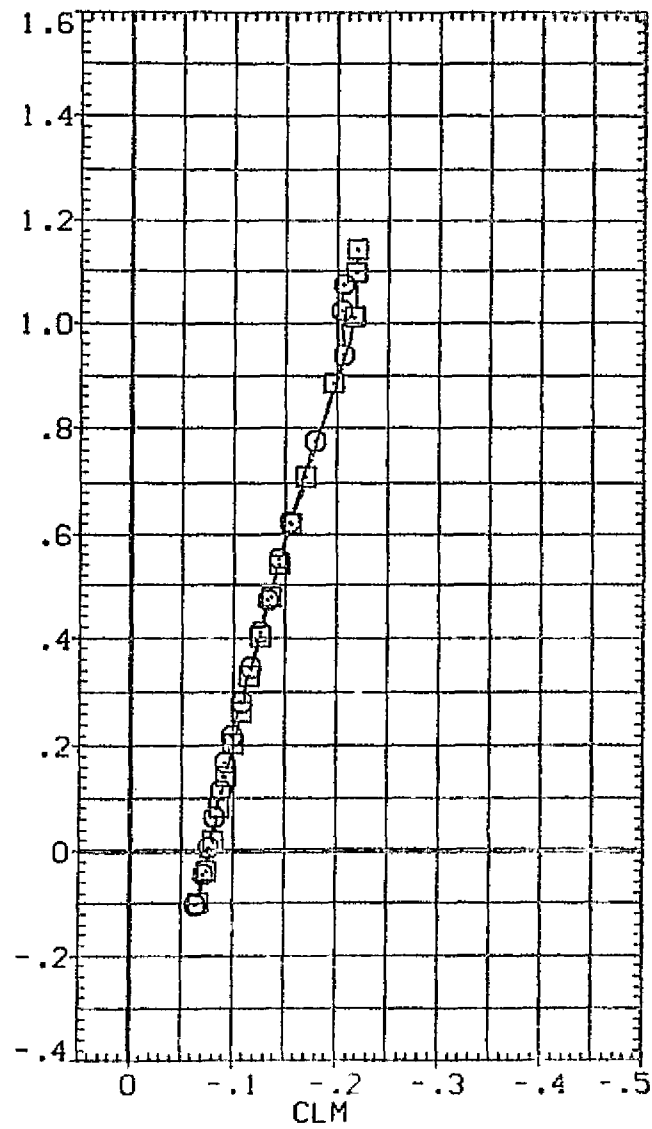
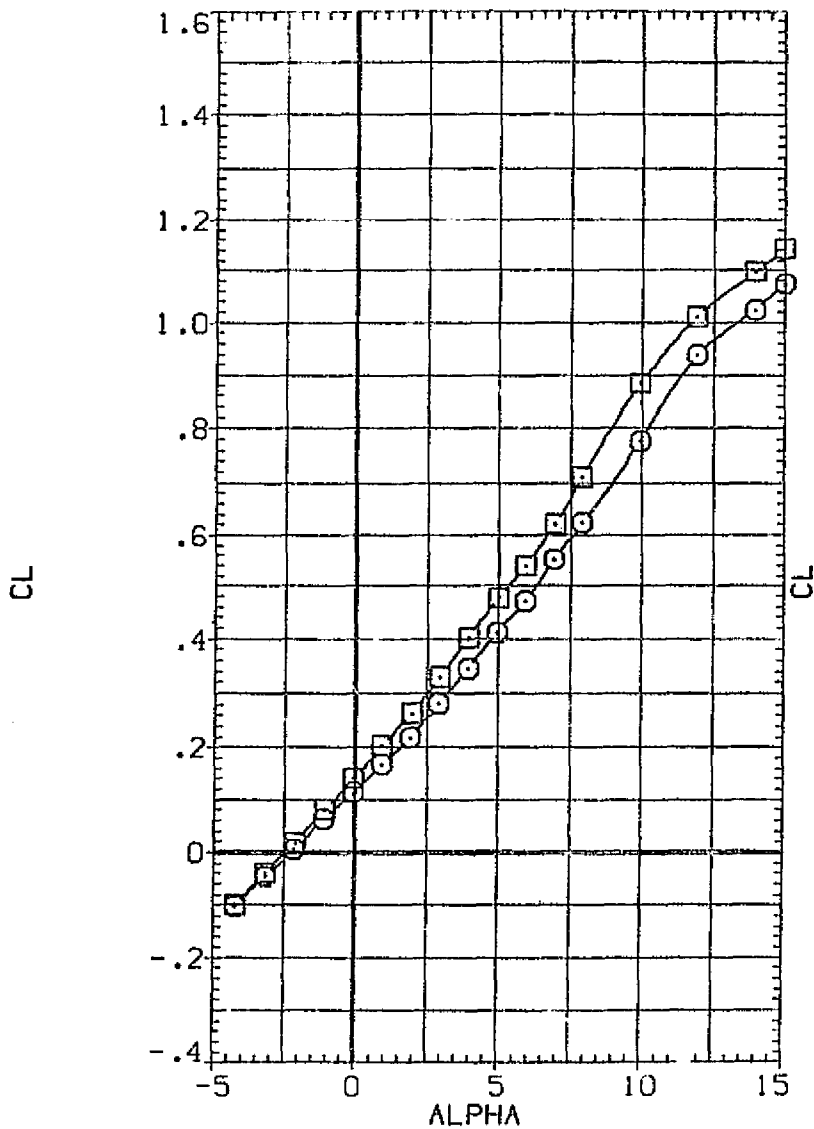

FIG. 13 EFFECTS OF BLOWING ON CONFIGURATION 2

(A) MACH = .70

DATA SET SYMBOL CONFIGURATION DESCRIPTION
 (RAT003) ○ CONFIGURATION 2 CL DESIGN=0.2
 (RAT006) □ CONFIGURATION 2 CL DESIGN=0.2

RN/L CTG
 5.500 .000
 5.500 .120

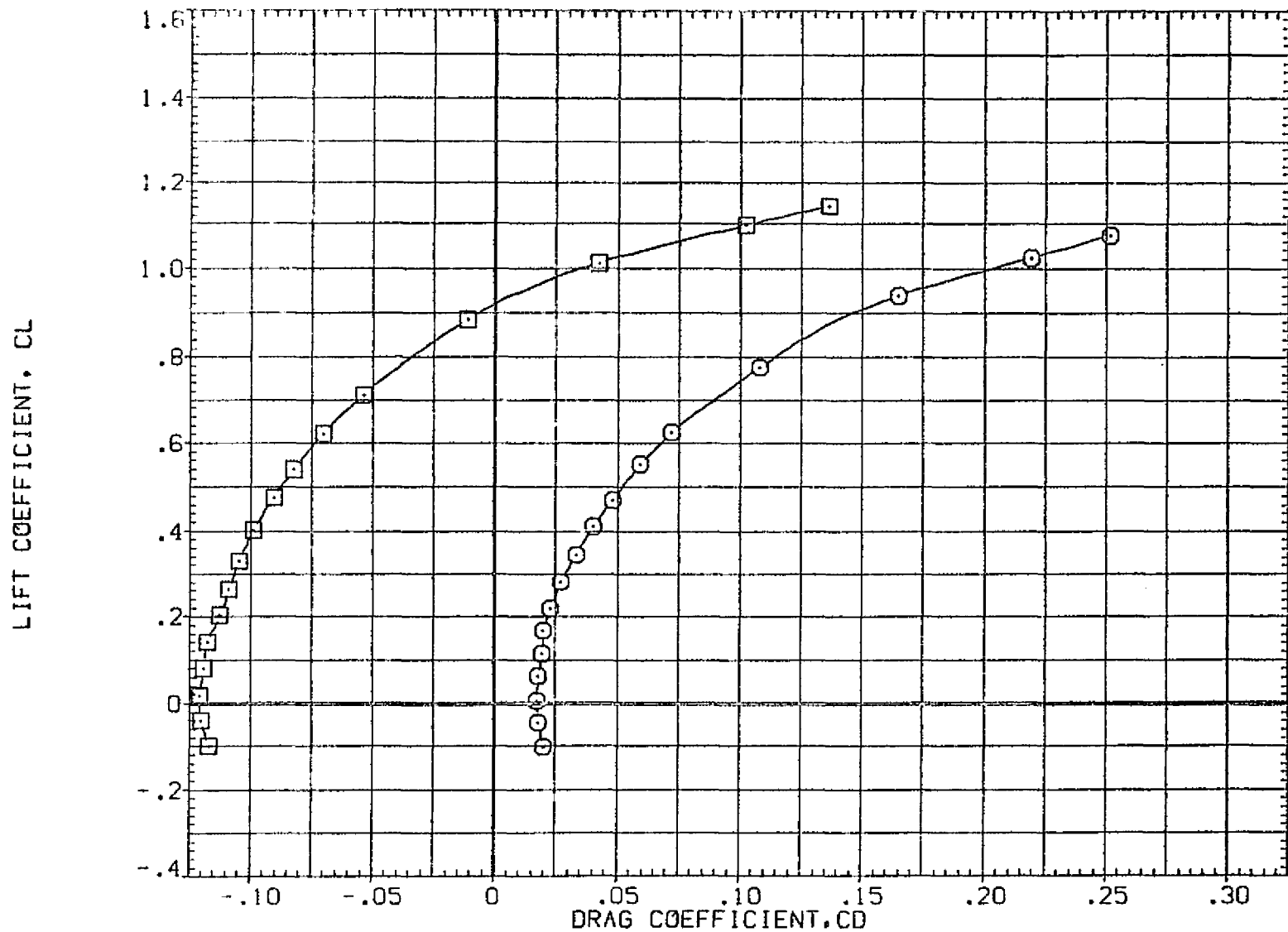

FIG. 13 EFFECTS OF BLOWING ON CONFIGURATION 2

(A) MACH = .70

DATA SET SYMBOL	CONFIGURATION	DESCRIPTION
{RAT003}	CONF I G U R A T I O N 2	C L D E S I G N = 0 . 2
{RAT004}	CONF I G U R A T I O N 2	C L D E S I G N = 0 . 2
{RAT005}	CONF I G U R A T I O N 2	C L D E S I G N = 0 . 2
{RAT006}	CONF I G U R A T I O N 2	C L D E S I G N = 0 . 2

RN/L	CTG
5.500	.000
5.500	.040
5.500	.080
5.500	.120

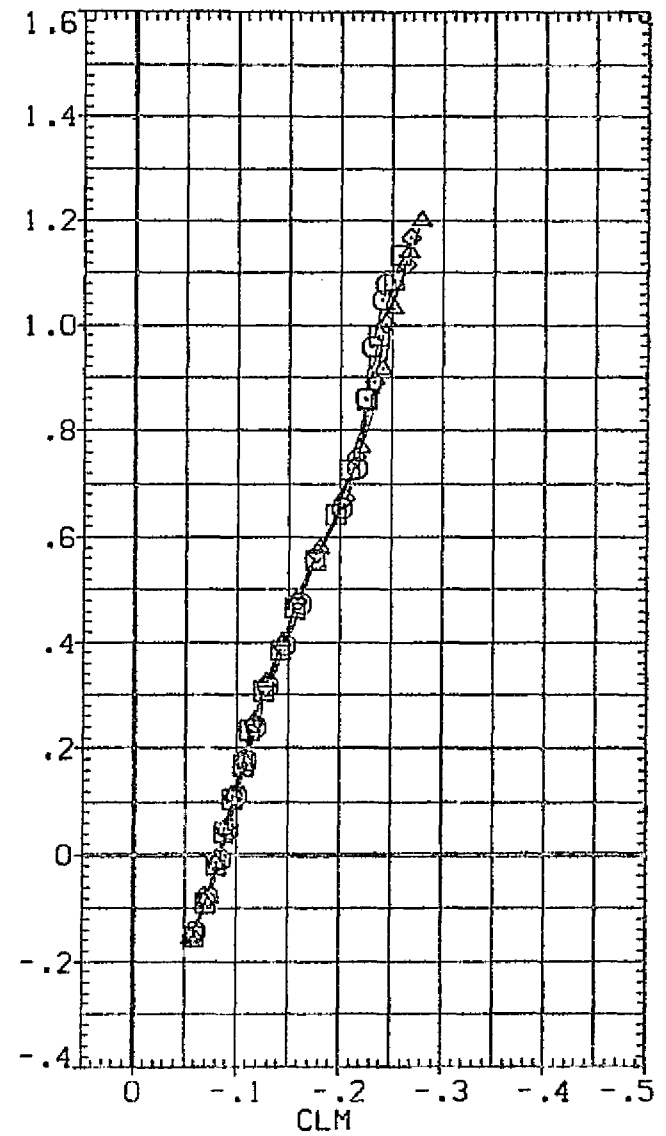
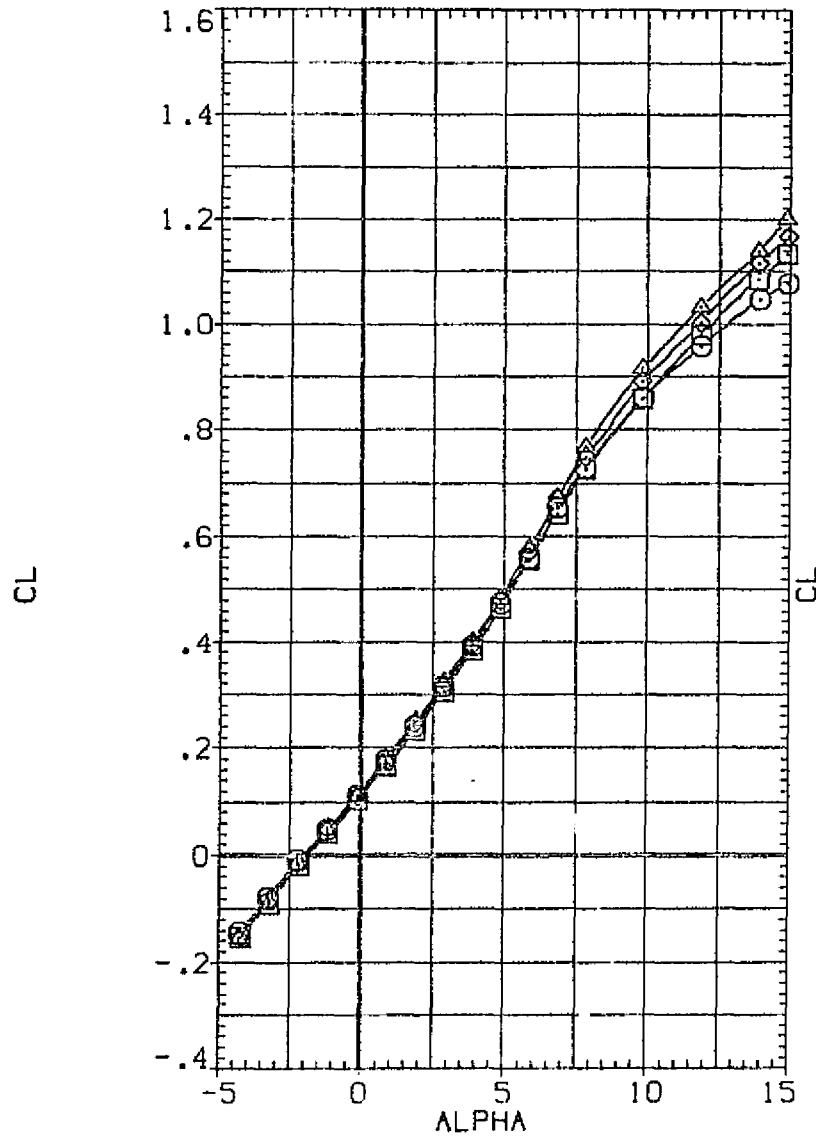

FIG. 13 EFFECTS OF BLOWING ON CONFIGURATION 2
(A) MACH = .90

DATA SET SYMBOL	CONFIGURATION DESCRIPTION	RN/L	CTG
(RAT003)	CONFIGURATION 2 CL DESIGN=0.2	5.500	.000
(RAT004)	CONFIGURATION 2 CL DESIGN=0.2	5.500	.040
(RAT005)	CONFIGURATION 2 CL DESIGN=0.2	5.500	.080
(RAT005)	CONFIGURATION 2 CL DESIGN=0.2	5.500	.120

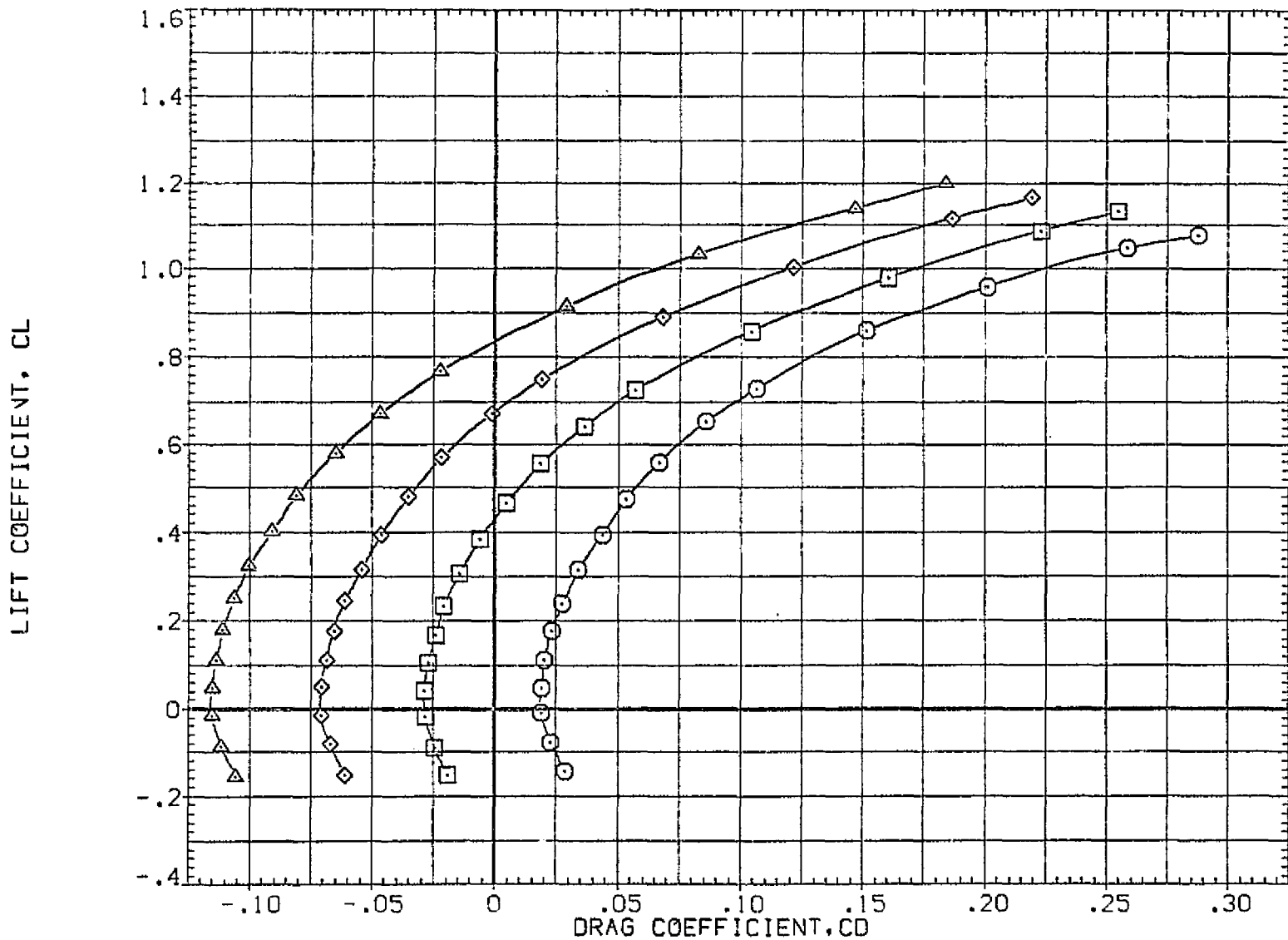

FIG. 13 EFFECTS OF BLOWING ON CONFIGURATION 2
(A) MACH = .90

DATA SET SYMBOL	CONFIGURATION	DESCRIPTION
(RAT003)	○	CONFIGURATION 2 CL DESIGN=0.2
(RAT006)	□	CONFIGURATION 2 CL DESIGN=0.2

RN/L	CTG
5.500	.000
5.500	.120

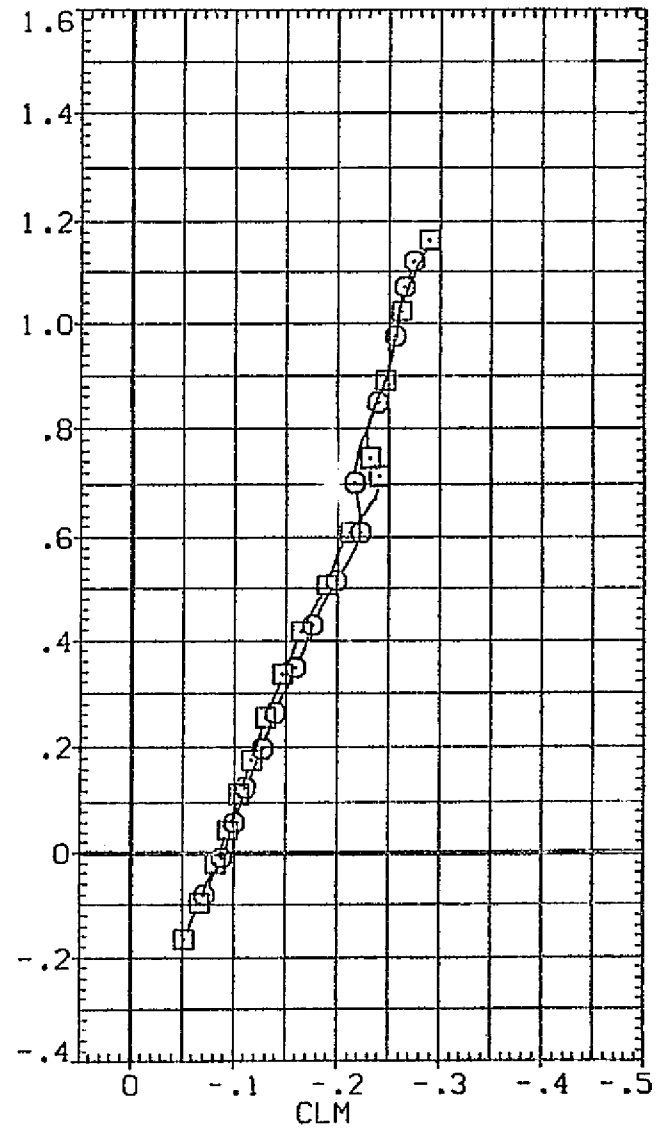
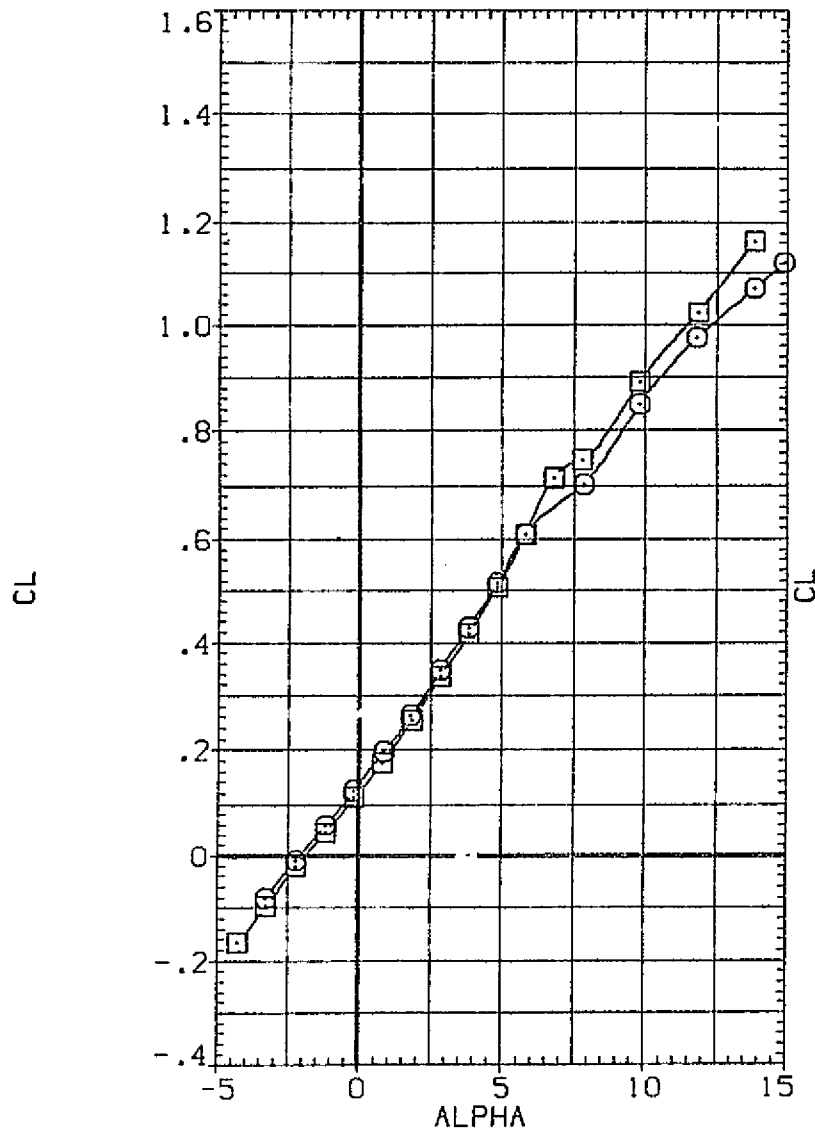

FIG. 13 EFFECTS OF BLOWING ON CONFIGURATION 2

(A)MACH = .95

DATA SET SYMBOL	CONFIGURATION	DESCRIPTION
(RAT003)	□	CONFIGURATION 2 CL DESIGN=0.2
(RAT006)	○	CONFIGURATION 2 CL DESIGN=0.2

RN/L	CTG
5.500	.000
5.500	.120

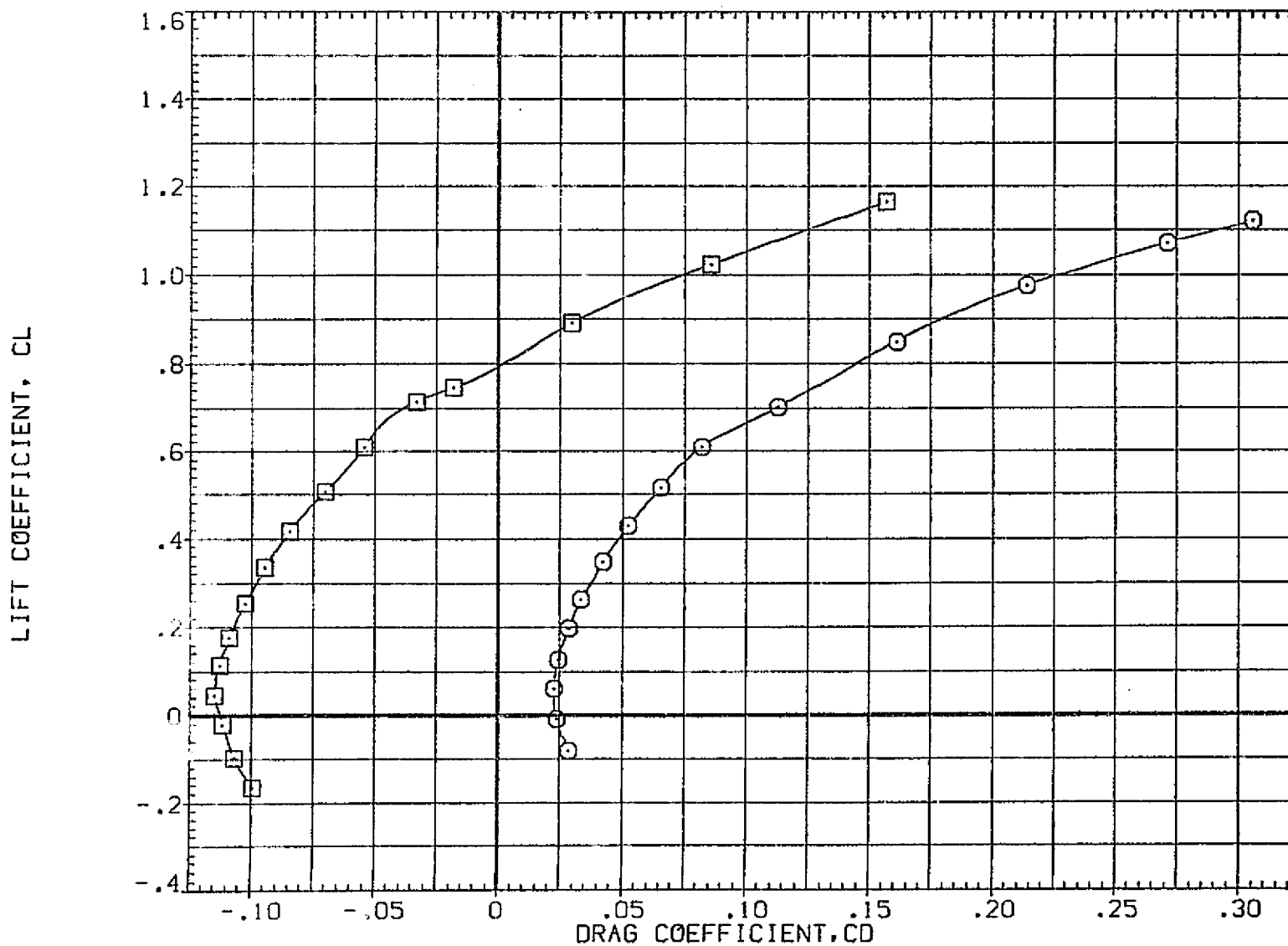

FIG. 13 EFFECTS OF BLOWING ON CONFIGURATION 2

(A)MACH = .95

DATA SET SYMBOL	CONFIGURATION	DESCRIPTION
(RAT007)	□	CONFIGURATION 3 LEADING EDGE CAMBERED
(RAT008)	○	CONFIGURATION 3 LEADING EDGE CAMBERED

RN/L	CTG
5.500	.000
5.500	.120

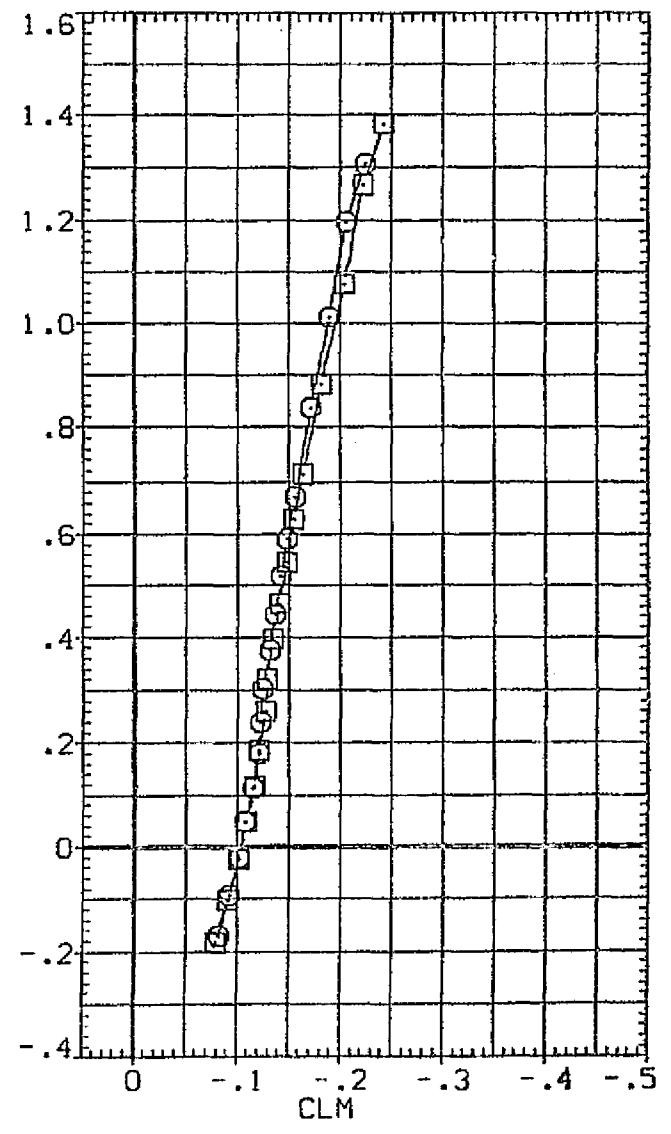
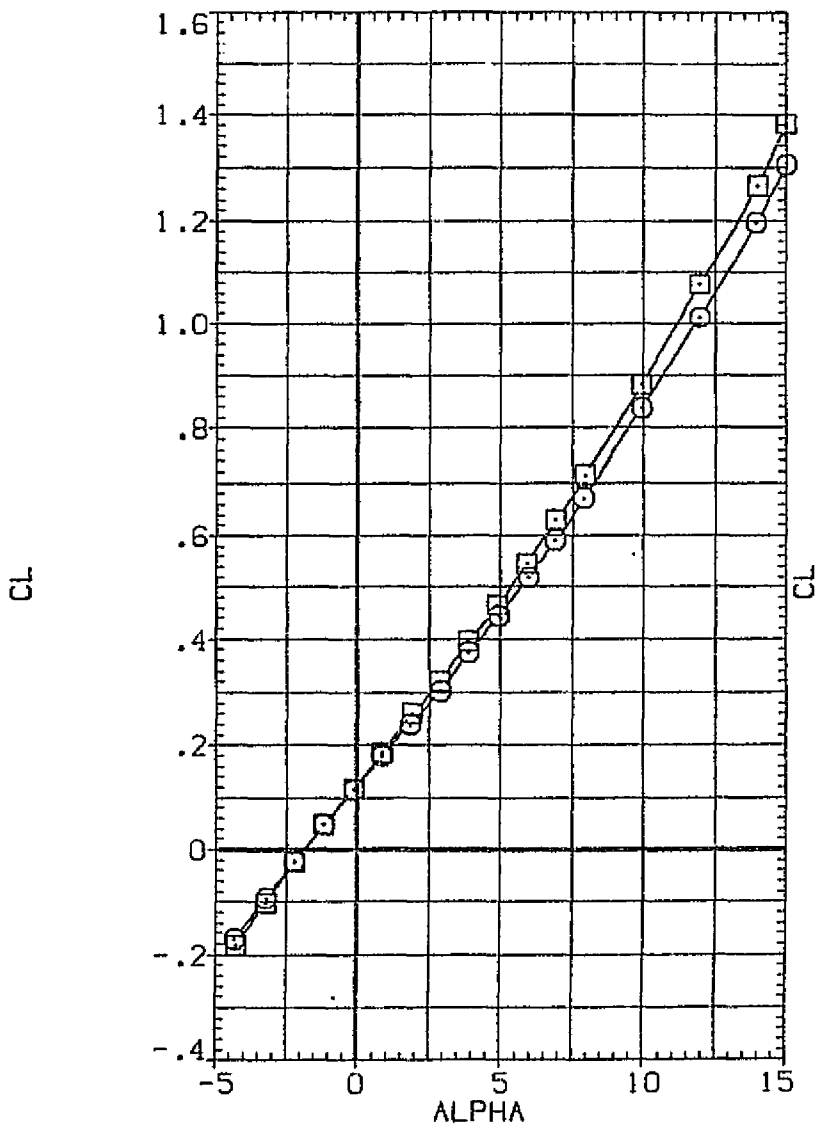

FIG. 13 EFFECTS OF BLOWING ON CONFIGURATION 3
 (A) MACH = .70

DATA SET SYMBOL	CONFIGURATION DESCRIPTION	RN/L	CTG
(RAT007)	○ CONFIGURATION 3 LEADING EDGE CAMBERED	5.500	.000
(RAT008)	□ CONFIGURATION 3 LEADING EDGE CAMBERED	5.500	.120

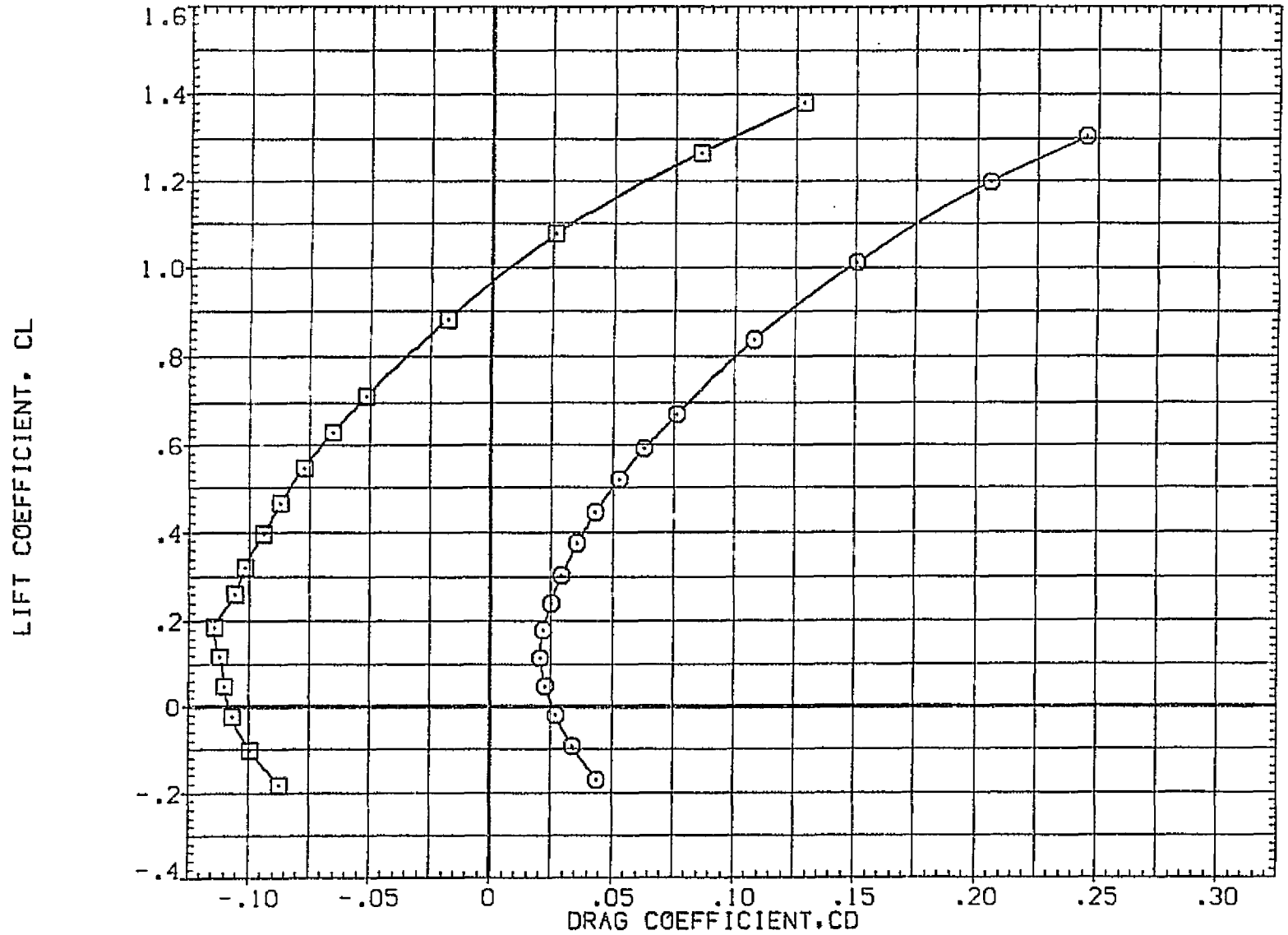

FIG. 13 EFFECTS OF BLOWING ON CONFIGURATION 3

(A)MACH = .70

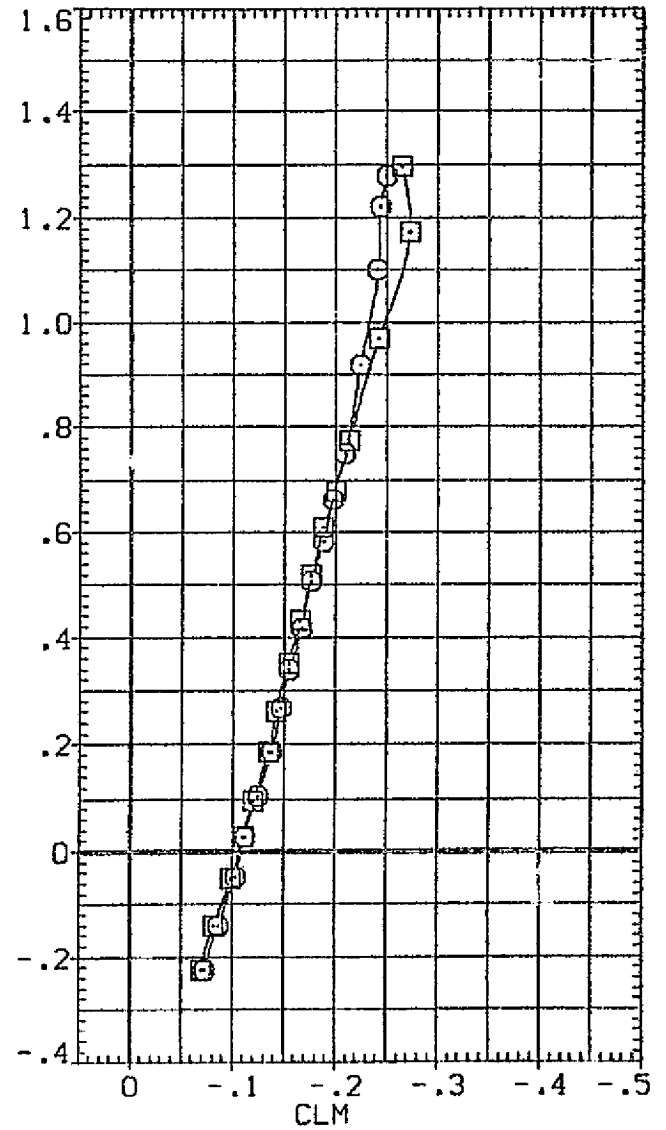
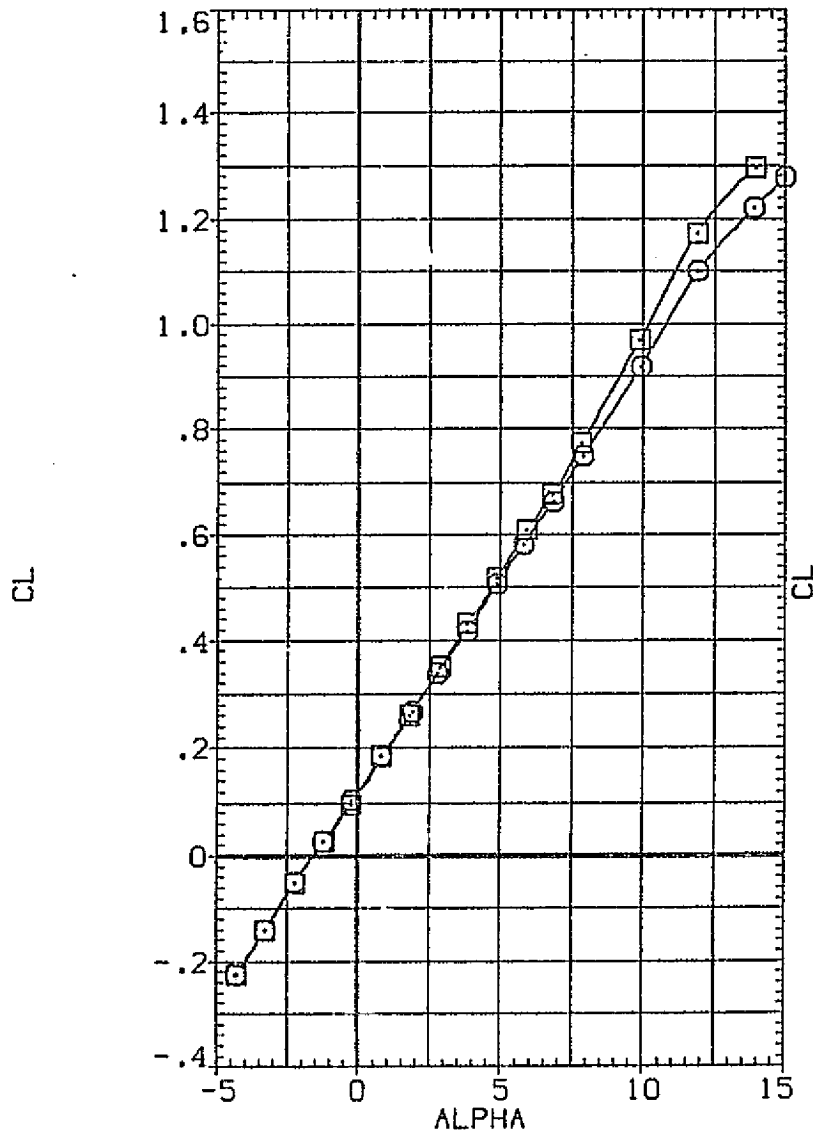

FIG. 13 EFFECTS OF BLOWING ON CONFIGURATION 3
 (B)MACH = .90

DATA SET SYMBOL	CONFIGURATION	DESCRIPTION
(RAT007)	○	CONFIGURATION 3 LEADING EDGE CAMBERED
(RAT008)	□	CONFIGURATION 3 LEADING EDGE CAMBERED

RN/L	CTG
5.500	.000
5.500	.120

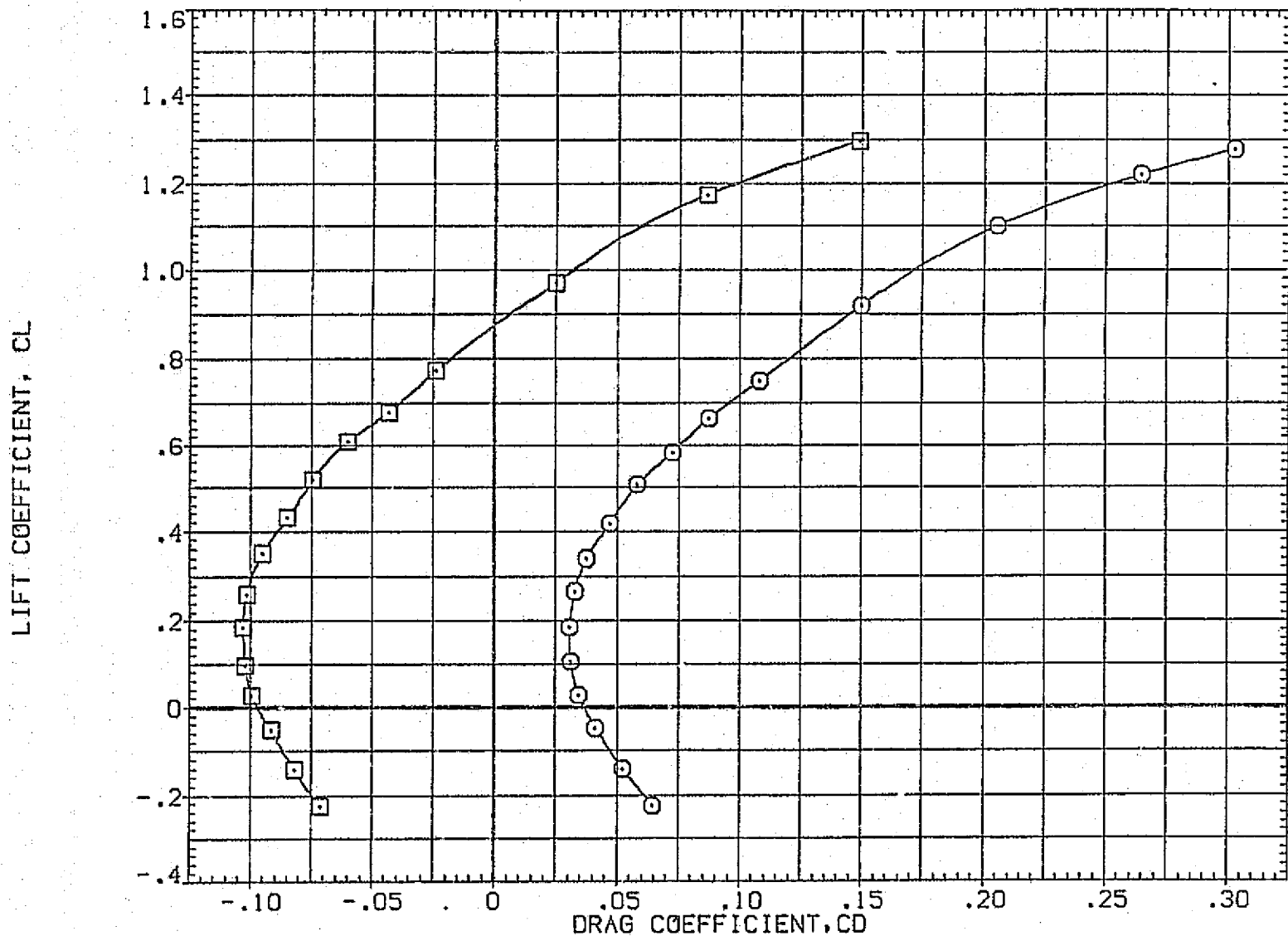

FIG. 13 EFFECTS OF BLOWING ON CONFIGURATION 3
 (B)MACH = .90

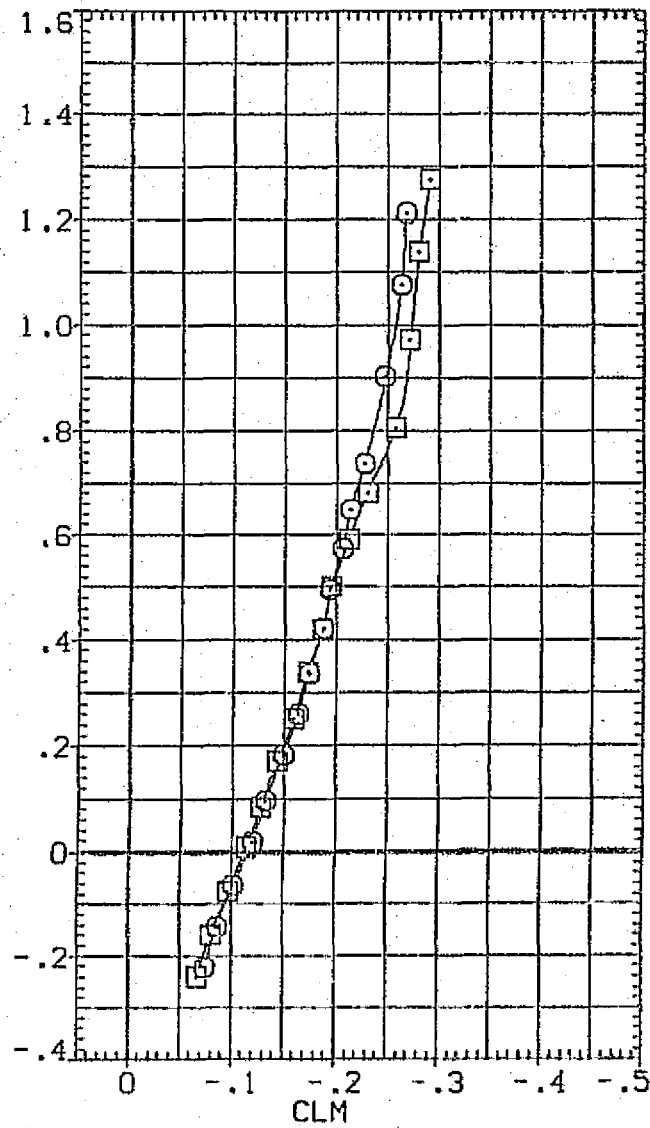
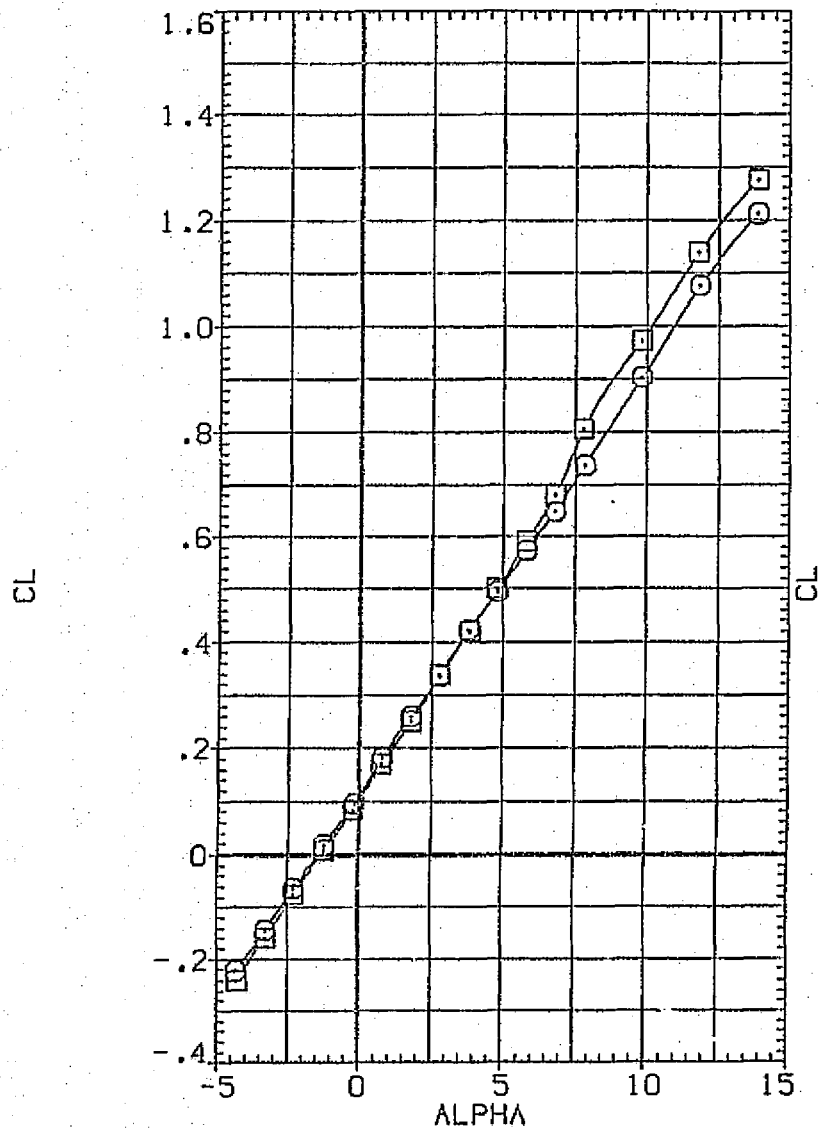

FIG. 13 EFFECTS OF BLOWING ON CONFIGURATION 3
 (CO)MACH = .95

DATA SET SYMBOL	CONFIGURATION DESCRIPTION
(RAT007)	○ CONFIGURATION 3 LEADING EDGE CAMBERED
(RAT008)	□ CONFIGURATION 3 LEADING EDGE CAMBERED

RN/L	CTG
5.500	.000
5.500	.120

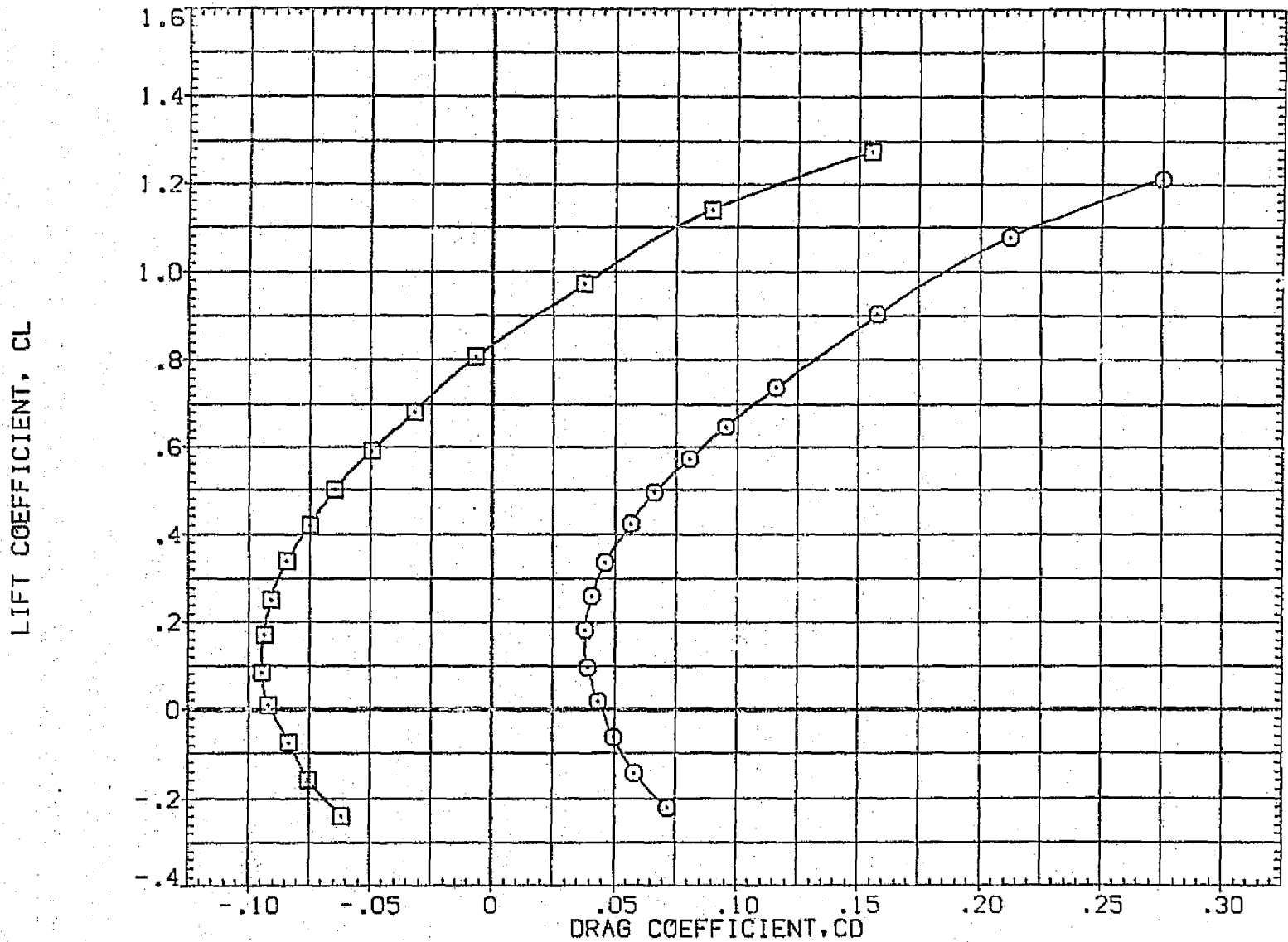

FIG. 13 EFFECTS OF BLOWING ON CONFIGURATION 3

(C)MACH = .95

DATA SET SYMBOL	CONFIGURATION DESCRIPTION	
(RAT010) ○	CONFIGURATION 4	CL DESIGN=0.5
(RAT013) □	CONFIGURATION 4	CL DESIGN=0.5

RN/L	CTG
5.500	.000
5.500	.120

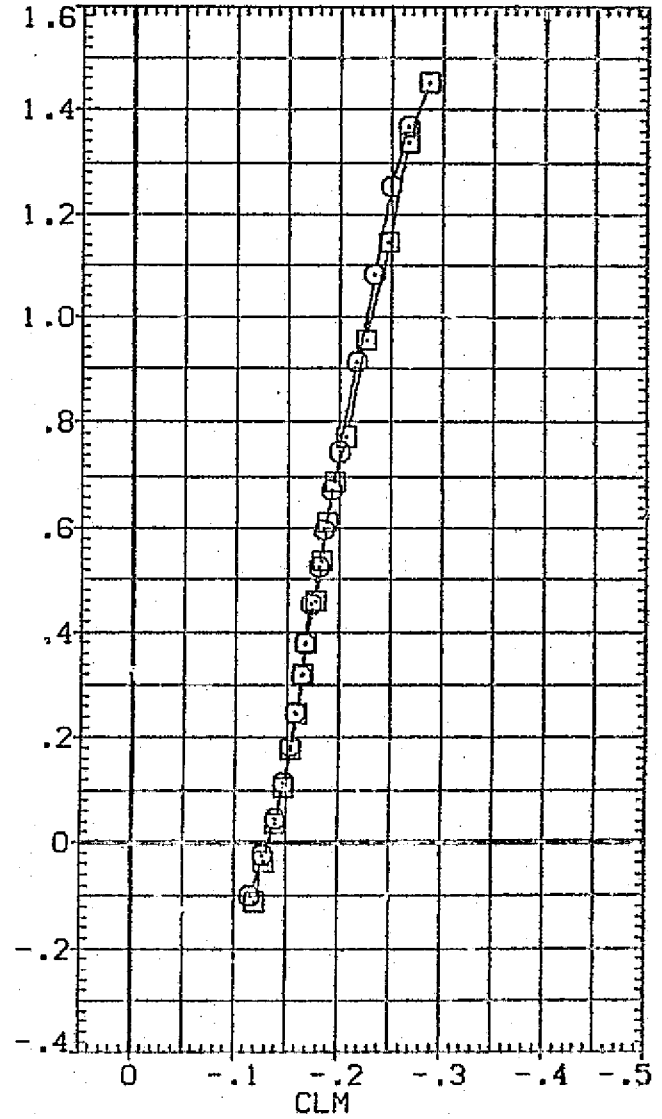
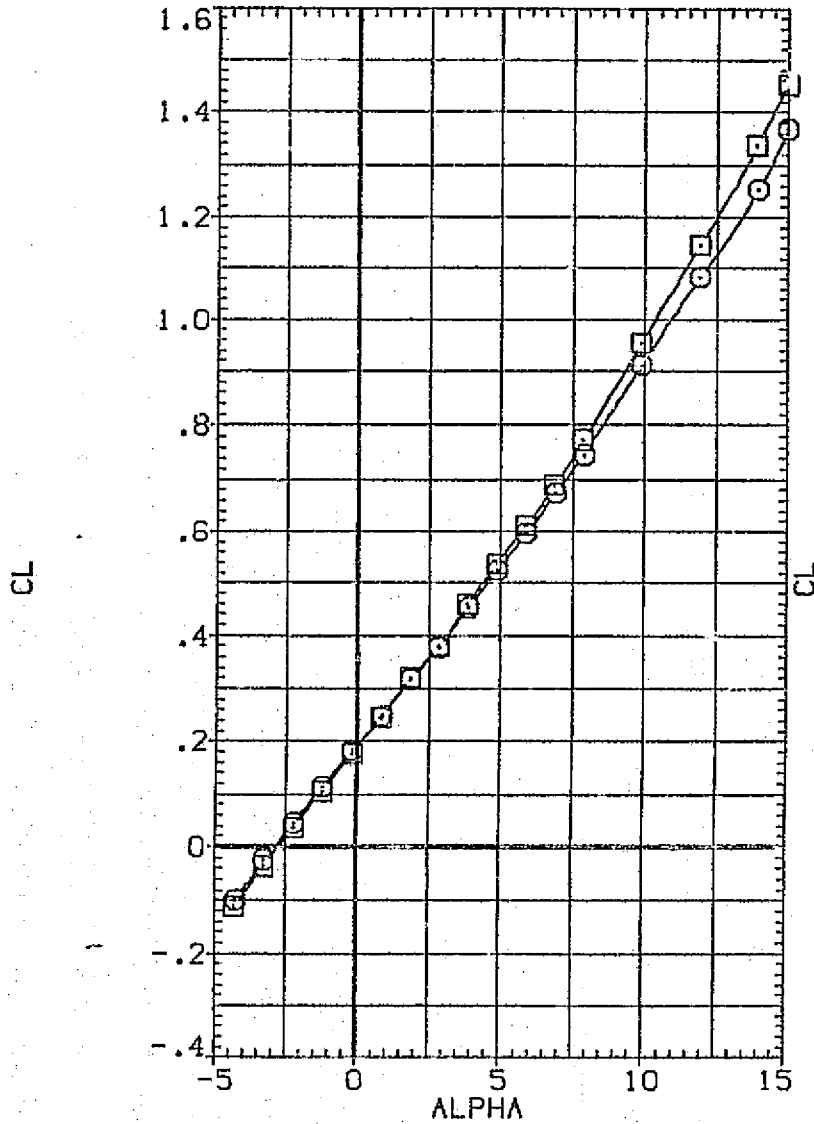

FIG. 13 EFFECTS OF BLOWING ON CONFIGURATION 4
CA/MACH = .70

DATA SET SYMBOL	CONFIGURATION DESCRIPTION
(RATO10) ○	CONFIGURATION 4 CL DESIGN=0.5
(RATO13) □	CONFIGURATION 4 CL DESIGN=0.5

RN/L	CTG
5.500	.000
5.500	.120

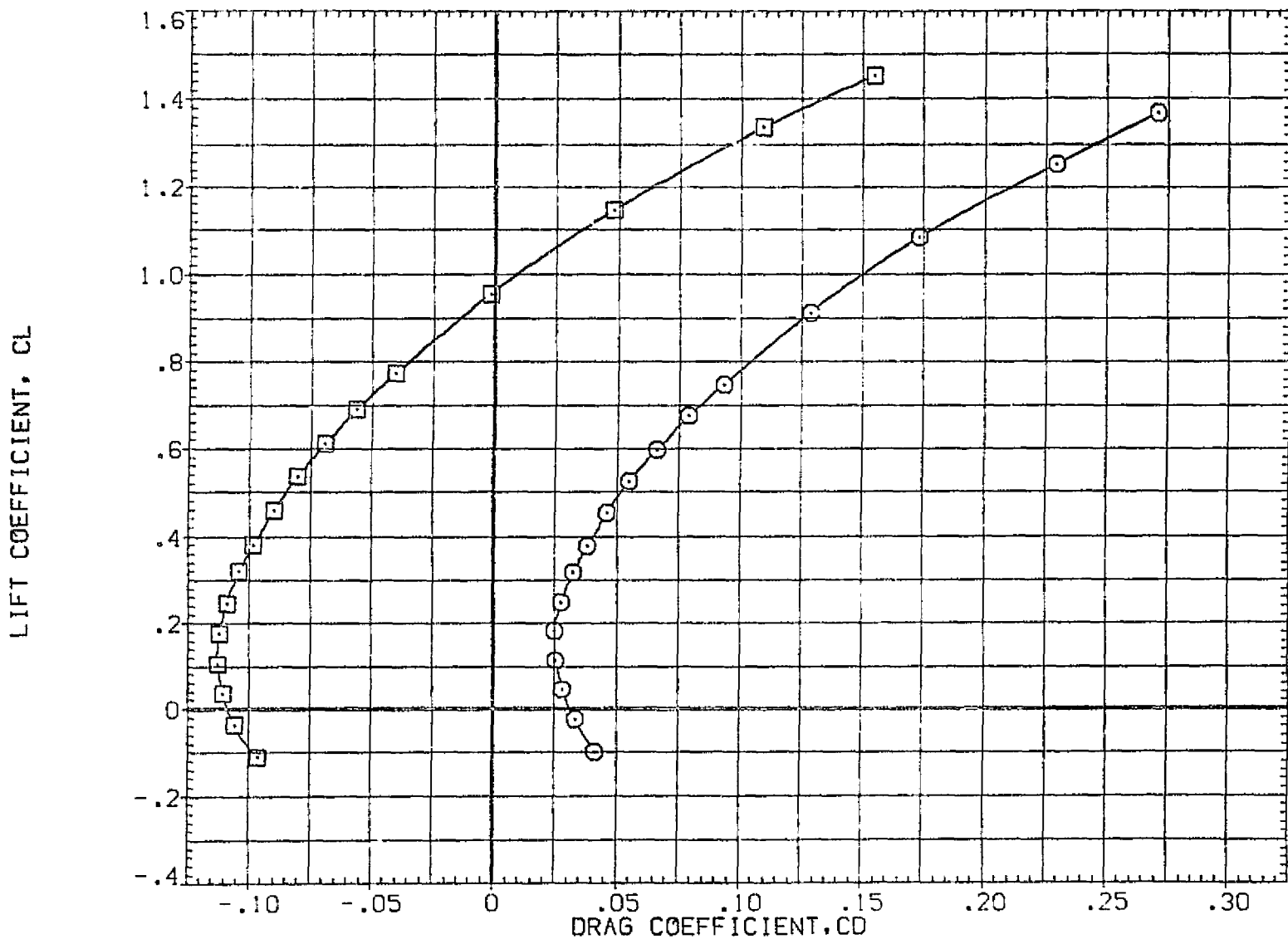

FIG. 13 EFFECTS OF BLOWING ON CONFIGURATION 4

(A) MACH = .70

DATA SET SYMBOL	CONFIGURATION DESCRIPTION
(RATO10)	○ CONFIGURATION 4 CL DESIGN=0.5
(RATO11)	□ CONFIGURATION 4 CL DESIGN=0.5
(RATO12)	◇ CONFIGURATION 4 CL DESIGN=0.5
(RATO13)	△ CONFIGURATION 4 CL DESIGN=0.5

RN/L	CTG
5.500	.000
5.500	.040
5.500	.080
5.500	.120

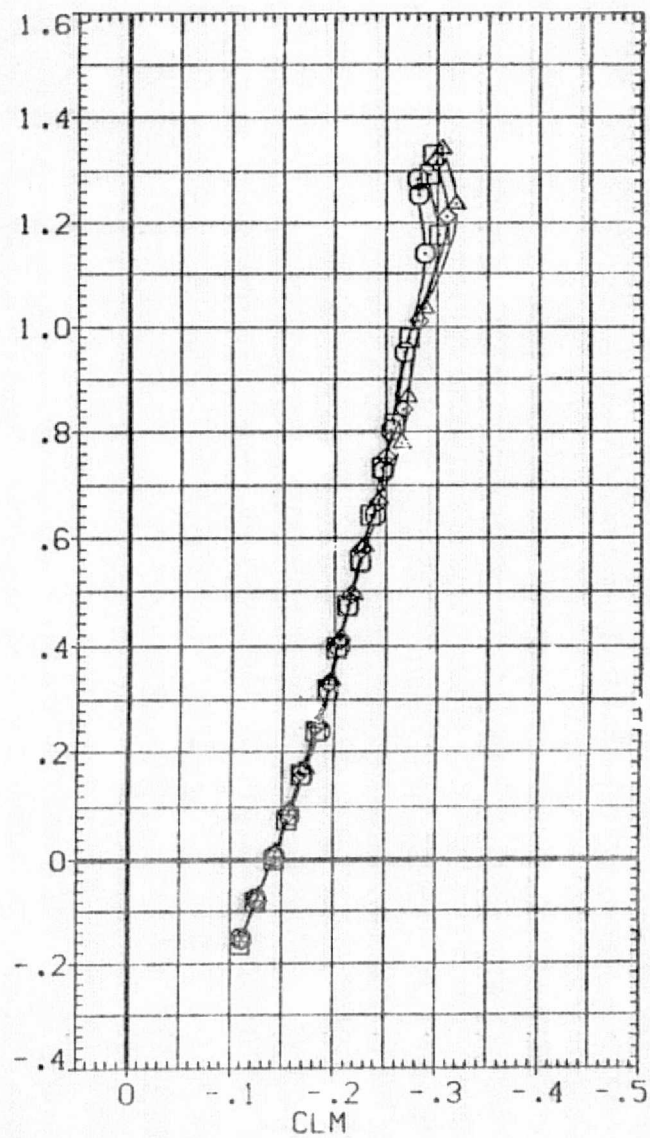
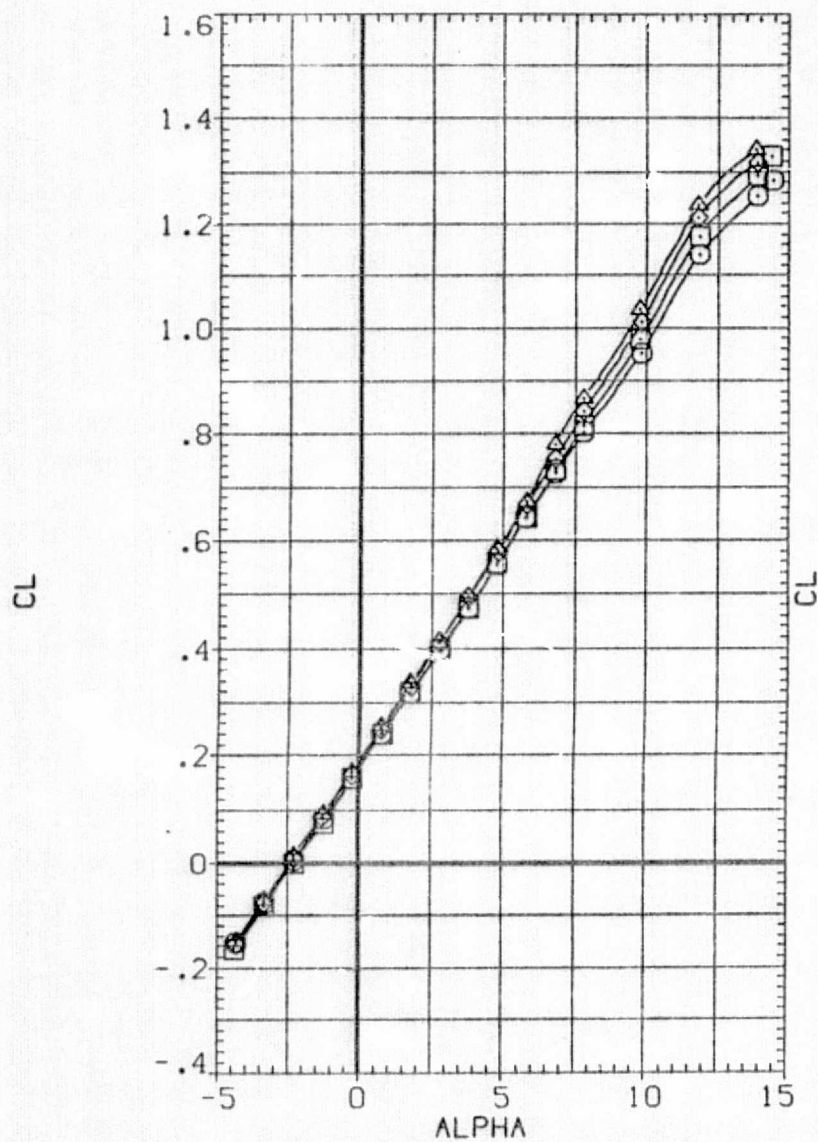

FIG. 13 EFFECTS OF BLOWING ON CONFIGURATION 4

(A)MACH = .90

DATA SET SYMBOL	CONFIGURATION DESCRIPTION	RN/L	CTG
(RATO10)	CONFIGURATION 4 CL DESIGN=0.5	5.500	.000
(RATO11)	CONFIGURATION 4 CL DESIGN=0.5	5.500	.040
(RATO12)	CONFIGURATION 4 CL DESIGN=0.5	5.500	.080
(RATO13)	CONFIGURATION 4 CL DESIGN=0.5	5.500	.120

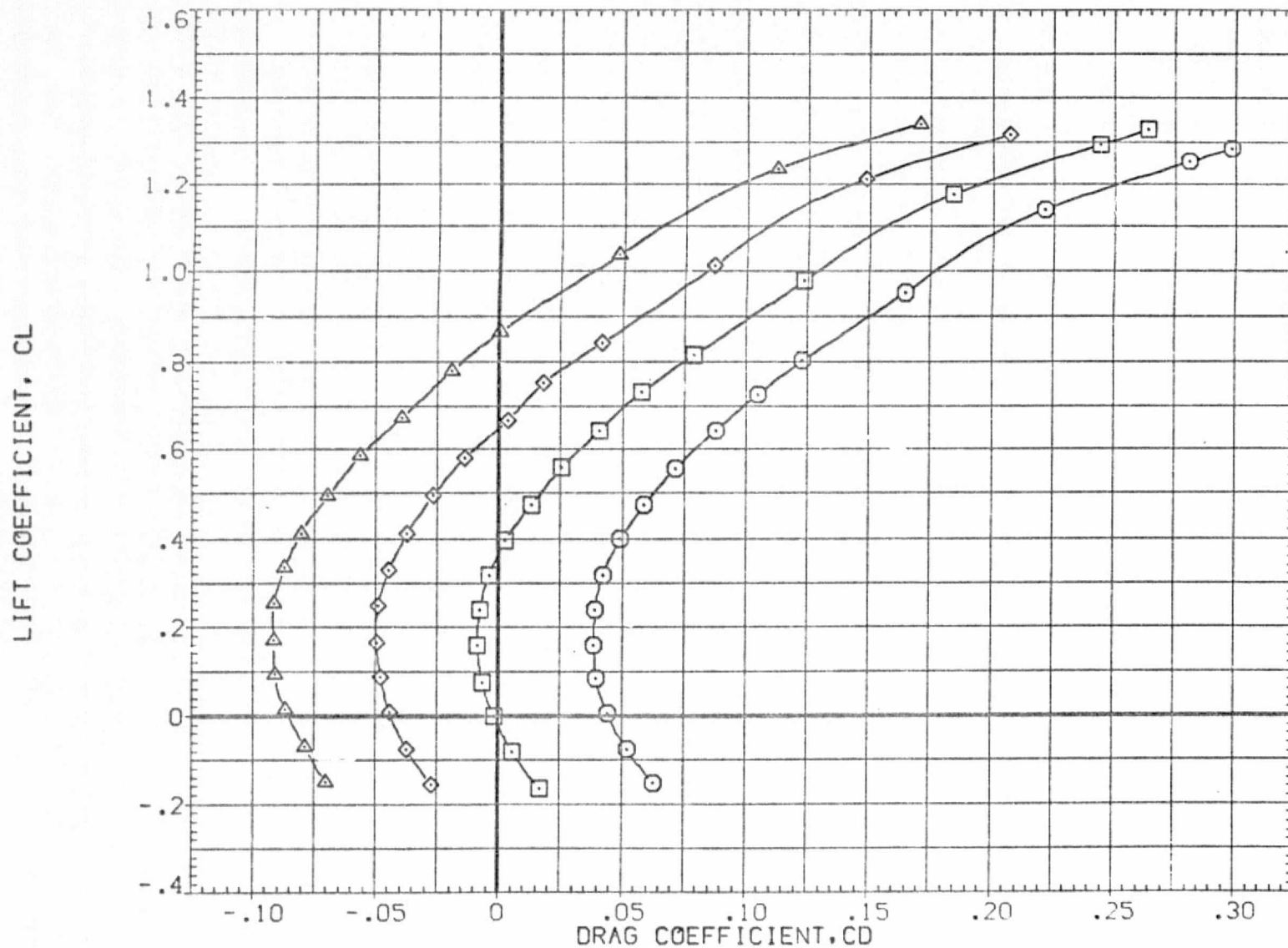

FIG. 13 EFFECTS OF BLOWING ON CONFIGURATION 4

(A)MACH = .90

DATA SET SYMBOL	CONFIGURATION DESCRIPTION
(RAT010) ○	CONFIGURATION 4 CL DESIGN=0.5
(RAT013) □	CONFIGURATION 4 CL DESIGN=0.5

RN/L	CTG
5.500	.000
5.500	.120

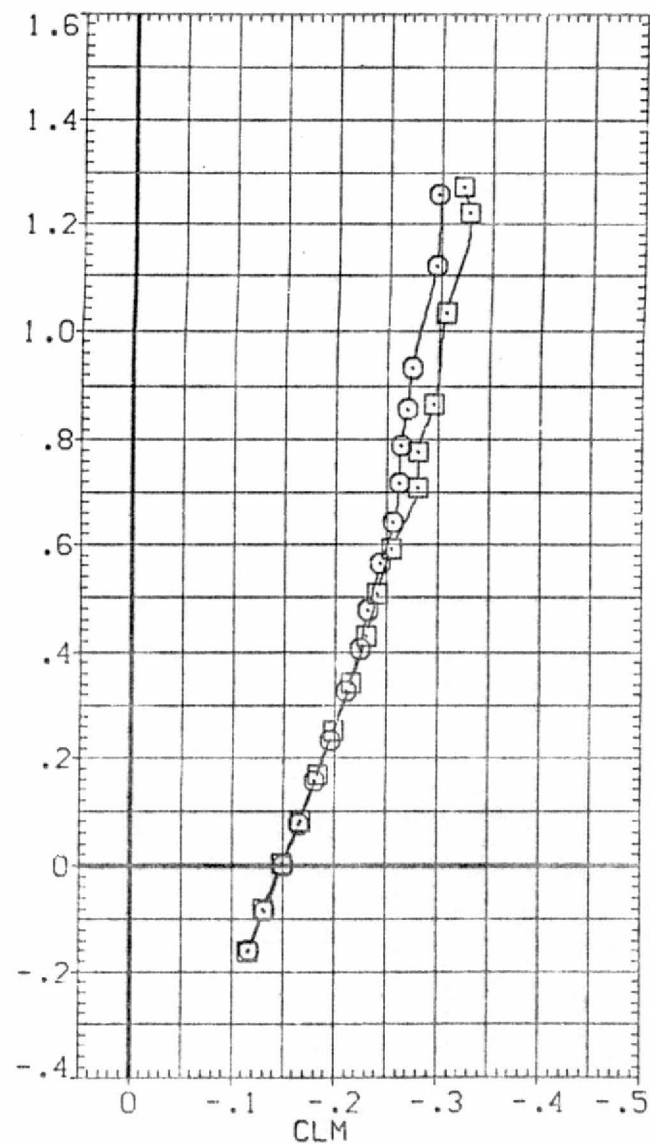
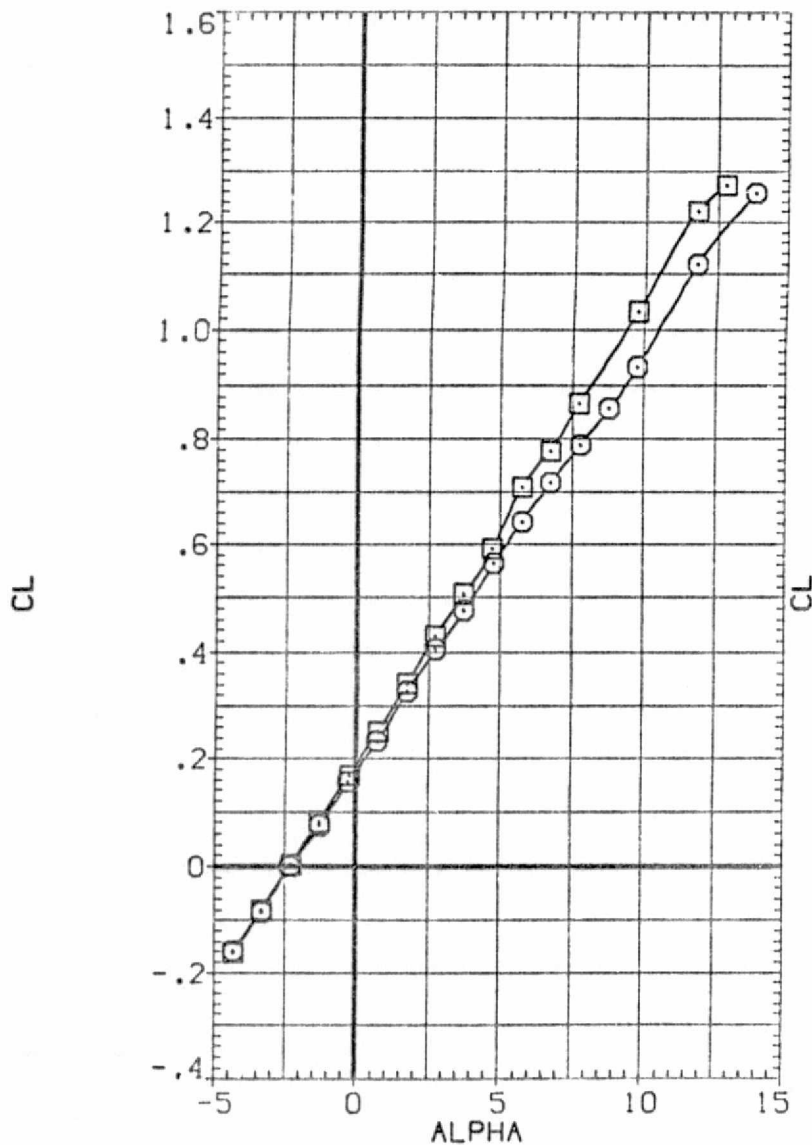

FIG. 13 EFFECTS OF BLOWING ON CONFIGURATION 4

(A) MACH = .95

DATA SET SYMBOL	CONFIGURATION DESCRIPTION
(RAT010)	○ CONFIGURATION 4 CL DESIGN=0.5
(RAT013)	□ CONFIGURATION 4 CL DESIGN=0.5

RN/L	CTG
5.500	.000
5.500	.120

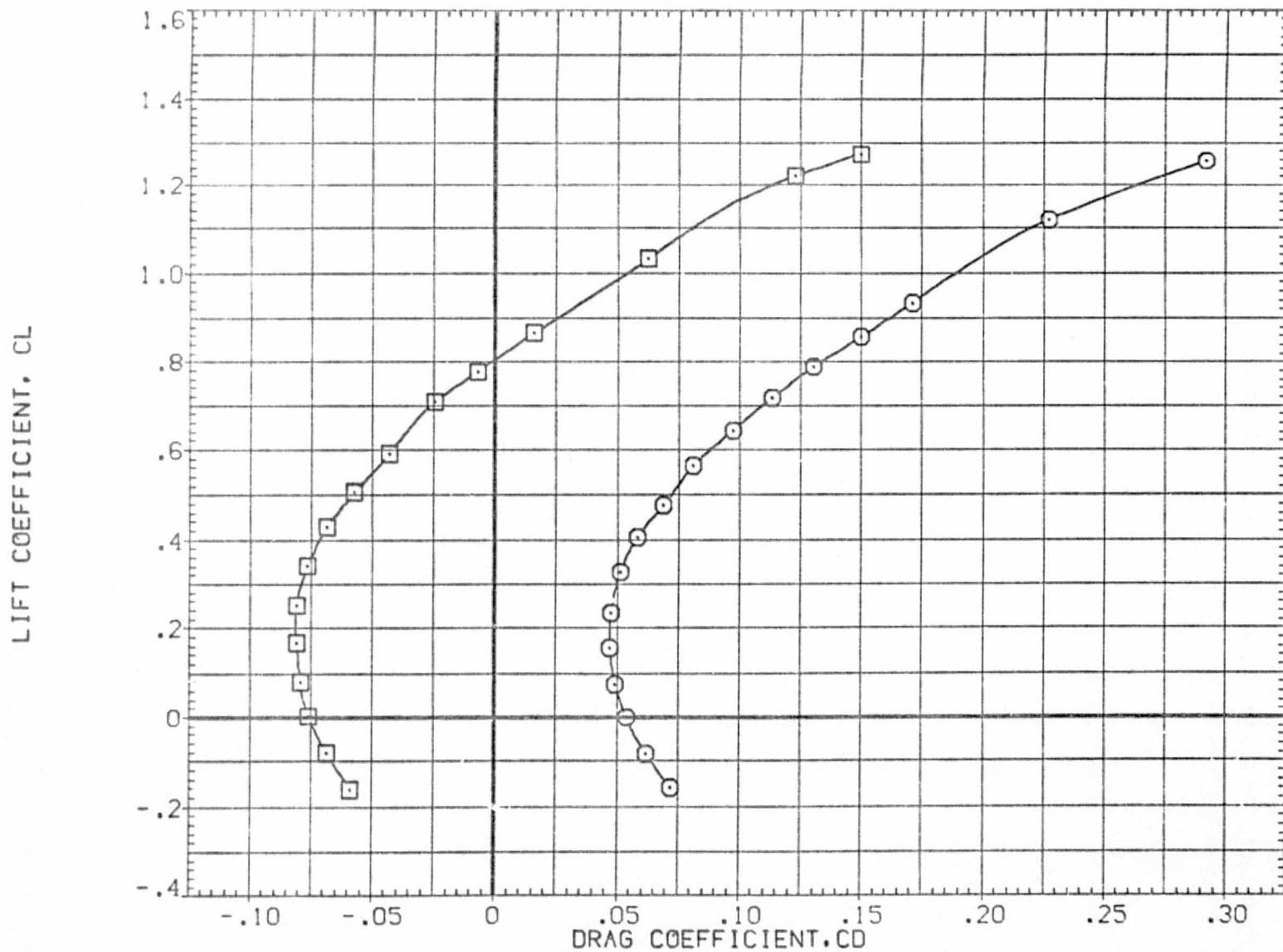

FIG. 13 EFFECTS OF BLOWING ON CONFIGURATION 4

(A) MACH = .95

DATA SET SYMBOL	CONFIGURATION	DESCRIPTION
(RATO17)	○	CONFIGURATION 5 ADEN FLAP DELF1=0
(RATO18)	□	CONFIGURATION 5 ADEN FLAP DELF1=0
(RATO19)	◇	CONFIGURATION 5 ADEN FLAP DELF1=0
(RATO20)	△	CONFIGURATION 5 ADEN FLAP DELF1=0

RN/L	CTG
5.500	.000
5.500	.040
5.500	.080
5.500	.120

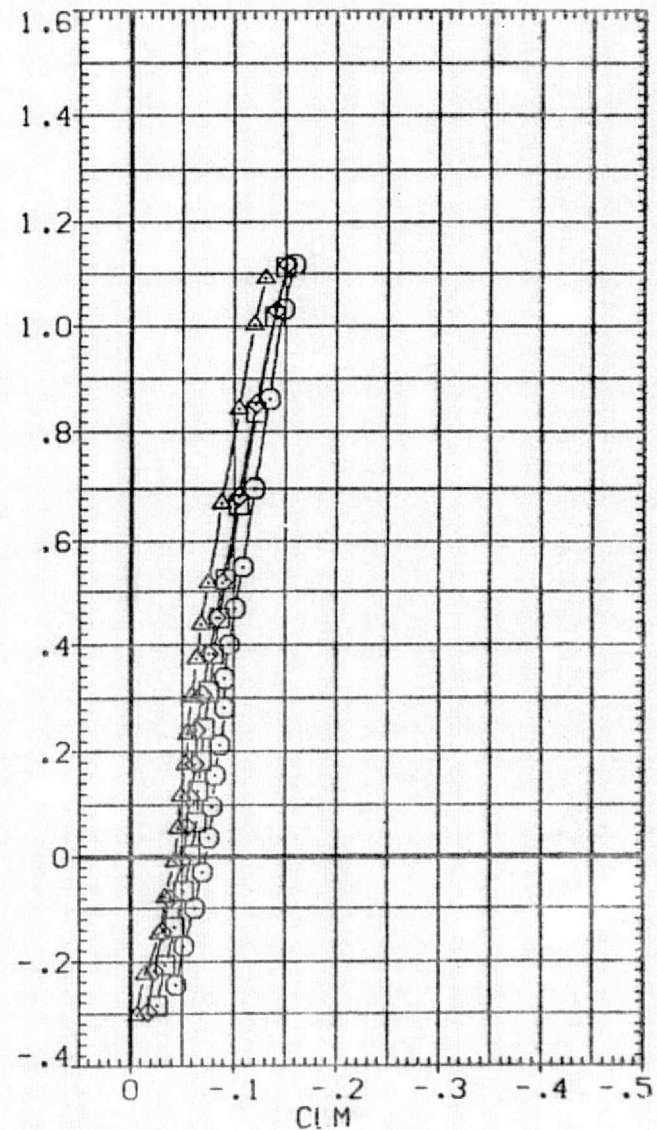
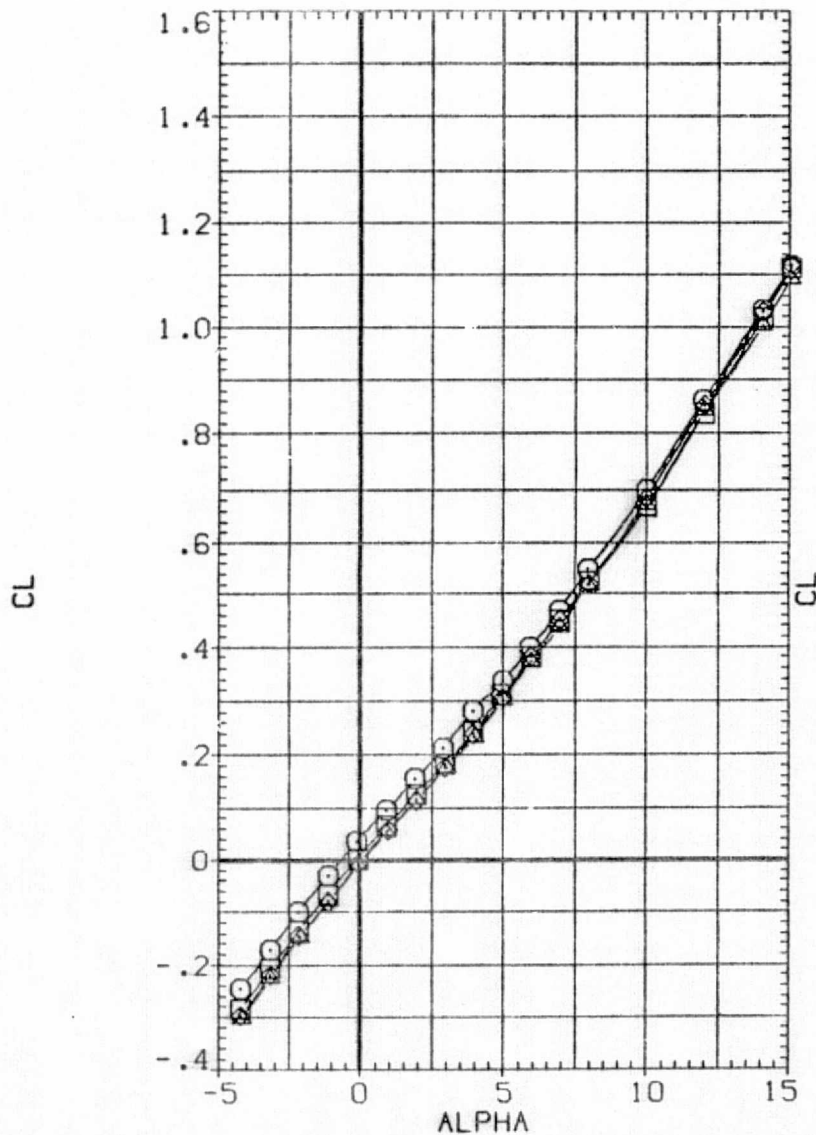

FIG. 13 EFFECTS OF BLOWING ON CONFIGURATION 5

(A) MACH = .70

DATA SET SYMBOL	CONFIGURATION	DESCRIPTION	RN/L	CTG
(RATO17)	○	CONFIGURATION 5 ADEN FLAP DELF1=0	5.500	.000
(RATO18)	□	CONFIGURATION 5 ADEN FLAP DELF1=0	5.500	.040
(RATO19)	◇	CONFIGURATION 5 ADEN FLAP DELF1=0	5.500	.080
(RATO20)	△	CONFIGURATION 5 ADEN FLAP DELF1=0	5.500	.120

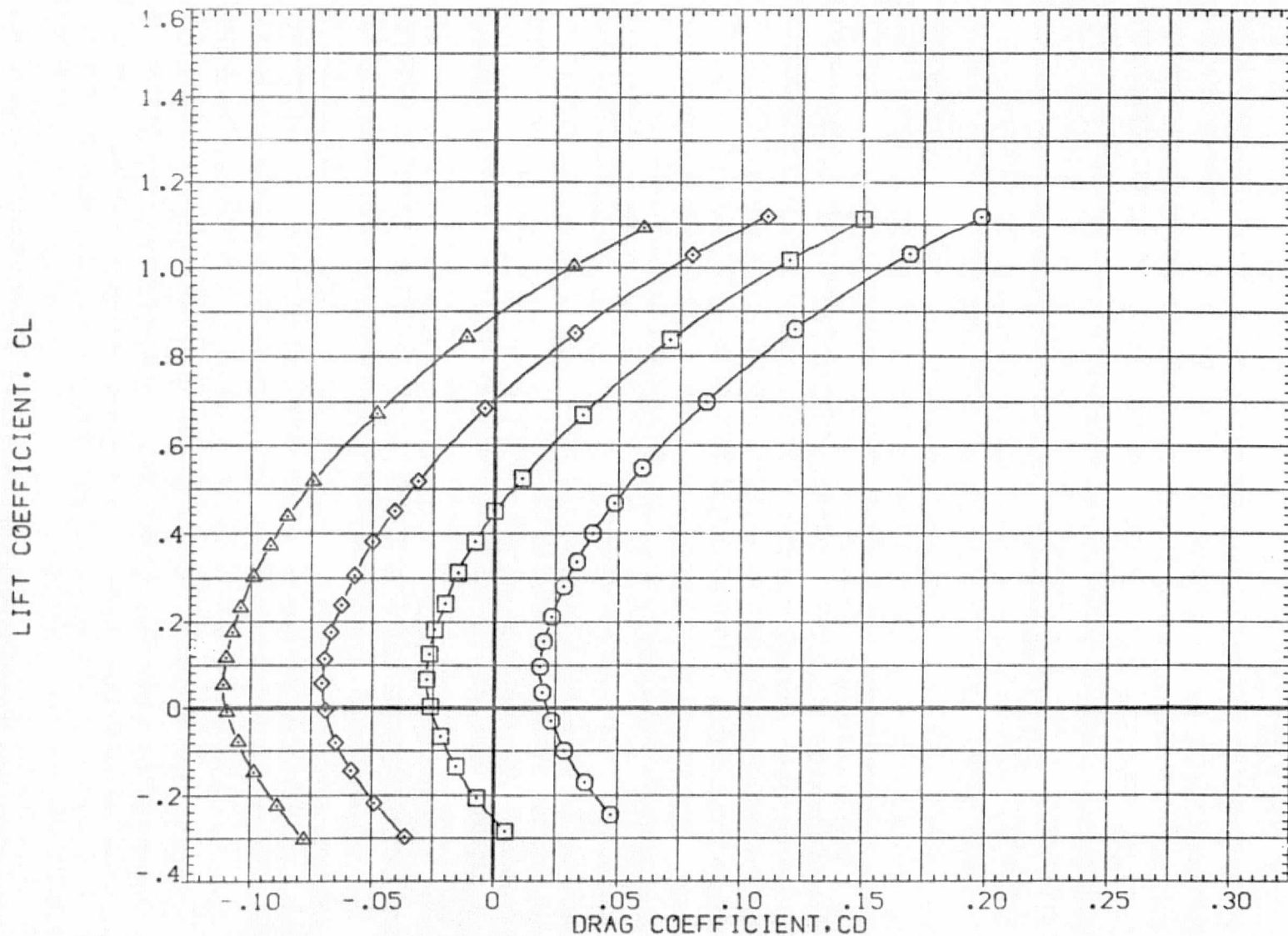

FIG. 13 EFFECTS OF BLOWING ON CONFIGURATION 5

(A)MACH = .70

DATA SET SYMBOL	CONFIGURATION	DESCRIPTION	DELFI
(RATO17)	□	ADEN FLAP	DELFI=0
(RATO18)	○	ADEN FLAP	DELFI=0
(RATO19)	△	ADEN FLAP	DELFI=0
(RATO20)	◇	ADEN FLAP	DELFI=0

RN/L	CTG
5.500	.000
5.500	.040
5.500	.080
5.500	.120

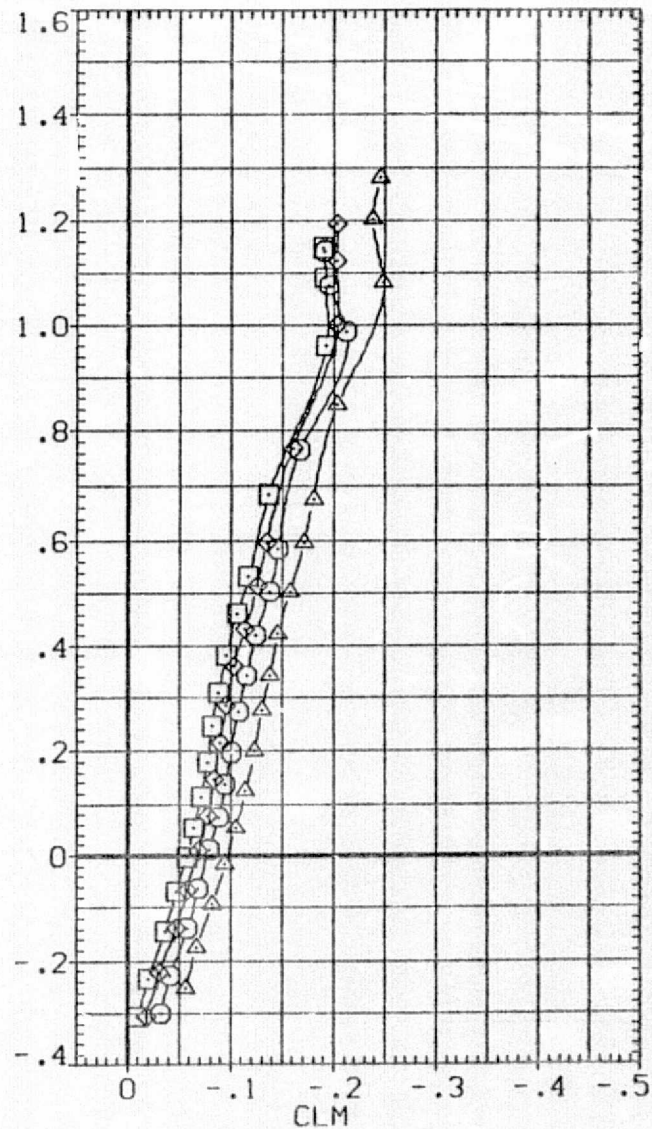
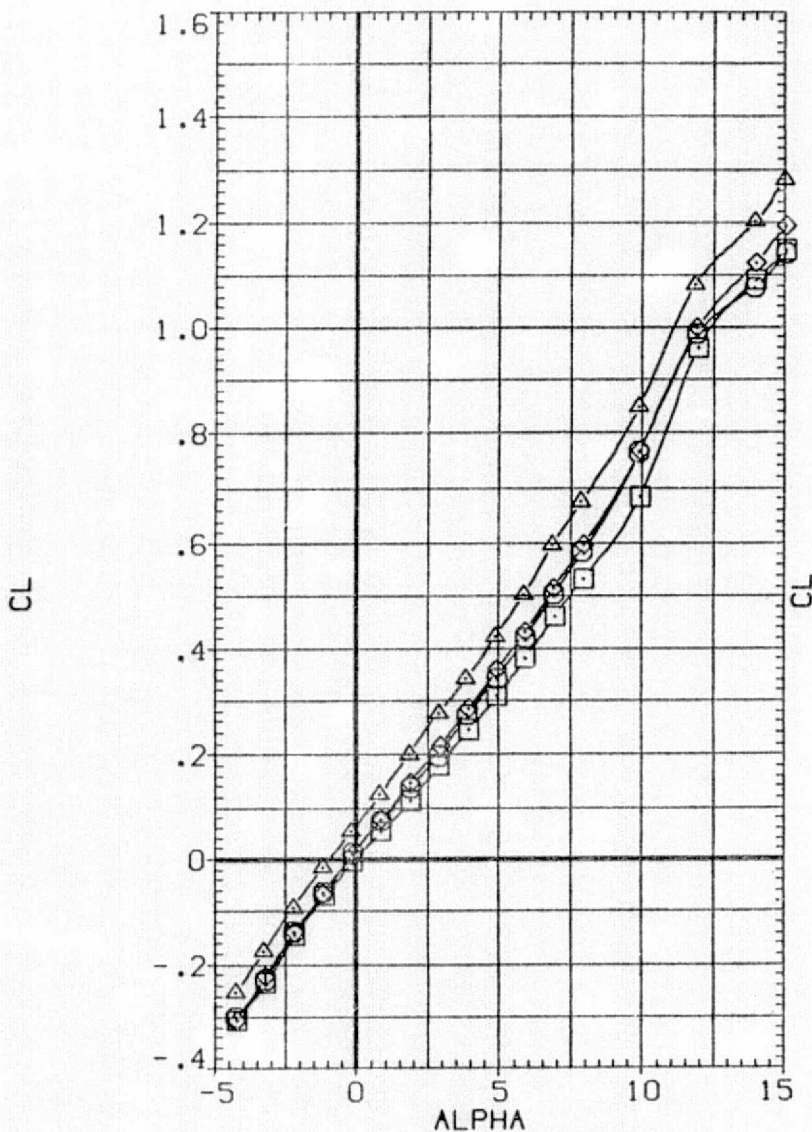

FIG. 13 EFFECTS OF BLOWING ON CONFIGURATION 5
(B)MACH = .90

DATA SET SYMBOL	CONFIGURATION DESCRIPTION	RN/L	CTG
(RAT017)	CONFIGURATION 5 ADEN FLAP DELF1=0	5.500	.000
(RAT018)	CONFIGURATION 5 ADEN FLAP DELF1=0	5.500	.040
(RAT019)	CONFIGURATION 5 ADEN FLAP DELF1=0	5.500	.080
(RAT020)	CONFIGURATION 5 ADEN FLAP DELF1=0	5.500	.120

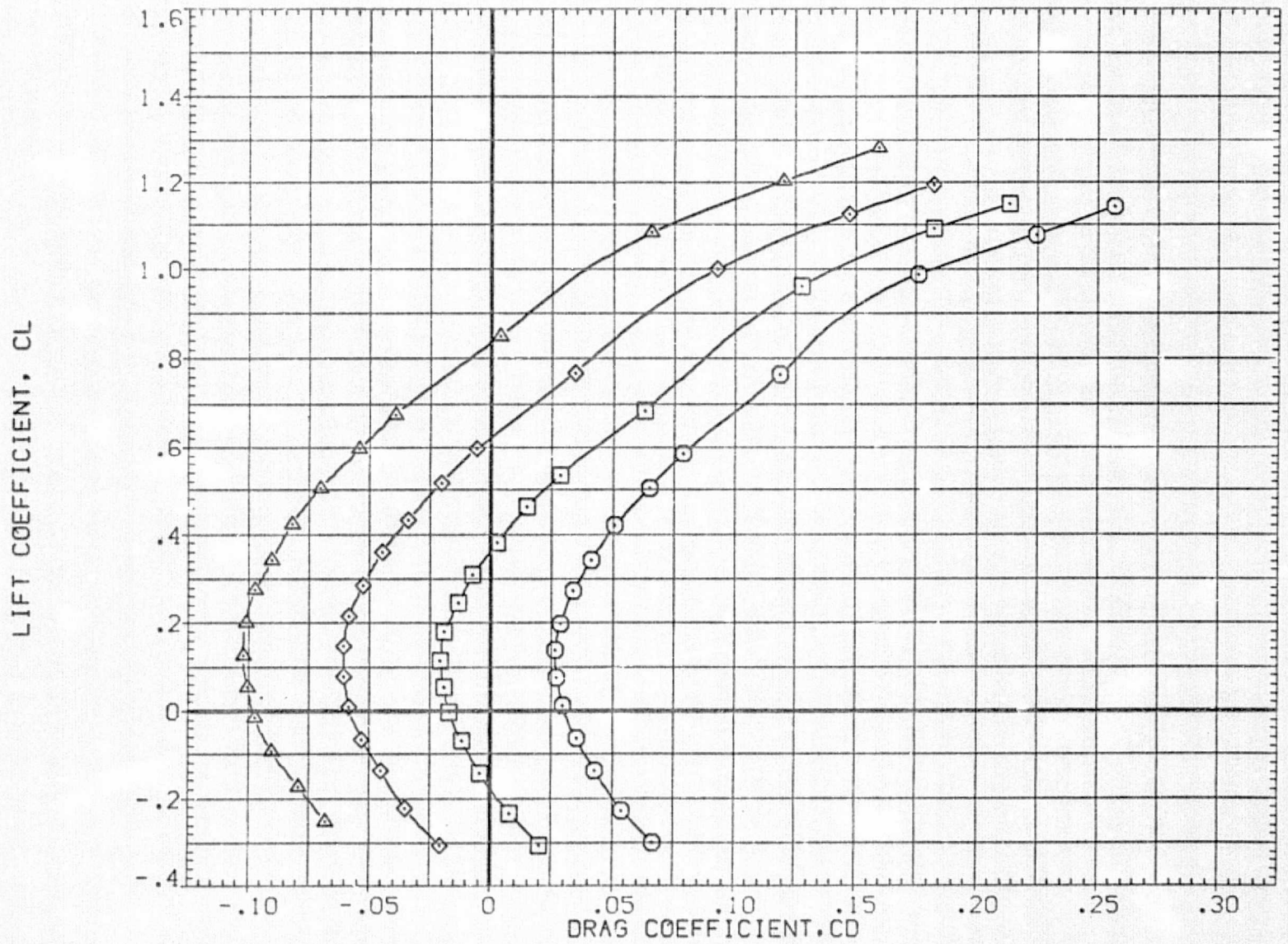

FIG. 13 EFFECTS OF BLOWING ON CONFIGURATION 5

(B)MACH = .90

DATA SET SYMBOL	CONFIGURATION	DESCRIPTION	DELFI=0
(RATO17)	□	ADEN FLAP	DELFI=0
(RATO18)	○	ADEN FLAP	DELFI=0
(RATO19)	◇	ADEN FLAP	DELFI=0
(RATO20)	△	ADEN FLAP	DELFI=0

RN/L	CTG
5.500	.000
5.500	.040
5.500	.080
5.500	.120

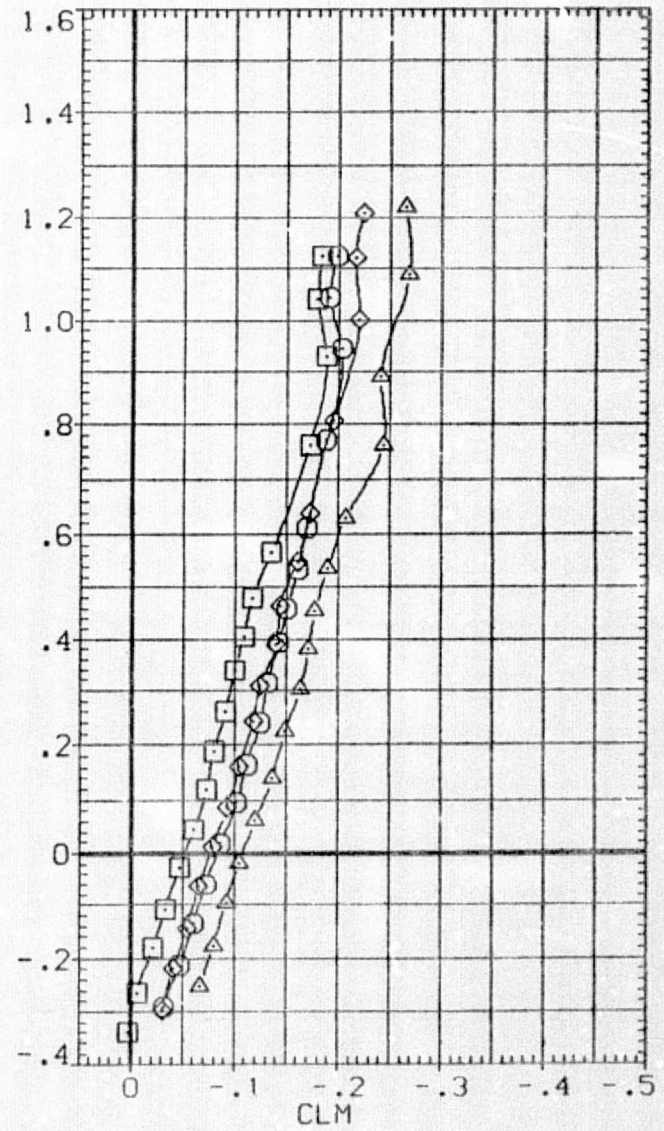
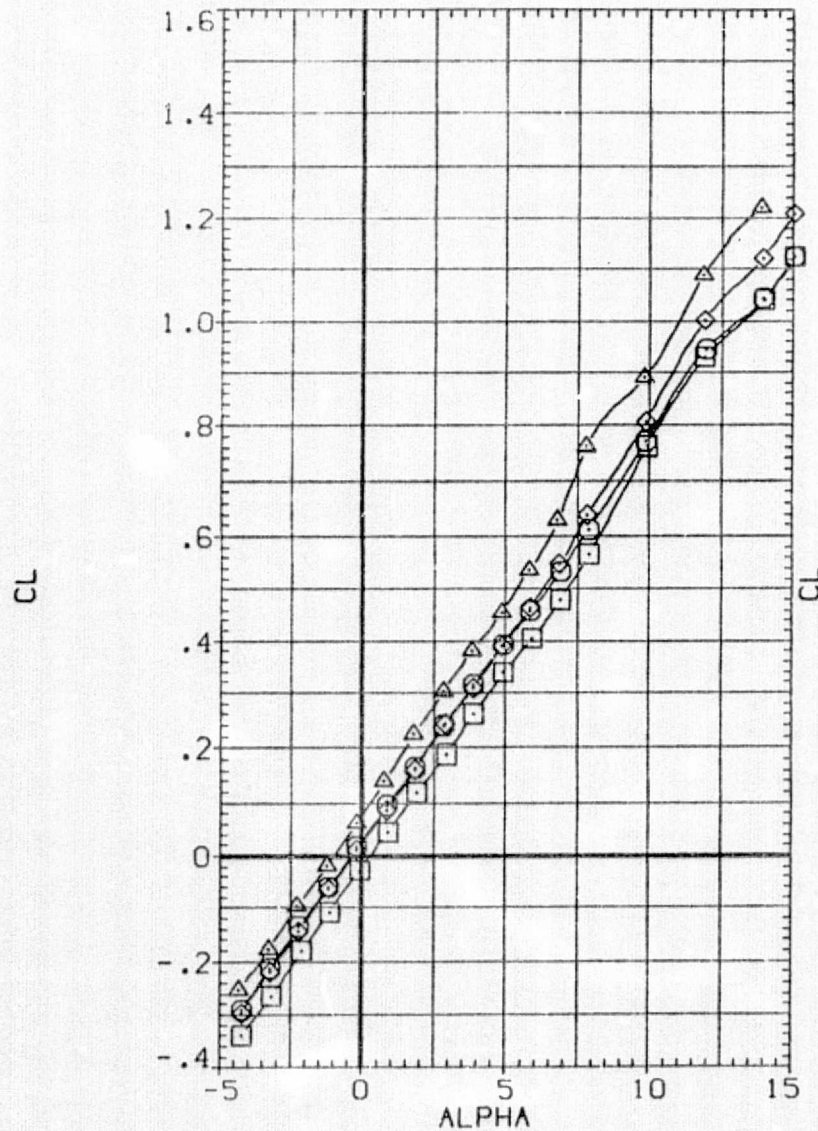

FIG. 13 EFFECTS OF BLOWING ON CONFIGURATION 5
(C)MACH = .95

DATA SET SYMBOL	CONFIGURATION	DESCRIPTION	DELFI	RN/L	CTG
(RATO17)	○	CONFIGURATION 5 ADEN FLAP	DELFI=0	5.500	.000
(RATO18)	□	CONFIGURATION 5 ADEN FLAP	DELFI=0	5.500	.040
(RATO19)	◇	CONFIGURATION 5 ADEN FLAP	DELFI=0	5.500	.080
(RATO20)	△	CONFIGURATION 5 ADEN FLAP	DELFI=0	5.500	.120

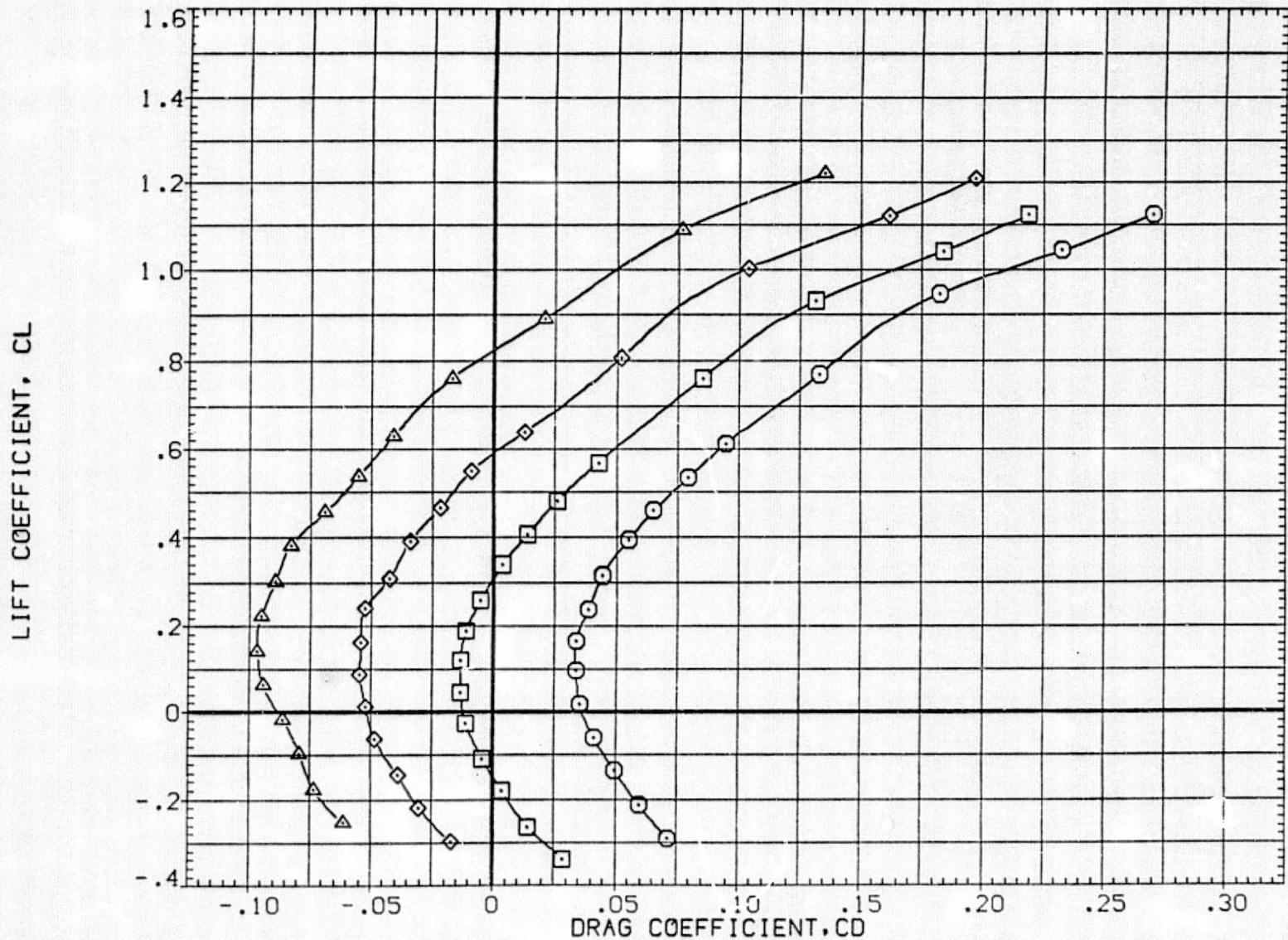

FIG. 13 EFFECTS OF BLOWING ON CONFIGURATION 5

(C)MACH = .95

DATA SET SYMBOL	CONFIGURATION	DESCRIPTION	DELTA
(RATO22)	6	ADEN FLAP	.15
(RATO23)	6	ADEN FLAP	.15
(RATO24)	6	ADEN FLAP	.15
(RATO25)	6	ADEN FLAP	.15

RN/L	CTG
5.500	.000
5.500	.040
5.500	.080
5.500	.120

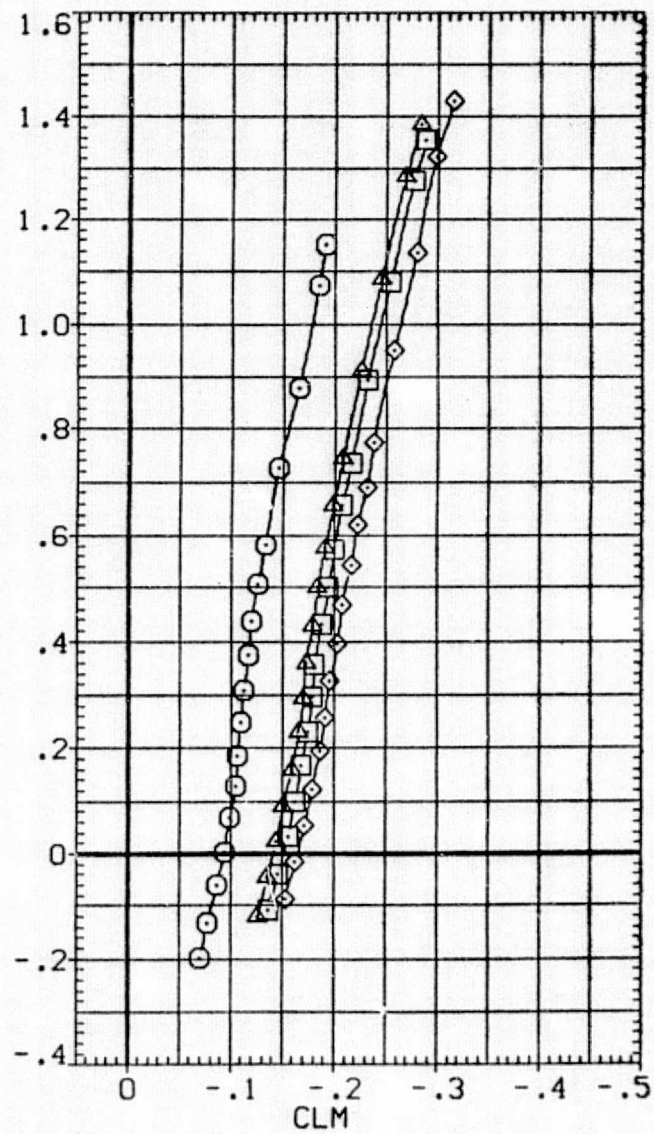
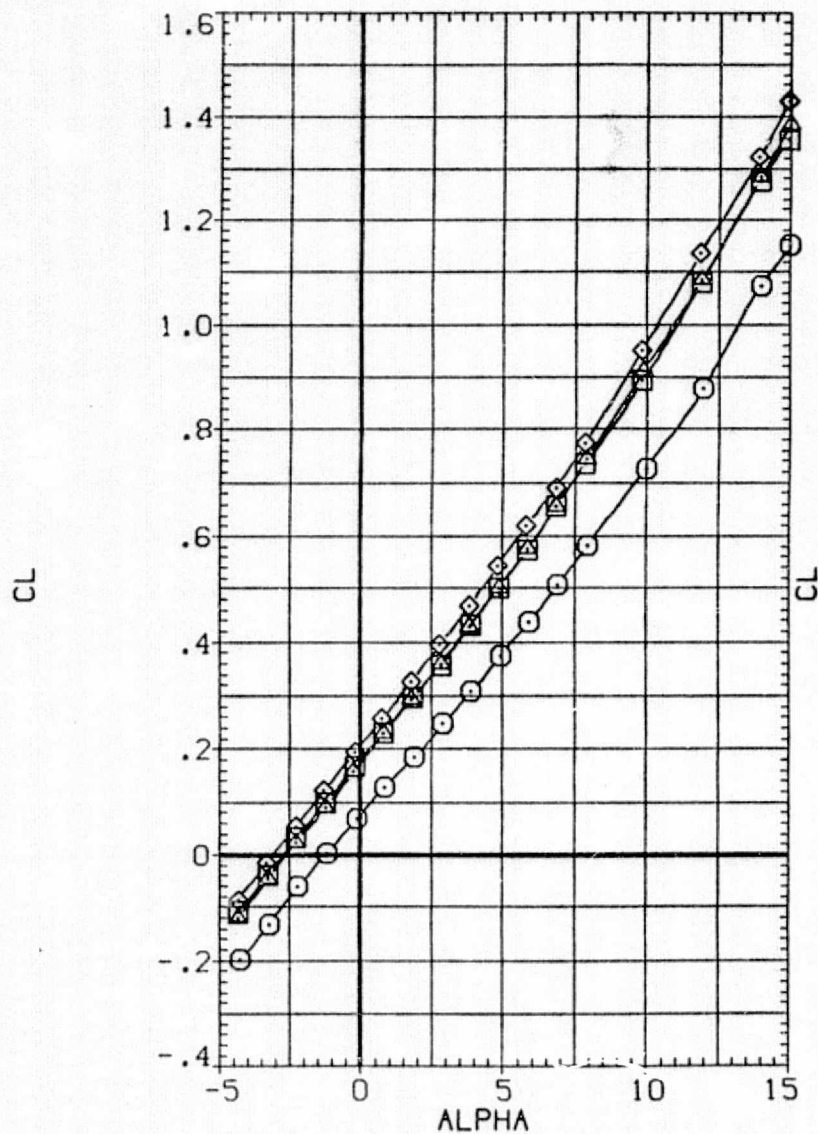

FIG. 13 EFFECTS OF BLOWING ON CONFIGURATION 6

(A)MACH = .70

DATA SET SYMBOL	CONFIGURATION DESCRIPTION	RN/L	CTG
(RATO22)	CONFIGURATION 6 ADEN FLAP DELFI=15	5.500	.000
(RATO23)	CONFIGURATION 6 ADEN FLAP DELFI=15	5.500	.040
(RATO24)	CONFIGURATION 6 ADEN FLAP DELFI=15	5.500	.080
(RATO25)	CONFIGURATION 6 ADEN FLAP DELFI=15	5.500	.120

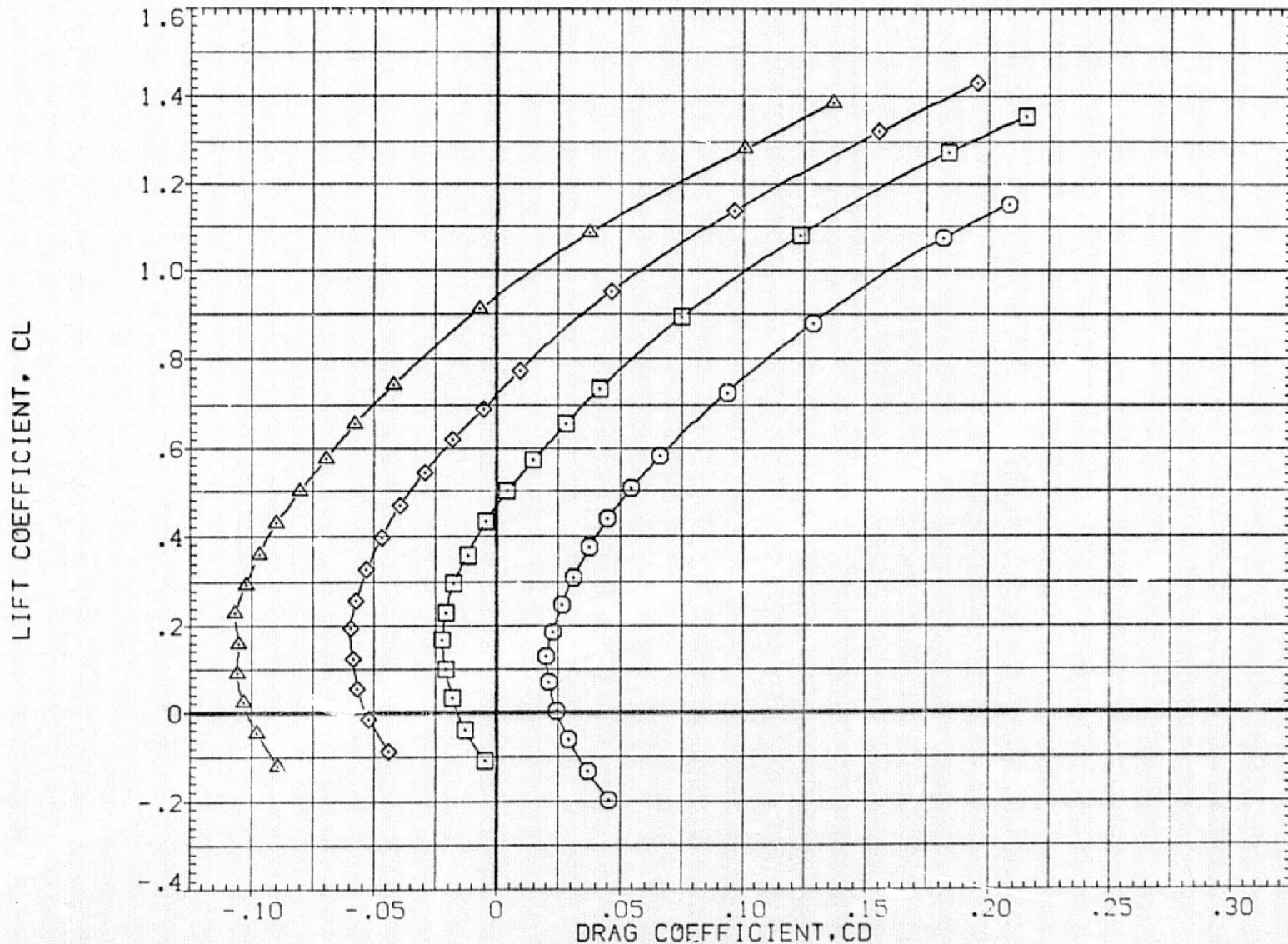

FIG. 13 EFFECTS OF BLOWING ON CONFIGURATION 6

(A) MACH = .70

DATA SET SYMBOL	CONFIGURATION	DESCRIPTION	DELFI=15
(RATO22)	□	ADEN FLAP	DELFI=15
(RATO23)	○	ADEN FLAP	DELFI=15
(RATO24)	◇	ADEN FLAP	DELFI=15
(RATO25)	△	ADEN FLAP	DELFI=15

RN/L	CTG
5.500	.000
5.500	.040
5.500	.080
5.500	.120

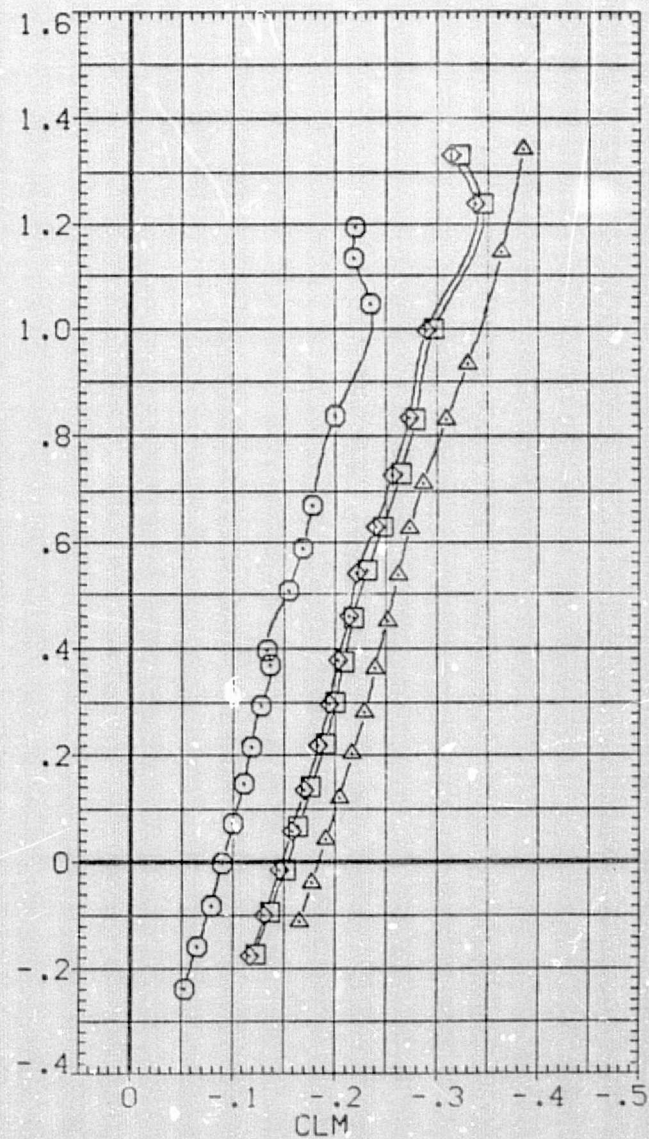
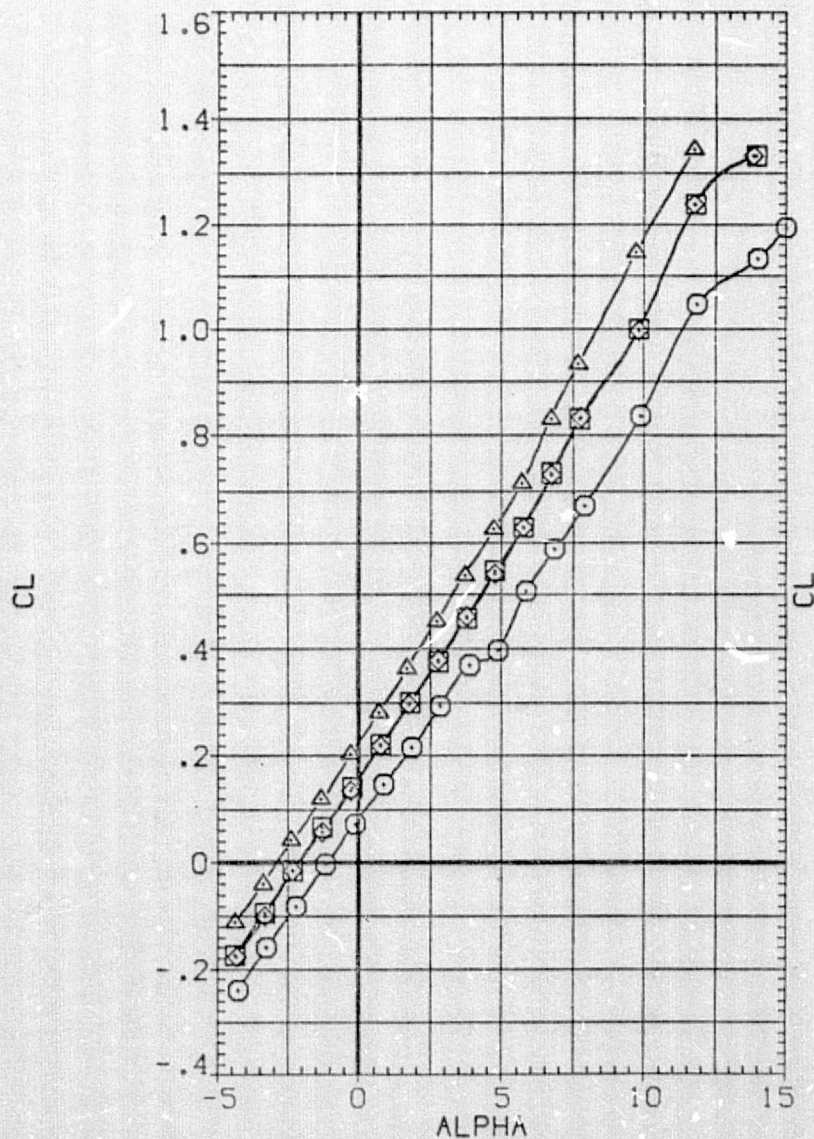

FIG. 13 EFFECTS OF BLOWING ON CONFIGURATION 6
(B)MACH = .90

DATA SET SYMBOL	CONFIGURATION DESCRIPTION	RN/L	CTG
(RATO22)	CONFIGURATION 6 ADEN FLAP DELF1=15	5.500	.000
(RATO23)	CONFIGURATION 6 ADEN FLAP DELF1=15	5.500	.040
(RATO24)	CONFIGURATION 6 ADEN FLAP DELF1=15	5.500	.080
(RATO25)	CONFIGURATION 6 ADEN FLAP DELF1=15	5.500	.120

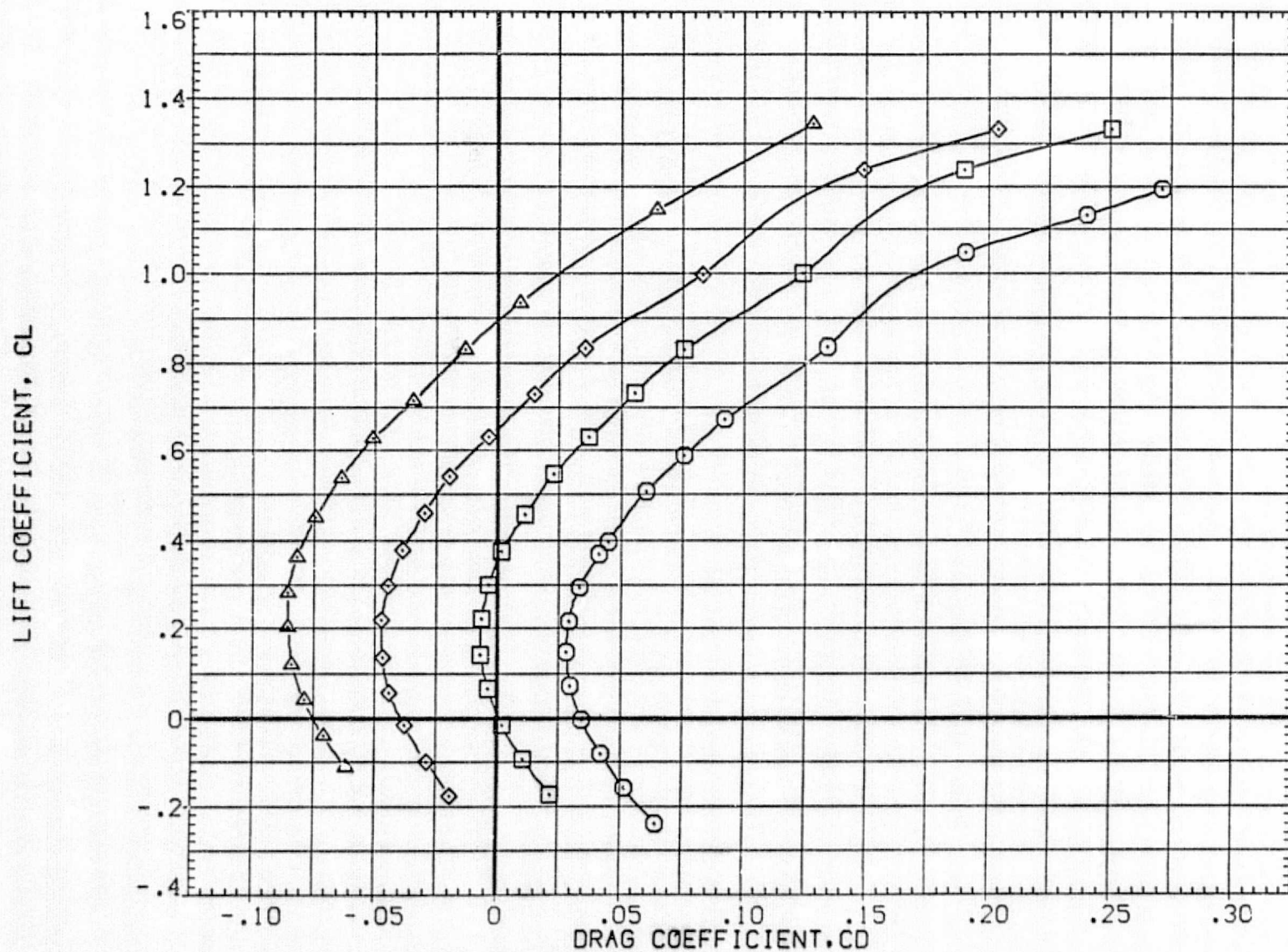

FIG. 13 EFFECTS OF BLOWING ON CONFIGURATION 6

(B)MACH = .90

DATA SET SYMBOL	CONFIGURATION DESCRIPTION
(RAT022) ○	CONFIGURATION 6 ADEN FLAP DELFI=15
(RAT025) □	CONFIGURATION 6 ADEN FLAP DELFI=15

RN/L	CTG
5.500	.000
5.500	.120

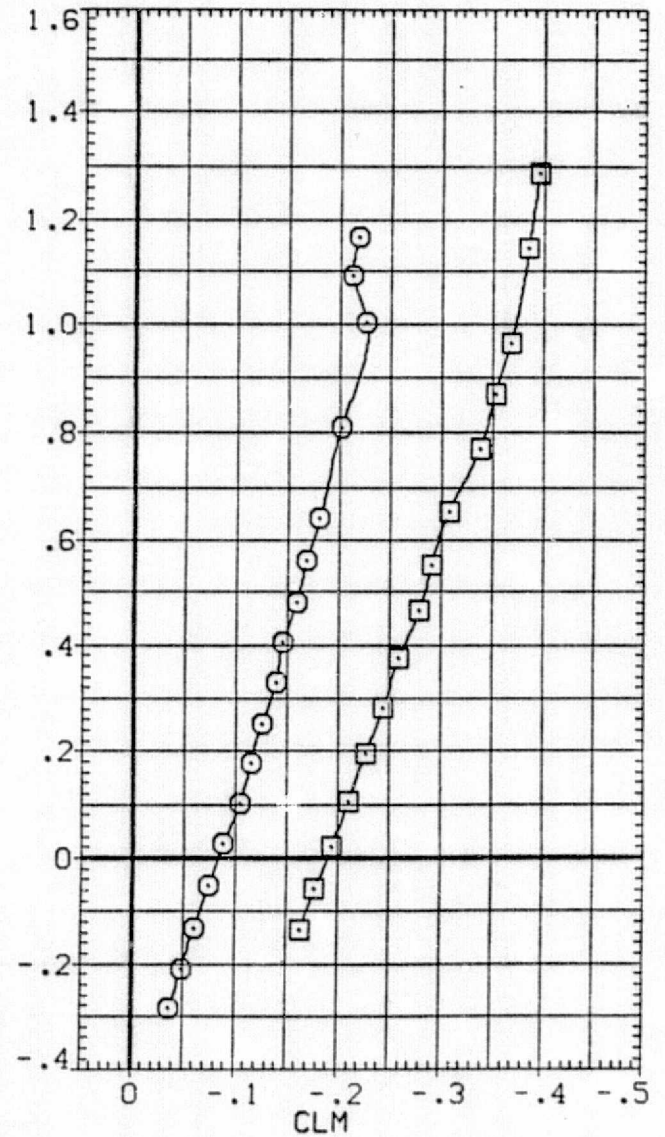
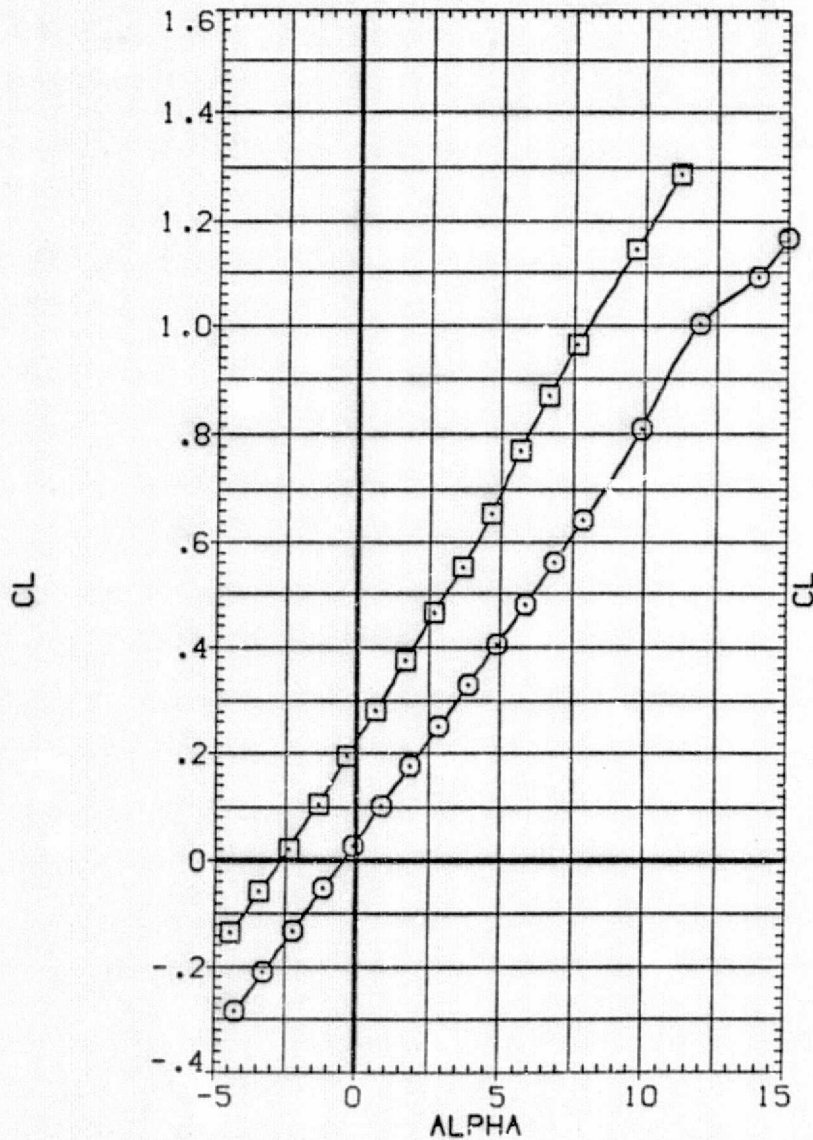

FIG. 13 EFFECTS OF BLOWING ON CONFIGURATION 6

(A) MACH = .95

DATA SET SYMBOL	CONFIGURATION DESCRIPTION
(RAT022)	CONFIGURATION 6 ADEN FLAP DELFI=15
(RAT025)	CONFIGURATION 6 ADEN FLAP DELFI=15

RN/L	CTG
5.500	.000
5.500	.120

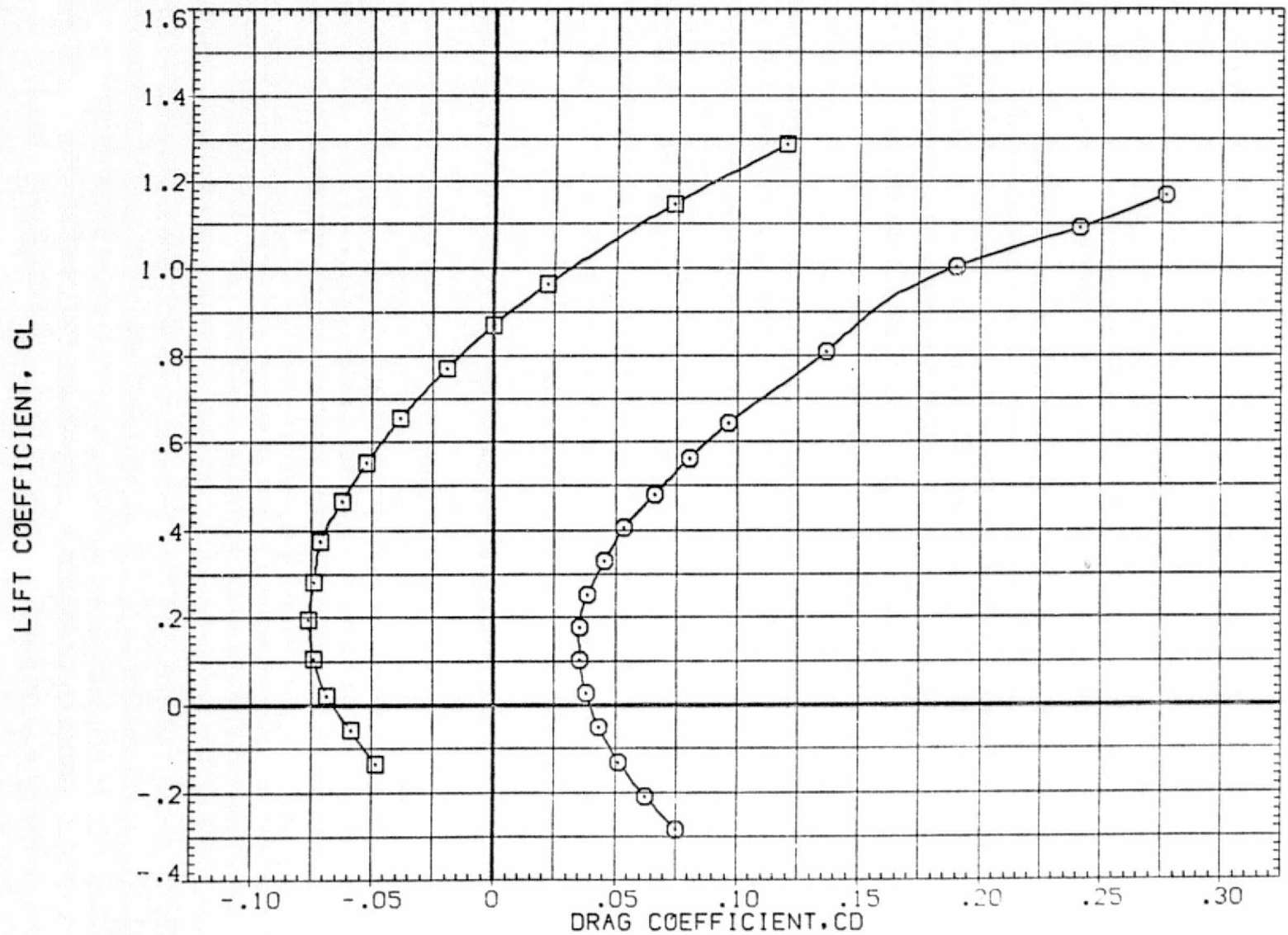

FIG. 13 EFFECTS OF BLOWING ON CONFIGURATION 6

(A) MACH = .95

DATA SET SYMBOL	CONFIGURATION	DESCRIPTION	DELFI
(RAT027)	○	CONFIGURATION 7	ADEN FLAP DELFI=30
(RAT028)	□	CONFIGURATION 7	ADEN FLAP DELFI=30
(RAT029)	◇	CONFIGURATION 7	ADEN FLAP DELFI=30
(RAT030)	△	CONFIGURATION 7	ADEN FLAP DELFI=30

RN/L	CTG
5.500	.000
5.500	.040
5.500	.080
5.500	.120

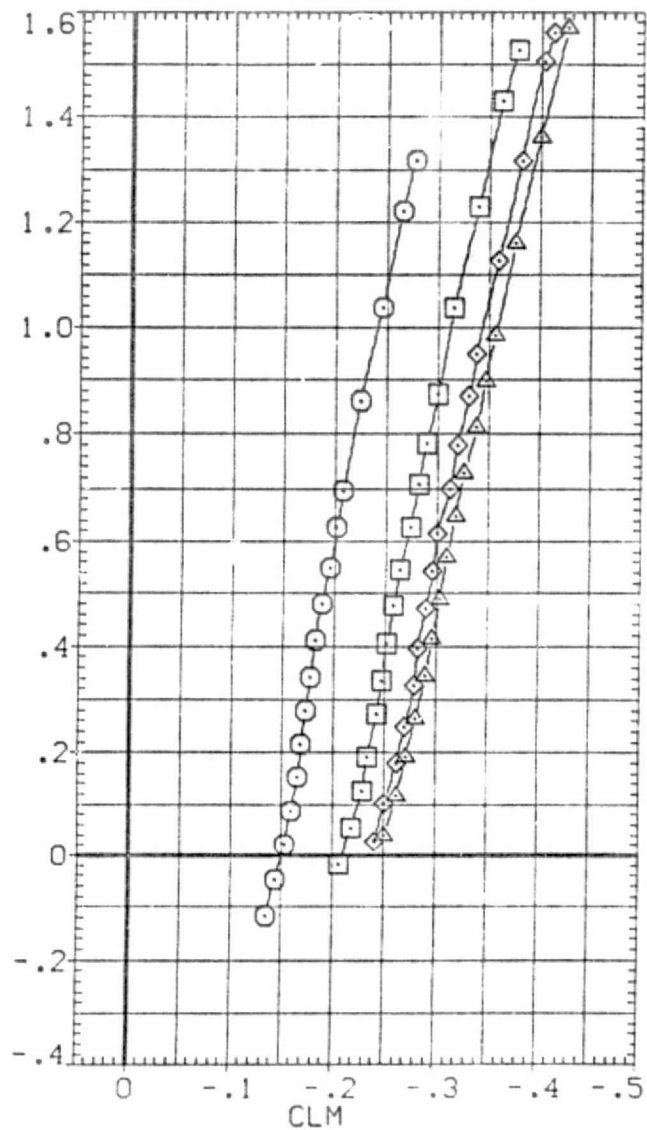
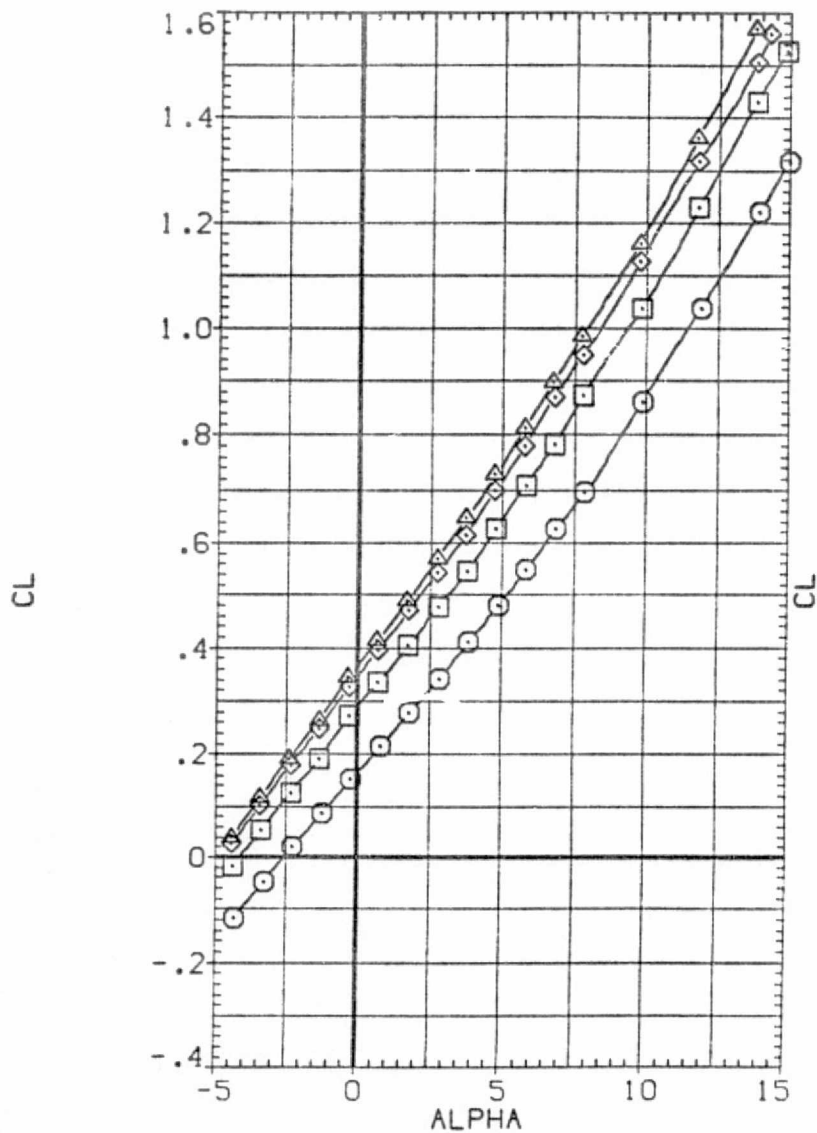

FIG. 13 EFFECTS OF BLOWING ON CONFIGURATION 7

(A) MACH = .70

DATA SET SYMBOL	CONFIGURATION DESCRIPTION	RN/L	CTG
(RAT027)	CONFIGURATION 7 ADEN FLAP DELFI=30	5.500	.000
(RAT028)	CONFIGURATION 7 ADEN FLAP DELFI=30	5.500	.040
(RAT029)	CONFIGURATION 7 ADEN FLAP DELFI=30	5.500	.080
(RAT030)	CONFIGURATION 7 ADEN FLAP DELFI=30	5.500	.120

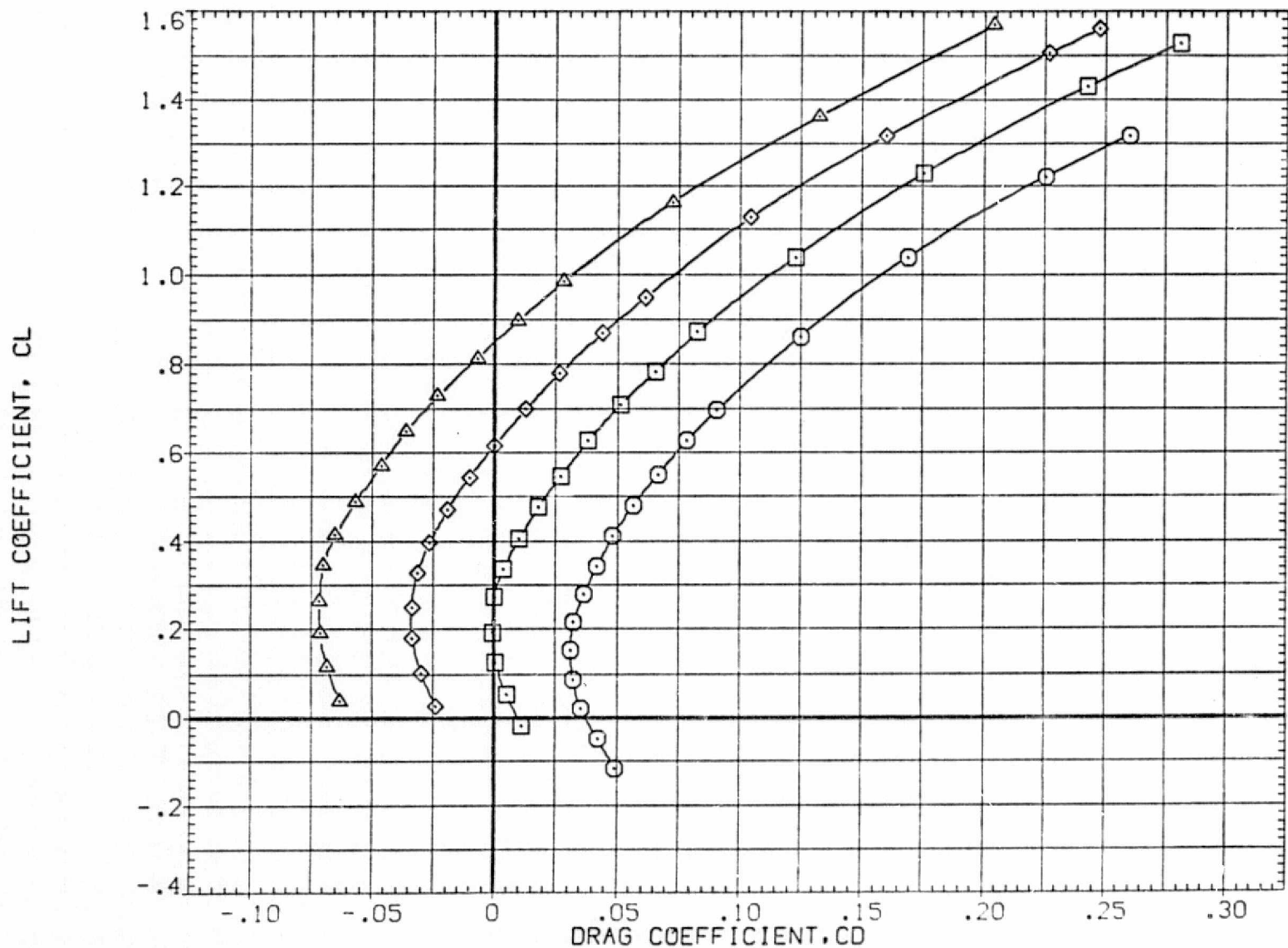

FIG. 13 EFFECTS OF BLOWING ON CONFIGURATION 7

(A) MACH = .70

DATA SET SYMBOL	CONFIGURATION	DESCRIPTION	DELFI
(RAT027)	7	ADEN FLAP	30
(RAT028)	7	ADEN FLAP	30
(RAT029)	7	ADEN FLAP	30
(RAT030)	7	ADEN FLAP	30

RN/L	CTG
5.500	.000
5.500	.040
5.500	.080
5.500	.120

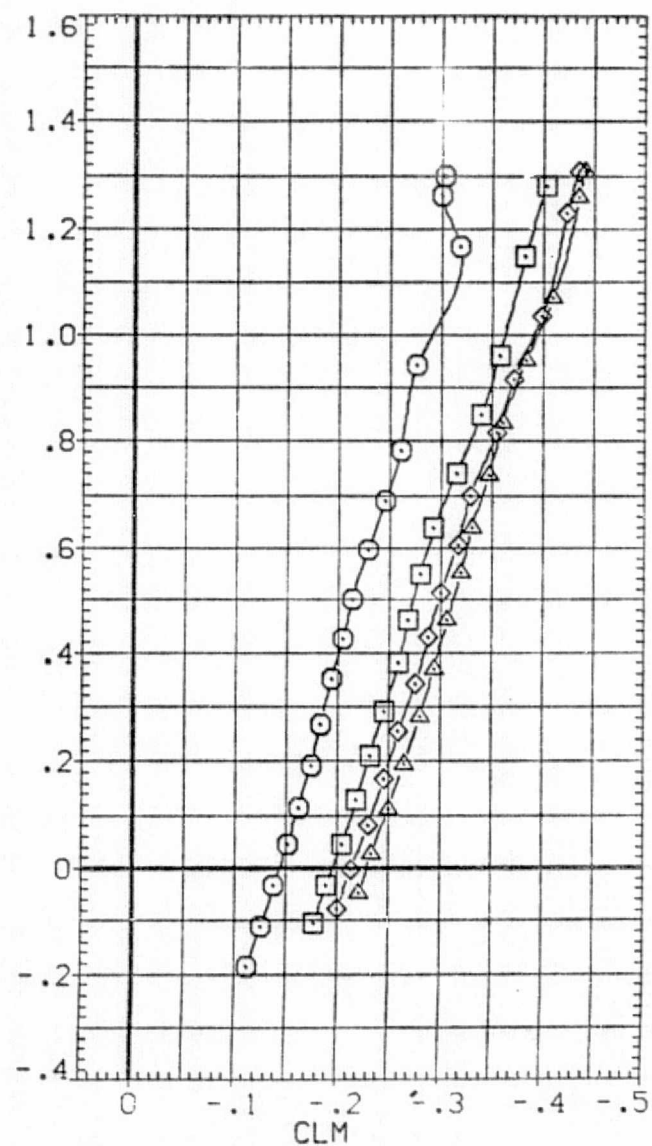
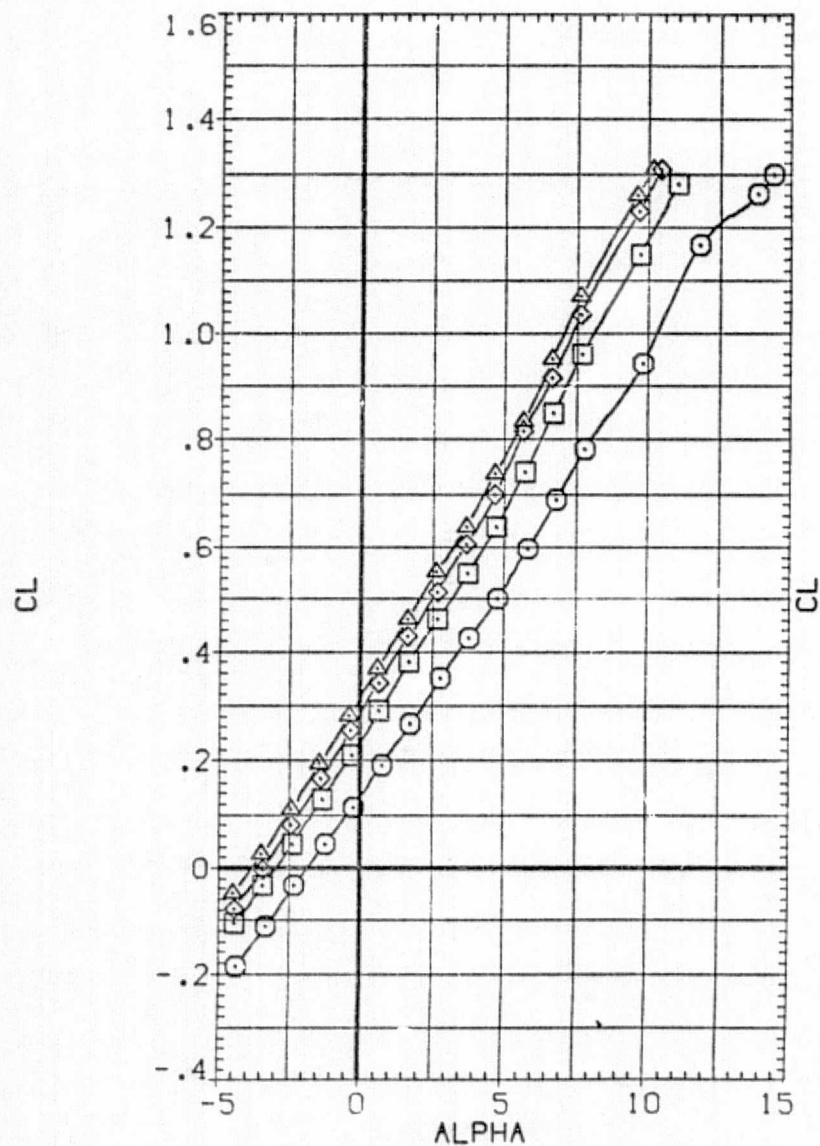

FIG. 13 EFFECTS OF BLOWING ON CONFIGURATION 7

(B)MACH = .90

DATA SET SYMBOL	CONFIGURATION DESCRIPTION	RN/L	CTG
(RATO27)	CONFIGURATION 7 ADEN FLAP DELFI=30	5.500	.000
(RATO28)	CONFIGURATION 7 ADEN FLAP DELFI=30	5.500	.040
(RATO29)	CONFIGURATION 7 ADEN FLAP DELFI=30	5.500	.080
(RATO30)	CONFIGURATION 7 ADEN FLAP DELFI=30	5.500	.120

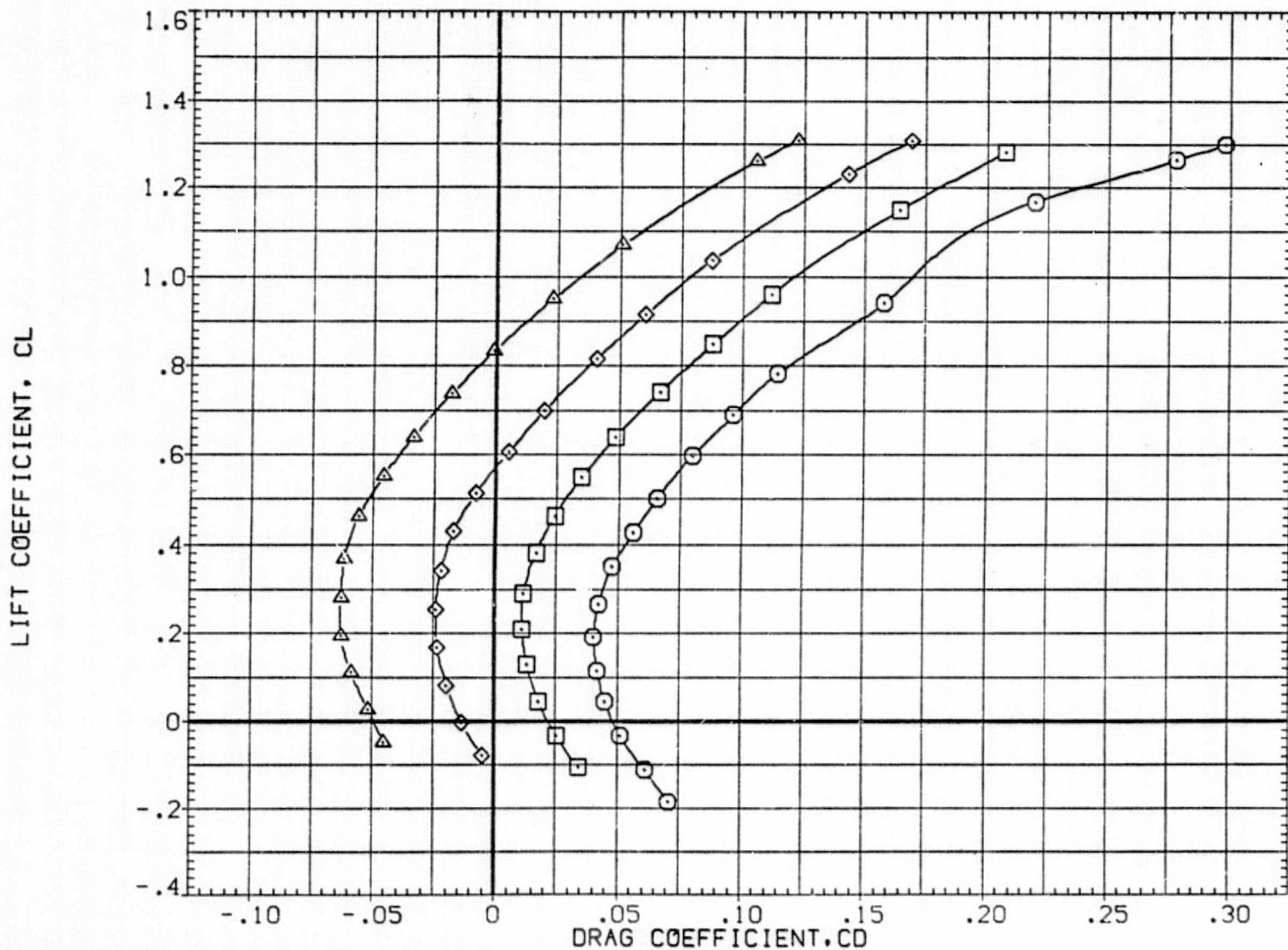

FIG. 13 EFFECTS OF BLOWING ON CONFIGURATION 7

(B)MACH = .90

DATA SET SYMBOL	CONFIGURATION DESCRIPTION
(RAT007)	○ CONFIGURATION 3 LEADING EDGE CAMBERED
(RAT017)	□ CONFIGURATION 5 ADEN FLAP DELFI=0
(RAT022)	◇ CONFIGURATION 6 ADEN FLAP DELFI=15
(RAT027)	△ CONFIGURATION 7 ADEN FLAP DELFI=30

RN/L	CTG
5.500	.000
5.500	.000
5.500	.000
5.500	.000

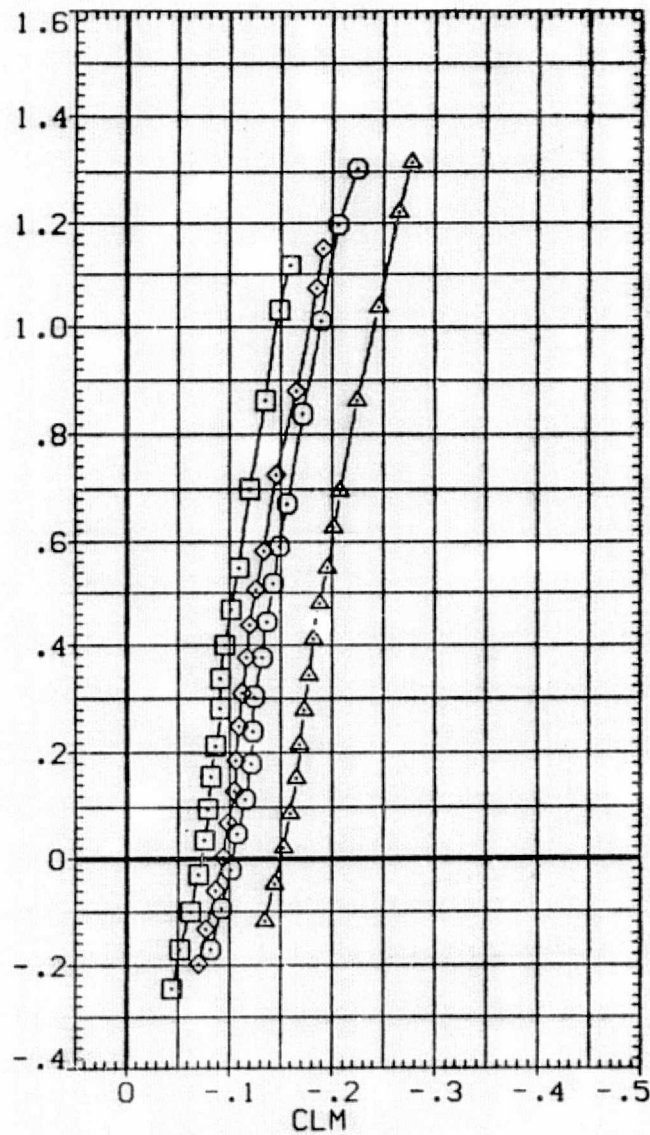
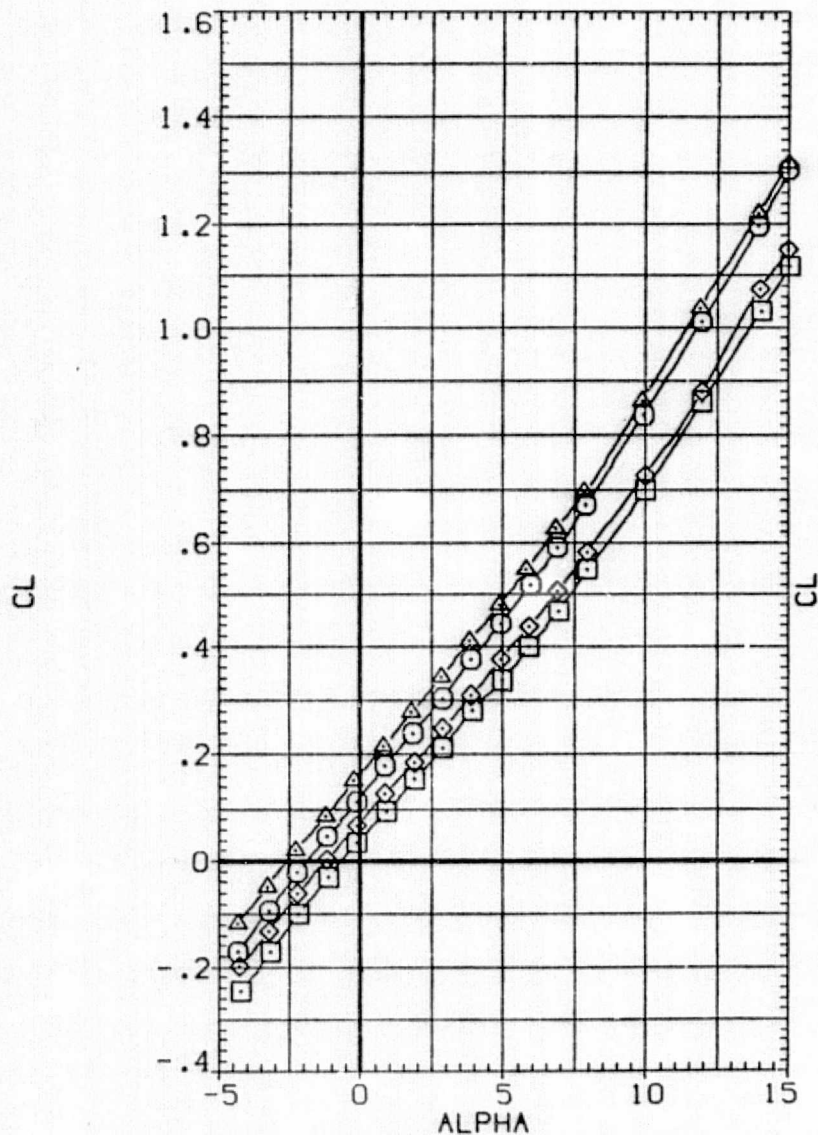

FIG. 14 FLAP EFFECTS WITH NO BLOWING
(A) MACH = .70

DATA SET SYMBOL	CONFIGURATION DESCRIPTION	RN/L	CTG
(RAT007)	CONFIGURATION 3 LEADING EDGE CAMBERED	5.500	.000
(RAT017)	CONFIGURATION 5 ADEN FLAP DELF1=0	5.500	.000
(RAT022)	CONFIGURATION 6 ADEN FLAP DELF1=15	5.500	.000
(RAT027)	CONFIGURATION 7 ADEN FLAP DELF1=30	5.500	.000

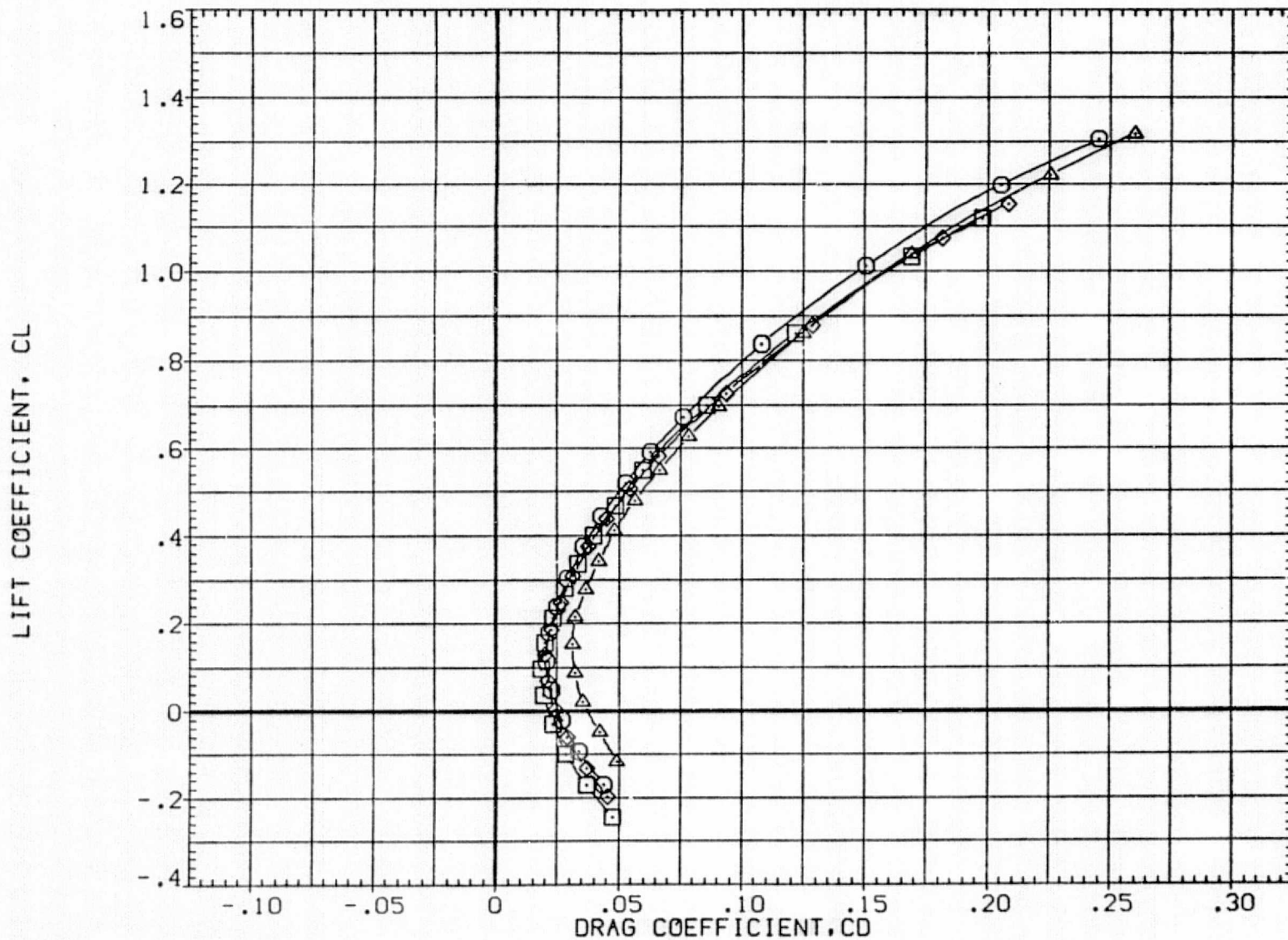

FIG. 14 FLAP EFFECTS WITH NO BLOWING

(A) MACH = .70

DATA SET SYMBOL	CONFIGURATION DESCRIPTION
(RAT007)	○ CONFIGURATION 3 LEADING EDGE CAMBERED
(RAT017)	◇ CONFIGURATION 5 ADEN FLAP DELF1=0
(RAT022)	□ CONFIGURATION 6 ADEN FLAP DELF1=15
(RAT027)	△ CONFIGURATION 7 ADEN FLAP DELF1=30

RN/L	CTG
5.500	.000
5.500	.000
5.500	.000
5.500	.000

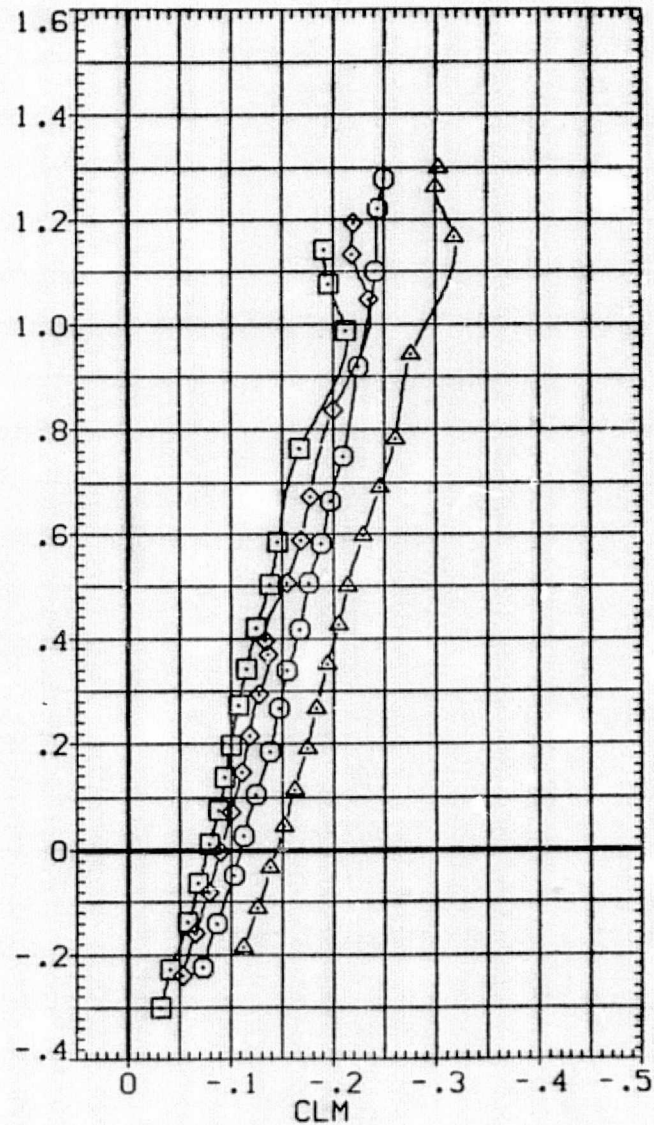
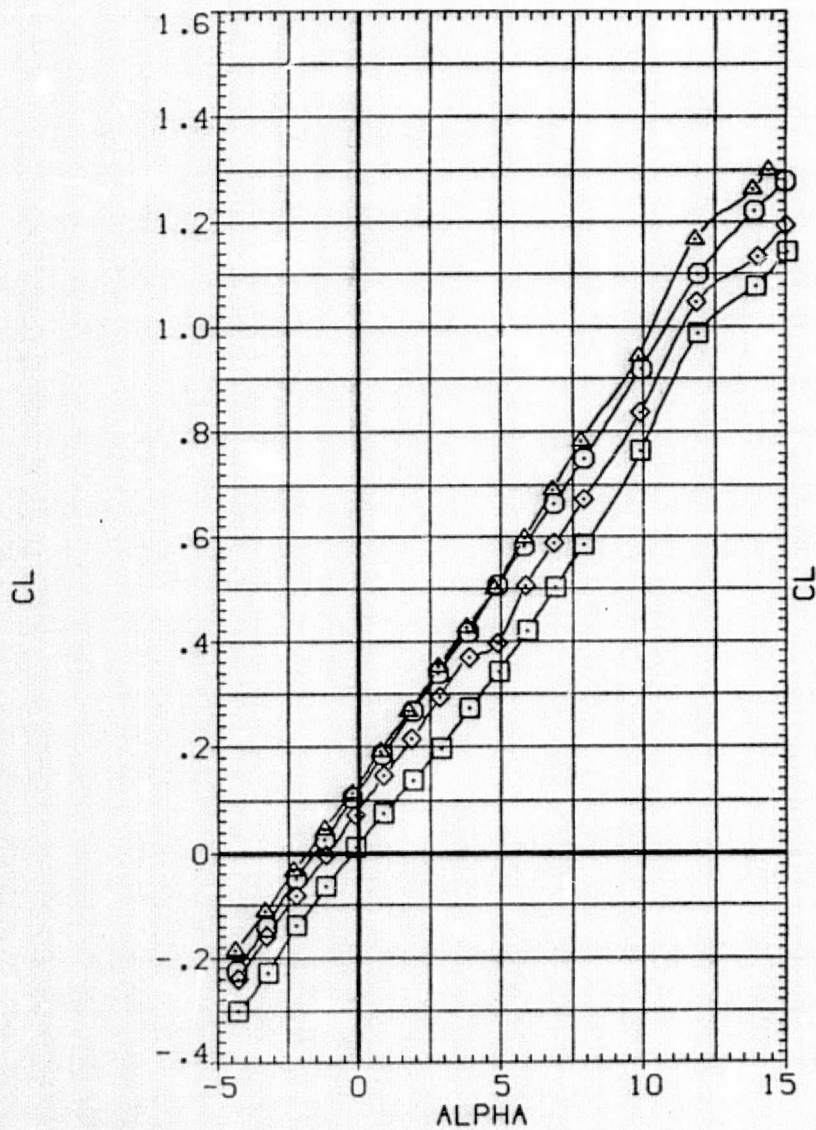

FIG. 14 FLAP EFFECTS WITH NO BLOWING
(B)MACH = .90

DATA SET SYMBOL	CONFIGURATION DESCRIPTION	RN/L	CTG
(RAT007)	CONFIGURATION 3 LEADING EDGE CAMBERED	5.500	.000
(RAT017)	CONFIGURATION 5 ADEN FLAP DELF1=0	5.500	.000
(RAT022)	CONFIGURATION 6 ADEN FLAP DELF1=15	5.500	.000
(RAT027)	CONFIGURATION 7 ADEN FLAP DELF1=30	5.500	.000

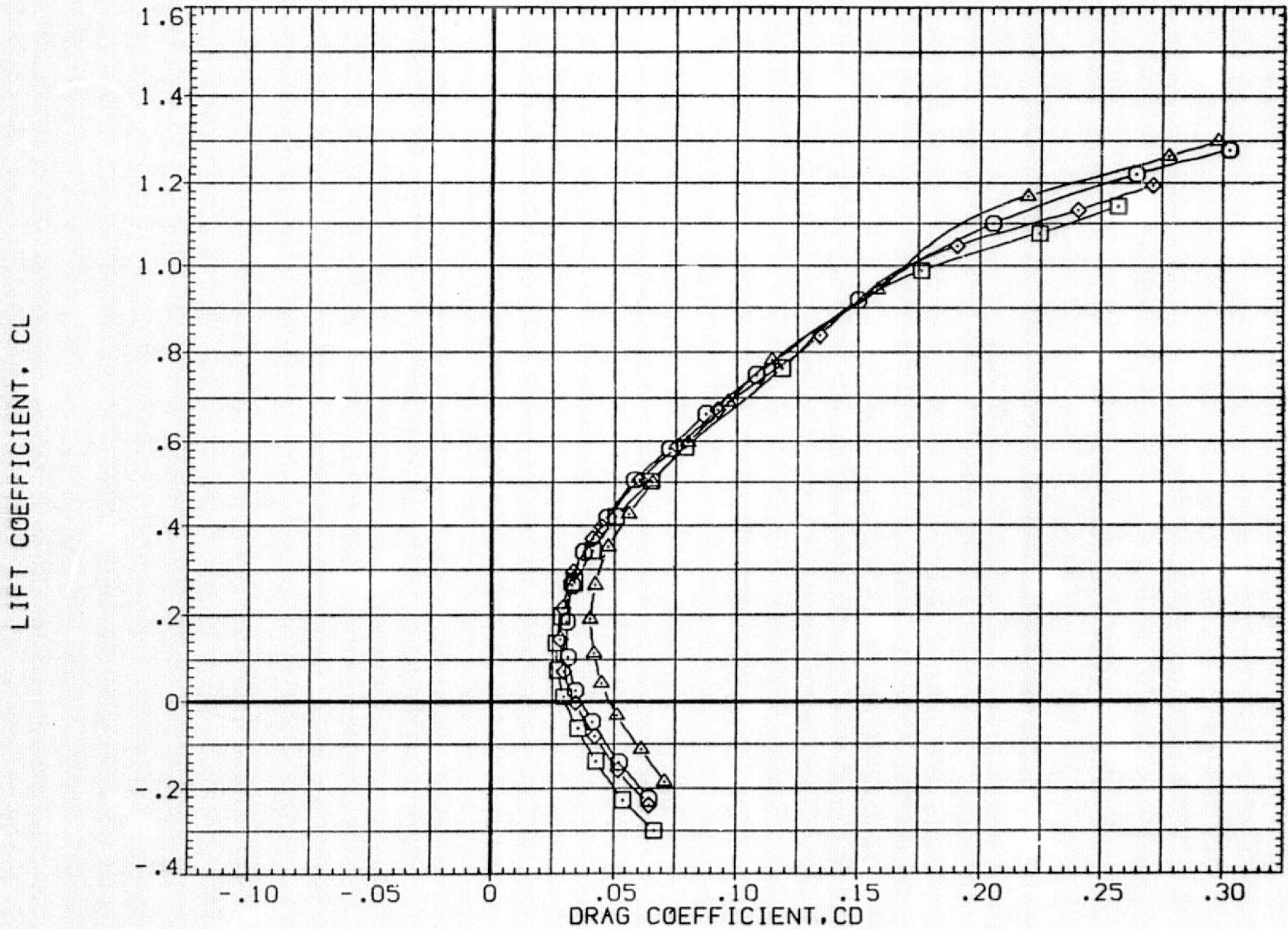

FIG. 14 FLAP EFFECTS WITH NO BLOWING

(B)MACH = .90

DATA SET SYMBOL	CONFIGURATION	DESCRIPTION
(RAT007)	○	CONFIGURATION 3 LEADING EDGE CAMBERED
(RAT017)	□	CONFIGURATION 5 ADEN FLAP DELFI=0
(RAT022)	◇	CONFIGURATION 6 ADEN FLAP DELFI=15

RN/L	CTG
5.500	.000
5.500	.000
5.500	.000

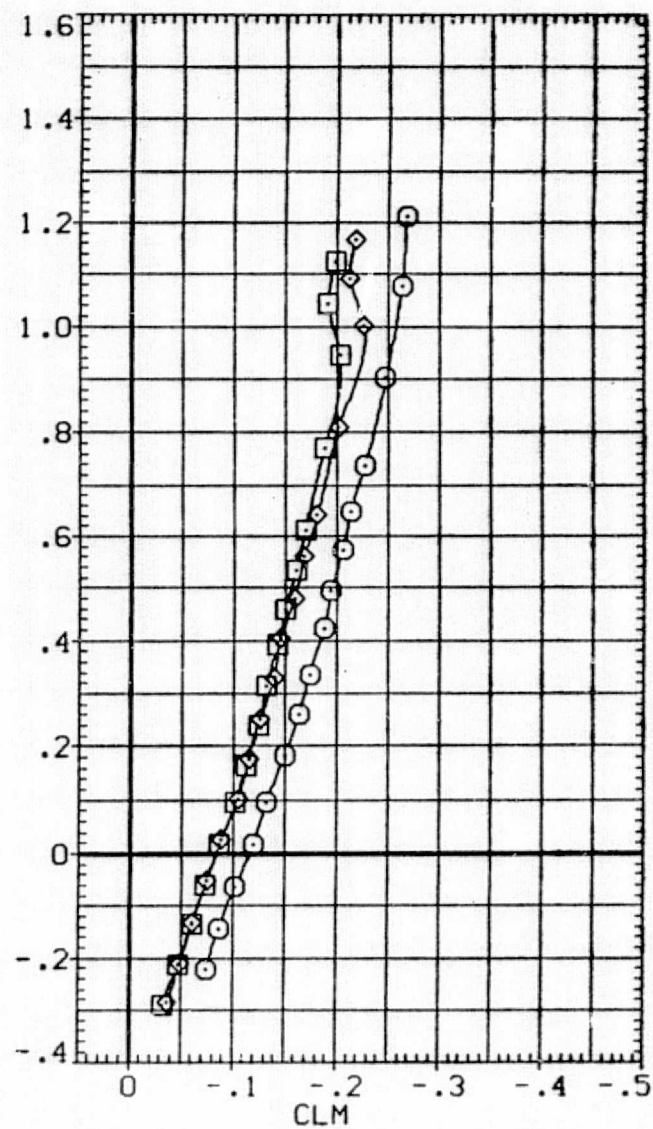
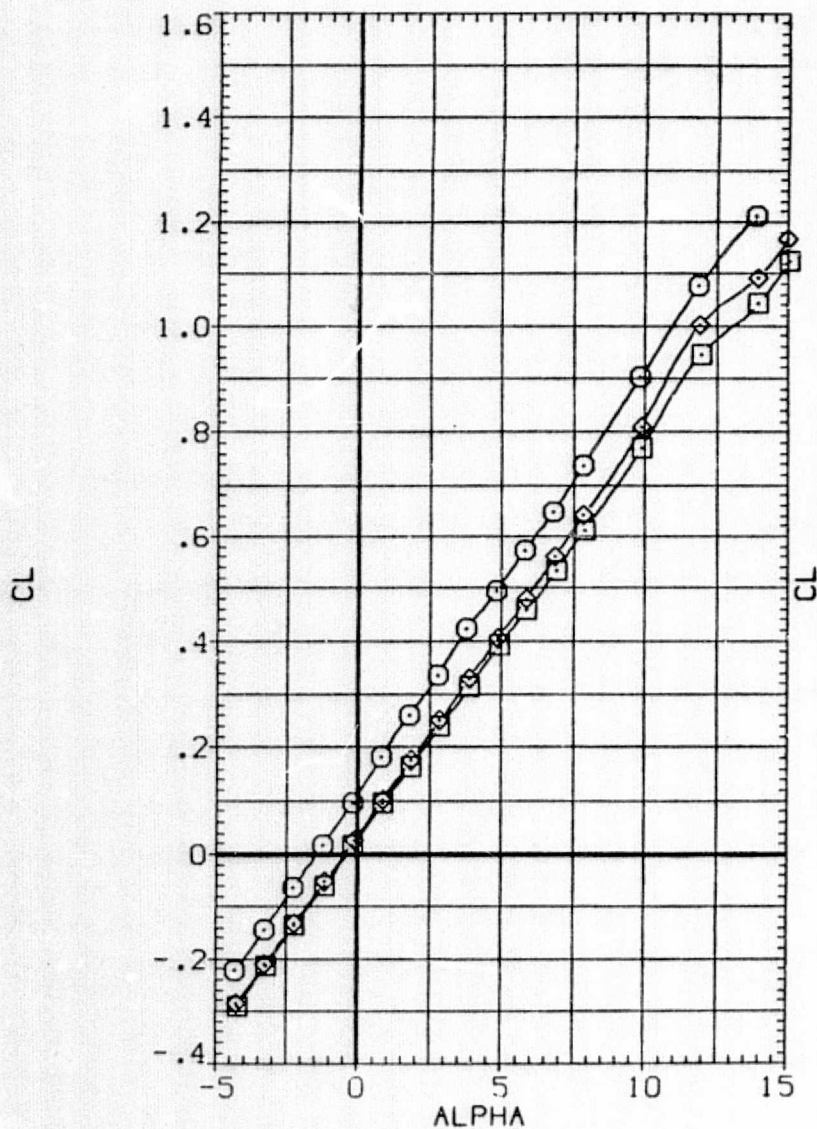

FIG. 14 FLAP EFFECTS WITH NO BLOWING

(A) MACH = .95

(RAT007)	○	CONFIGURATION 3	LEADING EDGE CAMBERED	5.500	.000
(RAT017)	□	CONFIGURATION 5	ADEN FLAP DELFI=0	5.500	.000
(RAT022)	◇	CONFIGURATION 6	ADEN FLAP DELFI=15	5.500	.000

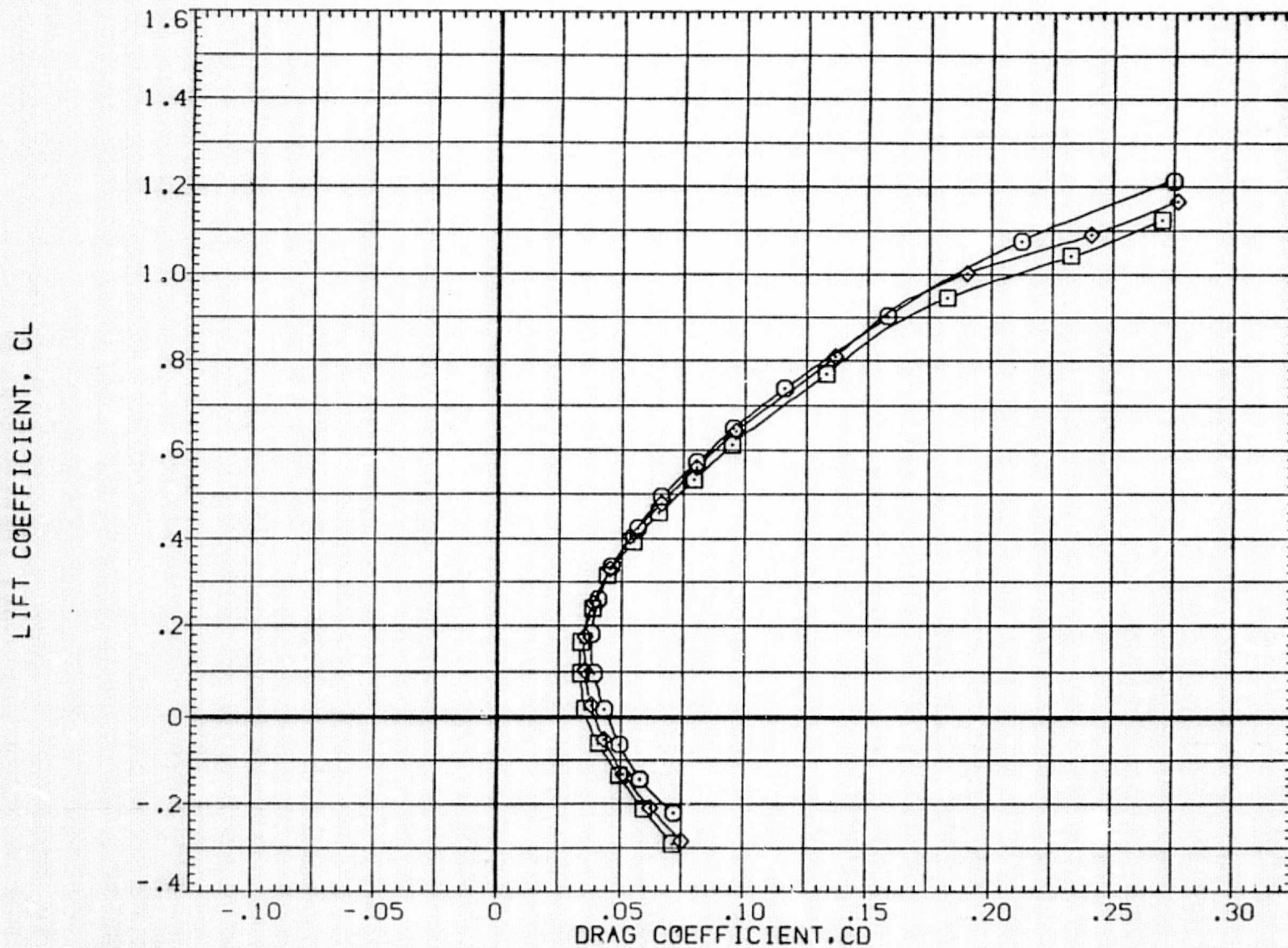

FIG. 14 FLAP EFFECTS WITH NO BLOWING
 (A) MACH = .95

DATA SET	SYMBOL	CONFIGURATION	DESCRIPTION
(RAT008)	○	CONFIGURATION 3	LEADING EDGE CAMBERED
(RAT020)	□	CONFIGURATION 5	ADEN FLAP DELF1=0
(RAT025)	◇	CONFIGURATION 6	ADEN FLAP DELF1=15
(RAT030)	△	CONFIGURATION 7	ADEN FLAP DELF1=30

RN/L	CTG
5.500	.120
5.500	.120
5.500	.120
5.500	.120

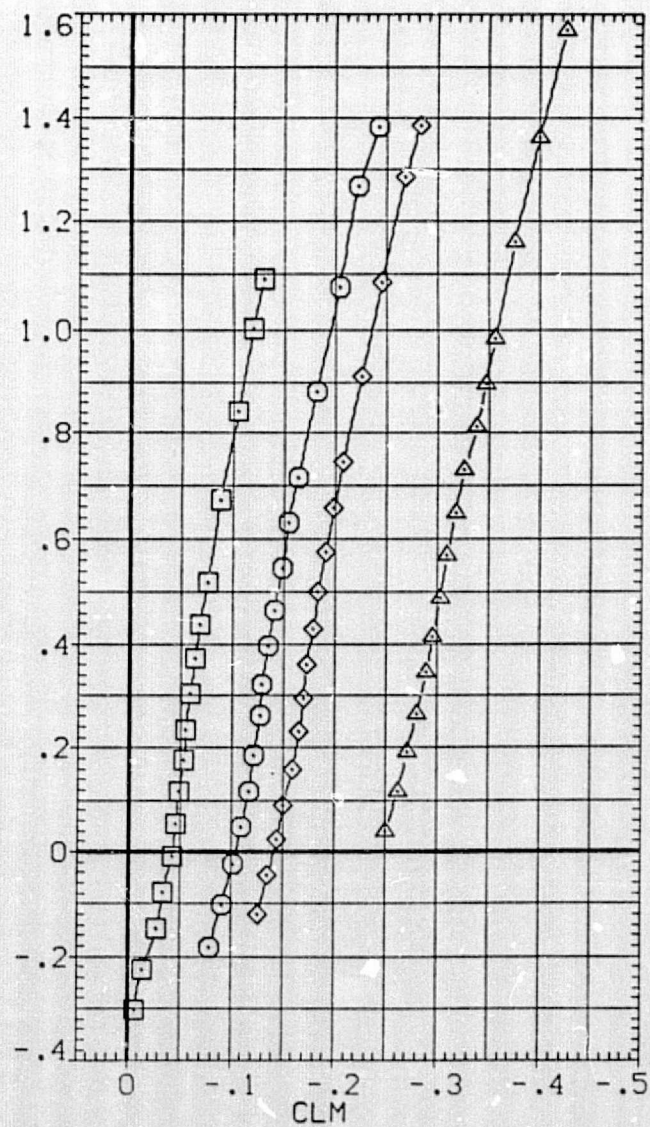
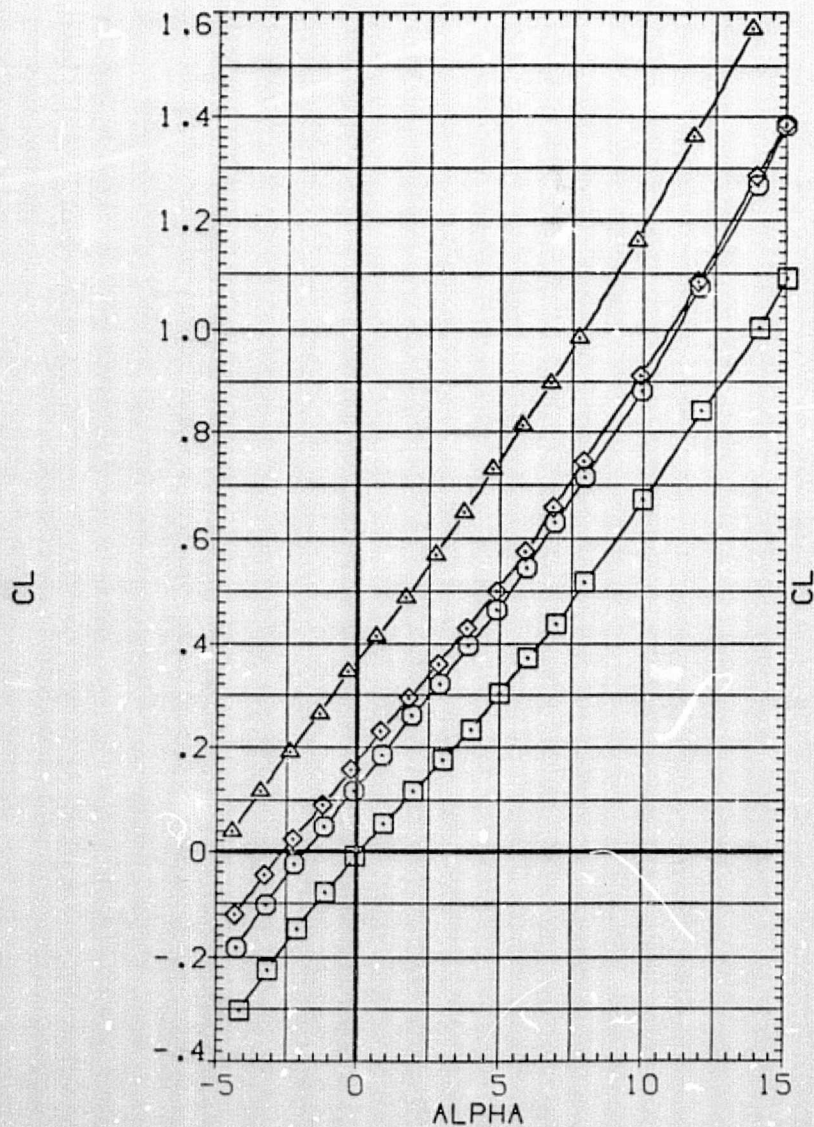

FIG. 14 FLAP EFFECTS WITH MAXIMUM BLOWING

DATA SET SYMBOL	CONFIGURATION	DESCRIPTION	RN/L	CTG
(RAT008)	○	CONFIGURATION 3	5.500	.120
(RAT020)	◇	CONFIGURATION 5	5.500	.120
(RAT025)	□	CONFIGURATION 6	5.500	.120
(RAT030)	△	CONFIGURATION 7	5.500	.120

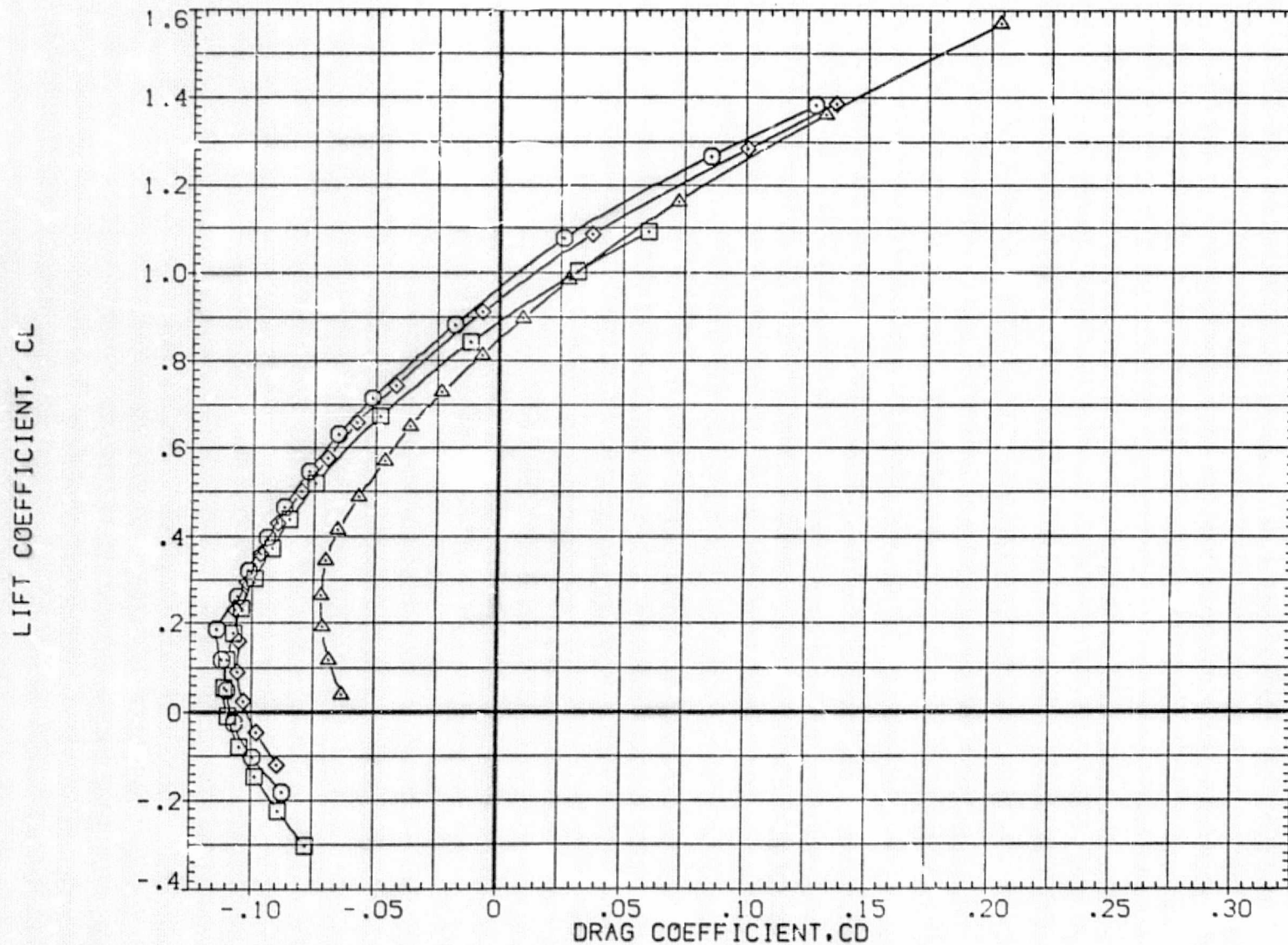

FIG. 14 FLAP EFFECTS WITH MAXIMUM BLOWING

(A) MACH = .70

DATA SET SYMBOL	CONFIGURATION	DESCRIPTION
(RAT008)	○	CONFIGURATION 3 LEADING EDGE CAMBERED
(RAT020)	□	CONFIGURATION 5 ADEN FLAP DELFI=0
(RAT025)	◇	CONFIGURATION 6 ADEN FLAP DELFI=15
(RAT030)	△	CONFIGURATION 7 ADEN FLAP DELFI=30

RN/L	CTG
5.500	.120
5.500	.120
5.500	.120
5.500	.120

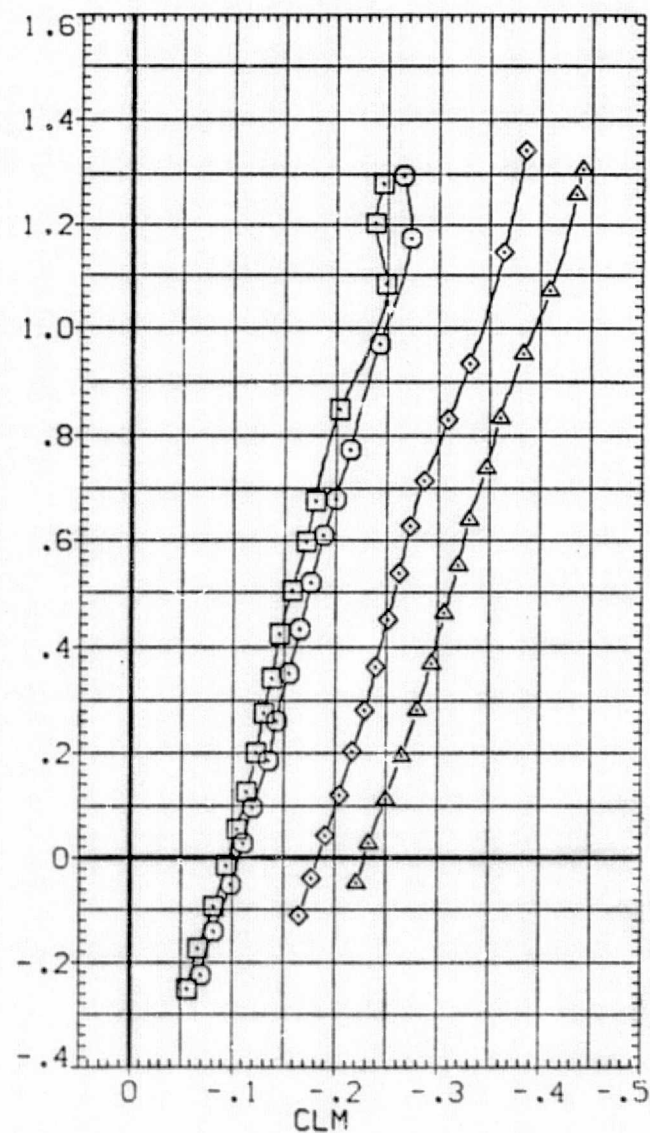
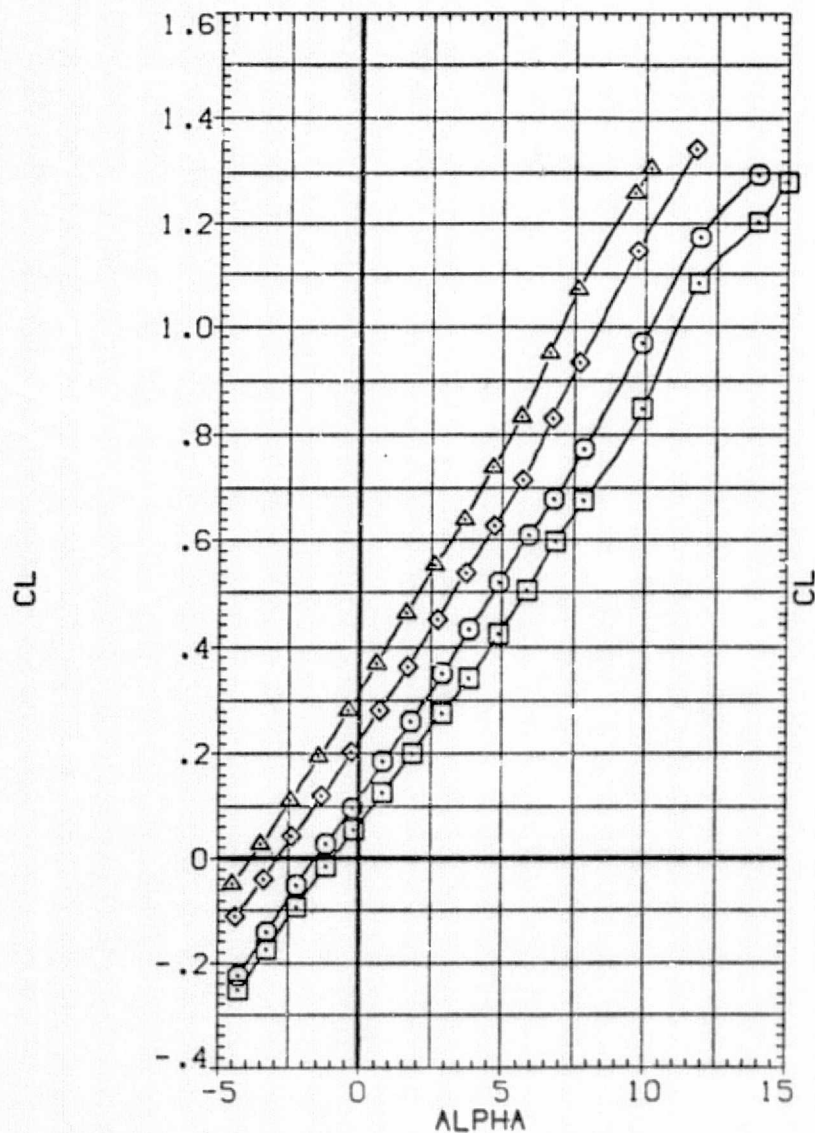

FIG. 14 FLAP EFFECTS WITH MAXIMUM BLOWING

(B)MACH = .90

DATA SET SYMBOL	CONFIGURATION DESCRIPTION	RN/L	CTG
(RAT008)	CONFIGURATION 3 LEADING EDGE CAMBERED	5.500	.120
(RAT020)	CONFIGURATION 5 ADEN FLAP DELFI=0	5.500	.120
(RAT025)	CONFIGURATION 6 ADEN FLAP DELFI=15	5.500	.120
(RAT030)	CONFIGURATION 7 ADEN FLAP DELFI=30	5.500	.120

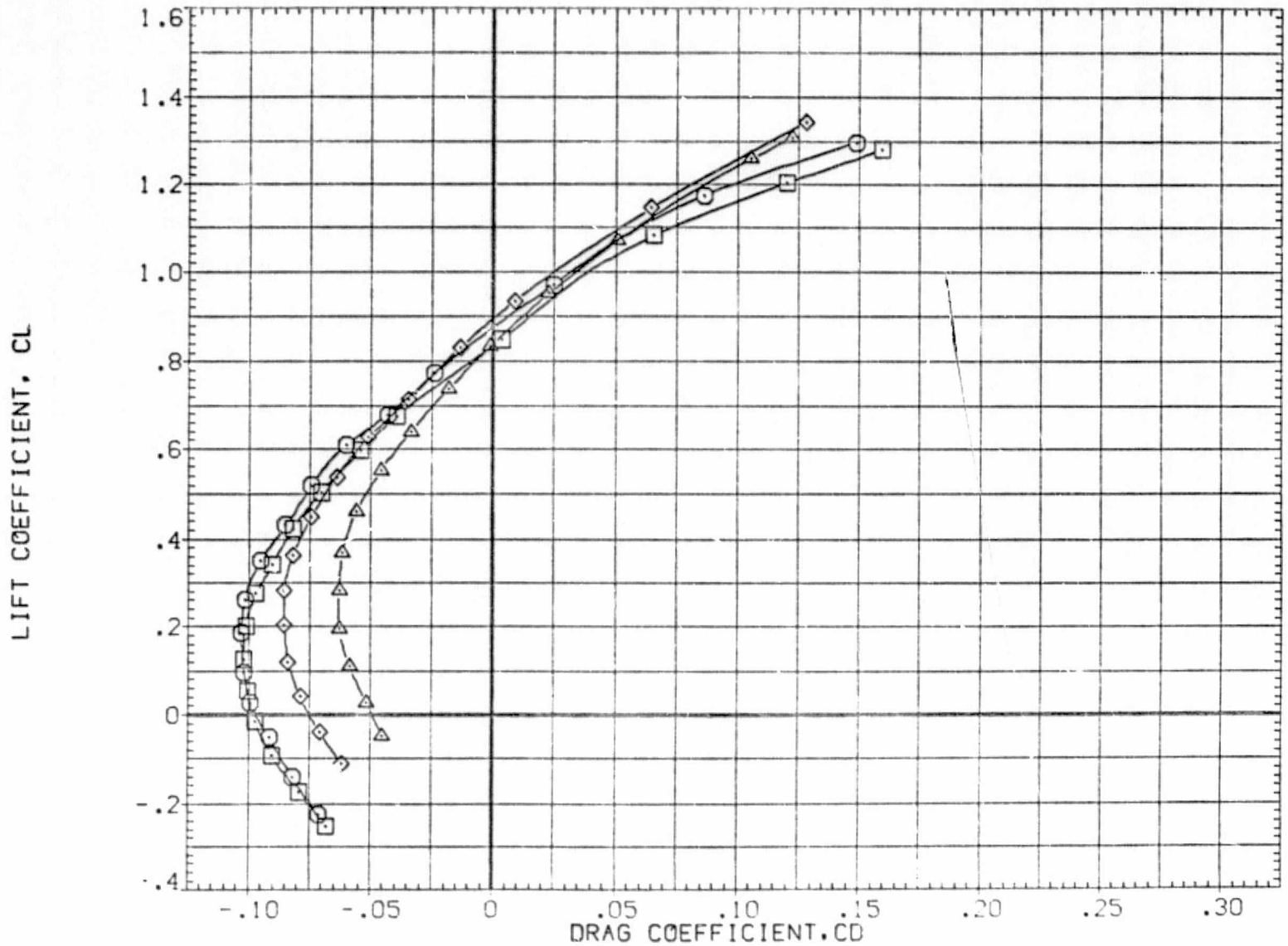

FIG. 14 FLAP EFFECTS WITH MAXIMUM BLOWING

(B)MACH = .90

DATA SET SYMBOL	CONFIGURATION	DESCRIPTION
(RAT008)	□	CONFIGURATION 3 LEADING EDGE CAMBERED
(RAT020)	○	CONFIGURATION 5 ADEN FLAP DELFI=0
(RAT025)	◇	CONFIGURATION 6 ADEN FLAP DELFI=15

RN/L	CTG
5.500	.120
5.500	.120
5.500	.120

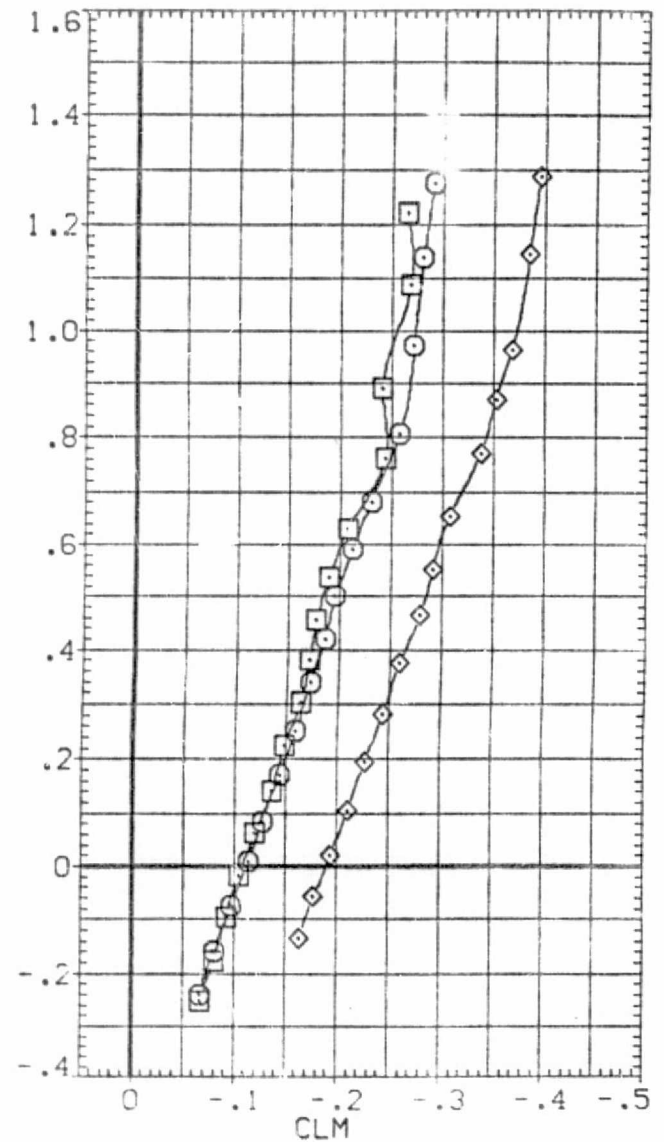
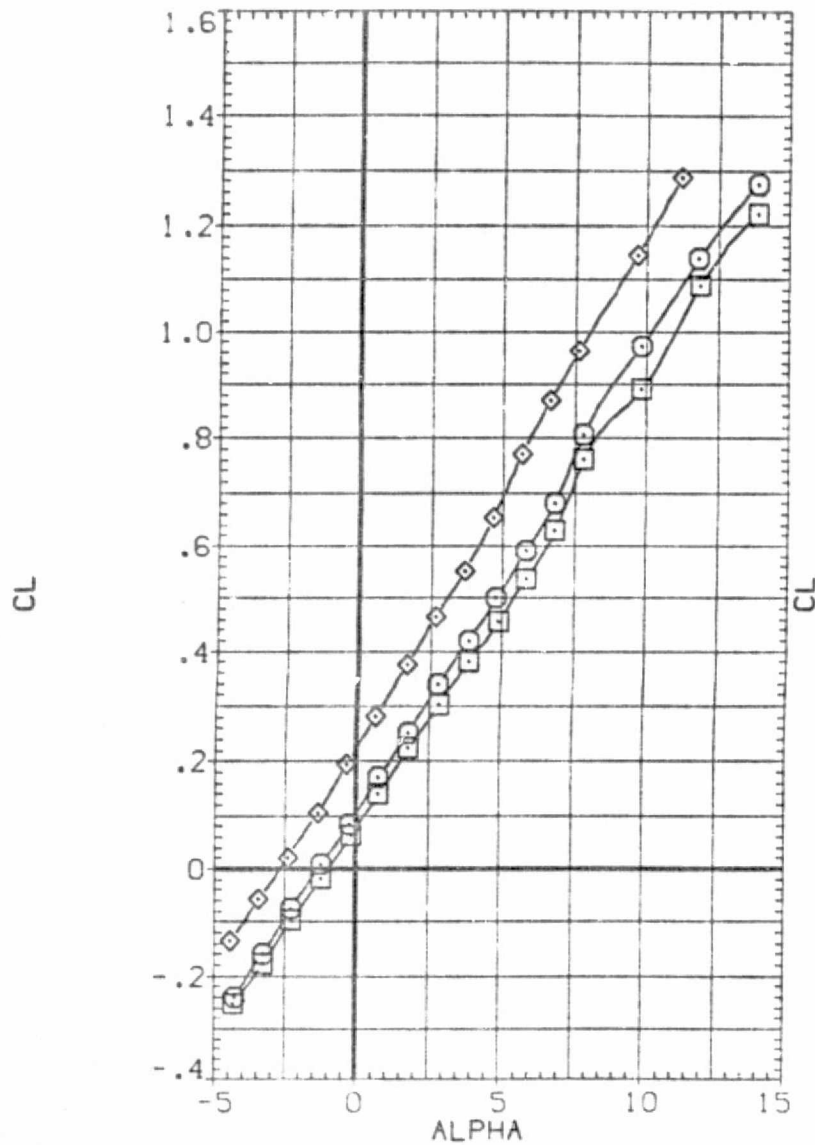

FIG. 14 FLAP EFFECTS WITH MAXIMUM BLOWING

(A) MACH = .95

DATA SET SYMBOL	CONFIGURATION DESCRIPTION	RN/L	CTG
(RAT008)	CONFIGURATION 3 LEADING EDGE CAMBERED	5.500	.120
(RAT020)	CONFIGURATION 5 ADEN FLAP DELFI=0	5.500	.120
(RAT025)	CONFIGURATION 6 ADEN FLAP DELFI=15	5.500	.120

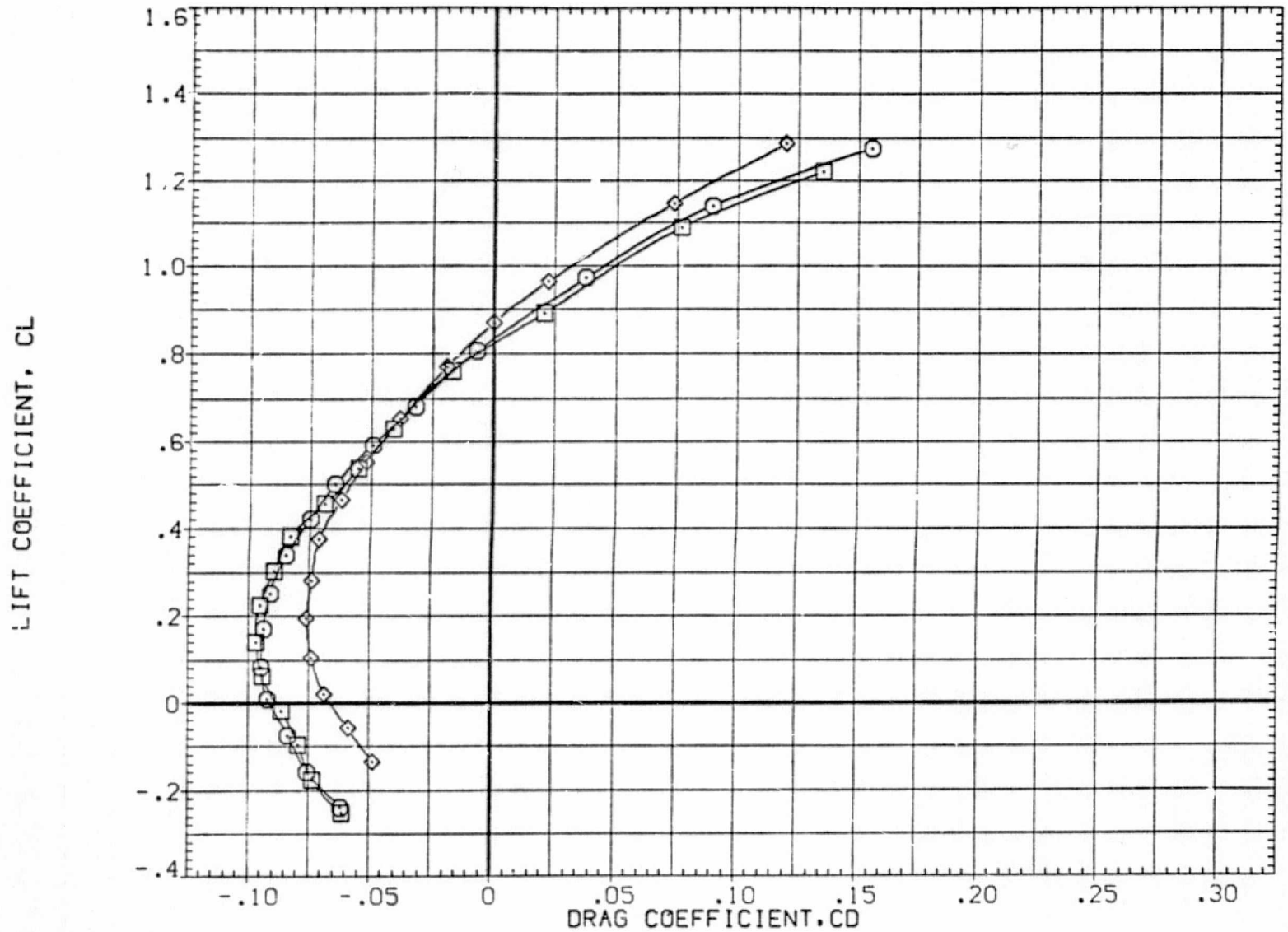

FIG. 14 FLAP EFFECTS WITH MAXIMUM BLOWING

(A) MACH = .95

SYMBOL	ALPHA	ZY/B	MACH
○	-.144	.250	.895
		.450	
		.650	
		.800	

PARAMETRIC VALUES		
BETA	.000	DELFI .000
DELFO	.000	DELFM .000

DATA SET	SYMBOL	CONFIGURATION DESCRIPTION
(RATU03)	OPEN	CONFIGURATION 2 CL DESIGN=0.2
(ZATL03)	FLAGGED	CONFIGURATION 2 CL DESIGN=0.2

	RN/L	CTG
UP SURF.	5.5000	.0000
LOW SURF.	5.5000	.0000

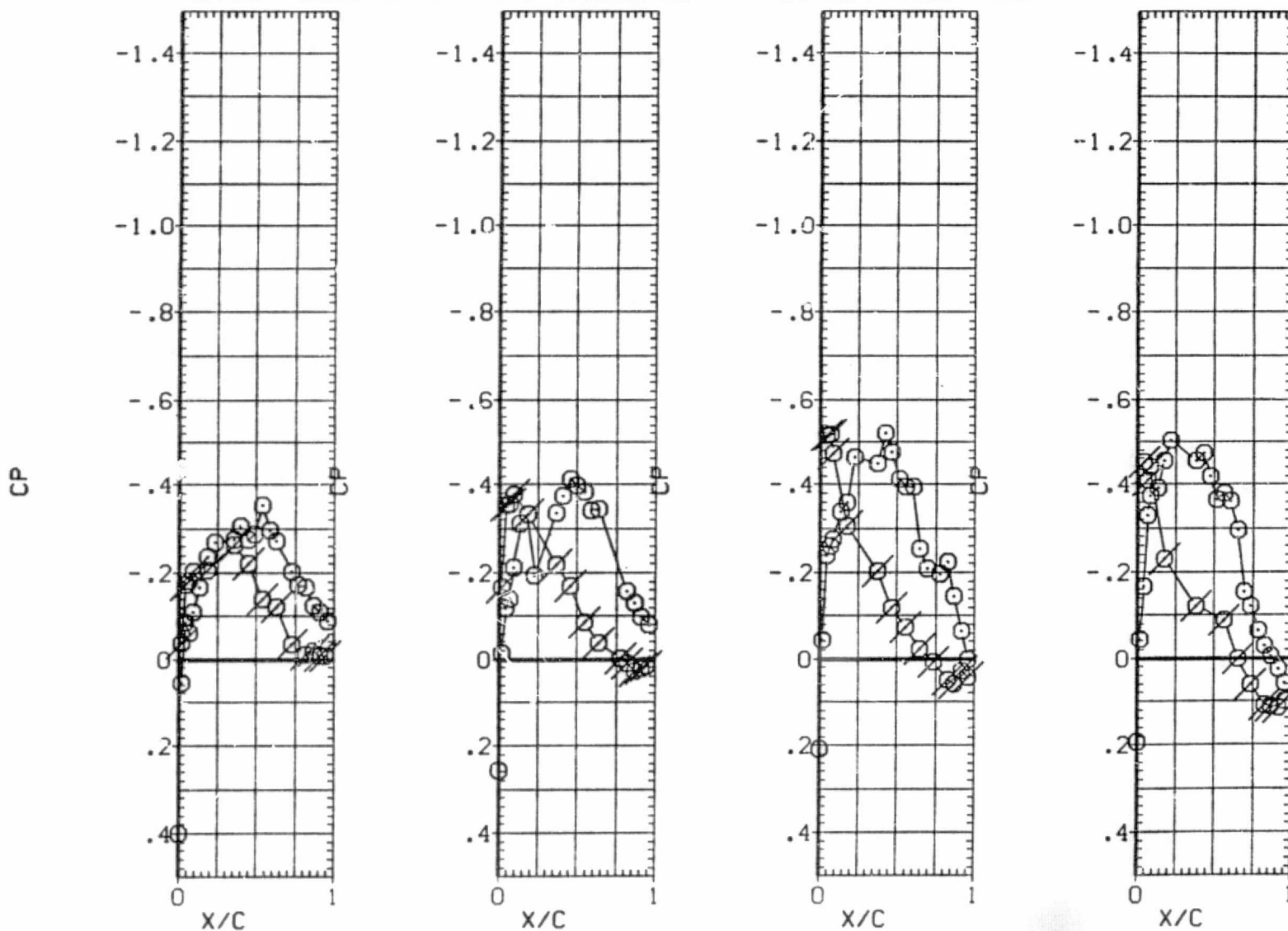

FIG. 15 PRESSURE DISTRIBUTIONS OVER CONFIGURATION 2 AT CTG=0.0

SYMBOL	ALPHA	2Y/B	MACH
○	3.849	.250	.895
		.450	
		.650	
		.800	

PARAMETRIC VALUES	
BETA	.000 DELFI .000
DELFO	.000 DELFM .000

DATA SET	SYMBOL	CONFIGURATION DESCRIPTION
(RATU03)	OPEN	CONFIGURATION 2 CL DESIGN=0.2
(ZATL03)	FLAGGED	CONFIGURATION 2 CL DESIGN=0.2

	RN/L	CTG
UP SURF.	5.5000	.0000
LOW SURF.	5.5000	.0000

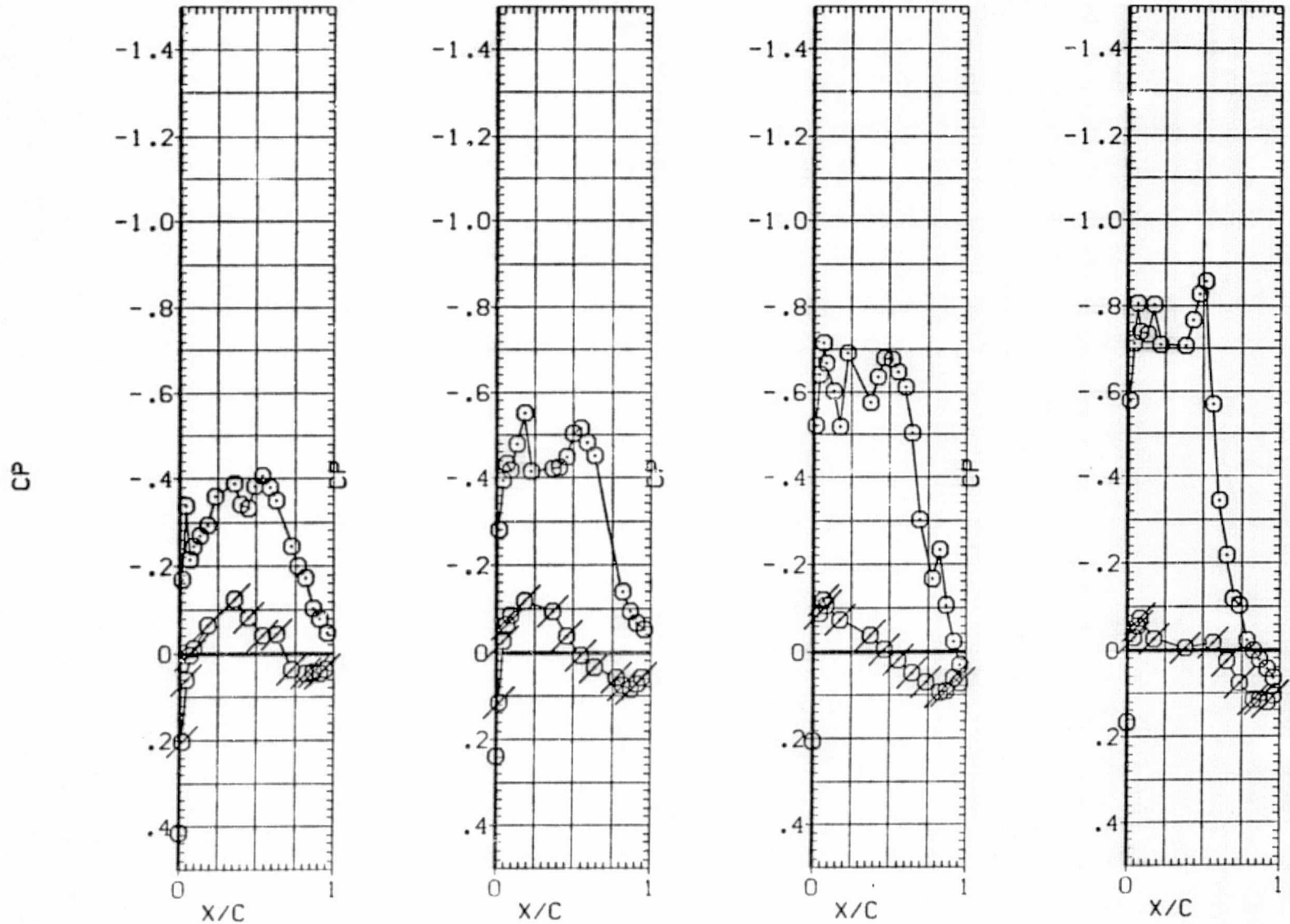

FIG. 15 PRESSURE DISTRIBUTIONS OVER CONFIGURATION 2 AT CTG=0.0

SYMBOL	ALPHA	2Y/B	MACH
○	7.810	.250	.895
		.450	
		.650	
		.800	

PARAMETRIC VALUES	
BETA	.000 DELFI .000
DELFO	.000 DELFM .000

DATA SET	SYMBOL	CONFIGURATION DESCRIPTION
(RATU03)	OPEN	CONFIGURATION 2 CL DESIGN=0.2
(ZATL03)	FLAGGED	CONFIGURATION 2 CL DESIGN=0.2

	RN/L	CTG
UP SURF.	5.5000	.0000
LOW SURF.	5.5000	.0000

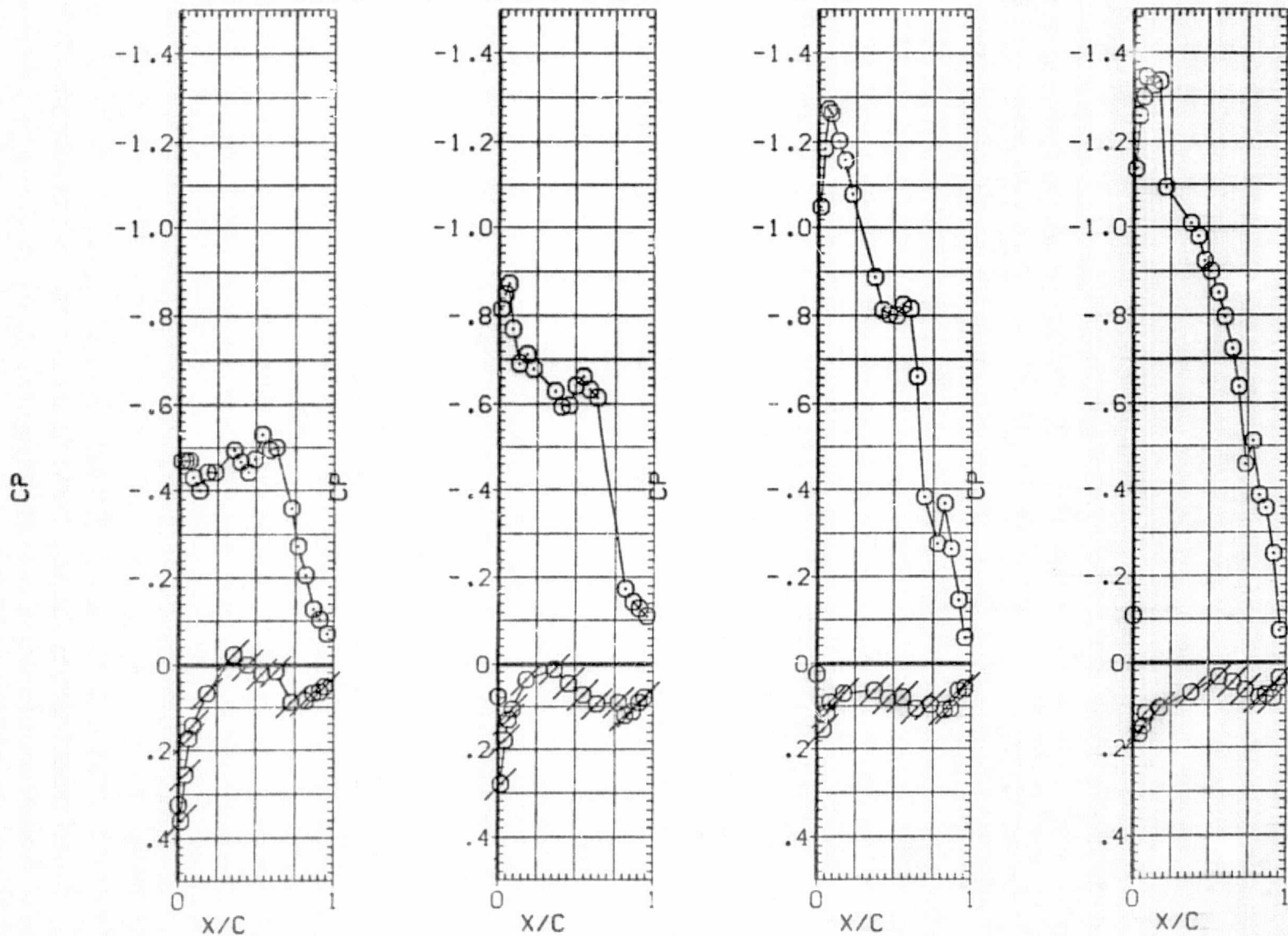

FIG. 15 PRESSURE DISTRIBUTIONS OVER CONFIGURATION 2 AT CTG=0.0

SYMBOL	ALPHA	2Y/B	MACH
○	11.861	.250	.895
		.450	
		.650	
		.800	

PARAMETRIC VALUES			
BETA	.000	DELFI	.000
DELFO	.000	DELFM	.000

DATA SET	SYMBOL	CONFIGURATION DESCRIPTION
(RATU03)	OPEN	CONFIGURATION 2 CL DESIGN=0.2
(ZATL03)	FLAGGED	CONFIGURATION 2 CL DESIGN=0.2

	RN/L	CTG
UP SURF.	5.5000	.0000
LOW SURF.	5.5000	.0000

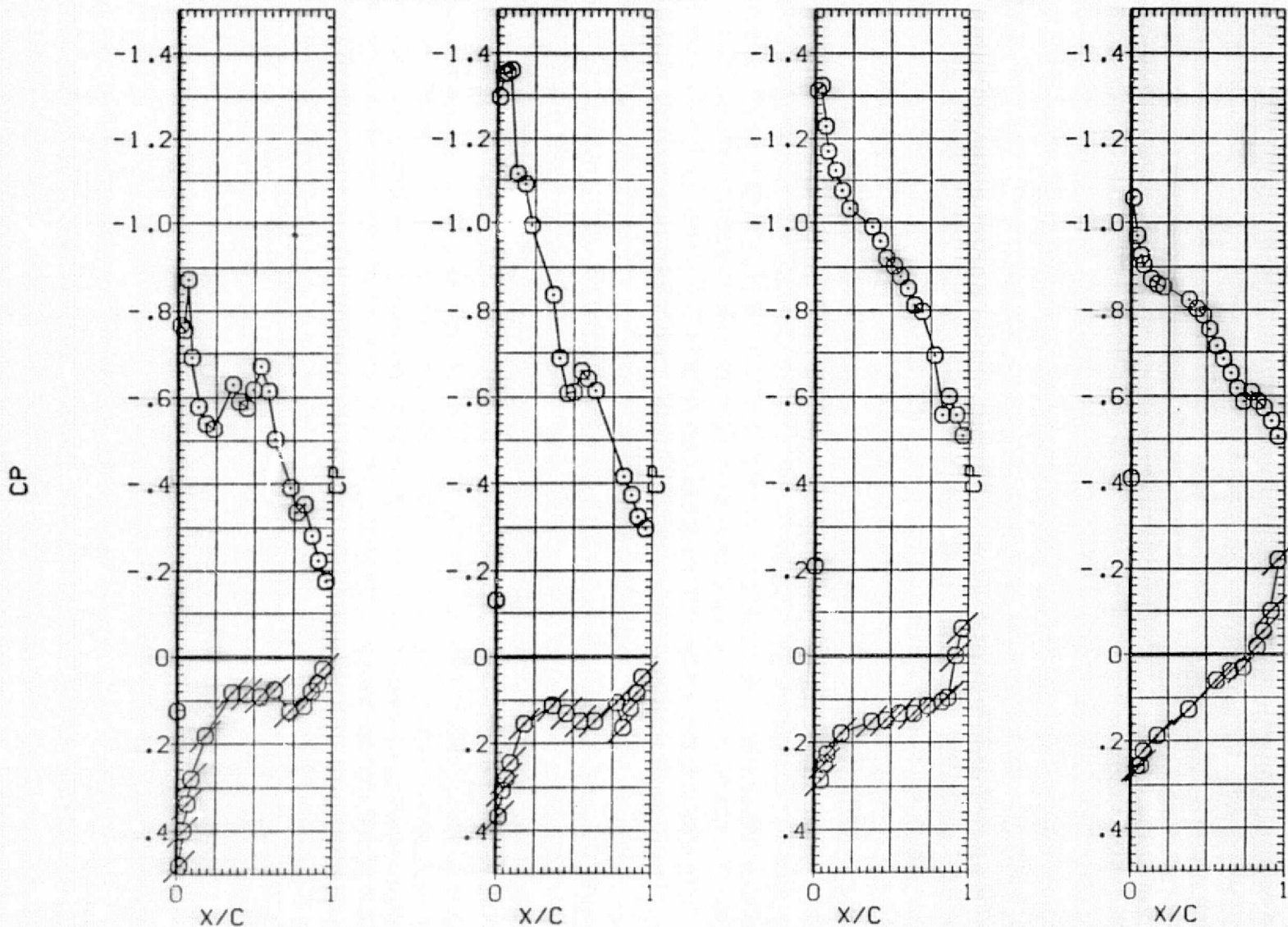

FIG. 15 PRESSURE DISTRIBUTIONS OVER CONFIGURATION 2 AT CTG=0.0

SYMBOL	ALPHA	2Y/B	MACH
○	-.138	.250	.902
		.450	
		.650	
		.800	

PARAMETRIC VALUES			
BETA	.000	DELFI	.000
DELFO	.000	DELFM	.000

DATA SET	SYMBOL	CONFIGURATION DESCRIPTION
(RATUD6)	OPEN	CONFIGURATION 2 CL DESIGN=0.2
(ZATL06)	FLAGGED	CONFIGURATION 2 CL DESIGN=0.2

	RN/L	CTG
UP SURF.	5.5000	.1200
LOW SURF.	5.5000	.1200

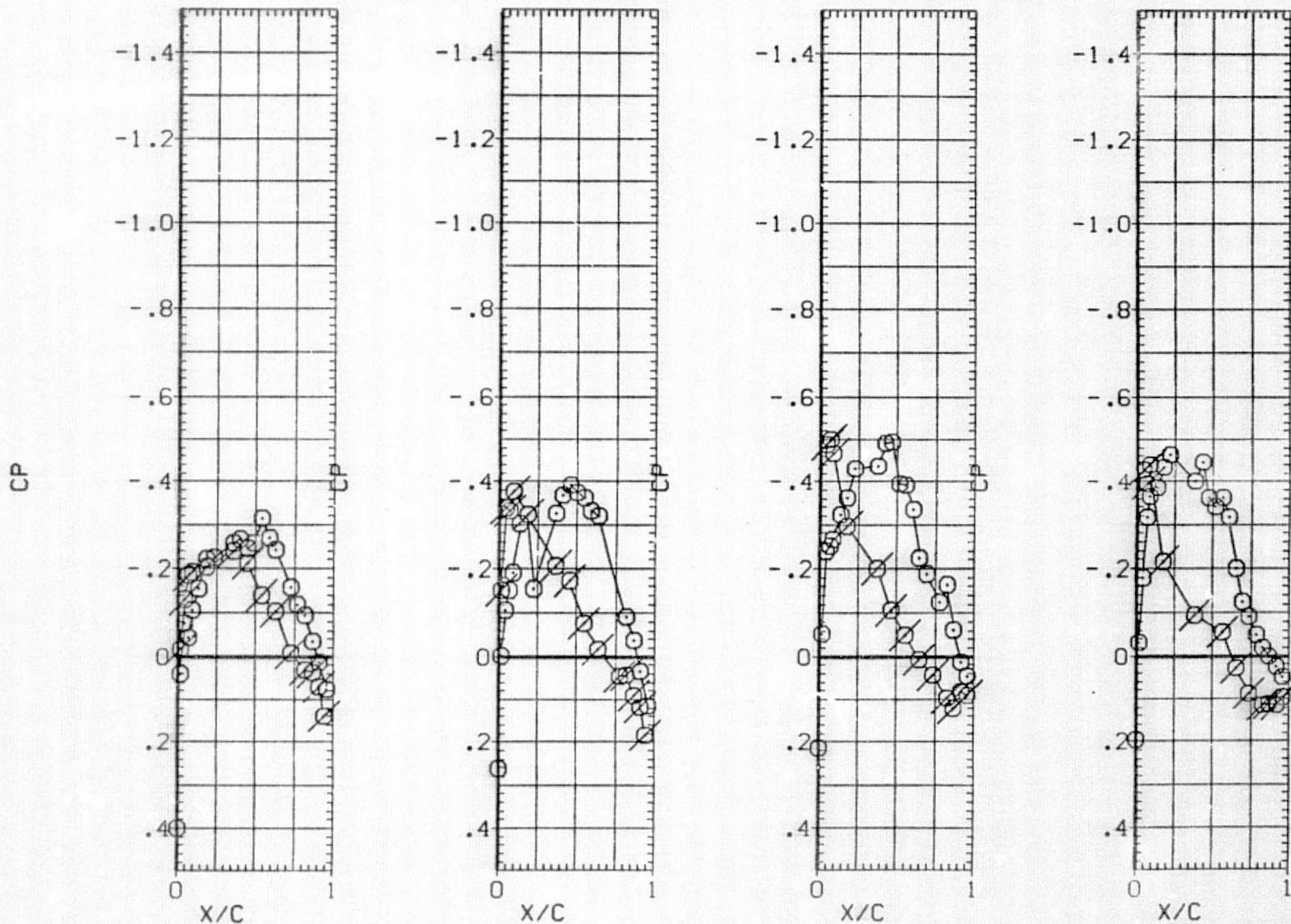

FIG. 15 PRESSURE DISTRIBUTIONS OVER CONFIGURATION 2 AT CTG=0.12

SYMBOL	ALPHA	2Y/B	MACH
○	3.852	.250	.902
		.450	
		.650	
		.800	

PARAMETRIC VALUES			
BETA	.000	DELFI	.000
DELFO	.000	DELFH	.000

DATA SET	SYMBOL	CONFIGURATION DESCRIPTION
(RATU06)	OPEN	CONFIGURATION 2 CL DESIGN=0.2
(ZATL06)	FLAGGED	CONFIGURATION 2 CL DESIGN=0.2

	RN/L	CTG
UP SURF.	5.5000	.1200
LOW SURF.	5.5000	.1200

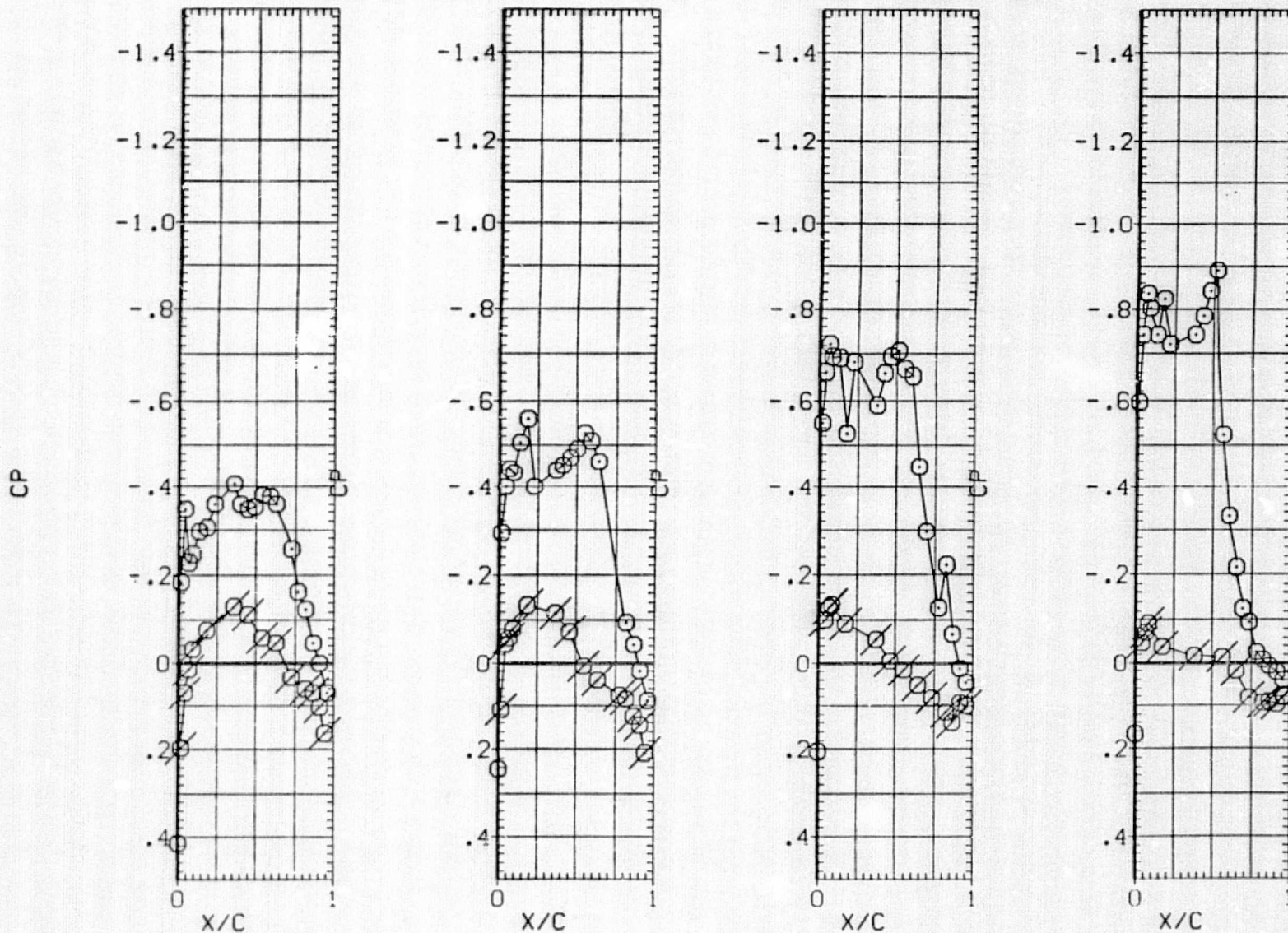

FIG. 15 PRESSURE DISTRIBUTIONS OVER CONFIGURATION 2 AT CTG=0.12

SYMBOL	ALPHA	2Y/B	MACH
○	7.818	.250	.902
		.450	
		.650	
		.800	

PARAMETRIC VALUES			
BETA	.000	DELFI	.000
DELFO	.000	DELFH	.000

DATA SET	SYMBOL	CONFIGURATION DESCRIPTION
(RATU06)	OPEN	CONFIGURATION 2 CL DESIGN=0.2
(ZATL06)	FLAGGED	CONFIGURATION 2 CL DESIGN=0.2

	RN/L	CTG
UP SURF.	5.5000	.1200
LOW SURF.	5.5000	.1200

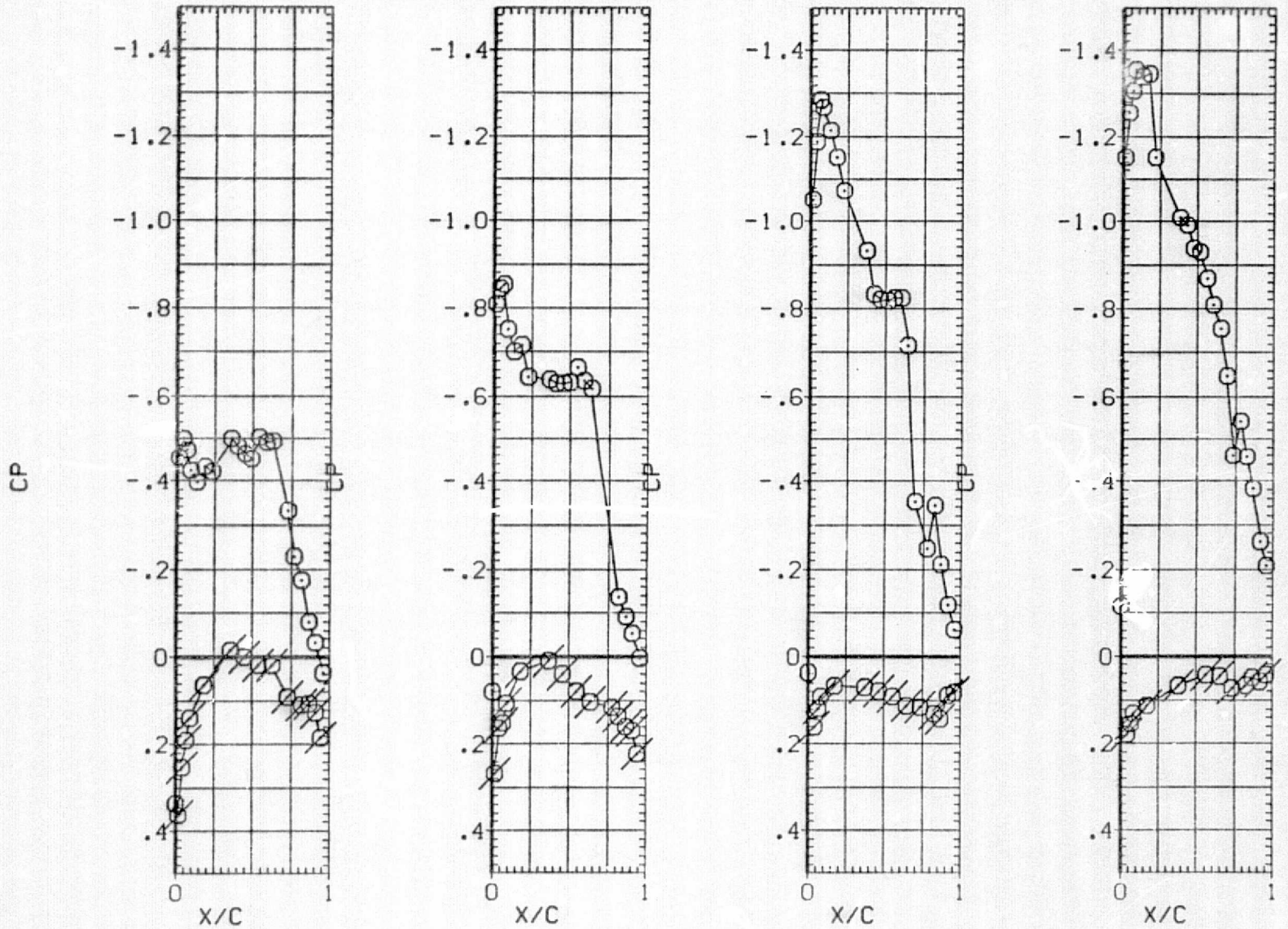

FIG. 15 PRESSURE DISTRIBUTIONS OVER CONFIGURATION 2 AT CTG=0.12

SYMBOL	ALPHA	2Y/B	MACH
○	11.841	.250	.902
		.450	
		.650	
		.800	

PARAMETRIC VALUES			
BETA	.000	DELFI	.000
DELFO	.000	DELFM	.000

DATA SET	SYMBOL	CONFIGURATION DESCRIPTION
(RATLOG)	OPEN	CONFIGURATION 2 CL DESIGN=0.2
(ZATLOG)	FLAGGED	CONFIGURATION 2 CL DESIGN=0.2

	RN/L	CTG
UP SURF.	5.5000	.1200
LOW SURF.	5.5000	.1200

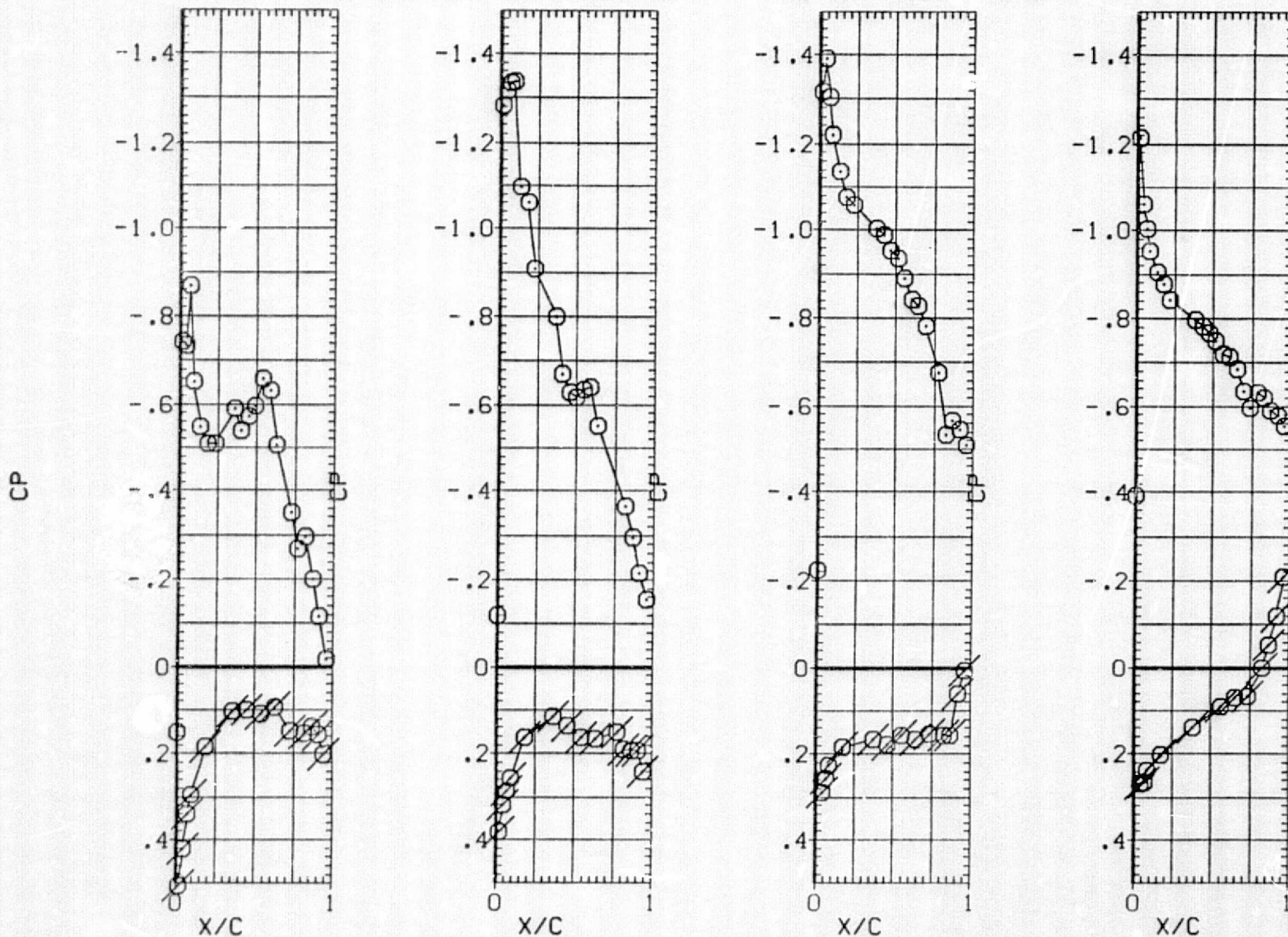

FIG. 15 PRESSURE DISTRIBUTIONS OVER CONFIGURATION 2 AT CTG=0.12

SYMBOL	ALPHA	ZY/B	MACH
○	-.234	.250	.899
		.450	
		.650	
		.800	

		PARAMETRIC VALUES	
BETA	.000	DELFI	.000
DELFO	.000	DELFM	8.000

DATA SET	SYMBOL	CONFIGURATION DESCRIPTION	RN/L	CTG
(RATU07)	OPEN	CONFIGURATION 3 LEADING EDGE CAMBERED UP SURF.	5.5000	.0000
(ZATL07)	FLAGGED	CONFIGURATION 3 LEADING EDGE CAMBERED LOW SURF.	5.5000	.0000

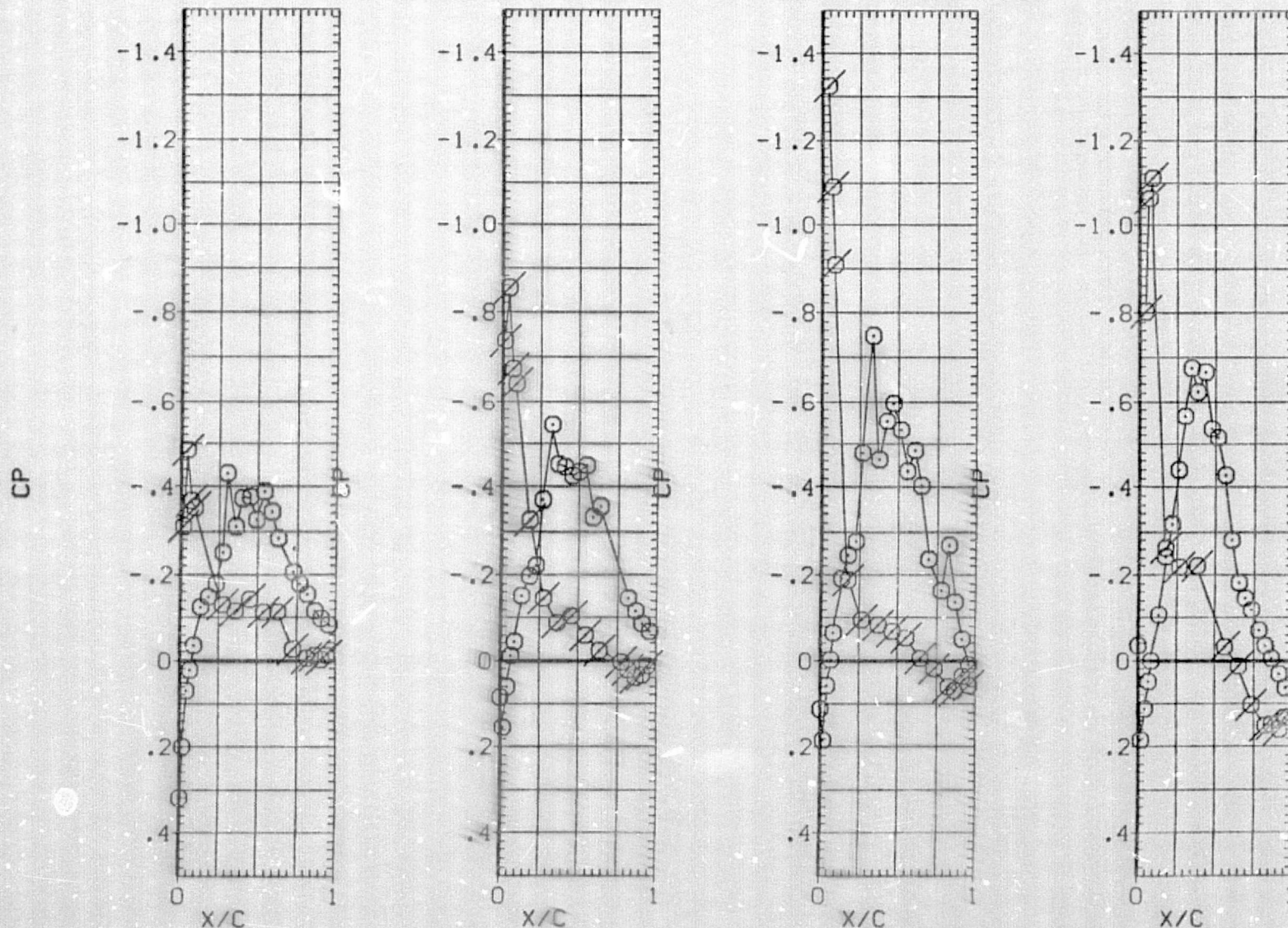

FIG. 15 PRESSURE DISTRIBUTIONS OVER CONFIGURATION 3 AT CTG=0.0

SYMBOL	ALPHA	ZY/B	MACH
○	3.816	.250	.899
		.450	
		.650	
		.800	

PARAMETRIC VALUES		
BETA	.000	DELFI .000
DELFO	.000	DELFM 8.000

DATA SET	SYMBOL	CONFIGURATION DESCRIPTION	RN/L	CTG
{RATU07}	OPEN	CONFIGURATION 3 LEADING EDGE CAMBERED UP SURF.	5.5000	.0000
{ZATL07}	FLAGGED	CONFIGURATION 3 LEADING EDGE CAMBERED LOW SURF.	5.5000	.0000

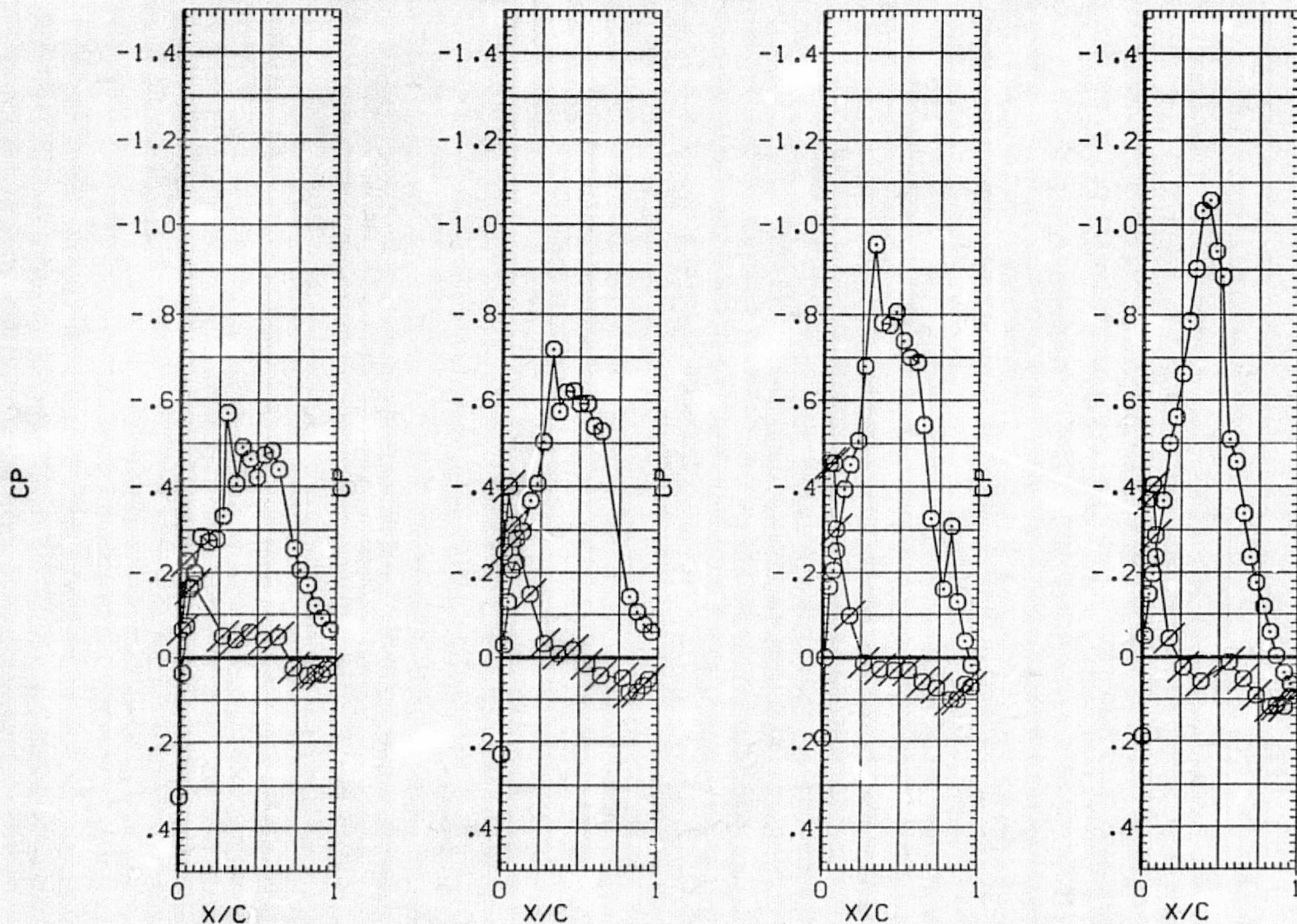

FIG. 15 PRESSURE DISTRIBUTIONS OVER CONFIGURATION 3 AT CTG=0.0

SYMBOL	ALPHA	2Y/B	MACH
○	7.878	.250	.899
		.450	
		.650	
		.800	

BETA	PARAMETRIC VALUES	
DELFO	.000	DELFI .000
	.000	DELFM 8.000

DATA SET	SYMBOL	CONFIGURATION DESCRIPTION	RN/L	CTG
(RATU07)	OPEN	CONFIGURATION 3 LEADING EDGE CAMBERED UP SURF.	5.5000	.0000
(ZATL07)	FLAGGED	CONFIGURATION 3 LEADING EDGE CAMBERED LOW SURF.	5.5000	.0000

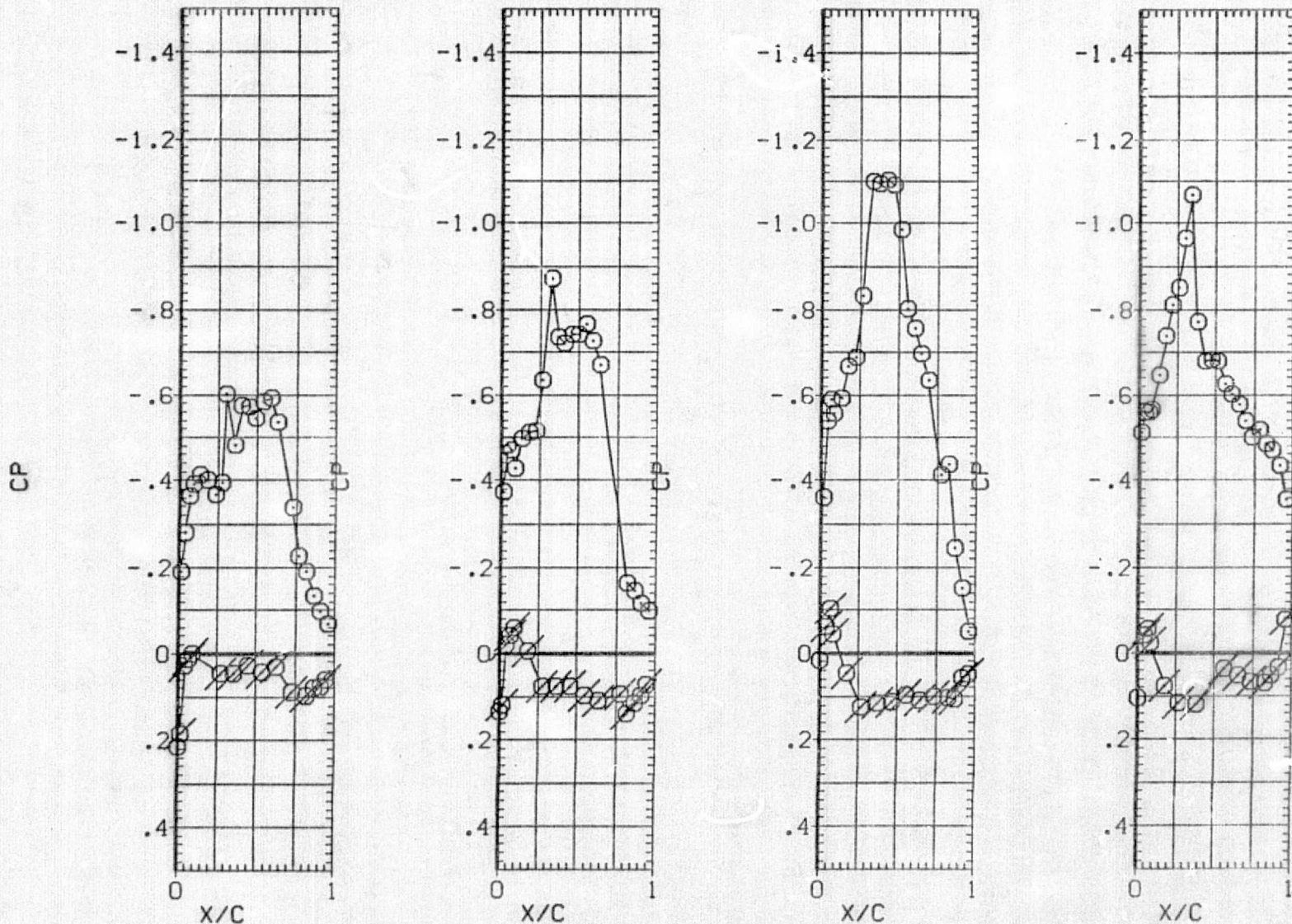

FIG. 15 PRESSURE DISTRIBUTIONS OVER CONFIGURATION 3 AT CTG=0.0

SYMBOL	ALPHA	2Y/B	MACH
○	11.914	.250	.899
		.450	
		.650	
		.800	

PARAMETRIC VALUES	
BETA	.000 DELFI .000
DELFO	.000 DELFM 8.000

DATA SET	SYMBOL	CONFIGURATION DESCRIPTION	RN/L	CTG
(RATU07)	OPEN	CONFIGURATION 3 LEADING EDGE CAMBERED UP SURF.	5.5000	.0000
(ZATL07)	FLAGGED	CONFIGURATION 3 LEADING EDGE CAMBERED LOW SURF.	5.5000	.0000

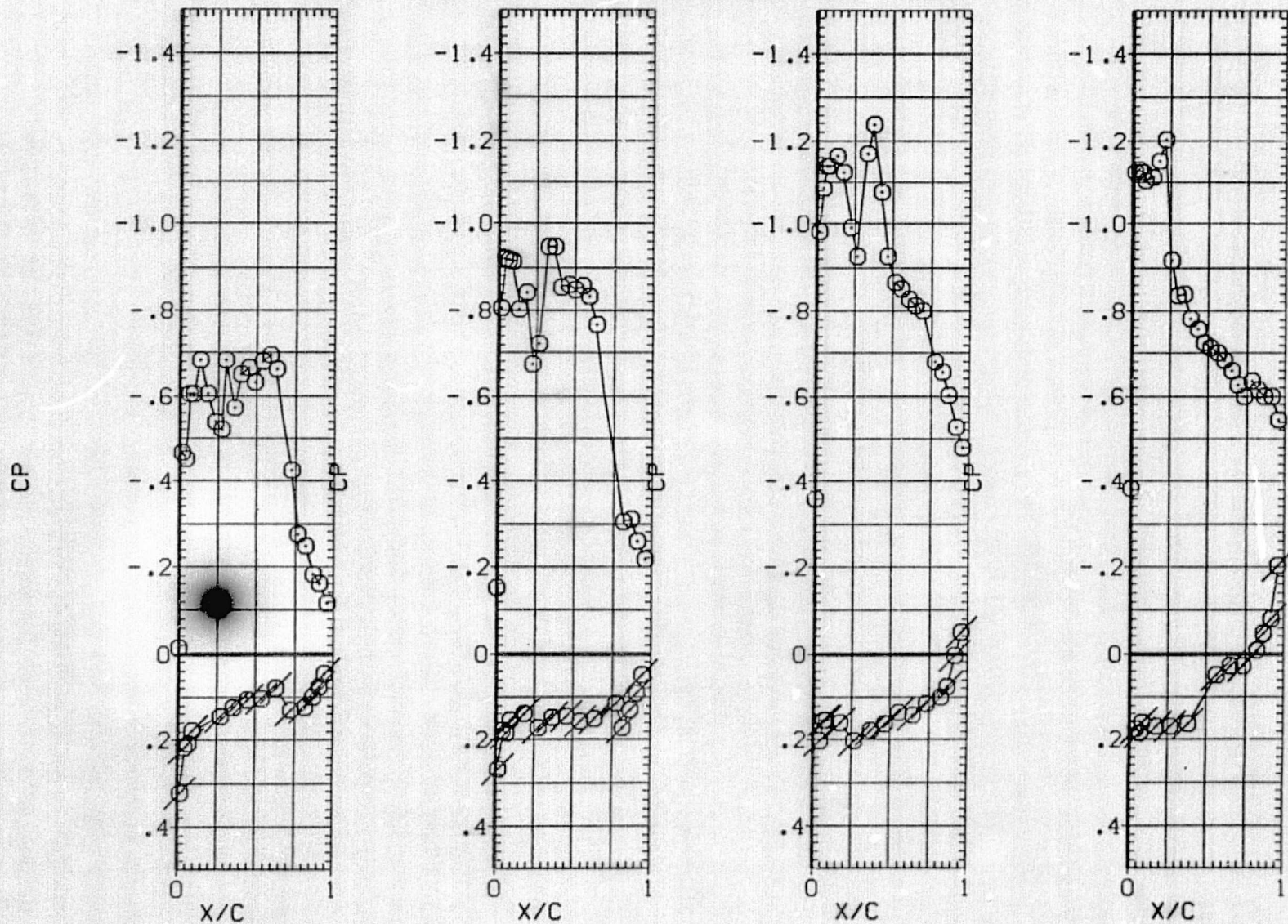

FIG. 15 PRESSURE DISTRIBUTIONS OVER CONFIGURATION 3 AT CTG=0.0

SYMBOL	ALPHA	2Y/B	MACH
○	-.250	.250	.901
		.450	
		.650	
		.800	

PARAMETRIC VALUES		
BETA	.000	DELFI 3.500
DELFO	3.500	DELFM 8.000

DATA SET	SYMBOL	CONFIGURATION DESCRIPTION
(RATU10)	OPEN	CONFIGURATION 4 CL DESIGN=0.5
(ZATL10)	FLAGGED	CONFIGURATION 4 CL DESIGN=0.5

	RN/L	CTG
UP SURF.	5.5000	.0000
LOV SURF.	5.5000	.0000

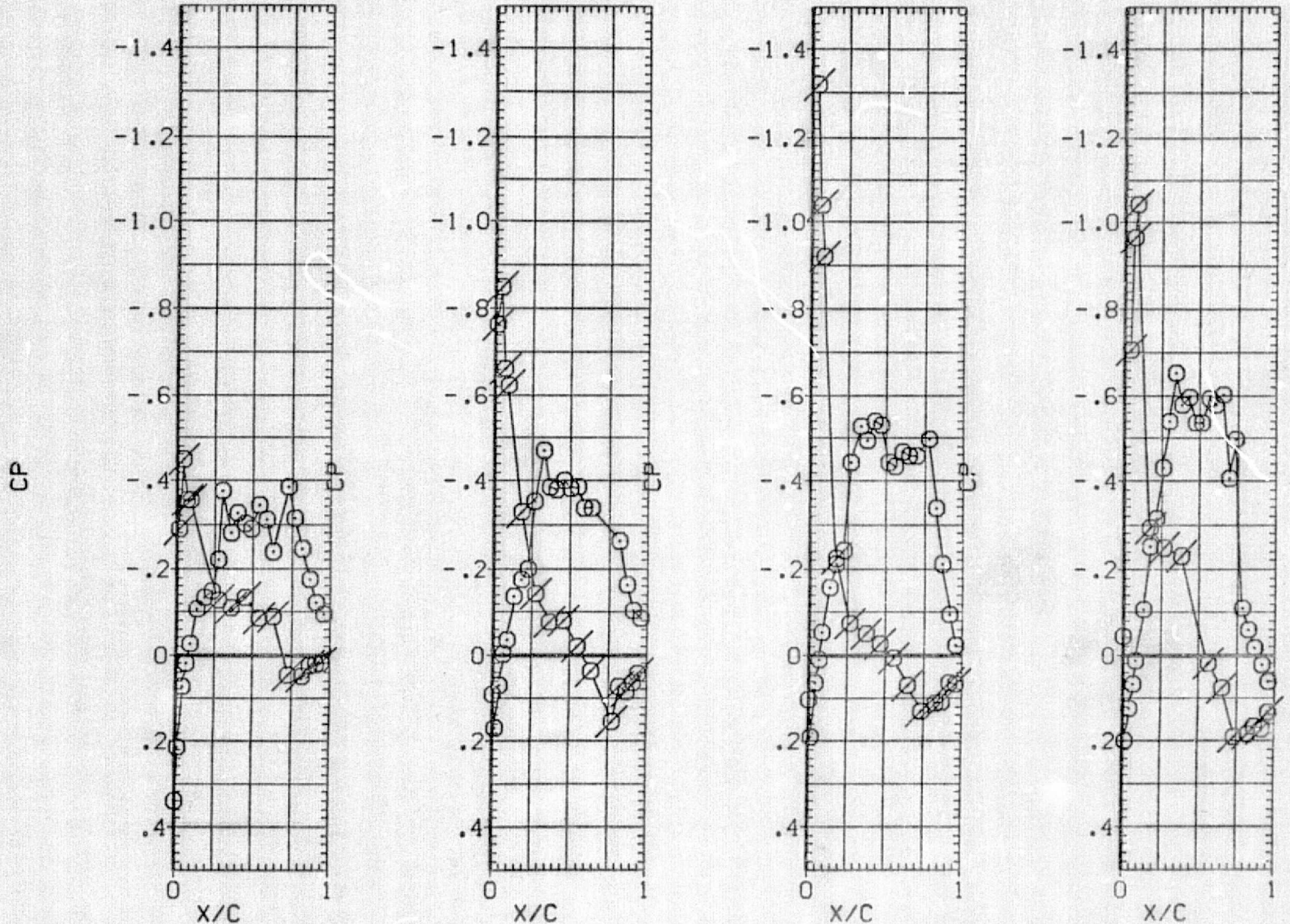

FIG. 15 PRESSURE DISTRIBUTIONS OVER CONFIGURATION 4 AT CTG=0.0

SYMBOL	ALPHA	2Y/B	MACH
○	3.757	.250	.901
		.450	
		.650	
		.800	

PARAMETRIC VALUES			
BETA	.000	DELFI	3.500
DELFO	3.500	DELFM	8.000

DATA SET	SYMBOL	CONFIGURATION DESCRIPTION
(RATU10)	OPEN	CONFIGURATION 4 CL DESIGN=0.5
(ZATL10)	FLAGGED	CONFIGURATION 4 CL DESIGN=0.5

	RN/L	CTG
UP SURF.	5.5000	.0000
LOW SURF.	5.5000	.0000

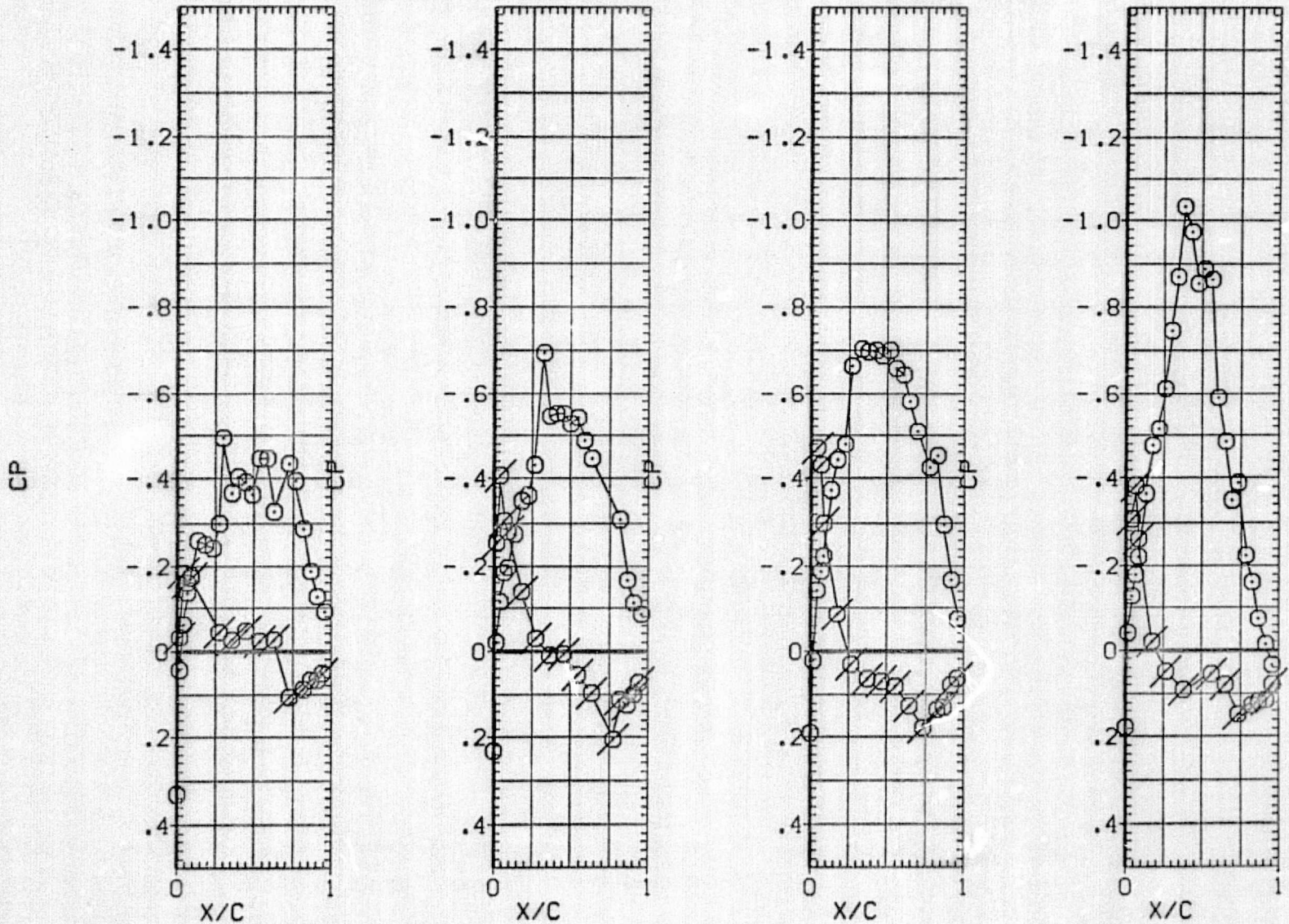

FIG. 15 PRESSURE DISTRIBUTIONS OVER CONFIGURATION 4 AT CTG=0.0

SYMBOL	ALPHA	2Y/B	MACH
○	7.776	.250	.901
		.450	
		.650	
		.800	

PARAMETRIC VALUES			
BETA	.000	DELTA	3.500
DELFO	3.500	DELFM	8.000

DATA SET	SYMBOL	CONFIGURATION DESCRIPTION
(RATUID)	OPEN	CONFIGURATION 4 CL DESIGN=0.5
(ZATLID)	FLAGGED	CONFIGURATION 4 CL DESIGN=0.5

	RN/L	CTG
UP SURF.	5.5000	.0000
LOW SURF.	5.5000	.0000

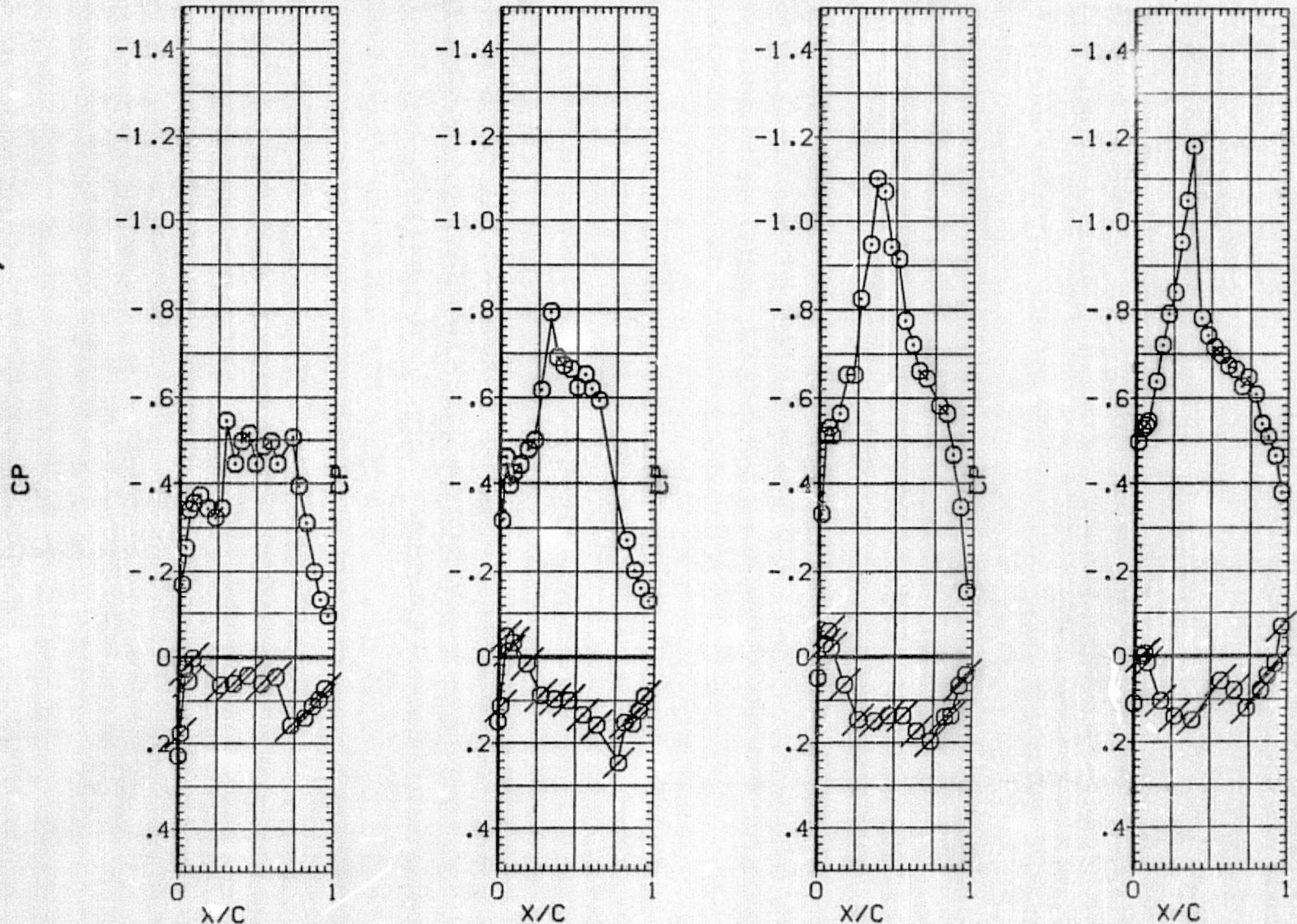

FIG. 15 PRESSURE DISTRIBUTIONS OVER CONFIGURATION 4 AT CTG=0.0

SYMBOL	ALPHA	2Y/B	MACH
○	11.826	.250	.901
		.450	
		.650	
		.800	

PARAMETRIC VALUES	
BETA	.000 DELFI 3.500
DELFO	3.500 DELFM 8.000

DATA SET	SYMBOL	CONFIGURATION DESCRIPTION
(RATU10)	OPEN	CONFIGURATION 4 CL DESIGN=0.5
(ZATL10)	FLAGGED	CONFIGURATION 4 CL DESIGN=0.5

	RN/L	CTG
UP SURF.	5.5000	.0000
LOW SURF.	5.5000	.0000

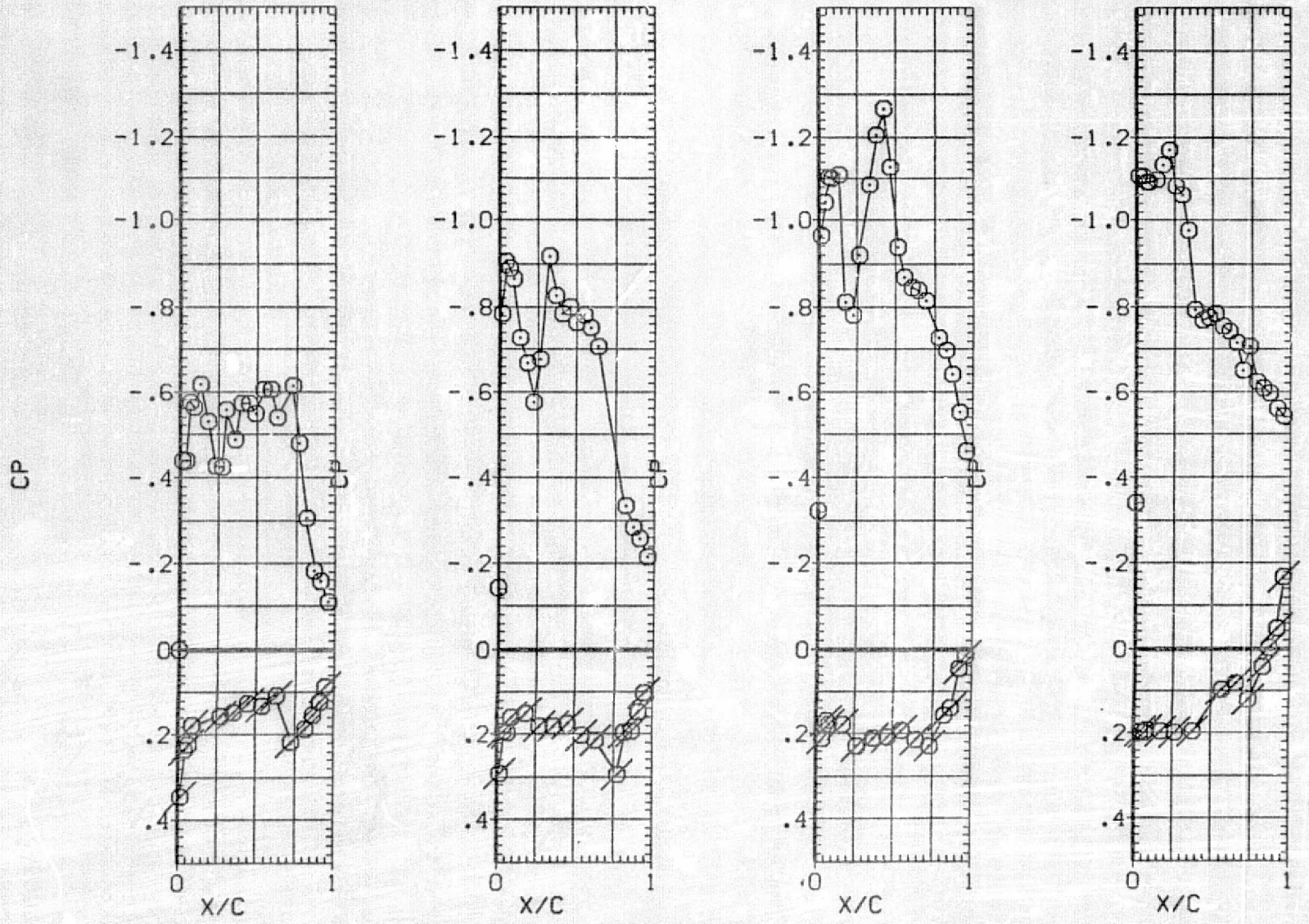

FIG. 15 PRESSURE DISTRIBUTIONS OVER CONFIGURATION 4 AT CTG=0.0

SYMBOL	ALPHA	2Y/B	MACH
○	-.251	.250	.902
		.450	
		.650	
		.800	

PARAMETRIC VALUES			
BETA	.000	DELFI	3.500
DELFO	3.500	DELFM	8.000

DATA SET	SYMBOL	CONFIGURATION DESCRIPTION
(RATU13)	OPEN	CONFIGURATION 4 CL DESIGN=0.5
(ZATL13)	FLAGGED	CONFIGURATION 4 CL DESIGN=0.5

	RN/L	CTG
UP SURF.	5.5000	.1200
LGY SURF.	5.5000	.1200

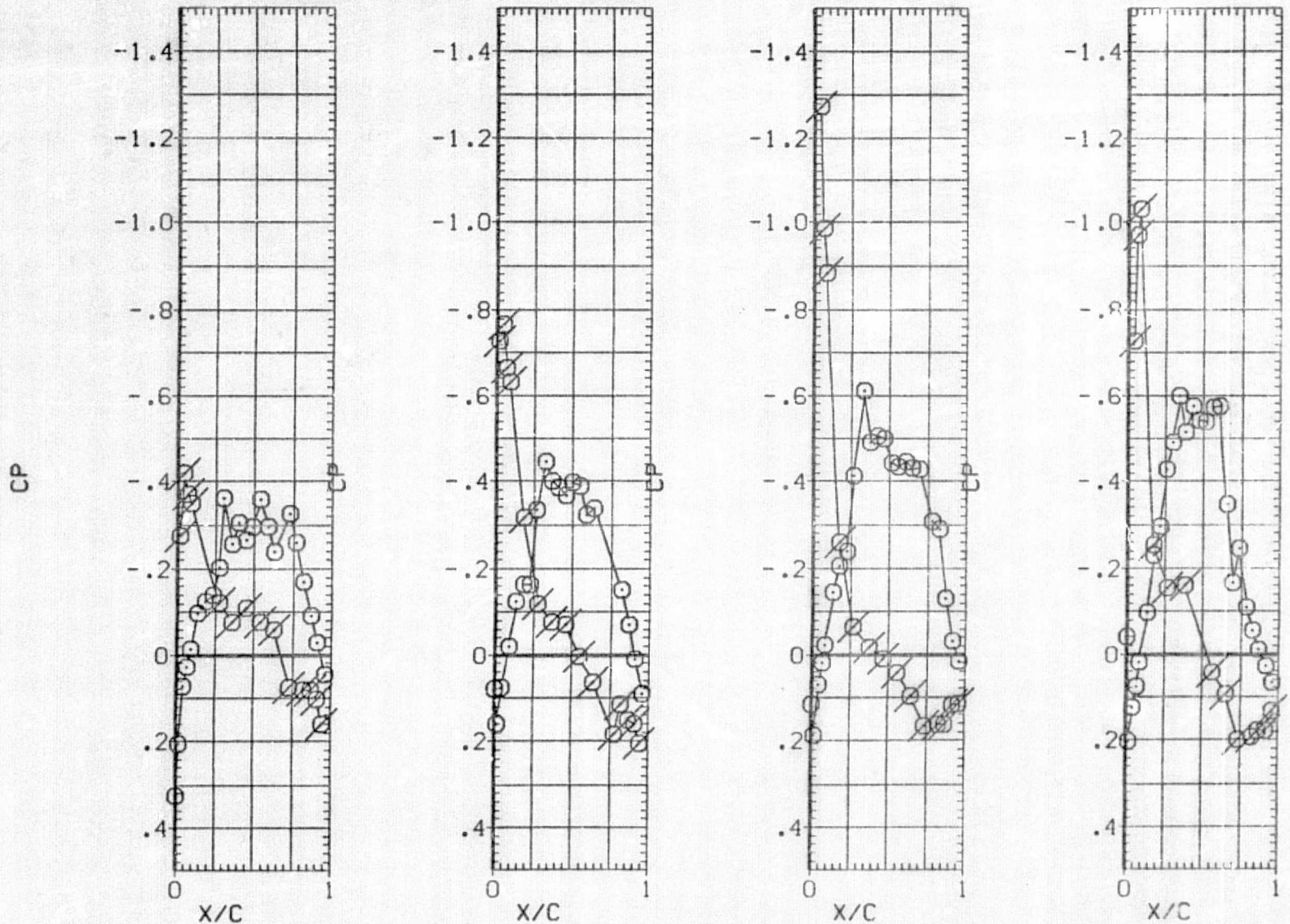

FIG. 15 PRESSURE DISTRIBUTIONS OVER CONFIGURATION 4 AT CTG=0.12

SYMBOL	ALPHA	2Y/B	MACH
○	3.758	.250	.902
		.450	
		.650	
		.800	

PARAMETRIC VALUES	
BETA	.000 DELFI 3.500
DELFO	3.500 DELFM 8.000

DATA SET	SYMBOL	CONFIGURATION DESCRIPTION
(RATU13)	OPEN	CONFIGURATION 4 CL DESIGN=0.5
(ZATL13)	FLAGGED	CONFIGURATION 4 CL DESIGN=0.5

	RN/L	CTG
UP SURF.	5.5000	.1200
LOW SURF.	5.5000	.1200

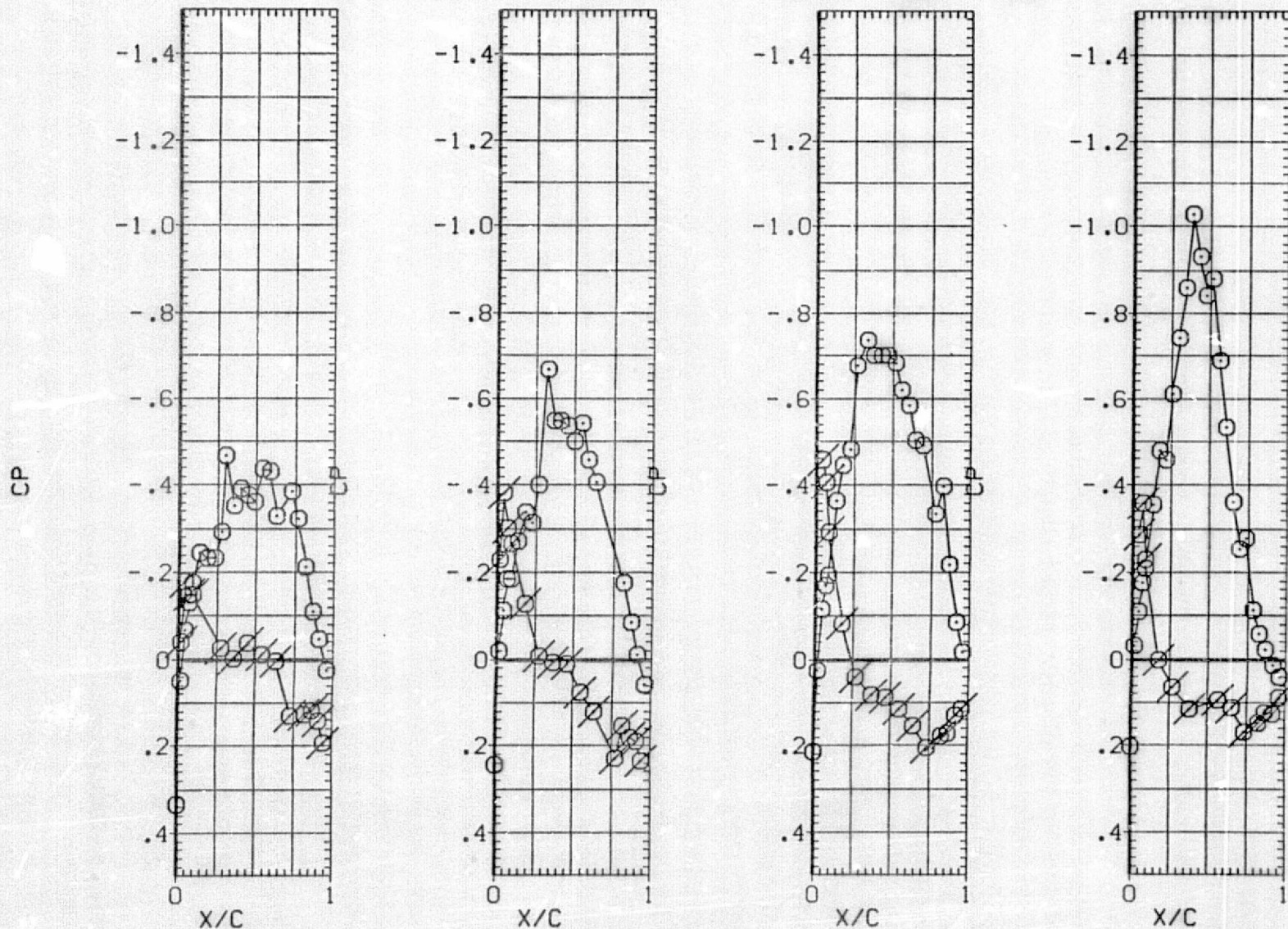

FIG. 15 PRESSURE DISTRIBUTIONS OVER CONFIGURATION 4 AT CTG=0.12

SYMBOL	ALPHA	2Y/B	MACH
○	7.776	.250	.902
		.450	
		.650	
		.800	

PARAMETRIC VALUES			
BETA	.000	DELFI	3.500
DELFO	3.500	DELFM	8.000

DATA SET	SYMBOL	CONFIGURATION DESCRIPTION
(RATU13)	OPEN	CONFIGURATION 4 CL DESIGN=0.5
(ZATL13)	FLAGGED	CONFIGURATION 4 CL DESIGN=0.5

	RN/L	CTG
UP SURF.	5.5000	.1200
LOW SURF.	5.5000	.1200

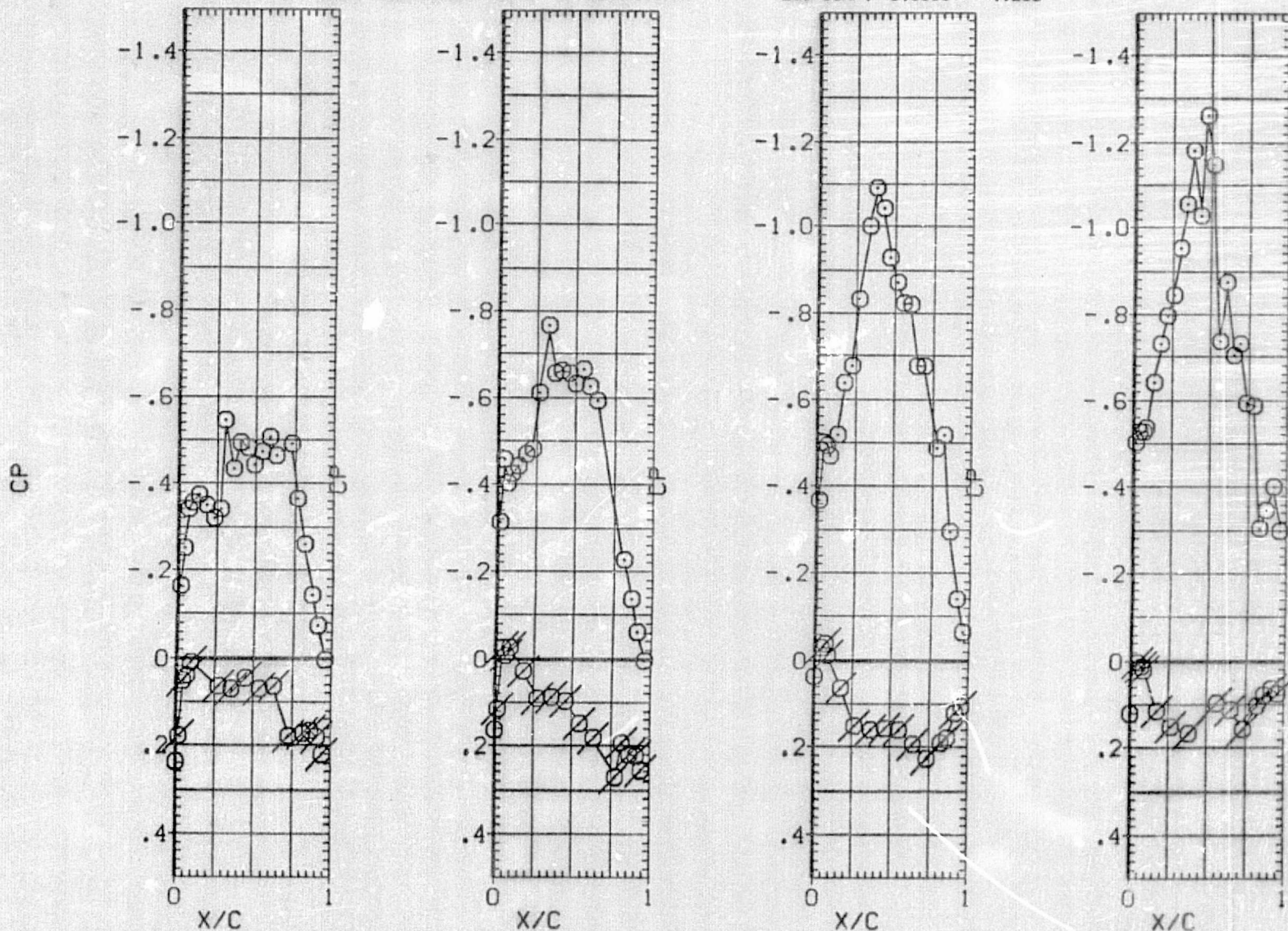

FIG. 15 PRESSURE DISTRIBUTIONS OVER CONFIGURATION 4 AT CTG=0.12

SYMBOL	ALPHA	2Y/B	MACH
○	11.802	.250	.902
		.450	
		.650	
		.800	

PARAMETRIC VALUES			
BETA	.000	DELFI	3.500
DELFO	3.500	DELFM	8.000

DATA SET	SYMBOL	CONFIGURATION DESCRIPTION
(RATU13)	OPEN	CONFIGURATION 4 CL DESIGN=0.5
(ZATL13)	FLAGGED	CONFIGURATION 4 CL DESIGN=0.5

	RN/L	CTG
UP SURF.	5.5000	.1200
LOW SURF.	5.5000	.1200

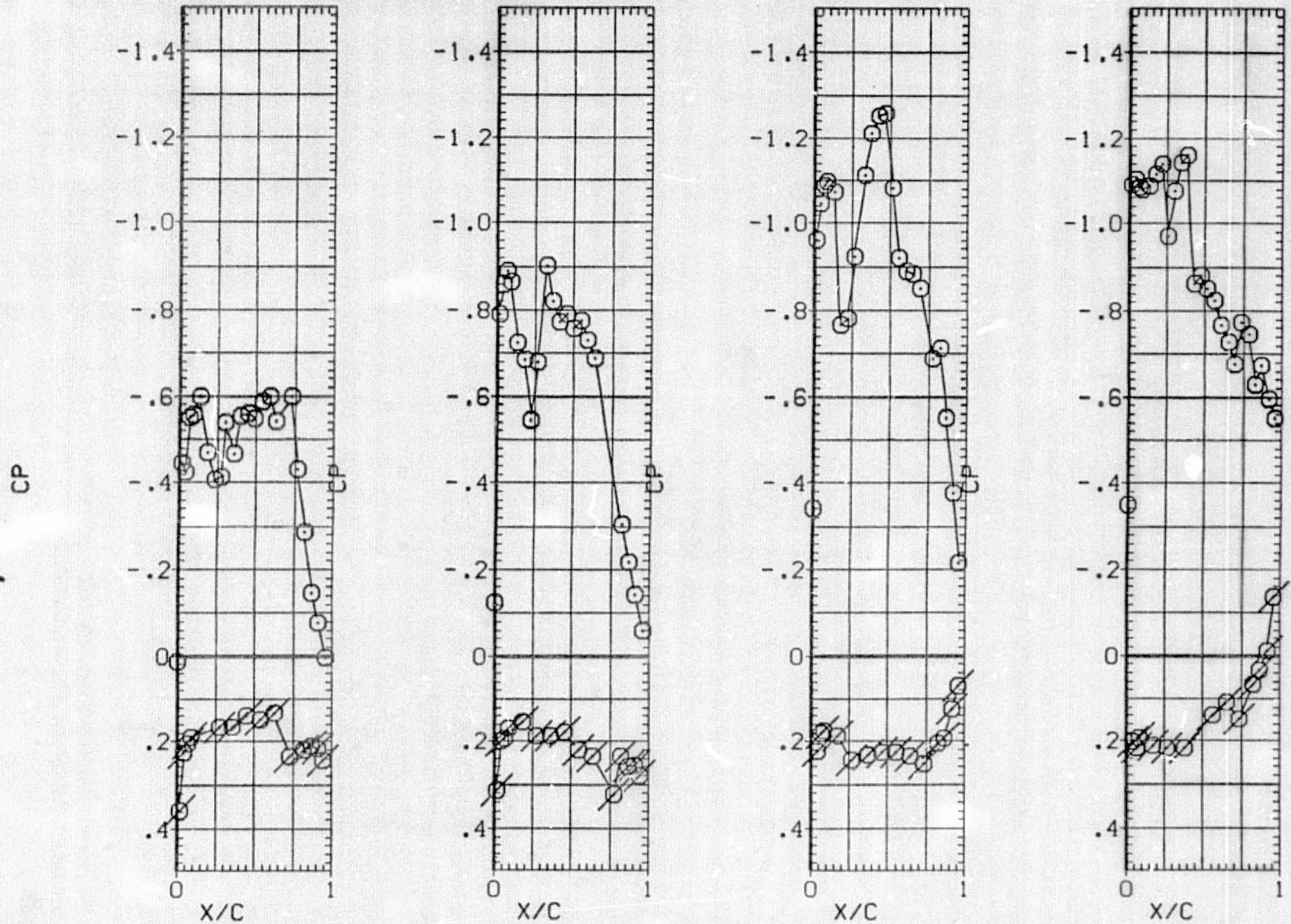

FIG. 15 PRESSURE DISTRIBUTIONS OVER CONFIGURATION 4 AT CTG=0.12

SYMBOL	ALPHA	2Y/B	MACH
O	-.138	.250	.899
		.450	
		.650	
		.800	

PARAMETRIC VALUES			
BETA	.000	DELFI	.000
DELFO	.000	DELFM	8.000

DATA SET	SYMBOL	CONFIGURATION DESCRIPTION
(RATU17)	OPEN	CONFIGURATION 5 ADEN FLAP DELFI=0
(ZATL17)	FLAGGED	CONFIGURATION 5 ADEN FLAP DELFI=0

	RN/L	CTG
UP SURF.	5.5000	.0000
LOW SURF.	5.5000	.0000

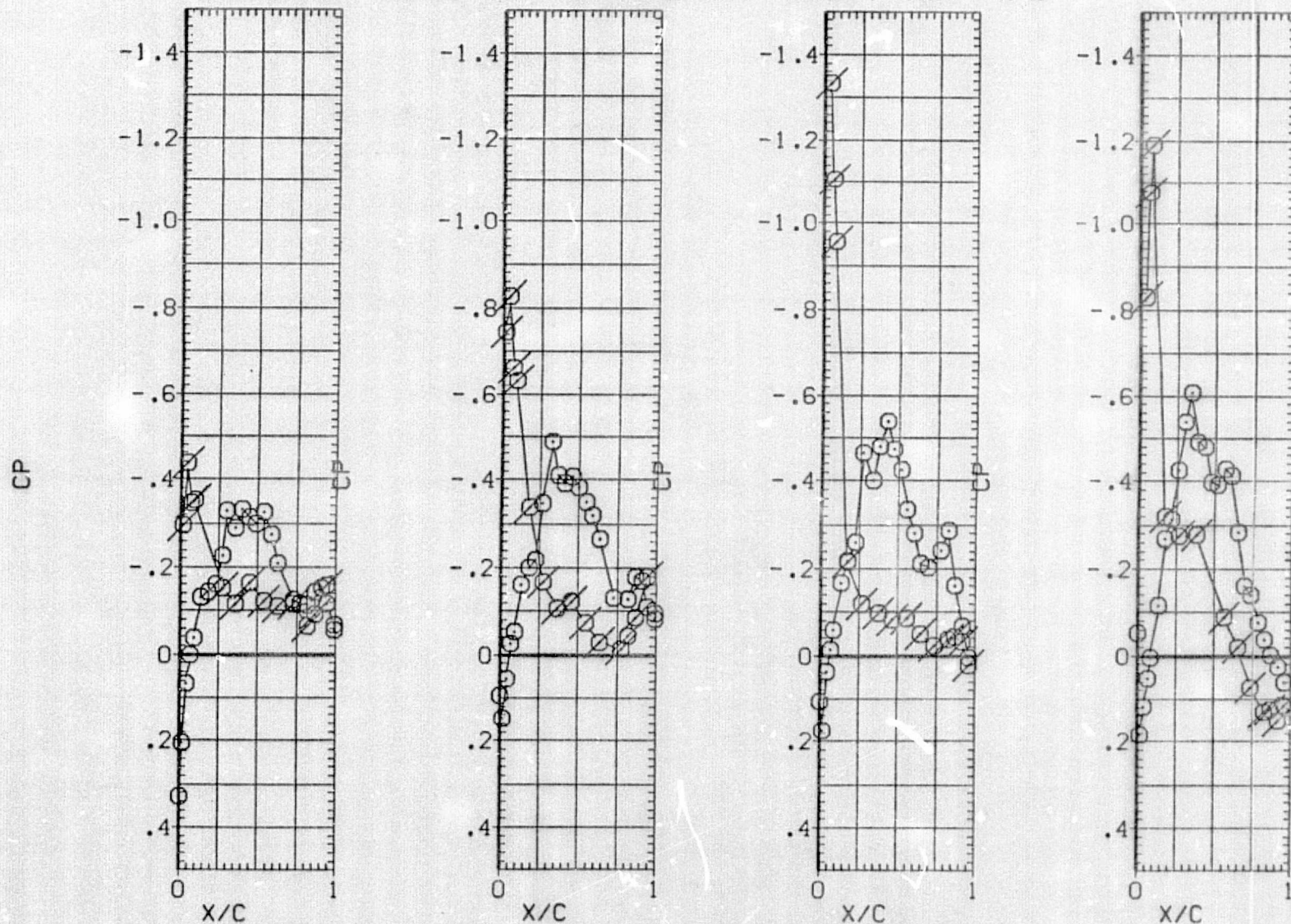

FIG. 15 PRESSURE DISTRIBUTIONS OVER CONFIGURATION 5 AT CTG=0.0

SYMBOL	ALPHA	2Y/B	MACH
○	3.883	.250	.899
		.450	
		.650	
		.800	

PARAMETRIC VALUES	
BETA	.000 DELFI .000
DELFO	.000 DELFM 8.000

DATA SET	SYMBOL	CONFIGURATION DESCRIPTION
(RATU17)	OPEN	CONFIGURATION 5 ADEN FLAP DELFI=0
(ZATL17)	FLAGGED	CONFIGURATION 5 ADEN FLAP DELFI=0

	RN/L	CTG
UP SURF.	5.5000	.0000
LOW SURF.	5.5000	.0000

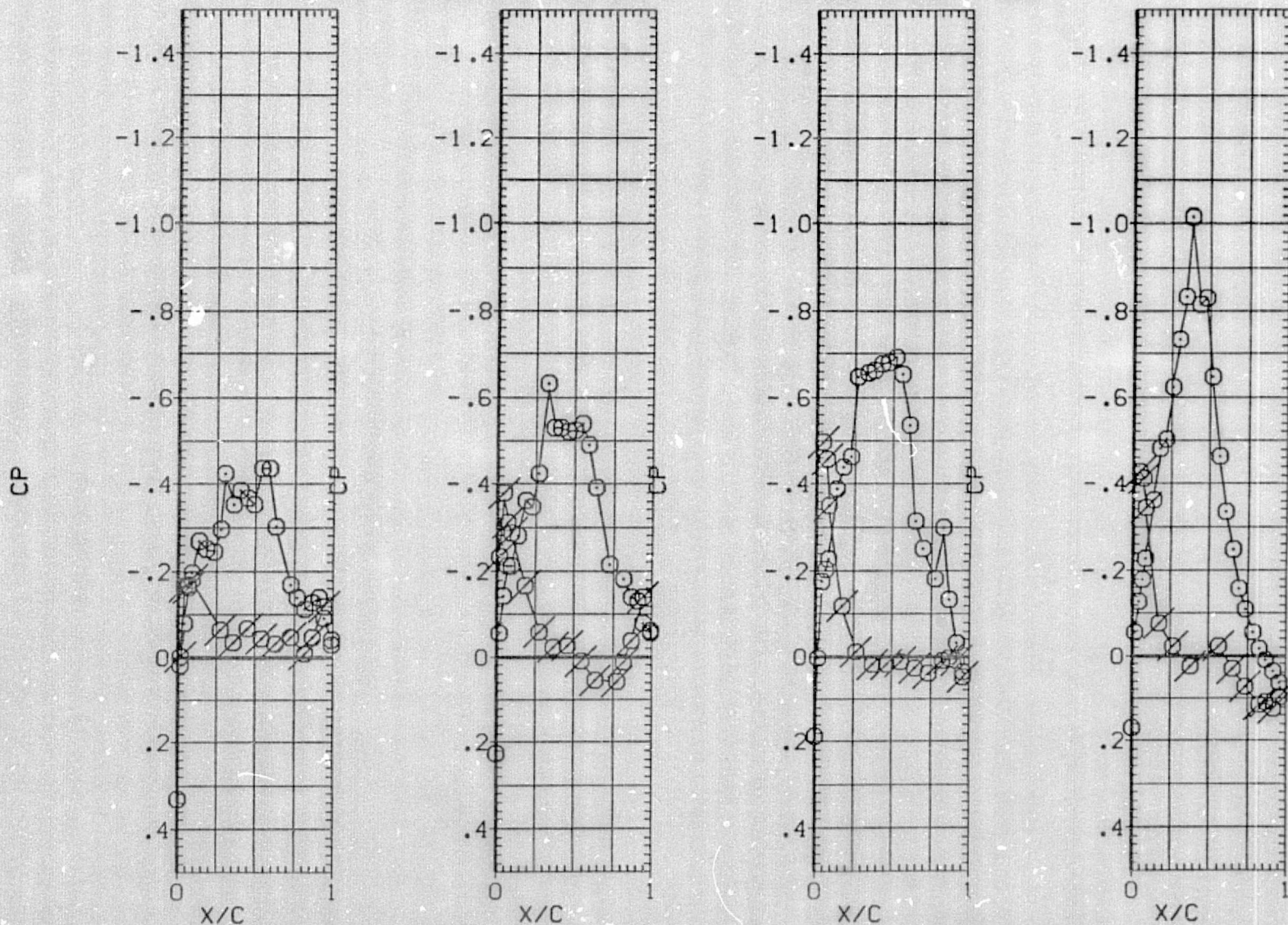

FIG. 15 PRESSURE DISTRIBUTIONS OVER CONFIGURATION 5 AT CTG=0.0

SYMBOL	ALPHA	2Y/B	MACH
○	7.911	.250	.899
		.450	
		.650	
		.800	

PARAMETRIC VALUES			
BETA	.000	DELFI	.000
DELFO	.000	DELFM	8.000

DATA SET	SYMBOL	CONFIGURATION DESCRIPTION
(RATL17)	OPEN	CONFIGURATION 5 ADEN FLAP DELFI=0
(ZATL17)	FLAGGED	CONFIGURATION 5 ADEN FLAP DELFI=0

	RN/L	CTG
UP SURF.	5.5000	.0000
LOW SURF.	5.5000	.0000

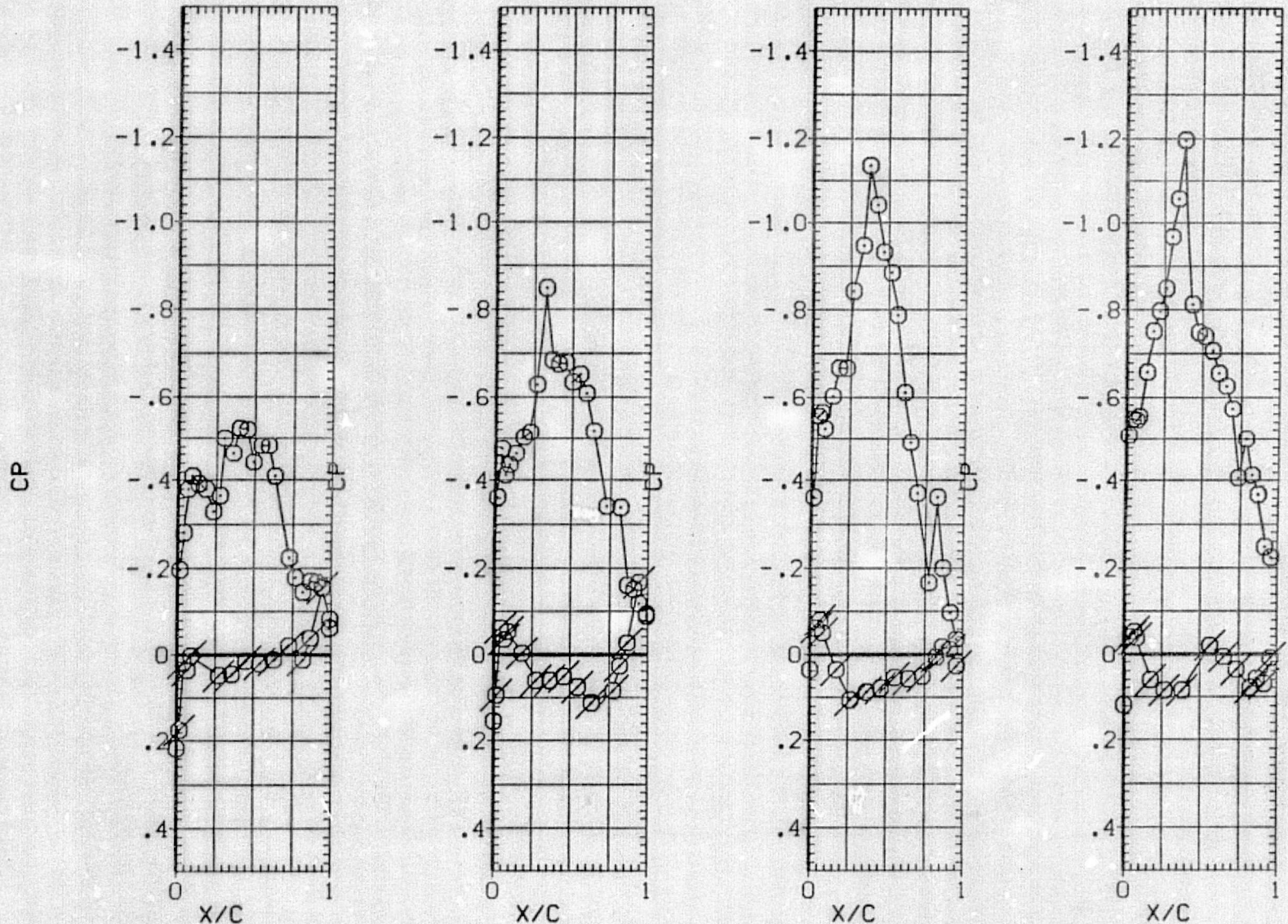

FIG. 15 PRESSURE DISTRIBUTIONS OVER CONFIGURATION 5 AT CTG=0.0

SYMBOL	ALPHA	2Y/B	MACH
○	11.912	.250	.899
		.450	
		.650	
		.800	

BETA	PARAMETRIC VALUES	
	.000	DELFI .000
DELFO	.000	DELFM 8.000

DATA SET	SYMBOL	CONFIGURATION DESCRIPTION
(RATU17)	OPEN	CONFIGURATION 5 ADEN FLAP DELFI=0
(ZATL17)	FLAGGED	CONFIGURATION 5 ADEN FLAP DELFI=0

	RN/L	CTG
UP SURF.	5.5000	.0000
LOW SURF.	5.5000	.0000

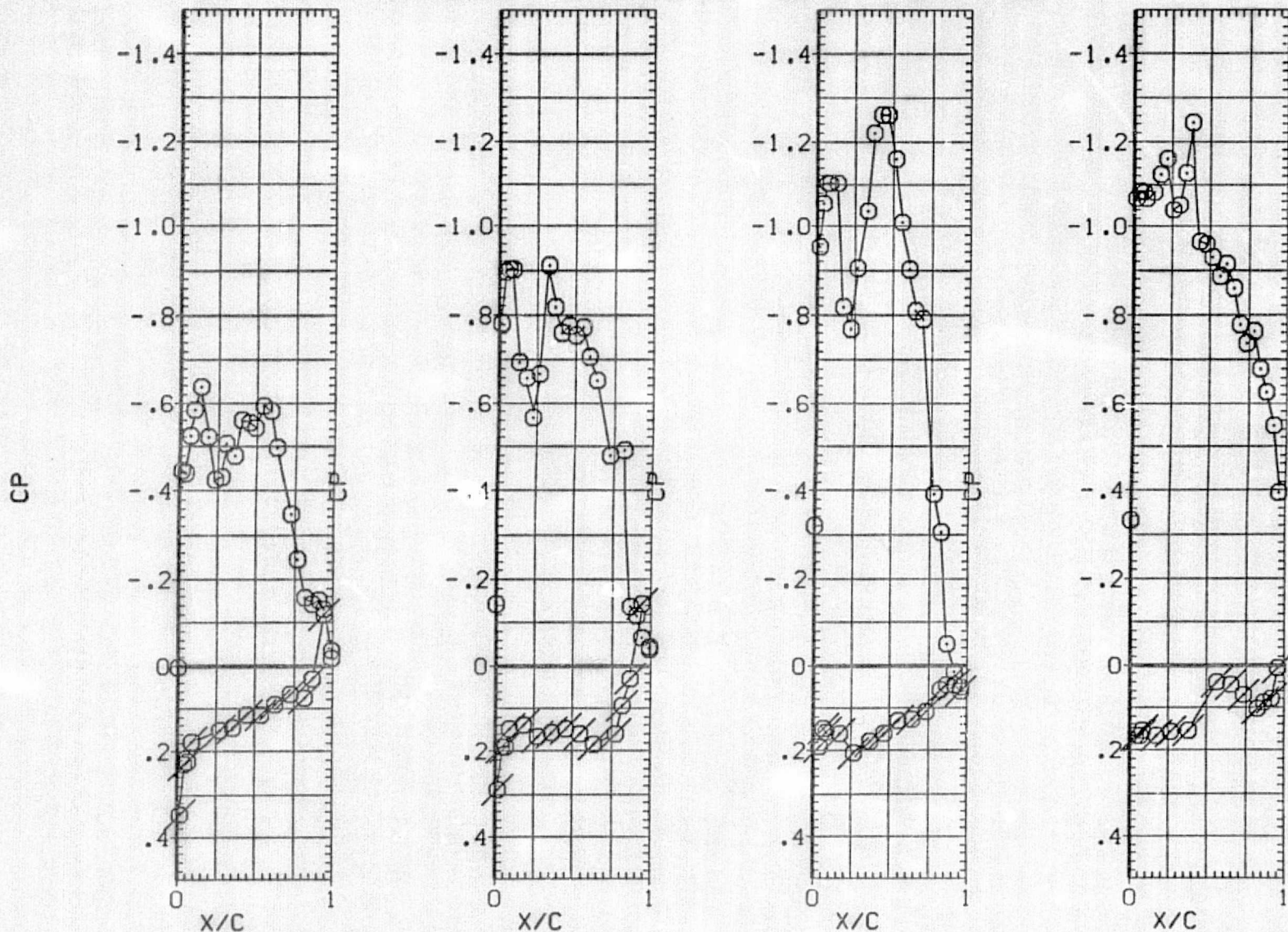

FIG. 15 PRESSURE DISTRIBUTIONS OVER CONFIGURATION 5 AT CTG=0.0

SYMBOL	ALPHA	ZY/B	MACH
○	3.943	.250	.902
		.450	
		.650	
		.800	

		PARAMETRIC VALUES		
BETA	.000	DELFI	.000	
DELFO	.000	DELFM	8.000	

DATA SET	SYMBOL	CONFIGURATION DESCRIPTION
(RATU18)	OPEN	CONFIGURATION 5 ADEN FLAP DELFI=0
(ZATL18)	FLAGGED	CONFIGURATION 5 ADEN FLAP DELFI=0

	RN/L	CTG
UP SURF.	5.5000	.0400
LOW SURF.	5.5000	.0400

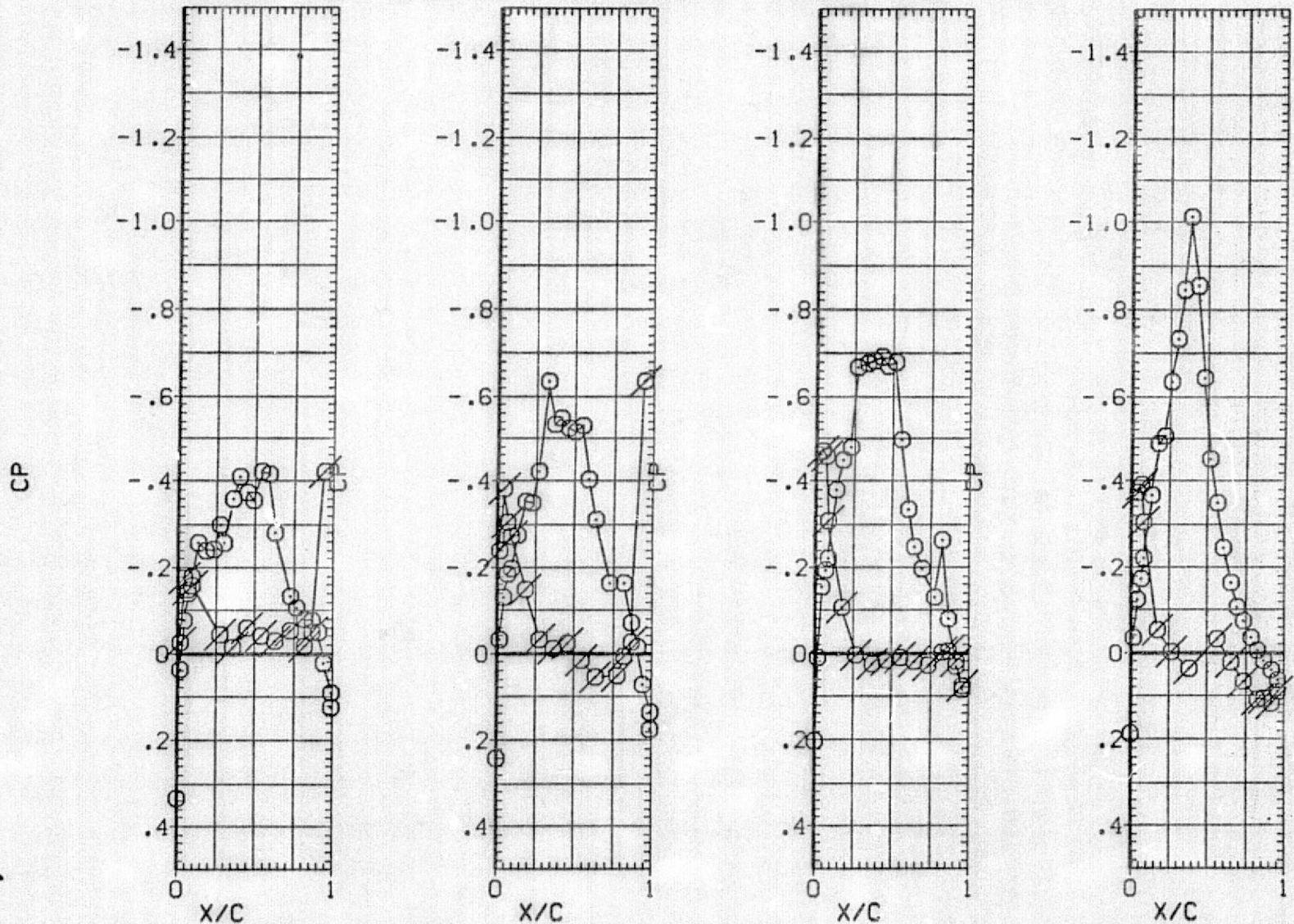

FIG. 15 PRESSURE DISTRIBUTIONS OVER CONFIGURATION 5 AT CTG=0.04

SYMBOL	ALPHA	2Y/B	MACH
○	3.904	.250	.899
		.450	
		.650	
		.800	

PARAMETRIC VALUES			
BETA	.000	DELFI	.000
DELFO	.000	DELFM	8.000

DATA SET	SYMBOL	CONFIGURATION DESCRIPTION
(RATU19)	OPEN	CONFIGURATION 5 ADEN FLAP DELFI=0
(ZATL19)	FLAGGED	CONFIGURATION 5 ADEN FLAP DELFI=0

	RN/L	CTG
UP SURF.	5.5000	.0800
LOW SURF.	5.5000	.0800

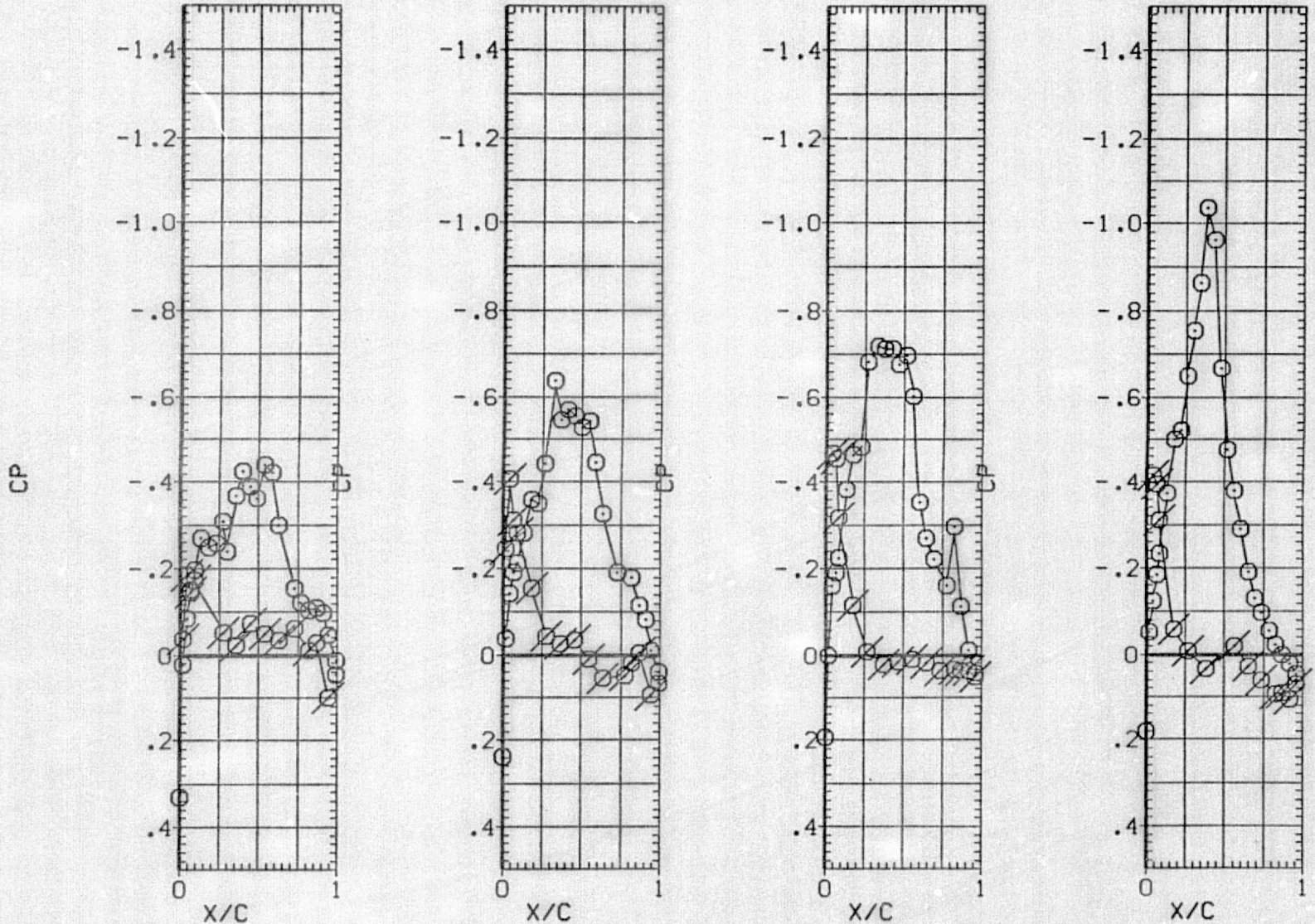

FIG. 15 PRESSURE DISTRIBUTIONS OVER CONFIGURATION 5 AT CTG=0.08

SYMBOL	ALPHA	2Y/B	MACH
○	-.188	.250	.903
		.450	
		.650	
		.800	

PARAMETRIC VALUES			
BETA	.000	DELFI	.000
DELFO	.000	DELFM	9.000

DATA SET	SYMBOL	CONFIGURATION DESCRIPTION	RN/L	CTG
(RATU20)	OPEN	CONFIGURATION 5 ADEN FLAP DELF1=0	UP SURF. 5.5000	.1200
(ZATL20)	FLAGGED	CONFIGURATION 5 ADEN FLAP DELF1=0	LOW SURF. 5.5000	.1200

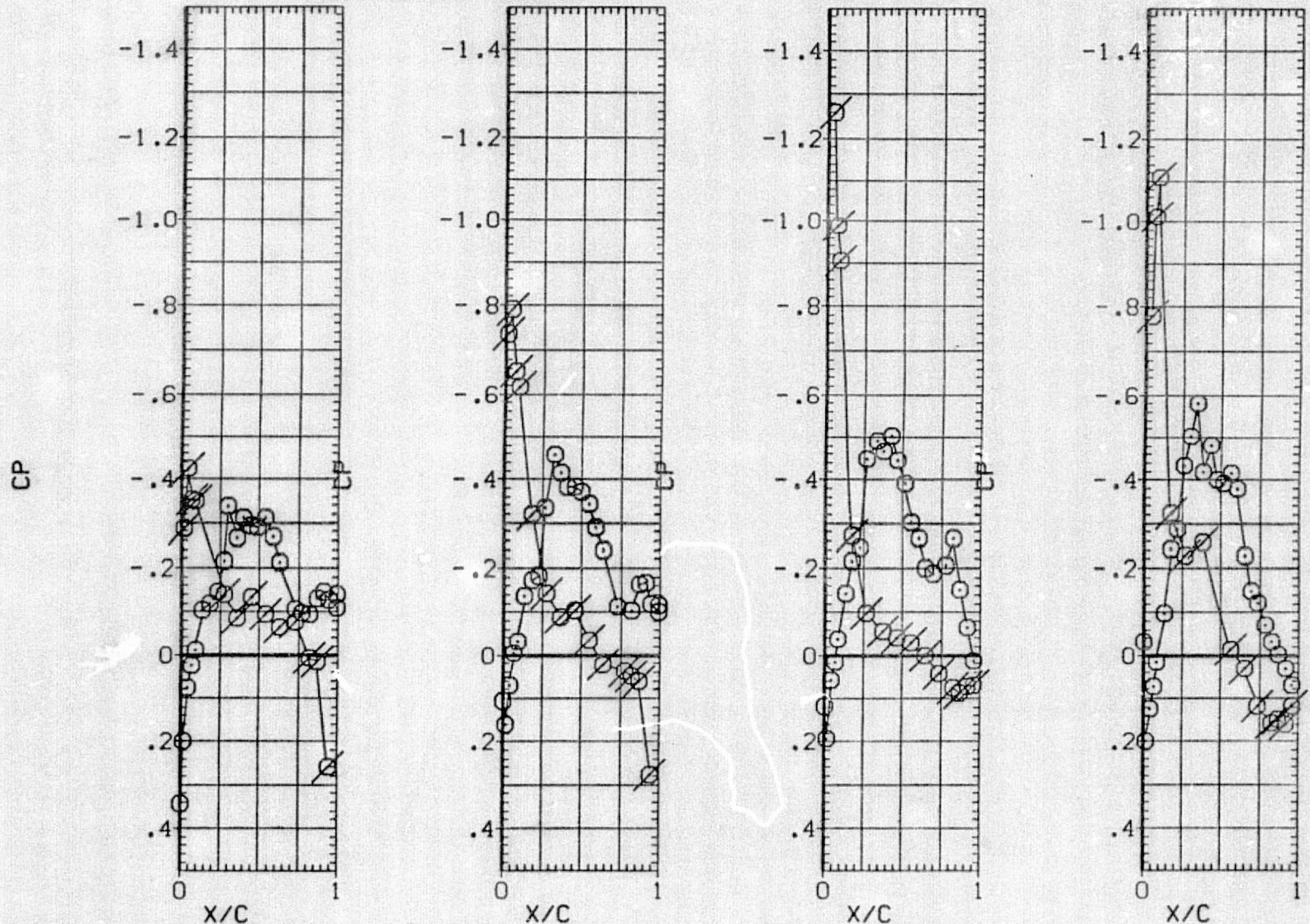

FIG. 15 PRESSURE DISTRIBUTIONS OVER CONFIGURATION 5 AT CTG=0.12

SYMBOL	ALPHA	2Y/B	MACH
○	3.843	.250	.903
		.450	
		.650	
		.800	

	PARAMETRIC VALUES		
BETA	.000	DELFI	.000
DELFO	.000	DELFM	8.000

DATA SET	SYMBOL	CONFIGURATION DESCRIPTION
(RATU20)	OPEN	CONFIGURATION 5 ADEN FLAP DELFI=0
(ZATL20)	FLAGGED	CONFIGURATION 5 ADEN FLAP DELFI=0

	RN/L	CTG
UP SURF.	5.5000	.1200
LOW SURF.	5.5000	.1200

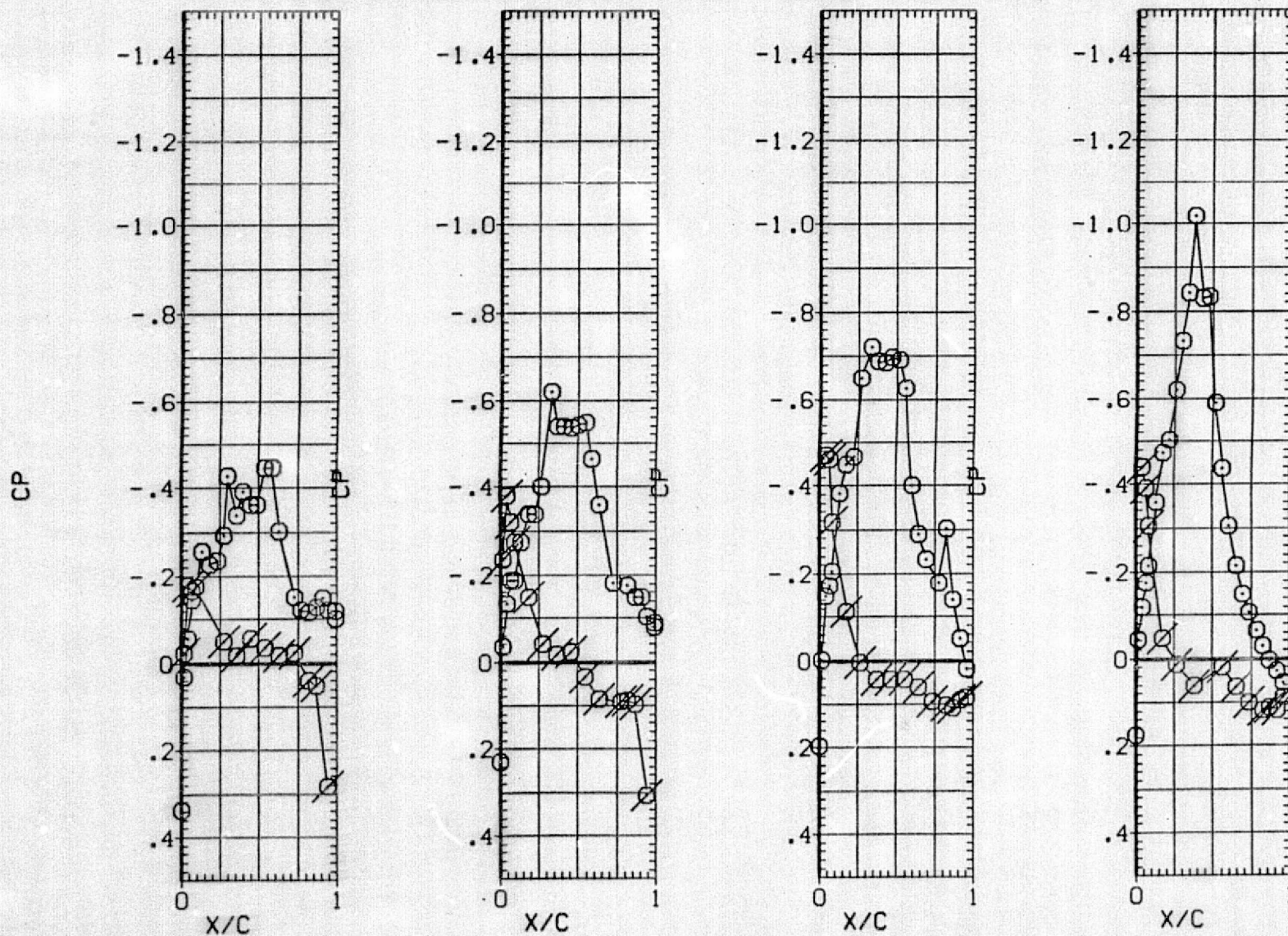

FIG. 15 PRESSURE DISTRIBUTIONS OVER CONFIGURATION 5 AT CTG=0.12

SYMBOL	ALPHA	2Y/B	MACH
○	7.852	.250	.903
		.450	
		.650	
		.800	

PARAMETRIC VALUES		
BETA	DELFI	.000
DELFO	DELFM	8.000

DATA SET	SYMBOL	CONFIGURATION DESCRIPTION
{RATU20}	OPEN	CONFIGURATION 5 ADEN FLAP DELFI=0
{ZATL20}	FLAGGED	CONFIGURATION 5 ADEN FLAP DELFI=0

	RN/L	CTG
UP SURF.	5.5000	.1200
LOW SURF.	5.5000	.1200

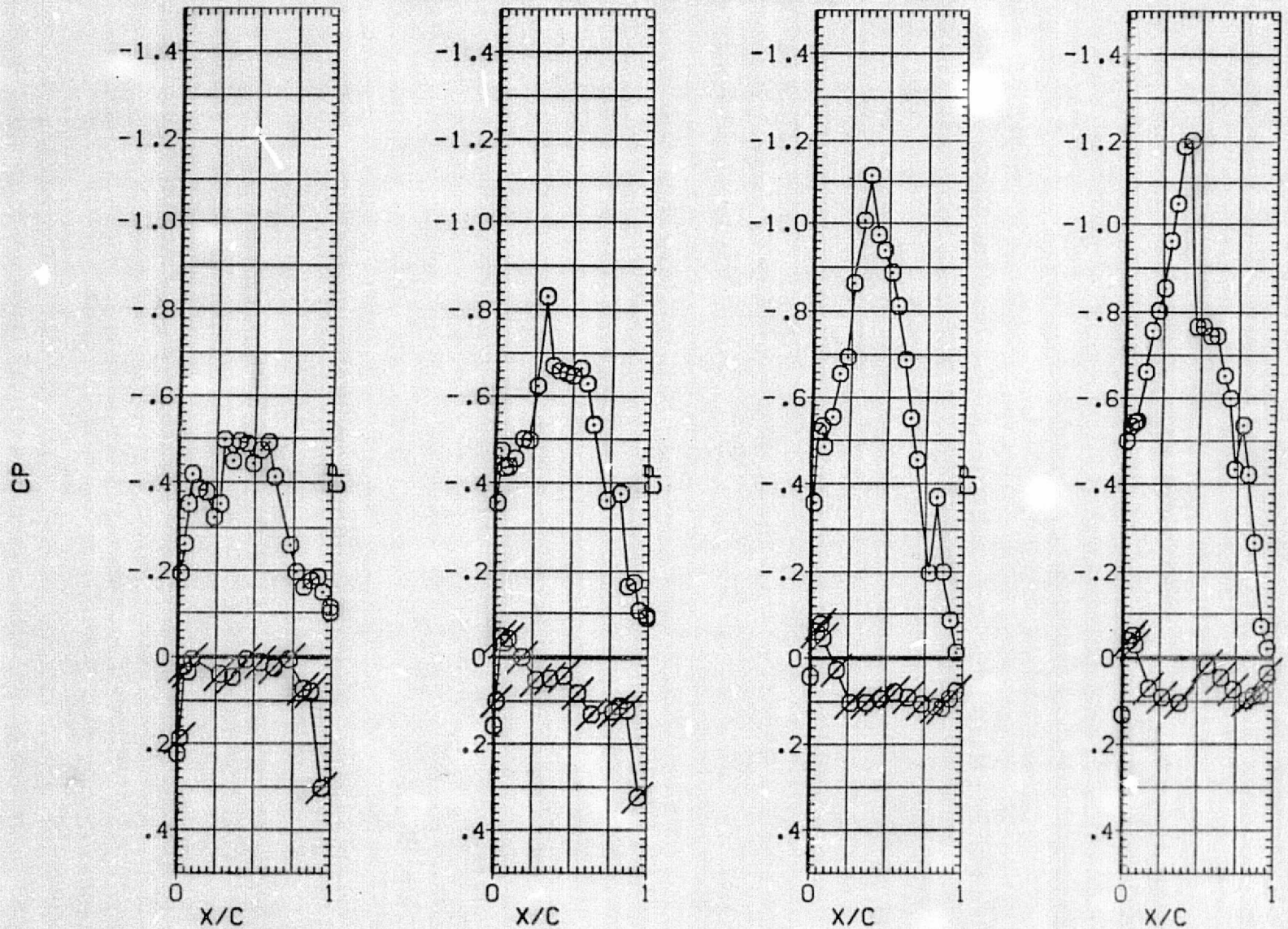

FIG. 15 PRESSURE DISTRIBUTIONS OVER CONFIGURATION 5 AT CTG=0.12

SYMBOL	ALPHA	ZY/B	MACH
○	11.862	.250	.903
		.450	
		.650	
		.800	

PARAMETRIC VALUES			
BETA	.000	DELFI	.000
DELFO	.000	DELFM	8.000

DATA SET	SYMBOL	CONFIGURATION DESCRIPTION
(RATU20)	OPEN	CONFIGURATION 5 ADEN FLAP DELFI=0
(ZATL20)	FLAGGED	CONFIGURATION 5 ADEN FLAP DELFI=0

	RN/L	CTG
UP SURF.	5.5000	.1200
LOW SURF.	5.5000	.1200

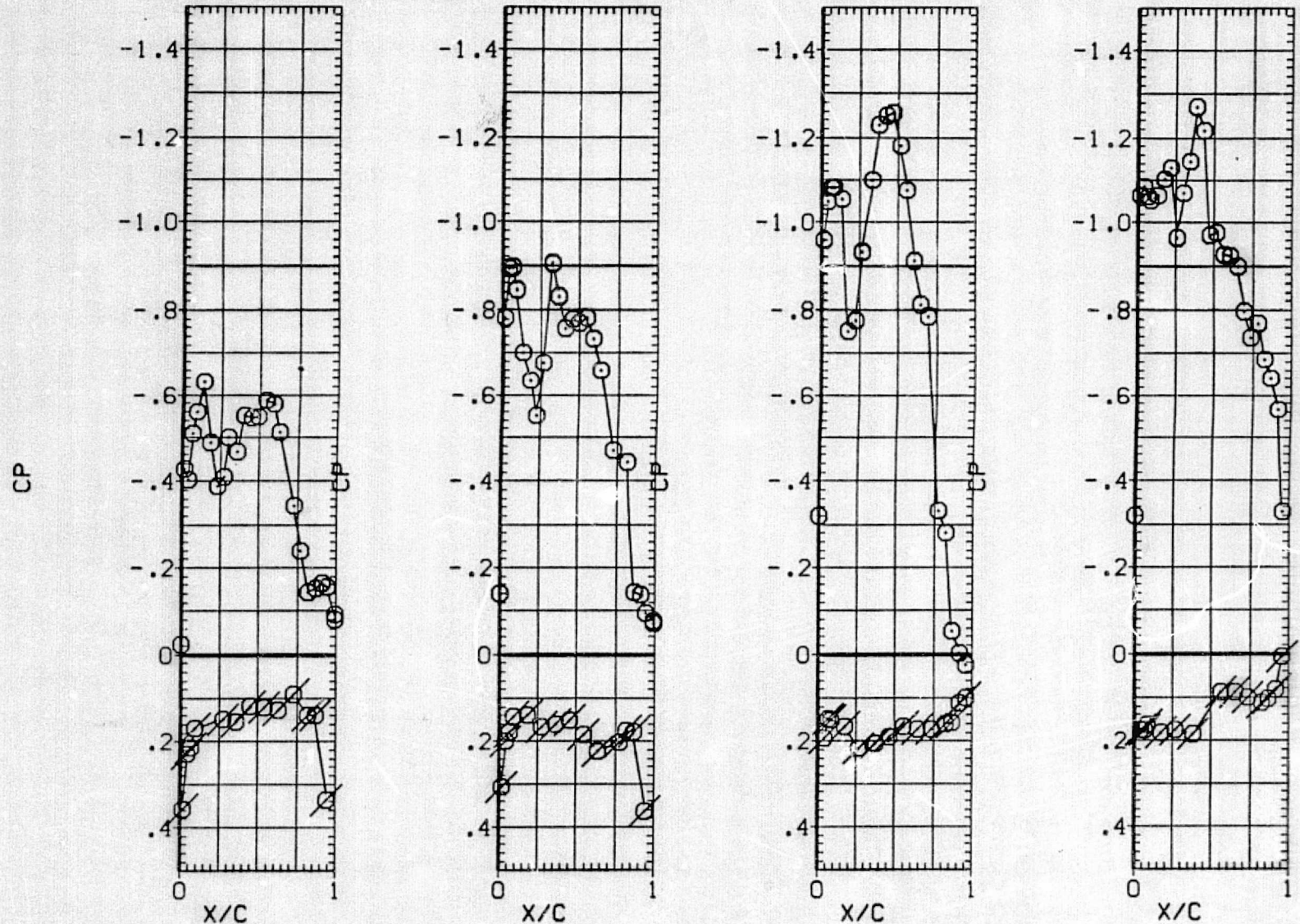

FIG. 15 PRESSURE DISTRIBUTIONS OVER CONFIGURATION 5 AT CTG=0.12

SYMBOL	ALPHA	2Y/B	MACH
○	-.161	.250	.900
		.450	
		.650	
		.800	

PARAMETRIC VALUES		
BETA	.000	DELFI 15.000
DELFO	.000	DELFM 8.000

DATA SET	SYMBOL	CONFIGURATION DESCRIPTION	RN/L	CTG
(RATU22)	OPEN	CONFIGURATION 6 ADEN FLAP DELFI=15	UP SURF. 5.5000	.0000
(ZATL22)	FLAGGED	CONFIGURATION 6 ADEN FLAP DELFI=15	LOW SURF. 5.5000	.0000

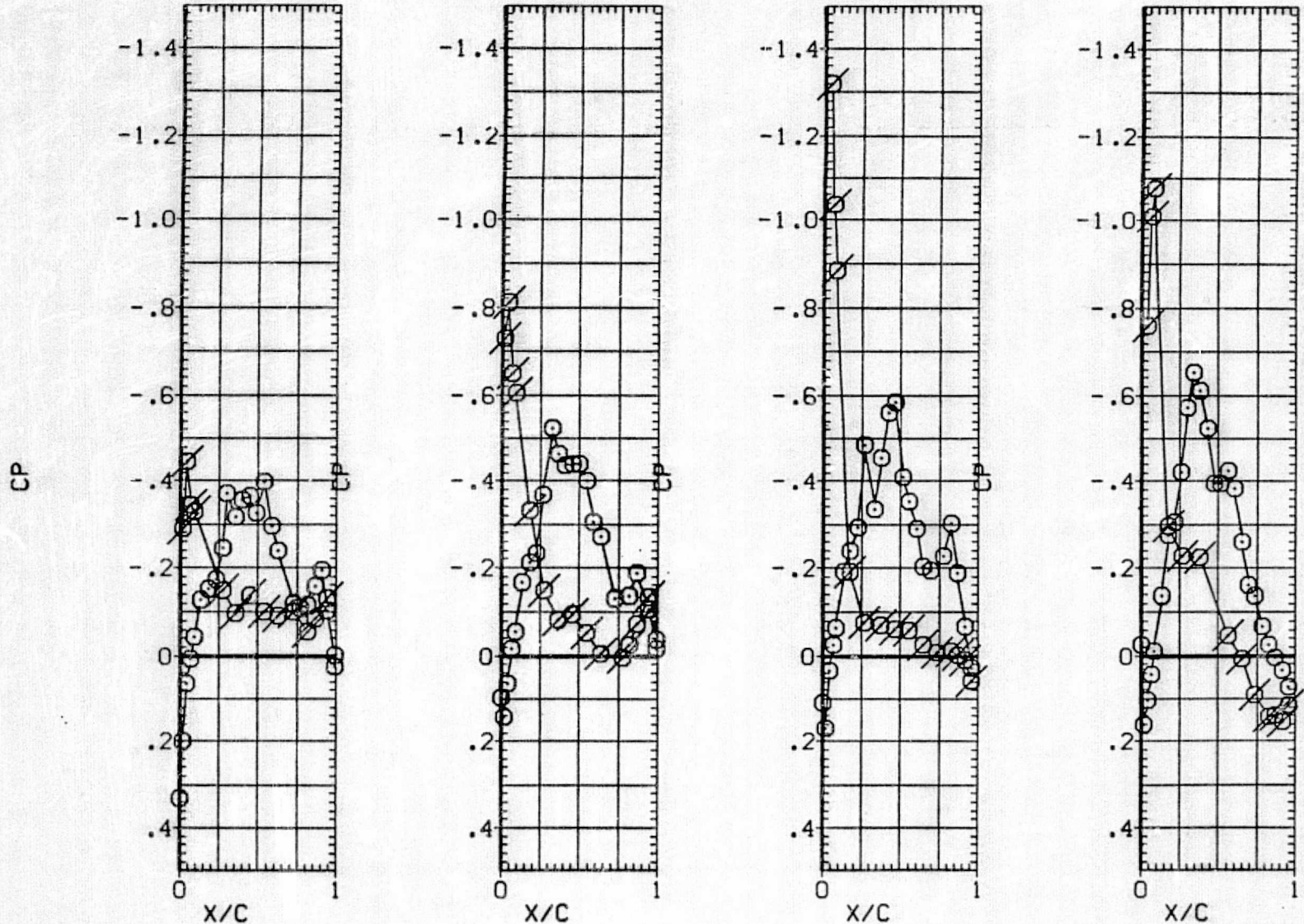

FIG. 15 PRESSURE DISTRIBUTIONS OVER CONFIGURATION 6 AT CTG=0.0

SYMBOL	ALPHA	2Y/B	MACH
○	3.870	.250	.900
		.450	
		.650	
		.800	

PARAMETRIC VALUES			
BETA	.000	DELFI	15.000
DELFO	.000	DELFM	8.000

DATA SET	SYMBOL	CONFIGURATION DESCRIPTION	RN/L	CTG
[RATU22]	OPEN	CONFIGURATION 6 ADEN FLAP DELFI=15	UP SURF. 5.5000	.0000
[ZATL22]	FLAGGED	CONFIGURATION 6 ADEN FLAP DELFI=15	LOW SURF. 5.5000	.0000

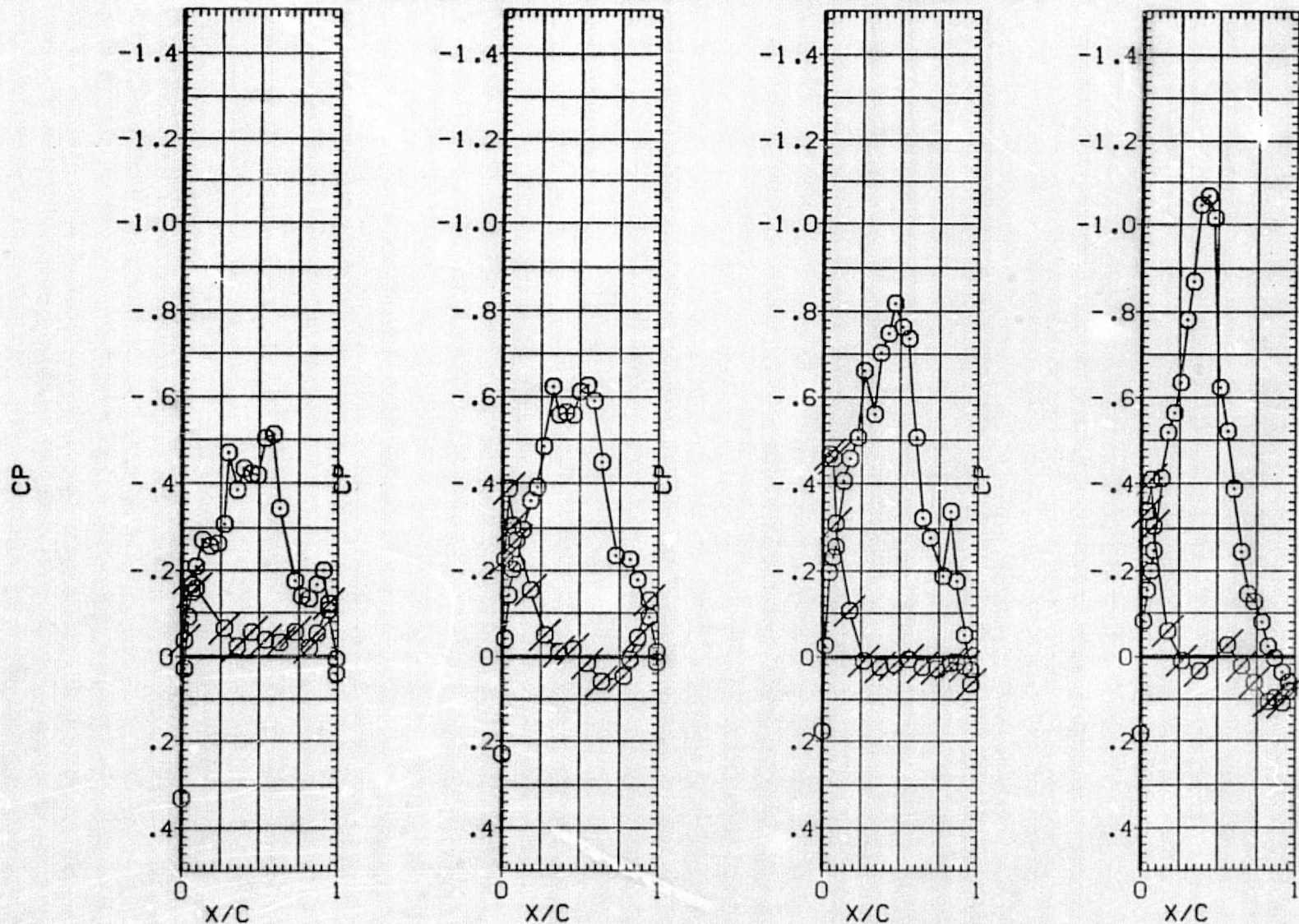

FIG. 15 PRESSURE DISTRIBUTIONS OVER CONFIGURATION 6 AT CTG=0.0

SYMBOL	ALPHA	2Y/B	MACH
○	7.868	.250	.900
		.450	
		.650	
		.800	

PARAMETRIC VALUES	
BETA	.000 DELF1 15.000
DELFC	.000 DELFM 8.000

DATA SET	SYMBOL	CONFIGURATION DESCRIPTION	RN/L	CTG
(RATU22)	OPEN	CONFIGURATION 6 ADEN FLAP DELF1=15	UP SURF. 5.5000	.0000
(ZATL22)	FLAGGED	CONFIGURATION 6 ADEN FLAP DELF1=15	LOW SURF. 5.5000	.0000

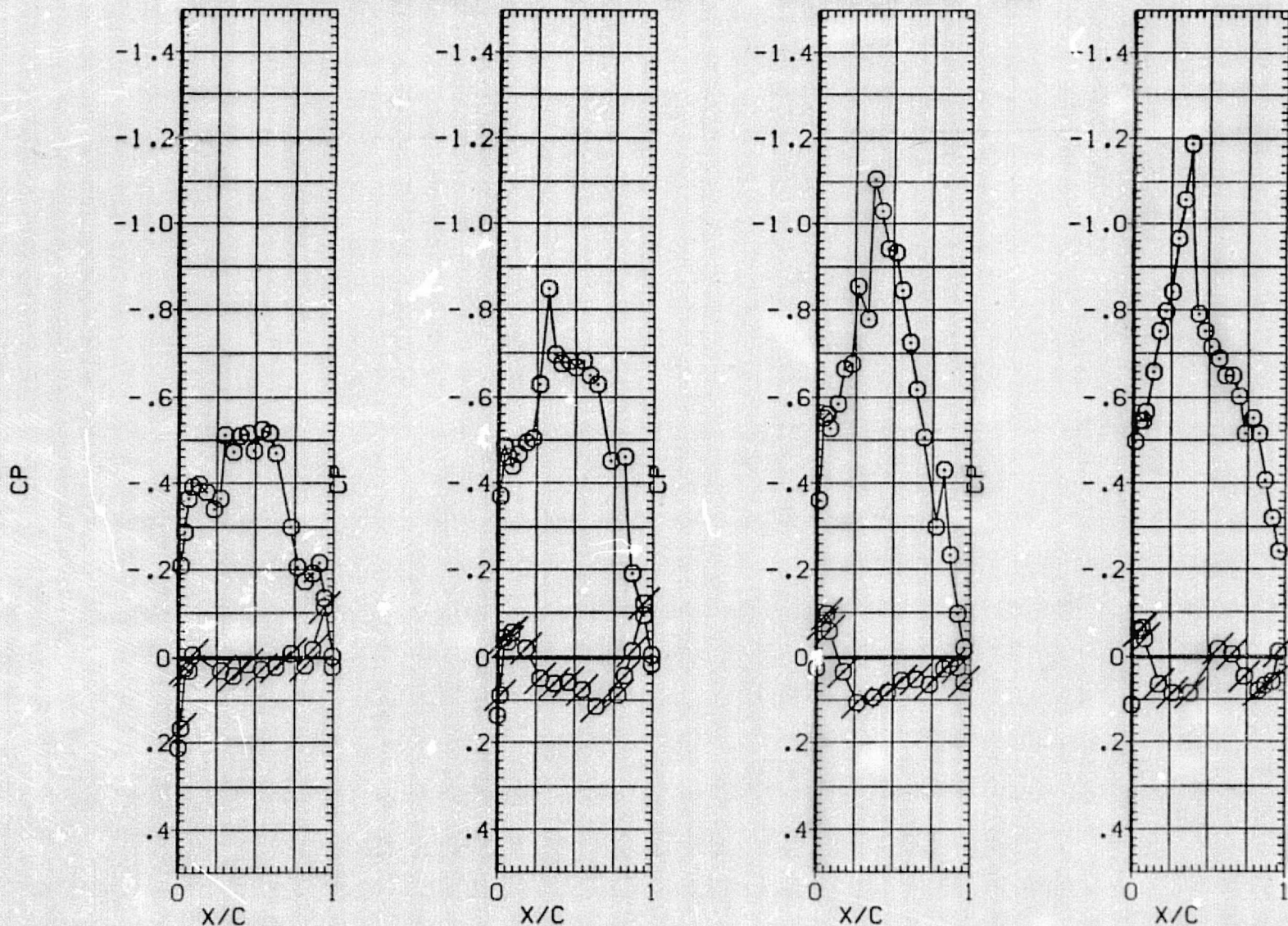

FIG. 15 PRESSURE DISTRIBUTIONS OVER CONFIGURATION 6 AT CTG=0.0

SYMBOL	ALPHA	ZY/B	MACH
○	11.862	.250	.900
		.450	
		.650	
		.800	

PARAMETRIC VALUES			
BETA	.000	DELFI	15.000
DELFO	.000	DELFM	8.000

DATA SET	SYMBOL	CONFIGURATION DESCRIPTION	RN/L	CTG
(RATU22)	OPEN	CONFIGURATION 6 ADEN FLAP DELFI=15	UP SURF. 5.5000	.0000
(ZATL22)	FLAGGED	CONFIGURATION 6 ADEN FLAP DELFI=15	LOW SURF. 5.5000	.0000

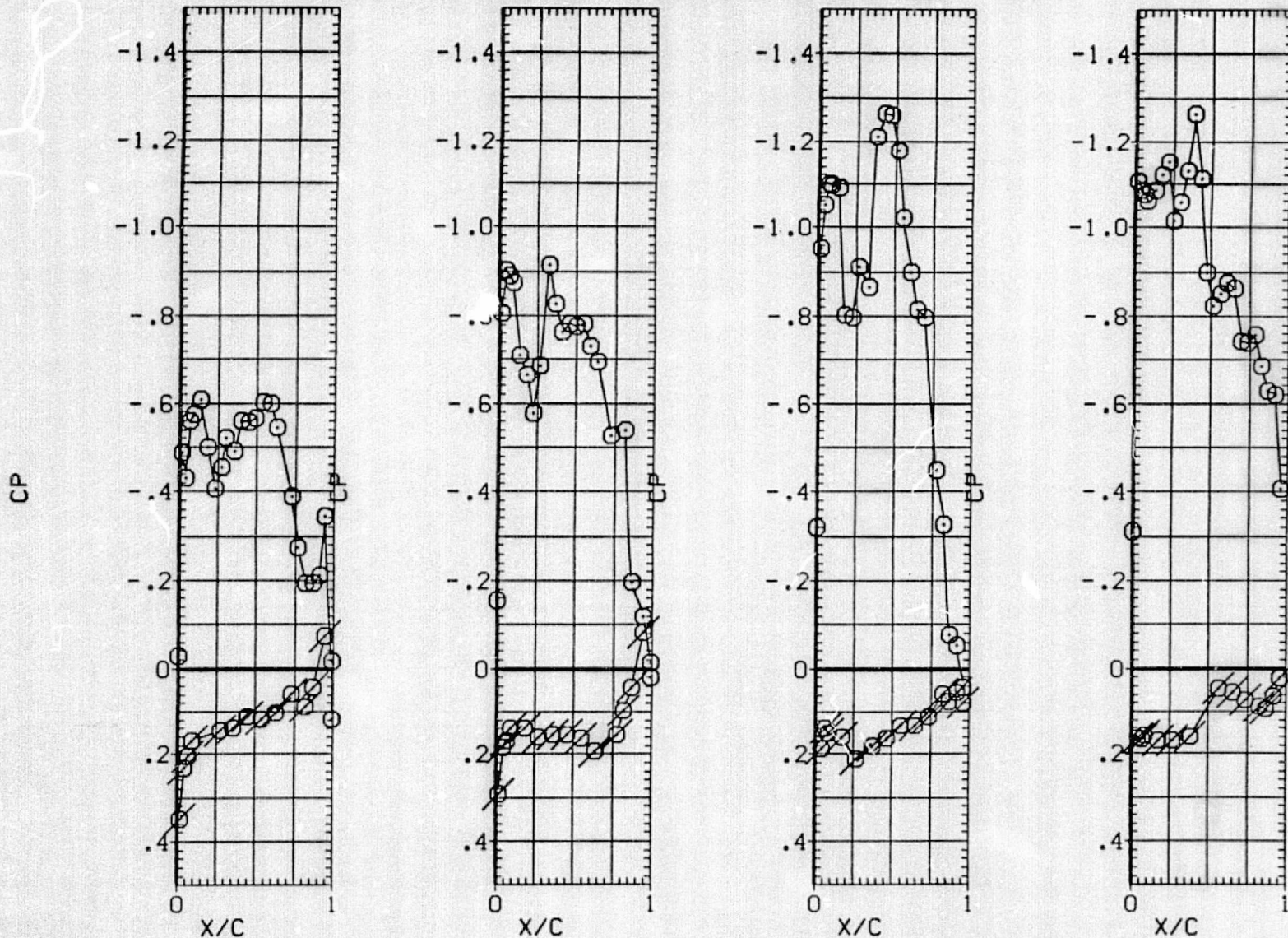

FIG. 15 PRESSURE DISTRIBUTIONS OVER CONFIGURATION 6 AT CTG=0.0

SYMBOL	ALPHA	2Y/B	MACH
○	3.757	.250	.899
		.450	
		.650	
		.800	

PARAMETRIC VALUES			
BETA	.000	DELFI	15.000
DELFO	.000	DELFM	8.000

DATA SET	SYMBOL	CONFIGURATION DESCRIPTION	RN/L	CTG
(RATU23)	OPEN	CONFIGURATION 6 ADEN FLAP DELFI=15	UP SURF. 5.5000	.0400
(ZATL23)	FLAGGED	CONFIGURATION 6 ADEN FLAP DELFI=15	LOW SURF. 5.5000	.0400

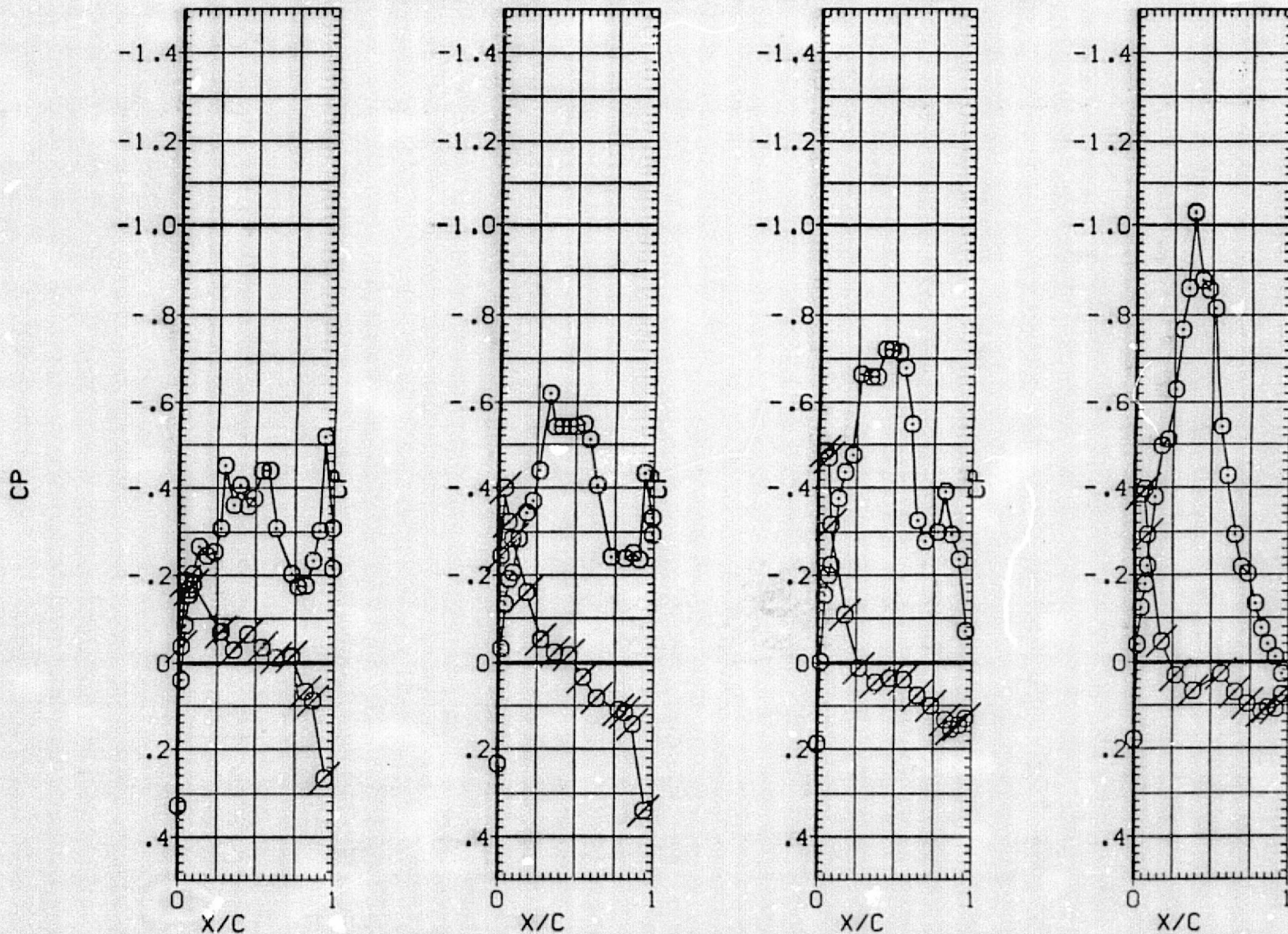

FIG. 15 PRESSURE DISTRIBUTIONS OVER CONFIGURATION 6 AT CTG=0.04

SYMBOL	ALPHA	2Y/B	MACH
○	3.768	.250	.900
		.450	
		.650	
		.800	

PARAMETRIC VALUES			
BETA	.000	DELFI	15.000
DELFO	.000	DELFM	8.000

DATA SET	SYMBOL	CONFIGURATION DESCRIPTION
(RATU24)	OPEN	CONFIGURATION 6 ADEN FLAP DELFI=15
(ZATL24)	FLAGGED	CONFIGURATION 6 ADEN FLAP DELFI=15

RN/L	CTG
UP SURF. 5.5000	.0800
LOW SURF. 5.5000	.0800

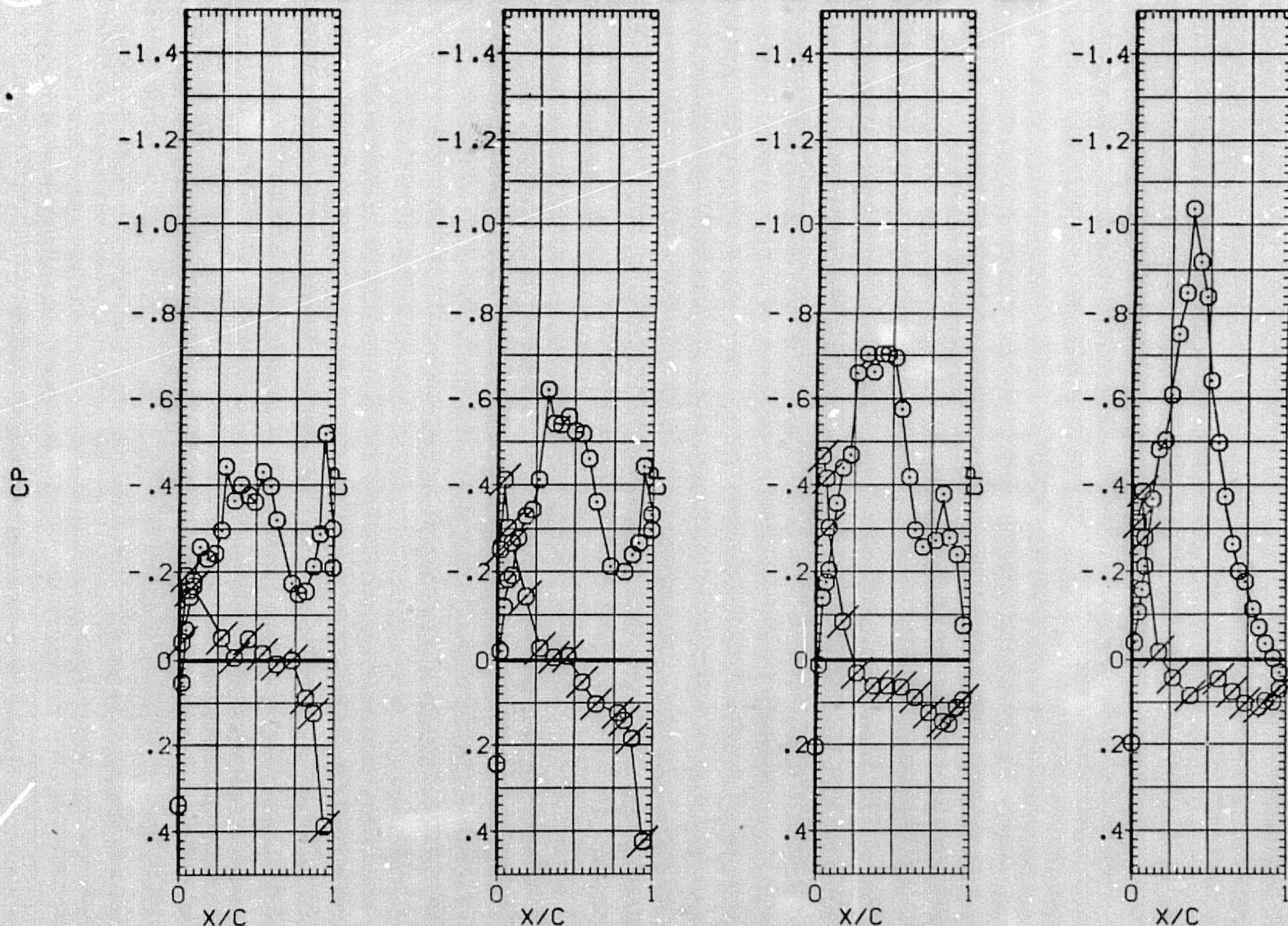

FIG. 15 PRESSURE DISTRIBUTIONS OVER CONFIGURATION 6 AT CTG=0.08

SYMBOL	ALPHA	2Y/B	MACH
○	-.313	.250	.899
		.450	
		.650	
		.800	

PARAMETRIC VALUES			
BETA	.000	DELFI	15.000
DELFO	.000	DELFM	8.000

DATA SET	SYMBOL	CONFIGURATION DESCRIPTION	RN/L	CTG
(RATU25)	OPEN	CONFIGURATION 6 ADEN FLAP DELFI=15	UP SURF. 5.5000	.1200
(ZATL25)	FLAGGED	CONFIGURATION 6 ADEN FLAP DELFI=15	LOW SURF. 5.5000	.1200

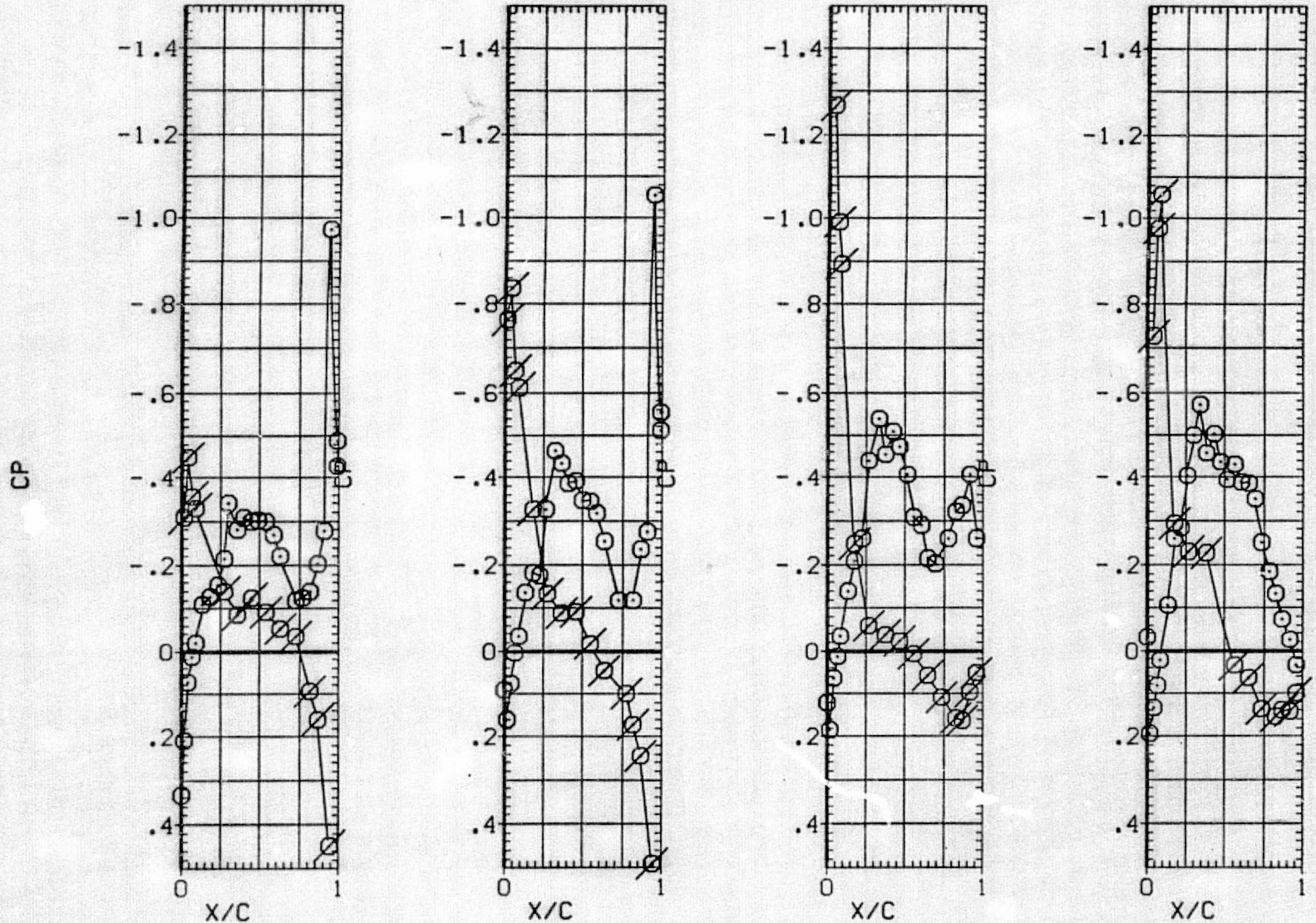

FIG. 15 PRESSURE DISTRIBUTIONS OVER CONFIGURATION 6 AT CTG=0.12

SYMBOL	ALPHA	2Y/B	MACH
○	3.689	.250	.899
		.450	
		.650	
		.800	

BETA	PARAMETRIC VALUES		
DELFO	.000	DELFI	15.000
	.000	DELFM	8.000

DATA SET	SYMBOL	CONFIGURATION DESCRIPTION	RN/L	CTG
(RATU25)	OPEN	CONFIGURATION 6 ADEN FLAP DELFI=15	UP SURF. 5.5000	.1200
(ZATL25)	FLAGGED	CONFIGURATION 6 ADEN FLAP DELFI=15	LOW SURF. 5.5000	.1200

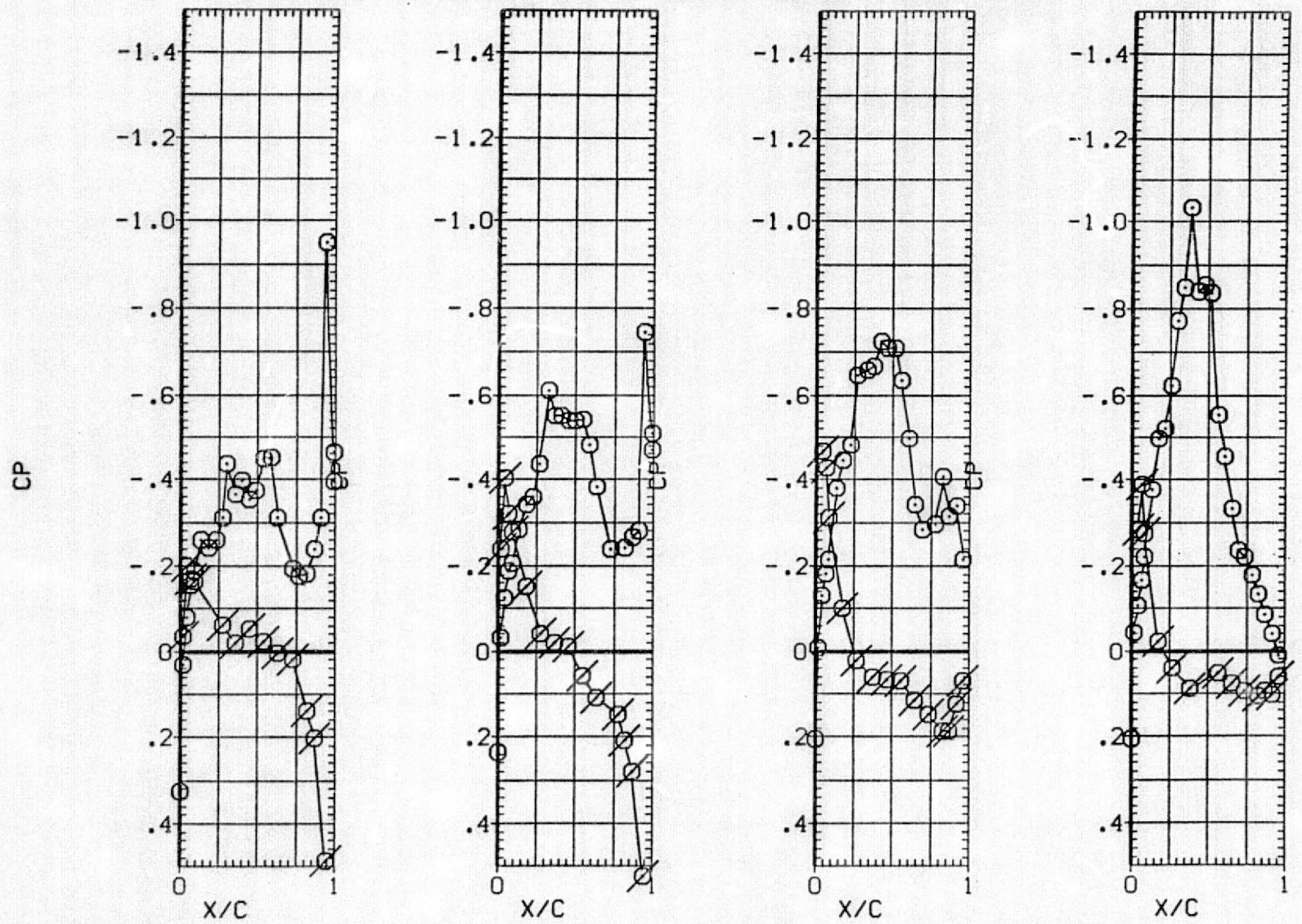

FIG. 15 PRESSURE DISTRIBUTIONS OVER CONFIGURATION 6 AT CTG=0.12

SYMBOL	ALPHA	2Y/B	MACH
○	7.687	.250	.899
		.450	
		.650	
		.800	

PARAMETRIC VALUES			
BETA	.000	DELFI	15.000
DELFO	30.000	DELFH	8.000

DATA SET	SYMBOL	CONFIGURATION DESCRIPTION	RN/L	CTG
(RATU25)	OPEN	CONFIGURATION 6 ADEN FLAP DELFI=15	UP SURF. 5.5000	.1200
(ZATL25)	FLAGGED	CONFIGURATION 6 ADEN FLAP DELFI=15	LOW SURF. 5.5000	.1200

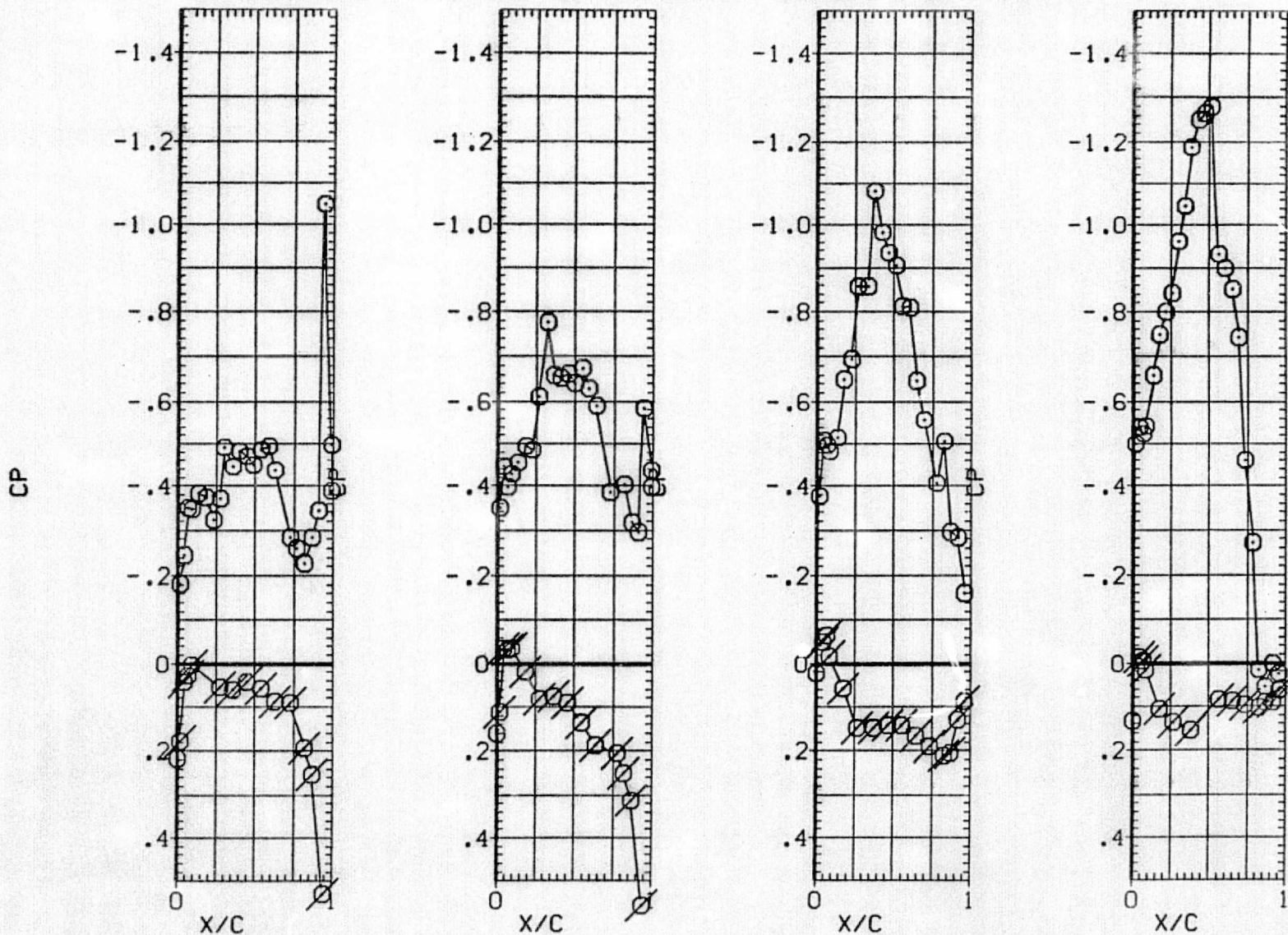

FIG. 15 PRESSURE DISTRIBUTIONS OVER CONFIGURATION 6 AT CTG=0.12

SYMBOL	ALPHA	2Y/B	MACH
○	11.730	.250	.899
		.450	
		.650	
		.800	

	PARAMETRIC VALUES		
BETA	.000	DELFI	15.000
DELFO	.000	DELFM	8.000

DATA SET	SYMBOL	CONFIGURATION DESCRIPTION	RN/L	CTG
(RATU25)	OPEN	CONFIGURATION 6 ADEN FLAP DELFI=15	UP SURF. 5.5000	.1200
(ZATL25)	FLAGGED	CONFIGURATION 6 ADEN FLAP DELFI=15	LOW SURF. 5.5000	.1200

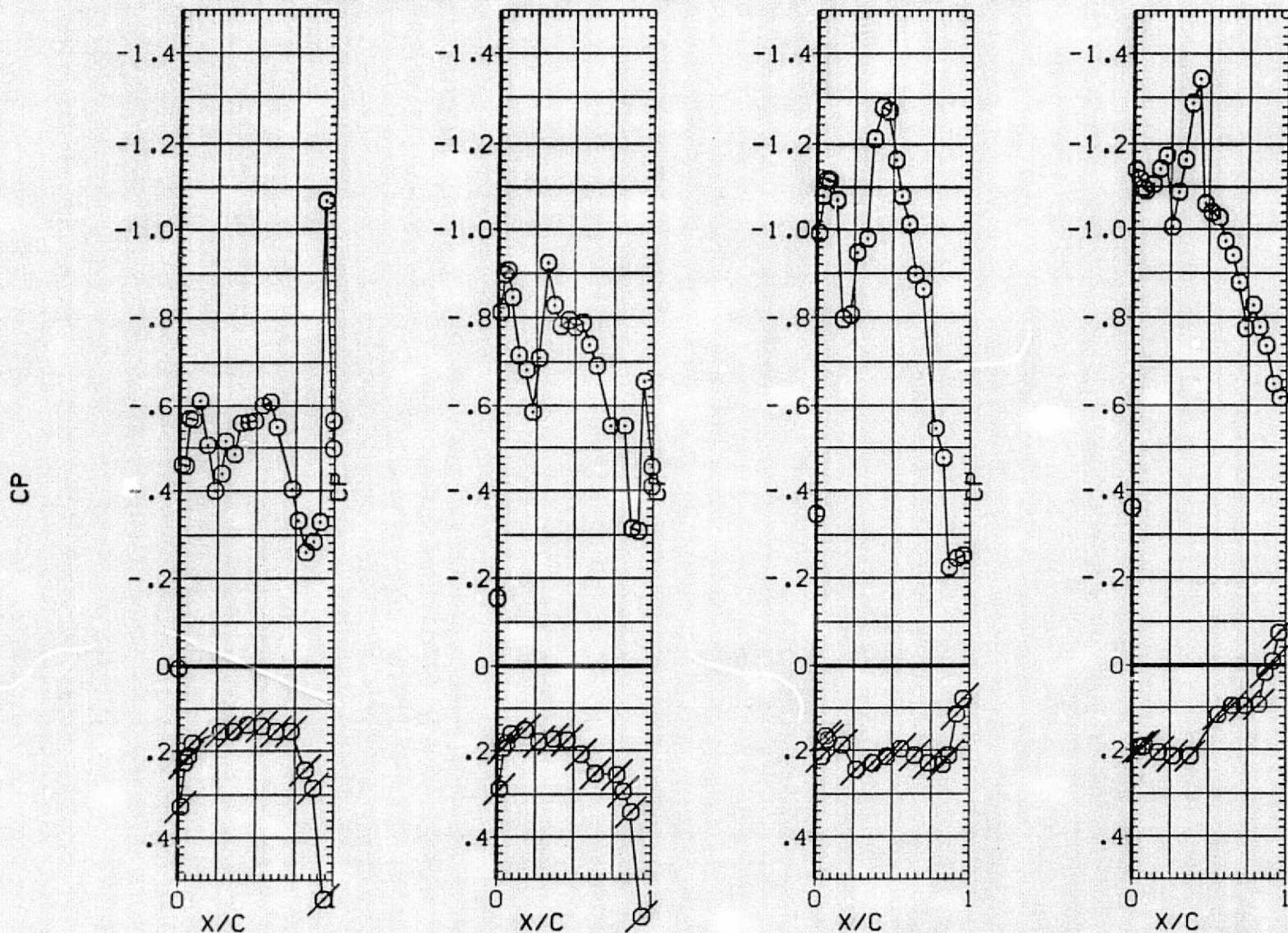

FIG. 15 PRESSURE DISTRIBUTIONS OVER CONFIGURATION 6 AT CTG=0.12

SYMBOL	ALPHA	2Y/B	MACH
○	-.260	.250	.900
		.450	
		.650	
		.800	

PARAMETRIC VALUES			
BETA	.000	DELFI	30.000
DELFO	.000	DELFM	8.000

DATA SET	SYMBOL	CONFIGURATION DESCRIPTION	RN/L	CTG
(RATU27)	OPEN	CONFIGURATION 7 ADEN FLAP DELFI=30	UP SURF. 5.5000	.0000
(ZATL27)	FLAGGED	CONFIGURATION 7 ADEN FLAP DELFI=30	LOV SURF. 5.5000	.0000

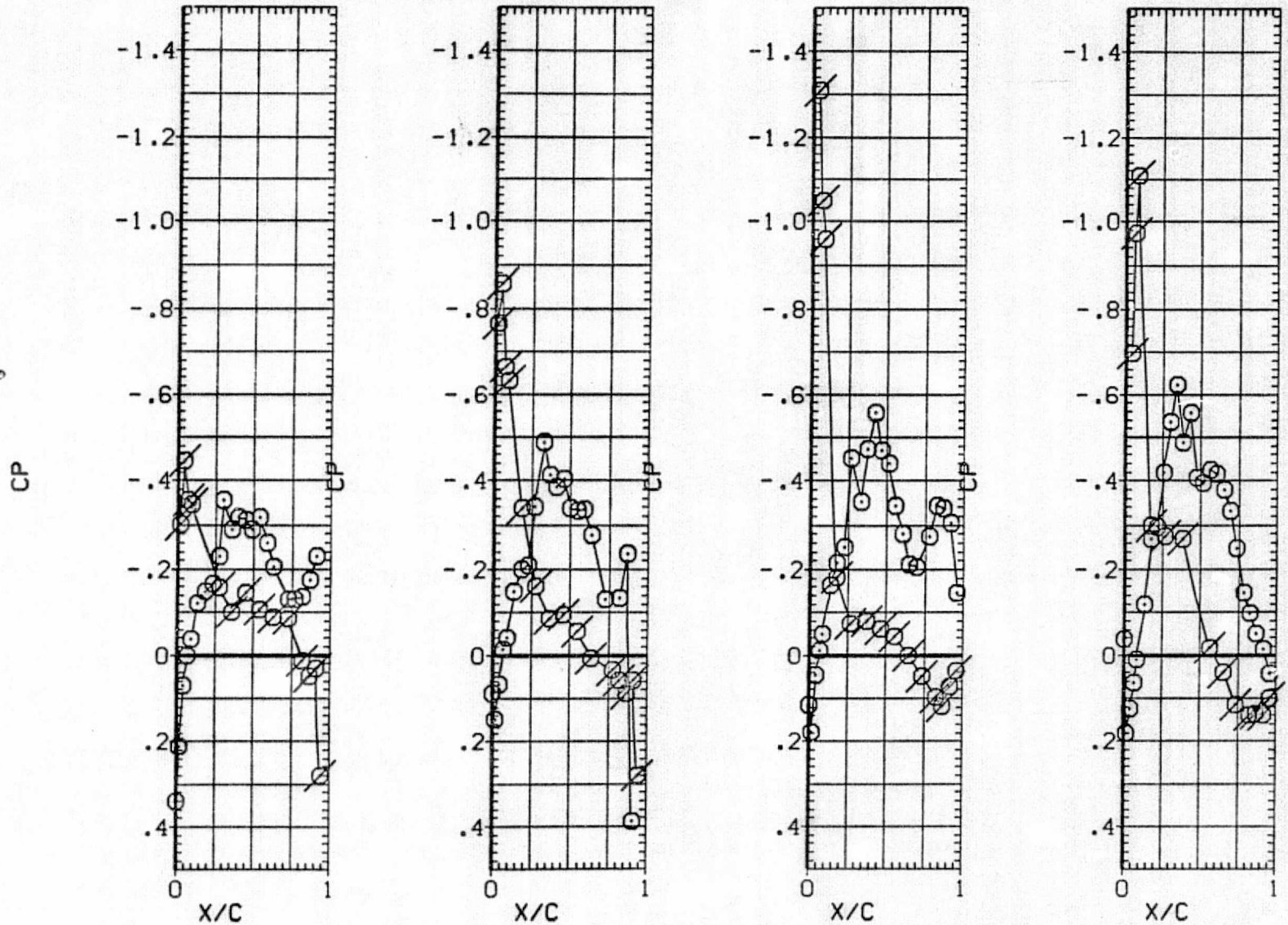

FIG. 15 PRESSURE DISTRIBUTIONS OVER CONFIGURATION 7 AT CTG=0.0

.450
.650
.800

BETA .000 DELF1 30.000
DELFO .000 DELFM 8.000

DATA SET	SYMBOL	CONFIGURATION DESCRIPTION	RN/L	CTG
(RATU27)	OPEN	CONFIGURATION 7 ADEN FLAP DELF1=30	UP SURF. 5.5000	.0000
(ZATL27)	FLAGGED	CONFIGURATION 7 ADEN FLAP DELF1=30	LOW SURF. 5.5000	.0000

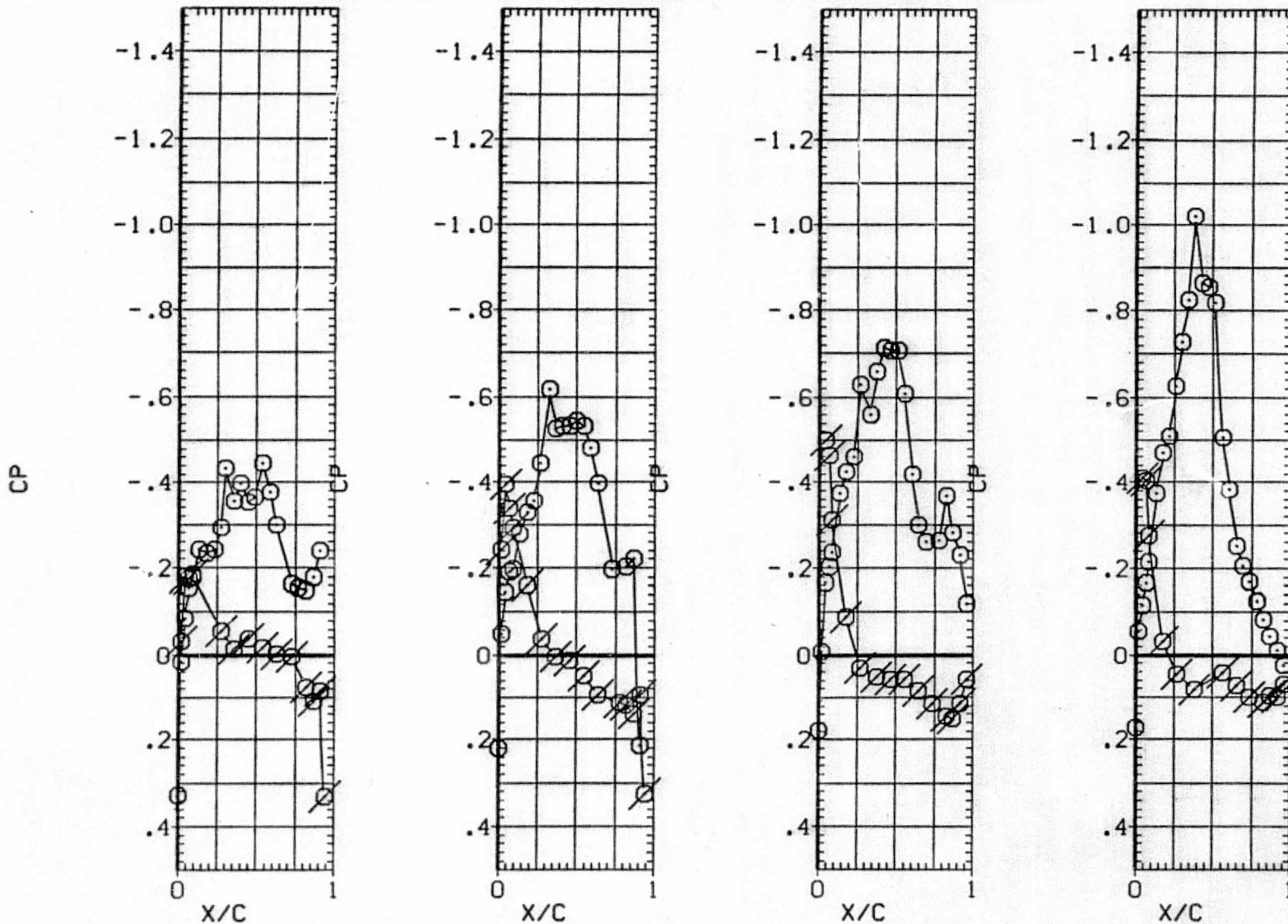

FIG. 15 PRESSURE DISTRIBUTIONS OVER CONFIGURATION 7 AT CTG=0.0

SYMBOL	ALPHA	ZY/B	MACH
○	7.757	.250	.900
		.450	
		.650	
		.800	

PARAMETRIC VALUES		
BETA	.000	DELFI 30.000
DELFO	.000	DELFM 8.000

DATA SET	SYMBOL	CONFIGURATION DESCRIPTION
(RATU27)	OPEN	CONFIGURATION 7 ADEN FLAP DELFI=30
(ZATL27)	FLAGGED	CONFIGURATION 7 ADEN FLAP DELFI=30

	RN/L	CTG
UP SURF.	5.5000	.0000
LOW SURF.	5.5000	.0000

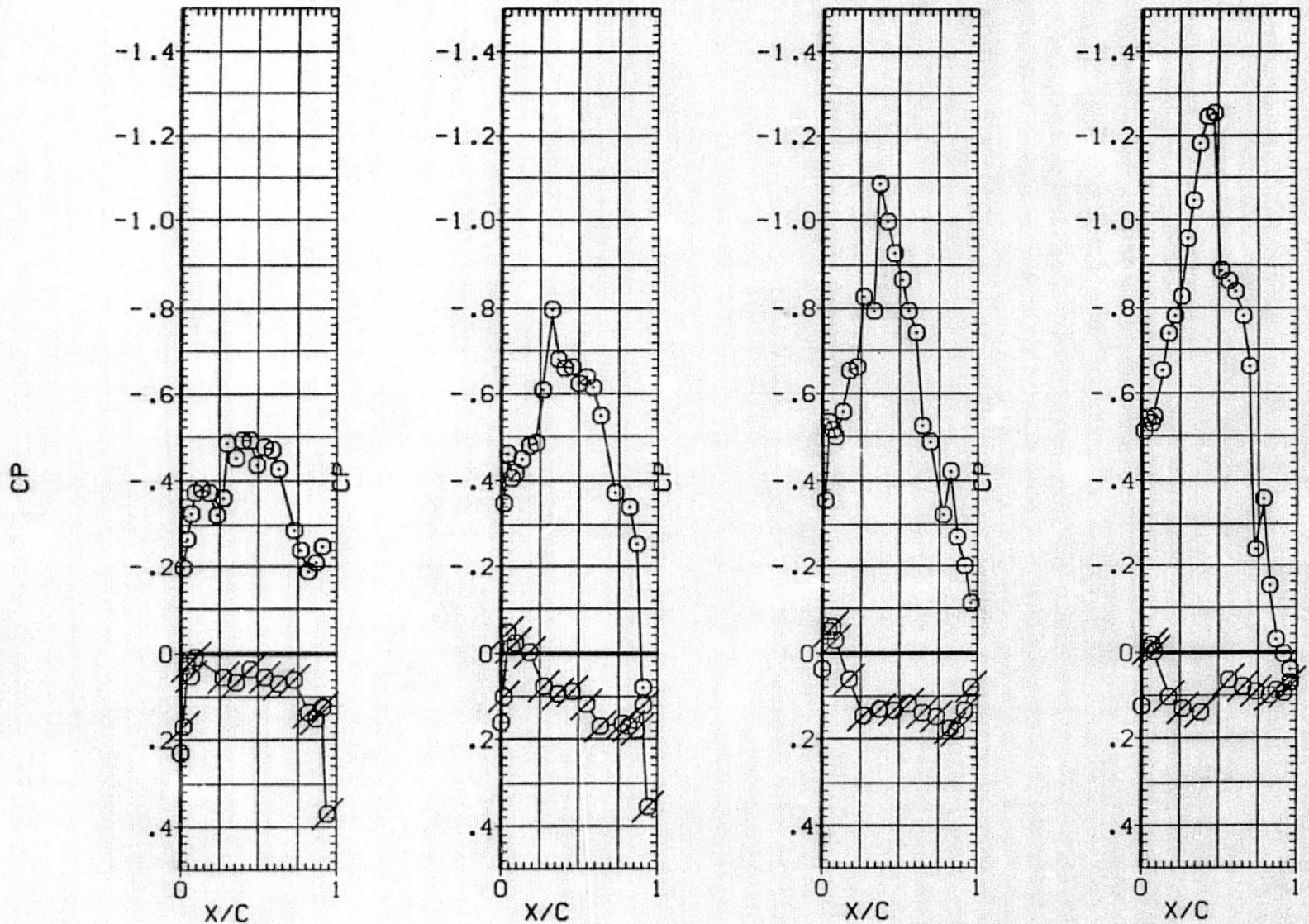

FIG. 15 PRESSURE DISTRIBUTIONS OVER CONFIGURATION 7 AT CTG=0.0

SYMBOL	ALPHA	ZY/B	MACH
○	11.794	.250	.900
		.450	
		.650	
		.800	

PARAMETRIC VALUES			
BETA	.000	DELFI	30.000
DELFO	.000	DELFM	8.000

DATA SET	SYMBOL	CONFIGURATION DESCRIPTION	RN/L	CTG
(RATU27)	OPEN	CONFIGURATION 7 ADEN FLAP DELFI=30	UP SURF. 5.5000	.0000
(ZATL27)	FLAGGED	CONFIGURATION 7 ADEN FLAP DELFI=30	LOW SURF. 5.5000	.0000

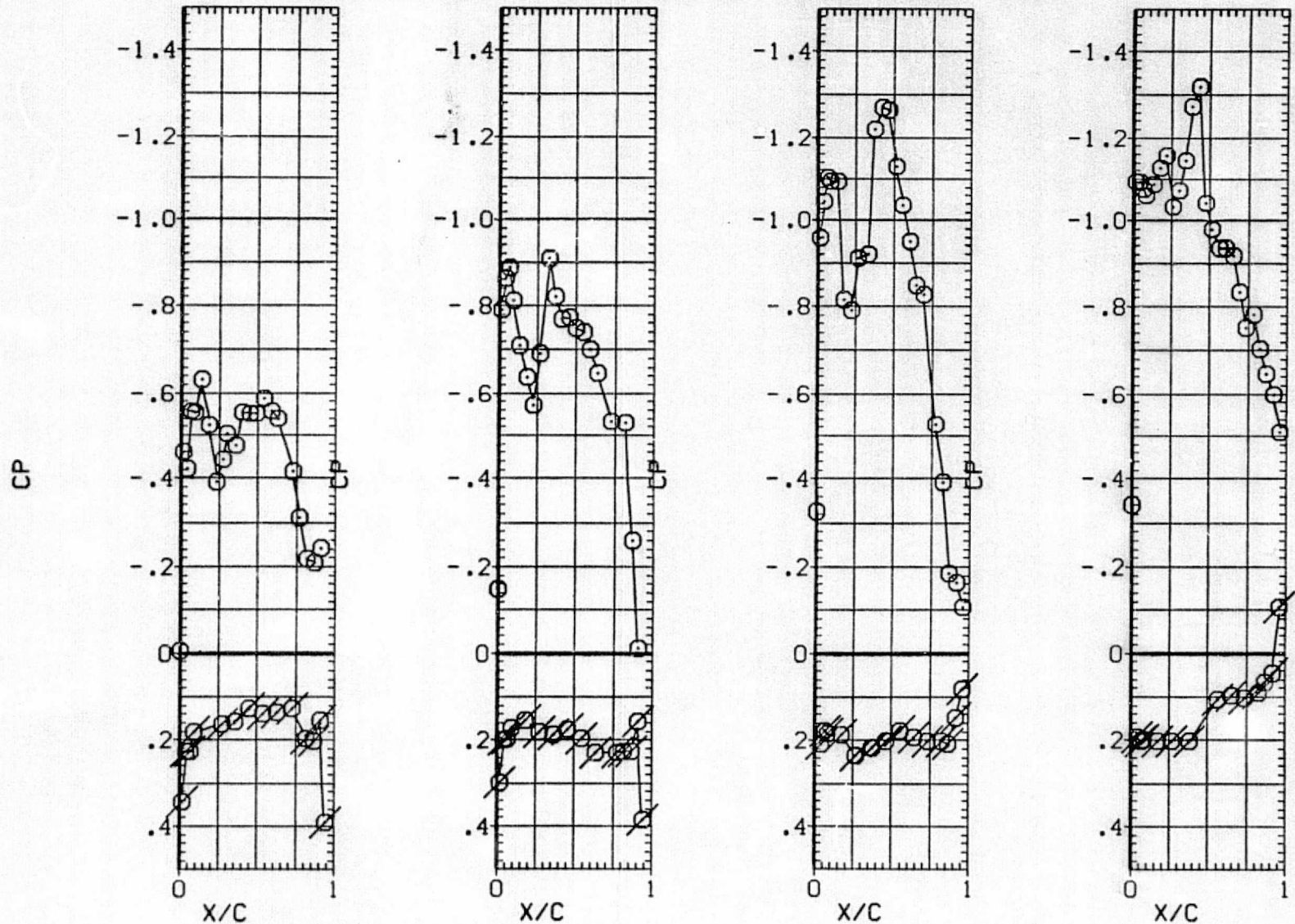

FIG. 15 PRESSURE DISTRIBUTIONS OVER CONFIGURATION 7 AT CTG=0.0

SYMBOL	ALPHA	2Y/B	MACH
○	3.698	.250	.900
		.450	
		.650	
		.800	

PARAMETRIC VALUES		
BETA	.000	DELFI 30.000
DELFO	.000	DELFM 8.000

DATA SET	SYMBOL	CONFIGURATION DESCRIPTION	RN/L	CTG
(RATU28)	OPEN	CONFIGURATION 7 ADEN FLAP DELFI=30	UP SURF. 5.5000	.0400
(ZATL28)	FLAGGED	CONFIGURATION 7 ADEN FLAP DELFI=30	LOW SURF. 5.5000	.0400

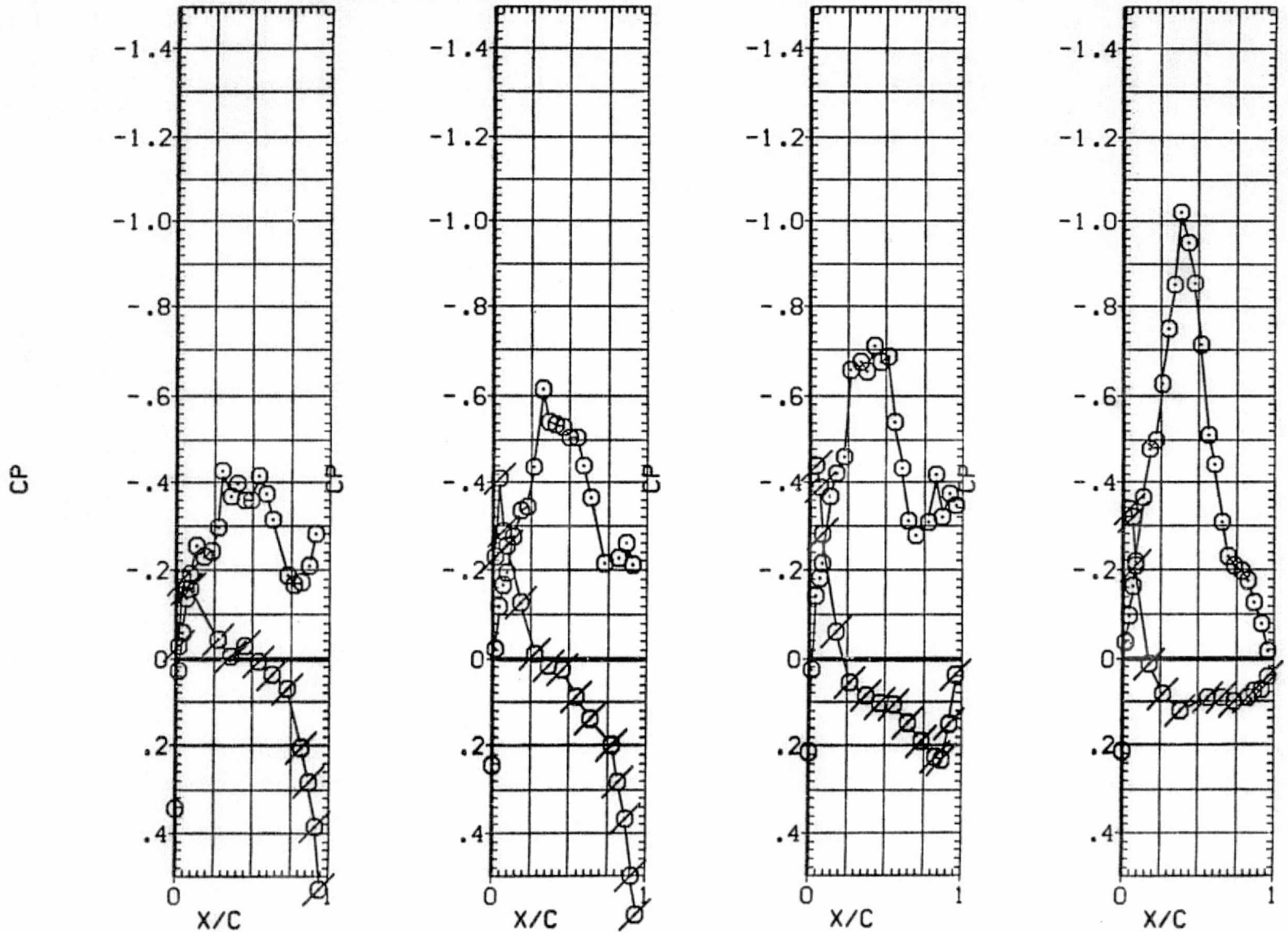

FIG. 15 PRESSURE DISTRIBUTIONS OVER CONFIGURATION 7 AT CTG=0.04

SYMBOL	ALPHA	2Y/B	MACH
○	3.657	.250	.901
		.450	
		.650°	
		.800	

	PARAMETRIC VALUES		
BETA	.000	DELFI	30.000
DELFO	.000	DELFM	8.000

DATA SET	SYMBOL	CONFIGURATION DESCRIPTION	RN/L	CTG
(RATU29)	OPEN	CONFIGURATION 7 ADEN FLAP DELFI=30	UP SURF. 5.5000	.0800
(ZATL29)	FLAGGED	CONFIGURATION 7 ADEN FLAP DELFI=30	LOW SURF. 5.5000	.0800

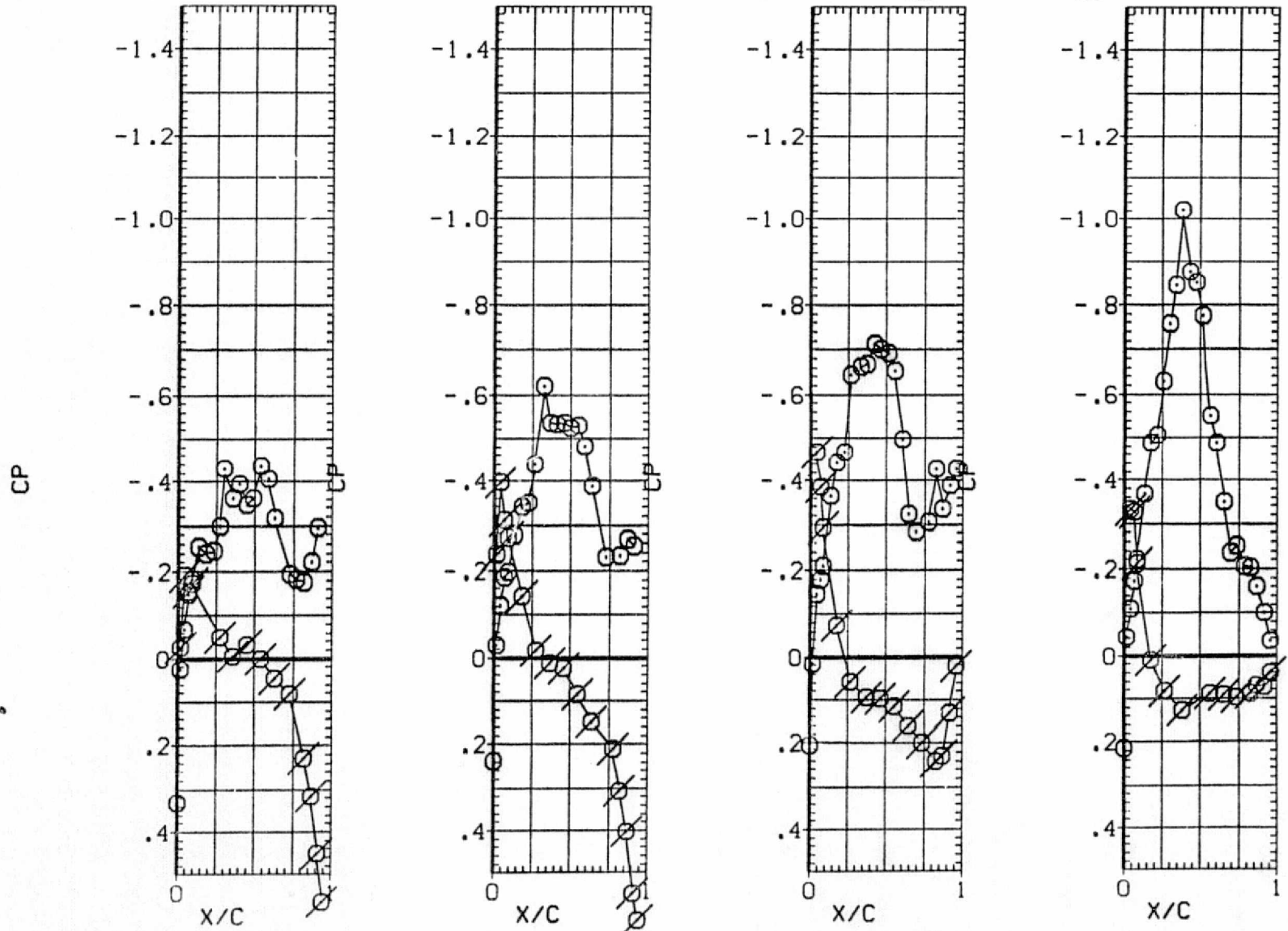

FIG. 15 PRESSURE DISTRIBUTIONS OVER CONFIGURATION 7 AT CTG=0.08

SYMBOL	ALPHA	2Y/B	MACH
○	-.406	.250	.900
		.450	
		.650	
		.800	

	PARAMETRIC VALUES		
BETA	.000	DELFI	30.000
DELFO	.000	DELFM	8.000

DATA SET	SYMBOL	CONFIGURATION DESCRIPTION	RN/L	CTG
(RATU30)	OPEN	CONFIGURATION 7 ADEN FLAP DELFI=30	UP SURF. 5.5000	.1200
(ZATL30)	FLAGGED	CONFIGURATION 7 ADEN FLAP DELFI=30	LOW SURF. 5.5000	.1200

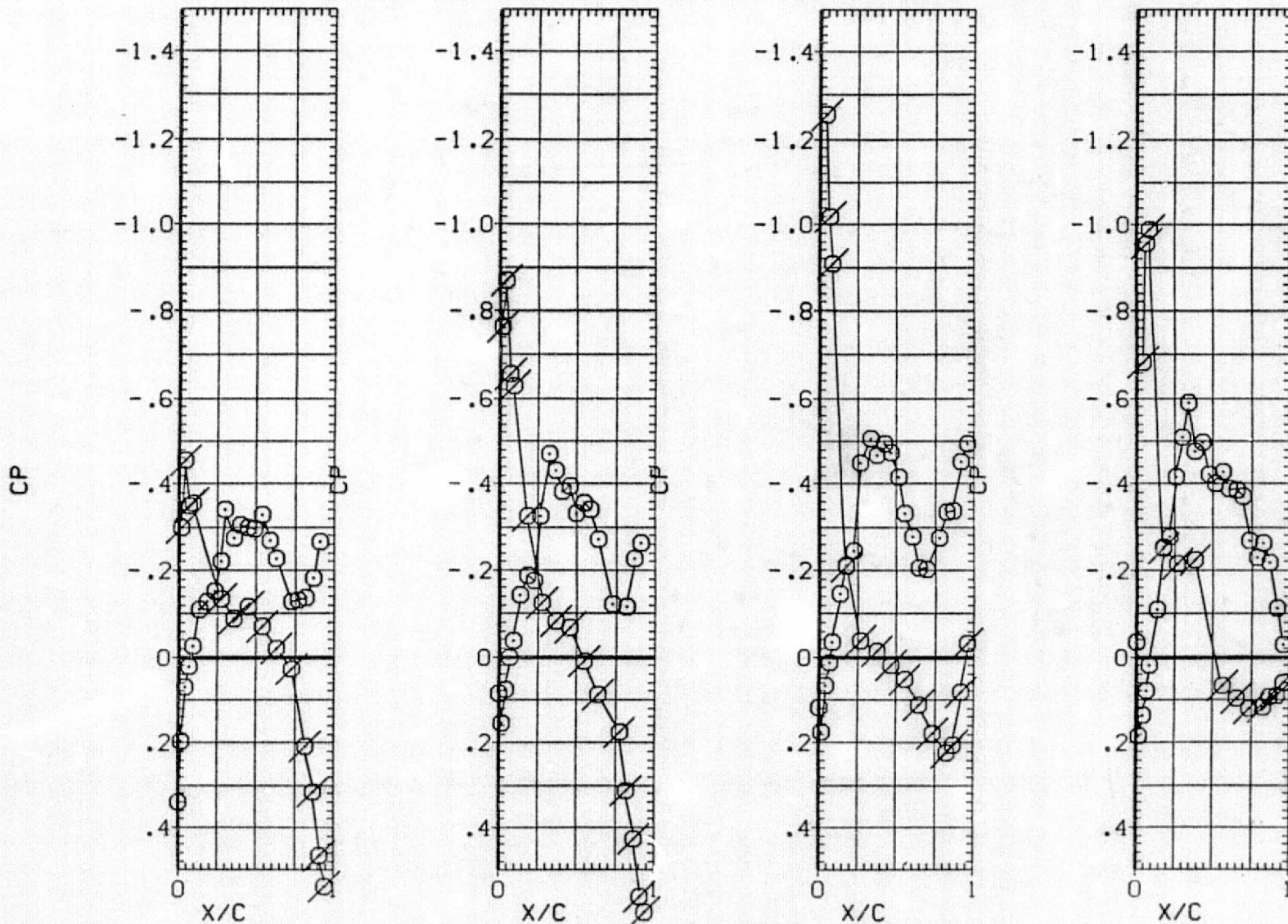

FIG. 15 PRESSURE DISTRIBUTIONS OVER CONFIGURATION 7 AT CTG=0.12

SYMBOL	ALPHA	2Y/B	MACH
○	3.646	.250	.900
		.450	
		.650	
		.800	

PARAMETRIC VALUES			
BETA	.000	DELFI	30.000
DELFO	.000	DELFM	8.000

DATA SET	SYMBOL	CONFIGURATION DESCRIPTION
(RATU30)	OPEN	CONFIGURATION 7 ADEN FLAP DELFI=30
(ZATL30)	FLAGGED	CONFIGURATION 7 ADEN FLAP DELFI=30

	RN/L	CTG
UP SURF.	5.5000	.1200
LOW SURF.	5.5000	.1200

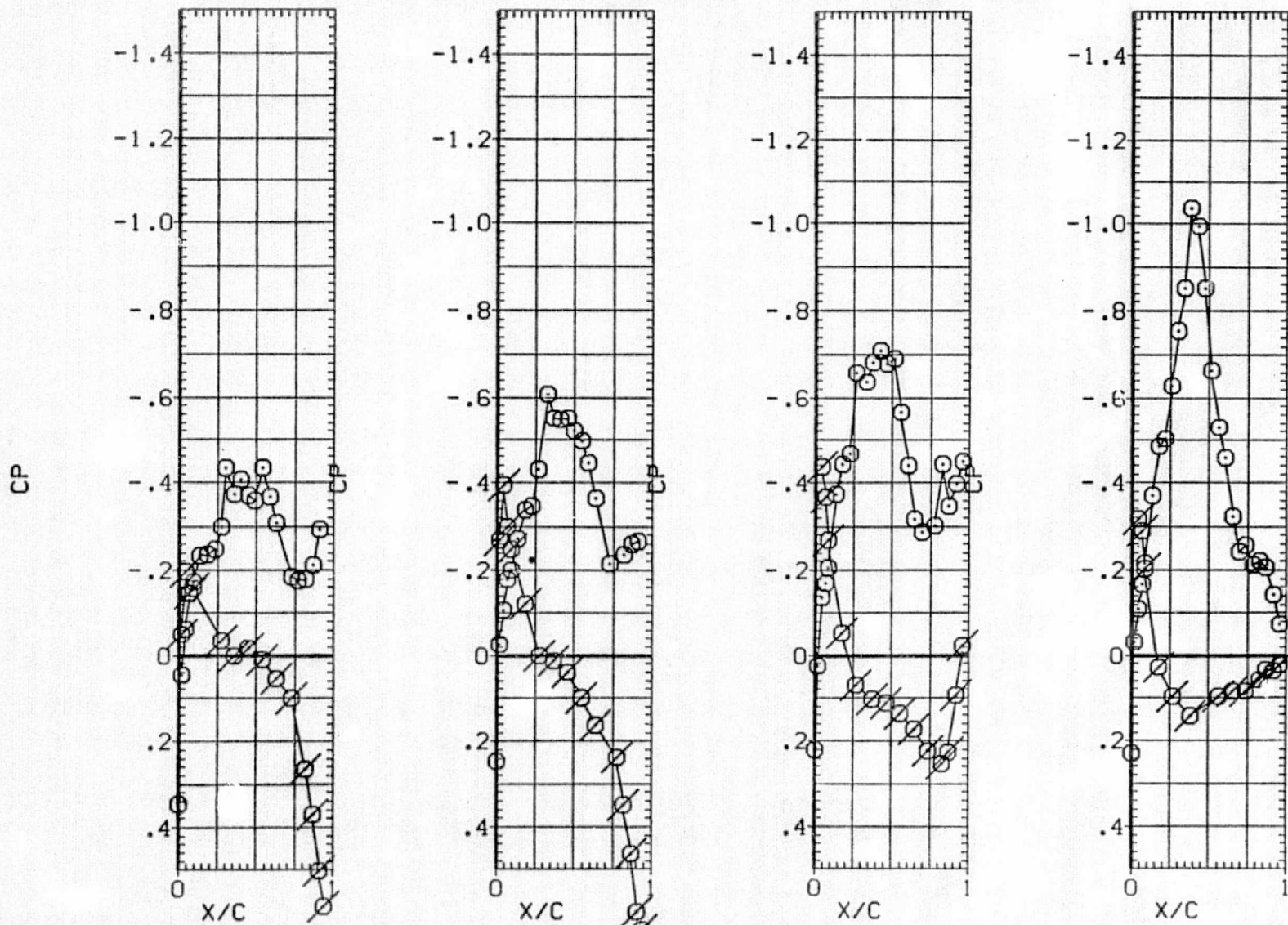

FIG. 15 PRESSURE DISTRIBUTIONS OVER CONFIGURATION 7 AT CTG=0.12

SYMBOL	ALPHA	2Y/B	MACH
○	7.616	.250	.900
		.450	
		.650	
		.800	

PARAMETRIC VALUES		
BETA	.000	DELFI 30.000
DELFO	.000	DELFM 8.000

DATA SET	SYMBOL	CONFIGURATION DESCRIPTION	RN/L	CTG
(RATU30)	OPEN	CONFIGURATION 7 ADEN FLAP DELFI=30	UP SURF. 5.5000	.1200
(ZATL30)	FLAGGED	CONFIGURATION 7 ADEN FLAP DELFI=30	LOW SURF. 5.5000	.1200

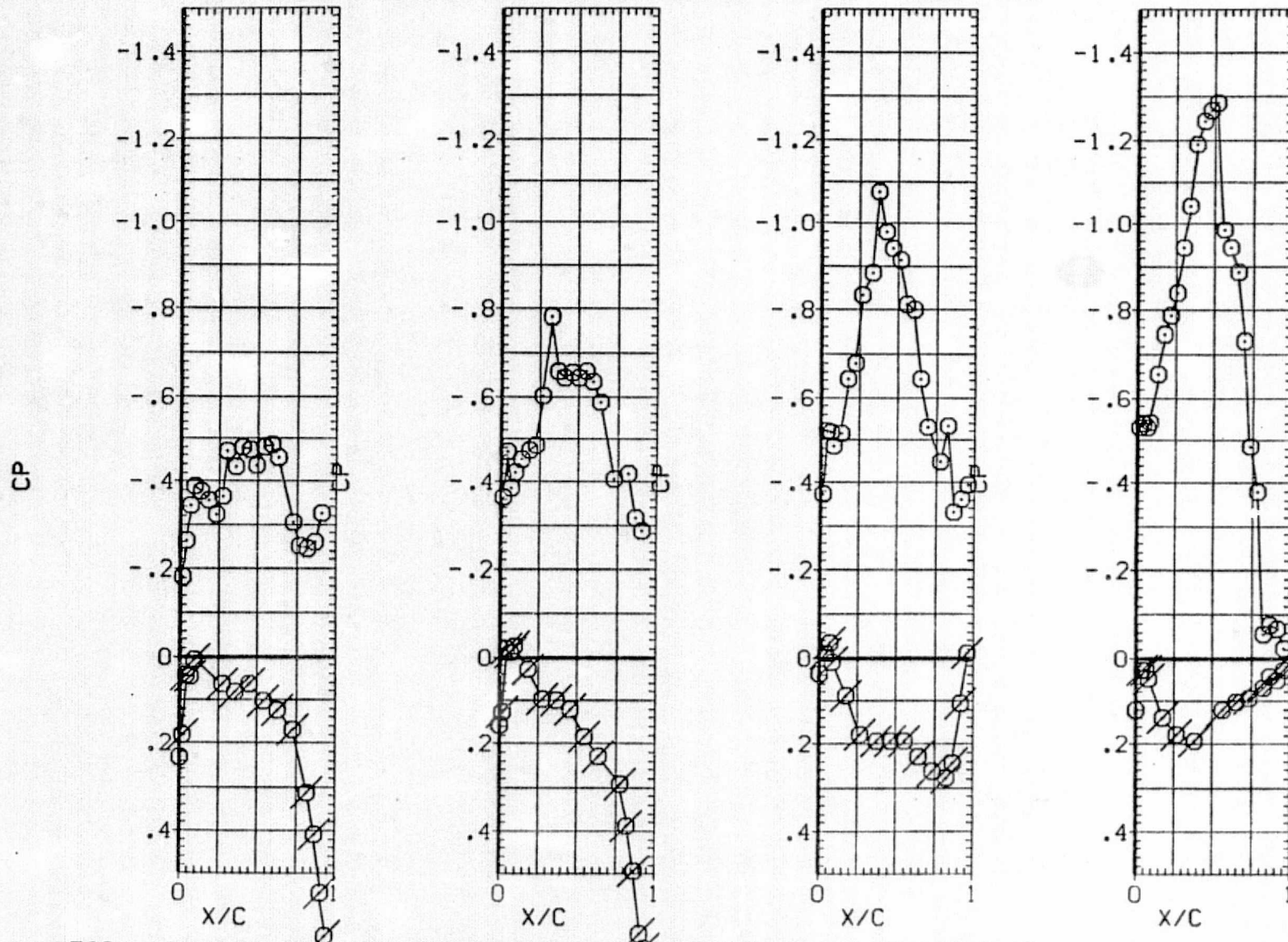

FIG. 15 PRESSURE DISTRIBUTIONS OVER CONFIGURATION 7 AT CTG=0.12