

(NASA-CR-137856) CHEMILUMINESCENCE STUDY ON  
THERMAL DEGRADATION OF AIRCRAFT TIRE  
ELASTOMERS Final Report (Battelle Columbus  
Labs., Ohio.) 63 p HC \$4.50 CSCL 11G  
N76-28423  
Unclas  
G3/27 47242

# RESEARCH REPORT

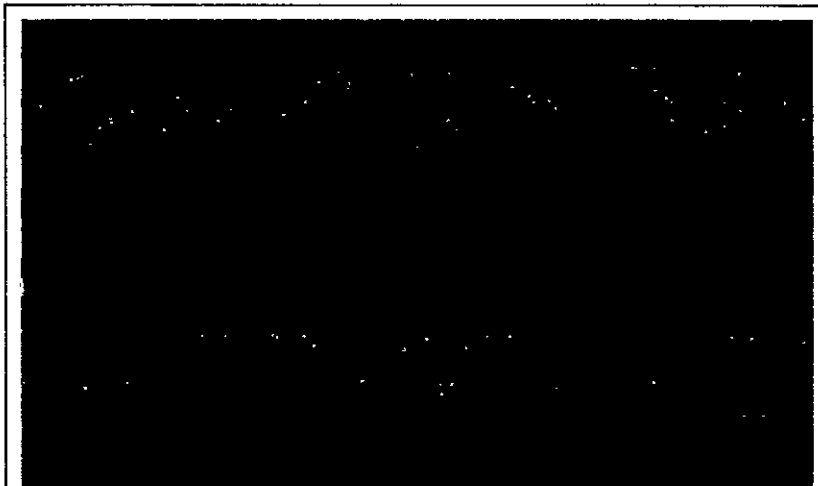

 **Battelle**  
Columbus Laboratories

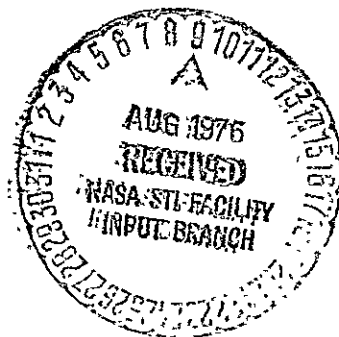

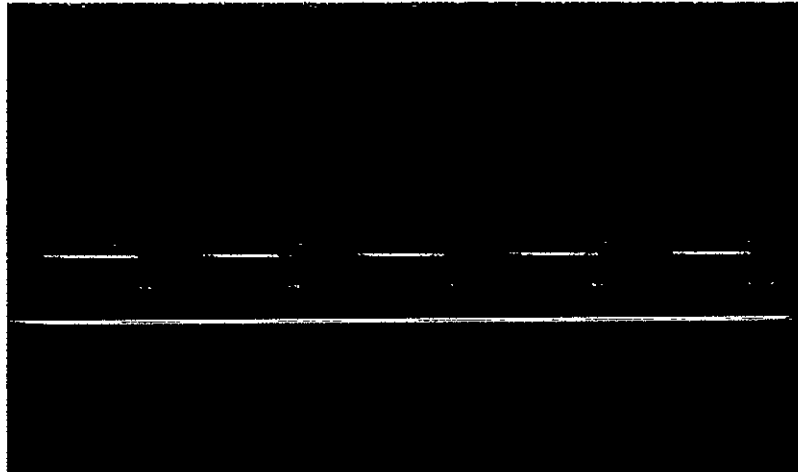

**BATTELLE'S COLUMBUS LABORATORIES** comprises the original research center of an international organization devoted to research and development.

Battelle is frequently described as a "bridge" between science and industry — a role it has performed in more than 90 countries. It conducts research encompassing virtually all facets of science and its application. It also undertakes programs in fundamental research and education.

Battelle-Columbus — with its staff of 2500 — serves industry and government through contract research. It pursues:

- research embracing the physical and life sciences, engineering, and selected social sciences
- design and development of materials, products, processes, and systems
- information analysis, socioeconomic and technical economic studies, and management planning research.

505 KING AVENUE • COLUMBUS, OHIO 43201

CHEMILUMINESCENCE STUDY ON THERMAL DEGRADATION  
OF AIRCRAFT TIRE ELASTOMERS

by

G. David Mendenhall, T. B. Stanford, and  
Richard A. Nathan

FINAL REPORT

June 30, 1976

Distribution of this report is provided in the interest of information  
exchange. Responsibility for the contents resides in  
the author or organization that prepared it.

Prepared under Contract No. NAS2-8195 by  
BATTELLE  
Columbus Laboratories  
505 King Avenue  
Columbus, Ohio 43201

for

AMES RESEARCH CENTER

NATIONAL AERONAUTICS AND SPACE ADMINISTRATION

TABLE OF CONTENTS

	<u>Page</u>
SUMMARY . . . . .	1
INTRODUCTION . . . . .	1
EXPERIMENTAL SECTION . . . . .	2
RESULTS AND DISCUSSION . . . . .	6
Oxidation of Polymers at 25 <sup>o</sup> C . . . . .	6
Chemiluminescence of Polymer Films at 172 <sup>o</sup> C . . . . .	7
FTIR Spectra of Polymers Oxidized for Different Times at 115 <sup>o</sup> C . . . . .	8
Chemiluminescence from Polymers at 91-143 <sup>o</sup> C . . . . .	9
Spectral Distribution of Chemiluminescence. . . . .	12
Chemiluminescence from Hydroperoxidized <u>cis</u> -1,4-Polyisoprene . . . . .	15
Conclusions . . . . .	15
REFERENCES . . . . .	17

LIST OF FIGURES

	<u>Page</u>
FIGURE 1. SCHEMATIC VIEW OF CHEMILUMINESCENCE APPARATUS . . . .	18
FIGURE 2. ARTIST'S SKETCH OF CHEMILUMINESCENCE APPARATUS. . . .	19
FIGURE 3. PHOTOMULTIPLIER DARK CURRENT VS APPLIED VOLTAGE . . . .	20
FIGURE 4. INFRARED SPECTRUM OF SINGLET OXYGENATED <u>cis</u> -1,4-POLYISOPRENE . . . . .	21
FIGURE 5. EFFECT OF ATMOSPHERE ON CHEMILUMINESCENCE FROM <u>cis</u> -1,4-POLYISOPRENE AT 172°C. . . . .	22
FIGURE 6. EFFECT OF ATMOSPHERE ON CHEMILUMINESCENCE FROM <u>trans</u> -POLYPENTENAMER AT 172°C. . . . .	23
FIGURE 7. EFFECT OF ATMOSPHERE ON CHEMILUMINESCENCE FROM <u>cis</u> -1,4-POLYBUTADIENE AT 172°C . . . . .	24
FIGURE 8. SAMPLE NO. 1. <u>cis</u> -1,4-POLYBUTADIENE, PURE FILM. . . .	25
FIGURE 9. SAMPLE NO. 2. <u>cis</u> -1,4-POLYBUTADIENE AFTER 11 MINUTES IN OXYGEN AT 115°C. . . . .	25
FIGURE 10. SAMPLE NO. 3. <u>cis</u> -1,4-POLYBUTADIENE AFTER 21 MINUTES IN OXYGEN AT 115°C. . . . .	26
FIGURE 11. <u>cis</u> -1,4-POLYBUTADIENE DIFFERENCE SPECTRUM (NO. 4 minus 0.8 x NO. 2) . . . . .	26
FIGURE 12. SAMPLE NO. 4. <u>cis</u> -1,4-POLYISOPRENE, PURE FILM . . . .	27
FIGURE 13. SAMPLE NO. 5. <u>cis</u> -1,4-POLYISOPRENE AFTER 12 MINUTES IN OXYGEN AT 115°C. . . . .	28
FIGURE 14. SAMPLE NO. 6. <u>cis</u> -1,4-POLYISOPRENE AFTER 22 MINUTES IN OXYGEN AT 115°C. . . . .	29
FIGURE 15. <u>cis</u> -1,4-POLYISOPRENE DIFFERENCE SPECTRUM (0.8 x NO. 6 minus NO. 5) . . . . .	30
FIGURE 16. SAMPLE NO. 7. <u>trans</u> -POLYPENTENAMER, PURE FILM . . . .	31
FIGURE 17. SAMPLE NO. 8. <u>trans</u> -POLYPENTENAMER AFTER 17 MINUTES IN OXYGEN AT 115°C. . . . .	32
FIGURE 18. SAMPLE NO. 9. <u>trans</u> -POLYPENTENAMER AFTER 27 MINUTES IN OXYGEN AT 115°C. . . . .	33
FIGURE 19. <u>trans</u> -POLYPENTENAMER DIFFERENCE SPECTRUM (0.55 x NO. 9 minus NO. 8). . . . .	34

LIST OF FIGURES  
(Continued)

	<u>Page</u>
FIGURE 20. SAMPLE NO. 10. 1,2-POLYBUTADIENE, PURE FILM . . . . .	35
FIGURE 21. SAMPLE NO. 11. 1,2-POLYBUTADIENE AFTER 24 MINUTES IN OXYGEN AT 115°C. . . . .	36
FIGURE 22. SAMPLE NO. 12. 1,2-POLYBUTADIENE AFTER 37 MINUTES IN OXYGEN AT 115°C. . . . .	37
FIGURE 23. 1,2-POLYBUTADIENE DIFFERENCE SPECTRUM (NO. 11 minus 0.5 x NO. 10). . . . .	38
FIGURE 24. REPRESENTATIVE CURVES FOR OXIDATIVE CHEMILUMINESCENCE FROM <u>cis</u> -1,4-POLYISOPRENE AT 96-142°C. . . . .	39
FIGURE 25. TEST OF CHEMILUMINESCENCE DATA FROM <u>cis</u> -1,4- POLYISOPRENE FOR KINETIC ORDER IN INITIATOR. . . . .	40
FIGURE 26. ARRHENIUS PLOT OF MAXIMUM CHEMILUMINESCENCE FROM <u>cis</u> -1,4-POLYISOPRENE IN OXYGEN. . . . .	41
FIGURE 27. CHEMILUMINESCENCE EMISSION AND SPECTRAL DISTRIBUTION FROM <u>cis</u> -1,4-POLYBUTADIENE AT 110°C IN ARGON . . . . .	42
FIGURE 28. CHEMILUMINESCENCE EMISSION AND SPECTRAL DISTRIBUTION FROM <u>cis</u> -1,4-POLYBUTADIENE AT 110°C IN OXYGEN. . . . .	43
FIGURE 29. CHEMILUMINESCENCE EMISSION AND SPECTRAL DISTRIBUTION FROM <u>trans</u> -POLYPENTENAMER AT 114°C UNDER ARGON. . . . .	44
FIGURE 30. CHEMILUMINESCENCE EMISSION AND SPECTRAL DISTRIBUTION FROM <u>trans</u> -POLYPENTENAMER AT 115°C IN OXYGEN. . . . .	45
FIGURE 31. CHEMILUMINESCENCE EMISSION AND SPECTRAL DISTRIBUTION FROM 1,2-POLYBUTADIENE AT 131°C IN ARGON . . . . .	46
FIGURE 32. CHEMILUMINESCENCE EMISSION AND SPECTRAL DISTRIBUTION FROM 1,2-POLYBUTADIENE AT 129°C IN OXYGEN. . . . .	47
FIGURE 33. CHEMILUMINESCENCE AND SPECTRAL DISTRIBUTION FROM <u>cis</u> -1,4-POLYISOPRENE IN OXYGEN AT 118°C. THE F( $\lambda$ ) VALUES WERE OBTAINED FROM SEVERAL RUNS. . . . .	48

LIST OF FIGURES  
(Continued)

	<u>Page</u>
FIGURE 34. TEMPERATURE DEPENDENCE OF MAXIMUM CHEMILUMINESCENCE FROM 1,2- AND <u>cis</u> -1,4-POLYBUTADIENE, AND FROM <u>trans</u> -POLYPENTENAMER IN OXYGEN. . . . .	49
FIGURE 35. TEMPERATURE DEPENDENCE OF MAXIMUM CHEMILUMINESCENCE FROM <u>trans</u> -POLYPENTENAMER UNDER ARGON. . . . .	50
FIGURE 36. ARRHENIUS PLOTS OF $1/t_{1/2}$ FOR 1,2- AND <u>cis</u> -1,4-POLYBUTADIENE IN OXYGEN. . . . .	51
FIGURE 37. ARRHENIUS PLOT OF $1/t_{1/2}$ FOR <u>trans</u> -POLYPENTENAMER UNDER ARGON. . . . .	52
FIGURE 38. ARRHENIUS PLOT OF $1/t_{1/2}$ FOR <u>cis</u> -1,4-POLYISOPRENE IN OXYGEN. . . . .	53
FIGURE 39. ARRHENIUS PLOT FOR CHEMILUMINESCENCE IN TEMPERATURE-JUMP EXPERIMENT WITH AUTOXIDIZED <u>cis</u> -1,4-POLYISOPRENE. . . . .	54
FIGURE 40. CHEMILUMINESCENCE AS A FUNCTION OF TEMPERATURE FOR AUTOXIDIZED AND SINGLET OXYGENATED <u>cis</u> -1,4-POLYISOPRENE.. EACH RUN CONTAINED 0.5 PERCENT 9,10-DIPHENYLANTHRACENE. . . . .	55

LIST OF TABLES

	<u>Page</u>
TABLE 1. CHEMILUMINESCENCE FROM PURE POLYMER FILMS AS A FUNCTION OF TIME . . . . .	6
TABLE 2. CHEMILUMINESCENCE FROM POLYMER FILMS ON SILVER CHLORIDE. . . . .	9
TABLE 3. EXPRESSIONS FOR MAXIMUM CHEMILUMINESCENCE INTENSITY FROM POLYMERS AS A FUNCTION OF TEMPERATURE. . . . .	13
TABLE 4. EQUATIONS TO DESCRIBE TEMPERATURE DEPENDENCE OF $t_{1/2}$ FOR POLYMERS. . . . .	13



## SUMMARY

Chemiluminescence, or the light accompanying a chemical reaction, is observed during autoxidation of many organic materials. Since the autoxidative process accounts in part for the degradation of rubber, including aircraft tires, it was felt that a study of the chemiluminescence from unsaturated elastomers could contribute significantly to an understanding of the degradation mechanism. The study has revealed similarities in chemiluminescence behavior between the four elastomers investigated that probably reflect similar oxidation mechanisms. A detailed interpretation of the results, at least at the higher temperatures in the study, is not yet possible because of the complicated nature of the system.

Oxidative chemiluminescence was observed from purified samples of cis-1,4-polybutadiene, cis-1,4-polyisoprene, trans-polypentenamer, and 1,2-polybutadiene in an oxygen atmosphere at 25-150°C. The emission was associated with oxidative changes. Under argon chemiluminescence from the thermal decomposition of peroxides and hydroperoxides was observed.

The time-dependence of the chemiluminescence at 91-143°C from cis-1,4-polyisoprene could be predicted by several semi-empirical equations. The emission from the other polymers under these conditions was complicated by a high counting rate from the polymers at the very beginning of the oxidation runs, which indicated the presence of peroxidic materials in the original samples.

The activation energies for chemiluminescence from partially oxidized and hydroperoxidized (with singlet molecular oxygen) cis-1,4-polyisoprene were both  $24 \pm 1$  kcal/mole in the range 25-50°C. This indicates a common mode of initiation, presumably by thermal decomposition of hydroperoxides in either system.

Future work in this area should be carried out at extended reaction times at temperatures between 50°C and 91°C, with larger samples, and with use of chemiluminescence in conjunction with other spectral (infrared, nuclear magnetic resonance) techniques or with simultaneous measurement of oxygen uptake. It would be in fact preferable to work with simple, nonpolymeric model hydrocarbons that are (1) more easily purified and (2) whose oxidation products and excited state products are known or can be characterized by conventional analytical techniques.

CHEMILUMINESCENCE STUDY ON THERMAL DEGRADATION  
OF AIRCRAFT TIRE ELASTOMERS

by

G. David Mendenhall, T. B. Stanford, and  
Richard A. Nathan

INTRODUCTION

NASA-Ames Research Center currently has a strong interest in the thermal oxidative behavior of polymeric materials used in aircraft tires. These include cis-1,4-polyisoprene, cis-1,4-polybutadiene, 1,2-polybutadiene, and trans-polybutadiene. Because aircraft tires are subjected to friction-induced high temperatures and mechanical stress, new and stronger materials are continually being sought. In addition, currently used elastomers are studied in an attempt to understand the thermal degradative mechanism so as to lead to materials with improved stability through structure modification or the use of additives.

Battelle-Columbus recommended the use of a novel technique, chemiluminescence, for the study of the oxidation properties of elastomers used in aircraft tires. Chemiluminescence is greatly superior to other possible methods in that high sensitivity and extreme precision can be achieved at low extents of reaction. Rates of oxidation uptake on the order of  $10^{-6}$  to  $10^{-14}$  mole/year can be studied conveniently by this technique.

It was hoped that the benefits from this program would allow the design and formulation of elastomers with high stability toward thermal oxidation.

Although some previous work has been carried out on the chemiluminescent behavior of saturated polymers, there have been few reports of chemiluminescence studies on unsaturated polymers or elastomers. Clearly a need existed for such work. Furthermore,

with only limited reports available on the chemiluminescence from olefin oxidations, there is a parallel interest in the study of the chemiluminescence of appropriate model compounds of unsaturated elastomers.

#### EXPERIMENTAL SECTION

Materials. cis-1,4-Polyisoprene and cis-1,4-polybutadiene were obtained from the B. F. Goodrich Research and Development Center, Brecksville, Ohio. trans-Polypentamer was obtained from the Farbenfabriken Bayer GmbH, Leverkusen, Germany. 1,2-Polybutadiene was obtained from the Institut Francais du Pétrole, Vernaison, France. The polymers were purified by three reprecipitations from benzene solution with methanol as precipitant. The solvents were reagent grade and were degassed by flushing with argon before use. Operations with the solutions were carried out in an argon or nitrogen atmosphere, and the final benzene stock solutions (~15 g/l) were stored in the dark under positive argon pressure. Polymer films were prepared by spreading layers of stock solution over plate glass sheets and allowing the solvent to evaporate. The glass (2-mm thick, single-strength sheet) was scratched on the reverse side to facilitate breaking into rectangular samples (3.7-cm x 3.5-cm cross section, with an average exposed weight of 4.2 mg polyisoprene). The glass-supported films were then mounted in aluminum 35-mm slide holders and stored in argon prior to chemiluminescence experiments. The films showed no noticeable differences in properties up to several months after preparation.

Apparatus and Procedure. A schematic view and an artist's view of the chemiluminescence apparatus are presented in Figures 1 and 2, respectively. The heart of the instrument is a 600-watt oven (with accessories for cooling) surrounded by a water-cooled shield to prevent the entire light-tight box from reaching the oven temperature. The oven is equipped for accurate variable temperature control (Foxboro Co. heater-proportional control unit) and with gas inlets for introducing any desired atmosphere. The mounted polymer films were placed on the stainless steel conveyor belt, then passed through a double set of pressure-activated doors into the sample chamber. The correct position of the film samples was determined by appropriate marks on the conveyor belt.

Chemiluminescence emission from the samples was focussed with a 2-inch quartz lens onto the detector of a 12-stage photomultiplier (RCA Model 4501/V4). Figure 3 shows the photomultiplier dark current plotted vs. applied voltage. From this figure we concluded that a voltage of 1500 volts optimally reduced variations due to changes in line voltage. The photomultiplier output was connected to a counter (General Radio Model 1191) whose output, expressed in analog or digital form, was usually set to average the photon counts over a 10-sec interval. This allowed us to eliminate spurious signals due to high-frequency noise in the line voltage (appearing when room lights were on or from unidentified sources). A strip-chart recorder connected to the counter permitted automatic data collection. A wheel containing up to 20 filters was positioned in the optical path to permit spectral analysis of the chemiluminescence by measuring the relative emission intensity after the light passes through the various filters. A manual and an automatic shutter were also positioned in the optical path to permit background counting.

For chemiluminescence experiments below 117°C, the polymer film, initially at 25°C, was placed in the oven preheated to the desired temperature. For experiments above 117°C, the time to warm the film to the oven temperature introduced a significant distortion in the shape of

the chemiluminescence intensity-time plots. To circumvent this difficulty, the film was placed in the oven at 25°C and flushed with argon for more than 20 min, and the oven was then heated to the desired temperature. At the start of the chemiluminescence measurement, the argon stream was changed to oxygen.

The low-intensity chemiluminescence from partially oxidized polyisoprene films (as well as from hydroperoxidized samples obtained through prior singlet oxidation) was corrected for background emission. The latter signal, amounting to 30-50 counts/sec under the experimental conditions employed, remained stable during 6 months' operation and is believed to be due to stray sources of light originating in the oven and photomultiplier housing, inherent noise from the photomultiplier tube, and cosmic radiation.

Reaction with Singlet Molecular Oxygen ( $^1O_2$ ). A solution of 0.19 g of purified cis-1,4-polyisoprene in 25 ml of benzene, containing 0.2 g of Rose Bengal chemically bound to polystyrene beads, <sup>(1)</sup> was placed in a Pyrex flask with provision for magnetic stirring and flushed with oxygen for 1 min. The flask was connected to a gas burette filled with oxygen, and the stirred mixture was irradiated for 50 min with the output from a 500-W projector lamp filtered through a Corning CS3-71 cutoff filter. After 55 min the solution absorbed  $13.0 \pm 0.5$  ml of oxygen, corresponding to about one hydroperoxide group per five monomer units. Absorption of oxygen by the solution was negligible before and after irradiation. The solution was filtered from the sensitizer beads and used immediately for casting films for chemiluminescence measurements or infrared analysis. The infrared spectrum of the  $^1O_2$ -treated polyisoprene (Figure 4) showed an O-H band at  $3400\text{ cm}^{-1}$  and a weak C-O absorption at  $1000\text{ cm}^{-1}$ ; the presence of a weak carbonyl absorption at  $1700\text{ cm}^{-1}$  indicated the occurrence of a small amount of polymer decomposition.

Examination of Polymer Autoxidation by Fourier Transform Infrared Spectroscopy. Benzene solutions of cis-1,4-polyisoprene, cis-1,4-polybutadiene, trans-polybutadiene, and 1,2-polybutadiene were prepared as described above and stored in an argon atmosphere. In order to allow simultaneous determination of chemiluminescence and of the changes in the infrared spectra, we chose to use silver chloride sheets as the support for the polymer films. The sheets were weighed carefully before and after depositing a film. Constancy in the final weight indicated the virtual absence of residual solvent in the sample. Contrary to our expectations, films prepared in air did not oxidize to an extent detectable by Fourier Transform infrared for several hours after preparation.

All of the film preparations on silver chloride were thus carried out in air and the samples were either used immediately or stored under nitrogen or argon until use. We expected the results to be comparable to those from films prepared by evaporation in a glove box in earlier studies, since we believe that significant residual amounts of oxygen were probably entrained in the silver chloride in the latter system.

The area of the silver chloride sheets was approximately  $9.7 \text{ cm}^2$  (1 in. x 1.5 in.). From the weights of polymer deposit, which varied between 0.0117 and 0.0050 g, and an approximate density for the polymers of 0.8, we calculate an average film thickness between  $1.5 \times 10^{-3}$  and  $6.4 \times 10^{-4}$  cm for our samples.

Silver chloride was found to react with the aluminum sample holders over extended periods. A dark, granular material was produced on the surface of the silver chloride film. This material is probably silver metal formed by the simple displacement reaction:

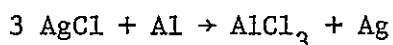

To prevent this reaction we used only the aluminum base plates to mount the samples, and the AgCl sheet was separated from it by a glass slide.

RESULTS AND DISCUSSION

Oxidation of Polymers at 25°C

Initially we planned to follow chemiluminescence and infrared spectral changes at 25°C from films of cis-1,4-polyisoprene, cis-1,4-polybutadiene, trans-polypentamer, and 1,2-polybutadiene. As seen from the data in Table 1, after periods up to 24 hours in air, only minor differences in chemiluminescence intensities were observed in the samples. Comparison of Fourier Transform infrared spectra made by subtracting the latter from the initial spectra revealed only minor changes whose interpretation was not clear.

TABLE 1. CHEMILUMINESCENCE FROM PURE POLYMER FILMS  
AS A FUNCTION OF TIME

Polymer, weight	Initial counts/sec <sup>(a)</sup>	Count/sec after (hr) in air <sup>(b)</sup>
<u>cis</u> -1,4-Polybutadiene, 0.0052 g	2.4	2.8 (22)
<u>trans</u> -Polypentamer, 0.0059 g	6.6	6.5 (24)
1,2-Polybutadiene, 0.0038 g	4.4	4.2 (24)
<u>cis</u> -1,4-Polyisoprene, 0.0040 g	0.8	3.9 (24)

(a) In oxygen atmosphere.

(b) At 25°C.

At 25°C conditions are rather ideal for study of polymer oxidation and chemiluminescence, since these conditions correspond to the average ambient ones. The changes in samples allowed to stand in air are quite slow, as would be expected. Chemiluminescence was seen easily in samples initially and after standing (Table 1). The differences are small, however, while consistent with the lack of any major changes in the infrared spectra and indicates that the oxidation of the samples has not proceeded to any great extent. The chemiluminescence measured from fresh polymer films was ascribed to ongoing oxidation, even though these films for infrared purposes were taken to be "pure"!

Chemiluminescence of Polymer  
Films at 172°C

Initial experiments were carried out at 172°C with films of cis-1,4-polybutadiene, trans-polypentamer, and cis-1,4-polyisoprene on aluminum. Counting rates in an oxygen atmosphere were among the highest ever recorded with our instrument. The rates dropped rapidly on replacement of the oxygen with argon (Figures 5-7), and this effect was nearly reversible, at least qualitatively. Superimposed on the changes to an argon atmosphere is a rather smooth decline in counting rate in oxygen with time. Under these conditions the samples became deeply colored and took on a mottled appearance.

At this temperature the degradation of the samples was so extensive that we attach no more than qualitative significance to our results. From the results shown in Figures 5-7 it is apparent that the presence of oxygen enhances chemiluminescence, as others<sup>(2)</sup> have also shown. It is rather surprising, in view of the deep-seated changes in the samples indicated by their appearance after exposure to these conditions, that there is not a greater variation in the counting rate with time. The overall decrease in counting rate in oxygen with time can be ascribed in part to self-absorption, due to production of colored products. Another factor may be the dilution of the sample with oxidation products, which would retard the rate of oxidation. 1,2-Polybutadiene was not examined at 172°C, although it would be expected to show very similar behavior.

We concluded that 172°C represented an upper limit to the study, while at 25°C the changes appeared inconveniently slow and the chemiluminescence could not be measured very accurately. We chose to repeat the experiment at intermediate temperatures, following changes both by chemiluminescence and by infrared. The latter study was performed with samples at 115°C on silver chloride sheets.



u

FTIR Spectra of Polymers Oxidized for  
Different Times at 115°C

Three samples each of cis-1,4-polyisoprene, cis-1,4-polybutadiene, trans-polybutadiene, and 1,2-polybutadiene were prepared as films on silver chloride. The first served as a reference sample. The second was placed in the oven until the counting rate was nearly constant. The third sample was placed in the oven for the same time as the second sample plus an increment of about 10 minutes. All three samples were scanned by Fourier Transform infrared spectroscopy and subtractive differences noted. The FTIR results appear in Figures 8 through 23. Sample numbers in these figures correspond to samples in Table 2 which lists the chemiluminescence data.

At 115°C the four polymers described above oxidized rapidly, as indicated by large chemiluminescence counts and gross changes in the infrared spectra of the samples (Figures 8 through 23). All samples show appearance of infrared bands at 3600-3200  $\text{cm}^{-1}$  (OH), 1700-1800  $\text{cm}^{-1}$  (C=O), and around 1000  $\text{cm}^{-1}$  (C-O). These correspond to absorption bands of expected oxidation products, including hydroperoxides, alcohols, ketones, aldehydes, etc. The shape of the carbonyl band indicates multiple products, and this is confirmed by splitting in the carbonyl region of the difference spectra (except in the 1,2-polybutadiene difference spectrum). The autoxidation is accompanied also by decreases in C=C and olefinic C-H absorptions. Some of these are revealed as positive bands in the difference spectra.

Due to the inconvenience (and expense) of preparing films on silver chloride, the remainder of the study was carried out with films deposited on glass slides. It was also reasoned that the IR changes would not give unexpected results, whereas the chemiluminescence behavior of the polymers was largely unknown.

TABLE 2. CHEMILUMINESCENCE FROM POLYMER FILMS  
ON SILVER CHLORIDE

Sample No.	Polymer	Weight, (g)	Treatment	Counts/sec
1	<u>cis</u> -1,4-Polybutadiene	0.0117	None, stored in Ar	(a)
2	<u>cis</u> -1,4-Polybutadiene	0.0076	11 min/115°C/O <sub>2</sub>	3.2 x 10 <sup>4</sup>
3	<u>cis</u> -1,4-Polybutadiene	0.0086	21 min/115°C/O <sub>2</sub>	2.5 x 10 <sup>4</sup>
4	<u>cis</u> -1,4-Polyisoprene	0.0053	None, stored in Ar	(a)
5	<u>cis</u> -1,4-Polyisoprene	0.0056	12 min/115°C/O <sub>2</sub>	3.6 x 10 <sup>4</sup>
6	<u>cis</u> -1,4-Polyisoprene	0.0066	22 min/115°C/O <sub>2</sub>	3.7 x 10 <sup>4</sup>
7	<u>trans</u> -Polypentenamer	0.0051	None, stored in Ar	(a)
8	<u>trans</u> -Polypentenamer	0.0060	17 min/115°C/O <sub>2</sub>	2.3 x 10 <sup>4</sup>
9	<u>trans</u> -Polypentenamer	0.0083	27 min/115°C/O <sub>2</sub>	2.5 x 10 <sup>4</sup>
10	1,2-Polybutadiene	0.0075	None, stored in Ar	(a)
11	1,2-Polybutadiene	0.0098	24 min/115°C/O <sub>2</sub>	3.5 x 10 <sup>4</sup>
12	1,2-Polybutadiene	0.0071	37 min/115°C/O <sub>2</sub>	2.4 x 10 <sup>4</sup>

(a) Chemiluminescence not measured. Used for infrared reference.

#### Chemiluminescence from Polymers at 91-143°C

Chemiluminescence-Autoxidation. Representative curves obtained for the oxidative chemiluminescence from cis-1,4-polyisoprene at 96-142°C are shown in Figure 24. The parameters used to characterize these curves are  $I_{\max}$ , the maximum intensity of chemiluminescence,<sup>(3)</sup> and  $t_{1/n}$ , the time required to reach  $(1/n)I_{\max}$ . These parameters, in the ideal case, are related to rate constants for the autoxidation and excited state reaction sequence.

The autoxidation mechanism was assumed to involve the generally accepted sequence of initiation, propagation, and termination steps involving free radicals. The initiation steps in the autoxidation may be bi- or unimolecular, or pseudounimolecular. In the bimolecular case, Scheme I is assumed to hold.<sup>(4,5)</sup>

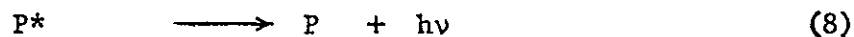
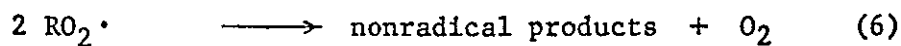
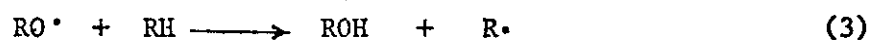
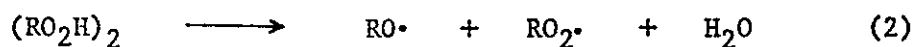
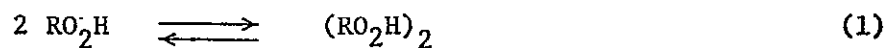
Scheme I

In this scheme P\* is the electronically excited product responsible for chemiluminescence, Q is the principal quenching species, presumably oxygen, RH is the polymer, and R· denotes different radical sites on the polyisoprene backbone. The use of steady-state approximation for R·, RO<sub>2</sub>·, RO<sub>2</sub>H, and P\*, by analogy to derivations by Lundeen and Livingston,<sup>(5a)</sup> and by Tobolsky, Metz, and Mesrobian<sup>(5b)</sup> for tetralin autoxidation, lead to the following expressions:

$$\left[ \frac{k_6 k_{-1}}{k_1 k_2} \right]^{1/2} \cdot \frac{1}{k_5 [\text{RH}]} = (t_{1/n} - t_{1/2n}) \ln \frac{n^{1/2} - 1}{(2n)^{1/2} - 1} \equiv L \quad (10)$$

...  
(n > 1)

Figure 25 shows the variation of  $L$  with change in  $n$  at three different temperatures. Scheme I leads into eq. (11).

$$I_{\max} = \frac{4 q_1 k_5^2 [RH]^2}{k_6} \quad (11)$$

$$\text{where } q_1 = k_7 k_8 / (k_8 + k_9 (Q)).$$

An Arrhenius plot for  $I_{\max}$  is presented in Figure 26, from which a value of  $E_a = 16.2$  kcal/mol is obtained.

The initiation, however, may be a unimolecular process, as in step (12), followed by steps (4) through (9), where  $M$  represents



some functional group or metal ion at constant concentration. In that case, the corresponding equations would be:

$$k_{12} = \frac{2}{(t_{1/n} - t_{1/2n})} \ln \frac{n^{1/2} - 1/2^{1/2}}{n^{1/2} - 1} \quad (13)$$

$$I_{\max} = \frac{q_1 k_5^2 [RH]^2}{k_6}$$

Included in Figure 25 is the variation of  $k_{12}$  with change in  $n$  at three different temperatures. It is apparent from the near constancy of  $L$  that this parameter gives a better description of the oxidative chemiluminescence than  $k_{12}$ , for  $n > 4$ .

Chemiluminescence from cis-1,4-polybutadiene, trans-poly-pentenamer, and 1,2-polybutadiene was examined under the same conditions as cis-1,4-polyisoprene. Representative curves for emission under oxygen and under argon are shown in Figures 27-32. The results were rendered difficult to interpret by the fact that relatively strong chemiluminescence was observed from the original samples when heated under argon, even though, as noted above, the films appeared spectroscopically pure. This result precluded an exact

analysis as was done for cis-1,4-polyisoprene, because it could not be assumed that the initial chemiluminescence behavior was due solely to the autocatalytic buildup of initiating species. In any case, the spectral shifts noted for cis-1,4-polyisoprene (Figure 33) also appeared during the autoxidation of the other polymers, which indicated the presence of multiple emitters and introduced an additional uncertainty into the treatment. We have made Arrhenius plots of both  $1/t_{1/2}$  and  $I_{\max}$  from the polymers, which show fairly linear behavior and can be described with the parameters given in Tables 3 and 4, respectively. The results are shown graphically in Figures 26 and 33-37 along with a plot of the  $t_{1/2}$  function for cis-1,4-polyisoprene. A linear plot of  $1/t_{1/2}$  vs  $T^{-1}$  is expected from a first-order initiation mode from which the following equation can be derived:

$$k_{12} = A_{12}e^{-E_{12}/RT} = \frac{2}{t_{1/2}} \ln \frac{1 - [\text{ROOH}]_0^{1/2}/[\text{ROOH}]_\infty^{1/2}}{1 - 1/n^{1/2}} \quad (14)$$

Equations 11 and 14 apply reasonably well even to describe the emission from trans-polypentenamer in argon (Tables 3 and 4), which presumably did not arise from an oxidative process. In the application of (14) we assumed  $[\text{ROOH}]_0 = 0$ .

#### Spectral Distribution of Chemiluminescence

While the nature of the emitters in the autoxidation of the polymers is not known, the high wavelengths in the spectral distribution do not correspond to simple aliphatic ketones. Recently, Beaven and Phillips<sup>(6)</sup> recorded phosphorescence spectra from oxidized, 1,4-polybutadiene films, at liquid nitrogen temperatures, and assigned the emission to  $\alpha,\beta$ -unsaturated ketones. Interestingly, their phosphorescence wavelengths appear to be close to those observed for chemiluminescence from cis-1,4-polyisoprene. Although infrared spectra of several polyisoprene films autoxidized on silver chloride sheets revealed no characteristic absorption at  $1650 \text{ cm}^{-1}$ , the presence of  $\alpha,\beta$ -unsaturated ketones in these films could not be ruled out since the amount necessary to account for the observed

chemiluminescence is well below the limit of IR detection. We were unable to record phosphorescence emission from partially oxidized films at  $-196^{\circ}\text{C}$ . This may have been due simply to the small amount of material present on the glass slides.

TABLE 3. EXPRESSIONS FOR MAXIMUM CHEMILUMINESCENCE INTENSITY FROM VARIOUS POLYMERS AS A FUNCTION OF TEMPERATURE

Polymer	Atmosphere	$I_{\max}$ (photons/g-sec) = $Ae^{-E_a/RT}$		
		A, photons/g-sec	$E_a$ , Kcal/mole	$I_{\max}$ at $100^{\circ}\text{C}$
<u>cis</u> -1,4-Polybutadiene	Oxygen	$1.91 \times 10^{20}$	20.4	$2.3 \times 10^8$
1,2-Polybutadiene	Oxygen	$4.83 \times 10^{23}$	25.2	$8.3 \times 10^8$
<u>cis</u> -1,4-Polyisoprene	Oxygen	$1.58 \times 10^{18}$	16.2	$5.1 \times 10^8$
<u>trans</u> -Polypentenamer	Argon	$3.22 \times 10^{21}$	23.8	$3.6 \times 10^7$

TABLE 4. EQUATIONS TO DESCRIBE TEMPERATURE DEPENDENCE OF  $t_{1/2}$  FOR VARIOUS POLYMERS

Polymer	Atmosphere	$1/t_{1/2} = Ae^{-E_a/RT}$	
		A, $\text{Sec}^{-1}$	$E_a$ , Kcal/mole
<u>cis</u> -1,4-Polybutadiene	Oxygen	$2.65 \times 10^4$	14.2
<u>cis</u> -1,4-Polyisoprene	Oxygen	$5.1 \times 10^9$	23.4
<u>trans</u> -Polypentenamer	Argon	$6.89 \times 10^3$	13.3

In all the polymers examined the spectral distribution changes with time both in oxygen and in argon (Figures 26-31). This result implicates the presence of at least two emitters in the samples. In some figures there is an apparent crossover of the  $f(\lambda)$  values, which is apparently an artifact due to light emission from a cutoff filter.

Temperature-Jump Measurements. A film of cis-1,4-polyisoprene was allowed to oxidize at 118°C until the chemiluminescence reached a maximum intensity, at which point the film was cooled rapidly to 28°C. The steady state emission was measured at this and several higher temperatures up to 66°C. The temperature was again lowered to 28°C and the procedure repeated. Under these low temperature conditions, the amount of initiator and the chemiluminescence intensity do not change appreciably during a given measurement. In terms of the two modes of initiation, the following equations can then be:

Unimolecular:

$$R_{\text{init}} = R_{\text{term}}$$

$$\begin{aligned} d[\text{RO}_2\text{H}]/dt &= k_{12}[\text{RO}_2\text{H}] \approx k_6[\text{RO}_2\cdot]^2 \\ \underline{I} = d(h\nu)/dt &= \frac{k_7k_8[\text{RO}_2\cdot]^2}{k_8 + k_9[\text{Q}]} \approx \frac{k_7k_8k_{12}[\text{RO}_2\text{H}]}{k_6(k_8 + k_9[\text{Q}])} \end{aligned} \quad (16)$$

$$\begin{aligned} E_{\text{I}} &\approx E_7 + E_8 + E_{12} - E_6 - E_9 \\ &\approx E_{12} \end{aligned} \quad (17)$$

Bimolecular:

$$\begin{aligned} k_2[(\text{RO}_2\text{H})_2] &= k_6[\text{RO}_2\cdot]^2 \\ \underline{I} &\approx \frac{k_7k_8k_2[(\text{RO}_2\text{H})_2]}{k_6(k_8 + k_9[\text{Q}])} = \frac{k_1k_2k_7k_8[(\text{RO}_2\text{H})_2]}{k_{-1}k_6(k_8 + k_9[\text{Q}])} \end{aligned} \quad (18)$$

$$\begin{aligned} E_{\text{I}} &\approx E_1 + E_2 + E_7 + E_8 - E_{-1} - E_6 - E_9 \\ &\approx E_1 + E_2 - E_{-1} \end{aligned} \quad (19)$$

From the Arrhenius plot for the temperature-jump approach (Figure 39),  $E_I$  was found to be  $19.8 \pm 0.7$  kcal/mol.

Since the chemiluminescence emission from the oxidized film was relatively weak, a second film was oxidized similarly, cooled, and 9,10-diphenylanthracene (0.5% by weight) was added to the product. The mixture was dissolved in benzene and the solvent allowed to evaporate. The chemiluminescence was greatly enhanced by this treatment, and an activation energy of 25.3 kcal/mol was obtained from the temperature dependence of the emission (Figure 40) between 29°C and 66°C. It should be noted that the activation energy obtained under these conditions was expected to be a different quantity than the  $E_{I\max}$  values obtained at higher temperatures (Figure 35). This difference is due to different limiting conditions of the autoxidation process.

#### Chemiluminescence from Hydroperoxidized cis-1,4-Polyisoprene

The technique of generating singlet oxygen with polymer-bound dye sensitizer in our hands produced a cleaner product than by conventional photosensitization with dissolved or solubilized sensitizers.<sup>(7)</sup> The fact that similar activation energies<sup>(8)</sup> are observed from singlet oxygenated and autoxidized polymers (Figure 40) suggests that hydroperoxides are the initiating species in both samples under these conditions.

#### Conclusions

The chemiluminescence emission from elastomers (cis-1,4-polyisoprene, cis-1,4-polybutadiene, trans-polybutadiene, and 1,2-polybutadiene) above 90°C show similar features of an autocatalytic buildup of chemiluminescence in oxygen to a maximum value followed by a decline. The decay of the chemiluminescence is probably associated with a slowing in the rate of oxidation of the materials, which



have already undergone extensive oxidation by the time the maximum intensity has been reached. This conclusion is similar to that drawn from results in liquid systems, <sup>(5a)</sup> and is in part a consequence of the decrease in the effective hydrocarbon concentration by dilution with oxidation products.

In argon a weaker level of chemiluminescence was observed that is ascribed to the decomposition of residual peroxides and hydroperoxides in the samples. Kock and Hol<sup>(2e)</sup> reached similar conclusions from the behavior of commercial polybutadiene samples.

The time and temperature dependence of the chemiluminescence from cis-1,4-polyisoprene in oxygen could be predicted reasonably well between 91 and 143°C from equations developed from a simplified reaction scheme. This result suggests that, in spite of the complicated nature of the oxidation, there is a similar overall mechanism operating for oxidative degradation over this temperature range.

The results and discussion are elaborated in more detail in a manuscript now in preparation. This manuscript will be an extension of the preprint, "Chemiluminescence Study of the Autoxidation of cis-1,4-Polyisoprene", submitted for the San Francisco meeting of the American Chemical Society, August 30-September 3, 1976.

REFERENCES

- (1) A. P. Schaap, A. L. Thayer, E. C. Blossey, and D. C. Neckers, J. Amer. Chem. Soc., 97, 3741 (1975).
- (2) (a) G. E. Ashby, J. Polym. Sci., 50, 99 (1961); (b) J. Stauff, H. Schmidkunz and G. Hartmann, Nature, 198, 281 (1963); (c) M. P. Schard and C. A. Russell, J. Appl. Polym. Sci., 8, 985, 997 (1964); (d) R. E. Barker, Jr., J. H. Daane, and P. M. Rentzepis, J. Polym. Sci., A, 3, 2033 (1965); (e) L. Reich and S. S. Stivala, ibid., A, 3, 4299 (1965); (f) R. J. de Kock and P.A.H.M. Hol, Int. Syn. Rubber Symp., Lect., 4th (2), 53 (1969); Chem. Abstr., 74, 4425 (1971); (g) U. Isacsson and G. Wettermark, Anal. Chim. Acta, 68, 339 (1974); (h) T. V. Pokholok, O. N. Karpukhin, and V. Ya. Shlyapintokh, J. Polym. Sci., Polym. Chem. Ed., 13, 525 (1975).
- (3) The intensity values in Figure 24 were those indicated on the chemiluminescence recorder and were not corrected for a geometrical factor ( $\sim 150$ ) and for photomultiplier counting efficiency (15%  $\pm$  10%, between 300 and 500 nm), which is a function of the emission wavelength. The data in Table 3 and in Figures 33-35. have been corrected for both factors.
- (4) (a) R. F. Vassil'ev, in "Progress in Reaction Kinetics", Vol. 4, G. Porter, Ed., Pergamon Press, Oxford, 1967, pp 305-352; (b) V. Ya. Shlyapintokh, O. N. Karpukhin, L. M. Postnikov, V. F. Tsepalov, A. A. Vichutinski, and I. V. Zakharov, "Chemiluminescence Techniques in Chemical Reactions", Consultants Bureau, New York, 1968; (c) R. F. Vassil'ev, Russ. Chem. Rev., 39, 529 (1970); (d) R. E. Kellogg, J. Amer. Chem. Soc., 91, 5433 (1969).
- (5) (a) G. Lundeen and R. Livingston, Photochem. Photobiol., 4, 1085 (1965); (b) A. V. Tobolsky, D. J. Metz, and R. B. Mesrobian, J. Amer. Chem. Soc., 72, 1942 (1950).
- (6) S. W. Beavan and D. Phillips, Europ. Polym. J., 10, 593 (1974); Rubber Chem. Technol., 48, 692 (1975).
- (7) M. L. Kaplan and P. G. Kelleher, Rubber Chem. Technol., 45, 423 (1972).
- (8) The temperature-dependence of chemiluminescence from the hydroperoxidized cis-1,4-polyisoprene has the same expression as that for the temperature jump approach.

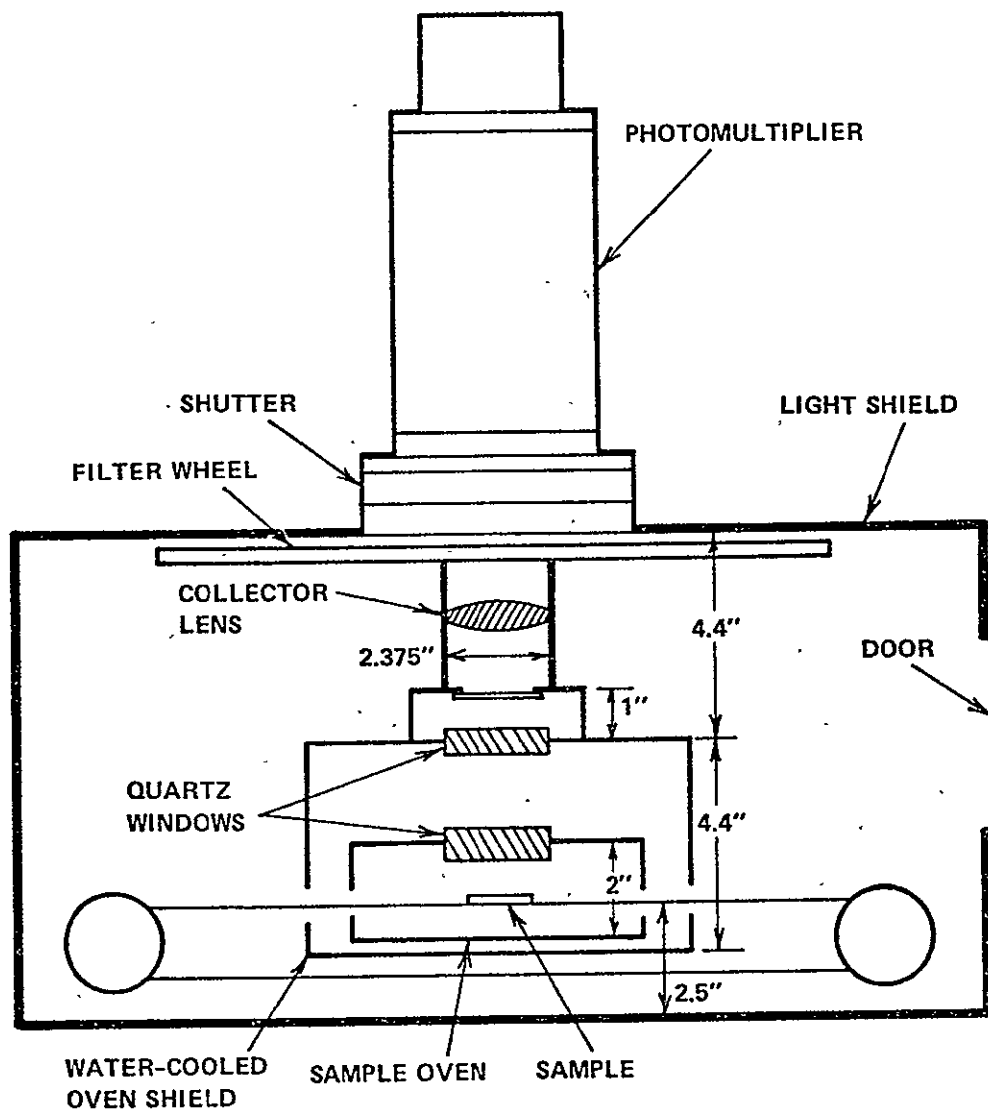

FIGURE 1. SCHEMATIC VIEW OF CHEMILUMINESCENCE APPARATUS

# PHOTON COUNTING INSTRUMENTATION FOR CHEMILUMINESCENCE STUDIES

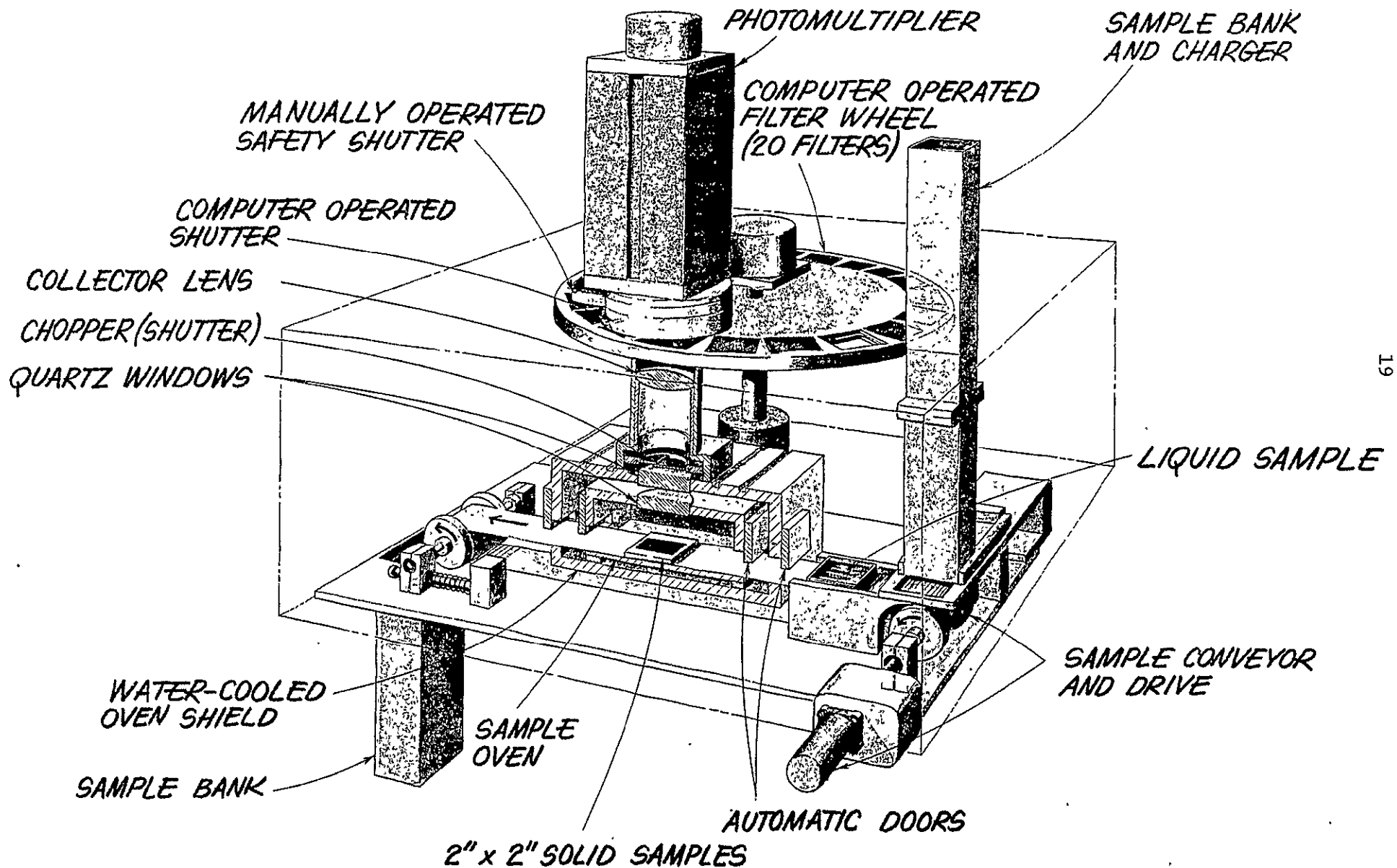

FIGURE 2. ARTIST'S SKETCH OF CHEMILUMINESCENCE APPARATUS

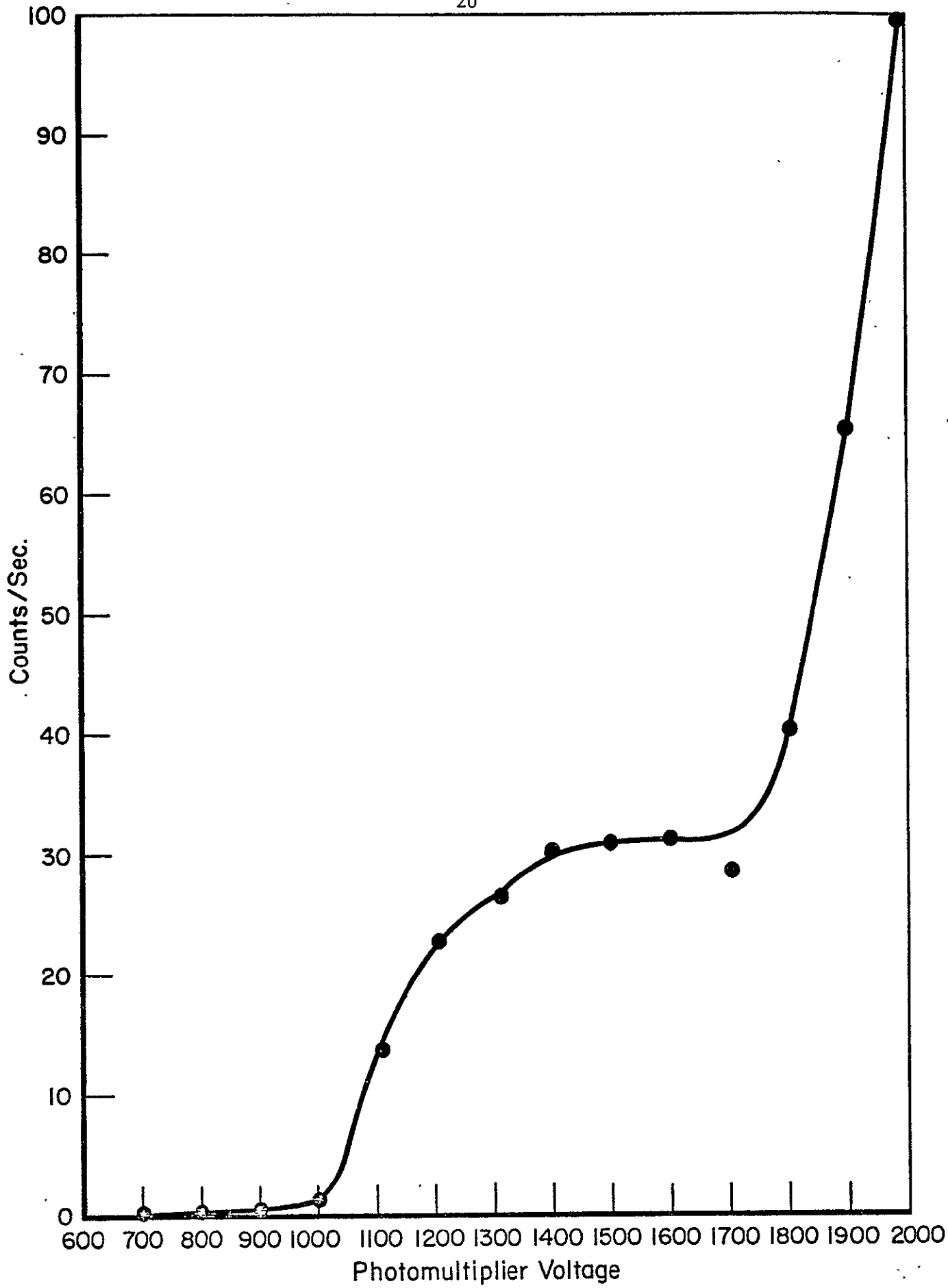

FIGURE 3. PHOTOMULTIPLIER DARK CURRENT VS APPLIED VOLTAGE  
REPRODUCED FROM THE ORIGINAL PAGE IS POOR

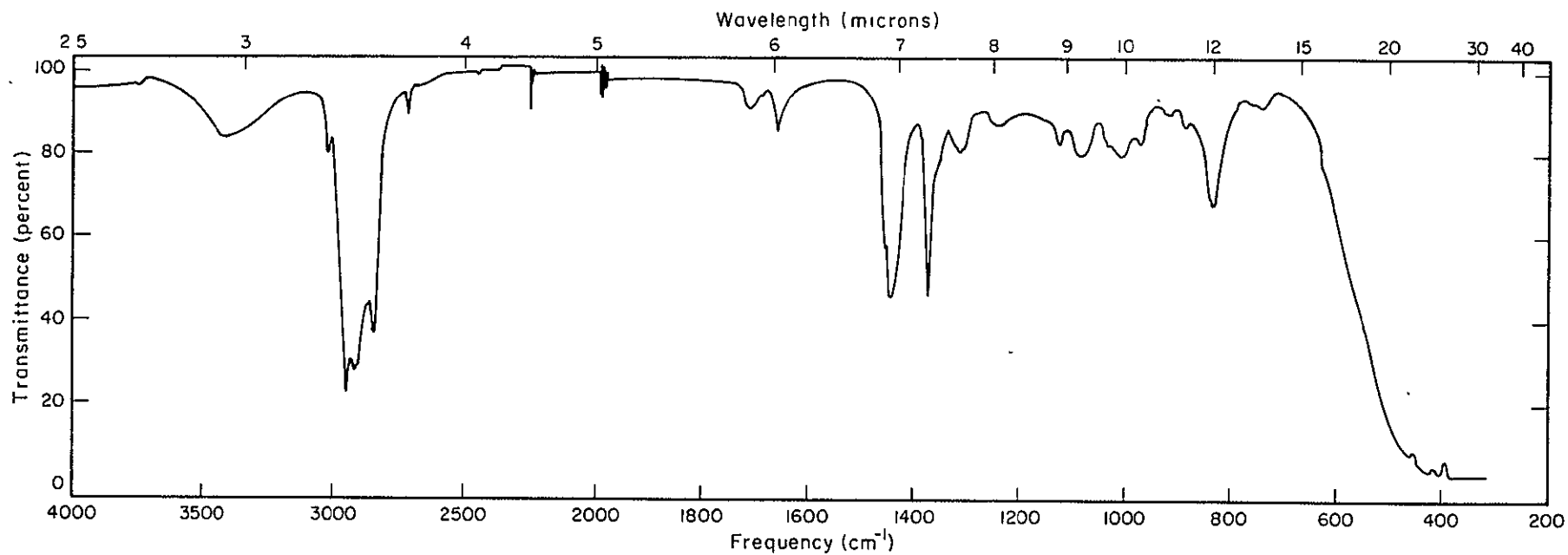

FIGURE 4. INFRARED SPECTRUM OF SINGLET OXYGENATED cis-1,4-POLYISOPRENE

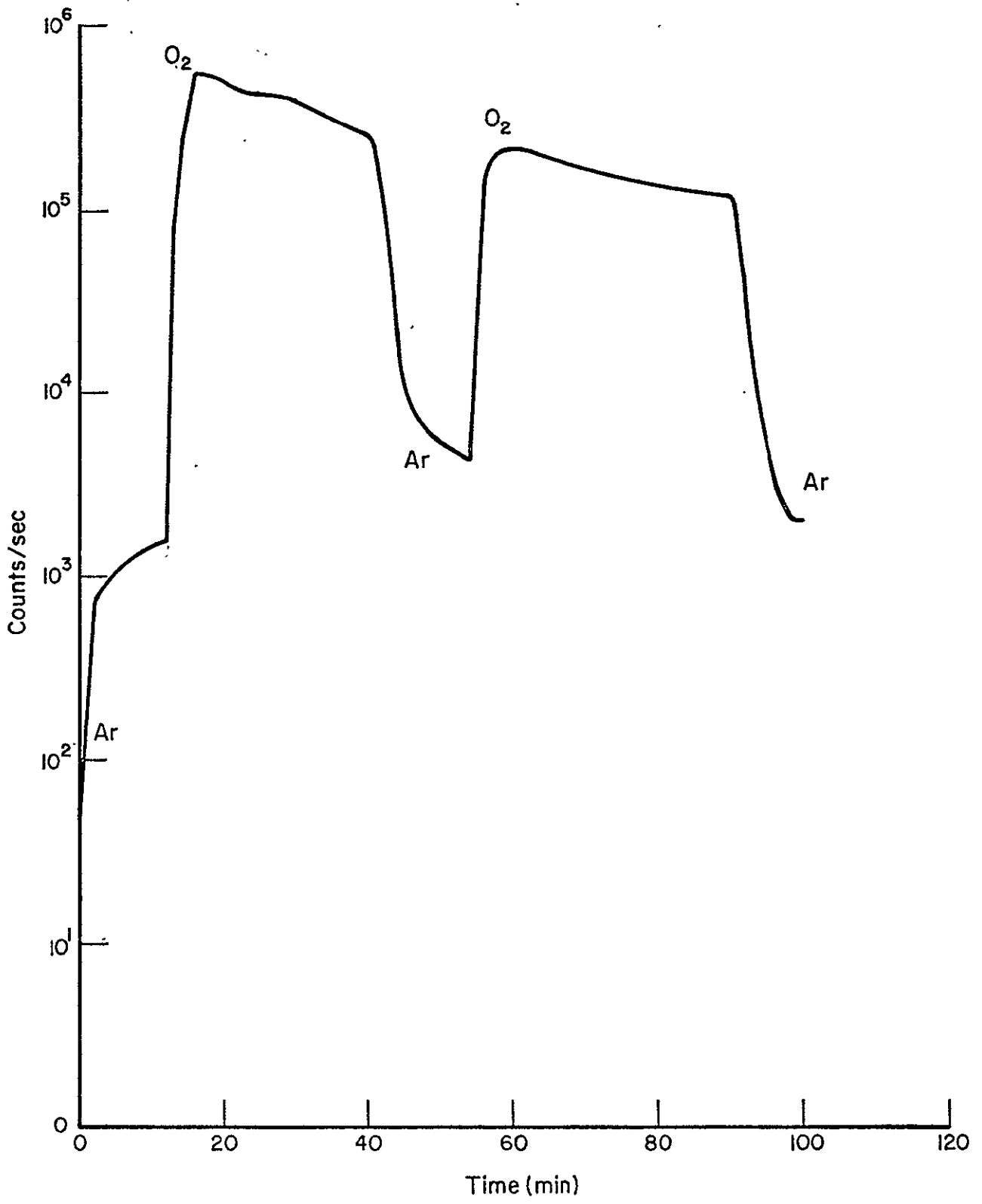

FIGURE 5. EFFECT OF ATMOSPHERE ON CHEMILUMINESCENCE FROM cis-1,4-POLYISOPRENE AT 172°C

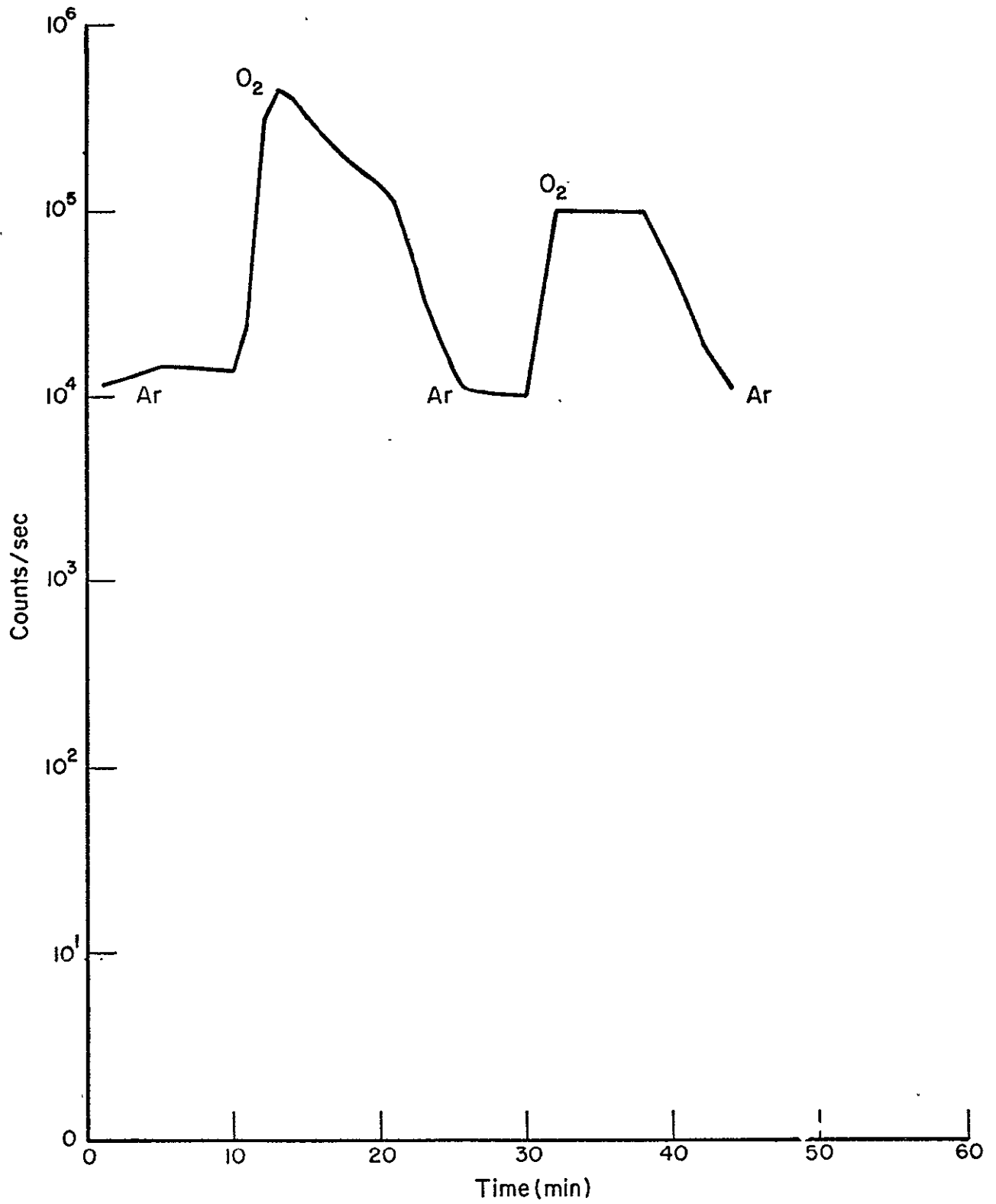

FIGURE 6. EFFECT OF ATMOSPHERE ON CHEMILUMINESCENCE FROM trans-POLYPENTENAMER AT 172°C



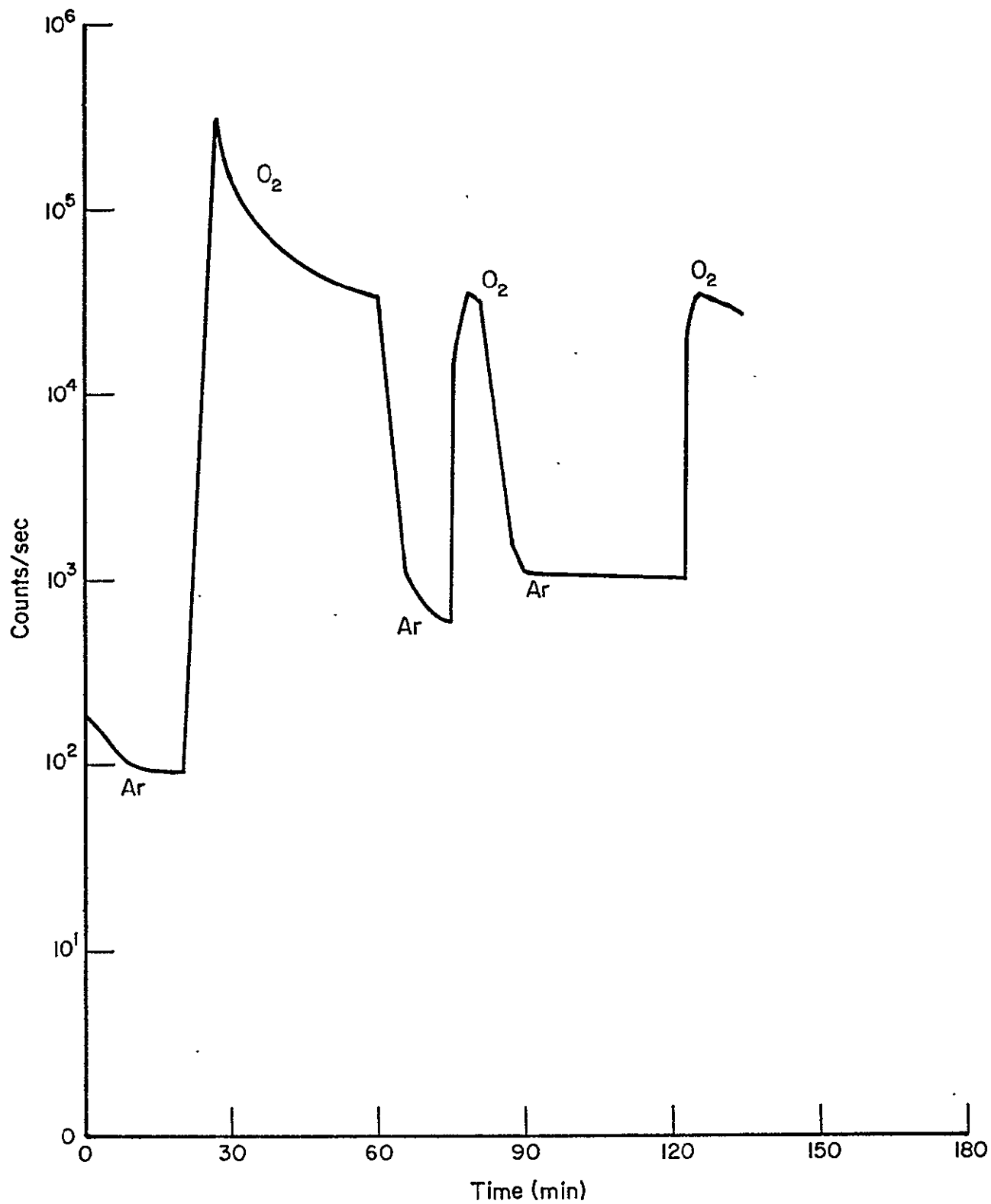

FIGURE 7. EFFECT OF ATMOSPHERE ON CHEMILUMINESCENCE FROM cis-1,4-POLYBUTADIENE AT 172°C

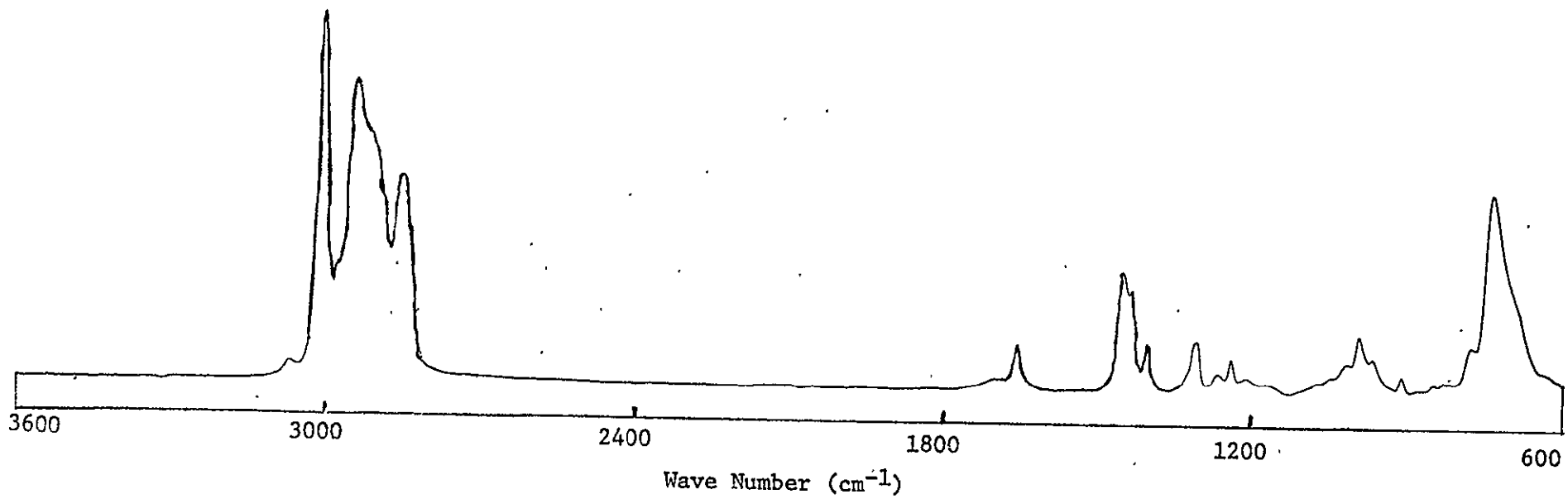

FIGURE 8. SAMPLE NO. 1. cis-1,4-POLYBUTADIENE, PURE FILM

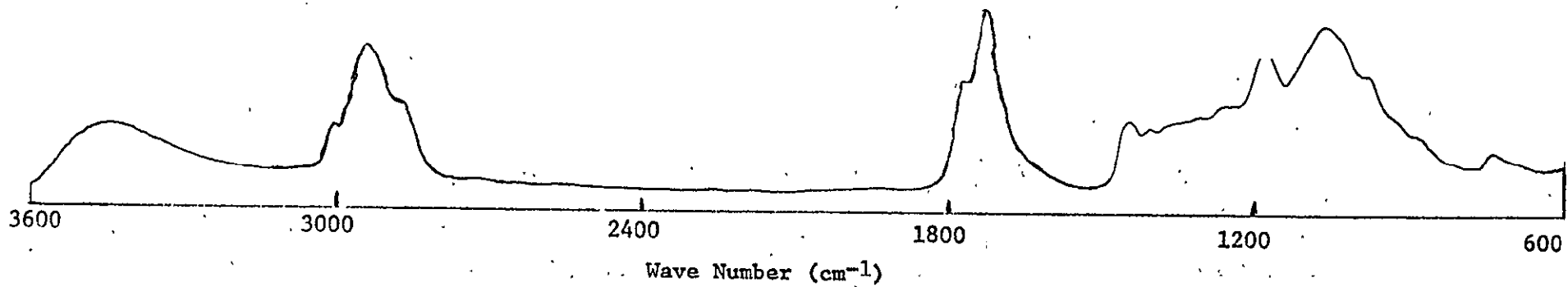

FIGURE 9. SAMPLE NO. 2. cis-1,4-POLYBUTADIENE AFTER  
11 MINUTES IN OXYGEN AT 115°C

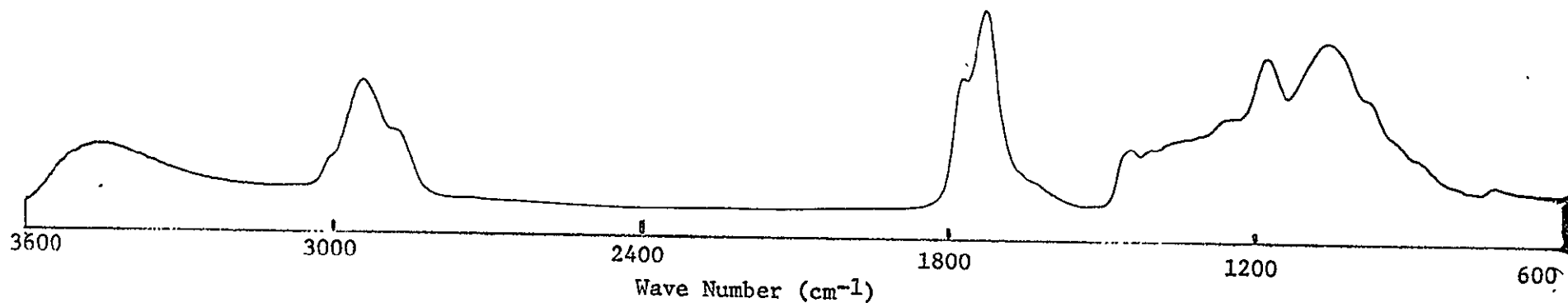

FIGURE 10. SAMPLE NO. 3  
AFTER 21 MINUTES : cis-1,4-POLYBUTADIENE  
IN OXYGEN AT 115°C

26

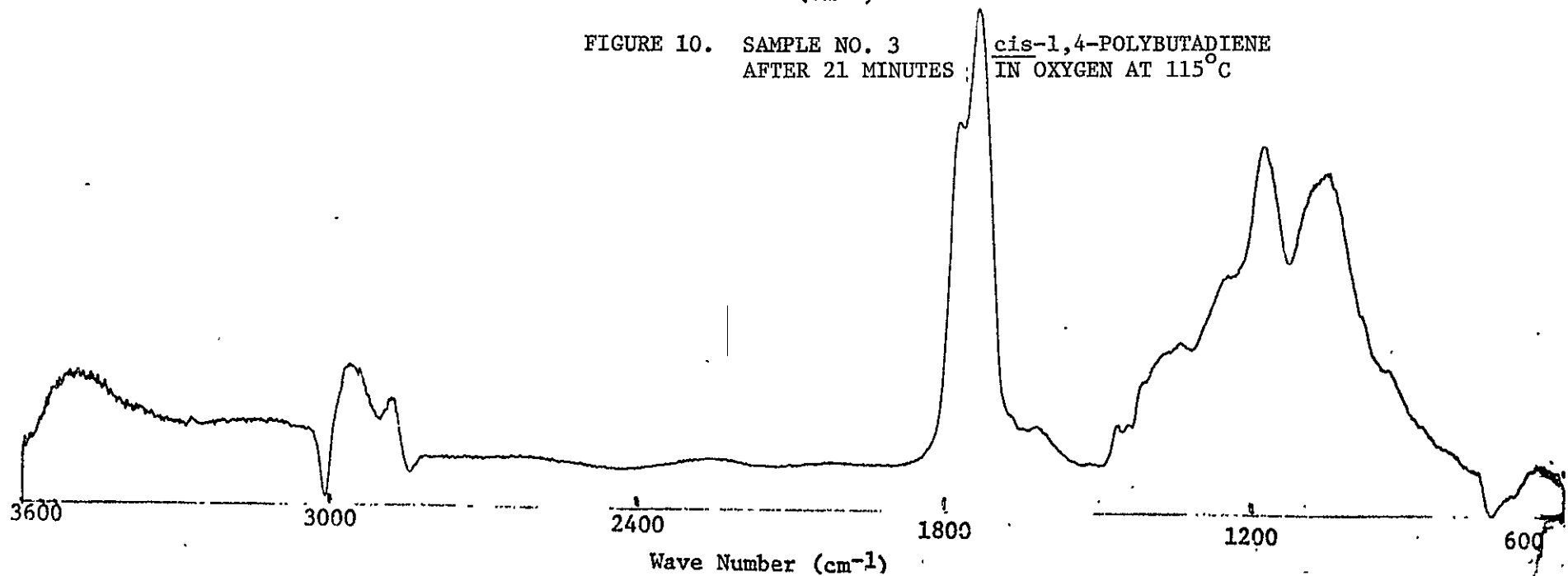

FIGURE 11. cis-1,4-POLYBUTADIENE DIFFERENCE SPECTRUM: (NO. 4 minus 0.8 x NO. 2)

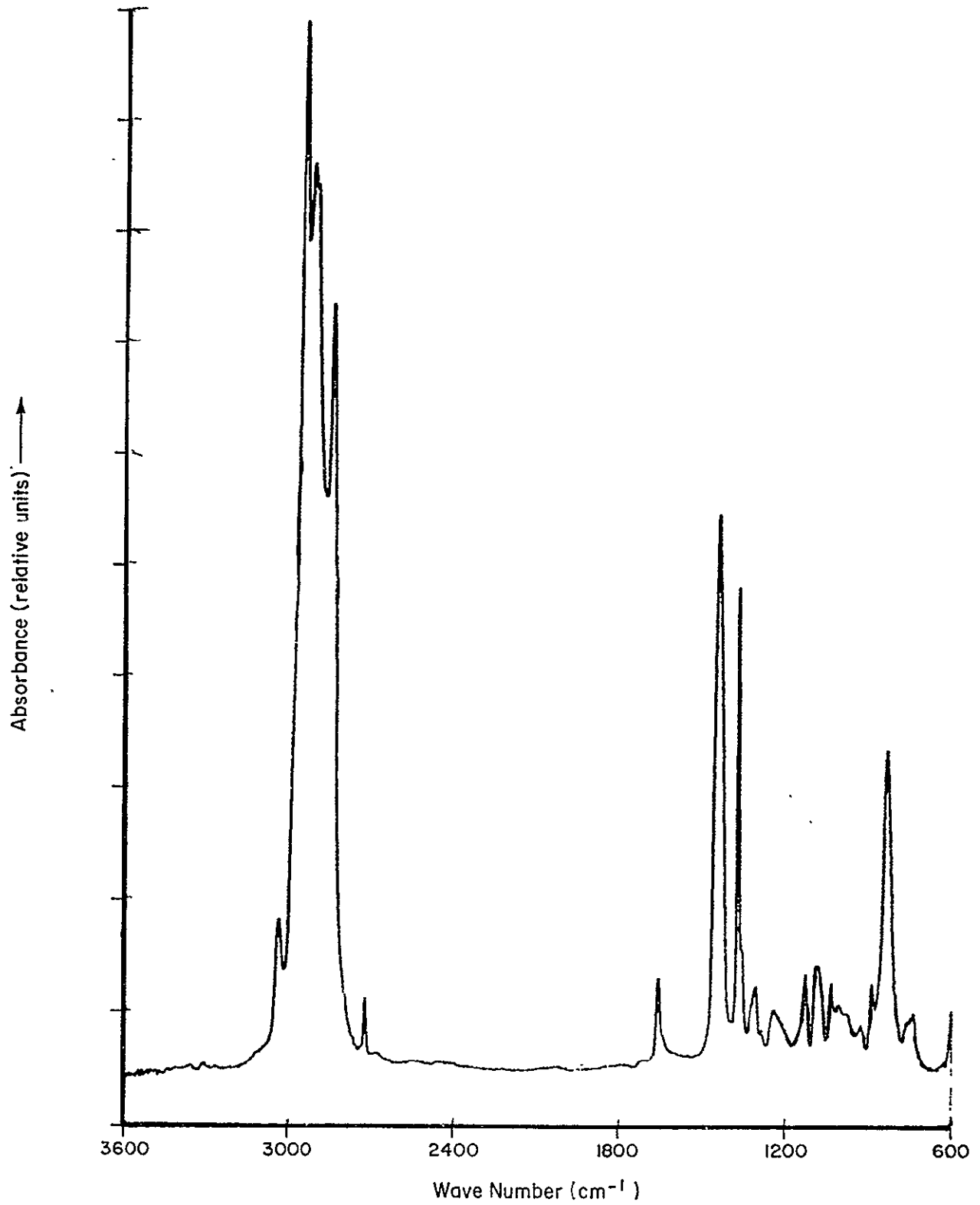

FIGURE 12. SAMPLE NO. 4. cis-1,4-POLYISOPRENE,  
PURE FILM

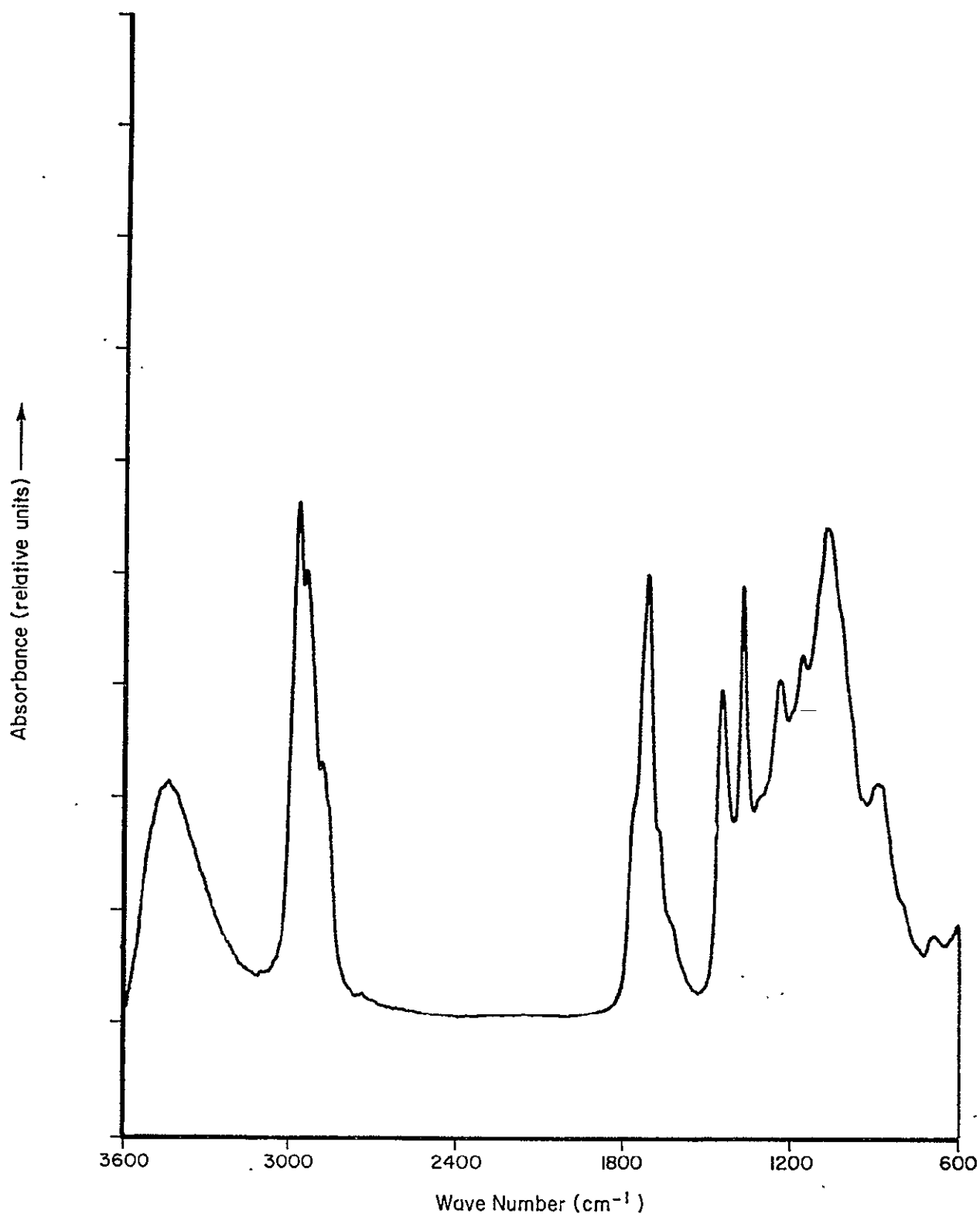

FIGURE 13. SAMPLE NO. 5. cis-1,4-POLYISOPRENE  
AFTER 12 MINUTES IN OXYGEN AT 115°C

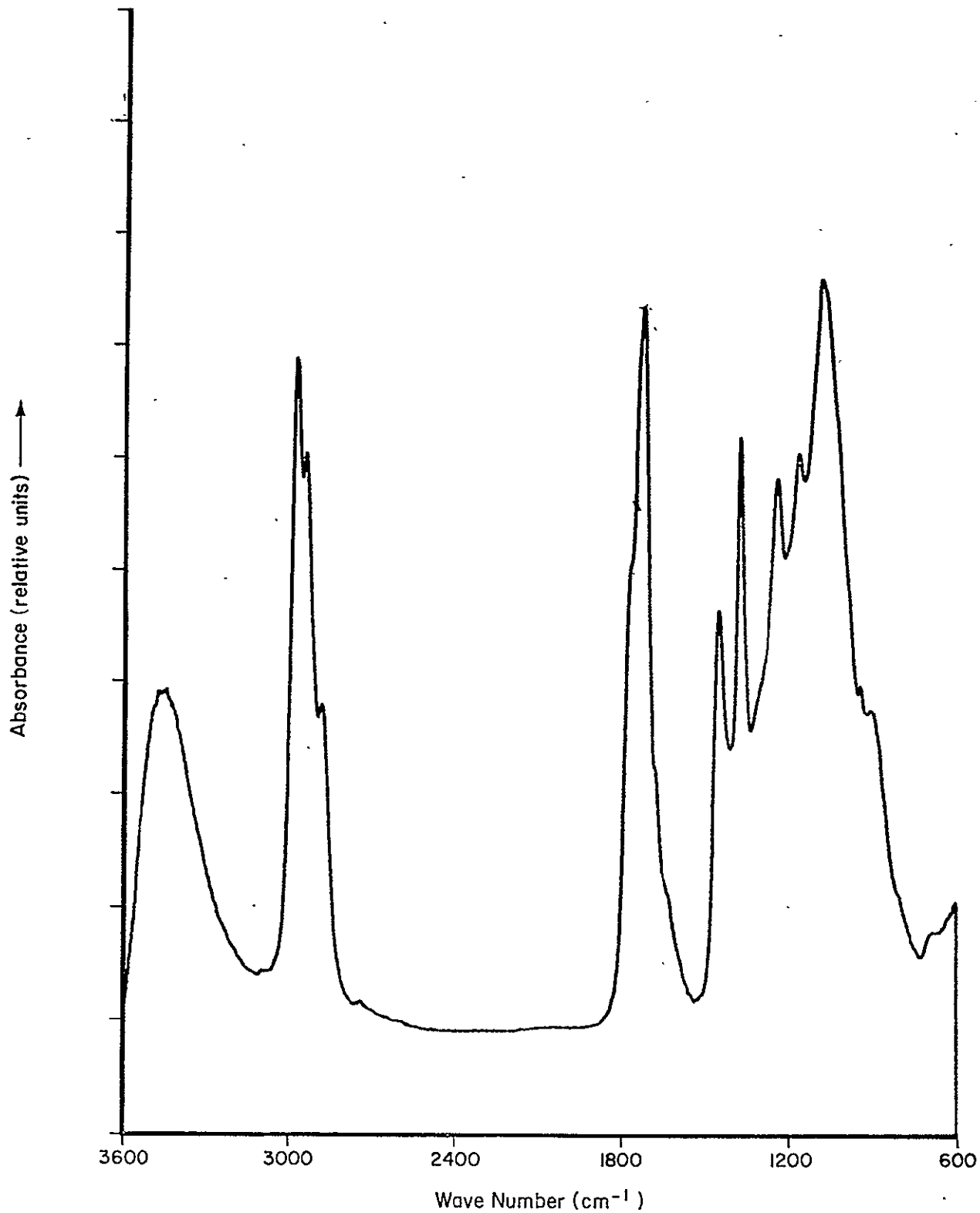

FIGURE 14. SAMPLE NO. 6. *cis*-1,4-POLYISOPRENE  
AFTER 22 MINUTES IN OXYGEN AT 115°C

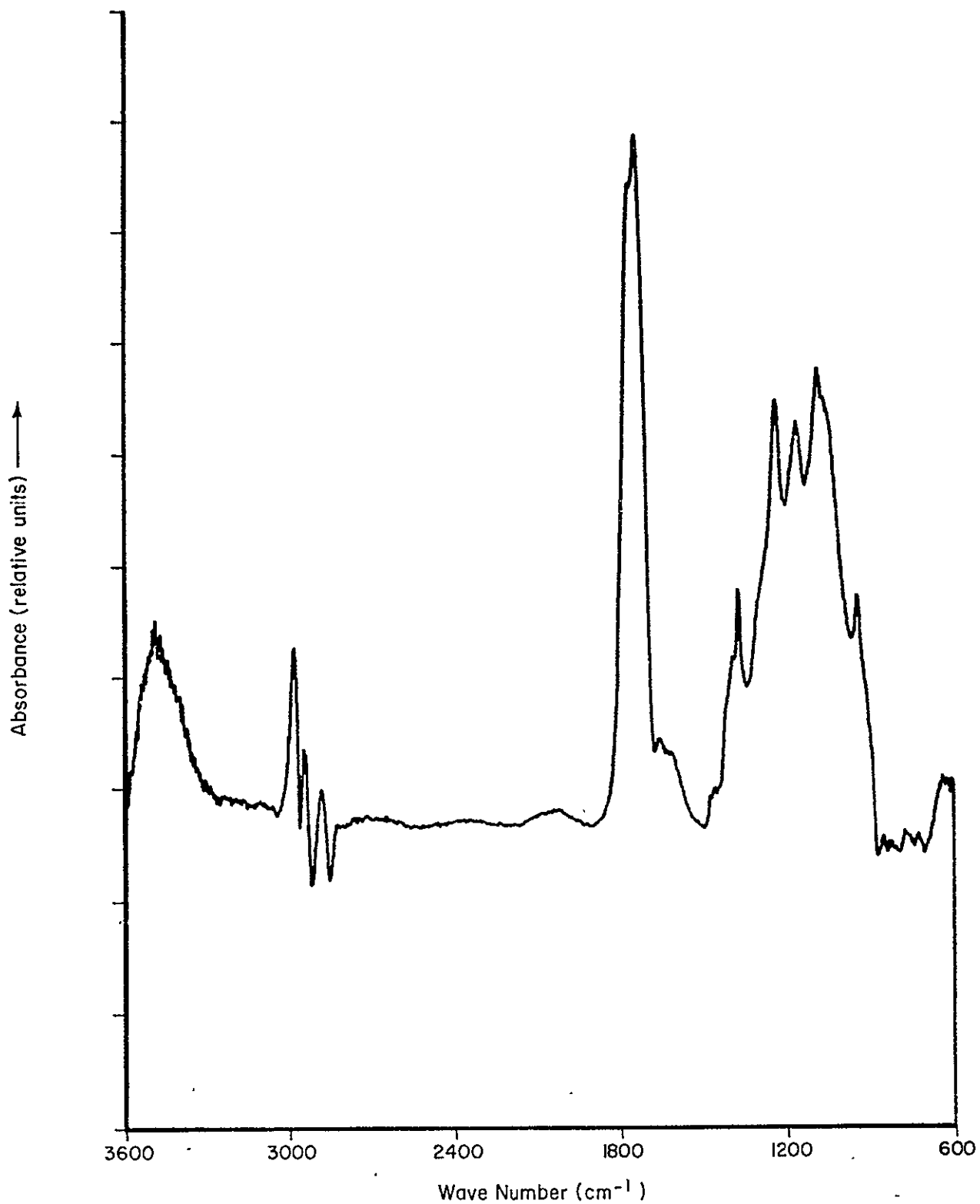

FIGURE 15. cis-1,4-POLYISOPRENE DIFFERENCE SPECTRUM  
(0.8 x NO. 6 minus NO. 5)

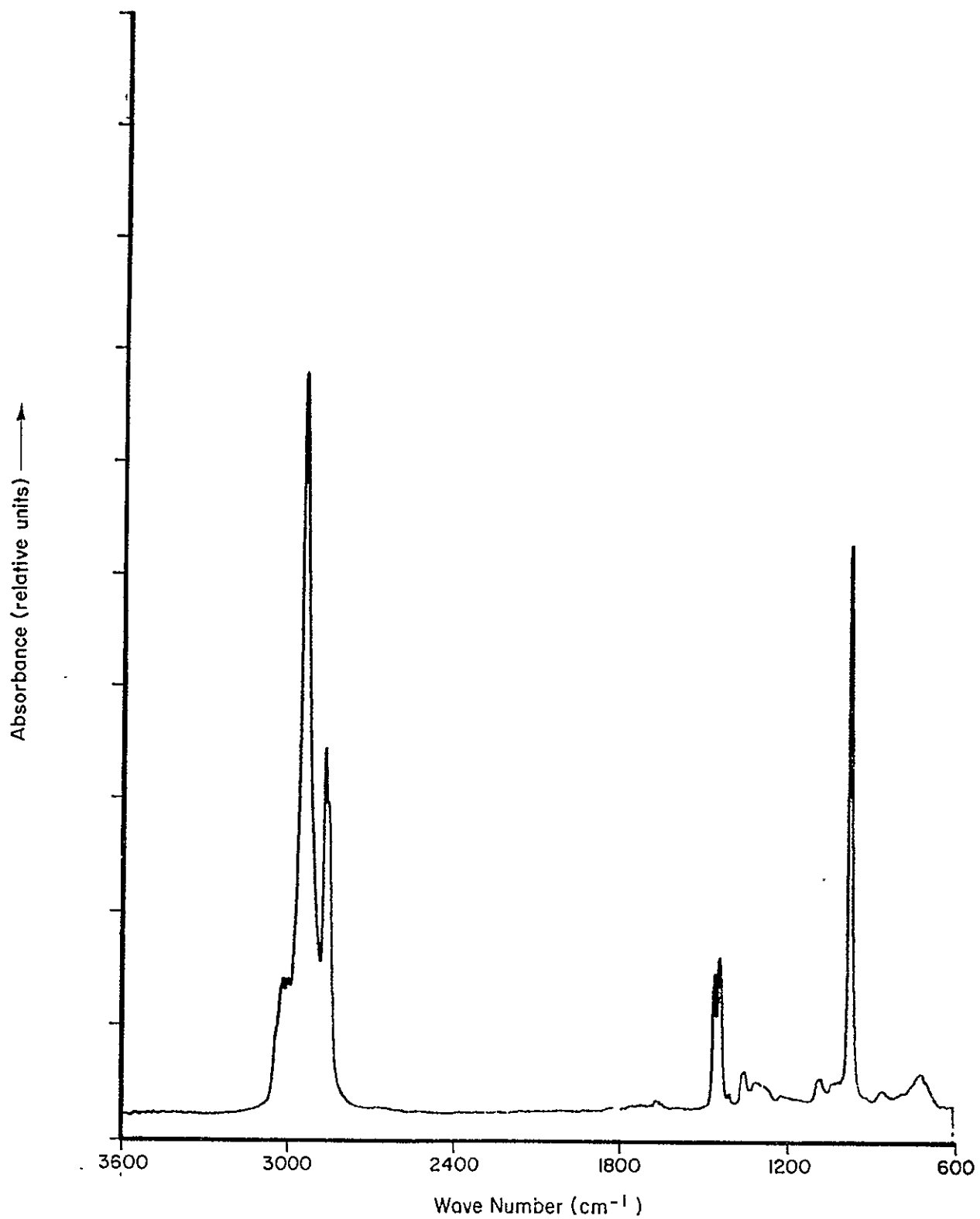

FIGURE 16. SAMPLE NO. 7. trans-POLYPENTENAMER,  
PURE FILM



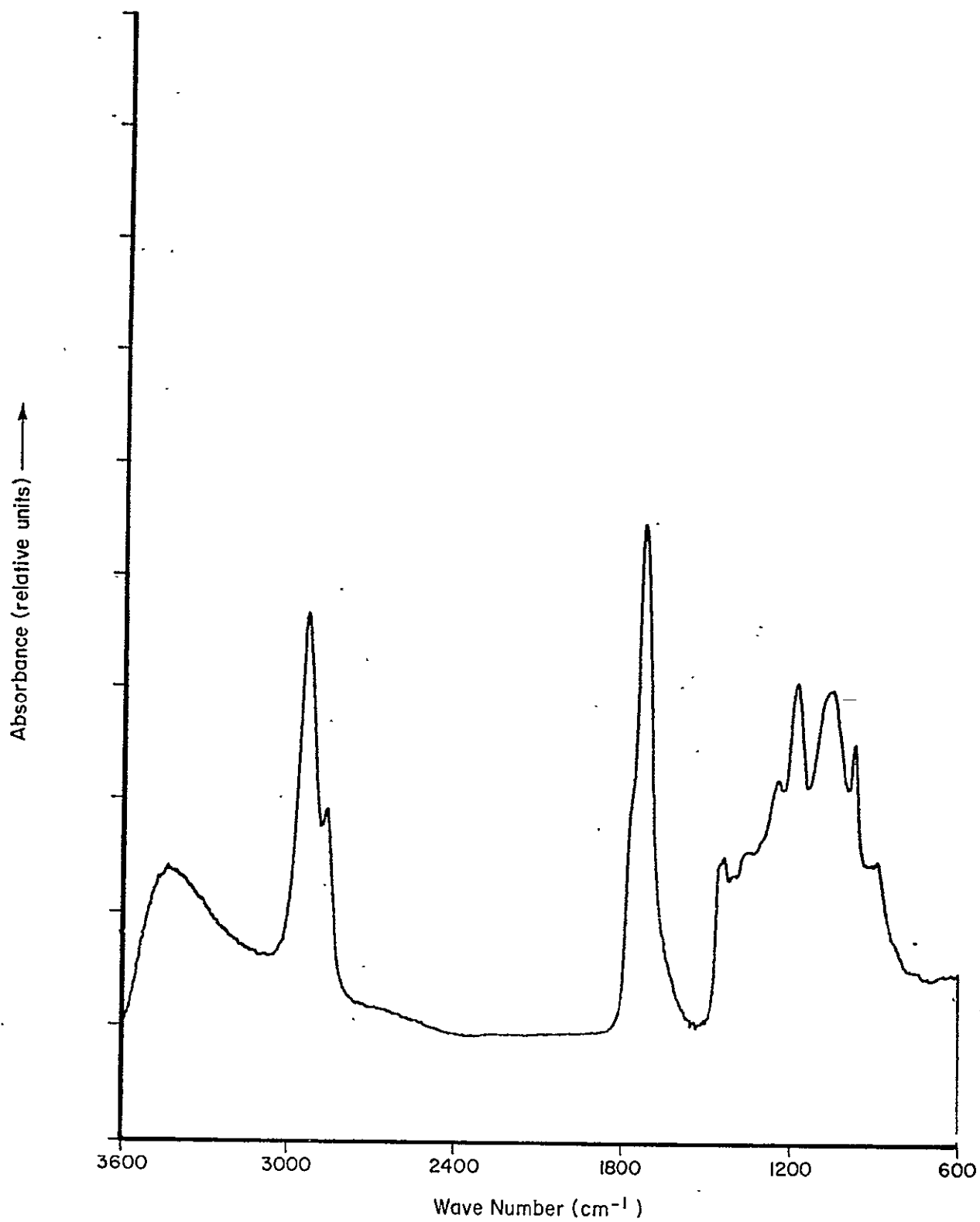

FIGURE 17. SAMPLE NO. 8. trans-POLYPENTENAMER AFTER 17 MINUTES IN OXYGEN AT 115°C

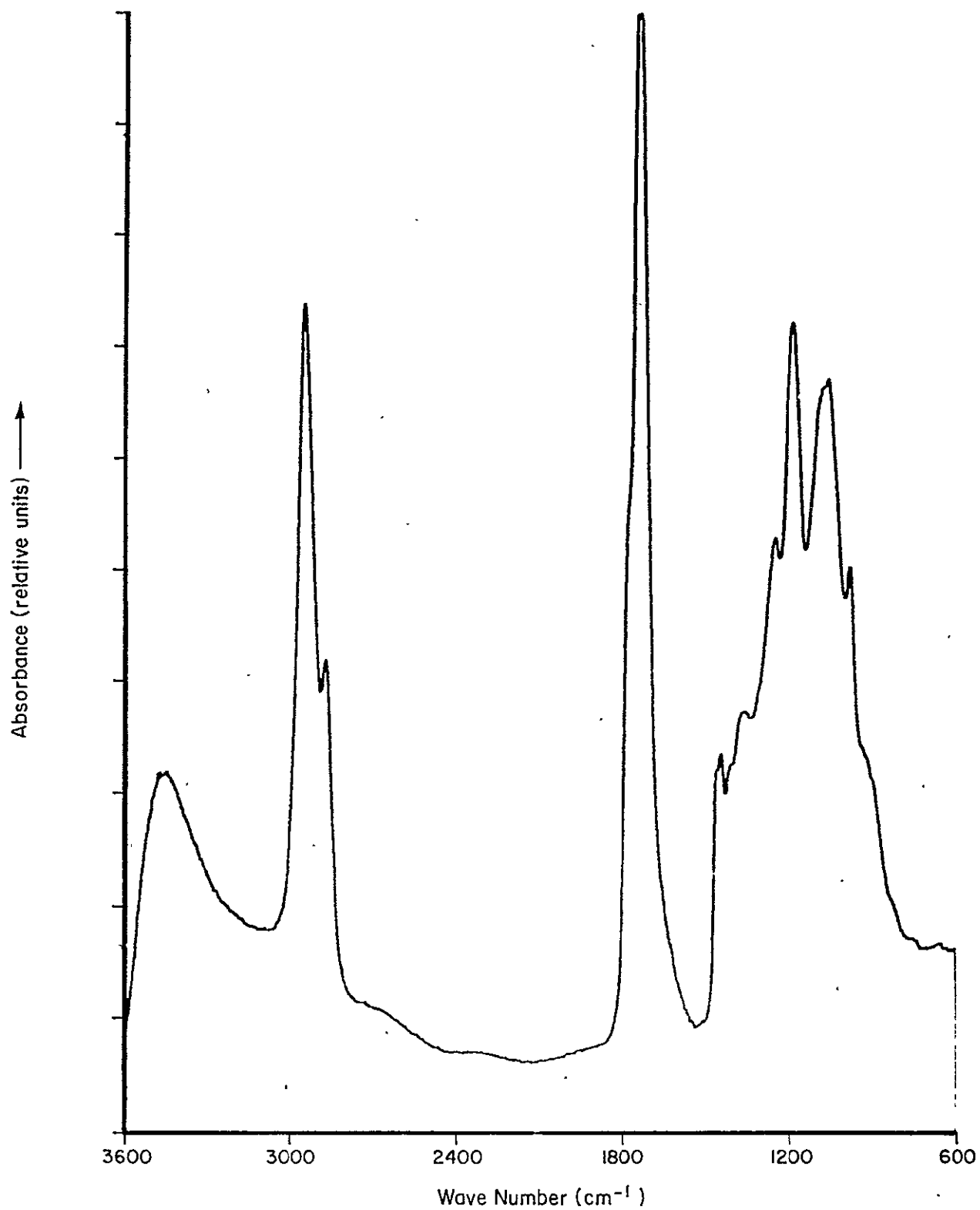

FIGURE 18. SAMPLE NO. 9. trans-POLYPENTENAMER AFTER 27 MINUTES IN OXYGEN AT 115°C

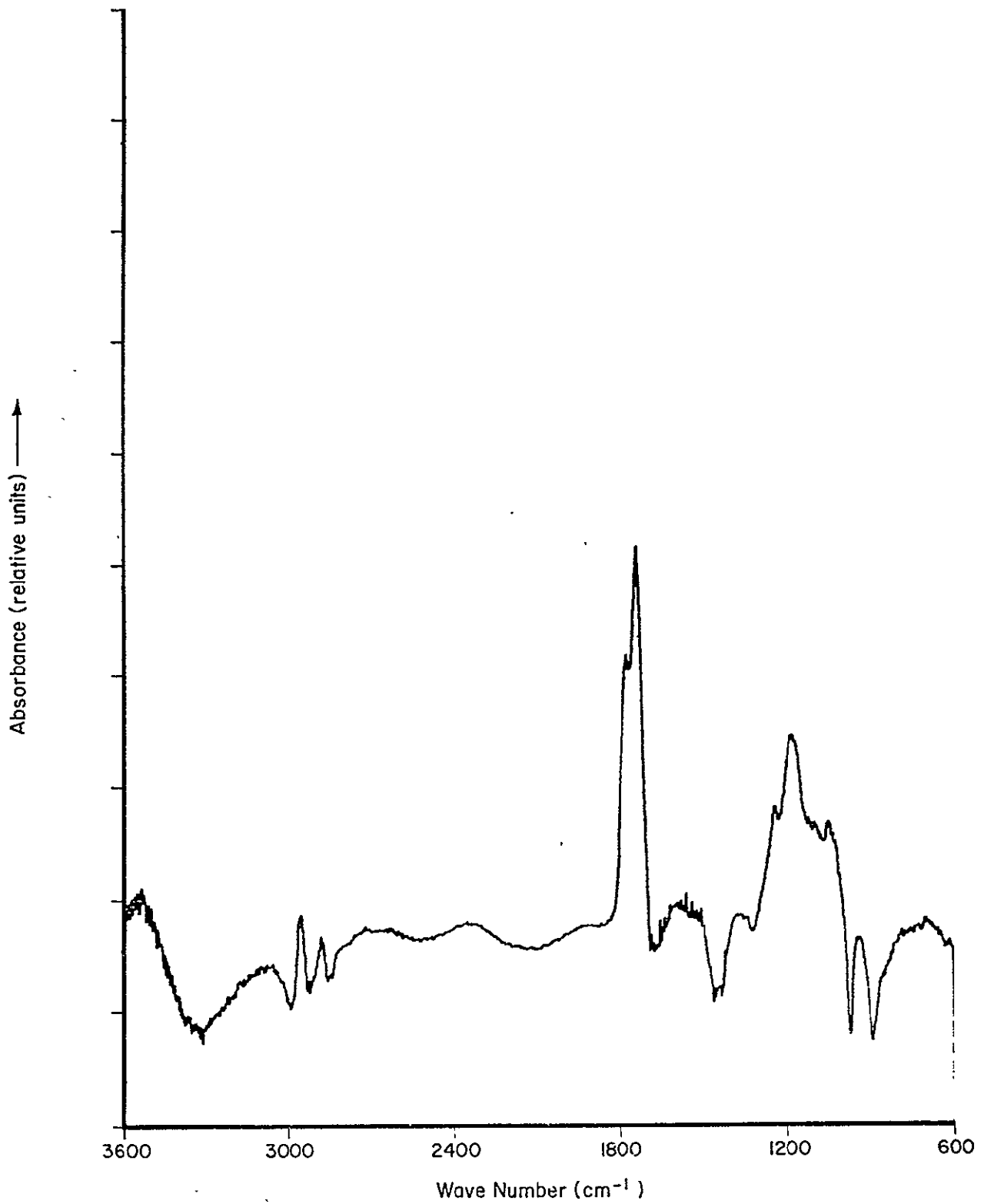

FIGURE 19. trans-POLYPENTENAMER DIFFERENCE SPECTRUM  
(0.55 x NO. 9 minus NO. 8)

REPRODUCIBILITY OF THE  
ORIGINAL PAGE IS POOR

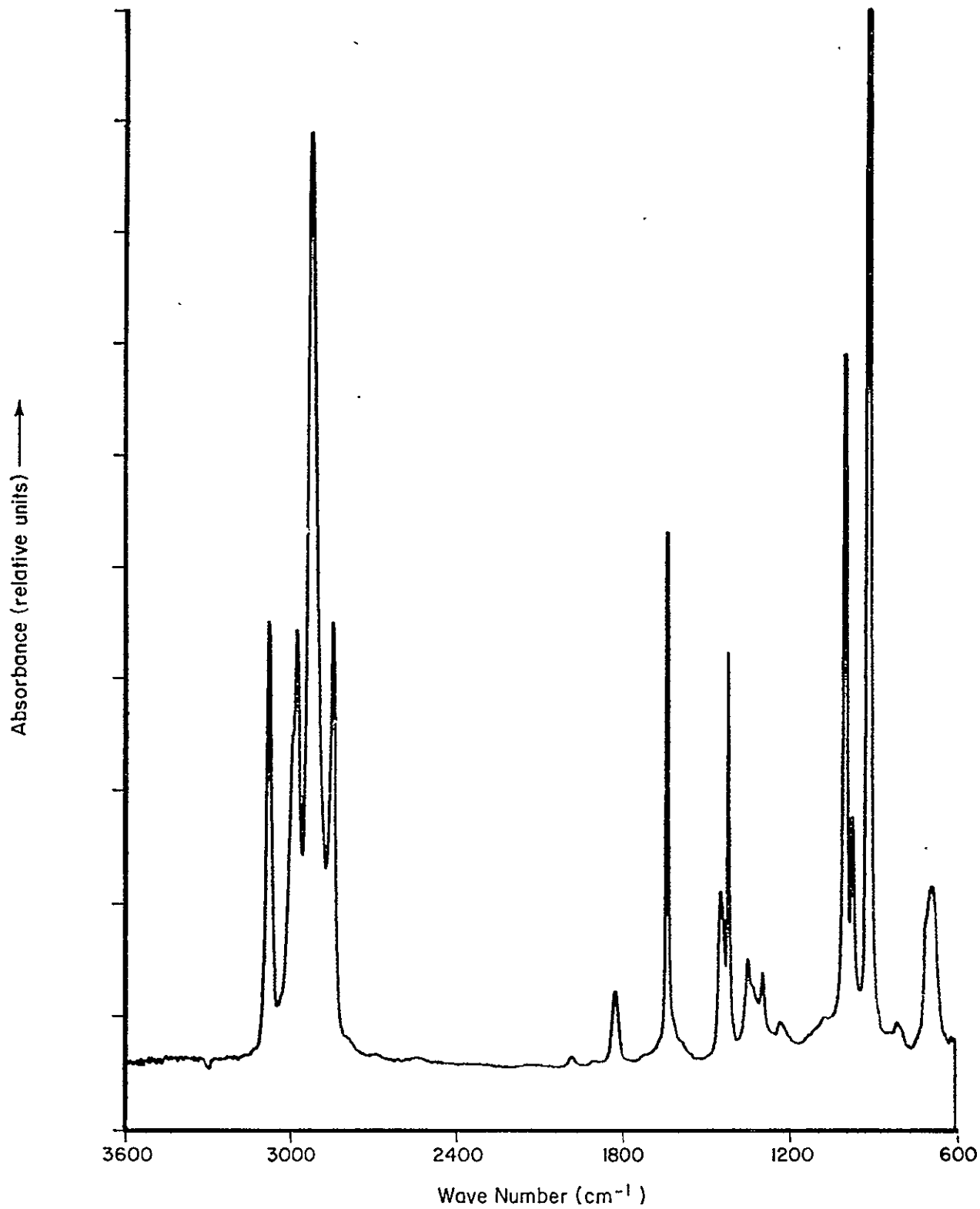

FIGURE 20. SAMPLE NO. 10. 1,2-POLYBUTADIENE,  
PURE FILM

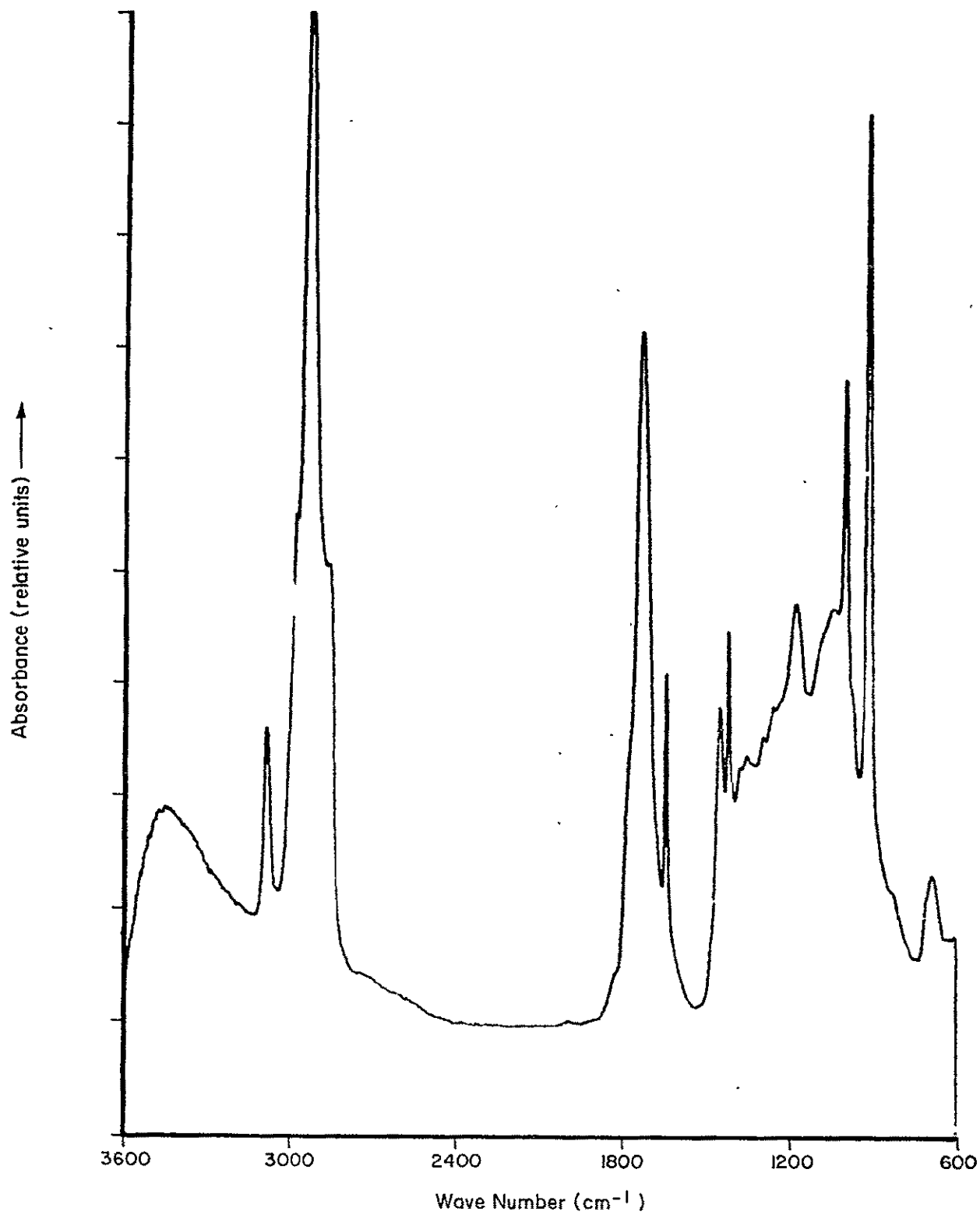

FIGURE 21. SAMPLE NO. 11. 1,2-POLYBUTADIENE AFTER 24 MINUTES IN OXYGEN AT 115°C

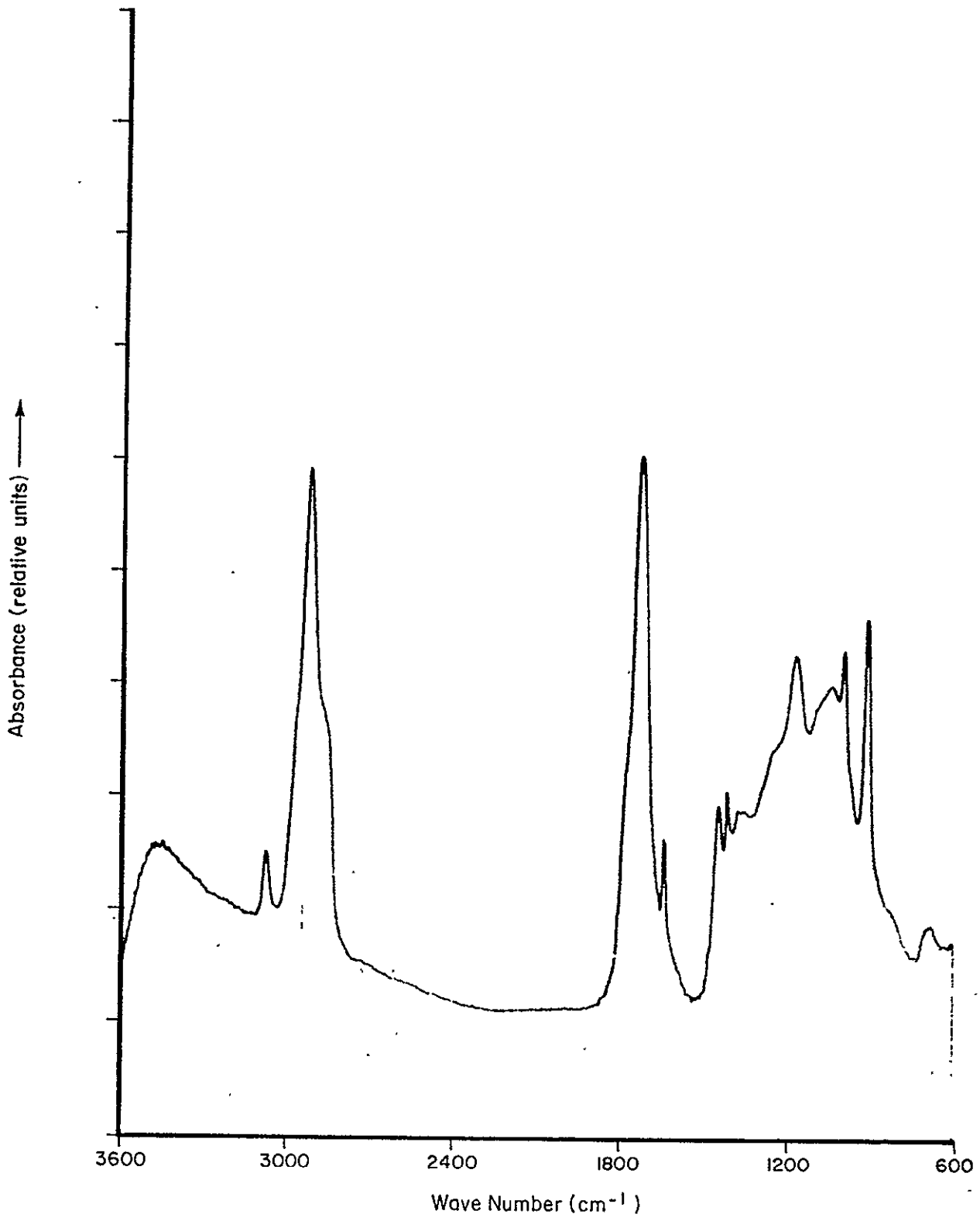

FIGURE 22. SAMPLE NO. 12. 1,2-POLYBUTADIENE AFTER 37 MINUTES IN OXYGEN AT 115°C

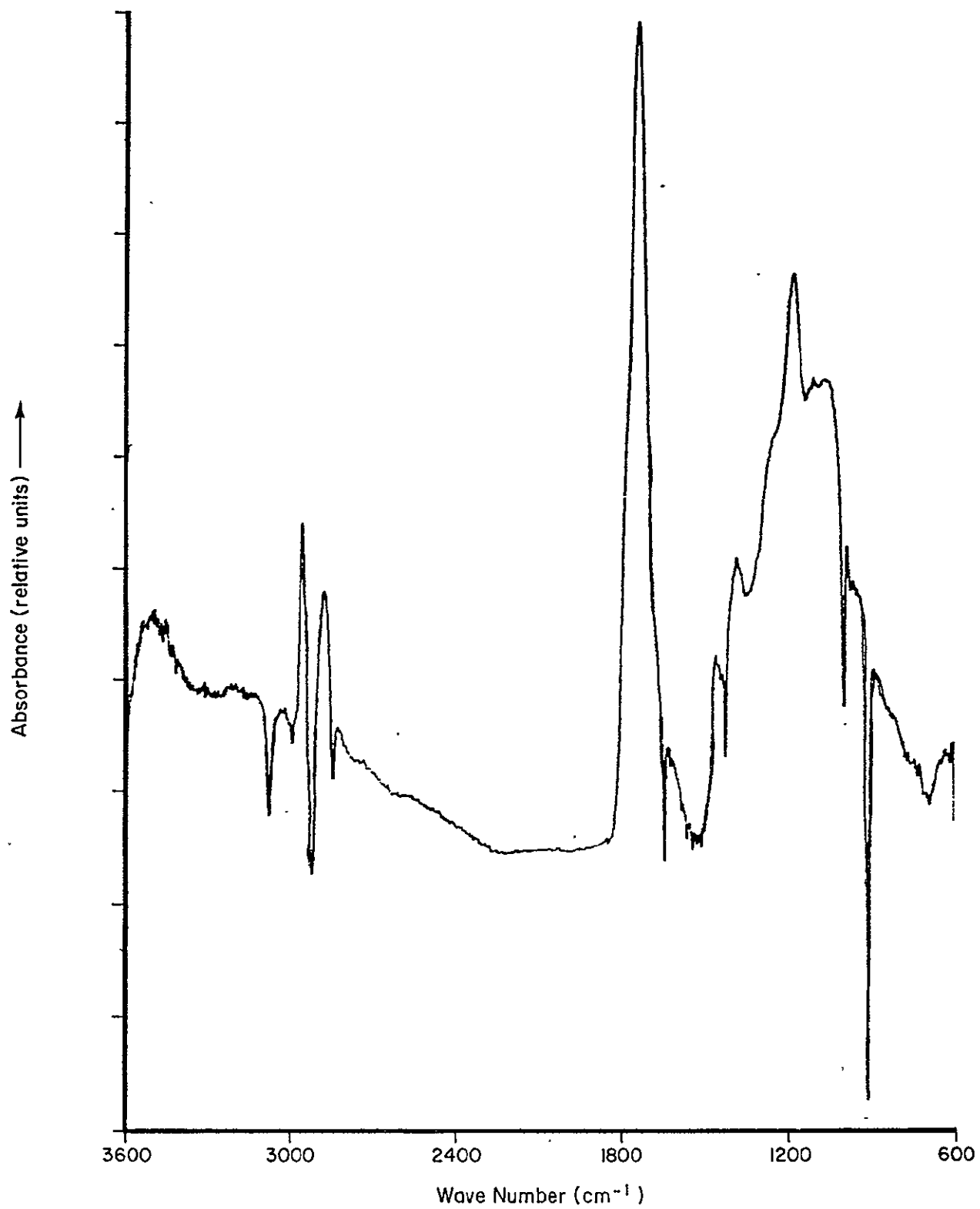

FIGURE 23. 1,2-POLYBUTADIENE DIFFERENCE SPECTRUM  
(NO. 11 minus 0.5 x NO. 10)

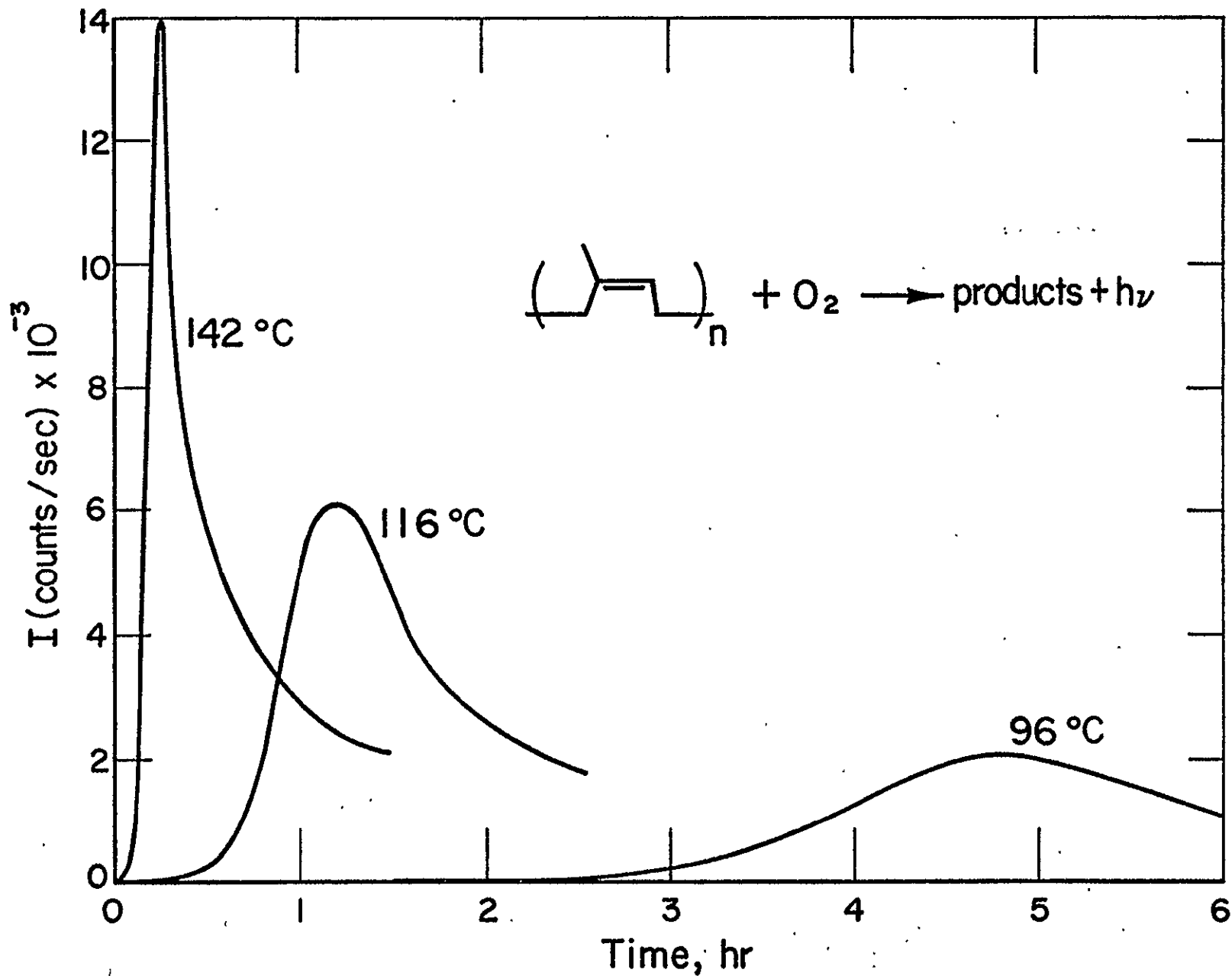

FIGURE 24. REPRESENTATIVE CURVES FOR OXIDATIVE CHEMILUMINESCENCE FROM cis-1,4-POLYISOPRENE AT 96-142°C



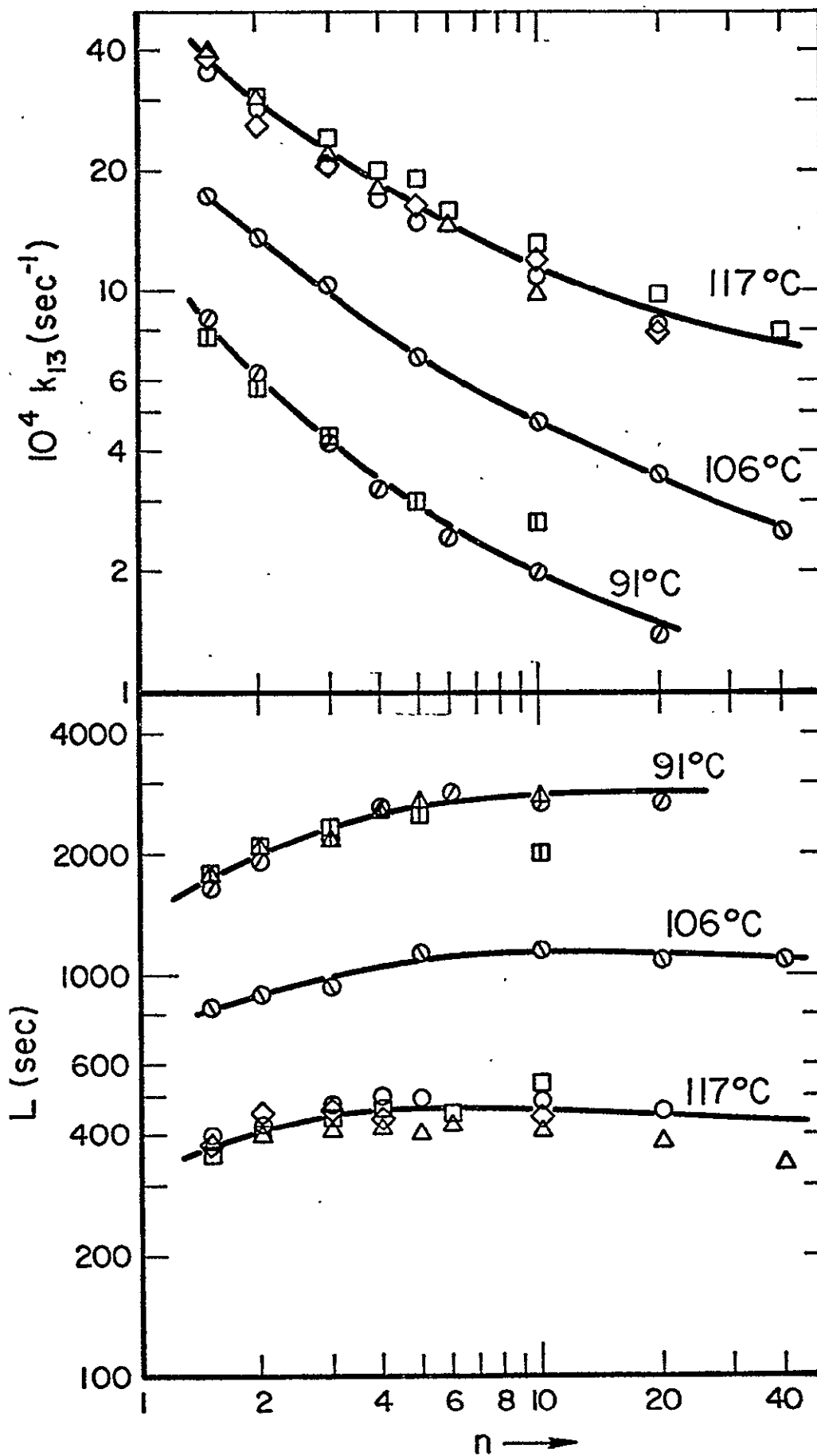

FIGURE 25. TEST OF CHEMILUMINESCENCE DATA FROM cis-1,4-POLYISOPRENE FOR KINETIC ORDER IN INITIATOR

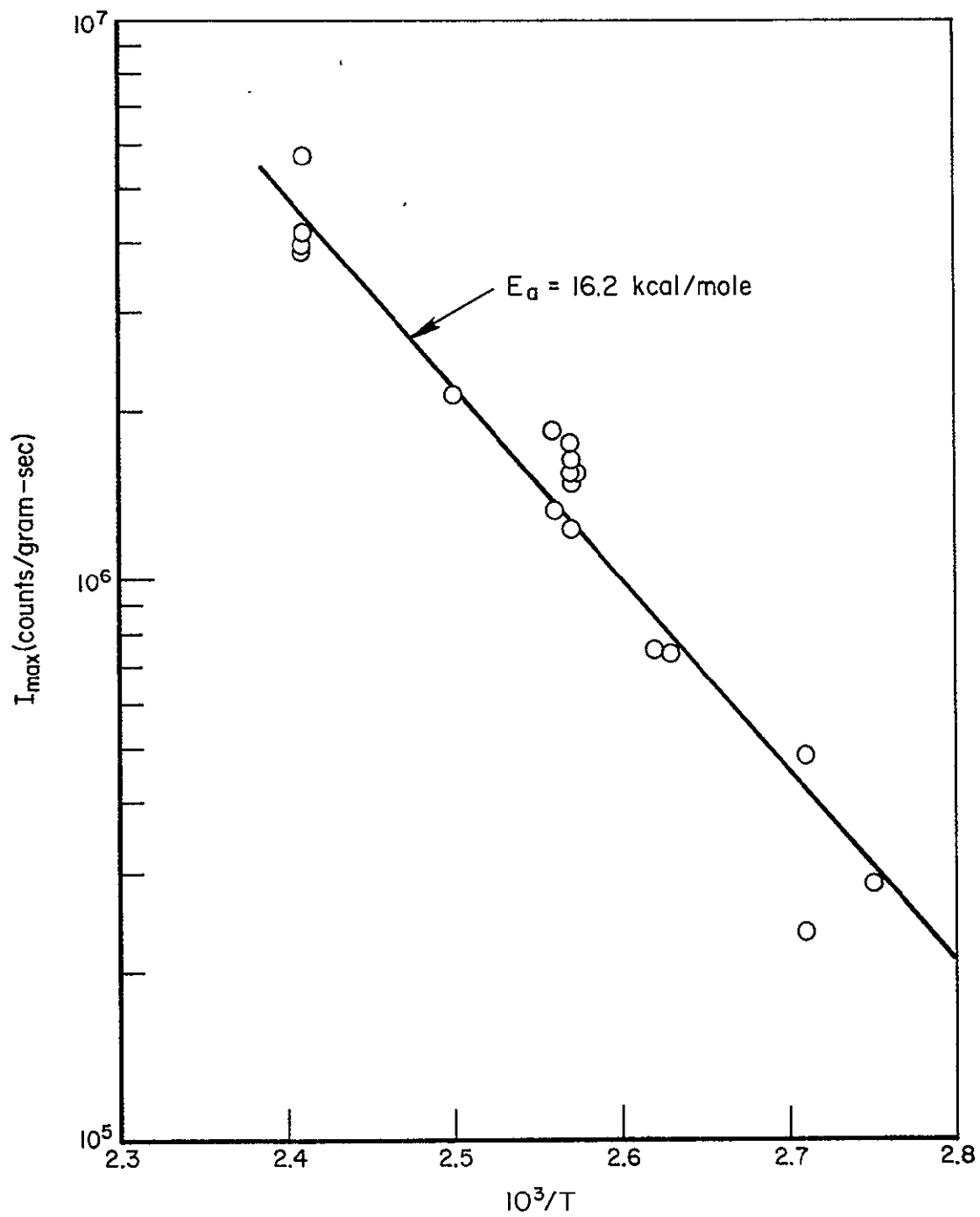

FIGURE 26. ARRHENIUS PLOT OF MAXIMUM CHEMILUMINESCENCE FROM cis-1,4-POLYISOPRENE IN OXYGEN

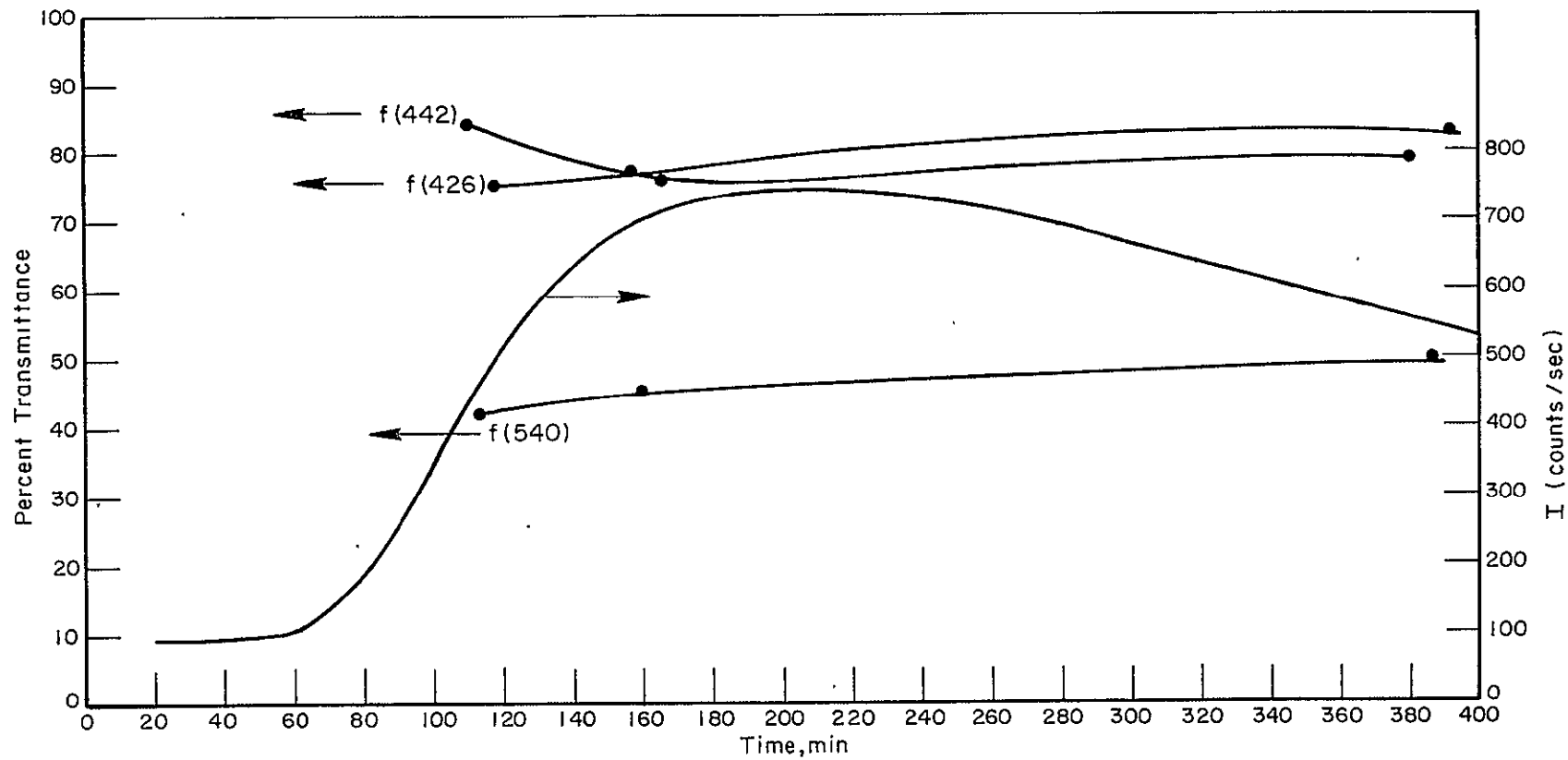

FIGURE 27. CHEMILUMINESCENCE EMISSION AND SPECTRAL DISTRIBUTION FROM cis-1,4-POLYBUTADIENE AT 110°C IN ARGON.

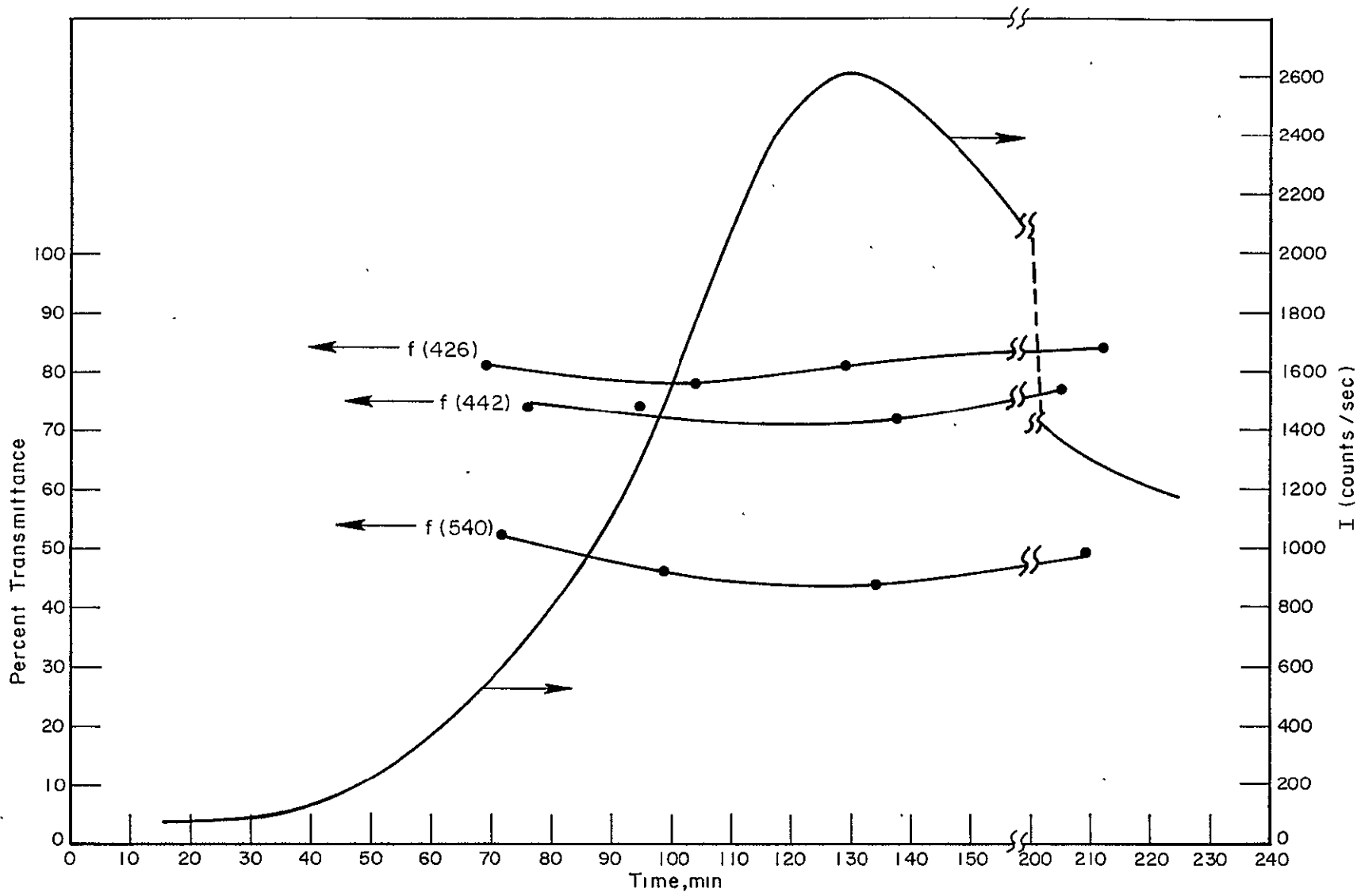

FIGURE 28. CHEMILUMINESCENCE EMISSION AND SPECTRAL DISTRIBUTION FROM cis-1,4-POLYBUTADIENE AT 110°C IN OXYGEN.

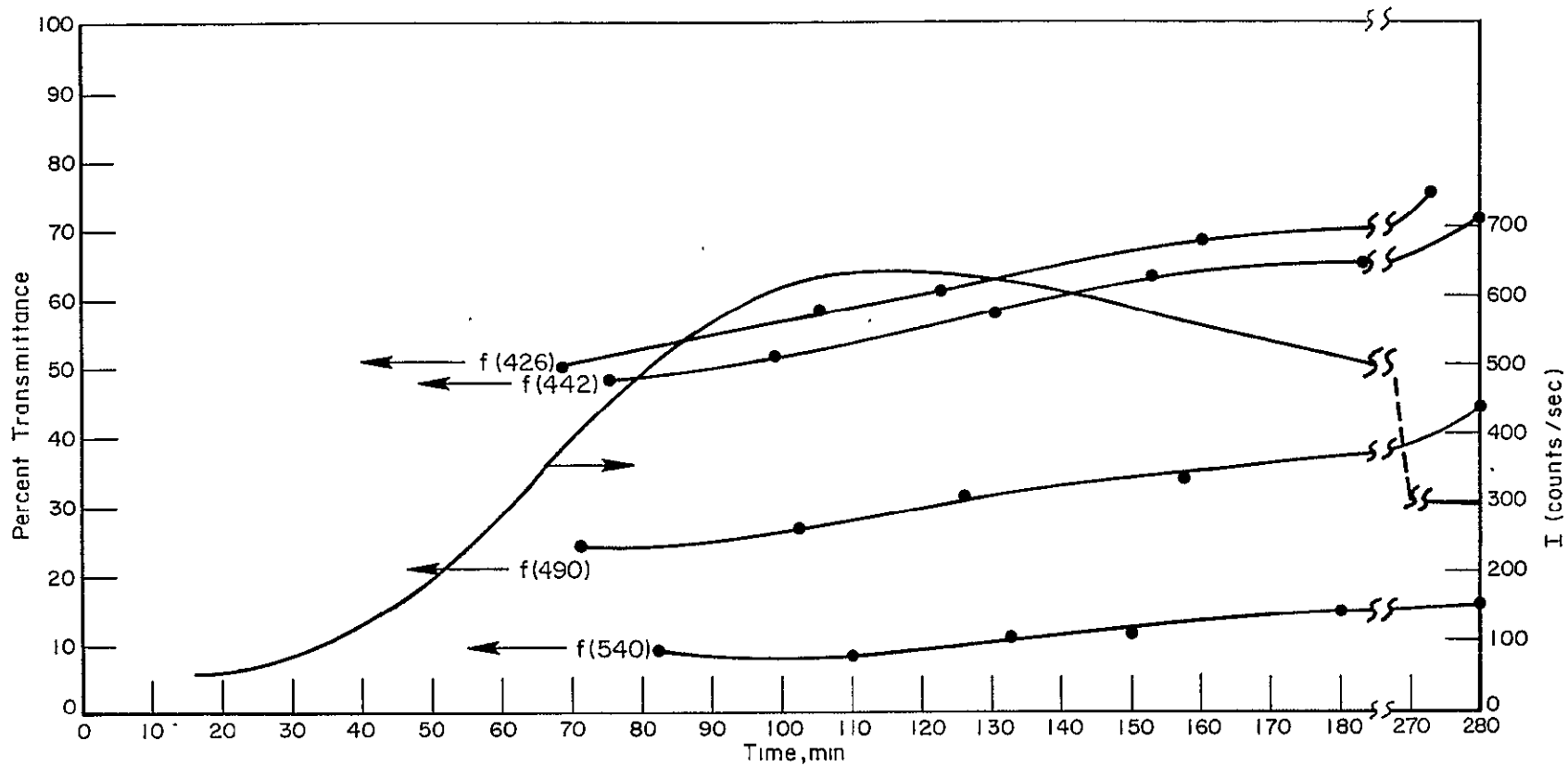

FIGURE 29. CHEMILUMINESCENCE EMISSION AND SPECTRAL DISTRIBUTION FROM trans-POLYPENTENAMER AT 114°C UNDER ARGON.

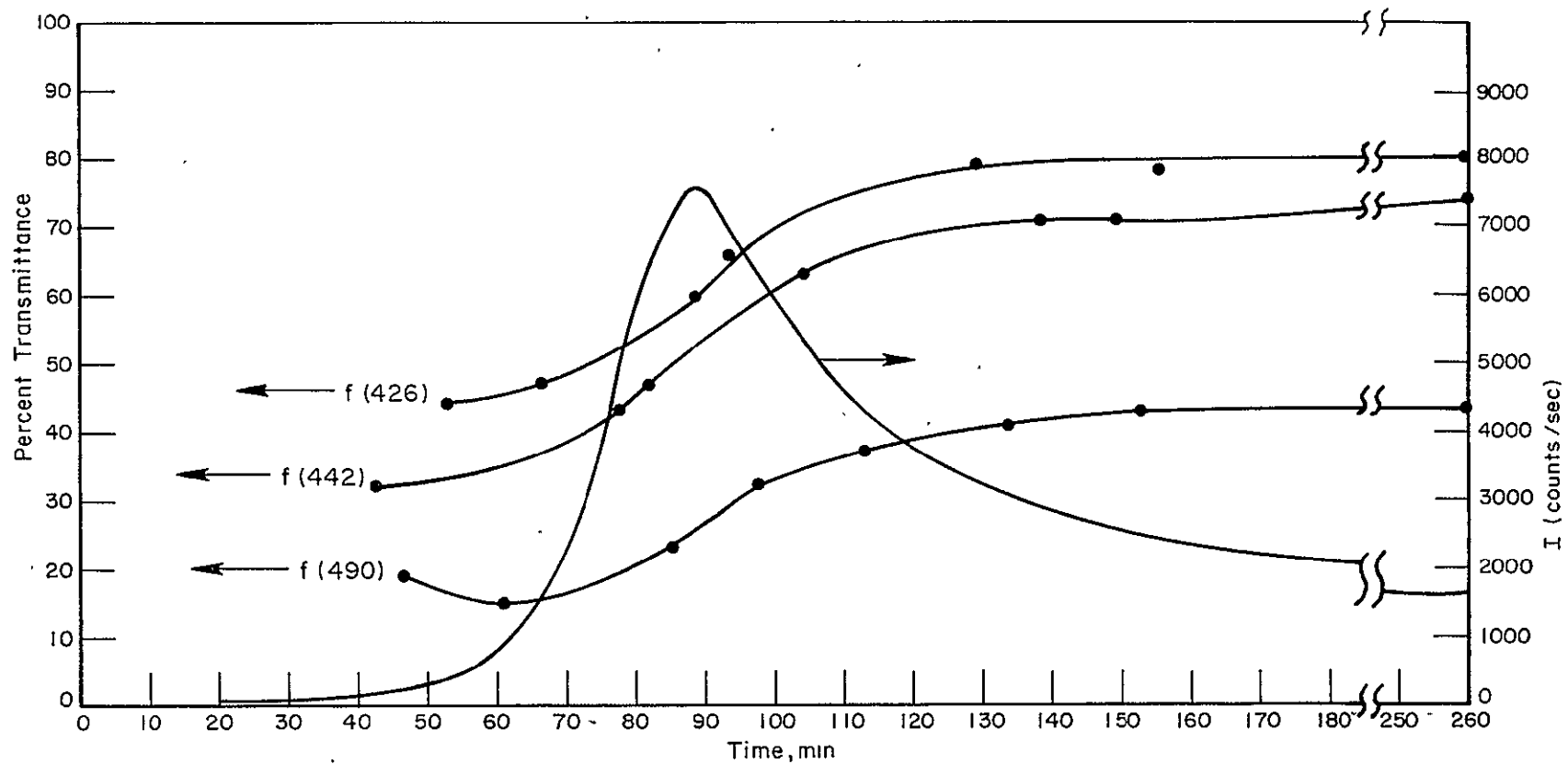

FIGURE 30. CHEMILUMINESCENCE EMISSION AND SPECTRAL DISTRIBUTION FROM trans-POLYPENTENAMER AT 11.5°C IN OXYGEN.

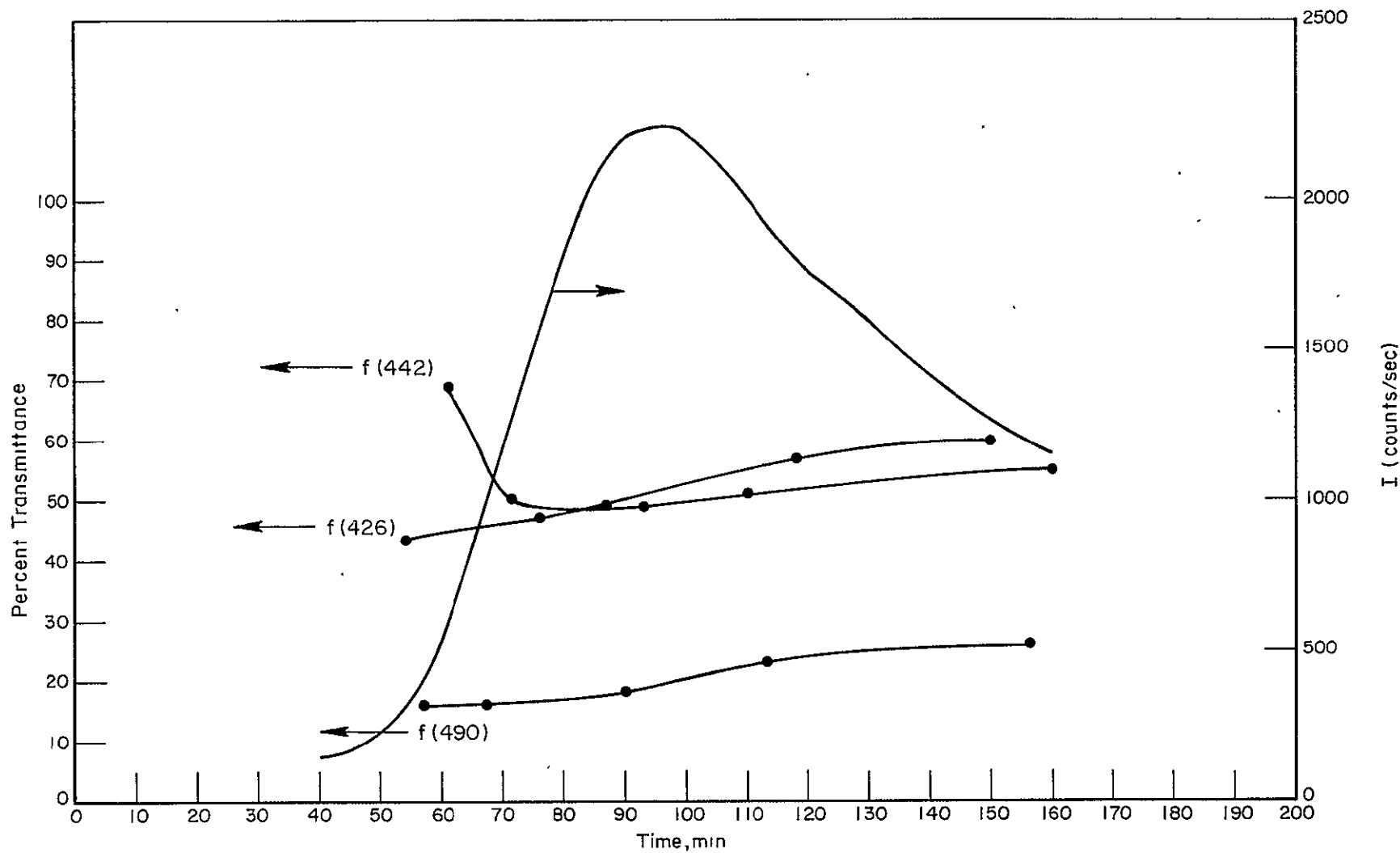

FIGURE 31. CHEMILUMINESCENCE EMISSION AND SPECTRAL DISTRIBUTION FROM 1,2-POLYBUTADIENE AT 131°C IN ARGON.

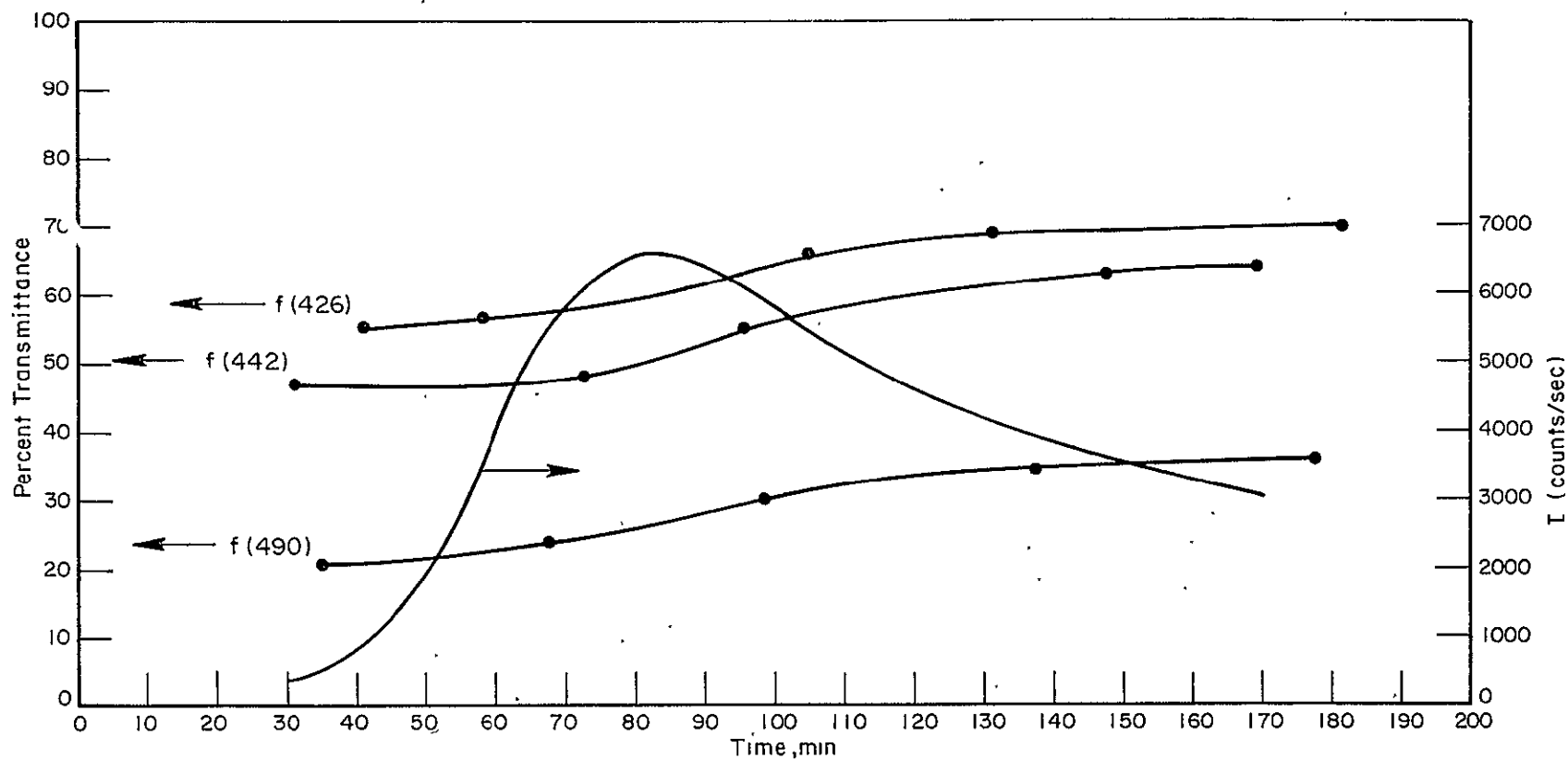

FIGURE 32. CHEMILUMINESCENCE EMISSION AND SPECTRAL DISTRIBUTION FROM 1,2-POLYBUTADIENE AT 129°C IN OXYGEN.



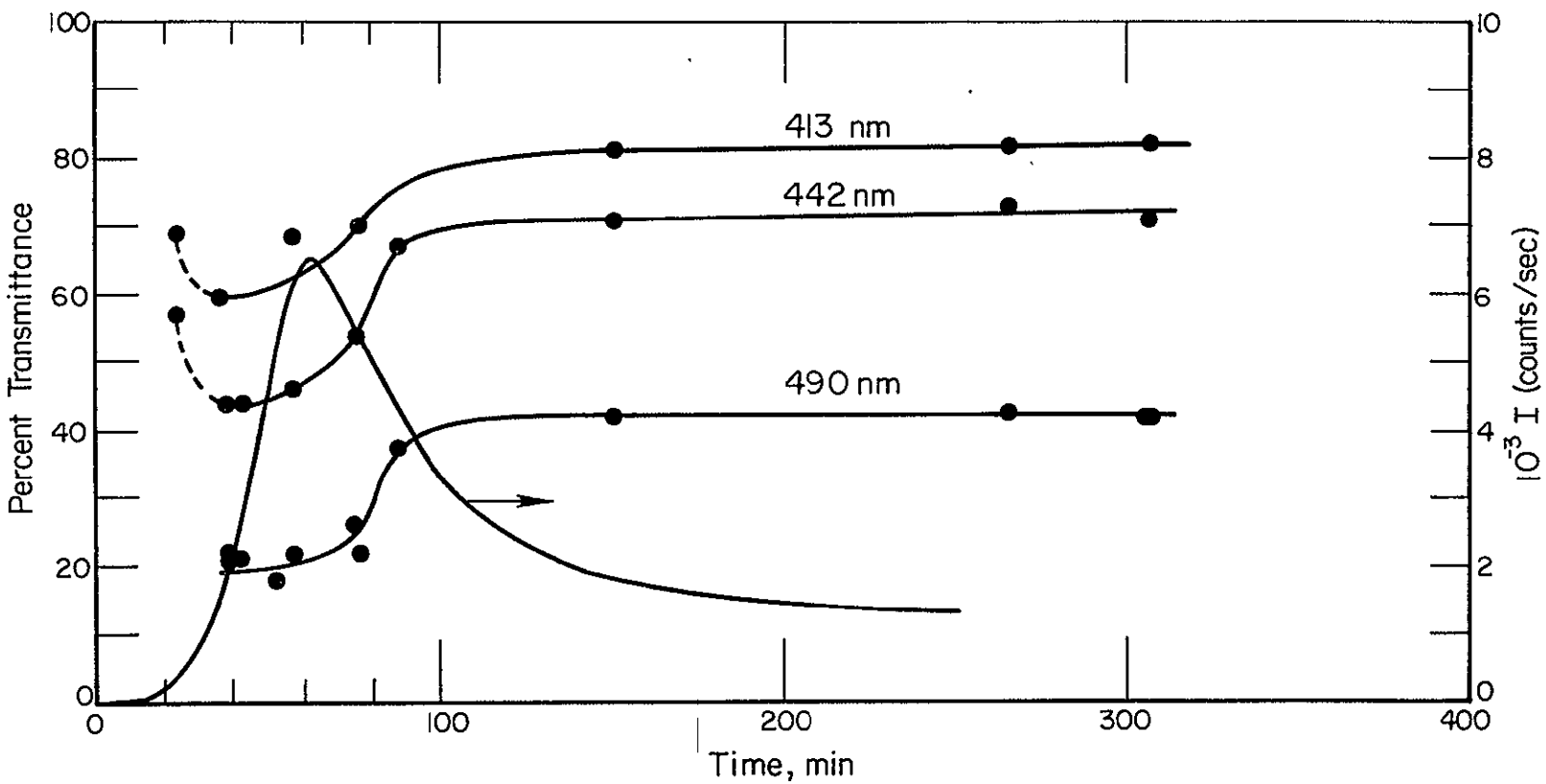

FIGURE 33. CHEMILUMINESCENCE AND SPECTRAL DISTRIBUTION FROM cis-1,4-POLYISOPRENE IN OXYGEN AT 118°C. THE  $F(\lambda)$  VALUES WERE OBTAINED FROM SEVERAL RUNS

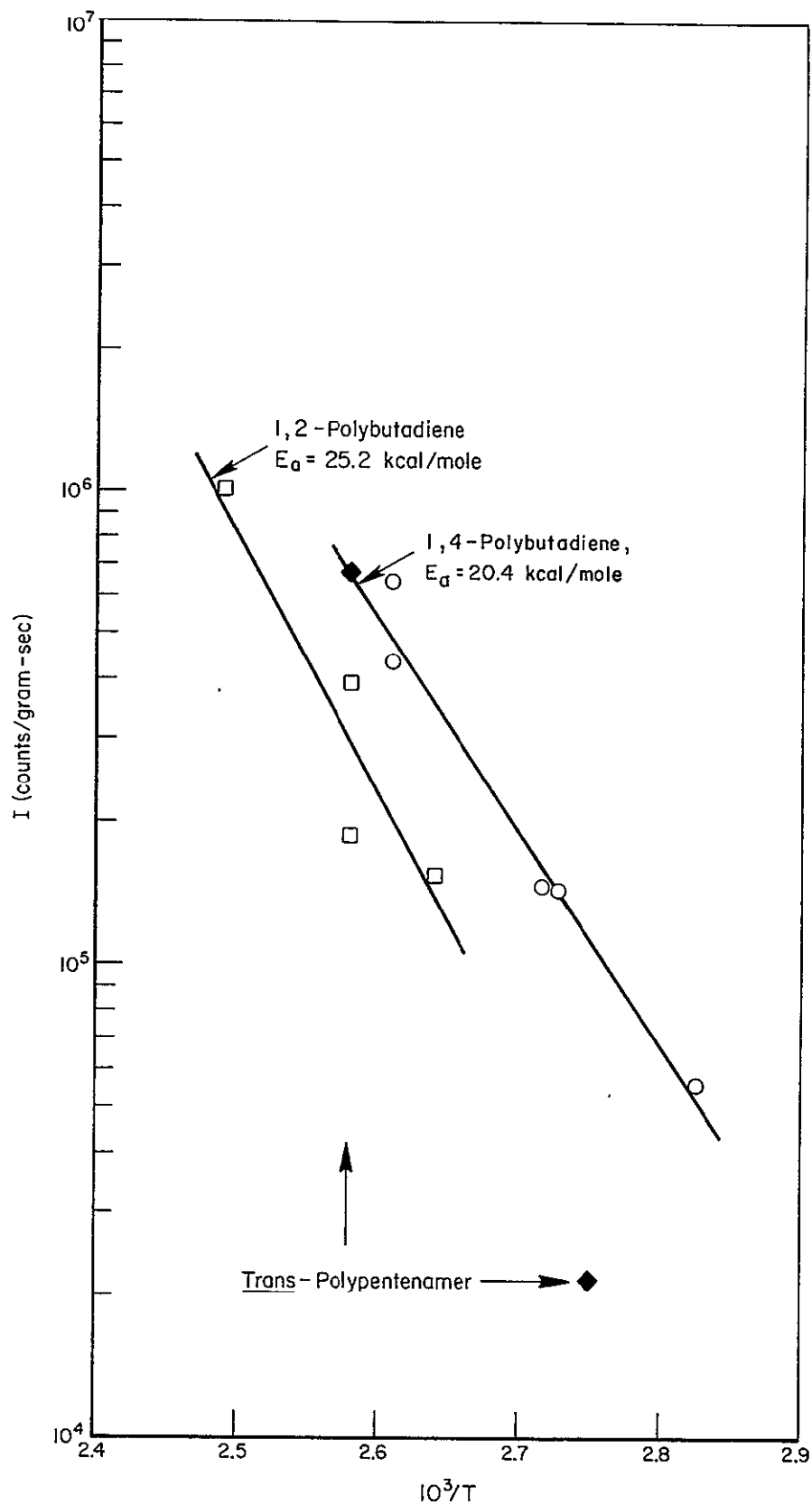

FIGURE 34. TEMPERATURE DEPENDENCE OF MAXIMUM CHEMILUMINESCENCE FROM 1,2- AND cis-1,4-POLYBUTADIENE, AND FROM trans-POLYPENTENAMER IN OXYGEN.

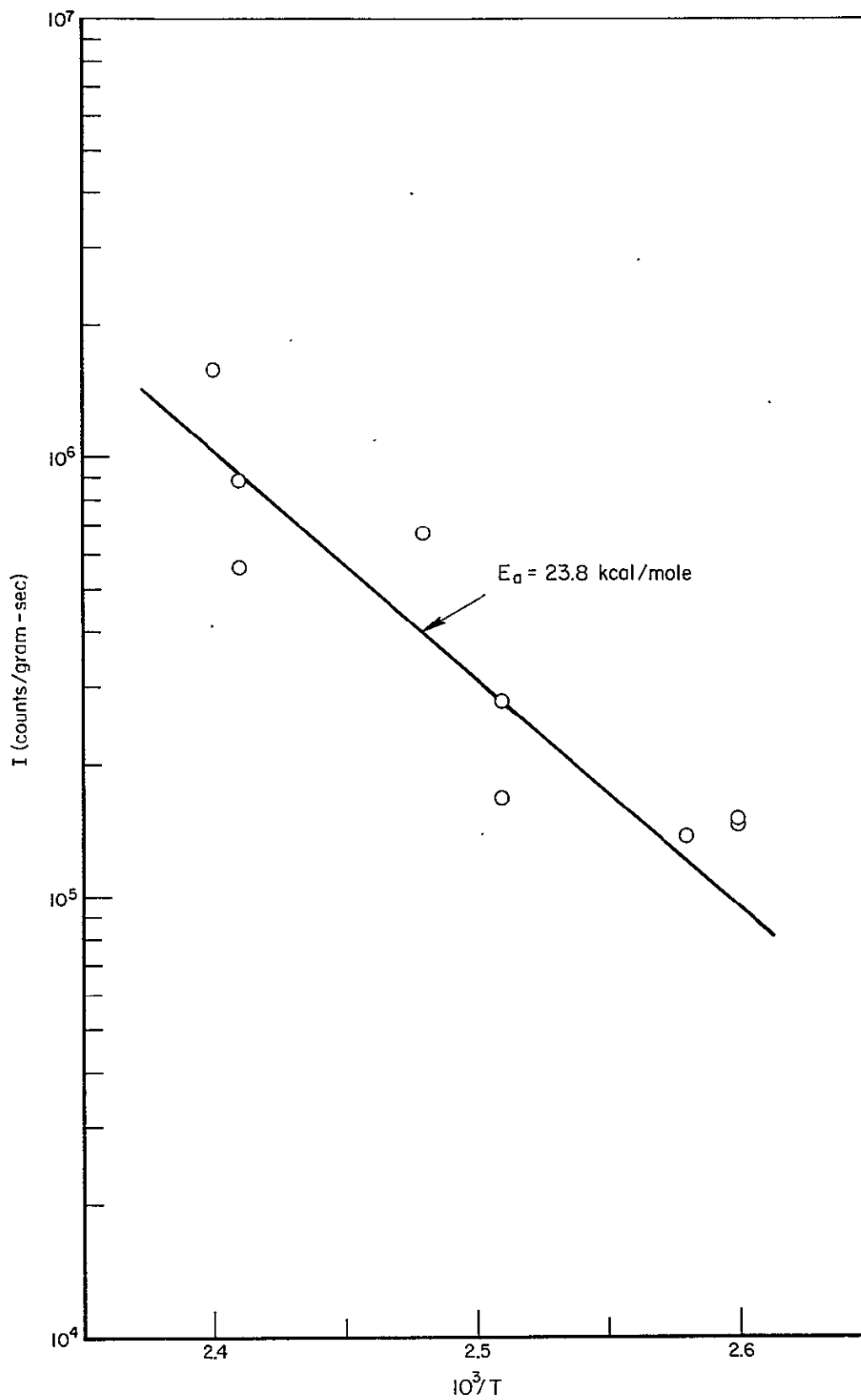

FIGURE 35. TEMPERATURE DEPENDENCE OF MAXIMUM CHEMILUMINESCENCE FROM trans-POLYPENTENAMER UNDER ARGON.

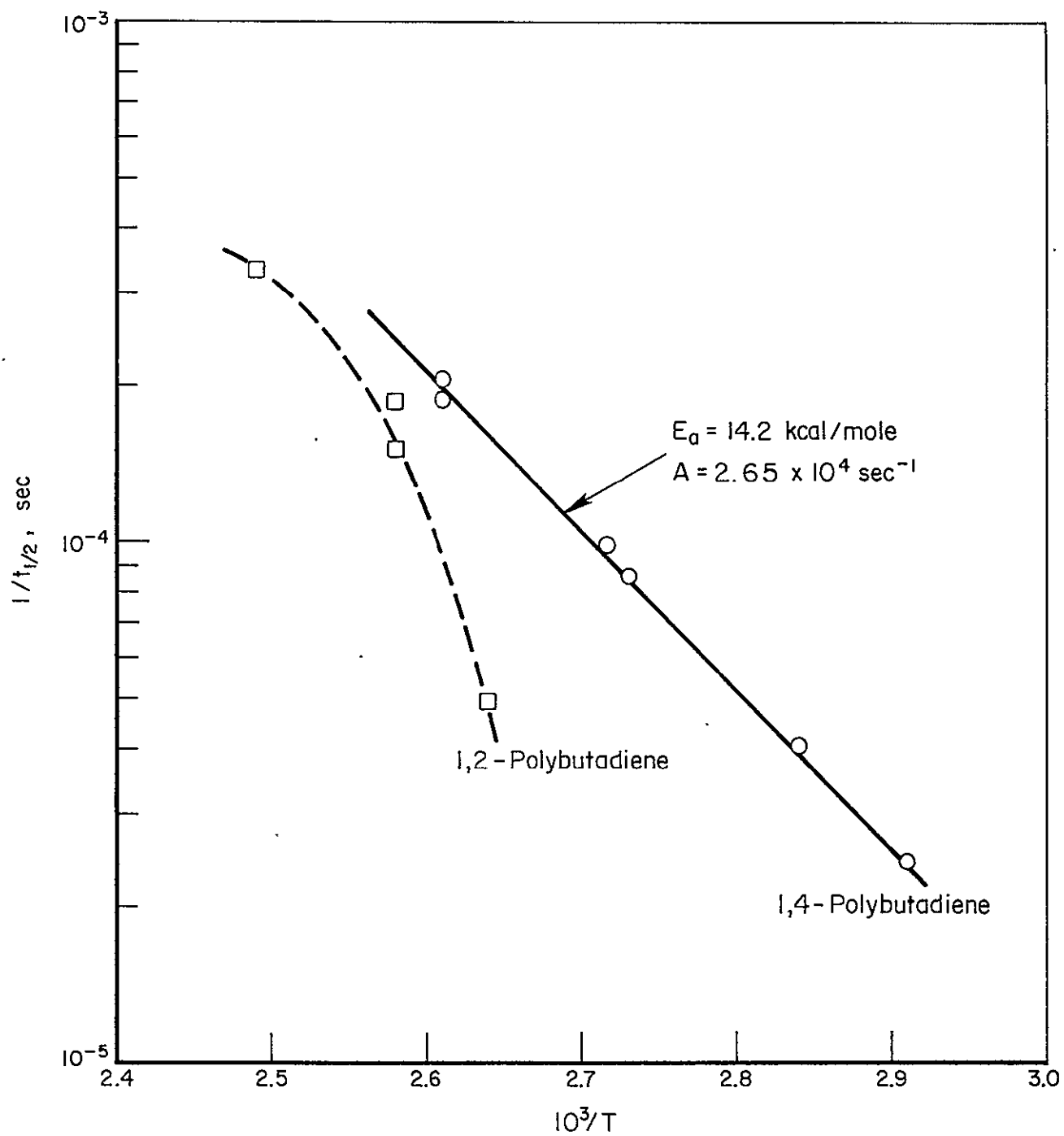

FIGURE 36. ARRHENIUS PLOTS OF  $1/t_{1/2}$  FOR 1,2- AND *cis*-1,4-POLYBUTADIENE IN OXYGEN.

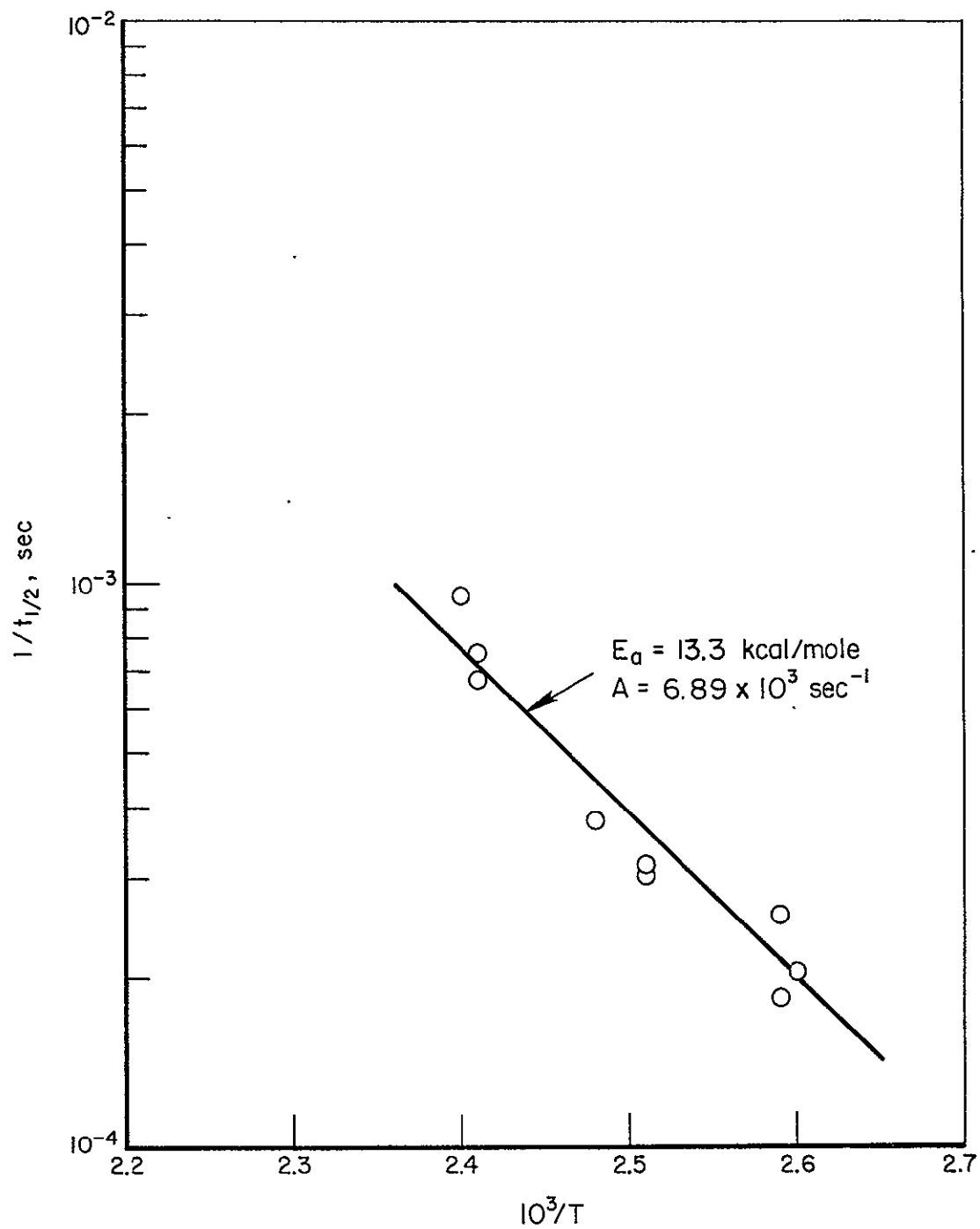

FIGURE 37. ARRHENIUS PLOT OF  $1/t_{1/2}$  FOR trans-POLYPENTENAMER UNDER ARGON.

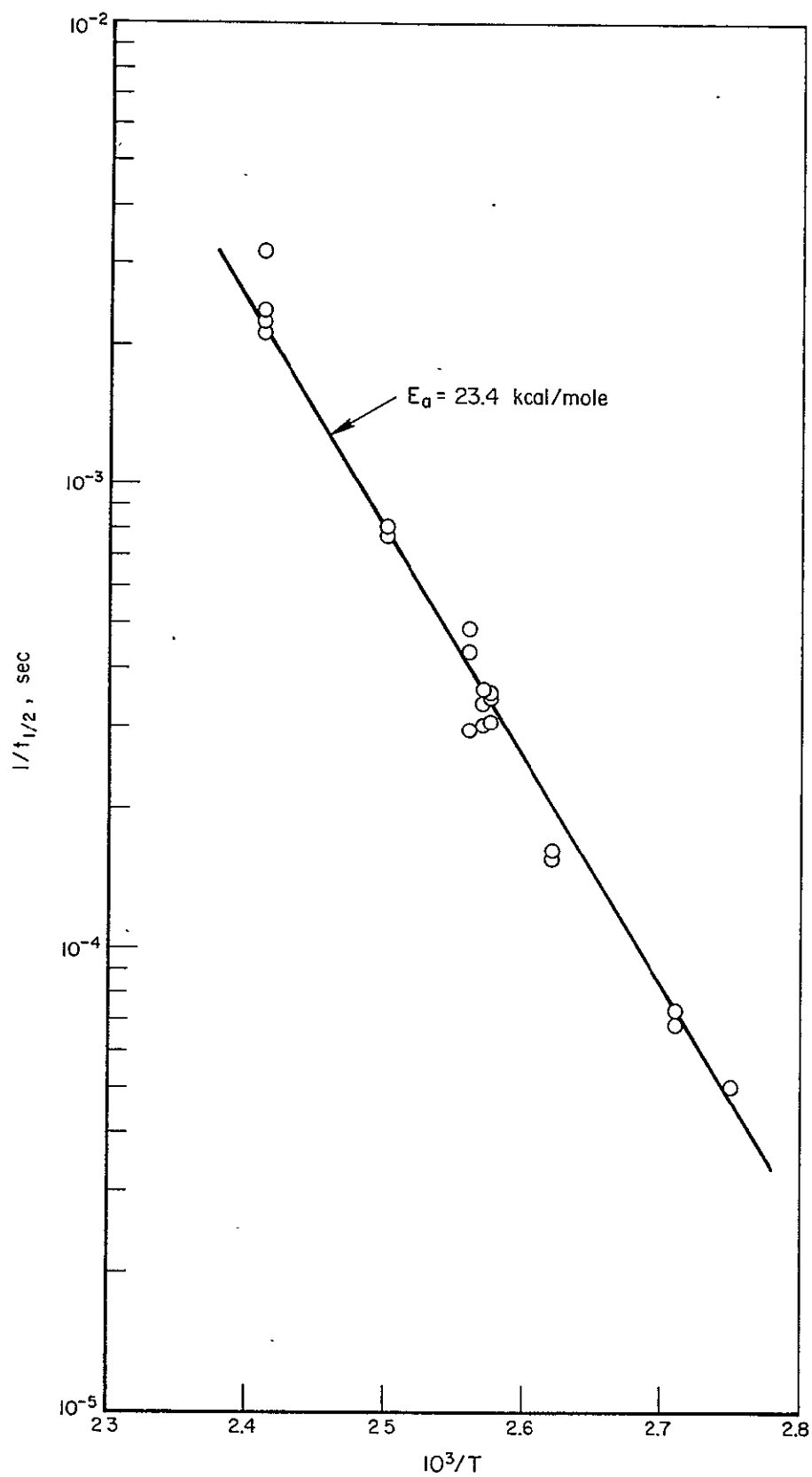

FIGURE 38. ARRHENIUS PLOT OF  $1/t_{1/2}$  FOR cis-1,4-POLYISOPRENE IN OXYGEN.

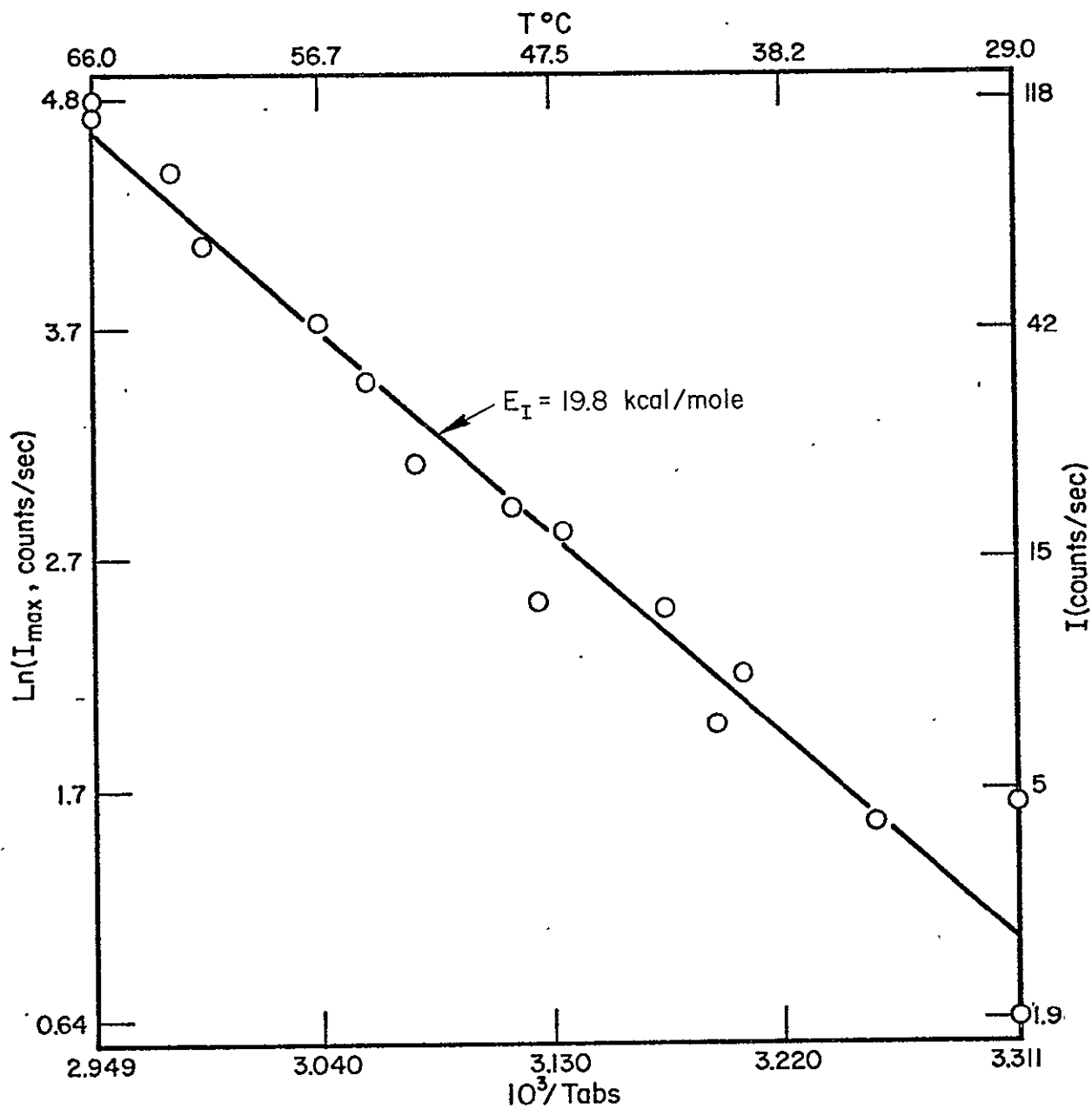

FIGURE 39. ARRHENIUS PLOT FOR CHEMILUMINESCENCE IN TEMPERATURE-JUMP EXPERIMENT WITH AUTOXIDIZED cis-1,4-POLYISOPRENE

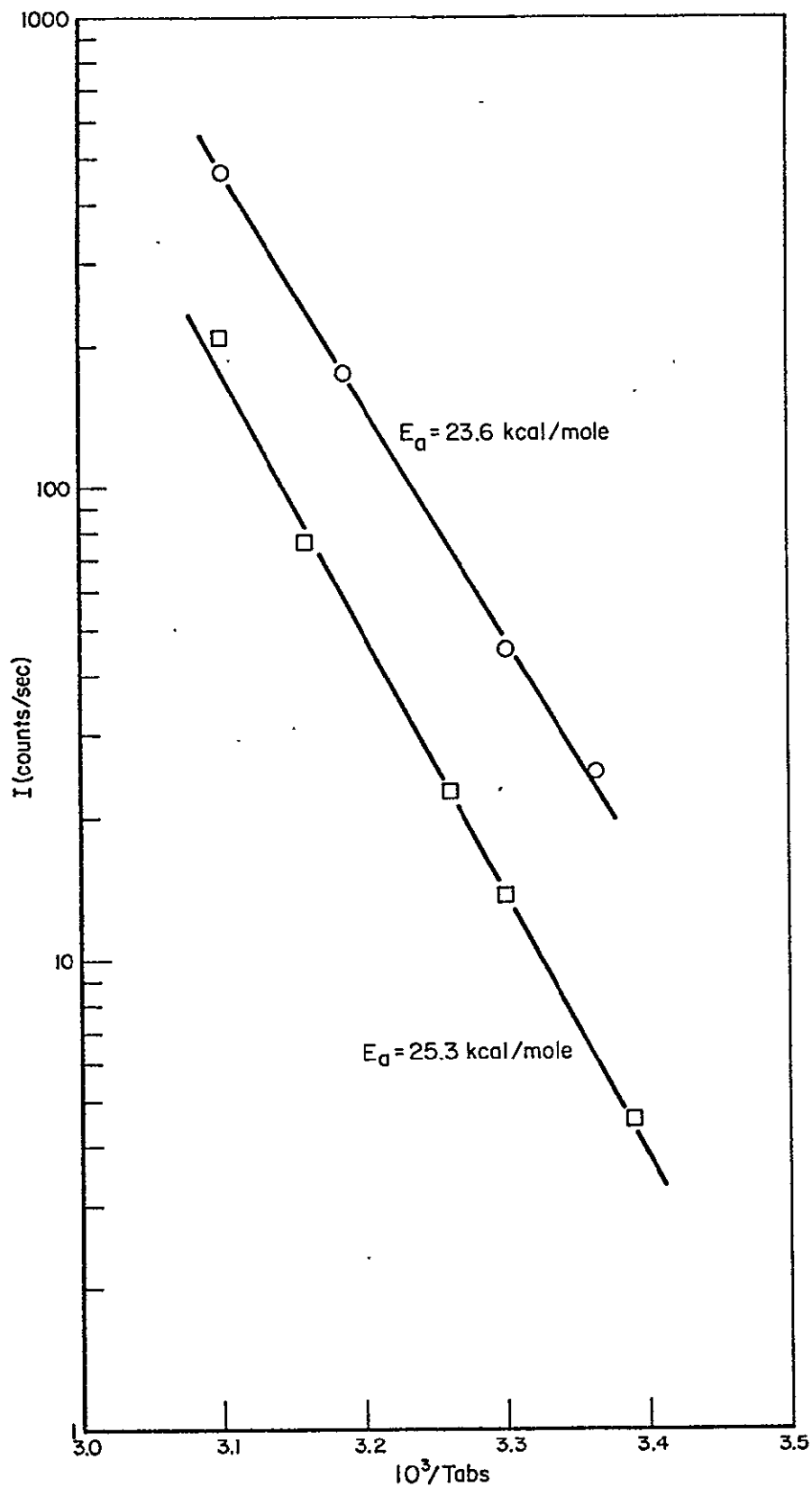

FIGURE 40. CHEMILUMINESCENCE AS A FUNCTION OF TEMPERATURE FOR AUTOXIDIZED ( $\square$ ) AND SINGLET OXYGENATED ( $\circ$ ) CIS-1,4-POLYISOPRENE. EACH RUN CONTAINED 0.5 PERCENT 9,10-DIPHENYLANTHRACENE.