

! N76-31137

SURVIVABLE FLIGHT CONTROL SYSTEM FLY-BY-WIRE DEVELOPMENT AND FLIGHT TEST

James E. Hunter
Air Force Flight Dynamics Laboratory

SUMMARY

The United States Air Force initiated the Survivable Flight Control System (SFCS) Advanced Development Program in July 1969 in which one of the major objectives was to establish the practicality of the Fly-by-Wire (FBW) concept for use in military fighter aircraft. This advanced development program provided for the design, fabrication, qualification, and highly successful flight test evaluation of a quad-redundant FBW primary flight control system in an F-4 aircraft without conventional mechanical controls.

Results from this intensive FBW advanced development effort indicate significant improvements in overall flight control system performance, reliability, safety and maintainability. Additionally, the strong and credible FBW technology base developed as a result of this program has paved the way for further exploitation through the application of advanced concepts such as Control Configured Vehicles and Multi-Mode Controls.

INTRODUCTION

The Air Force has accomplished a significant major milestone in advanced fighter flight control design and reliability with successful completion of its fly-by-wire flight test under the Survivable Flight Control System (SFCS) Program. This portion of the SFCS Program has consisted of a four year, \$16.5 million development program with primary objective for developing and flight testing control elements to improve combat survivability of aircraft weapon systems. The development program was performed by McDonnell Douglas under contract to the Air Force Flight Dynamics Laboratory, with Sperry Rand, General Electric, and Lear Siegler as the principal equipment suppliers. Although the primary purpose of this program was to develop a highly reliable flight control system designed to improve survivability, major improvements in handling qualities, stability and performance, and weapon delivery accuracy were also achieved goals.

The SFCS mechanized in a YF-4E test aircraft uses a quadruply redundant (two-fail operate), dispersed, three-axis, analog, fly-by-wire (FBW) primary flight control system allowing the pilot to command aircraft motion rather than the conventional control surface position. This is the first high performance fighter aircraft ever to fly using a futuristic "all electric" system.

The potential and advantages of FBW had been demonstrated in several

exploratory development programs beginning in 1959 at the Flight Dynamics Laboratory. FBW acceptance was dependent upon answering the question of whether electrical control systems, such as implemented in the SFCS, could be made as reliable as conventional mechanical control systems. The task, undertaken during the SFCS flight test, was to demonstrate that the system developed during this program performs significantly better with greater reliability than currently operational flight control systems.

TECHNICAL APPROACH

Simple direct mechanical linkages, cables, and feel springs for manual control can no longer cope with many of the control system problems associated with modern high performance aircraft and aerospace vehicles. In an effort to meet the greater demands of these advanced control system requirements, the flight control designer has been forced to increase the complexity of the mechanical system with a resulting increase in weight, volume, cost, and a decrease in flexibility and reliability. Often he is forced to compromise between the desired performance and design requirements and a practical mechanization. FBW not only meets the demands of these advanced control system design requirements but does so with a decrease in complexity, weight, volume and cost. It also provides an increase in flexibility, reliability, and by utilizing redundancy and dispersion increased survivability.

While providing improved survivability, it was felt and later verified that the use of FBW primary flight control would enable major improvements in the tactical capability of the vehicle. The design of the system was therefore based upon studies to define a set of control laws which provided nearly optimum aircraft response characteristics desired by pilots for use during the various mission tasks assigned to the test aircraft in its normal operational use.

Traditional performance criteria, such as many of those presented in MIL-F-8785B, were directed toward bounding the values of various short period response parameters such as frequency, damping, time constants, etc., which pilots have felt are consistent with the precision and control needed during maneuvering flight. Many of these parameters which are easily defined in terms of the basic aircraft dynamics are often masked by the forced response of multiloop high gain control systems. The newer control performance criteria express short period response in terms of a response envelope in the time domain. These criteria are applicable to both the high gain multiloop controlled aircraft response and the basic aircraft response, and are a supplement to the traditional forms of control performance criteria.

The new criteria used in the SFCS program consist of three basic time history performance criteria with boundaries on both the basic parameter and the time rate of change of that parameter. These parameters are a normalized blend of pitch rate and normal acceleration (C^*) for the pitch axis, a normalized roll rate (P_N) for the roll axis, and a normalized blend of lateral acceleration and sideslip (D^*) for the directional axis. A C^* criterion has been available for some time as documented in Reference 5. The definition of the C^* expression in equation form as used in the SFCS program is:

$$C^* = \Delta n_{zp} + K_2 q$$

Δn_{zp} = Incremental normal load factor at pilot station (g's)

q = Pitch rate (rad/sec)

$K_2 = C_2 V_{c0} =$ Pitch rate gain constant

$C_2 =$ Dimensional constant $(1/32.2 \frac{g's - sec^2}{ft})$

$V_{c0} =$ Crossover velocity (assume 400 ft/sec)

The Δn_{zp} is the total incremental load factor at the pilot station and includes normal effective acceleration at the aircraft center of gravity (c.g.) and the additional normal acceleration at the pilot station due to pitch acceleration (\dot{q}), multiplied by the moment arm from the vehicle c.g. to the pilot station. The studies reported in Reference 2 proposed modifications to the C^* boundary presented in Reference 5. Figure 1 shows the proposed normalized C^* envelope and a \dot{C}^* , or normalized rate of change of C^* , envelope. The \dot{C}^* envelope is required to control higher order effects such as low damped low amplitude oscillations which could be accommodated by the C^* envelope but still be undesirable.

The P_N response envelope is shown in Figure 2. Included also is a roll acceleration (P_N^*) response envelope. These envelopes restrict the roll mode response time constant, overshoot and oscillations.

The D^* criteria define the transient response characteristics in the directional axis due to a lateral step command input from the pilot. The D^* expression combines sideslip, which is considered the principal low speed handling quality parameter, and lateral acceleration, which is a more important consideration during high speed flight. The definition of the D^* expression in equation form as used in the SFCS program is:

$$D^* = \Delta n_{yp} + K_3 \beta$$

$$D_1^* = D^*/K_3 = \beta + \Delta n_{yp}/K_3$$

Δn_{yp} = Incremental lateral load factor at pilot station (g's)

β = Sideslip angle (rad)

$K_3 = C_3 q_{c0} =$ Slideslip gain constant

$C_3 =$ Dimensional constant $(-9.91 \times 10^{-3} \frac{g's - ft^2}{lb})$

$q_{c0} =$ Crossover Dynamic Pressure (assume 350 lb/ft²)

The Δn_{yp} is the total incremental lateral acceleration at the pilot station. It includes lateral acceleration at the aircraft c.g. and the additional lateral acceleration at the pilot station due to roll acceleration

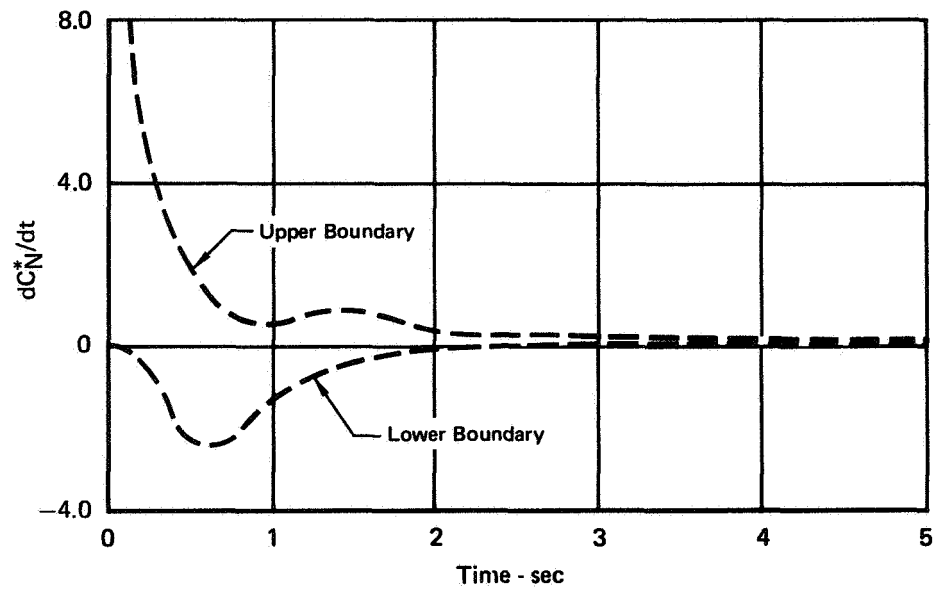
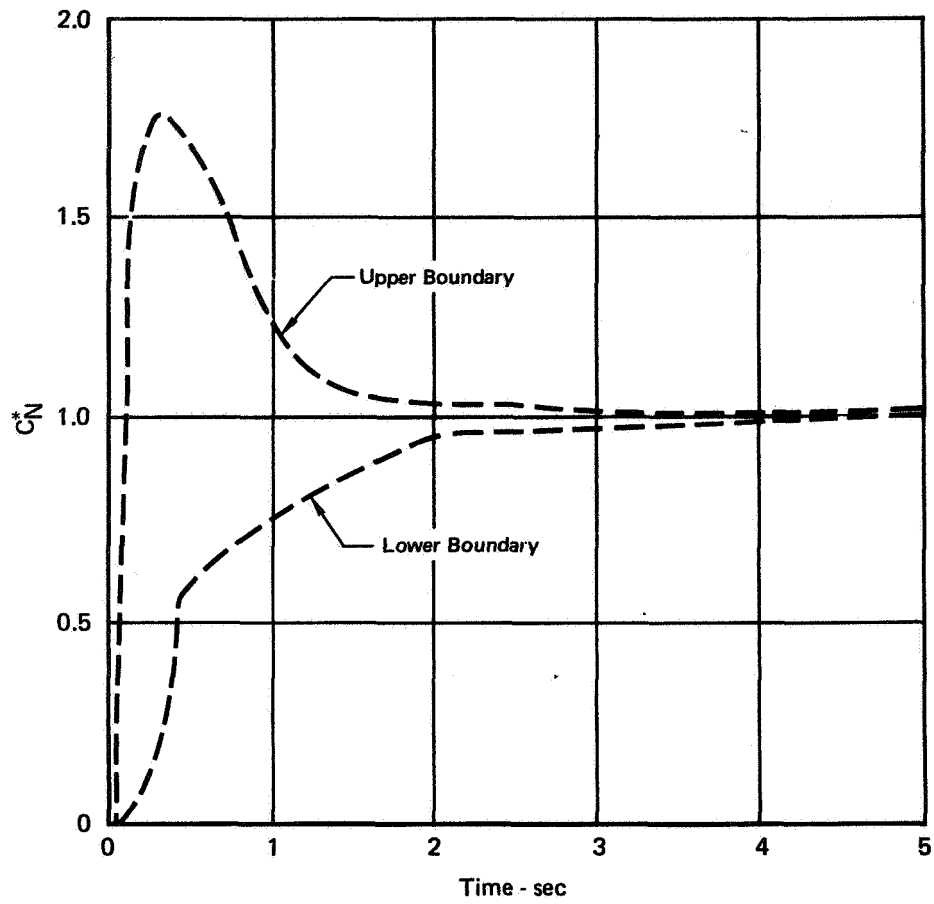

FIGURE 1
SFCS PITCH AXIS TIME HISTORY CRITERION

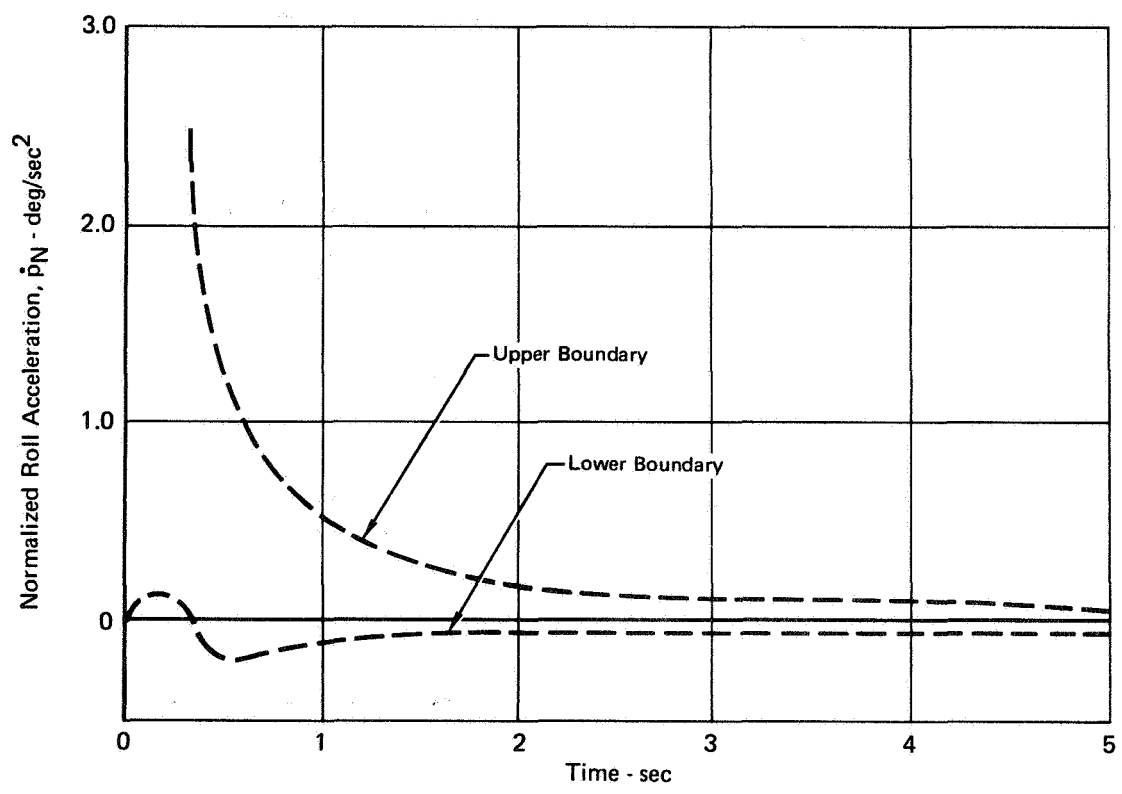
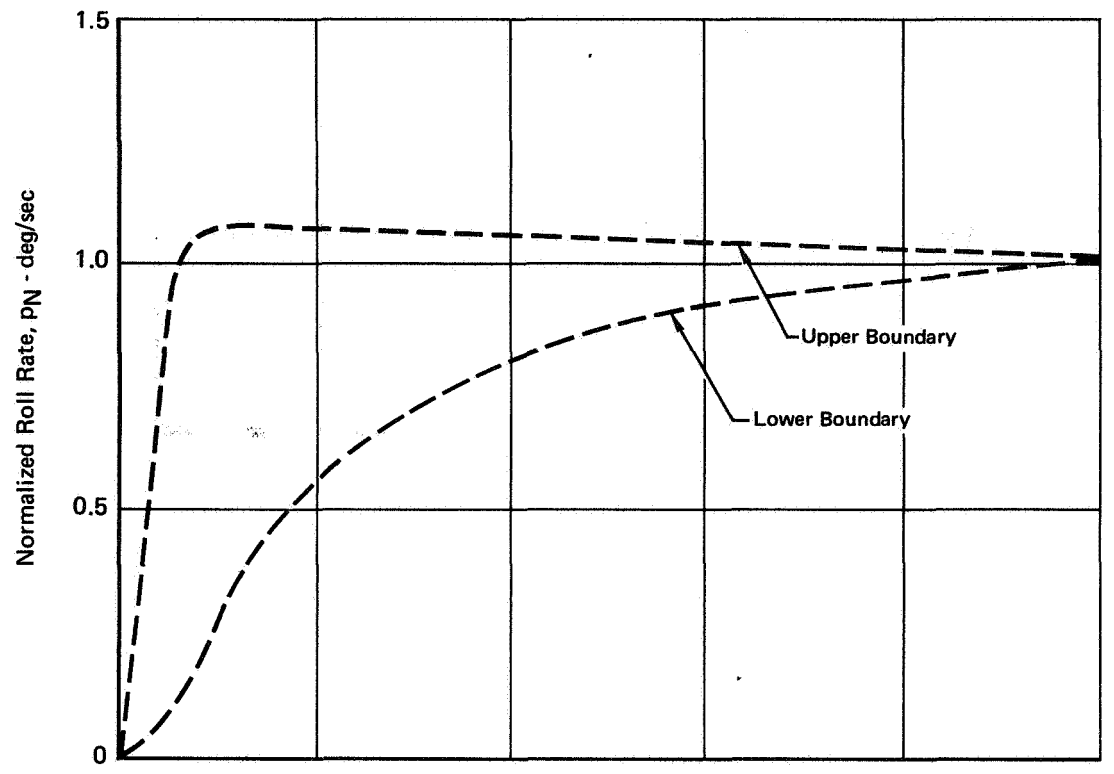

FIGURE 2
SFCS ROLL AXIS TIME HISTORY CRITERION

(\dot{p}) and yaw acceleration (\dot{r}) multiplied by the respective moment arms. The roll moment arm is the distance from the roll axis to the pilot station. The yaw moment arm is the distance from the aircraft c.g. to the pilot station.

In contrast to the C^* concept where the equivalent gain constant is a function of velocity, the D^* equation employs a crossover dynamic pressure to establish when low and high speed flying qualities are rated equally. The D^* equation can be modified to yield an expression which is more in harmony with the traditional lateral-directional handling qualities specifications on sideslip excursion limitations. This expression, D_1^* , has the sideslip units of degrees or radians. Figure 3 shows the D_1^* and \dot{D}_1^* , the rate of change of D_1^* , boundaries used in the SFCS program. The boundaries are expressed in terms of the factor "K", where "K" is the ratio of "commanded roll performance" to "applicable roll performance requirement" as defined in MIL-F-8785B.

Having now established the performance criterion a six-degree-of-freedom, man-in-the-loop simulation program was conducted to evaluate the control law implementation. This simulation included the capability to maneuver the aircraft throughout the F-4 flight envelope including stall and post stall conditions. As a result of this simulation, several design modifications were identified, evaluated, and subsequently implemented into the SFCS design. A series of simulations were used during the development and test of the SFCS to assist not only in the design, but to verify equipment performance, train pilots, and correlate flight test data. This test program has shown the importance of compatibility testing with a manned simulator in preparing for a flight test program. Reference 1 describes completely the thorough simulation effort which resulted in savings of time, money, and most importantly accelerated progression to three-axis FBW control of the aircraft in the very early stages of the flight test program.

SYSTEM DESCRIPTION

The SFCS is a three-axis, analog, fly-by-wire, primary flight control system using secondary actuators to provide position commands to the surface actuators.

The system functions in a closed loop as a direct function of pilot applied inputs to command aircraft motion, instead of surface position. In addition to conventional controls, a sidestick controller (SSC) located on the pilot's right-hand console is included for SFCS control. The final configuration of the SFCS as mechanized had no mechanical control of control surface position in any of the three axes. In addition to a normal mode of operation which commands aircraft motion, electrical backup modes command surface positions in the event of malfunctions of the normal mode. A capability for reversion to a mechanical backup mode, provided in the pitch and yaw axes for the early phase of the flight testing, was removed following flight test validation of the SFCS modes and functions.

The normal mode shown in Figure 4 utilizes rate and acceleration feedbacks to control aircraft motion. The three levels of closed-loop gain for the pitch and yaw normal modes may be selected either by the pilot or automatically by the adaptive gain computer. This variable gain system provides

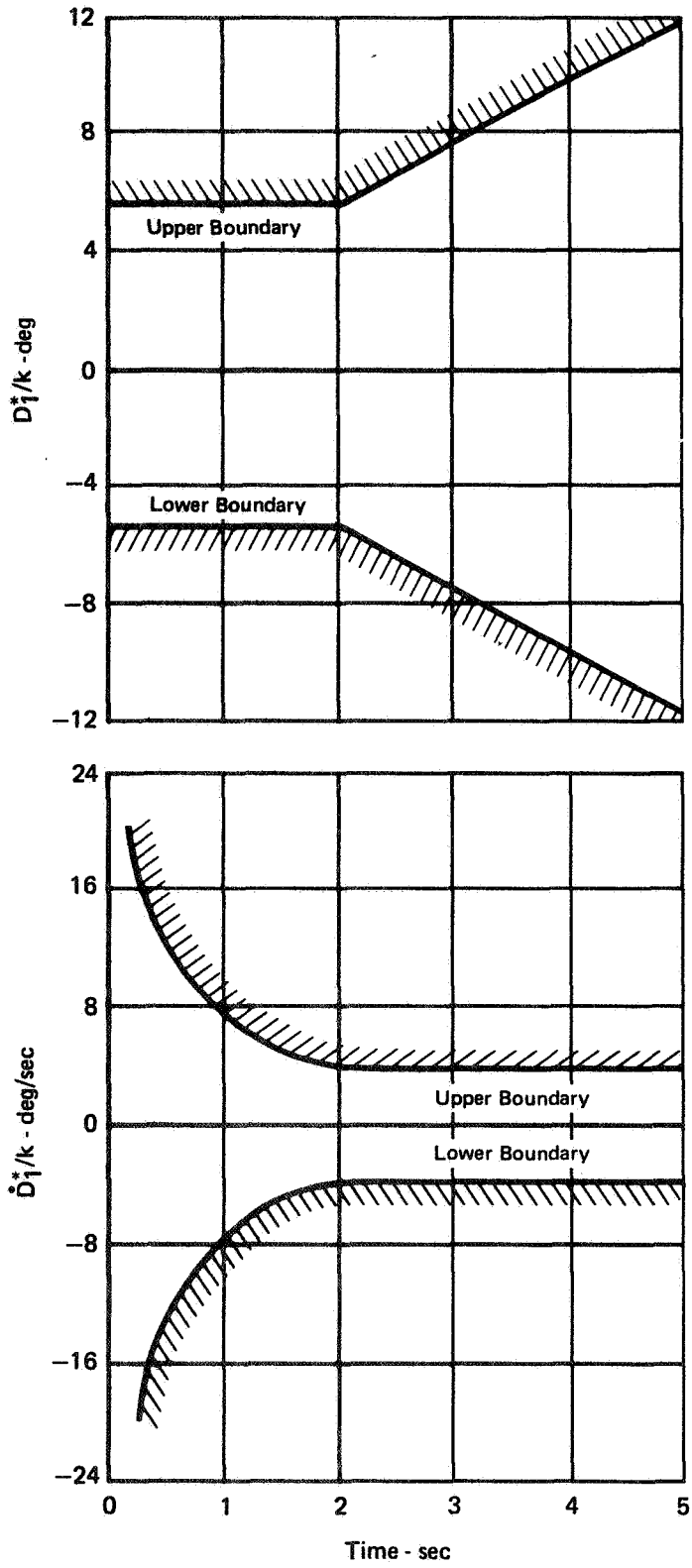

FIGURE 3
SFCS DIRECTIONAL TIME HISTORY CRITERIA

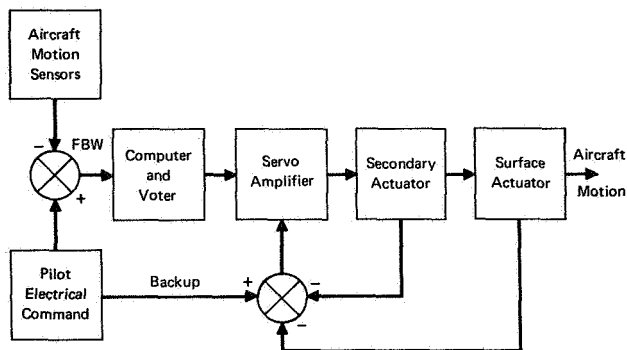

Figure 1 Survivable Flight Control System Mechanization

an almost unchanging aircraft dynamic response for varying flight conditions. The pitch axis normal mode provides a neutral speed stability (NSS) auto-trim function with the landing gear retracted. The auto-trim is provided by integration implemented in the forward loop. A stall warning function is provided through a blend of angle-of-attack and lagged pitch rate. Nose down pitch rates are rejected in

the control law so that pilot push-recovery from a stall condition is not impeded. The stall warning function is to reduce the command gain in the longitudinal axis, effectively increasing stick force per g, and to remove the roll rate feedback from the roll axis; both changes occur linearly as the stall region is penetrated.

Quadruplex (four channel) redundancy is used in all system components to provide improved system reliability and to achieve a two-fail operate system. Four transformer rectifiers (TR), each shunted by a battery, are independent power supplies. Two engine-driven ac generators provide the primary source of power to the four TRs. In the event of a single generator failure, the remaining unit can power all four TRs. If both generators fail, the batteries can power the SFCS for approximately one hour of flight time, sufficient to allow for a return to base. Three hydraulic pressure sources are normally available in the F-4 aircraft; PC-1, PC-2 and utility. A fourth hydraulic system, required to maintain quadruplex redundancy for the test aircraft, was an auxiliary power unit containing an electric motor driven hydraulic pump.

The necessary computations for the three control axes are performed by four analog computer voter units (CVU), one for each of the four channels. The quadruplex electrical signals in each of the three axes are processed by signal selection devices, and the selected signals are applied to electro-hydraulic secondary actuators. Four secondary actuators provide mechanical inputs to the rudder, stabilator and the two aileron and spoiler surface actuators. Each secondary actuator (SA) is quadruplex in that four identical units are integrated side by side and their output rams are force-summed providing a single point command. The CVUs monitor the status of each SA and will shut down any individual unit which is determined to have a significantly different differential hydraulic pressure than the differential hydraulic pressures of the other units of that SA. Reset switches with integral status indicator lights are installed on the main instrument panel of the test aircraft to provide continuous system status information. Momentary or inadvertent failures can be reset using these switches.

An extensive ground Built-In-Test (BIT) capability is included in the SFCS. The system automatically tests the SFCS with several hundred separate functional tests and subsequently indicates a GO or NO GO condition to the pilot and ground crew. Most detected failures are automatically isolated to a specific Line Replaceable Unit (LRU). LRU failure indications are

displayed on a maintenance test panel. In addition, the test number of any failed test is indicated to further help locate where in an LRU the failure occurred. The ground BIT requires approximately four minutes, and is positively deactivated during flight.

INSTRUMENTATION AND DATA ACQUISITION SYSTEM

The data acquisition system consisted of various instrumentation components located in the nose area of the test aircraft. The system included an Ampex AR 200 14 track magnetic tape recorder, PDM multicodecs, proportional NBFM multiplexing equipment, power supplies, and signal conditioning electronics. An L-Band UHF telemetry system was located in the center fuselage upper equipment bay. Approximately 275 data measurands were recorded during the initial SFCS flights. Certain measurands such as component temperatures and multichannel SFCS performance monitoring were deleted from the instrumentation once adequate data had been accumulated.

FLIGHT TEST APPROACH

Flight testing of the SFCS was initiated on 29 April 1972 from the contractor's facility in St. Louis and, on 5 July 1972, transferred to their Edwards AFB facility for further flight envelope expansion. Flight testing was structured into four progressive phases.

The first phase consisted of 27 flights, providing 23 hours of FBW flight time, and used to develop and evaluate the FBW flight control for all three axes while retaining a mechanical backup (MBU) system for the pitch and directional axes. During this phase the flight envelope and maneuvering boundaries were progressively expanded to cover the normal operating flight regime of the F-4. Conventional flight test techniques were used to examine the longitudinal stability and control as well as the lateral directional mode characteristics. It must be re-emphasized here that the program objectives were to develop and demonstrate a functional SFCS, not to optimize such a system for a particular aircraft such as the F-4. For this reason a minimal amount of effort was expended in axes optimization. Data was taken to investigate the system-component's operational environment as well as the effects of simulated equipment failures on the SFCS. Testing of the MBU system was limited to only that which was required to assure aircraft controllability when reverting to this mode. When confidence in the functional operation of the FBW system had been established the MBU was removed and the second phase of testing initiated.

The second phase of testing required 19 flights, providing 18 hours of FBW flight time. This period was used to continue evaluation of the SFCS performance with use of the Normal/Adaptive gain mode of operation. Aircraft flying qualities for gross maneuvering and precision of flying with the center-stick and sidestick controller and vernier control were evaluated as well as simulated combat maneuvering, instrument flying, and various other mission oriented tasks.

The third phase of system evaluation was conducted by the AF Flight Test Center. A team of Air Force test pilots flew 15 flights with emphasis on mission-oriented tasks. Testing included evaluations of stability and control, clean and with external tanks, electrical back-up control, air-to-air and air-to-ground tracking, gross maneuvering, and precision flying. Detailed test results of this portion of testing have been documented in Reference 7.

The fourth phase consisted of a total of 21 flights used for system demonstration, training and technology transition. The 21 flights were made by thirteen Air Force, Marine, and NASA pilots. All participants received back seat flights and three demonstration pilots flew two flights each from the front seat. The flights were generally designed to demonstrate SFCS performance and functional features, supersonic and transonic handling characteristics and maneuvering and precision flying.

SUMMARY OF AIRCRAFT FLIGHT CHARACTERISTICS

Longitudinal Stability and Control

When operating in the Normal FBW mode, pitch control was generally improved over the basic F-4. The pitch axis was better damped than the F-4 yet the aircraft still had adequate short period response. Pitch short period damping ranged from dead-beat to slightly over-damped throughout the flight envelope. The SFCS reduced the tendency to couple with the short period motion. Stick centering was greatly improved compared to the F-4 resulting in better PA configuration speed stability stick force cues.

The Neutral Speed Stability (NSS) function enhanced the longitudinal control characteristics by providing automatic pitch trim to maintain 1 g flight throughout the flight envelope with landing gear up. NSS tends to reduce the pilot work load during maneuvers involving rapid airspeed or altitude changes since manual trimming is not required. Consequently, pitch control is improved as only the constant maneuvering stick forces are required. Effectiveness of the NSS was very obvious during the decelerating wind-up turn maneuver through the transonic area. The normal F-4 nose rise was not present and manual trimming was not required.

The centerstick maneuvering force gradients for the longitudinal SFCS are compared to the basic F-4 for several flight conditions as shown in Figure 4. The data substantiates pilot comments of improved maneuvering pitch control over the F-4. The SFCS provides a more comfortable stick force gradient and stick displacement throughout the flight envelope allowing more precise control of pitch rate and g. The improved pitch control at the high g values is also attributed to the overall linearity of the F_s/g gradient versus g. The SFCS stick force per g characteristics obtained from flight test data compare favorably with the predicted values determined from earlier studies, analyses and simulations.

Pitch MED gain was determined to be optimum for takeoff and landing with manual gain selected in the FBW Normal mode. Low gain was then selected at 275-300 knots after takeoff. Takeoff in FBW requires only a small aft stick force to obtain the stabilator position for rotation at liftoff. The application of aft stick forces greater than required for full stabilator can delay subsequent nose down stabilator response. Takeoff control in

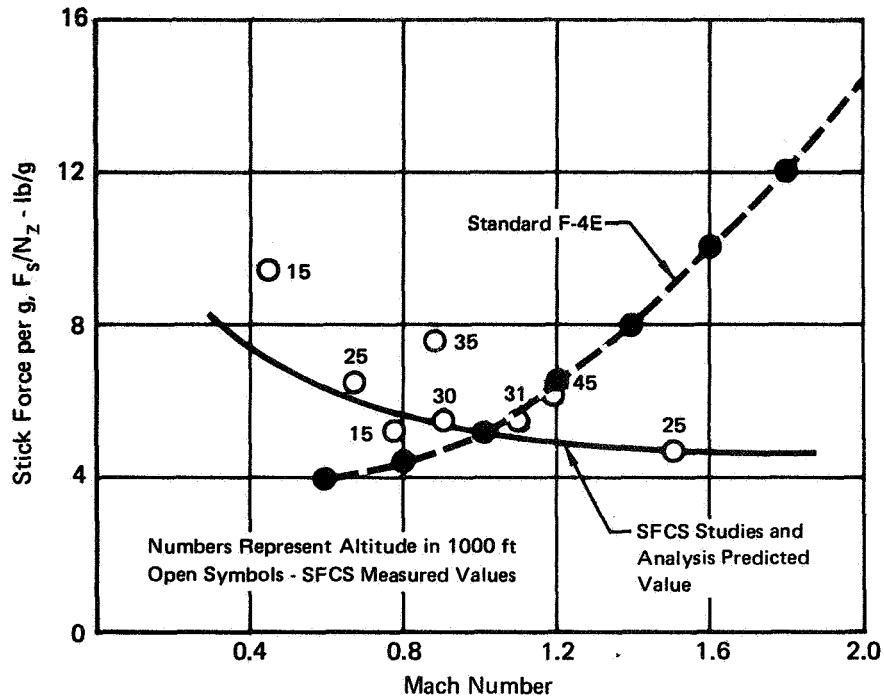

FIGURE 4
STICK FORCE PER G vs MACH NUMBER
 Adaptive Gain - Normal Mode

Normal mode is good. Pitch control is excellent for landing in Normal mode. Touch and go landings exhibited superior handling qualities and the presence of ground effect was not detectable.

The aircraft with external wing tanks installed was also well damped and exhibited no noticeable change to in-flight characteristics as compared to the clean SFCS aircraft.

Additional differences were noted in longitudinal response characteristics between the SFCS and a production F-4 aircraft. The SFCS aircraft has a tendency to maintain 1 g during stall approaches, necessitating pilot action to push the nose down for recovery. The SFCS also attempts to hold zero pitch rate at the top of a loop and the nose must be pulled down to complete the maneuver. Pilots adapted readily to these differences which were not considered deficiencies.

Lateral Stability and Control

During initial flight tests, the lateral control system was reported to be oversensitive around neutral at airspeeds above 250 knots in the cruise configuration. The control produced a sharp, abrupt first motion which was quite objectionable; however, the response was not considered objectionable for the steady command inputs required for gross maneuvering. In an effort to reduce this first motion characteristic, the roll rate to lateral force gain was substantially reduced in the first 1/3 of stick force, the aileron over travel was eliminated and the spoiler deadband increased. This resulted in very sluggish roll response and was considered unsatisfactory.

Various flight tests were conducted in an attempt to define roll power for small inputs around neutral for application to analog and simulation studies. Higher than anticipated roll power for small deflections was identified as a major cause of the high lateral sensitivity. The SFCS Flight Simulator was utilized extensively to evaluate design change candidates which would improve the lateral mechanization. Results indicated that a three gradient roll rate command would provide the most desirable lateral characteristics.

Since the three gradient roll rate command modification would not be available until Phase two, an interim modification was incorporated to improve the lateral axis sensitivity characteristics. The modification retained the original two gradient command, but provided decreased cruise configuration sensitivity and increased PA configuration sensitivity. The interim modification, installed for Flights 23 through 27, was reported to be a significant improvement over the previous configurations.

The three gradient roll rate command modification was installed during the Second Phase layup and subsequently evaluated throughout the flight envelope. It was concluded that the modified roll command was an improvement over the two gradient shaping, but that the lateral control had not been completely optimized.

Lateral response was well damped at all flight conditions except for small amplitude oscillations at high \bar{q} subsonic conditions and there is no tendency for control free divergence. Lateral response in the landing configuration is classified as good. In the clean configuration above 250 knots, the response is uncomfortably sharp and becomes objectionable in any tight control task such as tracking or formation flight. The problem was not one of roll rate attained but of high entry and recovery roll accelerations and was referred to by the pilots as "hard starts and stops".

The high control application rates possible with FBW technology permit reduction in the variation of roll time constant normally experienced as a function of flight condition. The design aim of a nearly constant roll rate time constant was achieved as shown in Figure 5. These data show that the SFCS roll time constant throughout much of the flight envelope closely matches that of the basic F-4 at high speed, low altitude flight. This fast roll response together with such other factors as stick torquing, linkage nonlinearities and high roll power at small surface deflections contributed to the high roll accelerations.

Roll rate to stick force ratios were also more uniform as shown in Figure 6. As illustrated in the flight test data, the variation in roll rate to stick force is substantially reduced as compared to the basic F-4 with yaw SAS. The three gradient roll command shaping provides higher ratios for larger commands to allow maximum roll rates to be obtained without excessive force.

Directional Stability and Control

Directional control was generally satisfactory throughout the flight envelope. Short period damping was essentially deadbeat to slightly overdamped. The roll-yaw crossfeed was initially weak in the PA configuration. The PA configuration roll-yaw crossfeed gains were modified with incorporation of the three-gradient roll command in the second phase. Roll-yaw crossfeed was improved for subsequent testing.

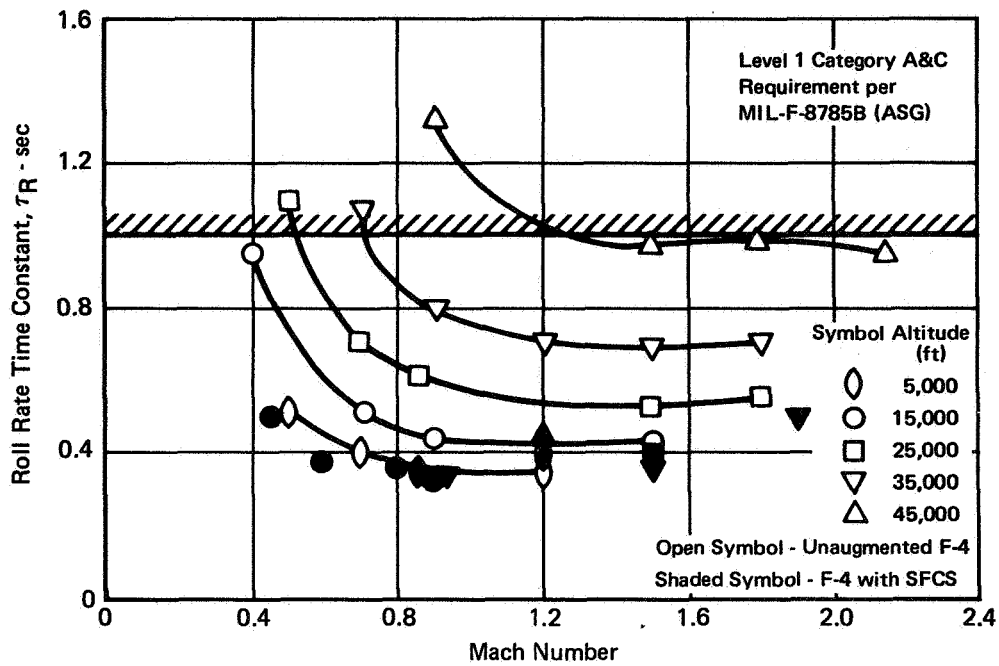

FIGURE 5
ROLL RATE TIME CONSTANT SFCS vs F-4

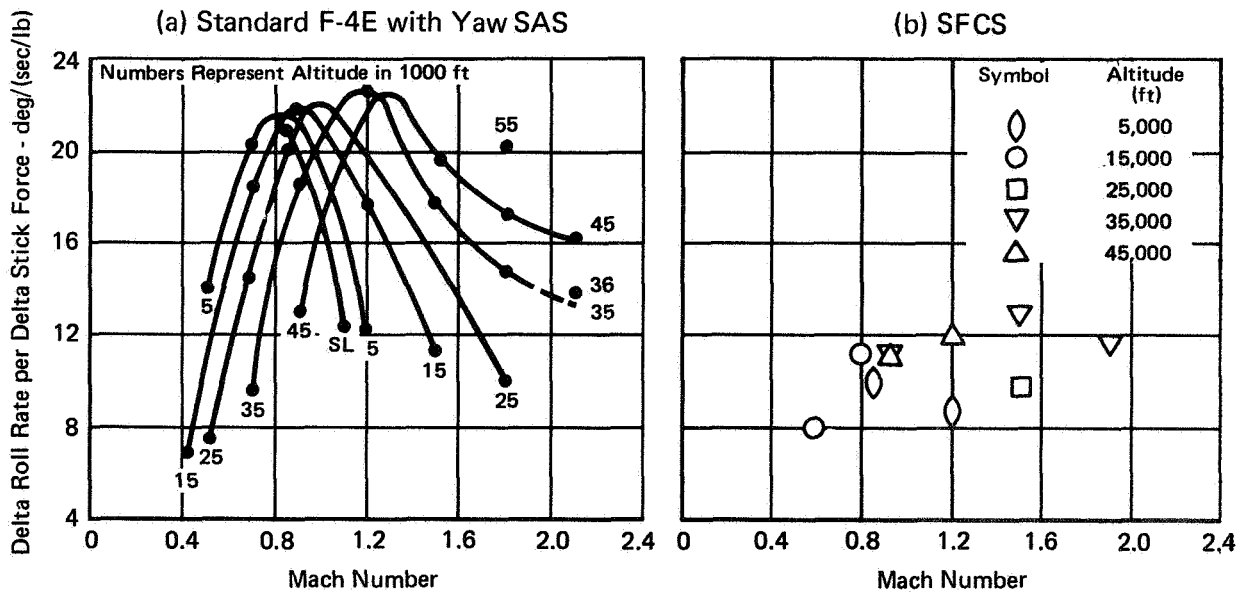

FIGURE 6
ROLL RATE PER STICK FORCE SFCS vs F-4

General Maneuvering

Various maneuvering tests were accomplished to evaluate FBW control for large command inputs. Maneuvering tasks included 360° rolls, Immelmann turns, transonic decelerating wind-up turns and 1/2 Cuban Eights. Overall, the maneuvers exhibited control characteristics which were improved over the basic F-4 aircraft. A more positive control of load factor was apparent during evaluation of wind-up turns. The deceleration through the transonic region while holding load factor is significantly improved since the normal F-4 pitch transient is eliminated by the blended rate and acceleration feedback and by the NSS trim function. The full rolls are more uniform due to the use of roll rate feedback. The Immelmann turn was reported to be more comfortable with the FBW control due to the roll-to-yaw crossfeed effectiveness.

Air-to-Air and Air-to-Ground Tracking

Air-to-air and air-to-ground tracking tasks were evaluated by three MCAIR pilots, two USAF evaluation pilots, and three USAF demonstration pilots. Qualitative pilot comments varied slightly; however, certain characteristics were noted by all three MCAIR pilots. The CSC was generally preferred for tracking by a majority of the pilots. The sharp lateral response discussed previously was irritating with either controller for the tracking task. When using the CSC, the normal tendency to "tighten up" resulted in torquing the grip, producing jerky lateral commands. The SSC provided better lateral control in this respect. However, there was a tendency to overcontrol in pitch with the SSC when making small corrections. A learning curve of two or three flights was required before effective tracking ability was attained. Air-to-ground tracking was satisfactory with either controller. Mild side-slip excursions or drift were noted on occasions; however, the ground target was regained easily.

SUMMARY OF SFCS SYSTEM OPERATION

Adaptive Gain Changer

This function operated satisfactorily throughout the program but it is felt that the complication of the design due to its inclusion was excessive for benefits achieved. A less complicated device, using a highly reliable air data system, would probably be sufficient for most vehicles.

Stall Warning Computer

The stall warning function was activated for evaluation on Flight No. 24 and subsequent flights during the first phase of flight testing. Functional operation of stall warning was verified during 1 g stall approaches and wind-up turns. Pilots commented that the pitch stall warning is effective in wind-up turns where significant pilot commands are being applied. Its effectiveness is severely limited in situations where only small pitch commands are being applied. For instance, the NSS function during a 1 g deceleration can stall the aircraft with no pilot command and consequently

no FBW stall warning stick force cues. The normal F-4 audio stall warning cues were retained to supply protection in this region. The environment of heavy wing rock was not explored to assess the total effectiveness of stall warning function in the lateral feedback loop. Flight data however, verified that the lateral function was operating satisfactorily.

Sidestick Controller

Although not optimized for this aircraft, the SSC provided an acceptable means of control for all tasks performed during the test program. It was inherently more sensitive to pilot inputs than the centerstick, but a relatively brief exposure was necessary for various pilots to become accustomed to it. The controller's mounting on the right console was not an optimum position for precision tasks such as landing. The input pivot was below the grip, and coordinated maneuvers were difficult to accomplish at high load factors.

Reliability and Maintainability

During 88.5 total program flying hours, only 5 equipment malfunctions were reported. Four of these failures were detected by BIT prior to flight. Only one non-resettable in-flight failure, a yaw rate gyro which does not effect safety of flight, occurred during the entire flight test program. The calculated probability of flight control failure, which is improved over the basic F-4, is 10.685×10^{-7} . This figure does not consider the improvement provided by EBU. Figures on maintenance manhours per flight hour also show improvement in the SFCS system when compared to the F-4 mechanical system.

In the last two months or 44 working days of flight testing the test aircraft flew 31 days, and in the last month of 23 working days the aircraft flew 21 days. Of a program total of 84 flights and 88.5 flight hours flown during 10 months, 41 flights and 42.8 flight hours were flown in the last two months. These last two months were without delays due to maintenance.

CONCLUSION

Future designs envisioned throughout the industry include such Configuration Controlled Vehicle features as Relaxed Static Stability, Direct Lift Control, Direct Side Force Control, Maneuver Load Control, etc., which may employ canards, movable tails and movable wing tips. These features provide significant maneuvering performance improvements and control techniques not possible with a mechanical control system. This makes mandatory the transition from a mechanical control system to FBW a basic necessity.

This program's flight testing has provided design criteria, reliability, cost and maintainability data, specification requirements, and most importantly, the confidence level required for installation of advanced flight control systems of this type in future aircraft.

REFERENCES

1. Hooker, D. S., Kisslinger, R. L., Smith, G. R., and Smyth, M. S., "Survivable Flight Control System Interim Report No. 1, Studies, Analysis and Approach", Technical Report AFFDL-TR-71-20, May 1971.
2. Kisslinger, R. L., and Wendl, M. J., "Survivable Flight Control System Interim Report No. 1, Studies, Analysis and Approach, Supplement for Control Criteria Studies", Technical Report AFFDL-TR-71-20, Supplement 1, May 1971.
3. Kisslinger, R. L., and Vetsch, G. J., "Survivable Flight Control System Interim Report No. 1, Studies, Analysis and Approach, Supplement for Control Law Development Studies", Technical Report AFFDL-TR-71-20, Supplement 2, May 1971.
4. Amies, G. E., Clark, C., Jones, C. L., and Smyth, M. S., "Survivable Flight Control System Interim Report No. 1, Studies, Analysis and Approach, Supplement of a Hydraulic Power and Actuation Studies", Technical Report AFFDL-TR-71-20, Supplement 3, May 1971.
5. Tobie, H. N., Elliott, E. M., "New Short Period Handling Quality Criterion for Fighter Aircraft", Boeing Document No. D6-17841 T/N, September 1974.
6. Hooker, D. S., Kisslinger, R. L., Smith, G. R., Smyth, M. S., "Survivable Flight Control System Final Report", Technical Report AFFDL-TR-73-105, December 1973.
7. Ettinger, R. C., Majoros, L. R., Powell, C. W., "Air Force Evaluation of the Fly-by-Wire Portion of the Survivable Flight Control System Advanced Development Program", Technical Report FTC-TR-73-32, August 1973.