

# NASA TECHNICAL MEMORANDUM

NASA TM X-73943

NASA TM X-73943

The Design, Development, and Flight Test Results of the  
Boeing 737 Aircraft Antennas for the ICAO Demonstration  
of the TRSB Microwave Landing System

By T G. Campbell, W. F. White, and M C. Gilreath

(NASA-TM-X-73943)	THE DESIGN, DEVELOPMENT,	N76-32146
AND FLIGHT TEST RESULTS OF THE BOEING 737	AIRCRAFT ANTENNAS FOR THE ICAO DEMONSTRATION	
OF THE TRSB MICROWAVE LANDING SYSTEM (NASA)		Unclas
96 p HC \$5.00	CSCL 17G G3/04	05324

This informal documentation medium is used to provide accelerated or special release of technical information to selected users. The contents may not meet NASA formal editing and publication standards, may be revised, or may be incorporated in another publication.

**NASA**  
National Aeronautics and  
Space Administration

**Langley Research Center**  
Hampton, Virginia 23665

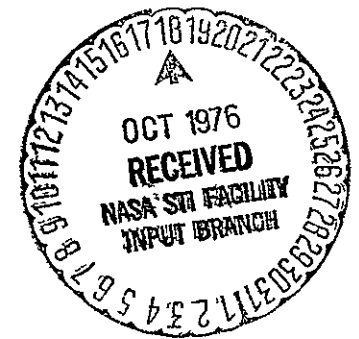

1 Report No NASA TM X-73943		2 Government Accession No		3 Recipient's Catalog No	
4 Title and Subtitle The Design, Development, and Flight Test Results of the Boeing 737 Aircraft Antennas for the ICAO Demonstration of the TRSB Microwave Landing System				5 Report Date August 17, 1976	
				6 Performing Organization Code	
7 Author(s) T. G. Campbell, W. F. White & M. C. Gilreath				8 Performing Organization Report No	
9 Performing Organization Name and Address NASA Langley Research Center Hampton, VA 23665 and National Aviation Facilities Experimental Center Atlantic City, NJ				10 Work Unit No	
				11 Contract or Grant No	
12 Sponsoring Agency Name and Address National Aeronautics & Space Administration Washington, DC 20546				13 Type of Report and Period Covered Technical Memorandum	
				14 Sponsoring Agency Code	
15 Supplementary Notes -					
16 Abstract  The Research Support Flight System (A modified Boeing 737) of NASA Langley Research Center was used to evaluate the performance of several aircraft antennas (and locations) for the Time Reference Scanning Beam (TRSB) Microwave Landing System (MLS). These tests were conducted at the National Aviation Facilities Experimental Center (NAFEC), Atlantic City, New Jersey on December 18, 1975. The flight tests consisted of measuring the signal strength and all pertinent MLS data during a straight-in approach, a racetrack approach, and ICAO approach profiles using the independent antenna-receiver combinations simultaneously on the aircraft. Signal drop-outs were experienced during the various approaches but only a small percentage could be attributed to antenna pattern effects.					
17 Key Words (Suggested by Author(s)) Microwave Landing System TRSB Aircraft Antennas			18 Distribution Statement  Unclassified - Unlimited		
19 Security Classif (of this report) Unclassified		20 Security Classif (of this page) Unclassified		21 No of Pages 93	22 Price* \$4.75

THE DESIGN, DEVELOPMENT, AND FLIGHT TEST RESULTS OF  
THE BOEING 737 AIRCRAFT ANTENNAS FOR THE ICAO DEMONSTRATION  
OF THE TRSB MICROWAVE LANDING SYSTEM

By Thomas G. Campbell, William F. White,  
and Melvin C. Gilreath

SUMMARY

Recently, the Research Support Flight System of the Langley Research Center - a Boeing 737 - was used to evaluate the performance of several aircraft antennas (and locations) for the Time Reference Scanning Beam (TRSB) Microwave Landing System (MLS). These tests were conducted at the National Aviation Facilities Experimental Center (NAFEC), Atlantic City, New Jersey, on December 18, 1975. The flight evaluation consisted of measuring the signal strength and all pertinent MLS data during a straight-in approach, a racetrack approach, and ICAO approach profiles using two independent antenna-receiver combinations simultaneously on the aircraft. Two C-band, monopole antennas were compared during the flight and these antennas were located at body stations 239.5 (top fuselage) and 1169 (top of vertical fin). During one of the race-track approaches, a third antenna at station 946.5 (bottom fuselage) was used for additional comparison purposes. By nature of the aircraft installation used, the cable losses associated with the vertical fin (M2) antenna were about 8 dB greater than the station 239 (M1) antenna. Consequently, the range obtained with each antenna was about 30 and 11 nautical miles, respectively. Signal drop outs were experienced during the various approach profiles but only a small percentage could be attributed to antenna pattern effects. Even though the in-beam and out-of-beam multipath levels were significant, the subsequent degradation of the MLS signals was considered minor. The complete RF configuration on the aircraft is described in this report, as well as the results during all approach profiles.

INTRODUCTION

The International Civil Aviation Organization (ICAO) has undertaken a program for the international standardization of a new approach and landing guidance system that will utilize C-band and Ku-band microwave frequencies. This Microwave Landing System (MLS) will eventually replace the Instrument Landing System (ILS) that has been in operation at airports for over 30 years. The United States' candidate for the international MLS is a Time Reference Scanning Beam System and this system was recently demonstrated to the All-Weather Operation Panel (AWOP) of ICAO at the National Aviation Facilities Experimental Center (NAFEC), near Atlantic City, New Jersey. The Research Support Flight System of the Langley Research Center (a modified Boeing 737) was used for the MLS-ICAO demonstration. Prior to the actual demonstration, NASA Langley Research Center conducted a development program to adapt the RSFS to use MLS

guidance for the MLS-ICAO demonstration. An important step in establishing the MLS airborne configuration for this demonstration was to determine an antenna and RF subsystem design that would provide adequate signal levels for the various RF links involved. Since in-beam and out-of-beam multipath effects and radiation pattern effects of the airborne antennas were not known exactly, it was necessary to conduct an antenna test and evaluation program to resolve these points. Scale model measurements using several antenna positions were conducted and the results of these measurements were used to select a design for flight testing. The purpose of this report is to describe this antenna program and to discuss the results. A brief description of the MLS will now be presented.

### BRIEF DESCRIPTION OF THE MICROWAVE LANDING SYSTEM

The Time Reference Scanning Beam approach for the MLS uses time differences between scanning beams for angle coding within a time-multiplexed signal format. As an aircraft approaches the runway, two separate antennas provide azimuth and elevation information to the aircraft. As discussed in reference 1, a signal is transmitted from the ground to the aircraft via the "TO" and "FRO" scan beams. The aircraft receiver processor detects an azimuth "TO" scan, for example, a few milliseconds later, the "FRO" scan is detected. The azimuth angle (location of aircraft from the centerline of the runway) can then be determined by the relation:

$$\theta = \frac{\Delta T - T_0}{K}$$

where  $\Delta T$  = the time interval between the "TO" and "FRO" scan beams

$T_0$  = time separation (in microseconds) for  $0^\circ$  (a constant for each function)

$K$  = scaling (in microseconds/degree) for scan rate (a constant for each function)

This scanning principle is used for each angle and data function, and in a similar fashion, the elevation angle data are processed and determined. The functions and radio frequencies involved in the MLS are as follows:

DME: Air-to-Ground	5003 to 5060 MHz, 20 frequencies, 3.0 MHz spacing
DME: Ground-to-Air	5068 to 5125 MHz, 20 frequencies

Azimuth Omni		Front Course
Azimuth - Scanning Beam	5130 to 5249.5 MHz, 200 frequencies, 0.6 MHz spacing	Front Course
Azimuth - Scanning Beam		Back Course
Elevation - Glideslope		Front Course
Elevation - Flare	15,409 to 15.675 MHz, 200 frequencies	Front Course

In the time-multiplexed signal format, the preamble to the pulse train is provided by the azimuth omni antenna and this signal must be properly received at all times. If an azimuth omni signal drop out does occur, then the scanning beam pulses will not be decoded. In the event that the azimuth omni is received and the scanning beam pulse is lost momentarily, or the data are of poor quality, then a data frame flag is initiated.

The MLS ground antenna planar arrays are shown in figure 1 and they utilize rapid scanning so that a fast update rate (reference 2) can be achieved. By analyzing the results of many scans, multipath errors can be reduced. The azimuth antenna is a horizontal array that is located about 8,500 feet past the runway threshold. The elevation-glideslope antenna is a vertical array that is located about 1,000 feet past the runway threshold. The elevation-flare antenna is also a vertical array and its location is shown in figure 1, also. The azimuth and elevation coverages provided by these antennas are shown in figure 2, and these coverages are compared to the ILS coverage presently provided.

The distance measuring equipment (DME) for MLS is not time multiplexed and is an independent function.

Since reflected signals from hangars, terrain effects, and other aircraft can degrade the quality of the MLS signals, the TRSB was designed so that multipath-reflection effects can be minimized. The out-of-beam and in-beam multipath effects are described in figures 3 and 4, respectively, and it can be seen that time gating and multipath averaging should reduce considerably multipath effects in the TRSB system. A photograph of an oscilloscope display of the time-multiplexed signal format showing multipath effects can be noted in figure 5.

### MLS AIRCRAFT ANTENNA REQUIREMENTS

Since specified approach profiles would be used for the MLS demonstration, the aircraft aspect angles for these profiles were used to generate the pattern coverage requirements. The pattern coverage requirements are presented in

figure 6, along with the ICAO-S, 130°, and 180° approach profiles. It can be seen that it would be very difficult for a single aircraft antenna to satisfy all of the desired pattern coverage conditions. The overall airborne antenna requirements can be summarized as follows:

- (1) Radiation pattern coverage

Profile	Azimuth	Elevation
180°	+ 171°	+ 26°, - 20°
130°	+ 121°	+ 26°, - 20°
S	+ 98°	+ 26°, - 31°

- (2) Polarization: Vertical
- (3) Gain: Must exceed RF component losses
- (4) An effective range of 30 nautical miles is desired
- (5) A single aircraft antenna is desired, if possible, so that front and back-course azimuth requirements could be met.

#### MLS ANTENNA DESIGN AND DEVELOPMENT PROGRAM FOR THE B-737

In order to determine the optimum airborne configuration for the MLS-ICAO demonstration, it was necessary to initiate an antenna design and development program that included scale modeling techniques as well as analytical methods to resolve the airframe effects for specific antenna locations. After the scale model tests were concluded, the results were used to select an antenna configuration for the ICAO demonstration. A full-scale flight test was then conducted to verify the antenna design and location on the aircraft.

The initial plans for the MLS-ICAO demonstration indicated that the Ku-band flare guidance system would not be used, therefore, the antenna tests and especially the scale model tests were conducted on that basis. Later in the schedule, the decision was made to add the Ku-band capability, so the Ku-band antenna data presented in this report are provided for information purposes only. The Ku-band aircraft antennas were not tested during the antenna flight evaluation tests. The results of the scale model tests will now be discussed.

#### Scale Model Tests

A one-eleventh scale model of the Boeing 737 was used for radiation pattern tests in the anechoic test chamber of the Flight Instrumentation Division of the Langley Research Center. The one-eleventh scale size was about as large as the antenna testing procedure could accommodate. Usually, the scale size dictates the radio frequency that would be used in the pattern

measurement, but since the full-scale MLS frequencies are 5 GHz and 15 GHz, exact electrical scaling could not be accomplished. Therefore, a frequency of 35 GHz was used for the scale model tests and it is believed that these patterns would be representative of those that would be measured at the exact scale frequency (11 x 5 GHz). Figure 7 shows a photograph of the one-eleventh scale model in the anechoic chamber during antenna testing.

Quarter wavelength stub antennas were placed at several locations on the Boeing 737 model. After extensive tests had been conducted, the position that appeared best to satisfy the requirements for MLS were at station 250 (position M1), the vertical fin (position M2), and the bottom of the fuselage at station 950 (position M3).

Typical elevation and azimuth plane radiation patterns for the M1 and M3 antennas are shown in figures 8 and 9, respectively. It can be seen that except for the back azimuth requirement, the M1 antenna position meets most of the coverage conditions for the ICAO profiles. The M3 antenna position would be required to provide the coverage for the back-course azimuth application. If both the M1 and M3 antennas were used together to provide the complete azimuth coverage, then a switching procedure during flight would be required.

In an attempt to achieve complete azimuth coverage using a single antenna, the vertical fin location was tested. Since it was apparent that multipath reflections from the top of the fuselage would influence the pattern characteristics of an antenna mounted on the vertical fin, two different configurations were measured and compared. In the first configuration, the antenna was mounted to the top surface of the vertical fin. The elevation plane pattern was measured for this condition and the results are presented in figure 10. It can be seen that multipath reflections produced strong interference pattern fluctuations at pitch angles from + 20° to + 60°. Also, the elevation plane coverage is not met but the full omni azimuth coverage would be provided. In an effort to reduce the multipath effect shown in figure 10, another vertical tail configuration was tested. This configuration used a cylindrical counterpoise on the leading edge of the vertical fin, and the omni antenna was placed on top of the counterpoise. Actually, it had been planned to use the counterpoise configuration to contain laser retro-reflectors for another flight program, so this installation was already available for the MLS-ICAO flight test. The dimensions of the cylindrical counterpoise are 9-3/4 inches x 7-1/2 inches. The installation on the actual aircraft will be discussed later in the report. The radiation patterns of the scale model were measured using the counterpoise and the results are shown in figure 11. Comparing the patterns in figures 10 and 11, it can be seen that the counterpoise does reduce the multipath reflections and the pattern fluctuations at the + 20° to + 60° pitch angles are also reduced. Even though this antenna does not meet all of the pitch angle coverage requirements, this antenna location may still prove to be an acceptable one in some flight applications. Since small pitch angles were expected for the B-737 flights, the vertical fin location was proposed for the antenna evaluation flight tests. Therefore, the flight test was conducted to measure the performance of these three antenna locations for the MLS.

As mentioned earlier, only the C-band (5 GHz) MLS frequencies were "scaled" during these antenna tests, so the performance characteristics of Ku-band (elevation flare) aircraft antennas were verified through full-scale measurements and pattern calculations. The installation of all antennas on the B-737 and the results of full-scale (element) tests will now be discussed.

#### Antenna Installation on the B-737 and Experiment Configuration

After completing the scale model measurements of the B-737, omni C-band antennas were mounted at the three locations mentioned. (M1) station 239.5, (M2) vertical fin, and (M3) station 946.5. The M1 antenna could not be mounted at the exact locations as tested (5.950), because of mechanical interference problems. In order to avoid the mechanical interference, the (M1) antenna was offset from the fuselage centerline and placed on the right buttock line. The azimuth pattern data will show that pattern asymmetry will be produced by using this location. Since left-turn approaches would be used during the flight test, the pattern asymmetry was not considered a problem. Later in the schedule, two Ku-band antennas were installed for the elevation flare functions; one antenna was an omni monopole antenna mounted at station 239, but on the opposite side of the fuselage from the C-band antenna. A flared waveguide horn was provided on the bottom fuselage at body station 189. All antenna locations are shown in figure 12. Two elevation flare antennas were provided at different fuselage heights so that flare guidance errors related to antenna location could be determined.

The physical configuration of the C-band and Ku-band monopoles is shown in figure 13, and the Ku-band horn configuration is shown in figure 14. Close-up photographs of all antenna locations on the B-737 are shown in figures 15, 16, 17, and 18.

In microwave antenna design and scale model techniques, it is a difficult task to get complete agreement between scale and full-scale measurement results. In the full-scale installation, the mounting procedure must adhere to flight quality acceptance standards and this usually means that electrical performance is affected. As an example, figure 19 shows the scale model measurements along with the full-scale measurement results of the C-band omni antenna. The differences caused by ground plane effects, dielectric radomes, etc., can be noted. A comparison of the Ku-band element patterns and the calculated patterns (antenna mounted to aircraft) are shown in figure 20. Azimuth and elevation plane patterns of the Ku-band horn antenna are shown in figure 21.

In order to minimize cable losses, Hellax (FHJ4-50B) coaxial cables were used to feed the C-band antennas and elliptical waveguide (EW132) fed each Ku-band antenna. The cable feeding the vertical fin antenna was routed through the leading edge of the vertical fin. First, the leading edge was removed and the cable was routed and clamped into position. Then the cable was routed through the aft baggage compartment. Actually, the task of installing the vertical fin antenna was easier than expected initially. Feed-through adapters were used on the aft pressurized bulkhead to connect the antenna to the receiver.



The angle receiver for the vertical fin antenna was located in the aft pallet to minimize cable losses. The M2 antenna was connected to an angle receiver located in the forward pallet. The experiment configuration showing the respective cable and waveguide lengths is shown in figure 22.

In order to insure that an adequate signal would be received for the DME receiver, a tunnel diode amplifier was used ahead of the power splitter as shown in figure 22. An attenuator pad was used to lower the level for the angle receiver. A limiter was the only component used between the vertical fin antenna and the aft receiver. In retrospect, the flight should have been conducted without the tunnel diode amplifier but an adequate comparison of the M1 and M2 antennas was still obtained. Before the antenna flight evaluation tests, each angle receiver was calibrated. The flight plan for the antenna test will now be discussed.

#### Antenna Evaluation Flight Plan

The objective of this flight test was to evaluate the performance of the M1, M2, and M3 antenna locations on the B-737 and to select the optimum system for the ICAO demonstration. Since separate angle receivers were provided, the antennas could be compared simultaneously during the various approaches and ICAO profiles.

The flights were conducted at the NAFEC airport near Atlantic City, New Jersey. All approaches were made to runway 4, on which the TRSB MLS is installed. A copy of the plan of test is included in Appendix A. Figures A-1 through A-4 of Appendix A show the flight profiles for the tests. Since the experimental systems were not installed on the aircraft, there was no guidance available from the MLS except for conventional displays of deviation from centerline and a 3° glidepath on final approach. The curved portions of the patterns were flown by ground reference. The actual aircraft position was tracked by both radar and phototheodolites.

An unplanned feature of the tests was the presence of a multipath-generating screen near the azimuth antenna. This screen caused an extra set of scanning beam pulses to appear at times corresponding to an azimuth angle of + 30°. The screen was erected to direct the multipath signals toward the rollout region of the runway, but the reflections were actually observed all along the final approach path. They did not appear to have any effect on receiver operation. The screen geometry is shown in figure 23.

#### Data Reduction

Radar plots of the aircraft track are included in this report. The tabulated radar data were used along with aircraft attitude data to calculate aspect angles for the aircraft antennas at points of interest. In addition to the radar and attitude information, two types of TRSB data were recorded.

A digital recorder provided a time-correlated record of all received TRSB angle and range data, as well as flags indicating bad data points. The following plots were made from these data. "AZ" shows a time history of the unfiltered azimuth angle output by the receiver. "FAZ" is a plot of the filtered angle. "PCNT AZ" is the percentage of good data points received, that is, the ones which were not accompanied by frame flags. The plot is a summary of the ratio of flagged data points to total points over 1-second intervals. "PCNT FAZ" is an analogous plot based on function flags, which are the flags displayed to the pilot. Corresponding quantities are plotted for elevation signals. There is only one DME plot since the DME does not have an unfiltered output. In addition, one of the flag summaries is replaced by "PCNT UP DT," which shows the proportion of recorded DME values which actually represent fresh data.

The receiver-detected video outputs were recorded on an analog tape recorder. A minicomputer system was used to digitize the signals, identify the various pulses, and plot signal strengths. A block diagram of the system is shown in figure 24. The computer also analyzed the digital data for detailed statistics on flags and dropouts.

#### Flight Test Results

The flight test was conducted on December 18, 1975. The radar plots of aircraft position and plots of the digital MLS data are presented in figures 25 through 43. It can be seen that large overshoots were experienced on the first high-speed patterns. This was due to a combination of winds which resulted in ground speeds up to 230 knots, and a lack of pilot familiarity with the landmarks used to define the paths.

Later runs followed the ground path fairly well, especially the ones made at low speeds. The vertical path tracking was considerably less successful until the final approach was reached, where glidepath guidance was available. Aircraft configuration changes were generally made too late to provide the decelerating speed profile requested, so that high speeds sometimes resulted in bank angles of 30° to 40° being used.

The signal strength plots for the azimuth omni ID and scanning beam signals are presented in figures 44 through 46. The omni signal appears intermittent in places due to a low recorded level. This resulted in the signal being only a few counts on the analog-to-digital converter, and it was sometimes not sufficiently above the noise level during conversion to be recognized as a pulse. In those cases, the computer plotted a zero level. Under normal circumstances where the signal was stronger, such a zero output from the computer indicated a missing data point or "dropout."

The computer program included a variable threshold feature so that the plotting of noise and multipath peaks could be suppressed if desired. The use of this feature results in plots like figure 44(a). When the threshold is set to zero, the result is a shaded plot like figure 44(f). The top of the

shaded area corresponds to the single scanning beam trace, which is the peak strength of the scanning beam pulses. The darker area covering the bottom third of the plot is due to multipath signal peaks, and the still darker area along the bottom of the plot is the noise level. The multipath signals may be seen more clearly from some of the later plots. Plots are included only for the azimuth signal as the elevation plots have not been analyzed yet.

The computer was used to search the digital TRSB tape for missing data points (dropouts). These dropout times are given in Table I. The signal strength at each dropout time was obtained from the plots to determine if the dropout was caused by insufficient signal level. Most of the dropouts were observed to occur on both angle receivers and were apparently due to malfunctions of the ground station.

As mentioned previously, the effective range for the M1 and M2 antennas was determined during the straight-in approach, and was measured to be about 30 nautical miles and 11 nautical miles, respectively. Additional losses (8 dB) in the M2 antenna circuit reduced the range considerably. Even though the receiver sensitivities were measured to be about - 100 dBm, the flight test demonstrated that at least - 90 dBm would be required for an adequate video signal. This fact is apparent especially in the M2 antenna circuit in that signals were received at ranges greater than 11 nautical miles but to achieve lock-on for the azimuth omni function, a - 90 dBm signal level had to be received. Some of the aspect angle data have been reduced and these results indicate that the pitch angle varied from - 2.5° to + 6.6° during final approach. Therefore, the pattern coverage below the nose provided by the M2 antenna was not a problem during the tests.

A statistical analysis of the azimuth and elevation data is presented in figure 47 and it can be noted that less than 1% data dropouts occurred for all cases.

The system margin calculations for the C-band functions are presented in Tables II and III along with the actual signal results.

## CONCLUSIONS

From the results of this antenna flight test, the loss parameters that can be tolerated in an airborne MLS configuration can be determined. The loss parameters associated with the vertical fin antenna were demonstrated to be about the limit for an effective performance of the airborne system. Since the forward antenna at station 250 performed exceptionally well as cable losses were minimized, this antenna/location was selected to be used during the MLS-ICAO demonstration. The only time that this antenna would not meet the coverage requirements would be for back-course azimuth conditions and this condition would not be tested during the demonstration. But, otherwise, this antenna location was satisfactory, including the racetrack (180°) approach.

Even though flight test results using the two Ku-band elevation-flare antennas cannot be reported at this time, the top omni antenna was selected for the ICAO demonstration. The Ku-band, RF link using the monopole antenna had sufficient margin. The height of the Ku-band monopole on the fuselage was expected to minimize flare guidance errors at low altitudes.

## REFERENCES

1. RTCA "A New Guidance System for Approach and Landing." SC117 Document No. DO-148, December 18, 1970.
2. "MLS Scanning Beam Antenna Implementation." J. R. Sebring and J. K. Ruth, Microwave Journal, January 1974.

TABLE I  
LISTING OF MLS AZIMUTH DATA DROP OUT TIMES

RUN #	APPROACH	DROP OUT TIMES		COMMENTS
1	Straight in	1239	9.634 9 708 12.150 17.330 19 846 23 546 24.805	All drop outs occurred greater than 33 miles out
2	130° approach			No drop outs in azimuth occurred
3	S-approach	1106	13 655	Drop out occurred on M2 antenna also
4	120° approach	1116	4 939 5 161 5.605 5.679 12.192 22 6 22 7 22 996 23.07  24.476	Drop outs       Outliers
5	130° approach	1127	49 67 49 892 49 966	Entry into coverage area
6	S-approach	1144	39.145	Drop outs occurred in both receivers
7	Racetrack	1157	28.554 28 628 28.702 28 776 28 850 28 924 28 998 31 662 31 736  1158 32.863 1159 42.426	Drop outs occurred on M2 antenna also
8	Racetrack (M1 and M3 antennas)	1211	25.084 25.158 25.232 25.306 25.38 25.454 26.712 26.786 27 008  1211 52.169 52 317 52 391 52.465 52 539 52.687 52 761 52.909 53 057 53.353 53.427 53 501 53.575 53.649 53 723 53 797 53 871 53 945 54 019 1212 59 882 1223 42.0	Drop outs occurred in both receivers
9	120° approach	1212 1223	59 882 42.0	Omni drop out No other drop outs

PRECEDING PAGE BLANK NOT FILMED

TABLE II

MLS SIGNAL STRENGTH PREDICTIONS AND RESULTS (RANGE 30 NM)

PARAMETER	AZIMUTH (5189.4 MHz) OMNI SIGNAL		AZIMUTH (5189.4 MHz) SCANNING BEAM		DME (5092 MHz) UPLINK SIGNAL		DME (5027 MHz) DOWN-LINK SIGNAL	
	FIN ANT.	STA. 250 ANT	FIN ANT.	STA. 250 ANT.	FIN ANT.	STA 250 ANT.	FIN ANT.	STA. 250 ANT
Ground Trans. Power	44 dB	44	44	44	53 dB	53 dB	54 dB	54
Ground Antenna Gain	15	15	30	30	15	15	15	15
Cable Loss	-3.0	-3.0	-3.0	-3.0	-3.0	-3.0	-3.0	-3.0
Space Loss	141.9	149.9	141.9	141.9	141.9	141.9	141.9	141.9
Aircraft Antenna Gain	-5.50	+2.0	-5.5	+2	-5.5	+2.0	-5.5	+2.0
Aircraft Cable Loss	-6.83	-1.43	-6.83	-1.43	-6.83	-1.43	-6.83	-1.43
Aircraft Component Loss	-1.00	-18.3	-1.00	-18.3	-1.00	-5.0	-1.00	-1.0
Polarization Loss	0	0	0	0	0	0	0	0
Aircraft Component Gain	0	+12.0**	0	+12.0	0	+12.0	0	0
Multipath Loss	0	0	0	0	0	0	0	0
Receiver Sensitivity	-103 dBm*	-103 dBm	-103 dBm	-103 dBm	-84 dBm	-84 dBm	-81 dBm	-81 dBm
Predicted Signal Level	-100	-90.2	-85	-75	-89.0	-79.0	-88	-76.0
Measured Signal Level	-98	-88.0	-93 dBm	-81.0	Not Meas.	Not Meas.	Not Meas.	Not Meas.
S/N Required for Lock (Exper- imentally Determined)	10 dB	10 dB	10 dB	10 dB	-----	-----	-----	-----
Actual Signal Margin	-5 dB	+5 dB	0	+12 dB	-1.3	+9.0	0	+8.57

TABLE III

KU-BAND

PARAMETER	ELEVATION FLARE 15,468.4 MHz	
	Waveguide Horn Antenna	Omni Stub Antenna
Ground Trans. Power	20 W, 43 dBm	43 dBm
Ground Antenna Gain <sup>o</sup>	29	29
Cable Loss	Included	Included
Space Loss	- 135.6	- 135.6
Aircraft Antenna Gain	+ 9.0	0 dB
Aircraft Waveguide Loss	- 3.6	- 3.0
Polarization Loss	0	0
Aircraft Component Gain	0	0
Multipath Loss	0	0
Receiver Sensitivity	- 96 dBm	- 96 dBm
Predicted Signal Level	- 58 dBm	- 67 dBm
S/N Required for Lock	10 dB	10 dB
Actual Margin	+ 28.40	+ 20.0
IF BW	150 kHz	



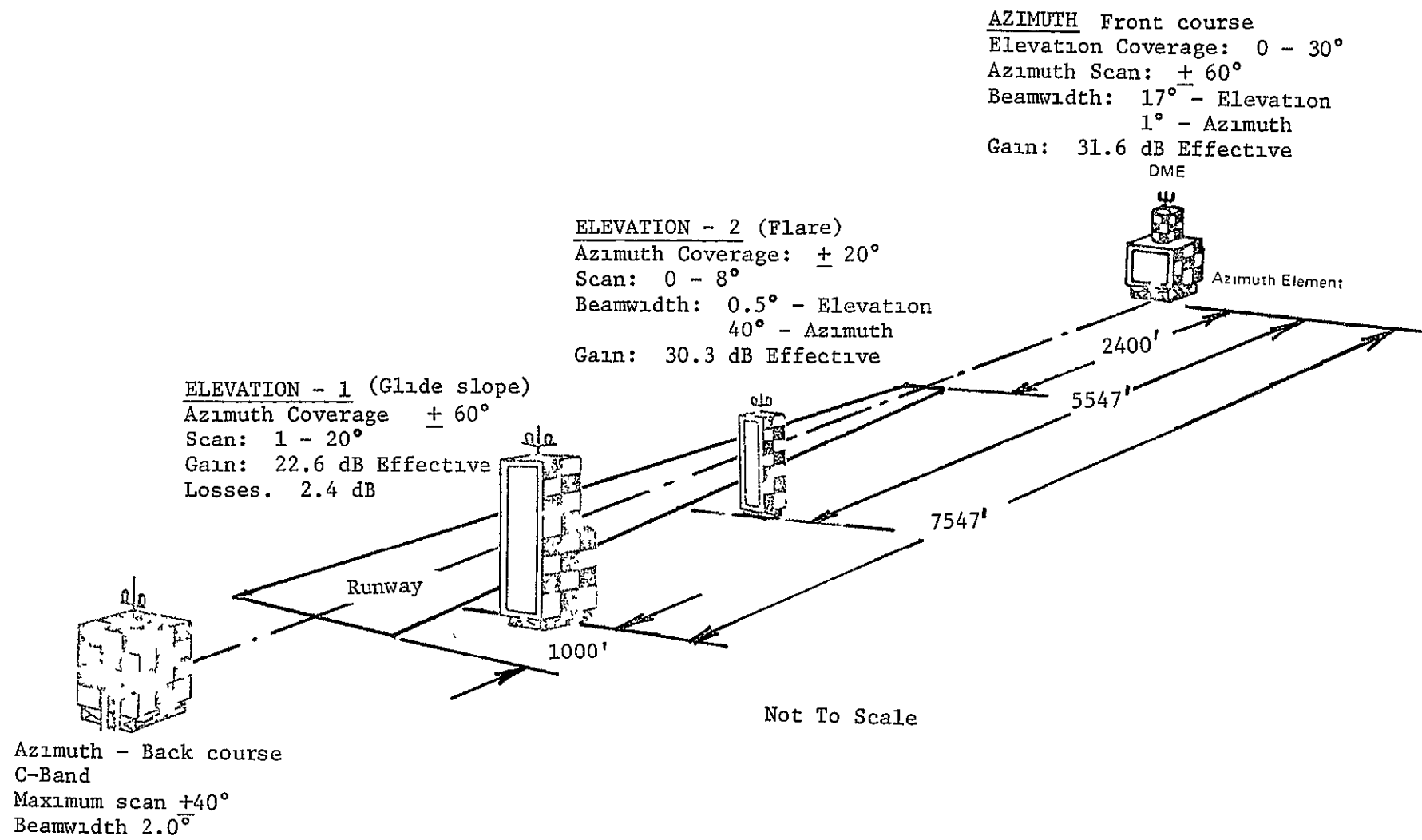

Figure 1. - MLS ground antenna configuration for category II and III.

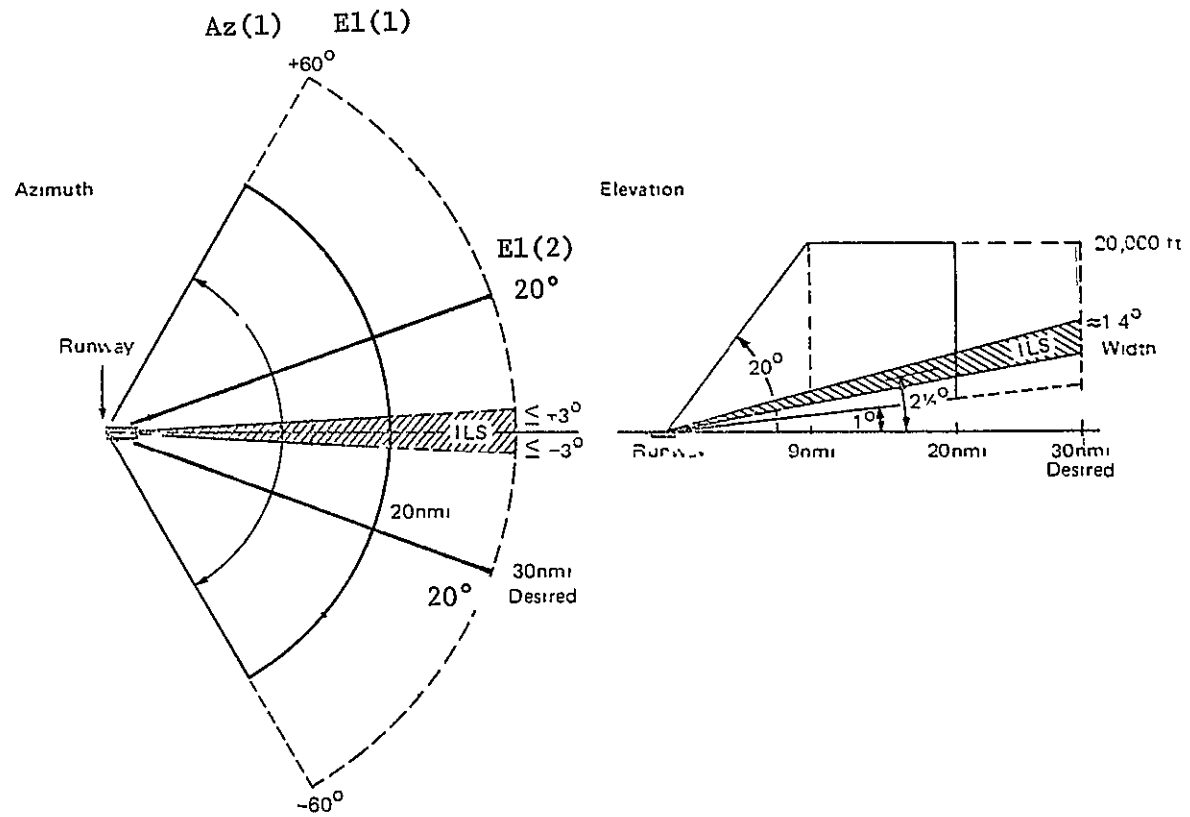

Figure 2. - MLS ground antenna coverage compared to ILS coverage.

### In-Beam Multipath

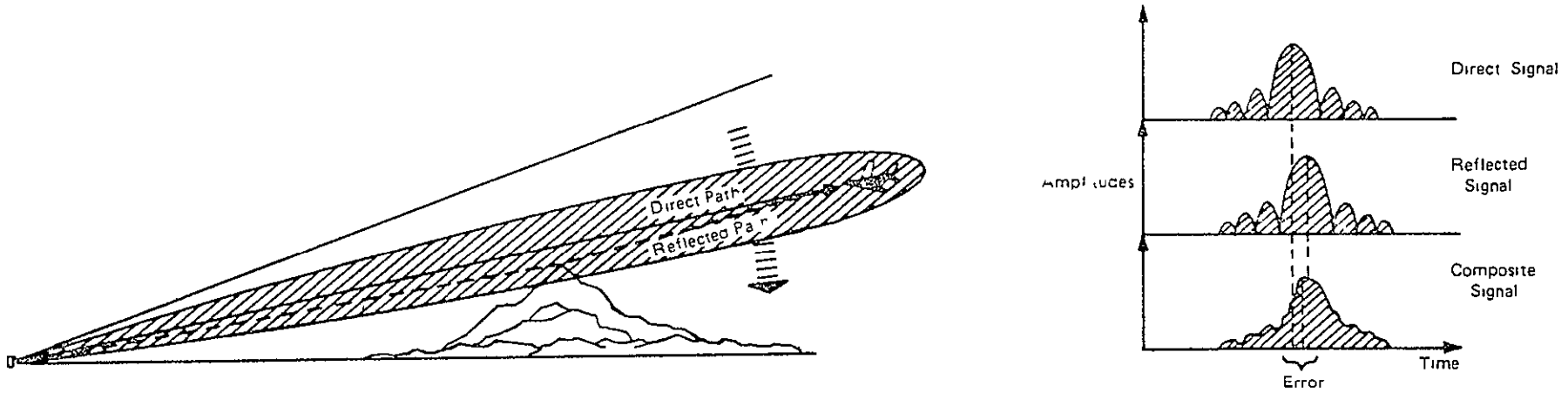

Figure 3. - Reduction of in-beam multipath effects by averaging in the TRSB.

### Out-of-Beam Multipath

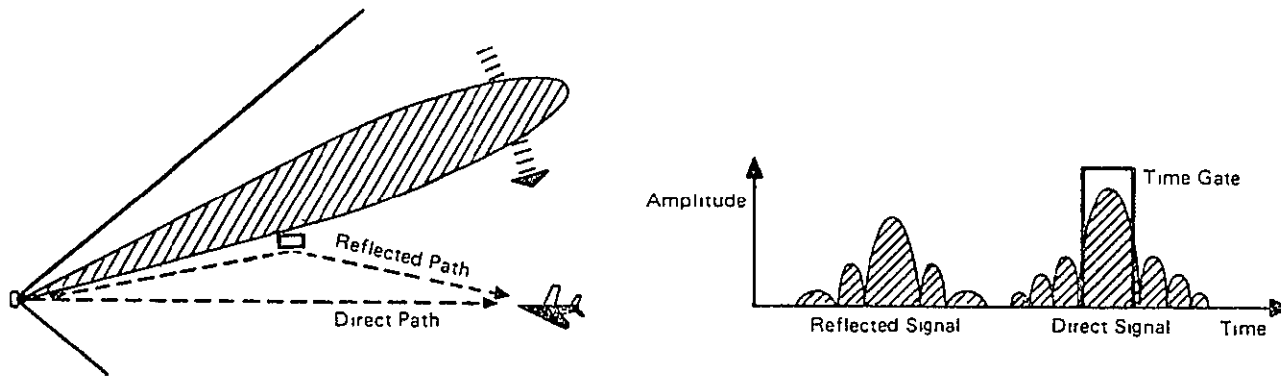

Figure 4. - Elimination of out-of-beam multipath by time gating in the TRSB.

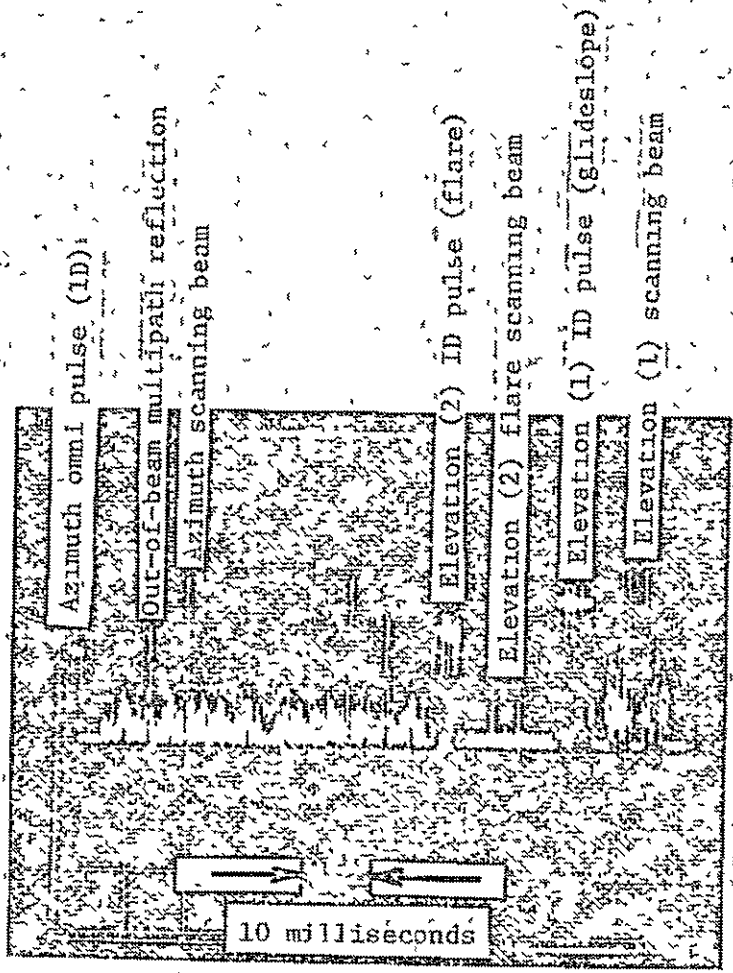

Figure 3 - Oscilloscope display of the time multiplexed MLS signal showing out-of-beam multipath

ANTENNA COVERAGE REQUIREMENTS

CURVE	AZIMUTH	ELEVATION
A	<u>+171°</u>	+26, -20°
B	<u>+121°</u>	+26, -20°
C	<u>+98°</u>	+26, -31°

CONSTANT 3° DESCENT  
 3 NAUTICAL MILES FINAL  
 140 KNOTS AIRSPEED  
 TURNS 7500 FEET RADIUS  
 13° NO WIND BANK ANGLES

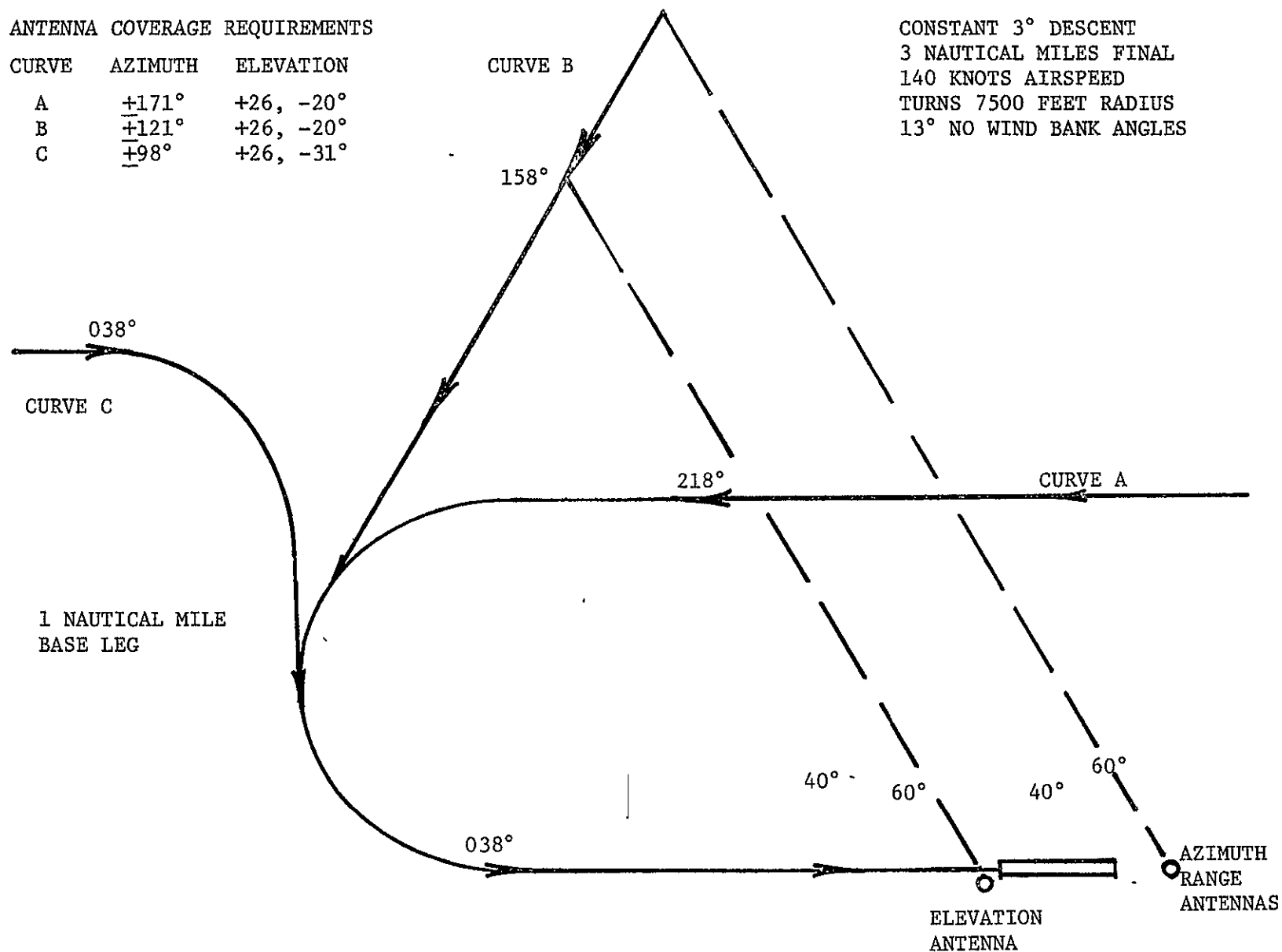

Figure 6. - Aircraft antenna pattern coverage for the three ICAO approach profiles.

NASA  
L-74-7896

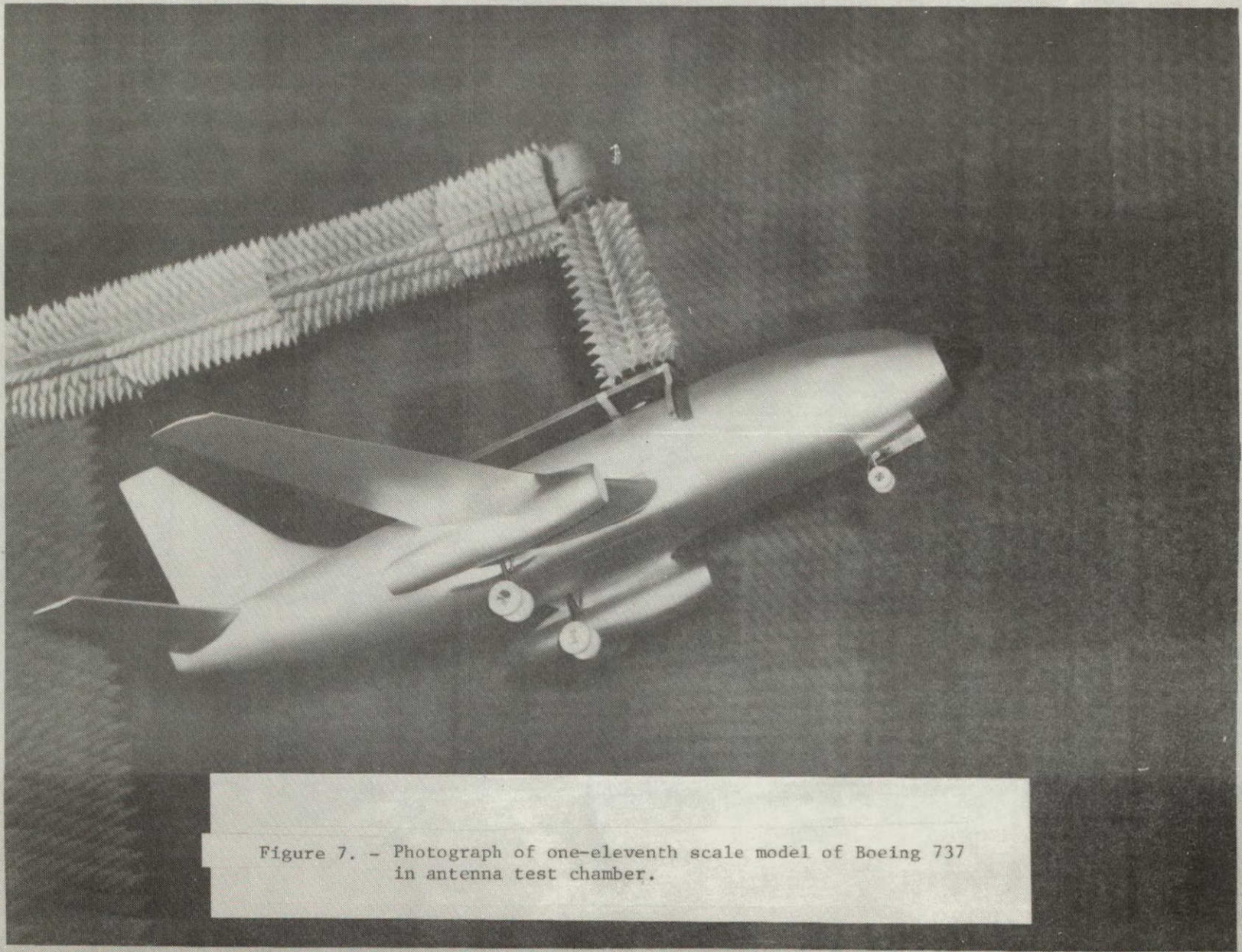

Figure 7. - Photograph of one-eleventh scale model of Boeing 737  
in antenna test chamber.

ORIGINAL PAGE IS  
OF POOR QUALITY

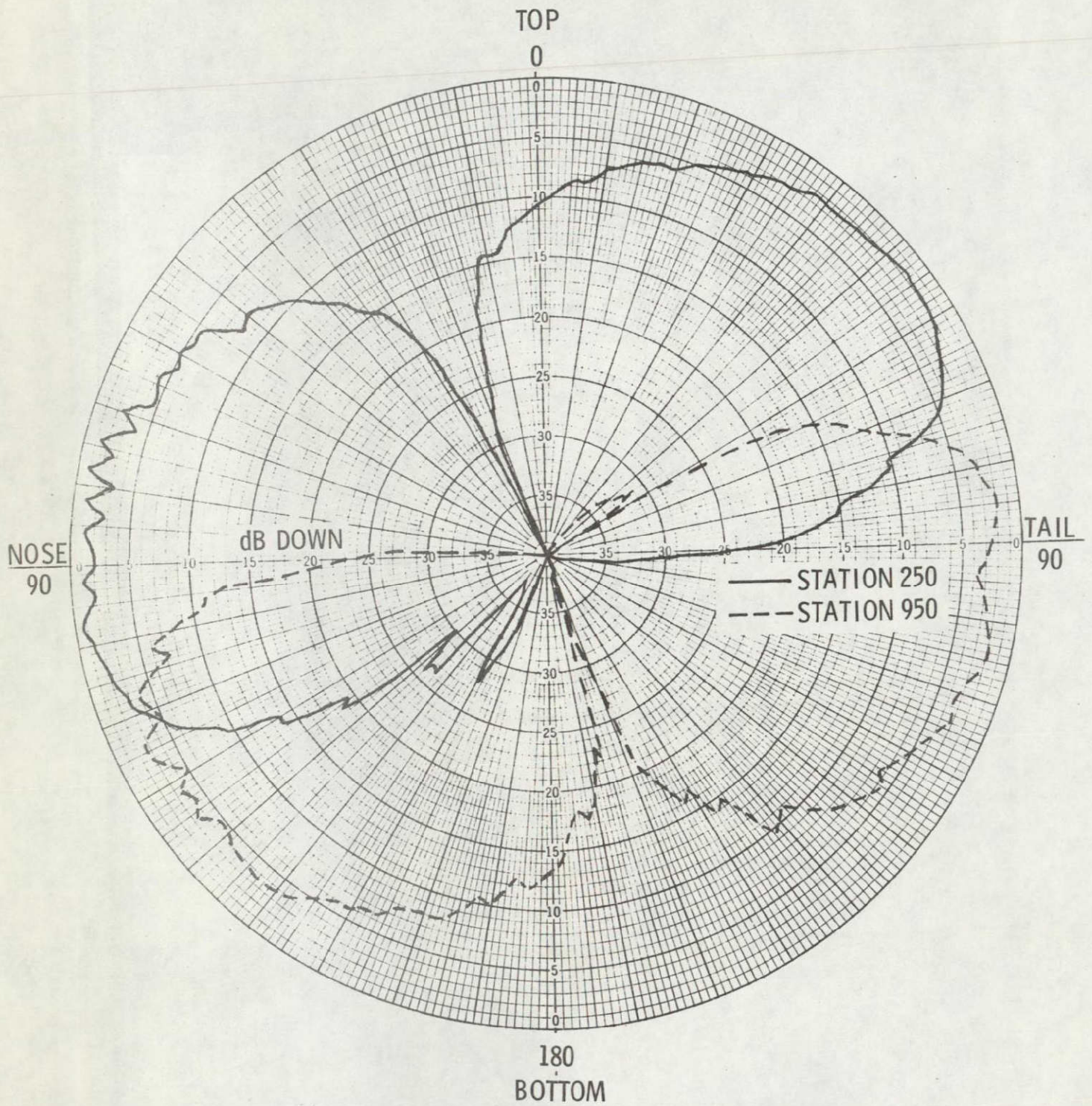

Figure 8. - Elevation plane radiation pattern of a monopole antenna located at stations 250 (top) and 950 (bottom).

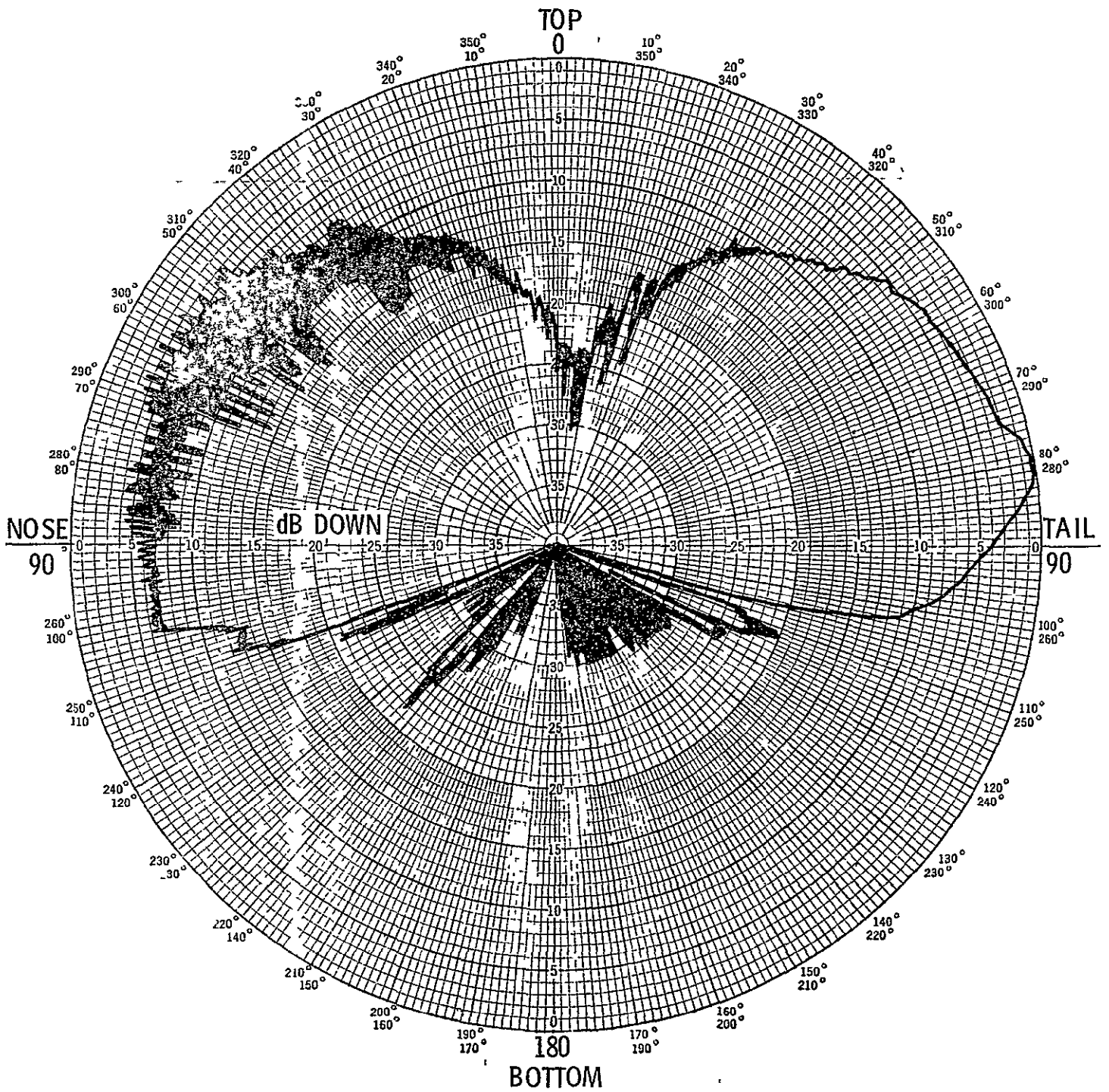

Figure 10. - Elevation plane radiation pattern of vertical fin antenna without counterpoise. Scale model results.



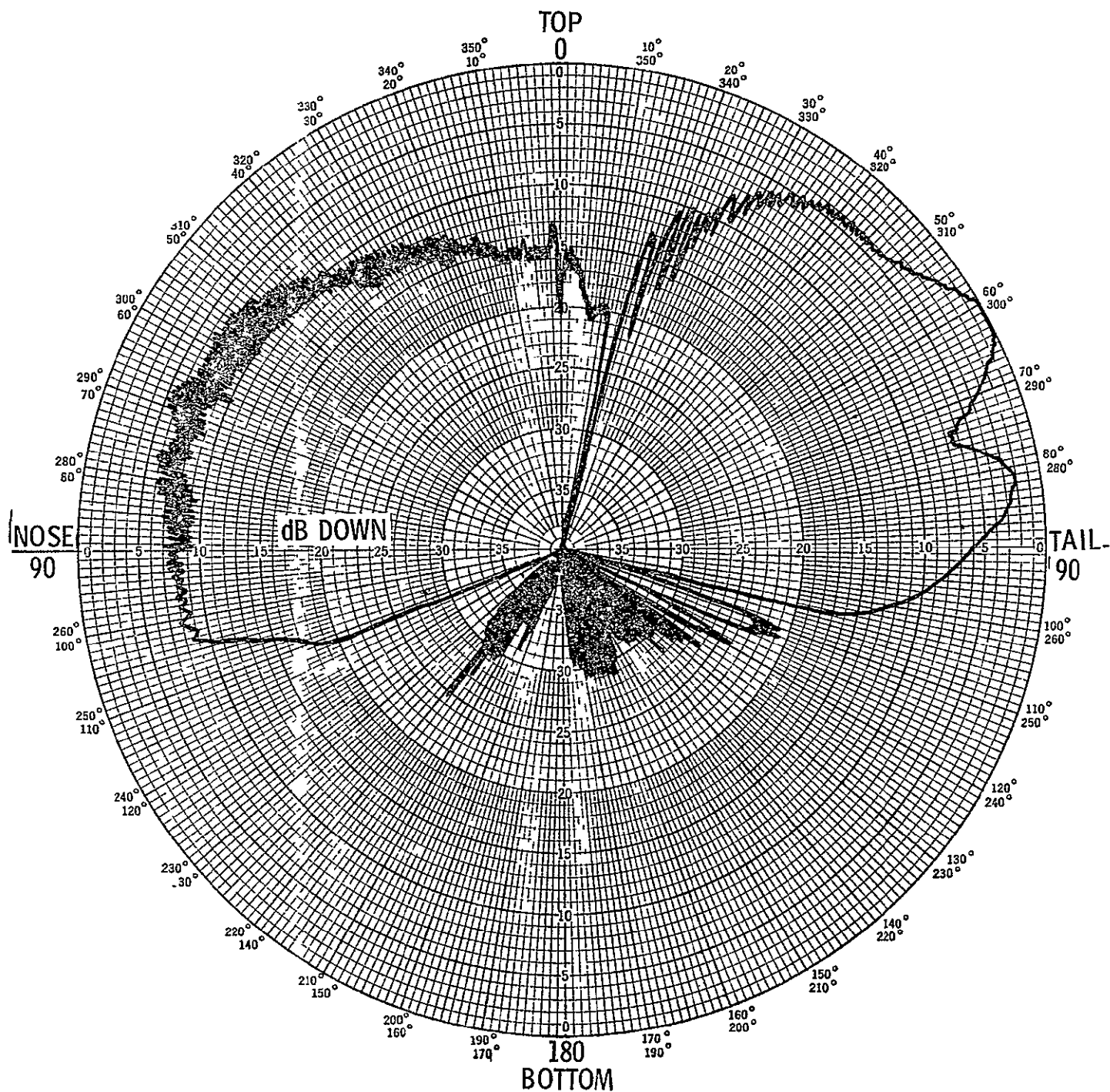

Figure 11. - Elevation plane radiation pattern of vertical fin antenna with counterpoise mounted on vertical fin. Scale model results.

# RSFS BASIC AIRPLANE AND OPERATING ENVELOPE

737 GENERAL ARRANGEMENT

MLS - Antenna Locations

Antenna	Body Station	Water Line	Buttock Line
Ku-band horn	180.5	173.0	R 3.3
Ku-band omni	239.0	283.5	L6
C-band omni	239.0	283.5	R6
C-band omni	946.5	169.0	
C-band omni (Vertical fin)	1169.75	542.5	

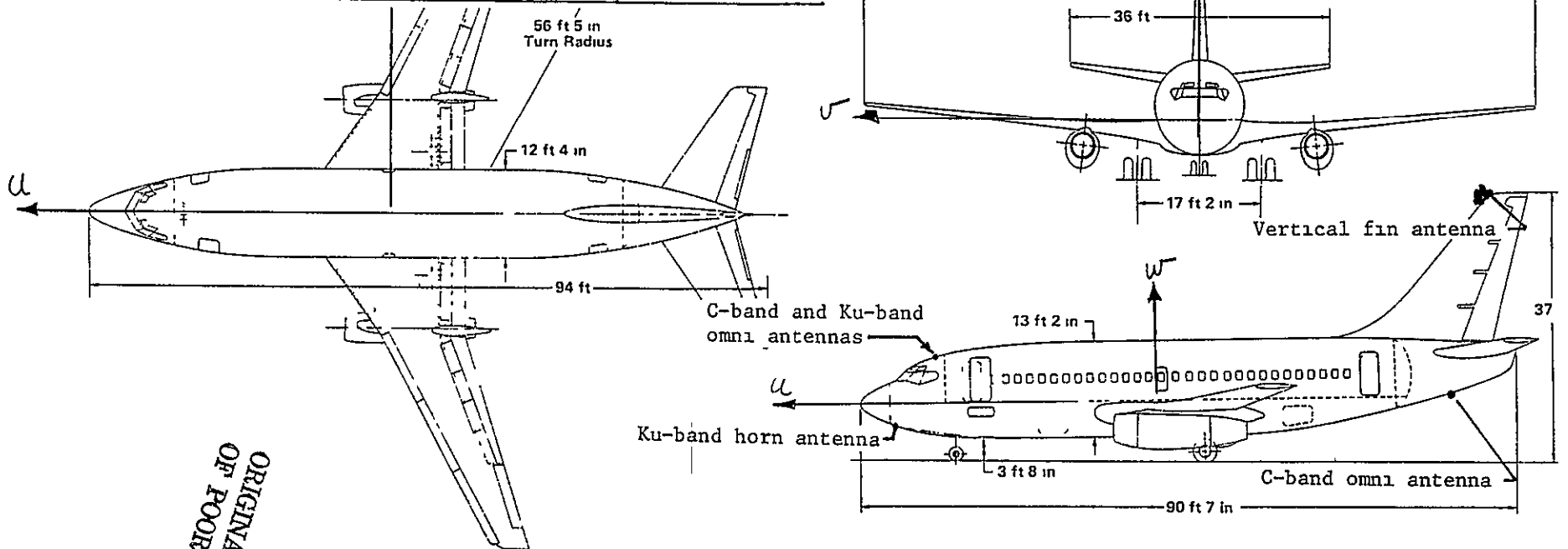

ORIGINAL PAGE IS OF POOR QUALITY

Figure 12. - Basic aircraft configuration of the RSFS showing the antenna location used for the MLS flight tests.

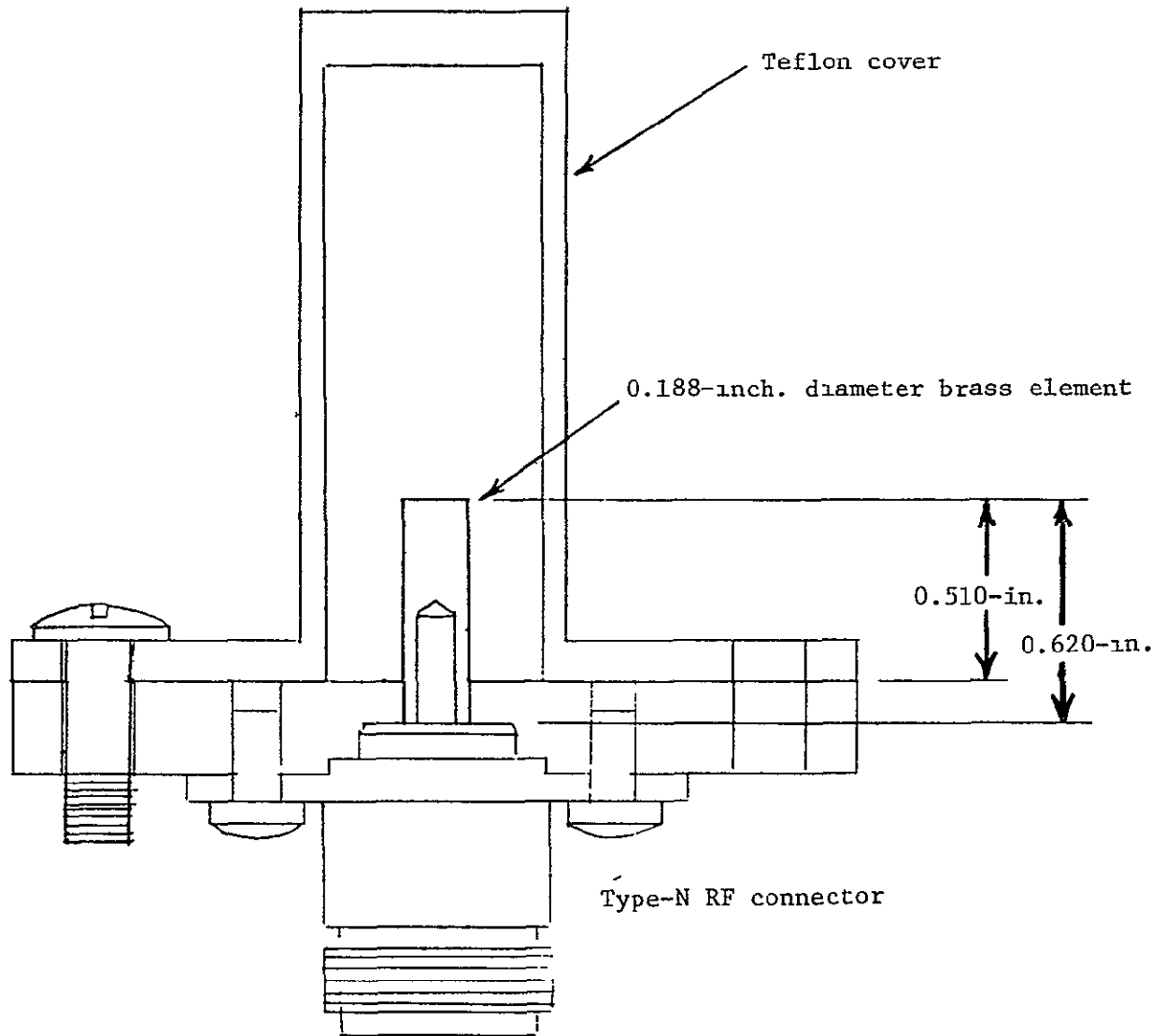

(a) C-band monopole

Figure 13. - Configuration of C-band and Ku-band monopole antenna for the B-737.

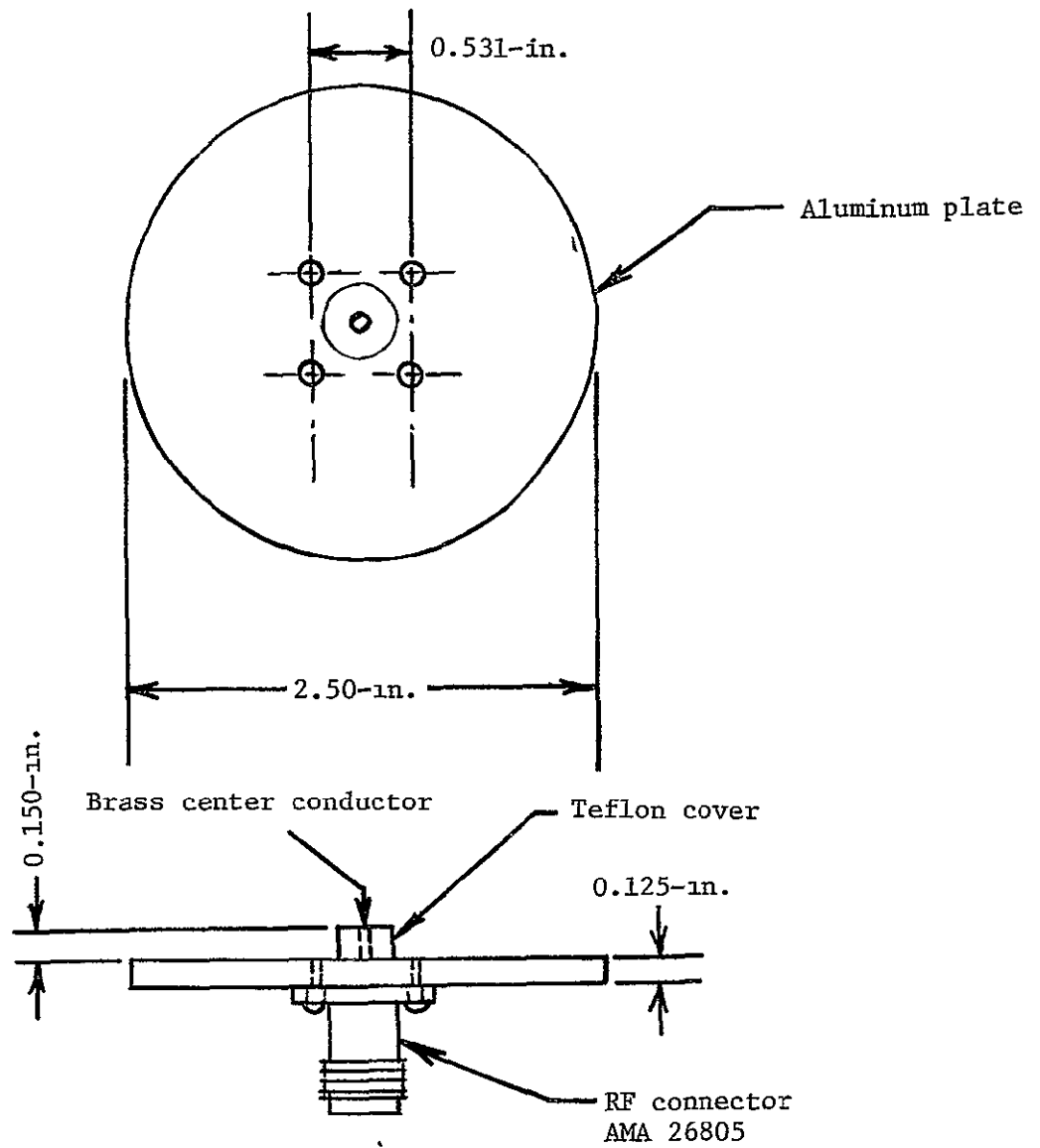

(b) Ku-band monopole

Figure 13 (concluded).

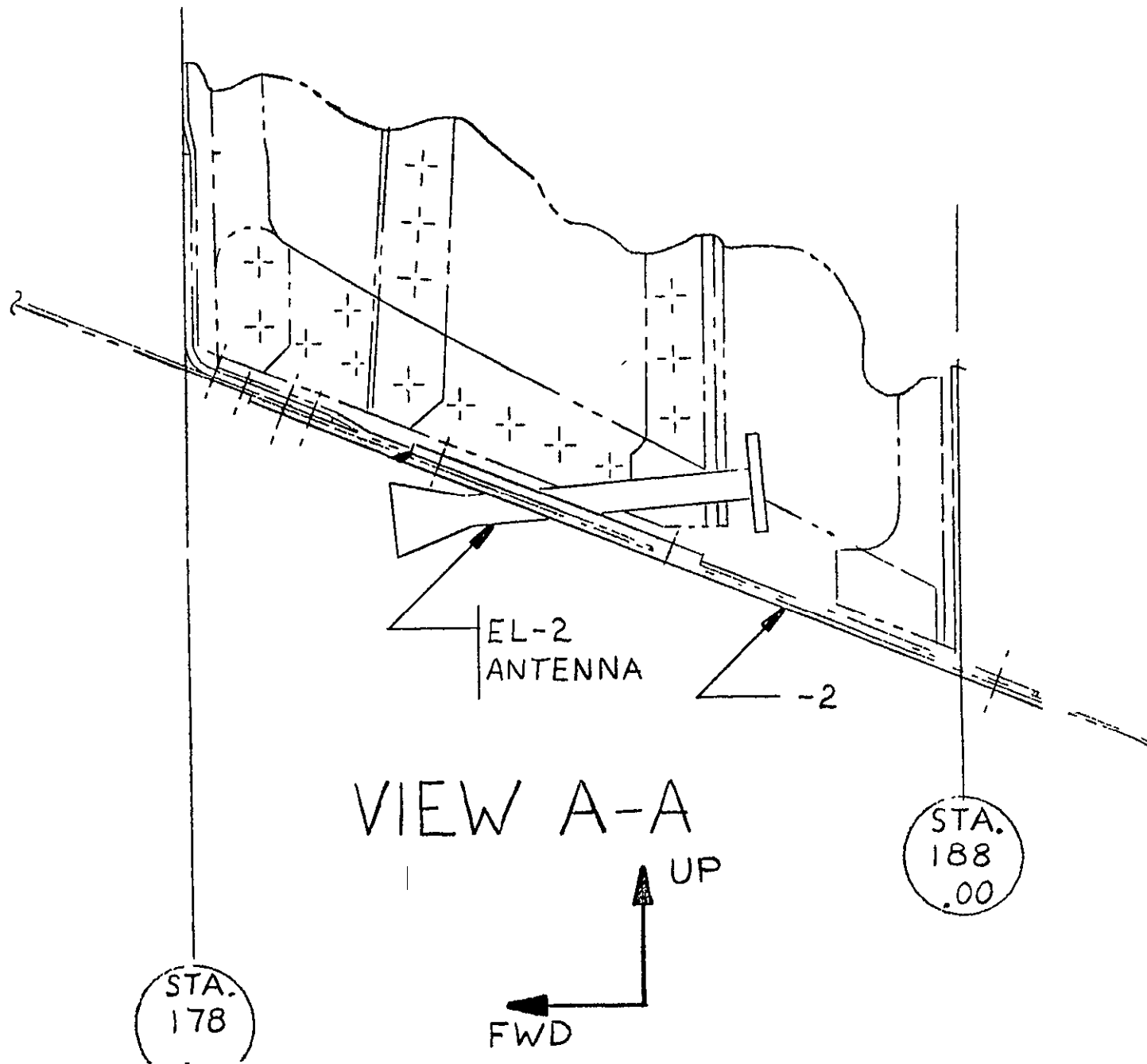
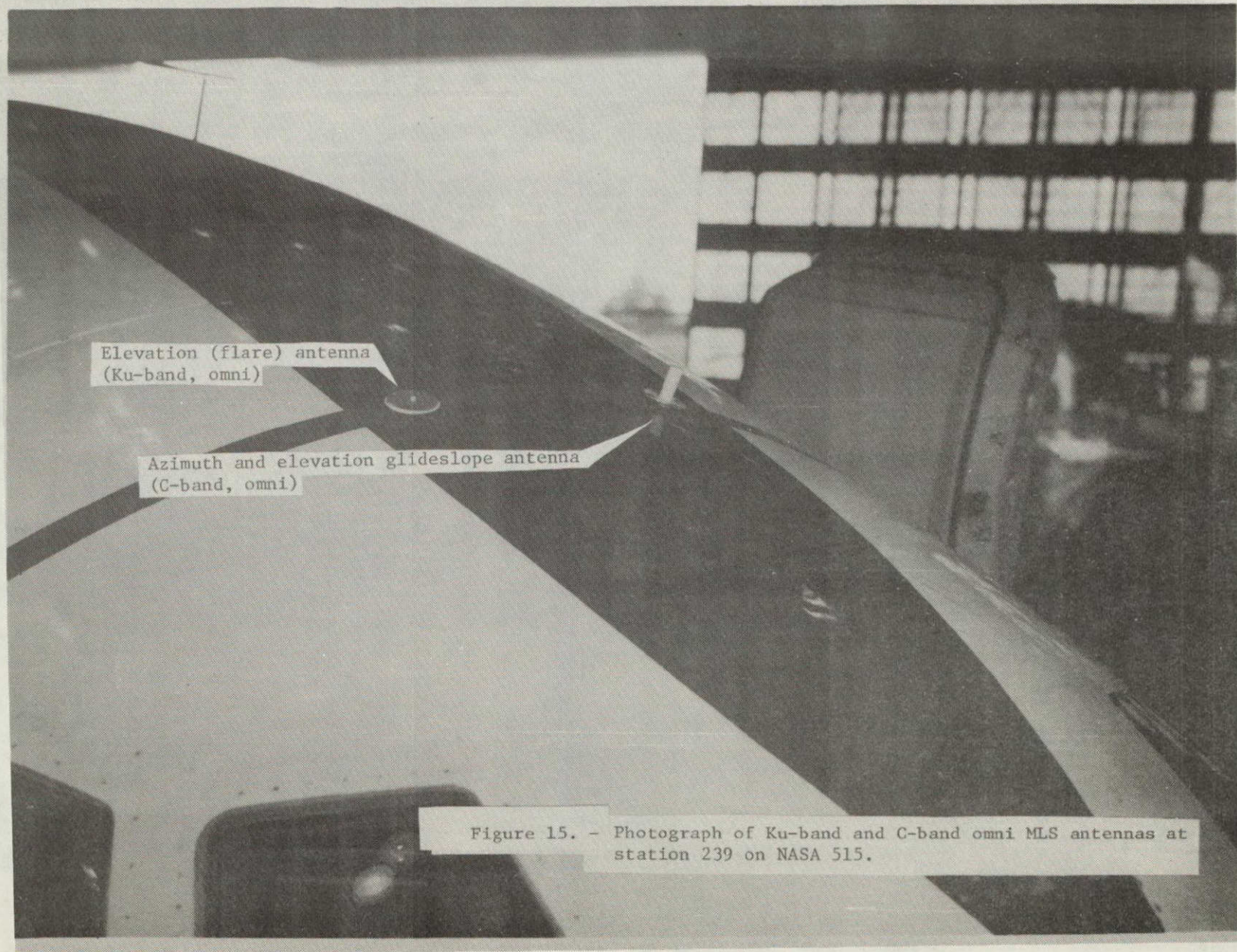

Figure 14. - Configuration of the Ku-band horn antenna for the B-737.

NASA  
I-76-4486

ORIGINAL PAGE IS  
OF POOR QUALITY



Elevation (flare) antenna  
(Ku-band, omni)

Azimuth and elevation glideslope antenna  
(C-band, omni)

Figure 15. - Photograph of Ku-band and C-band omni MLS antennas at station 239 on NASA 515.

NASA  
L-75-5885

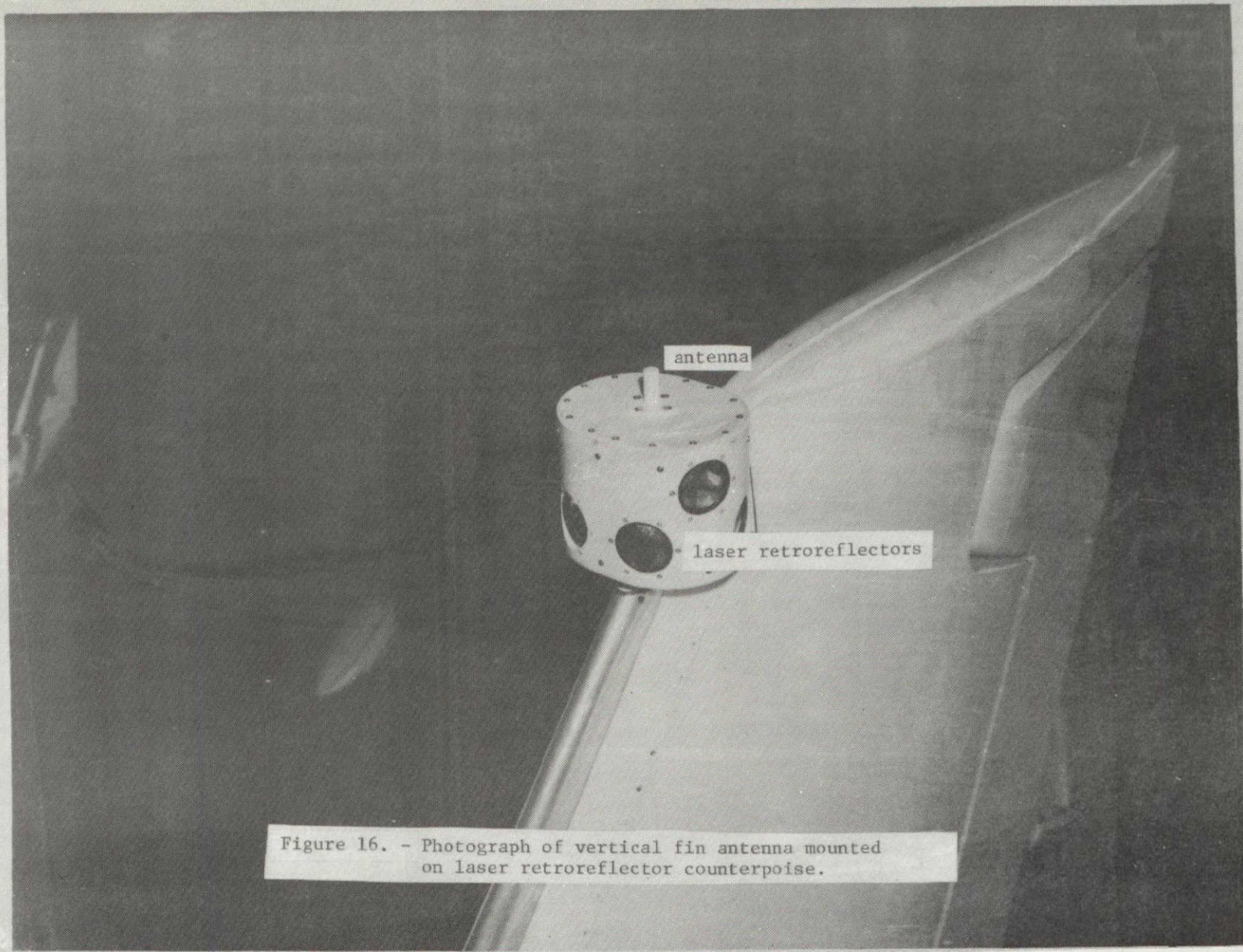

antenna

laser retroreflectors

Figure 16. - Photograph of vertical fin antenna mounted on laser retroreflector counterpoise.

OR. L-75-5885  
CHAS. W. W. W. W.

ORIGINAL PAGE IS  
OF POOR QUALITY

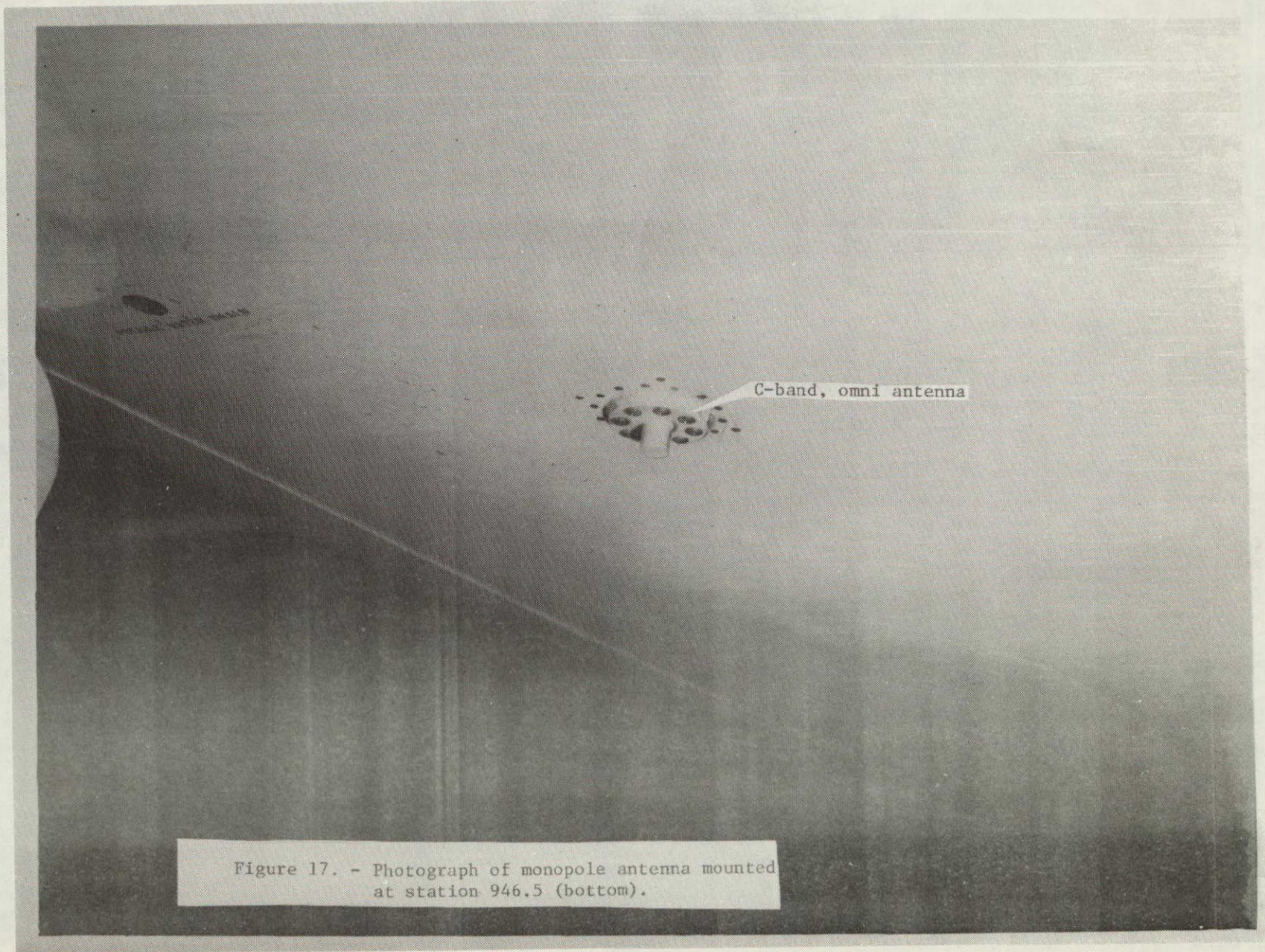
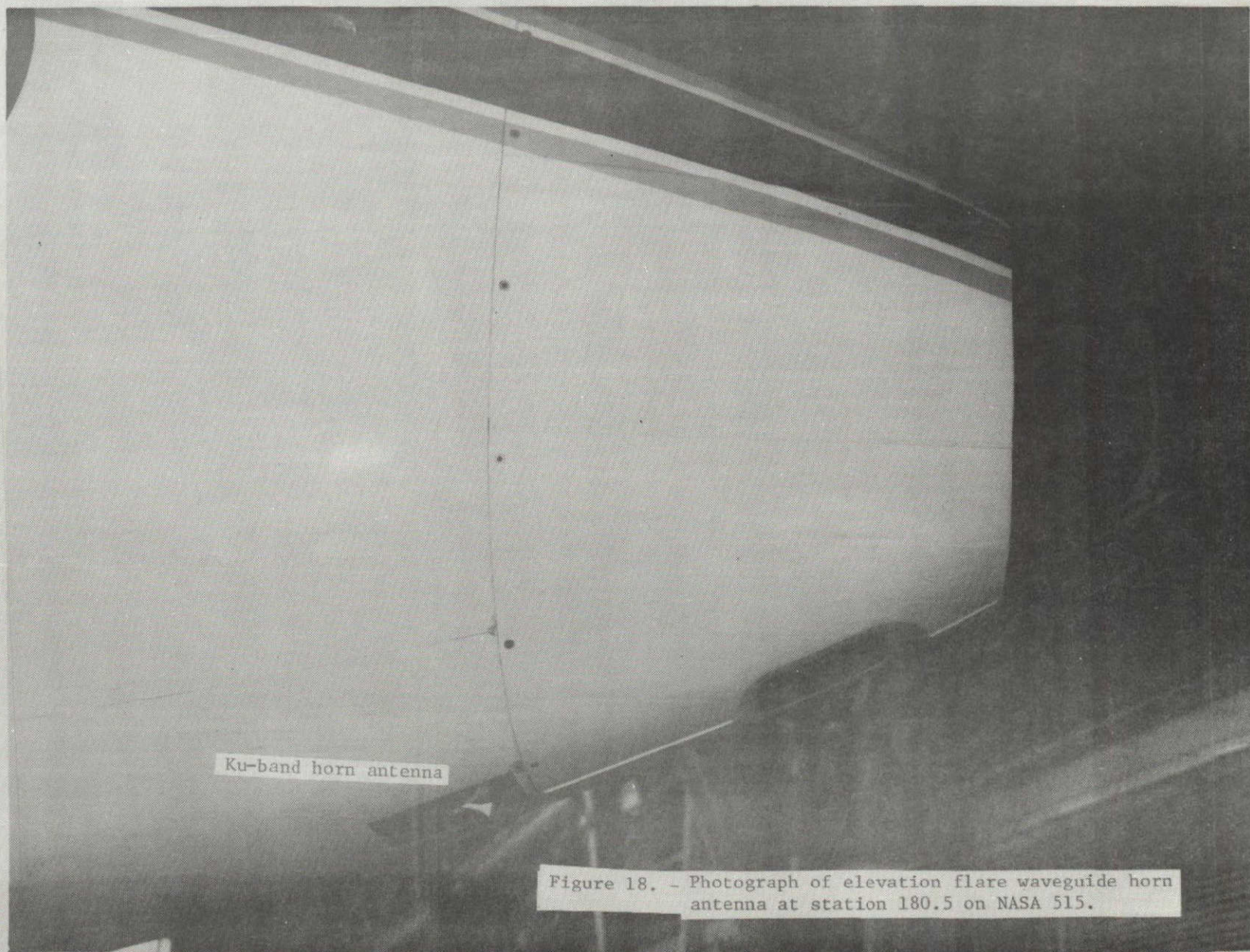

Figure 17. - Photograph of monopole antenna mounted  
at station 946.5 (bottom).



NASA  
1-76-4489



Ku-band horn antenna

Figure 18. - Photograph of elevation flare waveguide horn antenna at station 180.5 on NASA 515.

ORIGINAL PAGE IS  
OF POOR QUALITY

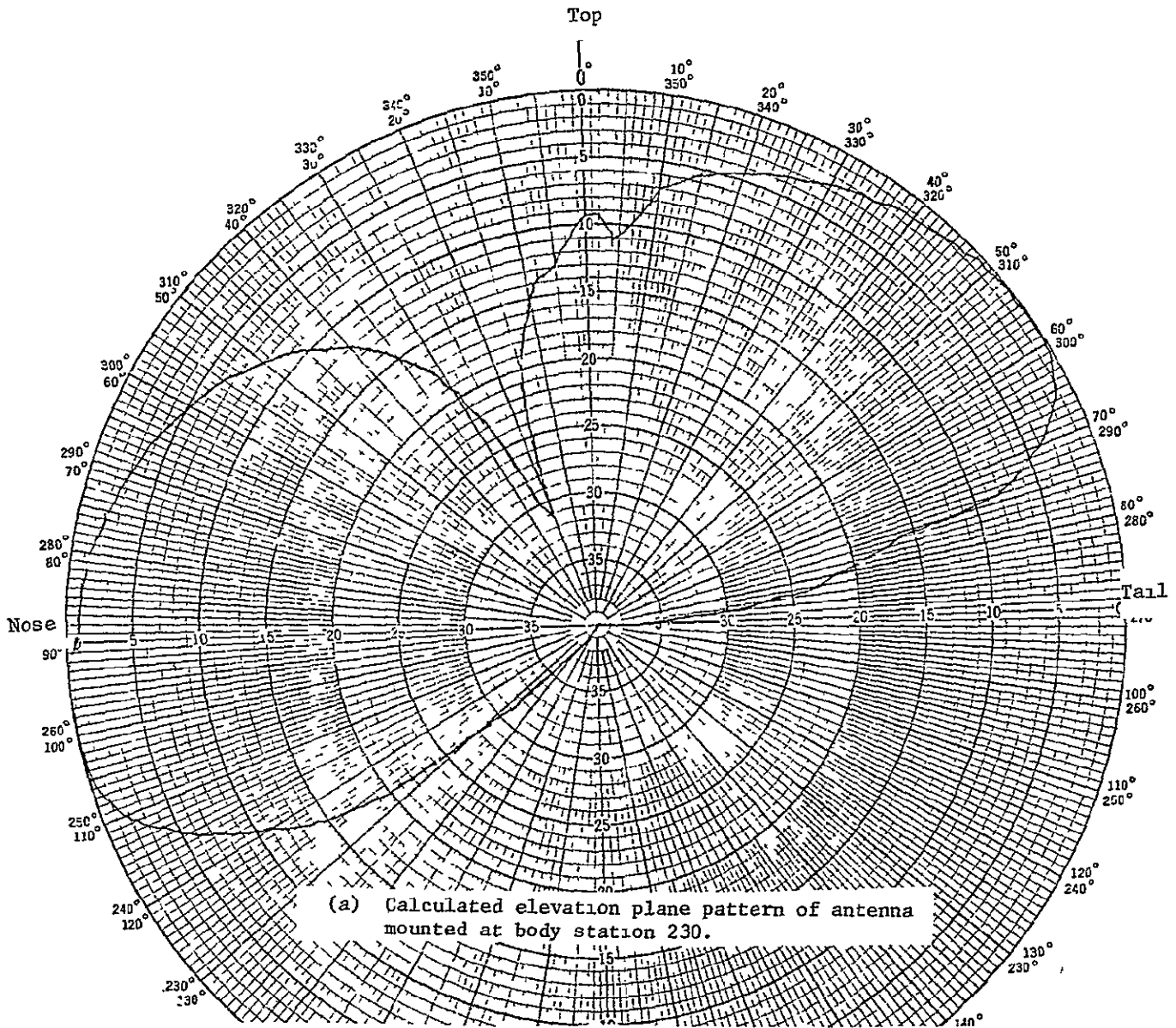

Figure 20. - Comparison of Ku-band calculated patterns and full scale element patterns.

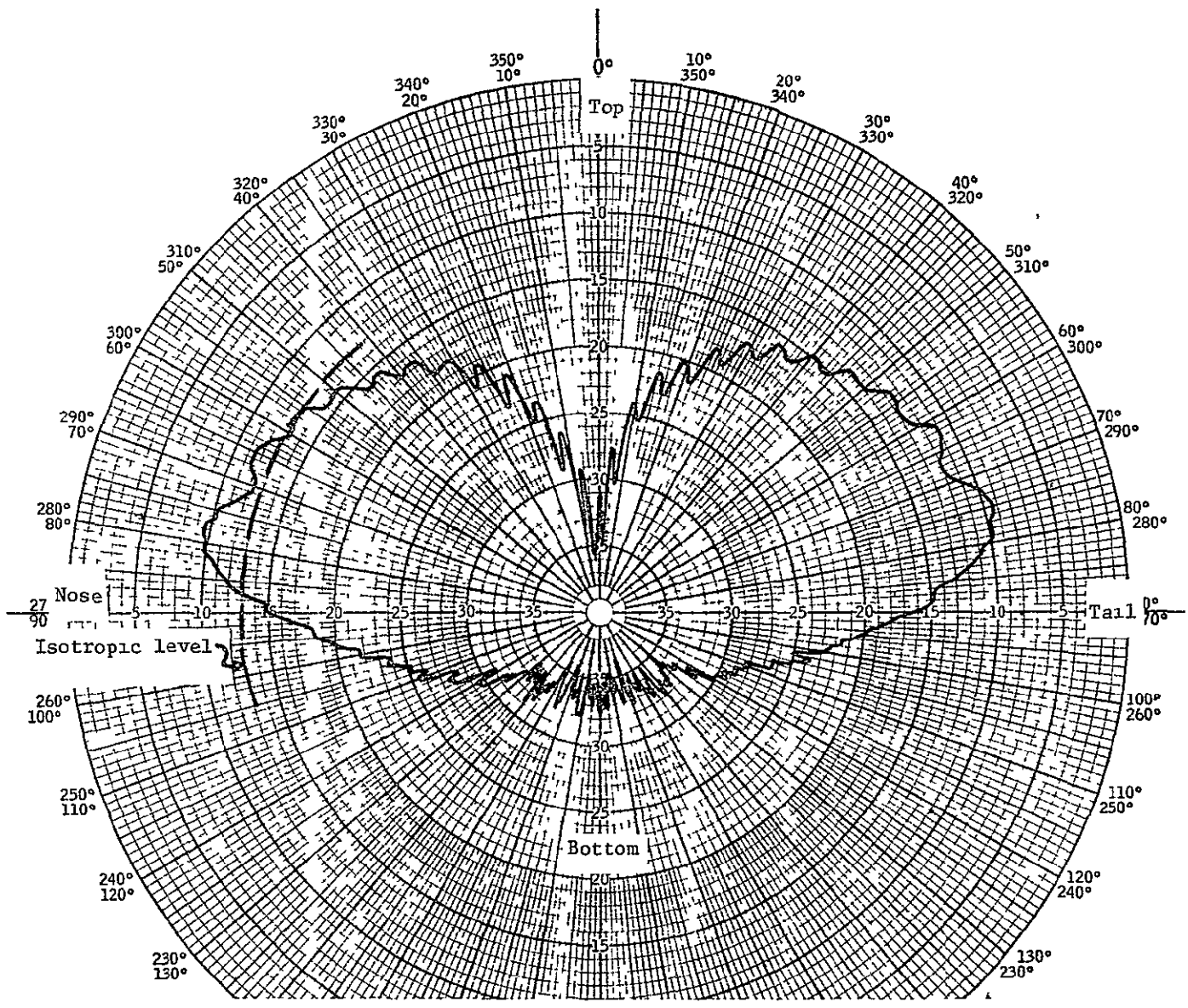
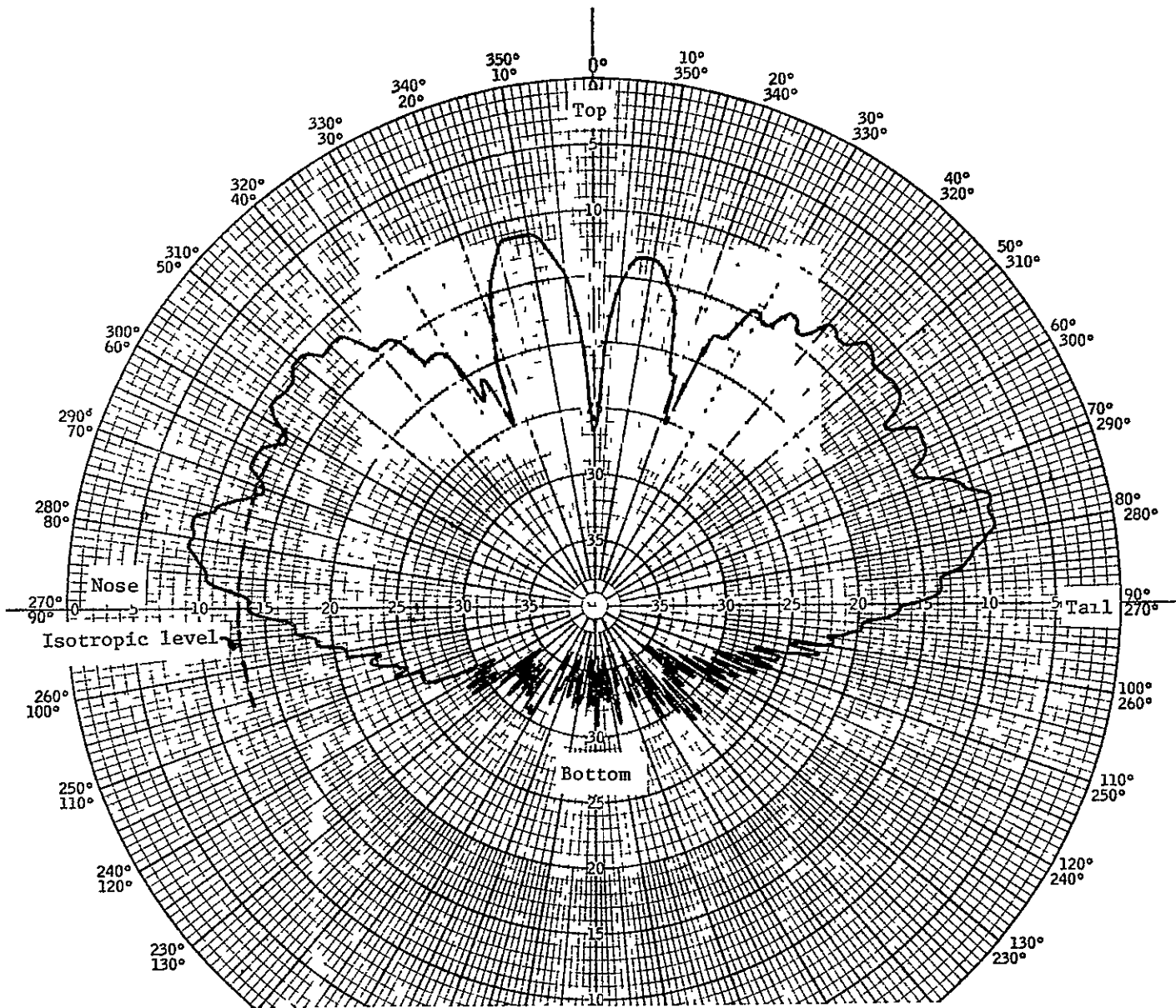

Figure 20(b) - Measured elevation plane pattern of Ku-band omni antenna mounted on smooth ground plane.



(c) Measured elevation plane pattern of Ku-band omni antenna mounted on 0.125-inch thick plate (2 inches in diameter). Assembly mounted on large plate

Figure 20 (concluded)

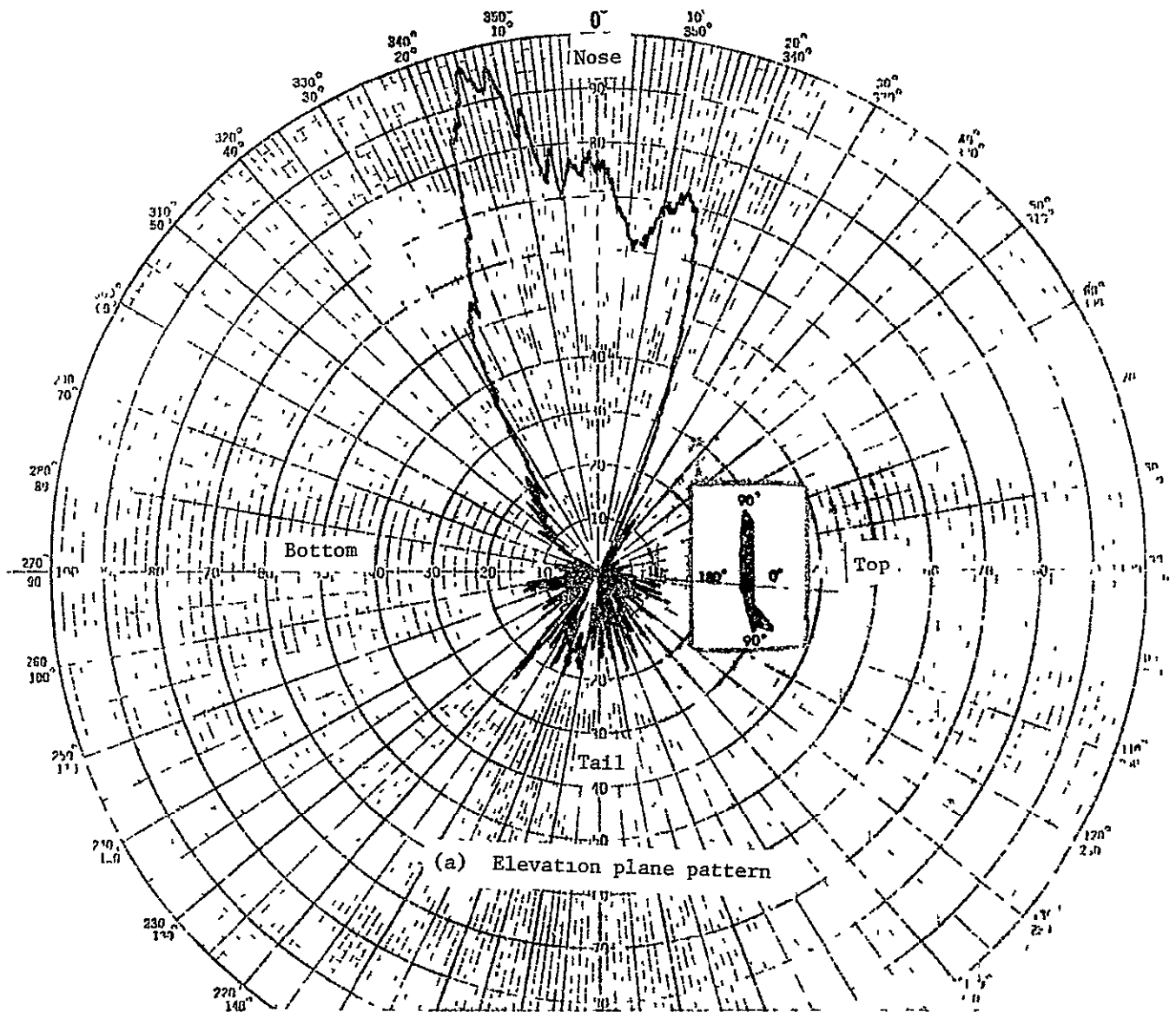
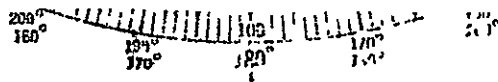

Figure 21. - Elevation and azimuthal plane patterns of Ku-band horn antenna mounted on full scale mock-up of B-737 nose



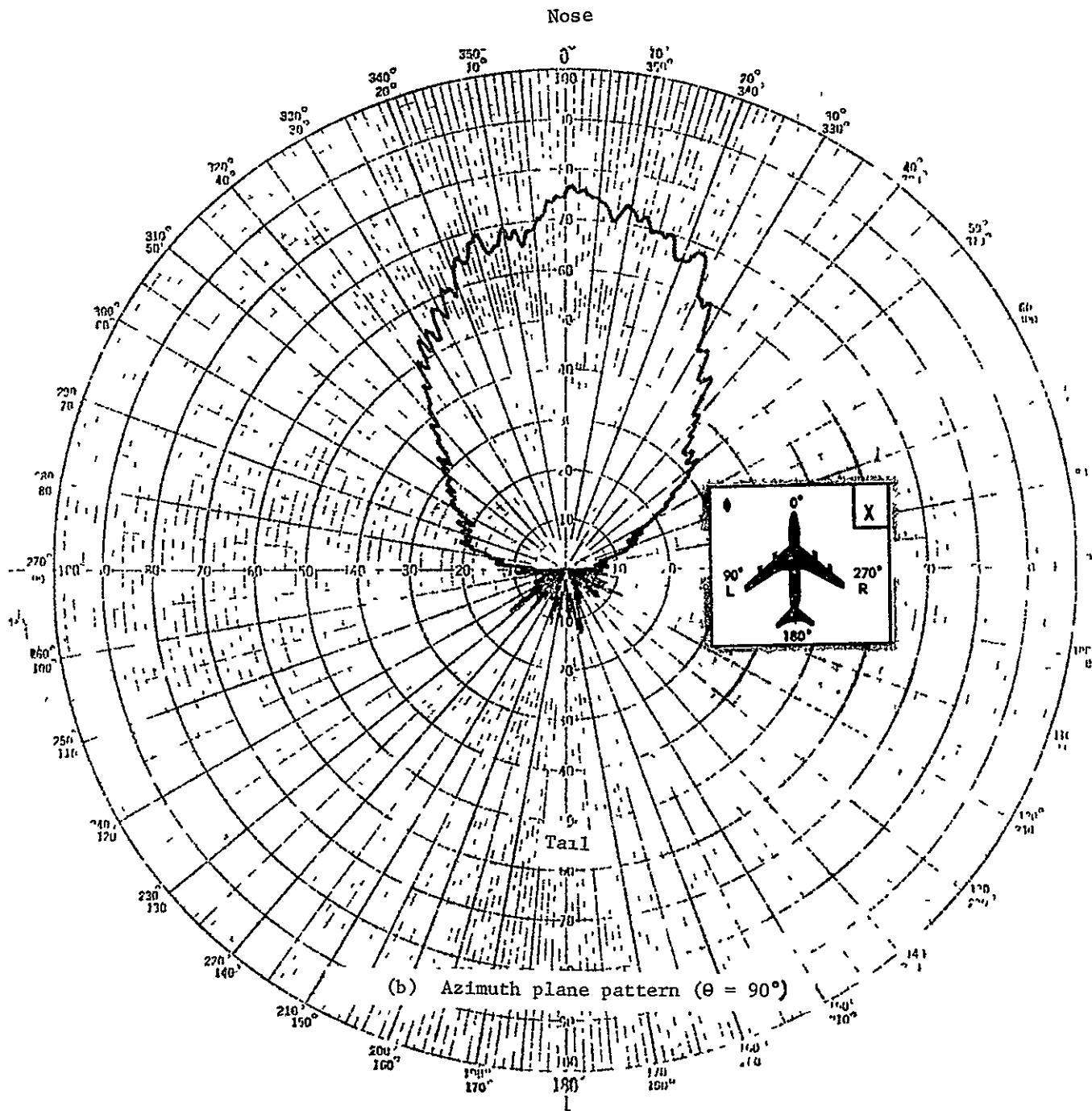

Figure 21 (concluded).

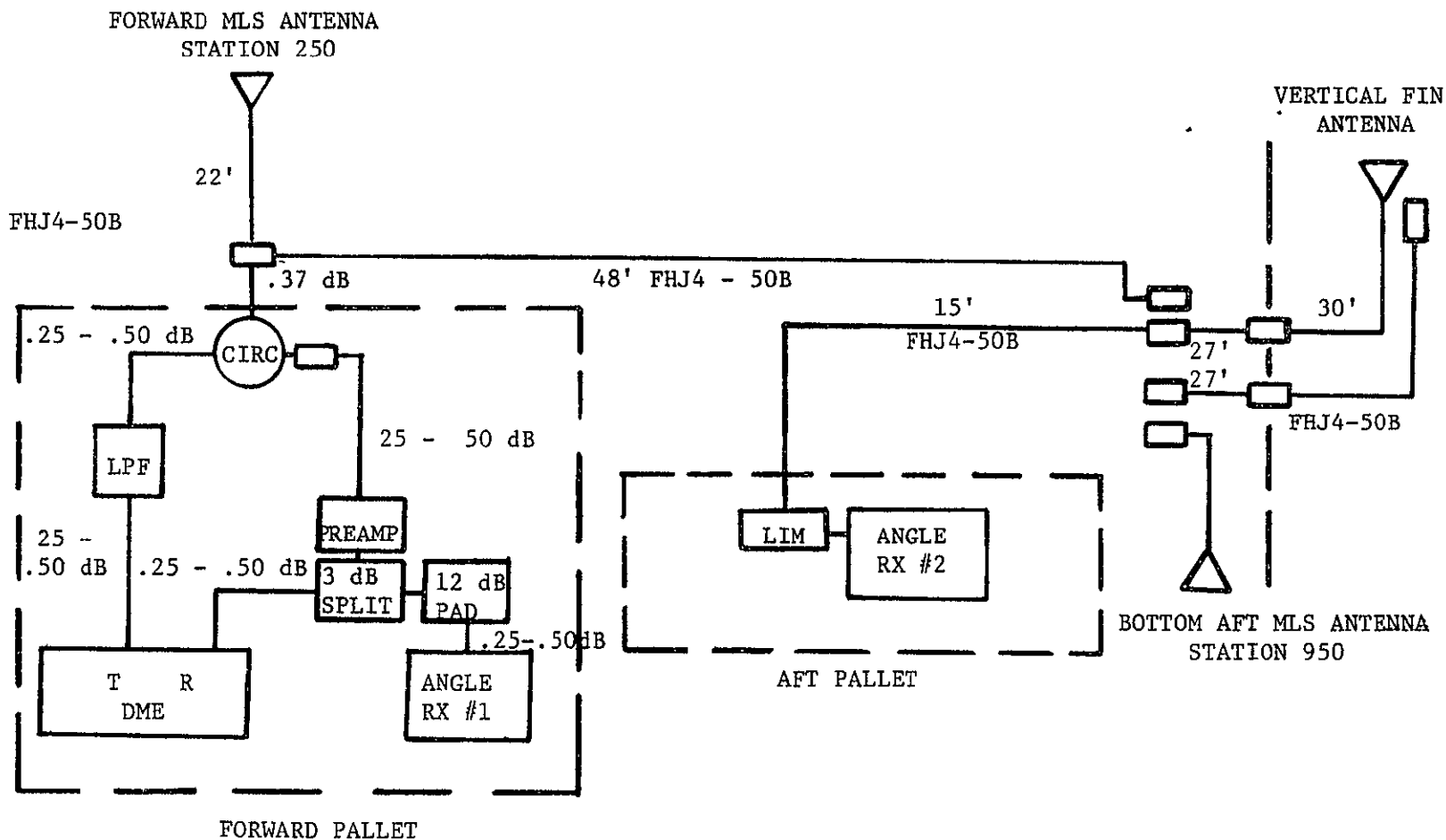

Figure 22 - RF experiment configuration for aircraft antenna tests

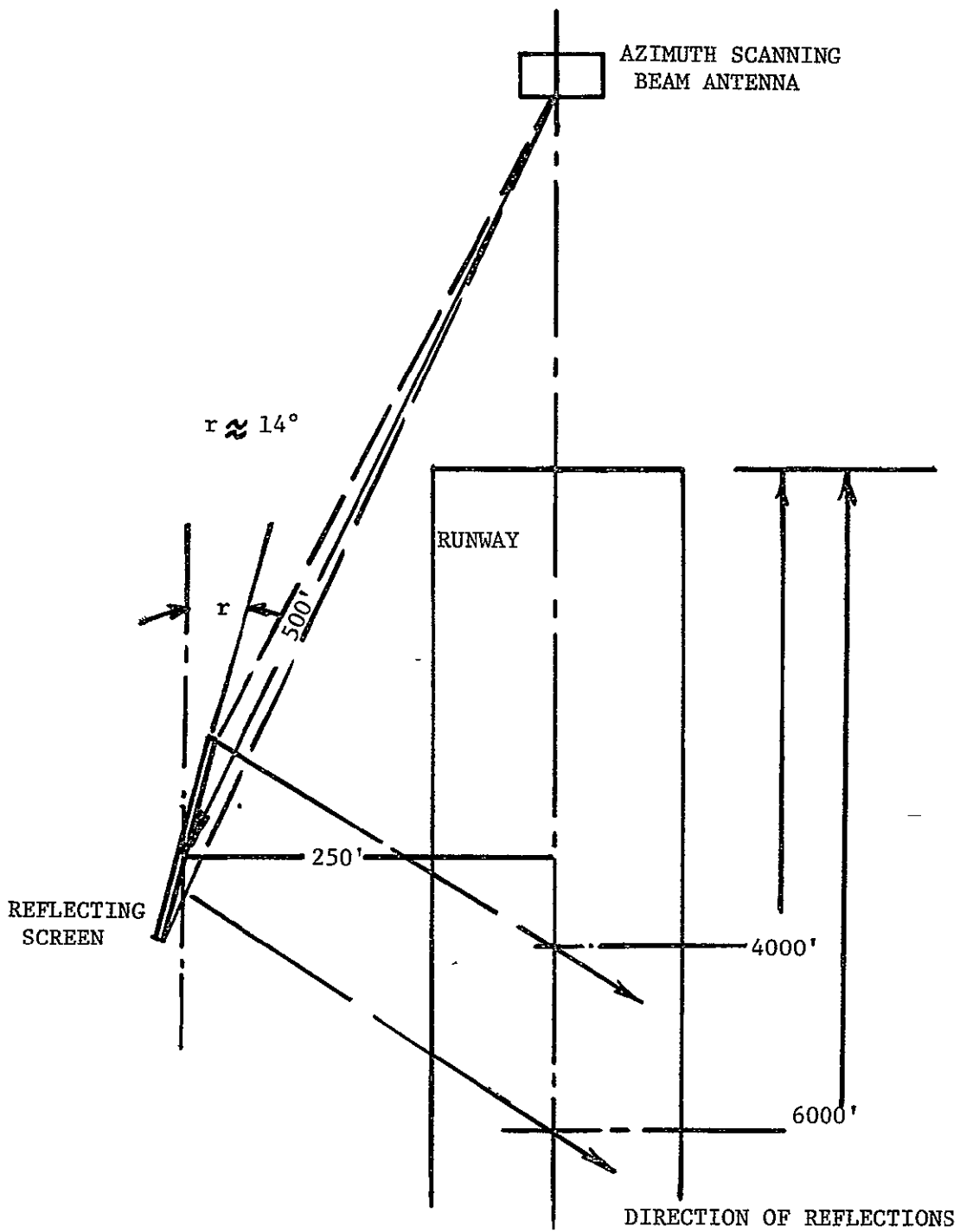

Figure 23. - Multipath screen location off runway 04 at NAFEC.



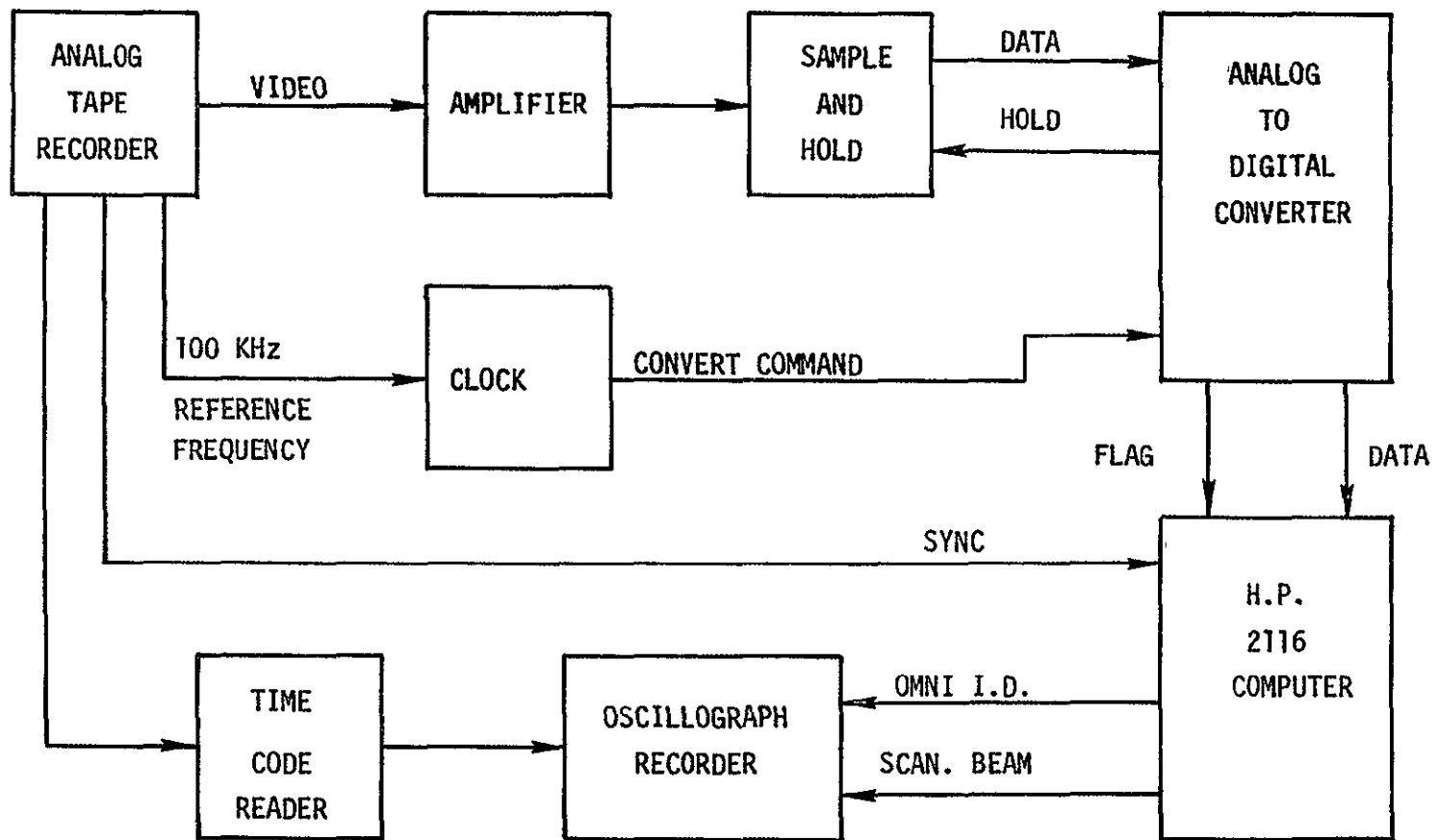
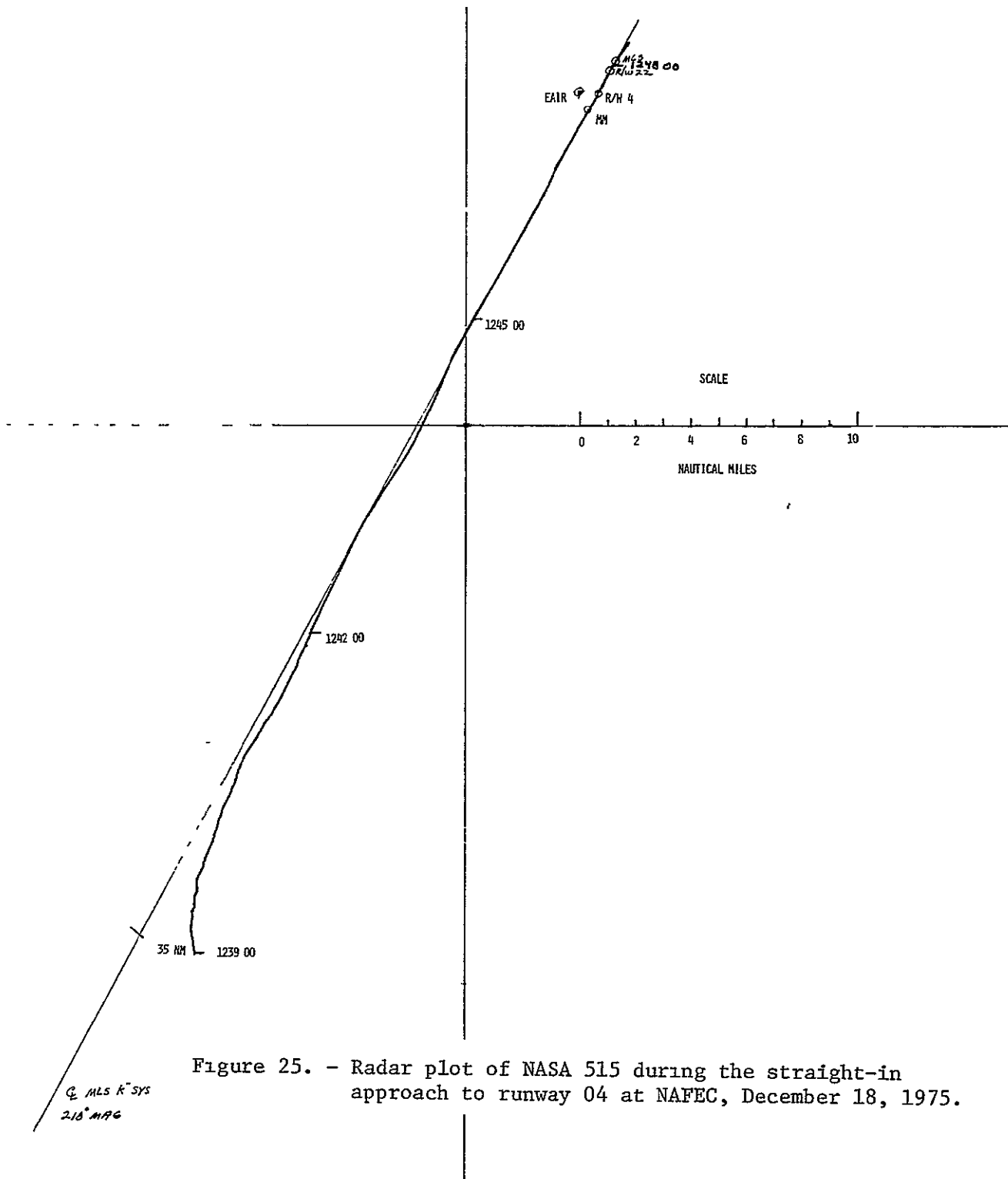
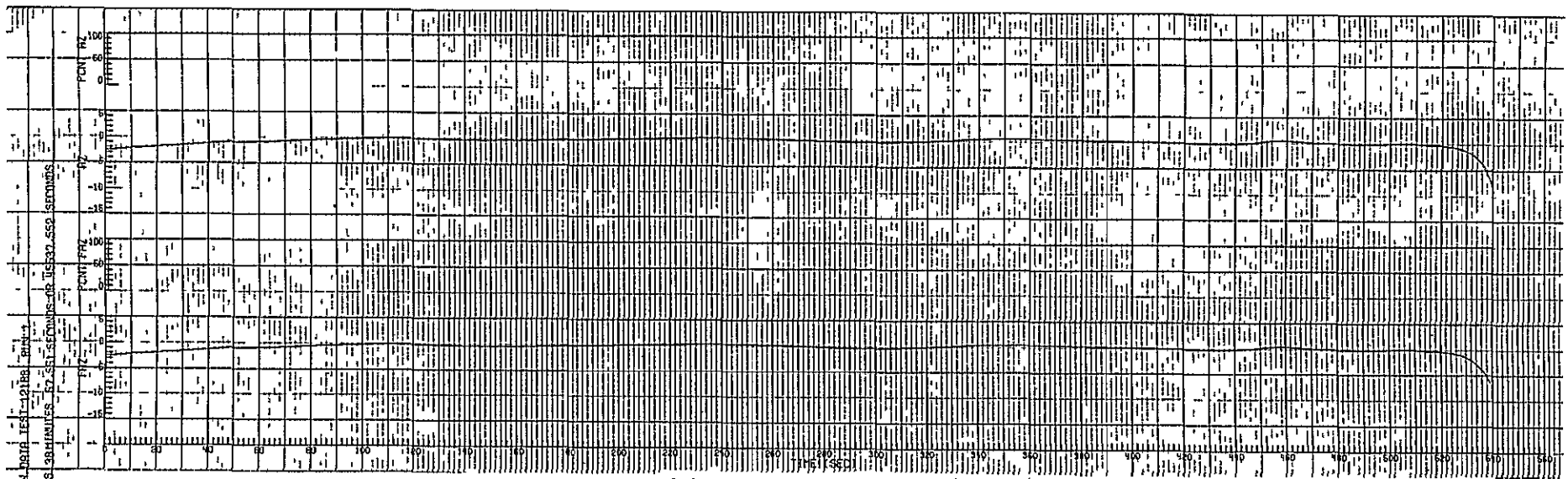

FIGURE 24. - Block Diagram of the data reduction system.



ORIGINAL PAGE IS  
OF POOR QUALITY



(a) Azimuth MLS data (Run 1)

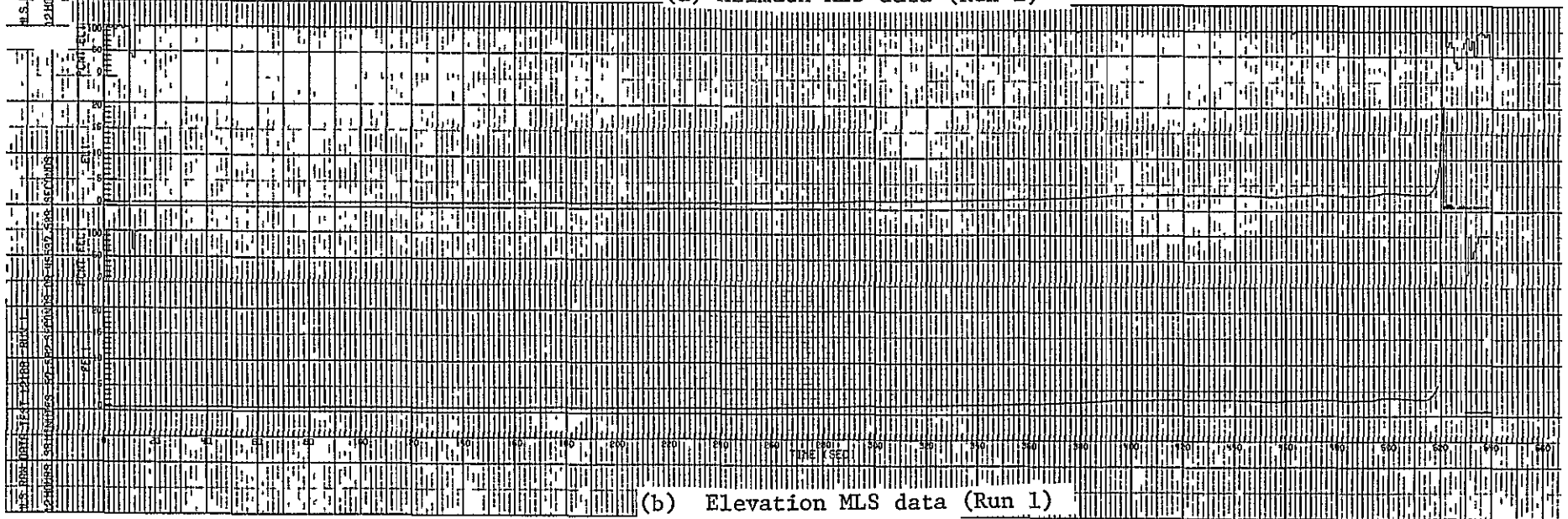

(b) Elevation MLS data (Run 1)

Figure 26. - Azimuth and elevation (C-band) MLS data for the straight-in approach (from 35 NM) to runway 04 at NAFEC using station 239 (M1) aircraft antenna.

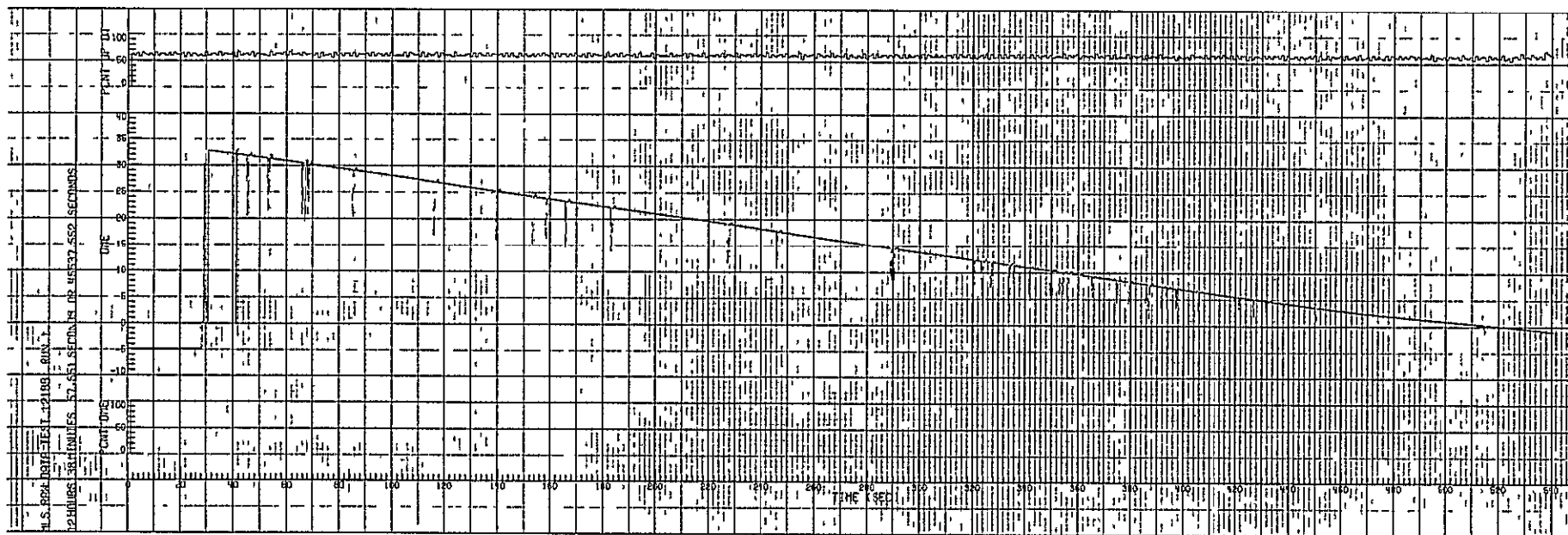

Figure 27. - DME data for the straight-in approach (from 35 NM) to runway 04 at NAFEC using station 239 (M1) aircraft antenna.

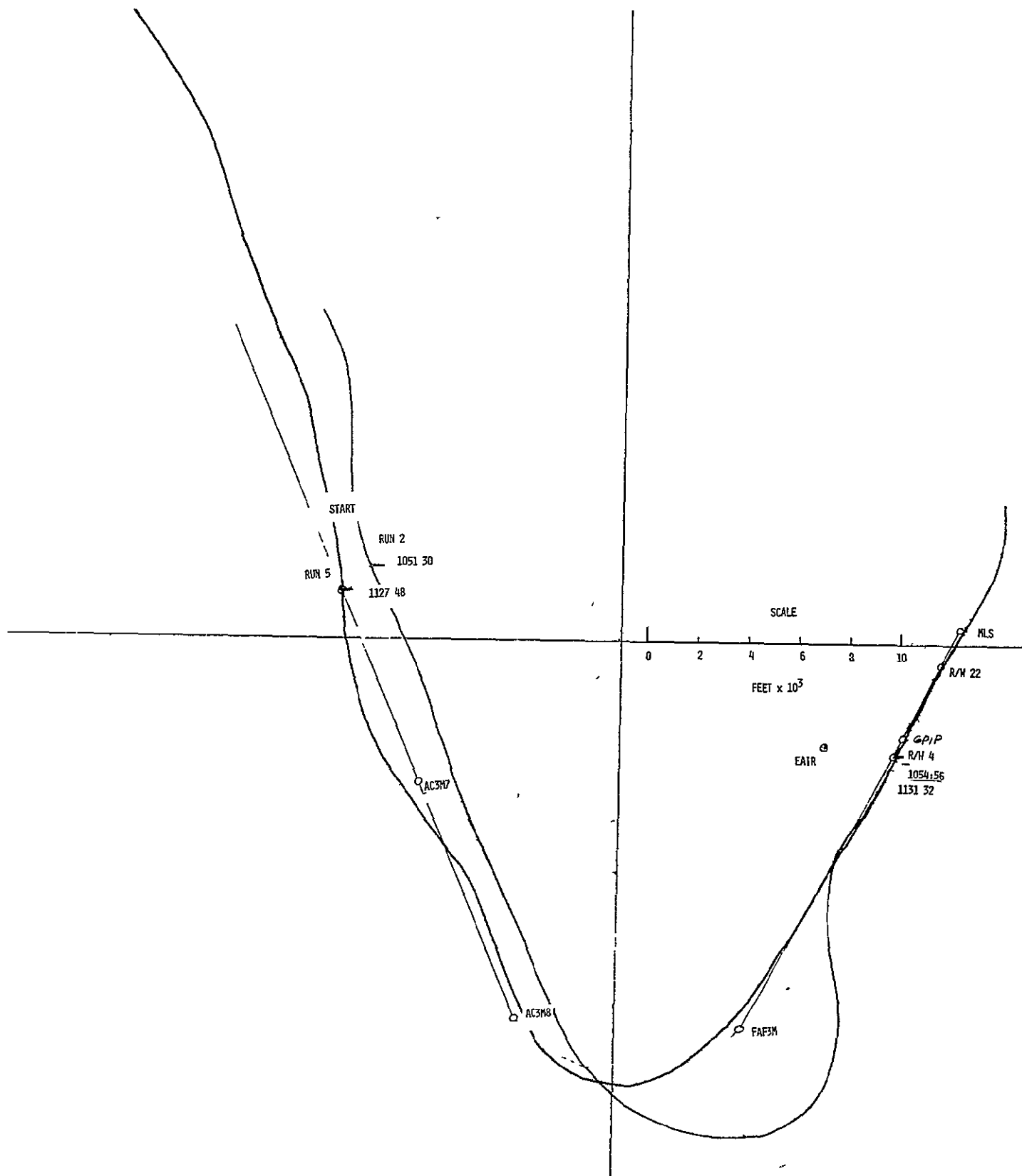

Figure 28. - Radar plot of NASA 515 during two approaches using the 130° profile, December 18, 1975.



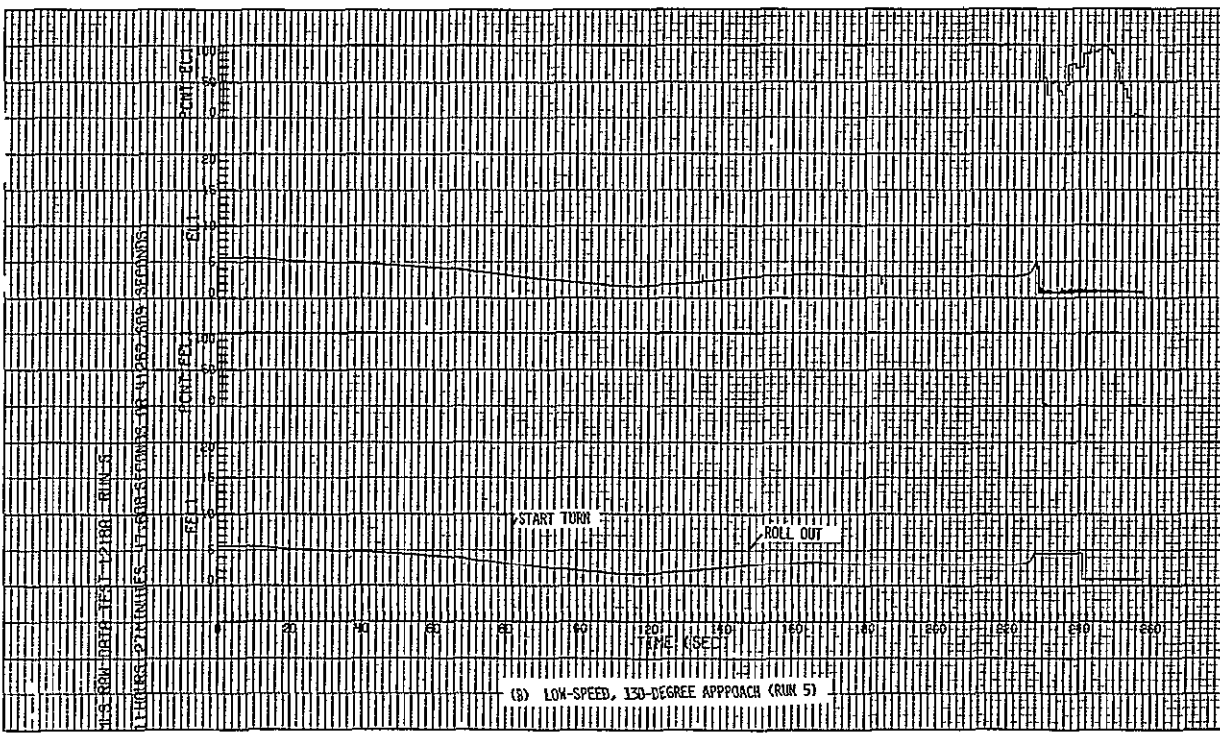
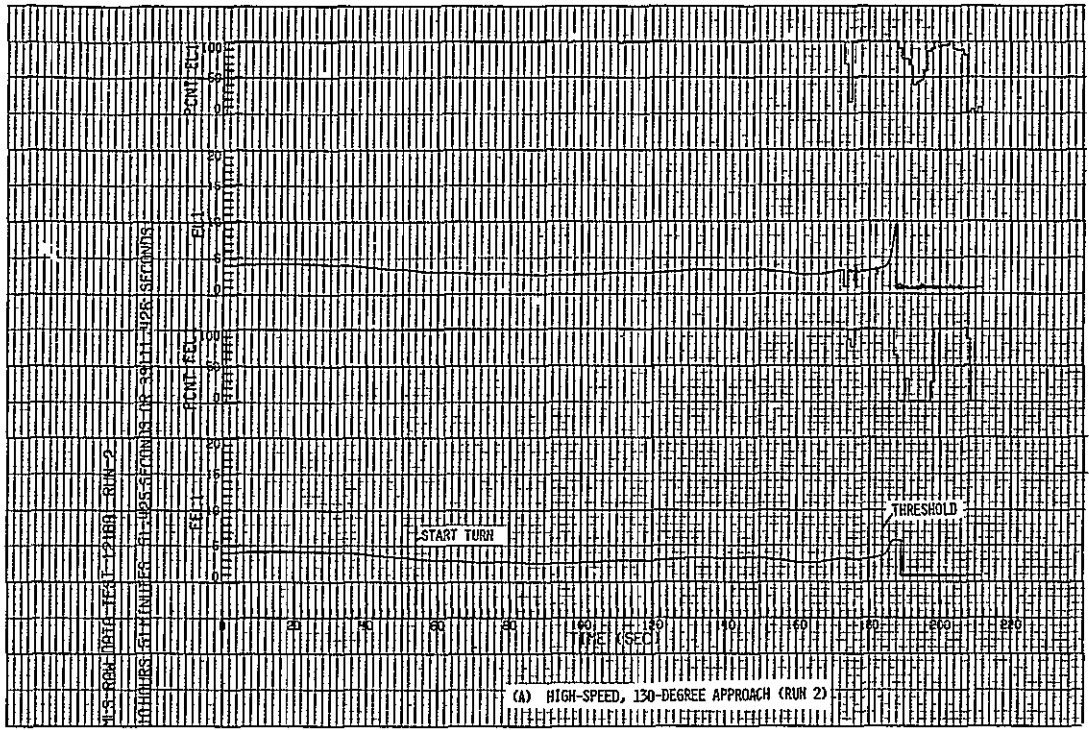

Figure 30. - Elevation (C-band) MLS data for high and low-speed 130° degree approaches to runway 04 at NAFEC using station 239 (M1) aircraft antenna.

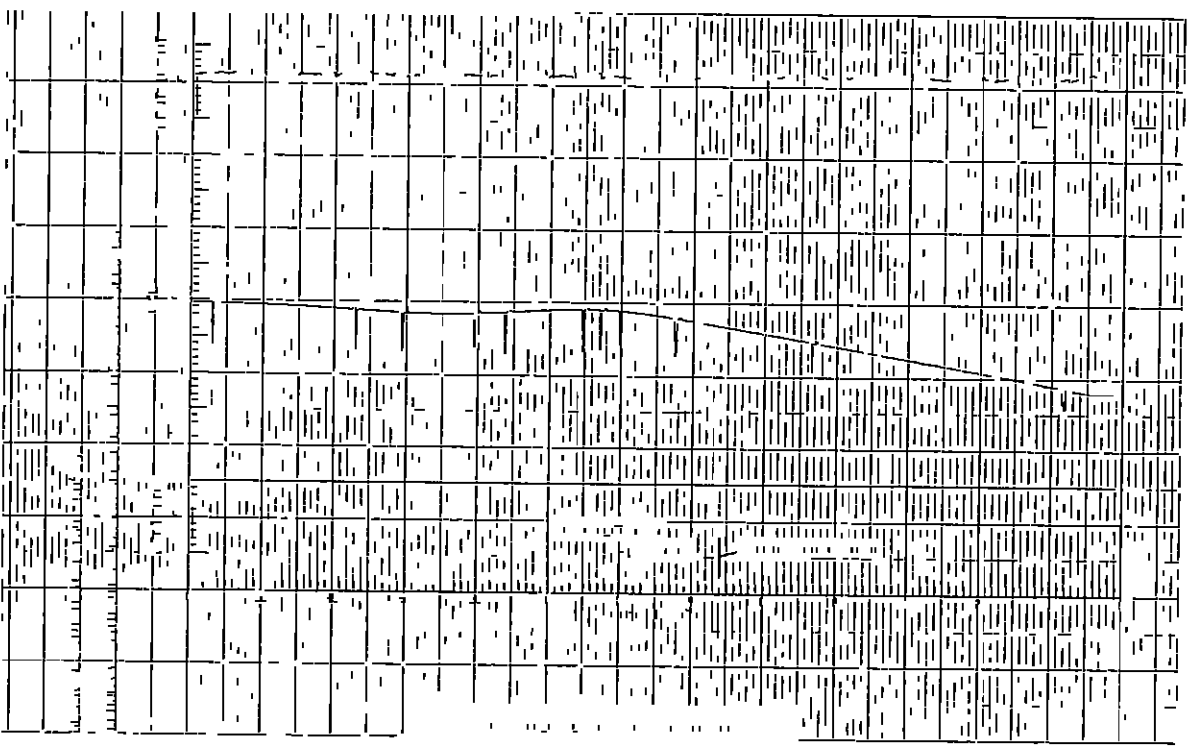
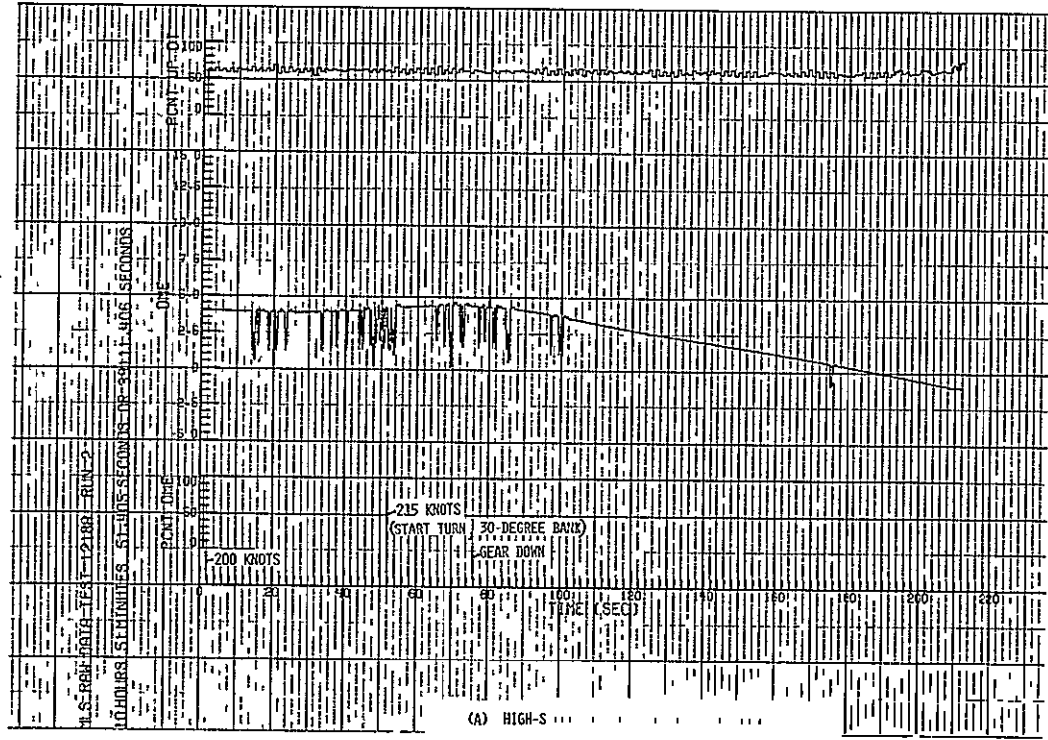

Figure 31. - DME data for high and low-speed 130° approaches to runway 04 at NAFEC using station 239 (M1) aircraft antenna.



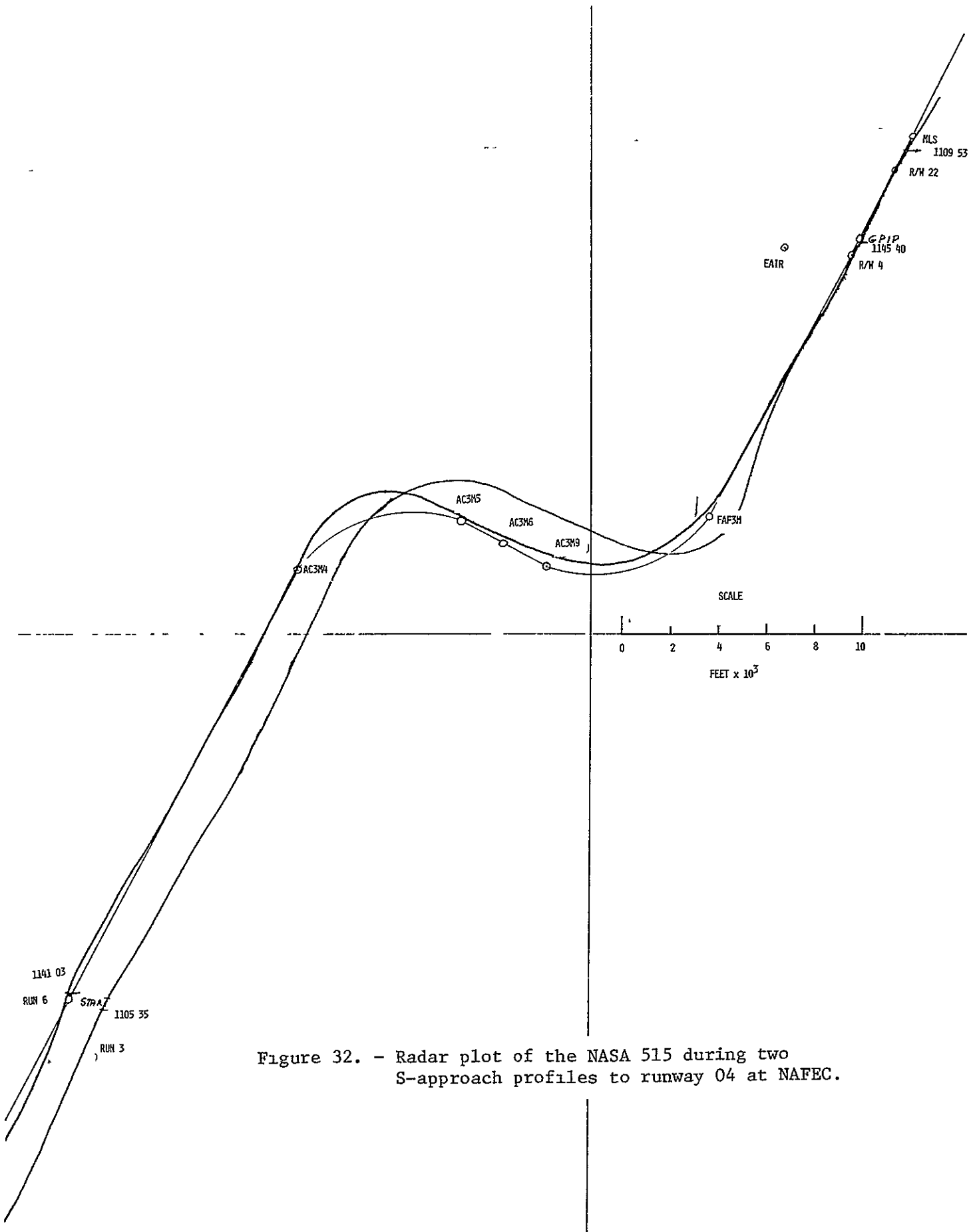
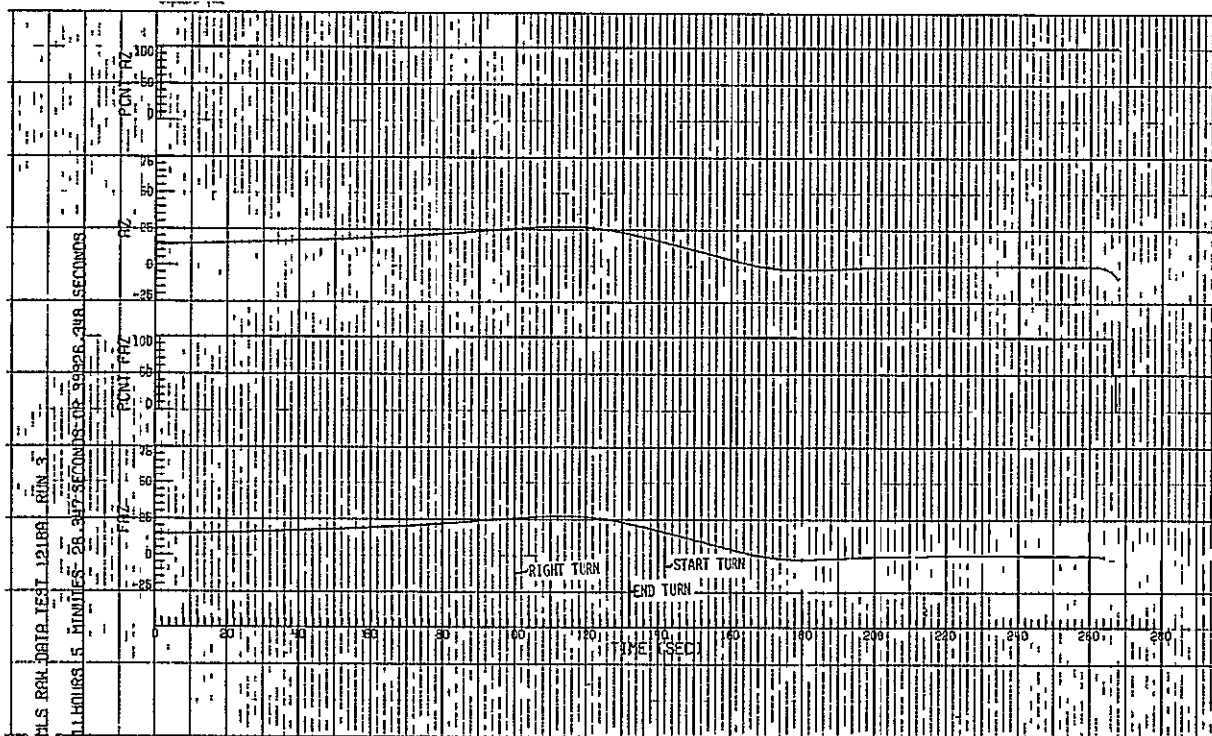
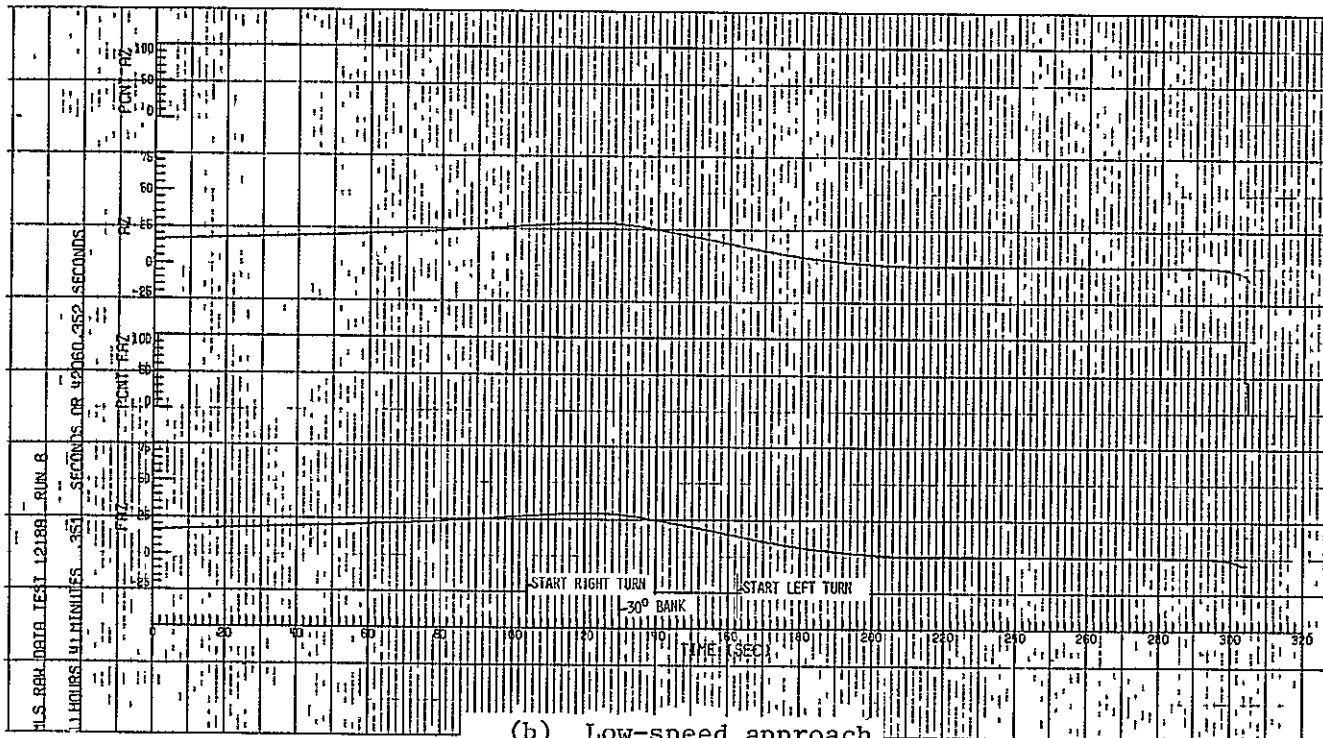

Figure 32. - Radar plot of the NASA 515 during two S-approach profiles to runway 04 at NAFEC.



(a) High-speed approach



(b) Low-speed approach

Figure 33. - Azimuth MLS data for high and low-speed S-turn approaches to runway 04 using station 239 (M1) aircraft antenna.

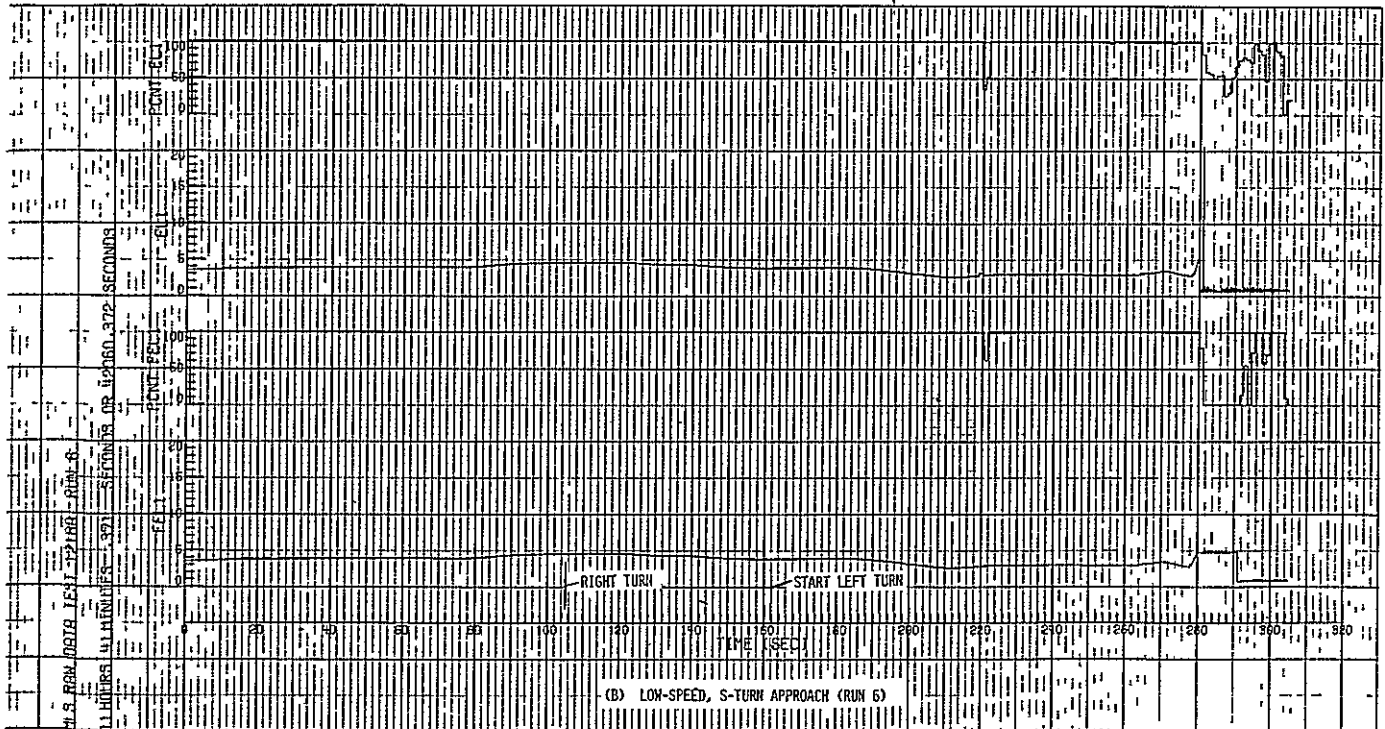
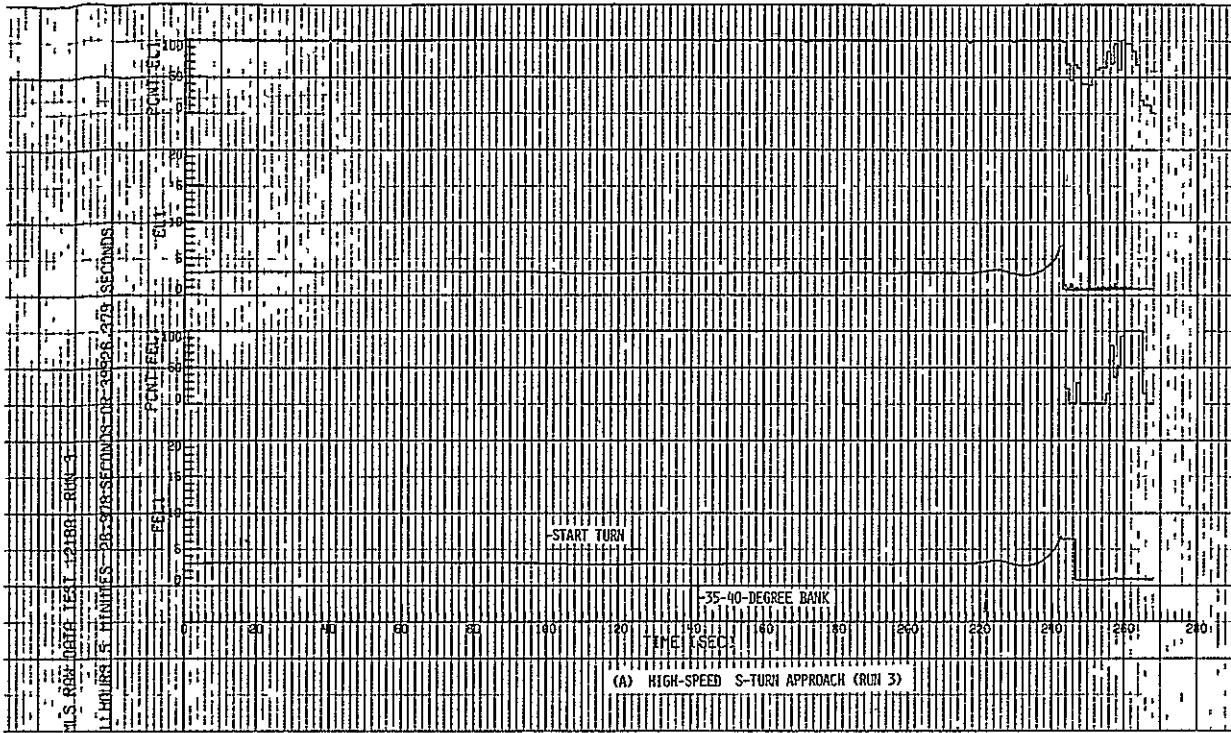

Figure 34. - Elevation (C-band) MLS data for high and low-speed S-turn approaches using (M1) antenna.



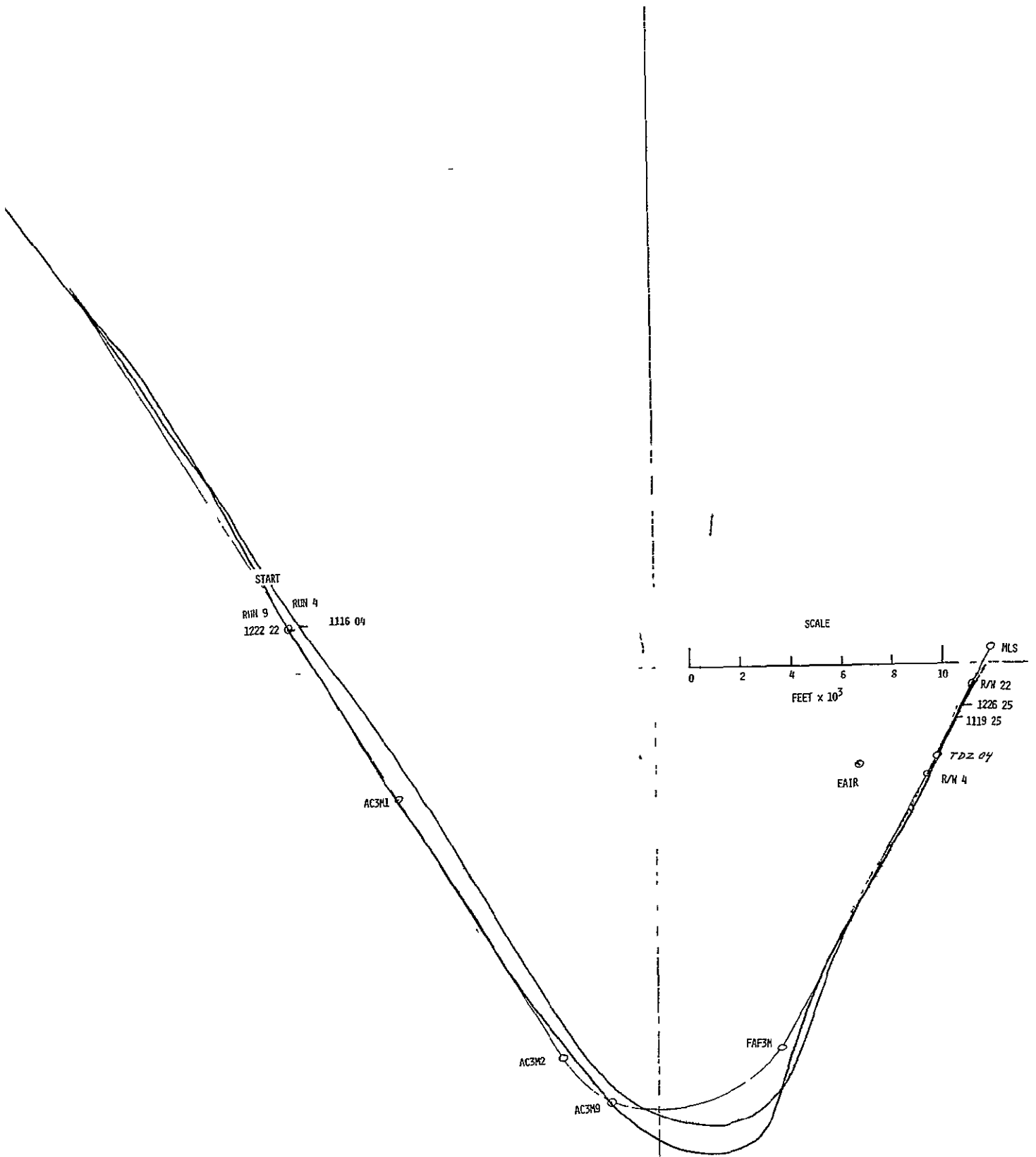

Figure 36. - Radar plot of the NASA 515 during two approaches using the 120° profile.

ORIGINAL PAGE IS  
OF POOR QUALITY

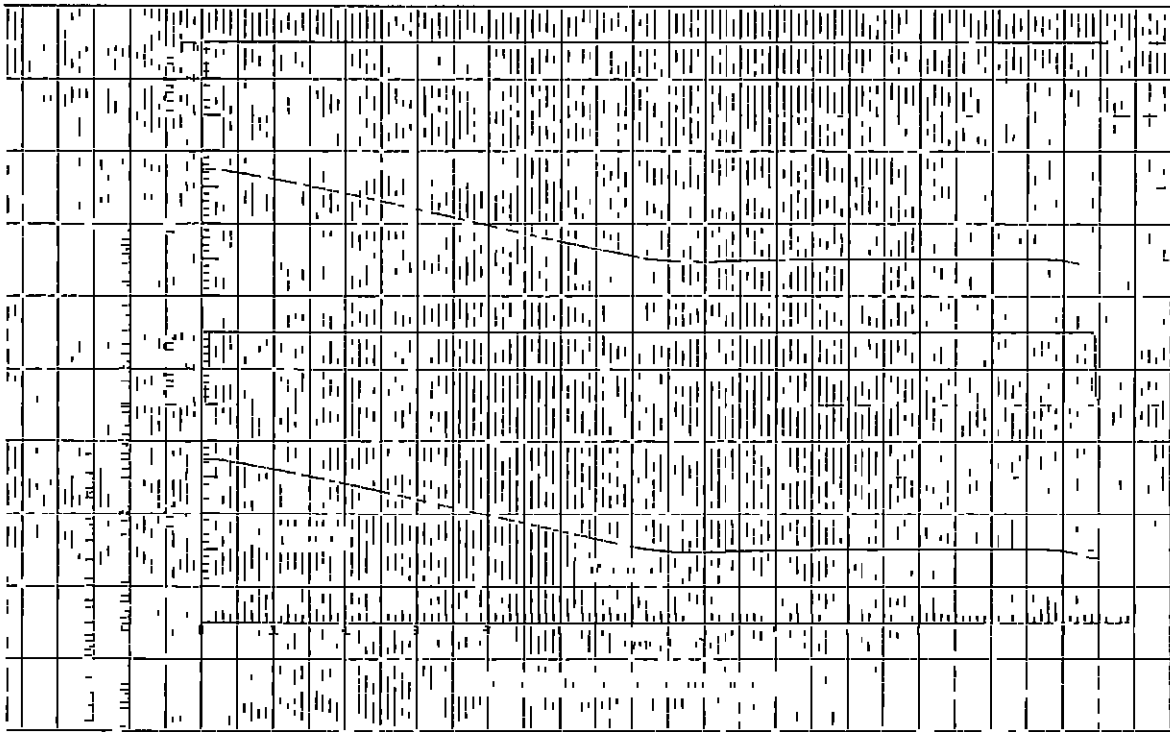
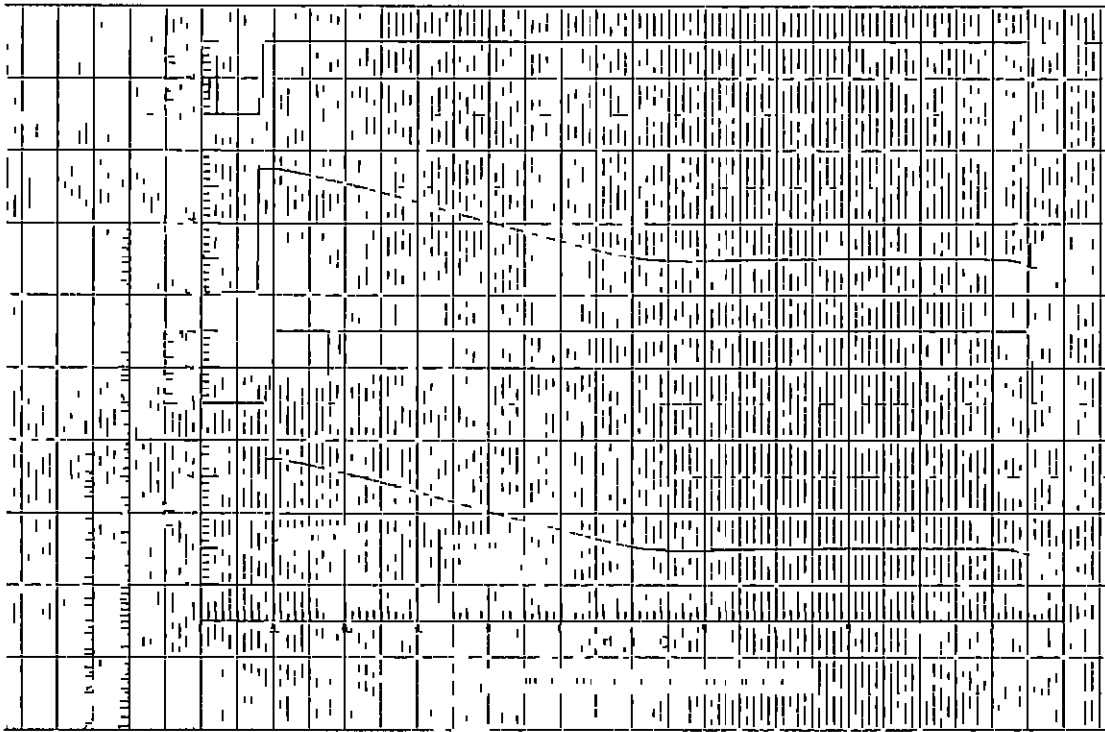

Figure 37. - Azimuth MLS data for high and low-speed 120° approaches using the M1 antenna.

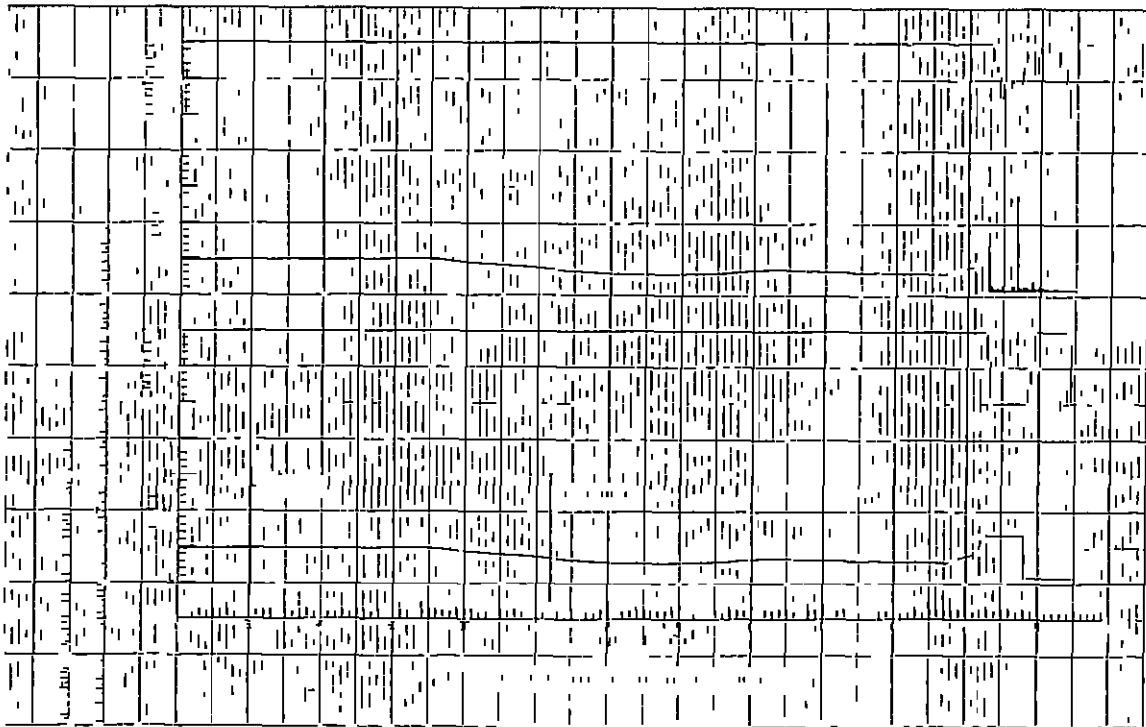
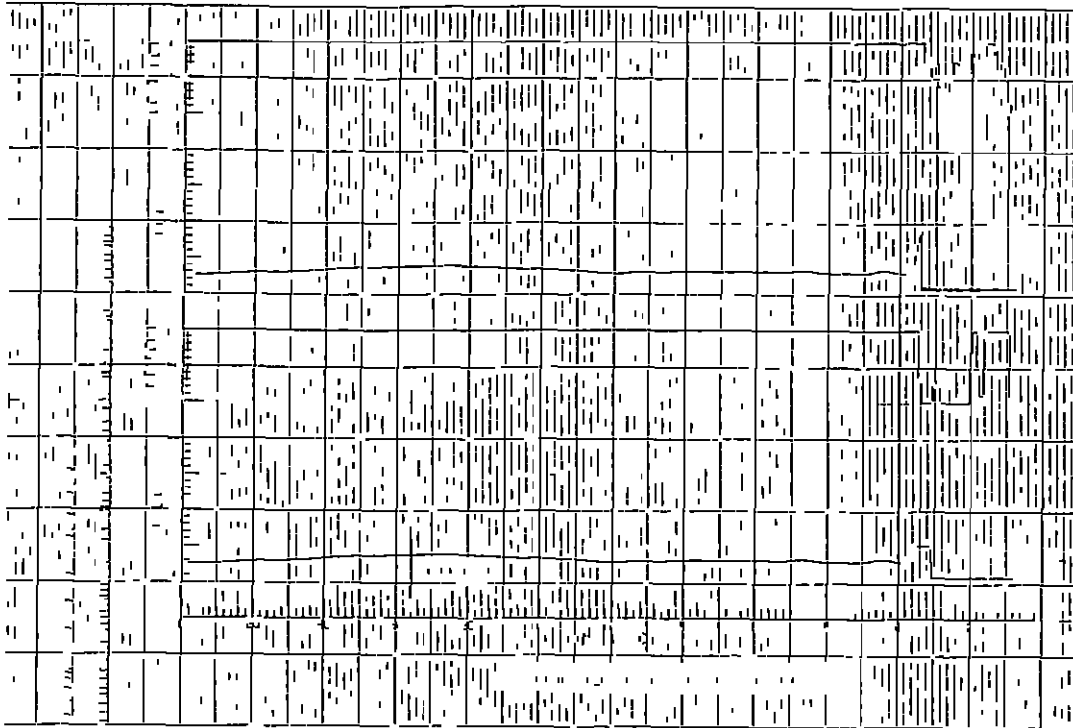

Figure 38. - Elevation (C-band) MLS data for high and low-speed approaches using the M1 antenna.

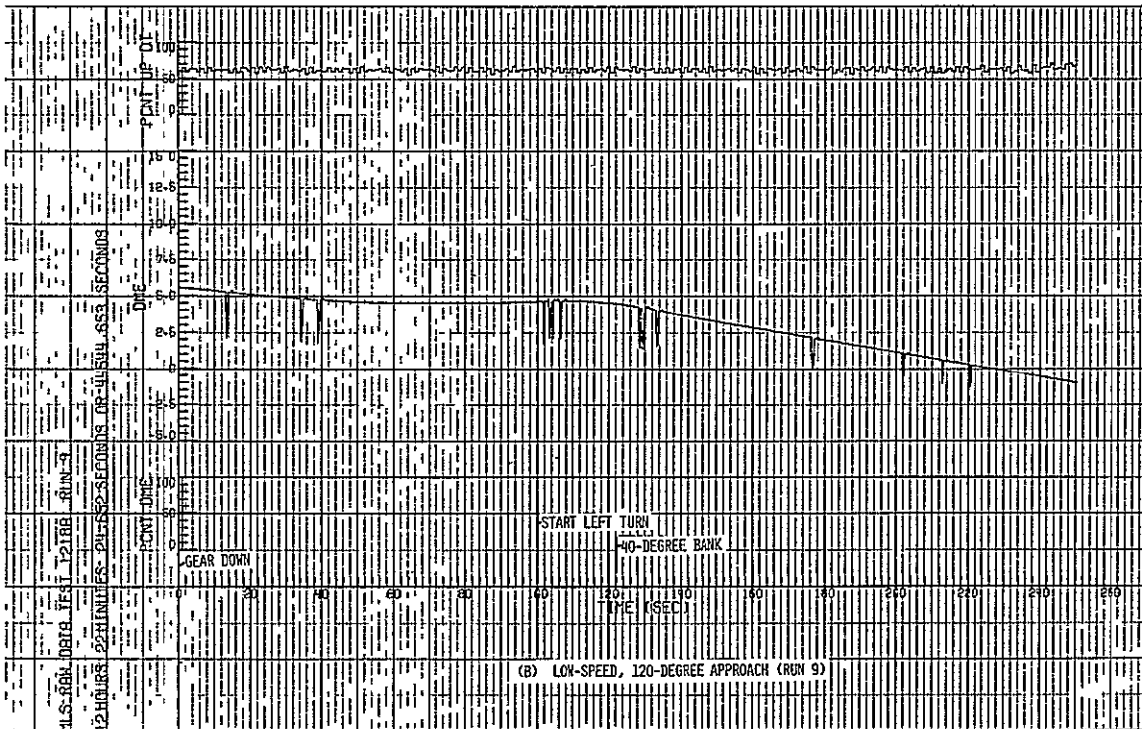
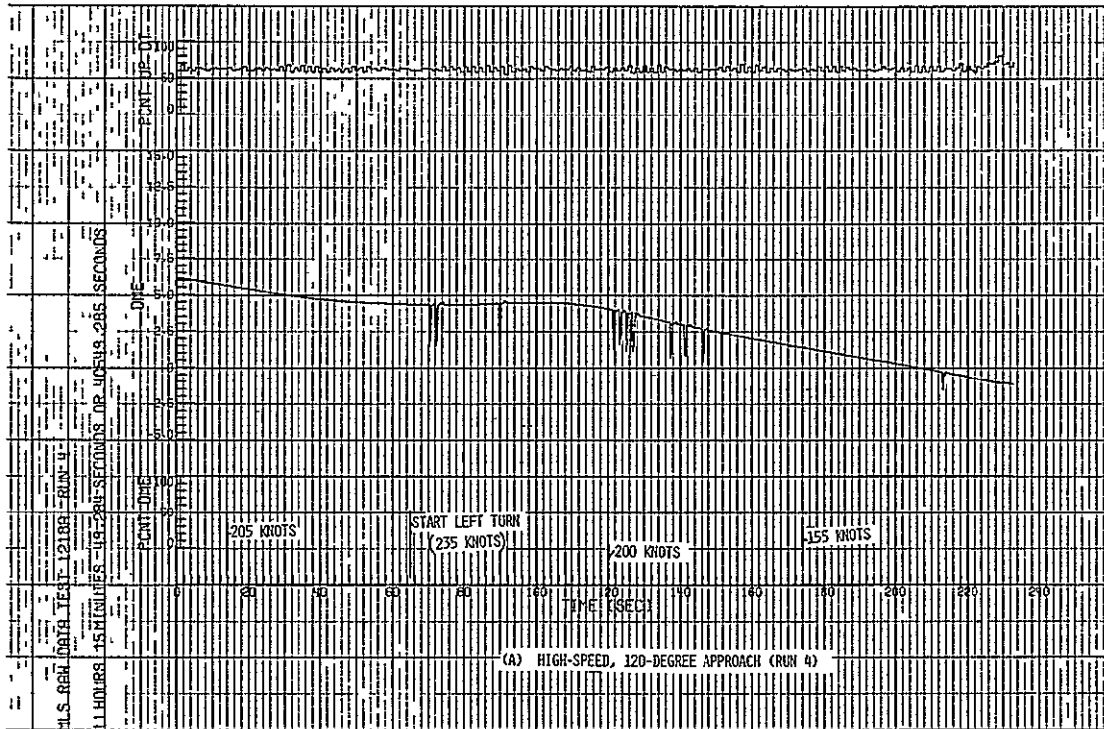

Figure 39. - DME data for high and low-speed 120° approaches using the M1 antenna.



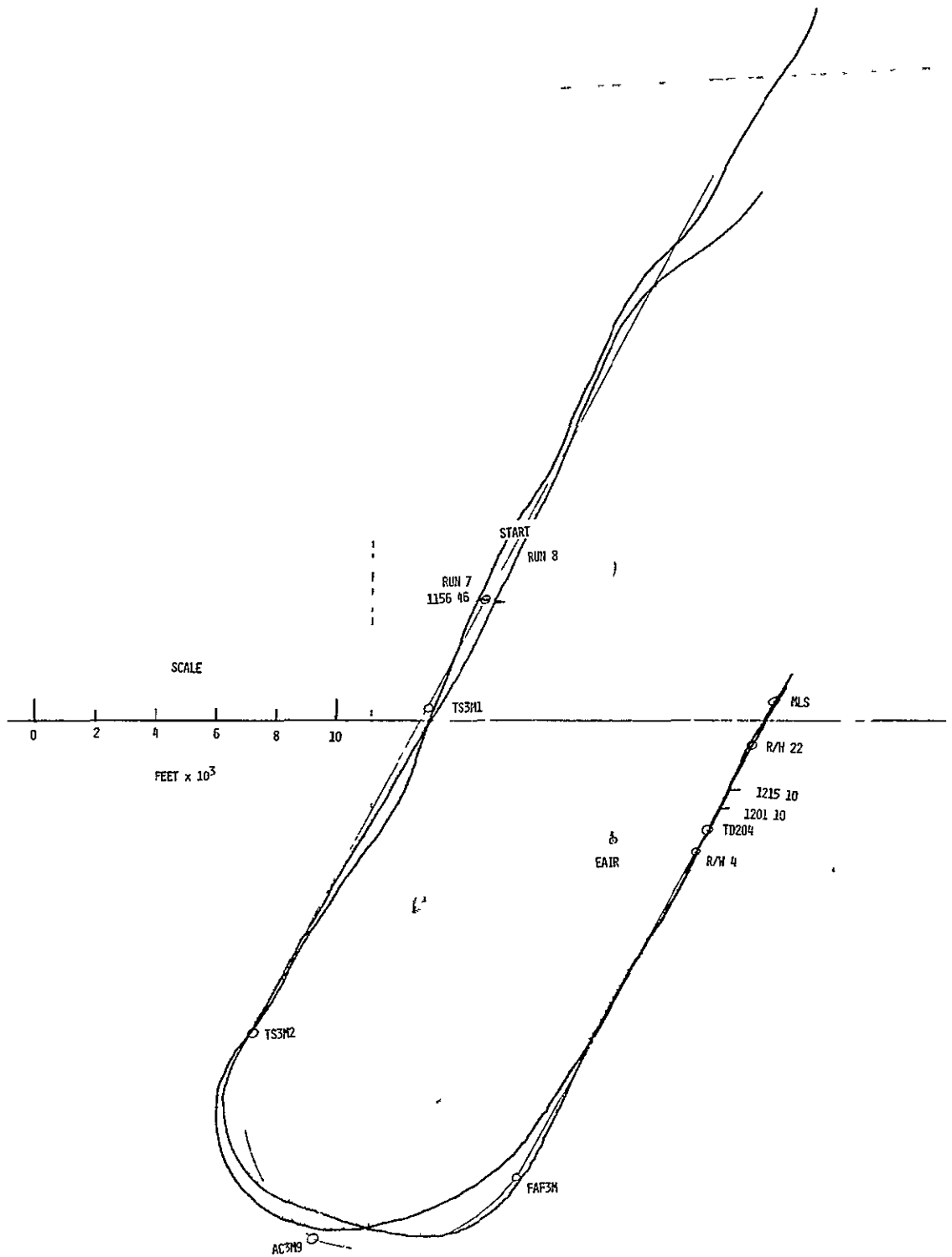

Figure 40. - Radar plot of NASA 515 during two approaches using 180° profile to runway 04 at NAFEC.

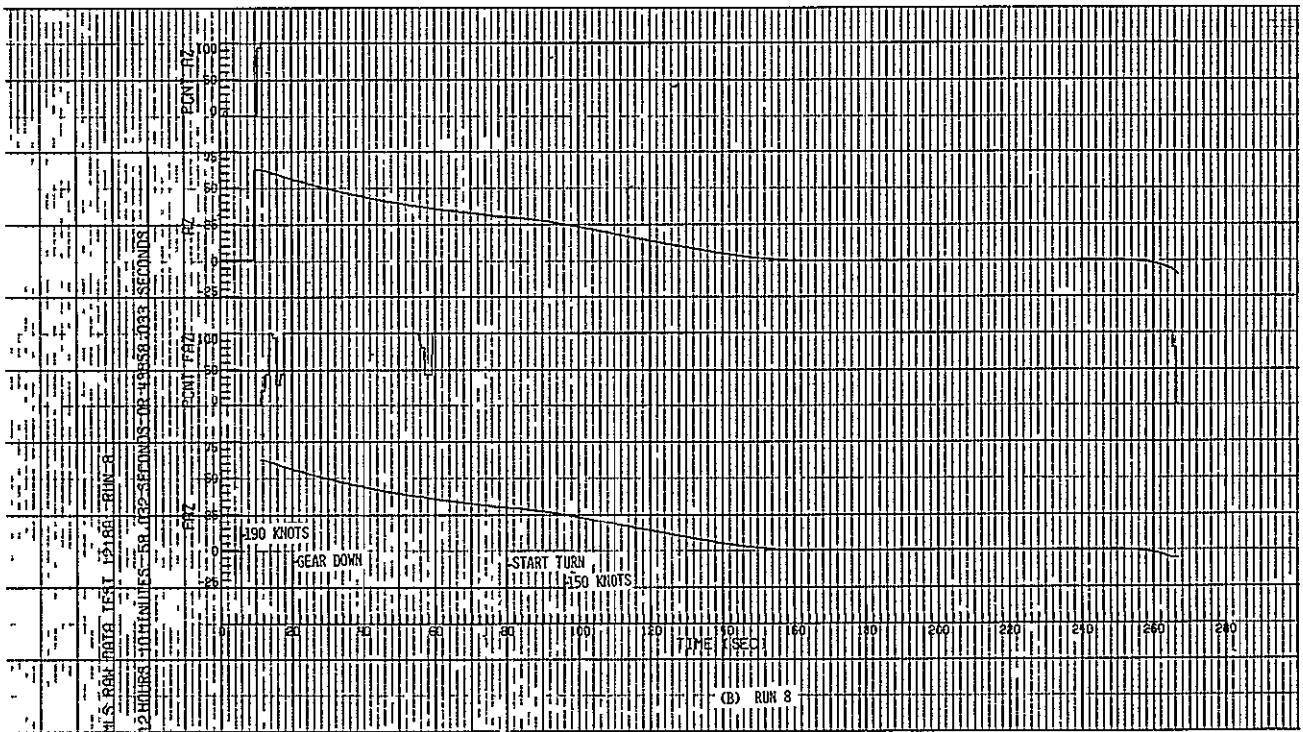
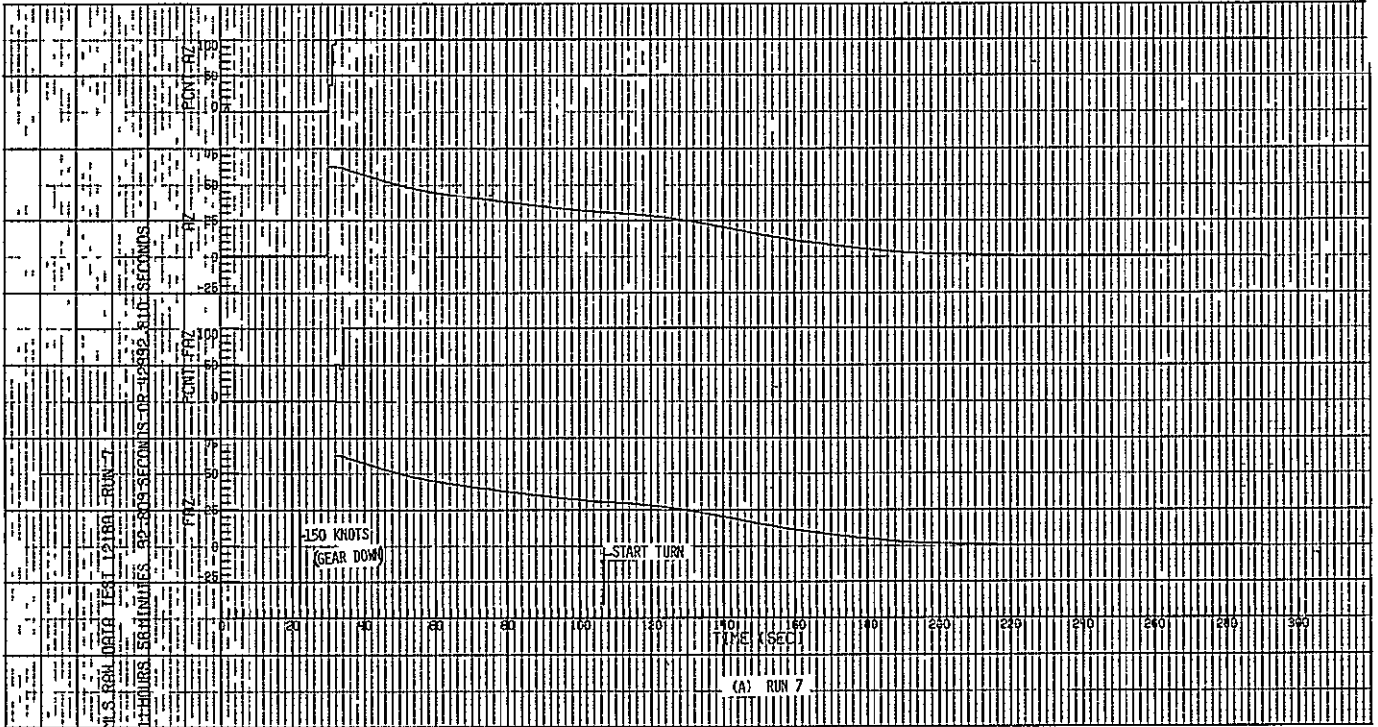

Figure 41. - Azimuth MLS data for two similar 180° approaches to runway 04 at NAFEC using the M1 antenna.

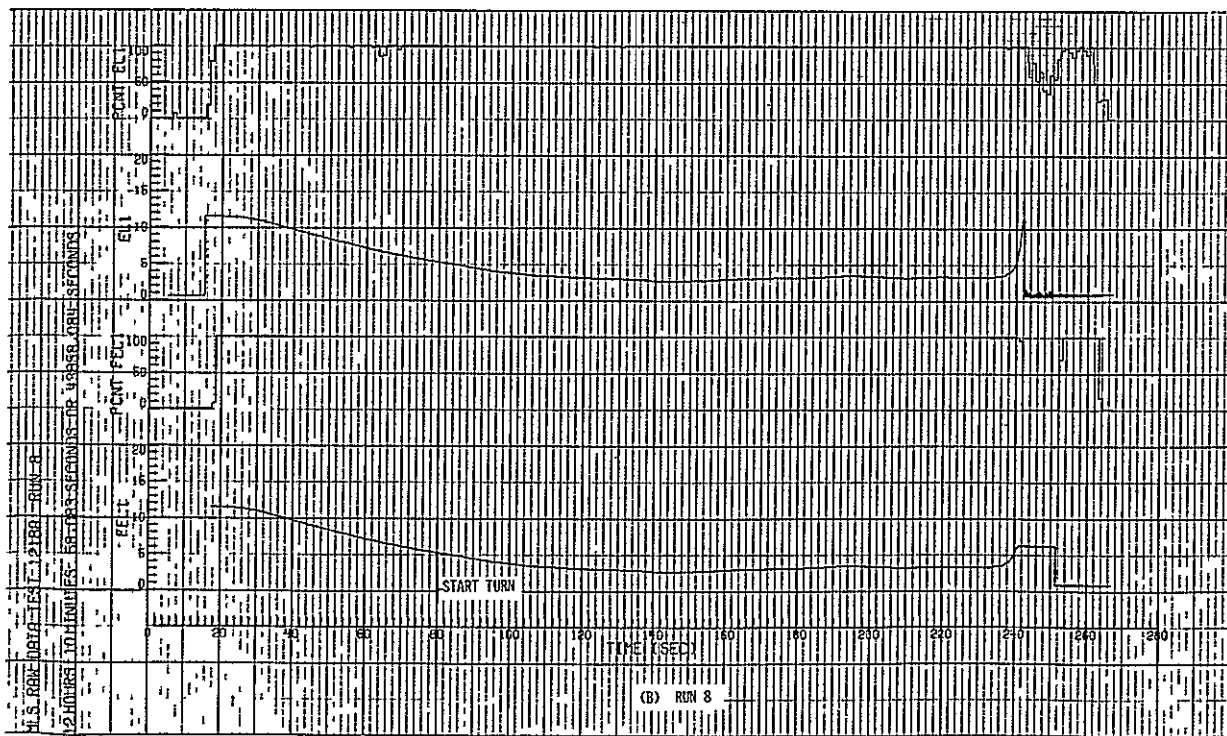
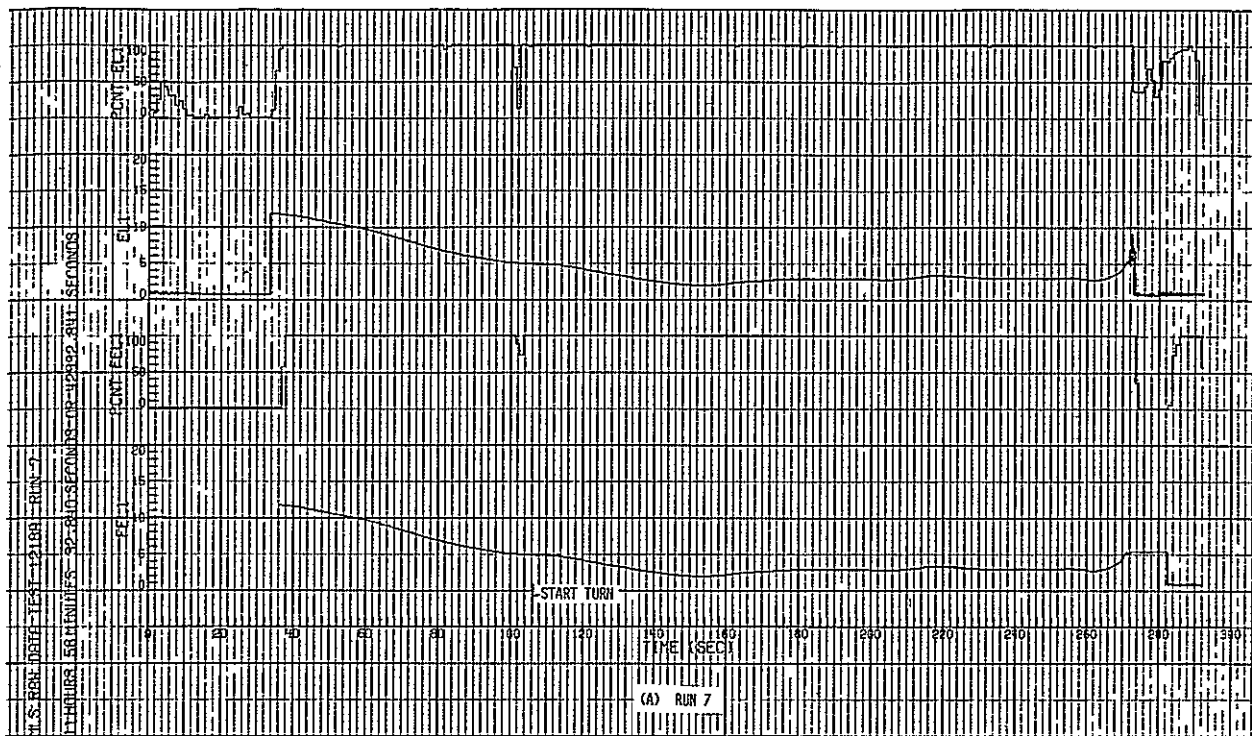

Figure 42. - Elevation (C-band) MLS data for two similar 180° approaches to runway 04 at NAFEC using the M1 antenna.

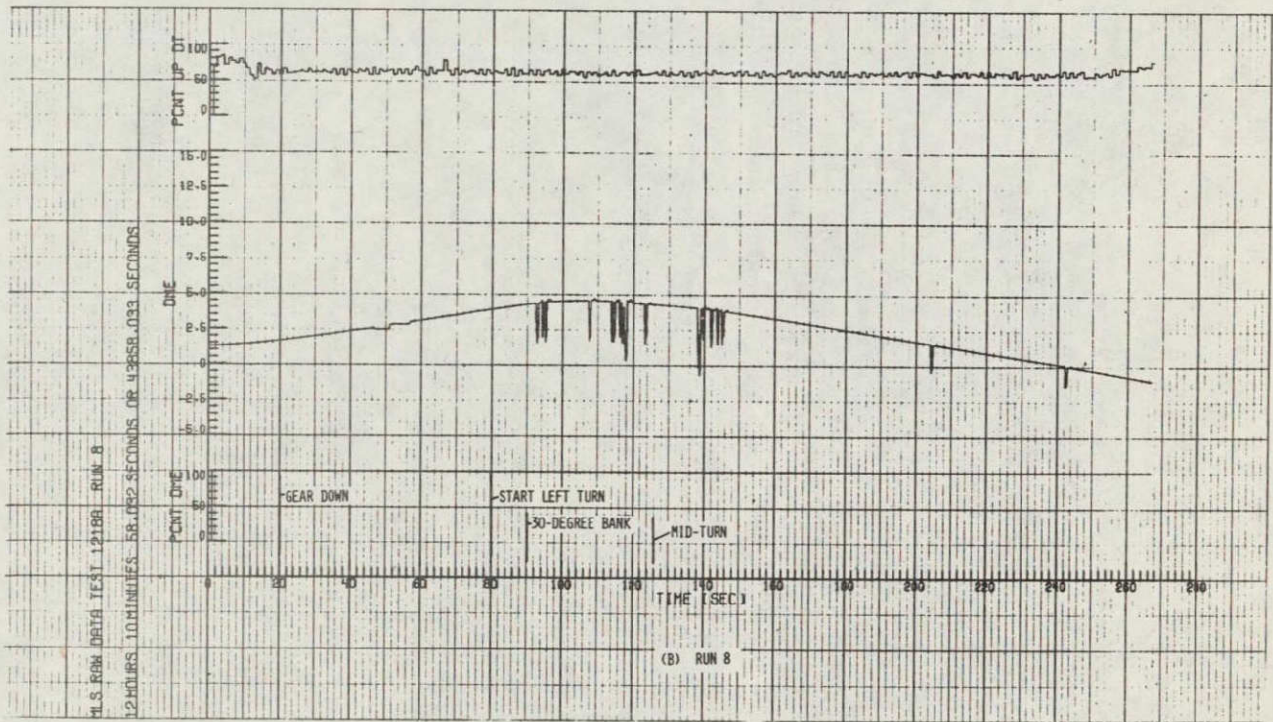
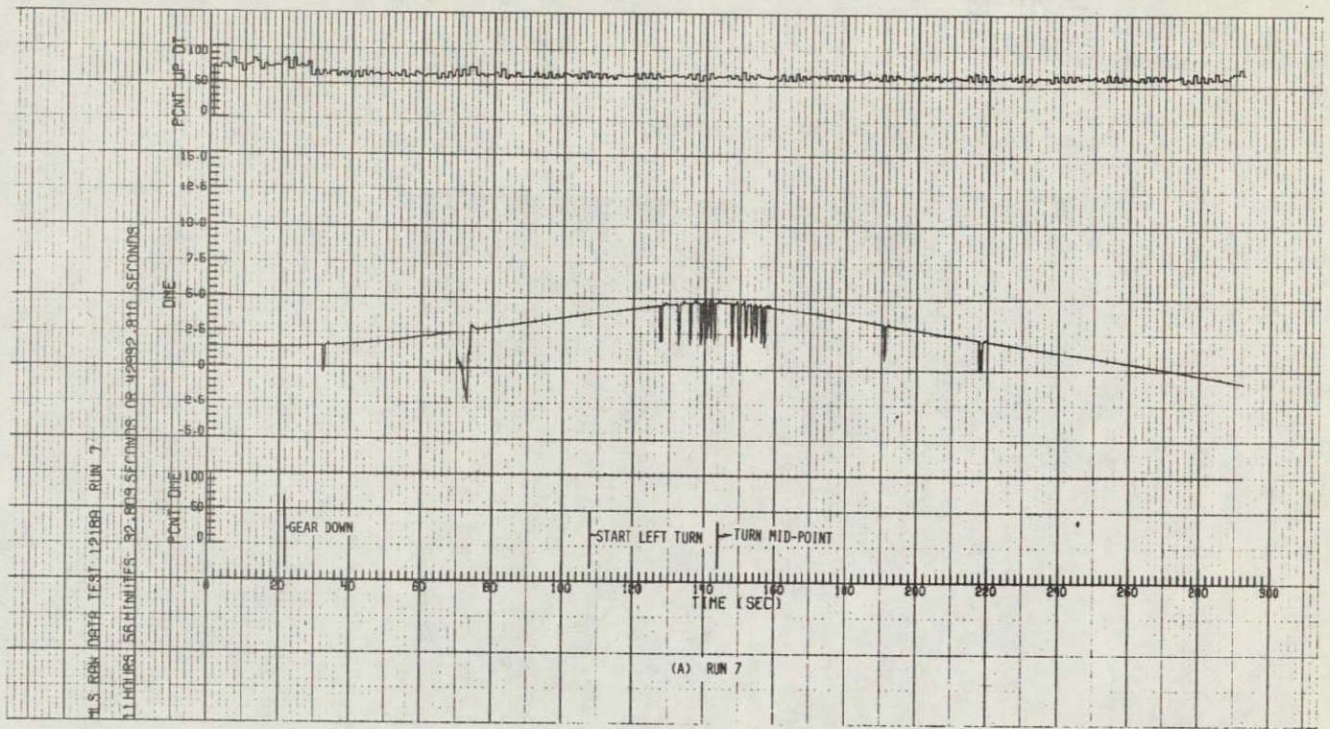
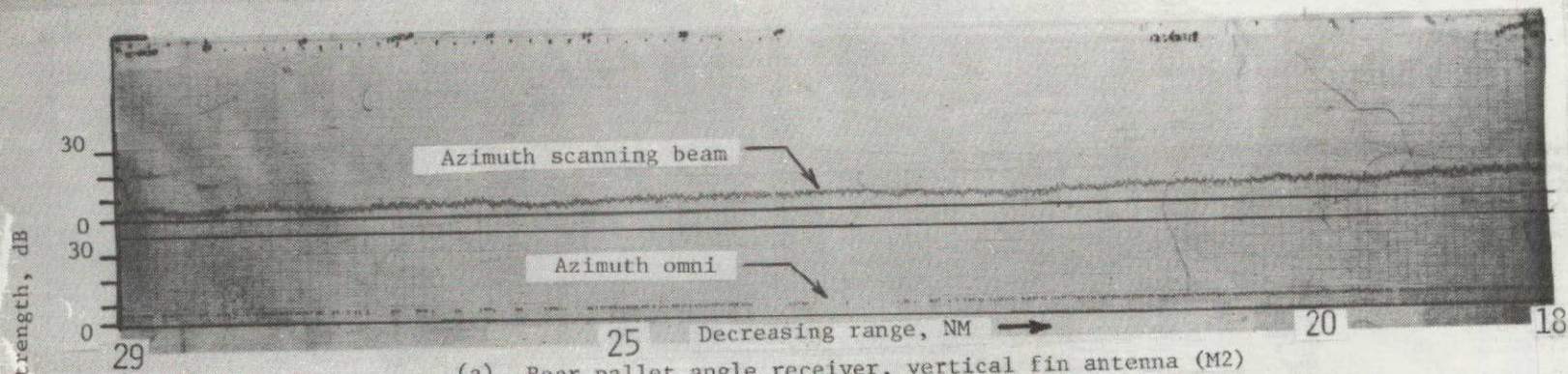
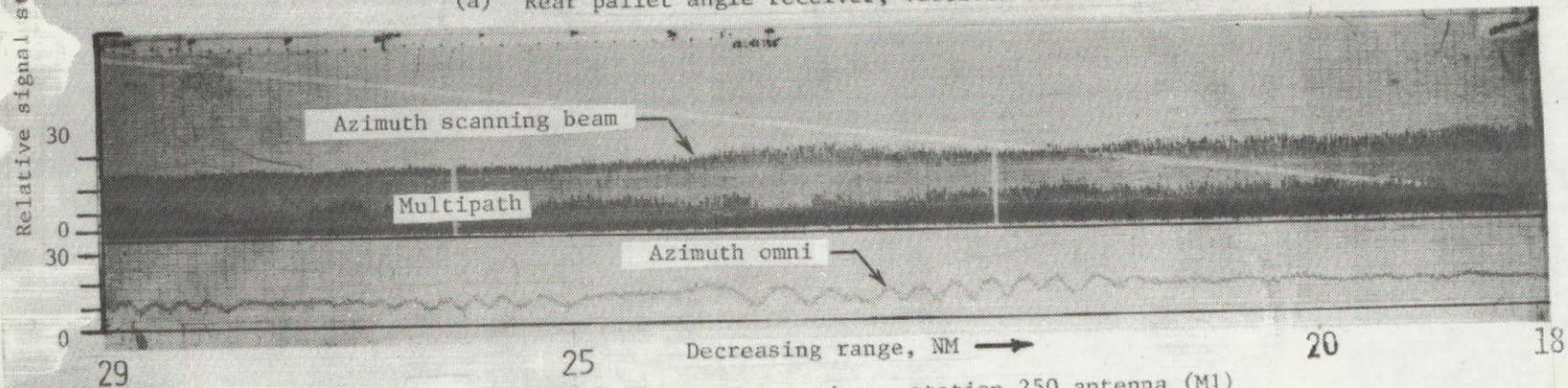

Figure 43. - DME data for two similar 180° approaches to runway 04 at NAFEC using the M1 antenna.



(a) Rear pallet angle receiver, vertical fin antenna (M2)



(b) Forward pallet angle receiver, station 250 antenna (M1)

Figure 44. - MLS signal strengths measured using the vertical fin (M2) antenna and the station 250 (M1) antenna during the straight-in approach.

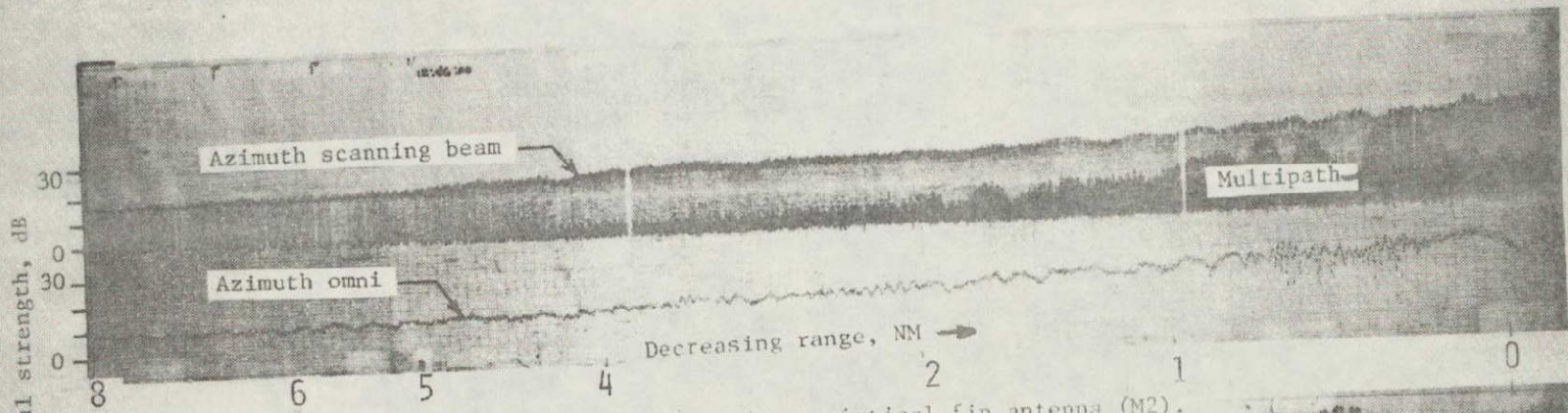

(e) Rear pallet angle receiver, vertical fin antenna (M2).

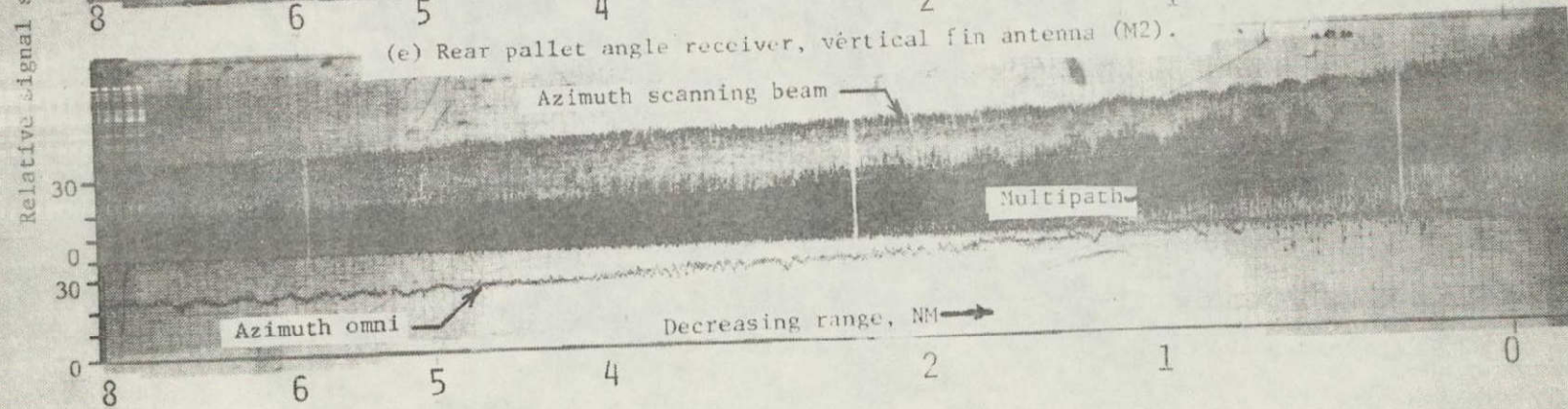

(f) Forward pallet angle receiver, station 250 (M1).

Figure 44 (concluded).

ORIGINAL PAGE IS  
OF POOR QUALITY

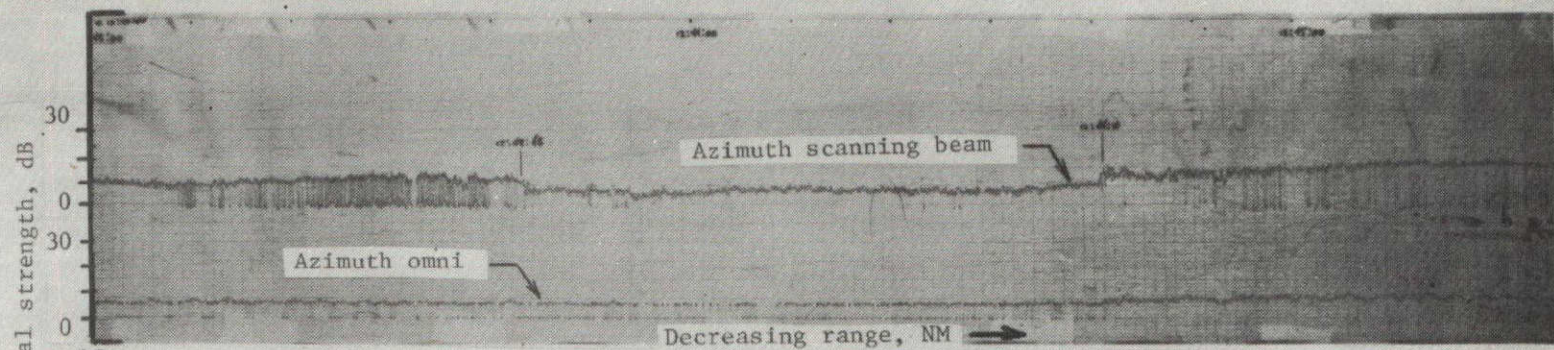

(c) Rear pallet angle receiver, vertical fin antenna (M2).

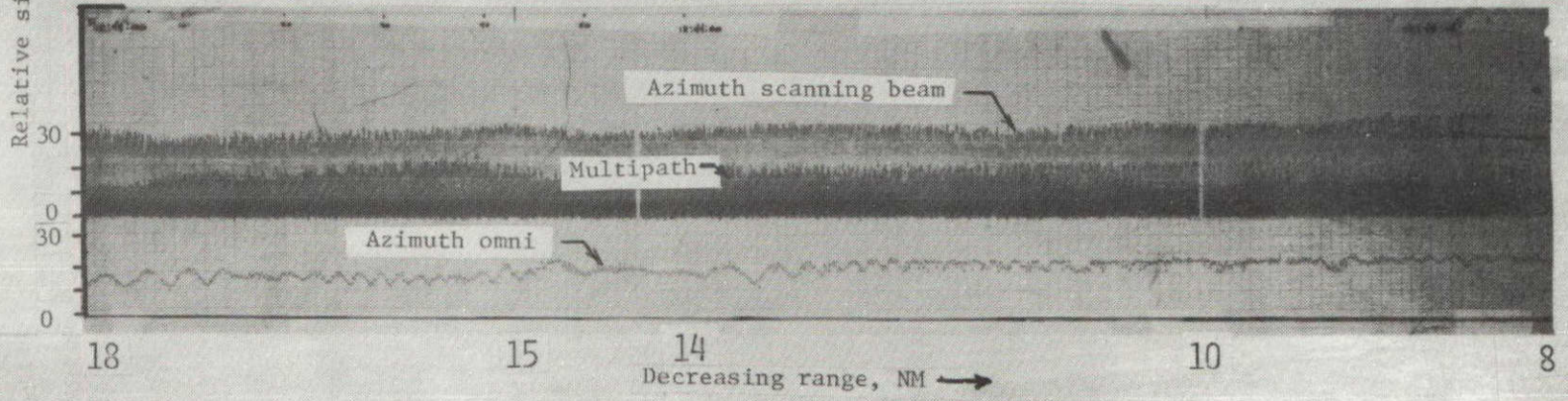

(d) Forward pallet angle receiver, station 250 antenna (M1).

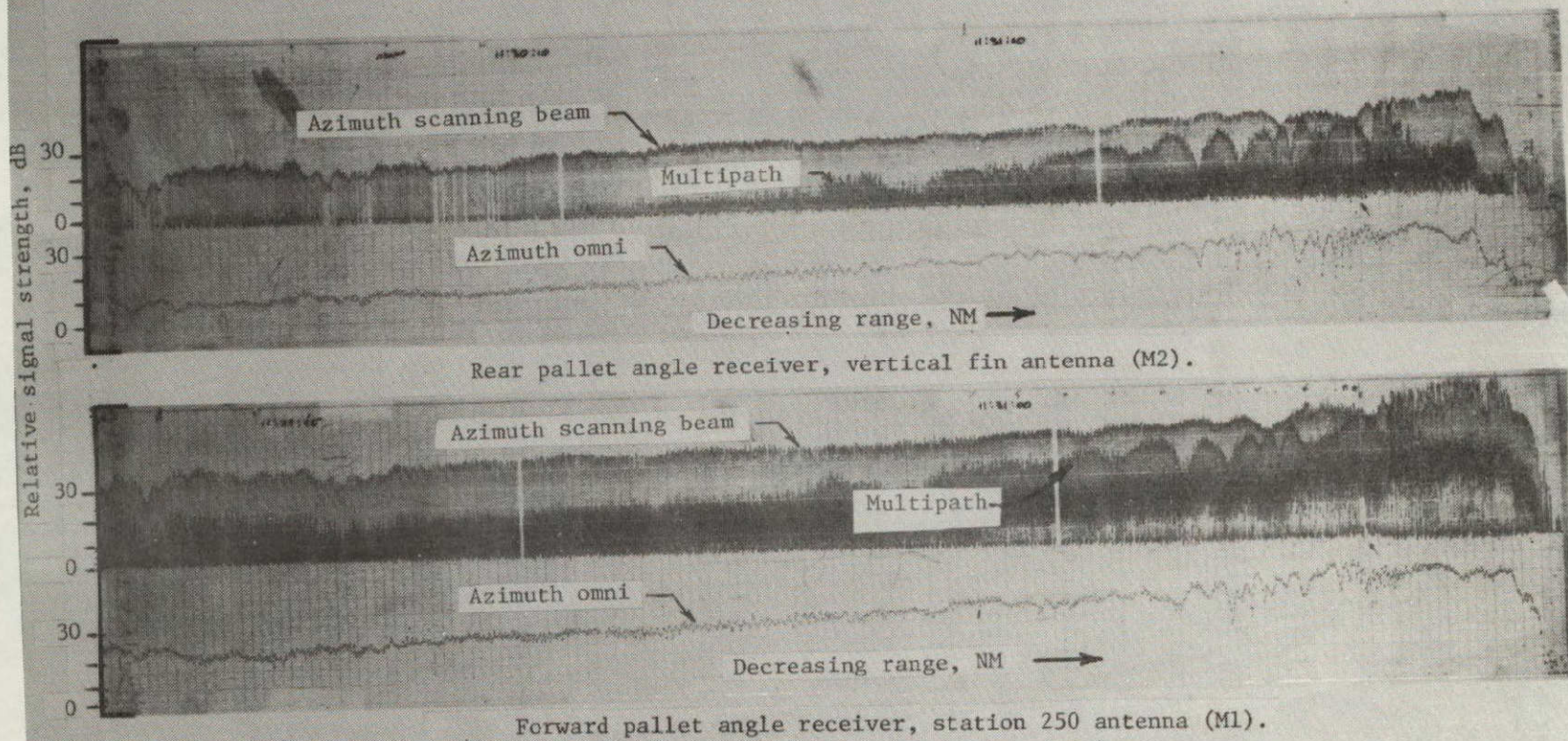

(b) Low-speed approach.

Figure 45 (concluded).



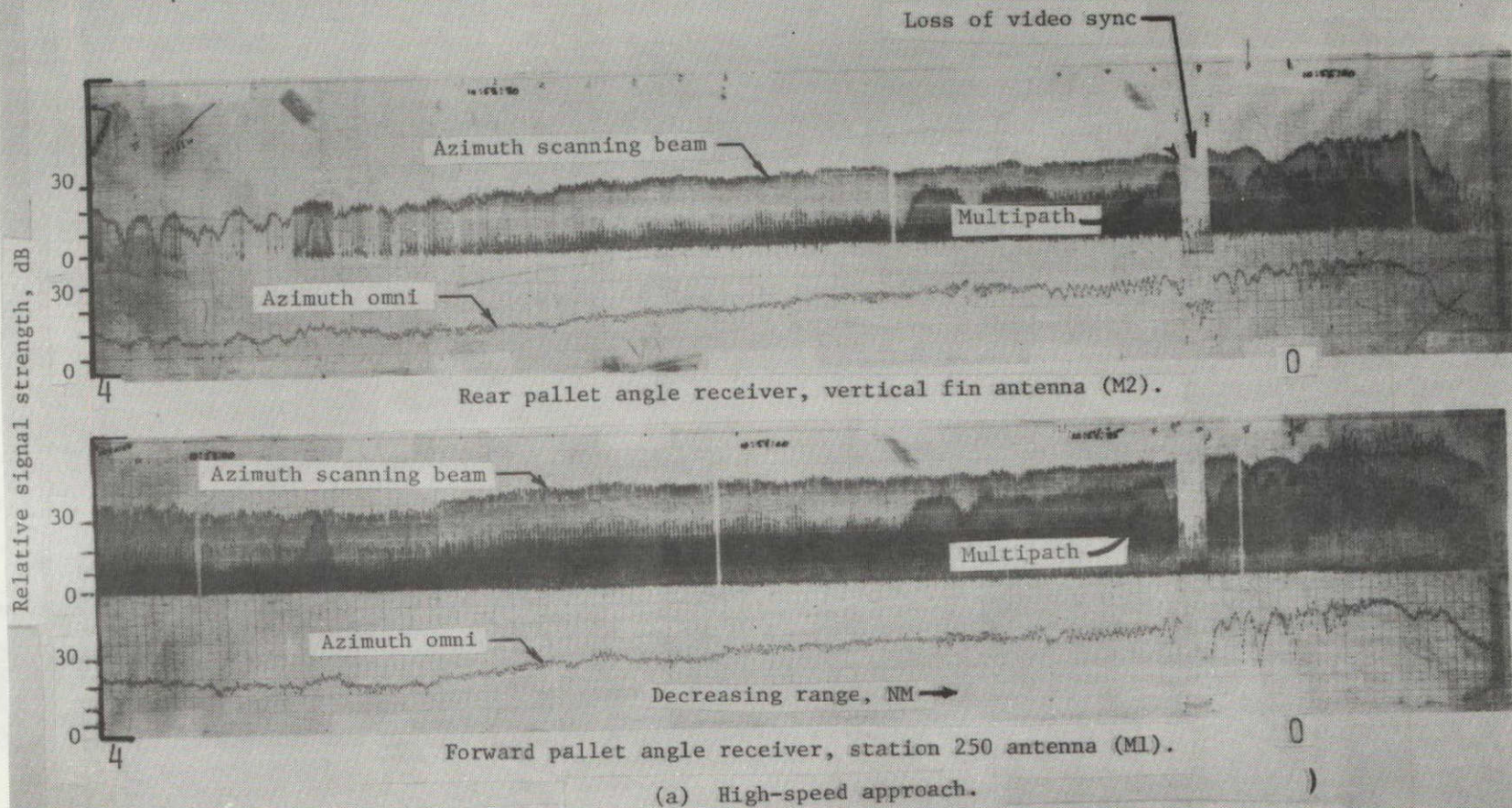
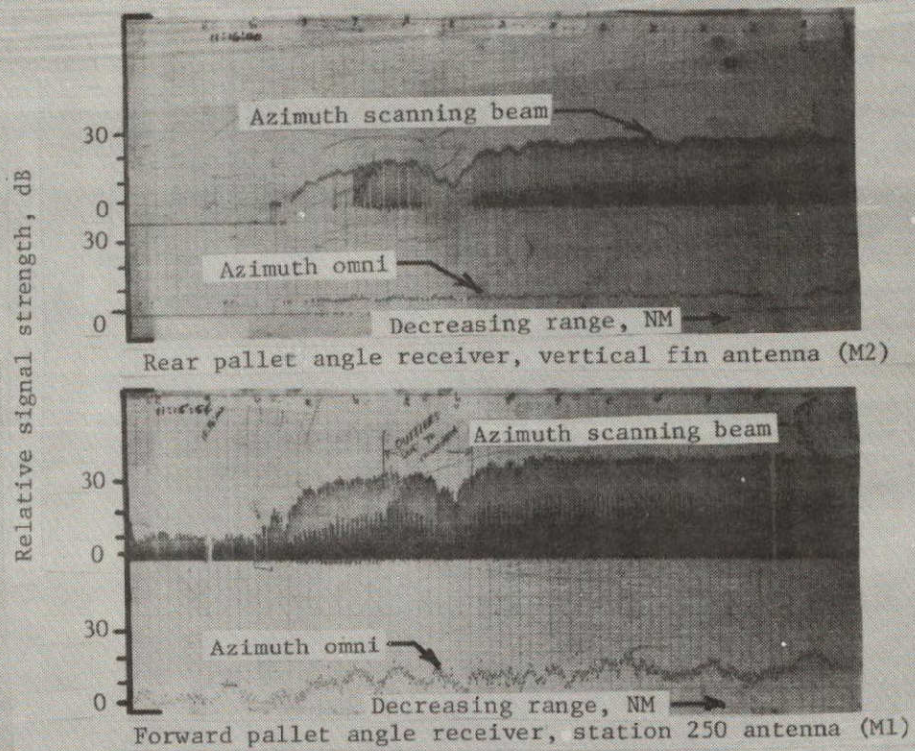

Figure 45. - MLS signal strengths measured using the station 250 (M1) antenna and the vertical fin (M2) antenna during two 130-degree approaches.



(a) High-speed approach.

Figure 46. - MLS signal strengths measured using the station 250 (ML) antenna and the vertical fin (M2) antenna during two 120-degree approaches.

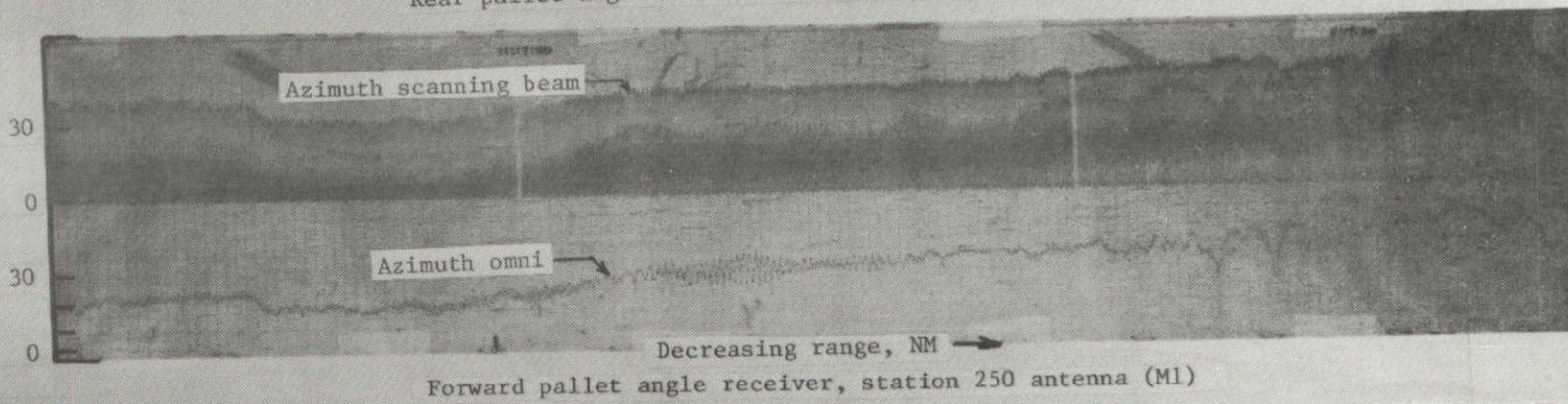
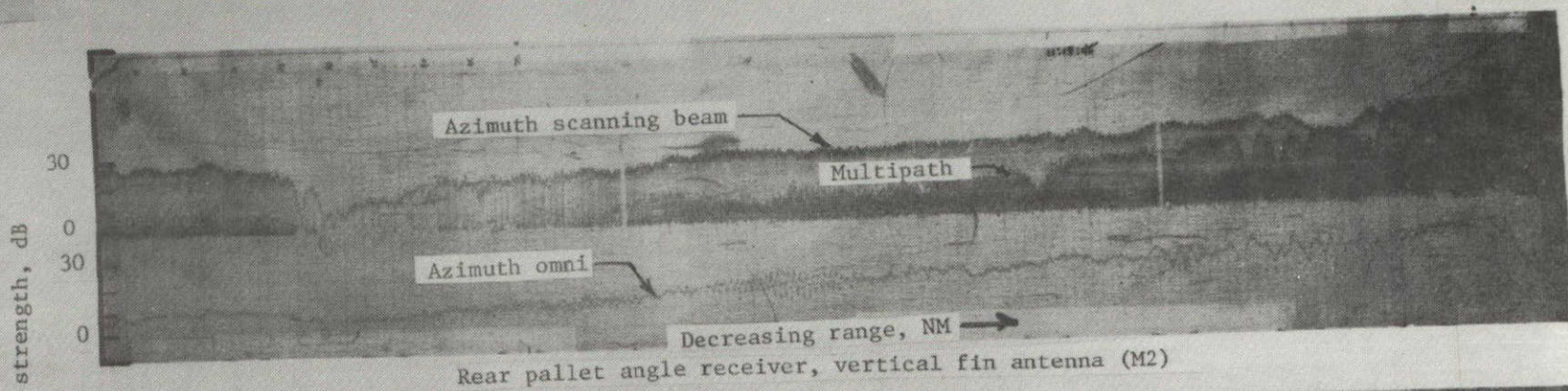
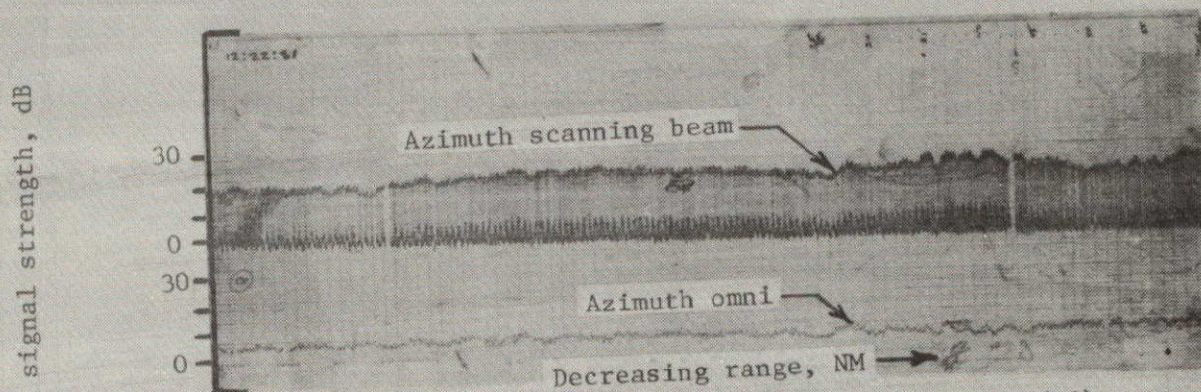
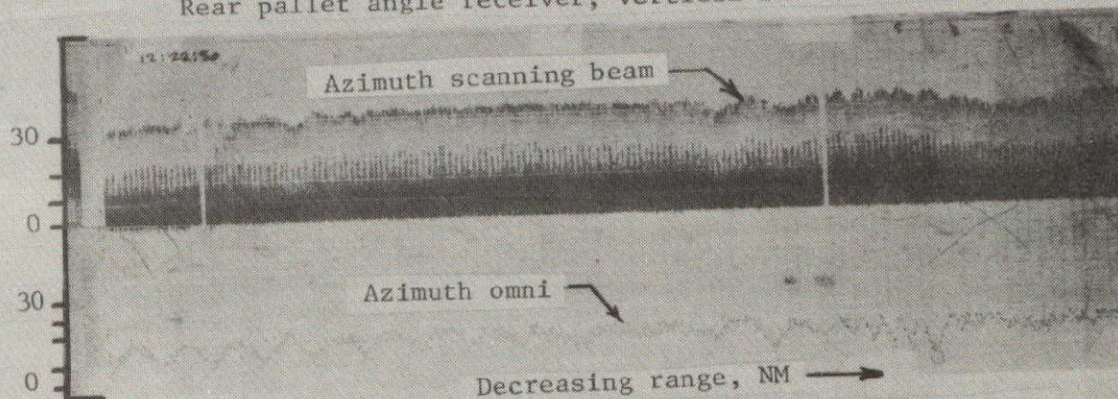

Figure 46(a) High-speed concluded.

ORIGINAL PAGE IS  
OF POOR QUALITY



Rear pallet angle receiver, vertical fin antenna (M2)



Forward pallet angle receiver, station 250 antenna (M1)

Figure 46(b). - Low-speed approach.

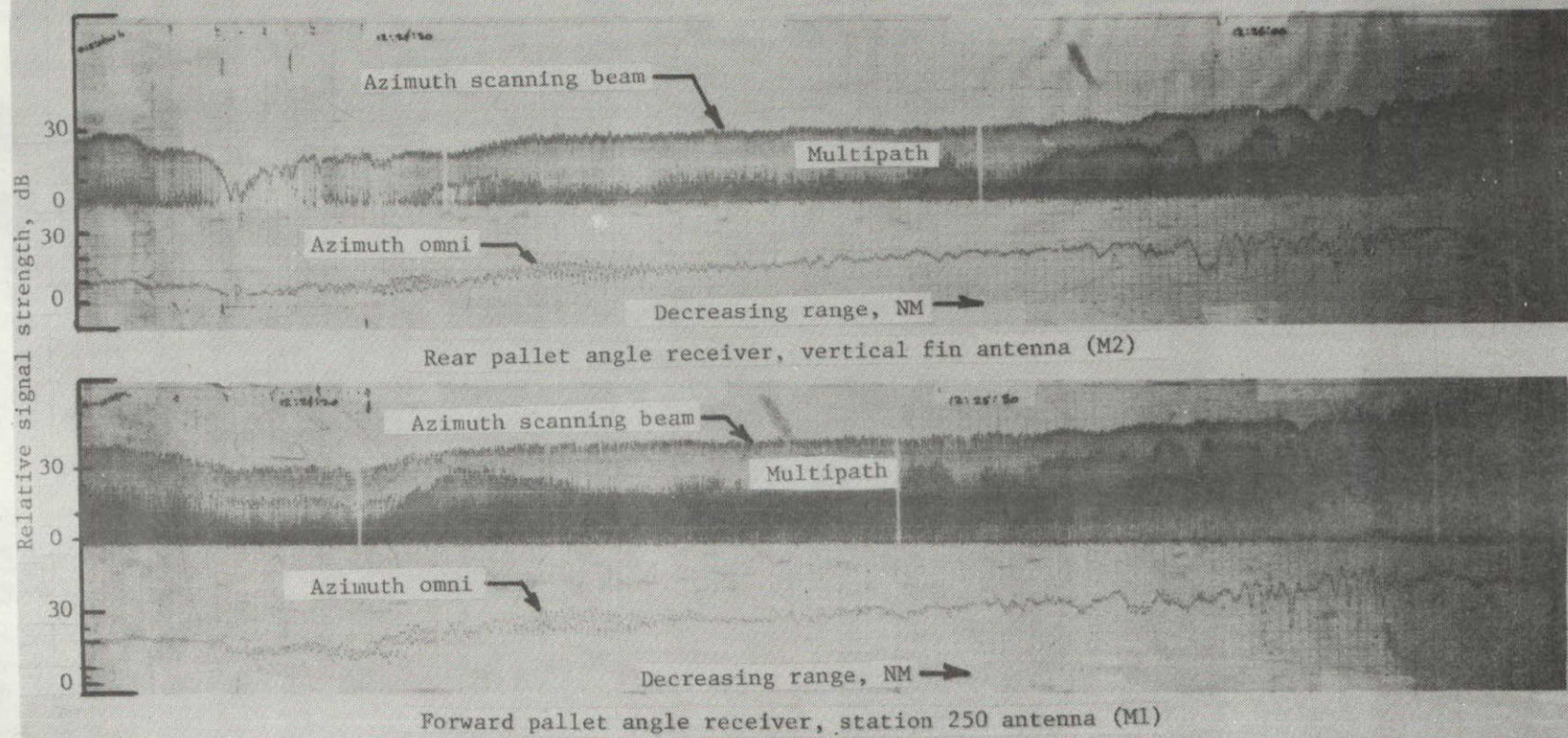

Figure 46(b). - Low-speed approach - concluded

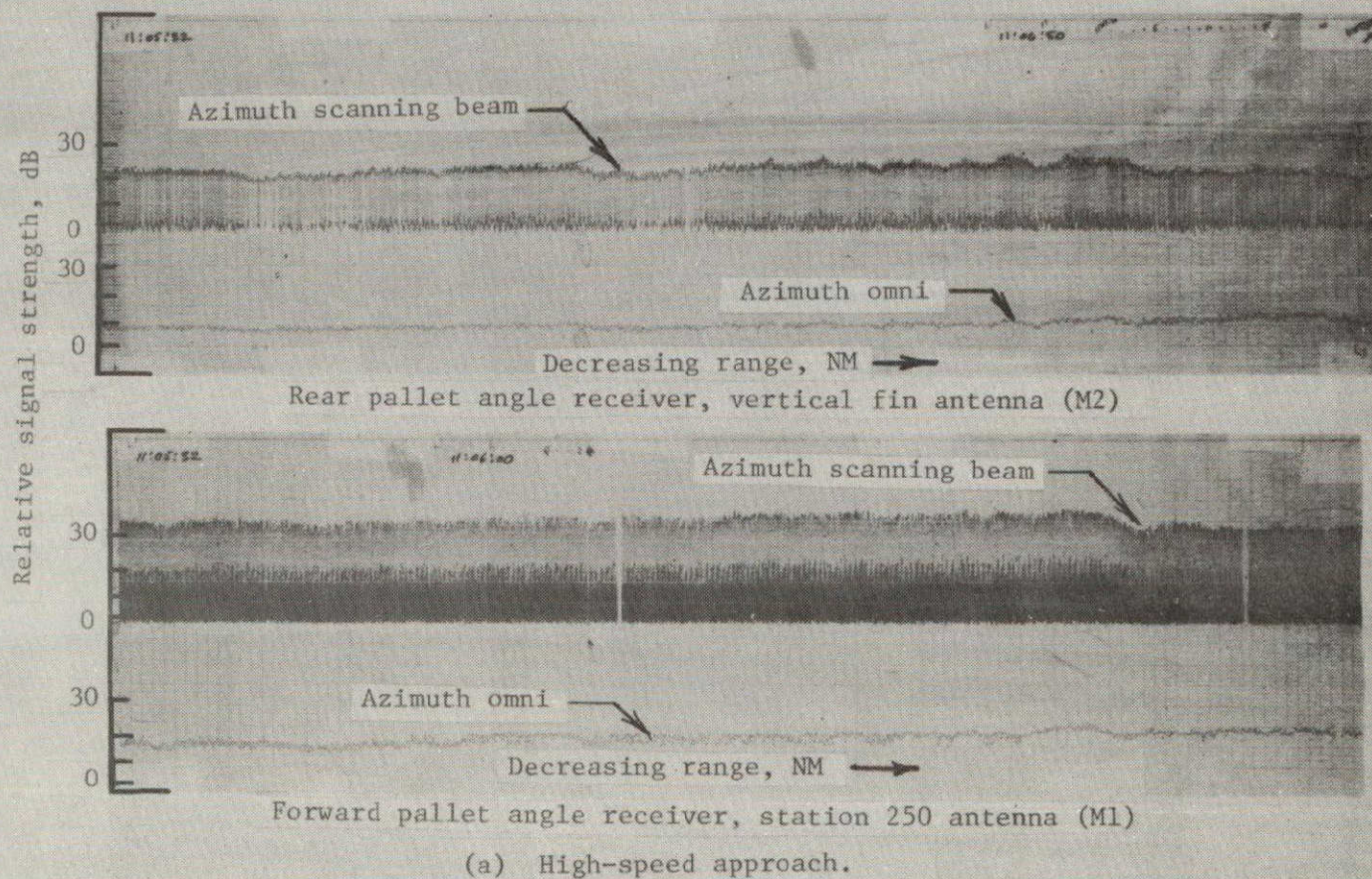

Figure 47. - MLS signal strengths measured using the station 250 (ML) antenna and the vertical fin (M2) antenna during two S-approaches.

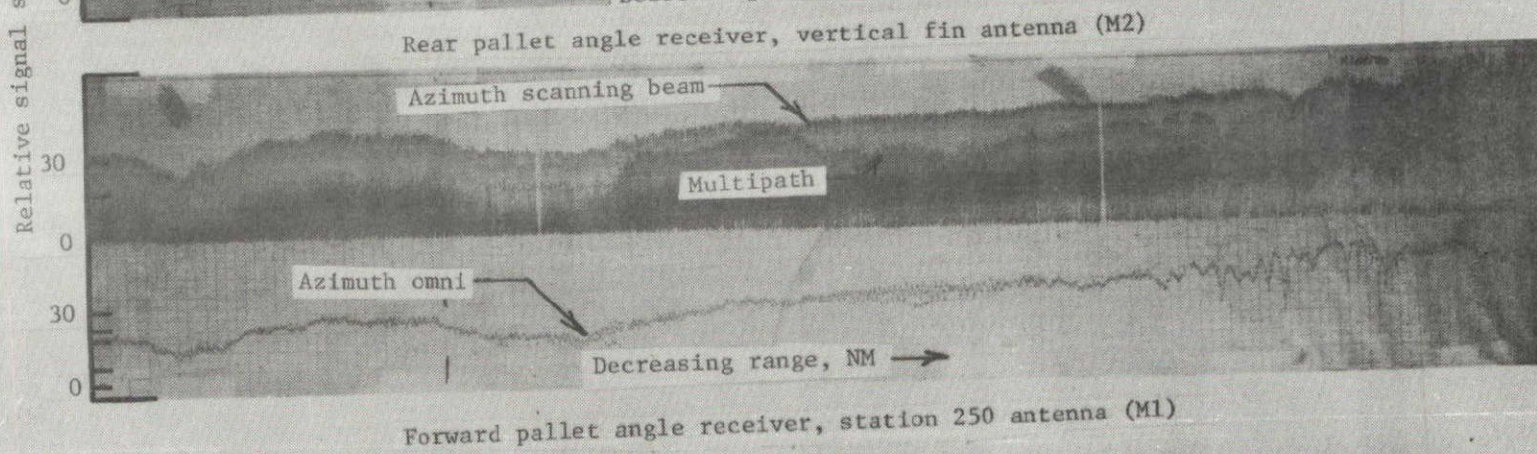
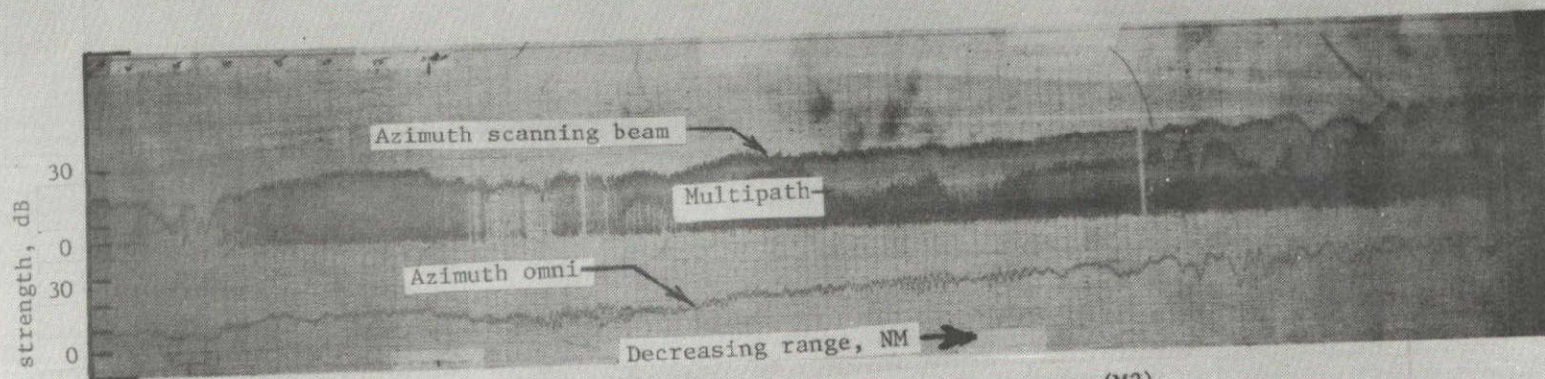

Figure 47(a). - High-speed approach concluded.

ORIGINAL PAGE IS  
OF POOR QUALITY

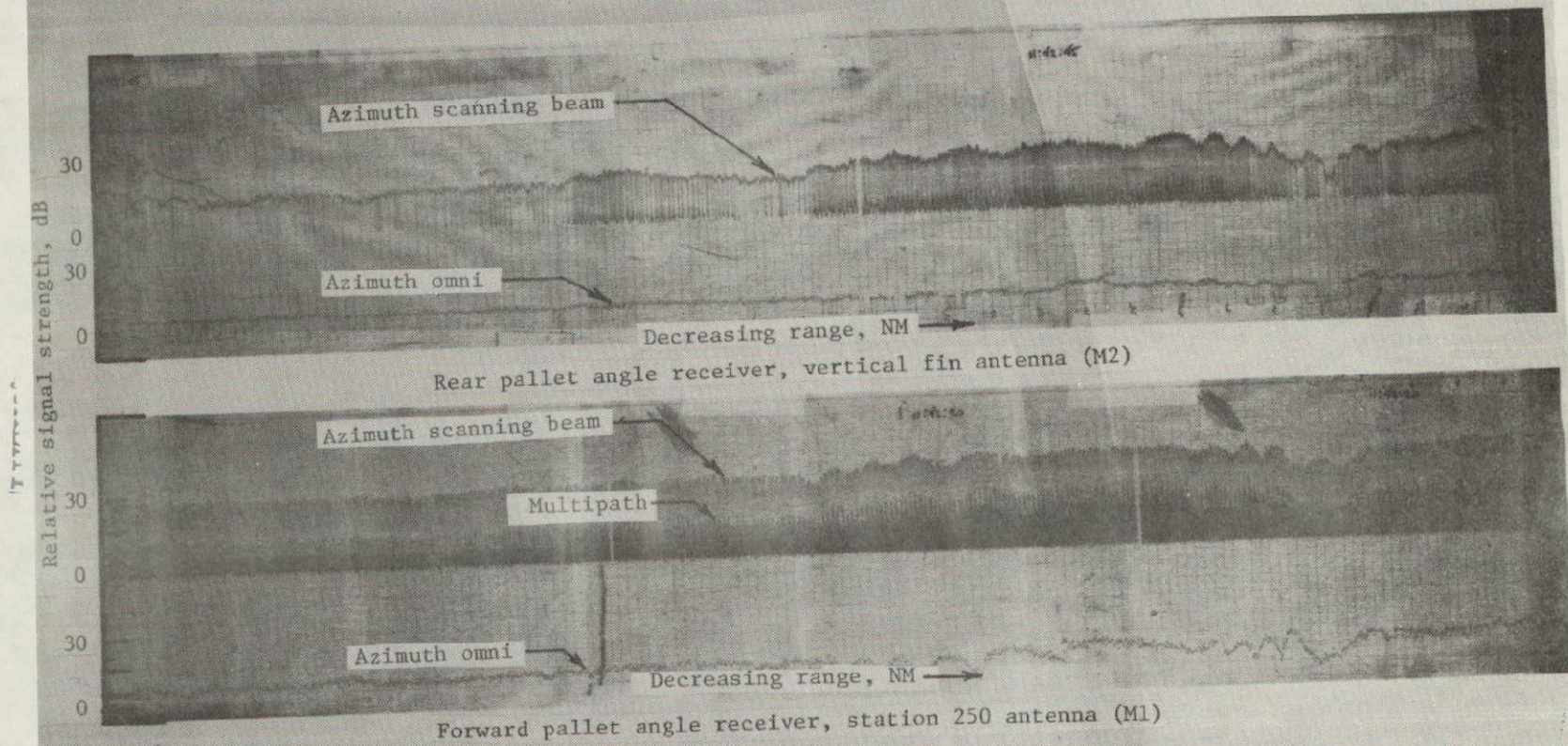

Figure 47(b). - Low-speed approach.



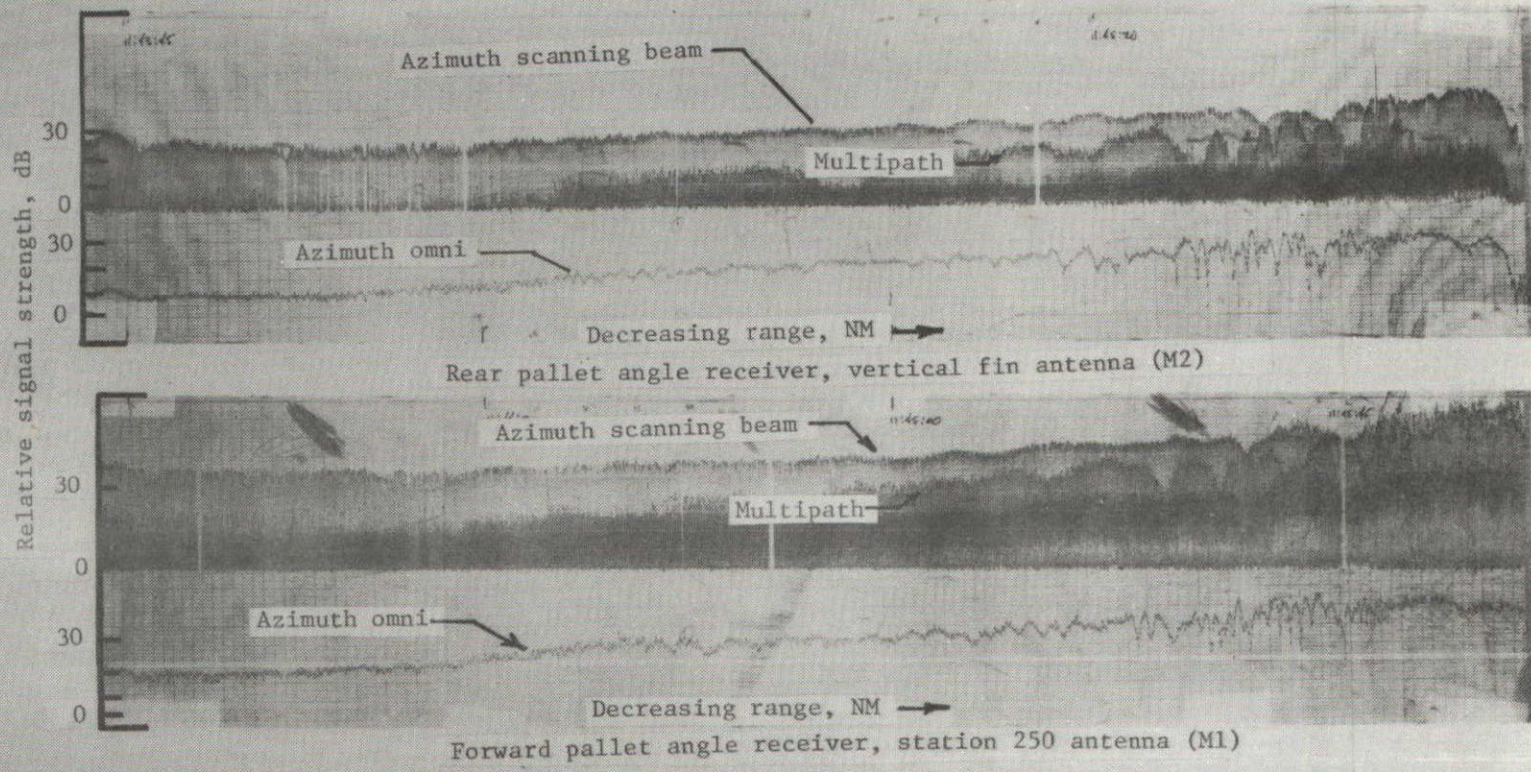

Figure 47(b). - Low-speed approach concluded. -

ORIGINAL PAGE IS  
OF POOR QUALITY

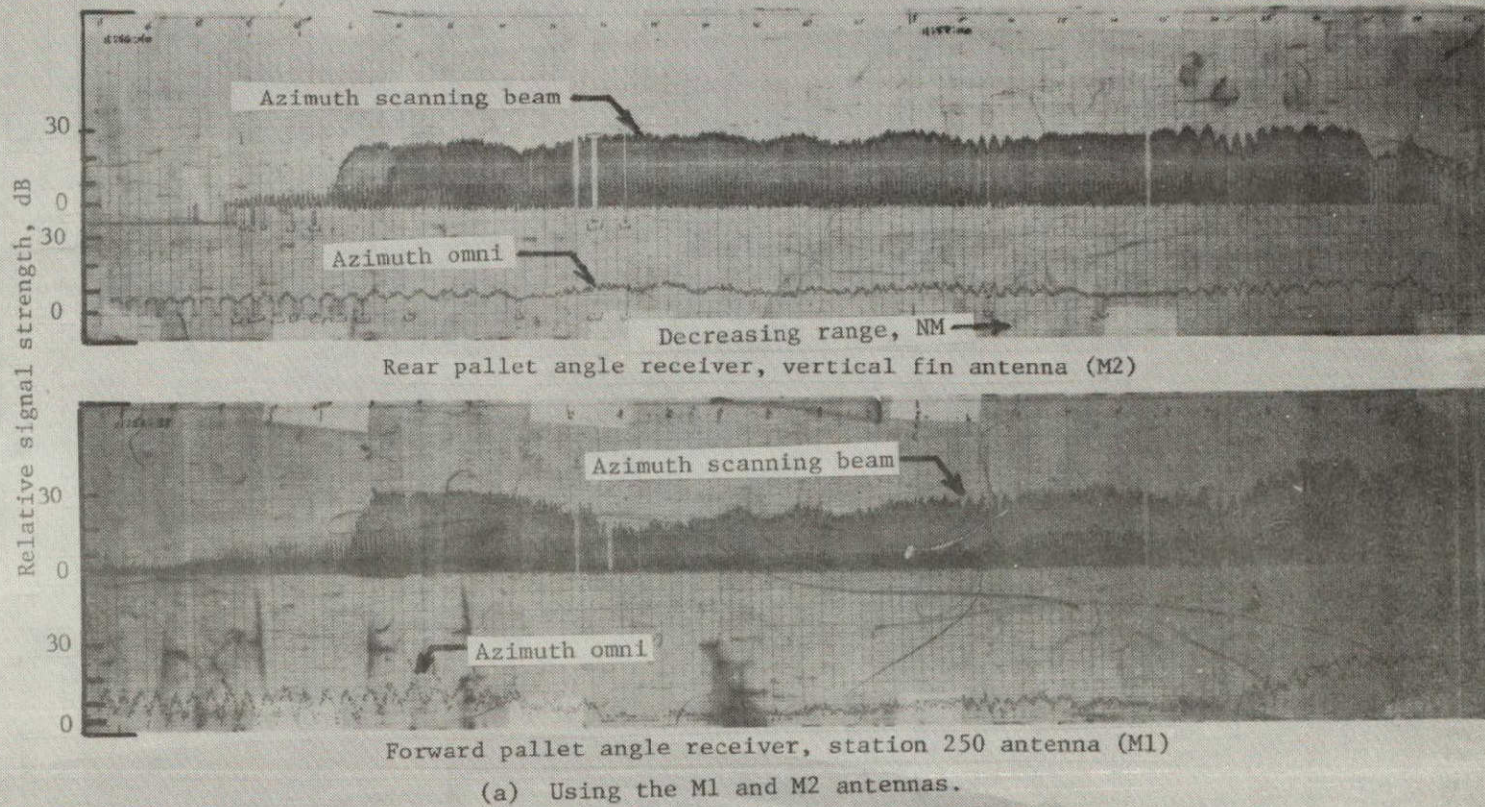
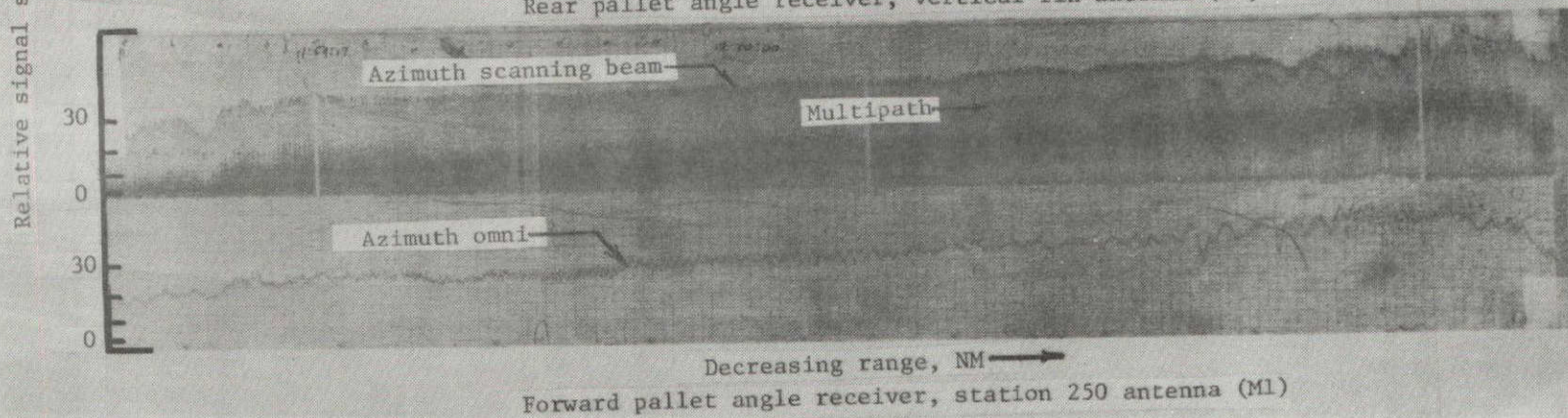
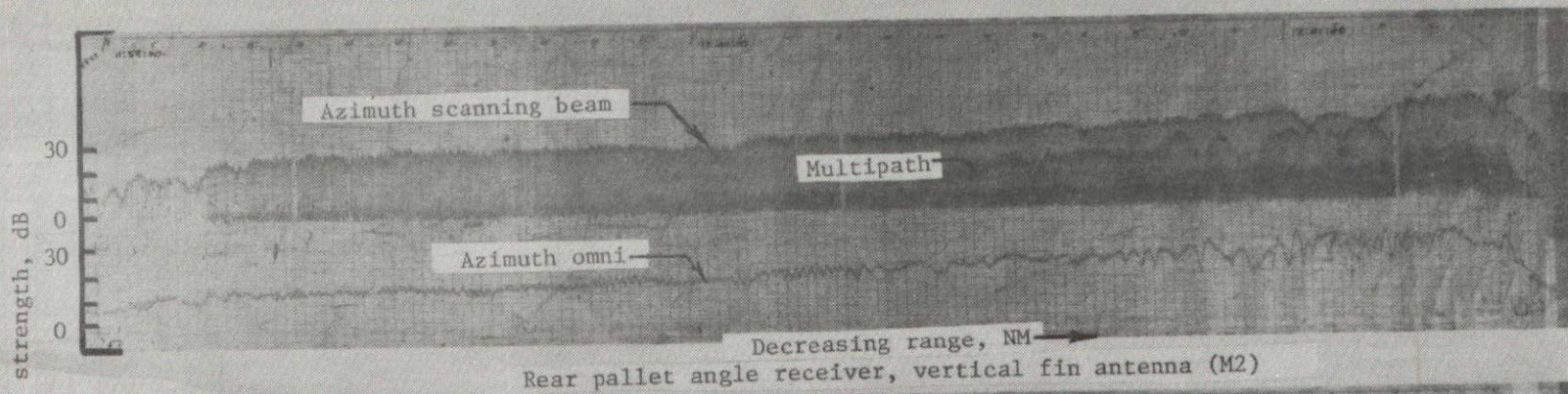

Figure 48. - MLS signal strengths measured using the station 250 (M1) antenna, vertical fin (M2) antenna, and the station 950 (M3) antenna during two racetrack approaches.



7

Figure 48(a) Using M1 and M2 antennas-concluded.

ORIGINAL PAGE IS  
OF POOR QUALITY

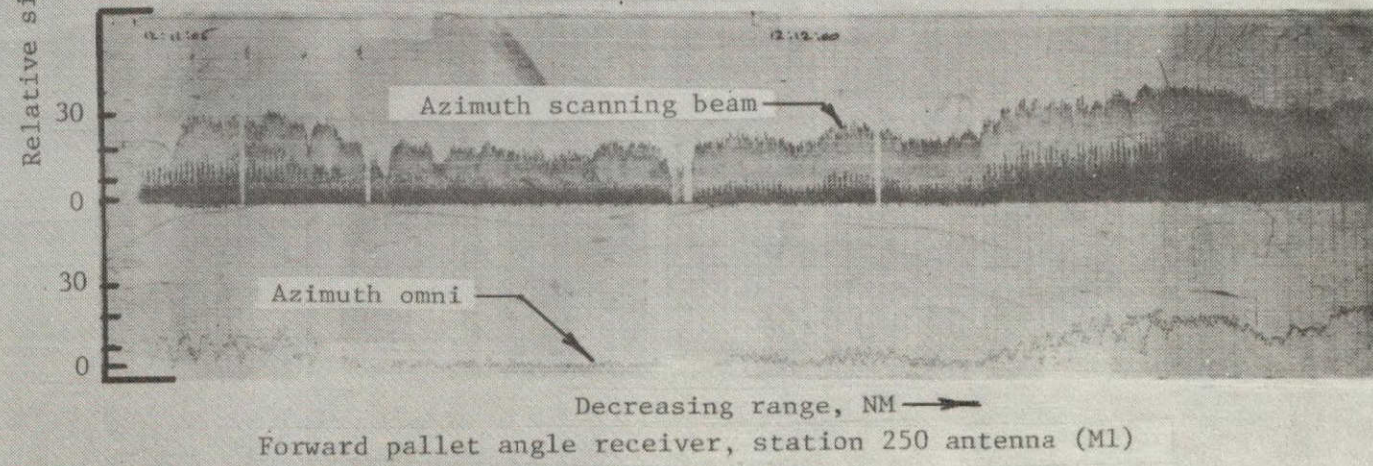
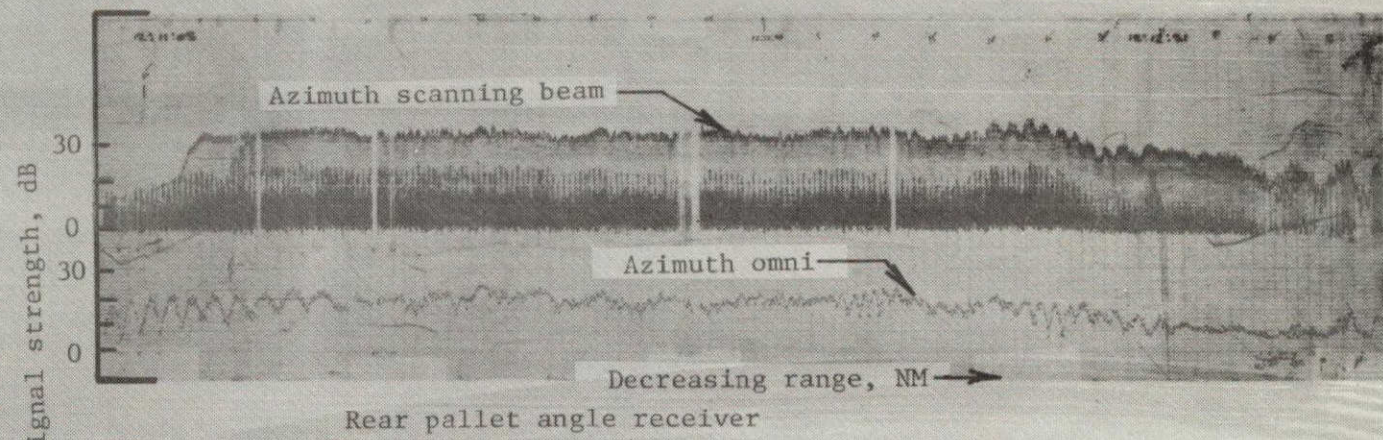
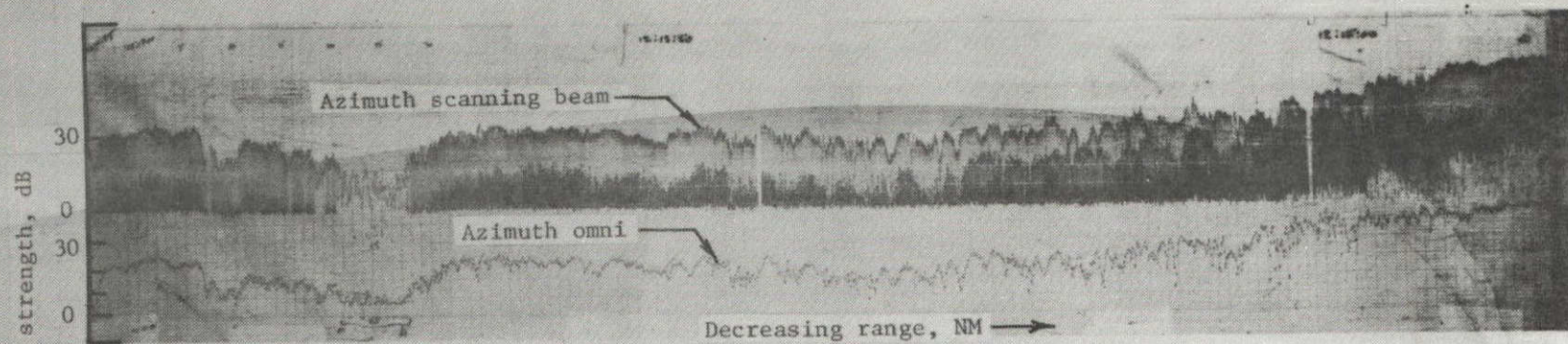
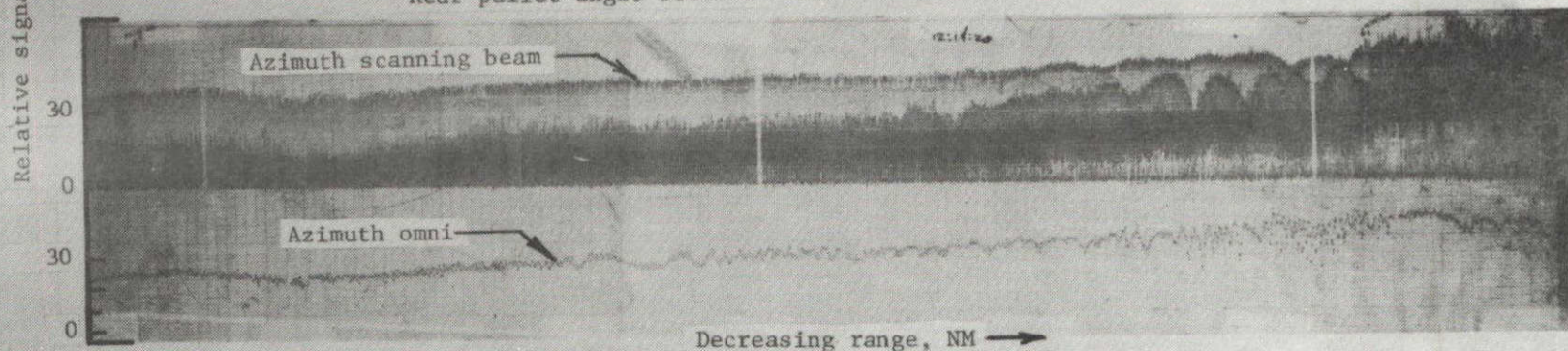

Figure 48(b). - Using M1 and M3 antennas.



Rear pallet angle receiver



Forward pallet angle receiver, station 250 antenna (M1)

Figure 48(b)-Using M1 and M3 antennas, concluded.

STATISTICAL ANALYSIS OF ELEVATION DATA  
DECEMBER 18, 1975 FLIGHTS

	ICAO PROFILES	RACETRACKS
NUMBER OF RECORDED POINTS	67 325	18 132
MISSING DATA (DROPOUTS)	0.12% (79)	0.28% (51)
FRAME FLAGS	0.27% (183)	0.45% (81)
FUNCTION FLAGS <sup>(1)</sup>	3	1
INCORRECT IDENTIFICATIONS <sup>(2)</sup>	0.02% (14)	0.04% (8)
OUTLIERS <sup>(3)</sup>	0.007% (5)	0.00% (0)

(1) FLAG DURATION FOR EACH OCCURENCE WAS 0.38 TO 0.40 SECONDS.

(2) MOST WERE ACTUALLY FLARE SIGNALS AND WERE FLAGGED.

(3) VALUE MORE THAN 0.2° FROM EXPECTED. ERRORS RANGED FROM -2.4° TO +0.95°.

(b) Elevation data results.

Figure 49. - concluded.

APPENDIX A

PLAN OF TEST

Antenna Evaluation Flight Tests

Plan of Test Number: M-7525

Title: MLS Antenna Measurements

Purpose:

This plan of test provides for the initial testing in preparation for the ICAO-MLS demonstration. The purposes of this testing include interfacing the FAA supplied equipment to the airplane, performing tests on the candidate demonstration antennas, and surveying the MLS signal characteristics.

This plan of test contains the following test items:

<u>Test Number</u>	<u>Title</u>
1.0.0	Taxi/Ground Checks
2.0.0	Straight-In Approach
3.0.0	Test Profiles

References:

October 2, 1975; Memorandum with Subject: ICAO-MLS Demonstration, December Test Flight

October 24, 1975; Memorandum with Subject: ICAO-MLS Demonstration, December Test Flights Data Requirements

Objectives:

Obtain data pertinent to interfacing and functioning of FAA equipment, MLS signal characteristics, and candidate demonstration antennas.

General Scheme of Operations:

Candidate demonstration antennas performance and MLS signal characteristics survey will be accomplished through flight tests at NAFEC with all aircraft and ground systems operating normally. All approaches will be made into Runway 4-22, with radar/theodolite tracking required on the test profiles only (3.0.0) Airborne data will be recorded pertaining to antenna performance and signal acquisition/dropout characteristics.

The NASA 515NA will fly to NAFEC the morning of the test day to have the FAA equipment installed and checked out. MLS signal checks and radar

calibration on the ground are planned for the afternoon just prior to the straight-in approach and test profile work. At the end of the test period, the FAA equipment will be removed and NASA 515NA will return to Langley.

The straight-in approach and the test profiles will be flown by the Research Pilot (First Officer) down to approximately 100 feet, where the Safety Pilot (Command Pilot) shall take over to complete the landing through touch-and-go.

#### Configuration

Airplane. - The test airplane is the Model 737-100, NASA 515NA. All tests will be conducted from the forward flight deck with manual control mode. MLS raw deviation signals shall be displayed on separate course deviation indicators for the Safety Pilot and Research Pilot.

Experimental Equipment. - The C-4000, ICP's, and ADEDS are not required for this test. INS Number 2, PADS, and the FAA supplied tape recorders and MLS avionics are required.

#### In-Flight Evaluation:

Pilot. - 1. Initial evaluation of test profiles at 120 knots (low speed) and using delayed flap technique for higher speed approach.

2. MLS signal characteristics evaluation on final leg of approach, down through flar and landing.

Test Engineer - 1. Perform ground checks of MLS signals and assist pilot in checking that proper MLS signals are being displayed in the cockpit.

2. Monitor MLS data being received, and record pertinent flight notes.

3. Set required MLS Azimuth and Elevation angles for the straight-in approach and test profiles.

#### Test Procedures:

1.0.0 Ground Calibration and checks (NAFEC)

1.1.0 Radar Calibration

<u>Test No.</u>	<u>Initial Conditions</u>	<u>Pilot Task</u>
1.1.1	Ground Tests	Safety pilot shall taxi and stop aircraft at the designated radar tracking calibration point.



## 1.2 0 MLS SIGNAL CHECKS

<u>Test No.</u>	<u>Initial Conditions</u>	<u>Pilot Task</u>
1.2.1	Ground Test	Safety pilot shall taxi and stop aircraft at threshold of Runway 4-22 for MLS signal checks (1/2 hour). The research pilot shall note and report to test engineer the MLS signal characteristics displayed on the course indicators. Azimuth radials (psuedo localizer) $\pm 2.5^\circ$ will be displayed and checked Full-scale deviation signals from the psuedo glideslope will also be checked for proper information.

## 2.0.0 STRAIGHT-IN APPROACH

<u>Test No.</u>	<u>Initial Conditions</u>	<u>Pilot Task</u>
2 1.0	Altitude 2,500 ft., Distance from threshold 35 nautical miles	Research pilot shall position airplane on straight-in course to Runway 4 approximately 35 nautical miles out at 2,500 feet. Level altitude will be maintained to the $3^\circ$ glideslope intercept point approximately 8 nautical miles from the threshold. Using the MLS deviation signals, the research pilot shall complete the approach to approximately 100 feet altitude where the safety pilot will take over and complete the landing through touch-and-go. The research pilot shall monitor and evaluate MLS signal characteristics during flare, landing, and touch-and-go

## 3 0.0 TEST PROFILES

<u>Test No.</u>	<u>Initial Conditions</u>	<u>Pilot Task</u>
3.1.1	Speed $V_{ref} 40^\circ$ Configuration - Gear down, Flaps $40^\circ$  STAR 4AC043 (figure A1)	Research pilot with the aid of voice vectors and topographic maps shall position the airplane to intercept the test profile at the start point. Voice guidance will be provided for the turn onto the final leg where the MLS signals on the CDI can then be used.

- 3.1.2 Speed  $V_{ref}$  40°  
Configuration -  
Gear down, Flaps  
40°  
STAR 2AC043  
(figure A2)
- Research pilot shall position the airplane to intercept the test profile at the start point. Voice guidance will be provided for the turn onto the final leg where the MLS signals on the CDI can then be used.
- 3.1.3 Speed  $V_{ref}$  40°  
Configuration -  
Gear down, Flaps  
40°  
STAR 3AC043  
(figure A3)
- Research pilot shall position the airplane to intercept the test profile at the start point. Voice guidance will be provided for the turn onto the final leg where the MLS signals on the CDI can then be used.
- 3.1.4 Speed  $V_{ref}$  40°  
Configuration -  
Gear down, Flaps  
40°  
STAR 1AC043  
(figure A4)
- Research pilot shall position the airplane to intercept the test profile at the start point. Voice guidance will be provided for the turn onto the final leg. MLS signals will be used on final only.

### 3.2.0 HIGHER-SPEED TESTS (DELAYED FLAP)

<u>Test No.</u>	<u>Initial Conditions</u>	<u>Pilot Task</u>
3.2.1	Speed 210 knots Configuration - Gear up, Flaps 0°  STAR 4AC043 (figure A1)	Research pilot with the aid of voice vectors and topographic maps shall position the airplane at the start point of the test profile at 210 knots. Flaps and thrust shall be selected so as to arrive at Waypoint AC3M8 at 170 knots; Waypoint FAF3M at 140 knots; and Waypoint TDZ04 at 120 knots. MLS deviation signals will be displayed on the CDI for the final leg only.
3.2.2	Speed 210 knots Configuration - Gear up, Flaps 0°  STAR 2AC043 (figure A2)	After positioning airplane at start point of test profile at 210 knots, research pilot will select flaps and thrust to arrive at Waypoint AC3M4 at 170 knots; Waypoint AC3M5 at 150 knots; Waypoint FAF3M at 140 knots; and Waypoint TDZ04 at 120 knots. MLS deviation signals will be provided for final leg only.

- |       |   |   |
|-------|---|---|
| 3.2.3 | Speed 120 knots<br>Configuration -<br>Gear up, Flaps 0°<br><br>STAR 3AC043<br>(figure A3) | After intercepting test profile at the start point at 210 knots, research pilot will select flaps and thrust to arrive at Waypoint TS3M2 at 150 knots; Waypoint FAF3M at 140 knots; and Waypoint TDZ04 at 120 knots. MLS signals will be provided for final leg only.   |
| 3.2.4 | Speed 210 knots<br>Configuration -<br>Gear up, Flaps 0°<br><br>STAR 1AC043<br>(figure A4) | Research pilot shall position the airplane at the start point of the test profile at 210 knots. Flaps and thrust shall be selected so as to arrive at Waypoint AC3M2 at 170 knots; Waypoint FAF3M at 140 knots; and Waypoint TDZ04 at 120 knots. MLS deviation signals will be displayed on CDI for final leg only. |

#### SUMMARY OF TEST CONDITIONS

1. Ground guidance - All runs will utilize a microwave instrument landing system on final straight-in portion only. Topographic maps and voice vectors will be used to aid the pilot in the initial part of each run including the turns.

2. Weather - Visibility - All runs will be made with at least 3500 feet of ceiling and 3 miles visibility.

Runway winds - 15 knots direct crosswind and 10 knots tailwind limits for landing. Low approaches will be considered if winds are higher.

3. Communications - Prior to start of test, the aircraft will establish communications with the NAFEC Tracking Facility on discrete test frequency (to be assigned).

4. Procedures - (a) Initial turn-on (left or right) for the straight-in approach will be made approximately 35 nautical miles from the threshold. The airplane will proceed to a touch and go using the MLS guidance.

(b) Each test profile (figures 1 through 4) illustrates an initial point to the final leg segment requiring voice vectors. The guidance for the final leg on all test profiles will be the MLS.

(c) Approach control will be advised of the type run.

(d) Each approach will be followed by a touch-and-go, except the final one will terminate in a full stop landing.

5. Tracking - (a) Test aircraft will synchronize time with the NAFEC Range Facility prior to commencing each flight.

(b) Test aircraft will advise Range Control of the start and end of each run.

(c) Range Control will advise Test Aircraft and ATC Coordinator when range is tracking.

(d) During approaches to Runway 4, M1 antenna will be the target tracked by the theodolite.

6. FAA Test Personnel - Normal FAA mission complement will consist of one pilot, one test engineer, an airborne lab technician, and a Bendix avionics specialist.

7. Proposed Scheduling - (a) The flight will be scheduled for the afternoon of December 11, 1975, with an acceptable period extending through December 16, 1975.

(b) The flight will be scheduled for 3.5 hours block-to-block.

8. Outline of Mission Procedures - Daily Flight Planning will be the responsibility of the RSFS Test Director closely coordinated with MLS Experimenter, NAFEC Project Engineer, NASA 515 crew, pilots, and instrumentation.

A. Prior to Mission: All participating personnel or organizational representatives will attend a pre-flight briefing in Room 308, Building 301 prior to the Test Flight. Briefing agenda will include the following items:

(1) Manifest - Crew Assignments

(2) Distribution of run schedule and scripts. All pertinent information on mission will be disseminated and discussed as required.

(3) Status of aircraft systems will be discussed and daily plan will be altered if necessary.

(4) Briefing about local conditions (weather, runway, traffic, etc).

(5) Explanation of mission plan as it affects work of tracking personnel.

(6) Briefing of local ATC personnel about mission plan and requirements.

(7) Assignment of discrete test frequency for the mission.

B. Prior to Taxi: Initial contact on assigned test frequency will be established by the NAFEC Project Engineer with the ATC Coordinator (Call Sign: Test-One), located in Control Tower and with the Tracking Facility (Call Sign: Range Control) located in Building 174. Aircraft time and range time will be synchronized.

C. Calibration: The aircraft will stop on point 115 on taxiway B between I and J to calibrate EAIR radar. Aircraft will proceed to threshold of Runway 4-22 for MLS signal checks.

D. Data Collection Segment: (1) Aircraft instrumentation recorders will be operating prior to start point for each profile through the end of each run.

(2) Range control will be advised that aircraft is initiating run.

(3) NAFEC Senior MLS Project Engineer normally will conduct all ground/range communications.

(4) Tracking for touch-and-go landings will be completed as aircraft passes over departure end of runway.

(5) Range Control will be advised at End of Run.

(6) A time history of noteworthy events pertinent to range coordination will be logged throughout mission by the NAFEC Test Engineer.

Data Recording: In-Flight - MLS data listed in Table I will be recorded on FAA supplied recorders.

Aircraft data listed in Table I will be recorded on the PADS. A list of the data labels and quantities from INS#2 to be recorded are presented in Table II.

On-Ground - Position data to be obtained from the NAFEC range is listed in Table I.

Data Reduction. Data reduction requirements for the antenna test are as follows:

(1) Computer printouts of time-correlated tracking data from NAFEC are required. In addition, plotboard tracks will be used.

(2) A time history of signal strength for the azimuth and elevation of transmitters is required. This will be obtained from the analog video recording made on the Honeywell 5600 recorder. These data will preferably be divided as to type of pulse: omni ID or scanning beam, azimuth, or elevation.

(3) A time history of bad data and dropouts is required. This will be obtained from the MLS digital recording made on the Kennedy 1708. A program is presently being developed by ACD to read these tapes and will provide the required data with little or no modification.

(4) A time history of antenna look angles to the azimuth and elevation sites is required. This will be obtained by using tracking data to calculate vectors from site to aircraft in runway coordinates and then using the PADS recorded data on aircraft attitude and heading to transform the vectors to aircraft body axes.

Data reduction requirements for filter testing are as follows:

(1) A merged tape containing unfiltered MLS position data correlated with smoothed tracking data is required. This tape will be produced using NAFEC software and facilities.

(2) A digital tape containing the aircraft variables listed in Table I is required. These data plus the merged tape above are to be input to a simulation of the MLS filters. The filter estimates are then to be compared to the tracking data for filter evaluation

A dubbed copy of the tracking tape and the Kennedy 1708 tape will be made available as soon after the flight as is practical and where possible carried on the return flight.

FAA will provide an IRIG-B time code generator synchronized to range time. Its output will be recorded on all the tape recorders.

A list of the static accuracies currently being obtained for the Table I measurements will be supplied as quickly as practical. —

TABLE AI

DATA REQUIREMENTS FOR DECEMBER TEST FLIGHT

A. MLS DATA

1. Analog receiver video (Honeywell 5600 Recorder)
2. Digital angle and range data (Kennedy 1708)

B. POSITION DATA (NAFEC)

1. Radar phototheodolite tracking tape (filtered but film correction not required) merged with Kennedy 1708 data
2. Plotboard Data

C. AIRCRAFT DATA

1. INS attitudes: pitch, roll, heading
  2. North and East velocities
  3. Along track and cross track accelerations
  4. Vertical acceleration
  5. Body rates: pitch, roll, yaw
  6. Linear airspeed
  7. Barometric altitude
  8. Baro altitude rate
  9. Stabilizer position
  10. Rudder position
  11. EPR 1 and 2
  12. Elevator position
- INS #2 ARINC 561 BUS  
See Table AII

TABLE AII

## INS NUMBER 2 ARINC 561 DATA BUS

Label (Octal)	Variable	Units	Range	Significant Bits
007	Cross runway error	Deg/180°	± 180°	16
010	Latitude	Deg/180°	± 180°	16
011	Longitude	Deg/180°	± 180°	16
014	True heading	Deg/180°	± 180°	16
021	Magnetic variation	Deg/180°	± 180°	16
025	Along track accel	Ft/sec <sup>2</sup>	± 256	16
026	Cross track accel.	Ft/sec <sup>2</sup>	± 256	16
066	North velocity	Knots	± 32,768	16
067	East velocity	Knots	± 32,768	16
160	Ground speed	Knots x 5	± 32,768	16
107	HDG - RWY HDG	Deg/180°	± 45°	16



TABLE AIII

SUMMARY OF TEST RUNS

PLAN OF TEST M7525

Run Number	Condition Number	Item	Condition	
			<u>Low Speed</u>	<u>Higher Speed</u>
	1.1.0	Radar Calibration		Taxiway B between I and J
	1.2.0	MLS Check		Threshold Runway 04
1	2.0.0	Straight In		1
2	3.1.1	Figure 1	1	
3	3.1.2	Figure 2	1	
4	3.1.3	Figure 3	1	
5	3.1.4	Figure 4	1	
6	3.2.1	Figure 1		1
7	3.2.2	Figure 2		1
8	3.2.3	Figure 3		1
9	3.2.4	Figure 4		1

ALL HEADINGS MAGNETIC  
 CONSTANT 3° DESCENT  
 WAYPOINT POSITIONS IN MLS COORDINATES  
 WAYPOINT ALTITUDES MSL

TOUCHDOWN AIMING POINT IS  
 214 FEET BEYOND EL1 ANTENNA

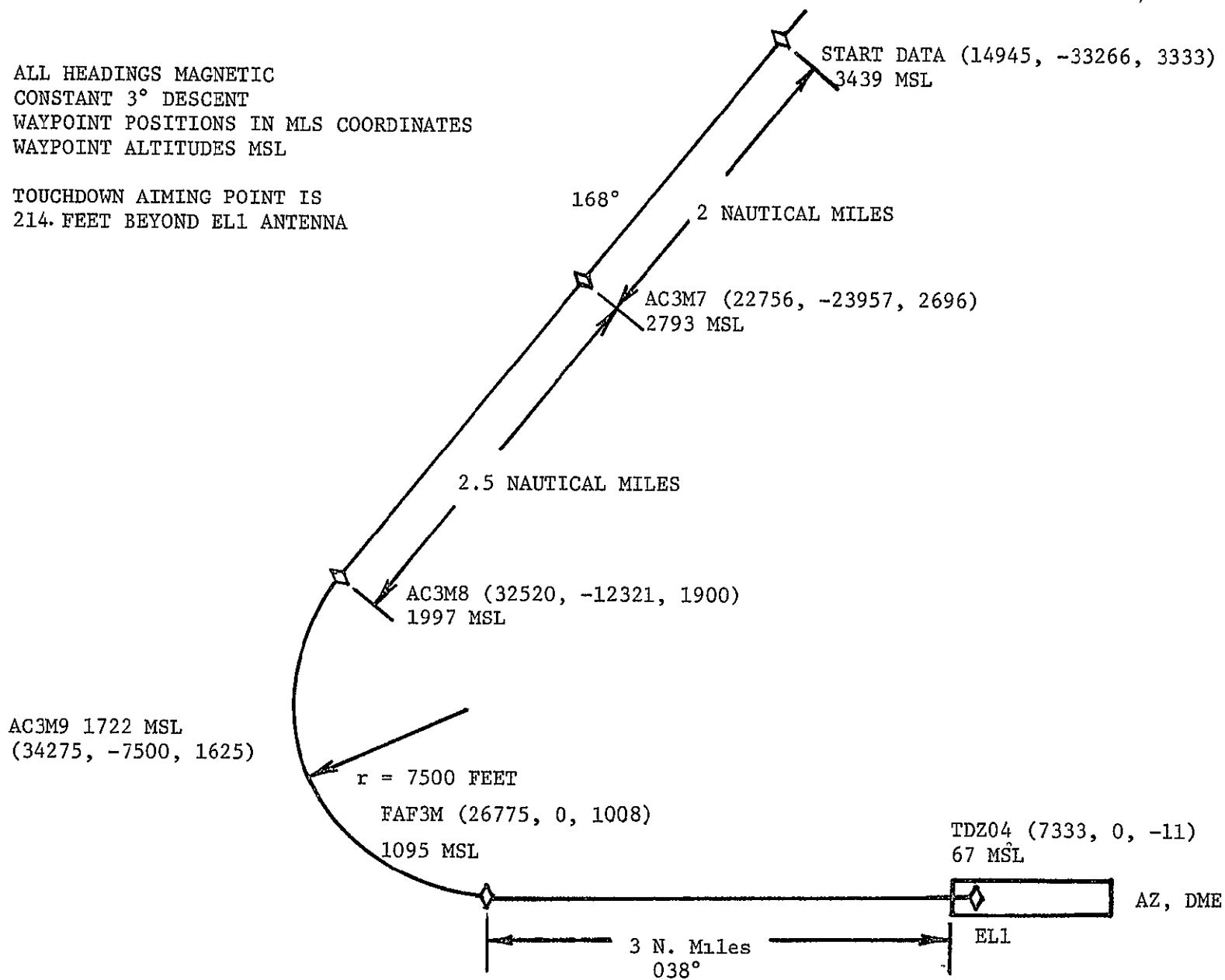

Figure A1. - Test profile number 1.

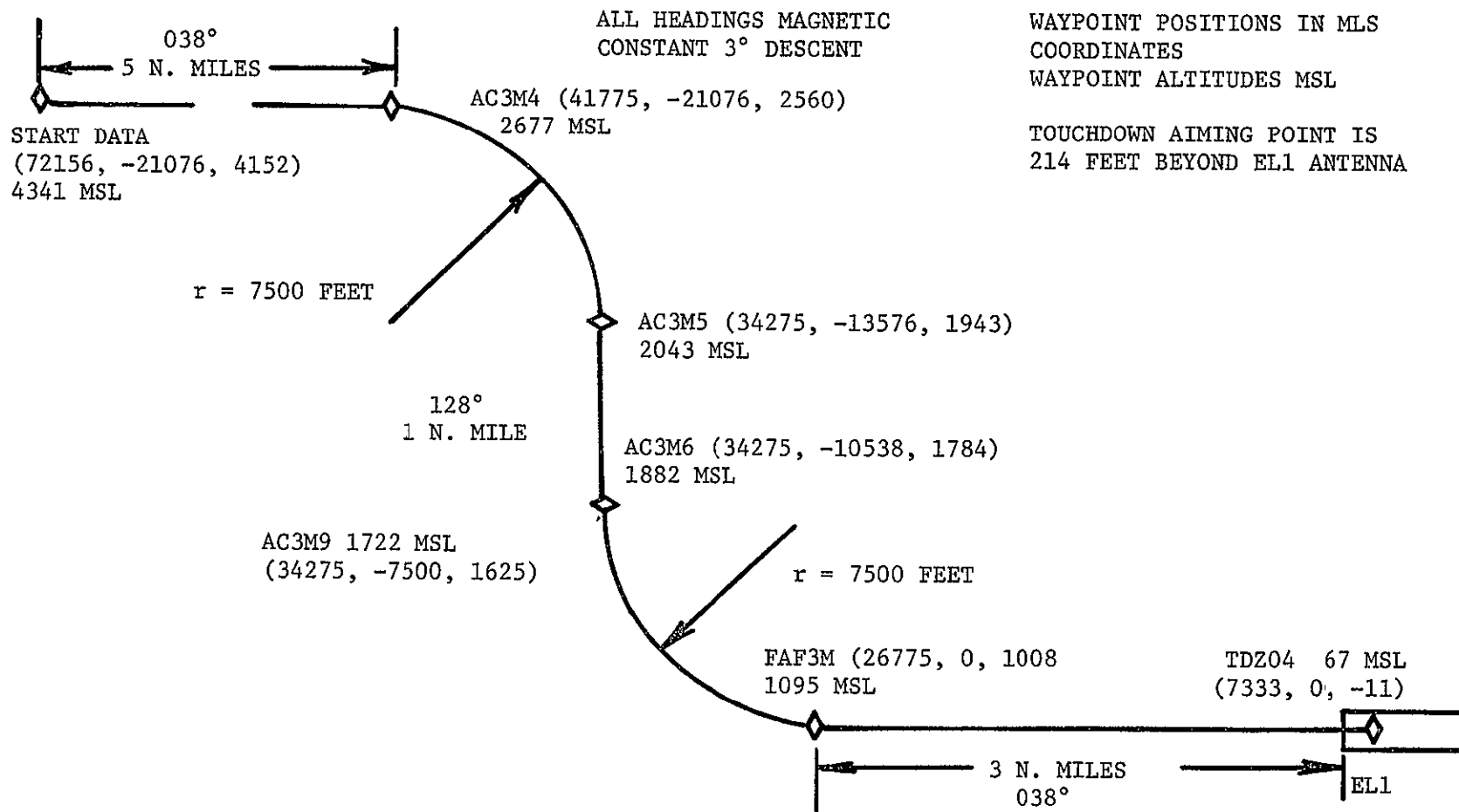

Figure A2. - Test profile number 2

ALL HEADINGS MAGNETIC  
CONSTANT 3° DESCENT

WAYPOINT POSITIONS IN MLS COORDINATES  
WAYPOINT ALTITUDES MSL

TOUCHDOWN AIMING POINT IS 214 FEET BEYOND EL1 ANTENNA

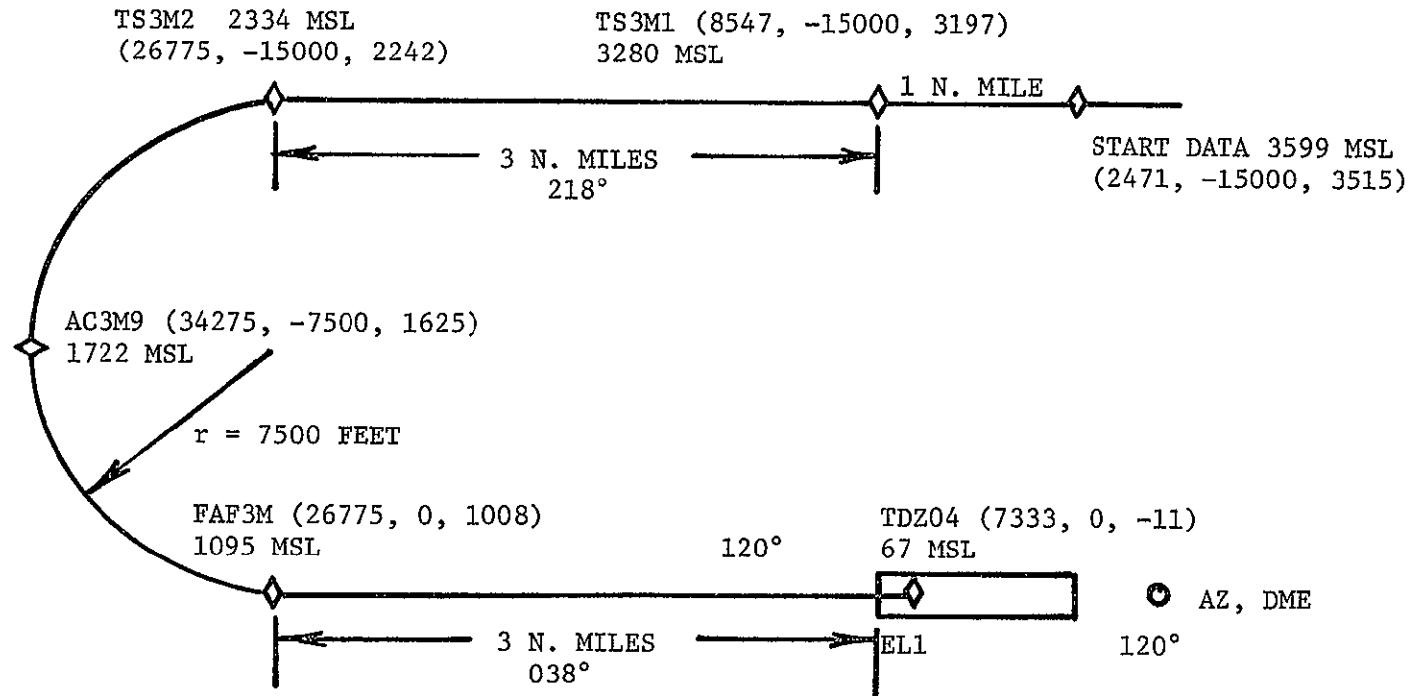

Figure A3. - Test profile number 3.

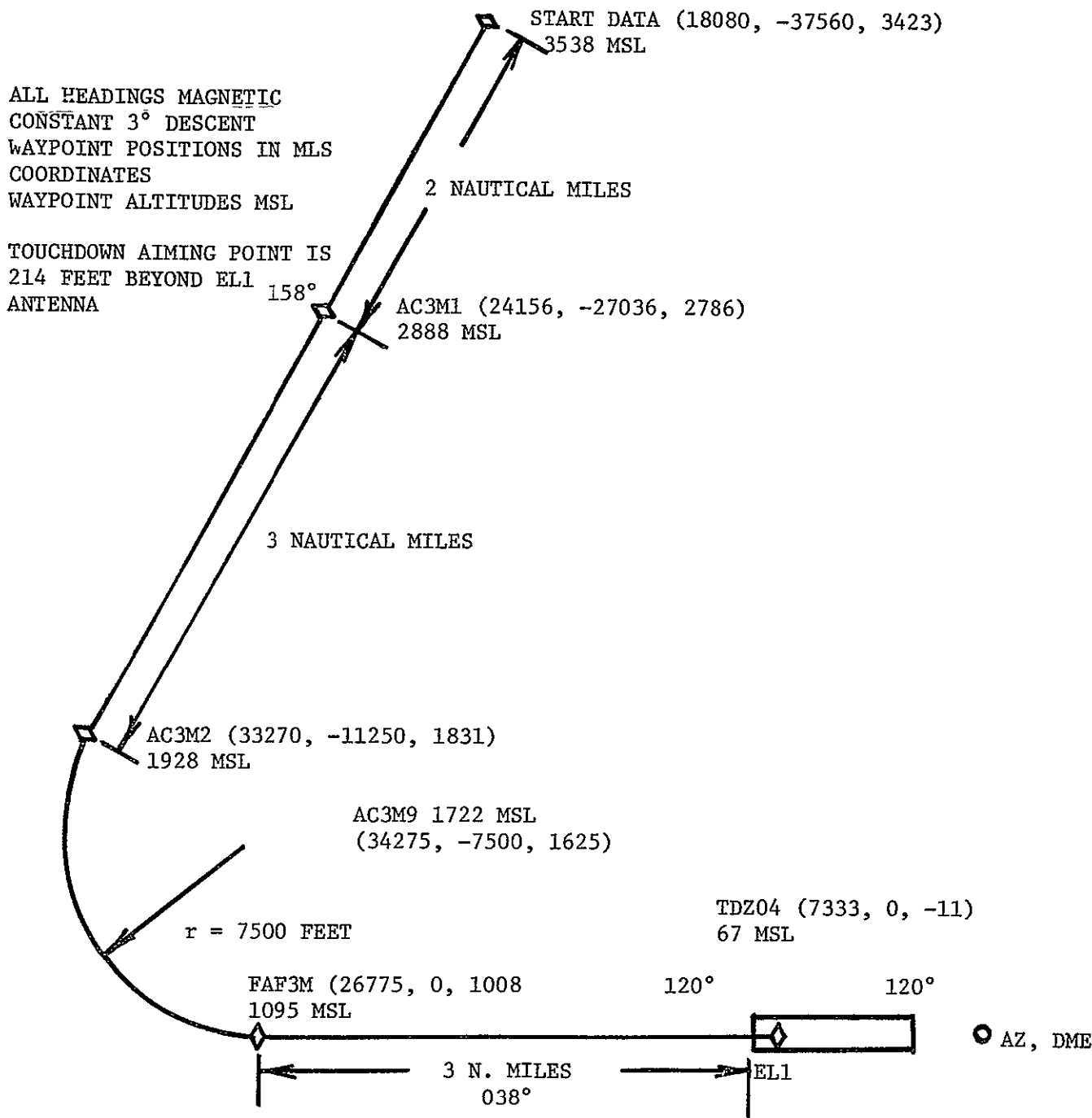

Figure A4. - Test profile number 4.