

General Disclaimer

One or more of the Following Statements may affect this Document

- This document has been reproduced from the best copy furnished by the organizational source. It is being released in the interest of making available as much information as possible.
- This document may contain data, which exceeds the sheet parameters. It was furnished in this condition by the organizational source and is the best copy available.
- This document may contain tone-on-tone or color graphs, charts and/or pictures, which have been reproduced in black and white.
- This document is paginated as submitted by the original source.
- Portions of this document are not fully legible due to the historical nature of some of the material. However, it is the best reproduction available from the original submission.

1. REPORT NO. NASA TM X-73349		2. GOVERNMENT ACCESSION NO.		3. RECIPIENT'S CATALOG NO.	
4. TITLE AND SUBTITLE SPACELAB EXPERIMENT COMPUTER STUDY Vol. I: Executive Summary (Presentation)				5. REPORT DATE April 1976	
				6. PERFORMING ORGANIZATION CODE	
7. AUTHOR(S) James L. Lewis, Bobby C. Hodges, and James O. Christy				8. PERFORMING ORGANIZATION REPORT #	
9. PERFORMING ORGANIZATION NAME AND ADDRESS George C. Marshall Space Flight Center Marshall Space Flight Center, Alabama 35812				10. WORK UNIT NO.	
				11. CONTRACT OR GRANT NO.	
12. SPONSORING AGENCY NAME AND ADDRESS National Aeronautics and Space Administration Washington, D. C. 20546				13. TYPE OF REPORT & PERIOD COVERED Technical Memorandum	
				14. SPONSORING AGENCY CODE	
15. SUPPLEMENTARY NOTES This is Volume I of five volumes.					
16. ABSTRACT The purpose of this study was to provide a quantitative cost for various Spacelab flight hardware configurations, along with varied software development options. The three major conclusions reached as a result of this study are as follows: 1. Spacelab program cost for software development and maintenance is independent of experimental hardware and software options. 2. Distributed standard computer concept simplifies software integration without a significant increase in cost. 3. Decision on flight computer hardware configuration should not be made until payload selection for a given mission and a detailed analysis of the mission requirements are completed. This report is published in five volumes: Volume I contains the Executive Summary (Presentation); Volume II, Study Elements and Approach; Volume III, Spacelab Cost Data; Volume IV, Spacelab User Cost Data (Central Experiment Computer); and Volume V, Spacelab User Cost Data (Distributed Computer). This is Volume I: Executive Summary (Presentation).					
17. KEY WORDS			18. DISTRIBUTION STATEMENT Unclassified-Unlimited		
19. SECURITY CLASSIF. (of this report) Unclassified		20. SECURITY CLASSIF. (of this page) Unclassified		21. NO. OF PAGES 68	22. PRICE NTIS

SPACELAB EXPERIMENT COMPUTER STUDY

TABLE OF CONTENTS

VOLUME I EXECUTIVE SUMMARY

Presentation Charts - April 1976
Backup Charts - April 1976

VOLUME II STUDY ELEMENTS AND APPROACH

- Section 1 Introduction
- Section 2 Groundrules and Assumptions
- Section 3 Options and Cost Elements
 - A. Options
 - B. Cost Elements
- Section 4 Summary of Software Requirements Analysis Study
- Section 5 Cost Analysis
 - A. Spacelab Costs
 - B. Spacelab User Costs
- Section 6 Cost Data Matrix
- Section 7 Costing Rationale
 - A. Minicomputers
 - B. Computer Interface Device (CID) and Real Time Simulation Test Set (RTSTS)
 - C. Costs Per Statement/Costs Per Instruction
 - D. Software Sizing
 - E. Central Experiment Computer Functions
 - F. Consumable Stock
 - G. Central Site Computer Additions
 - H. Equipment Maintenance
 - I. Miscellaneous Supporting Data

VOLUME III

SPACELAB COST DATA

Section 1. Costing Method

Section 2. Cost Data

VOLUME IV

**SPACELAB USER COST DATA (CENTRAL
EXPERIMENT COMPUTER)**

**Section 1. Option IA1 - Central With Mini,
Central Software Development
by Central Group.**

1.1 Costing Method

1.2 Cost Data

**Section 2. Option IA2A - Central With Mini,
Central Software Development by
PI at Central Facility.**

2.1 Costing Method

2.2 Cost Data

**Section 3. Option IA2B - Central With Mini,
Central Software Development by
PI at Central Facility Remote.**

3.1 Costing Method

3.2 Cost Data

**Section 4. Option IA3A - Central With Mini,
Software Development by PI at His
Facility. Real Time Simulation at
Central Facility.**

4.1 Costing Method

4.2 Cost Data

**Section 5. Option IA3B - Central With Mini,
Software Development by PI at
His Facility. Real Time Simulation
at His Facility for DEP.**

5.1 Costing Method

5.2 Cost Data

- Section 6.** Option IA4 - Central With Mini, Software Development by PI at His Facility. Not Compatible With Central Facility (This Option Not Included - Excessive Cost).
- 6.1 Costing Method
 - 6.2 Cost Data
- Section 7.** Option IB1 - Central with Standard Mini, Central Software Development by Central Group.
- 7.1 Costing Method
 - 7.2 Cost Data
- Section 8.** Option IB2A - Central With Standard Mini, Central Software Development by PI at Central Facility Local.
- 8.1 Costing Method
 - 8.2 Cost Data
- Section 9.** Option IB2B - Central With Standard Mini, Central Software Development by PI at Central Facility Remote.
- 9.1 Costing Method
 - 9.2 Cost Data
- Section 10.** Option IB3A - Central With Standard Mini, Software Development by PI on His Facility. Real Time Simulation at Central Facility.
- 10.1 Costing Method
 - 10.2 Cost Data
- Section 11.** Option IB3B - Central With Standard Mini, Software Development by PI on His Facility. Real Time Simulation at His Facility.
- 11.1 Costing Method
 - 11.2 Cost Data

Section 12. Option IB4 - Central With Standard Mini, Software Development by PI at His Facility. Not Compatible with Central Facility (This Option not included - Excessive Cost).

- 12.1 Costing Method
- 12.2 Cost Data

Section 13. Option IC1 - Central No Mini, Central Software Development Central Group.

- 13.1 Costing Method
- 13.2 Cost Data

Section 14. Option IC2A - Central No Mini, Central Software Development by PI at Central Facility Local.

- 14.1 Costing Method
- 14.2 Cost Data

Section 15. Option IC2B - Central No Mini, Central Software Development by PI at Central Facility Remote.

- 15.1 Costing Method
- 15.2 Cost Data

Section 16. Option IC3A - Central No Mini, Software Development by PI at His Facility. Real Time Simulation at Central Facility.

- 16.1 Costing Method
- 16.2 Cost Data

Section 17. Option IC3B - Central No Mini, Software Development by PI at His Facility. Real Time Simulation at His Facility.

- 17.1 Costing Method
- 17.2 Cost Data

**Section 18. Option 1C4 - Central No Mini
Software Development by PI
at His Facility. Not Compatible
with Central Facility (This Option
Not Included - Excessive Cost).**

18.1 Costing Method

18.2 Cost Data

Section 1. Option IIA1 - Distributed Non-Standard Mini, Central Software Development by Central Group. (Not Priced - Option Not Feasible).

- 1.1 Costing Method
- 1.2 Cost Data

Section 2. Option IIA2A - Distributed Non-Standard Mini, Central Software Development by PI at Central Facility Local. (Not Priced - Option Not Feasible).

- 2.1 Costing Method
- 2.2 Cost Data

Section 3. Option IIA2B - Distributed Non-Standard Mini, Central Software Development by PI at Central Facility Remote. (Not Priced - Option Not Feasible).

- 3.1 Costing Method
- 3.2 Cost Data

Section 4. Option IIA3A - Distributed Non-Standard Mini, Software Development by PI at His Facility. Real Time Simulation Testing at Central Facility. (Not Priced - Option Not Feasible).

- 4.1 Costing Method
- 4.2 Cost Data

Section 5. Option IIA3B - Distributed Non-Standard Mini, Software Development by PI at His Facility. Real Time Simulation Testing on RTSTS. (Not Priced - Option Not Feasible).

- 5.1 Costing Method
- 5.2 Cost Data

Section 6. Option IIA4 - Distributed Non-Standard Mini, Software Development by PI at His Facility. Not compatible with Central Facility.

6.1 Costing Method

6.2 Cost Data

Section 7. Option IIB1 - Distributed Standard Mini. Central Software Development by Central Group.

7.1 Costing Method

7.2 Cost Data

Section 8. Option IIB2A - Distributed Standard Mini, Central Software Development by PI at Central Facility Local.

8.1 Costing Method

8.2 Cost Data

Section 9. Option IIB2B - Distributed Standard Mini, Central Software Development by PI at Central Facility Remote.

9.1 Costing Method

9.2 Cost Data

Section 10. Option IIB3A - Distributed Standard Mini, Software Development by PI at His Facility. Real Time Simulation Testing at Central Facility.

10.1 Costing Method

10.2 Cost Data

Section 11. Option IIB3B - Distributed Standard Mini, Software Development by PI at His Facility. Real Time Simulation at His Facility.

11.1 Costing Method

11.2 Cost Data

Section 12. Option IIB4 - Distributed Standard Mini, Software Development by PI at His Facility. Not Compatible With Central Facility. (Same as Option IIB3B)

12.1 Costing Method

12.2 Cost Data

Section 13. Option IIB3B (Variation I)

13.1 Costing Method

13.2 Cost Data

Section 14. Option IIB3B (Variation II)

14.1 Costing Method

14.2 Costing Data

ORGANIZATION: DATA SYSTEMS LABORATORY	MARSHALL SPACE FLIGHT CENTER SPACELAB EXPERIMENT COMPUTER STUDY	NAME: J. T. POWELL DATE: APRIL 1976
---	---	--

PRESENTATION OUTLINE

STUDY DEFINITION

OBJECTIVE

APPROACH

METHOD

SOFTWARE REQUIREMENTS DEVELOPMENT

COSTING

SUMMARY

ORGANIZATION: DATA SYSTEMS LABORATORY	MARSHALL SPACE FLIGHT CENTER SPACELAB EXPERIMENT COMPUTER STUDY	NAME: J. T. POWELL DATE: APRIL 1976
---	---	--

OBJECTIVE OF STUDY

- TO DEFINE, VIA ANALYSIS AND TRADE STUDIES, THE MOST COST EFFECTIVE CONFIGURATION OF FLIGHT COMPUTATIONAL RESOURCES THAT WILL SATISFY SPACELAB USER REQUIREMENTS

APPROACH

- PROJECT COSTS ASSOCIATED WITH VARIOUS OPTIONS (CENTRALIZED VS. DISTRIBUTED) THAT CAN POTENTIALLY BE ADOPTED TO SATISFY THESE REQUIREMENTS
- PROJECT TOTAL COSTS ASSOCIATED WITH SOFTWARE DEVELOPMENT INCLUDING:
 - EXPERIMENT COMPUTER(S) SOFTWARE
 - SUBSYSTEM COMPUTER SOFTWARE
 - EGSE COMPUTER SOFTWARE
 - SUPPORT SOFTWARE
 - SIMULATION SOFTWARE
 - ASSOCIATED HARDWARE

ORGANIZATION: DATA SYSTEMS LABORATORY	MARSHALL SPACE FLIGHT CENTER SPACELAB EXPERIMENT COMPUTER STUDY	NAME: J. T. POWELL DATE: APRIL 1976
---	---	--

STUDY METHOD

- DERIVE COMPUTATION REQUIREMENTS FOR SPACELAB PAYLOAD ELEMENTS (EXPERIMENTS) BY DETAILED ANALYSIS OF THREE MISSIONS - EXTRAPOLATION TO 226 MISSIONS IN MISSION MODEL
 - SPEED
 - MEMORY - MAIN AND BULK
 - STATEMENTS TO BE CODED
- ESTIMATE SIZE OF EUROPEAN DELIVERED SOFTWARE AND THE EXPECTED CHANGE RATE
- DEFINE OPTIONS TO BE EVALUATED
- DEVELOP COMPREHENSIVE SET OF ASSUMPTIONS AND GROUND RULES
- DEFINE METHOD OF COSTING FOR EACH ELEMENT
- COMBINE COSTS TO DETERMINE YEARLY AND TOTAL COSTS
- MAINTAIN SEPARATION OF COSTS - SPACELAB AND USER
- EXAMINE MAJOR COST ELEMENTS FOR SENSITIVITY TO ASSUMPTIONS AND GROUND RULES
- MAINTAIN TRACEABILITY FOR ALL COST ELEMENTS

STUDY APPROACH

THE OVERALL APPROACH FOR SIZING EXPERIMENT APPLICATION SOFTWARE WAS TO REVIEW ALL PAYLOAD ELEMENTS CONTAINED IN THE SPACELAB MISSION MODEL (PM01, 75-253, DATED 11/75) WHICH CONSISTS OF 226 FLIGHT OF FORTY-FIVE (45) DIFFERENT MISSIONS. OF THIS TOTAL NUMBER OF MISSIONS THREE (3) WERE SELECTED FOR DETAILED ANALYSIS. THE THREE (3) SELECTED WERE MISSIONS EIGHT (8), FOURTEEN (14), and TWENTY ONE (21). FOR THESE THREE (3) THE DETAILED SOFTWARE REQUIREMENTS WERE DERIVED AT THE PAYLOAD ELEMENT FUNCTIONAL LEVEL. THE DERIVED REQUIREMENTS WERE STATED IN TERMS OF MAIN MEMORY, BULK MEMORY, AND EQUIVALENT ADDS PER SECOND, TEMPERED BY REALISTIC GROUND RULES APPLIED TO MINIMIZE THE TOTAL SOFTWARE JOB WHILE MAXIMIZING PAYLOAD RETURN. FOR DATA LISTED IN SPDA AS TBD, ENGINEERING ESTIMATES WERE USED. MISSION TIME LINES WERE APPLIED AND REQUIREMENTS WERE SUMMED, IF APPROPRIATE. FINALLY, THE DATA GENERATED WAS EXTRAPOLATED OVER THE MISSION MODEL AND YEARLY TOTALS GENERATED FOR SOFTWARE DEVELOPMENT, MAINTENANCE, AND DISTRIBUTION.

NOTE THAT THE THREE (3) MISSIONS ANALYZED IN DETAIL WERE MADE UP OF 20 PAYLOAD ELEMENTS, NEARLY HALF OF THE TOTAL (47). THE FINAL SOFTWARE REQUIREMENTS DATA IS REFLECTED IN GENERAL DYNAMICS (CONVAIR DIVISION) REPORT "SPACELAB PAYLOADS ACCOMMODATION STUDY," DATED MARCH 5, 1976, REPORT NO. CASD-NAS76-010, CONTRACT NAS8-29462.

ORGANIZATION: DATA SYSTEMS LABORATORY	MARSHALL SPACE FLIGHT CENTER SPACELAB EXPERIMENT COMPUTER STUDY	NAME: J. T. POWELL DATE: APRIL 1976
---	---	--

PRESENTATION OUTLINE

STUDY DEFINITION

OBJECTIVE

APPROACH

METHOD



SOFTWARE REQUIREMENTS DEVELOPMENT

COSTING

SUMMARY

ORGANIZATION DATA SYSTEMS LABORATORY	MARSHALL SPACE FLIGHT CENTER SPACELAB EXPERIMENTS COMPUTER STUDY	NAME: J. T. POWELL DATE: APRIL 1976
--	--	--

SOFTWARE REQUIREMENTS OVERALL APPROACH

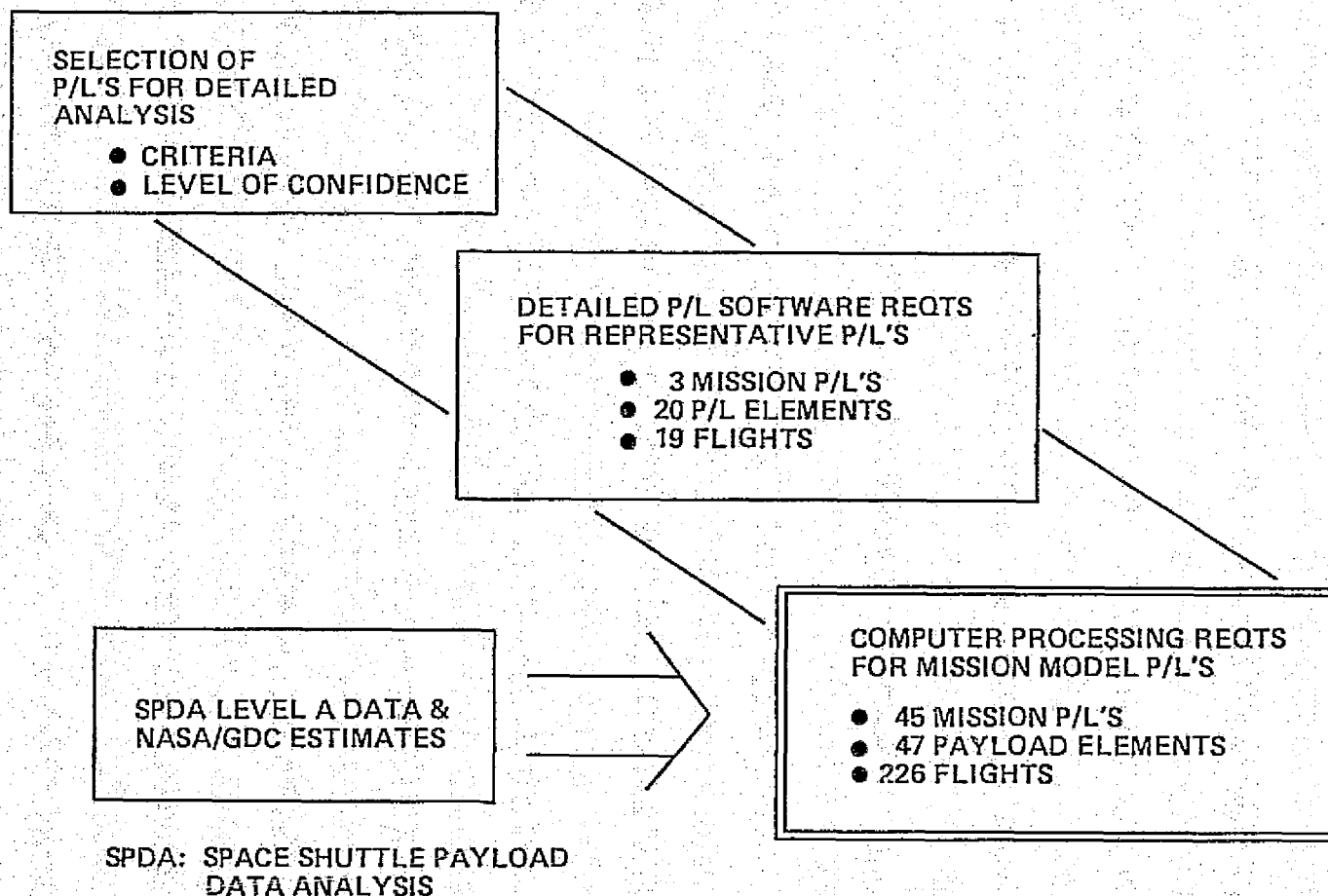

ORGANIZATION: DATA SYSTEMS LABORATORY	MARSHALL SPACE FLIGHT CENTER SPACELAB EXPERIMENT COMPUTER STUDY	NAME: J. T. POWELL DATE: APRIL 1976
<p style="text-align: center;">SOFTWARE REQUIREMENTS STUDY GROUNDRULES</p> <ul style="list-style-type: none"> ● DATA BASE USED <ul style="list-style-type: none"> ● JULY 1975 SPDA LEVEL A PAYLOAD DATA ● FOR MISSION 8, THE LEVEL 1 CONSTRAINTS FOR FIRST SPACELAB FLIGHT AND SPACELAB FIRST FLIGHT GUIDELINES - LEVEL 11 (BOTH DATED NOV. 1975) ● SPACELAB MISSION MODEL (PM01) 75-253, DATED 11/75 ● USE DETAILED ANALYSIS DATA (MISSIONS 8, 14, 21) TO REPLACE LEVEL A DATA FOR APPROPRIATE PAYLOAD ELEMENTS ● TALL POLES IDENTIFIED WILL BE FURTHER EVALUATED BY MSFC/GDC ● FUNCTIONS THAT CANNOT BE EFFICIENTLY HANDLED BY THE CREW MANUALLY SHALL BE CONSIDERED FOR AUTOMATION ● THE CREW SHOULD BE PROVIDED A LEVEL OF PAYLOAD CONTROL AND MONITORING THAT WILL YIELD HIGH CONFIDENCE OF PROPER EXPERIMENT OPERATION AND EXPERIMENT DATA QUALITY ● THROUGH MODEST INCREASES IN ON-BOARD PROCESSING, REAL-TIME TRANSMISSION REQUIREMENTS WILL BE MINIMIZED WHERE POSSIBLE ● PAYLOAD ELEMENT REQUIREMENTS WERE SUMMED FOR EACH MISSION IF POINTING REQUIREMENTS WERE COMPATIBLE 		

PAYLOADS USED FOR DETAILED ANALYSIS

MISSION 8 WAS SELECTED AT THE SPECIFIC REQUEST OF THE SPACELAB PROGRAM MANAGER. IT IS ATYPICAL SINCE IT IS THE FIRST SPACELAB FLIGHT, AND INCLUDES THE LARGEST NUMBER OF PAYLOAD ELEMENTS.

MISSIONS 14 AND 21 WERE SELECTED BECAUSE THEY REPRESENT A REASONABLE SPREAD OF REQUIREMENTS (LOW TO HIGH) AND BECAUSE GOOD DETAIL WAS AVAILABLE FROM PRIOR ANALYSES. THESE MISSIONS WERE ALSO COVERED IN THE CRAS STUDIES.

MISSIONS EXCEEDING CDMS CAPACITY

THE FIRST 3 MISSIONS, SHOWN OPPOSITE, SLIGHTLY EXCEED THE AVAILABLE OPERATIONS PER SECOND CAPACITY OF THE CENTRAL EXPERIMENT COMPUTER, WHEN THE OPERATING SYSTEM AND CONTINGENCY ARE CONSIDERED. IT WAS CONCLUDED THAT THESE 3 MISSIONS COULD BE ACCOMMODATED BY MINOR REVISION OF THE REQUIREMENT OR BY USING THE CONTINGENCY RESERVED.

THE LAST 4 MISSIONS LISTED EXCEED THE CURRENT AND ANTICIPATED STATE OF THE ART, IN TERMS OF OPERATIONS PER SECOND. IT WAS ASSUMED THAT THE FUNCTION COULD BE ACCOMPLISHED BY SPECIAL PURPOSE HARDWARE, YET TO BE DEFINED, AND THE SOFTWARE REQUIREMENTS WERE TREATED AS VALID. NO COSTS WERE INCLUDED FOR THE SPECIAL PURPOSE HARDWARE.

THE ATM/SPACELAB MISSION IS NO LONGER BEING CONSIDERED.

ORGANIZATION: DATA SYSTEMS LABORATORY	MARSHALL SPACE FLIGHT CENTER SPACELAB EXPERIMENT COMPUTER STUDY	NAME: J. T. POWELL
		DATE: APRIL 1976
PAYLOADS USED FOR DETAILED ANALYSIS		
<p style="text-align: center;"><u>MISSION 8</u> (JOINT NASA/ ESA)</p> <p>APE-01 LIDAR/LASER SOUNDER</p> <p>AP-09-S ELECTRON ACCELEROMETER</p> <p>AP-13-S LOW LIGHT LEVEL TV</p> <p>APE-07 PASSIVE ATMOSPHERE SOUNDER</p> <p>SPE-01 FREE-FLOW ELECTROPHORESIS FACILITY</p> <p>SPE-80/85 ISOTHERMAL MULTI-HEATING FACILITY</p> <p>EO-01-S ZERO G CLOUD PHYSICS</p> <p>ST-31-S DROP DYNAMICS FACILITY</p> <p>STE-10 ADVANCED HEAT PIPE</p> <p>LS-13-S LIFE SCIENCE PAYLOAD</p> <p>ASE-01 WIDE-FIELD CAMERA</p> <p>EOE-01 METRIC CAMERA</p> <p>EO-19-S MK II INTERFEROMETER</p> <p>CN-08-S OPEN TWT EXPERIMENTS</p> <p>—— VERIFICATION FLIGHT INSTRUMENTATION</p>	<p style="text-align: center;"><u>MISSION 14</u> (MULTIDISCIPLINE APPLICATIONS)</p> <p>CN-04-S ELECTROMAGNETIC ENVIRONMENT</p> <p>CN-08-S TWT OPEN ENVELOPE</p> <p>EO-20-S IMAGING RADAR</p> <p>OP-03-S MICROWAVE RADIO-METRY</p> <p>SP-31-S BIOLOGICAL/FURNACE SUBELEMENTS AND CORE</p>	<p style="text-align: center;"><u>MISSION 21</u> (COMBINED STELLAR ASTRONOMY)</p> <p>AS-01-S 1.5 M IR TELESCOPE</p> <p>AS-04-S 1.0 M UV/OPTICAL TELESCOPE</p>

II

ORGANIZATION:
**DATA SYSTEMS
LABORATORY**

**MARSHALL SPACE FLIGHT CENTER
SPACELAB EXPERIMENT
COMPUTER STUDY**

NAME:
J. T. POWELL
DATE:
APRIL 1976

EXAMPLE INTEGRATED PAYLOAD COMPUTER PROCESSING TIMELINE

ORIGINAL PAGE IS
OF POOR QUALITY

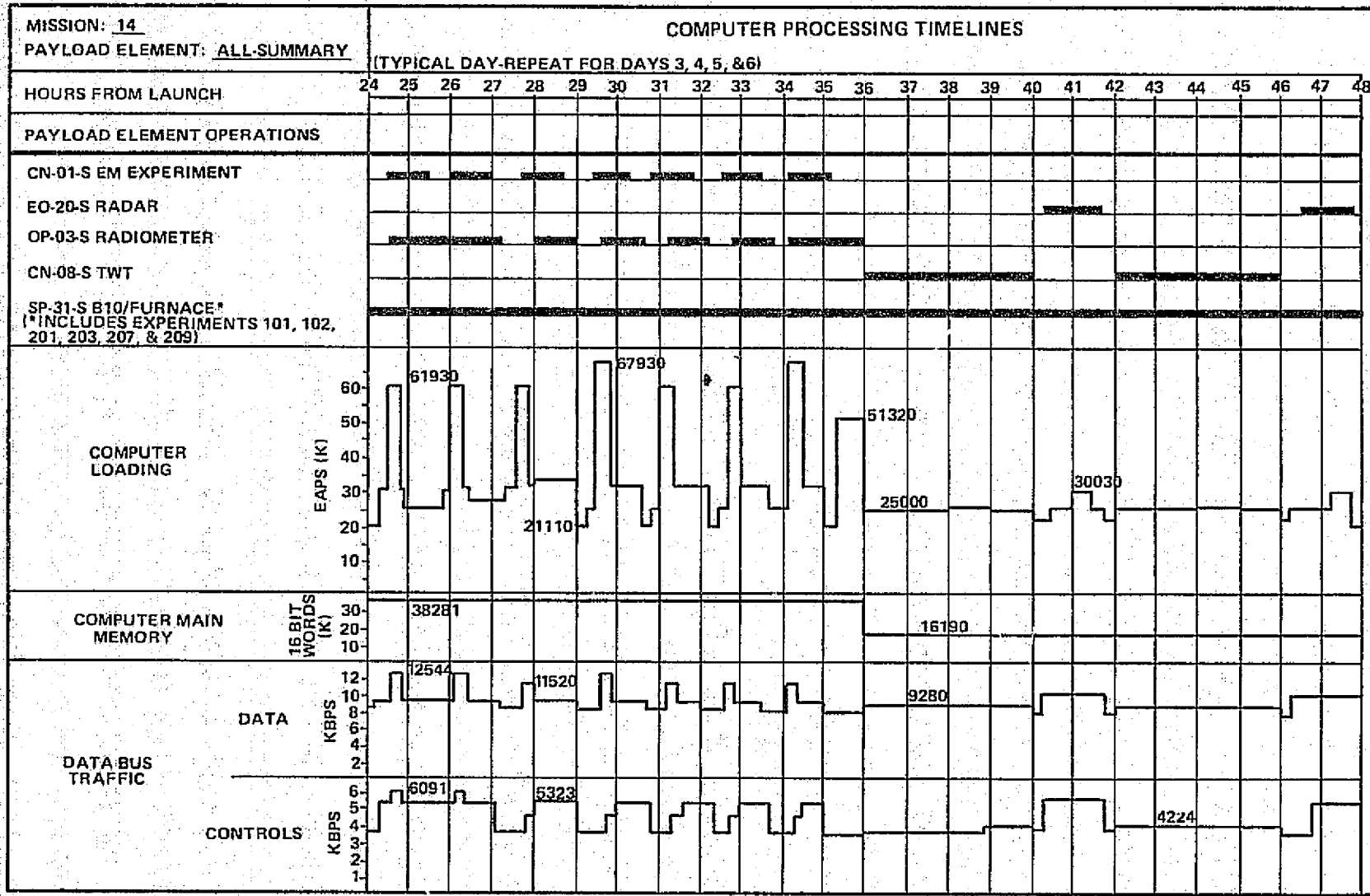

SPACELAB EXPERIMENT COMPUTER STUDY

NO. OF COMPUTATIONS PER SEC.

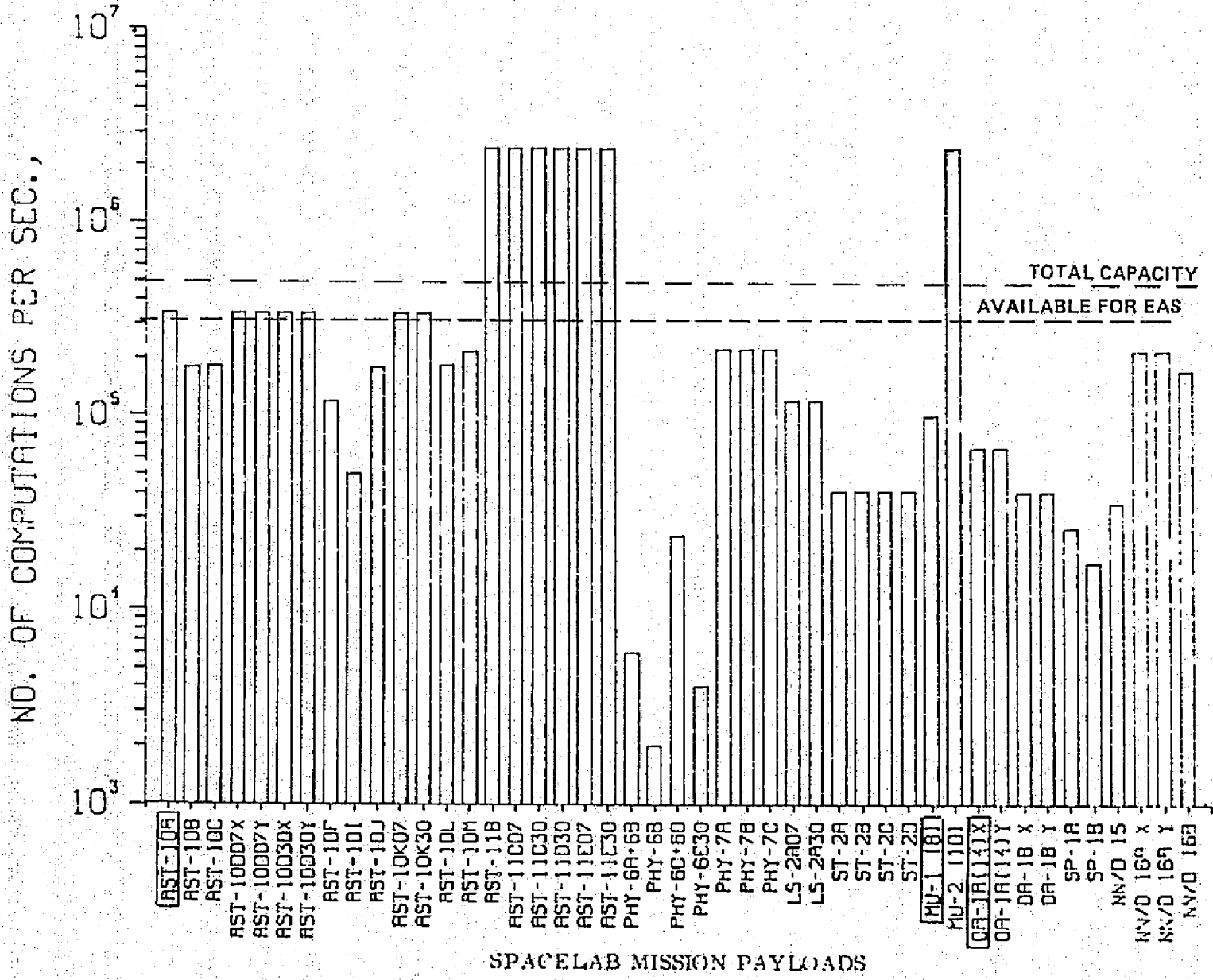

ORIGINAL PAGE IS
OF POOR QUALITY

RAPID ACCESS MEMORY

THE AVAILABLE TOTAL RAPID ACCESS MEMORY CAPACITY, SHOWN OPPOSITE, IS THAT OF THE BASELINE SYSTEM. THE CAPACITY AVAILABLE FOR EXPERIMENT APPLICATION SOFTWARE IS LESS BECAUSE OF REQUIREMENTS FOR OPERATING SYSTEM, COMMON CENTRAL SERVICES, AND CONTINGENCY. ADDITIONAL MEMORY MODULES CAN BE ADDED WITH NO DESIGN CHANGE TO ACCOMMODATE THE INDICATED REQUIREMENTS. ESTIMATED COSTS FOR THIS WERE INCLUDED IN THE OVERALL COST ANALYSIS.

BULK MEMORY

THE BULK MEMORY CAPACITY WAS EXCEEDED BY THE SAME 7 MISSIONS WHICH EXCEEDED THE COMPUTATIONS PER SECOND CAPACITY. NO COSTS WERE INCLUDED FOR MODIFICATION ON THE BASIS THAT THESE MISSIONS WOULD EITHER BE ELIMINATED, OR THE REQUIREMENT SOLVED BY THE SPECIAL-PURPOSE HARDWARE POSTULATED EARLIER.

ORGANIZATION: DATA SYSTEMS LABORATORY	MARSHALL SPACE FLIGHT CENTER SPACELAB EXPERIMENT COMPUTER STUDY	NAME: J. T. POWELL
		DATE: APRIL 1976

MISSIONS EXCEEDING CDMS CAPACITY

	<u>MISSION P/L</u>	<u>P/L ELEMENTS</u>	<u>P/L ELEMENT COMPS/SEC</u>	<u>MISSION COMPS/SEC</u>
1.	AST 10a	1M UV TELESCOPE 1M IR TELESCOPE	167,600 178,700	346,300
2.	AST 10d	1M UV TELESCOPE 3M AMBIENT TEMP. IR TELESCOPE	167,600 180,000	347,600
3.	AST 10k	1M UV TELESCOPE 2.5M IR TELESCOPE	167,600 180,000	347,600
4.	AST 11b/c	ATM SPACELAB	2,500,000*	2,500,000
5.	AST 11d	SOLAR ACTIVITY	2,500,000*	2,500,000
6.	AST 11e	SOLAR FINE POINTING	2,500,000*	2,500,000
7.	MU-2	X-RAY ANGULAR STRUCTURE SOLAR ACTIVITY GROWTH MK. II INTERFEROMETER	20,000 2,500,000* 7,600	2,527,600

*BASED ON PROCESSING (1024 X 1024) IMAGE EVERY 10 SECONDS.

ORIGINAL PAGE IS
OF POOR QUALITY

SPACELAB EXPERIMENT COMPUTER STUDY

RAPID ACCESS MEMORY

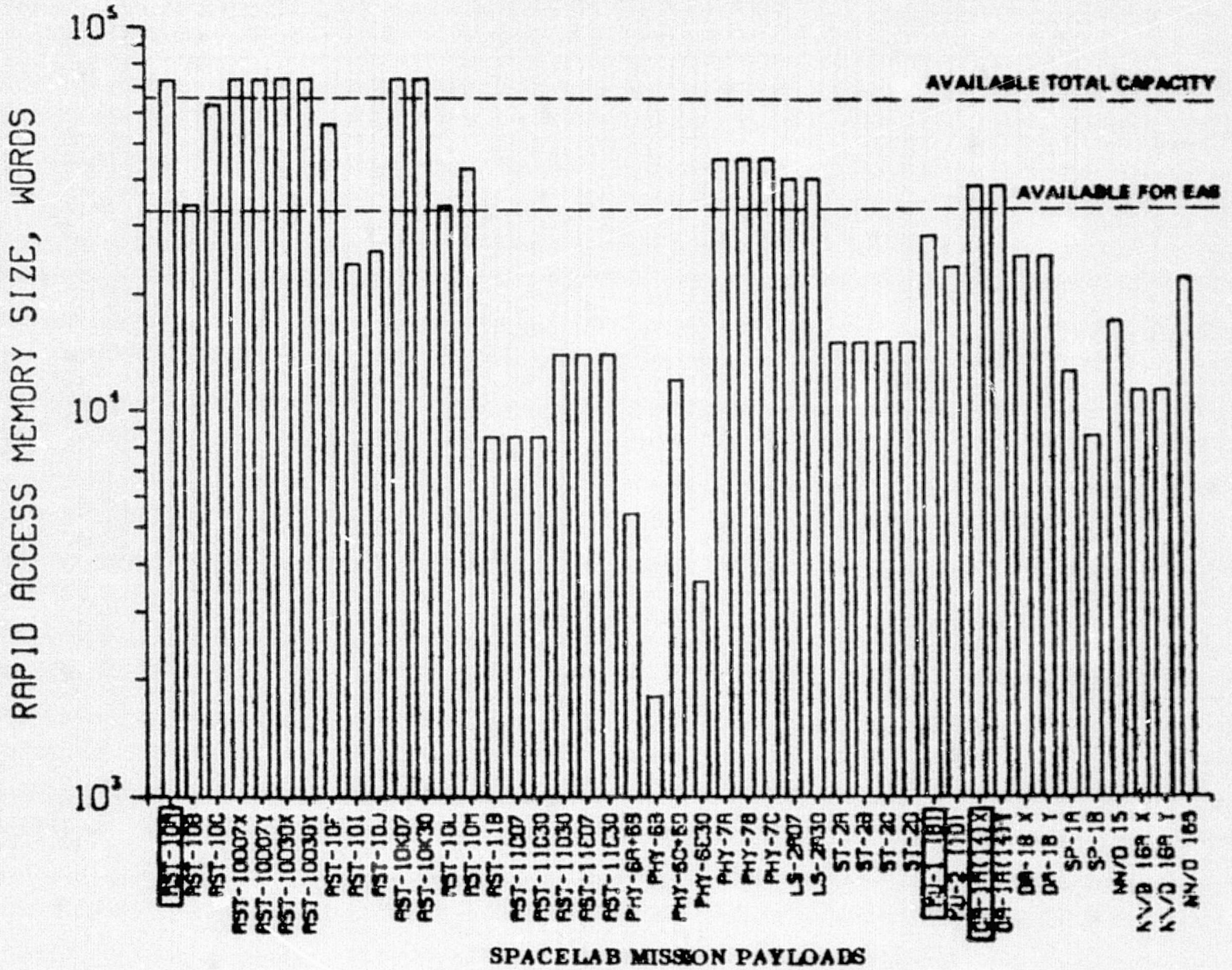

SPACELAB EXPERIMENT COMPUTER STUDY

BULK MEMORY

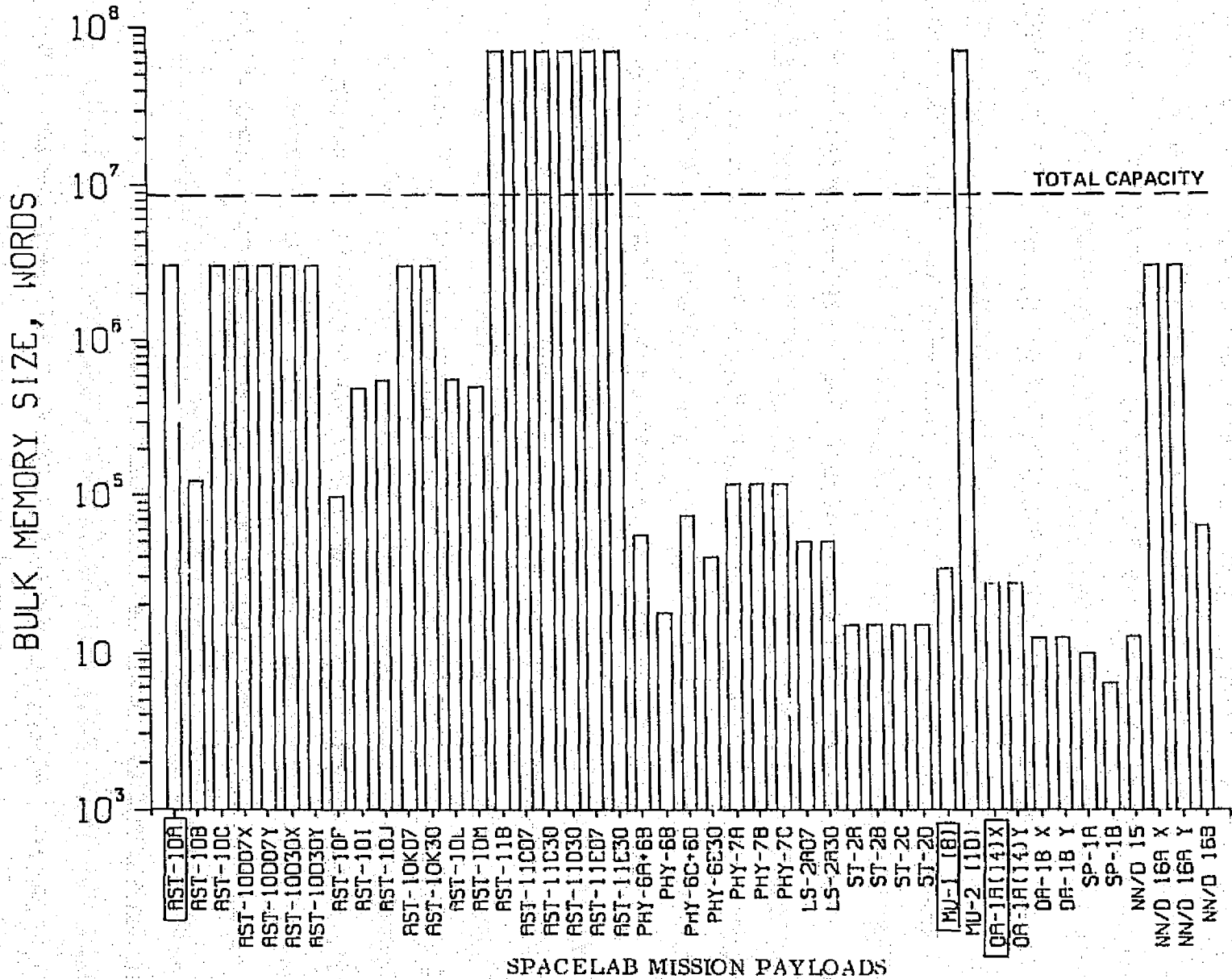

ORGANIZATION: DATA SYSTEMS LABORATORY	MARSHALL SPACE FLIGHT CENTER SPACELAB EXPERIMENT COMPUTER STUDY	NAME: J. T. POWELL
		DATE: APRIL 1976

ACCOMMODATION OF PAYLOAD REQUIREMENTS

- SPEED - CENTRAL EXPERIMENT COMPUTER CAN ACCOMMODATE ALL MISSIONS EXCEPT 7
 - THESE 7 HAVE STATED REQUIREMENTS THAT EXCEED STATE OF THE ART
 - MADE UP OF 4 PAYLOADS
- RAPID ACCESS MEMORY - MUST BE EXPANDED FOR SOME PAYLOADS
 - CAPABILITY INHERENT IN MACHINE - NO REDESIGN
- BULK MEMORY - CENTRAL MASS STORAGE CAN ACCOMMODATE ALL MISSIONS EXCEPT 7 (SAME 7 AS ABOVE)

COSTING APPROACH

THE COSTING APPROACH CONSISTED OF ESTABLISHING A COSTING METHOD FOR EACH COST FACTOR THAT WAS IDENTIFIED AS APPLICABLE TO THE COST ELEMENT WITHIN A GIVEN OPTION. THE COSTING METHOD EQUATION FOR EACH COST FACTOR WAS THEN APPLIED, YIELDING A RESULT IN TERMS OF: ONE TIME COST, COST PER FLIGHT, COST PER YEAR, USER COST, OR SPACELAB COST AS APPLICABLE. THIS DERIVED COST BY FACTORS WAS THEN SUMMED BY YEAR, ESCALATED, AND A TOTAL COST PER OPTION ESTABLISHED. THE TOTAL COST FOR EACH OPTION WAS THEN ANALYZED FOR SENSITIVITY TO THE COSTING RULES SUCH AS RATE OF CHANGE, COST PER STATEMENT, AND MISSION MODEL. DELTA TOTALS FOR EACH OPTION WERE DERIVED THUS GIVING VISIBILITY AS TO SENSITIVITY EFFECTS.

ORGANIZATION:

DATA SYSTEMS
LABORATORY

MARSHALL SPACE FLIGHT CENTER

SPACELAB EXPERIMENT
COMPUTER STUDY

NAME:

J. T. POWELL

DATE:

APRIL 1976

PRESENTATION OUTLINE

STUDY DEFINITION

OBJECTIVE

APPROACH

METHOD

SOFTWARE REQUIREMENTS DEVELOPMENT



COSTING

SUMMARY

OPTIONS CONSIDERED

THE TWO BASIC OPTIONS CONSIDERED FOR THIS STUDY ARE: EMPHASIS ON USE OF CENTRAL ONBOARD COMPUTING RESOURCES WITH OVERFLOW TO MINI'S, AS REQUIRED, AND EMPHASIS ON USE OF DISTRIBUTED MINI'S WITH CENTRAL RESOURCES PROVIDING STANDARD SERVICES. SUB-OPTIONS WITHIN EACH OPTION CONSIDERED SUCH ITEMS AS STANDARD MINI'S, AND VARIOUS EXPERIMENT APPLICATION SOFTWARE DEVELOPMENT OPTIONS. IN ALL, THIRTY (30) OPTIONS WERE IDENTIFIED AND A PRELIMINARY ANALYSIS MADE OF EACH. NINE (9) OF THE THIRTY (30) WERE ELIMINATED FROM FURTHER DETAIL ANALYSIS DUE TO EXCESSIVE COSTS, OR DUE TO THEIR BEING TOTALLY IMPRACTICAL TO IMPLEMENT AS WELL AS CONTAINING EXCESSIVE COST ELEMENTS. THE REMAINING TWENTY-ONE (21) WERE ANALYZED IN DETAIL AND THE RESULTS ARE INCLUDED IN VOLUME 2, BOOK 2, APPENDIX B1 THRU B30.

<p>ORGANIZATION: DATA SYSTEMS LABORATORY</p>	<p>MARSHALL SPACE FLIGHT CENTER SPACELAB EXPERIMENT COMPUTER STUDY</p>	<p>NAME: J. T. POWELL</p> <hr/> <p>DATE: APRIL 1976</p>
---	--	---

COSTING APPROACH

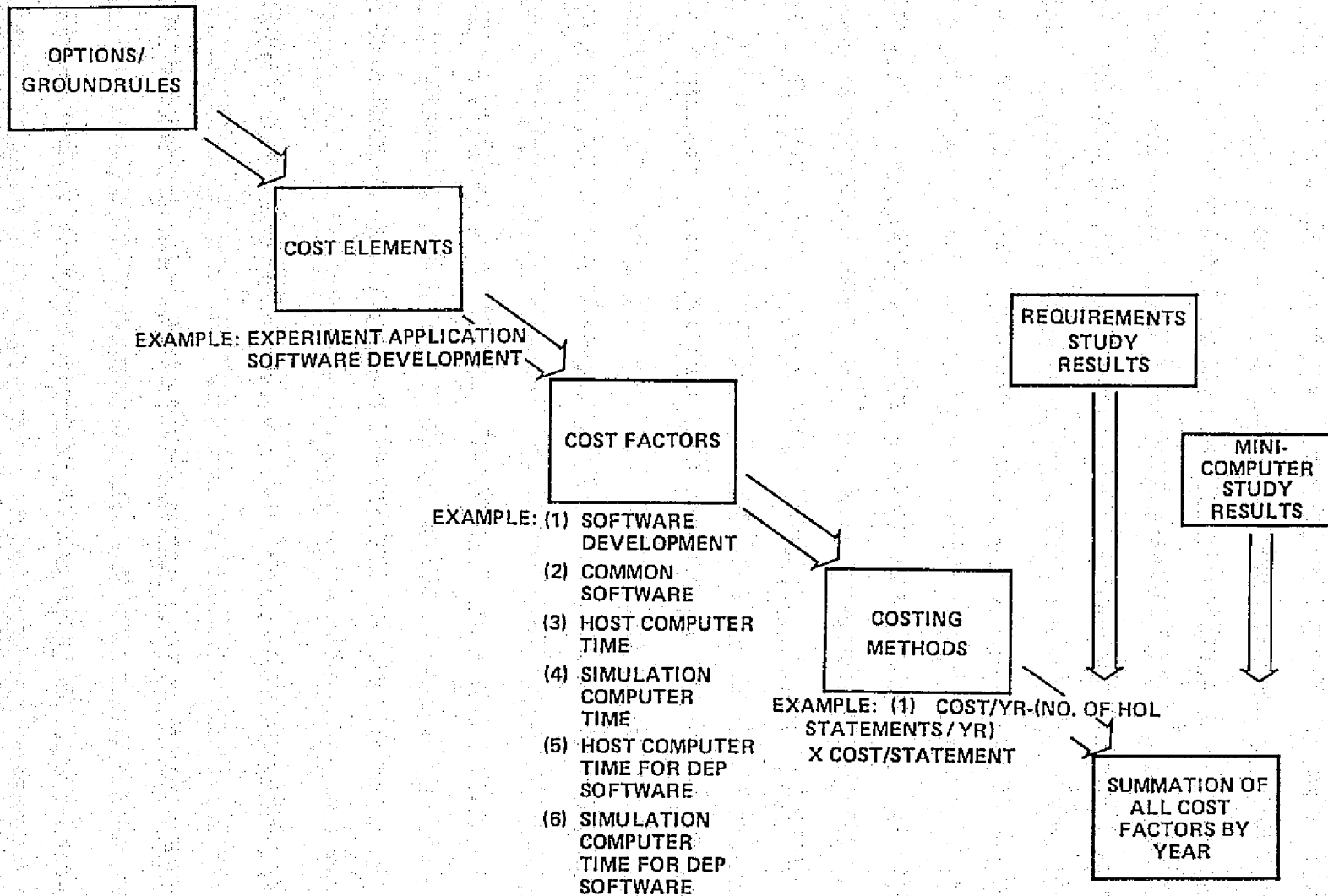

23

ORGANIZATION:

DATA SYSTEMS
LABORATORY

MARSHALL SPACE FLIGHT CENTER

SPACELAB EXPERIMENT
COMPUTER STUDY

NAME:

J. T. POWELL

DATE:

APRIL 1976

OPTIONS CONSIDERED

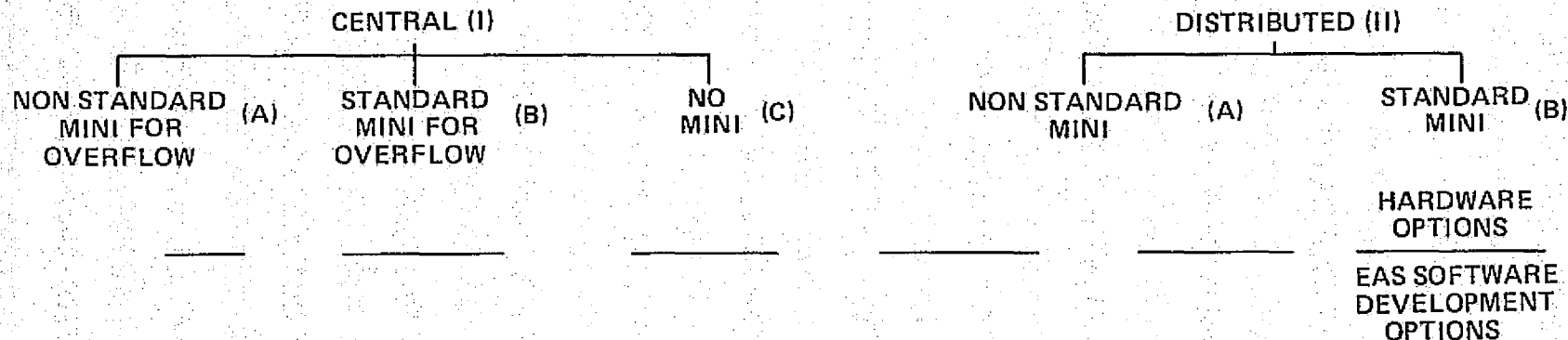

1. CENTRAL GROUP DEVELOPS EXPERIMENT APPLICATION SOFTWARE (EAS) AT CENTRAL SITE
2. PRINCIPAL INVESTIGATOR (PI) EXPERIMENT APPLICATION SOFTWARE (EAS) AT CENTRAL SITE
 - A. LOCAL TO CENTRAL SITE
 - B. UTILIZING REMOTE TERMINALS
3. PRINCIPAL INVESTIGATOR (PI) DEVELOPS EXPERIMENT APPLICATION SOFTWARE (EAS) ON HIS HOST THAT IS COMPATIBLE WITH CENTRAL SITE
 - A. ALL REALTIME SIMULATION AT CENTRAL SITE
 - B. REALTIME SIMULATION FOR DEDICATED EXPERIMENT PROCESSOR (DEP) EXPERIMENT APPLICATION SOFTWARE (EAS) ON REALTIME SIMULATION TEST SET (RTSTS) AT PRINCIPAL INVESTIGATOR (PI) FACILITY
4. PRINCIPAL INVESTIGATOR (PI) DEVELOPS EXPERIMENT APPLICATION SOFTWARE (EAS) ON HIS HOST THAT IS NOT COMPATIBLE WITH CENTRAL SITE.

ORGANIZATION: DATA SYSTEMS LABORATORY	MARSHALL SPACE FLIGHT CENTER SPACELAB EXPERIMENT COMPUTER STUDY	NAME: J. T. POWELL DATE: APRIL 1976
---	---	--

SPACELAB COST ELEMENTS

CDMS

- HARDWARE MODIFICATIONS
- SUBSYSTEM COMPUTER SOFTWARE DEVELOPMENT AND ACCEPTANCE
- SUBSYSTEM COMPUTER SOFTWARE MAINTENANCE
- SUBSYSTEM COMPUTER SOFTWARE CONFIGURATION MANAGEMENT, RELEASE, AND DISTRIBUTION
- EXPERIMENT COMPUTER SOFTWARE DEVELOPMENT AND ACCEPTANCE
- EXPERIMENT COMPUTER SOFTWARE MAINTENANCE
- EXPERIMENT COMPUTER SOFTWARE CONFIGURATION MANAGEMENT, RELEASE, AND DISTRIBUTIONS

EGSE

- HARDWARE MODIFICATIONS
- GROUND CHECKOUT SOFTWARE DEVELOPMENT AND ACCEPTANCE
- GROUND CHECKOUT SOFTWARE MAINTENANCE
- GROUND CHECKOUT SOFTWARE CONFIGURATION MANAGEMENT RELEASE, AND DISTRIBUTION
- EGSE COMPUTER SOFTWARE PRODUCTION SET DEVELOPMENT AND ACCEPTANCE
- EGSE COMPUTER SOFTWARE PRODUCTION SET MAINTENANCE
- EGSE COMPUTER SOFTWARE PRODUCTION SET CONFIGURATION MANAGEMENT, RELEASE, AND DISTRIBUTION

CENTRAL SITE

- FACILITY ACQUISITION
- FACILITY OPERATION AND MAINTENANCE
- HOST AND SIMULATION COMPUTER SUPPORT SOFTWARE DEVELOPMENT AND ACCEPTANCE
- HOST AND SIMULATION COMPUTER SUPPORT SOFTWARE MAINTENANCE

ORGANIZATION: DATA SYSTEMS LABORATORY	MARSHALL SPACE FLIGHT CENTER SPACELAB EXPERIMENT COMPUTER STUDY	NAME: J. T. POWELL
		DATE: APRIL 1976

USER COST ELEMENTS

<u>PI HOST COMPUTER</u>	<u>EXPERIMENT</u>	<u>DEP*</u>	<u>RTSTS*</u>
<ul style="list-style-type: none"> ● HOST AND SIMULATION COMPUTER SUPPORT SOFTWARE MAINTENANCE 	<ul style="list-style-type: none"> ● EAS DEVELOPMENT ● EAS MAINTENANCE ● EAS INTEGRATION ● EXPERIMENT PREFLIGHT CHECKOUT SOFTWARE DEVELOPMENT ● EXPERIMENT PREFLIGHT CHECKOUT SOFTWARE MAINTENANCE ● EAS DEPENDENT CENTRAL SITE HARDWARE SUPPLEMENT ● EAS DEPENDENT CENTRAL SITE SOFTWARE SUPPLEMENT ● EXPERIMENT REAL-TIME SIMULATION SOFTWARE DEVELOPMENT ● EXPERIMENT REAL-TIME SIMULATION SOFTWARE MAINTENANCE 	<ul style="list-style-type: none"> ● EXPERIMENT PROCESSOR ACQUISITION ● EXPERIMENT PROCESSOR MAINTENANCE AND DISTRIBUTION ● DEP SOFTWARE DEVELOPMENT AND PROCUREMENT ● DEP SOFTWARE MAINTENANCE AND DISTRIBUTION 	<ul style="list-style-type: none"> ● RTSTS ACQUISITION ● RTSTS MAINTENANCE, OPERATION, AND DISTRIBUTION ● RTSTS SUPPORT SOFTWARE DEVELOPMENT AND PROCUREMENT ● RTSTS SUPPORT SOFTWARE MAINTENANCE AND DISTRIBUTION
		*DEP - DISTRIBUTED EXPERIMENT PROCESSOR RTSTS - REAL-TIME SIMULATION TEST SET	

ORGANIZATION: DATA SYSTEMS LABORATORY	MARSHALL SPACE FLIGHT CENTER SPACELAB EXPERIMENT COMPUTER STUDY	NAME: J. T. POWELL
		DATE: APRIL 1976

OPTION/COST ELEMENT CORRELATION MATRIX

OPTIONS			SPACELAB COST ELEMENTS																	
			1. CDSE				2. EGSE				3. STIL									
			1.1 HARDWARE MODIFICATIONS	1.2 DISCRETE COMPUTER AND FACILITY	1.3 SYSTEMS COMPUTER SOFTWARE DEVELOPMENT	1.4 SUBSYSTEM COMPUTER SOFTWARE DEVELOPMENT	1.5 EXPERIMENTAL SOFTWARE DEVELOPMENT AND DISTRIBUTION	1.6 EXPERIMENTAL COMPUTER SOFTWARE DEVELOPMENT	1.7 EXPERIMENTAL COMPUTER SOFTWARE RELEASE AND DISTRIBUTION	2.1 HARDWARE MODIFICATIONS	2.2 GROUND CHECKOUT SOFTWARE DEVELOPMENT AND ACCEPTANCE	2.3 GROUND CHECKOUT SOFTWARE MAINTENANCE	2.4 GROUND CHECKOUT SOFTWARE SUPPORT SOFTWARE PRODUCTION AND DISTRIBUTION	2.5 EGS SOFTWARE DEVELOPMENT	2.6 EGS SOFTWARE SUPPORT SOFTWARE PRODUCTION AND DISTRIBUTION	3.1 FACILITY ACQUISITION	3.2 FACILITY OPERATIONAL AND MAINTENANCE	3.3 HOST AND SIMULATION COMPUTER SOFTWARE DEVELOPMENT AND ACCEPTANCE	3.4 HOST AND SIMULATION COMPUTER SUPPORT SOFTWARE MAINTENANCE	
I CENTRALIZED ONBOARD COMPUTING CONFIGURATION	A. NON-STANDARD MINICOMPUTER	1. CENTRAL GROUP DEVELOPS EAS AT CENTRAL FACILITY (STIL) 2. PI DEVELOPS EAS AT CENTRAL FACILITY A. LOCAL B. REMOTE 3. PI DEVELOPS EAS AT HIS FACILITY WHICH IS COMPATIBLE WITH STIL A. REALTIME SIMULATION @ STIL B. PI USES AN RTSTC 4. PI DEVELOPS EAS AT HIS FACILITY WHICH IS NOT COMPATIBLE WITH STIL																		
	B. STANDARD MINICOMPUTER	1. CENTRAL GROUP DEVELOPS EAS AT CENTRAL FACILITY (STIL) 2. PI DEVELOPS EAS AT CENTRAL FACILITY A. LOCAL B. REMOTE 3. PI DEVELOPS EAS AT HIS FACILITY WHICH IS COMPATIBLE WITH STIL A. REALTIME SIMULATION @ STIL B. PI USES AN RTSTC 4. PI DEVELOPS EAS AT HIS FACILITY WHICH IS NOT COMPATIBLE WITH STIL																		
	C. NO MINICOMPUTER	1. CENTRAL GROUP DEVELOPS EAS AT CENTRAL FACILITY (STIL) 2. PI DEVELOPS EAS AT CENTRAL FACILITY A. LOCAL B. REMOTE 3. PI DEVELOPS EAS AT HIS FACILITY WHICH IS COMPATIBLE WITH STIL A. REALTIME SIMULATION @ STIL B. PI USES AN RTSTC 4. PI DEVELOPS EAS AT HIS FACILITY WHICH IS NOT COMPATIBLE WITH STIL																		
II DISTRIBUTED ONBOARD COMPUTING CONFIGURATION	A. NON-STANDARD MINICOMPUTER	1. CENTRAL GROUP DEVELOPS EAS AT CENTRAL FACILITY (STIL) 2. PI DEVELOPS EAS AT CENTRAL FACILITY A. LOCAL B. REMOTE 3. PI DEVELOPS EAS AT HIS FACILITY WHICH IS COMPATIBLE WITH STIL A. REALTIME SIMULATION @ STIL B. PI USES AN RTSTC 4. PI DEVELOPS EAS AT HIS FACILITY WHICH IS NOT COMPATIBLE WITH STIL																		
	B. STANDARD MINICOMPUTER	1. CENTRAL GROUP DEVELOPS EAS AT CENTRAL FACILITY (STIL) 2. PI DEVELOPS EAS AT CENTRAL FACILITY A. LOCAL B. REMOTE 3. PI DEVELOPS EAS AT HIS FACILITY WHICH IS COMPATIBLE WITH STIL A. REALTIME SIMULATION @ STIL B. PI USES AN RTSTC 4. PI DEVELOPS EAS AT HIS FACILITY WHICH IS NOT COMPATIBLE WITH STIL																		

ORIGINAL PAGE IS
OF POOR QUALITY

ORGANIZATION: DATA SYSTEMS LABORATORY	MARSHALL SPACE FLIGHT CENTER SPACELAB EXPERIMENT COMPUTER STUDY	NAME: J. T. POWELL DATE: APRIL 1976
---	--	--

MAJOR COSTING RULES

● EXPERIMENT APPLICATION SOFTWARE CHANGE RATE:

40%	FIRST REFLY
30%	SECOND REFLY
20%	THIRD REFLY
10%	EACH SUCCEEDING REFLY

● EGSE SOFTWARE CHANGE RATE:

5%	EACH NEW FLIGHT
1%	EACH REFLIGHT

● SUBSYSTEM COMPUTER SOFTWARE CHANGE RATE:

5%	PER FLIGHT FOR 1ST THREE YEARS
10%	PER YEAR THEREAFTER

● ALL COSTS ESCALATED - 7% PER YEAR, COMPOUNDED ANNUALLY

● COST PER HIGHER ORDER LANGUAGE STATEMENT FOR EAS:

REQUIREMENTS ANALYSIS	\$ 15.00
DESIGN, CODE, VERIFICATION	\$ 30.00

\$ 45.00

● COST PER STATEMENT FOR INTEGRATION AND VERIFICATION IF IN CENTRAL COMPUTER
(NOT APPLICABLE TO EAS IN DISTRIBUTED COMPUTER OPTIONS) \$ 15.00

● COST PER CHECKOUT STATEMENT \$ 30.00

● COST PER ASSEMBLY LANGUAGE INSTRUCTION \$100.00

● ONE HIGHER ORDER LANGUAGE STATEMENT, WHEN COMPILED, RESULTS IN FIVE COMPUTER INSTRUCTIONS

● ONE MAN-YEAR OF EFFORT IS EQUIVALENT TO \$50,000 IN 1976

SPACELAB AND USER COST

THE TOTAL SPACELAB AND USER COSTS ARE SHOWN TO INDICATE DELTA COSTS BETWEEN OPTIONS. OPTION IIA4 IS SHOWN FOR COMPARISON AND IS AN INDICATOR OF THE HIGH COSTS ASSOCIATED WITH OPTIONS IA4, IB4, IC3B, IC4, IIA1, IIA2A, IIA2B, IIA3A, AND IIA3B WHICH ARE NOT INCLUDED.

ORGANIZATION: DATA SYSTEMS LABORATORY	MARSHALL SPACE FLIGHT CENTER SPACELAB EXPERIMENT COMPUTER STUDY	NAME: J. T. POWELL DATE: APRIL 1976
---	---	--

STATEMENTS TO BE CODED
OPTION IIB2A

COST ELEMENT	FY77	78	79	80	81	82	83	84	85	86	87	88	89	90	91
EAS DEVELOPMENT	-	-	-	4940	14596	8282	1240	3937	0	5183	4526	868	1550	-	-
EAS MAINTENANCE	-	-	-	-	3371	4443	7956	5344	7793	3969	5750	5618	5892	7877	7229
PREFLIGHT CHECKOUT S/W DEV	-	-	-	13020	4650	13950	3720	1860	0	2790	2790	930	930	-	-
PREFLIGHT CHECKOUT S/W MAINT	-	-	-	-	1302	558	2232	2511	4092	2790	4650	3627	4929	5022	5952
EXP. REAL TIME SIMULATION S/W DEV	-	-	-	19600	7000	21000	5600	2600	0	4200	4200	1400	1400	-	-
EXP. REAL TIME SIMULATION S/W MAINT	-	-	-	-	1960	840	3360	3780	6160	4200	7000	5460	7420	7560	8960
DEP OP SYS DEV	-	-	-	800	-	-	-	-	-	-	-	-	-	-	-
DEP OP SYS MAINT	-	-	-	-	40	40	40	40	40	40	40	40	40	40	40
STATEMENTS TOTAL	-	-	-	38360	32919	49113	24148	20272	18065	23172	26956	17945	22161	20499	22181

ORIGINAL PAGE IS
OF POOR QUALITY

31

<p>ORGANIZATION: DATA SYSTEMS LABORATORY</p>	<p>MARSHALL SPACE FLIGHT CENTER SPACELAB EXPERIMENT COMPUTER STUDY</p>	<p>NAME: J. T. POWELL</p> <p>DATE: APRIL 1976</p>
---	---	---

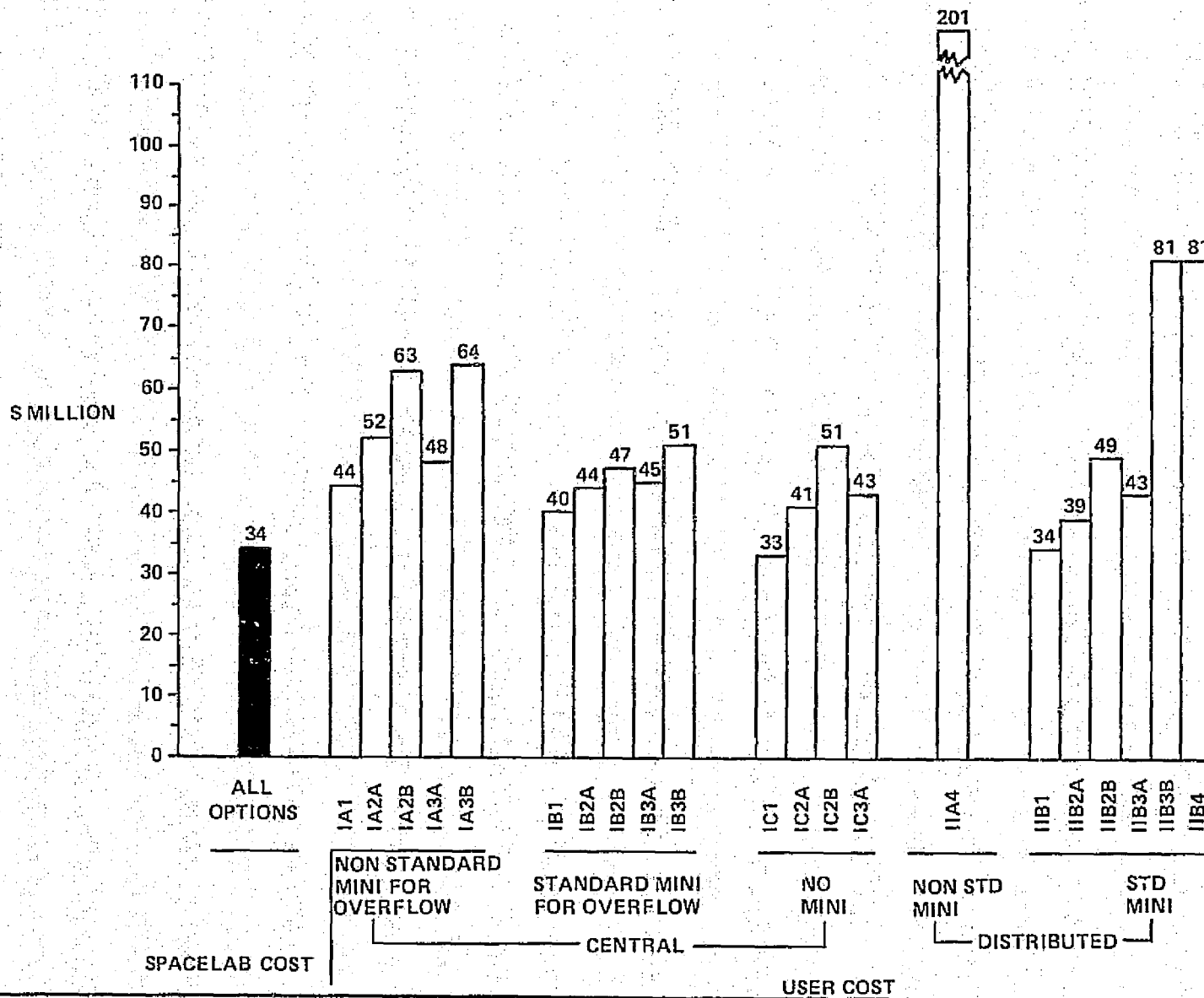

32

SENSITIVITY TO COST PER STATEMENT

AN ANALYSIS OF SENSITIVITY TO COST PER STATEMENT WAS EXERCISED FOR EACH OPTION USING, AS A BASE, 50% OF THE ORIGINAL ESTIMATED COST PER INSTRUCTION OR LANGUAGE STATEMENT AS APPLICABLE. THE RESULTING DELTA COSTS FOR COMPARABLE USER OPTIONS AS WELL AS SPACELAB DELTA COSTS ARE SHOWN. DELTA COSTS FOR ALL OPTIONS DUE TO COST PER STATEMENT SENSITIVITY ARE INCLUDED IN VOLUME 1, EXECUTIVE SUMMARY.

ALSO SHOWN, ON OPTION IIA4, IS THE EFFECT OF PARTIAL STANDARDIZATION OF MINICOMPUTERS; i. e., EACH OF 12 DISCIPLINES WOULD USE THE SAME TYPE OF COMPUTER.

ORGANIZATION: DATA SYSTEMS LABORATORY	MARSHALL SPACE FLIGHT CENTER SPACELAB EXPERIMENT COMPUTER STUDY	NAME: J. T. POWELL
		DATE: APRIL 1976

OPTIONS CONSIDERED

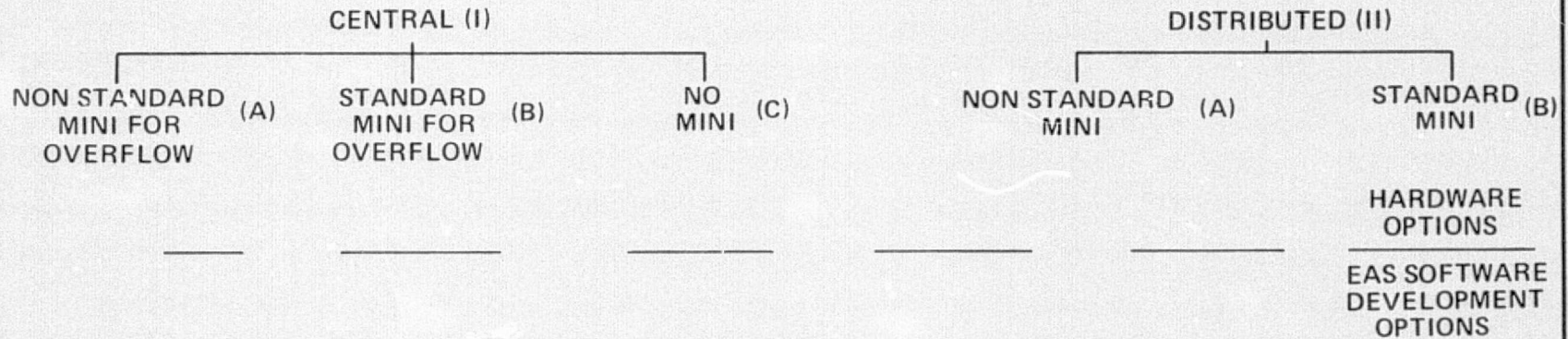

1. CENTRAL GROUP DEVELOPS EXPERIMENT APPLICATION SOFTWARE (EAS) AT CENTRAL SITE
2. PRINCIPAL INVESTIGATOR (PI) EXPERIMENT APPLICATION SOFTWARE (EAS) AT CENTRAL SITE
 - A. LOCAL TO CENTRAL SITE
 - B. UTILIZING REMOTE TERMINALS
3. PRINCIPAL INVESTIGATOR (PI) DEVELOPS EXPERIMENT APPLICATION SOFTWARE (EAS) ON HIS HOST THAT IS COMPATIBLE WITH CENTRAL SITE
 - A. ALL REALTIME SIMULATION AT CENTRAL SITE
 - B. REALTIME SIMULATION FOR DEDICATED EXPERIMENT PROCESSOR (DEP) EXPERIMENT APPLICATION SOFTWARE (EAS) ON REALTIME SIMULATION TEST SET (RTSTS) AT PRINCIPAL INVESTIGATOR (PI) FACILITY
4. PRINCIPAL INVESTIGATOR (PI) DEVELOPS EXPERIMENT APPLICATION SOFTWARE (EAS) ON HIS HOST THAT IS NOT COMPATIBLE WITH CENTRAL SITE.

SENSITIVITY TO MISSION RATE

IN ORDER TO INDICATE THE SENSITIVITY TO MISSION RATE AN EXERCISE WAS CONDUCTED USING A TWELVE (12) YEAR MISSION MODEL CONSISTING OF SEVENTY-SEVEN (77) TOTAL FLIGHTS. DELTA COSTS FOR THIS REDUCED MISSION MODEL ARE SHOWN FOR SPACELAB COST AND USER COSTS FOR SIX (6) COMPARABLE OPTIONS.

<p>ORGANIZATION DATA SYSTEMS LABORATORY</p>	<p>MARSHALL SPACE FLIGHT CENTER SPACELAB EXPERIMENT COMPUTER STUDY</p>	<p>NAME J. T. POWELL DATE APR'L 1976</p>
--	---	---

SENSITIVITY TO COST/STATEMENT

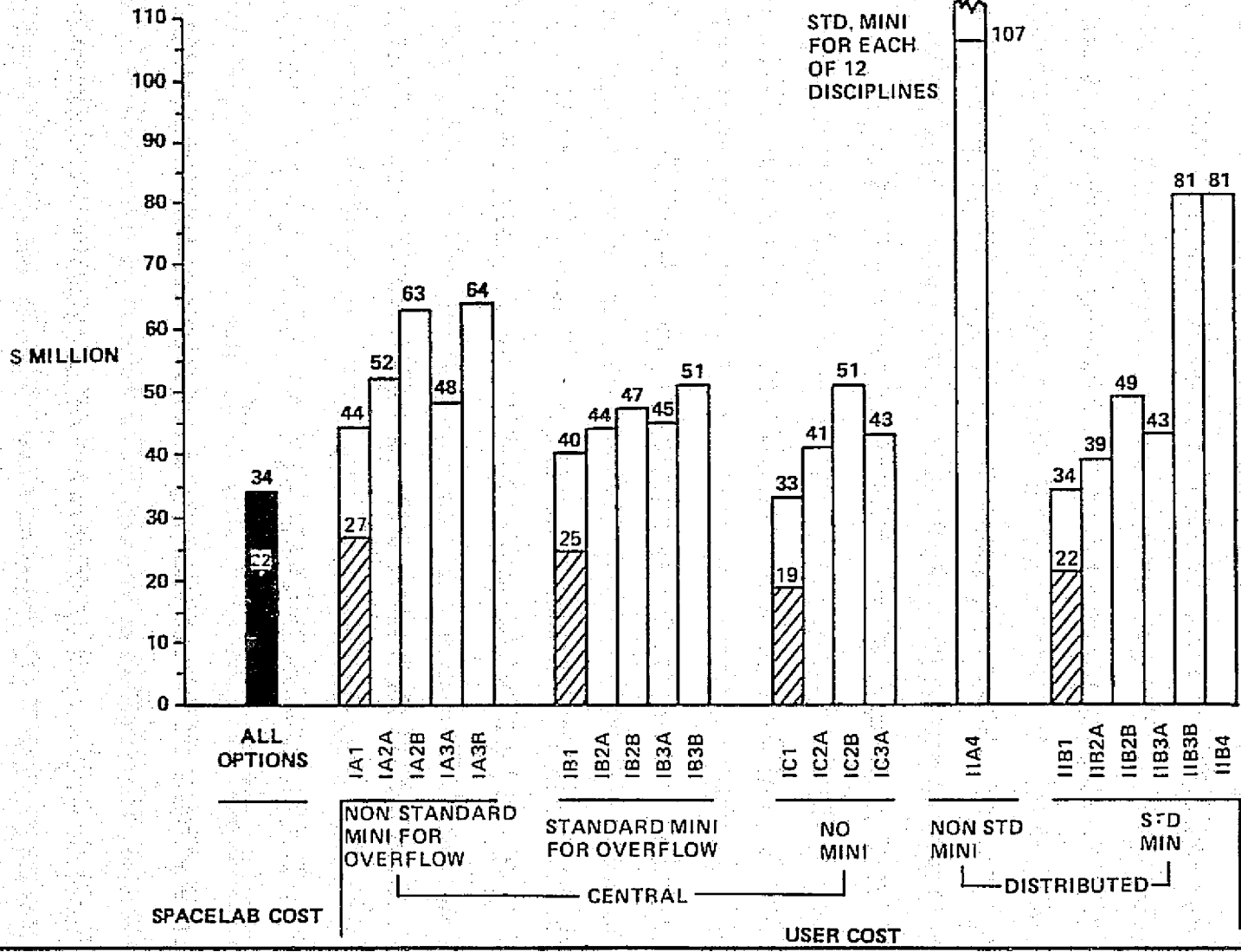

93

<p>ORGANIZATION</p> <p>DATA SYSTEMS LABORATORY</p>	<p>MARSHALL SPACE FLIGHT CENTER</p> <p>SPACELAB EXPERIMENT COMPUTER STUDY</p>	<p>NAME</p> <p>J. T. POWELL</p> <hr/> <p>DATE</p> <p>APRIL 1976</p>
---	---	---

37

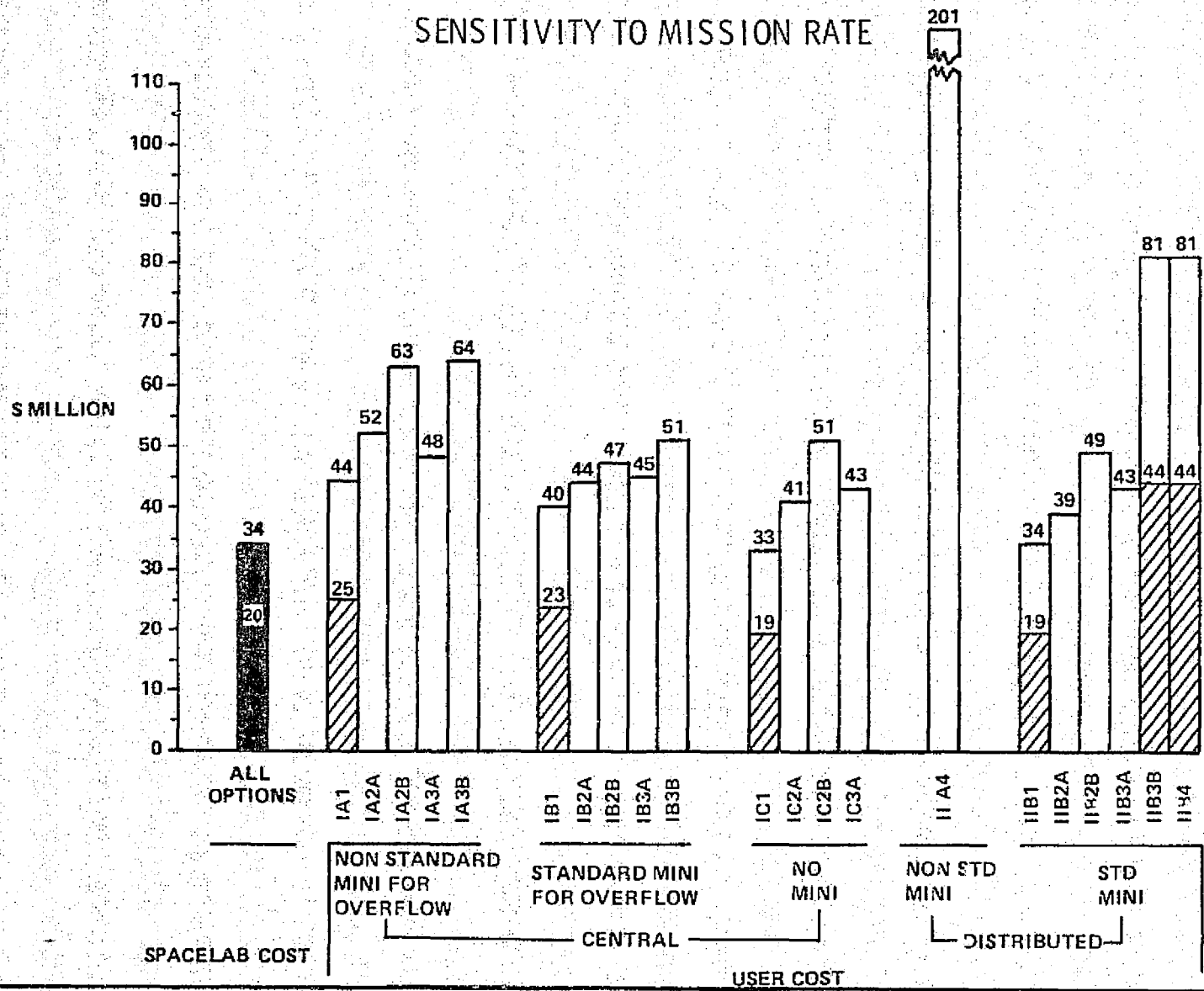

ORGANIZATION: DATA SYSTEMS LABORATORY	MARSHALL SPACE FLIGHT CENTER SPACELAB EXPERIMENT COMPUTER STUDY	NAME: J. T. POWELL
		DATE: APRIL 1976

PRESENTATION OUTLINE

STUDY DEFINITION

OBJECTIVE

APPROACH

METHOD

SOFTWARE REQUIREMENTS DEVELOPMENT

COSTING

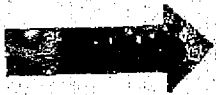

SUMMARY

ORGANIZATION DATA SYSTEMS LABORATORY	MARSHALL SPACE FLIGHT CENTER SPACELAB EXPERIMENT COMPUTER STUDY	NAME: J. T. POWELL DATE: APRIL 1976
--	---	--

SUMMARY

- SPACELAB SOFTWARE DEVELOPMENT AND MAINTENANCE COST IS INDEPENDENT OF OPTIONS
- COST IS NOT A SIGNIFICANT DRIVER BETWEEN CENTRAL AND DISTRIBUTED COMPUTER CONFIGURATIONS
- DISTRIBUTED COMPUTER CONCEPT SIMPLIFIES INTEGRATION WITHOUT SIGNIFICANT COST INCREASE
- STANDARD MINI HAS COST ADVANTAGES WHEN DEDICATED EXPERIMENT PROCESSOR IS SELECTED
- CENTRALIZED EXPERIMENT APPLICATION SOFTWARE DEVELOPMENT IS LEAST COST FOR ALL HARDWARE CONFIGURATIONS
- DECISION ON CENTRAL OR DEDICATED EXPERIMENT PROCESSOR SHOULD BE BASED ON ANALYSIS OF EACH MISSION REQUIREMENTS AFTER FINAL PAYLOAD SELECTION

ORGANIZATION: DATA SYSTEMS LABORATORY	MARSHALL SPACE FLIGHT CENTER SPACELAB EXPERIMENT COMPUTER STUDY	NAME: J. T. POWELL
		DATE: MARCH 1976

ASSUMED CDMS FUNCTIONAL CAPABILITIES

- CRT HAS REFRESH CAPABILITY
- SYSTEM SOFTWARE ACCEPTS & ACCUMULATES CONTROL DATA VIA KEYBOARD ENTRY
- SPACELAB PROVIDES CAPABILITY TO INITIATE AND SCHEDULE P/L APPLICATION SOFTWARE AT DISCRETE MISSION ELAPSED TIMES
- SPACELAB PROVIDES TRANSFER OF TIME AND STATE VECTORS FROM ORBITER TO EXPERIMENT COMPUTER
- P/L APPLICATION SOFTWARE NOT REQUIRED TO SCHEDULE AND CONTROL SPACELAB MAGNETIC RECORDERS
- SPACELAB PROVIDES TRANSFER OF UPLINK COMMANDS FROM ORBITER TO EXPERIMENT COMPUTER
- SPACELAB PROVIDES FOR INPUT OF HIGH RATE P/L DATA TO EXPERIMENT COMPUTER
- SPACELAB TRANSFERS IPS STATE VECTORS FROM SPACELAB SUBSYSTEM COMPUTER TO EXPERIMENT COMPUTER
- ALL APPLICATION PROGRAMS, DATA CONSTANTS AND DISPLAY FORMATS STORED IN BULK MEMORY
- ALL APPLICATION PROGRAMS DATA CONSTANTS, DISPLAY FORMATS AND BUFFER DATA MEMORY FOR ACTIVE PROGRAMS ARE INCLUDED IN THE ESTIMATE OF RAPID ACCESS MEMORY

ORGANIZATION:

DATA SYSTEMS
LABORATORY

MARSHALL SPACE FLIGHT CENTER

SPACELAB EXPERIMENT
COMPUTER STUDY

NAME:

J. T. POWELL

DATE:

MARCH 1976

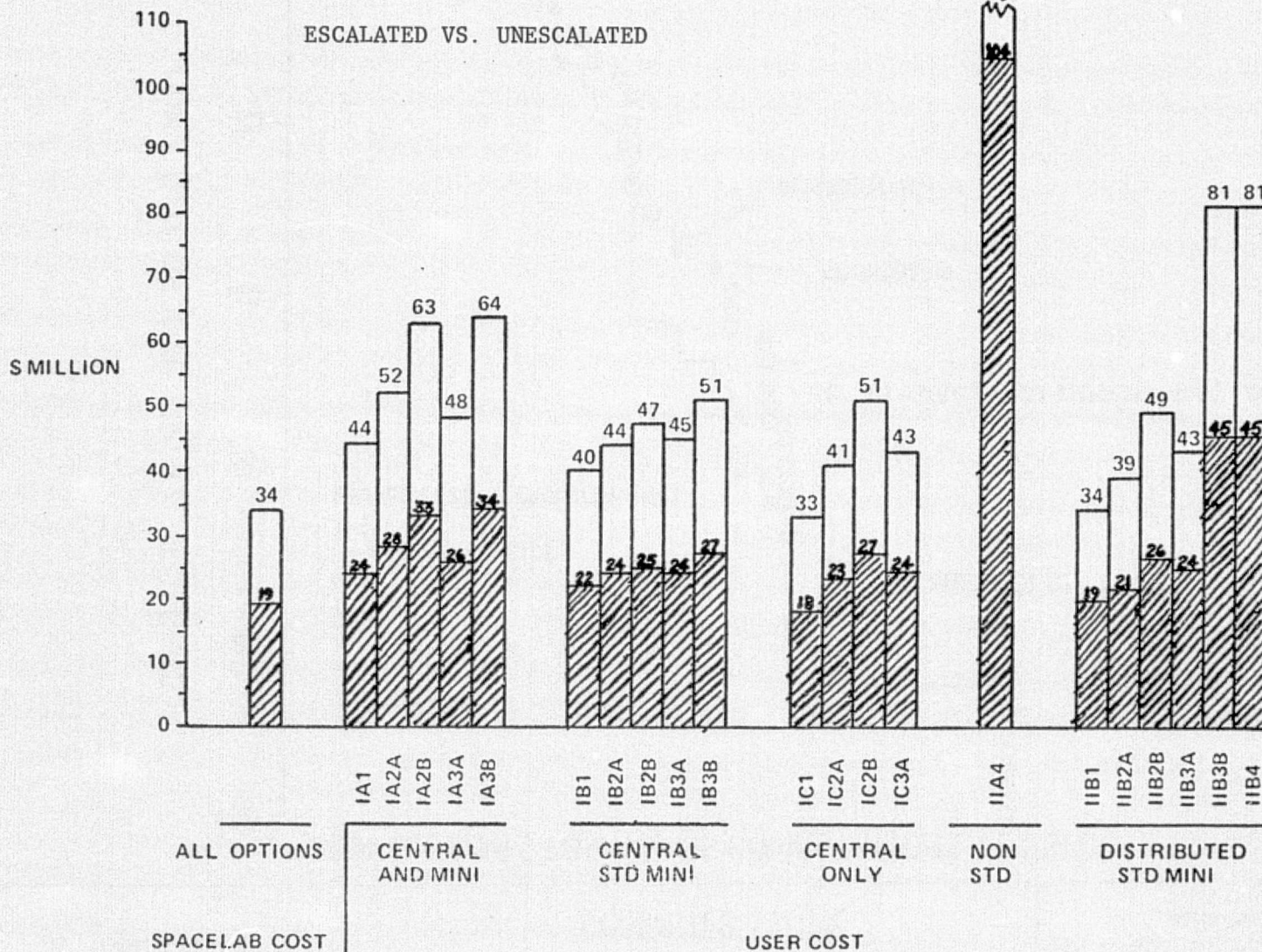

41

<p>ORGANIZATION: DATA SYSTEMS LABORATORY</p>	<p>MARSHALL SPACE FLIGHT CENTER SPACELAB EXPERIMENT COMPUTER STUDY</p>	<p>NAME: J. T. POWELL DATE: MARCH 1976</p>
---	---	---

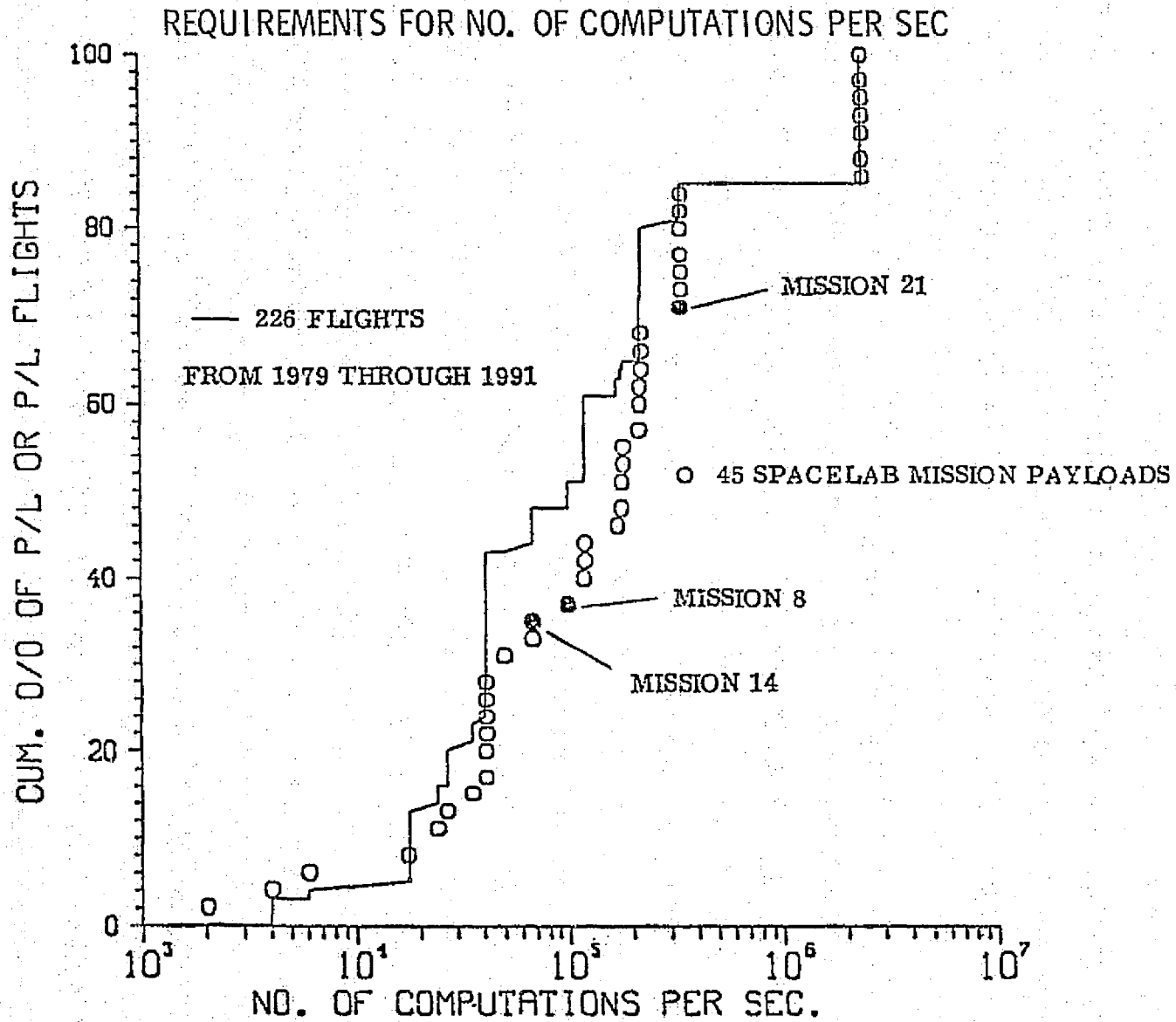

ORGANIZATION: DATA SYSTEMS LABORATORY	MARSHALL SPACE FLIGHT CENTER SPACELAB EXPERIMENT COMPUTER STUDY	NAME: J. T. POWELL DATE: MARCH 1976
---	---	--

ORIGINAL PAGE IS
OF POOR QUALITY

43

BULK MEMORY

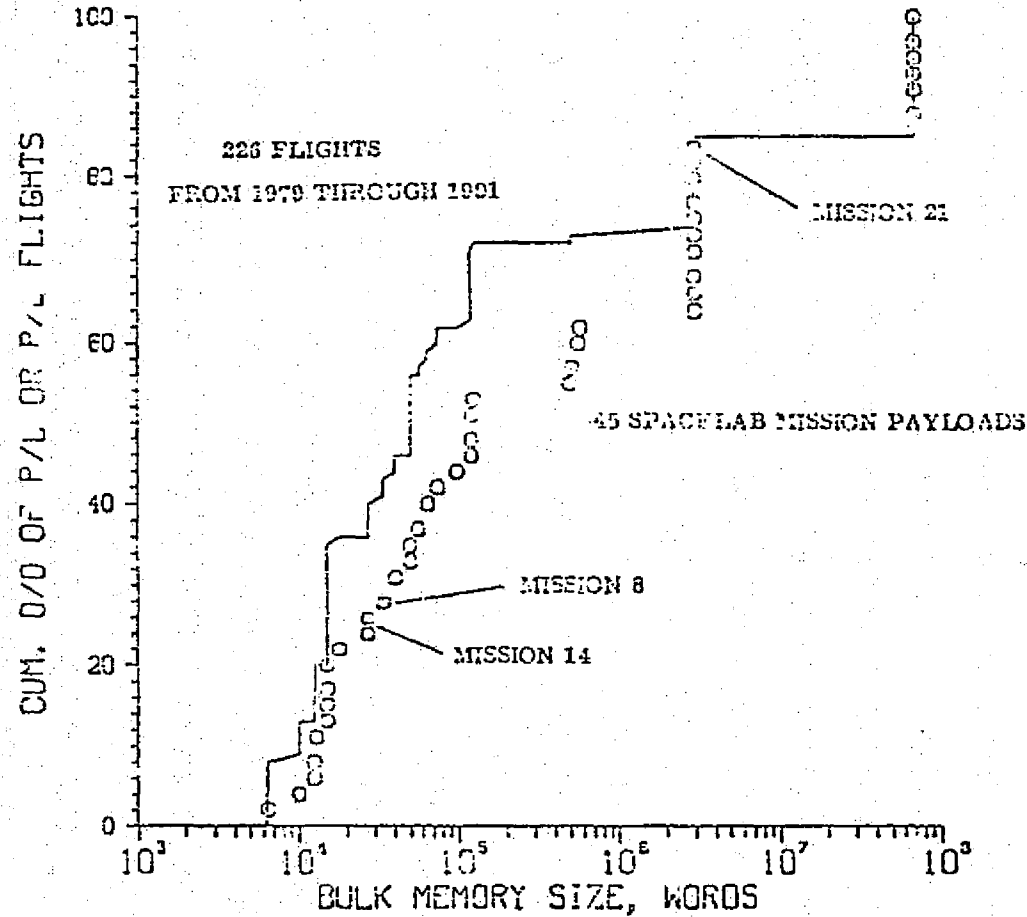

<p>ORGANIZATION: DATA SYSTEMS LABORATORY</p>	<p>MARSHALL SPACE FLIGHT CENTER SPACELAB EXPERIMENT COMPUTER STUDY</p>	<p>NAME: J. T. POWELL DATE: MARCH 1976</p>
---	---	---

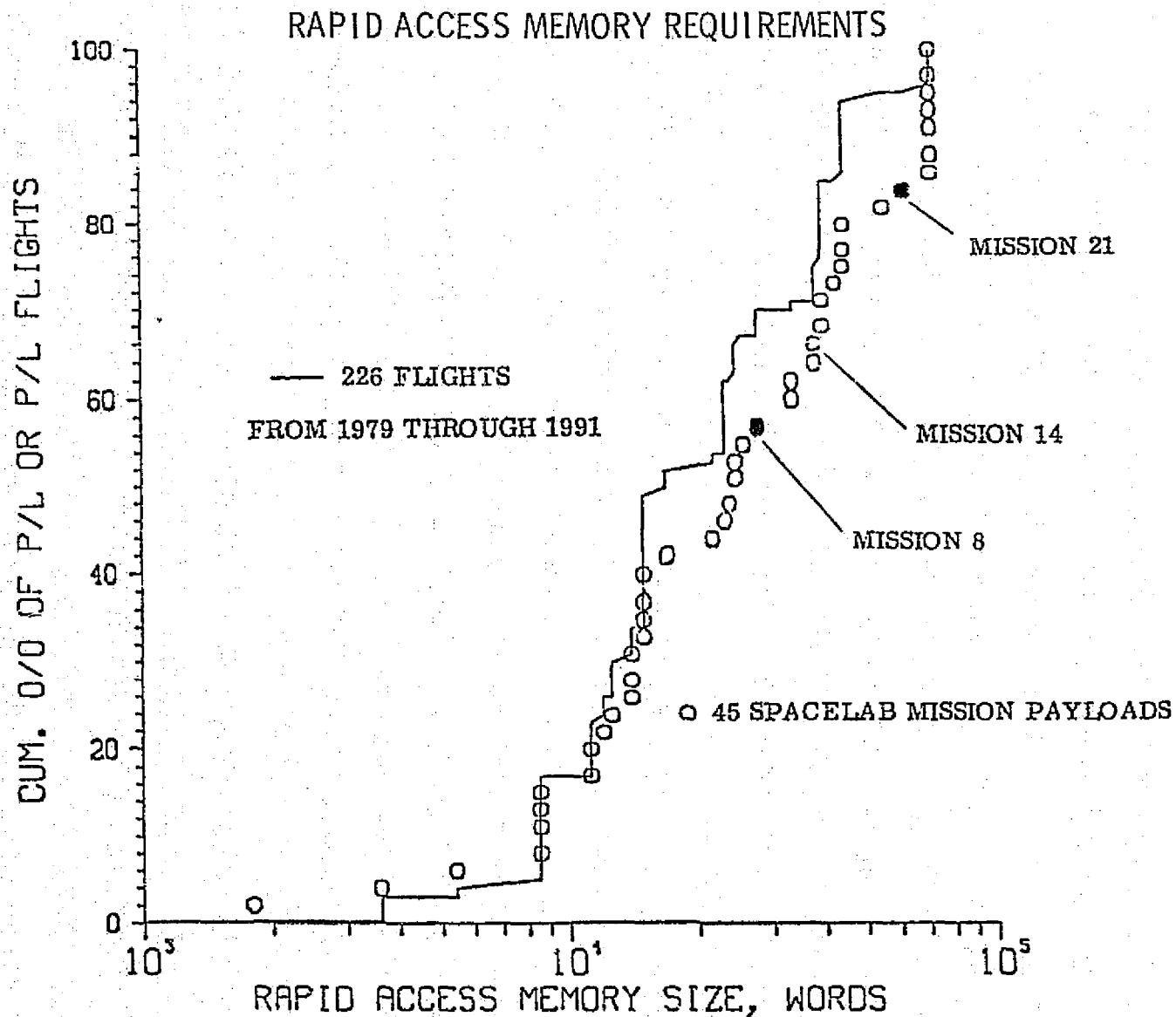

44

ORGANIZATION: DATA SYSTEMS LABORATORY	MARSHALL SPACE FLIGHT CENTER SPACELAB EXPERIMENT COMPUTER STUDY	NAME: J. T. POWELL <hr/> DATE: MARCH 1976
---	--	--

**REAL TIME SIMULATION TEST SET
(RTSTS)**

REQUIRED FOR USE BY PIs DEVELOPING DEP SOFTWARE

- **PERFORMS REAL TIME EXPERIMENT SIMULATIONS**

- **PERFORMS REAL TIME CDMS SIMULATIONS**
 - CENTRAL STANDARD SERVICES**
 - DISPLAY**
 - MASS STORAGE**

- **SERVES AS HOST COMPUTER FOR:**
 - ASSEMBLY**
 - COMPILATION**
 - LINK EDIT**
 - POST PROCESSING OF REAL TIME SIMULATIONS**

45

ORGANIZATION:

DATA SYSTEMS
LABORATORY

MARSHALL SPACE FLIGHT CENTER

SPACELAB EXPERIMENT
COMPUTER STUDY

NAME:

J. T. POWELL

DATE:

MARCH 1976

AVERAGE COST PER FLIGHT

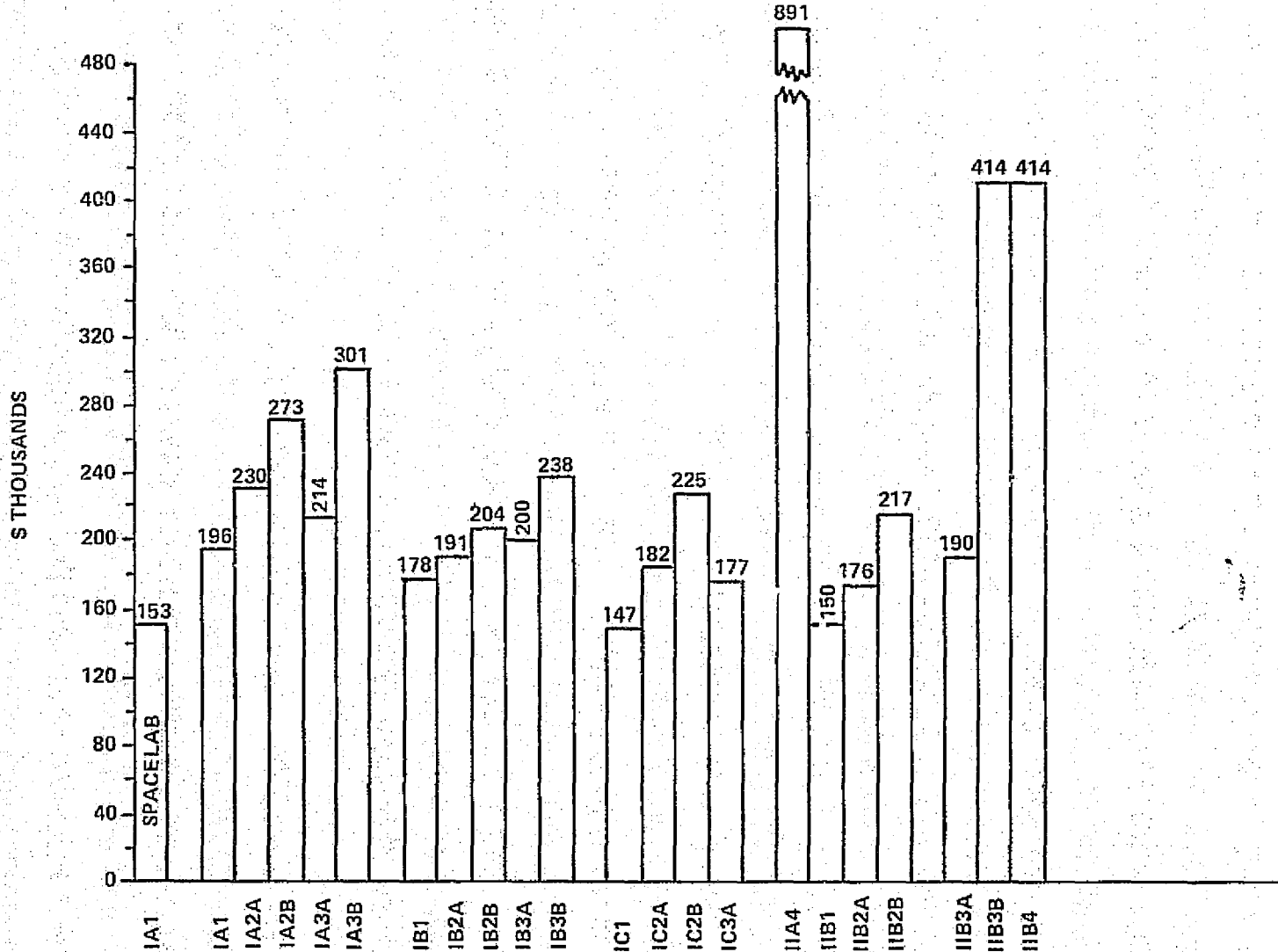

97

SPACELAB EXPERIMENT COMPUTER STUDY

SELECTION OF MISSIONS FOR DETAILED ANALYSIS EARLY SHUTTLE MISSION CANDIDATES

MISSION NO. NAME	8	10	12	14	19	21	26
CRITERIA FOR SELECTION	JOINT NASA/ESA	MULTI- DISCIPLINE	LIFE SCIENCES	MULTI- DISCIPLINE APPLIC.	AMPS	COMBINED ASTRONOMY	LIFE SCIENCES
Preliminary Mission Feasibility Established	MSFC Study	IMAP	IMAP DRM (PH A)	IMAP DRM	IMAP DRM	(DRM) ERNO Accom Analysis	(IMAP) (DRM) (PH A)
Anticipated Level of Computer Processing Requirements	Medium	Medium	Low	Low	High	High	Low
Availability of Existing or Near Term Supporting Data	Available - GDC Data Mgt. Study	Near Term - GDC Data Mgt. Study	Derivable from GDC Ph. A Study	Near Term -GDC Data Mgt. Study	-	Near Term -GDC Data Mgt. Study	Derivable from GDC Ph. A Study
Other Computer Processing Studies	-	CRASS	CRASS	CRASS	CRASS	CRASS	CRASS
Other Considerations	Close MSFC I/F	Payload Complement Expected to Change Soon	-	GDC Wrote DRM, Reviewed IMAP	Extremely Complex, Current Ph. B for Redefinition	Payload Discipline Specialist at GDC	-

Selected for detailed analysis

() Study has close relation to mission

CENTRAL SITE

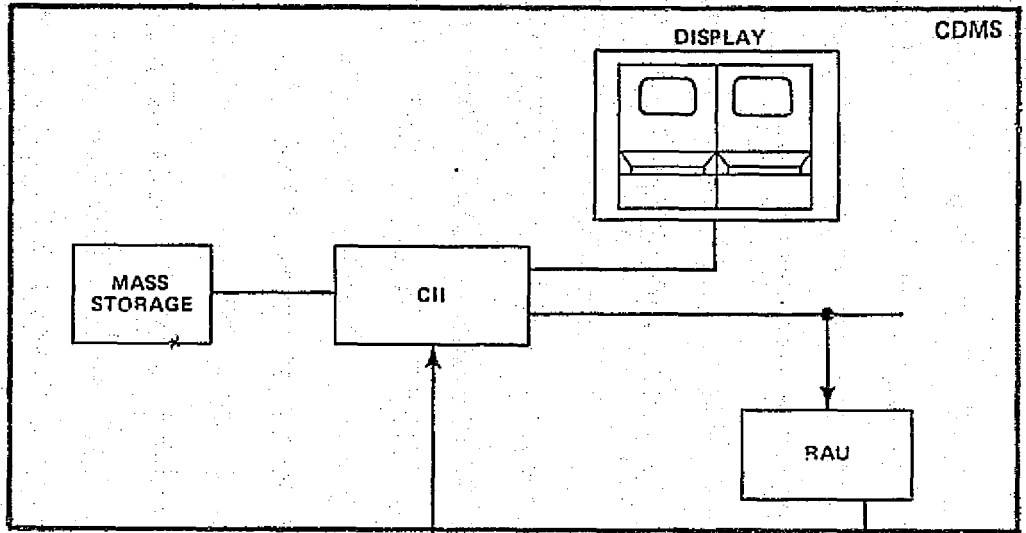

48

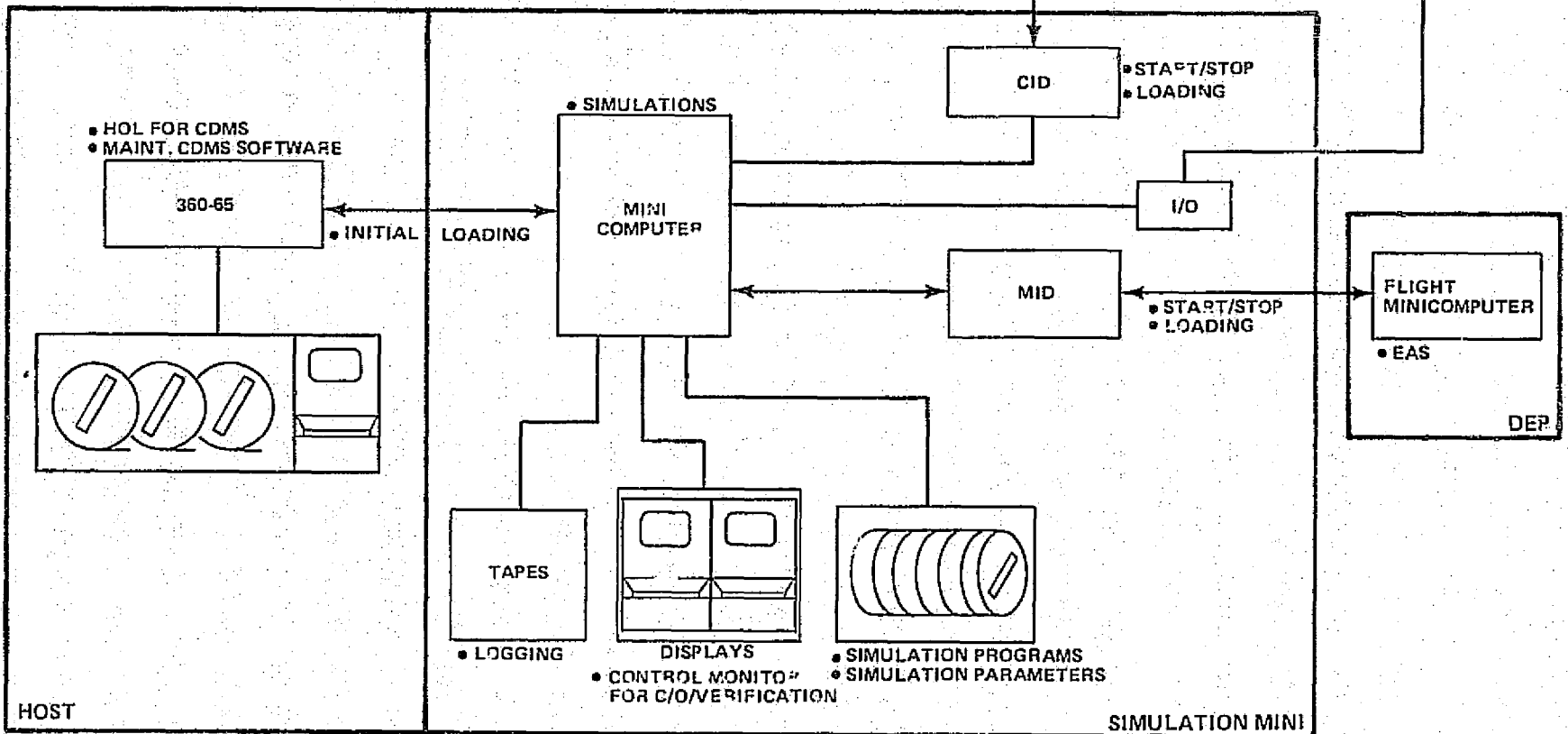

COMMAND DATA MANAGEMENT SYSTEM

ORBITER

SPACELAB

SUBSYSTEMS

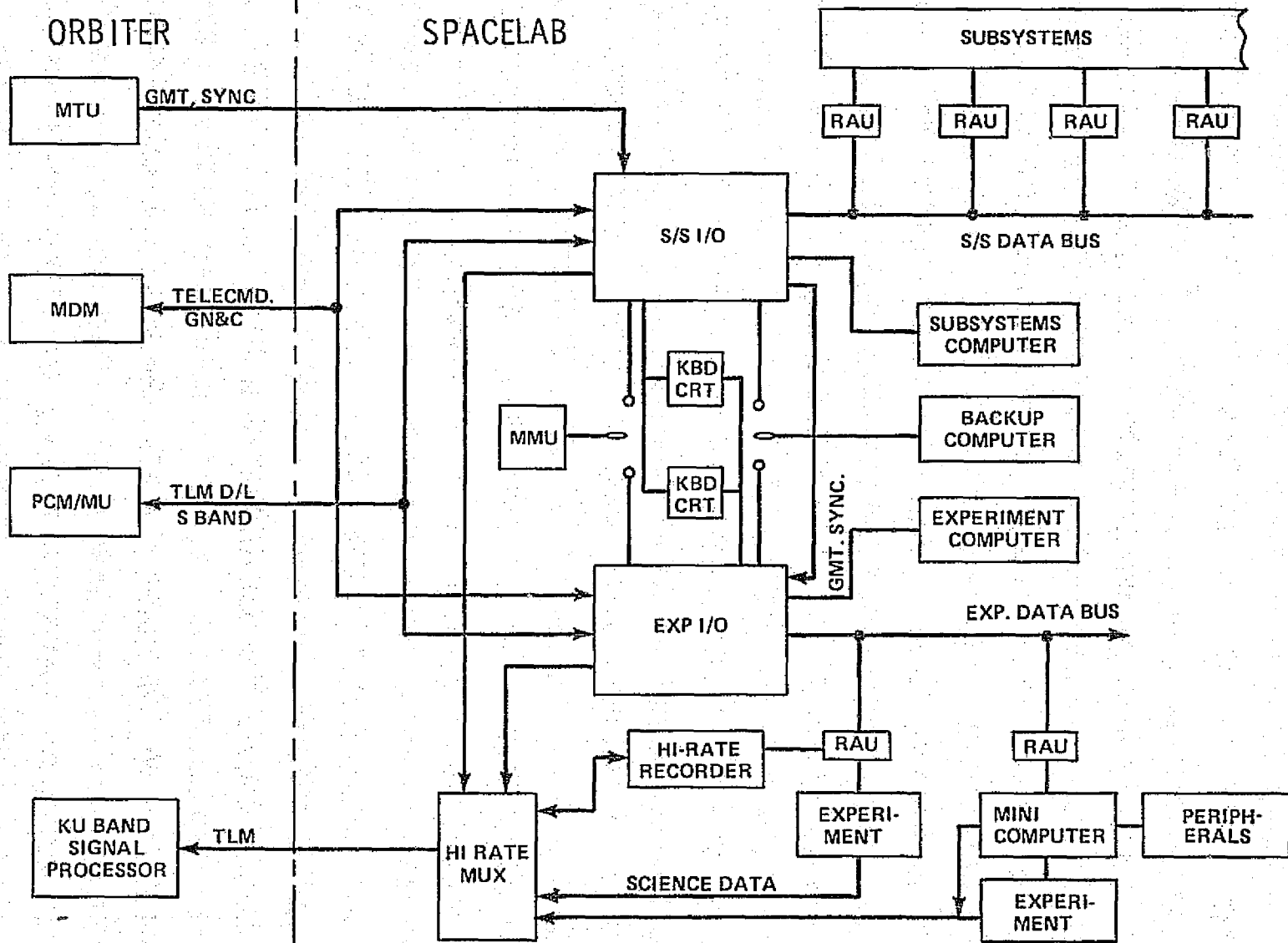

ORGANIZATION: DATA SYSTEMS LABORATORY	MARSHALL SPACE FLIGHT CENTER SPACELAB EXPERIMENT COMPUTER STUDY	NAME: J. T. POWELL
		DATE: APRIL 1976

CENTRAL EXPERIMENT COMPUTER FUNCTIONS

- NEEDED EVEN IF DISTRIBUTED COMPUTER CONFIGURATION IS ADOPTED
- EXECUTES STANDARD TASKS THAT ARE REQUIRED BY ALL PAYLOADS
- EXAMPLES ARE
 - DISPLAY
 - KEYBOARD
 - ORBITER COMMUNICATION
 - DISTRIBUTION OF UPLINK COMMANDS
 - PCM FORMATTING

ORGANIZATION: DATA SYSTEMS LABORATORY	MARSHALL SPACE FLIGHT CENTER SPACELAB EXPERIMENT COMPUTER STUDY	NAME: J. T. POWELL
		DATE: APRIL 1976
<p style="text-align: center;">OPTIONS NOT COSTED</p> <ul style="list-style-type: none"> ● 1A4 IMPRACTICAL TO DEVELOP SUPPORT SOFTWARE FOR CENTRAL COMPUTER TO RUN ON EACH NON STANDARD HOST 1B4 ● 1C4 ● 1C3B NO DEDICATED EXPERIMENT PROCESSOR (DEP) IN THIS OPTION - THEREFORE NO DEP SOFTWARE SIMULATION REQUIRED ● 11A1 IMPRACTICAL FOR CENTRAL SITE TO MAINTAIN SUPPORT FACILITIES FOR EVERY NON STANDARD DEP 11A2A 11A2B ● 11A3A IMPRACTICAL FOR CENTRAL SITE TO FURNISH SIMULATION FACILITIES FOR EVERY NON STANDARD DEP ● 11A3B COST IS THE SAME AS OPTION 11A4 		

ORGANIZATION:

MARSHALL SPACE FLIGHT CENTER

NAME:

J. T. POWELL

DATA SYSTEMS LABORATORY

SPACELAB EXPERIMENT COMPUTER STUDY

DATE:

APRIL 1976

(\$ K)

MAN YRS

3,500

3,000

2,500

2,000

1,500

1,000

SPACELAB COSTS

(\$ - ESCALATED)

25

20

15

10

5

77

78

79

80

81

82

83

84

85

86

87

88

89

90

91

52

ORGANIZATION:

MARSHALL SPACE FLIGHT CENTER

NAME:

J. T. POWELL

DATA SYSTEMS LABORATORY

SPACELAB EXPERIMENT COMPUTER STUDY

DATE:

APRIL 1976

OPTION I C1
(\$ - ESCALATED)

\$ K

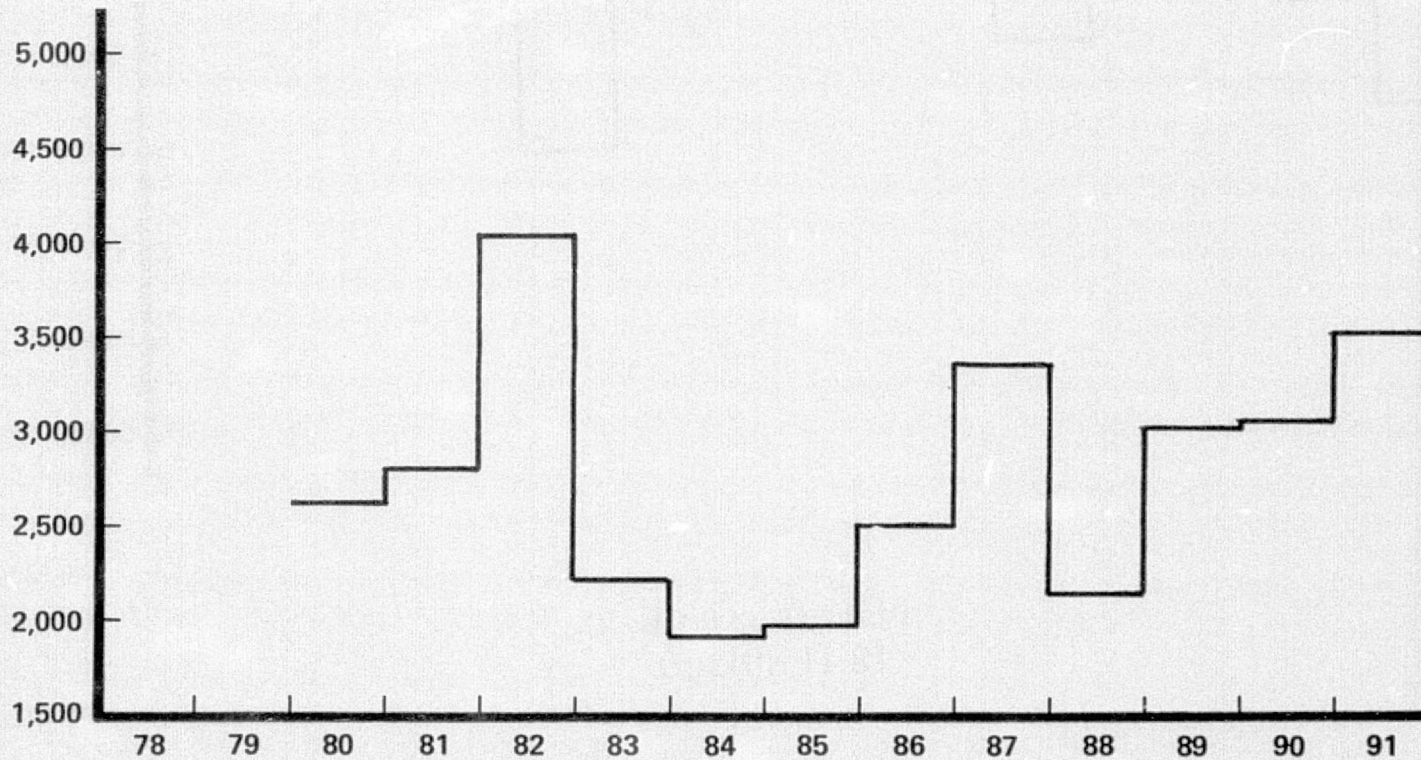

53

ORGANIZATION:

MARSHALL SPACE FLIGHT CENTER

NAME:

J. T. POWELL

DATA SYSTEMS LABORATORY

SPACELAB EXPERIMENT COMPUTER STUDY

DATE:

APRIL 1976

OPTION II B1
(\$ - ESCALATED)

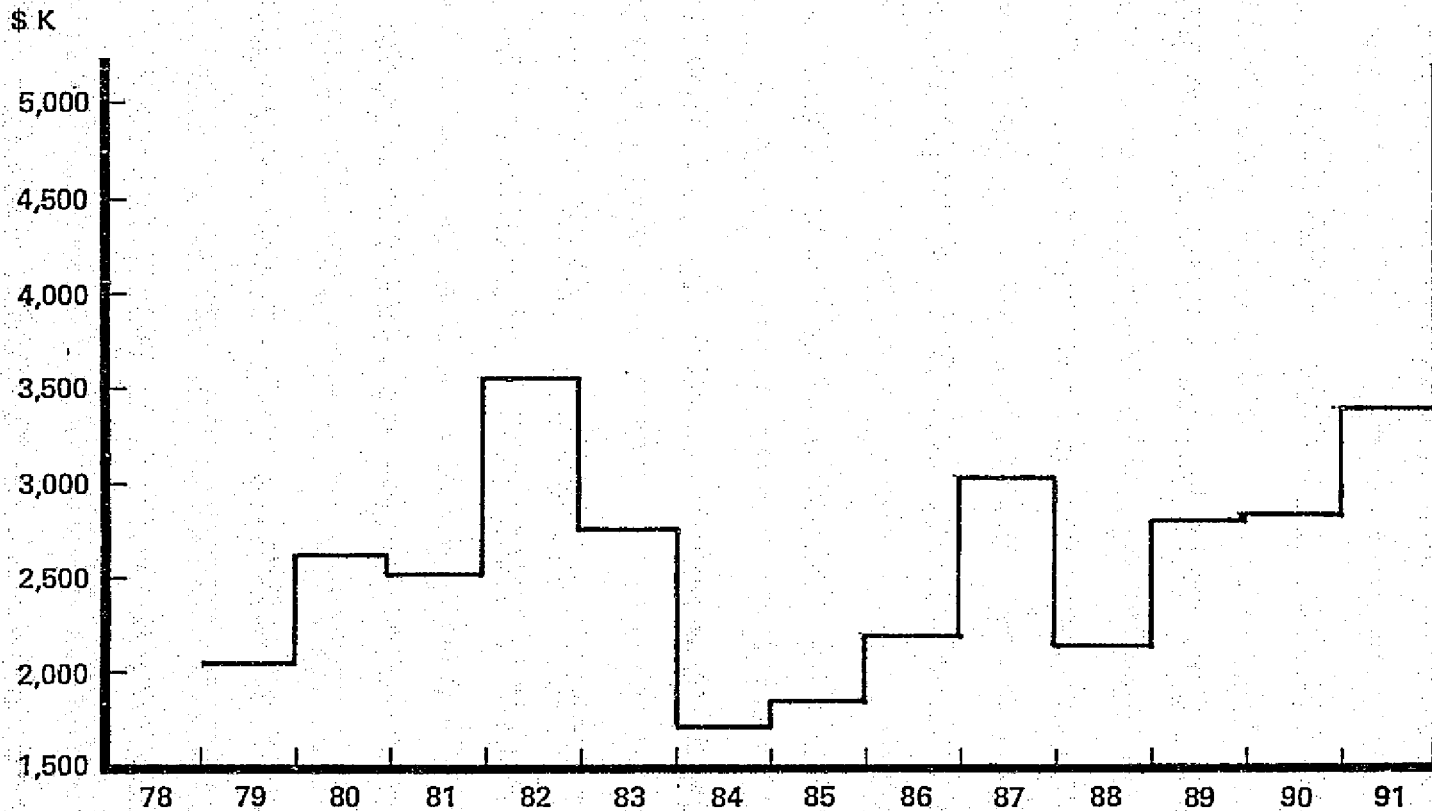

54

ORGANIZATION: DATA SYSTEMS LABORATORY	MARSHALL SPACE FLIGHT CENTER SPACELAB EXPERIMENT COMPUTER STUDY	NAME: J. T. POWELL DATE: APRIL 1976
---	---	--

CENTRAL SITE COSTS FOR EAS DEVELOPMENT

<u>ITEM</u>	<u>COST</u>	<u>COSTED TO</u>	<u>USE</u>
Main Memory (1 Megabyte)	\$393K	Spacelab	Allow 360-65 to Accommodate Through- out Requirements
Central Site Operation, Maintenance, and Consumables	\$123.22/Hr.	User	
Display Terminals (Qty. 8)	\$7,912 Total	User	Local Programmer Coding, Functional Simulation EAS Checkout
Display Terminals Maintenance	\$528/Yr.		
<u>OR</u>			
Remote Job Entry Terminal	\$43.45K Each		
Telecommunications Rental	\$15.72K/Yr./Terminal	User	Remote Programmer Coding, Functional Simulation EAS Checkout
Terminal Maintenance	\$3,180/Yr.		

SPACELAB EXPERIMENT COMPUTER STUDY

CENTRAL SITE FACILITY

360/65 AND PERIPHERALS	\$2,460 K
SIMULATION COMPUTER	137 K
COMPUTER INTERFACE DEVICE (CID)	186 K
COMMAND AND DATA MANAGEMENT SYSTEM (CDMS)	<u>1,920 K</u>
	\$4,703 K
OPERATIONS AND MAINTENANCE	511 K PER YEAR
	(\$245 PER HOUR)

ORGANIZATION:

MARSHALL SPACE FLIGHT CENTER

NAME:

J. T. POWELL

DATA SYSTEMS LABORATORY

SPACELAB EXPERIMENT COMPUTER STUDY

DATE:

APRIL 1976

(\$ K)

MAN YRS

SPACELAB COSTS

(\$ - ESCALATED)

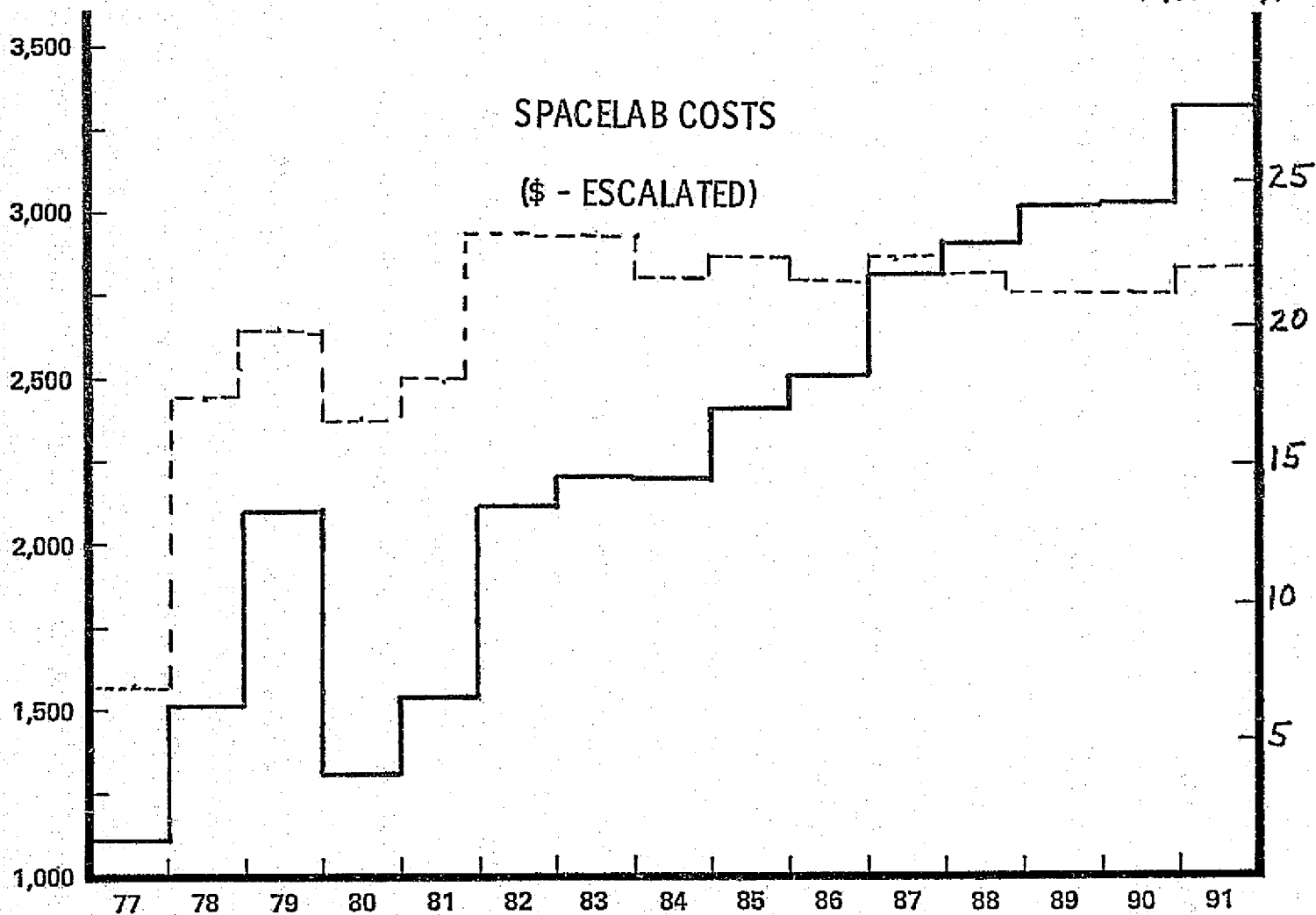

		<u>Escalated Average Cost/Flight (\$K)</u>
SPACELAB	All Options	153
EAS	IA1	196
	IA2A	230
	IA2B	273
	IA3A	214
	IA3B	301
	IB1	178
	IB2A	191
	IB2B	204
	IB3A	200
	IB3B	238
	IC1	147
	IC2A	182
	IC2B	225
	IC3A	177
	IIA4	891
	IIB1	150
	IIB2A	176
	IIB2B	217
	IIB3A	190
	IIB3B	414
	IIB4	414

APPROVAL

SPACELAB EXPERIMENT COMPUTER STUDY

Volume I: Executive Summary

By James L. Lewis, Bobby C. Hodges, and James O. Christy

The information in this report has been reviewed for security classification. Review of any information concerning Department of Defense or Atomic Energy Commission programs has been made by the MSFC Security Classification Officer. This report, in its entirety, has been determined to be unclassified.

This document has also been reviewed and approved for technical accuracy.



J. F. POWELL

Director, Data Systems Laboratory