

## General Disclaimer

### One or more of the Following Statements may affect this Document

- This document has been reproduced from the best copy furnished by the organizational source. It is being released in the interest of making available as much information as possible.
- This document may contain data, which exceeds the sheet parameters. It was furnished in this condition by the organizational source and is the best copy available.
- This document may contain tone-on-tone or color graphs, charts and/or pictures, which have been reproduced in black and white.
- This document is paginated as submitted by the original source.
- Portions of this document are not fully legible due to the historical nature of some of the material. However, it is the best reproduction available from the original submission.

**NASA CONTRACTOR  
REPORT**

**NASA CR-150160**

**(NASA-CR-150160) INVESTIGATION OF ORGANIC  
ADHESIVES FOR HYBRID MICRO CIRCUITS Final  
Report (Rockwell International Corp.,  
Anaheim, Calif.) 134 p HC A07/MF A01**

**N77-17241**

**Unclas**

**CSCI 11A G3/27 15604**

**INVESTIGATION OF ORGANIC ADHESIVES FOR HYBRID MICRO CIRCUITS**

By K. L. Perkins and J. J. Licari  
Rockwell International - Autonetics Group  
3370 Miraloma Avenue  
Anaheim, CA 92803

July 1975

Final Report

NASA Technical Manager  
S. V. Caruso, Electronics and Control Laboratory, MSFC



Prepared for

**NASA - GEORGE C. MARSHALL SPACE FLIGHT CENTER  
Marshall Space Flight Center, Alabama 35812**

TECHNICAL REPORT STANDARD TITLE PAGE

1. REPORT NO. NASA CR-150160	2. GOVERNMENT ACCESSION NO.	3. RECIPIENT'S CATALOG NO.	
4. TITLE AND SUBTITLE Investigation of Organic Adhesives for Hybrid Microcircuits		5. REPORT DATE July 1975	6. PERFORMING ORGANIZATION CODE
		8. PERFORMING ORGANIZATION REPORT # C75-647/201	
7. AUTHOR(S) K. L. Perkins and J. J. Licari		10. WORK UNIT NO.	
9. PERFORMING ORGANIZATION NAME AND ADDRESS Rockwell International - Autonetics Group 3370 Miraloma Avenue Anaheim, CA 92803		11. CONTRACT OR GRANT NO. NAS8-26384	
		13. TYPE OF REPORT & PERIOD COVERED Contractor Report Final	
12. SPONSORING AGENCY NAME AND ADDRESS National Aeronautics and Space Administration Washington, D. C. 20546		14. SPONSORING AGENCY CODE	
		15. SUPPLEMENTARY NOTES	
16. ABSTRACT  <p>Investigations of the properties of organic adhesives were conducted to acquire an adequate information base to generate a guideline document for the selection of adhesives for use in high reliability hybrid microcircuits. Specifically, investigations were made of (1) alternate methods for determining the outgassing of cured adhesives, (2) effects of long term aging at 150C on the electrical properties of conductive adhesives, (3) effects of shelf life age on adhesive characteristics, (4) bond strengths of electrically conductive adhesives on thick film gold metallization, (5) a copper filled adhesive, (6) effects of products outgassed from cured adhesives on device electrical parameters, (7) metal migration from electrically conductive adhesives, and (8) ionic content of electrically insulative adhesives.</p> <p>The tests performed during these investigations are described, and the results obtained are discussed.</p>			
17. KEY WORDS		18. DISTRIBUTION STATEMENT  Unclassified-Unlimited <i>see</i>  <i>F. Brooks Moore</i> F. BROOKS MOORE, Dir, E&C Lab	
19. SECURITY CLASSIF. (of this report)  Unclassified	20. SECURITY CLASSIF. (of this page)  Unclassified	21. NO. OF PAGES  133	22. PRICE  NTIS

## TABLE OF CONTENTS

	Page
LIST OF ILLUSTRATIONS . . . . .	ii
LIST OF TABLES . . . . .	vi
ABSTRACT . . . . .	viii
I. INTRODUCTION . . . . .	1
A. Review of Past Studies . . . . .	1
B. Scope of the Present Study . . . . .	2
II. DETAILED DISCUSSIONS OF INDIVIDUAL TASKS . . . . .	4
A. Alternate Methods for Determining the Outgassing of Cured Adhesives . . . . .	4
B. Effects of Long Term Aging at 150C on the Electrical Properties of Conductive Adhesives . . . . .	26
C. Effect of Shelf Life Age on Adhesive Characteristics . . . . .	35
D. Bond Strengths of Electrically Conductive Adhesives on Thick Film Gold Metallization . . . . .	40
E. Evaluation of a Copper Filled Adhesive . . . . .	44
F. Effects of Products Outgassed from Cured Adhesives on Device Electrical Parameters . . . . .	50
1. FET Test Specimens . . . . .	51
2. Thin Film Nichrome Chip Resistor Test Specimens . . . . .	87
3. Results of Gas Analysis . . . . .	99
G. Investigation of Metal Migration from Electrically Conductive Adhesives . . . . .	101
1. Comparative Evaluation of Conductive Adhesives . . . . .	108
2. Investigation of Silver Filled Adhesive Specimens Cooled Below the Dew Point . . . . .	114
H. Ionic Content of Electrically Insulative Adhesives . . . . .	119
III. SUMMARY AND CONCLUSIONS . . . . .	122



## LIST OF ILLUSTRATIONS

Figure		Page
1.	Weight Loss of Hysol 0151 at Constant Temperature (150°C) After Cure - As Measured on TGA Apparatus . . . . .	6
2.	Weight Loss of Ablefilm 517 at Constant Temperature (150°C) After Cure - As Measured on TGA Apparatus . . . . .	7
3.	Weight Loss of Eccobond 104 at Constant Temperature (150°C) After Cure - As Measured on TGA Apparatus . . . . .	8
4.	Weight Loss of Epo-Tek H61 at Constant Temperature (150°C) After Cure - As Measured on TGA Apparatus . . . . .	9
5.	Weight Loss of Epo-Tek H74 at Constant Temperature (150°C) After Cure - As Measured on TGA Apparatus . . . . .	10
6.	Weight Loss of Ablebond 36-2 at Constant Temperature (150°C) After Cure - As Measured on TGA Apparatus . . . . .	11
7.	Weight Loss of Epo-Tek H31 of Constant Temperature (150°C) After Cure - As Measured on TGA Apparatus . . . . .	12
8.	Weight Loss of Ablebond 58-1 at Constant Temperature (150°C) After Cure - As Measured on TGA Apparatus . . . . .	13
9.	Weight Loss of Epo-Tek H44 at Constant Temperature (150°C) After Cure - As Measured on TGA Apparatus . . . . .	14
10.	Weight Loss of Hysol 0151 at Constant Temperature (150°C) After Cure - As Measured on Analytical Balance . . . . .	15
11.	Weight Loss of Ablefilm 517 at Constant Temperature (150°C) After Cure - As Measured on Analytical Balance . . . . .	16
12.	Weight Loss of Eccobond 104 at Constant Temperature (150°C) After Cure - As Measured on Analytical Balance . . . . .	17
13.	Weight Loss of Epo-Tek H61 at Constant Temperature (150°C) After Cure - As Measured on Analytical Balance . . . . .	18
14.	Weight Loss of Epo-Tek H74 at Constant Temperature (150°C) After Cure - As Measured on Analytical Balance . . . . .	19
15.	Weight Loss of Ablebond 36-2 at Constant Temperature (150°C) After Cure - As Measured on Analytical Balance . . . . .	20
16.	Weight Loss of Epo-Tek H31 at Constant Temperature (150°C) After Cure - As Measured on Analytical Balance . . . . .	21

Figure		Page
17.	Weight Loss of Ablebond 58-1 at Constant Temperature (150°C) After Cure - As Measured on Analytical Balance . . . . .	22
18.	Weight Loss of Epo-Tek H44 at Constant Temperature (150°C) After Cure - As Measured on Analytical Balance . . . . .	23
19.	Test Substrate Used for Determining the Effects of Aging at 150°C on dc Bond Resistances . . . . .	27
20.	Test Specimen (With Capacitors) Used for Determining the Effects of Aging at 150°C on dc Bond Resistances . . . . .	27
21.	TGA Curve - Ablebond 163-14 . . . . .	45
22.	Weight Loss of Ablebond 163-14 at Constant Temperature (150°C) After Cure - As Measured on TGA Apparatus . . . . .	46
23.	Test Adapter for FET Device Test Specimens with Test Board Plugged In . . . . .	52
24.	Test Adapter for Thin Film Chip Resistor Test Specimens . . . . .	52
25.	Aging Fixture for Test Specimens . . . . .	52
26.	Layout of FET Test Devices (Cross Hatched Areas Indicate Aluminum Metallization) . . . . .	54
27.	Schematic Circuit Diagram of FET Test Devices . . . . .	55
28.	Diagram of Test Circuit for Measuring Effects of Surface Contaminants on FET Test Devices . . . . .	56
29.	Layout of FET Test Specimen . . . . .	57
30.	FET Device Test Specimen . . . . .	58
31.	Characteristics of FET Test Device Showing Damage to Calibrator FET Gate . . . . .	59
32.	FET Test Specimen CONTROL (No Adhesive) . . . . .	63
33.	FET Test Specimen CONTROL (No Adhesive) . . . . .	64
34.	FET Test Specimen Containing 22.7 mg of Hysol 0151 . . . . .	65
35.	FET Test Specimen Containing 2.5 mg of Hysol 0151 . . . . .	66
36.	FET Test Specimen Containing 28.0 mg of Ablefilm 517 . . . . .	67
37.	FET Test Specimen Containing 2.9 mg of Ablefilm 517 . . . . .	68

Figure		Page
38.	FET Test Specimen Containing 30.0 mg of Eccobond 104 . . . . .	69
39.	FET Test Specimen Containing 3.4 mg of Eccobond 104 . . . . .	70
40.	FET Test Specimen Containing 47.7 mg of Epo-Tek H61 . . . . .	71
41.	FET Test Specimen Containing 5.0 mg of Epo-Tek H61 . . . . .	72
42.	FET Test Specimen Containing 47.6 mg of Epo-Tek H74 . . . . .	73
43.	FET Test Specimen Containing 5.4 mg of Epo-Tek H74 . . . . .	74
44.	FET Test Specimen Containing 41.5 mg of Ablefilm 529 . . . . .	75
45.	FET Test Specimen Containing 4.4 mg of Ablefilm 529 . . . . .	76
46.	FET Test Specimen Containing 47.2 mg of Ablebond 36-2 . . . . .	77
47.	FET Test Specimen Containing 4.8 mg of Ablebond 36-2 . . . . .	78
48.	FET Test Specimen Containing 42.1 mg of Epo-Tek H31 . . . . .	79
49.	FET Test Specimen Containing 4.7 mg of Epo-Tek H31 . . . . .	80
50.	FET Test Specimen Containing 48.2 mg of DuPont 5504 . . . . .	81
51.	FET Test Specimen Containing 5.2 mg of DuPont 5504 . . . . .	82
52.	FET Test Specimen Containing 100.3 mg of Ablebond 58-1 . . . . .	83
53.	FET Test Specimen Containing 10.5 mg of Ablebond 58-1 . . . . .	84
54.	FET Test Specimen Containing 121.1 mg of Epo-Tek H44 . . . . .	85
55.	FET Test Specimen Containing 12.3 mg of Epo-Tek H44 . . . . .	86
56.	Layout of Thin Film Chip Resistor Test Specimens Containing Only Amount of Adhesive Required to Mount Chips. $R_1$ through $R_4$ are Glass Passivated Thin Film Nichrome Chip Resistors. $R_5$ is an Unpassivated Thin Film Nichrome Chip Resistor. $Z_1$ is a Chip Containing an Aluminum Conductor Pattern (Shown in Detail in Figure 58) . . . . .	90
57.	Layout of Thin Film Chip Resistor Test Specimens Containing Ten Times Amount of Adhesive Required to Mount Chips. $R_1$ Through $R_4$ are Glass Passivated Thin Film Nichrome Chip Resistors. $R_5$ and $R_6$ are Unpassivated Thin Film Nichrome Chip Resistors. $Z_1$ is a Chip Containing an Aluminum Conductor Pattern (Shown in detail in Figure 58) . . . . .	91
58.	Photograph of Chip With Aluminum Conductor Pattern . . . . .	92

Figure		Page
59.	Thin Film Chip Resistor Test Specimens . . . . .	93
60.	Basic Test Specimen for Investigation of Metal Migration . . .	102
61.	Test Specimen - Thick Film Gold Metallization with Conductive Adhesive Screened on One Side of Gaps . . . . .	102
62.	Photographs of Portions of Test Specimens Showing Effects Of Exposure to 82C/96% Relative Humidity Environment. Adhesive is Silver Filled (Ablebond 36-2). Gap Widths are 18.5 mils. Applied Potential was 360 Volts . . . . .	103
63.	X-Ray Image of Line at Right-Hand Edge of Gap in Figure 62b Showing Silver Has Bridged Gap . . . . .	105
64.	Photograph of Test Specimen Showing Complete Bridging of Gap by Silver Migration. Gap Width is Approximately 20 Mils. Applied Potential was 1 Volt. Test was Conducted with a Drop of Deionized Water Across Gap. Migration Shown Occurred in 7-3/4 minutes. . . . .	106
65.	Current Versus Time for Specimen Shown in Figure 64. . . . .	107
66.	Photograph of Test Specimen Showing Earlier Stage of Silver Migration Under the Same Conditions as for the Test Specimen Shown in Figure 64. Note that the Growth of Metallic Silver Dendrites is from the Gold (Negative Polarity) Terminal . . . . .	109
67.	Photograph Showing Silver Migration of Palladium-Silver Filled Adhesive (Ablebond 66-1). Gap Width is 20 mils. Applied Potential was 2 Volts. Test was Conducted with a Drop of Deionized Water Bridging the Gap. Migration Shown Occurred in Approximately 2-1/2 Hours . . . . .	111
68.	Photograph Showing Silver Migration of Palladium-Silver Filled Adhesive (Ablebond 66-1). Gap Width is 9 mils. Applied Potential was 2 volts. Test was Conducted with a Drop of Deionized Water Bridging the Gap. Migration Shown occurred in Approximately 2-1/2 Hours. Note that the Gap is Bridged in One Small Area . . . . .	113
69.	Photograph of test specimen showing gold migration. Gap Width is 11 to 19 mils. Applied Potential was 20 Volts. Test was Conducted with a Drop of Deionized Water Bridging the Gap. Slight Migration Shown Occurred in 5 Hours . . . . .	115
70.	Photographs of Test Specimens Cooled Below Room Dew Point so that the Moisture in the Air Condensed as Water. Adhesive is Silver Filled (Ablebond 36-2). Gap Width is 10 mils. . . . .	116

## LIST OF TABLES

Table	Page
1. Weight Loss of Cured Adhesives at a Constant Temperature of 150°C . . . . .	24
2. DC Bond Resistances for Gold Filled Adhesives - First Test . . . . .	29
3. DC Bond Resistances for Silver Filled Adhesives - First Test . . . . .	30
4. DC Bond Resistances - Ablebond 58-1 (Gold Filled) - Second Test . . . . .	31
5. DC Bond Resistances - Epo-Tek H44 (Gold Filled) - Second Test . . . . .	32
6. DC Bond Resistances - Ablebond 36-2 (Silver Filled) - Second Test . . . . .	33
7. DC Bond Resistances - Epo-Tek H31 (Silver Filled) - Second Test . . . . .	34
8. a. Bond Strength - Shelf Life Tests - Electrically Insulative Adhesives . . . . .	37
b. Bond Strength - Shelf Life Tests - Electrically Conductive Adhesives . . . . .	38
9. DC Bond Resistances - Shelf Life Tests . . . . .	39
10. Bond Strength of Freshly Prepared Specimens. Silicon Die on Thick Film Gold Metallization . . . . .	41
11. Room Temperature Bond Strength after 30 Minutes Immersion in Commonly Used Solvents. Silicon Die on Thick Film Gold Metallization . . . . .	42
12. Room Temperature Bond Strength as a Function of Aging - Silicon Die on Thick Film Gold Metallization . . . . .	43
13. Room Temperature Bond Strength - Ablebond 163-14 - Silicon Die on Thick Film Gold Metallization . . . . .	48
14. DC Bond Resistance - Ablebond 163-14 (Copper Filled) . . . . .	49
15. Summary of the Effects of Products Outgassed from Various Adhesives on FET Test Devices . . . . .	88
16. Data Obtained for Control Specimen (i.e., Containing No Adhesive) . . . . .	95
17. Data Obtained for a Test Specimen Showing Relatively Small Changes in Resistor Values . . . . .	95
18. Data Obtained for a Test Specimen Showing Relatively Large Changes in Resistor Values . . . . .	96
19. Results for Glass Passivated Thin Film Nichrome Chip Resistors for Large Amounts of Adhesives . . . . .	96
20. Results for Glass Passivated Thin Film Nichrome Chip Resistors for Small Amounts of Adhesives . . . . .	97
21. Results for Unpassivated Thin Film Nichrome Chip Resistors for Large Amounts of Adhesives . . . . .	97

Table	Page
22. Results for Unpassivated Thin Film Nichrome Chip Resistors for Small Amounts of Adhesives . . . . .	98
23. Results of Gas Analysis of FET Test Packages . . . . .	100
24. Results of Water Extract Analysis . . . . .	120

## I. INTRODUCTION

This study was a continuation of the effort to investigate the properties of organic adhesives to determine their suitability for use in the assembly of hybrid microcircuits for NASA/MSFC programs. The use of adhesives in hybrid applications is continuously increasing because adhesives simplify processing procedures and eliminate the necessity for employing high temperatures during assembly and packaging. Consequently, it is mandatory that guidelines and specifications for the selection of adhesives be developed. The overriding objective of this year's effort was the generation of a document providing specific guidelines for the testing and selecting of organic adhesives for use in the assembly of hybrid microcircuits. These guidelines will ensure that the resulting hardware incorporating these microcircuits will meet the stringent high reliability requirements of MSFC and NASA space applications.

### A. REVIEW OF PAST STUDIES

The initial study consisted of a preliminary investigation of selected electrically insulative adhesives. The objective was to identify and investigate adhesive properties that potentially could cause problems and to develop evaluation tests to quantify the extent to which these problems occur. Adhesive properties considered to be important were enumerated and briefly commented on, a general review of polymeric types of adhesives was given, and the major types of commercially available adhesives specifically designed for microelectronic use were identified. Due to program limitations, detailed investigations were restricted to only three properties - bond strength, outgassing after cure, and corrosivity to typical metallization systems. Specific tests were developed to evaluate these properties, and comparative results were obtained for selected adhesives representative of the major types. This study was documented in NASA TM X-64789.

A follow-on study was directed to further evaluation of electrically insulative adhesives, evaluation of selected electrically conductive adhesives, preliminary evaluation of the suitability of using organic materials as protective coatings for hybrid microcircuits, and the generation of a preliminary guideline specification for the selection of organic adhesives for use in high reliability hybrid microcircuits. The portion of the study concerned with adhesives included the following specific efforts:

1. Further investigation of the corrosivity of the electrically insulative adhesives to typical metallization systems.
2. Investigation of the bond strength, outgassing after cure, and corrosivity (to typical metallization systems) characteristics of the electrically conductive adhesives.
3. Measurements of weight loss during cure and thermal stability (weight loss as a function of temperature to 400 or 500C) for both the electrically insulative and electrically conductive adhesives.
4. Preliminary investigation of the feasibility of determining outgassing after cure characteristics of the adhesives from short term constant temperature (150C) runs using TGA equipment.
5. Evaluation of the comparative reliability of using electrically insulative and electrically conductive adhesives for mounting chip capacitors.
6. Generation of a preliminary guideline specification for selecting organic adhesives for high reliability hybrid microcircuits.

This study was documented in NASA TM X-64908. The preliminary guideline specification has been released as MSFC Drawing 16A02053.

#### B. SCOPE OF THE PRESENT STUDY

As previously stated, the most important final result of the present study was the generation of a guideline specification for the selection of organic adhesives for use in high reliability hybrid microcircuits. However, to acquire data to augment that previously obtained, and to provide an adequate technology base for the generation of this document, the following specific tasks were performed:

1. Alternate methods for determining the outgassing of cured adhesives were investigated.
2. The effects of long term aging (1000 hours) at 150C on the electrical properties of conductive adhesives were investigated.
3. The effects of shelf life age on adhesive characteristics were evaluated.
4. The bond strengths of electrically conductive adhesives on thick film gold metallization were evaluated.
5. A low cost copper filled adhesive was evaluated.
6. The effects of products outgassed from cured adhesives on device electrical parameters were evaluated.
7. Metal migration from electrically conductive adhesives was investigated.



8. The ionic content of selected electrically insulative adhesives was determined.

Each of these tasks will be discussed in detail in the following sections.

## II. DETAILED DISCUSSIONS OF INDIVIDUAL TASKS

### A. ALTERNATE METHODS FOR DETERMINING THE OUTGASSING OF CURED ADHESIVES

The outgassing of cured adhesives at a constant temperature of 150C was determined by two different methods. Both methods involved the measurement of weight loss. One method consisted of making extended runs of approximately two hours duration using the TGA (Thermal Gravimetric Analysis) apparatus. These runs were made at constant temperature (150C) in nitrogen. A continuous record of weight loss versus time is obtained by this method. The other method consisted of periodically weighing adhesive specimens on an analytical balance. Specimens used for this method were prepared by spreading the adhesives evenly into alumina cups 2.25 cm long by 1.80 cm wide by 0.15 cm deep. Approximately 0.5 gram samples of adhesive were used in all cases. These specimens were placed in an air circulating oven held at 150C and periodically removed for weighing. After removal from the oven, the specimens were placed in a dessicator and allowed to cool to room temperature before weighing. Weighing was made on an analytical balance capable of measuring to tenths of a milligram. Measurements were made out to approximately 1000 hours.

For the sample sizes used, calculations indicate that the accuracy of the first method (TGA) is approximately  $\pm 0.05\%$  while that of the second method is approximately  $\pm 0.1\%$ .

The nine adhesives (five electrically insulative and four electrically conductive) listed below were evaluated. All adhesives were cured in air at cure schedules recommended by their manufacturers.

<u>Adhesive</u>	<u>Manufacturer</u>	<u>Cure Schedule</u>
<u>Electrically Insulative Adhesives</u>		
Hysol 0151	Hysol Div., Dexter Corp.	2 hours at 60C
Ablefilm 517	Ablestik Labs	30 minutes at 150C
Eccobond 104	Emerson & Cuming, Inc.	3 hours at 150C
Epo-Tek H61	Epoxy Technology, Inc.	1 hour at 150C
Epo-Tek H74	Epoxy Technology, Inc.	40 minutes at 100C

Electrically Conductive Adhesives (Silver Filled)Ablebond 36-2  
Epo-Tek H31Ablestik Labs  
Epoxy Technology, Inc.30 minutes at 150C  
1 hour at 150CElectrically Conductive Adhesives (Gold Filled)Ablebond 58-1  
Epo-Tek H44Ablestik Labs  
Epoxy Technology, Inc.30 minutes at 150C  
1 hour at 150C

The TGA results are given in Figures 1 through 9. All graphs are plotted to the same scale for easy comparison. These results show that Hysol 0151 and Ablefilm 517 are by far the greatest outgassers and that all the other adhesives outgas very little (between 0.1 and 0.2% at the end of 2 hours). These results also indicate that while all the metal filled adhesives are low outgassers, the Epo-Tek adhesives tested outgas approximately twice as much as the Ablestik adhesives.

Results obtained from the much longer term runs using the analytical balance method are given in Figures 10 through 18. All graphs, except the one for Hysol 0151, are plotted to the same scale. Again, Hysol 0151 and Ablefilm 517 were the greatest outgassers. Hysol 0151 outgasses much more than Ablefilm 517 - over 4% compared to approximately 1% at the end of 1000 hours. All of the other adhesives outgas comparatively little (between 0.1 and 0.2% for the electrically insulative adhesives and between 0.3 and 0.6% for the electrically conductive adhesives). With the exception of Hysol 0151 and Ablefilm 517, the electrically insulative adhesives outgas less than the electrically conductive adhesives. This is a somewhat anomalous behavior because the metal filled adhesives contain from 60-80% metal filler. Thus on the basis of epoxy weight, the insulative adhesives should be much higher outgassers.

A general summary of the results obtained is given in Table 1. As can be seen from the Table, for the electrically insulative adhesives, the comparative ordering of the adhesives as outgassers based on the data obtained from the short-term (2 hour) TGA runs essentially corresponds to the ordering based on the 1000 hour data, especially if the weight loss during the first ten minutes is discounted. However, this is not the case for the electrically conductive adhesives. There does not seem to be a correlation of the two-hour TGA results with those obtained by the analytical balance method at the end of 1000 hours.

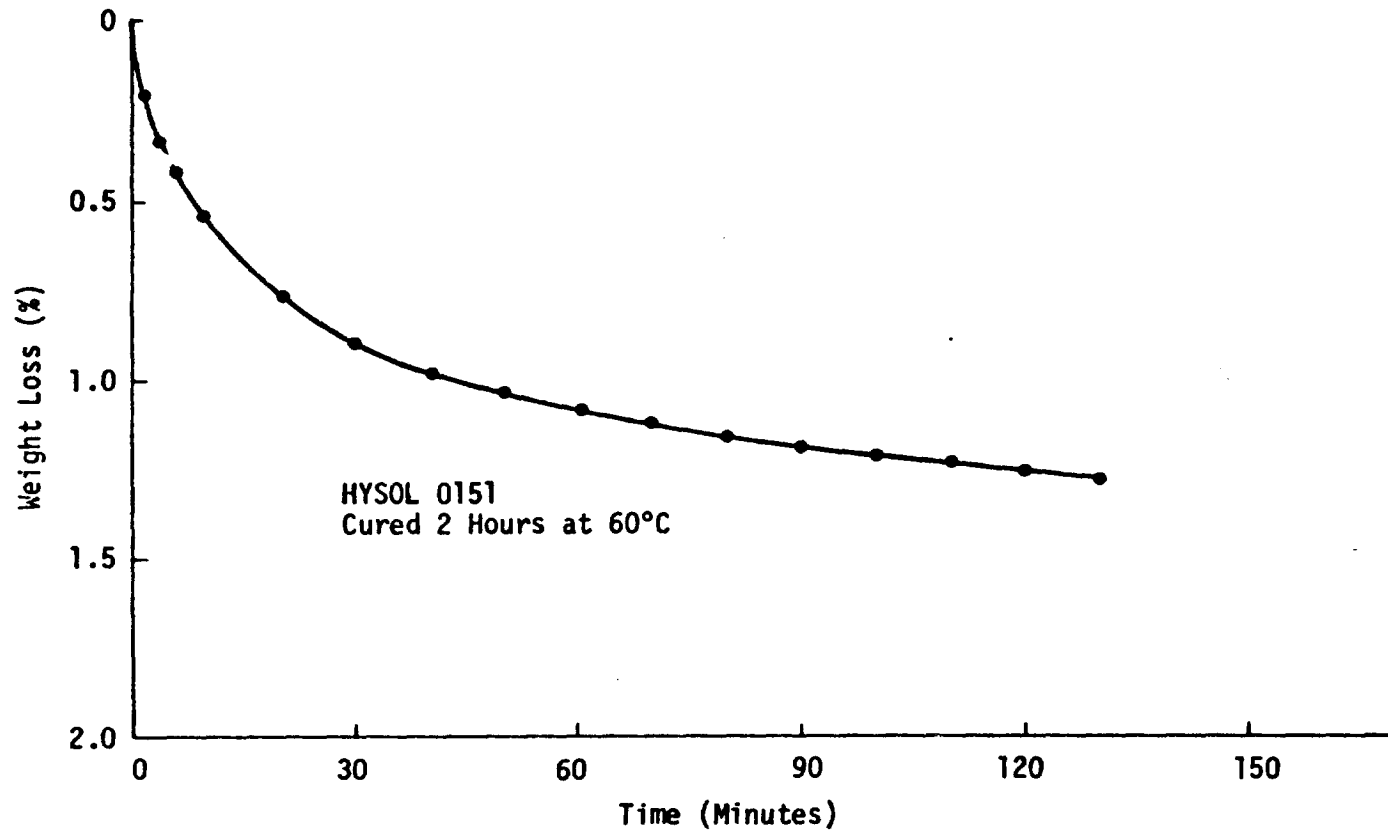

C75-647/201

Figure 1. Weight Loss of Hysol 0151 at Constant Temperature (150°C) After Cure - As measured on TGA Apparatus

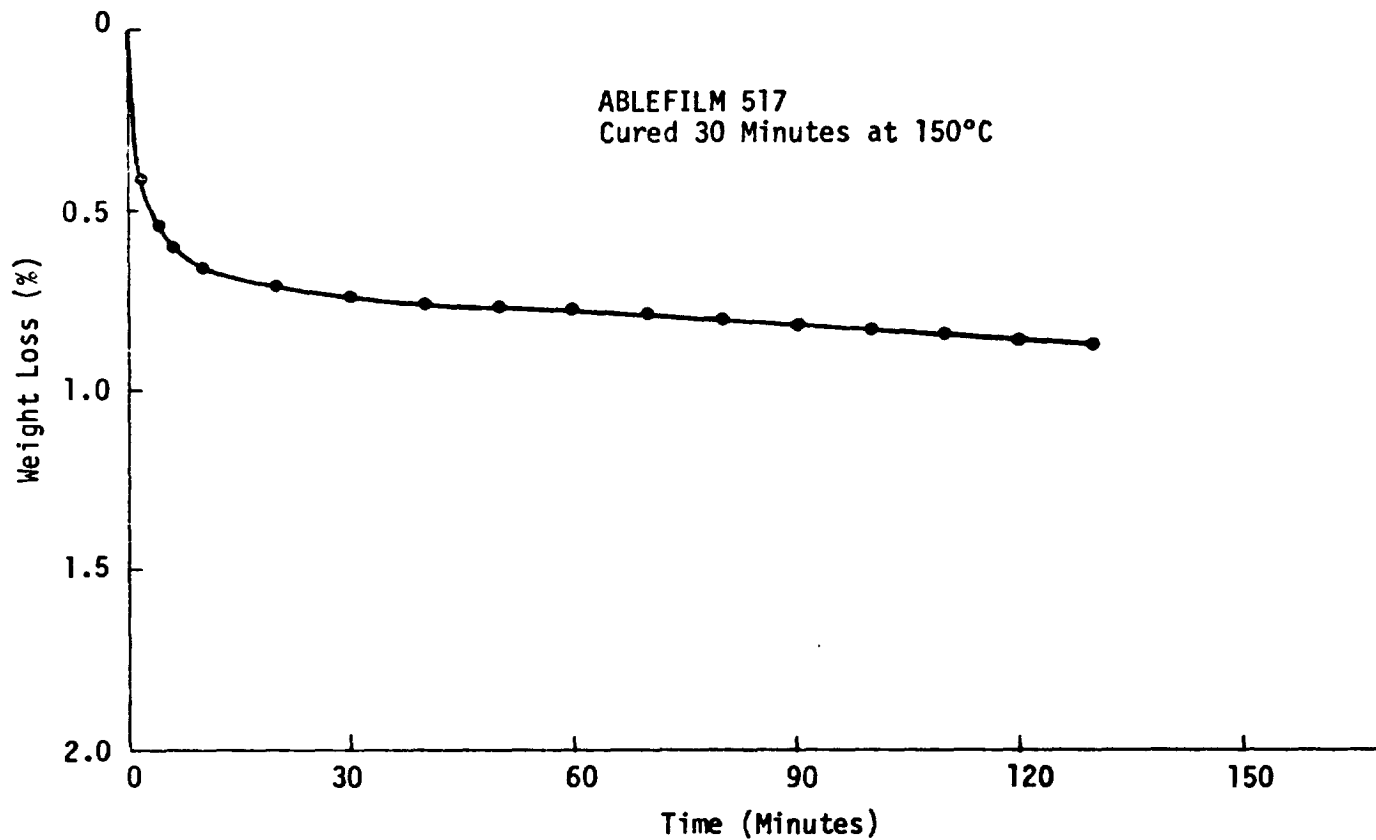

C75-647/201

Figure 2. Weight Loss of Ablefilm 517 at Constant Temperature (150°C)  
After Cure - As Measured on TGA Apparatus

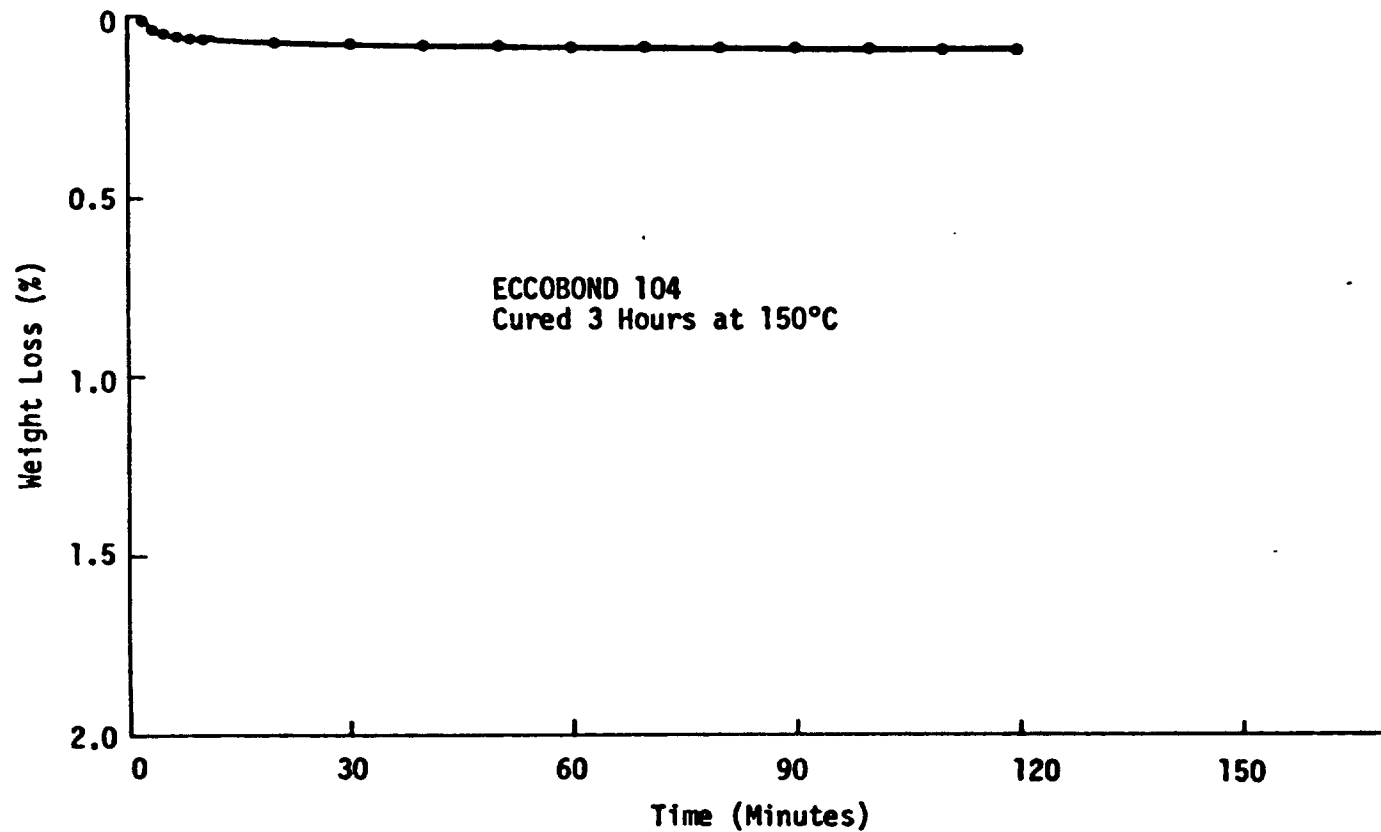
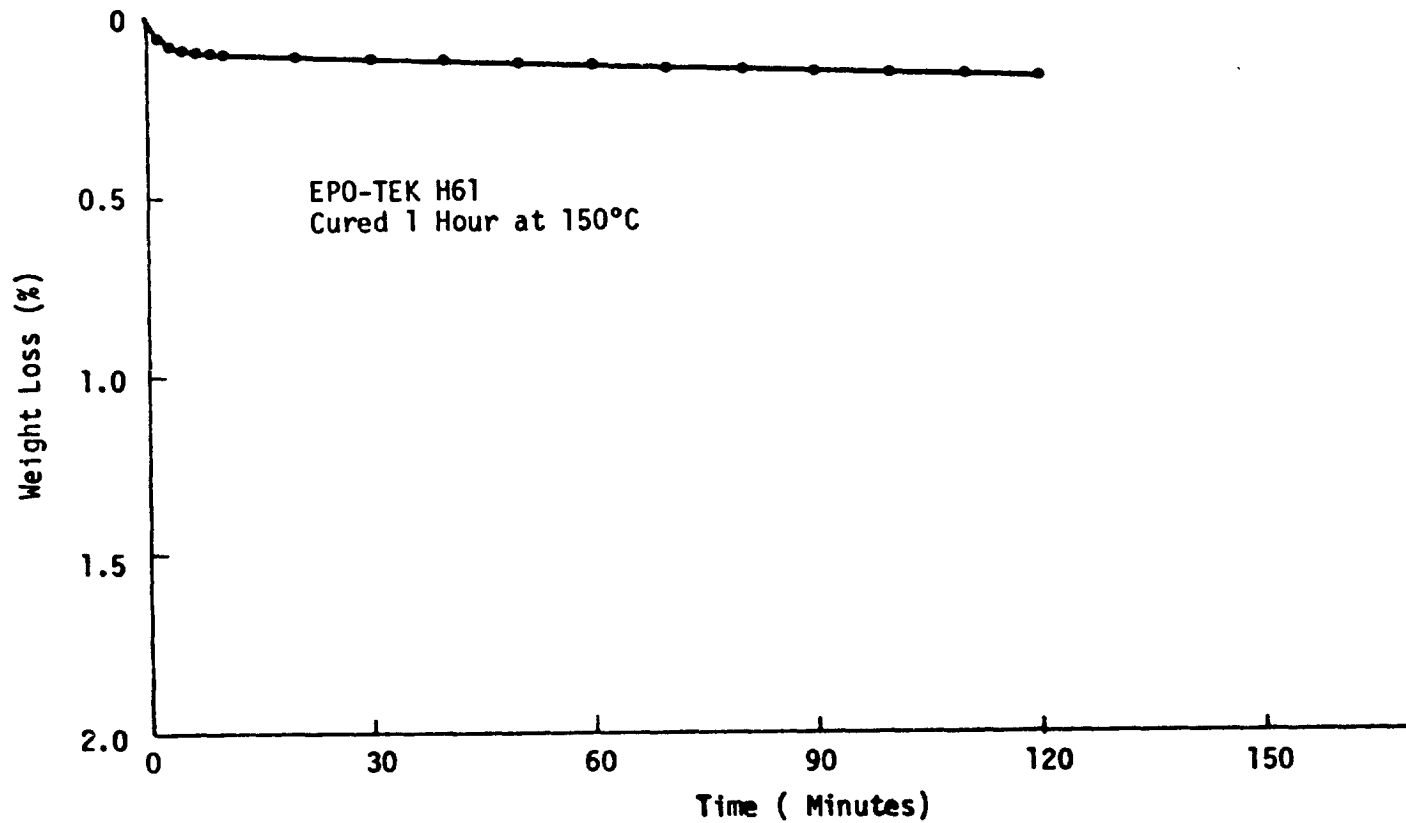

Figure 3. Weight Loss of Eccobond 104 at Constant Temperature (150°C) After Cure - As Measured on TGA Apparatus



C75-647/201

Figure 4. Weight Loss of Epo-Tek H61 at Constant Temperature (150°C) After Cure - As Measured on TGA Apparatus

C75-647/201

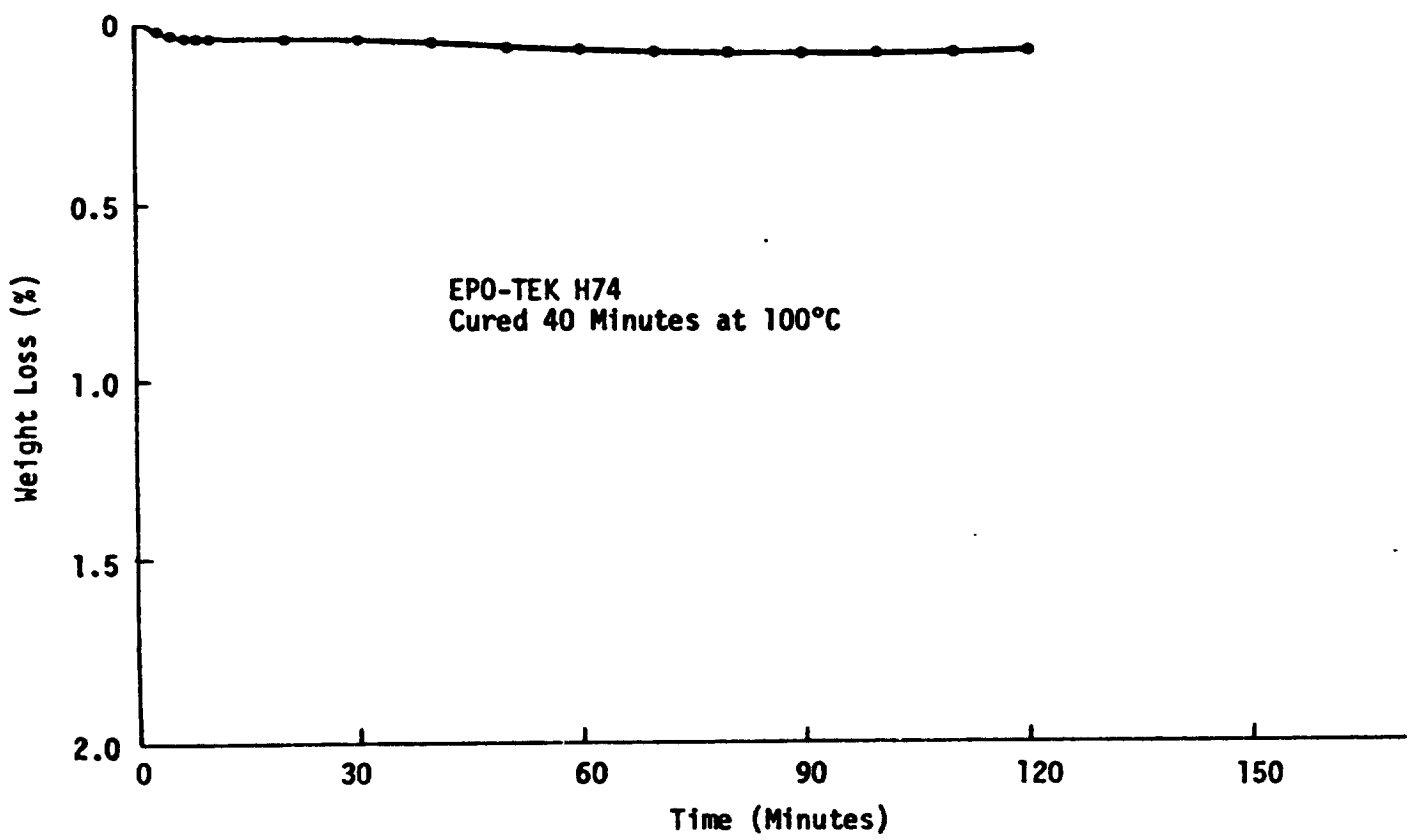
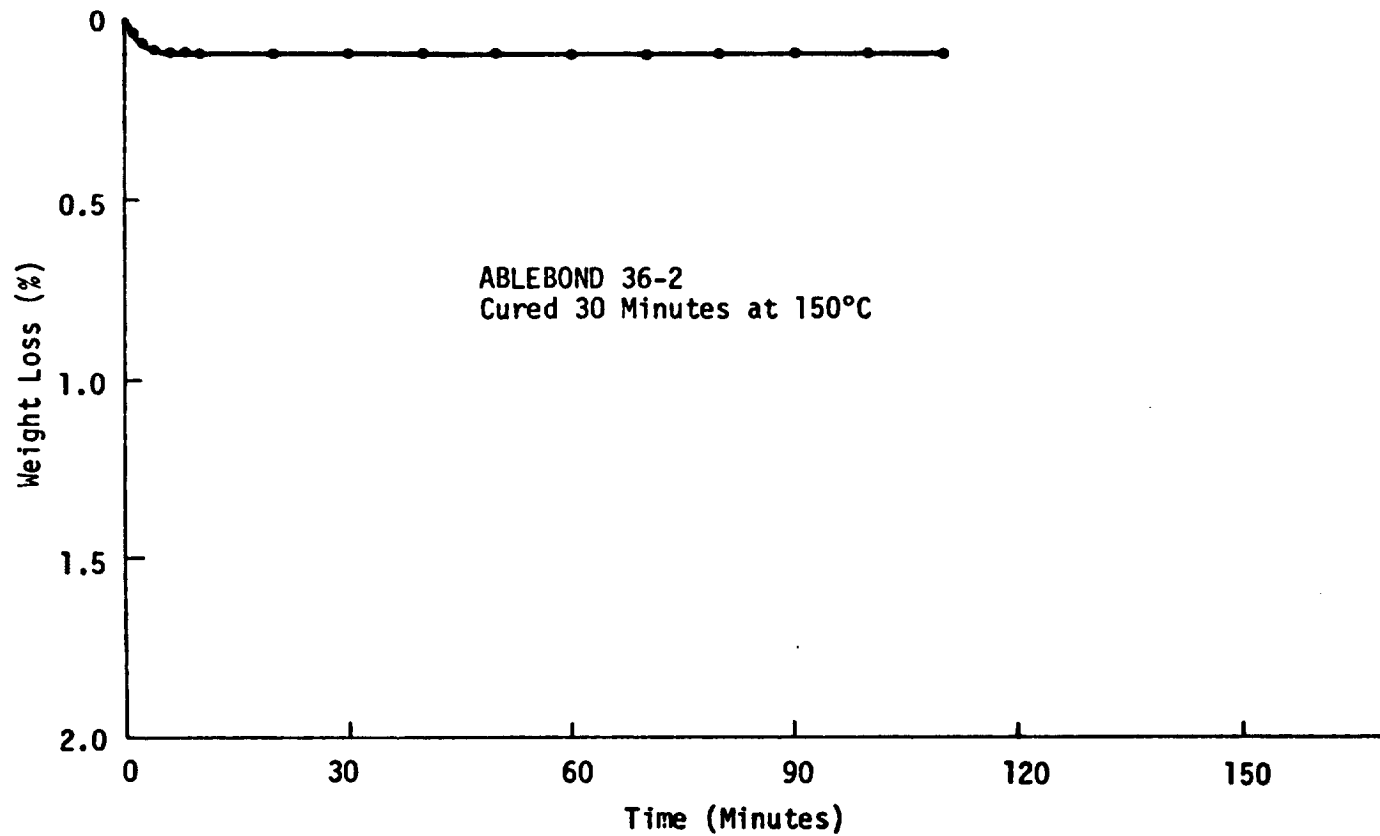

Figure 5. Weight Loss of Epo-Tek H74 at Constant Temperature (150°C) After Cure - As Measured on TGA Apparatus





C75-647/201

Figure 6. Weight Loss of Ablebond 36-2 at Constant Temperature (150°C) After Cure - As Measured on TGA Apparatus

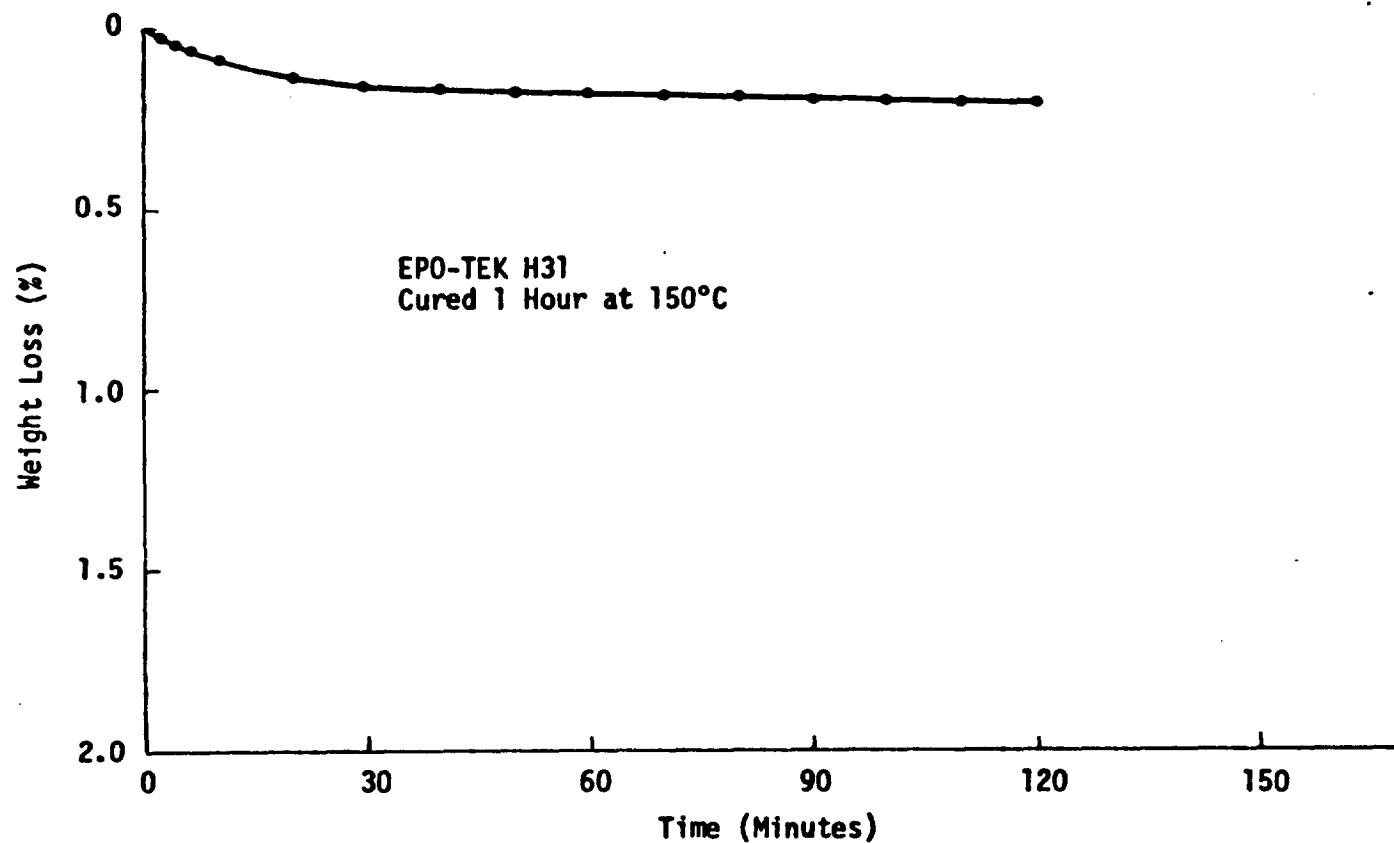
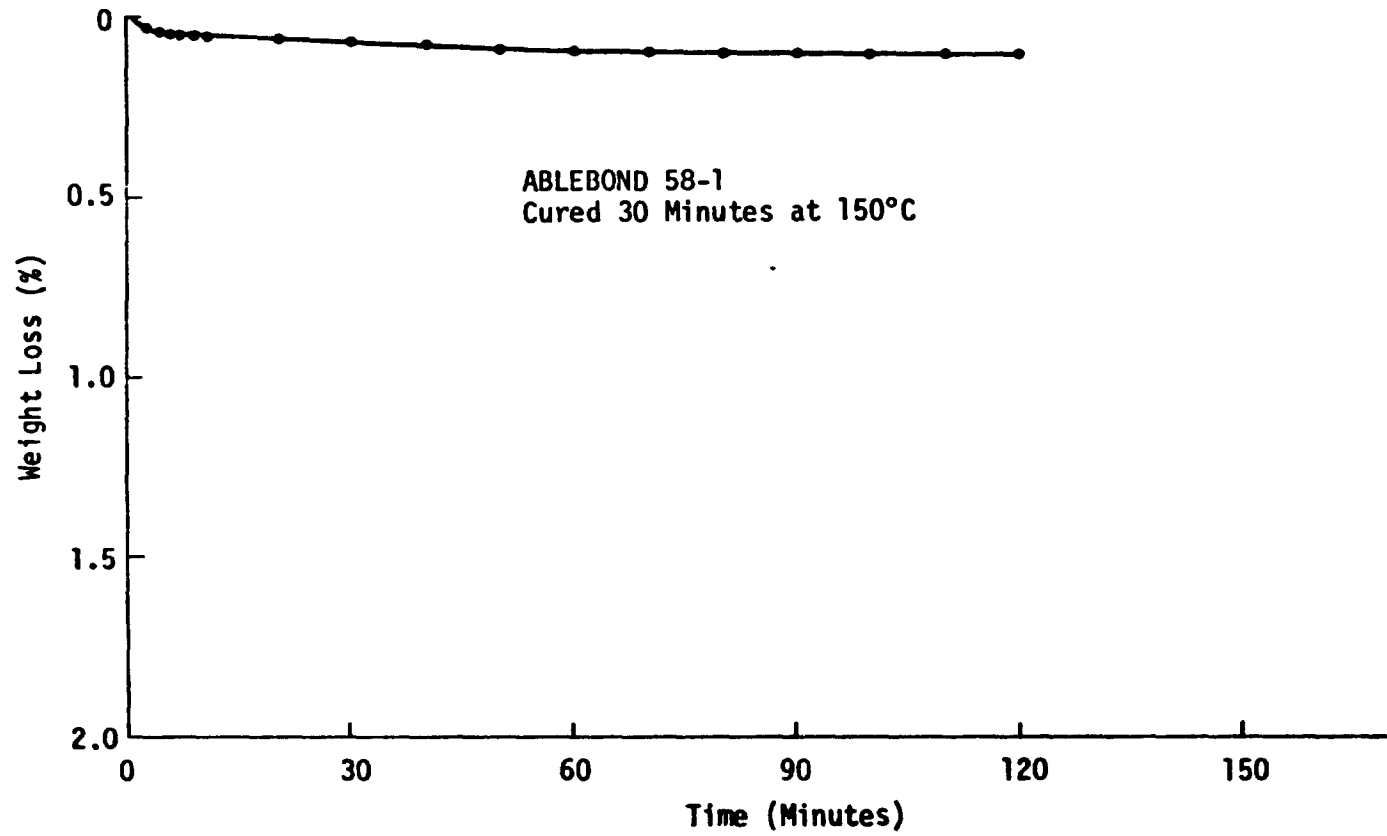

Figure 7. Weight Loss of Epo-Tek H31 at Constant Temperature (150°C) After Cure - As Measured on TGA Apparatus



C75-647/201

Figure 8. Weight Loss of Ablebond 58-1 at Constant Temperature (150°C) After Cure - As Measured on TGA Apparatus

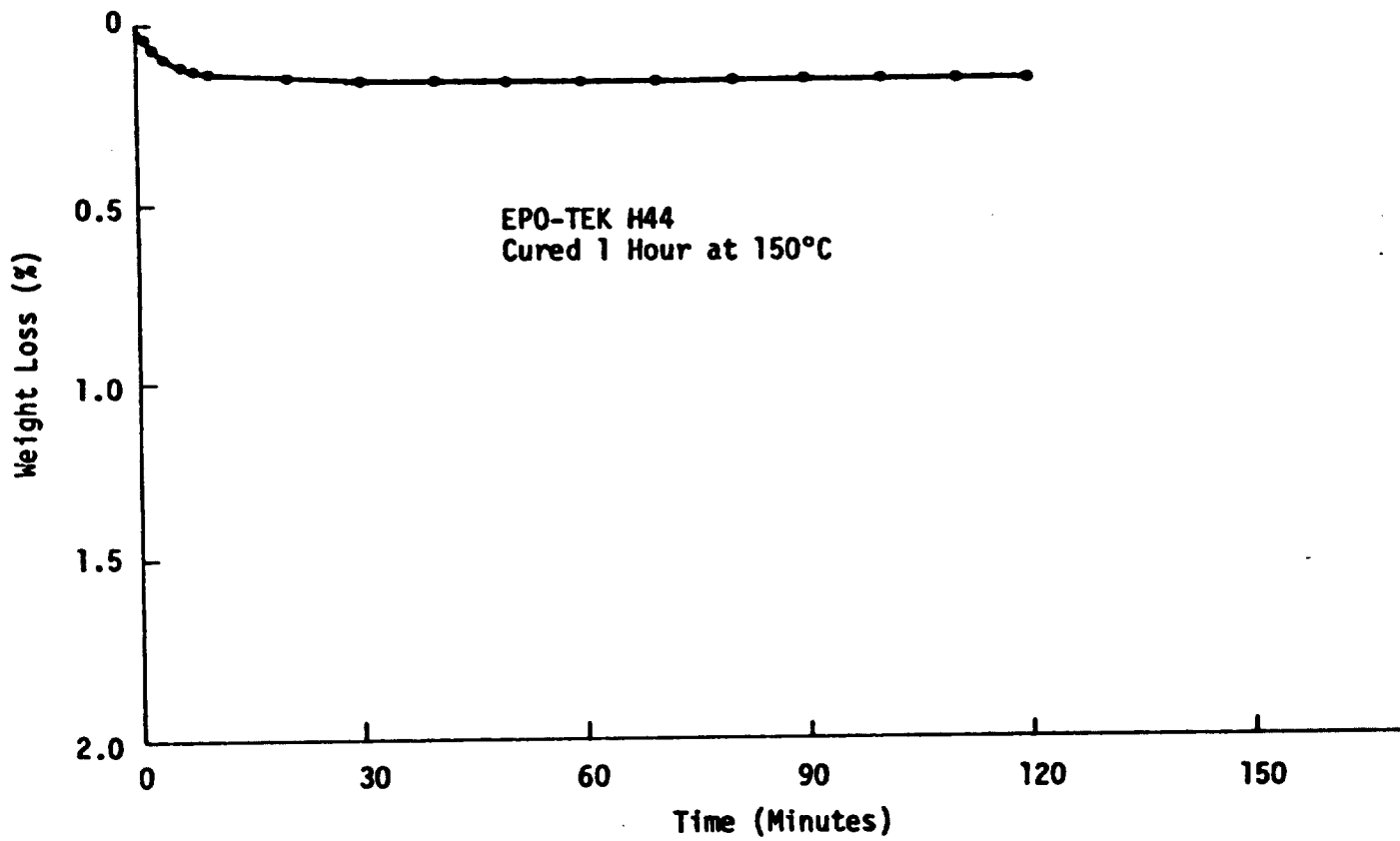
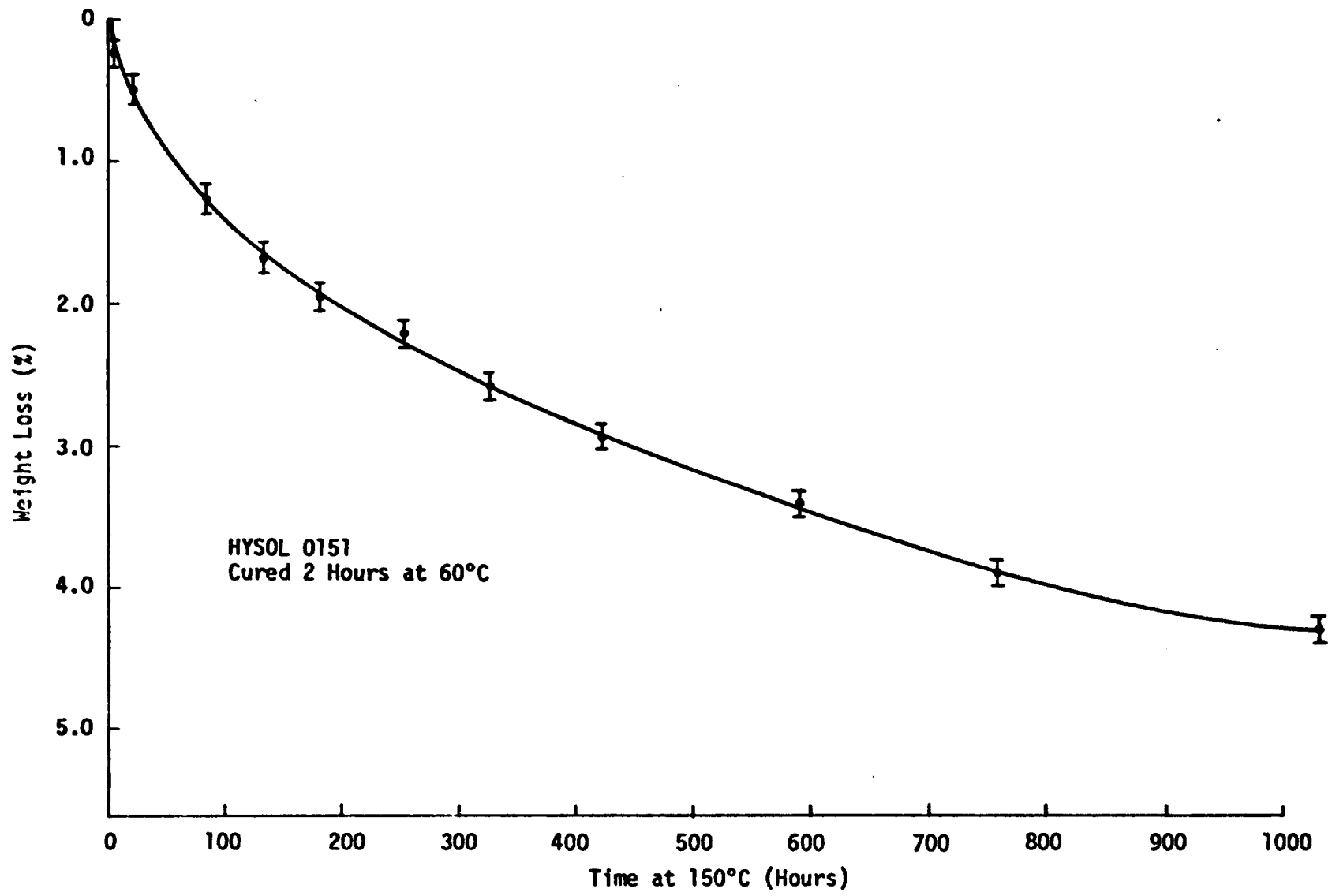

Figure 9. Weight Loss of Epo-Tek H44 at Constant Temperature (150°C)  
After Cure - As Measured on TGA Apparatus

C75-647/201



C75-647/201

Figure 10. Weight Loss of Hysol 0151 at Constant Temperature (150°C) After Cure - As Measured on Analytical Balance

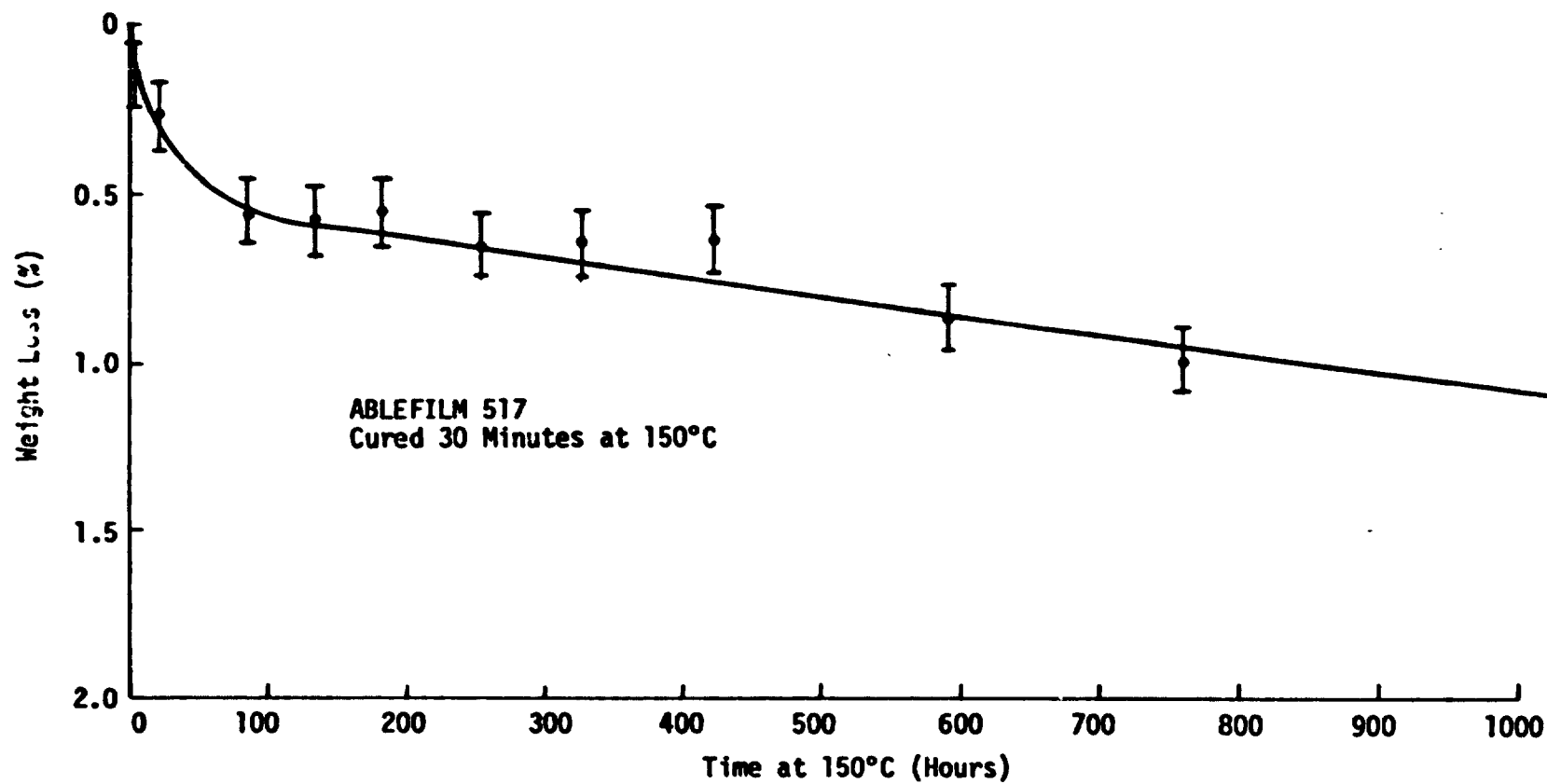
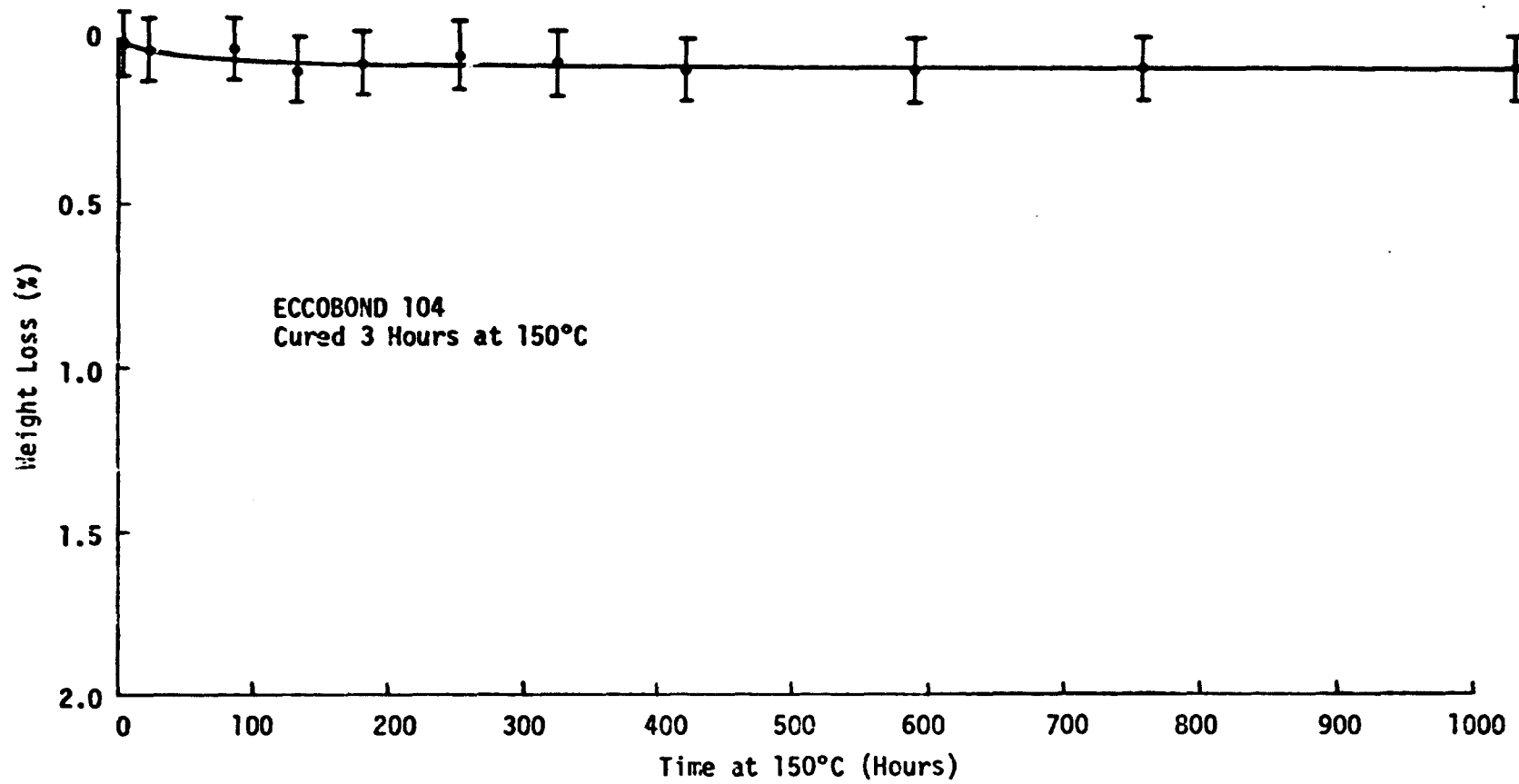
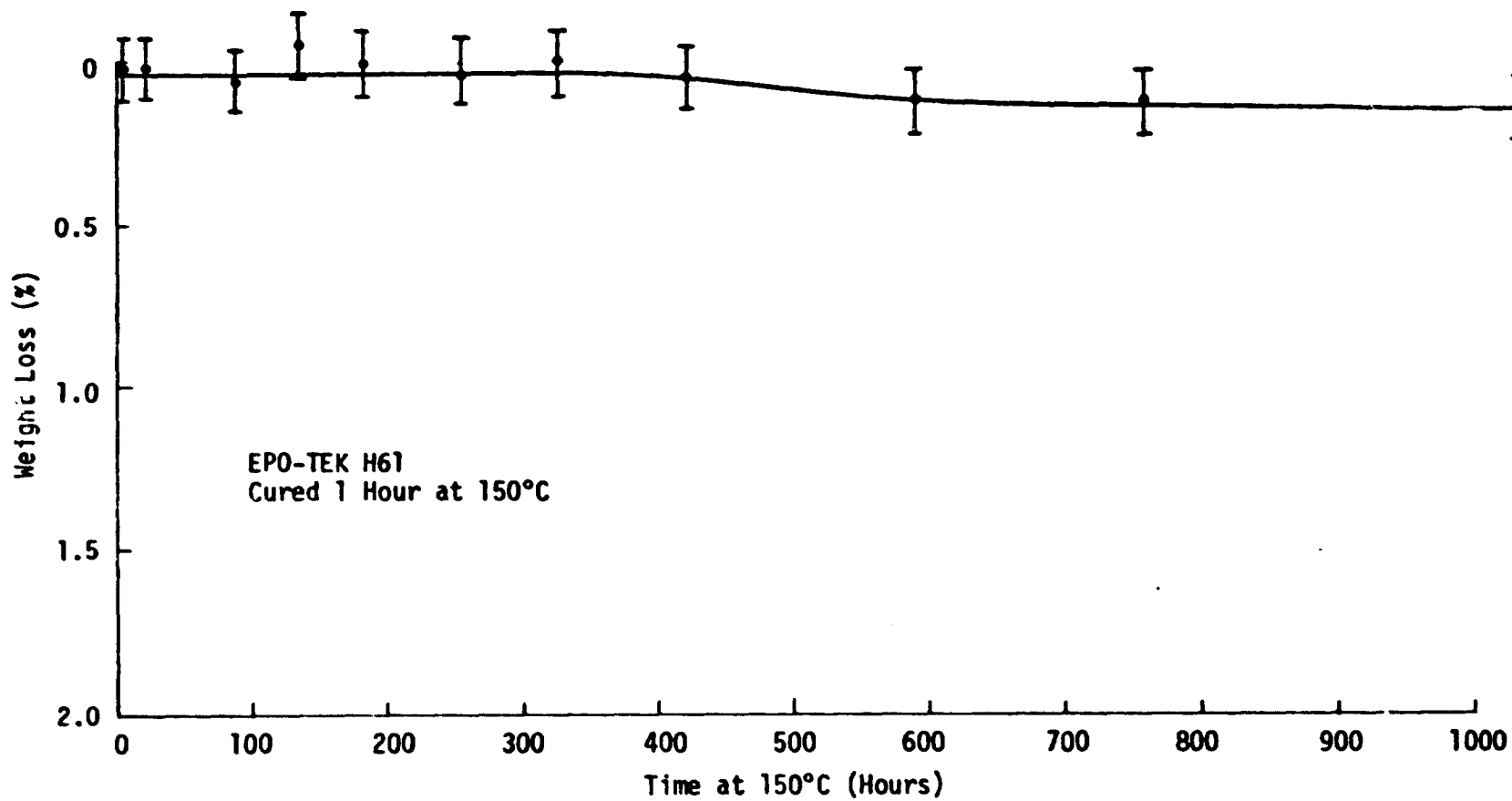

Figure 11. Weight Loss of Ablefilm 517 at Constant Temperature (150°C)  
After Cure - As Measured on Analytical Balance



C75-647/201

Figure 12. Weight Loss of Eccobond 104 at Constant Temperature (150°C) After Cure - As Measured on Analytical Balance



C75-647/201

Figure 13. Weight Loss of Epo-Tek H61 at Constant Temperature (150°C)  
After Cure - As Measured on Analytical Balance



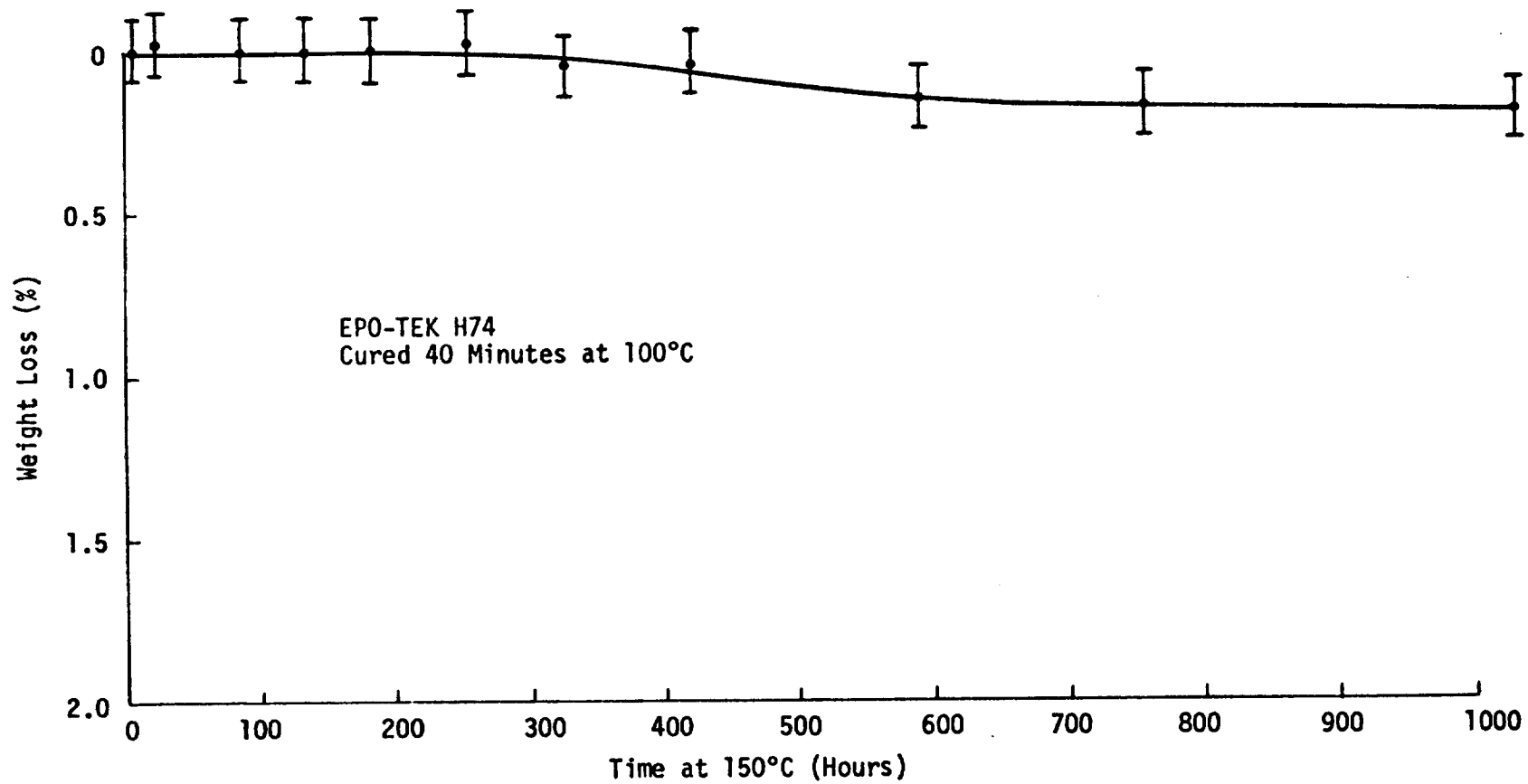

Figure 14. Weight Loss of Epo-Tek H74 at Constant Temperature (150°C)  
After Cure - As Measured on Analytical Balance

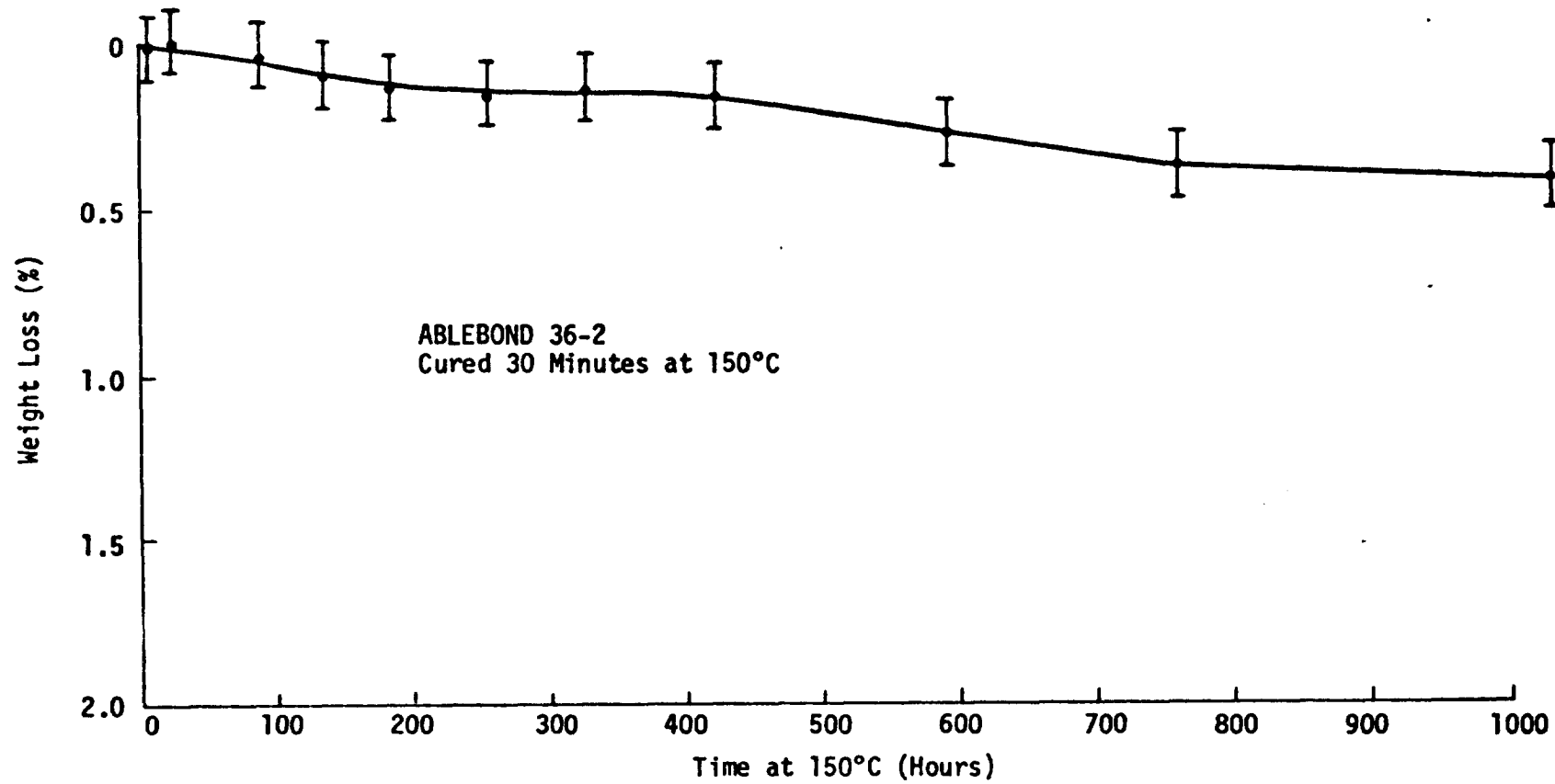
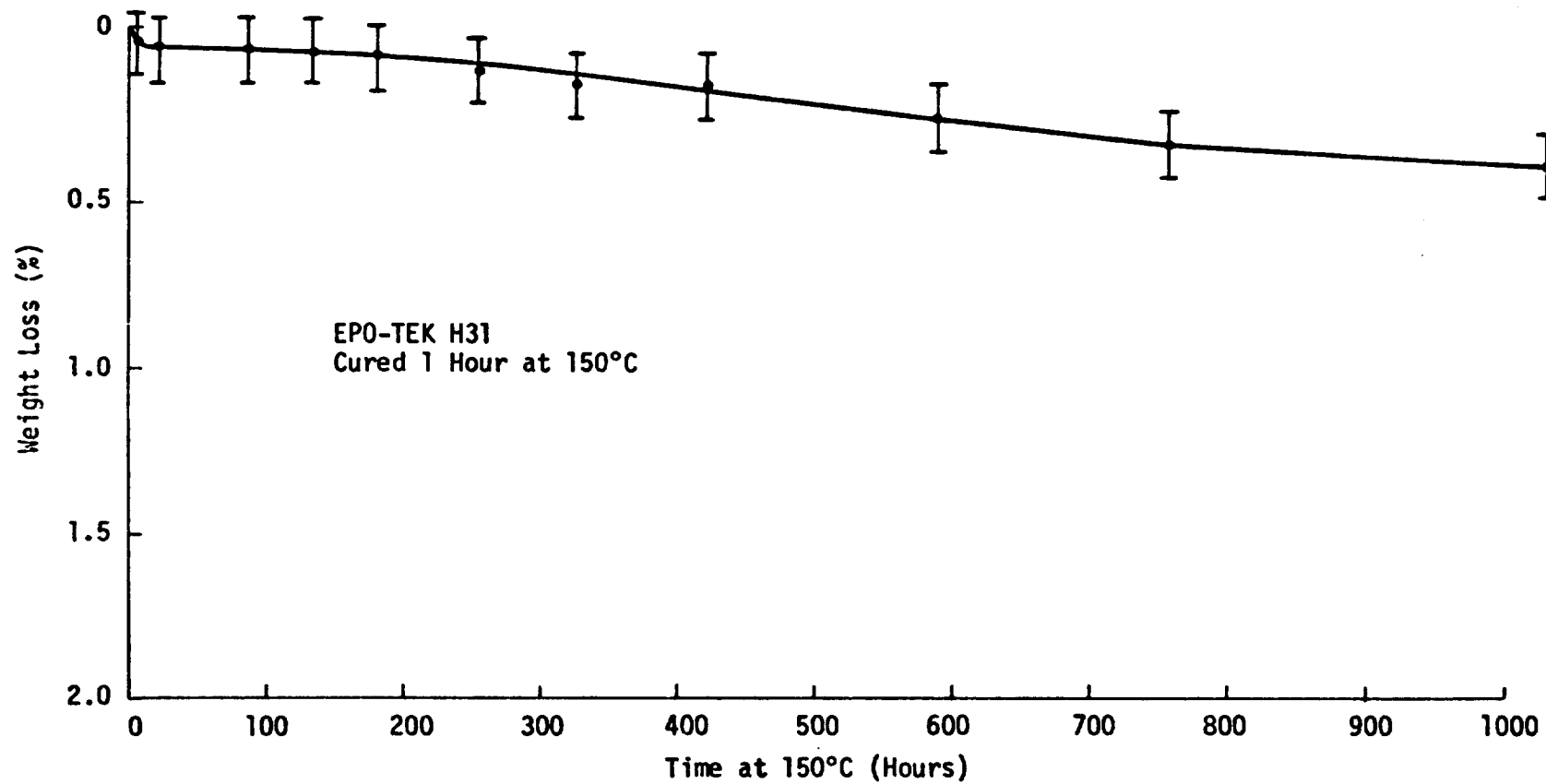

Figure 15. Weight Loss of Ablebond 36-2 at Constant Temperature (150°C)  
After Cure - As Measured on Analytical Balance



C75-647/201

Figure 16. Weight Loss of Epo-Tek H31 at Constant Temperature (150°C)  
After Cure - As Measured on Analytical Balance

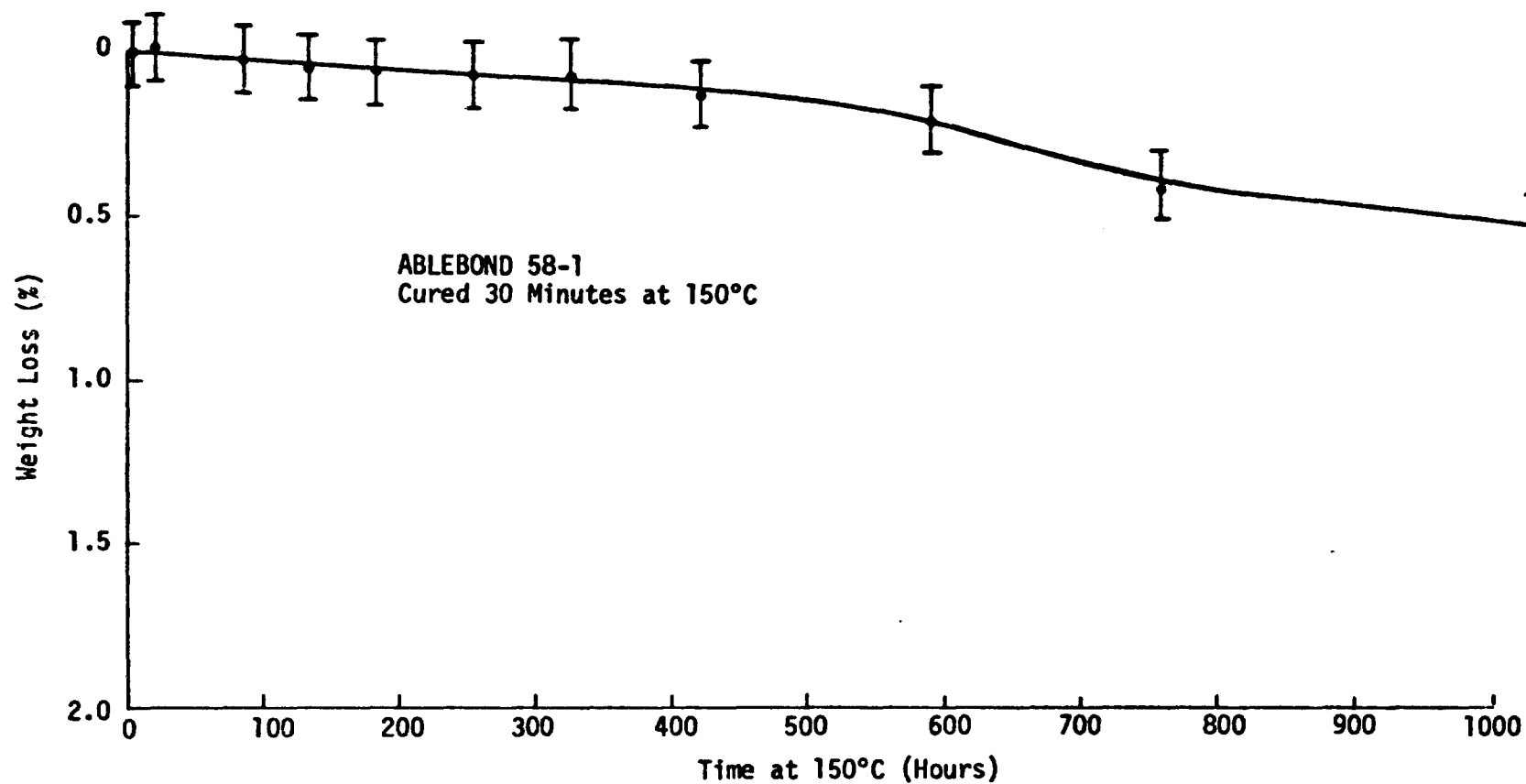
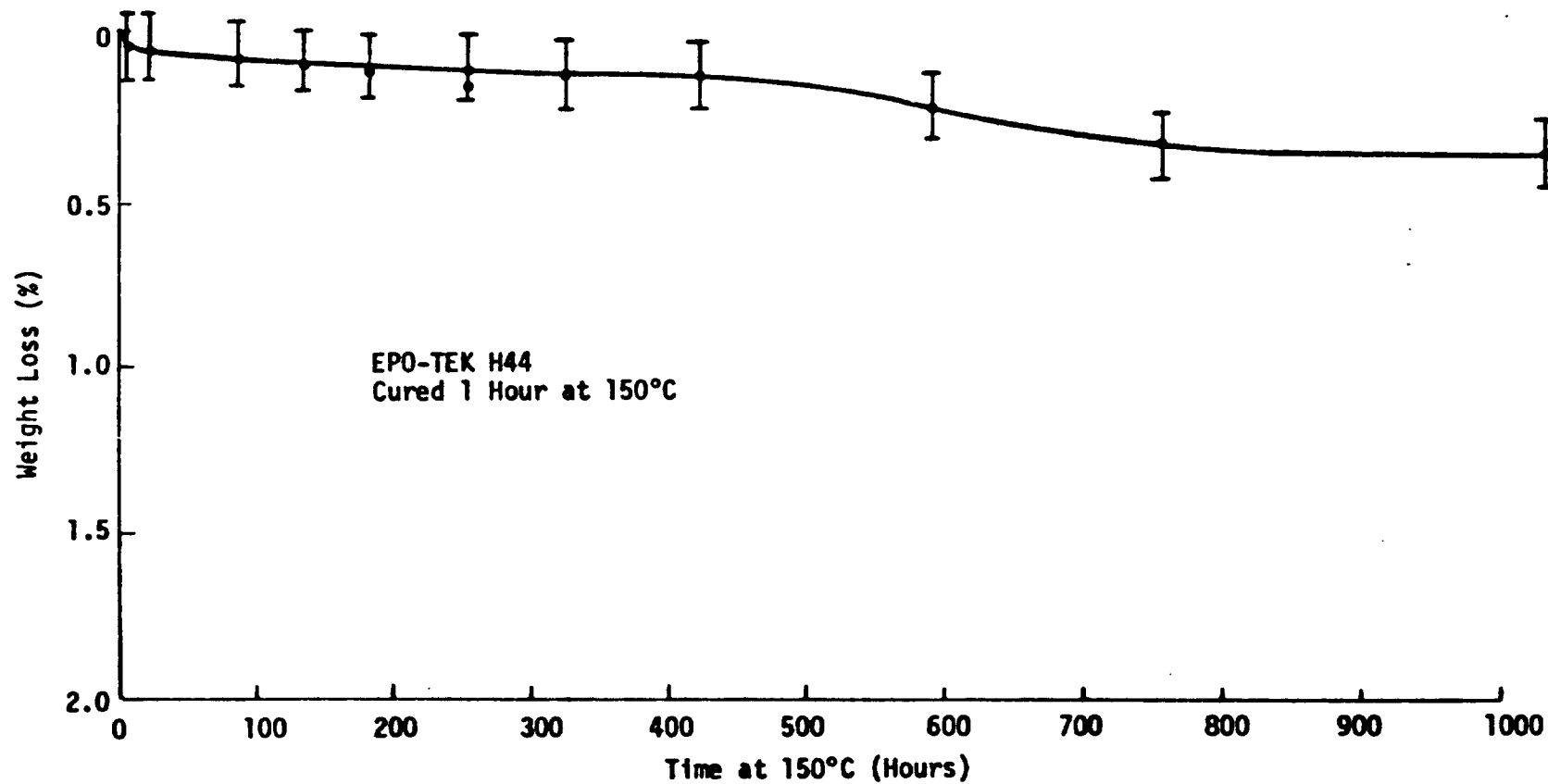

Figure 17. Weight Loss of Ablebond 58-1 at Constant Temperature (150°C) After Cure - As Measured on Analytical Balance



C75-647/201

Figure 18. Weight Loss of Epo-Tek H44 at Constant Temperature (150°C)  
After Cure - As Measured on Analytical Balance

Table 1. Weight Loss of Cured Adhesives at a Constant Temperature of 150°C

Adhesive	Measured on TGA			Measured on Analytical Balance	
	Weight Loss After First 10 Minutes (%)	Weight Loss After 2 Hours (%)	Weight Loss After 2 Hours Minus First 10 Minutes* (%)	Weight Loss After 1000 Hrs. (%)	Condition at End of 1000 Hours
<u>Electrically Insulative</u>					
Hysol 0151	0.56	1.26	0.70	4.28	Still Losing Weight
Ablefilm 517	0.67	0.86	0.19	1.09	Still Losing Weight
Eccobond 104	0.06	0.10	0.04	0.10	Leveled Off
Epo-Tek H61	0.11	0.18	0.07	0.16	Essentially Leveled Off
Epo-Tek H74	0.04	0.09	0.05	0.20	Essentially Leveled Off
<u>Electrically Conductive</u>					
Ablebond 36-2	0.10	0.10	Zero	0.42	Still Losing Weight Very Slightly
Epo-Tek H31	0.09	0.21	0.12	0.40	Still Losing Weight
Ablebond 58-1	0.06	0.10	0.04	0.52	Still Losing Weight
Epo-Tek H44	0.14	0.17	0.03	0.36	Still Losing Weight Very Slightly

\* Weight loss during first 10 minutes is considered to be due to gases adsorbed on the surface of the adhesive.

REPRODUCIBILITY OF THE ORIGINAL PAGE IS POOR

C75-647/201

74

In addition to the comparative magnitudes of the weight losses of the adhesives after 1000 hours, it is interesting to note that apparently some adhesives are no longer outgassing and others are. This is indicated in Table 1 under the heading "Condition at End of 1000 Hours." Further, there is evidence that the metal filled adhesives exhibit variations in their loss rates during the course of the 1000 hour/150C exposure.

From these results, it is obvious that the weight loss data obtained for adhesives from the short term (2 hour) TGA runs cannot be directly extrapolated to predict the weight losses of the adhesives at the end of 1000 hours. Also, for adhesives with comparable weight losses, the precise ordering of the adhesives according to the amounts of their weight losses may be different after 1000 hours exposure than that suggested by the two hour TGA data. However, the results obtained showed that the short term (2 hour) TGA test does distinguish high outgassing adhesives from low outgassing adhesives. Thus, this test is a practical, inexpensive, quick method for screening out adhesives which are excessive outgassers, and also would be useful as a receiving inspection test to assure batch-to-batch consistency. Since the 1000 hour test gives more complete detailed data of long term stability, it should be used for initial qualification of the adhesives.

In addition to the above discussion, there is an obvious observation that must be made. In many cases, the amount of weight loss that occurs after cure depends on the time-temperature schedules used in curing the adhesives. Consequently, to fairly evaluate the adhesives for particular applications, the weight losses should be determined after the adhesives have been subjected to the specific processing conditions used by the individual hybrid manufacturer. Thus, it is recommended that prior to testing, the adhesives should be cured in nitrogen for a total time equivalent to the normal cure time used by the particular hybrid manufacturer plus the additional time at elevated temperature that the hybrid is subjected to during subsequent assembly operations, stabilization bake, and preseal vacuum bakeout.

As a final comment, it must be emphasized that while high outgassing adhesives should be suspect, it should not be generalized that high outgassing adhesives deleteriously affect hybrid microcircuits and low outgassing adhesives do not. While the total amount of outgassing is an important indicator, and high outgassing is undesirable and risky from a contamination and corrosion standpoint, the chemical nature of the outgassed products is much more critical. Many outgassed

constituents are inert even in large concentrations. Others are very active (chemically and/or electrically) and can deleteriously affect electronic devices when present even in trace amounts.

#### B. EFFECTS OF LONG TERM AGING AT 150C ON THE ELECTRICAL PROPERTIES OF CONDUCTIVE ADHESIVES

The effects of aging at 150C on the dc resistances of conductive adhesives were investigated. Four conductive adhesives were tested; Ablebond 36-2 and Epo-Tek H31 (both silver filled) and Ablebond 58-1 and Epo-Tek H44 (both gold filled). Test specimens consisted of gold terminal capacitors mounted on thick film gold metallization. The capacitors used were manufactured by Monolithic Dielectric, Inc., and were approximately 0.254 cm (100 mils) long by 0.127 cm (50 mils) wide by 0.064 cm (25 mils) thick. The test substrates used were unglazed alumina 1.90 cm (0.75 inch) wide by 3.81 cm (1.50 inch) long with a single broken thick film gold stripe 0.127 cm (50 mils) wide on them. Each substrate accommodated four capacitors. Photographs of the test substrate and a typical test specimen are given in Figures 19 and 20.

Two substrates, each containing 4 capacitors, were prepared with each adhesive. Since each capacitor is bonded at both ends, this provided 16 bonds for each adhesive. The adhesives were all cured at 150C, the Epo-Tek adhesives for one hour and the Ablestik adhesives for 30 minutes as recommended by their respective manufacturers. The dc resistances of the bonds were measured by probing between the tops of the gold terminals of the capacitors and the thick film gold metallization adjacent to the bottoms of the capacitors using a Simpson Model 1699 Milliohmmeter. Initial values of bond resistances for both the silver and gold filled adhesives were all in the range  $13 \pm 2$  milliohms, i.e., the measured values ranged from 11 to 15 milliohms.

The test specimens were aged in an air circulating oven held at 150C but were removed and allowed to cool to room temperature prior to the measurement of their bond resistances. Measurements were made out to 1056 hours. Points at which measurements were made were 0, 24, 48, 72, 96, 216, 384, 552, 720, 888, and 1056 hours.

Results showed that within experimental error ( $\pm 3$  milliohms), the dc bond resistances of the test specimens made with the gold filled adhesives (Ablebond 58-1 and Epo-Tek H44) did not change during the complete duration of the testing period. However, for the silver filled adhesives (Ablebond 36-2 and Epo-Tek H31),



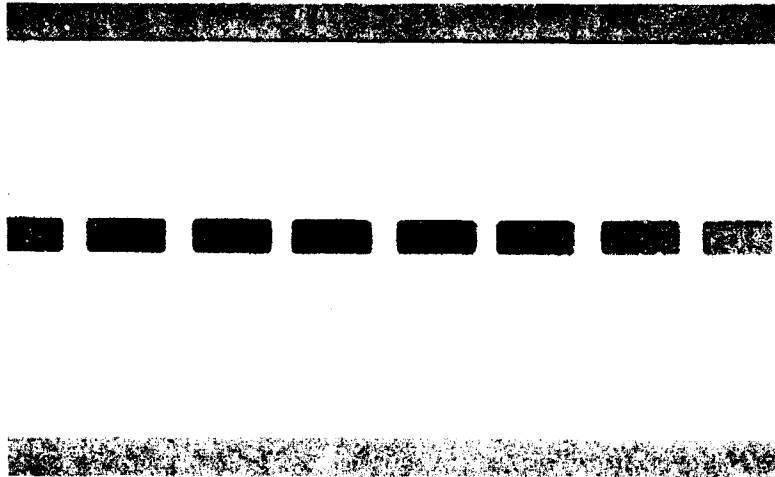

Figure 19. Test Substrate Used for Determining the Effects of Aging at 150°C on DC Bond Resistances

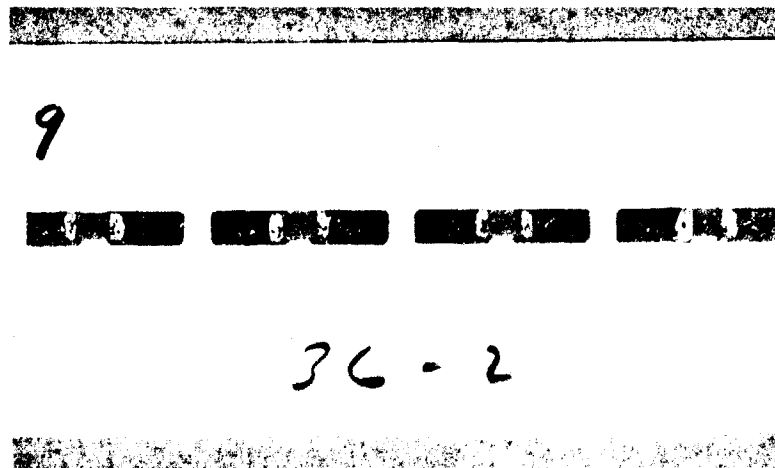

Figure 20. Test Specimen (with Capacitors) Used for Determining the Effects of Aging at 150°C on DC Bond Resistances

the bond resistances of approximately half of the test specimens increased - some excessively. Initial and final measurements are given in Tables 2 and 3 for comparison. These results indicated that for the present application (i.e., bonding gold terminal capacitors to thick film gold metallization), gold filled adhesives are superior to silver filled adhesives.

However, since this conclusion has a serious implication regarding the suitability of using silver filled adhesives in hybrid microcircuits, the tests were rerun to either substantiate or discount the results obtained. In this case, resistance measurements were made with a Dana Model 5500 Digital Voltmeter instead of the Simpson Model 1699 Milliohmmeter previously used. Measurement repeatability was no worse than  $\pm 2$  milliohms. Using this meter, the initial values of the dc bond resistances averaged six milliohms instead of the 13 or 14 milliohms obtained using the Simpson Model 1699 Milliohmmeter. Spot checking of the bond resistances of a number of the specimens with both meters showed that the observed difference was due simply to the fact that different meters and measuring techniques were used. While one would hope for more consistency, the fact that the readings differ is unimportant since the important factor is the changes in the dc bond resistance not their absolute values. Thus, as long as the same meter and measuring technique is used for an entire series of measurements, valid comparative results are obtained.

During this test, specimens also were visually examined at 30X at the end of each exposure interval prior to resistance measurement. There was no visual evidence at any time of mechanical degradation such as crazing or cracking of the adhesives, or hairline separation from the capacitor terminals. However, the silver filled adhesive, Ablebond 36-2, tarnished considerably and changed to a bronze or dark gold color. Also, in the case of both silver filled adhesives, the thick film gold metallization dulled or darkened in a small region immediately adjacent to the adhesives.

Results are given in Tables 4 through 7. Measurements were made at a number of points out to 1460 hours. As can be seen from Tables 4 and 5, the dc resistances of the bonds made with the gold filled adhesives (Ablebond 58-1 and Epo-Tek H44) did not change from their original values during the entire duration of the tests. However, reference to Tables 6 and 7 shows that many of those made with the silver filled adhesives increased. Approximately 75% of the bonds made with Ablebond 36-2 and all of the bonds except perhaps 1 or 2 made with Epo-Tek H31 were certainly affected. The increases for Ablebond 36-2 were moderate compared

TABLE 2. DC Bond Resistances for Gold Filled Adhesives - First Test

Initial DC Bond Resistance (milliohms)	DC Bond Resistance After 1056 Hours at 150C (milliohms)
Ablebond 58-1	
14	19
15	18
14	18
13	15
13	16
12	15
13	16
11	16
13	15
13	15
12	13
14	14
14	15
13	15
13	14
13	15
Epo-Tek H44	
14	15
14	15
14	14*
14	14*
14	14
14	14
14	13*
14	14*
14	14
14	13
14	15**
14	12**
14	12
13	13
14	13**
14	13**

\* - Specimen broke at the end of 384 hours during probing

\*\* - Specimen broke at the end of 720 hours during probing

TABLE 3. DC Bond Resistances for Silver Filled Adhesives - First Test

Initial DC Bond Resistance (milliohms)	DC Bond Resistance After 1056 Hours at 150C (milliohms)
Ablebond 36-2	
14	22
14	209
13	110
15	38
15	- *
15	- *
14	38
13	16
13	16
13	17
13	15**
13	18**
13	17
12	16
13	14
13	2470***
Epo-Tek H31	
14	16
15	17
12	16
15	25
14	29
13	21
13	25
12	27
15	- *
14	- *
13	21
24	840
13	14
14	17
13	20
13	1450

- \* - Specimen broke at the end of 24 hours during probing
- \*\* - Specimen broke at the end of 48 hours during probing
- \*\*\* - Specimen broke at the end of 216 hours during probing

TABLE 4. DC Bond Resistances - Ablebond 58-1 (Gold Filled) - Second Test

Time at 150°C (Hours)→	DC Bond Resistance (milliohms)												
	Zero	24	48	120	192	264	572	720	810	900	1036	1200	1460
Substrate 1	7	7	6	7	6	7	7	6	7	5	6	6	7
	7	8	7	7	7	7	7	7	7	5	6	6	6
	6	7	6	7	6	6	7	6	7	5	6	6	7
	7	6	7	7	6	6	7	6	6	5	5	5	6
	8	7	7	7	7	7	7	7	7	6	6	6	7
	7	7	7	7	7	7	6	7	7	5	6	6	7
	7	7	7	7	7	7	7	8	7	6	6	6	7
	7	7	6	6	6	6	6	7	6	5	6	5	6
Substrate 2	6	6	5	7	6	6	6	7	6	5	5	5	6
	7	7	6	7	6	6	7	7	7	5	6	6	6
	6	6	6	6	6	6	6	6	6	5	5	5	6
	6	6	7	7	6	6	7	6	6	5	6	6	6
	6	6	6	7	6	6	6	6	6	5	5	5	6
	6	7	6	6	6	6	7	6	6	5	6	5	7
	6	6	5	6	6	6	6	6	6	5	5	5	6
	6	6	6	7	7	6	6	6	6	6	5	5	6

TABLE 5. DC Bond Resistances - Epo-Tek H44 (Gold Filled) - Second Test

Time at 150°C (Hours)→	DC Bond Resistance (milliohms)												
	Zero	24	48	120	192	264	572	720	810	900	1036	1200	1460
Substrate 1	5	5	5	6	6	6	6	6	6	5	5	6	6
	6	6	5	7	6	6	6	6	6	5	5	6	6
	5	5	5	6	6	6	6	6	5	5	6	6	6
	6	6	5	7	5	6	6	6	5	5	5	5	6
	6	6	5	7	6	6	7	6	6	5	5	5	7
	6	6	5	7	6	6	6	6	6	5	5	5	6
	5	6	5	6	6	6	7	6	6	5	5	6	6
	6	6	5	7	6	6	6	6	6	5	5	5	6
Substrate 2	6	6	5	6	5	6	6	6	6	5	5	5	6
	6	6	5	7	6	6	6	6	6	5	5	6	6
	6	5	5	6	6	6	6	6	6	5	5	5	6
	6	6	6	6	6	6	7	6	6	5	5	5	6
	5	5	5	6	6	5	6	6	6	5	5	6	6
	6	6	5	7	6	6	6	6	6	5	5	5	7
	5	6	5	6	6	6	6	6	6	5	5	5	6
	6	6	6	7	5	6	6	6	6	5	5	5	6

C75-647/201

TABLE 6. DC Bond Resistances - Ablebond 36-2 (Silver Filled) - Second Test

Time at 150°C (Hours)→	DC Bond Resistance (milliohms)												
	Zero	24	48	120	192	264	572	720	810	900	1036	1200	1450
Substrate 1	5	6	6	7	6	7	8	8	8	7	9	9	9
	5	8	9	10	10	10	10	10	10	9	9	10	11
	5	6	6	7	7	6	7	7	8	7	7	8	10
	5	6	6	8	8	7	8	7	7	7	8	8	9
	5	6	6	7	7	6	8	8	9	7	8	9	10
	5	6	6	7	8	8	8	10	10	10	10	13	14
	6	6	7	8	8	8	10	10	10	10	10	11	12
	5	5	6	6	6	7	7	17	22	22	22	23	24
Substrate 2	6	5	6	7	7	7	11	12	14	13	18	22	28
	6	6	6	6	6	6	6	7	6	6	7	8	9
	5	6	6	7	6	6	7	7	6	6	6	7	7
	6	5	6	7	7	7	8	7	7	7	7	8	8
	6	6	6	7	7	7	10	10	11	10	12	13	14
	5	5	6	6	7	6	6	6	6	6	6	7	7
	5	6	5	6	6	6	6	6	6	6	6	8	10
	5	6	6	7	7	7	7	15	15	15	14	15	15

C75-647/201

TABLE 7. DC Bond Resistances - Epo-Tek H31 (Silver Filled) - Second Test

Time at 150°C (Hours)→	DC Bond Resistance (milliohms)												
	Zero	24	48	120	192	264	572	720	810	900	1036	1200	1460
Substrate 1	6	7	6	8	7	7	9	8	8	8	8	10	10
	7	9	8	10	9	9	11	11	11	11	14	14	15
	6	7	6	8	7	7	8	8	8	8	8	9	9
	5	6	7	8	7	8	8	9	7	7	7	9	8
	7	9	9	11	10	14	12	12	14	14	15	16	16
	8	8	8	11	11	13	15	16	17	18	21	22	24
	7	9	13	20	35	51	53	56	73	83	89	89	96
7	11	12	16	20	24	32	36	38	38	38	40	40	
Substrate 2	6	7	8	10	11	11	12	12	13	11	13	13	14
	6	7	9	16	18	21	25	26	27	22	27	31	41
	6	8	11	17	23	35	81	146	197	97	179	195	294
	5	8	9	10	9	11	15	20	26	34	51	60	83
	6	7	16	54	190	351	300	287	392	127	233	222	440
	7	9	31	730	1610	650	507	596	454	223	239	277	619
	11	57	141	346	468	1016	2150	1479	2482	1467	2060	2139	2780
6	7	7	9	8	7	9	8	9	8	10	13	17	

C75-647/201



to those for Epo-Tek H31. Resistances for Ablebond 36-2 increased by factors of from 2 to 5 or 6 over their original values. However, the situation was much worse for Epo-Tek H31. For this adhesive, approximately half of the bond resistances increased moderately as for Ablebond 36-2, and half increased by approximately an order of magnitude or more over their original values - up to the worst case, where the dc resistance changed from an original value of 11 milliohms to a final value of approximately 2.8 ohms.

These results substantiate those of the original tests. Consequently, it can be concluded that the long term electrical stability of gold filled adhesives is unquestionably superior to that of silver filled adhesives.

#### C. EFFECT OF SHELF LIFE AGE ON ADHESIVE CHARACTERISTICS

A series of tests were run to evaluate the effect of the age of adhesives on their bond strengths and bond resistances (in the case of the electrically conductive adhesives). These tests were conducted to determine the extent to which adhesive characteristics change during their shelf life. Fresh adhesives were obtained and stored at the temperatures recommended by the respective manufacturers. The adhesives were tested at approximately one month intervals for a period of six months. Five electrically insulative adhesives (Hysol 0151, Ablefilm 517, Eccobond 104, Epo-Tek H61 and Epo-Tek H74) and four electrically conductive adhesives (Ablebond 36-2, Epo-Tek H31, Ablebond 58-1 and Epo-Tek H44) were tested.

Cure schedules used for the various adhesives were as follows:

Hysol 0151	2 hours at 60C
Ablefilm 517	30 minutes at 150C
Eccobond 104	3 hours at 150C
Epo-Tek H61	1 hour at 150C
Epo-Tek H74	40 minutes at 100C
Ablebond 36-2	1 hour at 150C
Epo-Tek H31	1 hour at 150C
Ablebond 58-1	1 hour at 150C
Epo-Tek H44	1 hour at 150C

Bond strength specimens consisted of silicon die mounted on unglazed alumina substrates for the electrically insulative adhesives, and silicon die mounted on thick film gold metallized unglazed alumina substrates for the electrically conductive adhesives. Two substrates containing 10 die each (a total of 20 die) were prepared and tested for each adhesive. The test substrates were 1.90 cm (0.75 inch) wide by 3.81 cm (1.50 inch) long and the silicon die were 0.127 cm

(0.050 inch) square. DC bond resistance specimens consisted of silver terminal capacitors mounted on thick film gold metallization. The test substrates were the same as those used to evaluate the effect of aging at 150C on bond electrical resistance. Two substrates each containing four capacitors were prepared for each adhesive, so since each capacitor is bonded at both ends, 16 bonds were provided for each adhesive.

Bond strength measurements were made with the tester driven at a constant rate of approximately 0.05 inches/minute (0.127 cm/minute). Bond resistance measurements were made with a Dana Model 5500 Digital Voltmeter. Measurement repeatability was not worse than  $\pm 2$  milliohms. For both the bond strength and the dc bond resistance measurements, the specimens were tested 24 hours after they were prepared each month to ensure consistency. Bond strength results are reported by giving the low, high and average values of the total shear forces. For the dc bond resistances, only the average values are reported.

Results are given in Tables 8 and 9. Comparison of the values obtained for the dc resistances (Table 9) shows that the electrical characteristics of the conductive adhesives remained constant within measurement accuracy. Also, it is evident from a review of Tables 8a and 8b that all of the adhesives retained their bond strengths after six months storage at the temperatures recommended by the manufacturers. However, from the variations in the average values obtained for each adhesive over the test sequence, and from the wide spread in the values of bond strength measured for each adhesive during each specific test (shown in the parentheses), it also is evident that important bond parameters were not adequately controlled in the preparation of the test specimens. While some of the variation in the measured values of the bond strength can be attributed to imprecision in the tester and testing procedure, and possibly even to an innate characteristic of the adhesives, unquestionably the largest contributor was the lack of uniformity of bond line thickness and extent of filleting in specimen preparation.

For the present tests, the test specimens were prepared manually, and it was found to be impossible to obtain uniform bond line thicknesses and fillets. Variations are probably at least of the order of 50 to 100%, so the wide spread in the measured values of bond strength should be expected. Variations in fillet are especially critical for the small sized die, 0.127 cm (0.050 inch) square used. Consequently, caution should be exercised in interpreting the results obtained and in drawing specific conclusions from them. However, it should be noted that the smallest average value of bond strength obtained for any of the adhesives was 3.9 kgf which is equivalent to a bond strength of  $2.37 \times 10^7 \text{ N/m}^2$

TABLE 8a. Bond Strength - Shelf Life Tests\*  
Electrically Insulative Adhesives

Time After Manufacture	Average Shear Force (kgf)				
	Hysol 0151	Ablefilm 517	Eccobond 104	Epo-Tek H61	Epo-Tek H74
Two Weeks	6.4 (2.7 - 9.5)	10.8 (5.9 - 16.3)	9.2 (5.4 - 11.8)	6.6 (4.5 - 10.0)	7.8 (4.1 - 13.2)
Two Months	9.4 (5.0 - 14.1)	7.9 (3.6 - 10.9)	9.7 (6.4 - 12.7)	9.6 (6.8 - 13.2)	10.0 (7.7 - 12.7)
Three Months	4.0 (2.7 - 7.3)	6.9 (3.2 - 9.5)	6.8 (4.5 - 12.7)	9.7 (5.4 - 17.3)	10.4 (6.8 - 19.5)
Four Months	6.6 (3.6 - 10.4)	7.9 (3.2 - 12.3)	8.4 (4.1 - 12.7)	7.2 (3.6 - 10.9)	7.8 (4.1 - 12.7)
Five Months	7.1 (4.1 - 10.0)	7.5 (3.6 - 13.6)	8.5 (5.0 - 15.0)	10.2 (6.8 - 14.5)	8.3 (4.5 - 14.1)
Six Months	8.1 (4.1 - 12.3)	8.5 (5.0 - 12.3)	9.5 (4.6 - 13.2)	9.1 (6.8 - 12.7)	8.5 (5.0 - 12.3)

37

C75-647/201

\*Reported values are an average for 20 specimens. Specimens were 0.127 cm (0.050 inch) square silicon die mounted on unglazed alumina substrates. Minimum and maximum values measured are given in parentheses following the average values.

TABLE 8b. Bond Strength - Shelf Life Tests\*  
Electrically Conductive Adhesives

Time After Manufacture	Average Shear Force (kgf)			
	Ablebond 36-2	Epo-Tek H31	Ablebond 58-1	Epo-Tek H44
Two Weeks	4.0 (2.3 - 7.0)	4.7 (3.0 - 9.1)	5.7 (3.0 - 8.9)	5.6 (2.7 - 8.4)
Two Months	5.6 (1.8 - 10.0)	5.2 (3.2 - 8.2)	4.8 (2.7 - 7.3)	7.1 (4.5 - 12.7)
Three Months	4.4 (2.3 - 6.8)	6.2 (3.6 - 10.4)	7.6 (3.6 - 10.4)	7.7 (3.6 - 10.4)
Four Months	3.9 (2.3 - 7.3)	4.5 (2.7 - 7.7)	7.3 (4.5 - 10.0)	7.5 (3.2 - 10.4)
Five Months	6.0 (3.6 - 9.5)	6.4 (4.1 - 9.1)	8.2 (4.5 - 10.9)	8.8 (3.6 - 13.2)
Six Months	4.7 (2.7 - 7.7)	6.5 (3.6 - 10.4)	6.3 (3.6 - 8.2)	6.7 (3.6 - 9.5)

\*Reported values are an average for 20 specimens. Specimens were 0.127 cm (0.050 inch) square silicon die mounted on thick film gold metallized unglazed alumina substrates. Minimum and maximum values measured are given in parentheses following the average values.

TABLE 9. DC Bond Resistances - Shelf Life Tests\*

Adhesive	Average Resistance (milliohms)		
	Two Weeks After Manufacture	Two Months After Manufacture	Three Months After Manufacture
Ablebond 36-2	6	5	5
Epo-Tek H31	6	6	7
Ablebond 58-1	6	7	8
Epo-Tek H44	6	6	6

Adhesive	Average Resistance (milliohms)		
	Four Months After Manufacture	Five Months After Manufacture	Six Months After Manufacture
Ablebond 36-2	5	6	5
Epo-Tek H31	6	7	6
Ablebond 58-1	8	7	6
Epo-Tek H44	6	7	6

\*Reported values are an average for 16 bonds.

(3430 psi), and that the lowest bond strength observed in the complete series of measurements (1.8 kgf) is still equivalent to a bond strength of  $1.09 \times 10^7 \text{ N/m}^2$  (1580 psi). Bond strengths of this magnitude are considered sufficient for the present proposed applications.

These comments should not be construed as a recommendation that this method of measuring adhesive bond strengths be abandoned, but rather as a recommendation that a more reproducible method be used for preparing the test specimens. At least two such methods are available; (1) screen the adhesives and automatically place the die; or (2) use a die bonder which automatically dispenses a controllable amount of adhesive and places the die. Either of these methods can yield bonds of controllable uniform thickness and fillet.

Properly implemented as recommended, the use of small silicon die mounted on alumina or metallized alumina substrates (depending on whether the adhesive is electrically insulative or electrically conductive) is a much more realistic and economical (particularly in the case of gold filled adhesives) bond strength test than the commonly used aluminum-to-aluminum lap shear test.

#### D. BOND STRENGTHS OF ELECTRICALLY CONDUCTIVE ADHESIVES ON THICK FILM GOLD METALLIZATION

Previous bond strength measurements were made using silicon die mounted on unglazed alumina substrates. Since normal usage of conductive adhesives is to mount components on conductive pads, bond strength measurements for the conductive adhesives (Ablebond 58-1, Epo-Tek H44, Ablebond 36-2 and Epo-Tek H31) were made for 0.127 cm (0.050 inch) square silicon die mounted on thick film gold metallization. As previously, bond strengths were measured at room temperature and at 150C for freshly prepared specimens (i.e., immediately after cure), and at room temperature for specimens immersed for 30 minutes in isopropyl alcohol, Freon TF and Freon TMC (instead of the trichloroethylene previously used), and for specimens aged for 30, 60 and 90 days at both room temperature and 150C.

Results are given in Tables 10, 11 and 12. Comparison of the data given in Table 10 shows that the bond strengths of all of the adhesives are considerably less at 150C than they are at room temperature. However the bond strengths of the silver filled adhesives are degraded more than those of the gold filled adhesives. Reference to Table 11 shows that the bond strengths of the adhesives are not appreciably affected by 30 minutes immersion in the commonly used solvents, isopropyl alcohol, Freon TF, or Freon TMC. Review of the data of Table 12 indicates

TABLE 10. Bond Strength of Freshly Prepared Specimens\*.  
Silicon Die on Thick Film Gold Metallization

Adhesive	Tested at Room Temperature		Tested at 150°C	
	$10^7$ N/m <sup>2</sup>	psi	$10^7$ N/m <sup>2</sup>	psi
<u>Silver Filled</u>				
Ablebond 36-2	3.53	5120	0.80	1160
Epo-Tek H31	3.67	5320	0.55	800
<u>Gold Filled</u>				
Ablebond 58-1	3.34	4840	1.05	1525
Epo-Tek H44	3.72	5400	2.12	3080

\*Reported values are an average for ten specimens.

TABLE 11. Room Temperature Bond Strength after 30 Minutes Immersion in Commonly Used Solvents\*. Silicon Die on Thick Film Gold Metallization

Adhesive	Isopropyl Alcohol		Freon TF		Freon TMC	
	$10^7$ N/m <sup>2</sup>	psi	$10^7$ N/m <sup>2</sup>	psi	$10^7$ N/m <sup>2</sup>	psi
<u>Silver Filled</u>						
Ablebond 36-2	2.98	4320	3.28	4760	2.51	3640
Epo-Tek H31	3.74	5420	2.92	4240	4.01	5820
<u>Gold Filled</u>						
Ablebond 58-1	2.48	3600	2.67	3870	2.29	3320
Epo-Tek H44	3.92	5680	3.83	5560	4.05	5880

\*Reported values are an average for 10 specimens.



TABLE 12. Room Temperature Bond Strength as a Function of Aging\*  
Silicon Die on Thick Film Gold Metallization

Adhesive	Freshly Prepared		Aged 30 Days				Aged 60 Days				Aged 90 Days			
			At RT		At 150°C		At RT		At 150°C		At RT		At 150°C	
	$10^7$ N/m <sup>2</sup>	psi	$10^7$ N/m <sup>2</sup>	psi	$10^7$ N/m <sup>2</sup>	psi	$10^7$ N/m <sup>2</sup>	psi	$10^7$ N/m <sup>2</sup>	psi	$10^7$ N/m <sup>2</sup>	psi	$10^7$ N/m <sup>2</sup>	psi
<u>Silver Filled</u>														
Ablebond 36-2	3.53	5120	2.59	3760	3.48	5040	3.39	4920	4.77	6920	3.12	4520	2.71	3930
Epo-Tek H31	3.67	5320	2.37	3440	2.98	4320	2.26	3280	2.29	3320	3.12	4520	2.76	4000
<u>Gold Filled</u>														
Ablebond 58-1	3.34	4840	3.76	5450	3.89	5640	4.72	6840	3.45	5000	5.32	7720	4.96	7200
Epo-Tek H44	3.72	5400	3.17	4600	3.12	4520	3.75	5440	2.65	3840	3.86	5600	3.83	5560

\* Reported values are an average for ten specimens.

that the bond strengths of these adhesives also are not appreciably degraded by long term aging at either room temperature or 150C, and in some cases may be improved by such aging.

#### E. EVALUATION OF A COPPER FILLED ADHESIVE

Because of its cost advantage over silver or gold filled adhesives, a copper filled adhesive was evaluated for possible use in hybrid microcircuits. The specific adhesive evaluated was Ablebond 163-14. Discussion of the tests performed and the results obtained follows.

A regular pyrogram or TGA curve was run to determine its temperature stability, and a two hour run using the TGA apparatus at a constant temperature of 150C was made to determine its weight loss after cure characteristic. Results are shown in Figures 21 and 22. Comparison of these results with similar curves obtained for the gold and silver filled adhesives shows that this copper filled adhesive is able to withstand higher temperatures before decomposition occurs, and is a relatively low outgasser like Ablebond 36-2 and Ablebond 58-1.

Corrosivity was evaluated for thin film aluminum and thin and thick film gold metallization systems using the corrosivity test specimens. Testing consisted of exposing the specimens to an 80-85C/80-85% relative humidity environment for 24 hours with 30 volts applied between the lines of alternate line pairs (line pairs 1, 3, 5 and 7) for specimens with dots of adhesive on each line, and with approximately 20 ma current flowing through the lines of alternate line pairs for specimens with dots of adhesive bridging the lines of each line pair. No evidence of corrosion was found for any of the specimens.

However, for all three specimens (thin film aluminum and thin and thick film gold) with adhesive dots bridging the line pairs, many of the interline resistances were found to be very high (of the order of hundreds or thousands of ohms) after exposure to the test environment. Also, for the thin film aluminum specimen, the interline resistances of three of the line pairs were found to be high initially (i.e., immediately after cure). These resistances switched to a value corresponding to those of the other line pairs when an attempt was made to measure them on the 100K ohm scale of the Triplet VOM.

However, after exposure to the test environment, these resistances again increased to very high values. The original values of the interline resistances of the test specimens ranged from less than 1 ohm for the thin and thick film gold specimens to 10 to 15 ohms for the thin film aluminum specimen.

45

C75-647/201

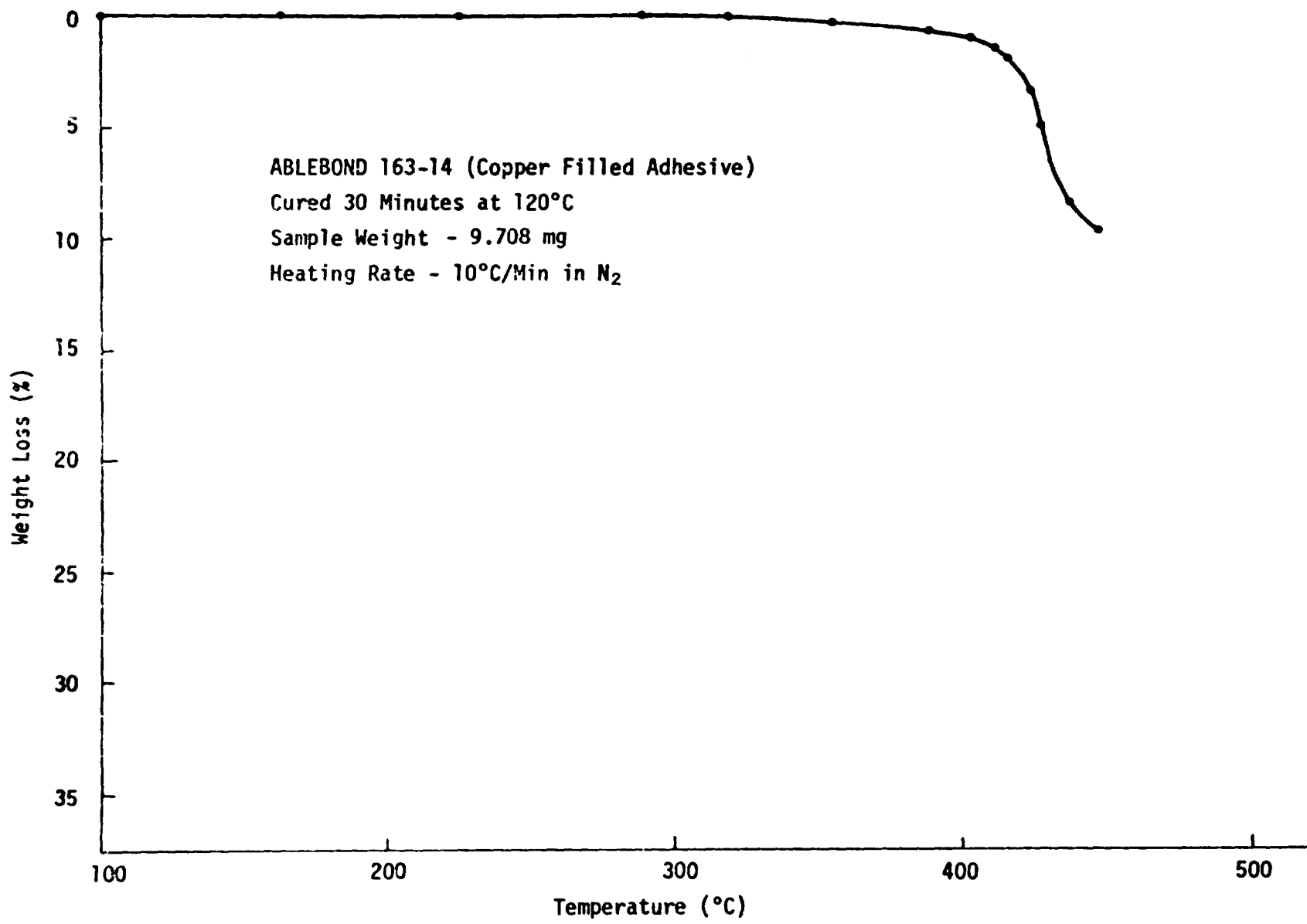

Figure 21. TGA Curve - Ablebond 163-14

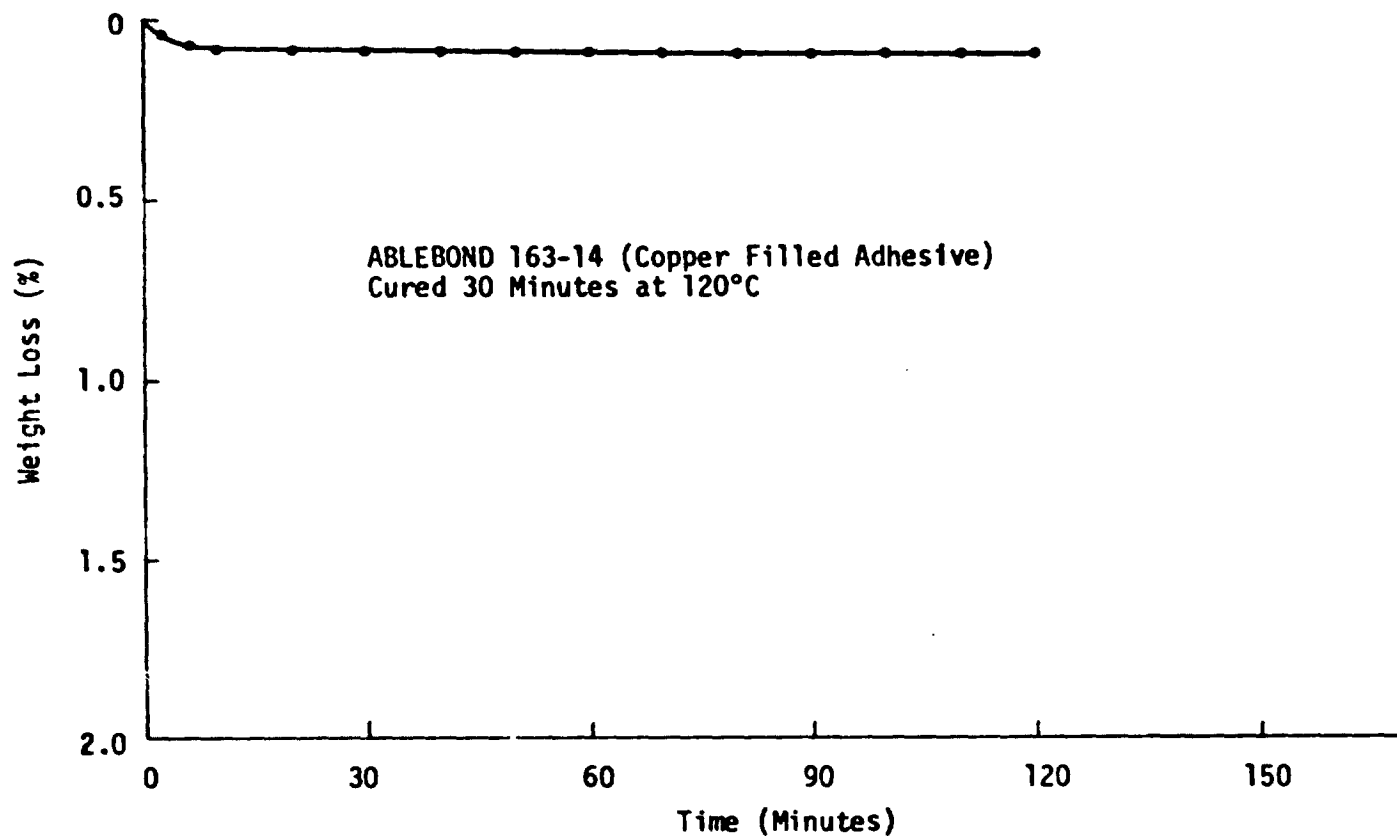

Figure 22. Weight Loss of Ablebond 163-14 at Constant Temperature (150°C) After Cure - As Measured on TGA Apparatus

Bond strength was measured at both room temperature and at 150C for freshly prepared specimens (i.e., immediately after cure), and at room temperature for specimens immersed for 30 minutes in isopropyl alcohol, Freon TF, and Freon TMC, and for specimens aged in air for 30, 60 and 90 days at both room temperature and at 150C. Test specimens consisted of 0.127 cm (0.050 inch) square silicon die on thick film gold metallization. Results are given below and in Table 13. Values are averages for ten specimens.

1. Freshly Prepared (tested at RT)	$3.75 \times 10^7 \text{ N/m}^2$ (5440 psi)
2. Freshly Prepared (tested at 150C)	$1.88 \times 10^7 \text{ N/m}^2$ (2720 psi)
3. After 30 minutes in isopropyl alcohol	$4.33 \times 10^7 \text{ N/m}^2$ (6280 psi)
4. After 30 minutes in Freon TF	$2.87 \times 10^7 \text{ N/m}^2$ (4160 psi)
5. After 30 minutes in Freon TMC	$3.86 \times 10^7 \text{ N/m}^2$ (5600 psi)

Reference to Table 13 shows that the bond strength of this adhesive is not affected by long term aging at room temperature, but is severely degraded by long term aging at 150C - down to only approximately 15% of its initial value after 90 days.

Tests were also made to determine the effect of aging at 150C on the dc resistances of bonds made with this adhesive. Data are given in Table 14. As can be seen, the dc bond resistances decreased during the first aging interval, indicating that the cure schedule recommended by the manufacturer was inadequate and that the specimens originally were not completely cured. During subsequent aging out to 1540 hours, the dc resistances of approximately 25% of the specimens remained unchanged within measurement accuracy and approximately 75% increased. However, in all cases the increases were small to moderate, and while the final resistance values are comparable to those for the silver filled adhesive Ablebond 36-2, the percent change from their original values is much less.

A summary of the results obtained follows. Thermal gravimetric analysis showed that this adhesive can withstand higher temperatures than the silver and gold filled adhesives before decomposition occurs, and that it is a low outgasser like Ablebond 36-2 and Ablebond 58-1. Corrosivity tests showed that this adhesive did not affect thin film aluminum or thin and thick film gold metallization systems; but that in many cases for the test specimens with adhesive bridging the line pairs, the interline resistances were very high (of the order of hundreds or thousands of ohms) either immediately after cure or after the specimens were exposed to the test environment. To a somewhat lesser extent, similar results were obtained for

TABLE 13. Room Temperature Bond Strength - Ablebond 163-14\*  
Silicon Die on Thick Film Gold Metallization

Freshly Prepared		Aged 30 Days				Aged 60 days				Aged 90 Days			
		At RT		At 150°C		At RT		At 150°C		At RT		At 150°C	
$10^7$ N/m <sup>2</sup>	psi	$10^7$ N/m <sup>2</sup>	psi	$10^7$ N/m <sup>2</sup>	psi	$10^7$ N/m <sup>2</sup>	psi	$10^7$ N/m <sup>2</sup>	psi	$10^7$ N/m <sup>2</sup>	psi	$10^7$ N/m <sup>2</sup>	psi
3.75	5440	4.50	6530	1.71	2480	4.55	6600	1.68	2440	4.66	6760	0.55	800

\*Reported values are an average for 10 specimens.

TABLE 14. DC Bond Resistance - Ablebond 163-14 (Copper Filled)

Time at 150°C (Hours)	DC Bond Resistance (milliohms)										
	Zero	27	96	232	396	653	796	935	1080	1300	1540
Substrate 1	17	9	10	9	9	10	9	9	9	10	11
	16	8	8	9	9	10	8	8	10	9	9
	20	15	15	16	17	17	17	16	17	20	21
	17	11	12	14	15	15	14	18	16	17	16
	18	19	11	12	12	13	12	11	14	13	18
	18	10	11	11	11	11	10	9	14	11	11
	16	9	10	10	11	11	10	9	11	12	13
	15	8	9	10	11	11	11	10	11	11	12
Substrate 2	15	8	7	8	9	9	9	10	12	9	11
	16	8	7	9	10	9	8	9	10	10	10
	17	14	15	15	17	17	17	17	19	21	24
	20	15	15	16	17	16	15	13	14	14	16
	17	10	11	10	11	11	10	9	10	10	10
	19	13	14	16	18	18	17	15	18	17	16
	19	13	14	15	16	16	15	18	17	16	17
	19	15	17	17	17	17	18	17	15	19	19

the silver and gold filled adhesives. Bond strength measurements showed that this adhesive has a bond strength comparable to or greater than the silver or gold filled adhesives under all conditions except extended aging at 150C. Under this condition, after 90 days the bond strength of this copper filled adhesive degraded to approximately 15% of its initial value while the bond strengths of the silver and gold filled adhesives did not degrade appreciably from their initial values.

This evaluation showed that, in general, this copper filled adhesive compares favorably with the silver and gold filled adhesives except in retention of bond strength after aging at elevated temperature, and in the effect of high temperature/relative humidity exposure on adhesive resistance. Because of these deficiencies, it is felt that further improvements are required before copper filled adhesives are considered for use in the assembly of high reliability hybrid microcircuits.

#### F. EFFECTS OF PRODUCTS OUTGASSED FROM CURED ADHESIVES ON DEVICE ELECTRICAL PARAMETERS

Tests were performed to determine empirically whether or not and to what extent the products outgassed from adhesives after cure contaminate the surfaces of hybrid microcircuit components and deleteriously affect their electrical characteristics. Program limitations made it impossible to test all of the different types of devices used in hybrid microcircuits, but two very different types of devices were tested. These were thin film nichrome chip resistors and a special test device containing metal-insulator-semiconductor field effect transistors. These particular devices were chosen since it is felt that contaminants can affect components either by directly modifying the surface resistivity or by establishing a surface charge.

Both unpassivated and glass passivated thin film nichrome chip resistors were tested. This not only provided a sensitive detector for changes due to the effects of the products outgassed from the adhesives, but also allowed evaluation of the effectiveness of glass passivation in eliminating these effects. The chip resistors used were supplied by Hybrid Systems Corporation. The special test device containing metal-insulator-semiconductor FET's was designed by Westinghouse Electric Corporation under an ECOM contract and is discussed in detail in ECOM Report 72-0217-F. Mr. I. H. Pratt of that agency provided these devices.

Eleven different adhesives (six electrically insulative and five electrically conductive) were evaluated. These were as follows:



Electrically Insulative Adhesives

Hysol 0151  
 Ablefilm 517  
 Eccobond 104  
 Epo-Tek H61  
 Epo-Tek H74  
 Ablefilm 529

Electrically Conductive AdhesivesSilver Filled

Ablebond 36-2  
 Epo-Tek H31  
 DuPont 5504

Gold Filled

Ablebond 58-1  
 Epo-Tek H44

Test specimens were prepared for each of the two different types of devices, and for two different amounts of each adhesive. Specific amounts of adhesives used in each case will be given later. In addition, in each case, two control specimens containing no adhesive were fabricated. A total of 48 test specimens were fabricated - 24 containing FET devices and 24 containing thin film nichrome chip resistors.

In all cases, the adhesives were cured for six hours at 150C in nitrogen, and the packages were vacuum baked at less than 1 Torr for two hours at 100C prior to sealing. Six hours was chosen as representative of the total minimum time the adhesives would be exposed at 150C as a result of curing and pre-seal stabilization bake. The packages were sealed in a seam sealer using a gold-tin preform between the package rim and lid, and then if required were touched up with solder to meet MIL-STD-883A hermeticity requirements. The packages used were 26 lead, gold-plated Kovar, butterfly-type packages of modular construction obtained from Tekform (Tekform Part Number 50168).

Testing consisted of aging the test specimens at 150C, periodically removing them from the oven, allowing them to cool to room temperature, and making the appropriate electrical measurements. These measurements were resistance for the thin film nichrome chip resistors, and the effective gate voltage of the ungated FET for the FET devices. Measurements were made out to 540 hours. Test boards, adapters and fixtures required to age the test specimens at 150C and functionally test the devices are shown in Figures 23 through 25.

- FET Test Specimens

The FET test devices consist of two identical FET's, one gated and the other ungated, symmetrically spaced with respect to an aluminum strip electrode. Device

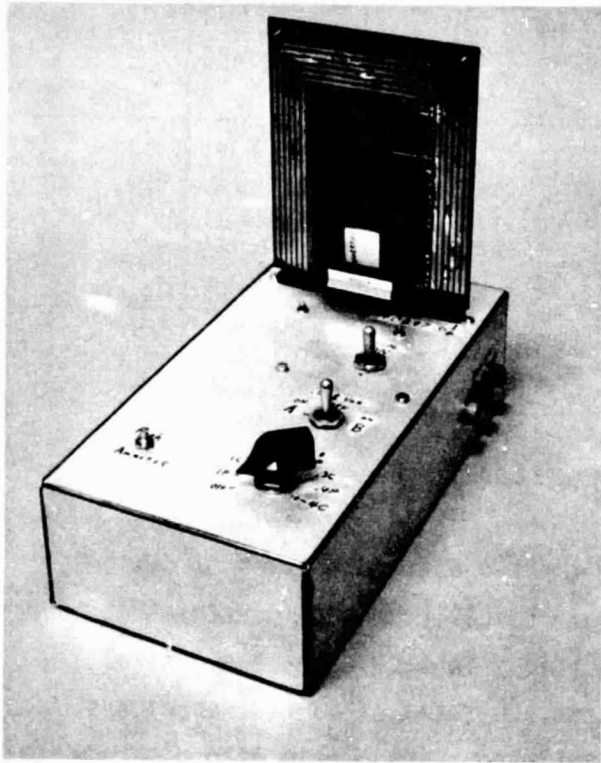

FIGURE 23. Test Adapter for FET Device Test Specimens with Test Board Plugged In

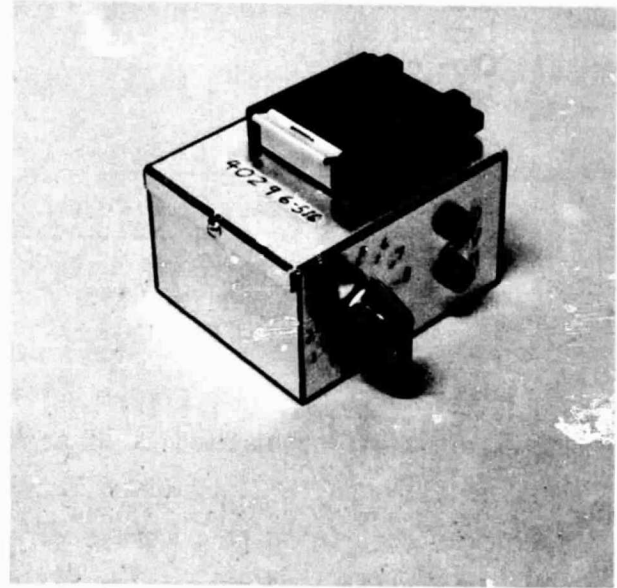

FIGURE 24. Test Adapter for Thin Film Chip Resistor Test Specimens

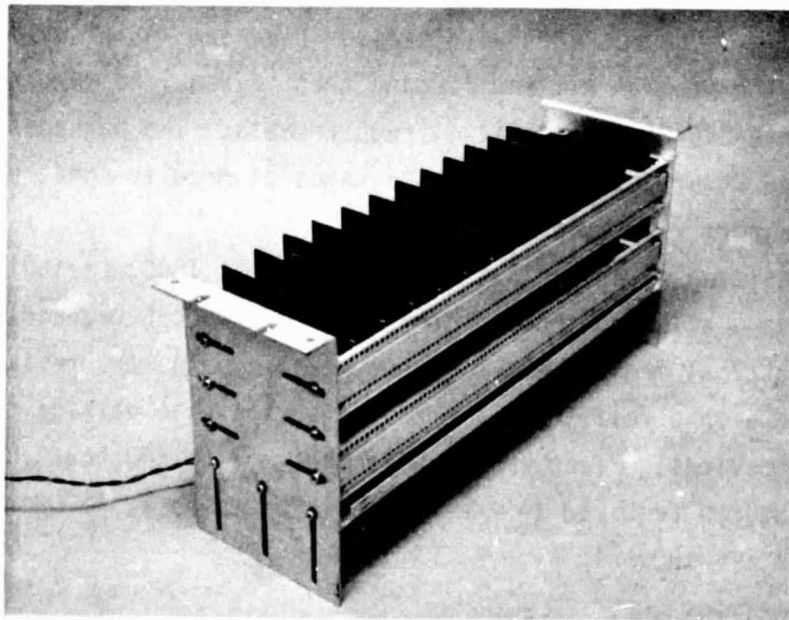

FIGURE 25. Aging Fixture for Test Specimens

layout is shown in Figure 26 and the corresponding schematic circuit diagram is given in Figure 27. Briefly, the theory of operation of this device is that contaminant products outgassed from adhesives will settle on the surface of the device and, if they are electrically deleterious, will establish an effective gate voltage on the ungated FET (called the probe FET), but will not affect the gate voltage of the gated FET (called the calibrator FET) since the channel region of this FET is protected by metallization. The quantitative effect of the contaminants is then measured by determining the effective gate voltage of the ungated or probe FET by varying the gate voltage of the gated or calibrator FET until the same drain current is obtained for both FET's for a fixed value of drain voltage. The circuit used for these measurements is shown in Figure 28. A low impedance ammeter must be used so that the voltage drop across it is negligible compared to the 0.5 volt source to drain voltage.

The layout of the FET test specimens is given in Figure 29. As shown, each specimen contains four devices. The specimens were fabricated by eutectically mounting the devices directly on the floor of the package using a pure gold ribbon preform. Electrical connections between the devices and the package leads were made by ultrasonically bonding 0.0025 cm (1 mil), one percent silicon aluminum wire. A photograph of a test specimen before lidding is shown in Figure 30.

Before fabricating all of the test specimens, several individual ones containing no adhesive were made and tested. This was done to develop proper assembly, handling, and testing procedures and techniques, and to gain familiarity with the operation of the devices. It was found that the initial characteristics (drain current and gate voltage) varied considerably from device to device. Also, in several cases during the course of testing specific devices, the gate voltage required to obtain a fixed value of drain current increased substantially. Since the drain current remained unchanged, this indicated that the characteristics of the ungated or probe FET had not changed, but that something had happened to the gated or calibrator FET and changed its operating characteristics. This was substantiated by comparing photographs of device characteristics obtained on a curve tracer before and after such a change occurred. These photographs are given in Figure 31. In these photographs, the characteristics of the gated or calibrator FET is given by a family of lines for one volt increments of gate voltage. Several values of the gate voltage are indicated. Since the gate voltage of the ungated or probe FET cannot be varied, its characteristic is given by a single line.

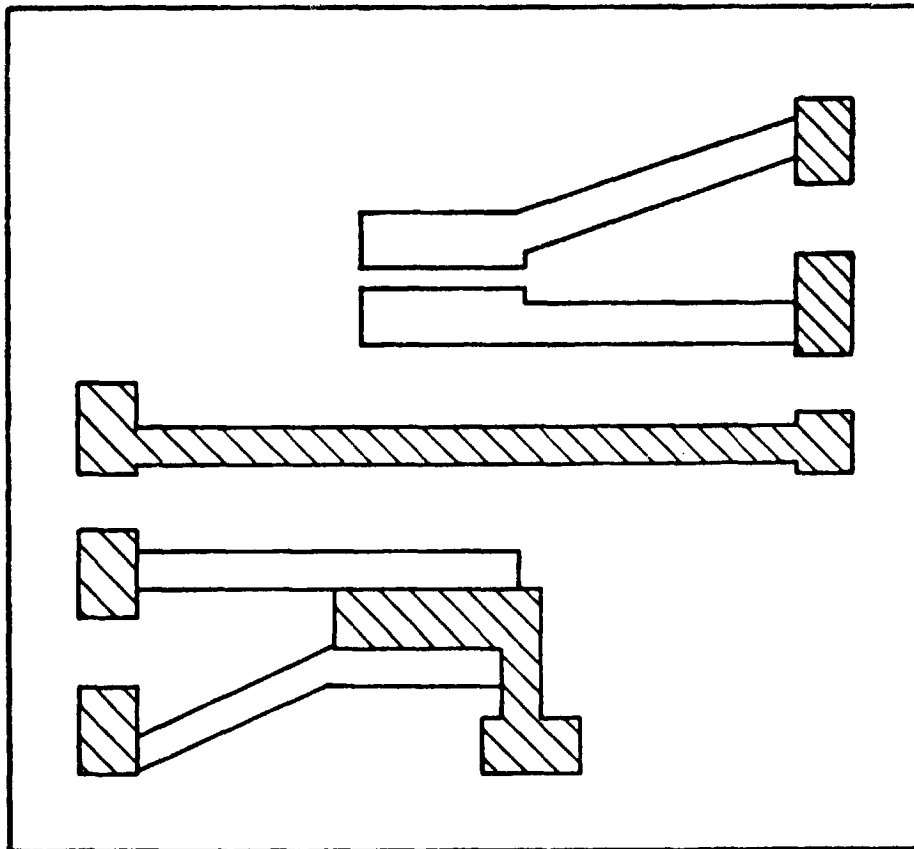

Figure 26. Layout of FET Test Devices (Cross Hatched Areas Indicate Aluminum Metallization)

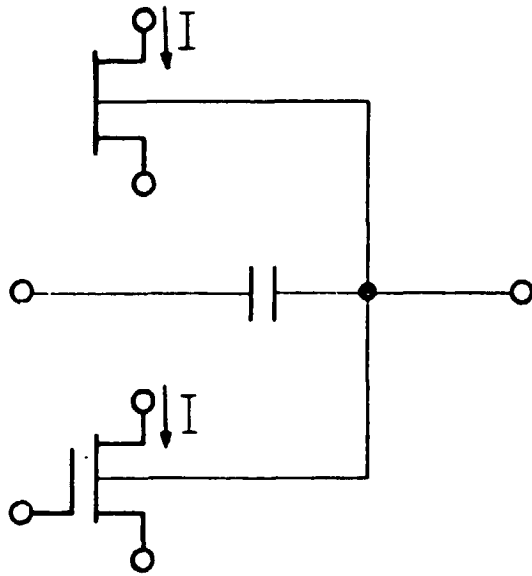

Figure 27. Schematic Circuit Diagram of FET Test Devices

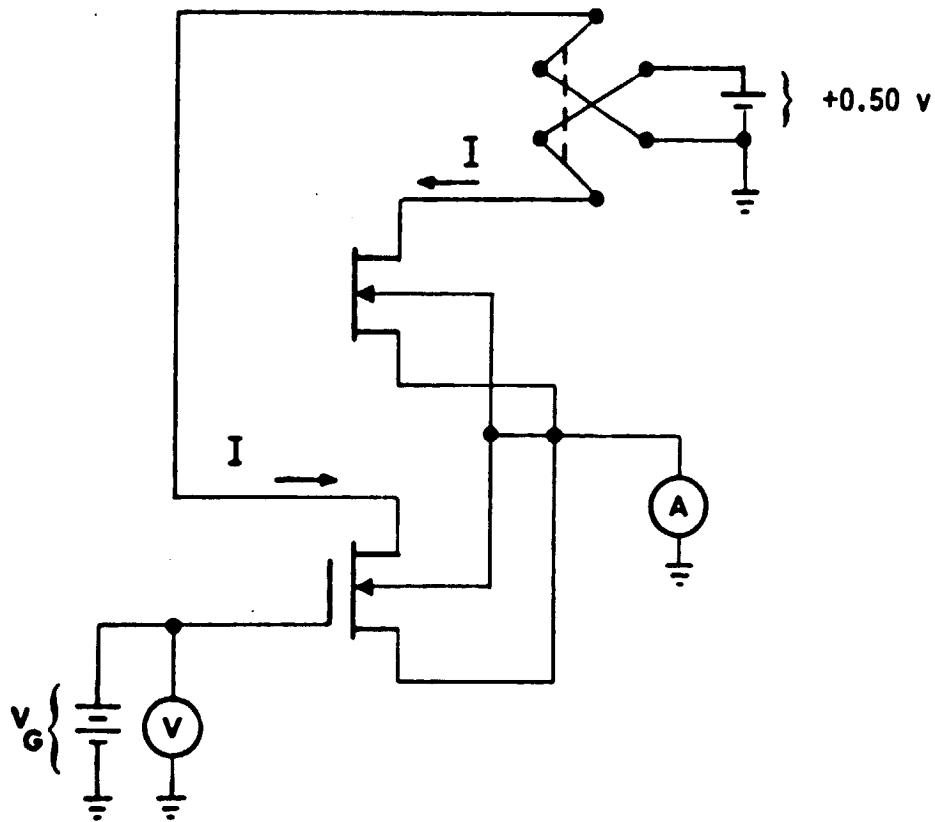

Figure 28. Diagram of Test Circuit for Measuring Effects of Surface Contaminants on FET Test Devices

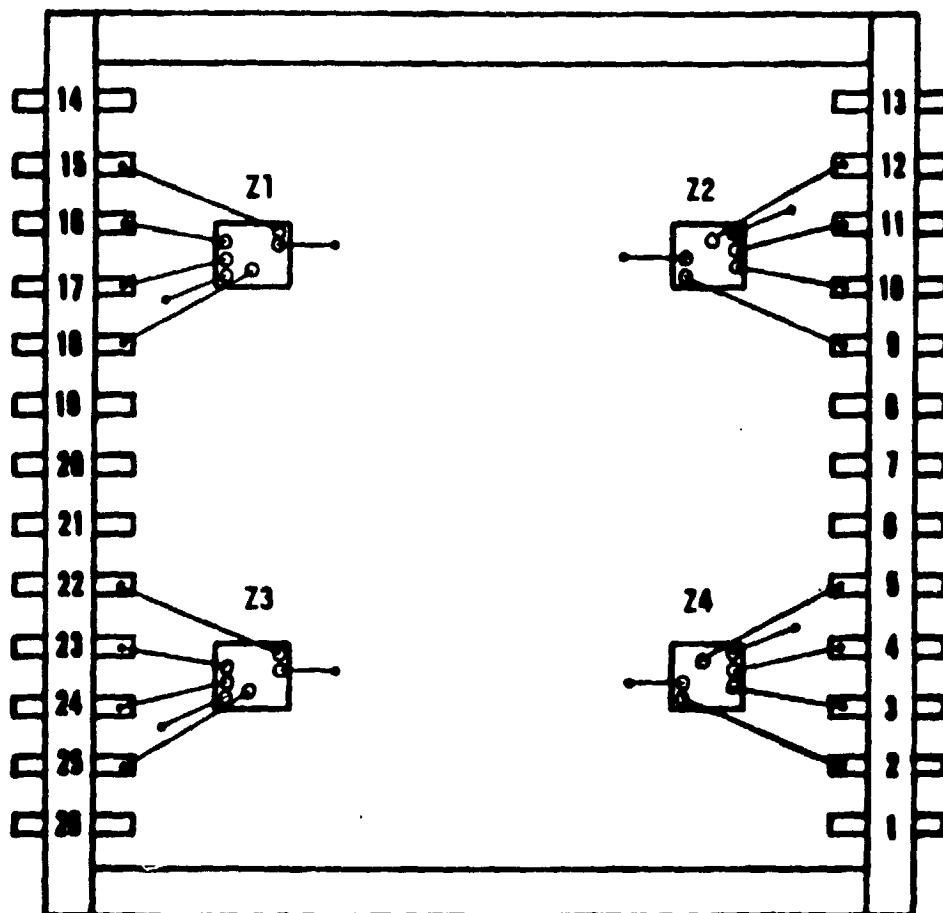

Figure 29. Layout of FET Test Specimen

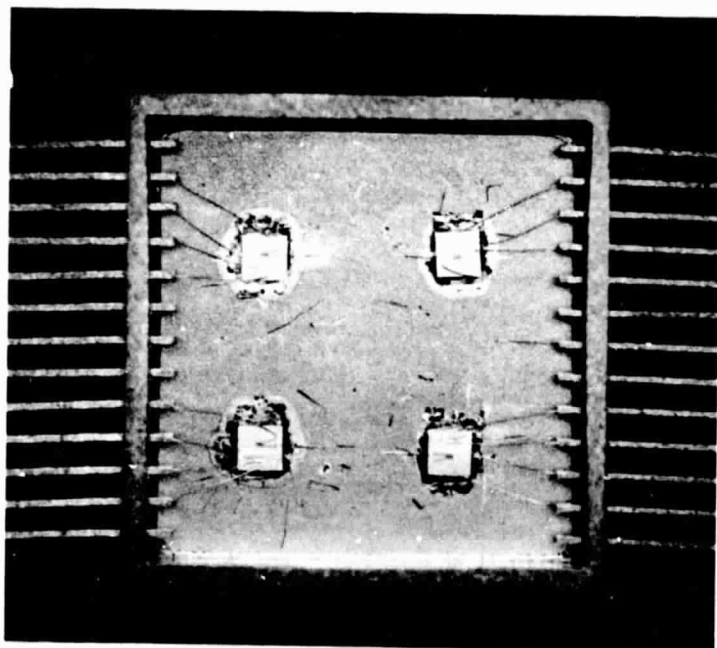
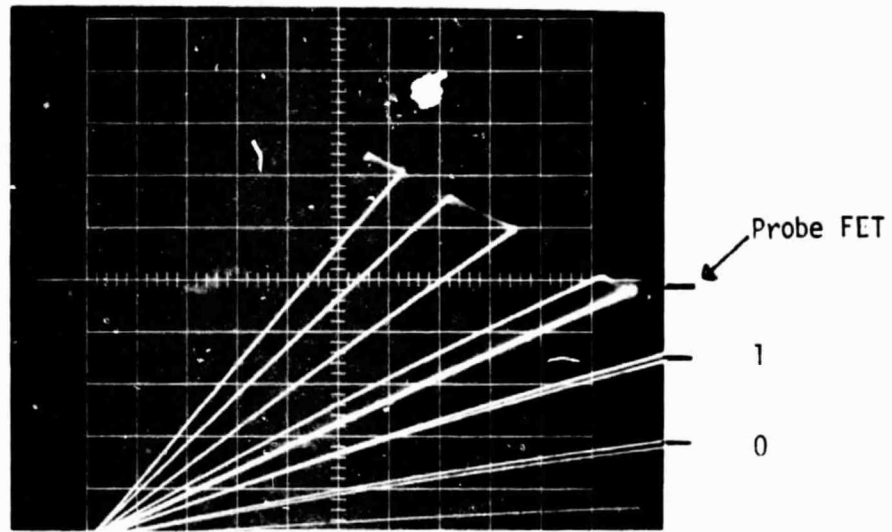
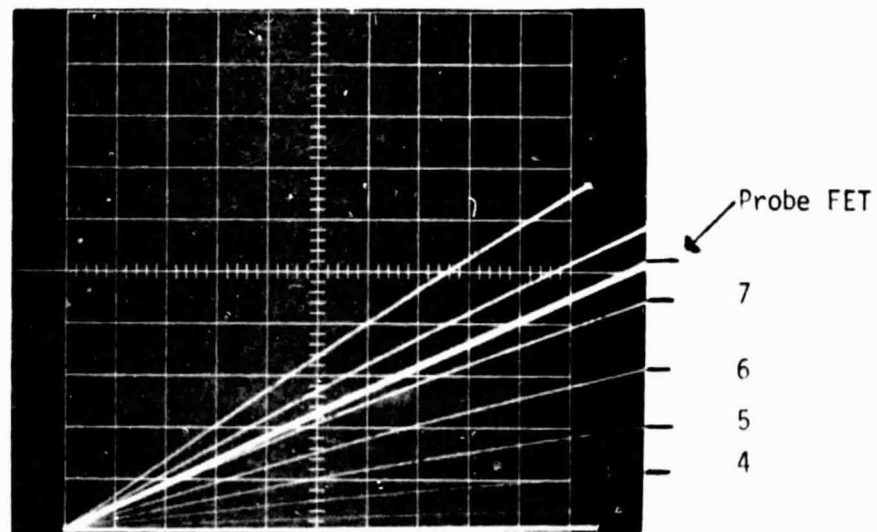

FIGURE 30. FET Device Test Specimen





(a) Before Observed Increase in Required Gate Voltage



(b) After Observed Increase in Required Gate Voltage

FIGURE 31. Characteristics of FET Test Device Showing Damage to Calibrator FET Gate

This is the brightest line on the photographs and is indicated by an arrow. As can be seen, the absolute position of this line has not changed in the two photographs, but its relative position with respect to the characteristics of the gated or calibrator FET has changed. Consequently, the characteristics of this FET (the gated or calibrator FET) have changed for some reason. The logical conclusion is that the gate of this FET has been damaged by static charges or voltage transients.

To protect the devices, zener diodes were added to the gate pins in the test adapter and to the gate inputs on each of the adapter boards, and the adapter boards were coated with Dow Corning R6101 to insulate all inputs. It was felt that this would adequately protect the devices from static charges that could occur during handling and eliminate the problem. However, as noted later, in spite of these precautions, in many cases such damage apparently still occurred during the evaluation tests.

Two test specimens were prepared for each adhesive. One contained approximately 10 times as much adhesive as the other. The larger amount was approximately equal to that required to mount the substrate appropriate to the package (i.e., a substrate 1.59 cm or 0.625 inches square) with a 0.008 cm (3 mil) thick bond line. The smaller amount was approximately 10% of this, which also is about the amount required to mount the average number of devices used in a hybrid microcircuit made using a substrate of this size. In all cases, the devices were eutectically mounted and the adhesives were spread evenly in the center of the lids. Actual amounts of adhesives used were as follows:

<u>Adhesive</u>	<u>Amount</u>	<u>Adhesive</u>	<u>Amount</u>
Hysol 0151	22.7 mg	Ablebond 36-2	47.2 mg
Hysol 0151	2.5 mg	Ablebond 36-2	4.8 mg
Ablefilm 517	28.0 mg	Epo-Tek H31	42.1 mg
Ablefilm 517	2.9 mg	Epo-Tek H31	4.7 mg
Eccobond 104	30.0 mg	DuPont 5504	48.2 mg
Eccobond 104	3.4 mg	DuPont 5504	5.2 mg
Epo-Tek H61	47.7 mg	Ablebond 58-1	100.3 mg
Epo-Tek H61	5.0	Ablebond 58-1	10.5 mg
Epo-Tek H74	47.6 mg	Epo-Tek H44	121.1 mg
Epo-Tek H74	5.4	Epo-Tek H44	12.3 mg
Ablefilm 529	41.5 mg		
Ablefilm 529	4.4 mg		

The specimens were functionally tested initially, and after 4, 20, 88, 128, 220, 288, 380, 448 and 540 hours aging at 150C. Measurement consisted of applying a dc potential of 0.5 volts to the drain of the ungated or probe FET and observing the value of the resulting drain current, and then applying the same value of dc potential (0.5 volts) to the drain of the gated or calibrator FET and increasing its gate voltage until the same value of drain current was obtained. Data recorded were the drain current of the ungated or probe FET, and the gate voltage of the gated or calibrator FET (which by implication also is the effective gate voltage of the ungated or probe FET). All measurements were made at room temperature. A dc potential of +40 volts was applied to the aluminum strip electrodes at all times.

Due to the lack of uniformity of the devices, the initial values of drain current ranged from a low of 4  $\mu$ a to a high of 763  $\mu$ a, and the initial values of gate voltage ranged from -1.5 volts to 18.5 volts. Obviously, it would be meaningless to try to obtain results by directly comparing these data. However, the important indicator in evaluating the deleterious effects of the products out-gassed from adhesives on these devices is the change in the values of the effective gate voltages, not their absolute values. Consequently, the data will be presented as change in effective gate voltage ( $\Delta V_G$ ) as a function of elapsed time at 150C.

This implies that the devices are operating in a region where specific values of  $\Delta V_G$  are equivalent and indicative of the same degree of increased contamination. For example, a 4 volt change in effective gate voltage from 1 to 5 volts is assumed to indicate the same increase in contamination as a 4 volt change from 10 to 14 volts. Since the devices were operated at only 0.5 volts drain voltage, this is probably a fairly reasonable assumption.

As previously discussed, these devices are very sensitive to static charges and consequently, are very easily damaged. Such damage shows as a step increase of unpredictable magnitude in the gate voltage of the gated or calibrator FET. Since a change in the effective gate voltage of the ungated or probe FET is the indicator of the presence and accumulation of contaminants on the device and is determined by measuring the gate voltage of the gated or calibrator FET, the occurrence of damage during handling of the test specimens may obscure the real effects resulting from contamination. This condition could have been avoided by designing the device with a protective diode in the gate input.

Data Analysis

In interpreting the data, it was assumed that if a large change in gate voltage was not also accompanied by a change in drain current, it was due to accidental damage rather than to contamination. Handling precautions were taken to eliminate the possibility of such damage, but in many instances it still occurred. Consequently, in many cases, the conclusions reached are qualified.

In addition to changes due to handling, slight changes may occur in the characteristics of the gated or calibrator FET as a result of long term exposure to the high temperature conditions used in stressing the test devices. Again, these changes will obscure the effects due to contaminants. While admittedly such changes may result in either apparent increases or decreases in gate voltage, the possibility of their occurrence and the assumption that contaminants cause only an increase in effective gate voltage was used in the interpretation of the data to conclude that negative gate voltage changes were not due to contaminants.

It is evident from this discussion that the FET devices, as presently designed, are not ideal for evaluating the contaminating effects of the products outgassed from adhesives after cure. The initial characteristics of the devices vary over a wide range, the devices are very easily damaged during routine handling, and the characteristics of the devices may drift as a result of long term, high temperature aging. Therefore, it was difficult to interpret the data, and to unequivocally relate changes in device parameters to the presence and accumulation of contamination. Thus, there is a definite need to select a simpler device or devices as a standard test vehicle for evaluating the contaminating effects of adhesives.

The results obtained from the present tests are given in Figures 32 through 55. Two figures are given for each adhesive. The first of each pair is for the package containing approximately 10 times as much adhesive as the second. Figures 32 and 33 show the results obtained for the two control specimens which do not contain any adhesive. Note that one of the devices in Figure 32 showed a rather large gate voltage decrease and two of the devices in Figure 33 showed moderate gate voltage decreases during the course of the test. This was assumed to be due to drift in the characteristics of the gated or calibrator FET. Also, while it does not show in the Figures, two sets of zero readings were taken 2 hours apart. Comparison of these readings showed that for five of the devices in the control specimens (two in one package, and three in the other), step increases occurred in their gate voltages without accompanying changes in their drain currents. One was relatively small, 1.3 volts. The others were large, 6.9, 7.9, 9.6 and 10.6 volts.

C75-647/201

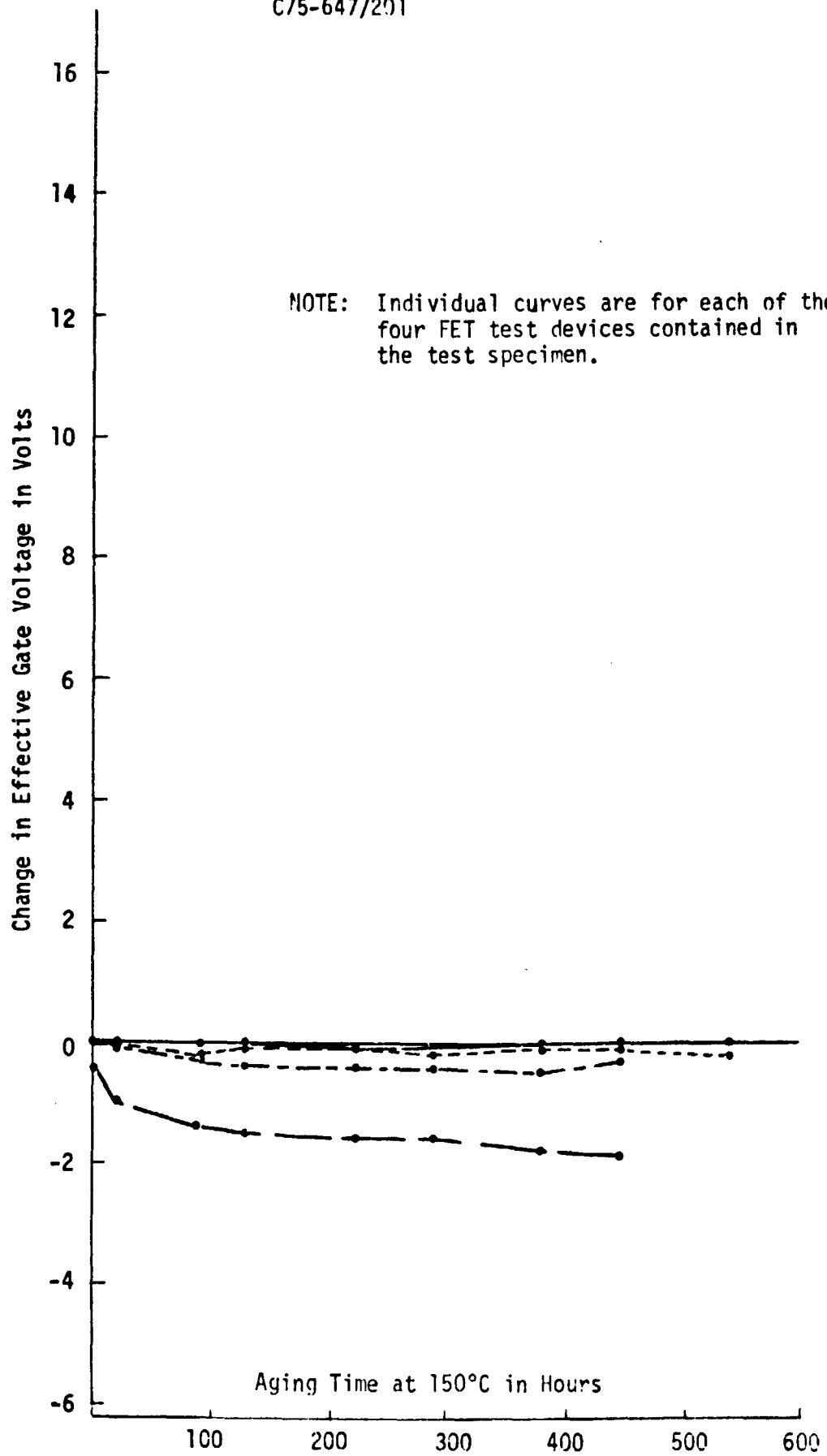

Figure 32. FET Test Specimen CONTROL (No Adhesive)

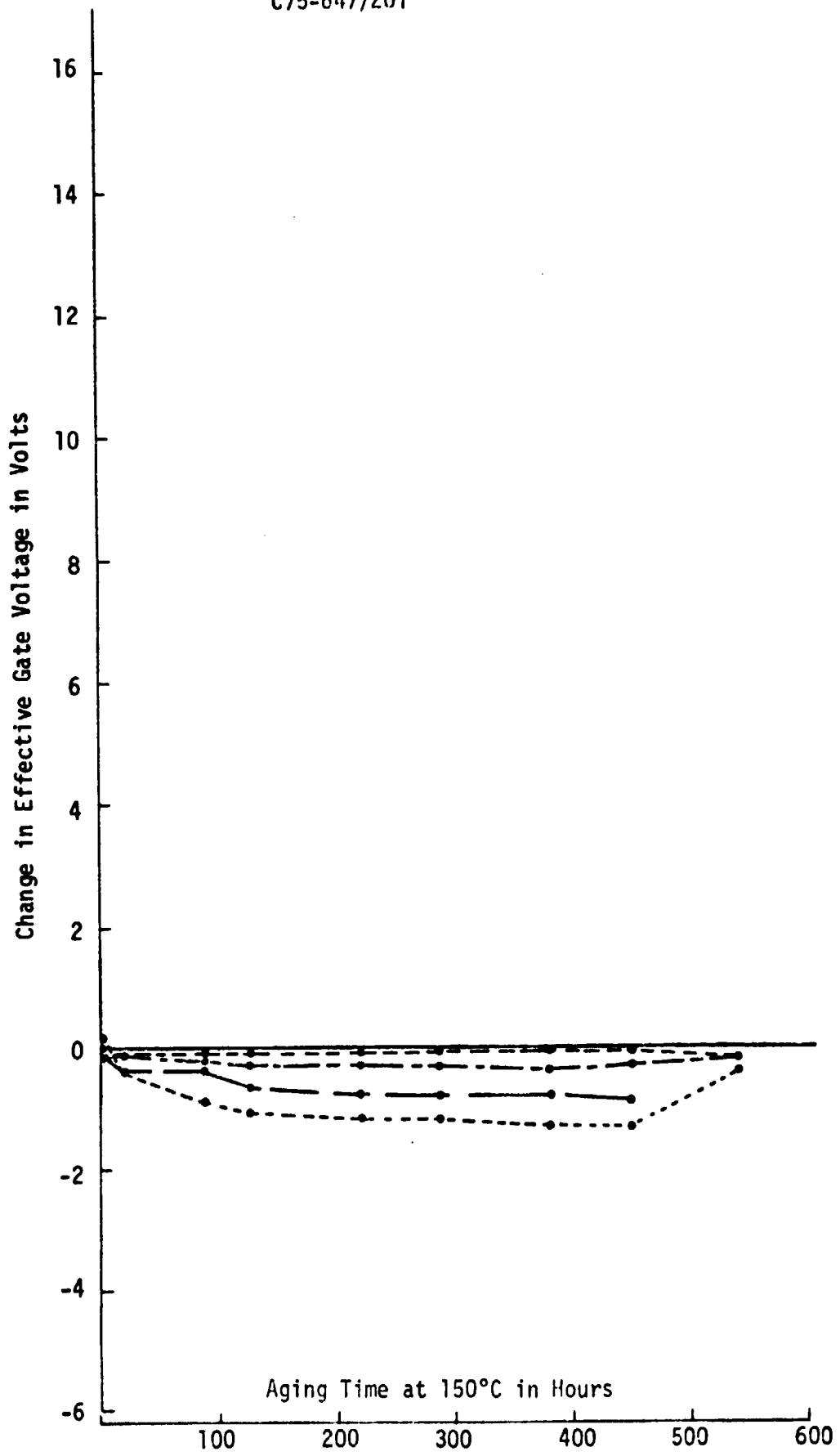

Figure 33. FET Test Specimen CONTROL (No Adhesive)

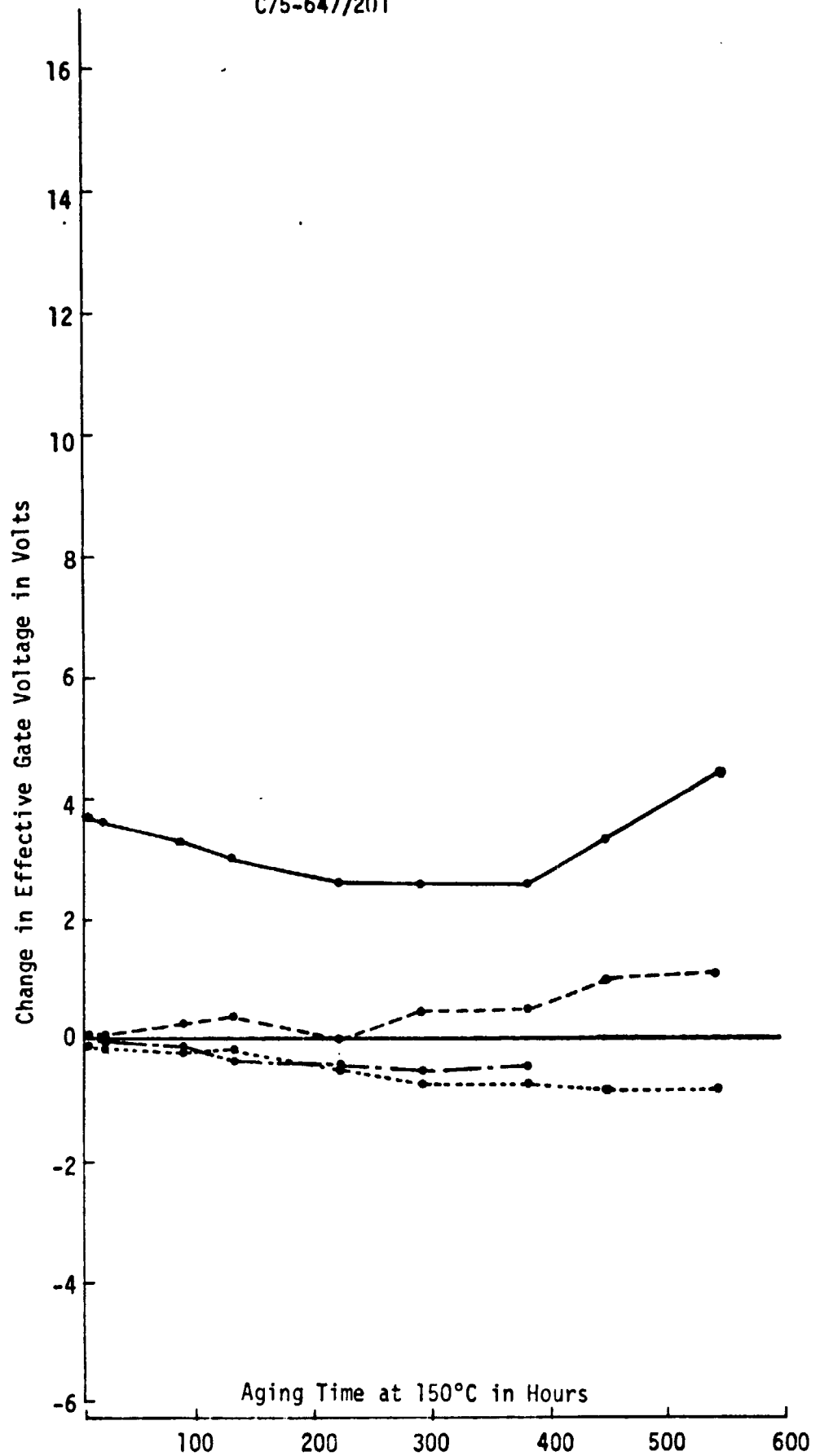

Figure 34. FET Test Specimen Containing 22.7 mg of Hysol 0151

C75-647/201

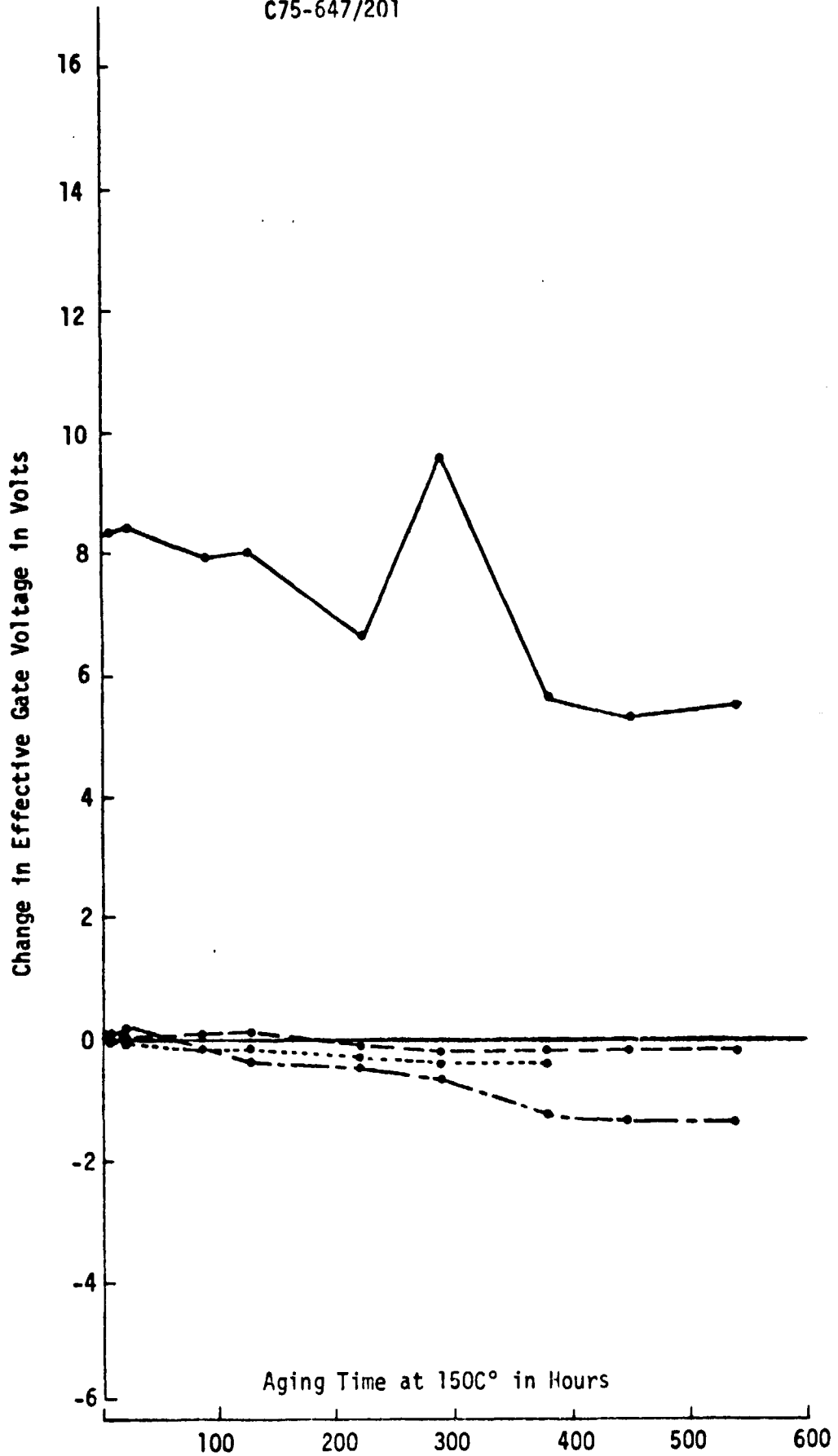

Figure 35. FET Test Specimen Containing 2.5 mg of Hysol 0151



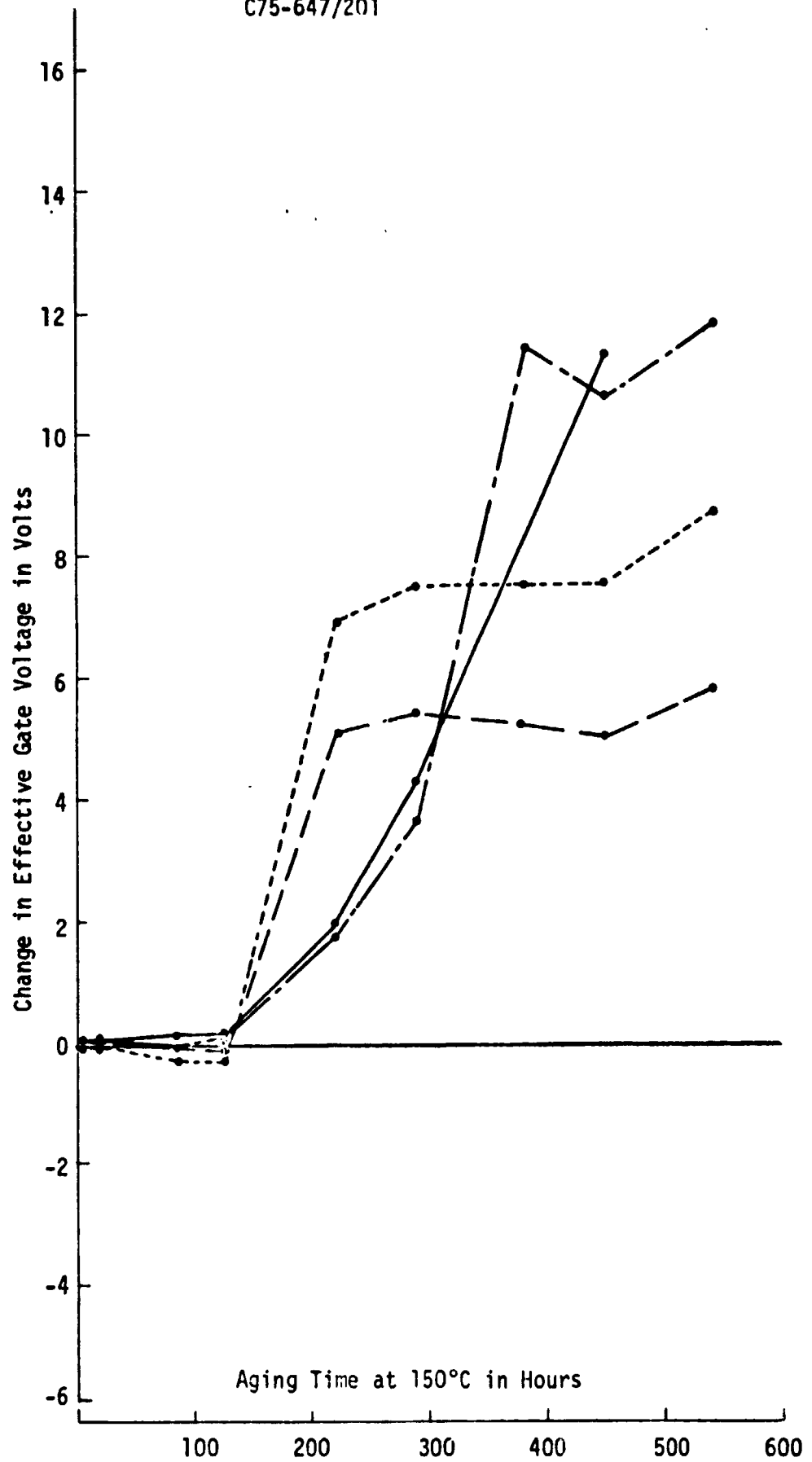

Figure 36. FET Test Specimen Containing 28.0 mg of Ablefilm 517

C75-647/201

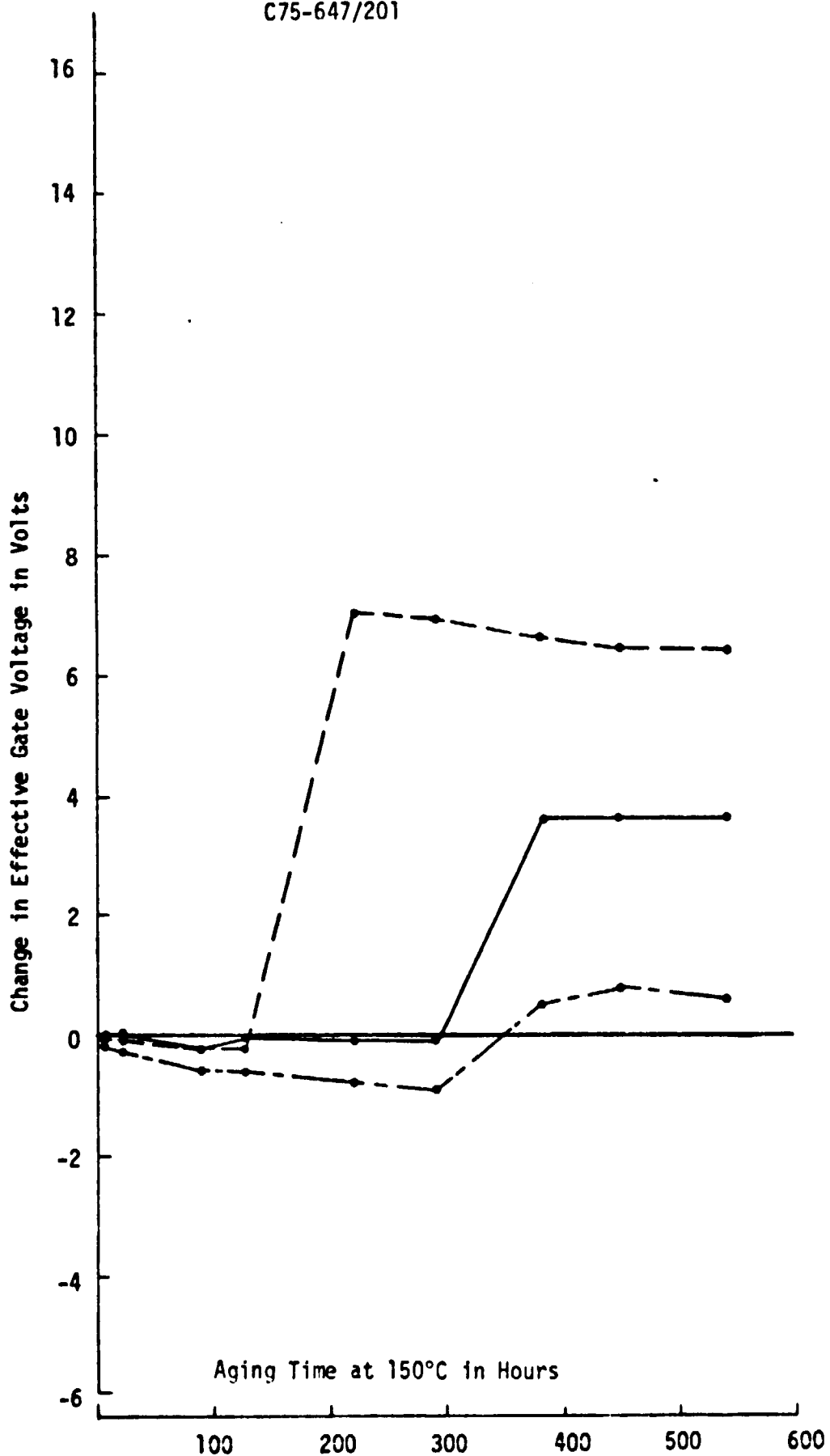

Figure 37. FET Test Specimen Containing 2.9 mg of Ablefilm 517

C75-647/201

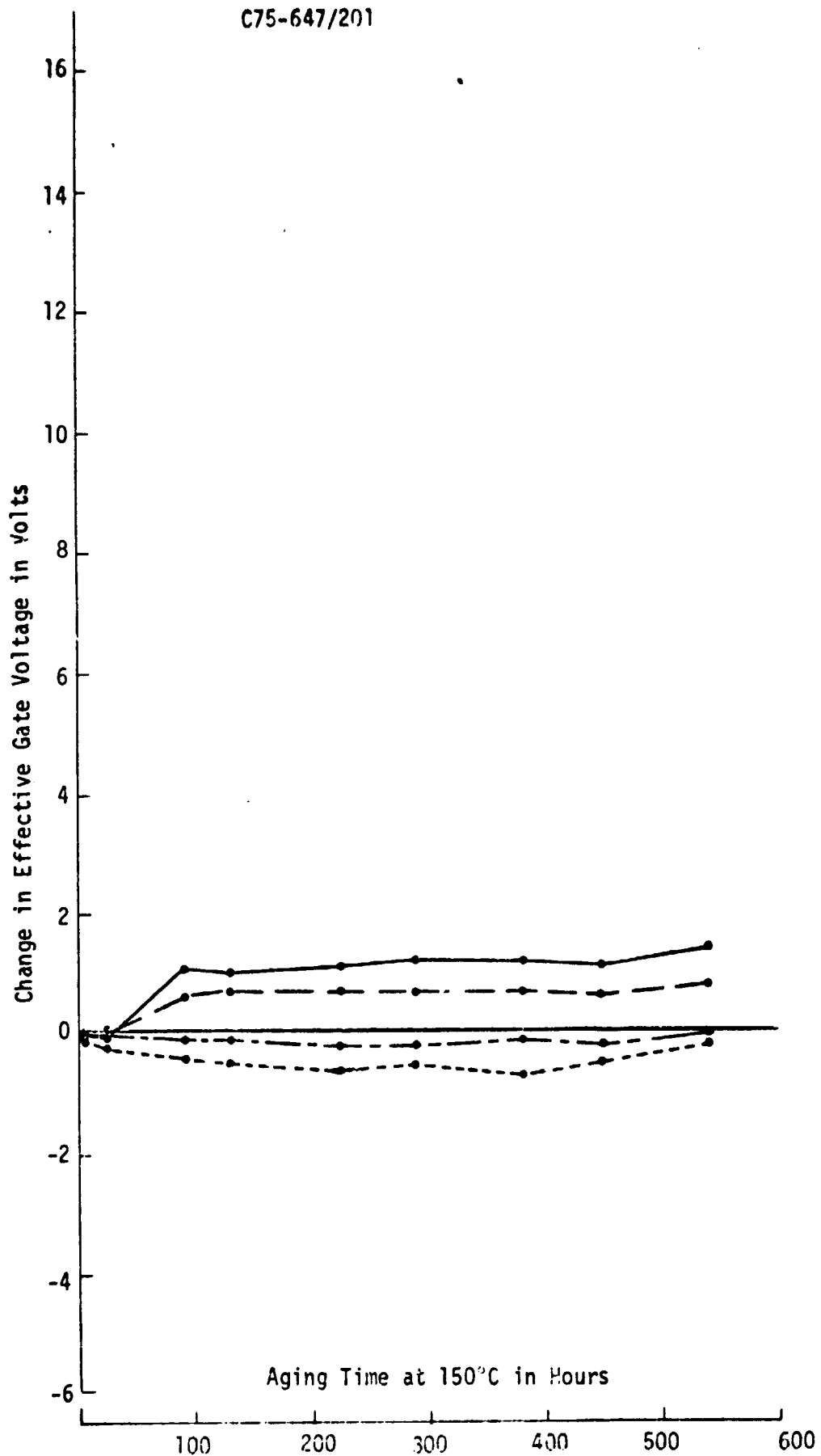

Figure 38. FET Test Specimen Containing 30.0 mg of Eccobond 104

C75-647/201

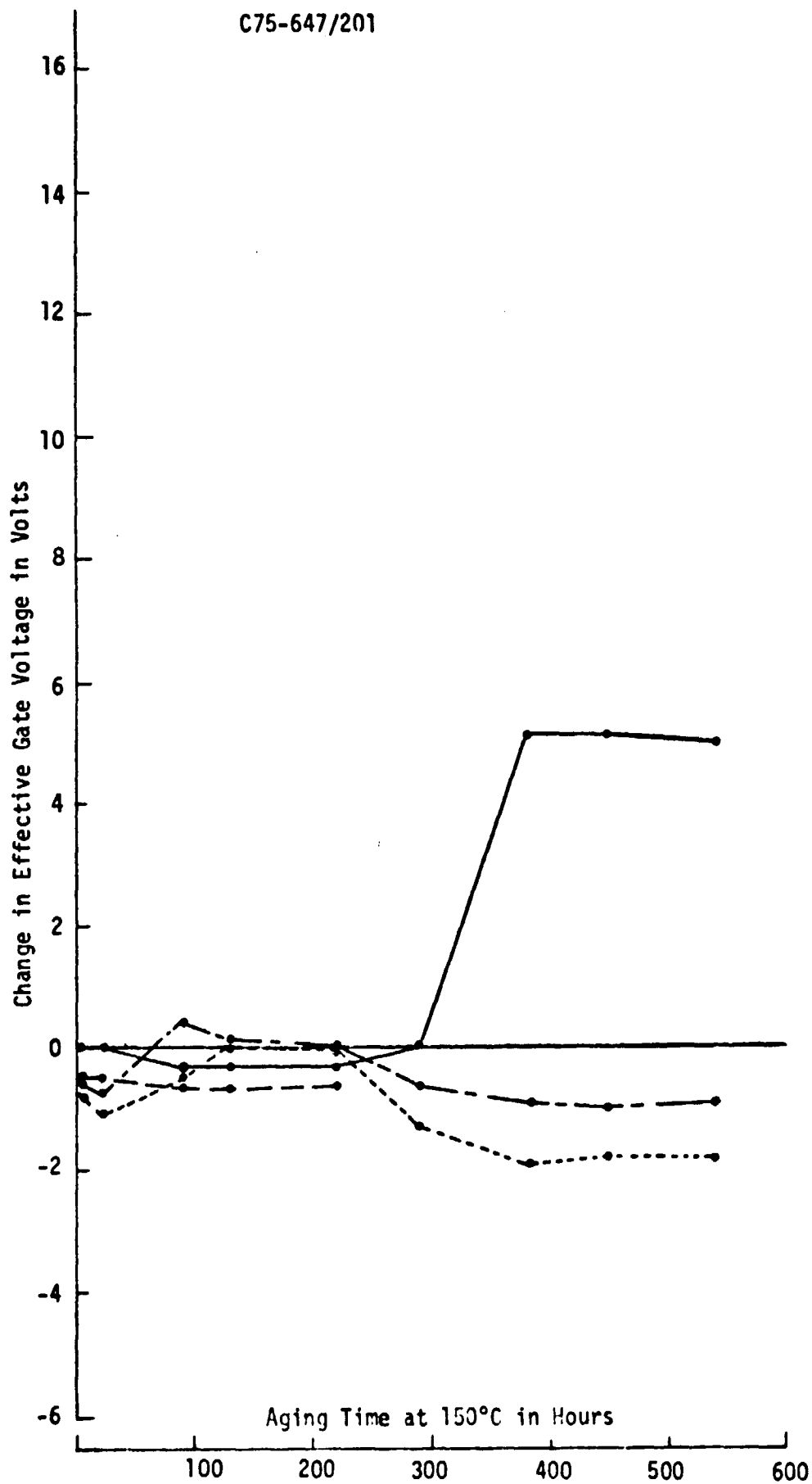

Figure 39. FET Test Specimen Containing 3.4 mg of Eccobond 104

C75-647/201

REPRODUCIBILITY OF THIS  
ORIGINAL PAGE IS POOR

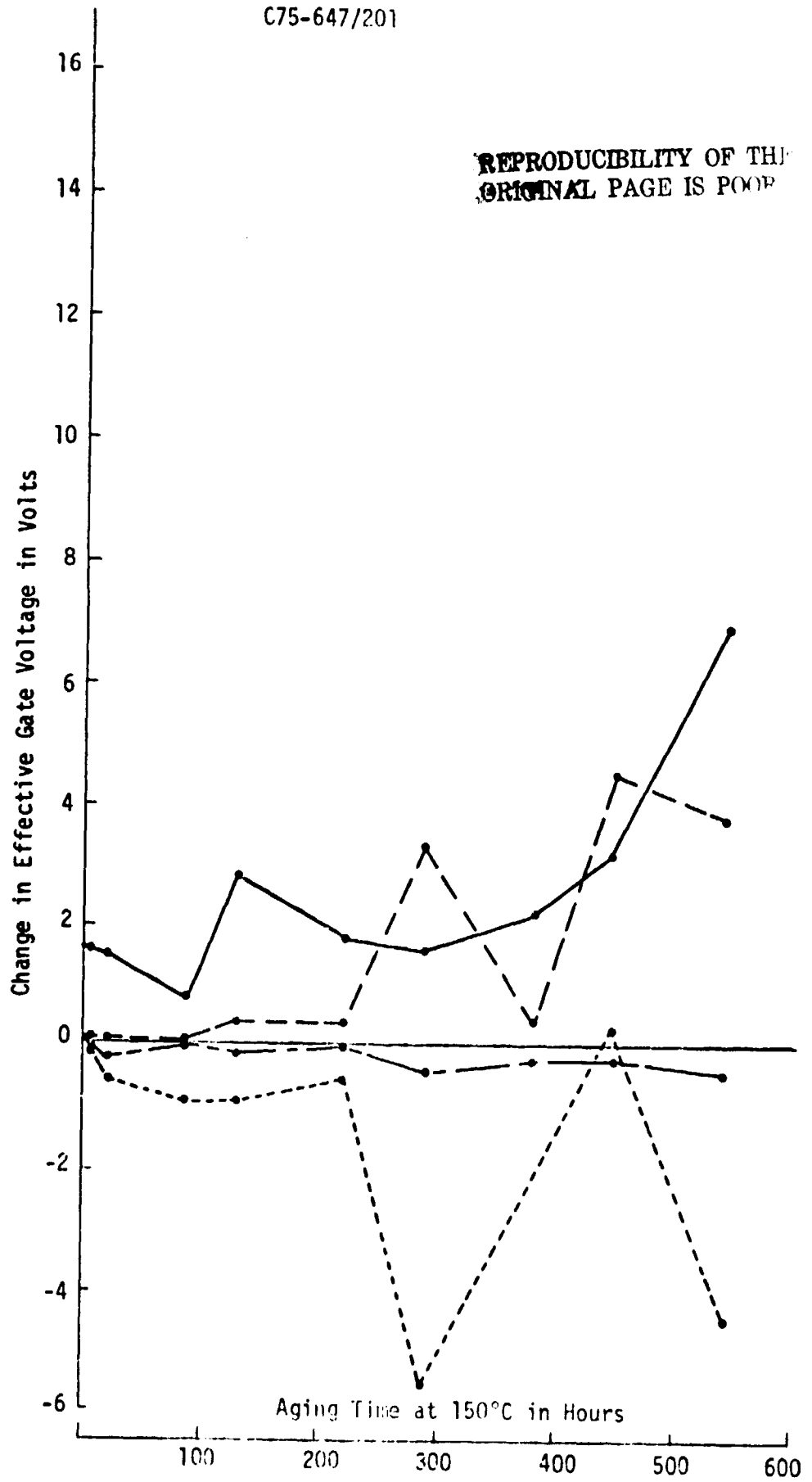

Figure 40 FET Test Specimen Containing 47.7 mg of  
Epo-Tek H61

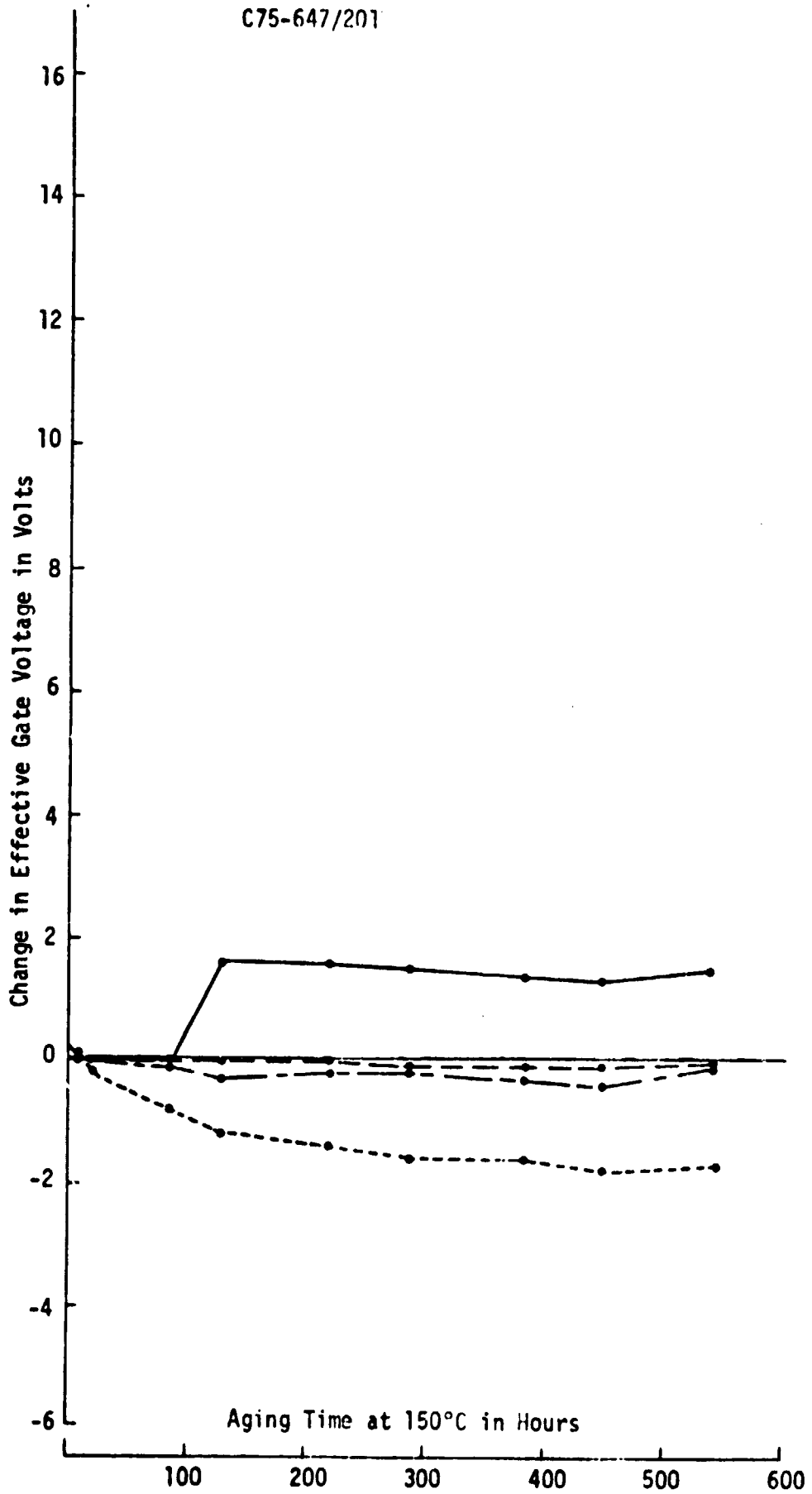

Figure 41. FET Test Specimen Containing 5.0 mg of Epo-Tek H61

C75-647/201

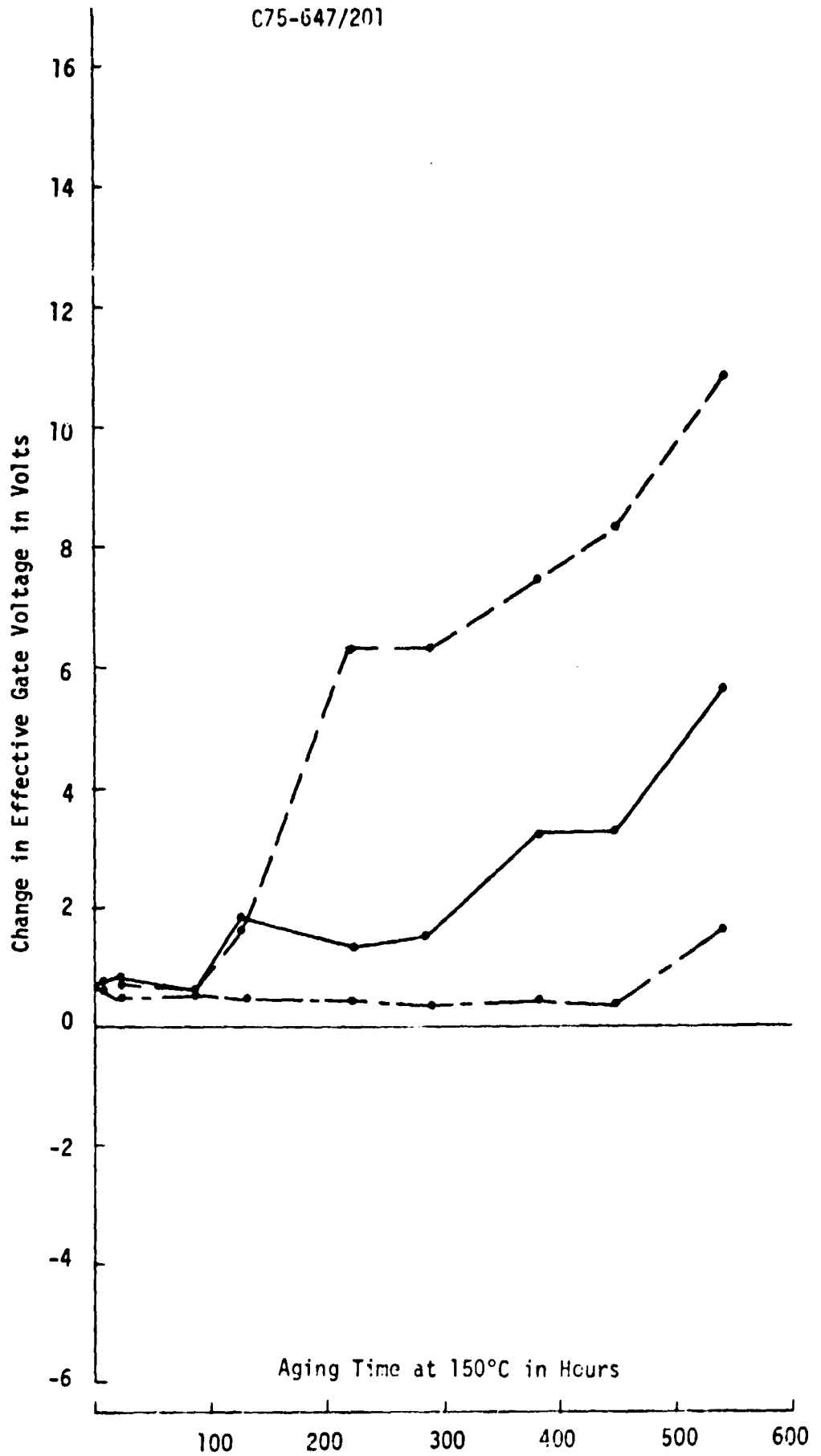

Figure 42. FET Test Specimen Containing 47.6 mg of Epo-Tek H74

C75-647/201

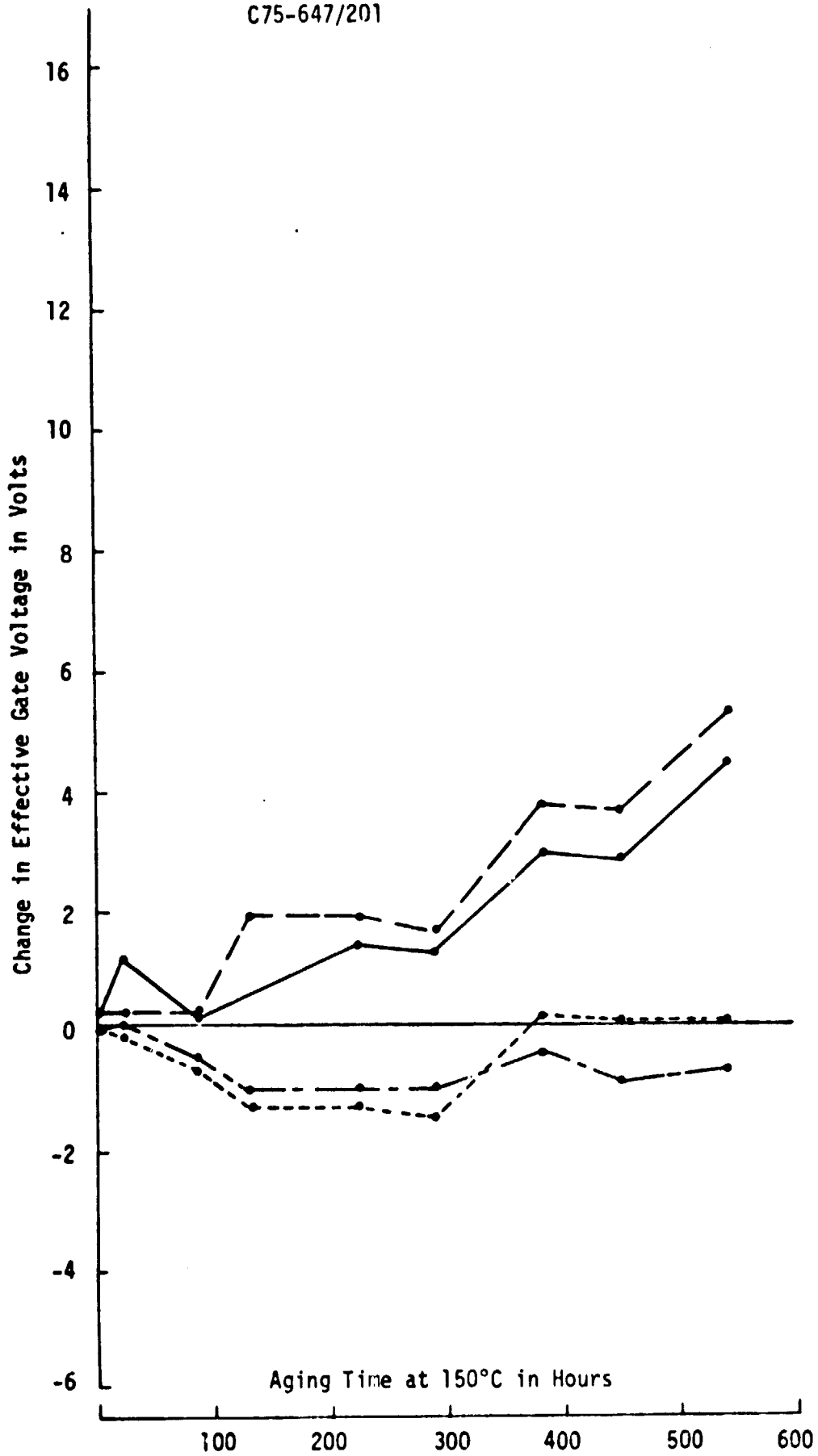

Figure 43. FET Test Specimen Containing 5.4 mg of Epo-Tek H74



C75-647/201

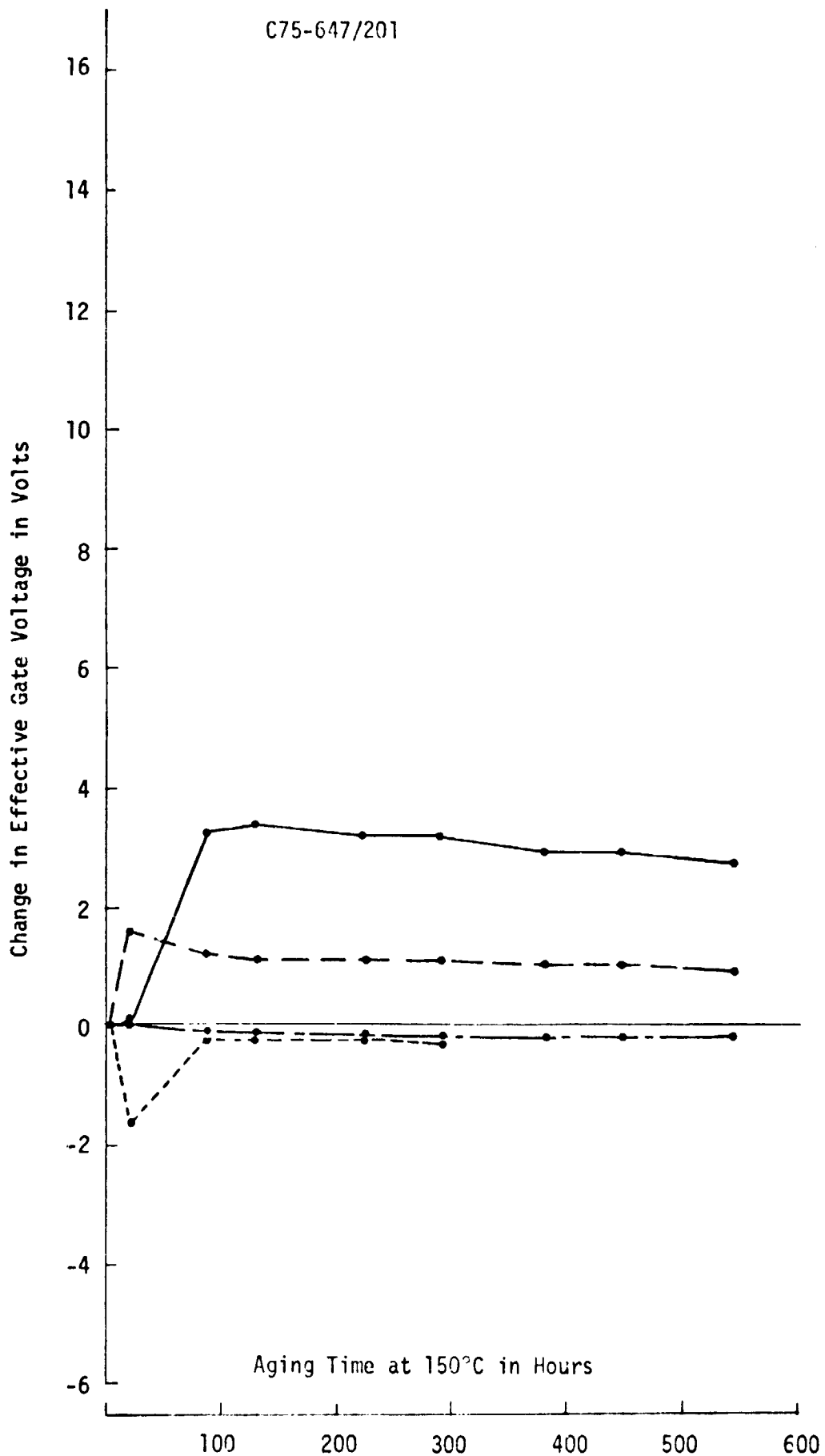

Figure 44. FET Test Specimen Containing 41.5 mg of Ablefilm 529

C75-647/201

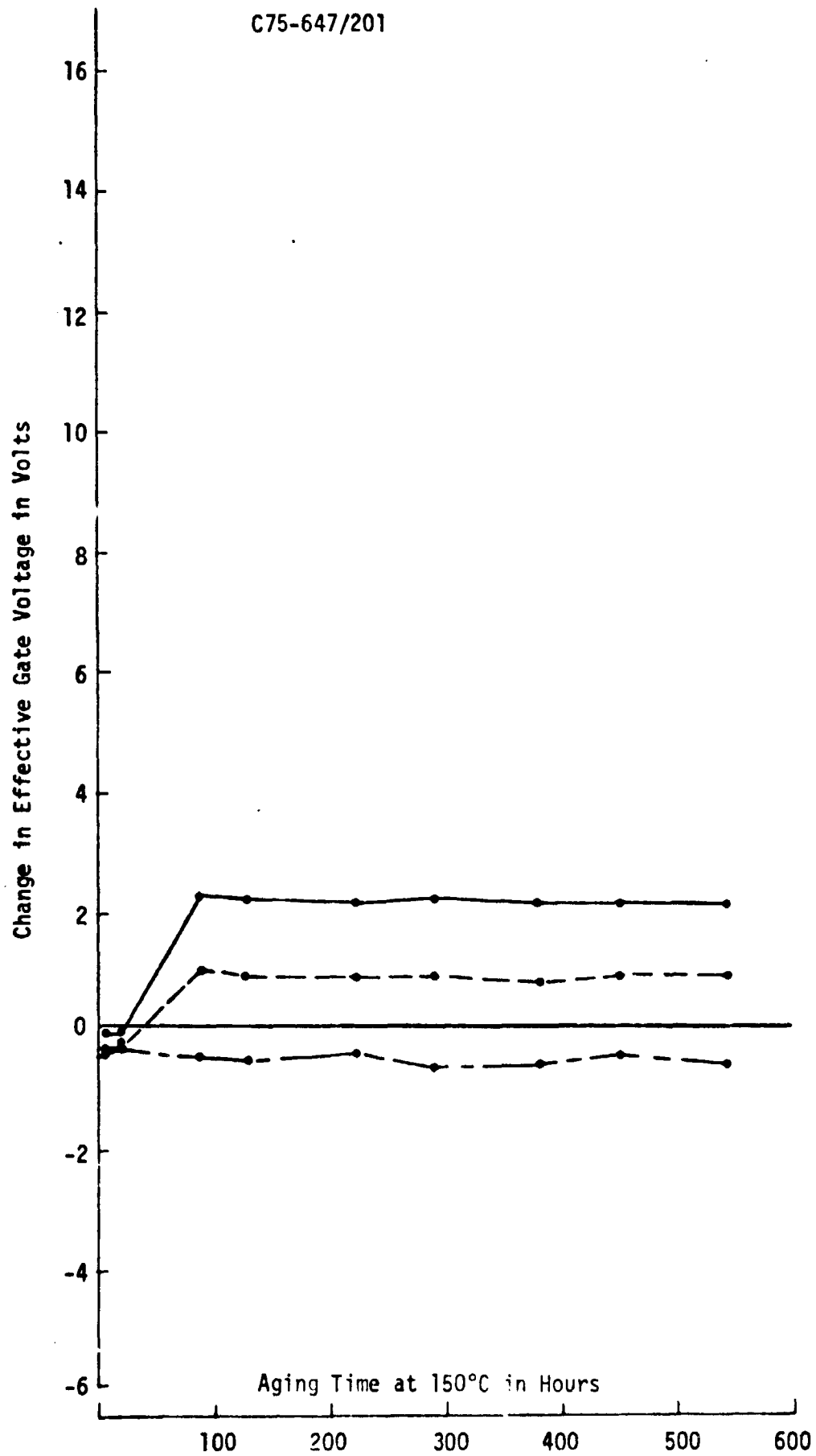

Figure 45. FET Test Specimen Containing 4.4 mg of Ablefilm 529

C75-647/201

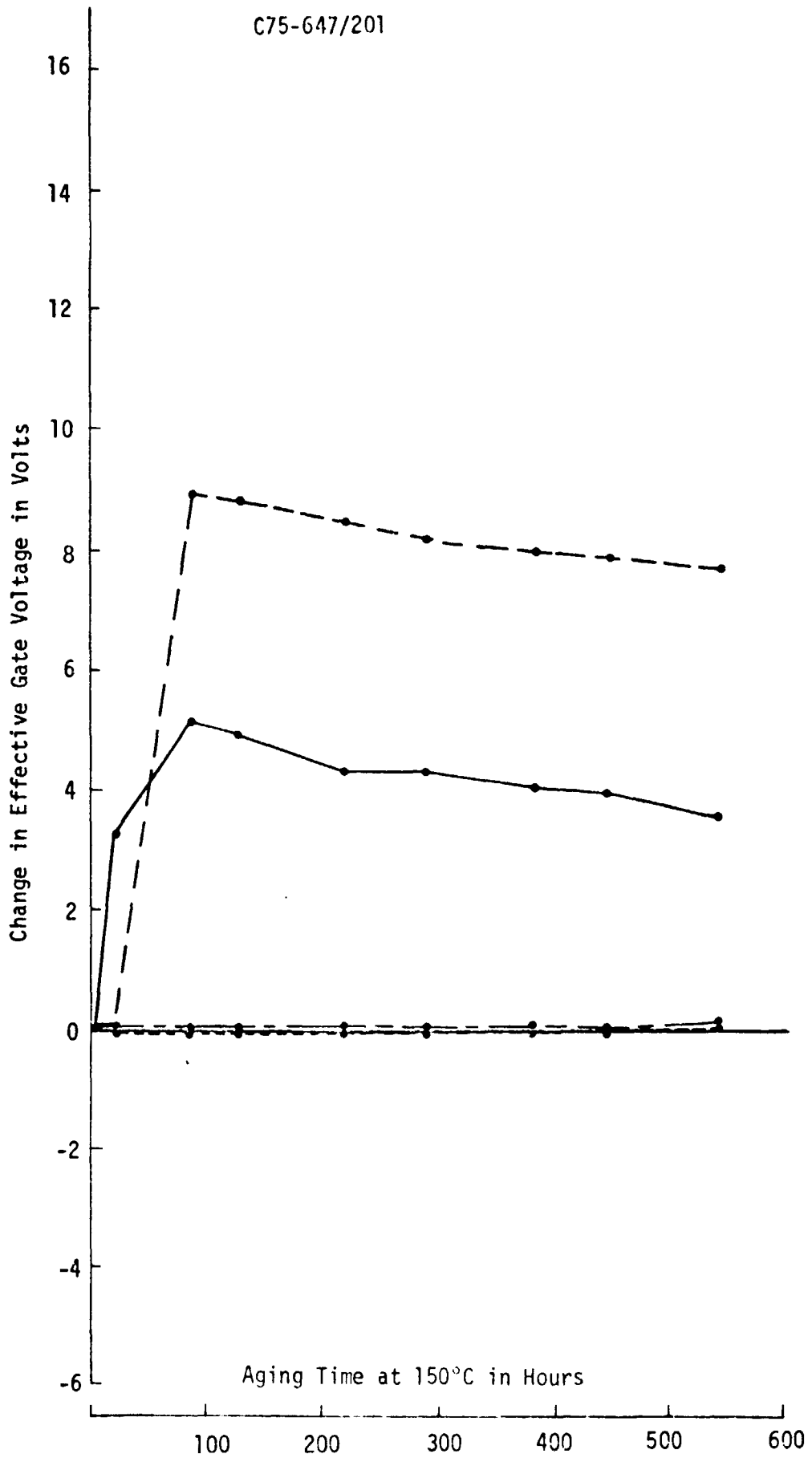

Figure 46. FET Test Specimen Containing 47.2 mg of Ablebond 36-2

C75-647/201

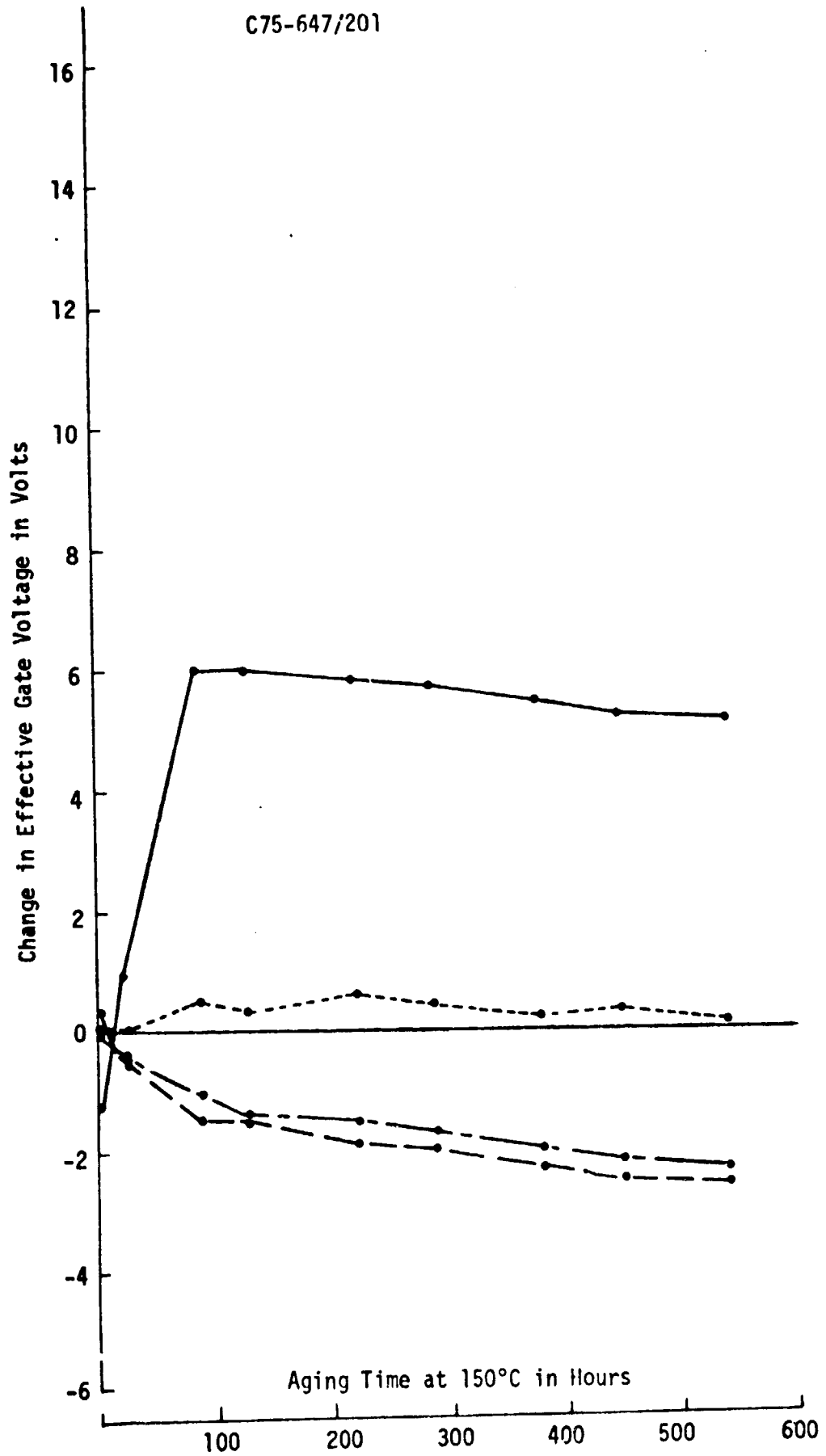

Figure 47. FET Test Specimen Containing 4.8 mg of Ablebond 36-2

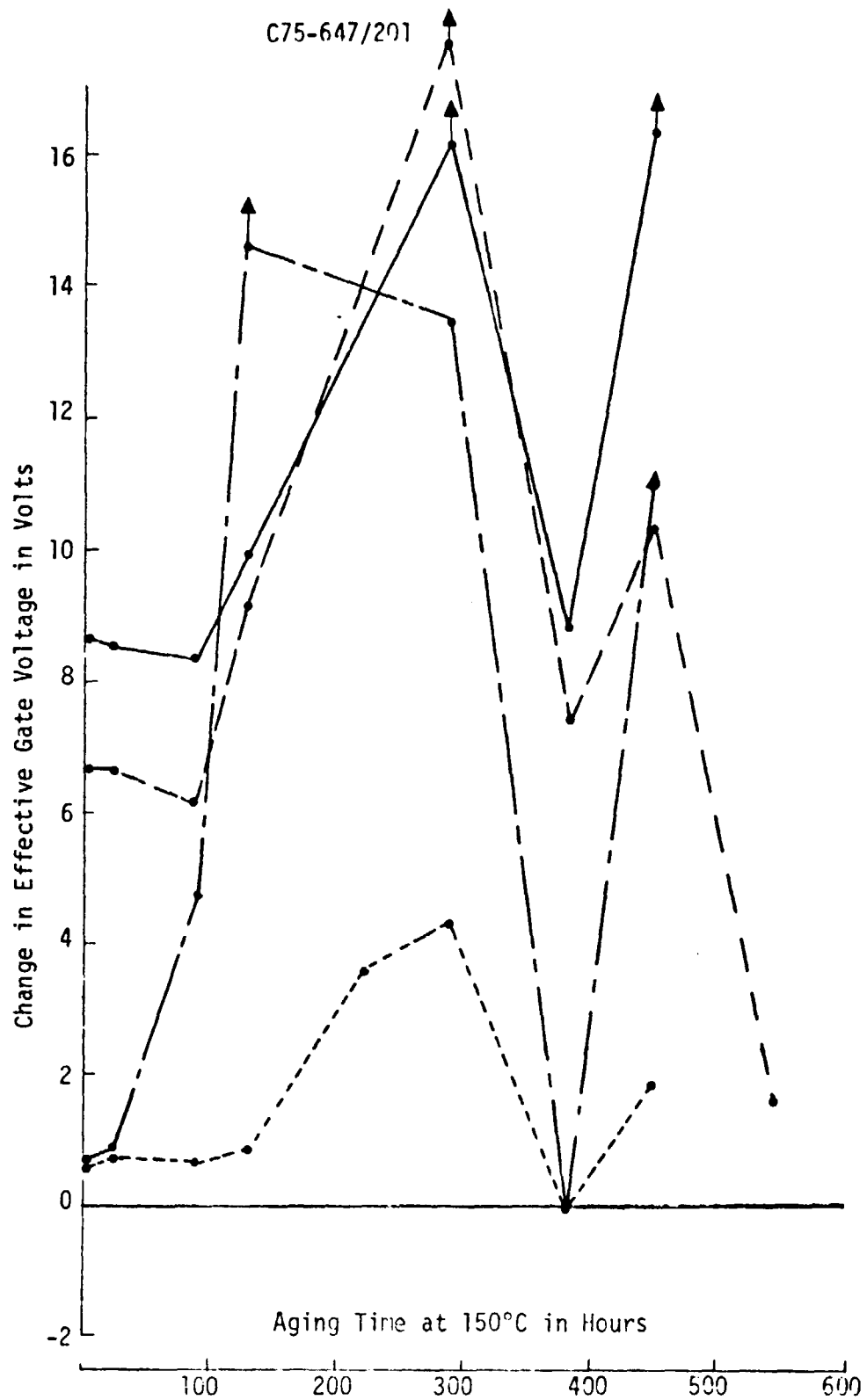

Figure 48. FET Test Specimen Containing 42.1 mg of Epo-Tek H31

C75-647/201

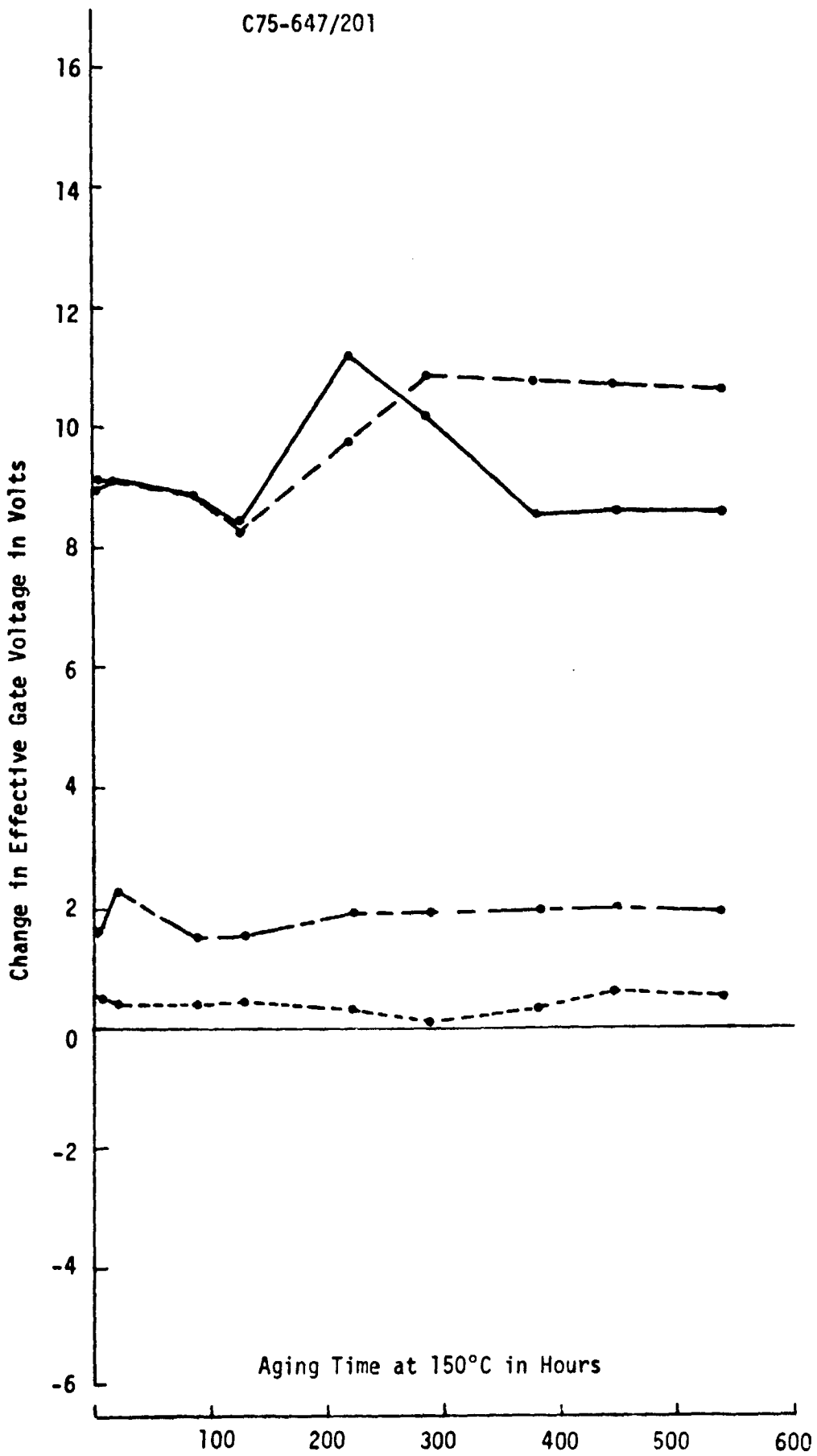

Figure 49. FET Test Specimen Containing 4.7 mg of EpoTek H31

C75-647/201

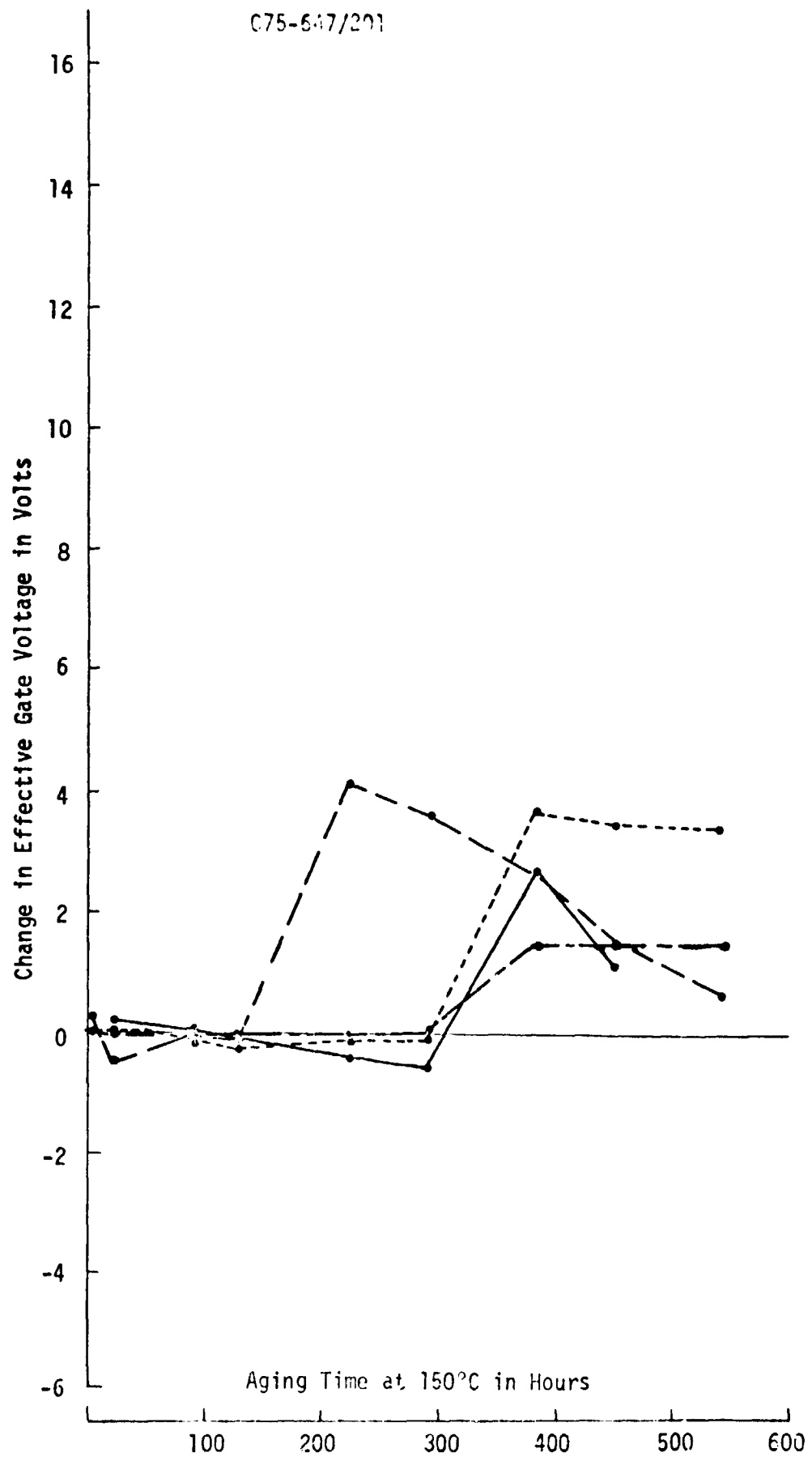

Figure 50. FET Test Specimen Containing 48.2 mg of DuPont 5504

C75-647/201

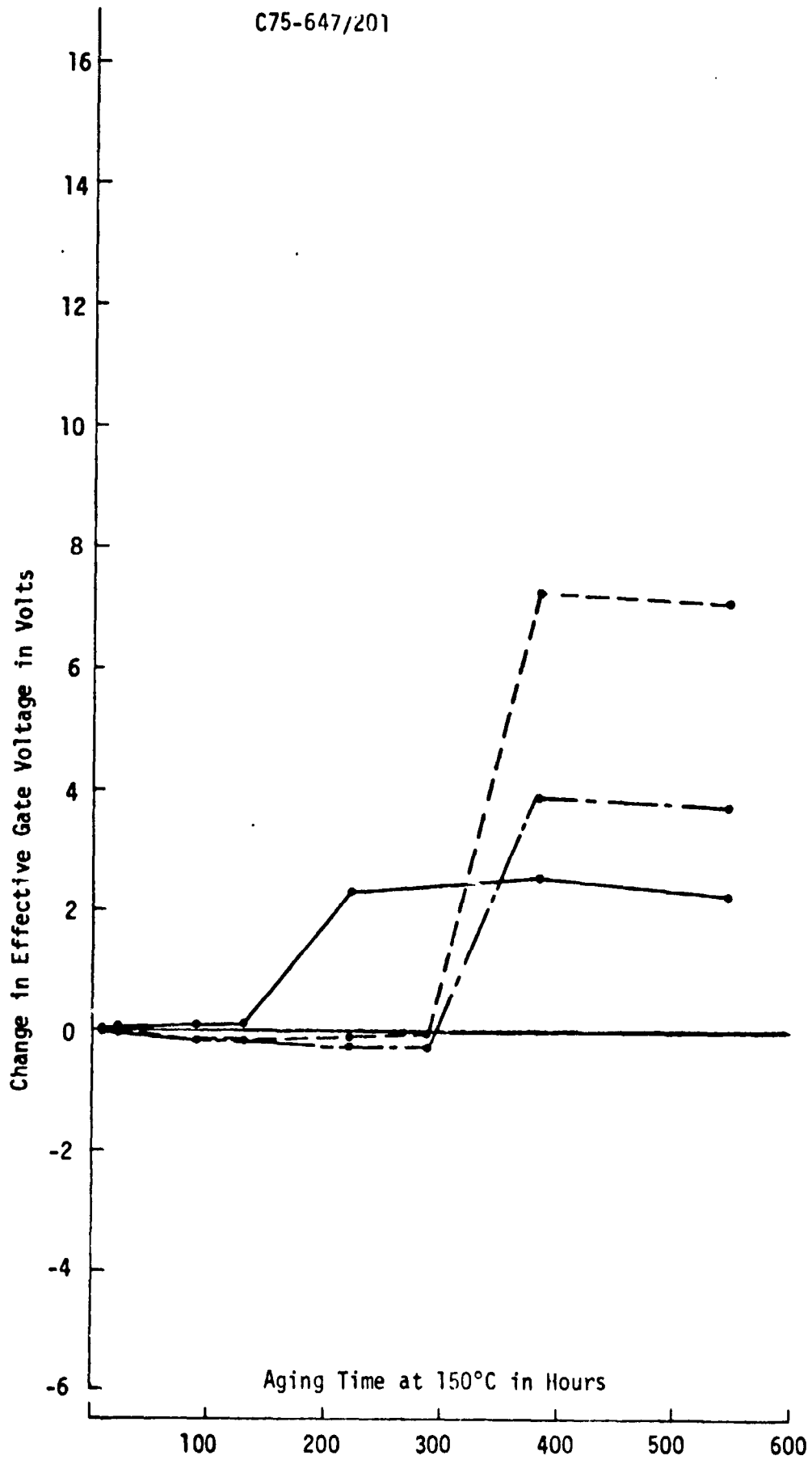

Figure 51. FET Test Specimen Containing 5.2 mg of DuPont 5504



C75-647/201

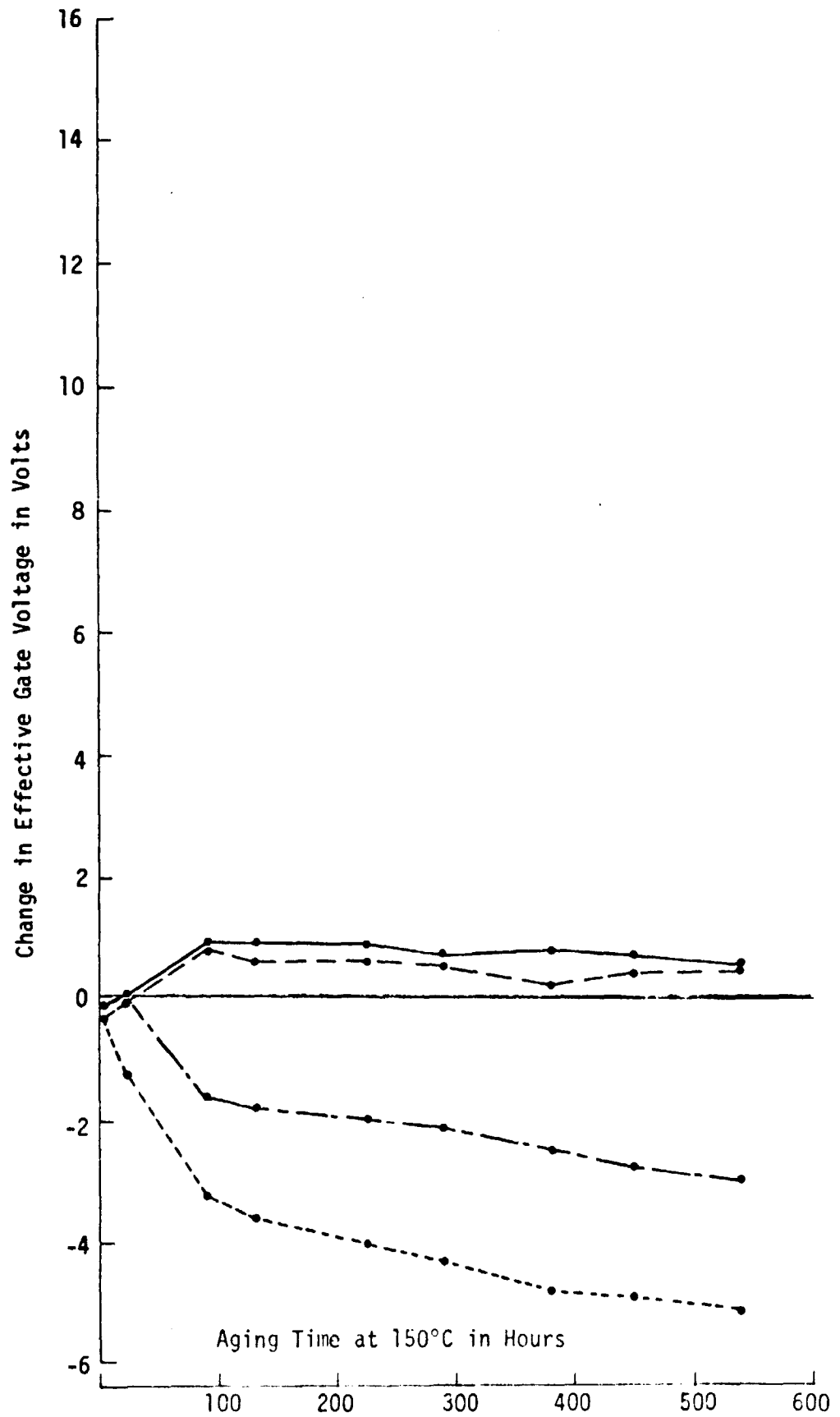

Figure 52. FET Test Specimen Containing 100.3 mg of Ablebond 58-1

C75-647/201

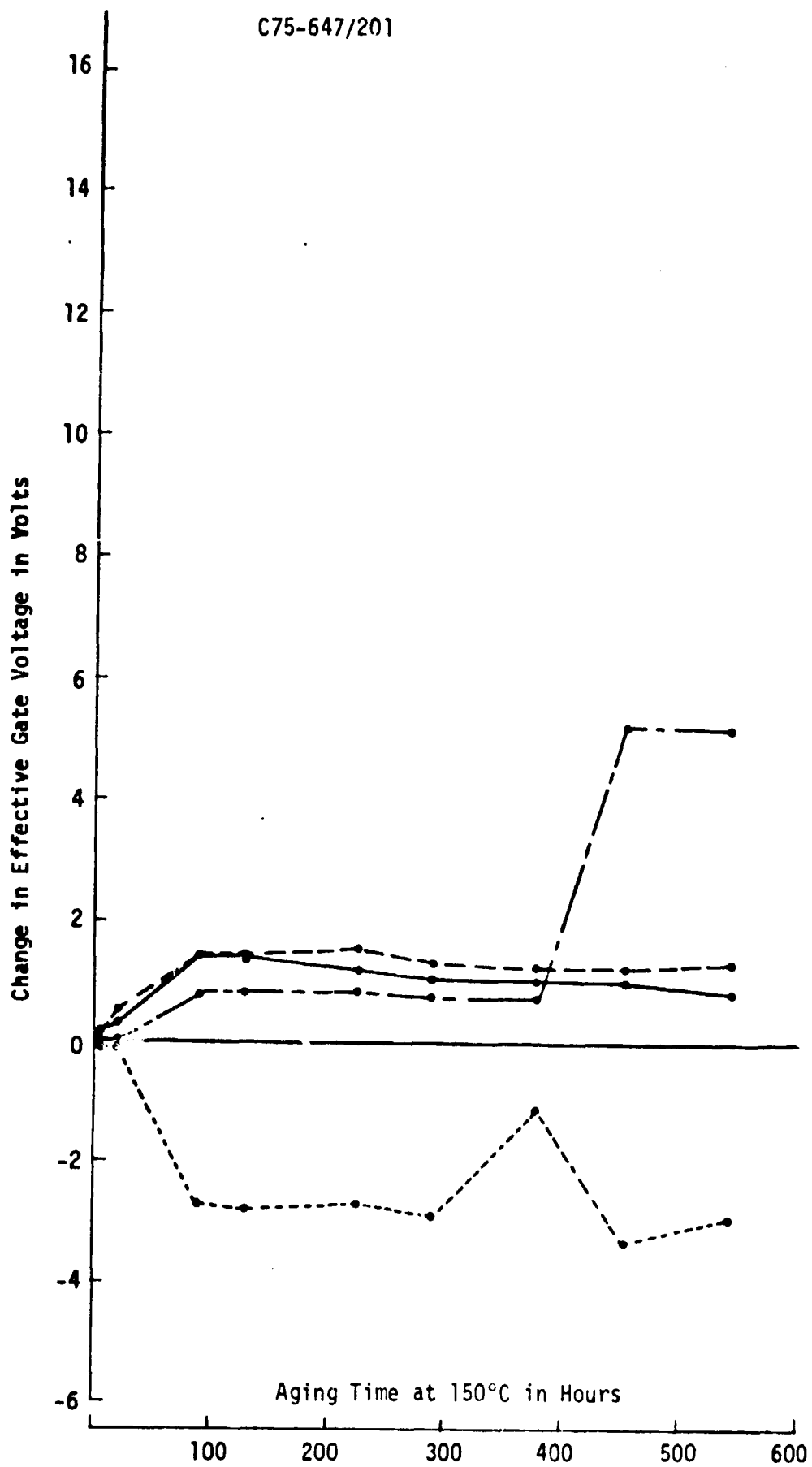

Figure 53. FET Test Specimen Containing 10.5 mg of Ablebond 58-1

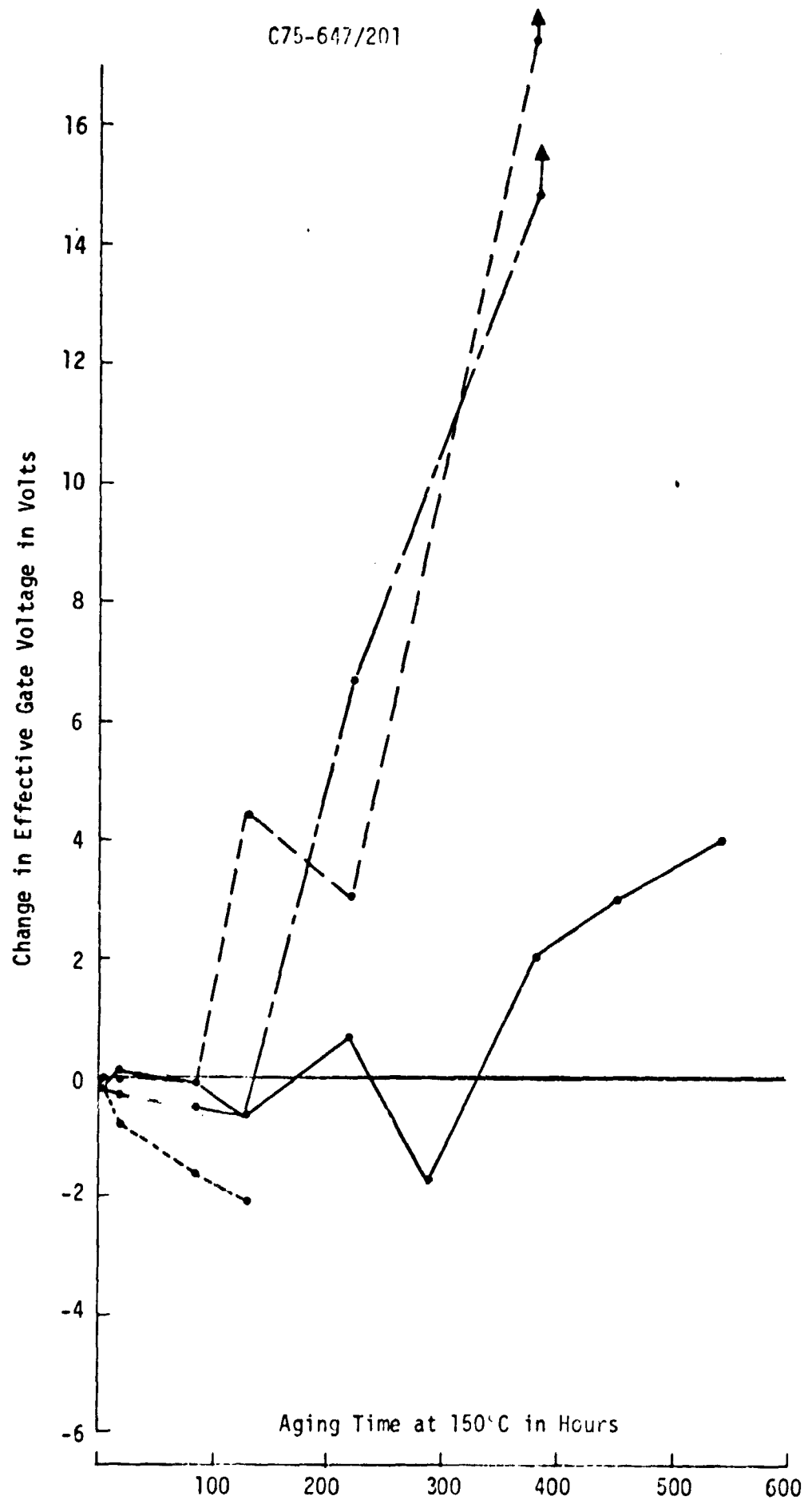

Figure 54. FET Test Specimen Containing 121.1 mg of Epo-Tek H44

C75-647/201

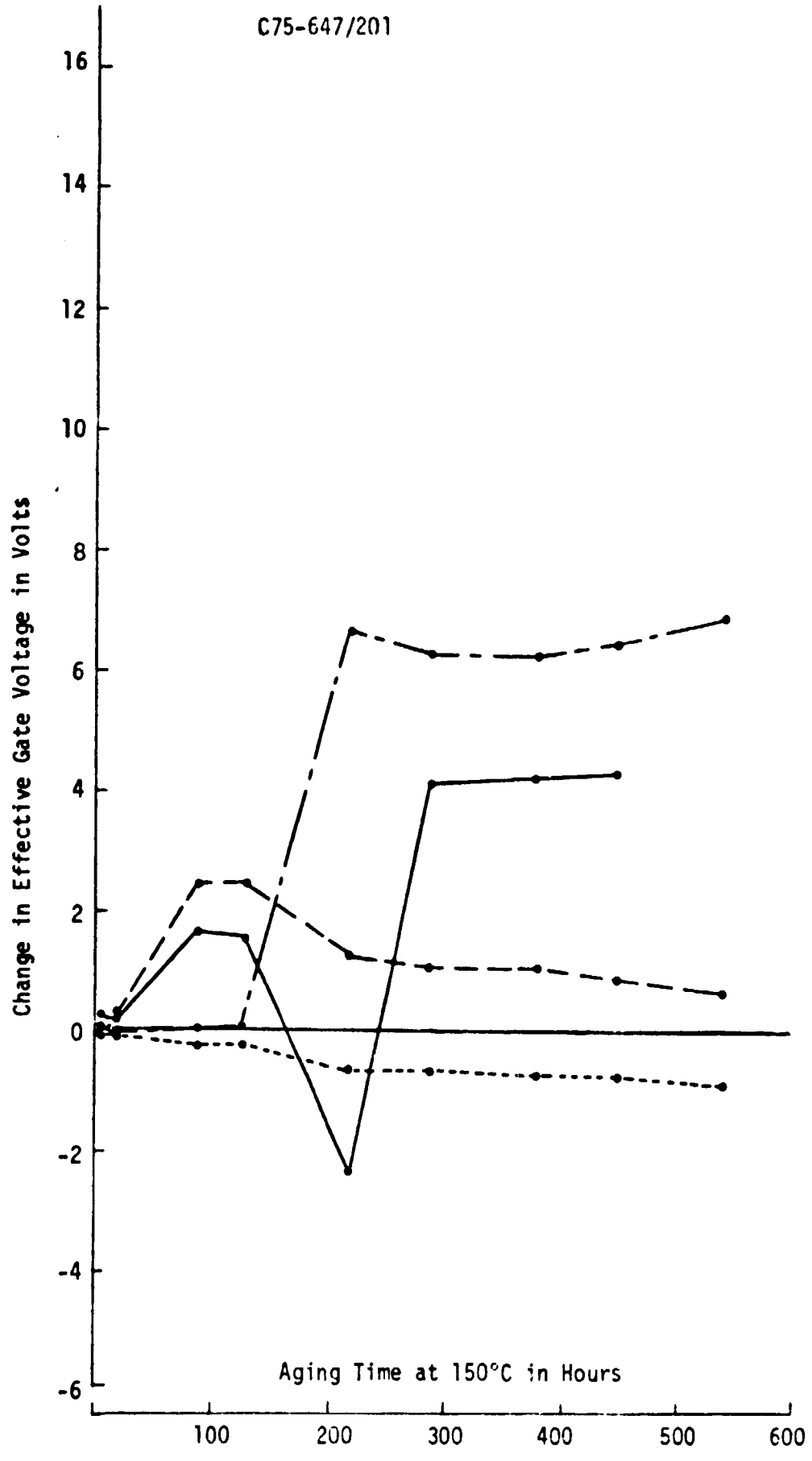

Figure 55. FET Test Specimen Containing 12.3 mg of Epo-Tek H44

Overall comparison and assessment of adhesives based on the FET test are given in Table 15.

## 2. Thin Film Nichrome Chip Resistor Test Specimens

The layouts of the test specimens used are shown in Figures 56 and 57. Each test specimen contains four glass passivated thin film nichrome chip resistors, but only one or two unpassivated thin film nichrome chip resistors. In addition, a chip with an aluminum conductor pattern (as shown in Figure 58) was included in each test specimen. As shown in Figures 56 and 57, only two of the longer adjacent conductor lines of this chip were connected to package leads for monitoring during testing.

As in the case of the FET's, 24 test specimens were fabricated - two containing no adhesive to serve as controls, and two containing two different amounts of each adhesive. Unlike the FET specimens in which all of the chips were eutectically mounted, the chips were mounted using the adhesive being tested. For each adhesive, one test specimen (the one containing only one unpassivated thin film nichrome chip resistor) contained only the amount of adhesive required to mount the chips, as determined by weighings before and after the chips were mounted. The other (the one containing two unpassivated thin film nichrome chip resistors) contained approximately 10 times this amount. The required additional amounts of adhesive were spread evenly in the center of the lids. Photographs of test specimens before lidding are shown in Figure 59. Actual amounts of adhesives used were as follows:

<u>Adhesive</u>	<u>Amount</u>	<u>Adhesive</u>	<u>Amount</u>
Hysol 0151	9.1 mg	Ablebond 36-2	60.7 mg
Hysol 0151	0.9 mg	Ablebond 36-2	6.2 mg
Ablefilm 517	38.0 mg	Epo-Tek H31	106.7 mg
Ablefilm 517	3.8 mg	Epo-Tek H31	10.3 mg
Eccobond 104	65.5 mg	DuPont 5504	41.1 mg
Eccobond 104	6.4 mg	DuPont 5504	4.1 mg
Epo-Tek H61	125.1 mg	Ablebond 58-1	80.9 mg
Epo-Tek H61	13.1 mg	Ablebond 58-1	8.1 mg
Epo-Tek H74	59.9 mg	Epo-Tek H44	103.4 mg
Epo-Tek H74	5.7 mg	Epo-Tek H44	10.6 mg
Ablefilm 529	131.4 mg		
Ablefilm 529	12.9 mg		

TABLE 15. Summary of the Effects of Products Outgassed from Various Adhesives on FET Test Devices

Figure No.	Adhesive	Amount (mg)	Effect	Comments
34	Hysol 0151	22.7	Possibly	Drain currents also are increasing for the two upper curves.
35	Hysol 0151	2.5	No	Large offsets in upper curve are not accompanied by increases in drain current.
36	Ablefilm 517	28.0	Yes	Large offsets are accompanied by increases in drain current.
37	Ablefilm 517	2.9	No	Large offsets are not accompanied by increases in drain current.
38	Eccobond 104	30.0	No	
39	Eccobond 104	3.4	No	Large offset is not accompanied by an increase in drain current.
40	Epo-Tek H61	47.7	Possibly	Upper curve shows definite trend and erratic upper curve is accompanied by slight increase in drain current.
41	Epo-Tek H61	5.0	No	Offset is not accompanied by an increase in drain current.
42	Epo-Tek H74	47.6	Probably	Two upper curves show definite increasing trends.
43	Epo-Tek H74	5.4	Possibly	Two upper curves show definite increasing trends.
44	Ablefilm 529	41.5	No	Offsets are not accompanied by increases in drain current and general trend is downward.
45	Ablefilm 529	4.4	No	Same as above.
46	Ablebond 36-2	47.2	No	Large offsets of two upper curves are not accompanied by increases in drain current, and trend after jump is downward. Also curves for two devices show zero change.
47	Ablebond 36-2	4.8	No	Large offset of upper curve is not accompanied by an increase in drain current, and trend after jump is downward. Also, curves for three devices do not indicate contamination effect.
48	Epo-Tek H31	42.1	Yes	Large changes in voltage are accompanied by large changes in drain current. Also erratic behavior.
49	Epo-Tek H31	4.7	No	Large offsets are not accompanied by increases in drain current and trend is flat.
50	DuPont 5504	48.2	No	Large offsets are not accompanied by increases in drain current and general trend is flat or downward.
51	DuPont 5504	5.2	No	Same as above.

92

TABLE 15. (continued)

Figure No.	Adhesive	Amount (mg)	Effect	Comments
52	Ablebond 58-1	100.3	No	Offsets are not accompanied by increases in drain current. Also package with larger amount showed no effect.
53	Ablebond 58-1	10.5	No	
54	Epo-Tek H44	121.1	Yes	Large changes in voltage are accompanied by large changes in drain current.
55	Epo-Tek H44	12.3	No	Large offsets are not accompanied by increases in drain current. Also general trend is flat or downward.

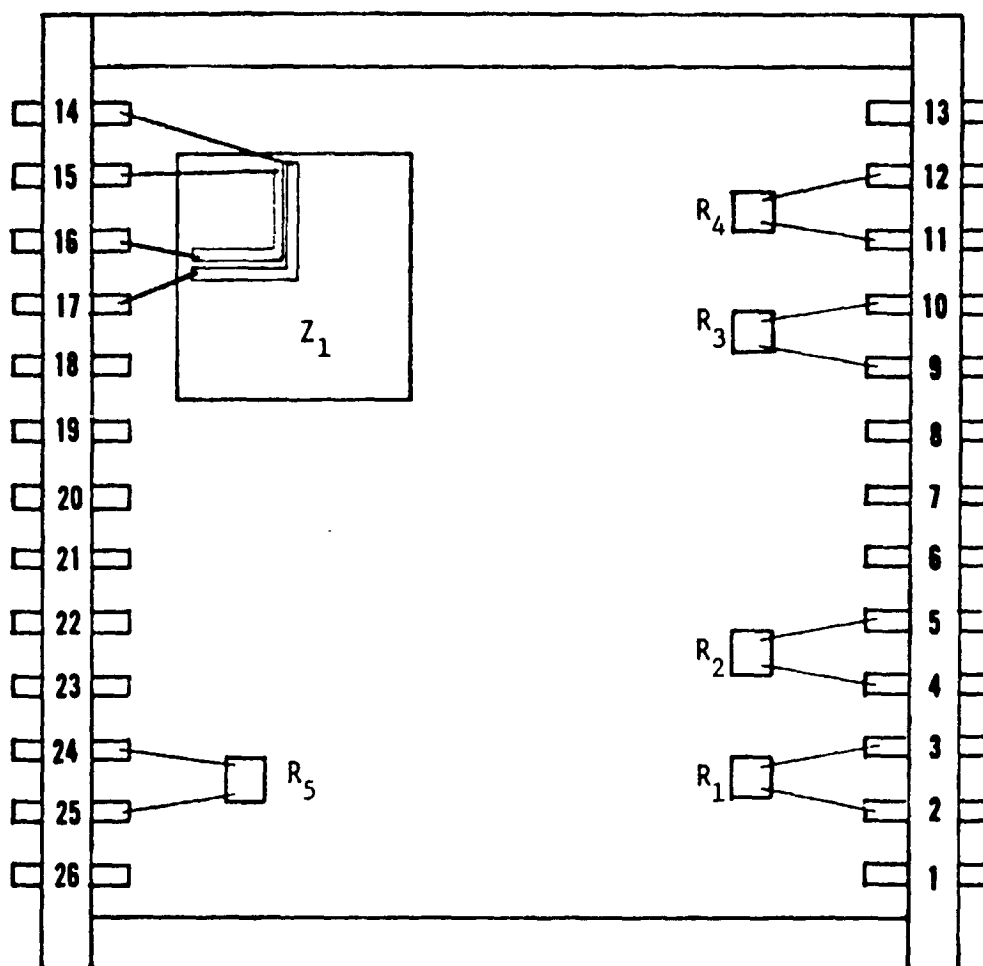

Figure 56. Layout of Thin Film Chip Resistor Test Specimens Containing Only Amount of Adhesive Required to Mount Chips.  $R_1$  through  $R_4$  are Glass Passivated Thin Film Nichrome Chip Resistors.  $R_5$  is an Unpassivated Thin Film Nichrome Chip Resistor.  $Z_1$  is a Chip Containing an Aluminum Conductor Pattern (Shown in Detail in Figure 58.)



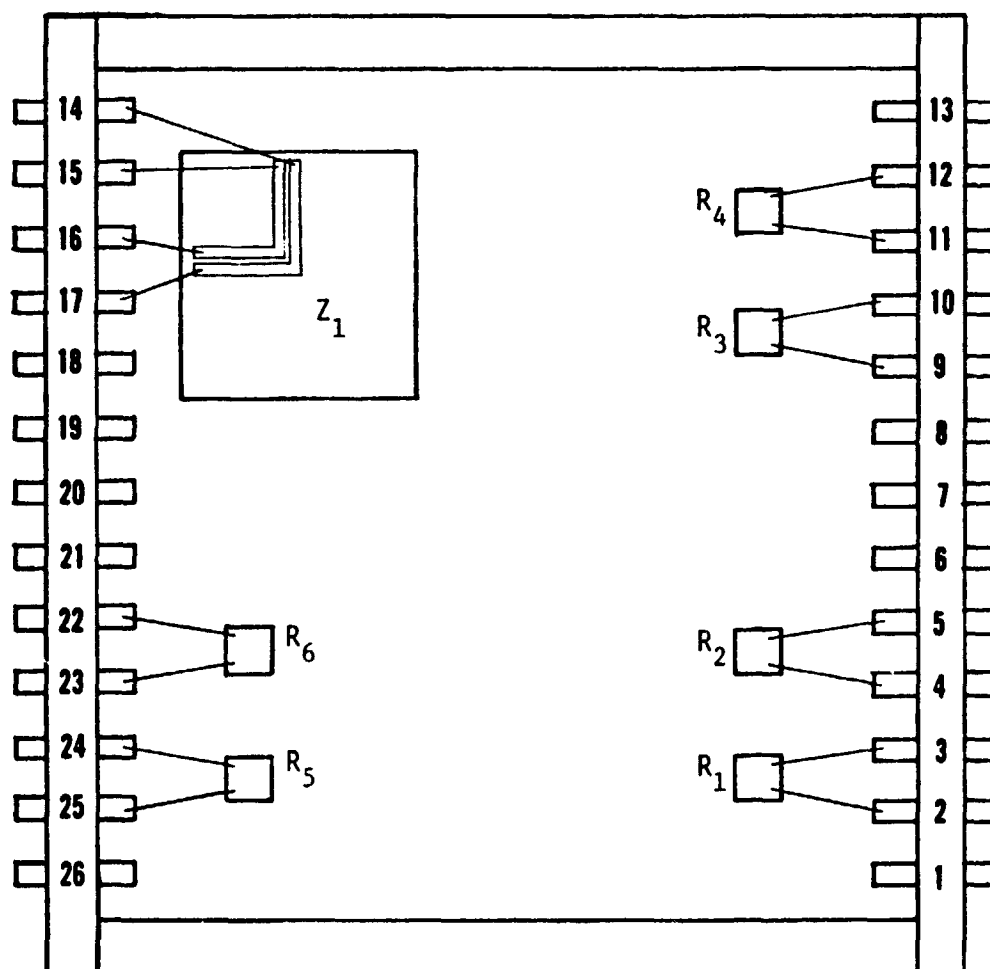

Figure 57. Layout of Thin Film Chip Resistor Test Specimens Containing Ten Times Amount of Adhesive Required to Mount Chips.  $R_1$  through  $R_4$  are Glass Passivated Thin Film Nichrome Chip Resistors.  $R_5$  and  $R_6$  are Unpassivated Thin Film Nichrome Chip Resistors.  $Z_1$  is a Chip Containing an Aluminum Conductor Pattern (Shown in Detail in Figure 58.)

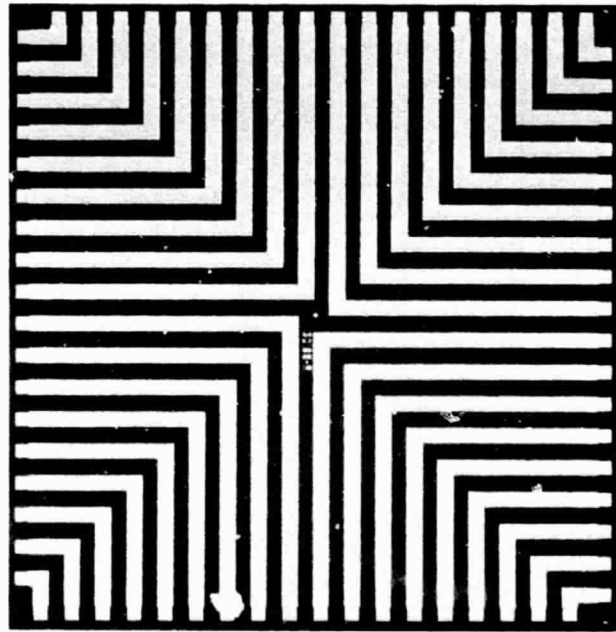

Figure 58. Photograph of Chip With Aluminum Conductor Pattern

REPRODUCIBILITY OF THE  
ORIGINAL PAGE IS POOR

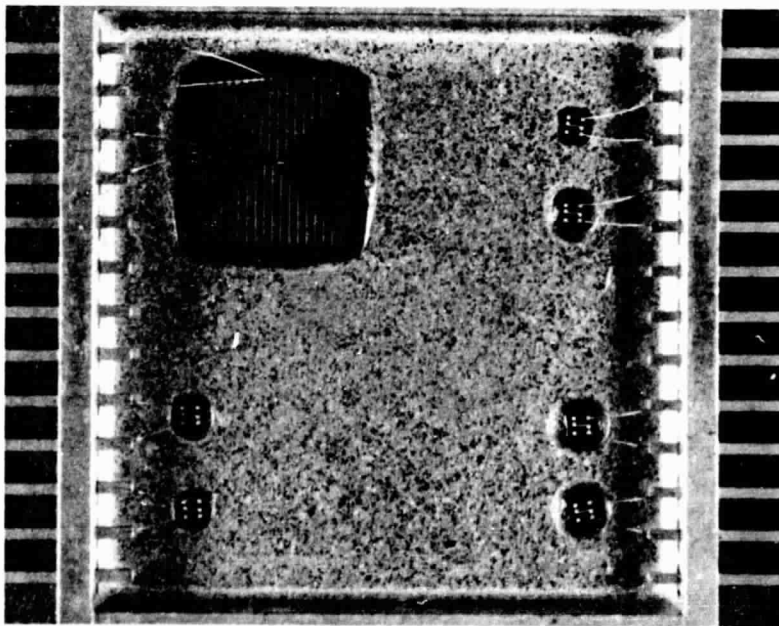
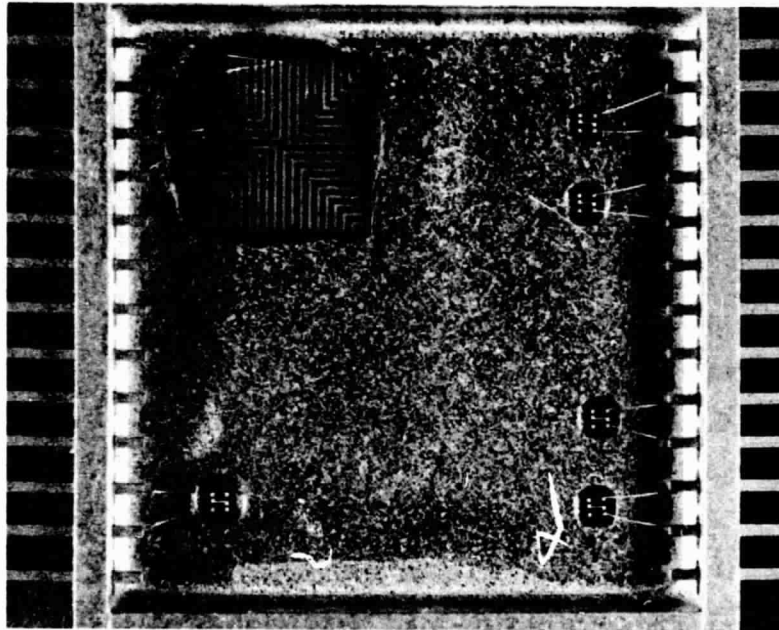

Figure 59. Thin Film Chip Resistor Test Specimens

Resistances were measured initially, and after 20, 40, 60, 80, 148, 220, 308, 380, 468, and 540 hours. A small current (10  $\mu$ a) was passed through each resistor/conductor while they were aged at 150C. All measurements were taken at room temperature.

In all cases, the measured values of the resistances of both the glass passivated and the unpassivated thin film nichrome chip resistors were either constant or monotonically non-decreasing within measurement repeatability over the entire duration of the test. Measurement repeatability was  $\pm 1$  in the third significant figure. Examples of complete sets of measurements are given in Tables 16 through 18. Table 16 is for a control specimen (i.e., no adhesive), Table 17 is for a specimen showing a relatively small change, and Table 18 is for a specimen showing a relatively large change. Table 16 shows that the resistor values did not change with aging at 150C when no adhesive was contained in the test package. Thus, even though in all cases the observed resistance changes were small, they are considered to be real and caused by contaminants outgassed from the adhesives. Results, presented as percentage changes in resistance, are given in Tables 19 through 22. Results given in Tables 19 and 20 are for glass passivated resistors for the large and the small amounts of adhesives, respectively. Results given in Tables 21 and 22 are for unpassivated resistors.

As shown in the last columns of Tables 19 through 22, judgement was made as to whether or not the observed resistance changes indicated that the products outgassed from the adhesives had a deleterious effect. The rationale used in making this judgment was as follows. Hybrid circuits are designed which require resistors whose values are accurate to and do not change by more than 1% in some cases, and 0.5% in others. Experimental error in the measurements was assumed to be  $\pm 0.25\%$ . Thus, it was decided that appropriate rating ranges were 0 to 0.25%, 0.25 to 0.75%, 0.75 to 1.25% and greater than 1.25%. The range 0 to 0.25% was considered to indicate no (or at least a negligible) effect, 0.25 to 0.75% to indicate a possible deleterious effect, 0.75 to 1.25% to indicate a probable deleterious effect, and greater than 1.25% to indicate a definite deleterious effect.

Comparison of Tables 19 and 21 shows that the results obtained for the glass passivated and the unpassivated thin film nichrome resistors are in good general agreement in distinguishing between adhesives which have relatively small and relatively large effects. However, there is considerable difference between

TABLE 16. Data Obtained for Control Specimen  
(i.e., Containing No Adhesive)

Hours at 150C	Unpassivated Thin Film Nichrome Chip Resistors (K Ohms)	Glass Passivated Thin Film Nichrome Chip Resistors (K Ohms)			
		R1	R2	R3	R4
0	294	529	519	504	536
20	294	530	519	504	537
40	294	530	519	504	537
60	294	530	519	504	537
80	294	530	519	504	537
148	294	529	519	504	536
220	294	530	519	504	537
308	294	530	519	504	537
380	294	530	519	504	537
468	294	530	519	504	536
540	294	530	519	504	536

TABLE 17. Data Obtained for a Test Specimen Showing  
Relatively Small Changes in Resistor Values

Hours at 150C	Unpassivated Thin Film Nichrome Chip Resistors (K Ohms)	Glass Passivated Thin Film Nichrome Chip Resistors (K Ohms)			
		R1	R2	R3	R4
0	503	505	514	530	524
20	504	505	514	530	524
40	504	505	515	530	525
60	505	505	514	530	524
80	505	505	514	530	524
148	505	505	514	530	524
220	506	506	514	530	525
308	506	506	515	531	525
380	506	506	515	531	526
468	507	506	515	531	526
540	507	506	515	531	525

TABLE 18. Data Obtained for a Test Specimen Showing Relatively Large Changes in Resistor Values

Hours at 150C	Unpassivated Thin Film Nichrome Chip Resistors (K Ohms)	Glass Passivated Thin Film Nichrome Chip Resistors (K Ohms)			
		R1	R2	R3	R4
0	493	511	514	509	527
20	495	514	511	510	528
40	496	514	512	510	528
60	497	515	512	511	529
80	498	515	513	511	529
148	500	517	514	512	530
220	502	518	515	514	532
308	504	519	517	515	533
380	504	520	517	516	534
468	505	520	517	516	534
540	505	520	518	516	534

TABLE 19. Results for Glass Passivated Thin Film Nichrome Chip Resistors for Large Amounts of Adhesives

Adhesive	Amount (mg)	Resistance Change (%)	Deleterious Effect of Outgassed Products
Controls	Zero	Zero	No No Possibly Probably ↑ ↓ Probably Yes Yes
Eccobond 104	65.5	0.19	
DuPont 5504	41.1	0.44	
Hysol 0151	9.1	0.84	
Ablefilm 517	38.0	0.88	
Ablebond 36-2	60.7	0.92	
Ablebond 58-1	80.9	0.97	
Epo-Tek H31	106.7	1.12	
Epo-Tek H74	59.9	1.17	
Epo-Tek H44	103.4	1.19	
Ablefilm 529	131.4	1.44	
Epo-Tek H61	125.1	1.46	

TABLE 20. Results for Glass Passivated Thin Film Nichrome Chip Resistors for Small Amounts of Adhesives

Adhesive	Amount (mg)	Resistance Change (%)	Deleterious Effect of Outgassed Products
Controls	Zero	Zero	No ↑ ↓ No Possibly Possibly
Ablefilm 517	3.8	Zero	
Epo-Tek H74	5.7	Zero	
Epo-Tek H44	10.6	Zero	
Ablebond 58-1	8.1	0.05	
Epo-Tek H31	10.3	0.14	
Ablefilm 529	12.9	0.14	
Eccobond 104	6.4	0.19	
Epo-Tek H61	13.1	0.24	
Ablebond 36-2	6.2	0.24	
DuPont 5504	4.1	0.34	
Hysol 0151	0.9	0.49	

TABLE 21. Results for Unpassivated Thin Film Nichrome Chip Resistors for Large Amounts of Adhesives

Adhesive	Amount (mg)	Resistance Change (%)	Deleterious Effect of Outgassed Products
Controls	Zero	Zero	No Probably Probably Yes ↑ ↓ Yes
Eccobond 104	65.5	0.79	
DuPont 5504	41.1	1.14	
Ablebond 58-1	80.9	1.48	
Ablebond 36-2	60.7	1.75	
Epo-Tek H74	59.9	1.82	
Hysol 0151	9.1	1.84	
Ablefilm 517	38.0	1.91	
Ablefilm 529	131.4	2.03	
Epo-Tek H61	125.1	2.43	
Epo-Tek H31	106.7	2.48	
Epo-Tek H44	103.4	4.35	

TABLE 22. Results for Unpassivated Thin Film Nichrome Chip Resistors for Small Amounts of Adhesives\*

Adhesive	Amount (mg)	Resistance Change (%)	Deleterious Effect of Outgassed Products
Controls	Zero	Zero	No
Ablefilm 517	3.8	Zero	No
Ablefilm 529	12.9	Zero	No
Epo-Tek H61	13.1	0.73	Possibly
Eccobond 104	6.4	0.75	Possibly
Ablebond 58-1	8.1	0.75	Possibly
Ablebond 36-2	6.2	0.98	Probably
Epo-Tek H31	10.3	1.10	Probably
Hysol 0151	0.9	1.28	Yes
Epo-Tek H44	10.6	3.07	Yes

\*DuPont 5504 (4.1 mg) and Epo-Tek H74 (5.7 mg) were not tested because resistors were damaged prior to commencement of test.



these results in the specific ordering of the adhesives. As the results given in Table 21 show, the unpassivated resistors are much more sensitive to the contaminants than the glass passivated resistors. Consequently, it is felt that the ordering in Table 21 is probably more nearly correct than that in Table 19. This conclusion is qualified due to the fact that in most cases the results given in Table 21 were obtained from measurements on only one resistor, while those given in Table 19 are an average for four resistors.

Comparison of these results with those obtained using the FET devices indicates that even the glass passivated resistors are much more sensitive to contaminants than the FET devices. Also, the thin film nichrome chip resistors do not require special precautions to avoid damaging them during handling as the FET devices do, much simpler measurements are required to accumulate the desired data, and the data is much easier to interpret. Without question, thin film nichrome chip resistors are superior as a test vehicle to compare the effects of products outgassed from adhesives. However, as for any device, it is not clear how the results obtained for one type of device can be extrapolated to predict effects on other types of devices.

Results obtained from measurements of the aluminum conductor lines were inconclusive. In almost all cases, the resistances decreased (probably due to further annealing). In a few cases it increased considerably. However, there was no correlation of this occurrence with the results obtained for the thin film resistors or with the amount of adhesive contained in the package. Since a problem in bonding was encountered during assembly, it is believed that the high resistances observed in some cases were due to bond degradation.

### 3. Results of Gas Analysis

The contents of all of the FET test packages containing the larger amounts of adhesives were analyzed using a gas chromatograph. The particular set-up used was a No. 5A seive and a Poropak Q column. This allows the moisture content and some gas constituents to be measured concurrently. Results obtained are shown in Table 23. Note that the data given for Epo-Tek H44 were obtained from analysis of the test package containing the smaller amount of this adhesive. The package containing the larger amount (121.1 mg) was discovered to be a leaker and could not be tested.

Review of Table 23 indicates only four pieces of data considered to be of any consequence. These are that 0.10% water was found in the package containing Hysol 0151, and a constituent which very probably is  $\text{BF}_3^*$  was found in the packages

\*Boron trifluoride

TABLE 23. Results of Gas Analysis of FET Test Packages

Adhesive	Amount (mg)	Constituent					
		H <sub>2</sub> O (%)	O <sub>2</sub> (%)	N <sub>2</sub> (%)	BF <sub>3</sub> ? (ppm)	Low Molecular Weight Hydrocarbons (ppm)	
Control	Zero	Zero	7.31	Balance		8	
Hysol 0151	22.7	0.10	1.17	↑		75	
Ablefilm 517	28.0	Zero	0.84		57		
Eccobond 104	30.0	↑	0.02		37		
Epo-Tek H61	47.7		4.72		347	3839	
Epo-Tek H74	47.6		Zero		63		
Ablefilm 529	41.5		Zero		21		
Ablebond 36-2	47.2		Zero		251		
Epo-Tek H31	42.1		3.43		147	4042	
DuPont 5504	48.2		0.08		2441		
Ablebond 58-1	100.3		4.52		559		
Epo-Tek H44*	12.3		Zero		Zero	Balance	114

\*The package containing the larger amount of Epo-Tek H44 (121.1 mg) was found to be a leaker at the time the gas analyses were made, so the package containing the smaller amount was analyzed.

containing Epo-Tek H61, H31 and H44. Their presence could account for the fact that these adhesives affected both the FET devices (see Table 15) and the glass passivated thin film nichrome chip resistors (see Table 19). However, the results of this analysis do not give any indication of why effects on FET devices were observed for Ablefilm 517 or Epo-Tek H74, or on glass passivated thin film nichrome chip resistors for most of the other adhesives. An analysis for ammonia and organic amines would provide a complete picture of all active contaminants. This analysis was not run because it requires a different chromatographic column and another set of samples.

#### G. INVESTIGATION OF METAL MIGRATION FROM ELECTRICALLY CONDUCTIVE ADHESIVES

Silver, silver-palladium, and gold filled adhesives were tested under a variety of conditions to investigate the occurrence of metal migration. The basic test specimen used in this investigation is shown in Figure 60. This specimen consisted of three thick film gold metallized lines 0.381 cm (150 mils) wide with 0.0127, 0.0254, and 0.0508 cm (5, 10, and 20 mils) gaps respectively, on a 1.90 cm (0.75 inch) wide by 3.81 cm (1.50 inch) long unglazed alumina substrate. Test specimens for specific adhesives were prepared by screening the adhesives on the metallization on one side of the gaps. A photograph of such a test specimen is given in Figure 61.

The silver filled adhesive Ablebond 36-2 was selected for initial testing. Several specimens were exposed to an 80C/80% relative humidity environment for 48 hours. Electric fields of up to 36 volts/mil (360 volts across a 10 mil gap) were applied. Visual inspection at 30X magnification after exposure did not give any evidence of silver migration. Also, resistance measurements made before and after exposure showed the gap resistances to be greater than  $10^{13}$  ohms. Therefore, it was concluded that these test conditions were insufficient to cause detectable silver migration in a reasonable length of time. Consequently, it was decided to increase the relative humidity to see if this would accelerate the occurrence of silver migration.

Three specimens were tested at 82C and 96% relative humidity with an applied electric field of approximately 20 volts/mil. One specimen was subjected to these conditions for 65 hours, another for 192 hours, and the third for 336 hours. The results obtained for the specimens exposed for 65 hours and for 336 hours were essentially the same, and differed from that obtained for the specimen exposed for 192 hours. Photographs are given in Figure 62. As can be seen from

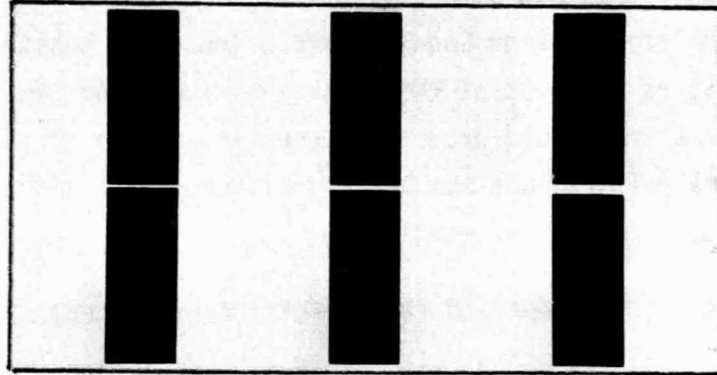

FIGURE 60. Basic Test Specimen for Investigation of Metal Migration

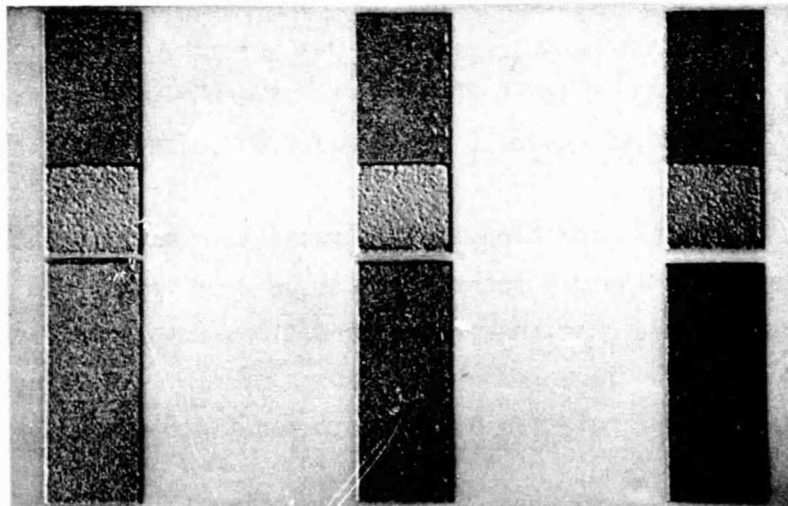
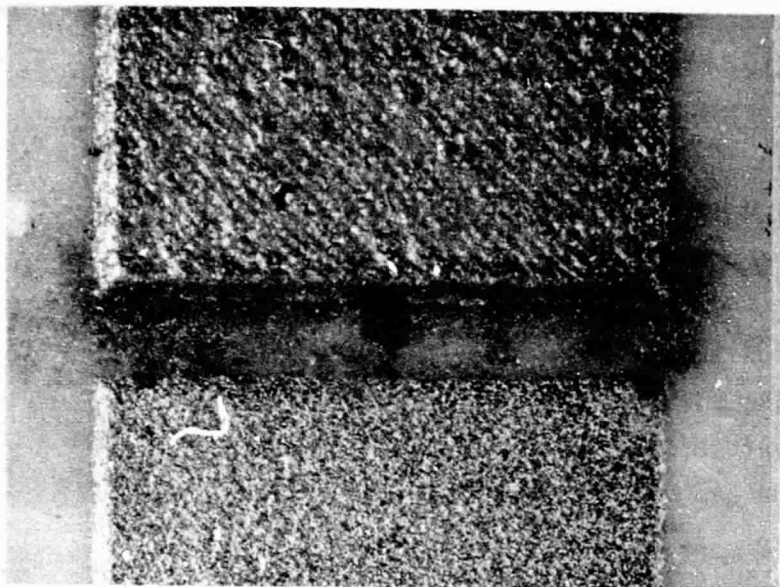

FIGURE 61. Test Specimen - Thick Film Gold Metallization with Conductive Adhesive Screened on One Side of Gaps

C75-647/201



Thick Film Gold Metallization  
Coated with Silver Filled  
Adhesive

Thick Film Gold Metallization  
(Uncoated)

(a) 65 Hours (And Essentially Also 336 Hours)

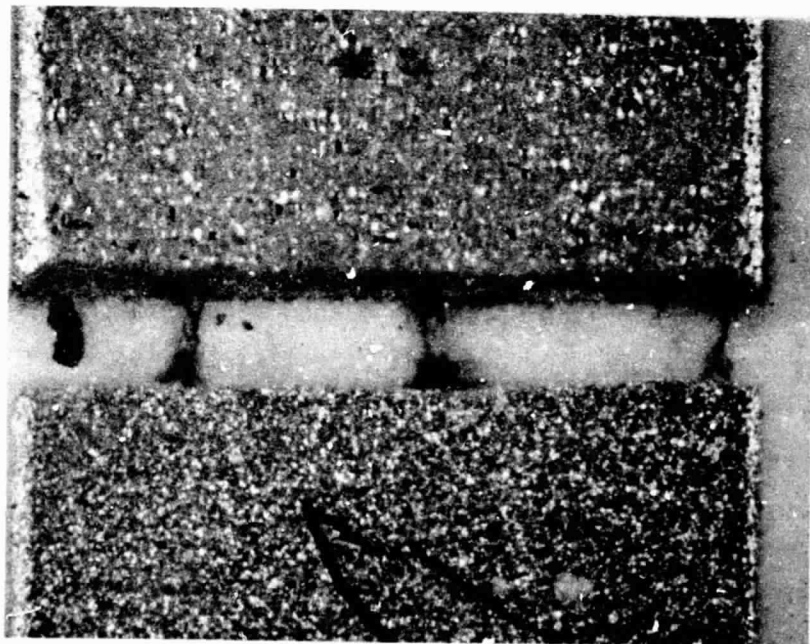

Thick Film Gold Metallization  
Coated with Silver Filled  
Adhesive

Thick Film Gold Metallization  
(Uncoated)

(b) 192 Hours

FIGURE 62. Photographs of Portions of Test Specimens Showing Effects of Exposure to 82C/96% Relative Humidity Environment. Adhesive is Silver Filled (Ablebond 36-2). Gap Widths are 18.5 mils. Applied Potential was 360 Volts.

Figure 62a, considerable darkening of the gap occurred in this case, indicating the occurrence of silver migration. Also, Figure 62b indicates that silver migration has occurred and completely bridged the gap in three different areas. However, measurements before and after exposure showed that the resistances of the gaps were greater than  $10^{13}$  ohms in all cases, indicating that appreciable silver migration had not occurred. Because of the contradictory nature of these results, the specimens were analyzed using the electron microprobe. Results for the specimen exposed for 65 hours showed that silver was present all throughout the gap and that large amounts of silver were present in the dark areas. Also, it was found that in some areas the silver had bridged the gap completely and even penetrated into the gold electrode. Results obtained from analysis of the line at the right-hand edge of the gap of the specimen exposed for 192 hours are shown in Figure 63. The silver adhesive coated gold metallization is at the top of the photograph and the uncoated gold metallization is at the bottom. It is evident from this Figure that silver had migrated and completely bridged the gap. Thus, it is established beyond doubt that silver migration does occur under these conditions.

While this method of testing does give results, the time required to run each test is very long. Consequently, it was recognized that if an adequate amount of data to meet the objective of this study was to be accumulated, an accelerated method of testing was required. It was decided that one such method consisted simply of testing the specimens with a drop of water bridging the gaps.

The initial test performed using this method gave a rather spectacular demonstration of silver migration. A drop of deionized water was placed across the 20 mil gap of a test specimen at room temperature, and one volt potential applied. Within approximately 30 seconds silver dendrites began to grow from the gold terminal (negative polarity) toward the terminal with the silver filled adhesive (Ablebond 36-2) screened on it (positive polarity) and quickly spanned the gap. Initial bridging occurred in 3-1/2 minutes and the gap was completely filled with silver in 7-3/4 minutes. At this time, the current through the gap had increased to 10 ma and the gap resistance had dropped to approximately 100 ohms. A photograph of the tested specimen is shown in Figure 64. A copy of the recorder chart showing the increase in current with time is given in Figure 65. For this test the recorder sensitivity was set for 10 ma full scale, so the initial current-time history is not shown. With the recorder set at this sensitivity, the initial indication of current coincides with the visual observation of initial bridging of the gap by the migrating silver.

C75-647/201



Silver Adhesive Coated Thick Film  
Gold Metallization

Uncoated Thick Film Gold Metallization

FIGURE 63. X-Ray Image of Line at Right-Hand Edge of  
Gap in Figure 62b Showing Silver has  
Bridged Gap

C75-647/201

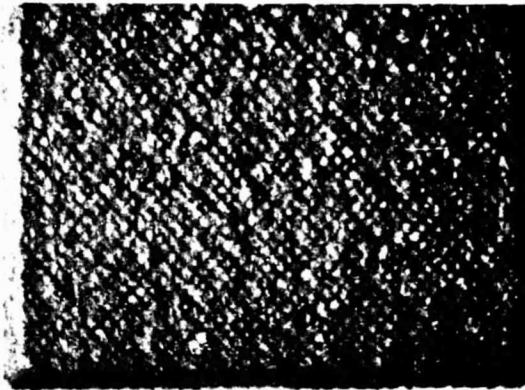

Thick Film Gold Metallization  
Coated with Silver-Filled  
Adhesive

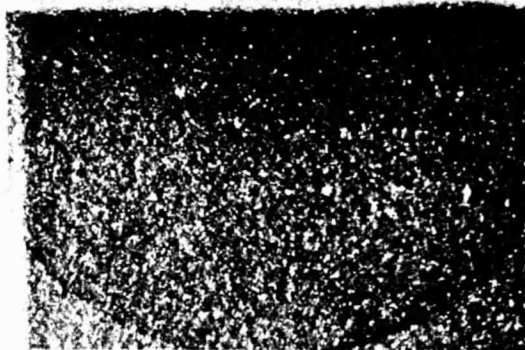

Thick Film Gold Metallization  
(Uncoated)

FIGURE 64. Photograph of Test Specimen Showing Complete Bridging of Gap by Silver Migration. Gap Width is Approximately 20 mils. Applied Potential Was 1 Volt. Test Was Conducted With a Drop of Deionized Water Across Gap. Migration Shown Occurred in 7-3/4 Minutes.

REPRODUCIBILITY OF  
ORIGINAL PAGE IS POOR



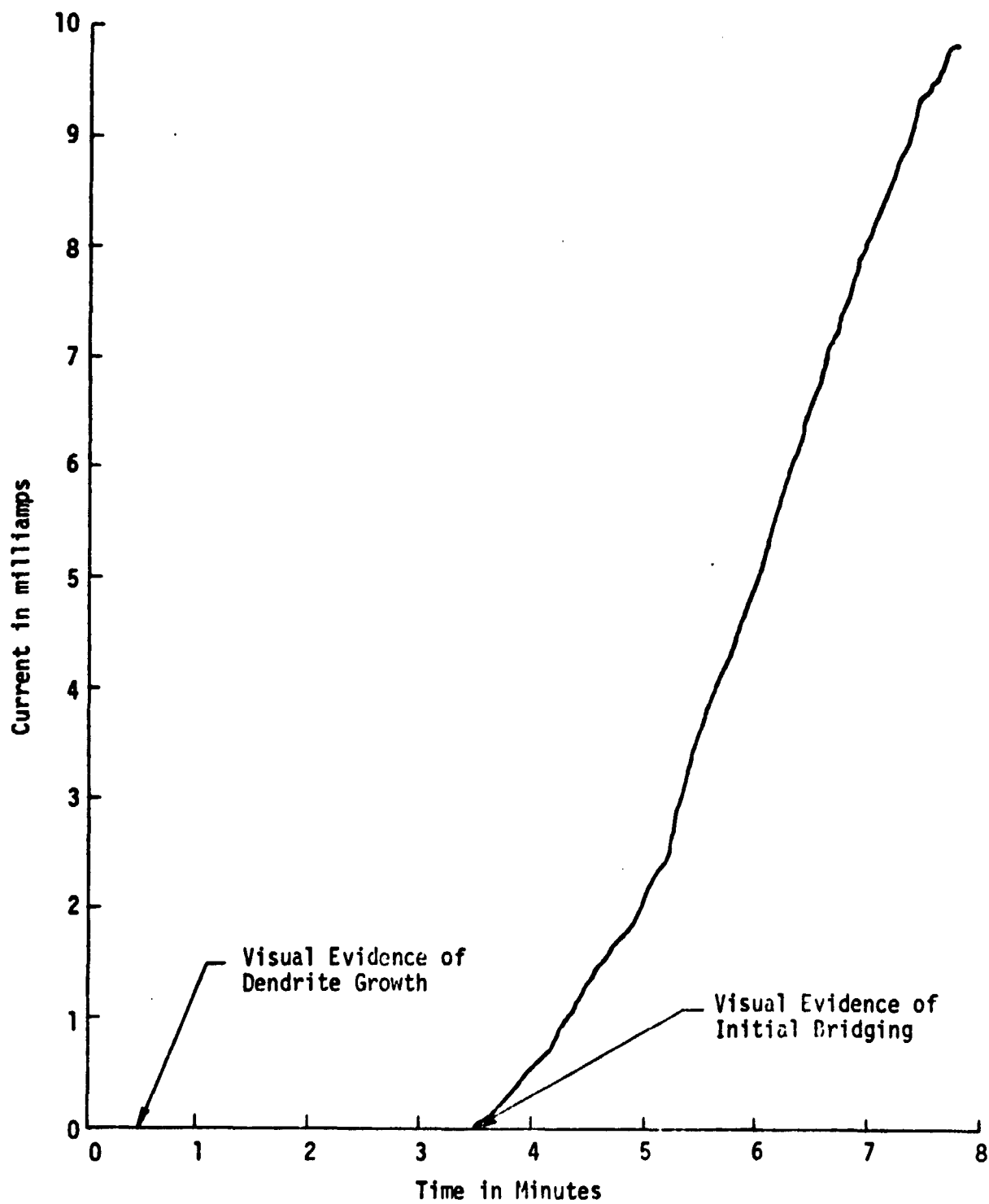

Figure 65. Current Versus Time for Specimen Shown in Figure 64.

The test was repeated under these same conditions and interrupted before complete bridging of the gap occurred (see Figure 66). At the time the test was terminated, the current was 4  $\mu$ a indicating a gap resistance of 250 kilohms. Initial current (i.e., when the one volt potential was first applied) after the drop of water was placed across the gap was 0.5  $\mu$ a, indicating the gap resistance to be 2 megohms. Examination of this photograph (Figure 66) clearly shows that there is no growth of silver dendrites from the silver filled adhesive coated terminal (positive polarity). The edge of this terminal did not visually change from its original condition. The metallic silver dendrites grew only from the gold terminal (negative polarity). This is as expected - silver ions which are positively charged are formed at the positive silver filled adhesive coated terminal, and migrate under the action of the applied field through the electrolyte (in this case, deionized water) to the negative gold terminal where they are neutralized and appear as metallic silver.

Since this method obviously gave an accelerated test for metal migration, it was used in further testing to comparatively evaluate several different silver filled adhesives, a palladium-silver filled adhesive, and a gold filled adhesive. In addition, tests were run to investigate the extent to which migration occurs for a silver filled adhesive when test specimens are cooled below the room dew point - in one case so that the moisture from the air is condensed as water, and in the other so that it is condensed as frost.

#### 1. Comparative Evaluation of Conductive Adhesives

##### a. Silver Filled Adhesives

Three silver filled adhesives were evaluated - Ablebond 36-2, Epo-Tek H31, and DuPont 5504. Several specimens of each adhesive were tested. All tests were made at room temperature. Tests were performed on 20 mil gap specimens with two volts applied potential. The gaps were completely bridged by drops of deionized water. The results obtained for all three of these adhesives were much the same. The initiation of dendritic growth was visually detectable (at 30X magnification) within just a few seconds (10 to 30), initial bridging of the gaps by migrating silver occurred within a few minutes (2 to 5), and the gaps were essentially completely filled with silver in just a few more minutes (2 to 7). The total elapsed time from initial application of voltage until this condition occurred ranged from 3 to 12 minutes for the various specimens tested.

C75-647/201

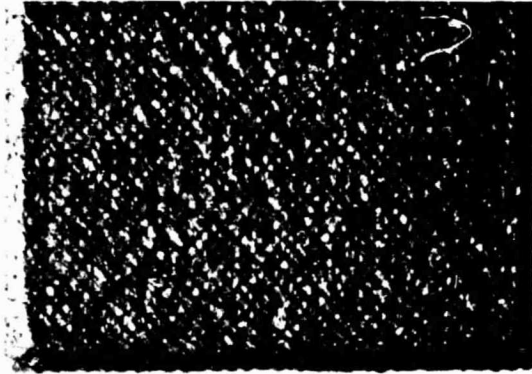

Thick Film Gold Metallization  
Coated with Silver-Filled  
Adhesive

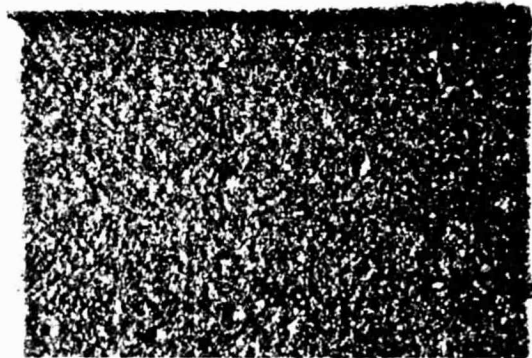

Thick Film Gold Metallization  
(Uncoated)

FIGURE 66. Photograph of Test Specimen Showing Earlier Stage of Silver Migration Under the Same Conditions as for the Test Specimen Shown in Figure 64. Note That the Growth of Metallic Silver Dendrites is from the Gold (Negative Polarity) Terminal

REPRODUCIBILITY OF THE  
ORIGINAL PAGE IS POOR

b. Palladium-Silver Filled Adhesive

Results obtained for the palladium-silver filled adhesive (Ablebond 66-1) were much different. For the first specimen tested, very slight dendritic growth was visually evident (at 30X magnification) about two minutes after the two volt potential was applied. At the end of five minutes, the current through the 20 mil gap had increased to only 5  $\mu$ a and remained essentially steady for the duration of the test (approximately 2-1/2 hours). During this time the silver migrated only a few mils. A photograph of this test specimen is given in Figure 67. Measurement showed that the silver migrated only about 5 mils. However, as shown in the figure, a large amount of silver grew from the sides of the gold terminal but did not grow closer than 12 or 13 mils to the adhesive coated gold terminal.

To allow comparison with the silver filled adhesives, two palladium-silver filled adhesive specimens were tested to failure. For the first specimen, dendritic growth was just visible at 30X after 1-1/2 minutes, and had increased to approximately 2 mils after 10 minutes. By the end of 40 minutes, one small spot had grown approximately 1/2 way across the gap, but the remainder had grown only 1/4 to 1/3 of the way across. After 1-1/2 hours, this spot had grown about 3/4 of the way across the gap, and bridged the gap after 2 hours and 10 minutes. The current was 10 to 12  $\mu$ a throughout the run until the gap was bridged, at which time it increased to 200  $\mu$ a, and then to 1 ma over the next few minutes. For the second specimen, dendritic growth was visible after 1 minute. Initially, the current was 2  $\mu$ a, increased to 5  $\mu$ a by the end of 10 minutes, and remained between 5 and 9  $\mu$ a during the rest of the run. Initial bridging occurred after 3-1/2 hours. At that time, the current jumped to 50  $\mu$ a and then increased to 200  $\mu$ a over the next 5 minutes. Bridging was caused by a spot only 1 or 2 mils wide. Elsewhere, silver migration had progressed only 10 to 50% (average approximately 25%) of the way across the gap.

Thus, for these two specimens of Ablebond 66-1, initial bridging by silver migration occurred in 2 hours and 10 minutes and in 3-1/2 hours, respectively. Compared to the time required for bridging to occur for the silver filled adhesive specimens (2 to 5 minutes), even the shorter time (2 hours and 10 minutes) indicated that the palladium-silver filled adhesive is better by a factor of 25 to 65. These results substantiate the claim that palladium-silver filled adhesives are considerably less prone to migration than silver filled adhesives.

C75-647/201

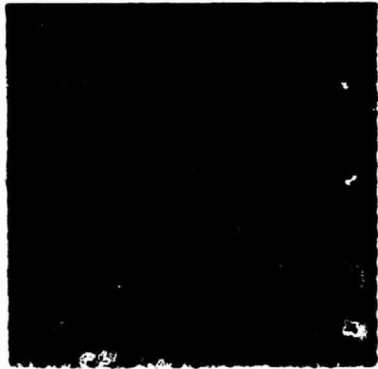

Thick Film Gold Metallization Coated  
with Palladium-Silver Filled Adhesive

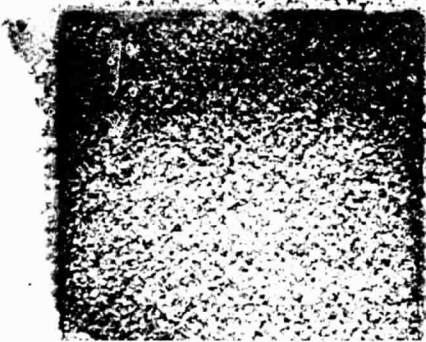

Thick Film Gold Metallization  
(Uncoated)

FIGURE 67. Photograph showing silver migration of palladium-silver filled adhesive (Ablebond 66-1). Gap width is 20 mils. Applied potential was 2 volts. Test was conducted with a drop of deionized water bridging the gap. Migration shown occurred in approximately 2-1/2 hours.

To acquire further information about this adhesive, additional tests were run on 10 mil and 5 mil gap specimens. A potential of two volts was applied in each case, giving electric fields of 0.2 volts/mil and 0.4 volts/mil, respectively. Results obtained were as follows. For the 10 mil gap specimen dendritic growth was just discernible after 1-1/2 minutes and had grown to 1 mil at the end of 4 or 5 minutes. At this time the current was 4 or 5  $\mu$ a, and slowly increased to 8  $\mu$ a by the end of approximately 2-1/2 hours. At this time, one small area which had been growing more rapidly than the rest bridged the gap and the current quickly increased to 0.5 or 0.6 ma. In 5 or 6 more minutes the current had increased to 1 ma and the test was terminated. A photograph of this specimen is given as Figure 68. Note, that except for the one small area where bridging occurred, the silver migrated less than half way across the gap.

For the 5 mil gap specimen, the initial resistance (before a drop of water was applied) was such that no current was indicated with the recorder set on its lowest scale (0.5  $\mu$ a). After the drop of water was placed across the gap, the current increased to 5  $\mu$ a. Initial dendritic growth was just noticeable at the end of 1/2 to 1 minute, and the dendrites had grown about half way across the gap in 2 to 2-1/2 minutes. At the end of 15 minutes, dendrites had grown 65 to 80% of the way across the gap at several points and the current had slowly increased to 7  $\mu$ a. At the end of 22 minutes, at one point a dendrite was within about 1 mil of bridging the gap, and bridged the gap at the end of 24 minutes. At this time the current jumped to 0.1 ma.

c. Gold Filled Adhesive

Two specimens of the gold filled adhesive, Ablebond 58-1, were tested to see if gold migration occurs. For the first test, 2 volts potential was applied across a 20 mil gap specimen (actually measured to have a gap width of from 18 to 20 mils). Before the water drop was applied across the gap, no current was detectable on the 0.5  $\mu$ a scale of the recorder. After the drop of water was applied, the current was 0.2  $\mu$ a, and increased to 1  $\mu$ a in about five minutes. The current then slowly increased to 4 or 5  $\mu$ a by the end of the test. The test was run for five hours. At the end of this time, there was just barely visible (at 30X) evidence of the beginning of the formation of gold dendrites.

The second test was run with 20 volts applied across a nominal 20 mil gap specimen. This specimen was prepared by hand, so the actual gap width varied from 11 to 20 mils. Consequently, the electric field strength varied from approximately 1 to 2 volts/mil. At this field strength there was considerable turbulence

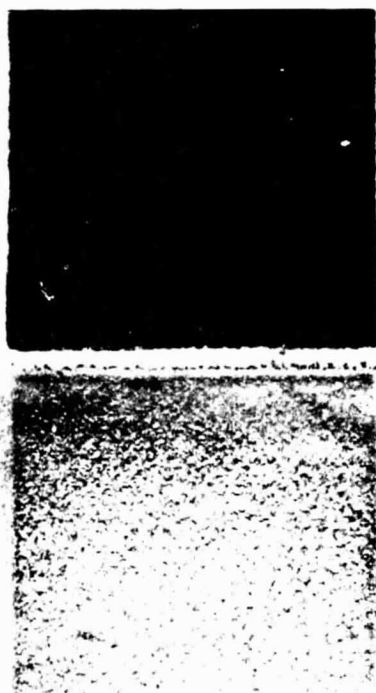

Thick Film Gold Metallization Coated  
with Palladium-Silver Filled Adhesive

Thick Film Gold Metallization  
(Uncoated)

REPRODUCIBILITY OF THE  
ORIGINAL PAGE IS POOR

FIGURE 66. Photograph showing silver migration of palladium-silver filled adhesive (Ablebond 66-1). Gap width is 9 mils. Applied potential was 2 volts. Test was conducted with a drop of deionized water bridging the gap. Migration shown occurred in approximately 2-1/2 hours. Note that the gap is bridged in one small area.

in the water drop, and the current ranged from 0.1 to 0.3 ma during the test. After 5 or 6 minutes, dendritic growth was just visible, but certainly was less than 1 mil. At the end of 1-1/2 hours, one small spot had migrated approximately 1/4 of the way across the gap. There was essentially no further change from this condition during the rest of the test which was terminated after 5 hours. A photograph of this test specimen is given in Figure 69. Measurement showed that except for the one small spot previously mentioned, the gold had migrated only approximately 3 mils.

Thus, while these tests showed that gold migrates under a severe environment, it certainly can be concluded that its migration is negligible compared to that of silver.

## 2. Investigation of Silver Filled Adhesive Specimens Cooled Below the Dew Point

Tests were run on dry specimens of the silver filled adhesive, Ablebond 36-2, cooled below the room dew point to investigate the effects of condensed moisture on silver migration. In one case, the test specimens were placed on an aluminum block immersed in ice water so that moisture from the air condensed as water. In the other case, the same setup was used but the ice was kept supercooled by periodically adding liquid nitrogen so that the moisture condensed as frost. Two specimens were tested in each case - the second for an electric field strength ten times greater than that applied to the first.

### a. Water Condensation

The first test was conducted with 2 volts applied across a 10 mil gap specimen. The initial resistance of the gap was such that no current was indicated with the recorder set on its lowest scale (0.5  $\mu$ a). After a few minutes (about 4), the condensation of water droplets on the surface was visually detectable (at 30X) but there was still no indication of current. At the end of 37 minutes, the water droplets had grown and dendritic growth was beginning in isolated places where the droplets had coalesced to bridge the gap. There was no dendritic growth prior to the coalescing of the droplets to form a continuous path between the terminals, and no dendritic growth on the other areas of the terminal. By the end of 51 minutes the current had increased to 1  $\mu$ a. At that time, the gap was bridged by migrating silver in one area and the current jumped to 1 ma. As more areas were bridged, the current quickly rose and had increased to 10 ma at the end of 57 minutes when the test was terminated. A photograph showing the condition of the test specimen at the end of the test is given as Figure 70a. Later measurement of the gap resistance after the specimen had dried, showed it to be greater than  $10^{13}$  ohms.



C75-647/201

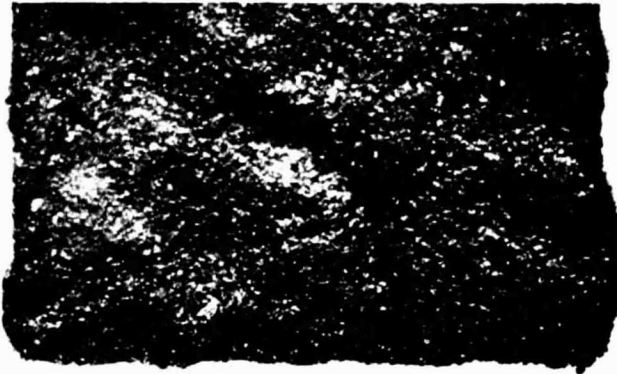

Thick Film Gold Metallization Coated  
with Gold Filled Adhesive  
(Ablebond 58-1)

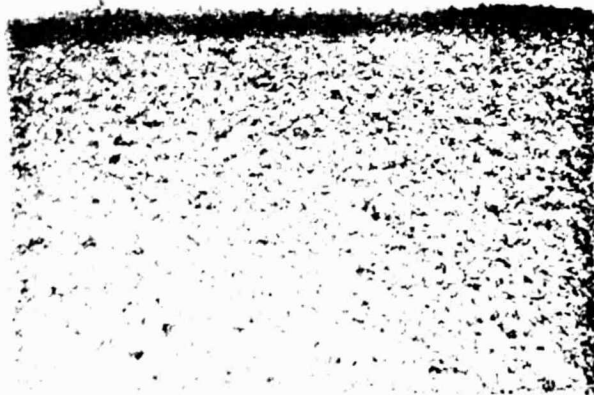

Thick Film Gold Metallization  
(Uncoated)

FIGURE 69. Photograph of test specimen showing gold migration. Gap width is 11 to 19 mils. Applied potential was 20 volts. Test was conducted with a drop of deionized water bridging the gap. Slight migration shown occurred in 5 hours.

C75-647/201

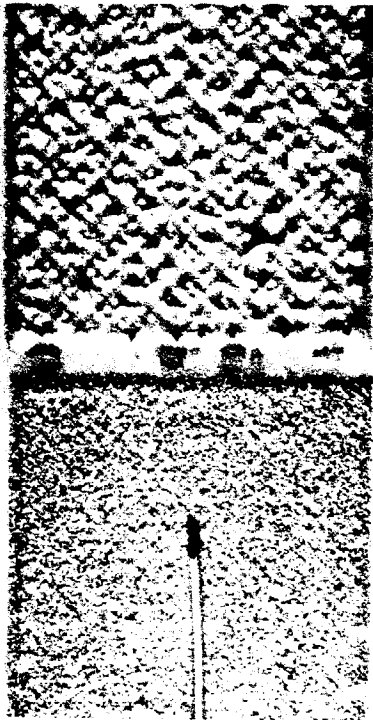

———— Thick Film Gold Metallization Coated  
with Silver Filled Adhesive

———— Thick Film Gold Metallization (Uncoated)

(a) Applied Potential - 2 Volts. Migration Shown Occurred in Approximately 1 Hour.

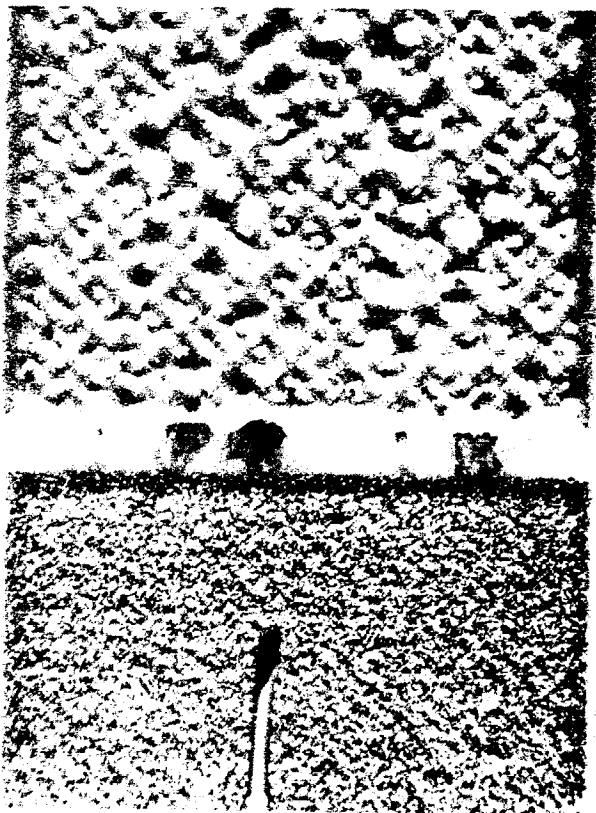

———— Thick Film Gold Metallization Coated  
with Silver Filled Adhesive

REPRODUCIBILITY OF THE  
ORIGINAL PAGE IS POOR

———— Thick Film Gold Metallization (Uncoated)

(b) Applied Potential - 20 Volts. Migration Shown Occurred in Approximately 1/2 Hour.

FIGURE 70. Photographs of test specimens cooled below room dew point so that the moisture in the air condensed as water. Adhesive is silver filled (Ablebond 36-2). Gap width is 10 mils.

It is interesting to compare this photograph with Figure 62b which was obtained for a test specimen (also Ablebond 36-2) exposed to an 82C/96% relative humidity environment for 192 hours with 360 volts applied across a nominal 20 mil gap specimen. In that case also, silver migration occurred in isolated areas. Correlation with present observations suggests that this was due to the fact that these areas were bridged by water droplets sometime during the course of the test. Also, measurement of the gap resistance of that specimen after the test was completed, showed it to be greater than  $10^{13}$  ohms.

The second test was conducted with 20 volts applied across a 10 mil gap specimen. Again, initially, the current was undetectable on the  $0.5 \mu\text{a}$  scale of the recorder. At the end of ten minutes, the droplets of water which had condensed on the surface were approximately 3 mils in diameter, and after 12 minutes, several droplets had coalesced so that in one place the gap was bridged about half-way across. After 15 minutes, several drops were almost completely bridging the gap and the whole surface was very wet. However, there was still no evidence of silver migration. At the end of 18 minutes, a drop bridged the gap, dendrites formed immediately, and the current jumped from  $0.4 \mu\text{a}$  to several hundred  $\mu\text{a}$ . There was considerable turbulence in the water drop and the current was erratic as dendrites grew and broke and silver accumulated along the edge of the drop and migrated across the gap on the surface. Subsequently, other drops bridged the gap and the current increased to 1 ma after about 1/2 hour. A photograph of the test specimen is given as Figure 70b.

These results show that silver migration does not occur when moisture is condensed as water until the gap is completely bridged - even for applied electric fields as high as 2 volts/mil. However, at this applied field strength, when the gap is completely bridged by water, silver migration bridges the gap immediately.

#### b. Frost Condensation

For the first test, a test specimen with a 20 mil gap was used with 20 volts applied potential. Again, initial current was undetectable on the lowest scale of the recorder. The condensation of frost was much more difficult to visually detect than the condensation of water, but certainly by the end of 40 minutes there was a thick, complete layer. The current remained at  $0.2 \mu\text{a}$  or less during the test, and there was no visual evidence (at 30X) of any dendritic formation. At the end of 1-1/4 hours, the test specimen was removed from the block with the voltage still applied. The frost melted immediately (a large amount of water formed showing that there had been a considerable layer of frost),

migrating silver bridged the gap almost instantaneously, and the current increased beyond 10 ma.

For the second test, 100 volts potential was applied across a 10 mil gap specimen. The test was run for 5-1/2 hours. The current remained undetectable on the 0.5  $\mu$ a scale throughout the test, and there was no evidence of migration. At the end of the test, the gap was perfectly clean.

These results show that silver migration does not occur when moisture is condensed as frost - even for applied electric fields as high as 10 volts/mil.

Several important conclusions can be drawn from the results obtained for the various tests performed during the course of this investigation of metal migration from electrically conductive adhesives. (1) While gold migration can occur, it is negligible under any reasonable conditions. (2) Silver migration does not occur until the gap is completely bridged by water. (3) When the gap is bridged by water, silver migrates very rapidly (in just a few minutes) from silver filled adhesives, even in the presence of weak electric fields (certainly as low as 50 mv/mil). (4) Silver migration does not occur if the gap is bridged by frost even under the presence of relatively high electric fields (certainly as high as 10 volts per mil). (5) Palladium-silver filled adhesives are less prone to silver migration than the silver filled adhesives by 1 to 2 orders of magnitude.

In a practical sense for hybrid microcircuit application, these conclusions mean that in order for silver migration to occur, the package must contain adequate moisture to have a dew point above 0°C, and sufficient to cause condensation great enough to form water droplets large enough to bridge the smallest line spacings. If reasonable precautions are taken, this situation can be avoided. These precautions consist in performing a good preseal vacuum bake-out, filling the packages with dry nitrogen, and maintaining hermeticity during the operating life of the hybrids. All of these are requirements of MIL-STD-883A. If MIL-STD-883A is met, there should be no silver migration problem. However, if package hermeticity is lost at some point, then silver migration could occur and circuit failure could be immediate. A further precaution that could be taken would be to use palladium-silver filled adhesives rather than silver filled adhesives, or better yet, gold filled adhesives. Provided, of course, that they meet all of the other requirements for microcircuit application.

Another possible precaution that could be taken would be the use of organic coatings. In an in-house study of various thick film metallization systems, it

was found that silver migration occurred very rapidly for platinum-silver metalized specimens. However, when these specimens were coated with various silicones, no migration occurred during runs of up to seven hours. Thus, coatings do provide excellent protection even under severe conditions. Admittedly, there are many factors which must be considered in determining the desirability of using coating materials on hybrid microcircuits; but if these requirements can be met, coatings would effectively eliminate the occurrence of silver migration, and also the possibility of temporary short circuits which could occur even in the absence of silver migration if adjacent lines at different potentials are bridged by a droplet of water.

#### H. IONIC CONTENT OF ELECTRICALLY INSULATIVE ADHESIVES

Water extract analyses were made on six electrically insulative adhesives (Hysol 0151, Ablefilm 517, Eccobond 104, Epo-Tek H61, Epo-Tek H74, and Ablefilm 529) to determine their electrical resistivity (total ion content), pH (hydrogen ion content), and chloride ion content.

Test specimens consisted of cured samples of the adhesives in glass stoppered Erlenmeyer flasks containing 125 ml of deionized water. The two film adhesives were cured between Teflon impregnated release cloths. The others were cured directly in the Erlenmeyer flasks. All adhesives were cured for 6 hours at 150C. The exact weights of the samples were determined by weighing on an analytical balance. Three specimens of each adhesive and three controls were run. These specimens were digested in an oven at 71C (160F) for 288 hours in accordance with Fed. Test Method Std. No. 406, Method 7071.

Measurements were made as follows. pH was determined with an Orion Model 801 pH meter using a standard combination electrode with the electrode immersed directly into the flasks. Readings were taken after the instrument had stabilized to  $\pm 0.002$  pH units. Conductivity (resistivity) was measured with an Industrial Instruments Model RC 16B2 conductance bridge using a  $10 \text{ cm}^{-1}$  standard platinum cell immersed directly into the flasks. Chloride ion content was determined by comparing the turbidity of samples of the water extracts (to which silver nitrate was added) in a Nessler tube to a series of chloride standards. This gave the amount of chloride present in the water extract samples. Calculations were then made to convert these results to micrograms per gram of adhesive (i.e., ppm).

The results obtained (normalized to 1 gram samples) are given in Table 24. As shown, Hysol 0151 and Epo-Tek H74 have relatively high chloride ion contents,

TABLE 24. Results of Water Extract Analysis\*

Adhesive	pH	Resistivity (ohm - cm)	Chloride (ppm)
Controls	5.83	510,000	Zero
Hysol 0151	6.28	49,000	380
Ablefilm 517	5.19	136,000	33.1
Eccobond 104	4.21	28,700	4.7
Epo-Tek H61	3.48	16,600	13.5
Epo-Tek H74	5.26	85,000	121
Ablefilm 529	6.26	166,000	2.7

\* Specimens were digested for 288 hours at 71C (160F).

and Epo-Tek H61 and Eccobond 104 have relatively low electrical resistivities. Both of these conditions are undesirable and could lead to the occurrence of corrosion - chemical corrosion in the case of chloride ions, and electrolytic corrosion in the case of low electrical resistivity.

Previously, corrosivity tests run at 85C/100% relative humidity and at 82C/84% relative humidity on thin film aluminum and thin and thick film gold metallization systems indicated that Hysol 0151, Epo-Tek H61, and Epo-Tek H74 caused corrosion (and/or discoloration) of these metallization systems. However, in general, Eccobond 104 was not found to cause corrosion. The only case where corrosion was observed for this adhesive was on the thin film aluminum specimen run at 85C/100% relative humidity, and in this case, the corrosion was very slight.

## III. SUMMARY AND CONCLUSIONS

Nine major tasks were performed during this study. The first eight were investigations of (1) alternate methods for determining the outgassing of cured adhesives, (2) effects of long term aging at 150C on the electrical properties of conductive adhesives, (3) effects of shelf life age on adhesive characteristics, (4) bond strengths of electrically conductive adhesives on thick film gold metallization, (5) a copper filled adhesive, (6) effects of products outgassed from cured adhesives on device electrical parameters, (7) metal migration from electrically conductive adhesives, and, (8) ionic content of electrically insulative adhesives. The ninth and most important was the generation (based on the results of these and previous investigations) of a guideline specification for the selection of organic adhesives for use in high reliability hybrid microcircuits for MSFC and NASA programs.

A summary of conclusions derived from the individual investigations discussed in detail in the previous Section follows.

A. Short term 2 hour runs using the TGA (Thermal Gravimetric Analysis) apparatus are adequate to distinguish high outgassing adhesives from low outgassing adhesives. This method is considered a practical, inexpensive, quick test for screening out adhesives which are excessive outgassers, and also could be used as a receiving inspection test to assure batch-to-batch consistency. On the other hand, the long term 1000 hour test involving periodic weighings using an analytical balance is recommended for initial qualification testing of adhesives since it gives more complete detailed data of their long term stability.

While high outgassing adhesives should be suspect, it should not be assumed that they deleteriously affect hybrid microcircuits and that low outgassing adhesives do not. The total amount of outgassing is an important indicator, and high outgassing is undesirable and risky from a contamination and corrosion standpoint, but the chemical nature of the outgassed products is much more critical. Many outgassed constituents are inert even



in large concentrations. Others are very active (chemically and/or electrically) and can deleteriously affect electronic devices when present even in trace amounts.

- B. The long term electrical stability of gold filled adhesives is superior to that of silver filled adhesives.
- C. All of the adhesives tested had shelf lives of at least six months when stored according to their manufacturer's instructions.

The use of small silicon die mounted on alumina substrates (for electrically insulative adhesives) and on metallized alumina substrates (for electrically conductive adhesives) is an adequate, and a much more realistic and economical (particularly in the case of gold filled adhesives) method for testing bond strength than the commonly used aluminum-to-aluminum lap shear test. Consequently, this method of testing is recommended. However, to obtain representative, reproducible results, the test specimens must be prepared with the same bond line thickness and filleting. Two methods of preparation are suggested, (1) screen the adhesives and automatically place the die, or (2) use a die bonder which automatically dispenses (stamps) a precise amount of adhesive and places the die.

- D. The bond strengths of the silver filled and gold filled adhesives were not affected by 30 minutes immersion in the cleaning solvents isopropyl alcohol, Freon TF or Freon TMC. However, it is recommended that hybrid manufacturers evaluate the adhesives for the specific solvents and conditions which they are using for cleaning.

The bond strengths of these adhesives also were not appreciably degraded by long term (90 days or approximately 2200 hours) aging at either room temperature or at 150C.

The bond strengths measured at 150C for these adhesives ranged from only 15% to 57% of the bond strengths measured at room temperature, and the bond strengths of the silver filled adhesives were degraded more than those of the gold filled adhesives. Reduction in bond strength at elevated temperatures such as 150C is beneficial in reworking hybrids. However, it is felt that the bond strength should not be less than  $6.9 \times 10^6 \text{ N/m}^2$  (1000 psi) at this temperature in order not to risk accidental device loss under some stress conditions.

- E. In general, the copper filled adhesive compared favorably with the silver filled and gold filled adhesives except in retention of bond strength after long term aging at 150C, and the effect of high temperature/relative humidity exposure on its resistance. Because of these deficiencies, it is felt that copper filled adhesives require further improvement before they can be considered for use in high reliability hybrid microcircuits.
- F. Comparison of the results obtained using FET devices and those obtained using thin film nichrome chip resistors indicates that the thin film nichrome chip resistors (even when they are glass passivated) are much more sensitive to contaminants than the FET devices. Also, the thin film nichrome chip resistors do not require special precautions to avoid damaging them during handling as the FET devices do, much simpler measurements are required to accumulate the desired data, and the data are much easier to interpret. Without question, thin film nichrome chip resistors are superior as a test vehicle to determine the effects of products outgassed from adhesives. However it is not clear how the results obtained for one type of device can be extrapolated to predict effects on other types of devices. Thus there is a definite need for further investigation directed to the selection of a device, devices, or a circuit which can be used as a standard test vehicle for evaluating the contaminating effects of products outgassed from adhesives.

The results of gas analyses of the contents of FET test packages indicates a possible correlation of the presence of  $\text{BF}_3$  (boron trifluoride) with the degradation of device electrical parameters.

- G. Several conclusions can be drawn from the investigation of metal migration from electrically conductive adhesives. (1) Gold migration can occur, but is negligible under any reasonable conditions. (2) Silver migration does not occur until the gap is completely bridged by water. (3) When the gap is bridged by water, silver migrates very rapidly (in a few minutes) from silver filled adhesives, even in the presence of weak electric fields (certainly as low as 50 mv/mil). (4) Silver migration does not occur if the gap is bridged by frost even under the presence of relatively high electric fields (certainly as high as 10 volts per mil). (5) Palladium-silver filled adhesives are less prone to silver migration than the silver filled adhesives by 1 to 2 orders of magnitude.

For hybrid microcircuit application, these conclusions mean that in order for silver migration to occur, the package must contain adequate moisture to have a dew point above 0°C, and sufficient to cause condensation great enough to form water droplets large enough to bridge the smallest line spacings. If reasonable precautions are taken, this situation can be avoided. These precautions consist in performing a good preseal vacuum bake-out, filling the package with dry nitrogen, and maintaining hermeticity during the operating life of the hybrid. All of these are requirements of MIL-STD-883A. Thus, if MIL-STD-883A is met, there should be no silver migration problem. However, if package hermeticity is lost at some point, then silver migration could occur and circuit failure could be immediate. A further precaution that could be taken to avoid the occurrence of silver migration would be to use palladium silver-filled adhesives rather than silver filled adhesives, or better yet gold filled adhesives, provided, of course, that they meet all of the other requirements for microcircuit application.

- H. Two electrically insulative adhesives were found to have relative high chloride ion content, and two others were found to have relative low electrical resistivities (high total ion content). Both of these conditions are undesirable and could lead to the occurrence of corrosion.