

N7721521  

A LASER TECHNIQUE FOR  
CHARACTERIZING THE GEOMETRY OF PLANT CANOPIES

V. C. Vanderbilt  
L. F. Silva  
M. E. Bauer

January 1977

Purdue University  
Laboratory for Applications  
of Remote Sensing  
1220 Potter Drive  
W. Lafayette, Indiana 47906

REPRODUCED BY  
U.S. DEPARTMENT OF COMMERCE  
NATIONAL TECHNICAL  
INFORMATION SERVICE  
SPRINGFIELD, VA 22161

This work was supported by the National Aeronautics and Space  
Administration (NASA) under contracts NAS9-14016 and NAS9-14970.

FRONT COVER: Data obtained over a plant canopy using the PURDUE/LARS laser probe provides numerical information concerning the location and orientation of foliage in the canopy. Such data is required as input to many models for the radiation regime in the canopy. This Information Note (1) describes the laser technique, (2) demonstrates the feasibility of the technique applied to two plant canopies, corn and wheat, and (3) offers suggestions for its implementation.

BACK COVER: The raw data acquired over wheat using the laser probe (the orange dots) is overlaid on a hypothetical wheat canopy. The analysis of the raw data involved definition of zenith angle bins, outlined by the black lines.

INSIDE BACK COVER: Estimates of the solar energy intercepted in one day in each layer by each component of the wheat canopy were obtained through analysis of the laser data. In addition the use of laser analysis techniques can provide estimates of solar power distribution, leaf area index, projected foliage area, foliage area and orientation and other important canopy parameters.

## STAR INFORMATION FORM

1. Report No. 120776	2. Government Accession No.	3. Recipient's Catalog No.	
4. Title and Subtitle A Laser Technique for Characterizing the Geometry of Plant Canopies		5. Report Date January 1977	
		6. Performing Organization Code	
7. Author(s) V. C. Vanderbilt L. F. Silva and M. E. Bauer		8. Performing Organization Report No. 120776	
		10. Work Unit No.	
9. Performing Organization Name and Address Purdue University Laboratory for Applications of Remote Sensing 1220 Potter Drive West Lafayette, Indiana 47906		11. Contract or Grant No. NAS9-14016 NAS9-14970	
		13. Type of Report and Period Covered	
12. Sponsoring Agency Name and Address National Aeronautics and Space Administration Johnson Space Center Houston, Texas Technical Monitor: Dr. Jon Erickson		14. Sponsoring Agency Code	
		15. Supplementary Notes	
16. Abstract			
<p><b>ORIGINAL PAGE IS OF POOR QUALITY</b></p> <p>A measurement technique is needed which is capable of providing timely information concerning the geometric characteristics of a vegetative canopy, the location and orientation of its foliage. Such data is required as input to many models for the radiation regime in a canopy. Therefore, this report</p> <ol style="list-style-type: none"> <li>(1) proposes such a technique, designated the 'laser technique,'</li> <li>(2) demonstrates the feasibility of the technique, and</li> <li>(3) offers suggestions for the implementation of the technique.</li> </ol> <p>Several kinds of information can be obtained using the laser technique. Two are examined. First, the interception of solar power by the canopy is investigated as a function of solar zenith angle (time), component of the canopy, and depth into the canopy. Second, the projected foliage area, cumulative leaf area, and view factors within the canopy are examined as a function of the same parameters.</p> <p>Two systems are proposed that are capable (1) of describing the geometrical aspects of a vegetative canopy and (2) of operation in an automatic mode. Either system would provide sufficient data to yield a numerical map of the foliage area in the canopy. Both systems would involve the collection of large data sets in a short time period using minimal manpower.</p>			
17. Key Words (Suggested by Author(s)) Laser Probe, Laser Technique, Crop Canopies, Plant Geometry, Point Quadrat, Power and Energy in Plant Canopies		18. Distribution Statement	
19. Security Classif. (of this report) Unclassified	20. Security Classif. (of this page) Unclassified	21. Number of Pages	22. Price*

#### ACKNOWLEDGEMENT

The authors acknowledge Drs. R. M. Hoffer, T. W. Mullikin, W. H. Stevenson, and W. L. Weeks for review of the manuscript. They acknowledge J. S. Ahlrichs, L. L. Biehl, R. W. Burch, W. W. Freestone, L. D. Rice, B. F. Robinson, A. S. Vanderbilt, J. N. Vanderbilt and personnel, too numerous to list, of the Laboratory for Applications of Remote Sensing for their timely contributions throughout the process of data acquisition and analysis. They thank E. French, manager of the North Dakota Agricultural Experiment Station at Williston, ND, and A. Owan, owner of the wheat field at Williston, ND, where wheat data were collected. They thank O. W. Luetkemeier, manager, Purdue University Agronomy Farm, W. Lafayette, Indiana, where corn data were collected. The research was truly a team effort.

## TABLE OF CONTENTS

	Page
LIST OF TABLES . . . . .	v
LIST OF FIGURES . . . . .	vii
ABSTRACT . . . . .	ix
CHAPTER I. INTRODUCTION . . . . .	1
CHAPTER II. REVIEW OF THE LITERATURE . . . . .	3
A. Mathematical models in the literature . . . . .	3
B. Methods of mathematical measurement of canopy structure . . . . .	4
1. Leaf area index . . . . .	4
2. Density function for location and direction . . . . .	4
3. Gap frequency . . . . .	4
a. Hemispherical photographs . . . . .	5
b. Photocell on a track . . . . .	5
c. Point Quadrats . . . . .	5
(1) Work by Warren Wilson . . . . .	5
(2) Apparatus . . . . .	6
(3) Foliage distribution with angle . . . . .	6
4. Other techniques . . . . .	7
5. Summary of methods . . . . .	8
C. Summary of review of literature . . . . .	8
CHAPTER III. EXPERIMENTAL AND ANALYTICAL METHODS . . . . .	9
A. Introduction . . . . .	9
B. Laser technique implemented on wheat . . . . .	10
1. Equipment used . . . . .	10
2. Measurement procedure . . . . .	10
3. Ground truth data collected . . . . .	11
4. Analysis of ground truth . . . . .	12
C. Laser technique implemented on corn . . . . .	12
1. Equipment used . . . . .	13
2. Measurement procedure . . . . .	13
3. Ground truth data collected . . . . .	14
4. Analysis of ground truth data . . . . .	14
CHAPTER IV. RESULTS . . . . .	19
A. Introduction . . . . .	19
B. A postulate . . . . .	20
C. Preliminary data analysis . . . . .	21
1. Intensity . . . . .	21
2. Absorption coefficient . . . . .	22
3. Intercepted flux . . . . .	23

D.	Power and energy in a wheat canopy . . . . .	23
1.	Preliminary analysis . . . . .	23
2.	Distribution of solar flux . . . . .	25
a.	Distribution by time and surface . . . . .	25
b.	Intercepted by layer . . . . .	27
c.	Energy by layer and component . . . . .	30
E.	Analysis of corn laser data . . . . .	33
1.	Preliminary analysis . . . . .	33
a.	Absorption coefficient . . . . .	33
b.	Light attenuation . . . . .	36
2.	Calculation of view factors . . . . .	38
a.	Observation of one surface from another surface . . . . .	38
b.	Observation of a component from a surface . . . . .	39
CHAPTER V. DISCUSSION . . . . .		44
A.	Advantages of laser technique . . . . .	44
1.	Potential automation . . . . .	44
2.	Other advantages . . . . .	45
B.	Limitations to laser technique . . . . .	45
1.	Data acquisition speed . . . . .	45
2.	Wheat, accuracy limitations . . . . .	46
a.	Quantization . . . . .	46
b.	Point spread function of laser beam . . . . .	46
c.	Canopy motion . . . . .	47
d.	Alternate analysis procedures . . . . .	47
3.	Corn, accuracy limitations . . . . .	48
a.	Quantization and canopy motion . . . . .	48
b.	Point spread function of beam . . . . .	48
C.	System design considerations . . . . .	48
1.	Specifications of optimal system . . . . .	48
2.	Descriptions of two realizable systems . . . . .	49
a.	Narrow beam system . . . . .	49
b.	broad beam system . . . . .	50
3.	Advantages and disadvantages of the broad beam system . . . . .	51
4.	Use of pattern recognition algorithms . . . . .	52
CHAPTER VI. SUMMARY AND CONCLUSIONS AND SUGGESTIONS FOR FURTHER RESEARCH . . . . .		53
BIBLIOGRAPHY . . . . .		55
APPENDIX . . . . .		59

## LIST OF TABLES

Table	Page
1. Coefficients, $a(i)$ , of seventh degree polynomial, $F_{nk}(n,1)$ .	11
2. Values of solar zenith and solar flux for the date 30 July 1975, at Williston, North Dakota.	11
3. Values of leaf area and average leaf height for canopy of corn by leaf number.	16
4. Number of leaves of corn by leaf number and layer number. Units are (number of leaves). A '-' signifies zero leaves.	16
5. Values of matrix, $M(i,k)$ . (unitless) A '-' signifies a value of 0.0.	17
6. Values of leaf area for green, dead, and total foliage and leaf area index by layer.	18
7. Values of matrix, $N_{jk}$ , for wheat canopy in units of (number of hits). A '-' signifies zero hits.	24
8. Values of matrix, $I_{jk}$ , for wheat canopy (dimensionless).	24
9. Values of matrix, $A_{jk}$ , for wheat canopy (dimensionless).	25
10. Distribution of solar flux in the wheat canopy. Units are (watts/square meter).	26
11. Solar Flux in the wheat canopy, $AB_{ik}$ , in units of (watts/square meter of layer).	28
12. Distribution of energy in the wheat canopy. Units are (watt-hours/square meter of layer).	31
13. Distribution of energy in the wheat canopy. Units are (percent).	32
14. Values of matrix, $N_{jk}$ , for the corn canopy.	33

15.	Values of matrix, $I_{jk}$ , for the corn canopy (dimensionless).	34
16.	Values of matrix, $A_{jk}$ , for the corn canopy (dimensionless).	34
17.	Values of the absorption coefficient, $K_{jk}$ , for the corn canopy. Units are (1/meters).	35
18.	Tabulation of total cross-sectional area and leaf area index (LAI) by layer in the corn canopy. Units are (square meters of foliage/square meter of layer).	36
19.	Values of matrix, $P(j,k,p)$ , for the corn canopy (dimensionless).	40
20.	Values of matrix, $P(H:m,p,q)$ , for the corn canopy (percent).	42
21.	Values of matrix, $P(H:m,p,q)$ , for the corn canopy (percent).	43
Appendix		
Table		
A1.	Values of matrix, $N_{jk1}$ , for wheat canopy. Units are (number of hits). A '-' signifies zero hits.	59
A2.	Values of solar flux in the wheat canopy, $AB_{ik1}$ . Units are (watts/square meter of layer).	60
A3.	Values of the matrix, $N_{jk1}$ , for the corn canopy. Units are (number of hits). A '-' signifies zero hits.	61
A4.	Values of the matrix, $A_{jk1}$ , for the corn canopy (dimensionless).	62
A5.	Values of absorption coefficient, $K_{jk1}$ , for the corn canopy. Units are (1/meters)	63
A6.	Values of matrix, $IUP$ , for the corn canopy (dimensionless).	64
A7.	Values of matrix, $P(H:m,p,q)$ , for the corn canopy (percent).	65
A8.	Values of matrix, $P(H:m,p,q)$ , for the corn canopy (percent).	66



## LIST OF FIGURES

Figure	Page
1. The laser technique was implemented in a wheat canopy. The height of the first impact of the laser beam with the canopy, a 'hit,' was measured for each hit as well as the ground distance of the hit from the laser.	9
2. Plan view of the wheat experimental plot. Laser was positioned sequentially over each 'x.'	10
3. Profile view of wheat experiment. The 'x' marks the ground location of the laser.	10
4. Structure of wheat plant	12
5. Plan view of the corn experimental plot. Laser was positioned sequentially over each 'x.' Each 'O' indicates a ground zero location.	12
6. Profile view of corn experiment. The 'x' marks the ground location of the laser.	13
7. The vegetative canopy was divided into layers of equal thickness. A surface separates two layers. Surface, k, is above layer, k, and below layer, k-1.	18
8. Solar flux, $AF_{ik}$ , for the date 30 July 1975.	26
9. Solar flux, $AF_{ik}$ , for the date 30 July 1975.	27
10. Solar flux, $AB_{ik}$ , intercepted by foliage (or soil) in each layer of the wheat canopy for 30 July 1975.	28
11. Solar flux, $AB_{ik}$ , intercepted by foliage (or soil) in each layer of the wheat canopy for 30 July 1975.	29
12. Solar flux, $AB_{ik1}$ , intercepted by each component in each layer in the wheat canopy for 30 July 1975.	29

13.	Percent of solar flux intercepted by . . . . .	30
	each component of the wheat canopy for	
	30 July 1975.	
14.	Solar flux, ABik1, intercepted by heads . . . . .	30
	and awns of each layer of the wheat	
	canopy for 30 July 1975.	
15.	Solar flux, ABik1, intercepted by leaves . . . . .	31
	and stems of each layer of the wheat	
	canopy for 30 July 1975.	
16.	Solar energy intercepted by components . . . . .	16
	of each layer of the wheat canopy for 30	
	July 1975.	
17.	Block diagram of narrow beam system . . . . .	49
18.	Block diagram of broad beam system . . . . .	50
19.	Amplitude response of photodetector . . . . .	51
	of broad beam system.	

## ABSTRACT

A measurement technique is needed which is capable of providing timely information concerning the geometric characteristics of a vegetative canopy, the location and orientation of its foliage. Such data is required as input to many models for the radiation regime in a canopy. Therefore, this report

- (1) proposes such a technique, designated the 'laser technique,'
- (2) demonstrates the feasibility of the technique, and
- (3) offers suggestions for the implementation of the technique.

Basically, the method, a variant of the point quadrat method, involves aiming a collimated light beam of very small cross section at a canopy and measuring the height at which the beam first hits a component of the canopy. Lasers are particularly well-suited to provide the small, intense beam required.

Several kinds of information can be obtained using the laser technique. Two are examined. First, the interception of solar power by the canopy is investigated as a function of solar zenith angle (time), component of the canopy, and depth into the canopy. Second, the projected foliage area, cumulative leaf area, and view factors within the canopy are examined as a function of the same parameters.

Feasibility of the proposed method is verified using data obtained from two vegetative crop canopies, wheat (*Triticum aestivum* L.) and corn (*Zea mays* L.).

Two systems are proposed that are capable (1) of describing the geometrical aspects of a vegetative canopy and (2) of operation in an automatic mode. Either system would provide sufficient data to yield a numerical map of the foliage area in the canopy. Both systems would involve the collection of large data sets in a short time period using minimal manpower.

## CHAPTER I

### INTRODUCTION

Images and data obtained from electrical-optical-mechanical devices such as cameras, return beam vidicons and line scanners have played an increasing role in the monitoring of earth's resources. Inventories of the wheat crop of the United States, monitoring of the spread of corn blight, and measuring the rate of desertification of the Sahel have been accomplished through the analysis of data obtained from such systems. Many of the airborne and spaceborne systems measure the radiation reflected from the earth's surface in the optical wavelengths. As such, the radiation reflected from a vegetative canopy is a boundary condition of the radiation regime in the canopy. The radiation regime depends in large part upon the structure of the canopy. An understanding of the dependence of the radiation regime in the canopy upon the canopy structure could potentially aid in the analysis of earth resources data returned by electrical-optical-mechanical systems.

Mathematical models have been promulgated to achieve understanding of the radiative transfer process in vegetative canopies. As discussed in Chapter II, such models involve, among many variables, a detailed mathematical description of the geometric characteristics of the canopy. The ideal data set, a foundation set for other sets, would contain detailed information concerning the location and orientation of foliage area within the canopy. The efficient, expeditious collection of geometrical data is central to a large body of research. Such data would serve as input to mathematical models for the radiation environment in a canopy. Yet, no system exists for analyzing canopies to yield the ideal data set.

A measurement technique capable of providing timely information concerning the location and orientation of foliage in a canopy is needed. Therefore, the objectives of this report are to

- (1) propose such a technique,
- (2) demonstrate the feasibility of the technique, and
- (3) offer suggestions for the implementation of the technique.

In Chapter III the technique, which involves the use of a low power laser, is proposed. Basically, the method, a variant of the point quadrat method, involves aiming a collimated light beam of very small cross section at a canopy and measuring the height at which the beam first hits a component of the canopy. Also recorded is the name of the component that was hit. Lasers are particularly well-suited to provide the small, intense beam required. The technique may be classified as a statistical simulation of sunlight.

Several kinds of information can be obtained using the laser technique. Two are examined here. First, the interception of solar power by the canopy is investigated as a function of solar zenith angle (time), component of the canopy, and depth into the canopy. Second, the projected foliage area,

cumulative leaf area, and view factors within the canopy are examined as a function of the same parameters.

The laser technique is the only method which has been used to identify directly individual canopy components as the intercepting elements of direct solar radiation. As a consequence it is also the only technique used to identify on a percentage basis the vegetative composition of the field of view of a line scanner or other such electrical-optical-mechanical device. Using the technique, calculation of the location of apparent projected foliage area is possible and view factors can be computed directly for any location in the canopy.

In Chapter IV feasibility of the proposed method is verified using data obtained from two vegetative crop canopies, wheat (*Triticum aestivum* L.) and corn (*Zea mays* L.).

In Chapter V two operational systems that are potentially capable of describing the geometrical aspects of a vegetative canopy are proposed. The systems, as envisioned, would operate in an automatic mode, allowing the acquisition of several million data points per man-hour of use. The analysis of these data would yield a numerical map of the foliage area in the canopy. Also in Chapter V several sources of error in the data that were analyzed in Chapter IV are discussed. Certain of the sources of error are significant barriers to the successful application of one or the other of the proposed systems to crops with various structural attributes. Measurement system-crop specificity based upon potential sources of error would offer a partial solution to the problem, albeit an undesirable one.

## CHAPTER II

### REVIEW OF LITERATURE

#### II.A. MATHEMATICAL MODELS

Numerous mathematical models for the radiation regime and photosynthetic activity in a vegetative canopy exist (See the review by Lemuer and Blad, 1974). Such models offer the potential of clarifying the role of structure in the radiation regime of a plant canopy.

Successful mathematical models of the radiation regime in a vegetative canopy involve the estimation of three flows of radiation - direct solar, diffuse skylight, and multiply scattered - as a function of position and direction in the canopy. The magnitude and direction of each flow is a function of two properties - the structural characteristics of the canopy and the spectral properties of its components (leaves, stems, etc). Input to such models, then, is generally of three types,

- (1) reflectance and transmittance spectra of canopy components,
- (2) direction, intensity, and spectral properties of the two radiation sources - direct sunlight, and diffuse skylight - illuminating the canopy,
- (3) detailed geometrical information concerning canopy structure.

Mathematical models described in the literature for the prediction of the canopy radiation regime in the visible and the thermal regions of the spectrum are numerous. Lemuer and Blad (1974) have reviewed the literature concerning canopy radiation models, but their review failed to reference many of the models that have been discussed in the literature. To quote Monteith (1969), "About half the literature published in the last 15 years is concerned with the development of more elaborate models - an indication that it is easier to investigate light distributions at the desk than in the field."

Monteith alludes to a universal problem. The acquisition of field data for both testing models and as input to models is not a trivial task. The input to models, as discussed above, is three faceted and includes both spectral and geometrical data. The spectral properties of the components of a canopy, the first input to a model, can be measured (Gausman, et al., 1969). The second input - the direction, intensity, and spectral properties of direct sunlight and diffuse skylight above the canopy - can be measured (Anderson, 1971) or estimated for average conditions (Anderson, 1966). However, the third input to a radiation model of the canopy, the measurement of detailed geometrical data concerning the structure of the canopy, is a more difficult undertaking. Excepting soil and stalks, the components of a vegetative canopy do not exhibit simple geometric shapes. Leaves are not squares nor triangles. A canopy by its very nature is a discontinuous arrangement of foliage. Discontinuities occur at foliage-air interfaces. Foliage forms curvilinear surfaces, that is, the normal to an elemental area

on a foliage surface is defined by an  $(x,y,z)$  location and by a  $(\theta,\phi)$  direction. The measurement of the canopy structure requires the determination of a function in  $(x,y,z,\theta,\phi)$ . Furthermore, a canopy is not regular as is a crystal and foliage is not uniformly spaced. No two plants in a canopy appear identical. Rather, measuring the canopy structure is a statistical problem and the functions in  $(x,y,z,\theta,\phi)$  must be statistical in nature. For example, the probability of finding foliage in a canopy between  $P_1, (x_1,y_1,z_1,\theta_1,\phi_1)$ , and  $P_2, (x_2,y_2,z_2,\theta_2,\phi_2)$ , is

$$\text{Probability} = \int_{P_1}^{P_2} f(x,y,z,\theta,\phi) dx dy dz d\theta d\phi$$

Two authors have categorized canopy structure on theoretical grounds (de Witt, 1965 and Nilson, 1971). The distribution of leaves with zenith angle was investigated by de Witt. He identified four classes of leaf distributions; horizontal, vertical, spherical, and a class with both vertical and horizontal leaves. Nilson summarized and proposed probability models for the dispersion of foliage. Foliage can be dispersed in regular fashion as a crystal lattice, in a completely random distribution, or clumped. He discussed in detail the application of the Poisson (or random), binomial, and Markov models to canopies.

## II.B. METHODS OF MATHEMATICAL MEASUREMENT OF CANOPY STRUCTURE

Many methods have been utilized to measure the canopy structure (Sestak, et al., 1971). No one method has proven suitable for use on all canopies, however, each method is applicable to specific types of canopies.

### II.B.1. LEAF AREA INDEX, LAI

Watson (1947, 1952) was the first person to define leaf area index (LAI). LAI is defined as the one sided area of all leaves above a unit area of ground. Several indexes closely related to LAI have been defined. Duncan, et al. (1967) developed an expression for the interception of direct beam radiation for a canopy involving the leaf area per increment of height. Warren Wilson (1963a) defines foliage density as the foliage area per unit volume of space. The foliage area is one-half the total foliage surface area. Monsi and Saeki (1953) and many other authors defined total downward cumulative leaf area index as the total leaf area per unit ground area between the top of the canopy and a considered depth. They empirically demonstrated that the attenuation of the direct solar beam in a canopy is exponentially related to downward cumulative leaf area index.

### II.B.2. DENSITY FUNCTION FOR LOCATION AND DIRECTION

Lemeur (1973) used a two-dimensional probability density function to describe the distribution of leaves with zenith and azimuth angles. Nichiporovich (1961) reported a plexiglass device for determining the angles of inclination of leaf blades with respect to the horizontal plane. Other authors have reported similar devices and several involving magnetic compasses. Loomis, et al. (1968) used a projection technique to measure the area and inclination angle of leaf segments of corn plants. Lang (1973) described an electronic apparatus which allowed coordinates in three dimensions to be collected in the field. Each leaf surface was approximated by a set of contiguous triangles. Leaf segment area and leaf segment azimuth and zenith angles were then calculated.

### II.B.3. MEASUREMENT OF GAP FREQUENCY

Many methods involve the measurement of the gap frequency of a canopy. Gap frequency is defined as the probability that a ray of light from above the horizontal will arrive, unattenuated, at a specified location in the canopy. Because 'gap frequency' is a probability, it is not actually a frequency. However, the term is commonly used in the literature. In general

gap frequency is a function of  $(x,y,z)$ , although most authors consider only variation of gap frequency as a function of depth in the canopy. Methods for the measurement of gap frequency follow.

### II.B.3.a. HEMISPHERICAL PHOTOGRAPHS

Bonhomme and Chartier (1972) used hemispherical photographs, taken with a fisheye lens, to study canopy structure (See the review by Anderson, 1971). The photographs were taken from the ground vertically up through the canopy on uniformly overcast days. Analysis of the photographs was accomplished using a simple analog-to-digital conversion apparatus. Using formulas developed by Warren Wilson (1963a), Bonhomme and Chartier analyzed data from a corn crop and a sweet potato crop to obtain the extinction coefficient, leaf area index, sunlit foliage area index and gap frequency at the soil surface.

The technique involving fisheye photographs probably requires the least time for data acquisition of all techniques. Moderate crop movement due to wind does not normally degrade the quality of the photographic data. Analysis of the photographic data is rapid using the apparatus of Bonhomme and Chartier (1972). Calculation of the foliage distribution with zenith angle is possible if the Fredholm integral is inverted (Miller, 1964). The hemispherical photograph technique does have disadvantages. If fisheye photographs are taken only at the soil surface, then a probability of gap can be calculated only for the soil surface. Bonhomme and Chartier had to average the results of the data analysis of 20 to 50 photographs to reduce the variance of the measurements to acceptable levels. (Although not noted by Bonhomme and Chartier, the variance estimate provided by the averaging process gives an indication of the uniformity of the canopy.) The bulk of the fisheye lens-camera system precludes collection of hemispherical photographs on dense compact canopies. The foliage of a dense canopy would be forced aside by the bulk of the camera and would clump around its periphery, leaving an absence of foliage above the lens. The photographs would record a disturbed canopy.

### II.B.3.b. PHOTOCELL TRAVERSING A HORIZONTAL TRACK

To estimate gap frequency Norman and Tanner, (1969), Lemeur, (1971), and numerous other authors used a technique involving a photocell mounted to a horizontal track in a canopy. The output of the photocell was monitored as the cell rapidly traversed the track. Estimation of gap frequency was accomplished using one of two methods. Gap frequency was equated with the ratio of average intensity measured over the length of the track in the canopy to the intensity measured above the canopy. Alternately, gap frequency was equated to the length of the sunlit portion of the horizontal track divided by the total length of the track. Both methods yield a spatially-averaged estimate of gap frequency of the canopy. The estimate, however, is valid only for the zenith and azimuth angles of the sun at the time of measurement and for the depth of the track in the canopy. Additionally, use of the technique requires that penumbra effects due to canopy foliage be considered. The technique involves a serial type of data collection and is time consuming.

### II.B.3.c. POINT QUADRATES

#### II.B.3.c.1. WORK BY WARREN WILSON

Warren Wilson (1959, 1960, 1963a, 1963b, 1965a, 1965b, 1967) analyzed canopy structure using the method of inclined point quadrats. The method involves the careful insertion of a pointed needle into the canopy at a particular set of zenith and azimuth angles. Data collection is accomplished by recording the location of each contact of the needle point with foliage. Also recorded are the zenith and azimuth angles of the needle.

Warren Wilson (1967) considered the penetration of sunlight into a canopy. He developed formulas and analyzed the theoretical function relating sunlit foliage area index to foliage area index to foliage zenith angle and point quadrat zenith angle (Warren Wilson, 1960, 1963a, 1965a, 1965b).



Central to the analysis is the formula of Reeve (Appendix to Warren Wilson, 1960) which relates projected leaf area to actual leaf area. For validity the Reeve formula requires two conditions; first, the foliage of a canopy must slope at only one zenith angle, and secondly, the foliage must slope non-preferentially toward all points of the compass. Lemuer (1973) found that the assumption that foliage is always uniformly distributed in azimuth is not a valid assumption. Hence, the Reeve formula cannot be applied universally.

Warren Wilson (1963b) analyzed errors in estimation of leaf area using point quadrats and found that errors could be large if large, unsharpened needles without pointed ends were used to measure small leaves. Warren Wilson found that the error could be as large as 100,000 per cent of actual value if blunt needles, 4 mm in diameter were used to measure short leaves, .1 mm wide. Conversely, he found that errors could be as small as 2 per cent of value if blunt needles, 2 mm in diameter, were used to measure infinitely long leaves 100 mm wide. To eliminate errors due to quadrat size Warren Wilson recommended the use of pointed needles.

Warren Wilson (1965b) analyzed the foliage distribution and light penetration for a canopy of lucerne using seven inclinations of quadrats. Additionally, he presented a theoretical discussion concerning foliage distribution and light penetration based upon the assumption that foliage is randomly dispersed (i.e. fits a Poisson distribution). He plotted the theoretical proportion of light intercepted by successive layers in a canopy, calculated for six sun inclinations and four foliage angles. Finally, he analyzed the validity of the assumption of random foliage dispersion, since the random dispersion assumed in theory is not necessarily present in the actual canopy. His analysis involved the characterization of canopies as containing either a clumped, random, or regular dispersion of foliage. Significant numbers of canopies were found to be either clumped or regular.

#### II.B.3.c.2. APPARATUS AND METHODS

Acquisition of point quadrat data using a needle requires a device to suspend the needle rigidly in two directions while allowing it to slip axially into the canopy in the third direction. Warren Wilson (1963b) illustrated such an apparatus with three legs, and a height of 70 cm, constructed of duralumin and brass. Woodell and Boorman (1966) described an inexpensive, compact, and durable point quadrat apparatus. Winkworth and Goodall (1962) discussed the construction of a crosswire sighting tube for point quadrat analysis. Knight (1973) reported the use of a motorized point quadrat frame in the determination of leaf area index in the Pawnee Grassland in northeastern Colorado. Knight used a formula for LAI developed by Warren Wilson (1963b) involving point quadrat measurements at three zenith angles, eight degrees, 32.5 degrees, and 65 degrees. Knight usually observed 350 needles at the eight degree angle and 750 needles at 32.5 and 65 degree angles. He reported 18 man-hours were required for one LAI determination.

#### II.B.3.c.3. POINT QUADRAT: FOLIAGE DISTRIBUTION WITH ANGLE

Miller (1964, 1967) and Philip (1965a, 1965b, 1966a, 1966b) described equations for the calculation of foliage distribution with zenith angle. The equations involve point quadrat data.

Miller (1964) described a formula for calculating the distribution of normals to the elemental areas as a function of zenith angle involving point quadrat observations obtained as a function of zenith angle. He first calculated average projected area in a direction of an elemental area assuming the zenith and azimuth angles of the normal to the elemental area were distributed measurably in zenith and uniformly in azimuth. He used the Reeve equation as the kernel in a linear integral transformation of the probability density function of normals to the elemental areas. Then, Miller derived an implicit solution for the inversion of the transformation. He obtained a formula involving third order derivatives for the probability density function of normals to the elemental areas involving point quadrat observations obtained as a function of zenith angle. Wang (1970) has reviewed certain techniques for the inversion of Fredholm integrals of the

first kind.

Miller (1967) also described an integral formula for average foliage density involving only point quadrat observations obtained as a function of zenith angle. Leaf area index is the integral of average foliage density.

Philip (1965a) calculated the foliage zenith angle density function for a canopy of lucerne using the Miller (1964) formula and point quadrat data. Miller (1967) noted that (Philip 1965a) did not clarify possible errors in the methods he used. Philip (1965b) analyzed the height and radial variation of foliage area in data obtained by Warren Wilson (1965) for a three-year-old population of 15 well-separated old-man saltbush plants. Philip (1966a, 1966b) extended the formula of Miller (1964) to stems.

Philip (1966b) considered statistical aspects of the use of point quadrats. He discussed optimal strategies for estimating foliage density and he developed a formula for estimating the number of point quadrat observations needed to attain a desired accuracy in the estimation of foliage area.

The technique of point quadrats, while time consuming to implement, continues to be used. Presumably, the technique remains viable because it is less time consuming, yet sufficiently accurate, compared to other methods when implemented on grasses and other low lying canopies. When the assumption of uniform foliage distribution in azimuth is valid, the calculation of foliage angle distribution with zenith is possible using point quadrat data (Miller, 1964). Application of the technique is generally limited to low lying canopies for which a suitable apparatus can be fabricated to support the quadrat needle. The technique is also limited to use on canopies on calm days or on canopies sheltered from the effects of wind.

#### II.B.4. OTHER TECHNIQUES

Smith, et al. (1975) used several techniques to obtain the leaf angle distribution of a wheat canopy. In applying the Fredholm inversion technique they obtained an estimate of probability of gap through the analysis of a series of photographs of a plot taken at several zenith angles of view. Their analysis consisted of overlaying on each photograph a transparent dot grid and recording the proportion of dots which do not intersect a foliage element.

The diffraction pattern technique is a second method Smith, et al. used to obtain leaf angle distributions. The technique involves the calculation of the two dimensional Fourier transform of a high contrast photo taken of a clump of wheat plants located in front of a white back drop. Photographs are taken of wheat clumps from two orthogonal directions. The amplitude of the Fourier transform of each photograph provides information concerning the thickness and average slope of the foliage in the photograph. Data reduction procedures involve the photographs of the wheat clumps taken in two directions and either (1) information obtained previously concerning the average azimuthal structure in a wheat canopy or (2) assumptions concerning the azimuthal distribution of foliage. Smith does not discuss a technique involving three orthogonal photographs. The Smith diffraction technique can be viewed as an adaptation of X-ray diffraction techniques involving auto-correlation.

Smith, et al. discussed a third technique which involves photographs of a wheat plant taken from two orthogonal directions. The photographs are digitized and the plant numerically reassembled using a computer program. The foliage angle distributions are then calculated by averaging the results of several plants. Smith did not explain why only two orthogonal photographs rather than three are required. The two-orthogonal photograph technique is not an in situ method and cannot, therefore, provide information concerning foliage dispersion. Smith has not rigorously justified his methods and, consequently, their validity cannot be closely scrutinized.

### II.B.5. SUMMARY OF METHODS

Cameras are parallel processors of information. Data collected using the hemispherical photograph technique are obtained in parallel over azimuth and zenith angles and serially for  $(x,y,z)$  location. Data obtained using the point quadrat technique are acquired serially for  $(x,y,z,\theta,\phi)$ . Probably the techniques most often used involve measurement of the distribution of foliage directly, using the meter stick and protractor and compass. These techniques are generally destructive to the canopy, process data in a serial fashion, and data acquisition is time consuming.

### II.C. SUMMARY OF REVIEW OF LITERATURE

The measurement of vegetative canopy structure is an area of current research interest. Numerous measurement procedures have been advocated. Canopy structure has been measured using techniques involving a meter stick, protractor and compass, electronic position indicator, "fisheye" photograph, photocell on a track, point quadrat needle, Fourier transform of a photograph, and an orthogonal set of three photographs. No one technique has been universally adopted as being superior to others. Each method has advocates and advantages and is applicable to specific types of canopies. The implementation of each technique requires more than minor effort; one (point quadrats) required 18 man-hours to obtain an estimation of leaf area index.

## CHAPTER III EXPERIMENTAL AND ANALYTICAL METHODS

### III.A. INTRODUCTION

As the review of literature has demonstrated, an improved technique is needed for the analysis of the structure of a vegetative canopy which would overcome the disadvantages of present methods. The improved technique should be capable of providing the third required input listed above to radiation transfer models of a crop canopy. Such an improved technique should, (1) provide, for any crop, a statistical density function in  $(x,y,z,\theta,\phi)$  representative of the structure of the crop canopy; (2) be simple; (3) involve rapid data acquisition and analysis; (4) be applicable in a mild wind; (5) be applicable to a crop canopy of any height; (6) be non-destructive of the canopy, and (7) "invoke no ad hoc hypotheses and absurd assumptions" (Monsi, et al. 1973).

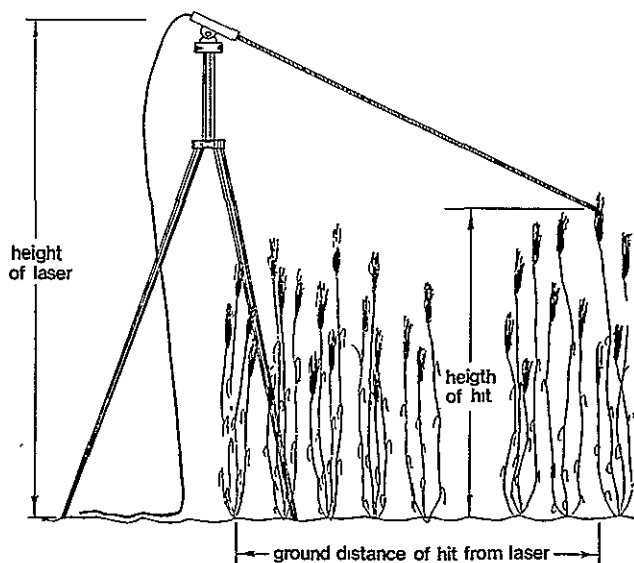

Figure 1. The laser technique. The height of the first impact of the laser beam with the canopy (a 'hit') was measured as well as the ground distance of the hit from the laser.

No such technique exists at present and it is doubtful if one could be developed. The specifications place particularly stringent restrictions upon the measurement method. However, techniques which meet almost all of the specifications and are superior to present methods should be developed.

In this report a variant of the point quadrat method called the laser technique is discussed and field tested. This method, in various forms, meets each specification listed above with varying degrees of success.

The laser technique was implemented on two canopies, corn and wheat, using a low power laser. Figure 1 illustrates the technique applied to wheat. The laser, Spectra Physics model 155 (Spectra

Physics Corporation, Mountain View, CA), was a HeNe gas laser nominally rated at 0.5 milliwatts of output light power with a wavelength of 0.6328 micrometers. The beam was nominally one millimeter in diameter at the exit orifice of the laser and diverged at an angle of one milliradian.

### III.B. LASER TECHNIQUE IMPLEMENTED ON WHEAT

The laser technique was first applied to a field of bearded spring wheat located near Williston, North Dakota, (48 degrees 10 minutes north latitude; 103 degrees 41 minutes west longitude). Wells, a durum variety released by the North Dakota Agricultural Experiment Station at Williston, was common to the Williston area during the summer of 1975. Data were collected on 30 July 1975 when the wheat was fully headed and in the dough stage of maturity (Large, 1954).

#### III.B.1. EQUIPMENT USED

Implementation of the laser technique on a wheat canopy required the laser, a source of 110vac power, a tripod with a pan head, a meter stick, a 100 foot tape measure, and three data collection assistants. The laser was mounted to the pan head and positioned over a row of wheat (figure 1). The azimuth direction of the pan head of the tripod was oriented so that the azimuth direction of the laser beam was across the rows. The tripod was adjusted such that the laser beam intersected the center of a row normal to the earth's surface. The height of the first impact of the beam with the canopy was measured and the component of the canopy (awn, head, leaf, stem, soil) that was hit was noted. The laser beam, being of finite cross-section, often hit foliage in the canopy at multiple locations. However, only data concerning the first hit were recorded. The end of the 100 foot tape was secured to the ground at the impact site, "ground zero." The tape was stretched at ground level across the rows.

Laser

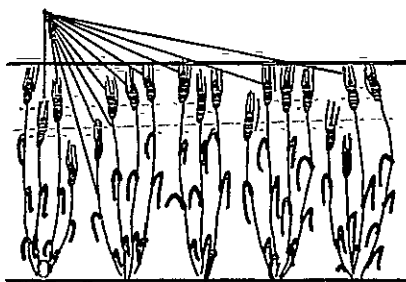

Figure 3. Profile view of wheat plot. The 'O' marks ground location of laser.

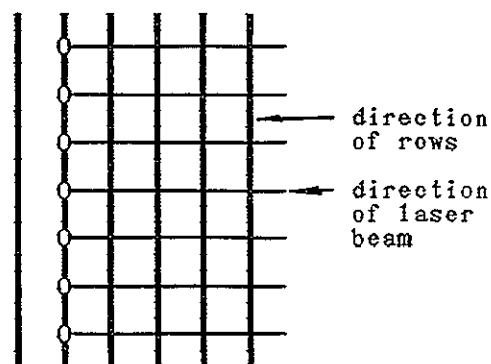

Figure 2. Plan view of wheat plot. Laser was positioned sequentially over each 'O.'

#### III.B.2. MEASUREMENT PROCEDURE

The data acquisition process, Figures 2 and 3, consisted of the following repeated in sequence:

(1) The zenith angle of the laser beam was incremented approximately 2.67 degrees by rotating a crank on the pan head 1.75 turns.

(2) The height of the impact of the laser beam was measured using the meter stick and the component that was hit was noted.

(3) The ground distance of the hit from ground zero was measured using the 100 foot tape.

(4) The process was repeated starting with step (1).

The process was continued until the zenith angle of the beam was greater than 80 degrees (less than 10 degrees from horizontal). Then, using the procedures above, a new "ground zero" site was selected and the process repeated. A total of seven ground zero sites were selected and each was the origin of an xyz coordinate system. Two hundred eighteen data points were obtained. The laser was always maintained at the same elevation above the ground, 1.10 meters. The zenith angle of the beam was not measured in the field. Rather, recording the (x,y,z) location of the laser and each hit allowed for the later computation of the zenith angle of the laser beam for each hit.

Incident solar radiation was monitored for 30 July 1975 at a

Table 2. Solar zenith and flux for 30 July 1975, Williston, ND

local time hours	solar zenith degrees	solar flux w/sq m
6.5	0.5	8.
7.0	5.0	57.
7.5	9.6	125.
8.0	14.4	203.
8.5	19.3	286.
9.0	24.3	368.
9.5	29.3	448.
10.0	34.3	523.
10.5	39.2	593.
11.0	43.9	657.
11.5	48.4	714.
12.0	52.6	763.
12.5	56.2	804.
13.0	59.1	836.
13.5	60.4	857.
14.0	61.6	868.
14.5	61.0	866.
15.0	59.2	851.
15.5	56.4	825.
16.0	52.9	785.
16.5	48.8	735.
17.0	44.3	672.
17.5	39.6	602.
18.0	34.7	525.
18.5	29.7	443.
19.0	24.7	360.
19.5	19.7	279.
20.0	14.8	204.
20.5	10.0	137.
21.0	5.3	75.
21.5	0.9	20.

Table 1. Coefficients of polynomial  $F_{nk}(n,1)$ , providing a functional relationship between local time and incident flux.

no.	coefficient
1	17222.45
2	- 10083.83
3	2407.080
4	- 308.7119
5	23.39899
6	- 1.047211
7	.02545412
8	- .0002580528

location adjacent to the field where laser data were collected. The monitoring equipment consisted of an Eppley pyranometer (Eppley Laboratory, Inc., Newport, Rhode Island) and a Rustrak 400A strip chart recorder (Gulton Industries, Inc., East Greenwich, Rhode Island). Data reduction procedures involved digitizing the plot of the incident flux at 0.25 hour intervals and then fitting a seventh order polynomial equation to the digital data. (The polynomial regression computer program was obtained from the "System/360 Scientific Subroutine Package, Version III Programmer's Manual," IBM Corporation, White Plains, New York.) The coefficients of the terms of the polynomial are tabulated (Table 1). For purposes of data analysis, the assumption was made that the total incident flux, as measured by the pyranometer, equaled the incident solar flux which arrived, unscattered, at the pyranometer after passage through the atmosphere. Then, the incident unscattered solar flux,  $F_{nk}(n,1)$ , at time,  $t_n$ , (local Williston, North Dakota, time) is given by the polynomial

$$F_{nk}(n,1) = a(1) + a(2) * t_n + a(3) * t_n^{**2} + a(4) * t_n^{**3} + a(5) * t_n^{**4} + a(6) * t_n^{**5} + a(7) * t_n^{**6} + a(8) * t_n^{**7} \quad (\text{watts/square meter}) \quad (\text{eq. III-1})$$

where \* signifies multiplication and \*\* signifies exponentiation such that  $t_n^{**4}$  indicates that  $(t_n)$  is raised to the power of 4.

Table 2 lists values of the polynomial.

### III.B.3. AGRONOMIC GROUND TRUTH DATA FOR WHEAT

Data were obtained with which to characterize the size and location of components of the wheat canopy. The stems in

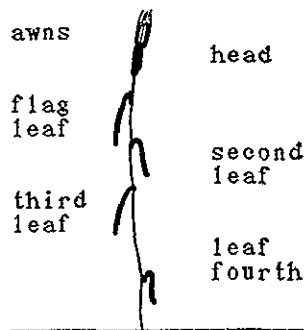

Figure 4. Structure of wheat plant.

four lengths of row, one meter long, were counted. The average of the four numbers was 84 stems per meter of row. The variance in the estimate was not computed. The average leaf area index of the four lengths of row was then calculated. First, the average leaf area per plant of a sample of 30 plants from each row length was calculated using the formula (Bauer, 1975),

$$\text{average leaf area per plant} = \frac{\sum \text{leaf length} \times \text{width} \times 0.75}{30 \text{ plant no.}}$$

To obtain leaf area index (LAI) the following formulas were used:

$$\text{leaf area meter of row} = \frac{\text{average leaf area plant} \times \text{plants meter of row}}$$

$$\text{LAI} = \frac{\text{leaf area meter of row}}{\text{ground area meter of row}}$$

Measured row width was 0.23 meter (9 inches). Average LAI for the lengths of row was 0.99.

### III.B.4. ANALYSIS OF GROUND TRUTH

To further characterize the field additional wheat samples from seven locations in the field were harvested. Each sample consisted of five plants. One half of the flag leaves of the 35 plants were chlorotic (Figure 4). All lower leaves were chlorotic. All harvested plants had flag leaves and leaves immediately below flag leaves ("second leaves"). Thirty three out of 35 harvested plants had "third leaves." Only four plants out of 35 had "fourth leaves." The height above ground at which each leaf departed the stem on each of the 35 plants was measured. For each plant the heights of the base of the head, tip of the head, and the topmost awn were measured. The diameter of the stem of each plant was also measured near the soil, just below the head and at the midpoint of the plant. The diameter of the head of each plant was measured. All measurements were made using a meter stick, 30 cm ruler, and vernier calipers.

### III.C. LASER TECHNIQUE IMPLEMENTED ON CORN

The laser technique was implemented on a field of corn located at the Purdue University Agronomy Farm, West Lafayette, Indiana (86 degrees 59 minutes west longitude; 40 degrees 38 minutes north latitude).

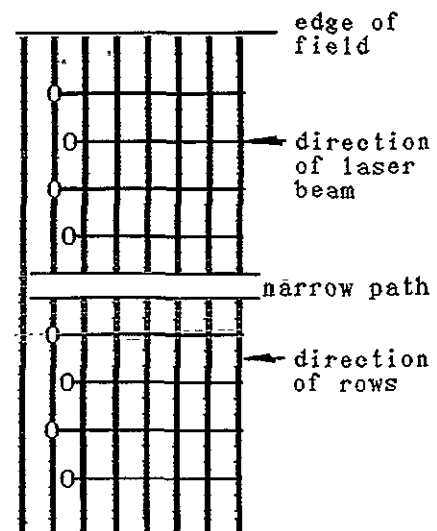

Figure 5. Plan view of corn plot. Laser was positioned sequentially over each '0,' a ground zero location.

The field was planted June 9, 1975, to Funk Brothers "supercross 5440." Data were collected during the days of 27, 28, 29, and 30 September 1975 when the corn canopy was in the dent stage of maturity (Hanway, 1963).

### III.C.1. EQUIPMENT USED

Implementation of the laser technique on a corn canopy required equipment similar to that used for data collection on wheat. However, instead of a tripod, the bucket of a "Hi-Ranger" vehicle served as a mobile aerial platform on which to mount the laser. Data collection procedures were also similar. The laser was mounted to a pan head secured to the bucket of the Hi Ranger. The bucket was positioned over a row of corn three to 10 meters into the field and 240 inches (6.1 meters) above the ground. Optimally, the laser should be located as far as possible above the canopy. Consequently, a height of 240 inches represents a compromise between (1) the need to position the laser far above the canopy, (2) the need to contain the experiment within a reasonably sized field, and (3) the need to complete the experiment with the physical resources available. Additional considerations are the row structure of the corn and the spreading properties of the laser beam (the effect of the laser beam diameter on the quality of the data is discussed in Chapter V.). The azimuth direction of the pan head was oriented so that the azimuth direction of the laser beam was across the rows of corn.

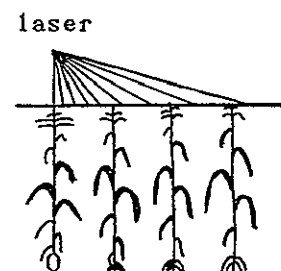

Figure 6. Profile view of corn plot.

### III.C.2. MEASUREMENT PROCEDURE

The location of the bucket and the orientation of the pan head were adjusted such that the laser beam was normal to the earth's surface and intersected either the center of a corn row or the center of the space between rows. The height of the impact of the beam with the canopy was measured. The component of the canopy (tassel, leaf, stalk, ear, soil) that was hit was recorded. Only the first impact of the beam with the canopy was measured and the foliage element which was first hit was not moved aside to allow the beam to penetrate further into the canopy. The 100 foot tape was stretched at ground level across the rows down a narrow path, a path that was cut through the corn canopy to facilitate data collection. The end of the tape was secured to the ground in the path adjacent to the impact site, "ground zero." The site of ground zero was at one end of the path and one to three meters into the canopy. The end of the tape served as the origin of an xyz coordinate system. Laser data were collected on either side of the path one to three meters into the canopy. The data acquisition process, Figures 5 and 6, consisted of repeating, in succession, the following:

- (1) The zenith angle of the laser beam was incremented approximately 0.75 degree by rotating a crank on the pan head 0.5 turns.
- (2) The height of the impact of the laser beam was measured using a stick, graduated in inches, and the component of the canopy that was hit was noted.
- (3) The ground distance of the hit from ground zero was measured using the 100 foot tape. The measurement was accomplished by noting the location of the hit relative to rows and projecting that location back to the 100 foot tape, located in the narrow path.
- (4) The process was repeated starting with step (1).

The process continued until the zenith angle of the beam was greater than 75 degrees. Then a new ground zero site was chosen in either (1) the center of the row or (2) in the center of the space between rows. Each site was chosen alternately. Data were acquired during evening hours under reduced ambient light conditions to allow ready identification of the location of the impact of the laser beam with foliage. During each evening of data collection, eight ground zero sites were chosen, four on each side of the narrow path. The four ground zero locations in a set were selected in sequence approximately one-half meter apart. To facilitate data collection



the 100 foot tape remained secured to the ground in the path adjacent to the original ground zero site. The end of the tape served as the origin of the xyz coordinate system for all data collected during one evening. A total of 1870 laser data points were measured during four evenings of data collection. Data were collected from a different location in the corn field each evening. The 100 foot tape was removed to the new location each evening. The laser was always maintained at the same elevation above the ground, 240 inches (6.1 meters). The zenith angle of the beam was not measured in the field. Rather, recording the (x,y,z) coordinates of the laser and each hit allowed for the later computation of the zenith angle of the laser beam for each hit.

### III.C.3. AGRONOMIC GROUND TRUTH FOR CORN

Data were obtained with which to characterize the size and location of components of the corn canopy. Data, needed for the calculation of average leaf area as a function of plant height, was obtained. Fifteen samples of two plants each were chosen at random locations in the field. The length, width, and leaf number were recorded for each leaf on each plant. Leaf number for a corn plant leaf is defined as the cumulative count of leaves from the ground to the considered leaf. Additionally, a viability estimate was made for each leaf. Viability for each leaf is the estimated proportion of healthy green foliage on the leaf.

Fifteen additional samples of two plants each were chosen at random in the field. For each plant the height of the center of the foliage of each leaf was measured. The leaf number was recorded. The average width of the rows was 0.76 meters (30 inches). The number of plants per 30.5 meters (100 feet) of row was counted at six locations in the field. Each location was chosen at random.

The corn borer, *Ostrinia Nubilalis* (Hubner), is capable of significantly altering the geometric structure of an infested corn plant. Because the laser experiment concerns the structure of the corn canopy, the magnitude of the infestation of corn bore in the field was measured by a census of infested plants in each sample of row 30.5 meters long. It was found that the upper portion of each stalk of fourteen percent of the plant population was no longer rigidly attached to the lower portion of each stalk. The upper portion of the stalk was on the ground, or it was hanging inverted beside the lower portion of the stalk. Or the upper stalk was lodged in foliage adjacent to the lower stalk. The fact that tassels were found near the ground corroborates the veracity of the analysis of the laser data in Chapter IV.

### III.C.4. ANALYSIS OF AGRONOMIC DATA FOR CORN

Analysis of the agronomic data involved calculation of the leaf area index (LAI). The analysis involved a linear transformation. First, the average leaf area and average height for each leaf number were computed for the 30 plants (Table 3) using the formulas

$$\text{average leaf area for leaf no(i)} = \frac{\sum_{j=1}^{30 \text{ plants}} \text{length} \cdot \text{width} \cdot 0.75 \text{ leaf}(i,j)}{\sum_{j=1}^{30 \text{ plants}} \text{leaf}(i,j)}$$

$$\text{average height of leaf no(i)} = \frac{\sum_{j=1}^{30 \text{ plants}} \text{height of leaf}(i,j)}{\sum_{j=1}^{30 \text{ plants}} \text{leaf}(i,j)}$$

The areas of green and dead foliage (Table 3) were computed using the

## formulas

$$\begin{array}{l} \text{average} \\ \text{green leaf} \\ \text{area of} \\ \text{leaf no(i)} \end{array} = \frac{\sum_j^{30 \text{ plants}} \text{area of leaf(i,j)} * \text{viability of leaf(i,j)}}{\sum_j^{30 \text{ plants}} \text{leaf(i,j)}}$$

$$\begin{array}{l} \text{average dead} \\ \text{leaf area of} \\ \text{leaf no(i)} \end{array} = \begin{array}{l} \text{total area} \\ \text{of leaf} \\ \text{no(i)} \end{array} - \begin{array}{l} \text{average green} \\ \text{leaf area of} \\ \text{leaf no(i)} \end{array}$$

The second step for calculating leaf area index involved determining the proportion of leaves by leaf number per layer in the canopy. The canopy was divided into ten layers, each layer being 0.3 meter thick (figure 7). Each leaf of each of the 30 plants was assigned a layer number, k, based upon the height of the center of the foliage of leaf(i,j). An array was computed (Table 4). Each (i,k) location in the array represents the total number of leaves for 30 plants with leaf number, i, and layer number, k. Each column of the array was normalized to obtain a matrix, M(i,k), (Table 5).

The final step for determining leaf area index involved the matrix equation

$$y = M x$$

where y(k) is the dead, green, or total leaf area by layer, k. The variable, x(i), is the dead, green, or total leaf area by leaf number, i. The leaf area index of a layer, k, was computed as

$$LAI_k(k) = y(k) / \text{ground area occupied by 30 plants}$$

and total leaf area index

$$LAI = \sum_k^{\text{all layers}} LAI_k(k)$$

Table 6 lists leaf area index and leaf area by layer.

Table 3. Average leaf area of the corn canopy, by leaf number.

	leaf area(sq cm)/leaf		
	no.	green	dead total
1	16.6	200.6	217.2
2	105.5	241.1	346.6
3	354.1	155.5	509.6
4	519.7	81.8	601.5
5	631.2	26.1	657.3
6	646.2	-	646.2
7	595.5	-	595.5
8	540.0	-	540.0
9	466.7	-	466.7
10	348.2	-	348.2
11	242.1	-	242.1
12	125.1	-	125.1
13	18.3	-	18.3

Table 4. Number of leaves of corn by leaf number and layer number. Units are (number of leaves). A '-' signifies zero leaves.

layer no.	leaf no(i)												
	1	2	3	4	5	6	7	8	9	10	11	12	13
2	29	17	3	-	-	-	-	-	-	-	-	-	-
3	1	8	10	6	4	-	-	-	-	-	-	-	-
4	-	5	9	7	4	-	-	-	-	-	-	-	-
5	-	-	8	11	7	8	7	1	-	-	-	-	-
6	-	-	-	6	14	13	5	5	1	-	-	-	-
7	-	-	-	-	-	9	14	6	3	1	1	-	-
8	-	-	-	-	-	-	4	18	18	5	3	1	-
9	-	-	-	-	-	-	-	-	8	24	18	7	3
10	-	-	-	-	-	-	-	-	-	-	6	11	2
11	-	-	-	-	-	-	-	-	-	-	-	-	-
sum=	30	30	30	30	29	30	30	30	30	30	28	19	5



Table 6. Values of leaf area for green, dead, and total foliage and leaf area index by layer.

layer no.	leaf area (sq cm/layer*plant)			leaf area index
	green	dead	total	
2	111.2	346.1	457.3	.246
3	337.7	142.8	480.5	.259
4	332.2	109.5	441.6	.238
5	766.6	77.8	844.4	.454
6	893.5	29.0	922.5	.496
7	646.7	-	646.7	.348
8	774.0	-	774.0	.417
9	615.7	-	615.7	.331
10	131.6	-	131.6	.071
11	-	-	-	-

leaf area index = 2.860

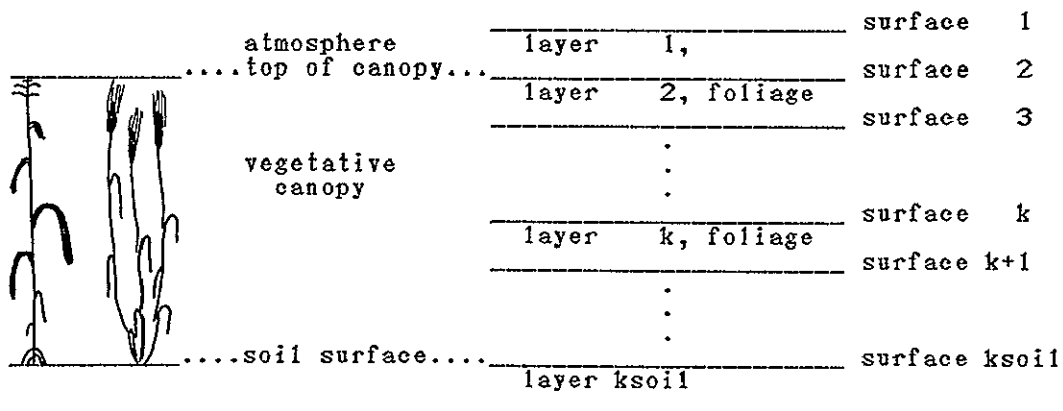

Figure 7. The vegetative canopy was divided into layers of equal thickness. A surface separates two layers. Surface, k, is above layer, k, and below layer, k-1.

## CHAPTER IV

### RESULTS

#### IV.A. INTRODUCTION

In the previous chapter the field procedures used during the laser experiment are discussed. In this chapter the laser data obtained using those procedures is analyzed. The analysis yielded numerical values for the following variables: absorption coefficient, intercepted direct beam solar energy and power; and view factors (Siegel and Howell, 1972) within the canopy.

The analysis of the laser data involved application of the theory of radiative transfer (Chandrasekhar, 1960, Siegel and Howell, 1972). In a source free, non-scattering, purely absorbing medium the radiative transfer equation describing the attenuation of a beam of light with depth,  $l$ , is

$$I(l) = I(0) \cdot \exp\left(-\int_0^l K(u) du\right) \quad (\text{eq. IV-1})$$

where

- $I(l)$  is the intensity of the beam in watts/square meter at depth,  $l$ , along the beam.
- $I(0)$  is the initial intensity of the beam.
- $K(l)$  is the absorption coefficient at depth,  $l$ , along the beam with units of 1/meters.
- $u$  is a dummy variable.

A vegetative canopy is, of course, not a source free, non-scattering, purely absorbing medium. Foliage in such a canopy, if observed in the visible region of the spectrum, would be black, and no optically black canopies exist. However, the nature of the measurement process used in the laser technique permits the use of equation IV-1. That is, during data acquisition, each laser 'hit' represented the interception of a ray of light by a component of the canopy, not the absorption of a ray of light. However, each hit stopped the forward travel of the laser beam as though the foliage were totally absorbing the beam. In order to develop the mathematical model describing the geometric structure of the canopy the assumption was made that the foliage did totally absorb the beam. Since the dispersion of the laser beam following the initial scattering by a component of the canopy was neither quantified nor monitored when data were acquired, such an assumption complements the experimental method. The assumption was made to permit analysis of the geometric, not spectral, properties of the canopy. It in no way identifies the spectral qualities of vegetative canopies. Furthermore, a scrutiny of the reasoning in this chapter will reveal that invoking the assumption in no way limits the scope of the report. Future research might well consider the effects of multiply scattered radiation in crop canopies. Such research is beyond the scope of this report which is fundamentally concerned with the measurement of the geometrical structure of a canopy, not

its radiation environment.

For analysis purposes the assumption was made that the canopy could be divided into layers of equal thickness (Figure 7). Each layer was assumed to contain an isotropic distribution of foliage in space. This assumption is, of course, untenable for analysis of data from most row crops. The foliage of crops planted in rows tends to clump along the rows. Consequently, invocation of the assumption must be defended, albeit inadequately, using other, extenuating circumstances; in the literature the assumption is frequently applied to the analysis of the structure of vegetative canopies (See Lemeur and Blad, 1974.). In a larger sense, however, the quality of the corn and wheat data, its complexity, does not justify a more rigorous analysis of it. As discussed in Chapter V, an analysis of a canopy in  $(x,y,z,\theta,0)$  not just in  $(z,\theta)$ , would require a much larger number of data points than were obtained from either the corn or the wheat fields described in Chapter III. As discussed in Chapter V, automated procedures would be required to adequately characterize the canopy in five space. Because an automated system was unavailable during data acquisition, data sufficient to characterize the canopy only in the vertical direction,  $z$ , and zenith angle,  $\theta$ , were acquired. The fact must be emphasized that the assumption of homogeneity in  $(x,y)$  is peculiar to the methods described in Chapter III. The assumption is not a prerequisite or cofactor to the laser technique. The feasibility of the laser technique is unaffected by whether or not the assumption is adopted, because implementation of the technique does not require its adoption.

The radiation transfer equation (eq. IV-1) was simplified to an equation compatible with digital analysis techniques. Arrays were substituted for continuous variables to obtain the equation,

$$I(j,p) = I(j,1) * \text{EXP} \left( - \sum_{k=1}^{p-1} \frac{K(j,k) * h}{\cos(\theta(j))} \right) \quad (\text{eq. IV-2})$$

where

- $K(j,k)$  is the absorption coefficient in the  $\theta(j)$  direction in layer,  $k$ .
- $h$  is the thickness of each layer.
- $I(j,k)$  is the intensity of the beam in the  $\theta(j)$  direction at the surface,  $k$ . As shown in Figure 7, surface,  $k$ , is between layer,  $k$ , and layer,  $k-1$ .
- $\theta(j)$  is the zenith angle of the beam, and can adopt any one of nine values,  $\theta(1)=5$  degrees,  $\theta(2)=15$  degrees,  $\theta(3)=25$  degrees,  $\theta(j)=(10j-5)$  degrees.

#### IV.B. A POSTULATE

All laser data (discussed in Chapter III) measured at a particular zenith angle represent the sites of interception of a beam of light by the foliage in the canopy. The proportion of laser hits at each location,  $(j,k,1)$ , (for the  $\theta(j)$  direction, layer,  $k$ , and component class,  $1$ ) equals the proportion of intercepted solar flux at each location,  $(j,k,1)$ , in the vegetative canopy for the case of the solar disc at zenith angle,  $\theta(j)$ .

The equality is postulated to hold provided three conditions are satisfied:

- (1) The cross-sectional area of the laser beam must be significantly smaller than the cross-sectional area of the individual components of the canopy. Ideally, the point spread function of the laser beam would be of zero diameter.
- (2) The fact that the solar disc is an extended source of radiation may

be neglected. (The solar disc occults 70 microsterradians of the heavens, about 0.5 degrees. If the sun must be regarded as an extended source, then the equality will hold provided integration is accomplished over the extent of the solar disc.)

(3) Laser data sufficient to allow reduction of measurement noise to acceptable levels are acquired.

As a consequence of the postulate, equation IV-2 may be utilized for the analysis of laser data.

#### IV.C. PRELIMINARY DATA ANALYSIS

All laser data points were assigned to bins in a three dimensional array. The assignment was accomplished on the basis of the zenith angle,  $\theta(j)$ , the layer,  $k$ , in the canopy, and the component class,  $l$ , that each point addressed. The number of points in a particular bin of the array,  $N_{jkl}(j,k,l)$ , equals the total number of impacts of the laser beam upon a particular component,  $l$ , of the canopy (leaves, for example), in a particular layer,  $k$ , of the canopy, and in a particular direction,  $\theta(j)$ , in the canopy. A matrix,  $N_{jk}(j,k)$ , two vectors,  $N_k(k)$  and  $N_j(j)$ , and a number,  $N$ , were defined:

$$N_{jk}(j,k) = \sum_{l=1}^{\text{all components}} N_{jkl}(j,k,l)$$

$$N_k(k) = \sum_{j=1}^{\text{all angles}} N_{jk}(j,k)$$

$$N_j(j) = \sum_{k=1}^{\text{all layers}} N_{jk}(j,k)$$

$$N = \sum_{j=1}^{\text{all angles}} N_j(j)$$

The matrix,  $N_{jk}(j,k)$ , identifies the number of data points in bins addressable by zenith angle index,  $j$ , and layer,  $k$ . The elements of the vector,  $N_k(k)$ , represent the number of data points in each layer,  $k$ . The elements of the vector,  $N_j(j)$ , represent the number of data points in each zenith angle window,  $\theta(j)$ . The number,  $N$ , identifies the total number of laser data points in the data set.

##### IV.C.1. INTENSITY, IJK

The average intensity of the laser beam as a function of direction,  $\theta(j)$ , and surface,  $k$ , in the canopy was defined. From the statement of the postulate above follows:

(1) All data points for a particular direction,  $\theta(j)$ , represent sites of interception of a beam of light in the canopy.

(2) Each site intercepts a portion of the beam equal to the proportion of laser hits at the site.

(3) The intensity of the beam in direction,  $\theta(m)$ , at surface,  $p$ , is given by



$$I(m,p) = I(m,1) * (1. - \sum_{k=1}^{p-1} N_{jk}(m,k)/N_j(m)) \quad (\text{eq. IV-3})$$

(4) Equation IV-2 and equation IV-3 are equivalent.

#### IV.C.2. ABSORPTION COEFFICIENT, KJK

The right half sides of the two equations, eq. IV-2 and eq. IV-3, may be equated and a solution found for the absorption coefficient of all components of layer, p, in direction, theta(m).

$$\begin{aligned} I(m,p)/I(m,1) &= (1. - \sum_{k=1}^{p-1} N_{jk}(m,k)/N_j(m)) \\ &= \sum_{k=p}^{k_{soil}} N_{jk}(m,k)/N_j(m) \\ I(m,p-1)/I(m,1) &= \sum_{k=p-1}^{k_{soil}} N_{jk}(m,k)/N_j(m) \\ I(m,p)/I(m,p-1) &= \frac{\sum_{k=p}^{k_{soil}} N_{jk}(m,k)}{\sum_{k=p-1}^{k_{soil}} N_{jk}(m,k)} \quad (\text{eq. IV-4}) \end{aligned}$$

$$\begin{aligned} I(m,p)/I(m,1) &= \text{EXP} \left( - \sum_{k=1}^{p-1} \frac{K(m,k) * h}{\cos(\text{theta}(m))} \right) \\ I(m,p)/I(m,p-1) &= \text{EXP} \left( - \frac{K(m,p-1) * h}{\cos(\text{theta}(m))} \right) \\ K(m,p-1) &= \cos(\text{theta}(m)) * \text{LN} \left( \frac{I(m,p-1)}{I(m,p)} \right) \quad (\text{eq. IV-5}) \end{aligned}$$

(provided the natural logarithm exists)

Substituting the right side of eq. IV-4 into eq. IV-5,

$$K_{jk}(m,p) = \frac{\sum_{k=p}^{ksoil} N_{jk}(m,k)}{\sum_{k=p+1}^{ksoil} N_{jk}(m,k)} \cdot \cos(\theta(m))/h \quad (\text{eq. IV-6})$$

The absorption coefficient,  $K_{jk}(m,p)$ , characterizing the attenuation of the direct solar flux for all components for direction,  $\theta(m)$ , and layer,  $p$ , is seen to be a function of the direction of view,  $\theta(m)$ , the thickness of each layer,  $h$ , and the number of laser hits in each bin of the matrix,  $N_{jk}$ . The absorption coefficient of a single component,  $q$ , (leaves, for example) of the canopy for a direction,  $j$ , and a layer,  $p$ , is a fraction of the absorption coefficient of all components.

$$K_{jkl}(m,p,q) = K_{jk}(m,p) \cdot N_{jkl}(m,p,q) / N_{jk}(m,p) \quad (\text{eq. IV-7})$$

The absorption coefficient can be equated to the total sunlit foliage area per unit volume of layer projected upon a plane normal to the sun's ray. As such, the coefficient,  $K_{jk}$ , is equal to the total cross-sectional area due to all components in a layer. For a canopy with a random dispersion of foliage the absorption coefficient,  $K_{jk}$ , is equivalent to the "apparent foliage denseness" of Warren Wilson, (1963).

#### IV.C.3. INTERCEPTED FLUX, $A_{jk}$

The change of the intensity across a layer,  $p$ , in direction,  $\theta(m)$ , is

$$A_{jk}(m,p) = I(m,p) - I(m,p+1) \\ = I(m,1) \cdot N_{jk}(m,p) / N_j(m) \quad (\text{eq. IV-8})$$

The contribution of a single component,  $q$ , to the change of the intensity across a layer,  $p$ , in a direction,  $\theta(m)$ , is

$$A_{jkl}(m,p,q) = A_{jk}(m,p) \cdot N_{jkl}(m,p,q) / N_{jk}(m,p) \quad (\text{eq. IV-9})$$

#### IV.D. POWER AND ENERGY IN A WHEAT CANOPY

The computation of the interception and attenuation of the power and energy in the direct solar beam in the wheat canopy involved three steps. The preliminary analysis involved computation of the value of each element of the arrays,  $I_{jk}$ ,  $A_{jk}$ , and  $A_{jkl}$ . Second, the interception of the direct solar flux in the canopy was computed as a function of time during the day of 30 July 1975, of layer in the canopy, and of component of the canopy. Finally, the energy of the direct solar beam intercepted in the canopy was computed as a function of depth and component.

##### IV.D.1. PRELIMINARY ANALYSIS, CALCULATION OF $I_{jk}$ , $A_{jk}$ , AND $A_{jkl}$

Each wheat laser data point was assigned to a bin of the three dimensional array,  $N_{jkl}(j,k,l)$ . Each bin in the array of wheat canopy data represented a ten degree zenith angle window, a layer in the canopy 0.1 meter thick, and one of five canopy components, awns, heads, stems, leaves, or soil. The array,  $N_{jkl}$ , of wheat data is tabulated in Table A1. The matrix,  $N_{jk}$ , is tabulated in Table 7.

Table 7. Values of matrix, Njk, for wheat canopy in units of (number of hits). A '-' signifies zero hits. Each entry signifies the number of laser hits in a particular layer and direction in the canopy.

Depth(m) <sup>*</sup>	Zenith Angle (degrees)								
	5	15	25	35	45	55	65	75	85
0.0-0.1	-	-	-	-	-	-	5.	13.	5.
0.1-0.2	-	-	-	1.	3.	8.	9.	12.	5.
0.2-0.3	-	1.	2.	5.	8.	5.	6.	1.	1.
0.3-0.4	3.	6.	-	3.	1.	6.	2.	-	-
0.4-0.5	1.	5.	3.	2.	4.	4.	1.	-	-
0.5-0.6	2.	3.	4.	6.	6.	2.	-	-	-
0.6-0.7	7.	2.	8.	1.	1.	-	-	-	-
0.7-0.8	1.	-	5.	3.	1.	-	-	-	-
0.8-0.9	3.	2.	-	-	-	-	-	-	-
0.9-1.0	1.	2.	3.	1.	-	-	-	-	-
soil	140.	3.	3.	2.	-	-	-	-	-

\*Indicates distance downward into the canopy from the tallest foliage in the experimental plot area.

Computation of the attenuating properties of the wheat canopy upon direct solar radiation completed the analysis of the laser data. Computation of numerical values for Ijk, Ajk, and Ajkl was accomplished and involved use of equations, IV-3, IV-8, and IV-9. The arrays, Ijk and Ajk, are tabulated in Tables 8 and 9. The proliferation of zero valued elements at locations in the arrays characterized by large zenith angles and/or the lower layers of the canopy is attributable to lack of laser data from such areas.

Table 8. Values of matrix, Ijk, for wheat canopy (dimensionless). Each column lists the intensity of a normalized light beam traversing the canopy downward and attenuated by foliage.

Depth(m) <sup>*</sup>	Zenith Angle (degrees)								
	5	15	25	35	45	55	65	75	85
.0	1.00	1.00	1.00	1.00	1.00	1.00	1.00	1.00	1.00
.1	1.00	1.00	1.00	1.00	1.00	1.00	.78	.50	.55
.2	1.00	1.00	1.00	.96	.88	.68	.39	.04	.09
.3	1.00	.96	.93	.75	.54	.48	.13	.0	.0
.4	.91	.71	.93	.63	.50	.24	.04	.0	.0
.5	.88	.50	.82	.54	.33	.08	.0	.0	.0
.6	.81	.38	.68	.29	.08	.0	.0	.0	.0
.7	.59	.29	.39	.25	.04	.0	.0	.0	.0
.8	.56	.29	.21	.13	.0	.0	.0	.0	.0
.9	.47	.21	.21	.13	.0	.0	.0	.0	.0
soil	.44	.13	.11	.08	.0	.0	.0	.0	.0

\* Indicates distance downward into the canopy from the tallest foliage in the experimental plot area.

Table 9. Values of matrix,  $A_{jk}$ , for wheat canopy (dimensionless). Each entry represents the proportion of the normalized light beam (listed in Table 8) intercepted by each layer.

Depth(m) <sup>a</sup>	Zenith Angle (degrees)								
	5	15	25	35	45	55	65	75	85
.0-.1	.0	.0	.0	.0	.0	.0	.22	.50	.45
.1-.2	.0	.0	.0	.04	.12	.32	.39	.46	.45
.2-.3	.0	.04	.07	.21	.33	.20	.26	.04	.09
.3-.4	.09	.25	.0	.13	.04	.24	.09	.0	.0
.4-.5	.03	.21	.11	.08	.17	.16	.04	.0	.0
.5-.6	.06	.13	.14	.25	.25	.08	.0	.0	.0
.6-.7	.22	.08	.29	.04	.04	.0	.0	.0	.0
.7-.8	.03	.0	.18	.12	.04	.0	.0	.0	.0
.8-.9	.09	.08	.0	.0	.0	.0	.0	.0	.0
.9-1.0	.03	.08	.11	.04	.0	.0	.0	.0	.0
soil	.44	.13	.11	.08	.0	.0	.0	.0	.0

<sup>a</sup> Indicates distance downward into the canopy from the tallest foliage in the experimental plot area.

#### IV.D.2. DISTRIBUTION OF SOLAR FLUX

Three distributions of solar flux in the wheat canopy were represented by the arrays,  $F_{nk}$ ,  $B_{nk}$ , and  $B_{nk1}$ . As discussed in Chapter III, the incident solar flux was measured above the canopy. Then, using the laser data, the solar flux was proportioned by layer to the various components of the canopy. At time intervals of one half hour the magnitude of the attenuated direct solar flux,  $F_{nk}(n,k)$ , was computed as a function of level,  $k$ , in the canopy. Also computed each half hour was the solar flux intercepted in each layer by each component,  $B_{nk1}(n,k,1)$ , and the solar flux intercepted in each layer,  $B_{nk}(n,k)$ . For each computation involving data obtained at time,  $t_n$ , the value of the zenith angle index,  $j$ , in the respective arrays,  $I_{jk}$ ,  $A_{jk}$ , and  $A_{jk1}$  was set equal to the zenith angle index of the solar disc at time,  $t_n$ . For example, at 10.0 hours, the solar zenith angle was 55.7 degrees; the index,  $j$ , was set equal to six in the arrays for all calculations involving data obtained at 10.0 hours.

##### IV.D.2.a. DISTRIBUTION OF SOLAR FLUX BY TIME AND SURFACE

Computation of the magnitude of the attenuated direct solar flux at a time,  $t_n$ , and a surface,  $k$ , in the canopy was accomplished with reference to the equation

$$F_{nk}(n,k) = F_{nk}(n,1) * I(m,k) \quad (\text{eq. IV-10})$$

where the index,  $m$ , is the index of the zenith angle of the sun at time,  $t_n$ , and the term,  $F_{nk}(n,1)$ , defined by equation III-1, is the solar flux, in watts per square meter, incident on the top surface of the canopy. The estimates of the solar flux in the canopy,  $A_{fik}(i,k)$ , at time,  $t_{ti}$ , were averaged over a time window 1.5 hours long:

$$A_{fik}(i,k) = (0.5 * F_{nk}(n,k) + F_{nk}(n+1,k) + F_{nk}(n+2,k) + 0.5 * F_{nk}(n+3,k)) / 3.0 \quad (\text{eq. IV-11})$$

Table 10. Distribution of solar flux in the wheat canopy. Units are (watts/square meter). Each column lists the intensity for a particular time of the direct solar beam traveling downward and attenuated by foliage in the canopy.

Surface (m)	Time (hours - local Williston, ND time)**									
	7.3	8.8	10.3	11.8	13.3	14.8	16.3	17.8	19.3	20.8
.0	96.	326.	556.	736.	843.	854.	756.	562.	321.	108.
.1	51.	219.	540.	736.	843.	854.	756.	546.	215.	55.
.2	7.	82.	378.	676.	826.	837.	695.	382.	81.	6.
.3	0.	26.	248.	480.	709.	718.	493.	251.	25.	0.
.4	0.	9.	147.	416.	658.	666.	428.	149.	8.	0.
.5	0.	0.	66.	326.	577.	584.	335.	67.	0.	0.
.6	0.	0.	9.	142.	412.	417.	146.	9.	0.	0.
.7	0.	0.	5.	112.	272.	276.	115.	5.	0.	0.
.8	0.	0.	0.	49.	144.	145.	50.	0.	0.	0.
.9	0.	0.	0.	49.	144.	145.	50.	0.	0.	0.
soil	0.	0.	0.	32.	81.	82.	33.	0.	0.	0.

\* Indicates distance downward into the canopy from the tallest foliage in the experimental plot area.

\*\* The solar zenith angle is listed as a function of time in Table 2. Solar noon occurred at 14.1 hours.

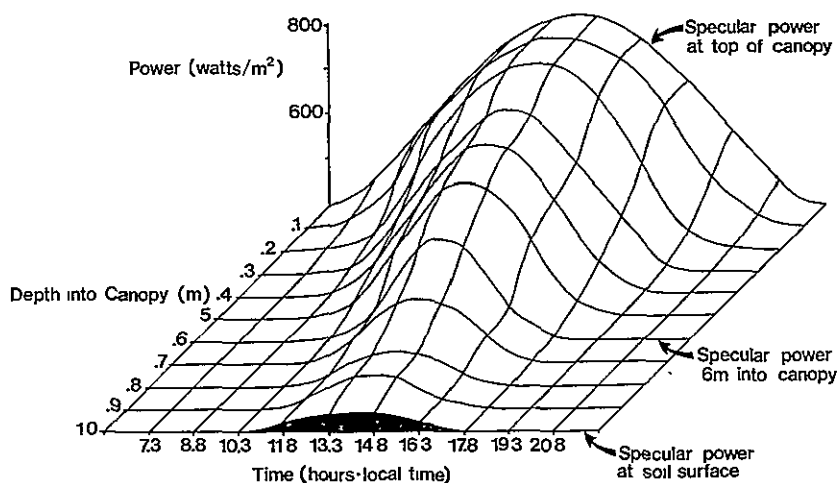

Figure 8. Solar flux,  $AF_{ik}$ , for 30 July 1975.

where  $tti = (tn+t(n+3))/2$ . (eq. IV-12)  
 and  $tt1 = (t1+t4)/2.0$   
 $ti2 = (t5+t8)/2.0$

The average direct beam solar flux decreases with depth in the canopy (Table 10 and Figures 8 and 9). Only near solar noon does an appreciable amount of the solar flux penetrate the total thickness of the canopy and illuminate the soil (Solar noon is defined as the time of solar zenith).

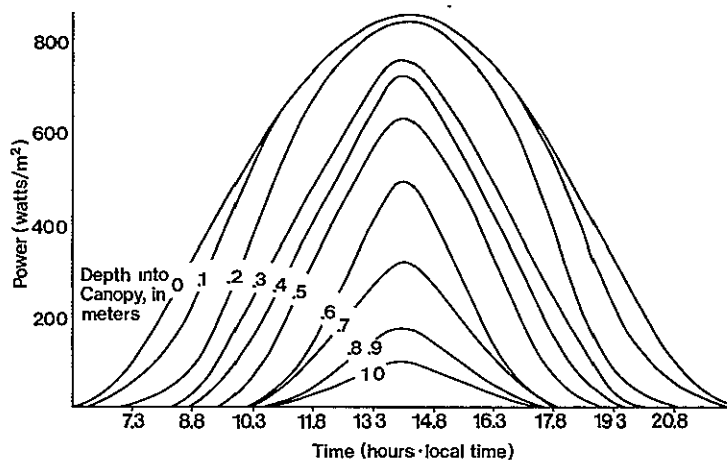

Figure 9. Solar flux,  $AF_{ik}$ , for 30 July 1975.

For 30 July 1975 that time was approximately 14.1 hours, local Williston, North Dakota, time.). At times near sunrise and sunset no significant solar flux filters even to the middle layers of the canopy.

#### IV.D.2.b. SOLAR FLUX INTERCEPTED BY LAYER

Computation of the direct beam solar flux intercepted in each layer of the canopy at a time,  $t_n$ , was accomplished with reference to the equation

$$B_{nk}(t_n, k) = F_{nk}(n, l) \cdot A(m, k) \quad (\text{eq. IV-13})$$

where index,  $m$ , is the index of the zenith angle of sun at time,  $t_n$ , and the term,  $F_{nk}(n, l)$ , is defined by equation, III-1. The estimates of intercepted solar flux were averaged over a time window 1.5 hours long:

$$AB_{ik}(i, k) = (.5 \cdot B_{nk}(n, k) + B_{nk}(n+1, k) + B_{nk}(n+2, k) + .5 \cdot B_{nk}(n+3, k)) / 3.0 \quad (\text{eq. IV-14})$$

where time,  $t_{ti}$ , is given by equation IV-12.

The magnitude of the direct solar beam flux intercepted by all components in a layer in the canopy varied during the course of the day (Table 11 and Figures 10 and 11). Note that laser data obtained for the canopy of wheat includes the variable 'depth in the canopy.' Depth is defined as the distance downward from the tallest wheat awn in the experimental plot area. Laser data obtained for the canopy of corn were measured by 'height in the canopy.' Height is defined as distance above the soil surface, the opposite of depth. At sun zenith angles near 90 degrees, near sunrise and sunset, only the foliage in the upper layers of the canopy intercepted direct solar flux. For a solar zenith angle of 75 degrees the value of the  $I_{jk}$  matrix reflects the fact that 96 percent of the incident solar flux was intercepted in the top two layers of the canopy. Near solar noon the foliage in the upper layers of the canopy intercepted a very small fraction of the direct solar flux incident on the canopy. Values of the matrix,  $I_{jk}$ , reflect that for the zenith angle of the sun at solar noon, 28 degrees, no significant portion of the solar flux is intercepted in the top two layers of the canopy. There is simply little foliage in the top layers to intercept significant flux.

Table 11. Solar Flux in the wheat canopy, ABik, in units of (watts/square meter of layer). Each entry represents the direct solar power intercepted by each layer in the canopy.

Depth(m) <sup>⊗</sup>	Time (hours - local Williston, ND time) <sup>⊗⊗</sup>									
	7.3	8.8	10.3	11.8	13.3	14.8	16.3	17.8	19.3	20.8
.0- .1	45.	107.	16.	0.	0.	0.	0.	16.	106.	53.
.1- .2	44.	137.	162.	60.	17.	18.	61.	163.	134.	50.
.2- .3	7.	56.	130.	197.	117.	119.	202.	132.	55.	6.
.3- .4	0.	17.	100.	63.	52.	53.	65.	101.	17.	0.
.4- .5	0.	9.	81.	90.	81.	82.	93.	82.	8.	0.
.5- .6	0.	0.	57.	184.	165.	167.	189.	58.	0.	0.
.6- .7	0.	0.	5.	31.	140.	141.	32.	5.	0.	0.
.7- .8	0.	0.	5.	63.	128.	130.	65.	5.	0.	0.
.8- .9	0.	0.	0.	0.	0.	0.	0.	0.	0.	0.
.9-1.0	0.	0.	0.	16.	63.	64.	17.	0.	0.	0.
soil	0.	0.	0.	32.	81.	82.	33.	0.	0.	0.

<sup>⊗</sup> Indicates distance downward into the canopy from the tallest foliage in the experimental plot area.

<sup>⊗⊗</sup> The solar zenith angle is listed as a function of time in Table 2. Solar noon occurred at 14.1 hours.

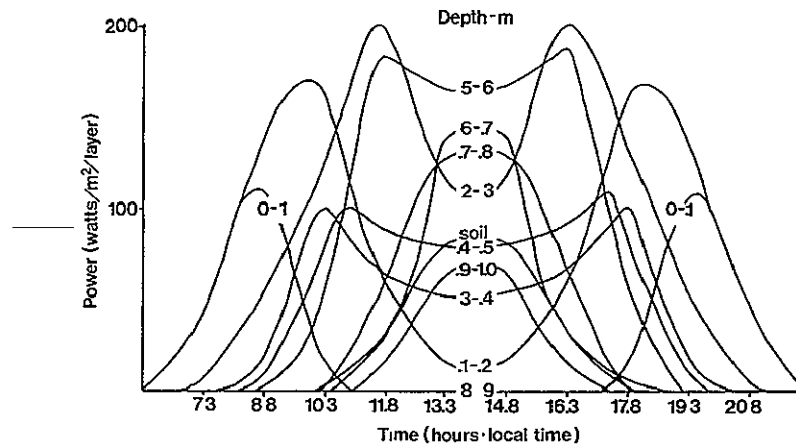

Figure 10. Solar flux, ABik, intercepted by foliage (or soil) in each layer of the wheat canopy for 30 July 1975.

The direct solar flux intercepted in each layer was proportioned to each component, 1, of the canopy in the layer according to the equation

$$Bnk1(n,k,1) = Fnk(n,1) * A(m,k,1) \quad (\text{eq. IV-15})$$

where index, m, is the index of the solar zenith angle at time, tn, and the term, Fnk(n,1), is defined by equation, III-1. The estimates of the intercepted solar flux were averaged over a time window 1.5 hours in duration.

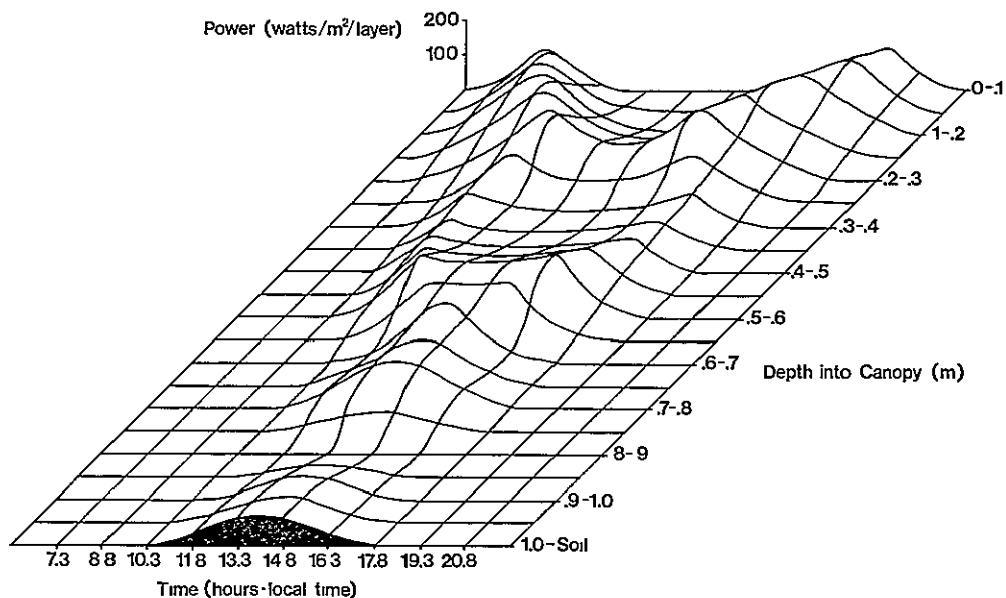
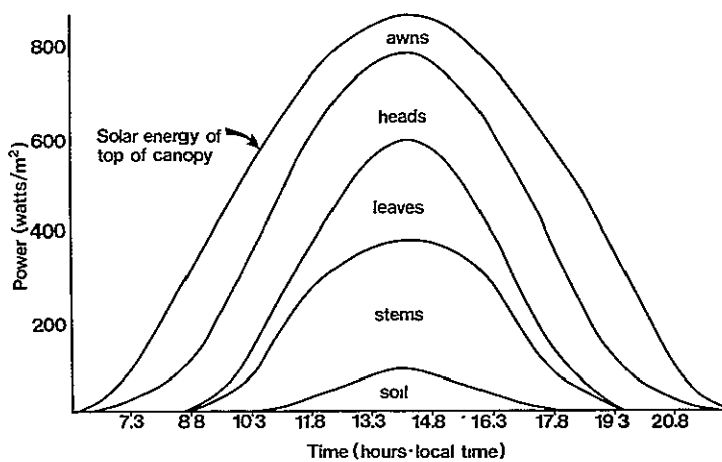

Figure 11. Solar flux, ABik, intercepted by foliage (or soil) in each layer of the wheat canopy for 30 July 1975.

Figure 12. Solar flux, ABik1, intercepted by each component in each layer in the wheat canopy for 30 July 1975.



$$ABik1(i,k,1) = (.5*Bnk(n,k,1)+Bnk1(n+1,k,1) + Bnk1(n+2,k,1)+.5*Bnk1(n+3,k,1))/3.0 \quad (\text{eq. IV-16})$$

where time, tti, is defined by equation IV-12.

The magnitude of the direct solar beam flux intercepted by each component of the canopy in a layer varied during the course of the day (Table A2 and Figures 12, 13, 14, and 15).



Figure 13.  
Percent of solar  
flux intercepted by  
each component of the  
wheat canopy for 30 July.

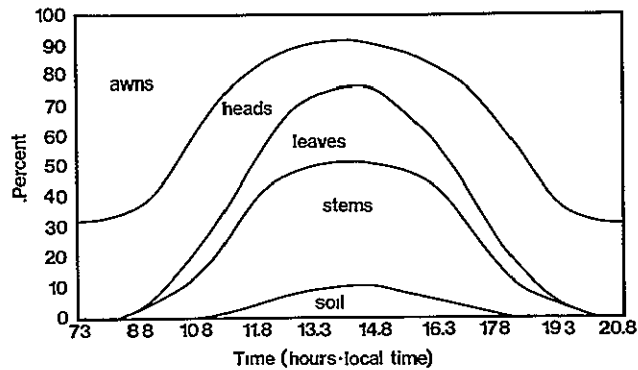
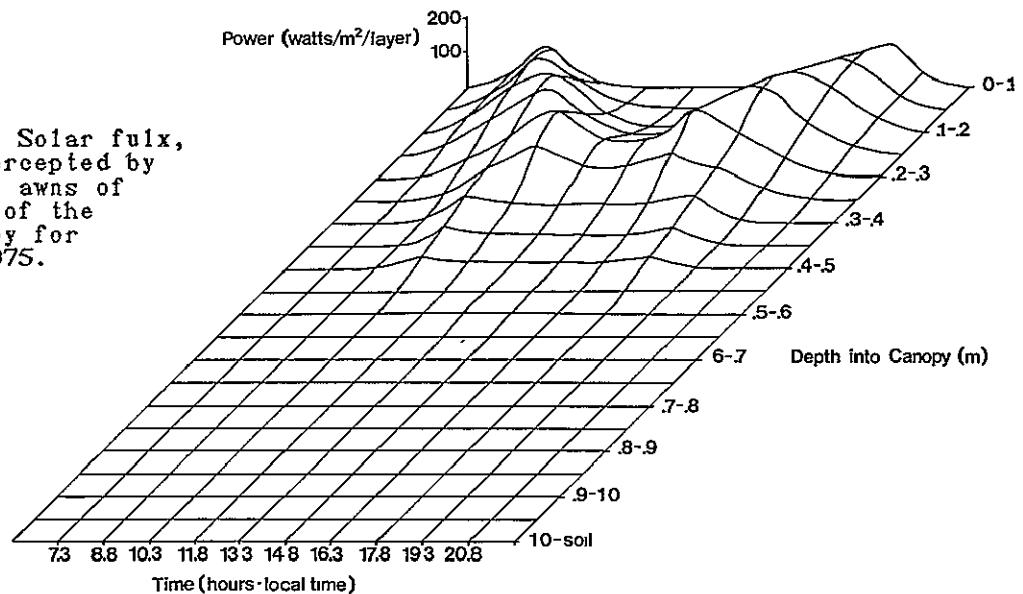

Figure 14. Solar flux,  
ABik1, intercepted by  
heads and awns of  
each layer of the  
wheat canopy for  
30 July 1975.



Immediately following sunrise and just prior to sunset heads and awns intercepted all of the solar flux. As shown in Figure 14, heads and awns intercepted approximately a constant magnitude of flux from 9.0 to 19.0 hours local time. Leaves, stems, and soil intercepted direct beam solar flux only during the middle hours of the solar day.

#### IV.D.2.e. ENERGY INTERCEPTED BY LAYER AND COMPONENT

The computation of the energy per square meter of the direct solar beam intercepted in each layer of the canopy and by each component of each layer was accomplished. The computation of the intercepted energy involved application of the techniques of numerical integration. The solar flux, the power per square meter, intercepted by each component of each layer was integrated numerically over the entire day of 30 July 1975. Implementation of the techniques of numerical integration involved use of the trapezoid rule (Conte 1965) and the array, Bnk1(n,k,1).

Figure 15. Solar flux, ABiki, intercepted by leaves and stems of each layer of the wheat canopy for 30 July 1975.

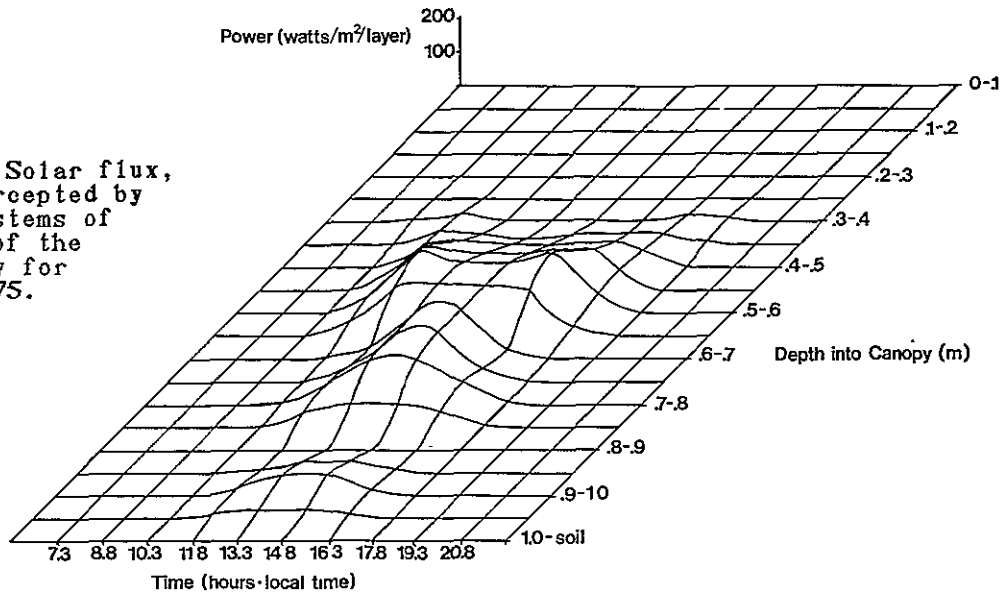

Table 12. Distribution of energy in the wheat canopy for the day of 30 July 1975. Units are (watt-hours/square meter of layer).

Depth(m)*						Total
	Leaves	Soil	Stems	Heads	Awns	
0.0-0.1	0.	0.	0.	64.	454.	518.
0.1-0.2	0.	0.	0.	426.	845.	1271.
0.2-0.3	0.	0.	0.	940.	592.	1532.
0.3-0.4	0.	0.	80.	541.	80.	701.
0.4-0.5	104.	0.	454.	138.	91.	788.
0.5-0.6	295.	0.	889.	46.	0.	1230.
0.6-0.7	243.	0.	286.	0.	0.	529.
0.7-0.8	298.	0.	295.	0.	0.	593.
0.8-0.9	0.	0.	0.	0.	0.	0.
0.9-1.0	93.	0.	148.	0.	0.	240.
soil	0.	341.	0.	0.	0.	341.
total =	1033.	341.	2152.	2156.	2062.	**7745.

\* Indicates distance downward into the canopy from the tallest foliage in the experimental plot area.

\*\* total energy for the entire day.

The calculated, direct beam solar energy in units of watt-hours per square meter was distributed to all components of the canopy and all layers of the canopy except one (Table 12). As shown in Figure 16, heads and awns intercepted all of the direct beam solar energy in the top layers of the canopy. Stems and leaves intercepted a significant portion of the energy in the middle layers of the canopy (Table 13). Little direct solar energy was intercepted in the bottom layers of foliage. No energy was intercepted in the layer between 0.8 and 0.9 meters depth in the canopy.

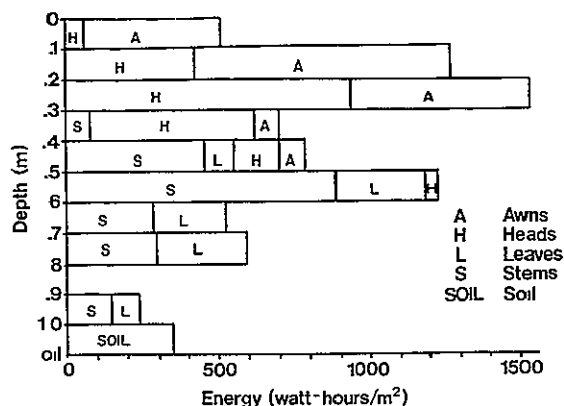

Figure 16. Solar energy intercepted by components of each layer of the wheat canopy for the date of 30 July 1975.

Table 13. Distribution of energy in the wheat canopy for the day of 30 July 1975. Units are (percent).

Depth(m) <sup>a</sup>	Leaves	Soil	Stems	Heads	Awns	Total
0.0-0.1	.0	.0	.0	0.83	5.86	6.69
0.1-0.2	.0	.0	.0	5.51	10.91	16.42
0.2-0.3	.0	.0	.0	12.13	7.65	19.78
0.3-0.4	.0	.0	1.03	6.99	1.03	9.06
0.4-0.5	1.34	.0	5.87	1.78	1.18	10.17
0.5-0.6	3.81	.0	11.47	0.60	.0	15.88
0.6-0.7	3.14	.0	3.70	.0	.0	6.84
0.7-0.8	3.85	.0	3.81	.0	.0	7.66
0.8-0.9	.0	.0	.0	.0	.0	.0
0.9-1.0	1.19	0.0	1.91	.0	.0	3.10
soil	.0	4.41	.0	.0	.0	4.41
Total	= 13.34	4.41	27.79	27.83	26.63	100.00

<sup>a</sup> Indicates distance downward into the canopy from the tallest foliage in the experimental plot area.

The anomalous result is attributable to laser data, insufficient to adequately characterize the canopy. The soil surface intercepted significant energy. As shown in Table 13, leaves intercepted about 13 percent of the total energy incident on 30 July 1975. Despite the fact that each other component of the canopy except soil intercepted more energy than leaves, the result is not unreasonable. The wheat canopy was fully headed and in the dough stage of maturity. One half of the flag leaves were dead. All other leaves were dead and withered. With most leaves dead the wheat plants had only limited ability to support photosynthetic activity. Furthermore, the wheat plants had only limited need of the energy provided by vigorous output of photosynthetic products by leaves.

Table 14. Values of matrix,  $N_{jk}$ , for the corn canopy. Units are (number of hits). Each entry signifies the number of laser hits in a particular direction and layer in the canopy.

Height(m) <sup>*</sup>	Zenith Angle (degrees)							
	5	15	25	35	45	55	65	75
2.7-3.0	0.	5.	1.	2.	3.	3.	10.	20.
2.4-2.7	12.	14.	17.	14.	41.	33.	47.	85.
2.1-2.4	26.	34.	32.	39.	49.	57.	73.	63.
1.8-2.1	19.	26.	31.	50.	40.	38.	52.	24.
1.5-1.8	36.	39.	39.	36.	21.	46.	23.	6.
1.2-1.5	35.	36.	36.	31.	34.	22.	16.	2.
.9-1.2	27.	22.	17.	16.	13.	16.	4.	1.
.6-.9	13.	5.	13.	13.	11.	9.	3.	1.
.3-.6	1.	3.	4.	5.	5.	0.	1.	0.
.0-.3	4.	3.	3.	2.	4.	1.	0.	0.
soil	84.	51.	43.	29.	18.	4.	0.	0.
Total	257.	238.	236.	237.	239.	229.	229.	202.

\* Indicates height above soil surface.

#### IV.E. ANALYSIS OF CORN LASER DATA

Analysis of the laser data obtained for the corn canopy involved prediction of various constants characterizing aspects of the geometrical structure of the canopy. The constants computed were

- (1) Absorption coefficient
- (2) Attenuation of a light beam traversing the canopy in any direction
- (3) Probability of view of one surface from a second surface in a particular direction.
- (4) Probability of view of a particular component of the canopy from a particular location in the canopy.

##### IV.E.1. PRELIMINARY ANALYSIS

The preliminary analysis of the data, the computation of the attenuating properties of the corn canopy upon a beam of light, involved use of equations IV-3, IV-8, and IV-9. Each corn laser data point was assigned a bin of the three dimensional array,  $N_{jkl}(j,k,l)$ . Each bin in the array of corn canopy data represented a ten degree zenith angle window, a layer in the canopy 0.3 meter thick, and one of five component classes, tassels, stalks, leaves, ears, or soil. The array of corn data,  $N_{jkl}$ , is tabulated in Table A3. The matrix,  $N_{jk}$ , is tabulated in Table 14. The arrays,  $I_{jk}$ ,  $A_{jk}$ , and  $A_{jkl}$ , are tabulated in Tables 15, 16, and A4. The proliferation of zero-valued elements at locations in the arrays characterized by large zenith angles and/or the lower layers of the canopy is again due to a lack of laser data from such areas of the canopy.

##### IV.E.1.a. ABSORPTION COEFFICIENT

Computation of the absorption coefficient of the components of each layer of the corn canopy, assuming perfectly black foliage, involved use of equations IV-6 and IV-7. The absorption coefficient has relevance only to the removal of flux from the direct solar beam. It provides no information concerning the attenuation of total light intensity in the canopy. The values of the absorption coefficients,  $K_{jk}$  and  $K_{jkl}$ , are tabulated in Tables 17 and A5. As shown in Table A5, significant cross sectional area of tassels is located below 2.1 meters and in the lower layers of the canopy.

Table 15. Values of matrix, Ijk, for the corn canopy (dimensionless). Each column lists the intensity of a normalized light beam traveling downward and attenuated by foliage in the canopy.

Height(m)*	Zenith Angle (degrees)							
	5	15	25	35	45	55	65	75
3.0	1.0	1.0	1.0	1.0	1.0	1.0	1.0	1.0
2.7	1.0	.979	.996	.992	.987	.987	.956	.901
2.4	.953	.920	.924	.932	.816	.843	.751	.480
2.1	.852	.777	.788	.768	.611	.594	.432	.168
1.8	.778	.668	.657	.557	.444	.428	.205	.050
1.5	.638	.504	.492	.405	.356	.227	.105	.020
1.2	.502	.353	.339	.274	.213	.131	.035	.010
.9	.397	.261	.267	.207	.159	.061	.017	.005
.6	.346	.239	.212	.152	.113	.022	.004	.0
.3	.342	.227	.195	.131	.092	.022	.0	.0
.0	.327	.214	.182	.122	.075	.017	.0	.0

\* Indicates height above soil surface.

Table 16. Values of matrix, Ajk, for the corn canopy (dimensionless). Each entry represents the proportion of the normalized light beam (listed in Table 15) intercepted by each layer.

Height(m)*	Zenith Angle (degrees)							
	5	15	25	35	45	55	65	75
2.7-3.0	.0	.021	.004	.008	.013	.013	.044	.099
2.4-2.7	.047	.059	.072	.059	.172	.144	.205	.421
2.1-2.4	.101	.143	.136	.165	.205	.249	.319	.312
1.8-2.1	.074	.109	.131	.211	.167	.166	.227	.119
1.5-1.8	.140	.164	.165	.152	.088	.201	.100	.030
1.2-1.5	.136	.151	.153	.131	.142	.096	.070	.010
.9-1.2	.105	.092	.072	.068	.054	.070	.017	.005
.6-.9	.051	.021	.055	.055	.046	.039	.013	.005
.3-.6	.004	.013	.017	.021	.021	.0	.004	.0
.0-.3	.016	.013	.013	.008	.017	.004	.0	.0
soil	.327	.214	.182	.122	.075	.017	.0	.0

\* Indicates height above soil surface.

The result is not necessarily anomalous. One effect of the infestation of the corn borer, discussed in Chapter III, in the canopy was that the upper story of many plants was toppled into lower layers of the canopy. The apparent lack of cross sectional area due to stalks in the zenith window of five degrees and elsewhere in the array is due to the acquisition of insufficient laser data with which to adequately characterize the projected area of stalks. The cross sectional area of tassels is concentrated in the upper portion of the canopy; of stalks, throughout the canopy; of leaves and ears, in the middle layers of the canopy.

Table 17. Values of the absorption coefficient,  $K_{jk}$ , for the corn canopy. Units are (1.0/meters).

Height(m) <sup>*</sup>	Zenith Angle (degrees)							
	5	15	25	35	45	55	65	75
2.7-3.0	.0	.068	.013	.023	.030	.025	.063	.090
2.4-2.7	.159	.200	.227	.168	.450	.302	.340	.543
2.1-2.4	.373	.543	.480	.530	.682	.669	.778	.904
1.8-2.1	.301	.488	.551	.877	.755	.627	1.049	1.056
1.5-1.8	.659	.906	.876	.870	.520	1.212	.947	.791
1.2-1.5	.797	1.148	1.123	1.065	1.204	1.052	1.548	.598
.9-1.2	.780	.978	.722	.772	.694	1.457	.976	.598
.6-.9	.453	.271	.698	.842	.806	1.969	1.953	.0
.3-.6	.038	.174	.252	.408	.483	.0	.0	.0
.0-.3	.154	.184	.204	.182	.473	.427	.0	.0
soil	.0	.0	.0	.0	.0	.0	.0	.0

\* Indicates height above soil surface.

Comparison was made between the leaf area index for each layer and the total leaf cross-sectional area per square meter of each layer. The laws of physics require that the leaf area index,  $LAI(p)$ , for layer,  $p$ , be greater than or equal to the total leaf cross-sectional area per square meter of layer,  $p$ , for any angle,  $\theta(j)$ .

$$LAI(p) > K_{jk1}(j,p,1)^*h$$

for  $j = 1,9$   
 $l = \text{leaves}$   
 $h = \text{thickness of layer}$

The proof is simple. A differential area,  $dA$ , with unit normal,  $n$ , and viewed by an observer from a direction specified by a unit direction vector,  $r$ , will project a one sided area,  $dA_p$ , to the observer.

$$dA_p = \begin{cases} (n \cdot r) * dA, & (n \cdot r) > 0.0 \\ -(n \cdot r) * dA, & (n \cdot r) < 0.0 \end{cases}$$

Now  $(n \cdot r) < 1.$ , therefore,

$$dA_p < dA$$

The leaf area index for a layer is the sum of many differential areas. Therefore, the projection of the leaf area of one square meter of layer is less than or equal to the leaf area of one square meter of layer.

The leaf area index per layer is larger than the cross-sectional area per square meter of layer with few exceptions (Table 18). The exceptions to the rule, for which

$$h * K_{jk1}(j,k,\text{leaves}) > LAI(k)$$

are to be found at the locations in the matrix,  $K_{jk1}$ , represented by large zenith angles and/or the lower layers of the canopy. These anomalies are attributable to the fact that insufficient laser data were acquired with which to characterize such areas of the canopy.

Table 18. Tabulation of total cross-sectional area and leaf area index (LAI) by layer in the corn canopy. Units are (square meters of foliage/square meter of layer).

Height(m)*	Zenith Angle (degrees)								LAI
	5	15	25	35	45	55	65	75	
2.7-3.0	.0	.004	.0	.0	.003	.0	.004	.001	.0
2.4-2.7	.028	.017	.024	.036	.046	.049	.059	.077	.071
2.1-2.4	.099	.153	.126	.135	.175	.190	.201	.198	.331
1.8-2.1	.086	.141	.144	.232	.198	.183	.303	.290	.417
1.5-1.8	.192	.258	.236	.225	.126	.308	.235	.237	.348
1.2-1.5	.212	.287	.271	.278	.287	.258	.348	.179	.496
.9-1.2	.225	.293	.217	.203	.160	.355	.146	.179	.454
.6-.9	.136	.065	.161	.194	.154	.459	.586	.0	.238
.3-.6	.011	.052	.057	.122	.087	.0	.0	.0	.259
.0-.3	.046	.037	.041	.027	.106	.128	.0	.0	.246

\* Indicates height above soil surface.

#### IV.E.1.b. LIGHT ATTENUATION

Many mathematical models for a canopy radiation environment require the calculation of a view factor, the probability of viewing a location, 'b,' from a location 'a,' for locations throughout the canopy and in any direction. Consequently, as the first step toward calculation of view factors, the attenuation of a beam of light traversing a canopy of black foliage in any direction was computed. Provided the foliage is randomly dispersed, the attenuating properties of a canopy layer in direction, r, and direction, -r, are identical; the total cross-sectional area is numerically equal to the absorption coefficient, K, in either direction. This assumption need not be invoked provided that laser data are acquired with the laser positioned in the canopy and aimed upward. Define IUP(m,p), the intensity of a beam of light at surface, p, traveling upward through the canopy at angle, theta(m),

$$IUP(m,p) = IUP(m,ksoil)$$

$$\circ \text{EXP} \left( - \sum_{k=p}^{ksoil} \frac{K_{jk}(m,k) * h}{\cos(\text{theta}(m))} \right) \quad (\text{eq. IV-17})$$

$$IUP(m,p+1) = IUP(m,ksoil)$$

$$\circ \text{EXP} \left( - \sum_{k=p+1}^{ksoil} \frac{K_{jk}(m,k) * h}{\cos(\text{theta}(m))} \right)$$

dividing

$$IUP(m,p) / IUP(m,p+1) = \text{EXP} \left( \frac{-K_{jk}(m,p) * h}{\cos(\text{theta}(m))} \right)$$

and

$$K_{jk}(m,p) = \text{LN} \left( \frac{IUP(m,p+1)}{IUP(m,p)} \right) \cdot \cos(\theta(m))$$

(eq. IV-18)

(provided the natural logarithm exists.)

Equating the right hand sides of equations IV-5 and IV-18, find

$$IUP(m,p-1) = IUP(m,p) \cdot I(m,p) / I(m,p-1)$$

(eq. IV-19)

The solution of equation IV-19, for  $IUP(m,1)$ , with  $IUP(m,k_{soil}) = I(m,1) = 1.0$ , is

$$IUP(m,1) = \text{EXP} \left( - \sum_{k=1}^{k_{soil}} \frac{K_{jk}(m,k) \cdot h}{\cos(\theta(m))} \right)$$

and, from equation IV-2, the solution of  $I(m,k_{soil})$  is

$$I(m,k_{soil}) = \text{EXP} \left( - \sum_{k=1}^{k_{soil}} \frac{K_{jk}(m,k) \cdot h}{\cos(\theta(m))} \right)$$

Since there can be no hits outside the canopy, the absorption coefficient of the sky is assumed zero, and

$$K_{jk}(m,1) = 0.0$$

Therefore,

$$IUP(m,1) = I(m,k_{soil}) \quad (\text{eq. IV-20})$$

for uniquely defined IUP.

A uniquely determined IUP(j,k) exists for (j,k) provided  $I(j,k_{soil})$  is non-zero valued. If  $I(j,k_{soil})$  is non-zero valued, the absorption coefficient,  $K_{jk}(j,k_{soil})$ , is defined and computation of IUP(j,k), for all k, involves use of equation IV-17 or repeated application of equation IV-19. As shown in Table A6, IUP(j,k) is tabulated for (j,k),  $j=1,6$  and all k. The fact that  $I(j,k_{soil})$ ,  $j=7,9$ , is identically zero precludes determination of unique values of IUP(j,k),  $j=7,9$ .

The definition of equation IV-19 completes the determination of the attenuating properties of the vegetative canopy, a canopy composed of black foliage, upon a beam of light. For a light beam of unit intensity entering the canopy in a downward direction,  $\theta(m)$ , the intensity at surface, p, is

$$I(m,p) = \text{EXP} \left( - \sum_{k=1}^{p-1} \frac{K_{jk}(m,k) \cdot h}{\cos(\theta(m))} \right)$$

(eq. IV-21)

For a beam of unit intensity entering the canopy in an upward direction,  $\theta(m)$ , the intensity at surface, p, is



$$IUP(m,p) = \text{EXP} \left( - \sum_{k=p}^{ksoil} \frac{Kjk(m,k) * h}{\cos(\theta(m))} \right) \quad (\text{eq. IV-22})$$

The absorption coefficient,  $Kjk(j,k)$ , is common to both equations.

#### IV.E.2. COMPUTATION OF VIEW FACTORS

##### IV.E.2.a. OBSERVATION OF ONE SURFACE FROM ANOTHER SURFACE

Computation of the probability of viewing a  $(j,k)$  location in the canopy from a surface,  $p$ , in the canopy, a view factor, involved the quantities,  $I(j,k)$  and  $IUP(j,k)$ . If

$$I(j,1) = IUP(j,ksoil) = 1.$$

then the quantities,  $I(j,x)$  and  $IUP(j,y)$ , represent probabilities. The quantity,  $I(j,x)$ , is the probability of an event,  $X$ , where  $X$  is the event that surface,  $x$ , is observed from above the canopy at angle,  $\theta(j)$ . The quantity,  $IUP(j,y)$ , is the probability of an event,  $Y$ , where  $Y$  is the event that surface,  $y$ , is observed from below the canopy at angle,  $\theta(j)$ .

Consider two surfaces,  $k$  and  $p$ . If  $k > p$ , the probability of event,  $K$ , is  $I(j,k)$ . The probability of event,  $P$ , is  $I(j,p)$ . The probability of event,  $P$ , given event,  $K$ , is  $1.0$ . The probability of event,  $K$  and  $P$ , is  $I(j,k)$ . The conditional probability, the probability of event,  $K$ , given event,  $P$ , is

$$P(K:P) = I(j,k)/I(j,p)$$

Similar arguments are proposed for  $k < p$ , involving  $IUP(j,k)$  and  $IUP(j,p)$  rather than  $I(j,k)$  and  $I(j,p)$ . Define the probability,  $P(j,k,p)$ , the probability of observing surface,  $k$ , at angle,  $\theta(j)$ , from surface,  $p$ , as

$$P(j,k,p) = \begin{cases} IUP(j,k)/IUP(j,p) & k < p \\ 1.0 & k = p \\ I(j,k)/I(j,p) & k > p \end{cases} \quad (\text{eq. IV-23})$$

provided that  $IUP(j,k)$ ,  $IUP(j,p)$ ,  $I(j,k)$ , and  $I(j,p)$  exist.

The quantity,  $P(j,k,p)$ , in equation IV-23 is a probability distribution. Both it and the probability density function that can be derived from it are view factors in a broad sense of the word. View factors are of prime importance in many models for the radiation environment in a canopy. They permit the calculation in a probabilistic manner of the flow of radiation from one location to another in the canopy. They function in a radiation model in a manner that is effectively similar to the process of recombination of holes and electrons in a semiconductor.

If  $p=1.0$ , then equation IV-23 simplifies

$$P(j,k,1) = I(j,k)/I(j,1)$$

Similarly, if  $p=ksoil$ , then equation IV-23 simplifies

$$P(j,k,ksoil) = IUP(j,k)/IUP(j,p)$$

The quantity,  $P(j,k,p)$ , represents the probability that an observer located on surface,  $p$ , in the canopy could observe, unimpaired by intervening foliage, a second surface,  $k$ , in direction,  $\theta(j)$ .

Values of  $P(j,k,p)$ ,  $j=1,6$ , are tabulated in Table 19. The view factor  $P(j,k,p)$  is the probability of observing in a particular direction one surface from another surface. Values of  $P(j,k,p)$ ,  $j=7,9$ , are not defined,

since  $IUP(j,k), j=7,9$ , does not exist uniquely.

#### IV.E.2.b. OBSERVATION OF A COMPONENT FROM A SURFACE

Computation of a second view factor, the probability of the unobstructed observation of a single element in component class,  $l=q$ , from a surface,  $p$ , in a direction,  $\theta(m)$ , involved the arrays,  $N_{jk1}$  and  $N_{jk}$ . Let the event of unobstructed observation of a single element in component class,  $l=q$ , from location,  $(m,p)$ , in the canopy be the event,  $H:m,p,q$ . Then the probability of event  $H:m,p,q$  is a frequency

$$P(H:m,p,q) = \frac{\begin{array}{l} \text{soil} \\ \sum_{k=p+1} N_{jk1}(m,k,q) \end{array}}{\begin{array}{l} \text{soil} \\ \sum_{k=p+1} N_{jk}(m,k) \end{array}} \quad \text{observation downward}$$

$$P(H:m,p,q) = \frac{\begin{array}{l} p \\ \sum_{k=1} N_{jk1}(m,k,q) \end{array}}{\begin{array}{l} p \\ \sum_{k=1} N_{jk}(m,k) \end{array}} \quad \text{observation upward}$$

(eq. IV-24)

where the numerator and denominator of each ratio represent, respectively, the total number of occurrences of event,  $H:m,p,q$ , and events,  $H:m,p,1,1=1,5$ . For observation upward the foliage dispersion in the canopy is assumed to be neither clumped nor regular.

As shown in Tables 20, 21, A7, and A8, values of  $P(H:m,p,q)$  for which  $N_{jk}(m, \text{soil})$  is identically zero are not listed. Insufficient laser data or no laser data is available to characterize such areas of the canopy. As shown in Tables 20 and A7, for observation downward in the canopy, the probability of viewing soil increases monotonically with depth for each  $\theta(j)$ . (The data in Tables 20 and A7 is numerically identical. The tabular presentation of the data is, however, different to emphasize its different aspects. Similarly, the numerical data in both Tables 21 and A8 is identical but the tabular presentation is different.) As shown in Tables 21 and A8, for observation upward in the canopy the probability of viewing sky increases monotonically with increasing height for each  $\theta(j)$ . The probability of observing an ear is greatest for an observer located on a surface in the middle portion of the canopy and looking up or down at 45 degrees. As shown in both Tables 20 and 21, the composition of the field of view of an observer changes rapidly with movement up or down in the canopy in all tabulated directions.

Table 19. Values of matrix, P(j,k,p), for the corn canopy (dimensionless). The matrix represents the probability of viewing a surface, S2, from a surface, S1, in a particular direction in the canopy.

Height(M)* of surface S1	Height(m)* of surface S2	5	15	Zenith 25	Angle (degrees) 35	45	55
0.0	3.0	.327	.214	.182	.122	.075	.017
	2.7	.327	.219	.183	.123	.076	.018
	2.4	.343	.233	.197	.131	.092	.021
	2.1	.384	.276	.231	.159	.123	.029
	1.8	.420	.321	.277	.220	.170	.041
	1.5	.512	.425	.371	.302	.212	.077
	1.2	.651	.607	.538	.446	.353	.133
	.9	.824	.823	.683	.592	.474	.286
	.6	.944	.895	.860	.806	.667	.800
	.3	.955	.944	.935	.935	.818	.800
.0	1.000	1.000	1.000	1.000	1.000	1.000	
0.3	3.0	.342	.227	.195	.131	.092	.022
	2.7	.342	.232	.196	.132	.093	.022
	2.4	.359	.247	.211	.140	.113	.026
	2.1	.402	.292	.247	.170	.151	.037
	1.8	.440	.340	.297	.235	.208	.051
	1.5	.537	.450	.397	.323	.259	.096
	1.2	.682	.643	.575	.477	.431	.167
	.9	.863	.871	.730	.633	.579	.357
	.6	.989	.947	.920	.861	.815	1.000
	.3	1.000	1.000	1.000	1.000	1.000	1.000
.0	.955	.944	.935	.935	.818	.800	
0.6	3.0	.346	.239	.212	.152	.113	.022
	2.7	.346	.245	.213	.153	.114	.022
	2.4	.363	.260	.229	.163	.138	.026
	2.1	.406	.308	.269	.198	.185	.037
	1.8	.445	.358	.323	.273	.255	.051
	1.5	.543	.475	.431	.375	.318	.096
	1.2	.690	.679	.625	.554	.529	.167
	.9	.873	.919	.794	.735	.711	.357
	.6	1.000	1.000	1.000	1.000	1.000	1.000
	.3	.989	.947	.920	.861	.815	1.000
.0	.944	.895	.860	.806	.667	.800	
0.9	3.0	.397	.261	.267	.207	.159	.061
	2.7	.397	.266	.268	.209	.161	.062
	2.4	.416	.283	.289	.222	.195	.073
	2.1	.466	.335	.339	.269	.260	.103
	1.8	.510	.390	.406	.371	.358	.143
	1.5	.622	.517	.543	.510	.447	.269
	1.2	.791	.738	.787	.754	.745	.467
	.9	1.000	1.000	1.000	1.000	1.000	1.000
	.6	.873	.919	.794	.735	.711	.357
	.3	.863	.871	.730	.633	.579	.357
.0	.824	.823	.683	.592	.474	.286	
1.2	3.0	.502	.353	.339	.274	.213	.131
	2.7	.502	.361	.340	.277	.216	.133
	2.4	.527	.384	.367	.294	.262	.155
	2.1	.589	.454	.430	.357	.349	.221
	1.8	.645	.528	.516	.492	.481	.306
	1.5	.787	.700	.690	.677	.600	.577
	1.2	1.000	1.000	1.000	1.000	1.000	1.000
	.9	.791	.738	.787	.754	.745	.467
	.6	.690	.679	.625	.554	.529	.167
	.3	.682	.643	.575	.477	.431	.167
.0	.651	.607	.538	.446	.353	.133	
1.5	3.0	.638	.504	.492	.405	.356	.227
	2.7	.638	.515	.494	.409	.360	.230
	2.4	.669	.548	.532	.434	.436	.269
	2.1	.749	.649	.624	.527	.582	.382
	1.8	.820	.755	.748	.727	.802	.531
	1.5	1.000	1.000	1.000	1.000	1.000	1.000
	1.2	.787	.700	.690	.677	.600	.577
	.9	.622	.517	.543	.510	.447	.269
	.6	.543	.475	.431	.375	.318	.096
	.3	.537	.450	.397	.323	.259	.096
.0	.512	.425	.371	.302	.212	.077	

ORIGINAL PAGE IS  
OF POOR QUALITY

Table 19. continued.

Height(m)* of surface S1	Height(m)* of surface S2	Zenith angle (degrees)					
		5	15	25	35	45	55
1.8	3.0	.778	.668	.657	.557	.444	.428
	2.7	.778	.682	.660	.562	.449	.434
	2.4	.816	.726	.711	.597	.544	.508
	2.1	.913	.859	.833	.725	.726	.721
	1.8	1.000	1.000	1.000	1.000	1.000	1.000
	1.5	.820	.755	.748	.727	.802	.531
	1.2	.645	.528	.516	.492	.481	.306
	.9	.510	.390	.406	.371	.358	.143
	.6	.445	.358	.323	.273	.255	.051
	.3	.440	.340	.297	.235	.208	.051
	.0	.420	.321	.277	.220	.170	.041
2.1	3.0	.852	.777	.788	.768	.611	.594
	2.7	.852	.794	.791	.774	.619	.602
	2.4	.894	.845	.853	.824	.749	.705
	2.1	1.000	1.000	1.000	1.000	1.000	1.000
	1.8	.913	.859	.833	.725	.726	.721
	1.5	.749	.649	.624	.527	.582	.382
	1.2	.589	.454	.430	.357	.349	.221
	.9	.466	.335	.339	.269	.260	.103
	.6	.406	.308	.269	.198	.185	.037
	.3	.402	.292	.247	.170	.151	.037
	.0	.384	.276	.231	.159	.123	.029
2.4	3.0	.953	.920	.924	.932	.816	.843
	2.7	.953	.940	.928	.940	.826	.854
	2.4	1.000	1.000	1.000	1.000	1.000	1.000
	2.1	.894	.845	.853	.824	.749	.705
	1.8	.816	.726	.711	.597	.544	.508
	1.5	.669	.548	.532	.434	.436	.269
	1.2	.527	.384	.367	.294	.262	.155
	.9	.416	.283	.289	.222	.195	.073
	.6	.363	.260	.229	.163	.138	.026
	.3	.359	.247	.211	.140	.113	.026
	.0	.343	.233	.197	.131	.092	.021
2.7	3.0	1.000	.979	.996	.992	.987	.987
	2.7	1.000	1.000	1.000	1.000	1.000	1.000
	2.4	.953	.940	.928	.940	.826	.854
	2.1	.852	.794	.791	.774	.619	.602
	1.8	.778	.682	.660	.562	.449	.434
	1.5	.638	.515	.494	.409	.360	.230
	1.2	.502	.361	.340	.277	.216	.133
	.9	.397	.266	.268	.209	.161	.062
	.6	.346	.245	.213	.153	.114	.022
	.3	.342	.232	.196	.132	.093	.022
	.0	.327	.219	.183	.123	.076	.018
3.0	3.0	1.000	1.000	1.000	1.000	1.000	1.000
	2.7	1.000	.979	.996	.992	.987	.987
	2.4	.953	.920	.924	.932	.816	.843
	2.1	.852	.777	.788	.768	.611	.594
	1.8	.778	.668	.657	.557	.444	.428
	1.5	.638	.504	.492	.405	.356	.227
	1.2	.502	.353	.339	.274	.213	.131
	.9	.397	.261	.267	.207	.159	.061
	.6	.346	.239	.212	.152	.113	.022
	.3	.342	.227	.195	.131	.092	.022
	.0	.327	.214	.182	.122	.075	.017

\* Indicates height above soil surface.

ORIGINAL PAGE IS  
OF POOR QUALITY

Table 20. Values of matrix,  $P(H:m,p,q)$ , for the corn canopy (percent). The matrix represents the probability of viewing a component of the canopy in a direction downward from a surface,  $S_1$ .

Height(m)* of surface $S_1$	Component	Zenith Angle (degrees)					
		5	15	25	35	45	55
3.0	tassels	3.5	6.3	5.9	5.1	13.4	9.6
	stems	.4	2.9	6.8	7.6	8.8	5.2
	leaves	61.5	67.2	66.5	73.8	66.5	81.7
	ears	1.9	2.1	2.5	1.3	3.8	1.7
	soil	32.7	21.4	18.2	12.2	7.5	1.7
2.7	tassels	3.5	4.7	5.5	4.3	12.7	8.4
	stems	.4	3.0	6.8	7.7	8.9	5.3
	leaves	61.5	68.2	66.8	74.5	66.9	82.7
	ears	1.9	2.1	2.6	1.3	3.8	1.8
	soil	32.7	21.9	18.3	12.3	7.6	1.8
2.4	tassels	1.6	.5	.9	2.7	2.1	2.1
	stems	.4	3.2	7.3	8.1	10.3	6.2
	leaves	61.6	70.8	69.3	74.7	73.8	87.6
	ears	2.0	2.3	2.8	1.4	4.6	2.1
	soil	34.3	23.3	19.7	13.1	9.2	2.1
2.1	tassels	.5	.0	.5	.5	.0	.7
	stems	.5	3.2	7.0	9.3	11.6	8.8
	leaves	58.4	66.5	66.1	72.5	69.9	84.6
	ears	2.3	2.7	3.2	1.6	6.2	2.9
	soil	38.4	27.6	23.1	15.9	12.3	2.9
1.8	tassels	.0	.0	.6	.8	.0	1.0
	stems	.5	3.1	5.8	8.3	11.3	11.2
	leaves	55.0	61.6	61.9	66.7	63.2	79.6
	ears	2.5	3.1	3.9	2.3	8.5	4.1
	soil	42.0	32.1	27.7	22.0	17.0	4.1
1.5	tassels	.0	.0	.0	1.0	.0	1.9
	stems	.0	2.5	5.2	8.3	11.8	9.6
	leaves	45.7	50.8	52.6	59.4	58.8	75.0
	ears	3.0	4.2	5.2	1.0	8.2	5.8
	soil	51.2	42.5	37.1	30.2	21.2	7.7
1.2	tassels	.0	.0	.0	.0	.0	3.3
	stems	.0	2.4	6.3	7.7	15.7	10.0
	leaves	34.1	36.9	40.0	46.2	45.1	70.0
	ears	.8	.0	.0	1.5	3.9	3.3
	soil	65.1	60.7	53.8	44.6	35.3	13.3
0.9	tassels	.0	.0	.0	.0	.0	7.1
	stems	.0	3.2	7.9	8.2	15.8	7.1
	leaves	17.6	14.5	23.8	32.7	34.2	57.1
	ears	.0	.0	.0	.0	2.6	.0
	soil	82.4	82.3	68.3	59.2	47.4	28.6
0.6	tassels	.0	.0	.0	.0	.0	.0
	stems	.0	1.8	4.0	2.8	11.1	.0
	leaves	5.6	8.8	10.0	16.7	22.2	20.0
	ears	.0	.0	.0	.0	.0	.0
	soil	94.4	89.5	86.0	80.6	66.7	80.0
0.3	tassels	.0	.0	.0	.0	.0	.0
	stems	.0	1.9	2.2	3.2	4.5	.0
	leaves	4.5	3.7	4.3	3.2	13.6	20.0
	ears	.0	.0	.0	.0	.0	.0
	soil	95.5	94.4	93.5	93.5	81.8	80.0
0.0	tassels	.0	.0	.0	.0	.0	.0
	stems	.0	.0	.0	.0	.0	.0
	leaves	.0	.0	.0	.0	.0	.0
	ears	.0	.0	.0	.0	.0	.0
	soil	100.0	100.0	100.0	100.0	100.0	100.0

\* Height is distance above soil surface.

Table 21. Values of matrix,  $P(H:m,p,q)$ , for the corn canopy (percent). The matrix represents the probability of viewing a component of the canopy in a direction upward from a surface,  $S_1$ .

Height(m)* of Surface $S_1$	Component	Zenith Angle (degrees)					
		5	15	25	35	45	55
3.0	sky	100.0	100.0	100.0	100.0	100.0	100.0
	tassels	.0	.0	.0	.0	.0	.0
	stems	.0	.0	.0	.0	.0	.0
	leaves	.0	.0	.0	.0	.0	.0
	ears	.0	.0	.0	.0	.0	.0
2.7	sky	100.0	97.9	99.6	99.2	98.7	98.7
	tassels	.0	1.7	.4	.8	.8	1.3
	stems	.0	.0	.0	.0	.0	.0
	leaves	.0	.4	.0	.0	.4	.0
	ears	.0	.0	.0	.0	.0	.0
2.4	sky	95.3	92.0	92.4	93.2	81.6	84.3
	tassels	1.9	5.9	5.1	2.5	11.7	7.8
	stems	.0	.0	.0	.0	.4	.0
	leaves	2.7	2.1	2.6	4.3	6.3	8.0
	ears	.0	.0	.0	.0	.0	.0
2.1	sky	85.2	77.7	78.8	76.8	61.1	59.4
	tassels	3.0	5.4	4.8	4.3	10.8	7.0
	stems	.0	.5	1.4	.5	1.9	.0
	leaves	11.8	16.4	15.0	18.4	26.2	33.6
	ears	.0	.0	.0	.0	.0	.0
1.8	sky	77.8	66.8	65.7	55.7	44.4	42.8
	tassels	3.2	4.7	4.0	3.1	7.9	5.1
	stems	.0	.9	3.3	3.6	4.8	.7
	leaves	19.0	27.6	27.0	37.5	43.0	51.4
	ears	.0	.0	.0	.0	.0	.0
1.5	sky	63.8	50.4	49.2	40.5	35.6	22.7
	tassels	2.6	3.5	3.6	2.3	6.3	2.7
	stems	.5	2.0	4.4	4.9	5.7	6.5
	leaves	33.1	44.1	42.8	50.8	50.5	67.1
	ears	.0	.0	.0	1.5	1.9	1.0
1.2	sky	50.2	35.3	33.9	27.4	21.3	13.1
	tassels	2.0	2.5	2.5	2.6	3.8	1.5
	stems	.4	2.2	3.9	6.4	5.8	7.6
	leaves	44.9	55.9	54.5	62.5	62.1	73.3
	ears	2.4	4.2	5.2	1.0	7.0	4.4
0.9	sky	39.7	26.1	26.7	20.7	15.9	6.1
	tassels	1.6	1.8	2.0	1.9	2.8	.7
	stems	.3	1.6	3.1	6.4	8.2	10.2
	leaves	55.7	67.4	64.2	68.7	65.9	77.5
	ears	2.7	3.1	4.1	2.3	7.2	5.4
0.6	sky	34.6	23.9	21.2	15.2	11.3	2.2
	tassels	1.4	1.7	1.6	1.4	2.0	7.4
	stems	.3	3.1	7.2	10.8	13.7	10.8
	leaves	61.3	68.4	66.8	70.9	65.2	77.7
	ears	2.4	2.8	3.2	1.7	7.7	1.9
0.3	sky	34.2	22.7	19.5	13.1	9.2	2.2
	tassels	1.4	1.6	1.4	1.2	1.6	7.4
	stems	.3	2.9	8.6	9.3	18.6	10.8
	leaves	61.8	70.1	67.5	74.9	64.3	77.7
	ears	2.3	2.7	3.0	1.5	6.3	1.9
0.0	sky	32.7	21.4	18.2	12.2	7.5	1.7
	tassels	1.3	1.5	1.3	1.2	1.3	5.9
	stems	.3	4.6	10.2	11.9	19.8	8.6
	leaves	63.5	69.9	67.4	73.3	66.2	82.2
	ears	2.2	2.5	2.8	1.4	5.2	1.5

\* Height is distance above soil surface.

## CHAPTER V

### DISCUSSION

The results presented in Chapter IV offer the capability of computing (1) the interception of direct beam solar power and energy in a canopy and (2) mathematical constants characterizing the geometric aspects of the structure of a canopy. However, the limitations to the technique also become apparent. In this chapter several limitations of the laser technique, the technique as it is described in Chapters III and IV, are discussed. The relative merits of the laser method are compared to other techniques which are described in the review of literature. The primary emphasis in the chapter will be on improved ways to implement the laser technique. An implementation scheme is proposed which is superior to the present technique and involves distance measuring equipment. An alternate scheme, also superior to the present technique, is proposed which involves a pulsed optical system.

#### V.A. ADVANTAGES OF LASER TECHNIQUE

##### V.A.1. AUTOMATION

Use of the laser technique does offer advantages when compared with other techniques. The technique was not automated during the data collection activity described in Chapter III. But, because it is amenable to automation, to the collection of millions of data points per man-hour, it enjoys a particular advantage over techniques ill-suited to automation.

Justification of the need for a large number of data points involves statistical considerations. The foliage distribution in vegetative canopies is variable. Even foliage distributions in canopies cultivated to achieve a uniform, regular distribution of foliage are variable. Yet, the number of data points in the measurement sample of the canopy must adequately represent the canopy in a statistically significant manner. Presumably, variations in sample location and sample size must be considered. Generally, the larger the sample size, the better the statistical characteristics of the sample are known. Suppose a canopy is to be measured in five-space,  $(x, y, z, \theta, \phi)$ . Let the space be divided into ten units on each axis. Further, select a maximum allowable quantization error of 0.1. The minimum number of required data points is, then,

$$(10 \times 10 \times 10 \times 10 \times 10 \text{ bins}) \times (10 \text{ points/bin}) = 1 \text{ million points}$$

Thus, to achieve a measurement accuracy of one part in 10 for each axis in five-space would require a minimum of one million data points.

It should not be assumed that a minimum of one million data points is required for all measurements in five-space using the laser technique. The size of the required data set for an experiment is specific to (1) the accuracy goals and mathematical manipulations of the analysis procedure and

(2) the condition of the crop canopy. An analysis procedure which involves integration (as, for example, the calculation in Chapter IV of the energy intercepted by the components of the wheat canopy) tends to reduce the variance, to average out "noise," in the analyzed data. Alternatively, an analysis procedure which involves differentiation (as, for example, the inversion of a Fredholm integral to obtain a probability density function of leaf area with zenith angle) tends to enhance noise in the data. To analyze the data and attain a specified level of accuracy would require more data points for an analysis involving differentiation than for one involving integration. Additionally, the variance in the laser data is a function of the variability of the geometry of the crop canopy. In general, it is anticipated that experiments involving laser data would require the acquisition of more than 10,000 data points, except for (1) those with trivial goals and (2) those which involve simplifying assumptions concerning the geometry of the canopy. Acquisition of large numbers of data points, presumably in a rapid fashion, is, therefore, a worthy goal.

If the laser technique were to be implemented infrequently, then the need for an automated technique would be questionable. Suitable resources can usually be mustered for data acquisition provided the need to acquire data seldom arises. However, the need for specific numerical knowledge of many canopies occurs throughout the growing season. And measurement of one canopy, once during the growing season, provides little data concerning that one canopy at other stages of crop growth. Nor does the one data set provide exact information pertinent to other canopies. And even if only one data set need be acquired, statistical considerations sometimes set extremely large lower limits on the number of required data points. Hence, for many situations a rapid, automated data acquisition system could conceivably be cost effective. Of the techniques reviewed in Chapter II only the laser technique can potentially achieve, through automation, digital data acquisition rates of several millions of data points per man-hour.

#### V.A.2. OTHER ADVANTAGES

Other advantages to use of the laser technique are that it is non-destructive and can be successfully implemented in moderately tall canopies such as corn. It should be noted that implementation of the point quadrat method on a moderately tall canopy such as corn or on a forest canopy does not appear feasible. As discussed in Chapter IV, the laser technique is the only one to identify in a canopy the sites of interception of solar power by component of the canopy (leaf, stem, head, etc.). Additionally, rapid data acquisition rates can potentially reduce or eliminate effects in laser data due to winds, effects discussed elsewhere in this chapter.

### V.B. LIMITATIONS OF THE LASER TECHNIQUE

#### V.B.1. DATA ACQUISITION SPEED

A superior method to measure canopy structure would presumably overcome the limitations of other measurement methods. In two significant areas, data acquisition time and data accuracy, the laser technique as described in Chapter III does not achieve this goal. The laser data from the canopy of wheat (about 200 points) were collected in 2.5 hours with a three person work crew - about 30 points per man-hour average. Acquisition of the data from the canopy of corn (about 1900 data points) required four nights of effort by four people working four hours each night - again an average of about 30 points per man-hour. Comparing these figures with Knight's data for acquisition of point quadrat data would indicate that the data acquisition process described in Chapter III - the non-automated version of the laser technique - is slower by a significant factor than data acquisition using the point quadrat method. Conversely, an automated version of the laser technique would potentially be faster by orders of magnitude than the point quadrat method. The conclusion, then, is that to realize the true potential of the laser technique, the method must be automated. Because other measurement techniques do not yield comparable data, a comparison of data acquisition times for other techniques is not possible.



## V.B.2. WHEAT: ACCURACY LIMITATIONS

Accuracy is the second significant limitation to the laser method as described in Chapter III. Limitations on the accuracy of the laser method implemented on the canopy of wheat involved several factors.

First, sufficient laser data must be acquired. To achieve a specified level of accuracy in the prediction of the attenuation of a beam of light at all levels in the canopy the number of hits in each bin must be commensurate with the accuracy desired. In other words the errors attributable to the quantized nature of the data must be insignificant compared to the desired accuracy of the data. Also, to engender reasonable confidence in the predicted attenuation of the hypothetical beam of light, the inclusion of additional data in the calculations must not significantly alter the predicted attenuating properties of the canopy at the level of accuracy specified. In both of these areas the accuracy of the data set from the canopy of wheat is quite limited. Many data bins contain no data points while many others contain only one, two, or three points. There were approximately 25 points in each zenith angle bin. The attenuation with depth of each composite beam is, therefore, subject to a 4 percent quantization error. Any increased accuracy requirements would require more data.

A second factor which can limit the accuracy of the laser technique involves the size of the cross section of the laser beam, its point spread function. Accurate laser data can be obtained only if the laser beam has a small cross section compared to the size of the foliage in the canopy being measured. Foliage is detected whenever the convolution of the foliage with the point spread function of the laser beam is non-zero. In other words detection occurs whenever any portion of the beam illuminates foliage. The apparent projected foliage area, the area computed using laser data, is larger than the actual area by a factor related to the apparent diameter of the point spread function of the beam. In order to estimate foliage area with no error, using the techniques described in Chapter III, the point spread function of the beam must have zero diameter, a physically unrealizable condition. Needle diameter is not an important consideration when acquiring point quadrat data because an acuminate needle is used (Chapter III, Warren Wilson, 1963b). Only foliage contacts with the point of the needle are counted.

In application of the methods described in Chapter III the beam point spread function must be of neglectable size compared to the size of the foliage components of the canopy. Noting the relative sizes of the laser beam cross section and the foliage, the error associated with the computed projected area of each component of the canopy may be calculated using the methods of Warren Wilson (1963b). For the canopy of wheat the error associated with prediction of the area of leaves, for example, is between 10 percent and 150 percent. To achieve an error rate of one per cent when estimating the area of awns requires that the diameter of the laser beam be 0.01 of the diameter of an awn. This beam size requirement was not achieved when the data from the wheat canopy was acquired. In fact, at times during the collection process the laser beam point spread function was 1000 times larger than the diameter of a typical awn, leading to an estimated error of 100,000 percent in the prediction of the projected area of awns. For this reason the projected areas of components of the wheat canopy were not calculated.

The attenuation of solar flux in the canopy was calculated. The effect of errors attributable to the beam point spread function upon the attenuation of solar flux by the canopy may be calculated. Let the actual projected area (per unit volume) in a direction in the canopy be  $Ka(l)$ , where  $l$  is distance along the beam. Let the estimated projected area (per unit volume) be

$$Ke(l) = (1+y(l))*Ka(l)$$

The estimated area calculated using the laser technique always is greater than the actual area by a factor which involves the size of the laser beam point spread function. Therefore,

$$y(l) > 0.0$$

Let the actual solar flux in the canopy, in direction  $l$ , be  $I_a(l)$ . Let the estimated solar flux, estimated using the laser data, in the canopy, in direction  $l$ , be  $I_e(l)$ . Then

$$I_e(l)/I_a(l) = \frac{I(\theta) \exp(-\int_0^1 K_e(u) du) / I(\theta)}{\exp(-\int_0^1 K_a(u) du)}$$

or

$$I_e(l)/I_a(l) = \exp(-\int_0^1 y(u) K_a(u) du)$$

Since  $y(u) K_a(u) > 0.0$ , therefore,  $I_e(l)/I_a(l) < 1.0$ . Thus, the estimate of the solar flux obtained using the laser technique is always smaller than the value of the actual flux for a particular distance into the canopy. The magnitude of the difference between the two will involve three factors, the size of the foliage relative to the laser beam, the total foliage projected area per unit volume, and the distance into the canopy.

Correction of the estimates of the projected areas of foliage and the attenuation of the solar beam in the canopy are possible. The case of awns in the data discussed in Chapter IV provides an example. The diameter of each awn was typically a fraction of one millimeter. The awns of each wheat head were clumped together in a tight bundle immediately above the head. The transmission of the bundle of awns was not measured but a reasonable estimate might be 50 percent. That is, one half of a beam of light incident on a bundle of awns is transmitted, unscattered, by the awns in the bundle. The implementation of the laser technique, as described in Chapter III, would, then, more accurately respond to the projected area of bundles of awns than to single awns for the wheat discussed in Chapter III. (This discussion is not germane to wheat canopies with awns which do not form tight, compact bundles.) To more accurately estimate the projected area of bundles of awns would entail a multistep process.

(1) The average transmission of a bundle of awns,  $T(j)$ , at zenith angle,  $\theta(j)$ , would be measured. The zenith angle,  $\theta(j)$ , is measured relative to the axis of vertical symmetry of the awn bundle.

(2) The number of hits,  $N_{jk1}(j,k,l)$ , attributable to bundles of awns in a bin of the laser data would be multiplied by the factor,  $(1-T(j))$ .

(3) The projected area would be calculated using

$$N_{jk1}(j,k,l) * (1-T(j))$$

as the number of hits instead of

$$N_{jk1}(j,k,l)$$

and using the procedures in Chapter IV.

(4) The projected area of bundles of awns would be corrected using the methods of Warren Wilson (1963b). Finally, the attenuating properties of the bundles of awns upon a beam of light would be calculated using the corrected projected areas.

A third factor limiting the accuracy of the laser technique involves canopy motion. To obtain accurate laser data using the non-automated techniques described in Chapter III the canopy must not be wind-blown and in motion during data acquisition. In the field of wheat discussed in Chapter III the canopy was in constant motion during the later stages of the data acquisition process. Canopy motion increased the potentiality that components near the top of the canopy would be hit. The motion of individual components increased their effective area due to the increased probability of illumination, and therefore a hit. As was reviewed in Chapter II, the deleterious effects of canopy motion upon data accuracy are not unique to the laser technique described in Chapter III.

If the analysis of the data from the canopy of wheat were to be repeated, one possible analysis approach would involve eliminating all hits

attributed to awns, and all hits acquired during the later stages of data acquisition when canopy motion was a deleterious factor. If the data contained no hits due to awns, the errors due to the size of the laser beam cross section drop to reasonable magnitudes. However, the arbitrary elimination of all hits attributable to awns from the data may not be justified. During data acquisition, observation of the canopy of wheat lead to the impression that for solar zenith angles of view near the horizontal that light involvement with awns is a significant factor in the attenuation of the direct solar flux. Thus, while hits in the data due to awns may be neglected with little consequence for zenith angles near vertical, hits due to awns must not be neglected in the data for zenith angles near horizontal.

To modify and improve the data acquisition procedures implemented on the canopy of wheat would involve (1) acquisition of more data points, (2) use of a laser beam with either a significantly smaller or significantly larger point spread function, and (3) carefully acquiring laser data during periods devoid of canopy motion.

### V.B.3. CORN: ACCURACY LIMITATIONS

Analysis of the data from the canopy of corn, as described in Chapter IV, involved a new technique for determining the projected area of foliage as a function of zenith angle, layer, and component in the canopy. The limitations to data accuracy, preeminent in the data from wheat, were reduced to manageable levels during acquisition of the data from the canopy of corn. Inaccuracies in the data from the canopy of corn attributable to canopy motion are non-existent; the data were acquired during windless evenings. Quantization errors were not an apparent problem, generally. The quantization error in each zenith angle bin was about 0.5 percent for the data considered in toto. Considering components of the canopy individually, data were acquired to adequately characterize (from a quantization error stand point) the projected area of leaves, stalks, and tassels in many bins. Insufficient data were obtained to characterize the projected area of ears to significant accuracy. Considered in toto, the data was inadequate to resolve the variability of the canopy for purposes of calculation of projected area. Such calculations involve, in the continuous analysis, a first order derivative and are susceptible to degradation by noise in the original data.

The second-source of error in the data from the canopy of wheat, the large cross-sectional area of the laser beam, was also a source of error in the data from the canopy of corn, but at a reduced magnitude. Calculated error (calculated using the methods of Warren Wilson, 1963b) in the projected area of leaves varied from one percent to 25 percent, while for stalks and tassels, from 10 percent to 200 percent.

In summary the estimates of foliage projected area as a function of zenith angle for the corn canopy contain errors. The magnitude of the errors in average is significantly less than the magnitude of the errors for the projected area estimates for the wheat canopy. Both the wheat and the corn data sets are usable for modeling purposes. The analysis of the wheat data set illustrates one method to calculate the attenuation of the direct solar flux in a canopy, the sites and magnitudes of the direct solar flux interception being the forcing function in a model of the radiation transfer process in the canopy. The analysis of the corn data set illustrates one method to calculate foliage projected area. The distribution of direct solar flux in the canopy coupled with knowledge of the projected area in  $(x, y, z, \theta, \phi)$  space and knowledge of the spectral properties of the foliage in the canopy provides the input to radiation transfer equations describing the radiation environment in the canopy.

### V.C. SYSTEM DESIGN CONSIDERATIONS

#### V.C.1. SPECIFICATIONS OF OPTIMAL SYSTEM

Automation of the acquisition of laser data is necessary to realize the statistical benefits that accrue with large data sample sets. An optimal

system design for the automation of the laser technique would allow for rapid, cost-effective acquisition of significant numbers of data points per man-hour. A data rate of several million data points per man-hour seems a reasonable goal. The automated device to achieve this goal would ideally be light, rugged, and easy to handle. The data, if acquired and stored in serial fashion, should probably be of digital format. Alternately, if a process involving parallel data acquisition is implemented, the data might just as easily be stored in either analog or digital format. The ideal automated system would provide data characterized by (1) negligible error attributable to the size of the point spread function of the laser beam and (2) acceptable spatial and angular resolution.

#### V.C.2. DESCRIPTIONS OF TWO REALIZABLE SYSTEMS

Unfortunately, no optimal system for the acquisition of laser data has been conceived. Two methods offer the possibility of a physically realizable, automated system for the acquisition of laser data. One method involves the use of laser distance measuring equipment of the type formerly manufactured by Spectra Physics Corporation, Mountain View, California. This method is characterized by the use of a laser beam with relatively small diameter compared to foliage size. The second technique involves the use of a broad laser beam, a beam with a point spread function many times larger than the size of the foliage being measured. Either method could potentially serve quite adequately as a laser data acquisition system.

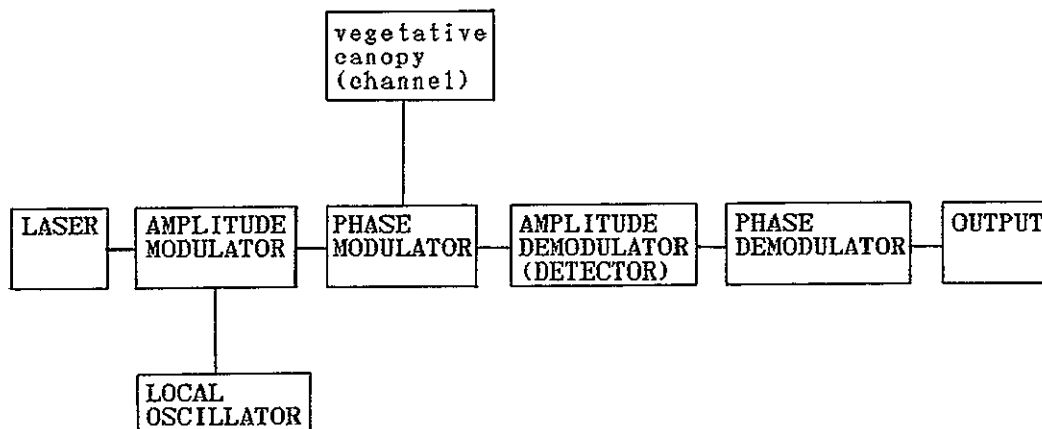

Figure 17. Block diagram of narrow beam system.

##### V.C.2.a. NARROW BEAM SYSTEM

Implementation of the narrow beam method (Figure 17) would entail amplitude modulation of the laser beam. The phase of the narrow beam upon reflection from foliage and return to a photodetector mounted with the laser would indicate the relative distance traveled by the beam as a portion of a wavelength of the modulating signal. Thus, if the phase of the return beam is 'x' degrees relative to the transmitted beam, then the distance traveled by the reflected beam is

$$(n + x/360) * L$$

where n is an integer, and L is the wavelength of the modulating signal. The

distance formula applies if the distance is less than the coherence length of the modulated beam, a distance in the hundreds of kilometers, assuming the modulating oscillator is reasonably stable. Presumably, the data would be recorded using a polar coordinate system and would include the phase and the direction of the return laser beam. A realizable and at the same time feasible narrow beam system would provide for a useful range of about 30 meters, a range limited by spreading effects associated with the beam diameter. Thus, the useful range would in reality be a function of the size of the foliage being measured and of the errors which could be tolerated in the measurement process. Significant data rates could be achieved through use of a scanning mirror in front of the laser and detector. Data rates of one thousand points per second (3.6 million points per hour) would be easily attainable using off-the-shelf hardware. A television raster-type scan would be one possible scanning mode. The use of magnetic tape for data storage purposes would appear advisable.

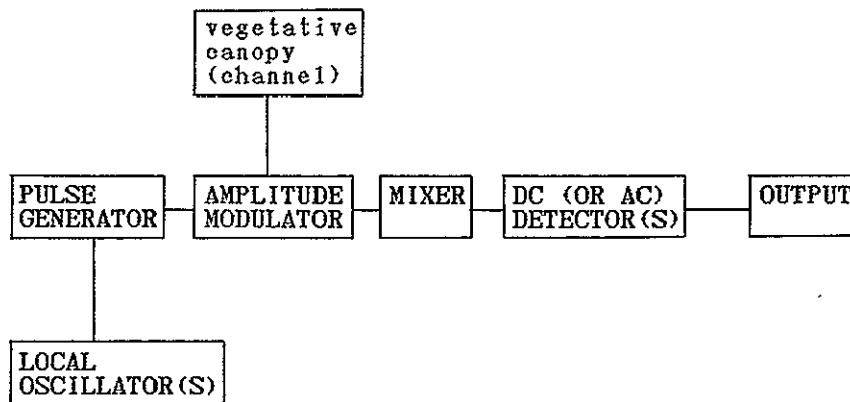

Figure 18. Block diagram of broad beam system.

#### V.C.2.b. BROAD BEAM SYSTEM

Implementation of the broad beam technique (Figure 18) would involve a pulsed optical system. The configuration of the broad beam (i.e. its size at ground level, its angular dispersion, etc.) would be determined by experimental considerations. For example, a broad beam system, operated at 20,000 meters above a forest canopy, might have a field of view normal to the earth and as large as 300 meters in diameter. The broad beam, operating in a pulsed mode, would be aimed at the canopy. A portion of each pulse of the broad beam would be reflected and detected by the photodetector. Making the assumptions that multiple scattering is present in the canopy at only neglectable levels at the wavelength of the light source, the response of the photodetector to each pulse will involve only the portion of the broad beam reflected by canopy foliage. If the foliage reflected the light in a Lambertian manner, the amplitude response of the photodetector as a function of time to each pulse incident upon the canopy would relate to the projected foliage area as a function of depth in the canopy. It should be noted that the pulse length of the light need not be exceedingly short. Provided the light input and output of the canopy are known, its transfer function can be calculated. A system could be designed with a pulse duration of one microsecond, a pulse length realizable using off-the-shelf hardware. However, for the limited analysis which follows the duration of the light pulse is assumed to be very short, a small fraction of a nanosecond.

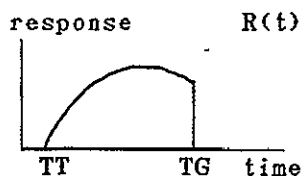

Figure 19. Amplitude response of photodetector of broad beam system.

The response,  $R(t)$ , would be as shown in Figure 19 where  $TG$  and  $TT$  are the times for the broad beam to travel from the system to the ground and back and from the system to the top of the canopy and back, respectively. Thus, each foliage element in the field of view of the system would reflect light in proportion to the foliage projected area in the direction of the broad beam system. Time and distance,  $l$ , in the canopy are related. The total power in the original beam is proportional to

$$\int_{TG}^{TT} R(t) dt = \int_{LG}^{LT} R(l) dl$$

where  $LT$  and  $LG$  are the heights of the top of the canopy and the ground, respectively. If the broad beam is of uniform intensity in cross section, and if the duration and/or rise time of the light pulse is adequate for the required spatial resolution along the beam, then foliage area at level,  $l$ , is given by the equation

$$\text{projected foliage area} = R(l) / \int_{LG}^L R(u) du$$

Unless sampling techniques are used in the system, the resolution in time - and therefore, distance in the canopy - is limited by the time response of the photodetector. A system with a photodetector with a time constant of one nanosecond would have a spatial resolution of the order of 30 centimeters. Significant resolution improvement could be achieved using electrical and/or mechanical sampling techniques, techniques used in sampling oscilloscopes. And the frequency response of the photodetectors in a sampling, broad beam, pulsed system would only need to be about 100 Hz. Data from the system could be recorded digitally using pencil and paper, a printer, or a magnetic tape recorder. Or data could be recorded in analog form as an x-y plot or a photograph of an oscilloscope face. Upon acquisition of each plot or photograph the system would be aimed at the canopy from a new location and/or direction for a new data run.

### V.C.3. ADVANTAGES AND DISADVANTAGES OF BROAD BEAM SYSTEM

The principle advantage of the broad beam technique over the narrow beam technique is that, if diffraction effects can be ignored, then the finite size of the point spread function of the light beam introduces no error in the data obtained using the broad beam technique.

There are several disadvantages associated with use of the broad beam technique. Sampling techniques must be used to achieve adequate spatial resolution along the beam. And successful implementation of the broad beam technique requires that all foliage have identical backscatter reflectance at the wavelength of the source of illumination. Data indicate that leaves from some plant species reflect light in a non-Lambertian fashion (Breece and Holmes, 1971). The optimal wavelength of light would appear to lie in the blue area of the spectrum for reasons which involve energy-matter interactions in the canopy. These interactions include both single and multiple scattering phenomena. Normally, multiple scattering effects are of neglectable importance in vegetative canopies in the wavelengths from 0.4 to 0.7 micrometers, particularly in the red and blue regions. However, increased reflectance in the yellow and red regions of the spectrum is characteristic of senescent, ochre vegetation as compared with green healthy vegetation. Ochre vegetation, when mixed with healthy green vegetation in sufficient proportion in the canopy would provide the potential to improperly weight the data obtained using a red light source. Hence, a light source at a wavelength in the other area of the spectrum characterized by abundant chlorophyll absorption, the blue region, would be preferable.

#### V.C.4. USE OF PATTERN RECOGNITION ALGORITHMS

Implementation of either automated method does allow the identification of the components of the canopy that were hit. The identification process would involve pattern recognition techniques and the use of a multispectral light source. The response of the foliage in each region of the visible spectrum (i.e. blue, green, and red) would form a vector. Assignment of the vector representing the foliage to classes of components in the canopy (soil, stalks, ears, etc.) would be accomplished using pattern recognition algorithms.

CHAPTER VI  
SUMMARY AND CONCLUSIONS  
AND SUGGESTIONS FOR FUTURE RESEARCH

The principal thrust of this report was to develop a feasible measurement technique for geometric characterization of vegetative canopies. The technique was to be workable under field conditions and capable of producing data usable for inputs to several available canopy models. The models usually predict canopy reflectance and/or emission and depend heavily on accurate input parameter data for reliable predictions.

The laser technique proposed in Chapter III involves a unique, relatively simple optical system and analysis procedure. The feasibility of the laser technique is demonstrated with some analytical examples in Chapter IV. The field data were used to calculate leaf area index, view factors, and foliage leaf area probability density functions in two sample canopies. These results are useful in predicting energy budgets, reflectance, and radiant temperatures in vegetative canopies. The latter two items are of direct importance, for example, to remote sensing scientists and engineers who are concerned with predicting crop yields from remotely sensed aircraft and satellite data.

The discussion in Chapter V pointed out the limitations of accuracy and applicability on the manual implementation of the laser technique as practiced in this report. Accurate results were shown to depend on large data sets. Here the emphasis was on the development of a basic field technique and no attempt was made to design and construct systems that are capable of acquiring large data sets rapidly and economically.

The results of the research described here can be summarized in two general statements:

- (a) The laser technique has been shown to be capable of producing basic geometric characterization of the geometric properties of vegetative canopies using field measurements that are superior to currently available procedures. Current procedures involve primarily mechanical (rather than optical) measurements which are generally subject to subjective experimental error or are not capable of producing large enough data sets for adequate statistical characterization of the canopy. The inadequacy of the mechanical procedures for acquiring canopy parametric data has seriously limited the applicability of the several excellent available radiation models to study critical problems in remote sensing of crops.
- (b) The optical technique proposed in the report is generally amenable to automation, thereby resulting in rapid production of the large data sets necessary to accurately, statistically characterize canopy geometry. Two systems (narrow and broad laser beam) are proposed that are capable of producing the large data sets required. However, the



economics of the proposed systems were not addressed.

The results of this report lead to the suggestion of several proposed areas of research. These are:

- (1) The details of the design of the narrow beam system should be investigated. The practical lower limit on beam diameter needs to be determined. A detailed design of the proposed system optics and electronics needs to be produced so as to evaluate the system costs and performance.
- (2) The proposed broad beam system needs to be designed in detail and investigated. The design trade-offs between signal sampling system complexity and detector system performance is of particular importance. The broad beam optical system is especially adaptable to a multispectral system and the details of such an optical system need to be investigated.
- (3) A multispectral laser system would, in principle, be capable of identifying canopy components as well as quantifying their geometry. A general research program that enquires into the spectral separability of canopy components (ie leaves, stems, etc.) and the impact of the results on the design of the laser probe optical system is indicated.
- (4) A survey of currently available models and their requirements for input data needs to be related to the output data format of the laser technique. Such a survey could lead to the selection of an optimum model-laser system implementation capable of producing results for several proposed projects concerned with LANDSAT C and the thematic mapper satellites. Already, some of the view factor data from the wheat experiment described in Chapter IV is being used in the development of radiance temperature calculations for wheat canopies as a function of canopy condition (geometry).
- (5) A cost-benefit study of the proposed laser systems is indicated. The improved performance of canopy models with superior laser input data needs to be related to the cost of acquisition and operation of the laser systems. In other words, is the improved performance of the model(s) with the laser data worth the cost of the laser system? The results of such a study would also impact the design of the proposed systems in items 1 and 2.

The technical feasibility of an original, unique laser system has been clearly established along with the value of the data that such a system could produce. The next steps involve the design and implementation of practical, economical data acquisition systems.

## BIBLIOGRAPHY

- Anderson, M. C., 1966. "Stand structure and Light Penetration II. A Theoretical Analysis." *Journal of Applied Ecology*. 3:41-54.
- Anderson, M. C., 1970. "Interpreting the Fraction of Solar Radiation Available in Forrest." *Agricultural Meteorology*. 7:19-28.
- Anderson, M. C., 1971. "Radiation and Crop Structure." in "Plant Photosynthetic Production." ed Sestak, Z., Catsky, J., and Jarvis, P. G., 412-456. Dr W. Junk N.V. The Hague. 818p.
- Bauer, M. E., 1975. Purdue/LARS, 1220 Potter Dr., W. Lafayette, Indiana, 47906. personal communication.
- Bonhomme, R. and Chartier, P., 1972. "The Interpretation and Automatic Measurement of Hemispherical Photographs to Obtain Sunlit Foliage Area and Gap Frequency." *Israel Journal of Agricultural Research*. 22:53-61.
- Breece, H. T. III and Holmes, R. A., 1971. "Bidirectional Scattering Characteristics of Healthy Green Soybean and Corn Leaves in Vivo." *Applied Optics*. 10:119-127.
- Chandrasekhar, S., 1960. "Radiative Transfer." Dover Publications, Inc. New York. 393p.
- Conte, S. D., 1965. "Elementary Numerical Analysis." McGraw-Hill Book Company, New York. 278p.
- de Wit, C. T., 1965. "Photosynthesis of Leaf Canopies." *Agriculture Research Report of Center for Agricultural Publishing and Documentation*. No. 663, 57p.
- Duncan, W. G., Loomis, R. S., Williams, W. A., and Hanan, R., 1967. "A Model for Simulating Photosynthesis in Plant Communities." *Hilgardia*. 38:181-205.
- Gausman, H. W., Allen, W. A., and Cardenas, R., 1969. "Reflectance of Cotton Leaves and Their Structure." *Remote Sensing of Environment*. 1:19-22.

Hanway, J. J., 1963. "Growth Stages of Corn (*Zea mays* L.)." *Agronomy Journal*. 55:487-492.

Knight, D. H., 1973. "Leaf Area Dynamics of a Shortgrass Parairie in Colorado." *Ecology*. 54:891-896.

Lang, A. R. G., 1973. "Leaf Orientation of a Cotton Plant." *Agricultural Meteorology*. 11:37-51.

Large, E. C., 1954. "Growth stages in Cereals." *Plant Pathology*. 3:128-129.

Lemeur, R., 1970. "Effects of Spatial leaf Distribution on Penetration and Interception of Direct Radiation." in "Proceedings of the Symposium on Plant Response to Climatic Factors." UNESCO. Paris. pp349-356.

Lemeur, R., 1973. "A method for Simulating the Direct Solar Radiation Regime in Sunflower, Jerusalem Articoke, Corn and Soybean Canopies using Actual Stand Structural Data." *Agricultural Meteorology*. 12:229-247.

Lemeur, R. and Blad, B. L., 1974. "A Critical Review of Light Models for estimating the Shortwave Radiation Regime of Plant Canopies." *Agricultural Meteorology*. 14:256-286.

Loomis, R. S., Williams, W. A., Duncan, W. G., Dovrat, A., and Nunez, F. A., 1968. "Quantitative Descriptions of Foliage Display and Light Absorption in Field Communities of Corn Plants." *Crop Science*. 8:352-356.

Miller, J. B., 1964. "An Integral Equation from Phytology." *Journal Australian Mathematical Society*. 4:397-402.

Miller, J. B., 1967. "A Formula for Average Foliage Density." *Australian Journal of Botany*. 15:141-144.

Monsi, M. and Saeki, T., 1953. "Über den Lichtfaktor in den Pflanzengesellschaften und seine Bedeutung für die Stoff Produktion." *Japannese Journal of Botany*. 14:22-52.

Monsi, M., Uehijima, Z., and Oikawa, T., 1973. "Structure of Foliage Canopies and Photosynthesis." *Annual Review of Ecology Systematics*. 4:301-327.

Monteith, J. L., 1965. "Light Interception and Radiative Exchange in Crop Stands." in "Physiological Aspects of Crop Yield," ed. Eastin, J. D., Haskins, F. A., Sullivan, C. Y., and van Bavel, C. H., pp99-113. Madison: American Society of Agronomy and Crop Science Society of America. 396p.

Nilson, T., 1971. "A Theoretical Analysis of the Frequency of Gaps in Plant Stands." *Agricultural Meteorology*. 8:25-38.

Nichiporovich, A. A., 1961. "Properties of Plant Crops as an Optical System." *Fiziologiya Rastenii*. 8:536-546.

Norman, J. M. and Tanner, C. B., 1969. "Transient Light Measurements in Plant Canopies." *Agronomy Journal*. 61:847-849.

Philip, J. R., 1965a. "The Distribution of Foliage Density with Foliage Angle Estimated from Inclined Point Quadrat Observations." *Australian Journal of Botany*. 13:357-366.

Philip, J. R., 1965b. "The Distribution of Foliage Density on Single Plants." *Australian Journal of Botany*. 13:411-418.

Philip, J. R., 1966a. "Some Integral Equations in Geometrical Probability." *Biometrika*. 53:365-374.

Philip, J. R., 1966b. "The use of Point Quadrats, with special reference to Stem-like organs." *Australian Journal of Botany*. 14:105-125.

Sestak, Z., Catsky, J., and Jarvis, P. G., 1971. "Plant Photosynthetic Production Manual of Methods." Dr. W. Junk N.V. The Hague. 818p.

Seigel, R. and Howell, J. R., 1972. "Thermal Radiation Heat Transfer." McGraw-Hill, New York. 814p.

Smith, J. A., Berry, J. K., and Heimes, F., 1975. Quarterly Progress Report for period May-August, 1975, NASA contract NAS 9-14467.

Wang, J. Y., 1970. "Theory and Applications of Inversion Techniques. A Review." Purdue Research Foundation - Research Project No. 5543, AA&ES 70-6, 99p.

Warren Wilson, J., 1959. "Analysis of the Spatial Distribution of Foliage by Two-dimensional Point Quadrats." *New Phytologist*. 58:92-101.

Warren Wilson, J., 1960. "Inclined Point Quadrats." *New Phytologist*. 59:1-8.

Warren Wilson, J., 1963a. "Estimation of Foliage Denseness and Foliage Angle by Inclined Point Quadrats." *Australian Journal of Botany*. 11:95-105.

Warren Wilson, J., 1963b. "Errors Resulting from Thickness of Point Quadrats." *Australian Journal of Botany*. 11:178-188.

Warren Wilson, J., 1965a. "Point Quadrat Analysis of Foliage Distribution for Plants Growing singly or in Rows." *Australian Journal of Botany*. 13:405-409.

Warren Wilson, J., 1965b. "Stand Structure and Light Penetration I. Analysis by Point Quadrats." *Journal of Applied Ecology*. 2:383-390.

Warren Wilson, J., 1967. "Stand Structure and Light Penetration III. Sunlit Foliage Area." *Journal of Applied Ecology*. 4:159-169.

Watson, D. J., 1947. "Comparative Physiological Studies on the Growth of Field Crops. II. The Effect of Varying Nutrient Supply on Net Assimilation Rate and Leaf Area." *Annals of Botany N.S.* 11:375-407.

Watson, D. J., 1952. "The Physiological Basis of Variation in Yield." *Advances in Agronomy*. 4:101-145.

Winkworth, R. E. and Goodall, D. W., 1962. "A crosswire sighting Tube for Point Quadrat Analysis." *Ecology*. 43:342-343.

Woodell, S. R. J. and Boorman, L. A., 1966. "A Light, Sturdy, Inexpensive Point Quadrat Frame." *Ecology*. 47:870-871.

Table A1. Values of matrix,  $N_{jkl}$ , for wheat canopy. Units are (number of hits). A '-' signifies zero hits. Each entry indicates the number of laser hits by direction, layer, and component in the canopy.

Component of canopy	Depth(m)*	Zenith Angle (degrees)									
		5	15	25	35	45	55	65	75	85	
awns	.0-.1	-	-	-	-	-	-	-	5.	10.	5.
	.1-.2	-	-	-	1.	2.	4.	8.	6.	3.	-
	.2-.3	-	-	1.	2.	3.	3.	1.	-	-	-
	.3-.4	-	1.	-	-	-	1.	1.	-	-	-
	.4-.5	-	-	1.	-	-	1.	-	-	-	-
	.5-.6	-	-	-	-	-	-	-	-	-	-
	.6-.7	-	-	-	-	-	-	-	-	-	-
	.7-.8	-	-	-	-	-	-	-	-	-	-
	.8-.9	-	-	-	-	-	-	-	-	-	-
	.9-1.0 soil	-	-	-	-	-	-	-	-	-	-
heads	.0-.1	-	-	-	-	-	-	-	3.	2.	-
	.1-.2	-	-	-	-	1.	4.	1.	6.	1.	-
	.2-.3	-	1.	1.	3.	5.	2.	5.	1.	1.	-
	.3-.4	3.	4.	-	3.	1.	4.	-	-	-	-
	.4-.5	1.	1.	-	-	1.	1.	1.	-	-	-
	.5-.6	-	-	1.	-	-	-	-	-	-	-
	.6-.7	-	-	-	-	-	-	-	-	-	-
	.7-.8	-	-	-	-	-	-	-	-	-	-
	.8-.9	-	-	-	-	-	-	-	-	-	-
	.9-1.0 soil	-	-	-	-	-	-	-	-	-	-
stems	.0-.1	-	-	-	-	-	-	-	-	-	-
	.1-.2	-	-	-	-	-	-	-	-	-	-
	.2-.3	-	-	-	-	-	-	-	-	-	-
	.3-.4	-	1.	-	-	-	1.	1.	-	-	-
	.4-.5	-	3.	1.	2.	2.	2.	-	-	-	-
	.5-.6	1.	3.	2.	5.	5.	-	-	-	-	-
	.6-.7	4.	1.	4.	1.	-	-	-	-	-	-
	.7-.8	-	-	2.	2.	-	-	-	-	-	-
	.8-.9	-	-	-	-	-	-	-	-	-	-
	.9-1.0 soil	-	1.	1.	1.	-	-	-	-	-	-
leaves	.0-.1	-	-	-	-	-	-	-	-	-	-
	.1-.2	-	-	-	-	-	-	-	-	-	-
	.2-.3	-	-	-	-	-	-	-	-	-	-
	.3-.4	-	-	-	-	-	-	-	-	-	-
	.4-.5	-	1.	1.	-	1.	-	-	-	-	-
	.5-.6	1.	-	1.	1.	1.	2.	-	-	-	-
	.6-.7	3.	1.	4.	-	1.	-	-	-	-	-
	.7-.8	1.	-	3.	1.	1.	-	-	-	-	-
	.8-.9	3.	2.	-	-	-	-	-	-	-	-
	.9-1.0 soil	1.	1.	2.	-	-	-	-	-	-	-
soil	.0-.1	-	-	-	-	-	-	-	-	-	-
	.1-.2	-	-	-	-	-	-	-	-	-	-
	.2-.3	-	-	-	-	-	-	-	-	-	-
	.3-.4	-	-	-	-	-	-	-	-	-	-
	.4-.5	-	-	-	-	-	-	-	-	-	-
	.5-.6	-	-	-	-	-	-	-	-	-	-
	.6-.7	-	-	-	-	-	-	-	-	-	-
	.7-.8	-	-	-	-	-	-	-	-	-	-
	.8-.9	-	-	-	-	-	-	-	-	-	-
	.9-1.0 soil	14.	3.	3.	2.	-	-	-	-	-	-

\* Indicates distance downward into the canopy from the tallest foliage in the experimental plot area.

ORIGINAL PAGE IS  
OF POOR QUALITY

Table A2. Values of solar flux in the wheat canopy, ABiki. Units are (watts/square meter of layer). Each entry lists the direct solar power intercepted by each layer and component class in the canopy.

Component Depth(m)*		Time (hours - local Williston, ND time)**									
of foliage		7.3	8.8	10.3	11.8	13.3	14.8	16.3	17.8	19.3	20.8
awns	.0-.1	41.	93.	16.	0.	0.	0.	0.	16.	91.	44.
	.1-.2	25.	98.	95.	45.	17.	18.	46.	95.	97.	26.
	.2-.3	0.	9.	62.	76.	50.	51.	78.	62.	8.	0.
	.3-.4	0.	9.	18.	0.	0.	0.	0.	18.	8.	0.
	.4-.5	0.	0.	15.	0.	15.	15.	0.	15.	0.	0.
	.5-.6	0.	0.	0.	0.	0.	0.	0.	0.	0.	0.
	.6-.7	0.	0.	0.	0.	0.	0.	0.	0.	0.	0.
	.7-.8	0.	0.	0.	0.	0.	0.	0.	0.	0.	0.
	.8-.9	0.	0.	0.	0.	0.	0.	0.	0.	0.	0.
	.9-1.0 soil	0.	0.	0.	0.	0.	0.	0.	0.	0.	0.
heads	.0-.1	4.	15.	0.	0.	0.	0.	0.	0.	15.	9.
	.1-.2	19.	38.	67.	14.	0.	0.	15.	68.	38.	24.
	.2-.3	7.	48.	69.	121.	67.	68.	124.	69.	47.	6.
	.3-.4	0.	0.	64.	63.	52.	53.	65.	65.	0.	0.
	.4-.5	0.	9.	23.	14.	0.	0.	15.	23.	8.	0.
	.5-.6	0.	0.	0.	0.	15.	15.	0.	0.	0.	0.
	.6-.7	0.	0.	0.	0.	0.	0.	0.	0.	0.	0.
	.7-.8	0.	0.	0.	0.	0.	0.	0.	0.	0.	0.
	.8-.9	0.	0.	0.	0.	0.	0.	0.	0.	0.	0.
	.9-1.0 soil	0.	0.	0.	0.	0.	0.	0.	0.	0.	0.
stems	.0-.1	0.	0.	0.	0.	0.	0.	0.	0.	0.	0.
	.1-.2	0.	0.	0.	0.	0.	0.	0.	0.	0.	0.
	.2-.3	0.	0.	0.	0.	0.	0.	0.	0.	0.	0.
	.3-.4	0.	9.	18.	0.	0.	0.	0.	18.	8.	0.
	.4-.5	0.	0.	39.	61.	50.	51.	63.	39.	0.	0.
	.5-.6	0.	0.	23.	153.	117.	119.	158.	23.	0.	0.
	.6-.7	0.	0.	0.	16.	79.	79.	17.	0.	0.	0.
	.7-.8	0.	0.	0.	32.	65.	66.	33.	0.	0.	0.
	.8-.9	0.	0.	0.	0.	0.	0.	0.	0.	0.	0.
	.9-1.0 soil	0.	0.	0.	16.	33.	33.	17.	0.	0.	0.
leaves	.0-.1	0.	0.	0.	0.	0.	0.	0.	0.	0.	0.
	.1-.2	0.	0.	0.	0.	0.	0.	0.	0.	0.	0.
	.2-.3	0.	0.	0.	0.	0.	0.	0.	0.	0.	0.
	.3-.4	0.	0.	0.	0.	0.	0.	0.	0.	0.	0.
	.4-.5	0.	0.	5.	14.	15.	15.	15.	5.	0.	0.
	.5-.6	0.	0.	34.	31.	33.	33.	32.	35.	0.	0.
	.6-.7	0.	0.	5.	14.	61.	62.	15.	5.	0.	0.
	.7-.8	0.	0.	5.	31.	63.	64.	32.	5.	0.	0.
	.8-.9	0.	0.	0.	0.	0.	0.	0.	0.	0.	0.
	.9-1.0 soil	0.	0.	0.	0.	31.	31.	0.	0.	0.	0.
soil	.0-.1	0.	0.	0.	0.	0.	0.	0.	0.	0.	0.
	.1-.2	0.	0.	0.	0.	0.	0.	0.	0.	0.	0.
	.2-.3	0.	0.	0.	0.	0.	0.	0.	0.	0.	0.
	.3-.4	0.	0.	0.	0.	0.	0.	0.	0.	0.	0.
	.4-.5	0.	0.	0.	0.	0.	0.	0.	0.	0.	0.
	.5-.6	0.	0.	0.	0.	0.	0.	0.	0.	0.	0.
	.6-.7	0.	0.	0.	0.	0.	0.	0.	0.	0.	0.
	.7-.8	0.	0.	0.	0.	0.	0.	0.	0.	0.	0.
	.8-.9	0.	0.	0.	0.	0.	0.	0.	0.	0.	0.
	.9-1.0 soil	0.	0.	0.	32.	81.	82.	33.	0.	0.	0.

\* Indicates distance downward into the canopy from the tallest foliage in the experimental plot area.  
 \*\* The solar zenith angle is listed as a function of time in Table 2. Solar noon occurred at 14.1 hours.

Table A3. Values of the matrix,  $N_{jkl}$ , for the corn canopy. Units are (number of hits). A '-' signifies zero hits. Each entry indicates the number of laser hits by direction, layer, and component in the canopy.

Component of foliage	Height(m)*	Zenith Angle (degrees)							
		5	15	25	35	45	55	65	75
tassels	2.7-3.0	-	4.	1.	2.	2.	3.	8.	19.
	2.4-2.7	5.	10.	11.	4.	26.	15.	20.	45.
	2.1-2.4	3.	1.	1.	5.	4.	3.	5.	14.
	1.8-2.1	1.	-	-	-	-	-	-	-
	1.5-1.8	-	-	1.	-	-	-	-	-
	1.2-1.5	-	-	-	1.	-	-	-	-
	.9-1.2	-	-	-	-	-	-	-	-
	.6-.9	-	-	-	-	-	1.	-	-
	.3-.6	-	-	-	-	-	-	-	-
	.0-.3	-	-	-	-	-	-	-	-
	soil	-	-	-	-	-	-	-	-
TOTAL		9.	15.	14.	12.	32.	22.	33.	78.
stems	2.7-3.0	-	-	-	-	-	-	-	-
	2.4-2.7	-	-	-	-	1.	-	-	-
	2.1-2.4	-	1.	3.	1.	3.	-	4.	3.
	1.8-2.1	-	1.	4.	6.	5.	1.	2.	2.
	1.5-1.8	1.	2.	3.	3.	2.	6.	4.	-
	1.2-1.5	-	1.	1.	3.	2.	2.	1.	-
	.9-1.2	-	-	-	1.	2.	2.	-	-
	.6-.9	-	1.	3.	3.	3.	1.	-	-
	.3-.6	-	-	1.	-	2.	-	-	-
	.0-.3	-	1.	1.	1.	1.	-	-	-
	soil	-	-	-	-	-	-	-	-
TOTAL		1.	7.	16.	18.	21.	12.	11.	5.
leaves	2.7-3.0	-	1.	-	-	1.	-	2.	1.
	2.4-2.7	7.	4.	6.	10.	14.	18.	27.	40.
	2.1-2.4	23.	32.	28.	33.	42.	54.	63.	46.
	1.8-2.1	18.	25.	27.	44.	35.	37.	50.	22.
	1.5-1.8	35.	37.	35.	31.	17.	39.	19.	6.
	1.2-1.5	31.	30.	29.	27.	27.	18.	12.	2.
	.9-1.2	26.	22.	17.	14.	10.	13.	2.	1.
	.6-.9	13.	4.	10.	10.	7.	7.	3.	1.
	.3-.6	1.	3.	3.	5.	3.	-	1.	-
	.0-.3	4.	2.	2.	1.	3.	1.	-	-
	soil	-	-	-	-	-	-	-	-
TOTAL		158.	160.	157.	175.	159.	187.	179.	119.
ears	2.7-3.0	-	-	-	-	-	-	-	-
	2.4-2.7	-	-	-	-	-	-	-	-
	2.1-2.4	-	-	-	-	-	-	1.	-
	1.8-2.1	-	-	-	-	-	-	-	-
	1.5-1.8	-	-	-	2.	2.	1.	-	-
	1.2-1.5	4.	5.	6.	-	5.	2.	3.	-
	.9-1.2	1.	-	-	1.	1.	1.	2.	-
	.6-.9	-	-	-	-	1.	-	-	-
	.3-.6	-	-	-	-	-	-	-	-
	.0-.3	-	-	-	-	-	-	-	-
	soil	-	-	-	-	-	-	-	-
TOTAL		5.	5.	6.	3.	9.	4.	6.	-
soil	2.7-3.0	-	-	-	-	-	-	-	-
	2.4-2.7	-	-	-	-	-	-	-	-
	2.1-2.4	-	-	-	-	-	-	-	-
	1.8-2.1	-	-	-	-	-	-	-	-
	1.5-1.8	-	-	-	-	-	-	-	-
	1.2-1.5	-	-	-	-	-	-	-	-
	.9-1.2	-	-	-	-	-	-	-	-
	.6-.9	-	-	-	-	-	-	-	-
	.3-.6	-	-	-	-	-	-	-	-
	.0-.3	-	-	-	-	-	-	-	-
	soil		84.	51.	43.	29.	18.	4.	-
TOTAL		84.	51.	43.	29.	18.	4.	-	

\* Indicates height above soil surface.

ORIGINAL PAGE IS  
OF POOR QUALITY



Table A4. Values of the matrix, Ajki, for the corn canopy (dimensionless). Each entry represents the proportion of the normalized light beam (listed in Table 15) intercepted by each layer and component.

Component of foliage	Height(m)*	Zenith Angle (degrees)							
		5	15	25	35	45	55	65	75
tassels	2.7-3.0	.0	.017	.004	.008	.008	.013	.035	.094
	2.4-2.7	.019	.042	.047	.017	.109	.066	.087	.223
	2.1-2.4	.012	.004	.004	.021	.017	.013	.022	.069
	1.8-2.1	.004	.0	.0	.0	.0	.0	.0	.0
	1.5-1.8	.0	.0	.004	.0	.0	.0	.0	.0
	1.2-1.5	.0	.0	.0	.004	.0	.0	.0	.0
	.9-1.2	.0	.0	.0	.0	.0	.0	.0	.0
	.6-.9	.0	.0	.0	.0	.0	.004	.0	.0
	.3-.6	.0	.0	.0	.0	.0	.0	.0	.0
	.0-.3	.0	.0	.0	.0	.0	.0	.0	.0
	soil	.0	.0	.0	.0	.0	.0	.0	.0
stems	2.7-3.0	.0	.0	.0	.0	.0	.0	.0	.0
	2.4-2.7	.0	.0	.0	.0	.004	.0	.0	.0
	2.1-2.4	.0	.004	.013	.004	.013	.0	.017	.015
	1.8-2.1	.0	.004	.017	.025	.021	.004	.009	.010
	1.5-1.8	.004	.008	.013	.013	.008	.026	.017	.0
	1.2-1.5	.0	.004	.004	.013	.008	.009	.004	.0
	.9-1.2	.0	.0	.0	.004	.008	.009	.0	.0
	.6-.9	.0	.004	.013	.013	.013	.004	.0	.0
	.3-.6	.0	.0	.004	.0	.008	.0	.0	.0
	.0-.3	.0	.004	.004	.004	.004	.0	.0	.0
	soil	.0	.0	.0	.0	.0	.0	.0	.0
leaves	2.7-3.0	.0	.004	.0	.0	.004	.0	.009	.005
	2.4-2.7	.027	.017	.025	.042	.059	.079	.118	.198
	2.1-2.4	.089	.134	.119	.139	.176	.236	.275	.228
	1.8-2.1	.070	.105	.114	.186	.146	.162	.218	.109
	1.5-1.8	.136	.155	.148	.131	.071	.170	.083	.030
	1.2-1.5	.121	.126	.123	.114	.113	.079	.052	.010
	.9-1.2	.101	.092	.072	.059	.042	.057	.009	.005
	.6-.9	.051	.017	.042	.042	.029	.031	.013	.005
	.3-.6	.004	.013	.013	.021	.013	.0	.004	.0
	.0-.3	.016	.008	.008	.004	.013	.004	.0	.0
	soil	.0	.0	.0	.0	.0	.0	.0	.0
ears	2.7-3.0	.0	.0	.0	.0	.0	.0	.0	.0
	2.4-2.7	.0	.0	.0	.0	.0	.0	.0	.0
	2.1-2.4	.0	.0	.0	.0	.0	.0	.004	.0
	1.8-2.1	.0	.0	.0	.0	.0	.0	.0	.0
	1.5-1.8	.0	.0	.0	.008	.008	.004	.0	.0
	1.2-1.5	.016	.021	.025	.0	.021	.009	.013	.0
	.9-1.2	.004	.0	.0	.004	.004	.004	.009	.0
	.6-.9	.0	.0	.0	.0	.004	.0	.0	.0
	.3-.6	.0	.0	.0	.0	.0	.0	.0	.0
	.0-.3	.0	.0	.0	.0	.0	.0	.0	.0
	soil	.0	.0	.0	.0	.0	.0	.0	.0
soil	2.7-3.0	.0	.0	.0	.0	.0	.0	.0	.0
	2.4-2.7	.0	.0	.0	.0	.0	.0	.0	.0
	2.1-2.4	.0	.0	.0	.0	.0	.0	.0	.0
	1.8-2.1	.0	.0	.0	.0	.0	.0	.0	.0
	1.5-1.8	.0	.0	.0	.0	.0	.0	.0	.0
	1.2-1.5	.0	.0	.0	.0	.0	.0	.0	.0
	.9-1.2	.0	.0	.0	.0	.0	.0	.0	.0
	.6-.9	.0	.0	.0	.0	.0	.0	.0	.0
	.3-.6	.0	.0	.0	.0	.0	.0	.0	.0
	.0-.3	.0	.0	.0	.0	.0	.0	.0	.0
	soil	.327	.214	.182	.122	.075	.017	.0	.0

\* Indicates height above soil surface.

Table A5. Values of absorption coefficient,  $K_{jki}$ , for the corn canopy. Units are (1.0/meters).

Component of foliage	Height(m)*	Zenith Angle (degrees)							
		5	15	25	35	45	55	65	75
tassels	2.7-3.0	.0	.055	.013	.023	.020	.025	.050	.085
	2.4-2.7	.066	.143	.147	.048	.285	.137	.145	.287
	2.1-2.4	.043	.016	.015	.068	.056	.035	.053	.201
	1.8-2.1	.016	.0	.0	.0	.0	.0	.0	.0
	1.5-1.8	.0	.0	.022	.0	.0	.0	.0	.0
	1.2-1.5	.0	.0	.0	.034	.0	.0	.0	.0
	.9-1.2	.0	.0	.0	.0	.0	.0	.0	.0
	.6-.9	.0	.0	.0	.0	.0	.219	.0	.0
	.3-.6	.0	.0	.0	.0	.0	.0	.0	.0
	.0-.3	.0	.0	.0	.0	.0	.0	.0	.0
	soil	.0	.0	.0	.0	.0	.0	.0	.0
stems	2.7-3.0	.0	.0	.0	.0	.0	.0	.0	.0
	2.4-2.7	.0	.0	.0	.0	.011	.0	.0	.0
	2.1-2.4	.0	.016	.045	.014	.042	.0	.043	.043
	1.8-2.1	.0	.019	.071	.105	.094	.016	.040	.088
	1.5-1.8	.018	.046	.067	.072	.050	.158	.165	.0
	1.2-1.5	.0	.032	.031	.103	.071	.096	.097	.0
	.9-1.2	.0	.0	.0	.048	.107	.182	.0	.0
	.6-.9	.0	.054	.161	.194	.220	.219	.0	.0
	.3-.6	.0	.0	.063	.0	.193	.0	.0	.0
	.0-.3	.0	.061	.068	.091	.118	.0	.0	.0
	soil	.0	.0	.0	.0	.0	.0	.0	.0
leaves	2.7-3.0	.0	.014	.0	.0	.010	.0	.013	.004
	2.4-2.7	.093	.057	.080	.120	.154	.165	.196	.255
	2.1-2.4	.330	.511	.420	.449	.585	.634	.672	.660
	1.8-2.1	.286	.469	.480	.772	.660	.610	1.009	.968
	1.5-1.8	.641	.860	.786	.749	.421	1.027	.782	.791
	1.2-1.5	.706	.957	.904	.927	.956	.860	1.161	.598
	.9-1.2	.751	.978	.722	.675	.533	1.184	.488	.598
	.6-.9	.453	.217	.537	.648	.513	1.531	1.953	.0
	.3-.6	.038	.174	.189	.408	.290	.0	.0	.0
	.0-.3	.154	.123	.136	.091	.355	.427	.0	.0
	soil	.0	.0	.0	.0	.0	.0	.0	.0
ears	2.7-3.0	.0	.0	.0	.0	.0	.0	.0	.0
	2.4-2.7	.0	.0	.0	.0	.0	.0	.0	.0
	2.1-2.4	.0	.0	.0	.0	.0	.0	.011	.0
	1.8-2.1	.0	.0	.0	.0	.0	.0	.0	.0
	1.5-1.8	.0	.0	.0	.048	.050	.026	.0	.0
	1.2-1.5	.091	.160	.187	.0	.177	.096	.290	.0
	.9-1.2	.029	.0	.0	.048	.053	.091	.488	.0
	.6-.9	.0	.0	.0	.0	.073	.0	.0	.0
	.3-.6	.0	.0	.0	.0	.0	.0	.0	.0
	.0-.3	.0	.0	.0	.0	.0	.0	.0	.0
	soil	.0	.0	.0	.0	.0	.0	.0	.0
soil	2.7-3.0	.0	.0	.0	.0	.0	.0	.0	.0
	2.4-2.7	.0	.0	.0	.0	.0	.0	.0	.0
	2.1-2.4	.0	.0	.0	.0	.0	.0	.0	.0
	1.8-2.1	.0	.0	.0	.0	.0	.0	.0	.0
	1.5-1.8	.0	.0	.0	.0	.0	.0	.0	.0
	1.2-1.5	.0	.0	.0	.0	.0	.0	.0	.0
	.9-1.2	.0	.0	.0	.0	.0	.0	.0	.0
	.6-.9	.0	.0	.0	.0	.0	.0	.0	.0
	.3-.6	.0	.0	.0	.0	.0	.0	.0	.0
	.0-.3	.0	.0	.0	.0	.0	.0	.0	.0
	soil	.0	.0	.0	.0	.0	.0	.0	.0

\* Indicates height above soil surface.

ORIGINAL PAGE IS  
OF POOR QUALITY

Table AG. Values of matrix, IUP, for the corn canopy (dimensionless). Each column represents the intensity of a normalized light beam traversing upward and attenuated by foliage in the canopy.

Height(m)*	Zenith Angle (degrees)					
	5	15	25	35	45	55
3.0	.327	.214	.182	.122	.075	.017
2.7	.327	.219	.183	.123	.076	.018
2.4	.343	.233	.197	.131	.092	.021
2.1	.384	.276	.231	.159	.123	.029
1.8	.420	.321	.277	.220	.170	.041
1.5	.512	.425	.371	.302	.212	.077
1.2	.651	.607	.538	.446	.353	.133
.9	.824	.823	.683	.592	.474	.286
.6	.944	.895	.860	.806	.667	.800
.3	.955	.944	.935	.935	.818	.800
.0	1.0	1.0	1.0	1.0	1.0	1.0

\* Indicates height above soil surface.

Table A7. Values of matrix, P(H:m,p,q), for the corn canopy (percent). The matrix represents the probability of viewing a component of the canopy in a direction downward from a surface, S1.

Probability of observing one or more	Height(m)* of Surface S1	Zenith Angle (degrees):					
		5	15	25	35	45	55
tasseis	3.0	3.5	6.3	5.9	5.1	13.4	9.6
	2.7	3.5	4.7	5.5	4.3	12.7	8.4
	2.4	1.6	.5	.9	2.7	2.1	2.1
	2.1	.5	.0	.5	.5	.0	.7
	1.8	.0	.0	.6	.8	.0	1.0
	1.5	.0	.0	.0	1.0	.0	1.9
	1.2	.0	.0	.0	.0	.0	3.3
	.9	.0	.0	.0	.0	.0	7.1
	.6	.0	.0	.0	.0	.0	.0
	.3	.0	.0	.0	.0	.0	.0
.0	.0	.0	.0	.0	.0	.0	
stems	3.0	.4	2.9	6.8	7.6	8.8	5.2
	2.7	.4	3.0	6.8	7.7	8.9	5.3
	2.4	.4	3.2	7.3	8.1	10.3	6.2
	2.1	.5	3.2	7.0	9.3	11.6	8.8
	1.8	.5	3.1	5.8	8.3	11.3	11.2
	1.5	.0	2.5	5.2	8.3	11.8	9.6
	1.2	.0	2.4	6.3	7.7	15.7	10.0
	.9	.0	3.2	7.9	8.2	15.8	7.1
	.6	.0	1.8	4.0	2.8	11.1	.0
	.3	.0	1.9	2.2	3.2	4.5	.0
.0	.0	.0	.0	.0	.0	.0	
leaves	3.0	61.5	67.2	66.5	73.8	66.5	81.7
	2.7	61.5	68.2	66.8	74.5	66.9	82.7
	2.4	61.6	70.8	69.3	74.7	73.8	87.6
	2.1	58.4	66.5	66.1	72.5	69.9	84.6
	1.8	55.0	61.6	61.9	66.7	63.2	79.6
	1.5	45.7	50.8	52.6	59.4	58.8	75.0
	1.2	34.1	36.9	40.0	46.2	45.1	70.0
	.9	17.6	14.5	23.8	32.7	34.2	57.1
	.6	5.6	8.8	10.0	16.7	22.2	20.0
	.3	4.5	3.7	4.3	3.2	13.6	20.0
.0	.0	.0	.0	.0	.0	.0	
ears	3.0	1.9	2.1	2.5	1.3	3.8	1.7
	2.7	1.9	2.1	2.6	1.3	3.8	1.8
	2.4	2.0	2.3	2.8	1.4	4.6	2.1
	2.1	2.3	2.7	3.2	1.6	6.2	2.9
	1.8	2.5	3.1	3.9	2.3	8.5	4.1
	1.5	3.0	4.2	5.2	1.0	8.2	5.8
	1.2	.8	.0	.0	1.5	3.9	3.3
	.9	.0	.0	.0	.0	2.6	.0
	.6	.0	.0	.0	.0	.0	.0
	.3	.0	.0	.0	.0	.0	.0
.0	.0	.0	.0	.0	.0	.0	
soil	3.0	32.7	21.4	18.2	12.2	7.5	1.7
	2.7	32.7	21.9	18.3	12.3	7.6	1.8
	2.4	34.3	23.3	19.7	13.1	9.2	2.1
	2.1	38.4	27.6	23.1	15.9	12.3	2.9
	1.8	42.0	32.1	27.7	22.0	17.0	4.1
	1.5	51.2	42.5	37.1	30.2	21.2	7.7
	1.2	65.1	60.7	53.8	44.6	35.3	13.3
	.9	82.4	82.3	68.3	59.2	47.4	28.6
	.6	94.4	89.5	86.0	80.6	66.7	80.0
	.3	95.5	94.4	93.5	93.5	81.8	80.0
.0	100.0	100.0	100.0	100.0	100.0	100.0	

\* Indicates height above soil surface.

ORIGINAL PAGE IS  
OF POOR QUALITY

Table A8. Values of matrix,  $P(H:m,p,q)$ , for the corn canopy (percent). The matrix represents the probability of viewing a component of the canopy in a direction upward from a surface, S1.

Probability of observing one or more	Height(m)* of surface S1	Zenith Angle (degrees)					
		5	15	25	35	45	55
sky	3.0	100.0	100.0	100.0	100.0	100.0	100.0
	2.7	100.0	97.9	99.6	99.2	98.7	98.7
	2.4	95.3	92.0	92.4	93.2	81.6	84.3
	2.1	85.2	77.7	78.8	76.8	61.1	59.4
	1.8	77.8	66.8	65.7	55.7	44.4	42.8
	1.5	63.8	50.4	49.2	40.5	35.6	22.7
	1.2	50.2	35.3	33.9	27.4	21.3	13.1
	.9	39.7	26.1	26.7	20.7	15.9	6.1
	.6	34.6	23.9	21.2	15.2	11.3	2.2
	.3	34.2	22.7	19.5	13.1	9.2	2.2
.0	32.7	21.4	18.2	12.2	7.5	1.7	
tassels	3.0	.0	.0	.0	.0	.0	.0
	2.7	.0	1.7	.4	.8	.8	1.3
	2.4	1.9	5.9	5.1	2.5	11.7	7.8
	2.1	3.0	5.4	4.8	4.3	10.8	7.0
	1.8	3.2	4.7	4.0	3.1	7.9	5.1
	1.5	2.6	3.5	3.6	2.3	6.3	2.7
	1.2	2.0	2.5	2.5	2.6	3.8	1.5
	.9	1.6	1.8	2.0	1.9	2.8	.7
	.6	1.4	1.7	1.6	1.4	2.0	7.4
	.3	1.4	1.6	1.4	1.2	1.6	7.4
.0	1.3	1.5	1.3	1.2	1.3	5.9	
stems	3.0	.0	.0	.0	.0	.0	.0
	2.7	.0	.0	.0	.0	.0	.0
	2.4	.0	.0	.0	.0	.4	.0
	2.1	.0	.5	1.4	.5	1.9	.0
	1.8	.0	.9	3.3	3.6	4.8	.7
	1.5	.5	2.0	4.4	4.9	5.7	6.5
	1.2	.4	2.2	3.9	6.4	5.8	7.6
	.9	.3	1.6	3.1	6.4	8.2	10.2
	.6	.3	3.1	7.2	10.8	13.7	10.8
	.3	.3	2.9	8.6	9.3	18.6	10.8
.0	.3	4.6	10.2	11.9	19.8	8.6	
leaves	3.0	.0	.0	.0	.0	.0	.0
	2.7	.0	.4	.0	.0	.4	.0
	2.4	2.7	2.1	2.6	4.3	6.3	8.0
	2.1	11.8	16.4	15.0	18.4	26.2	33.6
	1.8	19.0	27.6	27.0	37.5	43.0	51.4
	1.5	33.1	44.1	42.8	50.8	50.5	67.1
	1.2	44.9	55.9	54.5	62.5	62.1	73.3
	.9	55.7	67.4	64.2	68.7	65.9	77.5
	.6	61.3	68.4	66.8	70.9	65.2	77.7
	.3	61.8	70.1	67.5	74.9	64.3	77.7
.0	63.5	69.9	67.4	73.3	66.2	82.2	
ears	3.0	.0	.0	.0	.0	.0	.0
	2.7	.0	.0	.0	.0	.0	.0
	2.4	.0	.0	.0	.0	.0	.0
	2.1	.0	.0	.0	.0	.0	.0
	1.8	.0	.0	.0	.0	.0	.0
	1.5	.0	.0	.0	1.5	1.9	1.0
	1.2	2.4	4.2	5.2	1.0	7.0	4.4
	.9	2.7	3.1	4.1	2.3	7.2	5.4
	.6	2.4	2.8	3.2	1.7	7.7	1.9
	.3	2.3	2.7	3.0	1.5	6.3	1.9
.0	2.2	2.5	2.8	1.4	5.2	1.5	

\* Indicates height above soil surface.

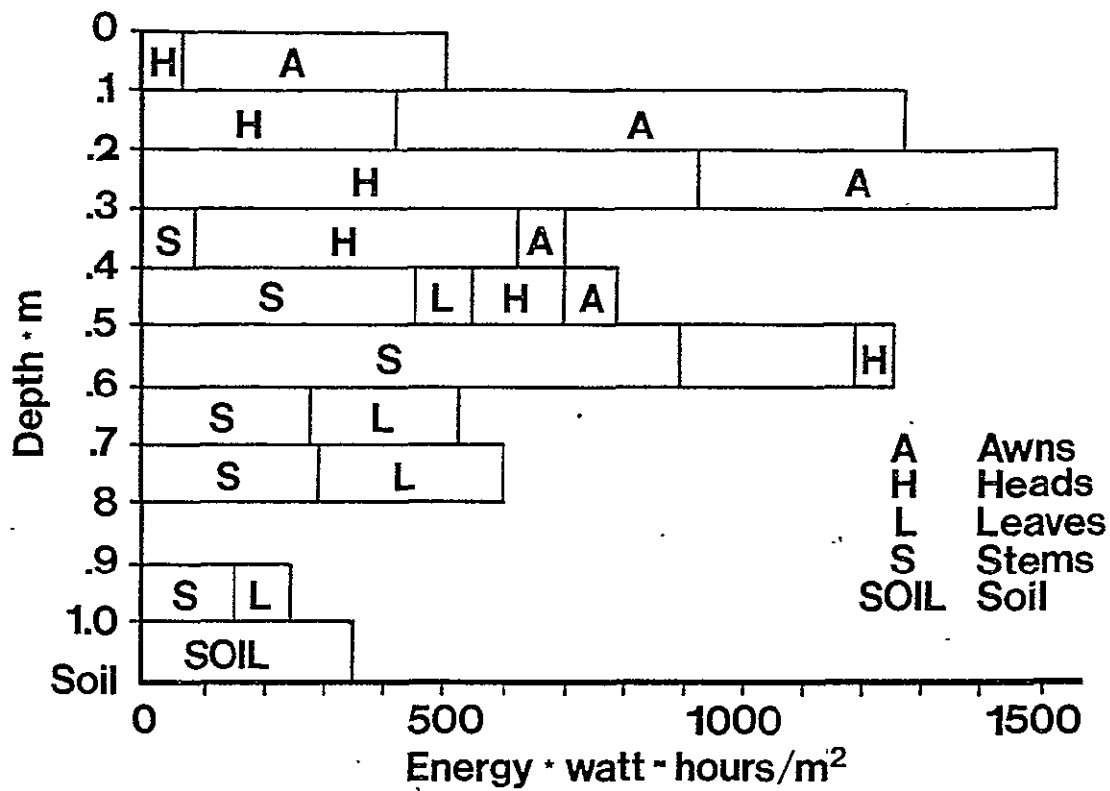

ABOVE: Estimates of the solar energy intercepted in one day in each layer by each component of the wheat canopy were obtained through analysis of the laser data. In addition the use of laser analysis techniques can provide estimates of solar power distribution, leaf area index, projected foliage area, foliage area and orientation and other important canopy parameters.

BACK COVER: The raw data acquired over wheat using the laser probe (the orange dots) is overlaid on a hypothetical wheat canopy. The analysis of the raw data involved definition of zenith angle bins, outlined by the black lines.