

National Aeronautics and Space Administration

Headquarters
Washington, D C 20546

ANNUAL CONFERENCE OF NASA CLINIC DIRECTORS

MARCH 18-20, 1975

(NASA-TM-74848) PROCEEDINGS OF THE ANNUAL
 CONFERENCE OF NASA CLINIC DIRECTORS,
 ENVIRONMENTAL HEALTH OFFICIALS, AND MEDICAL
 PROGRAM ADVISORS (National Aeronautics and
 Space Administration) 292 p HC A13/MF A01
 G3/52
 N77-30715
 THRU
 N77-30734
 Unclass
 45775

Proceedings of the ANNUAL CONFERENCE

of

NASA CLINIC DIRECTORS, ENVIRONMENTAL HEALTH OFFICIALS and MEDICAL PROGRAM ADVISORS

**WILLIAMSBURG, VIRGINIA
MARCH 18, 19, 20, 1975**

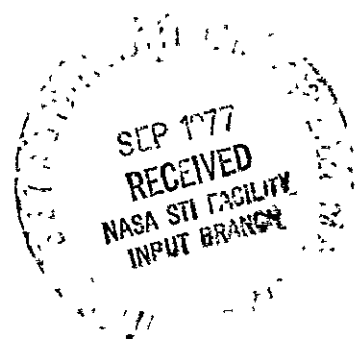

OFFICE OF PERSONNEL PROGRAMS

Office of Occupational Medicine and Environmental Health

PREFACE

These Proceedings are a representation of the interaction of participating members from the NASA Field Installations, NASA Consultants, and Environmental Health Specialists. Changes in program direction and content have been accomplished as a result of past meetings, and this material represents the major interest areas of the Occupational Medicine and Environmental Health Programs.

Our appreciation is extended to all participants for the worthwhile discussion of these topics.

A handwritten signature in black ink, reading "Louis B. Arnoldi, M.D.", with a stylized flourish at the end.

Louis B. Arnoldi, M.D.
Director
Office of Occupational Medicine

TABLE OF CONTENTS

	<u>Page</u>
Preface	i
Table of Contents	iii
NASA OCCUPATIONAL MEDICINE PROGRAMS -- OUR OBLIGATION TO MANAGEMENT	1
Louis B. Arnoldi, M.D., Director, Office of Occupational Medicine and Environmental Health	
ENVIRONMENTAL HEALTH TRENDS	43
Gene Proctor, Chief, Environmental Health	
CURRENT ASPECTS OF OCCUPATIONAL CHEMICAL CARCINOGENESIS	61
Dr. Donald Lassiter, Office of Standards, Occupational Safety and Health Administration, Department of Labor Washington, D.C.	
CONCEPTS IN HEALTH EVALUATION OF COMMERCIAL AND INDUSTRIAL CHEMICALS	75
Bernard P. McNamara, Ph.D., Biomedical Laboratory Edgewood Arsenal, Maryland	
EXERCISE STRESS TESTING	109
Benjamin Schuster, M.D. Director of Cardiac Diagnostic Laboratory Kettering Medical Center Dayton, Ohio	
REVIEW OF HEALTH MAINTENANCE PROGRAMS, 1960-1974-- NASA WALLOPS FLIGHT CENTER	119
Edward S. White, M.D. Medical Director Wallops Flight Center	
BEHAVIOR PATTERNS AND CORONARY HEART DISEASE	139
John C. Townsend, Ph.D. Department of Psychology and Psychiatry Catholic University of America Washington, D.C.	

	<u>Page</u>
JPL NOISE CONTROL PROGRAM	149
Al F. Klascius Industrial Hygiene Engineer Jet Propulsion Laboratory Pasadena, California	
ENVIRONMENTAL HEALTH CONCERNS IN NATURAL AND MAN-MADE ENVIRONMENTS	159
Charles P. Bergtholdt Occupational Health Officer NASA Johnson Space Center Houston, Texas	
THE U.S. ENVIRONMENTAL PROTECTION AGENCY NATIONAL POLLUTANT DISCHARGE ELIMINATION SYSTEM (NPDES)	167
Julian M. Earls, Ph.D. Office of Environmental Health NASA Lewis Research Center Cleveland, Ohio	
NASA LANGLEY PHYSICAL EXAMINATION PROGRAM	177
Robert L. McArthur Occupational Health Services NASA Langley Research Center Hampton, Virginia	
ANNUAL HEALTH EXAMINATION PROGRAM -- NASA AMES RESEARCH CENTER	189
Lewis Hughes, Ph.D. Health Officer NASA Ames Research Center Moffett Field, California	
EVALUATION OF CLASS II BIOLOGICAL CABINETS	225
Richard I. Chamberlin Industrial Hygiene Officer Massachusetts Institute of Technology Cambridge, Massachusetts	
DISABILITY RETIREMENT	237
Raymond L. Eck, M.D. Acting Assistant Director for Health U.S. Civil Service Commission Washington, D.C.	
MEDICAL SUITABILITY FOR FEDERAL EMPLOYMENT	255
Raymond L. Eck, M.D.	

	<u>Page</u>
A REVIEW OF CURRENT AND PROPOSED STANDARDS FOR OCCUPATIONAL EXPOSURES TO RADIO-FREQUENCY ENERGY	267
Lawrence T. Odland, Col., USAF, MC Commander USAF Radiological Health Laboratory Wright-Patterson Air Force Base, Ohio	
RADIATION MEASURING INSTRUMENTATION	279
Harley V. Piltingsrud, Capt., USAF, BSC USAF Radiological Health Laboratory Wright-Patterson Air Force Base, Ohio	
DEVELOPMENT AND APPLICATION OF FUNCTIONAL MANNING STANDARDS IN NASA	293
Walter A. Maull Office of Resources Management Office of Institutional Management NASA Headquarters, Washington, D.C.	
HYPERTENSION SCREENING	299
John Foulke, M.D. Medical Director NASA Goddard Space Flight Center Greenbelt, Maryland	

PROCEEDINGS
OF
THE ANNUAL CONFERENCE
OF
NASA CLINIC DIRECTORS,
ENVIRONMENTAL HEALTH OFFICIALS,
AND
MEDICAL PROGRAM ADVISORS

held at

HOSPITALITY HOUSE
Williamsburg, Virginia

March 18, 19, and 20, 1975

N77-30716

NASA OCCUPATIONAL MEDICINE PROGRAMS--
OUR OBLIGATION TO MANAGEMENT

Louis B. Arnoldi, M.D., and
Jean Mockbee

March 18, 1975

In the past, I have opened these meetings with a general greeting, delivered a brief summary of our past year's accomplishments, and have made a passing reference to the continuation of our good work. My remarks this morning, however, address a more serious topic and one of the utmost relevance to the future of our programs. They do not particularly concern the environmental health portion of our program because, so far, at least, these activities have apparently caught the public attention they deserve, and are each day becoming more cemented into the framework of our occupational environment. I am speaking here, primarily, of our efforts in preventive medicine, undertaken so ambitiously, eleven years ago, and today resting insecurely in a state of questionable continuation. The fault, I am sorry to say, lies mostly with ourselves, because in the practice of our clinical activities and in our concern over the individual health problems of our employee-patients, we have apparently overlooked the responsibility we have to those who have sponsored our programs. We have been so absorbed with the practice of medicine that we have forgotten that in an organization, we must practice management as well. The result has been the confusion and distress of our managers who see our program only twice a year--once when they report for their own physical examination, and once more when they sign the renewal of our next year's contract.

For some, there is an honest and sincere belief that health is an individual responsibility and that the employer has no obligation other than to provide a reasonably safe work environment. Others look at the

costs of medicine and the incomes of physicians outside, and the salaries paid to their own medical directors (often greatly in excess of that which they receive themselves) and view the whole science as an enormous rip-off. Some have given us the benefit of the doubt, but even they must concede that while they have no proof of our failure, they also have no evidence of our success, and while they would prefer to continue to believe our justifications, the relentless process of the annual budget gives them little choice.

"Medicine is an art and not science," we protest, "it cannot be ordered and managed as we would an assembly line, we are physicians, not auditors," we say. "Proof? What proof? No one has ever been able to show proof of success in our field," we argue, and we give up trying.

If there is one message I would have you carry away from this meeting this year, it is that the managing of a medical program, efficiently, economically, and effectively, and the gathering of the documented results of our efforts, is no longer a matter of choice. I am not speaking here of what has been politely requested, but of what is and will be openly demanded. Our mission for this year, and the next year, and the year after that, will be to meet this demand, to the best of our ability.

EVOLUTION OF NASA OCCUPATIONAL MEDICINE PROGRAMS

I would like now, to spend a few minutes reviewing with you some of the efforts undertaken by our own office. As I do so, it is with my sincerest gratitude for the information you have so loyally and patiently provided over the years and which we have used again and again as we have prepared the defense of our programs.

(Figure 1) The NASA occupational medicine programs were formally organized in the Fall of 1963. Within the first year, major programs had been established at Headquarters, Kennedy, Marshall, Goddard, and Wallops. The collection of statistical workload data began 1965. At that time, the average utilization rate for NASA programs was one visit per employee per year. In the succeeding years, programs at other Centers were initiated, on-going programs were expanded, and the result has been a consistent upward trend in the rate of employee visits, which today, is twice that of ten years ago.

(Figure 2) The same has been true of our examination programs. In 1965 our resources provided examinations to less than 20% of the population per year. Today, we operate at a level of 56%, almost two times our level ten years ago. For the past eleven years, we have supported an evolutionary concept of development, allowing each installation to grow at its own pace, and to organize to meet the unique demands of its own environment. It was a concept which was worth following because preventive medicine was a relatively new science and we had no models to imitate. In our belief, it has yielded untold benefits, as each

program has made its own unique and very special contribution to the science of occupational medicine. It is being challenged today, not because it was an improper method of operation, but because we now have new and different priorities. A very major one, and one which affects not only our programs, but all personnel programs throughout the Federal government, is the right of an employee to an equality of treatment, as much in his health care as in his career development. This is a priority which I believe we must honor, not because our managers have ordered it, but because it is basically right, and we believe in it ourselves. If it means that our programs must change because of it, we must see to it that they change for the better and that we not give up the advances we have made, but that we look for an respond to the challenges ahead.

MEDICAL FACILITY OPERATIONS

Recent additions to our PROM data system have included two on-line capabilities, the first, an ordinary information retrieval system, and the second, a new graphics display system, still in development, for which we were privileged to have been selected as the first user. These two systems have enabled us, finally, to review the 160,000 records contributed annually, by you, to the PROM system, and to use them in an assessment of the effectiveness of our programs. The following are a few examples of the output of the system.

(Figure 3) As we develop what will be the new policy for management of our programs, we will be looking at the current distribution of workload, the ratio of occupational to non-occupational visits, the ratio of first visits to revisits, and making other comparisons, and we will be attempting to establish what might be the optimum arrangement for medical care.

(Figure 4) An example is the current high level of non-occupational revisits at Goddard, almost twice that of Kennedy and four to five times that of Johnson and Marshall. We will be asked "Why" and "what are we getting from it?" and we must be able to reply with a reasonable explanation. Here, we believe we have a case--the use of revisits for an ambitious followup program in coronary risk factor control, but this must not only be shown, but sold as well.

(Figure 5) We have heard much in the past year about "zero base," "manning standards," and "productivity," and in the future we will also

be looking for more efficient means of using our medical teams. If we know, for instance, that Monday is always a heavy workload day for illness visits, and that there is very little we can do about it, we should look to the activities over which we have some control and can schedule, such as the treatments requested by the private physicians (Figure 6) and our examinations. This will require our time and our thought and a trial of alternative solutions, if we are to be successful, but the choice is only to do it ourselves, or to relinquish this chore to others who most assuredly will do it for us, and perhaps with far less insight or knowledge of how our programs operate.

(Figures 7 and 8) We must also be aware of trends in our medical practices. Once we have established a desired level of health care, whether we adopt one ratio or another, we must assure ourselves that it is maintained, and our data system will help us, by plotting weekly and monthly trends for various kinds of services. The examples here are first and revisit rates for both non-occupational conditions and occupational conditions, with what may be declines in activities at both Goddard and Marshall.

One use for these data will, we hope, be an improvement in the overall management of our programs. While we resist the big brother tendency to oversee and compare programs, pitting one against the other, we must concede that there is a potential for a mutual sharing of data and program philosophies, and if one program has truly built a better mousetrap, nothing will be lost by examining it in detail and perhaps modelling other programs after it.

EXAMINATION POLICY

The problem of immediate concern, and the one which is receiving the greatest attention at Headquarters, is a determination of what shall be an appropriate examination policy for NASA. While we have externally established guidelines for our so-called job-related examinations, and will be receiving many more in the future, no such direction has been supplied for our health maintenance programs. A number of proposals have been and will be made before the issue is settled. The heart of these proposals has been suggested by data collected from our own population.

(Figure 9) In a combined data base, constructed from special submissions by Marshall and Goddard to the PROM system, we prepared a special analysis of chronic disease prevalence, concentrating on diseases common in the young. We found that even among employees in their early twenties, abnormal findings were present in 60%. (Figure 10) Metabolic disorders were found in one out of every four persons in their late twenties and early thirties. (Figure 11) Hypertension was found in one out of sixteen examined under age forty, and heart disease in one out of a hundred (Figure 12). It was apparent, and convincingly so, that if economic necessity forced us to return to the old standard of examinations beginning at age forty, we would be failing in our own precept of preventive medicine. We had then, to find another way, and as of this date, we are considering alternatives of annual screening procedures and triennial examinations for those under 40 and annual examinations for those over 40, or perhaps annual screening and biennial examinations for all.

Another interesting product of the Goddard-Marshall data base was a confirmation of previous findings of differences in health risk among various occupational groups (Figure 13). Among males we found significant and consistently higher rates of hypertension, heart disease, stomach ulcer, and arthritis, among those employed in technician and administrative positions compared to those employed as scientists and engineers. These kinds of differences were among our first findings in the early years of our programs, and quite recently, they have been explored and confirmed among other organizations and industry, in a major research program funded by the National Institute for Occupational Safety and Health.

(Figure 14) We are only just beginning to study the health of our female employees, and regrettably, the Goddard-Marshall data base currently contains only 280 records on females. We compared non-professional with professional and found only small differences in hypertension, heart disease, and digestive disorders, but a significantly higher rate of arthritis among those in the professional category.

If certain diseases are concentrated only in particular segments of our population, we need to know about it, and to take it into consideration when we examine our employees. These are the kinds of studies which are needed and will ultimately be required if we are to improve our control over disabling chronic disease.

EFFECTS OF JOB STRESS

The same data base which has supplied us with the analysis of our medical facility operations, is capable of plotting trends, helpful in providing an insight into the relationship between job stress and employee health. This has been adequately demonstrated both at the Kennedy and Johnson Space Centers, during the manned Skylab program. (Figure 15) At Kennedy, the highest rates of illness visits among the manned stage and spacecraft contractors seem to have occurred in the months of preparation prior to launch, while the Civil Service population appears to have been affected more by the launch phase itself. (Figure 16) At Johnson, we have completed a thorough review of all illness visits and have isolated those categories most prone to increases during periods of intense work overload and deadline pressure. Our plans for the coming year will be to review the health of these populations, looking for chronic diseases which may have evolved from these early symptoms.

Observations of visit rates at the Lewis Research Center, during a period of a major reduction in force and the closing of its Plum Brook facility, prompted a more thorough review of visit patterns there. The results were (Figure 17) an increase in visits for headache, digestive disorders, and ill-defined symptoms and conditions, during the RIF period, compared to the periods both before and after; (Figure 18) an increase in requests for aspirin supply refills from seven to nineteen per month during the final months of the RIF; and (Figure 19) an increase in visits

for blood pressure check. The interesting thing about both the blood pressure visits and the visits for headache, digestive disorders and ill-defined symptoms, is that even though the population had decreased following the RIF, the visit rates for the post-RIF period did not return to the lower level of the pre-RIF period.

(Figure 20) At Goddard, where there is a strong return to work examination policy and, thus, a unique data base of major illness events, we have been following trends in chronic disease over the past nine years. The same effects of reductions in force are in evidence there, both in 1971 and again in 1973, and here, we are not dealing with minor symptoms and conditions, but with illness episodes which have caused significant quantities of job time loss.

(Figure 21) The extraordinary sensitivity of blood pressure visit data to periods of change in a population is observed again at NASA Headquarters in the Spring of 1974 after the announcement of the reorganization. The trend peaked in mid-summer and was on a downward slope (although still far from its earlier level) until in December, when a mandatory transfer policy was announced and selected candidates received their notification, and the curve was again on an upward slant.

(Figure 22) In an eight-year analysis of the Headquarters dynamic electrocardiogram data completed last summer, we have upward trends in the prevalence of both ventricular premature contractions and S-T segment changes, increasing from 2 to 3% of the population in 1967 and 15 to 20% of the population in 1973. This is a decline following the end of the

Gemini program, an increase as we approach the first of the manned lunar landings, and another increase in the recent years as the manned flight programs have been completed and we are left with only an uncertain future ahead.

The point is, that the effects of sudden changes in our occupational environment are apparent in the everyday health of our employees, and may be observed through even the simplest of data collection techniques in the medical facility. It is possible to assess the health of our occupational climate much as the indicators of new construction starts, bank lending, and mortgage foreclosures provide the stock market with an index of the health of the economy. We have an obligation to collect these data, to solicit the attention of our managers, and to convince them that their policies and programs sometimes have a very great impact on employee health.

EVIDENCE OF SUCCESS

Finally, we owe our management some evidence that our efforts in occupational medicine have been worthwhile. For the past eleven years, they have supported our programs, mostly on faith, and for a period when NASA was crashing to meet its superhuman goals and seemed to have all the money in the world to spend, we could well afford a little faith. Today our space environment, and, indeed, our whole political climate has changed. We are living in a time when the American people are demanding honesty, responsibility, efficiency, economy, and productivity in public affairs. The same qualities that we, as private citizens require of our utilities, our energy suppliers, our car manufacturers, and our food producers, will also be required of medicine--a dollar's worth of value for a dollar's worth of labor.

We have but a few scraps of evidence now: (Figure 23) a curve in sick leave usage which has remained at essentially the same level for the past five years, despite the fact that the average age of the population has increased by three years; (Figure 24) we have a declining rate of cardiovascular disease mortality at Headquarters; and (Figure 25) a prevalence rate of ischemic heart disease which is the same in 1973 as it was nine years ago, in a population which has also aged by three years. (Figure 26) Finally, we have a small, but consistent decrease in disease-caused deaths at the space flight centers and at Headquarters (where we have had our most ambitious preventive medicine program) and a consistent increase in disease-caused deaths at the research centers where preventive medicine efforts have been more modest.

We have been reluctant to draw attention to these measures, because we still know so little about the impact of the occupational environment on chronic disease, and from what evidence we do have, we see a high correlation between the peaks and valleys in disease trends, and the peaks and valleys in periods of job stress. Nevertheless, we must continue to search, continue to collect, continue to share what little evidence we have, because only by a patient piecing together of the parts, may we ultimately hope to visualize the whole. Our responsibility to our managers and our duty to the workforce whose health we are obligated to maintain, is an awareness of what can be healthful occupational environment, and what must be an effective program of occupational medicine.

The occupational physician is charged with the overall responsibility of maintaining and protecting the health of employees. Thus, to adequately perform his job, he must be well informed in regard to working conditions and potential health hazards that exist in each work place. Each OSHA standard and the mini standards currently being developed specify medical and biological monitoring as-well-as recordkeeping and reporting requirements.

For the occupational physician to keep abreast of varying work requirements of employees and their exposure to chemical, physical, biological and job stresses; he must rely on the services of environmental health personnel. Environmental health personnel must also rely on the occupation physician to ascertain the effectiveness of various types of control measures instituted.

The necessity of their continued close association cannot be over emphasized if OSHA goals, objectives, and requirements are to be met.

Figure 1
 TREND IN NASA INJURY AND ILLNESS VISITS, 1965-1974
 Visits Per Employee Per Year

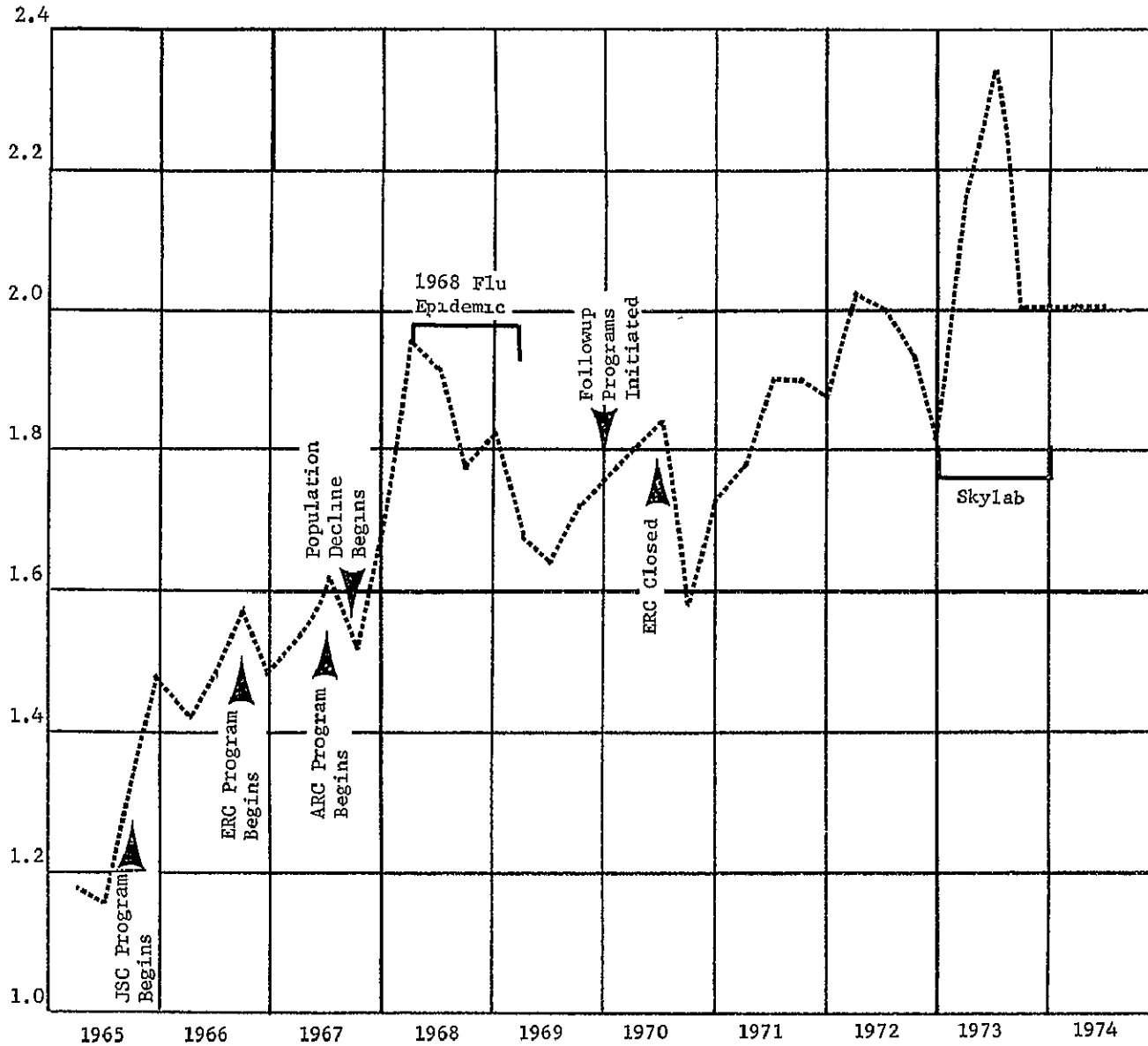

Figure 2

TREND IN NASA EXAMINATION PROGRAMS, 1965-1974
 Percentage of Population Examined Per Year

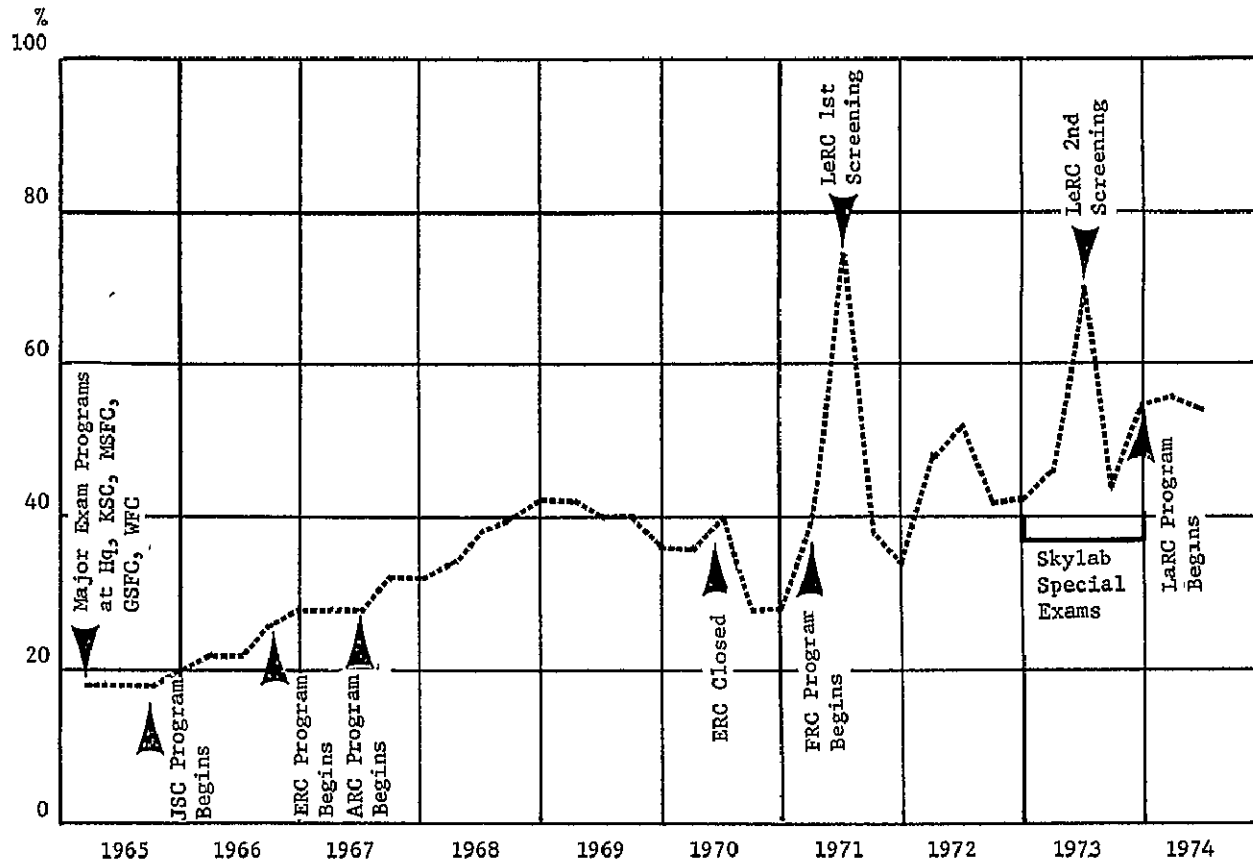

Figure 3

NASA OCCUPATIONAL MEDICINE PROGRAMS
 Medical Facility Utilization, 1973
 Percentage Distribution of Visits,
 by Visit Type

Population
 Kennedy 16,972
 Johnson 9,554
 Goddard 3,852
 Marshall 5,287

NASA Kennedy Space Center

1- 0 09%
 2- 7 57%
 3- 11 95%
 4- 39 82%
 5- 15 85%
 6- 6 77%
 7- 4 77%
 8- 13 19%

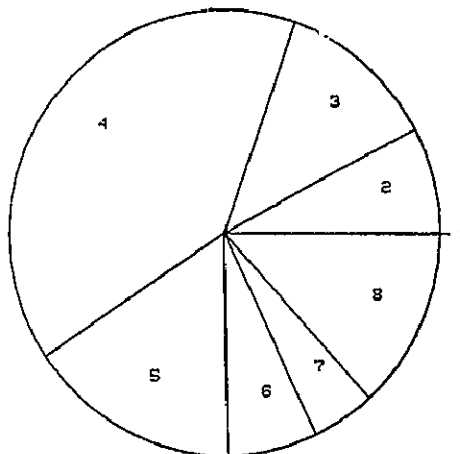

NASA Johnson Space Center

1- 0 7%
 2- 6 81%
 3- 1 84%
 4- 52 18%
 5- 8 28%
 6- 6 80%
 7- 0 73%
 8- 22 82%

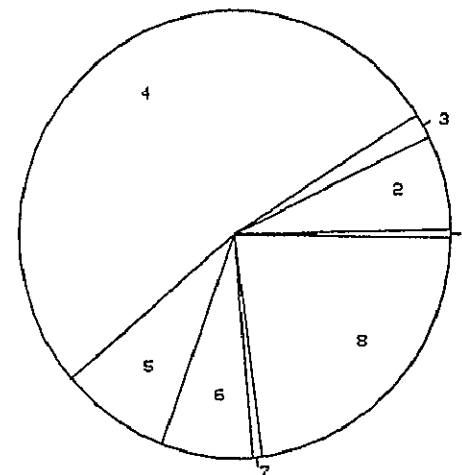

NASA Goddard Space Flight Center

1- 0 12%
 2- 4 66%
 3- 2 99%
 4- 25 95%
 5- 25 69%
 6- 5 75%
 7- 1 89%
 8- 33 85%

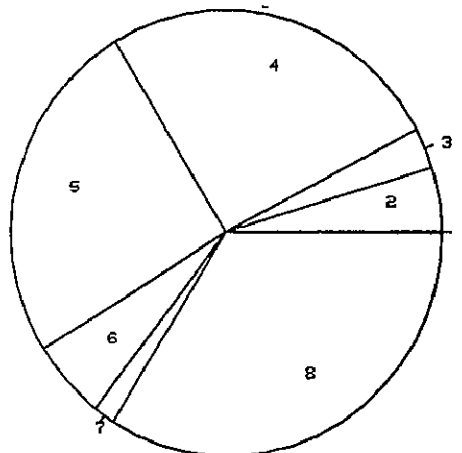

NASA Marshall Space Flight Center

1- 0 52%
 2- 11 65%
 3- 7 32%
 4- 26 38%
 5- 5 16%
 6- 5 55%
 7- 1 29%
 8- 41 71%

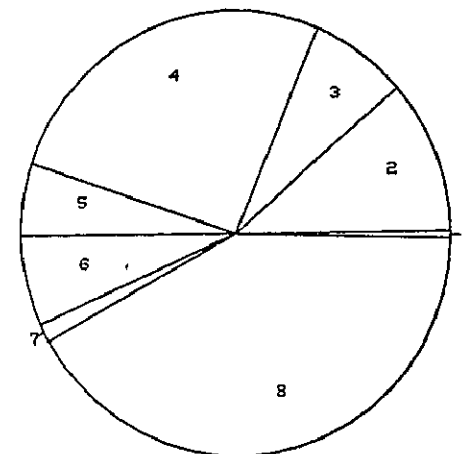

1 Occ Ill First Visit
 2 Occ. Inj. First Visit
 3 Occ Inj. Revisit
 4 Non-occ. Ill First Visit
 5 Non-occ Ill Revisit
 6 Non-occ Inj First Visit
 7 Non-occ Inj Revisit
 8 Treatments Requested by
 Private Physicians

Figure 4

NASA OCCUPATIONAL MEDICINE PROGRAMS
 Medical Facility Utilization, 1973
 Frequency Distribution of Illness First Visits
 and Revisits, by Diagnosis

Population
 Kennedy 16,972
 Johnson 9,554
 Goddard 3,852
 Marshall 5,287

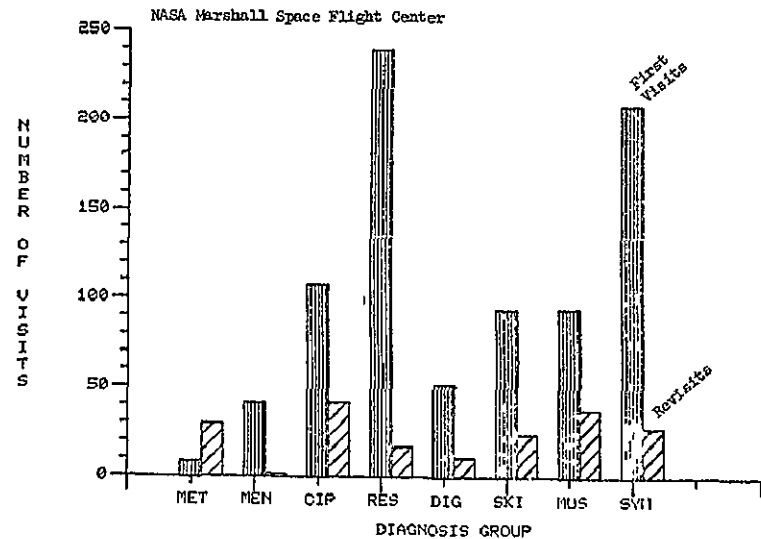
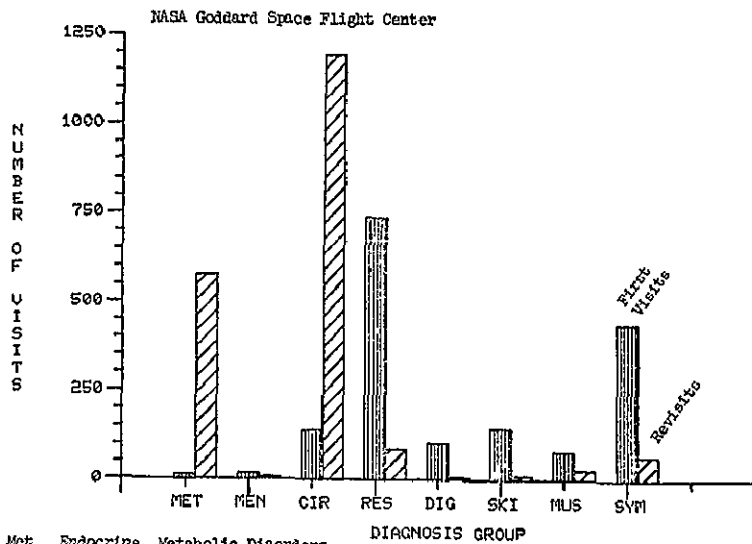
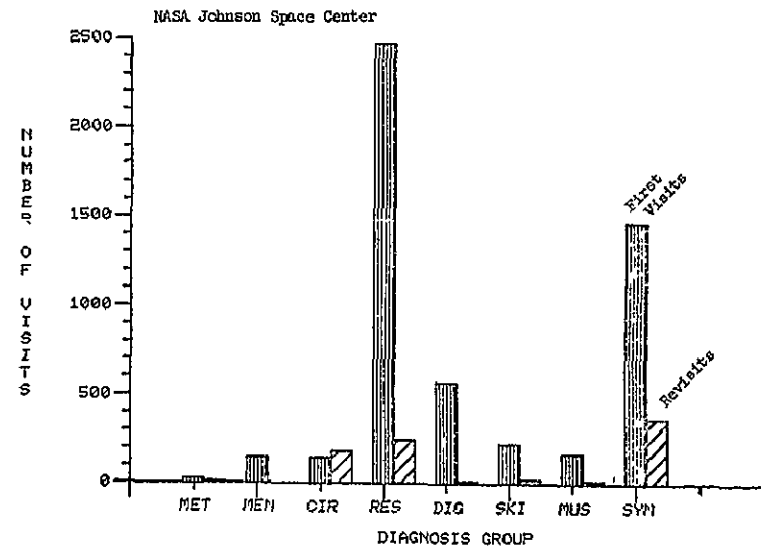
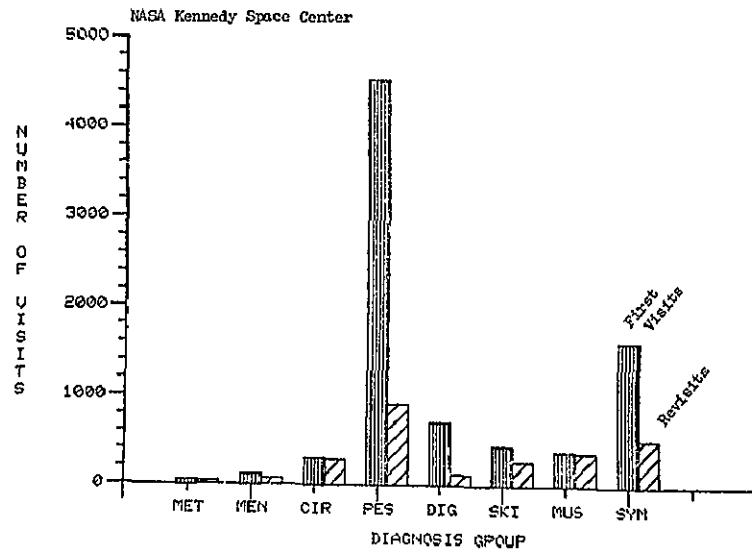

Met Endocrine, Metabolic Disorders
 Men Mental Disorders
 Cir Circulatory Disorders
 Res Respiratory Disorders
 Dig Digestive Disorders
 Ski Skin Disorders
 Mus Musculoskeletal Disorders
 Syn Ill-defined Symptoms

FROM GRAPHICS
 7502

Figure 5

NASA OCCUPATIONAL MEDICINE PROGRAMS
 Medical Facility Utilization, 1973
 Percentage Distribution of Non-occupational Illness
 and Injury First Visits, by Day of Week

Population	
Kennedy	16,972
Johnson	9,554
Goddard	3,852
Marshall	5,287

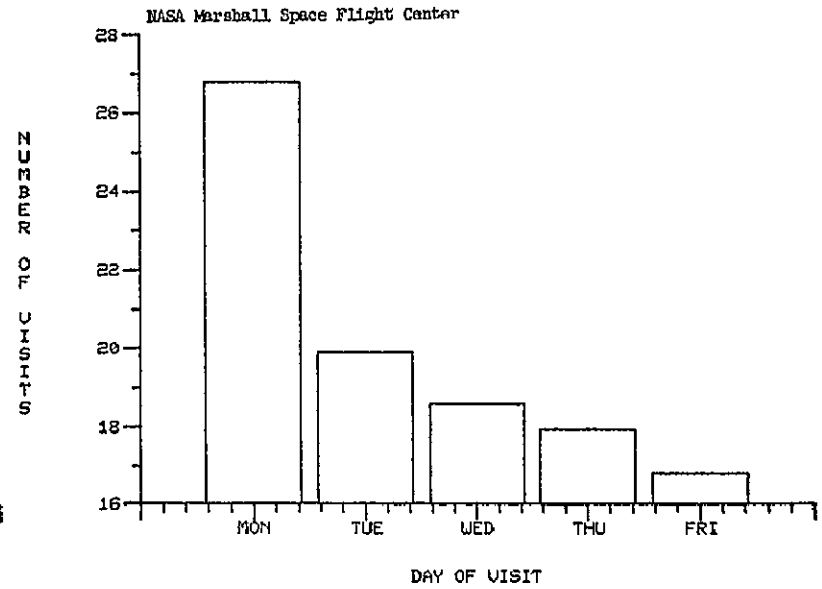
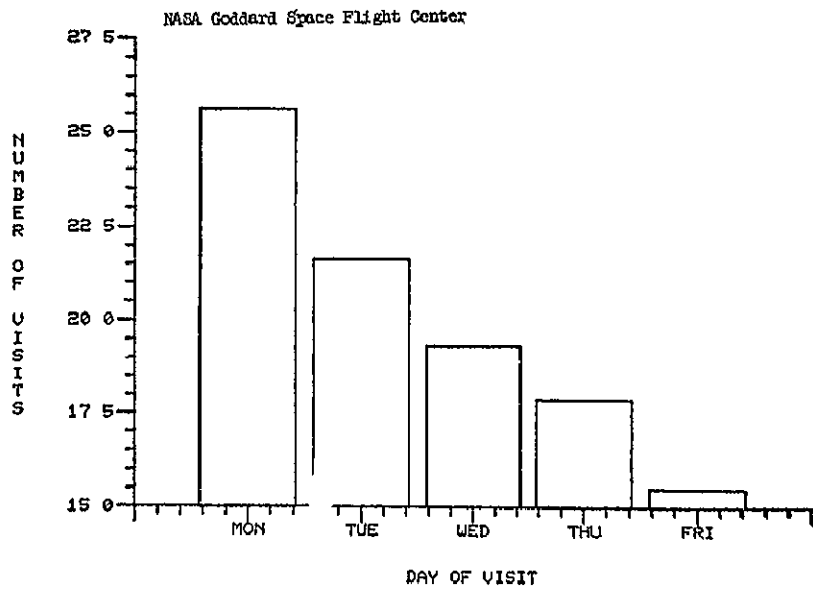
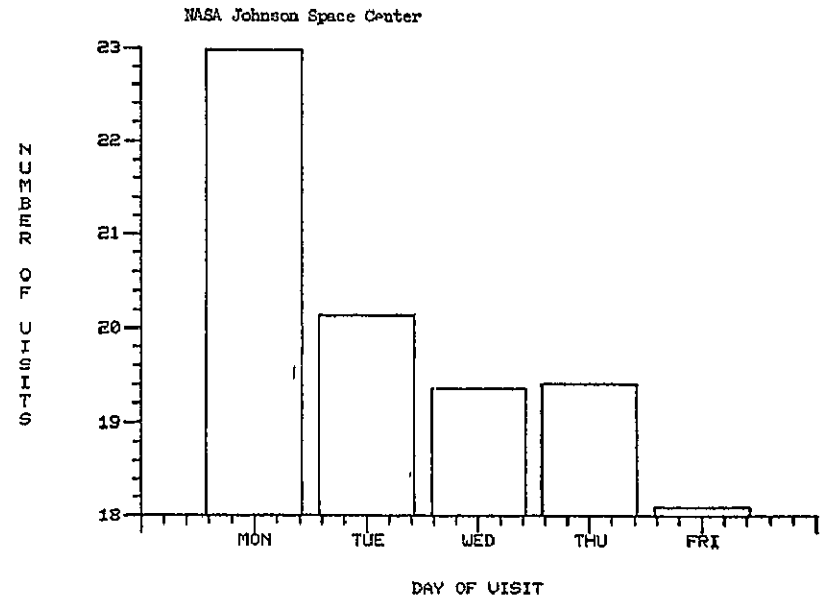
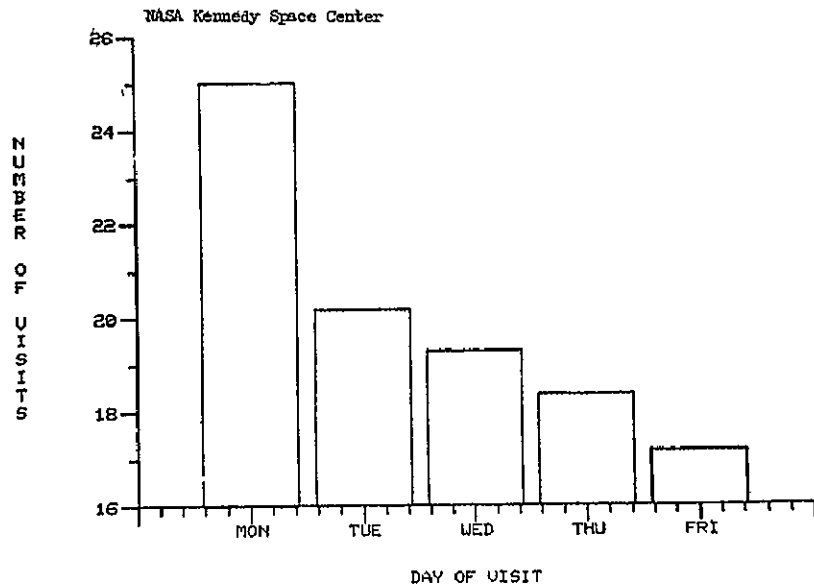

Figure 6

NASA OCCUPATIONAL MEDICINE PROGRAM
 Medical Facility Utilization, 1973
 Percentage Distribution of Visits for
 Treatments Requested by Private Physicians
 By Day of Week

Population
 Kennedy 10,972
 Johnson 7,554
 Goddard 11,052
 Marshall 5,237

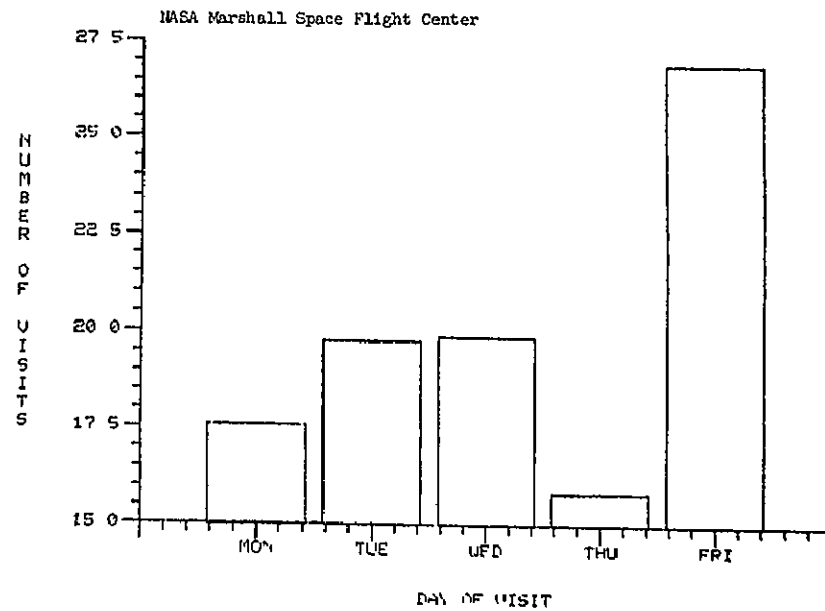
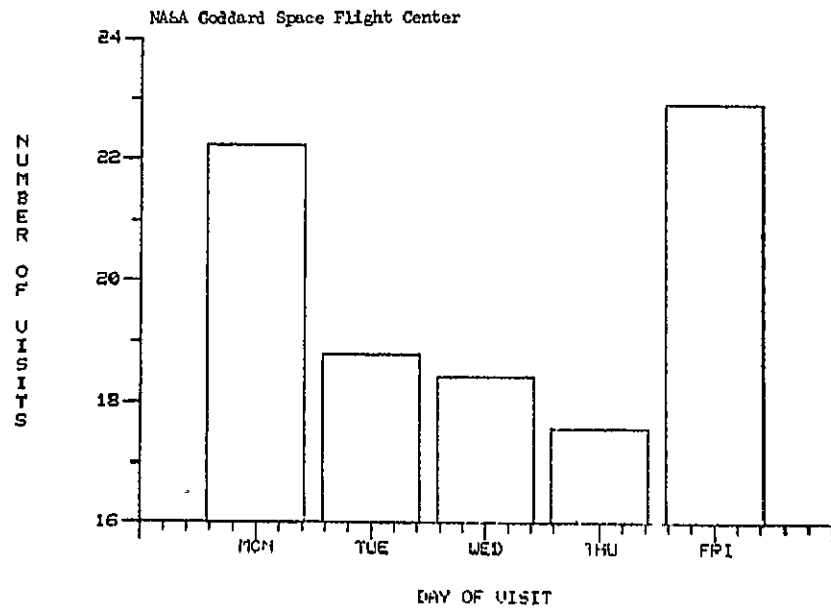
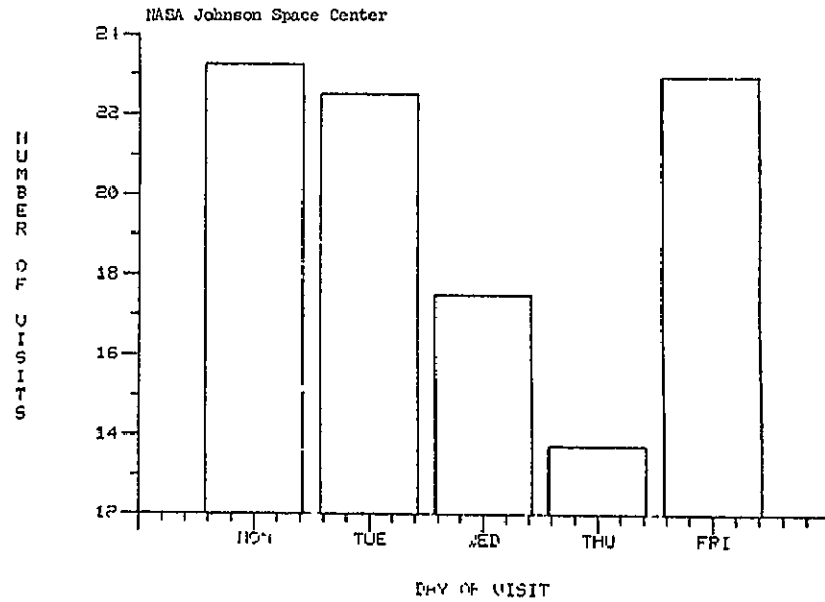
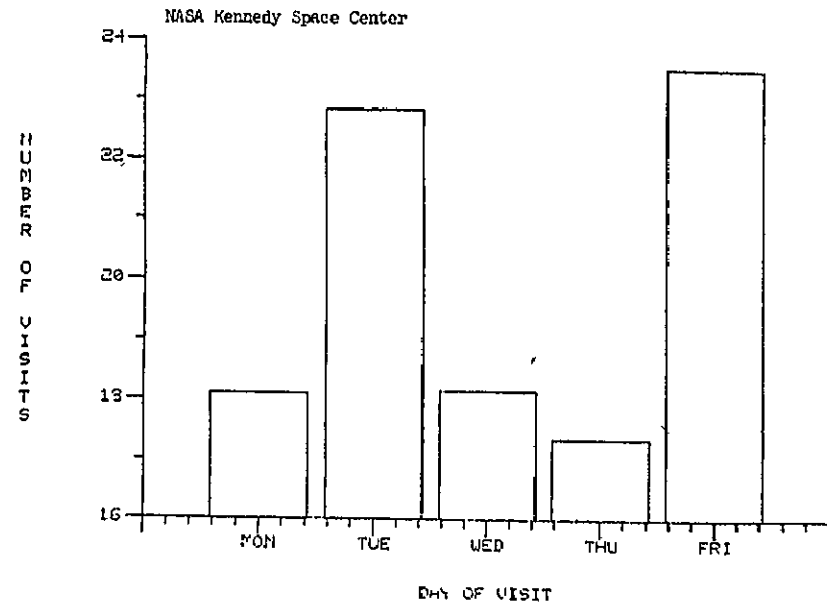
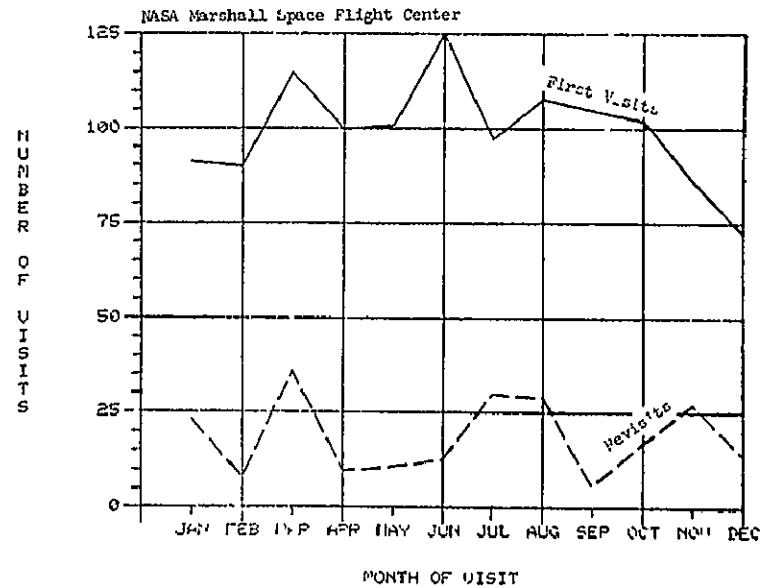
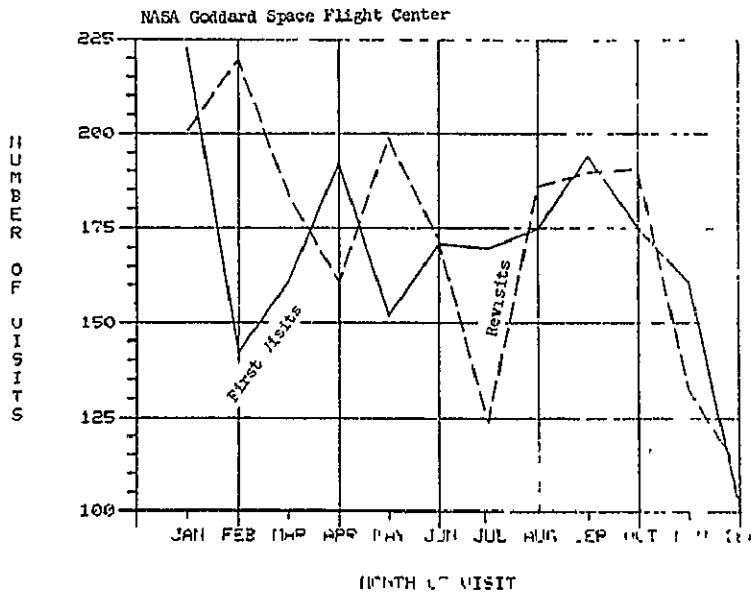
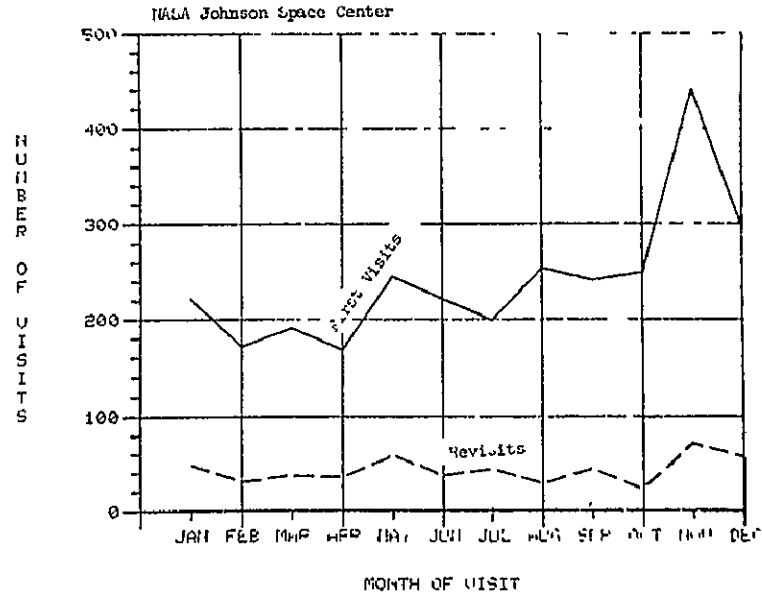
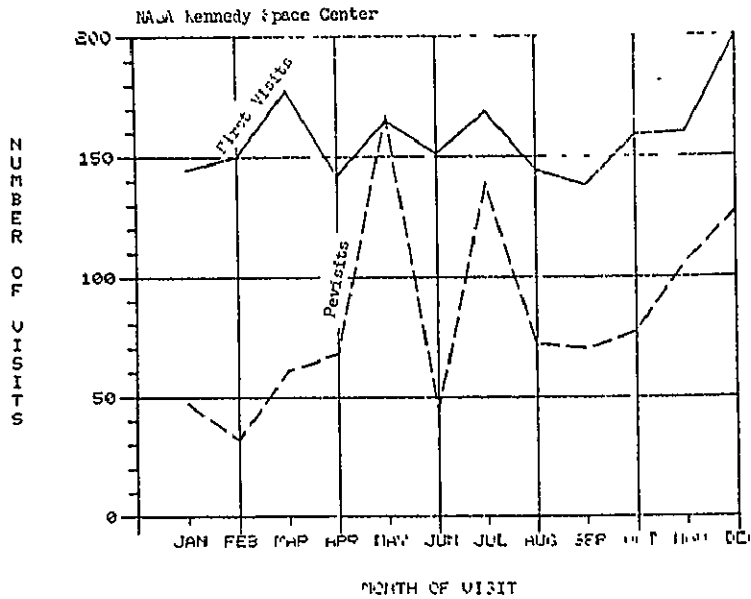

Figure 7

NASA OCCUPATIONAL MEDICINE PROGRAM
 Medical Facility Utilization, 1977
 Frequency Distribution of First Visits and Revisits
 by Month of Visit (Civil Service Employees)

Location
 Name
 Location
 Name
 Location
 Name



REPRODUCIBILITY OF THE ORIGINAL PAGE IS POOR

PRO-GW-111C
 1/02

Figure 8

NASA OCCUPATIONAL MEDICINE PROGRAMS
 Medical Facility Utilization, 1973
 Frequency Distribution of Occupational Injury
 First Visits and Revisits, by Month

Population
 Kennedy 16,572
 Johnson 9,554
 Goddard 2,662
 Marshall 2,207

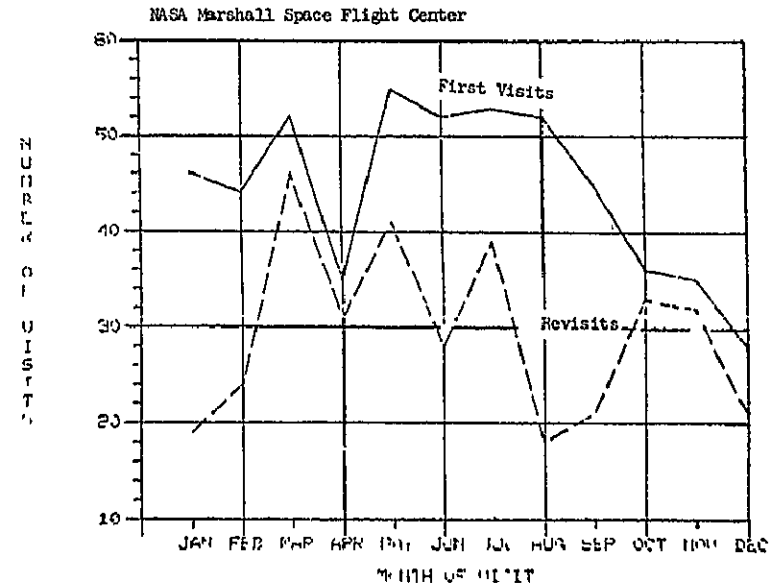
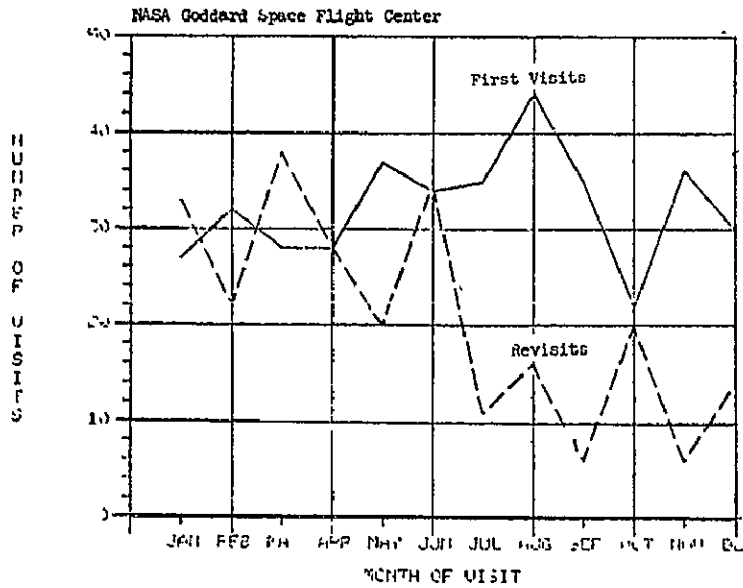
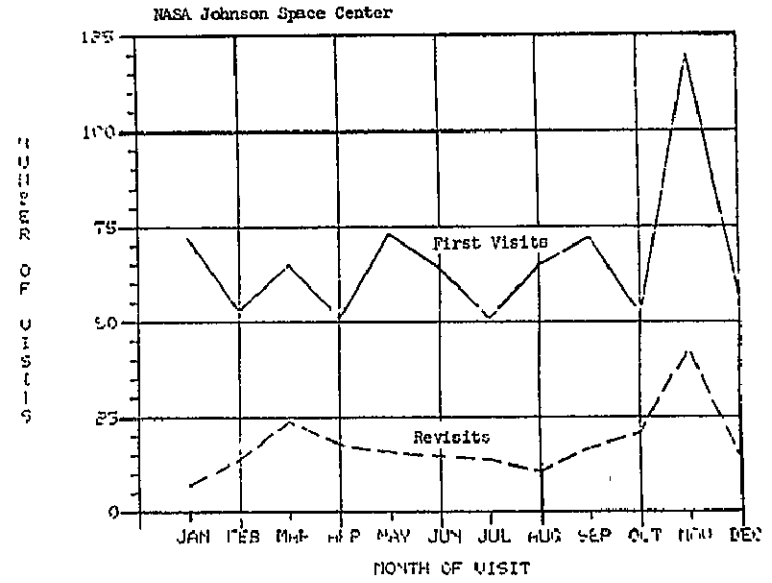
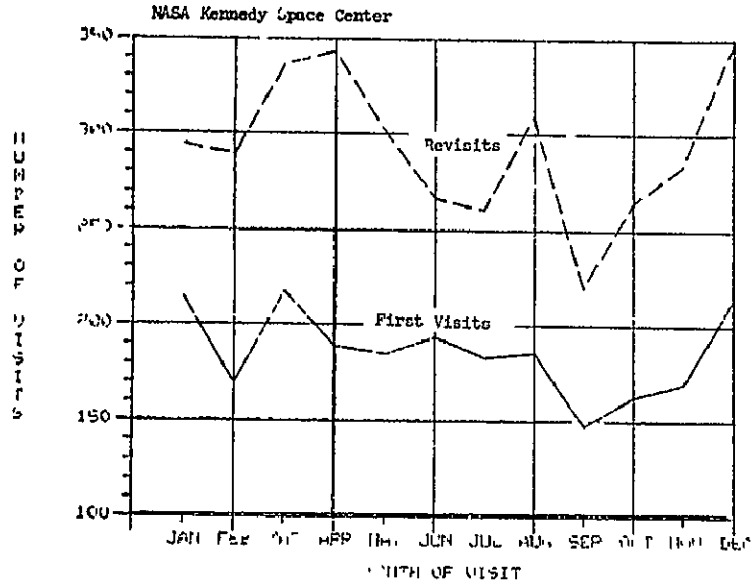

Figure 9

PREVALENCE OF ABNORMAL FINDINGS, IN MALE AND FEMALE EMPLOYEES
 NASA GSFC-MSFC Combined Examination Data Base, 1973

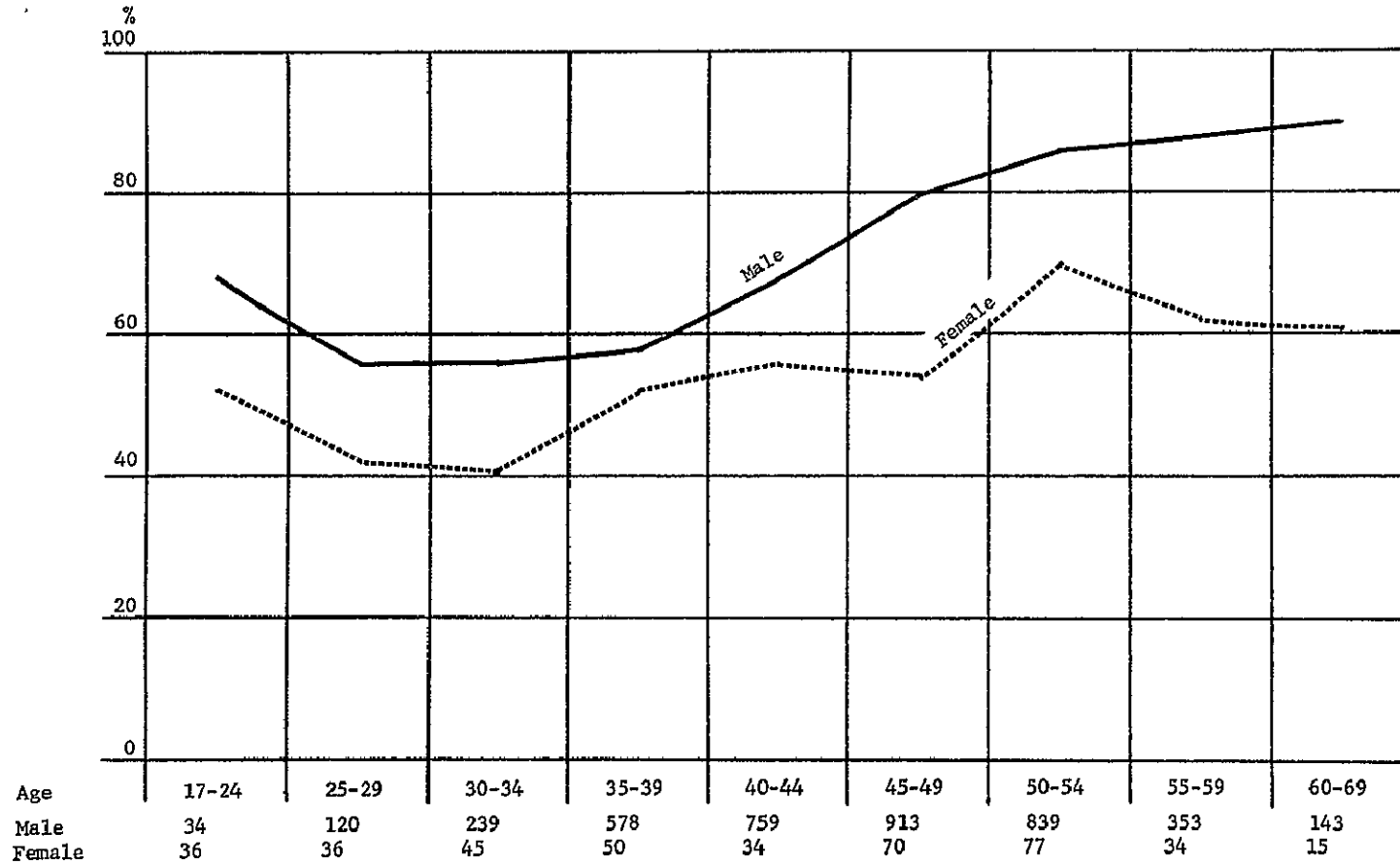

Figure 10

PREVALENCE OF METABOLIC DISORDERS, IN MALE AND FEMALE EMPLOYEES
 NASA GSFC-MSFC Combined Examination Data Base, 1973

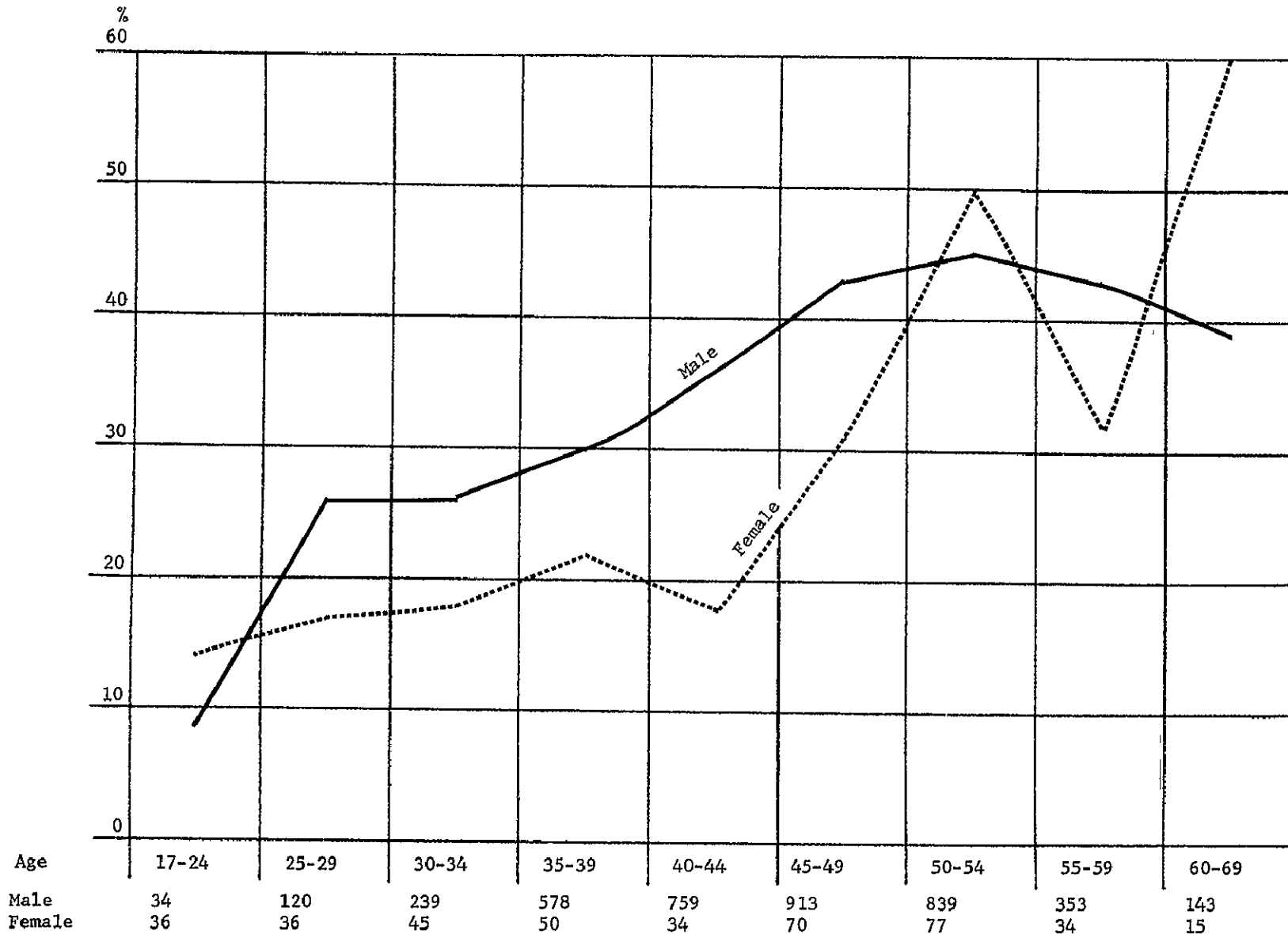

Figure 11

PREVALENCE OF HYPERTENSION, IN MALE AND FEMALE EMPLOYEES
 NASA GSFC-MSFC Combined Examination Data Base, 1973

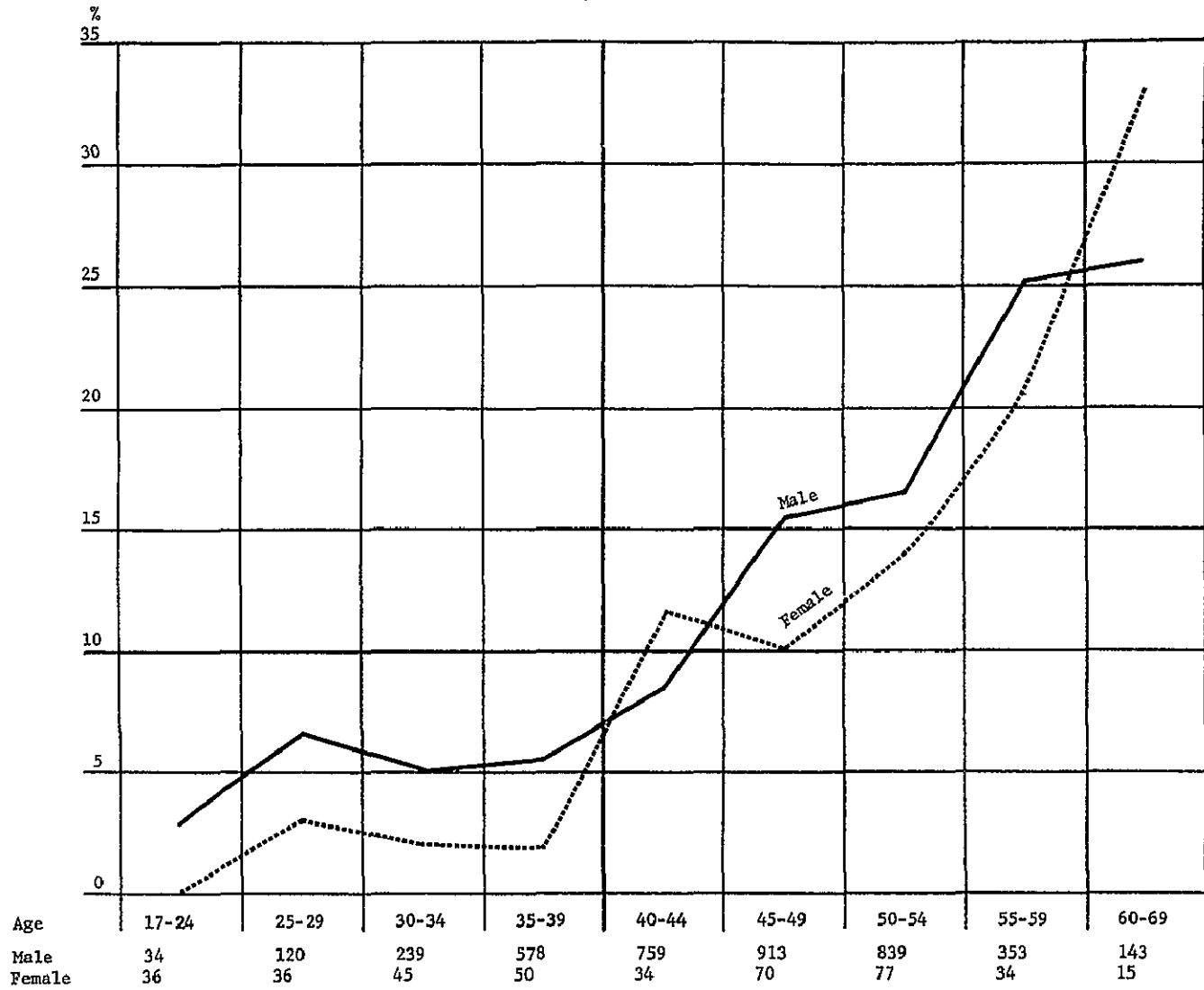

Figure 12

PREVALENCE OF HEART DISEASE, IN MALE AND FEMALE EMPLOYEES
 NASA GSFC-MSFC Combined Examination Data Base, 1973

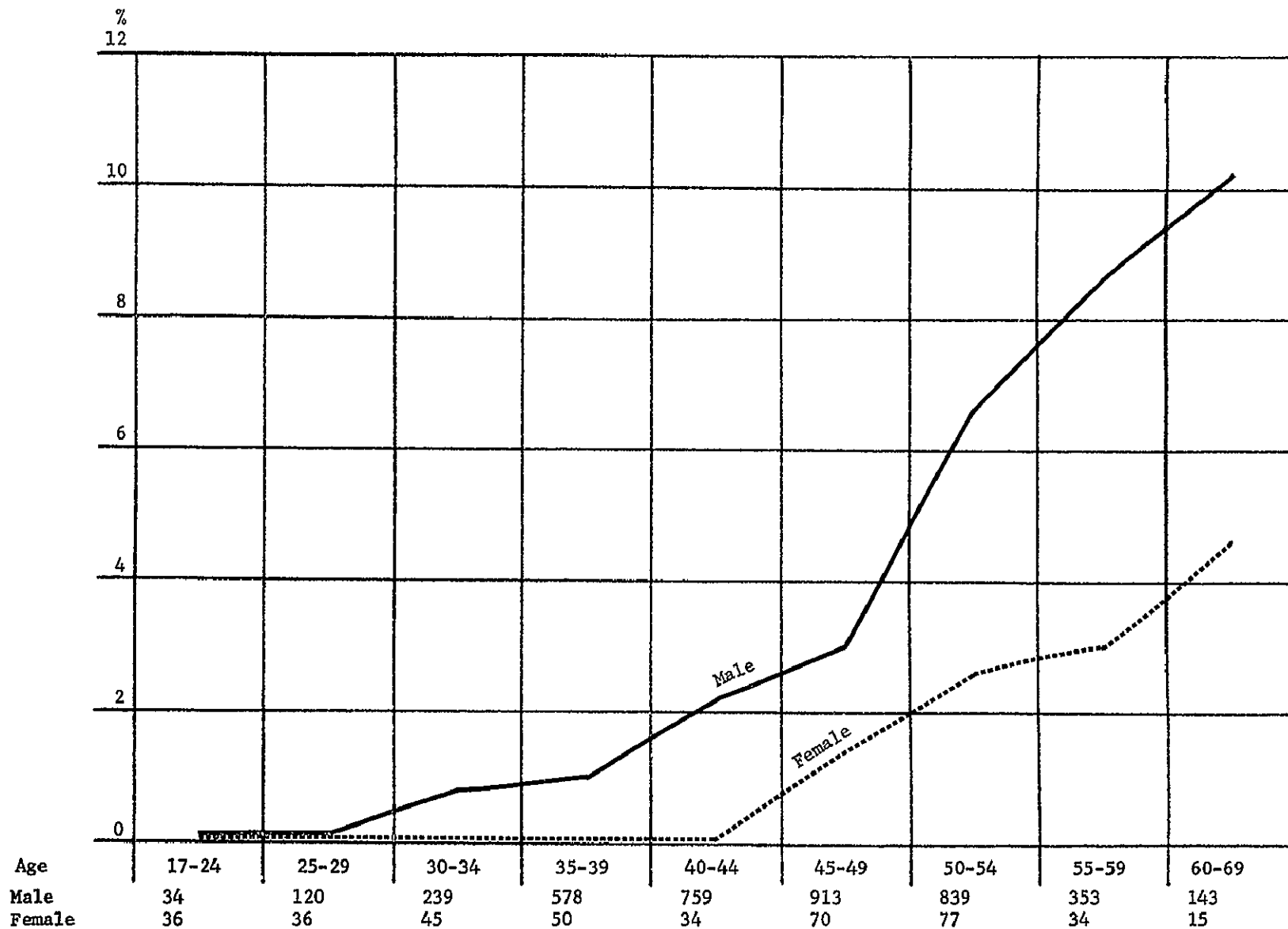

Figure 13
 PREVALENCE OF DISABLING DISEASE, BY OCCUPATION
 NASA-GSFC Combined Examination Data Base, 1973
 Male Employees, Over Age 35

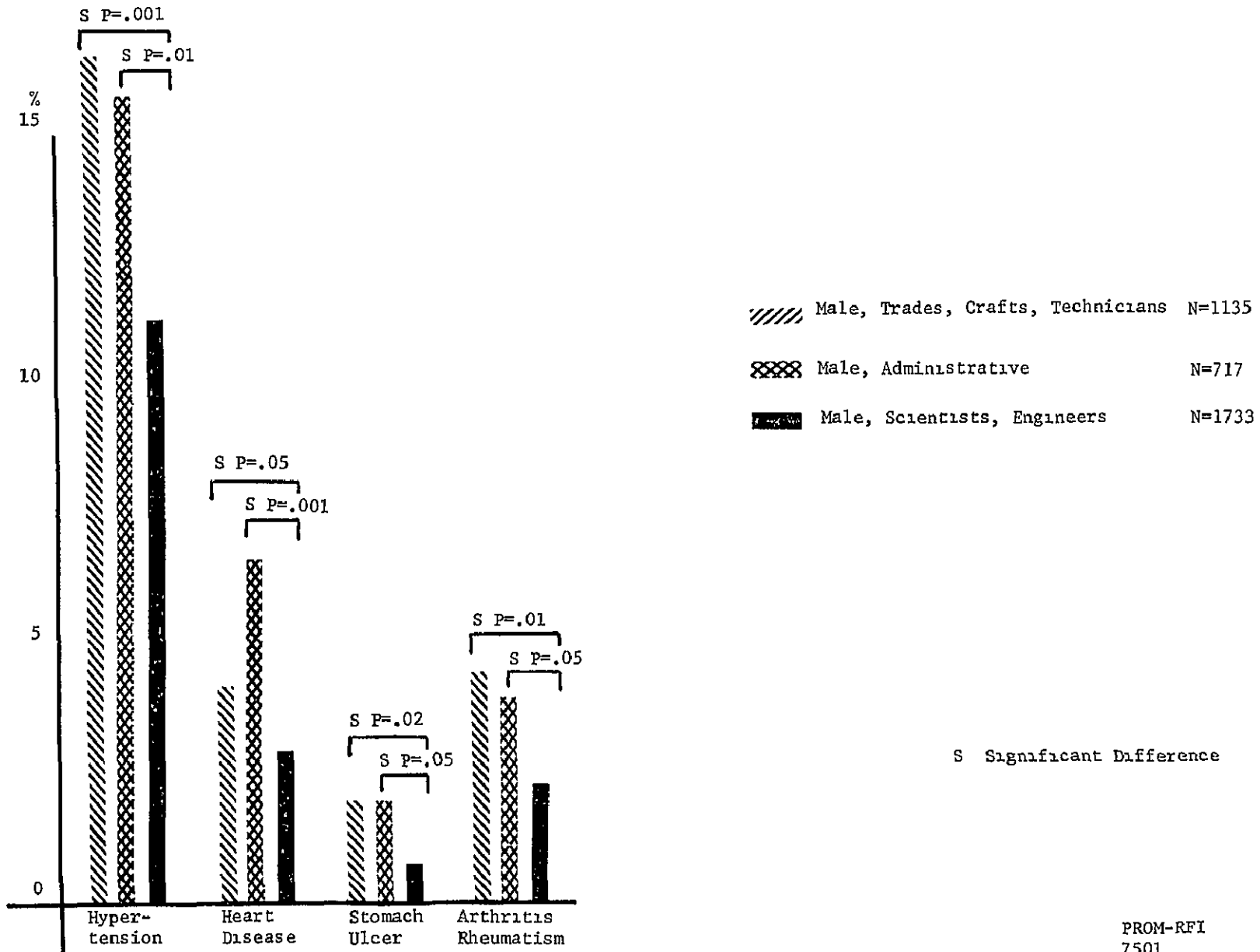

Figure 14
 PREVALENCE OF DISABLING DISEASE, BY OCCUPATION
 NASA-GSFC Combined Examination Data Base, 1973
 Female Employees, Over Age 35

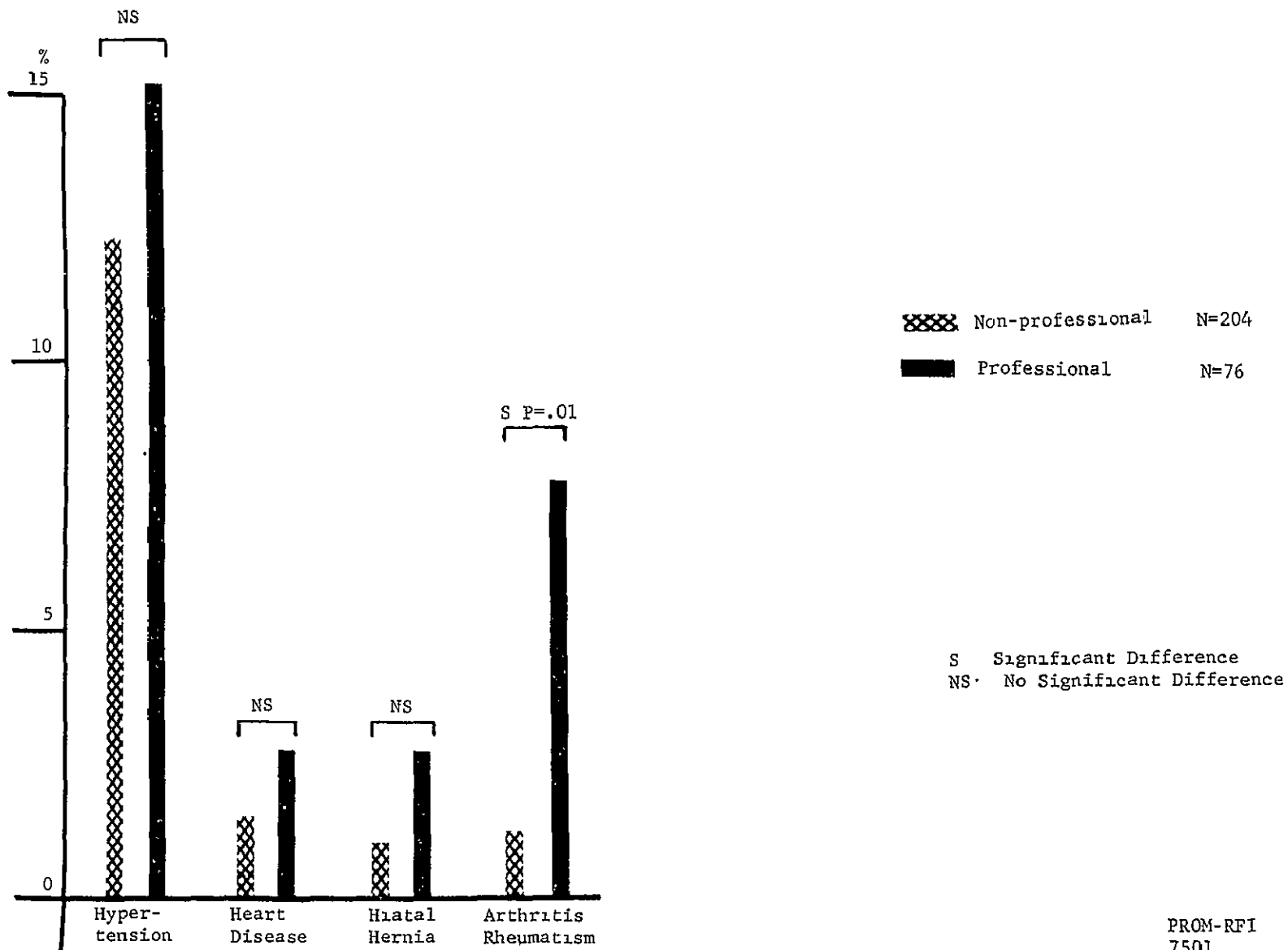

Figure 15

NASA KENNEDY SPACE CENTER
Medical Facility Utilization, 1973
Frequency Distribution of Visits, by Week

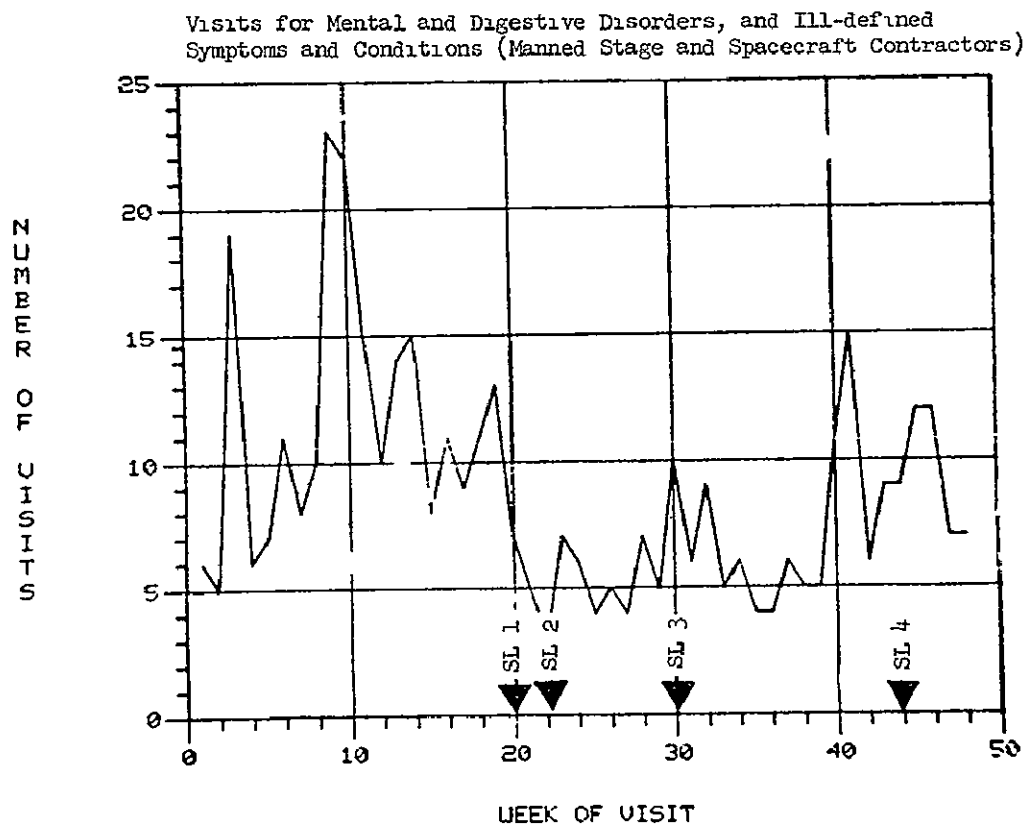
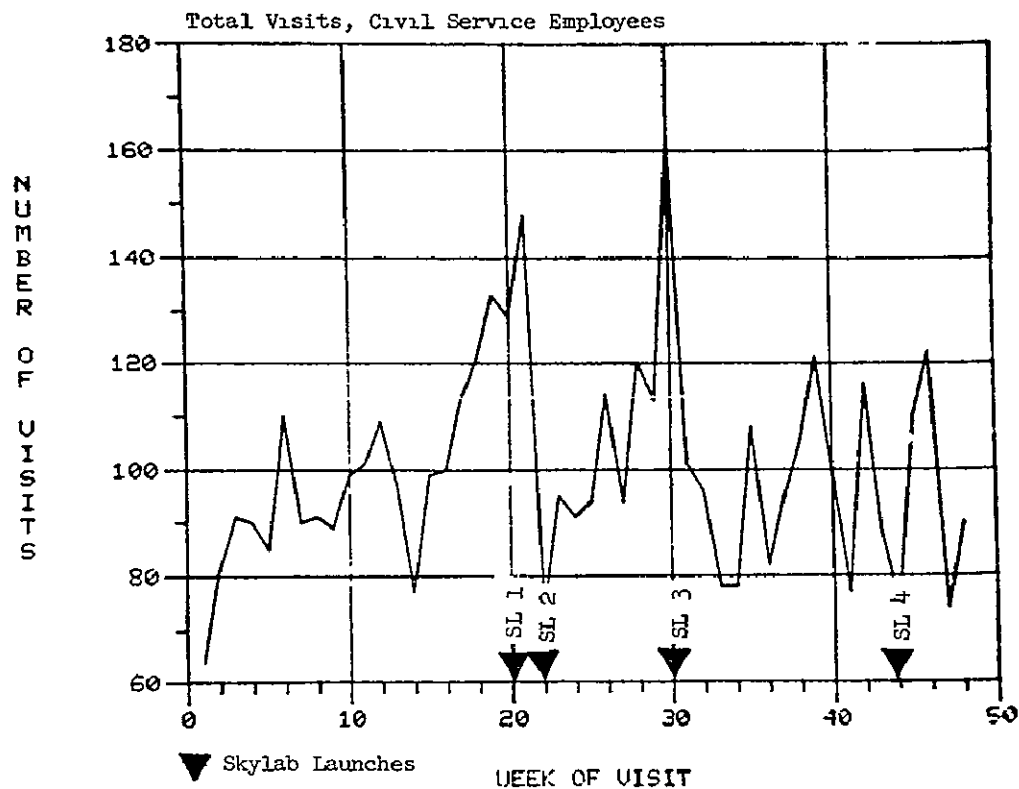

Figure 16

NASA JOHNSON SPACE CENTER
Medical Facility Utilization, 1973
Frequency Distribution of Visits, by Week

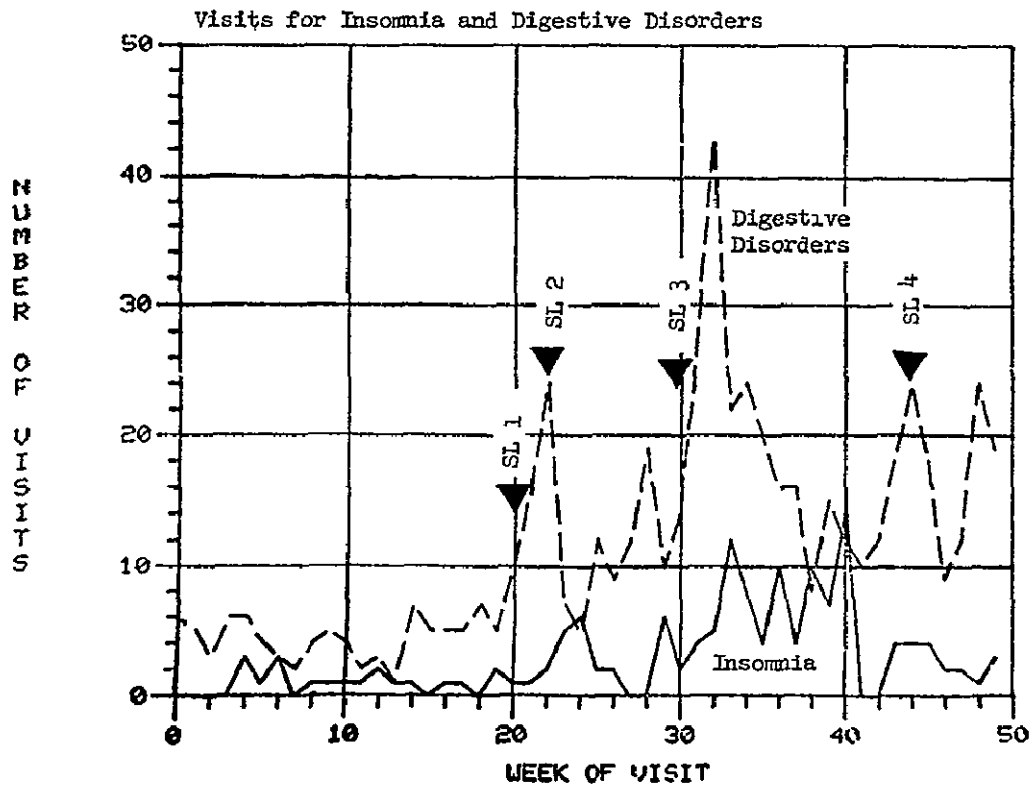
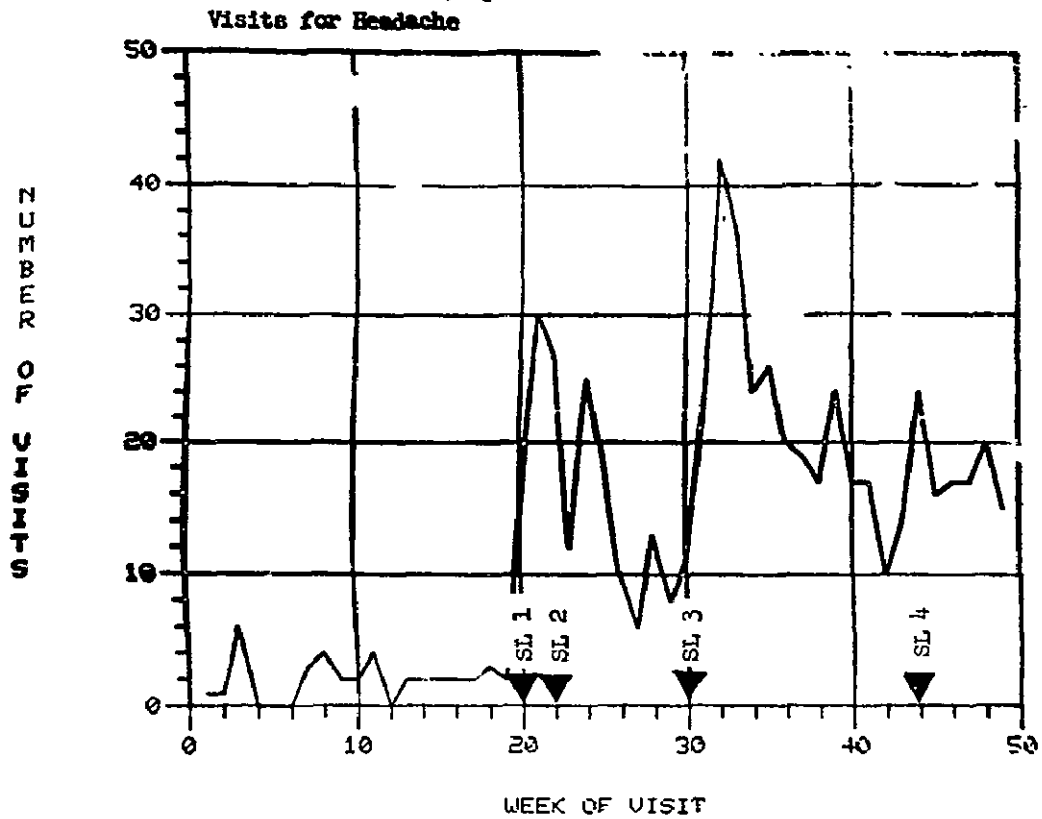

Figure 17

NASA LEWIS RESEARCH CENTER
Trend in Employee Illness Visits, 1972-1973
Visits for Headache, Digestive Disorders, and
Ill-defined Symptoms and Conditions

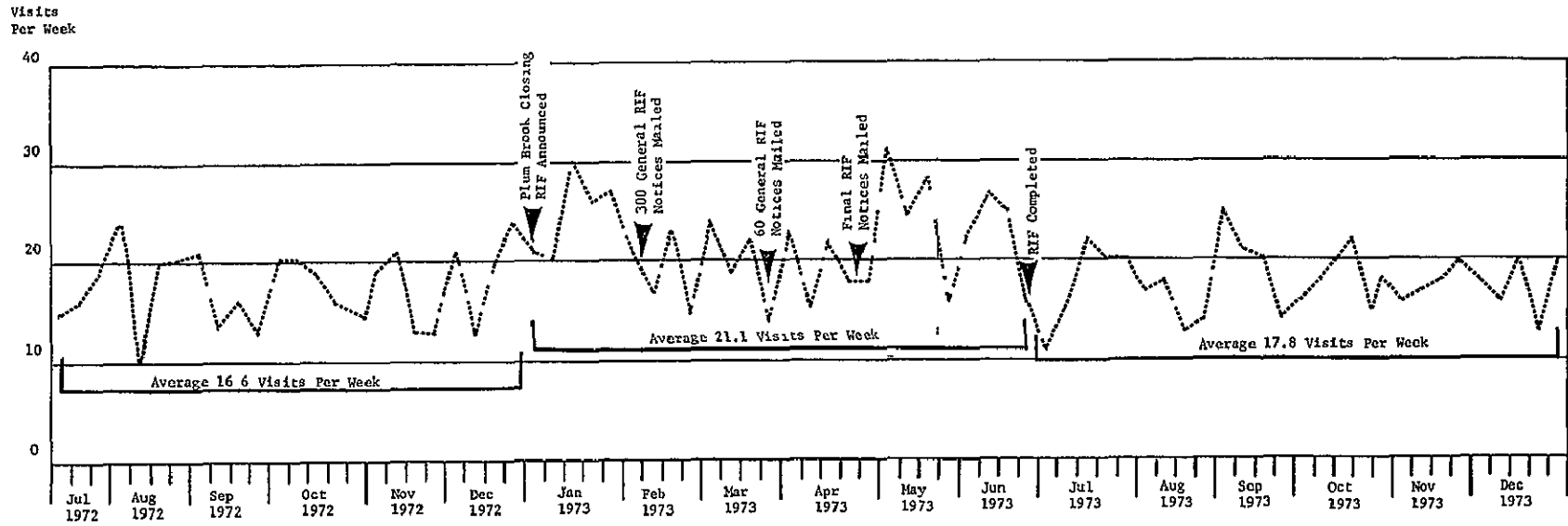

Figure 18

NASA LEWIS RESEARCH CENTER
Trend in Employee Illness Visits, 1972-1973
Visits for Aspirin Supply Refills

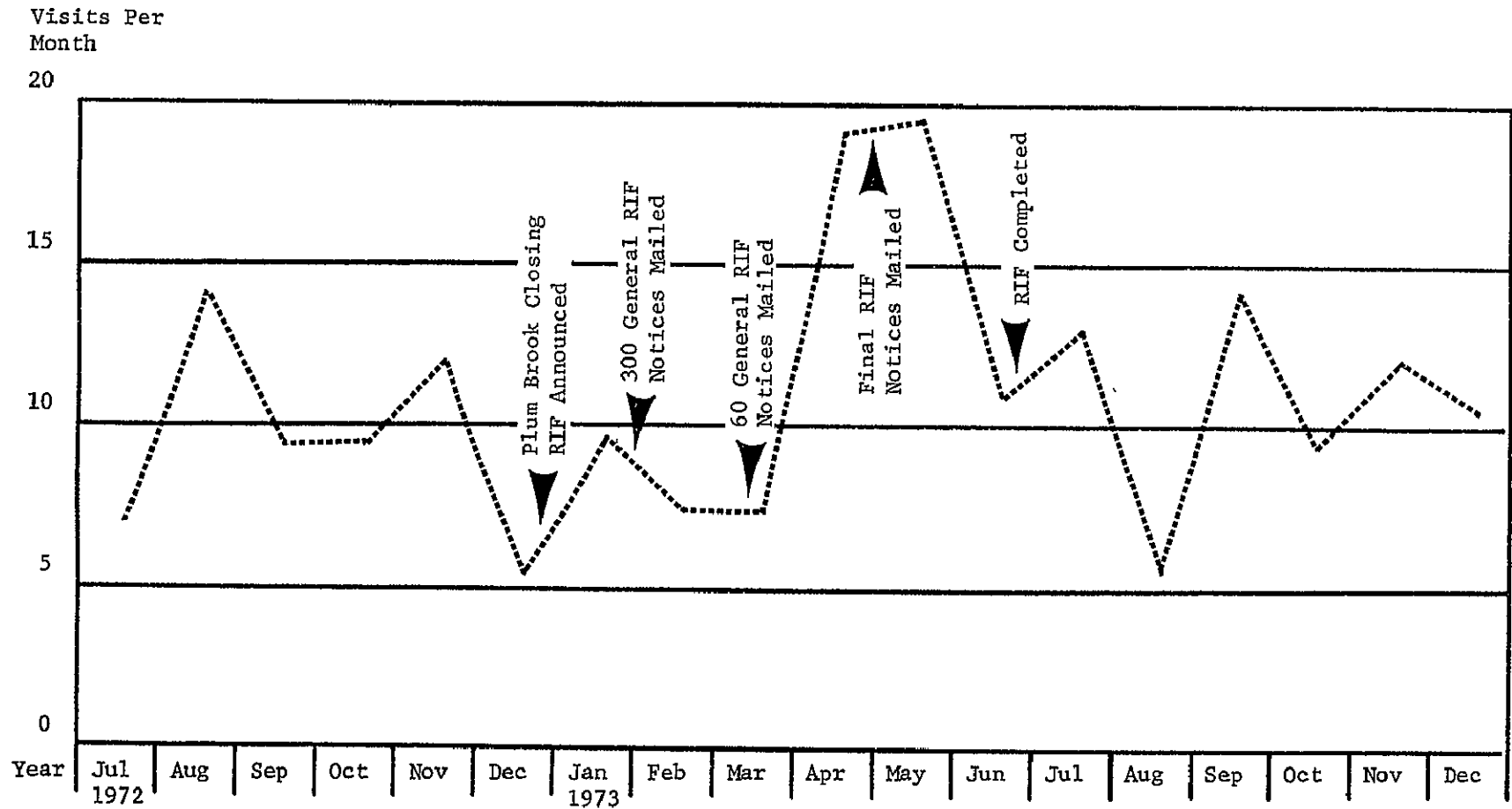

Figure 19

NASA LEWIS RESEARCH CENTER
Trend in Employee Illness Visits, 1972-1973
Visits for Blood Pressure Review

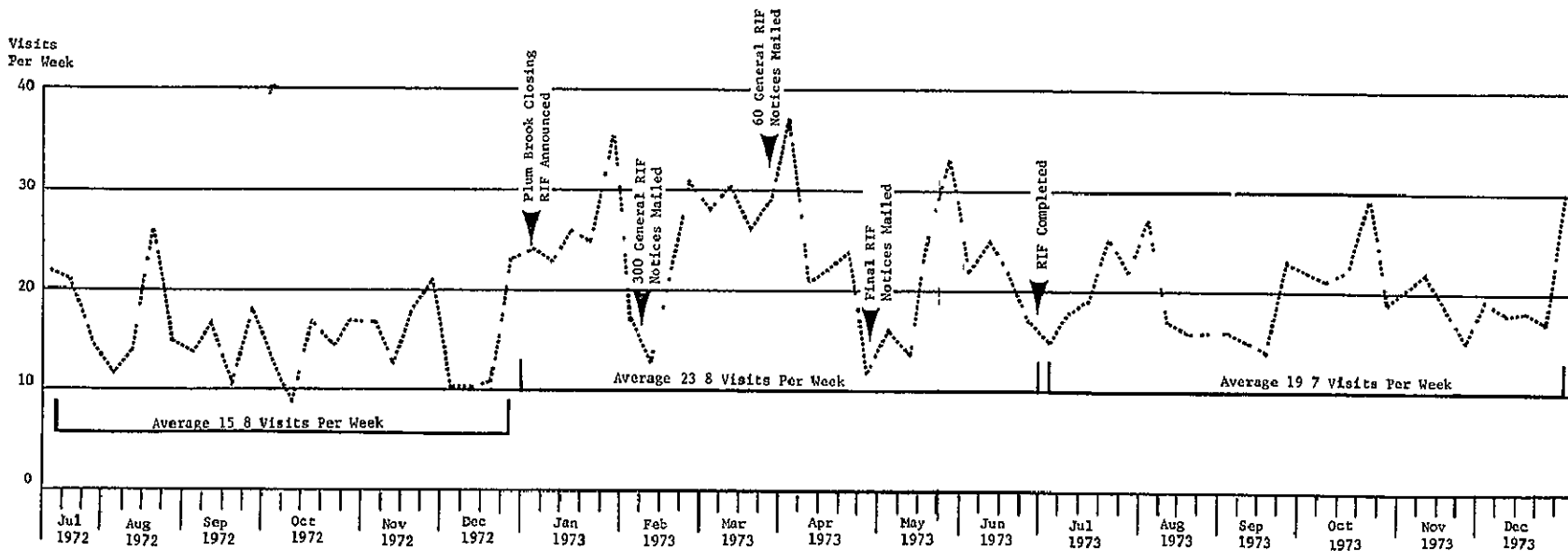
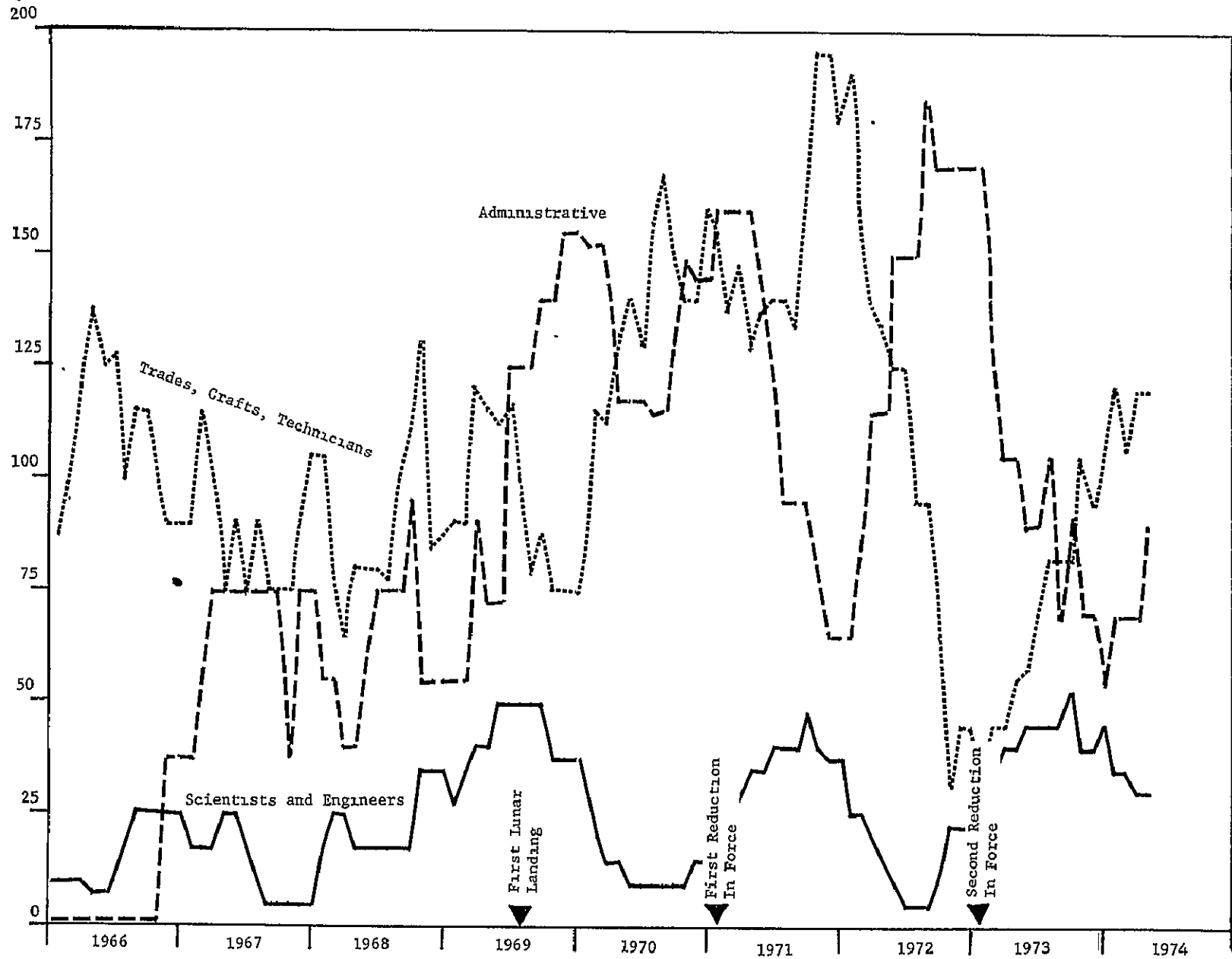

Figure 20

NASA GODDARD SPACE FLIGHT CENTER
Trend in Major Illness Events, 1966-1974¹
Rate Per 10,000 (12 Month Moving Average)

Cardiovascular Disease Events



1. Illness Causing Loss of Five or More Consecutive Work Days

Figure 21

NASA HEADQUARTERS MEDICAL FACILITY
Visits for Blood Pressure Check
(Visits Per Employee Per Year)

1.6

1.4

1.2

1.0

.8

.6

.4

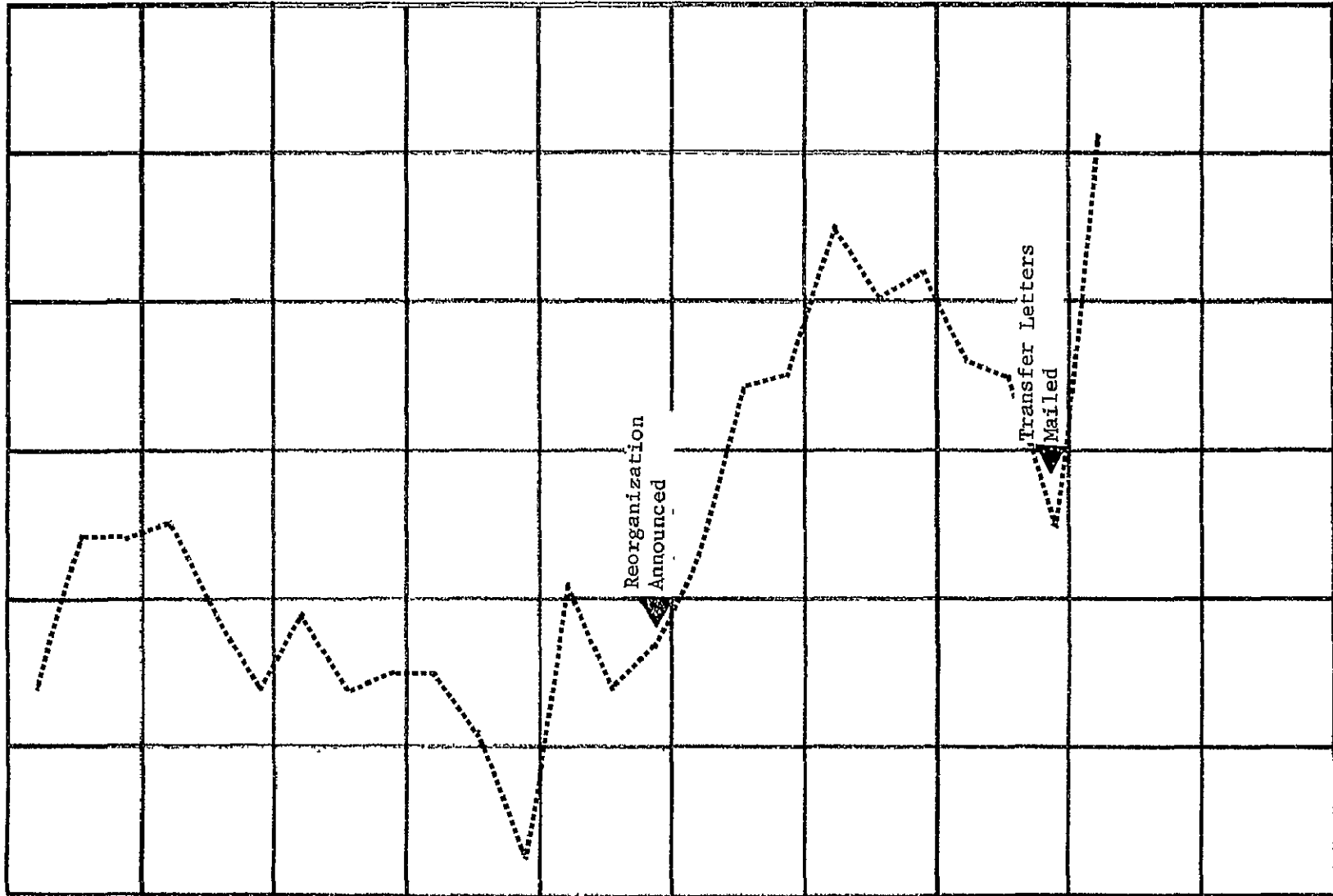

Jan-Mar
1973

Apr-Jun
1973

Jul-Sep
1973

Oct-Dec
1973

Jan-Mar
1974

Apr-Jun
1974

Jul-Sep
1974

Oct-Dec
1974

Jan-Mar
1975

Apr-Jun
1975

Figure 22
 NASA HEADQUARTERS
 Dynamic Electrocardiogram Program
 Prevalence of Ventricular Premature Contractions,
 and S-T Segment Changes
 (Percentage of Employees Examined)

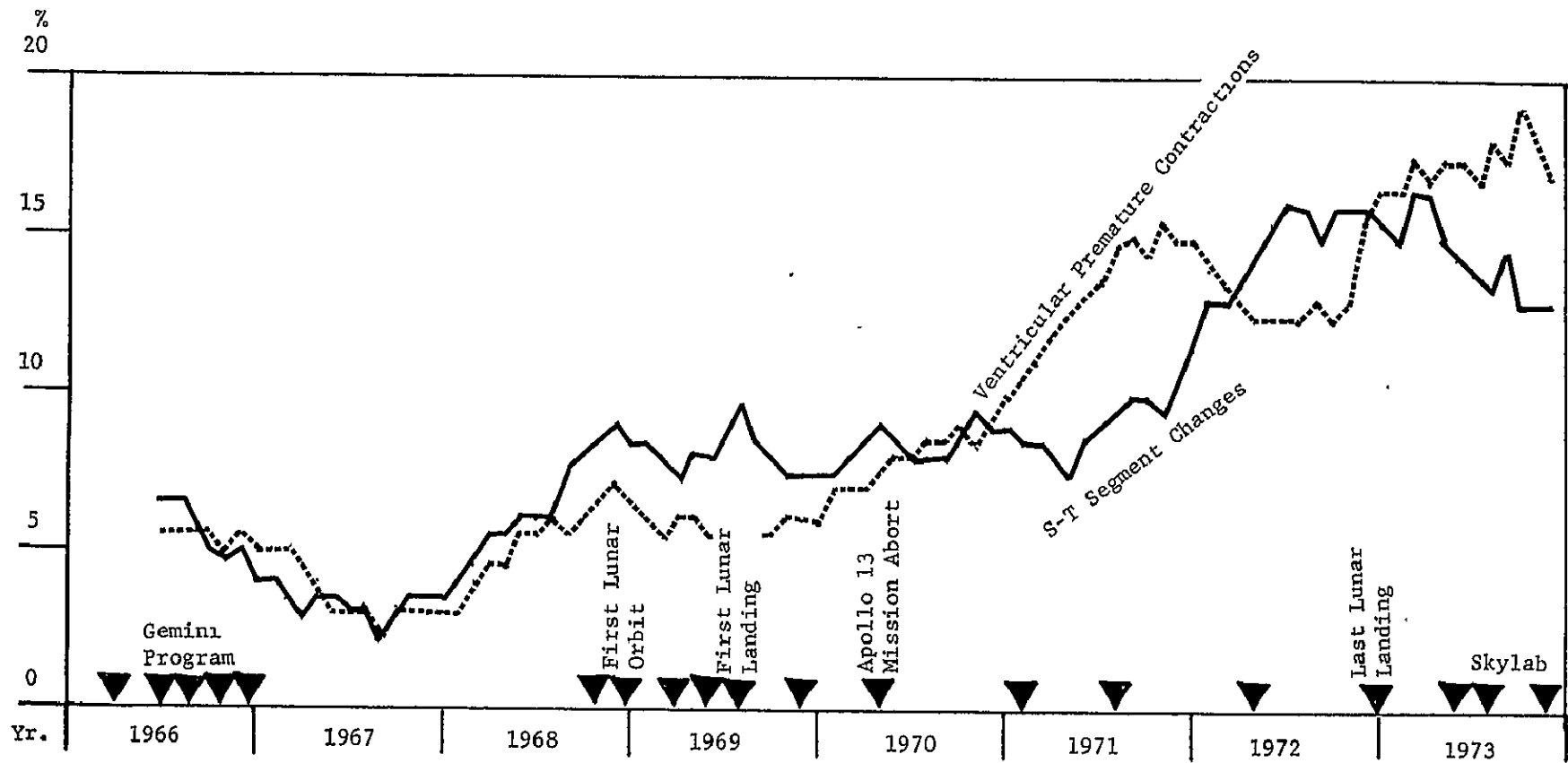

▼ Manned Missions

Figure 23
 NASA EMPLOYEE LEAVE USAGE, 1969-1973
 Days Per Employee Per Year

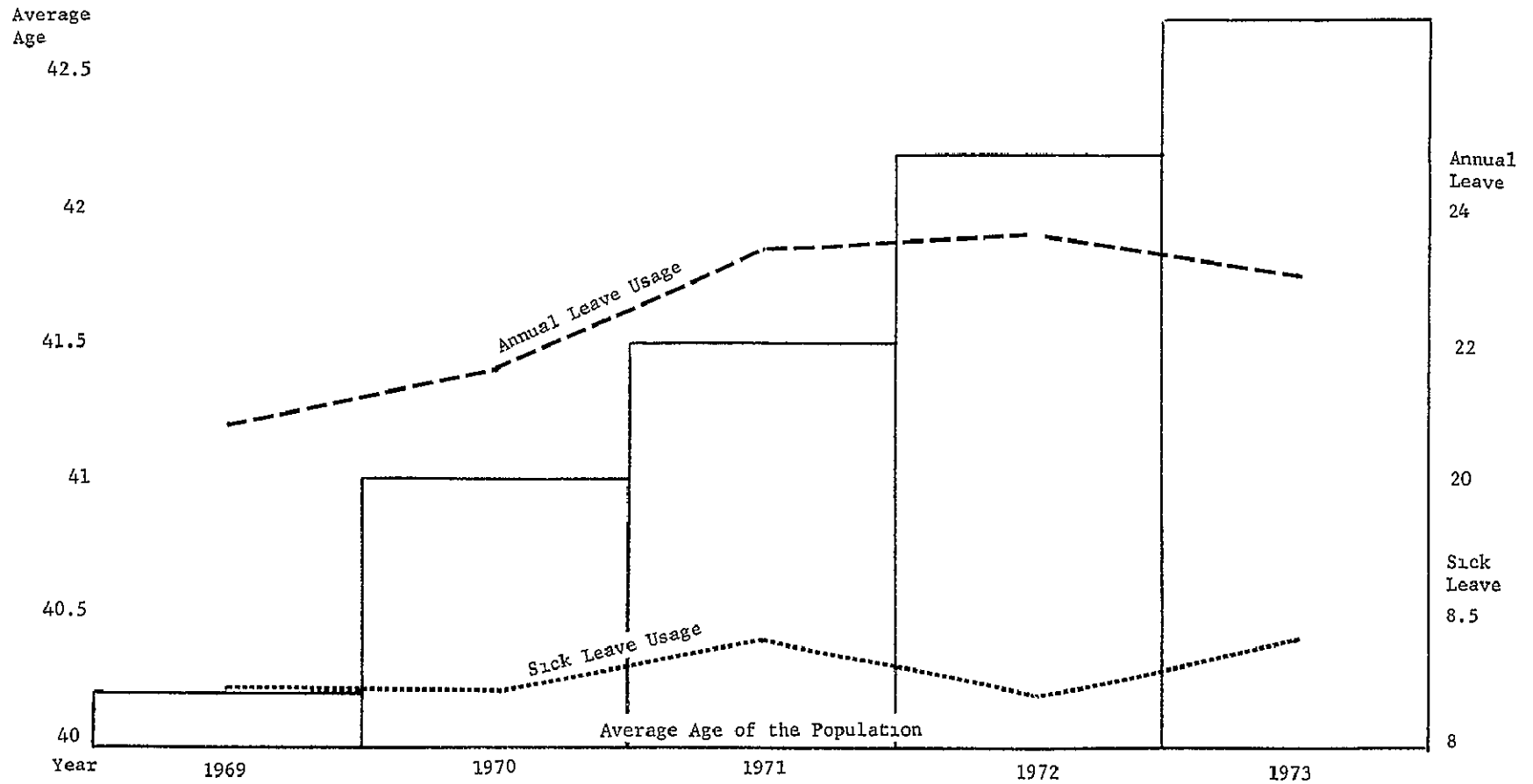
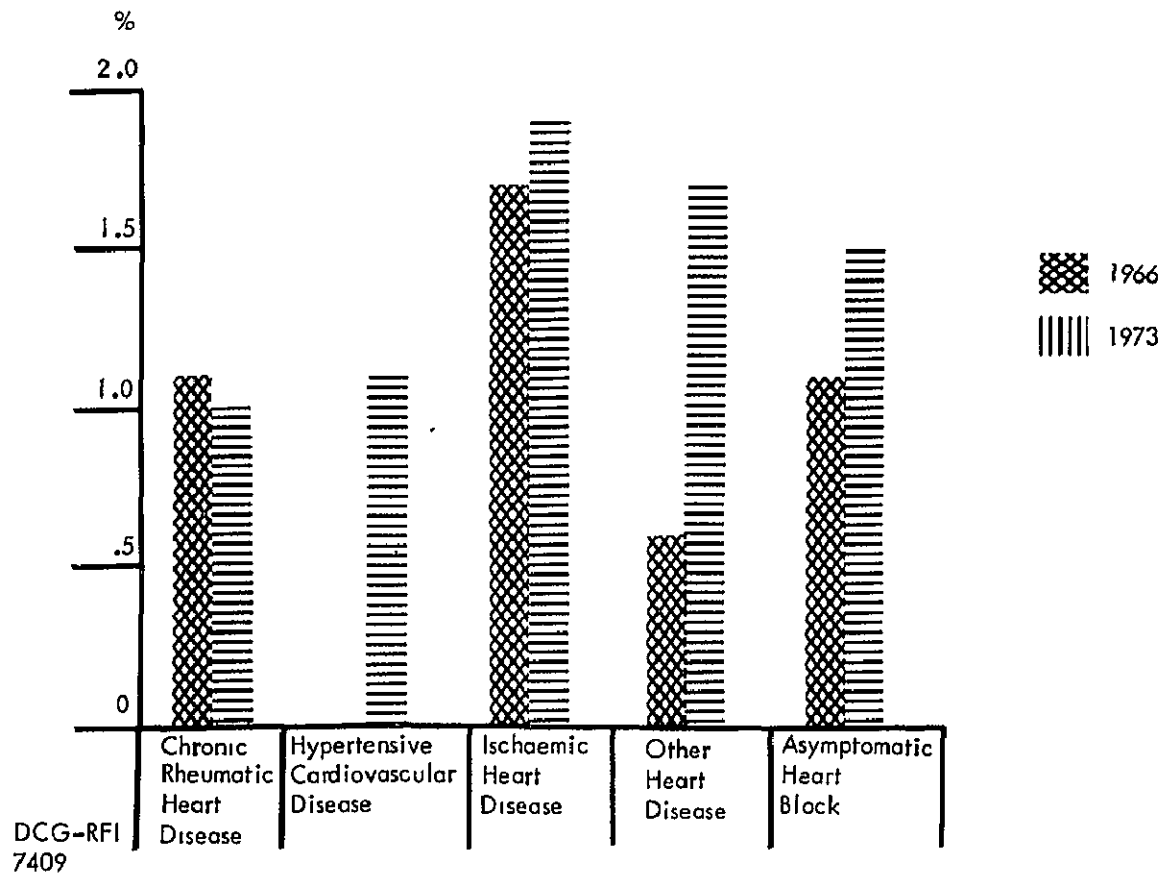

Figure 24

TREND IN DISEASE CAUSED MORTALITIES, NASA HEADQUARTERS EMPLOYEES



Figure 25
NASA HEADQUARTERS
Dynamic Electrocardiogram Program
Prevalence of Heart Disease, 1966-1973



TREND IN DISEASE CAUSED MORTALITIES, IN NASA EMPLOYEES

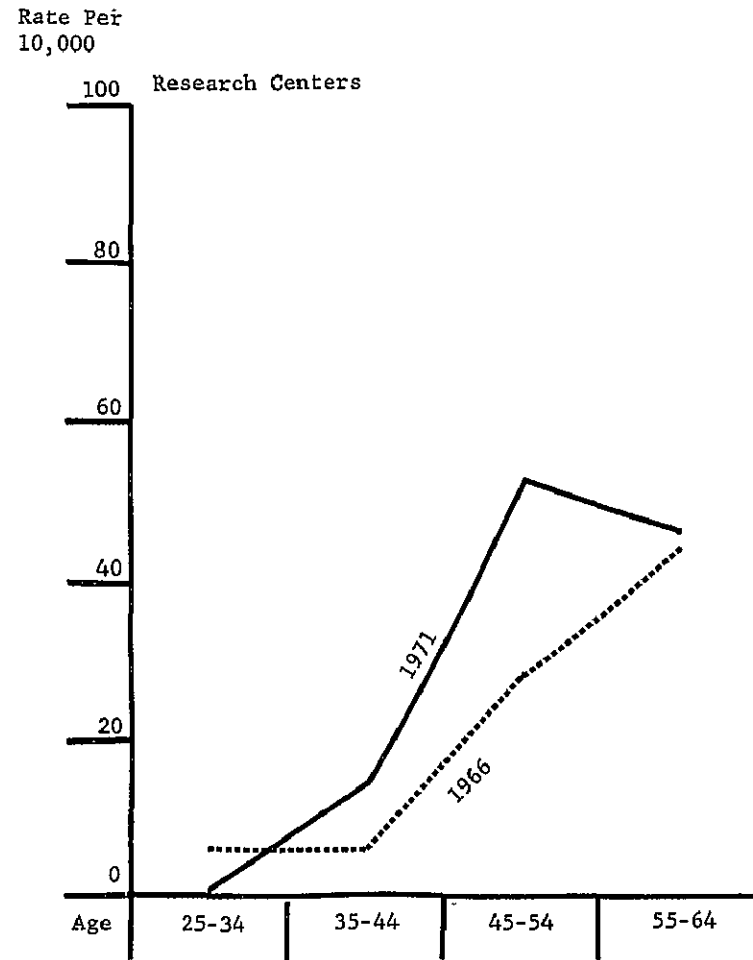
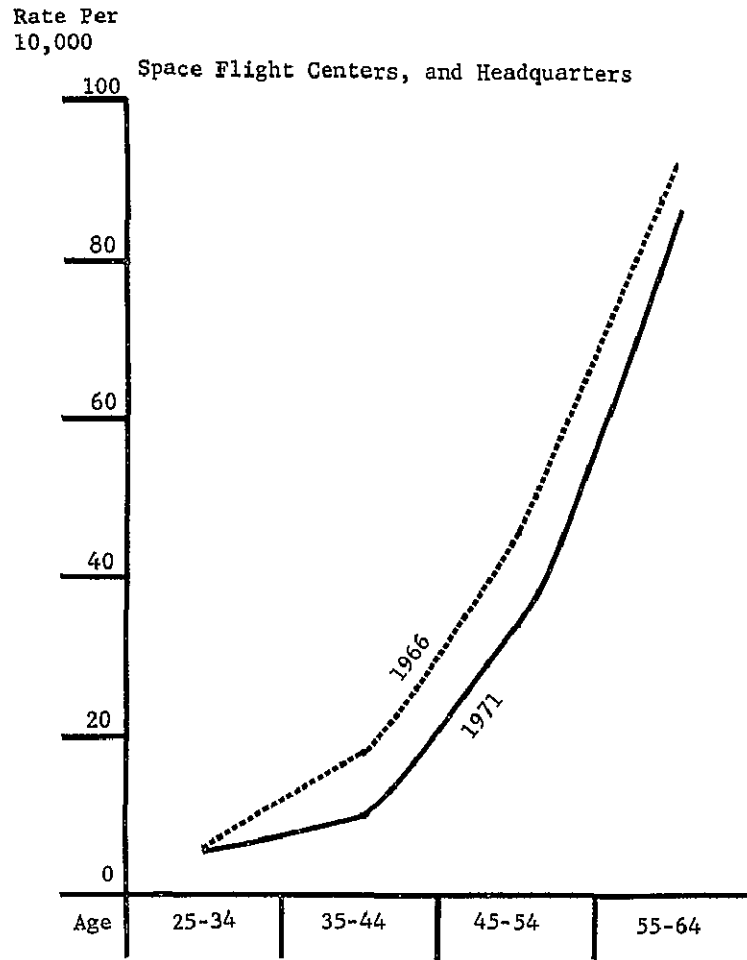

ENVIRONMENTAL HEALTH TRENDS

Gene Proctor
Chief, Environmental Health

Environmental health trends, concerns, conflicts, and developments over the past few months are reviewed. Copies of the vu-graphs used in the presentation follow.

GROWING CONCERN OVER HEALTH HAZARDS

EXPOSURE LIMITS CONSTANTLY REDUCED

LOT OF PUBLICITY

COURT ACTIONS

CONCERN OF UNIONS

LOT OF ACTIVITY IN STANDARDS DEVELOPMENT

LEGISLATIVE ACTIVITY

MORE PEOPLE INVOLVED

LOT OF CONCERN OVER CARCINOGENS

SPECIFIC HEALTH CONCERNS

VINYL CHLORIDE AND ANGIOSARCOMA

CARCINOGENS IN DRINKING WATER

SPRAY ADHESIVES

METHYL BUTYL KETONE AND PERIPHERAL NEUROPATHY

LEAD:

- GASOLINE
- PAINT
- EVAPORATED MILK
- SILVERWARE

FREONS AND OZONE DEPLETION

VINYLDINE CHLORIDE

NOISE

CARBON DIOXIDE BUILDUP AND COOLING OF EARTH

SULFATES AND AUTOMOBILE POLLUTION CONTROL

AROMATICS IN GASOLINE

BENZENE AND LEUKEMIA

ARSENIC

SPECIFIC HEALTH CONCERNS
(continued)

MERCURY VAPOR LAMPS AND SKIN BURNS

CHLORINATED PESTICIDES

OSHA CARCINOGENS

FOOD COLORING

MEAT PRESERVATIVES

SASSAFRAS

PLASTIC PYROLYSIS PRODUCTS AND MEAT WRAPPERS

HAIR SPRAYS

STYRENE AND VOCAL CORD NODES AND TUMORS

RF RADIATION

IONIZING RADIATION

FIBERGLAS

JOB STRESS

ORGANIC DUSTS

PNEUMONITIS FROM ORGANIC DUSTS

CAUSED BY MICROORGANISMS, ANIMAL PROTEINS, FUNGI SPORES, AND INSECTS

FARMERS LUNG	-	MOLDY HAY
BAGASSOSIS	-	SUGAR CANE WASTE
MUSHROOM PICKERS DISEASE	-	MOLDY VEGETABLE COMPOST
AIR CONDITIONING-HEATING DISEASE	-	CONTAMINATED DUSTS
JOINERS DISEASE	-	UNKNOWN
DETERGENT DISEASE	-	ENZYME DETERGENTS
SUBEROSIS	-	MOLDY CORK DUST
BREWERS LUNG	-	MALT OR BARLEY DUST
CHEESE WASHERS LUNG	-	CHEESE MOLD
BIBLE PRINTERS DISEASE	-	MOLDY TYPE-SETTING WATER

26 TOTAL LISTED IN RECENT ARTICLE OF HEALTH AND SAFETY MAGAZINE

PERTINENT DEVELOPMENTS

NIOSH TOXIC SUBSTANCES LIST REVISED

CRITERIA DOCUMENTS

PUBLICATIONS

DIRECTOR NAMED

SAMPLING DATA SHEETS

MANUAL OF ANALYTICAL METHODS

STATUS IN HEW

OSHA PRIORITY ON HEALTH STANDARDS

OSHA-NIOSH STANDARDS COMPLETION PROJECT

RENAMING OF FEDERAL ADVISORY SAFETY COUNCIL

HAZARDOUS MATERIAL LABELING COMMITTEE

SRI CRITERIA DOCUMENT DEVELOPMENT

LESS TRAINING MONEY

TECHNICIAN TRAINING IN JUNIOR COLLEGES

ENVIRONMENTAL AND MEDICAL MONITORING REQUIREMENTS ARE INCREASING

ENVIRONMENTAL HEALTH AND MEDICAL PROGRAMS -

DEVELOPING AND EXPANDING

NPDES

CRITERIA DOCUMENTS COMPLETED

AMMONIA

INORGANIC ARSENIC

ASBESTOS

BENZENE

BERYLLIUM

CARBON MONOXIDE

CHLOROFORM

CHROMIC ACID

COKE OVEN EMISSIONS

COTTON DUST

HOT ENVIRONMENTS

INORGANIC LEAD

INORGANIC MERCURY

NOISE

CRYSTALLINE SILICA

SULFUR DIOXIDE

TOLUENE

TOLUENE DIISOCYANATE

TRICHLOROETHYLENE

ULTRAVIOLET RADIATION

CRITERIA DOCUMENTS - JUNE

ANILINE

CADMUM

CARBON TETRACHLORIDE

DIOXANE

LABELING OF HAZARDOUS MATERIALS

FLUORIDES

HEXAVALENT CHROMIUM COMPOUNDS

HYDROGEN CYANIDE

METHYLENE CHLORIDE

NITRIC ACID

OXIDES OF NITROGEN

PARATHION

SODIUM HYDROXIDE

XYLENE

ZINC CHLORIDE

ZINC OXIDE

CRITERIA DOCUMENTS IN FY 1976

CHLORINE

ETHYLENE DICHLORIDE

FIBROUS GLASS

FLUORINE

FORMALDEHYDE

HYDROGEN FLUORIDE

PHENOL

PHOSGENE

PHOSPHINE

PHOSPHORIC ACID

PHOSPHORUS

SODIUM CYANIDE

TETRACHLOROETHYLENE

1, 1, 1, TRICHLOROETHANE

PERTINENT DEVELOPMENTS
(continued)

EXPANSION OF TOXICOLOGICAL CAPABILITIES

DuPONT

CONSORTIUM OF INDUSTRIES

CONSULTANTS INCREASING

PESTICIDE TRAINING FOR CERTIFICATION - CORNELL UNIVERSITY

CARCINOGEN IDENTIFICATION - TRACOR JITCO

BLACK LUNG VICTIM COMPENSATION

STANDARDS AND ENVIRONMENTAL IMPACT STATEMENTS

ECONOMIC FEASIBILITY

TECHNICAL FEASIBILITY

INFORMATION SOURCES INCREASING

WATER HYACINTHS AND CONTROL OF WATER POLLUTION

HEALTH AND SAFETY REGULATIONS FOR FEDERAL WORKERS

DRINKING WATER LEGISLATION

TOXIC SUBSTANCES LEGISLATION PENDING

NOISE STANDARD NEAR

VINYL CHLORIDE STANDARD

PERTINENT DEVELOPMENTS
(continued)

ERDA AND NRC

AIR PROGRAMS FOR NEW STATIONARY SOURCES

STANDARDS ON DEMOLITION AND RENOVATION OF ASBESTOS-CONTAINING
STRUCTURES

OIL POLLUTION

SOLID WASTE DISPOSAL

AIR EFFLUENT - OPACITY STANDARDS

OIL AND HAZARDOUS SUBSTANCES POLLUTION CONTINGENCY PLANS

EXECUTIVE ORDER - PREVENTION, CONTROL, AND ABATEMENT OF
ENVIRONMENTAL POLLUTION AT FEDERAL FACILITIES

CORPS OF ENGINEERS PROCEDURES - RIVERS AND HARBORS ACT

REGULATIONS FOR ADMINISTRATION AND ENFORCEMENT OF THE
RADIATION CONTROL FOR HEALTH AND SAFETY ACT

FEDERAL ENERGY CONSERVATION REGULATIONS

AEC REGULATIONS ON RADIOACTIVE PACKAGES

AEC - FEES FOR LICENSES

PERFORMANCE STANDARDS FOR IONIZING RADIATION EMITTING PRODUCTS

PERTINENT DEVELOPMENTS
(continued)

OZONE GENERATOR REGULATIONS

FOOD SERVICE SANITATION

AEC REGULATORY GUIDES

GENERAL REQUIREMENTS OF EO 11807 AND "PROVISIONS"

DESIGNATE OFFICIAL	AVAILABILITY OF RECORDS
GOVERNMENT - SET EXAMPLE	RECORD RETENTION
MANAGEMENT INFORMATION SYSTEM	SUMMARY POSTING
ADOPT STANDARDS	AGENCY POLICY
COMPLAINT PROCEDURES	ORGANIZATION AND PROCEDURES
PERIODIC INSPECTIONS	GOALS AND OBJECTIVES
HAZARD ABATEMENT	PROGRAM EVALUATION
TRAINING	PRIORITIES
ANNUAL REPORT	FUNDS
OBSERVE GUIDELINES	COMMITTEES
ANNUAL DOL EVALUATION	POSTING OF NOTICES
FEDERAL ADVISORY COUNCIL ON OCCUPATIONAL SAFETY AND HEALTH	REPORTING HAZARDS
APPLICABLE ONLY TO FEDERAL EMPLOYEES	PROTECTION OF COMPLAINANTS
RECORDKEEPING AND REPORTING - MANDATORY	WALK-AROUND RIGHTS
OTHER PROVISION ASPECTS - REQUIRED	ADVANCE NOTICE
EMPLOYEE INVOLVEMENT	FIELD FEDERAL SAFETY AND HEALTH COUNCILS
SERIOUS ACCIDENTS	

CONFLICTS

CARCINOGENS AND EXPOSURE LIMITS

TOXIC SUBSTANCE LIST - 1400

FDA AND DELANEY LAWS

TOXICOLOGIST CONCERN

CIGARETTES

SPRAY ADHESIVES SCARE

EPA COURT DECISIONS

LEAD IN GASOLINE PHASE OUT

RESERVE MINING CO. - ASBESTOS IN LAKE SUPERIOR

MAN AS THE TEST ANIMAL

LEGISLATION ON SHIFT OF BURDEN OF PROOF

CLEAN AIR VERSUS JOBS

CATALYTIC CONVERTERS AND SULFATE EMISSIONS

HEALTH CARE COSTS IN 1970:

AIR POLLUTION - \$62 - \$311 MILLION

SMOKING - \$4.23 MILLION

LEAD IN GASOLINE VS. AROMATICS IN GASOLINE

TOXIC SUBSTANCES LEGISLATION AND SMALL FIRMS

CONFLICTS
(Continued)

RELAXING OF POLLUTION STANDARDS DUE TO FUEL SHORTAGE

POLLUTION CONTROLS AND STIMULUS TO ECONOMY

OSHA HEALTH STANDARDS DEVELOPMENT

POLITICS AND STANDARDS DELAY

COURT DECISIONS

MOCA REMANDED

CMME REMANDED

MEDICAL EXAMINATION FOR 14 CARCINOGENS

PESTICIDES - EMERGENCY TEMPORARY STANDARDS

LAPSES IN OSHA ADMINISTRATION AND REORGANIZATIONS

ENVIRONMENTAL IMPACT STATEMENTS

TECHNICAL AND ECONOMICAL FEASIBILITY

INFLATION FROM STANDARDS

ENGINEERING CONTROL VS. PERSONAL PROTECTION

PENDING COURT ACTION - COMPLY VS. NOT COMPLY

MONITORING AND SHORTAGES OF:

OCCUPATIONAL PHYSICIANS

INDUSTRIAL HYGIENISTS

CONFLICTS
(Continued)

13,000 COMPOUNDS IN TOXIC SUBSTANCES LIST

HEALTH REPRESENTATION ON FEDERAL ADVISORY COUNCIL ON OCCUPATIONAL
SAFETY AND HEALTH

OSHA VS. MEDICAL

OSHA AGREEMENT STATES

CONFLICTS WITH STANDARDS - NOISE, ARSENIC

DEVELOPMENT OF CRITERIA DOCUMENTS VS. MANPOWER

MANPOWER SHORTAGE

TRAINING GRANTS CURTAILMENT

TRAINING FEE FOR SHORT COURSES

ADMINISTRATIVE VS. TECHNICAL JOBS

REQUIREMENTS AND ENFORCEMENT

BUDGET DECREASES AND REQUIREMENT INCREASES

ECONOMY AND HEALTH

MOST OSHA PROBLEMS HEALTH RELATED, HOWEVER, OSHA IS MORE SAFETY ORIENTED

TRADE NAMES PROBLEM

ENERGY AND HEALTH

LOW TOXICITY TODAY - EXTREMELY TOXIC TOMORROW

STRESS A BIG OCCUPATIONAL HAZARD

FUTURE OUTLOOK

MORE USE OF TECHNICIANS IN FUTURE

COORDINATION OF EPA, OSHA, NIOSH, NRC, BRH ACTIVITIES

CLOSER REVIEW OF STANDARDS, RULES, REGULATIONS BEFORE RELEASE

MORE ATTENTION TO ECONOMIC FEASIBILITY

MORE HEALTH SCARES AND CONCERN

BETTER SCREENING OF COMMERCIAL PRODUCTS FOR TOXICITY

MORE INFORMATION ON TRADE NAME MATERIALS

INCREASED MEDICAL MONITORING

INCREASED DEMAND FOR OCCUPATIONAL HEALTH PERSONNEL

MORE PAPER WORK

MORE ENFORCEMENT

MORE TRAINING

MORE FRUSTRATIONS FOR AWHILE DUE TO ECONOMY

POSSIBLY LESS SUPPORT FROM MANAGEMENT

RELUCTANCE TO PROVIDE MONEY - FOR HAZARD CONTROL AND MANPOWER

PROGRAM DELAYS

PRESSURE TO USE AVAILABLE RESOURCES EFFECTIVELY

PROBLEMS IN MEETING REQUIREMENTS

IMPORTANT TO RETAIN OUR SENSE OF DIRECTION AND DEDICATION

13

N77-30718

CURRENT ASPECTS OF
OCCUPATIONAL CHEMICAL CARCINOGENESIS

Presented by

Dr. Donald Lassiter
Office of Standards
Occupational Safety and Health Administration
Washington, D.C.

Williamsburg, Virginia
March 18, 1975

60
PAGE INTENTIONALLY BLANK

CURRENT ASPECTS OF OCCUPATIONAL CHEMICAL CARCINOGENESIS

The Occupational Safety and Health Act of 1970 established two new Federal organizations: The National Institute for Occupational Safety and Health (NIOSH) within the Department of Health, Education, and Welfare and the Occupational Safety and Health Administration (OSHA) within the Department of Labor. In very general terms, NIOSH was mandated the responsibility for occupational safety and health research leading to the development of recommended occupational safety and health standards for the consideration of OSHA, which was mandated the responsibility for promulgation and enforcement of such standards. NIOSH fulfills its statutory obligation to provide recommended standards to OSHA through documentation of criteria on which recommendations are based. These recommendations and the accompanying documentation are developed into Criteria Documents which are then transmitted to OSHA and are published for consideration of the general public. These documents, then, have formed the basis of the health standards promulgated by OSHA.

The other route available for standard setting by OSHA is through promulgation of an emergency temporary standard by its publication in the Federal Register. This route is more expedient and is reserved for emergency situations. It was via this emergency temporary route that standards concerned with control of occupational exposure to 14 chemical carcinogens was

promulgated in May of 1973. The final rule was promulgated in January of 1974.

It has been estimated that well over 50 percent of all human cancer is induced by chemicals present in the environment. Boyland (England) has further estimated that 90 percent of all human tumors result from the action of chemicals of environmental or endogenous origin, with the remainder due to viruses and radiation. Many of the chemicals present in our environment have been tested for carcinogenicity and the National Cancer Institute (NCI) has published a series of monographs which summarize, but do not evaluate, experimental evidence related to the carcinogenic potential of approximately 1,000 of these chemical substances. Chemicals on the NCI list are included in a larger listing prepared by NIOSH, entitled the Toxic Substances List, which is published annually as required by the Occupational Safety and Health Act of 1970. This latter list identifies chemicals which have been documented to be toxic, carcinogenic or otherwise neoplastic. Several other Federal agencies including the Department of Defense, the Food and Drug Administration (FDA), the Environmental Protection Agency (EPA) and the Consumer and Product Safety Commission are also interested in surveillance of chemicals which have a demonstrated toxic or carcinogenic effect.

The legal mandates of several Federal agencies related to the control of human exposure to carcinogenic substances are well known. The Delaney amendment to the Federal Food, Drug,

and Cosmetics Act has provided the FDA with a mandate to prohibit food additives which have a demonstrated carcinogenic potential for humans or for animals, if by comparable human exposure routes. The Occupational Safety and Health Act of 1970, while not addressing the question of occupational exposure to carcinogens directly, does provide that, insofar as practicable, no worker shall suffer diminished health, loss of functional capacity, or decreased life span as a result of his work experience. It is clearly evident that occupationally-induced cancer touches on all three of these areas. The entry of OSHA into the area of mandatory occupational safety and health standards for the control of carcinogens in the workplace has forced the reconsideration of questions regarding carcinogenicity which hithertofore had remained largely open-ended and in the exclusive domain of oncologists and other biomedical scientists concerned with mechanisms of carcinogenicity. Although various Federal agencies including the FDA, National Cancer Institute (NCI), Department of Agriculture (USDA), and the National Center for Disease Control (CDC) have been active in the area of cancer prevention and control, the promulgation by the Department of Labor on May 3, 1973, of an emergency temporary standard for the control of 14 carcinogens marked the first Federal attempt to mandatorily control occupational exposure to chemical carcinogens. Prior to that time only the State of Pennsylvania had enacted legislation to effectively control worker exposure to chemical carcinogens. For the most

part, the 14 chemical carcinogens included in the emergency standard had been considered to be potentially carcinogenic for humans by industrial hygienists, including the American Conference of Governmental Industrial Hygienists (ACGIH). This non-governmental organization had included, in a separate appendix, a growing list of chemical carcinogens in its yearly listing of threshold limit values (TLV). The recommended control was that no exposure to these substances should occur by any route. In the 1972 TLV list the carcinogens were arbitrarily divided into two groups according to whether they were considered to be primarily animal or human carcinogens, and in the 1973 list this same classification scheme was altered to include exposure values for several of the substances.

The 1972 ACGIH TLV list served as the principal guideline for the NIOSH recommendation to OSHA that occupational exposure to 15 carcinogenic substances should be controlled. These substances included:

1. 4-Aminodiphenyl
2. 4-Nitrobiphenyl
3. bis(Chloromethyl) ether
4. Chloromethyl methyl ether
5. 4-Dimethylaminoazobenzene
6. N-Nitrosodimethylamine
7. 2-Acetylaminofluorene
8. beta-Naphthylamine
9. alpha-Naphthylamine

10. Benzidine and its salts
11. 3,3'-Dichlorobenzidine and its salts
12. Ethyleneimine
13. 4,4'-Methylene-bis(2-chloroaniline) - commonly called MOCA
14. beta-Propiolactone
15. Dimethyl Sulfate

Dimethyl sulfate was later deleted from the NIOSH and OSHA lists because of insufficient evidence of its carcinogenic hazard for humans. It should be mentioned that alpha-naphthylamine was never included as a carcinogen by the ACGIH.

The 14 carcinogen standards promulgated by OSHA are primarily work practice standards containing control procedures for isolation of processes involving potential exposure to any of the 14 chemicals.

From the historical viewpoint, the term occupational cancer has been intimately associated with the dyestuffs industry and with the older term, "aniline cancer." With the introduction of the "aniline" dyes, workers in this industry began to acquire exposure to a number of previously unknown synthetic aromatic amines derived from benzene and naphthol. Rehn is credited with the first published account of occupational bladder cancer associated with exposure to the chemicals in this industry in 1895.

In the 1930's several important papers were published by Hueper, Bonser and Berenblum concerning the etiology of "aniline

cancer." The exposure of individuals to a number of chemicals in this industry, however, did little to assist in the search for specific etiologic agents. In his 1934 review Hueper mentioned the beginning of what was to become a growing controversy concerning etiology of occupational bladder cancer. He stated that aniline, benzidine, and naphthylamine were the principal etiologic candidates but emphasized that in 1931, Hamilton had recognized several major epidemiologic "pitfalls" including:

- 1) Worker exposure to more than one suspect compound; further complicated by shifting of workers between departments
- 2) Different degrees of exposure hazard between processes
- 3) Unsuspected impurities in trace amounts possibly more harmful than the parent compound
- 4) Composition of dyes and production methodology in different factories complicating statistical comparison

To a very great extent these same epidemiologic "pitfalls" are valid to the present day. This is not the case for several of the more potent carcinogenic aromatic amines, however. The capacity of beta-naphthylamine, benzidine, 4-aminodiphenyl, and 4-nitrodiphenyl to induce bladder cancer in humans represents one of the more well-documented cause and effect relationships

in occupational medicine. Mixed exposure to other aromatic amines, including 3,3'-dichlorobenzidine and alpha-naphthylamine has precluded the direct assertion that these are, likewise, carcinogenic for man, although both have induced cancer in animals. Very recently, 3,3'-dichlorobenzidine has been demonstrated to be of greater carcinogenicity than was previously suspected.

Explosive revelations such as those which characterized the finding that vinyl chloride induced angiosarcoma of the liver in exposed workers are very rare, at least for the present. Few would dispute the conclusion, however, that if those employees who contracted this fatal liver tumor had not been exposed to vinyl chloride the probability of their contracting this rare disease would have been infinitesimally small. Absolute prevention of this particular tumor could have been assured if substantial exposure to vinyl chloride had not occurred. The greatly increased incidence of mesothelioma among asbestos workers, and of "oat cell" carcinoma of the lung among chloromethylation workers represent still other instances of occurrence of rare cancers in much greater frequency among exposed workers than among the general population or unexposed cohorts.

The truly alarming, common feature in each of these instances has been retrospective recognition of cause and effect some twenty or more years following initiation of exposure. During these periods of latency many more tumors

undoubtedly have been initiated and now only await clinical verification. Unfortunately, such experiences have been necessitated in the past to clearly demonstrate the need for exposure controls.

Herein lies one of the more important considerations concerning the documentation of carcinogenic hazard and the extrapolation to man of positive tests for carcinogenicity in animals. Which experimental animals, exposed by which administrative routes represent the best models? Although no hard and fast rules are available as guidelines, it is generally recognized that evidence documenting the induction of tumors in at least two animal species by routes comparable with possible human exposure should preexist prior to the consideration that the substances are potentially carcinogenic for humans. However, this general consideration must be evaluated within the legislative mandate stated earlier; that all employees are to be protected insofar as practicable. The dilemma created by these circumstances requires that all available information and data concerning the hazard of occupational exposure to a given substance be reviewed and evaluated. Each experimental investigation must be evaluated on its own merits before extrapolation to the occupational environment can be attempted.

The problem of occupational carcinogenesis as concerns a specific chemical substance is largely a question of hazard evaluation. In some instances an increased incidence of tumor

production in a defined work force has thrown suspicion on a chemical substance previously considered either innocuous or, at most, hazardous from aspects other than carcinogenic potential. In other instances the results of animal experimentation have demonstrated a carcinogenic potential for a specific chemical substance. A very recent example of both instances has been the problem associated with vinyl chloride. The mechanisms of carcinogenesis are far from being completely understood, and the variables surrounding occupational carcinogenesis do little to clarify the situation even when a specific agent is suspect. The more important aspect of occupational cancer must be correlation of exposure with effect, at least from the standpoint of control procedures. Health hazards associated with occupational exposure to a specific chemical substance must be considered not only from the aspects of its acute or chronic toxicity, but also from its potential to induce tumors. There can be no clear distinction between classic toxicity and oncogenesis until the mechanisms of both are completely understood for a given chemical substance. The literature is replete with instances of tumor induction in animals exposed by one or more of several routes to a large variety of chemical substances. Although even one such finding should immediately alert industry and governmental agencies alike to a possible problem, certainly in-depth review and critical evaluation is necessary prior to establishment of mandatory control standards by such agencies. Such in-depth

review requires that all available information and data bearing on the problem be considered and evaluated on its merits.

Some have criticized the promulgation of standards for the control of chemical substances based solely on their potential to induce cancer as being premature and not based on sound scientific evidence that all of the substances in question were proven carcinogens for man. Certainly degrees of carcinogenicity do exist and it is entirely possible that thresholds for tumor induction may exist. If this latter hypothesis can be proven, then control procedures based on limiting concentrations may be feasible. Until such time, however, only stringent control procedures will suffice to assure that employees are adequately protected from chemical substances considered to be potentially carcinogenic for humans. The assessment of carcinogenic potential for a specific chemical substance must include the consideration of published information, monitoring and control data from affected industry, and the in-depth, epidemiologic experience of affected employees. Negative experience in industry regarding incidence of cases of human cancer must be considered not only in terms of pure versus mixed exposures, but also in the light of the proven experience in the dyestuffs industry that the average latency period for development of bladder cancer is approximately 20 years.

Surely the knowledge that a chemical substance has a demonstrated potential to induce cancer in animals must be

evaluated by industry in terms of establishing minimum controls, appraisal of employees, and accurate recordkeeping procedures on environmental levels of employee exposure and health experience. In view of the latency period documented in the dyestuffs industry for induction of bladder cancer, nothing short of follow-up until the death of the employee will permit the accurate epidemiologic assessment of employee exposure to many of the chemicals presently in use today by industry.

114

N77-30719

CONCEPTS IN HEALTH EVALUATION OF COMMERCIAL AND INDUSTRIAL CHEMICALS

PRESENTATION

TO

THE CONFERENCE OF NASA CLINIC DIRECTORS, ENVIRONMENTAL HEALTH OFFICIALS, AND
MEDICAL PROGRAM ADVISORS

BY

BERNARD P. McNAMARA, Ph.D.

AT

Williamsburg, Virginia

18 March 1975

-75-

74
PAGE INTENTIONALLY BLANK

This paper addresses the problem of the time required to evaluate the long-term effects of commercial or industrial chemicals on the health of man.

Many laws*dictate that all chemicals to which men are exposed, must be tested for all short- and long-term effects on all organs or functions of the body. Testing a single compound for all effects requires the expenditure of hundreds-of-thousands of dollars and commits many research workers, many laboratory facilities, and much animal holding space for prolonged periods of time. Considering the number of chemicals in our environment, it is questionable that there are enough toxicologists or laboratory facilities to comply with the laws.

Philosophies of Safety Evaluation. Much of our safety evaluation follows precepts which were promulgated for new drugs. These require that therapeutic and toxic doses be studied for site of action, rates of absorption, distribution in the body, metabolism, excretion, time of onset and duration of effects. The information needed to evaluate industrial chemicals may be much less than that required for new drugs. It should be necessary only to determine that a specified dose will produce no toxic effects. However, the test protocol must assure that all organs and functions have been monitored.

Long-Term vs Short-Term Testing. Long-term (LT) studies frequently are performed by exposing rats or mice for 1 to 2 years, a large portion of their life span. However, many noted toxicologists state that

* Food, Drug, and Cosmetic Act, 1938; Food Additive Amendment, 1954; Consumer Product Safety Act, 1972; Department of Transportation Act, 1966; National Environmental Policy Act, 1969; Clean Air Act Amendment, 1970; Occupational Safety and Health Act, 1970; and Toxic Substance Control Act, Pending.

a given dose of any substance will produce its effects (with the possible exception of carcinogenicity and mutagenicity) in 90 days or not at all. They further state that the no effect level for a lifetime can be derived from 90-day tests. There is an indication that carcinogenicity and mutagenicity can be detected in a short-term (ST) study as well.

Weil and McCollister determined the doses of 33 compounds that have no effect in rats at 90 days and at 2 years.¹ These compounds were diverse in chemical structure, pharmacologic type, and toxicity as judged by LD50's or ST and LT no effect doses.

Despite these variations among the compounds, relationships exist whereby the LT doses can be derived from the ST doses. The animals were observed for 36 criteria of toxicity including mortality, food intake, weight, pathology, hematology, blood chemistry, central nervous system effects, fertility, cholinesterase, and neoplasia. The most sensitive criteria were body weight, liver or kidney weight/body weight ratio, and kidney pathology. These investigators believe that only these parameters need be followed in 90-day tests.

Table I shows that:

(1) for 27% of the compounds the LT no effect dose was the same (or greater than) the ST no effect dose.

(2) for 51% of the compounds the LT dose was less than the ST dose by a factor of 2 or less.

(3) the ST dose divided by factors of 5, 10, or 12 would encompass the LT for 91, 97, and 100% of the compounds, respectively. (Table 1).

1. Weil, C. S., and D. D. McCollister, Agr & Food Chem 16:686-91 (1963).

Table I. Safety Factors for 33 Compounds in Rats*

Factor**	No. of compounds influenced	Percent of compounds influenced
1	9	27
2	17	51
5	30	91
10	32	97
12	33	100

* Weil & McCollister, Agr & Food Chem, 11:486-491 (1963).

** Short-term no effect dose/factor = Long-term no effect dose.

The important feature of these data is that there is a 97 to 100% likelihood that 1/10 to 1/12 of the ST no effect dose can be given repeatedly throughout a lifetime without producing toxic effects.

In a later study, Weil et al² compared single-dose LD50's with 7-day and 90-day no effect doses. They concluded that the single-dose LD50 divided by 6 or 20 would encompass the 7-day no effect. Also, the 7-day no effect dose divided by 6.2 would include the 90-day no effect dose for 95% of the compounds tested. These data indicate that an LT no-effect dose can be predicted from a single dose LD50.

The opinions of Weil et al² have been supported by others. H.M. Peck³ showed that of 11 drugs studied for 6 months or longer, all produced effects within the first 2 weeks (Table II). Only one of these compounds produced an additional effect after 3 months.

The viewpoint of the Expert Committee on Drug Toxicity of the Association of the British Pharmaceutical Industry is:

"We have been unable to find any evidence that these considerably prolonged (2 years) experiments give any useful information whatsoever (apart from carcinogenicity) that cannot be predicted from the results of shorter studies....We have recommended that studies should never be less than three weeks, and need not exceed six months duration." It was recommended also that studies of reproduction be done separately from general toxicity.

2. Weil et al. TAP:426-431, 1969.

3. Peck, H. M., An Appraisal of Drug Safety Evaluation in Animals and the Extrapolation of Results to man. Raven Press, N.Y. pp 449-471 (1968).

TABLE II.

APPROXIMATE DURATION OF DRUG ADMINISTRATION REQUIRED TO DEFINE TOXICITY¹ IN ANIMALS

(H. M. PECK IN IMPORTANCE OF FUNDAMENTAL PRINCIPLES IN
DRUG EVALUATION RAVEN PRESS, 1968)

COMPOUND	DURATION IN MONTHS							
	1/2	1	2	3	6	12	18	24
INDOMETHACIN	X	X	O	O	O	O	O	O
HYDROCHLOROTHIAZIDE	X	X	O	O	O			
AMILORIDE HCL	X	X	O	O	O	O	O	
CYPROHEPTADINE	X	X	O	O	O			
AMITRIPTYLINE	X	X	O	O	O	O		
METHYL-DOPA	X	X	X	O	O	X ²		
PENICILLAMINE	X	X	X	X	O			
ETHACRYNIC ACID	X	X	X	X	O	O	O	
PROTRIPTYLINE HCL	X	O	O	O	O	O	O	
THIABENDAZOLE	X	X	X	X	O	O	O	O
DEXAMETHASONE	X	X	X	O	O			

CODE: X = TOXICITY DEMONSTRATED

O = CONTINUING DURATION OF STUDY - NO ADDITIONAL TOXICITY

¹BY PHYSICAL EXAMINATION, OR HEMATOLOGIC, BIOCHEMICAL AND/OR ANATOMICAL STUDIES.

²ADDITIONAL FINDING OF PRECIPITATE IN KIDNEYS. NO EARLIER SACRIFICE, SO TIME OF ONSET NOT KNOWN. FOUND IN RATS BUT NOT IN DOGS OR MONKEYS.

A committee of the American Society of Toxicology, chaired by D. D. McCollister stated "With the exception of carcinogenicity and certain rare neurological effects, there is little, if any, additional information obtained on the character of toxic effects that are not detected within 3-months of testing."⁴

In their review on chronic toxicity testing, Barnes and Denz⁵ concluded that there is little value in testing beyond 3 to 6 months.

The Ciba Drug Company in Basel, Switzerland, conducted tests for 10 to 108 days on 46 compounds and then retested them at their laboratory in Summit, N. J.⁶ Only two toxic effects were found in the second study that had not been noted in the first. All signs were noted within 8 weeks.

J. P. Frawley collected 2-year toxicity data on 220 substances; distribution of the no effect levels is shown in table III. Only 19/220 compounds showed any toxic effect below 10 ppm. All 19 were pesticides or heavy metals. Only 1/132 other compounds was toxic below 100 ppm. Frawley concluded that a safe level of 0.1 ppm could be established without experiment for all compounds other than pesticides and heavy metals.⁷

W. Hayes stated that the ratio between the single-dose LD50 and the 90-day LD50 is a measure of the cumulative toxicity of a compound.⁸ If the ratio is 2.0 or less, the compound is noncumulative. The greater the ratio is, the greater the cumulative capacity. For 16 compounds these ratios ranged from 0.04 for potassium cyanide to 60.8 for mirex. This

4. Society of Toxicology Newsletter, 1974.

5. Barnes et al., Pharmacol Rev 6:191-242 (1954).

6. Bein, H.J. Proc Europ Soc Study of Drug Tox II:15-24 (1963)

7. Frawley, J.P. Food Cosmetic Toxicol 5:293-308 (1967)

8. Hayes, W. Essays on Toxicology, Vol 3, 65-67 (1972).

Table III. Distribution of "No Effect" Levels in 2-Year Chronic Studies⁷

"No Effect" Level (ppm)	All Compounds (220)	Heavy Metals & Pesticides (88)	Other (132)
< 1	5	5	0
< 10	19	19	0
< 100	40	39	1
< 1000	101	72	29
< 10,000	151	86	65

reiterates the thought that acute LD50's may be related to LT toxic effects.

To test the concepts advanced by the previously mentioned authors, 82 LT studies, covering 122 compounds and 566 dose levels, were collected from the literature. These studies were analyzed to note what information would have been lost had the experiment been terminated in 3 months or, conversely, what important information was obtained by continuing the experiment beyond 3 months. Eight of 122 compounds produced an effect in less than 3 months but ^{also} produced an effect at a lower dose level after 3 months.

The studies of Weil and McCollister¹ were conducted by the same investigators, using a relatively homogeneous group of rats and consistent criteria for toxicological measurement (Table IV). The no effect doses were determined with precision.

The literature review covered compounds, investigators, animal species, and criteria of toxicity that varied greatly. Many of these studies were performed for purposes other than determining no effect doses. Frequently, the doses were spaced widely and it was not possible to fix precisely the no effect doses.

Despite the welter of information, an agreement with the data of Weil and McCollister concerning relationships of LD50's, ST, and LT doses for individual compounds can be seen.

Figure 1 shows frequency distributions for these relationships based on the data of Weil and McCollister. Some of these data appear in tabular

TABLE IV
SUMMARY OF DATA FROM VARIOUS LITERATURE SOURCES

<u>Type of Compounds:</u>	Diverse drugs and chemicals
<u>Species:</u>	Mice, rats, dogs, fish, chickens, monkeys, cats, pigs, guinea pigs, hamsters
<u>Criteria:</u>	Diverse over-all. Highly specific in some studies (enzyme changes, reproduction, neurotoxicity, tapetum lucidum, fibrillation, auditory).

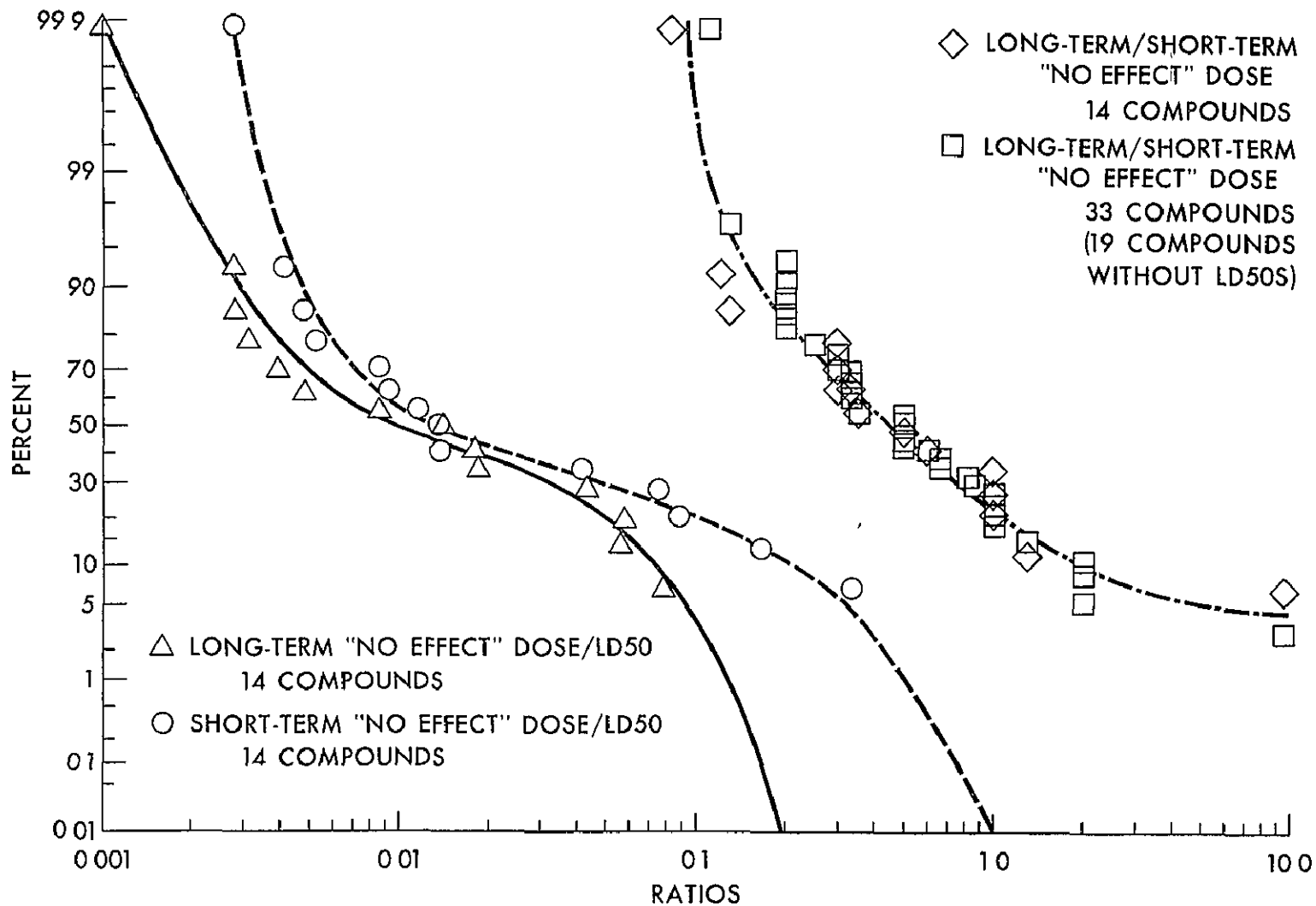

Figure 1. Relationship Between Long-Term and Short-Term "No-Effect" Dose and LD50; and Long-Term and Short-Term "No-Effect" Dose for Various Chemicals
Data from Weil and McCollister, Agr & Food Chem 11:489-491 1963.

form in table I. The abscissa gives the ratios of the LT and ST no effect doses/LD50's, and the ratios of the LT/ST no effect doses. The ordinate gives the cumulative percent of compounds exhibiting a specified ratio.

As mentioned before (table I), for 27% of the compounds the LT no-effect dose was the same or larger than the ST no-effect dose. Some were 10 times larger; this indicates the development of tolerance. For 51% of the compounds, the LT was less than the ST dose by a factor of 2 (ratio = 0.5) or less; and 0.1 of the ST would include 99% of the LT no-effect doses.

Of the LD50, 0.1 takes in 20% of the ST no-effect doses and 4% of the LT no-effect doses; 0.01 includes 57% of the ST and 50% of the LT doses; and 0.001 includes 100% of the ST and 99% of the LT no-effect doses.

Figure 2 shows the corresponding frequency distribution for data from the literature review. The data are spread about 1/2 log further than that of Weil and McCollister, which is understandable because of the greater variations among the studies. Because of the greater spread of the data, the LT/ST ratios are given by the additional scale on the abscissa. Despite the technical differences, the patterns of frequency distribution for the data of Weil and McCollister and that of the literature review are similar.

Figure 3 shows the frequency distribution for the data of Weil and McCollister and the data from the other literature sources. Most of the points data/follow a consistent pattern (Table V).

It can be anticipated that for 95% of chemical compounds the LD50/100 will produce no effects in 3 months; the LD50/1000 will produce no effects

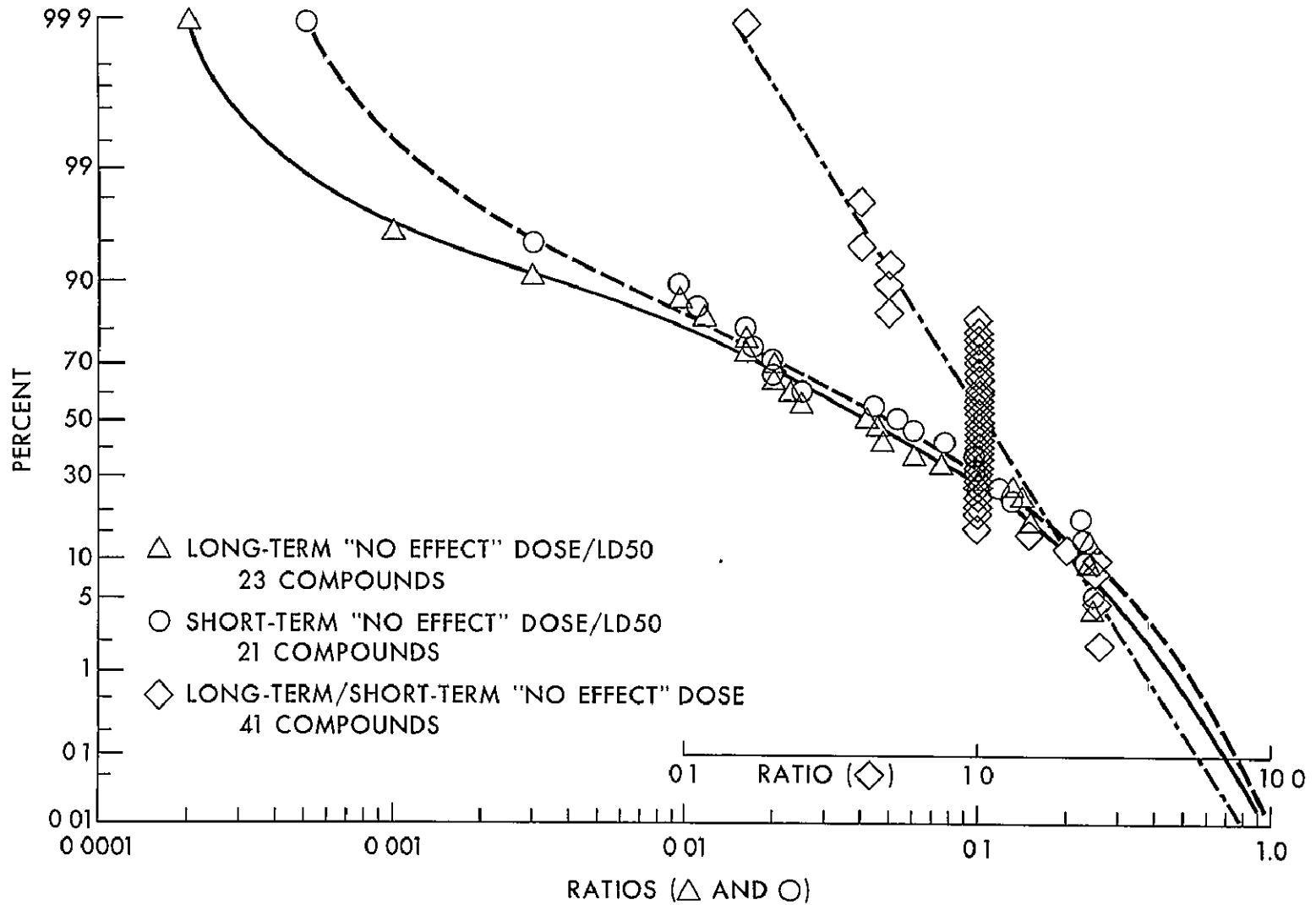

Figure 2. Relationship Between Long-Term and Short-Term "No-Effect" Dose and LD50; and Long-Term and Short-Term "No-Effect" Dose for Various Chemicals
Data from various literature sources.

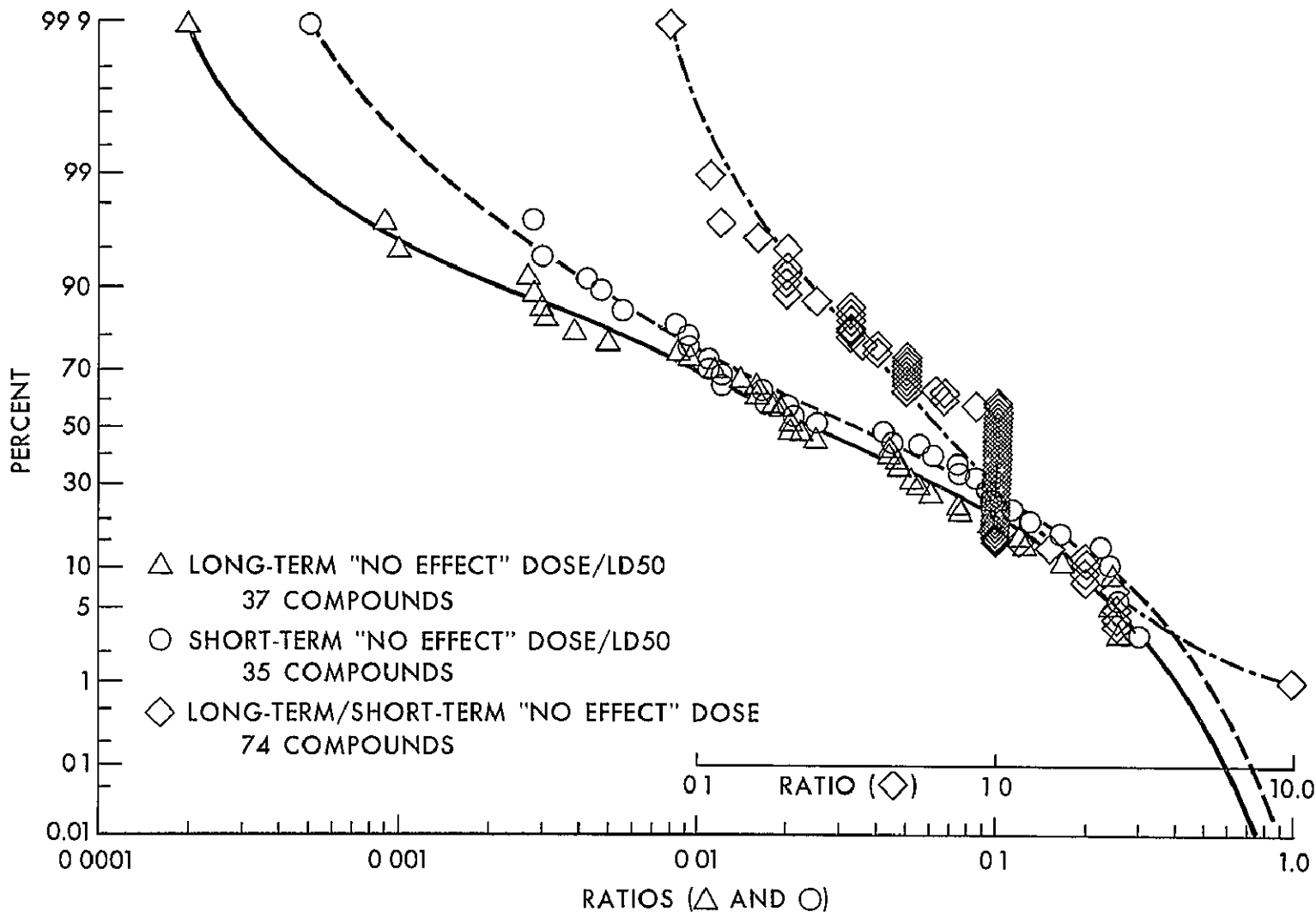

Figure 3. Relationship Between Long-Term and Short-Term "No-Effect" Dose and LD50; and Long-Term and Short-Term "No-Effect" Dose for Various Chemicals
Data from figures 1 and 2 combined.

TABLE V
 PREDICTION OF LONG-TERM "NO EFFECT" DOSES

Dose	Repeated dosage which will produce "no effect" in:
LD50/100	3 months
LD50/1000	Life time
3-month "no effect" dose/10	Life time

in a lifetime; and the ST/10 will produce no effects in a lifetime. This information supports the view that most commercial chemicals could be screened adequately in 3 months, except for carcinogenic and mutagenic effects. The following evidence indicates that even these two effects may be detected in a short-term test.

Reproduction and Mutagenesis.

Numerous tests are used to study the various aspects of reproduction (fig 4). A three-generation test in rats frequently is used to include all of these phases. Hopefully, it would reveal dominant lethal mutagenesis in the first generation and recessive mutations in the second and third generations. However, it is unlikely that the second and third generations supply any information on mutagenicity. In addition, a three-generation test requires about 10 months of working time.

Figure 5 shows a one-generation test where the male and female parents are exposed for 13 weeks, a period sufficient to manifest most toxic signs. The male germ cells are exposed during their entire spermatogenic cycle. The female is exposed during 17.5 estrus cycles. The exposures are continued through a period of mating, organogenesis and gestation. The mother and off-spring are observed for any post-natal effects of a chemical.

This test should assess the impact of all ST and LT toxic effects on mating, fertility, fetal toxicity, dominant lethal mutagenesis, teratogenesis, gestational and post-natal effects on survival; growth, lactation, etc., in a period of 4 months.

FIGURE 4

REPRODUCTION

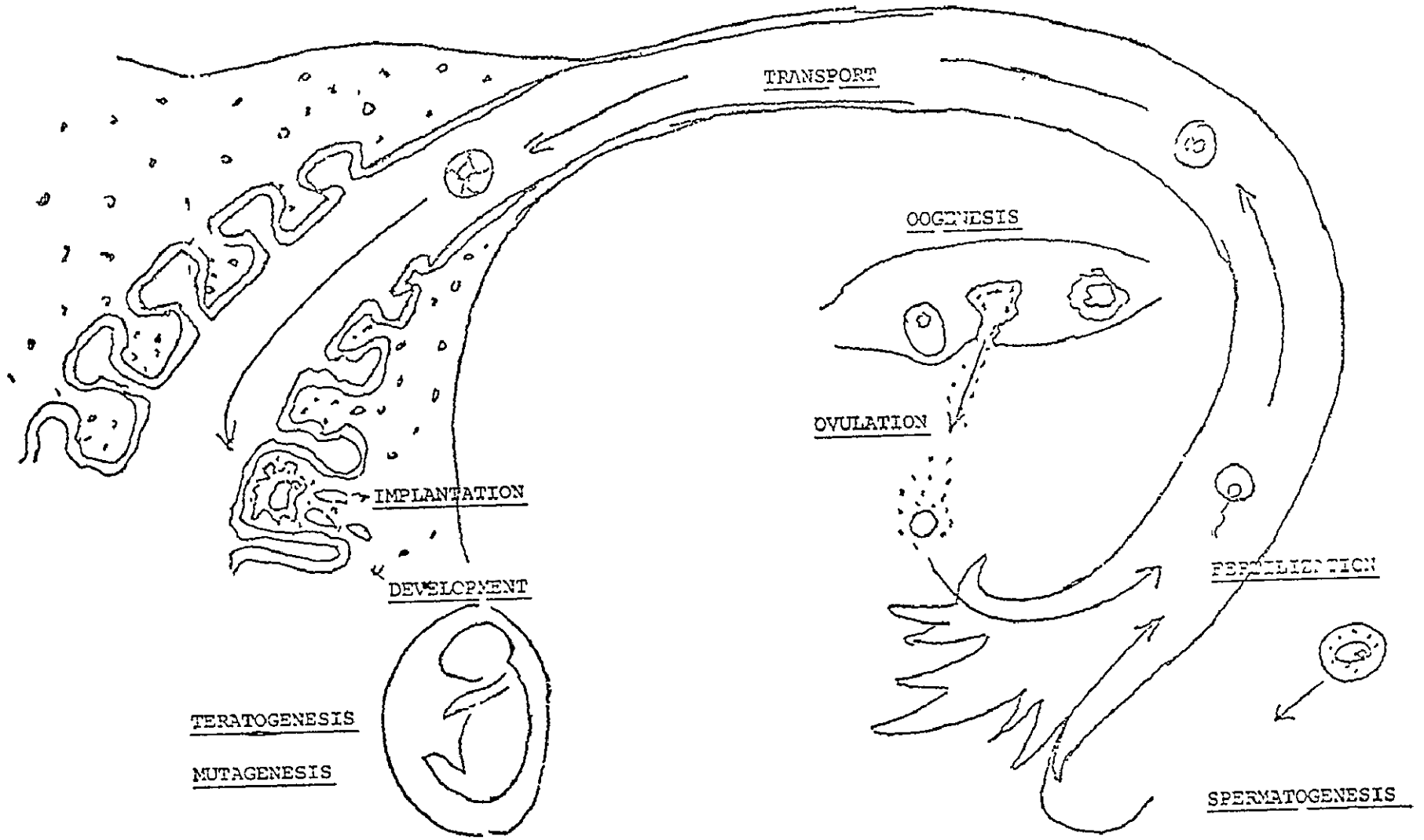

92

FIGURE 5
ONE-GENERATION REPRODUCTION STUDY IN RATS

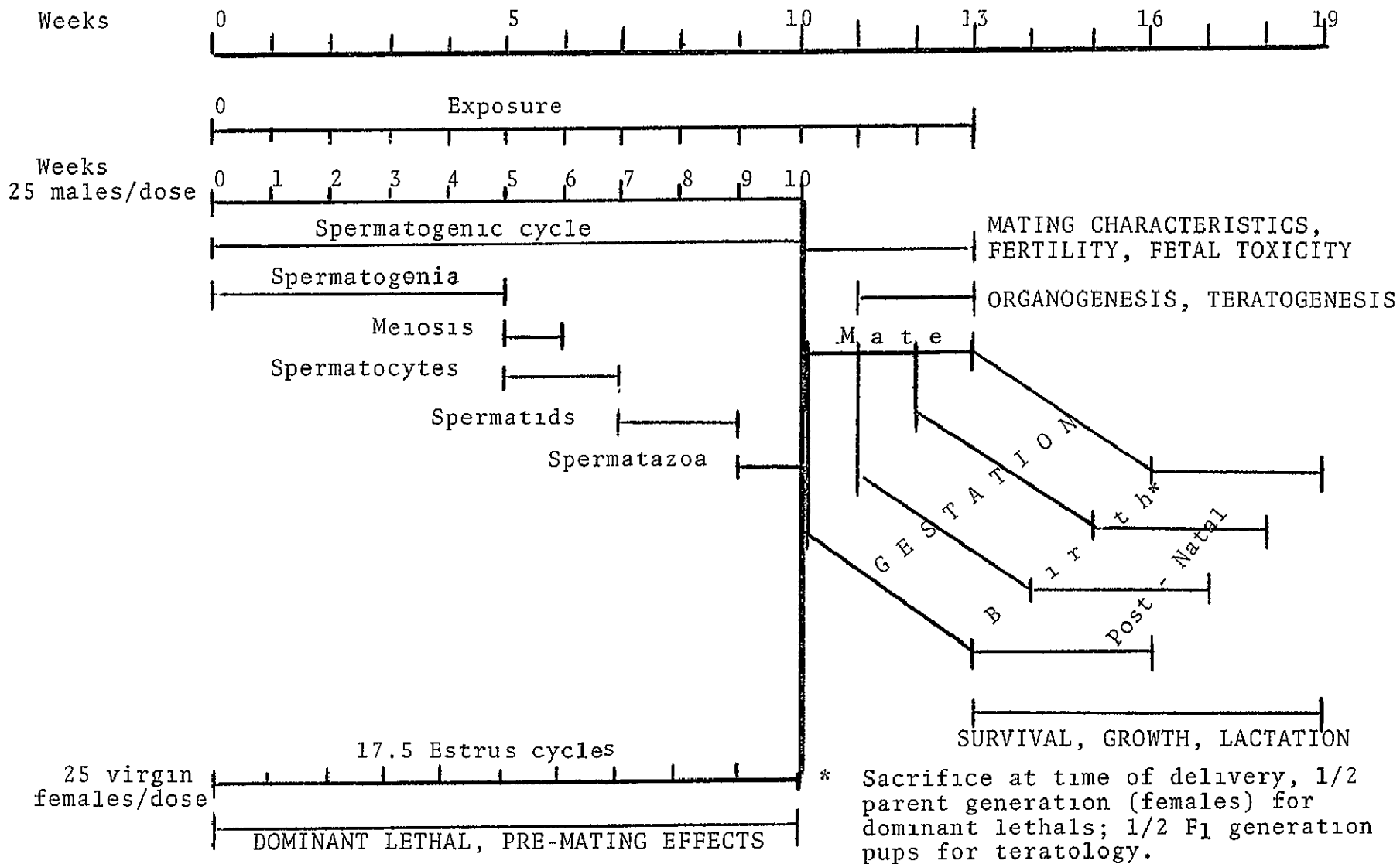

"No effect" according to this test includes all male and female aspects of reproduction and dominant lethal mutagenesis in a single generation. It is unlikely that subsequent generations would furnish more information on mutagenesis.

Mutagenesis, generally, is revealed in microorganisms, molds, plants, cell cultures, or insects. Mammals are of lesser value as can be seen by comparing the mouse and the *Drosophila*. The genome of the mouse has 20 pairs of chromosomes; that of the fly has 4 pairs. A single-point attack in the mouse would involve a smaller percentage of the total genome than a similar attack in the fly; consequently, a lower frequency of mutations would be expected in the mouse. This frequency is decreased further because of a greater tendency for crossover among chromosomes in the mouse.

Visible, dominant or recessive mutations are infrequent in the mouse.

Sex-linked recessives in *Drosophila* have been used for routine bioassay of mutagens (fig 6). Visible mutations in the eyes, body, wings, and bristles can be detected in the first generation of male flies. The fruit fly can be used to reveal dominant lethals, partial or whole chromosome loss, translocations, recessive lethals, gene or point mutations and small deletions, visible mutations at specific loci (*Minutes*) and nondisjunction.

The test reveals mutagenic potential but not mutagenic hazard to man; however, it is on similar bases that other compounds have been termed mutagens. The primary value of this test is to compare the potency of new chemicals and known mutagens.

FIGURE 6

MUTAGENESIS

DROSOPHILA

NORMAL

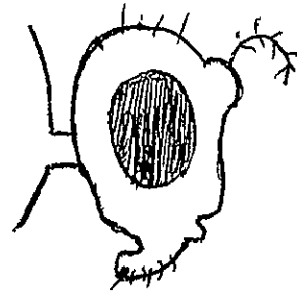

BAR

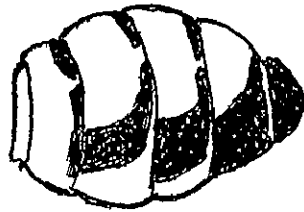
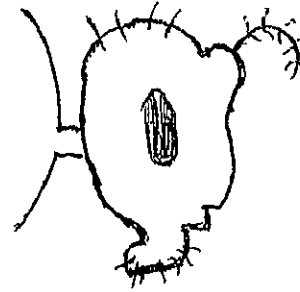

DARK

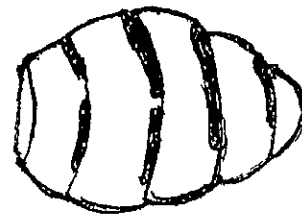

LIGHT

Carcinogenicity. Mutagenesis is considered to be a step in carcinogenesis. There is good correlation between mutagenic and carcinogenic potency for a number of compounds. The test used to detect mutagenesis in fruit flies has been proposed as a screening test for carcinogenesis. There is much controversy over the value of any test for cancer. There is no guarantee that animals and man will give the same carcinogenic response to a chemical. A compound may produce a tumor in one species but not in another. It may attack one organ in one species and a different organ in a second species. In the same species, a carcinogen may be 100% or 0% effective depending upon the experimental conditions.

The most widely accepted method tests mice for 18 months and rats for 24 months. This is expensive in money, time, and facility commitments.

In recent years, a number of short-term cancer tests have been proposed. These use species or simplified cell systems which are further from man than are mice and rats. Nevertheless, there is need for fast, simple tests to screen the masses of commercial chemicals. Possibly, the problem may be solved by use of a battery of short-term tests coupled with more careful observation for precancerous signs in exposed animals.

Precancerous Signs. The literature is replete with pharmacological, histological, and biochemical effects produced by known carcinogens (table VI). Many of the effects appear within a few hours or days and disappear within several weeks of exposure. Many investigators feel that such signs can be expected, generally. A brief search of the literature revealed more than 30 carcinogens which are known to produce early precancerous signs (table VII).

TABLE VI.

PRECANCEROUS INDICATORS

CLINICAL SIGNS OR MEASUREMENTS

ANOREXIA, VOMITING, HEMORRHAGE, DECREASED BODY WEIGHT,
HYPERBILIRUBINEMIA, BSP RETENTION, DECREASE IN HEMOGLOBIN,
PLATELETS, LEUKOCYTES, AND NEUTRAPHILS.

HISTOLOGICAL

ORGAN DAMAGE -- LIVER, LUNGS, KIDNEY, BREAST, GONAD,
BONE MARROW, INTESTINAL EPITHELIUM.

TISSUE CHANGES -- PROLIFERATION, HYPERPLASIA, VESICULATION
OF ENDOPLASMIC RETICULUM, ENLARGED
NUCLEI, SQUAMOUS METAPLASIA, MITOSIS,
FIBROSIS, NECROSIS.

BIOCHEMICAL AND ENZYMATIC -- CHANGES IN GLUCOSE-6-PHOSPHATASE,
FORMINOGLUTAMIC ACID TRANSFERASE, UROCANASE,
FORMYLASE, METHYL-H₄-FOLATE DEHYDROGENASE,
HISTIDASE, GLUTAMIC OXALACETIC TRANSAMINASE
AND CARBONYL TRANSFERASE, AND ORNITHINE.

TABLE VII

**CARCINOGENS KNOWN TO PRODUCE
PRECANCEROUS SIGNS**

ACETAMIDE
ACETOHYDROXAMIC ACID
2-ACETYLAMINOFLUORENE AND DERIVATIVES
AMMONIUM POTASSIUM SELENIDE
2,2'-AZONAPHTHALENE,3,4,5,6-DIBENZCARBAZOLE
BENZO[A] PYRENE
BENZIDINE
CADMIUM
CARBON TETRACHLORIDE
DAUNOMYCIN
N,N,-DIMETHYL-4-AMINOBENZENE
7,12-DIMETHYLBENZ(A)ANTHRACENE
DIEMTHYLNITROSAMINE
ETHIONINE
HEXACHLOROPHENE
HYDRAZINE
METHYLAZOXYMETHANOL
METHYLNITROSO-P-TOLYLSULFONAMIDE
METHYLNITROSOUREA
METHYLNITROSOURETHANE
NAPHTHALENE
B-NAPHTHYLAMINE
ALPHA-NAPHTHYLISOTHIOCYANATE
NICKEL CARBONYL
SENECIO ALKALOIDS
TANNIC ACID
THIOACETAMIDE
THIOUREA
URANIUM
URETHANE
X-IRRADIATION

As to short-term tests for cancer, a recent report by Stoltz et al.⁹ and other experts in this area concluded that tests involving mutagenicity, DNA repair synthesis, and/or cell transformation offer promise as screens for carcinogens (fig. 7).

Precancerous signs and pathology, and mutation in *Drosophila* have been discussed.

Cell Transformation. As shown in figure 7, the growth of normal cells is orderly, controlled, and contact-inhibited from overpopulation. These features are lost when cells are transformed by a carcinogen. Inoculation of altered cells into animals gives rise to sarcomas; inoculation from normal colonies does not. There is good correlation between known carcinogenic activity of chemicals and cell transformation.

Tumor Associated Fibrinolysis. Transformed cells release a protease which dissolves fibrin clots. The induction of fibrinolysis correlates with transformation. It appears within 1 hour of incubation with a carcinogen.

DNA Repair Synthesis. It is assumed that the carcinogenic process involves chemical interaction with DNA. The altered DNA is repaired. The repair process, which uses a greater than normal amount of DNA precursors can be noted by using a labeled precursor (tritiated thymidine). The labeled DNA can be measured by the number of dark spots on a radiogram.

Other possible short-term tests are in table VI^{II}.

Metabolism and Isoenzyme Changes. Neoplasia is associated with alterations in isoenzyme patterns. As cells lose their identity and function, normal enzymes are replaced by isoenzymes. Changes include:

glucokinase	—————>	hexokinase
adolase B	—————>	adolase A
pyruvate kinase II	—————>	pyruvate kinase I

9. Stoltz et al., TAP 29:157-180 (1974).

FIGURE 7

CARCINOGENICITY

(POSSIBLE SHORT-TERM TESTS)

PRECANCEROUS SIGNS AND PATHOLOGY

MUTAGENESIS IN DROSOPHILA

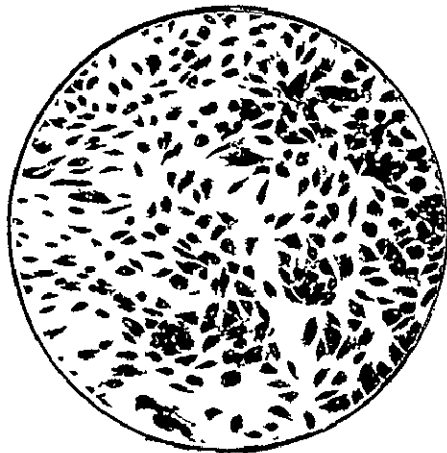

NORMAL

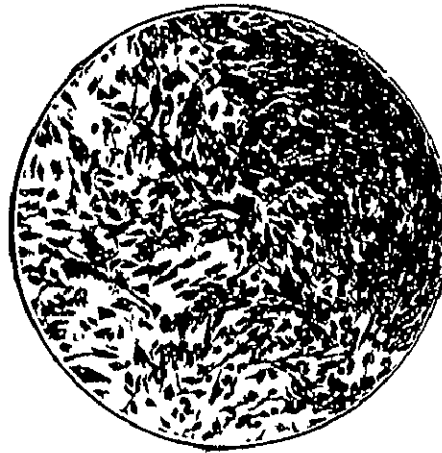

TRANSFORMED

CELL TRANSFORMATION
and
FIBRINOLYSIS

H₃THYMIDINE

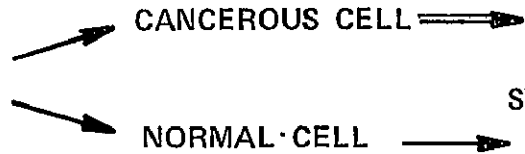

CANCEROUS CELL

NORMAL CELL

DNA
SYNTHESIS



RADIOGRAM - DNA SYNTHESIS

Table VIII. POSSIBLE SHORT-TERM CANCER TESTS

Isoenzymes

Glucokinase \longrightarrow Hexokinase
Aldolase B \longrightarrow Aldolase A
Pyruvate Kinase II \longrightarrow Pyruvate Kinase I

Cholesterol Synthesis

The rate of cholesterol synthesis in mammalian liver is regulated by the microsomal enzyme, hydroxy - methyl - glutaryl- CoA- reductase. When cholesterol is ingested, the activity of the enzyme and the rate of cholesterol synthesis decreases. In malignant tissue the feedback control disappears months before the appearance of the tumor.

SUGGESTED PROGRAMS

The foregoing information indicates that a short-term test may be sufficient to screen for any toxicological effect of commercial chemicals, providing that all organs and functions have been observed adequately. Table IX shows a program devised to monitor all organs and functions in a short-term test. The left column gives the test and the right column gives organ or function tested.

Acute Oral LD50. The acute oral LD50 should be determined in two species, one of which is not a rodent. This technique has been described by the Food and Drug Administration¹⁰ and others. Toxic signs noted while conducting the LD50 test may give insight as to signs which may appear during the 3-month study.

Short-Term Test. Two dose levels (1/100, 1/1000 LD50) should be administered orally and by inhalation to appropriate numbers of rats, guinea pigs, rabbits, dogs, and fruit flies for periods of 90 days or less (Table IX).

Toxic Signs. All animals are observed daily for the presence or absence of toxic signs. Most of the observations can be made quickly using a checklist and without the use of sophisticated equipment. Local effects on the cornea, eyes, conjunctiva, and iris can be noted daily using the criteria of the FDA.¹⁰ Observation of the lens requires use of the ophthalmoscope. Retinal examination requires ophthalmoscope, electroretinograms, or histology. Food and water consumption are noted daily and body weight is measured weekly (table IX).

Hypersensitization. The Landsteiner technique can be used as a routine test for hypersensitization. Guinea pigs are exposed cutaneously for a period of 3 weeks. After a 2-week rest period, a dose known to be ineffective in a

^{10.} Appraisal of the Safety of Chemicals in Food, Drugs, and Cosmetics. Association of Food & Drug Officials of the US. pp 36-45 (1959).

TABLE IX. TOXICOLOGICAL TESTING PROGRAM

TEST	ORGAN, SYSTEM, FUNCTION, OR PROCESS MONITORED
ACUTE LD50, ORAL, 2 SPECIES	
TOXIC SIGNS	GENERAL, ALL SYSTEMS
SHORT-TERM TESTS - 2 DOSE LEVELS	
INITIAL - 0.01, 0.001, LD50	
DAILY TOXIC SIGNS	GENERAL, ALL SYSTEMS
BLOOD CHEMISTRY AND HEMATOLOGY DAY -14, -7, +3, +7, +30, +60, +90 (RATS)	HEMATOPOETIC SYSTEM (RBC-WBC, A/G), ANTIBODIES, PROTEIN SYNTHESIS, LIVER AND KIDNEY FUNCTION, ENDOCRINE SYSTEM, SALT-WATER BALANCE.
-103-	
PATHOLOGY, DAY -14, -7, +3, +7, +30, +60, +90 (RATS)	BRAIN, HEART, LUNG, KIDNEY, LIVER, INTESTINES, SPLEEN, BONE MARROW, GONAD, LYMPHOID & MYELOID TISSUE, MITOSIS.
EYE AND SKIN (FDA) - RABBITS	LOCAL
EYE EXAMINATION (RABBITS, DOGS)	VISION
CONDITIONED AVOIDANCE - DOG	MENTAL & PHYSICAL PERFORMANCE, BEHAVIOR, AUDITORY, VISION.
LANDSTEINER (GUINEA PIG)	RETICULOENDOTHELIAL SYSTEM - SENSITIZATION
REPRODUCTIVE SCREEN	REPRODUCTION, MUTAGENESIS, TERATOGENESIS, FERTILITY, FETAL TOXICITY.
DROSOPHILA (SMALL GENE DELETIONS AND PHENOTYPIC CHANGES)	MUTAGENESIS, CARCINOGENESIS.
PRECANCEROUS LESIONS OR SIGNS; CELL CULTURE TRANSFORMATION; DNA REPAIR SYNTHESIS	CARCINOGENICITY

previously unexposed animal is applied. The appearance of erythema, edema, or necrosis indicates sensitization.

Blood Chemistry, Hematology, and Pathology. Blood and tissues from representative animals are studied before and 3, 7, 30, 60, and 90 days after beginning of exposure. These measurements monitor all of the systems shown in fig. 8. Tissue samples should be examined for the precancerous lesions.

Mental, Physical, Auditory, and Visual Performance can be monitored by use of learned behavioral patterns in dogs (fig. 9). The animals are trained to jump from one compartment through a window to a second compartment in response to a visual or auditory signal. By changing the intensity and frequency of the sound, audiograms can be developed for dogs. Measures of visual acuity are less efficient.

The measurement of blood pressure, heart rate, electrocardiogram, and blood flow; neuromuscular function; and respiratory rate and amplitude can be used to study all of the systems shown on fig. 10. In addition to the central nervous, neuromuscular, and respiratory systems, these measurements can be used to reveal abnormalities in sensory receptors, neural pathways and effector organs throughout the body. As shown, tetanizing stimulation of the sciatic nerve produced contraction of the gastrocnemius muscle and reflex increase in blood pressure and respiration. Occlusion of the carotid artery causes increased blood pressure and heart rate. Pressure on the ocular muscles decreases blood pressure and respiration. Many other reflexes can be used.

FIGURE 8

HEMATOPOIETIC SYSTEM, LIVER AND KIDNEY FUNCTION, ENDOCRINE SYSTEM (Salt - H₂O),
RETICULOENDOTHELIAL SYSTEM, ALL ORGANS, NEOPLASIA

-105-

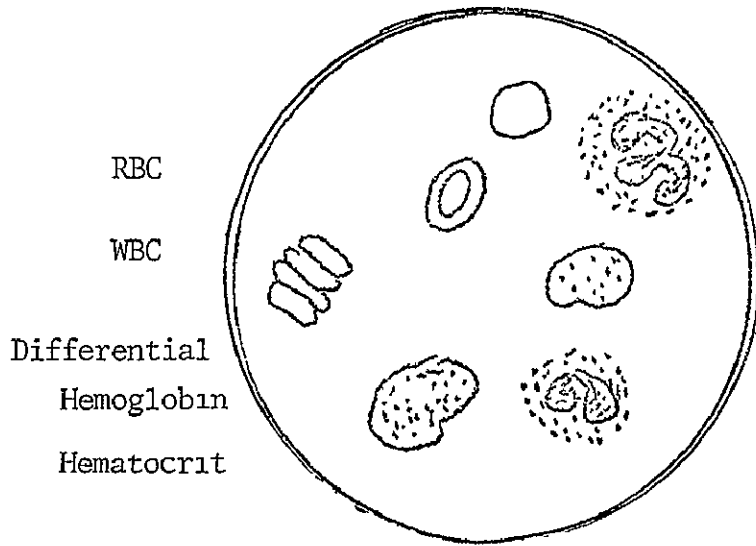

RBC

WBC

Differential

Hemoglobin

Hematocrit



Enlarged tubular
cells and nuclei
in renal papilla
at

4 weeks

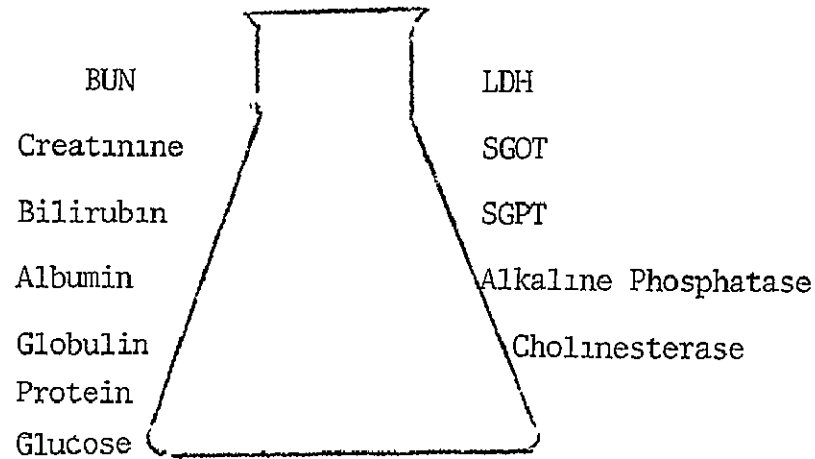

Na, K, Cl, CO₂

FIGURE 9

**MENTAL, PHYSICAL, VISUAL, AND AUDITORY
PERFORMANCE TESTS**

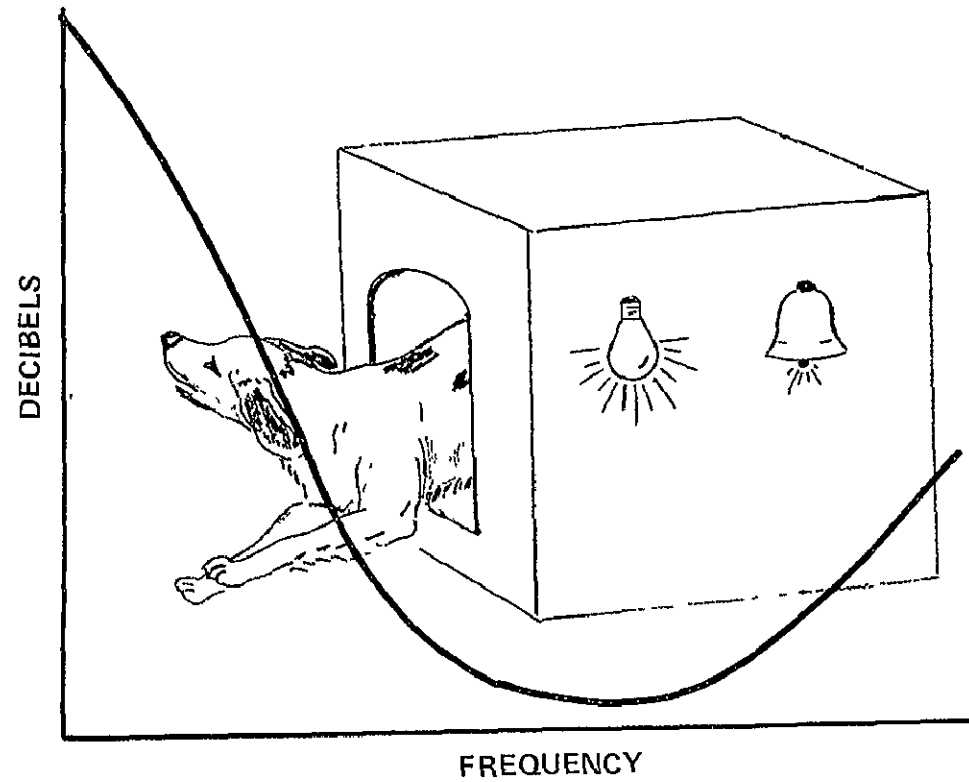
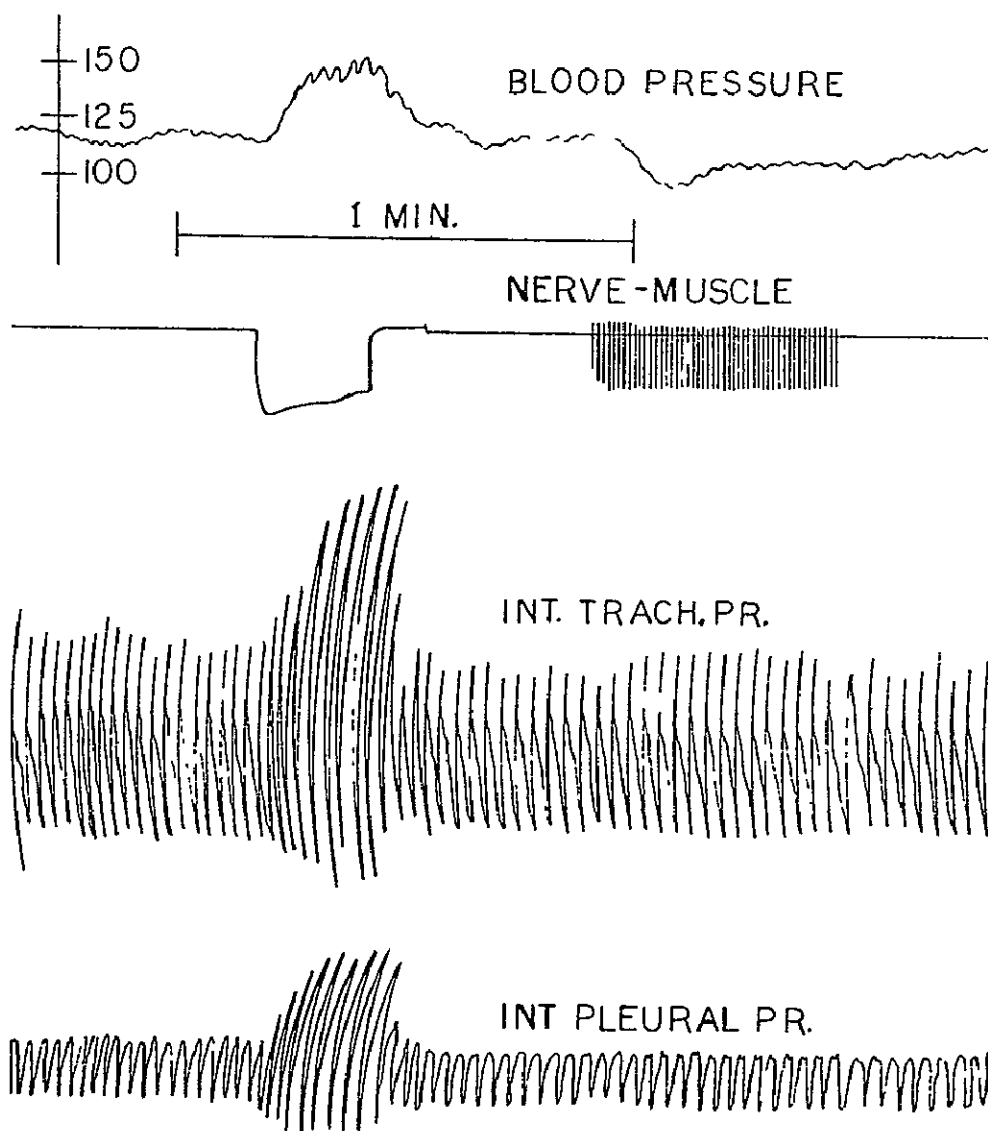

FIGURE 10

ASSESSMENT OF AUTONOMIC, NEUROMUSCULAR, CARDIOVASCULAR,
RESPIRATORY, AND NEUROHUMORAL RECEPTOR AND EFFECTOR SYSTEM:
AND BASAL METABOLIC RATE



SUMMARY.

Man is exposed to many commercial and industrial chemicals. All of these cannot be studied in detail for all toxic effects but a greater number could be tested if an evaluation was directed toward establishing dose levels which produce no toxic signs. There is much information indicating that "no-effect" dose levels for most, if not all, toxic signs can be determined in toxicity tests of 3 to 4 months duration. The time and cost required for detailed toxicological testing has hindered safety evaluation of many chemicals in our environment. The determination of no-effect exposure levels based on short-term testing is better than no limits at all.

A test program establishing the no-effect levels should monitor all organs and functions of the body for presence or absence of toxicological effects in the simplest and most economical way possible. A prototype program is presented.

N77-30720

EXERCISE STRESS TESTING

Presented by

Benjamin Schuster, M.D.
Director of Cardiac Diagnostic Laboratory
Kettering Medical Center
Dayton, Ohio

Williamsburg, Virginia
March 19, 1975

EXERCISE STRESS TESTING

Benjamin Schuster, MD
Director of Cardiac Diagnostic Laboratory
Kettering Medical Center

A large percentage of the 600,000 people who die of coronary disease each year do not suspect that they are exposed to the risk of sudden death. More than half of those with significant coronary narrowing do not have chest pain or other symptoms recognized as angina or any other form of heart disease. It seems likely, however, that many may have exercise intolerance or indigestion or other nondescript symptoms thought to be due to smoking, lack of exercise or too much rich food. A careful physical examination, history and resting electrocardiogram fails to establish the presence of occult coronary disease. How then can we identify these people in order to avert the catastrophe about to overtake them? Not only is this information important to safeguard the life and health of the individual, but if such a person is engaged in an occupation where his optimum performance is essential to the safety of others, it is doubly important that he be identified while still functioning.

In the last few years it has been possible by invasive procedures such as heart catheterization and coronary angiography to better understand the factors that lead up to sudden incapacitations. Our knowledge of the anatomy of the coronary circulation and of the way the heart muscle functions when placed under stress is still incomplete, but has placed us in a position that we can predict with considerable accuracy how a cardiac will respond to stress, and what can be expected in the way of future coronary heart disease.

It seems self evident that everyone at risk cannot, and should not, be subjected to coronary angiography. It has become possible, however, by exercise stress testing and other non-invasive means to find out a great deal about cardiac function. This report will outline some of the factors involved and describe the present "state of the art".

EXERCISE EVALUATION OF CARDIAC PATIENTS - PHYSIOLOGY

When the normal heart is exercised it can be noted that systolic pressure rises but the diastolic pressure does not increase significantly. This means that the force of contraction increases along with the heart rate but the filling pressure of the left ventricle is relatively constant, even though the rate of filling is markedly increased. The stroke volume may also increase slightly. No significant change in myocardial metabolism as measured by coronary sinus lactate, K⁺ and coronary AV O₂ difference occurs even though the rate of O₂ consumption by the heart is markedly increased. Because the extraction of O₂ from the coronary circulation is near maximum at rest, it is essential that a linear increase in coronary flow occur with increased work, and it turns out that the myocardial O₂ uptake increases linearly with the pulse as well as with the patient's total O₂ utilization.

110
^
PAGE INTENTIONALLY BLANK

A totally different situation develops with coronary patients. As soon as the myocardial O₂ demand increases to where the coronary flow cannot supply the ischemic muscle, characteristic hemodynamic changes occur. The left ventricular pressure curves with an increase in diastolic pressure due to a decrease in compliance (an increase in stiffness) of the muscular wall may be due to incomplete relaxation of some of the muscle fibers brought about by the metabolic effects of ischemia. The stiffness may also decrease the rate of pressure rise or the Dp/Dt. The force of atrial systole is often relected in the ventricle by an "atrial kick". As the left ventricular diastolic pressure rises the electrocardiographic ST segments become depressed. It may be that the increase in subendocardial capillary pressure further obstructs coronary flow resulting in a vicious circle of rising diastolic pressure, decreasing coronary flow and less contractile strength. The excellent correlation of these factors with metabolic changes has been demonstrated by Case.

It is important to point out that onset of ST segment depression is coincident with the mechanical or hemodynamic as well as the metablic processes that accompany ischemia.

PROTOCOL

The design of a stress test should be one that enables us to determine at what metabolic load the ischemic process develops. It has been shown that this is reproduceable if one does not change the level of catecholamines or the peripheral resistance significantly. By multiplying the systolic blood pressure and the pulse rate, a simple index of myocardial oxygen consumption can be obtained, (double product). This product may be calculated at each level of increased stress. By applying a formula proposed by Balke and Ware, the body's total O₂ consumption can also be derived. Another parameter of measurement is the so-called MET. This is the multiple of the basal O₂ consumption for each level of exercise. The first stage of the protocol to be described is 4 METS. or 4 times the resting oxygen consumption. Finally, it is important to use the same protocol each time so that a patient's performance can be compared from time to time. This allows one to evaluate change in status based on the progression of the disease or as related to treatment. The pulse response to the standard protocol for the normals should be known because evidence has accumulated that patients with poor ventricular function may lose their chronotropic response to exercise and the knowledge of this is important in their management.

There is some controversy concerning the optimum amount of stress to be applied. Proponents of a sub-maximal protocol claim it is safer. If one analyzes the complications from stress testing it becomes evident that they occur at low levels of stress in severely disabled patients. Therefore, taking those who tolerate exercise well to their maximum predicted pulse rate does not add to the risk but does add to the information obtained. We use the maximum predicted pulse values of Robinson which coincides with maximum cardiac output, thus making it possible to estimate

the maximum aerobic capacity as well as to avoid missing those with ischemia at or near maximum work loads. The most important single element in getting good data and doing the test safely resides in the Cardiologist conducting the procedure. Never should a stress test be done without an experienced physician in attendance.

The test should be terminated when significant anginal pain, or ST segment depression develops. There are times when a dropping BP, decreasing pulse rate or the appearance of the patient should be reason enough for terminating the test. On the other hand there are times when a complaining patient should be encouraged to continue if one wants to collect the maximum amount of information. Recent published work by Rochmis suggests the risk of stress testing is less than one death in 3,000 tests. We have had 3 deaths in over 8,000 tests. Based on our experience the safety factor has been improved a good deal recently with no deaths or infarctions in the past 3,000 tests. Continuous monitoring of the EKG, defibrillator and other facilities for resuscitation must be immediately available at all time.

EKG CHANGES

The electrocardiographic lead most useful is a bipolar one approximating V5 in configuration (CM5). Evidence is available to demonstrate that this gives adequate data in 90% of the cases. We use 3 leads, however, and often find the VF and VI lead contribute to the evaluation. The VI lead is especially helpful in the evaluation of arrhythmias.

If the EKG complex is normal prior to exercise the most reliable change indicating ischemia is a flattened depressed ST segment one to one and a half MM below the P-Q junction. If this progresses to a downsloping pattern it probably adds more validity. However, an upsloping ST is often present with ischemia. If one measures .06 sec. from the J point and finds the ST still 1.0 to 1.5 mm. depressed it is very likely that ischemia is present.

A number of other EKG changes have been highly significant in our experience, but their consideration is not within the scope of this report.

COMPARISON WITH CORONARY ANGIOGRAMS

A recent study of 650 patients correlating the maximum stress test of Bruce with coronary angiograms was published by Bartel and associates. They found that 65 percent of 451 subjects with significant coronary disease (70 percent or greater obstruction) had positive tests. Although the rate of false negatives is high, they found only 9 percent false positives which tends to agree with Margin and McConahay. Bartel used 1 mm. ST depression as a positive test. They also found that among their subjects who had typical angina by history and also developed angina during the stress test, 97 percent had significant coronary artery disease.

From the data available at this time the following statements regarding average correlations between catheterization data and maximal stress testing seem in order.

1. Subjects with single vessel disease and significant narrowing of 70 percent luminal diameter or more - 40 percent positive.
2. Subjects with two vessel disease - 65 per cent positive.
3. Subjects with three vessel disease - 78 percent positive.
4. Subjects with left main disease - 85 percent positive.
5. Subjects with 1.0 mm. ST depression have a 90 percent chance of having coronary disease or evidence of significant left ventricular dysfunction.
6. Subjects with 1.5 mm. ST depression has a 94 to 96 percent chance of having coronary disease or evidence of significant left ventricular dysfunction.
7. Subjects with 2 mm. or more ST depression have a 98 percent chance of having coronary disease or evidence of significant left ventricular dysfunction.
8. When evaluating subjects with lesser degrees of coronary narrowing, the reliability of the positive test decreases but the number of false negatives will decrease.

MEMORIAL HOSPITAL FOLLOW-UP STUDY

PREDICTIVE IMPLICATIONS

We have obtained follow-up data in 2700 patients previously referred for maximal treadmill tests. Their follow-up events were analyzed by the life table method of Cutler and Ederer. The events recorded as significant in follow-up were:

1. Progression of angina
2. Myocardial infarction
3. Death due to heart disease

These were analyzed both as individual occurrences and as a group so that a patient with any of the three was included as having an event. If a subject did not have angina at the time of the test, its subsequent appearance was entered as progression of angina. Otherwise evidence of either increase in frequency or severity, as judged by the type of precipitating factors, was used to denote progression.

Subjects were diagnosed as positive if they had ST depression of 1.5 mm. or more .08 seconds from the J point. ST segment slopes of flat, upsloping or downsloping were included. Those diagnosed as equivocal included ST depression of 5 mm. to 1.4 mm, multifocal or frequent PVCs with exercise and poor chronotropic response falling more than one standard deviation below the mean heart rate response for age and sex.

The incidence of coronary events in the positive responders is almost 10 percent per year. It can be seen that the equivocals fall so far below those with a negative diagnosis that there must be a large number of subjects with coronary disease in this group. The 4 year incidence of events in those diagnosed as positive is 46 percent as opposed to the negative responders of 7 percent, almost a sevenfold difference. The 25 percent incidence of abnormal events in the equivocals has resulted in our revision of the criteria for a positive test to 1.0 mm. ST depression at .08 seconds from the J point.

After 8 years 76 percent of the positive responders had some coronary event. This amounts to 9.5 percent a year. The 4 year incidence of myocardial infarctions is 15 percent in positives as opposed to 1 percent in the negative responders. The 4 year incidence of 5 percent in the equivocals (5 X the negatives) also suggests that some of these were really positive. The 8 year data is quite similar showing 27 percent incidence of infarctions in the positives resulting in an average of about 3.5 percent per year. It is interesting how closely this fits Mattingly's data from the double Master's Test where the incidence of infarctions were 5 percent a year. The incidence of death is similar to that for infarction, averaging about 3.3 percent per year.

POOR CHRONOTROPIC RESPONSE

When the pulse response to exercise falls considerable below average for age and sex, the incidence of a future myocardial infarction and all coronary events is slightly greater than in those with ischemic ST depression and a normal pulse response. The poor pulse response appears to have the same long term significance even in the absence of ST segments as a classical early ischemic responder. Approximately 15 percent a year have some coronary event. There is no statistical difference in those with ST segment depression and bradycardia with all positive responders.

MALES VS: FEMALES

There have been studies reporting a higher incidence of positive responders in females of each age group to various types of stress test. The incidence of the coronary events in males and females with classical ST segment abnormalities

is not statistically different although there is a slight trend for the females to have more events. This would suggest to us that there is no significant variation in the overall incidence of coronary disease in those diagnosed as positive. We have often wondered if many women with low serum potassium and other non-coronary causes for ST abnormalities are misdiagnosed as positives by our laboratory. This data would suggest that this has not been the case. When analyzing for death only, however, the incidence in females with a positive test tends to be significantly less for the first 3 or 4 years, but within 5 years there is no longer any difference. When carefully analyzing the age groupings, it appears that the difference is not due to age, but is a real difference between the sexes.

TIME OF ONSET OF ST DEPRESSION

It would be a logical conclusion to believe that ST depression resulting from very mild exercise is more severe than that occurring at a work load near peak capacity. In order to evaluate this we have analyzed the follow-up events in those who had ST depression of 2 mm. or more manifested at the various work levels of our protocol: 3, 5 and 7 minutes respectively. The work load at which the ischemic changes are determined are of prime importance in the evaluation of the severity of the disease. The incidence of coronary events in a subject with a 2 mm. ST depression at 3 minutes of our protocol (working at 1.7 MPH on a 10% incline) is 4 times that of a subject requiring 4 MPH to initiate ST changes (7th minute of our protocol). It is interesting that the prevalence of anginal pain associated with ischemia at high levels of exercise is also decreased.

EFFECT OF A PREVIOUS MYOCARDIAL INFARCTION

Bruce has shown that the incidence of a positive test in any group is less if a previous myocardial infarction has taken place. It would appear that even though previous infarction decreases the sensitivity of the test, those who had suffered a previous infarction would have a worse prognosis than those who had not, averaging 7.5 percent a year.

A negative stress test in a subject with a previous infarction is no protection against the appearance of a coronary event. This is what one would expect if we really gave it serious consideration. Those who have a positive test after sustaining an infarction however, have an 81 percent likelihood of having some coronary event in 5 years, whereas those who have not had an infarction have a 34 percent chance - the difference is more than twice as great. The standard deviations indicate that the difference is highly significant between these groups.

SUMMARY

The predictive power of the negative as well as the positive maximum stress test can now provide us with a very useful tool in the management of our coronary patients. The early studies of the Master's Test suggested this to be, but validation

with the maximum test was needed to place it in proper perspective. This data on equivocal also is extremely helpful and has led us to re-evaluate our ideas about the significance of the type of changes that are of clinical value.

It has long been believed that coronary angiography would be the ultimate test allowing us to predict the future of subjects with coronary heart disease. If our preliminary data are confirmed, it may be that stress testing will be almost as reliable. When comparing the life table figures of Brusckke, Proudfoot and Sones with our subjects having early onset of ischemia, the curves are statistically equivalent.

WHOM TO TEST

This method can be done in a number of ways and probably should be part of a complete physical in all men over 35 and women over 45. It is the most reliable non-invasive method of uncovering occult coronary insufficiency. It can be used also as a yardstick to quantitate the degree of disability and to evaluate progressive changes with time or after treatment. The response can be used to prescribe occupational work capacity. It can be used to measure the patients conditioning and can dramatize the capacity of a patient to exercise often to his own amazement. A good exercise stress test may do wonders for the psyche of a man worrying about his heart. I believe every bus driver, commercial airman and others engaged in occupations where sudden incapacitation will endanger the lives of the public as well as the individual should have a maximum stress test at least once a year.

Stress testing has come of age. Its application in the evaluation of circulatory dynamics is indispensable in modern medicine. No Cardiologist, however brilliant, can deduce the information in his history or physical that can be uncovered with the proper application of stress testing.

N77-30721

REVIEW OF HEALTH MAINTENANCE PROGRAM FINDINGS
1960 - 1974

NASA WOLLOPS FLIGHT CENTER

Edward S. White, M.D.
Medical Director
Wallops Flight Center

NASA WALLOPS FLIGHT CENTER
REVIEW OF HEALTH MAINTENANCE PROGRAM FINDINGS
1960 - 1974

Edward S. White, M.D.
Medical Director

The NASA Wallops Flight Center is located on the Atlantic east coast of Virginia on the mainland opposite the Assateague Island National Seashore, over 60 miles from the nearest major urban center. It lies in the center of a flat peninsula where, in the surrounding area, the primary occupations are farming and fishing. Wallops was established in 1945 as a Pilotless Aircraft Research Station for launching rockets as an adjunct to the Langley Laboratory located at Hampton, Virginia. In 1958, it, along with the other NACA laboratories, was absorbed into the newly organized National Aeronautics and Space Administration.

The primary mission of Wallops, throughout the past 15 years of NASA, has been the preparation, assembly, launch, tracking, and acquisition of scientific information from space vehicles. Research is directed toward gathering information about the earth's atmosphere and its near space environment. Its facilities are utilized by scientists from NASA research centers, other government agencies, colleges and universities, and the worldwide scientific community. Wallops has successfully launched 16 satellites and approximately 8,000 research vehicles.

The employee population is predominantly male (87% of the workforce) with over 50% employed as technicians, another 22% as scientists and engineers, and the remaining 26% in administrative professions. The workforce numbered 171 when Wallops joined NASA, grew to 576 in 1967, and in the past seven years has declined to 434 (Figure 1). The first compilation of age statistics was in 1966. At that time the average age was 41. Today, it is 45, having advanced by four years since 1968.

Health maintenance examinations have been conducted at the Center since 1960. An automated medical data base was compiled in 1972. Records on all separated employees have been retained by the medical facility and it is planned to ultimately include these in the Wallops file. The present data base contains 2,341 examination records on 389 employees. The following summary is a preliminary analysis of these data, with an emphasis on the primary mission of the program - the early detection and control of cardiovascular disease. Because of the small number of records on female employees (26 total), these have been excluded from the analysis. Also excluded are 28 records on which the history data was incomplete. The remaining 335 records on which the analysis is based, are all male employees.

Family History of Heart Disease

Cardiovascular disease, in particular that occurring prior to the age of 70, is not unknown to the inhabitants of Wallops Island. In a review of 331 health records of male parents of Wallops employees, 3%

have died of heart disease while still in their forties, and 6% have died in their fifties. Of the 184 deaths recorded, 125 occurred before age 70, and of these, 54% were due to cardiovascular disease. Of the 88 male parents under age 70, still alive, 11% have documented histories of heart disease. Three-hundred-sixty-two records on male siblings under age 70 are also available, and of these, 6% have heart disease.

Comparison of WFC Data with that of Other NASA Populations

The prevalence of heart disease is 4% in the NASA population (as measured in the combined NASA Goddard and Marshall Space Flight Centers' data base). It is 5% among Wallops employees, and 6% among male siblings of Wallops employees (Figure 2). Although the prevalence of heart disease is higher for each age group among Wallops employees compared to that found in the Goddard and Marshall populations, none of the differences are significant. There is also no significant difference in the prevalence of heart disease among Wallops employees and their male siblings.

In the prevalence of hypertension, the rate for Wallops is slightly lower than that for Goddard and Marshall, but the difference, again, is not significant (Figure 3). In the prevalence of hypercholesterolemia, the rate for Wallops is higher but also not significant (Figure 4). Finally, in the category of chronic digestive disorders (including ulcer of the stomach or duodenum, diverticulitis and chronic enteritis) the rates for Wallops were consistently, but not significantly, higher than those found in other NASA populations (Figure 5).

Control of Hypertension and Hypercholesterolemia

The prevalence of hypertension in the Wallops population has fluctuated from 4% to 12% over the last ten years, and the prevalence of hypercholesterolemia has fluctuated from 43% to 58% (Figure 6). Periods of good control of either condition have been sporadic, and usually offset by a subsequent detection of new cases. At the end of 1972, the trend in hypertension was upward, while the prevalence of hypercholesterolemia had been declining for three years.

Of the 89 detected cases of hypertension on record from 1960 to 1972, 49 have been confirmed by repeat measurements. In the Wallops population, new cases have been detected at a rate of approximately 2% per year. Attempts to control individual cases of hypertension are reported in Figure 7.

Twenty-one cases were detected in the years 1960 to 1965. Of these, only five (24%) have been able to maintain consistent control, and at the time of their last physical examination, 52% were still uncontrolled. Eighteen more cases were detected from 1966 to 1971, and of these, two-thirds have been brought under control, leaving one-third uncontrolled.

Generally, new cases are introduced at the rate of two or three per year. Several years have produced greater than average increases, notably 1965, 1969, and 1972. In 1969, six new cases were detected. These were accompanied by six more employees whose blood pressure had been previously brought under control and now were uncontrolled. Essentially the same condition prevailed again in 1972, when ten new

cases were detected, and ten more previously controlled cases returned to the uncontrolled category.

Significant and consistent reductions in cholesterol levels have been achieved only over the past three years (Figure 8). The greatest decline has been in the younger age groups, with the prevalence dropping from 46% to 19% among those in the 20 to 34 age groups, and from 60% to 40% in the 35 to 44 age group. Reductions have also been achieved in those over 45, but the decline has been less, from 66% to 55%. Whether these declines have been effected by conscientious efforts to reduce cholesterol, or by other factors, is unknown, but it is interesting to note that the degree of change is greater among the younger employees, thereby reinforcing preventive medicine's case for early detection.

Trends in Chronic Disease

One of the advantages of maintaining a data base over such a long period is the ability to plot trends in disease and to see where you are going and where you have been, and what effects your preventive medicine efforts have had, if any. In Figure 9, we have plotted the rates of fatal and non-fatal cardiovascular disease illness episodes for the period from 1959 to 1974. We see from the graph a rather obvious sequencing of events with peaks in non-fatal events, followed one to two years later by peaks in fatal events. This we might well expect because those whose physiology has been weakened by a first episode often succumb within a few years, with a final and fatal episode. More interesting, would be a discovery of what causes the peaks in the first place. If we assure that the workforce remains stable, we have nothing to which to attribute increases in

cardiovascular disease except the natural processes of aging and if this were true, at Wallops we should expect to find only a gently sloping upward trend.

Studies conducted elsewhere in NASA have demonstrated the need to look not only at peaks in illness episodes, but for peaks in physiological measures as well, measures which are taken routinely as part of the physical examination process and have been found to precede illness events by one to two years. In Figure 10, we see trends in diastolic blood pressure and cholesterol plotted against the trend in cardiovascular illness events.

The average diastolic blood pressure for a population appears to rise, beginning two to three years before we see an increase in illness events, and at Wallops we have three consistent examples of this effect. Mean cholesterol fluctuates widely as well, but appears to rise closer to the period of increased illness, preceding it by perhaps, only a year. Once again, we should be concerned with what causes the increase in cardiovascular illness, but even more, we should consider what causes the increase in the coronary risk factors which appear to precede the events, and, in particular, we should look at elements in our own work environment.

Attempts to prove the effectiveness of preventive medicine activities suffer from these fluctuations. For example, we noted a sudden increase in new cases in hypertension in 1972, and now we see that the average blood pressure levels have risen not only for the 32 hypertensive employees, but for the entire population of 300. The same is true for cholesterol

control. We may be tempted to congratulate ourselves on the dramatic reduction in hypercholesterolemia over the past three years, only to find, one year hence, that we were only on the downswing of the cholesterol curve, and that the rates are once again on the increase.

Summary

We seem to have, at Wallops, a population subjected periodically to the stresses of deadline pressures and work overloads, and in the past years to recurring job insecurity. In a sense, it is a miniature of NASA itself, with all the past pride and glory, and all the present confusion and disillusionment. Still, compared with what we know from the family histories, Wallops employees seem to have fared on worse than their siblings in their proneness to cardiovascular disease. We have no direct evidence to support our conclusions, only hypotheses. We have noted among the family histories, no infrequent notations of alcoholism and suicide. We have noted too, the almost total absence of any reference to chronic digestive disease. Finally, we have observed almost the precise same prevalence of cardiovascular disease. Knowing the environment of the Flight Center and the environment of the surrounding community, it is possible to imagine that the stresses produced by the NASA environment are no worse in terms of detriment to health than perhaps the futurity and boredom of a rural life in which prosperity is as illusory as the future of the space program itself. If this is true, then the two life styles offset each other and the rates of disease remain the same.

There is a further aspect, however, and one which we in the field of preventive medicine would like to believe. As the equal stress of the hectic NASA environment and the boredom of life in the surrounding farms is possible, so too is the fact that there may have been greater health risk at NASA all along, but that it has been lessened over the years by medical intervention. If we had a method of proving this, our case for occupational medicine programs would surely be made. Unfortunately, we do not, and the prospect for obtaining future proof is dim. To the regret of those who sponsor our programs, as well as to ourselves, we must therefore, continue on faith, not sure that periodic examination programs help, but just as certain that they do not hurt either in the control of chronic disease.

Figure 1
 NASA WALLOPS FLIGHT CENTER
 Population Change, 1958-1974

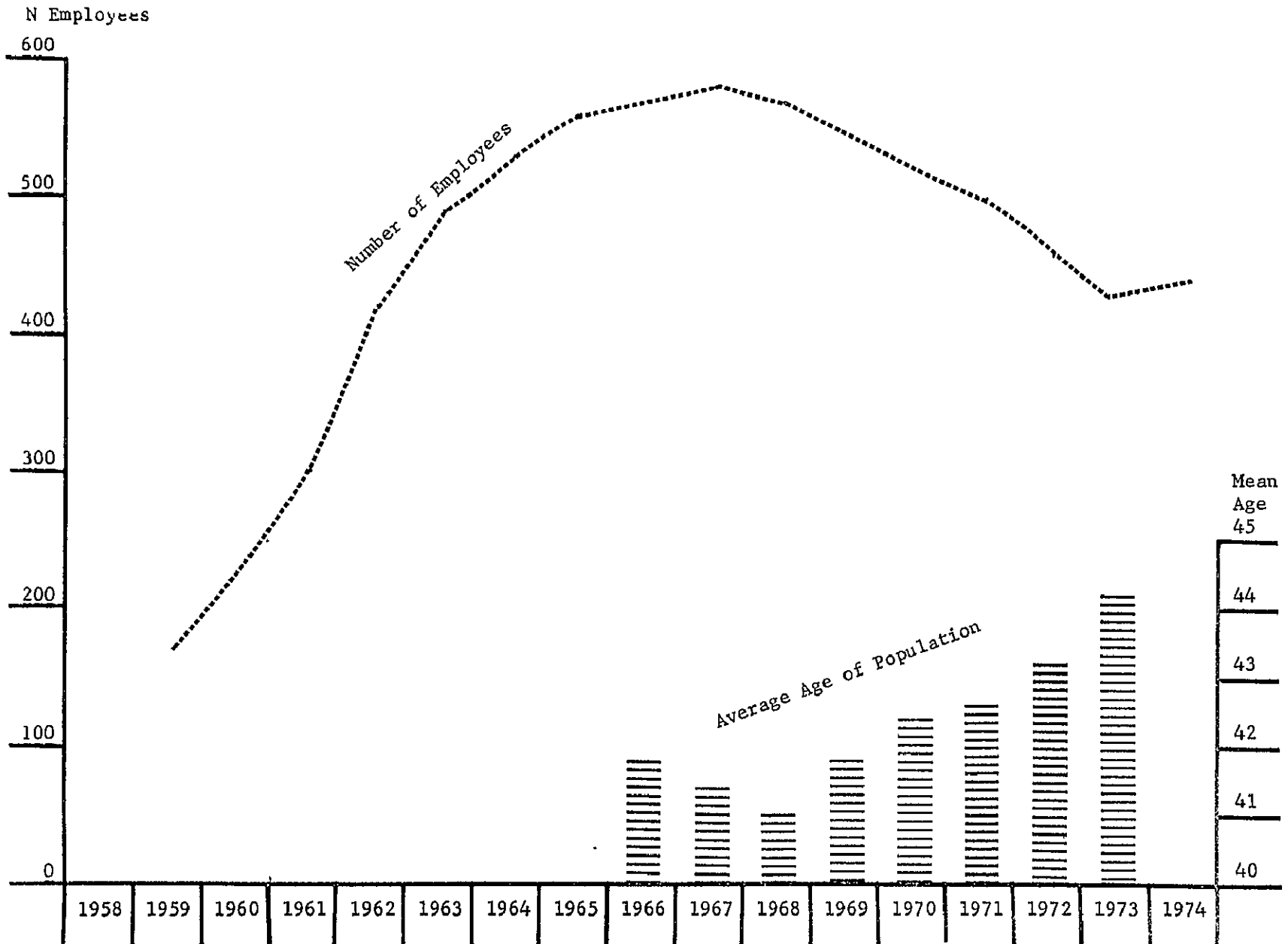

Figure 2
 NASA WALLOPS FLIGHT CENTER
 Comparison of Cardiovascular Disease Prevalence
 Among Wallops Male Employees, Male Siblings of
 Wallops Employees, and Male Employees of
 NASA Goddard and Marshall Space Flight Centers

N Records
 335 WFC Employees
 362 Male Siblings, of
 WFC Employees
 3978 Male Employees of
 NASA GSFC and MSFC

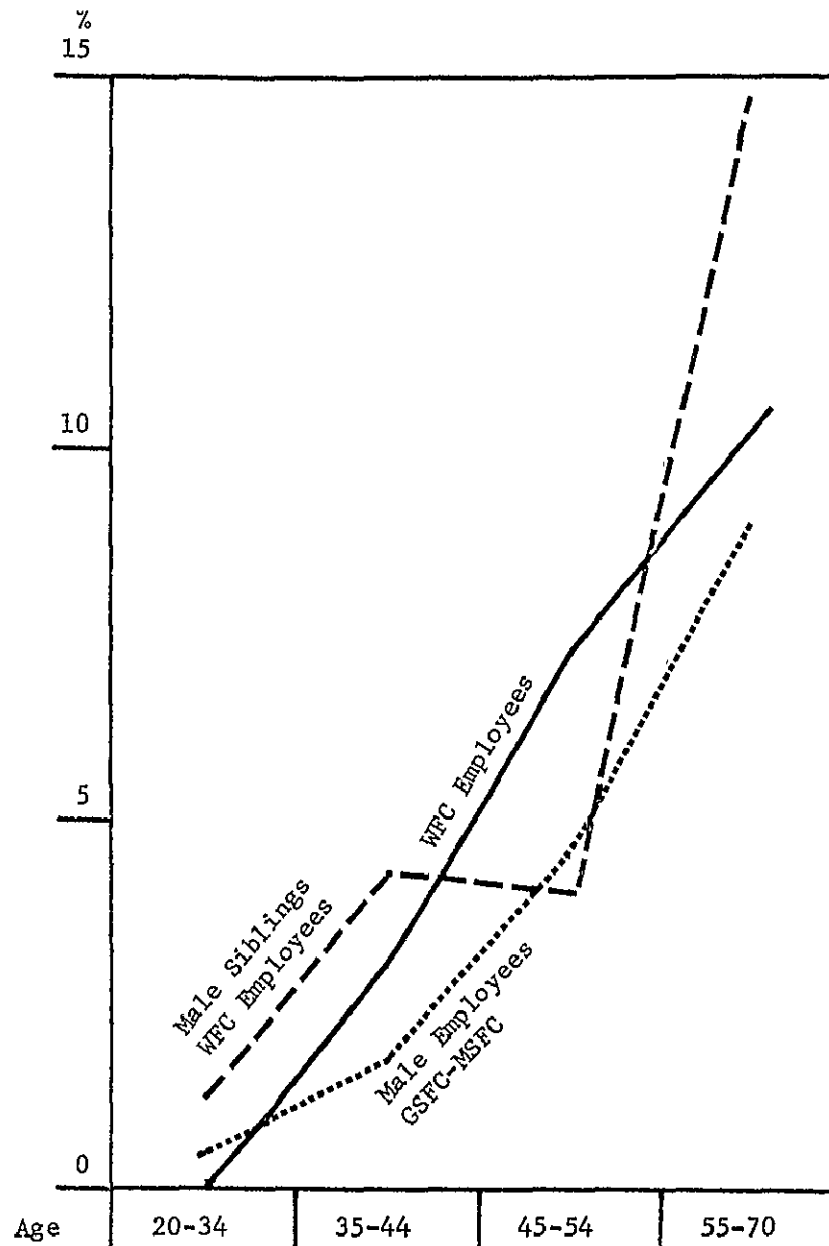

Figure 3

NASA Wallops Flight Center
Comparison of Hypertension Prevalence
Among Wallops Male Employees and Male Employees
of NASA Goddard and Marshall Space Flight Centers

N Records
335 WFC Employees
3978 Male Employees of
NASA GSFC and MSFC

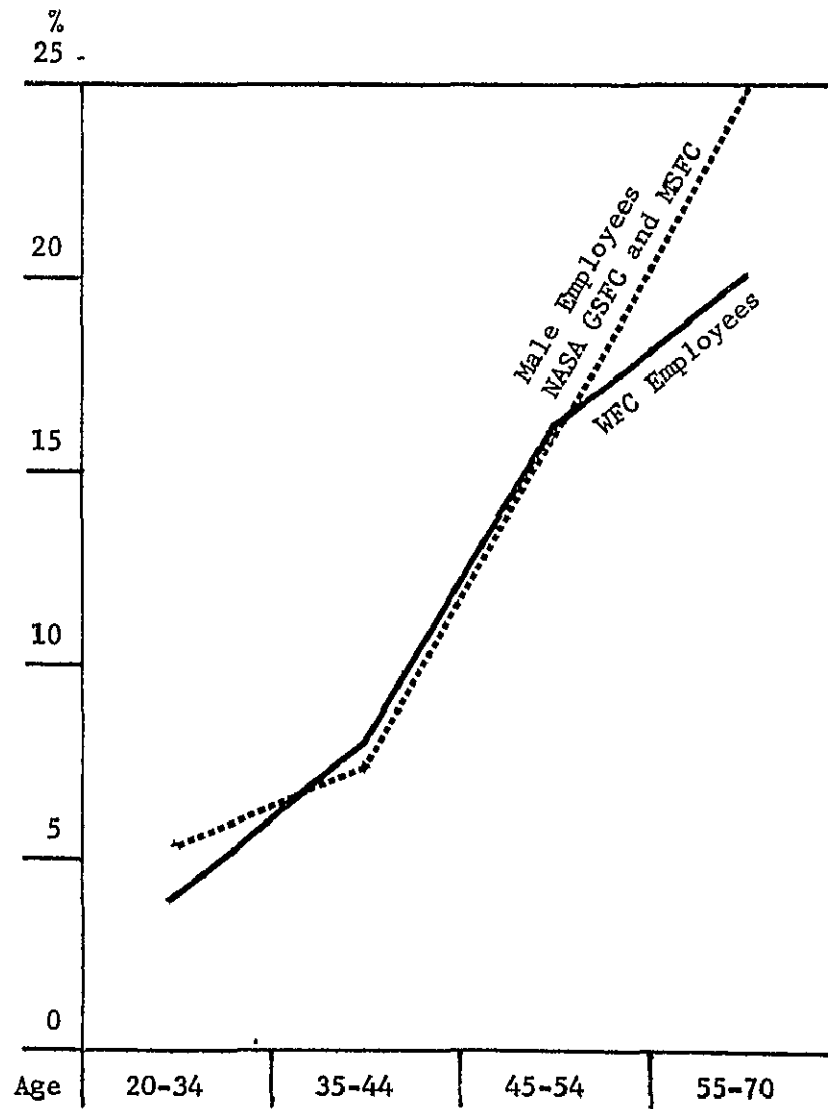

Figure 4

NASA Wallops Flight Center

Comparison of Hypercholesterolemia Prevalence
Among Wallops Male Employees and Male Employees
of NASA Goddard and Marshall Space Flight Centers

N Records
335 WFC Employees
3978 Male Employees of
NASA GSFC and MSFC

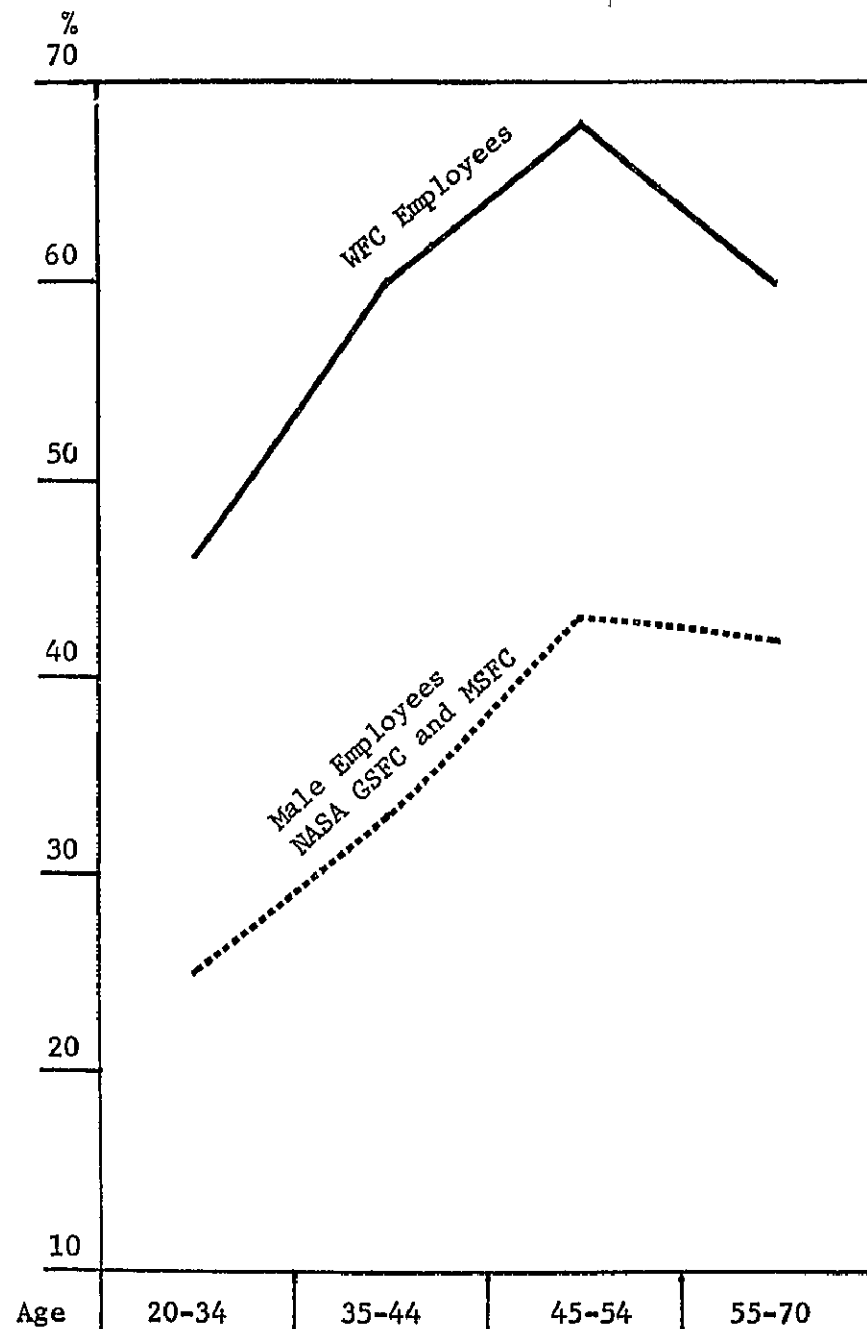

Figure 5

NASA WALLOPS FLIGHT CENTER
Prevalence of Digestive Disease
Comparison of Wallops Male Employees and
Male Employees of NASA Goddard and Marshall
Space Flight Centers

N Records
335 WFC Employees
3978 Male Employees of
NASA GSFC and MSFC

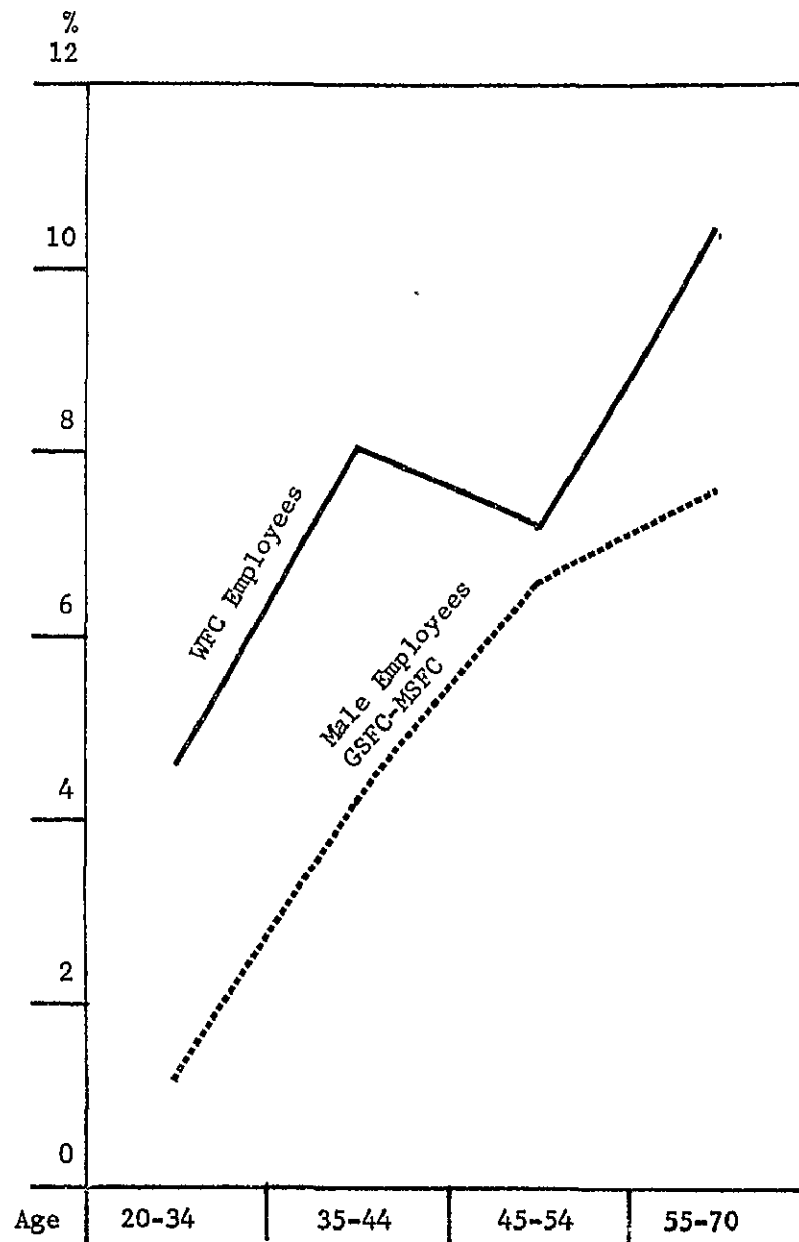
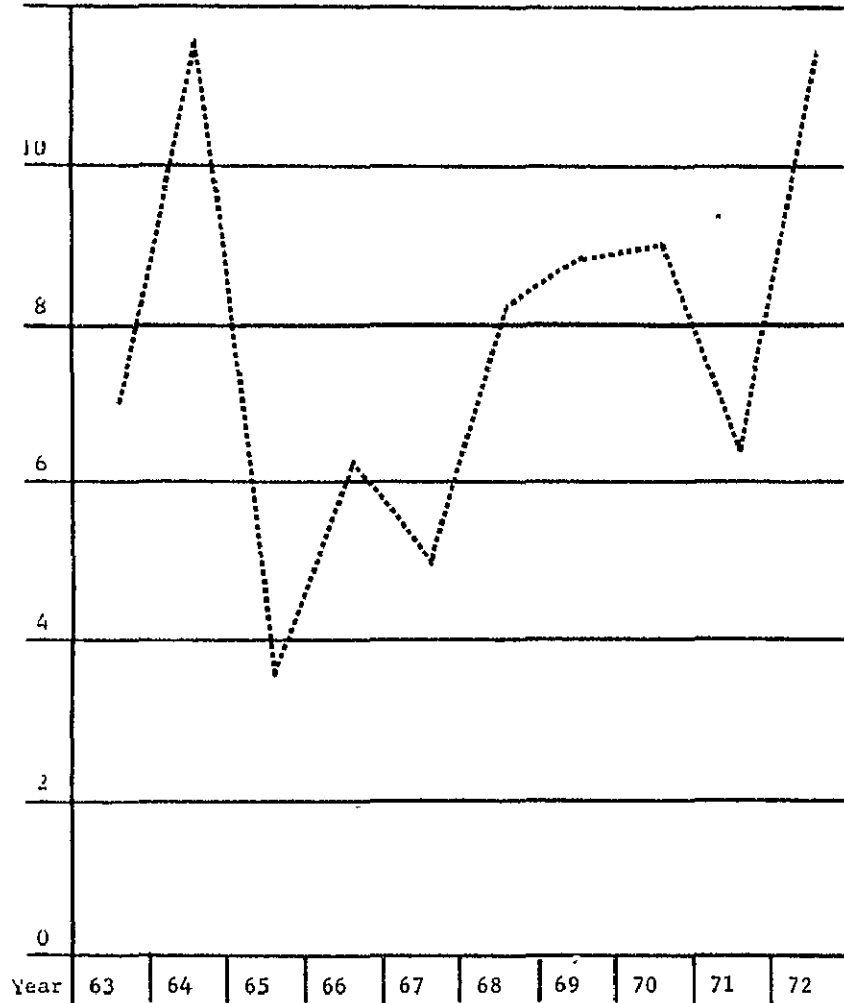

Figure 6

NASA Wallops Flight Center
Prevalence of Hypertension and Hypercholesterolemia
1963-1972

Prevalence of Hypertension
(Percentage of Employees
Examined)



Prevalence of Hypercholesterolemia
(Percentage of Employees Examined)

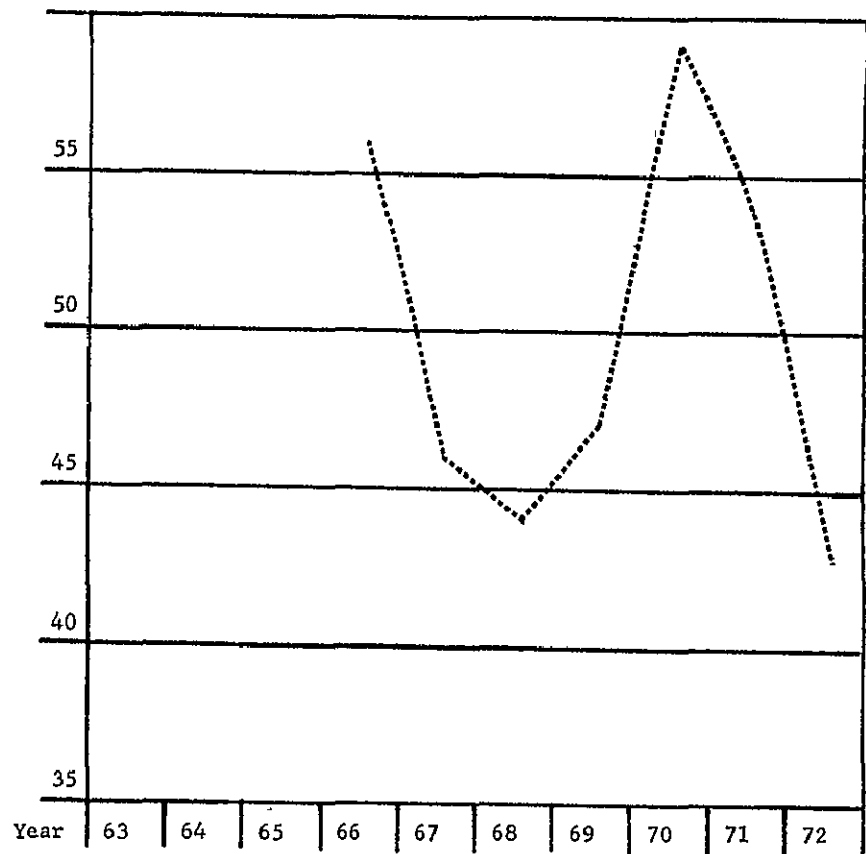

Figure 7

JSA MAILBOX HEIGHT LENGTH
 In Reaction and Control of Hypertension
 1960-1974

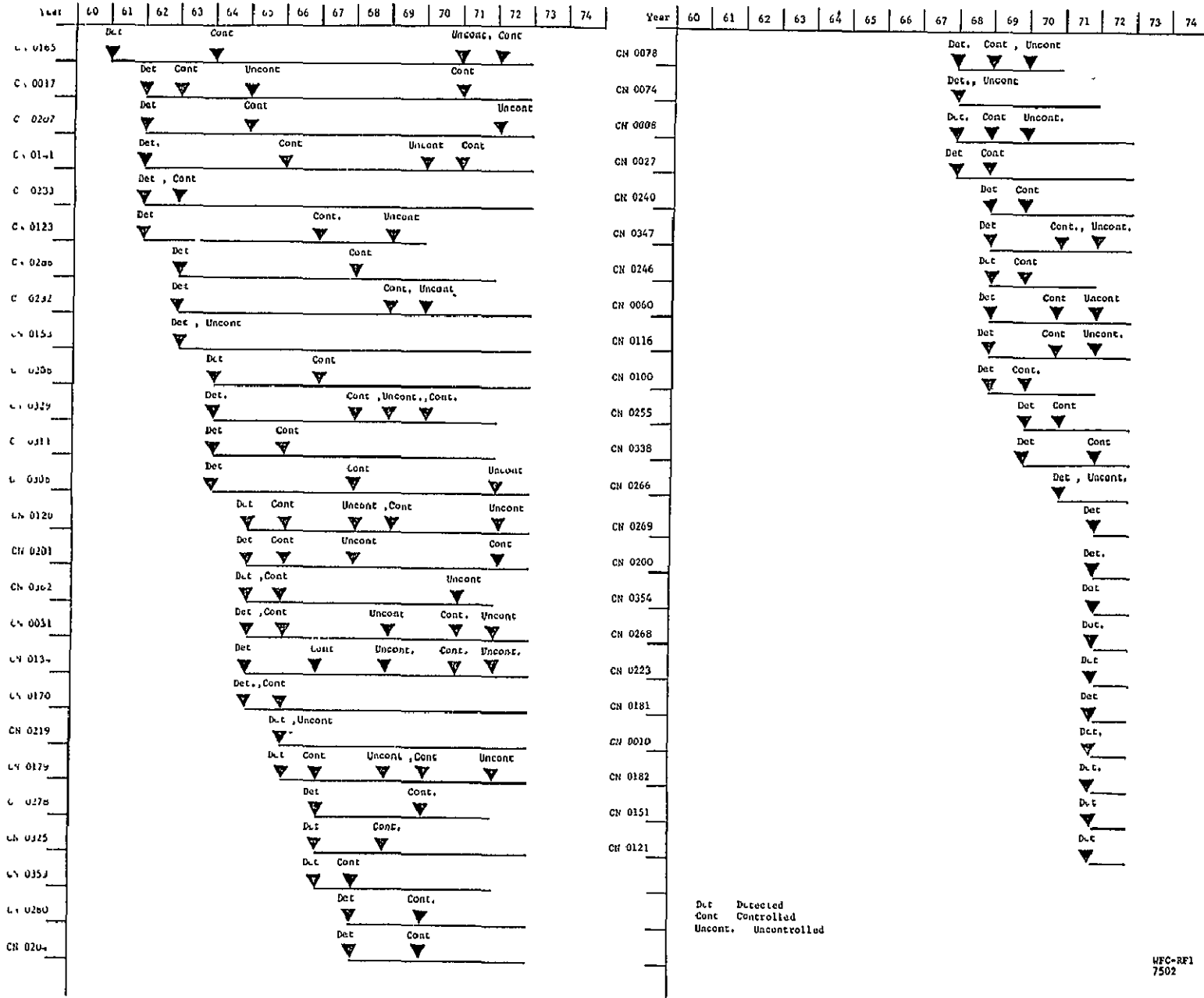

Figure 8
NASA Wallops Flight Center
Prevalence of Hypercholesterolemia
1970-1972

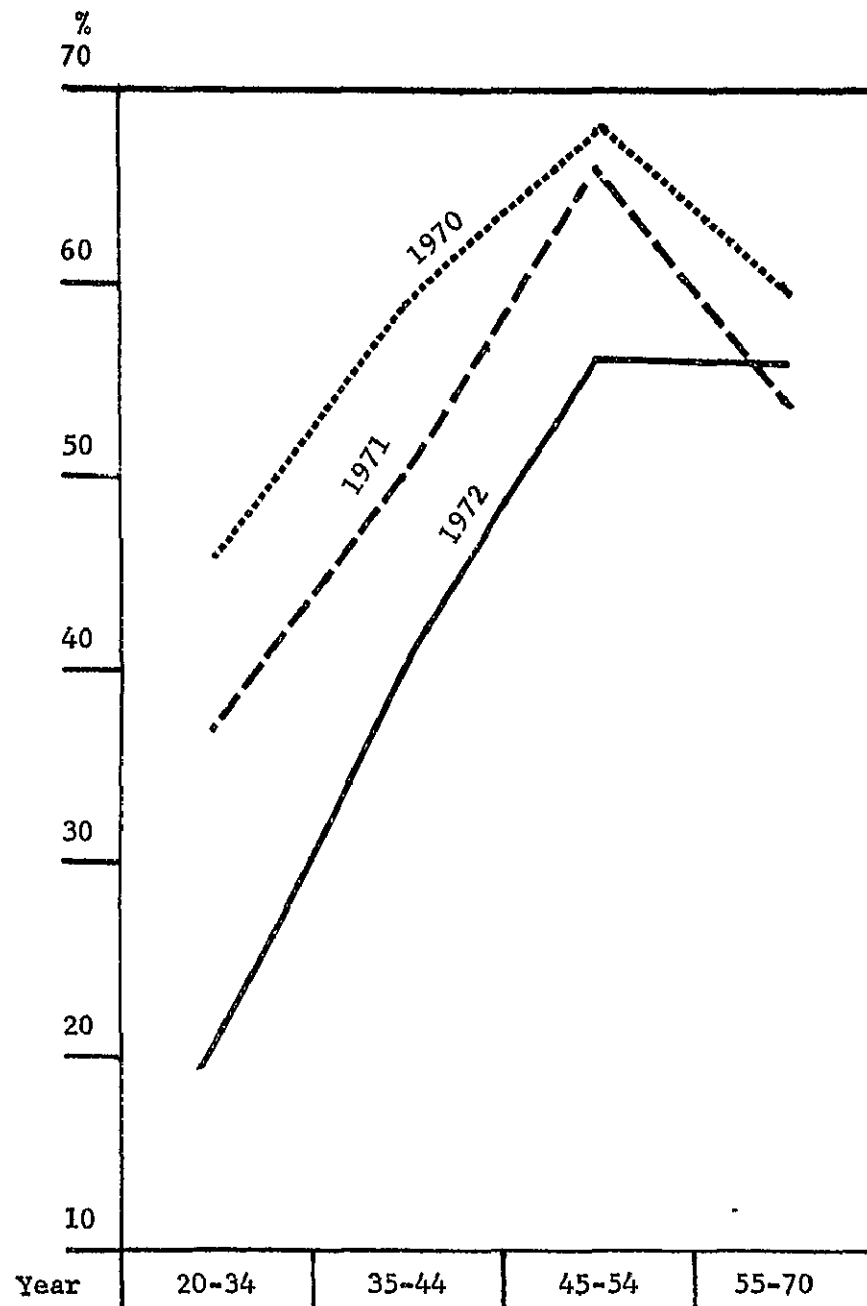

Figure 9
NASA WALLOPS FLIGHT CENTER
Fatal and Non-fatal CHD Events
1959-1974
Rate Per 10,000

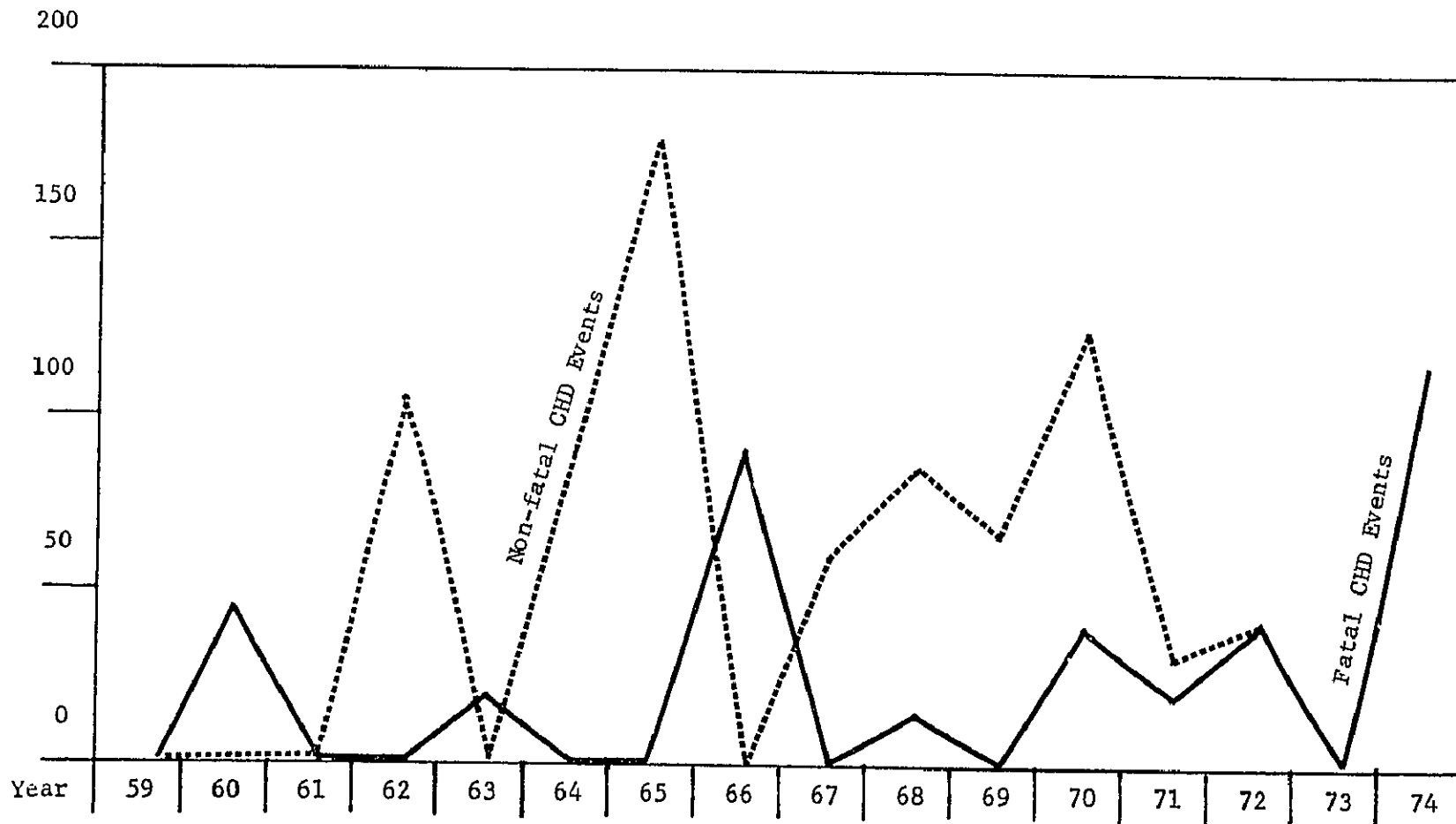
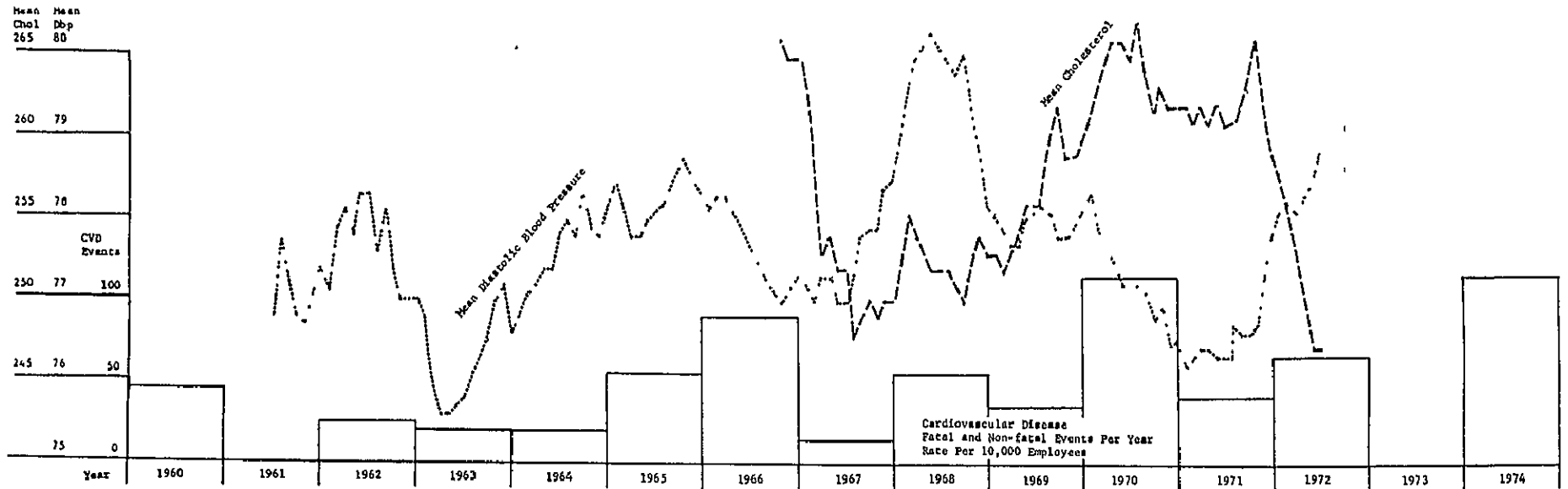

Figure 10

NASA Wallops Flight Center
 Trend in Coronary Risk Factors and
 Cardiovascular Disease Events, 1960-1974
 12 Month Moving Average



N77-30722

BEHAVIOR PATTERNS AND CORONARY HEART DISEASE

Presented by

John C. Townsend, Ph.D.
Department of Psychology and Psychiatry
Catholic University of America
Washington, D.C.

Williamsburg, Virginia
March 19, 1975

BEHAVIOR PATTERNS AND CORONARY HEART DISEASE

Jeremiah P. Cronin, B.A.
John C. Townsend, Ph.D.

This study attempts to clarify the relationships between Type A-B behavior patterns, cardiac risk factors, and coronary heart disease (CHD).

In investigating the effects of emotional behavior on the development of coronary heart disease, Drs. Ray Rosenmann and Meyer Friedman are following a tradition in medicine which dates back to the 19th Century. Results from their Western Group Collaborative Study indicate that Type A behavior is independently associated with CHD.

While this is much more support for coronary risk factors as causal agents of CHD, there are findings which have cast doubt on this explanation. Some studies have traced the increasing rates of CHD in industrialized society to rich, high-fat diets, and sedentary life styles. However, some primitive societies with similar diets have remained free of CHD. This was found also in a study of Federal prison inmates. Also, while the transition from the 19th to the 20th Century has seen an increase in incidence of CHD, the composition of the diet has remained essentially the same in lipid content.

The role of diet has been further weakened by findings that white American females are less susceptible than are American males to CHD. This cannot be attributed to sex hormone differences since black American women, as well as Mexican and African females are prone to develop CHD.

140
~~PROFITATIONALLY BLANK~~

The prevalence of the Type A-B behavior patterns is thought by Drs. Rosenman and Friedman to depend upon the milieu in which a group of individuals exists. The difference in this society between men and women in terms of socioeconomic milieu is presumably a factor in the disparity in prevalence rates for CHD for the two sexes.

Many physicians criticize the concept of any one behavior pattern playing a role in the development of CHD. Also, the concept of Type A as coronary-prone appears to be undergoing redefinition in that there appears to be evidence that the coronary-prone individual may be non-competitive with his peers, and may be phlegmatic. These characteristics are polar opposites to some of those which compose the Type A cluster. Further, psychologists have maintained that the Type A individual might be less coronary-prone because he acts out his emotional states while the Type B person appears to internalize them, the latter being thought to be more conducive to psychomatic disorders.

To contribute to the resolution of this controversy, the following hypotheses were advanced:

- a. A group high in terms of conventional, non-behavior pattern risk factors will differ significantly in incidence of CHD from a comparable low risk factor group.
- b. A Type A group will differ significantly from a Type B group in incidence of CHD.
- c. Behavior pattern type (A - B) will interact with the conventional risk factors and produce an increased incidence of CHD.

The following procedures were used to test the hypotheses:

Three-hundred forty-five NASA Headquarters employees, who in 1972 received an executive physical, including dynamic electrocardiography, comprised the sample. These men also completed the Jenkins Activity Scale (See Figure 1), which provided a Type A - Type B classification and score, and factor scores for Hard Driving, Job Involvement, and Speed and Impatience.

Risk factors used in the analysis were family history of coronary heart disease, smoking, cholesterol, obesity, systolic blood pressure, diastolic blood pressure, blood sugar, uric acid, erythrocyte sedimentation rate, and white blood count.

Exam summaries were examined for risk factors and each risk factor score was weighted according to a method devised by Dr. Robert L. Fleck of NASA Headquarters. A composite risk factor score was produced by summing the weights. Composite scores of 4 and over were placed in the High Risk Factor Category, and those below 4 were considered to be in the Low Risk Category.

The dependent variable consisted of scores taken from a scale of cardiac fitness which had been derived as follows: Coded diagnoses of cardiac abnormalities obtained from dynamic electrocardiograph recordings of six hours' duration were compiled into a list of patterns. Four NASA-affiliated cardiologists then rated the patterns according to the probability of their manifestation of coronary heart disease. Thus, the derived score indicates the probability of having CHD when a given pattern is present.

In order to establish the validity of the cardiac fitness scale, a sample of 100 scores in the form of a rectangular distribution was drawn from the population of scale scores. A cardiologist (with no knowledge of the scale score) examined medical exam summaries of each case and sorted them into two categories: one containing those which had signs and symptoms of CHD, and those lacking such indications. (Dynamic Electrocardiograph results were not included in the exam summaries.) A computed biserial correlation of +.84 indicates a high degree of relationship between a low score on the cardiac fitness scale and the presence of CHD.

Scores on the dependent variable, cardiac fitness, were normalized to meet the assumption of the analysis of variance technique. A 2 x 2 double classification analysis of various model was used to analyze the separate and interactive effects of High or Low Risk Factor and Type A or Type B traits on the dependent variable (See Tables 1 and 2).

Results indicate that the Type A-B variable has a significant effect on a measure of coronary heart disease. It is, however, the interaction of the Type B factor with a high risk factor composite score which is most significant ($p \leq .01$) in terms of its effect on the dependent variable. Risk factor score, by itself, was not found to be significantly related to CHD in the working population from which the sample was drawn. Of particular interest is the significantly higher incidence of CHD in the Type B group.

In terms of the hypotheses presented earlier and within the limits imposed by the methodology, the following conclusions appear warranted:

1. The conventional, non-behavior pattern risk factors alone were not significantly related to CHD in the sample utilized in the study.

2. A significantly higher incidence of CHD is associated with the Type B rather than the Type A behavior pattern.

3. Behavior pattern type interacts significantly with conventional risk factors such that those who are Type B and are in the high conventional risk factor group have the highest incidence of CHD.

It would appear that unless one is already in the high conventional risk factor category, his behavior type makes an insignificant contribution to his susceptibility to CHD.

**THE JENKINS ACTIVITY SURVEY
FOR HEALTH PREDICTION, FORM B**

Medical research is trying to track down the causes of several diseases which are attacking increasing numbers of adults. We hope you will join your fellow employees who are assisting this research by answering the questions on the following pages.

Please mark the answers that are true for you. Each person is different, so there are no "right" or "wrong" answers. Of course, all you tell us is **strictly confidential**—to be seen only by the research team. Do not ask anyone else about how to reply to the items. It is your personal opinion that we want.

Your assistance will be greatly appreciated

—C. David Jenkins, Ph.D., Ray H. Rosenman, M.D., Stephen J. Zyzanski, Ph.D.

If a sudden change in your health has recently led you to change your job or your usual way of living, please give details here:

(If you have listed an illness or accident above, please answer the ACTIVITY SURVEY the way you would have **before** this health change occurred.)

FOR EACH OF THE FOLLOWING ITEMS, PLEASE CIRCLE THE NUMBER OF THE ONE BEST ANSWER:

1. Do you ever have trouble finding time to get your hair cut or styled?

1. Never

2.

Occasionally

3. Almost always.

2. Does your job "stir you into action"?

1. Less often than most people's jobs

2. About average.

3.

More often than most people's jobs.

3. Is your everyday life filled mostly by

1.

Problems needing solution.

3. A rather predictable routine of events.

2.

Challenges needing to be met

4. Not enough things to keep me interested or busy

4. Some people live a calm, predictable life. Others find themselves often facing unexpected changes, frequent interruptions, inconveniences or "things going wrong". How often are you faced with these minor (or major) annoyances or frustrations?

1.

Several times a day.

3. A few times a week.

5. Once a month or less.

2.

About once a day.

4. Once a week

MEAN CORONARY FITNESS INDEX SCORES

		RISK FACTOR		
		HI	LO	
TYPE	A	52.54	55.26	53.9
	B	57.58	55.24	56.41
		55.06	55.25	

TABLE 1

ANALYSIS OF VARIANCE SUMMARY TABLE

<u>SOURCE</u>	<u>SS</u>	<u>df</u>	<u>MS</u>	<u>F</u>	<u>P</u>
TYPE A-B	171.2	1	171.2	5.18	.05
RISK FACTOR HI-LO	42.1	1	42.1	1.27	NS.
INTERACTION	421.7	1	421.7	12.77	.01
ERROR	11259.3	341	33.02		
TOTAL	11894.3	344			

TABLE 2

NASA HQ QG 75-16085 (1)
5-5-75

N77-30723

JPL NOISE CONTROL PROGRAM*

Al F. Klascius
Industrial Hygiene Engineer
Jet Propulsion Laboratory
Pasadena, California

*This paper represents the results of one phase of research carried out at the Jet Propulsion Laboratory, California Institute of Technology, under contract NAS 7-100, sponsored by the National Aeronautics and Space Administration.

JPL NOISE CONTROL PROGRAM

Al F. Klascius

Webster's Dictionary characterizes noise as usually unpleasant, undesired, and unwanted but also sometimes as pleasant. What are unpleasant noises to some may be pleasant to others. Evaluating how much sound is noise and what is pleasant is a complex problem. Enjoyable sounds can be louder than annoying ones. The problem is that the quantities to be measured must include man's reaction to the sound, a reaction that may be determined by such varied factors as the time of day, his physical condition, characteristics of the sound, and attitude toward the person or device generating the sound. It is impossible to include all of these parameters in one simple measurement. The best that one can do is to gain an understanding of man's responses to sound in order to develop ratings for quantifying noise pollution.

How does man's hearing mechanism judge the loudness of a sound, and how does he determine the degree to which it annoys him? Sound at sufficiently high levels will cause hearing loss whether the sound is pleasant or unpleasant. Some medical people have related noise to digestive, circulatory, and nervous system damage. It has caused allergies, migraines, and general fatigue. In animal tests using high levels of sound, atrophy of the liver and convulsions have been induced. Exceptionally violent noise has caused temporary blindness, lack of coordination, nausea, and even unconsciousness. In other studies, research scientists examined a group of workers who had been exposed for 1 to 4 years to noise levels in the 110 to 124 dBa range for 8 hours each workday; the investigators found a narrowing of the field of vision that appeared to be permanent. The control workers, who had been employed for only 6 months, also demonstrated a progressive narrowing of the field of vision.

150
PAGE INTENTIONALLY BLANK

Periodic audiometer tests, before and after exposure, will show how much damage is being done, and susceptible individuals can then be transferred to less noisy areas. When a hearing loss is noticeable, it is too late to help. There is nothing medically or surgically that can be done to restore hearing to normal. Hearing aids can help somewhat, but they cannot restore normal hearing ability.

Sound waves travel through the air much like ripples in a pond when a stone is tossed in; the alternating rings of compressed and rarefied air move away from a central source at a constant speed. As each wave—first a compression and then a rarefaction—encounters an object, it exerts a force (a push and a pull) on the object. This is why sound can break a glass or cause a window screen to vibrate.

For humans, sound has two significant characteristics: pitch and loudness. Pitch is the height or depth of a tone or sound, depending on the relative rapidity of the vibration (called the frequency) by which it is produced. The sound that a piece of chalk makes on a blackboard, for example, can have an annoying pitch. Loudness is determined by how well we can hear the sound. It is the intensity combined with the reception characteristics of the ear. Our ears hear better at the intermediate than at very low or very high frequencies. A sound level meter can measure the intensity precisely and determine how hard our ear drums are being bombarded with sound.

Pain occurs as the ear unsuccessfully attempts to protect itself against excessive sound through a mechanism referred to as the acoustic reflex. When sound enters the ear, the waves pass through the ear canal to the eardrum, which vibrates. The eardrum conducts these vibrations to three tiny bones called the ossicles—the smallest bones in the body. It is here that the acoustic reflex occurs. The ossicles modify the loudness of sound before it enters the inner ear. Normal action of the ossicles may amplify soft sounds or dampen loud sounds as their tiny muscles contract to decrease the pressure of the sound waves.

This acoustic reflex protects the inner ear from extra-loud sounds by reducing them. However, the protection is not complete. The reflex occurs on command from the brain a few hundredths of a second after the loud sound is first sensed, so at least some of the sound at full loudness gets through to the delicate inner ear before the reflex goes into operation. In the case of impact noise, such as a shotgun blast, the reflex is virtually useless as a defense. Furthermore, since muscles cannot contract indefinitely, their sound dampening capacity is limited. If the loud sound is sustained, the inner ear may still be bombarded with excessive sound pressure even after the reflex has had a chance to work.

The most difficult part of an ear protection program is getting the employees to wear the protectors regularly. In this effort, it is absolutely necessary to have the full support of all levels of management. This is especially true of the supervisors, who must encourage and enforce the wearing of ear protectors. They can hardly do so effectively if they themselves are not convinced of the desirability of the ear protector. Supervisors should make a point of wearing their ear protectors in noisy areas in order to set the proper example.

Exposed employees must be convinced of the necessity of wearing ear protection. They may not think of their work as being particularly noisy, since they have become accustomed to it. They may feel that their hearing has not been impaired so far and therefore is not likely to be in the future. It is true that certain individuals are less susceptible to hearing damage but it may be that a hearing loss has crept up unnoticed because of this slow rate of progression.

Some employees may realize that their hearing is not as good as it used to be but refuse to admit it or attribute it to advancing age. They may also feel that their hearing has already been damaged and that protection now is futile. An employee may feel that he is tough enough to resist the rigors of his job and resent the suggestion that he needs ear protection.

Employees must be told that the environment is sufficiently noisy to impair their hearing and given the basic reasons why ear protection should be used:

- (1) To prevent permanent hearing damage.
- (2) To prevent temporary hearing loss.

In addition, they should be told that

- (1) Wearing ear protectors in steady noise will allow an employee to hear speech at least as well as he could without protectors.
- (2) Ear protectors will not impair the ability to hear warning signals or sounds indicating malfunction of machinery.
- (3) Wearing ear protectors on a noisy job will improve efficiency, reduce fatigue, and add to the overall comfort of the worker.

At JPL we have taken the approach that if there is a potential risk of hearing damage, the best protection possible should be provided. This is why we require the use of ear covers for protection. Ear plugs may not be used. Employees exposed to noise are kept aware that the ear protection is for their own safety. Failure to wear ear protection in a posted area is conspicuous to supervisors and others in the area. In our program, we have experienced little difficulty in getting employees to wear their ear protectors, although we have numerous areas in which uncontrolled noise levels could create hearing problems. I will review some of these areas so that you can compare them to some of your own operations.

In our Space Flight Operations center, we have a generator room in the building. The generators are used to supply electrical power to the building during critical periods of a space mission. Normally, commercial power is used, but when a critical period is reached, the generators are started up and the power for the building is switched over to them. The main generator room contains three diesel-powered generators. Noise levels in the main generator room range from

109 to 112 dBa, or 24 to 27 dBa above the JPL allowable exposure level of 85 dBa. Octave band analysis showed the highest levels to be at 500 Hz. This is the point at which the hearing response of the human ear begins to drop as the frequency gets lower. Exposure of personnel in the main generator room is relatively low, because the only type of work done there is to take readings of meter dials and make slight adjustments to the diesel engines. The total time spent in this room is on the order of 5 to 10 minutes, and the entrances to the room are posted that hearing protection is required at all times, regardless of the reason or length of time spent in the room. The reason for this requirement, in addition to the fact that protection is desirable even for short periods, is the possibility that someone may find a malfunction while making a routine inspection and spend a longer period of time there than expected. The operator spends the bulk of his time in the control room adjacent to the main generator room. The readings obtained in the control room were 75 dBa. Therefore, unlimited amounts of time could be spent in the control room without harmful exposure to noise.

Similar conditions exist at our tracking station in Goldstone, California. Each site within the overall complex has its own emergency power generating building. The generators are also diesel operated, and there are similar arrangements at the three main generator building locations. The sound levels in the main generator rooms vary from 105 to 108 dBa. Each of the buildings contains four diesel-powered generators. They are smaller and run at a higher RPM than the ones in Pasadena, accounting for the noise peak frequency of about 1000 Hz shown by an octave band analysis. The doors to the main generator room at each location are posted requiring the wearing of ear covers. The control rooms at each site have measured levels of 73 dBa, which is well below any presently known hazard level.

We also have some research facilities where high noise levels are encountered. Our hydro lab generates noise levels of 115 to 125 dBa in the hydro testing of rocket engines. A large volume of water at high pressure is forced through the limited opening in the rocket engine. High-pitched noise around 8000 Hz in frequency is generated by the water flowing at tremendous speed. The tests are only about 5-10 minutes in duration, and the highest intensity is reached for a period of only 1 minute. These tests have been performed for years. All personnel involved have been using ear protection during this time, and no perceptible hearing loss has ever been found among them. This history indicates that they are being adequately protected from hearing damage.

Another area with high noise levels involves spacecraft testing in an acoustic chamber, where the spacecraft is exposed to levels of 160 to 170 dBa. The testing is done in a sealed chamber, which is fed by special acoustic horns mounted in the room where the chamber is located. The room containing the horns was found to have noise levels of 110 to 120 dBa when the level inside of the chamber was up to 160 to 170 dBa. The room in which the energy is generated is closed and locked during testing and would not be entered except in an unusual situation. The acoustic chamber, which is about 25 feet high and 10 feet in diameter, with 30-inch-thick concrete walls, is sealed and locked, with no access during testing. The noise level in the control room area is about 65 to 70 dBa during testing and poses no threat to the operator's hearing.

The carpenter shop uses many power tools that generate high noise levels. A DeWalt radial saw generates 90 dBa when running and 115 dBa when cutting. A planer generates 83 dBa when running and 102 dBa when cutting. A shaper measures 102 dBa while running or cutting, a dado about the same. A joiner was measured at 96 and 100 dBa, while a table saw was found to run at 84 and saw at 99 dBa. While these machines create high noise levels, the noise problem is not as great as that which would be found in a production-type carpenter shop. Our shop is a

custom-made operation, and the machines are only in use when a particular cut or shape is required. Some machines may be idle all day, depending on the orders to be filled. Measurements of average noise levels made during a day of operation indicated that the wearing of ear protection, which would have to be put on and taken off each time the machines were in use, was not practical or necessary in view of the short time exposures involved.

Most of the noise level surveys that are made at JPL are not related to potential hearing damage. They are made in areas where the type of work being done requires a sufficiently low noise level to enable the personnel to concentrate on the job they have to do. Computer areas are one type of operation where noise is constant all day at levels of 75 to 80 dBa. After measurements were taken the equipment as well as the size and shape of the room were considered with respect to reducing the sound levels. Covers were designed for the printers which cut the noise by 10 to 15 dBa. The inside of other noisy equipment was lined with sound-absorbent material to reduce the noise output. Some of the ceilings and walls were treated with acoustic absorbing tile. In some cases, an area was sectioned off with acoustical curtains to prevent the penetration of noise into another more critical area.

There are many ways in which we have reduced noise through calculations and trial and error. Many offices and drafting areas have had acoustical absorbent tile installed to reduce the ambient noise level. The noise levels outside some of our wind tunnel operations had to be reduced to avoid exposing passersby to excessive noise. The exhaust air from a wind tunnel test is pushed outside into the surrounding environment. Noise level patterns are plotted around a building and the surrounding area to determine what the levels are and how far out the potentially hazardous levels extend. When levels are found that are in excess of the JPL standard, various means (such as mufflers and diversion devices) are used to reduce them. All persons that are required to wear ear protection are

given annual audiometer tests. (In special cases the test is given more often.) The testing is done in our own audiometer booth by the two nurses who run our first aid facility, both of whom are certified to give audiometer tests in our booth. The JPL doctor evaluates the results and determines whether any corrective action is required. If an employee shows a decline in hearing perception, he is removed from the noise exposure to determine whether this is the cause. (He could be a rock fan or play in a rock group, which might be causing the hearing loss.) If the person is removed from a noise source and continues to show loss, an inquiry is made as to his activities while he is not on the job. Case histories are kept on each individual and updated each time an audiogram is made to note any changes in the person's outside activities. The audiometer booth is checked to make certain that the noise levels inside meet the requirements of the ANSI standard for audiometer booths. Each time our booth was measured, it was found to be well within the ANSI standard requirements.

In our search for noisy areas, we try not to overlook any possible location. We have taken readings of the dishwashing operation in our two cafeterias. The employees are those of a caterer, but the equipment belongs to the government. The levels were found to vary from 80 to 83 dBa at the ear level of the operator. In the cafeteria dining room, during the periods of heaviest usage, the noise level ranged from 90 to 95 dBa with little contribution from mechanical devices.

09
N77-30724

ENVIRONMENTAL HEALTH CONCERNS IN
NATURAL AND MAN-MADE ENVIRONMENTS

by

Charles P. Bergtholdt, M.P.H.
Occupational Health Officer

Life Sciences Directorate
NASA Johnson Space Center
Houston, Texas

Presented at NASA Annual Conference
of the NASA Clinic Directors,
Environmental Health Officials
and Medical Program Advisors

Williamsburg, Virginia
March 18 - 20, 1975

Environmental Health Concerns

In Natural and Man-Made Environments

Support services for the JSC Occupational Health Program are furnished by a full time, onboard staff of physicians, nurses, industrial hygienists, sanitary engineers, health physicists, and technicians contracted through the Kelsey-Seybold Clinic. This is the largest medical clinic in Houston with excellent home base capabilities to respond to the needs of our center. I am the JSC Technical Manager of this contract operation and have four JSC representatives, professionally qualified in various aspects of the program, who are directly responsible for monitoring their specific area of interest and for evaluating the work performance.

In the Occupational Health Program, attention is given to significant medical and environmental health matters that may have an impact on future space flight missions, on community relations, and on the overall health and morale of employees. The program is divided into two main services: Occupational medicine and environmental health.

It must, of course, be recognized that occupational medicine factors, per se, dovetail with field studies to provide an integrated and complete approach to any occupational health problem. Today my comments will be directed essentially toward environmental health concerns in natural and man-made environments.

Industrial hygiene and environmental health aspects of ground operations at JSC are typical of most research and development institutions. Major areas of concern are:

1. Toxic substances, including solvents, rocket propellants, metal finishing fluids, metallic vapors, dusts and fumes, ozone and other reactants from welding or plasma arc operations, and so forth.
2. Noise, as relevant both to hearing conservation, and to communications interference.
3. Nonionizing electromagnetic radiations - considerations ranging from adequate work place illumination to protection against ultraviolet, infrared and microwave radiation hazards.
4. Ionizing radiations from high voltage electronic equipment, X-ray diffraction units, diagnostic x-ray units, radiographic operations and numerous research radiation sources.
5. Biohazards and Sanitation

Each of the above categories are well represented within the spacecraft environment. The major difference from the ground situation is that aboard a spacecraft such as Skylab, we are discussing an essentially closed environment.

This required increased regard of chronic low-level effects. In addition, the physiological aspects peculiar to the spacecraft environment required consideration. These aspects include zero gravity, atmospheric pressure of 5 psia, a breathing mixture of 70% oxygen, 30% nitrogen, confinement, and although unplanned, the effects associated with internal spacecraft temperature excursions in the region of 110° to 130° F.

The Skylab workshop development was unique from the standpoint of the detailed design and review emphasis placed on Health and Safety considerations. The original Skylab name "Apollo Applications Program" is aptly descriptive of the progressive adaptation of experience gained from Apollo and its forerunner programs. But beyond being a space vehicle and a complex scientific laboratory, Skylab was a home which boasted a wide range of modern conveniences. The work and home environments thus were combined and controlled in a manner which was enviable even by earth standards.

Although the Skylab vehicle offered a unique environment, most, if not all of the specific environmental problems were solved by methods often utilized for similar parallel problems on ground. Let us review briefly the list of problem areas presented earlier and compare some ground and space related problems.

Potential Spacecraft Problem	Comparable Ground Situation
Ozone, Ultraviolet Produced	Ozone from Xenon Lamps, Carbon Arc Projectors
Ozone, Electrostatic Workbench	Ozone from Electrostatic Precipitators
Mercury Vapor	Broken Thermometer, Vacuum Gauges
Oxygen Deficiency (Launch with Pure N ₂)	Tank Entry, Ventilation of Liquid N ₂ Boil Off
Containment of Experimental Combustion Products, Welding Fumes	Similar Products, often Less Controlled than Onboard

Offgassing of plasticisers and organic solvents is a recognized area of concern for space vehicles as well as other closed systems. Established methods of materials control, bake-out procedures, and onboard testing of atmospheric controls are expected to suffice in maintaining offgas products at acceptable levels under ordinary conditions. Loss of the Skylab's thermal shield immediately following launch, however, gave rise to additional concern for possible offgassing of toluene diisocyanate (TDI) and the composition product carbon monoxide from polyurethane insulation.

A number of steps were taken to insure crew protection against these possible contaminants. First, the workshop was purged by four depressurization cycles from 5 psia prior to command module docking. Next, the crewmen checked the multiple docking adapter (MDA) and CO and TDI by using draeger air sampling tubes. Toxic gases were not detected in the MDA. Finally, the pilot entered the workshop to begin operation of the atmospheric circulation fans. For respiratory protection he wore a hopcalite-charcoal filter mask. Before doffing the mask, further samples were taken for CO and TDI. These samples were negative. Each of these contingency procedures represented direct application of routine industrial hygiene methods as practiced for ground based facilities.

NOISE

Considerably fewer noise problems have arisen aboard space vehicles than occur due to ground operations. Other than launch noise, the only spacecraft problems have been from stabilizer firings during sleep intervals and other nighttime noises. In fact, the lowered pressure in all U. S. manned vehicles to date has decreased the ability of sound to "Carry" through the spacecraft. Intercom systems were utilized in Skylab to ease this communication problem. Skylab was designed to limit ambient noise below 72.5 dBA. Inflight measurements, using a B&K portable sound level meter indicated sound pressure levels ranging from 55 DBA in the airlock module to a low of 46 dBA in the airlock module to a low of 46 dBA in the experiment compartment.

Ground facility sound pressure levels range to and above the current 8-hour occupational standard of 90 dBA in some areas. At JSC, noise problem areas include the acoustical and vibration test facility, aircraft operations flight facilities, the central heating and cooling building, the emergency power building, various ultrasonic cleaner installations (especially multiple units), computer facilities, and large hydraulic or pneumatic system installations. Ear protection and exposure time limits are utilized for personnel protection.

Audiometric testing is performed for all persons working in potentially noise hazardous areas. In addition to octave band analysis, we utilize a personnel noise dosimeter system to determine integrated exposure of individuals for whom calculated exposure might be inaccurate or questionable.

NOIONIZING RADIATION

Common ground problems involve ultraviolet germicidal lamp installations. Solar lighting simulators, arc welding, laser operations, microwave generators (radar, ranging devices and microwave ovens), infrared sources and general illumination surveillance.

Spacecraft problems have included potential ultraviolet exposures to eyes and skin from solar radiations reflected from the earth and subsequently entering the spacecraft through the SOL9 (Ultraviolet Photography) window, accidental direct viewing of solar or nuclear test radiations, observation of electron beam welding, and viewing of an argon laser beacon as an experimental navigation aid. Implementation of appropriate design constraints and use of onboard safety procedures insured that no inflight problems arose in these areas.

IONIZING RADIATIONS

There are five AEC licenses issued to JSC authorizing:

- (1) Broad Research and Development Programs
- (2) Radioactive Material for Human Use
- (3) Multicurie Calibration Sources
- (4) Special Nuclear Material
- (5) Source Material

There are approximately 3900 sources of ionizing radiation for which JSC is accountable to the AEC. In addition, there are 34 X-ray producing machines maintained by JSC which require periodic monitoring as required by Department of Labor Regulations.

Proposals for use of ionizing radiations require special authorization and review by the JSC Radiation Safety Committee. These proposed operations are reviewed and evaluated prior to committee review and are surveyed periodically after approval is granted. Individuals not proficient in handling ionizing radiation are provided with appropriate training by the Health Physics staff prior to initial operations.

Many of the radiation sources covered by AEC licenses at JSC subsequently are flown aboard manned space vehicles. For example, more than 200 individual sources with an activity total of approximately 40 curies were flown aboard the Skylab missions. In addition, the human use of radioisotopes at JSC centers specifically on studies involving flight crews. The radiation does from isotope studies, X-rays, external radiation from onboard sources, Van Allen belts, solar, and cosmic radiations must be summed in order to evaluate overall astronaut radiation dose for a given mission.

Radiation doses from the natural (Van Allen and cosmic) radiation sources were dominant in the Skylab missions. Dose equivalents were as high as 18 rem to skin, 12 to the lens of the eye, and 8 rem to blood forming organs on the third Skylab mission (84 day duration). In contrast, radioisotopes provided wholebody doses of only approximately 0.3 rem for the Skylab crewmen, and the onboard source dose contribution was negligible thanks to appropriate design and procedural techniques.

N77-30725

THE U. S. ENVIRONMENTAL PROTECTION AGENCY
NATIONAL POLLUTANT DISCHARGE ELIMINATION SYSTEM
(NPDES)

Julian Manly Earls, Ph. D.

Dr. Earls is Chief, Office of Environmental Health
Lewis Research Center
Cleveland, Ohio

-167-

166
1
PAGE INTENTIONALLY BLANK

Introduction

The theory and scope of water pollution enforcement in the United States was drastically revised in the fall of 1972 with the passage of the Federal Water Pollution Control Act of 1972¹ and the Marine Protection, Research, and Sanctuaries Act of 1972.² The two laws extend federal enforcement to intrastate waters for the first time, give the federal Environmental Protection Agency (EPA) control over most ocean dumping and call for national enforcement based primarily on effluent limitations, rather than protection of the receiving waterway.

The 1972 law establishes a national system of permits³ to control discharges. The permits are issued by the EPA or by the states with EPA approval. Each permit specifies which substances may be discharged, in what amounts, and how soon effluent quality must be improved. The "ocean dumping" provisions of the Marine Protection, Research and Sanctuaries Act of 1972 empower EPA to grant dumping permits. Material flowing directly from an outfall into an ocean is covered by discharge permits, not by ocean dumping permits.

The Corps of Engineers maintains permit authority over dumping of dredging spoils, and placing of fill under the Rivers and Harbors Act of 1899,⁴ which still remains in effect. Discharge

permits issued under the Rivers and Harbors Act are temporarily valid, although new permits will be issued only under the 1972 law.

Description of Systems

In June 1971 Lewis Research Center (LeRC) submitted to the Corps of Engineers an Application for a Permit to Discharge in Navigable Waters or Their Tributaries. The LeRC is situated on 350 acres of land, adjacent to the Cleveland Hopkins International Airport in Cleveland, Ohio. The major facilities at LeRC include two supersonic wind tunnels, a Propulsion Sciences Laboratory, an Engine Research Building, Zero Gravity Facilities, and an Electronic Propulsion Laboratory.

The LeRC has separate storm, sanitary, and industrial waste sewer systems.

In the storm sewer system, drainage is from roof surfaces, parking areas, surfaced roads, unimproved land, et cetera. By natural runoff this drainage enters catch basins and then to storm sewers with 13 discharge points which are either to Abrams Creek or Rocky River. Nine of the outfall effluents are monitored on a regular basis and four are not monitored at all. Sampling is not necessary at four outfalls because these are low flow discharges and experience has shown that pollution from them is minimal.

All the LeRC sanitary wastes, with the exception of the wastes from the Rocket Combustion Laboratory, are pumped to the Cleveland Municipal Sewer System. The average daily sanitary waste flow from LeRC is approximately 173,000 gallons per day.

In general LeRC accomplishes treatment and removal of industrial wastes at the source. All buildings, test cells, laboratories and other activities discharge industrial wastes to basins or tanks near the function. The industrial waste system collects nondomestic wastes, principally cooling water which may have been contaminated as a result of research and testing operations. The necessary treatments for these wastes are accomplished prior to discharging them into the industrial waste sewer system.

All industrial wastes are discharged into a special industrial waste sewer system and then collected in two, 800,000 gallons each, retention basins. These two basins are connected in series and the first basin is equipped with an oil separator. The overflow from the first basin is discharged into the second. Adjacent to the 800,000 gallon retention basins are two 400,000 gallon capacity basins. Connections exist to pump to these 400,000 gallon basins from the larger ones if additional treatment is required.

The wastes from the industrial sewer system can be discharged to the storm sewer system or the sanitary sewer system. Discharge to the sanitary sewer system is rare.

NPDES Permit

In March 1974, almost three years after submitting the application to the Corps of Engineers, the EPA sent LeRC a draft NPDES permit. In June 1974 the EPA issued to LeRC NPDES Permit Number OH 0000418. The permit covered nine outfalls and Figure 1 is typical of the effluent limitations and monitoring requirements imposed.

An investigation and evaluation of a proposed sampling and flow measurement system for LeRC revealed that costs in excess of \$120,000 would be required to achieve compliance with the NPDES permit. These costs would not include sampling analyses. Approximately 50 percent of these costs were for continuous flow measurement devices and new manhold structures or access stairways to discharge points.

As a result of these cost estimates and the nature of the LeRC effluent (once through cooling water), LeRC's Office of Environmental Health made a proposal to the EPA. The following modifications were proposed to the EPA in August 1974:

1. The frequency of monitoring should be changed from twice to once weekly, which would still provide adequate quality check for the discharge from LeRC.
2. The sampling location should be changed from "at the discharge point prior to mixing with the waters of Abrams Creek" to "upstream of the outfalls on NASA property."
3. The requirement for continuous flow measurement and recording devices should be changed to **allow estimation of flow rates based on periodic flow measurements.**

On October 24-25, 1974 the Michigan-Ohio District Office of the EPA performed a compliance monitoring survey to assess LeRC's compliance with NPDES Permit OH 0000418. As a result of the survey in January 1975, the EPA agreed to **modify the Permit in accordance with the LeRC request of August 1974.**

State of Ohio Requirements

Prior to final issuance of the NPDES Permit, the draft Permit was issued for Public Notice. Interested persons and organizations were given 30 days to submit comments to the EPA. The State of Ohio did not submit comments during the 30 day comment period. However, after the Permit was issued, the State of Ohio requested that monthly monitoring reports be provided to the State

in the form of a State Report. In view of the costs associated with the analysis of water data and the completion of duplicative report forms, it was suggested that Federal installations not be required to provide monitoring data under the NPDES Permit in any other requested format. A letter from the Regional Administrator of EPA was sent to all States in Region V (Minnesota, Wisconsin, Michigan, Illinois, Ohio). The letter advised the States that EPA's approach concerning reporting requirements was as stated in the above suggestion. The NPDES Permit requires quarterly rather than monthly reports.

Summary

The LeRC experience has been that the EPA is supportive of requests and suggestions which are reasonable. However, they may require sampling data as supportive evidence. The State requirements will certainly vary from location to location but the NASA centers should correspond with the respective Regional EPA Office. In any case, the States should be advised to direct their comments to the EPA and the EPA will, where applicable, incorporate the State's requirements into the Center's NPDES Permit.

References

1. Federal Water Pollution Control Act of 1972, P. L. 92-500
2. Marine Protection, Research and Sanctuaries Act of 1972,
P. L. 92-532, 86 Stat, 1052
3. National Pollutant Discharge Elimination System 40 CFR 125
4. Rivers and Harbors Act of 1899, 30 stat 1151, 1152, 1153

PART I

A. EFFLUENT LIMITATIONS AND MONITORING REQUIREMENTS

During the period beginning June 21, 1974 and lasting until June 18, 1979 the permittee is authorized to discharge from outfall serial number 001

Such discharges shall be limited and monitored by the permittee as specified below:

EFFLUENT CHARACTERISTIC	DISCHARGE LIMITATIONS				MONITORING REQUIREMENTS	
	kg/day	(lbs/day)	Other Units	(Specify)	Measurement Frequency	Sample Type
Flow M ³ /Day (MGD)	-	-	-	-	Continuous	-
Oil	-	-	-	10 mg/l	Twice weekly	Grab
Suspended Solids	27 (59)	81 (177)	10 mg/l	30 mg/l	Twice Weekly	24 hr. composite
Residual Chlorine*	-	-	-	0.5 mg/l	Twice Weekly	Grab
Chromium*	-	-	0.1 mg/l	0.2 mg/l	Twice weekly	24 hr. composite
Zinc*	-	-	-	1.0 mg/l	Twice weekly	24 hr. composite
Phosphorous*	2.7 (5.9)	13.4 (29.5)	1.0	5 mg/l	Twice weekly	24 hr. composite
Iron*	-	-	-	0.3 mg/l	Twice weekly	24 hr. composite

*When added to process water

The pH shall not be less than 6.5 nor greater than 8.5 and shall be monitored for each sample.

There shall be no discharge of floating solids or visible foam in other than trace amounts.

Samples taken in compliance with the monitoring requirements specified above shall be taken at the following location: at the discharge point prior to mixing with the waters of Abrams Creek.

N77-30726

NASA LANGLEY PHYSICAL EXAMINATION PROGRAM

Presented by

Robert L. McArthur
Occupational Health Services
Langley Research Center
Hampton, Virginia

Williamsburg, Virginia
March 19, 1975

NASA LANGLEY PHYSICAL EXAMINATION PROGRAM

Robert L. McArthur
Occupational Health Services
Langley Research Center

In October of 1973, the Occupational Health Services, with the advice and counselling of NASA Headquarters in Washington, D.C., set forth to improve the "Physical Examination Program" for all of Langley Research Center's employees. Budgetary limitations were not discussed at this time, nor were the methods by which we could improve our program.

A comprehensive survey was made of the entire area, and medical facilities capable of providing satisfactory and economical services within a reasonable traveling range of the Center were not too numerous.

After exploring all avenues of available areas, the Newport News Health Center, adjacent to Riverside Hospital, appeared to be in a better position capable of providing for our needs within reasonable traveling distance than any of the other resources that were investigated.

On consultation with the medical and administrative staff of the Health Center we were pleased to learn that physical examinations similar to what we had envisioned for our employees were being given to several small business concerns in the area and could also be provided for us with any adaptations that we might require.

We met with officials from the Health Center and arrived at a physical examination program which we felt would be second to none and financially attractive to those concerned with our budget.

The services for which we contracted are as follows:

1. Physical examination to include a complete history with printout. (To be based on questionnaire developed by Dr. Kanter, University of Kentucky, as modified.)
2. Complete physical with printout. (To be based on Physical Exam developed by Dr. Kanter, University of Kentucky, as modified.)

This will include the following specific items:

- a. Height
 - b. Weight
 - c. Temperature
 - d. Blood Pressure (arms and legs)
 - e. Genitalia and rectal exam of males; vaginal and rectal exam of females
3. Tests:
- a. Audiometry
 - b. Visual Acuity
 - c. Tonometry
 - d. Pulmonary Function
 - e. Urinalysis
 - f. SMA 6 and 14
 - g. Blood sugar 2 hr. (to provide Glucola to NASA)

- h. Guaiac
- i. PAP test
- j. VDRL
- k. Chest X-ray (PA and lateral) and Interpretation EKG

The questionnaire which we send to everyone before they have their physical exam, is one compiled by Dr. Irving P. Kanter, University of Kentucky Medical Center, and provides the Health Center with very useful statistical information.

In the beginning of the program, a copy of the entire physical report was sent to each individual's family doctor as it was listed in the questionnaire. This idea was met with some objections from the local medical society, and coupled with the erroneous idea that we were going to eliminate the "family doctor concept;" we were forced to reorganize our original policy. After consultation with some of the doctors involved in the disagreement, we agreed not to send the employee's physical report to them, but we would send them a notice stating that their patient had a physical examination as a NASA employee at the Newport News Health Center and a copy of the results are available upon request.

We at first thought this objection was "nit picking" on the part of the medical profession, but as it was pointed out to us, it was possible for one doctor to receive numerous physical reports all at one time, which obligated him to immediately review them in case there was some abnormality that needed immediate attention.

We concurred with their thinking and after this matter was settled, our program progressed very smoothly, and now we send out daily copies of physical reports to employees' family physicians at their request. As a matter of fact, quite a few of the doctors have found these reports so helpful that they have informed us not to wait until they are requested, but that they be automatically sent to them.

We sent out a notice to all Langley Research Center employees, except those who were already receiving a physical examination (e.g., executives, radiation workers, etc.) explaining the proposed voluntary program and asked that the notice be returned with name, phone number, etc., if they were interested. At the present time we now have approximately 2,800 employees enrolled. After our first year of examinations, all of the job-related physicals were transferred into this program.

After we received such a large response, our next problem was, "In what order are we going to send them?" If we took them alphabetically, the "Abbotts, Andersons, and Askews" would be happy, but the "Williamsons, Youngs, and others" would not. So we devised a system which we feel is equitable and has worked satisfactorily. I would like to show you Figure 1 and explain.

The bottom horizontal line indicates ages 18 to 70 years old. The left-hand vertical line indicates the number of employees from 0 to 160. The dotted lines indicate the number of employees in each age group, the full lines represent the number of employees in each age group who have signed up for the examination. The cross hatched areas indicate the number of employees we examined in fiscal year 1974.

These quantities do not indicate the number of job-related physicals, since this change was only effective July 1, 1974.

We decided to start at age 40 on the examinations and work up two and down one, (e.g., 40 and 41, then 39, 42, and 43, then 38). We picked 40 years of age because of the old saying, "Life begins at 40." No one ever told us what life begins to do at 40, but from the statistics we have obtained, it is quite obvious that life begins to go down hill. I hate to disillusion any of you who have not reached this magic age, but you may as well find out sooner than later.

In the fiscal year 1974, our initial budget allowed us to examine 804 employees as indicated in Figure 1. After several months of operation, additional funds were obtained which enabled us to examine a total of 875 employees.

In each age group when there is a specific number to send, we send them according to their birth dates. We have a numerical computer read-out of everyone's birthday, and we start at January 1 of the desired year and come down the list until we obtain the predetermined number to be examined. If someone's birthday occurs in the later part of the year, for example, September, October, November, or December, we can tell them that they will probably not receive their examination until the latter part of the fiscal year.

We maintain a "stand-by" list for those who may be having specific problems as related to us by their family physicians. When cancellations are received due to travel, vacations, etc., we fill these vacancies from our "stand-by" list.

At least one week in advance of the employee's scheduled appointment, they receive a printed notice informing them of the date, time, and place to report, along with a medical questionnaire to be completed prior to their appointment date.

The employees report to the Health Center at 8:00 a.m., and by 12:00 noon, they have had their examinations and are on their way back to work. After the examination is completed and the physicians or nurse practitioners discover some unusual findings that may require immediate attention, we are contacted and informed of the problem. We then call the employee, and if possible, their family physicians and explain to them the specific problem.

If the examination does not reveal abnormalities that require immediate attention, the report is then picked up by someone in the health office, recorded as to date of examination and when it left the Health Center, then delivered to our contract physician for medical evaluation.

When the reports are evaluated they are then picked up from the contract physician and filed in the employee's regular medical file. There are two separate forms used to notify the employee of the results of their examination, either of which is filled in by the physician. One form states that "all results have been found to be within normal tolerances," the other form indicates that "further study should be made" of whatever abnormality is stated by the physician.

Whatever form is filled in, it is then copied, the original kept with the records and the copy sent to each individual employee. This copy is placed in a special envelope marked with the employee's name

and mail stop, and in large letters, "CONFIDENTIAL - TO BE OPENED BY ADDRESSEE ONLY." It is then sealed, taped, put in a regular mail distribution envelope, and sent to the employee.

IF the employee does not have a family physician and they desire to have one, we extend our efforts to see that one is made available.

As each report returns to our office, we note the date it was returned, the employee's age, the type and number of abnormalities. This information is useful in compiling statistics for future reference.

During the fiscal year 1974, our budget allowed us to provide examinations for 874 employees. These were employees ranging in ages from 18 to 68. Of this total number, we found 720 abnormalities involving 448 employees, or a total of 51% of those examined with one or more abnormalities. See Figure 2.

ABNORMAL RESULTS FROM EMPLOYEES PHYSICAL EXAMINATIONS FISCAL YEAR 1974

1.	HYPERTENSION	106	20.	ANAL FISSURE	2	39.	GENITAL MASS	1
2.	HEART DISEASE	9	21.	RECTAL POLYP	4	40.	LOW CHOLESTEROL	1
3.	OBESITY	30	22.	ABDOMINAL MASS	3	41.	LOW POTASSIUM	1
4.	ELEVATED CHOLESTEROL	25	23.	LUMPS IN BREAST	3	42.	DEC. PULMON-VENT.	3
5.	ELEVATED BLOOD SUGAR	85	24.	LYMPH NODES	2	43.	HEART MURMUR	2
6.	ELEVATED BILE	6	25.	LIPOMAS	2	44.	REPEAT PAP TEST	1
7.	ELEVATED B.U.N.	3	26.	NASAL POLYPS	3	45.	VISION DEFICIENCY	1
8.	ELEVATED URIC ACID	30	27.	ENLARGED LIVER	5	46.	BLOOD IN URINE	1
9.	HIGH WHITE COUNT	8	28.	PELVIC EXAM	6			
10.	LOW WHITE COUNT	4	29.	VENEREAL DISEASE	2			
11.	ANEMIA	12	30.	INGUINAL HERNIA	8			
12.	HYPOGYCEMIA	6	31.	VARICOSE VEINS	2			
13.	RECHECK SERUM SODIUM	3	32.	POSS. EMPHYSEMA	13			
14.	S G O T ENZYMES	1	33.	REPEAT CHEST X-RAY	59			
15.	C P K ENZYMES (HIGH)	1	34.	LIVER PROFILE	11			
16.	URINARY TRACT INFECTION	93	35.	REPEAT E K G	14			
17.	PROTEIN IN URINE	3	36.	THYROID ABNORM.	5			
18.	BLOOD IN STOOL	29	37.	GLAUCOMA	10			
19.	PROSTATE TROUBLE	13	38.	HEARING LOSS	35			
				(HIGH FREQUENCY)			FIGURE 5	

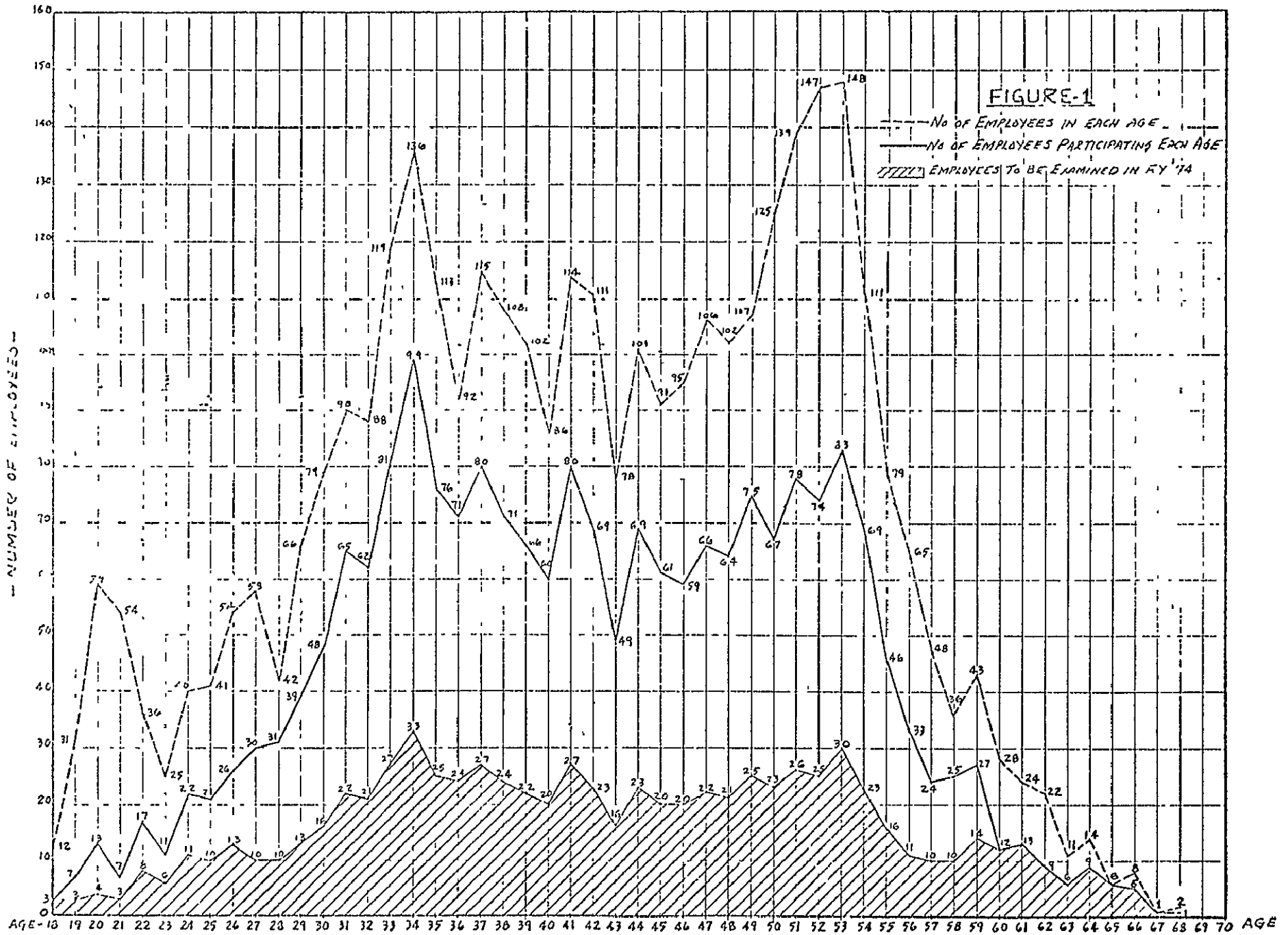

N77-30727

D12

ANNUAL HEALTH EXAMINATION PROGRAM
AMES RESEARCH CENTER

Lewis Hughes, Ph.D. and Joseph LaDou, M.D.

Dr. Hughes is Health Officer, Ames Research Center, Moffett Field, California, and Technical Monitor, NASA Contract NAS 2-7628, Operation of Ames Health Unit.

Dr. LaDou is Medical Director of the Peninsula Industrial Medical Clinic, Sunnyvale, California, and Program Manager, NASA Contract NAS 2-7628, Operation of Ames Health Unit, Ames Research Center, Moffett Field, California.

Reprint requests to Ames Health Unit, Ames Research Center, Moffett Field, California 94035 (Dr. LaDou).

The concept of Automated Multiphasic Health Testing (AMHT) is now common to the practice of occupational health. The New York Telephone Company AMHT program combines both the mobile testing concept and health screening in an established industrial medical office.¹ Labor and management have joined together in support of a large health testing program for the California Cannery Workers.² Other major corporation medical departments have studied the yield of pathology from periodic health examinations; among them are General Electric,³ Westinghouse,⁴ and Consolidated Edison of New York.⁵ Preliminary efforts at benefit-cost analysis of preventive medical programs are included in all of these company-sponsored studies.

In 1969 Stanford Research Institute conducted a comprehensive cost-modeling study in preventive medical health testing.⁶ In that study of government-sponsored screening centers, it was stated that, "The value of automated multiphasic health testing and its proper role in the entire health delivery system is in the most beneficial utilization of scarce resources -- primarily in costs and in time of medical practitioners. A first step is to determine the dollar costs of health testing and the time required to support such a program, for physicians and other medical personnel who otherwise would be free to allocate their time in other ways."

An automated multiphasic health testing program at the Kaiser-Permanente Medical Facility, Oakland, California, has been studied and the program subjected to a cost analysis,⁸ including dollar cost per positive test result.⁹ This study clearly

indicates that the prevalence of an abnormal test depends on the specific population examined, especially in terms of the age-sex composition. In the discussion of their cost analysis, the authors stated, "It is evident from this analysis that automated multiphasic screening results in an economical unit cost per test. It is estimated that to provide the same battery of tests by traditional nonautomated methods would cost four to five times as much. It is to be emphasized that the unit cost of \$21.32 per multiphasic screening is critically related to a patient load of about 2,000 per month. If only 1,000 patients were screened monthly, the cost per patient would probably increase to \$40 to \$50. If 3,000 patients could be screened per month, the unit cost would probably decrease to \$15 to \$17."

These assumptions are based on inflexible cost parameters. The following study compares the costs of multiphasic health testing in a low-volume setting with those of the Kaiser-Permanente high-volume program. The study was conducted at the Ames Health Unit, Ames Research Center, a typical occupational health facility. The cost analysis of multiphasic health testing in low volume as performed at that facility has been reported¹⁰ and produces a cost experience common to that of larger AMHT facilities. The small amount of space required, together with fewer personnel and less equipment, permits the utilization of the cost savings common to many health programs.

COMPARISON OF HIGH-VOLUME AND LOW-VOLUME MULTIPHASIC TESTING

Description of the Programs

The Kaiser-Permanente AMHT programs are operated in two laboratories, one in San Francisco and one in Oakland. Each operates on a 40-hour week and examines approximately 500 patients a week. In an average period of three hours, a patient receives the following screening tests and procedures:

Electrocardiography

Six leads recorded simultaneously on paper (including cardiologist's interpretations).

Blood pressure and pulse rate

Measured in the supine position with automated instruments.

Anthropometry

Weight, subscapular and triceps skinfold thickness, height, and a dozen body measurements recorded by an automated anthropometer and punched directly into cards.

Chest X-ray

70-mm posteroanterior view (including radiologist's interpretation).

Mammography

Cephalocaudad and lateral views of each breast in women over the age of 47 (including radiologist's interpretation).

Visual acuity and pupillary light reflex

Tested by reading a wall chart and by a pupillary light reflex test.

3
E

Tonometry

Ocular tension measured by a Schiøtz tonometer.

Retinal photography

One eye (with ophthalmologist's interpretation).

Ankle reflex

One-half relaxation time and experimental pain reaction test (measured as pain tolerance to increasing pressure on the Achilles tendon).

Spirometry

With forced expiratory vital capacity (one second, two second, and total) and peak flow rate.

Audiometry

Tested with an automated audiometer for six tones.

Tetanus toxoid immunization

With a high-pressure jet injector.

Medical questionnaire

Self-administered for present and past history; a set of 200 medical questions and an additional set of 155 psychologic questions on prepunched sort cards for automatic computer processing.

Clinical laboratory tests

Including hemoglobin, white-cell count, Venereal Disease Research Laboratories test for syphilis (VDRL), rheumatoid factor (latex-fixation slide test), blood grouping, eight blood chemical determinations (serum glucose, creatinine, albumin, total protein, cholesterol, uric acid, calcium, and transaminase), urinalysis for pH, blood, glucose and protein (paper strip tests), and a urine culture for six hours with triphenyltetrazolium chloride.

Before the patient leaves the laboratory, "on-line" computer processing "advise" supplemental tests and appointment for the patient, to be completed before he sees his physician.

The Ames Health Unit of Ames Research Center, Moffett Field, California, is operated as an occupational health facility by the National Aeronautics and Space Administration. It provides annual periodic health examinations to 30 patients per week. In an average period of two hours, a patient receives the following tests and procedures:

<u>Electrocardiography</u>	Full 12-lead recording (reviewed by the physician prior to stress electrocardiography).
<u>Stress electrocardiography</u>	On a treadmill to 90 percent maximal pulse rate (monitored by the physician and interpreted later by a cardiologist).
<u>Blood pressure</u>	With standard sphygmomanometer.
<u>Height and weight</u>	With standard office equipment.
<u>Chest X-ray</u>	14 x 17 posteroanterior view (including radiologist's interpretation).
<u>Visual acuity</u>	Tested with a 12-slide panel common to industrial screening practices.

<u>Tonometry</u>	Ocular tension measured by a Schiötz tonometer.
<u>Spirometry</u>	With forced expiratory vital capacity (one second, two second, and total) and peak flow rate.
<u>Audiometry</u>	Tested with an automated audiometer for six tones (interpreted by an audiologist).
<u>Tine test</u>	For tuberculosis (read by the nurse at a separate visit after 48 hours).
<u>Clinical laboratory tests</u>	Including a complete blood count, VDRL, serum triglyceride, and automated panel (for glucose, creatinine, albumin, total protein, cholesterol, uric acid, calcium, and transaminase), urinalysis for pH, blood, glucose, and protein, and microscopic analysis.

The patient is returned for an examination with the physician and review of the above tests in approximately two weeks.

Cost Analysis

The direct costs for the Arnes Health Unit annual physical examination are shown in Table 1. These costs include the physician costs for interpretations of electrocardiogram, X-ray films, and monitoring of the stress electrocardiography. The direct costs per patient for the year beginning July 1, 1973, through June 30, 1974, were \$43.06 for the multiphasic screening panel and \$14.25 for the physician examination. The total direct cost was \$57.31 per patient.

Depreciation of purchased capital equipment was calculated by the straight-line method at the rate of 1.5 percent per month. This approach is in conformity with Kaiser-Permanente accounting practices, which allows comparison of the two multiphasic programs.⁸

Table 1 also presents the cost per examination of disposable supplies, forms, and equipment maintenance and repairs necessary to multiphasic health testing and physical examinations.

The salaries and wages shown in Table 1, which include salary burden and contract overhead, constitute the most expensive operational category for the multiphasic health testing and physical examination, averaging \$38.81 per patient.

The percentage of direct costs allocated to equipment depreciation, salaries and wages, and supplies is shown in Table 2. The experience in the low-volume setting

of the Ames Health Unit is very similar to that of the Kaiser-Permanente high-volume multiphasic laboratory. Health testing is a labor-intensive activity whose costs are primarily related to salaries and wages. Although the initial investment in capital equipment is often a limiting factor in the development of a multiphasic laboratory, the unit cost for depreciation of capitalized equipment is comparatively small.

Indirect costs were determined for the Ames Health Unit which allow further comparison with published Kaiser-Permanente data shown in Table 3. These include multiphasic health testing space requirements. The Ames Health Unit operates in a 700-square-foot facility whereas the Kaiser-Permanente multiphasic laboratory contains 7,000 square feet. The Kaiser-Permanente costs were computed for the period from September 1, 1967, through August 31, 1968. The Ames Health Unit costs were computed for the period from June 30, 1973, through July 1, 1974.

Not all portions of the two multiphasic health testing programs are comparable. For instance, the stress electrocardiography performed at the Ames Health Unit accounts for much of the difference in total unit costs between the two projects. Table 4 presents a comparison between those portions of the high-volume and low-volume testing programs that are clearly similar. To effect the comparison, we have eliminated the stress electrocardiography from the Ames Health Unit data

and the mammography, minifilm chest X-ray, Snellen visual acuity, retinal photography, ankle reflex tests, and health questionnaire from the Kaiser-Permanente data. The tine test and tetanus immunization are considered sufficiently identical in labor and equipment to be included in this comparison. The total unit costs of comparable portions of the two multiphasic settings are then \$21.09 in the Ames Health Unit low-volume program and \$17.96 in the Kaiser-Permanente high-volume setting.

Cost Analysis per Positive Test

Table 5 compares the characteristics of the patient population of the Kaiser-Permanente program and the Ames Health Unit. The Ames group reflects a male preponderance typical of occupational settings with an average age of 45. The Kaiser-Permanente group is more typical of the sex distribution of voluntary participants in a health testing program that is not related to the work environment. The similarity of average ages between the two groups allows the following comparisons. The group sizes reflect the number of participants in annual health testing programs. The Ames Health Unit group represents 860 complete examinations, the Kaiser-Permanente group, 44,663 evaluations.

Criteria for Positive (Abnormal) Findings

Electrocardiography

Clinically important abnormalities were reported, including atrial flutter or fibrillation, atrioventricular block of first, second, or third degree, ST-T variations, left or right intraventricular conduction delay, left or right ventricular hypertrophy, atrial abnormality, short PR interval, Wolff-Parkinson-White syndrome, probably recent or old myocardial infarct, and prolonged QT or QTA segment. Not classified as "positive" were examinations with reports of "borderline" or "nonspecific changes," sinus tachycardia or bradycardia and supraventricular premature beats.

Stress electrocardiography

Stress electrocardiography was considered abnormal if clear-cut ischemic changes were demonstrated, if ventricular, nodal, or supra-nodal premature contractions developed during exercise--whether or not they were present at rest--and increase in frequency during the exercise period or rest period thereafter. Sinus arrhythmias were not included except in those cases identified by the cardiologist as abnormal. A mixed group of marginally positive ST-T changes that could not be regarded as normal but did not fully fit the definition of a positive test were excluded.

Blood pressure

Examinations were considered positive with systolic blood pressure of 160 mm of mercury or higher or diastolic blood pressure of 90 or higher, or both.

Height and weight

Diagnosis of overweight-obesity was done by the examining physician.

Chest
roetgenography

Clinically important abnormalities were reported, including suspicious density or lung lesion, lung fibrosis, hyperlucent lung, mediastinal abnormality, hilar enlargement, hiatus hernia, dilated thoracic aorta, prominent left cardiac contour, cardiac enlargement, other cardiovascular abnormality or bone lesion. Not included were the following conditions, lung calcifications, fibronodular or fibrocalcific lesion, pleural thickening or adhesions, blunted costophrenic angle, rib anomaly, scoliosis, previous chest surgery, mastectomy, and calcific or tortuous aorta.

Visual acuity

Visual acuity of 20/40 or less and any significant change since the prior examination were used to determine positive findings.

Tonometry

Ocular tension was considered elevated if 25 mm of mercury or more was measured.

Respirometry

Positive evidence of obstructive lung disease was determined if one-second forced expiratory volume was 70 percent or less of vital capacity.

Audiometry

A clinically important hearing loss was defined as one in which there was a hearing deficit of 60 decibels or more at the frequencies of 1000, 2000, or 3000 cycles per second.

Tine test

Positive tests were recorded as induration greater than 6 mm in diameter.

Blood panels

Laboratory tests were reported as positive when not within the ranges of normal for the Ames Health Unit and Kaiser-Permanente AMHT laboratories.

Urinalysis

Any 1+ to 4+ reading of enzyme paper for glucose, protein, etc., was considered positive. The Kaiser-Permanente program collected mid-stream "clean catch" urine specimens. The development of a pink color in six hours of incubation with triphenyltetrazolium was classified as a positive test, corresponding to a 100,000 or more bacilli per cubic millimeter by colony count. The Ames Health Unit laboratory examined urinary sediment which the physician interpreted as normal or evidencing infection or other pathology.

Physical examination

The physician recorded findings of the history and physical examination as positive when they might reasonably require treatment or the patient's well being would be improved by treatment. For example, positive findings included skin

lesions which demonstrated crusting or ease of bleeding. An asymptomatic solitary lipoma would not be recorded as a positive finding. Other positive findings included otitis, hernia, neuropathies, organomegaly, poorly controlled diabetes mellitus, congestive heart failure and emphysema.

The yield of positive findings is summarized in Table 6 for the Ames Health Unit. The unit cost of each test, as a function of the yield of positive findings, then yields a cost per positive finding, which is a method of cost-effectiveness analysis commonly used by the Kaiser-Permanente AMHT in former studies.⁹ Included in this analysis is the cost per positive finding for the physical examination. The cost of each physical examination in terms of equipment, supplies, and labor is \$14.25. The yield of positive findings in 25.3 percent of patients produces a cost of \$56.32 per positive case.

Table 7 reorders these various tests in order of increasing cost per positive finding. This measure of cost-effectiveness demonstrates that blood pressure, by virtue of its low cost in terms of equipment and labor, and relatively high yield of positive findings, is the most cost-effective of the multiphasic tests at the Ames Health Unit. Because of its high yield of positive findings, the stress electrocardiogram, despite its greater costs in equipment and labor, produces a lower cost per positive finding than

the resting electrocardiogram. The chest X-ray, because of its high costs and low yield of positive findings, is not cost-effective. The physician is credited only with yield of positive cases, despite the fact that many cases have multiple findings. The cost per positive case with a physical examination is \$56.32.

The comparison of yields of positive findings between the Ames Health Unit and the Kaiser-Permanente groups is shown in Table 8. These data represent tests of a comparable nature. Some variation in electrocardiography interpretation is apparent. The Kaiser-Permanente urinalysis includes urine culture which is not done at the Ames Health Unit. The remaining tests had comparable criteria for determining positive findings in both testing programs.

Table 9 presents the costs per positive finding for those tests shown in Table 4 to be comparable in equipment and delivery. Since tetanus toxoid yields no positive findings, it cannot be compared to the fine test. Unlike the case of unit costs, total cost per positive finding is lower in the Ames Health Unit group, with a total of \$181.60 compared with the Kaiser-Permanente group figure of \$218.86. This difference is primarily accounted for by an unexplained low yield of positive elevations of ocular tension in the Kaiser-Permanente group.

Comment

Multiphasic health testing is a vehicle for case-finding that deserves a place in the small group practice medical setting. The Ames Health Unit serves as an example of a typical low-volume medical practice with a patient flow of 30 complete physical examinations per week. The total unit cost of the multiphasic screening panel and physician's examination is compatible with the payment capabilities of many patients, employees, and insurance plans. The assumption that cost-effective complete examinations can only be achieved in high-volume testing centers, such as the Kaiser-Permanente Automated Multiphasic Health Testing laboratories, is unfounded.

Multiphasic health testing is a labor-intensive activity whose majority costs are related to salaries and wages in both the high-volume and low-volume setting. The demand for health testing personnel in the low-volume setting is an economy of scale compared with the high-volume setting. Two medical technicians and a supervising physician provide the necessary staff for the Ames Health Unit program. The Kaiser-Permanente AMHT laboratory staff is more than ten times as large.

A further economy of scale in indirect costs is related to the utilization of 700 square feet for multiphasic health testing at the Ames Health Unit and more than 7,000 square feet at the Kaiser-Permanente AMHT laboratory.

Equipment depreciation, even with a patient volume of only 30 examinations

per week, represents a small cost compared with salaries and wages. It represents a lower cost than disposable supplies in both the high-volume and low-volume settings. Hence, the labor-savings in low-volume testing are sufficiently advantageous to yield comparable unit costs for multiphasic health testing.

An additional advantage of health testing in the low-volume setting is the relative ease with which complex studies can be added to the program. Stress electrocardiography requires a significant capital outlay for equipment and entails continuous physician monitoring. The peak patient flow for such an examination with one treadmill and one three-channel electrocardiography machine would be about 12 patients per day. This type of limited program would be uneconomic to introduce into a health testing setting such as the Kaiser-Permanente AMHT laboratories which screen 100 patients per day. Stress electrocardiography is added to a low-volume testing program, such as the Ames Health Unit, with minor changes in personnel and space allocation.

A further cost advantage of the low-volume multiphasic program is that sophisticated data processing is not required. Traditional methods of dictation, transcription, and filing common to most medical practices are sufficient to support the requirements of multiphasic health testing. Automated devices are available to simplify various portions of the multiphasic health testing panel, including branch-chain patient history devices and the Rudmose audiometer. Freedom from the requirement to automate

the entire system is a marked advantage to the low-volume setting whose staff should be hesitant to become committed to the development costs of a "software" program.

Those items in Table 4 that show a higher comparable unit cost for specific tests in the Ames Health Unit include electrocardiography, audiometry, and clinical laboratory. The Kaiser-Permanente program uses a specially designed system that records only six leads of the traditional electrocardiogram. The Ames Health Unit program produces a complete 12-lead electrocardiogram. Because of requirements imposed by the Occupational Safety and Health Administration, an audiologist's interpretation of audiograms is a necessary feature of the Ames Health Unit program. The cost related to this interpretation accounts for much of the difference between the two programs. The low-volume setting must rely on contract laboratory services for results of blood tests and urinalysis, and costs related to transportation, reporting, and contract laboratory profit would partially explain the difference noted between the two programs.

The cost figures for the Kaiser-Permanente AMHT program are for the period from September 1, 1967, through August 31, 1968. Since the Kaiser program has not published increased cost figures to nonsubscribers since that time, it is assumed that increased efficiency has equalled increased labor costs. The cost figures for the Ames Health Unit program are for the period from June 30, 1973, through July 1, 1974. Inflationary pressures are now adding an estimated 10 percent increase in program costs for the contract year 1974-75.

The incidence of positive findings in multiphasic health testing and physical examinations at the Ames Health Unit is similar to that found in the high-volume setting. From Tables 6 and 7 it can be seen that an expensive test, such as stress electrocardiography, can be more cost-effective than the traditional resting electrocardiogram when the cost is studied as a function of the yield of abnormal findings. Thus, in the low-volume setting, stress electrocardiography can be utilized as a screening vehicle despite the common practice of identifying this test solely as a diagnostic procedure.

Resting electrocardiography and chest X-ray are not cost-effective as screening tests. At the Ames Health Unit, they are now considered as alternatives in the annual health examination program and are performed at the discretion of the examining physician. This approach allows significant savings in the health program without altering its case-finding effectiveness.

The physical examination, with its expensive labor commitment, is relatively cost-effective on a case-finding basis. Since many abnormal cases have two or more findings per patient, the physician's cost effectiveness is even greater than is shown in Table 7.

In all cases the Ames Health Unit staff followed the Kaiser-Permanente protocol for positive (abnormal) findings. The higher yield of abnormal resting electrocardiogram and lower yield of positive tonometric findings in the Kaiser group are unexplained.

These variations make it difficult to compare the costs per positive findings in the two groups. However, it is clear from these data that the similar unit costs of health testing, and similar yields of positive findings, produce comparable cost-effectiveness in both low-volume and high-volume multiphasic health testing programs.

The data strongly suggest that occupational and private medical settings should consider the cost-effectiveness of low-volume multiphasic health testing. The traditional view that large numbers of examinations on a daily basis are required to produce reasonable costs is not supported by the experience of the Ames Health Unit.

Summary

Cost analysis of a low-volume multiphasic health testing program (30 patients/week) has demonstrated that unit costs are similar to those reported by high-volume automated programs (500 patients/week). This comparability in unit costs appears to result from the savings in personnel and space requirements of the smaller program as compared with the larger ones.

Cost effectiveness studies (costs per positive findings) of comparable test groups have yielded similar results. This fact leads the authors to suggest that physicians should consider establishing multiphasic health testing programs in occupational and small group medical settings.

References

1. Collins GH Jr, Dupong WG, Fitzpatrick MM, Frederik WS, Levy BF, Scott MR, Stratton KL, Walsh JM, Wood LW and Zaves NA: Multiphasic health screening in industry, *J Occup Med* 14:435-496, 1972.
2. Yedidia A, Bunow MA and Muldavin M: Mobile multiphasic screening in an industrial setting, *J Occup Med* 11:602-663, 1969.
3. Grimaldi JV: Evaluative periodic physicals, *J Occup Med* 7:365-374, 1965.
4. Burr HB: Westinghouse management health examinations - their investment value, *J Occup Med* 2:80-90, 1960.
5. Franco SC, Gere AJ and Murphy GT: Periodic health examinations, *J Occup Med* 3:13, 1961.
6. Chadwick JH, De Lang JJ, Greyson M: Cost and Operations Analysis of Automated Multiphasic Health Testing, Interim Report RM 8063-2, December, 1969, and Automated Multiphasic Health Testing (AMHT) Cost Finding System Handbook, Stanford Research Institute, Menlo Park, California, July, 1970, p.1.
7. Collen MF: Periodic health examinations using an automated multitest laboratory, *JAMA* 195:830-833, 1966.
8. Collen MF, Kidd PH, Feldman R and Cutler JL: Cost analysis of a multiphasic screening program, *New Engl J Med* 280:1043-1045, 1969.

9. Collen MF, Feldman R, SiegelauB AB and Crawford D: Dollar cost per positive test for automated multiphasic screening. *New Engl J Med* 283:459-463, 1970.
10. LaDou J: Multiphasic health testing in the clinic setting, *Calif Med* 115:34-37, 1971.

Table 1. -- Costs of Multiphasic Test Battery
Ames Health Unit (30 patients/week)

	Equipment Depreciation per Test	Supplies per Test	Salaries and Wages per Test	Total
Electrocardiography	\$.11	\$.20	\$ 4.40	\$ 4.71
Stress Electrocardiography	1.20	2.25	15.59	19.04
Blood Pressure	.02	-	.12	.14
Height and Weight	.01	-	.16	.17
Chest X-Ray	2.25	2.27	2.90	7.42
Visual Acuity	.07	.02	.64	.73
Tonometry	.02	.04	.40	.46
Spirometry	.06	.10	.16	.32
Audiometry	.32	.05	1.06	1.43
Tine Test	-	.25	.22	.47
Blood Panels	-	-	-	* 7.86
Urinalysis	.02	.13	.16	<u>.31</u>
				43.06
Physician's History and Physical Examination	.20	1.05	13.00	<u>14.25</u>
				\$57.31

* Contract laboratory fee plus handling cost

Table 2. -- Cost allocation (Percent) of Multiphasic Test Battery

	Equipment Depreciation	Salaries and Wages	Supplies
Ames Health Unit (30 patients/week)	11%	74%	15%
Kaiser-Permanente (500 patients/week)	9	70	21

Table 3. -- Total Unit Costs of Multiphasic Test Battery

	Ames Health Unit (30 patients/week)	Kaiser-Permanente (500 patients/week)
Reception, Supervision, etc.	\$ 2.92	\$ 2.89
Electrocardiography	4.71	1.02
Stress Electrocardiography	19.04	-
Blood Pressure	.14	.42
Anthropometry	.17	.46
Chest X-Ray	7.42	.46
Mammography	-	1.34
Visual Acuity	.73	.29
Tonometry	.46	.55
Retinal Photography	-	.66
Ankle Reflex Tests	-	.24
Spirometry	.32	.31
Audiometry	1.43	.25
Immunization	.47	.53
Questionnaire	-	.37
Clinical Laboratory	8.17	4.49
Computer Center & Data Processing	1.20	4.50 ⁽¹⁾
Central Staff	<u>1.10</u>	<u>2.54⁽¹⁾</u>
TOTAL	\$ 48.28	\$ 21.32

(1) Cost includes \$3.25 per patient for pure research and evaluation.

Table 4. -- Comparable Total Unit Costs of
Multiphasic Test Battery

	Ames Health Unit (30 patients/week)	Kaiser-Permanente (500 patients/week)
Reception, Supervision, etc.	\$ 2.92	\$ 2.89
Electrocardiography	4.71	1.02
Blood Pressure	.14	.42
Anthropometry	.17	.46
Tonometry	.46	.55
Spirometry	.32	.31
Audiometry	1.43	.25
Immunization	.47	.53
Clinical Laboratory	8.17	4.49
Computer Center and Data Processing	1.20	4.50
Central Staff	<u>1.10</u>	<u>2.54</u>
TOTAL	\$ 21.09	\$ 17.96

Table 5. -- Characteristics of Test Groups

	Mean Age	% Male
Ames Health Unit N = 860	45.0	80.0
Kaiser-Permanente N = 44,663	44.9	44.2

Table 6. -- Yield and Cost of Positive Finding
(Ames Health Unit)

	Percent Positive	Unit Cost	Cost/Positive Case
Electrocardiography	4.1 %	\$ 4.71	\$ 114.88
Stress Electrocardiography	34.0	19.04	56.00
Blood Pressure	13.1	.14	1.07
Height and Weight	14.3	.17	1.19
Chest X-Ray	4.1	7.42	180.98
Visual Acuity	6.7	.73	10.90
Tonometry	2.9	.46	15.86
Spirometry	2.3	.32	13.91
Audiometry	17.2	1.43	8.31
Tine Test	1.5	.47	31.33
Blood Panels	33.4	7.86	23.53
Urinalysis	4.4	.31	7.05
Physician's History and Physical Examination	25.3	14.25	56.32

Table 7. -- Multiphasic Test Battery by Cost-effectiveness --
 Cost per Positive Finding

Blood Pressure	\$ 1.07
Height and Weight	1.19
Urinalysis	7.05
Audiometry	8.31
Visual Acuity	10.90
Spirometry	13.90
Tonometry	15.86
Blood Panels	23.53
Tine Test	31.33
Stress Electrocardiography	56.00
Physician's History and Physical Examination	56.32
Electrocardiography	114.88
Chest X-Ray	180.98

Table 8. - Yield of Positive Findings

	Ames-Health Unit (30 patients/week)	Kaiser-Permanente (500 patients/week)
Electrocardiography	4.1	17.3
Blood Pressure	13.1	15.8
Chest X-Ray	4.1	7.4
Visual Acuity	6.7	15.8
Tonometry	2.9	0.3
Spirometry	2.3	2.2
Audiometry	17.2	16.2
Blood Panels	33.4	39.4
Urinalysis	4.4	14.6

Table 9. -- Comparable Costs per Positive Finding

	Ames Health Unit (30 patients/week)	Kaiser-Permanente (500 patients/week)
Electrocardiography	\$ 114.88	\$ 5.90
Blood Pressure	1.07	2.66
Tonometry	15.86	183.00
Spirometry	10.90	14.10
Audiometry	8.31	1.55
Blood Panels	23.53	9.18
Urinalysis	<u>7.05</u>	<u>2.47</u>
TOTALS	\$ 181.60	\$ 218.86

REPRODUCIBILITY OF THE
ORIGINAL PAGE IS POOR

DB

N77-30728

EVALUATION OF CLASS II BIOLOGICAL CABINETS

Presented by

Richard I. Chamberlin
Industrial Hygiene Engineer
Massachusetts Institute of Technology
Cambridge, Massachusetts

Williamsburg, Virginia
March 20, 1975

224
n
PRICE ~~UNDETERMINED~~ BLANK

Evaluation of Class II Biological Cabinets

Our first real interest in Class II biohazard cabinets came in early 1973, when we were asked to review available units for use in the new Cancer Research Center being planned for M.I.T. Since there was a commitment to have at least one section of the Center operational within one year, our recommendation for the cabinetry had to be developed quickly to insure that it could be engineered into the overall plans for the facility.

A Class II biohazard cabinet can be defined as a ventilated cabinet for personnel and product protection, having an open front in the cabinet with inward flow for personnel protection and HEPA filtered mass recirculated airflow for product protection. The opening in the front of the cabinet is about 8" high when cabinet is in use. The units have self contained fan systems which draw the air in through the front opening, recirculate air to the work chamber and also exhaust a portion of the air through additional HEPA filters. The quantity of air exhausted is usually adjusted to maintain an average face velocity of 80 fpm through the open front. In many cases the exhaust air is recirculated to the work room atmosphere. For our building, however, no recirculation to the room was to be allowed and all units would exhaust to the outside atmosphere. All subsequent testing was also done under this exhaust mode.

Basic investigations, consisting primarily of airflow measurements and visual smoke tests, were made on four commercially available units. The results indicated that performance varied considerably between units, it could be easily interfered with, and all had features which should be improved upon. It was decided therefore to outline the performance desired and to include in the overall equipment specifications a set of performance tests. It was

intended that this would shift the responsibility for producing an acceptable cabinet to the manufacturer. The tests were similar to those we had developed earlier for checking aerodynamic performance of laboratory hoods, and involved an uranine aerosol as the test media. Although several companies initiated testing with the intention of bidding the job, only one completed their studies and submitted a model for our final tests. A copy of the requirements can be obtained from the writer. Of prime importance was the proof that under conditions specified, the losses to the room were less than 0.00002% of the concentration in the work area, and the unit was selected for installation.

A few of the manufacturers raised the question as to the need for the testing procedures we had proposed, since they had previously tested their equipment using various biological agents. In our opinion the biological testing procedures referred to, leave much to be desired, particularly from the standpoint of the air sampling techniques used and the time required to obtain answers. For example, assuming that generation of known concentrations in the appropriate aerosol size is accomplished and that the AGI and slit type samplers, or even open petri dishes as proposed in some tests, are strategically placed the subsequent handling and incubation time make these tests cumbersome and results questionable.

It is interesting to note the National Sanitation Foundation, under industry sponsorship, is developing a standard for Class II cabinets and in their draft of the standard a biological test is proposed. There is opposition on the review committee, however, and the question as to whether a true leakage value will be attained is being asked. We have not proposed substitution of our uranine test, for although it has the desired sensitivity and can be

completed in a short time, it also has the disadvantage of being a particulate type aerosol. It is our firm opinion that the best test media would be a true gas and our recent efforts have been directed to that end.

We are presently using sulfur hexafluoride with excellent results. It is non-toxic, extremely stable, readily available in a pure state, is not a natural background contaminant and can be easily detected. We have adapted a small portable gas chromatograph, with a column, that is specific, sensitive, and produces rapid results.

During this time period, late 1973, early 1974, use of energy saving devices also became very fashionable and the use of Class II bio-cabinets, as a substitute for regular laboratory hoods was suggested as a means to save energy. The total air quantity exhausted for bio-cabinets being much less due to the restricted sash opening, made the proposal of great interest to those responsible for operating costs. Of particular interest was the combination type biocabinet developed by the National Cancer Institute and which was manufactured and sold by several companies.

The Environmental Services Branch of the National Institutes of Health also expressed interest in evaluating the containment provided by this NCI clean air safety cabinet with respect to chemical usage. The evaluation to be based on aerodynamic performance under the various modes of operation. A small study was undertaken with the intention of applying our gas testing technique.

A cabinet, as manufactured by one of the major companies in the field, was shipped to us early in April, 1974. The company had pre-tested the unit prior to shipping, using the tests specified by NCI, and their personnel set-up

the unit in our test room. The exhaust outlet was then connected to the ventilating system. This system contains a calibrated orifice with a manometer readout for the airflow range desired for the tests planned. However, the calibration curve was rechecked at five (5) different airflows, using 20 point pitot traverses and this was done with the cabinet in place. Exhaust calibration check was satisfactory.

The recirculating fans within the cabinet were then set to provide an average downward velocity, across the cabinet interior of approximately 50 fpm. This was accomplished using a properly calibrated Alnor Thermo-Anemometer and taking a total of 96 readings in a plane two inches below the foam pad. The actual average velocity attained was 53 fpm and the high-low readings were 57 and 48 fpm respectively.

Initial testing was then instituted, with exhaust volume set to provide an average face velocity of 100 fpm and recirculating fans set as indicated (50 fpm downward velocity). The test gas, sulfur hexafluoride, was then introduced into the recirculating air-flow by means of a distribution tube placed in the trough at the forward edge of the cabinet. The gas was introduced at a flowrate of one liter per minute. Air samples were then taken using the portable gas chromatograph equipped with a special column and an electron capture detector. The unit had been calibrated and can easily detect SF6 in concentrations of 0.5 PPB. These air samples, taken within minutes, showed SF6 in the Test Room air and definite leakage along the upper airfoil particularly at the corners. At this point, gas tests were discontinued.

A special manifold was then adapted to the lower cabinet so that smoke could be introduced beyond the absolute filters and into the inlet plenum for each of the recirculating fans. Smoke introduced in this manner could be seen leaking from the cabinet in the area near the upper corners of the air foil. This smoke test was repeated several times, and leakage was obvious each time. It was felt that this not only confirmed the initial gas test but indicated that these leaks were due to construction flaws.

Arrangements were made to demonstrate the problems encountered. Representatives of NIH, NCI, and the manufacturer attended a meeting and smoke tests were repeated to visually demonstrate losses. The unit was then partially dismantled by the manufacturer's engineers and all agreed that several seams, particularly in the pressurized return plenum, needed additional sealing. Although welding or permanent sealing could not be accomplished readily, the representatives agreed to properly seal the unit so further tests could be conducted. The sealing was completed within a few days and several smoke tests revealed no visual losses from these sources, so the unit was re-assembled.

The recirculating air was rechecked for 50 fpm downward velocity and the exhaust air volume set so as to provide an average face velocity of 100 fpm through the sash opening when the sash was fully lowered to the stops which set it for the 8" position. Smoke was then introduced beyond the filters for the recirculating air. No visual losses occurred, but considerable smoke was drawn towards the front of the cabinet and down through the slot at the forward edge of the work surface.

The recirculating air was shut off and the smoke introduced directly into the work area of the cabinet while being exhausted as above. The smoke patterns were uniform, essentially horizontal to the rear with minimal turbulence and the cabinet quickly cleared.

The planned series of tests were then undertaken, and in all of these a mannequin was set-up in front of the unit with both arms projecting into the cabinet to assimilate actual working conditions.

SERIES NO. 1 ---- URANINE DYE TEST, using aerosol dispersing unit located so that the discharge was downward and the forward edge of discharge opening was 6 inches in from the plane of the sash opening and at the same level as the bottom edge of sash, when sash was fully lowered to sash stops and located midway between the cabinet sides.

This test was used initially since a similar test had been included as part of a performance specification for cabinets evaluated recently. The exhaust volume required for that test provided an average velocity of 80 fpm through the face opening while 100 fpm was provided initially for this cabinet test. Tests were conducted with exhaust only (80 fpm), same exhaust flow but with recirculation "on" (50 fpm average downward velocity), exhaust volume equal to 50 fpm average face velocity with same recirculation as noted and at exhaust to provide 140 fpm average face velocity with same recirculation as noted. Results of these tests are included in Table 1 below.

TABLE 1

<u>Test No.</u>	<u>Time of Test Mins.</u>	<u>Conditions of Test</u>	<u>Result in percent of Cabinet Concentration of Uranine detected</u>
1	60	100% exh.--80 fpm face Velocity and No Recirculation	None detected--at Operator's Breathing Zone-- $\angle 0.00002\%$ None detected at Operator's Chest Level None Detected-- $\angle 0.00002\%$ At Right Corner None Detected $\angle 0.00002\%$
2	75	Same as Test No. 1	None detected at same locations $\angle 0.00002\%$
3	75	Exhaust Volume equal to 80 fpm face velocity & recirculation on (50 fpm downward velocity)	0.0011% at BZ--Operator 0.0008% at Lower Rt. Corner
4	90	Same as No. 3	0.0012% at BZ--Operator 0.0008% at Lower Rt. Corner
5	75	Exhaust Volume Equal to 50 fpm face velocity & recirculation on (50 fpm)	0.006% at BZ of Operator 0.001% at Lower Rt. Corner
6	80	Exhaust Volume equal to 140 fpm face Velocity & Recirculation on 50 fpm	0.001% at BZ of Operator 0.0007% at Lower Rt. Corner

SERIES NO. 2 --- URANINE DYE introduced at Lower Cabinet -- into inlet plenums for recirculating fans. (Same as smoke tests discussed in introduction.) These tests were conducted with exhaust volume set to provide 100 fpm average velocity through sash opening with sash fully lowered to sash stops and with recirculating fan on. Results in Table 2.

TABLE 2

<u>Test No.</u>	<u>Time</u>	<u>Conditions of Test</u>	<u>Results in % Loss</u>
7	85 min.	100 fpm exhaust Recirculation ON (50 fpm)	0.0035% at Front of Operator 0.002% BZ Operator
8	80 min.	Same as #7	0.0033% at Front of Operator 0.0017% BZ of Operator

SERIES NO. 3 --- URANINE DYE was introduced into work area of Cabinet. Diffuser pipe was a 1 inch copper pipe, 50 inches long, with a series of 1/16 inch holes on 1/2 inch centers along the entire length. The pipe was located in the upper front of the cabinet work area, two inches down from the foam pad and 4 inches in from the plane of the sash opening. Tests conducted under various conditions and results are shown in Table #3 below. The sash was fully lowered to sash stops.

TABLE 3

<u>Test #</u>	<u>Time (MINS)</u>	<u>Conditions of Test</u>	<u>Results % Loss</u>
9	83	100 fpm average face velocity-No Recirculation	∠0.00002 at front of Operator ∠0.00002 at BZ of Operator
10	73	100 fpm average face Recirculation ON	0.00014% at front of operator 0.00011% at BZ of operator

SERIES NO. 4--- USE OF SF6 GAS as test media. Gas introduced through diffuser pipe noted in Series #3. The sash was fully lowered to sash stops.

TABLE 4

<u>Test No.</u>	<u>Condition of Test</u>	<u>Result in % of Hood Concentration At Position Noted</u>
11	SF6 dispersed through pipe 100 fpm average face velocity No Recirculation	None detected (ND) Front of Operator N.D. at Corners N.D. at Lower arm of Operator N.D. in General Room Air after 60 min. run. Therefore all losses, based on hood concentrations, were less than 0.00002%

12	Same as #11 but with air recirculator ON at 50 fpm down flow	Front of Operator 0.00012% Lower Arm of Operator 0.02% General Room after 72 minute run 0.0004%
13	50 fpm face velocity 50 fpm recirculation velocity	Front of Operator 0.005% Lower Arm of Operator 0.008% General Room after 60 minute run 0.00035%

GENERAL DISCUSSION:---

All tests were conducted without external interference and with the mannequin in the sitting position as noted. The SF6 samples were of course spot samples but satisfactory agreement was obtained between long term continuous sampling (uranine tests) and spot samples for SF6 over comparable time intervals.

Smoke tests conducted illustrated that the recirculating air is drawn towards the front of cabinet, and it would be subject to loss by outside interference.

It was also noted that the perforated plate over the front trough has sufficient resistance to air flow, that when removed the recirculating air flow increases significantly.

There are many parts of this unit that should not be exposed to corrosive or highly flammable gases or vapor.

There is a need for a manometer or other device to indicate condition of filters in recirculating system.

It should be noted that additional tests should be conducted with sash fully opened and at varying recirculation rates. It was also noted that stops prevented the sash from being closed, and the advantage of being able to close the sash should be considered.

CONCLUSIONS: ----

1. This cabinet, if used in the total exhaust no recirculation mode, could be used with toxic chemicals.
2. The use of the cabinet in the recirculation mode should be limited to relatively non-toxic particulates.
3. Use of highly corrosive liquids should be prohibited if any spill potential exists.

D14

N77-30729

DISABILITY RETIREMENT

Raymond L. Eck, M.D.
Acting Assistant Director for Health
U.S. Civil Service Commission
Washington, D.C. 20415

DISABILITY RETIREMENT

Raymond L. Eck, M.D.
Acting Assistant Director for Health
U.S. Civil Service Commission

Eligibility for disability retirement is attained when the employee has five or more years of creditable service under the retirement law and becomes totally disabled for useful and efficient service in the grade and class of the position occupied not due to intemperance, vicious habits, or willful misconduct within the last five years.

The same basic medical principles apply to the evaluation of claims for disability retirement as apply to determining medical suitability for initial employment. General guidelines and a few standards can be given, but the basic problem is evaluating the employee's ability to perform useful and efficient service without hazard to others and with no undue hazard to the employee himself. In addition to the medical factors covering eligibility for disability retirement, there are certain legal and administrative factors also involved.

Beginning July 1, 1968, there was a change in the procedures for agency-filed claims for disability retirement and there is pending a clarification of the regulations pertaining to periodic and fitness-for-duty examinations. These procedural changes will be of primary interest to administrators and personnel officials, but a brief resume of them may be helpful to medical officers.

The agency may require three types of medical examinations:

- (1) Preemployment or preplacement examinations are primarily performed for the placement in arduous or hazardous

positions. The medical requirements for such positions should be the minimal necessary for adequate performance of the duties of the position without hazard to the employee or others.

Such examinations may also be performed when a question arises as to the physical and mental status of an individual applying for a sedentary position. These are usually the results of answers to questions on the history Form 177 or the interview by the appointing officer.

- (2) Periodic (i.e., annual) examinations are those performed on a regular recurrent basis for employees who are required to meet certain physical standards for continued employment, such as fire fighters and motor vehicle operators. Due to environmental hazards, periodic examinations are required for some positions. As an example, examinations of employees working in high noise areas.

The fact that periodic examinations are to be performed should be stated in the specifications of the positions so that they are a requirement of employment and not misconstrued as a fitness-for-duty examination. Periodic examinations should not be required, however, unless it can be shown that they are necessary due to the hazards involved.

- (3) A fitness-for-duty examination is an agency ordered examination which is not a preemployment or a periodic examination. It is required when the performance of the employee is inadequate and there is no reason to believe that the deficiencies are due to a health problem, either physical or mental. In the order to the employee to report for an examination, he must be given the reason for the examination, informed of the type and scope of the examination, and told that if he objects to being examined by the agency medical officer, he may participate in the selection of an examiner not connected with the agency.

The examiner selected must be Board-certified in the appropriate specialty, acceptable to the agency, and must agree to make a full report of his examination to the agency. A psychiatric examination may not be ordered unless a review of performance and conduct by three agency officials results in a decision that a psychiatric examination is needed or is recommended by a physician who has examined the employee. If a psychiatric examination is required, an employee representative must be named to assist the employee.

All periodic and fitness-for-duty examinations are to be at the expenses of the agency.

The retirement law provides that the disability must have developed in the last position occupied by the employee.

- (1) Reduction-in-force action which would effect the transfer of the employee from a position for which he is medically qualified to a position which is beyond his physical capacity does not entitle the employee to disability retirement. If he was not disabled for the duties of the position which he left and he did not become disabled for the duties of the position to which he was transferred, disability retirement is not warranted.
- (2) Impairments which existed at the time of initial employment can not be used to support the application for disability retirement unless aggravation has occurred. The employee who, because of impairments, was required to perform only part of the duties of his position to begin with and later, due to changes in the work force is required to perform all of the duties of his position which he never could perform, does not entitle him to disability retirement.
- (3) An offer by the agency to transfer an employee who meets requirements for disability retirement to a position for which he is medically qualified but of a different grade and class does not negate the employee's right to disability retirement if he so elects. Transfers of this kind are to be encouraged, but they are not mandatory on the part of the agency nor the employee. If an employee has become disabled for the position which he occupies and is trans-

ferred to another position for which is is also disabled, he may exercise his right of retirement from the former position.

- (4) The closing of a facility, a transfer of functions to a new locality or reduction in force actions will frequently trigger a number of disability retirement applications. Many of these will be legitimate and will come from employees who have continued to work in spite of conditions which would normally be considered disabling. Others, however, are less legitimate and require very careful scrutiny.
- (5) The fact that a disabling impairment can be corrected by surgery (e.g., hernia) does not negate entitlement to disability retirement if otherwise eligible. We cannot require the employee to undergo surgery.
- (6) The retirement law does not specify that the impairment must be expected to last for a year or more to warrant disability retirement. However, as a general practice, we do not grant disability retirement for disabling impairments in which recovery can be reasonably expected within a year or less. It would be completely impractical to attempt to discuss in detail all of the disease entities and physical impairments for which disability retirement can be granted. We will discuss a few in rather general terms and repeat, again, that we can give only general

guidelines and that the determinations must be made by a careful clinical evaluation of the total man.

Before discussing in a very general manner some of the disabling impairments, we would like to discuss briefly what we need from you when you are examining an applicant for employment or examining an employee who is being considered for disability retirement.

If your report of examination is to be used in support of a medical disqualification for employment, the imposition of restrictions on what an employee may be permitted to do or to support an application for disability retirement, we need a detailed report of your clinical findings. Merely listing the degree of hypertension without giving associated clinical findings and symptoms is of very little help to us in evaluating the individual. Limitations imposed for arthritis without describing the affected joints and the limitation of motion give no evaluation of the degree of functional impairment.

Cardiovascular Disorders

Currently, nearly 30 percent of the claims for disability retirement are based on disorders of the cardiovascular system. Adequate medical evidence must be developed in all cases, and, particularly, in this area. Reliance on an isolated finding or development may be very misleading. A finding of hypertension, asymptomatic, and with no clinical evidence of pathology, even though the hypertension is severe, is rarely disabling.

Symptomatic hypertension with associated changes such as headaches, dizziness, retinal changes, or impaired kidney function may be disabling for even sedentary jobs.

Coronary Artery Disease

These cases must be assessed with regard to the degree of organic involvement, the physical and emotional demands of the job, and the employee's emotional reaction to the impairment. The finding through routine medical examination of abnormalities in the electrocardiogram of a person who is performing adequately and who has no history of a heart attack, is asymptomatic, and is not disabling.

Myocardial Infarction

This is always temporarily disabling. Permanent or long-term disability depends upon the degree of organic recovery, the demands of the position, and the emotional reaction of the person to the illness. An EKG which indicates no residual myocardial damage will usually permit the employee to return to his former position even though the duties are arduous.

Caution should be exercised in returning such an employee to a position requiring irregular peaks of high energy expenditure, or to a position in which a sudden incapacity would endanger others. In some persons, the occurrence of a myocardial infarction or acute coronary insufficiency is so

devastating emotionally that total disability for any employment ensues though the organic impairment is slight.

Valvular Lesions

These, per se, are of relatively little importance in disability retirement evaluations. The main problem in evaluation is to determine the remaining functional capacity.

Functional capacity for the job occupied may be unimpaired in a relatively severe valvular lesion that is fully compensated.

Peripheral Vascular Disorders

Varicose veins, even though large and sacculated, are rarely disabling unless there is evidence of circulatory stasis manifested by swelling, pigmentation, or ulceration. Symptomatic impairment of the peripheral arterial circulation will produce relatively early disability in those whose work requires considerable standing and walking.

Neuropsychiatric Disorders

Claims for disability retirement based on a psychiatric disorder are usually the most controversial and require the most complete medical documentation. In all claims filed by the agency against the employee's wishes, unless there is evidence that the employee has been legally committed to a mental institution, an examination by a psychiatrist, preferably one not employed by the agency, should be sought.

An overt psychiatric break is nearly always permanently disqualifying for a position in which the use of firearms is

required, or where the safety of others is a critical factor as with air traffic control specialists, or in positions involving major decisions based on stable judgment of the employee.

The classification of mental disability by a psychiatrist is not always uniform and may result from a different interpretation of the symptoms and may represent a variation in the symptomatology with the passage of time between the examinations. A clear detailed report of the clinical findings is much more important than the diagnostic label attached to these findings.

The adjudication of the claims for disability retirement based on a psychiatric disorder should be based on the following:

- (1) A current report of a psychiatric evaluation or a report from a hospital if the employee is presently hospitalized.
- (2) A supervisory report concerning on-the-job performance and behavior. This report should be detailed and factual. Nondisruptive eccentric behavior does not warrant allowance if the actual performance is satisfactory. Conversely, severely disruptive behavior may warrant allowance even though the specific tasks are performed well. A typist who might be able to type extremely well, but whose behavior was so disruptive that the production was markedly impaired would be considered disabled.

Alcoholism

An employee whose absence, tardiness, or unsatisfactory work performance, suspected to be due to alcoholism, should be referred by the employee's supervisor to the appropriate counseling service of the agency. Agencies should not separate or institute involuntary disability application of known or suspected alcoholism unless the employee has been adequately counseled and given the opportunity to overcome his alcoholism. These guidelines apply equally as well to known or suspected drug addiction of employees whose work performance is not up to the standards.

Only after adequate counseling has failed shall an agency separate an employee who has less than five years' service or institute an agency-filed disability claim for those having five years' service. Disability claims in which there is a long history of excessive use of alcohol present a special problem. The retirement law provides that disability retirement would not be given to an individual whose impairment is due to intemperance, vicious habits, or willful misconduct within the past five years. The intemperance has been legally interpreted to refer to alcoholism. We have taken the position that in these cases where degenerative changes have occurred such as polyneuritis, cirrhosis of the liver, or chronic brain syndrome, we cannot be positive that the use of alcohol was the sole etiologic agent. Thus, we adjudicate the claim not on the

basis of the possibility, or, even the probable etiology, but one the degree of disability which is caused by the deteriorative change. If the interference with performance is due not to deteriorative changes, but to the injudicious and excessive use of alcohol, we reject the claim only if there is a showing that there is no primary psychiatric disorder of which the drinking is a secondary symptom.

Orthopedic Disorders

As you are all well aware, we are not able to objectively measure pain. Most of the claims in the orthopedic field are based on the arthritic changes. While the evaluation of some of these claims requires a certain degree of clairvoyance, we must still secure a current complete orthopedic evaluation, including adequate X-ray studies and such laboratory procedures as are indicated. The orthopedist's report should describe fully any limitation of motion, muscle spasm or weakness, evidence of muscle atrophy, joint swelling, neurologic deficit, and, particularly, any apparent discrepancy between subjective complaints and objective findings.

Pes Planus

This disorder is usually congenital or a very early development. Thus, the basic disorder antedates employment; however, with advancing age, increase in weight and an increase in the associated pronation, the condition becomes aggravated and may become severely disabling.

Diabetes

Mild diabetes, controlled by diet and oral hypoglycemics is not disabling for any except the most demanding positions. Diabetes controlled by small amounts of insulin, about 25 units or less, is not disabling except for the most demanding positions requiring irregular and prolonged hours of work and extreme peaks of energy expenditure. These extreme peaks of energy expenditure are very apt to occur in firefighters. Nonhazardous arduous work is suitable for a relatively severe but reasonably controlled diabetic. By the term "reasonably well controlled" we do not refer to the optimum control that is considered desirable in treatment. We are speaking only of control which permits normal performance. A persistent or recurrent glycosuria or an elevated blood sugar may be entirely consistent with satisfactory on-the-job performance. Glucose tolerance studies are of importance in the initial diagnosis of some cases of diabetes. These studies are of little or no value in evaluating the severity of an already diagnosed diabetic. Unless the diabetic is hospitalized for exhaustive studies, the most reliable method of evaluating the severity of the case is by a comprehensive report from the physician who is treating the patient. The evaluation of the complications of diabetes should be made concerning their contributions to disability.

Malignancies

Nonmetastatic malignancies are seldom disabling unless the required treatment of the primary growth has been so radical that the residuals of the surgery are disabling. Metastatic involvement may be considered disabling in nearly all cases although there are some who are willing or able to work for considerable periods after the metastasis was discovered.

Pulmonary Disorders

Active pulmonary tuberculosis, even though minimal, warrants allowance of the claim even though some may become inactive and noninfective in less than a year of treatment.

Extensive pulmonary tuberculosis treated by surgery and chemotherapy may continue to be totally disabling after the arrest of the disease because of the inadequacy of the remaining functional pulmonary tissue. Pulmonary function studies may be needed to accurately assess the remaining functional capacity. Disability due to emphysema cannot be well evaluated without pulmonary functional studies.

Vision

The evaluation of claims based on visual impairment should be made after the best correction has been obtained. In most sedentary jobs, the acuity of distant vision is of really little importance. In motor vehicle operators, the primary need relates to distant vision. Loss of vision in one eye is usually considered disabling for a position which requires a good judgment of depth perception.

Hearing Impairment

There are several factors to consider in the evaluation of this problem. One is hearing actually required on the job. We have found that the deaf can work well in a number of positions, including some of the trades in which oral communications are not necessary. Post office distribution clerks, mail handlers, and card punch operators are positions which require little oral communication. Positions which require oral communication and the use of the telephone should be evaluated only after corrective efforts have been made through the use of a hearing aid. However, some people, even though the loss appears to be correctable by a hearing aid, are unable to tolerate one and are truly disabled. Another factor is the hazards involved in acoustic trauma. There are questions in this area which have not been fully resolved. Currently, we will allow a claim for disability retirement from an individual who is otherwise eligible, is working in an acoustically traumatizing environment, and has a demonstrable progressive hearing loss, even though the loss has not yet invaded the speech frequencies and does not actually interfere with performance. The allowance is based on the potential hazard to the remaining hearing of the individual. Conversely, we are reluctant to allow an agency claim in a similar situation if the employee understands the hazard and

(3) Sometimes, as a part of the symptoms of the illness, the employee may refuse to be examined. In such cases, after every effort to secure the employee's cooperation has failed, medical allowance of the claim may still be warranted if the aberrant or disruptive behavior and inadequate performance have been extremely well documented.

In the controversies which arise in these claims, the employee may attempt to refute the agency's claim by a report from a psychiatrist whom he has consulted. While these reports may, at times, be very helpful, the examining psychiatrist in such cases usually has no background information and may arrive at an erroneous conclusion.

This is particularly true with paranoids if the examiner has failed to invade the area of the paranoid delusions.

Convulsive Disorders

The development of a convulsive disorder or a disturbed state of consciousness, such as narcolepsy, is disabling for all hazardous duty positions. In these cases, an accurate detailed description of the seizure or the narcolepsy by supervisors or coworkers may be more revealing than an extensive neurological and psychiatric examination. These disorders, controlled to the point of permitting adequate performance, are not disabling for nonhazardous positions.

still desires to continue working. We recognize that such a practice may involve the agency in increased costs for occupationally-caused disabilities.

MEDICAL SUITABILITY FOR FEDERAL EMPLOYMENT

Raymond L. Eck, M.D.
Acting Assistant Director for Health
U.S. Civil Service Commission

In determining the employability of applicants for employment, we need first to apply sound medical judgment in evaluating what the applicant is able to do, what capacities are required for adequate performance in the position applied for, and to consider the basic policy of the Commission concerning medical qualifications for employment.

It is the policy of the Commission to require only the minimal physical and mental capacities which are necessary for safe and efficient performance of the specific job involved. An applicant may be well able to perform the duties of a specific position, but not able to perform all of the same class. A carpenter laying floors will not require the same physical abilities as one who works on ladders.

Impairments which currently do not preclude adequate and safe performance, but which may shorten the period of employability are not considered disqualifying. It is especially important that this principle be followed in evaluating applicants with asymptomatic hypertension or those who have made a good recovery from a myocardial infarction. To adequately evaluate an applicant's fitness for employment, the examiner needs information in addition to that which he gains from his examination. He needs:

- (1) An adequate job description, including a description of the work environment.

(2) A copy of the application, Standard Form 60 or Standard Form 171. This gives information as to his or her previous employment history.

(3) Medical History on Standard Form 177 (sedentary positions).

There has been several important changes in the determination of Medical Suitability for Federal Employment since January 1, 1974.

Question 29 on the Personnel Qualification Statement (Standard Form 171) is deleted. This question concerned the history of heart disease, epilepsy, diabetes, nervous and mental conditions, and tuberculosis. Until current stocks of the old form are deleted, applicants need not answer that question.

As of January 1, 1974, agencies were authorized to reject eligibles on medical grounds. Applications are no longer referred to Civil Service Commission Medical Officers for determination, prior to certification, of medical eligibility. Instead, the determination is made by the appointing officer, during the selection process, under the recommendation of the agency Medical Officer.

The only forms to be used are Standard Form 78 or Standard Form 177. In sedentary positions where a physical examination is not ordinarily required, an examination can be requested if there are questions raised due to material in the 177, or during the interview on which the appointing officer has doubts whether the applicant is capable of performing the duties without hazard to himself or others. The reasons for requesting such an examination must be recorded and attached to the applicant's file. If it is found that the applicant does not possess the necessary medical

qualifications, the appointing officer must notify the applicant in writing of the deficiencies found, the position description, and the reason for objecting. In the case of non-veterans, the notification must include the statement that he has only been considered ineligible for the current position.

In cases of veterans preference, the position must be kept open until the medical evidence is reviewed by a Civil Service Commission Medical Officer who can sustain the action, thus opening the position for another applicant.

If the Commission medical officer finds the veterans preference applicant eligible, the appointing officer is to appoint the applicant to the position held open pending review.

Waivers should be granted veteran preference when they do not meet the standards if it can be shown that they are capable of performing the duties of the position and without hazard to themselves or to others.

When the appointing officer returns the certification to the area office of the Civil Service Commission, the file must include a copy of the notice to the applicant on the position description, and the medical evidence which will be sealed and marked "Medical Confidential."

The certifying office will forward this to the Area Office of the Civil Service Commission. Commission medical officers will make the determination whether to remove the applicant's name from the list of eligibles or restrict eligibility in terms of positions requiring specific medical capacities.

An applicant receiving a notice of rejection can request a review from the appropriate Commission certifying office giving reasons for his opinion that the determination was incorrect. He can submit additional medical evidence with this request for review. The request for review, along with the applicant's file and new evidence (if submitted), is forwarded to the Civil Service Medical Officer who will make a determination of future eligibility in cases of veterans preference that he has or has not been made eligible for the position applied for.

In all of the blue collar jobs, this evaluation will be based on a medical examination with the findings reported on Standard Form 78. A medical examination is not required for those in the GS schedule who are to be appointed to a sedentary or light duty position in which there are no hazards involved. In sedentary positions, it is rare that an applicant is medically disqualified because of the results of a preemployment medical examination. In lieu of the medical examination, the applicant will be required to fill out a health questionnaire and a medical examination will be required only when a specific need is indicated by the responses to the questionnaire. It is our opinion that this method will be a satisfactory selection technique and will save a great deal of scarce medical manpower.

It will not be possible to discuss all impairments which may affect employability, nor will it be possible to discuss the specific medical requirements of all positions. I will discuss some of them and for others, the basic principles within the stated Commission policy should be applied.

Visual requirements for motor vehicle operator:

Binocular vision

20/40 one eye, 20/70 in other eye

Visual requirements for firefighter:

Binocular vision

20/30 one eye, 20/70 other eye

without glasses

This requirement permits the firefighter to continue to function even though his glasses become inoperative.

Hearing:

Most positions require only the ability to hear ordinary conversation with or without a hearing aid. Some positions are suitable for the deaf, i.e., distribution clerk in Post Offices, card punch operations, boilermakers, and some specific positions in the blue collar category, such as carpenters, electricians, masons, and other similar positions in which oral communication is not absolutely essential. Impaired hearing in the frequencies above 2000 is seldom disabling for any position.

This presents a special problem in applicants who are to be employed in areas of high noise levels. Acoustic trauma will produce a progressive hearing loss in the higher frequencies in some individuals. It is our opinion that an applicant with normal hearing in the speech frequencies should not be disqualified for employment in high noise areas. Even in those who already have a hearing loss in the high frequencies, it is difficult to predict accurately what will happen in the future.

Cardiovascular

Departures from normal in this field require a careful and complete evaluation of the total individual. A decision based on an isolated physical finding may frequently be misleading.

Valvular lesions are to be evaluated with reference to the degree of cardiac malfunction associated with the lesion. A man who is accustomed to arduous work may be able to continue at the same work level with a well compensated valvular lesion even though manifested by a marked murmur.

Asymptomatic uncomplicated hypertension, even though quite severe, is not to be considered disabling and does not warrant rejection for employment. We have established no maximum or minimum blood pressure readings which, per se, are disqualifying. Statistically, the hypertensive individual will not have as long a period of employability as the normotensive, but he should not be denied the opportunity for employment during the period in which he is able to perform satisfactorily.

If the medical officer recommends that a hypertensive applicant not be appointed, the recommendation should be supported by a complete clinical evaluation which would include a description of symptoms and abnormal findings, and include an EKG, a chest X-ray, and kidney function studies.

Coronary Artery Disease

Applicants with a history of coronary artery disease, including myocardial infarction, must be evaluated with regard to the residual functional impairment. Some with complete recovery are able to return to full employment in arduous duty positions. Some residual impairment which is mildly symptomatic is consistent with employment in administrative and light duty positions. The finding through routine medical examination of abnormalities in the EKG in a person who has been performing adequately, is asymptomatic, and who has no history of a heart attack is not disabling.

Diabetes

A diabetic with reasonable control through diet, oral hypoglycemics on insulin up to 25 units, are medically suitable for all except motor vehicle operators. A diabetic with reasonable control through diet, oral hypoglycemics on insulin up to 25 units are medically suitable for all except the most demanding and hazardous positions. Employees requiring more than 25 units are not suitable for hazardous duties, involving moving machinery or working on heights. Diabetics requiring the use of more than 25 units of insulin can be found suitable for motor vehicle operator if it can be shown there has been no reaction or coma during the past two years, have a current state drivers license, and a good driving and safety record.

Orthopedic Disabilities or Amputations

It is not possible to state accurately that an amputation is disqualifying for a certain job except where the limitation of function is obviously severe. The adjustment that some amputees make

to their impairment and the skill which they develop in using the prosthesis is phenomenal. Amputees should not be disqualified unless there is an actual showing that they cannot perform the duties of the position without hazard. Impairments of the back are probably the most difficult to evaluate concerning employability. Here, there needs to be, in addition to careful physical examination, a careful review of the employment history of the individual. If the individual has been able to satisfactorily perform arduous duties, in all probability, he can continue to do so. Routine X-ray evidence of arthritis can be of some value in the evaluation, but we will not support the rejection of an applicant where the rejection is based solely on X-ray findings in an individual who is asymptomatic. From the review of thousands of cases of disability retirement, it is concluded that there is little relationship between X-ray evidence of arthritis of the spine and the subjective symptomatology from the arthritis.

Pes Planus

Severe symptomatic degrees of Pes Planus are disabling for positions that require heavy work, walking, and standing. We should not confuse the symptomatic flat foot with the asymptomatic anatomical flatness. Those with asymptomatic anatomically flat feet may give a very positive response to the wet towel footprint test and yet have no callouses and no evidence of any interference with weight bearing.

Hernia

Hernia, even though small and reducible, is disqualifying for all arduous duty positions. It is not disqualifying for sedentary positions. The so-called "potential hernia" as indicated by an enlarged or relaxed ring is not disqualifying. To be disqualifying, an actual hernia must be present.

Pulmonary Disorders

Applicants who have indicated a history of pulmonary tuberculosis must be evaluated to ascertain that the disease is arrested and non-infectious. Active tuberculosis is, of course, always disqualifying. Extensive tuberculosis that has been treated by surgery and chemotherapy may continue to be disqualifying after the disease has been arrested because of insufficient functioning pulmonary tissue remaining. To evaluate this condition, and also to evaluate emphysema, pulmonary function studies may be required.

Psychiatric Disorders

It is recognized that individuals who have had an overt psychiatric illness may statistically present a greater risk for future disability than those who have never been ill. However, we should not deny these people employment when they are in adequate remission and have no handicap except the fact that they once were ill. For approval for Federal employment, we require current evidence that the applicant is in good health. That evidence will usually consist of a current report from a physician or hospital familiar with the diagnosis, treatment, and prognosis of the individual.

A psychiatric illness several years in the past which has been followed by a normal employment history at a level commensurate with the individual's training provides a sound basis for determining that the individual is suitable without other evidence.

Epilepsy

A diagnosis of epilepsy, even though apparently completely controlled by medication, is disqualifying for working at heights, around dangerous power-driven machinery. An epileptic having no seizures for two years, with or without medication is qualified for a motor vehicle license if he or she has a current state driver's license, a good driving and safety record, and no side effects of the condition or medication that would be deemed hazardous. For non-hazardous work, including arduous, an epileptic whose seizures are controlled to the point which would permit adequate performance is medically suitable for Federal employment. For these positions, we do not require an absolute freedom from seizures. As a rough rule, we will approve for employment a reasonably controlled epileptic in a position which involves no hazards greater than he would encounter in his ordinary living at home.

Malignancies

It is seldom that we will be confronted with an application from an individual who has a diagnosed malignancy which has not been treated. The applicant who gives a history of radiological treatment and has no disabling residuals, should be approved for employ-

ment. Approval should be granted even though insufficient time has passed in which to evaluate the efficacy of the treatment. We recognize that some of these cases will have recurrences which will be disabling. We are firmly of the opinion that they should not be denied normal opportunities during the period in which they are able to function productively.

N77-30731

D16

A REVIEW OF CURRENT AND PROPOSED STANDARDS
FOR OCCUPATIONAL EXPOSURES TO RADIO-FREQUENCY ENERGY

Colonel L. T. Odland, USAF, MC
Consultant to Hq NASA
Division of Occupational Medicine

from the

USAF Radiological Health Laboratory (AFLC)
Wright-Patterson Air Force Base OH 45433

Opinions expressed in this paper are those of
the author, and in no way reflect official policies
of the United States Air Force or NASA

-267-

266
PAGE INTENTIONALLY BLANK

A Review of Current and Proposed Standards
for Occupational Exposures to Radio-Frequency Energy

During the past 20 years, the value of 10 mW/cm^2 has been recognized by many workers as a safe level for occupational exposures to microwave energy (100 MHz to 100 GHz), and the experience of occupational medicine during this period has provided clinical support for the validity of this value. However, until relatively recently (3-5 years) it was rather difficult in many cases, and nearly impossible in others, to quickly and accurately survey the work environment in an attempt to insure compliance with 10 mW/cm^2 level. If all the data could be reconstructed, it is likely that we would find that many workers have been routinely exposed to values, perhaps 5 or 6 times as great as the 10 mW/cm^2 , during their working careers. Yet, clinically, we have seen no physical injury over the years.

Even though values greater than 10 mW/cm^2 may be entirely safe, based on current knowledge, every attempt must be made to reduce occupational exposures to a level as low as possible, consistent with operational needs. But this goal will not be reached merely by setting a standard and contentedly believing that the question has been fully addressed.

There are at least five essential aspects of an acceptable r-f occupational exposure control program—the setting of exposure limits or guides being but the first step.

Table I summarizes exposure standards adopted or being considered by six groups in the United States. For continuous exposures, 10 mW/cm^2 has become a consensus value in this country. When we review values for permissible brief exposures, there is virtually no consensus, which most likely means that none reflect an acceptable brief exposure value.

Surveillance of the work environment is the second factor in formulating an acceptable r-f control program. The mere setting of a standard is of practically no value unless the work environment is routinely evaluated, to insure safe practices and procedures. Table II summarizes surveillance aspects of the various programs in being or under consideration. It can be seen that only the US Air Force has a definite goal-oriented program to evaluate the work environment.

Before any meaningful surveillance effort can be started, an installation-wide inventory of all r-f emitters must be prepared. In the US Air Force, this includes airborne units as well as all ground-based equipment. The next step is to classify these emitters according to functional and hazard categories, as shown in the table. This effort immediately eliminates many of the emitters from further consideration, as it becomes apparent that they are not hazardous. Once the inventory is compiled and classified, those presenting an actual or possible hazard can then be programmed for on-site surveys. Of great importance is the inclusion of maintenance and repair facilities in this effort. Experience has suggested that, certainly, the greatest potential for overexposures of workers is in the shops, particularly when pressures are exerted by management to hasten the repair or checkout of a particular system. Once a cycle of inventory, classification, and survey, has been completed, medical officials must keep abreast of inventory changes and modifications which could alter the classification of a given unit.

The third ingredient of an acceptable program is the medical surveillance of the workers. Over the years it has become standard practice to provide pre-employment physical examinations, and post or termination examinations. In selected occupations, periodic examinations are provided because the particular hazard of the occupation has been conclusively shown to produce illness, and while the worker should not be used as a sampling system, it is only good medicine to provide him with every safeguard available.

Table III outlines the medical surveillance procedures recommended by the groups currently concerned with occupational control of r-f hazards. Only the Department of Defense addresses the question of medical surveillance, while ANSI is proposing an extensive program. A "routine" physical (preplacement) is proposed. However, when applied to r-f hazards, a "routine" physical becomes merely another tooth in the gear of defensive medicine. If given as only a preplacement examination, without regard to potential r-f hazards, it has a definite place in any occupational medicine program. But, we must not fool ourselves into believing that a "routine" physical is going to uncover any untoward effects of r-f exposures. Of course, all programs outlined add additional emphasis on the eye, and the ANSI proposal (Table IV) is nothing short of a full-blown research protocol. It must be strongly emphasized that the ANSI proposal is just that—a proposal. What will appear in the final draft of the standard may vary widely from what is proposed. One point in defense of the ANSI proposal is that it represents the first attempt to evaluate changes other than those involving the lens

of the eye. Virtually all occupational medicine programs involving r-f hazards have, and still do, focused their efforts on eye changes. Yet, one is extremely hard pressed to find any evidence of eye damage subsequent to, or associated with, occupational exposures to r-f energies. We may be looking in the wrong places, and this is what the ANSI proposal may be trying to tell us.

The major problem confronting those who would implement a medical surveillance program designed for those workers who may be occupationally exposed to power densities in excess of those permitted by standards, is to define or delineate the r-f or "microwave" worker. Radio-frequency energies are so ubiquitous in our technological society that it is hard to determine just those workers who may, or perhaps do, expose themselves to doses beyond the recommended levels. And it appears that this problem will remain with us until some type of personnel dosimeter is available. With such a device, it should be possible, within a few months of work experience, to accurately identify the "microwave" worker on any installation.

Investigation of actual or suspected accidental overexposures of personnel to r-f energies is the fourth point in an acceptable r-f control program (Table V). Many incidents occur yearly, but only a few are properly investigated and documented in order to protect the interests of the patient and the employer. Each year several individuals claim that their health and well-being has been seriously impaired by some incident or accident associated with employment that occurred several years ago. Symptoms and findings pertaining to opacities of the lens usually predominate, since, experimentally, cataracts can be produced in animals by r-f energies. In addition, some medical observers feel that an overexposure or series of overexposures at age 20-30, could produce lens changes several decades later, at which time it is virtually impossible, clinically, to discriminate between senile or presenile cataracts and changes which are claimed to have been caused by r-f overexposures. At some point these claims must be judged. Without evidence or data pertaining to the exposure or exposures, the patient may be denied full consideration of his problem.

In the US Air Force, investigations are required whenever there is a suspected overexposure, and if subsequent investigation indicates an actual exposure of over 20 mW/cm^2 did occur, the patient(s) is referred for a complete medical evaluation and followup, as may be indicated.

The US Navy requires reports of exposures in excess of 50 mW/cm^2 for any time period, and follow-on medical evaluations at 2 and 4-week

intervals.

Closely related to the previous aspect of an r-f control program is the fifth factor, which relates to documentation and proper maintenance of records of all pertinent data applicable to a given real or suspected incident/accident of overexposure.

The US Air Force and US Navy require extensive investigations of accidents, to define their content and make provisions for reporting and maintaining records. Table VI gives details of documentation required.

TABLE I
EXPOSURE LIMITS—RF RADIATION

<u>Agency</u>	<u>Continuous</u>	<u>Brief</u>	<u>Frequencies</u>
USAF AFR 161-	Less than 10 MHz 50 mW/cm ²	Less than 10 MHz 36,000 mW-sec/cm ²	10 MHz - 100 GHz
	Gtr than 10 MHz 10 mW/cm ²	Gtr than 10 MHz 18,000 mW-sec/cm ²	
USA TBMED 270	10 mW/cm ²	$T_p = \frac{6000}{W^2}$	100 MHz-100 GHz
USN BUMED Instr 6470.13	10 mW/cm ²	300 mj/cm ² (3-30 sec)	100 MHz-100 GHz
OSHA 1910.97	10 mW/cm ²	1 mW-hr/cm ² (0.1 hr period)	10 MHz -100 GHz
ANSI C95.1	10 mW/cm ²	1 mW-hr/cm ² (0.1 hr period)	10 MHz -100 GHz
ACGIH TLV-1973	10 mW/cm ²	10-25 mW/cm ² (10 min/hr x 8)	100 MHz-100 GHz

TABLE II

SURVEILLANCE OF WORK ENVIRONMENT

<u>USAF</u>	<u>USA</u>
1. Installation-wide inventory	Generalized
2. Classification	<u>USN</u>
a. Functional category	None
Food process	
RADAR	<u>OSHA</u>
Communications	
Nav Aids	None
Traffic surveillance	
Meterology	<u>ANSI</u>
Metrology	None
b. Hazard class	
Actual or great potential	<u>ACGIH</u>
Hazard possible	
Hazard probability low	None
Not hazardous	
3. On-site Surveys	
Ovens	
4. Review of inventory and changes	

TABLE III
MEDICAL SURVEILLANCE

USAF

Pre-employment examination—emphasis on eye

Annual physical examination—emphasis on eye

USA

Preplacement examination (routine)—emphasis on eye

Periodic "usually" at annual interval—emphasis on eye

USN

Preplacement examination (routine)—emphasis on eye

Periodic at 3-year interval—emphasis on eye

Eliminates those with lenticular opacities from RF-related jobs

OSHA

None

ANSI

Proposal

ACGIH

None

TABLE IV

PHYSICAL EXAMINATION PROPOSED AS PRE-EMPLOYMENT EXAMINATION FOR MICROWAVE OCCUPATIONAL WORKERS—ANSI

1. In addition to the normal industry pre-employment physical, the following specific tests should be performed:
 - a. Lipid profile (fasting sample to include total lipids, cholesterol, triglycerides and phospholipids).
 - b. Serum cortisol (morning sample).
 - c. Immunoglobulin electrophoresis.
 - d. Complete blood count—hematocrit (capillary tube methods), white blood count, red blood count, differential.
 - e. Dilated ophthalmological examination, including biomicroscopic exam for opacities, vacuoles, and posterior subcapsular irradianance; ophthalmoscopic exam of fundus oculi.
 - f. Routine neurological examination.
2. In the medical history, a note should be made of previous exposure to occupational ionizing or nonionizing radiation.
3. Optional tests that should be included, providing adequate facilities are available:
 - a. T3 and T4 tests for thyroid evaluation.
 - b. EEG.

TABLE V
ACCIDENT/INCIDENT INVESTIGATION

USAF

Any case of suspected overexposure

Exposures above 20 mW/cm² (referred to USAFSAM for
evaluation)

USN

50 mW/cm² for any time period

2 and 4-week followup

USA

None

OSHA

None

ANSI

None

ACGIH

None

TABLE VI

RECORDS AND REPORTS OF ACCIDENTS/INCIDENTS

USAF

Administrative details
Reconstruct incident with measurements
All results of medical evaluations
Complete description of emitter
Entire report on file in repository

USN

Letter report for exposures of 50-500 mW/cm²
Submitted to Chief, BuMed within 30 days:
 personnel exposed
 narrative of incident
 estimate of level of exposure
 description of symptoms/findings
Telegraphic interim report within 48 hours, if exposure
 exceeds 500 mW/cm²

USA

In preparation

OSHA

None

ANSI

None

ACGIH

None

N77-30732

RADIATION MEASURING INSTRUMENTATION

Presented by

Harley V. Piltingsrud, Capt., USAF, BSC
Chief, Radiation Measurements Division
USAF Radiological Health Laboratory (AFLC)
Wright-Patterson Air Force Base

RADIATION MEASURING INSTRUMENTATION

In the process of meeting operational needs for radiation hazard assessments in the US Air Force, the USAF Radiological Health Laboratory has found it necessary to develop radiation measuring devices not available through commercial sources or other government agencies.

A selection of these have been chosen for presentation at this conference of NASA Clinical Directors, based on their possible application to NASA programs. These are:

- a. An Improved Detector Probe for PuAm Survey Instrument.
- b. A Passive Broad-Energy Response Neutron Spectrometer-Dosimeter.
- c. A Portable Ultraviolet Spectroradiometer.
- d. A Pocket Ionization Chamber Radiation Dosimetry System.

A brief description of each of these devices follows:

1. An Improved Detector Probe for PuAm Survey Instrument—Over the past three years the US Air Force has used and maintained approximately 12 survey instrument kits for detection of plutonium-ameridium. The instruments consisted of two main parts—a rate meter assembly, which contained batteries and a high-voltage power supply, and a detector probe, consisting of a 5-inch diameter x 1/16-inch thick sodium-iodide (thallium-activated) NaI(Tl) scintillation crystal, mounted on a 5-inch diameter x approximately 3-inch thick quartz light pipe, which is attached to a 5-inch diameter photomultiplier (PM) tube. These components are contained in a stainless-steel case having a 5-inch diameter by 0.010-inch thick beryllium (Be) window in it.

To date, several of the detector probes have failed due to cracked crystals, defective PM tubes, holes in Be windows, and seal failures in the outer casings. It is estimated that the mean time between failure for these probes is about three years. Repair of these probes is both expensive (at least \$1 thousand each) and time consuming (at least two months). No field repair of the probes is possible due to the controlled conditions necessary to handle the hygroscopic (NaI(Tl)), and also the cement used to assemble the internal components. Prototypes for a follow-on instrument

to the above were developed by a commercial firm under contract to the Air Force, under identification nomenclature of AN/PDR-69. This instrument proved to be generally inferior to the instrument it was to replace, however, some advances were made in its detector probe construction. The probe on this instrument uses a 5-inch x 1/8 inch calcium-fluoride (europium-activated CaF(Eu)) scintillation crystal, a conical plastic light pipe, and a 3½-inch PM tube. A 5-inch x 0.026-inch Be window is used with an aluminum outer case. Field probe disassembly and repair is possible with this instrument, however, problems exist with the cost and fragility of the Be window, and the poor detector resolution due to the small PM tube and light pipe design.

Due to the unsatisfactory status of the above equipment, an effort was made to design a satisfactory probe to be used with the original survey equipment ratemeter (the Eberline Instrument Company PRM-5).

Procedure—The improved detector consists of a 5-inch diameter x 1/8-inch thick CaF(Eu) scintillation crystal, directly coupled to a 5-inch diameter PM tube. These are mounted in an aluminum container with an 0.0006-inch thick aluminum window supported and covered by a ¼-inch thick x 4-¾-inch diameter styrofoam disk. Further details are as follows (see Atch 1):

(a) Scintillation Crystal—A CaF(Eu) crystal was chosen, mainly due to its nonhygroscopic properties. In 1/8-inch thick sections it is very rugged, and has mechanical properties similar to pyrex glass. Because of these properties, it is easy to store spare crystals for future repair work. This crystal also has an index of refraction (1.45) very close to that of the glass window of the PM tube; hence, direct coupling of the two is possible with a minimum of light transmission losses. It has been found that a silicone grease compound (Dow-Corning 20-057) serves as an effective wide temperature range coupling media between the two. The 1/8-inch crystal thickness was chosen following empirically-derived guidelines arrived at in the development of the AN/PDR-69.

(b) Photomultiplier Tube—A 5-inch diameter (~4.8 inch photocathode diameter) Bi-alkali photocathode PM tube was chosen due to its compatibility with the scintillation crystal diameter, its low noise level, its low cost, and its availability (at least two US vendors). Tests were conducted, using a Space Research Corporation Model 125B01 tube.

(c) Window Material—A decision was made not to hermetically seal the outer enclosure, allowing the use of more inexpensive and effective window materials. The window consists of a layer of aluminum foil 0.0006-inch thick, laid over a $\frac{1}{4}$ -inch section of styrofoam (facing out). This forms both a rugged and cheap (less than 20¢) window. The styrofoam firmly supports the aluminum foil light shield, and also provides a very effective protective cushion for the scintillation crystal if the probe should be dropped on its face. The windows can be field replaced in a few minutes if damaged or contaminated.

Conclusions—The improved detector probe has many advantages over the previously developed probes while still maintaining the essential performance characteristics of them. Its light weight and small size also permit its use in a much smaller transportation case. The size of this case permits one to travel with it as carry-on luggage on commercial airlines. Experience has shown that this can be a most important feature for practical field use of the instrument. Users of this probe have also preferred its integral handle and quick-connect cable connector (Kings KV79-25) over past designs. A diagram of probe construction is presented in Atch 1.

2. A Passive Broad-Energy-Response Neutron Spectrometer-Dosimeter—

The neutron spectrometer-dosimeter described is a completely passive device, intended for use in the measurement of the flux and energy spectra of neutrons in mixed radiation fields of charged particles, photons and neutrons. Its basic principle of operation is similar to that described by Engelke, wherein a stepwise response curve for the (n, α) reaction in ${}^6\text{Li}$ as a function of radius from the centre of an 18-inch-diameter polyethylene sphere was measured. This curve was compared with theoretical response curves and the response curves obtained from exposures of the sphere to known energy and flux neutron fields in order to derive the spectra and flux of the measured neutron field. Previous applications of this principle required an omni-directional rotation of the sphere at a rate much higher than the rate of change of the radiation field being measured. The device utilizes an array of sensors throughout the sphere, making it a completely isotropic and passive sensor. Proton and photon field intensities and energies are also believed to be identifiable with this technique. Atch 2 shows sphere in various states of assembly.

3. A Portable Ultraviolet Spectroradiometer—Over the past several years increasing attention has been directed to exposure of individuals to man-made electromagnetic radiation in both the occupational and the general environment, reflecting an increase in public awareness of the hazards of

these radiations under certain circumstances. Also, the passage of more comprehensive laws dealing with environmental control, and the increase in knowledge in these areas resulting from scientific research, has stimulated great interest.

While instrumentation has been available to adequately define radiation environments over certain portions of the electromagnetic spectrum, a particular problem has existed in the area of survey instruments for evaluating personnel hazards due to ultraviolet radiations. The instrument described herein was designed and constructed in an effort to provide an operational solution to this problem. Its basic design and performance criteria should be:

- (a) An integral sensitivity of at least 1×10^{-7} W/cm² over the ultraviolet spectrum from 230 nm to 400 nm.
- (b) Resolution of the spectral energy distribution of a light source with a full-width half-maximum resolution not greater than 10 nm.
- (c) A 10^5 to 1 rejection of light from a source which is greater than 25 nm from the wavelengths being measured (to reject visible sunlight from measurements of low-intensity ultraviolet radiations).
- (d) Compact (10^4 cc) and light (less than 5 kg).
- (e) Rugged and stable under normal field use conditions.
- (f) Low power requirements.
- (g) Simple to use (operable by a technician trained in its use).
- (h) An acceptance angle no less than 30°

Description—Light enters the monochromator through a double hemispherical ultraviolet quartz lens, having both inner and outer surfaces sandblasted to form diffusers. Light of the wavelength predetermined by the monochromator setting, enters a Bi-alkali restricted cathode type photomultiplier (PM) tube. High voltage for the PM tube is provided by a miniature DC to DC convertor at two pre-set voltages, with regulation provided by two Victoreen Instrument Company coronotron tubes (VR1 and VR2), which provide approximately a 10^4 gain difference for the PM tube.

Output from the PM tube anode enters a field effect transistor input operational amplifier, the gain of which is determined by feedback resistors R1, R2, R3 and R4. Feedback capacitors C1 and C2 are used for

integrate positions. Resistors R23, R24 and R25, provide range calibrations for the two rate-meter high-voltage ranges and the integrate position. A 50 μ A meter movement is used for readout.

Power for the high voltage supply is provided by four Type AA dry cells (B3-B6), and that for the operational amplifier by two Ray-O-Vac #1604, 9-Volt batteries (B1 and B2). These provide 100 hours of operating service.

Conclusions—The instrument described appears to satisfy the requirements set out in the first paragraph. It has a stable sensitivity, at least, an order of magnitude greater than required; its volume is about half that stated in the first paragraph, and its weight is \sim 3 kg. Its full-width, half-maximum acceptance angle is nearly 40° , which appears to be an important characteristic for survey work, particularly with nonpoint sources.

This device will measure irradiance versus wavelength over a wavelength range of 240 nm to 700 nm, at irradiance levels necessary for assessing ultraviolet hazards. The instrument appears to function usefully at wavelengths between 210-240 nm, however, accurate calibrations have not been completed because of nonavailability of an adequate calibration source. The instrument's provision for an integrate mode also makes measurements of very short duration exposures possible.

4. A Pocket Ionization Chamber Radiation Dosimetry System—This dosimetry system is based around an indirect reading pocket ionization chamber design. A simple tissue equivalent plastic-walled ionization chamber is worn on the individual being monitored (two chambers per person are recommended, to provide cross-check capability). This chamber is charged to a predetermined charge level by the charger-reader. After it has been worn the amount of charge loss in the chamber due to ionization caused by radiation is measured by the charger-reader electrometer, and the individual's radiation exposure is indicated.

The end caps of the dosimeters have an integral pocket clip for attachment of the dosimeters to an individual's clothing. The end cap also contains a small amount of desiccant (moisture removing material), which keeps moisture from collecting on the insulators of the ionization chamber. Atch 5 shows the dosimeter and charger-reader. Atch 6 demonstrates the improved performance of the new system as compared to the best alternate systems.

1" = 2"

DETECTOR PROBE BREAKDOWN

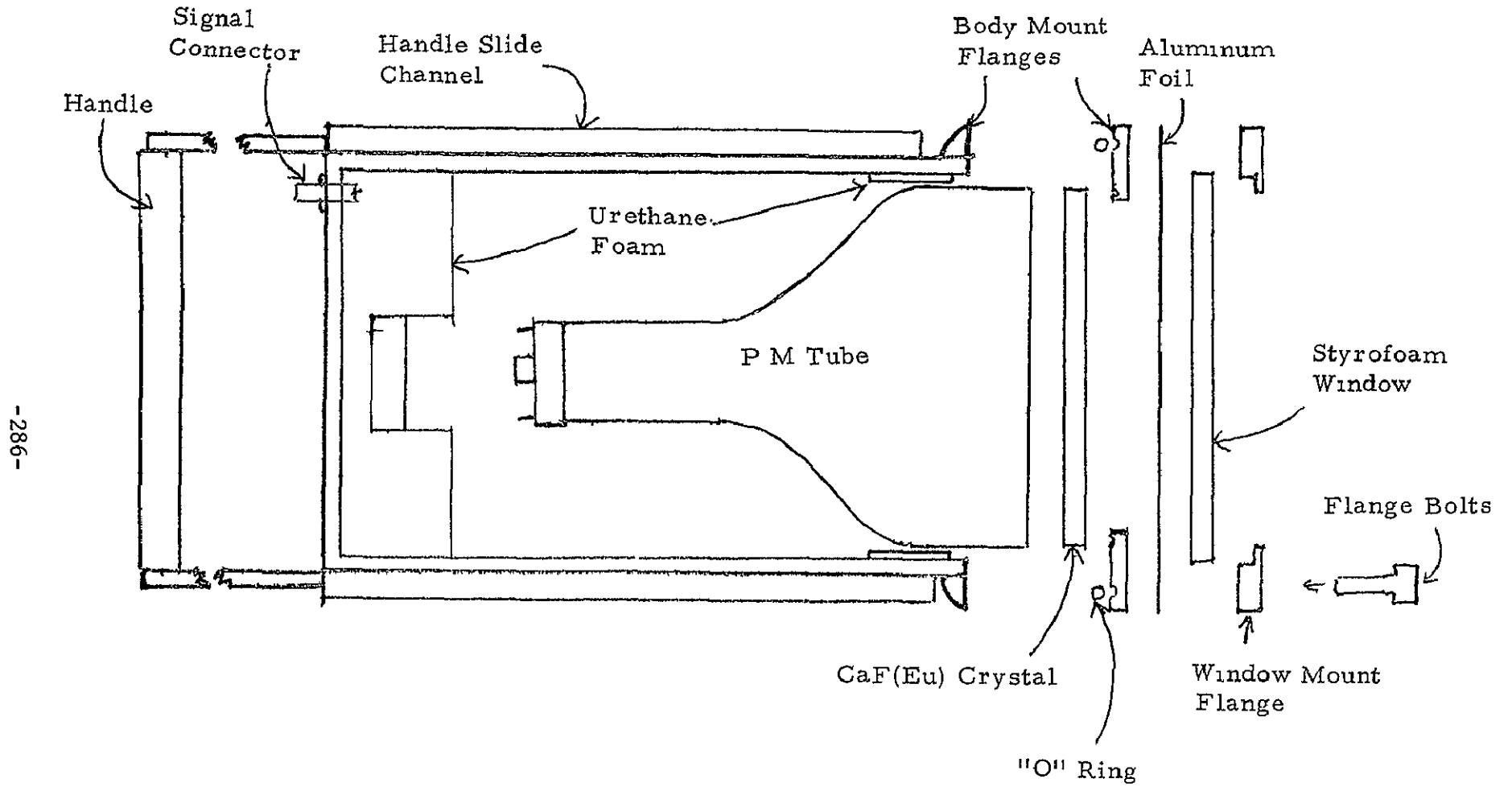

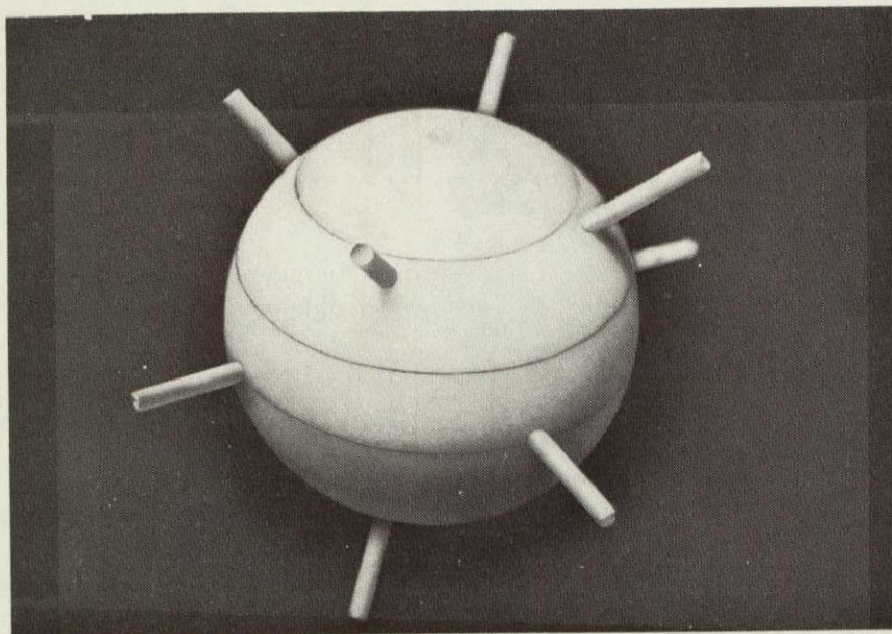

FIG. 1. Sphere with dosimeter holding rods partially inserted.

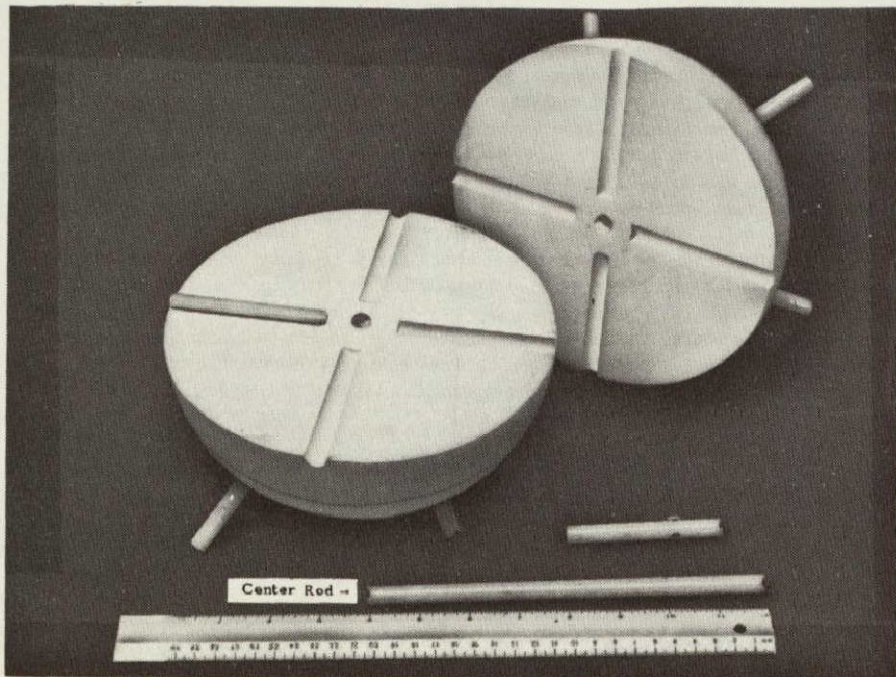

FIG. 2. Sphere split into two sections.

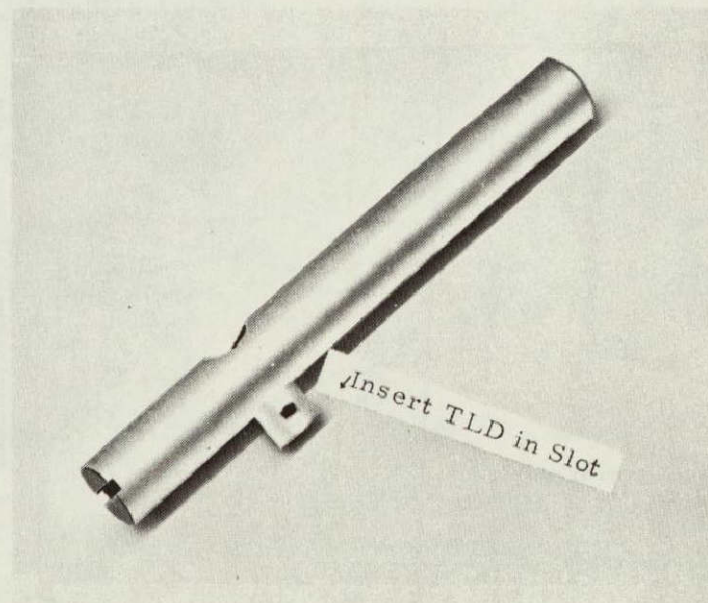
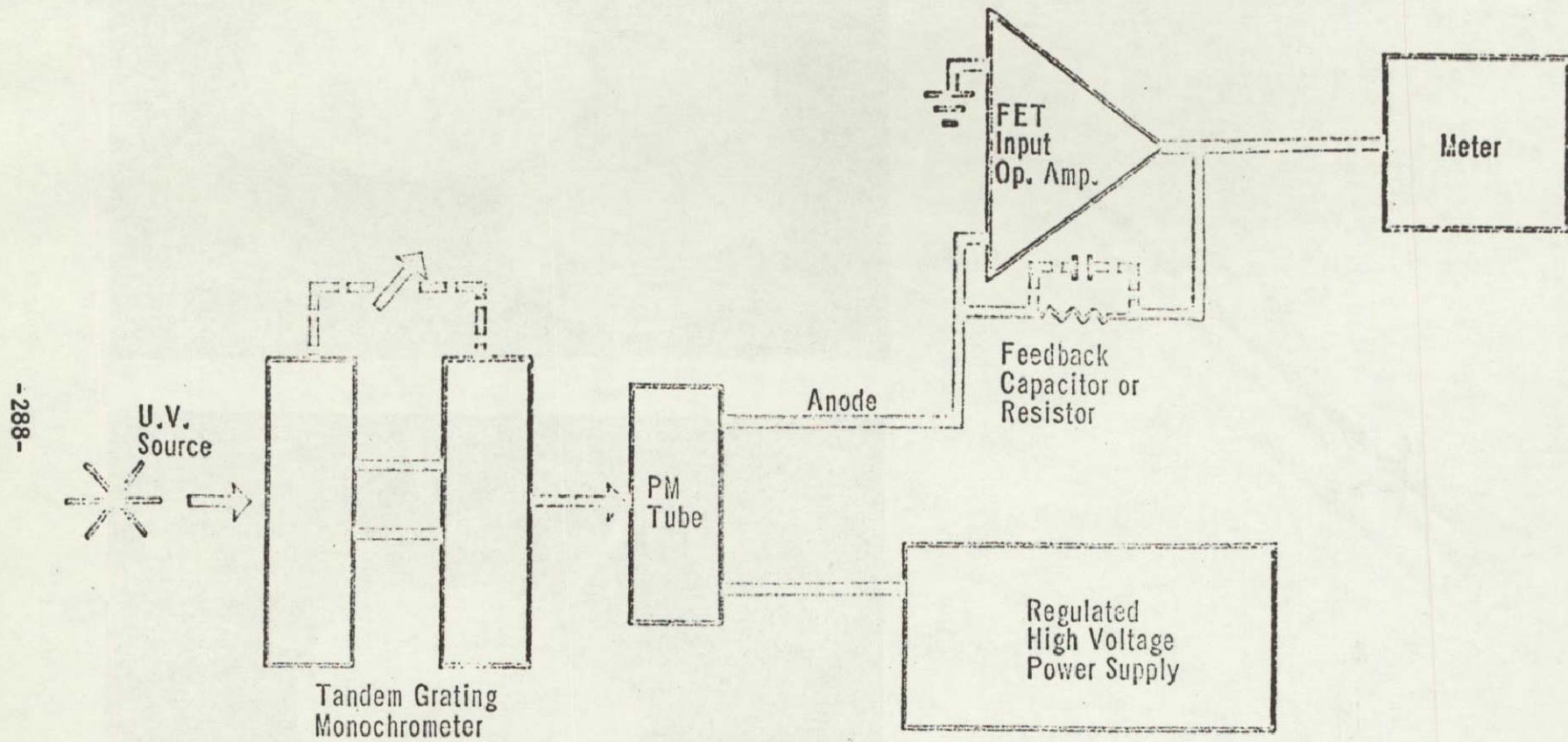

FIG. 3. Dosimeter holding rod.

Top



-288-

Capt Harley V. Piltingsrud, USAF, BSC

Top

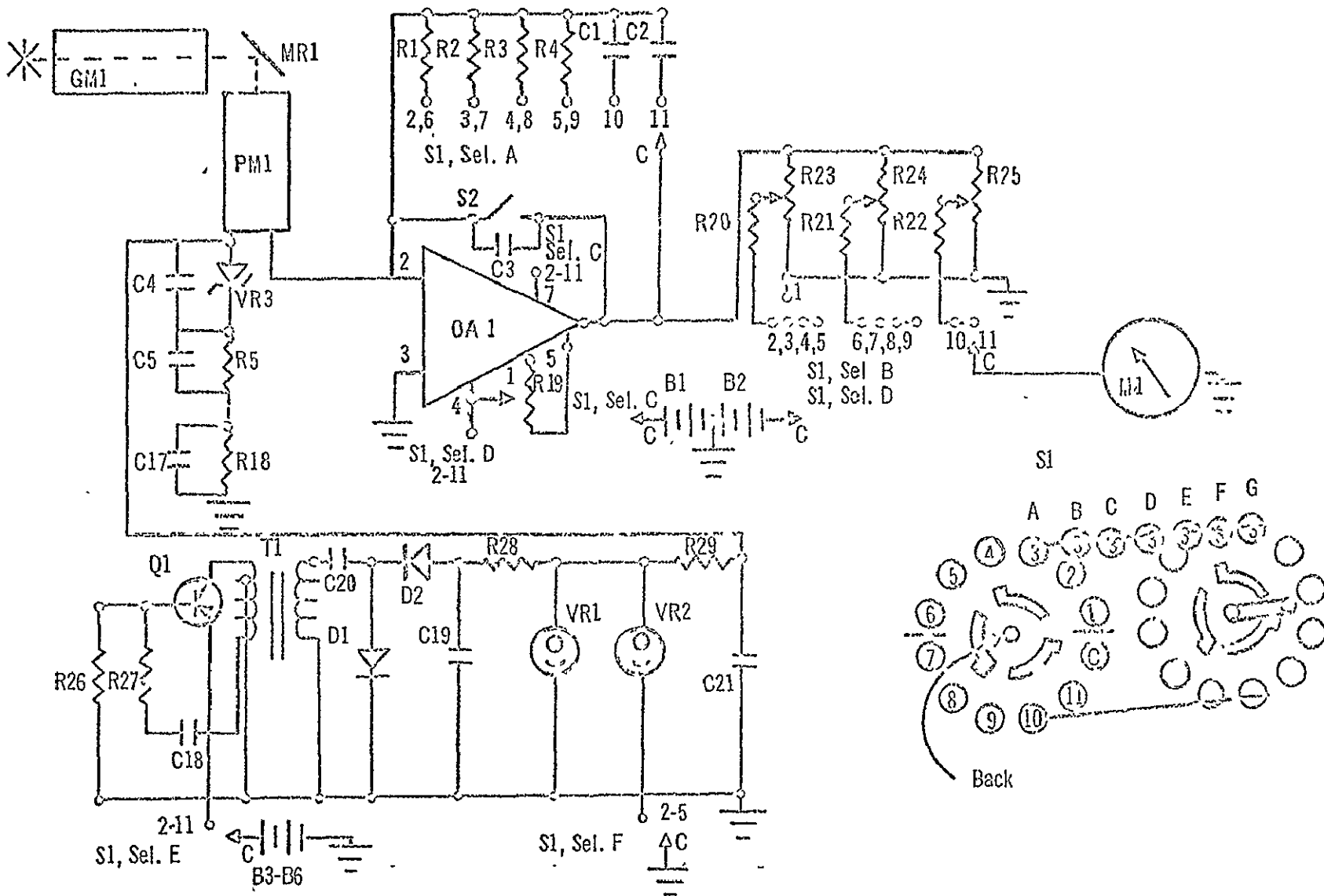

-289-

Capt Harley V. Piltingsrud, USAF, BSC

CHARGER READER :

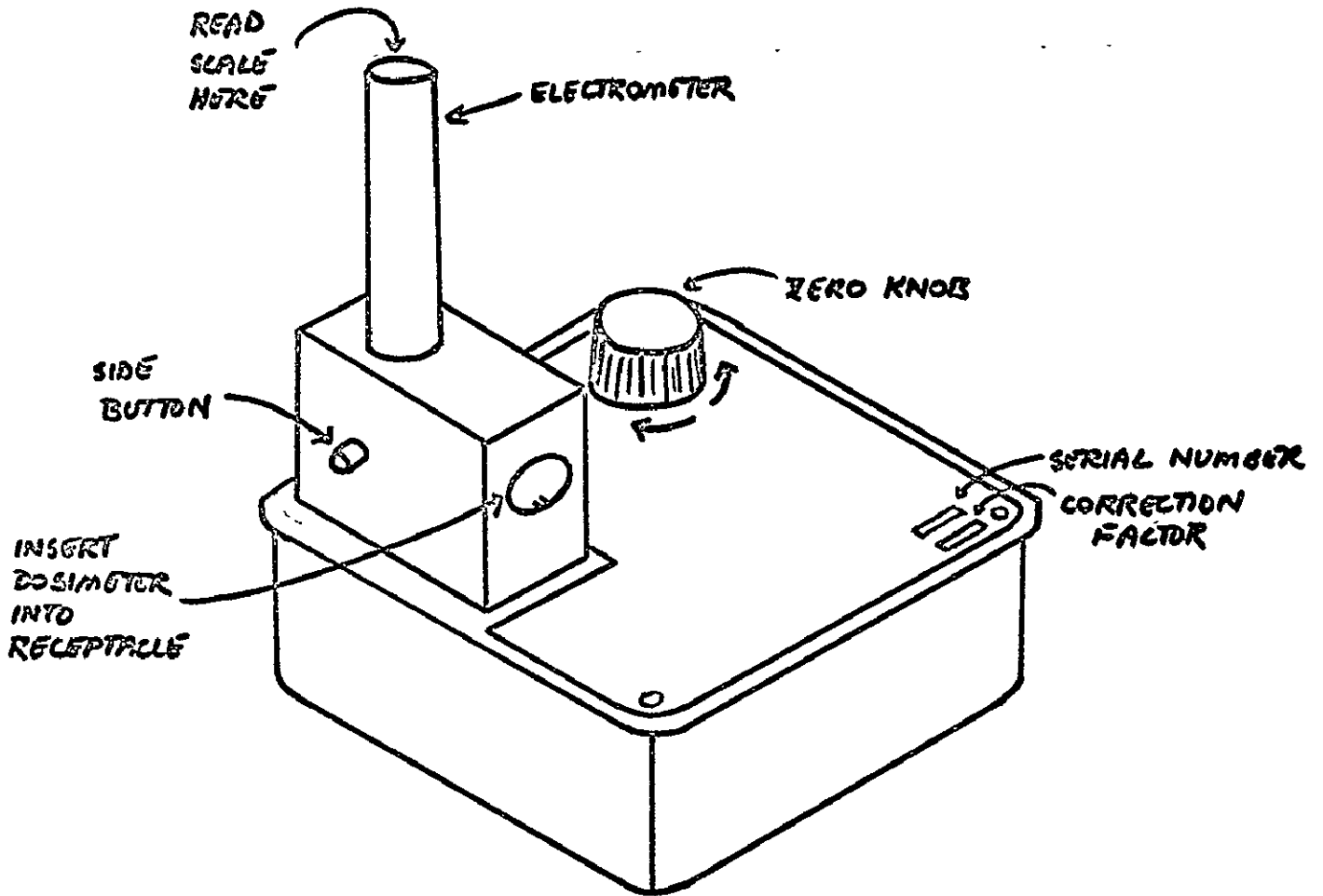

DOSIMETER :

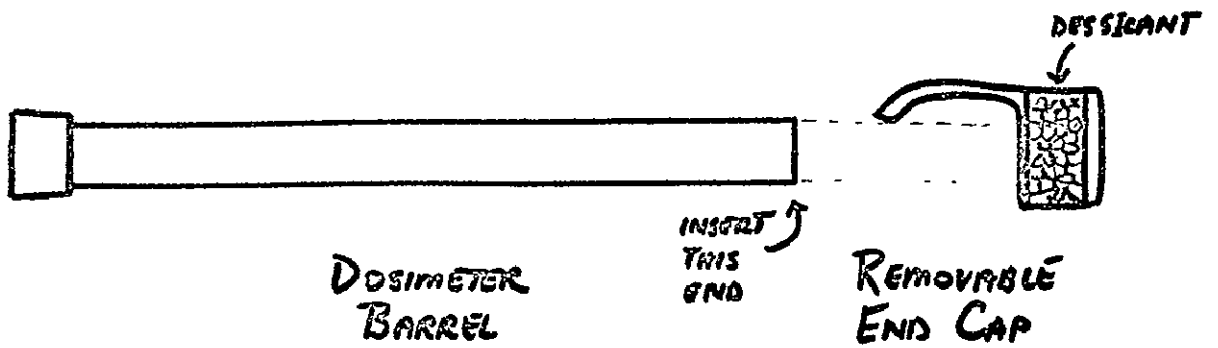

4

MAXIMUM ERROR USING MAXIMUM CORRECTION FACTOR

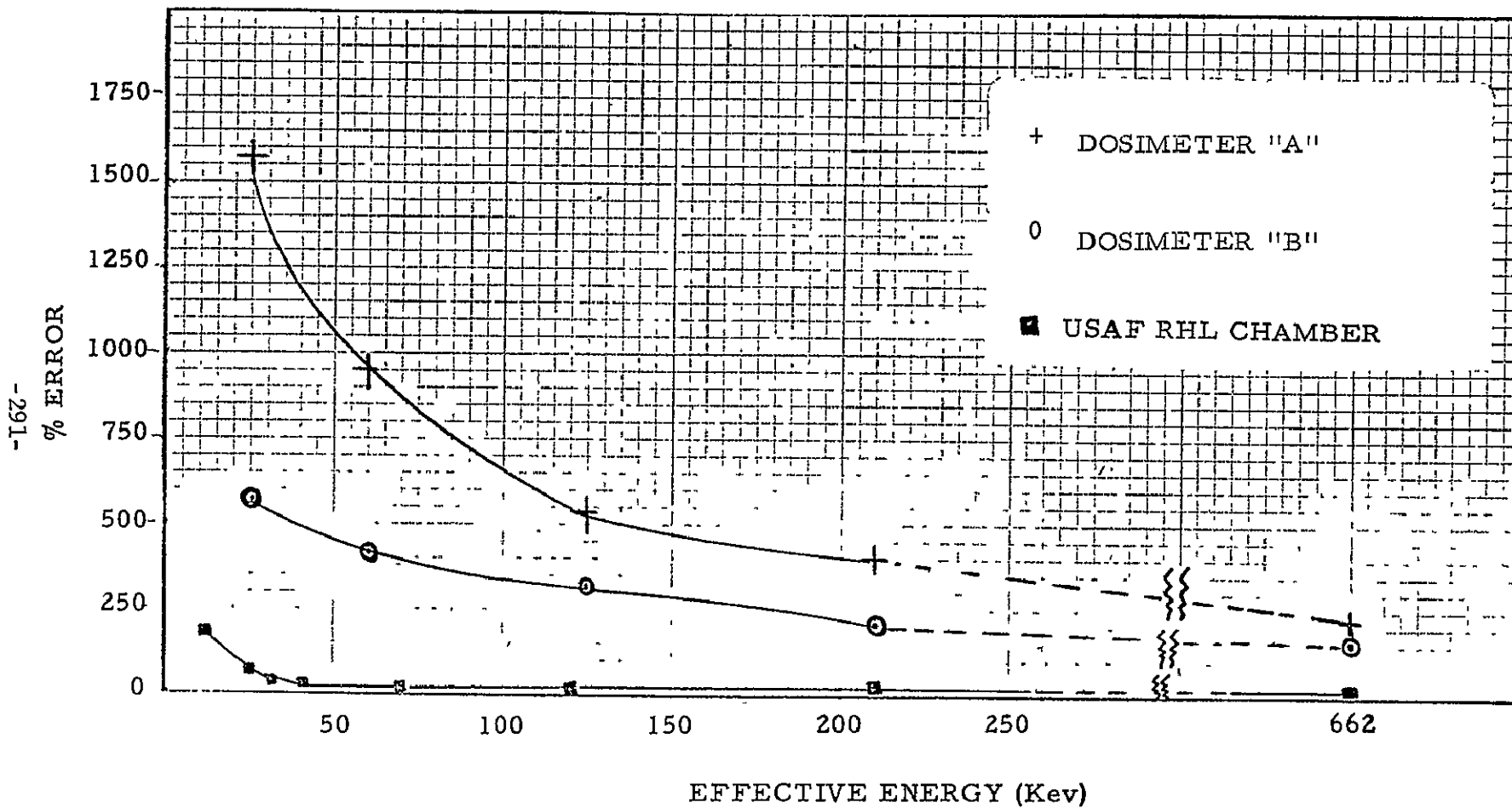

D18

N77-30733

DEVELOPMENT AND APPLICATION

of

FUNCTIONAL MANNING STANDARDS

in the

NATIONAL AERONAUTICS AND SPACE ADMINISTRATION

delivered before the

ANNUAL CONFERENCE

NASA CLINIC DIRECTORS, ENVIRONMENTAL HEALTH OFFICERS,
AND MEDICAL PROGRAM ADVISORS

by

Walter A. Maul

Office of Resources Management

Office of the Assistant Administrator
for Institutional Management

March 20, 1975

Williamsburg, Virginia

During the Zero Base Reviews conducted at all field centers during CY 74, one of the judgments consistently rendered by participants was that NASA needs a set of measures on which center directors and other managers can rely for gauging their needs for manpower, relative to workload, in functional areas. In August, 1974, a letter was sent from Headquarters to field centers requesting the initial information needed to begin development of the needed measures--the number of Zero Base positions in each of twenty-six separate functions.

An effort was then made to determine a significant workload indicator for each function from reports, budgets, and other documents available at Headquarters which could provide an adequate data base. Typically, the factors determined to be significant were total budgeted dollars, budgeted R&D dollars, in-house population, civil service population, or similar gross measures. The numerical values associated with these measures were then paired with the respective numbers of Zero Base positions by field center and function to constitute data points.

A statistical technique known as regression analysis was then applied to obtain a mathematical equation which describes the relationship between the workload indicator

for each function and the required manpower. (For instance, in the standard for Occupational and Environmental Health, the relationship between total in-house manpower and the manpower required to do occupational and environmental health work was described.) The equations thus derived were used to construct the requirements tables in the first-cut standards. We have a high level of confidence in certain of the standards and less confidence in others. The objective of the teleconferences currently underway, and my presence here today, is to confirm or improve the validity of a selected group of six in the near term and eventually all of the first-cut standards.

The process of challenging the validity of a standard once it is established, however, must continue. The dynamic character of NASA, advancing technology, changing national policies and priorities, and many other factors influence the way work is accomplished and the concomitant need for manpower. Periodically, the validity of each standard will have to be tested. Some will require review more frequently than others. And any standard whose validity is analytically faulted at any time will be immediately reviewed.

We recognize that there is some apprehension in the minds of many as to the purpose to which the standards will be put once they are developed. I can say to you unequivocally that the first purpose of the manning standards effort is to provide an additional set of reference points to those in NASA like yourselves who are tasked with the hard responsibility for getting work done. These standards will prove to be important tools to everyone in NASA concerned with obtaining maximum utility from scarce resources.

Above all, manning standards will not constrain you as managers, nor will they abridge or encroach upon your prerogatives as managers. The effort to develop manning standards also does not imply that you cannot manage without them, since you evidently have done so and, exceedingly well, to NASA's credit and the Nation's benefit. But even very good managers can do a better job with more effective tools. To reject manning standards on the basis that they constitute constraint on the manager is analogous to rejecting a power saw for a carpenter because it will interfere with or prevent his use of a hand saw.

In summary then, all that Todd Groo, Joe Malaga, Charlie Tulip, myself and others have been emphasizing is that although manning standards are of particular value to managers, they serve all who seek efficient and effective utilization of an essential resource, and constructive innovation in organizational life.

Among the principal obligations of every manager is the determination of the minimum level of resources needed for mission accomplishment. He must also be able to support the determination with justification sufficient to convince others higher in the supervisory chain of the validity of the determination.

These difficult tasks of determination and justification are substantially aided when the manager has access to objective data or indices for guidance. The purpose of the functional manning standard development effort is to produce such a set of indices to aid in determining and justifying requirements for functional manpower.

N77-30734

HYPERTENSION SCREENING

Presented by

John Foulke, M.D.
Medical Director
Goddard Space Flight Center
Greenbelt, Maryland

Williamsburg, Virginia
March 20, 1975

HYPERTENSION SCREENING
GODDARD SPACE FLIGHT CENTER
1974-1975

In this country, the well known statistics for hypertension and its control are both striking and unacceptable. Figures widely published in the medical and lay presses indicate that there are between twenty-three and thirty-five million hypertensives of whom about fifty percent have no knowledge of their disease. Of those who are aware of their hypertension, only about fifty percent are receiving treatment, and of those receiving treatment only about fifty percent are adequately controlled. Other population studies have suggested that about 30 percent of known hypertensives have a history of taking drugs in the past, but are currently untreated and still hypertensive. Despite the ease of determining hypertension and of controlling it satisfactorily in up to eighty to eighty-five percent of cases, these statistics have prevailed.

Numerous reasons have been proposed for these discouraging figures including the lack of readily available detection areas, poor patient interest due to a lack of knowledge or understanding of the problem, the failure of physicians to impress upon their patients the need for therapy, as well as the need for regular long-term followup for an often symptom-less disorder, the past tendency for many physicians to minimize the importance of mild to moderate hypertension and, ineffective followup mechanisms. At times in the past, a patient's knowledge of his own blood pressure level often has been discouraged. Patient education has been minimal and it has not been uncommon for clinic physicians to tell their patients that they should not worry about their hypertension, that they should not inquire about the level, and that indeed the level would have little meaning to them anyway.

Several other impediments to hypertensive evaluations and compliance to an anti-hypertensive therapeutic program include long periods of waiting to see the doctor,

the lack of symptoms in most patients, side effects of the more potent anti-hypertensives, which at times are used without giving milder drugs an initial adequate trial, and the cost of medication and continuing long term care.

The purpose of this study was to measure the response to an announcement of hypertension screening for all employees at the Goddard Space Flight Center, to compare the results and statistics to those of the general studies previously mentioned, and to determine where our best future efforts might be placed. An attempt was made to eliminate, or minimize significantly, as many as possible of those previously mentioned adverse factors which come into play in detection and initial management. Education and patient awareness of the problem, as well as the need for continuing followup care, were stressed. The results of the study are presented here.

All Goddard Space Flight Center Civil Service personnel were invited by two announcements in the Goddard weekly employees' news bulletin to come to the Health Unit for a blood pressure determination. To avoid unnecessary waiting, each employee who responded was given a specific time for a scheduled appointment. Blood pressures were determined in both the sitting and the standing positions by a nurse, and if the levels were found to be elevated or borderline, they were determined again by a physician. Only one nurse and one physician took part in the entire study. Following the initial visit, the employee saw the same physician on all subsequent visits.

Although many studies have defined hypertension as greater than or equal to 160/95, for the purpose of this study, hypertension was considered when diastolic pressures were above 90 or systolic pressures were above 140 mm. of mercury. Thus, we included "borderline hypertensives."

Persons found to be hypertensive for the first time were re-examined in a

period of one or two weeks and if hypertension was confirmed, the significance was explained, and the implications of the disease as well as the importance of continued treatment and regular followup were stressed in a detailed, thorough and unrushed manner.

The employees were then directed to see their own personal physicians for hypertensive evaluations and treatment. Persons who knew of their hypertension, but had not seen their physicians or who had not received adequate therapy were likewise referred back to their doctors. All of the hypertensive patients were seen again on at least two or three additional occasions during the initial phase of this study over a three month period.

The results of the initial study are as follows: (Figure 1) Slightly over 20 percent of the Goddard population, 804 employees, were screened for hypertension. Of this number, 615 were found to be normotensive and were not followed but were told of the importance of blood pressure determinations on a regular basis in the future. Using blood pressure criteria previously stated, 189 hypertensives were discovered. About 74 percent or 139 of these patients already knew of their hypertension, while 26 percent or 50 were newly discovered. The mean age of all hypertensives was 46.3 years.

Of the fifty "newly detected hypertensives," nine had actually been documented by blood pressure readings during previous Health Unit visits (Figure 2). In six of these nine cases, the Health Unit physician recorded the diagnosis in the chart, but either the patient was not told of the diagnosis or he subsequently forgot it. In the remaining three cases, the elevated blood pressure levels were recorded, but the diagnosis of hypertension was not made by the physician. Forty-two or 84 percent of the 50 "newly discovered" hypertensives followed the suggestion of the Health Unit physician and saw their private physicians following their

screening, while 8 or 16 percent did not. Thus, despite individual educational sessions and urgings that medical care be sought, 16 percent of newly discovered hypertensives failed to follow through.

After referral of the 42 newly discovered hypertensives, 37 or 88 percent were treated with drugs, three or 7 percent with salt reduction and diet alone, and 2 were not treated at all by their personal physicians, because of their failure to confirm hypertension using their own diagnostic criteria (Figure 3).

Of those patients treated, 70 percent (26) realized control of their hypertension to normal levels of pressure and 22 percent (8) underwent significant reductions during the observation period (Figure 4). Eight percent (3) had no demonstrable benefits from treatment. The most effective regimen of antihypertensive medication was thiazide diuretics alone, or thiazides plus Aldomet or Aldactone. It is apparent that our early results with newly discovered hypertensives receiving adequate therapy were only fairly good. Of 50 patients identified for the first time as hypertensive, 26 had normal blood pressures three months after the beginning of the program. A group of special concern is the 16 percent who failed to followup with a private physician despite intensive counselling.

Among the 139 employees who had previously known of their hypertension, 77 or 55 percent were being treated at the time of this screening, while 62 or 45 percent were not receiving treatment despite diastolic pressure ranges between 92 and 110, findings which are similar to nationwide surveys (Figure 5). The blood pressure range of 44 of the treated group who were doing well was 137/77 to 140/90. Fourteen others had blood pressure levels which had been reduced while 19 patients were still hypertensive with blood pressures between 149/95 and 164/116. Inadequate followup by the personal physician was common in this group. It was not unusual for these patients to be given refillable prescriptions for many months without physician visits, and in one case a patient had been refilling his

prescription for almost two years without a recheck of his blood pressure.

All sixty-two of the 139 patients who knew of their hypertension but were not taking therapy, were told to contact their physicians regarding their new blood pressure findings for possible institution or resumption of therapy. However, only 23 who were given this suggestion actually were placed on therapy, while the remaining 39 either did not report to their physicians or were not placed on drugs after visiting them. In other words, despite a vigorous individual educational effort, 63 percent of these patients remained untreated in the early part of the study. Although there was concern on the part of the patient who knew of his hypertension to have his blood pressure rechecked in a screening program, the majority did not start or resume therapy. Of the 23 who started therapy, 20 reverted to normal pressure levels, while three did not.

Studies have suggested that about 50 percent of persons treated for hypertension probably discontinue therapy within three months of its institution, and most actually become lost to present methods of followup.

Preliminary figures from our most recent followup study, being completed now, some six months since the end of the initial phase of the study, suggest that our experience with newly discovered and recently treated hypertensives is similar to that of others previously mentioned. Of the original 37 new hypertensives who were placed on therapy, only 20 currently remain on therapy after 6 months, a "drop out" rate of 46 percent. On the positive side, however, 18 of the 20 who continue therapy are adequately controlled.

Most persons who discontinued treatment were patients whose followup visits with their treating physicians were as remote as 6 to 12 months from the initial treatment visit. Without the educational reinforcement provided by frequent followup visits, they became unconcerned and stopped therapy on their own because they felt well.

We have thus concluded from a preliminary review of this study, that the Goddard hypertensive population is similar to the general hypertensive population. Despite great efforts in initial education and counselling, the treatment drop out rate is similar to that cited in other studies. It is our opinion that this education and counselling must be continued on a regular and frequent basis after initial counselling in order to keep patients in a therapeutic program. This on going effort which, in many cases, is not adequately provided by the treating physician, can and should be provided in the industrial clinic or health unit to effectively re-enforce meaningful treatment.

John D. Foulke, M. D.
Medical Director, GSFC

FIGURE 1
HYPERTENSION SCREENING
GSFC - 1974

NUMBER SCREENED _____	804
NORMOTENSIVES (< 140/90 _____)	615 (77%)
HYPERTENSIVES (> 140/90 _____)	189 (23%)
WITHOUT KNOWLEDGE _____	50 (25.8%)
WITH KNOWLEDGE _____	139 (74.2%)
MEAN AGE OF HYPERTENSIVES _____	46.3 yr.
FAILURE TO RETURN FOR FOLLOW-UP _____	7

FIGURE 2

NEWLY DETECTED HYPERTENSIVES

NUMBER	<u>50</u>
NUMBER PREVIOUSLY DOCUMENTED AT GSFC	<u>9</u>
NUMBER WHO FOLLOWED UP WITH PMD	<u>42 (84%)</u>
NUMBER WHO FAILED TO SEE PMD	<u>8 (16%)</u>

FIGURE 3
FORTY-TWO HYPERTENSIVES REFERRED
FOR THERAPY

NUMBER TREATED WITH DRUGS _____	37 (88%)
NUMBER TREATED WITH NO RESTRICTION AND/OR DIET ALONE _____	3 (7%)
NUMBER NOT TREATED AT ALL _____	2 (5%)

FIGURE 4

THIRTY-SEVEN TREATED PATIENTS

PRESSURE NORMALIZED	26 (70%)
PRESSURE REDUCED	8 (22%)
NO IMPROVEMENT	3 (8%)

FIGURE 5
PREVIOUSLY KNOWN HYPERTENSIVES

NUMBER _____	139
BEING TREATED BY PMD _____	77 (55%)
NORMAL BP _____	44
REDUCED BP _____	14
ABNORMAL BP (149/95 - 164/116) _____	19
NOT BEING TREATED _____	62 (45%)
DIASTOLIC RANGE _____	92-110
REPORTED RESULTS AND TREATED _____	23
NORMAL BP _____	20
NOT IMPROVED _____	3
EITHER DID NOT REPORT RESULTS TO PMD OR WERE NOT PLACED ON THERAPY _____	39