

NASA Technical Memorandum 74049

SUBSONIC LONGITUDINAL AND LATERAL-DIRECTIONAL STATIC
AERODYNAMIC CHARACTERISTICS OF A GENERAL RESEARCH
FIGHTER CONFIGURATION EMPLOYING A JET SHEET VORTEX
GENERATOR

(NASA-TM-74049) SUBSONIC LONGITUDINAL AND
LATERAL-DIRECTIONAL STATIC AERODYNAMIC
CHARACTERISTICS OF A GENERAL RESEARCH
FIGHTER CONFIGURATION EMPLOYING A JET SHEET
VORTEX GENERATOR (NASA) 189 p HC A09/MF A01 G3/02

N78-20071

Unclas
11894

JARRETT K. HUFFMAN AND CHARLES H. FOX, JR., NASA
LANGLEY RESEARCH CENTER AND
HENRY ZIEGLER, NORTHROP CORPORATION

January 1978



National Aeronautics and
Space Administration

Langley Research Center
Hampton, Virginia 23665

ABSTRACT

A new configuration concept for developing vortex lift, which replaces the physical wing strake with a jet sheet generated fluid strake, was investigated on a general research fighter model. The vertical and horizontal location of the jet sheet with respect to the wing leading edge was studied over a momentum coefficient range from 0 to 0.24. This study was conducted in the Langley 7- by 10-foot high speed tunnel over a Mach number range from 0.3 to 0.8. The angle of attack range investigated was from -2° to 30° at sideslip angles of 0° , -5° , and 5° .

The results are presented without analysis in order to expedite publication.

INTRODUCTION

The design requirement for efficient supersonic performance dictates that a fighter configuration have a low aspect ratio thin wing; however, with such a wing it is difficult to develop the high lift coefficients required for subsonic and transonic maneuvering. These conflicting requirements have resulted in the development of innovative subsonic aerodynamic design concepts that take advantage of the strong leading edge vortex which is shed from thin slender wings and strakes at angle of attack.

It is shown in reference 1 that, for slender wings, the vortex bursting point moves forward from the trailing edge as the angle of attack is increased. Thin wings with low leading edge sweep experience vortex bursting at low angle of attack so that vortex-induced effects are essentially non-existent for such wings. In reference 2, a method was developed for predicting vortex-induced effects on thin wings with fully developed vortex flow. The analytical results based on this method show that, if vortex bursting can be avoided or delayed to higher angles of attack, a large improvement in lift capability is possible for sharp edged wings of moderate leading edge sweep as well as for slender wings with high leading-edge sweep.

One method for achieving the desired vortex flow is to use a sharp edged highly swept wing strake. (See reference 3). Another method that has received research attention involves a spanwise blowing jet located on the upper surface of the wing. (See reference 4). A new method has been suggested which replaces the strake with a jet sheet formed by blowing from a series of small in-line orifices in the side of the fuselage forward of the wing.

This jet sheet will have a vorticity distribution associated with it and will also induce a stable vortex flow about the jet sheet similar to the vortex generated by a strake. The jet sheet or fluid strake has an advantage over the physical strake in that the blowing jet would only be turned on when needed and could be modulated whereas the physical strake is always present.

It is the purpose of this paper to present, without discussion, the results of a study of the effect of the vertical and horizontal location of a jet sheet with respect to the wing leading edge as well as the effect of jet blowing rate on the aerodynamic characteristics of a general research fighter model. This study was conducted in the Langley 7- by 10-foot high speed tunnel over a Mach number range from 0.3 to 0.8. The angle-of-attack range investigated was from -2° to approximately 30° at sideslip angles of 0° , 5° , and -5° .

The concept of a jet sheet vortex generator was formulated, and preliminary experimental studies conducted, by Northrop. A joint NASA-Northrop research effort was undertaken to design the modifications to an existing NASA wind tunnel model and to conduct the present wind tunnel investigation.

SYMBOLS

The International System of Units, with the U.S. Customary Units presented in parenthesis, is used for the physical quantities in this report (See reference 5). The measurements and calculations were made in the U.S. Customary Units. The plotted data presented in this report are referred to the stability axis system. The reference center for moments is shown in Figure 1(a). The symbols in parenthesis are used in Table II.

AF	axial force, N (lb)
AF _T	axial force corrected for thrust effects, N (lb)
b	wing reference span, .54356 m (21.40 inches)
\bar{c}	wing reference chord, .24554 m (9.669 inches)
(CAF(BA))	body axis axial force coefficient, $\frac{AF}{qS}$
C _D (CD(SA))	stability axis drag coefficient, $\frac{Drag}{qS}$
C _D _T (CDT)	stability axis drag coefficient corrected for thrust effects
C _L (CL(SA))	stability axis lift coefficient, $\frac{Lift}{qS}$
C _L _T (CLT)	stability axis lift coefficient corrected for thrust effects
C _l ₂ (CRM(SA))	stability axis rolling moment coefficient, $\frac{Rolling\ moment}{qSb}$
C _l ₂ _T (CRTS)	stability axis rolling moment coefficient corrected for thrust effects

ORIGINAL PAGE IS
OF POOR QUALITY

$C_{l_{T\beta}}$	beta derivative of stability axis rolling moment coefficient corrected for thrust effects, computed between $\beta = 5^\circ$ and $\beta = -5^\circ$
$(CNF(BA))$	body axis normal force coefficient, $\frac{NF}{qS}$
$C_n(CYM(SA))$	stability axis yawing moment coefficient, $\frac{\text{Yawing moment}}{qSb}$
$C_{n_T}(CYTS)$	stability axis yawing moment coefficient corrected for thrust effects
$C_{n_{T\beta}}$	beta derivative of stability axis yawing moment coefficient corrected for thrust effects between $\beta = 5^\circ$ and $\beta = -5^\circ$
$C_m(CPM(SA))$	stability axis pitching moment coefficient, $\frac{\text{Pitching moment}}{qS\bar{c}}$
$C_{m_T}(CMST)$	stability axis pitching moment coefficient corrected for thrust effects
$(CPB(1))$	balance chamber pressure coefficient, $\frac{\text{Chamber pressure} - p_\infty}{q}$
$(CPM(BA))$	body axis pitching moment coefficient, $\frac{PM}{qS\bar{c}}$
$(CRM(BA))$	body axis rolling moment coefficient, $\frac{RM}{qSb}$
$(CSF(BA))$	body axis side force coefficient, $\frac{SF}{qS}$
C_T	thrust coefficient, $\frac{\text{Thrust force}}{qS}$
$(CYM(BA))$	body axis yawing moment coefficient, $\frac{YM}{qSb}$
$C_Y(CSF(SA))$	stability axis side force coefficient, $\frac{\text{Side force}}{qS}$

C_{Y_T} (CYST) stability axis side force coefficient corrected for thrust effects
 $C_{Y_T\beta}$ beta derivative of stability axis side force coefficient corrected
for thrust effects, computed between $\beta = 5^\circ$ and $\beta = -5^\circ$
 C_μ (CMU) momentum coefficient
 g acceleration of gravity, m/sec (ft/sec)
 M (MACH) free stream Mach number
 NF normal force, N (lb)
 NF_T normal force corrected for thrust effects, N (lb)
 p_∞ (P1) free stream static pressure, Pa (lb/ft²)
 p_{t_p} plenum total pressure, Pa (lb/ft²)
 P_p (PLENP) plenum differential pressure in lb/in²)
 PM pitching moment, cm-N (in-lb)
 PM_T pitching moment corrected for thrust effects, cm-N (in-lb)
 $q(Q)$ free stream dynamic pressure, Pa (lb/ft²)
 RM rolling moment, cm-N (in-lb)
 RM_T rolling moment corrected for thrust effects, cm-N (in-lb)
 S wing reference area, .11557 m² (1.244 ft²)
 SF side force, N (lb)
 SF_T side force corrected for thrust effects, N (lb)
 T thrust force, N (lb)
 T_p (TPLEN) plenum total temperature in °R
(TP) test point number
 V (VTOT) velocity of jet, m/sec (ft/sec)
 W_p (WTFLO) weight flow of jet, kg/sec (lb/sec)

YM yawing moment, cm-N (in-lb)
YM_T yawing moment corrected for thrust effects, cm-N (in-lb)
 α (ALPHA) angle of attack, degrees
 β (BETA) angle of sideslip, degrees

MODEL

F fuselage
W₁ mid-wing
W₂ low-wing
V vertical tail
H horizontal tail
N₁ aft nozzle configuration
N₂ forward nozzle configuration

DESCRIPTION OF MODEL.

A drawing of the general research model is presented in Figure 1. Photographs of the model installed in the Langley 7- by 10-foot high speed tunnel are presented in Figure 2. The basic model consisted of a simple wing-fuselage-vertical tail combination. The uncambered and untwisted wing had an aspect ratio of 2.56 and a taper ratio of 0.19 based on the theoretical root chord, a leading edge sweep of 44° , and a NACA 64A series airfoil section in the streamwise direction with a thickness ratio of 6 percent at the fuselage juncture and 4 percent at the wing tip. The wing height was varied as shown in Figures 1(a), 2(e), and 2(f) so that the configuration represented either a mid-wing or a low-wing configuration.

The lower forward portion of the fuselage contained the model air supply plenum and twenty individual nozzle orifices on each side of the fuselage (See Figures 1(b), 2(d), and 2(h)). The plenum was connected to the 7- by 10-foot high speed tunnel low mass flow balance air fixture (See Figures 2(g) and 2(h)) and the high pressure air was delivered through the 7- by 10-foot high speed tunnel air sting. Details and locations of the nozzle orifices are shown in Figure 1(b). The longitudinal displacement of the fluid strake was accomplished through selectively blocking off groups of orifices inside the plenum. Nozzle configurations N_1 and N_2 each consisted of a different group of ten contiguous orifices on each side of the fuselage. (See Figure 1(a)).

The single centerline-mounted uncambered and untwisted vertical tail had a sharp leading edge with a sweep angle of 51.7° and an exposed area of 12.5 percent of the wing area. One configuration employed an uncambered and untwisted horizontal tail which had a sharp leading edge with a sweep angle of 51.7° and an exposed area of 25 percent of the wing area. The horizontal and vertical tails had a circular arc airfoil section with a thickness ratio of 6 percent at the fuselage juncture and 4 percent at the tip.

APPARATUS, TESTS, AND CORRECTIONS

The investigation was conducted in the Langley 7- by 10-foot high speed tunnel. (See reference 6). Forces and moments were measured on a six component strain gage balance mounted in an air fixture which was mounted internally in the model. (See Figures 2(g) and 2(h)). High pressure air was delivered across the balance to the model plenum by means of two S-shaped tubes. A complete calibration of the balance used in the study mounted in this air fixture has been made. This calibration demonstrated that the air crossing the balance does not affect any component except axial force. The effect on axial force is a tare effect which is a linear function of the pressure.

The model plenum included instrumentation to measure plenum stagnation pressure and temperature. These data were used to calculate the balance axial force pressure tare and the jet velocity.

The high pressure air system included a calibrated venturi type flow meter located in the main air supply line. This flow meter data was used to calculate the total jet weight flow.

The model was tested with two nozzle configurations (See Figure 1). These nozzle configurations were statically calibrated in the tunnel with the model removed (See Figure 2(h)). The static calibration resulted in six component force and moment data as a function of plenum pressure. The force and moment data were found to be linear functions of the plenum pressure. The resulting linear calibration equations were used to correct the aerodynamic data for thrust effects and are presented in the section on Data Reduction.

The left and right side orifices of each nozzle configuration were calibrated both independently of each other and combined. The resulting thrust data is presented in Figure 20.

The tests were made over a Mach number range of 0.3 to 0.8 which corresponds to a Reynolds number range of 1.5×10^6 to 3.0×10^6 based on the wing mean geometric chord. The angle of attack range was from -2° to 30° at sideslip angles of 0° , 5° , and -5° . The angles of attack and sideslip have been corrected for the effects of balance and sting bending under load. The angle of attack range was obtained through two separate setups, one for the range -2° to 20° and the other for the range 10° to 30° (See Figures 2(a) and 2(b)).

The drag measurements of the balance have been adjusted to a condition of free stream static pressure acting on the base of the model. Jet boundary and blockage corrections have been applied to the data based on references 7 and 8 respectively.

Transition strips 0.16 cm in width of No. 100 carborundum grains were placed 1.78 cm streamwise aft of the leading edge of the wing, vertical tail, and horizontal tail as well as 3.81 cm aft of the nose of the fuselage based on reference 9.

DATA REDUCTION

Note that the equations in this section are given in the U.S. Customary Units in which the calculations were actually performed.

The balance measured total aerodynamic plus thrust loads. Forces and moments corresponding to these total loads were calculated based on the balance calibration.

The jet velocity was calculated from

$$V = 109.6 \left[T_p \left(1 - \left(\frac{P_\infty}{P_{t_p}} \right)^{2/7} \right)^{1/2} \right]$$

The momentum coefficient was then computed from

$$C_\mu = \frac{1}{gqS} \dot{W}_p V$$

For the static calibrations, the thrust was computed as:

$$T = [NF^2 + AF^2 + SF^2]^{1/2}$$

Calibration of the sealed plenum resulted in the axial force pressure tare correction given by:

$$AF = AF - .00084 P_p$$

Calibration of the plenum for nozzle configuration N_1 determined the following thrust corrections:

$$NF_T = NF - .01617 P_p$$

$$AF_T = AF + .038833 P_p$$

$$PM_T = PM - .22167 P_p$$

$$RM_T = RM$$

$$YM_T = YM - .017 P_p$$

$$SF_T = SF + .0021667 P_p$$

For nozzle configuration N_2 , the thrust corrections were determined to be:

$$NF_T = NF - .01617 P_p$$

$$AF_T = AF + .038833 P_p$$

$$PM_T = PM - .22167 P_p$$

$$RM_T = RM$$

$$YM_T = YM - .0125 P_p$$

$$SF_T = SF + .0021667 P_p$$

The stability axis coefficients are given by:

$$C_{L} = \frac{NF}{qS} \cos \alpha - \frac{AF}{qS} \sin \alpha$$

$$C_{D} = \frac{NF}{qS} \sin \alpha + \frac{AF}{qS} \cos \alpha$$

$$C_{m} = \frac{PM}{qSc}$$

$$C_{\ell} = \frac{RM}{qSb} \cos \alpha + \frac{YM}{qSb} \sin \alpha$$

$$C_{n} = -\frac{RM}{qSb} \sin \alpha + \frac{YM}{qSb} \cos \alpha$$

$$C_{Y} = \frac{SF}{qS}$$

The stability axis coefficients corrected for thrust effects are given by:

$$C_{L_T} = \frac{NF_T}{qS} \cos \alpha - \frac{AF_T}{qS} \sin \alpha$$

$$C_{D_T} = \frac{NF_T}{qS} \sin \alpha + \frac{AF_T}{qS} \cos \alpha$$

$$C_{m_T} = \frac{PM_T}{qSc}$$

$$C_{\ell_T} = \frac{RM_T}{qSb} \cos \alpha + \frac{YM_T}{qSb} \sin \alpha$$

$$C_{n_T} = -\frac{RM_T}{qSb} \sin \alpha + \frac{YM_T}{qSb} \cos \alpha$$

$$C_{Y_T} = \frac{SF_T}{qS}$$

ORIGINAL PAGE IS
OF POOR QUALITY.

PRESENTATION OF RESULTS

The results are presented without analysis in order to expedite publication. The longitudinal data are presented in the following figures:

	<u>Figure</u>
Effect of blowing on:	
Configuration $FW_1 N_1 V$	
M = 0.3	3
M = 0.5	4
M = 0.7	5
Configuration $FW_2 N_1 V$	
M = 0.3	6
M = 0.7	7
Configuration $FW_2 N_2 V$	
M = 0.3	8
M = 0.7	9
Configuration $FW_1 N_2 V$	
M = 0.3	10
M = 0.7	11
Configuration $FW_1 N_1 VH$	
M = 0.3	12
M = 0.7	13

The lateral-directional derivatives are presented in the following figures:

Figure

Effect of blowing on:

Configuration FW₁N₁V

M = 0.3 14

M = 0.5 15

M = 0.7 16

Configuration FW₁N₁

M = 0.3 17

M = 0.5 18

M = 0.7 19

The run schedule is presented in Table I. A tabulation of the aerodynamic coefficients is presented in Table II.

REFERENCES

1. Wentz, W. H. Jr.; and Kohlman, D. L.: Wind Tunnel Investigations of Vortex Breakdown on Slender Sharp-Edged Wings. NASA CR-98737, 1968.
2. Polhamus, Edward C.: A Concept of the Vortex Lift of Sharp-Edge Delta Wings Based on a Leading-Edge Suction Analogy. NASA TN D-3767, 1966.
3. Henderson, William P., and Huffman, Jarrett K.: Effect of Wing Design on the Longitudinal Aerodynamic Characteristics of a Wing-Body Model at Subsonic Speeds. NASA TN D-7099, 1972.
4. Erickson, Gary E., and Campbell, James F.: Augmentation of Maneuver Performance by Spanwise Blowing. NASA TM X-73998, 1977.
5. Mechtly, E. A.: The International System of Units, NASA SP-7012, 1964.
6. Fox, Charles H. Jr., and Huffman, Jarrett K.: Calibration and Test Capabilities of the Langley 7- by 10-foot High Speed Tunnel. NASA TM X-74027, 1977.
7. Gillis, Clarence L.; Polhamus, Edward C., and Gray, Joseph L. Jr.: Charts for Determining Jet-Boundary Corrections for Complete Models in 7- by 10-foot Closed Rectangular Wind Tunnels. NACA WR-L-123, 1945.
8. Herriott, John G.: Blockage Corrections for Three-Dimensional-Flow Closed-Thrust Wind Tunnels, with Consideration of the Effect of Compressibility. NACA Report 995, 1950.
9. Braslow, Albert L.; Hicks, Raymond M.; and Harris, Roy V. Jr.: Use of Grit-Type Boundary-Layer Transition Trips on Wind-Tunnel Models. NASA TN D-3579, 1966.

TABLE I.- RUN SCHEDULE

Run	M	α Range	β , deg	C_{μ} Nominal	Configuration
20	.3	Low	0	.05	F W ₁ N ₁ V
21	.3			0	↓
22	.7			0	
23	.3			.05	
24	↓			.1	
25				.2	
26	↓			.24	
27	.7			.05	↓
28	.3			0	F W ₂ N ₁ V
29	↓			.05	
30				.1	
31				.2	
32	↓			.24	
33	.7			0	
34	.7			.05	↓
35	.3			.05	F W ₂ N ₂ V
36	↓			.1	
37				.2	
38	↓			.24	
39	.7			.05	↓
40	.3			.05	F W ₁ N ₂ V
41	↓			.1	
42	↓			.2	
43	↓			.24	
44	.7			.05	↓

ORIGINAL PAGE IS
OF POOR QUALITY

TABLE I.- Continued.

Run	M	α Range	β , deg	C_u Nominal	Configuration				
45	.3	High	0	0	F W ₁ N ₁ V				
46				.05					
47				.1					
48				.2					
49				.24					
50				0	F W ₂ N ₁ V				
51				.05					
52				.1					
53				.2					
54				.24					
55	.5			0	F W ₁ N ₁ V				
56				.05					
57				.09					
58	.3		5	0					
59				.05					
60				.1					
61				.2					
62				.24					
63	.5			.09					
64				0					
65				.05					
66	.3			0	F W ₁ N ₁				
67				.05					
68				.1					
69				.2					

TABLE I.- Continued.

Run	M	α Range	β , deg	C_{μ} Nominal	Configuration				
70	.3	High	5	.24	F W ₁ N ₁				
71	.5			.09					
72	↓			.05					
73	↓			0					
74	.3		-5.01	0					
75	↓			.05					
76	↓			.1					
77	↓			.2					
78	↓			.24					
79	.5			.09					
80	↓			0					
81	↓			.05					
82	.3			0	F W ₁ N ₁ V				
83	↓			.05					
84	↓			.1					
85	↓			.2					
86	↓			.24					
87	.5			.09					
88	↓			.05					
89	↓			0					
90	↓	Low	0	0					
91	↓			.05					
92	↓			.09					
93	.8			0					
94	.8			.05					

TABLE I.- Continued.

Run	M	α Range	β , deg	C_H Nominal	Configuration				
95	.3	Low	5.	0	F W ₁ N ₁ V				
96	↓			.05					
97				.1					
98				.2					
99	↓			.24					
100	.5			.09					
101	↓			.05					
102	↓			0					
103	.7			0					
104	.7			.05					
105	.3			0	F W ₁ N ₁				
106	↓			.05					
107				.1					
108				.2					
109	↓			.24					
110	.5			.09					
111	↓			.05					
112	↓			0					
113	.7			0					
114	.7			.05					
115	.3		-5.	0					
116	↓			.05					
117				.1					
118	↓			.2					
119	↓			.24					

TABLE I.- Concluded.

Run	M	α Range	β , deg	C_{μ} Nominal	Configuration				
120	.5	Low	-5.	.09	F W ₁ N ₁				
121	↓			.05					
122	↓			0					
123	.7			0					
124	.7			.05					
125	.3			0	F W ₁ N ₁ V				
126	↓			.05					
127	↓			.1					
128	↓			.2					
129	↓			.24					
130	.5			.09					
131	↓			.05					
132	↓			0					
133	.7			0					
134	.7		↓	.05					
135	.3		0	0	F W ₁ N ₁ V H				
136	↓			.05					
137	↓			.1					
138	↓			.2					
139	↓			.24					
140	.7			.05					
141	.7	↓	↓	0					

TABLE II. TABULATION OF THE AERODYNAMIC COEFFICIENTS

			NASA LANGLEY				7 X 10 HIGH SPEED TUNNEL						
TEST TP	21 MACH	Q PA	RUN 20		CNF(BA)	CAF(BA)	CPH(BA)	CRM(BA)	CYM(BA)	CSF(BA)	TPLEN DEG K		
			ALPHA DEG	BETA DEG									
5703	.301	6061.2	-.02	-.00	-.0064	.0171	-.0029	.0019	-.0022	.0079	295.9		
5704	.300	6048.6	-.02	-.00	-.0134	-.0125	-.0006	.0016	-.0018	.0070	294.1		
5705	.299	6004.6	-1.79	-.00	-.1235	-.0158	-.0061	.0014	-.0019	.0069	293.5		
5706	.300	6046.7	-.08	-.00	-.0182	-.0115	.0010	.0020	-.0018	.0074	293.4		
5707	.302	6103.8	2.02	-.00	.0887	-.0128	.0075	.0016	-.0018	.0072	293.1		
5708	.301	6071.3	4.03	-.00	.1928	-.0169	.0127	.0021	-.0017	.0082	292.9		
5709	.300	6051.1	6.13	-.00	.3221	-.0236	.0147	.0024	-.0017	.0071	292.7		
5710	.300	6016.0	8.36	-.00	.4665	-.0311	.0153	.0020	-.0019	.0071	292.5		
5711	.297	5925.6	10.43	-.00	.5816	-.0360	.0177	.0021	-.0019	.0072	292.3		
5712	.299	6005.5	12.66	-.00	.7011	-.0381	.0204	.0016	-.0024	.0084	292.0		
5713	.300	6043.0	14.83	-.00	.8113	-.0404	.0184	.0011	-.0024	.0081	291.7		
5714	.297	5925.8	16.99	.00	.9225	-.0423	.0115	.0022	-.0030	.0072	291.5		
5715	.299	5985.5	19.18	.00	1.0115	-.0423	.0022	.0040	-.0039	.0079	291.2		
5716	.298	5955.1	21.56	.00	1.0951	-.0446	-.0008	.0036	-.0040	.0074	290.9		
5717	.302	6105.6	23.50	.00	1.1511	-.0409	-.0065	.0012	-.0035	.0086	290.7		
5718	.300	6039.4	23.84	.00	1.1574	-.0406	-.0093	.0012	-.0037	.0077	290.5		
5719	.299	6009.7	-.03	-.00	-.0113	-.0102	-.0004	.0019	-.0019	.0079	290.0		
5720	.300	6035.3	-.03	-.00	-.0070	.0210	-.0029	.0017	-.0026	.0101	289.7		

TEST TP	21 ALPHA DEG	BETA DEG	RUN 20		CPH(SA)	CRM(SA)	CYM(SA)	CSF(SA)	P1 PA	CPB(1)	VTOT M/SEC		
			CL(SA)	CO(SA)									
5703	-.02	-.00	-.0064	.0171	-.0029	.0019	-.0022	.0079	95753.5	-.116	.0		
5704	-.02	-.00	-.0134	-.0125	-.0006	.0016	-.0018	.0070	95767.7	-.120	530.0		
5705	-1.79	-.00	-.1240	-.0119	-.0061	.0014	-.0018	.0069	95814.9	-.122	528.5		
5706	-.08	-.00	-.0182	-.0115	.0010	.0020	-.0018	.0074	95769.9	-.120	527.8		
5707	2.02	-.00	.0891	-.0096	.0075	.0016	-.0018	.0072	95712.4	-.117	527.8		
5708	4.03	-.00	.1935	-.0033	.0127	.0020	-.0019	.0082	95751.9	-.120	527.7		
5709	6.13	-.00	.3228	.0109	.0147	.0022	-.0019	.0071	95774.3	-.130	527.6		
5710	8.36	-.00	.4661	.0371	.0153	.0017	-.0022	.0071	95809.8	-.142	527.5		
5711	10.43	-.00	.5785	.0699	.0177	.0018	-.0022	.0072	95906.5	-.150	528.1		
5712	12.66	-.00	.6924	.1164	.0204	.0011	-.0027	.0084	95815.9	-.156	525.7		
5713	14.83	-.00	.7946	.1685	.0184	.0005	-.0026	.0081	95774.5	-.162	526.7		
5714	16.99	.00	.8947	.2291	.0115	.0012	-.0035	.0072	95899.0	-.169	526.0		
5715	19.18	.00	.9693	.2923	.0022	.0025	-.0050	.0079	95831.6	-.177	526.2		
5716	21.56	.00	1.0349	.3609	-.0008	.0018	-.0051	.0074	95860.5	-.183	525.4		
5717	23.50	.00	1.0719	.4216	-.0065	-.0003	-.0037	.0086	95699.1	-.196	525.8		
5718	23.84	.00	1.0750	.4307	-.0093	-.0004	-.0038	.0077	95767.6	-.197	526.0		
5719	-.03	-.00	-.0113	-.0102	-.0004	.0019	-.0019	.0079	95804.7	-.120	524.8		
5720	-.03	-.00	-.0070	.0210	-.0029	.0017	-.0026	.0101	95781.4	-.118	.0		

TEST TP	21 Q	ALPHA PA	BETA DEG	RUN 20 BETA DEG	CLT	CDT	CMST	CRTS	CYTS	CYST	CMU	WTFLO	PLENP		
														KG/SEC	PSI
5703	6061.2	-.02	-.00	0.0000	0.0000	0.0000	0.0000	0.0000	0.0000	0.0000	.0000	.0116	.0		
5704	6048.6	-.02	-.00	-.0236	.0170	-.0179	.0016	-.0024	.0086	.0494	.0651	119.0			
5705	6004.6	-1.79	-.00	-.1352	.0177	-.0234	.0015	-.0024	.0085	.0489	.0641	117.5			
5706	6046.7	-.08	-.00	-.0301	.0174	-.0160	.0020	-.0024	.0090	.0482	.0638	116.6			
5707	6103.8	2.02	-.00	.0761	.0186	-.0094	.0016	-.0024	.0088	.0479	.0639	116.9			
5708	6071.3	4.03	-.00	.1795	.0246	-.0043	.0019	-.0025	.0098	.0481	.0640	117.1			
5709	6051.1	6.13	-.00	.3077	.0384	-.0024	.0021	-.0025	.0087	.0484	.0641	117.2			
5710	6016.0	8.36	-.00	.4498	.0642	-.0019	.0016	-.0028	.0087	.0488	.0642	117.4			
5711	5925.8	10.43	-.00	.5609	.0971	.0001	.0017	-.0028	.0089	.0507	.0656	118.7			
5712	6005.5	12.66	-.00	.6744	.1418	.0035	.0009	-.0033	.0100	.0479	.0632	115.2			
5713	6043.0	14.83	-.00	.7755	.1935	.0013	.0003	-.0032	.0097	.0484	.0641	117.2			
5714	5925.8	16.99	.00	.8744	.2536	-.0059	.0011	-.0041	.0089	.0492	.0640	116.6			
5715	5935.5	19.18	.00	.9481	.3160	-.0191	.0023	-.0055	.0095	.0490	.0644	117.3			
5716	5955.1	21.56	.00	1.0128	.3836	-.0181	.0016	-.0056	.0090	.0487	.0638	116.4			
5717	6105.6	23.50	.00	1.0495	.4431	-.0234	-.0005	-.0042	.0102	.0478	.0641	117.2			
5718	6039.4	23.84	.00	1.0521	.4524	-.0265	-.0007	-.0044	.0093	.0483	.0641	117.9			
5719	6009.7	-.03	-.00	-.0234	.0189	-.0176	.0019	-.0024	.0095	.0485	.0642	116.7			
5720	6035.3	-.03	-.00	0.0000	0.0000	0.0000	0.0000	0.0000	0.0000	.0000	.0118	-.0			

ORIGINAL PAGE IS
OF POOR QUALITY

NASA LANGLEY

7 X 10 HIGH SPEED TUNNEL

TEST TP	21 MACH	Q PA	RUN ALPHA DEG	BETA DEG	CNF(BA)	CAF(BA)	CPH(BA)	CRM(BA)	CYN(BA)	CSF(BA)	TPLEN DEG K
5734	.300	5920.8	-.01	-.00	-.0051	.0172	-.0028	.0020	-.0022	.0068	288.2
5735	.299	5934.6	-1.75	-.00	-.1074	.0138	-.0070	.0015	-.0021	.0067	288.2
5736	.301	6035.4	.02	-.00	.0031	.0173	-.0017	.0015	-.0023	.0072	288.2
5737	.303	6092.4	2.06	-.00	.1069	.0151	.0033	.0021	-.0023	.0075	288.2
5738	.301	6019.4	4.06	.00	.2152	.0095	.0072	.0023	-.0023	.0067	288.2
5739	.302	6049.6	6.15	.00	.3346	.0026	.0091	.0024	-.0025	.0074	288.2
5740	.300	5999.6	8.32	.00	.4629	-.0027	.0119	.0020	-.0030	.0075	288.3
5741	.300	5979.1	10.39	.00	.5688	-.0074	.0145	.0026	-.0028	.0073	288.4
5742	.299	5965.4	12.60	.00	.6767	-.0088	.0175	.0021	-.0032	.0083	288.4
5743	.298	5909.0	14.80	.00	.7886	-.0088	.0122	.0021	-.0033	.0085	288.5
5744	.297	5876.4	17.05	.00	.8882	-.0067	.0052	.0013	-.0034	.0099	288.5
5745	.298	5907.6	19.07	-.00	.9397	.0003	-.0124	.0003	-.0024	.0089	288.6
5746	.297	5863.8	21.13	-.00	.9658	.0023	-.0201	.0009	-.0028	.0098	288.6
5747	.300	6000.4	23.27	-.00	1.0213	.0003	-.0209	.0011	-.0023	.0112	288.7
5748	.301	6023.1	23.72	-.00	1.0387	-.0004	-.0212	.0012	-.0020	.0109	288.7
5749	.299	5950.9	-.01	-.00	-.0050	.0166	-.0014	.0021	-.0022	.0071	288.8

TEST TP	21 ALPHA DEG	BETA DEG	RUN CL(SA)	CD(SA)	CPH(SA)	CRM(SA)	CYN(SA)	CSF(SA)	P1 PA	CPB(1)	VTDT M/SEC
5734	-.01	-.00	-.0051	.0172	-.0028	.0020	-.0022	.0068	94955.4	-.116	0.0
5735	-1.75	-.00	-.1069	.0171	-.0070	.0015	-.0021	.0067	95006.5	-.117	0.0
5736	.02	-.00	.0031	.0173	-.0017	.0015	-.0023	.0072	94900.2	-.116	0.0
5737	2.06	-.00	.1062	.0189	.0033	.0020	-.0023	.0075	94891.4	-.117	0.0
5738	4.06	.00	.2140	.0247	.0072	.0021	-.0025	.0067	94934.7	-.120	0.0
5739	6.15	.00	.3324	.0384	.0091	.0021	-.0028	.0074	94912.3	-.125	0.0
5740	8.32	.00	.4585	.0642	.0119	.0015	-.0032	.0075	94969.0	-.135	0.0
5741	10.39	.00	.5609	.0953	.0145	.0020	-.0032	.0073	94999.6	-.146	0.0
5742	12.60	.00	.6623	.1391	.0175	.0013	-.0035	.0083	95019.7	-.154	0.0
5743	14.80	.00	.7647	.1930	.0212	.0012	-.0038	.0085	95084.2	-.158	0.0
5744	17.05	.00	.8511	.2541	.0252	.0002	-.0036	.0099	95123.1	-.163	0.0
5745	19.07	-.00	.8880	.3073	-.0124	-.0005	-.0024	.0089	95096.5	-.174	0.0
5746	21.13	-.00	.9000	.3502	-.0201	-.0001	-.0029	.0098	95148.4	-.184	0.0
5747	23.27	-.00	.9381	.4037	-.0209	.0001	-.0026	.0112	95008.8	-.185	0.0
5748	23.72	-.00	.9511	.4176	-.0212	-.0000	-.0030	.0109	94988.4	-.185	0.0
5749	-.01	-.00	-.0050	.0166	-.0014	.0021	-.0022	.0071	95084.4	-.117	0.0

TEST TP	21 C PA	ALPHA DEG	RUN BETA DEG	CLT	CDT	CMST	CRTS	CYTS	CYST	CMU	WTFLD KG/SEC	PLENPSI PSI
5734	5960.8	-.01	-.00	-.0051	.0172	-.0028	.0020	-.0022	.0068	0.0000	0.0000	.0
5735	5934.6	-1.75	-.00	-.1069	.0171	-.0070	.0015	-.0021	.0067	0.0000	0.0000	.0
5736	6035.4	.02	-.00	.0031	.0173	-.0017	.0015	-.0023	.0072	0.0000	0.0000	.0
5737	6092.4	2.06	-.00	.1062	.0189	.0033	.0020	-.0023	.0075	0.0000	0.0000	.0
5738	6019.4	4.06	.00	.2140	.0247	.0072	.0021	-.0025	.0067	0.0000	0.0000	.0
5739	6049.6	6.15	.00	.3324	.0384	.0091	.0021	-.0028	.0074	0.0000	0.0000	-.1
5740	5999.6	8.32	.00	.4585	.0642	.0119	.0015	-.0032	.0075	0.0000	0.0000	-.1
5741	5979.1	10.39	.00	.5609	.0953	.0145	.0020	-.0032	.0073	0.0000	0.0000	-.2
5742	5965.4	12.60	.00	.6623	.1391	.0175	.0013	-.0035	.0083	0.0000	0.0000	-.2
5743	5909.0	14.80	.00	.7647	.1930	.0212	.0012	-.0038	.0085	0.0000	0.0000	-.3
5744	5876.4	17.05	.00	.8511	.2541	.0252	.0002	-.0036	.0099	0.0000	0.0000	-.3
5745	5907.6	19.07	-.00	.8880	.3073	-.0124	-.0005	-.0024	.0089	0.0000	0.0000	-.3
5746	5863.8	21.13	-.00	.9000	.3502	-.0201	-.0001	-.0029	.0098	0.0000	0.0000	-.3
5747	6000.4	23.27	-.00	.9381	.4037	-.0209	.0001	-.0026	.0112	0.0000	0.0000	-.4
5748	6023.1	23.72	-.00	.9511	.4176	-.0212	-.0000	-.0030	.0109	0.0000	0.0000	-.4
5749	5950.9	-.01	-.00	-.0050	.0166	-.0014	.0021	-.0022	.0071	0.0000	0.0000	-.1

ORIGINAL PAGE IS OF POOR QUALITY

NASA LANGLEY

7 X 10 HIGH SPEED TUNNEL

TEST TP	21		RUN 22		CNF(BA)	CAF(BA)	CPH(BA)	CRM(BA)	CYM(BA)	CSF(BA)	TPLEN DEG K
	MACH	Q PA	ALPHA DEG	BETA DEG							
5750	.704	25127.6	-.04	-.00	-.0020	.0149	-.0031	.0017	-.0024	.0077	291.1
5751	.696	24739.5	-2.06	-.00	-.1241	.0128	-.0073	.0016	-.0023	.0082	291.8
5752	.699	24892.0	.01	-.00	-.0018	.0146	-.0032	.0020	-.0025	.0081	292.5
5753	.706	25243.4	2.34	.00	.1276	.0113	.0014	.0023	-.0025	.0072	293.1
5754	.703	25078.5	4.71	.00	.2630	.0048	.0036	.0022	-.0026	.0068	293.9
5755	.702	25054.9	7.25	.01	.4156	.0003	.0034	.0022	-.0030	.0064	294.9
5756	.702	25046.8	9.65	.01	.5432	-.0021	.0064	.0034	-.0027	.0048	295.8
5757	.697	24794.6	12.01	.01	.6439	-.0010	.0045	.0024	-.0028	.0051	296.4
5758	.690	24468.5	14.36	.01	.7547	-.0004	-.0031	.0021	-.0032	.0063	296.8
5759	.697	24775.5	16.69	.01	.8373	.0013	-.0159	.0021	-.0030	.0066	297.4
5760	.691	24535.5	18.82	-.00	.8744	.0042	-.0221	.0006	-.0014	.0056	297.9
5761	.698	24906.1	20.91	-.01	.8809	.0051	-.0196	-.0004	-.0002	.0048	299.7
5762	.700	25004.2	-.03	-.00	-.0019	.0134	-.0027	.0016	-.0027	.0079	301.2

TEST TP	21		RUN 22		CPH(SA)	CRM(SA)	CYM(SA)	CSF(SA)	P1 PA	CPB(L)	VTOT M/SEC
	ALPHA DEG	BETA DEG	CL(SA)	CD(SA)							
5750	-.04	-.00	-.0020	.0149	-.0031	.0017	-.0024	.0077	72512.2	-.123	0.0
5751	-2.06	-.00	-.1235	.0173	-.0073	.0017	-.0023	.0082	73008.3	-.123	0.0
5752	.01	-.00	-.0018	.0146	-.0032	.0020	-.0025	.0081	72801.0	-.123	0.0
5753	2.34	.00	.1271	.0165	.0014	.0022	-.0026	.0072	72324.5	-.125	0.0
5754	4.71	.00	.2617	.0264	.0036	.0020	-.0028	.0068	72531.2	-.129	0.0
5755	7.25	.01	.4123	.0521	.0034	.0018	-.0032	.0064	72551.1	-.135	0.0
5756	9.65	.01	.5358	.0890	.0064	.0029	-.0032	.0048	72588.2	-.144	0.0
5757	12.01	.01	.6300	.1330	.0045	.0017	-.0033	.0051	72882.0	-.152	0.0
5758	14.36	.01	.7312	.1867	-.0031	.0012	-.0036	.0063	73319.1	-.158	0.0
5759	16.69	.01	.8017	.2417	-.0159	.0012	-.0035	.0066	72955.4	-.170	0.0
5760	18.82	-.00	.8263	.2860	-.0221	.0002	-.0015	.0056	73317.4	-.181	0.0
5761	20.91	-.01	.8210	.3192	-.0196	-.0005	-.0000	.0048	72969.1	-.182	0.0
5762	-.03	-.00	-.0019	.0134	-.0027	.0016	-.0027	.0079	72937.5	-.122	0.0

TEST TP	21		RUN 22		CDT	CMST	CRTS	CYTS	CYST	CMU	WTFLO KG/SEC	PLENP PSI
	Q PA	ALPHA DEG	BETA DEG	CLT								
5750	25127.6	-.04	-.00	-.0020	.0149	-.0031	.0017	-.0024	.0077	0.0000	0.0000	.1
5751	24739.5	-2.06	-.00	-.1235	.0173	-.0073	.0017	-.0023	.0082	0.0000	0.0000	-.0
5752	24892.0	.01	-.00	-.0018	.0146	-.0032	.0020	-.0025	.0081	0.0000	0.0000	-.0
5753	25243.4	2.34	.00	.1271	.0165	.0014	.0022	-.0026	.0072	0.0000	0.0000	.0
5754	25078.5	4.71	.00	.2617	.0264	.0036	.0020	-.0028	.0068	0.0000	0.0000	.0
5755	25054.9	7.25	.01	.4123	.0521	.0034	.0018	-.0032	.0064	0.0000	0.0000	-.1
5756	25046.8	9.65	.01	.5358	.0890	.0064	.0029	-.0032	.0048	0.0000	0.0000	-.1
5757	24794.6	12.01	.01	.6300	.1330	.0045	.0017	-.0033	.0051	0.0000	0.0000	-.3
5758	24468.5	14.36	.01	.7312	.1867	-.0031	.0012	-.0036	.0063	0.0000	0.0000	-.5
5759	24775.5	16.69	.01	.8017	.2417	-.0159	.0012	-.0035	.0066	0.0000	0.0000	-1.1
5760	24535.5	18.82	-.00	.8263	.2860	-.0221	.0002	-.0015	.0056	0.0000	0.0000	-1.0
5761	24906.1	20.91	-.01	.8210	.3192	-.0196	-.0005	-.0000	.0048	0.0000	0.0000	-1.1
5762	25004.2	-.03	-.00	-.0019	.0134	-.0027	.0016	-.0027	.0079	0.0000	0.0000	-.1

NASA LANGLEY

7 X 10 HIGH SPEED TUNNEL

TEST TP	21 MACH	C PA	RUN 23 ALPHA DEG	BETA DEG	CNF(BA)	CAF(BA)	CPM(BA)	CRM(BA)	CYM(BA)	CSF(BA)	TPLEN DEG K
5767	.304	6116.2	-.00	-.00	-.0031	.0173	-.0019	.0012	-.0024	.0086	294.5
5768	.298	5905.7	.01	-.00	-.0090	-.0103	.0025	.0018	-.0016	.0070	290.9
5769	.298	5896.3	-1.85	-.00	-.1185	-.0136	-.0042	.0016	-.0015	.0064	290.6
5770	.301	6001.7	.02	-.00	-.0100	-.0099	.0023	.0023	-.0019	.0080	290.3
5771	.302	6057.0	2.06	-.00	.0948	-.0119	.0089	.0020	-.0017	.0084	290.1
5772	.299	5936.6	4.05	-.00	.1970	-.0164	.0129	.0024	-.0014	.0077	289.8
5773	.300	5987.3	6.22	-.00	.3327	-.0234	.0149	.0029	-.0017	.0073	289.6
5774	.299	5957.5	8.39	-.00	.4720	-.0305	.0160	.0023	-.0019	.0081	289.4
5775	.299	5943.4	10.56	-.00	.5987	-.0349	.0185	.0022	-.0019	.0070	289.2
5776	.299	5958.6	12.69	-.00	.7059	-.0379	.0215	.0018	-.0023	.0086	288.9
5777	.299	5957.4	14.86	-.00	.8232	-.0404	.0178	.0015	-.0023	.0095	288.7
5778	.298	5911.2	16.99	.00	.9318	-.0423	.0107	.0026	-.0027	.0086	288.5
5779	.301	6012.9	19.32	.00	1.0300	-.0435	.0028	.0029	-.0028	.0073	288.3
5780	.295	5802.2	21.38	.00	1.1016	-.0471	.0003	.0015	-.0026	.0069	288.2
5781	.295	5796.7	23.45	-.00	1.1692	-.0448	-.0051	-.0001	-.0017	.0072	287.9
5782	.299	5955.8	23.87	-.00	1.1722	-.0410	-.0102	-.0011	-.0011	.0067	287.8
5783	.298	5888.5	-.01	-.00	-.0034	-.0109	.0001	.0020	-.0014	.0078	287.5

TEST TP	21 ALPHA DEG	BETA DEG	RUN 23 CL(SA)	CD(SA)	CPM(SA)	CRM(SA)	CYM(SA)	CSF(SA)	P1 PA	CPB(1)	VTOT M/SEC
5767	-.00	-.00	-.0031	.0173	-.0019	.0012	-.0024	.0086	94769.8	-.117	.0
5768	.01	-.00	-.0090	-.0103	.0025	.0018	-.0016	.0070	94992.3	-.119	525.8
5769	-1.85	-.00	-1.189	-.0098	-.0042	.0017	-.0015	.0064	94999.1	-.122	525.9
5770	.02	-.00	-.0100	-.0099	.0023	.0023	-.0019	.0080	94883.5	-.120	526.0
5771	2.06	-.00	.0952	-.0085	.0089	.0019	-.0018	.0084	94827.4	-.119	526.7
5772	4.05	-.00	.1976	-.0025	.0129	.0023	-.0016	.0077	94953.6	-.119	526.6
5773	6.22	-.00	.3333	.0128	.0149	.0027	-.0020	.0073	94893.6	-.130	526.6
5774	8.39	-.00	.4714	.0387	.0160	.0020	-.0022	.0081	94918.1	-.142	526.5
5775	10.56	-.00	.5949	.0754	.0185	.0019	-.0022	.0070	94927.8	-.150	526.4
5776	12.69	-.00	.6970	.1181	.0215	.0013	-.0026	.0086	94903.3	-.156	526.2
5777	14.86	-.00	.8060	.1721	.0178	.0009	-.0026	.0095	94903.2	-.163	526.1
5778	16.99	.00	.9035	.2319	.0107	.0017	-.0033	.0086	94948.5	-.169	525.9
5779	19.32	.00	.9864	.2998	.0028	.0018	-.0036	.0073	94839.7	-.177	525.8
5780	21.38	.00	1.0430	.3577	.0003	.0005	-.0030	.0069	95062.5	-.182	525.5
5781	23.45	-.00	1.0904	.4242	-.0051	-.0008	-.0015	.0072	95065.1	-.192	525.2
5782	23.87	-.00	1.0885	.4370	-.0102	-.0014	-.0006	.0067	94893.4	-.195	525.4
5783	-.01	-.00	-.0034	-.0109	.0001	.0020	-.0014	.0078	94969.6	-.119	525.2

TEST TP	21 Q PA	ALPHA DEG	RUN 23 BETA DEG	CLT	CDT	CMST	CRTS	CYTS	CYST	CMU	WTFLD KG/SEC	PLENP PSI
5767	6116.2	-.00	-.00	0.0000	0.0000	0.0000	0.0000	0.0000	0.0000	.0000	.0119	-.2
5768	5905.7	.01	-.00	-.0212	.0191	-.0149	.0018	-.0022	.0086	.0495	.0642	116.1
5769	5896.3	-1.85	-.00	-.1303	.0202	-.0217	.0017	-.0021	.0081	.0499	.0646	116.6
5770	6001.7	.02	-.00	-.0221	.0192	-.0149	.0023	-.0025	.0096	.0490	.0646	116.9
5771	6057.0	2.06	-.00	.0819	.0203	-.0083	.0019	-.0024	.0100	.0493	.0655	118.4
5772	5936.6	4.05	-.00	.1831	.0265	-.0048	.0023	-.0022	.0094	.0504	.0656	119.0
5773	5987.3	6.22	-.00	.3178	.0410	-.0027	.0027	-.0026	.0090	.0501	.0658	119.1
5774	5957.5	8.39	-.00	.4547	.0665	-.0017	.0019	-.0028	.0098	.0504	.0658	119.2
5775	5943.4	10.56	-.00	.5772	.1026	.0008	.0017	-.0028	.0086	.0505	.0658	119.3
5776	5958.6	12.69	-.00	.6782	.1445	.0038	.0011	-.0032	.0103	.0505	.0660	119.4
5777	5957.4	14.86	-.00	.7863	.1979	.0000	.0007	-.0031	.0112	.0505	.0660	119.6
5778	5911.2	16.99	.00	.8827	.2571	-.0072	.0015	-.0039	.0103	.0510	.0662	119.6
5779	6012.9	19.32	.00	.9648	.3237	-.0147	.0016	-.0042	.0089	.0501	.0661	119.6
5780	5802.2	21.38	.00	1.0198	.3817	-.0179	.0002	-.0036	.0086	.0518	.0660	119.6
5781	5796.7	23.45	-.00	1.0664	.4474	-.0232	-.0010	-.0021	.0089	.0519	.0661	119.5
5782	5955.8	23.87	-.00	1.0649	.4594	-.0279	-.0017	-.0012	.0084	.0506	.0662	119.8
5783	5888.5	-.01	-.00	-.0161	.0195	-.0178	.0020	-.0021	.0095	.0512	.0663	119.9

ORIGINAL PAGE IS OF POOR QUALITY

NASA LANGLEY

7 X 10 HIGH SPEED TUNNEL

TEST TP	21 MACH	Q PA	RUN 24 ALPHA DEG	BETA DEG	CNF(BA)	CAF(BA)	CPH(BA)	CRH(BA)	CYM(BA)	CSF(BA)	TPLEN DEG K
5784	.300	5994.6	.00	-.00	-.0037	-.0362	.0085	.0021	-.0010	.0068	284.0
5785	.299	5947.7	-1.73	-.00	-.1056	-.0399	-.0003	.0017	-.0010	.0064	284.0
5786	.301	6013.9	.00	-.00	-.0064	-.0359	.0082	.0021	-.0012	.0068	283.9
5787	.303	6073.3	2.09	-.00	.0863	-.0367	.0165	.0024	-.0004	.0076	283.9
5788	.302	6061.5	4.11	-.00	.2028	-.0418	.0172	.0029	-.0008	.0066	283.8
5789	.301	6019.1	6.17	-.00	.3357	-.0483	.0172	.0032	-.0013	.0054	283.8
5790	.301	6029.6	8.36	-.00	.4801	-.0558	.0161	.0025	-.0016	.0067	283.8
5791	.301	5997.3	10.44	.00	.6183	-.0615	.0172	.0039	-.0013	.0054	283.7
5792	.299	5951.5	12.84	-.00	.7753	-.0692	.0259	.0024	-.0010	.0079	283.7
5793	.298	5917.9	15.05	-.00	.8950	-.0742	.0356	.0008	-.0000	.0077	283.7
5794	.300	5978.7	17.08	-.00	.9697	-.0761	.0320	.0003	-.0004	.0060	283.7
5795	.300	5962.0	19.28	-.00	1.0802	-.0797	.0270	.0012	-.0008	.0058	283.7
5796	.296	5818.7	21.45	.00	1.1888	-.0849	.0197	.0022	-.0017	.0061	283.7
5797	.297	5864.1	23.52	.00	1.2701	-.0870	.0135	.0038	-.0031	.0049	283.7
5798	.300	5988.6	24.00	.00	1.2863	-.0850	.0103	.0043	-.0029	.0036	283.7
5799	.300	5961.3	.01	-.00	-.0028	-.0379	.0071	.0023	-.0009	.0070	283.6

TEST TP	21 ALPHA DEG	BETA DEG	RUN 24 CL(SA)	CO(SA)	CPH(SA)	CRM(SA)	CYM(SA)	CSF(SA)	P1 PA	CPB(1)	VTOT M/SEC
5784	.00	-.00	-.0037	-.0362	.0085	.0021	-.0010	.0068	94848.8	-.119	564.0
5785	-1.73	-.00	-.1067	-.0367	-.0003	.0017	-.0010	.0064	94889.4	-.122	564.0
5786	.00	-.00	-.0064	-.0359	.0082	.0021	-.0012	.0068	94818.3	-.118	564.1
5787	2.09	-.00	.0876	-.0336	.0165	.0024	-.0005	.0076	94756.1	-.116	564.1
5788	4.11	-.00	.2053	-.0271	.0172	.0028	-.0010	.0066	94771.8	-.121	564.0
5789	6.17	-.00	.3389	-.0119	.0172	.0030	-.0016	.0054	94812.9	-.127	564.0
5790	8.36	-.00	.4831	.0145	.0161	.0023	-.0019	.0067	94798.5	-.138	563.9
5791	10.44	.00	.6192	.0515	.0172	.0036	-.0020	.0054	94825.6	-.146	563.9
5792	12.84	-.00	.7713	.1049	.0259	.0022	-.0016	.0079	94872.4	-.158	563.9
5793	15.05	-.00	.8836	.1607	.0356	.0007	-.0002	.0077	94899.2	-.166	563.9
5794	17.08	-.00	.9493	.2121	.0320	.0004	.0003	.0060	94828.0	-.173	563.9
5795	19.28	-.00	1.0460	.2814	.0270	.0009	-.0012	.0058	94842.2	-.178	563.9
5796	21.45	.00	1.1375	.3558	.0197	.0014	-.0023	.0061	94990.9	-.180	563.8
5797	23.52	.00	1.1993	.4271	.0135	.0023	-.0044	.0049	94937.9	-.188	563.8
5798	24.00	.00	1.2097	.4456	.0103	.0027	-.0044	.0036	94802.3	-.190	564.0
5799	.01	-.00	-.0028	-.0379	.0071	.0023	-.0009	.0070	94830.7	-.118	564.0

TEST TP	21 Q PA	ALPHA DEG	RUN 24 BETA DEG	CLT	CDT	CMST	CRTS	CYTS	CYST	CMU	WTFLOD KG/SEC	PLENP PSI
5784	5994.6	.00	-.00	-.0270	.0199	-.0246	.0021	-.0022	.0099	.0989	.1214	225.0
5785	5947.7	-1.73	-.00	-.1286	.0207	-.0337	.0017	-.0021	.0096	.0999	.1217	225.4
5786	6013.9	.00	-.00	-.0297	.0201	-.0249	.0021	-.0024	.0099	.0989	.1218	225.6
5787	6073.3	2.09	-.00	.0624	.0211	-.0163	.0024	-.0016	.0107	.0979	.1217	225.7
5788	6061.5	4.11	-.00	.1782	.0267	-.0157	.0027	-.0021	.0097	.0982	.1219	225.6
5789	6019.1	6.17	-.00	.3097	.0413	-.0159	.0029	-.0027	.0085	.0990	.1220	225.6
5790	6029.6	8.36	-.00	.4520	.0665	-.0170	.0021	-.0031	.0098	.0987	.1218	225.6
5791	5997.3	10.44	.00	.5860	.1026	-.0160	.0034	-.0031	.0085	.0992	.1218	225.7
5792	5951.5	12.84	-.00	.7357	.1549	-.0075	.0019	-.0027	.0111	.0999	.1218	225.6
5793	5917.9	15.05	-.00	.8459	.2096	.0019	.0004	-.0014	.0109	.1005	.1218	225.7
5794	5978.7	17.08	-.00	.9103	.2591	-.0013	.0001	-.0008	.0091	.0997	.1220	225.7
5795	5962.0	19.28	-.00	1.0050	.3271	-.0065	.0005	-.0023	.0089	.0999	.1220	225.8
5796	5818.7	21.45	.00	1.0938	.4010	-.0149	.0010	-.0034	.0094	.1023	.1219	225.8
5797	5864.1	23.52	.00	1.1544	.4704	-.0205	.0018	-.0055	.0081	.1016	.1220	225.8
5798	5988.6	24.00	.00	1.1653	.4876	-.0230	.0022	-.0055	.0067	.0996	.1222	226.0
5799	5961.3	.01	-.00	-.0264	.0189	-.0264	.0023	-.0021	.0101	.1001	.1222	226.4

NASA LANGLEY

7 X 10 HIGH SPEED TUNNEL

TEST TP	21 MACH	Q PA	RUN 25 ALPHA DEG	BETA DEG	CNF(BA)	CAF(BA)	CPM(BA)	CRM(BA)	CYM(BA)	CSF(BA)	TPLEN DEG K
5804	.300	5975.4	-.01	-.00	-.0035	.0170	-.0026	.0019	-.0025	.0075	289.0
5805	.300	5968.7	.04	-.00	-.0203	-.0911	.0365	.0019	.0003	.0042	280.6
5806	.300	5967.3	-1.82	-.00	-.1213	-.0939	.0206	.0011	.0006	.0058	280.6
5807	.301	5984.1	.11	-.00	-.0158	-.0898	.0360	.0030	.0001	.0060	280.7
5808	.302	6029.0	2.06	-.00	.0438	-.0909	.0429	.0004	.0014	.0065	280.8
5809	.302	6036.8	4.09	-.00	.1759	-.0950	.0376	.0043	.0002	.0005	281.0
5810	.302	6029.8	6.22	.00	.3305	-.1025	.0328	.0043	.0003	-.0024	281.1
5811	.300	5971.1	8.34	-.00	.4808	-.1112	.0294	.0022	-.0004	.0024	281.3
5812	.301	6001.7	10.53	.00	.6521	-.1176	.0236	.0022	-.0006	.0022	281.5
5813	.299	5921.5	12.85	-.00	.8505	-.1276	.0234	.0042	-.0002	.0036	281.6
5814	.300	5954.9	15.14	.00	1.0432	-.1338	.0220	.0051	-.0006	.0049	281.8
5815	.298	5886.8	17.35	-.00	1.2029	-.1441	.0260	-.0009	.0005	.0025	281.9
5816	.301	5986.6	19.72	-.00	1.2765	-.1505	.0513	-.0006	.0013	.0006	282.1
5817	.298	5887.5	21.82	-.01	1.3529	-.1550	.0506	-.0037	.0032	.0020	282.2
5818	.299	5921.8	23.75	-.00	1.4358	-.1565	.0446	.0014	.0007	.0024	282.3
5819	.301	6002.6	24.19	-.00	1.4336	-.1550	.0447	-.0029	.0024	-.0010	282.3
5820	.300	5961.2	.05	-.00	-.0116	-.0944	.0317	.0014	.0002	.0034	282.5

TEST TP	21 ALPHA DEG	BETA DEG	RUN 25 CL(SA)	CD(SA)	CPM(SA)	CRM(SA)	CYM(SA)	CSF(SA)	P1 PA	CPB(1)	VTOT M/SEC
5804	-.01	-.00	-.0035	.0170	-.0026	.0019	-.0025	.0075	94669.3	-.116	.0
5805	.04	-.00	-.0202	-.0911	.0365	.0019	.0003	.0042	94655.4	-.117	595.8
5806	-1.82	-.00	-.1242	-.0900	.0206	.0011	.0006	.0058	94656.8	-.119	595.3
5807	.11	-.00	-.0157	-.0898	.0360	.0030	.0001	.0060	94636.5	-.118	595.4
5808	2.06	-.00	.0470	-.0893	.0429	.0004	.0013	.0065	94592.3	-.117	595.6
5809	4.09	-.00	.1822	-.0822	.0376	.0043	-.0001	.0005	94584.1	-.120	595.9
5810	6.22	.00	.3397	-.0661	.0328	.0043	-.0002	-.0024	94590.6	-.127	596.1
5811	8.34	-.00	.4918	-.0403	.0294	.0021	-.0008	.0024	94651.6	-.136	596.3
5812	10.53	.00	.6626	.0035	.0236	.0021	-.0010	.0022	94614.1	-.147	596.6
5813	12.85	-.00	.8576	.0648	.0234	.0040	-.0011	.0036	94698.0	-.151	596.8
5814	15.14	.00	1.0419	.1434	.0220	.0048	-.0019	.0049	94662.6	-.156	597.0
5815	17.35	-.00	1.1912	.2211	.0260	-.0007	.0008	.0025	94734.3	-.163	597.1
5816	19.72	-.00	1.2525	.2889	.0513	-.0001	.0015	.0006	94623.2	-.171	597.4
5817	21.82	-.01	1.3136	.3590	.0506	-.0022	.0044	.0020	94724.6	-.173	597.5
5818	23.75	-.00	1.3772	.4351	.0446	.0016	.0001	.0024	94688.8	-.177	597.6
5819	24.19	-.00	1.3712	.4460	.0447	-.0016	.0034	-.0010	94601.6	-.178	597.7
5820	.05	-.00	-.0115	-.0944	.0317	.0014	.0002	.0034	94656.5	-.117	597.8

TEST TP	21 Q FA	ALPHA DEG	RUN 25 BETA DEG	CLT	CDT	CMST	CRTS	CYTS	CYST	CMU	WTFLO KG/SEC	PLENP PSI
5804	5975.4	-.01	-.00	0.0000	0.0000	0.0000	0.0000	0.0000	0.0000	.0000	.0115	-.0
5805	5968.7	.04	-.00	-.0693	.0169	-.0272	.0019	-.0019	.0103	.1983	.2294	431.3
5806	5967.3	-1.82	-.00	-.1653	.0181	-.0425	.0011	-.0016	.0117	.1956	.2265	426.4
5807	5984.1	.11	-.00	-.0602	.0165	-.0268	.0030	-.0021	.0119	.1952	.2266	426.2
5808	6029.0	2.06	-.00	-.0008	.0150	-.0196	.0003	-.0008	.0124	.1942	.2270	427.1
5809	6036.8	4.09	-.00	.1307	.0202	-.0250	.0042	-.0022	.0064	.1945	.2276	427.8
5810	6029.8	6.22	.00	.2842	.0348	-.0299	.0041	-.0024	.0035	.1951	.2279	428.7
5811	5971.1	8.34	-.00	.4320	.0596	-.0341	.0017	-.0029	.0084	.1974	.2283	429.3
5812	6001.7	10.53	.00	.5992	.1006	-.0396	.0017	-.0032	.0082	.1969	.2287	429.9
5813	5921.5	12.85	-.00	.7893	.1607	-.0407	.0035	-.0033	.0096	.1993	.2284	430.4
5814	5954.9	15.14	.00	.9703	.2359	-.0418	.0042	-.0040	.0109	.1982	.2283	430.5
5815	5886.8	17.35	-.00	1.1151	.3120	-.0386	-.0014	-.0014	.0086	.2008	.2286	430.8
5816	5986.6	19.72	-.00	1.1740	.3752	-.0122	-.0008	-.0006	.0066	.1977	.2288	431.2
5817	5887.5	21.82	-.01	1.2305	.4437	-.0140	-.0031	.0023	.0081	.2010	.2288	431.3
5818	5921.8	23.75	-.00	1.2919	.5164	-.0197	.0007	-.0020	.0084	.2000	.2288	431.1
5819	6002.6	24.19	-.00	1.2864	.5257	-.0187	-.0025	.0014	.0050	.1971	.2286	431.4
5820	5961.2	.05	-.00	-.0567	.0138	-.0322	.0014	-.0020	.0094	.1987	.2288	431.7

ORIGINAL PAGE
OF POOR QUALITY

NASA LANGLEY

7 X 10 HIGH SPEED TUNNEL

TEST TP	21 MACH	Q PA	RUN 26		CNF(BA)	CAF(BA)	CPH(BA)	CRM(BA)	CYM(BA)	CSF(BA)	TPLN DEG K
			ALPHA DEG	BETA DEG							
5821	.300	5974.5	.07	-.00	-.0107	-.1153	.0424	.0025	.0013	.0049	282.1
5822	.300	5955.6	-1.69	-.00	-.1072	-.1193	.0275	.0014	.0015	.0016	282.1
5823	.300	5974.1	.03	-.00	-.0093	-.1155	.0432	.0017	.0014	.0035	282.1
5824	.301	5999.6	2.14	-.00	.0453	-.1167	.0530	.0009	.0019	.0045	282.1
5825	.303	6065.7	4.13	-.00	.1734	-.1192	.0434	.0032	.0014	-.0003	282.1
5826	.301	5988.0	6.18	-.00	.3263	-.1272	.0391	.0048	.0019	-.0029	282.2
5827	.300	5944.0	8.36	.00	.4853	-.1354	.0340	.0024	.0007	-.0015	282.2
5828	.301	5997.4	10.53	.00	.6594	-.1420	.0305	.0028	-.0001	-.0014	282.3
5829	.298	5873.8	12.79	.00	.8705	-.1523	.0216	.0042	.0002	-.0004	282.4
5830	.299	5907.5	15.09	-.00	1.0625	-.1577	.0228	.0017	.0003	.0034	282.4
5831	.299	5908.9	17.32	-.00	1.2353	-.1677	.0260	-.0032	.0006	.0026	282.5
5832	.298	5881.5	19.49	-.00	1.3629	-.1768	.0381	-.0081	.0017	-.0013	282.6
5833	.298	5901.2	21.70	-.00	1.4082	-.1811	.0580	.0001	.0006	-.0012	282.7
5834	.297	5851.9	23.83	-.00	1.4892	-.1845	.0550	-.0016	.0016	-.0012	282.7
5835	.301	5992.6	24.13	-.00	1.4850	-.1801	.0519	.0015	.0007	.0012	282.7
5836	.300	5944.7	.05	-.00	-.0130	-.1170	.0427	.0015	.0009	.0030	282.7

TEST TP	21 ALPHA DEG	BETA DEG	RUN 26		CPM(SA)	CRM(SA)	CYM(SA)	CSF(SA)	P1 PA	CPB(1)	VTOT M/SEC
			CL(SA)	CD(SA)							
5821	.07	-.00	-.0106	-.1153	.0424	.0025	.0013	.0049	94634.1	-.117	605.7
5822	-1.69	-.00	-.1107	-.1161	.0275	.0013	.0015	.0016	94648.8	-.117	605.7
5823	.03	-.00	-.0092	-.1155	.0432	.0017	.0014	.0035	94625.0	-.118	605.8
5824	2.14	-.00	.0497	-.1149	.0530	.0009	.0018	.0045	94602.7	-.117	605.8
5825	4.13	-.00	.1815	-.1064	.0434	.0033	.0011	-.0003	94514.7	-.121	605.9
5826	6.18	-.00	.3381	-.0914	.0391	.0050	.0014	-.0029	94621.3	-.126	605.9
5827	8.36	.00	.4998	-.0634	.0340	.0025	.0003	-.0015	94662.8	-.135	605.9
5828	10.53	.00	.6742	-.0191	.0305	.0028	-.0006	-.0014	94605.0	-.142	606.0
5829	12.79	.00	.8826	.0442	.0216	.0041	-.0007	-.0004	94734.4	-.146	606.0
5830	15.09	-.00	1.0669	.1244	.0228	.0017	-.0002	.0034	94692.4	-.153	606.1
5831	17.32	-.00	1.2292	.2076	.0260	-.0028	.0015	.0026	94689.7	-.164	606.2
5832	19.49	-.00	1.3438	.2881	.0381	-.0071	.0043	-.0013	94716.2	-.173	606.3
5833	21.70	-.00	1.3754	.3524	.0580	.0003	.0005	-.0012	94698.9	-.173	606.4
5834	23.83	-.00	1.4366	.4329	.0550	-.0008	.0021	-.0012	94745.6	-.173	606.4
5835	24.13	-.00	1.4289	.4427	.0519	.0016	.0000	.0012	94596.5	-.174	606.5
5836	.05	-.00	-.0129	-.1170	.0427	.0015	.0009	.0030	94653.4	-.117	606.5

TEST TP	21 Q PA	ALPHA DEG	BETA DEG	CLT	CDT	CHST	CRTS	CYTS	CYST	CHU	WTFLO KG/SEC	PLENP PSI
5822	5955.6	-1.69	-.00	-.1606	.0145	-.0487	.0014	-.0011	.0088	.2394	.2718	514.3
5823	5974.1	.03	-.00	-.0629	.0131	-.0328	.0017	-.0012	.0107	.2386	.2717	514.4
5824	5999.6	2.14	-.00	-.0085	.0112	-.0227	.0008	-.0008	.0116	.2376	.2717	514.6
5825	6065.7	4.13	-.00	.1199	.0159	-.0312	.0031	-.0014	.0067	.2345	.2720	514.7
5826	5988.0	6.18	-.00	.2711	.0306	-.0368	.0047	-.0012	.0043	.2383	.2720	514.5
5827	5944.0	8.36	.00	.4276	.0568	-.0424	.0021	-.0023	.0057	.2402	.2721	514.7
5828	5997.4	10.53	.00	.5983	.0972	-.0453	.0023	-.0032	.0058	.2379	.2719	514.5
5829	5873.8	12.79	.00	.8004	.1598	-.0557	.0035	-.0033	.0069	.2424	.2713	514.7
5830	5907.5	15.09	-.00	.9806	.2360	-.0541	.0011	-.0027	.0106	.2416	.2719	514.9
5831	5908.9	17.32	-.00	1.1386	.3158	-.0509	-.0036	-.0011	.0098	.2412	.2715	514.9
5832	5881.5	19.49	-.00	1.2488	.3933	-.0391	-.0080	.0017	.0060	.2424	.2716	515.0
5833	5901.2	21.70	-.00	1.2767	.4535	-.0190	-.0006	-.0020	.0061	.2416	.2715	514.9
5834	5851.9	23.83	-.00	1.3335	.5311	-.0227	-.0019	-.0004	.0061	.2440	.2719	515.1
5835	5992.6	24.13	-.00	1.3276	.5381	-.0240	.0005	-.0023	.0083	.2380	.2716	515.1
5836	5944.7	.05	-.00	-.0669	.0125	-.0338	.0015	-.0018	.0102	.2399	.2715	515.3

NASA LANGLEY

7 X 10 HIGH SPEED TUNNEL

TEST TP	21		RUN 27		CNF(BA)	CAF(BA)	CPH(BA)	CRM(BA)	CYH(BA)	CSF(BA)	TPLEN DEG K
	MACH	Q PA	ALPHA DEG	BETA DEG							
5837	.700	24873.0	-.02	-.00	-.0074	-.0125	.0024	.0023	-.0018	.0083	283.9
5838	.692	24480.1	-2.13	-.01	-.1278	-.0148	-.0043	.0014	-.0018	.0083	283.9
5839	.696	24636.7	-.06	-.01	-.0113	-.0127	.0022	.0022	-.0017	.0084	283.9
5840	.707	25236.7	2.45	-.00	.1198	-.0151	.0072	.0025	-.0016	.0071	283.9
5841	.711	25406.7	4.92	.00	.2728	-.0205	.0090	.0025	-.0016	.0051	283.9
5842	.705	25117.0	7.27	.00	.4191	-.0257	.0087	.0023	-.0021	.0044	283.8
5843	.705	25125.5	9.72	.01	.5583	-.0263	.0045	.0025	-.0022	.0032	283.7
5844	.701	24907.5	12.35	.01	.6913	-.0282	.0013	.0020	-.0026	.0037	283.8
5845	.694	24566.7	14.56	.01	.7860	-.0302	.0050	.0022	-.0029	.0044	283.8
5846	.691	24410.2	16.89	.01	.8721	-.0307	.0073	.0038	-.0034	.0061	283.7
5847	.690	24357.3	19.26	.02	.9717	-.0328	.0026	.0051	-.0049	.0091	283.7
5848	.697	24718.7	21.49	.02	1.0200	-.0299	-.0068	.0061	-.0064	.0101	283.7
5849	.697	24689.5	.00	-.00	-.0055	-.0126	.0031	.0019	-.0019	.0083	283.5

TEST TP	21		RUN 27		CPH(SA)	CRM(SA)	CYH(SA)	CSF(SA)	P1 PA	CPB(1)	VTOT M/SEC
	ALPHA DEG	BETA DEG	CL(SA)	CD(SA)							
5837	-.02	-.00	-.0074	-.0125	.0024	.0023	-.0018	.0083	72414.5	-.125	613.3
5838	-2.13	-.01	-.1282	-.0100	-.0043	.0015	-.0017	.0083	72977.6	-.127	613.1
5839	-.06	-.01	-.0113	-.0127	.0022	.0022	-.0017	.0084	72732.5	-.124	613.3
5840	2.45	-.00	.1203	-.0100	.0072	.0024	-.0018	.0071	72027.4	-.128	613.8
5841	4.92	.00	.2736	.0030	.0090	.0023	-.0019	.0051	71766.4	-.136	613.9
5842	7.27	.00	.4190	.0275	.0087	.0020	-.0023	.0044	72185.0	-.140	613.6
5843	9.72	.01	.5547	.0684	.0045	.0021	-.0025	.0032	72172.7	-.152	613.6
5844	12.35	.01	.6813	.1204	.0013	.0014	-.0029	.0037	72437.4	-.159	613.4
5845	14.56	.01	.7683	.1684	.0050	.0014	-.0033	.0044	72835.4	-.165	613.1
5846	16.89	.01	.8434	.2241	.0073	.0027	-.0044	.0061	73047.1	-.172	613.0
5847	19.26	.02	.9281	.2897	.0026	.0032	-.0063	.0091	73113.2	-.190	612.8
5848	21.49	.02	.9600	.3458	-.0068	.0034	-.0082	.0101	72727.5	-.206	613.1
5849	.00	-.00	-.0055	-.0126	.0031	.0019	-.0019	.0083	72679.4	-.124	613.0

TEST TP	21		RUN 27		CLT	CDT	CMST	CRTS	CYTS	CYST	CMU	WTFLO KG/SEC	PLENP PSI
	ALPHA DEG	BETA DEG	CL(SA)	CD(SA)									
5837	24873.0	-.02	-.00	-.0186	.0143	-.0135	.0023	-.0023	.0098	.0498	.2334	446.8	
5838	24480.1	-2.13	-.01	-.1386	.0177	-.0205	.0015	-.0023	.0098	.0508	.2344	448.0	
5839	24636.7	-.06	-.01	-.0226	.0145	-.0138	.0022	-.0022	.0100	.0506	.2346	448.6	
5840	25236.7	2.45	-.00	.1081	.0161	-.0065	.0024	-.0023	.0086	.0495	.2350	448.9	
5841	25406.7	4.92	.00	.2603	.0283	-.0066	.0023	-.0024	.0066	.0492	.2349	449.0	
5842	25117.0	7.27	.00	.4046	.0526	-.0070	.0019	-.0029	.0059	.0498	.2353	448.9	
5843	25125.5	9.72	.01	.5393	.0928	-.0113	.0020	-.0031	.0047	.0497	.2352	449.2	
5844	24907.5	12.35	.01	.6646	.1443	-.0146	.0013	-.0035	.0052	.0501	.2349	448.9	
5845	24566.7	14.56	.01	.7504	.1920	-.0112	.0012	-.0038	.0059	.0507	.2346	448.8	
5846	24410.2	16.89	.01	.8244	.2471	-.0090	.0025	-.0049	.0076	.0511	.2349	448.9	
5847	24357.3	19.26	.02	.9082	.3119	-.0136	.0030	-.0068	.0107	.0512	.2350	448.4	
5848	24718.7	21.49	.02	.9996	.3669	-.0229	.0032	-.0087	.0116	.0505	.2353	448.8	
5849	24689.5	.00	-.00	-.0168	.0146	-.0129	.0019	-.0025	.0098	.0506	.2355	449.3	

ORIGINAL PAGE IS
OF POOR QUALITY

NASA LANGLEY

7 X 10 HIGH SPEED TUNNEL

TEST TP	21 MACH	Q PA	RUN ALPHA DEG	28 BETA DEG	CNF(BA)	CAF(BA)	CPH(BA)	CRH(BA)	CYH(BA)	CSF(BA)	TPLEN DEG K
5863	.299	5936.9	-.00	-.00	-.0026	.0176	-.0026	.0021	-.0021	.0071	299.9
5864	.298	5891.0	-1.70	-.00	-.1048	.0143	-.0075	.0013	-.0023	.0067	299.9
5865	.301	5985.0	-.00	-.00	-.0002	.0175	-.0027	.0020	-.0025	.0084	299.8
5866	.302	6039.3	2.10	-.00	.1123	.0153	.0033	.0025	-.0025	.0086	299.6
5867	.304	6092.3	4.07	.00	.2159	.0097	.0074	.0026	-.0026	.0075	299.5
5868	.304	6103.8	6.18	.00	.3371	.0026	.0100	.0029	-.0030	.0084	299.4
5869	.303	6058.2	8.26	.00	.4512	-.0028	.0113	.0017	-.0032	.0087	299.4
5870	.299	5909.6	10.55	.00	.5803	-.0075	.0145	.0018	-.0032	.0092	299.3
5871	.298	5898.0	12.79	-.00	.6885	-.0097	.0167	.0009	-.0033	.0110	299.2
5872	.299	5934.7	14.89	.00	.8012	-.0090	.0110	.0021	-.0037	.0114	299.2
5873	.297	5855.3	16.99	-.00	.8932	-.0056	.0014	.0016	-.0037	.0129	299.2
5874	.302	6034.0	19.08	-.00	.9259	.0008	-.0135	-.0002	-.0024	.0119	299.2
5875	.300	5964.9	21.08	-.01	.8859	.0046	-.0045	-.0033	.0022	.0129	299.1
5876	.299	5911.4	23.24	-.00	.9480	.0011	.0007	-.0008	-.0022	.0135	299.1
5877	.302	6049.4	23.69	-.00	.9844	.0004	.0024	-.0002	-.0022	.0129	299.1
5878	.301	5989.9	-.02	-.00	-.0037	.0168	-.0025	.0018	-.0026	.0083	299.1

TEST TP	21 ALPHA DEG	BETA DEG	RUN CL(SA)	28 CD(SA)	CPH(SA)	CRN(SA)	CYH(SA)	CSF(SA)	P1 PA	CP8(1)	VTOT H/SEC
5863	-.00	-.00	-.0026	.0176	-.0026	.0021	-.0021	.0071	94620.9	-.117	0.0
5864	-1.70	-.00	-.1044	.0174	-.0075	.0013	-.0022	.0067	94670.1	-.117	0.0
5865	-.00	-.00	-.0002	.0175	-.0027	.0020	-.0025	.0084	94564.8	-.116	0.0
5866	2.10	-.00	.1117	.0195	.0033	.0024	-.0026	.0086	94506.8	-.116	0.0
5867	4.07	.00	.2146	.0250	.0074	.0024	-.0027	.0075	94451.3	-.118	0.0
5868	6.18	.00	.3348	.0389	.0100	.0025	-.0033	.0084	94432.5	-.125	0.0
5869	8.26	.00	.4469	.0620	.0113	.0012	-.0034	.0087	94475.2	-.134	0.0
5870	10.55	.00	.5718	.0989	.0145	.0012	-.0035	.0092	94631.0	-.143	0.0
5871	12.79	-.00	.6736	.1430	.0167	.0002	-.0035	.0110	94635.5	-.153	0.0
5872	14.89	.00	.7766	.1972	.0110	.0011	-.0041	.0114	94593.8	-.160	0.0
5873	16.99	-.00	.8559	.2556	.0014	.0005	-.0040	.0129	94676.2	-.161	0.0
5874	19.08	-.00	.8747	.3034	-.0135	-.0010	-.0022	.0119	94485.3	-.179	0.0
5875	21.08	-.01	.8250	.3228	-.0045	-.0023	-.0032	.0129	94557.7	-.188	0.0
5876	23.24	-.00	.8706	.3750	.0007	-.0016	-.0017	.0135	94613.4	-.197	0.0
5877	23.69	-.00	.9013	.3959	.0024	-.0011	-.0020	.0129	94462.4	-.202	0.0
5878	-.02	-.00	-.0037	.0168	-.0025	.0018	-.0026	.0083	94531.5	-.117	0.0

TEST TP	21 Q PA	ALPHA DEG	RUN BETA DEG	28 CLT	CDT	CMST	CRTS	CYTS	CYST	CMU	WTFLO KG/SEC	PLENP- PSI
5863	5936.9	-.00	-.00	-.0026	.0176	-.0026	.0021	-.0021	.0071	0.0000	0.0000	.1
5864	5891.0	-1.70	-.00	-.1044	.0174	-.0075	.0013	-.0022	.0067	0.0000	0.0000	.1
5865	5985.0	-.00	-.00	-.0002	.0175	-.0027	.0020	-.0025	.0084	0.0000	0.0000	.1
5866	6039.3	2.10	-.00	.1117	.0195	.0033	.0024	-.0026	.0086	0.0000	0.0000	.1
5867	6092.3	4.07	.00	.2146	.0250	.0074	.0024	-.0027	.0075	0.0000	0.0000	.1
5868	6103.8	6.18	.00	.3348	.0389	.0100	.0025	-.0033	.0084	0.0000	0.0000	.1
5869	6058.2	8.26	.00	.4469	.0620	.0113	.0012	-.0034	.0087	0.0000	0.0000	.1
5870	5909.6	10.55	.00	.5718	.0989	.0145	.0012	-.0035	.0092	0.0000	0.0000	.1
5871	5898.0	12.79	-.00	.6736	.1430	.0167	.0002	-.0035	.0110	0.0000	0.0000	.0
5872	5934.7	14.89	.00	.7766	.1972	.0110	.0011	-.0041	.0114	0.0000	0.0000	-.1
5873	5855.3	16.99	-.00	.8559	.2556	.0014	.0005	-.0040	.0129	0.0000	0.0000	-.1
5874	6034.0	19.08	-.00	.8747	.3034	-.0135	-.0010	-.0022	.0119	0.0000	0.0000	-.1
5875	5964.9	21.08	-.01	.8250	.3228	-.0045	-.0023	-.0032	.0129	0.0000	0.0000	-.1
5876	5911.4	23.24	-.00	.8706	.3750	.0007	-.0016	-.0017	.0135	0.0000	0.0000	-.1
5877	6049.4	23.69	-.00	.9013	.3959	.0024	-.0011	-.0020	.0129	0.0000	0.0000	-.2
5878	5989.9	-.02	-.00	-.0037	.0168	-.0025	.0018	-.0026	.0083	0.0000	0.0000	.1

NASA LANGLEY

7 X 10 HIGH SPEED TUNNEL

TEST TP	21 MACH	Q PA	RUN 29 ALPHA DEG	BETA DEG	CNF(BA)	CAF(BA)	CPH(BA)	CRM(BA)	CYM(BA)	CSF(BA)	TPLEN DEG K
5879	.300	5944.2	-.02	-.00	-.0103	-.0109	.0011	.0023	-.0016	.0071	294.8
5880	.299	5912.0	-1.75	-.00	-.1125	-.0142	-.0043	.0015	-.0018	.0069	294.5
5881	.301	5998.7	.01	-.00	-.0096	-.0109	.0020	.0019	-.0019	.0080	294.1
5882	.302	6043.9	2.21	-.00	.0981	-.0124	.0090	.0023	-.0017	.0076	293.7
5883	.304	6108.0	4.06	-.00	.2111	-.0175	.0130	.0019	-.0018	.0092	293.3
5884	.300	5964.5	6.23	-.00	.3472	-.0251	.0151	.0021	-.0022	.0092	293.0
5885	.300	5969.4	8.29	-.00	.4799	-.0308	.0164	.0019	-.0024	.0093	292.7
5886	.300	5946.9	10.47	-.00	.6023	-.0356	.0204	.0015	-.0022	.0092	292.5
5887	.298	5883.1	12.82	-.00	.7244	-.0395	.0216	.0023	-.0022	.0095	292.2
5888	.296	5826.7	14.76	-.00	.8107	-.0407	.0203	.0019	-.0029	.0106	291.9
5889	.297	5830.7	16.97	.00	.9138	-.0400	.0069	.0012	-.0031	.0094	291.7
5890	.300	5970.6	19.08	-.00	.9944	-.0372	-.0059	-.0007	-.0018	.0066	291.5
5891	.306	6176.2	21.19	-.00	1.0336	-.0333	-.0101	-.0016	-.0014	.0089	291.3
5892	.304	6093.1	23.32	-.02	1.0043	-.0290	-.0005	-.0090	.0079	.0073	291.0
5893	.305	6125.7	23.65	-.01	.9927	-.0280	.0004	-.0063	.0062	.0068	290.8
5894	.301	5979.7	-.01	-.00	-.0028	-.0096	.0003	.0022	-.0016	.0079	289.8

TEST TP	21 ALPHA DEG	BETA DEG	RUN 29 CL(SA)	CD(SA)	CPH(SA)	CRM(SA)	CYM(SA)	CSF(SA)	P1 PA	CPB(1)	VTDT M/SEC
5879	-.02	-.00	-.0103	-.0109	.0011	.0023	-.0016	.0071	94579.3	-.119	530.7
5880	-1.75	-.00	-.1129	-.0108	-.0043	.0016	-.0017	.0069	94616.8	-.122	530.7
5881	.01	-.00	-.0096	-.0109	.0020	.0019	-.0019	.0080	94522.3	-.120	531.4
5882	2.21	-.00	.0985	-.0086	.0090	.0022	-.0017	.0076	94475.9	-.118	531.6
5883	4.06	-.00	.2118	-.0025	.0130	.0018	-.0019	.0092	94410.0	-.121	531.6
5884	6.23	-.00	.3478	.0127	.0151	.0018	-.0025	.0092	94558.1	-.132	531.4
5885	8.29	-.00	.4793	.0387	.0164	.0015	-.0026	.0093	94547.4	-.143	531.3
5886	10.47	-.00	.5988	.0744	.0204	.0011	-.0024	.0092	94566.3	-.150	531.0
5887	12.82	-.00	.7151	.1221	.0216	.0017	-.0026	.0095	94629.7	-.157	530.8
5888	14.76	-.00	.7943	.1673	.0203	.0011	-.0033	.0106	94684.0	-.160	530.6
5889	16.97	.00	.8857	.2284	.0069	.0002	-.0033	.0094	94677.8	-.168	530.4
5890	19.08	-.00	.9519	.2899	-.0059	-.0012	-.0014	.0066	94530.3	-.181	530.4
5891	21.19	-.00	.9757	.3426	-.0101	-.0020	-.0007	.0089	94315.9	-.192	530.4
5892	23.32	-.02	.9337	.3709	-.0005	-.0051	.0109	.0073	94407.9	-.204	530.1
5893	23.65	-.01	.9206	.3725	.0004	-.0033	.0082	.0068	94373.5	-.205	530.1
5894	-.01	-.00	-.0028	-.0096	.0003	.0022	-.0016	.0079	94542.1	-.119	529.6

TEST TP	21 Q PA	ALPHA DEG	RUN 29 BETA DEG	CLT	CDT	CMST	CRTS	CYTS	CYST	CMU	WTFLO KG/SEC	PLENP PSI
5879	5944.2	-.02	-.00	-.0226	.0187	-.0163	.0023	-.0022	.0087	.0486	.0628	117.6
5880	5912.0	-1.75	-.00	-.1244	.0194	-.0219	.0016	-.0023	.0086	.0498	.0641	118.0
5881	5998.7	.01	-.00	-.0220	.0189	-.0156	.0019	-.0025	.0096	.0498	.0649	119.7
5882	6043.9	2.21	-.00	.0849	.0208	-.0086	.0022	-.0023	.0093	.0498	.0653	120.7
5883	6108.0	4.06	-.00	.1974	.0262	-.0045	.0017	-.0025	.0109	.0494	.0655	121.0
5884	5964.5	6.23	-.00	.3320	.0416	-.0029	.0018	-.0031	.0109	.0506	.0656	121.3
5885	5969.4	8.29	-.00	.4624	.0670	-.0015	.0014	-.0033	.0110	.0507	.0658	121.5
5886	5946.9	10.47	-.00	.5807	.1022	.0023	.0009	-.0030	.0109	.0509	.0658	121.6
5887	5883.1	12.82	-.00	.6957	.1494	.0033	.0016	-.0032	.0112	.0514	.0657	121.7
5888	5826.7	14.76	-.00	.7738	.1942	.0019	.0009	-.0039	.0124	.0520	.0659	121.8
5889	5830.7	16.97	.00	.8642	.2545	-.0115	.0000	-.0039	.0111	.0520	.0660	121.8
5890	5970.6	19.06	-.00	.9299	.3146	-.0240	-.0014	-.0020	.0083	.0507	.0660	121.9
5891	6176.2	21.19	-.00	.9536	.3656	-.0276	-.0023	-.0013	.0105	.0492	.0661	122.0
5892	6093.1	23.32	-.02	.9104	.3935	-.0182	-.0054	.0103	.0089	.0498	.0661	122.1
5893	6125.7	23.65	-.01	.8972	.3949	-.0172	-.0035	.0076	.0085	.0497	.0663	122.3
5894	5979.7	-.01	-.00	-.0157	.0212	-.0179	.0022	-.0023	.0096	.0514	.0670	123.2

ORIGINAL PAGE IS OF POOR QUALITY

NASA LANGLEY

7 X 10 HIGH SPEED TUNNEL

TEST TP	21		RUN 30		CNF(BA)	CAF(BA)	CPN(BA)	CRM(BA)	CYM(BA)	CSF(BA)	TPLEN DEG K
	MACH	Q PA	ALPHA DEG	BETA DEG							
5895	.300	5949.0	-.01	-.00	-.0085	-.0364	.0090	.0023	-.0009	.0077	285.7
5896	.299	5909.5	-1.75	-.00	-.1101	-.0397	.0011	.0014	-.0011	.0081	285.1
5897	.301	5979.3	-.01	-.00	-.0128	-.0351	.0095	.0024	-.0010	.0083	284.7
5898	.304	6109.1	2.08	-.00	.0805	-.0363	.0170	.0024	-.0007	.0099	284.3
5899	.302	6039.4	4.10	-.00	.2111	-.0426	.0172	.0024	-.0010	.0088	284.1
5900	.298	5898.0	6.37	-.00	.3679	-.0507	.0186	.0020	-.0022	.0100	283.9
5901	.302	6047.3	8.37	-.00	.5183	-.0548	.0224	.0028	-.0022	.0106	283.6
5902	.302	6043.1	10.58	-.00	.6566	-.0603	.0289	.0031	-.0016	.0095	283.5
5903	.301	5987.6	12.85	-.00	.7856	-.0665	.0349	.0014	-.0003	.0107	283.3
5904	.304	6109.3	14.93	-.00	.8906	-.0706	.0367	.0018	.0003	.0134	283.2
5905	.302	6025.9	17.08	-.01	.9702	-.0741	.0307	-.0008	.0007	.0119	283.1
5906	.298	5888.8	19.20	-.01	1.0733	-.0755	.0129	-.0035	.0008	.0101	283.0
5907	.298	5872.9	21.31	-.00	1.1638	-.0755	.0027	-.0033	.0005	.0078	283.0
5908	.298	5880.8	23.43	-.00	1.2420	-.0691	-.0120	.0019	-.0021	.0112	282.9
5909	.303	6051.1	23.85	-.00	1.2437	-.0674	-.0123	.0018	-.0023	.0105	282.9
5910	.302	6015.2	.03	-.00	-.0054	-.0359	.0064	.0023	-.0009	.0087	282.6

TEST TP	ALPHA DEG	BETA DEG	RUN 30		CPN(SA)	CRM(SA)	CYM(SA)	CSF(SA)	P1 PA	CPB(I)	VTDT M/SEC
			CL(SA)	CD(SA)							
5895	-.01	-.00	-.0085	-.0364	.0090	.0023	-.0009	.0077	94577.8	-.118	568.2
5896	-1.75	-.00	-.1113	-.0363	.0011	.0014	-.0011	.0081	94622.4	-.121	567.8
5897	-.01	-.00	-.0128	-.0351	.0095	.0024	-.0010	.0083	94542.6	-.116	567.4
5898	2.08	-.00	.0817	-.0334	.0170	.0024	-.0007	.0099	94407.1	-.119	567.2
5899	4.10	-.00	.2136	-.0274	.0172	.0024	-.0011	.0088	94486.4	-.121	566.9
5900	6.37	-.00	.3713	-.0096	.0186	.0017	-.0024	.0100	94634.5	-.126	566.6
5901	8.37	-.00	.5208	.0212	.0224	.0024	-.0026	.0106	94473.6	-.135	566.5
5902	10.58	-.00	.6565	.0613	.0289	.0027	-.0021	.0095	94475.7	-.144	566.3
5903	12.85	-.00	.7807	.1098	.0349	.0013	-.0006	.0107	94533.9	-.162	566.2
5904	14.93	-.00	.8788	.1612	.0367	.0018	-.0002	.0134	94403.0	-.171	566.1
5905	17.08	-.01	.9492	.2141	.0307	-.0006	.0009	.0119	94488.3	-.175	566.0
5906	19.20	-.01	1.0385	.2817	.0129	-.0030	.0019	.0101	94636.6	-.180	565.8
5907	21.31	-.00	1.1117	.3525	.0027	-.0030	.0016	.0078	94654.0	-.187	565.8
5908	23.43	-.00	1.1670	.4305	-.0120	.0009	-.0027	.0112	94645.7	-.194	565.7
5909	23.85	-.00	1.1647	.4413	-.0123	.0007	-.0028	.0105	94464.3	-.198	565.8
5910	.03	-.00	-.0054	-.0359	.0064	.0023	-.0009	.0087	94507.7	-.119	565.6

TEST TP	21	Q PA	ALPHA DEG	RUN 30		CDT	CMST	CRTS	CYTS	CYST	CMU	WTFLD KG/SEC	PLENP PSI
				BETA DEG	CLT								
5895		5949.0	-.01	-.00	-.0330	.0225	-.0257	.0023	-.0021	.0110	.1034	.1250	234.4
5896		5909.5	-1.75	-.00	-.1342	.0237	-.0339	.0015	-.0023	.0114	.1042	.1253	234.6
5897		5979.3	-.01	-.00	-.0373	.0236	-.0252	.0024	-.0022	.0115	.1031	.1255	234.8
5898		6109.1	2.08	-.00	.0557	.0232	-.0170	.0023	-.0019	.0131	.1010	.1256	235.0
5899		6039.4	4.10	-.00	.1853	.0288	-.0172	.0023	-.0023	.0121	.1020	.1255	234.9
5900		5898.0	6.37	-.00	.3400	.0468	-.0166	.0016	-.0037	.0133	.1047	.1259	234.9
5901		6047.3	8.37	-.00	.4884	.0752	-.0120	.0023	-.0038	.0139	.1021	.1259	235.1
5902		6043.1	10.58	-.00	.6220	.1141	-.0055	.0025	-.0033	.0128	.1023	.1260	235.2
5903		5987.6	12.85	-.00	.7438	.1616	.0003	.0010	-.0017	.0139	.1031	.1259	235.2
5904		6109.3	14.93	-.00	.8408	.2106	.0027	.0015	-.0013	.0166	.1012	.1261	235.3
5905		6025.9	17.08	-.01	.9088	.2628	-.0038	-.0009	-.0002	.0151	.1026	.1262	235.3
5906		5888.8	19.20	-.01	.9953	.3299	-.0224	-.0034	.0008	.0134	.1050	.1262	235.3
5907		5872.9	21.31	-.00	1.0666	.3993	-.0327	-.0034	.0005	.0111	.1054	.1264	235.4
5908		5880.8	23.43	-.00	1.1204	.4756	-.0474	.0004	-.0039	.0145	.1052	.1263	235.5
5909		6051.1	23.85	-.00	1.1190	.4848	-.0467	.0002	-.0039	.0138	.1022	.1262	235.7
5910		6015.2	.03	-.00	-.0298	.0226	-.0282	.0023	-.0021	.0120	.1031	.1267	235.7

NASA LANGLEY

7 X 10 HIGH SPEED TUNNEL

TEST TP	21 MACH	Q PA	RUN 31 ALPHA DEG	BETA DEG	CNF(BA)	CAF(BA)	CPH(BA)	CRM(BA)	CYM(BA)	CSF(BA)	TPLEN DEG K
5911	.300	5972.1	.06	-.00	-.0125	-.0857	.0329	.0031	.0008	.0074	279.1
5912	.297	5862.8	-1.69	-.00	-.1046	-.0906	.0172	.0021	.0014	.0068	279.0
5913	.302	6034.3	.04	-.00	-.0112	-.0853	.0316	.0021	.0006	.0069	279.0
5914	.298	5902.2	2.06	-.00	.0693	-.0903	.0350	.0020	.0012	.0068	279.0
5915	.301	5993.2	4.17	-.00	.2180	-.0934	.0289	.0032	.0014	.0041	278.9
5916	.300	5970.7	6.27	-.00	.3762	-.1008	.0269	.0018	.0008	.0023	278.9
5917	.300	5953.7	8.52	-.00	.5562	-.1062	.0259	.0030	.0002	.0069	278.8
5918	.303	6087.2	10.55	-.00	.7118	-.1093	.0331	.0038	-.0007	.0061	278.7
5919	.301	6012.6	12.86	-.00	.8777	-.1168	.0356	.0040	-.0005	.0069	278.6
5920	.297	5831.5	15.05	-.00	1.0360	-.1284	.0395	-.0013	-.0013	.0049	278.5
5921	.296	5825.3	17.22	-.00	1.1509	-.1384	.0462	.0041	.0023	.0088	278.5
5922	.295	5758.1	19.47	-.00	1.2266	-.1449	.0622	-.0048	-.0003	.0026	278.4
5923	.296	5818.3	21.49	-.01	1.2900	-.1458	.0544	-.0053	.0044	.0047	278.3
5924	.299	5934.3	23.64	-.01	1.3608	-.1408	.0273	-.0013	.0020	.0068	278.3
5925	.301	5994.0	24.01	.00	1.3652	-.1354	.0161	.0041	-.0020	.0111	278.3
5926	.301	5993.9	.03	-.00	-.0123	-.0872	.0303	.0033	.0011	.0079	278.3

TEST TP	21 ALPHA DEG	BETA DEG	RUN 31 CL(SA)	CD(SA)	CPM(SA)	CRH(SA)	CYM(SA)	CSF(SA)	P1 PA	CPB(1)	VTOT M/SEC
5911	.06	-.00	-.0124	-.0857	.0329	.0031	.0008	.0074	94554.8	-.119	594.2
5912	-1.69	-.00	-.1073	-.0875	.0172	.0021	.0014	.0068	94670.0	-.115	594.1
5913	.04	-.00	-.0112	-.0853	.0316	.0021	.0006	.0069	94490.0	-.120	594.3
5914	2.06	-.00	.0725	-.0878	.0350	.0020	.0011	.0068	94635.7	-.118	594.2
5915	4.17	-.00	.2243	-.0773	.0289	.0033	.0012	.0041	94545.0	-.121	594.2
5916	6.27	-.00	.3849	-.0591	.0269	.0019	.0006	.0023	94565.1	-.125	594.2
5917	8.52	-.00	.5658	-.0226	.0259	.0030	-.0002	.0069	94583.0	-.132	594.1
5918	10.55	-.00	.7198	.0229	.0331	.0036	-.0014	.0061	94439.7	-.140	594.1
5919	12.86	-.00	.8817	.0814	.0356	.0038	-.0014	.0069	94516.2	-.157	594.0
5920	15.05	-.00	1.0338	.1451	.0395	-.0016	-.0010	.0049	94704.1	-.174	593.8
5921	17.22	-.00	1.1403	.2085	.0462	.0046	.0009	.0088	94712.3	-.178	593.7
5922	19.47	-.00	1.2047	.2722	.0622	-.0047	.0013	.0026	94780.6	-.183	593.6
5923	21.49	-.01	1.2537	.3370	.0544	-.0033	.0060	.0047	94718.2	-.190	593.6
5924	23.64	-.01	1.3031	.4166	.0273	-.0004	.0623	.0068	94596.5	-.195	593.6
5925	24.01	.00	1.3022	.4318	.0161	.0029	-.0035	.0111	94532.1	-.198	593.7
5926	.03	-.00	-.0123	-.0872	.0303	.0033	.0011	.0079	94534.0	-.119	593.7

TEST TP	21 Q PA	ALPHA DEG	RUN 31 BETA DEG	CLT	CDT	CHST	CRTS	CYTS	CYST	CMU	WTFLD KG/SEC	PLENP PSI
5911	5972.1	.06	-.00	-.0573	.0219	-.0307	.0031	-.0014	.0134	.1972	.2289	430.2
5912	5862.8	-1.69	-.00	-.1497	.0237	-.0477	.0021	-.0008	.0129	.2011	.2292	431.1
5913	6034.3	.04	-.00	-.0558	.0216	-.0316	.0021	-.0015	.0128	.1954	.2292	431.8
5914	5902.2	2.06	-.00	.0231	.0199	-.0296	.0019	-.0011	.0129	.2002	.2296	432.0
5915	5993.2	4.17	-.00	.1717	.0269	-.0348	.0032	-.0010	.0101	.1970	.2295	432.1
5916	5970.7	6.27	-.00	.3283	.0436	-.0370	.0016	-.0016	.0083	.1978	.2296	432.4
5917	5953.7	8.52	-.00	.5090	.0780	-.0382	.0027	-.0024	.0130	.1985	.2297	432.5
5918	6087.2	10.55	-.00	.6569	.1192	-.0296	.0032	-.0035	.0120	.1939	.2294	432.6
5919	6012.6	12.86	-.00	.8141	.1763	-.0279	.0033	-.0035	.0129	.1964	.2296	432.7
5920	5831.5	15.05	-.00	.9604	.2402	-.0260	-.0021	-.0031	.0111	.2025	.2297	432.7
5921	5825.3	17.22	-.00	1.0633	.3009	-.0194	.0039	-.0012	.0150	.2034	.2305	432.7
5922	5758.1	19.47	-.00	1.1232	.3626	-.0041	-.0054	-.0008	.0089	.2052	.2299	432.9
5923	5818.3	21.49	-.01	1.1699	.4235	-.0112	-.0041	.0039	.0203	.2034	.2302	432.9
5924	5934.3	23.64	-.01	1.2178	.4983	-.0371	-.0013	.0003	.0129	.1992	.2300	433.0
5925	5994.0	24.01	.00	1.2172	.5122	-.0477	.0020	-.0055	.0172	.1972	.2299	433.2
5926	5993.9	.03	-.00	-.0573	.0208	-.0335	.0033	-.0011	.0139	.1973	.2301	433.3

ORIGINAL PAGE IS OF POOR QUALITY

NASA LANGLEY

7 X 10 HIGH SPEED TUNNEL

TEST TP	21		RUN 32		CNF(BA)	CAF(BA)	CPH(BA)	CRM(BA)	CYM(BA)	CSF(BA)	TPLEN DEG K
	MACH	Q PA	ALPHA DEG	BETA DEG							
5927	.301	5980.5	.03	-.01	-.0120	-.1046	.0358	.0028	.0022	.0068	277.8
5928	.300	5961.4	-1.71	-.00	-.1002	-.1089	.0218	.0020	.0019	.0038	278.0
5929	.302	6014.3	.19	-.00	-.0048	-.1046	.0388	.0014	.0018	.0048	278.1
5930	.297	5852.9	2.27	-.00	.0770	-.1122	.0416	.0009	.0020	.0072	278.2
5931	.299	5936.5	4.08	-.00	.2172	-.1155	.0331	.0018	.0017	.0051	278.3
5932	.304	6121.3	6.21	-.00	.3762	-.1163	.0304	.0002	.0017	.0011	278.5
5933	.304	6117.6	8.56	-.00	.5558	-.1226	.0311	.0034	.0023	.0040	278.7
5934	.297	5862.5	10.44	-.00	.7239	-.1324	.0346	.0021	.0002	.0036	278.8
5935	.297	5853.7	12.92	-.00	.9031	-.1392	.0377	.0041	-.0012	.0067	279.0
5936	.295	5772.4	15.25	-.00	1.0779	-.1500	.0419	.0026	.0006	.0061	279.1
5937	.295	5787.6	17.33	-.00	1.2253	-.1609	.0427	.0003	.0021	.0068	279.3
5938	.296	5820.4	19.69	-.01	1.2865	-.1674	.0646	-.0012	.0030	.0076	279.4
5939	.300	5949.3	21.56	-.01	1.3282	-.1651	.0644	-.0061	.0062	.0042	279.6
5940	.301	5984.2	23.84	-.01	1.4165	-.1657	.0654	-.0055	.0068	.0027	279.7
5941	.302	6031.4	24.07	-.00	1.4222	-.1644	.0651	.0011	.0027	.0058	279.8
5942	.297	5840.9	.06	-.00	-.0074	-.1106	.0395	.0035	.0022	.0048	280.2
5943	0.000	47.9	.36	-.00	2.3898	.6935	-.7257	.0252	.0241	.1783	282.1

TEST TP	21		RUN 32		CPM(SA)	CRM(SA)	CYM(SA)	CSF(SA)	P1 PA	CPB(1)	VTDT M/SEC
	ALPHA DEG	BETA DEG	CL(SA)	CD(SA)							
5927	.03	-.01	-.0120	-.1046	.0358	.0028	.0022	.0068	94552.8	-.120	600.1
5928	-1.71	-.00	-.1034	-.1058	.0218	.0020	.0020	.0038	94573.6	-.119	600.4
5929	.19	-.00	-.0045	-.1046	.0388	.0014	.0018	.0048	94517.7	-.119	600.6
5930	2.27	-.00	.0814	-.1091	.0416	.0010	.0020	.0072	94691.8	-.119	600.8
5931	4.08	-.00	.2249	-.0997	.0331	.0019	.0015	.0051	94602.8	-.121	601.1
5932	6.21	-.00	.3866	-.0749	.0304	.0004	.0017	.0011	94402.8	-.121	600.7
5933	8.56	-.00	.5679	-.0386	.0311	.0037	.0017	.0040	94404.4	-.129	600.9
5934	10.44	-.00	.7359	.0010	.0346	.0021	-.0002	.0036	94671.6	-.136	600.9
5935	12.92	-.00	.9114	.0662	.0377	.0037	-.0020	.0067	94680.8	-.152	601.2
5936	15.25	-.00	1.0794	.1387	.0419	.0027	-.0001	.0061	94759.0	-.168	601.3
5937	17.33	-.00	1.2177	.2113	.0427	.0009	.0019	.0068	94743.2	-.174	601.4
5938	19.69	-.01	1.2677	.2758	.0646	-.0001	.0032	.0076	94711.1	-.179	601.6
5939	21.56	-.01	1.2959	.3346	.0644	-.0034	.0081	.0042	94571.8	-.189	601.9
5940	23.84	-.01	1.3626	.4210	.0454	-.0023	.0084	.0027	94537.5	-.192	602.1
5941	24.07	-.00	1.3655	.4300	.0451	.0021	.0020	.0058	94488.0	-.194	602.2
5942	.06	-.00	-.0073	-.1106	.0395	.0035	.0022	.0048	94697.6	-.117	602.6
5943	.36	-.00	2.3854	.7085	-.7257	.0253	.0240	.1783	100749.9	.048	32.3

TEST TP	21		RUN 32		CLT	CDT	CMST	CRTS	CYTS	CYST	CMU	WTFLO KG/SEC	PLENP PSI
	Q PA	ALPHA DEG	BETA DEG	CLT									
5927	5980.5	.03	-.01	-.0643	.0209	-.0383	.0028	-.0004	.0138	.2323	.2674	502.2	
5928	5961.4	-1.71	.00	-.1522	.0220	-.0527	.0020	-.0006	.0108	.2339	.2682	503.7	
5929	6014.3	.19	-.00	-.0572	.0207	-.0354	.0014	-.0007	.0118	.2323	.2686	505.1	
5930	5852.9	2.27	-.00	.0225	.0180	-.0347	.0009	-.0007	.0144	.2397	.2697	506.3	
5931	5936.5	4.08	-.00	.1627	.0240	-.0424	.0018	-.0011	.0123	.2366	.2699	507.8	
5932	6121.3	6.21	-.00	.3228	.0410	-.0417	.0001	-.0008	.0079	.2256	.2655	500.1	
5933	6117.6	8.56	-.00	.4994	.0746	-.0411	.0033	-.0007	.0108	.2257	.2654	499.9	
5934	5862.5	10.44	-.00	.6606	.1168	-.0407	.0017	-.0028	.0107	.2355	.2653	500.0	
5935	5853.7	12.92	-.00	.8310	.1788	-.0378	.0031	-.0046	.0139	.2360	.2654	500.3	
5936	5772.4	15.25	-.00	.9932	.2496	-.0346	.0020	-.0026	.0133	.2393	.2653	500.5	
5937	5787.6	17.33	-.00	1.1277	.3187	-.0336	.0001	-.0006	.0140	.2387	.2653	500.8	
5938	5820.4	19.69	-.01	1.1739	.3789	-.0114	-.0010	.0007	.0148	.2378	.2656	501.1	
5939	5949.3	21.56	-.01	1.2008	.4325	-.0100	-.0044	.0057	.0113	.2328	.2657	501.3	
5940	5984.2	23.84	-.01	1.2642	.5145	-.0285	-.0033	.0061	.0097	.2314	.2657	501.5	
5941	6031.4	24.07	-.00	1.2675	.5224	-.0283	.0010	-.0003	.0127	.2298	.2658	501.8	
5942	5840.9	.06	-.00	-.0609	.0179	-.0364	.0035	-.0004	.0120	.2373	.2657	502.3	
5943	47.9	.36	-.00	0.0000	0.0000	0.0000	0.0000	0.0000	0.0000	.0721	.0123	-.1	

NASA LANGLEY

7 X 10 HIGH SPEED TUNNEL

TEST TP	21 MACH	Q PA	RUN 33 ALPHA DEG	BETA DEG	CNF(BA)	CAF(BA)	CPH(BA)	CRM(BA)	CYH(BA)	CSF(BA)	TPLEN DEG K
5958	.698	24430.2	-.04	-.00	-.0018	.0149	-.0039	.0023	-.0026	.0082	296.1
5959	.694	24223.0	-2.14	-.00	-.1267	.0173	-.0081	.0023	-.0023	.0078	296.8
5960	.698	24410.8	-.04	-.00	-.0033	.0150	-.0042	.0025	-.0026	.0082	297.4
5961	.708	24882.1	2.46	-.00	.1338	.0170	.0013	.0023	-.0028	.0082	298.5
5962	.715	25207.6	4.97	.00	.2814	.0288	.0036	.0022	-.0030	.0082	299.5
5963	.709	24932.8	7.16	.00	.4085	.0505	.0037	.0018	-.0033	.0077	301.0
5964	.697	24388.1	9.56	.00	.5385	.0870	.0064	.0003	-.0033	.0080	302.3
5965	.697	24373.2	11.96	.00	.6315	.1317	.0046	.0015	-.0035	.0077	303.3
5966	.698	24391.7	14.37	.01	.7349	.1877	-.0051	.0015	-.0041	.0090	303.9
5967	.705	24723.1	16.69	.00	.8057	.2429	-.0189	.0013	-.0041	.0103	304.6
5968	.697	24378.2	18.81	-.00	.8259	.2853	-.0202	-.0001	-.0025	.0085	305.4
5969	.695	24273.9	21.06	-.01	.8053	.3147	-.0054	-.0005	-.0008	.0084	306.3
5970	.699	24463.5	-.04	-.00	-.0013	.0132	-.0038	.0022	-.0027	.0084	310.0

TEST TP	21 ALPHA DEG	BETA DEG	RUN 33 CL(SA)	CD(SA)	CPH(SA)	CRM(SA)	CYH(SA)	CSF(SA)	P1 PA	CPB(1)	VTOT M/SEC
5958	-.04	-.00	-.0018	.0149	-.0039	.0023	-.0026	.0082	71533.3	-.125	0.0
5959	-2.14	-.00	-.1267	.0173	-.0081	.0023	-.0023	.0078	71861.8	-.124	0.0
5960	-.04	-.00	-.0033	.0150	-.0042	.0025	-.0026	.0082	71553.9	-.124	0.0
5961	2.46	-.00	.1338	.0170	.0013	.0023	-.0028	.0082	70969.2	-.125	0.0
5962	4.97	.00	.2814	.0288	.0036	.0022	-.0030	.0082	70911.9	-.129	0.0
5963	7.16	.00	.4085	.0505	.0037	.0018	-.0033	.0077	70847.3	-.135	0.0
5964	9.56	.00	.5385	.0870	.0064	.0003	-.0033	.0080	71662.7	-.141	0.0
5965	11.96	.00	.6315	.1317	.0046	.0015	-.0035	.0077	71676.8	-.151	0.0
5966	14.37	.01	.7349	.1877	-.0051	.0015	-.0041	.0090	71579.2	-.159	0.0
5967	16.69	.00	.8057	.2429	-.0189	.0013	-.0041	.0103	71133.2	-.174	0.0
5968	18.81	-.00	.8259	.2853	-.0202	-.0001	-.0025	.0085	71633.0	-.182	0.0
5969	21.06	-.01	.8053	.3147	-.0054	-.0005	-.0008	.0084	71826.5	-.186	0.0
5970	-.04	-.00	-.0013	.0132	-.0038	.0022	-.0027	.0084	71495.8	-.123	0.0

TEST TP	21 Q PA	ALPHA DEG	RUN 33 BETA DEG	CLT	COT	CMST	CRTS	CYTS	CYST	CMU	WTFLO KG/SEC	PLENP PSI
5958	24430.2	-.04	-.00	-.0018	.0149	-.0039	.0023	-.0026	.0082	0.0000	0.0000	-.9
5959	24223.0	-2.14	-.00	-.1267	.0173	-.0081	.0023	-.0023	.0078	0.0000	0.0000	-.6
5960	24410.8	-.04	-.00	-.0033	.0150	-.0042	.0025	-.0026	.0082	0.0000	0.0000	-.8
5961	24882.1	2.46	-.00	.1338	.0170	.0013	.0023	-.0028	.0082	0.0000	0.0000	-1.0
5962	25207.6	4.97	.00	.2814	.0288	.0036	.0022	-.0030	.0082	0.0000	0.0000	-1.0
5963	24932.8	7.16	.00	.4085	.0505	.0037	.0018	-.0033	.0077	0.0000	0.0000	-1.0
5964	24388.1	9.56	.00	.5385	.0870	.0064	.0003	-.0033	.0080	0.0000	0.0000	-1.1
5965	24373.2	11.96	.00	.6315	.1317	.0046	.0015	-.0035	.0077	0.0000	0.0000	-1.3
5966	24391.7	14.37	.01	.7349	.1877	-.0051	.0015	-.0041	.0090	0.0000	0.0000	-1.6
5967	24723.1	16.69	.00	.8057	.2429	-.0189	.0013	-.0041	.0103	0.0000	0.0000	-1.8
5968	24378.2	18.81	-.00	.8259	.2853	-.0202	-.0001	-.0025	.0085	0.0000	0.0000	-2.0
5969	24273.9	21.06	-.01	.8053	.3147	-.0054	-.0005	-.0008	.0084	0.0000	0.0000	-2.3
5970	24463.5	-.04	-.00	-.0013	.0132	-.0038	.0022	-.0027	.0084	0.0000	0.0000	-1.7

ORIGINAL PAGE IS
OF POOR QUALITY

NASA LANGLEY

7 X 10 HIGH SPEED TUNNEL

TEST TP	21 MACH	Q PA	RUN ALPHA	34 BETA DEG	CNF(BA)	CAF(BA)	CPH(BA)	CRM(BA)	CYM(BA)	CSF(BA)	TPLEN DEG K
5971	.700	24552.4	-0.03	-0.00	-0.0127	-0.0129	.0021	.0024	-0.0020	.0083	295.4
5972	.680	23558.5	-2.09	-0.00	-0.1328	-0.0162	-0.0041	.0017	-0.0021	.0078	295.5
5973	.695	24316.5	-0.06	-0.00	-0.0183	-0.0136	.0021	.0023	-0.0019	.0083	295.6
5974	.705	24771.4	2.37	-0.00	.1155	-0.0164	.0057	.0021	-0.0020	.0091	295.7
5975	.699	24489.4	4.71	-0.00	.2659	-0.0235	.0086	.0023	-0.0019	.0069	296.2
5976	.706	24863.0	7.34	.00	.4336	-0.0283	.0096	.0019	-0.0026	.0061	296.9
5977	.706	24832.1	9.83	.01	.5828	-0.0304	.0114	.0015	-0.0026	.0040	297.5
5978	.702	24616.9	12.24	.01	.7051	-0.0328	.0167	.0022	-0.0032	.0046	298.2
5979	.705	24803.6	14.82	.01	.8077	-0.0338	.0190	.0042	-0.0034	.0055	299.2
5980	.706	24813.6	16.98	.01	.8822	-0.0314	.0036	.0040	-0.0033	.0059	300.2
5981	.696	24338.4	19.17	.00	.9644	-0.0302	-0.0092	-0.0014	-0.0001	-0.0015	301.0
5982	.707	24865.6	21.39	.00	.9829	-0.0279	-0.0090	.0003	-0.0022	.0060	302.5
5983	.702	24656.5	-0.01	-0.00	-0.0097	-0.0151	.0009	.0023	-0.0019	.0087	306.1

TEST TP	21 ALPHA DEG	BETA DEG	RUN CL(SA)	34 CD(SA)	CPH(SA)	CRM(SA)	CYM(SA)	CSF(SA)	P1 PA	CPB(1)	WTDT M/SEC
5971	-0.03	-0.00	-0.0127	-0.0129	.0021	.0024	-0.0020	.0083	71500.8	-0.124	625.8
5972	-2.09	-0.00	-0.1333	-0.0114	-0.0041	.0018	-0.0020	.0078	72833.8	-0.127	625.3
5973	-0.06	-0.00	-0.0183	-0.0136	.0021	.0023	-0.0019	.0083	71838.3	-0.123	626.3
5974	2.37	-0.00	.1155	-0.0116	.0057	.0021	-0.0021	.0091	71249.4	-0.127	627.0
5975	4.71	-0.00	.2669	-0.0015	.0086	.0022	-0.0021	.0069	71682.5	-0.126	627.4
5976	7.34	.00	.4337	.0273	.0096	.0016	-0.0028	.0061	71214.1	-0.141	628.4
5977	9.83	.01	.5795	.0696	.0114	.0010	-0.0028	.0040	71171.8	-0.154	628.8
5978	12.24	.01	.6961	.1175	.0167	.0015	-0.0036	.0046	71453.2	-0.161	629.3
5979	14.82	.01	.7895	.1739	.0190	.0032	-0.0043	.0055	71200.6	-0.164	630.5
5980	16.98	.01	.8529	.2276	.0036	.0029	-0.0044	.0059	71204.3	-0.174	631.5
5981	19.17	.00	.9208	.2881	-0.0092	-0.0013	.0004	-0.0015	71839.4	-0.186	632.0
5982	21.39	.00	.9254	.3325	-0.0090	-0.0009	-0.0021	.0060	71152.6	-0.194	634.0
5983	-0.01	-0.00	-0.0097	-0.0151	.0009	.0023	-0.0019	.0087	71395.6	-0.123	637.8

TEST TP	21 Q PA	ALPHA DEG	RUN BETA DEG	34 CLT	CDT	CMST	CRTS	CYTS	CYST	CMU	WTFLO KG/SEC	PLENP PSI
5971	24552.4	-0.03	-0.00	-0.0239	.0141	-0.0138	.0024	-0.0025	.0098	.0506	.2291	442.8
5972	23558.5	-2.09	-0.00	-0.1440	.0172	-0.0208	.0018	-0.0026	.0094	.0529	.2304	444.9
5973	24316.5	-0.06	-0.00	-0.0297	.0139	-0.0141	.0023	-0.0025	.0099	.0516	.2313	447.3
5974	24771.4	2.37	-0.00	.1031	.0150	-0.0103	.0020	-0.0027	.0106	.0509	.2322	449.2
5975	24489.4	4.71	-0.00	.2532	.0249	-0.0077	.0021	-0.0027	.0084	.0516	.2327	450.7
5976	24863.0	7.34	.00	.4190	.0527	-0.0064	.0015	-0.0034	.0076	.0508	.2320	450.5
5977	24832.1	9.83	.01	.5638	.0943	-0.0046	.0009	-0.0033	.0055	.0507	.2312	449.1
5978	24616.9	12.24	.01	.6792	.1417	.0006	.0013	-0.0041	.0061	.0511	.2307	448.5
5979	24803.6	14.82	.01	.7717	.1972	.0030	.0030	-0.0049	.0070	.0506	.2300	448.1
5980	24813.6	16.98	.01	.8343	.2502	-0.0124	.0027	-0.0049	.0074	.0506	.2296	448.0
5981	24338.4	19.17	.00	.9010	.3103	-0.0253	-0.0015	-0.0002	.0000	.0516	.2293	448.1
5982	24865.6	21.39	.00	.9051	.3536	-0.0249	-0.0007	-0.0027	.0075	.0505	.2287	448.5
5983	24656.5	-0.01	-0.00	-0.0210	.0122	-0.0152	.0023	-0.0025	.0102	.0511	.2281	449.4

NASA LANGLEY

7 X 10 HIGH SPEED TUNNEL

TEST TP	21 MACH	Q PA	RUN 35 ALPHA DEG	BETA DEG	CNF(BA)	CAF(BA)	CPN(BA)	CRM(BA)	CYM(BA)	CSF(BA)	TPLEN DEG K
5999	.299	5832.1	-.02	-.00	-.0057	.0174	-.0020	.0021	-.0022	.0074	297.5
6000	.301	5897.2	-.03	-.00	-.0119	-.0144	.0006	.0023	-.0019	.0066	297.3
6001	.300	5868.9	-1.84	-.00	-.1236	-.0186	-.0065	.0017	-.0017	.0052	297.0
6002	.300	5891.5	-.06	-.00	-.0127	-.0137	.0018	.0027	-.0018	.0070	296.8
6003	.302	5957.0	1.99	-.00	.0889	-.0147	.0089	.0025	-.0015	.0079	296.4
6004	.303	5988.4	4.25	-.00	.2269	-.0205	.0122	.0023	-.0019	.0091	296.1
6005	.304	6033.4	6.12	-.00	.3435	-.0261	.0159	.0026	-.0019	.0085	295.9
6006	.295	5673.8	8.11	-.00	.4628	-.0334	.0215	.0019	-.0023	.0088	295.6
6007	.295	5674.7	10.35	-.00	.5917	-.0387	.0252	.0017	-.0024	.0084	295.3
6008	.301	5915.5	12.60	.00	.6918	-.0395	.0249	.0021	-.0025	.0086	295.0
6009	.299	5837.8	14.92	.00	.7937	-.0392	.0164	.0016	-.0028	.0091	294.9
6010	.297	5753.0	16.87	.00	.8921	-.0371	.0035	.0013	-.0025	.0084	294.7
6011	.305	6049.4	19.12	-.00	.9540	-.0326	-.0084	.0011	-.0036	.0132	294.5
6012	.303	5988.8	21.18	-.01	.9027	-.0261	.0018	-.0009	.0003	.0124	294.3
6013	.302	5950.5	23.25	-.00	.9164	-.0271	.0088	.0019	-.0033	.0156	294.1
6014	.301	5897.7	23.57	-.00	.9234	-.0283	.0084	.0016	-.0033	.0165	293.9
6015	.296	5726.6	.00	-.00	-.0080	-.0134	.0017	.0024	-.0018	.0078	293.4

TEST TP	21 ALPHA DEG	BETA DEG	RUN 35 CL(SA)	CD(SA)	CPN(SA)	CRM(SA)	CYM(SA)	CSF(SA)	P1 PA	CPB(1)	VTOT M/SEC
5999	-.02	-.00	-.0057	.0174	-.0020	.0021	-.0022	.0074	93230.3	-.118	.0
6000	-.03	-.00	-.0119	-.0144	.0006	.0023	-.0019	.0066	93221.6	-.120	536.2
6001	-1.84	-.00	-.1242	-.0146	-.0065	.0017	-.0016	.0052	93246.1	-.123	536.1
6002	-.06	-.00	-.0127	-.0137	.0018	.0027	-.0018	.0070	93227.0	-.120	534.9
6003	1.99	-.00	.0894	-.0116	.0089	.0024	-.0016	.0079	93165.3	-.118	534.7
6004	4.25	-.00	.2278	-.0037	.0122	.0021	-.0021	.0091	93126.0	-.119	534.4
6005	6.12	-.00	.3443	.0107	.0159	.0024	-.0021	.0085	93077.4	-.130	534.3
6006	8.11	-.00	.4629	.0322	.0215	.0015	-.0026	.0088	93448.1	-.145	533.7
6007	10.35	-.00	.5890	.0682	.0252	.0013	-.0027	.0084	93440.4	-.156	533.5
6008	12.60	.00	.6838	.1123	.0249	.0015	-.0029	.0086	93186.4	-.165	533.6
6009	14.92	.00	.7770	.1665	.0164	.0008	-.0032	.0091	93265.0	-.166	533.5
6010	16.87	.00	.8645	.2234	.0035	.0005	-.0028	.0084	93347.2	-.166	533.2
6011	19.12	-.00	.9120	.2818	-.0084	-.0001	-.0038	.0132	93044.5	-.186	533.5
6012	21.18	-.01	.8912	.3018	.0018	-.0007	.0006	.0124	93107.2	-.199	533.2
6013	23.25	-.00	.8527	.3369	.0088	.0004	-.0038	.0156	93157.2	-.218	532.9
6014	23.57	-.00	.8577	.3432	.0084	.0002	-.0036	.0165	93214.1	-.222	532.8
6015	.00	-.00	-.0080	-.0134	.0017	.0024	-.0018	.0078	93408.0	-.120	532.3

TEST TP	21 Q PA	ALPHA DEG	RUN 35 BETA DEG	CLT	CDT	CMST	CRTS	CYTS	CYST	CMU	WTFLO KG/SEC	PLENP PSI
5999	5832.1	-.02	-.00	0.0000	0.0000	0.0000	0.0000	0.0000	0.0000	.0000	.0124	-.2
6000	5897.2	-.03	-.00	-.0247	.0163	-.0176	.0023	-.0023	.0084	.0521	.0661	121.1
6001	5868.9	-1.84	-.00	-.1360	.0167	-.0247	.0017	-.0021	.0069	.0508	.0642	121.4
6002	5891.5	-.06	-.00	-.0253	.0168	-.0161	.0027	-.0023	.0087	.0522	.0663	119.8
6003	5957.0	1.99	-.00	.0758	.0180	-.0089	.0024	-.0020	.0096	.0508	.0654	120.0
6004	5988.4	4.25	-.00	.2132	.0252	-.0094	.0021	-.0025	.0108	.0505	.0653	119.8
6005	6033.4	6.12	-.00	.3289	.0389	-.0016	.0023	-.0026	.0101	.0501	.0653	119.8
6006	5673.8	8.11	-.00	.4454	.0615	.0029	.0015	-.0030	.0105	.0533	.0654	119.8
6007	5674.7	10.35	-.00	.5704	.0970	.0065	.0012	-.0031	.0102	.0533	.0654	120.0
6008	5915.5	12.60	.00	.6648	.1392	.0070	.0014	-.0033	.0103	.0511	.0655	120.2
6009	5837.8	14.92	.00	.7567	.1929	-.0018	.0007	-.0036	.0108	.0521	.0658	120.3
6010	5753.0	16.87	.00	.8429	.2496	-.0150	.0004	-.0032	.0102	.0527	.0657	120.4
6011	6049.4	19.12	-.00	.8905	.3058	-.0260	-.0003	-.0042	.0149	.0503	.0659	120.6
6012	5988.8	21.18	-.01	.8286	.3253	-.0160	-.0009	-.0002	.0140	.0508	.0659	120.6
6013	5950.5	23.25	-.00	.8291	.3597	-.0091	.0003	-.0042	.0173	.0511	.0659	120.5
6014	5897.7	23.57	-.00	.8338	.3661	-.0096	-.0000	-.0041	.0182	.0516	.0660	120.6
6015	5726.6	.00	-.00	-.0211	.0182	-.0169	.0024	-.0023	.0096	.0533	.0662	120.8

ORIGINAL PAGE IS OF POOR QUALITY

NASA LANGLEY

7 X 10 HIGH SPEED TUNNEL

TEST TP	21 MACH	Q PA	RUN 36 ALPHA DEG	BETA DEG	CNF(BA)	CAF(BA)	CPM(BA)	CRM(BA)	CYM(BA)	CSF(BA)	TPLEN DEG K
6016	.301	5913.7	.00	-.00	-.0128	-.0389	.0114	.0029	-.0015	.0066	290.6
6017	.301	5896.6	-1.76	-.00	-.1105	-.0428	.0030	.0025	-.0010	.0061	290.5
6018	.301	5917.7	.05	-.00	-.0127	-.0391	.0119	.0027	-.0015	.0059	290.3
6019	.303	5972.7	2.10	-.00	.0819	-.0397	.0195	.0024	-.0012	.0083	290.3
6020	.299	5836.6	4.29	-.00	.2344	-.0475	.0194	.0025	-.0014	.0059	290.4
6021	.304	6021.1	6.12	.00	.3592	-.0512	.0214	.0029	-.0024	.0066	290.4
6022	.303	5977.7	8.33	.00	.5005	-.0572	.0310	.0035	-.0029	.0075	290.4
6023	.298	5788.2	10.59	.00	.6293	-.0655	.0402	.0021	-.0023	.0079	290.5
6024	.300	5870.2	12.83	-.00	.7409	-.0693	.0464	.0006	-.0004	.0074	290.6
6025	.298	5790.1	15.08	-.00	.8380	-.0736	.0480	.0006	-.0013	.0068	290.8
6026	.299	5823.6	16.97	.00	.9262	-.0750	.0354	.0033	-.0040	.0080	290.9
6027	.299	5827.4	19.10	.00	1.0378	-.0746	.0154	.0024	-.0040	.0065	291.2
6028	.299	5849.7	21.35	.00	1.1252	-.0692	-.0059	.0020	-.0052	.0072	291.4
6029	.298	5807.0	23.40	.02	1.1356	-.0671	-.0035	.0116	-.0142	.0108	291.6
6030	.298	5808.5	23.76	.02	1.1318	-.0653	-.0010	.0119	-.0145	.0112	291.8
6031	.302	5935.5	-.01	-.00	-.0093	-.0422	.0096	.0029	-.0011	.0051	292.5

TEST TP	21 ALPHA DEG	BETA DEG	RUN 36 CL(SA)	CD(SA)	CPM(SA)	CRM(SA)	CYM(SA)	CSF(SA)	P1 PA	CPB(1)	VTOT M/SEC
6016	.00	-.00	-.0128	-.0389	.0114	.0029	-.0015	.0066	93228.0	-.119	572.3
6017	-1.76	-.00	-.1117	-.0394	.0030	.0025	-.0010	.0061	93228.4	-.123	572.7
6018	.05	-.00	-.0127	-.0391	.0119	.0027	-.0015	.0059	93223.4	-.119	572.4
6019	2.10	-.00	.0833	-.0367	.0195	.0024	-.0012	.0083	93168.0	-.118	572.1
6020	4.29	-.00	.2373	-.0299	.0194	.0024	-.0016	.0059	93291.4	-.118	572.2
6021	6.12	.00	.3626	-.0126	.0214	.0026	-.0027	.0066	93078.1	-.125	572.5
6022	8.33	.00	.5035	.0158	.0310	.0030	-.0033	.0075	93143.4	-.133	572.6
6023	10.59	.00	.6306	.0512	.0402	.0016	-.0027	.0079	93336.6	-.154	572.6
6024	12.83	-.00	.7378	.0969	.0464	.0005	-.0005	.0074	93250.3	-.172	572.3
6025	15.08	-.00	.8283	.1470	.0480	.0002	-.0015	.0068	93343.2	-.177	572.8
6026	16.97	.00	.9078	.1985	.0354	.0020	-.0048	.0080	93296.5	-.175	573.2
6027	19.10	.00	1.0051	.2691	.0154	.0010	-.0046	.0065	93307.8	-.180	573.1
6028	21.35	.00	1.0731	.3453	-.0059	-.0000	-.0056	.0072	93267.5	-.191	573.1
6029	23.40	.02	1.0689	.3894	-.0035	.0050	-.0176	.0108	93319.0	-.195	573.7
6030	23.76	.02	1.0621	.3962	-.0010	.0030	-.0181	.0112	93309.9	-.196	573.6
6031	-.01	-.00	-.0093	-.0422	.0096	.0029	-.0011	.0051	93184.4	-.119	574.9

TEST TP	21 Q PA	ALPHA DEG	RUN 36 BETA DEG	CLT	CDT	CRST	CRTS	CYTS	CYST	CMU	WTFLO KG/SEC	PLENP PSI
6016	5913.7	.00	-.00	-.0368	.0187	-.0226	.0029	-.0024	.0099	.1026	.1224	228.0
6017	5896.6	-1.76	-.00	-.1342	.0196	-.0314	.0026	-.0018	.0093	.1035	.1231	229.9
6018	5917.7	.05	-.00	-.0368	.0187	-.0223	.0027	-.0024	.0092	.1026	.1225	229.1
6019	5972.7	2.10	-.00	.0575	.0194	-.0142	.0023	-.0021	.0115	.1011	.1219	227.9
6020	5836.6	4.29	-.00	.2086	.0267	-.0152	.0023	-.0025	.0092	.1039	.1224	228.6
6021	6021.1	6.12	.00	.3330	.0414	-.0122	.0025	-.0036	.0097	.1005	.1221	229.1
6022	5977.7	8.33	.00	.4715	.0692	-.0028	.0029	-.0042	.0107	.1018	.1227	229.6
6023	5788.2	10.59	.00	.5955	.1050	.0052	.0015	-.0035	.0112	.1053	.1229	229.7
6024	5870.2	12.83	-.00	.7013	.1482	.0121	.0003	-.0014	.0107	.1027	.1217	228.2
6025	5790.1	15.08	-.00	.7891	.1977	.0130	-.0000	-.0023	.0101	.1051	.1227	229.4
6026	5823.6	16.97	.00	.8670	.2479	.0005	.0018	-.0057	.0113	.1047	.1228	230.4
6027	5827.4	19.10	.00	.9628	.3166	-.0193	.0007	-.0055	.0098	.1037	.1218	228.9
6028	5849.7	21.35	.00	1.0293	.3907	-.0403	-.0003	-.0064	.0105	.1032	.1217	227.8
6029	5807.0	23.40	.02	1.0228	.4339	-.0384	.0047	-.0184	.0141	.1046	.1223	229.6
6030	5808.5	23.76	.02	1.0161	.4402	-.0357	.0047	-.0189	.0145	.1045	.1222	228.5
6031	5935.5	-.01	-.00	-.0334	.0158	-.0247	.0029	-.0020	.0084	.1030	.1228	230.3

NASA LANGLEY

7 X 10 HIGH SPEED TUNNEL

TEST TP	21		RUN 37		CNF(BA)	CAF(BA)	CPM(BA)	CRM(BA)	CYN(BA)	CSF(BA)	TPLEN DEG K
	MACH	Q PA	ALPHA DEG	BETA DEG							
6032	.301	5899.0	.02	-.00	-.0145	-.0993	.0371	.0029	.0004	.0017	295.3
6033	.300	5881.3	-1.77	-.00	-.1101	-.1045	.0221	.0017	.0004	.0003	295.8
6034	.301	5902.3	-.02	-.00	-.0166	-.1002	.0357	.0029	.0003	.0002	296.4
6035	.302	5932.9	2.08	-.00	.0572	-.1021	.0449	.0028	.0003	.0021	296.8
6036	.301	5912.6	4.09	.00	.2111	-.1070	.0361	.0024	-.0003	.0009	297.2
6037	.302	5953.5	6.19	.00	.3716	-.1111	.0335	.0027	-.0007	.0024	297.5
6038	.299	5852.4	8.39	.00	.5571	-.1178	.0416	.0012	-.0014	.0005	297.9
6039	.300	5877.2	10.63	.01	.6877	-.1248	.0519	.0052	-.0048	.0027	298.2
6040	.293	5619.1	12.75	.01	.8465	-.1380	.0565	.0061	-.0047	.0035	298.4
6041	.298	5812.4	15.00	.00	.9760	-.1421	.0622	.0031	-.0023	.0079	298.6
6042	.301	5901.5	17.16	-.00	1.0679	-.1461	.0679	-.0021	.0001	.0055	298.8
6043	.298	5791.7	19.43	-.00	1.1534	-.1517	.0637	.0005	-.0001	.0011	298.9
6044	.298	5800.9	21.46	.00	1.2431	-.1517	.0469	.0021	-.0018	.0011	299.0
6045	.299	5846.7	23.64	-.00	1.3374	-.1404	.0048	.0012	-.0005	.0039	299.2
6046	.301	5897.0	23.98	-.00	1.3266	-.1371	.0032	.0010	-.0003	.0058	299.4
6047	.300	5867.7	.06	-.00	-.0217	-.1024	.0382	.0033	.0004	.0004	300.1

TEST TP	21		RUN 37		CPM(SA)	CRM(SA)	CYN(SA)	CSF(SA)	P1 PA	CPB(1)	VTOT M/SEC
	ALPHA DEG	BETA DEG	CL(SA)	CD(SA)							
6032	.02	-.00	-.0145	-.0993	.0371	.0029	.0004	.0017	93202.3	-.119	612.2
6033	-1.77	-.00	-.1133	-.1011	.0221	.0017	.0004	.0003	93224.3	-.121	612.7
6034	-.02	-.00	-.0166	-.1002	.0357	.0029	.0003	.0002	93188.6	-.119	613.4
6035	2.08	-.00	.0609	-.0999	.0449	.0028	.0002	.0021	93163.4	-.119	613.8
6036	4.09	.00	.2182	-.0917	.0361	.0024	-.0004	.0009	93179.4	-.118	614.1
6037	6.19	.00	.3814	-.0704	.0335	.0026	-.0009	.0024	93140.6	-.121	614.5
6038	8.39	.00	.5683	-.0353	.0416	.0010	-.0015	.0005	93254.5	-.125	614.9
6039	10.63	.01	.6989	.0042	.0519	.0043	-.0057	.0027	93233.4	-.145	615.1
6040	12.75	.01	.8561	.0522	.0565	.0049	-.0059	.0035	93493.8	-.160	615.2
6041	15.00	.00	.9795	.1154	.0622	.0024	-.0030	.0079	93279.5	-.174	615.4
6042	17.16	-.00	1.0634	.1755	.0679	-.0019	.0007	.0055	93189.5	-.181	615.7
6043	19.43	-.00	1.1382	.2407	.0637	.0005	-.0002	.0011	93304.3	-.182	615.7
6044	21.46	.00	1.2124	.3136	.0469	.0013	-.0025	.0011	93293.0	-.189	615.8
6045	23.64	-.00	1.2814	.4077	.0048	.0009	-.0009	.0039	93226.5	-.196	616.1
6046	23.98	-.00	1.2678	.4138	.0032	.0006	-.0007	.0058	93167.3	-.195	616.3
6047	.06	-.00	-.0216	-.1024	.0382	.0033	.0004	.0004	93218.1	-.119	617.0

TEST TP	21		RUN 37		CLT	CDT	CMST	CRTS	CYTS	CYST	CMU	WTFLO KG/SEC	PLENP* PSI
	Q PA	ALPHA DEG	BETA DEG	CLT									
6032	5899.0	.02	-.00	-.0601	.0102	-.0276	.0029	-.0013	.0078	.2016	.2244	432.5	
6033	5881.3	-1.77	-.00	-.1557	.0103	-.0429	.0018	-.0012	.0064	.2026	.2246	432.9	
6034	5902.3	-.02	-.00	-.0622	.0094	-.0290	.0029	-.0014	.0063	.2017	.2242	432.8	
6035	5932.9	2.08	-.00	.0115	.0074	-.0195	.0027	-.0014	.0082	.2009	.2242	433.0	
6036	5912.6	4.09	.00	.1650	.0141	-.0285	.0023	-.0021	.0070	.2015	.2240	432.6	
6037	5953.5	6.19	.00	.3247	.0328	-.0306	.0025	-.0026	.0085	.2002	.2240	432.7	
6038	5852.4	8.39	.00	.5067	.0673	-.0237	.0008	-.0032	.0067	.2039	.2241	432.8	
6039	5877.2	10.63	.01	.6336	.1038	-.0130	.0040	-.0073	.0089	.2024	.2233	432.2	
6040	5619.1	12.75	.01	.7841	.1537	-.0113	.0045	-.0076	.0099	.2116	.2232	431.9	
6041	5812.4	15.00	.00	.9061	.2107	-.0034	.0020	-.0047	.0141	.2046	.2231	431.6	
6042	5901.5	17.16	-.00	.9877	.2665	.0033	-.0024	-.0008	.0116	.2013	.2229	431.6	
6043	5791.7	19.43	-.00	1.0574	.3303	-.0020	-.0001	-.0018	.0073	.2049	.2226	431.5	
6044	5800.9	21.46	.00	1.1287	.4001	-.0188	.0007	-.0040	.0073	.2046	.2226	431.4	
6045	5846.7	23.64	-.00	1.1951	.4904	-.0604	.0003	-.0025	.0190	.2030	.2225	431.5	
6046	5897.0	23.98	-.00	1.1817	.4953	-.0614	.0001	-.0022	.0119	.2014	.2225	431.6	
6047	5267.7	.06	-.00	-.0675	.0076	-.0268	.0033	-.0012	.0066	.2028	.2227	432.1	

NASA LANGLEY

7 X 10 HIGH SPEED TUNNEL

TEST TP	21		RUN 38		CNF(BA)	CAF(BA)	CPH(BA)	CRM(BA)	CYM(BA)	CSF(BA)	TLEN DEG K
	MACH	Q PA	ALPHA DEG	BETA DEG							
6048	.300	5868.0	.07	-.00	-.0200	-.1230	.0519	.0030	.0011	-.0004	302.2
6049	.299	5847.6	-1.71	.00	-.1120	-.1277	.0342	.0014	.0009	-.0035	302.5
6050	.302	5936.0	.07	-.00	-.0225	-.1217	.0514	.0030	.0011	-.0008	302.7
6051	.300	5876.9	2.05	-.00	.0318	-.1252	.0608	.0025	.0008	-.0007	303.0
6052	.300	5865.9	4.16	.00	.2041	-.1307	.0485	.0021	.0000	-.0005	303.3
6053	.300	5887.6	6.14	.00	.3511	-.1344	.0443	.0028	-.0005	-.0007	303.5
6054	.301	5899.1	8.47	.00	.5581	-.1398	.0481	.0027	-.0015	-.0004	303.8
6055	.299	5848.5	10.57	.01	.7041	-.1472	.0601	.0068	-.0042	.0013	304.0
6056	.299	5816.5	13.12	.00	.9944	-.1579	.0646	.0071	-.0039	.0032	304.2
6057	.299	5821.5	15.06	.00	1.0014	-.1644	.0690	.0061	-.0017	.0056	304.5
6058	.258	5784.3	17.19	-.00	1.1211	-.1728	.0706	.0001	.0011	.0028	304.7
6059	.297	5756.8	19.40	-.00	1.1992	-.1784	.0756	-.0031	.0021	-.0008	304.8
6060	.298	5796.3	21.76	-.00	1.2841	-.1786	.0618	-.0012	.0022	-.0025	305.1
6061	.300	5861.8	23.54	-.01	1.3517	-.1697	.0307	-.0006	.0065	.0047	305.2
6062	.299	5838.5	24.03	-.02	1.3622	-.1684	.0245	-.0045	.0122	.0058	305.4
6063	.301	5906.9	.01	-.00	-.0264	-.1234	.0521	.0032	.0010	-.0009	305.8

TEST TP	21		RUN 38		CPH(SA)	CRM(SA)	CYM(SA)	CSF(SA)	P1 PA	CPB(1)	VTOT M/SEC
	ALPHA DEG	BETA DEG	CL(SA)	CD(SA)							
6048	.07	-.00	-.0199	-.1231	.0519	.0030	.0011	-.0004	93244.9	-.120	626.8
6049	-1.71	.00	-.1158	-.1243	.0342	.0014	.0010	-.0035	93265.3	-.120	627.1
6050	.07	-.00	-.0223	-.1217	.0514	.0030	.0011	-.0008	93160.1	-.120	627.4
6051	2.05	-.00	.0363	-.1240	.0608	.0025	.0008	-.0007	93221.3	-.117	627.7
6052	4.16	.00	.2131	-.1156	.0485	.0021	-.0001	-.0005	93228.9	-.118	627.9
6053	6.14	.00	.3634	-.0961	.0443	.0028	-.0008	-.0007	93178.8	-.120	628.2
6054	8.47	.00	.5726	-.0560	.0481	.0024	-.0019	-.0004	93171.7	-.125	628.4
6055	10.57	.01	.7191	-.0156	.0601	.0059	-.0054	.0013	93224.6	-.138	628.6
6056	13.12	.00	.9069	.0493	.0646	.0060	-.0054	.0032	93251.4	-.158	628.8
6057	15.06	.00	1.0097	.1015	.0690	.0055	-.0033	.0056	93253.0	-.169	629.0
6058	17.19	-.00	1.1221	.1662	.0706	.0004	.0010	.0028	93298.6	-.176	629.2
6059	19.40	-.00	1.1904	.2301	.0756	-.0023	.0030	-.0008	93342.2	-.180	629.3
6060	21.76	-.00	1.2588	.3102	.0618	-.0003	.0025	-.0025	93275.2	-.189	629.6
6061	23.54	-.01	1.3070	.3842	.0307	.0020	.0062	.0047	93225.3	-.196	629.8
6062	24.03	-.02	1.3127	.4008	.0245	.0009	.0129	.0058	93232.8	-.196	629.9
6063	.01	-.00	-.0263	-.1234	.0521	.0032	.0010	-.0009	93177.0	-.120	630.4

TEST TP	21		RUN 38		CLT	CDT	CMST	CRTS	CYTS	CYST	CHU	WTFLO KG/SEC	PLENP PSI
	Q PA	ALPHA DEG	BETA DEG	BETA DEG									
6048	5868.0	.07	-.00	-.0736	.0054	-.0241	.0030	-.0009	.0068	.2401	.2596	504.7	
6049	5847.6	-1.71	.00	-.1657	.0063	-.0420	.0015	-.0010	.0037	.2410	.2596	505.0	
6050	5936.0	.07	-.00	-.0754	.0054	-.0237	.0030	-.0009	.0063	.2373	.2593	505.1	
6051	5876.9	2.05	-.00	-.0217	.0024	-.0150	.0025	-.0012	.0064	.2398	.2593	504.9	
6052	5865.9	4.16	.00	.1503	.0088	-.0275	.0020	-.0021	.0067	.2402	.2591	504.8	
6053	5887.6	6.14	.00	.2967	.0255	-.0313	.0026	-.0027	.0064	.2390	.2587	504.3	
6054	5899.1	8.47	.00	.5011	.0625	-.0273	.0021	-.0038	.0067	.2383	.2584	504.1	
6055	5848.5	10.57	.01	.6428	.1012	-.0159	.0056	-.0073	.0085	.2406	.2585	503.8	
6056	5816.5	13.12	.00	.8250	.1631	-.0118	.0056	-.0073	.0104	.2416	.2581	503.8	
6057	5821.5	15.06	.00	.9241	.2124	-.0074	.0050	-.0052	.0128	.2413	.2579	503.6	
6058	5784.3	17.19	-.00	1.0319	.2745	-.0062	-.0002	-.0008	.0101	.2430	.2580	503.6	
6059	5750.8	19.40	-.00	1.0955	.3354	-.0017	-.0029	-.0011	.0065	.2441	.2576	503.4	
6060	5796.3	21.76	-.00	1.1605	.4107	-.0148	-.0010	.0007	.0047	.2422	.2576	503.3	
6061	5861.8	23.54	-.01	1.2068	.4805	-.0451	.0012	.0044	.0118	.2395	.2574	503.3	
6062	5838.5	24.03	-.02	1.2113	.4966	-.0515	.0001	.0112	.0130	.2405	.2574	503.1	
6063	5906.9	.01	-.00	-.0794	.0040	-.0231	.0032	-.0010	.0062	.2376	.2571	503.3	

NASA LANGLEY

7 X 10 HIGH SPEED TUNNEL

TEST TP	21		RUN 39		CNF(BA)	CAF(BA)	CPH(BA)	CRM(BA)	CYM(BA)	CSF(BA)	TPLEN DEG K
	MACH	Q PA	ALPHA DEG	BETA DEG							
6064	.701	24500.0	-.08	-.00	-.0152	-.0148	.0024	.0025	-.0019	.0080	306.6
6065	.690	23970.2	-2.09	-.00	-.1276	-.0175	-.0041	.0023	-.0018	.0067	306.9
6066	.707	24825.5	-.06	-.00	-.0124	-.0147	.0026	.0027	-.0019	.0078	307.0
6067	.710	24940.4	2.29	-.00	.1173	-.0177	.0058	.0022	-.0021	.0089	307.2
6068	.708	24837.0	4.78	-.00	.2747	-.0242	.0095	.0026	-.0018	.0066	307.2
6069	.708	24837.9	7.26	.00	.4362	-.0286	.0108	.0022	-.0024	.0058	307.3
6070	.706	24746.7	9.78	.01	.5845	-.0314	.0151	.0018	-.0029	.0052	307.4
6071	.701	24518.6	12.33	.01	.6982	-.0324	.0184	.0025	-.0026	.0059	307.4
6072	.697	24303.9	14.46	.00	.7659	-.0307	.0132	.0023	-.0022	.0063	307.5
6073	.697	24347.0	16.84	-.00	.8553	-.0282	-.0027	.0007	-.0023	.0074	307.6
6074	.701	24526.8	18.92	.00	.9139	-.0259	-.0107	.0011	-.0021	.0073	307.6
6075	.696	24278.3	21.11	-.00	.9307	-.0258	-.0011	.0004	-.0013	.0059	307.7
6076	.696	24255.8	-.07	-.00	-.0112	-.0150	.0029	.0025	-.0021	.0085	307.7

TEST TP	21		RUN 39		CPH(SA)	CRM(SA)	CYM(SA)	CSF(SA)	P1 PA	CPB(1)	VTOT M/SEC
	ALPHA DEG	BETA DEG	CL(SA)	CD(SA)							
6064	-.08	-.00	-.0152	-.0148	.0024	.0025	-.0019	.0080	71304.5	-.126	638.4
6065	-2.09	-.00	-.1281	-.0128	-.0041	.0023	-.0017	.0067	71997.7	-.128	638.3
6066	-.06	-.00	-.0125	-.0147	.0026	.0027	-.0019	.0078	70867.2	-.127	639.2
6067	2.29	-.00	.1179	-.0130	.0058	.0021	-.0022	.0089	70708.7	-.128	639.5
6068	4.78	-.00	.2758	-.0012	.0095	.0024	-.0020	.0066	70861.3	-.130	639.5
6069	7.26	.00	.4363	.0268	.0108	.0019	-.0027	.0058	70849.4	-.147	639.6
6070	9.78	.01	.5814	.0684	.0151	.0012	-.0032	.0052	70981.6	-.154	639.6
6071	12.33	.01	.6890	.1175	.0184	.0019	-.0031	.0059	71276.6	-.165	639.5
6072	14.46	.00	.7493	.1615	.0132	.0017	-.0027	.0063	71565.3	-.164	639.4
6073	16.84	-.00	.8268	.2207	-.0027	-.0000	-.0024	.0074	71501.3	-.170	639.5
6074	18.92	.00	.8729	.2718	-.0107	.0004	-.0023	.0073	71242.0	-.184	639.7
6075	21.11	-.00	.8775	.3112	-.0011	-.0001	-.0014	.0059	71682.0	-.196	639.5
6076	-.07	-.00	-.0112	-.0150	.0029	.0025	-.0021	.0085	71631.5	-.124	639.6

TEST TP	21		RUN 39		CDT	CMST	CRTS	CYTS	CYST	CMU	WTFLO KG/SEC	PLENP PSI
	Q PA	ALPHA DEG	BETA DEG	CLT								
6064	24500.0	-.08	-.00	-.0266	.0127	-.0138	.0025	-.0023	.0096	.0514	.2279	450.0
6065	23970.2	-2.09	-.00	-.1388	.0157	-.0207	.0024	-.0021	.0083	.0526	.2283	450.0
6066	24825.5	-.06	-.00	-.0237	.0124	-.0134	.0027	-.0023	.0093	.0509	.2282	450.4
6067	24940.4	2.29	-.00	.1056	.0135	-.0101	.0021	-.0026	.0104	.0507	.2285	451.0
6068	24837.0	4.78	-.00	.2622	.0249	-.0065	.0024	-.0024	.0081	.0509	.2283	451.1
6069	24837.9	7.26	.00	.4217	.0523	-.0053	.0018	-.0031	.0074	.0510	.2287	451.3
6070	24746.7	9.78	.01	.5655	.0933	-.0010	.0012	-.0036	.0068	.0512	.2287	451.7
6071	24518.6	12.33	.01	.6719	.1420	.0021	.0018	-.0035	.0074	.0516	.2286	451.7
6072	24303.9	14.46	.00	.7312	.1855	-.0032	.0016	-.0031	.0079	.0521	.2288	451.8
6073	24347.0	16.84	-.00	.8077	.2439	-.0191	-.0001	-.0028	.0090	.0520	.2288	452.0
6074	24526.8	18.92	.00	.8531	.2942	-.0270	.0002	-.0027	.0089	.0517	.2289	452.0
6075	24278.3	21.11	-.00	.8567	.3330	-.0175	-.0003	-.0018	.0075	.0523	.2291	452.4
6076	24255.8	-.07	-.00	-.0228	.0129	-.0135	.0025	-.0025	.0100	.0523	.2289	451.9

ORIGINAL PAGE IS OF POOR QUALITY.

NASA LANGLEY

7 X 10 HIGH SPEED TUNNEL

TEST TP	21 HACH	Q PA	RUN 40		CNF(BA)	CAF(BA)	CPH(BA)	CRM(BA)	CYH(BA)	CSF(BA)	TPLEN DEG K
			ALPHA DEG	BETA DEG							
6090	.299	5832.0	-.01	-.00	-.0071	.0175	-.0025	.0021	-.0024	.0082	309.9
6091	.300	5881.7	-.01	-.00	-.0137	-.0101	.0028	.0023	-.0019	.0070	304.2
6092	.299	5834.0	-1.75	-.00	-.1168	-.0137	-.0039	-.0019	-.0018	.0068	303.8
6093	.301	5917.6	-.02	-.00	-.0178	-.0104	.0037	.0020	-.0019	.0076	303.3
6094	.302	5933.8	2.06	-.00	.0898	-.0112	.0112	.0022	-.0015	.0092	302.9
6095	.302	5932.6	4.17	-.00	.2081	-.0156	.0158	.0022	-.0017	.0094	302.5
6096	.301	5919.4	6.20	-.00	.3333	-.0229	.0159	.0026	-.0019	.0086	302.3
6097	.300	5865.2	8.27	-.00	.4636	-.0292	.0170	.0020	-.0021	.0088	301.9
6098	.299	5853.3	10.47	.00	.5994	-.0338	.0202	.0013	-.0030	.0085	301.6
6099	.299	5833.7	12.66	.00	.7164	-.0378	.0248	.0013	-.0029	.0089	301.4
6100	.299	5823.0	14.90	.00	.8123	-.0389	.0214	.0019	-.0031	.0080	301.0
6101	.297	5763.0	17.12	.00	.9326	-.0417	.0113	.0021	-.0030	.0082	300.8
6102	.299	5833.2	19.17	.00	1.0238	-.0431	.0037	.0012	-.0029	.0069	300.5
6103	.298	5808.1	21.28	-.00	1.0984	-.0378	-.0090	-.0019	-.0008	.0074	300.2
6104	.301	5891.7	23.35	-.02	1.0977	-.0320	-.0146	-.0109	.0091	.0064	299.9
6105	.302	5951.1	23.72	-.02	1.0902	-.0310	-.0144	-.0105	.0099	.0062	299.8
6106	.299	5848.0	-.01	-.00	-.0055	-.0095	.0015	.0024	-.0018	.0092	299.2

TEST TP	21 ALPHA DEG	BETA DEG	RUN 40		CPH(SA)	CRM(SA)	CYH(SA)	CSF(SA)	P1 PA	CPB(1)	VTOT M/SEC
			CL(SA)	CD(SA)							
6090	-.01	-.00	-.0071	.0175	-.0025	.0021	-.0024	.0082	93281.3	-.116	.0
6091	-.01	-.00	-.0137	-.0101	.0028	.0023	-.0019	.0070	93228.9	-.119	541.6
6092	-1.75	-.00	-.1172	-.0101	-.0039	.0020	-.0017	.0068	93272.1	-.121	542.0
6093	-.02	-.00	-.0178	-.0104	.0037	.0020	-.0019	.0076	93175.7	-.120	542.6
6094	2.06	-.00	.0902	-.0080	.0112	.0021	-.0016	.0092	93155.7	-.117	541.1
6095	4.17	-.00	.2087	-.0004	.0158	.0021	-.0018	.0094	93168.5	-.119	540.2
6096	6.20	-.00	.3338	.0132	.0159	.0024	-.0022	.0086	93184.3	-.129	540.2
6097	8.27	-.00	.4630	.0379	.0170	.0017	-.0024	.0088	93242.1	-.141	540.1
6098	10.47	.00	.5956	.0756	.0202	.0007	-.0032	.0085	93246.7	-.151	539.9
6099	12.66	.00	.7072	.1202	.0248	.0006	-.0031	.0089	93267.3	-.155	539.8
6100	14.90	.00	.7950	.1712	.0214	.0010	-.0035	.0080	93285.3	-.161	539.5
6101	17.12	.00	.9035	.2348	.0113	.0011	-.0035	.0082	93341.2	-.169	539.3
6102	19.17	.00	.9812	.2955	.0037	.0002	-.0031	.0069	93272.9	-.178	539.2
6103	21.28	-.00	1.0372	.3634	-.0090	-.0021	-.0001	.0074	93280.8	-.187	539.0
6104	23.35	-.02	1.0205	.4057	-.0146	-.0064	.0127	.0064	93193.0	-.192	538.8
6105	23.72	-.02	1.0105	.4103	-.0144	-.0056	.0133	.0062	93134.5	-.194	538.8
6106	-.01	-.00	-.0055	-.0095	.0015	.0024	-.0018	.0092	93244.9	-.119	538.3

TEST TP	21 Q PA	ALPHA DEG	RUN 40		CLT	CDT	CMST	CRTS	CYTS	CYST	CMU	WTFLO KG/SEC	PLENP PSI
			BETA DEG	CLT									
6090	5832.0	-.01	-.00	0.0000	0.0000	0.0000	0.0000	0.0000	0.0000	.0000	.0122	-.1	
6091	5881.7	-.01	-.00	-.0264	.0203	-.0152	.0023	-.0023	.0087	.0519	.0651	119.9	
6092	5834.0	-1.75	-.00	-.1292	.0213	-.0222	.0020	-.0022	.0085	.0528	.0656	121.3	
6093	5917.6	-.02	-.00	-.0307	.0206	-.0146	.0020	-.0023	.0093	.0529	.0667	122.7	
6094	5933.8	2.06	-.00	.0764	.0220	-.0068	.0021	-.0020	.0109	.0511	.0647	120.8	
6095	5932.6	4.17	-.00	.1940	.0288	-.0020	.0021	-.0023	.0111	.0508	.0644	119.9	
6096	5919.4	6.20	-.00	.3179	.0420	-.0020	.0023	-.0026	.0103	.0514	.0651	120.3	
6097	5865.2	8.27	-.00	.4459	.0664	-.0012	.0016	-.0028	.0105	.0521	.0654	120.6	
6098	5853.3	10.47	.00	.5774	.1036	.0020	.0006	-.0037	.0102	.0524	.0656	120.8	
6099	5833.7	12.66	.00	.6878	.1476	.0065	.0005	-.0035	.0106	.0525	.0656	121.0	
6100	5823.0	14.90	.00	.7745	.1979	.0030	.0009	-.0040	.0097	.0527	.0656	121.2	
6101	5763.0	17.12	.00	.8817	.2610	-.0072	.0010	-.0040	.0100	.0532	.0657	121.3	
6102	5833.2	19.17	.00	.9587	.3206	-.0147	.0000	-.0035	.0086	.0528	.0660	121.4	
6103	5808.1	21.28	-.00	1.0137	.3878	-.0275	-.0023	-.0005	.0092	.0530	.0660	121.5	
6104	5891.7	23.35	-.02	.9965	.4289	-.0328	-.0065	.0123	.0081	.0523	.0660	121.6	
6105	5951.1	23.72	-.02	.9866	.4331	-.0325	-.0058	.0129	.0079	.0518	.0661	121.6	
6106	5848.0	-.01	-.00	-.0185	.0216	-.0169	.0024	-.0023	.0109	.0527	.0662	121.8	

NASA LANGLEY

7 X 10 HIGH SPEED TUNNEL

TEST TP	21 MACH	Q PA	RUN 41 ALPHA DEG	BETA DEG	CHF(BA)	CAF(BA)	CPM(BA)	CRM(BA)	CYN(BA)	CSF(BA)	TPLEN DEG K
6107	.300	5886.9	-0.00	-0.00	-0.0080	-0.0356	.0116	.0024	-0.0014	.0072	296.2
6108	.299	5851.5	-1.68	-0.00	-0.1018	-0.0390	.0032	.0017	-0.0012	.0069	295.9
6109	.300	5886.3	.03	-0.00	-0.0080	-0.0355	.0117	.0027	-0.0013	.0064	295.7
6110	.302	5940.8	2.02	-0.00	.0808	-0.0358	.0210	.0022	-0.0007	.0078	295.6
6111	.301	5921.5	4.15	-0.00	.2070	-0.0407	.0208	.0025	-0.0013	.0056	295.5
6112	.302	5950.6	6.32	-0.00	.3477	-0.0481	.0204	.0025	-0.0016	.0065	295.4
6113	.299	5848.9	8.51	.00	.4956	-0.0554	.0236	.0026	-0.0022	.0066	295.3
6114	.299	5834.4	10.60	.00	.6383	-0.0612	.0277	.0029	-0.0029	.0045	295.3
6115	.299	5847.9	12.72	.00	.7774	-0.0676	.0317	.0015	-0.0016	.0049	295.2
6116	.298	5802.7	14.90	-0.00	.8827	-0.0738	.0403	-0.0011	-0.0009	.0063	295.3
6117	.298	5817.2	17.09	.00	.9754	-0.0751	.0340	.0007	-0.0016	.0052	295.3
6118	.299	5845.1	19.26	.00	1.0883	-0.0787	.0214	.0019	-0.0028	.0052	295.3
6119	.299	5843.4	21.32	.00	1.1869	-0.0808	.0128	.0018	-0.0028	.0056	295.4
6120	.302	5937.4	23.54	.00	1.2885	-0.0725	-0.0129	.0002	-0.0024	.0046	295.5
6121	.302	5956.2	23.88	.00	1.2979	-0.0720	-0.0163	.0010	-0.0024	.0059	295.6
6122	.299	5824.2	-0.00	-0.00	-0.0006	-0.0383	.0090	.0028	-0.0010	.0052	295.9

TEST TP	21 ALPHA DEG	BETA DEG	RUN 41 CL(SA)	CD(SA)	CPM(SA)	CRM(SA)	CYN(SA)	CSF(SA)	PI PA	CPB(1)	VTOT M/SEC
6107	-0.00	-0.00	-0.0080	-0.0356	.0116	.0024	-0.0014	.0072	93201.8	-0.118	577.8
6108	-1.68	-0.00	-0.1029	-0.0360	.0032	.0018	-0.0012	.0069	93235.1	-0.121	577.5
6109	.03	-0.00	-0.0080	-0.0355	.0117	.0027	-0.0013	.0064	93199.4	-0.118	577.5
6110	2.02	-0.00	.0820	-0.0330	.0210	.0022	-0.0008	.0078	93148.3	-0.117	577.1
6111	4.15	-0.00	.2094	-0.0256	.0208	.0024	-0.0014	.0056	93161.8	-0.119	577.0
6112	6.32	-0.00	.3509	-0.0095	.0204	.0023	-0.0018	.0065	93138.0	-0.126	577.0
6113	8.51	.00	.4983	.0186	.0236	.0022	-0.0025	.0066	93241.8	-0.132	576.9
6114	10.60	.00	.6387	.0572	.0277	.0023	-0.0034	.0045	93259.8	-0.148	576.9
6115	12.72	.00	.7733	.1052	.0317	.0012	-0.0019	.0049	93237.4	-0.154	576.9
6116	14.90	-0.00	.8720	.1556	.0403	-0.0012	-0.0006	.0063	93286.2	-0.163	577.0
6117	17.09	.00	.9544	.2149	.0340	.0002	-0.0017	.0052	93277.8	-0.168	577.1
6118	19.26	.00	1.0533	.2848	.0214	.0009	-0.0033	.0052	93241.8	-0.178	577.2
6119	21.32	.00	1.1350	.3563	.0128	.0007	-0.0033	.0056	93247.3	-0.184	577.0
6120	23.54	.00	1.2103	.4481	-0.0129	-0.0007	-0.0022	.0046	93132.2	-0.187	577.3
6121	23.88	.00	1.2159	.4596	-0.0163	-0.0001	-0.0026	.0059	93125.4	-0.187	577.4
6122	-0.00	-0.00	-0.0006	-0.0383	.0090	.0028	-0.0010	.0052	93263.7	-0.118	577.7

TEST TP	21 Q PA	ALPHA DEG	BETA DEG	RUN 41 CLT	CDT	CMST	CRTS	CYTS	CYST	CMU	WTFLO KG/SEC	PLENP PSI
6107	5886.9	-0.00	-0.00	-0.0321	.0222	-0.0226	.0024	-0.0023	.0104	.0105	.1195	227.8
6108	5851.5	-1.68	-0.00	-0.1254	.0229	-0.0312	.0018	-0.0021	.0102	.0101	.1207	227.9
6109	5886.3	.03	-0.00	-0.0322	.0225	-0.0225	.0027	-0.0022	.0096	.0103	.1216	228.5
6110	5940.8	2.02	-0.00	.0562	.0233	-0.0128	.0022	-0.0016	.0110	.0120	.1213	227.2
6111	5921.5	4.15	-0.00	.1814	.0300	-0.0131	.0023	-0.0023	.0088	.0120	.1209	227.6
6112	5950.6	6.32	-0.00	.3209	.0447	-0.0134	.0022	-0.0027	.0097	.0106	.1210	227.7
6113	5848.9	8.51	.00	.4657	.0726	-0.0108	.0021	-0.0034	.0098	.0106	.1213	227.9
6114	5834.4	10.60	.00	.6040	.1102	-0.0068	.0022	-0.0043	.0077	.0104	.1215	228.0
6115	5847.9	12.72	.00	.7367	.1568	-0.0028	.0010	-0.0027	.0081	.0107	.1213	228.3
6116	5802.7	14.90	-0.00	.8331	.2062	.0055	-0.0015	-0.0014	.0096	.0107	.1216	228.6
6117	5817.2	17.09	.00	.9137	.2639	-0.0007	-0.0001	-0.0025	.0085	.0105	.1217	228.7
6118	5845.1	19.26	.00	1.0110	.3320	-0.0131	.0006	-0.0041	.0085	.0104	.1216	228.9
6119	5843.4	21.32	.00	1.0912	.4018	-0.0217	.0004	-0.0041	.0088	.0107	.1213	228.1
6120	5937.4	23.54	.00	1.1654	.4912	-0.0469	-0.0011	-0.0030	.0078	.0103	.1215	228.5
6121	5956.2	23.88	.00	1.1709	.5023	-0.0501	-0.0004	-0.0034	.0091	.0102	.1218	228.4
6122	5824.2	-0.00	-0.00	-0.0251	.0204	-0.0256	.0028	-0.0019	.0085	.0104	.1216	228.7

ORIGINAL PAGE IS
OF POOR QUALITY

NASA LANGLEY

7 X 10 HIGH SPEED TUNNEL

TEST TP	21 MACH	Q PA	RUN 42 ALPHA DEG	BETA DEG	CNF(BA)	CAF(BA)	CPH(BA)	CRM(BA)	CYM(BA)	CSF(8A)	TPLEN DEG K
6123	.300	5869.3	.04	-.00	-.0023	-.0928	.0357	.0031	.0003	.0036	296.1
6124	.300	5869.5	-1.79	-.00	-.1103	-.0978	.0194	.0016	.0002	.0015	296.5
6125	.301	5891.5	.09	-.00	.0005	-.0931	.0370	.0030	.0003	.0024	296.8
6126	.302	5934.2	2.09	-.00	.0571	-.0942	.0472	.0020	.0005	.0013	297.2
6127	.302	5953.5	4.27	-.00	.2067	-.0982	.0382	.0030	-.0002	.0014	297.5
6128	.302	5942.1	6.23	-.00	.3387	-.1037	.0340	.0029	-.0005	.0025	297.9
6129	.300	5885.4	8.63	.00	.5323	-.1125	.0304	.0028	-.0007	.0005	298.1
6130	.299	5850.4	10.65	.00	.6913	-.1205	.0310	.0041	-.0020	.0010	298.3
6131	.300	5868.5	12.99	.00	.8498	-.1276	.0350	.0053	-.0026	.0018	298.5
132	.299	5832.7	15.22	.00	1.0448	-.1368	.0371	.0046	-.0010	.0020	298.6
6133	.300	5882.5	17.25	-.00	1.1755	-.1444	.0413	-.0003	.0004	.0021	298.8
6134	.299	5845.2	19.58	-.00	1.2395	-.1504	.0589	-.0025	.0001	-.0004	298.9
6135	.300	5879.0	21.60	.00	1.3085	-.1519	.0538	-.0044	-.0012	-.0063	299.0
6136	.303	5995.9	23.62	.00	1.3991	-.1467	.0312	.0000	-.0023	-.0047	299.0
6137	.304	6007.1	24.14	.00	1.4117	-.1434	.0197	.0016	-.0025	-.0021	299.1
6138	.298	5792.7	.05	-.00	-.0026	-.0971	.0362	.0031	.0005	.0017	299.3

TEST TP	21 ALPHA DEG	BETA DEG	RUN 42 CL(SA)	CD(SA)	CPH(SA)	CRM(SA)	CYM(SA)	CSF(SA)	P1 PA	CPB(1)	VTBT M/SEC
6123	.04	-.00	-.0022	-.0928	.0357	.0031	.0003	.0036	93221.2	-.117	612.8
6124	-1.79	-.00	-.1134	-.0943	.0194	.0016	.0002	.0015	93229.6	-.120	613.2
6125	.09	-.00	.0007	-.0931	.0370	.0030	.0003	.0024	93203.3	-.117	613.6
6126	2.09	-.00	.0605	-.0921	.0472	.0020	.0004	.0013	93156.8	-.117	614.0
6127	4.27	-.00	.2134	-.0825	.0382	.0030	-.0004	.0014	93144.9	-.118	614.3
6128	6.23	-.00	.3480	-.0663	.0340	.0028	-.0008	.0025	93149.4	-.124	614.6
6129	8.63	.00	.5431	-.0313	.0304	.0027	-.0011	.0005	93201.6	-.132	614.9
6130	10.65	.00	.7017	.0094	.0310	.0037	-.0028	.0010	93243.0	-.139	615.0
6131	12.99	.00	.8763	.0711	.0350	.0045	-.0038	.0018	93218.9	-.153	615.2
6132	15.22	.00	1.0441	.1422	.0371	.0042	-.0022	.0020	93255.6	-.164	615.3
6133	17.25	-.00	1.1654	.2106	.0413	-.0002	.0004	.0021	93207.7	-.170	615.5
6134	19.58	-.00	1.2182	.2738	.0589	-.0023	.0009	-.0004	93241.7	-.174	615.6
6135	21.60	.00	1.2725	.3404	.0538	-.0045	.0005	-.0063	93206.3	-.177	615.8
6136	23.62	.00	1.3407	.4260	.0312	-.0009	-.0021	-.0047	93076.6	-.182	615.9
6137	24.14	.00	1.3469	.4465	.0197	.0004	-.0029	-.0021	93058.5	-.186	615.9
6138	.05	-.00	-.0025	-.0971	.0362	.0031	.0005	.0017	93303.5	-.117	616.0

TEST TP	21 Q PA	ALPHA DEG	RUN 42 BETA DEG	CLT	CDT	CMST	CRTS	CYTS	CYST	CMU	WTFLO KG/SEC	PLENP ⁷ PSI
6123	5869.3	.04	-.00	-.0480	.0169	-.0290	.0031	-.0014	.0098	.2024	.2239	430.8
6124	5869.5	-1.79	-.00	-.1596	.0168	-.0454	.0016	-.0014	.0076	.2024	.2237	430.9
6125	5891.5	.09	-.00	-.0451	.0163	-.0276	.0030	-.0014	.0085	.2019	.2238	431.3
6126	5934.2	2.09	-.00	.0113	.0149	-.0170	.0019	-.0012	.0073	.2007	.2240	431.5
6127	5953.5	4.27	-.00	.1605	.0219	-.0256	.0028	-.0020	.0074	.1995	.2232	430.6
6128	5942.1	6.23	-.00	.2914	.0364	-.0299	.0026	-.0024	.0085	.1997	.2230	430.3
6129	5885.4	8.63	.00	.4817	.0699	-.0342	.0024	-.0027	.0066	.2016	.2228	430.4
6130	5850.4	10.65	.00	.6363	.1090	-.0340	.0034	-.0044	.0071	.2028	.2227	430.3
6131	5868.5	12.99	.00	.8071	.1677	-.0298	.0042	-.0054	.0079	.2023	.2229	430.6
6132	5832.7	15.22	.00	.9708	.2366	-.0280	.0038	-.0038	.0082	.2037	.2230	430.7
6133	5825.5	17.25	-.00	1.0894	.3016	-.0234	-.0007	-.0011	.0082	.2020	.2229	430.9
6134	5845.2	19.58	-.00	1.1381	.3622	-.0062	-.0029	-.0007	.0057	.2031	.2227	431.0
6135	5879.0	21.60	.00	1.1897	.4255	-.0109	-.0051	-.0010	-.0002	.2024	.2231	431.1
6136	5995.9	23.62	.00	1.2566	.5066	-.0322	-.0015	-.0036	.0013	.1984	.2231	431.1
6137	6007.1	24.14	.00	1.2623	.5261	-.0436	-.0002	-.0044	.0036	.1978	.2228	430.8
6138	5792.7	.05	-.00	-.0489	.0140	-.0293	.0031	-.0012	.0079	.2053	.2229	431.0

NASA LANGLEY

7 X 10 HIGH SPEED TUNNEL

TEST TP	21		RUN 43		CNF(SA)	CAF(SA)	CPH(SA)	CRM(SA)	CYH(SA)	CSF(SA)	TPLEN DEG K
	MACH	Q PA	ALPHA DEG	BETA DEG							
6139	.300	5881.4	.06	-0.00	-.0043	-.1148	.0469	.0028	.0009	.0013	299.8
6140	.300	5870.3	-1.72	-0.00	-.0971	-.1192	.0297	.0020	.0012	-.0017	300.0
6141	.300	5887.2	.02	-0.00	-.0065	-.1151	.0461	.0025	.0009	.0019	300.2
6142	.301	5907.7	2.26	-0.00	.0497	-.1161	.0600	.0019	.0010	-.0011	300.4
6143	.301	5921.9	4.06	.00	.1777	-.1194	.0486	.0033	.0007	-.0024	300.6
6144	.302	5947.3	6.23	.00	.3325	-.1244	.0424	.0032	.0003	-.0004	300.8
6145	.301	5910.2	8.37	.00	.5081	-.1323	.0369	.0025	-.0002	-.0008	301.0
6146	.300	5865.9	10.59	.00	.6907	-.1415	.0338	.0043	-.0014	-.0020	301.2
6147	.299	5839.5	12.72	.00	.8631	-.1482	.0374	.0069	-.0015	-.0020	301.4
6148	.300	5876.8	15.18	.00	1.0578	-.1557	.0415	.0086	-.0007	-.0003	301.6
6149	.298	5789.9	17.21	.00	1.2091	-.1672	.0413	.0031	.0003	-.0011	301.8
6150	.301	5905.0	19.55	.00	1.3017	-.1734	.0583	-.0020	-.0008	-.0039	302.0
6151	.301	5906.6	21.53	.00	1.3520	-.1751	.0632	-.0031	-.0004	-.0004	302.2
6152	.304	6032.4	23.61	-0.00	1.4239	-.1715	.0479	-.0001	.0012	-.0023	302.4
6153	.301	5905.9	24.20	-0.00	1.4644	-.1735	.0390	-.0000	.0041	-.0043	302.6
6154	.300	5859.2	.07	-0.00	-.0057	-.1178	.0471	.0030	.0011	.0005	303.2

TEST TP	21		RUN 43		CPH(SA)	CRM(SA)	CYH(SA)	CSF(SA)	P1 PA	CPB(1)	VTOT M/SEC
	ALPHA DEG	BETA DEG	CL(SA)	CO(SA)							
6139	.06	-0.00	-.0041	-.1148	.0469	.0028	.0009	.0013	93203.8	-.118	624.1
6140	-1.72	-0.00	-.1006	-.1163	.0297	.0020	.0012	-.0017	93228.6	-.119	624.3
6141	.02	-0.00	-.0064	-.1151	.0461	.0025	.0009	.0019	93204.5	-.118	624.4
6142	2.26	-0.00	.0543	-.1140	.0600	.0020	.0010	-.0011	93181.7	-.117	624.6
6143	4.06	.00	.1857	-.1066	.0486	.0033	.0005	-.0024	93177.4	-.119	624.8
6144	6.23	.00	.3441	-.0875	.0424	.0032	-.0001	-.0004	93143.2	-.124	625.0
6145	8.37	.00	.5219	-.0970	.0369	.0024	-.0005	-.0008	93174.1	-.131	625.2
6146	10.59	.00	.7050	-.0121	.0338	.0040	-.0022	-.0020	93232.9	-.139	625.4
6147	12.72	.00	.8745	.0455	.0374	.0064	-.0030	-.0020	93254.4	-.145	625.6
6148	15.18	.00	1.0617	.1267	.0415	.0081	-.0029	-.0003	93219.3	-.159	625.9
6149	17.21	.00	1.2044	.1980	.0413	.0031	-.0006	-.0011	93306.3	-.166	626.0
6150	19.55	.00	1.2847	.2722	.0583	-.0022	-.0001	-.0039	93179.0	-.174	626.3
6151	21.53	.00	1.3219	.3333	.0632	-.0030	.0008	-.0074	93180.8	-.170	626.5
6152	23.61	-0.00	1.3734	.4131	.0479	.0004	.0011	-.0023	93049.3	-.184	626.8
6153	24.20	-0.00	1.4068	.4421	.0390	.0017	.0038	-.0043	93178.0	-.183	626.9
6154	.07	-0.00	-.0056	-.1178	.0471	.0030	.0011	.0005	93237.9	-.117	627.5

TEST TP	21		RUN 43		CLT	CDT	CMST	CRTS	CYTS	CYST	CMU	WTFLO KG/SEC	PLENP PS1
	Q PA	ALPHA DEG	BETA DEG	CLT									
6139	5881.4	.06	-0.00	-.0574	.0127	-.0284	.0028	-.0010	.0084	.2387	.2598	501.9	
6140	5870.3	-1.72	-0.00	-.1502	.0135	-.0460	.0021	-.0007	.0055	.2398	.2604	503.4	
6141	5887.2	.02	-0.00	-.0596	.0123	-.0292	.0025	-.0010	.0090	.2382	.2594	502.2	
6142	5907.7	2.26	-0.00	-.0035	.0107	-.0150	.0019	-.0009	.0060	.2369	.2588	501.5	
6143	5921.9	4.06	.00	.1243	.0159	-.0261	.0032	-.0014	.0047	.2362	.2585	501.1	
6144	5947.3	6.23	.00	.2783	.0319	-.0319	.0030	-.0020	.0066	.2352	.2585	500.7	
6145	5910.2	8.37	.00	.4513	.0607	-.0379	.0021	-.0024	.0062	.2367	.2584	500.8	
6146	5865.9	10.59	.00	.6293	.1035	-.0416	.0036	-.0041	.0052	.2383	.2581	500.7	
6147	5839.5	12.72	.00	.7942	.1588	-.0383	.0060	-.0049	.0052	.2395	.2581	500.9	
6148	5876.8	15.18	.00	.9771	.2359	-.0338	.0076	-.0048	.0068	.2379	.2580	501.3	
6149	5789.9	17.21	.00	1.1147	.3057	-.0351	.0025	-.0025	.0061	.2416	.2581	501.2	
6150	5905.0	19.55	.00	1.1924	.3741	-.0167	-.0028	-.0019	.0032	.2372	.2583	501.4	
6151	5906.6	21.53	.00	1.2262	.4319	-.0117	-.0037	-.0010	-.0003	.2371	.2581	501.4	
6152	6032.4	23.61	-0.00	1.2763	.5063	-.0255	-.0004	-.0006	.0046	.2321	.2579	501.4	
6153	5905.9	24.20	-0.00	1.3066	.5362	-.0360	.0009	.0020	.0028	.2372	.2580	501.7	
6154	5859.2	.07	-0.00	-.0590	.0102	-.0284	.0030	-.0008	.0077	.2392	.2579	501.9	

ORIGINAL PAGE IS OF POOR QUALITY

NASA LANGLEY

7 X 10 HIGH SPEED TUNNEL

TEST TP	21 MACH	Q PA	RUN 44 ALPHA DEG	BETA DEG	CNF(BA)	CAF(BA)	CPH(BA)	CRM(BA)	CYM(BA)	CSF(BA)	TLEN DEG K
6155	.710	24978.4	-.01	-.00	-.0087	-.0133	.0023	.0024	-.0020	.0086	304.8
6156	.689	23943.8	-2.09	-.00	-.1265	-.0163	-.0047	.0012	-.0019	.0075	305.0
6157	.700	24459.9	-.03	-.00	-.0086	-.0136	.0026	.0028	-.0017	.0078	305.1
6158	.713	25134.7	2.41	-.00	.1173	-.0158	.0076	.0026	-.0013	.0066	305.3
6159	.713	25127.0	4.76	.00	.2659	-.0218	.0087	.0025	-.0018	.0051	305.6
6160	.712	25035.4	7.25	.01	.4246	-.0265	.0066	.0023	-.0021	.0037	305.8
6161	.706	24768.9	9.85	.01	.5683	-.0297	.0079	.0027	-.0024	.0033	306.0
6162	.702	24554.6	12.26	.01	.6965	-.0310	.0169	.0029	-.0021	.0021	306.2
6163	.695	24246.1	14.67	.01	.8091	-.0324	.0115	.0012	-.0020	.0025	306.3
6164	.694	24207.6	17.13	.01	.9267	-.0338	.0026	.0002	-.0015	.0009	306.5
6165	.692	24112.3	19.15	.00	.9916	-.0290	-.0193	-.0003	-.0015	.0010	306.6
6166	.695	24265.5	21.44	.00	1.0233	-.0266	-.0203	.0004	-.0014	.0022	306.8
6167	.698	24387.0	-.02	-.00	-.0067	-.0139	.0031	.0026	-.0018	.0080	307.1

TEST TP	21 ALPHA DEG	BETA DEG	RUN 44 CL(SA)	CD(SA)	CPH(SA)	CRM(SA)	CYM(SA)	CSF(SA)	P1 PA	CPB(1)	WTOT M/SEC
6155	-.01	-.00	-.0087	-.0133	.0023	.0024	-.0020	.0086	70705.7	-.126	637.2
6156	-2.09	-.00	-.1271	-.0117	-.0047	.0013	-.0019	.0075	72099.4	-.126	636.5
6157	-.03	-.00	-.0086	-.0136	.0026	.0028	-.0016	.0078	71398.2	-.124	637.0
6158	2.41	-.00	.1179	-.0109	.0076	.0026	-.0014	.0066	70551.4	-.129	637.8
6159	4.76	.00	.2667	.0003	.0087	.0023	-.0020	.0051	70516.1	-.132	638.0
6160	7.25	.01	.4245	.0273	.0066	.0020	-.0024	.0037	70639.7	-.141	638.2
6161	9.85	.01	.5650	.0680	.0079	.0023	-.0028	.0033	70992.5	-.153	638.1
6162	12.26	.01	.6872	.1176	.0169	.0024	-.0027	.0021	71281.1	-.157	638.2
6163	14.67	.01	.7910	.1736	.0115	.0007	-.0022	.0025	71698.3	-.162	638.0
6164	17.13	.01	.8955	.2407	.0026	-.0002	-.0015	.0009	71749.1	-.172	638.1
6165	19.15	.00	.9462	.2980	-.0193	-.0008	-.0013	.0010	71872.6	-.185	638.2
6166	21.44	.00	.9623	.3493	-.0203	-.0001	-.0014	.0022	71677.7	-.193	638.5
6167	-.02	-.00	-.0067	-.0139	.0031	.0026	-.0018	.0080	71505.1	-.124	639.1

TEST TP	21 Q PA	ALPHA DEG	RUN 44 BETA DEG	CLT	CDT	CMST	CRTS	CYTS	CYST	CMU	WTFLO KG/SEC	PLENP PSI
6155	24978.4	-.01	-.00	-.0199	.0138	-.0136	.0024	-.0024	.0101	.0508	.2299	451.8
6156	23943.8	-2.09	-.00	-.1378	.0169	-.0213	.0013	-.0023	.0091	.0529	.2298	451.6
6157	24459.9	-.03	-.00	-.0201	.0140	-.0137	.0028	-.0021	.0093	.0518	.2296	451.8
6158	25134.7	2.41	-.00	.1055	.0155	-.0083	.0025	-.0018	.0081	.0504	.2295	451.9
6159	25127.0	4.76	.00	.2534	.0262	-.0072	.0023	-.0024	.0066	.0504	.2294	451.8
6160	25035.4	7.25	.01	.4100	.0526	-.0093	.0019	-.0028	.0052	.0507	.2296	451.7
6161	24768.9	9.85	.01	.5492	.0929	-.0081	.0022	-.0032	.0049	.0511	.2292	451.5
6162	24554.6*	12.26	.01	.6702	.1421	.0006	.0023	-.0031	.0036	.0516	.2291	451.7
6163	24246.1	14.67	.01	.7727	.1976	-.0050	.0006	-.0026	.0040	.0522	.2293	451.7
6164	24207.6	17.13	.01	.8762	.2640	-.0138	-.0004	-.0019	.0025	.0523	.2291	451.7
6165	24112.3	19.15	.00	.9260	.3206	-.0358	-.0009	-.0017	.0026	.0525	.2292	451.7
6166	24265.5	21.44	.00	.9413	.3709	-.0367	-.0003	-.0018	.0038	.0522	.2289	451.8
6167	24387.0	-.02	-.00	-.0182	.0138	-.0133	.0026	-.0023	.0096	.0520	.2289	451.9

NASA LANGLEY

7 X 10 HIGH SPEED TUNNEL

TEST TP	21 MACH	Q PA	RUN ALPHA DEG	45 BETA DEG	CNF(BA)	CAF(BA)	CPN(BA)	CRM(BA)	CYM(BA)	CSF(BA)	TPLEN DEG K
6185	0.000	47.9	11.02	.13	.1210	-.0065	-.0274	-.0001	.0089	-.0354	282.8
6186	.302	6178.1	11.56	.13	.6224	-.0099	.0152	-.0016	-.0007	-.0055	282.9
6187	.302	6156.9	10.17	.12	.5379	-.0096	.0123	-.0007	-.0008	-.0059	283.0
6188	.301	6126.5	10.70	.12	.5710	-.0100	.0135	-.0013	-.0011	-.0050	283.1
6189	.301	6134.6	12.52	.14	.6687	-.0088	.0154	.0000	-.0007	-.0057	283.1
6190	.300	6073.9	14.44	.16	.7667	-.0093	.0124	.0009	-.0008	-.0061	283.2
6191	.299	6068.1	16.48	.18	.8653	-.0073	.0054	.0006	-.0012	-.0060	283.3
6192	.299	6044.6	18.55	.21	.9369	-.0002	-.0133	.0006	-.0020	-.0050	283.4
6193	.299	6040.1	20.51	.23	.9554	.0033	-.0214	.0005	-.0018	-.0041	283.5
6194	.298	6005.4	22.72	.25	1.0169	.0014	-.0238	.0003	-.0027	-.0033	283.6
6195	.299	6042.0	24.78	.27	1.1008	-.0029	-.0287	-.0005	-.0027	-.0020	283.7
6196	.298	6017.7	26.93	.30	1.2258	-.0083	-.0384	.0014	-.0049	-.0017	283.8
6197	.299	6062.5	29.13	.32	1.3072	-.0143	-.0420	.0024	-.0070	-.0012	283.9
6198	.300	6076.9	30.49	.34	1.3279	-.0178	-.0405	.0021	-.0074	-.0031	284.0
6199	.300	6101.1	11.53	.13	.6208	-.0109	.0151	-.0015	-.0008	-.0049	284.3

TEST TP	21 ALPHA DEG	BETA DEG	RUN CL(SA)	45 CD(SA)	CPH(SA)	CRM(SA)	CYN(SA)	CSF(SA)	P1 PA	CPB(1)	VTOT M/SEC
6185	11.02	.13	.1200	.0167	-.0274	.0016	.0087	-.0354	103025.3	.081	0.0
6186	11.56	.13	.6117	.1150	.0152	-.0017	-.0004	-.0059	96616.4	-.147	0.0
6187	10.17	.12	.5311	.0855	.0123	-.0008	-.0007	-.0059	96639.0	-.139	0.0
6188	10.70	.12	.5629	.0962	.0135	-.0014	-.0008	-.0050	96675.4	-.142	0.0
6189	12.52	.14	.6547	.1363	.0154	-.0001	-.0007	-.0057	96665.7	-.149	0.0
6190	14.44	.16	.7448	.1822	.0124	.0007	-.0010	-.0061	96731.9	-.152	0.0
6191	16.48	.18	.8319	.2384	.0054	.0002	-.0013	-.0060	96738.7	-.156	0.0
6192	18.55	.21	.8883	.2979	-.0133	-.0001	-.0021	-.0050	96763.3	-.167	0.0
6193	20.51	.23	.8937	.3378	-.0214	-.0001	-.0019	-.0041	96764.7	-.175	0.0
6194	22.72	.25	.9375	.3940	-.0238	-.0008	-.0026	-.0033	96797.6	-.177	0.0
6195	24.78	.27	1.0007	.4589	-.0287	-.0016	-.0022	-.0020	96759.3	-.182	0.0
6196	26.93	.30	1.0966	.5479	-.0384	-.0010	-.0050	-.0017	96781.3	-.187	0.0
6197	29.13	.32	1.1488	.6239	-.0420	-.0013	-.0073	.0012	96732.8	-.196	0.0
6198	30.49	.34	1.1533	.6585	-.0405	-.0019	-.0075	.0031	96722.8	-.202	0.0
6199	11.53	.13	.6104	.1135	.0151	-.0016	-.0005	-.0049	96703.2	-.146	0.0

TEST TP	21 Q PA	ALPHA DEG	RUN BETA DEG	45 CLT	CDT	CMST	CRTS	CYTS	CYST	CMU	WTFLO KG/SEC	PLENP PSI
6185	47.9	11.02	.13	.1200	.0167	-.0274	.0016	.0087	-.0354	0.0000	0.0000	.1
6186	6178.1	11.56	.13	.6117	.1150	.0152	-.0017	-.0004	-.0059	0.0000	0.0000	-.2
6187	6156.9	10.17	.12	.5311	.0855	.0123	-.0008	-.0007	-.0059	0.0000	0.0000	-.2
6188	6126.5	10.70	.12	.5629	.0962	.0135	-.0014	-.0008	-.0050	0.0000	0.0000	-.2
6189	6134.6	12.52	.14	.6547	.1363	.0154	-.0001	-.0007	-.0057	0.0000	0.0000	-.2
6190	6073.9	14.44	.16	.7448	.1822	.0124	.0007	-.0010	-.0061	0.0000	0.0000	-.3
6191	6068.1	16.48	.18	.8319	.2384	.0054	.0002	-.0013	-.0060	0.0000	0.0000	-.3
6192	6044.6	18.55	.21	.8883	.2979	-.0133	-.0001	-.0021	-.0050	0.0000	0.0000	-.3
6193	6040.1	20.51	.23	.8937	.3378	-.0214	-.0001	-.0019	-.0041	0.0000	0.0000	-.4
6194	6005.4	22.72	.25	.9375	.3940	-.0238	-.0008	-.0026	-.0033	0.0000	0.0000	-.4
6195	6042.0	24.78	.27	1.0007	.4589	-.0287	-.0016	-.0022	-.0020	0.0000	0.0000	-.5
6196	6017.7	26.93	.30	1.0966	.5479	-.0384	-.0010	-.0050	-.0017	0.0000	0.0000	-.5
6197	6062.5	29.13	.32	1.1488	.6239	-.0420	-.0013	-.0073	.0012	0.0003	0.0000	-.6
6198	6076.9	30.49	.34	1.1533	.6585	-.0405	-.0019	-.0075	.0031	0.0000	0.0000	-.7
6199	6101.1	11.53	.13	.6104	.1135	.0151	-.0016	-.0005	-.0049	0.0000	0.0000	-.3

ORIGINAL PAGE IS OF POOR QUALITY.

NASA LANGLEY

7 X 10 HIGH SPEED TUNNEL

TEST TP	21 MACH	Q PA	RUN 46 ALPHA DEG	BETA DEG	CNF(BA)	CAF(BA)	CPH(BA)	CRH(BA)	CYM(BA)	CSF(BA)	TLEN DEG K
6200	.300	6104.7	11.56	.13	.6425	-.0423	.0174	-.0002	-.0001	-.0079	284.5
6201	.300	6099.3	10.15	.11	.5515	-.0417	.0138	-.0003	-.0002	-.0065	284.4
6202	.300	6093.9	10.69	.12	.5906	-.0418	.0153	-.0002	-.0003	-.0080	284.4
6203	.300	6103.2	12.59	.14	.6995	-.0432	.0194	-.0009	-.0002	-.0081	284.3
6204	.301	6117.5	14.53	.16	.8040	-.0440	.0170	-.0001	-.0006	-.0080	284.2
6205	.300	6092.5	16.50	.19	.9055	-.0463	.0127	.0002	-.0012	-.0081	284.1
6206	.300	6096.6	18.62	.21	1.0081	-.0476	.0035	.0017	-.0021	-.0079	284.0
6207	.297	5984.9	20.71	.23	1.0873	-.0501	-.0010	.0014	-.0028	-.0071	283.9
6208	.299	6069.5	22.83	.25	1.1462	-.0481	-.0040	-.0010	-.0019	-.0081	283.7
6209	.299	6062.0	24.83	.27	1.1730	-.0428	-.0130	-.0011	-.0016	-.0063	283.6
6210	.300	6107.7	27.01	.29	1.1883	-.0428	-.0164	-.0039	.0012	-.0050	283.5
6211	.298	6016.5	29.14	.32	1.2271	-.0449	-.0153	-.0016	-.0015	-.0016	283.4
6212	.297	5976.8	30.45	.33	1.2443	-.0468	-.0152	-.0007	-.0026	.0007	283.3
6213	.300	6097.0	11.55	.13	.6427	-.0416	.0182	-.0003	-.0004	-.0067	283.1

TEST TP	21 ALPHA DEG	BETA DEG	RUN 46 CL(SA)	CD(SA)	CPH(SA)	CRH(SA)	CYM(SA)	CSF(SA)	P1 PA	CPB(1)	VTOT M/SEC
6200	11.56	.13	.6379	.0873	.0174	-.0002	-.0001	-.0079	96693.7	-.150	519.6
6201	10.15	.11	.5502	.0561	.0138	-.0003	-.0001	-.0065	96699.3	-.145	519.6
6202	10.69	.12	.5881	.0685	.0153	-.0003	-.0003	-.0080	96699.7	-.146	519.6
6203	12.59	.14	.6921	.1103	.0194	-.0009	-.0000	-.0081	96695.2	-.152	519.7
6204	14.53	.16	.7894	.1590	.0170	-.0002	-.0005	-.0080	96680.2	-.156	519.7
6205	16.50	.19	.8814	.2128	.0127	-.0001	-.0012	-.0081	96705.7	-.164	519.6
6206	18.62	.21	.9705	.2768	.0035	.0009	-.0025	-.0079	96701.0	-.169	519.7
6207	20.71	.23	1.0347	.3377	-.0010	.0003	-.0031	-.0071	96812.3	-.175	519.6
6208	22.83	.25	1.0751	.4004	-.0040	-.0016	-.0014	-.0081	96721.1	-.185	519.6
6209	24.83	.27	1.0825	.4538	-.0130	-.0017	-.0010	-.0063	96727.0	-.192	519.6
6210	27.01	.29	1.0781	.5015	-.0164	-.0029	.0028	-.0050	96677.0	-.196	519.6
6211	29.14	.32	1.0936	.5583	-.0153	-.0022	-.0005	-.0016	96772.4	-.209	519.4
6212	30.45	.33	1.0964	.5902	-.0152	-.0019	-.0019	.0007	96815.0	-.221	519.4
6213	11.55	.13	.6380	.0879	.0182	-.0004	-.0004	-.0067	96696.5	-.149	519.4

TEST TP	21 Q PA	ALPHA DEG	RUN 46 BETA DEG	CLT	CDT	CHST	CRIS	CYTS	CYST	CMU	WTFLO KG/SEC	PLENP PSI
6200	6104.7	11.56	.13	.6204	.1130	.0004	-.0003	-.0007	-.0063	.0482	.0654	117.4
6201	6099.3	10.15	.11	.5333	.0824	-.0033	-.0005	-.0007	-.0049	.0483	.0655	117.6
6202	6098.9	10.69	.12	.5709	.0946	-.0018	-.0004	-.0009	-.0063	.0483	.0655	117.8
6203	6103.2	12.59	.14	.6741	.1359	.0024	-.0011	-.0006	-.0064	.0484	.0657	117.9
6204	6117.5	14.53	.16	.7705	.1839	-.0000	-.0004	-.0011	-.0064	.0483	.0656	118.0
6205	6092.5	16.50	.19	.8616	.2372	-.0044	-.0003	-.0018	-.0065	.0485	.0657	118.2
6206	6096.6	18.62	.21	.9498	.3005	-.0137	.0007	-.0031	-.0063	.0486	.0659	118.4
6207	5984.9	20.71	.23	1.0127	.3610	-.0185	.0001	-.0037	-.0055	.0497	.0661	118.5
6208	6069.5	22.83	.25	1.0526	.4226	-.0213	-.0019	-.0019	-.0064	.0499	.0659	118.7
6209	6062.0	24.83	.27	1.0591	.4753	-.0303	-.0019	-.0016	-.0066	.0490	.0660	118.9
6210	6107.7	27.01	.29	1.0541	.5220	-.0336	-.0032	.0023	-.0034	.0487	.0660	119.0
6211	6016.5	29.14	.32	1.0685	.5782	-.0327	-.0024	-.0010	-.0000	.0495	.0662	119.0
6212	5976.8	30.45	.33	1.0706	.6096	-.0327	-.0022	-.0024	.0024	.0499	.0663	119.1
6213	6097.0	11.55	.13	.6202	.1141	.0010	-.0005	-.0010	-.0051	.0490	.0664	119.2

NASA LANGLEY

7 X 10 HIGH SPEED TUNNEL

TEST TP	21	MACH	0		RUN 47		CNF(BA)	CAF(BA)	CPH(BA)	CRH(BA)	CYM(BA)	CSF(BA)	TPLEN DEG K
			PA	BETA DEG	ALPHA DEG	BETA DEG							
6214		.300	6089.3	.13	11.59	.13	.6794	-.0700	.0217	.0019	-.0002	-.0085	280.1
6215		.300	6091.9	.12	10.20	.12	.5655	-.0674	.0181	.0015	-.0004	-.0085	280.1
6216		.300	6078.9	.12	10.71	.12	.6115	-.0685	.0190	.0021	-.0004	-.0080	280.1
6217		.300	6101.1	.14	12.59	.14	.7499	-.0728	.0259	.0009	.0001	-.0081	280.2
6218		.300	6092.9	.16	14.54	.16	.8539	-.0779	.0367	-.0003	.0008	-.0072	280.2
6219		.299	6061.6	.18	16.57	.18	.9445	-.0794	.0349	-.0012	.0007	-.0086	280.3
6220		.299	6068.1	.21	18.71	.21	1.0460	-.0821	.0285	.0002	-.0003	-.0083	280.3
6221		.299	6047.0	.23	20.81	.23	1.1542	-.0852	.0205	.0012	-.0019	-.0081	280.4
6222		.296	5939.0	.26	22.88	.26	1.2396	-.0891	.0118	.0014	-.0028	-.0103	280.4
6223		.298	6005.2	.28	25.03	.28	1.3382	-.0851	-.0058	.0034	-.0041	-.0115	280.4
6224		.298	6020.0	.30	27.16	.30	1.3973	-.0828	-.0182	.0062	-.0062	-.0065	280.5
6225		.299	6051.3	.33	29.29	.33	1.4274	-.0826	-.0232	.0041	-.0061	-.0069	280.5
6226		.297	5993.1	.34	30.62	.34	1.4654	-.0838	-.0288	.0028	-.0060	-.0064	280.5
6227		.298	6020.8	.13	11.61	.13	.6908	-.0720	.0209	.0020	.0002	-.0099	280.6

TEST TP	21	ALPHA DEG	BETA DEG	RUN 47		CPH(SA)	CRH(SA)	CYM(SA)	CSF(SA)	P1 PA	CPB(1)	VTOT M/SEC
				CL(SA)	CD(SA)							
6214		11.59	.13	.6796	.0679	.0217	.0018	-.0006	-.0085	96703.0	-.145	560.1
6215		10.20	.12	.5685	.0338	.0181	.0014	-.0007	-.0085	96700.3	-.140	560.1
6216		10.71	.12	.6136	.0463	.0190	.0020	-.0008	-.0080	96713.9	-.142	560.0
6217		12.59	.14	.7477	.0924	.0259	.0009	-.0001	-.0081	96683.8	-.150	560.2
6218		14.54	.16	.8461	.1390	.0367	-.0001	.0008	-.0072	96692.4	-.158	560.1
6219		16.57	.18	.9279	.1933	.0349	-.0009	.0010	-.0086	96720.0	-.163	560.2
6220		18.71	.21	1.0171	.2577	.0285	.0001	-.0004	-.0083	96718.4	-.168	560.2
6221		20.81	.23	1.1092	.3304	.0205	.0005	-.0022	-.0081	96733.6	-.173	560.3
6222		22.88	.26	1.1768	.3998	.0118	.0002	-.0031	-.0103	96853.5	-.174	560.2
6223		25.03	.28	1.2485	.4890	-.0058	.0013	-.0052	-.0115	96776.2	-.183	560.4
6224		27.16	.30	1.2810	.5642	-.0182	.0027	-.0083	-.0065	96760.4	-.194	560.4
6225		29.29	.33	1.2854	.6262	-.0232	.0006	-.0073	-.0069	96729.2	-.202	560.4
6226		30.62	.34	1.3037	.6743	-.0288	-.0006	-.0066	-.0064	96790.1	-.208	560.4
6227		11.61	.13	.6911	.0685	.0209	.0020	-.0002	-.0099	96767.9	-.145	560.5

TEST TP	21	Q PA	ALPHA DEG	BETA DEG	CLT	CDT	CHST	CRTS	CYTS	CYST	CHU	WTFLO KG/SEC	PLEMP PS1
6214		6089.3	11.59	.13	.6453	.1183	-.0116	.0016	-.0017	-.0053	.0995	.1249	229.2
6215		6091.9	10.20	.12	.5355	.0850	-.0151	.0012	-.0018	-.0053	.0995	.1250	229.3
6216		6078.9	10.71	.12	.5801	.0973	-.0143	.0018	-.0019	-.0048	.0996	.1248	229.2
6217		6101.1	12.59	.14	.7126	.1421	-.0073	.0007	-.0012	-.0050	.0992	.1248	229.3
6218		6092.9	14.54	.16	.8093	.1875	.0035	-.0004	-.0003	-.0041	.0993	.1248	229.2
6219		6061.6	16.57	.18	.8893	.2408	.0015	-.0012	-.0001	-.0055	.1001	.1250	229.3
6220		6068.1	18.71	.21	.9767	.3036	-.0048	-.0002	-.0015	-.0051	.0997	.1247	229.1
6221		6047.0	20.81	.23	1.0670	.3750	-.0130	.0001	-.0033	-.0050	.1003	.1250	229.3
6222		5939.0	22.88	.26	1.1322	.4436	-.0223	-.0002	-.0042	-.0071	.1020	.1249	229.3
6223		6005.2	25.03	.28	1.2028	.5307	-.0395	.0008	-.0062	-.0083	.1010	.1250	229.4
6224		6020.0	27.16	.30	1.2339	.6041	-.0518	.0022	-.0094	-.0033	.1006	.1248	229.4
6225		6051.3	29.29	.33	1.2371	.6641	-.0566	.0001	-.0084	-.0037	.1002	.1250	229.4
6226		5993.1	30.62	.34	1.2541	.7114	-.0626	-.0012	-.0076	-.0032	.1012	.1250	229.4
6227		6020.8	11.61	.13	.6564	.1195	-.0127	.0018	-.0013	-.0067	.1006	.1248	229.5

NASA LANGLEY

7 X 10 HIGH SPEED TUNNEL

TEST TP	21 MACH	Q PA	RUN 48 ALPHA DEG	BETA DEG	CHF(BA)	CAF(BA)	CPM(BA)	CRM(BA)	CYM(BA)	CSF(BA)	TPLEN DEG K
6228	.300	6098.7	11.67	.13	.7476	-.1271	.0198	.0029	.0011	-.0145	281.4
6229	.300	6099.7	10.30	.12	.6013	-.1237	.0237	.0011	.0014	-.0150	281.8
6230	.300	6092.9	10.87	.12	.6625	-.1259	.0224	.0022	.0013	-.0156	282.1
6231	.300	6106.1	12.66	.14	.8460	-.1307	.0206	.0040	.0009	-.0144	282.7
6232	.300	6073.6	14.58	.16	.9964	-.1364	.0233	.0017	-.0001	-.0128	283.0
6233	.302	6151.4	16.78	.19	1.1619	-.1447	.0223	-.0013	.0007	-.0150	283.5
6234	.299	6056.1	18.88	.21	1.2889	-.1569	.0362	-.0017	.0011	-.0167	283.8
6235	.300	6083.4	21.05	.23	1.3302	-.1590	.0533	-.0035	.0012	-.0168	284.1
6236	.296	5934.4	23.14	.25	1.4244	-.1642	.0475	-.0022	-.0001	-.0177	284.4
6237	.295	5918.0	25.18	.28	1.4828	-.1600	.0311	-.0050	-.0043	-.0188	284.6
6238	.302	6149.8	27.34	.30	1.5645	-.1547	.0132	-.0079	-.0033	-.0255	285.0
6239	.300	6078.4	29.49	.33	1.6443	-.1552	-.0020	-.0062	-.0067	-.0268	285.3
6240	.302	6172.1	30.85	.35	1.6455	-.1494	-.0122	.0069	-.0159	-.0188	285.5
6241	.300	6109.6	11.65	.13	.7426	-.1307	.0197	.0026	.0011	-.0151	286.2

TEST TP	21 ALPHA DEG	BETA DEG	RUN 48 CL(SA)	CD(SA)	CPM(SA)	CRM(SA)	CYM(SA)	CSF(SA)	P1 PA	CPB(1)	VTOT M/SEC
6228	11.67	.13	.7579	.0267	.0198	.0031	.0004	-.0145	96679.5	-.143	596.4
6229	10.30	.12	.6138	-.0142	.0237	.0014	.0012	-.0150	96678.5	-.138	596.8
6230	10.87	.12	.6743	.0013	.0224	.0024	.0009	-.0156	96685.7	-.140	597.2
6231	12.66	.14	.8541	.0578	.0206	.0041	-.0000	-.0144	96671.8	-.145	597.9
6232	14.58	.16	.9987	.1187	.0233	.0016	-.0005	-.0128	96699.1	-.151	598.3
6233	16.78	.19	1.1542	.1968	.0223	-.0010	.0010	-.0150	96617.5	-.155	598.7
6234	18.88	.21	1.2703	.2687	.0362	-.0013	.0016	-.0167	96717.7	-.158	599.0
6235	21.05	.23	1.2986	.3295	.0533	-.0029	.0024	-.0168	96688.8	-.164	599.4
6236	23.14	.25	1.3744	.4087	.0475	-.0021	.0008	-.0177	96844.7	-.164	599.6
6237	25.18	.28	1.4100	.4860	.0311	-.0064	-.0017	-.0188	96856.4	-.167	599.9
6238	27.34	.30	1.4608	.5810	.0132	-.0086	.0007	-.0255	96612.5	-.178	600.4
6239	29.49	.33	1.5076	.6743	-.0020	-.0087	-.0028	-.0268	96687.2	-.184	600.6
6240	30.85	.35	1.4892	.7156	-.0122	-.0023	-.0172	-.0188	96587.4	-.191	600.9
6241	11.65	.13	.7537	.0220	.0197	.0028	.0006	-.0151	96661.4	-.143	601.7

TEST TP	21 Q PA	ALPHA DEG	RUN 48 BETA DEG	CLT	CDT	CMST	CRTS	CYTS	CYST	CHU	WTFLD KG/SEC	PLENP PSI
6228	6098.7	11.67	.13	.6924	.1227	-.0435	.0027	-.0017	-.0086	.1969	.2325	437.5
6229	6099.7	10.30	.12	.5506	.0834	-.0397	.0010	-.0010	-.0090	.1969	.2324	438.1
6230	6092.9	10.87	.12	.6101	.0985	-.0412	.0020	-.0013	-.0096	.1976	.2328	438.7
6231	6106.1	12.66	.14	.7869	.1528	-.0428	.0036	-.0022	-.0085	.1972	.2326	438.9
6232	6073.6	14.58	.16	.9279	.2120	-.0406	.0010	-.0026	-.0067	.1983	.2324	439.2
6233	6151.4	16.78	.19	1.0809	.2861	-.0407	-.0016	-.0011	-.0091	.1957	.2322	439.1
6234	6056.1	18.88	.21	1.1925	.3567	-.0278	-.0020	-.0005	-.0107	.1989	.2322	439.4
6235	6083.4	21.05	.23	1.2178	.4141	-.0105	-.0037	.0003	-.0107	.1980	.2321	439.3
6236	5934.4	23.14	.25	1.2885	.4924	-.0178	-.0030	-.0013	-.0115	.2031	.2321	439.4
6237	5918.0	25.18	.28	1.3210	.5668	-.0345	-.0073	-.0038	-.0126	.2035	.2319	439.4
6238	6149.8	27.34	.30	1.3722	.6555	-.0499	-.0096	-.0012	-.0196	.1960	.2319	439.5
6239	6078.4	29.49	.33	1.4153	.7462	-.0658	-.0098	-.0047	-.0208	.1982	.2316	439.6
6240	6172.1	30.85	.35	1.3966	.7842	-.0751	-.0034	-.0190	-.0128	.1953	.2317	439.6
6241	6109.6	11.65	.13	.6881	.1183	-.0438	.0024	-.0016	-.0091	.1973	.2314	439.6

NASA LANGLEY

7 X 10 HIGH SPEED TUNNEL

TEST TP	21 MACH	Q PA	RUN 49		CNF(BA)	CAF(BA)	CPH(BA)	CRM(BA)	CYM(BA)	CSF(BA)	TPLN DEG K
			ALPHA DEG	BETA DEG							
6242	.300	6096.5	11.67	.13	.7546	-.1504	.0220	.0032	.0019	-.0165	290.5
6243	.300	6089.3	10.25	.12	.5929	-.1461	.0282	.0017	.0022	-.0168	290.7
6244	.299	6050.7	10.73	.12	.6469	-.1485	.0269	.0015	.0020	-.0166	290.9
6245	.301	6128.1	12.74	.14	.8571	-.1521	.0217	.0035	.0014	-.0158	291.0
6246	.300	6100.2	14.67	.16	1.0175	-.1579	.0254	.0003	.0005	-.0151	291.2
6247	.299	6068.1	16.77	.19	1.1740	-.1669	.0253	-.0023	.0010	-.0174	291.3
6248	.298	6026.4	19.02	.21	1.3437	-.1789	.0312	-.0040	.0019	-.0186	291.5
6249	.297	5961.8	21.05	.23	1.3921	-.1862	.0554	.0006	.0016	-.0181	291.7
6250	.302	6180.7	23.21	.25	1.4457	-.1816	.0534	-.0005	.0005	-.0164	291.8
6251	.299	6060.8	25.32	.27	1.5249	-.1848	.0491	-.0055	.0005	-.0180	291.9
6252	.298	6014.1	27.42	.29	1.6058	-.1836	.0340	-.0118	.0036	-.0230	292.1
6253	.299	6053.0	29.64	.32	1.6977	-.1762	.0020	-.0088	-.0000	-.0193	292.2
6254	.298	6028.9	30.86	.33	1.7200	-.1774	-.0022	-.0088	-.0021	-.0162	292.3
6255	.300	6092.8	11.68	.13	.7544	-.1515	.0228	.0024	.0017	-.0170	292.5

TEST TP	21 ALPHA DEG	BETA DEG	RUN 49		CPH(SA)	CRM(SA)	CYM(SA)	CSF(SA)	P1 PA	CPB(1)	VTDT M/SEC
			CL(SA)	CD(SA)							
6242	11.67	.13	.7694	.0054	.0220	.0035	.0012	-.0165	96670.7	-.142	613.0
6243	10.25	.12	.6095	-.0383	.0282	.0021	.0018	-.0168	96675.9	-.137	613.2
6244	10.73	.12	.6632	-.0254	.0269	.0019	.0017	-.0166	96716.2	-.138	613.4
6245	12.74	.14	.8695	.0406	.0217	.0037	.0006	-.0158	96635.3	-.142	613.6
6246	14.67	.16	1.0243	.1050	.0254	.0004	.0005	-.0151	96657.6	-.147	613.8
6247	16.77	.19	1.1722	.1788	.0253	-.0019	.0016	-.0174	96691.3	-.155	614.0
6248	19.02	.21	1.3287	.2687	.0312	-.0032	.0031	-.0186	96741.7	-.158	614.1
6249	21.05	.23	1.3661	.3261	.0554	.0011	.0013	-.0181	96802.5	-.162	614.3
6250	23.21	.25	1.4003	.4028	.0534	-.0002	.0006	-.0164	96563.6	-.166	614.5
6251	25.32	.27	1.4575	.4850	.0491	-.0048	.0028	-.0180	96685.6	-.166	614.6
6252	27.42	.29	1.5100	.5764	.0340	-.0088	.0087	-.0230	96734.2	-.170	614.7
6253	29.64	.32	1.5627	.6864	.0020	-.0077	.0043	-.0193	96693.5	-.177	614.9
6254	30.86	.33	1.5674	.7300	-.0022	-.0086	.0027	-.0162	96718.7	-.181	615.0
6255	11.68	.13	.7694	.0043	.0228	.0027	.0012	-.0170	96651.8	-.142	615.3

TEST TP	21 Q PA	ALPHA DEG	BETA DEG	CLT	CDT	CMST	CRTS	CYTS	CYST	CMU	WTFLO KG/SEC	PLENP PSI
6243	6089.3	10.25	.12	.5363	.0749	-.0452	.0016	-.0007	-.0099	.2306	.2645	506.8
6244	6050.7	10.73	.12	.5886	.0879	-.0471	.0014	-.0008	-.0097	.2321	.2644	507.1
6245	6128.1	12.74	.14	.7920	.1499	-.0514	.0032	-.0019	-.0089	.2295	.2647	507.2
6246	6100.2	14.67	.16	.9427	.2121	-.0480	-.0003	-.0020	-.0082	.2306	.2647	507.3
6247	6068.1	16.77	.19	1.0863	.2836	-.0486	-.0026	-.0008	-.0105	.2320	.2648	507.8
6248	6026.4	19.02	.21	1.2381	.3706	-.0431	-.0040	.0007	-.0116	.2334	.2646	507.6
6249	5961.8	21.05	.23	1.2709	.4259	-.0198	.0002	-.0011	-.0110	.2361	.2646	507.8
6250	6180.7	23.21	.25	1.3049	.4955	-.0191	-.0012	-.0017	-.0096	.2275	.2642	507.8
6251	6060.8	25.32	.27	1.3568	.5759	-.0248	-.0059	.0004	-.0111	.2323	.2645	507.8
6252	6014.1	27.42	.29	1.4051	.6643	-.0405	-.0100	.0064	-.0160	.2339	.2643	508.0
6253	6053.0	29.64	.32	1.4553	.7696	-.0721	-.0089	.0021	-.0123	.2327	.2646	507.8
6254	6028.9	30.86	.33	1.4578	.8113	-.0766	-.0099	.0005	-.0092	.2338	.2648	508.1
6255	6092.8	11.68	.13	.6934	.1158	-.0508	.0022	-.0013	-.0101	.2313	.2646	508.1

ORIGINAL PAGE IS
OF POOR QUALITY

NASA LANGLEY

7 X 10 HIGH SPEED TUNNEL

TEST TP	21 MACH	0 PA	RUN 50 ALPHA DEG	BETA DEG	CNF(SA)	CAF(SA)	CPM(SA)	CRM(SA)	CYM(SA)	CSF(SA)	TLEN DEG K
6268	.298	6011.4	11.56	.13	.6236	-.0089	.0144	-.0009	-.0004	-.0086	291.0
6269	.300	6077.4	10.21	.12	.5404	-.0086	.0110	-.0007	-.0007	-.0070	290.9
6270	.300	6090.8	10.76	.12	.5747	-.0089	.0125	-.0011	-.0006	-.0073	290.9
6271	.300	6102.1	12.53	.14	.6702	-.0085	.0150	-.0000	-.0003	-.0086	290.8
6272	.300	6073.2	14.48	.16	.7688	-.0085	.0106	.0012	-.0005	-.0096	290.8
6273	.300	6072.8	16.62	.19	.8670	-.0051	.0012	.0007	-.0010	-.0098	290.8
6274	.298	6023.2	18.49	.21	.9225	.0015	-.0158	.0003	-.0006	-.0086	290.8
6275	.300	6079.2	20.48	.24	.8812	.0071	-.0084	.0039	-.0070	-.0042	290.8
6276	.296	5951.1	22.64	.25	.9275	.0045	-.0014	.0003	-.0021	-.0055	290.9
6277	.301	6104.2	24.82	.28	1.0322	-.0006	-.0048	.0008	-.0029	-.0059	290.8
6278	.298	6019.7	27.07	.30	1.1461	-.0061	-.0150	.0017	-.0043	-.0054	290.9
6279	.298	6000.1	29.14	.32	1.2494	-.0118	-.0228	.0027	-.0057	-.0048	290.8
6280	.299	6048.9	30.53	.34	1.2999	-.0159	-.0280	.0026	-.0068	-.0036	290.9
6281	.299	6055.1	11.55	.13	.6208	-.0098	.0144	-.0009	-.0007	-.0072	288.5

TEST TP	21 ALPHA DEG	BETA DEG	RUN 50 CL(SA)	CD(SA)	CPM(SA)	CRM(SA)	CYM(SA)	CSF(SA)	P1 PA	CPB(1)	VTOT M/SEC
6268	11.56	.13	.6127	.1162	.0144	-.0010	-.0002	-.0086	96655.6	-.144	0.0
6269	10.21	.12	.5334	.0873	.0110	-.0008	-.0005	-.0070	96586.6	-.138	0.0
6270	10.76	.12	.5663	.0985	.0125	-.0012	-.0004	-.0073	96569.2	-.141	0.0
6271	12.53	.14	.6560	.1371	.0150	-.0001	-.0003	-.0086	96557.3	-.147	0.0
6272	14.48	.16	.7466	.1840	.0106	.0011	-.0008	-.0096	96582.0	-.152	0.0
6273	16.62	.19	.8322	.2432	.0012	.0004	-.0011	-.0098	96585.6	-.159	0.0
6274	18.49	.21	.8744	.2939	-.0158	.0001	-.0007	-.0086	96639.9	-.171	0.0
6275	20.48	.24	.8230	.3150	-.0084	.0012	-.0080	-.0042	96577.4	-.181	0.0
6276	22.64	.25	.8542	.3612	-.0015	-.0006	-.0020	-.0055	96710.8	-.189	0.0
6277	24.82	.28	.9371	.4328	-.0048	-.0004	-.0030	-.0059	96546.3	-.198	0.0
6278	27.07	.30	1.0234	.5161	-.0150	-.0004	-.0046	-.0054	96631.0	-.206	0.0
6279	29.14	.32	1.0970	.5981	-.0228	-.0004	-.0063	-.0048	96647.8	-.214	0.0
6280	30.53	.34	1.1277	.6466	-.0280	-.0012	-.0072	-.0036	96592.7	-.219	0.0
6281	11.55	.13	.6102	.1147	.0144	-.0011	-.0005	-.0072	96589.6	-.144	0.0

TEST TP	21 0 PA	ALPHA DEG	RUN 50 BETA DEG	CLT	CDT	CRMST	CRTS	CYTS	CYST	CMU	WTFLD KG/SEC	PLENP PSI
6268	6011.4	11.56	.13	.6127	.1162	.0144	-.0010	-.0002	-.0086	0.0000	0.0000	-.0
6269	6077.4	10.21	.12	.5334	.0873	.0110	-.0008	-.0005	-.0070	0.0000	0.0000	-.0
6270	6090.8	10.76	.12	.5663	.0985	.0125	-.0012	-.0004	-.0073	0.0000	0.0000	-.0
6271	6102.1	12.53	.14	.6560	.1371	.0150	-.0001	-.0003	-.0086	0.0000	0.0000	-.1
6272	6073.2	14.48	.16	.7466	.1840	.0106	.0011	-.0008	-.0096	0.0000	0.0000	-.2
6273	6072.8	16.62	.19	.8322	.2432	.0012	.0004	-.0011	-.0098	0.0000	0.0000	-.2
6274	6023.2	18.49	.21	.8744	.2939	-.0158	.0001	-.0007	-.0086	0.0000	0.0000	-.2
6275	6079.2	20.48	.24	.8230	.3150	-.0084	.0012	-.0080	-.0042	0.0000	0.0000	-.2
6276	5951.1	22.64	.25	.8542	.3612	-.0015	-.0006	-.0020	-.0055	0.0000	0.0000	-.3
6277	6104.2	24.82	.28	.9371	.4328	-.0048	-.0004	-.0030	-.0059	0.0000	0.0000	-.5
6278	6019.7	27.07	.30	1.0234	.5161	-.0150	-.0004	-.0046	-.0054	0.0000	0.0000	-.4
6279	6000.1	29.14	.32	1.0970	.5981	-.0228	-.0004	-.0063	-.0048	0.0000	0.0000	-.4
6280	6048.9	30.53	.34	1.1277	.6466	-.0280	-.0012	-.0072	-.0036	0.0000	0.0000	-.5
6281	6055.1	11.55	.13	.6102	.1147	.0144	-.0011	-.0005	-.0072	0.0000	0.0000	-.6

NASA LANGLEY

7 X 10 HIGH SPEED TUNNEL

TEST TP	21 MACH	Q PA	RUN 51 ALPHA DEG	BETA DEG	CNF(BA)	CAF(BA)	CPM(BA)	CRH(BA)	CYM(BA)	CSF(BA)	TPLEN DEG K
6282	.301	6114.3	11.58	.13	.6554	-.0399	.0180	-.0001	.0000	-.0104	289.1
6283	.301	6105.6	10.27	.12	.5704	-.0384	.0152	-.0004	-.0000	-.0108	289.0
6284	.300	6088.4	10.69	.12	.6008	-.0388	.0158	-.0006	-.0000	-.0108	288.8
6285	.301	6111.8	12.63	.14	.7140	-.0404	.0198	-.0002	.0001	-.0117	289.7
6286	.301	6112.7	14.40	.16	.7896	-.0402	.0172	.0001	-.0004	-.0117	288.6
6287	.300	6087.6	16.50	.19	.8943	-.0391	.0030	.0008	-.0011	-.0119	288.4
6288	.299	6050.5	18.62	.21	.9758	-.0374	-.0087	-.0004	-.0005	-.0138	288.3
6289	.300	6088.1	20.65	.23	1.0380	-.0338	-.0163	-.0020	-.0004	-.0127	288.2
6290	.298	6003.3	22.87	.24	.9985	-.0290	-.0061	-.0078	.0071	-.0115	288.1
6291	.298	6016.2	24.80	.27	.9962	-.0292	.0015	-.0003	-.0012	-.0069	288.0
6292	.300	6097.4	26.92	.30	1.0582	-.0327	.0015	.0000	-.0026	-.0037	287.9
6293	.298	6019.8	29.09	.32	1.1224	-.0381	.0022	.0008	-.0044	.0006	287.8
6294	.296	5946.1	30.37	.33	1.1628	-.0413	.0034	-.0001	-.0039	-.0008	287.7
6295	.299	6062.1	11.59	.13	.6587	-.0398	.0179	-.0004	-.0000	-.0109	287.4

TEST TP	21 ALPHA DEG	BETA DEG	RUN 51 CL(SA)	CD(SA)	CPM(SA)	CRM(SA)	CYM(SA)	CSF(SA)	P1 PA	CP8(1)	VTOT M/SEC
6282	11.58	.13	.6501	.0925	.0180	-.0001	.0000	-.0104	96530.9	-.149	525.5
6283	10.27	.12	.5681	.0640	.0152	-.0004	.0001	-.0108	96538.1	-.143	525.4
6284	10.69	.12	.5976	.0732	.0158	-.0006	.0001	-.0108	96553.3	-.145	525.4
6285	12.63	.14	.7056	.1166	.0198	-.0002	.0001	-.0117	96529.5	-.151	525.3
6286	14.40	.16	.7748	.1574	.0172	-.0000	-.0004	-.0117	96525.9	-.155	525.2
6287	16.50	.19	.8686	.2165	.0030	.0005	-.0013	-.0119	96552.2	-.163	525.1
6288	18.62	.21	.9366	.2762	-.0087	-.0006	-.0004	-.0138	96591.0	-.174	525.0
6289	20.65	.23	.9832	.3344	-.0163	-.0020	.0003	-.0127	96545.4	-.184	524.9
6290	22.87	.24	.9313	.3614	-.0061	-.0045	.0096	-.0115	96638.1	-.191	524.7
6291	24.80	.27	.9166	.3913	.0015	-.0007	-.0010	-.0069	96620.1	-.214	524.7
6292	26.92	.30	.9583	.4500	.0015	-.0012	-.0024	-.0037	96535.1	-.226	524.6
6293	29.09	.32	.9994	.5124	.0022	-.0014	-.0043	.0006	96614.5	-.231	524.5
6294	30.37	.33	1.0242	.5522	.0034	-.0021	-.0033	-.0008	96693.5	-.236	524.3
6295	11.59	.13	.6533	.0934	.0179	-.0004	.0001	-.0109	96572.1	-.149	524.2

TEST TP	21 Q PA	ALPHA DEG	RUN 51 BETA DEG	CLT	CDT	CHST	CRTS	CYTS	CYST	CMU	WTFLO KG/SEC	PLENP PSI
6282	6114.3	11.58	.13	.6322	.1188	.0007	-.0002	-.0006	-.0088	.0485	.0651	119.9
6283	6105.6	10.27	.12	.5508	.0907	-.0022	-.0005	-.0005	-.0091	.0487	.0654	120.0
6284	6088.4	10.69	.12	.5800	.0999	-.0016	-.0007	-.0005	-.0092	.0489	.0654	120.2
6285	6111.8	12.63	.14	.6872	.1426	.0024	-.0003	-.0005	-.0101	.0488	.0656	120.2
6286	6112.7	14.40	.16	.7556	.1828	-.0002	-.0002	-.0010	-.0100	.0488	.0655	120.4
6287	6087.6	16.50	.19	.8484	.2413	-.0145	.0003	-.0019	-.0102	.0490	.0656	120.4
6288	6050.5	18.62	.21	.9154	.3004	-.0263	-.0008	-.0010	-.0121	.0492	.0654	120.4
6289	6088.1	20.65	.23	.9613	.3577	-.0337	-.0022	-.0002	-.0111	.0491	.0657	120.4
6290	6003.3	22.87	.24	.9081	.3841	-.0238	-.0047	.0090	-.0098	.0496	.0656	120.4
6291	6016.2	24.80	.27	.8927	.4132	-.0161	-.0010	-.0015	-.0052	.0495	.0656	120.4
6292	6097.4	26.92	.30	.9339	.4708	-.0160	-.0015	-.0029	-.0021	.0489	.0656	120.5
6293	6019.8	29.09	.32	.9740	.5325	-.0154	-.0017	-.0048	.0022	.0495	.0656	120.5
6294	5946.1	30.37	.33	.9980	.5719	-.0145	-.0024	-.0039	.0009	.0501	.0656	120.5
6295	6062.1	11.59	.13	.6352	.1200	.0003	-.0005	-.0005	-.0092	.0493	.0658	120.5

NASA LANGLEY

7 X 10 HIGH SPEED TUNNEL

TEST TP	21	MACH	0	PA	ALPHA DEG	BETA DEG	CNF(BA)	CAF(BA)	CPH(BA)	CRM(BA)	CYN(BA)	CSF(BA)	TPLEN DEG K
6296		.300	6093.7	11.64	.13	.7031	-.0670	.0280	.0013	.0009	-.0128	284.6	
6297		.300	6083.0	10.25	.12	.6019	-.0646	.0245	.0019	.0001	-.0128	284.5	
6298		.300	6083.5	10.85	.12	.6503	-.0657	.0262	.0018	.0004	-.0128	284.5	
6299		.300	6087.0	12.65	.14	.7677	-.0695	.0304	-.0005	.0015	-.0130	284.6	
6300		.300	6087.7	14.59	.16	.8698	-.0744	.0329	-.0005	.0017	-.0110	284.6	
6301		.300	6077.6	16.60	.18	.9529	-.0762	.0287	-.0010	.0018	-.0131	284.7	
6302		.298	6023.3	18.52	.21	1.0454	-.0764	.0129	-.0016	.0014	-.0146	284.8	
6303		.298	6010.5	20.76	.23	1.1428	-.0764	.0011	-.0031	.0007	-.0182	284.8	
6304		.297	5960.3	22.92	.25	1.2008	-.0696	-.0163	-.0002	.0000	-.0135	285.0	
6305		.296	5924.7	24.98	.27	1.2390	-.0694	-.0160	-.0063	.0050	-.0128	285.1	
6306		.300	6086.4	27.03	.28	1.2429	-.0679	-.0105	-.0079	.0056	-.0072	285.3	
6307		.298	6010.1	29.19	.32	1.2413	-.0703	.0019	.0013	-.0035	-.0035	285.4	
6308		.298	6016.5	30.54	.34	1.2570	-.0723	.0036	.0031	-.0072	-.0029	285.6	
6309		.299	6053.5	11.65	.13	.7124	-.0698	-.0269	.0010	.0009	-.0122	286.0	

TEST TP	21	ALPHA DEG	BLTA DEG	RUN CL(SA)	52	CD(SA)	CPH(SA)	CRM(SA)	CYN(SA)	CSF(SA)	P1 PA	CPB(1)	VTOT M/SEC
6296		11.64	.13	.7021	.0762	.0280	.0014	.0006	-.0128	96531.0	-.145	564.9	
6297		10.25	.12	.6038	.0436	.0245	.0019	-.0003	-.0128	96543.4	-.136	564.8	
6298		10.85	.12	.6510	.0579	.0262	.0019	-.0001	-.0128	96542.9	-.139	564.9	
6299		12.65	.14	.7643	.1003	.0304	-.0001	.0016	-.0130	96539.2	-.152	564.9	
6300		14.59	.16	.8605	.1471	.0329	-.0001	.0018	-.0110	96532.0	-.163	564.9	
6301		16.60	.18	.9349	.1992	.0287	-.0005	.0020	-.0131	96540.0	-.169	565.0	
6302		18.52	.21	1.0155	.2597	.0129	-.0011	.0019	-.0146	96599.6	-.173	565.0	
6303		20.76	.23	1.0957	.3336	.0011	-.0027	.0018	-.0182	96619.3	-.180	565.1	
6304		22.92	.25	1.1331	.4035	-.0163	-.0002	.0001	-.0135	96670.6	-.187	565.2	
6305		24.98	.27	1.1524	.4604	-.0160	-.0036	.0072	-.0128	96702.2	-.191	565.3	
6306		27.03	.28	1.1380	.5043	-.0105	-.0045	.0086	-.0072	96533.1	-.201	565.6	
6307		29.19	.32	1.1179	.5441	.0019	-.0006	-.0037	-.0035	96612.9	-.222	565.6	
6308		30.54	.34	1.1194	.5764	.0036	-.0010	-.0078	-.0029	96611.8	-.240	565.8	
6309		11.65	.13	.7118	.0755	.0269	.0011	.0006	-.0122	96568.8	-.145	566.3	

TEST TP	21	0	ALPHA DEG	BETA DEG	CLT	CDT	CMST	CRTS	CYTS	CYST	CMU	WTFLO KG/SEC	PLENP PSI
6296		6093.7	11.64	.13	.6677	.1268	-.0053	.0012	-.0005	-.0097	.0990	.1233	230.2
6297		6083.0	10.25	.12	.5705	.0951	-.0089	.0017	-.0014	-.0096	.0993	.1235	230.3
6298		6083.5	10.85	.12	.6172	.1090	-.0072	.0016	-.0011	-.0097	.0991	.1233	230.4
6299		6087.0	12.65	.14	.7289	.1504	-.0030	-.0004	.0005	-.0098	.0991	.1233	230.4
6300		6087.7	14.59	.16	.8234	.1959	-.0005	-.0004	.0007	-.0079	.0991	.1233	230.4
6301		6077.6	16.60	.18	.8961	.2467	-.0048	-.0008	.0009	-.0099	.0992	.1233	230.4
6302		6023.3	18.52	.21	.9747	.3063	-.0208	-.0015	.0008	-.0114	.1002	.1233	230.4
6303		6010.5	20.76	.23	1.0531	.3787	-.0327	-.0031	.0007	-.0150	.1004	.1233	230.4
6304		5960.3	22.92	.25	1.0884	.4474	-.0504	-.0006	-.0010	-.0103	.1011	.1231	230.3
6305		5924.7	24.98	.27	1.1059	.5028	-.0503	-.0041	.0061	-.0095	.1017	.1232	230.3
6306		6086.4	27.03	.28	1.0913	.5440	-.0439	-.0050	.0076	-.0040	.0988	.1228	230.2
6307		6010.1	29.19	.32	1.0692	.5825	-.0319	-.0011	-.0047	-.0003	.1001	.1229	230.2
6308		6016.5	30.54	.34	1.0698	.6136	-.0302	-.0016	-.0088	.0003	.1000	.1227	230.2
6309		6053.5	11.65	.13	.6771	.1264	-.0066	.0009	-.0005	-.0091	.0995	.1228	230.2

NASA LANGLEY

7 X 10 HIGH SPEED TUNNEL

TEST TP	21 MACH	Q PA	RUN 53 ALPHA DEG	BETA DEG	CNF(BA)	CAF(BA)	CPH(BA)	CRM(BA)	CYM(BA)	CSF(BA)	TPLEN DEG K
6310	.301	6123.2	11.73	.13	.7826	-.1205	.0324	.0029	-.0002	-.0153	286.7
6311	.301	6108.4	10.31	.12	.6618	-.1188	.0285	.0025	.0007	-.0163	287.1
6312	.301	6107.5	10.83	.12	.7103	-.1200	.0301	.0030	.0003	-.0157	287.7
6313	.301	6111.4	12.72	.15	.8576	-.1247	.0334	.0029	-.0005	-.0172	288.3
6314	.300	6094.3	14.66	.17	.9864	-.1313	.0359	.0012	.0004	-.0219	288.7
6315	.300	6081.1	16.81	.19	1.1117	-.1408	.0419	.0003	.0019	-.0202	289.2
6316	.298	6009.6	18.89	.20	1.1901	-.1477	.0544	-.0079	.0057	-.0217	289.7
6317	.299	6029.0	20.96	.22	1.2497	-.1472	.0435	-.0079	.0075	-.0219	290.0
6318	.294	5851.3	23.08	.25	1.3333	-.1491	.0227	-.0065	.0048	-.0152	290.3
6319	.297	5982.1	25.21	.28	1.3768	-.1374	-.0031	.0004	-.0053	-.0199	290.6
6320	.299	6030.3	27.36	.32	1.4689	-.1357	-.0121	.0071	-.0114	-.0181	290.7
6321	.297	5984.1	29.40	.36	1.5002	-.1385	-.0071	.0243	-.0251	-.0216	290.9
6322	.298	6001.4	30.76	.38	1.5272	-.1399	-.0033	.0297	-.0303	-.0218	291.0
6323	.297	5983.8	11.71	.13	.7882	-.1257	.0326	.0032	-.0002	-.0157	291.2

TEST TP	21 ALPHA DEG	BETA DEG	RUN 53 CL(SA)	CD(SA)	CPH(SA)	CRM(SA)	CYM(SA)	CSF(SA)	P1 PA	CP8(I)	VTOT M/SEC
6310	11.73	.13	.7907	.0410	.0324	.0028	-.0008	-.0153	96494.5	-.140	601.1
6311	10.31	.12	.6724	.0015	.0285	.0026	.0002	-.0163	96513.4	-.132	601.8
6312	10.83	.12	.7202	.0156	.0301	.0030	-.0003	-.0157	96508.2	-.136	602.4
6313	12.72	.15	.8640	.0673	.0334	.0028	-.0011	-.0172	96513.7	-.145	602.8
6314	14.66	.17	.9875	.1227	.0359	.0012	.0001	-.0219	96522.5	-.158	603.1
6315	16.81	.19	1.1049	.1867	.0419	.0008	.0018	-.0202	96538.6	-.167	603.6
6316	18.89	.20	1.1738	.2455	.0544	-.0057	.0079	-.0217	96613.5	-.172	604.0
6317	20.96	.22	1.2196	.3095	.0435	-.0046	.0098	-.0219	96593.1	-.179	604.3
6318	23.08	.25	1.2850	.3854	.0227	-.0041	.0070	-.0152	96774.4	-.184	604.5
6319	25.21	.28	1.3042	.4621	-.0031	-.0019	-.0050	-.0199	96628.7	-.189	604.9
6320	27.36	.32	1.3670	.5545	-.0121	.0011	-.0134	-.0181	96576.2	-.189	605.2
6321	29.40	.36	1.3749	.6159	-.0071	.0088	-.0338	-.0216	96626.6	-.200	605.3
6322	30.76	.38	1.3839	.6610	-.0033	.0101	-.0412	-.0218	96606.5	-.215	605.4
6323	11.71	.13	.7973	.0369	.0326	.0031	-.0008	-.0157	96626.9	-.140	605.6

TEST TP	21 Q PA	ALPHA DEG	RUN 53 BETA DEG	CLT	CDT	CMST	CRTS	CYTS	CYST	CMU	WTFLO KG/SEC	PLENP PSI
6310	6123.2	11.73	.13	.7267	.1348	-.0295	.0023	-.0029	-.0095	.1924	.2263	429.6
6311	6108.4	10.31	.12	.6102	.0975	-.0338	.0022	-.0019	-.0104	.1934	.2267	431.4
6312	6107.5	10.83	.12	.6572	.1110	-.0322	.0026	-.0024	-.0099	.1933	.2263	431.2
6313	6111.4	12.72	.15	.7982	.1602	-.0287	.0023	-.0032	-.0113	.1925	.2254	429.9
6314	6094.3	14.66	.17	.9186	.2132	-.0261	.0007	-.0020	-.0161	.1922	.2243	428.4
6315	6081.1	16.81	.19	1.0326	.2747	-.0202	.0002	-.0003	-.0143	.1927	.2243	427.9
6316	6009.6	18.89	.20	1.0974	.3319	-.0085	-.0064	.0059	-.0158	.1948	.2238	428.0
6317	6029.0	20.96	.22	1.1405	.3927	-.0191	-.0054	.0078	-.0160	.1942	.2237	427.9
6318	5851.3	23.08	.25	1.2003	.4682	-.0418	-.0050	.0049	-.0091	.2002	.2238	428.0
6319	5982.1	25.21	.28	1.2183	.5399	-.0663	-.0029	-.0069	-.0139	.1959	.2237	428.3
6320	6030.3	27.36	.32	1.2789	.6285	-.0748	.0001	-.0153	-.0122	.1946	.2239	428.5
6321	5984.1	29.40	.36	1.2835	.6873	-.0703	.0078	-.0357	-.0157	.1964	.2242	428.5
6322	6001.4	30.76	.38	1.2911	.7299	-.0663	.0089	-.0431	-.0159	.1956	.2239	426.4
6323	5983.8	11.71	.13	.7320	.1326	-.0306	.0027	-.0030	-.0097	.1961	.2237	428.3

ORIGINAL PAGE IS
OF POOR QUALITY

NASA LANGLEY

7 X 10 HIGH SPEED TUNNEL

TEST TP	21 MACH	Q PA	RUN 54		CNF(BA)	CAF(BA)	CPH(BA)	CRM(BA)	CYH(BA)	CSF(BA)	TPLEN DEG K
			ALPHA DEG	BETA DEG							
6324	.301	6105.0	11.75	.13	.8046	-.1447	.0364	.0027	.0007	-.0168	292.5
6325	.301	6104.2	10.30	.12	.6675	-.1415	.0327	.0015	.0017	-.0175	292.6
6326	.301	6105.8	10.83	.12	.7194	-.1425	.0341	.0022	.0015	-.0186	292.8
6327	.301	6108.5	12.78	.15	.8817	-.1476	.0379	.0021	.0006	-.0182	292.9
6328	.300	6094.0	14.70	.17	1.0102	-.1547	.0404	.0004	.0008	-.0206	293.1
6329	.300	6073.1	16.81	.19	1.1552	-.1643	.0425	-.0004	.0019	-.0233	293.3
6330	.301	6122.9	19.07	.21	1.2993	-.1716	.0569	-.0057	.0035	-.0216	293.5
6331	.299	6049.6	21.01	.23	1.3156	-.1753	.0582	-.0022	.0039	-.0214	293.7
6332	.297	5984.3	23.08	.25	1.3800	-.1746	.0409	.0003	-.0004	-.0148	293.9
6333	.299	6031.0	25.22	.27	1.4491	-.1681	.0153	-.0054	-.0004	-.0176	294.2
6334	.298	5995.6	27.43	.30	1.5571	-.1646	-.0068	-.0054	-.0015	-.0122	294.3
6335	.299	6027.6	29.59	.33	1.5581	-.1622	.0004	.0049	-.0110	-.0108	294.5
6336	.300	6068.9	30.79	.36	1.5427	-.1617	.0076	.0111	-.0158	-.0125	294.7
6337	.300	6075.8	11.75	.13	.8069	-.1478	.0379	.0028	.0011	-.0185	295.2

TEST TP	21 ALPHA DEG	BETA DEG	RUN 54		CPH(SA)	CRM(SA)	CYH(SA)	CSF(SA)	P1 PA	CPB(1)	VTOT H/SEC
			CL(SA)	CD(SA)							
6324	11.75	.13	.8172	.0222	.0364	.0028	.0002	-.0168	96476.2	-.135	615.2
6325	10.30	.12	.6821	-.0198	.0327	.0018	.0014	-.0175	96475.2	-.130	615.3
6326	10.83	.12	.7334	-.0048	.0341	.0024	.0011	-.0186	96475.5	-.132	615.5
6327	12.78	.15	.8925	.0511	.0379	.0022	.0001	-.0182	96476.0	-.138	615.7
6328	14.70	.17	1.0164	.1066	.0404	.0006	.0007	-.0206	96487.8	-.153	616.0
6329	16.81	.19	1.1534	.1768	.0425	.0002	.0020	-.0233	96506.3	-.166	616.2
6330	19.07	.21	1.2463	.2491	.0569	-.0042	.0052	-.0216	96457.6	-.171	616.5
6331	21.01	.23	1.2909	.3081	.0582	-.0007	.0044	-.0214	96541.0	-.175	616.7
6332	23.08	.25	1.3380	.3804	.0409	.0001	-.0005	-.0148	96604.3	-.178	616.8
6333	25.22	.27	1.3826	.4652	.0153	-.0051	.0020	-.0176	96555.3	-.184	617.1
6334	27.43	.30	1.4579	.5711	-.0068	-.0055	.0012	-.0122	96594.2	-.186	617.3
6335	29.59	.33	1.4350	.6283	.0004	-.0012	-.0119	-.0108	96560.7	-.190	617.5
6336	30.79	.36	1.4080	.6509	.0076	-.0015	-.0193	-.0125	96517.5	-.202	617.8
6337	11.75	.13	.8200	.0196	.0379	.0029	.0005	-.0185	96517.0	-.135	618.3

TEST TP	21 Q PA	ALPHA DEG	RUN 54		CDT	CMST	CRTS	CYTS	CYST	CNU	WTFLO KG/SEC	PLENP PSI
			BETA DEG	CLT								
6324	6105.0	11.75	.13	.7413	.1333	-.0370	.0022	-.0023	-.0099	.2296	.2632	507.2
6325	6104.2	10.30	.12	.6092	.0929	-.0405	.0013	-.0011	-.0106	.2293	.2627	506.0
6326	6105.8	10.83	.12	.6594	.1072	-.0390	.0020	-.0014	-.0117	.2295	.2629	506.0
6327	6108.5	12.78	.15	.8146	.1607	-.0353	.0016	-.0023	-.0113	.2298	.2633	507.1
6328	6094.0	14.70	.17	.9346	.2140	-.0332	-.0001	-.0017	-.0137	.2308	.2637	508.2
6329	6073.1	16.81	.19	1.0673	.2816	-.0314	-.0005	-.0005	-.0163	.2317	.2637	508.5
6330	6122.9	19.07	.21	1.1569	.3496	-.0164	-.0050	.0028	-.0147	.2299	.2637	508.6
6331	6049.6	21.01	.23	1.1969	.4067	-.0160	-.0016	.0020	-.0144	.2329	.2638	509.1
6332	5984.3	23.08	.25	1.2394	.4766	-.0342	-.0009	-.0029	-.0078	.2353	.2636	509.1
6333	6031.0	25.22	.27	1.2813	.5570	-.0592	-.0062	-.0003	-.0106	.2338	.2638	509.2
6334	5995.6	27.43	.30	1.3525	.6594	-.0818	-.0067	-.0011	-.0052	.2350	.2636	509.1
6335	6027.6	29.59	.33	1.3269	.7122	-.0742	-.0024	-.0142	-.0037	.2339	.2636	509.4
6336	6068.9	30.79	.36	1.2989	.7319	-.0665	.0001	-.0215	-.0055	.2323	.2636	509.4
6337	6075.8	11.75	.13	.7435	.1316	-.0361	.0024	-.0020	-.0115	.2319	.2631	509.1

NASA LANGLEY

7 X 10 HIGH SPEED TUNNEL

TEST TP	21 MACH	Q PA	ALPHA DEG	BETA DEG	RUN 55 ALPHA DEG	BETA DEG	CNF(BA)	CAF(BA)	CPH(BA)	CRM(BA)	CYH(BA)	CSF(BA)	TPLN DEG K
6350	.506	15403.0	12.34	.14	.6332	.1323	.0115	-.0002	-.0006	-.0061	85996.7	-.149	0.0
6351	.502	15208.4	10.91	.12	.5611	.1009	.0116	-.0005	-.0006	-.0052	86258.4	-.142	0.0
6352	.502	15207.5	11.40	.12	.5875	.1109	.0130	-.0007	-.0005	-.0054	86268.9	-.145	0.0
6353	.502	15215.0	13.36	.15	.6780	.1549	.0119	.0008	-.0008	-.0067	86276.3	-.151	0.0
6354	.501	15167.9	15.41	.17	.7704	.2074	.0039	.0005	-.0011	-.0061	86303.6	-.156	0.0
6355	.501	15159.5	17.43	.19	.8396	.2624	-.0090	.0001	-.0017	-.0049	86339.7	-.163	0.0
6356	.498	15025.2	19.49	.21	.8912	.3020	-.0189	.0002	-.0016	-.0039	86486.4	-.172	0.0
6357	.498	15029.9	21.66	.23	.8543	.3443	-.0149	-.0011	-.0010	-.0028	86498.6	-.177	0.0
6358	.497	14994.3	23.84	.26	.9159	.4053	-.0141	-.0016	-.0013	-.0032	86548.5	-.187	0.0
6359	.499	15047.5	26.14	.28	.9882	.4799	-.0182	-.0022	-.0013	-.0047	86487.9	-.197	0.0
6360	.498	15030.6	28.32	.30	1.0560	.5580	-.0254	-.0028	-.0006	-.0053	86507.0	-.205	0.0
6361	.497	14977.4	30.46	.33	1.1004	.6301	-.0292	-.0017	-.0037	-.0026	86557.7	-.218	0.0
6362	.494	14801.2	31.90	.31	1.1312	.6824	-.0310	-.0063	.0081	-.0060	86762.2	-.229	0.0
6363	.501	15148.9	12.34	.14	.6405	.1322	.0118	.0001	-.0007	-.0063	86304.4	-.149	0.0

TEST TP	21 Q PA	ALPHA DEG	BETA DEG	RUN 55 BETA DEG	CLT	CDT	CRST	CRTS	CYTS	CYST	CMU	WTFLO KG/SEC	PLENP PSI
6350	15403.0	12.34	.14	.6332	.1323	.0115	-.0002	-.0006	-.0061	0.0000	0.0000	0.0000	.1
6351	15208.4	10.91	.12	.5611	.1009	.0116	-.0005	-.0006	-.0052	0.0000	0.0000	0.0000	.0
6352	15207.5	11.40	.12	.5875	.1109	.0130	-.0007	-.0005	-.0054	0.0000	0.0000	0.0000	-.1
6353	15215.0	13.36	.15	.6780	.1549	.0119	.0008	-.0008	-.0067	0.0000	0.0000	0.0000	-.2
6354	15167.9	15.41	.17	.7704	.2074	.0039	.0005	-.0011	-.0061	0.0000	0.0000	0.0000	-.3
6355	15159.5	17.43	.19	.8396	.2624	-.0090	.0001	-.0017	-.0049	0.0000	0.0000	0.0000	-.4
6356	15025.2	19.49	.21	.8912	.3020	-.0189	.0002	-.0016	-.0039	0.0000	0.0000	0.0000	-.4
6357	15029.9	21.66	.23	.8543	.3443	-.0149	-.0011	-.0010	-.0028	0.0000	0.0000	0.0000	-.5
6358	14994.3	23.84	.26	.9159	.4053	-.0141	-.0016	-.0013	-.0032	0.0000	0.0000	0.0000	-.6
6359	15047.5	26.14	.28	.9882	.4799	-.0182	-.0022	-.0013	-.0047	0.0000	0.0000	0.0000	-1.2
6360	15030.6	28.32	.30	1.0560	.5580	-.0254	-.0028	-.0006	-.0053	0.0000	0.0000	0.0000	-1.0
6361	14977.4	30.46	.33	1.1004	.6301	-.0292	-.0017	-.0037	-.0026	0.0000	0.0000	0.0000	-1.1
6362	14801.2	31.90	.31	1.1312	.6824	-.0310	-.0063	.0081	-.0060	0.0000	0.0000	0.0000	-1.6
6363	15148.9	12.34	.14	.6405	.1322	.0118	.0001	-.0007	-.0063	0.0000	0.0000	0.0000	-.2

ORIGINAL PAGE IS
OF POOR QUALITY

NASA LANGLEY

7 X 10 HIGH SPEED TUNNEL

TEST TP	21 MACH	Q PA	RUN 56 ALPHA DEG	BETA DEG	CNF(BA)	CAF(BA)	CPM(BA)	CRM(BA)	CYM(BA)	CSF(BA)	TPLEN DEG K
6364	.500	15109.5	12.39	.14	.6666	-.0336	.0177	.0003	-.0003	-.0080	287.6
6365	.499	15060.7	10.99	.12	.5867	-.0329	.0155	.0006	-.0005	-.0075	287.6
6366	.499	15072.7	11.42	.13	.6157	-.0332	.0165	.0004	-.0004	-.0079	286.9
6367	.501	15178.7	13.42	.15	.7240	-.0342	.0158	.0005	-.0002	-.0088	288.0
6368	.501	15167.7	15.44	.17	.8185	-.0345	.0121	-.0001	-.0005	-.0083	288.3
6369	.500	15122.4	17.61	.19	.9142	-.0363	.0086	.0013	-.0017	-.0066	288.7
6370	.499	15053.1	19.76	.22	.9934	-.0382	.0057	.0018	-.0025	-.0065	289.0
6371	.500	15094.2	21.93	.25	1.0745	-.0369	-.0023	.0038	-.0044	-.0046	289.7
6372	.501	15149.4	24.10	.27	1.1173	-.0350	-.0086	.0044	-.0059	-.0028	290.5
6373	.499	15058.9	26.25	.29	1.1599	-.0373	-.0107	.0010	-.0027	-.0072	291.5
6374	.502	15242.2	28.44	.30	1.1949	-.0403	-.0073	-.0027	-.0021	-.0070	292.2
6375	.499	15060.2	30.60	.32	1.2468	-.0442	-.0065	-.0020	-.0028	-.0055	293.0
6376	.502	15212.5	31.93	.34	1.2662	-.0461	-.0054	-.0006	-.0039	-.0043	294.3
6377	.500	15132.0	12.37	.14	.6662	-.0364	.0160	.0002	-.0004	-.0071	295.6

TEST TP	21 ALPHA DEG	BETA DEG	RUN 56 CL(SA)	CD(SA)	CPM(SA)	CRM(SA)	CYM(SA)	CSF(SA)	P1 PA	CPB(1)	VTOT M/SEC
6364	12.39	.14	.6583	.1102	.0177	.0003	-.0004	-.0080	86385.2	-.154	585.4
6365	10.99	.12	.5822	.0796	.0155	.0005	-.0006	-.0075	86424.5	-.150	585.5
6366	11.42	.13	.6101	.0894	.0165	.0003	-.0004	-.0079	86406.4	-.151	584.9
6367	13.42	.15	.7121	.1348	.0158	.0004	-.0003	-.0088	86307.6	-.156	586.1
6368	15.44	.17	.7982	.1846	.0121	-.0002	-.0004	-.0083	86296.0	-.160	586.4
6369	17.61	.19	.8823	.2420	.0086	.0008	-.0020	-.0066	86310.5	-.170	586.8
6370	19.76	.22	.9478	.2999	.0057	.0008	-.0029	-.0065	86472.0	-.179	587.0
6371	21.93	.25	1.0105	.3670	-.0023	.0019	-.0055	-.0046	86348.4	-.191	587.8
6372	24.10	.27	1.0342	.4243	-.0086	.0016	-.0072	-.0028	86361.7	-.197	589.5
6373	26.25	.29	1.0568	.4795	-.0107	-.0002	-.0028	-.0072	86424.1	-.206	589.6
6374	28.44	.30	1.0700	.5336	-.0073	-.0034	-.0006	-.0070	86235.4	-.220	590.4
6375	30.60	.32	1.0948	.5962	-.0065	-.0032	-.0013	-.0055	86363.7	-.241	591.2
6376	31.93	.34	1.0990	.6305	-.0054	-.0026	-.0030	-.0043	86229.0	-.257	592.5
6377	12.37	.14	.6615	.1078	.0160	.0001	-.0004	-.0071	86380.9	-.154	593.8

TEST TP	21 Q PA	ALPHA DEG	RUN 56 BETA DEG	CLT	CDT	CMST	CRTS	CYTS	CYST	CMU	WTFLO KG/SEC	PLEMP PSI
6364	15109.5	12.39	.14	.6411	.1347	.0014	.0001	-.0009	-.0065	.0496	.1479	279.4
6365	15060.7	10.99	.12	.5655	.1047	-.0009	.0004	-.0011	-.0059	.0499	.1483	280.2
6366	15072.7	11.42	.13	.5932	.1144	.0001	.0002	-.0010	-.0063	.0498	.1483	280.4
6367	15178.7	13.42	.15	.6945	.1590	-.0006	.0003	-.0009	-.0073	.0496	.1483	280.5
6368	15167.7	15.44	.17	.7797	.2082	-.0042	-.0004	-.0010	-.0067	.0495	.1480	280.7
6369	15122.4	17.61	.19	.8629	.2650	-.0078	.0006	-.0026	-.0051	.0497	.1479	280.5
6370	15053.1	19.76	.22	.9275	.3222	-.0108	.0006	-.0035	-.0050	.0500	.1480	280.6
6371	15094.2	21.93	.25	.9894	.3885	-.0187	.0016	-.0061	-.0030	.0499	.1478	280.7
6372	15149.4	24.10	.27	1.0124	.4448	-.0249	.0014	-.0077	-.0013	.0497	.1477	280.6
6373	15058.9	26.25	.29	1.0340	.4994	-.0272	-.0005	-.0034	-.0057	.0500	.1474	280.9
6374	15242.2	28.44	.30	1.0468	.5523	-.0235	-.0036	-.0011	-.0055	.0494	.1472	280.9
6375	15060.2	30.60	.32	1.0706	.6142	-.0229	-.0034	-.0018	-.0039	.0500	.1471	281.0
6376	15212.5	31.93	.34	1.0747	.6479	-.0217	-.0029	-.0034	-.0028	.0495	.1467	281.0
6377	15132.0	12.37	.14	.6442	.1324	-.0004	.0000	-.0010	-.0055	.0497	.1464	281.2

NASA LANGLEY

7 X 10 HIGH SPEED TUNNEL

TEST TP	21 MACH	O PA	RUN 57		CNF(BA)	CAF(BA)	CPH(BA)	CRM(BA)	CYH(BA)	CSF(BA)	TLEN DEG K
			ALPHA DEG	BETA DEG							
6378	.500	15143.6	12.44	.14	.6927	-.0640	.0223	-.0001	.0001	-.0119	296.2
6379	.498	15016.5	10.99	.12	.5980	-.0610	.0178	.0001	.0001	-.0112	296.1
6380	.499	15073.4	11.42	.13	.6279	-.0618	.0184	.0002	.0001	-.0119	295.9
6381	.504	15305.9	13.56	.15	.7629	-.0648	.0270	.0007	.0001	-.0128	296.1
6382	.504	15330.4	15.67	.17	.8766	-.0672	.0332	.0024	-.0010	-.0107	296.2
6383	.500	15124.0	17.76	.20	.9962	-.0710	.0309	.0009	-.0014	-.0117	296.2
6384	.497	14983.9	20.03	.22	1.0917	-.0738	.0275	-.0027	-.0006	-.0157	296.3
6385	.493	14781.5	22.21	.24	1.1852	-.0747	.0161	-.0004	-.0017	-.0151	296.4
6386	.493	14737.3	24.28	.25	1.2386	-.0671	-.0079	-.0008	.0020	-.0095	296.7
6387	.496	14926.6	26.49	.25	1.2384	-.0647	-.0092	-.0089	.0077	-.0130	296.9
6388	.495	14868.6	28.52	.27	1.2694	-.0676	-.0010	-.0115	.0081	-.0155	297.2
6389	.497	14965.8	30.62	.30	1.2763	-.0697	.0084	-.0069	.0059	-.0161	297.5
6390	.494	14796.8	32.04	.33	1.3184	-.0730	.0083	-.0034	.0000	-.0101	297.7
6391	.500	15117.9	12.46	.14	.6951	-.0647	.0223	-.0001	-.0000	-.0128	298.2

TEST TP	21 ALPHA DEG	BETA DEG	RUN 57		CPH(SA)	CRM(SA)	CYH(SA)	CSF(SA)	P1 PA	CP8(1)	VTOT M/SEC
			CL(SA)	CD(SA)							
6378	12.44	.14	.6902	.0867	.0223	-.0001	.0002	-.0119	86364.2	-.157	624.3
6379	10.99	.12	.5986	.0541	.0178	.0001	.0001	-.0112	86436.5	-.151	624.2
6380	11.42	.13	.6277	.0638	.0184	.0002	.0000	-.0119	86395.8	-.153	624.0
6381	13.56	.15	.7568	.1158	.0270	.0007	-.0000	-.0128	86178.0	-.160	624.3
6382	15.67	.17	.8622	.1721	.0332	.0020	-.0016	-.0107	86146.1	-.163	624.4
6383	17.76	.20	.9704	.2362	.0309	.0004	-.0015	-.0117	86319.9	-.169	624.4
6384	20.03	.22	1.0509	.3045	.0275	-.0027	.0004	-.0157	86917.5	-.178	624.4
6385	22.21	.24	1.1294	.3789	.0161	-.0010	-.0014	-.0151	86770.5	-.186	624.4
6386	24.28	.25	1.1566	.4482	-.0079	.0000	.0022	-.0095	86721.6	-.194	624.6
6387	26.49	.25	1.1372	.4945	-.0052	-.0045	.0109	-.0130	86502.4	-.203	625.0
6388	28.52	.27	1.1477	.5466	-.0010	-.0062	.0126	-.0155	86560.6	-.217	625.3
6389	30.62	.30	1.1338	.5901	.0084	-.0030	.0086	-.0161	86483.4	-.239	625.6
6390	32.04	.33	1.1563	.6375	.0083	-.0029	.0018	-.0101	86642.3	-.251	625.7
6391	12.46	.14	.6927	.0868	.0223	-.0001	.0000	-.0128	86347.3	-.158	626.5

TEST TP	21 O PA	ALPHA DEG	RUN 57		CLT	CDT	CMST	CRTS	CYTS	CYST	CMU	WTFLO KG/SEC	PLENP PSI
			BETA DEG	CLT									
6378	15143.6	12.44	.14	.6591	.1311	-.0073	-.0003	-.0008	-.0091	.0934	.2616	507.5	
6379	15016.5	10.99	.12	.5684	.0997	-.0120	-.0001	-.0010	-.0084	.0942	.2616	507.4	
6380	15073.4	11.42	.13	.5971	.1090	-.0113	.0000	-.0010	-.0091	.0939	.2621	507.8	
6381	15305.9	13.56	.15	.7251	.1592	-.0023	.0005	-.0010	-.0101	.0925	.2620	507.9	
6382	15330.4	15.67	.17	.8290	.2142	.0040	.0017	-.0026	-.0080	.0924	.2619	507.9	
6383	15124.0	17.76	.20	.9352	.2776	.0012	.0001	-.0025	-.0089	.0936	.2619	508.0	
6384	14983.9	20.03	.22	1.0138	.3449	-.0025	-.0031	-.0006	-.0129	.0945	.2618	508.0	
6385	14781.5	22.21	.24	1.0862	.4184	-.0142	-.0014	-.0024	-.0123	.0957	.2616	508.0	
6386	14737.3	24.28	.25	1.1158	.4864	-.0383	-.0004	.0012	-.0066	.0961	.2618	507.7	
6387	14926.6	26.49	.25	1.0956	.5306	-.0353	-.0049	.0099	-.0101	.0949	.2616	508.0	
6388	14868.6	28.52	.27	1.1046	.5813	-.0311	-.0067	.0117	-.0126	.0952	.2615	507.9	
6389	14965.8	30.62	.30	1.0898	.6230	-.0216	-.0035	.0077	-.0132	.0946	.2613	508.0	
6390	14796.8	32.04	.33	1.1110	.6697	-.0220	-.0034	.0009	-.0072	.0957	.2614	507.9	
6391	15117.9	12.46	.14	.6614	.1313	-.0074	-.0003	-.0010	-.0100	.0937	.2610	508.0	

ORIGINAL PAGE IS OF POOR QUALITY

NASA LANGLEY

7 X 10 HIGH SPEED TUNNEL

TEST TP	21 MACH	Q PA	RUN 58 ALPHA DEG	BETA DEG	CNF(BA)	CAF(BA)	CPH(BA)	CRM(BA)	CYM(BA)	CSF(BA)	TPLEN DEG K
6404	.301	6107.6	11.56	5.04	.6203	-.0087	.0138	-.0100	.0136	-.0697	301.6
6405	.301	6090.6	10.44	5.05	.5523	-.0089	.0123	-.0110	.0139	-.0685	301.4
6406	.301	6084.1	10.69	5.05	.5659	-.0087	.0123	-.0111	.0138	-.0685	301.3
6407	.301	6106.1	12.66	5.04	.6801	-.0079	.0110	-.0083	.0126	-.0700	301.1
6408	.302	6123.3	14.43	5.03	.7712	-.0085	.0095	-.0074	.0107	-.0691	301.0
6409	.300	6079.6	16.54	5.01	.8712	-.0076	.0012	-.0054	.0076	-.0650	300.9
6410	.300	6079.8	18.59	4.99	.9318	-.0028	-.0107	-.0002	-.0004	-.0506	300.8
6411	.299	6006.3	20.63	4.96	.9639	.0032	-.0312	.0023	-.0106	-.0388	300.7
6412	.297	5962.1	22.97	4.91	1.0464	.0007	-.0341	.0002	-.0117	-.0346	300.7
6413	.300	6075.6	24.86	4.87	1.1032	-.0030	-.0360	.0026	-.0173	-.0264	300.6
6414	.300	6075.6	27.09	4.83	1.2061	-.0088	-.0385	.0100	-.0292	-.0190	300.6
6415	.300	6057.1	29.38	4.76	1.2815	-.0140	-.0387	.0053	-.0287	-.0124	300.5
6416	.300	6046.4	30.60	4.72	1.3254	-.0172	-.0410	.0030	-.0294	-.0092	300.5
6417	.301	6088.1	11.57	5.04	.6179	-.0084	.0131	-.0100	.0135	-.0698	300.4

TEST TP	21 ALPHA DEG	BETA DEG	RUN 58 CL(SA)	CD(SA)	CPH(SA)	CRM(SA)	CYM(SA)	CSF(SA)	P1 PA	CPB(1)	VTOT M/SEC
6404	11.56	5.04	.6095	.1159	.0138	-.0071	.0153	-.0697	96171.7	-.146	0.0
6405	10.44	5.05	.5448	.0913	.0123	-.0083	.0157	-.0685	96183.4	-.144	0.0
6406	10.69	5.05	.5577	.0965	.0123	-.0084	.0157	-.0685	96189.6	-.144	0.0
6407	12.66	5.04	.6653	.1414	.0110	-.0053	.0141	-.0700	96166.5	-.148	0.0
6408	14.43	5.03	.7490	.1839	.0095	-.0045	.0122	-.0691	96145.1	-.154	0.0
6409	16.54	5.01	.8373	.2408	.0012	-.0030	.0088	-.0650	96190.9	-.163	0.0
6410	18.59	4.99	.8841	.2944	-.0107	-.0004	-.0004	-.0506	96189.5	-.168	0.0
6411	20.63	4.96	.9010	.3427	-.0312	-.0016	-.0108	-.0388	96264.2	-.172	0.0
6412	22.97	4.91	.9631	.4090	-.0341	-.0044	-.0109	-.0346	96307.5	-.179	0.0
6413	24.86	4.87	1.0022	.4611	-.0360	-.0049	-.0168	-.0264	96187.1	-.186	0.0
6414	27.09	4.83	1.0778	.5414	-.0385	-.0044	-.0306	-.0190	96184.9	-.197	0.0
6415	29.38	4.76	1.1236	.6165	-.0387	-.0094	-.0276	-.0124	96202.7	-.208	0.0
6416	30.60	4.72	1.1496	.6599	-.0410	-.0124	-.0269	-.0092	96213.4	-.216	0.0
6417	11.57	5.04	.6070	.1157	.0131	-.0071	.0152	-.0698	96175.2	-.147	0.0

TEST TP	21 Q PA	ALPHA DEG	RUN 58 BETA DEG	CLT	CDT	CMST	CRTS	CYTS	CYST	CMU	WTFLOD KG/SEC	PLENPP PSI
6404	6107.6	11.56	5.04	.6095	.1159	.0138	-.0071	.0153	-.0697	0.0000	0.0000	-.0
6405	6090.6	10.44	5.05	.5448	.0913	.0123	-.0083	.0157	-.0685	0.0000	0.0000	-.1
6406	6084.1	10.69	5.05	.5577	.0965	.0123	-.0084	.0157	-.0685	0.0000	0.0000	-.1
6407	6106.1	12.66	5.04	.6653	.1414	.0110	-.0053	.0141	-.0700	0.0000	0.0000	-.1
6408	6123.3	14.43	5.03	.7490	.1839	.0095	-.0045	.0122	-.0691	0.0000	0.0000	-.1
6409	6079.6	16.54	5.01	.8373	.2408	.0012	-.0030	.0088	-.0650	0.0000	0.0000	-.2
6410	6079.8	18.59	4.99	.8841	.2944	-.0107	-.0004	-.0004	-.0506	0.0000	0.0000	-.2
6411	6006.3	20.63	4.96	.9010	.3427	-.0312	-.0016	-.0108	-.0388	0.0000	0.0000	-.2
6412	5962.1	22.97	4.91	.9631	.4090	-.0341	-.0044	-.0109	-.0346	0.0000	0.0000	-.3
6413	6075.6	24.86	4.87	1.0022	.4611	-.0360	-.0049	-.0168	-.0264	0.0000	0.0000	-.3
6414	6075.6	27.09	4.83	1.0778	.5414	-.0385	-.0044	-.0306	-.0190	0.0000	0.0000	-.4
6415	6057.1	29.38	4.76	1.1236	.6165	-.0387	-.0094	-.0276	-.0124	0.0000	0.0000	-.5
6416	6046.4	30.60	4.72	1.1496	.6599	-.0410	-.0124	-.0269	-.0092	0.0000	0.0000	-.6
6417	6088.1	11.57	5.04	.6070	.1157	.0131	-.0071	.0152	-.0698	0.0000	0.0000	-.1

NASA LANGLEY

7 X 10 HIGH SPEED TUNNEL

TEST TP	21 MACH	0 PA	RUN 59 ALPHA DEG	BETA DEG	CNF(BA)	CAF(BA)	CPM(BA)	CRM(BA)	CYN(BA)	CSF(BA)	TPLEN DEG K
6418	.301	6100.8	11.58	5.05	.6320	-.0368	.0193	-.0106	.0131	-.0723	295.8
6419	.301	6091.7	10.36	5.05	.5531	-.0357	.0177	-.0105	.0133	-.0719	295.1
6420	.301	6087.3	10.74	5.05	.5783	-.0359	.0183	-.0104	.0134	-.0723	294.9
6421	.301	6097.5	12.56	5.04	.6883	-.0371	.0206	-.0108	.0121	-.0714	294.6
6422	.301	6085.3	14.43	5.03	.7937	-.0395	.0196	-.0092	.0102	-.0707	294.3
6423	.301	6084.8	16.57	5.01	.9083	-.0423	.0141	-.0076	.0071	-.0658	294.2
6424	.299	6033.2	18.74	4.98	1.0135	-.0446	.0043	-.0043	.0033	-.0583	293.8
6425	.298	5999.8	20.91	4.95	1.1003	-.0469	-.0037	-.0027	-.0006	-.0510	293.6
6426	.300	6072.3	22.88	4.91	1.1594	-.0473	-.0053	-.0036	-.0033	-.0457	293.3
6427	.299	6019.4	25.00	4.86	1.2136	-.0410	-.0248	-.0027	-.0066	-.0381	293.1
6428	.302	6142.5	27.34	4.81	1.2636	-.0408	-.0315	.0050	-.0195	-.0215	293.0
6429	.300	6041.2	29.36	4.76	1.2794	-.0422	-.0340	.0073	-.0265	-.0144	292.8
6430	.300	6070.0	30.56	4.73	1.2980	-.0435	-.0359	.0104	-.0326	-.0094	292.6

TEST TP	21 ALPHA DEG	BETA DEG	RUN 59 CL(SA)	CD(SA)	CPM(SA)	CRM(SA)	CYN(SA)	CSF(SA)	P1 PA	CPB(I)	VTDT M/SEC
6418	11.58	5.05	.6266	.0908	.0193	-.0078	.0150	-.0723	96161.9	-.156	532.8
6419	10.36	5.05	.5505	.0643	.0177	-.0079	.0149	-.0719	96171.4	-.152	532.4
6420	10.74	5.05	.5749	.0724	.0183	-.0077	.0151	-.0723	96172.8	-.154	532.2
6421	12.56	5.04	.6799	.1135	.0206	-.0079	.0141	-.0714	96162.6	-.157	532.0
6422	14.43	5.03	.7785	.1596	.0196	-.0063	.0122	-.0707	96174.7	-.160	531.8
6423	16.57	5.01	.8827	.2185	.0141	-.0052	.0090	-.0658	96175.2	-.160	531.7
6424	18.74	4.98	.9741	.2834	.0043	-.0030	.0045	-.0583	96225.9	-.168	531.4
6425	20.91	4.95	1.0445	.3488	-.0037	-.0028	.0004	-.0510	96259.5	-.180	531.1
6426	22.88	4.91	1.0865	.4073	-.0053	-.0046	-.0016	-.0457	96178.2	-.188	531.0
6427	25.00	4.86	1.1172	.4757	-.0248	-.0053	-.0049	-.0381	96233.1	-.194	530.8
6428	27.34	4.81	1.1412	.5441	-.0315	-.0045	-.0196	-.0215	96097.8	-.198	530.8
6429	29.36	4.76	1.1357	.5905	-.0340	-.0066	-.0266	-.0144	96207.1	-.213	530.6
6430	30.56	4.73	1.1399	.6224	-.0359	-.0076	-.0334	-.0094	96168.3	-.221	530.4

TEST TP	21 Q PA	ALPHA DEG	RUN 59 BETA DEG	CLT	CDT	CNST	CRTS	CYTS	CYST	CMU	WTFLO KG/SEC	PLENP PSI
6418	6100.8	11.58	5.05	.6084	.1175	.0017	-.0079	.0144	-.0706	.0497	.0657	121.6
6419	6091.7	10.36	5.05	.5328	.0915	.0000	-.0080	.0143	-.0703	.0498	.0659	121.8
6420	6087.3	10.74	5.05	.5571	.0995	.0006	-.0078	.0145	-.0706	.0499	.0659	122.0
6421	6097.5	12.56	5.04	.6612	.1400	.0030	-.0081	.0135	-.0697	.0499	.0661	122.0
6422	6085.3	14.43	5.03	.7589	.1855	.0019	-.0065	.0116	-.0690	.0499	.0660	122.2
6423	6084.8	16.57	5.01	.8621	.2437	-.0036	-.0054	.0084	-.0641	.0501	.0662	122.2
6424	6033.2	18.74	4.98	.9524	.3080	-.0136	-.0032	.0039	-.0567	.0504	.0661	122.2
6425	5999.8	20.91	4.95	1.0218	.3727	-.0217	-.0030	-.0002	-.0493	.0508	.0663	122.2
6426	6072.3	22.88	4.91	1.0633	.4301	-.0231	-.0049	-.0022	-.0440	.0502	.0664	122.3
6427	6019.4	25.00	4.86	1.0929	.4979	-.0428	-.0056	-.0054	-.0364	.0506	.0662	122.3
6428	6142.5	27.34	4.81	1.1165	.5649	-.0491	-.0048	-.0201	-.0198	.0497	.0664	122.4
6429	6041.2	29.36	4.76	1.1099	.6107	-.0519	-.0069	-.0272	-.0128	.0505	.0663	122.4
6430	6070.0	30.56	4.73	1.1137	.6420	-.0537	-.0079	-.0339	-.0077	.0503	.0665	122.4

ORIGINAL PAGE IS
OF POOR QUALITY

NASA LANGLEY

7 X 10 HIGH SPEED TUNNEL

TEST TP	21		RUN 60		CNF(BA)	CAF(BA)	CPH(BA)	CRH(BA)	CYM(BA)	CSF(BA)	TPLEN DEG K
	MACH	Q PA	ALPHA DEG	BETA DEG							
6432	.301	6101.1	11.60	5.05	.6766	-.0643	.0199	-.0082	.0128	-.0743	289.1
6433	.301	6083.7	10.49	5.05	.5904	-.0624	.0165	-.0089	.0132	-.0752	288.9
6434	.300	6070.0	10.73	5.05	.6119	-.0631	.0172	-.0090	.0132	-.0751	288.8
6435	.301	6093.4	12.67	5.04	.7571	-.0675	.0227	-.0075	.0124	-.0754	288.8
6436	.301	6110.1	14.62	5.03	.8578	-.0715	.0341	-.0115	.0110	-.0717	288.8
6437	.301	6101.7	16.61	5.01	.9522	-.0738	.0311	-.0084	.0094	-.0661	288.7
6438	.300	6046.9	18.76	4.98	1.0652	-.0784	.0243	-.0062	.0049	-.0603	288.8
6439	.298	5990.7	20.91	4.95	1.1634	-.0828	.0177	-.0034	-.0006	-.0536	288.9
6440	.299	6020.3	23.04	4.91	1.2592	-.0857	.0080	.0001	-.0054	-.0480	289.0
6441	.299	6028.9	25.27	4.87	1.3317	-.0859	.0010	.0027	-.0088	-.0463	289.2
6442	.301	6080.3	27.21	4.82	1.3857	-.0821	-.0111	.0034	-.0146	-.0426	289.4
6443	.299	6020.7	29.55	4.76	1.4464	-.0811	-.0270	.0071	-.0230	-.0274	289.5
6444	.299	6034.2	30.74	4.73	1.4674	-.0830	-.0277	.0105	-.0282	-.0211	289.6
6445	.303	6158.1	11.63	5.05	.6879	-.0672	.0169	-.0080	.0133	-.0764	290.0

TEST TP	21		RUN 60		CPH(SA)	CRH(SA)	CYM(SA)	CSF(SA)	P1 PA	CPB(1)	VTDT M/SEC
	ALPHA DEG	BETA DEG	CL(SA)	CD(SA)							
6432	11.60	5.05	.6757	.0730	.0199	-.0054	.0142	-.0743	96134.5	-.152	569.7
6433	10.49	5.05	.5919	.0461	.0165	-.0063	.0146	-.0752	96152.6	-.147	569.6
6434	10.73	5.05	.6129	.0519	.0172	-.0063	.0146	-.0751	96167.0	-.148	569.6
6435	12.67	5.04	.7534	.1002	.0227	-.0046	.0137	-.0754	96139.6	-.155	569.6
6436	14.62	5.03	.8481	.1473	.0341	-.0083	.0136	-.0717	96118.1	-.160	569.7
6437	16.61	5.01	.9336	.2019	.0311	-.0054	.0114	-.0661	96127.0	-.162	569.7
6438	18.76	4.98	1.0339	.2683	.0243	-.0043	.0066	-.0603	96177.6	-.162	569.8
6439	20.91	4.95	1.1163	.3379	.0177	-.0034	.0007	-.0536	96239.9	-.170	569.9
6440	23.04	4.91	1.1922	.4140	.0080	-.0020	-.0050	-.0480	96205.5	-.182	570.1
6441	25.27	4.87	1.2410	.4907	.0010	-.0013	-.0091	-.0463	96196.5	-.192	570.3
6442	27.21	4.82	1.2700	.5605	-.0111	-.0036	-.0146	-.0426	96142.6	-.201	570.6
6443	29.55	4.76	1.2983	.6427	-.0270	-.0052	-.0235	-.0274	96204.0	-.209	570.7
6444	30.74	4.73	1.3036	.6788	-.0277	-.0053	-.0296	-.0211	96188.6	-.215	570.9
6445	11.63	5.05	.6873	.0728	.0169	-.0052	.0146	-.0764	96061.1	-.152	571.5

TEST TP	21		RUN 60		CMST	CRTS	CYTS	CYST	CMU	WTFLO KG/SEC	PLENP PSI	
	ALPHA DEG	BETA DEG	CLT	CDT								
6432	6101.1	11.60	5.05	.6413	.1237	-.0135	-.0057	.0131	-.0712	.0996	.1231	230.7
6433	6083.7	10.49	5.05	.5583	.0975	-.0170	-.0065	.0135	-.0720	.1004	.1238	230.9
6434	6070.0	10.73	5.05	.5790	.1035	-.0165	-.0066	.0135	-.0719	.1003	.1234	231.4
6435	6093.4	12.67	5.04	.7179	.1504	-.0108	-.0049	.0126	-.0722	.1000	.1235	231.6
6436	6110.1	14.62	5.03	.8109	.1962	.0006	-.0086	.0125	-.0686	.0998	.1236	231.8
6437	6101.7	16.61	5.01	.8947	.2492	-.0024	-.0057	.0103	-.0629	.1000	.1237	232.0
6438	6046.9	18.76	4.98	.9928	.3150	-.0096	-.0047	.0055	-.0571	.1010	.1238	232.2
6439	5990.7	20.91	4.95	1.0731	.3834	-.0166	-.0038	-.0004	-.0504	.1020	.1238	232.3
6440	6020.3	23.04	4.91	1.1475	.4577	-.0261	-.0024	-.0061	-.0448	.1015	.1238	232.6
6441	6028.9	25.27	4.87	1.1946	.5327	-.0331	-.0018	-.0102	-.0431	.1016	.1240	232.9
6442	6080.3	27.21	4.82	1.2226	.6005	-.0449	-.0042	-.0156	-.0394	.1007	.1239	233.1
6443	6020.7	29.55	4.76	1.2488	.6812	-.0611	-.0058	-.0246	-.0241	.1021	.1244	233.2
6444	6034.2	30.74	4.73	1.2533	.7162	-.0618	-.0060	-.0306	-.0178	.1018	.1243	233.5
6445	6158.1	11.63	5.05	.6527	.1236	-.0166	-.0054	.0135	-.0733	.1000	.1244	234.0

NASA LANGLEY

7 X 10 HIGH SPEED TUNNEL

TEST TP	21 MACH	Q PA	RUN 61 ALPHA DEG	BETA DEG	CNF(BA)	CAF(BA)	CPH(BA)	CRM(BA)	CYM(BA)	CSF(BA)	TPLEN DEG K
6446	.301	6096.4	11.67	5.05	.7447	-.1215	.0142	-.0057	.0141	-.0827	292.3
6447	.301	6079.7	10.37	5.05	.6143	-.1187	.0160	-.0078	.0147	-.0828	292.5
6448	.300	6069.2	10.74	5.05	.6533	-.1201	.0151	-.0071	.0148	-.0831	292.7
6449	.300	6075.8	12.79	5.04	.8470	-.1259	.0148	-.0071	.0130	-.0821	292.8
6450	.301	6093.0	14.63	5.03	1.0008	-.1308	.0145	-.0076	.0114	-.0813	292.9
6451	.301	6082.4	16.72	5.01	1.1541	-.1383	.0136	-.0072	.0099	-.0819	292.9
6452	.299	6027.1	18.96	4.98	1.2656	-.1487	.0299	-.0165	.0090	-.0789	293.0
6453	.299	6016.2	21.22	4.94	1.3412	-.1533	.0367	-.0148	.0075	-.0744	293.0
6454	.299	6033.8	23.49	4.90	1.4302	-.1553	.0348	-.0146	.0046	-.0679	293.0
6455	.301	6078.8	25.28	4.87	1.4713	-.1456	.0142	-.0081	-.0070	-.0535	293.0
6456	.300	6052.8	27.38	4.83	1.5108	-.1443	.0093	.0045	-.0236	-.0432	292.9
6457	.298	5989.3	29.60	4.78	1.5864	-.1479	.0047	.0071	-.0317	-.0405	292.9
6458	.301	6079.0	30.88	4.75	1.5885	-.1451	.0030	.0152	-.0405	-.0389	292.9
6459	.302	6130.7	11.66	5.05	.7414	-.1216	.0152	-.0061	.0142	-.0836	292.8

TEST TP	21 ALPHA DEG	BETA DEG	RUN 61 CL(SA)	CD(SA)	CPH(SA)	CRM(SA)	CYM(SA)	CSF(SA)	P1 PA	CP8(1)	VTOT M/SEC
6446	11.67	5.05	.7538	-.0316	.0142	-.0028	.0150	-.0827	96130.0	-.151	607.2
6447	10.37	5.05	.6257	-.0062	.0160	-.0050	.0159	-.0828	96147.8	-.149	607.4
6448	10.74	5.05	.6642	.0037	.0151	-.0043	.0158	-.0831	96159.0	-.150	607.7
6449	12.79	5.04	.8539	.0647	.0148	-.0040	.0143	-.0821	96152.1	-.153	607.9
6450	14.63	5.03	1.0014	.1263	.0145	-.0045	.0129	-.0813	96129.3	-.154	608.0
6451	16.72	5.01	1.1451	.1996	.0136	-.0040	.0116	-.0819	96140.5	-.157	608.1
6452	18.96	4.98	1.2453	.2706	.0299	-.0127	.0138	-.0789	96191.7	-.166	608.1
6453	21.22	4.94	1.3057	.3426	.0367	-.0111	.0124	-.0744	96207.1	-.171	608.2
6454	23.49	4.90	1.3736	.4276	.0348	-.0116	.0101	-.0679	96184.6	-.175	608.2
6455	25.28	4.87	1.3926	.4965	.0142	-.0103	-.0029	-.0535	96137.4	-.177	608.2
6456	27.38	4.83	1.4079	.5668	.0093	-.0068	-.0230	-.0432	96162.1	-.184	608.1
6457	29.60	4.78	1.4525	.6550	.0047	-.0095	-.0310	-.0405	96224.4	-.191	608.1
6458	30.88	4.75	1.4379	.6907	.0030	-.0077	-.0425	-.0389	96130.5	-.202	608.1
6459	11.66	5.05	.7506	.0308	.0152	-.0031	.0151	-.0836	96076.3	-.151	608.1

TEST TP	21 Q PA	ALPHA DEG	RUN 61 BETA DEG	CLT	CDT	CMST	CRTS	CYTS	CYST	CMU	WTFLO KG/SEC	PLENP PSI
6446	6096.4	11.67	5.05	.6896	.1259	-.0481	-.0032	.0129	-.0768	.1934	.2242	429.8
6447	6079.7	10.37	5.05	.5633	.0900	-.0464	-.0054	.0138	-.0769	.1940	.2242	430.4
6448	6069.2	10.74	5.05	.6010	.0997	-.0476	-.0047	.0137	-.0772	.1949	.2248	430.9
6449	6075.8	12.79	5.04	.7873	.1584	-.0479	-.0045	.0122	-.0761	.1945	.2245	431.3
6450	6093.0	14.63	5.03	.9320	.2176	-.0480	-.0051	.0108	-.0754	.1943	.2249	431.6
6451	6082.4	16.72	5.01	1.0723	.2886	-.0491	-.0047	.0095	-.0760	.1946	.2248	431.9
6452	6027.1	18.96	4.98	1.1683	.3574	-.0334	-.0134	.0118	-.0729	.1966	.2250	431.9
6453	6016.2	21.22	4.94	1.2252	.4265	-.0268	-.0119	.0103	-.0684	.1972	.2253	432.2
6454	6033.8	23.49	4.90	1.2900	.5080	-.0284	-.0125	.0080	-.0619	.1964	.2250	432.3
6455	6078.8	25.28	4.87	1.3072	.5738	-.0486	-.0113	-.0049	-.0475	.1951	.2252	432.4
6456	6052.8	27.38	4.83	1.3193	.6412	-.0538	-.0078	-.0250	-.0372	.1959	.2252	432.6
6457	5989.3	29.60	4.78	1.3600	.7267	-.0591	-.0106	-.0330	-.0344	.1982	.2255	432.7
6458	6079.0	30.88	4.75	1.3452	.7593	-.0598	-.0089	-.0444	-.0330	.1953	.2255	432.8
6459	6130.7	11.66	5.05	.6863	.1252	-.0471	-.0035	.0130	-.0777	.1936	.2254	432.7

NASA LANGLEY

7 X 10 HIGH SPEED TUNNEL

TEST TP	21 MACH	Q PA	RUN 62 ALPHA DEG	BETA DEG	CNF(BA)	CAF(BA)	CPM(BA)	CRM(BA)	CYM(BA)	CSF(BA)	TPL EN DEG K
6460	.300	6074.6	11.68	5.05	.7584	-.1429	.0165	-.0048	.0153	-.0848	293.4
6461	.300	6064.7	10.31	5.05	.6099	-.1395	.0210	-.0072	.0158	-.0851	293.5
6462	.300	6052.4	10.73	5.05	.6529	-.1407	.0186	-.0061	.0156	-.0854	293.7
6463	.300	6063.3	12.73	5.04	.8588	-.1470	.0161	-.0069	.0140	-.0838	293.8
6464	.300	6049.6	14.66	5.03	1.0154	-.1529	.0160	-.0093	.0121	-.0829	293.9
6466	.300	6044.5	18.98	4.98	1.3432	-.1698	.0158	-.0136	.0085	-.0817	294.2
6467	.298	5980.3	21.03	4.95	1.4081	-.1789	.0413	-.0150	.0072	-.0766	294.3
6468	.300	6046.8	23.31	4.90	1.4835	-.1792	.0409	-.0141	.0055	-.0701	294.5
6469	.302	6117.0	25.78	4.86	1.5314	-.1679	.0175	-.0043	-.0115	-.0486	294.6
6470	.300	6046.5	27.51	4.82	1.5926	-.1705	.0157	-.0052	-.0151	-.0478	294.8
6471	.300	6038.3	29.59	4.76	1.6627	-.1718	.0088	-.0048	-.0211	-.0424	294.9
6472	.300	6065.6	30.97	4.74	1.6607	-.1692	.0065	.0062	-.0344	-.0354	295.0
6473	.302	6122.1	11.68	5.05	.7497	-.1434	.0158	-.0052	.0152	-.0857	295.4

TEST TP	21 ALPHA DEG	BETA DEG	RUN 62 CL(SA)	CD(SA)	CPH(SA)	CRM(SA)	CYM(SA)	CSF(SA)	P1 PA	CPB(1)	VTOT M/SEC
6460	11.68	5.05	.7716	.0136	.0165	-.0016	.0160	-.0848	96128.3	-.151	616.4
6461	10.31	5.05	.6250	-.0282	.0210	-.0043	.0168	-.0851	96138.6	-.149	616.6
6462	10.73	5.05	.6677	-.0166	.0186	-.0031	.0165	-.0854	96151.5	-.149	616.7
6463	12.73	5.04	.8701	.0458	.0161	-.0036	.0152	-.0838	96140.1	-.153	616.9
6464	14.66	5.03	1.0210	.1091	.0160	-.0060	.0140	-.0829	96154.5	-.153	617.0
6466	18.98	4.98	1.3254	.2763	.0158	-.0101	.0124	-.0817	96159.8	-.168	617.3
6467	21.03	4.95	1.3785	.3383	.0413	-.0115	.0121	-.0766	96227.0	-.171	617.4
6468	23.31	4.90	1.4334	.4223	.0409	-.0108	.0106	-.0701	96150.6	-.171	617.7
6469	25.78	4.86	1.4520	.5148	.0175	-.0089	-.0085	-.0486	96077.8	-.174	617.9
6470	27.51	4.82	1.4913	.5844	.0157	-.0116	-.0110	-.0478	96150.9	-.180	618.0
6471	29.59	4.76	1.5306	.6716	.0088	-.0146	-.0160	-.0424	96161.9	-.187	618.1
6472	30.97	4.74	1.5109	.7096	.0065	-.0124	-.0327	-.0354	96136.0	-.197	618.2
6473	11.68	5.05	.7632	.0113	.0158	-.0020	.0159	-.0857	96078.5	-.152	618.6

TEST TP	21 Q PA	ALPHA DEG	RUN 62 BETA DEG	CLT	CDT	CMST	CRTS	CYTS	CYST	CMU	WTFLO KG/SEC	PLENP PSI
6460	6074.6	11.68	5.05	.6954	.1254	-.0573	-.0021	.0135	-.0778	.2320	.2641	507.9
6461	6064.7	10.31	5.05	.5513	.0857	-.0529	-.0047	.0143	-.0781	.2324	.2640	507.8
6462	6052.4	10.73	5.05	.5930	.0969	-.0555	-.0036	.0139	-.0784	.2331	.2641	508.1
6463	6063.3	12.73	5.04	.7916	.1566	-.0579	-.0042	.0127	-.0768	.2325	.2639	508.3
6464	6049.6	14.66	5.03	.9386	.2174	-.0582	-.0066	.0115	-.0759	.2332	.2641	508.4
6466	6044.5	18.98	4.98	1.2350	.3782	-.0585	-.0110	.0100	-.0747	.2332	.2637	508.4
6467	5980.3	21.03	4.95	1.2835	.4379	-.0338	-.0124	.0097	-.0695	.2359	.2638	508.6
6468	6046.8	23.31	4.90	1.3356	.5171	-.0333	-.0118	.0082	-.0631	.2333	.2638	508.7
6469	6117.0	25.78	4.86	1.3513	.6043	-.0559	-.0100	-.0108	-.0417	.2308	.2639	508.8
6470	6046.5	27.51	4.82	1.3867	.6718	-.0586	-.0128	-.0133	-.0406	.2336	.2640	508.9
6471	6038.3	29.59	4.76	1.4228	.7552	-.0656	-.0159	-.0183	-.0353	.2337	.2636	508.8
6472	6065.6	30.97	4.74	1.4016	.7902	-.0675	-.0137	-.0349	-.0284	.2327	.2636	508.9
6473	6122.1	11.68	5.05	.6873	.1226	-.0576	-.0025	.0134	-.0787	.2307	.2637	509.1

ORIGINAL PAGE IS OF POOR QUALITY

JIMMUT 02822 M01H 01 X Y
NASA LANGLEY

7 X 10 HIGH SPEED TUNNEL

TEST TP	21	HE3PT	(A)3P22	RUN# 63	ALPHA	BETA	CNF(BA)	CAF(BA)	CPH(BA)	CRM(BA)	CYM(BA)	CSF(BA)	CPB(1)	WTOT	PLENP
6474	15115.7	12.46	5.07	6789	1.366	-0.013	-0.0025	0.149	-0.0794	86166.5	-0.164	625.0	511.2		
6475	15127.0	11.43	5.07	6804	1.042	-0.0153	-0.0068	0.159	-0.0789	86186.2	-0.161	625.1	511.2		
6476	15087.7	11.43	5.07	6819	1.108	-0.0147	-0.0062	0.158	-0.0773	86189.7	-0.162	625.3	511.2		
6477	15097.0	13.71	5.06	6834	1.191	-0.0099	-0.0017	0.125	-0.0749	86201.3	-0.166	625.5	511.2		
6478	15104.3	15.68	5.05	6849	1.382	-0.0022	-0.0013	0.099	-0.0704	86166.2	-0.169	625.5	511.2		
6479	15059.4	17.90	5.04	6864	1.296	-0.0034	-0.0034	0.064	-0.0693	86242.9	-0.168	625.5	511.2		
6480	14953.1	20.06	5.02	6879	1.070	-0.0057	-0.0025	0.054	-0.0654	86358.9	-0.173	625.6	511.2		
6481	14985.6	22.26	5.02	6894	1.070	-0.0061	-0.0013	0.059	-0.0594	86289.4	-0.190	625.7	511.2		
6482	15217.0	24.40	5.06	6909	1.463	-0.0228	-0.0016	0.009	-0.0487	86048.3	-0.194	626.0	511.2		
6483	14983.6	26.62	5.03	6924	1.308	-0.0233	-0.0033	0.083	-0.0403	86348.4	-0.202	625.9	511.2		
6484	15039.5	28.73	5.06	6939	1.234	-0.0228	-0.0073	0.214	-0.0361	86281.1	-0.219	626.1	511.2		
6485	14983.2	30.83	5.04	6954	1.639	-0.0122	-0.0127	0.219	-0.0306	86352.2	-0.238	626.1	511.2		
6486	14475.4	32.42	5.07	6969	1.016	-0.0013	-0.0155	0.077	-0.0797	86909.5	-0.163	626.1	511.2		

TEST TP	21	HE3PT	(A)3P22	RUN# 63	ALPHA	BETA	CLT	COY	CMST	CRTS	CYTS	CYST	CMU	WTFLO	PLENP
6474	15115.7	12.46	5.07	6789	1.366	-0.013	-0.0025	0.149	-0.0794	86166.5	-0.164	625.0	511.2		
6475	15127.0	11.43	5.07	6804	1.042	-0.0153	-0.0068	0.159	-0.0789	86186.2	-0.161	625.1	511.2		
6476	15087.7	11.43	5.07	6819	1.108	-0.0147	-0.0062	0.158	-0.0773	86189.7	-0.162	625.3	511.2		
6477	15097.0	13.71	5.06	6834	1.191	-0.0099	-0.0017	0.125	-0.0749	86201.3	-0.166	625.5	511.2		
6478	15104.3	15.68	5.05	6849	1.382	-0.0022	-0.0013	0.099	-0.0704	86166.2	-0.169	625.5	511.2		
6479	15059.4	17.90	5.04	6864	1.296	-0.0034	-0.0034	0.064	-0.0693	86242.9	-0.168	625.5	511.2		
6480	14953.1	20.06	5.02	6879	1.070	-0.0057	-0.0025	0.054	-0.0654	86358.9	-0.173	625.6	511.2		
6481	14985.6	22.26	5.02	6894	1.070	-0.0061	-0.0013	0.059	-0.0594	86289.4	-0.190	625.7	511.2		
6482	15217.0	24.40	5.06	6909	1.463	-0.0228	-0.0016	0.009	-0.0487	86048.3	-0.194	626.0	511.2		
6483	14983.6	26.62	5.03	6924	1.308	-0.0233	-0.0033	0.083	-0.0403	86348.4	-0.202	625.9	511.2		
6484	15039.5	28.73	5.06	6939	1.234	-0.0228	-0.0073	0.214	-0.0361	86281.1	-0.219	626.1	511.2		
6485	14983.2	30.83	5.04	6954	1.639	-0.0122	-0.0127	0.219	-0.0306	86352.2	-0.238	626.1	511.2		
6486	14475.4	32.42	5.07	6969	1.016	-0.0013	-0.0155	0.077	-0.0797	86909.5	-0.163	626.1	511.2		

TEST TP	21	HE3PT	(A)3P22	RUN# 63	ALPHA	BETA	CLT	COY	CMST	CRTS	CYTS	CYST	CMU	WTFLO	PLENP
6474	15115.7	12.46	5.07	6789	1.366	-0.013	-0.0025	0.149	-0.0794	86166.5	-0.164	625.0	511.2		
6475	15127.0	11.43	5.07	6804	1.042	-0.0153	-0.0068	0.159	-0.0789	86186.2	-0.161	625.1	511.2		
6476	15087.7	11.43	5.07	6819	1.108	-0.0147	-0.0062	0.158	-0.0773	86189.7	-0.162	625.3	511.2		
6477	15097.0	13.71	5.06	6834	1.191	-0.0099	-0.0017	0.125	-0.0749	86201.3	-0.166	625.5	511.2		
6478	15104.3	15.68	5.05	6849	1.382	-0.0022	-0.0013	0.099	-0.0704	86166.2	-0.169	625.5	511.2		
6479	15059.4	17.90	5.04	6864	1.296	-0.0034	-0.0034	0.064	-0.0693	86242.9	-0.168	625.5	511.2		
6480	14953.1	20.06	5.02	6879	1.070	-0.0057	-0.0025	0.054	-0.0654	86358.9	-0.173	625.6	511.2		
6481	14985.6	22.26	5.02	6894	1.070	-0.0061	-0.0013	0.059	-0.0594	86289.4	-0.190	625.7	511.2		
6482	15217.0	24.40	5.06	6909	1.463	-0.0228	-0.0016	0.009	-0.0487	86048.3	-0.194	626.0	511.2		
6483	14983.6	26.62	5.03	6924	1.308	-0.0233	-0.0033	0.083	-0.0403	86348.4	-0.202	625.9	511.2		
6484	15039.5	28.73	5.06	6939	1.234	-0.0228	-0.0073	0.214	-0.0361	86281.1	-0.219	626.1	511.2		
6485	14983.2	30.83	5.04	6954	1.639	-0.0122	-0.0127	0.219	-0.0306	86352.2	-0.238	626.1	511.2		
6486	14475.4	32.42	5.07	6969	1.016	-0.0013	-0.0155	0.077	-0.0797	86909.5	-0.163	626.1	511.2		

NASA LANGLEY

7 X 10 HIGH SPEED TUNNEL

TEST TP	21		RUN 64		CNF(BA)	CAF(BA)	CPN(BA)	CRM(BA)	CYM(BA)	CSF(BA)	TPLEN DEG K
	MACH	Q PA	ALPHA DEG	BETA DEG							
6501	.502	15098.6	12.30	5.06	.6518	-.0071	.0086	-.0090	.0140	-.0716	288.4
6502	.498	14903.4	10.84	5.06	.5673	-.0088	.0103	-.0112	.0144	-.0692	288.7
6503	.497	14855.2	11.32	5.06	.5956	-.0088	.0114	-.0116	.0144	-.0699	288.9
6504	.502	15101.4	13.34	5.06	.7037	-.0073	.0078	-.0081	.0129	-.0720	289.2
6505	.501	15047.3	15.34	5.05	.8006	-.0067	.0011	-.0067	.0104	-.0694	289.6
6506	.501	15033.9	17.40	5.03	.8822	-.0041	-.0099	-.0043	.0056	-.0612	290.0
6507	.500	14995.1	19.35	5.04	.8846	.0034	-.0259	.0030	-.0111	-.0410	290.4
6508	.498	14891.8	21.46	4.99	.9255	.0030	-.0233	-.0047	-.0073	-.0416	290.7
6509	.495	14755.0	23.77	4.93	.9952	-.0007	-.0175	-.0099	-.0052	-.0431	290.9
6510	.495	14734.8	25.99	4.88	1.1070	-.0053	-.0233	-.0125	-.0066	-.0418	291.2
6511	.500	15012.8	28.39	4.80	1.2122	-.0119	-.0294	-.0196	-.0036	-.0399	291.5
6512	.497	14836.7	30.68	4.71	1.3056	-.0172	-.0340	-.0289	.0006	-.0351	291.8
6513	.500	14966.9	31.95	4.67	1.3611	-.0210	-.0339	-.0287	-.0027	-.0297	292.1
6514	.501	15062.5	12.30	5.06	.6527	-.0084	.0099	-.0078	.0137	-.0712	293.0

TEST TP	21		RUN 64		CPN(SA)	CRM(SA)	CYM(SA)	CSF(SA)	P1 PA	CPB(1)	VTOT M/SEC
	ALPHA DEG	BETA DEG	CL(SA)	CD(SA)							
6501	12.30	5.06	.6384	.1319	.0086	-.0058	.0155	-.0716	85545.9	-.147	0.0
6502	10.84	5.06	.5588	.0981	.0103	-.0083	.0163	-.0692	85797.3	-.144	0.0
6503	11.32	5.06	.5857	.1082	.0114	-.0086	.0164	-.0699	85829.7	-.145	0.0
6504	13.34	5.06	.6864	.1553	.0078	-.0049	.0144	-.0720	85548.2	-.152	0.0
6505	15.34	5.05	.7739	.2053	.0011	-.0033	.0118	-.0694	85585.4	-.157	0.0
6506	17.40	5.03	.8431	.2599	-.0099	-.0024	.0066	-.0612	85633.7	-.166	0.0
6507	19.35	5.04	.8335	.2962	-.0259	-.0009	-.0115	-.0410	85694.3	-.168	0.0
6508	21.46	4.99	.8603	.3413	-.0233	-.0071	-.0051	-.0416	85813.5	-.177	0.0
6509	23.77	4.93	.9111	.4005	-.0175	-.0112	-.0008	-.0431	85971.9	-.186	0.0
6510	25.99	4.88	.9973	.4804	-.0233	-.0142	-.0005	-.0418	85962.9	-.195	0.0
6511	28.39	4.80	1.0720	.5659	-.0294	-.0190	.0062	-.0399	85619.6	-.215	0.0
6512	30.68	4.71	1.1317	.6512	-.0340	-.0246	.0153	-.0351	85916.6	-.223	0.0
6513	31.95	4.67	1.1659	.7025	-.0339	-.0257	.0129	-.0297	85675.6	-.242	0.0
6514	12.30	5.06	.6395	.1308	.0099	-.0046	.0151	-.0712	85654.2	-.148	0.0

TEST TP	21		RUN 64		CLT	CDT	CMST	CRTS	CYTS	CYST	CHU	WTFLO KG/SEC	PLENP PSI
	Q PA	ALPHA DEG	BETA DEG	CLT									
6501	15098.6	12.30	5.06	.6384	.1319	.0086	-.0058	.0155	-.0716	0.0000	0.0000	0.0	
6502	14903.4	10.84	5.06	.5588	.0981	.0103	-.0083	.0163	-.0692	0.0000	0.0000	.1	
6503	14855.2	11.32	5.06	.5857	.1082	.0114	-.0086	.0164	-.0699	0.0000	0.0000	.1	
6504	15101.4	13.34	5.06	.6864	.1553	.0078	-.0049	.0144	-.0720	0.0000	0.0000	-.1	
6505	15047.3	15.34	5.05	.7739	.2053	.0011	-.0033	.0118	-.0694	0.0000	0.0000	-.3	
6506	15033.9	17.40	5.03	.8431	.2599	-.0099	-.0024	.0066	-.0612	0.0000	0.0000	-.3	
6507	14995.1	19.35	5.04	.8335	.2962	-.0259	-.0009	-.0115	-.0410	0.0000	0.0000	-.4	
6508	14891.8	21.46	4.99	.8603	.3413	-.0233	-.0071	-.0051	-.0416	0.0000	0.0000	-.5	
6509	14755.0	23.77	4.93	.9111	.4005	-.0175	-.0112	-.0008	-.0431	0.0000	0.0000	-.7	
6510	14734.8	25.99	4.88	.9973	.4804	-.0233	-.0142	-.0005	-.0418	0.0000	0.0000	-1.0	
6511	15012.8	28.39	4.80	1.0720	.5659	-.0294	-.0190	.0062	-.0399	0.0000	0.0000	-1.0	
6512	14836.7	30.68	4.71	1.1317	.6512	-.0340	-.0246	.0153	-.0351	0.0000	0.0000	-1.1	
6513	14966.9	31.95	4.67	1.1659	.7025	-.0339	-.0257	.0129	-.0297	0.0000	0.0000	-1.2	
6514	15062.5	12.30	5.06	.6395	.1308	.0099	-.0046	.0151	-.0712	0.0000	0.0000	-.2	

NASA LANGLEY

7 X 10 HIGH SPEED TUNNEL

TEST TP	21		RUN 65		CNF(BA)	CAF(BA)	CPM(BA)	CRM(BA)	CYM(BA)	CSF(BA)	TPLEN DEG K
	MACH	Q PA	ALPHA DEG	BETA DEG							
6515	.499	14937.5	12.36	5.06	.6678	-.0364	.0192	-.0104	.0139	-.0739	287.0
6516	.498	14883.1	10.98	5.06	.9889	-.0358	.0157	-.0105	.0145	-.0745	286.8
6517	.500	14983.7	11.40	5.07	.6159	-.0359	.0165	-.0107	.0145	-.0764	286.8
6518	.503	15126.0	13.40	5.06	.7189	-.0365	.0197	-.0105	.0129	-.0725	286.6
6519	.502	15067.3	15.59	5.05	.8307	-.0381	.0147	-.0088	.0100	-.0697	286.5
6520	.500	14982.6	17.57	5.03	.9205	-.0398	.0098	-.0065	.0062	-.0648	286.5
6521	.498	14917.5	19.66	5.02	.9999	-.0430	.0068	-.0020	-.0004	-.0548	286.5
6522	.497	14858.0	21.89	4.99	1.0886	-.0429	-.0005	-.0001	-.0066	-.0490	286.4
6523	.496	14782.6	23.99	4.96	1.1504	-.0388	-.0200	-.0001	-.0110	-.0473	286.4
6524	.497	14826.0	26.19	4.91	1.1919	-.0396	-.0199	-.0019	-.0124	-.0447	286.4
6525	.497	14856.2	28.38	4.83	1.2143	-.0412	-.0122	-.0116	-.0088	-.0419	286.4
6526	.496	14800.3	30.51	4.76	1.2352	-.0446	-.0048	-.0136	-.0070	-.0430	286.5
6527	.498	14920.9	31.97	4.70	1.2803	-.0471	-.0045	-.0183	-.0019	-.0452	286.6
6528	.498	14887.6	12.35	5.06	.6674	-.0374	.0193	-.0104	.0138	-.0737	287.1

TEST TP	21		RUN 65		CPM(SA)	CRM(SA)	CYM(SA)	CSF(SA)	P1 PA	CPB(1)	VTOT M/SEC
	ALPHA DEG	BETA DEG	CL(SA)	CD(SA)							
6515	12.36	5.06	.6602	.1074	.0192	-.0072	.0158	-.0739	85706.7	-.157	585.0
6516	10.98	5.06	.5849	.0770	.0157	-.0075	.0162	-.0745	85762.2	-.153	585.0
6517	11.40	5.07	.6108	.0866	.0165	-.0076	.0163	-.0764	85646.0	-.155	585.1
6518	13.40	5.06	.7078	.1311	.0197	-.0072	.0150	-.0725	85544.2	-.159	585.1
6519	15.59	5.05	.8104	.1865	.0147	-.0058	.0120	-.0697	85550.2	-.165	585.2
6520	17.57	5.03	.8896	.2399	.0098	-.0043	.0078	-.0648	85650.7	-.170	585.2
6521	19.66	5.02	.9560	.2959	.0068	-.0020	.0003	-.0548	85765.1	-.181	585.1
6522	21.89	4.99	1.0261	.3660	-.0005	-.0025	-.0061	-.0490	85806.8	-.190	585.1
6523	23.99	4.96	1.0668	.4324	-.0200	-.0045	-.0100	-.0473	85923.5	-.196	585.1
6524	26.19	4.91	1.0870	.4904	-.0199	-.0072	-.0103	-.0447	85900.8	-.203	585.2
6525	28.38	4.83	1.0880	.5409	-.0122	-.0143	-.0022	-.0419	85802.1	-.217	585.3
6526	30.51	4.76	1.0869	.5887	-.0048	-.0153	.0009	-.0430	85856.6	-.249	585.4
6527	31.97	4.70	1.1111	.6379	-.0045	-.0166	.0081	-.0492	85790.0	-.270	585.6
6528	12.35	5.06	.6599	.1062	.0193	-.0072	.0157	-.0737	85754.0	-.157	586.3

TEST TP	21		RUN 65		CDT	CMST	CRTS	CYTS	CYST	CMU	WTFLO KG/SEC	PLENP PSI
	MACH	Q PA	ALPHA DEG	BETA DEG								
6515	14937.5	12.36	5.06	.6429	.1321	.0028	-.0073	.0153	-.0724	.0501	.1478	278.4
6516	14883.1	10.98	5.06	.5681	.1022	-.0008	-.0076	.0156	-.0730	.0505	.1483	279.1
6517	14983.7	11.40	5.07	.5939	.1117	.0001	-.0077	.0158	-.0748	.0503	.1486	279.9
6518	15126.0	13.40	5.06	.6901	.1553	.0034	-.0073	.0144	-.0710	.0500	.1492	280.4
6519	15067.3	15.59	5.05	.7917	.2102	-.0017	-.0059	.0114	-.0682	.0502	.1494	281.2
6520	14982.6	17.57	5.03	.8699	.2632	-.0068	-.0045	.0073	-.0632	.0506	.1496	281.8
6521	14917.5	19.66	5.02	.9355	.3186	-.0099	-.0022	-.0003	-.0532	.0509	.1500	282.1
6522	14858.0	21.89	4.99	1.0045	.3880	-.0173	-.0027	-.0066	-.0474	.0512	.1501	282.5
6523	14782.6	23.99	4.96	1.0443	.4536	-.0369	-.0048	-.0105	-.0457	.0515	.1503	282.6
6524	14826.0	26.19	4.91	1.0638	.5108	-.0368	-.0074	-.0108	-.0432	.0513	.1501	283.1
6525	14856.2	28.38	4.83	1.0640	.5603	-.0290	-.0146	-.0027	-.0403	.0514	.1507	283.4
6526	14800.3	30.51	4.76	1.0620	.6073	-.0217	-.0156	.0004	-.0414	.0516	.1506	283.6
6527	14920.9	31.97	4.70	1.0860	.6557	-.0213	-.0169	.0076	-.0436	.0512	.1506	283.8
6528	14887.6	12.35	5.06	.6422	.1316	.0024	-.0074	.0151	-.0721	.0514	.1507	284.6

ORIGINAL PAGE IS OF POOR QUALITY

NASA LANGLEY

7 X 10 HIGH SPEED TUNNEL

TEST TP	21 MACH	Q PA	RUN 66		CNF(BA)	CAF(BA)	CPH(BA)	CRM(BA)	CYM(BA)	CSF(BA)	TPLEN DEG K
			ALPHA DEG	BETA DEG							
6544	.303	6153.4	11.56	5.06	.6253	-.0098	.0189	-.0034	-.0125	-.0289	295.6
6545	.303	6136.5	10.29	5.06	.5400	-.0097	.0170	-.0040	-.0128	-.0261	295.6
6546	.301	6068.3	10.75	5.06	.5710	-.0101	.0175	-.0040	-.0129	-.0259	295.7
6547	.302	6089.1	12.58	5.06	.6718	-.0089	.0171	-.0018	-.0127	-.0292	295.7
6548	.301	6074.8	14.45	5.04	.7706	-.0096	.0146	-.0012	-.0139	-.0304	295.8
6549	.300	6029.7	16.43	5.02	.8646	-.0086	.0065	.0006	-.0170	-.0264	295.8
6550	.301	6041.3	18.52	5.00	.9295	-.0037	-.0040	.0049	-.0257	-.0098	295.9
6551	.299	5986.6	20.62	4.97	.9581	.0031	-.0265	.0066	-.0299	-.0093	295.9
6552	.299	5977.4	22.74	4.92	1.0106	.0008	-.0276	.0024	-.0274	-.0094	295.9
6553	.300	6022.8	24.85	4.88	1.1032	-.0033	-.0316	.0040	-.0288	-.0076	296.0
6554	.300	6035.5	27.00	4.84	1.1996	-.0090	-.0362	.0111	-.0336	-.0119	296.0
6555	.300	6003.3	29.24	4.77	1.2746	-.0139	-.0371	.0097	-.0333	-.0106	296.1
6556	.300	6031.5	30.52	4.73	1.3121	-.0171	-.0375	.0066	-.0322	-.0085	296.1
6557	.301	6053.3	11.56	5.06	.6186	-.0095	.0184	-.0034	-.0126	-.0291	296.2

TEST TP	21 ALPHA DEG	BETA DEG	RUN 66		CPH(SA)	CRM(SA)	CYM(SA)	CSF(SA)	P1 PA	CP8(1)	VTOT M/SEC
			CL(SA)	CD(SA)							
6544	11.56	5.06	.6145	.1157	.0189	-.0058	-.0116	-.0289	95435.0	-.155	0.0
6545	10.29	5.06	.5331	.0869	.0170	-.0062	-.0119	-.0261	95453.0	-.150	0.0
6546	10.75	5.06	.5629	.0966	.0175	-.0063	-.0119	-.0259	95522.7	-.152	0.0
6547	12.58	5.06	.6577	.1376	.0171	-.0046	-.0120	-.0292	95502.6	-.155	0.0
6548	14.45	5.04	.7486	.1830	.0146	-.0046	-.0131	-.0304	95521.1	-.158	0.0
6549	16.43	5.02	.8318	.2363	.0065	-.0043	-.0165	-.0264	95567.0	-.169	0.0
6550	18.52	5.00	.8825	.2918	-.0040	-.0035	-.0260	-.0098	95557.3	-.181	0.0
6551	20.62	4.97	.8956	.3403	-.0265	-.0044	-.0303	-.0093	95615.1	-.188	0.0
6552	22.74	4.92	.9317	.3913	-.0276	-.0084	-.0262	-.0094	95624.8	-.194	0.0
6553	24.85	4.88	1.0024	.4606	-.0316	-.0084	-.0278	-.0076	95574.7	-.202	0.0
6554	27.00	4.84	1.0730	.5365	-.0362	-.0054	-.0350	-.0119	95565.6	-.210	0.0
6555	29.24	4.77	1.1190	.6105	-.0371	-.0078	-.0338	-.0106	95599.2	-.214	0.0
6556	30.52	4.73	1.1389	.6516	-.0375	-.0107	-.0311	-.0085	95567.8	-.219	0.0
6557	11.56	5.06	.6080	.1147	.0184	-.0058	-.0116	-.0291	95550.3	-.155	0.0

TEST TP	21 G PA	ALPHA DEG	RUN 66		CLT	CDT	CMST	CRTS	CYTS	CYST	CMU	WTFLO KG/SEC	PLENP PSI
			BETA DEG	CLT									
6544	6153.4	11.56	5.06	.6145	.1157	.0189	-.0058	-.0116	-.0289	0.0000	0.0000	0.0000	-.1
6545	6136.5	10.29	5.06	.5331	.0869	.0170	-.0062	-.0119	-.0261	0.0000	0.0000	0.0000	-.1
6546	6068.3	10.75	5.06	.5629	.0966	.0175	-.0063	-.0119	-.0259	0.0000	0.0000	0.0000	-.0
6547	6089.1	12.58	5.06	.6577	.1376	.0171	-.0046	-.0120	-.0292	0.0000	0.0000	0.0000	-.1
6548	6074.8	14.45	5.04	.7486	.1830	.0146	-.0046	-.0131	-.0304	0.0000	0.0000	0.0000	-.1
6549	6029.7	16.43	5.02	.8318	.2363	.0065	-.0043	-.0165	-.0264	0.0000	0.0000	0.0000	-.2
6550	6041.3	18.52	5.00	.8825	.2918	-.0040	-.0035	-.0260	-.0098	0.0000	0.0000	0.0000	-.2
6551	5986.6	20.62	4.97	.8956	.3403	-.0265	-.0044	-.0303	-.0093	0.0000	0.0000	0.0000	-.2
6552	5977.4	22.74	4.92	.9317	.3913	-.0276	-.0084	-.0262	-.0094	0.0000	0.0000	0.0000	-.3
6553	6022.8	24.85	4.88	1.0024	.4606	-.0316	-.0084	-.0278	-.0076	0.0000	0.0000	0.0000	-.4
6554	6035.5	27.00	4.84	1.0730	.5365	-.0362	-.0054	-.0350	-.0119	0.0000	0.0000	0.0000	-.4
6555	6003.3	29.24	4.77	1.1190	.6105	-.0371	-.0078	-.0338	-.0106	0.0000	0.0000	0.0000	-.5
6556	6031.5	30.52	4.73	1.1389	.6516	-.0375	-.0107	-.0311	-.0085	0.0000	0.0000	0.0000	-.5
6557	6053.3	11.56	5.06	.6080	.1147	.0184	-.0058	-.0116	-.0291	0.0000	0.0000	0.0000	-.1

NASA LANGLEY

7 X 10 HIGH SPEED TUNNEL

TEST TP	21 MACH	Q PA	RUN 67		CNF(BA)	CAF(BA)	CPH(BA)	CRM(BA)	CYM(BA)	CSF(BA)	TPLEN DEG K
			ALPHA DEG	BETA DEG							
6558	.300	6026.0	11.57	5.06	.6358	-.0395	.0231	-.0038	-.0137	-.0303	292.4
6559	.300	6013.6	10.45	5.07	.5605	-.0387	.0208	-.0036	-.0141	-.0287	292.0
6560	.300	6022.2	10.68	5.07	.5753	-.0391	.0214	-.0033	-.0141	-.0291	291.8
6561	.300	6039.1	12.64	5.06	.6919	-.0406	.0247	-.0041	-.0137	-.0314	291.5
6562	.300	6031.2	14.49	5.04	.7969	-.0428	.0251	-.0029	-.0137	-.0342	291.4
6563	.300	6036.9	16.63	5.02	.9073	-.0455	.0196	-.0017	-.0147	-.0329	291.2
6564	.299	5974.6	18.62	5.00	1.0047	-.0476	.0104	.0008	-.0174	-.0281	291.1
6565	.300	6020.8	20.84	4.96	1.0953	-.0493	.0017	.0025	-.0219	-.0209	290.9
6566	.300	6004.7	22.97	4.92	1.1637	-.0506	.0005	.0015	-.0262	-.0133	290.8
6567	.301	6045.9	24.93	4.88	1.2077	-.0433	-.0164	.0011	-.0288	-.0045	290.7
6568	.301	6050.9	27.20	4.82	1.2496	-.0439	-.0237	.0048	-.0301	-.0033	290.5
6569	.300	6028.4	29.27	4.76	1.2657	-.0447	-.0280	.0060	-.0299	-.0065	290.5
6570	.300	6026.4	30.56	4.73	1.2973	-.0470	-.0335	.0100	-.0326	-.0119	290.4
6571	.301	6047.8	11.57	5.06	.6382	-.0395	.0230	-.0036	-.0138	-.0296	290.2

TEST TP	21 ALPHA DEG	BETA DEG	RUN 67		CPH(SA)	CRM(SA)	CYM(SA)	CSF(SA)	P1 PA	CPB(1)	VTOT M/SEC
			CL(SA)	CD(SA)							
6558	11.57	5.06	.6309	.0888	.0231	-.0064	-.0126	-.0303	95579.5	-.164	528.9
6559	10.45	5.07	.5582	.0636	.0208	-.0061	-.0132	-.0287	95595.2	-.160	529.4
6560	10.68	5.07	.5726	.0681	.0214	-.0059	-.0132	-.0291	95586.3	-.161	529.8
6561	12.64	5.06	.6840	.1118	.0247	-.0070	-.0125	-.0314	95568.6	-.164	530.0
6562	14.49	5.04	.7823	.1579	.0251	-.0062	-.0126	-.0342	95576.8	-.166	530.0
6563	16.63	5.02	.8824	.2161	.0196	-.0058	-.0135	-.0329	95570.9	-.173	530.0
6564	18.62	5.00	.9673	.2757	.0104	-.0048	-.0167	-.0281	95636.1	-.183	529.9
6565	20.84	4.96	1.0412	.3436	.0017	-.0054	-.0214	-.0209	95584.4	-.194	529.9
6566	22.97	4.92	1.0912	.4073	.0005	-.0008	-.0247	-.0133	95602.6	-.204	529.7
6567	24.93	4.88	1.1135	.4698	-.0164	-.0111	-.0266	-.0045	95560.5	-.209	529.8
6568	27.20	4.82	1.1315	.5320	-.0237	-.0094	-.0289	-.0033	95556.2	-.212	529.7
6569	29.27	4.76	1.1259	.5798	-.0280	-.0094	-.0290	-.0065	95579.7	-.222	529.6
6570	30.56	4.73	1.1410	.6192	-.0335	-.0080	-.0331	-.0119	95581.9	-.227	529.5
6571	11.57	5.06	.6331	.0893	.0230	-.0063	-.0128	-.0296	95566.2	-.164	529.4

TEST TP	21 Q PA	ALPHA DEG	BETA DEG	CLT	CDT	CMST	CRTS	CYTS	CYST	CMU	WTFLO KG/SEC	PLENP PSI
6558	6026.0	11.57	5.06	.6128	.1154	.0056	-.0066	-.0132	-.0287	.0493	.0648	119.5
6559	6013.6	10.45	5.07	.5405	.0909	.0031	-.0063	-.0138	-.0270	.0502	.0659	120.9
6560	6022.2	10.68	5.07	.5546	.0955	.0036	-.0060	-.0138	-.0274	.0506	.0664	121.8
6561	6039.1	12.64	5.06	.6651	.1387	.0068	-.0071	-.0131	-.0297	.0507	.0667	122.5
6562	6031.2	14.49	5.04	.7624	.1842	.0071	-.0064	-.0132	-.0325	.0509	.0669	122.8
6563	6036.9	16.63	5.02	.8615	.2417	.0016	-.0060	-.0141	-.0312	.0510	.0671	123.1
6564	5974.6	18.62	5.00	.9453	.3008	-.0078	-.0050	-.0173	-.0263	.0515	.0671	123.2
6565	6020.8	20.84	4.96	1.0184	.3677	-.0164	-.0057	-.0220	-.0192	.0513	.0673	123.4
6566	6004.7	22.97	4.92	1.0674	.4308	-.0176	-.0091	-.0253	-.0115	.0513	.0672	123.4
6567	6045.9	24.93	4.88	1.0891	.4921	-.0345	-.0114	-.0271	-.0028	.0510	.0672	123.5
6568	6050.9	27.20	4.82	1.1062	.5534	-.0417	-.0097	-.0295	-.0016	.0510	.0673	123.5
6569	6028.4	29.27	4.76	1.0998	.6003	-.0461	-.0097	-.0296	-.0048	.0513	.0674	123.6
6570	6026.4	30.56	4.73	1.1144	.6391	-.0516	-.0083	-.0337	-.0102	.0512	.0673	123.5
6571	6047.8	11.57	5.06	.6145	.1167	.0049	-.0064	-.0134	-.0279	.0511	.0674	123.7

ORIGINAL PAGE IS
OF POOR QUALITY

NASA LANGLEY

7 X 10 HIGH SPEED TUNNEL

TEST TP	21 MACH	Q PA	RUN 68 ALPHA DEG	BETA DEG	CNF(BA)	CAF(BA)	CPM(BA)	CRM(BA)	CYM(BA)	CSF(BA)	TPLEN DEG K
6572	.300	6029.4	11.59	5.06	.6698	-.0673	.0250	-.0013	-.0145	-.0326	287.4
6573	.300	6022.3	10.55	5.07	.5931	-.0655	.0225	-.0020	-.0143	-.0315	287.3
6574	.300	6022.8	10.78	5.07	.6097	-.0656	.0223	-.0016	-.0144	-.0328	287.3
6575	.301	6054.7	12.60	5.06	.7451	-.0698	.0285	-.0008	-.0148	-.0338	287.3
6576	.301	6048.1	14.57	5.04	.8502	-.0742	.0400	-.0044	-.0148	-.0339	287.3
6577	.300	6037.2	16.71	5.02	.9501	-.0770	.0392	-.0023	-.0147	-.0326	287.3
6578	.301	6052.1	18.70	5.00	1.0559	-.0800	.0320	.0004	-.0157	-.0323	287.3
6579	.299	5988.7	20.82	4.96	1.1471	-.0841	.0248	.0020	-.0183	-.0296	287.3
6580	.299	5994.3	23.08	4.92	1.2508	-.0874	.0144	.0051	-.0227	-.0239	287.3
6581	.301	6043.0	25.16	4.88	1.3274	-.0876	.0101	.0067	-.0282	-.0169	287.3
6582	.301	6047.1	27.22	4.83	1.3842	-.0838	-.0036	.0059	-.0292	-.0209	287.3
6583	.301	6055.3	29.36	4.77	1.4323	-.0811	-.0220	.0073	-.0322	-.0116	287.3
6584	.300	6024.2	30.72	4.73	1.4631	-.0836	-.0244	.0110	-.0344	-.0118	287.3
6585	.300	6041.2	11.61	5.06	.6766	-.0682	.0234	-.0010	-.0146	-.0335	287.4

TEST TP	21 ALPHA DEG	BETA DEG	RUN 68 CL(SA)	CD(SA)	CPM(SA)	CRM(SA)	CYM(SA)	CSF(SA)	P1 PA	CPB(1)	VTOT M/SEC
6572	11.59	5.06	.6697	.0686	.0250	-.0041	-.0140	-.0326	95597.5	-.160	568.1
6573	10.55	5.07	.5950	.0442	.0225	-.0046	-.0137	-.0315	95604.5	-.156	568.0
6574	10.78	5.07	.6112	.0496	.0223	-.0042	-.0139	-.0328	95606.0	-.156	568.0
6575	12.60	5.06	.7423	.0944	.0285	-.0040	-.0142	-.0338	95572.6	-.164	568.0
6576	14.57	5.04	.8415	.1420	.0400	-.0080	-.0132	-.0339	95576.1	-.168	568.0
6577	16.71	5.02	.9321	.1995	.0392	-.0065	-.0134	-.0326	95588.1	-.173	568.0
6578	18.70	5.00	1.0258	.2628	.0320	-.0046	-.0150	-.0323	95571.9	-.179	569.1
6579	20.82	4.96	1.1021	.3291	.0248	-.0046	-.0178	-.0296	95638.3	-.189	568.1
6580	23.08	4.92	1.1850	.4098	.0144	-.0042	-.0228	-.0239	95632.4	-.197	568.1
6581	25.16	4.88	1.2387	.4850	.0101	-.0059	-.0284	-.0169	95581.5	-.203	568.2
6582	27.22	4.83	1.2693	.5586	-.0036	-.0081	-.0287	-.0209	95577.2	-.214	568.2
6583	29.36	4.77	1.2861	.6317	-.0220	-.0094	-.0316	-.0116	95568.5	-.222	568.3
6584	30.72	4.73	1.3005	.6755	-.0244	-.0081	-.0352	-.0118	95599.8	-.227	568.3
6585	11.61	5.06	.6765	.0693	.0234	-.0039	-.0141	-.0335	95590.1	-.160	568.4

TEST TP	21 Q PA	ALPHA DEG	RUN 68 BETA DEG	CLT	CDT	CMST	CRTS	CYTS	CYST	CMU	WTFLO KG/SEC	PLENP PSI
6572	6029.4	11.59	5.06	.6350	.1197	-.0086	-.0044	-.0151	-.0294	.1004	.1230	229.9
6573	6022.3	10.55	5.07	.5613	.0958	-.0111	-.0048	-.0148	-.0283	.1006	.1232	229.6
6574	6022.8	10.78	5.07	.5773	.1011	-.0114	-.0044	-.0150	-.0296	.1006	.1232	229.6
6575	6054.7	12.60	5.06	.7069	.1446	-.0050	-.0043	-.0154	-.0306	.1000	.1231	229.6
6576	6048.1	14.57	5.04	.8044	.1911	.0064	-.0083	-.0143	-.0307	.1001	.1231	229.8
6577	6037.2	16.71	5.02	.8931	.2472	.0056	-.0068	-.0145	-.0295	.1004	.1232	229.8
6578	6052.1	18.70	5.00	.9852	.3090	-.0015	-.0050	-.0161	-.0291	.1001	.1231	230.1
6579	5988.7	20.82	4.96	1.0593	.3743	-.0091	-.0051	-.0189	-.0264	.1014	.1235	230.1
6580	5994.3	23.08	4.92	1.1405	.4533	-.0195	-.0047	-.0239	-.0207	.1013	.1234	230.3
6581	6043.0	25.16	4.88	1.1930	.5265	-.0236	-.0064	-.0294	-.0137	.1007	.1237	230.5
6582	6047.1	27.22	4.83	1.2221	.5984	-.0372	-.0087	-.0297	-.0177	.1005	.1235	230.5
6583	6055.3	29.36	4.77	1.2395	.6696	-.0556	-.0100	-.0327	-.0084	.1005	.1237	230.6
6584	6024.2	30.72	4.73	1.2508	.7125	-.0582	-.0087	-.0362	-.0086	.1009	.1235	230.7
6585	6041.2	11.61	5.06	.6417	.1205	-.0104	-.0042	-.0152	-.0303	.1011	.1241	231.1

NASA LANGLEY

7 X 10 HIGH SPEED TUNNEL

TEST TP	21 MACH	Q PA	RUN 69 ALPHA DEG	BETA DEG	CNF(BA)	CAF(BA)	CPH(BA)	CRM(BA)	CYM(BA)	CSF(BA)	TPLEN DEG K
6586	.301	6048.8	11.66	5.07	.7360	-.1207	.0223	-.0011	-.0138	-.0385	286.2
6587	.300	6039.7	10.42	5.07	.6072	-.1179	.0237	-.0008	-.0133	-.0382	286.4
6588	.301	6075.8	10.78	5.07	.6524	-.1187	.0232	-.0001	-.0134	-.0380	286.6
6589	.300	6040.5	12.72	5.06	.8352	-.1249	.0229	.0002	-.0145	-.0387	286.8
6590	.300	6027.5	14.64	5.05	.9898	-.1307	.0225	-.0009	-.0148	-.0418	287.1
6591	.300	6041.0	16.95	5.02	1.1634	-.1393	.0239	-.0015	-.0157	-.0414	287.3
6592	.300	6005.2	18.97	4.99	1.2506	-.1476	.0398	-.0123	-.0170	-.0374	287.5
6593	.300	6031.1	21.14	4.96	1.3326	-.1520	.0446	-.0080	-.0194	-.0317	287.8
6594	.302	6083.9	23.25	4.92	1.4049	-.1531	.0438	-.0084	-.0222	-.0252	288.0
6595	.301	6069.8	25.26	4.88	1.4762	-.1464	.0231	-.0055	-.0244	-.0234	288.4
6596	.302	6087.1	27.50	4.83	1.4962	-.1429	.0151	.0090	-.0317	-.0308	288.8
6597	.301	6056.1	29.58	4.78	1.5656	-.1466	.0128	.0097	-.0329	-.0321	289.3
6598	.301	6060.5	30.88	4.75	1.5902	-.1477	.0099	.0156	-.0359	-.0398	289.6
6599	.301	6076.3	11.68	5.07	.7429	-.1242	.0213	.0010	-.0137	-.0390	290.8

TEST TP	21 ALPHA DEG	BETA DEG	RUN 69 CL(SA)	CD(SA)	CPH(SA)	CRM(SA)	CYM(SA)	CSF(SA)	P1 PA	CP8(L)	VTOT M/SEC
6586	11.66	5.07	.7452	.0306	.0223	-.0017	-.0137	-.0385	95585.6	-.159	601.1
6587	10.42	5.07	.6185	-.0062	.0237	-.0032	-.0129	-.0382	95591.7	-.157	601.3
6588	10.78	5.07	.6630	.0054	.0232	-.0026	-.0131	-.0380	95560.7	-.157	601.4
6589	12.72	5.06	.8422	.0621	.0229	-.0030	-.0141	-.0387	95597.6	-.161	601.7
6590	14.64	5.05	.9907	.1238	.0225	-.0046	-.0140	-.0418	95611.2	-.165	602.0
6591	16.95	5.02	1.1534	.2060	.0239	-.0060	-.0146	-.0414	95595.1	-.172	602.2
6592	18.97	4.99	1.2307	.2668	.0398	-.0172	-.0121	-.0374	95634.6	-.180	602.5
6593	21.14	4.96	1.2978	.3388	.0446	-.0145	-.0152	-.0317	95602.6	-.186	602.8
6594	23.25	4.92	1.3513	.4139	.0438	-.0165	-.0171	-.0252	95546.9	-.189	603.1
6595	25.26	4.88	1.3976	.4975	.0231	-.0154	-.0197	-.0234	95567.0	-.194	603.4
6596	27.50	4.83	1.3932	.5640	.0151	-.0067	-.0322	-.0308	95548.8	-.203	603.9
6597	29.58	4.78	1.4339	.6454	.0128	-.0078	-.0334	-.0321	95584.7	-.210	604.3
6598	30.88	4.75	1.4406	.6894	.0099	-.0049	-.0390	-.0398	95577.8	-.214	604.7
6599	11.68	5.07	.7526	.0288	.0213	-.0018	-.0136	-.0390	95566.9	-.159	605.9

TEST TP	21 Q PA	ALPHA DEG	RUN 69 BETA DEG	CLT	CDT	CMST	CRTS	CYTS	CYST	CNU	WTFLO KG/SEC	PLENP PSI
6586	6048.8	11.66	5.07	.6809	.1255	-.0403	-.0021	-.0158	-.0326	.1952	.2268	429.4
6587	6039.7	10.42	5.07	.5557	.0903	-.0390	-.0036	-.0151	-.0323	.1956	.2269	429.3
6588	6075.8	10.78	5.07	.6001	.1009	-.0391	-.0030	-.0153	-.0321	.1943	.2267	429.2
6589	6040.5	12.72	5.06	.7757	.1560	-.0399	-.0035	-.0163	-.0326	.1955	.2267	429.4
6590	6027.5	14.64	5.05	.9208	.2157	-.0404	-.0052	-.0162	-.0358	.1960	.2267	429.6
6591	6041.0	16.95	5.02	1.0800	.2949	-.0389	-.0067	-.0167	-.0355	.1957	.2267	429.9
6592	6005.2	18.97	4.99	1.1538	.3535	-.0233	-.0179	-.0141	-.0314	.1970	.2267	429.8
6593	6031.1	21.14	4.96	1.2179	.4222	-.0183	-.0153	-.0172	-.0257	.1962	.2267	430.0
6594	6083.9	23.25	4.92	1.2691	.4936	-.0185	-.0174	-.0190	-.0193	.1942	.2263	430.0
6595	6069.8	25.26	4.88	1.3125	.5745	-.0395	-.0163	-.0216	-.0175	.1950	.2265	430.2
6596	6087.1	27.50	4.83	1.3054	.6374	-.0473	-.0077	-.0342	-.0249	.1943	.2262	430.2
6597	6056.1	29.58	4.78	1.3430	.7159	-.0499	-.0088	-.0353	-.0261	.1952	.2259	430.2
6598	6060.5	30.88	4.75	1.3482	.7578	-.0528	-.0060	-.0408	-.0338	.1952	.2259	430.3
6599	6076.3	11.68	5.07	.6881	.1235	-.0412	-.0022	-.0157	-.0331	.1947	.2254	430.2

ORIGINAL PAGE IS OF POOR QUALITY

NASA LANGLEY

7 X 10 HIGH SPEED TUNNEL

TEST TP	21 MACH	Q PA	RUN 70 ALPHA DEG	BETA DEG	CNF(BA)	CAF(BA)	CPH(BA)	CRM(BA)	CYM(BA)	CSF(BA)	TPLEN DEG K
6600	.301	6052.4	11.68	5.07	.7555	-.1489	.0200	.0027	-.0128	-.0403	296.1
6601	.300	6034.3	10.60	5.07	.6378	-.1465	.0231	.0005	-.0124	-.0404	296.6
6602	.301	6043.6	10.76	5.07	.6551	-.1469	.0226	.0010	-.0125	-.0407	296.9
6603	.301	6059.6	12.66	5.06	.8489	-.1528	.0205	.0008	-.0135	-.0412	297.3
6604	.300	6021.7	14.69	5.05	1.00190	-.1599	.0225	-.0027	-.0138	-.0432	297.8
6605	.300	6011.1	16.76	5.03	1.1772	-.1672	.0241	-.0048	-.0155	-.0446	298.3
6606	.299	5984.5	18.97	5.00	1.3412	-.1776	.0242	-.0059	-.0184	-.0402	298.8
6607	.299	5993.2	21.07	4.96	1.4024	-.1849	.0488	-.0094	-.0203	-.0321	299.2
6608	.300	6032.2	23.26	4.92	1.4707	-.1860	.0488	-.0076	-.0222	-.0243	299.6
6609	.300	6014.5	25.37	4.88	1.5267	-.1786	.0293	-.0016	-.0252	-.0226	300.0
6610	.301	6057.2	27.52	4.82	1.5998	-.1787	.0235	-.0045	-.0260	-.0280	300.3
6611	.301	6043.6	29.76	4.76	1.6666	-.1793	.0142	-.0036	-.0292	-.0288	300.7
6612	.300	6018.6	30.96	4.73	1.6669	-.1784	.0121	-.0044	-.0326	-.0356	300.9
6613	.301	6043.8	11.68	5.07	.7489	-.1520	.0216	.0024	-.0127	-.0416	301.7

TEST TP	21 ALPHA DEG	BETA DEG	RUN 70 CL(SA)	CD(SA)	CPH(SA)	CRM(SA)	CYM(SA)	CSF(SA)	P1 PA	CPB(L)	VTOT M/SEC
6600	11.68	5.07	.7700	.0072	.0200	.0000	-.0131	-.0403	95599.7	-.159	619.5
6601	10.60	5.07	.6539	-.0267	.0231	-.0018	-.0123	-.0404	95617.7	-.155	620.0
6602	10.76	5.07	.6710	-.0220	.0226	-.0014	-.0125	-.0407	95607.9	-.156	620.4
6603	12.66	5.06	.8617	.0370	.0205	.0022	-.0133	-.0412	95593.6	-.161	620.9
6604	14.69	5.05	1.0262	.1037	.0225	-.0061	-.0127	-.0432	95630.8	-.164	621.3
6605	16.76	5.03	1.1754	.1795	.0241	-.0091	-.0134	-.0446	95641.8	-.169	621.9
6606	18.97	5.00	1.3261	.2680	.0242	-.0116	-.0155	-.0402	95669.8	-.178	622.4
6607	21.07	4.96	1.3751	.3317	.0488	-.0160	-.0156	-.0321	95660.7	-.183	622.8
6608	23.26	4.92	1.4246	.4100	.0488	-.0158	-.0174	-.0243	95619.4	-.183	623.3
6609	25.37	4.88	1.4560	.4928	.0293	-.0122	-.0221	-.0226	95638.4	-.186	623.6
6610	27.52	4.82	1.5013	.5807	.0235	-.0160	-.0210	-.0280	95592.0	-.195	624.0
6611	29.76	4.76	1.5359	.6714	.0142	-.0176	-.0235	-.0288	95608.0	-.204	624.4
6612	30.96	4.73	1.5211	.7046	.0121	-.0130	-.0302	-.0356	95634.1	-.210	624.7
6613	11.68	5.07	.7641	-.0027	.0216	-.0003	-.0129	-.0416	95611.1	-.157	625.5

TEST TP	21 Q PA	ALPHA DEG	RUN 70 BETA DEG	CLT	CDT	CMST	CRTS	CYTS	CYST	CMU	WTFLO KG/SEC	PLENP PSI
6600	6052.4	11.68	5.07	.6934	.1195	-.0541	-.0005	-.0156	-.0333	.2332	.2631	508.1
6601	6034.3	10.60	5.07	.5792	.0874	-.0513	-.0023	-.0148	-.0334	.2339	.2629	508.2
6602	6043.6	10.76	5.07	.5961	.0917	-.0517	-.0018	-.0150	-.0337	.2336	.2628	508.3
6603	6059.6	12.66	5.06	.7833	.1480	-.0536	-.0020	-.0158	-.0342	.2333	.2630	508.6
6604	6021.7	14.69	5.05	.9433	.2125	-.0521	-.0068	-.0152	-.0361	.2348	.2628	508.7
6605	6011.1	16.76	5.03	1.0985	.2854	-.0506	-.0098	-.0159	-.0376	.2352	.2625	508.8
6606	5984.5	18.97	5.00	1.2347	.3710	-.0509	-.0125	-.0179	-.0331	.2363	.2624	508.9
6607	5993.2	21.07	4.96	1.2802	.4311	-.0262	-.0170	-.0180	-.0250	.2359	.2622	508.9
6608	6032.2	23.26	4.92	1.3265	.5091	-.0256	-.0168	-.0197	-.0172	.2343	.2619	509.0
6609	6014.5	25.37	4.88	1.3542	.5845	-.0454	-.0133	-.0245	-.0155	.2352	.2619	509.0
6610	6057.2	27.52	4.82	1.3969	.6679	-.0506	-.0172	-.0233	-.0210	.2335	.2617	509.0
6611	6043.6	29.76	4.76	1.4278	.7547	-.0602	-.0189	-.0257	-.0218	.2342	.2618	509.3
6612	6018.6	30.96	4.73	1.4109	.7859	-.0626	-.0144	-.0324	-.0286	.2353	.2618	509.3
6613	6043.8	11.68	5.07	.6873	.1155	-.0528	-.0008	-.0154	-.0346	.2341	.2612	509.4

NASA LANGLEY

7 X 10 HIGH SPEED TUNNEL

TEST TP	21	Q PA	RUN 71		CNF(SA)	CAF(SA)	CPH(SA)	CRM(SA)	CYM(SA)	CSF(SA)	TPLEN- DEG K
			ALPHA DEG	BETA DEG							
6614	.501	15045.5	12.47	5.11	.7132	-.0674	.0224	-.0020	-.0134	-.0358	304.2
6615	.499	14952.2	11.05	5.11	.5996	-.0645	.0205	-.0028	-.0129	-.0354	304.3
6616	.497	14845.5	11.44	5.11	.6316	-.0658	.0211	-.0019	-.0131	-.0357	304.5
6617	.502	15122.8	13.64	5.11	.7890	-.0693	.0252	.0058	-.0137	-.0356	304.7
6618	.501	15080.0	15.72	5.09	.8808	-.0727	.0381	.0025	-.0142	-.0370	304.8
6619	.499	14958.7	17.76	5.08	.9883	-.0748	.0340	.0006	-.0163	-.0382	305.0
6620	.500	15010.6	20.06	5.05	1.0920	-.0769	.0275	-.0005	-.0184	-.0388	305.1
6621	.497	14866.4	22.21	5.03	1.2030	-.0764	.0112	.0016	-.0241	-.0311	305.2
6622	.499	14970.0	24.52	4.98	1.2647	-.0692	-.0160	.0057	-.0287	-.0169	305.2
6623	.500	14999.9	26.52	4.94	1.2986	-.0694	-.0165	.0042	-.0297	-.0181	305.4
6624	.499	14952.1	28.85	4.87	1.3540	-.0729	-.0146	.0002	-.0289	-.0197	305.5
6625	.501	15041.4	30.77	4.81	1.3660	-.0749	-.0086	-.0026	-.0273	-.0237	305.6
6626	.501	15033.5	31.92	4.77	1.3569	-.0756	.0044	-.0052	-.0230	-.0348	305.7
6627	.500	15022.2	12.46	5.11	.7109	-.0673	.0229	.0014	-.0134	-.0356	306.0

TEST TP	21	ALPHA DEG	BETA DEG	RUN 71		CPM(SA)	CRM(SA)	CYM(SA)	CSF(SA)	P1 PA	CPB(1)	VTOT M/SEC
				CL(SA)	CD(SA)							
6614		12.47	5.11	.7110	.0882	.0224	-.0010	-.0135	-.0358	85654.2	-.173	633.4
6615		11.05	5.11	.6009	.0516	.0205	-.0052	-.0122	-.0354	85790.8	-.169	633.5
6616		11.44	5.11	.6321	.0608	.0211	-.0044	-.0125	-.0357	85875.7	-.171	633.6
6617		13.64	5.11	.7830	.1188	.0252	.0024	-.0147	-.0356	85651.4	-.173	633.9
6618		15.72	5.09	.8675	.1686	.0381	-.0014	-.0144	-.0370	85696.9	-.174	634.0
6619		17.76	5.08	.9640	.2302	.0340	-.0044	-.0157	-.0382	85746.4	-.180	634.2
6620		20.06	5.05	1.0522	.3023	.0275	-.0067	-.0171	-.0388	85777.5	-.191	634.2
6621		22.21	5.03	1.1426	.3841	.0112	-.0077	-.0230	-.0311	85861.2	-.201	634.3
6622		24.52	4.98	1.1794	.4618	-.0160	-.0067	-.0285	-.0169	85820.9	-.209	634.3
6623		26.52	4.94	1.1929	.5179	-.0165	-.0095	-.0284	-.0181	85697.7	-.217	634.6
6624		28.85	4.87	1.2211	.5896	-.0146	-.0138	-.0254	-.0197	85770.7	-.231	634.6
6625		30.77	4.81	1.2121	.6345	-.0086	-.0162	-.0222	-.0237	85652.1	-.247	634.9
6626		31.92	4.77	1.1917	.6534	.0044	-.0166	-.0168	-.0348	85663.0	-.264	635.0
6627		12.46	5.11	.7087	.0877	.0229	-.0015	-.0134	-.0356	85771.2	-.173	635.3

TEST TP	21	Q PA	ALPHA DEG	BETA DEG	CLT	CDT	CMST	CRTS	CYTS	CYST	CMU	WTFLO KG/SEC	PLENP PSI
6615		14952.2	11.05	5.11	.5702	.0977	-.0096	-.0054	-.0132	-.0325	.0954	.2601	511.2
6616		14845.5	11.44	5.11	.6009	.1070	-.0093	-.0046	-.0135	-.0329	.0962	.2603	511.4
6617		15122.8	13.64	5.11	.7507	.1629	-.0046	.0022	-.0157	-.0327	.0944	.2601	511.2
6618		15080.0	15.72	5.09	.8335	.2117	.0081	-.0017	-.0154	-.0342	.0947	.2602	511.4
6619		14958.7	17.76	5.08	.9282	.2724	.0038	-.0047	-.0167	-.0353	.0955	.2603	511.4
6620		15010.6	20.06	5.05	1.0148	.3429	-.0025	-.0071	-.0181	-.0359	.0951	.2600	511.4
6621		14866.4	22.21	5.03	1.1033	.4236	-.0192	-.0080	-.0239	-.0283	.0961	.2600	511.6
6622		14970.0	24.52	4.98	1.1389	.4994	-.0461	-.0071	-.0295	-.0141	.0952	.2599	510.8
6623		14999.9	26.52	4.94	1.1511	.5540	-.0466	-.0099	-.0294	-.0153	.0954	.2604	511.6
6624		14952.1	28.85	4.87	1.1778	.6241	-.0448	-.0143	-.0263	-.0169	.0955	.2600	511.3
6625		15041.4	30.77	4.81	1.1678	.6674	-.0386	-.0167	-.0230	-.0209	.0950	.2600	511.7
6626		15033.5	31.92	4.77	1.1468	.6854	-.0256	-.0171	-.0177	-.0320	.0950	.2599	511.6
6627		15022.2	12.46	5.11	.6770	.1329	-.0072	-.0017	-.0144	-.0327	.0952	.2599	511.9

ORIGINAL PAGE IS
OF POOR QUALITY

NASA LANGLEY

7 X 10 HIGH SPEED TUNNEL

TEST TP	21 MACH	Q PA	RUN 72		CNF(BA)	CAF(BA)	CPM(BA)	CRM(BA)	CYM(BA)	CSF(BA)	TLEN DEG K
			ALPHA DEG	BETA DEG							
6628	.501	15047.2	12.36	5.10	.6598	-.0383	.0236	-.0032	-.0138	-.0308	305.5
6629	.499	14961.2	11.01	5.11	.5850	-.0376	.0207	-.0034	-.0139	-.0304	305.3
6630	.499	14969.7	11.40	5.11	.6058	-.0377	.0210	-.0036	-.0137	-.0309	305.2
6631	.501	15073.3	13.42	5.10	.7141	-.0384	.0244	-.0035	-.0139	-.0307	305.0
6632	.501	15078.7	15.41	5.08	.8115	-.0394	.0206	-.0028	-.0145	-.0311	304.8
6633	.500	15014.7	17.61	5.07	.9059	-.0409	.0146	-.0005	-.0170	-.0290	304.6
6634	.501	15080.2	19.78	5.05	.9975	-.0431	.0111	-.0036	-.0220	-.0228	304.5
6635	.497	14866.5	21.95	5.03	1.0907	-.0434	.0044	-.0054	-.0294	-.0153	304.4
6636	.500	14986.2	24.15	4.99	1.1436	-.0390	-.0147	-.0037	-.0300	-.0166	304.4
6637	.503	15136.9	26.36	4.93	1.1833	-.0402	-.0142	-.0003	-.0259	-.0225	304.1
6638	.501	15064.3	28.37	4.85	1.2016	-.0422	-.0093	-.0093	-.0196	-.0249	304.0
6639	.498	14881.9	30.58	4.76	1.2435	-.0457	-.0038	-.0150	-.0122	-.0322	303.9
6640	.497	14867.4	31.91	4.70	1.2862	-.0484	-.0051	-.0201	-.0061	-.0343	303.8
6641	.500	15013.9	12.37	5.10	.6630	-.0380	-.0242	-.0032	-.0140	-.0309	303.6

TEST TP	21 ALPHA DEG	BETA DEG	RUN 72		CPM(SA)	CRM(SA)	CYM(SA)	CSF(SA)	P1 PA	CPB(1)	WTOT W/SEC
			CL(SA)	CD(SA)							
6628	12.36	5.10	.6527	-.1038	.0236	-.0061	-.0128	-.0308	85728.9	-.166	603.5
6629	11.01	5.11	.5814	-.0747	.0207	-.0060	-.0130	-.0304	85807.3	-.164	603.3
6630	11.40	5.11	.6013	-.0828	.0210	-.0062	-.0128	-.0309	85833.3	-.164	603.2
6631	13.42	5.10	.7035	-.1283	.0244	-.0067	-.0127	-.0307	85622.3	-.168	603.2
6632	15.41	5.08	.7928	-.1776	.0206	-.0065	-.0133	-.0311	85698.9	-.171	602.9
6633	17.61	5.07	.8758	-.2351	.0146	-.0056	-.0160	-.0290	85775.7	-.182	602.7
6634	19.78	5.05	.9533	-.2970	.0111	-.0041	-.0220	-.0228	85700.1	-.197	602.7
6635	21.95	5.03	1.0279	-.3674	.0044	-.0060	-.0293	-.0153	85853.3	-.206	602.4
6636	24.15	4.99	1.0995	-.4323	-.0147	-.0089	-.0289	-.0166	85720.9	-.212	602.4
6637	26.36	4.93	1.0781	-.4894	-.0142	-.0112	-.0233	-.0225	85637.3	-.215	602.4
6638	28.37	4.85	1.0773	-.5339	-.0093	-.0175	-.0129	-.0249	85724.3	-.227	602.2
6639	30.58	4.76	1.0938	-.5932	-.0038	-.0191	-.0028	-.0322	85878.0	-.255	601.9
6640	31.91	4.70	1.1174	-.6389	-.0051	-.0203	.0054	-.0343	85861.0	-.272	601.9
6641	12.37	5.10	.6558	-.1049	.0242	-.0061	-.0130	-.0309	85729.4	-.166	601.8

TEST TP	21 Q PA	ALPHA DEG	BETA DEG	RUN 72		CMST	CRTS	CYTS	CYST	CHU	WTFLO KG/SEC	PLENPSI
				CLT	CDT							
6628	15047.2	12.36	5.10	.6355	-.1284	.0073	-.0062	-.0133	-.0292	.0497	.1432	278.2
6629	14961.2	11.01	5.11	.5647	-.0998	.0043	-.0061	-.0136	-.0288	.0501	.1435	278.4
6630	14969.7	11.40	5.11	.5845	-.1078	.0046	-.0063	-.0133	-.0294	.0501	.1435	278.4
6631	15073.3	13.42	5.10	.6859	-.1525	.0081	-.0068	-.0132	-.0291	.0497	.1435	278.6
6632	15078.7	15.41	5.08	.7743	-.2012	.0043	-.0067	-.0138	-.0296	.0498	.1438	278.7
6633	15014.7	17.61	5.07	.8564	-.2580	.0018	-.0058	-.0166	-.0274	.0500	.1438	278.7
6634	15080.2	19.78	5.05	.9331	-.3191	.0052	-.0042	-.0225	-.0213	.0499	.1441	278.9
6635	14866.5	21.95	5.03	1.0066	-.3890	.0121	-.0062	-.0298	-.0137	.0506	.1441	278.6
6636	14986.2	24.15	4.99	1.0375	-.4530	.0311	-.0091	-.0294	-.0151	.0501	.1440	278.9
6637	15136.9	26.36	4.93	1.0556	-.5090	.0305	-.0115	-.0238	-.0210	.0497	.1442	279.0
6638	15064.3	28.37	4.85	1.0540	-.5528	.0256	-.0178	-.0134	-.0233	.0499	.1442	278.9
6639	14881.9	30.58	4.76	1.0695	-.6114	.0204	-.0194	-.0033	-.0306	.0505	.1443	278.8
6640	14867.4	31.91	4.70	1.0927	-.6565	.0216	-.0206	.0049	-.0328	.0506	.1444	279.1
6641	15013.9	12.37	5.10	.6385	-.1296	.0078	-.0062	-.0135	-.0293	.0501	.1443	279.1

NASA LANGLEY

7 X 10 HIGH SPEED TUNNEL

TEST TP	21 MACH	Q PA	RUN 73		CNF(BA)	CAF(BA)	CPH(BA)	CRM(BA)	CYH(BA)	CSF(BA)	TLEN DEG K
			ALPHA DEG	BETA DEG							
6642	.500	15017.3	12.30	5.10	.6479	-.0076	.0154	-.0013	-.0132	-.0288	302.5
6643	.500	15009.1	10.95	5.10	.5712	-.0094	.0167	-.0041	-.0134	-.0253	303.6
6644	.501	15038.5	11.48	5.10	.6065	-.0093	.0170	-.0044	-.0134	-.0272	304.2
6645	.501	15074.3	13.44	5.10	.7084	-.0078	.0134	-.0013	-.0138	-.0296	304.7
6646	.501	15076.9	15.49	5.09	.8031	-.0073	.0068	-.0000	-.0164	-.0273	305.1
6647	.499	14963.8	17.46	5.07	.8785	-.0047	-.0045	.0017	-.0220	-.0173	305.3
6648	.500	14993.9	19.40	5.07	.8812	-.0033	-.0206	.0077	-.0320	-.0094	305.5
6649	.499	14935.7	21.54	5.01	.9199	.0027	-.0155	-.0019	-.0255	-.0114	305.8
6650	.496	14805.5	23.84	4.95	.9991	-.0013	-.0123	-.0079	-.0216	-.0141	305.9
6651	.494	14702.7	26.20	4.89	1.1043	-.0067	-.0197	-.0102	-.0211	-.0165	306.0
6652	.498	14923.2	28.31	4.82	1.1989	-.0116	-.0255	-.0185	-.0163	-.0167	306.1
6653	.497	14831.3	30.61	4.71	1.3024	-.0180	-.0294	-.0299	-.0111	-.0072	306.3
6654	.500	14979.9	31.92	4.68	1.3497	-.0210	-.0297	-.0295	-.0120	-.0081	306.4
6655	.500	15024.7	12.29	5.10	.6475	-.0089	.0152	-.0014	-.0133	-.0286	306.9

TEST TP	21 ALPHA DEG	BETA DEG	RUN 73		CPH(SA)	CRM(SA)	CYH(SA)	CSF(SA)	P1 PA	CPB(1)	VTOT H/SEC
			CL(SA)	CD(SA)							
6642	12.30	5.10	.6347	.1305	.0154	-.0041	-.0127	-.0288	85731.3	-.156	0.0
6643	10.95	5.10	.5626	.0992	.0167	-.0066	-.0124	-.0253	85799.2	-.154	0.0
6644	11.48	5.10	.5962	.1116	.0170	-.0070	-.0123	-.0272	85709.4	-.156	0.0
6645	13.44	5.10	.6908	.1571	.0134	-.0045	-.0131	-.0296	85709.9	-.156	0.0
6646	15.49	5.09	.7759	.2075	.0068	-.0044	-.0158	-.0273	85717.6	-.165	0.0
6647	17.46	5.07	.8395	.2591	-.0045	-.0049	-.0215	-.0173	85801.5	-.179	0.0
6648	19.40	5.07	.8301	.2958	-.0206	-.0034	-.0328	-.0094	85768.6	-.186	0.0
6649	21.54	5.01	.8546	.3403	-.0155	-.0111	-.0230	-.0114	85786.5	-.192	0.0
6650	23.84	4.95	.9144	.4026	-.0123	-.0159	-.0165	-.0141	85935.1	-.201	0.0
6651	26.20	4.89	.9938	.4815	-.0197	-.0184	-.0144	-.0165	86103.5	-.212	0.0
6652	28.31	4.82	1.0611	.5583	-.0255	-.0240	-.0055	-.0167	85826.5	-.221	0.0
6653	30.61	4.71	1.1301	.6476	-.0294	-.0313	.0056	-.0072	85906.2	-.234	0.0
6654	31.92	4.68	1.1567	.6959	-.0297	-.0313	.0054	-.0081	85762.1	-.247	0.0
6655	12.29	5.10	.6345	.1291	.0152	-.0042	-.0127	-.0286	85780.7	-.156	0.0

TEST TP	21 Q PA	ALPHA DEG	BETA DEG	CLT	CDT	CMST	CRTS	CYTS	CYST	CMU	WTFLO KG/SEC	PLENPSI
6643	15009.1	10.95	5.10	.5626	.0992	.0167	-.0066	-.0124	-.0253	0.0000	0.0000	-6
6644	15038.5	11.48	5.10	.5962	.1116	.0170	-.0070	-.0123	-.0272	0.0000	0.0000	-7
6645	15074.3	13.44	5.10	.6908	.1571	.0134	-.0045	-.0131	-.0296	0.0000	0.0000	-7
6646	15076.9	15.49	5.09	.7759	.2075	.0068	-.0044	-.0158	-.0273	0.0000	0.0000	-9
6647	14963.8	17.46	5.07	.8395	.2591	-.0045	-.0049	-.0215	-.0173	0.0000	0.0000	-9
6648	14993.9	19.40	5.07	.8301	.2958	-.0206	-.0034	-.0328	-.0094	0.0000	0.0000	-1.0
6649	14935.7	21.54	5.01	.8546	.3403	-.0155	-.0111	-.0230	-.0114	0.0000	0.0000	-1.1
6650	14805.5	23.84	4.95	.9144	.4026	-.0123	-.0159	-.0165	-.0141	0.0000	0.0000	-1.2
6651	14702.7	26.20	4.89	.9938	.4815	-.0197	-.0184	-.0144	-.0165	0.0000	0.0000	-1.4
6652	14923.2	28.31	4.82	1.0611	.5583	-.0255	-.0240	-.0055	-.0167	0.0000	0.0000	-2.1
6653	14831.3	30.61	4.71	1.1301	.6476	-.0294	-.0313	.0056	-.0072	0.0000	0.0000	-1.7
6654	14979.9	31.92	4.68	1.1567	.6959	-.0297	-.0313	.0054	-.0081	0.0000	0.0000	-1.8
6655	15024.7	12.29	5.10	.6345	.1291	.0152	-.0042	-.0127	-.0286	0.0000	0.0000	-7

NASA LANGLEY

7 X 10 HIGH SPEED TUNNEL

TEST TP	.21 MACH	Q PA	ALPHA DEG	BETA DEG	CL(SA)	CD(SA)	CPM(SA)	CRM(SA)	CYM(SA)	CSF(SA)	CPB(L)	WTOT M/SEC
6667	0.000	47.9	11.10	-4.79	.0634	-.0267	-.0115	-.0032	-.0041	.0512	101917.9	.136
6668	.301	6045.1	11.65	-4.81	.6105	-.1168	.0165	.0061	.0122	.0252	95633.5	-.158
6669	.300	6044.0	10.41	-4.84	.5377	.0896	.0145	.0072	.0122	.0235	95634.7	-.154
6670	.300	6041.8	10.84	-4.83	.5645	.0988	.0154	.0066	.0123	.0245	95637.0	-.157
6671	.300	6020.8	12.64	-4.79	.6562	.1379	.0155	.0066	.0120	.0262	95658.9	-.160
6672	.298	5959.6	14.69	-4.73	.7590	.1889	.0127	.0060	.0131	.0279	95723.0	-.163
6673	.299	5992.8	16.66	-4.67	.8396	.2424	.0056	.0055	.0161	.0227	95681.5	-.174
6674	.300	6010.7	18.69	-4.60	.8849	.2968	-.0072	.0034	.0267	.0051	95666.7	-.181
6675	.301	6045.5	20.73	-4.52	.9026	.3446	-.0272	.0050	.0289	.0065	95633.1	-.188
6676	.299	6006.7	22.79	-4.44	.9411	.3965	-.0288	.0069	.0268	.0069	95673.7	-.196
6677	.299	5997.6	24.91	-4.35	.9997	.4613	-.0320	.0061	.0289	.0092	95680.9	-.201
6678	.300	6010.3	27.24	-4.25	1.0677	.5401	-.0358	.0065	.0310	.0112	95665.2	-.209
6679	.301	6047.0	29.50	-4.13	1.1196	.6180	-.0379	.0099	.0273	.0110	95626.1	-.216
6680	.301	6052.6	30.68	-4.07	1.1543	.6658	-.0407	.0131	.0245	.0070	95624.2	-.223
6681	.302	6119.4	11.68	-4.81	.6101	.1173	.0165	.0064	.0121	.0257	95561.0	-.159

TEST TP	.21 ALPHA DEG	BETA DEG	CL(SA)	CD(SA)	CPM(SA)	CRM(SA)	CYM(SA)	CSF(SA)	P1 PA	CPB(L)	WTOT M/SEC
6667	11.10	-4.79	.0634	-.0267	-.0115	-.0032	-.0041	.0512	101917.9	.136	0.0
6668	11.65	-4.81	.6105	-.1168	.0165	.0061	.0122	.0252	95633.5	-.158	0.0
6669	10.41	-4.84	.5377	.0896	.0145	.0072	.0122	.0235	95634.7	-.154	0.0
6670	10.84	-4.83	.5645	.0988	.0154	.0066	.0123	.0245	95637.0	-.157	0.0
6671	12.64	-4.79	.6562	.1379	.0155	.0066	.0120	.0262	95658.9	-.160	0.0
6672	14.69	-4.73	.7590	.1889	.0127	.0060	.0131	.0279	95723.0	-.163	0.0
6673	16.66	-4.67	.8396	.2424	.0056	.0055	.0161	.0227	95681.5	-.174	0.0
6674	18.69	-4.60	.8849	.2968	-.0072	.0034	.0267	.0051	95666.7	-.181	0.0
6675	20.73	-4.52	.9026	.3446	-.0272	.0050	.0289	.0065	95633.1	-.188	0.0
6676	22.79	-4.44	.9411	.3965	-.0288	.0069	.0268	.0069	95673.7	-.196	0.0
6677	24.91	-4.35	.9997	.4613	-.0320	.0061	.0289	.0092	95680.9	-.201	0.0
6678	27.24	-4.25	1.0677	.5401	-.0358	.0065	.0310	.0112	95665.2	-.209	0.0
6679	29.50	-4.13	1.1196	.6180	-.0379	.0099	.0273	.0110	95626.1	-.216	0.0
6680	30.68	-4.07	1.1543	.6658	-.0407	.0131	.0245	.0070	95624.2	-.223	0.0
6681	11.68	-4.81	.6101	.1173	.0165	.0064	.0121	.0257	95561.0	-.159	0.0

TEST TP	.21 Q PA	ALPHA DEG	BETA DEG	CLT	CDT	CMST	CRTS	CYTS	CYST	CHU	WTFLO KG/SEC	PLENP PSI
6667	47.9	11.10	-4.79	.0634	-.0267	-.0115	-.0032	-.0041	.0512	0.0000	0.0000	.1
6668	6045.1	11.65	-4.81	.6105	-.1168	.0165	.0061	.0122	.0252	0.0000	0.0000	.1
6669	6044.0	10.41	-4.84	.5377	.0896	.0145	.0072	.0122	.0235	0.0000	0.0000	.1
6670	6041.8	10.84	-4.83	.5645	.0988	.0154	.0066	.0123	.0245	0.0000	0.0000	.1
6671	6020.8	12.64	-4.79	.6562	.1379	.0155	.0066	.0120	.0262	0.0000	0.0000	.0
6672	5959.6	14.69	-4.73	.7590	.1889	.0127	.0060	.0131	.0279	0.0000	0.0000	-.0
6673	5992.8	16.66	-4.67	.8396	.2424	.0056	.0035	.0161	.0227	0.0000	0.0000	-.1
6674	6010.7	18.69	-4.60	.8849	.2968	-.0072	.0034	.0267	.0051	0.0000	0.0000	-.1
6675	6045.5	20.73	-4.52	.9026	.3446	-.0272	.0050	.0289	.0065	0.0000	0.0000	-.2
6676	6006.7	22.79	-4.44	.9411	.3965	-.0288	.0069	.0268	.0069	0.0000	0.0000	-.2
6677	5997.6	24.91	-4.35	.9997	.4613	-.0320	.0061	.0289	.0092	0.0000	0.0000	-.7
6678	6010.3	27.24	-4.25	1.0677	.5401	-.0358	.0065	.0310	.0112	0.0000	0.0000	-.4
6679	6047.0	29.50	-4.13	1.1196	.6180	-.0379	.0099	.0273	.0110	0.0000	0.0000	-.4
6680	6052.6	30.68	-4.07	1.1543	.6658	-.0407	.0131	.0245	.0070	0.0000	0.0000	-.5
6681	6119.4	11.68	-4.81	.6101	.1173	.0165	.0064	.0121	.0257	0.0000	0.0000	.0

ORIGINAL PAGE IS OF POOR QUALITY

NASA LANGLEY

7 X 10 HIGH SPEED TUNNEL

TEST TP	21		RUN 75		CNF(BA)	CAF(BA)	CPM(BA)	CRM(BA)	CYM(BA)	CSF(BA)	TPLEN DEG K
	MACH	Q PA	ALPHA DEG	BETA DEG							
6682	.300	6014.9	11.69	-4.82	.6421	-.0378	.0227	.0052	.0155	.0261	299.4
6683	.301	6048.2	10.43	-4.85	.5580	-.0371	.0197	.0051	.0161	.0238	299.0
6684	.301	6054.7	10.91	-4.84	.5895	-.0379	.0217	.0051	.0158	.0250	298.6
6685	.301	6063.4	12.73	-4.79	.7001	-.0402	.0273	.0053	.0153	.0271	298.2
6686	.300	6010.8	14.59	-4.73	.7951	-.0418	.0258	.0040	.0151	.0269	297.9
6687	.299	6002.2	16.66	-4.67	.9025	-.0438	.0201	.0033	.0157	.0249	297.6
6688	.301	6046.2	18.85	-4.59	1.0082	-.0453	.0107	.0027	.0164	.0189	297.4
6689	.301	6063.9	20.80	-4.52	1.0843	-.0473	.0055	.0006	.0197	.0111	297.1
6690	.300	6015.7	23.03	-4.43	1.1660	-.0479	.0022	-.0020	.0266	-.0012	296.8
6691	.298	5938.4	25.08	-4.34	1.2229	-.0442	-.0138	-.0063	.0296	-.0004	296.6
6692	.299	5979.6	27.16	-4.26	1.2585	-.0424	-.0289	-.0126	.0353	.0026	296.4
6693	.300	6011.4	29.33	-4.16	1.2976	-.0444	-.0344	-.0167	.0357	.0165	296.1
6694	.299	5995.1	30.68	-4.09	1.3281	-.0455	-.0377	-.0156	.0327	.0236	296.0
6695	.302	6100.9	11.69	-4.82	.6504	-.0385	.0226	.0051	.0156	.0267	295.5

TEST TP	21		RUN 75		CPM(SA)	CRM(SA)	CYM(SA)	CSF(SA)	P1 PA	CPB(1)	VTOT M/SEC
	ALPHA DEG	BETA DEG	CL(SA)	CD(SA)							
6682	11.69	-4.82	.6364	.0931	.0227	.0083	.0142	.0261	95678.7	-.169	535.2
6683	10.43	-4.85	.5555	.0646	.0197	.0080	.0149	.0238	95644.0	-.165	536.4
6684	10.41	-4.84	.5861	.0744	.0217	.0080	.0146	.0250	95635.8	-.168	537.6
6685	12.73	-4.79	.6917	.1150	.0273	.0085	.0137	.0271	95627.8	-.170	537.9
6686	14.59	-4.73	.7800	.1599	.0258	.0076	.0136	.0269	95683.0	-.168	537.7
6687	16.66	-4.67	.8771	.2167	.0201	.0077	.0141	.0249	95692.0	-.175	537.4
6688	18.85	-4.59	.9687	.2828	.0107	.0079	.0146	.0189	95645.9	-.186	537.3
6689	20.80	-4.52	1.0305	.3409	.0055	.0075	.0183	.0111	95624.0	-.197	537.1
6690	23.03	-4.43	1.0917	.4121	.0022	.0086	.0253	-.0012	95677.9	-.202	536.8
6691	25.08	-4.34	1.1263	.4783	-.0138	.0068	.0294	-.0004	95758.7	-.210	536.6
6692	27.16	-4.26	1.1391	.5369	-.0289	.0049	.0372	.0026	95715.6	-.217	536.4
6693	29.33	-4.16	1.1530	.5969	-.0344	.0030	.0393	.0165	95682.4	-.217	536.3
6694	30.68	-4.09	1.1654	.6384	-.0377	.0033	.0361	.0236	95701.0	-.220	536.1
6695	11.69	-4.82	.6447	.0941	.0226	.0082	.0142	.0267	95588.6	-.169	535.9

TEST TP	21		RUN 75		CDT	CMST	CRTS	CYTS	CYST	CMU	WTFLO KG/SEC	PLENP PSI
	Q PA	ALPHA DEG	BETA DEG	CLT								
6682	6014.9	11.69	-4.82	.6183	.1197	.0051	.0082	.0136	.0277	.0500	.0648	119.6
6683	6048.2	10.43	-4.85	.5377	.0920	.0019	.0078	.0143	.0255	.0509	.0662	122.0
6684	6054.7	10.91	-4.84	.5677	.1022	.0035	.0079	.0140	.0267	.0517	.0672	124.7
6685	6063.4	12.73	-4.79	.6723	.1424	.0090	.0084	.0131	.0288	.0519	.0675	125.6
6686	6010.8	14.59	-4.73	.7595	.1869	.0073	.0075	.0130	.0286	.0524	.0677	125.9
6687	6002.2	16.66	-4.67	.8556	.2430	.0016	.0075	.0135	.0267	.0526	.0679	125.9
6688	6046.2	18.85	-4.59	.9464	.3081	-.0076	.0077	.0140	.0206	.0523	.0679	126.0
6689	6063.9	20.80	-4.52	1.0073	.3653	-.0129	.0073	.0177	.0128	.0521	.0680	126.2
6690	6015.7	23.03	-4.43	1.0675	.4359	-.0163	.0083	.0247	.0005	.0526	.0681	126.2
6691	5938.4	25.08	-4.34	1.1009	.5015	-.0326	.0066	.0289	.0013	.0533	.0681	126.2
6692	5979.6	27.16	-4.26	1.1130	.5589	-.0476	.0046	.0366	.0044	.0529	.0681	126.2
6693	6011.4	29.33	-4.16	1.1262	.6178	-.0530	.0027	.0388	.0182	.0527	.0682	126.3
6694	5995.1	30.68	-4.09	1.1381	.6588	-.0563	.0029	.0356	.0254	.0530	.0684	126.3
6695	6100.9	11.69	-4.82	.6258	.1218	.0043	.0080	.0136	.0284	.0519	.0683	126.4

NASA LANGLEY

7 X 10 HIGH SPEED TUNNEL

TEST TP	21 MACH	0 PA	RUN 76		CNF(BA)	CAF(BA)	CPH(BA)	CRM(BA)	CYM(BA)	CSF(BA)	TPLEN DEG K
			ALPHA DEG.	BETA DEG.							
6696	.301	6046.1	11.73	-4.82	.6848	-.0660	.0252	.0052	.0170	.0266	291.6
6697	.301	6053.8	10.49	-4.85	.5802	-.0628	.0223	.0059	.0174	.0244	291.5
6698	.301	6050.6	10.95	-4.84	.6206	-.0641	.0228	.0055	.0174	.0258	291.4
6699	.300	6034.7	12.81	-4.79	.7643	-.0703	.0284	.0044	.0167	.0293	291.3
6700	.295	6002.5	14.65	-4.74	.8552	-.0743	.0396	.0052	.0164	.0306	291.2
6701	.298	5969.6	16.65	-4.67	.9470	-.0758	.0387	.0030	.0176	.0282	291.2
6702	.300	6034.4	18.88	-4.59	1.0491	-.0787	.0329	.0017	.0187	.0235	291.2
6703	.300	6024.9	20.99	-4.52	1.1506	-.0815	.0227	.0003	.0206	.0175	291.2
6704	.298	5969.3	23.26	-4.42	1.2579	-.0845	.0136	-.0012	.0241	.0043	291.2
6705	.297	5923.5	25.20	-4.34	1.3425	-.0838	.0023	-.0022	.0270	.0003	291.2
6706	.297	5932.1	27.35	-4.25	1.4114	-.0784	-.0195	-.0136	.0323	.0071	291.3
6707	.300	6015.3	29.46	-4.16	1.4499	-.0794	-.0218	-.0239	.0373	.0112	291.4
6708	.301	6054.1	30.74	-4.11	1.4784	-.0797	-.0330	-.0300	.0418	.0136	291.6
6709	.301	6047.0	11.73	-4.82	.6897	-.0691	.0220	.0048	.0171	.0264	292.0

TEST TP	21 ALPHA DEG	BETA DEG	RUN 76		CPH(SA)	CRM(SA)	CYM(SA)	CSF(SA)	P1 PA	CPB(1)	VTOT M/SEC
			CL(SA)	CD(SA)							
6696	11.73	-4.82	.6839	.0745	.0252	.0085	.0156	.0266	95646.1	-.170	572.7
6697	10.49	-4.85	.5819	.0439	.0223	.0097	.0160	.0244	95635.9	-.166	572.7
6698	10.95	-4.84	.6215	.0550	.0228	.0087	.0160	.0258	95643.0	-.167	572.7
6699	12.81	-4.79	.7608	.1008	.0284	.0080	.0153	.0293	95664.8	-.173	572.6
6700	14.65	-4.74	.8462	.1444	.0396	.0092	.0145	.0306	95695.1	-.171	572.6
6701	16.65	-4.67	.9291	.1987	.0387	.0079	.0161	.0282	95729.6	-.173	572.6
6702	18.88	-4.59	1.0181	.2651	.0329	.0077	.0171	.0235	95662.9	-.186	572.7
6703	20.99	-4.52	1.1034	.3360	.0227	.0077	.0191	.0175	95673.2	-.192	572.7
6704	23.26	-4.42	1.1890	.4190	.0136	.0084	.0226	.0043	95732.7	-.197	572.6
6705	25.20	-4.34	1.2504	.4958	.0023	.0095	.0254	.0043	95779.2	-.202	572.7
6706	27.35	-4.25	1.2897	.5788	-.0195	.0028	.0349	.0071	95765.4	-.213	572.7
6707	29.46	-4.16	1.3015	.6440	-.0218	-.0025	.0442	.0112	95678.3	-.224	573.0
6708	30.74	-4.11	1.3114	.6872	-.0330	-.0044	.0513	.0136	95637.6	-.229	573.1
6709	11.73	-4.82	.6893	.0726	.0220	.0082	.0158	.0264	95643.2	-.170	573.6

TEST TP	21 0 PA	ALPHA DEG	RUN 76		CLT	CDT	CMST	CRTS	CYTS	CYST	CMU	WTFLO KG/SEC	PLENP PSI
			BETA DEG	CLT									
6696	6046.1	11.73	-4.82	.6489	.1257	-.0086	.0083	.0144	.0298	.1012	.1234	231.5	
6697	6053.8	10.49	-4.85	.5480	.0958	-.0115	.0088	.0149	.0276	.1010	.1232	231.8	
6698	6050.6	10.95	-4.84	.5871	.1068	-.0110	.0084	.0149	.0290	.1015	.1239	232.3	
6699	6034.7	12.81	-4.79	.7247	.1517	-.0056	.0077	.0142	.0325	.1016	.1237	232.6	
6700	6002.5	14.65	-4.74	.8082	.1943	.0053	.0089	.0134	.0339	.1023	.1238	232.8	
6701	5969.6	16.65	-4.67	.8891	.2476	.0042	.0075	.0149	.0315	.1033	.1244	233.0	
6702	6034.4	18.88	-4.59	.9767	.3119	-.0012	.0073	.0160	.0267	.1019	.1240	233.0	
6703	6024.9	20.99	-4.52	1.0602	.3814	-.0114	.0072	.0180	.0207	.1023	.1243	233.1	
6704	5969.3	23.26	-4.42	1.1436	.4630	-.0208	.0080	.0215	.0076	.1031	.1241	233.1	
6705	5923.5	25.20	-4.34	1.2032	.5386	-.0325	.0090	.0243	.0076	.1040	.1242	233.3	
6706	5932.1	27.35	-4.25	1.2410	.6197	-.0542	.0022	.0338	.0103	.1038	.1241	233.2	
6707	6015.3	29.46	-4.16	1.2519	.6826	-.0561	-.0031	.0432	.0145	.1024	.1242	233.4	
6708	6054.1	30.74	-4.11	1.2613	.7244	-.0670	-.0050	.0503	.0168	.1019	.1243	233.4	
6709	6047.0	11.73	-4.82	.6541	.1242	-.0121	.0080	.0146	.0296	.1022	.1245	233.4	

NASA LANGLEY

7 X 10 HIGH SPEED TUNNEL

TEST TP	21 MACH	Q PA	RUN 77 ALPHA DEG	BETA DEG	CNF(BA)	CAF(BA)	CPM(BA)	CRM(BA)	CYM(BA)	CSF(BA)	TPLEN DEG K
6710	.300	6017.7	11.77	-4.82	.7436	-.1239	.0234	.0038	.0195	.0197	294.8
6711	.300	6030.4	10.68	-4.84	.6379	-.1211	.0234	.0045	.0193	.0179	295.4
6712	.300	6024.3	10.38	-4.84	.6573	-.1221	.0226	.0048	.0194	.0179	295.9
6713	.299	5989.9	12.81	-4.79	.8436	-.1303	.0213	.0050	.0196	.0205	296.6
6714	.301	6059.0	14.76	-4.74	1.0102	-.1360	.0200	.0043	.0189	.0225	297.1
6715	.300	6030.2	16.89	-4.67	1.1664	-.1447	.0238	.0013	.0196	.0235	297.5
6716	.300	6017.4	16.98	-4.60	1.2578	-.1519	.0380	.0050	.0199	.0185	297.9
6717	.300	6033.4	21.02	-4.52	1.3291	-.1535	.0360	-.0001	.0222	.0141	298.2
6718	.298	5950.0	23.48	-4.42	1.4155	-.1554	.0315	-.0046	.0253	.0055	298.5
6719	.301	6052.4	25.40	-4.35	1.4705	-.1481	.0196	-.0074	.0284	.0094	298.8
6720	.299	5975.8	27.50	-4.25	1.5474	-.1519	.0150	-.0108	.0286	.0152	299.1
6721	.299	5997.2	29.70	-4.15	1.6263	-.1512	.0052	-.0177	.0314	.0129	299.3
6722	.299	6003.6	31.04	-4.09	1.6640	-.1522	.0030	-.0228	.0348	.0109	299.5
6723	.302	6114.8	11.78	-4.82	.7467	-.1267	.0228	.0037	.0197	.0182	300.0

TEST TP	21 ALPHA DEG	BETA DEG	RUN 77 CL(SA)	CD(SA)	CPM(SA)	CRM(SA)	CYM(SA)	CSF(SA)	P1 PA	CPB(1)	VTOT M/SEC
6710	11.77	-4.82	.7533	.0303	.0234	.0077	.0183	.0197	95665.6	-.163	610.0
6711	10.68	-4.84	.6493	-.0008	.0234	.0080	.0181	.0179	95648.9	-.160	610.6
6712	10.88	-4.84	.6685	.0042	.0226	.0084	.0181	.0179	95648.5	-.161	611.2
6713	12.81	-4.79	.8515	.0600	.0213	.0092	.0180	.0205	95691.3	-.167	612.0
6714	14.76	-4.74	1.0115	.1259	.0200	.0090	.0172	.0225	95618.9	-.170	612.5
6715	16.89	-4.67	1.1581	.2004	.0238	.0069	.0184	.0235	95649.1	-.175	612.9
6716	18.98	-4.60	1.2346	.2654	.0380	.0112	.0172	.0185	95662.6	-.185	613.3
6717	21.02	-4.52	1.2957	.3335	.0360	.0078	.0207	.0141	95647.2	-.189	613.6
6718	23.48	-4.42	1.3602	.4214	.0315	.0058	.0250	.0055	95739.9	-.189	613.9
6719	25.40	-4.35	1.3919	.4970	.0196	.0055	.0288	.0094	95632.6	-.197	614.3
6720	27.50	-4.25	1.4427	.5797	.0150	.0036	.0304	.0152	95712.9	-.206	614.5
6721	29.70	-4.15	1.4875	.6744	.0052	.0002	.0361	.0129	95695.2	-.212	614.8
6722	31.04	-4.09	1.5042	.7276	.0030	-.0016	.0415	.0109	95687.2	-.215	615.0
6723	11.78	-4.82	.7568	.0284	.0228	.0077	.0186	.0182	95567.2	-.165	615.6

TEST TP	21 Q PA	ALPHA DEG	RUN 77 BETA DEG	CLT	CDT	CMST	CRTS	CYTS	CYST	CMU	WTFLO KG/SEC	PLENP PSI
6710	6017.7	11.77	-4.82	.6880	.1257	-.0396	.0073	.0162	.0256	.1959	.2231	429.6
6711	6030.4	10.68	-4.84	.5860	.0956	-.0395	.0076	.0160	.0239	.1953	.2228	429.3
6712	6024.3	10.38	-4.84	.6048	.1005	-.0404	.0080	.0160	.0238	.1958	.2228	429.8
6713	5989.9	12.81	-4.79	.7841	.1548	-.0421	.0087	.0159	.0265	.1971	.2228	430.2
6714	6059.0	14.76	-4.74	.9417	.2173	-.0427	.0084	.0151	.0284	.1951	.2228	430.5
6715	6030.2	16.89	-4.67	1.0846	.2896	-.0392	.0063	.0163	.0294	.1961	.2228	430.6
6716	6017.4	18.98	-4.60	1.1619	.3521	-.0252	.0105	.0152	.0244	.1963	.2224	430.6
6717	6033.4	21.02	-4.52	1.2159	.4172	-.0270	.0070	.0187	.0200	.1961	.2226	430.8
6718	5950.0	23.48	-4.42	1.2757	.5027	-.0324	.0049	.0230	.0116	.1988	.2225	430.9
6719	6052.4	25.40	-4.35	1.3062	.5742	-.0433	.0046	.0269	.0154	.1954	.2223	431.0
6720	5975.8	27.50	-4.25	1.3531	.6546	-.0487	.0026	.0284	.0212	.1981	.2224	431.1
6721	5997.2	29.70	-4.15	1.3954	.7456	-.0582	-.0009	.0342	.0189	.1972	.2221	431.2
6722	6003.6	31.04	-4.09	1.4106	.7956	-.0604	-.0027	.0396	.0169	.1971	.2222	431.1
6723	6114.8	11.78	-4.82	.6924	.1226	-.0394	.0072	.0165	.0241	.1935	.2220	430.9

NASA LANGLEY

7 X 10 HIGH SPEED TUNNEL

TEST TP	21 MACH	Q PA	RUN ALPHA DEG	BETA DEG	CNF(BA)	CAF(BA)	CPM(BA)	CRM(BA)	CYM(BA)	CSF(BA)	TPLEN DEG K
6724	.301	6047.4	11.79	-4.82	.7578	-.1494	.0250	.0034	.0198	.0163	301.7
6725	.301	6047.9	10.63	-4.85	.6439	-.1461	.0262	.0045	.0199	.0141	302.1
6726	.301	6048.1	10.87	-4.84	.6672	-.1473	.0257	.0040	.0199	.0149	302.6
6727	.300	6028.0	12.86	-4.79	.8612	-.1548	.0227	.0048	.0200	.0170	303.0
6728	.298	5957.7	14.85	-4.73	1.0382	-.1632	.0217	.0044	.0197	.0189	303.3
6729	.298	5941.0	16.91	-4.67	1.2004	-.1718	.0244	.0036	.0201	.0185	303.7
6730	.299	5998.8	19.07	-4.59	1.3282	-.1794	.0333	.0043	.0224	.0112	304.0
6731	.300	6023.9	21.06	-4.52	1.3927	-.1832	.0459	.0021	.0232	.0071	304.4
6732	.299	5976.6	23.38	-4.43	1.4784	-.1863	.0469	-.0005	.0250	.0020	304.6
6733	.298	5963.3	25.52	-4.34	1.5364	-.1858	.0463	-.0038	.0272	-.0010	305.0
6734	.300	6037.4	27.64	-4.25	1.6106	-.1804	.0331	-.0074	.0288	.0082	305.2
6735	.298	5959.4	29.94	-4.14	1.6770	-.1810	.0269	-.0169	.0332	.0145	305.5
6736	.300	6045.3	31.09	-4.09	1.6792	-.1786	.0247	-.0241	.0380	.0118	305.8
6737	.299	5998.1	11.81	-4.82	.7633	-.1535	.0254	.0028	.0203	.0161	306.3

TEST TP	21 ALPHA DEG	BETA DEG	RUN CL(SA)	CD(SA)	CPM(SA)	CRM(SA)	CYM(SA)	CSF(SA)	P1 PA	CPB(1)	VTGT M/SEC
6724	11.79	-4.82	.7724	.0085	.0250	.0074	.0187	.0163	95631.1	-.160	625.4
6725	10.63	-4.85	.6598	-.0247	.0262	.0081	.0188	.0141	95630.5	-.157	625.8
6726	10.87	-4.84	.6830	-.0188	.0257	.0077	.0188	.0149	95630.4	-.159	626.4
6727	12.86	-4.79	.8740	.0408	.0227	.0091	.0184	.0170	95651.5	-.163	626.8
6728	14.85	-4.73	1.0454	.1084	.0217	.0093	.0179	.0189	95725.0	-.165	627.1
6729	16.91	-4.67	1.1935	.1848	.0244	.0093	.0182	.0185	95742.5	-.172	627.5
6730	19.07	-4.59	1.3140	.2643	.0333	.0114	.0197	.0112	95682.0	-.181	627.9
6731	21.06	-4.52	1.3656	.3294	.0459	.0103	.0209	.0071	95662.5	-.188	628.3
6732	23.38	-4.43	1.4309	.4157	.0469	.0095	.0232	.0020	95712.1	-.189	628.6
6733	25.52	-4.34	1.4665	.4942	.0463	.0083	.0262	-.0010	95732.7	-.194	628.9
6734	27.64	-4.25	1.5104	.5874	.0331	.0068	.0289	.0082	95651.1	-.204	629.2
6735	29.94	-4.14	1.5436	.6802	.0269	.0019	.0372	.0145	95730.7	-.210	629.5
6736	31.09	-4.09	1.5302	.7142	.0247	-.0010	.0450	.0118	95645.2	-.214	629.8
6737	11.81	-4.82	.7786	.0059	.0254	.0069	.0193	.0161	95689.5	-.160	630.3

TEST TP	21 Q PA	ALPHA DEG	RUN BETA DEG	CLT	CDT	CMST	CRTS	CYTS	CYST	CMU	WTFLO KG/SEC	PLENP PSI
6724	6047.4	11.79	-4.82	.6955	.1208	-.0492	.0069	.0162	.0233	.2333	.2605	508.2
6725	6047.9	10.63	-4.85	.5852	.0891	-.0480	.0076	.0162	.0211	.2336	.2607	508.4
6726	6048.1	10.87	-4.84	.6078	.0949	-.0486	.0072	.0163	.0219	.2337	.2606	509.1
6727	6028.0	12.86	-4.79	.7947	.1522	-.0519	.0085	.0159	.0240	.2347	.2606	509.3
6728	5957.7	14.85	-4.73	.9611	.2183	-.0538	.0087	.0154	.0261	.2376	.2607	509.6
6729	5941.0	16.91	-4.67	1.1100	.2920	-.0514	.0085	.0157	.0256	.2384	.2606	510.0
6730	5998.8	19.07	-4.59	1.2224	.3672	-.0418	.0105	.0173	.0183	.2363	.2607	510.1
6731	6023.9	21.06	-4.52	1.2709	.4286	-.0288	.0093	.0185	.0141	.2353	.2605	510.2
6732	5976.6	23.38	-4.43	1.3315	.5117	-.0284	.0084	.0208	.0091	.2371	.2604	510.3
6733	5963.3	25.52	-4.34	1.3634	.5867	-.0292	.0072	.0238	.0061	.2375	.2601	510.2
6734	6037.4	27.64	-4.25	1.4052	.6749	-.0415	.0056	.0266	.0192	.2349	.2602	510.5
6735	5959.4	29.94	-4.14	1.4335	.7645	-.0487	.0006	.0349	.0216	.2378	.2600	510.5
6736	6045.3	31.09	-4.09	1.4200	.7951	-.0499	-.0023	.0428	.0189	.2346	.2601	510.4
6737	5998.1	11.81	-4.82	.7007	.1196	-.0497	.0064	.0168	.0232	.2364	.2598	510.6

NASA LANGLEY

7 X 10 HIGH SPEED TUNNEL

TEST TP	21 MACH	Q PA	RUN 79 ALPHA DEG	BETA DEG	CNF(BA)	CAF(BA)	CPM(BA)	CRM(BA)	CYM(BA)	CSF(BA)	TPLEN DEG K
6738	.500	14999.9	12.58	-4.85	.7067	-.0673	.0261	-.0021	.0169	.0182	308.0
6739	.500	15024.2	11.24	-4.88	.6142	-.0647	.0209	.0043	.0171	.0197	308.2
6740	.501	15058.2	11.59	-4.88	.6376	-.0652	.0218	.0038	.0170	.0188	308.3
6741	.498	14927.7	13.62	-4.83	.7620	-.0691	.0313	.0008	.0167	.0181	308.5
6742	.499	14939.0	15.67	-4.77	.8700	-.0718	.0379	.0011	.0166	.0195	308.6
6743	.500	15003.5	17.91	-4.71	.9772	-.0732	.0355	-.0005	.0181	.0179	308.8
6744	.501	15068.9	20.06	-4.64	1.0786	-.0755	.0310	.0002	.0199	.0160	308.9
6745	.500	15012.2	22.30	-4.56	1.1746	-.0747	.0163	.0019	.0266	.0054	309.2
6746	.496	14792.5	24.50	-4.50	1.2424	-.0751	.0098	-.0060	.0314	.0109	309.4
6747	.500	15026.6	26.72	-4.42	1.2827	-.0705	-.0093	-.0148	.0364	.0114	309.6
6748	.500	14992.9	28.68	-4.36	1.3297	-.0731	-.0108	-.0204	.0383	.0249	309.7
6749	.499	14970.9	30.87	-4.27	1.3949	-.0769	-.0151	-.0244	.0399	.0341	309.9
6750	.496	14805.4	32.30	-4.19	1.4281	-.0793	-.0156	-.0199	.0382	.0364	310.0
6751	.499	14972.6	12.57	-4.85	.7078	-.0677	.0264	.0018	.0170	.0186	310.3

TEST TP	21 ALPHA DEG	BETA DEG	RUN 79 CL(SA)	CD(SA)	CPM(SA)	CRM(SA)	CYM(SA)	CSF(SA)	P1 PA	CPB(11)	VTOT M/SEC
6738	12.58	-4.85	.7044	.0883	.0261	.0058	.0160	.0182	85747.2	-.178	637.4
6739	11.24	-4.88	.6150	.0562	.0209	.0075	.0160	.0197	85747.4	-.173	637.6
6740	11.59	-4.88	.6377	.0642	.0218	.0071	.0158	.0188	85753.5	-.174	637.8
6741	13.62	-4.83	.7568	.1123	.0313	.0047	.0161	.0181	85817.7	-.179	637.9
6742	15.67	-4.77	.8571	.1658	.0379	.0056	.0157	.0195	85837.9	-.182	638.0
6743	17.91	-4.71	.9524	.2308	.0355	.0051	.0174	.0179	85813.5	-.187	638.2
6744	20.06	-4.64	1.0391	.2990	.0310	.0070	.0186	.0160	85745.7	-.197	638.4
6745	22.30	-4.56	1.1151	.3765	.0163	.0118	.0239	.0054	85805.3	-.201	638.6
6746	24.50	-4.50	1.1617	.4468	.0098	.0076	.0311	.0109	86002.8	-.212	638.7
6747	26.72	-4.42	1.1774	.5139	-.0093	.0032	.0392	.0114	85782.2	-.223	639.0
6748	28.68	-4.36	1.2017	.5739	-.0108	.0005	.0434	.0249	85810.1	-.233	639.1
6749	30.87	-4.27	1.2367	.6498	-.0151	-.0004	.0467	.0341	85812.4	-.243	639.3
6750	32.30	-4.19	1.2695	.6960	-.0156	.0036	.0429	.0364	85953.5	-.252	639.3
6751	12.57	-4.85	.7056	.0880	.0264	.0054	.0162	.0186	85846.3	-.178	639.7

TEST TP	21 Q PA	ALPHA DEG	RUN 79 BETA DEG	CLT	CDT	CMST	CRTS	CYTS	CYST	CMU	WTFLO KG/SEC	PLENP PSI
6738	14999.9	12.58	-4.85	.6725	.1335	-.0040	.0055	.0150	.0210	.0954	.2591	512.3
6739	15024.2	11.24	-4.88	.5843	.1021	-.0092	.0073	.0149	.0226	.0952	.2590	512.3
6740	15058.2	11.59	-4.88	.6068	.1098	-.0082	.0069	.0148	.0217	.0950	.2590	512.4
6741	14927.7	13.62	-4.83	.7240	.1571	.0010	.0044	.0151	.0210	.0957	.2586	512.3
6742	14939.0	15.67	-4.77	.8227	.2094	.0076	.0053	.0147	.0223	.0957	.2588	512.4
6743	15003.5	17.91	-4.71	.9165	.2728	.0053	.0048	.0164	.0207	.0953	.2587	512.4
6744	15068.9	20.06	-4.64	1.0017	.3395	.0010	.0067	.0176	.0188	.0949	.2587	512.5
6745	15012.2	22.30	-4.56	1.0761	.4157	-.0139	.0114	.0229	.0083	.0953	.2586	512.5
6746	14792.5	24.50	-4.50	1.1206	.4850	-.0208	.0072	.0301	.0138	.0966	.2585	512.6
6747	15026.6	26.72	-4.42	1.1355	.5499	-.0394	.0027	.0383	.0142	.0951	.2582	512.6
6748	14992.9	28.68	-4.36	1.1585	.6085	-.0410	-.0001	.0424	.0277	.0954	.2585	512.7
6749	14970.9	30.87	-4.27	1.1921	.6828	-.0453	-.0010	.0458	.0369	.0955	.2584	512.7
6750	14805.4	32.30	-4.19	1.2036	.7282	-.0461	.0030	.0420	.0393	.0966	.2583	512.5
6751	14972.6	12.57	-4.85	.6736	.1333	-.0038	.0052	.0152	.0215	.0955	.2580	512.7

ORIGINAL PAGE IS OF POOR QUALITY

NASA LANGLEY

7 X 10 HIGH SPEED TUNNEL

TEST TP	21 MACH	Q PA	RUN 80		CNF(BA)	CAF(BA)	CPH(BA)	CRM(BA)	CYM(BA)	CSF(BA)	TPLEN DEG K
			ALPHA DEG	BETA DEG							
6756	.497	14863.9	12.41	-4.85	.6499	-.0072	.0134	.0037	.0138	.0257	304.1
6757	.501	15069.1	11.24	-4.88	.5853	-.0091	.0136	.0049	.0138	.0241	303.9
6758	.500	15035.1	11.53	-4.87	.6042	-.0087	.0143	.0049	.0139	.0241	304.0
6759	.499	14976.8	13.51	-4.82	.7096	-.0071	.0124	.0037	.0143	.0265	304.1
6760	.498	14940.1	15.36	-4.78	.7967	-.0069	.0076	.0021	.0161	.0255	304.2
6761	.500	15023.6	17.53	-4.71	.8813	-.0038	-.0058	.0012	.0212	.0164	304.2
6762	.499	14965.7	19.63	-4.66	.8811	.0044	-.0209	.0057	.0311	.0102	304.3
6763	.495	14748.4	21.71	-4.56	.9222	.0037	-.0151	.0027	.0254	.0127	304.4
6764	.494	14729.6	23.91	-4.46	.9909	-.0000	-.0125	.0075	.0215	.0141	304.5
6765	.499	14977.0	26.18	-4.35	1.0921	-.0046	-.0172	.0136	.0162	.0165	304.6
6766	.493	14703.5	28.39	-4.22	1.2154	-.0099	-.0270	.0221	.0127	.0123	304.8
6767	.497	14869.6	30.65	-4.09	1.2999	-.0157	-.0318	.0271	.0107	.0050	304.9
6768	.497	14875.4	32.11	-4.02	1.3518	-.0191	-.0327	.0272	.0105	.0066	305.0
6769	.503	15154.0	12.44	-4.85	.6560	-.0071	.0127	.0036	.0137	.0273	305.4

TEST TP	21 ALPHA DEG	BETA DEG	RUN 80		CPH(SA)	CRM(SA)	CYM(SA)	CSF(SA)	P1 PA	CPB(1)	VTOT M/SEC
			CL(SA)	CD(SA)							
6756	12.41	-4.85	.6363	.1326	.0134	.0066	.0127	.0257	86034.5	-.158	0.0
6757	11.24	-4.88	.5758	.1052	.0136	.0075	.0126	.0241	85846.4	-.157	0.0
6758	11.53	-4.87	.5938	.1122	.0143	.0076	.0127	.0241	85852.9	-.158	0.0
6759	13.51	-4.82	.6916	.1589	.0124	.0069	.0130	.0265	85910.2	-.160	0.0
6760	15.36	-4.78	.7701	.2043	.0076	.0063	.0150	.0255	85935.6	-.167	0.0
6761	17.53	-4.71	.8415	.2619	-.0058	.0076	.0198	.0164	85892.9	-.183	0.0
6762	19.63	-4.66	.8284	.3002	-.0209	.0050	.0312	.0102	85933.4	-.187	0.0
6763	21.71	-4.56	.8554	.3446	-.0151	.0119	.0226	.0127	86126.9	-.194	0.0
6764	23.91	-4.46	.9059	.4015	-.0125	.0156	.0167	.0141	86206.1	-.203	0.0
6765	26.18	-4.35	.9821	.4776	-.0172	.0194	.0086	.0165	85953.5	-.213	0.0
6766	28.39	-4.22	1.0740	.5691	-.0270	.0255	.0007	.0123	86272.9	-.224	0.0
6767	30.65	-4.09	1.1263	.6492	-.0318	.0288	-.0046	.0050	86073.1	-.236	0.0
6768	32.11	-4.02	1.1551	.7024	-.0327	.0286	-.0056	.0066	85979.1	-.253	0.0
6769	12.44	-4.85	.6421	.1345	.0127	.0065	.0126	.0273	85728.0	-.159	0.0

TEST TP	21 Q PA	ALPHA DEG	RUN 80		CLT	COT	CMST	CRTS	CYTS	CYST	CMU	WTFLO KG/SEC	PLENP PSI
			BETA DEG	CLT									
6756	14863.9	12.41	-4.85	.6363	.1326	.0134	.0066	.0127	.0257	0.0000	0.0000	0.0000	-.2
6757	15069.1	11.24	-4.88	.5758	.1052	.0136	.0075	.0126	.0241	0.0000	0.0000	0.0000	-.1
6758	15035.1	11.53	-4.87	.5938	.1122	.0143	.0076	.0127	.0241	0.0000	0.0000	0.0000	-.1
6759	14976.8	13.51	-4.82	.6916	.1589	.0124	.0069	.0130	.0265	0.0000	0.0000	0.0000	-.2
6760	14940.1	15.36	-4.78	.7701	.2043	.0076	.0063	.0150	.0255	0.0000	0.0000	0.0000	-.2
6761	15023.6	17.53	-4.71	.8415	.2619	-.0058	.0076	.0198	.0164	0.0000	0.0000	0.0000	-.4
6762	14965.7	19.63	-4.66	.8284	.3002	-.0209	.0050	.0312	.0102	0.0000	0.0000	0.0000	-.4
6763	14748.4	21.71	-4.56	.8554	.3446	-.0151	.0119	.0226	.0127	0.0000	0.0000	0.0000	-.5
6764	14729.6	23.91	-4.46	.9059	.4015	-.0125	.0156	.0167	.0141	0.0000	0.0000	0.0000	-.6
6765	14977.0	26.18	-4.35	.9821	.4776	-.0172	.0194	.0086	.0165	0.0000	0.0000	0.0000	-.8
6766	14703.5	28.39	-4.22	1.0740	.5691	-.0270	.0255	.0007	.0123	0.0000	0.0000	0.0000	-1.0
6767	14869.6	30.65	-4.09	1.1263	.6492	-.0318	.0288	-.0046	.0050	0.0000	0.0000	0.0000	-1.1
6768	14875.4	32.11	-4.02	1.1551	.7024	-.0327	.0286	-.0056	.0066	0.0000	0.0000	0.0000	-1.2
6769	15154.0	12.44	-4.85	.6421	.1345	.0127	.0065	.0126	.0273	0.0000	0.0000	0.0000	-.2

NASA LANGLEY

7 X 10 HIGH SPEED TUNNEL

TEST TP	21 MACH	Q PA	RUN 81 ALPHA DEG	BETA DEG	CHF(BA)	CAF(BA)	CPM(BA)	CRM(BA)	CYM(BA)	CSF(BA)	TPLEN DEG K
6770	.500	15008.9	12.49	-4.85	.6666	-.0340	.0228	.0051	.0152	.0259	295.5
6771	.501	15080.0	11.19	-4.89	.5915	-.0333	.0206	.0058	.0154	.0259	295.2
6772	.500	15006.8	11.58	-4.88	.6201	-.0337	.0208	.0058	.0154	.0260	295.0
6773	.500	15016.3	13.67	-4.82	.7292	-.0347	.0206	.0042	.0154	.0267	294.9
6774	.497	14887.8	15.67	-4.77	.8273	-.0359	.0185	.0041	.0159	.0263	294.8
6775	.497	14868.1	17.71	-4.70	.9121	-.0366	.0131	.0037	.0174	.0235	294.7
6776	.500	15019.0	19.99	-4.63	.9997	-.0391	.0107	.0028	.0207	.0176	294.7
6777	.496	14840.6	22.25	-4.55	1.0821	-.0387	.0045	.0033	.0266	.0087	294.7
6778	.500	15010.2	24.26	-4.48	1.1299	-.0364	-.0060	.0018	.0273	.0116	294.8
6779	.497	14877.7	26.66	-4.37	1.1707	-.0370	-.0085	.0032	.0255	.0154	294.9
6780	.504	15208.7	28.58	-4.27	1.2021	-.0390	-.0038	.0073	.0212	.0199	295.1
6781	.504	15237.0	30.80	-4.14	1.2652	-.0423	-.0055	.0132	.0129	.0257	295.3
6782	.499	14950.3	32.15	-4.04	1.3284	-.0456	-.0126	.0208	.0063	.0277	295.5
6783	.502	15114.0	12.49	-4.85	.6670	-.0348	.0207	.0049	.0150	.0269	296.0

TEST TP	21 ALPHA DEG	BETA DEG	RUN 81 CL(SA)	CD(SA)	CPN(SA)	CRM(SA)	CYM(SA)	CSF(SA)	P1 PA	CPB(1)	VTOT M/SEC
6770	12.49	-4.85	.6582	.1109	.0228	.0082	.0137	.0259	85846.7	-.171	594.0
6771	11.19	-4.89	.5867	.0821	.0206	.0086	.0140	.0259	85844.3	-.168	593.8
6772	11.58	-4.88	.6142	.0915	.0208	.0088	.0139	.0260	85838.8	-.170	593.6
6773	13.67	-4.82	.7167	.1386	.0206	.0077	.0140	.0267	85899.6	-.172	593.4
6774	15.67	-4.77	.8063	.1889	.0185	.0083	.0142	.0263	85999.6	-.176	593.2
6775	17.71	-4.70	.8800	.2426	.0131	.0088	.0154	.0235	86100.0	-.185	593.0
6776	19.99	-4.63	.9528	.3050	.0107	.0098	.0185	.0176	85931.1	-.202	593.0
6777	22.25	-4.55	1.0162	.3739	.0045	.0131	.0234	.0087	86130.0	-.207	592.9
6778	24.26	-4.48	1.0451	.4310	-.0060	.0128	.0242	.0116	85880.4	-.213	593.1
6779	26.66	-4.37	1.0629	.4921	-.0085	.0144	.0214	.0154	85991.4	-.224	593.1
6780	28.58	-4.27	1.0742	.5409	-.0038	.0166	.0151	.0199	85599.2	-.239	593.5
6781	30.80	-4.14	1.1084	.6115	-.0055	.0179	.0044	.0257	85565.2	-.257	593.7
6782	32.15	-4.04	1.1490	.6682	-.0126	.0209	-.0057	.0277	85900.1	-.273	593.6
6783	12.49	-4.85	.6588	.1103	.0207	.0080	.0136	.0269	85773.1	-.171	594.2

TEST TP	21 Q PA	ALPHA DEG	RUN 81 BETA DEG	CLT	CDT	CMST	CRTS	CYTS	CYST	CMU	WTFLO KG/SEC	PLENP PSI
6770	15008.9	12.49	-4.85	.6407	.1357	.0063	.0081	.0131	.0275	.0504	.1470	280.9
6771	15080.0	11.19	-4.89	.5699	.1072	.0041	.0085	.0134	.0275	.0502	.1471	281.2
6772	15006.8	11.58	-4.88	.5972	.1166	.0043	.0086	.0134	.0276	.0506	.1476	281.3
6773	15016.3	13.67	-4.82	.6988	.1631	.0041	.0076	.0135	.0282	.0504	.1472	281.1
6774	14887.8	15.67	-4.77	.7874	.2128	.0018	.0081	.0136	.0279	.0508	.1473	281.0
6775	14868.1	17.71	-4.70	.8603	.2659	-.0036	.0087	.0149	.0250	.0507	.1469	280.7
6776	15019.0	19.99	-4.63	.9324	.3272	-.0058	.0096	.0180	.0192	.0502	.1469	280.4
6777	14840.6	22.25	-4.55	.9947	.3955	-.0121	.0129	.0229	.0103	.0507	.1466	280.1
6778	15010.2	24.26	-4.48	1.0231	.4516	-.0225	.0126	.0236	.0132	.0502	.1467	279.9
6779	14877.7	26.66	-4.37	1.0398	.5120	-.0251	.0141	.0208	.0170	.0506	.1466	279.7
6780	15208.7	28.58	-4.27	1.0510	.5595	-.0200	.0163	.0146	.0214	.0495	.1464	279.7
6781	15237.0	30.80	-4.14	1.0846	.6292	-.0217	.0177	.0039	.0272	.0493	.1462	279.6
6782	14950.3	32.15	-4.04	1.1243	.6857	-.0291	.0206	-.0062	.0292	.0502	.1461	279.5
6783	15114.0	12.49	-4.85	.6416	.1348	.0044	.0079	.0131	.0284	.0496	.1456	279.2

ORIGINAL PAGE IS
OF POOR QUALITY

NASA LANGLEY

7 X 10 HIGH SPEED TUNNEL

TEST TP	21 MACH	Q PA	RUN 82 ALPHA DEG	BETA DEG	CNF(BA)	CAF(BA)	CPH(BA)	CRM(BA)	CYM(BA)	CSF(BA)	TPLEN DEG K
6796	.299	6012.8	11.65	-4.80	.6201	-.0085	.0135	.0117	-.0178	.0762	302.7
6797	.300	6014.9	10.44	-4.83	.5486	-.0090	.0125	.0130	-.0187	.0762	302.7
6798	.300	6017.3	10.80	-4.82	.5696	-.0087	.0132	.0124	-.0185	.0754	302.7
6799	.299	5999.3	12.65	-4.77	.6753	-.0086	.0129	.0118	-.0171	.0764	302.6
6800	.299	5992.1	14.55	-4.72	.7756	-.0090	.0101	.0102	-.0152	.0748	302.6
6801	.300	6024.8	16.60	-4.65	.8702	-.0083	.0022	.0077	-.0126	.0709	302.5
6802	.299	6006.7	18.74	-4.58	.9290	-.0026	-.0112	.0012	-.0031	.0540	302.5
6803	.299	5990.5	20.77	-4.51	.9712	.0026	-.0312	-.0005	.0067	.0442	302.5
6804	.298	5965.2	22.89	-4.42	1.0243	.0007	-.0324	.0001	.0092	.0376	302.4
6805	.299	5982.7	24.92	-4.34	1.0978	-.0029	-.0335	-.0020	.0147	.0303	302.4
6806	.300	6028.8	27.04	-4.25	1.1915	-.0082	-.0364	-.0076	-.0236	.0236	302.3
6807	.301	6055.9	29.22	-4.15	1.2660	-.0133	-.0373	-.0056	.0250	.0215	302.3
6808	.299	6008.5	30.68	-4.07	1.3275	-.0168	-.0406	-.0011	.0237	.0155	302.3
6809	.302	6108.2	11.66	-4.80	.6200	-.0081	.0133	.0117	-.0178	.0748	302.3

TEST TP	21 ALPHA DEG	BETA DEG	RUN 82 CL(SA)	CD(SA)	CPH(SA)	CRM(SA)	CYM(SA)	CSF(SA)	P1 PA	CPB(I)	VTOT M/SEC
6796	11.65	-4.80	.6091	.1169	.0135	.0079	-.0198	.0762	95796.3	-.146	0.0
6797	10.44	-4.83	.5411	.0905	.0125	.0094	-.0207	.0762	95791.8	-.146	0.0
6798	10.80	-4.82	.5612	.0982	.0132	.0087	-.0205	.0754	95791.5	-.147	0.0
6799	12.65	-4.77	.6608	.1394	.0129	.0078	-.0193	.0764	95808.3	-.148	0.0
6800	14.55	-4.72	.7530	.1861	.0101	.0061	-.0172	.0748	95817.7	-.151	0.0
6801	16.60	-4.65	.8363	.2407	.0022	.0038	-.0142	.0709	95782.0	-.163	0.0
6802	18.74	-4.58	.8807	.2959	-.0112	.0001	-.0033	.0540	95802.6	-.168	0.0
6803	20.77	-4.51	.9072	.3468	-.0312	.0019	.0064	.0442	95826.3	-.172	0.0
6804	22.89	-4.42	.9433	.3992	-.0324	.0037	.0084	.0376	95852.9	-.176	0.0
6805	24.92	-4.34	.9969	.4599	-.0335	.0044	.0142	.0303	95827.8	-.185	0.0
6806	27.04	-4.25	1.0650	.5344	-.0364	.0040	.0245	.0236	95779.4	-.197	0.0
6807	29.22	-4.15	1.1114	.6063	-.0373	.0073	.0245	.0215	95751.0	-.206	0.0
6808	30.68	-4.07	1.1503	.6628	-.0406	.0112	.0210	.0155	95798.9	-.214	0.0
6809	11.66	-4.80	.6088	.1174	.0133	.0079	-.0198	.0748	95689.6	-.146	0.0

TEST TP	21 Q PA	ALPHA DEG	RUN 82 BETA DEG	CLT	CDT	CMST	CRTS	CYTS	CYST	CMU	WTFLO KG/SEC	PLENP PSI
6796	6012.8	11.65	-4.80	.6091	.1169	.0135	.0079	-.0198	.0762	0.0000	0.0000	-.2
6797	6014.9	10.44	-4.83	.5411	.0905	.0125	.0094	-.0207	.0762	0.0000	0.0000	-.1
6798	6017.3	10.80	-4.82	.5612	.0982	.0132	.0087	-.0205	.0754	0.0000	0.0000	-.1
6799	5999.3	12.65	-4.77	.6608	.1394	.0129	.0078	-.0193	.0764	0.0000	0.0000	-.1
6800	5992.1	14.55	-4.72	.7530	.1861	.0101	.0061	-.0172	.0748	0.0000	0.0000	-.1
6801	6024.8	16.60	-4.65	.8363	.2407	.0022	.0038	-.0142	.0709	0.0000	0.0000	-.2
6802	6006.7	18.74	-4.58	.8807	.2959	-.0112	.0001	-.0033	.0540	0.0000	0.0000	-.2
6803	5990.5	20.77	-4.51	.9072	.3468	-.0312	.0019	.0064	.0442	0.0000	0.0000	-.3
6804	5965.2	22.89	-4.42	.9433	.3992	-.0324	.0037	.0084	.0376	0.0000	0.0000	-.3
6805	5982.7	24.92	-4.34	.9969	.4599	-.0335	.0044	.0142	.0303	0.0000	0.0000	-.4
6806	6028.8	27.04	-4.25	1.0650	.5344	-.0364	.0040	.0245	.0236	0.0000	0.0000	-.4
6807	6055.9	29.22	-4.15	1.1114	.6063	-.0373	.0073	.0245	.0215	0.0000	0.0000	-.5
6808	6008.5	30.68	-4.07	1.1503	.6628	-.0406	.0112	.0210	.0155	0.0000	0.0000	-.5
6809	6108.2	11.66	-4.80	.6088	.1174	.0133	.0079	-.0198	.0748	0.0000	0.0000	-.1

NASA LANGLEY

7 X 10 HIGH SPEED TUNNEL

TEST TP	21 MACH	0 PA	RUN 83 ALPHA DEG	BETA DEG	CNF(BA)	CAF(BA)	CPH(BA)	CRM(BA)	CYH(BA)	CSF(BA)	TPLEN DEG K
6810	.300	6046.9	11.68	-4.80	.6393	-.0390	.0206	.0133	-.0165	.0771	298.3
6811	.301	6059.4	10.47	-4.83	.5574	-.0385	.0183	.0134	-.0168	.0777	298.0
6812	.300	6033.2	10.86	-4.82	.5845	-.0389	.0195	.0134	-.0168	.0777	297.7
6813	.299	6013.4	12.65	-4.77	.6942	-.0412	.0239	.0130	-.0156	.0768	297.5
6814	.300	6015.9	14.55	-4.72	.7926	-.0424	.0225	.0113	-.0137	.0736	297.3
6815	.300	6021.4	16.67	-4.65	.9057	-.0443	.0194	.0108	-.0115	.0676	297.1
6816	.300	6030.2	18.79	-4.57	1.0078	-.0465	.0067	.0098	-.0103	.0617	296.9
6817	.300	6028.7	20.97	-4.49	1.0926	-.0492	.0012	.0059	-.0061	.0510	296.8
6818	.300	6019.9	23.17	-4.41	1.1712	-.0492	-.0041	.0035	-.0012	.0448	296.7
6819	.301	6076.7	25.08	-4.33	1.2138	-.0446	-.0204	-.0034	.0091	.0359	296.6
6820	.300	6027.6	27.14	-4.25	1.2519	-.0432	-.0317	-.0101	.0230	.0231	296.4
6821	.297	5926.0	29.25	-4.16	1.2846	-.0458	-.0329	-.0139	.0315	.0198	296.3
6822	.299	6014.6	30.68	-4.08	1.3148	-.0470	-.0335	-.0122	.0310	.0229	296.2
6823	.301	6058.7	11.68	-4.80	.6415	-.0398	.0204	.0134	-.0163	.0761	296.0

TEST TP	21 ALPHA DEG	BETA DEG	RUN 83 CL(SA)	CD(SA)	CPH(SA)	CRM(SA)	CYH(SA)	CSF(SA)	P1 PA	CPB(1)	VTDT M/SEC
6810	.11.68	-4.80	.6340	.0912	.0206	.0097	-.0189	.0771	95765.6	-.159	535.5
6811	.10.47	-4.83	.5551	.0634	.0183	.0101	-.0189	.0777	95761.0	-.156	536.8
6812	.10.86	-4.82	.5814	.0719	.0195	.0100	-.0190	.0777	95781.6	-.157	536.8
6813	.12.65	-4.77	.6864	.1118	.0239	.0093	-.0180	.0768	95807.7	-.160	536.7
6814	.14.55	-4.72	.7779	.1580	.0225	.0075	-.0161	.0736	95801.1	-.158	536.6
6815	.16.67	-4.65	.8803	.2174	.0154	.0070	-.0141	.0676	95797.3	-.158	536.5
6816	.18.79	-4.57	.9690	.2807	.0067	.0060	-.0129	.0617	95786.0	-.167	536.3
6817	.20.97	-4.49	1.0378	.3451	.0012	.0033	-.0078	.0510	95793.1	-.179	536.2
6818	.23.17	-4.41	1.0961	.4155	-.0041	.0028	-.0025	.0448	95800.2	-.189	536.1
6819	.25.08	-4.33	1.1182	.4742	-.0204	.0008	.0097	.0359	95742.8	-.199	536.1
6820	.27.14	-4.25	1.1337	.5326	-.0317	.0015	.0251	.0231	95787.4	-.207	535.9
6821	.29.25	-4.16	1.1432	.5877	-.0329	.0033	.0343	.0198	95893.9	-.213	535.8
6822	.30.68	-4.08	1.1548	.6305	-.0335	.0053	.0329	.0229	95801.1	-.218	535.8
6823	.11.68	-4.80	.6362	.0909	.0204	.0098	-.0187	.0761	95748.1	-.159	535.7

TEST TP	21 0 PA	ALPHA DEG	RUN 83 BETA DEG	CLT	CDT	CMST	CRTS	CYTS	CYST	CMU	WTFLO KG/SEC	PLENP PSI
6810	6046.9	11.68	-4.80	.6156	.1182	.0028	.0096	-.0195	.0788	.0514	.0670	121.8
6811	6059.4	10.47	-4.83	.5369	.0913	.0001	.0100	-.0195	.0794	.0522	.0681	124.5
6812	6033.2	10.86	-4.82	.5629	.0998	.0013	.0099	-.0197	.0794	.0525	.0681	124.9
6813	6013.4	12.65	-4.77	.6670	.1393	.0056	.0091	-.0187	.0786	.0527	.0682	125.1
6814	6015.9	14.55	-4.72	.7575	.1849	.0041	.0073	-.0167	.0753	.0527	.0683	125.1
6815	6021.4	16.67	-4.65	.8590	.2434	-.0029	.0069	-.0147	.0693	.0527	.0683	125.3
6816	6030.2	18.79	-4.57	.9468	.3059	-.0116	.0058	-.0135	.0634	.0526	.0683	125.3
6817	6028.7	20.97	-4.49	1.0146	.3695	-.0171	.0031	-.0084	.0527	.0528	.0685	125.3
6818	6019.9	23.17	-4.41	1.0720	.4390	-.0225	.0025	-.0031	.0465	.0528	.0685	125.3
6819	6076.7	25.08	-4.33	1.0935	.4966	-.0387	.0005	.0091	.0376	.0524	.0685	125.4
6820	6027.6	27.14	-4.25	1.1080	.5544	-.0500	.0012	.0245	.0248	.0528	.0685	125.3
6821	5926.0	29.25	-4.16	1.1162	.6089	-.0515	.0030	.0337	.0216	.0537	.0687	125.4
6822	6014.6	30.68	-4.08	1.1277	.6507	-.0519	.0050	.0323	.0247	.0528	.0685	125.5
6823	6058.7	11.68	-4.80	.6174	.1186	.0021	.0097	-.0193	.0779	.0526	.0686	125.5

ORIGINAL PAGE IS
OF POOR QUALITY

NASA LANGLEY

7 X 10 HIGH SPEED TUNNEL

TEST TP	21 MACH	0 PA	RUN 84 ALPHA DEG	BETA DEG	CNF(BA)	CAF(BA)	CPM(BA)	CRM(BA)	CYM(BA)	CSF(BA)	TPLEN DEG K
6824	.301	6056.0	11.70	-4.80	.6781	-.0688	.0228	.0132	-.0152	.0786	294.1
6825	.301	6065.8	10.47	-4.83	.5751	-.0656	.0206	.0144	-.0158	.0780	294.2
6826	.301	6072.2	10.88	-4.82	.6077	-.0666	.0215	.0141	-.0158	.0790	294.2
6827	.300	6050.5	12.80	-4.77	.7555	-.0725	.0262	.0126	-.0142	.0776	294.3
6828	.299	6011.5	14.59	-4.72	.8509	-.0768	.0355	.0130	-.0119	.0741	294.4
6829	.300	6027.3	16.70	-4.65	.9461	-.0778	.0345	.0090	-.0084	.0681	294.5
6830	.299	6015.1	18.80	-4.58	1.0500	-.0818	.0291	.0066	-.0048	.0603	294.6
6831	.299	5988.7	20.87	-4.51	1.1484	-.0850	.0195	.0056	-.0015	.0521	294.7
6832	.298	5965.1	23.15	-4.41	1.2585	-.0880	.0091	.0048	-.0014	.0451	294.8
6833	.299	5989.9	25.20	-4.33	1.3434	-.0860	-.0042	.0021	.0054	.0410	294.9
6834	.299	6006.4	27.32	-4.25	1.3979	-.0803	-.0213	-.0124	.0206	.0281	295.1
6835	.299	5989.4	29.44	-4.16	1.4464	-.0819	-.0247	-.0237	.0357	.0147	295.2
6836	.300	6029.7	30.82	-4.10	1.4714	-.0831	-.0342	-.0304	.0449	.0061	295.3
6837	.303	6147.8	11.74	-4.80	.6840	-.0705	.0206	.0136	-.0152	.0761	295.5

TEST TP	21 ALPHA DEG	BETA DEG	RUN 84 CL(SA)	CD(SA)	CPM(SA)	CRM(SA)	CYM(SA)	CSF(SA)	P1 PA	CP8(I)	VTOT M/SEC
6824	11.70	-4.80	.6780	.0702	.0228	.0099	-.0176	.0786	95757.8	-.161	575.1
6825	10.47	-4.83	.5774	.0401	.0206	.0112	-.0182	.0780	95753.4	-.156	575.2
6826	10.88	-4.82	.6094	.0493	.0215	.0109	-.0181	.0790	95740.7	-.157	575.2
6827	12.80	-4.77	.7528	.0967	.0262	.0091	-.0166	.0776	95769.8	-.163	575.3
6828	14.59	-4.72	.8428	.1400	.0355	.0096	-.0148	.0741	95811.2	-.163	575.4
6829	16.70	-4.65	.9285	.1973	.0345	.0062	-.0106	.0681	95794.6	-.155	575.5
6830	18.80	-4.58	1.0203	.2610	.0291	.0047	-.0066	.0603	95805.3	-.167	575.6
6831	20.87	-4.51	1.1034	.3297	.0195	.0047	-.0034	.0521	95828.2	-.178	575.7
6832	23.15	-4.41	1.1918	.4138	.0091	.0038	-.0032	.0451	95858.0	-.187	575.8
6833	25.20	-4.33	1.2521	.4942	-.0042	.0043	.0040	.0410	95823.6	-.193	575.9
6834	27.32	-4.25	1.2788	.5702	-.0213	-.0016	.0240	.0281	95809.7	-.204	576.1
6835	29.44	-4.16	1.2999	.6396	-.0247	-.0031	.0428	.0147	95820.7	-.214	576.2
6836	30.82	-4.10	1.3062	.6824	-.0342	-.0031	.0542	.0061	95785.3	-.223	576.3
6837	11.74	-4.80	.6840	.0701	.0206	.0102	-.0176	.0761	95661.6	-.161	576.7

TEST TP	21 0 PA	ALPHA DEG	RUN 84 BETA DEG	CLT	CDT	CMST	CRTS	CYTS	CYST	CMU	WTFLO KG/SEC	PLENP PSI
6824	6056.0	11.70	-4.80	.6431	.1213	-.0110	.0096	-.0188	.0818	.1009	.1227	231.7
6825	6065.8	10.47	-4.83	.5436	.0919	-.0132	.0110	-.0193	.0812	.1006	.1225	231.7
6826	6072.2	10.88	-4.82	.5753	.1008	-.0122	.0106	-.0193	.0822	.1004	.1224	231.6
6827	6050.5	12.80	-4.77	.7169	.1472	-.0076	.0089	-.0178	.0807	.1009	.1225	231.7
6828	6011.5	14.59	-4.72	.8050	.1897	.0015	.0093	-.0159	.0773	.1015	.1225	231.7
6829	6027.3	16.70	-4.65	.8891	.2455	.0005	.0059	-.0117	.0713	.1014	.1227	231.8
6830	6015.1	18.80	-4.58	.9790	.3078	-.0049	.0043	-.0078	.0635	.1014	.1223	231.8
6831	5988.7	20.87	-4.51	1.0603	.3752	-.0146	.0043	-.0045	.0554	.1019	.1224	231.8
6832	5965.1	23.15	-4.41	1.1467	.4577	-.0252	.0034	-.0042	.0484	.1024	.1225	231.9
6833	5989.9	25.20	-4.33	1.2057	.5363	-.0384	.0037	.0030	.0442	.1018	.1223	231.9
6834	6006.4	27.32	-4.25	1.2310	.6105	-.0553	-.0022	.0229	.0313	.1017	.1224	231.9
6835	5989.4	29.44	-4.16	1.2504	.6782	-.0589	-.0037	.0417	.0179	.1018	.1222	232.0
6836	6029.7	30.82	-4.10	1.2562	.7195	-.0681	-.0037	.0531	.0093	.1014	.1225	232.0
6837	6147.8	11.74	-4.80	.6496	.1206	-.0128	.0100	-.0188	.0793	.0994	.1224	232.1

NASA LANGLEY

7 X 10 HIGH SPEED TUNNEL

TEST TP	21 MACH	0 PA	RUN ALPHA DEG	85 BETA DEG	CNF(BA)	CAF(BA)	CPH(BA)	CRM(BA)	CYM(BA)	CSF(BA)	TPLEN DEG K
6838	.300	6023.6	11.77	-4.80	.7308	-.1264	.0216	.0127	-.0137	.0713	297.5
6839	.300	6024.1	10.50	-4.83	.6133	-.1230	.0229	.0132	-.0142	.0712	297.6
6840	.300	6037.2	10.86	-4.82	.6474	-.1238	.0227	.0133	-.0141	.0713	297.7
6841	.295	6006.7	12.77	-4.77	.8280	-.1311	.0203	.0133	-.0128	.0708	297.9
6842	.299	5989.6	14.75	-4.72	1.0103	-.1383	.0197	.0118	-.0111	.0702	298.0
6843	.300	6036.6	16.87	-4.65	1.1560	-.1451	.0225	.0088	-.0090	.0676	298.1
6844	.300	6023.4	18.96	-4.58	1.2482	-.1523	.0368	.0124	-.0075	.0603	298.2
6845	.300	6031.6	21.10	-4.50	1.3281	-.1545	.0334	.0074	-.0032	.0526	298.4
6846	.298	5957.2	23.29	-4.42	1.4040	-.1556	.0313	.0008	.0060	.0358	298.4
6847	.298	5966.5	25.69	-4.32	1.4763	-.1503	.0196	-.0048	.0177	.0278	298.6
6848	.299	6005.8	27.52	-4.25	1.5395	-.1500	.0154	-.0102	.0233	.0232	298.8
6849	.299	5992.4	29.68	-4.15	1.6094	-.1511	.0079	-.0176	.0311	.0122	298.9
6850	.300	6046.5	31.04	-4.09	1.6432	-.1508	.0041	-.0242	.0375	.0048	299.1
6851	.303	6153.3	11.79	-4.80	.7321	-.1257	.0222	.0126	-.0137	.0707	299.5

TEST TP	21 ALPHA DEG	BFTA DEG	RUN CL(SA)	85 CD(SA)	CPH(SA)	CRM(SA)	CYM(SA)	CSF(SA)	P1 PA	CPB(1)	VTOT M/SEC
6838	11.77	-4.80	.7413	.0253	.0216	.0096	-.0160	.0713	95788.3	-.153	613.0
6839	10.50	-4.83	.6255	-.0092	.0229	.0104	-.0163	.0712	95794.6	-.150	613.1
6840	10.86	-4.82	.6592	.0004	.0227	.0105	-.0163	.0713	95774.0	-.150	613.3
6841	12.77	-4.77	.8365	.0552	.0203	.0101	-.0154	.0708	95803.4	-.156	613.5
6842	14.75	-4.72	1.0122	.1235	.0197	.0086	-.0137	.0702	95823.0	-.159	613.6
6843	16.87	-4.65	1.1483	.1967	.0225	-.0058	-.0112	.0676	95773.7	-.162	613.8
6844	18.96	-4.58	1.2299	.2615	.0368	.0093	-.0111	.0603	95797.4	-.175	613.8
6845	21.10	-4.50	1.2946	.3339	.0334	.0057	-.0056	.0526	95783.3	-.180	614.0
6846	23.29	-4.42	1.3511	.4123	.0313	.0031	.0052	.0358	95868.0	-.180	614.0
6847	25.69	-4.32	1.3954	.5046	.0196	.0033	.0180	.0278	95854.9	-.185	614.2
6848	27.52	-4.25	1.4347	.5782	.0154	.0017	.0253	.0232	95813.7	-.193	614.4
6849	29.68	-4.15	1.4731	.6655	.0079	.0001	.0357	.0122	95834.5	-.200	614.5
6850	31.04	-4.09	1.4857	.7180	.0041	-.0014	.0446	.0048	95774.5	-.206	614.7
6851	11.79	-4.80	.7424	.0265	.0222	.0096	-.0160	.0707	95658.3	-.154	615.2

TEST TP	21 0 PA	ALPHA DEG	RUN BETA DEG	85 CLT	CDT	CMST	CRTS	CYTS	CYST	CMU	WTFLO KG/SEC	PLENPP PSI
6838	6023.6	11.77	-4.80	.6757	.1212	-.0417	.0092	-.0181	.0772	.1961	.2226	432.0
6839	6024.1	10.50	-4.83	.5620	.0881	-.0404	.0100	-.0185	.0772	.1963	.2228	432.1
6840	6037.2	10.86	-4.82	.5953	.0971	-.0405	.0100	-.0185	.0772	.1961	.2230	432.3
6841	6006.7	12.77	-4.77	.7690	.1503	-.0432	.0096	-.0176	.0768	.1970	.2227	432.6
6842	5989.6	14.75	-4.72	.9412	.2165	-.0440	.0080	-.0159	.0763	.1978	.2230	432.6
6843	6036.6	16.87	-4.65	1.0745	.2862	-.0407	.0051	-.0133	.0736	.1961	.2227	432.6
6844	6023.4	18.96	-4.58	1.1528	.3485	-.0266	.0086	-.0131	.0663	.1967	.2229	432.6
6845	6031.6	21.10	-4.50	1.2144	.4178	-.0299	.0050	-.0077	.0586	.1963	.2227	432.6
6846	5957.2	23.29	-4.42	1.2666	.4941	-.0328	.0022	.0032	.0418	.1988	.2227	432.8
6847	5966.5	25.69	-4.32	1.3078	.5827	-.0444	.0024	.0160	.0338	.1984	.2225	432.6
6848	6005.8	27.52	-4.25	1.3451	.6530	-.0482	.0007	.0234	.0292	.1972	.2226	432.7
6849	5992.4	29.68	-4.15	1.3806	.7371	-.0558	-.0010	.0338	.0182	.1978	.2227	432.6
6850	6046.5	31.04	-4.09	1.3924	.7867	-.0590	-.0025	.0427	.0108	.1959	.2225	432.6
6851	6153.3	11.79	-4.80	.6781	.1204	-.0398	.0091	-.0181	.0766	.1924	.2222	432.5

NASA LANGLEY

7 X 10 HIGH SPEED TUNNEL

TEST TP	21 MACH	Q PA	RUN 86 ALPHA DEG	BETA DEG	CNF(BA)	CAF(BA)	CPH(BA)	CRM(BA)	CYH(BA)	CSF(BA)	TPLEN DEG K
6852	.300	6046.4	11.79	-4.80	.7457	-.1501	.0240	.0119	-.0128	.0684	302.3
6853	.301	6058.3	10.53	-4.83	.6207	-.1461	.0258	.0130	-.0133	.0674	302.6
6854	.301	6063.5	11.11	-4.81	.6768	-.1478	.0257	.0124	-.0133	.0678	302.9
6855	.300	6049.3	12.84	-4.77	.8519	-.1348	.0202	.0133	-.0119	.0669	303.2
6856	.299	5996.7	14.74	-4.72	1.0210	-.1621	.0182	.0118	-.0108	.0676	303.5
6857	.297	5939.4	17.01	-4.65	1.2026	-.1725	.0215	.0108	-.0087	.0658	303.7
6858	.300	6046.6	19.22	-4.57	1.3247	-.1791	.0322	.0134	-.0075	.0612	304.0
6859	.300	6024.4	21.16	-4.50	1.3928	-.1835	.0429	.0093	-.0044	.0519	304.2
6860	.298	5973.8	23.34	-4.41	1.4675	-.1860	.0434	.0056	.0021	.0368	304.5
6861	.300	6021.7	25.65	-4.32	1.5386	-.1821	.0386	.0003	.0121	.0224	304.7
6862	.298	5951.4	27.58	-4.24	1.6045	-.1818	.0301	-.0055	.0220	.0183	305.1
6863	.298	5974.8	29.74	-4.15	1.6581	-.1803	.0267	-.0167	.0334	.0145	305.4
6864	.299	5991.8	31.09	-4.09	1.6817	-.1802	.0239	-.0247	.0402	.0095	305.6
6865	.303	6155.5	11.79	-4.80	.7420	-.1499	.0246	.0113	-.0128	.0675	306.2

TEST TP	21 ALPHA DEG	BETA DEG	RUN 86 CL(SA)	CD(SA)	CPH(SA)	CRM(SA)	CYH(SA)	CSF(SA)	PI PA	CPB(1)	VTOT M/SEC
6852	11.79	-4.80	.7607	.0054	.0240	.0090	-.0149	.0684	95758.8	-.149	626.0
6853	10.53	-4.83	.6370	-.0302	.0258	.0104	-.0155	.0674	95748.9	-.146	626.3
6854	11.11	-4.81	.6926	-.0146	.0257	.0096	-.0155	.0678	95755.1	-.147	626.7
6855	12.84	-4.77	.8650	.0383	.0202	.0103	-.0146	.0669	95758.0	-.152	627.0
6856	14.74	-4.72	1.0286	.1029	.0182	.0087	-.0134	.0676	95813.0	-.151	627.3
6857	17.01	-4.65	1.2005	.1869	.0215	.0078	-.0115	.0658	95879.8	-.161	627.5
6858	19.22	-4.57	1.3098	.2668	.0322	.0102	-.0115	.0612	95760.8	-.177	627.8
6859	21.18	-4.50	1.3651	.3321	.0429	.0071	-.0074	.0519	95790.8	-.179	628.0
6860	23.34	-4.41	1.4211	.4106	.0434	.0059	-.0003	.0368	95843.8	-.176	628.3
6861	25.65	-4.32	1.4658	.5018	.0386	.0055	.0108	.0224	95786.9	-.182	628.6
6862	27.58	-4.24	1.5064	.5816	.0301	.0053	.0220	.0183	95866.9	-.187	628.9
6863	29.74	-4.15	1.5292	.6659	.0267	.0021	.0373	.0145	95836.0	-.195	629.2
6864	31.09	-4.09	1.5332	.7142	.0239	-.0004	.0472	.0095	95819.2	-.203	629.4
6865	11.79	-4.80	.7570	.0048	.0246	.0085	-.0149	.0675	95640.0	-.149	630.1

TEST TP	21 Q PA	ALPHA DEG	RUN 86 BETA DEG	CLT	CDT	CMST	CRTS	CYTS	CYST	CHU KG/SEC	PLENP PSI
6852	6046.4	11.79	-4.80	.6837	.1179	-.0503	.0085	-.0175	.0754	.2350	508.9
6853	6058.3	10.53	-4.83	.5626	.0837	-.0484	.0099	-.0180	.0744	.2345	508.9
6854	6063.5	11.11	-4.81	.6171	.0984	-.0484	.0091	-.0180	.0748	.2343	509.0
6855	6049.3	12.84	-4.77	.7859	.1494	-.0541	.0097	-.0171	.0739	.2351	509.3
6856	5996.7	14.74	-4.72	.9452	.2122	-.0568	.0080	-.0160	.0746	.2371	509.3
6857	5939.4	17.01	-4.65	1.1119	.2939	-.0542	.0070	-.0140	.0730	.2394	509.5
6858	6046.6	19.22	-4.57	1.2188	.3686	-.0422	.0093	-.0139	.0682	.2352	509.7
6859	6024.4	21.16	-4.50	1.2703	.4310	-.0318	.0061	-.0098	.0590	.2361	509.7
6860	5973.8	23.34	-4.41	1.3218	.5066	-.0319	.0049	-.0027	.0440	.2380	509.5
6861	6021.7	25.65	-4.32	1.3636	.5930	-.0361	.0044	.0085	.0294	.2362	509.6
6862	5951.4	27.58	-4.24	1.3999	.6704	-.0454	.0041	.0197	.0255	.2389	509.5
6863	5974.8	29.74	-4.15	1.4200	.7502	-.0485	.0008	.0350	.0216	.2378	509.2
6864	5991.8	31.09	-4.09	1.4222	.7957	-.0511	-.0018	.0450	.0165	.2371	509.5
6865	6155.5	11.79	-4.80	.6813	.1154	-.0484	.0080	-.0174	.0744	.2309	509.5

ORIGINAL PAGE IS
OF POOR QUALITY

NASA LANGLEY

7 X 10 HIGH SPEED TUNNEL

TEST TP	21 MACH	Q PA	RUN 87 ALPHA DEG	BETA DEG	CNF(BA)	CAF(BA)	CPH(BA)	CRM(BA)	CYM(BA)	CSF(BA)	TPLEN DEG K
6866	.501	15060.8	12.55	-4.80	.7013	-.0661	.0221	.0106	-.0174	.0713	307.7
6867	.501	15049.4	11.25	-4.83	.6143	-.0637	.0173	.0130	-.0175	.0741	307.8
6868	.501	15048.6	11.57	-4.83	.6360	-.0642	.0180	.0127	-.0177	.0736	308.0
6869	.500	15024.8	13.73	-4.77	.7647	-.0680	.0277	.0090	-.0162	.0691	308.1
6870	.497	14886.5	15.64	-4.73	.8668	-.0711	.0341	.0084	-.0134	.0661	308.3
6871	.500	15012.7	17.86	-4.67	.9752	-.0728	.0315	.0064	-.0084	.0584	308.4
6872	.499	14994.5	20.14	-4.60	1.0826	-.0755	.0266	.0061	-.0024	.0490	308.5
6873	.495	14789.2	22.21	-4.52	1.1777	-.0750	.0110	.0087	.0002	.0460	308.7
6874	.498	14922.9	24.45	-4.47	1.2356	-.0741	.0051	-.0007	.0121	.0390	308.8
6875	.500	15034.3	26.58	-4.41	1.2754	-.0700	-.0127	-.0111	.0265	.0228	308.9
6876	.498	14908.3	28.73	-4.35	1.3425	-.0733	-.0122	-.0186	.0399	.0190	309.0
6877	.502	15121.9	30.94	-4.27	1.3852	-.0761	-.0135	-.0218	.0444	.0201	309.1
6878	.501	15075.9	32.30	-4.19	1.4081	-.0780	-.0123	-.0174	.0426	.0223	309.2
6879	.503	15186.0	12.58	-4.80	.7038	-.0659	.0229	.0101	-.0175	.0719	309.4

TEST TP	21 ALPHA DEG	BETA DEG	RUN 87 CL(SA)	CD(SA)	CPM(SA)	CRM(SA)	CYM(SA)	CSF(SA)	P1 PA	CPB(1)	VTOT M/SEC
6866	12.55	-4.80	.6989	.0978	.0221	.0065	-.0192	.0713	85846.7	-.166	636.7
6867	11.25	-4.83	.6149	.0574	.0173	.0093	-.0187	.0741	85810.7	-.162	636.8
6868	11.57	-4.83	.6360	.0646	.0180	.0089	-.0199	.0736	85815.0	-.164	636.9
6869	13.73	-4.77	.7590	.1155	.0277	.0049	-.0179	.0691	85892.4	-.170	637.0
6870	15.64	-4.73	.8539	.1652	.0341	.0045	-.0152	.0661	86020.9	-.173	637.1
6871	17.86	-4.67	.9506	.2297	.0315	.0035	-.0099	.0584	85903.4	-.175	637.4
6872	20.14	-4.60	1.0424	.3019	.0266	.0049	-.0044	.0490	85920.0	-.176	637.5
6873	22.21	-4.52	1.1187	.3756	.0110	.0081	-.0031	.0460	86102.4	-.189	637.5
6874	24.45	-4.47	1.1955	.4440	.0051	.0044	.0113	.0390	86037.5	-.203	637.6
6875	26.58	-4.41	1.1719	.5081	-.0127	.0019	.0287	.0228	85910.2	-.214	637.8
6876	28.73	-4.35	1.2125	.5810	-.0122	.0029	.0440	.0190	85966.8	-.231	637.9
6877	30.94	-4.27	1.2272	.6470	-.0135	.0041	.0493	.0201	85720.3	-.240	638.1
6878	32.30	-4.19	1.2319	.6865	-.0123	.0080	.0453	.0223	85777.4	-.248	638.2
6879	12.58	-4.80	.7012	.0890	.0229	.0060	-.0192	.0719	85743.5	-.167	638.5

TEST TP	21 Q PA	ALPHA DEG	RUN 87 BETA DEG	CLT	CDT	CHST	CRTS	CYTS	CYST	CMU I	MTFLO KG/SEC	PLENP PSI
6866	15060.8	12.55	-4.80	.6674	.1325	-.0077	.0063	-.0202	.0741	.0947	.2587	508.6
6867	15049.4	11.25	-4.83	.5845	.1028	-.0125	.0091	-.0207	.0770	.0947	.2584	508.3
6868	15048.6	11.57	-4.83	.6053	.1099	-.0118	.0087	-.0209	.0764	.0946	.2582	508.0
6869	15024.8	13.73	-4.77	.7266	.1596	-.0022	.0047	-.0189	.0720	.0947	.2580	508.0
6870	14886.5	15.64	-4.73	.8197	.2086	.0040	.0042	-.0162	.0690	.0956	.2580	507.9
6871	15012.7	17.86	-4.67	.9150	.2714	.0016	.0032	-.0109	.0612	.0948	.2579	508.0
6872	14994.5	20.14	-4.60	1.0051	.3422	-.0033	.0045	-.0054	.0518	.0950	.2580	508.1
6873	14789.2	22.21	-4.52	1.0795	.4151	-.0193	.0077	-.0041	.0488	.0963	.2579	508.1
6874	14922.9	24.45	-4.47	1.1152	.4815	-.0250	.0040	.0103	.0419	.0954	.2579	508.2
6875	15034.3	26.58	-4.41	1.1305	.5439	-.0425	.0014	.0278	.0257	.0948	.2580	508.4
6876	14908.3	28.73	-4.35	1.1694	.6155	-.0423	.0023	.0430	.0218	.0955	.2578	508.3
6877	15121.9	30.94	-4.27	1.1834	.6794	-.0431	.0036	.0484	.0229	.0942	.2578	508.5
6878	15075.9	32.30	-4.19	1.1872	.7179	-.0420	.0075	.0444	.0251	.0946	.2580	508.5
6879	15186.0	12.58	-4.80	.6700	.1333	-.0066	.0058	-.0202	.0747	.0939	.2578	508.7

NASA LANGLEY

7 X 10 HIGH SPEED TUNNEL

TEST TP	21 MACH	0 PA	RUN 88		CNF(BA)	CAF(BA)	CPH(BA)	CRM(BA)	CYH(BA)	CSF(BA)	TPLEN DEG K
			ALPHA DEG	BETA DEG							
6880	.500	15002.8	12.48	-4.80	.6654	-.0380	.0185	.0132	-.0176	.0767	308.4
6881	.500	15016.3	11.26	-4.83	.6024	-.0374	.0162	.0144	-.0181	.0778	308.2
6882	.501	15090.7	11.57	-4.83	.6175	-.0372	.0164	.0142	-.0181	.0771	308.0
6883	.500	15007.6	13.59	-4.78	.7265	-.0383	.0168	.0123	-.0163	.0746	307.9
6884	.499	14995.5	15.56	-4.72	.8204	-.0393	.0138	.0119	-.0138	.0701	307.7
6885	.500	15046.5	17.60	-4.66	.9071	-.0398	.0082	.0112	-.0101	.0640	307.5
6886	.499	15006.0	19.86	-4.59	1.0009	-.0426	.0060	.0092	-.0058	.0573	307.3
6887	.497	14898.1	22.12	-4.52	1.0754	-.0427	.0002	.0084	-.0012	.0506	307.0
6888	.500	15023.3	24.25	-4.45	1.1318	-.0404	-.0105	.0051	.0068	.0446	306.9
6889	.498	14951.0	26.30	-4.37	1.1671	-.0404	-.0130	.0050	.0120	.0371	306.8
6890	.499	14990.0	28.51	-4.26	1.2052	-.0427	-.0062	.0084	.0115	.0369	306.6
6891	.500	15027.7	30.71	-4.14	1.2586	-.0460	-.0054	.0101	.0095	.0366	306.5
6892	.497	14868.3	32.13	-4.04	1.3221	-.0492	-.0114	.0201	-.0005	.0438	306.4
6893	.501	15096.6	12.47	-4.80	.6625	-.0371	.0184	.0133	-.0175	.0767	306.1

TEST TP	21 ALPHA DEG	BETA DEG	RUN 88		CPH(SA)	CRM(SA)	CYH(SA)	CSF(SA)	PI PA	CPB(1)	VTOT M/SEC
			CL(SA)	CD(SA)							
6880	12.48	-4.80	.6579	.1066	.0185	.0091	-.0201	.0767	85893.1	-.164	606.5
6881	11.26	-4.83	.5981	.0810	.0162	.0106	-.0206	.0778	85852.6	-.163	606.4
6882	11.57	-4.83	.6124	.0874	.0164	.0102	-.0205	.0771	85842.1	-.163	606.2
6883	13.59	-4.78	.7152	.1334	.0168	.0082	-.0188	.0746	85874.2	-.165	606.1
6884	15.56	-4.72	.8009	.1823	.0138	.0077	-.0165	.0701	85881.4	-.166	605.9
6885	17.60	-4.66	.8767	.2363	.0082	.0076	-.0130	.0640	85843.0	-.169	605.7
6886	19.86	-4.59	.9558	.3000	.0060	.0067	-.0086	.0573	85957.1	-.179	605.5
6887	22.12	-4.52	1.0123	.3654	.0002	.0073	-.0042	.0506	86065.5	-.189	605.2
6888	24.25	-4.45	1.0485	.4281	-.0105	.0075	.0041	.0446	85917.5	-.197	605.1
6889	26.30	-4.37	1.0642	.4810	-.0130	.0097	.0085	.0371	85954.0	-.209	605.0
6890	28.51	-4.26	1.0794	.5377	-.0062	.0129	.0061	.0369	85871.8	-.231	604.9
6891	30.71	-4.14	1.1055	.6032	-.0054	.0136	.0030	.0366	85869.8	-.251	604.6
6892	32.13	-4.04	1.1458	.6614	-.0114	.0167	-.0111	.0438	86007.1	-.267	604.6
6893	12.47	-4.80	.6549	.1068	.0184	.0092	-.0200	.0767	85827.0	-.164	604.5

TEST TP	21 0 PA	ALPHA DEG	RUN 88		CLT	CDT	CMST	CRTS	CYTS	CYST	CMU	WTFLD KG/SEC	PLENPP PSI
			BETA DEG	CLT									
6880	15002.8	12.48	-4.80	.6405	.1313	.0021	.0090	-.0206	.0782	.0499	.1424	279.5	
6881	15016.3	11.26	-4.83	.5813	.1060	-.0003	.0105	-.0211	.0794	.0498	.1423	279.6	
6882	15090.7	11.57	-4.83	.5956	.1122	.0001	.0101	-.0211	.0786	.0496	.1425	279.6	
6883	15007.6	13.59	-4.78	.6974	.1578	.0003	.0080	-.0193	.0762	.0499	.1426	279.7	
6884	14995.5	15.56	-4.72	.7822	.2060	-.0027	.0076	-.0171	.0716	.0499	.1426	279.7	
6885	15046.5	17.60	-4.66	.8572	.2593	-.0082	.0074	-.0135	.0656	.0498	.1429	279.8	
6886	15006.0	19.86	-4.59	.9354	.3223	-.0104	.0065	-.0091	.0588	.0499	.1429	279.9	
6887	14898.1	22.12	-4.52	.9909	.3870	-.0164	.0071	-.0048	.0521	.0503	.1430	280.1	
6888	15023.3	24.25	-4.45	1.0265	.4487	-.0269	.0072	.0036	.0461	.0499	.1429	280.0	
6889	14951.0	26.30	-4.37	1.0413	.5009	-.0295	.0095	.0080	.0387	.0501	.1431	280.2	
6890	14990.0	28.51	-4.26	1.0558	.5567	-.0227	.0126	.0056	.0384	.0499	.1429	280.3	
6891	15027.7	30.71	-4.14	1.0814	.6212	-.0219	.0133	.0025	.0382	.0499	.1431	279.7	
6892	14868.3	32.13	-4.04	1.1208	.6791	-.0280	.0164	-.0116	.0454	.0504	.1430	280.3	
6893	15096.6	12.47	-4.80	.6376	.1314	.0021	.0091	-.0205	.0782	.0497	.1432	280.4	

ORIGINAL PAGE IS OF POOR QUALITY

NASA LANGLEY

7 X 10 HIGH SPEED TUNNEL

TEST TP	21 MACH	Q PA	RUN 89 ALPHA DEG	BETA DEG	CNF(BA)	CAF(BA)	CPM(BA)	CRM(BA)	CYM(BA)	CSF(BA)	TPLEM DEG K
6894	.500	15022.7	12.42	-4.80	.6542	-.0063	.0100	.0115	-.0184	.0782	305.0
6895	.501	15061.4	11.19	-4.83	.5850	-.0086	.0111	.0130	-.0196	.0783	305.4
6896	.500	15027.1	11.51	-4.82	.6052	-.0080	.0112	.0126	-.0191	.0779	305.8
6897	.500	15046.6	13.42	-4.78	.7065	-.0070	.0080	.0116	-.0173	.0772	306.0
6898	.499	14975.3	15.56	-4.73	.8086	-.0067	.0017	.0094	-.0143	.0748	306.1
6899	.502	15111.5	17.59	-4.67	.8790	-.0033	-.0102	.0072	-.0095	.0662	306.3
6900	.501	15100.9	19.53	-4.63	.8836	.0037	-.0251	-.0011	.0088	.0496	306.4
6901	.500	15012.7	21.69	-4.54	.9223	.0029	-.0199	.0062	.0056	.0461	306.4
6902	.496	14913.5	23.99	-4.43	.9944	-.0010	-.0158	.0101	.0041	.0441	306.4
6903	.494	14724.3	26.14	-4.33	1.0951	-.0053	-.0207	.0141	.0033	.0435	306.5
6904	.497	14880.9	28.39	-4.22	1.2093	-.0109	-.0298	.0199	.0014	.0390	306.6
6905	.498	14940.6	30.78	-4.09	1.3079	-.0169	-.0366	.0252	.0011	.0294	306.6
6906	.495	14790.0	32.08	-4.02	1.3576	-.0202	-.0364	.0258	.0034	.0249	306.7
6907	.499	14976.2	12.43	-4.80	.6550	-.0074	.0090	.0118	-.0184	.0776	307.0

TEST TP	21 ALPHA DEG	BETA DEG	RUN 89 CL(SA)	CD(SA)	CPM(SA)	CRM(SA)	CYM(SA)	CSF(SA)	P1 PA	CPB(1)	WTOT M/SEC
6894	12.42	-4.80	.6402	.1345	.0100	.0073	-.0204	.0782	85860.1	-.149	0.0
6895	11.19	-4.83	.5755	.1051	.0111	.0090	-.0217	.0783	85865.9	-.149	0.0
6896	11.51	-4.82	.5946	.1129	.0112	.0085	-.0213	.0779	85865.5	-.148	0.0
6897	13.42	-4.78	.6889	.1571	.0080	.0073	-.0195	.0772	85897.5	-.154	0.0
6898	15.56	-4.73	.7808	.2105	.0017	.0052	-.0163	.0748	85980.1	-.161	0.0
6899	17.59	-4.67	.8389	.2624	-.0102	.0040	-.0112	.0662	85826.9	-.165	0.0
6900	19.53	-4.63	.8316	.2988	-.0251	.0019	.0086	.0456	85794.0	-.169	0.0
6901	21.69	-4.54	.8559	.3435	-.0199	.0078	.0029	.0461	85916.4	-.176	0.0
6902	23.99	-4.43	.9089	.4034	-.0158	.0109	-.0003	.0441	86047.1	-.185	0.0
6903	26.14	-4.33	.9855	.4777	-.0207	.0141	-.0033	.0435	86245.7	-.198	0.0
6904	28.39	-4.22	1.0690	.5655	-.0298	.0181	-.0082	.0390	85990.3	-.211	0.0
6905	30.78	-4.09	1.1322	.6548	-.0366	.0222	-.0120	.0294	86007.0	-.227	0.0
6906	32.08	-4.02	1.1610	.7039	-.0364	.0236	-.0108	.0249	86113.2	-.240	0.0
6907	12.43	-4.80	.6412	.1338	.0090	.0076	-.0205	.0776	85968.8	-.149	0.0

TEST TP	21 Q PA	ALPHA DEG	RUN 89 BETA DEG	CLT	CDT	CMST	CRTS	CYTS	CYST	CHU	WTFLD KG/SEC	PLENP PSI
6894	15022.7	12.42	-4.80	.6402	.1345	.0100	.0073	-.0204	.0782	0.0000	0.0000	-.3
6895	15061.4	11.19	-4.83	.5755	.1051	.0111	.0090	-.0217	.0783	0.0000	0.0000	-.2
6896	15027.1	11.51	-4.82	.5946	.1129	.0112	.0085	-.0213	.0779	0.0000	0.0000	-.3
6897	15046.6	13.42	-4.78	.6889	.1571	.0080	.0073	-.0195	.0772	0.0000	0.0000	-.3
6898	14975.3	15.56	-4.73	.7808	.2105	.0017	.0052	-.0163	.0748	0.0000	0.0000	-.4
6899	15111.5	17.59	-4.67	.8389	.2624	-.0102	.0040	-.0112	.0662	0.0000	0.0000	-.5
6900	15100.9	19.53	-4.63	.8316	.2988	-.0251	.0019	.0086	.0456	0.0000	0.0000	-.6
6901	15012.7	21.69	-4.54	.8559	.3435	-.0199	.0078	.0029	.0461	0.0000	0.0000	-.7
6902	14913.5	23.99	-4.43	.9089	.4034	-.0158	.0109	-.0003	.0441	0.0000	0.0000	-.8
6903	14724.3	26.14	-4.33	.9855	.4777	-.0207	.0141	-.0033	.0435	0.0000	0.0000	-1.0
6904	14880.9	28.39	-4.22	1.0690	.5655	-.0298	.0181	-.0082	.0390	0.0000	0.0000	-1.2
6905	14940.6	30.78	-4.09	1.1322	.6548	-.0366	.0222	-.0120	.0294	0.0000	0.0000	-1.3
6906	14790.0	32.08	-4.02	1.1610	.7039	-.0364	.0236	-.0108	.0249	0.0000	0.0000	-1.4
6907	14976.2	12.43	-4.80	.6412	.1338	.0090	.0076	-.0205	.0776	0.0000	0.0000	-.3

NASA LANGLEY

7 X 10 HIGH SPEED TUNNEL

TEST TP	21 MACH	Q PA	RUN 90 ALPHA DEG	BETA DEG	CNF(BA)	CAF(BA)	CPM(BA)	CRM(BA)	CYM(BA)	CSF(BA)	TPLEN DEG' K
6923	.500	15121.8	-.02	-.00	-.0004	.0152	-.0024	.0018	-.0020	.0070	295.6
6924	.500	15123.5	-1.94	-.03	-.1126	.0128	-.0078	.0017	-.0021	.0073	296.2
6925	.503	15299.1	.00	-.00	-.0008	.0150	-.0025	.0019	-.0022	.0076	296.8
6926	.499	15050.6	2.17	.03	.1082	.0123	.0022	.0022	-.0022	.0073	297.6
6927	.499	15084.3	4.40	.06	.2289	.0057	.0053	.0024	-.0021	.0066	298.7
6928	.500	15125.1	6.74	.09	.3604	-.0012	.0070	.0022	-.0021	.0058	299.6
6929	.500	15136.6	8.87	.12	.4818	-.0055	.0085	.0010	-.0024	.0056	300.1
6930	.501	15165.6	11.17	.15	.5950	-.0072	.0127	.0002	-.0022	.0050	300.7
6931	.499	15071.8	13.46	.18	.6940	-.0070	.0110	.0019	-.0023	.0052	301.0
6932	.501	15177.8	15.75	.21	.7972	-.0056	.0031	.0014	-.0023	.0059	301.4
6933	.501	15174.7	17.89	.24	.8696	-.0019	-.0119	.0017	-.0023	.0066	302.3
6934	.502	15239.7	20.05	.27	.8776	.0033	-.0181	.0013	-.0017	.0069	302.9
6935	.499	15086.2	22.15	.30	.9008	.0023	-.0129	-.0001	-.0008	.0056	303.7
6936	.501	15173.9	24.35	.33	.9853	-.0018	-.0141	.0001	-.0010	.0057	304.3
6937	.502	15237.2	25.07	.34	1.0172	-.0035	-.0148	.0011	-.0017	.0062	305.0
6938	.500	15148.8	-.03	-.00	-.0031	.0129	-.0026	.0018	-.0022	.0083	306.8

TEST TP	21 ALPHA DEG	BETA DEG	RUN 90 CL(SA)	CD(SA)	CPM(SA)	CRM(SA)	CYM(SA)	CSF(SA)	P1 PA	CPB(1)	VTOT H/SEC
6923	-.02	-.00	-.0004	.0152	-.0024	.0018	-.0020	.0070	86425.2	-.115	0.0
6924	-1.94	-.03	-.1121	.0166	-.0078	.0018	-.0021	.0073	86385.1	-.117	0.0
6925	.00	-.00	-.0008	.0150	-.0025	.0019	-.0022	.0076	86244.6	-.115	0.0
6926	2.17	.03	.1077	.0164	.0022	.0021	-.0023	.0073	86445.1	-.116	0.0
6927	4.40	.06	.2278	.0233	.0053	.0022	-.0023	.0066	86404.8	-.118	0.0
6928	6.74	.09	.3581	.0411	.0070	.0019	-.0024	.0058	86359.9	-.125	0.0
6929	8.87	.12	.4769	.0689	.0085	.0006	-.0025	.0056	86382.1	-.133	0.0
6930	11.17	.15	.5851	.1082	.0127	-.0002	-.0022	.0050	86333.7	-.143	0.0
6931	13.46	.18	.6766	.1548	.0110	.0014	-.0026	.0052	86423.0	-.150	0.0
6932	15.75	.21	.7687	.2110	.0031	.0007	-.0026	.0059	86371.8	-.154	0.0
6933	17.89	.24	.8282	.2653	-.0119	.0009	-.0028	.0066	86378.9	-.163	0.0
6934	20.05	.27	.8233	.3040	-.0181	.0006	-.0020	.0069	86302.3	-.172	0.0
6935	22.15	.30	.8335	.3417	-.0129	-.0004	-.0007	.0056	86482.8	-.175	0.0
6936	24.35	.33	.8983	.4047	-.0141	-.0003	-.0009	.0057	86288.5	-.187	0.0
6937	25.07	.34	.9228	.4278	-.0148	.0002	-.0020	.0062	86225.3	-.192	0.0
6938	-.03	-.00	-.0030	.0129	-.0026	.0018	-.0022	.0083	86417.0	-.114	0.0

TEST TP	21 Q PA	ALPHA DEG	RUN 90 BETA DEG	CLT	CDT	CMST	CRTS	CYTS	CYST	CMU	WTFLO KG/SEC	PLENPSI
6923	15121.8	-.02	-.00	-.0004	.0152	-.0024	.0018	-.0020	.0070	0.0000	0.0000	-.1
6924	15123.5	-1.94	-.03	-.1121	.0166	-.0078	.0018	-.0021	.0073	0.0000	0.0000	-.1
6925	15299.1	.00	-.00	-.0008	.0150	-.0025	.0019	-.0022	.0076	0.0000	0.0000	-.1
6926	15050.6	2.17	.03	.1077	.0164	.0022	.0021	-.0023	.0073	0.0000	0.0000	-.2
6927	15084.3	4.40	.06	.2278	.0233	.0053	.0022	-.0023	.0066	0.0000	0.0000	-.2
6928	15125.1	6.74	.09	.3581	.0411	.0070	.0019	-.0024	.0058	0.0000	0.0000	-.2
6929	15136.6	8.87	.12	.4769	.0689	.0085	.0006	-.0025	.0056	0.0000	0.0000	-.2
6930	15165.6	11.17	.15	.5851	.1082	.0127	-.0002	-.0022	.0050	0.0000	0.0000	-.4
6931	15071.8	13.46	.18	.6766	.1548	.0110	.0014	-.0026	.0052	0.0000	0.0000	-.4
6932	15177.8	15.75	.21	.7687	.2110	.0031	.0007	-.0026	.0059	0.0000	0.0000	-.5
6933	15174.7	17.89	.24	.8282	.2653	-.0119	.0009	-.0028	.0066	0.0000	0.0000	-.6
6934	15239.7	20.05	.27	.8233	.3040	-.0181	.0006	-.0020	.0069	0.0000	0.0000	-.7
6935	15086.2	22.15	.30	.8335	.3417	-.0129	-.0004	-.0007	.0056	0.0000	0.0000	-.8
6936	15173.9	24.35	.33	.8983	.4047	-.0141	-.0003	-.0009	.0057	0.0000	0.0000	-.9
6937	15237.2	25.07	.34	.9228	.4278	-.0148	.0002	-.0020	.0062	0.0000	0.0000	-1.0
6938	15148.8	-.03	-.00	-.0030	.0129	-.0026	.0018	-.0022	.0083	0.0000	0.0000	-.3

ORIGINAL PAGE IS OF POOR QUALITY

NASA LANGLEY

7 X 10 HIGH SPEED TUNNEL

TEST TP	21 MACH	Q PA	RUN 91 ALPHA DEG	BETA DEG	CNF(BA)	CAF(BA)	CPH(BA)	CRM(BA)	CYN(BA)	CSF(BA)	TPLEN DEG K
6939	.500	15152.4	-.01	-.00	-.0094	-.0129	.0031	.0016	-.0020	.0072	294.3
6940	.502	15194.3	-1.92	-.03	-.1156	-.0145	-.0038	.0016	-.0017	.0079	293.8
6941	.500	15126.4	.03	-.00	-.0096	-.0128	.0032	.0023	-.0019	.0075	293.3
6942	.500	15143.2	2.20	.03	.0950	-.0148	.0094	.0023	-.0014	.0074	293.1
6943	.502	15204.9	4.40	.06	.2155	-.0197	.0122	.0022	-.0016	.0062	293.0
6944	.501	15152.3	6.64	.09	.3556	-.0260	.0139	.0029	-.0019	.0052	293.0
6945	.499	15091.0	8.96	.12	.4912	-.0307	.0145	.0011	-.0024	.0048	293.0
6946	.501	15161.0	11.17	.15	.5990	-.0327	.0175	.0015	-.0021	.0044	293.1
6947	.501	15180.0	13.54	.18	.7189	-.0344	.0165	.0016	-.0019	.0038	293.3
6948	.505	15353.6	15.80	.21	.8153	-.0346	.0127	.0011	-.0018	.0033	293.4
6949	.502	15213.9	18.08	.25	.9071	-.0370	.0092	.0033	-.0026	.0045	293.9
6950	.500	15109.8	20.32	.28	.9884	-.0386	.0069	.0029	-.0033	.0046	294.2
6951	.499	15052.9	22.48	.31	1.0589	-.0368	-.0013	.0041	-.0039	.0047	294.7
6952	.502	15195.3	24.63	.35	1.0962	-.0359	-.0065	.0051	-.0051	.0069	295.2
6953	.498	15032.5	25.22	.35	1.1159	-.0364	-.0086	.0049	-.0047	.0057	295.7
6954	.500	15135.5	-.01	-.00	-.0074	-.0137	.0022	.0020	-.0020	.0082	296.3

TEST TP	21 ALPHA DEG	BETA DEG	RUN 91 CL(SA)	CD(SA)	CPH(SA)	CRM(SA)	CYN(SA)	CSF(SA)	P1 PA	CP8(1)	VTOT M/SEC
6939	-.01	-.00	-.0094	-.0129	.0031	.0016	-.0020	.0072	86413.6	-.115	592.3
6940	-1.92	-.03	-.1160	-.0107	-.0038	.0016	-.0017	.0079	86290.7	-.119	591.8
6941	.03	-.00	-.0096	-.0128	.0032	.0023	-.0019	.0075	86438.7	-.115	591.4
6942	2.20	.03	.0955	-.0111	.0094	.0022	-.0015	.0074	86428.1	-.117	591.0
6943	4.40	.06	.2164	-.0031	.0122	.0021	-.0018	.0062	86352.4	-.123	590.8
6944	6.64	.09	.3562	.0153	.0139	.0027	-.0022	.0052	86405.6	-.131	590.7
6945	8.96	.12	.4900	.0461	.0145	.0007	-.0025	.0048	86411.2	-.139	590.8
6946	11.17	.15	.5940	.0839	.0175	.0010	-.0024	.0044	86386.6	-.147	591.0
6947	13.54	.18	.7070	.1349	.0165	.0011	-.0022	.0038	86332.2	-.153	591.2
6948	15.80	.21	.7939	.1887	.0127	.0006	-.0021	.0033	86160.6	-.160	591.5
6949	18.08	.25	.8738	.2463	.0092	.0023	-.0035	.0045	86321.9	-.168	592.0
6950	20.32	.28	.9403	.3070	.0069	.0016	-.0041	.0046	86363.6	-.177	592.3
6951	22.48	.31	.9925	.3708	-.0013	.0023	-.0052	.0047	86409.6	-.187	592.8
6952	24.63	.35	1.0114	.4242	-.0065	.0025	-.0067	.0069	86297.6	-.197	593.2
6953	25.22	.35	1.0250	.4426	-.0086	.0025	-.0064	.0057	86454.2	-.198	593.6
6954	-.01	-.00	-.0074	-.0137	.0022	.0020	-.0020	.0082	86384.7	-.115	594.5

TEST TP	21 Q PA	ALPHA DEG	RUN 91 BETA DEG	CLT	CDT	CMST	CRTS	CYTS	CYST	CMU	WTFLO KG/SEC	PLENP PSI
6939	15152.4	-.01	-.00	-.0209	.0148	-.0133	.0016	-.0025	.0088	.0495	.1463	280.1
6940	15194.3	-1.92	-.03	-.1266	.0172	-.0201	.0016	-.0022	.0094	.0494	.1464	279.9
6941	15126.4	.03	-.00	-.0212	.0149	-.0132	.0023	-.0025	.0091	.0497	.1469	280.6
6942	15143.2	2.20	.03	.0829	.0160	-.0069	.0022	-.0020	.0089	.0495	.1464	279.8
6943	15204.9	4.40	.06	.2029	.0234	-.0040	.0020	-.0023	.0077	.0491	.1460	278.9
6944	15152.3	6.64	.09	.3417	.0413	-.0023	.0026	-.0028	.0067	.0493	.1461	278.8
6945	15091.0	8.96	.12	.4743	.0716	-.0019	.0006	-.0031	.0063	.0495	.1459	278.9
6946	15161.0	11.17	.15	.5774	.1087	.0013	.0009	-.0029	.0060	.0494	.1463	279.2
6947	15180.0	13.54	.18	.6894	.1590	.0003	.0010	-.0028	.0054	.0494	.1465	279.4
6948	15353.6	15.80	.21	.7756	.2118	-.0034	.0004	-.0026	.0048	.0488	.1463	279.6
6949	15213.9	18.08	.25	.8544	.2689	-.0071	.0022	-.0040	.0060	.0494	.1466	280.4
6950	15109.8	20.32	.28	.9199	.3290	-.0095	.0014	-.0046	.0061	.0498	.1466	280.2
6951	15052.9	22.48	.31	.9711	.3921	-.0177	.0021	-.0057	.0063	.0500	.1465	280.5
6952	15195.3	24.63	.35	.9896	.4444	-.0228	.0022	-.0072	.0084	.0493	.1460	279.5
6953	15032.5	25.22	.35	1.0027	.4628	-.0251	.0022	-.0069	.0073	.0499	.1460	280.1
6954	15135.5	-.01	-.00	-.0189	.0141	-.0141	.0020	-.0025	.0098	.0498	.1464	280.8

NASA LANGLEY

7 X 10 HIGH SPEED TUNNEL

TEST TP	21		RUN 92		CNF(BA)	CAF(BA)	CPN(BA)	CRM(BA)	CYM(BA)	CSF(BA)	TPLEN DEG K
	MACH	Q PA	ALPHA DEG	BETA DEG							
6955	.499	15073.8	.02	-.00	-.0094	-.0375	.0114	.0025	-.0011	.0070	296.2
6956	.500	15121.3	-1.88	-.03	-.1109	-.0395	.0012	.0012	-.0011	.0064	296.8
6957	.501	15166.7	.07	-.00	-.0077	-.0378	.0112	.0024	-.0012	.0072	297.8
6958	.500	15124.7	2.18	.03	.0822	-.0403	.0151	.0022	-.0007	.0051	298.3
6959	.500	15148.7	4.37	.06	.2145	-.0452	.0163	.0026	-.0010	.0039	298.9
6960	.499	15093.5	6.69	.09	.3600	-.0527	.0172	.0026	-.0010	.0028	299.4
6961	.502	15215.1	8.98	.12	.4924	-.0561	.0176	.0020	-.0013	.0004	299.9
6962	.500	15142.9	11.25	.15	.6211	-.0615	.0193	.0010	-.0016	.0008	300.3
6963	.501	15176.5	13.68	.19	.7591	-.0659	.0278	.0013	-.0015	-.0004	301.1
6964	.498	15042.6	15.98	.22	.8776	-.0690	.0336	.0020	-.0022	.0008	302.1
6965	.498	15019.6	18.31	.25	1.0000	-.0726	.0306	.0014	-.0021	.0006	303.1
6966	.500	15117.8	20.62	.28	1.0824	-.0739	.0266	-.0019	-.0011	-.0041	304.1
6967	.499	15087.5	22.76	.31	1.1737	-.0727	.0125	.0003	-.0014	-.0052	304.7
6968	.500	15102.4	24.89	.34	1.2240	-.0675	-.0086	.0025	-.0001	.0000	305.9
6969	.498	15016.4	25.45	.34	1.2300	-.0671	-.0093	.0005	.0012	-.0003	306.5
6970	.500	15134.6	.04	-.00	-.0078	-.0401	.0115	.0022	-.0012	.0066	308.2

TEST TP	21		RUN 92		CPN(SA)	CRM(SA)	CYM(SA)	CSF(SA)	P1 PA	CPB(1)	VTOT M/SEC
	ALPHA DEG	BETA DEG	CL(SA)	CD(SA)							
6955	.02	-.00	-.0093	-.0375	.0114	.0025	-.0011	.0070	86455.0	-.116	624.3
6956	-1.88	-.03	-.1122	-.0358	.0012	.0012	-.0011	.0064	86418.1	-.118	624.9
6957	.07	-.00	-.0076	-.0378	.0112	.0024	-.0012	.0072	86382.3	-.114	626.0
6958	2.18	.03	.0837	-.0371	.0151	.0021	-.0007	.0051	86394.4	-.117	626.6
6959	4.37	.06	.2173	-.0287	.0163	.0025	-.0012	.0039	86406.4	-.120	627.2
6960	6.69	.09	.3637	-.0104	.0172	.0024	-.0013	.0028	86460.5	-.126	627.7
6961	8.98	.12	.4951	.0214	.0176	.0018	-.0016	.0004	86318.9	-.139	628.3
6962	11.25	.15	.6212	.0608	.0193	.0007	-.0017	.0008	86402.6	-.150	628.7
6963	13.66	.19	.7531	.1155	.0278	.0009	-.0018	-.0004	86351.9	-.158	629.5
6964	15.98	.22	.8627	.1754	.0336	.0013	-.0027	.0008	86482.5	-.161	630.5
6965	18.31	.25	.9721	.2452	.0306	.0007	-.0024	.0006	86444.0	-.169	631.5
6966	20.62	.28	1.0391	.3120	.0266	-.0022	-.0003	-.0041	86410.1	-.177	632.6
6967	22.76	.31	1.1104	.3871	.0266	-.0022	-.0014	-.0052	86448.9	-.185	633.1
6968	24.89	.34	1.1387	.4538	.0125	-.0003	-.0011	-.0000	86336.8	-.195	634.3
6969	25.45	.34	1.1395	.4680	-.0086	.0022	-.0011	.0000	86440.3	-.195	635.0
6970	.04	-.00	-.0078	-.0401	-.0093	.0010	.0008	-.0003	86400.7	-.115	636.8

TEST TP	21		RUN 92		CLT	CDT	CMST	CRTS	CYTS	CYST	CMU	WTFLO KG/SEC	PLENP PSI
	Q PA	ALPHA DEG	BETA DEG	BETA DEG									
6955	15073.8	.02	-.00	-.0303	.0128	-.0183	.0025	-.0022	.0098	.0942	.2626	507.6	
6956	15121.3	-1.88	-.03	-.1314	.0151	-.0284	.0013	-.0021	.0092	.0940	.2627	508.0	
6957	15166.7	.07	-.00	-.0285	.0123	-.0184	.0024	-.0023	.0100	.0937	.2622	508.2	
6958	15124.7	2.18	.03	.0608	.0123	-.0146	.0021	-.0018	.0079	.0940	.2621	508.5	
6959	15148.7	4.37	.06	.1927	.0197	-.0133	.0024	-.0022	.0067	.0938	.2616	508.5	
6960	15093.5	6.69	.09	.3370	.0372	-.0126	.0023	-.0023	.0056	.0942	.2616	508.4	
6961	15215.1	8.98	.12	.4667	.0675	-.0119	.0017	-.0026	.0032	.0934	.2613	508.7	
6962	15142.9	11.25	.15	.5909	.1060	-.0104	.0005	-.0028	.0036	.0939	.2611	508.9	
6963	15176.5	13.66	.19	.7210	.1592	-.0018	.0006	-.0028	.0024	.0937	.2609	508.6	
6964	15042.6	15.98	.22	.8286	.2181	.0037	.0010	-.0037	.0036	.0944	.2602	508.1	
6965	15019.6	18.31	.25	.9363	.2865	.0008	.0004	-.0034	.0035	.0945	.2595	507.9	
6966	15117.8	20.62	.28	1.0019	.3516	-.0030	-.0025	-.0013	-.0013	.0937	.2586	507.3	
6967	15087.5	22.76	.31	1.0717	.4253	-.0171	-.0007	-.0024	-.0023	.0938	.2583	506.8	
6968	15102.4	24.89	.34	1.0987	.4905	-.0382	.0018	-.0020	.0028	.0938	.2579	506.7	
6969	15016.4	25.45	.34	1.0988	.5046	-.0391	.0005	-.0001	.0025	.0943	.2576	507.0	
6970	15134.6	.04	-.00	-.0287	.0100	-.0181	.0022	-.0022	.0094	.0936	.2570	507.2	

ORIGINAL PAGE IS OF POOR QUALITY.

NASA LANGLEY

7 X 10 HIGH SPEED TUNNEL

TEST TP	21 MACH	Q PA	RUN 93 ALPHA DEG	BETA DEG	CNF(BA)	CAF(BA)	CPM(BA)	CRM(BA)	CYM(BA)	CSF(BA)	TPLEN DEG K
6975	.782	29236.2	-.03	-.00	.0001	.0153	-.0035	.0017	-.0025	.0078	319.9
6976	.776	28952.7	-2.20	-.03	-.1329	.0129	-.0075	.0019	-.0024	.0084	320.4
6977	.784	29351.0	-.14	-.00	-.0104	.0152	-.0043	.0018	-.0025	.0078	321.0
6978	.798	29956.2	2.40	.03	.1310	.0123	-.0001	.0019	-.0024	.0070	321.6
6979	.814	30681.9	5.01	.06	.2856	.0057	-.0001	.0021	-.0022	.0053	322.3
6980	.811	30575.7	7.80	.10	.4511	.0021	-.0038	.0015	-.0023	.0044	323.3
6981	.802	30117.0	9.90	.13	.5532	.0022	-.0042	.0023	-.0021	.0037	324.4
6982	.797	29915.4	12.37	.16	.6666	.0041	-.0100	.0025	-.0021	.0036	325.1
6983	.798	29982.7	14.75	.19	.7511	.0053	-.0181	.0024	-.0027	.0056	325.7
6984	.783	29255.5	17.11	.22	.8354	.0057	-.0294	.0018	-.0024	.0057	326.5
6985	.782	29249.9	18.09	.23	.8577	.0062	-.0335	.0013	-.0018	.0049	327.4
6986	.780	29166.9	-.06	-.00	-.0017	.0143	-.0038	.0020	-.0024	.0077	329.4

TEST TP	21 ALPHA DEG	BETA DEG	RUN 93 CL(SA)	CD(SA)	CPM(SA)	CRM(SA)	CYM(SA)	CSF(SA)	P1 PA	CPB(1)	VTOT M/SEC
6975	-.03	-.00	.0002	.0153	-.0035	.0017	-.0025	.0078	68279.2	-.121	0.0
6976	-2.20	-.03	-.1323	.0180	-.0075	.0019	-.0023	.0084	68692.3	-.121	0.0
6977	-.14	-.00	-.0103	.0152	-.0043	.0018	-.0025	.0078	68184.2	-.121	0.0
6978	2.40	.03	.1304	.0177	-.0001	.0018	-.0025	.0070	67212.6	-.122	0.0
6979	5.01	.06	.2840	.0306	-.0001	.0019	-.0023	.0053	66131.0	-.130	0.0
6980	7.80	.10	.4466	.0634	-.0038	.0012	-.0025	.0044	66381.8	-.134	0.0
6981	9.90	.13	.5446	.0973	-.0042	.0019	-.0025	.0037	66970.3	-.141	0.0
6982	12.37	.16	.6502	.1468	-.0100	.0020	-.0026	.0036	67264.4	-.149	0.0
6983	14.75	.19	.7250	.1963	-.0181	.0016	-.0032	.0056	67258.9	-.154	0.0
6984	17.11	.22	.7967	.2512	-.0294	.0010	-.0028	.0057	68232.1	-.166	0.0
6985	18.09	.23	.8134	.2722	-.0335	.0007	-.0021	.0049	68327.1	-.172	0.0
6986	-.06	-.00	-.0017	.0143	-.0038	.0020	-.0024	.0077	68437.8	-.121	0.0

TEST TP	21 Q PA	ALPHA DEG	RUN 93 BETA DEG	CLT	CDT	CMST	CRTS	CYTS	CYST	CMU	WTFLO KG/SEC	PLENP PSI
6975	29236.2	-.03	-.00	.0002	.0153	-.0035	.0017	-.0025	.0078	0.0000	0.0000	-.2
6976	28952.7	-2.20	-.03	-.1323	.0180	-.0075	.0019	-.0023	.0084	0.0000	0.0000	-.2
6977	29351.0	-.14	-.00	-.0103	.0152	-.0043	.0018	-.0025	.0078	0.0000	0.0000	-.2
6978	29956.2	2.40	.03	.1304	.0177	-.0001	.0018	-.0025	.0070	0.0000	0.0000	-.2
6979	30681.9	5.01	.06	.2840	.0306	-.0001	.0019	-.0023	.0053	0.0000	0.0000	-.3
6980	30575.7	7.80	.10	.4466	.0634	-.0038	.0012	-.0025	.0044	0.0000	0.0000	-.3
6981	30117.0	9.90	.13	.5446	.0973	-.0042	.0019	-.0025	.0037	0.0000	0.0000	-.4
6982	29915.4	12.37	.16	.6502	.1468	-.0100	.0020	-.0026	.0036	0.0000	0.0000	-.5
6983	29982.7	14.75	.19	.7250	.1963	-.0181	.0016	-.0032	.0056	0.0000	0.0000	-.6
6984	29255.5	17.11	.22	.7967	.2512	-.0294	.0010	-.0028	.0057	0.0000	0.0000	-.8
6985	29249.9	18.09	.23	.8134	.2722	-.0335	.0007	-.0021	.0049	0.0000	0.0000	-.9
6986	29166.9	-.06	-.00	-.0017	.0143	-.0038	.0020	-.0024	.0077	0.0000	0.0000	-.5

NASA LANGLEY

7 X 10 HIGH SPEED TUNNEL

TEST TP	21 MACH	Q PA	RUN 94 ALPHA DEG	BETA DEG	CNF(BA)	CAF(BA)	CPH(BA)	CRM(BA)	CYH(BA)	CSF(BA)	TPLEN DEG K
6987	.787	29491.2	-.05	-.00	-.0120	-.0093	.0029	.0022	-.0017	.0072	303.8
6988	.783	29304.7	-2.24	-.03	-.1418	-.0110	-.0018	.0019	-.0018	.0080	303.5
6989	.801	30078.4	-.11	-.01	-.0200	-.0088	.0020	.0023	-.0017	.0072	303.6
6990	.808	30407.1	2.44	.03	.1163	-.0113	.0062	.0027	-.0014	.0059	303.8
6991	.805	30284.6	5.21	.06	.2928	-.0170	.0069	.0026	-.0016	.0037	304.2
6992	.810	30490.1	7.50	.10	.4348	-.0196	.0040	.0030	-.0015	.0015	304.5
6993	.804	30256.7	10.11	.13	.5704	-.0197	-.0041	.0023	-.0021	.0021	305.0
6994	.799	30010.4	12.47	.16	.6957	-.0199	-.0125	.0029	-.0024	.0035	305.7
6995	.794	29820.7	14.98	.20	.7963	-.0229	-.0112	.0043	-.0027	.0036	306.5
6996	.787	29482.6	17.48	.23	.8982	-.0253	-.0095	.0034	-.0029	.0037	307.4
6997	.781	29209.6	18.55	.24	.9277	-.0263	-.0105	.0032	-.0030	.0039	308.2
6998	.766	28452.7	-.05	-.00	-.0120	-.0115	.0020	.0019	-.0018	.0078	310.0

TEST TP	21 ALPHA DEG	BETA DEG	RUN 94 CL(SA)	CD(SA)	CPH(SA)	CRM(SA)	CYH(SA)	CSF(SA)	P1 PA	CPB(1)	VTOT M/SEC
6987	-.05	-.00	-.0120	-.0092	.0029	.0022	-.0017	.0072	67955.8	-.124	643.1
6988	-2.24	-.03	-.1421	-.0055	-.0018	.0020	-.0018	.0080	68219.5	-.123	642.7
6989	-.11	-.01	-.0201	-.0088	.0020	.0023	-.0016	.0072	67048.2	-.124	643.6
6990	2.44	.03	.1167	-.0064	.0062	.0027	-.0015	.0059	66603.7	-.130	644.0
6991	5.21	.06	.2932	.0097	.0069	.0025	-.0018	.0037	66711.5	-.132	644.3
6992	7.50	.10	.4336	.0373	.0040	.0027	-.0019	.0015	66403.2	-.139	644.9
6993	10.11	.13	.5650	.0808	-.0041	.0019	-.0024	.0021	66802.7	-.150	645.1
6994	12.47	.16	.6738	.1287	-.0125	.0023	-.0029	.0035	67136.4	-.156	645.7
6995	14.98	.20	.7752	.1837	-.0112	.0034	-.0037	.0036	67489.7	-.162	646.2
6996	17.48	.23	.8643	.2457	-.0095	.0024	-.0038	.0037	67953.4	-.174	647.0
6997	18.55	.24	.8879	.2703	-.0105	.0021	-.0039	.0039	68338.1	-.181	647.6
6998	-.05	-.00	-.0120	-.0115	.0020	.0019	-.0018	.0078	69362.8	-.123	648.9

TEST TP	21 Q PA	ALPHA DEG	RUN 94 BETA DEG	CLT	CDT	CMST	CRTS	CYTS	CYST	CMU	WTFLO KG/SEC	PLENP PSI
6987	29491.2	-.05	-.00	-.0228	.0166	-.0124	.0022	-.0022	.0086	.0488	.2586	510.1
6988	29304.7	-2.24	-.03	-.1519	.0209	-.0171	.0020	-.0023	.0094	.0492	.2589	510.1
6989	30078.4	-.11	-.01	-.0306	.0166	-.0130	.0023	-.0022	.0086	.0480	.2589	510.7
6990	30407.1	2.44	.03	.1051	.0182	-.0086	.0026	-.0020	.0073	.0475	.2589	510.6
6991	30284.6	5.21	.06	.2804	.0338	-.0080	.0024	-.0023	.0051	.0476	.2586	510.8
6992	30490.1	7.50	.10	.4200	.0608	-.0108	.0027	-.0024	.0029	.0474	.2589	511.0
6993	30256.7	10.11	.13	.5502	.1038	-.0190	.0018	-.0029	.0035	.0477	.2584	510.9
6994	30010.4	12.47	.16	.6579	.1513	-.0276	.0022	-.0034	.0050	.0481	.2584	511.1
6995	29820.7	14.98	.20	.7583	.2057	-.0263	.0033	-.0042	.0050	.0484	.2580	511.1
6996	29482.6	17.48	.23	.8462	.2672	-.0248	.0022	-.0043	.0051	.0490	.2577	511.3
6997	29209.6	18.55	.24	.8692	.2916	-.0260	.0019	-.0044	.0053	.0494	.2572	511.4
6998	28452.7	-.05	-.00	-.0231	.0154	-.0139	.0019	-.0024	.0093	.0507	.2568	511.2

C-2

NASA LANGLEY

7 X 10 HIGH SPEED TUNNEL

TEST TP	21 MACH	Q PA	RUN 95 ALPHA DEG	BETA DEG	CNF(BA)	CAF(BA)	CPM(BA)	CRM(BA)	CYM(BA)	CSF(BA)	TPLEN DEG K
7014	.301	6098.0	-0.09	5.01	-0.0068	.0154	-0.0005	-0.0058	.0130	-0.0585	294.5
7015	.300	6062.6	-2.02	4.98	-0.1340	.0094	-0.0069	-0.0040	.0123	-0.0567	294.5
7016	.301	6105.9	-0.07	5.01	-0.0123	.0152	-0.0013	-0.0062	.0130	-0.0583	294.5
7017	.302	6169.6	1.97	5.03	.1020	.0137	.0040	-0.0073	.0129	-0.0576	294.6
7018	.302	6147.8	3.89	5.05	.2000	.0086	.0070	-0.0084	.0128	-0.0593	294.6
7019	.302	6157.9	6.00	5.07	.3176	.0020	.0088	-0.0092	.0128	-0.0593	294.7
7020	.301	6113.6	8.26	5.08	.4502	-0.0045	.0104	-0.0104	.0128	-0.0603	294.8
7021	.300	6068.0	10.49	5.08	.5667	-0.0085	.0128	-0.0106	.0126	-0.0618	295.0
7022	.299	6042.9	12.51	5.08	.6682	-0.0095	.0126	-0.0085	.0116	-0.0622	295.1
7023	.299	6044.4	14.62	5.08	.7636	-0.0102	.0096	-0.0069	.0094	-0.0615	295.2
7024	.301	6107.4	16.86	5.06	.8647	-0.0094	-0.0004	-0.0051	.0064	-0.0573	295.4
7025	.300	6075.9	18.93	5.05	.9058	-0.0034	-0.0130	.0018	-0.0056	-0.0396	295.5
7026	.299	6040.1	21.14	5.02	.9524	.0000	-0.0300	.0017	-0.0115	-0.0305	295.6
7027	.299	6023.3	23.11	4.98	1.0034	-0.0022	-0.0315	.0003	-0.0132	-0.0284	295.7
7028	.300	6069.9	23.91	4.97	1.0359	-0.0033	-0.0319	.0004	-0.0141	-0.0243	295.8
7029	.299	6054.5	-0.07	5.01	-0.0081	.0137	-0.0012	-0.0054	.0130	-0.0576	295.9

TEST TP	21 ALPHA DEG	BETA DEG	RUN 95 CL(SA)	CD(SA)	CPM(SA)	CRM(SA)	CYM(SA)	CSF(SA)	P1 PA	CPB(1)	VTOT M/SEC
7014	-0.09	5.01	-0.0068	.0154	-0.0005	-0.0059	.0130	-0.0585	96449.7	-0.125	0.0
7015	-2.02	4.98	-0.1336	.0142	-0.0069	-0.0044	.0121	-0.0567	96486.8	-0.124	0.0
7016	-0.07	5.01	-0.0123	.0153	-0.0013	-0.0062	.0130	-0.0583	96441.4	-0.124	0.0
7017	1.97	5.03	.1015	.0172	.0040	.0068	.0131	-0.0576	96374.7	-0.127	0.0
7018	3.89	5.05	.1990	.0222	.0070	-0.0075	.0133	-0.0593	96402.6	-0.128	0.0
7019	6.00	5.07	.3156	.0352	.0088	-0.0078	.0137	-0.0593	96390.4	-0.131	0.0
7020	8.26	5.08	.4461	.0602	.0104	-0.0084	.0141	-0.0603	96433.4	-0.135	0.0
7021	10.49	5.08	.5588	.0948	.0128	-0.0081	.0143	-0.0618	96481.1	-0.142	0.0
7022	12.51	5.08	.6544	.1354	.0126	-0.0058	.0132	-0.0622	96507.4	-0.145	0.0
7023	14.62	5.08	.7415	.1829	.0096	-0.0043	.0108	-0.0615	96505.6	-0.153	0.0
7024	16.86	5.06	.8302	.2419	-0.0004	-0.0030	.0076	-0.0573	96439.5	-0.164	0.0
7025	18.93	5.05	.8579	.2907	-0.0130	-0.0001	-0.0059	-0.0396	96472.8	-0.167	0.0
7026	21.14	5.02	.8884	.3435	-0.0300	-0.0026	-0.0114	-0.0305	96508.3	-0.171	0.0
7027	23.11	4.98	.9238	.3918	-0.0315	-0.0049	-0.0122	-0.0284	96524.5	-0.176	0.0
7028	23.91	4.97	.9484	.4168	-0.0319	-0.0054	-0.0131	-0.0243	96472.4	-0.179	0.0
7029	-0.07	5.01	-0.0081	.0137	-0.0012	-0.0055	.0130	-0.0576	96495.3	-0.124	0.0

TEST TP	21 Q PA	ALPHA DEG	RUN 95 BETA DEG	CLT	CDT	CMST	CRTS	CYTS	CYST	CMU	WTFLO KG/SEC	PLENP PSI
7014	6098.0	-0.09	5.01	-0.0068	.0154	-0.0005	-0.0059	.0130	-0.0585	0.0000	0.0000	.1
7015	6062.6	-2.02	4.98	-0.1336	.0142	-0.0069	-0.0044	.0121	-0.0567	0.0000	0.0000	.1
7016	6105.9	-0.07	5.01	-0.0123	.0153	-0.0013	-0.0062	.0130	-0.0583	0.0000	0.0000	.1
7017	6169.6	1.97	5.03	.1015	.0172	.0040	-0.0068	.0131	-0.0576	0.0000	0.0000	.0
7018	6147.8	3.89	5.05	.1990	.0222	.0070	-0.0075	.0133	-0.0593	0.0000	0.0000	.0
7019	6157.9	6.00	5.07	.3156	.0352	.0088	-0.0078	.0137	-0.0593	0.0000	0.0000	-0.0
7020	6113.6	8.26	5.08	.4461	.0602	.0104	-0.0084	.0141	-0.0603	0.0000	0.0000	.0
7021	6068.0	10.49	5.08	.5588	.0948	.0128	-0.0081	.0143	-0.0618	0.0000	0.0000	.0
7022	6042.9	12.51	5.08	.6544	.1354	.0126	-0.0058	.0132	-0.0622	0.0000	0.0000	-0.0
7023	6044.4	14.62	5.08	.7415	.1829	.0096	-0.0043	.0108	-0.0615	0.0000	0.0000	-0.1
7024	6107.4	16.86	5.06	.8302	.2419	-0.0004	-0.0030	.0076	-0.0573	0.0000	0.0000	-0.1
7025	6075.9	18.93	5.05	.8579	.2907	-0.0130	-0.0001	-0.0059	-0.0396	0.0000	0.0000	-0.2
7026	6040.1	21.14	5.02	.8884	.3435	-0.0300	-0.0026	-0.0114	-0.0305	0.0000	0.0000	-0.1
7027	6023.3	23.11	4.98	.9238	.3918	-0.0315	-0.0049	-0.0122	-0.0284	0.0000	0.0000	-0.2
7028	6069.9	23.91	4.97	.9484	.4168	-0.0319	-0.0054	-0.0131	-0.0243	0.0000	0.0000	-0.2
7029	6054.5	-0.07	5.01	-0.0081	.0137	-0.0012	-0.0055	.0130	-0.0576	0.0000	0.0000	.1

NASA LANGLEY

7 X 10 HIGH SPEED TUNNEL

TEST TP	21 MACH	Q PA	RUN 96		CNF(BA)	CAF(BA)	CPM(BA)	CRM(BA)	CYH(BA)	CSF(BA)	TPLEN DEG K
			ALPHA DEG	BETA DEG							
7030	.301	6097.9	-.08	5.01	-.0152	-.0171	.0003	-.0074	.0127	-.0630	299.2
7031	.299	6051.3	-1.96	4.98	-.1385	-.0221	-.0080	-.0052	.0127	-.0606	299.1
7032	.299	6048.8	-.09	5.01	-.0199	-.0169	-.0007	-.0076	.0125	-.0632	294.9
7033	.301	6110.6	2.02	5.04	.1000	-.0180	.0085	-.0085	.0117	-.0646	294.7
7034	.301	6126.1	3.90	5.06	.1940	-.0224	.0115	-.0084	.0113	-.0647	294.6
7035	.301	6123.0	6.15	5.07	.3235	-.0284	.0126	-.0086	.0118	-.0652	294.5
7036	.301	6120.9	8.15	5.08	.4487	-.0346	.0138	-.0096	.0123	-.0663	294.3
7037	.301	6110.1	10.38	5.09	.5722	-.0388	.0176	-.0101	.0123	-.0651	294.2
7038	.300	6073.3	12.51	5.08	.6809	-.0418	.0210	-.0108	.0113	-.0661	294.0
7039	.299	6031.2	14.73	5.08	.7943	-.0449	.0195	-.0093	.0088	-.0627	293.9
7040	.300	6082.7	16.88	5.06	.9020	-.0473	.0130	-.0078	.0062	-.0575	293.7
7041	.300	6068.8	19.00	5.04	.9930	-.0491	.0033	-.0038	.0023	-.0517	293.6
7042	.299	6029.5	21.40	5.01	1.0779	-.0520	-.0028	-.0024	-.0020	-.0426	293.5
7043	.299	6036.3	23.36	4.98	1.1409	-.0534	-.0042	-.0024	-.0052	-.0376	293.4
7044	.300	6075.9	24.04	4.96	1.1547	-.0486	-.0156	-.0028	-.0050	-.0376	293.4
7045	.298	6018.5	-.08	5.01	-.0134	-.0161	.0009	-.0072	.0123	-.0614	293.1

TEST TP	21 ALPHA DEG	BETA DEG	RUN 96		CPM(SA)	CRM(SA)	CYM(SA)	CSF(SA)	P1 PA	CPB(1)	VTOT H/SEC
			CL(SA)	CD(SA)							
7030	-.08	5.01	-.0152	-.0170	.0003	-.0075	.0127	-.0630	96448.4	-.127	531.9
7031	-1.96	4.98	-.1392	-.0173	-.0080	-.0056	.0125	-.0606	96494.7	-.126	531.6
7032	-.09	5.01	-.0199	-.0169	-.0007	-.0076	.0125	-.0632	96499.5	-.126	531.3
7033	2.02	5.04	.1006	-.0145	.0085	-.0081	.0120	-.0646	96434.3	-.129	531.3
7034	3.90	5.06	.1951	-.0092	.0115	-.0074	.0118	-.0647	96422.3	-.130	531.2
7035	6.15	5.07	.3247	.0064	.0126	-.0073	.0127	-.0652	96420.1	-.140	531.0
7036	8.15	5.08	.4491	.0294	.0138	-.0078	.0136	-.0663	96418.9	-.144	531.0
7037	10.38	5.09	.5698	.0650	.0176	-.0077	.0139	-.0651	96429.3	-.151	530.9
7038	12.51	5.08	.6738	.1067	.0210	-.0081	.0133	-.0661	96467.8	-.157	530.8
7039	14.73	5.08	.7796	.1585	.0195	-.0068	.0109	-.0627	96506.1	-.159	530.7
7040	16.88	5.06	.8769	.2166	.0130	-.0057	.0082	-.0575	96452.1	-.160	530.7
7041	19.00	5.04	.9549	.2769	.0033	-.0029	.0034	-.0517	96466.7	-.168	530.7
7042	21.40	5.01	1.0225	.3450	-.0028	-.0030	-.0010	-.0426	96509.4	-.178	530.6
7043	23.36	4.98	1.0686	.4033	-.0042	-.0042	-.0038	-.0376	96500.8	-.187	530.6
7044	24.04	4.96	1.0743	.4260	-.0156	-.0046	-.0035	-.0376	96458.6	-.190	530.6
7045	-.08	5.01	-.0134	-.0161	.0009	-.0072	.0123	-.0614	96524.8	-.126	530.4

TEST TP	21 Q PA	ALP-DEG	RUN 96		CDT	CMST	CRTS	CYTS	CYST	CMU	WTFLO KG/SEC	PLENP PSI
			BETA DEG	CLT								
7030	6097.9	-.08	5.01	-.0276	.0127	-.0173	-.0075	.0121	-.0613	.0498	.0659	121.3
7031	6051.3	-1.96	4.98	-.1506	.0130	-.0257	-.0056	.0119	-.0589	.0502	.0660	121.1
7032	6048.8	-.09	5.01	-.0323	.0131	-.0183	-.0076	.0119	-.0615	.0501	.0658	120.9
7033	6110.6	2.02	5.04	.0873	.0147	-.0089	-.0081	.0114	-.0630	.0494	.0656	121.0
7034	6126.1	3.90	5.06	.1808	.0194	-.0059	-.0076	.0112	-.0631	.0493	.0657	121.0
7035	6123.0	6.15	5.07	.3093	.0344	-.0048	-.0074	.0121	-.0636	.0493	.0657	121.0
7036	6120.9	8.15	5.08	.4327	.0569	-.0036	-.0079	.0130	-.0646	.0495	.0658	121.1
7037	6110.1	10.38	5.09	.5523	.0919	.0001	-.0078	.0133	-.0635	.0496	.0660	121.2
7038	6073.3	12.51	5.08	.6552	.1331	.0033	-.0082	.0127	-.0644	.0500	.0661	121.3
7039	6031.2	14.73	5.08	.7599	.1845	.0018	-.0069	.0103	-.0610	.0504	.0661	121.5
7040	6082.7	16.88	5.06	.8563	.2416	-.0046	-.0059	.0076	-.0558	.0500	.0662	121.6
7041	6068.8	19.00	5.04	.9333	.3012	-.0144	-.0031	.0028	-.0500	.0502	.0663	121.7
7042	6029.5	21.40	5.01	.9998	.3685	-.0207	-.0032	-.0015	-.0409	.0504	.0662	121.8
7043	6036.3	23.36	4.98	1.0491	.4260	-.0220	-.0045	-.0044	-.0359	.0504	.0662	121.8
7044	6075.9	24.04	4.96	1.0507	.4483	-.0333	-.0049	-.0040	-.0359	.0503	.0665	121.9
7045	6018.5	-.08	5.01	-.0260	.0143	-.0171	-.0072	.0116	-.0597	.0507	.0665	122.2

NASA LANGLEY

7 X 10 HIGH SPEED TUNNEL

TEST TP	21		RUN 97								TPLEN DEG K
	MACH	Q PA	ALPHA DEG	BETA DEG	CNF(BA)	CAF(BA)	CPH(BA)	CRN(BA)	CYM(BA)	CSF(BA)	
7046	.300	6079.1	-.08	5.01	-.0227	-.0426	.0108	-.0096	.0131	-.0685	290.5
7047	.300	6059.1	-2.06	4.98	-.1378	-.0481	.0002	-.0066	.0132	-.0641	290.2
7048	.300	6080.6	-.06	5.01	-.0214	-.0425	.0111	-.0100	.0131	-.0675	290.1
7049	.301	6128.2	1.85	5.04	.0787	-.0429	.0176	-.0090	.0113	-.0691	289.9
7050	.304	6229.8	4.09	5.06	.1935	-.0467	.0198	-.0077	.0111	-.0688	289.8
7051	.302	6159.0	5.98	5.07	.3125	-.0526	.0182	-.0078	.0121	-.0688	289.7
7052	.301	6128.7	8.19	5.08	.4592	-.0599	.0173	-.0096	.0120	-.0688	289.6
7053	.300	6064.7	10.27	5.09	.5912	-.0656	.0192	-.0087	.0120	-.0696	289.6
7054	.299	6045.0	12.56	5.09	.7404	-.0721	.0249	-.0075	.0111	-.0691	289.6
7055	.300	6083.0	14.78	5.07	.8482	-.0763	.0368	-.0109	.0100	-.0655	289.6
7056	.299	6043.3	16.97	5.06	.9443	-.0797	.0334	-.0085	.0082	-.0599	289.6
7057	.298	6015.6	19.20	5.04	1.0556	-.0843	.0264	-.0065	.0038	-.0533	289.6
7058	.299	6034.1	21.33	5.01	1.1463	-.0877	.0191	-.0037	-.0016	-.0453	289.6
7059	.301	6124.8	23.43	4.98	1.2383	-.0897	.0096	-.0000	-.0062	-.0412	289.7
7060	.301	6096.8	24.17	4.97	1.2593	-.0910	.0076	-.0005	-.0075	-.0404	289.7
7061	.300	6064.7	-.07	5.01	-.0161	-.0433	.0107	-.0095	.0132	-.0672	289.8

TEST TP	21		RUN 97					P1 PA	CP8(I)	VTOT M/SEC	
	ALPHA DEG	BETA DEG	CL(SA)	CD(SA)	CPH(SA)	CRN(SA)	CYM(SA)				CSF(SA)
7046	-.08	5.01	-.0227	-.0426	.0108	-.0096	.0131	-.0685	96461.0	-.126	571.4
7047	-2.06	4.98	-.1394	-.0431	.0002	-.0070	.0130	-.0641	96478.2	-.124	571.1
7048	-.06	5.01	-.0215	-.0425	.0111	-.0100	.0131	-.0675	96460.8	-.126	571.0
7049	1.85	5.04	.0800	-.0403	.0176	-.0086	.0116	-.0691	96409.0	-.128	570.9
7050	4.09	5.06	.1964	-.0328	.0198	-.0069	.0116	-.0688	96303.1	-.133	570.9
7051	5.98	5.07	.3163	-.0198	.0182	-.0065	.0128	-.0688	96375.6	-.135	570.7
7052	8.19	5.08	.4631	.0061	.0173	-.0077	.0132	-.0688	96408.6	-.141	570.4
7053	10.27	5.09	.5934	.0409	.0192	-.0064	.0134	-.0696	96475.5	-.146	570.3
7054	12.56	5.09	.7383	.0907	.0249	-.0049	.0125	-.0691	96493.0	-.153	570.3
7055	14.78	5.07	.8396	.1426	.0368	-.0080	.0124	-.0655	96453.3	-.158	570.3
7056	16.97	5.06	.9264	.1993	.0334	-.0058	.0103	-.0599	96493.4	-.162	570.3
7057	19.20	5.04	1.0246	.2675	.0264	-.0049	.0057	-.0533	96523.7	-.161	570.4
7058	21.33	5.01	1.0996	.3353	.0191	-.0040	-.0002	-.0453	96502.7	-.170	570.4
7059	23.43	4.98	1.1718	.4101	.0096	-.0025	-.0057	-.0412	96402.4	-.183	570.6
7060	24.17	4.97	1.1862	.4326	.0076	-.0026	-.0071	-.0404	96434.0	-.187	570.6
7061	-.07	5.01	-.0162	-.0433	.0107	-.0095	.0132	-.0672	96471.0	-.127	570.8

TEST TP	21		RUN 97				CRTS	CYTS	CYST	CMU	WTFLD KG/SEC	PLENP PSI
	Q PA	ALPHA DEG	BETA DEG	CLT	CDT	CMST						
7046	6079.1	-.08	5.01	-.0465	.0146	-.0229	-.0096	.0120	-.0653	.1012	.1243	232.5
7047	6059.1	-2.06	4.98	-.1612	.0151	-.0336	-.0070	.0118	-.0609	.1018	.1247	232.7
7048	6080.6	-.06	5.01	-.0452	.0147	-.0227	-.0100	.0119	-.0644	.1011	.1244	232.7
7049	6128.2	1.85	5.04	.0546	.0156	-.0159	-.0087	.0105	-.0659	.1005	.1245	232.7
7050	6229.8	4.09	5.06	.1692	.0213	-.0132	-.0069	.0105	-.0657	.0987	.1244	232.9
7051	6159.0	5.98	5.07	.2870	.0340	-.0152	-.0067	.0117	-.0656	.1000	.1246	232.9
7052	6128.7	8.19	5.08	.4317	.0588	-.0162	-.0079	.0121	-.0656	.1000	.1241	232.0
7053	6064.7	10.27	5.09	.5598	.0929	-.0146	-.0066	.0122	-.0664	.1013	.1244	231.9
7054	6045.0	12.56	5.09	.7025	.1415	-.0090	-.0052	.0113	-.0659	.1012	.1239	231.9
7055	6083.0	14.78	5.07	.8021	.1917	.0032	-.0083	.0113	-.0623	.1011	.1245	232.0
7056	6043.3	16.97	5.06	.8868	.2473	-.0005	-.0061	.0092	-.0567	.1016	.1243	232.1
7057	6015.6	19.20	5.04	.9829	.3141	-.0077	-.0053	.0046	-.0500	.1023	.1246	232.3
7058	6034.1	21.33	5.01	1.0564	.3802	-.0149	-.0044	-.0013	-.0420	.1019	.1245	232.5
7059	6124.8	23.43	4.98	1.1276	.4528	-.0239	-.0029	-.0067	-.0381	.1004	.1245	232.5
7060	6096.8	24.17	4.97	1.1411	.4749	-.0261	-.0031	-.0082	-.0372	.1011	.1248	232.6
7061	6064.7	-.07	5.01	-.0400	.0141	-.0232	-.0095	.0120	-.0640	.1016	.1247	232.7

ORIGINAL PAGE IS
OF POOR QUALITY

NASA LANGLEY

7 X 10 HIGH SPEED TUNNEL

TEST TP	21 MACH	0 PA	RUN 98 ALPHA DEG	BETA DEG	CNF(BA)	CAF(BA)	CPM(BA)	CRM(BA)	CYM(BA)	CSF(BA)	TPLEN DEG K
7062	.302	6150.5	-.04	5.01	-.0288	-.0942	.0300	-.0133	.0152	-.0729	288.8
7063	.301	6104.3	-1.99	4.98	-.1359	-.1004	.0145	-.0066	.0166	-.0696	289.2
7064	.300	6080.9	-.03	5.01	-.0307	-.0958	.0308	-.0131	.0152	-.0731	289.6
7065	.302	6160.8	2.01	5.04	.0762	-.0954	.0372	-.0105	.0121	-.0777	290.0
7066	.302	6168.1	3.95	5.06	.1782	-.0993	.0378	-.0050	.0121	-.0759	290.6
7067	.302	6163.5	6.07	5.08	.3143	-.1056	.0304	-.0077	.0133	-.0742	291.2
7068	.300	6095.6	8.22	5.09	.4659	-.1136	.0247	-.0078	.0136	-.0759	291.8
7069	.300	6068.5	10.30	5.09	.6370	-.1210	.0181	-.0070	.0134	-.0760	292.3
7070	.299	6052.6	12.77	5.09	.8344	-.1289	.0169	-.0075	.0118	-.0745	292.7
7071	.299	6044.4	14.84	5.08	1.0031	-.1349	.0160	-.0080	.0106	-.0750	293.2
7072	.301	6128.1	17.11	5.06	1.1401	-.1420	.0164	-.0083	.0093	-.0743	293.6
7073	.300	6089.5	19.38	5.03	1.2397	-.1514	.0334	-.0207	.0089	-.0724	294.1
7074	.301	6118.5	21.67	5.00	1.3189	-.1560	.0367	-.0150	.0069	-.0665	294.5
7075	.300	6076.1	23.66	4.97	1.3853	-.1591	.0372	-.0192	.0054	-.0590	294.9
7076	.300	6060.9	24.33	4.95	1.4076	-.1594	.0345	-.0148	.0040	-.0554	295.4
7077	.298	5988.9	-.05	5.01	-.0300	-.1031	.0298	-.0129	.0155	-.0746	297.0

TEST TP	21 ALPHA DEG	BETA DEG	RUN 98 CL(SA)	CD(SA)	CPM(SA)	CRM(SA)	CYM(SA)	CSF(SA)	P1 PA	CPB(1)	VTOT M/SEC
7062	-.04	5.01	-.0289	-.0942	.0300	-.0133	.0152	-.0729	96444.4	-.126	603.6
7063	-1.99	4.98	-.1393	-.0956	.0145	-.0072	.0164	-.0696	96430.1	-.128	604.0
7064	-.03	5.01	-.0308	-.0958	.0308	-.0132	.0152	-.0731	96455.6	-.126	604.4
7065	2.01	5.04	.0795	-.0927	.0372	-.0101	.0125	-.0777	96375.9	-.129	604.8
7066	3.95	5.06	.1846	-.0866	.0378	-.0041	.0124	-.0759	96367.3	-.134	605.5
7067	6.07	5.08	.3238	-.0718	.0304	-.0063	.0140	-.0742	96374.3	-.137	606.1
7068	8.22	5.09	.4774	-.0458	.0247	-.0058	.0145	-.0759	96444.5	-.143	606.7
7069	10.30	5.09	.6483	-.0052	.0181	-.0045	.0144	-.0760	96471.9	-.148	607.2
7070	12.77	5.09	.8422	.0586	.0169	-.0047	.0131	-.0745	96483.7	-.152	607.7
7071	14.84	5.08	1.0042	.1266	.0160	-.0050	.0123	-.0750	96490.3	-.150	608.1
7072	17.11	5.06	1.1314	.1997	.0164	-.0052	.0113	-.0743	96403.4	-.161	608.6
7073	19.38	5.03	1.2198	.2685	.0334	-.0166	.0152	-.0724	96443.7	-.168	609.1
7074	21.67	5.00	1.2833	.3421	.0367	-.0114	.0120	-.0665	96409.1	-.170	609.6
7075	23.66	4.97	1.3327	.4102	.0372	-.0118	.0110	-.0590	96456.5	-.172	609.9
7076	24.33	4.95	1.3482	.4347	.0345	-.0119	.0097	-.0554	96471.6	-.172	610.4
7077	-.05	5.01	-.0301	-.1030	.0298	-.0129	.0155	-.0746	96550.3	-.125	612.1

TEST TP	21 0 PA	ALPHA DEG	RUN 98 BETA DEG	CLT	CDT	CMST	CRTS	CYTS	CYST	CMU	WTFLO KG/SEC	PLENP PSI
7062	6150.5	-.04	5.01	-.0726	.0109	-.0320	-.0133	.0130	-.0670	.1931	.2272	432.2
7063	6104.3	-1.99	4.98	-.1796	.0115	-.0479	-.0071	.0142	-.0637	.1944	.2269	431.7
7064	6080.9	-.03	5.01	-.0749	.0103	-.0318	-.0132	.0130	-.0672	.1951	.2267	431.8
7065	6160.8	2.01	5.04	.0323	.0103	-.0246	-.0101	.0103	-.0719	.1925	.2264	431.3
7066	6168.1	3.95	5.06	.1340	.0146	-.0240	-.0043	.0102	-.0701	.1923	.2263	431.5
7067	6163.5	6.07	5.08	.2693	.0277	-.0314	-.0065	.0119	-.0684	.1925	.2261	431.8
7068	6095.6	8.22	5.09	.4186	.0527	-.0378	-.0061	.0124	-.0700	.1947	.2259	431.8
7069	6068.5	10.30	5.09	.5858	.0915	-.0446	-.0049	.0123	-.0700	.1954	.2255	431.7
7070	6052.6	12.77	5.09	.7754	.1528	-.0460	-.0052	.0110	-.0686	.1959	.2253	431.6
7071	6044.4	14.84	5.08	.9339	.2184	-.0471	-.0056	.0102	-.0690	.1962	.2252	431.6
7072	6128.1	17.11	5.06	1.0586	.2875	-.0458	-.0059	.0093	-.0684	.1937	.2252	431.6
7073	6089.5	19.38	5.03	1.1430	.3538	-.0291	-.0173	.0132	-.0665	.1947	.2248	431.6
7074	6118.5	21.67	5.00	1.2036	.4239	-.0256	-.0122	.0099	-.0606	.1937	.2245	431.6
7075	6076.1	23.66	4.97	1.2497	.4896	-.0254	-.0127	.0090	-.0531	.1949	.2242	431.2
7076	6060.9	24.33	4.95	1.2640	.5134	-.0283	-.0127	.0078	-.0495	.1953	.2240	431.3
7077	5988.9	-.05	5.01	-.0749	.0047	-.0338	-.0129	.0133	-.0686	.1979	.2236	431.6

NASA LANGLEY

7 X 10 HIGH SPEED TUNNEL

TEST TP	21 MACH	0		RUN 99		CNF(BA)	CAF(BA)	CPM(BA)	CRM(BA)	CYM(BA)	CSF(BA)	TPLEN DEG K
		PA	BETA DEG	ALPHA DEG	BETA DEG							
7078	.300	6063.0	-0.03	5.01	5.01	-.0324	-.1262	.0391	-.0154	.0160	-.0791	302.8
7079	.300	6060.0	-1.88	4.98	4.98	-.1268	-.1314	.0208	-.0064	.0175	-.0726	303.5
7080	.300	6073.7	-.04	5.01	5.01	-.0333	-.1266	.0381	-.0153	.0159	-.0792	304.1
7081	.301	6110.3	1.88	5.04	5.04	.0682	-.1265	.0461	-.0121	.0128	-.0824	304.7
7082	.302	6153.0	3.91	5.06	5.06	.1666	-.1291	.0457	-.0035	.0129	-.0798	305.2
7083	.303	6173.3	6.14	5.08	5.08	.3213	-.1353	.0350	-.0064	.0144	-.0793	305.7
7084	.301	6108.8	8.18	5.09	5.09	.4618	-.1428	.0283	-.0072	.0143	-.0799	306.1
7085	.299	6029.7	10.39	5.09	5.09	.6504	-.1518	.0180	-.0056	.0143	-.0811	306.6
7086	.302	6141.6	12.62	5.09	5.09	.8347	-.1570	.0169	-.0058	.0130	-.0793	307.1
7087	.298	5990.5	14.89	5.08	5.08	1.0102	-.1666	.0177	-.0100	.0110	-.0774	307.5
7088	.298	6001.8	17.14	5.06	5.06	1.1785	-.1746	.0179	-.0120	.0099	-.0794	308.0
7089	.299	6035.0	19.36	5.04	5.04	1.3277	-.1838	.0183	-.0147	.0080	-.0773	308.5
7090	.301	6110.7	21.47	5.01	5.01	1.3715	-.1888	.0441	-.0178	.0072	-.0699	309.0
7091	.300	6074.6	23.67	4.97	4.97	1.4415	-.1919	.0439	-.0158	.0066	-.0638	309.5
7092	.299	6051.7	24.40	4.95	4.95	1.4658	-.1930	.0425	-.0148	.0047	-.0585	309.9
7093	.298	6006.6	-.03	5.01	5.01	-.0422	-.1311	.0421	-.0149	.0157	-.0787	311.0

TEST TP	21 ALPHA DEG	BETA DEG	RUN 99		CPM(SA)	CRM(SA)	CYN(SA)	CSF(SA)	P1 PA	CPB(11)	VTDT M/SEC
			CL(SA)	CD(SA)							
7078	-.03	5.01	-.0325	-.1262	.0391	-.0154	.0160	-.0791	96474.0	-.127	626.3
7079	-1.88	4.98	-.1310	-.1272	.0208	-.0069	.0173	-.0726	96479.0	-.126	627.0
7080	-.04	5.01	-.0333	-.1266	.0381	-.0153	.0159	-.0792	96461.9	-.126	627.7
7081	1.88	5.04	.0723	-.1242	.0461	-.0117	.0132	-.0824	96424.6	-.130	628.3
7082	3.91	5.06	.1751	-.1175	.0457	-.0026	.0132	-.0798	96383.9	-.134	628.8
7083	6.14	5.08	.3339	-.1002	.0350	-.0049	.0150	-.0793	96362.2	-.137	629.4
7084	8.18	5.09	.4774	-.0756	.0283	-.0050	.0152	-.0799	96429.6	-.143	629.8
7085	10.39	5.09	.6671	-.0320	.0180	-.0029	.0151	-.0811	96911.1	-.148	630.3
7086	12.62	5.09	.8489	.0292	.0169	-.0028	.0140	-.0793	96390.5	-.153	630.8
7087	14.89	5.08	1.0191	.0986	.0177	-.0069	.0132	-.0774	96548.7	-.150	631.2
7088	17.14	5.06	1.1776	.1804	.0179	-.0086	.0130	-.0794	96536.8	-.157	631.7
7089	19.36	5.04	1.3135	.2667	.0183	-.0112	.0124	-.0773	96501.4	-.167	632.2
7090	21.47	5.01	1.3454	.3262	.0441	-.0139	.0132	-.0699	96421.6	-.170	632.7
7091	23.67	4.97	1.3973	.4029	.0439	-.0118	.0124	-.0638	96460.6	-.170	633.3
7092	24.40	4.95	1.4146	.4298	.0425	-.0115	.0104	-.0585	96484.6	-.169	633.6
7093	-.03	5.01	-.0423	-.1311	.0421	-.0149	.0157	-.0787	96585.2	-.124	634.7

TEST TP	21 0 PA	ALPHA DEG	RUN 99		CLT	CDT	CMST	CRTS	CYTS	CYST	CMU	WTFLO KG/SEC	PLENP PSI
			BETA DEG	CLT									
7078	6063.0	-.03	5.01	5.01	-.0848	-.0003	-.0352	-.0154	.0134	-.0721	.2339	.2615	510.4
7079	6060.0	-1.88	4.98	4.98	-.1793	.0003	-.0535	-.0069	.0147	-.0656	.2338	.2610	510.1
7080	6073.7	-.04	5.01	5.01	-.0855	-.0010	-.0361	-.0153	.0133	-.0722	.2335	.2609	510.3
7081	6110.3	1.88	5.04	5.04	.0163	-.0012	-.0276	-.0118	.0107	-.0755	.2319	.2605	510.3
7082	6153.0	3.91	5.06	5.06	.1151	.0027	-.0275	-.0028	.0106	-.0729	.2303	.2602	510.3
7083	6173.3	6.14	5.08	5.08	.2695	.0172	-.0380	-.0051	.0125	-.0724	.2297	.2602	510.4
7084	6108.8	8.18	5.09	5.09	.4081	.0406	-.0454	-.0054	.0127	-.0729	.2321	.2600	510.5
7085	6029.7	10.39	5.09	5.09	.5925	.0830	-.0567	-.0034	.0126	-.0741	.2351	.2597	510.6
7086	6141.6	12.62	5.09	5.09	.7712	.1391	-.0565	-.0034	.0115	-.0723	.2311	.2598	510.8
7087	5990.5	14.89	5.08	5.08	.9351	.2081	-.0575	-.0075	.0107	-.0703	.2370	.2597	510.8
7088	6001.8	17.14	5.06	5.06	1.0895	.2863	-.0572	-.0093	.0105	-.0723	.2366	.2596	510.8
7089	6035.0	19.36	5.04	5.04	1.2219	.3686	-.0565	-.0121	.0100	-.0702	.2352	.2593	511.0
7090	6110.7	21.47	5.01	5.01	1.2513	.4234	-.0296	-.0149	.0108	-.0630	.2321	.2589	510.7
7091	6074.6	23.67	4.97	4.97	1.2989	.4970	-.0303	-.0129	.0100	-.0568	.2334	.2586	510.8
7092	6051.7	24.40	4.95	4.95	1.3146	.5230	-.0320	-.0126	.0081	-.0515	.2344	.2585	510.9
7093	6006.6	-.03	5.01	5.01	-.0951	-.0039	-.0330	-.0149	.0131	-.0716	.2361	.2580	511.0

ORIGINAL PAGE IS OF POOR QUALITY

NASA LANGLEY

7 X 10 HIGH SPEED TUNNEL

TEST TP	21 MACH	Q PA	RUN 100		CNF(BA)	CAF(BA)	CPH(BA)	CRM(BA)	CYH(BA)	CSF(BA)	TPLN DEG K
			ALPHA DEG	BETA DEG							
7094	.499	15072.6	-.05	5.03	-.0207	-.0443	.0098	-.0099	.0131	-.0719	313.9
7095	.498	15056.9	-2.13	5.00	-.1409	-.0475	.0000	-.0077	.0142	-.0672	314.1
7096	.501	15194.1	-.12	5.03	-.0267	-.0440	.0096	-.0098	.0133	-.0726	314.4
7097	.503	15312.7	2.14	5.06	.0976	-.0454	.0167	-.0085	.0121	-.0750	314.5
7098	.504	15316.4	4.16	5.08	.2067	-.0504	.0170	-.0075	.0131	-.0740	314.7
7099	.504	15336.6	6.51	5.09	.3520	-.0562	.0173	-.0099	.0136	-.0734	314.8
7100	.503	15265.4	8.80	5.10	.4835	-.0600	.0167	-.0107	.0147	-.0751	315.0
7101	.499	15083.7	11.12	5.10	.6237	-.0655	.0172	-.0088	.0148	-.0761	315.1
7102	.497	14997.0	13.65	5.11	.7835	-.0714	.0224	-.0019	.0127	-.0733	315.2
7103	.496	14943.3	15.82	5.10	.8787	-.0746	.0335	-.0035	.0085	-.0681	315.3
7104	.495	14903.5	18.08	5.09	.9817	-.0767	.0293	-.0057	.0042	-.0650	315.5
7105	.496	14946.6	20.40	5.08	1.0809	-.0787	.0230	-.0066	-.0006	-.0614	315.5
7106	.499	15095.7	22.45	5.06	1.1625	-.0758	.0061	-.0034	-.0055	-.0562	315.6
7107	.500	15139.1	24.64	5.03	1.2261	-.0701	-.0201	.0012	-.0088	-.0450	315.7
7108	.498	15064.2	25.43	5.01	1.2447	-.0705	-.0214	.0010	-.0108	-.0425	315.8

TEST TP	21 ALPHA DEG	BETA DEG	RUN 100		CPH(SA)	CRM(SA)	CYH(SA)	CSF(SA)	PI PA	CPB(1)	VTOT M/SEC
			CL(SA)	CD(SA)							
7094	-.05	5.03	-.0207	-.0443	.0098	-.0100	.0130	-.0719	86547.2	-.132	642.9
7095	-2.13	5.00	-.1425	-.0422	.0000	-.0082	.0139	-.0672	86615.0	-.126	643.1
7096	-.12	5.03	-.0268	-.0439	.0096	-.0099	.0133	-.0726	86471.6	-.132	643.4
7097	2.14	5.06	.0993	-.0417	.0167	-.0080	.0124	-.0750	86331.8	-.132	643.7
7098	4.16	5.08	.2098	-.0353	.0170	-.0065	.0136	-.0740	86260.8	-.141	643.9
7099	6.51	5.09	.3561	-.0159	.0173	-.0083	.0146	-.0734	86307.9	-.143	644.0
7100	8.80	5.10	.4870	.0147	.0167	-.0083	.0162	-.0751	86336.9	-.153	644.1
7101	11.12	5.10	.6247	.0560	.0172	-.0058	.0162	-.0761	86501.8	-.162	644.2
7102	13.65	5.11	.7782	.1156	.0224	.0012	.0128	-.0733	86622.6	-.166	644.2
7103	15.82	5.10	.8657	.1678	.0335	-.0011	.0092	-.0681	86661.0	-.169	644.3
7104	18.08	5.09	.9571	.2317	.0293	-.0041	.0057	-.0650	86770.5	-.164	644.3
7105	20.40	5.08	1.0405	.3030	.0230	-.0064	.0018	-.0614	86743.3	-.172	644.4
7106	22.45	5.06	1.1033	.3739	.0061	-.0052	-.0038	-.0562	86574.4	-.186	644.6
7107	24.64	5.03	1.1437	.4474	-.0201	-.0026	-.0085	-.0450	86522.2	-.190	644.7
7108	25.43	5.01	1.1544	.4708	-.0214	-.0037	-.0102	-.0425	86603.9	-.193	644.7

TEST TP	21 Q PA	ALPHA DEG	RUN 100		CDT	CMST	CRTS	CYTS	CYST	CMU	WTFLO KG/SEC	PLENP PSI
			BETA DEG	CLT								
7094	15072.6	-.05	5.03	-.0418	.0064	-.0201	-.0100	.0120	-.0691	.0944	.2557	510.6
7095	15056.9	-2.13	5.00	-.1617	.0092	-.0299	-.0082	.0129	-.0644	.0945	.2555	510.3
7096	15194.1	-.12	5.03	-.0476	.0064	-.0200	-.0099	.0122	-.0697	.0938	.2557	510.7
7097	15312.7	2.14	5.06	.0767	.0073	-.0128	-.0081	.0113	-.0722	.0930	.2555	510.8
7098	15316.4	4.16	5.08	.1855	.0129	-.0124	-.0066	.0126	-.0712	.0930	.2554	510.8
7099	15336.6	6.51	5.09	.3299	.0312	-.0121	-.0084	.0136	-.0707	.0929	.2555	510.9
7100	15265.4	8.80	5.10	.4588	.0610	-.0128	-.0085	.0152	-.0723	.0933	.2553	510.8
7101	15083.7	11.12	5.10	.5942	.1016	-.0127	-.0060	.0152	-.0733	.0944	.2553	510.8
7102	14997.0	13.65	5.11	.7456	.1601	-.0077	.0009	.0118	-.0705	.0950	.2553	510.9
7103	14943.3	15.82	5.10	.8313	.2112	.0034	-.0014	.0082	-.0653	.0954	.2554	510.9
7104	14903.5	18.08	5.09	.9209	.2738	-.0009	-.0045	.0047	-.0621	.0955	.2551	510.6
7105	14946.6	20.40	5.08	1.0028	.3435	-.0071	-.0068	.0008	-.0585	.0952	.2549	510.5
7106	15095.7	22.45	5.06	1.0645	.4126	-.0238	-.0056	-.0048	-.0533	.0943	.2549	510.5
7107	15139.1	24.64	5.03	1.1036	.4844	-.0498	-.0030	-.0095	-.0422	.0940	.2549	510.6
7108	15064.2	25.43	5.01	1.1136	.5075	-.0513	-.0041	-.0111	-.0396	.0945	.2549	510.4

NASA LANGLEY

7 X 10 HIGH SPEED TUNNEL

TEST TP	21 MACH	Q PA	RUN 101 ALPHA DEG		BETA DEG	CNF(BA)	CAF(BA)	CPH(BA)	CRM(BA)	CYM(BA)	CSF(BA)	TPLEN DEG K
7109	.500	15166.5	-0.08	5.03	5.03	-.0180	-.0190	.0035	-.0080	.0134	-.0660	314.7
7110	.498	15062.1	-2.19	4.99	4.99	-.1487	-.0225	-.0046	-.0061	.0134	-.0622	314.5
7111	.500	15146.6	-.06	5.03	5.03	-.0163	-.0189	.0039	-.0079	.0135	-.0670	314.3
7112	.503	15273.6	2.16	5.06	5.06	.1061	-.0209	.0101	-.0085	.0123	-.0695	314.2
7113	.504	15336.0	4.47	5.08	5.08	.2254	-.0259	.0125	-.0087	.0123	-.0670	314.0
7114	.502	15221.7	6.57	5.09	5.09	.3542	-.0314	.0136	-.0097	.0131	-.0691	313.9
7115	.502	15222.9	8.67	5.10	5.10	.4775	-.0358	.0140	-.0116	.0134	-.0699	313.7
7116	.501	15167.3	11.11	5.10	5.10	.6022	-.0379	.0177	-.0103	.0135	-.0706	313.6
7117	.499	15053.7	13.33	5.10	5.10	.7049	-.0399	.0204	-.0103	.0119	-.0681	313.4
7118	.499	15107.9	15.86	5.09	5.09	.8222	-.0413	.0146	-.0085	.0087	-.0649	313.3
7119	.496	14955.6	18.01	5.09	5.09	.9107	-.0438	.0107	-.0055	.0042	-.0589	313.2
7120	.501	15172.7	20.25	5.08	5.08	.9967	-.0456	.0074	-.0012	-.0024	-.0497	313.1
7121	.500	15133.1	22.30	5.06	5.06	1.0674	-.0454	.0012	-.0003	-.0079	-.0452	313.0
7122	.495	14882.0	24.47	5.03	5.03	1.1338	-.0419	-.0193	.0003	-.0117	-.0438	312.8
7123	.498	15039.2	25.25	5.02	5.02	1.1501	-.0421	-.0194	.0015	-.0138	-.0426	312.7
7124	.489	14559.1	-.09	5.03	5.03	-.0161	-.0193	.0043	-.0083	.0134	-.0670	312.3

TEST TP	21 ALPHA DEG	BETA DEG	RUN 101 CL(SA)		CD(SA)	CPH(SA)	CRM(SA)	CYM(SA)	CSF(SA)	P1 PA	CPB(1)	VTOT M/SEC
7109	-.08	5.03	-.0180	-.0190	.0035	-.0080	.0134	-.0660	86495.7	-.130	612.6	
7110	-2.19	4.99	-.1494	-.0168	-.0046	-.0066	.0131	-.0622	86621.7	-.125	612.2	
7111	-.06	5.03	-.0163	-.0189	.0039	-.0079	.0135	-.0670	86524.2	-.130	612.1	
7112	2.16	5.06	.1065	-.0169	.0101	-.0080	.0126	-.0695	86377.0	-.130	612.1	
7113	4.47	5.08	.2267	-.0083	.0125	-.0078	.0130	-.0670	86308.5	-.137	612.0	
7114	6.57	5.09	.3555	.0093	.0136	-.0082	.0142	-.0691	86385.9	-.142	611.8	
7115	8.67	5.10	.4774	.0365	.0140	-.0094	.0150	-.0699	86390.0	-.145	611.6	
7116	11.11	5.10	.5982	.0789	.0177	-.0075	.0152	-.0706	86496.2	-.150	611.4	
7117	13.33	5.10	.6951	.1236	.0204	-.0073	.0139	-.0681	86530.5	-.156	611.3	
7118	15.86	5.09	.8021	.1849	.0146	-.0058	.0107	-.0649	86556.9	-.160	611.1	
7119	18.01	5.09	.8796	.2400	.0107	-.0039	.0057	-.0589	86733.0	-.168	610.9	
7120	20.25	5.08	.9509	.3021	.0074	-.0019	-.0018	-.0497	86479.5	-.179	610.9	
7121	22.30	5.06	1.0048	.3630	.0012	-.0027	-.0074	-.0452	86530.3	-.186	610.8	
7122	24.47	5.03	1.0493	.4316	-.0193	-.0046	-.0108	-.0438	86728.6	-.194	610.5	
7123	25.25	5.02	1.0582	.4524	-.0194	-.0045	-.0131	-.0426	86546.3	-.198	610.5	
7124	-.09	5.03	-.0162	-.0193	.0043	-.0083	.0133	-.0670	87124.0	-.131	609.7	

TEST TP	21 Q PA	ALPHA DEG	RUN 101 BETA DEG		CLT	CDT	CMST	CRTS	CYTS	CYST	CMU	WTFLO KG/SEC	PLENPI PSI
7109	15166.5	-.08	5.03	-.0295	.0087	-.0128	-.0080	.0128	-.0645	.0495	.1417	280.6	
7110	15062.1	-2.19	4.99	-.1599	.0114	-.0210	-.0066	.0125	-.0607	.0498	.1414	280.5	
7111	15146.6	-.06	5.03	-.0278	.0088	-.0125	-.0079	.0129	-.0655	.0496	.1416	280.5	
7112	15273.6	2.16	5.06	.0944	.0101	-.0061	-.0081	.0120	-.0680	.0491	.1415	280.6	
7113	15336.0	4.47	5.08	.2132	.0181	-.0036	-.0078	.0124	-.0655	.0490	.1418	280.5	
7114	15221.7	6.57	5.09	.3409	.0353	-.0027	-.0082	.0136	-.0676	.0494	.1419	280.5	
7115	15222.9	8.67	5.10	.4619	.0620	-.0023	-.0095	.0144	-.0684	.0493	.1418	280.5	
7116	15167.3	11.11	5.10	.5816	.1038	.0014	-.0076	.0147	-.0690	.0495	.1419	280.5	
7117	15053.7	13.33	5.10	.6774	.1481	.0040	-.0074	.0134	-.0666	.0499	.1418	280.5	
7118	15107.9	15.86	5.09	.7834	.2085	-.0018	-.0060	.0102	-.0634	.0497	.1418	280.5	
7119	14955.6	18.01	5.09	.8598	.2631	-.0059	-.0041	.0052	-.0574	.0503	.1421	280.6	
7120	15172.7	20.25	5.08	.9306	.3241	-.0089	-.0021	-.0024	-.0481	.0495	.1421	280.6	
7121	15133.1	22.30	5.06	.9836	.3842	-.0152	-.0029	-.0079	-.0436	.0497	.1422	280.5	
7122	14882.0	24.47	5.03	1.0270	.4523	-.0359	-.0048	-.0113	-.0423	.0505	.1421	280.5	
7123	15039.2	25.25	5.02	1.0358	.4727	-.0359	-.0048	-.0136	-.0411	.0501	.1424	280.5	
7124	14559.1	-.09	5.03	-.0281	.6095	-.0127	-.0083	.0128	-.0654	.0517	.1426	280.4	

NASA LANGLEY

7 X 10 HIGH SPEED TUNNEL

TEST TP	21 MACH	Q PA	RUN 102		CNF(BA)	CAF(BA)	CPM(BA)	CRH(BA)	CYM(BA)	CSF(BA)	TLEN DEG K
			ALPHA DEG	BETA DEG							
7125	.500	15121.6	-.09	5.02	-.0128	.0120	.0008	-.0063	.0135	-.0591	310.8
7126	.497	15008.2	-2.01	4.99	-.1368	.0082	-.0044	-.0042	.0130	-.0577	311.4
7127	.504	15330.4	-.00	5.02	-.0064	.0113	.0008	-.0057	.0135	-.0585	312.0
7128	.501	15191.1	2.11	5.05	.1054	.0093	.0050	-.0079	.0138	-.0605	312.4
7129	.503	15282.6	4.20	5.07	.2176	.0031	.0074	-.0088	.0138	-.0612	312.8
7130	.502	15234.5	6.47	5.08	.3532	-.0032	.0088	-.0098	.0141	-.0631	313.1
7131	.501	15164.0	8.81	5.09	.4828	-.0086	.0091	-.0117	.0138	-.0647	313.6
7132	.500	15122.9	10.97	5.10	.5867	-.0101	.0123	-.0110	.0134	-.0657	314.0
7133	.497	15010.9	13.31	5.10	.6967	-.0097	.0080	-.0076	.0119	-.0669	314.3
7134	.498	15063.2	15.59	5.09	.7904	-.0094	.0013	-.0060	.0090	-.0636	314.5
7135	.497	15002.7	17.77	5.08	.8698	-.0062	-.0102	-.0040	.0042	-.0553	314.7
7136	.500	15129.0	19.84	5.09	.8702	.0005	-.0242	.0019	-.0110	-.0370	314.9
7137	.501	15191.6	21.93	5.05	.9110	-.0004	-.0201	-.0053	-.0075	-.0380	315.1
7138	.496	14937.0	24.24	5.00	.9844	-.0041	-.0159	-.0100	-.0059	-.0386	315.3
7139	.496	14939.5	24.97	4.98	1.0095	-.0056	-.0166	-.0112	-.0055	-.0393	315.4
7140	.490	14622.5	-.06	5.02	-.0114	.0102	.0007	-.0067	.0135	-.0587	315.7

TEST TP	21 ALPHA DEG	BETA DEG	RUN 102		CPM(SA)	CRH(SA)	CYM(SA)	CSF(SA)	P1 PA	CPB(1)	VTOT M/SEC
			CL(SA)	CD(SA)							
7125	-.09	5.02	-.0128	.0120	.0008	-.0064	.0135	-.0591	86544.0	-.126	0.0
7126	-2.01	4.99	-.1364	.0130	-.0044	-.0047	.0129	-.0577	86673.0	-.127	0.0
7127	-.00	5.02	-.0064	.0113	.0008	-.0057	.0135	-.0585	86309.6	-.126	0.0
7128	2.11	5.05	.1050	.0132	.0050	-.0074	.0141	-.0605	86467.5	-.128	0.0
7129	4.20	5.07	.2168	.0190	.0074	-.0078	.0144	-.0612	86302.5	-.132	0.0
7130	6.47	5.08	.3513	.0367	.0088	-.0082	.0151	-.0631	86414.4	-.134	0.0
7131	8.81	5.09	.4784	.0655	.0091	-.0095	.0155	-.0647	86471.9	-.137	0.0
7132	10.97	5.10	.5779	.1017	.0123	-.0083	.0153	-.0657	86542.0	-.141	0.0
7133	13.31	5.10	.6802	.1510	.0080	-.0047	.0133	-.0669	86555.9	-.149	0.0
7134	15.59	5.09	.7639	.2033	.0013	-.0034	.0103	-.0636	86603.3	-.156	0.0
7135	17.77	5.08	.8302	.2595	-.0102	-.0025	.0052	-.0553	86675.7	-.163	0.0
7136	19.84	5.09	.8183	.2958	-.0242	-.0020	-.0110	-.0370	86523.6	-.167	0.0
7137	21.93	5.05	.8452	.3398	-.0201	-.0078	-.0050	-.0380	86426.7	-.175	0.0
7138	24.24	5.00	.8993	.4004	-.0159	-.0116	-.0013	-.0386	86733.6	-.185	0.0
7139	24.97	4.98	.9175	.4211	-.0166	-.0125	-.0002	-.0393	86697.5	-.186	0.0
7140	-.06	5.02	-.0114	.0102	.0007	-.0067	.0135	-.0587	87112.1	-.126	0.0

TEST TP	21 O PA	ALPHA DEG	RUN 102		CLT	CDT	CMST	CRTS	CYTS	CYST	CRU	WTFLO KG/SEC	PLENP PSI
			BETA DEG	CLT									
7125	15121.6	-.09	5.02	-.0128	.0120	.0008	-.0064	.0135	-.0591	0.0000	0.0000	0.0000	-.5
7126	15008.2	-2.01	4.99	-.1364	.0130	-.0044	-.0047	.0129	-.0577	0.0000	0.0000	0.0000	-.6
7127	15330.4	-.00	5.02	-.0064	.0113	.0008	-.0057	.0135	-.0585	0.0000	0.0000	0.0000	-.5
7128	15191.1	2.11	5.05	.1050	.0132	.0050	-.0074	.0141	-.0605	0.0000	0.0000	0.0000	-.6
7129	15282.6	4.20	5.07	.2168	.0190	.0074	-.0078	.0144	-.0612	0.0000	0.0000	0.0000	-.6
7130	15234.5	6.47	5.08	.3513	.0367	.0088	-.0082	.0151	-.0631	0.0000	0.0000	0.0000	-.7
7131	15164.0	8.81	5.09	.4784	.0655	.0091	-.0095	.0155	-.0647	0.0000	0.0000	0.0000	-.7
7132	15122.9	10.97	5.10	.5779	.1017	.0123	-.0083	.0153	-.0657	0.0000	0.0000	0.0000	-.8
7133	15010.9	13.31	5.10	.6802	.1510	.0080	-.0047	.0133	-.0669	0.0000	0.0000	0.0000	-.8
7134	15063.2	15.59	5.09	.7639	.2033	.0013	-.0034	.0103	-.0636	0.0000	0.0000	0.0000	-1.0
7135	15002.7	17.77	5.08	.8302	.2595	-.0102	-.0025	.0052	-.0553	0.0000	0.0000	0.0000	-1.0
7136	15129.0	19.84	5.09	.8183	.2958	-.0242	-.0020	-.0110	-.0370	0.0000	0.0000	0.0000	-1.1
7137	15191.6	21.93	5.05	.8452	.3398	-.0201	-.0078	-.0050	-.0380	0.0000	0.0000	0.0000	-1.2
7138	14937.0	24.24	5.00	.8993	.4004	-.0159	-.0116	-.0013	-.0386	0.0000	0.0000	0.0000	-1.4
7139	14939.5	24.97	4.98	.9175	.4211	-.0166	-.0125	-.0002	-.0393	0.0000	0.0000	0.0000	-1.4
7140	14622.5	-.06	5.02	-.0114	.0102	.0007	-.0067	.0135	-.0587	0.0000	0.0000	0.0000	-.7

NASA LANGLEY

7 X 10 HIGH SPEED TUNNEL

TEST TP	21 MACH	0 PA	RUN 103 ALPHA DEG	BETA DEG	CNF(BA)	CAF(BA)	CPH(BA)	CRM(BA)	CYM(BA)	CSF(BA)	TPLEN DEG K
7141	.696	25128.7	-.09	5.03	-.0076	.0115	-.0012	-.0067	.0156	-.0630	317.4
7142	.695	25117.5	-2.41	5.00	-.1617	.0076	-.0062	-.0044	.0146	-.0606	317.8
7143	.699	25290.2	-.06	5.03	-.0087	.0112	-.0012	-.0068	.0156	-.0633	318.2
7144	.703	25481.2	2.38	5.06	.1265	.0083	.0030	-.0089	.0160	-.0646	318.7
7145	.706	25642.2	4.59	5.07	.2530	.0025	.0042	-.0097	.0160	-.0660	319.3
7146	.703	25497.9	7.20	5.09	.4065	-.0029	.0035	-.0112	.0160	-.0679	320.3
7147	.701	25384.6	9.42	5.10	.5185	-.0038	.0055	-.0091	.0162	-.0701	320.8
7148	.699	25272.5	11.78	5.11	.6265	-.0035	.0018	-.0081	.0148	-.0704	321.6
7149	.697	25194.1	14.30	5.12	.7358	-.0030	-.0078	-.0071	.0119	-.0686	322.2
7150	.692	24941.1	16.56	5.12	.8159	-.0017	-.0181	-.0065	.0074	-.0615	323.0
7151	.698	25207.3	18.60	5.13	.8499	.0015	-.0266	-.0026	-.0027	-.0476	323.8
7152	.698	25210.3	-.10	5.03	-.0085	.0105	-.0010	-.0068	.0157	-.0631	324.1

TEST TP	21 ALPHA DEG	BETA DEG	RUN 103 CL(SA)	CD(SA)	CPH(SA)	CRM(SA)	CYM(SA)	CSF(SA)	P1 PA	CPB(1)	VTOT M/SEC
7141	-.09	5.03	-.0076	.0115	-.0012	-.0067	.0155	-.0630	74097.6	-.130	0.0
7142	-2.41	5.00	-.1612	.0144	-.0062	-.0050	.0144	-.0606	74201.2	-.130	0.0
7143	-.06	5.03	-.0087	.0112	-.0012	-.0068	.0156	-.0633	73880.9	-.131	0.0
7144	2.38	5.06	.1260	.0135	.0030	-.0082	.0163	-.0646	73700.4	-.132	0.0
7145	4.59	5.07	.2520	.0227	.0042	-.0084	.0167	-.0660	73444.5	-.136	0.0
7146	7.20	5.09	.4037	.0481	.0035	-.0091	.0173	-.0679	73626.2	-.140	0.0
7147	9.42	5.10	.5121	.0811	.0055	-.0063	.0175	-.0701	73760.7	-.144	0.0
7148	11.78	5.11	.6140	.1245	.0018	-.0049	.0161	-.0704	73909.1	-.146	0.0
7149	14.30	5.12	.7138	.1788	-.0078	-.0039	.0133	-.0686	74010.9	-.152	0.0
7150	16.56	5.12	.7826	.2309	-.0181	-.0041	.0090	-.0615	74344.9	-.160	0.0
7151	18.60	5.13	.8050	.2725	-.0266	-.0034	-.0017	-.0476	73995.1	-.164	0.0
7152	-.10	5.03	-.0085	.0105	-.0010	-.0068	.0157	-.0631	73981.7	-.131	0.0

TEST TP	21 G PA	ALPHA DEG	RUN 103 BETA DEG	CLT	CDT	CMST	CRTS	CYTS	CYST	CMU	WTFLD KG/SEC	PLENP PS1
7141	25128.7	-.09	5.03	-.0076	.0115	-.0012	-.0067	.0155	-.0630	0.0000	0.0000	-.9
7142	25117.5	-2.41	5.00	-.1612	.0144	-.0062	-.0050	.0144	-.0606	0.0000	0.0000	-1.1
7143	25290.2	-.06	5.03	-.0087	.0112	-.0012	-.0068	.0156	-.0633	0.0000	0.0000	-1.0
7144	25481.2	2.38	5.06	.1260	.0135	.0030	-.0082	.0163	-.0646	0.0000	0.0000	-1.0
7145	25642.2	4.59	5.07	.2520	.0227	.0042	-.0084	.0167	-.0660	0.0000	0.0000	-1.2
7146	25497.9	7.20	5.09	.4037	.0481	.0035	-.0091	.0173	-.0679	0.0000	0.0000	-1.6
7147	25384.6	9.42	5.10	.5121	.0811	.0055	-.0063	.0175	-.0701	0.0000	0.0000	-1.6
7148	25272.5	11.78	5.11	.6140	.1245	.0018	-.0049	.0161	-.0704	0.0000	0.0000	-1.4
7149	25194.1	14.30	5.12	.7138	.1788	-.0078	-.0039	.0133	-.0686	0.0000	0.0000	-1.4
7150	24941.1	16.56	5.12	.7826	.2309	-.0181	-.0041	.0090	-.0615	0.0000	0.0000	-1.5
7151	25207.3	18.60	5.13	.8050	.2725	-.0266	-.0034	-.0017	-.0476	0.0000	0.0000	-1.6
7152	25210.3	-.10	5.03	-.0085	.0105	-.0010	-.0068	.0157	-.0631	0.0000	0.0000	-1.2

ORIGINAL PAGE IS
OF POOR QUALITY

NASA LANGLEY

7 X 10 HIGH SPEED TUNNEL

TEST 21		RUN 104									
TP	MACH	Q PA	ALPHA DEG	BETA DEG	CNF(BA)	CAF(BA)	CPM(BA)	CRM(BA)	CYM(BA)	CSF(BA)	TPLEN DEG K
7153	.703	25477.7	-1.10	5.05	-.0166	-.0145	.0030	-.0084	.0145	-.0708	307.9
7154	.697	25196.5	-2.28	5.01	-.1542	-.0180	-.0044	-.0065	.0152	-.0664	307.8
7155	.700	25361.4	-.04	5.05	-.0184	-.0149	.0026	-.0084	.0143	-.0703	307.8
7156	.703	25478.0	2.28	5.08	.1134	-.0172	.0087	-.0086	.0141	-.0731	307.8
7157	.707	25654.2	4.48	5.09	.2391	-.0219	.0087	-.0094	.0146	-.0727	307.8
7158	.709	25756.0	6.98	5.10	.3908	-.0267	.0094	-.0109	.0151	-.0734	307.8
7159	.707	25678.5	9.41	5.11	.5209	-.0277	.0067	-.0102	.0157	-.0747	308.0
7160	.703	25465.2	12.02	5.12	.6540	-.0296	.0046	-.0092	.0151	-.0748	308.3
7161	.698	25215.2	14.28	5.12	.7458	-.0295	.0015	-.0102	.0116	-.0699	308.6
7162	.701	25416.4	16.81	5.12	.8530	-.0307	.0019	-.0071	.0062	-.0618	308.9
7163	.699	25271.1	19.23	5.14	.9571	-.0338	.0007	-.0019	-.0019	-.0526	309.3
7164	.698	25216.1	-.11	5.05	-.0186	-.0159	.0013	-.0082	.0144	-.0704	312.0
7165	0.000	47.2	-.11	5.00	-.4712	-1.4682	.3680	.0312	-.0761	.3829	320.5

TEST 21		RUN 104									
TP	ALPHA DEG	BETA DEG	CL(SA)	CD(SA)	CPM(SA)	CRM(SA)	CYM(SA)	CSF(SA)	P1 PA	CP8(1)	VTOT M/SEC
7153	-.10	5.05	-.0166	-.0145	.0030	-.0085	.0144	-.0708	73657.5	-.132	638.3
7154	-2.28	5.01	-.1548	-.0119	-.0044	-.0071	.0149	-.0664	73987.4	-.131	638.0
7155	-.04	5.05	-.0184	-.0149	.0026	-.0084	.0143	-.0703	73871.6	-.133	638.1
7156	2.28	5.06	.1140	-.0126	.0087	-.0081	.0144	-.0731	73623.4	-.131	638.2
7157	4.48	5.09	.2401	-.0032	.0087	-.0082	.0153	-.0727	73390.2	-.140	638.4
7158	6.98	5.10	.3911	.0210	.0094	-.0089	.0163	-.0734	73255.0	-.148	638.5
7159	9.41	5.11	.5184	.0578	.0067	-.0075	.0172	-.0747	73404.6	-.153	638.6
7160	12.02	5.12	.6456	.1073	.0046	-.0058	.0166	-.0748	73640.8	-.157	638.7
7161	14.28	5.12	.7301	.1554	.0015	-.0070	.0138	-.0699	73972.9	-.158	638.8
7162	16.81	5.12	.8254	.2172	.0019	-.0050	.0079	-.0614	73795.3	-.162	639.2
7163	19.23	5.14	.9149	.2833	.0007	-.0025	-.0012	-.0526	73928.4	-.173	639.6
7164	-.11	5.05	-.0186	-.0158	.0013	-.0082	.0144	-.0704	73975.1	-.132	642.4
7165	-.11	5.00	-.4741	-1.4672	.3680	.0314	-.0761	.3829	102746.2	.592	165.8

TEST 21		RUN 104										
TP	Q PA	ALPHA DEG	BETA DEG	CLT	CDT	CMST	CRTS	CYTS	CYST	CMU	WTFLO KG/SEC	PLENP PSI
7153	25477.7	-1.10	5.05	-.0276	.0119	-.0126	-.0085	.0139	-.0694	.0495	.2281	450.5
7154	25196.5	-2.28	5.01	-.1648	.0153	-.0202	-.0070	.0144	-.0649	.0500	.2281	450.4
7155	25361.4	-.04	5.05	-.0294	.0117	-.0131	-.0084	.0137	-.0688	.0497	.2281	450.4
7156	25478.0	2.28	5.08	.1020	.0133	-.0069	-.0081	.0139	-.0716	.0495	.2281	450.4
7157	25654.2	4.48	5.09	.2271	.0221	-.0067	-.0083	.0147	-.0713	.0491	.2280	450.2
7158	25756.0	6.98	5.10	.3771	.0456	-.0060	-.0090	.0157	-.0719	.0489	.2280	450.3
7159	25678.5	9.41	5.11	.5034	.0819	-.0088	-.0076	.0166	-.0732	.0491	.2278	450.2
7160	25465.2	12.02	5.12	.6295	.1308	-.0110	-.0059	.0161	-.0733	.0494	.2276	450.0
7161	25215.2	14.28	5.12	.7127	.1785	-.0142	-.0072	.0132	-.0684	.0499	.2276	450.1
7162	25416.4	16.81	5.12	.8072	.2394	-.0137	-.0051	.0074	-.0603	.0496	.2275	450.3
7163	25271.1	19.23	5.14	.8956	.3048	-.0150	-.0027	-.0017	-.0511	.0498	.2273	450.0
7164	25216.1	-.11	5.05	-.0297	.0109	-.0145	-.0082	.0139	-.0689	.0500	.2268	450.3
7165	47.2	-.11	5.00	0.0000	0.0000	0.0000	0.0000	0.0000	0.0000	.4115	.0135	-2.0

NASA LANGLEY

7 X 10 HIGH SPEED TUNNEL

TEST TP	21 MACH	Q PA	RUN 105 ALPHA DEG	BETA DEG	CNF(BA)	CAF(BA)	CPH(BA)	CRM(BA)	CYM(BA)	CSF(BA)	TPLEN DEG K
7178	.300	6095.5	-0.07	5.02	-.0126	.0155	.0017	.0011	-.0124	-.0176	320.6
7179	.300	6081.2	-1.63	5.00	-.1144	.0113	-.0031	.0027	-.0123	-.0173	320.4
7180	.300	6093.3	-.04	5.02	-.0127	.0158	.0019	.0007	-.0124	-.0181	320.3
7181	.300	6079.7	1.88	5.05	.0968	.0147	.0067	-.0008	-.0128	-.0186	320.0
7182	.301	6111.2	3.84	5.07	.1981	.0097	.0099	-.0015	-.0129	-.0187	319.9
7183	.300	6085.2	5.97	5.09	.3177	.0037	.0122	-.0025	-.0136	-.0189	319.4
7184	.300	6084.4	8.12	5.10	.4415	-.0022	.0142	-.0037	-.0139	-.0205	319.2
7185	.301	6104.2	10.29	5.10	.5583	-.0064	.0170	-.0038	-.0133	-.0230	318.9
7186	.300	6093.7	12.61	5.10	.6662	-.0070	.0167	-.0016	-.0129	-.0281	318.7
7187	.300	6071.5	14.65	5.09	.7637	-.0083	.0148	-.0006	-.0145	-.0275	318.5
7188	.300	6089.6	16.82	5.08	.8623	-.0072	.0057	.0009	-.0182	-.0217	318.1
7189	.300	6072.4	19.03	5.06	.9130	-.0003	-.0095	.0060	-.0275	-.0064	317.9
7190	.300	6086.1	21.02	5.03	.9436	.0027	-.0248	.0053	-.0289	-.0063	317.8
7191	.301	6128.1	23.24	4.99	1.0070	.0000	-.0272	.0031	-.0278	-.0044	317.6
7192	.301	6107.4	23.78	4.98	1.0214	-.0008	-.0278	.0041	-.0283	-.0032	317.5
7193	.300	6084.3	-.09	5.02	-.0117	.0168	.0012	.0009	-.0124	-.0179	317.2

TEST TP	21 ALPHA DEG	BETA DEG	RUN 105 CL(SA)	CD(SA)	CPH(SA)	CRM(SA)	CYM(SA)	CSF(SA)	P1 PA	CPB(1)	VTOT M/SEC
7178	-.07	5.02	-.0126	.0155	.0017	.0011	-.0124	-.0176	96438.7	-.133	0.0
7179	-1.63	5.00	-.1140	.0146	-.0031	.0030	-.0122	-.0173	96450.4	-.133	0.0
7180	-.04	5.02	-.0127	.0159	.0019	.0008	-.0124	-.0181	96437.6	-.133	0.0
7181	1.88	5.05	.0963	.0179	.0067	-.0012	-.0128	-.0186	96459.2	-.134	0.0
7182	3.84	5.07	.1970	.0230	.0099	-.0023	-.0128	-.0187	96424.5	-.133	0.0
7183	5.97	5.09	.3156	.0367	.0122	-.0039	-.0132	-.0189	96456.3	-.134	0.0
7184	8.12	5.10	.4374	.0602	.0142	-.0057	-.0133	-.0205	96450.4	-.141	0.0
7185	10.29	5.10	.5505	.0934	.0170	-.0061	-.0124	-.0230	96429.6	-.149	0.0
7186	12.61	5.10	.6516	.1386	.0167	-.0044	-.0123	-.0281	96440.6	-.153	0.0
7187	14.65	5.09	.7410	.1851	.0148	-.0043	-.0139	-.0275	96466.1	-.161	0.0
7188	16.82	5.08	.8275	.2426	.0057	-.0044	-.0177	-.0217	96443.1	-.172	0.0
7189	19.03	5.06	.8632	.2974	-.0095	-.0033	-.0280	-.0064	96462.9	-.180	0.0
7190	21.02	5.03	.8798	.3410	-.0248	-.0054	-.0289	-.0063	96451.1	-.187	0.0
7191	23.24	4.99	.9253	.3974	-.0272	-.0081	-.0267	-.0044	96400.5	-.194	0.0
7192	23.78	4.98	.9350	.4111	-.0278	-.0077	-.0275	-.0032	96423.8	-.195	0.0
7193	-.09	5.02	-.0116	.0169	.0012	.0010	-.0124	-.0179	96443.6	-.134	0.0

TEST TP	21 Q PA	ALPHA DEG	BETA DEG	RUN 105 CLT	CDT	CMST	CRTS	CYTS	CYST	CMU	WTFLO KG/SEC	PLENP PSI
7178	6095.5	-.07	5.02	-.0126	.0155	.0017	.0011	-.0124	-.0176	0.0000	0.0000	.0
7179	6081.2	-1.63	5.00	-.1140	.0146	-.0031	.0030	-.0122	-.0173	0.0000	0.0000	.0
7180	6093.3	-.04	5.02	-.0127	.0159	.0019	.0008	-.0124	-.0181	0.0000	0.0000	.0
7181	6079.7	1.88	5.05	.0963	.0179	.0067	-.0012	-.0128	-.0186	0.0000	0.0000	.0
7182	6111.2	3.84	5.07	.1970	.0230	.0099	-.0023	-.0128	-.0187	0.0000	0.0000	-.0
7183	6085.2	5.97	5.09	.3156	.0367	.0122	-.0039	-.0132	-.0189	0.0000	0.0000	-.0
7184	6084.4	8.12	5.10	.4374	.0602	.0142	-.0057	-.0133	-.0205	0.0000	0.0000	-.0
7185	6104.2	10.29	5.10	.5505	.0934	.0170	-.0061	-.0124	-.0230	0.0000	0.0000	-.0
7186	6093.7	12.61	5.10	.6516	.1386	.0167	-.0044	-.0123	-.0281	0.0000	0.0000	-.1
7187	6071.5	14.65	5.09	.7410	.1851	.0148	-.0043	-.0139	-.0275	0.0000	0.0000	-.1
7188	6089.6	16.82	5.08	.8275	.2426	.0057	-.0044	-.0177	-.0217	0.0000	0.0000	-.1
7189	6072.4	19.03	5.06	.8632	.2974	-.0095	-.0033	-.0280	-.0064	0.0000	0.0000	-.2
7190	6086.1	21.02	5.03	.8798	.3410	-.0248	-.0054	-.0289	-.0063	0.0000	0.0000	-.2
7191	6128.1	23.24	4.99	.9253	.3974	-.0272	-.0081	-.0267	-.0044	0.0000	0.0000	-.3
7192	6107.4	23.78	4.98	.9350	.4111	-.0278	-.0077	-.0275	-.0032	0.0000	0.0000	-.3
7193	6084.3	-.09	5.02	-.0116	.0169	.0012	.0010	-.0124	-.0179	0.0000	0.0000	.0

ORIGINAL PAGE IS
OF POOR QUALITY

NASA LANGLEY

7 X 10 HIGH SPEED TUNNEL

TEST TP	21 MACH	0 PA	RUN 106		CNF(BA)	CAF(BA)	CPM(BA)	CRM(BA)	CYM(BA)	CSF(BA)	TPLEN DEG K
			ALPHA DEG	BETA DEG							
7194	.301	6099.4	-.08	5.02	-.0217	-.0091	.0061	-.0007	-.0133	-.0206	310.3
7195	.300	6082.8	-1.69	5.00	-.1269	-.0130	-.0006	.0012	-.0124	-.0204	309.9
7196	.301	6096.8	-.04	5.02	-.0215	-.0085	.0064	-.0008	-.0134	-.0210	309.6
7197	.301	6105.6	1.85	5.05	.0802	-.0091	.0134	-.0017	-.0143	-.0226	309.1
7198	.300	6085.7	3.89	5.07	.1915	-.0141	.0169	-.0016	-.0147	-.0244	308.4
7199	.301	6124.4	6.00	5.09	.3140	-.0197	.0183	-.0020	-.0149	-.0233	308.2
7200	.300	6091.7	8.13	5.10	.4460	-.0261	.0193	-.0030	-.0147	-.0250	307.5
7201	.300	6080.4	10.44	5.10	.5750	-.0306	.0226	-.0033	-.0141	-.0264	307.3
7202	.300	6076.8	12.58	5.10	.6831	-.0335	.0251	-.0041	-.0139	-.0283	307.1
7203	.301	6100.8	14.83	5.09	.7950	-.0365	.0240	-.0027	-.0138	-.0311	306.8
7204	.300	6072.3	16.88	5.07	.9017	-.0395	.0185	-.0022	-.0146	-.0299	306.7
7205	.301	6099.9	19.05	5.05	.9941	-.0408	.0078	.0014	-.0178	-.0235	306.5
7206	.300	6060.4	21.37	5.02	1.0742	-.0432	.0008	.0035	-.0228	-.0143	306.4
7207	.299	6057.2	23.60	4.99	1.1466	-.0445	-.0002	.0028	-.0277	-.0065	306.2
7208	.300	6075.2	23.99	4.98	1.1546	-.0407	-.0085	.0022	-.0277	-.0038	306.0
7209	.301	6098.9	-.09	5.02	-.0137	-.0083	.0030	-.0004	-.0132	-.0207	305.5

TEST TP	21 ALPHA DEG	BETA DEG	RUN 106		CPM(SA)	CRM(SA)	CYM(SA)	CSF(SA)	P1 PA	CPB(1)	VTQT M/SEC
			CL(SA)	CD(SA)							
7194	-.08	5.02	-.0217	-.0090	.0061	-.0007	-.0133	-.0206	96424.9	-.134	548.7
7195	-1.69	5.00	-.1272	-.0092	-.0006	.0016	-.0123	-.0204	96445.3	-.138	548.1
7196	-.04	5.02	-.0216	-.0085	.0064	-.0008	-.0134	-.0210	96427.2	-.134	545.8
7197	1.85	5.05	.0805	-.0066	.0134	-.0022	-.0142	-.0226	96418.0	-.132	545.5
7198	3.89	5.07	.1920	-.0011	.0169	-.0025	-.0146	-.0244	96442.2	-.132	545.0
7199	6.00	5.09	.3143	.0133	.0183	-.0036	-.0146	-.0233	96401.7	-.142	544.9
7200	8.13	5.10	.4452	.0373	.0193	-.0051	-.0142	-.0250	96432.7	-.149	544.3
7201	10.44	5.10	.5710	.0741	.0226	-.0058	-.0133	-.0264	96444.4	-.159	543.6
7202	12.58	5.10	.6740	.1161	.0251	-.0070	-.0127	-.0283	96448.2	-.162	543.2
7203	14.83	5.09	.7779	.1681	.0240	-.0061	-.0126	-.0311	96431.6	-.167	542.9
7204	16.88	5.07	.8743	.2241	.0185	-.0064	-.0133	-.0299	96459.4	-.174	542.8
7205	19.05	5.05	.9530	.2859	.0078	-.0045	-.0173	-.0235	96429.0	-.184	542.7
7206	21.37	5.02	1.0161	.3512	.0008	-.0051	-.0225	-.0143	96477.7	-.192	542.5
7207	23.60	4.99	1.0686	.4182	-.0002	-.0085	-.0266	-.0065	96474.1	-.202	542.4
7208	23.99	4.98	1.0715	.4322	-.0085	-.0092	-.0262	-.0038	96453.2	-.202	542.3
7209	-.09	5.02	-.0137	-.0082	.0030	-.0004	-.0132	-.0207	96417.5	-.134	541.9

TEST TP	21 0 FA	ALPHA DEG	RUN 106		CDT	CMST	CRTS	CYTS	CYST	CMU	WTFLO KG/SEC	PLENP' PSI
			BETA DEG	CLT								
7194	6099.4	-.08	5.02	-.0343	.0212	-.0118	-.0007	-.0139	-.0189	.0504	.0650	123.5
7195	6082.8	-1.69	5.00	-.1389	.0214	-.0185	.0016	-.0130	-.0187	.0505	.0649	123.1
7196	6096.8	-.04	5.02	-.0341	.0216	-.0114	-.0008	-.0140	-.0193	.0504	.0650	123.0
7197	6105.6	1.85	5.05	.0670	.0232	-.0045	-.0022	-.0148	-.0209	.0504	.0651	123.2
7198	6085.7	3.89	5.07	.1773	.0283	-.0010	-.0026	-.0152	-.0227	.0506	.0653	123.4
7199	6124.4	6.00	5.09	.2987	.0420	.0005	-.0037	-.0152	-.0216	.0504	.0654	123.6
7200	6091.7	8.13	5.10	.4284	.0655	.0014	-.0052	-.0148	-.0233	.0506	.0654	123.6
7201	6080.4	10.44	5.10	.5532	.1015	.0048	-.0059	-.0139	-.0247	.0503	.0649	122.8
7202	6076.8	12.58	5.10	.6552	.1427	.0073	-.0071	-.0133	-.0266	.0503	.0649	122.4
7203	6100.8	14.83	5.09	.7581	.1939	.0063	-.0063	-.0132	-.0294	.0500	.0649	122.4
7204	6072.3	16.88	5.07	.8535	.2493	.0007	-.0065	-.0139	-.0282	.0503	.0649	122.4
7205	6099.9	19.05	5.05	.9314	.3102	-.0099	-.0047	-.0178	-.0218	.0500	.0649	122.5
7206	6060.4	21.37	5.02	.9934	.3747	-.0170	-.0053	-.0230	-.0126	.0504	.0650	122.5
7207	6057.2	23.60	4.99	1.0449	.4409	-.0180	-.0088	-.0271	-.0048	.0504	.0651	122.5
7208	6075.2	23.99	4.98	1.0478	.4546	-.0264	-.0095	-.0268	-.0021	.0503	.0650	122.6
7209	6098.9	-.09	5.02	-.0261	.0218	-.0147	-.0004	-.0138	-.0190	.0502	.0653	122.5

NASA LANGLEY

7 X 10 HIGH SPEED TUNNEL

TEST TP	21 MACH	0 PA	RUN 107		CNF(BA)	CAF(BA)	CPH(BA)	CRH(BA)	CYM(BA)	CSF(BA)	TPLEN DEG K
			ALPHA DEG	BETA DEG							
7210	.300	6086.0	-.08	5.02	-.0162	-.0356	.0124	-.0024	-.0126	-.0253	302.5
7211	.301	6096.7	-1.75	5.00	-.1181	-.0402	.0032	-.0004	-.0117	-.0241	302.5
7212	.301	6095.9	-.05	5.02	-.0147	-.0359	.0126	-.0025	-.0127	-.0257	302.6
7213	.300	6078.2	1.86	5.05	.0877	-.0374	.0177	-.0021	-.0139	-.0283	302.7
7214	.300	6093.2	3.95	5.08	.2005	-.0421	.0197	-.0003	-.0148	-.0278	302.8
7215	.300	6092.8	6.01	5.09	.3260	-.0470	.0183	-.0016	-.0143	-.0267	303.0
7216	.301	6110.0	8.17	5.10	.4659	-.0539	.0174	-.0023	-.0146	-.0285	303.1
7217	.301	6103.2	10.30	5.10	.6064	-.0597	.0197	-.0018	-.0143	-.0297	303.2
7218	.301	6095.9	12.58	5.10	.7460	-.0661	.0260	-.0004	-.0147	-.0312	303.3
7219	.300	6076.4	14.74	5.09	.8465	-.0708	.0379	-.0044	-.0143	-.0310	303.5
7220	.300	6077.7	17.01	5.07	.9503	-.0742	.0352	-.0031	-.0144	-.0292	303.6
7221	.300	6074.6	19.20	5.05	1.0558	-.0785	.0289	-.0020	-.0150	-.0275	303.9
7222	.300	6088.2	21.27	5.03	1.1477	-.0821	.0204	-.0023	-.0180	-.0249	304.0
7223	.301	6111.7	23.45	4.99	1.2369	-.0849	.0102	.0051	-.0224	-.0191	304.2
7224	.300	6067.6	24.07	4.98	1.2585	-.0860	.0087	.0049	-.0234	-.0172	304.3
7225	.300	6091.9	-.09	5.02	-.0122	-.0389	.0095	-.0024	-.0122	-.0265	304.7

TEST TP	21 ALPHA DEG	BETA DEG	RUN 107		CPH(SA)	CRH(SA)	CYM(SA)	CSF(SA)	P1 PA	CPB(1)	VTOT M/SEC
			CL(SA)	CD(SA)							
7210	-.08	5.02	-.0163	-.0356	.0124	-.0024	-.0126	-.0253	96428.4	-.133	582.9
7211	-1.75	5.00	-.1193	-.0366	.0032	-.0000	-.0117	-.0241	96413.7	-.134	582.9
7212	-.05	5.02	-.0147	-.0359	.0126	-.0025	-.0127	-.0257	96417.8	-.133	583.1
7213	1.86	5.05	.0889	-.0345	.0177	-.0026	-.0138	-.0283	96431.2	-.131	583.4
7214	3.95	5.08	.2029	-.0282	.0197	-.0013	-.0147	-.0278	96422.0	-.132	583.6
7215	6.01	5.09	.3291	-.0126	.0183	-.0031	-.0140	-.0267	96421.9	-.137	582.9
7216	8.17	5.10	.4688	.0128	.0174	-.0043	-.0141	-.0285	96403.2	-.145	583.0
7217	10.30	5.10	.6073	.0497	.0197	-.0043	-.0138	-.0297	96413.7	-.153	583.0
7218	12.58	5.10	.7425	.0979	.0260	-.0036	-.0142	-.0312	96418.7	-.162	583.2
7219	14.74	5.09	.8366	.1469	.0379	-.0079	-.0127	-.0310	96436.9	-.167	583.3
7220	17.01	5.07	.9304	.2071	.0352	-.0071	-.0129	-.0292	96440.1	-.173	583.5
7221	19.20	5.05	1.0229	.2731	.0289	-.0069	-.0135	-.0275	96441.3	-.179	583.9
7222	21.27	5.03	1.0993	.3398	.0204	-.0044	-.0176	-.0249	96424.2	-.188	584.0
7223	23.45	4.99	1.1686	.4142	.0102	-.0042	-.0226	-.0191	96398.1	-.195	584.3
7224	24.07	4.98	1.1841	.4347	.0087	-.0051	-.0234	-.0172	96447.6	-.196	584.4
7225	-.09	5.02	-.0123	-.0389	.0095	-.0024	-.0122	-.0265	96413.4	-.134	584.9

TEST TP	21 Q PA	ALPHA DEG	RUN 107		CLT	CDT	CMST	CRTS	CYTS	CYST	CNU	WTFLO KG/SEC	PLENP PSI
			BETA DEG	CLT									
7210	6086.0	-.08	5.02	-.0399	.0214	-.0213	-.0024	-.0138	-.0221	.1005	.1212	231.8	
7211	6096.7	-1.75	5.00	-.1412	.0209	-.0304	.0000	-.0128	-.0209	.1003	.1212	232.0	
7212	6095.9	-.05	5.02	-.0384	.0211	-.0211	-.0025	-.0139	-.0225	.1005	.1214	232.3	
7213	6078.2	1.86	5.05	.0632	.0220	-.0161	-.0026	-.0150	-.0251	.1011	.1216	233.0	
7214	6093.2	3.95	5.08	.1752	.0272	-.0141	-.0014	-.0159	-.0246	.1009	.1217	233.3	
7215	6092.8	6.01	5.09	.2998	.0411	-.0151	-.0032	-.0152	-.0235	.0995	.1201	230.2	
7216	6110.0	8.17	5.10	.4377	.0652	-.0158	-.0045	-.0152	-.0254	.0992	.1201	230.0	
7217	6103.2	10.30	5.10	.5741	.1009	-.0135	-.0045	-.0149	-.0266	.0992	.1199	229.9	
7218	6095.9	12.58	5.10	.7073	.1478	-.0072	-.0038	-.0154	-.0280	.0995	.1202	230.0	
7219	6076.4	14.74	5.09	.7995	.1956	.0045	-.0082	-.0138	-.0278	.0998	.1200	230.1	
7220	6077.7	17.01	5.07	.8913	.2544	.0018	-.0075	-.0140	-.0260	.0999	.1202	230.4	
7221	6074.6	19.20	5.05	.9819	.3189	-.0046	-.0072	-.0146	-.0244	.0999	.1200	230.6	
7222	6088.2	21.27	5.03	1.0568	.3841	-.0131	-.0048	-.0187	-.0218	.0998	.1202	230.7	
7223	6111.7	23.45	4.99	1.1245	.4567	-.0232	-.0047	-.0236	-.0160	.0995	.1201	230.9	
7224	6067.6	24.07	4.98	1.1393	.4770	-.0249	-.0056	-.0244	-.0140	.1002	.1202	231.0	
7225	6091.9	-.09	5.02	-.0358	.0179	-.0240	-.0024	-.0133	-.0234	.1000	.1203	231.4	

ORIGINAL PAGE IS
OF POOR QUALITY

NASA LANGLEY

7 X 10 HIGH SPEED TUNNEL

TEST TP	21	MACH	0	RUN 108	ALPHA	BETA	CNF(BA)	CAF(BA)	CPM(BA)	CRM(BA)	CYM(BA)	CSF(BA)	TPLEN	
			PA		DEG	DEG							DEG K	
7226	.301	6097.4			-.07	5.02	-.0288	-.0929	.0303	-.0057	-.0103	-.0329	306.3	
7227	.301	6094.9			-1.67	5.00	-.1136	-.0971	.0170	.0002	-.0086	-.0295	306.4	
7228	.301	6095.8			.02	5.03	-.0231	-.0930	.0312	-.0062	-.0105	-.0341	306.5	
7229	.301	6105.8			1.87	5.06	.0739	-.0935	.0376	-.0046	-.0130	-.0382	306.6	
7230	.301	6108.9			3.88	5.08	.1760	-.0964	.0387	.0015	-.0141	-.0359	306.9	
7231	.300	6057.2			6.07	5.09	.3212	-.1038	.0313	-.0007	-.0135	-.0347	307.2	
7232	.300	6063.7			8.18	5.10	.4723	-.1102	.0260	-.0011	-.0131	-.0364	307.4	
7233	.300	6076.3			10.46	5.11	.6549	-.1172	.0188	.0002	-.0132	-.0383	307.6	
7234	.300	6084.7			12.65	5.10	.8275	-.1237	.0198	-.0001	-.0140	-.0387	307.9	
7235	.300	6068.6			14.88	5.10	.9940	-.1304	.0198	-.0013	-.0143	-.0399	308.1	
7236	.301	6103.0			17.08	5.08	1.1465	-.1381	.0198	-.0012	-.0153	-.0400	308.5	
7237	.300	6064.4			19.37	5.05	1.2414	-.1482	.0389	-.0117	-.0165	-.0346	308.8	
7238	.300	6092.3			21.45	5.02	1.3111	-.1521	.0434	-.0083	-.0186	-.0294	309.1	
7239	.299	6054.9			23.61	4.99	1.3860	-.1552	.0433	-.0089	-.0214	-.0204	309.3	
7240	.300	6084.2			24.20	4.97	1.4015	-.1545	.0416	-.0091	-.0218	-.0187	309.7	
7241	.300	6060.5			-.06	5.02	-.0292	-.0964	.0312	-.0058	-.0101	-.0338	310.7	
TEST TP	21	ALPHA	BETA	RUN 108	CL(SA)	CPM(SA)	CRM(SA)	CYM(SA)	CSF(SA)	P1	CPB(1)	VTDT		
		DEG	DEG							PA		M/SEC		
7226		-.07	5.02		-.0289	-.0929	.0303	-.0057	-.0103	-.0329	96399.4	-.134	621.7	
7227		-1.67	5.00		-.1164	-.0937	.0170	.0004	-.0086	-.0295	96403.5	-.139	621.8	
7228		.02	5.03		-.0231	-.0930	.0312	-.0062	-.0105	-.0341	96401.4	-.134	621.9	
7229		1.87	5.06		.0770	-.0910	.0376	-.0050	-.0129	-.0382	96394.1	-.132	622.0	
7230		3.88	5.08		.1821	-.0843	.0387	.0005	-.0141	-.0359	96385.7	-.134	622.3	
7231		6.07	5.09		.3304	-.0692	.0313	-.0022	-.0134	-.0347	96439.7	-.138	622.6	
7232		8.18	5.10		.4832	-.0419	.0260	-.0030	-.0128	-.0364	96431.4	-.146	622.8	
7233		10.46	5.11		.6653	.0037	.0188	-.0022	-.0130	-.0383	96421.6	-.154	623.0	
7234		12.65	5.10		.8345	.0605	.0198	-.0031	-.0136	-.0387	96410.7	-.159	623.3	
7235		14.88	5.10		.9942	.1292	.0198	-.0049	-.0135	-.0399	96429.6	-.166	623.5	
7236		17.08	5.08		1.1365	.2047	.0198	-.0056	-.0143	-.0400	96395.8	-.172	624.0	
7237		19.37	5.05		1.2203	.2719	.0389	-.0165	-.0117	-.0346	96428.0	-.179	624.3	
7238		21.45	5.02		1.2759	.3379	.0434	-.0145	-.0142	-.0294	96402.0	-.184	624.6	
7239		23.61	4.99		1.3322	.4128	.0433	-.0167	-.0160	-.0204	96444.9	-.188	624.8	
7240		24.20	4.97		1.3416	.4336	.0416	-.0172	-.0162	-.0187	96418.8	-.188	625.1	
7241		-.06	5.02		-.0293	-.0964	.0312	-.0058	-.0101	-.0338	96424.0	-.134	626.2	
TEST TP	21	0	ALPHA	RUN 108	CLT	CDT	CMST	CRTS	CYTS	CYST	CMU	WFFLD	PLEN P	
		PA	DEG		D=G							KG/SEC	PSI	
7226		6097.4	-.07		5.02	-.0729	.0131	-.0322	-.0057	-.0125	-.0270	.1939	.2196	431.9
7227		6094.9	-1.67		5.00	-.1574	.0134	-.0455	.0005	-.0108	-.0236	.1941	.2198	431.8
7228		6095.8	.02		5.03	-.0672	.0129	-.0314	-.0062	-.0126	-.0282	.1943	.2199	432.0
7229		6105.8	1.87		5.06	.0295	.0132	-.0248	-.0051	-.0150	-.0323	.1939	.2198	432.0
7230		6108.9	3.88		5.08	.1310	.0182	-.0237	.0004	-.0163	-.0300	.1937	.2197	432.0
7231		6057.2	6.07		5.09	.2750	.0321	-.0317	-.0024	-.0155	-.0287	.1955	.2196	432.1
7232		6063.7	8.18		5.10	.4241	.0573	-.0369	-.0033	-.0150	-.0304	.1955	.2199	432.2
7233		6076.3	10.46		5.11	.6025	.1002	-.0439	-.0026	-.0152	-.0324	.1948	.2194	432.1
7234		6084.7	12.65		5.10	.7681	.1544	-.0429	-.0036	-.0158	-.0327	.1948	.2196	432.2
7235		6068.6	14.88		5.10	.9240	.2207	-.0430	-.0055	-.0156	-.0340	.1953	.2196	432.1
7236		6103.0	17.08		5.08	1.0633	.2930	-.0427	-.0063	-.0164	-.0341	.1943	.2195	432.3
7237		6064.4	19.37		5.05	1.1431	.3578	-.0241	-.0172	-.0137	-.0286	.1957	.2195	432.4
7238		6092.3	21.45		5.02	1.1960	.4205	-.0192	-.0153	-.0163	-.0235	.1948	.2194	432.5
7239		6054.9	23.61		4.99	1.2487	.4928	-.0197	-.0176	-.0180	-.0145	.1956	.2190	432.4
7240		6084.2	24.20		4.97	1.2578	.5123	-.0211	-.0181	-.0182	-.0128	.1947	.2188	432.0
7241		6060.5	-.06		5.02	-.0736	.0103	-.0318	-.0058	-.0123	-.0279	.1959	.2190	432.1

NASA LANGLEY

7 X 10 HIGH SPEED TUNNEL

TEST TP	21 MACH	Q PA	RUN 109 ALPHA DEG	BETA DEG	CNF(BA)	CAF(BA)	CPM(BA)	CRM(BA)	CYM(BA)	CSF(BA)	TPLEN DEG K
7242	.300	6074.8	-0.05	5.03	-0.0346	-0.1178	.0410	-0.0077	-0.0099	-0.0368	312.8
7243	.300	6081.7	-1.68	5.00	-0.1163	-0.1221	.0251	.0002	-0.0080	-0.0323	313.1
7244	.300	6090.1	-0.00	5.03	-0.0313	-0.1178	.0413	-0.0077	-0.0099	-0.0377	313.4
7245	.301	6107.0	1.89	5.06	.0627	-0.1179	.0485	-0.0067	-0.0124	-0.0426	313.7
7246	.301	6094.6	3.96	5.08	.1715	-0.1215	.0480	.0033	-0.0133	-0.0406	314.2
7247	.302	6132.2	6.08	5.09	.3175	-0.1267	.0378	.0000	-0.0127	-0.0370	314.4
7248	.300	6080.4	8.16	5.10	.4683	-0.1341	.0304	-0.0002	-0.0125	-0.0388	314.6
7249	.301	6096.2	10.41	5.11	.6559	-0.1413	.0203	.0014	-0.0125	-0.0406	314.8
7250	.300	6079.4	12.72	5.10	.8472	-0.1492	.0200	.0005	-0.0131	-0.0395	315.0
7251	.300	6055.4	14.89	5.10	1.0155	-0.1562	.0212	-0.0028	-0.0137	-0.0424	315.2
7252	.300	6058.8	17.09	5.08	1.1779	-0.1638	.0223	-0.0046	-0.0154	-0.0426	315.5
7253	.300	6082.9	19.45	5.05	1.3349	-0.1744	.0243	-0.0079	-0.0184	-0.0359	315.8
7254	.300	6060.9	21.73	5.02	1.3791	-0.1810	.0496	-0.0105	-0.0200	-0.0284	316.0
7255	.301	6100.4	23.70	4.99	1.4483	-0.1823	.0480	-0.0088	-0.0214	-0.0208	316.3
7256	.300	6078.4	24.31	4.97	1.4675	-0.1833	.0476	-0.0079	-0.0219	-0.0192	316.6
7257	.300	6078.5	-0.05	5.03	-0.0376	-0.1200	.0412	-0.0080	-0.0100	-0.0375	317.7

TEST TP	21 ALPHA DEG	BETA DEG	RUN 109 CL(SA)	CD(SA)	CPM(SA)	CRM(SA)	CYM(SA)	CSF(SA)	P1 PA	CP8(I)	VTOT M/SEC
7242	-0.05	5.03	-0.0347	-0.1178	.0410	-0.0077	-0.0099	-0.0368	96402.7	-0.133	636.7
7243	-1.68	5.00	-0.1198	-0.1187	.0251	.0004	-0.0080	-0.0323	96394.1	-0.138	637.0
7244	-0.00	5.03	-0.0313	-0.1178	.0413	-0.0077	-0.0099	-0.0377	96386.4	-0.133	637.3
7245	1.89	5.06	.0665	-0.1198	.0485	-0.0071	-0.0122	-0.0426	96369.0	-0.133	637.5
7246	3.96	5.08	.1795	-0.1094	.0480	.0023	-0.0135	-0.0406	96380.0	-0.135	638.0
7247	6.08	5.09	.3292	-0.0924	.0378	-0.0013	-0.0127	-0.0370	96342.7	-0.138	638.2
7248	8.16	5.10	.4826	-0.0662	.0304	-0.0020	-0.0124	-0.0388	96396.9	-0.145	638.4
7249	10.41	5.11	.6707	-0.0204	.0203	-0.0009	-0.0126	-0.0406	96383.8	-0.153	638.6
7250	12.72	5.10	.8593	.0410	.0200	-0.0024	-0.0129	-0.0395	96395.9	-0.158	638.8
7251	14.89	5.10	1.0216	.1100	.0212	-0.0062	-0.0125	-0.0424	96429.9	-0.163	639.1
7252	17.09	5.08	1.1740	.1897	.0223	-0.0090	-0.0133	-0.0426	96426.3	-0.169	639.3
7253	19.45	5.05	1.3168	.2801	.0243	-0.0136	-0.0147	-0.0359	96401.1	-0.178	639.7
7254	21.73	5.02	1.3482	.3424	.0496	-0.0171	-0.0147	-0.0284	96423.0	-0.182	639.9
7255	23.70	4.99	1.3995	.4151	.0480	-0.0167	-0.0161	-0.0208	96380.7	-0.182	640.2
7256	24.31	4.97	1.4128	.4370	.0476	-0.0162	-0.0167	-0.0192	96404.6	-0.181	640.5
7257	-0.05	5.03	-0.0377	-0.1200	.0412	-0.0080	-0.0100	-0.0375	96390.2	-0.133	641.6

TEST TP	21 Q PA	ALPHA DEG	RUN 109 BETA DEG	CLT	CDT	CMST	CRTS	CYTS	CYST	CMU	WTFLO KG/SEC	PLENP PSI
7242	6074.8	-0.05	5.03	-0.0869	.0080	-0.0333	-0.0077	-0.0125	-0.0298	.2340	.2579	511.3
7243	6081.7	-1.68	5.00	-0.1684	.0085	-0.0491	.0005	-0.0106	-0.0253	.2340	.2580	511.4
7244	6090.1	-0.00	5.03	-0.0835	.0075	-0.0327	-0.0077	-0.0124	-0.0307	.2329	.2571	510.7
7245	6107.0	1.89	5.06	.0105	.0073	-0.0252	-0.0072	-0.0147	-0.0356	.2323	.2570	510.1
7246	6094.6	3.96	5.08	.1189	.0118	-0.0259	.0021	-0.0161	-0.0337	.2325	.2565	510.1
7247	6132.2	6.08	5.09	.2645	.0257	-0.0356	-0.0016	-0.0152	-0.0300	.2312	.2565	510.1
7248	6080.4	8.16	5.10	.4131	.0505	-0.0436	-0.0024	-0.0149	-0.0318	.2331	.2564	510.1
7249	6096.2	10.41	5.11	.5968	.0932	-0.0536	-0.0014	-0.0151	-0.0336	.2326	.2565	510.3
7250	6079.4	12.72	5.10	.7807	.1519	-0.0541	-0.0030	-0.0154	-0.0325	.2333	.2564	510.3
7251	6055.4	14.89	5.10	.9385	.2183	-0.0532	-0.0068	-0.0150	-0.0354	.2341	.2562	510.5
7252	6058.8	17.09	5.08	1.0869	.2947	-0.0521	-0.0097	-0.0158	-0.0355	.2342	.2563	510.7
7253	6082.9	19.45	5.05	1.2256	.3811	-0.0498	-0.0144	-0.0171	-0.0289	.2333	.2562	511.0
7254	6060.9	21.73	5.02	1.2526	.4401	-0.0248	-0.0181	-0.0171	-0.0214	.2341	.2560	511.0
7255	6100.4	23.70	4.99	1.3015	.5088	-0.0259	-0.0177	-0.0184	-0.0138	.2325	.2559	510.9
7256	6078.4	24.31	4.97	1.3134	.5300	-0.0266	-0.0173	-0.0191	-0.0122	.2334	.2558	511.3
7257	6076.5	-0.05	5.03	-0.0899	.0056	-0.0330	-0.0080	-0.0125	-0.0305	.2334	.2553	510.6

ORIGINAL PAGE IS OF POOR QUALITY

NASA LANGLEY

7 X 10 HIGH SPEED TUNNEL

TEST TP	21 MACH	Q PA	RUN 110 ALPHA DEG	BETA DEG	CNF(BA)	CAF(BA)	CPH(BA)	CRM(BA)	CYM(BA)	CSF(BA)	TPLEN DEG K
7262	.498	15036.3	-.07	5.07	-.0209	-.0423	.0112	-.0028	-.0134	-.0289	315.0
7263	.498	15032.9	-1.89	5.03	-.1258	-.0452	.0031	.0001	-.0122	-.0255	316.9
7264	.501	15159.1	-.03	5.07	-.0195	-.0425	.0109	-.0024	-.0134	-.0296	317.8
7265	.501	15147.8	1.99	5.10	.0973	-.0443	.0175	-.0017	-.0147	-.0324	318.6
7266	.498	15027.6	4.13	5.12	.2135	-.0500	.0175	.0002	-.0145	-.0303	319.8
7267	.501	15174.4	6.46	5.13	.3534	-.0555	.0178	-.0026	-.0139	-.0305	321.1
7268	.500	15098.7	8.80	5.14	.4892	-.0599	.0178	-.0040	-.0136	-.0323	321.6
7269	.499	15081.6	11.26	5.15	.6372	-.0653	.0194	-.0020	-.0130	-.0349	322.0
7270	.499	15043.4	13.49	5.15	.7712	-.0705	.0258	.0018	-.0133	-.0357	322.4
7271	.501	15146.2	15.89	5.14	.8779	-.0729	.0352	.0019	-.0136	-.0369	322.9
7272	.500	15105.5	18.28	5.13	.9964	-.0756	.0308	.0002	-.0160	-.0383	323.3
7273	.498	15026.8	20.50	5.11	1.0949	-.0781	.0254	-.0011	-.0180	-.0387	323.5
7274	.500	15120.6	22.60	5.09	1.1862	-.0735	.0014	.0034	-.0259	-.0262	323.7
7275	.502	15223.5	24.74	5.06	1.2403	-.0690	-.0184	.0049	-.0281	-.0174	324.0
7276	.502	15226.1	25.35	5.05	1.2515	-.0690	-.0185	.0048	-.0286	-.0167	324.1
7277	.499	15063.6	-.10	5.07	-.0232	-.0436	.0120	-.0030	-.0134	-.0300	324.4

TEST TP	21 ALPHA DEG	BETA DEG	RUN 110 CL(SA)	CD(SA)	CPH(SA)	CRM(SA)	CYM(SA)	CSF(SA)	P1 PA	CPB(I)	VTOT M/SEC
7262	-.07	5.07	-.0209	-.0423	.0112	-.0028	-.0134	-.0289	86449.2	-.139	644.2
7263	-1.89	5.03	-.1272	-.0411	.0031	.0005	-.0122	-.0255	86444.1	-.140	646.2
7264	-.03	5.07	-.0196	-.0425	.0109	-.0024	-.0134	-.0296	86345.4	-.138	647.1
7265	1.99	5.10	.0968	-.0409	.0175	-.0022	-.0147	-.0324	86318.3	-.138	647.9
7266	4.13	5.12	.2165	-.0345	.0175	-.0008	-.0145	-.0303	86469.3	-.142	649.0
7267	6.46	5.13	.3574	-.0154	.0178	-.0042	-.0135	-.0305	86300.4	-.145	650.5
7268	8.80	5.14	.4926	.0156	.0178	-.0060	-.0128	-.0323	86381.2	-.159	651.0
7269	11.26	5.15	.6377	.0604	.0194	-.0045	-.0123	-.0349	86419.6	-.171	651.4
7270	13.49	5.15	.7663	.1114	.0258	-.0014	-.0134	-.0357	86428.6	-.175	651.7
7271	15.89	5.14	.8643	.1701	.0352	-.0019	-.0138	-.0369	86320.9	-.175	652.1
7272	18.28	5.13	.9699	.2407	.0308	-.0049	-.0152	-.0383	86371.2	-.180	652.4
7273	20.50	5.11	1.0529	.3103	.0254	-.0073	-.0165	-.0387	86462.0	-.192	652.6
7274	22.60	5.09	1.1233	.3881	.0014	-.0068	-.0252	-.0262	86387.9	-.196	653.0
7275	24.74	5.06	1.1553	.4564	-.0184	-.0073	-.0276	-.0174	86236.6	-.206	653.3
7276	25.35	5.05	1.1605	.4735	-.0185	-.0079	-.0279	-.0167	86282.2	-.209	653.4
7277	-.10	5.07	-.0232	-.0435	.0120	-.0030	-.0134	-.0300	86407.7	-.139	653.7

TEST TP	21 Q PA	ALPHA DEG	RUN 110 BETA DEG	CLT	CDT	CMST	CRTS	CYTS	CYST	CMU	WTFLO KG/SEC	PLENP PSI
7262	15036.3	-.07	5.07	-.0421	.0086	-.0189	-.0028	-.0144	-.0260	.0948	.2555	511.9
7263	15032.9	-1.89	5.03	-.1467	.0105	-.0270	.0005	-.0132	-.0227	.0949	.2549	512.3
7264	15159.1	-.03	5.07	-.0405	.0080	-.0189	-.0024	-.0144	-.0268	.0938	.2538	511.7
7265	15147.8	1.99	5.10	.0760	.0087	-.0123	-.0023	-.0157	-.0296	.0938	.2533	511.2
7266	15027.6	4.13	5.12	.1917	.0147	-.0125	-.0009	-.0155	-.0275	.0945	.2527	511.2
7267	15174.4	6.46	5.13	.3309	.0323	-.0120	-.0043	-.0146	-.0277	.0938	.2527	512.0
7268	15098.7	8.80	5.14	.4640	.0624	-.0121	-.0062	-.0138	-.0294	.0943	.2527	511.9
7269	15081.6	11.26	5.15	.6071	.1060	-.0106	-.0047	-.0133	-.0321	.0944	.2525	511.9
7270	15043.4	13.49	5.15	.7339	.1559	-.0042	-.0016	-.0144	-.0329	.0945	.2520	511.7
7271	15146.2	15.89	5.14	.8304	.2128	.0055	-.0022	-.0148	-.0341	.0936	.2511	510.2
7272	15105.5	18.28	5.13	.9341	.2820	.0010	-.0052	-.0162	-.0354	.0939	.2510	510.2
7273	15026.8	20.50	5.11	1.0153	.3504	-.0046	-.0077	-.0175	-.0359	.0944	.2509	510.3
7274	15120.6	22.60	5.09	1.0845	.4266	-.0284	-.0072	-.0262	-.0234	.0939	.2510	510.8
7275	15223.5	24.74	5.06	1.1154	.4932	-.0480	-.0077	-.0285	-.0146	.0934	.2514	511.1
7276	15226.1	25.35	5.05	1.1201	.5099	-.0481	-.0083	-.0288	-.0139	.0934	.2513	511.2
7277	15063.6	-.10	5.07	-.0442	.0072	-.0179	-.0030	-.0144	-.0271	.0942	.2508	510.5

NASA LANGLEY

7 X 10 HIGH SPEED TUNNEL

TEST TP	21 MACH	Q PA	RUN 111 ALPHA DEG	BETA DEG	CNF(BA)	CAF(BA)	CPH(BA)	CRM(BA)	CYM(BA)	CSF(BA)	TPLEN DEG K
7278	.501	15192.9	-1.11	5.06	-.0201	-.0182	.0052	-.0010	-.0131	-.0242	322.8
7279	.500	15099.3	-1.82	5.03	-.1287	-.0207	-.0011	.0010	-.0123	-.0213	322.7
7280	.501	15193.1	.01	5.06	-.0134	-.0180	.0058	-.0009	-.0130	-.0244	322.5
7281	.503	15252.5	1.99	5.09	.0958	-.0198	.0114	-.0017	-.0145	-.0262	322.3
7282	.501	15168.4	4.18	5.11	.2120	-.0247	.0142	-.0014	-.0147	-.0253	321.9
7283	.501	15166.8	6.42	5.13	.3475	-.0302	.0154	-.0024	-.0142	-.0261	321.4
7284	.501	15146.2	8.73	5.14	.4830	-.0353	.0171	-.0050	-.0144	-.0272	321.2
7285	.501	15158.9	11.02	5.14	.5972	-.0371	.0200	-.0036	-.0136	-.0296	321.0
7286	.499	15070.8	13.35	5.14	.7052	-.0390	.0237	-.0039	-.0138	-.0299	320.9
7287	.498	15035.4	15.64	5.13	.8131	-.0404	.0196	-.0030	-.0144	-.0306	320.7
7288	.500	15119.9	17.91	5.12	.9048	-.0417	.0146	-.0003	-.0172	-.0275	320.5
7289	.500	15108.8	20.21	5.11	.9961	-.0442	.0106	.0041	-.0226	-.0207	320.3
7290	.499	15062.2	22.43	5.10	1.0783	-.0439	.0043	.0061	-.0298	-.0147	320.1
7291	.502	15188.4	24.56	5.06	1.1268	-.0394	-.0142	.0039	-.0295	-.0174	319.9
7292	.501	15186.3	25.14	5.05	1.1412	-.0401	-.0146	.0036	-.0290	-.0187	319.7
7293	.499	15060.3	-1.11	5.06	-.0209	-.0172	.0060	-.0006	-.0129	-.0235	319.0

TEST TP	21 ALPHA DEG	BETA DEG	RUN 111 CL(SA)	CD(SA)	CPH(SA)	CRM(SA)	CYM(SA)	CSF(SA)	P1 PA	CPB(1)	VTOT M/SEC
7278	-1.11	5.06	-.0202	-.0182	.0052	-.0009	-.0131	-.0242	86329.7	-.138	620.9
7279	-1.82	5.03	-.1293	-.0166	-.0011	.0014	-.0123	-.0213	86358.3	-.138	620.7
7280	.01	5.06	-.0134	-.0181	.0058	-.0009	-.0130	-.0244	86341.9	-.138	620.6
7281	1.99	5.09	.0964	-.0164	.0114	-.0022	-.0145	-.0262	86224.9	-.136	620.5
7282	4.18	5.11	.2132	-.0092	.0142	-.0025	-.0145	-.0253	86291.3	-.142	620.1
7283	6.42	5.13	.3487	.0089	.0154	-.0040	-.0139	-.0261	86296.6	-.147	619.8
7284	8.73	5.14	.4828	.0364	.0171	-.0071	-.0135	-.0272	86353.7	-.155	619.5
7285	11.02	5.14	.5933	.0777	.0200	-.0061	-.0127	-.0296	86357.0	-.161	619.2
7286	13.35	5.14	.6951	.1249	.0237	-.0069	-.0125	-.0299	86396.0	-.165	619.1
7287	15.64	5.13	.7939	.1802	.0196	-.0067	-.0131	-.0306	86437.6	-.171	618.9
7288	17.91	5.12	.8738	.2386	.0146	-.0056	-.0163	-.0275	86384.5	-.181	618.8
7289	20.21	5.11	.9500	.3027	.0106	-.0039	-.0226	-.0207	86359.5	-.198	618.6
7290	22.43	5.10	1.0135	.3708	.0043	-.0057	-.0299	-.0147	86456.2	-.204	618.2
7291	24.56	5.06	1.0413	.4325	-.0142	-.0087	-.0284	-.0174	86265.1	-.208	618.1
7292	25.14	5.05	1.0501	.4485	-.0146	-.0091	-.0278	-.0187	86356.6	-.208	617.9
7293	-1.11	5.06	-.0209	-.0172	.0060	-.0005	-.0129	-.0235	86388.9	-.138	617.4

TEST TP	21 Q PA	ALPHA DEG	RUN 111 BETA DEG	CLT	CDT	CMST	CRTS	CYTS	CYST	CMU	WTFLOD KG/SEC	PLENP* PSI
7278	15192.9	-1.11	5.06	-.0317	.0096	-.0112	-.0009	-.0137	-.0227	.0499	.1411	282.3
7279	15099.3	-1.82	5.03	-.1400	.0117	-.0177	.0014	-.0129	-.0198	.0503	.1412	282.4
7280	15193.1	.01	5.06	-.0249	.0097	-.0106	-.0009	-.0136	-.0228	.0500	.1413	282.6
7281	15252.5	1.99	5.09	.0839	.0108	-.0050	-.0022	-.0150	-.0247	.0499	.1417	282.7
7282	15168.4	4.18	5.11	.1996	.0178	-.0023	-.0025	-.0151	-.0237	.0502	.1419	283.0
7283	15166.8	6.42	5.13	.3341	.0353	-.0011	-.0041	-.0144	-.0245	.0503	.1421	283.5
7284	15146.2	8.73	5.14	.4670	.0643	.0005	-.0072	-.0141	-.0256	.0503	.1421	283.4
7285	15158.9	11.02	5.14	.5765	.1029	.0035	-.0062	-.0133	-.0280	.0502	.1420	283.1
7286	15070.8	13.35	5.14	.6773	.1495	.0071	-.0071	-.0131	-.0284	.0505	.1420	283.2
7287	15035.4	15.64	5.13	.7750	.2042	.0030	-.0069	-.0136	-.0291	.0507	.1422	283.2
7288	15119.9	17.91	5.12	.8541	.2616	-.0020	-.0058	-.0168	-.0260	.0505	.1425	283.4
7289	15108.8	20.21	5.11	.9294	.3250	-.0060	-.0041	-.0232	-.0192	.0504	.1423	283.4
7290	15062.2	22.43	5.10	.9920	.3923	-.0123	-.0060	-.0304	-.0131	.0505	.1420	283.1
7291	15188.4	24.56	5.06	1.0191	.4530	-.0306	-.0090	-.0289	-.0158	.0502	.1424	282.9
7292	15186.3	25.14	5.05	1.0278	.4688	-.0310	-.0093	-.0283	-.0172	.0501	.1423	283.0
7293	15066.3	-1.11	5.06	-.0326	.0110	-.0107	-.0005	-.0135	-.0220	.0507	.1428	283.7

ORIGINAL PAGE IS OF POOR QUALITY

NASA LANGLEY

7 X 10 HIGH SPEED TUNNEL

TEST TP	21 MACH	Q PA	RUN 112		CNF(RA)	CAF(BA)	CPH(BA)	CRM(BA)	CYH(BA)	CSF(BA)	TPLEN DEG K
			ALPHA DEG	BETA DEG							
7295	.501	15147.8	-1.11	5.05	-.0138	.0132	.0026	.0009	-.0127	-.0169	317.5
7296	.500	15125.1	-1.33	5.03	-.1224	.0104	-.0012	.0023	-.0126	-.0167	317.7
7297	.500	15125.8	-.05	5.05	-.0103	.0131	.0029	.0008	-.0128	-.0170	317.8
7298	.501	15149.0	1.96	5.08	.1011	.0110	.0071	-.0007	-.0129	-.0173	317.8
7299	.499	15080.2	4.14	5.10	.2167	.0050	.0098	-.0018	-.0130	-.0185	317.8
7300	.500	15103.6	6.41	5.12	.3477	-.0012	.0110	-.0029	-.0134	-.0197	317.7
7301	.501	15137.8	8.67	5.13	.4747	-.0065	.0117	-.0048	-.0137	-.0217	317.7
7302	.502	15193.0	10.97	5.14	.5866	-.0083	.0158	-.0043	-.0131	-.0244	317.7
7303	.499	15075.3	13.29	5.14	.6959	-.0074	.0126	-.0012	-.0137	-.0279	317.7
7304	.499	15072.6	15.66	5.13	.8004	-.0069	.0055	-.0003	-.0165	-.0250	317.7
7305	.499	15048.3	17.78	5.13	.8751	-.0038	-.0062	.0015	-.0226	-.0144	317.7
7306	.501	15143.9	19.35	5.12	.9870	.0032	-.0203	.0058	-.0303	-.0088	317.6
7307	.500	15113.2	22.01	5.07	.9095	.0023	-.0146	-.0028	-.0246	-.0119	317.6
7308	.495	14860.9	24.26	5.02	.9861	-.0016	-.0120	-.0077	-.0212	-.0137	317.6
7309	.500	15116.4	24.87	5.00	1.0105	-.0030	-.0126	-.0095	-.0201	-.0152	317.6
7310	.499	15051.7	-.10	5.05	-.0134	.0126	.0022	.0011	-.0128	-.0173	317.7

TEST TP	21 ALPHA DEG	BETA DEG	RUN 112		CPH(SA)	CRM(SA)	CYH(SA)	CSF(SA)	P1 PA	CPB(1)	WTOT M/SEC
			CL(SA)	CD(SA)							
7295	-.11	5.05	-.0138	.0133	.0026	.0009	-.0127	-.0169	86314.9	-.137	0.0
7296	-1.83	5.03	-.1220	.0143	-.0012	.0027	-.0126	-.0167	86308.1	-.137	0.0
7297	-.05	5.05	-.0103	.0131	.0029	.0008	-.0128	-.0170	86309.3	-.137	0.0
7298	1.96	5.08	.1007	.0145	.0071	-.0011	-.0128	-.0173	86289.5	-.138	0.0
7299	4.14	5.10	.2158	.0206	.0098	-.0027	-.0129	-.0185	86376.7	-.138	0.0
7300	6.41	5.12	.3457	.0376	.0110	-.0044	-.0130	-.0197	86364.0	-.142	0.0
7301	8.67	5.13	.4703	.0651	.0117	-.0068	-.0129	-.0217	86310.8	-.148	0.0
7302	10.97	5.14	.5774	.1035	.0158	-.0067	-.0121	-.0244	86297.4	-.152	0.0
7303	13.29	5.14	.6789	.1528	.0126	-.0043	-.0130	-.0279	86422.4	-.154	0.0
7304	15.66	5.13	.7725	.2094	.0055	-.0047	-.0158	-.0250	86376.3	-.165	0.0
7305	17.78	5.13	.8345	.2636	-.0062	-.0055	-.0220	-.0144	86404.1	-.179	0.0
7306	19.85	5.12	.8238	.3008	-.0203	-.0049	-.0305	-.0088	86302.2	-.186	0.0
7307	22.01	5.07	.8423	.3430	-.0146	-.0118	-.0217	-.0119	86332.4	-.190	0.0
7308	24.26	5.02	.8997	.4037	-.0120	-.0157	-.0161	-.0137	86620.3	-.199	0.0
7309	24.87	5.00	.9180	.4223	-.0126	-.0170	-.0142	-.0152	86313.1	-.202	0.0
7310	-.10	5.05	-.0134	.0126	.0022	.0011	-.0128	-.0173	86385.7	-.137	0.0

TEST TP	21 Q PA	ALPHA DEG	RUN 112		CDT	CMST	CRTS	CYTS	CYST	CMU	WTFLO KG/SEC	PLENPSI
			BETA DEG	CLT								
7295	15147.8	-.11	5.05	-.0138	.0133	.0026	.0009	-.0127	-.0169	0.0000	0.0000	-.1
7296	15125.1	-1.33	5.03	-.1220	.0143	-.0012	.0027	-.0126	-.0167	0.0000	0.0000	-.2
7297	15125.8	-.05	5.05	-.0103	.0131	.0029	.0008	-.0128	-.0170	0.0000	0.0000	-.1
7298	15149.0	1.96	5.08	.1007	.0145	.0071	-.0011	-.0128	-.0173	0.0000	0.0000	-.1
7299	15080.2	4.14	5.10	.2158	.0206	.0098	-.0027	-.0129	-.0185	0.0000	0.0000	-.1
7300	15103.6	6.41	5.12	.3457	.0376	.0110	-.0044	-.0130	-.0197	0.0000	0.0000	-.2
7301	15137.8	8.67	5.13	.4703	.0651	.0117	-.0068	-.0129	-.0217	0.0000	0.0000	-.2
7302	15193.0	10.97	5.14	.5774	.1035	.0158	-.0067	-.0121	-.0244	0.0000	0.0000	-.3
7303	15075.3	13.29	5.14	.6789	.1528	.0126	-.0043	-.0130	-.0279	0.0000	0.0000	-.4
7304	15072.6	15.66	5.13	.7725	.2094	.0055	-.0047	-.0158	-.0250	0.0000	0.0000	-.4
7305	15048.3	17.78	5.13	.8345	.2636	-.0062	-.0055	-.0220	-.0144	0.0000	0.0000	-.5
7306	15143.9	19.85	5.12	.8238	.3008	-.0203	-.0049	-.0305	-.0088	0.0000	0.0000	-.6
7307	15113.2	22.01	5.07	.8423	.3430	-.0146	-.0118	-.0217	-.0119	0.0000	0.0000	-.7
7308	14860.9	24.26	5.02	.8997	.4037	-.0120	-.0157	-.0161	-.0137	0.0000	0.0000	-.8
7309	15116.4	24.87	5.00	.9180	.4223	-.0126	-.0170	-.0142	-.0152	0.0000	0.0000	-.9
7310	15051.7	-.10	5.05	-.0134	.0126	.0022	.0011	-.0128	-.0173	0.0000	0.0000	-.2

NASA LANGLEY

7 X 10 HIGH SPEED TUNNEL

TEST TP	21 MACH	0 PA	RUN 113 ALPHA DEG	BETA DEG	CNF(BA)	CAF(BA)	CPH(BA)	CRM(BA)	CYM(BA)	CSF(BA)	TPLEN DEG K
7311	.701	25416.6	-.12	5.09	-.0093	.0125	.0025	.0010	-.0131	-.0180	317.9
7312	.701	25395.3	-2.02	5.07	-.1352	.0098	-.0013	.0025	-.0130	-.0175	317.9
7313	.699	25299.5	.01	5.09	-.0025	.0125	.0028	.0010	-.0132	-.0181	318.1
7314	.701	25414.9	2.15	5.12	.1167	.0097	.0067	-.0010	-.0130	-.0185	318.4
7315	.701	25378.4	4.49	5.14	.2483	.0037	.0080	-.0020	-.0132	-.0200	318.7
7316	.701	25393.0	7.00	5.16	.3978	-.0014	.0080	-.0036	-.0137	-.0217	319.2
7317	.701	25364.6	9.42	5.17	.5209	-.0034	.0095	-.0039	-.0132	-.0249	319.6
7318	.704	25527.3	11.84	5.19	.6260	-.0018	.0064	-.0013	-.0136	-.0275	319.9
7319	.701	25380.7	14.25	5.19	.7307	-.0012	-.0020	-.0008	-.0157	-.0266	320.0
7320	.701	25396.4	16.54	5.19	.8156	.0004	-.0141	-.0005	-.0198	-.0212	320.5
7321	.700	25334.4	18.74	5.19	.8579	.0041	-.0232	.0008	-.0255	-.0130	320.6
7322	.702	25430.7	20.99	5.14	.8654	.0048	-.0192	-.0062	-.0210	-.0188	320.7
7323	.699	25267.4	-.09	5.09	-.0061	.0120	.0026	.0006	-.0131	-.0178	320.7

TEST TP	21 ALPHA DEG	BETA DEG	RUN 113 CL(SA)	CD(SA)	CPH(SA)	CRM(SA)	CYM(SA)	CSF(SA)	P1 PA	CP8(1)	VTOT H/SEC
7311	-.12	5.09	-.0093	.0125	.0025	.0010	-.0131	-.0180	73799.9	-.141	0.0
7312	-2.02	5.07	-.1348	.0146	-.0013	.0030	-.0129	-.0175	73830.3	-.140	0.0
7313	.01	5.09	-.0025	.0125	.0028	.0010	-.0132	-.0181	73906.7	-.141	0.0
7314	2.15	5.12	.1162	.0140	.0067	-.0015	-.0129	-.0185	73849.4	-.141	0.0
7315	4.49	5.14	.2473	.0232	.0080	-.0030	-.0130	-.0200	73867.8	-.142	0.0
7316	7.00	5.16	.3950	.0469	.0080	-.0053	-.0131	-.0217	73820.9	-.147	0.0
7317	9.42	5.17	.5144	.0819	.0095	-.0060	-.0124	-.0249	73841.9	-.154	0.0
7318	11.84	5.19	.6131	.1266	.0064	-.0041	-.0130	-.0275	73682.9	-.157	0.0
7319	14.25	5.19	.7085	.1787	-.0020	-.0046	-.0151	-.0266	73871.0	-.165	0.0
7320	16.54	5.19	.7817	.2325	-.0141	-.0061	-.0188	-.0212	73794.4	-.181	0.0
7321	18.74	5.19	.8112	.2795	-.0232	-.0075	-.0244	-.0130	73872.1	-.184	0.0
7322	20.99	5.14	.8063	.3146	-.0192	-.0133	-.0174	-.0188	73743.6	-.188	0.0
7323	-.09	5.09	-.0061	.0121	.0026	.0006	-.0131	-.0178	73954.2	-.140	0.0

TEST TP	21 0 PA	ALPHA DEG	RUN 113 BETA DEG	CLT	CDT	CMST	CRTS	CYTS	CYST	CMU	WTFLO KG/SEC	PLENP PSI
7311	25416.6	-.12	5.09	-.0093	.0125	.0025	.0010	-.0131	-.0180	0.0000	0.0000	-.5
7312	25395.3	-2.02	5.07	-.1348	.0146	-.0013	.0030	-.0129	-.0175	0.0000	0.0000	-.5
7313	25299.5	.01	5.09	-.0025	.0125	.0028	.0010	-.0132	-.0181	0.0000	0.0000	-.5
7314	25414.9	2.15	5.12	.1162	.0140	.0067	-.0015	-.0129	-.0185	0.0000	0.0000	-.7
7315	25378.4	4.49	5.14	.2473	.0232	.0080	-.0030	-.0130	-.0200	0.0000	0.0000	-.4
7316	25393.0	7.00	5.16	.3950	.0469	.0080	-.0053	-.0131	-.0217	0.0000	0.0000	-.4
7317	25364.6	9.42	5.17	.5144	.0819	.0095	-.0060	-.0124	-.0249	0.0000	0.0000	-.5
7318	25527.3	11.84	5.19	.6131	.1266	.0064	-.0041	-.0130	-.0275	0.0000	0.0000	-.7
7319	25380.7	14.25	5.19	.7085	.1787	-.0020	-.0046	-.0151	-.0266	0.0000	0.0000	-.8
7320	25396.4	16.54	5.19	.7817	.2325	-.0141	-.0061	-.0188	-.0212	0.0000	0.0000	-1.1
7321	25334.4	18.74	5.19	.8112	.2795	-.0232	-.0075	-.0244	-.0130	0.0000	0.0000	-1.3
7322	25430.7	20.99	5.14	.8063	.3146	-.0192	-.0133	-.0174	-.0188	0.0000	0.0000	-1.2
7323	25267.4	-.09	5.09	-.0061	.0121	.0026	.0006	-.0131	-.0178	0.0000	0.0000	-.6

ORIGINAL PAGE IS OF POOR QUALITY

NASA LANGLEY

7 X 10 HIGH SPEED TUNNEL

TEST TP	21 MACH	Q PA	RUN 114 ALPHA DEG	BETA DEG	CNF(BA)	CAF(BA)	CPH(BA)	CRM(BA)	CYM(BA)	CSF(BA)	TPLEN DEG K
7324	.699	25301.0	-.08	5.11	-.0161	-.0143	.0071	-.0008	-.0145	-.0256	310.4
7325	.699	25287.7	-2.02	5.07	-.1351	-.0165	.0010	.0004	-.0133	-.0221	310.2
7326	.701	25416.1	-.05	5.11	-.0155	-.0142	.0068	-.0009	-.0144	-.0255	310.2
7327	.701	25427.9	2.25	5.14	.1131	-.0167	.0123	-.0009	-.0148	-.0276	310.1
7328	.700	25362.7	4.69	5.16	.2559	-.0223	.0125	-.0019	-.0149	-.0262	310.2
7329	.700	25357.4	7.03	5.18	.3948	-.0264	.0134	-.0037	-.0145	-.0279	310.5
7330	.700	25320.4	9.48	5.19	.5285	-.0278	.0110	-.0028	-.0137	-.0306	310.6
7331	.700	25329.9	11.90	5.19	.6507	-.0293	.0090	-.0022	-.0135	-.0318	310.9
7332	.701	25369.3	14.55	5.19	.7578	-.0287	.0054	-.0034	-.0149	-.0312	311.2
7333	.701	25364.7	16.76	5.19	.8494	-.0301	.0058	-.0013	-.0179	-.0274	311.5
7334	.702	25462.4	19.19	5.20	.9547	-.0335	.0040	.0036	-.0235	-.0227	312.1
7335	.700	25320.7	-.12	5.11	-.0190	-.0154	.0059	-.0010	-.0144	-.0255	313.3

TEST TP	21 ALPHA DEG	BETA DEG	RUN 114 CL(SA)	CD(SA)	CPH(SA)	CRM(SA)	CYM(SA)	CSF(SA)	P1 PA	CPB(1)	VTDT M/SEC
7324	-.08	5.11	-.0161	-.0143	.0071	-.0008	-.0145	-.0256	73905.4	-.142	640.7
7325	-2.02	5.07	-.1356	-.0118	.0010	.0008	-.0133	-.0221	73977.6	-.141	640.5
7326	-.05	5.11	-.0155	-.0142	.0068	-.0009	-.0144	-.0255	73838.2	-.141	640.6
7327	2.25	5.14	.1137	-.0122	.0123	-.0015	-.0147	-.0276	73865.6	-.141	640.6
7328	4.69	5.16	.2569	-.0013	.0125	-.0032	-.0147	-.0262	73848.6	-.150	640.6
7329	7.03	5.18	.3950	.0221	.0134	-.0055	-.0140	-.0279	73890.0	-.154	640.9
7330	9.48	5.19	.5259	.0596	.0110	-.0050	-.0130	-.0306	73892.5	-.165	641.1
7331	11.90	5.19	.6427	.1055	.0090	-.0050	-.0128	-.0318	73874.3	-.168	641.4
7332	14.55	5.19	.7407	.1626	.0054	-.0071	-.0136	-.0312	73811.5	-.173	641.8
7333	16.76	5.19	.8220	.2162	.0058	-.0065	-.0167	-.0274	73818.9	-.187	642.0
7334	19.19	5.20	.9126	.2821	.0040	-.0043	-.0234	-.0227	73745.3	-.202	642.6
7335	-.12	5.11	-.0190	-.0154	.0059	-.0010	-.0144	-.0255	73919.4	-.141	643.8

TEST TP	21 Q PA	ALPHA DEG	BETA DEG	RUN 114 CLT	CDT	CMST	CRTS	CYTS	CYST	CMU	WTFLO KG/SEC	PLENP PSI
7324	25301.0	-.08	5.11	-.0272	.0123	-.0086	-.0008	-.0150	-.0242	.0496	.2263	449.9
7325	25287.7	-2.02	5.07	-.1458	.0152	-.0147	.0008	-.0139	-.0206	.0497	.2268	450.3
7326	25416.1	-.05	5.11	-.0265	.0123	-.0088	-.0009	-.0150	-.0240	.0496	.2271	450.4
7327	25427.9	2.25	5.14	.1016	.0138	-.0034	-.0015	-.0153	-.0261	.0495	.2269	451.1
7328	25362.7	4.69	5.16	.2437	.0242	-.0032	-.0032	-.0153	-.0247	.0497	.2270	450.9
7329	25357.4	7.03	5.18	.3808	.0471	-.0023	-.0056	-.0145	-.0265	.0497	.2271	451.3
7330	25320.4	9.48	5.19	.5105	.0840	-.0047	-.0051	-.0136	-.0291	.0498	.2270	451.5
7331	25329.9	11.90	5.19	.6264	.1293	-.0068	-.0051	-.0133	-.0303	.0497	.2268	452.0
7332	25369.3	14.55	5.19	.7233	.1856	-.0104	-.0072	-.0141	-.0297	.0498	.2274	452.0
7333	25364.7	16.76	5.19	.8037	.2385	-.0099	-.0066	-.0173	-.0259	.0496	.2265	451.0
7334	25462.4	19.19	5.20	.8936	.3035	-.0117	-.0045	-.0239	-.0212	.0495	.2265	450.5
7335	25320.7	-.12	5.11	-.0301	.0113	-.0098	-.0010	-.0150	-.0240	.0499	.2264	451.2

NASA LANGLEY

7 X 10 HIGH SPEED TUNNEL

TEST TP	21 MACH	Q PA	RUN 115		CNF(BA)	CAF(BA)	CPH(BA)	CRM(BA)	CYM(BA)	CSF(BA)	TPLEN DEG K
			ALPHA DEG	BETA DEG							
7349	.300	6066.8	.06	-5.03	-.0087	.0153	.0028	.0011	.0138	.0242	317.0
7350	.299	6021.6	-1.52	-5.05	-.1117	.0110	-.0014	-.0009	.0139	.0252	316.8
7351	.300	6070.8	.10	-5.02	-.0053	.0153	.0023	.0010	.0139	.0241	316.7
7352	.301	6107.8	2.03	-4.99	.1019	.0138	.0075	.0028	.0137	.0240	316.7
7353	.301	6114.5	3.99	-4.96	.2068	.0086	.0104	.0040	.0137	.0240	316.6
7354	.301	6092.1	6.15	-4.91	.3278	.0019	.0125	.0058	.0135	.0237	316.5
7355	.301	6098.3	8.29	-4.86	.4502	-.0041	.0137	.0059	.0127	.0256	316.4
7356	.301	6084.0	10.45	-4.80	.5608	-.0070	.0168	.0038	.0121	.0282	316.3
7357	.299	6014.5	12.64	-4.74	.6701	-.0093	.0173	.0038	.0121	.0309	316.2
7358	.299	6027.9	15.01	-4.66	.7843	-.0106	.0133	.0020	.0137	.0319	316.1
7359	.300	6045.2	16.98	-4.59	.8717	-.0097	.0056	.0005	.0165	.0248	316.0
7360	.299	6019.1	19.12	-4.52	.9192	-.0024	-.0109	-.0058	.0259	.0094	316.0
7361	.300	6042.9	21.16	-4.43	.9508	.0005	-.0254	-.0047	.0273	.0116	315.9
7362	.300	6043.1	23.34	-4.33	1.0112	-.0020	-.0272	-.0034	.0259	.0118	315.9
7363	.302	6119.1	23.87	-4.31	1.0172	-.0029	-.0273	-.0039	.0260	.0122	315.8
7364	.300	6056.1	.07	-5.02	-.0093	.0147	.0032	.0009	.0138	.0235	315.8

TEST TP	21 ALPHA DEG	BETA DEG	RUN 115		CPH(SA)	CRM(SA)	CYM(SA)	CSF(SA)	P1 PA	CPB(1)	VTOT M/SEC
			CL(SA)	CD(SA)							
7349	.06	-5.03	-.0087	.0153	.0028	.0011	.0138	.0242	96165.6	-.139	0.0
7350	-1.52	-5.05	-.1114	.0139	-.0014	-.0013	.0139	.0252	96199.6	-.139	0.0
7351	.10	-5.02	-.0053	.0153	.0023	.0010	.0139	.0241	96145.2	-.139	0.0
7352	2.03	-4.99	.1013	.0174	.0075	.0033	.0136	.0240	96109.6	-.139	0.0
7353	3.99	-4.96	.2057	.0230	.0104	.0050	.0134	.0240	96101.4	-.138	0.0
7354	6.15	-4.91	.3257	.0370	.0125	.0072	.0128	.0237	96124.8	-.138	0.0
7355	8.29	-4.86	.4461	.0609	.0137	.0076	.0118	.0256	96120.2	-.145	0.0
7356	10.45	-4.80	.5527	.0949	.0168	.0059	.0112	.0282	96179.0	-.151	0.0
7357	12.64	-4.74	.6559	.1376	.0173	.0063	.0110	.0309	96198.0	-.156	0.0
7358	15.01	-4.66	.7603	.1929	.0133	.0055	.0127	.0319	96179.9	-.166	0.0
7359	16.98	-4.59	.8365	.2453	.0056	.0053	.0156	.0248	96162.5	-.174	0.0
7360	19.12	-4.52	.8693	.2988	-.0109	.0030	.0264	.0094	96189.8	-.178	0.0
7361	21.16	-4.43	.8865	.3436	-.0254	.0055	.0271	.0116	96169.8	-.187	0.0
7362	23.34	-4.33	.9292	.3987	-.0272	.0071	.0251	.0118	96171.9	-.195	0.0
7363	23.87	-4.31	.9314	.4089	-.0273	.0069	.0254	.0122	96137.3	-.196	0.0
7364	.07	-5.02	-.0093	.0147	.0032	.0009	.0138	.0235	96149.1	-.139	0.0

TEST TP	21 Q PA	ALPHA DEG	RUN 115		CLT	CDT	CMST	CRTS	CYTS	CYST	CHU	WTFLO KG/SEC	PLENP PSI
			BETA DEG	CLT									
7349	6066.8	.06	-5.03	-.0087	.0153	.0028	.0011	.0138	.0242	0.0000	0.0000	0.0000	-.0
7350	6021.6	-1.52	-5.05	-.1114	.0139	-.0014	-.0013	.0139	.0252	0.0000	0.0000	0.0000	-.1
7351	6070.8	.10	-5.02	-.0053	.0153	.0023	.0010	.0139	.0241	0.0000	0.0000	0.0000	-.0
7352	6107.8	2.03	-4.99	.1013	.0174	.0075	.0033	.0136	.0240	0.0000	0.0000	0.0000	-.0
7353	6114.5	3.99	-4.96	.2057	.0230	.0104	.0050	.0134	.0240	0.0000	0.0000	0.0000	-.0
7354	6092.1	6.15	-4.91	.3257	.0370	.0125	.0072	.0128	.0237	0.0000	0.0000	0.0000	-.1
7355	6098.3	8.29	-4.86	.4461	.0609	.0137	.0076	.0118	.0256	0.0000	0.0000	0.0000	-.0
7356	6084.0	10.45	-4.80	.5527	.0949	.0168	.0059	.0112	.0282	0.0000	0.0000	0.0000	-.1
7357	6014.5	12.64	-4.74	.6559	.1376	.0173	.0063	.0110	.0309	0.0000	0.0000	0.0000	-.2
7358	6027.9	15.01	-4.66	.7603	.1929	.0133	.0055	.0127	.0319	0.0000	0.0000	0.0000	-.1
7359	6045.2	16.98	-4.59	.8365	.2453	.0056	.0053	.0156	.0248	0.0000	0.0000	0.0000	-.2
7360	6019.1	19.12	-4.52	.8693	.2988	-.0109	.0030	.0264	.0094	0.0000	0.0000	0.0000	-.2
7361	6042.9	21.16	-4.43	.8865	.3436	-.0254	.0055	.0271	.0116	0.0000	0.0000	0.0000	-.2
7362	6043.1	23.34	-4.33	.9292	.3987	-.0272	.0071	.0251	.0118	0.0000	0.0000	0.0000	-.3
7363	6119.1	23.87	-4.31	.9314	.4089	-.0273	.0069	.0254	.0122	0.0000	0.0000	0.0000	-.3
7364	6056.1	.07	-5.02	-.0093	.0147	.0032	.0009	.0138	.0235	0.0000	0.0000	0.0000	-.1

ORIGINAL PAGE IS
OF POOR QUALITY

NASA LANGLEY

7 X 10 HIGH SPEED TUNNEL

TEST TP	21 MACH	Q PA	RUN 116 ALPHA DEG	BETA DEG	CNF(BA)	CAF(BA)	CPM(BA)	CRM(BA)	CYM(BA)	CSF(BA)	TPLEN DEG K
7365	.300	6069.4	.06	-5.03	-.0156	-.0118	.0067	.0025	.0156	.0280	310.7
7366	.300	6054.8	-1.54	-5.05	-.1200	-.0157	.0007	.0005	.0152	.0270	310.3
7367	.301	6081.7	.13	-5.03	-.0122	-.0113	.0067	.0028	.0156	.0285	310.0
7368	.300	6076.9	2.05	-5.00	.0932	-.0124	.0123	.0037	.0162	.0290	309.4
7369	.301	6079.5	3.99	-4.96	.1982	-.0170	.0159	.0042	.0166	.0294	309.1
7370	.300	6056.3	6.15	-4.92	.3232	-.0227	.0172	.0053	.0161	.0279	308.8
7371	.300	6050.6	8.27	-4.87	.4539	-.0298	.0195	.0056	.0154	.0293	308.5
7372	.302	6124.6	10.46	-4.81	.5769	-.0338	.0216	.0050	.0148	.0294	308.2
7373	.301	6113.2	12.69	-4.74	.6874	-.0375	.0261	.0045	.0141	.0314	308.0
7374	.300	6051.5	14.88	-4.67	.7997	-.0402	.0242	.0034	.0142	.0319	307.6
7375	.301	6098.7	17.12	-4.59	.9074	-.0422	.0173	.0036	.0142	.0274	307.4
7376	.300	6043.8	19.21	-4.51	1.0004	-.0448	.0088	.0032	.0151	.0218	307.2
7377	.300	6073.5	21.32	-4.42	1.0734	-.0467	.0034	-.0005	.0199	.0147	306.9
7378	.301	6084.7	23.47	-4.33	1.1462	-.0468	-.0001	-.0018	.0258	.0033	306.8
7379	.302	6127.6	24.04	-4.30	1.1549	-.0465	.0003	-.0029	.0270	.0041	306.6
7380	.299	6014.0	.07	-5.03	-.0060	-.0115	.0048	.0023	.0156	.0286	306.1

TEST TP	21 ALPHA DEG	BETA DEG	RUN 116 CL(SA)	CD(SA)	CPM(SA)	CRM(SA)	CYM(SA)	CSF(SA)	P1 PA	CPB(1)	VTDT M/SEC
7365	.06	-5.03	-.0156	-.0118	.0067	.0025	.0156	.0280	96137.1	-.138	545.3
7366	-1.54	-5.05	-.1203	-.0125	.0007	.0001	.0152	.0270	96149.0	-.140	544.7
7367	.13	-5.03	-.0122	-.0114	.0067	.0029	.0156	.0285	96117.4	-.139	544.4
7368	2.05	-5.00	.0936	-.0090	.0123	.0043	.0161	.0290	96157.8	-.137	543.9
7369	3.99	-4.96	.1989	-.0031	.0159	.0053	.0162	.0294	96119.4	-.140	543.8
7370	6.15	-4.92	.3238	.0121	.0172	.0070	.0154	.0279	96144.0	-.146	543.5
7371	8.27	-4.87	.4535	.0358	.0195	.0077	.0144	.0293	96150.0	-.155	543.3
7372	10.46	-4.81	.5734	.0715	.0216	.0076	.0137	.0294	96119.3	-.162	543.2
7373	12.69	-4.74	.6789	.1144	.0261	.0074	.0128	.0314	96130.6	-.166	543.1
7374	14.88	-4.67	.7832	.1665	.0242	.0069	.0129	.0319	96140.7	-.172	542.8
7375	17.12	-4.59	.8796	.2269	.0173	.0077	.0125	.0274	96091.6	-.179	542.7
7376	19.21	-4.51	.9594	.2868	.0088	.0060	.0132	.0218	96146.3	-.188	542.5
7377	21.32	-4.42	1.0169	.3468	.0034	.0067	.0187	.0147	96124.5	-.197	542.4
7378	23.47	-4.33	1.0700	.4137	-.0001	.0087	.0244	.0033	96118.8	-.202	542.2
7379	24.04	-4.30	1.0737	.4280	.0003	.0084	.0259	.0041	96132.4	-.202	542.1
7380	.07	-5.03	-.0060	-.0115	.0048	.0023	.0156	.0286	96181.6	-.138	541.8

TEST TP	21 Q PA	ALPHA DEG	RUN 116 BETA DEG	CLT	CDT	CMST	CRTS	CYTS	CYST	CMU	WTFLO KG/SEC	PLENP PSI
7365	6069.4	.06	-5.03	-.0279	.0178	-.0108	.0025	.0150	.0296	.0491	.0631	120.3
7366	6054.8	-1.54	-5.05	-.1319	.0174	-.0168	.0002	.0146	.0287	.0492	.0632	119.9
7367	6081.7	.13	-5.03	-.0245	.0181	-.0107	.0029	.0150	.0301	.0490	.0632	119.9
7368	6076.9	2.05	-5.00	.0802	.0200	-.0051	.0043	.0155	.0307	.0490	.0632	120.1
7369	6079.5	3.99	-4.96	.1846	.0255	-.0016	.0053	.0156	.0310	.0492	.0635	120.2
7370	6056.3	6.15	-4.92	.3083	.0403	-.0003	.0069	.0148	.0296	.0493	.0635	120.2
7371	6050.6	8.27	-4.87	.4370	.0634	.0020	.0076	.0138	.0310	.0494	.0635	120.3
7372	6124.6	10.46	-4.81	.5560	.0982	.0042	.0075	.0131	.0311	.0489	.0637	120.5
7373	6113.2	12.69	-4.74	.6604	.1404	.0087	.0073	.0122	.0330	.0490	.0637	120.6
7374	6051.5	14.88	-4.67	.7636	.1921	.0066	.0067	.0123	.0336	.0496	.0638	120.7
7375	6098.7	17.12	-4.59	.8591	.2515	-.0002	.0075	.0119	.0291	.0493	.0639	120.8
7376	6043.8	19.21	-4.51	.9379	.3110	-.0088	.0078	.0126	.0234	.0497	.0640	120.9
7377	6073.5	21.32	-4.42	.9945	.3700	-.0142	.0065	.0181	.0163	.0496	.0641	121.0
7378	6084.7	23.47	-4.33	1.0468	.4360	-.0176	.0084	.0238	.0049	.0495	.0641	120.9
7379	6127.6	24.04	-4.30	1.0504	.4500	-.0171	.0081	.0253	.0058	.0492	.0642	121.1
7380	6014.0	.07	-5.03	-.0186	.0186	-.0130	.0023	.0150	.0303	.0501	.0642	121.2

NASA LANGLEY

7 X 10 HIGH SPEED TUNNEL

TEST TP	21 MACH	Q PA	RUN 117		CNF(BA)	CAF(BA)	CPM(BA)	CRM(BA)	CYM(BA)	CSF(BA)	TPLEN DEG K
			ALPHA DEG	BETA DEG							
7381	.300	6064.1	.07	-5.03	-.0157	-.0383	.0139	.0046	.0165	.0324	302.6
7382	.299	6025.7	-1.62	-5.05	-.1175	-.0432	.0050	.0016	.0155	.0299	302.5
7383	.300	6059.3	.07	-5.03	-.0163	-.0383	.0140	.0046	.0166	.0317	302.4
7384	.301	6098.7	2.17	-5.00	.0984	-.0390	.0191	.0050	.0176	.0321	302.3
7385	.301	6089.5	-4.15	-4.96	.2002	-.0431	.0224	.0041	.0183	.0301	302.3
7386	.301	6101.6	6.16	-4.92	.3302	-.0488	.0203	.0055	.0174	.0281	302.3
7387	.300	6065.9	8.46	-4.86	.4757	-.0567	.0220	.0057	.0166	.0280	302.3
7388	.299	6033.9	10.44	-4.81	.6043	-.0626	.0228	.0052	.0164	.0290	302.4
7389	.299	6022.9	12.69	-4.75	.7536	-.0708	.0281	.0042	.0157	.0325	302.4
7390	.300	6051.5	14.93	-4.67	.8586	-.0754	.0395	.0044	.0159	.0334	302.4
7391	.301	6090.1	17.19	-4.59	.9550	-.0780	.0372	.0018	.0168	.0315	302.5
7392	.300	6043.2	19.32	-4.51	1.0504	-.0816	.0316	.0010	.0176	.0272	302.6
7393	.300	6048.8	21.42	-4.42	1.1463	-.0841	.0224	-.0003	.0193	.0206	302.7
7394	.301	6111.8	23.61	-4.33	1.2276	-.0856	.0127	-.0017	.0222	.0103	302.7
7395	.301	6088.7	24.16	-4.30	1.2613	-.0866	.0108	-.0025	.0239	.0080	302.8
7396	.301	6083.3	.07	-5.03	-.0130	-.0407	.0122	.0046	.0165	.0301	303.1

TEST TP	21 ALPHA DEG	BETA DEG	RUN 117		CPM(SA)	CRM(SA)	CYM(SA)	CSF(SA)	P1 PA	CPB(I)	VTDT M/SEC
			CL(SA)	CD(SA)							
7381	.07	-5.03	-.0156	-.0384	.0139	.0046	.0165	.0324	96129.1	-.139	583.4
7382	-1.62	-5.05	-.1187	-.0398	.0050	.0012	.0155	.0299	96163.0	-.141	583.1
7383	.07	-5.03	-.0162	-.0384	.0140	.0046	.0166	.0317	96132.1	-.138	583.0
7384	2.17	-5.00	.0998	-.0352	.0191	.0056	.0174	.0321	96092.2	-.136	583.0
7385	4.15	-4.96	.2028	-.0285	.0224	.0055	.0179	.0301	96101.4	-.139	583.0
7386	6.16	-4.92	.3335	-.0131	.0203	.0074	.0167	.0261	96089.8	-.146	583.0
7387	8.46	-4.86	.4789	.0139	.0220	.0081	.0155	.0280	96125.7	-.157	583.0
7388	10.44	-4.81	.6057	.0479	.0228	.0081	.0152	.0290	96153.9	-.164	583.1
7389	12.69	-4.75	.7508	.0966	.0281	.0075	.0144	.0325	96163.4	-.169	583.1
7390	14.93	-4.67	.8491	.1484	.0395	.0084	.0142	.0334	96128.7	-.171	583.2
7391	17.19	-4.59	.9354	.2077	.0372	.0067	.0155	.0315	96089.6	-.178	583.3
7392	19.32	-4.51	1.0182	.2704	.0316	.0067	.0163	.0272	96144.2	-.188	583.4
7393	21.42	-4.42	1.0978	.3403	.0224	.0068	.0180	.0206	96144.3	-.192	583.5
7394	23.61	-4.33	1.1592	.4132	.0127	.0074	.0210	.0103	96134.2	-.197	583.6
7395	24.16	-4.30	1.1863	.4373	.0108	.0075	.0228	.0080	96104.8	-.200	583.7
7396	.07	-5.03	-.0130	-.0407	.0122	.0046	.0165	.0301	96121.5	-.138	584.1

TEST TP	21 Q PA	ALPHA DEG	BETA DEG	CLT	CDT	CMST	CRTS	CYTS	CYST	CMU	WTFLO KG/SEC	PLENPP PSI
7382	6025.7	-1.62	-5.05	-.1410	.0184	-.0290	.0012	.0144	.0331	.1006	.1201	231.9
7383	6059.3	.07	-5.03	-.0401	.0188	-.0198	.0046	.0155	.0349	.1002	.1202	231.9
7384	6098.7	2.17	-5.00	.0739	.0207	-.0145	.0056	.0162	.0353	.0996	.1203	232.1
7385	6089.5	4.15	-4.96	.1750	.0266	-.0112	.0054	.0168	.0333	.0996	.1202	232.2
7386	6101.6	6.16	-4.92	.3039	.0409	-.0133	.0072	.0156	.0313	.0994	.1202	232.3
7387	6065.9	8.46	-4.86	.4469	.0670	-.0118	.0079	.0144	.0312	.1003	.1205	232.3
7388	6033.9	10.44	-4.81	.5717	.1002	-.0112	.0079	.0140	.0322	.1009	.1206	232.4
7389	6022.9	12.69	-4.75	.7147	.1475	-.0059	.0073	.0132	.0357	.1008	.1203	232.4
7390	6051.5	14.93	-4.67	.8111	.1978	.0056	.0081	.0131	.0367	.1004	.1203	232.6
7391	6090.1	17.19	-4.59	.8959	.2752	.0035	.0063	.0144	.0347	.0998	.1203	232.6
7392	6043.2	19.32	-4.51	.9766	.3168	-.0024	.0063	.0152	.0305	.1006	.1204	232.7
7393	6048.8	21.42	-4.42	1.0545	.3851	-.0115	.0063	.0169	.0238	.1006	.1205	232.8
7394	6111.8	23.61	-4.33	1.1146	.4559	-.0209	.0069	.0200	.0135	.0996	.1204	232.9
7395	6088.7	24.16	-4.30	1.1412	.4797	-.0229	.0071	.0218	.0112	.1000	.1205	232.9
7396	6083.3	.07	-5.03	-.0369	.0166	-.0217	.0046	.0153	.0333	.1004	.1208	233.4

ORIGINAL PAGE IS OF POOR QUALITY

NASA LANGLEY

7 X 10 HIGH SPEED TUNNEL

TEST TP	21 MACH	C PA	RUN 118		CNF(BA)	CAF(BA)	CPM(BA)	CRM(BA)	CYM(BA)	CSF(BA)	TPLEN DEG K
			ALPHA DEG	BETA DEG							
7397	.300	6073.9	.10	-5.03	-.0190	-.0936	.0314	.0085	.0185	.0301	303.6
7398	.300	6054.0	-1.44	-5.05	-.0961	-.0980	.0213	.0031	.0172	.0282	303.8
7399	.300	6063.7	.16	-5.03	-.0171	-.0940	.0317	.0085	.0187	.0305	303.9
7400	.300	6122.1	2.13	-5.00	.0836	-.0932	.0385	.0079	.0200	.0316	304.0
7401	.300	6065.2	4.05	-4.97	.1719	-.0967	.0427	.0037	.0205	.0272	304.2
7402	.301	6090.0	6.21	-4.92	.3326	-.1029	.0312	.0062	.0191	.0227	304.3
7403	.302	6149.1	8.43	-4.86	.4909	-.1100	.0266	.0046	.0183	.0205	304.4
7404	.301	6074.5	10.60	-4.81	.6547	-.1178	.0251	.0040	.0184	.0231	304.4
7405	.302	6121.4	12.82	-4.74	.8430	-.1260	.0237	.0038	.0186	.0241	304.5
7406	.302	6116.1	15.03	-4.68	1.0146	-.1334	.0237	.0014	.0181	.0273	304.7
7407	.300	6047.6	17.44	-4.59	1.1732	-.1435	.0261	.0007	.0186	.0251	304.9
7408	.299	6035.2	19.48	-4.51	1.2452	-.1504	.0413	.0022	.0190	.0200	305.0
7409	.300	6048.0	21.79	-4.41	1.3187	-.1516	.0388	-.0007	.0212	.0132	305.1
7410	.300	6059.8	23.77	-4.33	1.3824	-.1515	.0357	-.0037	.0241	.0099	305.4
7411	.300	6054.3	24.35	-4.30	1.4042	-.1493	.0316	-.0042	.0257	.0087	305.9
7412	.300	6046.3	.12	-5.03	-.0203	-.0965	.0316	.0084	.0185	.0291	306.6

TEST TP	21 ALPHA DEG	BETA DEG	RUN 118		CPM(SA)	CRM(SA)	CYM(SA)	CSF(SA)	P1 PA	CPB(1)	VTOT M/SEC
			CL(SA)	CD(SA)							
7397	.10	-5.03	-.0188	-.0936	.0314	.0085	.0185	.0301	96098.5	-.136	619.9
7398	-1.44	-5.05	-.0985	-.0955	.0213	.0027	.0172	.0282	96119.3	-.137	619.1
7399	.16	-5.03	-.0166	-.0941	.0317	.0085	.0187	.0305	96104.4	-.136	619.2
7400	2.13	-5.00	.0870	-.0900	.0385	.0086	.0197	.0316	96046.3	-.136	619.4
7401	4.05	-4.97	.1783	-.0843	.0427	.0052	.0202	.0272	96107.6	-.139	619.5
7402	6.21	-4.92	.3418	-.0664	.0312	.0083	.0183	.0227	96087.2	-.145	619.6
7403	8.43	-4.86	.5017	-.0369	.0266	.0073	.0174	.0205	96070.3	-.153	619.8
7404	10.60	-4.81	.6652	.0046	.0251	.0074	.0174	.0231	96091.1	-.160	619.8
7405	12.82	-4.74	.8499	.0642	.0237	.0078	.0173	.0241	96040.8	-.167	620.0
7406	15.03	-4.68	1.0145	.1343	.0237	.0060	.0171	.0273	96045.1	-.171	620.1
7407	17.44	-4.59	1.1623	.2146	.0261	.0062	.0176	.0251	96119.8	-.179	620.2
7408	19.48	-4.51	1.2241	.2734	.0413	.0084	.0171	.0200	96133.7	-.187	620.3
7409	21.79	-4.41	1.2808	.3487	.0388	.0072	.0200	.0132	96132.4	-.191	620.5
7410	23.77	-4.33	1.3263	.4185	.0357	.0063	.0236	.0099	96120.7	-.193	620.8
7411	24.35	-4.30	1.3409	.4428	.0316	.0068	.0251	.0087	96129.4	-.192	621.3
7412	.12	-5.03	-.0201	-.0965	.0316	.0084	.0185	.0291	96120.6	-.136	622.1

TEST TP	21 Q PA	ALPHA DEG	RUN 118 BETA DEG	CLT	CDT	CMST	CRIS	CYTS	CYST	CMU	WTFLO KG/SEC	PLENP PSI
7398	6054.0	-1.44	-5.05	-.1401	.0118	-.0415	.0027	.0151	.0341	.1946	.2198	430.3
7399	6063.7	.16	-5.03	-.0613	.0118	-.0309	.0085	.0165	.0364	.1940	.2194	430.1
7400	6122.1	2.13	-5.00	.0394	.0133	-.0235	.0085	.0176	.0374	.1922	.2194	430.4
7401	6065.2	4.05	-4.97	.1268	.0183	-.0199	.0050	.0180	.0331	.1943	.2197	430.3
7402	6090.0	6.21	-4.92	.2866	.0339	-.0312	.0080	.0161	.0286	.1935	.2196	430.6
7403	6149.1	8.43	-4.86	.4432	.0604	-.0352	.0070	.0153	.0263	.1921	.2201	430.9
7404	6074.5	10.60	-4.81	.6023	.1007	-.0375	.0070	.0152	.0290	.1942	.2198	430.8
7405	6121.4	12.82	-4.74	.7839	.1570	-.0384	.0074	.0152	.0300	.1927	.2197	430.9
7406	6116.1	15.03	-4.68	.9448	.2247	-.0385	.0054	.0150	.0332	.1929	.2197	431.1
7407	6047.6	17.44	-4.59	1.0482	.3028	-.0367	.0056	.0155	.0310	.1945	.2190	430.4
7408	6035.2	19.48	-4.51	1.1467	.3591	-.0216	.0077	.0151	.0259	.1950	.2191	430.5
7409	6048.0	21.79	-4.41	1.2002	.4310	-.0241	.0064	.0180	.0192	.1950	.2195	430.6
7410	6059.8	23.77	-4.33	1.2429	.4979	-.0270	.0055	.0216	.0158	.1945	.2192	430.9
7411	6054.3	24.35	-4.30	1.2566	.5215	-.0312	.0059	.0231	.0146	.1947	.2192	431.0
7412	6046.3	.12	-5.03	-.0648	.0100	-.0313	.0084	.0163	.0351	.1951	.2190	431.3

MASA LANGLEY

7 X 10 HIGH SPEED TUNNEL

TEST TP	21	MACH	Q PA	RUN 119		CNF(BA)	CAF(BA)	CPM(BA)	CRM(BA)	CYM(BA)	CSF(BA)	TPLEN DEG K
				ALPHA DEG	BETA DEG							
7413	.300	6063.8	.11	-5.03	-.0228	-.1181	.0410	.0097	.0196	.0274	.0274	308.3
7414	.300	6044.4	-1.45	-5.05	-.1025	-.1228	.0260	.0028	.0178	.0243	.0243	308.6
7415	.300	6056.1	.18	-5.03	-.0232	-.1188	.0412	.0099	.0195	.0277	.0277	309.1
7416	.301	6076.5	2.08	-5.01	.0746	-.1185	.0499	.0083	.0210	.0310	.0310	309.3
7417	.301	6078.8	4.06	-4.97	.1600	-.1209	.0524	.0031	.0213	.0239	.0239	309.8
7418	.301	6109.9	6.18	-4.92	.3220	-.1268	.0388	.0066	.0202	.0195	.0195	309.9
7419	.301	6087.3	8.39	-4.87	.4914	-.1358	.0316	.0050	.0192	.0178	.0178	310.2
7420	.301	6077.8	10.55	-4.81	.6604	-.1432	.0278	.0034	.0190	.0189	.0189	310.5
7421	.300	6041.3	12.81	-4.74	.8523	-.1529	.0234	.0034	.0190	.0214	.0214	310.6
7422	.300	6044.1	15.05	-4.67	1.0367	-.1604	.0227	.0032	.0186	.0245	.0245	310.9
7423	.300	6046.4	17.34	-4.59	1.2062	-.1695	.0256	.0027	.0194	.0219	.0219	311.1
7424	.301	6076.0	19.60	-4.51	1.3251	-.1782	.0351	.0037	.0211	.0129	.0129	311.5
7425	.300	6050.7	21.69	-4.42	1.3881	-.1828	.0491	.0005	.0222	.0089	.0089	311.8
7426	.300	6072.6	23.83	-4.33	1.4572	-.1838	.0495	-.0007	.0240	.0038	.0038	312.2
7427	.299	6036.2	24.36	-4.30	1.4724	-.1849	.0506	-.0013	.0246	.0025	.0025	312.4
7428	.300	6038.8	.10	-5.03	-.0277	-.1219	.0411	.0097	.0196	.0266	.0266	313.4

TEST TP	21	ALPHA DEG	BETA DEG	RUN 119		CPM(SA)	CRM(SA)	CYM(SA)	CSF(SA)	PI PA	CPB(1)	VTOT M/SEC
				CL(SA)	CD(SA)							
7413	.11	-5.03	-.0226	-.1182	.0410	.0097	.0195	.0274	96098.9	-.135	632.2	
7414	-1.45	-5.05	-.1055	-.1202	.0260	.0024	.0179	.0243	96119.2	-.136	632.5	
7415	.18	-5.03	-.0228	-.1189	.0412	.0100	.0195	.0277	96123.9	-.135	633.0	
7416	2.08	-5.01	.0788	-.1157	.0499	.0091	.0207	.0310	96086.9	-.136	633.2	
7417	4.06	-4.97	.1682	-.1093	.0524	.0046	.0210	.0239	96086.5	-.140	633.7	
7418	6.18	-4.92	.3338	-.0913	.0388	.0088	.0194	.0195	96058.5	-.145	633.9	
7419	8.39	-4.87	.5060	-.0626	.0316	.0076	.0183	.0178	96077.7	-.148	634.2	
7420	10.55	-4.81	.6755	-.0198	.0278	.0069	.0181	.0189	96080.8	-.156	634.5	
7421	12.81	-4.74	.8649	.0399	.0234	.0075	.0177	.0214	96119.0	-.161	634.6	
7422	15.05	-4.67	1.0428	.1143	.0227	.0079	.0172	.0245	96115.0	-.166	634.9	
7423	17.34	-4.59	1.2019	.1976	.0256	.0084	.0177	.0219	96114.9	-.175	635.2	
7424	19.60	-4.51	1.3080	.2767	.0351	.0106	.0187	.0129	96109.5	-.183	635.6	
7425	21.69	-4.42	1.3574	.3431	.0491	.0087	.0205	.0089	96129.6	-.188	635.9	
7426	23.83	-4.33	1.4072	.4207	.0495	.0091	.0223	.0038	96106.7	-.189	636.3	
7427	24.36	-4.30	1.4176	.4389	.0506	.0090	.0229	.0025	96143.6	-.190	636.5	
7428	.10	-5.03	-.0277	-.1219	.0411	.0097	.0195	.0266	96119.7	-.135	637.6	

TEST TP	21	Q PA	ALPHA DEG	BETA DEG	CLT	CDT	CMST	CRTS	CYTS	CYST	CMU	WTFLO KG/SEC	PLENP PSI
7414	6044.4	-1.45	-5.05	-.1550	.0076	-.0486	.0024	.0153	.0314	.2352	.2595	511.3	
7415	6056.1	.18	-5.03	-.0757	.0070	-.0332	.0100	.0169	.0347	.2342	.2588	510.7	
7416	6076.5	2.08	-5.01	.0220	.0079	-.0243	.0090	.0181	.0380	.2336	.2589	510.9	
7417	6078.8	4.06	-4.97	.1071	.0123	-.0217	.0044	.0184	.0309	.2334	.2586	510.8	
7418	6109.9	6.18	-4.92	.2686	.0274	-.0351	.0085	.0168	.0264	.2324	.2587	511.3	
7419	6087.3	8.39	-4.87	.4359	.0540	-.0425	.0074	.0157	.0248	.2334	.2587	511.4	
7420	6077.8	10.55	-4.81	.6009	.0943	-.0465	.0064	.0155	.0259	.2338	.2586	511.6	
7421	6041.3	12.81	-4.74	.7855	.1516	-.0513	.0070	.0152	.0284	.2353	.2587	511.6	
7422	6044.1	15.05	-4.67	.9590	.2228	-.0521	.0072	.0147	.0316	.2353	.2587	511.8	
7423	6046.4	17.34	-4.59	1.1139	.3028	-.0491	.0076	.0152	.0290	.2352	.2586	512.1	
7424	6076.0	19.60	-4.51	1.2164	.3777	-.0393	.0097	.0162	.0199	.2343	.2587	512.2	
7425	6050.7	21.69	-4.42	1.2617	.4412	-.0256	.0077	.0180	.0160	.2352	.2584	512.2	
7426	6072.6	23.83	-4.33	1.3082	.5149	-.0250	.0080	.0199	.0108	.2344	.2584	512.6	
7427	6036.2	24.36	-4.30	1.3171	.5327	-.0243	.0079	.0205	.0096	.2356	.2580	512.5	
7428	6038.8	.10	-5.03	-.0805	.0048	-.0338	.0097	.0170	.0337	.2355	.2576	512.4	

ORIGINAL PAGE IS
OF POOR QUALITY

NASA LANGLEY

7 X 10 HIGH SPEED TUNNEL

TEST TP	21 MACH	Q PA	RUN 120		CNF(BA)	CAF(BA)	CPM(BA)	CRM(BA)	CYN(BA)	CSF(BA)	TPLEN DEG_K
			ALPHA DEG	BETA DEG							
7429	.500	15073.5	.06	-5.08	-.0175	-.0418	.0108	.0042	.0180	.0310	315.0
7430	.498	14986.3	-1.62	-5.09	-.1194	-.0447	.0036	.0020	.0164	.0289	315.1
7431	.500	15107.3	.14	-5.08	-.0139	-.0418	.0113	.0041	.0180	.0314	315.2
7432	.501	15129.8	2.18	-5.06	.1012	-.0434	.0184	.0040	.0189	.0325	315.4
7433	.500	15110.4	4.32	-5.01	.2122	-.0481	.0184	.0037	.0191	.0266	315.6
7434	.501	15139.6	6.63	-4.96	.3580	-.0545	.0195	.0056	.0179	.0225	315.8
7435	.501	15122.7	8.91	-4.91	.4975	-.0598	.0202	.0059	.0170	.0223	315.9
7436	.499	15006.7	11.24	-4.84	.6389	-.0641	.0224	.0033	.0164	.0208	316.0
7437	.500	15075.5	13.80	-4.78	.7691	-.0681	.0328	-.0001	.0163	.0201	316.1
7438	.500	15090.9	16.02	-4.71	.8822	-.0707	.0376	.0001	.0165	.0210	316.2
7439	.500	15082.9	18.37	-4.63	.9847	-.0725	.0351	-.0013	.0184	.0210	316.2
7440	.501	15114.9	20.58	-4.55	1.0727	-.0750	.0316	.0000	.0199	.0172	316.2
7441	.498	14957.3	22.73	-4.47	1.1649	-.0739	.0174	.0013	.0267	.0085	316.3
7442	.502	15166.0	24.94	-4.40	1.2184	-.0704	.0012	-.0074	.0311	.0103	316.3
7443	.500	15106.3	25.43	-4.37	1.2287	-.0682	-.0101	-.0075	.0320	.0056	316.3
7444	.501	15106.0	.07	-5.08	-.0183	-.0417	.0114	.0043	.0179	.0314	316.3

TEST TP	21 ALPHA DEG	BETA DEG	RUN 120		CPM(SA)	CRM(SA)	CYN(SA)	CSF(SA)	P1 PA	CPB(1)	VTOT M/SEC
			CL(SA)	CD(SA)							
7429	.06	-5.08	-.0175	-.0418	.0108	.0042	.0180	.0310	86219.8	-.143	644.6
7430	-1.62	-5.09	-.1206	-.0413	.0036	.0016	.0164	.0289	86287.5	-.145	644.7
7431	.14	-5.08	-.0138	-.0418	.0113	.0041	.0180	.0314	86210.6	-.142	644.8
7432	2.18	-5.06	.1028	-.0396	.0184	.0048	.0187	.0325	86129.3	-.143	645.1
7433	4.32	-5.01	.2153	-.0320	.0184	.0051	.0188	.0266	86235.9	-.149	645.2
7434	6.63	-4.96	.3619	-.0127	.0195	.0079	.0171	.0225	86111.2	-.153	645.6
7435	8.91	-4.91	.5008	.0179	.0202	.0085	.0159	.0223	86124.6	-.162	645.7
7436	11.24	-4.84	.6392	.0616	.0224	.0064	.0155	.0208	86256.3	-.174	645.7
7437	13.80	-4.78	.7632	.1172	.0328	.0038	.0158	.0201	86174.8	-.178	645.7
7438	16.02	-4.71	.8675	.1756	.0376	.0047	.0158	.0210	86151.7	-.182	645.8
7439	18.37	-4.63	.9574	.2415	.0351	.0046	.0179	.0184	86197.8	-.189	645.8
7440	20.58	-4.55	1.0306	.3070	.0316	.0070	.0186	.0172	86185.7	-.199	645.8
7441	22.73	-4.47	1.1030	.3819	.0174	.0115	.0242	.0085	86321.7	-.202	645.8
7442	24.94	-4.40	1.1345	.4500	.0012	.0064	.0313	.0103	86086.3	-.213	646.0
7443	25.43	-4.37	1.1389	.4659	-.0101	.0069	.0321	.0056	86156.8	-.217	646.0
7444	.07	-5.08	-.0183	-.0418	.0114	.0043	.0179	.0314	86136.5	-.143	645.9

TEST TP	21 Q PA	ALPHA DEG	RUN 120		CLT	CDT	CMST	CRTS	CYTS	CYST	CMU	WTFLO KG/SEC	PLENP PSI
			BETA DEG	BETA DEG									
7429	15073.5	.06	-5.08	-.0388	.0092	-.0193	.0042	.0170	.0338	.0953	.2573	514.7	
7430	14986.3	-1.62	-5.09	-.1406	.0106	-.0267	.0016	.0154	.0318	.0959	.2574	515.0	
7431	15107.3	.14	-5.08	-.0351	.0090	-.0187	.0041	.0169	.0342	.0951	.2573	514.8	
7432	15129.8	2.18	-5.06	.0797	.0105	-.0116	.0047	.0177	.0353	.0949	.2571	514.9	
7433	15110.4	4.32	-5.01	.1902	.0173	-.0117	.0051	.0177	.0294	.0951	.2572	515.5	
7434	15139.6	6.63	-4.96	.3350	.0354	-.0106	.0077	.0161	.0253	.0951	.2575	515.7	
7435	15122.7	8.91	-4.91	.4719	.0650	-.0099	.0083	.0149	.0251	.0951	.2573	515.8	
7436	15006.7	11.24	-4.84	.6082	.1078	-.0079	.0062	.0144	.0237	.0958	.2571	515.7	
7437	15075.5	13.80	-4.78	.7304	.1617	.0027	.0035	.0148	.0229	.0951	.2565	514.1	
7438	15090.9	16.02	-4.71	.8330	.2187	.0075	.0044	.0148	.0239	.0952	.2568	514.4	
7439	15082.9	18.37	-4.63	.9212	.2832	.0050	.0043	.0169	.0212	.0952	.2567	514.5	
7440	15114.9	20.58	-4.55	.9928	.3472	.0016	.0066	.0176	.0201	.0951	.2571	514.8	
7441	14957.3	22.73	-4.47	1.0633	.4211	-.0130	.0111	.0232	.0113	.0961	.2569	515.1	
7442	15166.0	24.94	-4.40	1.0939	.4871	-.0288	.0060	.0304	.0132	.0948	.2571	515.6	
7443	15106.3	25.43	-4.37	1.0779	.5028	-.0402	.0065	.0312	.0084	.0951	.2569	515.2	
7444	15106.0	.07	-5.08	-.0396	.0091	-.0187	.0043	.0169	.0343	.0951	.2567	514.8	

NASA LANGLEY

7 X 10 HIGH SPEED TUNNEL

TEST TP	21	MACH	Q PA	RUN 121		CNF(BA)	CAF(BA)	CPM(BA)	CRM(BA)	CYN(BA)	CSF(BA)	TPLEN DEG K
				ALPHA DEG	BETA DEG							
7445		.499	15012.6	.08	-5.08	-.0128	-.0168	.0057	.0032	.0164	.0299	316.3
7446		.499	15036.6	-1.65	-5.09	-.1177	-.0192	.0001	.0015	.0157	.0283	316.2
7447		.501	15126.0	.12	-5.08	-.0087	-.0163	.0059	.0027	.0164	.0298	313.7
7448		.499	15039.6	2.15	-5.05	.1046	-.0185	.0108	.0042	.0171	.0294	313.5
7449		.502	15184.8	4.30	-5.01	.2191	-.0230	.0138	.0043	.0176	.0271	313.3
7450		.501	15129.0	6.59	-4.96	.3552	-.0291	.0151	.0062	.0165	.0252	313.0
7451		.501	15114.9	8.97	-4.90	.4931	-.0338	.0180	.0059	.0154	.0256	314.9
7452		.500	15065.8	11.18	-4.84	.6142	-.0358	.0201	.0055	.0147	.0257	314.7
7453		.501	15119.4	13.55	-4.78	.7174	-.0374	.0206	.0042	.0148	.0254	314.5
7454		.502	15184.3	15.87	-4.71	.8194	-.0381	.0167	.0044	.0158	.0248	314.2
7455		.501	15110.4	18.09	-4.63	.9115	-.0394	.0121	.0039	.0177	.0215	314.0
7456		.501	15108.9	20.45	-4.55	1.0052	-.0421	.0097	.0028	.0208	.0161	313.8
7457		.500	15076.3	22.52	-4.46	1.0654	-.0414	.0052	.0035	.0259	.0081	313.6
7458		.503	15224.5	24.70	-4.38	1.1159	-.0393	-.0050	.0009	.0273	.0110	313.3
7459		.498	14996.0	25.21	-4.35	1.1274	-.0397	-.0074	.0001	.0279	.0114	313.1
7460		.499	15048.1	.09	-5.08	-.0119	-.0156	.0059	.0025	.0164	.0302	312.4

TEST TP	21	ALPHA DEG	BETA DEG	RUN 121		CPM(SA)	CRM(SA)	CYN(SA)	CSF(SA)	P1 PA	CPB(1)	VTDT M/SEC
				CL(SA)	CD(SA)							
7445		.08	-5.08	-.0127	-.0168	.0057	.0032	.0164	.0299	86255.6	-.145	614.3
7446		-1.65	-5.09	-.1182	-.0158	.0001	.0010	.0158	.0283	86205.6	-.144	614.4
7447		.12	-5.08	-.0087	-.0163	.0059	.0027	.0164	.0298	86158.3	-.144	613.8
7448		2.15	-5.05	.1052	-.0146	.0108	.0048	.0170	.0294	86270.1	-.143	613.5
7449		4.30	-5.01	.2202	-.0065	.0138	.0056	.0172	.0271	86053.3	-.148	613.5
7450		6.59	-4.96	.3562	.0118	.0151	.0080	.0157	.0252	86113.7	-.152	613.2
7451		8.97	-4.90	.4923	.0435	.0180	.0082	.0142	.0256	86124.3	-.161	613.1
7452		11.18	-4.84	.6095	.0840	.0201	.0083	.0133	.0257	86177.5	-.169	612.9
7453		13.55	-4.78	.7062	.1317	.0206	.0076	.0134	.0254	86114.4	-.171	612.6
7454		15.87	-4.71	.7986	.1874	.0167	.0085	.0140	.0248	86040.2	-.175	612.6
7455		18.09	-4.63	.8787	.2455	.0121	.0092	.0156	.0215	86163.7	-.188	612.4
7456		20.45	-4.55	.9566	.3118	.0097	.0099	.0185	.0161	86133.2	-.203	612.3
7457		22.52	-4.46	.9999	.3699	.0052	.0132	.0226	.0081	86177.5	-.208	612.0
7458		24.70	-4.38	1.0302	.4306	-.0050	.0122	.0244	.0110	86016.8	-.212	611.9
7459		25.21	-4.35	1.0370	.4442	-.0074	.0119	.0252	.0114	86272.5	-.214	611.6
7460		.09	-5.08	-.0118	-.0156	.0059	.0025	.0164	.0302	86211.6	-.144	611.0

TEST TP	21	Q PA	ALPHA DEG	RUN 121		CLT	CDT	CMST	CRTS	CYTS	CYST	CRU	WTFLOD KG/SEC	PLENP PSI
				BETA DEG	CLT									
7445		15012.6	.08	-5.08	-.0244	.0112	-.0108	.0032	.0159	.0315	.0497	.1402	280.7	
7446		15036.6	-1.65	-5.09	-.1290	.0126	-.0164	.0010	.0152	.0299	.0499	.1410	281.8	
7447		15126.0	.12	-5.08	-.0203	.0114	-.0105	.0027	.0159	.0314	.0493	.1404	280.8	
7448		15039.6	2.15	-5.05	.0926	.0129	-.0057	.0048	.0164	.0310	.0497	.1407	280.8	
7449		15184.8	4.30	-5.01	.2066	.0202	-.0025	.0055	.0167	.0286	.0492	.1407	280.9	
7450		15129.0	6.59	-4.96	.3416	.0381	-.0013	.0080	.0151	.0268	.0494	.1409	281.2	
7451		15114.9	8.97	-4.90	.4765	.0692	.0016	.0081	.0137	.0271	.0495	.1409	281.2	
7452		15065.8	11.18	-4.84	.5927	.1091	.0036	.0081	.0128	.0273	.0497	.1412	281.5	
7453		15119.4	13.55	-4.78	.6884	.1561	.0041	.0075	.0128	.0270	.0495	.1411	281.6	
7454		15184.3	15.87	-4.71	.7799	.2109	.0003	.0084	.0135	.0263	.0494	.1413	281.9	
7455		15110.4	18.09	-4.63	.8590	.2684	-.0043	.0090	.0151	.0231	.0497	.1416	282.0	
7456		15108.9	20.45	-4.55	.9359	.3339	-.0068	.0097	.0180	.0176	.0498	.1419	282.3	
7457		15076.3	22.52	-4.46	.9784	.3913	-.0113	.0129	.0220	.0096	.0499	.1419	282.4	
7458		15224.5	24.70	-4.38	1.0081	.4510	-.0214	.0120	.0239	.0125	.0495	.1421	282.8	
7459		14996.0	25.21	-4.35	1.0143	.4648	-.0240	.0117	.0247	.0130	.0502	.1422	283.0	
7460		15048.1	.09	-5.08	-.0236	.0125	-.0108	.0025	.0159	.0317	.0502	.1427	283.3	

ORIGINAL PAGE IS
OF POOR QUALITY

NASA LANGLEY

7 X 10 HIGH SPEED TUNNEL

TEST TP	21 MACH	Q PA	RUN 122 ALPHA DEG	BETA DEG	CNF(BA)	CAF(BA)	CPH(BA)	CRM(BA)	CYM(BA)	CSF(BA)	TPLEN DEG K
7477	.499	14900.3	.05	-5.06	-.0063	.0123	.0022	.0014	.0145	.0241	299.4
7478	.497	14808.7	-1.96	-5.09	-.1384	.0086	-.0020	-.0011	.0145	.0247	299.7
7479	.500	14959.8	.10	-5.06	-.0055	.0121	.0026	.0013	.0142	.0243	300.1
7480	.503	15081.3	2.29	-5.03	.1144	.0074	.0036	.0139	.0240	.0240	300.5
7481	.501	14999.5	4.34	-4.99	.2280	.0095	.0056	.0138	.0231	.0231	301.0
7482	.502	15067.0	6.53	-4.95	.3509	.0108	-.0029	.0108	.0061	.0140	301.4
7483	.501	14997.7	8.75	-4.90	.4776	.0117	-.0073	.0117	.0058	.0131	302.0
7484	.500	14953.8	11.12	-4.84	.5957	.0140	-.0084	.0140	.0034	.0131	302.5
7485	.497	14798.4	13.46	-4.78	.7107	.0116	-.0086	.0116	.0037	.0136	303.0
7486	.499	14881.8	15.71	-4.71	.8041	.0116	-.0085	.0116	.0019	.0161	303.3
7487	.498	14846.9	17.82	-4.64	.8775	.0116	-.0078	.0116	.0006	.0220	303.7
7488	.496	14767.4	20.04	-4.57	.8780	.0119	-.0202	.0119	-.0039	.0294	304.0
7489	.500	14943.3	22.16	-4.47	.9158	.0116	-.0135	.0116	.0032	.0241	304.3
7490	.499	14906.8	24.30	-4.36	.9817	.0118	-.0118	.0118	.0069	.0213	304.5
7491	.499	14916.7	25.01	-4.33	1.0124	.0128	-.0128	.0128	.0083	.0204	304.7
7492	.500	14944.9	.06	-5.06	-.0056	.0111	.0027	.0008	.0143	.0244	305.0

TEST TP	21 ALPHA DEG	BETA DEG	RUN 122 CL(SA)	CD(SA)	CPH(SA)	CRM(SA)	CYM(SA)	CSF(SA)	P1 PA	CPB(1)	VTDT M/SEC
7477	.05	-5.06	-.0063	.0123	.0022	.0014	.0145	.0241	85546.0	-.146	0.0
7478	-1.96	-5.09	-.1380	.0133	-.0020	-.0016	.0145	.0247	85598.0	-.145	0.0
7479	.10	-5.06	-.0055	.0121	.0026	.0013	.0142	.0243	85421.7	-.145	0.0
7480	2.29	-5.03	.1144	.0141	.0074	.0036	.0139	.0240	85297.6	-.145	0.0
7481	4.34	-4.99	.2280	.0207	.0095	.0056	.0138	.0231	85386.0	-.143	0.0
7482	6.53	-4.95	.3489	.0371	.0108	.0077	.0132	.0231	85314.3	-.146	0.0
7483	8.75	-4.90	.4731	.0655	.0117	.0077	.0121	.0253	85374.0	-.152	0.0
7484	11.12	-4.84	.5861	.1067	.0148	.0059	.0121	.0274	85420.6	-.157	0.0
7485	13.46	-4.78	.6932	.1571	.0116	.0068	.0123	.0292	85587.3	-.159	0.0
7486	15.71	-4.71	.7764	.2096	.0054	.0061	.0150	.0273	85498.7	-.169	0.0
7487	17.82	-4.64	.8368	.2640	-.0078	.0073	.0207	.0166	85538.3	-.185	0.0
7488	20.04	-4.57	.8242	.3026	-.0202	.0064	.0290	.0129	85628.1	-.188	0.0
7489	22.16	-4.47	.8479	.3459	-.0135	.0120	.0211	.0159	85435.2	-.196	0.0
7490	24.30	-4.36	.8960	.4012	-.0118	.0150	.0165	.0159	85477.0	-.205	0.0
7491	25.01	-4.33	.9194	.4241	-.0128	.0162	.0150	.0159	85512.8	-.208	0.0
7492	.06	-5.06	-.0056	.0111	.0027	.0008	.0143	.0244	85433.3	-.145	0.0

TEST TP	21 Q PA	ALPHA DEG	RUN 122 BETA DEG	CLT	CDT	CMST	CRYS	CYTS	CYST	CHU	WTFLO KG/SEC	PLENP [†] PSI
7477	14900.3	.05	-5.06	-.0063	.0123	.0022	.0014	.0145	.0241	0.0000	0.0000	-.1
7478	14808.7	-1.96	-5.09	-.1380	.0133	-.0020	-.0016	.0145	.0247	0.0000	0.0000	-.1
7479	14959.8	.10	-5.06	-.0055	.0121	.0026	.0013	.0142	.0243	0.0000	0.0000	-.1
7480	15081.3	2.29	-5.03	.1144	.0141	.0074	.0036	.0139	.0240	0.0000	0.0000	-.1
7481	14999.5	4.34	-4.99	.2280	.0207	.0095	.0056	.0138	.0231	0.0000	0.0000	-.1
7482	15067.0	6.53	-4.95	.3489	.0371	.0108	.0077	.0132	.0231	0.0000	0.0000	-.2
7483	14997.7	8.75	-4.90	.4731	.0655	.0117	.0077	.0121	.0253	0.0000	0.0000	-.2
7484	14953.8	11.12	-4.84	.5861	.1067	.0148	.0059	.0121	.0274	0.0000	0.0000	-.2
7485	14798.4	13.46	-4.78	.6932	.1571	.0116	.0068	.0123	.0292	0.0000	0.0000	-.3
7486	14881.8	15.71	-4.71	.7764	.2096	.0054	.0061	.0150	.0273	0.0000	0.0000	-.4
7487	14846.9	17.82	-4.64	.8368	.2640	-.0078	.0073	.0207	.0166	0.0000	0.0000	-.5
7488	14767.4	20.04	-4.57	.8242	.3026	-.0202	.0064	.0290	.0129	0.0000	0.0000	-.6
7489	14943.3	22.16	-4.47	.8479	.3459	-.0135	.0120	.0211	.0159	0.0000	0.0000	-.7
7490	14906.8	24.30	-4.36	.8960	.4012	-.0118	.0150	.0165	.0159	0.0000	0.0000	-.8
7491	14916.7	25.01	-4.33	.9194	.4241	-.0128	.0162	.0150	.0159	0.0000	0.0000	-.9
7492	14944.9	.06	-5.06	-.0056	.0111	.0027	.0008	.0143	.0244	0.0000	0.0000	-.1

NASA LANGLEY

7 X 10 HIGH SPEED TUNNEL

TEST TP	21 MACH	Q PA	RUN 123		CNF(BA)	CAF(BA)	CPH(BA)	CRM(BA)	CYH(BA)	CSF(BA)	TPLEN DEG K
			ALPHA DEG	BETA DEG							
7493	.701	25082.4	.07	-5.11	-.0019	.0110	.0033	.0011	.0146	.0244	306.1
7494	.698	24948.8	-2.07	-5.13	-.1402	.0084	-.0006	-.0015	.0148	.0252	306.4
7495	.703	25195.4	.10	-5.11	-.0008	.0111	.0033	.0010	.0146	.0248	306.8
7496	.708	25422.2	2.38	-5.08	.1288	.0078	.0070	.0034	.0147	.0246	307.3
7497	.697	24913.7	4.76	-5.04	.2642	.0014	.0082	.0051	.0146	.0238	309.7
7498	.701	25070.0	7.14	-4.99	.4023	-.0036	.0073	.0063	.0145	.0240	310.2
7499	.699	24999.1	9.58	-4.94	.5328	-.0053	.0080	.0046	.0140	.0257	310.8
7500	.697	24920.0	11.97	-4.89	.6388	-.0037	.0049	.0032	.0139	.0276	311.4
7501	.698	24960.2	14.42	-4.83	.7424	-.0030	-.0023	.0032	.0156	.0280	311.9
7502	.694	24761.7	16.67	-4.76	.8232	-.0016	-.0133	.0033	.0193	.0238	312.3
7503	.698	24952.5	18.76	-4.73	.8400	.0035	-.0237	-.0042	.0305	.0134	312.7
7504	.700	25053.5	.09	-5.11	.0010	.0106	.0037	.0010	.0146	.0246	312.9

TEST TP	21 ALPHA DEG	BETA DEG	RUN 123		CPH(SA)	CRM(SA)	CYH(SA)	CSF(SA)	PI PA	CPB(SA)	VTOT M/SEC
			CL(SA)	CD(SA)							
7493	.07	-5.11	-.0019	.0110	.0033	.0011	.0146	.0244	73018.2	-.149	0.0
7494	-2.07	-5.13	-.1398	.0135	-.0006	-.0020	.0147	.0252	73182.3	-.147	0.0
7495	.10	-5.11	-.0008	.0111	.0033	.0011	.0146	.0248	72866.0	-.149	0.0
7496	2.38	-5.08	.1284	.0132	.0070	.0040	.0146	.0246	72547.6	-.150	0.0
7497	4.76	-5.04	.2631	.0233	.0082	.0063	.0141	.0238	73193.3	-.148	0.0
7498	7.14	-4.99	.3996	.0464	.0073	.0080	.0136	.0240	72980.5	-.152	0.0
7499	9.58	-4.94	.5263	.0835	.0080	.0068	.0130	.0257	73073.7	-.158	0.0
7500	11.97	-4.89	.6257	.1288	.0049	.0060	.0130	.0276	73185.1	-.160	0.0
7501	14.42	-4.83	.7198	.1820	-.0023	.0070	.0144	.0280	73220.6	-.168	0.0
7502	16.67	-4.76	.7891	.2346	-.0133	.0087	.0175	.0238	73428.8	-.185	0.0
7503	18.76	-4.73	.7943	.2735	-.0237	.0058	.0303	.0134	73137.1	-.184	0.0
7504	.09	-5.11	.0010	.0106	.0037	.0010	.0146	.0246	73059.8	-.148	0.0

TEST TP	21 Q PA	ALPHA DEG	BETA DEG	CLT	CDT	CMST	CRTS	CYTS	CYST	CHU	WTFLO KG/SEC	PLENPSI
7494	24948.8	-2.07	-5.13	-.1398	.0135	-.0006	-.0020	.0147	.0252	0.0000	0.0000	-.2
7495	25195.4	.10	-5.11	-.0008	.0111	.0033	.0011	.0146	.0248	0.0000	0.0000	-.2
7496	25422.2	2.38	-5.08	.1284	.0132	.0070	.0040	.0146	.0246	0.0000	0.0000	-.2
7497	24913.7	4.76	-5.04	.2631	.0233	.0082	.0063	.0141	.0238	0.0000	0.0000	-.3
7498	25070.0	7.14	-4.99	.3996	.0464	.0073	.0080	.0136	.0240	0.0000	0.0000	-.4
7499	24999.1	9.58	-4.94	.5263	.0835	.0080	.0068	.0130	.0257	0.0000	0.0000	-.4
7500	24920.0	11.97	-4.89	.6257	.1288	.0049	.0060	.0130	.0276	0.0000	0.0000	-.5
7501	24960.2	14.42	-4.83	.7198	.1820	-.0023	.0070	.0144	.0280	0.0000	0.0000	-.7
7502	24761.7	16.67	-4.76	.7891	.2346	-.0133	.0087	.0175	.0238	0.0000	0.0000	-.8
7503	24952.5	18.76	-4.73	.7943	.2735	-.0237	.0058	.0303	.0134	0.0000	0.0000	-.9
7504	25053.5	.09	-5.11	.0010	.0106	.0037	.0010	.0146	.0246	0.0000	0.0000	-.9

NASA LANGLEY

7 X 10 HIGH SPEED TUNNEL.

TEST TP	21 MACH	Q PA	RUN 124 ALPHA DEG	BETA DEG	CNF(BA)	CAF(BA)	CPM(BA)	CRM(BA)	CYM(BA)	CSF(BA)	TPLEN DEG K
7505	.699	25002.9	.09	-5.13	-.0056	-.0150	.0085	.0028	.0174	.0319	295.1
7506	.698	24950.0	-2.09	-5.15	-.1428	-.0179	.0013	.0010	.0161	.0302	294.9
7507	.700	25055.9	.15	-5.13	-.0039	-.0150	.0080	.0027	.0173	.0318	295.0
7508	.705	25267.0	2.49	-5.10	.1238	-.0175	.0130	.0037	.0175	.0317	295.0
7509	.709	25480.4	4.75	-5.06	.2549	-.0226	.0122	.0049	.0178	.0274	295.2
7510	.704	25239.5	7.18	-5.01	.4070	-.0277	.0131	.0061	.0166	.0262	295.4
7511	.702	25158.9	9.62	-4.95	.5408	-.0297	.0121	.0053	.0159	.0250	295.8
7512	.697	24916.8	12.16	-4.89	.6687	-.0307	.0097	.0050	.0153	.0264	296.2
7513	.698	24932.2	14.60	-4.82	.7659	-.0306	.0072	.0071	.0157	.0270	296.6
7514	.696	24859.5	16.85	-4.75	.8471	-.0322	.0076	.0062	.0170	.0261	297.2
7515	.698	24953.5	19.34	-4.69	.9511	-.0338	.0023	.0026	.0216	.0212	297.8
7516	.699	24992.1	.08	-5.13	-.0077	-.0165	.0068	.0025	.0174	.0321	300.8

TEST TP	21 ALPHA DEG	BETA DEG	RUN 124 CL(SA)	CD(SA)	CPM(SA)	CRM(SA)	CYM(SA)	CSF(SA)	P1 PA	CPB(1)	VTOT N/SEC.
7505	.09	-5.13	-.0056	-.0150	.0085	.0029	.0174	.0319	73061.3	-.146	625.3
7506	-2.09	-5.15	-.1433	-.0127	.0013	.0004	.0161	.0302	73212.8	-.146	625.1
7507	.15	-5.13	-.0039	-.0150	.0080	.0028	.0173	.0318	73024.9	-.146	625.3
7508	2.49	-5.10	.1244	-.0121	.0130	.0045	.0174	.0317	72710.8	-.148	625.5
7509	4.75	-5.06	.2559	-.0014	.0122	.0064	.0173	.0274	72437.0	-.158	626.0
7510	7.18	-5.01	.4072	.0234	.0131	.0081	.0157	.0262	72764.0	-.160	626.0
7511	9.62	-4.95	.5381	.0611	.0121	.0079	.0148	.0250	72865.1	-.171	626.3
7512	12.16	-4.89	.6601	.1108	.0097	.0081	.0139	.0264	73189.2	-.174	626.5
7513	14.60	-4.82	.7489	.1634	.0072	.0103	.0134	.0270	73169.0	-.174	626.9
7514	16.85	-4.75	.8201	.2147	.0076	.0109	.0145	.0261	73316.6	-.184	627.5
7515	19.34	-4.69	.9086	.2830	.0023	.0096	.0196	.0212	73133.7	-.203	628.2
7516	.08	-5.13	-.0077	-.0165	.0068	.0025	.0173	.0321	73070.8	-.147	631.5

TEST TP	21 Q PA	ALPHA DEG	RUN 124 BETA DEG	CLT	CDT	CMST	CRTS	CYTS	CYST	CHU	WTFLO KG/SEC	PLENP PSI
7505	25002.9	.09	-5.13	-.0168	.0119	-.0074	.0029	.0168	.0334	.0505	.2330	450.7
7506	24950.0	-2.09	-5.15	-.1536	.0148	-.0147	.0004	.0156	.0317	.0506	.2334	451.0
7507	25055.9	.15	-5.13	-.0152	.0118	-.0079	.0028	.0168	.0333	.0504	.2331	451.3
7508	25267.0	2.49	-5.10	.1122	.0141	-.0028	.0044	.0168	.0332	.0500	.2333	451.6
7509	25480.4	4.75	-5.06	.2427	.0241	-.0035	.0063	.0168	.0289	.0496	.2333	452.0
7510	25239.5	7.18	-5.01	.3928	.0485	-.0027	.0080	.0151	.0277	.0501	.2331	452.0
7511	25158.9	9.62	-4.95	.5226	.0857	-.0038	.0078	.0143	.0265	.0503	.2332	452.5
7512	24916.8	12.16	-4.89	.6434	.1350	-.0063	.0080	.0134	.0279	.0507	.2327	452.1
7513	24932.2	14.60	-4.82	.7312	.1858	-.0088	.0107	.0129	.0285	.0506	.2325	452.0
7514	24859.5	16.85	-4.75	.8014	.2374	-.0085	.0107	.0139	.0276	.0507	.2322	451.7
7515	24953.5	19.34	-4.69	.8890	.3048	-.0137	.0094	.0190	.0227	.0506	.2321	451.8
7516	24992.1	.08	-5.13	-.0190	.0106	-.0092	.0025	.0168	.0336	.0505	.2307	452.3

ORIGINAL PAGE IS OF POOR QUALITY

NASA LANGLEY

7 X 10 HIGH SPEED TUNNEL

TEST TP	21	MACH	Q PA	RUN 125 ALPHA DEG	BETA DEG	CHF(BA)	CAF(BA)	CPH(BA)	CRM(BA)	CYH(BA)	CSF(BA)	TPLEN DEG K
7530		.301	6044.4	.09	-5.01	-.0054	.0155	-.0003	.0093	-.0180	.0747	312.5
7531		.301	6030.4	-1.71	-5.03	-.1228	.0104	-.0054	.0073	-.0173	.0732	312.5
7532		.301	6035.2	.26	-5.01	.0051	.0158	-.0001	.0096	-.0182	.0755	312.5
7533		.302	6070.8	2.00	-4.98	.1022	.0142	.0046	.0110	-.0183	.0758	312.5
7534		.302	6061.8	4.03	-4.94	.2100	.0088	.0070	.0123	-.0180	.0743	312.5
7535		.302	6082.5	6.15	-4.89	.3287	.0019	.0084	.0138	-.0182	.0744	312.5
7536		.299	5977.1	8.34	-4.84	.4551	-.0036	.0093	.0141	-.0185	.0753	312.5
7537		.302	6071.2	10.47	-4.79	.5666	-.0065	.0119	.0118	-.0181	.0765	312.4
7538		.301	6034.6	12.62	-4.72	.6701	-.0083	.0121	.0115	-.0168	.0764	312.4
7539		.300	6005.8	14.78	-4.65	.7735	-.0091	.0084	.0096	-.0148	.0760	312.4
7540		.299	5980.0	17.03	-4.57	.8699	-.0091	.0001	.0074	-.0125	.0716	312.3
7541		.301	6018.8	19.11	-4.50	.9081	-.0023	-.0153	-.0007	.0011	.0515	312.3
7542		.300	5983.3	21.17	-4.42	.9516	.0009	-.0309	-.0004	.0070	.0446	312.3
7543		.300	5993.3	23.29	-4.32	.9996	-.0012	-.0309	-.0004	.0100	.0376	312.2
7544		.299	5958.5	23.93	-4.30	1.0224	-.0024	-.0314	-.0016	.0119	.0357	312.2
7545		.299	5947.1	.09	-5.01	-.0051	.0152	-.0001	.0095	-.0180	.0740	312.2

TEST TP	21	ALPHA DEG	BETA DEG	RUN 125 CL(SA)	CD(SA)	CPH(SA)	CRM(SA)	CYH(SA)	CSF(SA)	P1 PA	CPB(1)	VTOT M/SEC
7530		.09	-5.01	-.0055	.0155	-.0003	.0093	-.0180	.0747	95179.8	-.131	0.0
7531		-1.71	-5.03	-.1224	.0140	-.0054	.0078	-.0170	.0732	95194.4	-.128	0.0
7532		.26	-5.01	.0050	.0158	-.0001	.0095	-.0182	.0755	95187.2	-.130	0.0
7533		2.00	-4.98	.1016	.0178	.0046	.0104	-.0187	.0758	95152.9	-.132	0.0
7534		4.03	-4.94	.2088	.0235	.0070	.0110	-.0188	.0743	95164.9	-.135	0.0
7535		6.15	-4.89	.3266	.0371	.0084	.0118	-.0195	.0744	95140.4	-.137	0.0
7536		8.34	-4.84	.4508	.0625	.0093	.0112	-.0204	.0753	95232.5	-.141	0.0
7537		10.47	-4.79	.5584	.0966	.0119	.0083	-.0200	.0765	95147.1	-.142	0.0
7538		12.62	-4.72	.6557	.1382	.0121	.0075	-.0189	.0764	95183.3	-.147	0.0
7539		14.78	-4.65	.7503	.1855	.0084	.0055	-.0167	.0760	95216.9	-.153	0.0
7540		17.03	-4.57	.8344	.2461	.0001	.0034	-.0141	.0716	95245.9	-.166	0.0
7541		19.11	-4.50	.8588	.2951	-.0153	-.0003	.0013	.0515	95201.0	-.169	0.0
7542		21.17	-4.42	.8870	.3444	-.0309	.0021	.0067	.0446	95243.8	-.171	0.0
7543		23.29	-4.32	.9186	.3942	-.0309	.0035	.0093	.0376	95239.2	-.175	0.0
7544		23.93	-4.30	.9354	.4126	-.0314	.0034	.0115	.0357	95282.3	-.177	0.0
7545		.09	-5.01	-.0052	.0151	-.0001	.0095	-.0180	.0740	95271.5	-.130	0.0

TEST TP	21	Q PA	ALPHA DEG	RUN 125 BETA DEG	CLT	CDT	CMST	CRTS	CYTS	CYST	CMU	WTFLO KG/SEC	PLENP PS1
7530		6044.4	.09	-5.01	-.0055	.0155	-.0003	.0093	-.0180	.0747	0.0000	0.0000	.0
7531		6030.4	-1.71	-5.03	-.1224	.0140	-.0054	.0078	-.0170	.0732	0.0000	0.0000	-.0
7532		6035.2	.26	-5.01	.0050	.0158	-.0001	.0095	-.0182	.0755	0.0000	0.0000	-.0
7533		6070.8	2.00	-4.98	.1016	.0178	.0046	.0104	-.0187	.0758	0.0000	0.0000	-.0
7534		6061.8	4.03	-4.94	.2088	.0235	.0070	.0110	-.0188	.0743	0.0000	0.0000	-.0
7535		6082.5	6.15	-4.89	.3266	.0371	.0084	.0118	-.0195	.0744	0.0000	0.0000	-.0
7536		5977.1	8.34	-4.84	.4508	.0625	.0093	.0112	-.0204	.0753	0.0000	0.0000	-.0
7537		6071.2	10.47	-4.79	.5584	.0966	.0119	.0083	-.0200	.0765	0.0000	0.0000	-.1
7538		6034.6	12.62	-4.72	.6557	.1382	.0121	.0075	-.0189	.0764	0.0000	0.0000	-.1
7539		6005.8	14.78	-4.65	.7503	.1855	.0084	.0055	-.0167	.0760	0.0000	0.0000	-.2
7540		5980.0	17.03	-4.57	.8344	.2461	.0001	.0034	-.0141	.0716	0.0000	0.0000	-.2
7541		6018.8	19.11	-4.50	.8588	.2951	-.0153	-.0003	.0013	.0515	0.0000	0.0000	-.3
7542		5983.3	21.17	-4.42	.8870	.3444	-.0309	.0021	.0067	.0446	0.0000	0.0000	-.2
7543		5993.3	23.29	-4.32	.9186	.3942	-.0309	.0035	.0093	.0376	0.0000	0.0000	-.3
7544		5958.5	23.93	-4.30	.9354	.4126	-.0314	.0034	.0115	.0357	0.0000	0.0000	-.3
7545		5947.1	.09	-5.01	-.0052	.0151	-.0001	.0095	-.0180	.0740	0.0000	0.0000	-.1

NASA LANGLEY

7 X 10 HIGH SPEED TUNNEL

TEST TP	21 MACH	Q PA	RUN 126 ALPHA DEG		BETA DEG	CNF(BA)	CAF(BA)	CPH(BA)	CRN(BA)	CYM(BA)	CSF(BA)	TPLEN DEG K
7546	.300	6004.8	.07	-5.01	-0.145	-0.0116	.0031	.0111	-.0165	.0791	.0791	305.3
7547	.300	5990.3	-1.84	-5.03	-0.1364	-0.0168	-.0053	.0087	-.0166	.0765	.0765	305.0
7548	.301	6032.6	.17	-5.01	-0.0086	-0.0108	.0034	.0112	-.0167	.0803	.0803	304.6
7549	.302	6059.0	2.01	-4.98	-0.0939	-0.0119	.0096	.0122	-.0158	.0805	.0805	304.2
7550	.301	6043.0	4.01	-4.95	-.1989	-0.0164	.0127	.0122	-.0153	.0800	.0800	304.0
7551	.301	6018.5	6.15	-4.90	-.3273	-0.0223	.0141	.0137	-.0159	.0805	.0805	303.7
7552	.300	6014.6	8.27	-4.85	-.4537	-0.0291	.0161	.0136	-.0164	.0800	.0800	303.5
7553	.300	5988.6	10.43	-4.79	-.5786	-0.0336	.0185	.0130	-.0166	.0791	.0791	303.3
7554	.299	5973.0	12.65	-4.72	-.6910	-0.0374	.0235	.0128	-.0155	.0781	.0781	303.1
7555	.301	6020.1	14.87	-4.65	-.8001	-0.0392	.0192	.0113	-.0136	.0745	.0745	303.0
7556	.300	5992.5	17.10	-4.57	-.9074	-0.0419	.0130	.0113	-.0121	.0701	.0701	302.8
7557	.299	5970.7	19.22	-4.49	-.9980	-0.0443	.0053	.0103	-.0110	.0634	.0634	302.7
7558	.300	5983.9	21.30	-4.41	-1.0707	-0.0469	-.0004	.0057	-.0056	.0549	.0549	302.6
7559	.299	5976.6	23.48	-4.31	-1.1477	-0.0467	-.0062	.0042	-.0014	.0486	.0486	302.5
7560	.300	6007.3	24.10	-4.29	-1.1658	-0.0472	-.0068	.0030	-.0015	.0463	.0463	302.4
7561	.300	5991.5	.05	-5.01	-.0072	-0.0108	.0014	.0112	-.0165	.0802	.0802	302.1

TEST TP	21 ALPHA DEG	BETA DEG	RUN 126 CL(SA)	CD(SA)	CPH(SA)	CRN(SA)	CYM(SA)	CSF(SA)	P1 PA	CPB(1)	VTOT M/SEC
7546	.07	-5.01	-.0144	-0.0116	.0031	.0111	-.0165	.0791	95204.3	-.130	541.6
7547	-1.84	-5.03	-.1369	-0.0124	-.0053	.0092	-.0163	.0765	95217.5	-.128	540.8
7548	.17	-5.01	-.0086	-0.0108	.0034	.0112	-.0167	.0803	95171.8	-.131	540.3
7549	2.01	-4.98	-.0939	-0.0086	.0096	.0116	-.0162	.0805	95144.2	-.134	540.0
7550	4.01	-4.95	-.1996	-0.0024	.0127	.0111	-.0161	.0800	95160.9	-.137	539.8
7551	6.15	-4.90	-.3278	.0129	.0141	.0119	-.0173	.0805	95188.4	-.142	539.7
7552	8.27	-4.85	-.4532	.0365	.0161	.0111	-.0181	.0800	95190.7	-.147	539.4
7553	10.43	-4.79	-.5752	.0718	.0185	.0098	-.0187	.0791	95214.3	-.155	539.3
7554	12.65	-4.72	-.6824	.1148	.0235	.0091	-.0179	.0781	95230.8	-.158	539.2
7555	14.87	-4.65	-.7833	.1675	.0192	.0074	-.0160	.0745	95181.6	-.155	539.1
7556	17.10	-4.57	-.8796	.2267	.0130	.0073	-.0149	.0701	95207.0	-.158	539.0
7557	19.22	-4.49	-.9570	.2867	.0053	.0061	-.0138	.0634	95230.9	-.167	539.0
7558	21.30	-4.41	-1.0146	.3453	-.0004	.0033	-.0073	.0549	95226.2	-.179	538.8
7559	23.48	-4.31	-1.0713	.4145	-.0062	.0033	-.0030	.0486	95237.4	-.189	538.8
7560	24.10	-4.29	-1.0834	.4329	-.0068	.0033	-.0002	.0463	95211.9	-.192	538.7
7561	.05	-5.01	-.0072	-0.0108	.0014	.0111	-.0165	.0802	95214.8	-.130	538.4

TEST TP	21 Q PA	ALPHA DEG	BETA DEG	RUN 126 CLT	CDT	CMST	CRS	CYTS	CYST	CNU	WTFLO KG/SEC	PLENP PSI
7546	6004.8	.07	-5.01	-.0270	.0185	-0.0147	.0111	-.0171	.0808	.0506	.0648	121.0
7547	5990.3	-1.84	-5.03	-.1484	.0180	-0.0230	.0092	-.0169	.0781	.0502	.0643	120.1
7548	6032.6	.17	-5.01	-.0210	.0188	-0.0141	.0112	-.0173	.0820	.0498	.0642	119.7
7549	6059.0	2.01	-4.98	.0810	.0205	-0.0078	.0116	-.0168	.0822	.0496	.0643	119.8
7550	6043.0	4.01	-4.95	.1852	.0263	-0.0048	.0111	-.0167	.0817	.0498	.0643	119.9
7551	6018.5	6.15	-4.90	.3123	.0412	-0.0035	.0118	-.0179	.0821	.0502	.0646	119.9
7552	6014.6	8.27	-4.85	.4366	.0642	-.0015	.0110	-.0187	.0817	.0500	.0644	120.0
7553	5988.6	10.43	-4.79	.5575	.0990	.0008	.0097	-.0193	.0808	.0503	.0645	120.1
7554	5973.0	12.65	-4.72	.6637	.1414	.0058	.0089	-.0185	.0798	.0505	.0646	120.1
7555	6020.1	14.87	-4.65	.7637	.1931	.0016	.0073	-.0166	.0762	.0502	.0647	120.2
7556	5992.5	17.10	-4.57	.8589	.2517	-.0047	.0071	-.0155	.0718	.0503	.0646	120.2
7557	5970.7	19.22	-4.49	.9352	.3110	-.0125	.0059	-.0144	.0651	.0504	.0645	120.3
7558	5983.9	21.30	-4.41	.9921	.3667	-.0181	.0031	-.0079	.0566	.0505	.0647	120.3
7559	5976.6	23.48	-4.31	1.0478	.4371	-0.0240	.0030	-.0035	.0503	.0505	.0647	120.4
7560	6007.3	24.10	-4.29	1.0598	.4551	-0.0245	.0031	-.0004	.0480	.0502	.0647	120.4
7561	5991.5	.05	-5.01	-.0197	.0192	-0.0164	.0111	-.0171	.0819	.0505	.0649	120.3

NASA LANGLEY

7 X 10 HIGH SPEED TUNNEL

TEST TP	21 MACH	Q PA	RUN 127		CNF(BA)	CAF(BA)	CPM(BA)	CRN(BA)	CYM(BA)	CSF(BA)	TPLEN DEG K
			ALPHA DEG	BETA DEG							
7562	.300	6006.2	.07	-5.01	-.0133	-.0378	.0101	.0130	-.0158	.0837	298.9
7563	.300	5998.5	-1.82	-5.04	-.1265	-.0431	-.0002	.0105	-.0164	.0811	298.9
7564	.300	6011.6	.15	-5.01	-.0103	-.0380	.0110	.0131	-.0158	.0835	298.8
7565	.301	6048.0	2.04	-4.98	.0940	-.0382	.0153	.0133	-.0144	.0830	298.8
7566	.302	6089.3	4.02	-4.95	.1958	-.0420	.0191	.0119	-.0135	.0807	298.8
7567	.302	6060.8	6.16	-4.90	.3302	-.0482	.0173	.0135	-.0147	.0799	298.8
7568	.301	6048.5	8.46	-4.85	.4810	-.0567	.0190	.0144	-.0150	.0787	298.8
7569	.301	6022.5	10.58	-4.79	.6162	-.0524	.0198	.0129	-.0149	.0792	298.8
7570	.300	6010.6	12.65	-4.73	.7497	-.0693	.0248	.0115	-.0136	.0796	298.8
7571	.299	5974.4	14.90	-4.66	.8632	-.0751	.0355	.0125	-.0108	.0762	298.8
7572	.300	5990.8	17.05	-4.58	.9560	-.0778	.0359	.0104	-.0088	.0703	298.8
7573	.299	5952.5	19.26	-4.50	1.0536	-.0814	.0299	.0078	-.0055	.0627	298.8
7574	.299	5969.2	21.39	-4.41	1.1484	-.0836	.0199	.0074	-.0027	.0553	298.8
7575	.299	5949.7	23.51	-4.31	1.2354	-.0862	.0107	.0061	-.0017	.0484	298.8
7576	.300	5979.4	24.21	-4.28	1.2619	-.0860	.0070	.0049	-.0011	.0469	298.8
7577	.300	5995.5	.07	-5.01	-.0092	-.0386	.0085	.0132	-.0157	.0827	298.7

TEST TP	21 ALPHA DEG	BETA DEG	RUN 127		CPM(SA)	CRN(SA)	CYM(SA)	CSF(SA)	P1 PA	CPB(1)	VTOT M/SEC
			CL(SA)	CD(SA)							
7562	.07	-5.01	-.0132	-.0378	.0101	.0130	-.0158	.0837	95192.7	-.130	579.8
7563	-1.82	-5.04	-.1278	-.0391	-.0002	.0111	-.0160	.0811	95200.7	-.126	579.7
7564	.15	-5.01	-.0102	-.0381	.0110	.0131	-.0158	.0835	95187.0	-.131	579.8
7565	2.04	-4.98	.0953	-.0349	.0153	.0128	-.0149	.0830	95151.1	-.130	579.6
7566	4.02	-4.95	.1983	-.0282	.0191	.0109	-.0143	.0807	95112.4	-.135	579.6
7567	6.16	-4.90	.3335	-.0125	.0173	.0119	-.0161	.0799	95138.9	-.139	579.7
7568	8.46	-4.85	.4841	.0148	.0190	.0120	-.0169	.0787	95156.5	-.144	579.8
7569	10.58	-4.79	.6171	.0519	.0198	.0099	-.0171	.0792	95176.3	-.149	579.9
7570	12.65	-4.73	.7467	.0965	.0248	.0082	-.0158	.0796	95182.5	-.156	579.9
7571	14.90	-4.66	.8535	.1493	.0355	.0093	-.0137	.0762	95222.5	-.152	580.0
7572	17.05	-4.58	.9368	.2060	.0359	.0074	-.0114	.0703	95208.9	-.156	580.1
7573	19.26	-4.50	1.0215	.2706	.0299	.0056	-.0078	.0627	95242.6	-.164	580.0
7574	21.39	-4.41	1.0998	.3410	.0199	.0059	-.0052	.0553	95238.2	-.175	579.6
7575	23.51	-4.31	1.1673	.4137	.0107	.0049	-.0040	.0484	95262.0	-.187	579.4
7576	24.21	-4.28	1.1862	.4389	.0070	.0041	-.0030	.0469	95227.5	-.190	579.4
7577	.07	-5.01	-.0091	-.0386	.0085	.0132	-.0157	.0827	95193.7	-.130	579.3

TEST TP	21 Q PA	ALPHA DEG	RUN 127		CLT	CDT	CMST	CRTS	CYTS	CYST	CMU	NTFLD KG/SEC	PLENP PSI
			BETA DEG	CLT									
7562	6006.2	.07	-5.01	-.0372	.0194	-.0238	.0130	-.0170	.0869	.1014	.1213	230.2	
7563	5998.5	-1.82	-5.04	-.1498	.0190	-.0341	.0111	-.0172	.0843	.1015	.1213	230.2	
7564	6011.6	.15	-5.01	-.0342	.0192	-.0228	.0131	-.0170	.0867	.1016	.1216	230.5	
7565	6048.0	2.04	-4.98	.0697	.0210	-.0183	.0128	-.0161	.0862	.1003	.1209	229.8	
7566	6089.3	4.02	-4.95	.1709	.0264	-.0142	.0108	-.0155	.0838	.0998	.1211	229.7	
7567	6060.8	6.16	-4.90	.3039	.0414	-.0162	.0117	-.0173	.0831	.1005	.1213	230.2	
7568	6048.5	8.46	-4.85	.4522	.0676	-.0147	.0119	-.0181	.0819	.1009	.1215	230.6	
7569	6022.5	10.58	-4.79	.5831	.1038	-.0140	.0097	-.0182	.0824	.1015	.1218	231.0	
7570	6010.6	12.65	-4.73	.7107	.1474	-.0091	.0080	-.0170	.0828	.1017	.1217	231.1	
7571	5974.4	14.90	-4.66	.8153	.1991	.0013	.0090	-.0148	.0794	.1024	.1218	231.4	
7572	5990.8	17.05	-4.58	.8968	.2542	.0018	.0070	-.0126	.0735	.1022	.1219	231.7	
7573	5952.5	19.26	-4.50	.9794	.3175	-.0044	.0052	-.0089	.0660	.1028	.1218	231.8	
7574	5969.2	21.39	-4.41	1.0565	.3859	-.0141	.0055	-.0063	.0585	.1018	.1210	230.1	
7575	5949.7	23.51	-4.31	1.1223	.4570	-.0234	.0045	-.0051	.0517	.1019	.1208	229.4	
7576	5979.4	24.21	-4.28	1.1410	.4814	-.0269	.0036	-.0041	.0501	.1014	.1209	229.2	
7577	5995.5	.07	-5.01	-.0330	.0185	-.0252	.0132	-.0168	.0858	.1011	.1208	229.1	

ORIGINAL PAGE IS OF POOR QUALITY

NASA LANGLEY

7 X 10 HIGH SPEED TUNNEL

TEST TP	21 MACH	Q PA	RUN 128 ALPHA DEG	BETA DEG	CNF(BA)	CAF(BA)	CPH(BA)	CRH(BA)	CYM(BA)	CSF(BA)	TPLEN DEG-K
7578	.300	6006.4	.10	-5.02	-.0178	-.0914	.0296	.0174	-.0143	.0841	297.1
7579	.300	5997.5	-1.76	-5.04	-.1163	-.0967	.0156	.0115	-.0157	.0816	297.2
7580	.300	5998.0	.19	-5.01	-.0131	-.0916	.0296	.0175	-.0141	.0836	297.4
7581	.301	6038.2	2.03	-4.99	.0808	-.0912	.0362	.0164	-.0119	.0837	297.6
7582	.301	6037.8	4.20	-4.95	.1803	-.0942	.0402	.0125	-.0112	.0782	297.8
7583	.302	6073.8	6.18	-4.90	.3307	-.0999	.0292	.0137	-.0124	.0735	298.0
7584	.301	6027.1	8.32	-4.85	.4897	-.1089	.0254	.0145	-.0125	.0725	298.2
7585	.300	5999.4	10.40	-4.80	.6417	-.1161	.0237	.0126	-.0126	.0742	298.4
7586	.299	5966.1	12.79	-4.73	.8409	-.1267	.0186	.0098	-.0121	.0740	298.7
7587	.299	5973.1	15.05	-4.66	1.0216	-.1341	.0166	.0078	-.0104	.0738	299.0
7588	.300	5980.8	17.23	-4.58	1.1715	-.1423	.0179	.0065	-.0096	.0723	299.3
7589	.300	5999.1	19.56	-4.49	1.2433	-.1481	.0345	.0078	-.0066	.0638	299.7
7590	.299	5955.6	21.63	-4.41	1.3258	-.1501	.0290	.0060	-.0026	.0553	300.0
7591	.299	5951.7	23.73	-4.32	1.3956	-.1521	.0291	.0020	.0043	.0442	300.4
7592	.300	5999.2	24.37	-4.29	1.4193	-.1487	.0247	.0010	.0077	.0392	300.7
7593	.300	5988.3	.12	-5.02	-.0156	-.0956	.0289	.0173	-.0139	.0820	301.8

TEST TP	21 ALPHA DEG	BETA DEG	RUN 128 CL(SA)	CD(SA)	CPH(SA)	CRH(SA)	CYM(SA)	CSF(SA)	P1 PA	CPB(1)	VTOT M/SEC
7578	.10	-5.02	-.0177	-.0914	.0296	.0174	-.0143	.0841	95180.2	-.127	612.8
7579	-1.76	-5.04	-.1192	-.0931	.0156	.0120	-.0153	.0816	95190.1	-.123	612.9
7580	.19	-5.01	-.0128	-.0916	.0296	.0175	-.0142	.0836	95187.7	-.125	613.1
7581	2.03	-4.99	.0840	-.0883	.0362	.0160	-.0125	.0837	95143.6	-.129	613.3
7582	4.20	-4.95	.1867	-.0808	.0402	.0116	-.0121	.0782	95146.4	-.136	613.5
7583	6.18	-4.90	.3395	-.0637	.0292	.0123	-.0138	.0735	95110.5	-.140	613.8
7584	8.32	-4.85	.5003	-.0369	.0254	.0125	-.0145	.0725	95158.4	-.138	613.9
7585	10.40	-4.80	.6521	.0016	.0237	.0101	-.0147	.0742	95182.8	-.138	614.2
7586	12.79	-4.73	.8480	.0627	.0186	.0069	-.0140	.0740	95214.4	-.148	614.5
7587	15.05	-4.66	1.0214	.1358	.0166	.0049	-.0121	.0738	95205.8	-.149	614.8
7588	17.23	-4.58	1.1611	.2110	.0179	.0033	-.0111	.0723	95198.9	-.161	615.1
7589	19.56	-4.49	1.2212	.2767	.0345	.0052	-.0088	.0638	95188.6	-.175	615.5
7590	21.63	-4.41	1.2878	.3491	.0290	.0046	-.0046	.0553	95242.3	-.177	615.8
7591	23.73	-4.32	1.3388	.4223	.0291	.0035	.0032	.0442	95246.4	-.178	616.1
7592	24.37	-4.29	1.3542	.4503	.0247	.0041	.0066	.0392	95200.0	-.178	616.5
7593	.12	-5.02	-.0154	-.0957	.0289	.0173	-.0139	.0820	95185.9	-.127	617.6

TEST TP	21 Q PA	ALPHA DEG	RUN 128 BETA DEG	CLT	CDT	CMST	CRTS	CYTS	CYST	CMU	WTFLO KG/SEC	PLENP PSI
7578	6006.4	.10	-5.02	-.0625	.0157	-.0337	.0174	-.0165	.0901	.1973	.2233	430.8
7579	5997.5	-1.76	-5.04	-.1606	.0157	-.0479	.0121	-.0175	.0876	.1975	.2232	431.0
7580	5998.0	.19	-5.01	-.0579	.0156	-.0338	.0175	-.0164	.0896	.1974	.2231	431.0
7581	6038.2	2.03	-4.99	.0358	.0167	-.0268	.0159	-.0147	.0897	.1963	.2232	430.9
7582	6037.8	4.20	-4.95	.1345	.0224	-.0228	.0114	-.0143	.0842	.1963	.2231	431.1
7583	6073.8	6.18	-4.90	.2841	.0370	-.0335	.0120	-.0160	.0795	.1952	.2230	431.3
7584	6027.1	8.32	-4.85	.4408	.0625	-.0377	.0122	-.0166	.0785	.1967	.2230	431.3
7585	5999.4	10.40	-4.80	.5887	.0992	-.0398	.0097	-.0168	.0802	.1976	.2229	431.4
7586	5966.1	12.79	-4.73	.7802	.1581	-.0452	.0064	-.0162	.0800	.1985	.2226	431.3
7587	5973.1	15.05	-4.66	.9499	.2283	-.0471	.0043	-.0142	.0798	.1984	.2226	431.5
7588	5980.8	17.23	-4.58	1.0863	.3007	-.0458	.0027	-.0132	.0783	.1982	.2226	431.3
7589	5999.1	19.56	-4.49	1.1430	.3630	-.0289	.0044	-.0109	.0698	.1973	.2221	431.3
7590	5955.6	21.63	-4.41	1.2060	.4331	-.0349	.0038	-.0067	.0613	.1989	.2222	431.2
7591	5951.7	23.73	-4.32	1.2540	.5033	-.0348	.0027	.0011	.0502	.1989	.2219	430.9
7592	5999.2	24.37	-4.29	1.2692	.5296	-.0387	.0032	.0046	.0452	.1970	.2214	431.0
7593	5988.3	.12	-5.02	-.0604	.0117	-.0346	.0173	-.0161	.0880	.1976	.2212	430.7

NASA LANGLEY

7 X 10 HIGH SPEED TUNNEL

TEST TP	21	HACH	Q PA	RUN 129 ALPHA DEG	BETA DEG	CNF(BA)	CAF(BA)	CPN(BA)	CRM(BA)	CYN(BA)	CSF(BA)	TPLEN DEG K
7599	.301	6012.7	.13	-5.02	-0.349	-0.1132	.0439	.0186	-.0137	.0821	95097.7	298.3
7600	.301	6013.6	-1.69	-5.04	-.1290	-.1145	.0274	.0119	-.0151	.0801	95097.1	298.6
7601	.301	6017.1	.11	-5.02	-.0345	-.1135	.0433	.0185	-.0136	.0823	95094.2	298.9
7602	.302	6057.2	2.06	-4.99	.0669	-.1106	.0517	.0168	-.0122	.0850	95054.5	299.3
7603	.300	5981.2	4.12	-4.95	.1640	-.1057	.0552	.0104	-.0117	.0783	95134.3	299.8
7604	.304	6126.6	6.09	-4.90	.3236	-.0870	.0402	.0128	-.0129	.0720	94986.3	300.2
7605	.302	6062.6	8.31	-4.85	.5007	-.0594	.0335	.0138	-.0136	.0691	95055.5	300.9
7606	.300	5996.8	10.52	-4.79	.6671	-.0189	.0295	.0099	-.0140	.0708	95118.2	301.5
7607	.299	5968.5	12.78	-4.73	.8582	.0401	.0230	.0062	-.0134	.0714	95139.1	302.2
7608	.301	6038.9	14.98	-4.66	1.0340	.1141	.0195	.0054	-.0118	.0713	95063.5	303.0
7609	.300	5981.3	17.26	-4.58	1.1933	.1947	.0197	.0043	-.0115	.0704	95127.2	304.0
7610	.299	5965.1	19.61	-4.49	1.3061	.2762	.0337	.0067	-.0099	.0628	95157.7	304.9
7611	.300	5994.3	21.65	-4.41	1.3554	.3430	.0396	.0021	-.0043	.0524	95131.6	306.1
7612	.300	6002.7	23.83	-4.31	1.4140	.4236	.0409	.0026	.0029	.0381	95125.1	307.4
7613	.300	6009.8	24.44	-4.29	1.4259	.4446	.0414	.0029	.0052	.0356	95121.1	308.5
7614	.299	5941.2	.13	-5.02	-.0209	-.1261	.0381	.0188	-.0134	.0808	95172.6	311.6

TEST TP	21	ALPHA DEG	BETA DEG	RUN 129 CL(SA)	CD(SA)	CPN(SA)	CRM(SA)	CYN(SA)	CSF(SA)	P1 PA	CPB(1)	VTDT M/SEC
7599	.13	-5.02	-.0349	-.1132	.0439	.0186	-.0137	.0821	95097.7	-.123	-.123	622.3
7600	-1.69	-5.04	-.1290	-.1145	.0274	.0119	-.0151	.0801	95097.1	-.122	-.122	622.5
7601	.11	-5.02	-.0345	-.1135	.0433	.0185	-.0136	.0823	95094.2	-.122	-.122	622.9
7602	2.06	-4.99	.0669	-.1106	.0517	.0168	-.0122	.0850	95054.5	-.130	-.130	623.2
7603	4.12	-4.95	.1640	-.1057	.0552	.0104	-.0117	.0783	95134.3	-.136	-.136	623.7
7604	6.09	-4.90	.3236	-.0870	.0402	.0128	-.0129	.0720	94986.3	-.140	-.140	624.3
7605	8.31	-4.85	.5007	-.0594	.0335	.0138	-.0136	.0691	95055.5	-.137	-.137	624.9
7606	10.52	-4.79	.6671	-.0189	.0295	.0099	-.0140	.0708	95118.2	-.131	-.131	625.5
7607	12.78	-4.73	.8582	.0401	.0230	.0062	-.0134	.0714	95139.1	-.145	-.145	626.2
7608	14.98	-4.66	1.0340	.1141	.0195	.0054	-.0118	.0713	95063.5	-.147	-.147	627.1
7609	17.26	-4.58	1.1933	.1947	.0197	.0043	-.0115	.0704	95127.2	-.165	-.165	628.2
7610	19.61	-4.49	1.3061	.2762	.0337	.0067	-.0099	.0628	95157.7	-.175	-.175	629.1
7611	21.65	-4.41	1.3554	.3430	.0396	.0021	-.0043	.0524	95131.6	-.177	-.177	630.4
7612	23.83	-4.31	1.4140	.4236	.0409	.0026	.0029	.0381	95125.1	-.174	-.174	631.7
7613	24.44	-4.29	1.4259	.4446	.0414	.0029	.0052	.0356	95121.1	-.173	-.173	632.8
7614	.13	-5.02	-.0209	-.1261	.0381	.0188	-.0134	.0808	95172.6	-.125	-.125	636.1

TEST TP	21	Q PA	ALPHA DEG	RUN 129 BETA DEG	CLT	CDT	CMST	CRTS	CYTS	CYST	CMU	WTFLO KG/SEC	PLENP PSI
7599	6012.7	.13	-5.02	-.0880	.0135	-.0310	.0186	-.0163	.0892	.2359	.2359	.2632	510.2
7600	6013.6	-1.69	-5.04	-.1780	.0137	-.0474	.0120	-.0176	.0872	.2357	.2357	.2630	509.7
7601	6017.1	.11	-5.02	-.0874	.0129	-.0314	.0185	-.0162	.0894	.2356	.2356	.2628	509.4
7602	6057.2	2.06	-4.99	.0101	.0131	-.0225	.0167	-.0148	.0920	.2340	.2340	.2626	509.4
7603	5981.2	4.12	-4.95	.1020	.0174	-.0200	.0102	-.0143	.0854	.2370	.2370	.2624	509.4
7604	6126.6	6.09	-4.90	.2589	.0311	-.0332	.0125	-.0154	.0790	.2314	.2314	.2622	509.6
7605	6062.6	8.31	-4.85	.4308	.0573	-.0407	.0134	-.0161	.0761	.2335	.2335	.2616	509.7
7606	5996.8	10.52	-4.79	.5919	.0963	-.0455	.0084	-.0165	.0778	.2362	.2362	.2615	509.5
7607	5968.5	12.78	-4.73	.7782	.1528	-.0524	.0056	-.0160	.0785	.2372	.2372	.2611	509.6
7608	6038.9	14.98	-4.66	.9506	.2225	-.0550	.0047	-.0143	.0784	.2349	.2349	.2613	509.9
7609	5981.3	17.26	-4.58	1.1048	.3007	-.0555	.0036	-.0140	.0775	.2371	.2371	.2607	509.9
7610	5965.1	19.61	-4.49	1.2130	.3788	-.0418	.0059	-.0124	.0699	.2380	.2380	.2606	510.2
7611	5994.3	21.65	-4.41	1.2592	.4417	-.0355	.0011	-.0067	.0595	.2369	.2369	.2601	510.2
7612	6002.7	23.83	-4.31	1.3142	.5184	-.0341	.0016	.0005	.0451	.2369	.2369	.2600	510.4
7613	6009.8	24.44	-4.29	1.3252	.5384	-.0336	.0019	.0028	.0427	.2373	.2373	.2603	510.7
7614	5941.2	.13	-5.02	-.0747	.0023	-.0378	.0188	-.0160	.0880	.2394	.2394	.2582	510.9

ORIGINAL PAGE IS
OF POOR QUALITY

NASA LANGLEY

7 X 10 HIGH SPEED TUNNEL

TEST TP	21 MACH	Q PA	RUN 130		CNF(BA)	CAF(BA)	CPM(BA)	CRM(BA)	CYM(BA)	CSF(BA)	TPLEN DEG K
			ALPHA DEG	BETA DEG							
7615	.500	14943.3	.07	-5.04	-.0172	-.0438	.0070	.0133	-.0158	.0848	318.4
7616	.499	14859.3	-1.89	-5.05	-.1294	-.0473	-.0022	.0111	-.0174	.0816	318.9
7617	.500	14904.2	.11	-5.04	-.0146	-.0441	.0077	.0131	-.0157	.0846	319.3
7618	.501	14998.2	2.23	-5.01	.1056	-.0455	.0150	.0127	-.0150	.0865	319.6
7619	.502	15035.5	4.32	-4.97	.2139	-.0500	.0154	.0118	-.0145	.0796	319.9
7620	.502	15042.7	6.71	-4.91	.3652	-.0565	.0162	.0145	-.0150	.0739	320.1
7621	.499	14869.5	8.88	-4.86	.5006	-.0619	.0163	.0143	-.0160	.0728	320.3
7622	.499	14883.1	11.14	-4.80	.6341	-.0655	.0183	.0116	-.0170	.0727	320.4
7623	.497	14776.1	13.61	-4.73	.7715	-.0706	.0281	.0080	-.0151	.0692	320.5
7624	.497	14768.2	16.08	-4.66	.8889	-.0739	.0338	.0075	-.0121	.0641	320.6
7625	.501	14952.6	18.24	-4.59	.9871	-.0752	.0308	.0040	-.0074	.0561	320.7
7626	.498	14811.1	20.55	-4.51	1.0928	-.0792	.0277	.0044	-.0020	.0476	320.8
7627	.497	14776.5	22.65	-4.43	1.1782	-.0774	.0111	.0073	-.0003	.0472	320.8
7628	.497	14802.8	24.82	-4.35	1.2350	-.0713	-.0150	-.0015	-.0086	.0362	320.9
7629	.499	14899.7	25.46	-4.34	1.2477	-.0708	-.0168	-.0065	-.0150	.0308	320.9
7630	.499	14899.1	.07	-5.04	-.0200	-.0437	.0090	.0135	-.0160	.0853	321.0

TEST TP	21 ALPHA DEG	BETA DEG	RUN 130		CPM(SA)	CRM(SA)	CYM(SA)	CSF(SA)	P1 PA	CPB(1)	VTOT N/SEC
			CL(SA)	CD(SA)							
7615	.07	-5.04	-.0171	-.0438	.0070	.0133	-.0158	.0848	85294.4	-.136	648.5
7616	-1.89	-5.05	-.1309	-.0430	-.0022	.0117	-.0170	.0816	85379.4	-.130	648.9
7617	.11	-5.04	-.0145	-.0441	.0077	.0131	-.0157	.0846	85327.8	-.136	649.3
7618	2.23	-5.01	.1073	-.0413	.0150	.0121	-.0155	.0865	85214.8	-.136	649.7
7619	4.32	-4.97	.2171	-.0338	.0154	.0107	-.0154	.0796	85180.6	-.143	650.0
7620	6.71	-4.91	.3693	-.0134	.0162	.0126	-.0165	.0739	85173.0	-.148	650.2
7621	8.88	-4.86	.5042	.0161	.0163	.0116	-.0180	.0728	85358.5	-.153	650.3
7622	11.14	-4.80	.6348	.0582	.0183	.0081	-.0189	.0727	85332.8	-.158	650.4
7623	13.61	-4.73	.7664	.1129	.0281	.0042	-.0166	.0692	85453.3	-.164	650.5
7624	16.08	-4.66	.8746	.1752	.0338	.0039	-.0137	.0641	85464.9	-.171	650.6
7625	18.24	-4.59	.9610	.2375	.0308	.0015	-.0082	.0561	85259.5	-.173	650.8
7626	20.55	-4.51	1.0510	.3095	.0277	.0035	-.0034	.0476	85423.7	-.178	650.8
7627	22.65	-4.43	1.1172	.3822	.0111	.0067	-.0031	.0472	85525.3	-.192	650.7
7628	24.82	-4.35	1.1509	.4537	-.0150	.0022	-.0085	.0362	85444.9	-.200	650.9
7629	25.46	-4.34	1.1570	.4726	-.0168	.0006	-.0163	.0308	85345.8	-.204	650.9
7630	.07	-5.04	-.0200	-.0437	.0090	.0134	-.0160	.0853	85331.6	-.136	651.0

TEST TP	21 Q PA	ALPHA DEG	RUN 130 BETA DEG	CLT	CDT	CMST	CRTS	CYTS	CYST	CMU	WFFLO KG/SEC	PLENP PSI
7616	14859.3	-1.89	-5.05	-.1507	.0094	-.0327	.0117	-.0181	.0845	.0965	.2553	513.5
7617	14904.2	.11	-5.04	-.0361	.0073	-.0227	.0131	-.0167	.0875	.0962	.2550	513.5
7618	14998.2	2.23	-5.01	.0840	.0089	-.0152	.0121	-.0165	.0893	.0955	.2546	513.2
7619	15035.5	4.32	-4.97	.1921	.0155	-.0147	.0106	-.0164	.0824	.0953	.2546	513.3
7620	15042.7	6.71	-4.91	.3422	.0347	-.0140	.0125	-.0176	.0768	.0953	.2546	513.4
7621	14869.5	8.88	-4.86	.4750	.0638	-.0142	.0115	-.0190	.0757	.0964	.2545	513.5
7622	14883.1	11.14	-4.80	.6038	.1047	-.0122	.0079	-.0199	.0755	.0963	.2544	513.3
7623	14776.1	13.61	-4.73	.7332	.1583	-.0026	.0040	-.0176	.0721	.0970	.2544	513.6
7624	14768.2	16.08	-4.66	.8394	.2191	.0031	.0036	-.0148	.0670	.0971	.2544	513.3
7625	14952.6	18.24	-4.59	.9246	.2796	.0005	.0011	-.0092	.0589	.0958	.2543	513.5
7626	14811.1	20.55	-4.51	1.0126	.3504	-.0029	.0031	-.0044	.0505	.0968	.2544	513.4
7627	14776.5	22.65	-4.43	1.0773	.4218	-.0196	.0063	-.0040	.0501	.0969	.2541	513.3
7628	14802.8	24.82	-4.35	1.1095	.4917	-.0457	.0018	.0075	.0391	.0969	.2545	513.0
7629	14899.7	25.46	-4.34	1.1155	.5098	-.0472	.0002	.0154	.0337	.0962	.2543	513.1
7630	14899.1	.07	-5.04	-.0415	.0078	-.0215	.0134	-.0171	.0881	.0962	.2542	513.5

NASA LANGLEY

7 X 10 HIGH SPEED TUNNEL

TEST TP	21 MACH	Q PA	RUN 131 ALPHA DEG	BETA DEG	CNF(BA)	CAF(BA)	CPH(BA)	CRM(BA)	CYM(BA)	CSF(BA)	TPLEN DEG K
7631	.500	14917.9	.05	-5.03	-.0127	-.0177	.0029	.0115	-.0177	.0837	319.6
7632	.498	14819.8	-1.93	-5.05	-.1371	-.0210	-.0041	.0096	-.0179	.0807	319.5
7633	.501	14998.3	.10	-5.03	-.0128	-.0174	.0031	.0115	-.0177	.0839	319.2
7634	.501	14980.1	2.23	-5.00	.1068	-.0195	.0088	.0131	-.0165	.0833	319.0
7635	.501	14962.9	4.19	-4.96	.2112	-.0240	.0112	.0129	-.0160	.0806	318.8
7636	.502	15009.9	6.52	-4.91	.3513	-.0298	.0126	.0147	-.0171	.0788	318.6
7637	.501	14951.4	8.85	-4.86	.4863	-.0348	.0150	.0143	-.0177	.0770	318.4
7638	.499	14897.3	11.16	-4.80	.6111	-.0368	.0166	.0134	-.0176	.0759	318.3
7639	.498	14821.7	13.46	-4.73	.7131	-.0387	.0180	.0123	-.0158	.0729	318.0
7640	.498	14827.3	15.73	-4.66	.8208	-.0399	.0139	.0122	-.0130	.0692	317.9
7641	.497	14805.6	17.97	-4.59	.9040	-.0409	.0088	.0105	-.0090	.0619	317.7
7642	.496	14737.2	20.26	-4.51	1.0004	-.0439	.0068	.0090	-.0051	.0559	317.4
7643	.498	14822.1	22.42	-4.43	1.0659	-.0428	-.0008	.0090	-.0006	.0501	317.3
7644	.497	14762.6	24.58	-4.36	1.1170	-.0427	-.0058	.0038	.0093	.0429	317.1
7645	.500	14914.9	25.24	-4.33	1.1205	-.0410	-.0110	.0034	.0109	.0418	317.0
7646	.492	14546.7	.03	-5.03	-.0155	-.0175	.0030	.0118	-.0175	.0839	316.5

TEST TP	21 ALPHA DEG	BETA DEG	RUN 131 CL(SA)	CD(SA)	CPH(SA)	CRM(SA)	CYM(SA)	CSF(SA)	P1 PA	CPB(1)	VTDI M/SEC
7631	.05	-5.03	-.0127	-.0177	.0029	.0115	-.0177	.0837	85297.8	-.138	618.2
7632	-1.93	-5.05	-.1377	-.0164	-.0041	.0102	-.0176	.0807	85407.1	-.129	618.0
7633	.10	-5.03	-.0128	-.0174	.0031	.0115	-.0177	.0839	85197.0	-.137	617.9
7634	2.23	-5.00	.1074	-.0153	.0088	.0124	-.0170	.0833	85224.2	-.137	617.7
7635	4.19	-4.96	.2124	-.0085	.0112	.0117	-.0169	.0806	85260.0	-.142	617.4
7636	6.52	-4.91	.3524	.0103	.0126	.0127	-.0187	.0788	85202.8	-.145	617.3
7637	8.85	-4.86	.4859	.0404	.0150	.0114	-.0197	.0770	85255.3	-.153	617.0
7638	11.16	-4.80	.6067	.0821	.0166	.0097	-.0199	.0759	85310.9	-.158	616.9
7639	13.46	-4.73	.7025	.1285	.0180	.0083	-.0183	.0729	85400.5	-.162	616.6
7640	15.73	-4.66	.8009	.1842	.0139	.0082	-.0158	.0692	85388.1	-.165	616.4
7641	17.97	-4.59	.8726	.2400	.0088	.0073	-.0118	.0619	85503.4	-.168	616.1
7642	20.26	-4.51	.9538	.3052	.0068	.0067	-.0079	.0559	85528.2	-.179	615.9
7643	22.42	-4.43	1.0016	.3669	-.0008	.0081	-.0040	.0501	85405.1	-.187	615.8
7644	24.58	-4.36	1.0336	.4257	-.0058	.0073	.0069	.0429	85486.2	-.198	615.6
7645	25.24	-4.33	1.0310	.4407	-.0110	.0077	.0084	.0418	85339.2	-.202	615.5
7646	.03	-5.03	-.0155	-.0175	.0030	.0118	-.0176	.0839	85746.0	-.136	614.9

TEST TP	21 Q PA	ALPHA DEG	RUN 131 BETA DEG	CLT	CDT	CHST	CRTS	CYTS	CYST	CNU	WTFLO KG/SEC	PLENP PSI
7631	14917.9	.05	-5.03	-.0244	.0104	-.0137	.0115	-.0183	.0853	.0505	.1407	281.1
7632	14819.8	-1.93	-5.05	-.1486	.0123	-.0209	.0103	-.0182	.0823	.0508	.1408	281.3
7633	14998.3	.10	-5.03	-.0245	.0106	-.0135	.0115	-.0183	.0855	.0502	.1407	281.4
7634	14980.1	2.23	-5.00	.0947	.0123	-.0077	.0124	-.0176	.0849	.0502	.1407	281.1
7635	14962.9	4.19	-4.96	.1987	.0186	-.0054	.0116	-.0174	.0821	.0503	.1406	281.0
7636	15009.9	6.52	-4.91	.3377	.0368	-.0039	.0126	-.0193	.0804	.0501	.1408	280.9
7637	14951.4	8.85	-4.86	.4700	.0664	-.0015	.0113	-.0203	.0786	.0503	.1407	280.8
7638	14897.3	11.16	-4.80	.5897	.1075	-.0000	.0096	-.0204	.0775	.0505	.1408	280.9
7639	14821.7	13.46	-4.73	.6844	.1533	.0013	.0082	-.0188	.0745	.0508	.1411	280.9
7640	14827.3	15.73	-4.66	.7819	.2082	-.0028	.0081	-.0164	.0708	.0508	.1411	280.8
7641	14805.6	17.97	-4.59	.8526	.2633	-.0079	.0071	-.0123	.0634	.0508	.1411	280.8
7642	14737.2	20.26	-4.51	.9327	.3278	-.0100	.0065	-.0084	.0575	.0511	.1411	281.1
7643	14822.1	22.42	-4.43	.9799	.3886	-.0175	.0079	-.0045	.0517	.0508	.1411	281.0
7644	14762.6	24.58	-4.36	1.0109	.4466	-.0226	.0071	.0064	.0445	.0511	.1414	281.1
7645	14914.9	25.24	-4.33	1.0084	.4612	-.0277	.0074	.0079	.0434	.0506	.1415	280.9
7646	14546.7	.03	-5.03	-.0275	.0114	-.0140	.0118	-.0181	.0855	.0518	.1416	281.1

ORIGINAL PAGE IS
OF POOR QUALITY

NASA LANGLEY

7 X 10 HIGH SPEED TUNNEL

TEST TP	21 MACH	Q PA	RUN 132 ALPHA DEG	BETA DEG	CNF(BA)	CAF(BA)	CPN(BA)	CRM(BA)	CYM(BA)	CSF(BA)	TPLEN DEG K
7647	.500	14932.4	.04	-5.02	-.0081	.0141	.0009	.0098	-.0194	.0790	314.5
7648	.499	14876.6	-1.94	-5.05	-.1382	.0102	-.0037	.0072	-.0188	.0787	315.1
7649	.500	14937.4	.11	-5.02	-.0038	.0138	.0009	.0099	-.0195	.0796	315.4
7650	.503	15071.0	2.12	-4.99	.1093	.0114	.0052	.0117	-.0197	.0785	315.7
7651	.502	15021.2	4.43	-4.95	.2328	.0049	.0072	.0131	-.0195	.0778	315.9
7652	.502	15040.4	6.50	-4.90	.3498	-.0014	.0078	.0146	-.0194	.0762	316.1
7653	.500	14932.0	8.79	-4.85	.4805	-.0059	.0088	.0140	-.0197	.0770	316.3
7654	.500	14915.2	11.03	-4.80	.5889	-.0069	.0113	.0114	-.0186	.0769	316.4
7655	.499	14864.3	13.49	-4.73	.7102	-.0072	.0077	.0115	-.0168	.0769	316.5
7656	.497	14767.4	15.89	-4.66	.8142	-.0070	.0002	.0089	-.0134	.0736	316.6
7657	.499	14891.5	17.97	-4.59	.8719	-.0030	-.0117	.0060	-.0075	.0631	316.6
7658	.497	14782.4	19.93	-4.55	.8779	.0028	-.0246	.0003	.0082	.0466	316.6
7659	.497	14759.0	22.35	-4.43	.9195	.0014	-.0178	.0073	.0050	.0458	316.7
7660	.498	14816.7	25.00	-4.30	1.0104	-.0032	-.0159	.0111	.0040	.0448	316.7
7661	.501	14950.8	.06	-5.02	-.0053	.0131	.0003	.0099	-.0194	.0789	316.8

TEST TP	21 ALPHA DEG	BETA DEG	RUN 132 CL(SA)	CD(SA)	CPH(SA)	CRM(SA)	CYM(SA)	CSF(SA)	P1 PA	CPB(1)	VTOT M/SEC
7647	.04	-5.02	-.0081	.0141	.0009	.0098	-.0194	.0790	85312.0	-.135	0.0
7648	-1.94	-5.05	-.1378	.0148	-.0037	.0079	-.0186	.0787	85341.8	-.133	0.0
7649	.11	-5.02	-.0039	-.0138	.0009	.0099	-.0196	.0796	85259.4	-.135	0.0
7650	2.12	-4.99	.1088	-.0154	.0052	.0110	-.0201	.0785	85164.1	-.135	0.0
7651	4.43	-4.95	.2317	.0229	.0072	.0115	-.0205	.0778	85181.6	-.139	0.0
7652	6.50	-4.90	.3477	.0382	.0078	.0123	-.0209	.0762	85154.6	-.141	0.0
7653	8.79	-4.85	.4757	.0676	.0088	.0109	-.0216	.0770	85327.8	-.144	0.0
7654	11.03	-4.80	.5793	.1059	.0113	.0076	-.0205	.0769	85281.3	-.147	0.0
7655	13.49	-4.73	.6923	.1587	.0077	.0072	-.0190	.0769	85333.3	-.154	0.0
7656	15.89	-4.66	.7850	.2162	.0002	.0049	-.0153	.0736	85445.3	-.160	0.0
7657	17.97	-4.59	.8303	.2662	-.0117	.0034	-.0090	.0631	85355.8	-.163	0.0
7658	19.93	-4.55	.8244	.3019	-.0246	.0031	.0076	.0466	85429.9	-.170	0.0
7659	22.35	-4.43	.8499	.3509	-.0178	.0086	.0018	.0458	85460.5	-.177	0.0
7660	25.00	-4.30	.9171	.4241	-.0159	.0117	-.0011	.0448	85447.6	-.189	0.0
7661	.06	-5.02	-.0053	.0131	.0003	.0099	-.0194	.0789	85246.4	-.134	0.0

TEST TP	21 Q PA	ALPHA DEG	RUN 132 BETA DEG	CLT	CDT	CMST	CRYS	CYTS	CYST	CMU	WTFLO KG/SEC	PLENP PSI
7647	14932.4	.04	-5.02	-.0081	.0141	.0009	.0098	-.0194	.0790	0.0000	0.0000	-.3
7648	14876.6	-1.94	-5.05	-.1378	.0148	-.0037	.0079	-.0186	.0787	0.0000	0.0000	-.3
7649	14937.4	.11	-5.02	-.0039	.0138	.0009	.0099	-.0196	.0796	0.0000	0.0000	-.3
7650	15071.0	2.12	-4.99	.1088	.0154	.0052	.0110	-.0201	.0785	0.0000	0.0000	-.3
7651	15021.2	4.43	-4.95	.2317	.0229	.0072	.0115	-.0205	.0778	0.0000	0.0000	-.3
7652	15040.4	6.50	-4.90	.3477	.0382	.0078	.0123	-.0209	.0762	0.0000	0.0000	-.4
7653	14932.0	8.79	-4.85	.4757	.0676	.0088	.0109	-.0216	.0770	0.0000	0.0000	-.4
7654	14915.2	11.03	-4.80	.5793	.1059	.0113	.0076	-.0205	.0769	0.0000	0.0000	-.5
7655	14864.3	13.49	-4.73	.6923	.1587	.0077	.0072	-.0190	.0769	0.0000	0.0000	-.6
7656	14767.4	15.89	-4.66	.7850	.2162	.0002	.0049	-.0153	.0736	0.0000	0.0000	-.6
7657	14891.5	17.97	-4.59	.8303	.2662	-.0117	.0034	-.0090	.0631	0.0000	0.0000	-.7
7658	14782.4	19.93	-4.55	.8244	.3019	-.0246	.0031	.0076	.0466	0.0000	0.0000	-.9
7659	14759.0	22.35	-4.43	.8499	.3509	-.0178	.0086	.0018	.0458	0.0000	0.0000	-.9
7660	14816.7	25.00	-4.30	.9171	.4241	-.0159	.0117	-.0011	.0448	0.0000	0.0000	-1.1
7661	14950.8	.06	-5.02	-.0053	.0131	.0003	.0099	-.0194	.0789	0.0000	0.0000	-.4

NASA LANGLEY

7 X 10 HIGH SPEED TUNNEL

TEST TP	21 MACH	Q PA	RUN 133		CNF(BA)	CAF(BA)	CPH(BA)	CRM(BA)	CYH(BA)	CSF(BA)	TPLEN DEG K
			ALPHA DEG	BETA DEG							
7662	.700	24994.7	.06	-5.03	-.0013	.0128	-.0006	.0102	-.0210	.0812	317.8
7663	.695	24754.5	-2.06	-5.06	-.1395	.0102	-.0042	.0077	-.0204	.0810	318.1
7664	.698	24505.1	.06	-5.03	-.0029	.0130	-.0006	.0101	-.0211	.0814	319.4
7665	.708	25406.8	2.29	-5.00	.1235	.0099	.0029	.0126	-.0213	.0810	319.6
7666	.705	25268.7	4.69	-4.96	.2614	.0038	.0040	.0137	-.0212	.0806	318.6
7667	.708	25374.7	7.26	-4.91	.4152	-.0016	.0032	.0156	-.0216	.0805	319.2
7668	.702	25106.6	9.59	-4.86	.5391	-.0032	.0031	.0134	-.0213	.0808	319.7
7669	.699	24988.7	11.98	-4.80	.6413	-.0019	.0002	.0115	-.0194	.0794	320.2
7670	.697	24848.7	14.31	-4.75	.7398	-.0014	-.0073	.0112	-.0167	.0777	320.5
7671	.699	24947.1	16.63	-4.69	.8275	.0000	-.0190	.0105	-.0121	.0726	320.8
7672	.699	24940.4	18.71	-4.68	.8306	.0040	-.0277	-.0007	.0093	.0458	321.0
7673	.700	25017.8	.06	-5.03	-.0001	.0126	-.0003	.0105	-.0213	.0819	321.0

TEST TP	21 ALPHA DEG	BETA DEG	RUN 133		CPH(SA)	CRM(SA)	CYH(SA)	CSF(SA)	P1 PA	CPB(1)	VTOT M/SEC
			CL(SA)	CD(SA)							
7662	.06	-5.03	-.0013	.0128	-.0006	.0102	-.0210	.0812	72951.3	-.139	0.0
7663	-2.06	-5.06	-.1390	.0152	-.0042	.0084	-.0201	.0810	73188.3	-.135	0.0
7664	.06	-5.03	-.0029	.0130	-.0006	.0101	-.0211	.0814	73006.0	-.138	0.0
7665	2.29	-5.00	.1230	.0148	.0029	.0118	-.0218	.0810	72387.2	-.142	0.0
7666	4.69	-4.96	.2602	.0252	.0040	.0119	-.0223	.0806	72537.8	-.143	0.0
7667	7.26	-4.91	.4121	.0506	.0032	.0127	-.0234	.0805	72395.8	-.145	0.0
7668	9.59	-4.86	.5321	.0867	.0031	.0096	-.0233	.0808	72742.7	-.150	0.0
7669	11.98	-4.80	.6277	.1312	.0002	.0073	-.0214	.0794	72967.3	-.152	0.0
7670	14.31	-4.75	.7172	.1815	-.0073	.0067	-.0190	.0777	73088.9	-.159	0.0
7671	16.63	-4.69	.7928	.2369	-.0190	.0065	-.0146	.0726	72951.5	-.164	0.0
7672	18.71	-4.68	.7855	.2702	-.0277	.0024	.0090	.0458	72969.6	-.166	0.0
7673	.06	-5.03	-.0001	.0126	-.0003	.0105	-.0213	.0819	72915.4	-.138	0.0

TEST TP	21 Q PA	ALPHA DEG	RUN 133		CLT	CDT	CNST	CRTS	CYTS	CYST	CMU	MTFLD KG/SEC	PLENP PSI
			BETA DEG	CLT									
7662	24994.7	.06	-5.03	-.0013	.0128	-.0006	.0102	-.0210	.0812	0.0000	0.0000	-.5	
7663	24754.5	-2.06	-5.06	-.1390	.0152	-.0042	.0084	-.0201	.0810	0.0000	0.0000	-.6	
7664	24905.1	.06	-5.03	-.0029	.0130	-.0006	.0101	-.0211	.0814	0.0000	0.0000	-.6	
7665	25406.8	2.29	-5.00	.1230	.0148	.0029	.0118	-.0218	.0810	0.0000	0.0000	-.8	
7666	25268.7	4.69	-4.96	.2602	.0252	.0040	.0119	-.0223	.0806	0.0000	0.0000	-1.4	
7667	25374.7	7.26	-4.91	.4121	.0506	.0032	.0127	-.0234	.0805	0.0000	0.0000	-.7	
7668	25106.6	9.59	-4.86	.5321	.0867	.0031	.0096	-.0233	.0808	0.0000	0.0000	-1.1	
7669	24988.7	11.98	-4.80	.6277	.1312	.0002	.0073	-.0214	.0794	0.0000	0.0000	-.8	
7670	24848.7	14.31	-4.75	.7172	.1815	-.0073	.0067	-.0190	.0777	0.0000	0.0000	-1.2	
7671	24947.1	16.63	-4.69	.7928	.2369	-.0190	.0065	-.0146	.0726	0.0000	0.0000	-1.3	
7672	24940.4	18.71	-4.68	.7855	.2702	-.0277	.0024	.0090	.0458	0.0000	0.0000	-1.5	
7673	25017.8	.06	-5.03	-.0001	.0126	-.0003	.0105	-.0213	.0819	0.0000	0.0000	-1.0	

ORIGINAL PAGE IS
OF POOR QUALITY

NASA LANGLEY

7' X 10' HIGH SPEED TUNNEL

TEST TP	21 MACH	Q PA	RUN 134 ALPHA DEG	BETA DEG	CMF(BA)	CAF(BA)	CPH(BA)	CRH(BA)	CYM(BA)	CSF(BA)	TPLEN DEG K
7674	.701	25057.7	.08	-5.05	-.0062	-.0142	.0031	.0118	-.0188	.0887	309.7
7675	.699	24927.1	-2.04	-5.07	-.1396	-.0170	-.0041	.0105	-.0194	.0864	310.1
7676	.703	25137.7	.08	-5.05	-.0082	-.0142	.0027	.0121	-.0189	.0887	310.2
7677	.702	25123.7	2.29	-5.02	.1188	-.0165	.0083	.0128	-.0166	.0893	310.4
7678	.708	25389.1	4.65	-4.98	.2488	-.0218	.0078	.0136	-.0181	.0834	310.7
7679	.703	25165.7	7.13	-4.92	.4039	-.0270	.0081	.0146	-.0195	.0826	311.0
7680	.701	25036.5	9.62	-4.86	.5429	-.0291	.0070	.0137	-.0202	.0817	311.6
7681	.659	24960.1	12.04	-4.80	.6647	-.0258	.0037	.0134	-.0143	.0795	312.1
7682	.697	24849.9	14.51	-4.74	.7681	-.0296	-.0002	.0145	-.0162	.0756	312.5
7683	.694	24695.6	17.10	-4.67	.8614	-.0323	.0018	.0129	-.0115	.0689	313.0
7684	.699	24925.4	19.20	-4.62	.9444	-.0342	.0004	.0077	-.0043	.0594	314.6
7685	.701	25034.0	.06	-5.05	-.0055	-.0154	.0025	.0119	-.0188	.0887	

TEST TP	21 ALPHA DEG	BETA DEG	RUN 134 CL(SA)	CD(SA)	CPH(SA)	CRM(SA)	CYM(SA)	CSF(SA)	P1 PA	CPB(T)	VTOT M/SEC
7674	.08	-5.05	-.0061	-.0142	.0031	.0118	-.0188	.0887	72892.7	-.139	640.7
7675	-2.04	-5.07	-.1401	-.0120	-.0041	.0112	-.0191	.0864	72963.8	-.134	640.8
7676	.08	-5.05	-.0082	-.0142	.0027	.0121	-.0189	.0887	72751.1	-.139	641.1
7677	2.29	-5.02	.1194	-.0117	.0083	.0120	-.0193	.0893	72735.1	-.139	641.2
7678	4.65	-4.98	.2498	-.0016	.0078	.0121	-.0192	.0834	72431.8	-.151	641.7
7679	7.13	-4.92	.4041	.0233	.0081	.0123	-.0212	.0826	72675.8	-.151	641.9
7680	9.62	-4.86	.5402	.0620	.0070	.0101	-.0222	.0817	72842.5	-.156	641.9
7681	12.04	-4.80	.6563	.1094	.0037	.0091	-.0216	.0795	72931.9	-.161	642.6
7682	14.51	-4.74	.7510	.1639	-.0002	.0100	-.0193	.0756	73083.9	-.163	643.0
7683	17.10	-4.67	.8329	.2223	.0018	.0089	-.0148	.0689	73284.7	-.170	643.3
7684	19.20	-4.62	.9031	.2783	.0004	.0059	-.0066	.0594	72974.5	-.178	644.0
7685	.06	-5.05	-.0054	-.0154	.0025	.0118	-.0188	.0887	72850.9	-.141	645.8

TEST TP	21 Q PA	ALPHA DEG	RUN 134 BETA DEG	CLT	CDT	CMST	CRTS	CYTS	CYST	CMU	MTFLD KG/SEC	PLENP PSI
7674	25057.7	.08	-5.05	-.0174	.0127	-.0127	.0118	-.0194	.0902	.0502	.2267	450.5
7675	24927.1	-2.04	-5.07	-.1503	.0154	-.0200	.0113	-.0196	.0879	.0504	.2264	449.9
7676	25137.7	.08	-5.05	-.0193	.0125	-.0131	.0121	-.0194	.0902	.0500	.2262	449.8
7677	25123.7	2.29	-5.02	.1072	.0145	-.0075	.0120	-.0199	.0908	.0499	.2259	449.7
7678	25389.1	4.65	-4.98	.2367	.0239	-.0079	.0121	-.0197	.0849	.0495	.2262	450.2
7679	25165.7	7.13	-4.92	.3897	.0484	-.0077	.0122	-.0217	.0841	.0499	.2262	450.0
7680	25036.5	9.62	-4.86	.5247	.0866	-.0089	.0100	-.0228	.0832	.0503	.2263	449.3
7681	24960.1	12.04	-4.80	.6397	.1335	-.0122	.0090	-.0222	.0810	.0504	.2259	450.4
7682	24849.9	14.51	-4.74	.7333	.1973	-.0162	.0098	-.0198	.0771	.0505	.2255	450.5
7683	24695.6	17.10	-4.67	.8140	.2491	-.0143	.0088	-.0153	.0704	.0504	.2257	450.5
7684	24925.4	19.20	-4.62	.8830	.3001	-.0156	.0057	-.0071	.0605	.0504	.2255	450.6
7685	25034.0	.06	-5.05	-.0167	.0115	-.0134	.0118	-.0193	.0902	.0503	.2252	450.7

NASA LANGLEY

7 X 10 HIGH SPEED TUNNEL

TEST TP	21 MACH	Q PA	RUN 135		CNF(SA)	CAF(SA)	CPH(SA)	CRH(SA)	CYH(SA)	CSF(SA)	TPLEN DEG K
			ALPHA DEG	BETA DEG							
7704	.300	6055.3	-.01	-.00	-.0072	.0193	-.0042	.0019	-.0016	.0050	293.5
7705	.300	6056.0	-1.87	-.03	-.1371	.0138	.0005	.0017	-.0014	.0049	293.5
7706	.299	6019.3	.06	.00	-.0024	.0196	-.0043	.0023	-.0017	.0051	293.6
7707	.301	6092.5	1.92	.03	.1056	.0182	-.0078	.0021	-.0017	.0049	293.6
7708	.302	6102.7	3.94	.06	.2247	.0128	-.0173	.0023	-.0016	.0046	293.6
7709	.301	6088.3	6.01	.09	.3552	.0064	-.0331	.0027	-.0017	.0044	293.6
7710	.301	6073.9	8.26	.12	.4996	.0001	-.0516	.0012	-.0018	.0040	293.6
7711	.300	6055.8	10.27	.15	.6212	-.0036	-.0676	.0002	-.0019	.0030	293.7
7712	.300	6028.7	12.43	.18	.7354	-.0043	-.0866	.0018	-.0016	.0029	293.8
7713	.300	6030.9	14.59	.21	.8636	-.0054	-.1201	.0017	-.0017	.0028	293.8
7714	.298	5963.5	16.84	.24	.9955	-.0040	-.1634	.0019	-.0020	.0042	293.8
7715	.299	6021.7	19.08	.28	1.0742	.0041	-.2123	.0012	-.0019	.0047	293.9
7716	.301	6059.7	20.81	.30	1.1553	.0041	-.2602	.0017	-.0026	.0051	293.9
7717	.299	6004.4	22.98	.33	1.2613	.0012	-.3113	.0013	-.0022	.0063	294.0
7718	.300	6031.0	23.63	.34	1.2938	-.0003	-.3243	.0016	-.0031	.0068	294.0
7719	.300	6030.4	-.03	-.00	-.0079	.0189	-.0041	.0019	-.0018	.0049	294.1

TEST TP	21 ALPHA DEG	BETA DEG	RUN 135		CPH(SA)	CRH(SA)	CYH(SA)	CSF(SA)	P1 PA	CPB(1)	VTOT M/SEC
			CL(SA)	CD(SA)							
7704	-.01	-.00	-.0071	.0193	-.0042	.0019	-.0016	.0050	95880.6	-.106	0.0
7705	-1.87	-.03	-.1366	.0183	.0005	.0018	-.0013	.0049	95877.6	-.106	0.0
7706	.06	.00	-.0024	.0196	-.0043	.0023	-.0017	.0051	95916.5	-.105	0.0
7707	1.92	.03	.1049	.0217	-.0078	.0021	-.0018	.0049	95841.7	-.106	0.0
7708	3.94	.06	.2233	.0282	-.0173	.0022	-.0018	.0046	95830.9	-.106	0.0
7709	6.01	.09	.3526	.0435	-.0331	.0025	-.0020	.0044	95846.0	-.109	0.0
7710	8.26	.12	.4944	.0719	-.0516	.0009	-.0020	.0040	95861.1	-.116	0.0
7711	10.27	.15	.6119	.1072	-.0676	-.0001	-.0019	.0030	95878.3	-.124	0.0
7712	12.43	.18	.7191	.1540	-.0866	.0014	-.0020	.0029	95908.4	-.136	0.0
7713	14.59	.21	.8371	.2123	-.1201	.0012	-.0021	.0028	95912.9	-.145	0.0
7714	16.84	.24	.9540	.2845	-.1634	.0013	-.0024	.0042	95977.5	-.154	0.0
7715	19.08	.28	1.0139	.3550	-.2123	.0005	-.0022	.0047	95909.0	-.170	0.0
7716	20.81	.30	1.0785	.4143	-.2602	.0006	-.0030	.0051	95862.9	-.170	0.0
7717	22.98	.33	1.1608	.4935	-.3113	.0004	-.0025	.0063	95928.6	-.181	0.0
7718	23.63	.34	1.1854	.5183	-.3243	.0002	-.0035	.0068	95906.1	-.184	0.0
7719	-.03	-.00	-.0079	.0189	-.0041	.0019	-.0018	.0049	95904.6	-.105	0.0

TEST TP	21 O PA	ALPHA DEG	RUN 135		CDT	CMST	CRTS	CYTS	CYST	CMPJ	WTFLO KG/SEC	PLENP PSI
			BETA DEG	CLT								
7704	6055.3	-.01	-.00	-.0071	.0193	-.0042	.0019	-.0016	.0050	0.0000	0.0000	-.0
7705	6056.0	-1.87	-.03	-.1366	.0183	.0005	.0018	-.0013	.0049	0.0000	0.0000	-.2
7706	6019.3	.06	.00	-.0024	.0196	-.0043	.0023	-.0017	.0051	0.0000	0.0000	-.1
7707	6092.5	1.92	.03	.1049	.0217	-.0078	.0021	-.0018	.0049	0.0000	0.0000	-.1
7708	6102.7	3.94	.06	.2233	.0282	-.0173	.0022	-.0018	.0046	0.0000	0.0000	-.0
7709	6088.3	6.01	.09	.3526	.0435	-.0331	.0025	-.0020	.0044	0.0000	0.0000	-.1
7710	6073.9	8.26	.12	.4944	.0719	-.0516	.0009	-.0020	.0040	0.0000	0.0000	-.2
7711	6055.8	10.27	.15	.6119	.1072	-.0676	-.0001	-.0019	.0030	0.0000	0.0000	-.2
7712	6028.7	12.43	.18	.7191	.1540	-.0866	.0014	-.0020	.0029	0.0000	0.0000	-.2
7713	6030.9	14.59	.21	.8371	.2123	-.1201	.0012	-.0021	.0028	0.0000	0.0000	-.2
7714	5963.5	16.84	.24	.9540	.2845	-.1634	.0013	-.0024	.0042	0.0000	0.0000	-.2
7715	6021.7	19.08	.28	1.0139	.3550	-.2123	.0005	-.0022	.0047	0.0000	0.0000	-.3
7716	6059.7	20.81	.30	1.0785	.4143	-.2602	.0006	-.0030	.0051	0.0000	0.0000	-.6
7717	6004.4	22.98	.33	1.1608	.4935	-.3113	.0004	-.0025	.0063	0.0000	0.0000	-.3
7718	6031.0	23.63	.34	1.1854	.5183	-.3243	.0002	-.0035	.0068	0.0000	0.0000	-.3
7719	6030.4	-.03	-.00	-.0079	.0189	-.0041	.0019	-.0018	.0049	0.0000	0.0000	-.1

ORIGINAL PAGE IS
OF POOR QUALITY

NASA LANGLEY

7 X 10 HIGH SPEED TUNNEL

TEST TP	21 MACH	Q PA	RUN 136 ALPHA DEG	BETA DEG	CNF(BA)	CAF(BA)	CPH(BA)	CRH(BA)	CYH(BA)	CSF(BA)	TPLEN DEG K
7720	.300	6057.4	-.03	-.00	-.0142	-.0115	-.0019	.0020	-.0013	-.0046	293.2
7721	.301	6065.8	-1.83	-.03	-.1386	-.0166	.0002	.0019	-.0014	-.0048	292.9
7722	.300	6059.0	-.01	-.00	-.0097	-.0115	-.0014	.0019	-.0013	-.0048	292.7
7723	.301	6077.5	1.95	.03	.0954	-.0121	-.0009	.0023	-.0012	.0049	292.4
7724	.301	6083.5	3.94	-.06	.2216	-.0157	-.0254	.0024	-.0010	.0040	292.2
7725	.302	6128.9	6.00	.09	.3662	-.0218	-.0461	.0027	-.0009	.0022	291.9
7726	.302	6099.3	8.07	.12	.5061	-.0284	-.0625	.0020	-.0008	.0018	291.8
7727	.301	6082.9	10.31	.15	.6471	-.0332	-.0771	.0014	-.0008	.0018	291.6
7728	.301	6063.8	12.47	.18	.7676	-.0365	-.0896	.0013	-.0007	.0017	291.4
7729	.299	6016.5	14.62	.21	.8946	-.0387	-.1156	.0015	-.0012	.0012	291.2
7730	.299	6007.1	16.83	.24	1.0338	-.0416	-.1543	.0020	-.0019	.0021	290.9
7731	.299	6009.7	18.91	.27	1.1543	-.0433	-.1989	.0029	-.0025	.0024	290.7
7732	.298	5954.4	20.92	.30	1.2619	-.0465	-.2419	.0012	-.0015	.0017	290.5
7733	.299	6012.4	23.11	.33	1.3740	-.0454	-.2870	-.0011	-.0003	.0020	290.3
7734	.301	6067.3	23.76	.34	1.3992	-.0426	-.3026	-.0004	-.0000	.0032	290.2
7735	.299	5998.8	-.02	-.00	-.0087	-.0101	-.0018	.0020	-.0013	.0050	289.7

TEST TP	21 ALPHA DEG	BETA DEG	RUN 136 CL(SA)	CD(SA)	CPH(SA)	CRM(SA)	CYH(SA)	CSF(SA)	P1 PA	CPB(I)	VTOT M/SEC
7720	-.03	-.00	-.0142	-.0115	-.0019	.0020	-.0013	.0046	95873.3	-.109	529.3
7721	-1.83	-.03	-.1391	-.0121	.0002	.0019	-.0014	.0048	95862.8	-.111	529.6
7722	-.01	-.00	-.0097	-.0115	-.0014	.0019	-.0013	.0048	95869.9	-.109	529.5
7723	1.95	.03	.0958	-.0089	-.0009	.0022	-.0012	.0049	95853.9	-.107	529.2
7724	3.94	.06	.2222	-.0004	-.0254	.0023	-.0012	.0040	95847.6	-.108	529.1
7725	6.00	.09	.3665	.0166	-.0461	.0026	-.0012	.0022	95800.0	-.112	529.0
7726	8.07	.12	.5051	.0429	-.0625	.0019	-.0012	.0018	95831.1	-.123	528.8
7727	10.31	.15	.6426	.0832	-.0771	.0012	-.0010	.0018	95848.2	-.133	528.6
7728	12.47	.18	.7573	.1302	-.0896	.0012	-.0009	.0017	95865.9	-.143	528.4
7729	14.62	.21	.8754	.1883	-.1156	.0011	-.0015	.0012	95921.2	-.152	528.2
7730	16.83	.24	1.0016	.2596	-.1543	.0013	-.0024	.0021	95927.8	-.160	528.0
7731	18.91	.27	1.1060	.3332	-.1989	.0019	-.0033	.0024	95918.2	-.168	527.8
7732	20.92	.30	1.1953	.4072	-.2419	.0005	-.0018	.0017	95976.0	-.174	527.7
7733	23.11	.33	1.2816	.4975	-.2870	-.0012	.0001	.0020	95915.4	-.186	527.6
7734	23.76	.34	1.2978	.5248	-.3026	-.0004	.0001	.0032	95864.7	-.190	527.5
7735	-.02	-.00	-.0087	-.0101	-.0018	.0020	-.0013	.0050	95929.5	-.109	527.1

TEST TP	21 Q FA	ALPHA DEG	RUN 136 BETA DEG	CLT	CDT	CMST	CRTS	CYTS	CYST	CMU	WTFLE KG/SEC	PLENP PSI
7720	6057.4	-.03	-.00	-.0265	.0180	-.0193	.0020	-.0019	.0063	.0497	.0557	119.4
7721	6065.8	-1.33	-.03	-.1505	.0179	-.0173	.0019	-.0020	.0065	.0497	.0657	120.2
7722	6059.0	-.01	-.00	-.0221	.0182	-.0149	.0019	-.0019	.0065	.0498	.0658	120.4
7723	6077.5	1.95	.03	.0825	.0203	-.0154	.0022	-.0018	.0065	.0496	.0658	120.4
7724	6083.5	3.94	.06	.2078	.0283	-.0429	.0023	-.0018	.0057	.0496	.0659	120.6
7725	6128.9	6.00	.09	.3512	.0446	-.0635	.0026	-.0018	.0038	.0493	.0660	120.6
7726	6099.3	8.07	.12	.4888	.0705	-.0800	.0018	-.0018	.0034	.0495	.0660	120.6
7727	6082.9	10.31	.15	.6251	.1101	-.0940	.0011	-.0016	.0034	.0497	.0660	120.6
7728	6063.8	12.47	.18	.7388	.1565	-.1071	.0010	-.0015	.0034	.0499	.0661	120.6
7729	6016.5	14.62	.21	.8558	.2142	-.1333	.0010	-.0021	.0029	.0502	.0661	120.6
7730	6007.1	16.83	.24	.9809	.2847	-.1720	.0012	-.0030	.0038	.0504	.0662	120.7
7731	6009.7	18.91	.27	1.0845	.3575	-.2146	.0017	-.0039	.0040	.0502	.0661	120.6
7732	5954.4	20.92	.30	1.1727	.4310	-.2598	.0003	-.0024	.0034	.0508	.0662	120.7
7733	6012.4	23.11	.33	1.2583	.5202	-.3047	-.0014	-.0004	.0037	.0503	.0662	120.8
7734	6067.3	23.76	.34	1.2745	.5470	-.3202	-.0007	-.0004	.0049	.0498	.0662	120.9
7735	5998.8	-.02	-.00	-.0213	.0201	-.0196	.0020	-.0019	.0066	.0505	.0664	120.9

NASA LANGLEY

7 X 10 HIGH SPEED TUNNEL

TEST TP	21 MACH	Q PA	RUN 137		CNF(BA)	CAF(BA)	CPH(BA)	CRH(BA)	CYH(BA)	CSF(BA)	TPLEN DEG K
			ALPHA DEG	BETA DEG							
7736	.300	6050.3	.00	.00	-.0138	-.0354	.0063	.0017	-.0009	.0028	286.0
7737	.301	6087.2	-1.87	-.03	-.1385	-.0406	.0060	.0018	-.0009	.0047	285.7
7738	.301	6065.6	.06	.00	-.0097	-.0351	.0062	.0020	-.0010	.0038	285.5
7739	.301	6072.5	2.01	.03	.0844	-.0356	.0084	.0026	-.0004	.0034	285.3
7740	.303	6138.0	4.00	.06	.2187	-.0389	-.0213	.0026	-.0005	.0021	285.2
7741	.303	6164.6	6.03	.09	.3754	-.0453	-.0464	.0026	-.0005	.0006	285.0
7742	.302	6120.4	8.23	.12	.5381	-.0531	-.0723	.0020	-.0007	.0014	284.9
7750	.303	6146.9	10.56	.15	.7046	-.0600	-.0864	.0031	-.0001	.0014	283.9
7751	.299	6021.5	12.68	.18	.8461	-.0675	-.0931	.0025	.0003	.0007	283.7
7752	.300	6033.2	14.63	.21	.9688	-.0727	-.1075	.0028	.0001	.0016	283.6
7753	.298	5965.8	16.79	.24	1.0875	-.0756	-.1402	.0010	.0008	-.0005	283.5
7754	.302	6118.4	19.01	.27	1.2225	-.0781	-.1825	.0018	.0001	.0005	283.4
7755	.299	5987.0	21.41	.31	1.3685	-.0839	-.2295	.0032	-.0014	.0012	283.4
7756	.300	6036.1	23.14	.33	1.4760	-.0866	-.2667	.0036	-.0019	.0006	283.3
7757	.298	5965.7	23.89	.34	1.5188	-.0883	-.2822	.0026	-.0019	.0000	283.2
7758	.299	6005.7	.00	-.00	-.0046	-.0366	.0041	.0021	-.0006	.0030	283.0

TEST TP	21 ALPHA DEG	BETA DEG	RUN 137		CPH(SA)	CRH(SA)	CYH(SA)	CSF(SA)	P1 PA	CPB(1)	VTOT M/SEC
			CL(SA)	CD(SA)							
7736	.00	.00	-.0138	-.0354	.0063	.0017	-.0009	.0028	95881.4	-.107	566.6
7737	-1.87	-.03	-.1398	-.0361	.0060	.0019	-.0008	.0047	95843.8	-.111	566.3
7738	.06	.00	-.0096	-.0352	.0062	.0020	-.0010	.0038	95866.3	-.107	566.1
7739	2.01	.03	.0856	-.0326	.0084	.0026	-.0004	.0034	95859.1	-.109	566.0
7740	4.00	.06	.2209	-.0235	-.0213	.0026	-.0007	.0021	95797.3	-.107	565.9
7741	6.03	.09	.3781	-.0056	-.0464	.0025	-.0008	.0006	95769.5	-.110	565.8
7742	8.23	.12	.5402	.0244	-.0723	.0019	-.0010	.0014	95815.8	-.118	565.5
7750	10.56	.15	.7036	.0702	-.0864	.0030	-.0007	.0014	95774.4	-.132	565.0
7751	12.68	.18	.8403	.1199	-.0931	.0025	-.0003	.0007	95903.6	-.146	564.6
7752	14.63	.21	.9558	.1743	-.1075	.0027	-.0006	.0016	95888.4	-.154	564.6
7753	16.79	.24	1.0630	.2417	-.1402	.0011	.0005	-.0005	95964.1	-.161	564.6
7754	19.01	.27	1.1813	.3244	-.1825	.0018	-.0005	.0005	95797.5	-.169	564.5
7755	21.41	.31	1.3047	.4215	-.2295	.0025	-.0024	.0012	95928.3	-.172	564.5
7756	23.14	.33	1.3913	.5004	-.2667	.0026	-.0032	.0006	95880.4	-.180	564.4
7757	23.89	.34	1.4244	.5344	-.2822	.0016	-.0028	.0000	95957.5	-.183	564.3
7758	.00	-.00	-.0046	-.0366	.0041	.0020	-.0006	.0030	95908.7	-.107	564.1

TEST TP	21 Q PA	ALPHA DEG	RUN 137		CLT	CDT	CMST	CRTS	CYTS	CYST	CMU	TFLO KG/SEC	FLENP PSI
			BETA DEG	CLT									
7736	6050.3	.00	.00	-.0374	.0213	-.0273	.0017	-.0021	.0004	.1003	.1244	229.8	
7737	6087.2	-1.87	-.03	-.1614	.0211	-.0273	.0019	-.0020	.0076	.1002	.1244	229.7	
7738	6065.6	.06	.00	-.0333	.0215	-.0272	.0020	-.0021	.0070	.1007	.1246	229.8	
7739	6072.5	2.01	.03	.0601	.0232	-.0250	.0025	-.0016	.0065	.1007	.1248	230.1	
7740	6138.0	4.00	.06	.1937	.0307	-.0544	.0025	-.0018	.0052	.0996	.1248	230.2	
7741	6164.6	6.03	.09	.3491	.0475	-.0794	.0024	-.0019	.0037	.0992	.1249	230.3	
7742	6120.4	8.23	.12	.5090	.0766	-.1055	.0018	-.0022	.0045	.0997	.1246	229.8	
7750	6146.9	10.56	.15	.6703	.1212	-.1196	.0028	-.0018	.0045	.1001	.1257	231.3	
7751	6021.5	12.68	.18	.8044	.1706	-.1270	.0023	-.0014	.0039	.1021	.1256	231.1	
7752	6033.2	14.63	.21	.9182	.2238	-.1413	.0024	-.0018	.0048	.1021	.1260	231.6	
7753	5965.8	16.79	.24	1.0231	.2903	-.1745	.0008	-.0007	.0027	.1034	.1262	231.7	
7754	6118.4	19.01	.27	1.1406	.3702	-.2159	.0014	-.0016	.0037	.1006	.1260	231.7	
7755	5987.0	21.41	.31	1.2612	.4666	-.2637	.0020	-.0035	.0044	.1029	.1260	231.8	
7756	6036.1	23.14	.33	1.3468	.5438	-.3006	.0021	-.0043	.0038	.1021	.1261	231.9	
7757	5965.7	23.89	.34	1.3788	.5777	-.3164	.0012	-.0039	.0033	.1034	.1262	231.8	
7758	6005.7	.00	-.00	-.0287	.0211	-.0300	.0020	-.0018	.0062	.1028	.1264	232.0	

ORIGINAL PAGE IS OF POOR QUALITY

NASA LANGLEY

7 X 10 HIGH SPEED TUNNEL

TEST TP	21 MACH	0 PA	RUN 138 ALPHA DEG	BETA DEG	CNF(BA)	CAF(BA)	CPH(BA)	CRM(BA)	CYM(BA)	CSF(BA)	TPLEN DEG K
7759	.301	6073.5	.01	-.00	-.0083	-.0849	.0230	.0020	.0007	.0011	279.2
7760	.301	6091.7	-1.85	-.03	-.1288	-.0904	.0168	.0029	.0012	.0034	279.1
7761	.301	6061.6	.03	-.00	-.0099	-.0848	.0239	.0019	.0006	.0008	279.0
7762	.301	6080.1	2.19	.03	.0696	-.0855	.0304	.0023	.0009	.0014	278.9
7763	.302	6116.6	4.06	.06	.2089	-.0891	-.0021	.0037	.0008	-.0023	278.9
7764	.302	6129.0	6.23	.09	.3916	-.0955	-.0373	.0043	.0011	-.0062	278.8
7765	.300	6023.4	8.14	.12	.5468	-.1039	-.0685	.0030	.0014	-.0076	278.7
7766	.303	6143.8	10.35	.15	.7229	-.1089	-.0922	.0036	.0005	-.0068	278.7
7767	.300	6030.9	12.62	.18	.9227	-.1171	-.0970	.0049	.0011	-.0043	278.7
7768	.299	6006.3	14.78	.21	1.1064	-.1293	-.1127	.0016	.0013	-.0018	278.7
7769	.298	5980.9	17.20	.24	1.2721	-.1369	-.1290	.0020	.0014	-.0060	278.7
7770	.299	6003.7	19.25	.27	1.3810	-.1425	-.1512	-.0030	.0043	-.0070	278.8
7771	.298	5977.8	21.28	.30	1.4914	-.1475	-.1860	-.0010	.0030	-.0059	278.9
7772	.299	5984.8	23.31	.33	1.6057	-.1489	-.2329	-.0007	.0031	-.0041	279.1
7773	.302	6101.7	24.07	.34	1.6415	-.1489	-.2482	.0015	.0013	-.0020	279.2
7774	.300	6023.6	.01	-.00	-.0049	-.0876	.0247	.0021	.0008	.0014	279.8

TEST TP	21 ALPHA DEG	BETA DEG	RUN 138 CL(SA)	CD(SA)	CPM(SA)	CRM(SA)	CYM(SA)	CSF(SA)	P1 PA	CPB(1)	VTOT M/SEC
7759	.01	-.00	-.0083	-.0849	.0230	.0020	.0007	.0011	95837.7	-.107	593.9
7760	-1.85	-.03	-.1316	-.0862	.0168	.0029	.0013	.0034	95815.3	-.108	593.7
7761	.03	-.00	-.0099	-.0848	.0239	.0019	.0006	.0008	95850.2	-.106	593.5
7762	2.19	.03	.0726	-.0828	.0304	.0023	.0008	.0014	95827.5	-.110	593.4
7763	4.06	.06	.2147	-.0740	-.0021	.0037	.0005	-.0023	95792.7	-.110	593.4
7764	6.23	.09	.3996	-.0525	-.0373	.0044	.0007	-.0062	95783.0	-.112	593.4
7765	8.14	.12	.5560	-.0254	-.0685	.0032	.0010	-.0076	95693.6	-.117	593.2
7766	10.35	.15	.7307	.0228	-.0922	.0036	-.0002	-.0068	95760.7	-.131	593.3
7767	12.62	.18	.9260	.0874	-.0970	.0050	-.0000	-.0043	95679.0	-.141	593.2
7768	14.78	.21	1.1018	.1610	-.1127	.0019	.0009	-.0018	95908.1	-.150	593.2
7769	17.20	.24	1.2557	.2453	-.1290	.0023	.0008	-.0060	95931.3	-.157	593.2
7770	19.25	.27	1.3508	.3208	-.1512	-.0014	.0050	-.0070	95905.9	-.165	593.3
7771	21.28	.30	1.4432	.4039	-.1860	.0001	.0031	-.0059	95934.6	-.173	593.4
7772	23.31	.33	1.5336	.4986	-.2329	.0006	.0031	-.0041	95921.8	-.172	593.6
7773	24.07	.34	1.5595	.5336	-.2482	.0019	.0006	-.0020	95804.8	-.176	593.8
7774	.01	-.00	-.0049	-.0876	.0247	.0021	.0008	.0014	95679.0	-.106	594.4

TEST TP	21 0 PA	ALPHA DEG	RUN 138 BETA DEG	CLT	COT	CMST	CRTS	CYTS	CYST	CMU	WTFLO KG/SEC	PLENP PSI
7759	6073.5	.01	-.00	-.0526	.0214	-.0398	.0020	-.0014	.0070	.1971	.2328	431.9
7760	6091.7	-1.85	-.03	-.1723	.0210	-.0457	.0029	-.0009	.0093	.1964	.2327	431.4
7761	6061.6	.03	-.00	-.0542	.0214	-.0388	.0019	-.0016	.0067	.1973	.2327	430.7
7762	6080.1	2.19	.03	.0247	.0214	-.0321	.0023	-.0014	.0073	.1966	.2326	430.8
7763	6116.6	4.06	.06	.1635	.0279	-.0642	.0036	-.0016	.0036	.1954	.2326	431.0
7764	6129.0	6.23	.09	.3447	.0473	-.0994	.0041	-.0015	-.0003	.1952	.2328	431.2
7765	6023.4	8.14	.12	.4967	.0742	-.1317	.0029	-.0012	-.0016	.1990	.2333	431.3
7766	6143.8	10.35	.15	.6688	.1182	-.1542	.0033	-.0023	-.0009	.1949	.2331	431.4
7767	6030.9	12.62	.18	.8592	.1820	-.1602	.0046	-.0022	.0017	.1986	.2332	431.7
7768	6006.3	14.78	.21	1.0312	.2535	-.1762	.0013	-.0012	.0042	.1991	.2329	431.8
7769	5980.9	17.20	.24	1.1810	.3351	-.1927	.0017	-.0013	.0000	.2002	.2331	431.6
7770	6003.7	19.25	.27	1.2732	.4075	-.2147	-.0022	.0030	-.0010	.1994	.2330	431.4
7771	5977.8	21.28	.30	1.3622	.4881	-.2497	-.0007	.0011	.0001	.1999	.2326	431.4
7772	5984.8	23.31	.33	1.4497	.5798	-.2965	-.0003	.0011	.0019	.1996	.2324	431.5
7773	6101.7	24.07	.34	1.4762	.6122	-.3106	.0010	-.0014	.0039	.1960	.2326	431.6
7774	6023.6	.01	-.00	-.0495	.0195	-.0385	.0021	-.0014	.0074	.1986	.2324	431.6

NASA LANGLEY

7 X 10 HIGH SPEED TUNNEL

TEST TP	21	MACH	Q PA	RUN 139			CAF(BA)	CPN(BA)	CRM(BA)	CYM(BA)	CSF(BA)	TPLEN DEG K
				ALPHA DEG	BETA DEG	CHF(BA)						
7775	.301	6067.0	.02	-.00	.0018	-.1100	.0306	.0019	.0018	-.0013	282.9	
7776	.301	6080.7	-1.85	-.03	-.1287	-.1163	.0211	.0026	.0021	.0000	283.3	
7777	.300	6042.6	.06	-.00	.0019	-.1111	.0308	.0019	.0020	-.0023	283.7	
7778	.300	6049.1	1.99	.03	.0573	-.1118	.0395	.0015	.0017	-.0023	284.1	
7779	.302	6099.6	3.89	.06	.1962	-.1149	.0021	.0031	.0019	-.0050	284.5	
7780	.302	6131.0	6.00	.09	.3748	-.1209	-.0326	.0053	.0026	-.0089	284.9	
7781	.301	6062.3	8.28	.12	.5715	-.1303	-.0734	.0035	.0027	-.0109	285.2	
7782	.300	6034.7	10.64	.15	.7668	-.1393	-.0942	.0037	.0016	-.0101	285.6	
7783	.300	6051.2	12.57	.18	.9442	-.1454	-.1021	.0045	.0015	-.0082	285.8	
7784	.301	6087.4	14.84	.21	1.1352	-.1521	-.1161	.0004	.0008	-.0068	286.2	
7785	.299	6018.4	17.04	.24	1.3206	-.1628	-.1399	-.0016	.0015	-.0090	286.7	
7786	.298	5947.2	19.30	.27	1.4738	-.1749	-.1581	-.0060	.0023	-.0106	287.0	
7787	.298	5982.8	21.27	.30	1.5507	-.1776	-.1818	-.0028	.0025	-.0109	287.3	
7788	.299	6014.8	23.46	.33	1.6614	-.1789	-.2238	.0020	.0012	-.0062	287.6	
7789	.299	6019.6	24.13	.34	1.7052	-.1811	-.2374	-.0010	.0034	-.0099	287.8	
7790	.299	5999.7	.01	-.00	-.0061	-.1148	.0311	.0016	.0016	-.0017	288.5	

TEST TP	21	ALPHA DEG	BETA DEG	RUN 139			CRM(SA)	CYM(SA)	CSF(SA)	P1 PA	CPB(1)	WTDI M/SEC
				CL(SA)	CD(SA)	CPH(SA)						
7775	.02	-.00	.0019	-.1100	.0306	.0019	.0018	-.0013	95832.9	-.107	605.7	
7776	-1.85	-.03	-.1324	-.1120	.0211	.0026	.0021	.0000	95813.2	-.107	606.1	
7777	.06	-.00	.0020	-.1111	.0308	.0019	.0020	-.0023	95859.9	-.107	606.5	
7778	1.99	.03	.0612	-.1098	.0395	.0016	.0016	-.0023	95853.1	-.110	606.9	
7779	3.89	.06	.2035	-.1013	.0021	.0033	.0017	-.0050	95801.6	-.110	607.3	
7780	6.00	.09	.3854	-.0811	-.0326	.0056	.0020	-.0089	95774.2	-.111	607.7	
7781	8.28	.12	.5843	-.0467	-.0734	.0039	.0022	-.0109	95839.4	-.116	608.1	
7782	10.64	.15	.7794	.0047	-.0942	.0039	.0009	-.0101	95868.3	-.126	608.5	
7783	12.57	.18	.9533	.0635	-.1021	.0047	.0005	-.0082	95850.9	-.137	608.7	
7784	14.84	.21	1.1363	.1437	-.1161	.0006	.0007	-.0068	95813.1	-.148	609.2	
7785	17.04	.24	1.3103	.2313	-.1399	-.0011	.0018	-.0090	95892.1	-.154	609.6	
7786	19.30	.27	1.4488	.3219	-.1581	-.0050	.0041	-.0106	95963.2	-.158	610.0	
7787	21.27	.30	1.5095	.3970	-.1818	-.0017	.0033	-.0109	95922.6	-.165	610.3	
7788	23.46	.33	1.5953	.4974	-.2238	.0023	.0003	-.0062	95889.1	-.172	610.6	
7789	24.13	.34	1.6303	.5319	-.2374	.0005	.0035	-.0099	95887.7	-.173	610.9	
7790	.01	-.00	-.0061	-.1148	.0311	.0016	.0016	-.0017	95898.1	-.107	611.6	

TEST TP	21	Q PA	ALPHA DEG	BETA DEG	CLT	CDT	CMST	CRTS	CYTS	CYST	CMU	WTFLO KG/SEC	PLENP PSI
7775	6067.0	.02	-.00	-.0505	.0156	-.0436	.0019	-.0007	.0057	.2360	.2731	510.0	
7776	6080.7	-1.85	-.03	-.1805	.0149	-.0529	.0027	-.0004	.0070	.2351	.2724	509.7	
7777	6042.6	.06	-.00	-.0506	.0148	-.0436	.0019	-.0006	.0047	.2365	.2721	509.4	
7778	6049.1	1.99	.03	.0045	.0142	-.0348	.0015	-.0009	.0048	.2362	.2719	509.2	
7779	6099.6	3.89	.06	.1432	.0197	-.0716	.0031	-.0008	.0020	.2344	.2718	509.3	
7780	6131.0	6.00	.09	.3210	.0370	-.1059	.0053	-.0005	-.0019	.2329	.2714	509.3	
7781	6062.3	8.28	.12	.5145	.0701	-.1475	.0035	-.0004	-.0038	.2357	.2713	509.5	
7782	6034.7	10.64	.15	.7044	.1191	-.1687	.0034	-.0017	-.0030	.2369	.2714	509.6	
7783	6051.2	12.57	.18	.8747	.1750	-.1765	.0041	-.0020	-.0011	.2363	.2713	509.8	
7784	6087.4	14.84	.21	1.0538	.2514	-.1900	-.0001	-.0018	.0002	.2349	.2711	510.0	
7785	6018.4	17.04	.24	1.2228	.3369	-.2146	-.0018	-.0006	-.0020	.2374	.2706	509.7	
7786	5947.2	19.30	.27	1.3561	.4252	-.2337	-.0058	.0017	-.0035	.2403	.2705	509.7	
7787	5982.8	21.27	.30	1.4139	.4965	-.2571	-.0026	.0009	-.0038	.2388	.2704	509.9	
7788	6014.8	23.46	.33	1.4965	.5926	-.2986	.0013	-.0021	.0009	.2375	.2701	509.8	
7789	6019.6	24.13	.34	1.5304	.6259	-.3121	-.0006	.0012	-.0029	.2373	.2701	509.9	
7790	5999.7	.01	-.00	-.0590	.0122	-.0439	.0016	-.0010	.0054	.2381	.2698	510.1	

ORIGINAL PAGE IS OF POOR QUALITY

NASA LANGLEY

7 X 10 HIGH SPEED TUNNEL

TEST TP	21 MACH	0 PA	RUN 140 ALPHA DEG	BETA DEG	CNF(BA)	CAF(BA)	CPH(BA)	CRN(BA)	CYM(BA)	CSF(BA)	TPLEN DEG K
7791	.700	25225.5	-.06	-.00	-.0072	-.0106	-.0022	.0025	-.0009	.0038	290.6
7792	.694	24910.2	-2.26	-.03	-.1509	-.0074	-.0016	.0019	-.0012	.0054	290.8
7793	.703	25347.9	-.00	-.00	-.0044	-.0103	-.0018	.0023	-.0010	-.0045	291.0
7794	.706	25509.7	2.22	.03	.1278	-.0126	-.0165	.0024	-.0009	.0040	291.1
7795	.711	25760.0	4.60	.06	.2887	-.0174	-.0322	.0027	-.0009	.0019	291.1
7796	.708	25585.2	6.92	.09	.4467	-.0225	-.0484	.0021	-.0013	.0003	291.1
7797	.704	25414.0	9.23	.13	.5800	-.0234	-.0626	.0019	-.0011	-.0012	291.1
7798	.701	25248.9	11.70	.16	.7201	-.0251	-.0862	.0022	-.0010	-.0018	291.2
7799	.698	25091.9	14.22	.19	.8603	-.0271	-.1174	.0021	-.0012	-.0012	291.2
7800	.697	25033.4	16.26	.22	.9678	-.0277	-.1608	.0026	-.0011	-.0016	291.1
7801	.694	24925.3	18.32	.25	1.0889	-.0299	-.2008	.0028	-.0017	-.0012	291.1
7802	.692	24802.8	20.55	.30	1.2114	-.0317	-.2510	.0048	-.0046	-.0011	291.1
7803	.690	24714.6	22.51	.32	1.2990	-.0298	-.3139	.0026	-.0027	-.0018	291.1
7804	.684	24486.0	24.49	.36	1.4124	-.0329	-.3599	.0042	-.0051	-.0011	291.0
7805	.701	25235.9	-.05	-.00	-.0056	-.0103	-.0005	.0021	-.0011	.0048	290.8

TEST TP	21 ALPHA DEG	BETA DEG	RUN 140 CL(SA)	CD(SA)	CPH(SA)	CRN(SA)	CYM(SA)	CSF(SA)	P1 PA	CPB(1)	VTOT M/SEC
7791	-.06	-.00	-.0072	-.0106	-.0022	.0025	-.0009	.0038	73443.4	-.112	620.2
7792	-2.26	.03	-.1509	-.0074	-.0016	.0019	-.0012	.0054	73880.5	-.113	620.2
7793	-.00	-.00	-.0044	-.0103	-.0018	.0023	-.0010	.0045	73258.5	-.112	620.7
7794	2.22	.03	.1278	-.0076	-.0165	.0024	-.0010	.0040	73050.9	-.117	621.0
7795	4.60	.06	.2892	.0058	-.0322	.0027	-.0011	.0019	72727.4	-.117	621.2
7796	6.92	.09	.4462	.0314	-.0484	.0019	-.0015	.0003	72965.2	-.124	621.1
7797	9.23	.13	.5763	.0698	-.0626	.0017	-.0014	-.0012	73199.6	-.136	620.9
7798	11.70	.16	.7103	.1214	-.0862	.0020	-.0014	-.0018	73416.0	-.145	620.8
7799	14.22	.19	.8406	.1850	-.1174	.0018	-.0017	-.0012	73614.6	-.158	620.7
7800	16.26	.22	.9369	.2443	-.1608	.0022	-.0018	-.0016	73688.1	-.171	620.6
7801	18.32	.25	1.0432	.3139	-.2008	.0021	-.0025	-.0012	73837.4	-.185	620.4
7802	20.55	.30	1.1454	.3955	-.2510	.0029	-.0060	.0011	74040.9	-.198	620.3
7803	22.51	.32	1.2086	.4685	-.3139	.0014	-.0035	-.0018	74157.3	-.207	620.2
7804	24.49	.36	1.2990	.5555	-.3599	.0017	-.0064	-.0011	74404.8	-.221	620.0
7805	-.05	-.00	-.0057	-.0103	-.0005	.0021	-.0011	.0048	73464.3	-.113	620.5

TEST TP	21 0 PA	ALPHA DEG	RUN 140 BETA DEG	CLT	CDT	CMST	CRTS	CYTS	CYST	CMU	WTFLO KG/SEC	PLENP PSI
7791	25225.5	-.06	-.00	-.0183	.0161	-.0179	.0025	-.0015	.0053	.0500	.2346	449.2
7792	24910.2	-2.26	-.03	-.1610	.0200	-.0175	.0019	-.0017	.0069	.0505	.2344	449.7
7793	25347.9	-.00	-.00	-.0154	.0162	-.0175	.0023	-.0016	.0060	.0497	.2345	449.8
7794	25509.7	2.22	.03	.1161	.0183	-.0321	.0024	-.0015	.0055	.0494	.2343	450.3
7795	25760.0	4.60	.06	.2763	.0309	-.0476	.0026	-.0016	.0034	.0490	.2345	450.1
7796	25585.2	6.92	.09	.4322	.0562	-.0639	.0018	-.0020	.0018	.0493	.2345	449.8
7797	25414.0	9.23	.13	.5612	.0942	-.0783	.0017	-.0019	.0003	.0496	.2343	449.7
7798	25248.9	11.70	.16	.6940	.1452	-.1019	.0019	-.0020	-.0003	.0499	.2343	449.7
7799	25091.9	14.22	.19	.8232	.2082	-.1332	.0016	-.0022	.0003	.0502	.2343	449.6
7800	25033.4	16.26	.22	.9187	.2669	-.1766	.0021	-.0023	-.0001	.0504	.2346	449.6
7801	24925.3	18.32	.25	1.0240	.3359	-.2167	.0020	-.0031	.0003	.0505	.2342	449.5
7802	24802.8	20.55	.30	1.1253	.4169	-.2670	.0027	-.0065	.0027	.0508	.2345	449.8
7803	24714.6	22.51	.32	1.1877	.4893	-.3300	.0012	-.0040	-.0002	.0510	.2346	450.1
7804	24486.0	24.49	.36	1.2772	.5758	-.3761	.0015	-.0069	.0004	.0514	.2345	449.9
7805	25235.9	-.05	-.00	-.0167	.0163	-.0162	.0021	-.0017	.0063	.0501	.2352	449.8

NASA LANGLEY

7 X 10 HIGH SPEED TUNNEL

TEST TP	21 MACH	Q PA	RUN 141 ALPHA DEG	BETA DEG	CNF(BA)	CAF(BA)	CPH(BA)	CRM(BA)	CYM(BA)	CSF(BA)	TPLEN DEG K
7807	.700	25193.1	-.07	-.00	-.0024	.0173	-.0068	.0025	-.0017	.0054	294.5
7808	.695	24970.1	-2.25	-.03	-.1519	.0139	-.0022	.0020	-.0017	.0061	295.8
7809	.702	25321.5	.03	.00	.0036	.0171	-.0070	.0020	-.0020	.0062	296.8
7810	.704	25384.5	2.29	.03	.1359	.0140	-.0105	.0022	-.0017	.0050	298.5
7811	.706	25520.6	4.56	.06	.2780	.0080	-.0214	.0026	-.0014	.0035	299.9
7812	.706	25488.7	6.93	.09	.4356	.0032	-.0400	.0021	-.0018	.0035	300.7
7813	.701	25229.1	9.26	.12	.5755	.0004	-.0589	.0005	-.0016	.0025	301.8
7815	.701	25250.8	11.52	.15	.6837	.0019	-.0782	.0022	-.0015	.0016	303.3
7816	.697	25035.3	13.83	.19	.8141	.0023	-.1215	.0023	-.0017	.0018	303.7
7817	.695	24926.4	15.93	.22	.9311	.0035	-.1743	.0022	-.0017	.0019	304.0
7818	.689	24656.7	17.97	.25	1.0219	.0055	-.2306	.0011	-.0009	.0010	304.3
7819	.689	24654.7	20.02	.27	1.0974	.0061	-.3008	.0003	-.0001	.0002	304.6
7820	.690	24721.5	22.00	.31	1.2050	.0021	-.3365	.0009	-.0010	.0002	305.0
7821	.691	24763.1	24.17	.34	1.3384	-.0026	-.3726	.0011	-.0015	-.0010	305.3
7822	.700	25209.2	-.03	-.00	.0019	.0158	-.0067	.0022	-.0017	.0058	306.8

TEST TP	21 ALPHA DEG	BETA DEG	RUN 141 CL(SA)	CD(SA)	CPH(SA)	CRM(SA)	CYM(SA)	CSF(SA)	P1 PA	CPB(I)	VTOT M/SEC
7807	-.07	-.00	-.0024	.0173	-.0068	.0025	-.0017	.0054	73467.9	-.110	0.0
7808	-2.25	-.03	-.1512	.0199	-.0022	.0021	-.0016	.0061	73768.6	-.111	0.0
7809	.03	.00	.0036	.0171	-.0070	.0020	-.0020	.0062	73318.0	-.111	0.0
7810	2.29	.03	.1353	.0194	-.0105	.0021	-.0017	.0050	73228.9	-.110	0.0
7811	4.56	.06	.2765	.0300	-.0214	.0025	-.0016	.0035	73081.1	-.111	0.0
7812	6.93	.09	.4320	.0557	-.0400	.0018	-.0020	.0035	73141.2	-.116	0.0
7813	9.26	.12	.5679	.0930	-.0589	.0003	-.0017	.0025	73434.2	-.127	0.0
7815	11.52	.15	.6695	.1385	-.0782	.0018	-.0019	.0016	73402.2	-.140	0.0
7816	13.83	.19	.7899	.1969	-.1215	.0018	-.0022	.0018	73705.9	-.149	0.0
7817	15.93	.22	.8944	.2589	-.1743	.0016	-.0022	.0019	73820.7	-.158	0.0
7818	17.97	.25	.9704	.3204	-.2306	.0007	-.0012	.0010	74174.9	-.169	0.0
7819	20.02	.27	1.0290	.3815	-.3008	.0003	-.0000	.0002	74223.7	-.184	0.0
7820	22.00	.31	1.1165	.4534	-.3365	.0004	-.0013	.0002	74087.8	-.204	0.0
7821	24.17	.34	1.2221	.5457	-.3726	.0004	-.0018	-.0010	74030.2	-.225	0.0
7822	-.03	-.00	.0019	.0158	-.0067	.0022	-.0017	.0058	73440.6	-.110	0.0

TEST TP	21 Q PA	ALPHA DEG	RUN 141 BETA DEG	CLT	CDT	CHST	CRTS	CYTS	CYST	CMU	WFLB KG/SEC	PLENP PSI
7807	25193.1	-.07	-.00	-.0024	.0173	-.0068	.0025	-.0017	.0054	0.0000	0.0000	-.3
7808	24970.1	-2.25	-.03	-.1512	.0199	-.0022	.0021	-.0016	.0061	0.0000	0.0000	-.5
7809	25321.5	.03	.00	.0036	.0171	-.0070	.0020	-.0020	.0062	0.0000	0.0000	-.5
7810	25384.5	2.29	.03	.1353	.0194	-.0105	.0021	-.0017	.0050	0.0000	0.0000	-.2
7811	25520.6	4.56	.06	.2765	.0300	-.0214	.0025	-.0016	.0035	0.0000	0.0000	-.2
7812	25488.7	6.93	.09	.4320	.0557	-.0400	.0018	-.0020	.0035	0.0000	0.0000	-.3
7813	25229.1	9.26	.12	.5679	.0930	-.0589	.0003	-.0017	.0025	0.0000	0.0000	-.3
7815	25250.8	11.52	.15	.6695	.1385	-.0782	.0018	-.0019	.0016	0.0000	0.0000	-.5
7816	25035.3	13.83	.19	.7899	.1969	-.1215	.0018	-.0022	.0018	0.0000	0.0000	-.7
7817	24926.4	15.93	.22	.8944	.2589	-.1743	.0016	-.0022	.0019	0.0000	0.0000	-.9
7818	24656.7	17.97	.25	.9704	.3204	-.2306	.0007	-.0012	.0010	0.0000	0.0000	-.9
7819	24654.7	20.02	.27	1.0290	.3815	-.3008	.0003	-.0000	.0002	0.0000	0.0000	-1.0
7820	24721.5	22.00	.31	1.1165	.4534	-.3365	.0004	-.0013	.0002	0.0000	0.0000	-1.2
7821	24763.1	24.17	.34	1.2221	.5457	-.3726	.0004	-.0018	-.0010	0.0000	0.0000	-1.4
7822	25209.2	-.03	-.00	.0019	.0158	-.0067	.0022	-.0017	.0058	0.0000	0.0000	-.7

ORIGINAL PAGE IS
OF POOR QUALITY

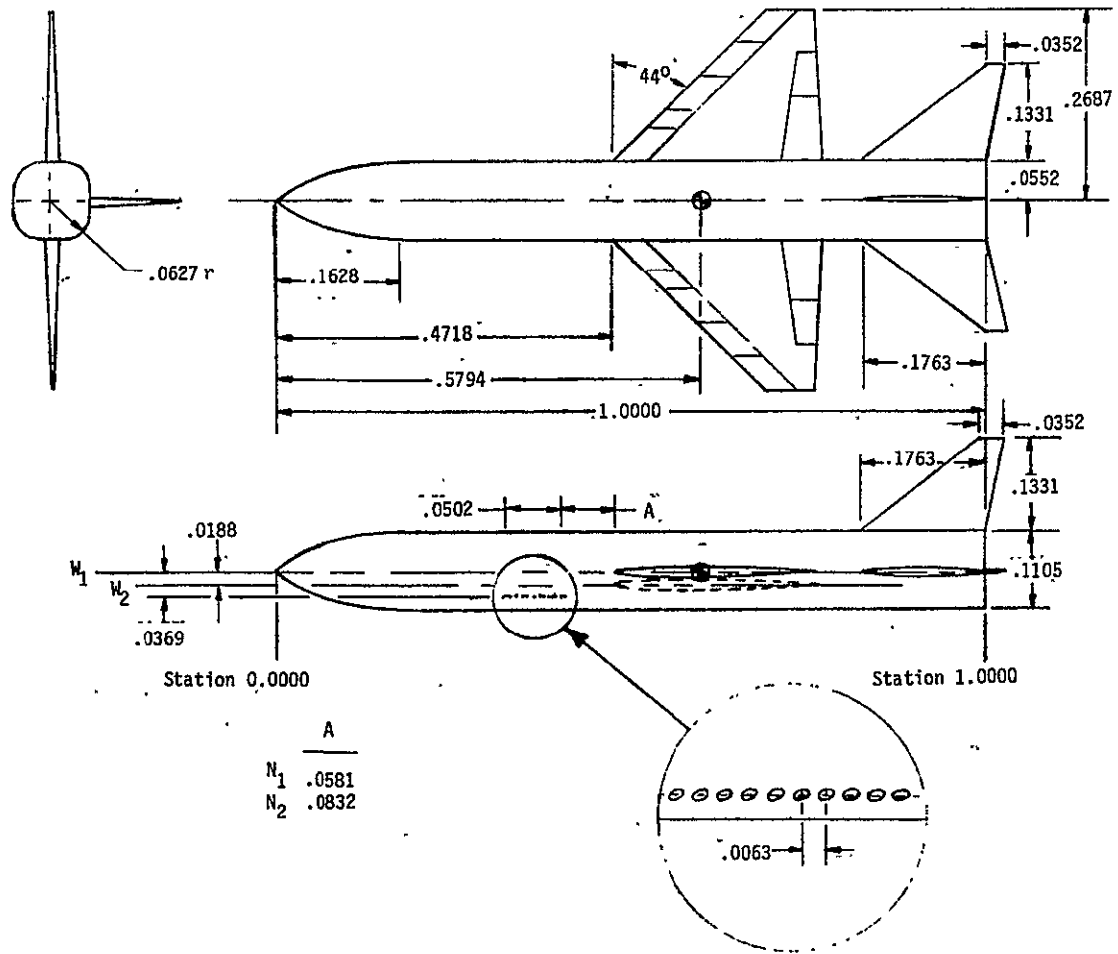

(a) General arrangement of the model.
 Figure 1. Drawings of the model tested. All dimensions are based on a body length of 1.0105 m. (39.870 in.)

ORIGINAL PAGE IS
 OF POOR QUALITY

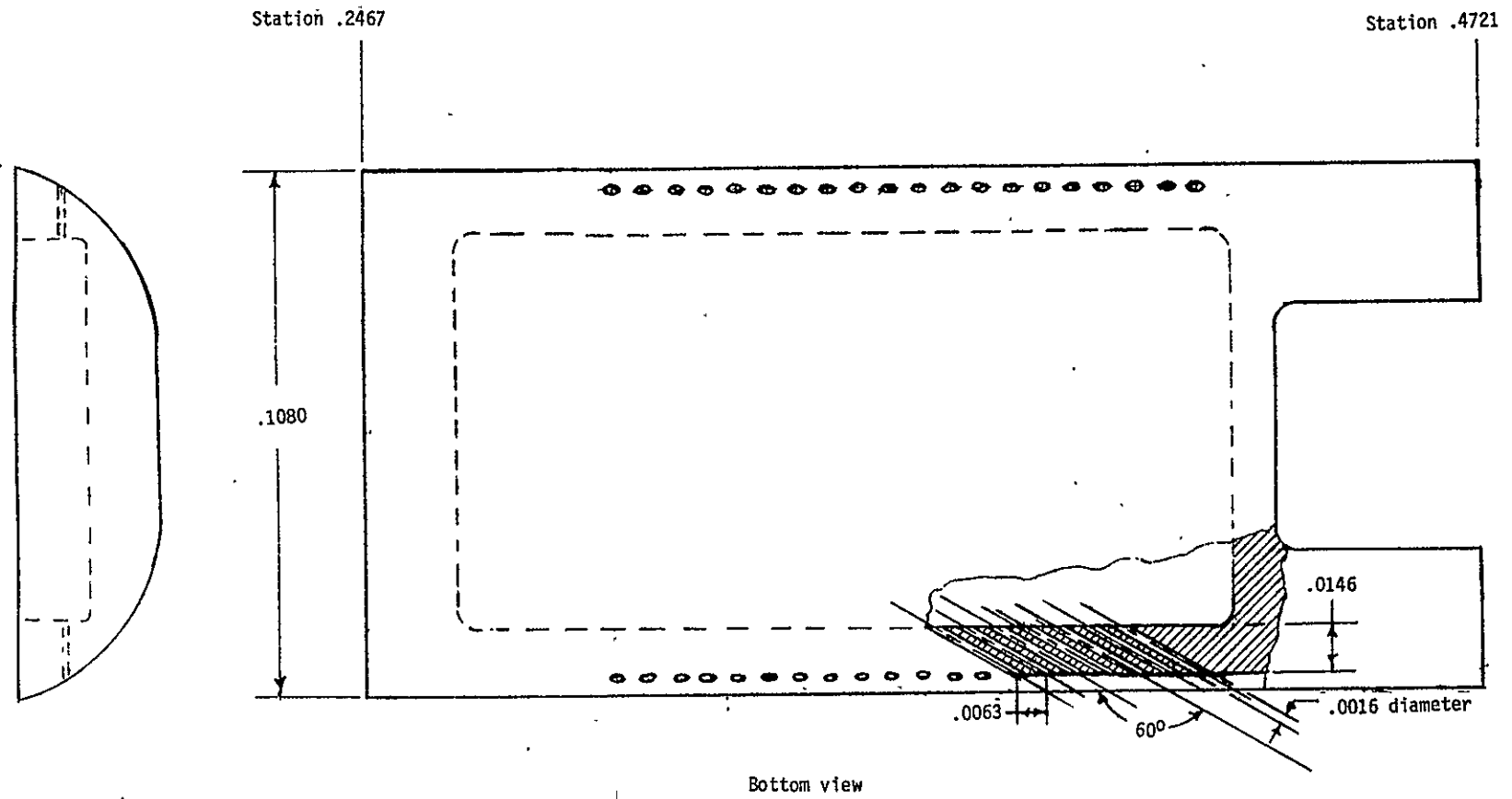

(b) The lower section of the model plenum showing details of the nozzles.
 Figure 1. Concluded.

ORIGINAL PAGE IS
OF POOR QUALITY

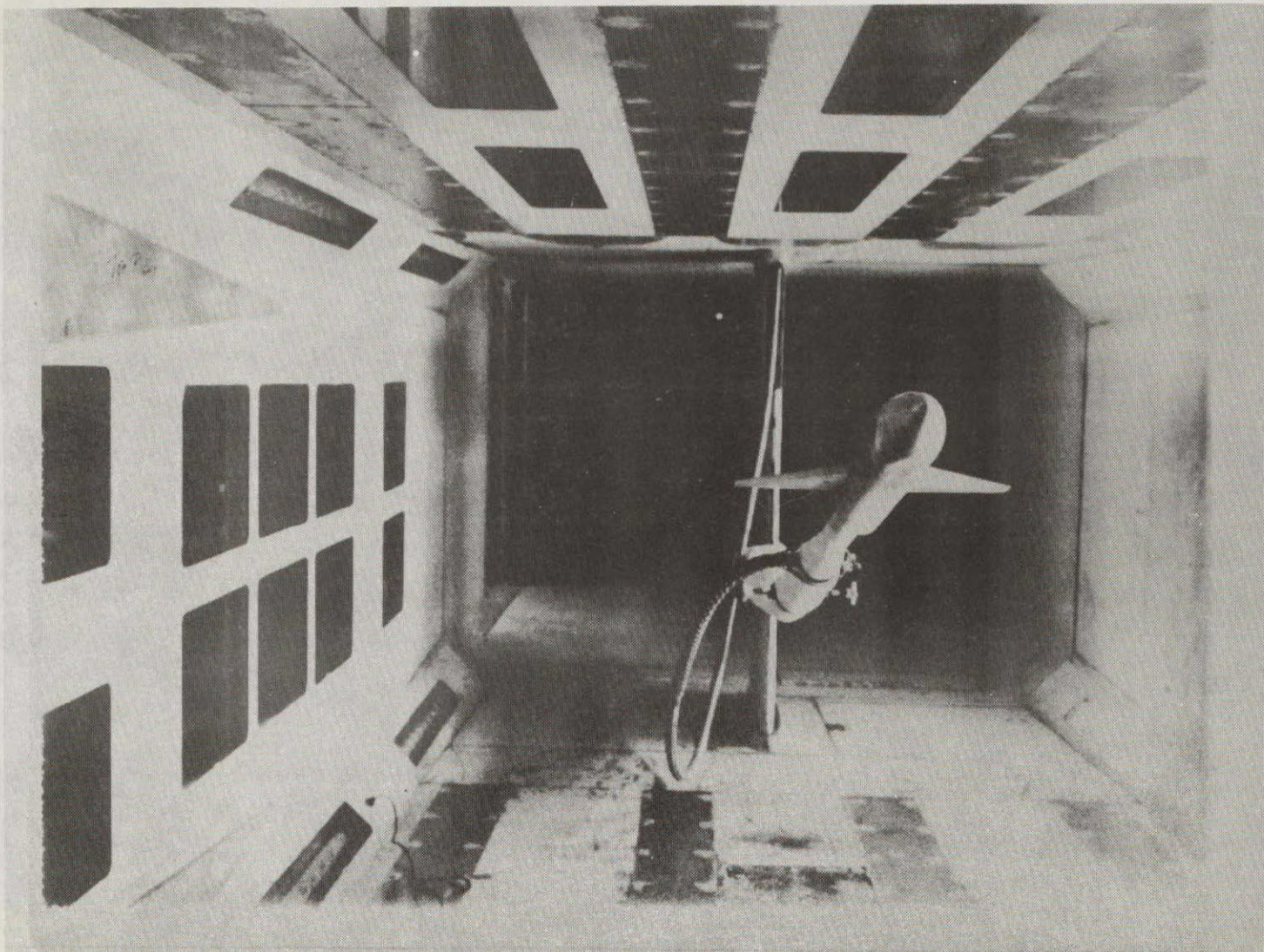

(a) The setup for the pitch range from -2° to 22° .
Figure 2. Photographs of the model installed in the Langley 7- by 10-foot high speed tunnel.

ORIGINAL PAGE IS
OF POOR QUALITY

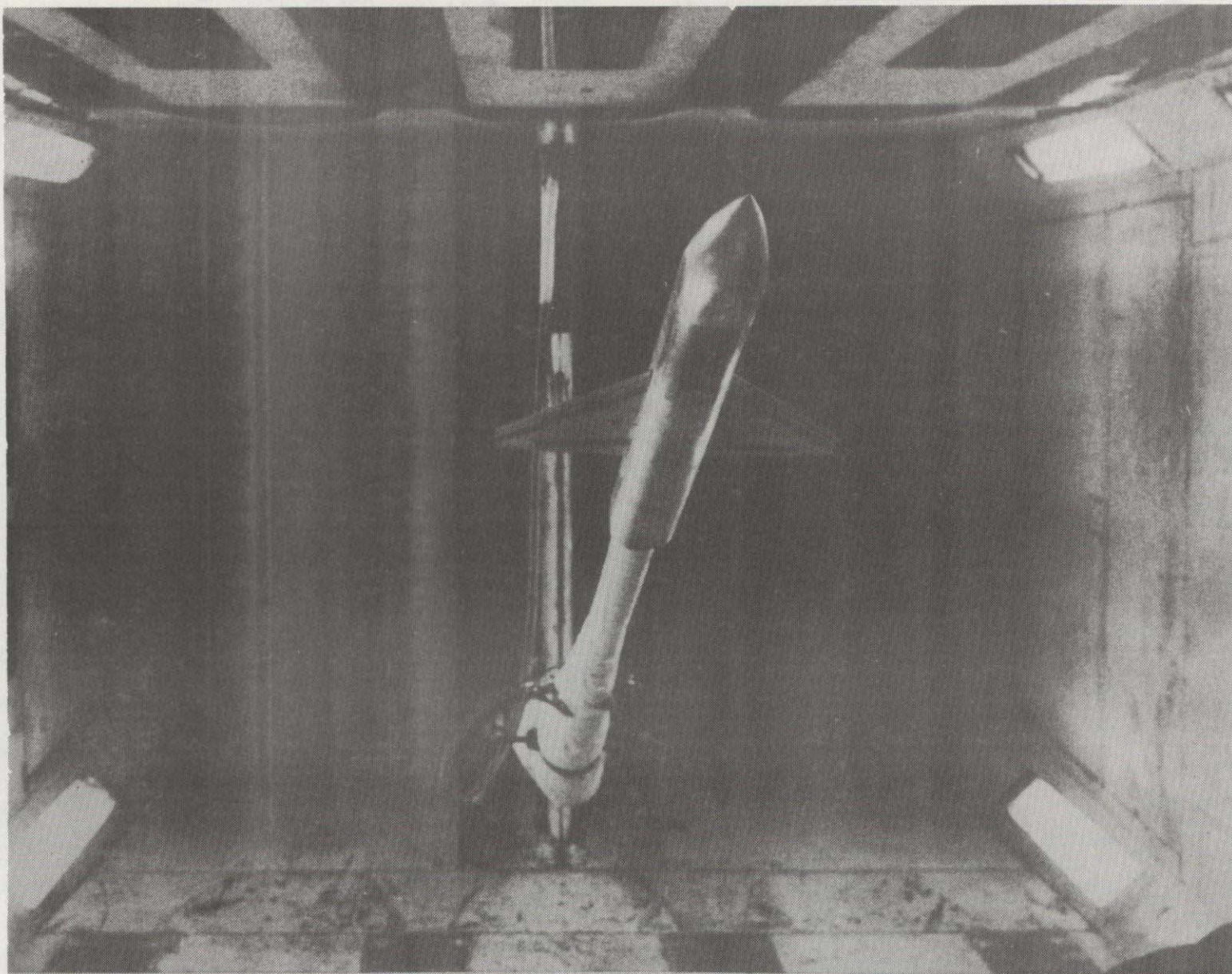

(b) The setup for the pitch range from 10° to 30° .
Figure 2. Continued.

ORIGINAL PAGE IS
OF POOR QUALITY

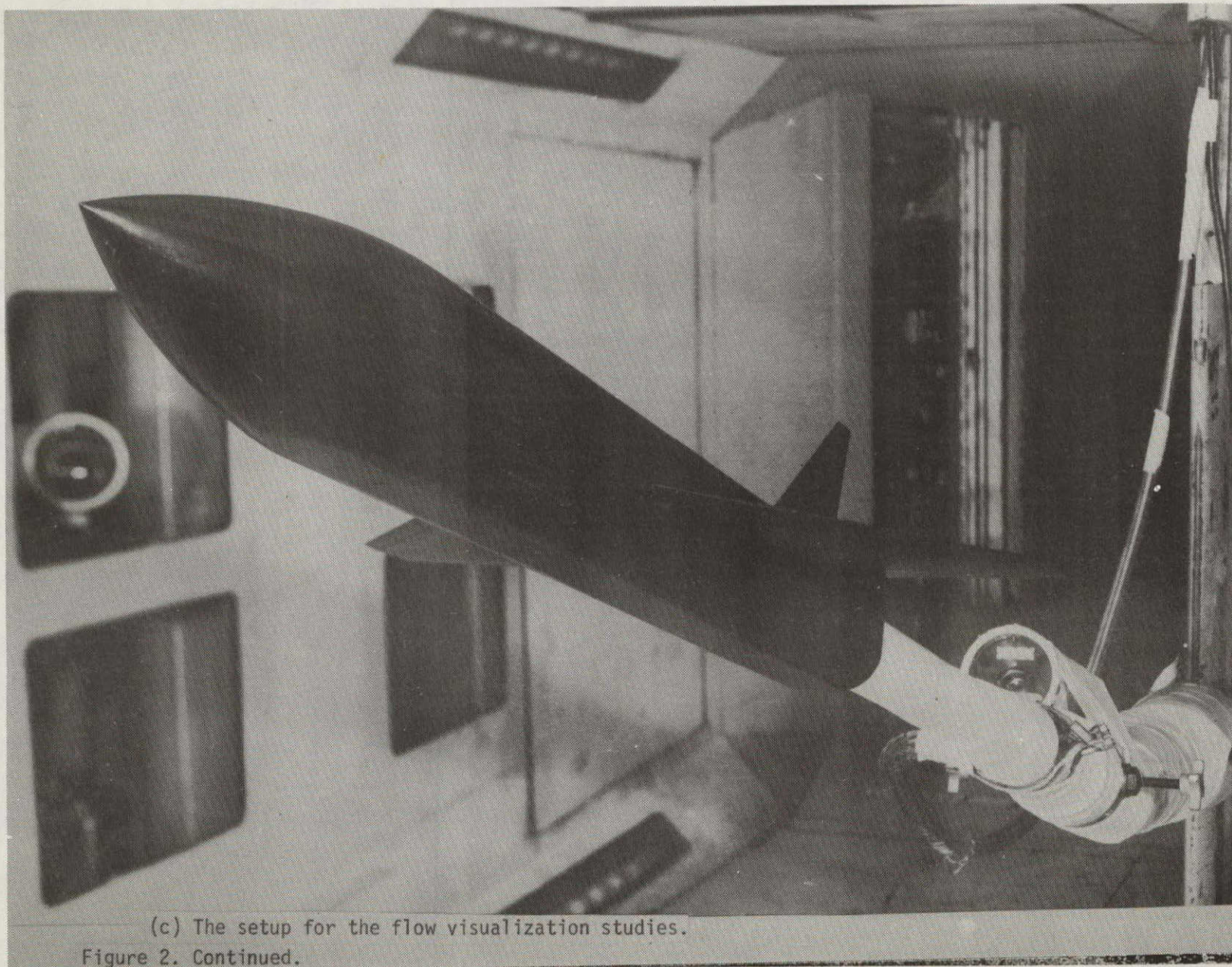

(c) The setup for the flow visualization studies.

Figure 2. Continued.

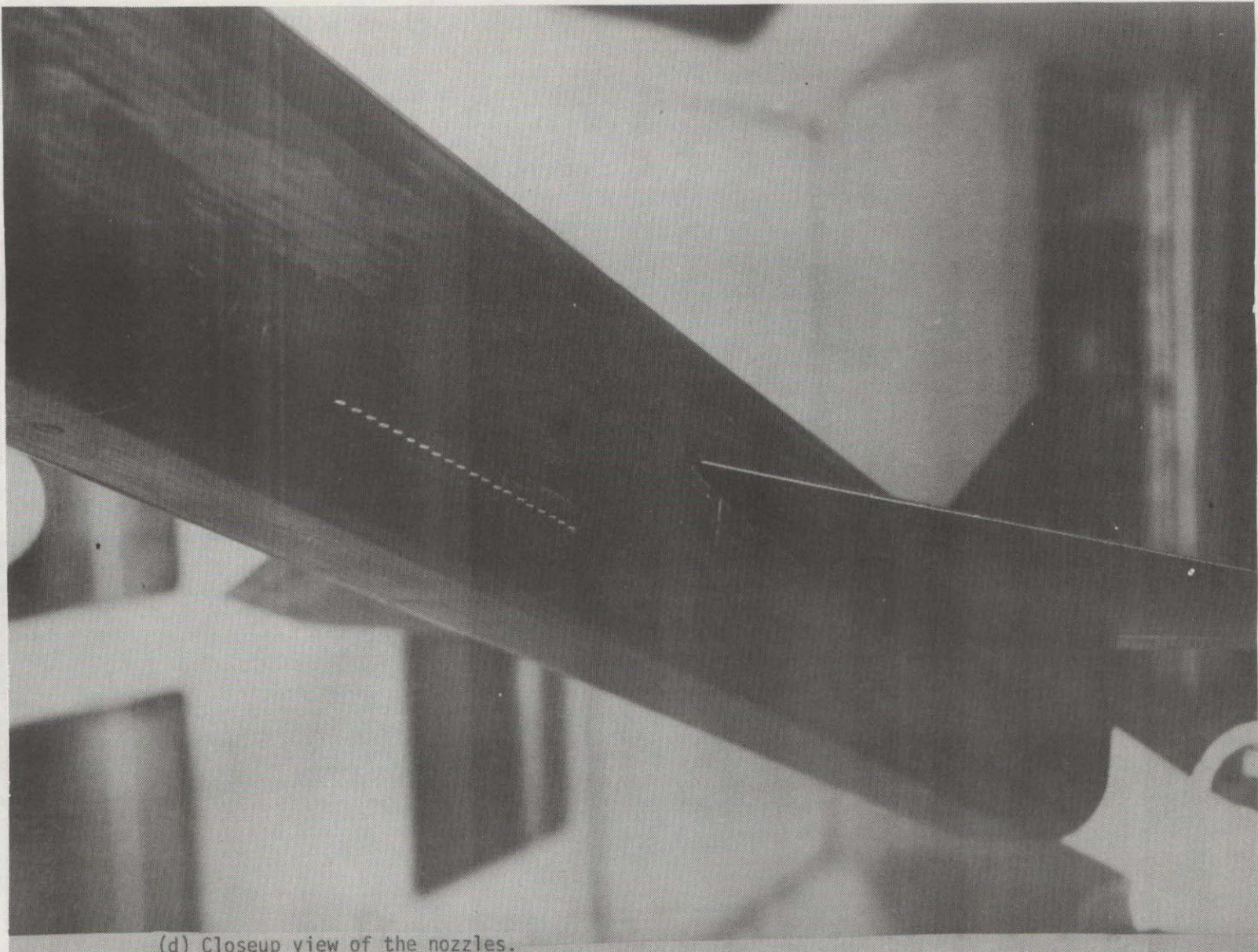

(d) Closeup view of the nozzles.
Figure 2. Continued.

NO. 10000 107714
051167 10000

ORIGINAL PAGE IS
OF POOR QUALITY



(e) The mid-wing configuration.
Figure 2. Continued.

OF BOOK OFFICIAL
ORIGINAL 5708 15

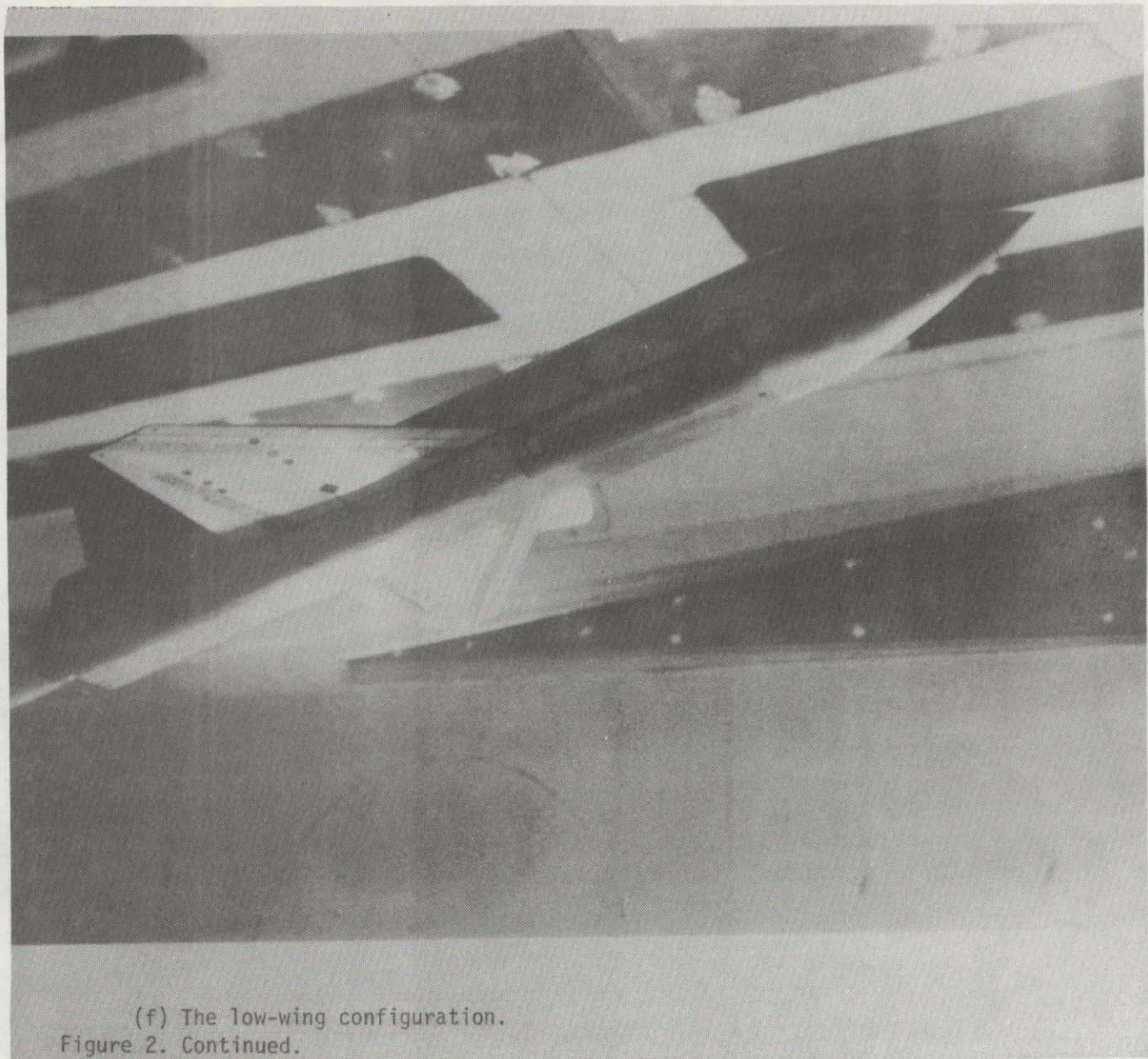

(f) The low-wing configuration.
Figure 2. Continued.

ORIGINAL PAGE IS
OF POOR QUALITY

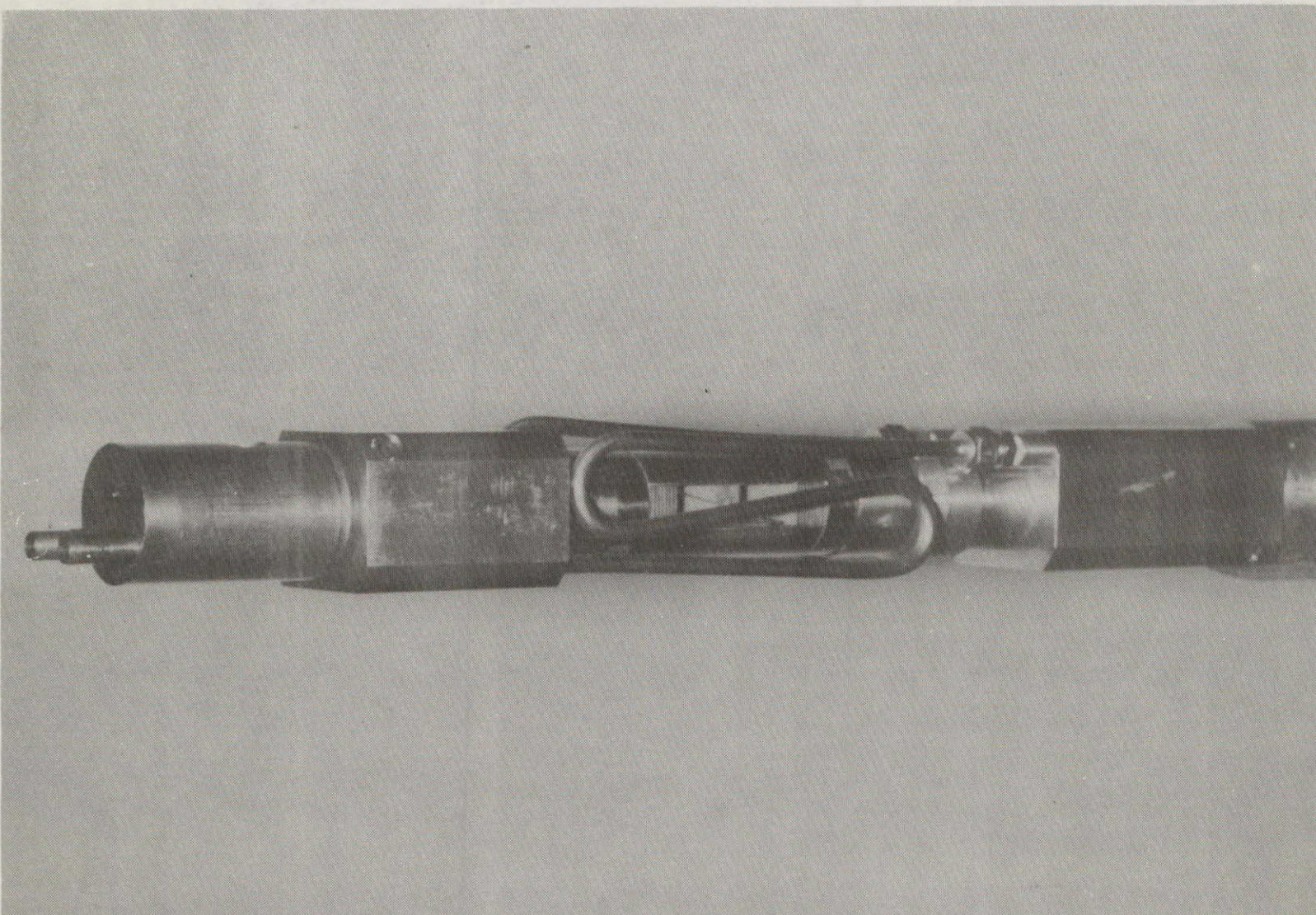

(g) Closeup view of the Langley 737-B balance mounted in the 7- by 10-foot high speed tunnel low mass flow air fixture.

Figure 2. Continued.

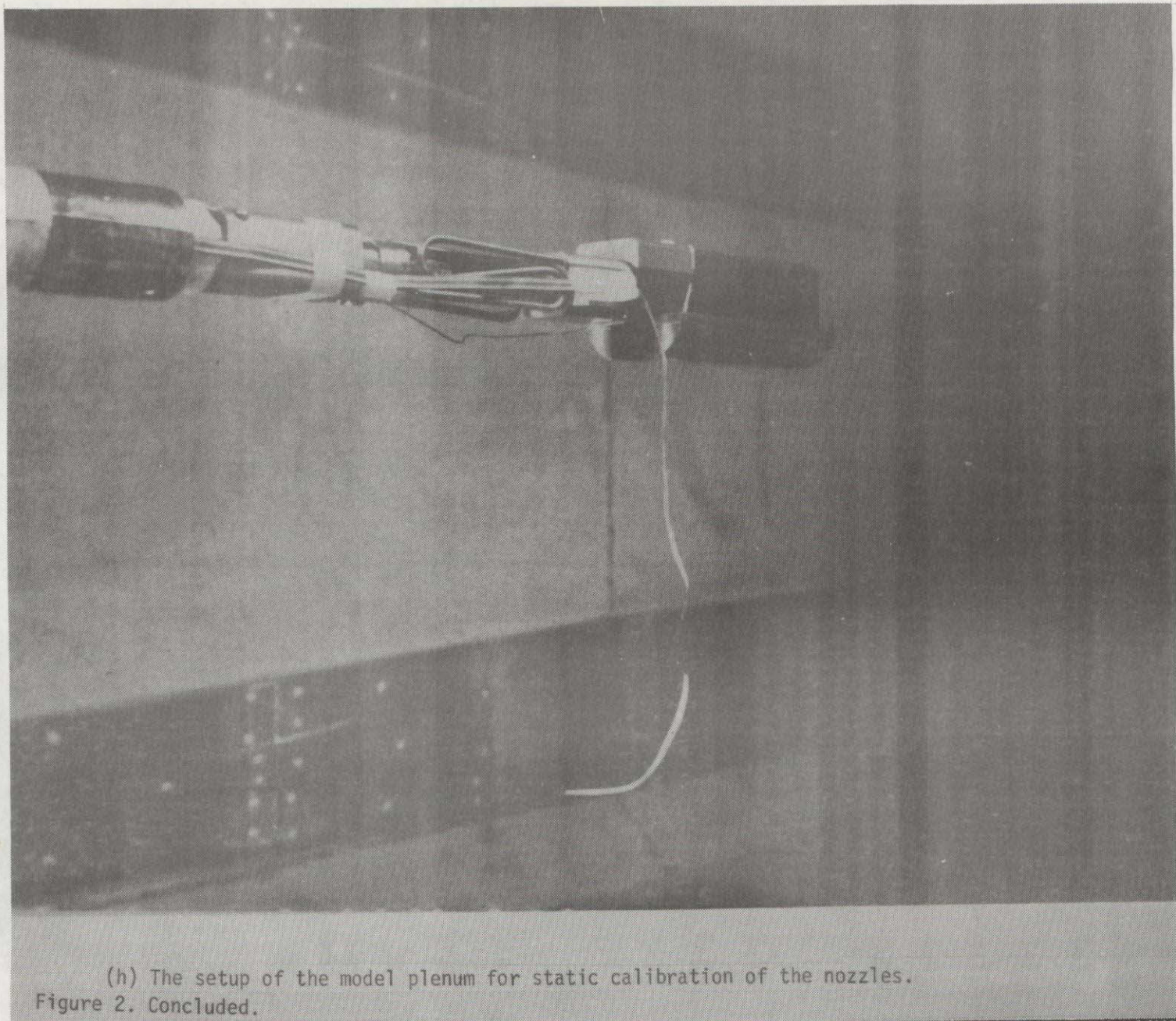

(h) The setup of the model plenum for static calibration of the nozzles.
Figure 2. Concluded.

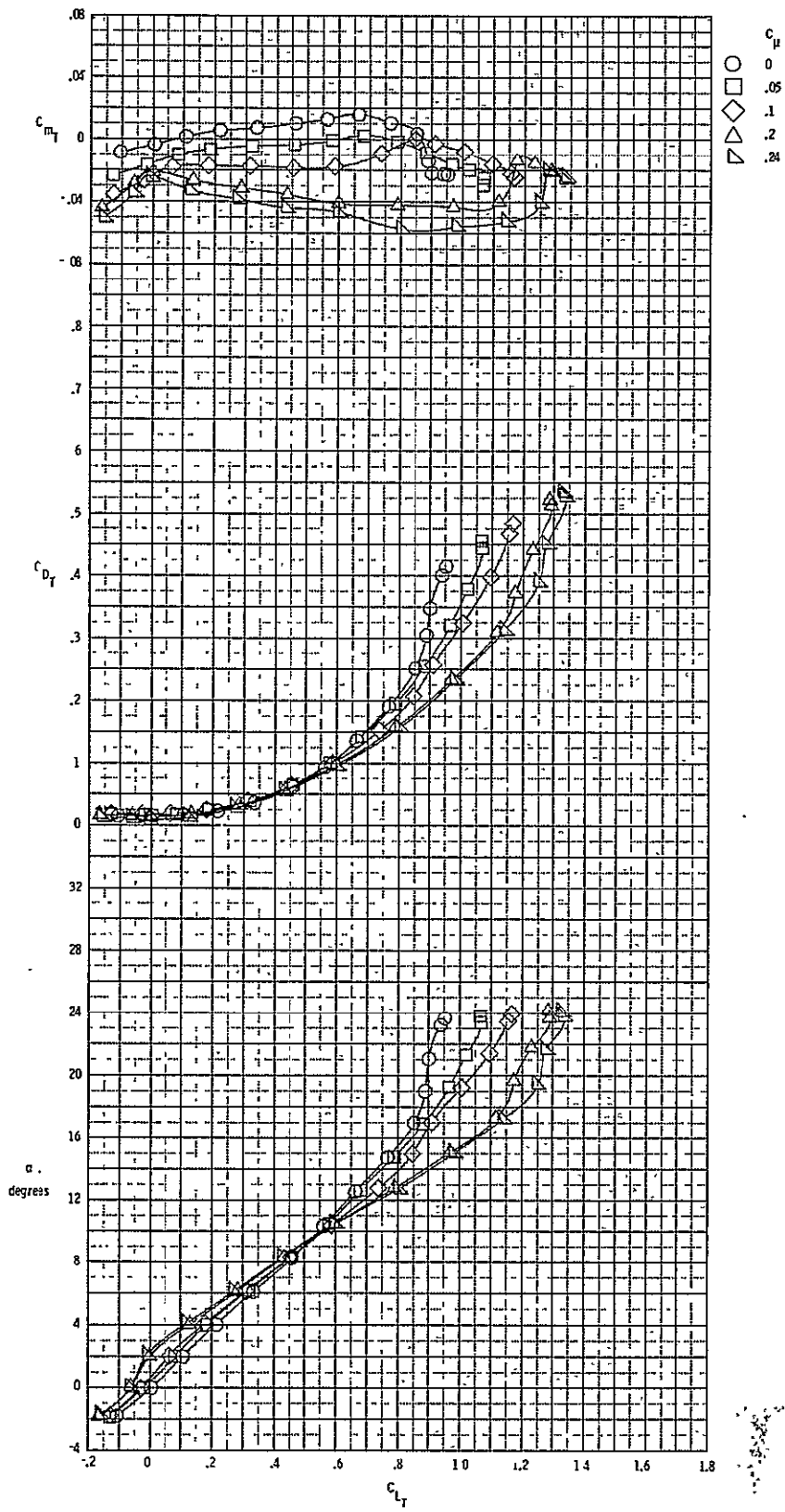

(a) Low angle data
 Figure 3. The effect of blowing on the aerodynamic characteristics of configuration FW₁V. M = 0.3, $\beta = 0^\circ$.

ORIGINAL PAGE IS
 OF POOR QUALITY

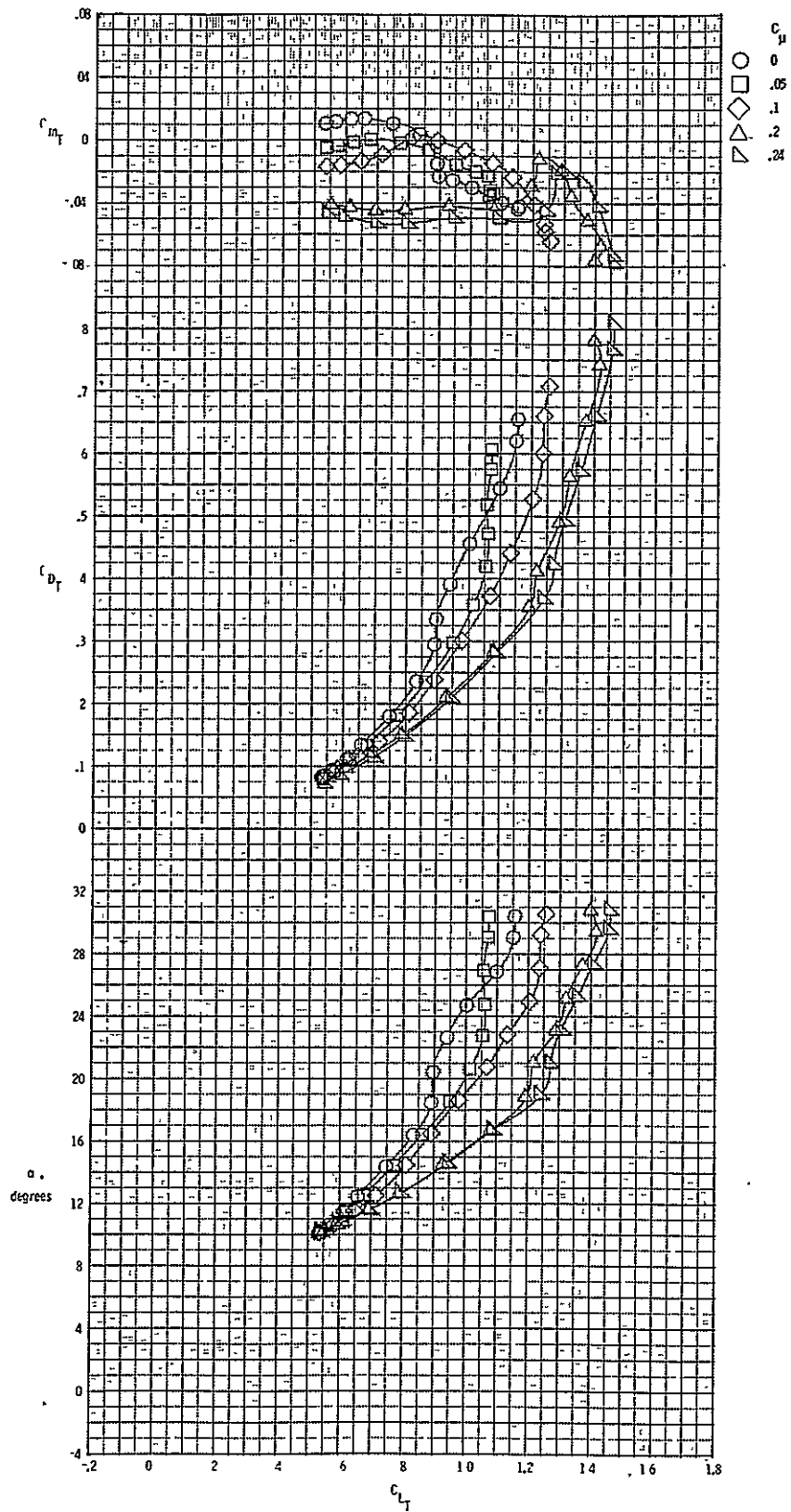

(b) High angle data
Figure 3. Continued.

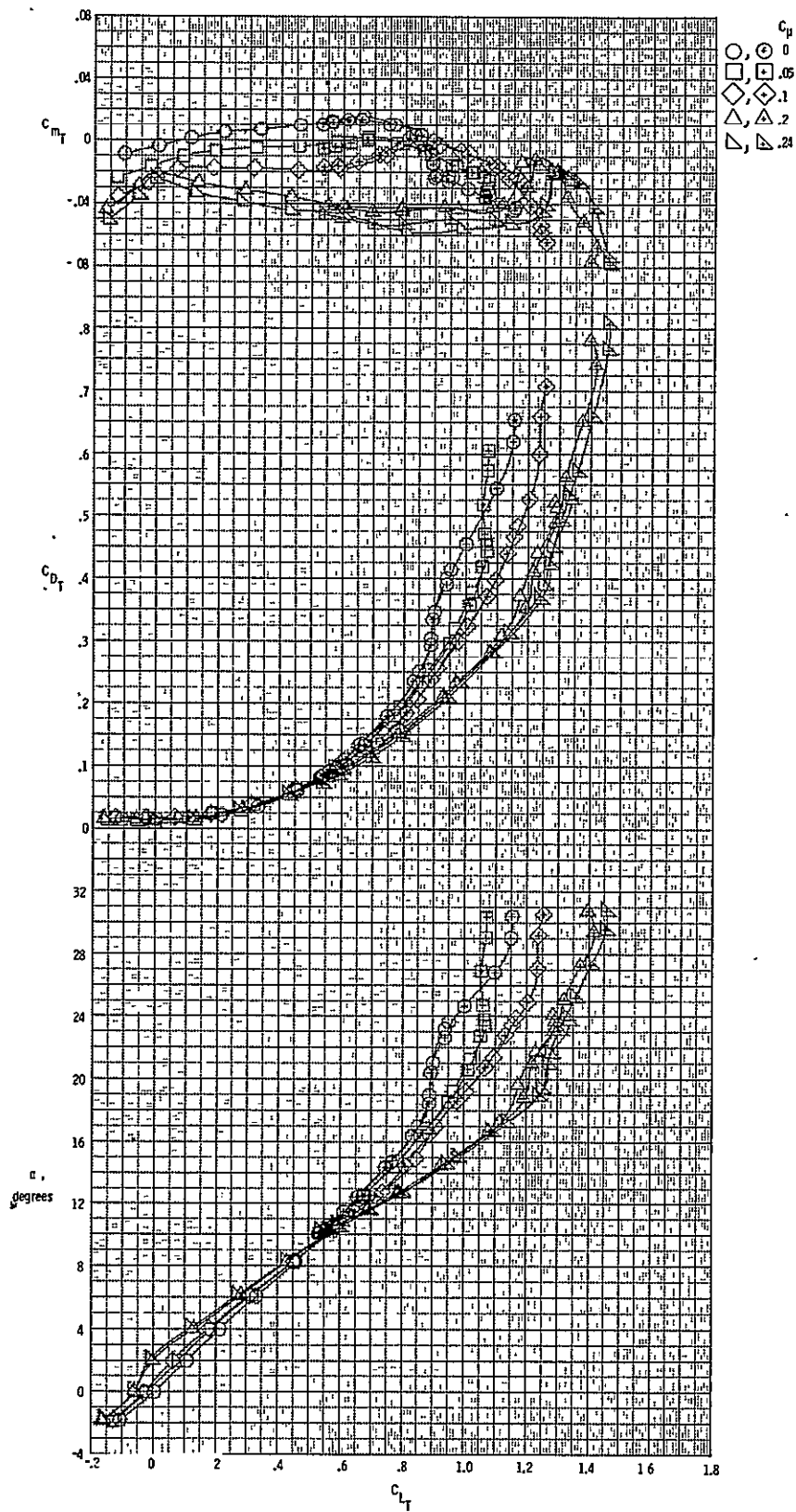

(c) Low angle data and high angle data
 Figure 3. Concluded.

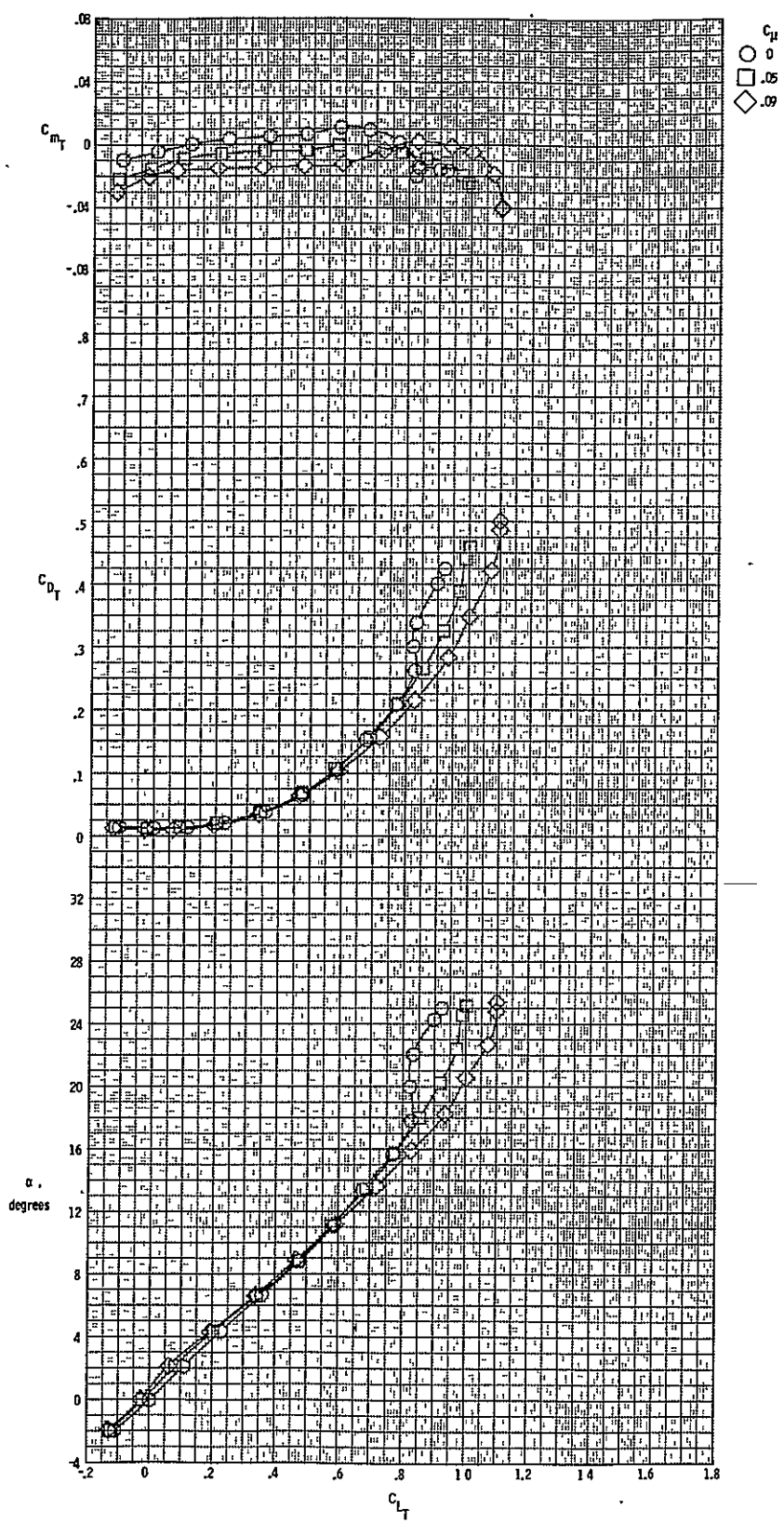

(a) Low angle data
 Figure 4. The effect of blowing on the aerodynamic characteristics of configuration FW1N1V. $M = 0.5$, $\beta = 0^\circ$.

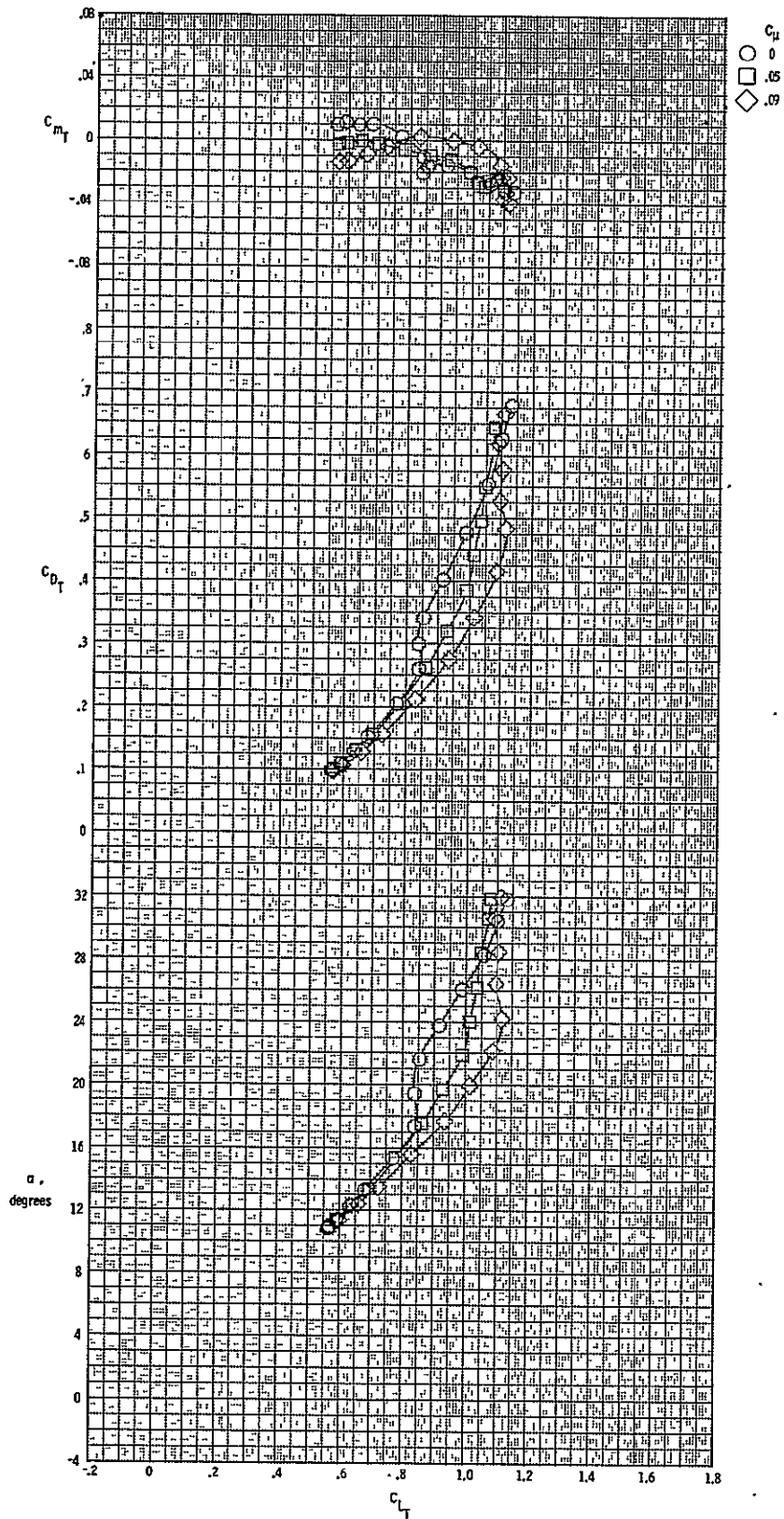

(b) High angle data
 Figure 4. Continued.

ORIGINAL PAGE IS
 OF POOR QUALITY

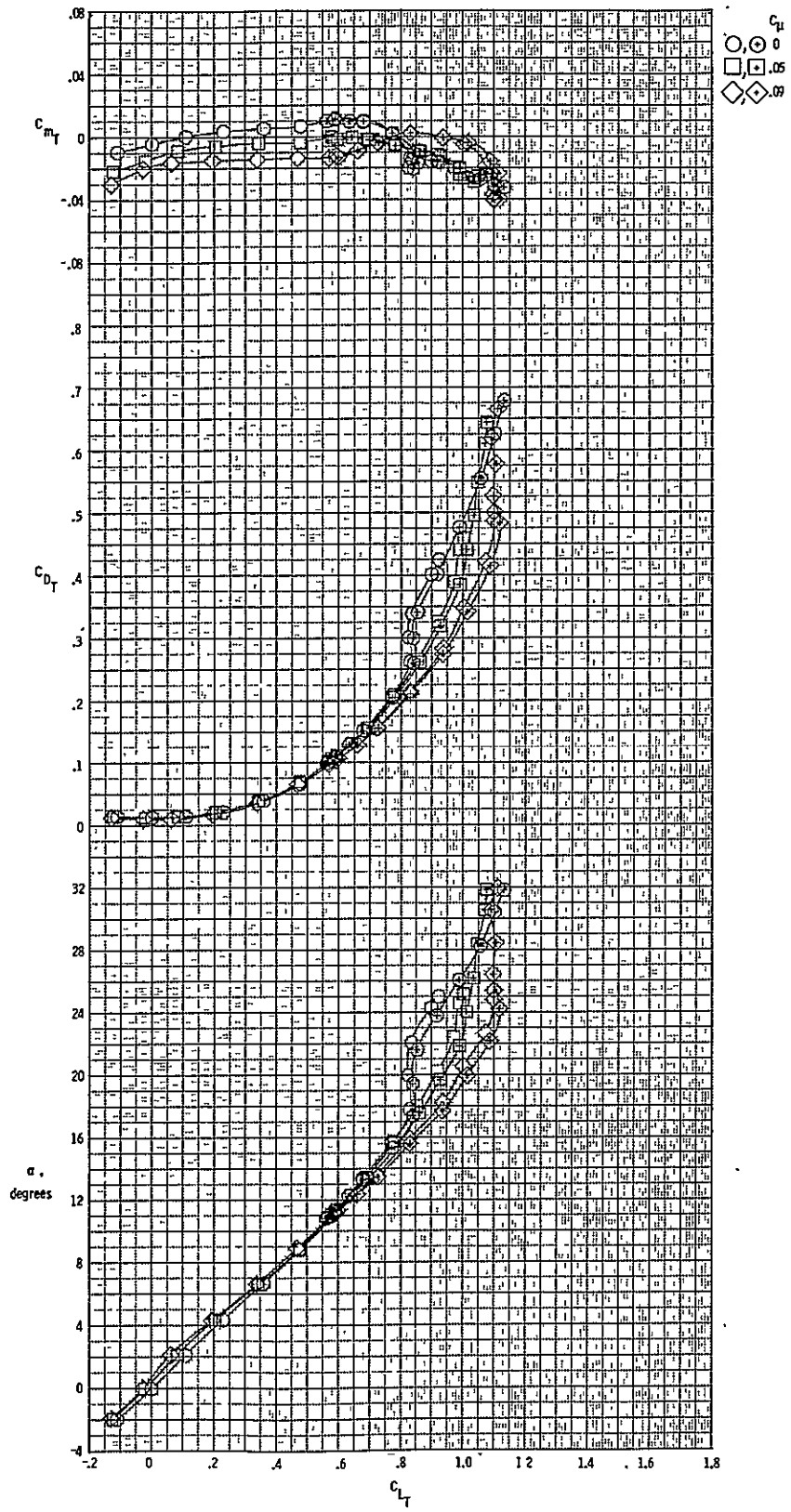

(c) Low angle data and high angle data
 Figure 4. Concluded.

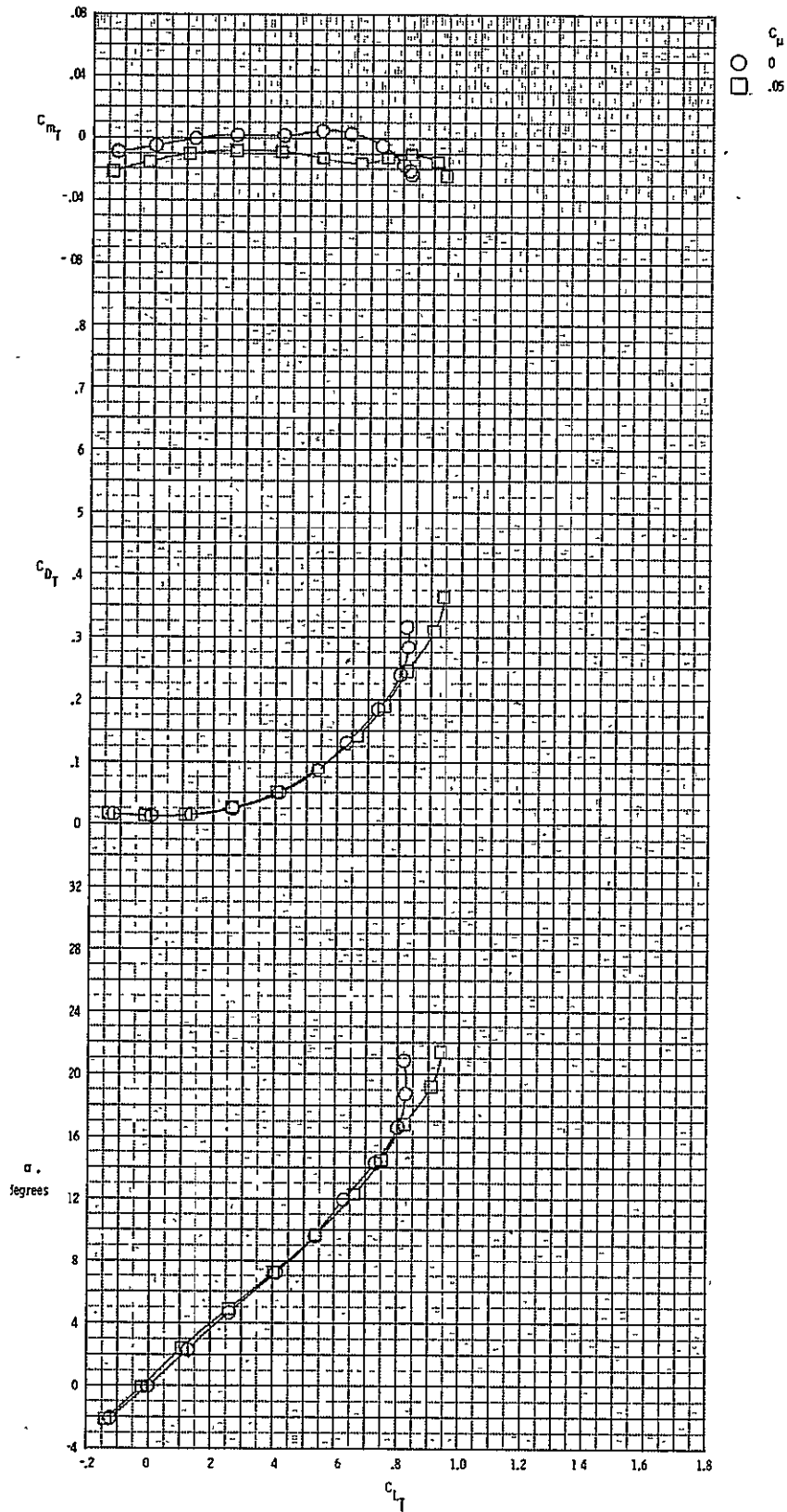
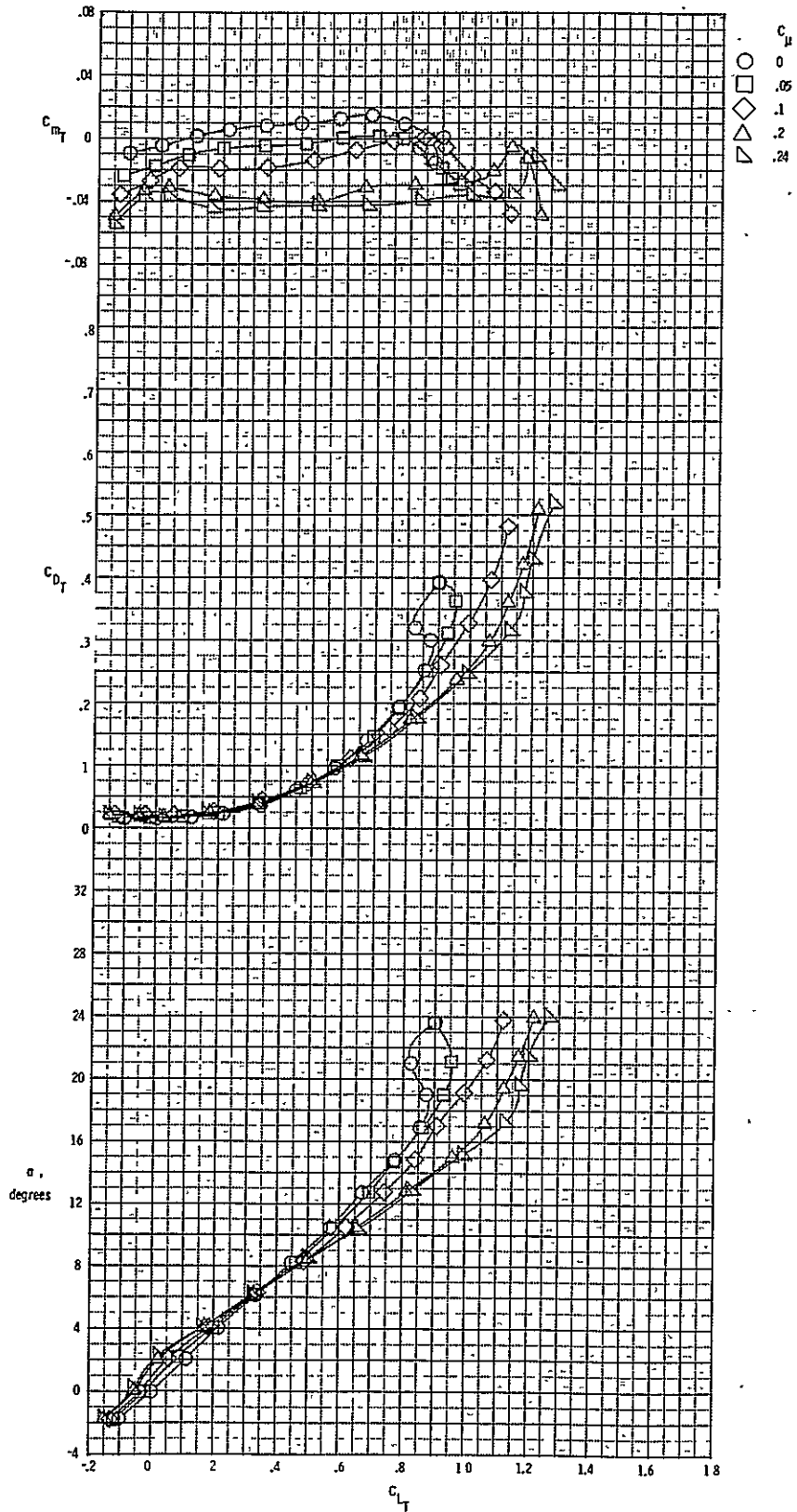
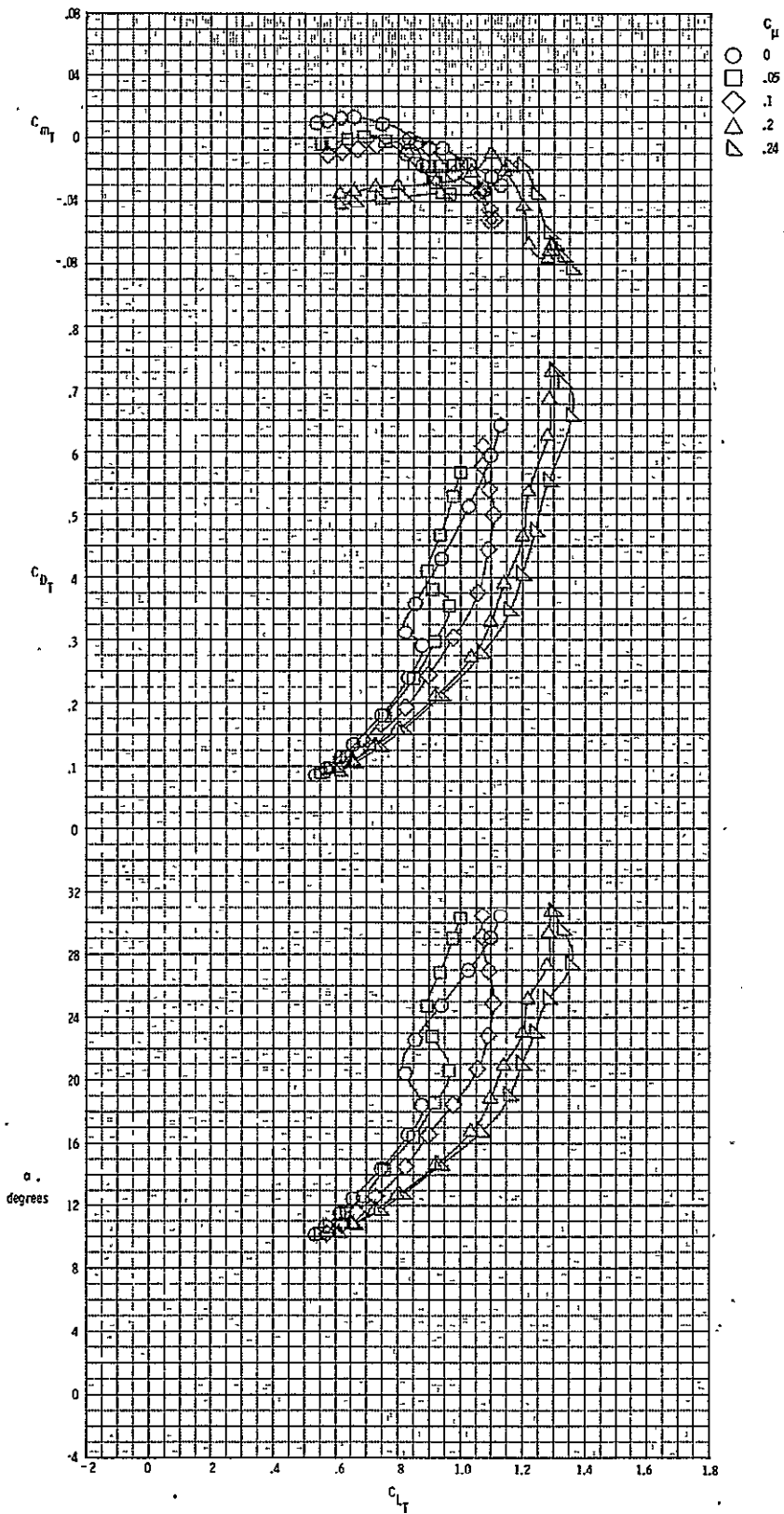

Figure 5. The effect of blowing on the aerodynamic characteristics of configuration FW₁V. M = 0.7, $\beta = 0^\circ$. Low angle data

ORIGINAL PAGE IS
OF POOR QUALITY



(a) Low angle data
 Figure 6. The effect of blowing on the aerodynamic characteristics of configuration FW₂N₁V. $M = 0.3$, $\beta = 0^\circ$.



(b) High angle data
Figure 6. Continued.

ORIGINAL PAGE IS
OF POOR QUALITY.

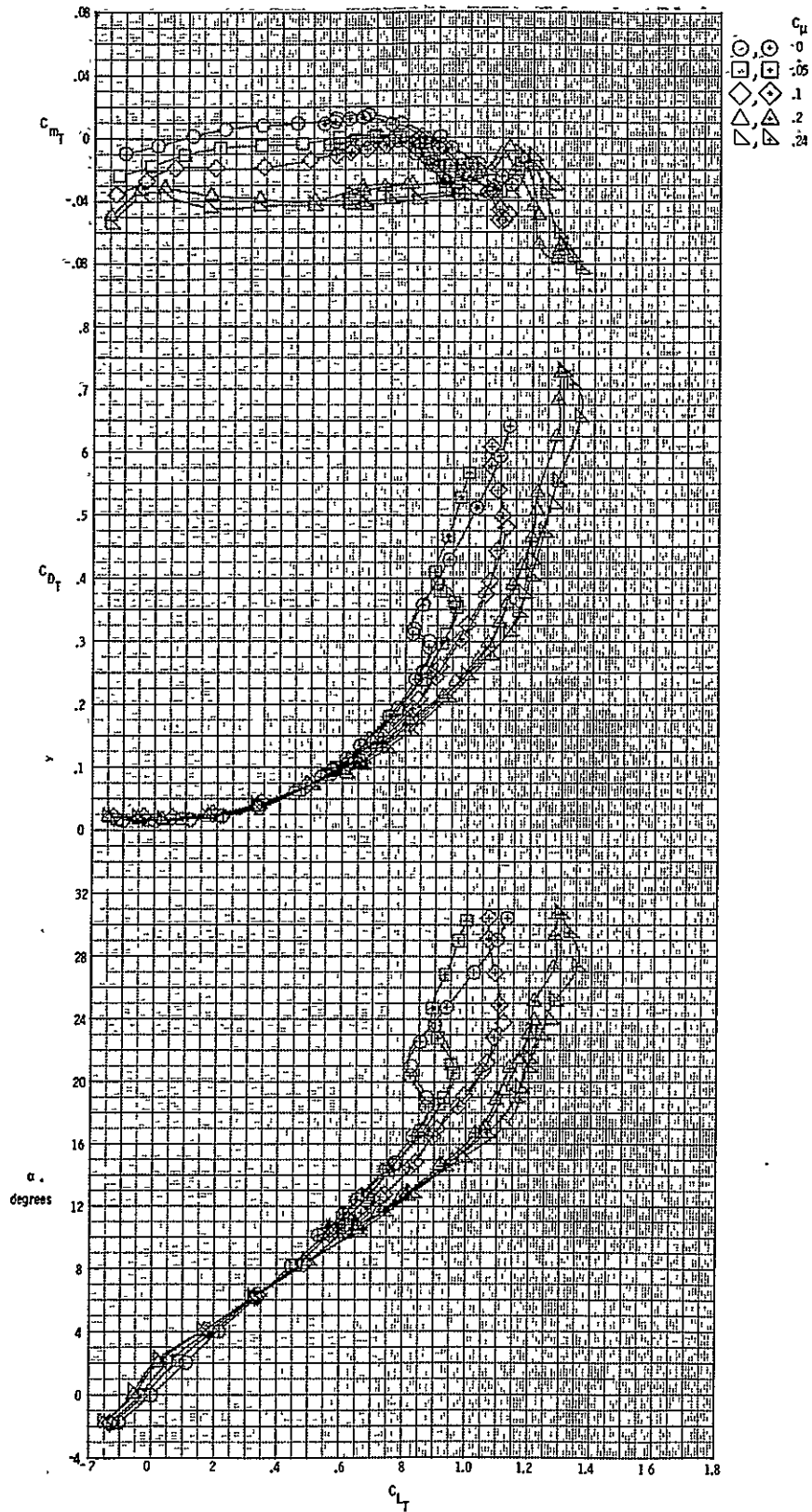

(c) Low angle data and high angle data
 Figure 6. Concluded.

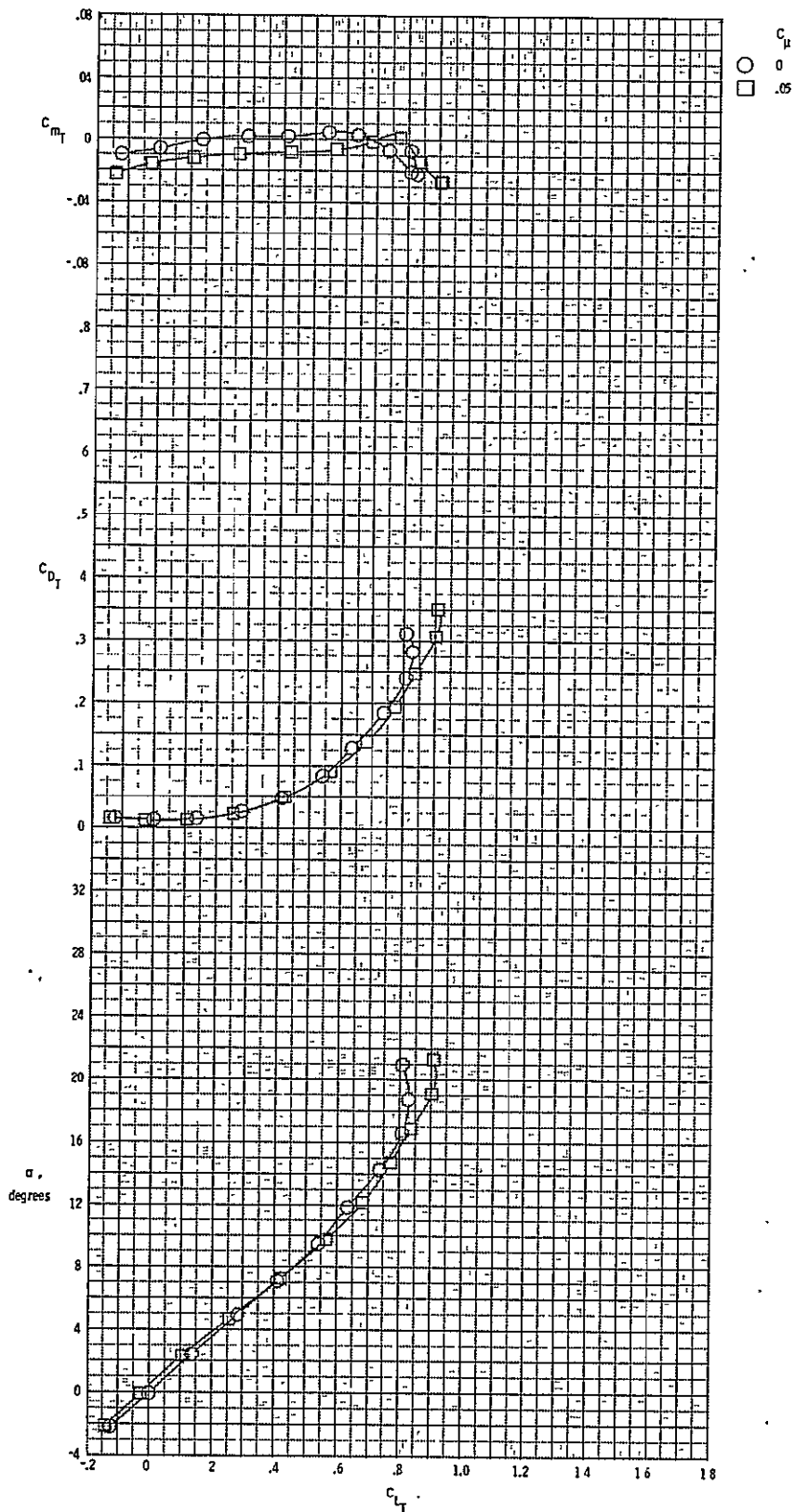

Figure 7. The effect of blowing on the aerodynamic characteristics of configuration FW₂N₁V. M = 0.7, $\beta = 0^\circ$. Low angle data

ORIGINAL PAGE IS
OF POOR QUALITY

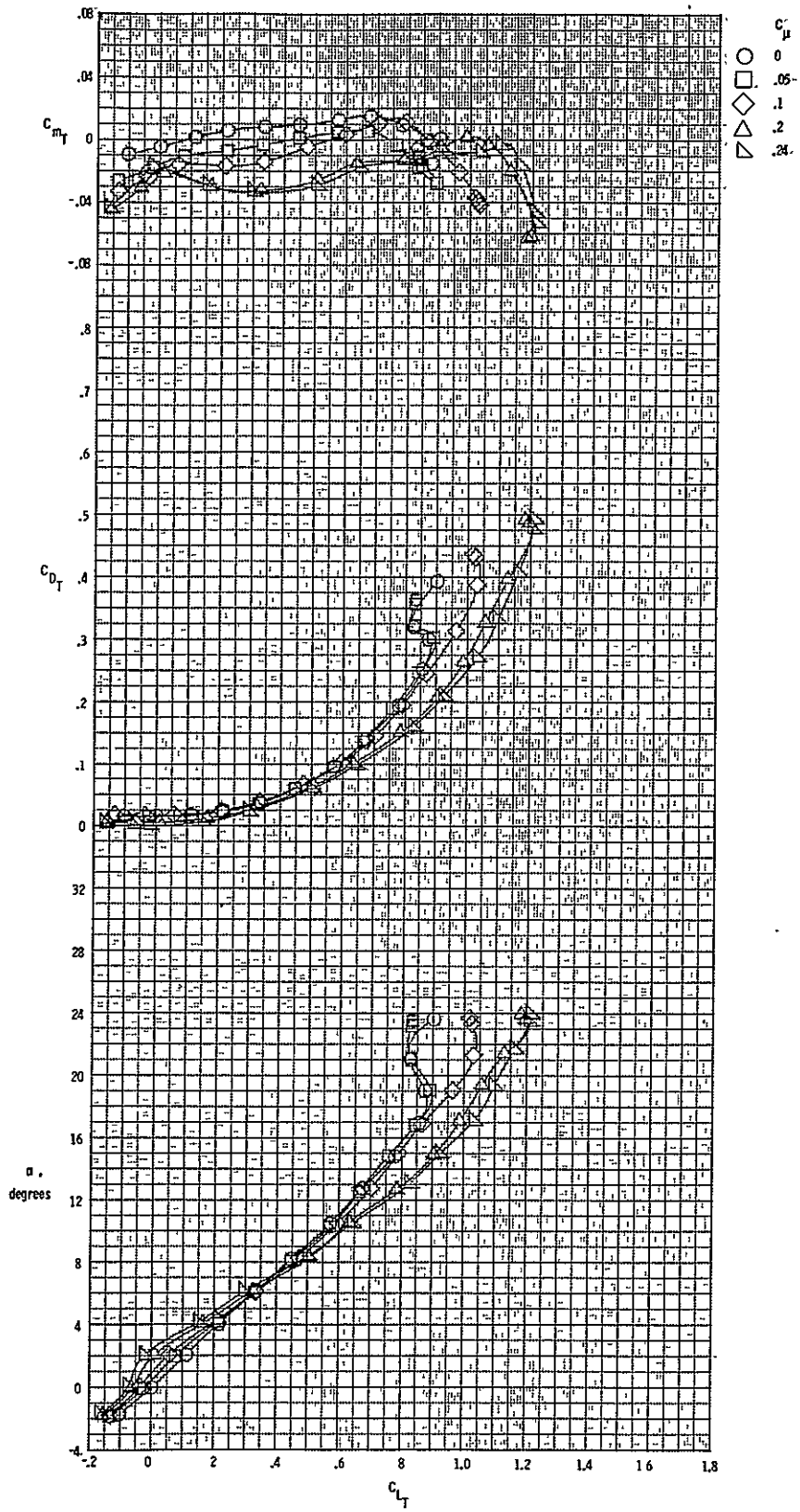
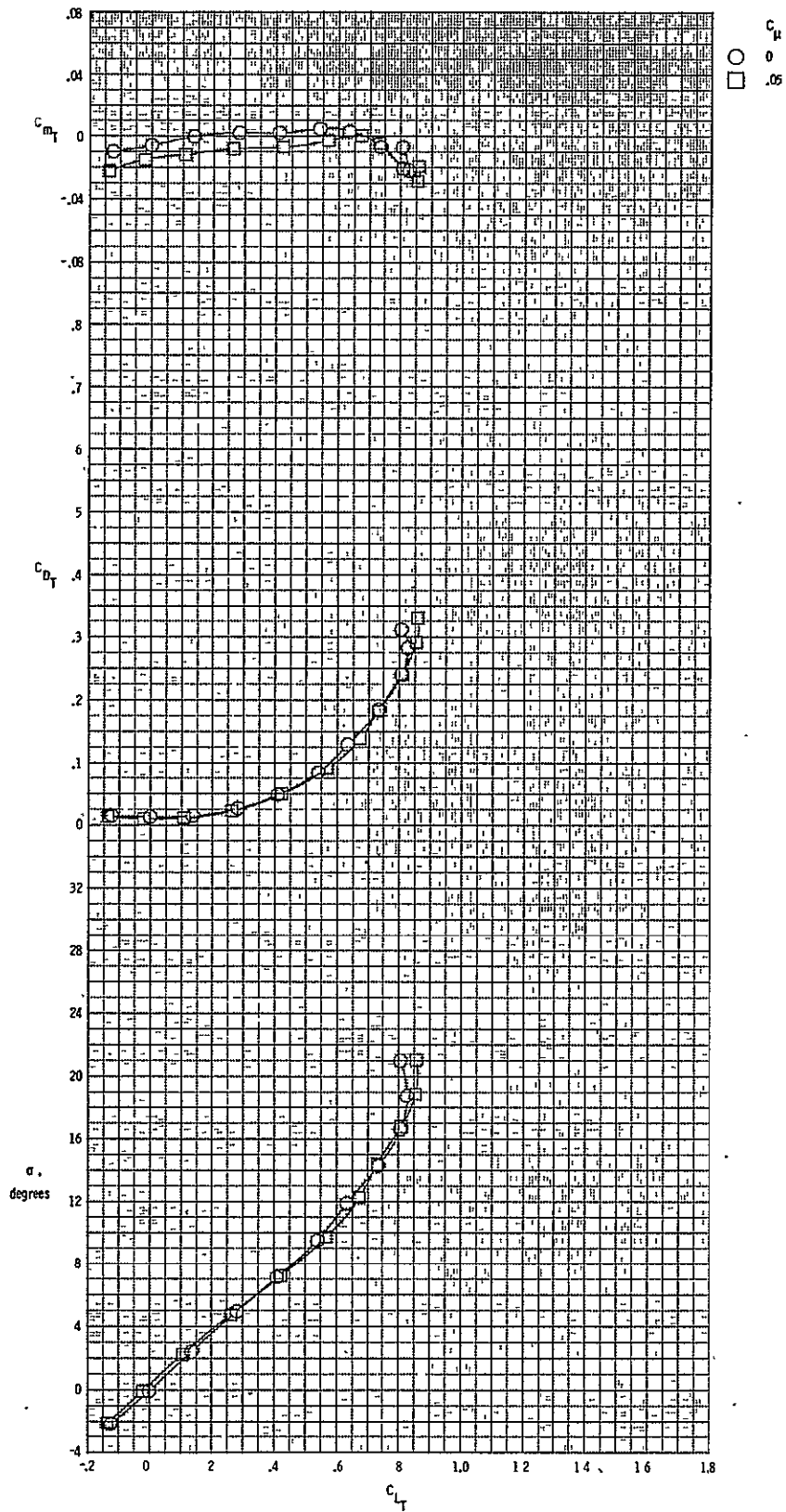

Figure 8. The effect of blowing on the aerodynamic characteristics of configuration FW₂N₂V. M = 0.3, β = 0°. Low angle data



ORIGINAL PAGE IS
OF POOR QUALITY

Figure 9. The effect of blowing on the aerodynamic characteristics of configuration FW12V. $M = 0.7$, $\beta = 0^\circ$. Low angle data

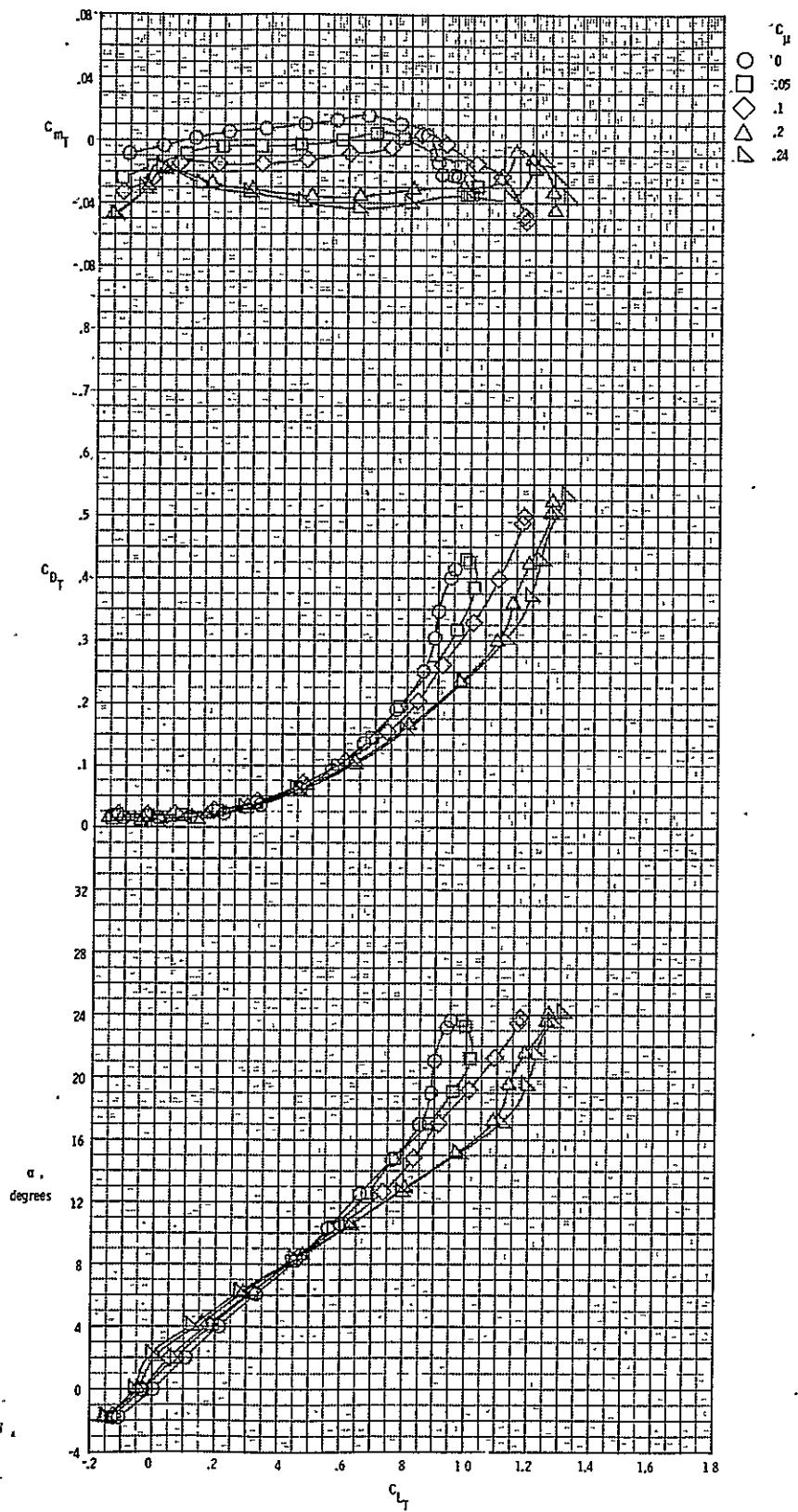
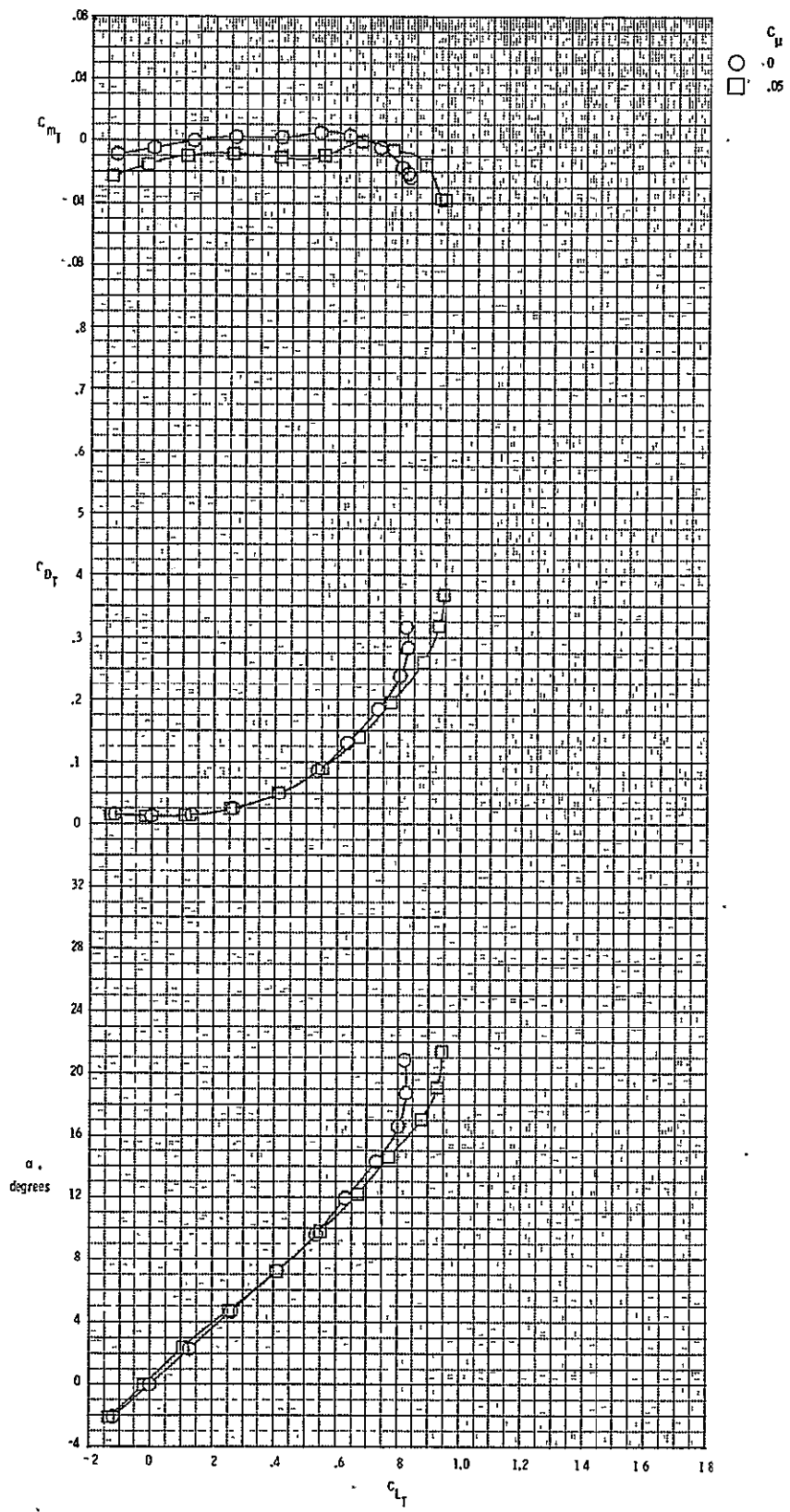

Figure 10. The effect of blowing on the aerodynamic characteristics of configuration FW₁N₂V. $M = 0.3, \beta = 0^\circ$. Low angle data



ORIGINAL PAGE IS
OF POOR QUALITY

Figure 11. The effect of blowing on the aerodynamic characteristics of configuration FW₁N₂V. M = 0.7, $\beta = 0^\circ$. Low angle data

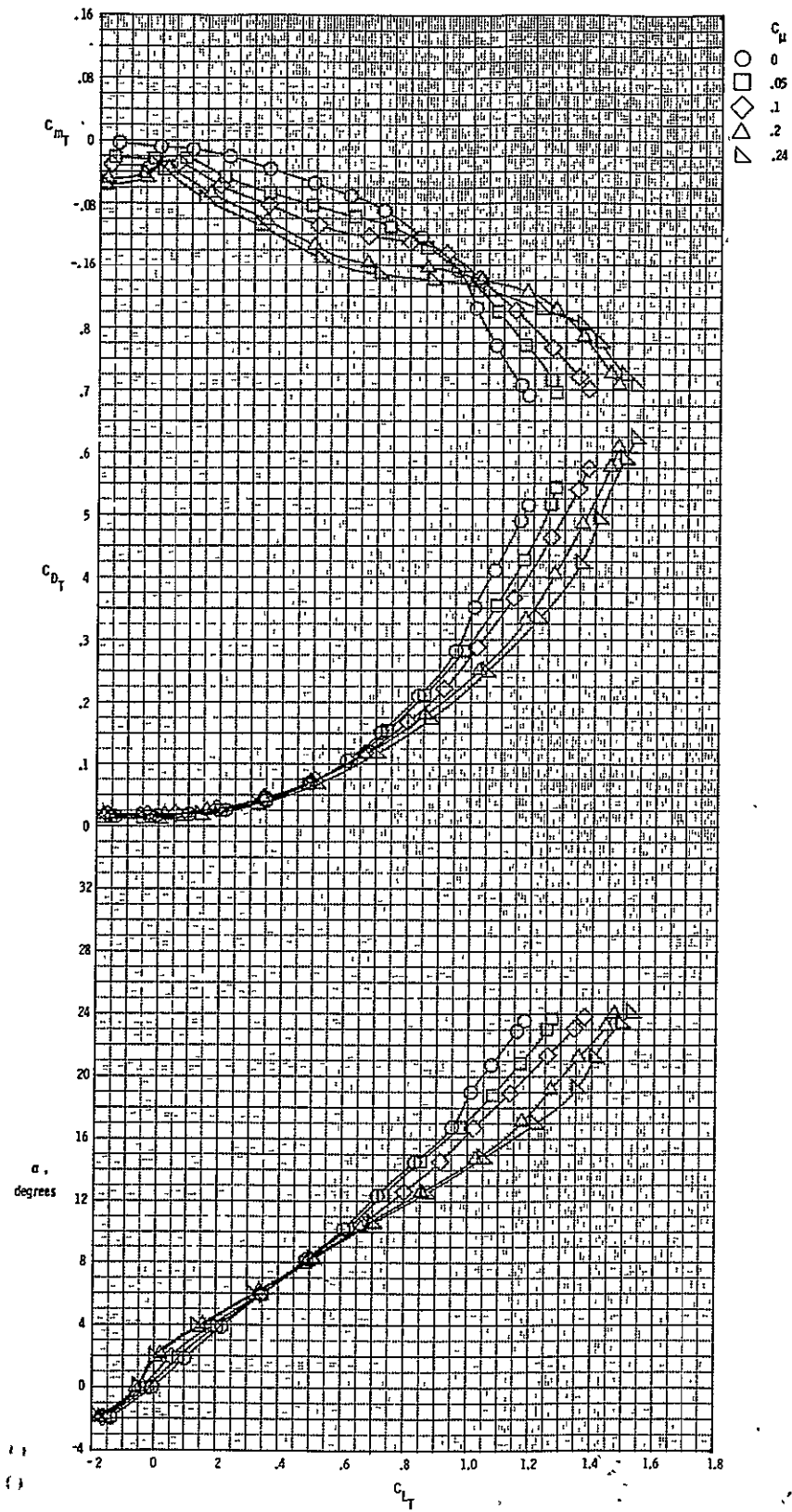

Figure 12. The effect of blowing on the aerodynamic characteristics of configuration FW1N1VH. $M = 0.3$, $\beta = 0^\circ$. Low angle data

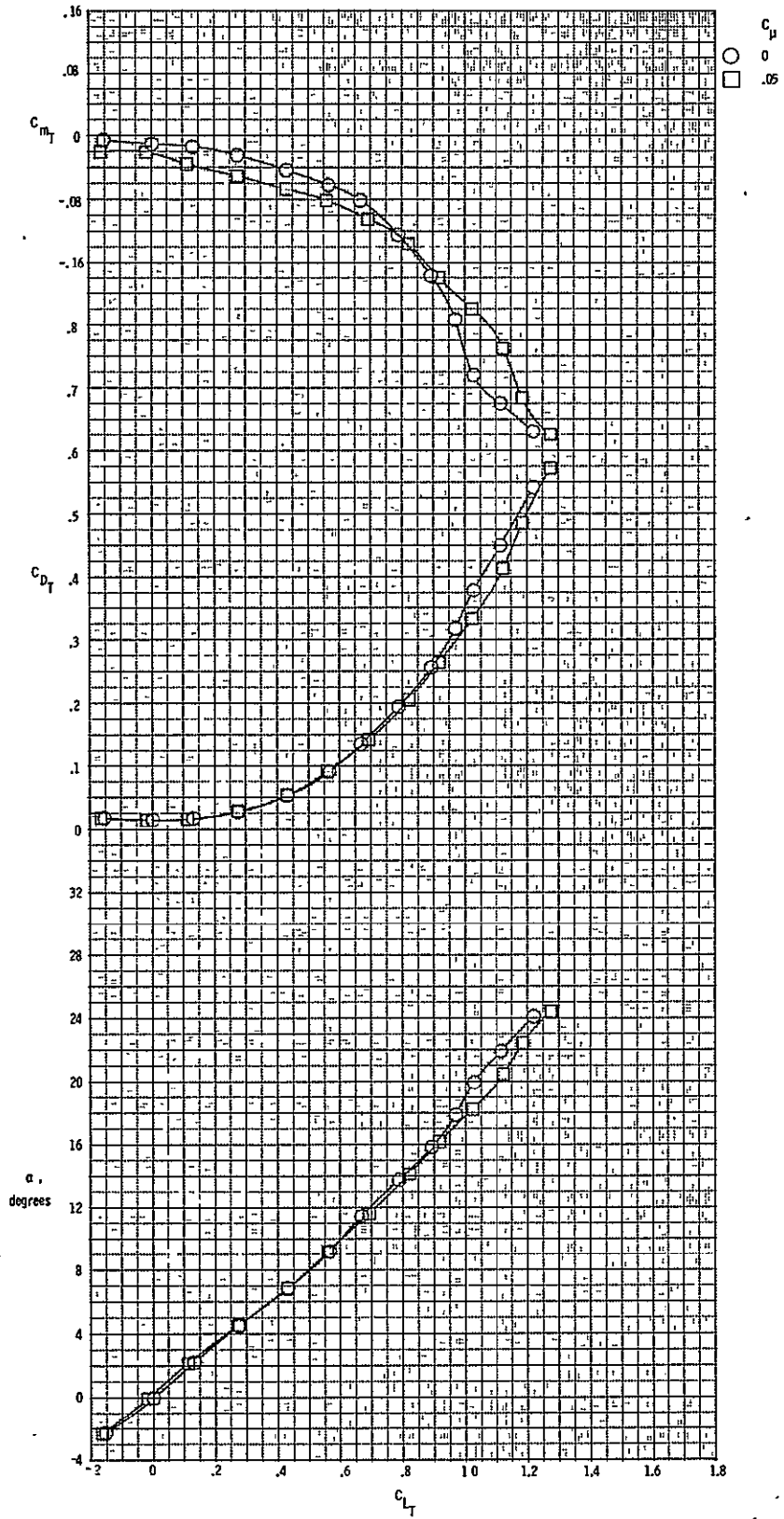
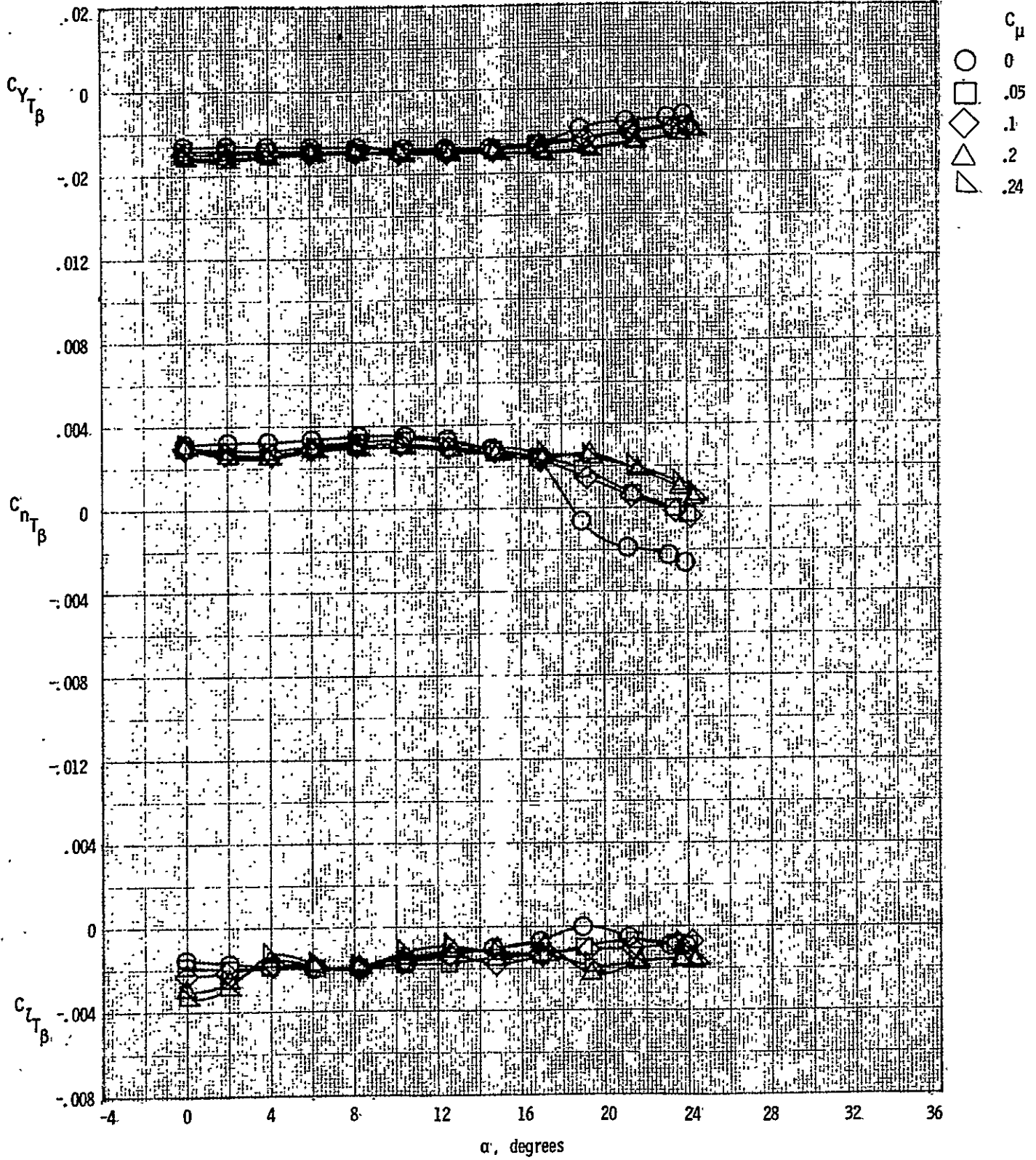

Figure 13. The effect of blowing on the aerodynamic characteristics of configuration FW₁N₁VH. M = 0.7, $\beta = 0^\circ$. Low angle data.

ORIGINAL PAGE IS
OF POOR QUALITY



(a) Low angle data.

Figure 14. - The effect of blowing on the aerodynamic characteristics of configuration FW₁N₁V. M_∞ = 0.3

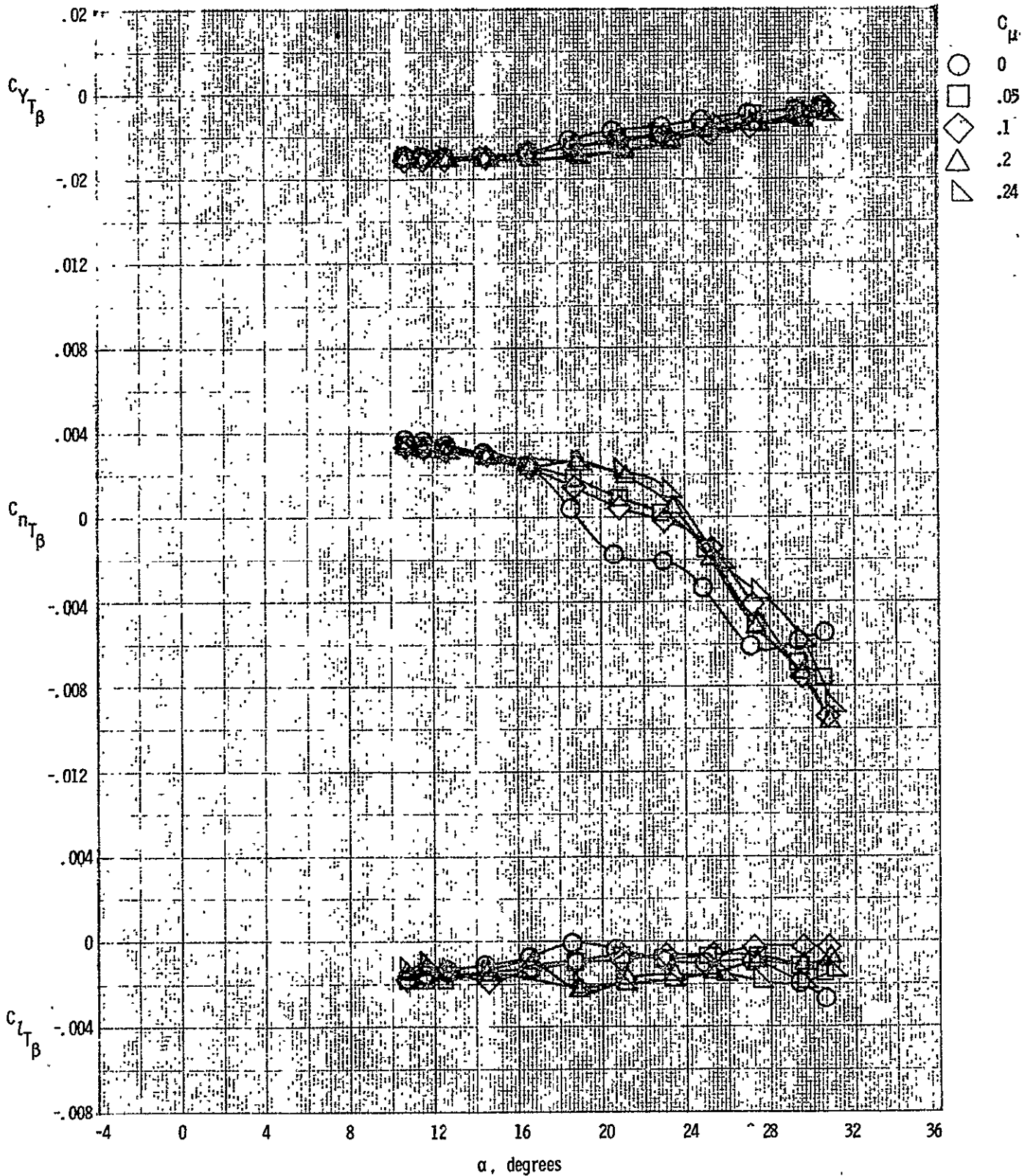

(b) High angle data.

Figure 14. - Continued.

ORIGINAL PAGE IS
OF POOR QUALITY

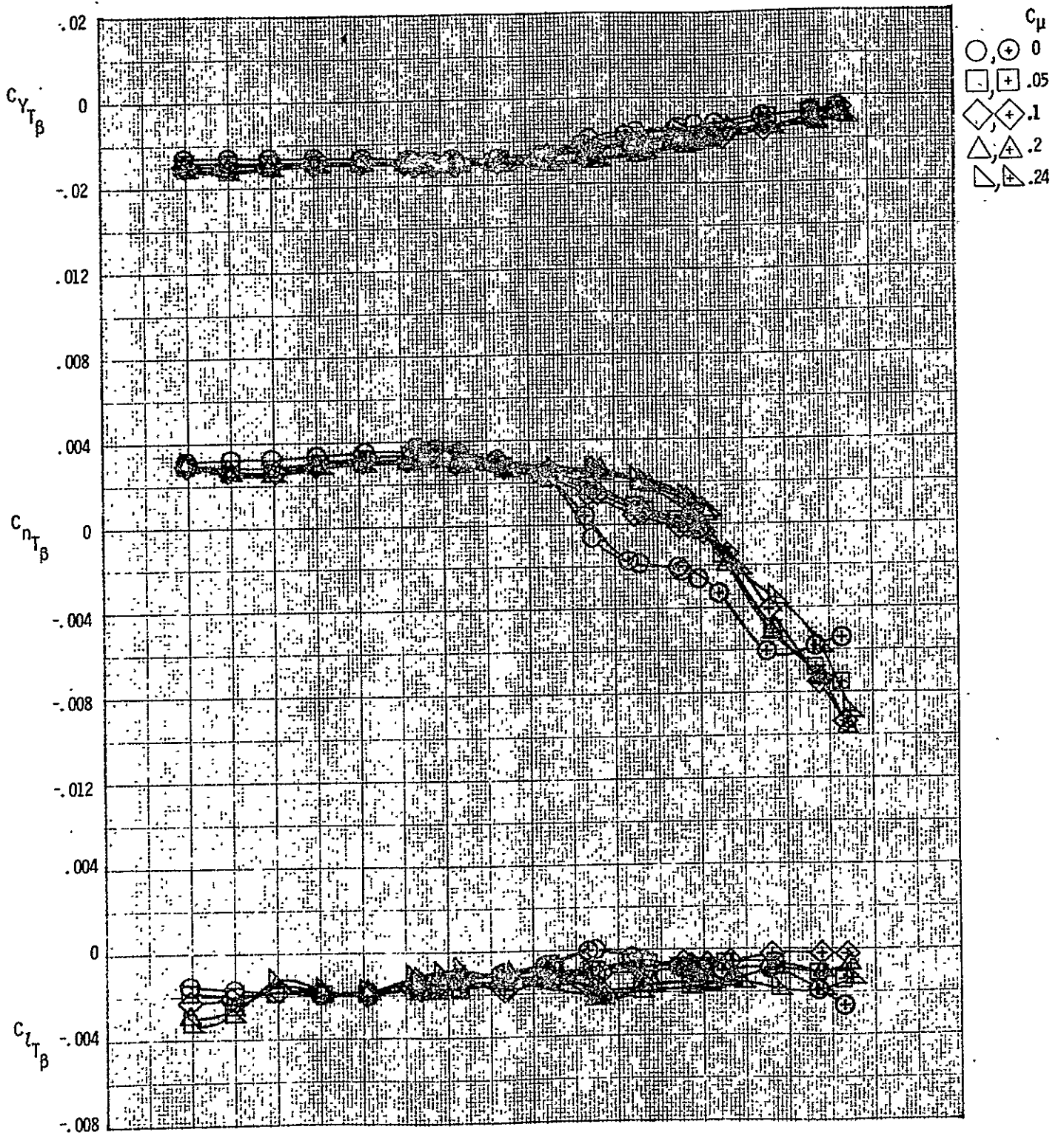

(c) Low angle data and high angle data.
 Figure 14. - Concluded.

ORIGINAL PAGE IS
OF POOR QUALITY

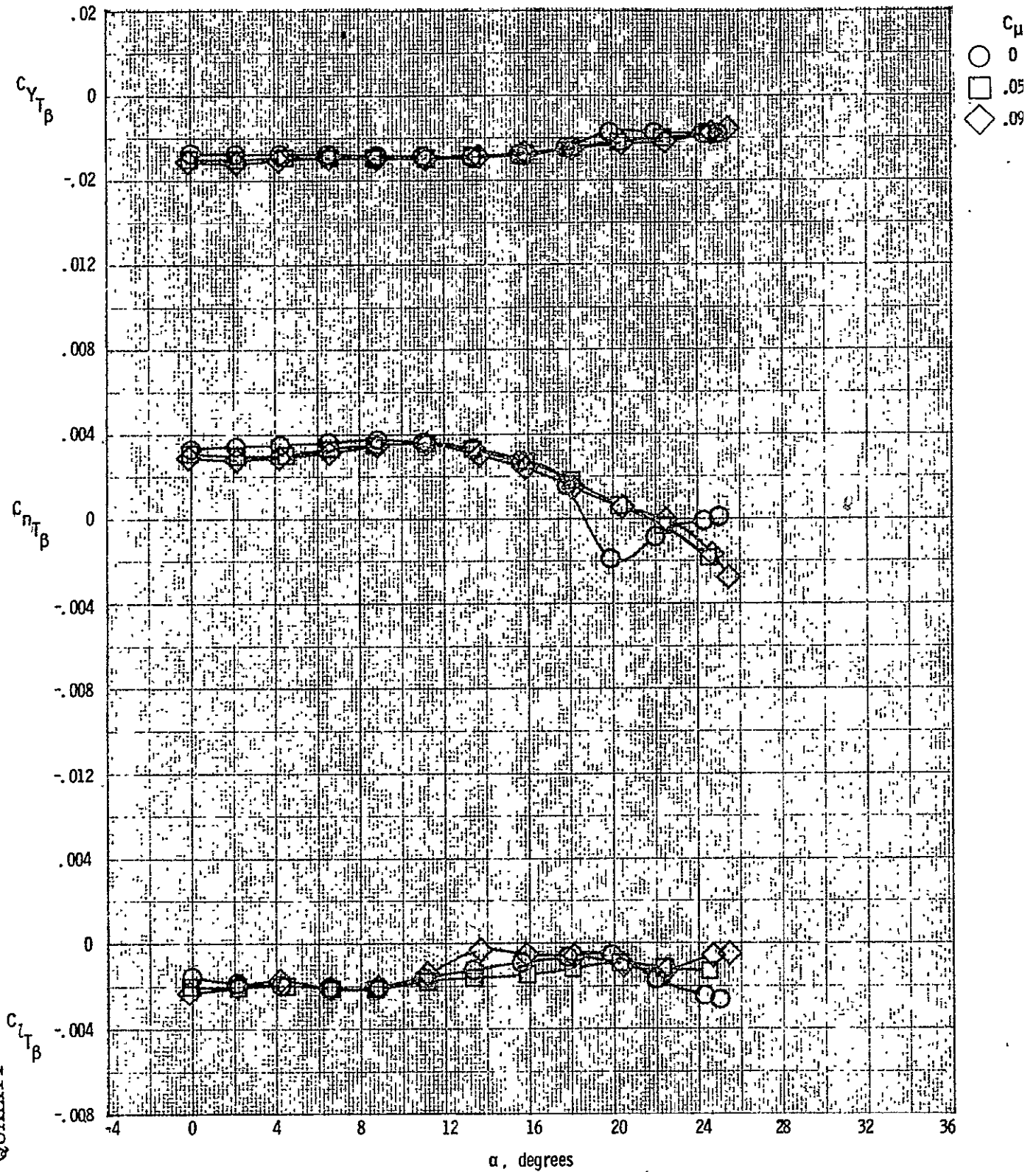

(a) Low angle data.

Figure 15. - The effect of blowing on the aerodynamic characteristics of configuration FW_1N_1V . $M = 0.5$.

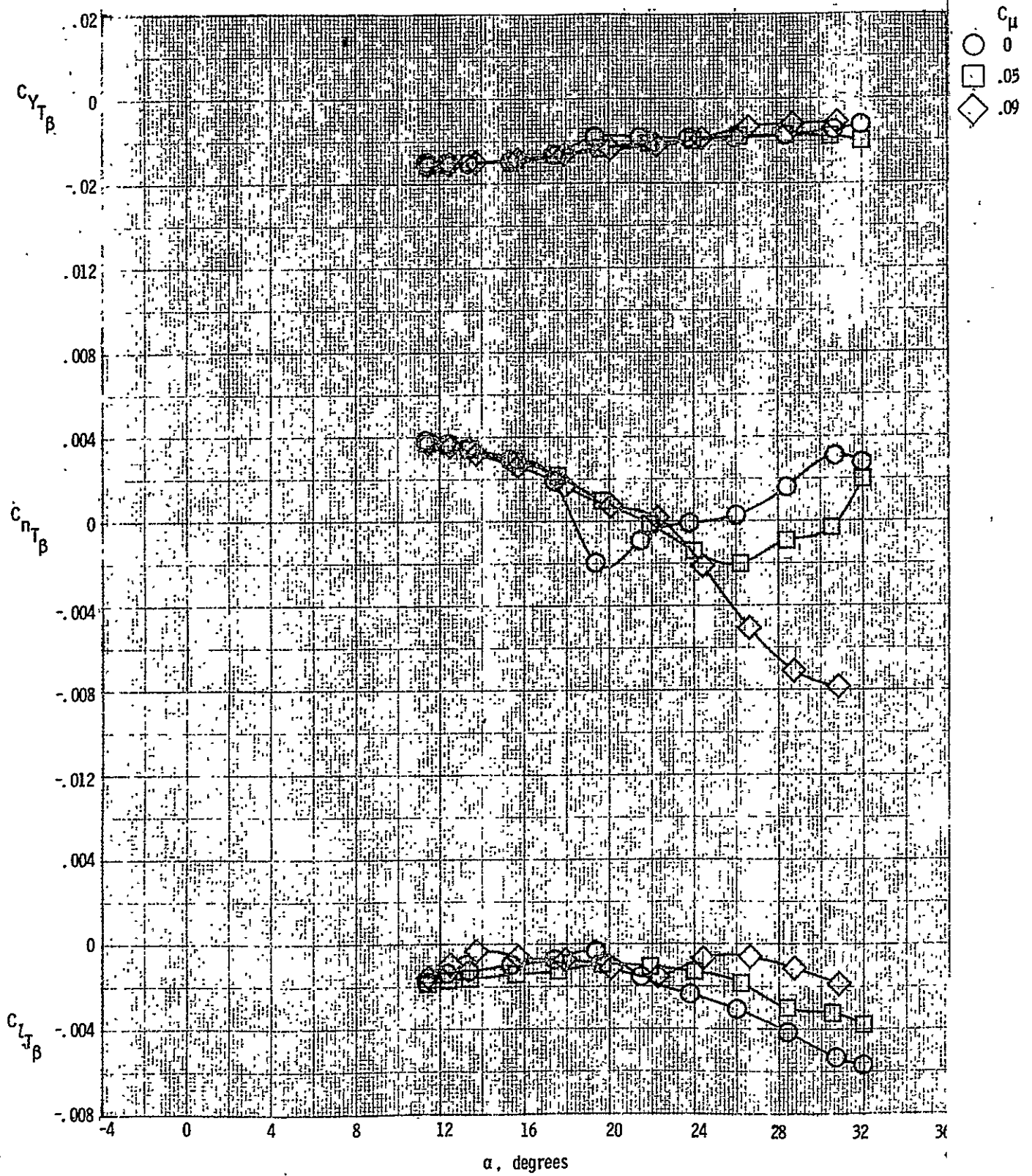

(b) High angle data.
 Figure 15, $\frac{1}{2}$ Continued.

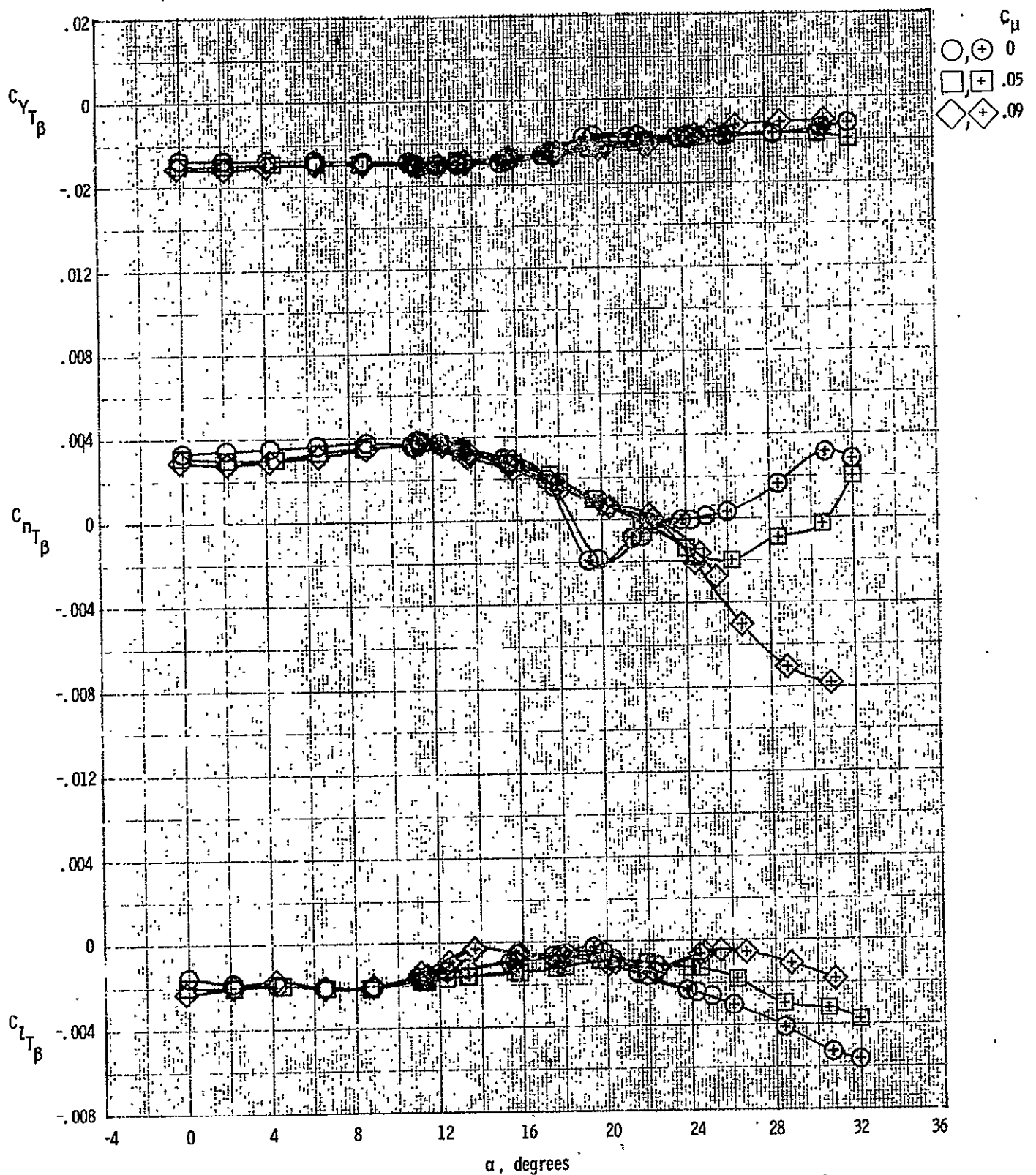

(c) Low angle data and high angle data.
 Figure 15. - Concluded.

ORIGINAL PAGE IS
 OF POOR QUALITY

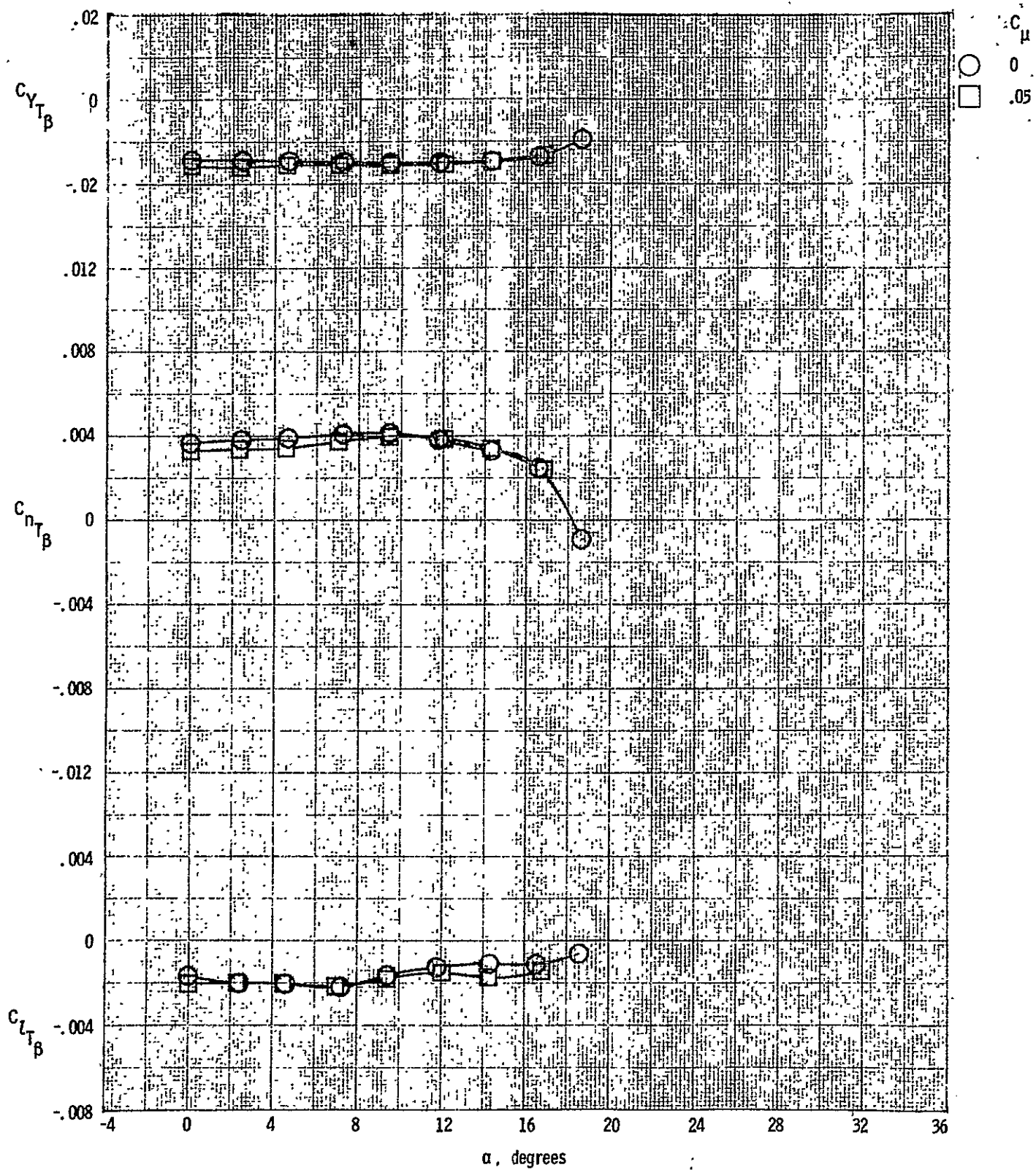
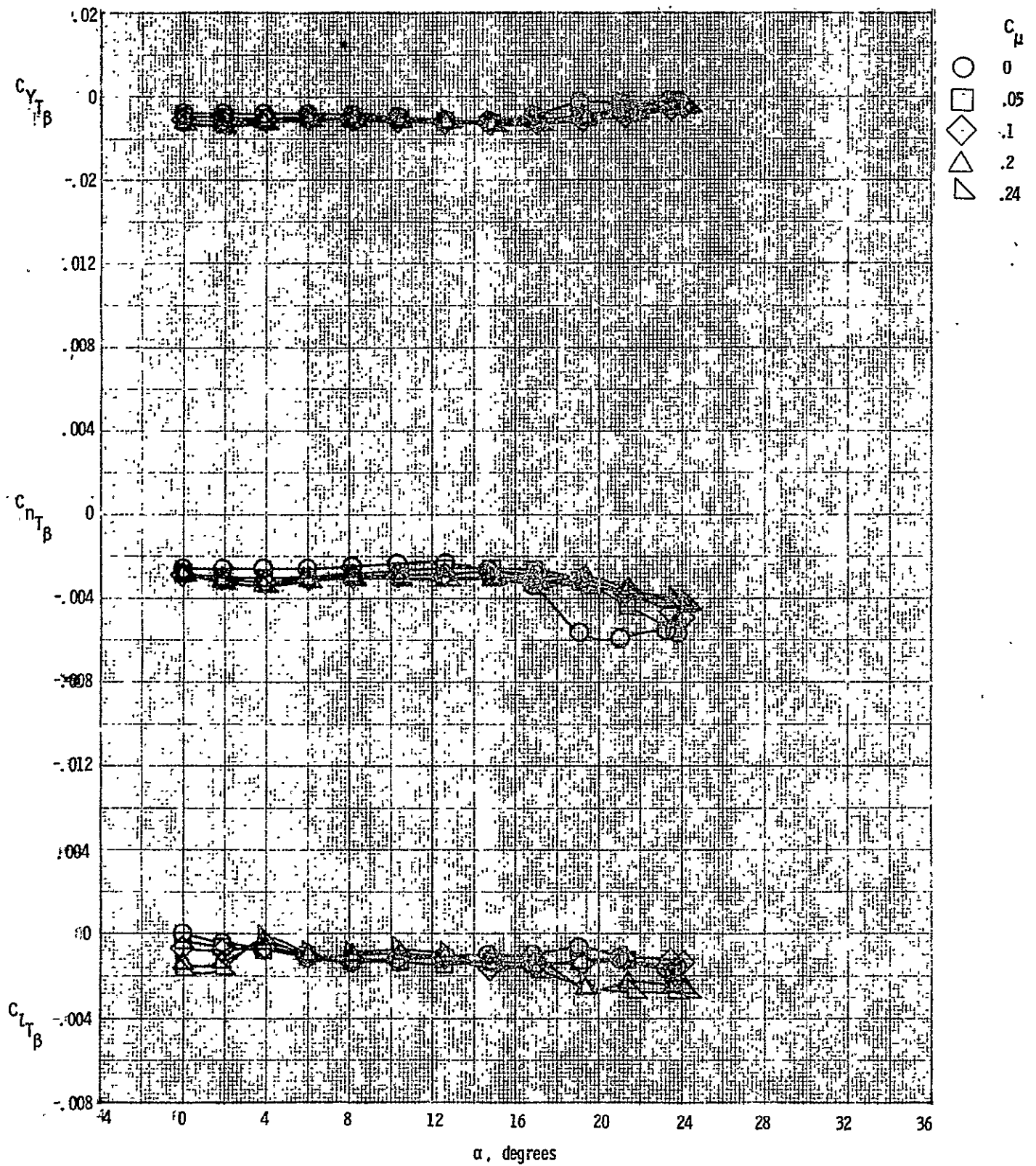

Figure 16. - The effect of blowing on the aerodynamic characteristics of configuration FW₁N₁V. M = 0.7.



ORIGINAL PAGE IS
OF POOR QUALITY

(a) Low angle data.

Figure 17. - The effect of blowing on the aerodynamic characteristics of configuration FW₁N₁. M = 0.3.

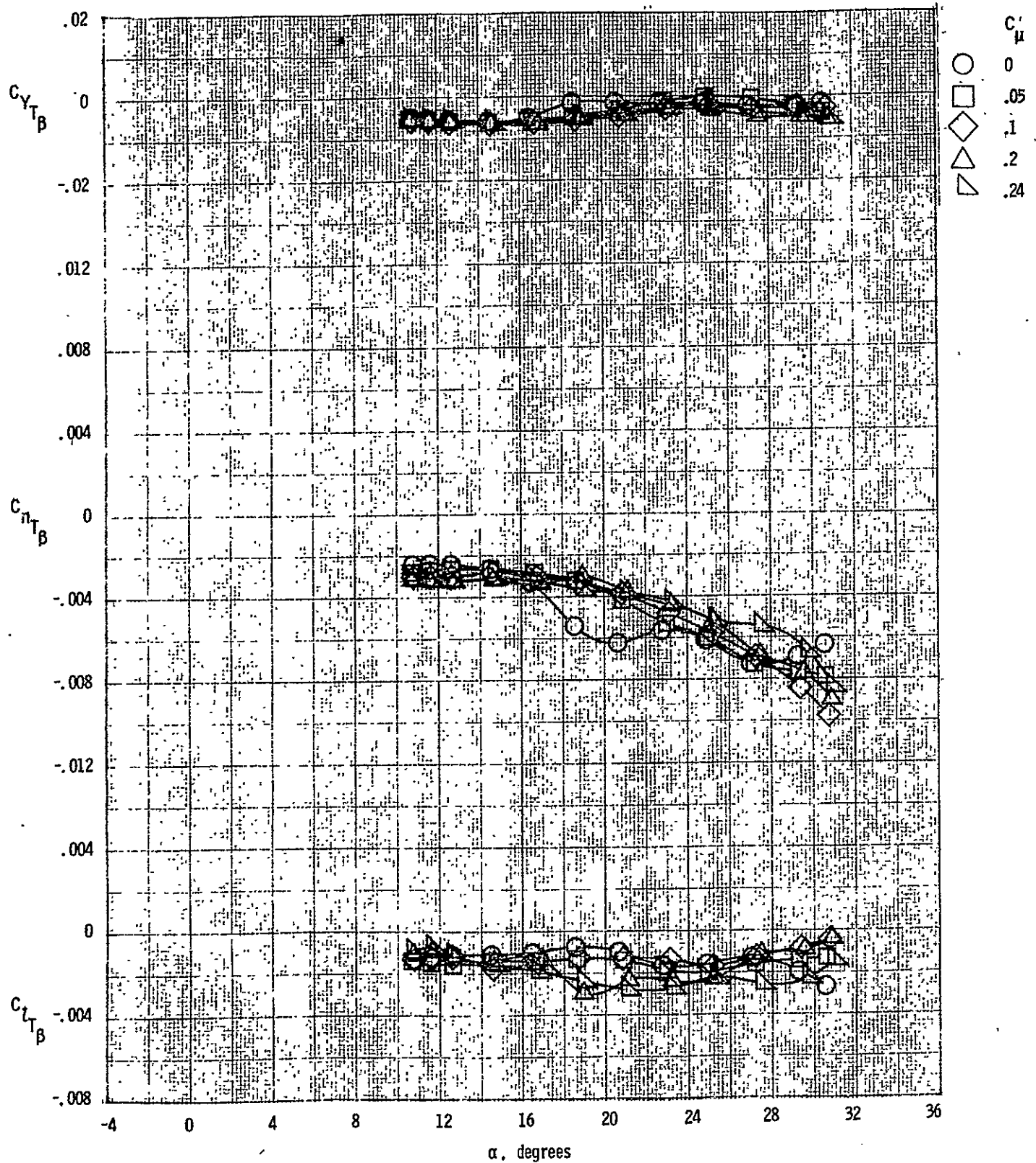

(b) High angle data:
Figure 17. - Continued.

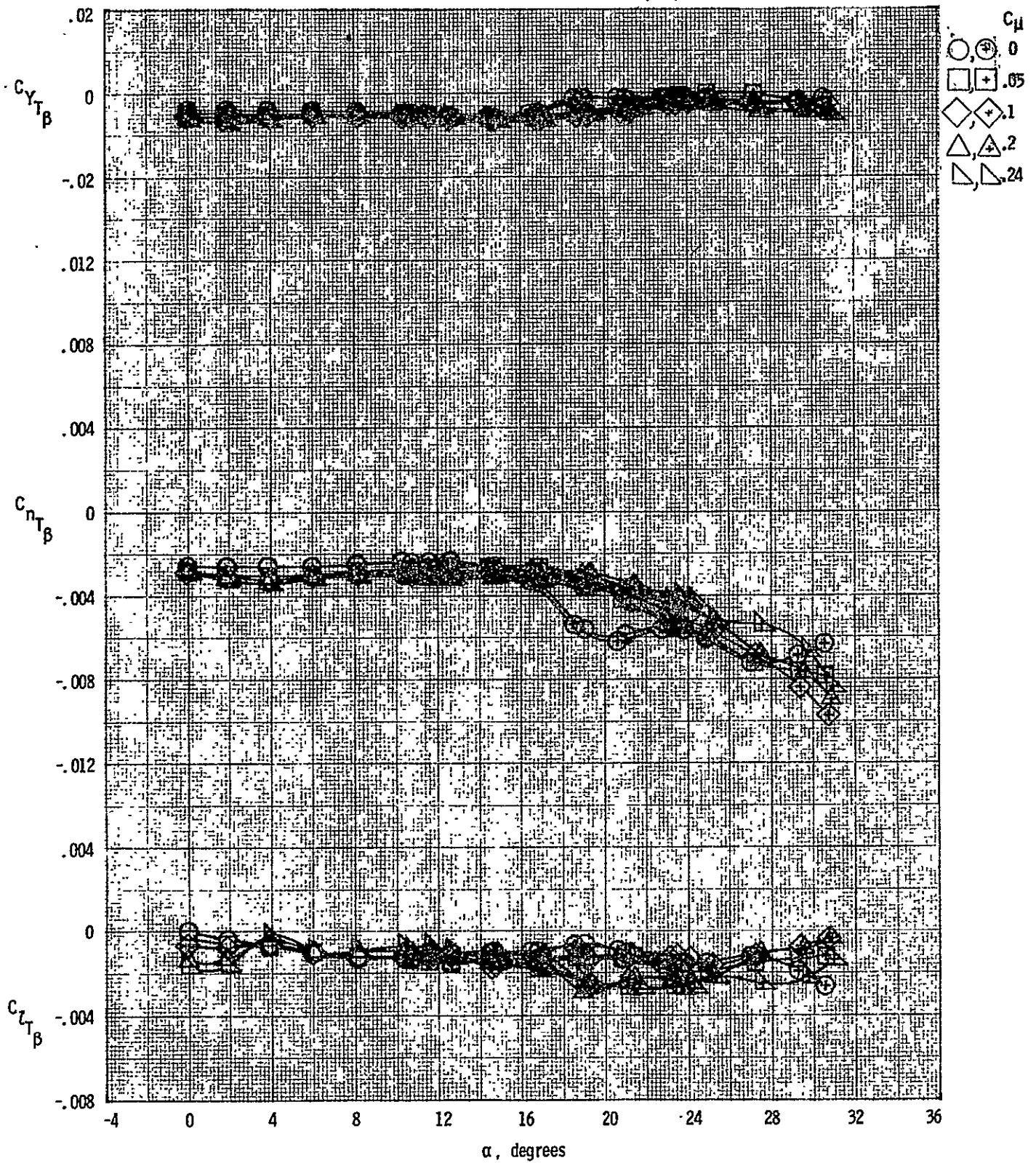

(c) Low angle data and high angle data.
 Figure 17. - Concluded.

ORIGINAL PAGE IS
 OF POOR QUALITY

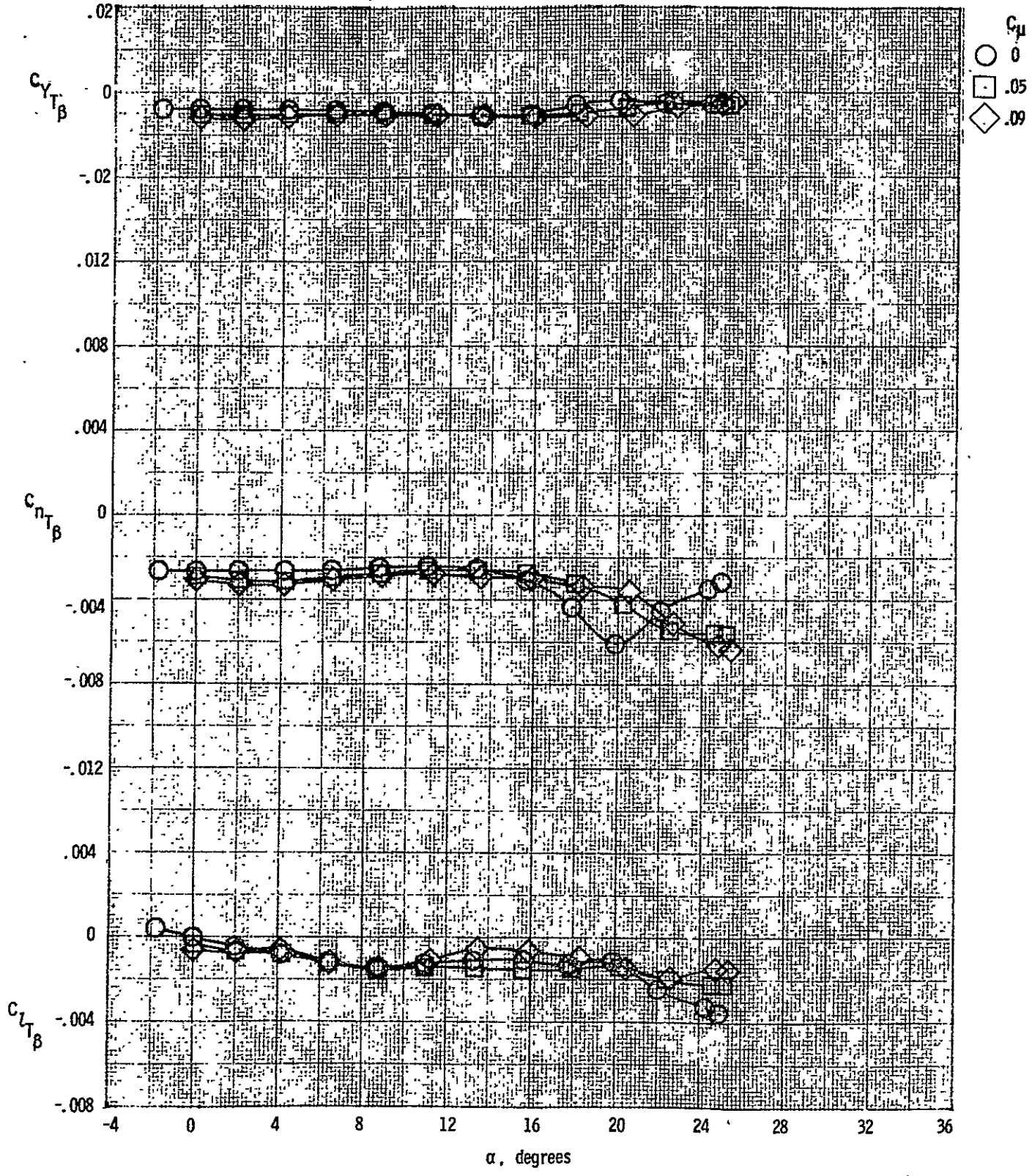

(a) Low angle data.

Figure 18.- The effect of blowing on the aerodynamic characteristics of configuration FW_1N_1 . $M = 0.5$.

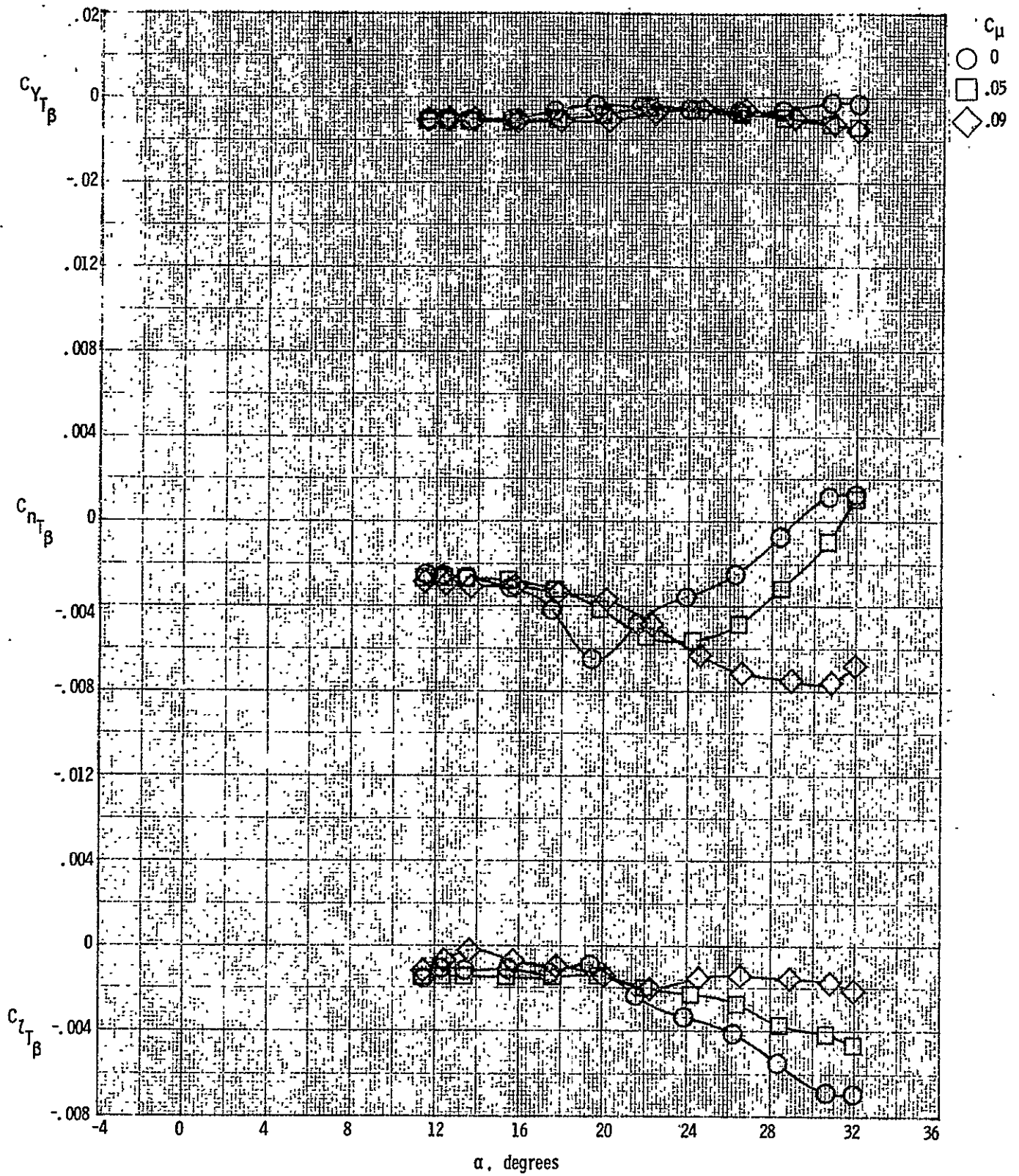

(b) High angle data.
Figure 18. - Continued.

ORIGINAL PAGE IS
OF POOR QUALITY

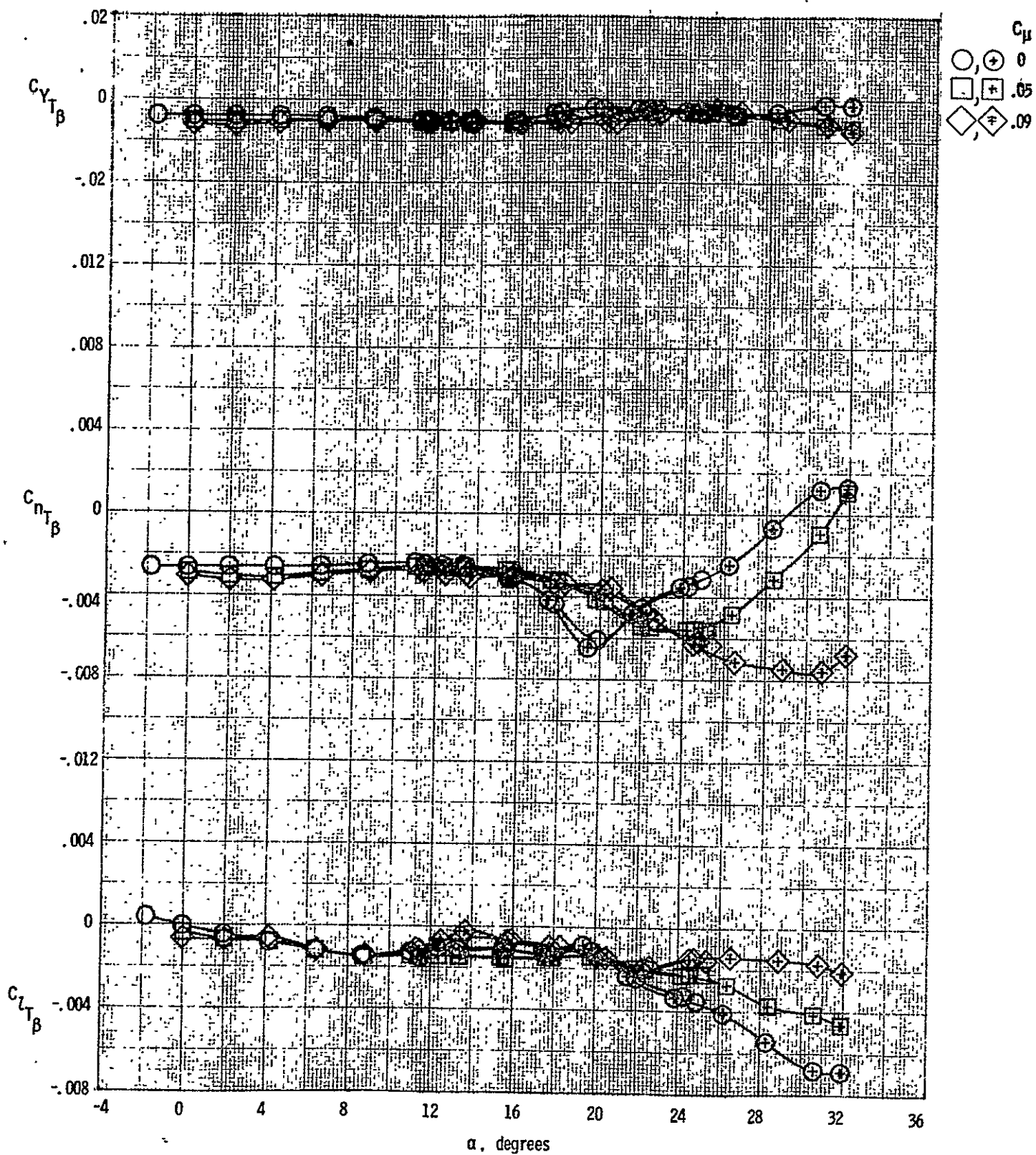

(c) Low angle data and high angle data.
 Figure 18. - Concluded.

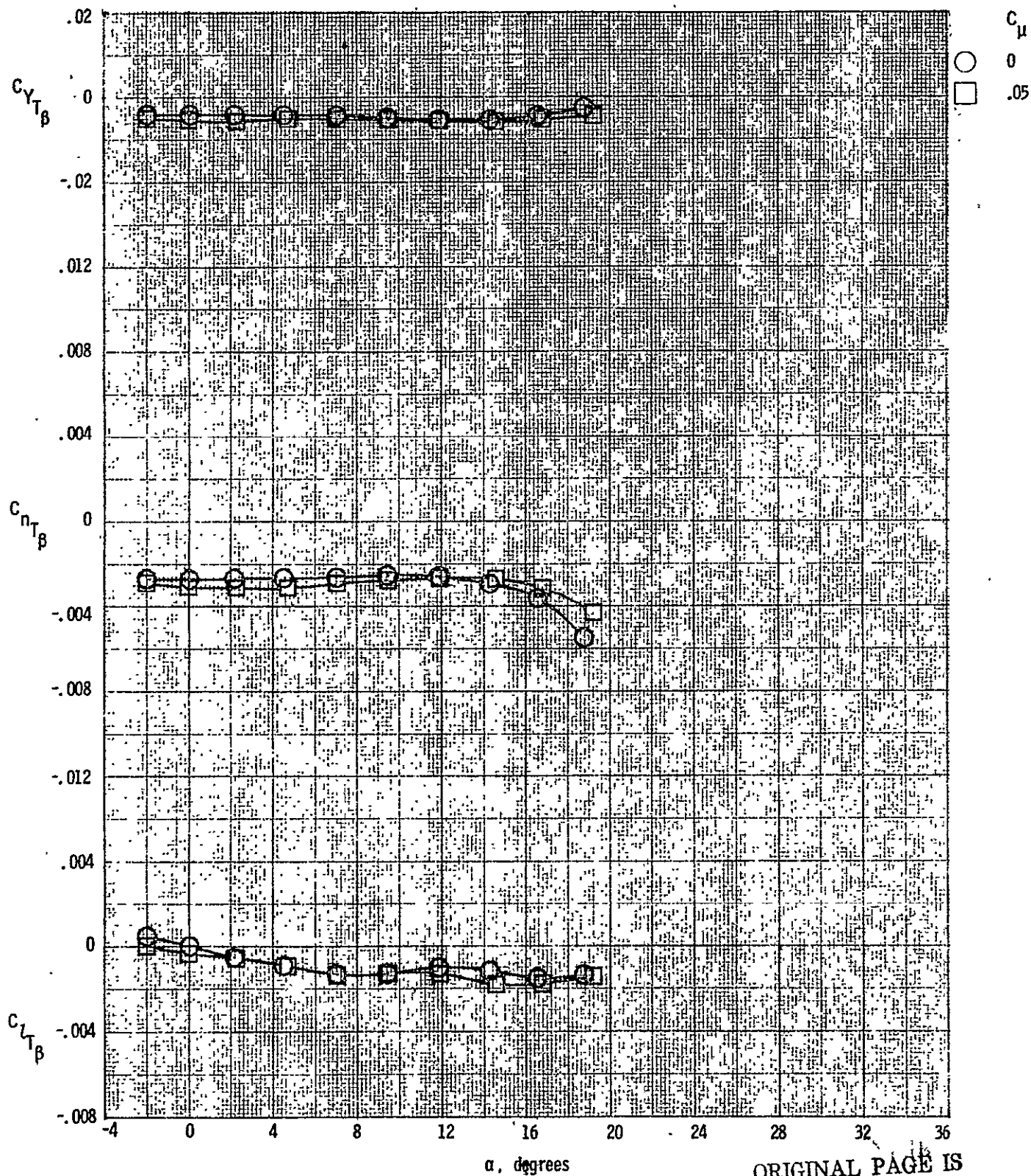

ORIGINAL PAGE IS OF POOR QUALITY

Figure 19. - The effect of blowing on the aerodynamic characteristics of configuration FW_1N_1 . $M = 0.7$.

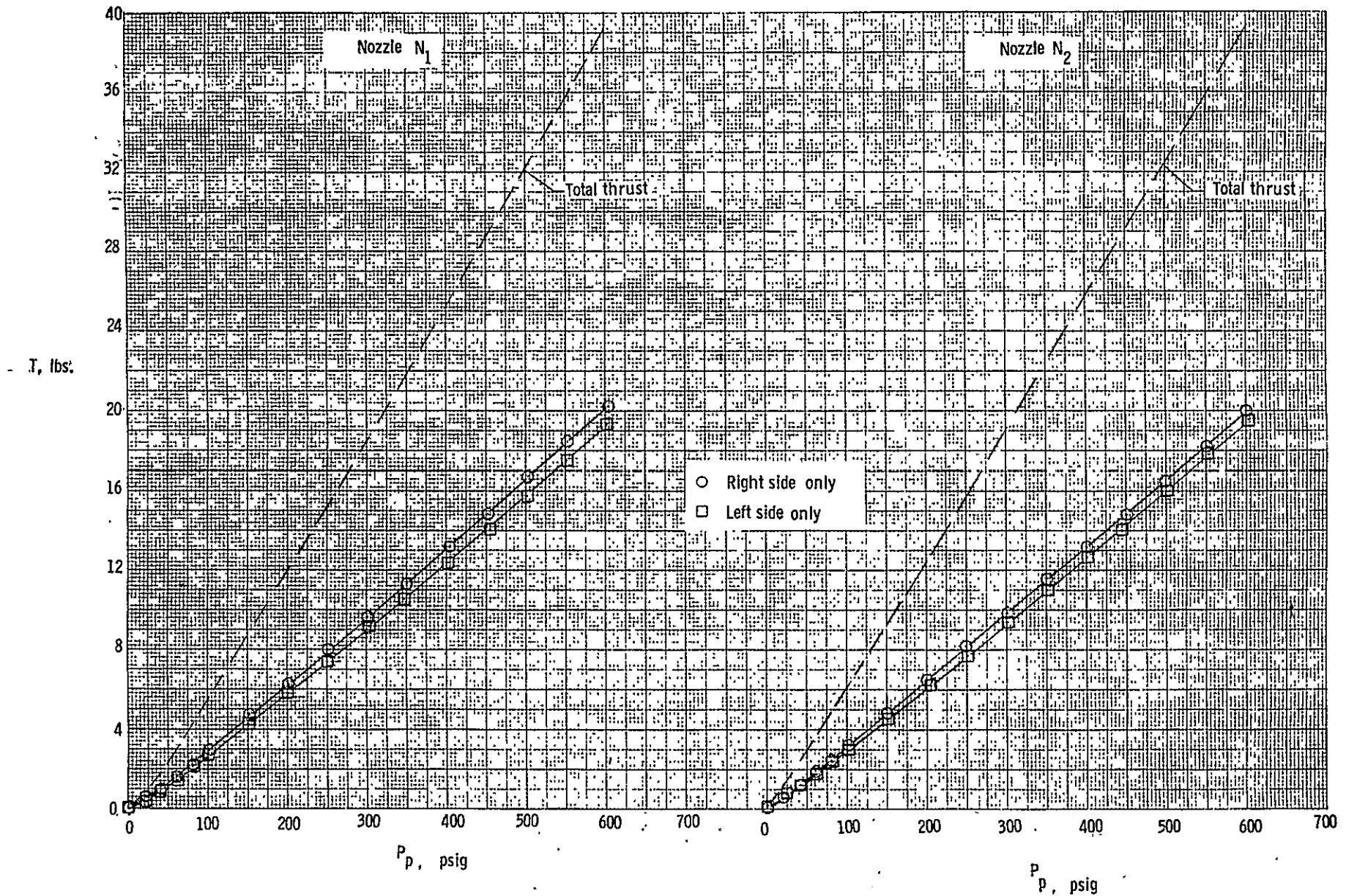

(a) Thrust as a function of plenum pressure
 Figure 20. Thrust calibration of the two nozzle configurations tested.

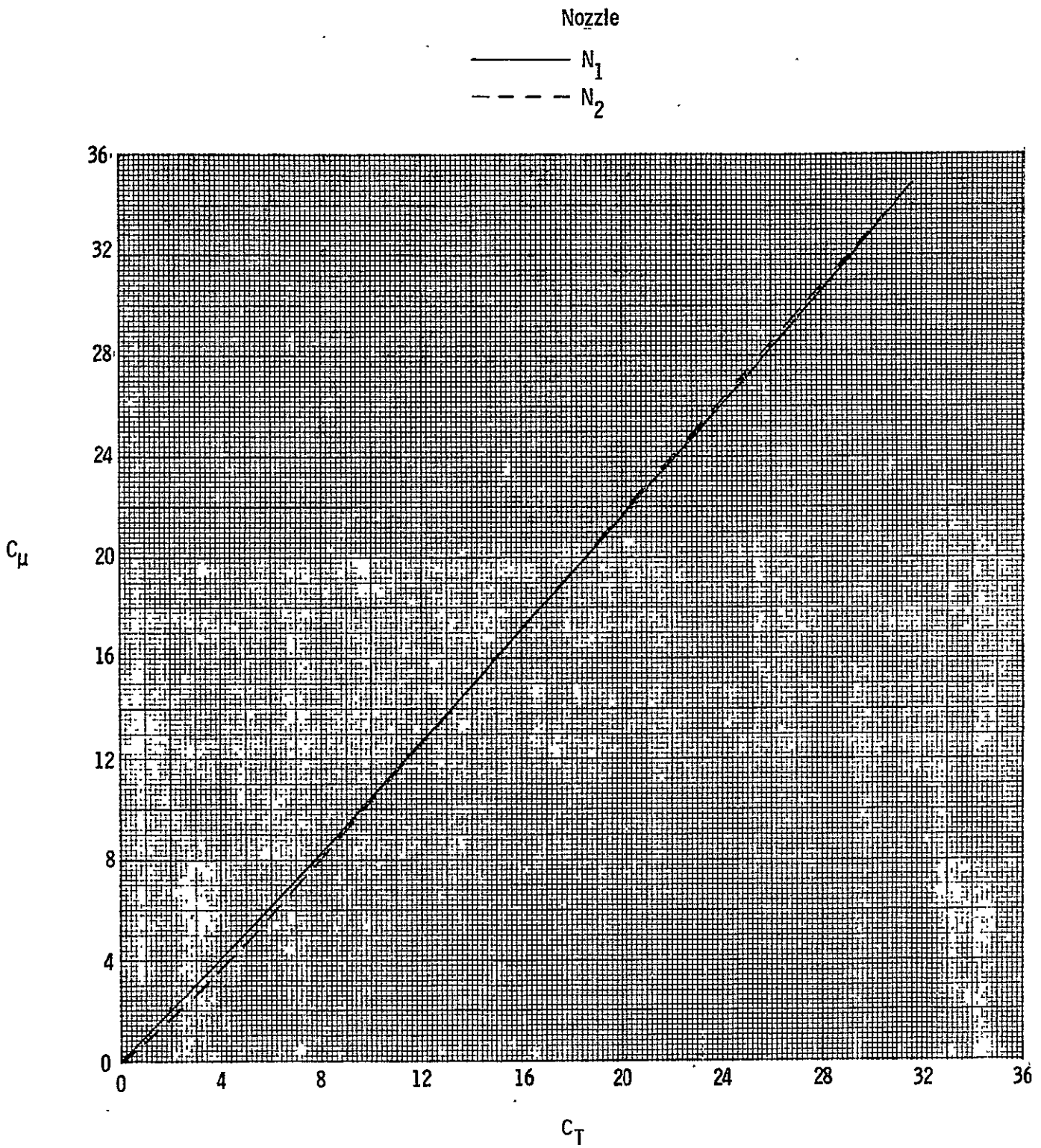

(b) C_μ versus C_T (for unit q).

Figure 20.- Concluded.

ORIGINAL PAGE IS
OF POOR QUALITY

1. Report No. NASA TM 74049		2. Government Accession No.		3. Recipient's Catalog No.	
4. Title and Subtitle SUBSONIC LONGITUDINAL AND LATERAL-DIRECTIONAL STATIC AERODYNAMIC CHARACTERISTICS OF A GENERAL RESEARCH FIGHTER CONFIGURATION EMPLOYING A JET SHEET VORTEX GENERATOR				5. Report Date January 1978	
				6. Performing Organization Code	
7. Author(s) Jarrett K. Huffman and Charles H. Fox, Jr., NASA Langley Research Center and Henry Ziegler, Northrop Corporation				8. Performing Organization Report No.	
9. Performing Organization Name and Address NASA Langley Research Center Hampton, Virginia 23665				10. Work Unit No. 505-11-23-13	
				11. Contract or Grant No.	
12. Sponsoring Agency Name and Address National Aeronautics and Space Administration Washington, DC 20546				13. Type of Report and Period Covered Technical Memorandum	
				14. Sponsoring Agency Code	
15. Supplementary Notes					
16. Abstract A new configuration concept for developing vortex lift, which replaces the physical wing strake with a jet sheet generated fluid strake, was investigated on a general research fighter model. The vertical and horizontal location of the jet sheet with respect to the wing leading edge was studied over a momentum coefficient range from 0 to 0.24. This study was conducted in the Langley 7- by 10-foot high speed tunnel over a Mach number range from 0.3 to 0.8. The angle-of-attack range investigated was from -2° to 30° at sideslip angles of 0° , -5° , and 5° . The results are presented without analysis in order to expedite publication.					
17. Key Words (Suggested by Author(s)) Fluid Strake Jet Sheet Vortex Lift			18. Distribution Statement Unclassified - Unlimited Star Category - 02		
19. Security Classif. (of this report) Unclassified		20. Security Classif. (of this page) Unclassified		21. No. of Pages 188	22. Price* \$7.50